

Introdução às Estruturas Aeronáutica

Escola Politécnica da USP
Departamento de Engenharia
Mecânica

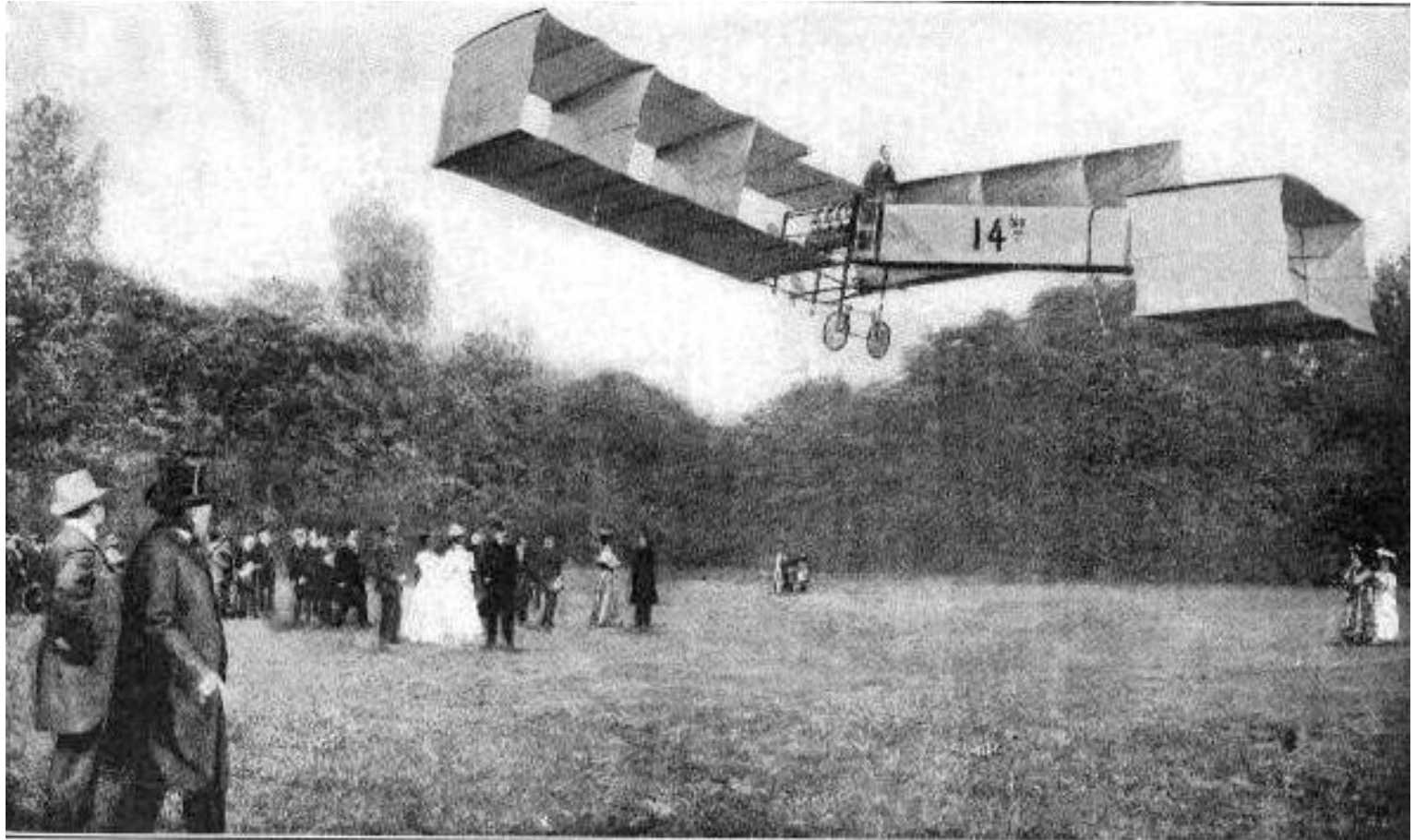





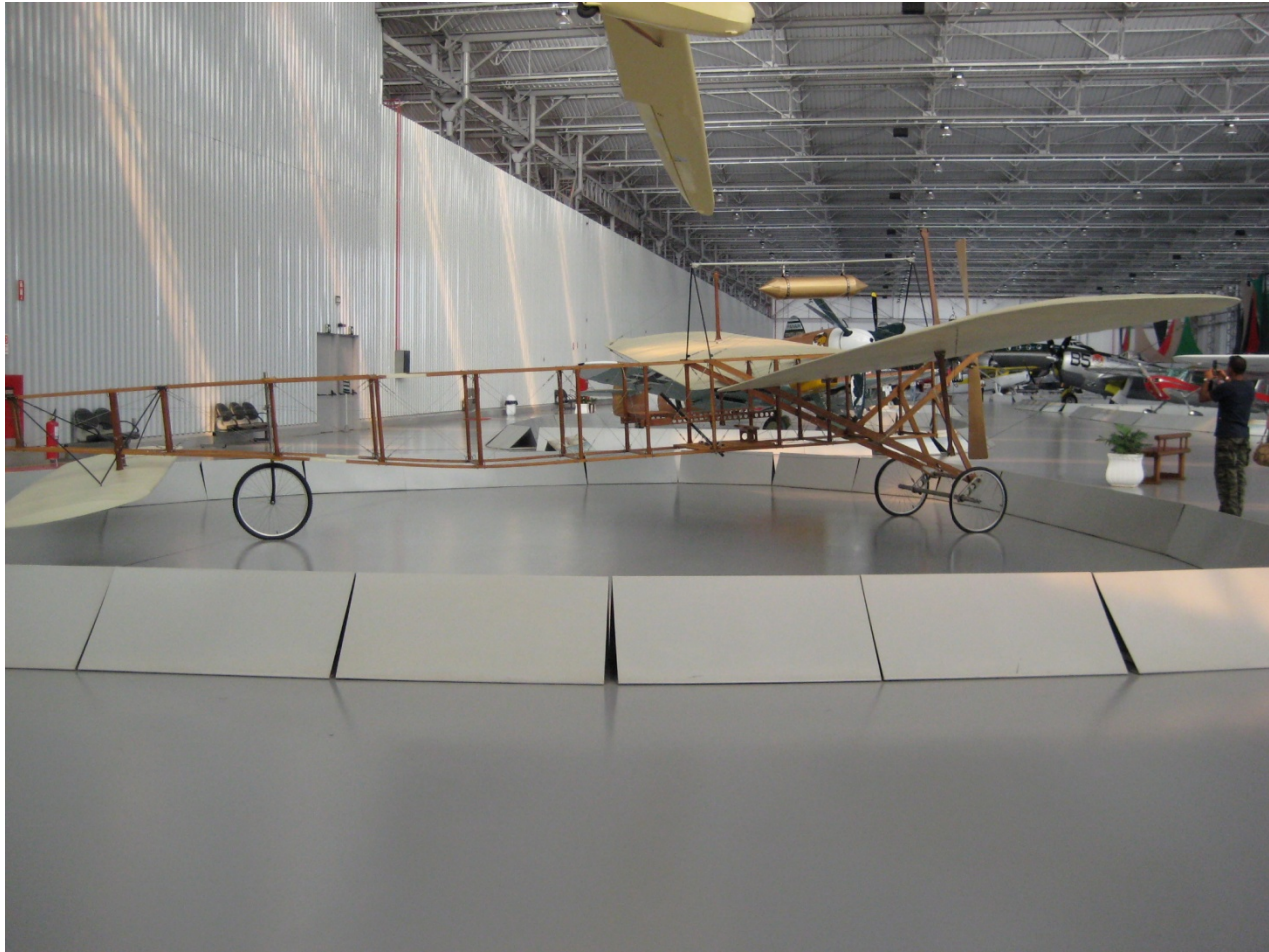

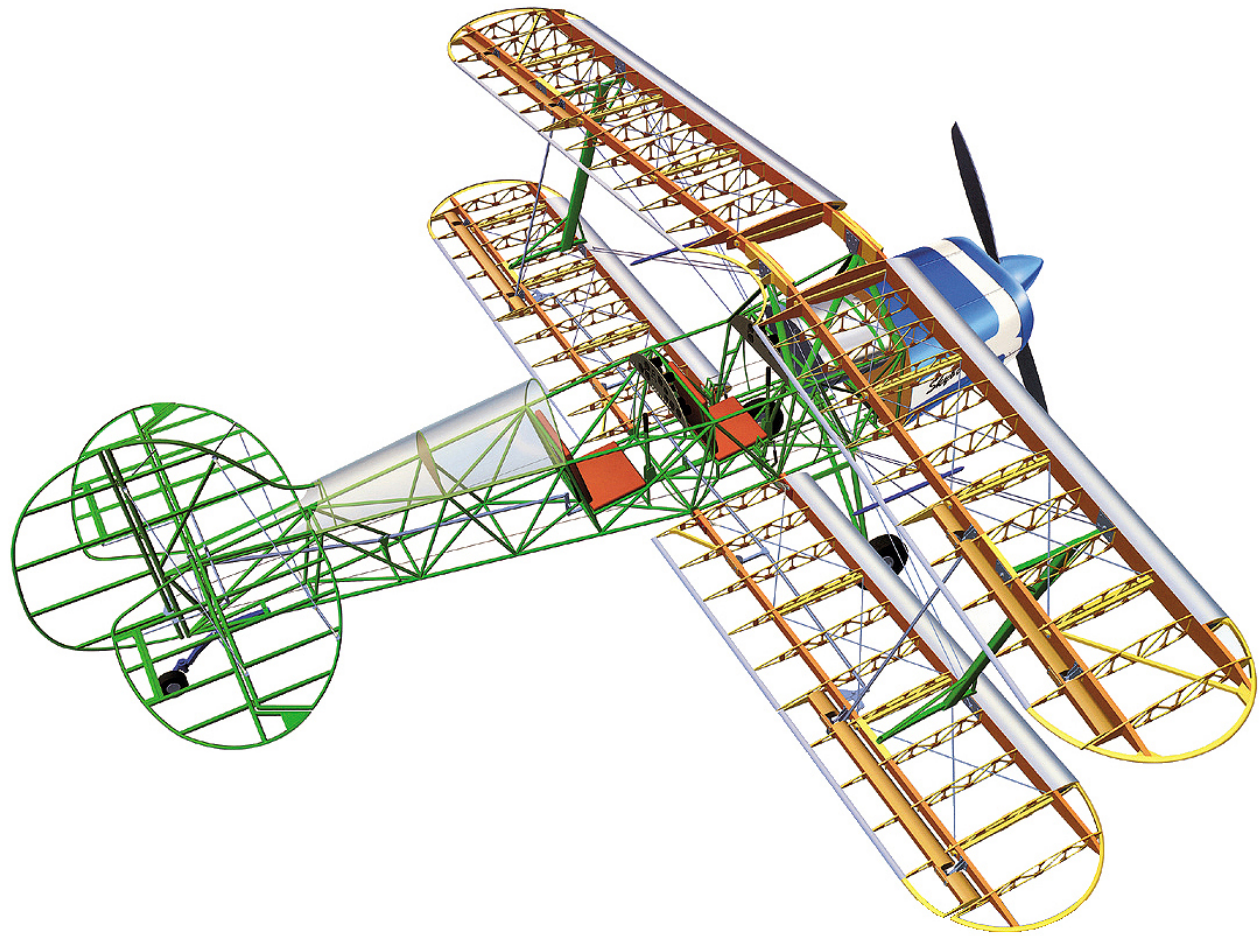



ESCLUSIVA
PER ILLUSTRAZIONE



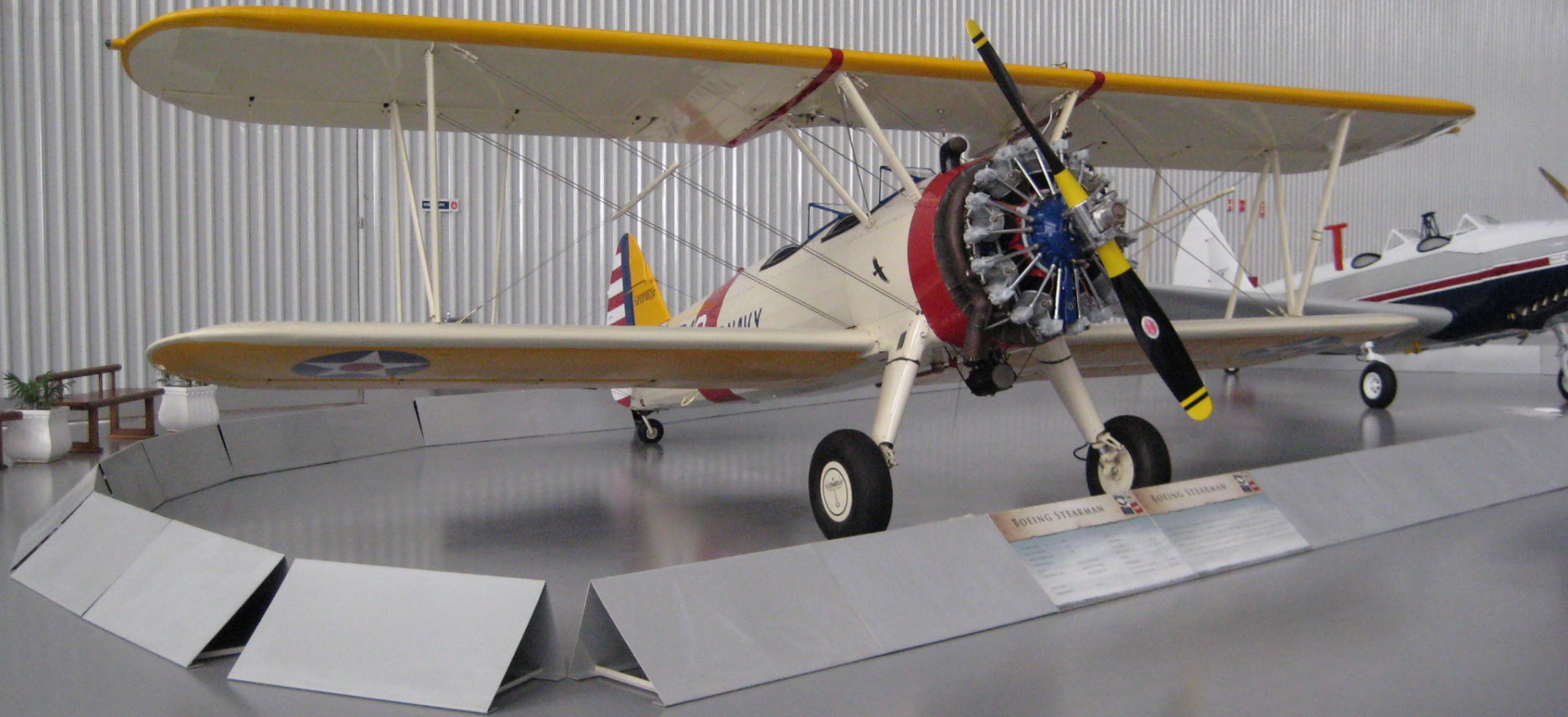

FOCKE WULF FW 190A-5

Drawn by A.L.Bentley © 1981

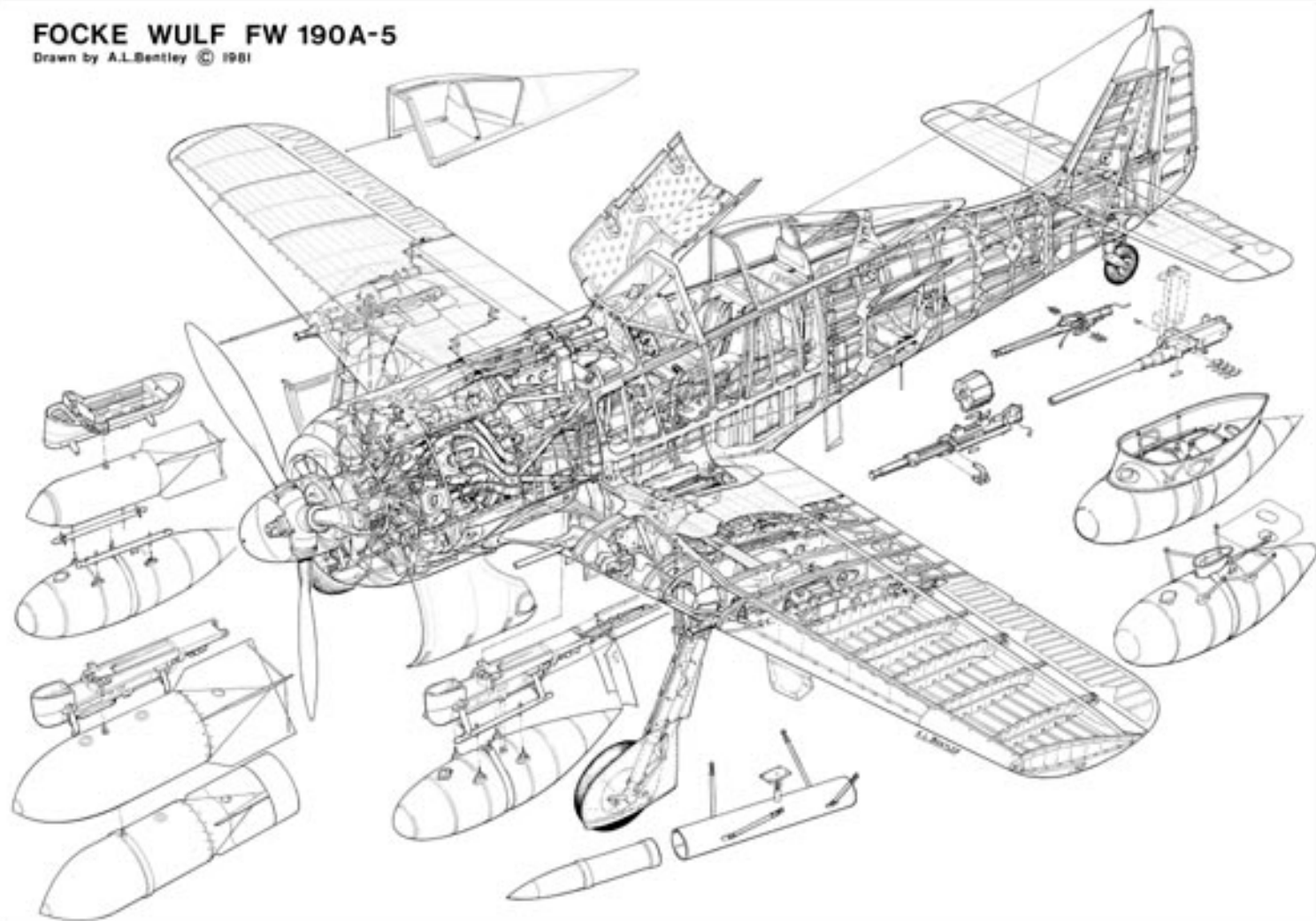

Focke Wulf FW190A-6
A.L.Bentley © 1999

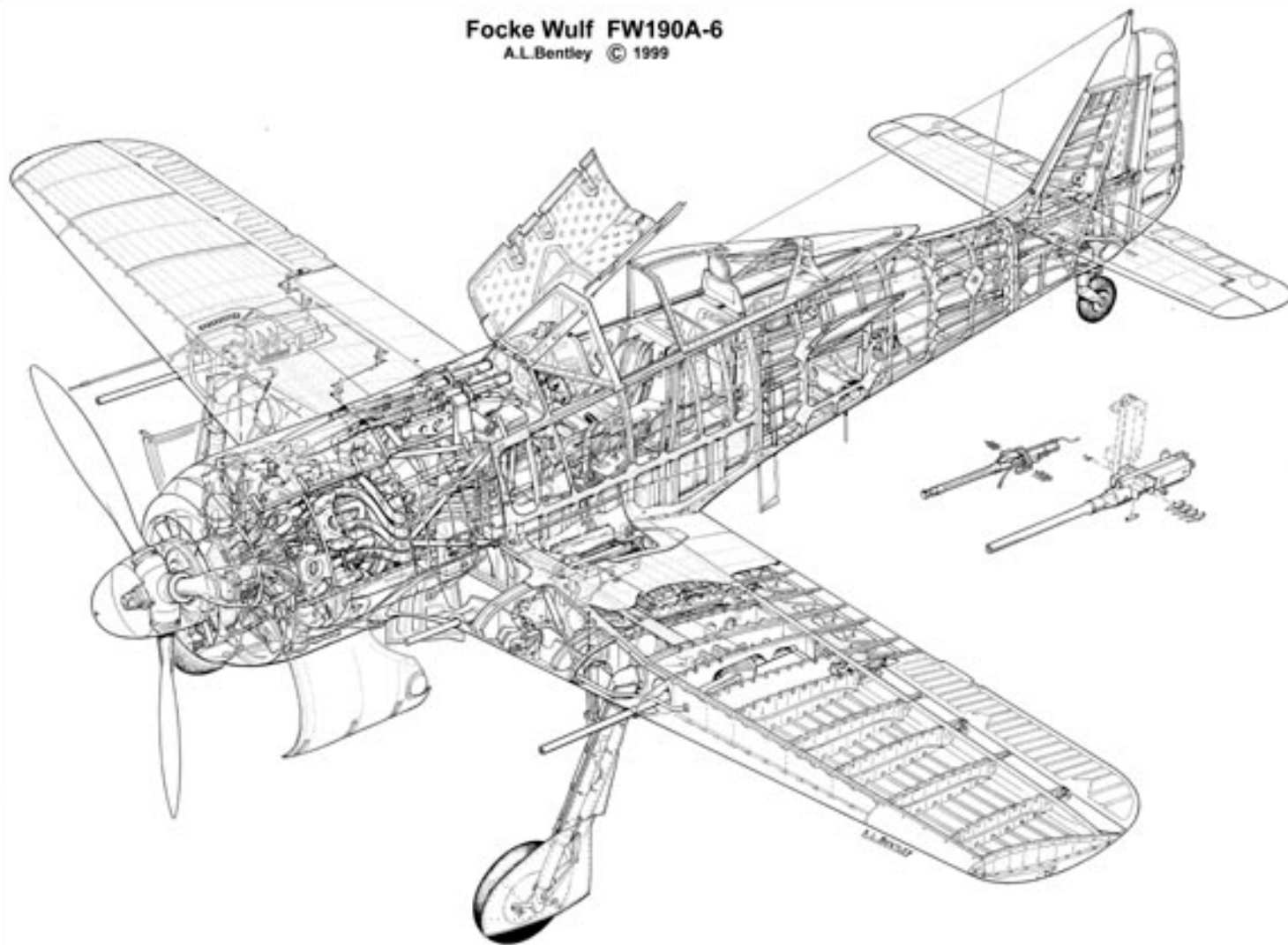

Focke Wulf FW190A-6/R2
A.L.Bentley © 1999

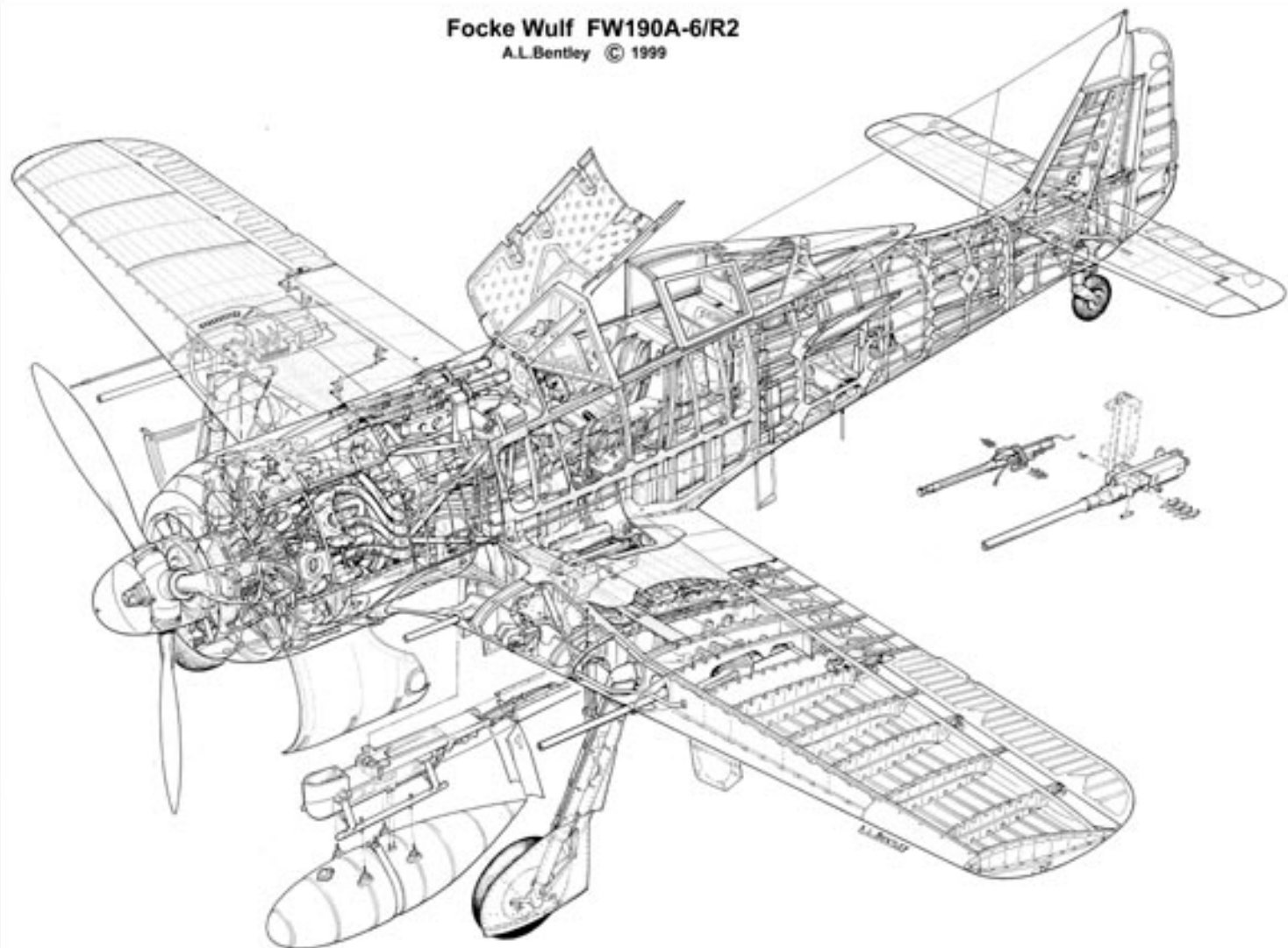

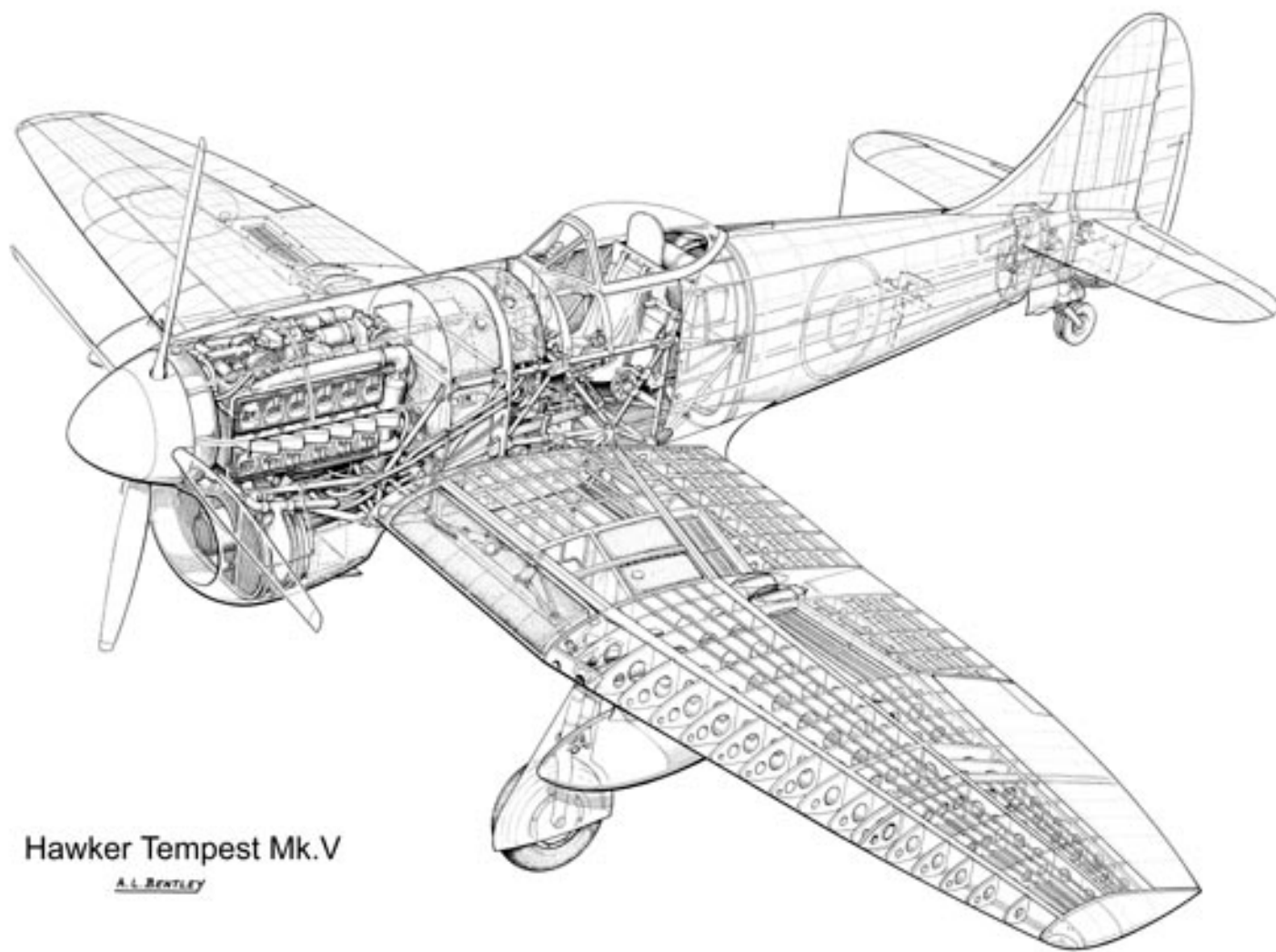

Hawker Tempest Mk.V

A.L. Bentley

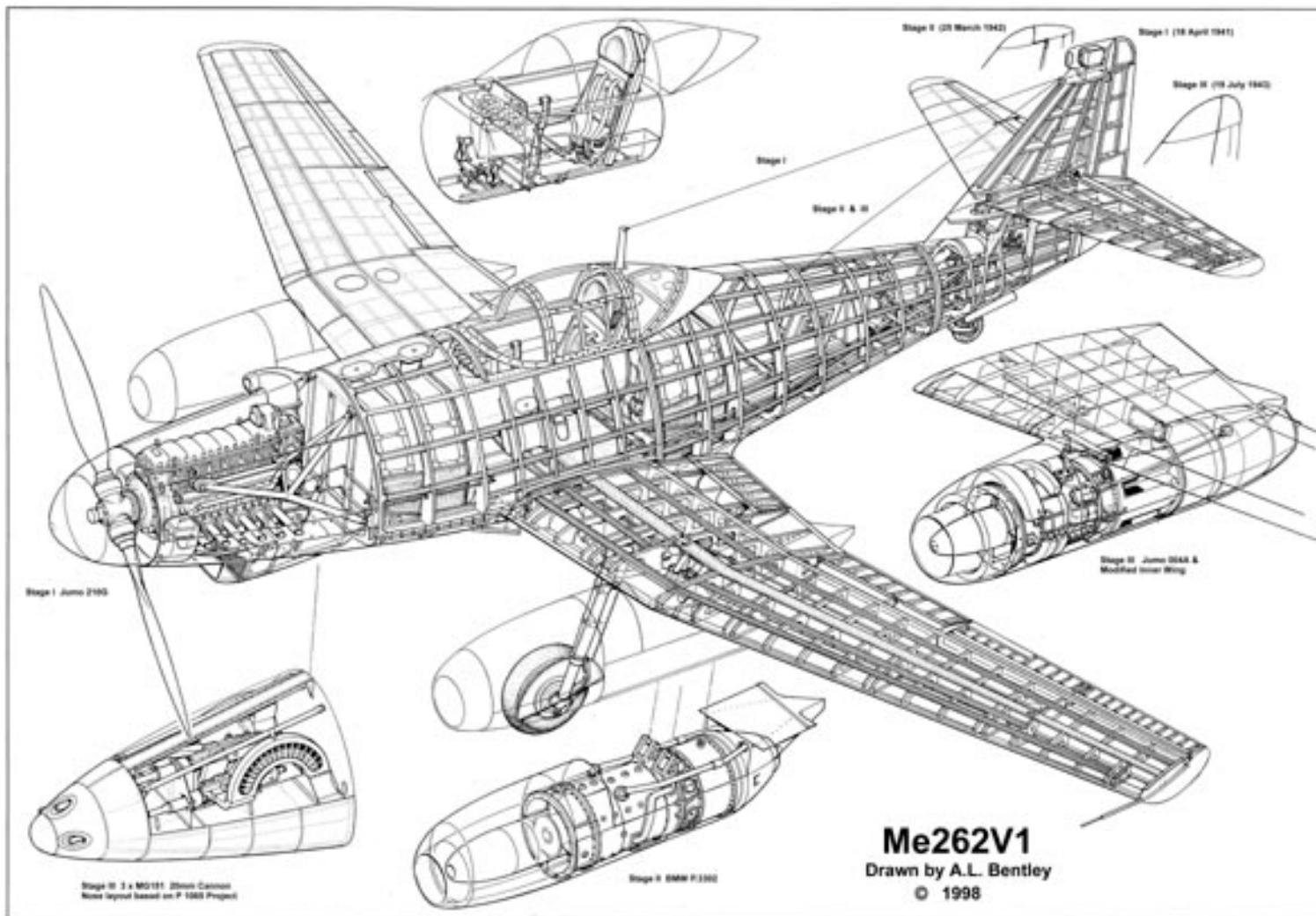

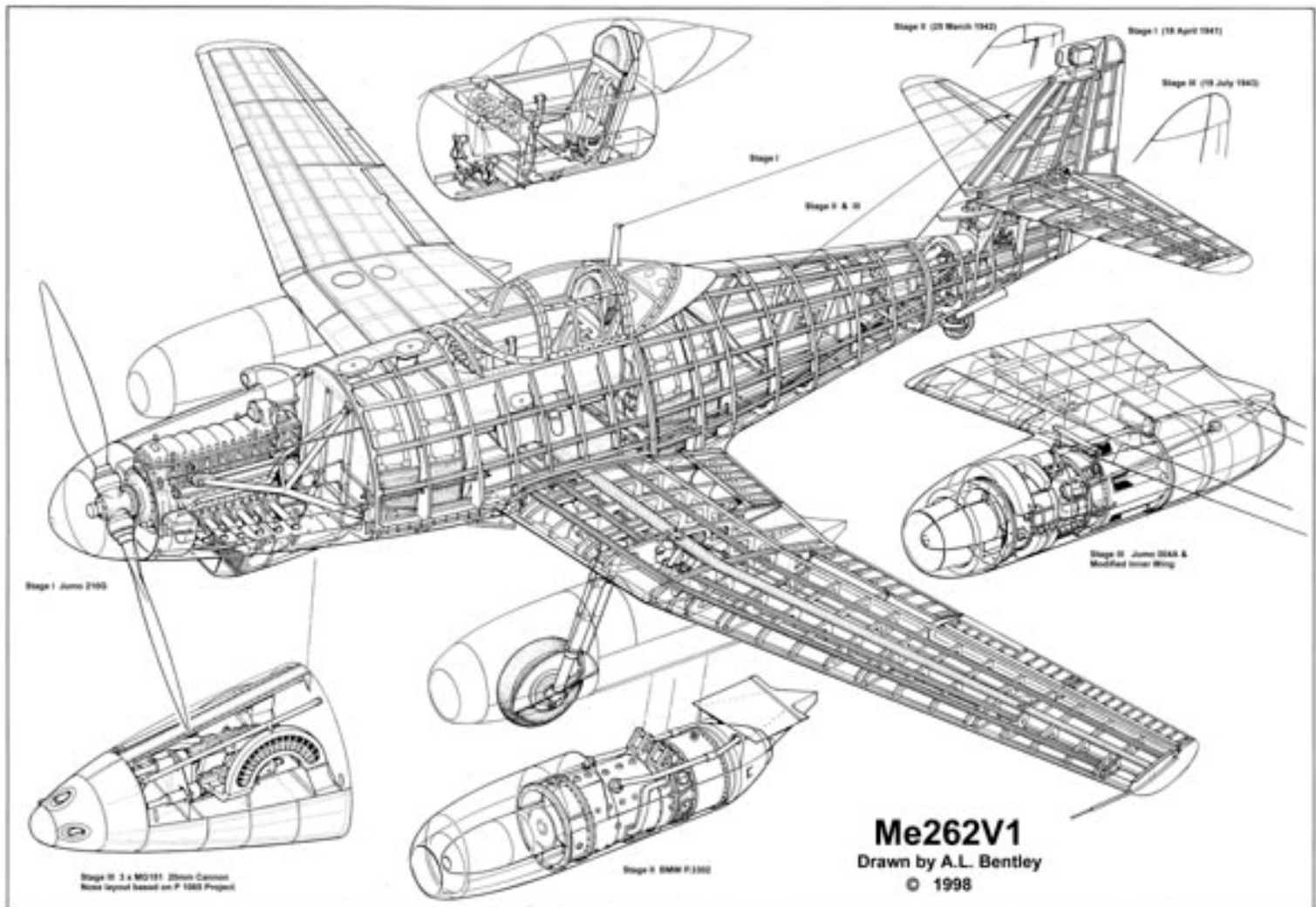



Vorsicht beim öffnen
Kühler ist im Haubentiel eingebaut

SAIDA

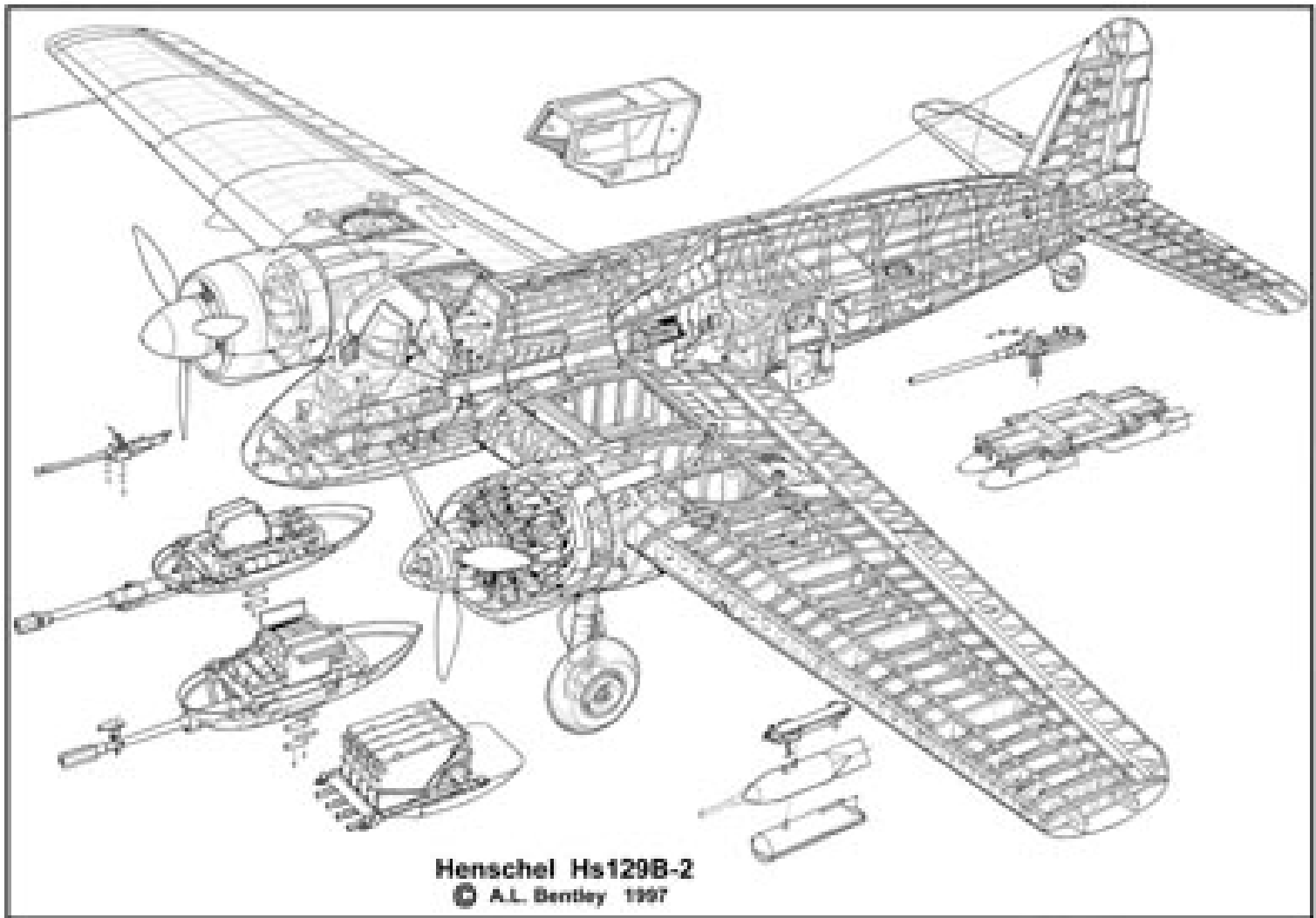

Henschel Hs129B-2
© A.L. Bentley 1997

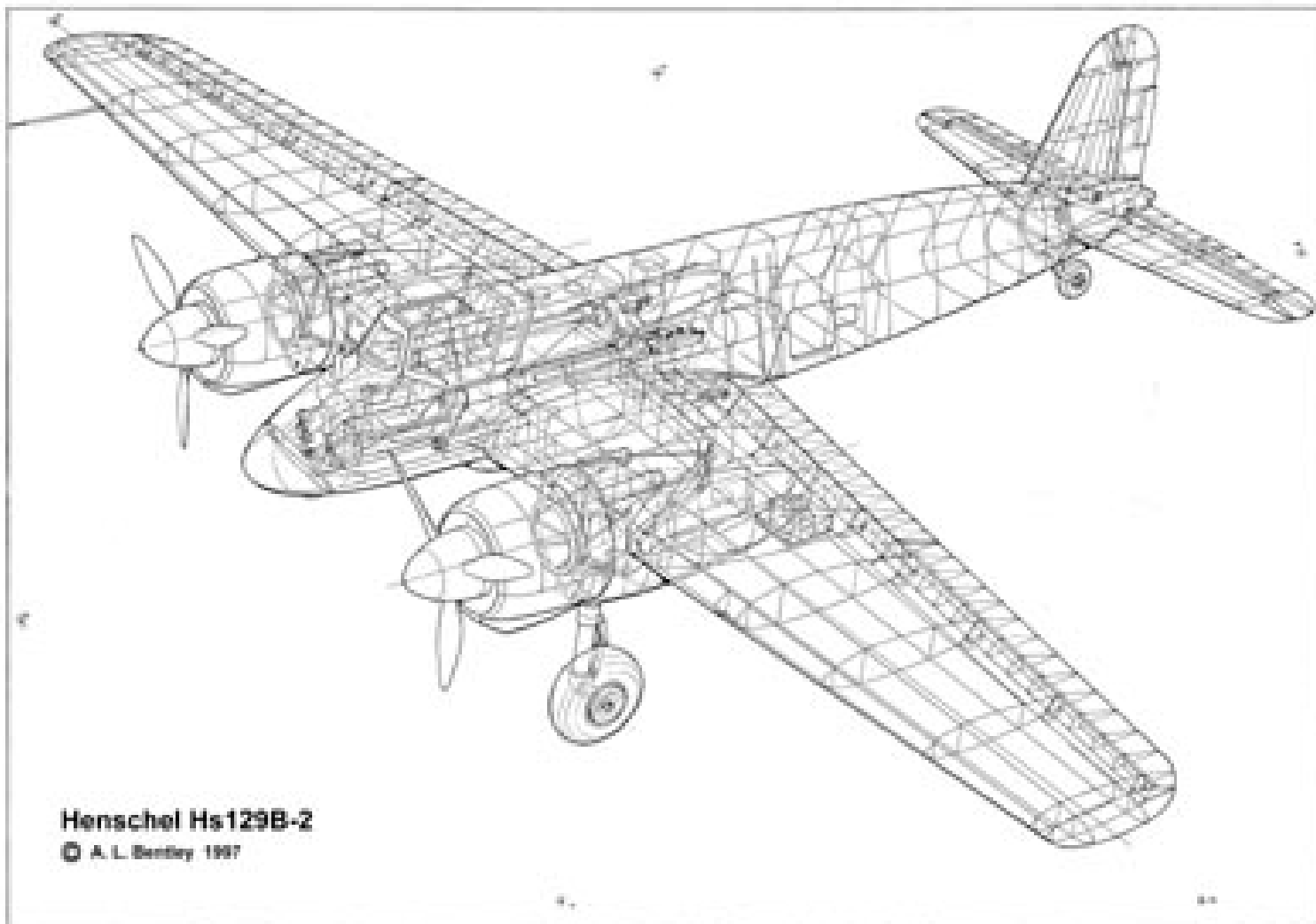

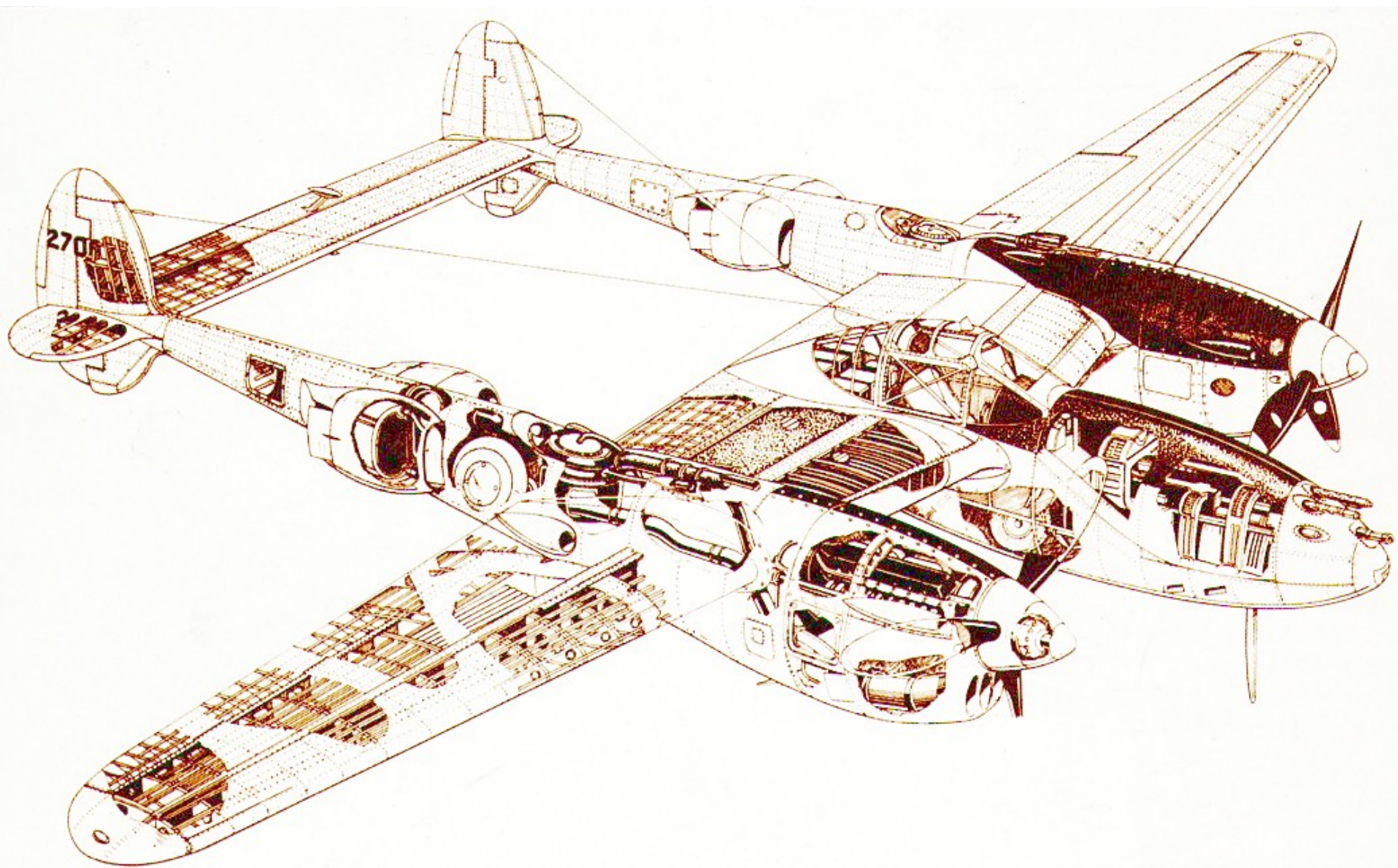

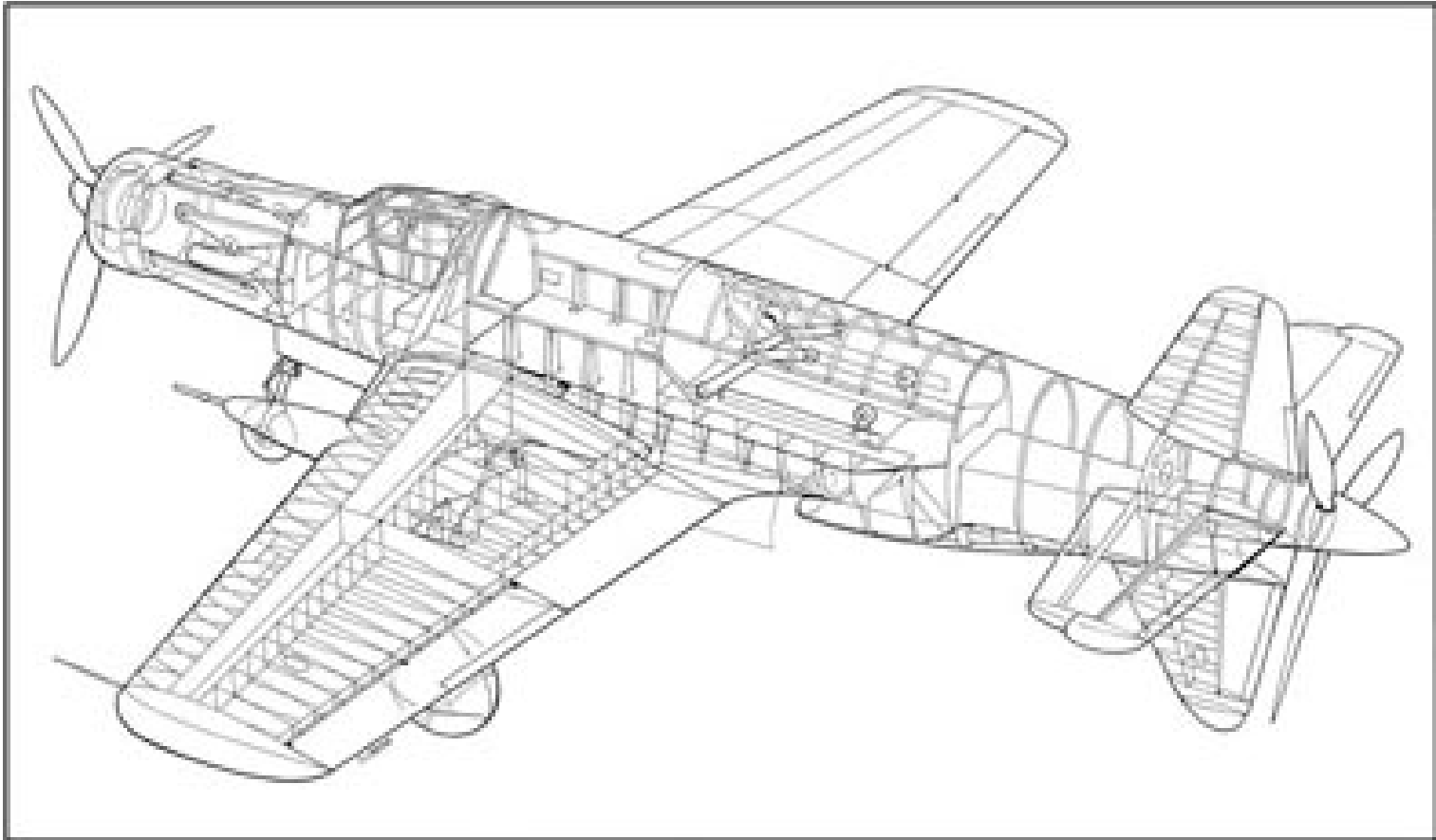



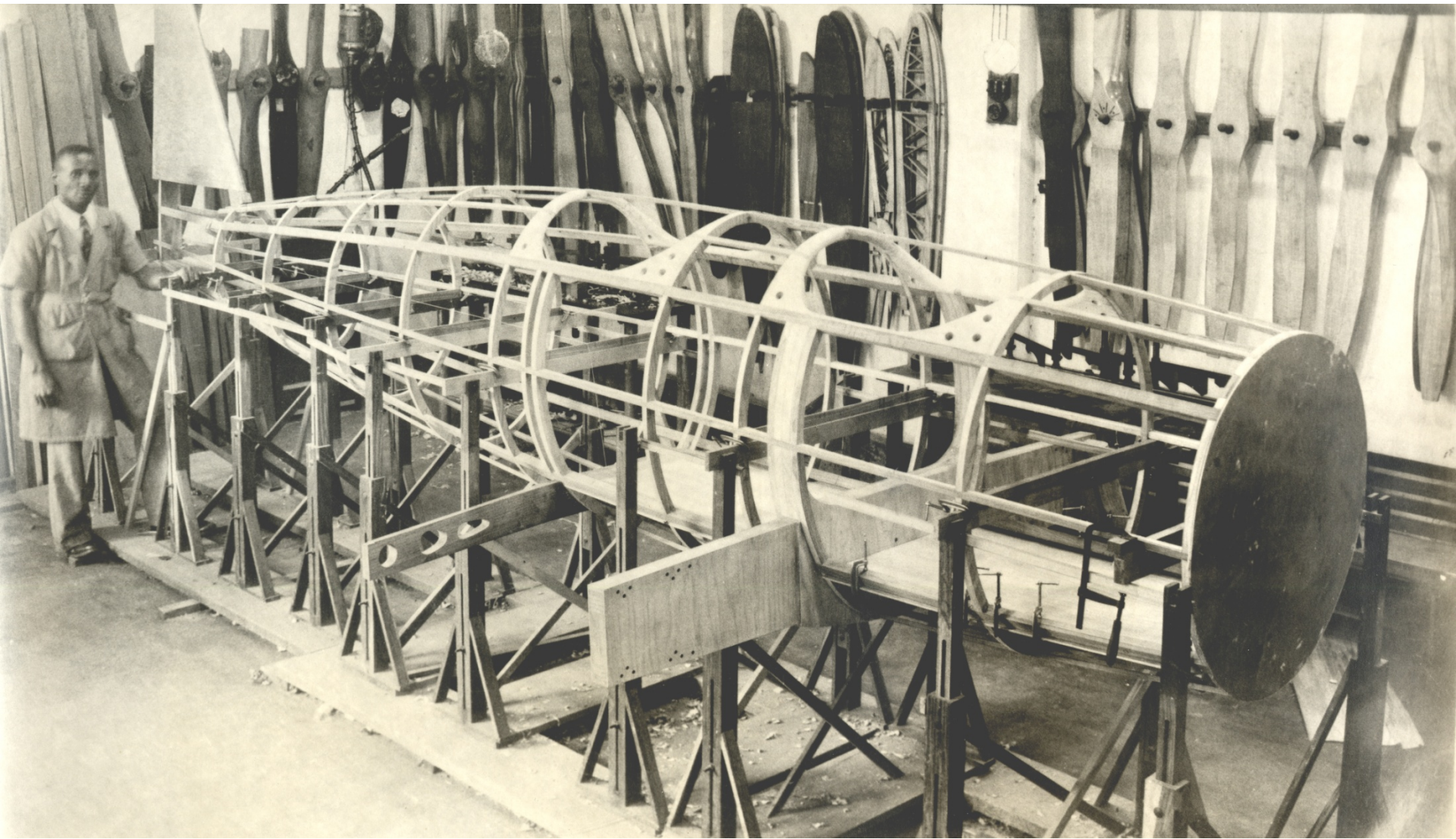

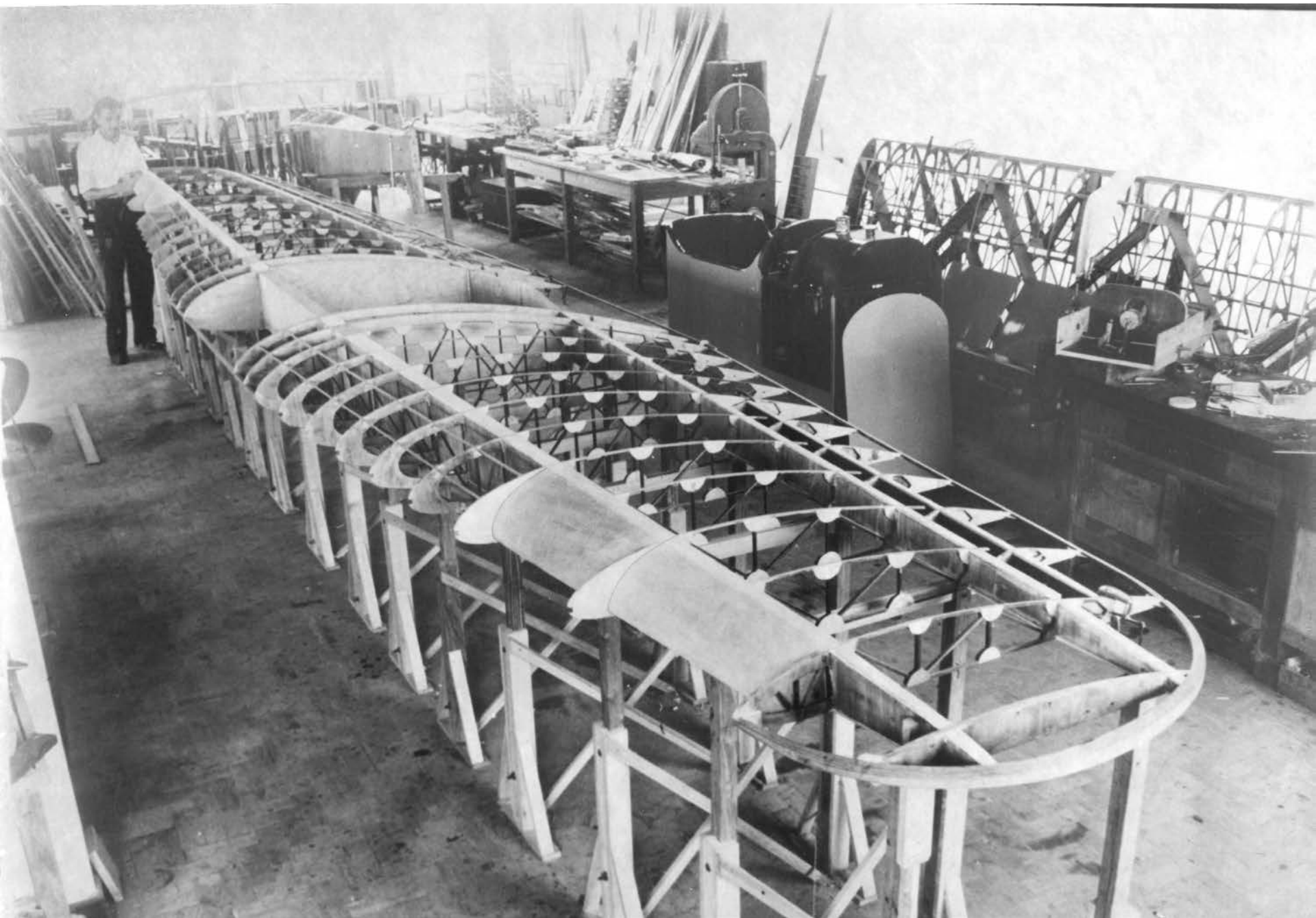



NC16072
U.S. MAIL AIR EXPRESS

United Air Lines

Mainliner

UNITED
AIR LINES



STATE OF
CALIFORNIA







A320



A380



La Cabine



Renault Kangoo









6247

MIIG-15
MIIG-15

NAS

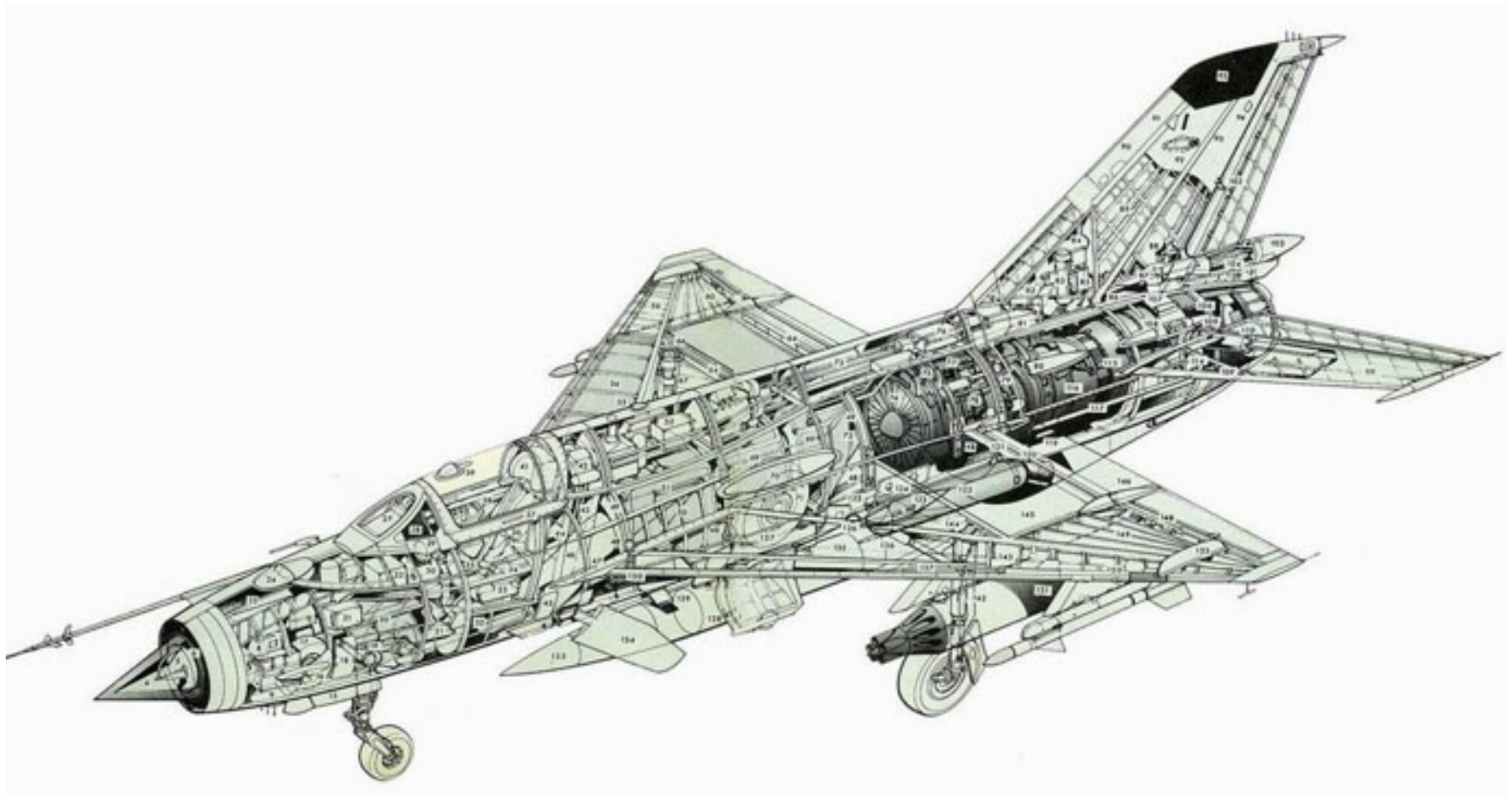

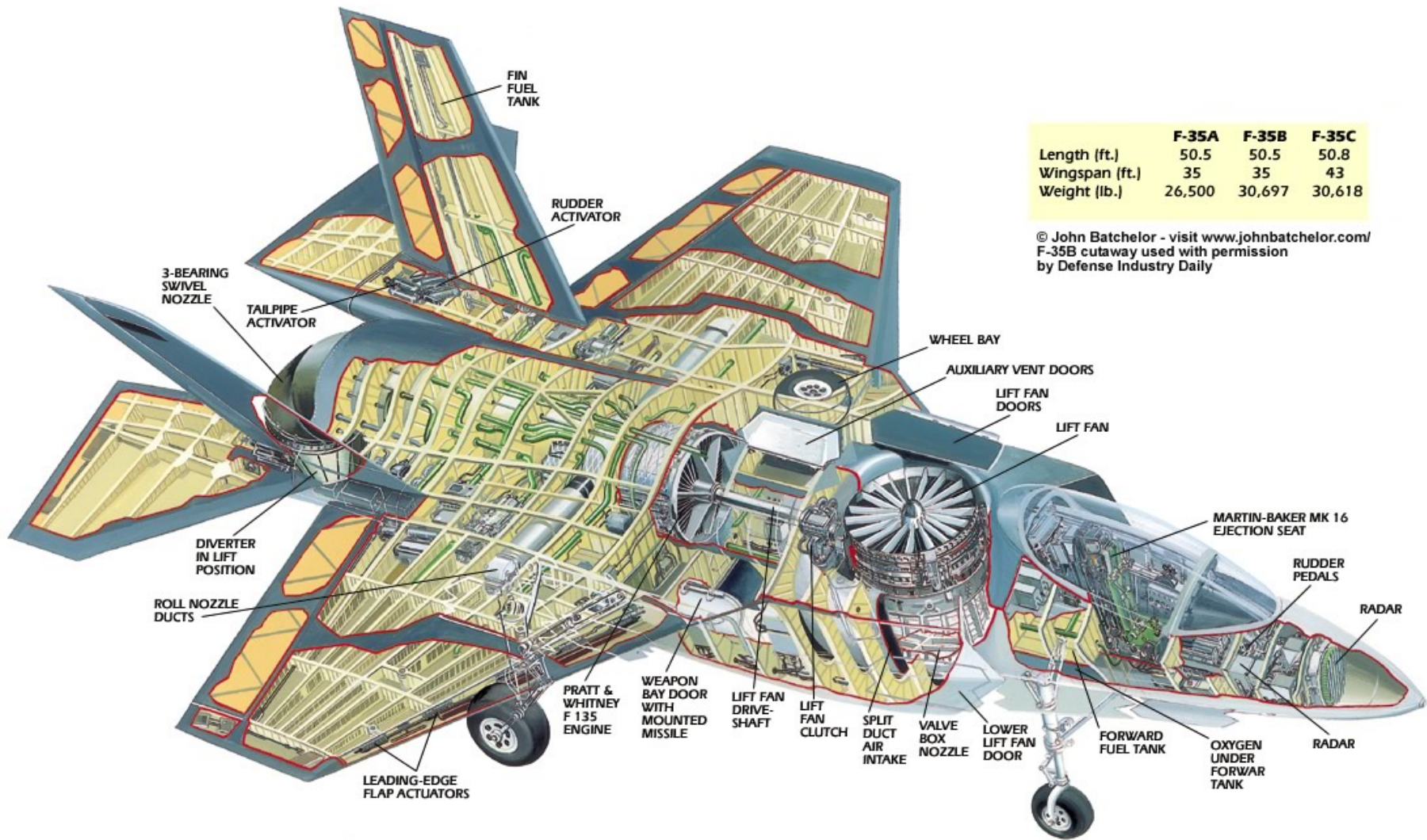

	F-35A	F-35B	F-35C
Length (ft.)	50.5	50.5	50.8
Wingspan (ft.)	35	35	43
Weight (lb.)	26,500	30,697	30,618

© John Batchelor - visit www.johnbatchelor.com/
 F-35B cutaway used with permission
 by Defense Industry Daily

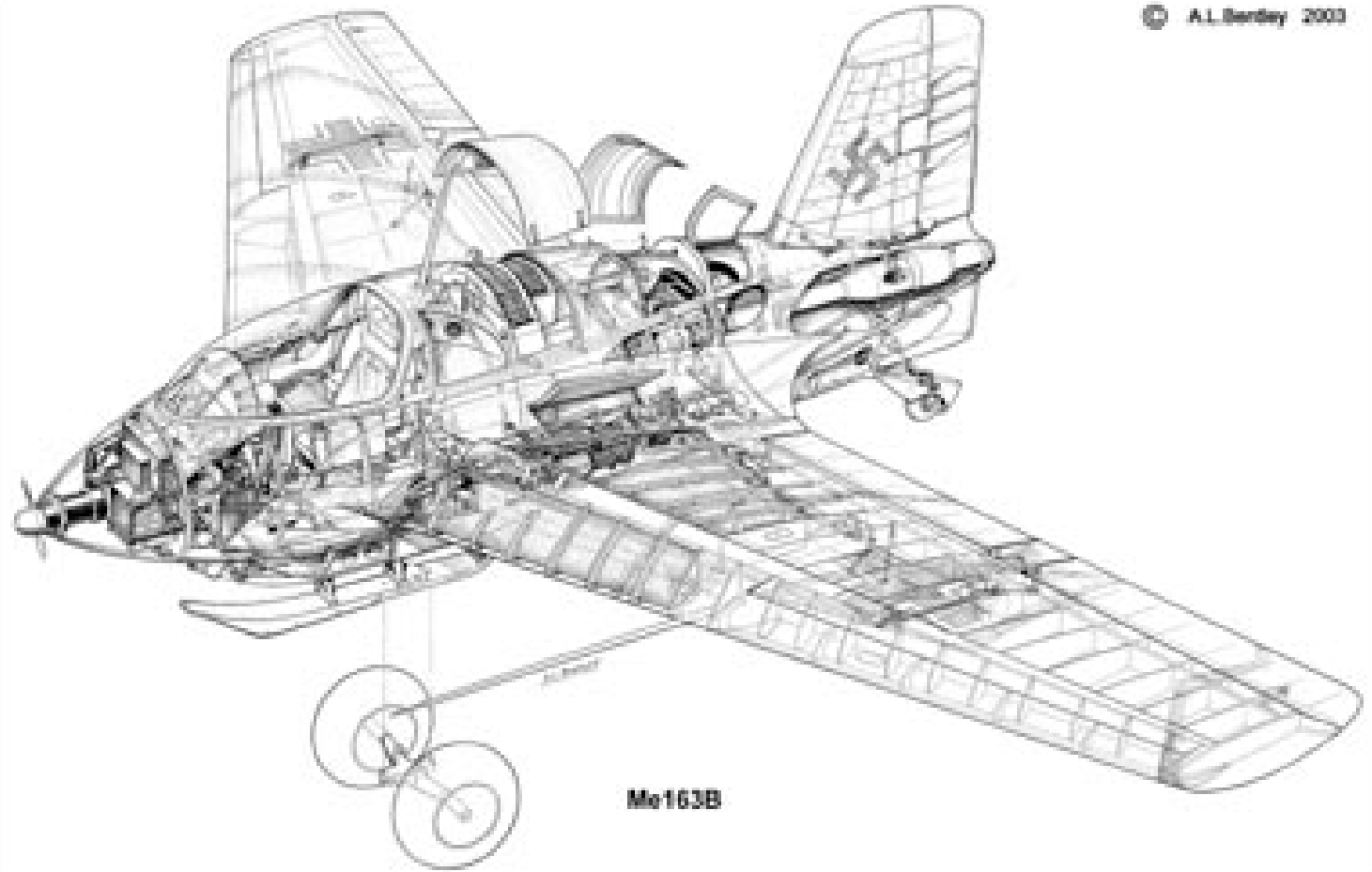

Me163B