



POLI USP

PEF - Engenharia de Estruturas e Geotécnica

PEF 3404

PONTES E GRANDES ESTRUTURAS

Kalil Skaf

Rui Nobhiro Oyamada

2021

Moodle USP

<https://edisciplinas.usp.br/>

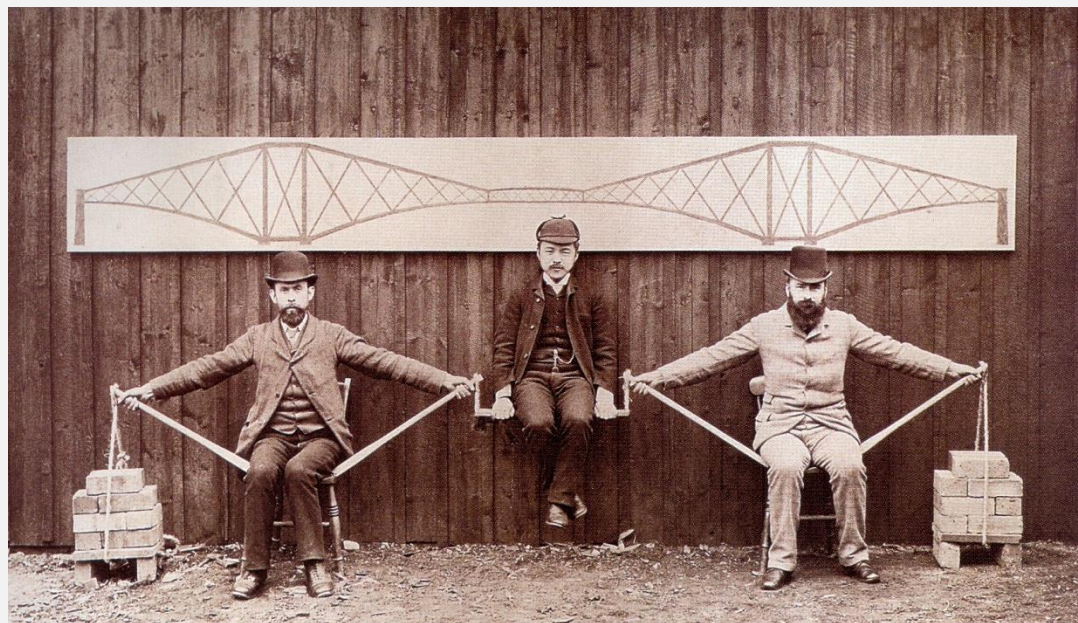

FORTH BRIDGE – Edinburgh - Scotland

PEF 3404 – PONTES E GRANDES ESTRUTURAS

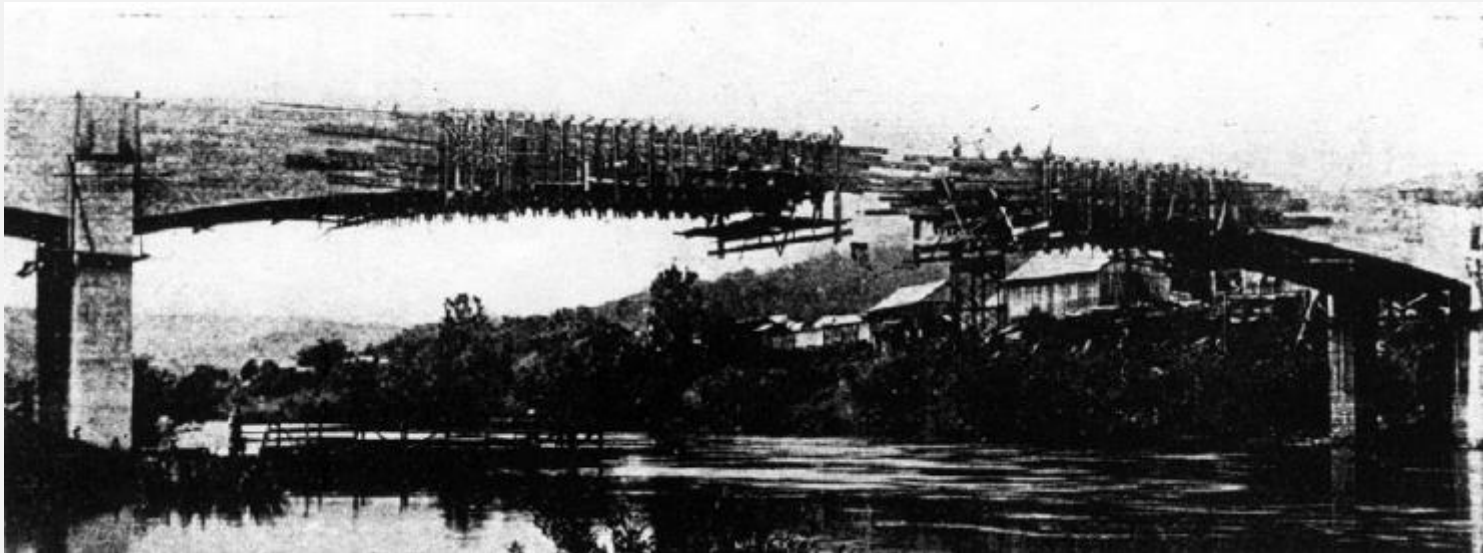

Rio dos Peixes, Brasil, 1930
Viga em concreto armado – vão 68m

PEF 3404 – PONTES E GRANDES ESTRUTURAS



Construção do Arco

PEF 3404 – PONTES E GRANDES ESTRUTURAS

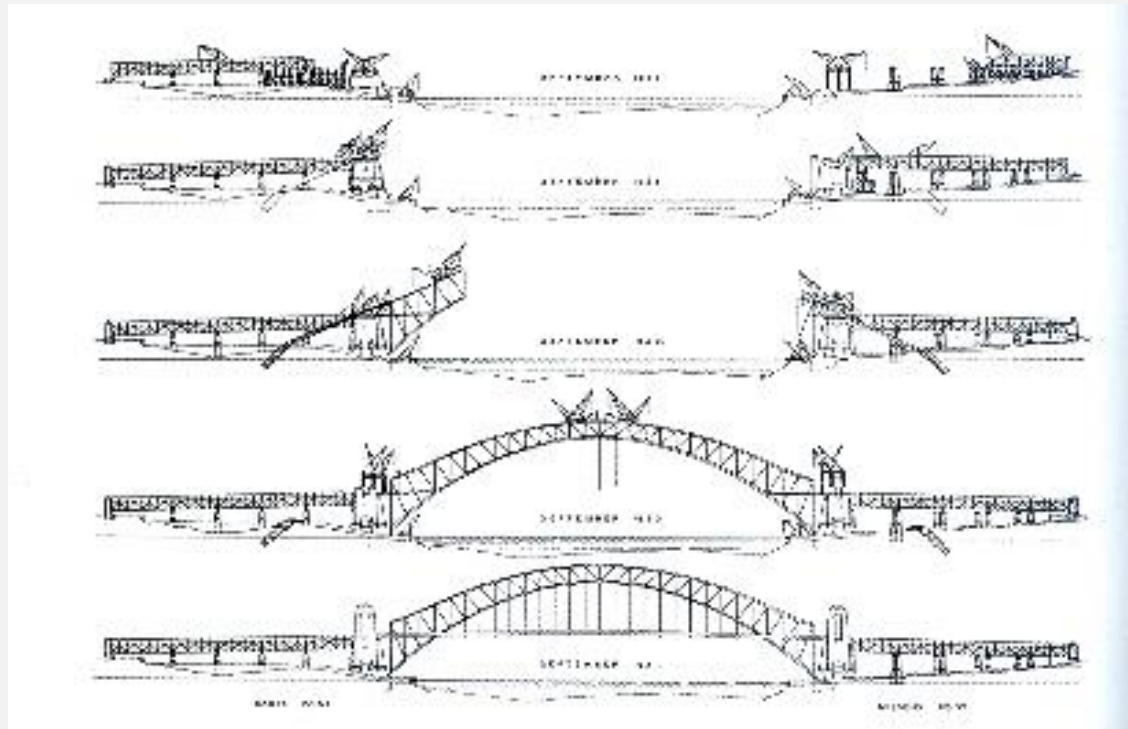

SYDNEY HARBOUR BRIDGE - 1932

PEF 3404 – PONTES E GRANDES ESTRUTURAS



Stolmasundet, Noruega, 1998
Viga de concreto – vão 301m

PEF 3404 – PONTES E GRANDES ESTRUTURAS



Bridge to Russky Island – Russia, 2012
Estaiada – Vão de 1104m

PEF 3404 – PONTES E GRANDES ESTRUTURAS

Complexo Viário Jacu-Pêssego



PEF 3404 – PONTES E GRANDES ESTRUTURAS

Complexo Viário Jacu-Pêssego



PEF 3404 – PONTES E GRANDES ESTRUTURAS

CONTROLE DE FLECHAS EM BALANÇOS SUCESSIVOS

- Apresentar um método racional para fixação das cotas de execução de obras construídas por segmentos

PROPÓSITOS:

- Controle de flechas de pontes construídas pelo método dos balanços sucessivos
- perdas progressivas de protensão
- esforços e deslocamentos diferidos

PEF 3404 – PONTES E GRANDES ESTRUTURAS

FUNÇÃO DE FLUÊNCIA

$$\varepsilon_{c,\text{total}} = \varepsilon_c + \varepsilon_{cc} = \varepsilon_c \cdot (1 + \phi)$$

RETRAÇÃO DO CONCRETO

$$\varepsilon_{cs}(t, t_0) = \varepsilon_{cs\infty} [\beta_s(t) - \beta_s(t_0)]$$

RELAXAÇÃO DO AÇO

$$\Psi(t, t_0) = \Psi_{1000} \left(\frac{t - t_0}{1000} \right)^{0,15}$$

PEF 3404 – PONTES E GRANDES ESTRUTURAS

As pontes construídas por balanços sucessivos estão sujeitas a mais de um carregamento, em diferentes datas, com diferentes módulos de elasticidade do concreto.

Cada conjunto de cabos ao ser protendido solicita as aduelas já executadas em condições diferentes de módulos de elasticidade e de coeficiente de fluência.

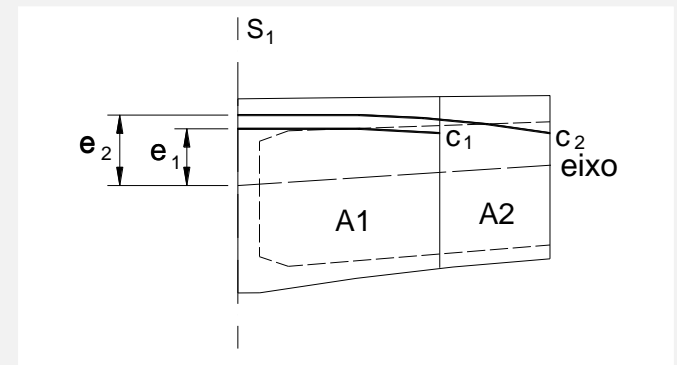
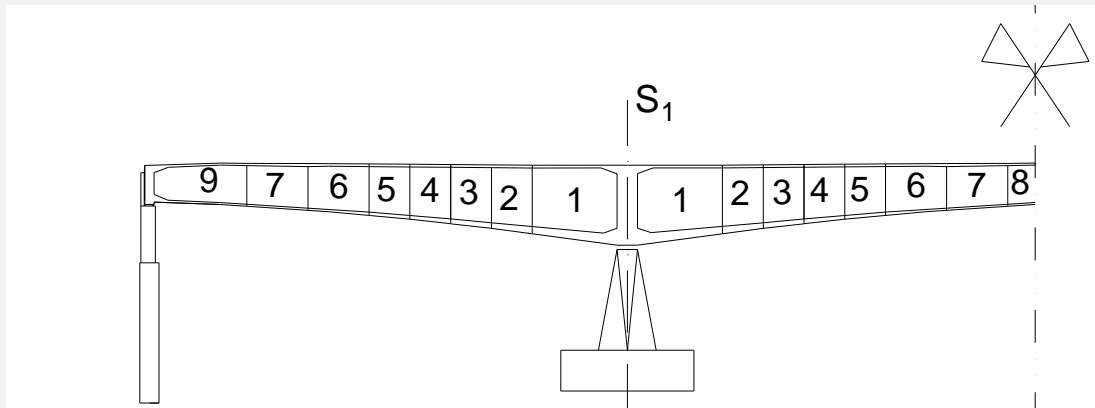

PEF 3404 – PONTES E GRANDES ESTRUTURAS

Para o 1º CICLO

- Concretagem da aduela 1

$$\sigma_{gt1,1}^1 = \frac{M_{gt1}^1}{W_1}$$

- Protensão do cabo equivalente 1

$$\sigma_{p1,1}^1 = - \left(\frac{P_{1,1}^1}{A_1} + \frac{P_{1,1}^1 \cdot e_1}{W_1} \right)$$

PEF 3404 – PONTES E GRANDES ESTRUTURAS

Para o 2º CICLO

- Concretagem da aduela 2

$$\sigma_{gt1,2}^1 = \frac{M_{gt2}^1}{W_1}$$

$$\sigma_{gt2,2}^1 = \frac{M_{gt2}^1}{W_2}$$

PEF 3404 – PONTES E GRANDES ESTRUTURAS

Para o 2º CICLO

- Protensão do cabo equivalente 2

$$\sigma_{p2,2}^1 = - \left(\frac{P_{2,2}^1}{A_1} + \frac{P_{2,2}^1 \cdot e_2}{W_2} \right)$$

força no cabo 1 no 2º ciclo

$$P_{1,2}^1 = P_{1,1}^1 + \Delta P_{1,2}^1$$

$$\Delta P_{1,2}^1 = \Delta \varepsilon_{1,2} E_p A_p - 0,83 \sigma_{p1,0} \psi_{1,2} A_p$$

$$\Delta \varepsilon_{1,2} = \frac{\sigma_{gt1,1}^1 + \sigma_{p1,1}^1}{E_{c28}} \phi_{1,2} + \varepsilon_{cs1,2} + \frac{\Delta \sigma_{p1,2}^1 + \sigma_{gt1,2}^1}{E_{c7}}$$

PEF 3404 – PONTES E GRANDES ESTRUTURAS

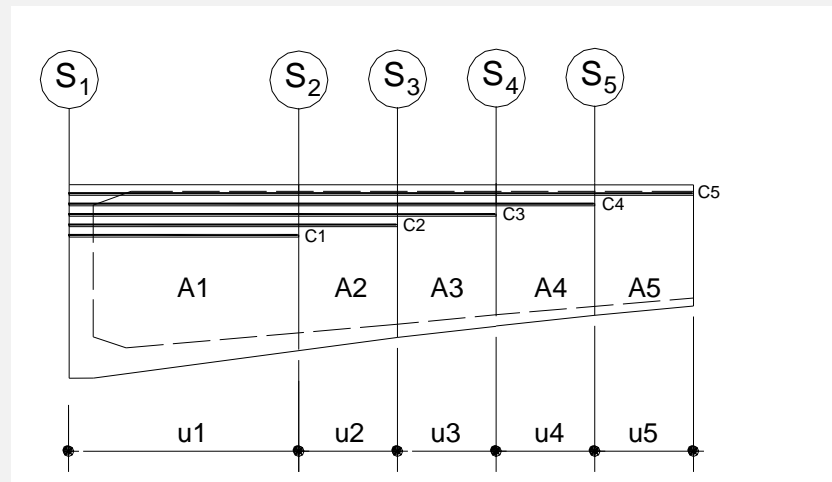

Seção	S1	S2	S3	S4	S5
Cabo					
C1	$P_{1,5}^1$				
C2	$P_{2,5}^1$	$P_{2,5}^2$			
C3	$P_{3,5}^1$	$P_{3,5}^2$	$P_{3,5}^3$		
C4	$P_{4,5}^1$	$P_{4,5}^2$	$P_{4,5}^3$	$P_{4,5}^4$	
C5	$P_{5,5}^1$	$P_{5,5}^2$	$P_{5,5}^3$	$P_{5,5}^4$	$P_{5,5}^5$

IMPLANTAÇÃO GERAL
Escala 1:500

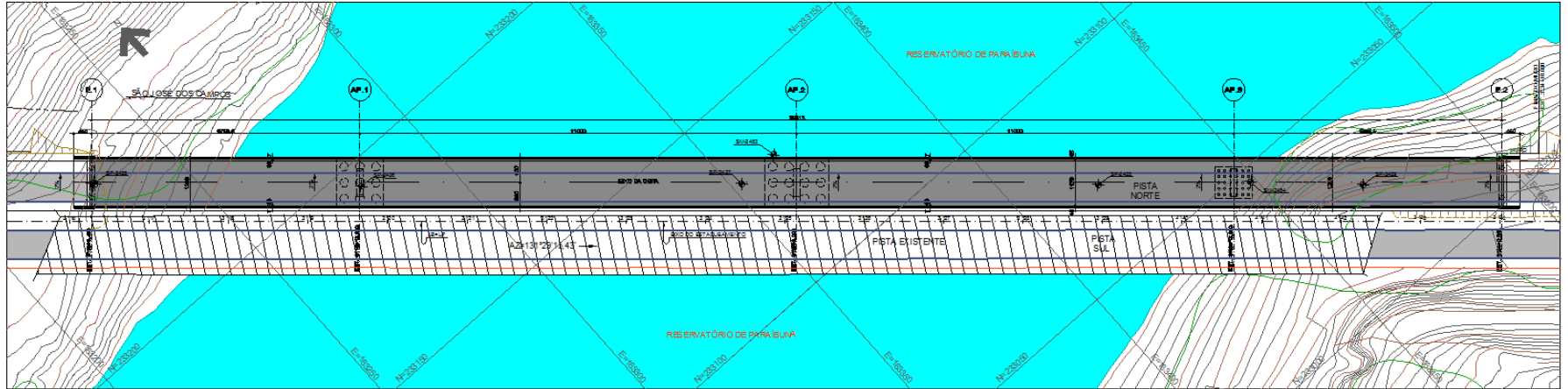

CORTE LONGITUDINAL NO EIXO DA OBRA
Escala 1:500

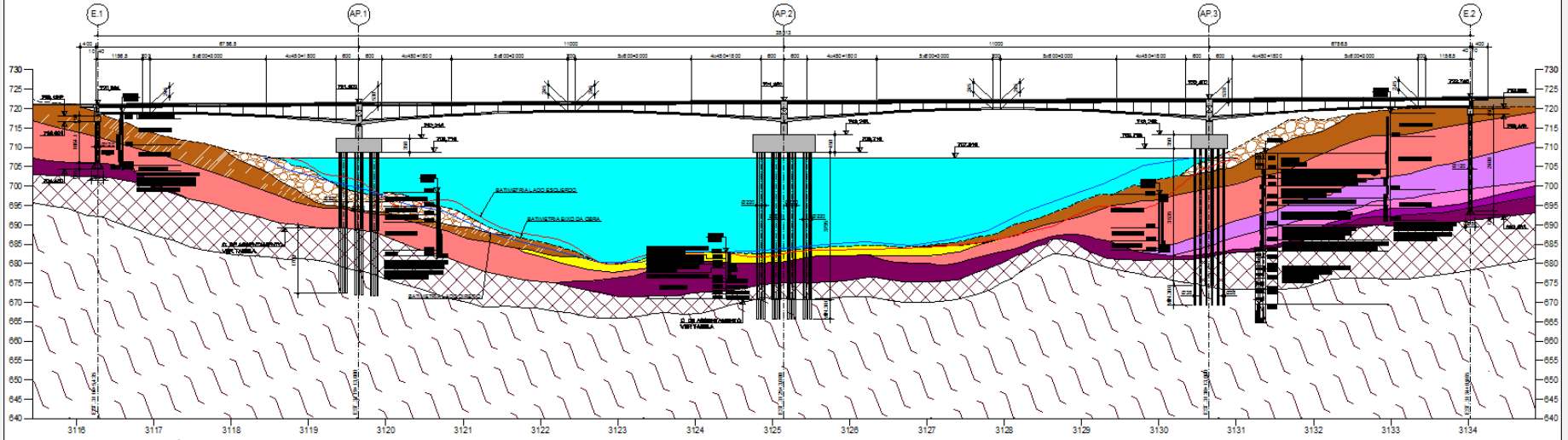

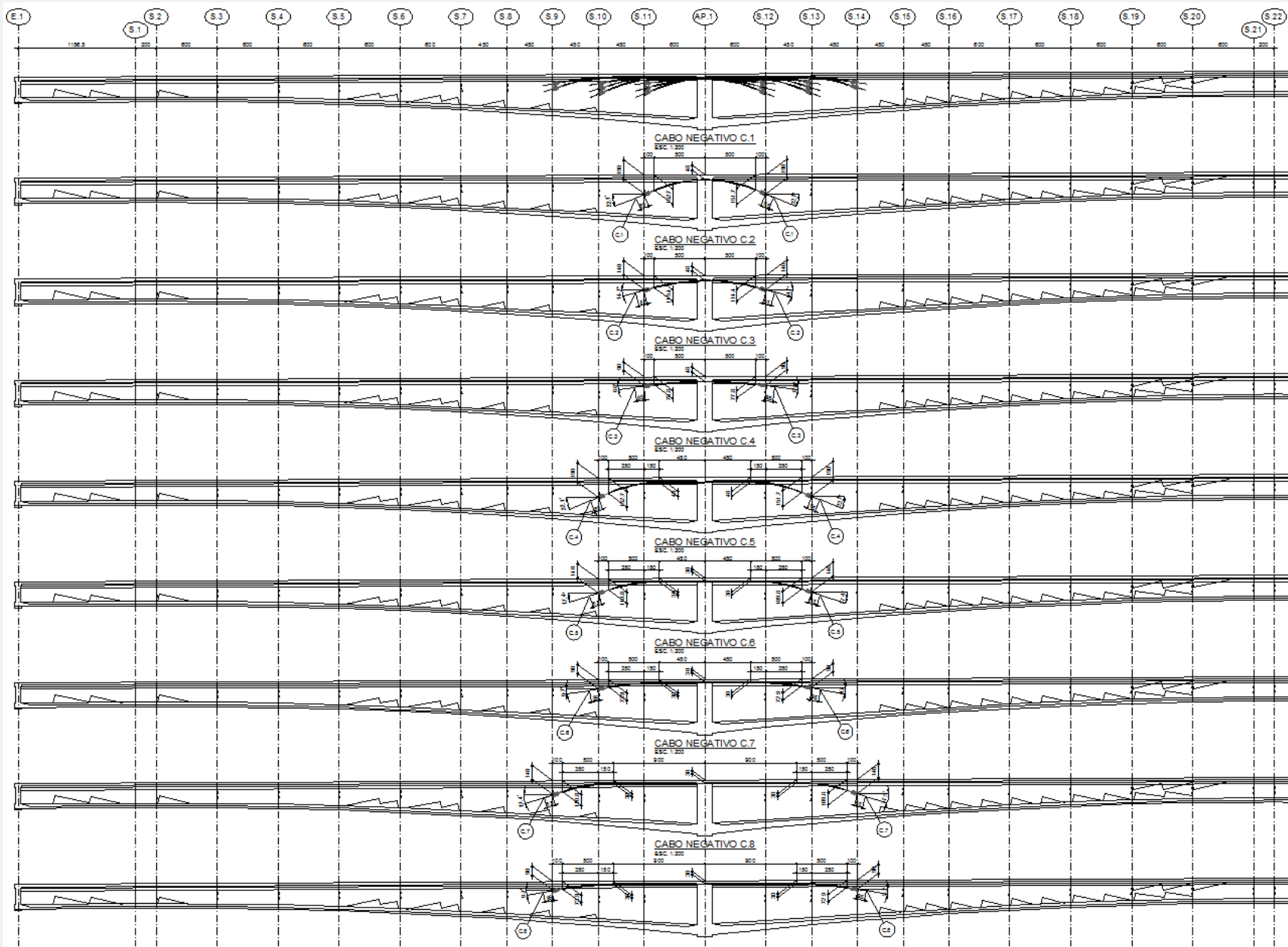

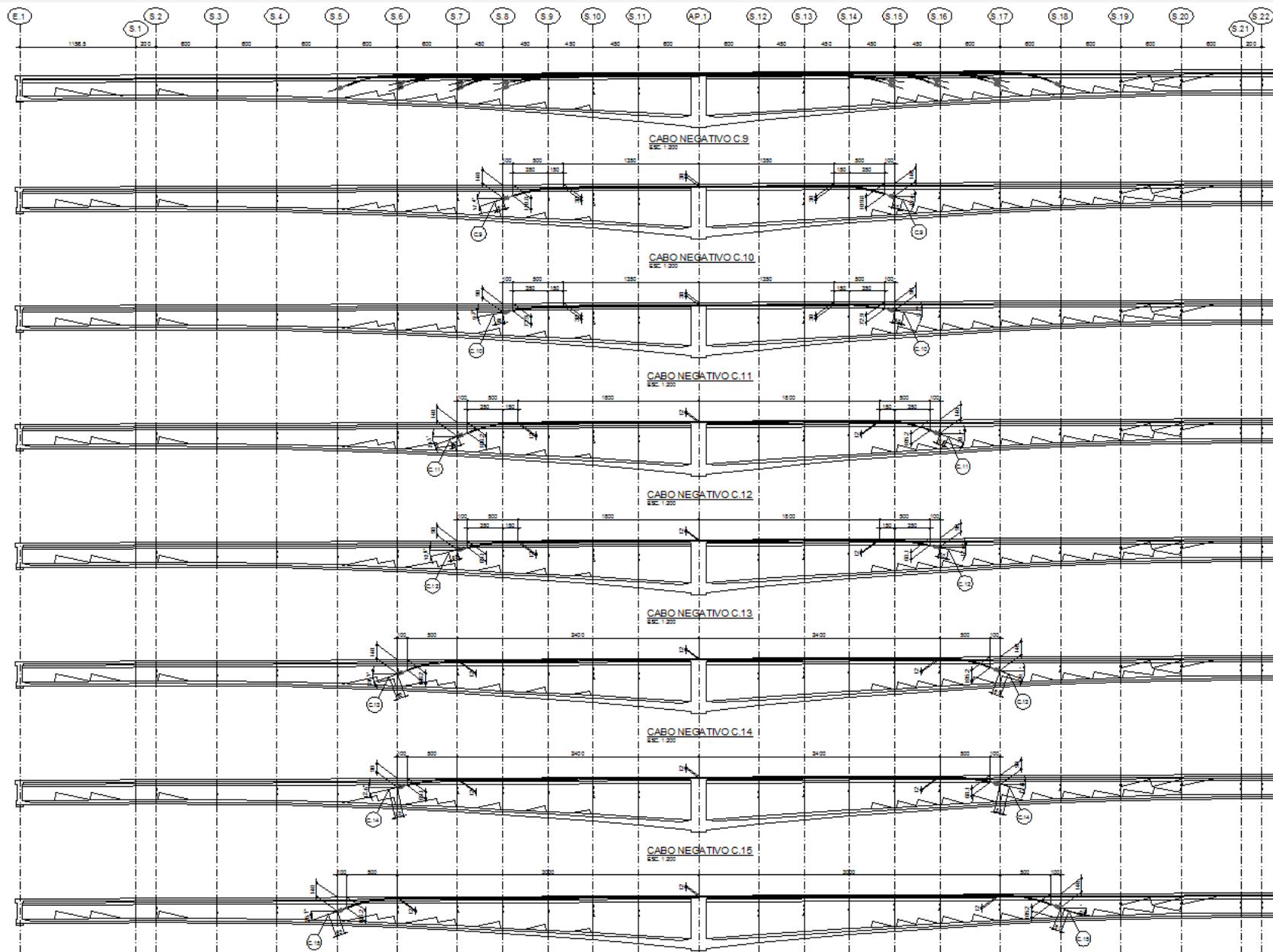

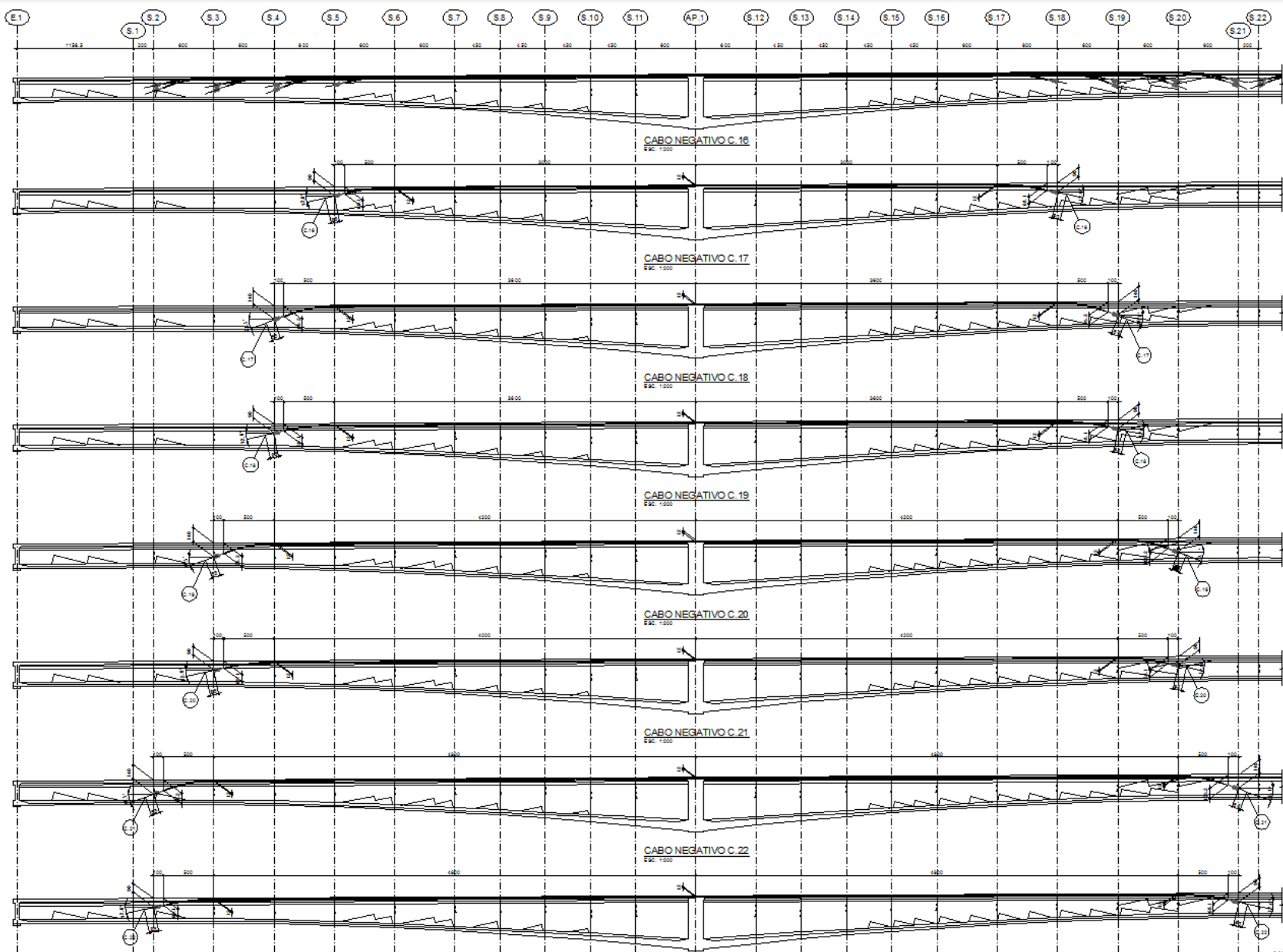

PEF 3404 – PONTES E GRANDES ESTRUTURAS

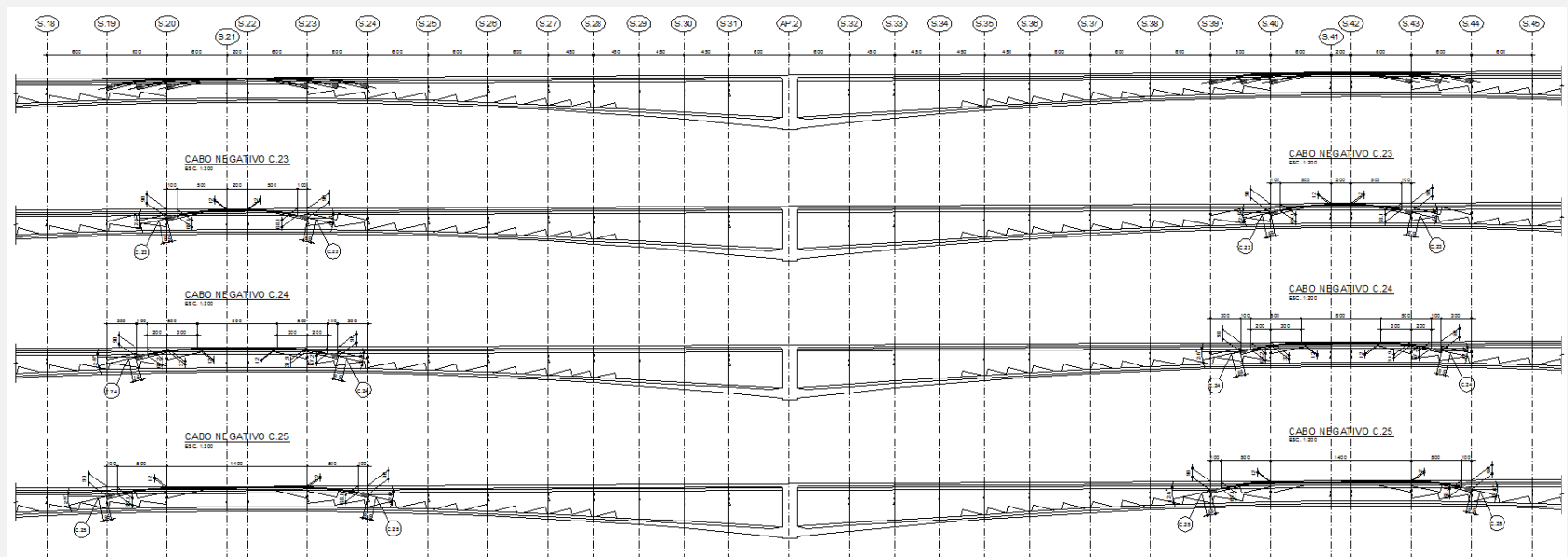

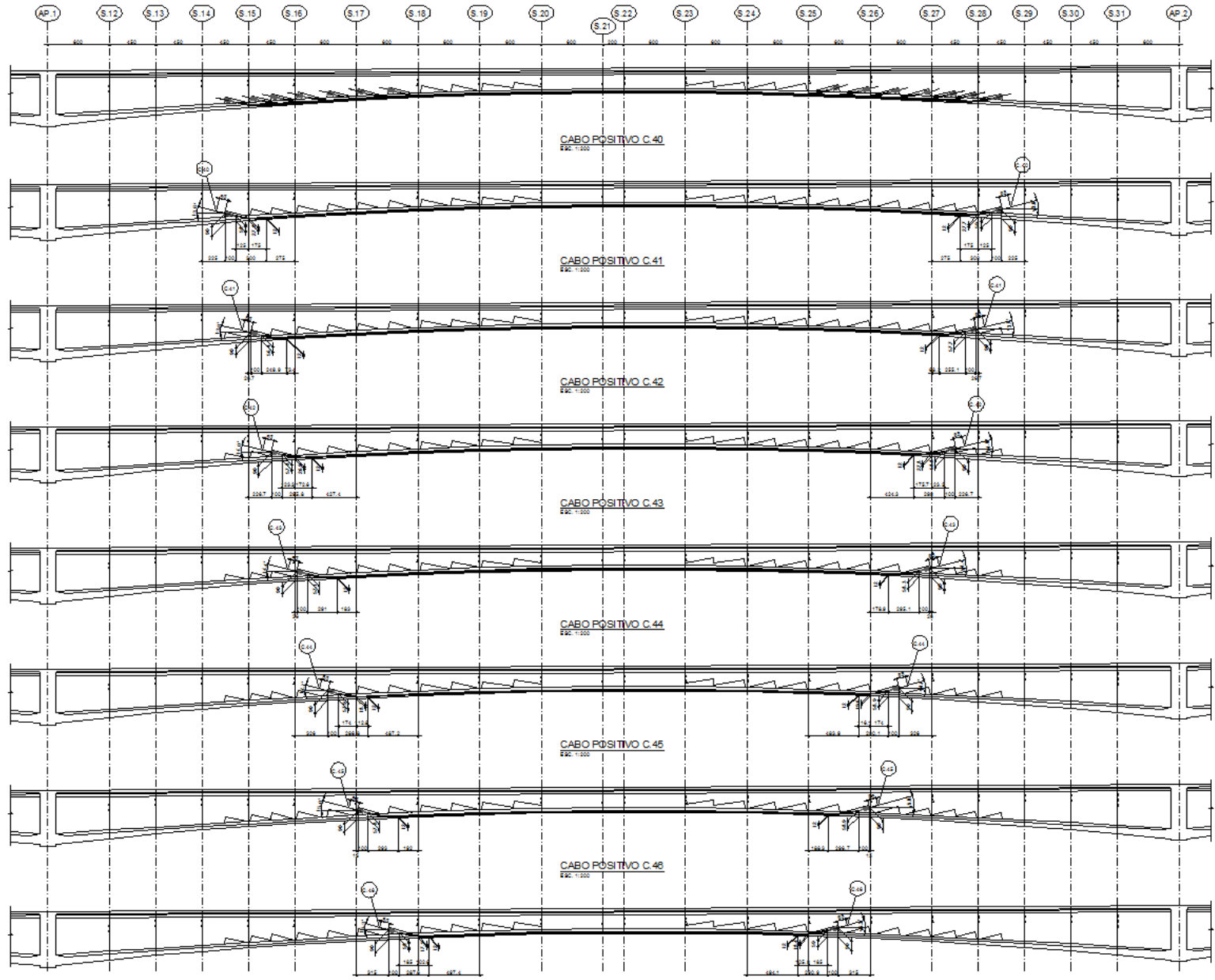



– Seção transversal no vão

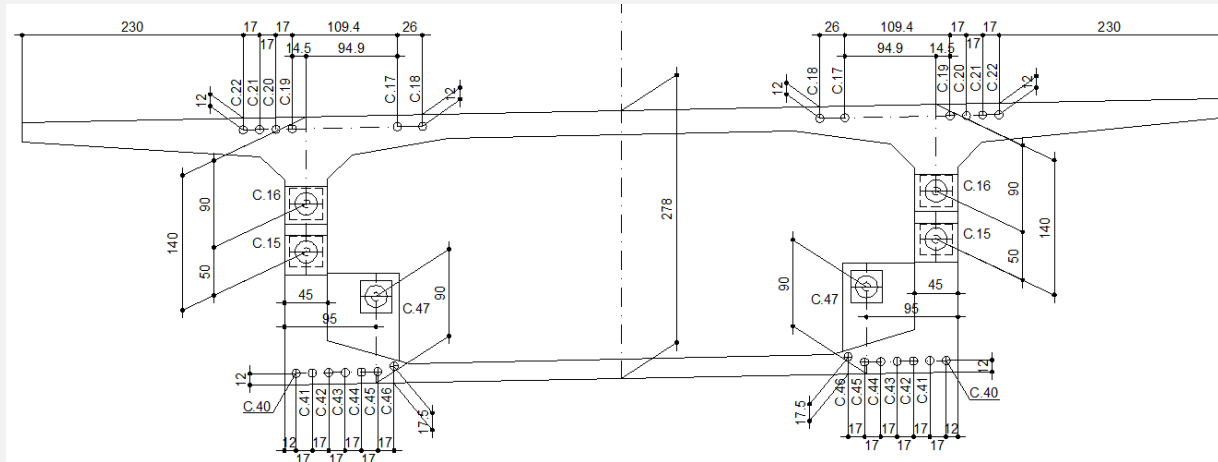

– Seção transversal sobre o apoio

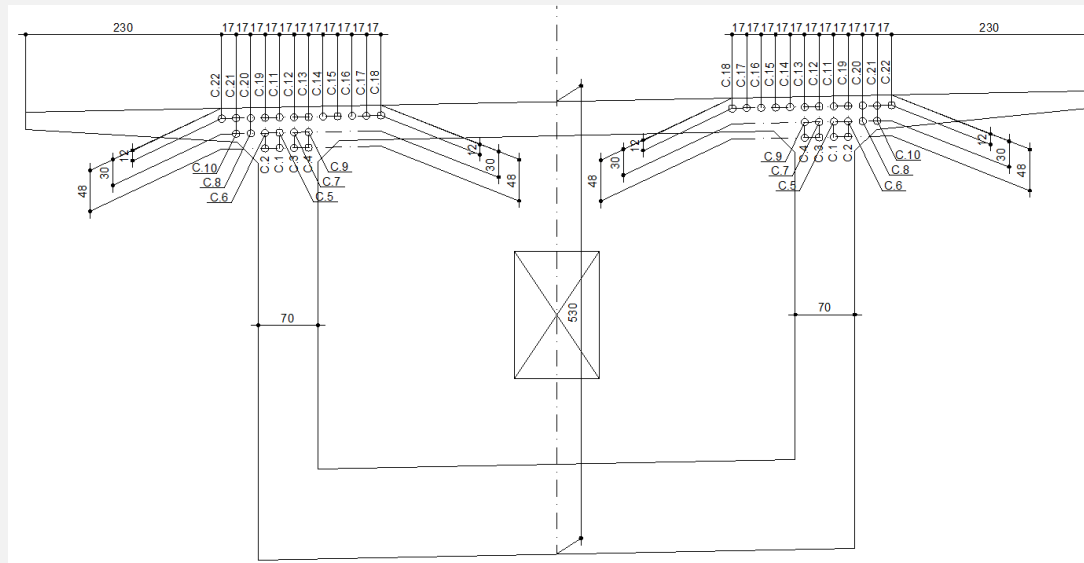

PEF 3404 – PONTES E GRANDES ESTRUTURAS

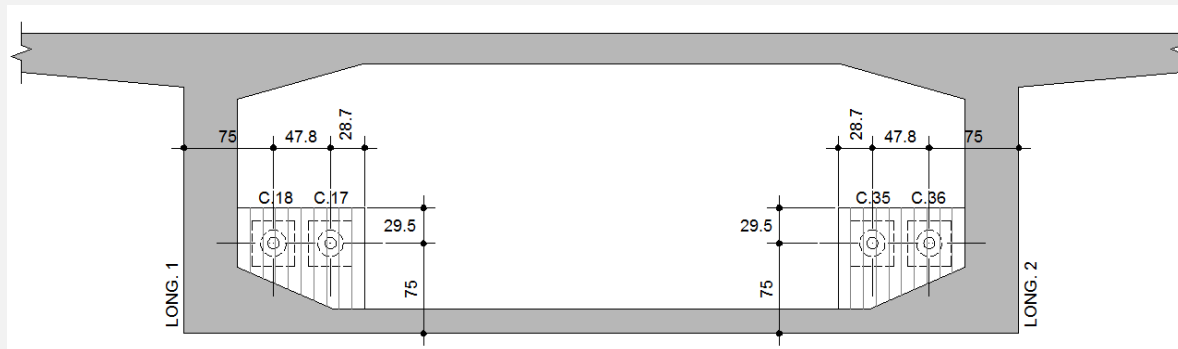
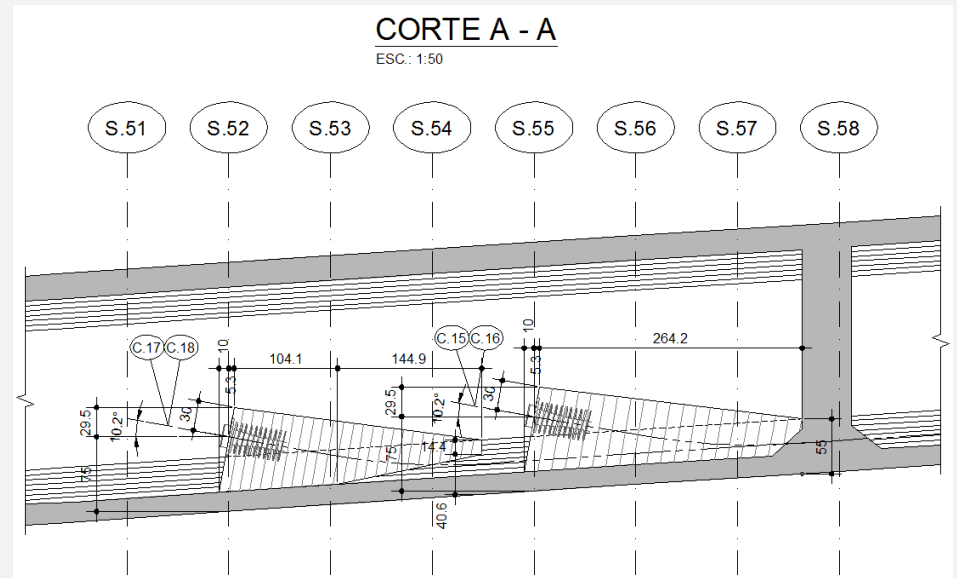
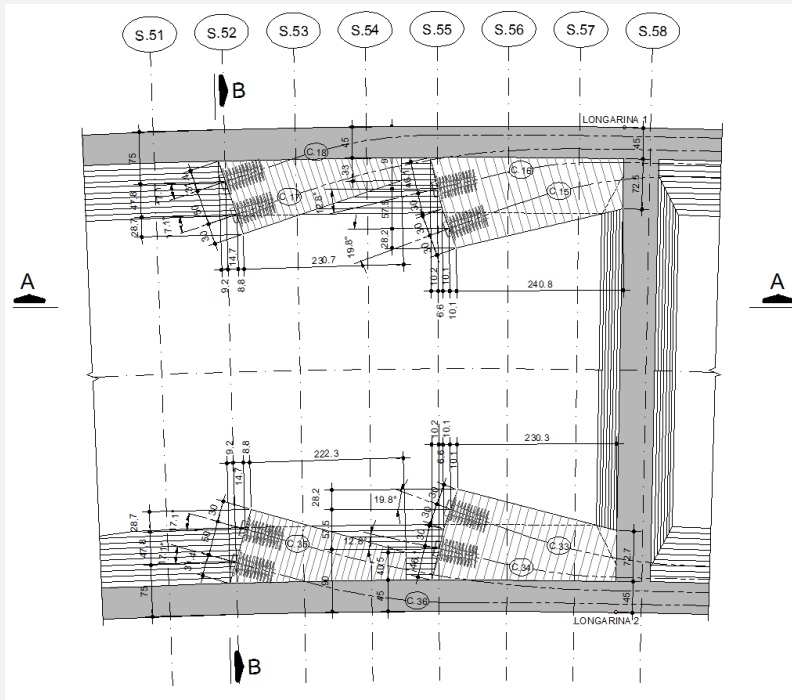

PEF 3404 – PONTES E GRANDES ESTRUTURAS

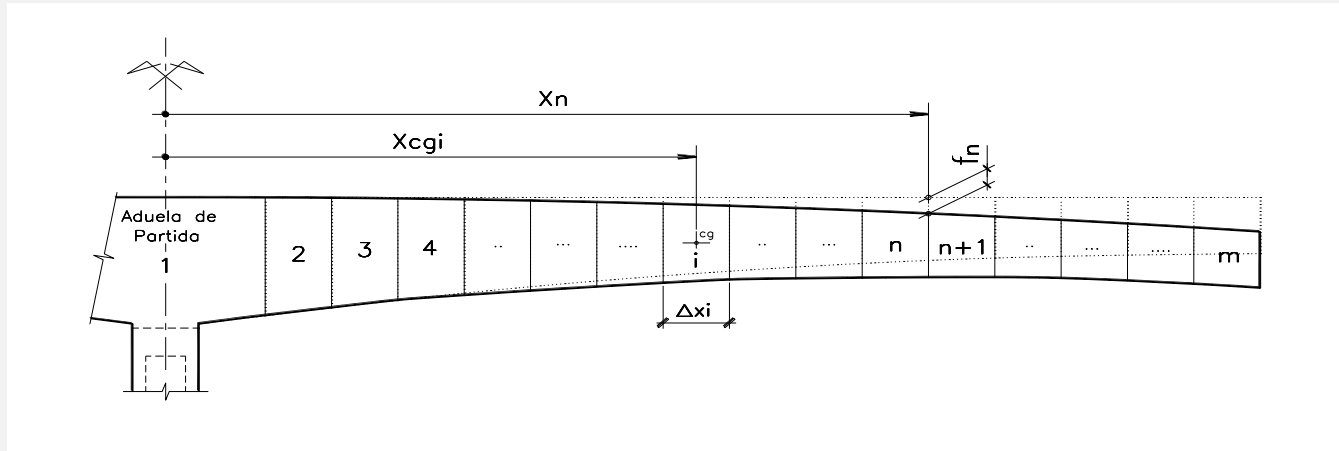

$$f^n = \sum_{i=1}^n \left[\frac{X_n - X_{cgi}}{I_i} \Delta x_i \left(\sum_{j=1}^m \frac{M_j^i}{E_{j-i+1}} \left(1 + \phi_{j-i+1} \frac{E_{j-i+1}}{E_{c28}} \right) \right) \right]$$

PEF 3404 – PONTES E GRANDES ESTRUTURAS

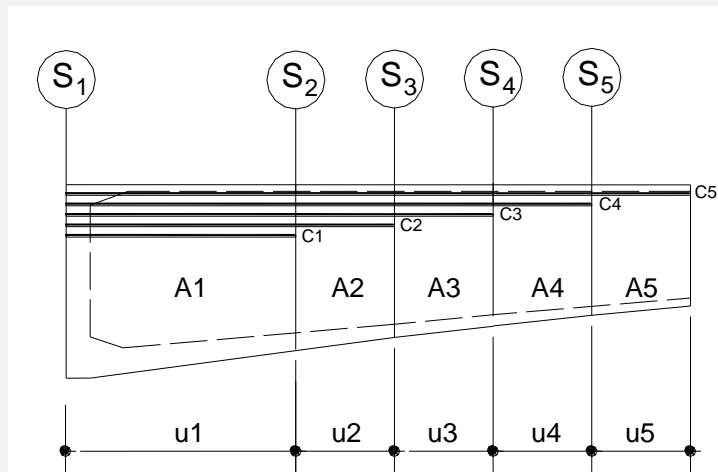

Ciclo	1º	2º	3º	4º	5º
Aduela					
A1	f_1^1	f_2^1	f_3^1	f_4^1	f_5^1
A2		f_2^2	f_3^2	f_4^2	f_5^2
A3			f_3^3	f_4^3	f_5^3
A4				f_4^4	f_5^4
A5					f_5^5

PEF 3404 – PONTES E GRANDES ESTRUTURAS

Contra-flechas relativas

$$cf_i = \theta_i u_i$$

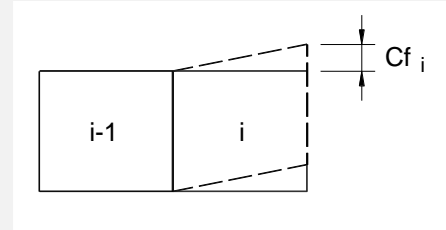

Contra-flechas absolutas

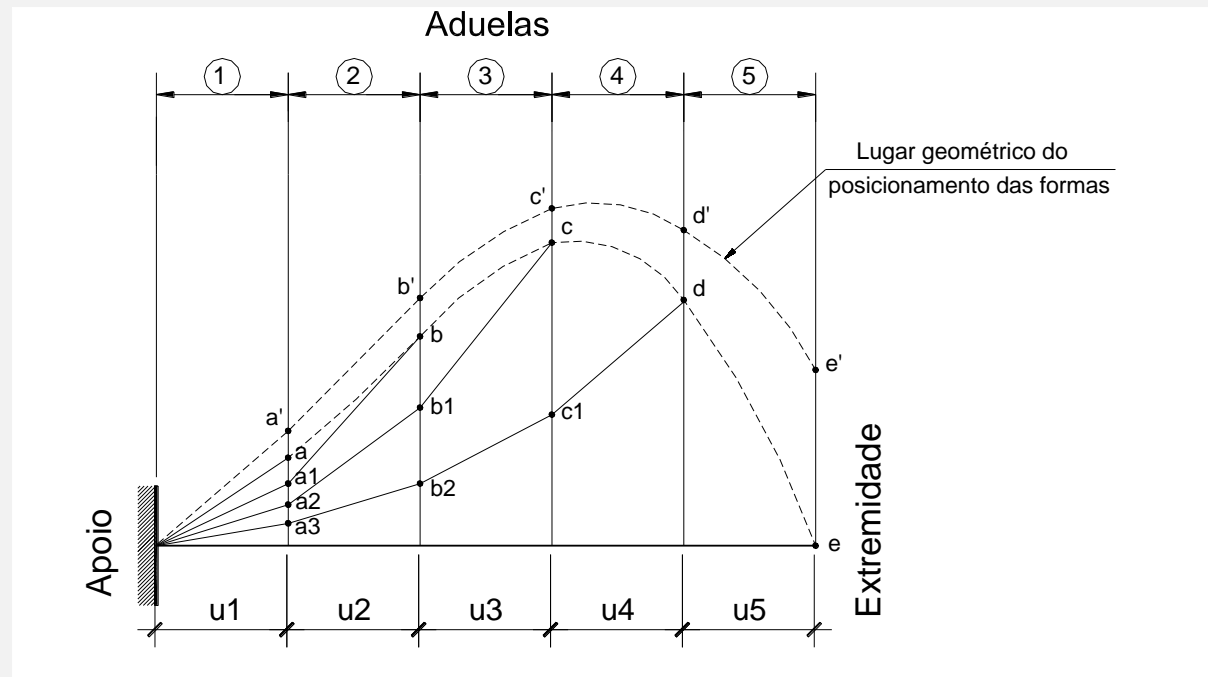

PEF 3404 – PONTES E GRANDES ESTRUTURAS

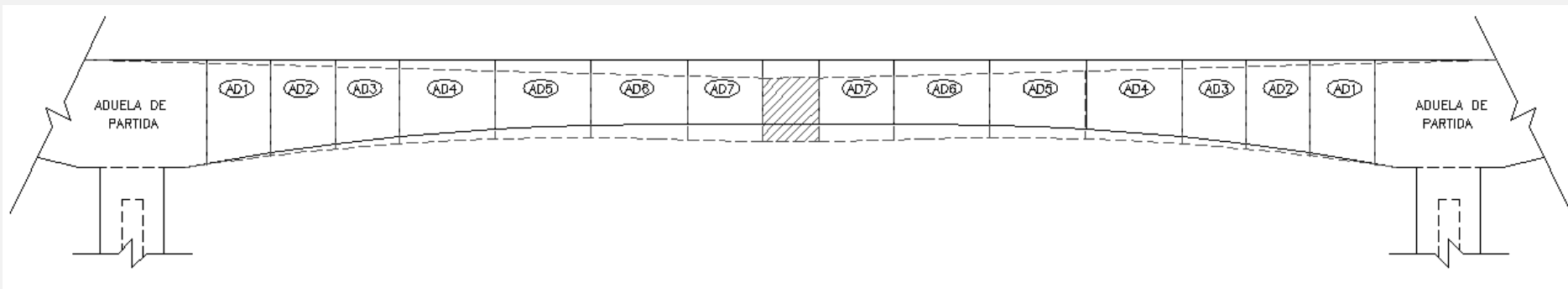
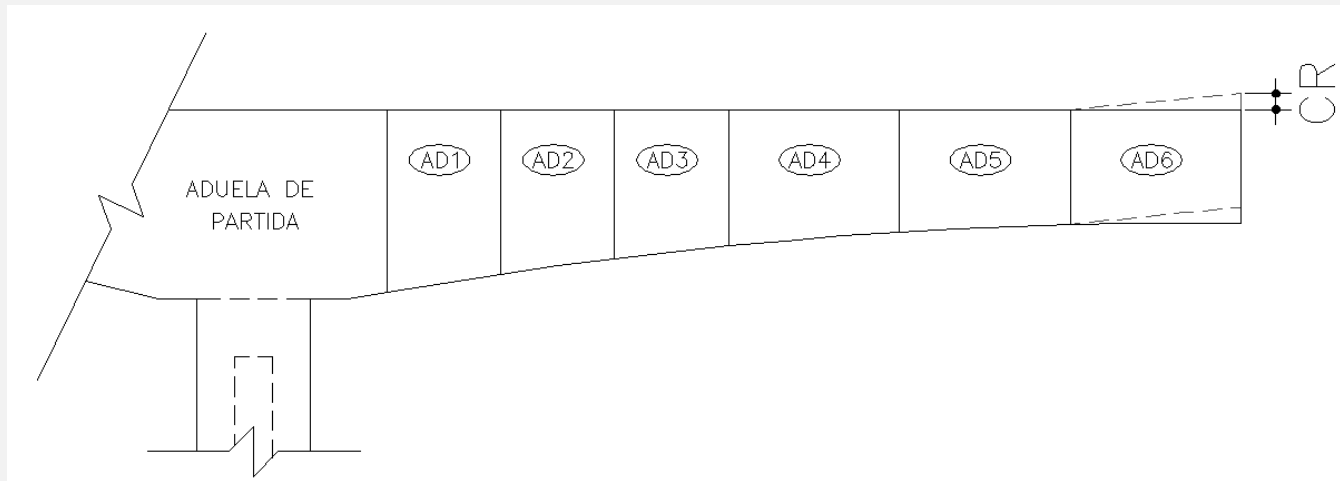

PEF 3404 – PONTES E GRANDES ESTRUTURAS

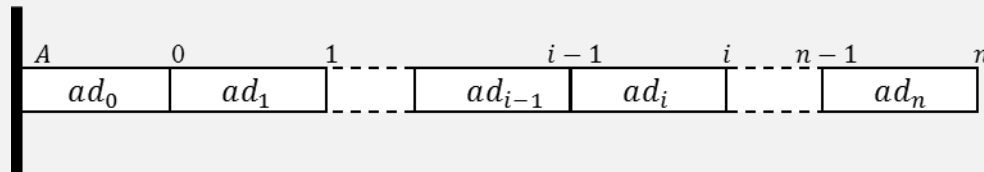

$$a_{i,j}^{(acum)} = \sum_{k=0}^i a_{k,j}^{(isol)} \text{ com } \{i = 0, \dots, n\}$$

$a_{i,j}^{(acum)}$ os deslocamentos acumulados no ponto j até a aduela ad_i

	ponto A	ponto 0	ponto 1	ponto 2	ponto 3	ponto 4
ad₀	$a_{0,A}^{(acum)}$	$a_{0,0}^{(acum)}$	$a_{0,1}^{(acum)}$			
ad₁	$a_{1,A}^{(acum)}$	$a_{1,0}^{(acum)}$	$a_{1,1}^{(acum)}$	$a_{1,2}^{(acum)}$		
ad₂	$a_{2,A}^{(acum)}$	$a_{2,0}^{(acum)}$	$a_{2,1}^{(acum)}$	$a_{2,2}^{(acum)}$	$a_{2,3}^{(acum)}$	
ad₃	$a_{3,A}^{(acum)}$	$a_{3,0}^{(acum)}$	$a_{3,1}^{(acum)}$	$a_{3,2}^{(acum)}$	$a_{3,3}^{(acum)}$	$a_{3,4}^{(acum)}$
ad₄	$a_{4,A}^{(acum)}$	$a_{4,0}^{(acum)}$	$a_{4,1}^{(acum)}$	$a_{4,2}^{(acum)}$	$a_{4,3}^{(acum)}$	$a_{4,4}^{(acum)}$

PEF 3404 – PONTES E GRANDES ESTRUTURAS

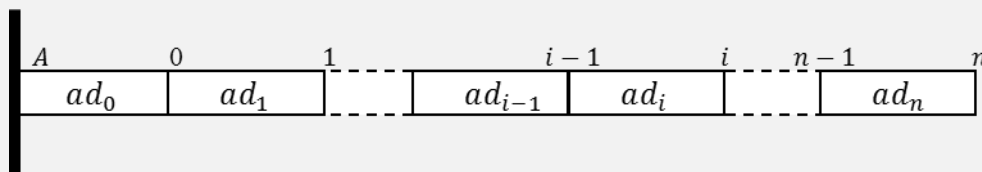

Para se ter os deslocamentos anulados ao final da construção deve-se começar com as cotas virtuais $-a_{n,j}^{(acum)}$ com $\{j = 0, \dots, n\}$.

$$a_{i,j}^{(ctfl)} = a_{i,j}^{(acum)} - a_{n,j}^{(acum)} \text{ com } \{j = 0, \dots, n\}.$$

	ponto A	ponto 0	ponto 1	ponto 2	ponto 3	ponto 4
ad₀	$a_{0,A}^{(ctrf)}$	$a_{0,0}^{(ctrf)}$	$a_{0,1}^{(ctrf)}$			
ad₁	$a_{1,A}^{(ctrf)}$	$a_{1,0}^{(ctrf)}$	$a_{1,1}^{(ctrf)}$	$a_{1,2}^{(ctrf)}$		
ad₂	$a_{2,A}^{(ctrf)}$	$a_{2,0}^{(ctrf)}$	$a_{2,1}^{(ctrf)}$	$a_{2,2}^{(ctrf)}$	$a_{2,3}^{(ctrf)}$	
ad₃	$a_{3,A}^{(ctrf)}$	$a_{3,0}^{(ctrf)}$	$a_{3,1}^{(ctrf)}$	$a_{3,2}^{(ctrf)}$	$a_{3,3}^{(ctrf)}$	$a_{3,4}^{(ctrf)}$
ad₄	$a_{4,A}^{(ctrf)}$	$a_{4,0}^{(ctrf)}$	$a_{4,1}^{(ctrf)}$	$a_{4,2}^{(ctrf)}$	$a_{4,3}^{(ctrf)}$	$a_{4,4}^{(ctrf)}$

DETERMINAÇÃO DAS CONTRAFLECHAS

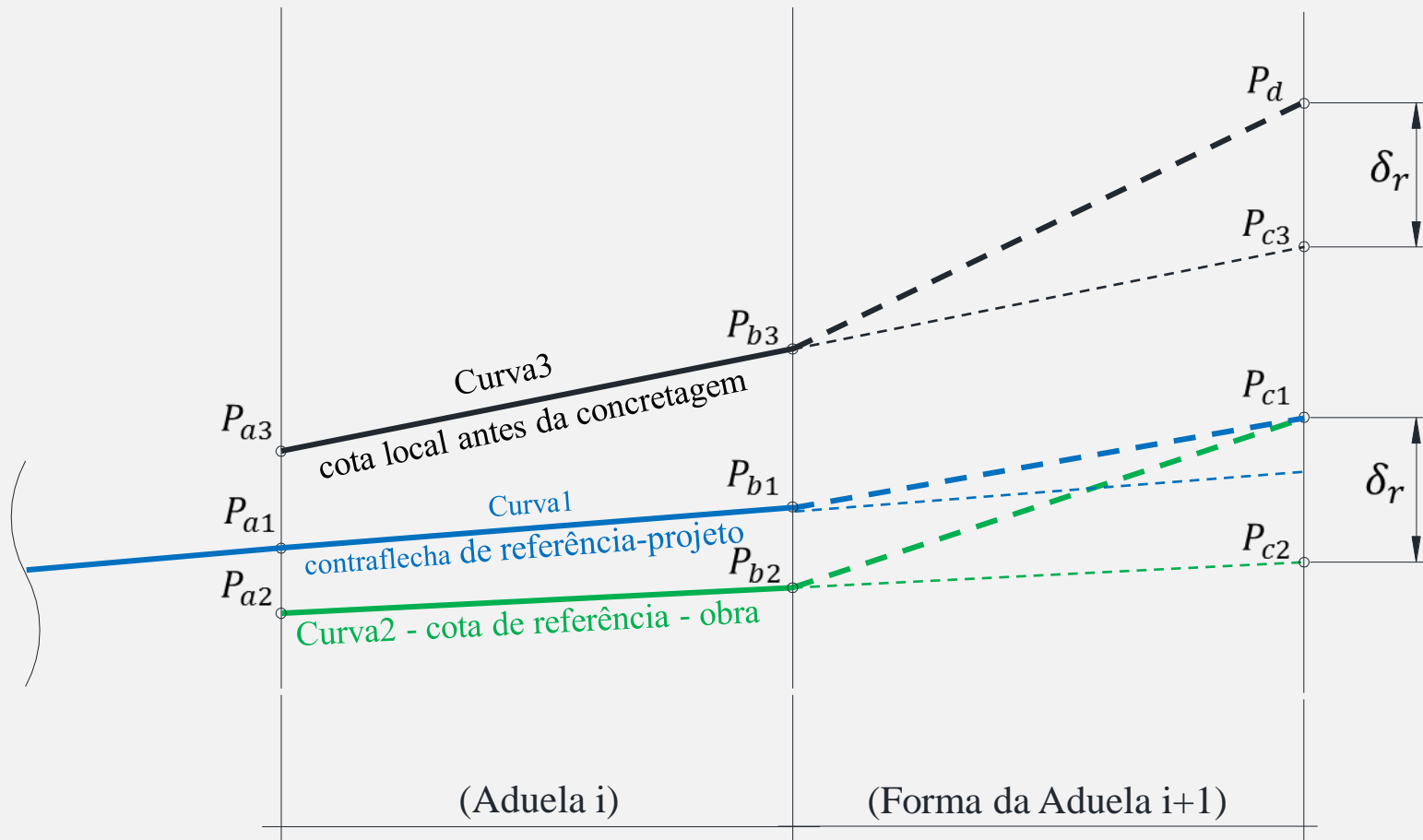

PEF 3404 – PONTES E GRANDES ESTRUTURAS



Figura H.1 – Configuração das ações na combinação especial

a) Combinação Especial 1

$$1,35 \cdot \left(\sum_{i=1}^{m-1} G_{nk,aduela\ i} + \delta \cdot G_{nk,aduela\ m} + G_{nk,tre} \right) \oplus 1,30 \cdot \left(\sum_{i=1}^{m-1} G_{sk,aduela\ i} + G_{sk,tre} \right) \oplus 1,35 \cdot Q_k \oplus 1,2 \cdot 0,6 \cdot F_{w,k}$$

b) Combinação Especial 2

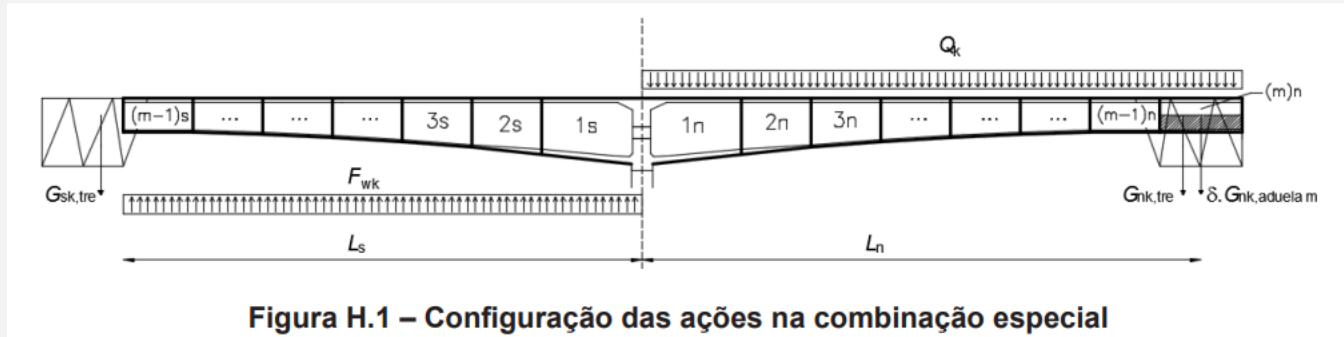
$$1,05 \cdot \left(\sum_{i=1}^{m-1} G_{nk,aduela\ i} + \delta \cdot G_{nk,aduela\ m} + G_{nk,tre} \right) \oplus 1,00 \cdot \left(\sum_{i=1}^{m-1} G_{sk,aduela\ i} + G_{sk,tre} \right) \oplus 1,35 \cdot Q_k \oplus 1,2 \cdot 0,6 \cdot F_{w,k}$$

onde \oplus significa “combinar com”.

PEF 3404 – PONTES E GRANDES ESTRUTURAS

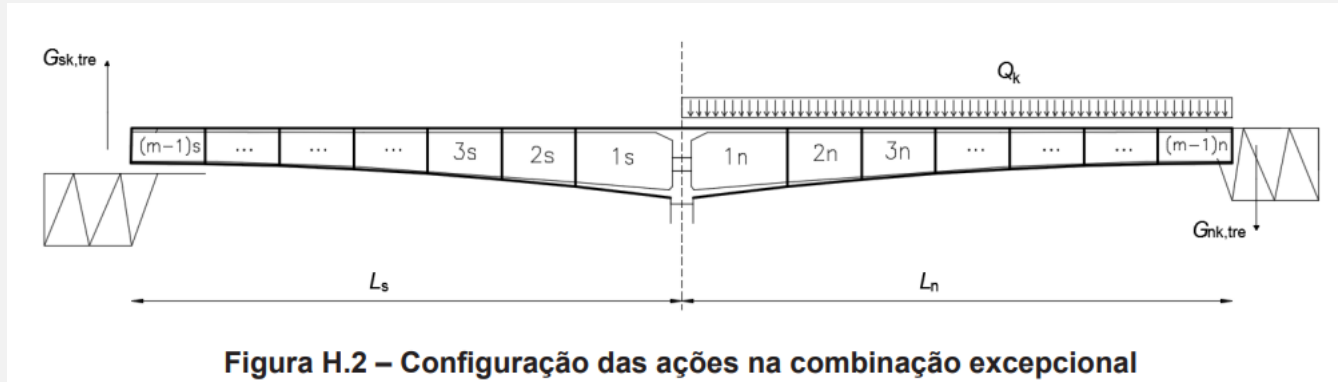

a) Combinação Excepcional

$$1,0 \cdot \left(\sum_{i=1}^{m-1} G_{nk,aduela\ i} + G_{nk,tre} \right) \oplus 1,0 \cdot \left(\sum_{i=1}^{m-1} G_{sk,aduela\ i} - G_{sk,tre} \right) \oplus \Psi_0 \cdot Q_k$$

onde \oplus significa "combinar com"

PEF 3404 – PONTES E GRANDES ESTRUTURAS



PEF 3404 – PONTES E GRANDES ESTRUTURAS



PEF 3404 – PONTES E GRANDES ESTRUTURAS



PEF 3404 – PONTES E GRANDES ESTRUTURAS



PEF 3404 – PONTES E GRANDES ESTRUTURAS

