

PEF3200
Aula 6
3 mai
PROF. NAKAO

❖ **Diagramas de esforços solicitantes de estruturas espaciais**

Planar Equations of Equilibrium

For a planar body to be in equilibrium, any one of the following sets of 3 equations may be used to solve for the unknown variables.

1. $\sum F_x = 0$, $\sum F_y = 0$, and $\sum M_A = 0$, where the resultant moment is with respect to any axis z or any point A in the xy -plane, or
2. $\sum F_x = 0$, $\sum M_A = 0$, and $\sum M_B = 0$, provided that the line connecting the points A and B is not perpendicular to the x axis, or
3. $\sum M_A = 0$, $\sum M_B = 0$, and $\sum M_C = 0$, where points A , B , and C are not collinear

Type of Support or Connection

Reaction*

1. Hinge or pin

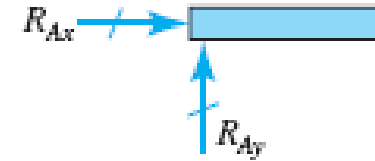
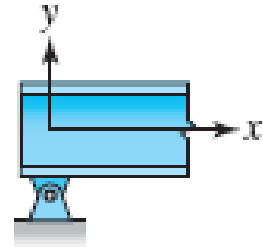

2. Roller

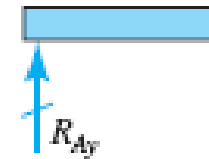
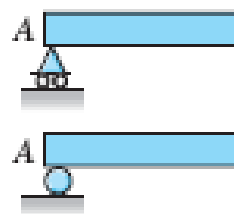
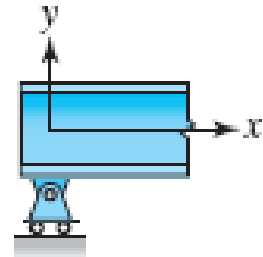

3. Cable or link

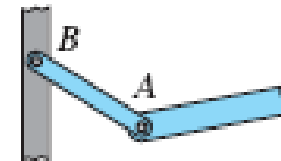
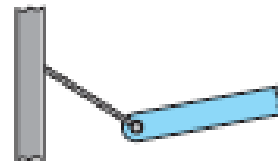

4. Fixed or clamped

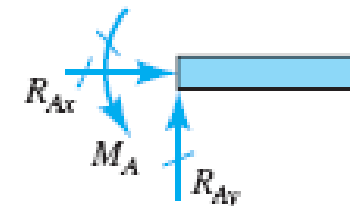
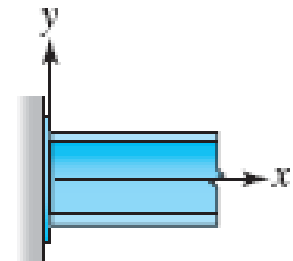

REVIEW OF STATIC EQUILIBRIUM

Types of loads: External loads and Internal loads

- External loads are due to surface forces and body forces
 - Surface forces can be for example, a concentrated load acting at a point or a distributed load both acting on the surface of a body
 - Body forces act on a volumetric portion of the body, for example, magnetic force or gravitational force
 - Reaction forces caused by the supports
- Internal loads can be considered as forces of interaction between the constituent material particles of the body

CONDITIONS OF EQUILIBRIUM

- When a system of forces acting upon a body has zero resultant, the body is said to be in force equilibrium.
- The equations of static equilibrium require:
- $\Sigma F_x = 0$; $\Sigma F_y = 0$, and $\Sigma F_z = 0$
- $\Sigma M_x = 0$; $\Sigma M_y = 0$, and $\Sigma M_z = 0$
- In other words, for a body to be in static equilibrium, the sum of all forces acting upon a body in any direction is zero and also the sum of all moments taken about any axis is also zero.

5. Guided

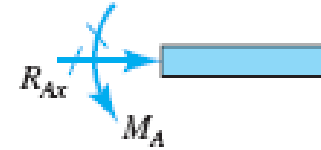
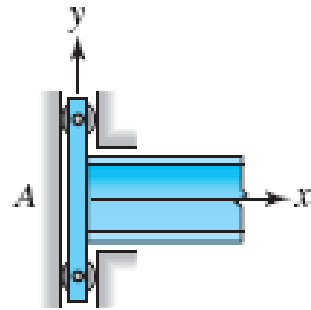

6. Ball and socket
(nonplanar)

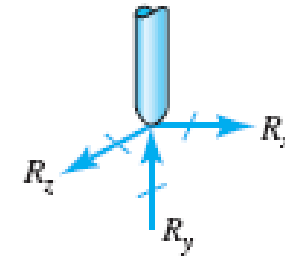
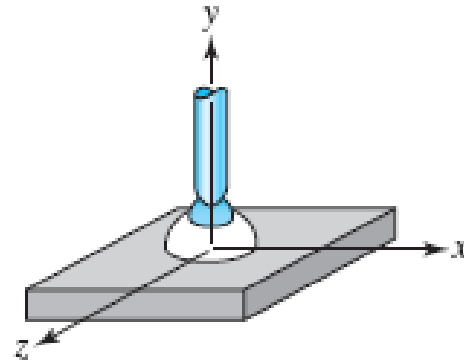

7. Fixed
(nonplanar)

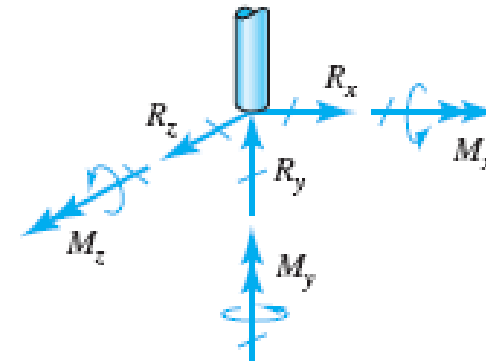
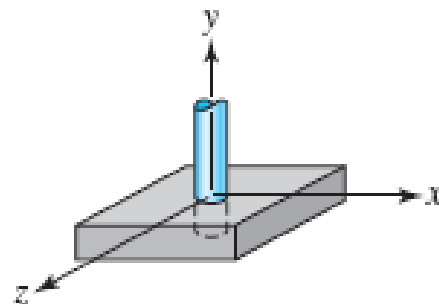

*Usually the reaction will be identified in this text with a *slash* drawn through its vector as shown.

Freebody diagrams

1. Select the free body to be used.
2. Detach this body from its supports and separate it from any other bodies. (If internal force resultants are to be found, use the method of sections).
3. Show on the sketch all of the external forces acting on the body. Location, magnitude, and direction of each force should be marked on the sketch.
4. Label significant points and include dimensions. Any other detail, however, should be omitted.

ESFORÇOS SOLICITANTES EM ESTRUTURAS ESPACIAIS

No esboço dos gráficos dos esforços solicitantes deve-se observar que:

- ❖ Se a estrutura é uma **barra poligonal engastada em um único ponto o caminhamento dos esforços deve ser da extremidade livre para o apoio**, não havendo a necessidade da obtenção das reações que poderão ser obtidas a partir dos esforços solicitantes junto ao engastamento.
- ❖ Se a estrutura tem **vários apoios é necessário obter as reações nos apoios, fazer o diagrama do corpo livre e acompanhar o caminhamento dos esforços entre os apoios**, pois é a estrutura que leva os esforços até os apoios.

EXTRA (aula 5)

1ª Questão: Uma escada reta está apoiada em um ponto A de uma laje (horizontal) com muito atrito e em um ponto B (4 m acima da laje) de uma parede lisa (vertical). Se o comprimento da escada é 5 m e seu peso é 100 N então determine

- 1) um modelo matemático para a situação classificando os apoios A e B (em engastamento, articulação fixa ou articulação móvel) e determine as reações nesses apoios;
- 2) as equações do momento fletor e da força cortante na barra AB, considerando o ponto A como a origem da variável x que segue no eixo da escada, a partir dos valores das reações obtidos em 1).

EXERCÍCIO 10. (aula 5)

Determinar as reações no engastamento da estrutura espacial da figura

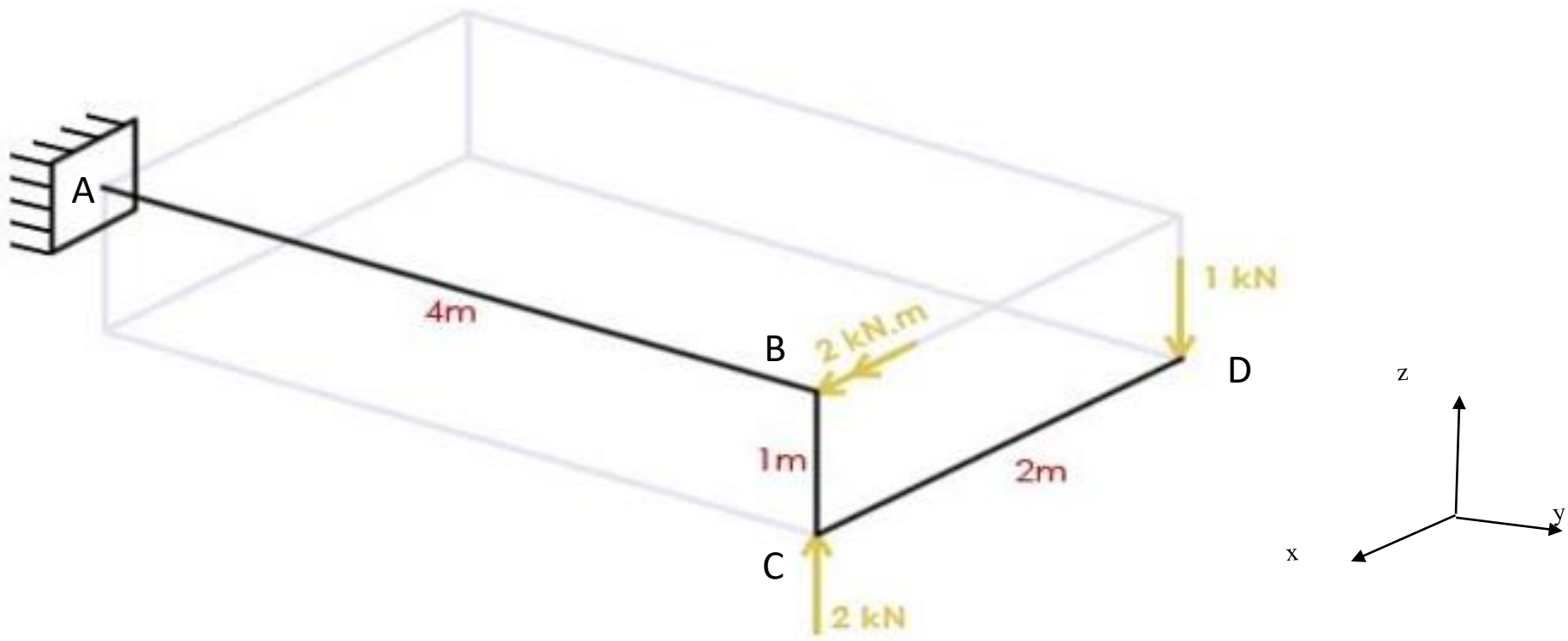

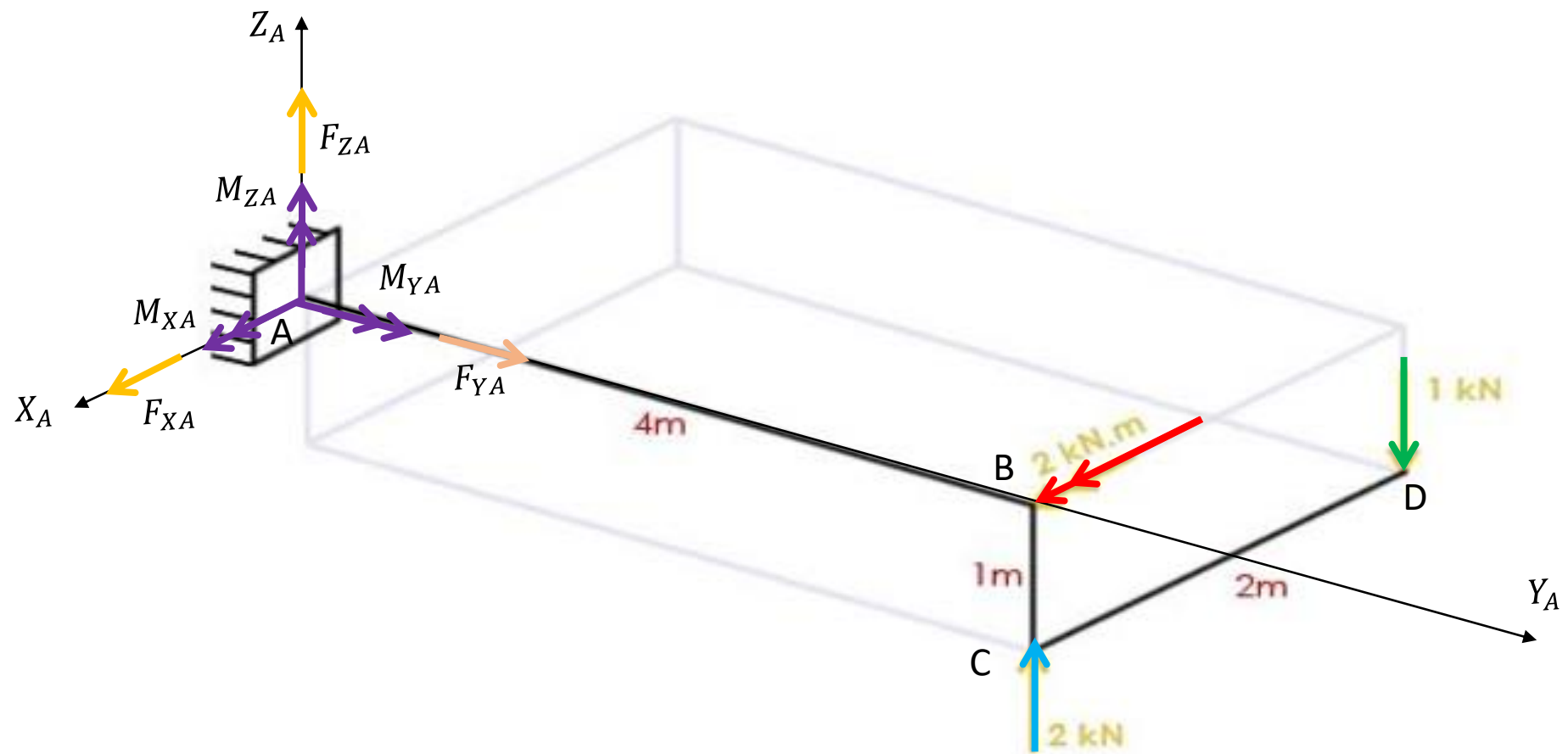

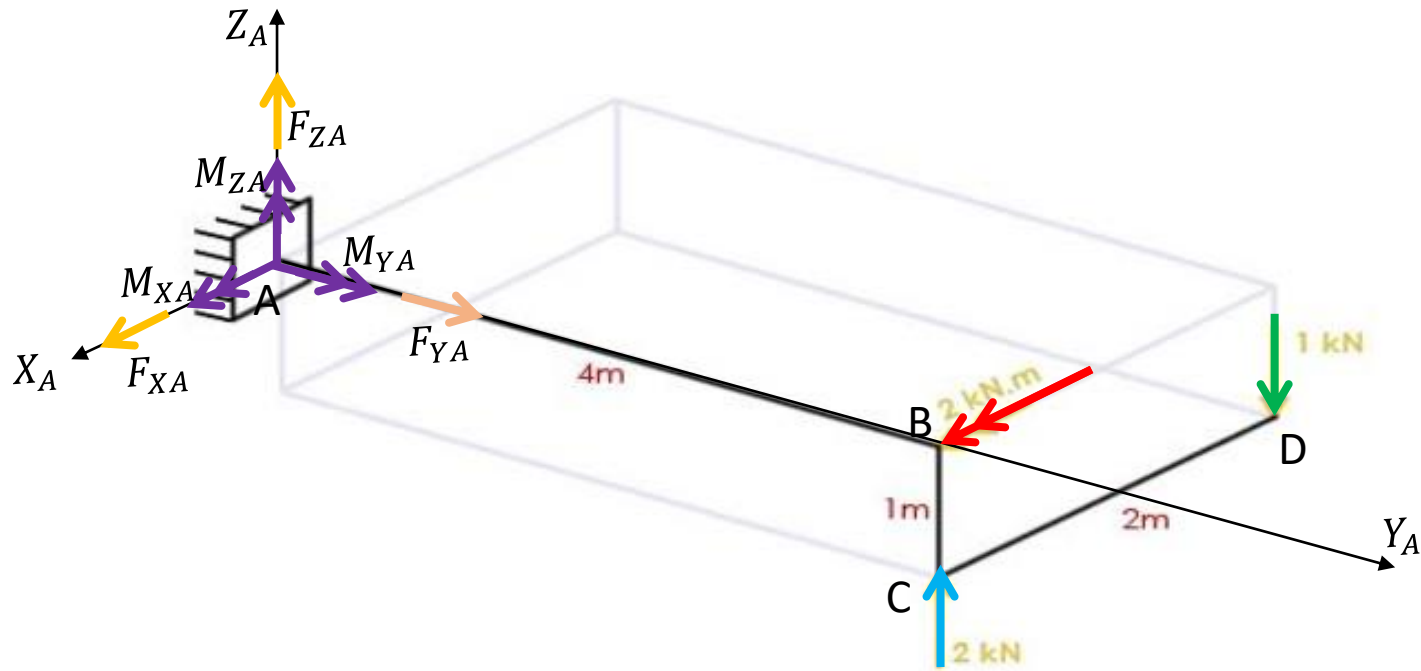

$$1. \sum F_{(X)} = 0 = F_{XA} \rightarrow F_{XA} = 0 \text{ kN}$$

$$2. \sum F_{(Y)} = 0 = F_{YA} \rightarrow F_{YA} = 0 \text{ kN}$$

$$3. \sum F_{(Z)} = 0 = F_{ZA} + 2 - 1 \rightarrow F_{ZA} = -1 \text{ kN}$$

$$4. \sum M_{(XA)} = 0 = M_{XA} + 2 - 1 * 4 + 2 * 4 \rightarrow M_{XA} = -6 \text{ kNm}$$

$$5. \sum M_{(YA)} = 0 = M_{YA} - 1 * 2 \rightarrow M_{YA} = 2 \text{ kNm}$$

$$6. \sum M_{(ZA)} = 0 = M_{ZA} \rightarrow M_{ZA} = 0 \text{ kNm}$$

TEOREMA DO CORTE: SEÇÕES C1, C2, B1, B2, A1

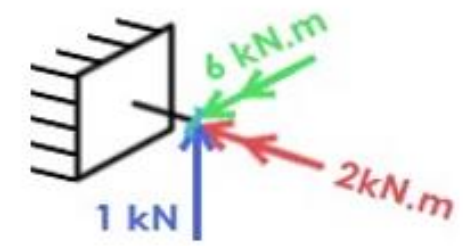
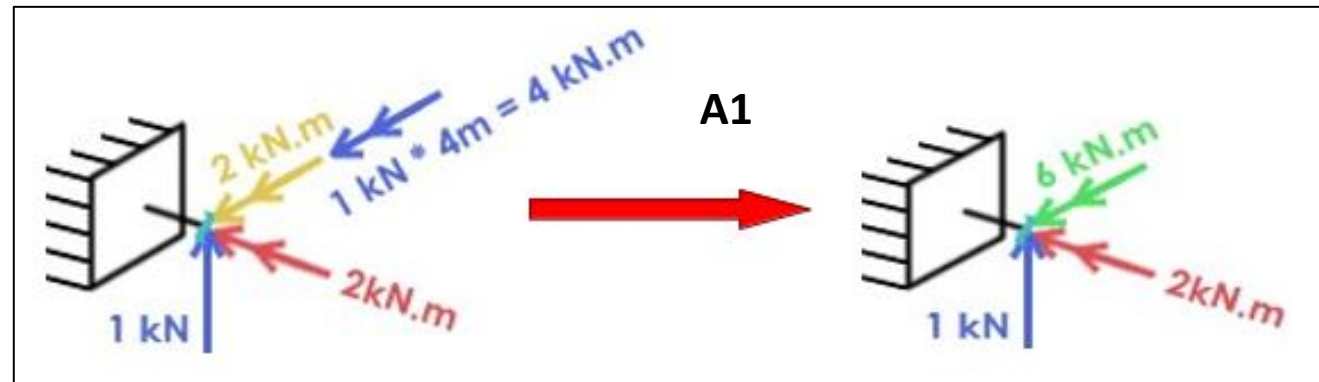
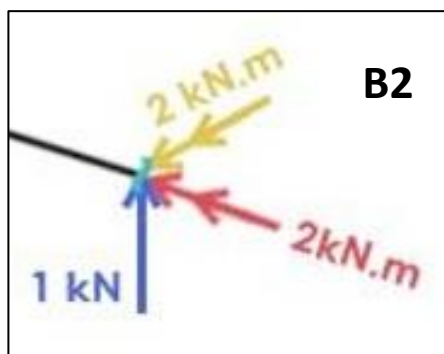
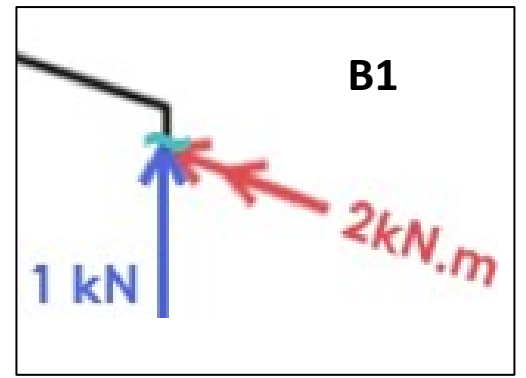
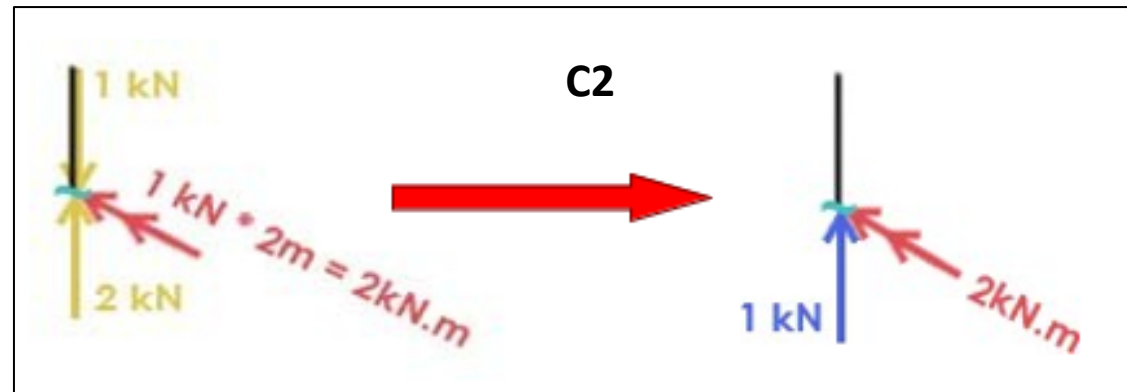
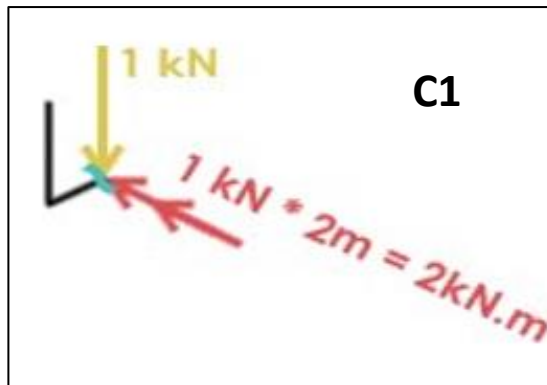
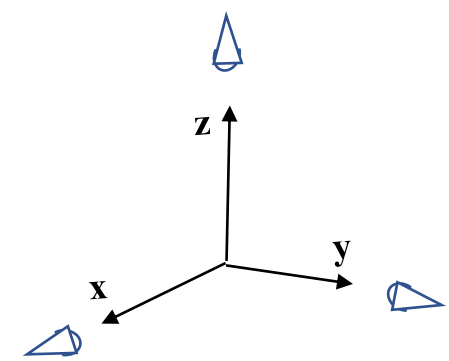
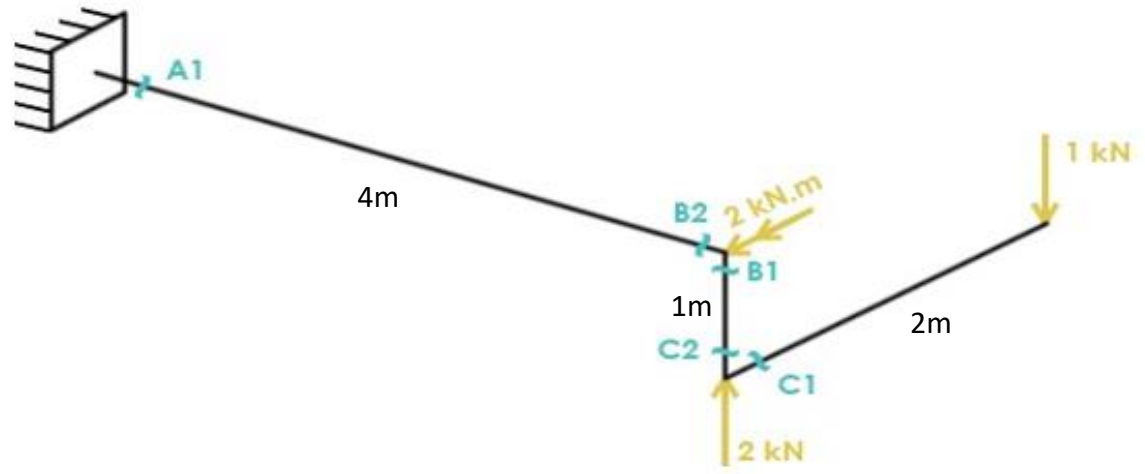

DIAGRAMAS DOS ESFORÇOS SOLICITANTES: FORÇA NORMAL E FORÇA CORTANTE

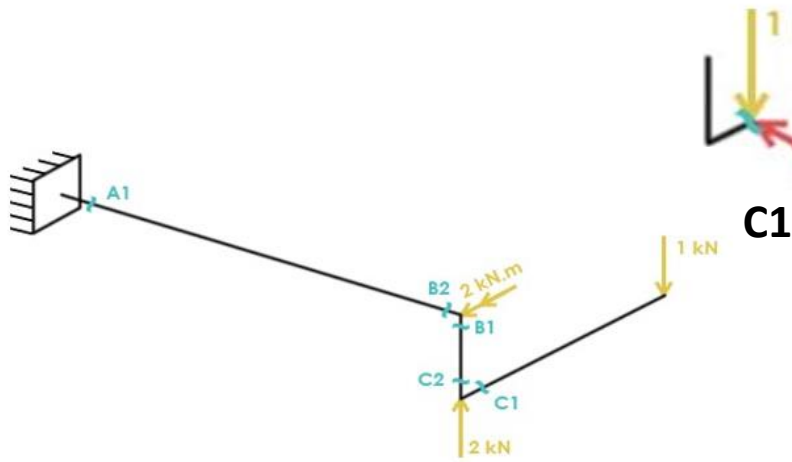

FORÇA NORMAL

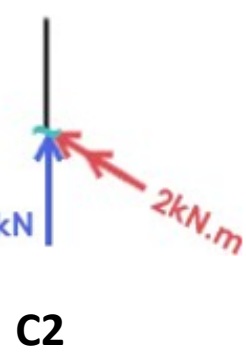
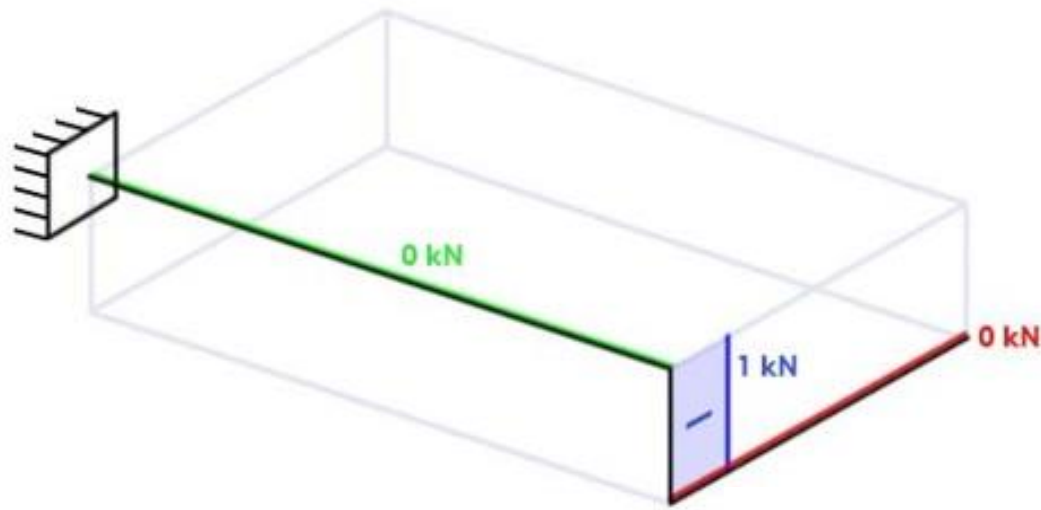

C2

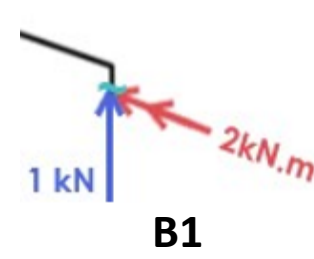

B1

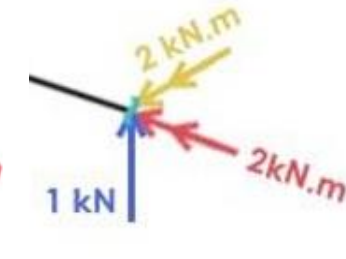

B2

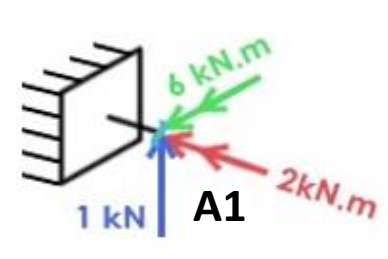

A1

FORÇA CORTANTE

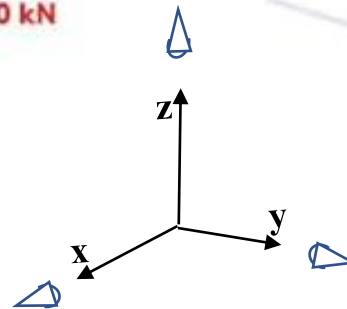
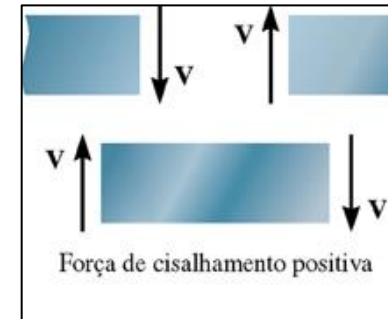
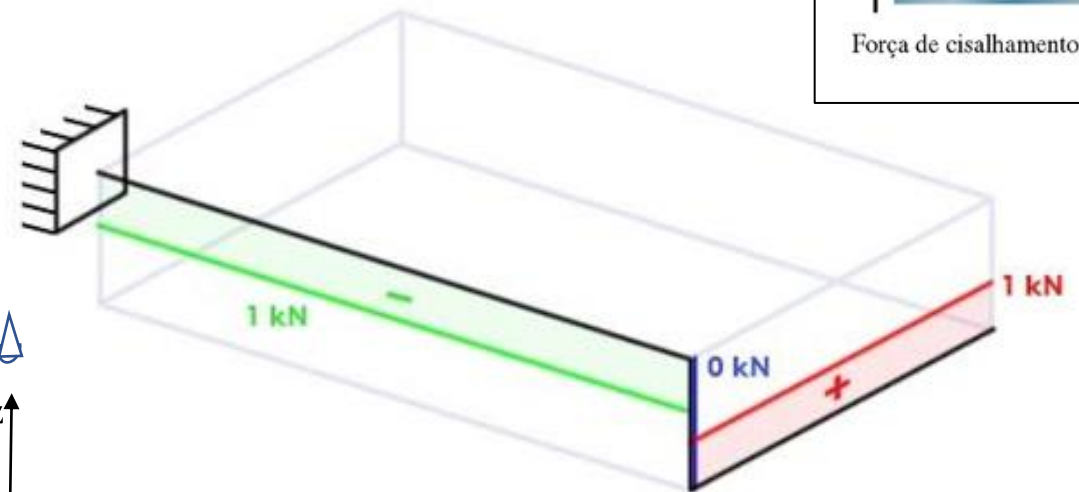

DIAGRAMAS DOS ESFORÇOS SOLICITANTES: MOMENTO FLETOR E MOMENTO DE TORÇÃO

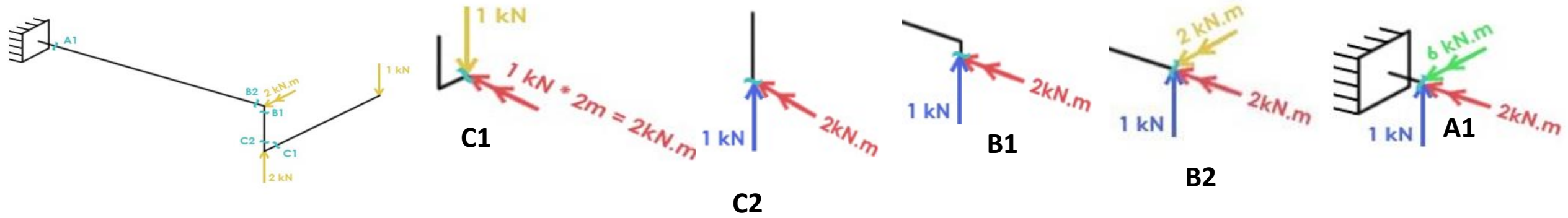

MOMENTO FLETOR

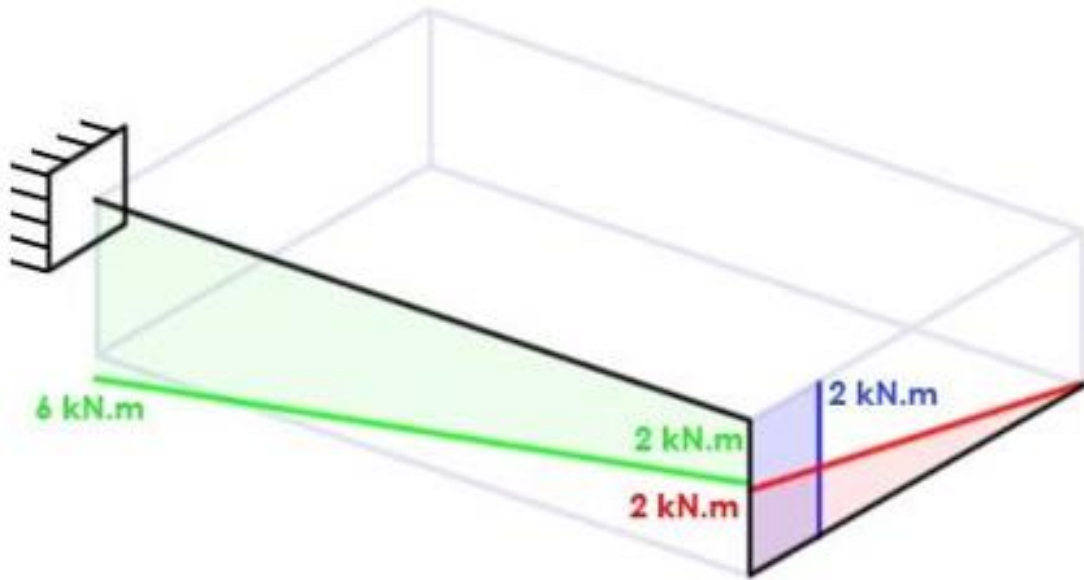

MOMENTO DE TORÇÃO

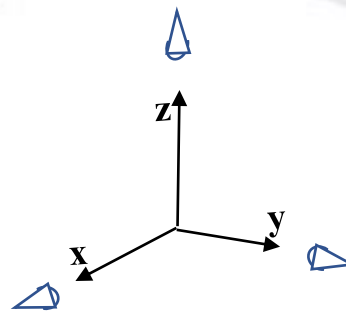
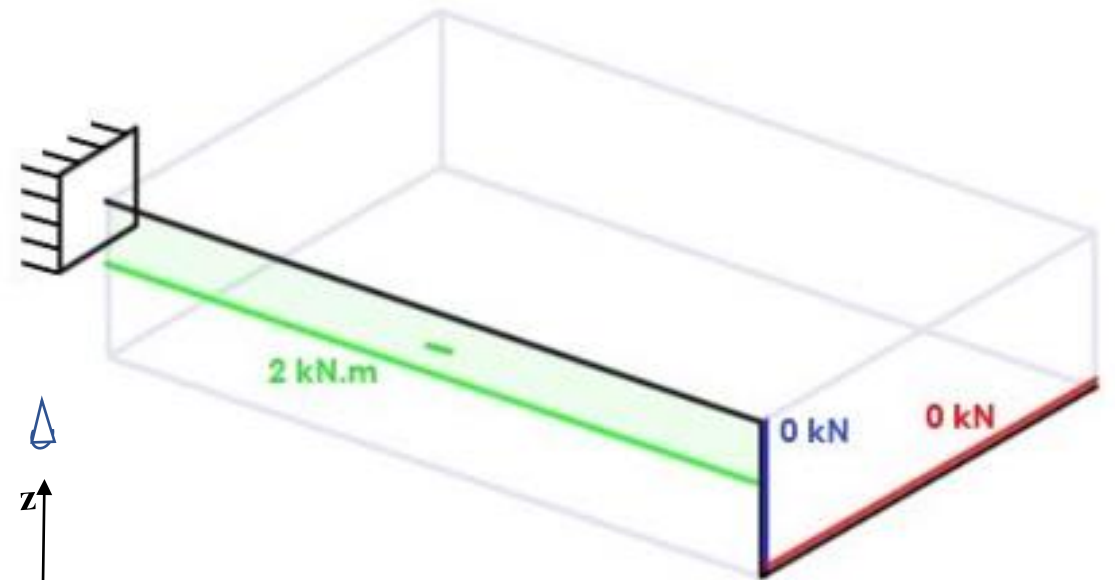

EXERCÍCIO 11. (aula 5)

P1 2020

A viga principal $ABCD$ da figura está apoiada em A , C e D por barras curtas nas direções dos eixos ortogonais x , y e z . A barra AB na direção do eixo y está submetida a um carregamento uniformemente variado de zero a $10 \frac{\text{kN}}{\text{m}}$ na direção do eixo x ; a barra BC está na direção do eixo x ; a barra CD na direção do eixo z está submetida a um carregamento uniforme de $10 \frac{\text{kN}}{\text{m}}$ na direção do eixo y ; em B há uma força concentrada de 20 kN na direção z . Determine: a) as reações dos apoios A , C e D ; b) os diagramas dos esforços solicitantes na barra CD , considerando o observador de frente aos eixos.

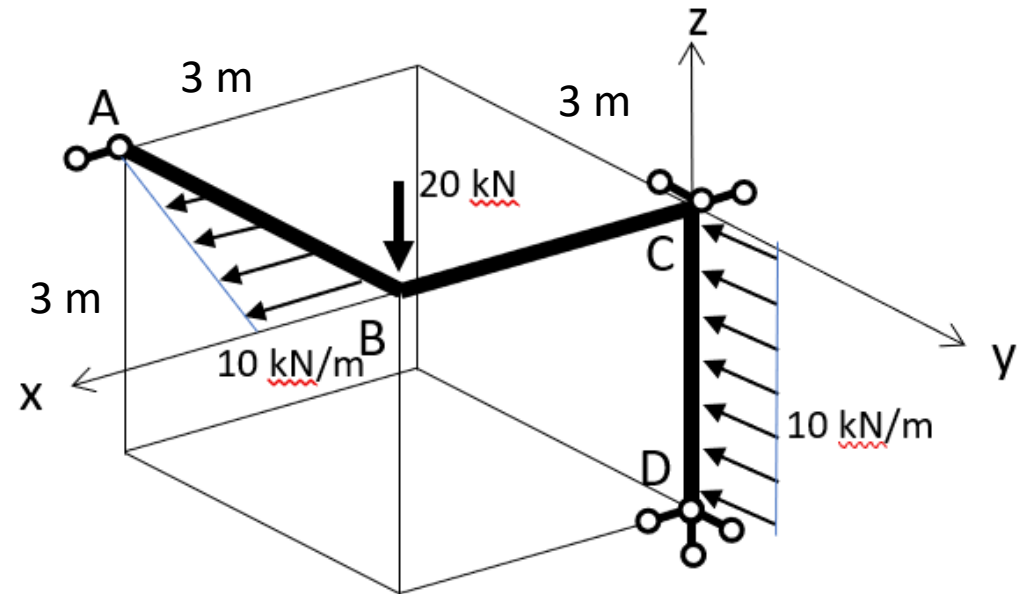
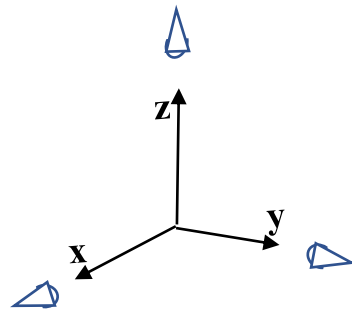

$$10 \frac{kN}{m} * 3m \div 2 = 15 kN$$

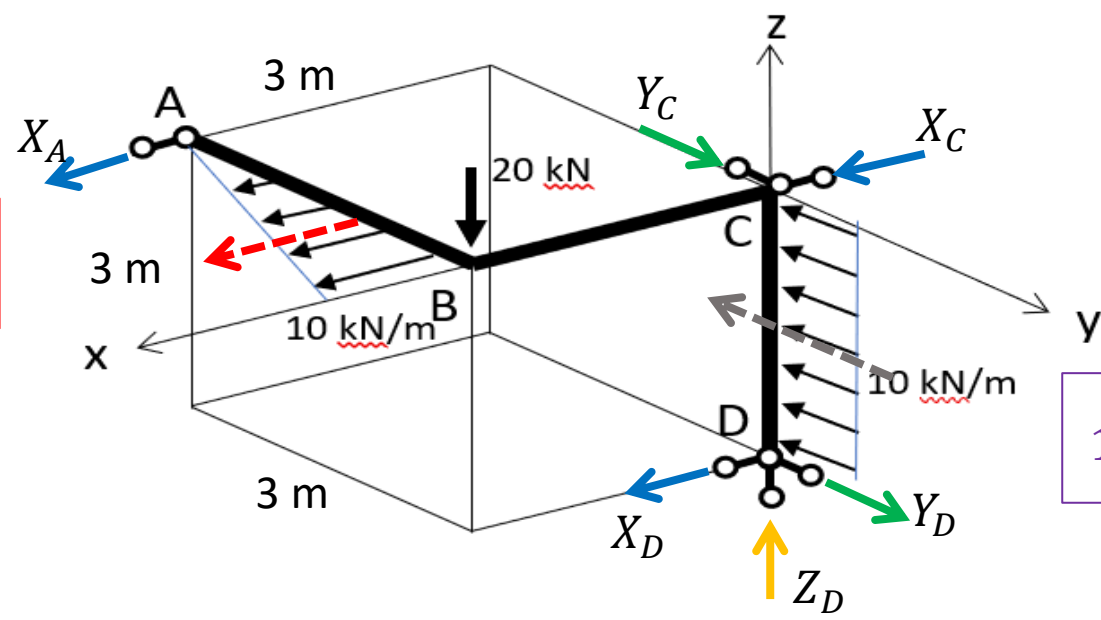

$$10 \frac{kN}{m} * 3m = 30 kN$$

$$\left\{ \begin{array}{l} \sum X = 0 = X_A + 15 + X_C + X_D \Rightarrow X_C = -30kN \\ \sum Y = 0 = Y_C - 30 + Y_D \Rightarrow Y_C = 15kN \\ \sum Z = 0 = -20 + Z_D \Rightarrow Z_D = 20kN \\ \sum M_x = 0 = -30 * 1,5 + Y_D * 3 \Rightarrow Y_D = 15kN \\ \sum M_y = 0 = 20 * 3 - X_D * 3 \Rightarrow X_D = 20kN \\ \sum M_z = 0 = X_A * 3 + 15 * 1 \Rightarrow X_A = -5kN \end{array} \right.$$

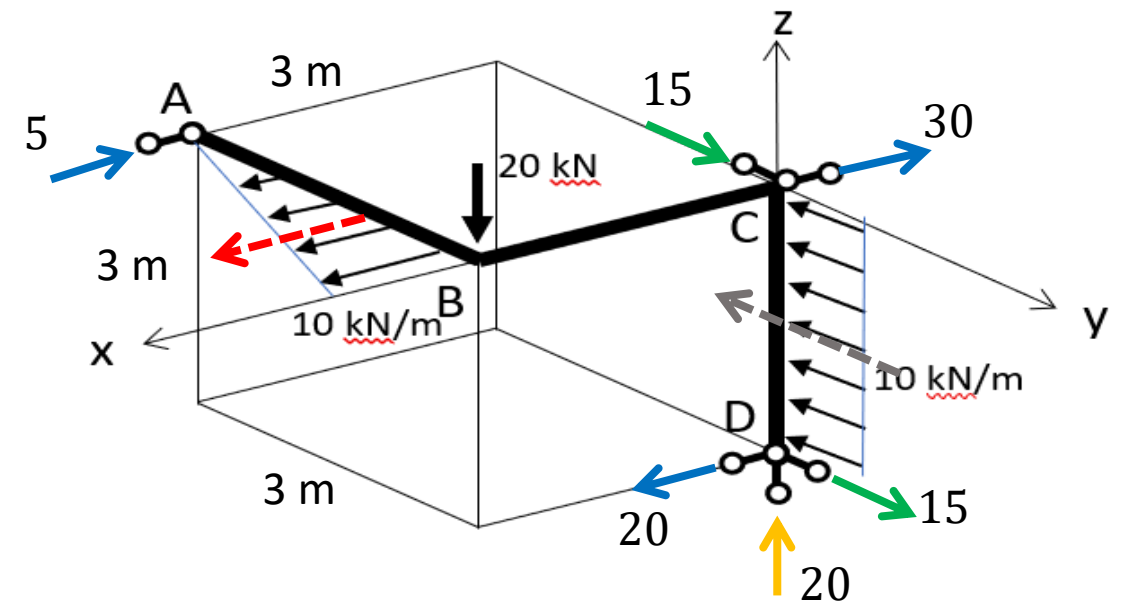

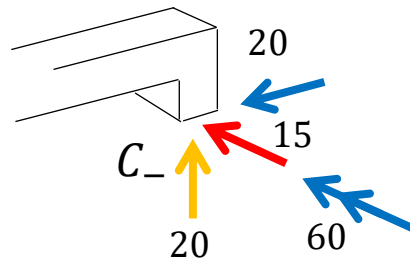
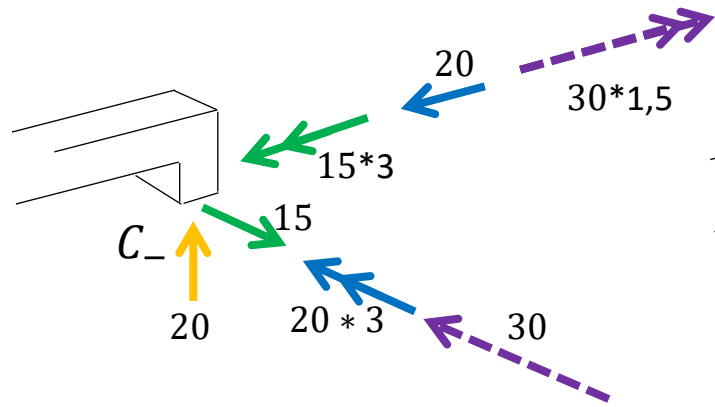
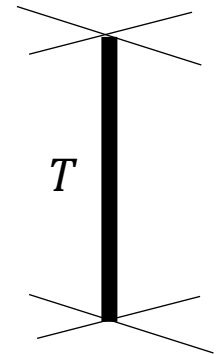
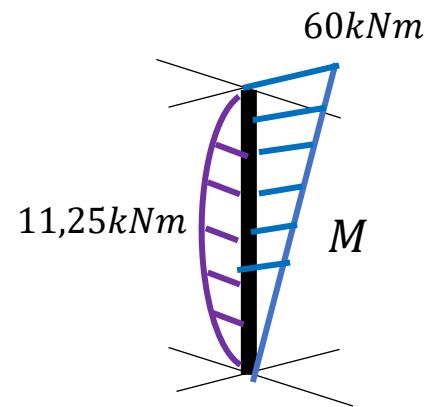
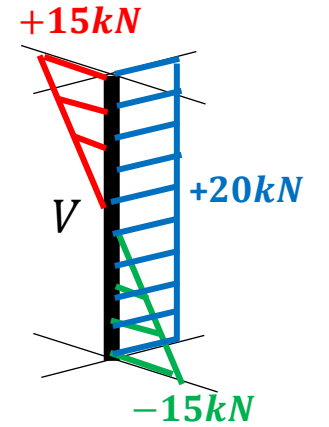
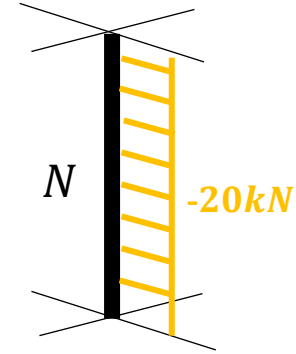
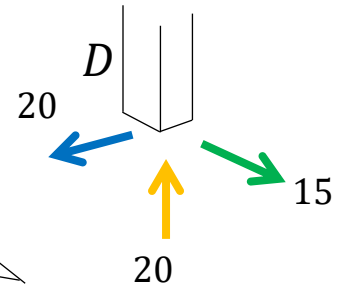
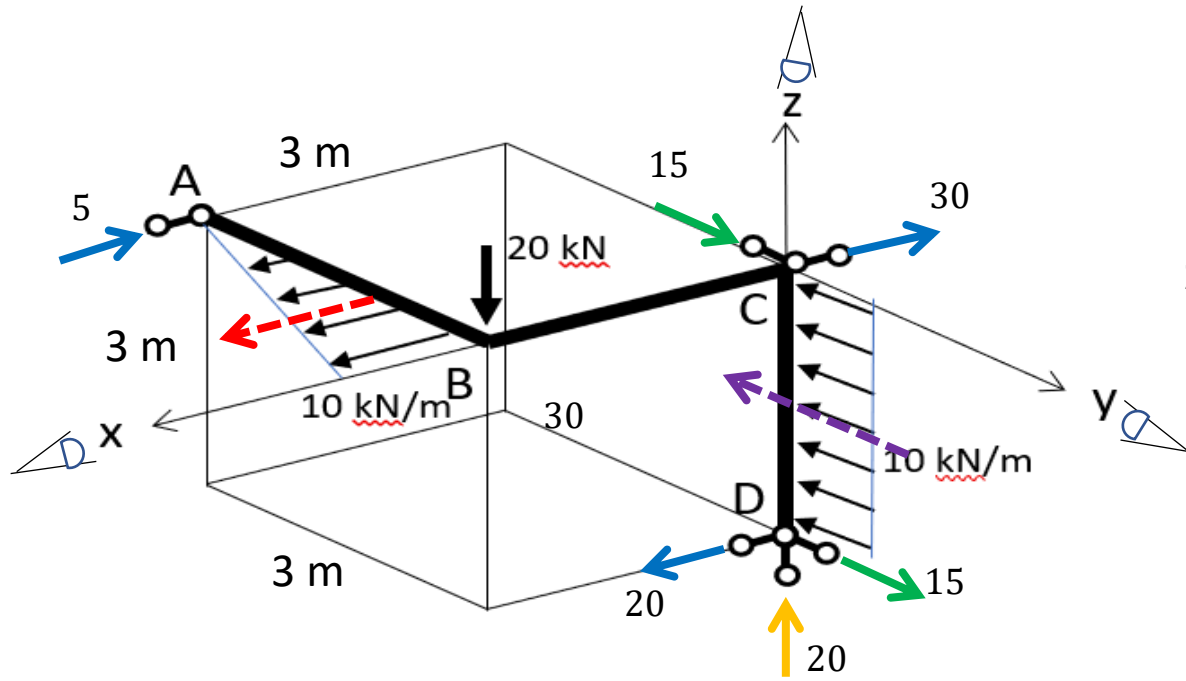

$$\frac{pl^2}{8} = \frac{10 \cdot 3^2}{8} = 11,25 \text{ kNm}$$

ESFORÇOS SOLICITANTES EM ESTRUTURAS ESPACIAIS

No esboço dos gráficos dos esforços solicitantes deve-se observar que:

- ❖ **O “teorema do corte” deve ser aplicado em seções próximas a esforços ativos ou quando se tem mudança de carregamento ou quando há mudanças de direção das barras da estrutura.**
- ❖ As forças normais e os momentos fletores e de torção são reduzidos/transferidos de uma seção a outra sem novos acréscimos.
- ❖ As forças cortantes são reduzidas/transferidas de uma seção para a outra acrescentando um momento fletor para que os sistemas sejam mecanicamente equivalentes.

EXERCÍCIO 1.

Esboçar o diagrama dos esforços solicitantes na estrutura espacial

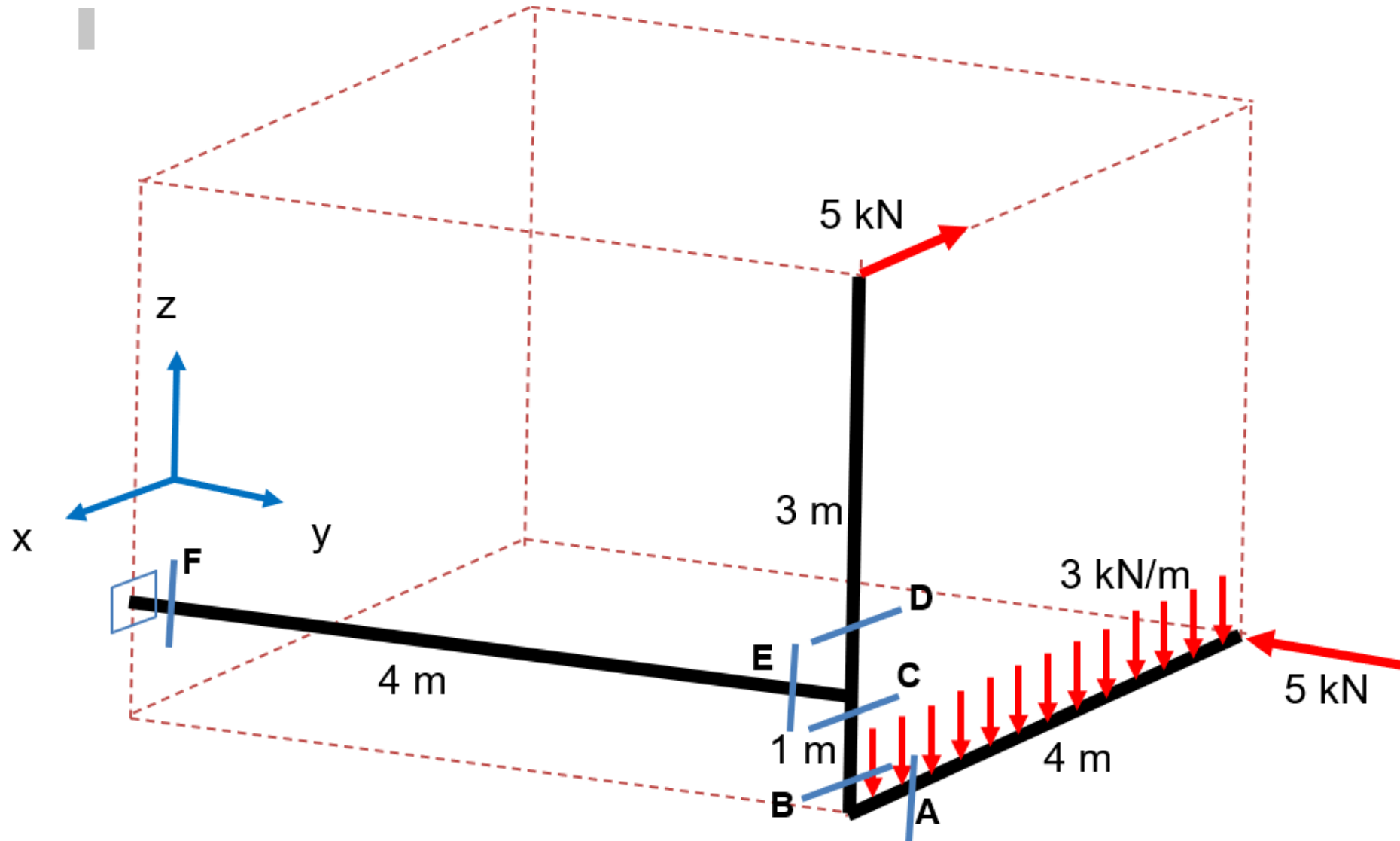

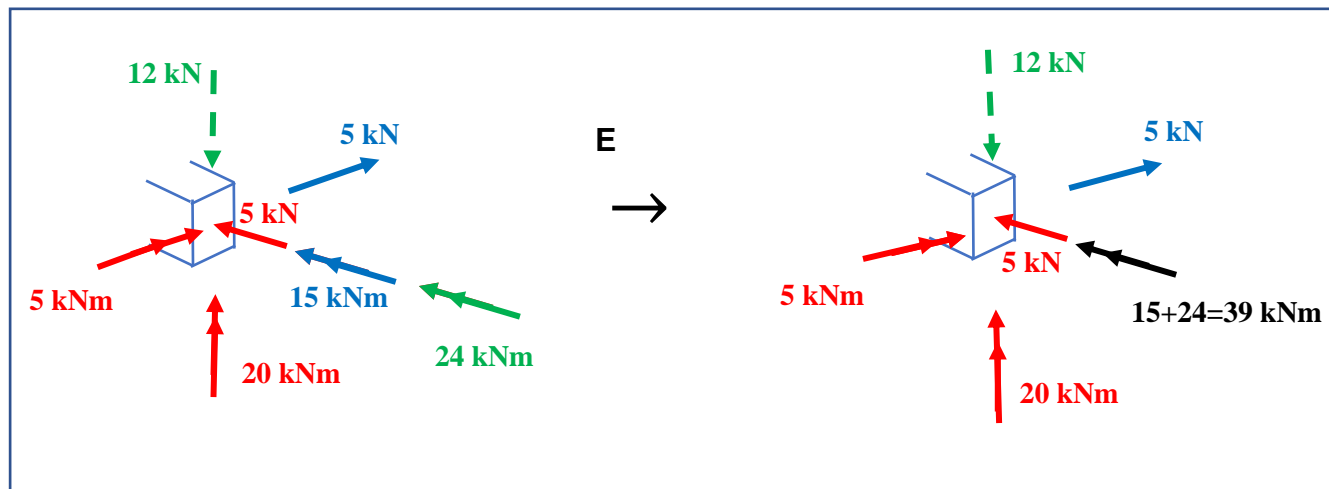
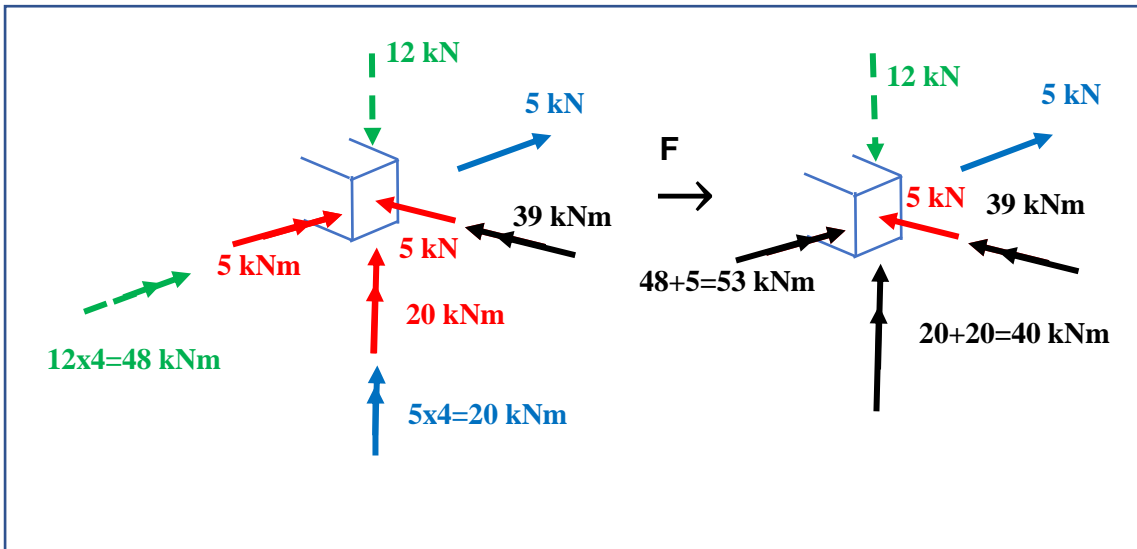
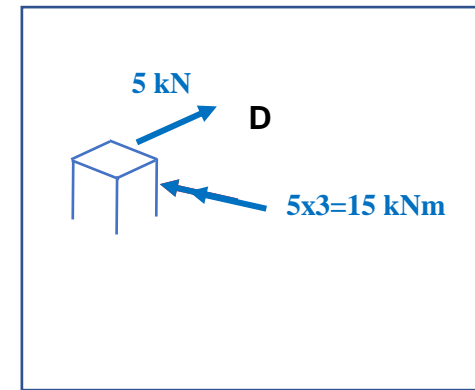
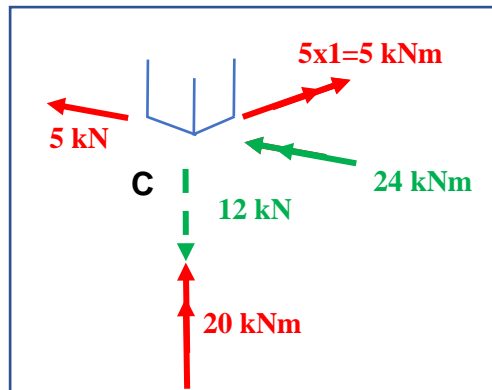
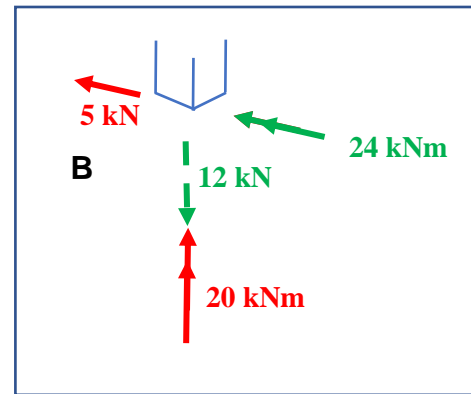
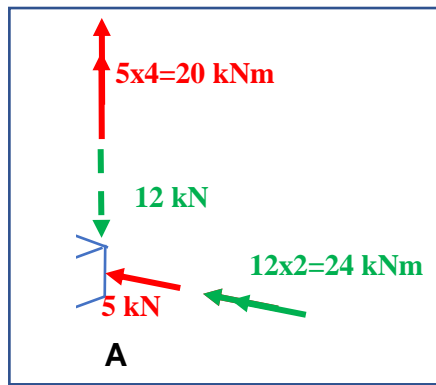
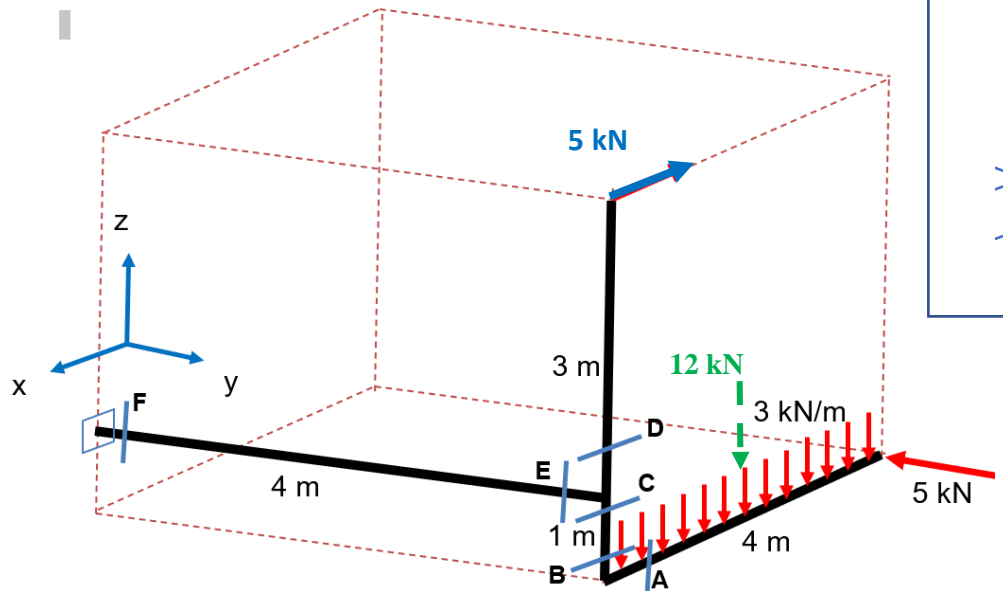

SEÇÃO E

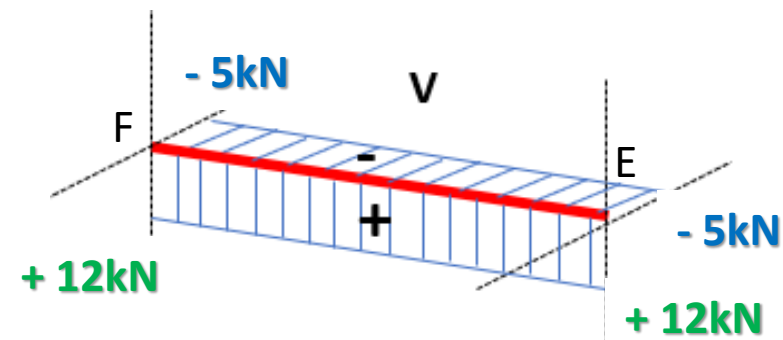
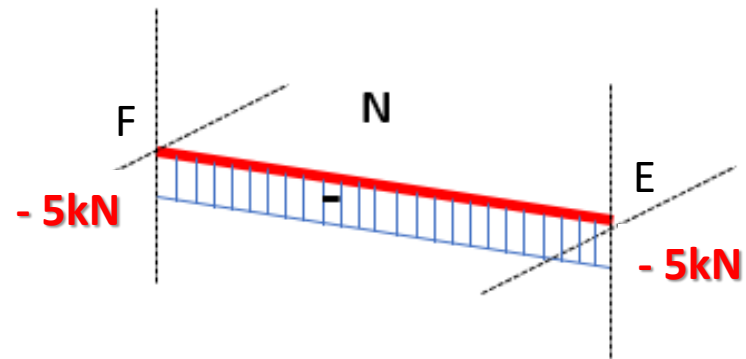
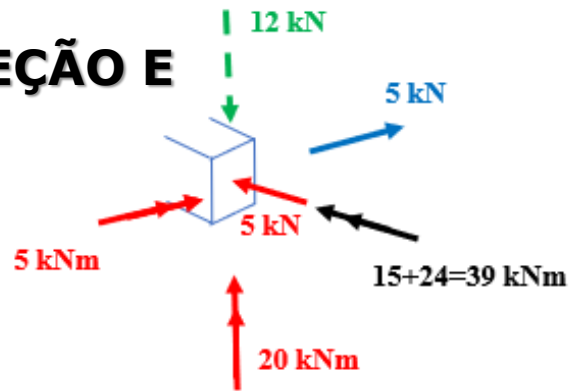

SEÇÃO F

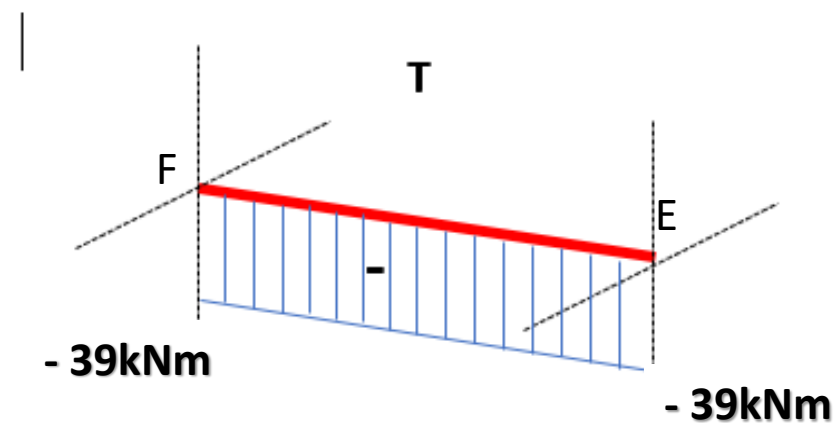
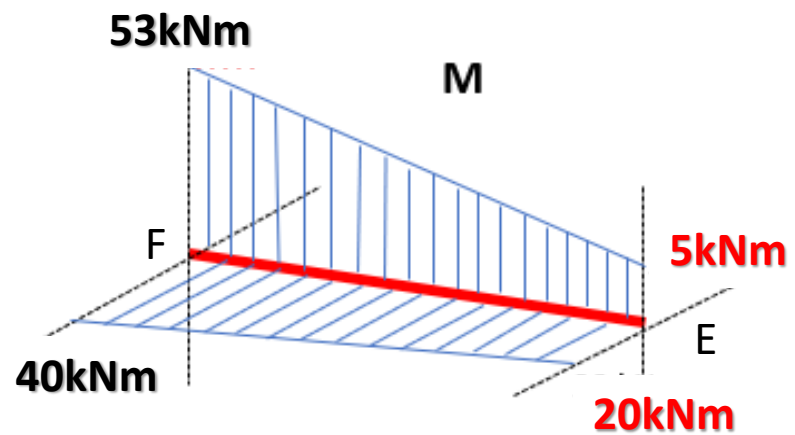
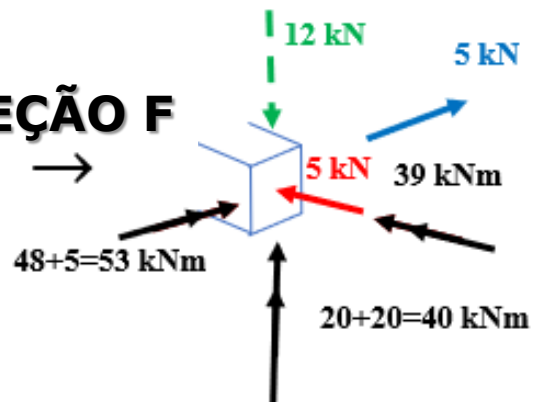

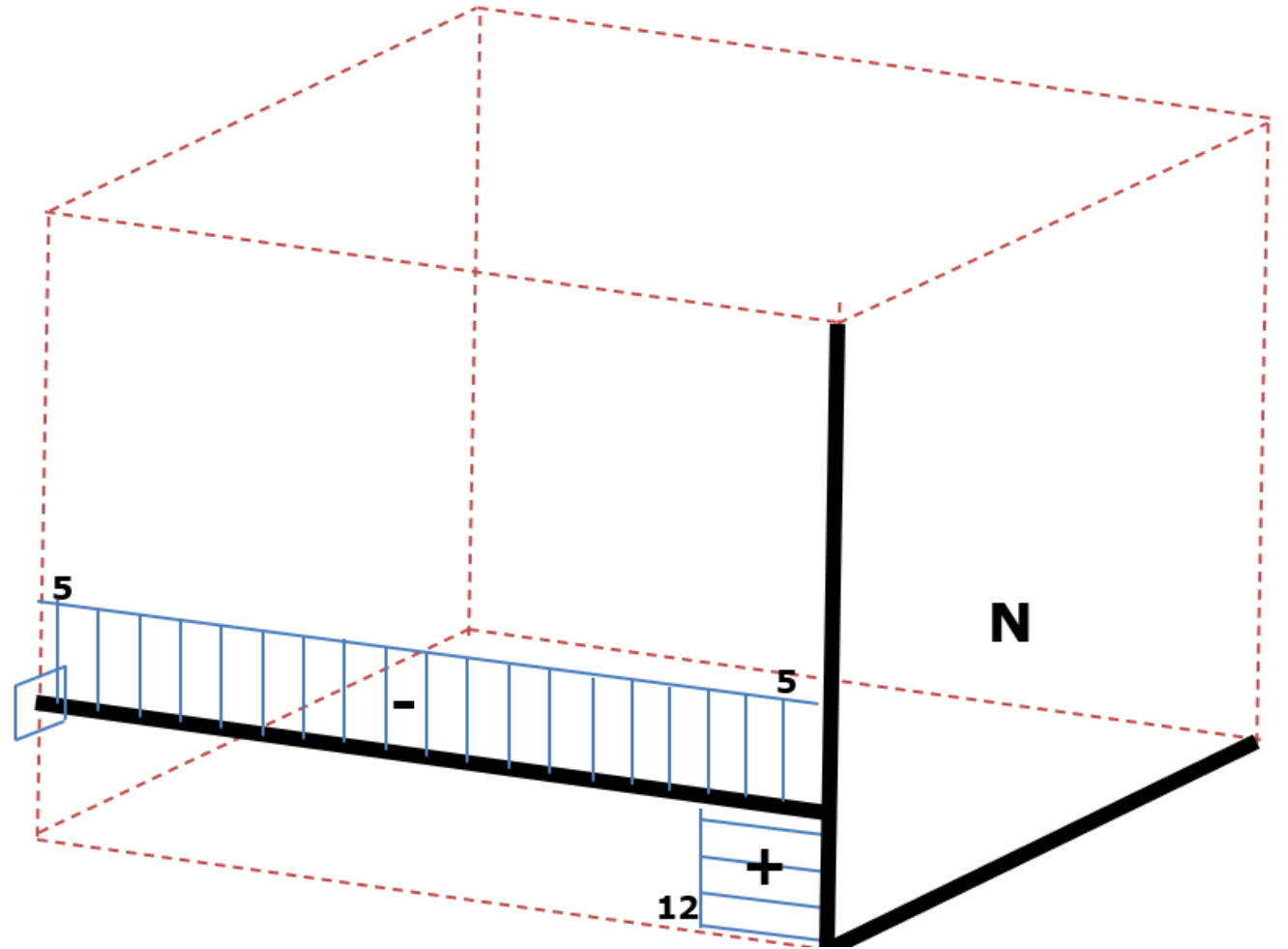
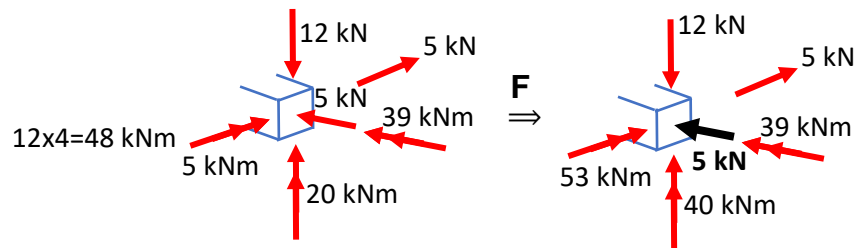
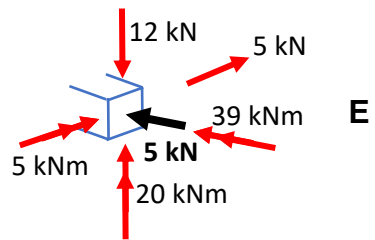
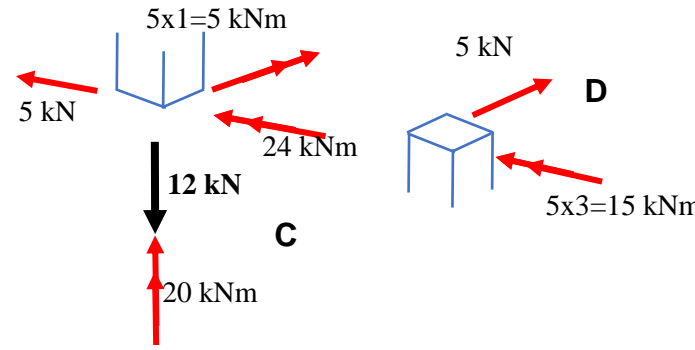
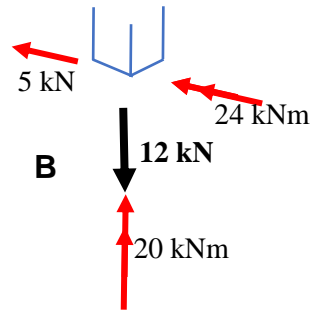
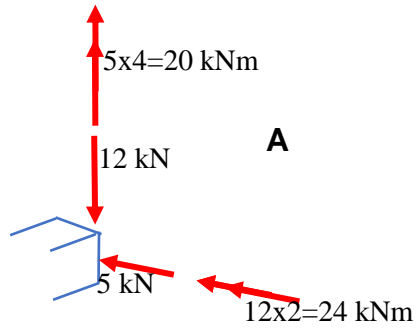
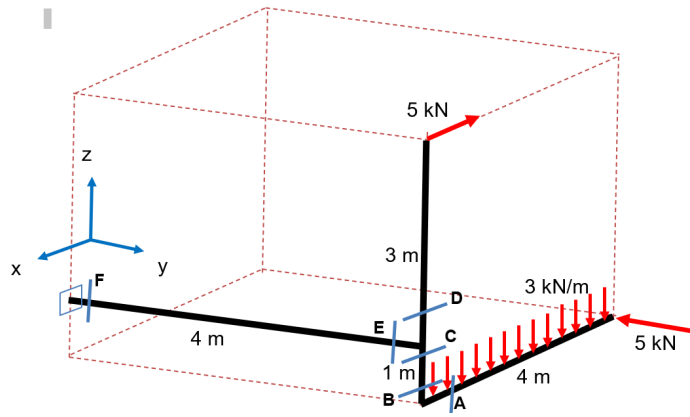

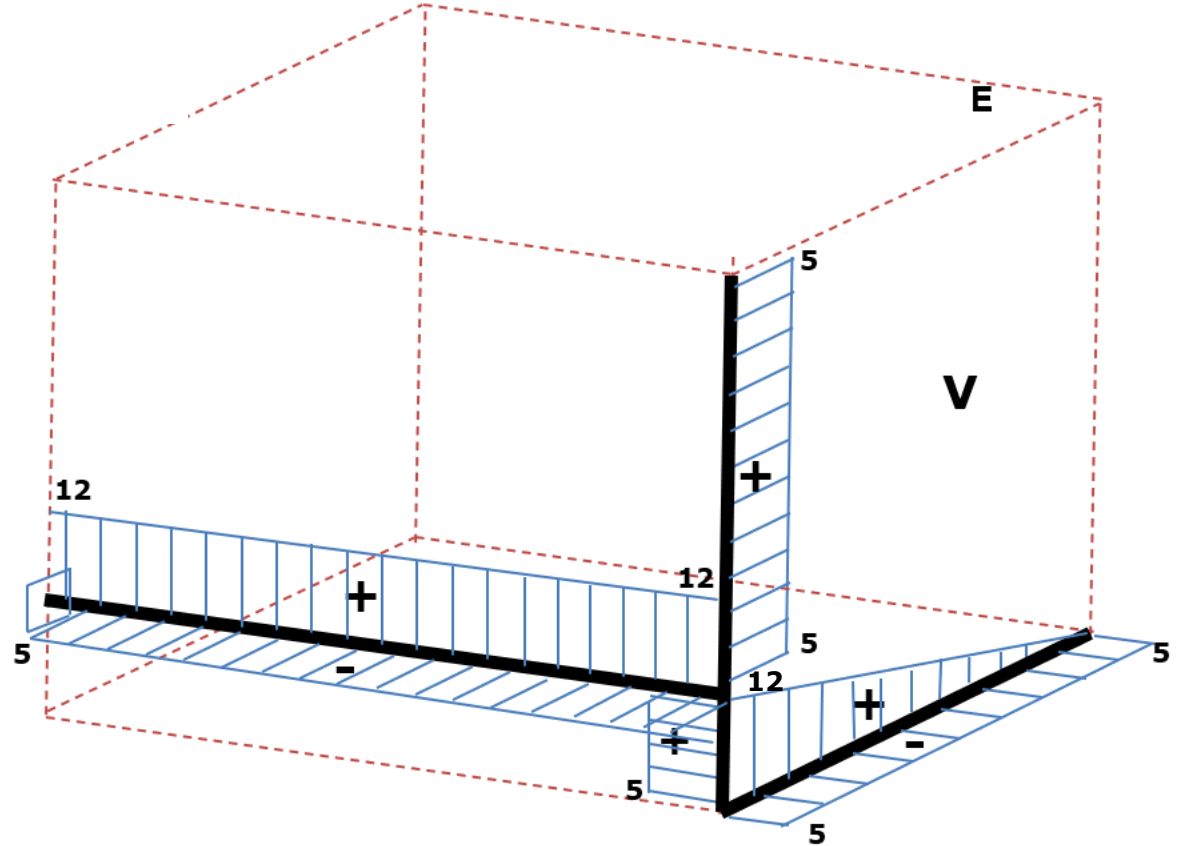
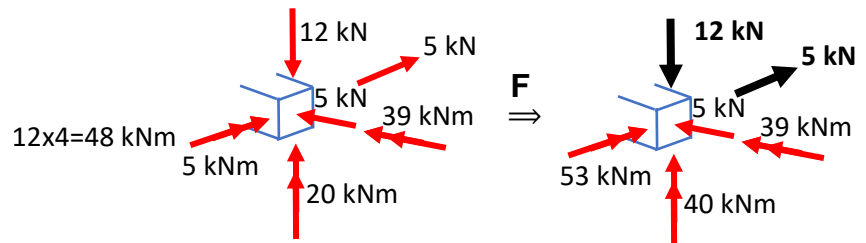
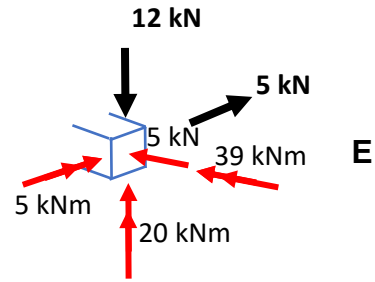
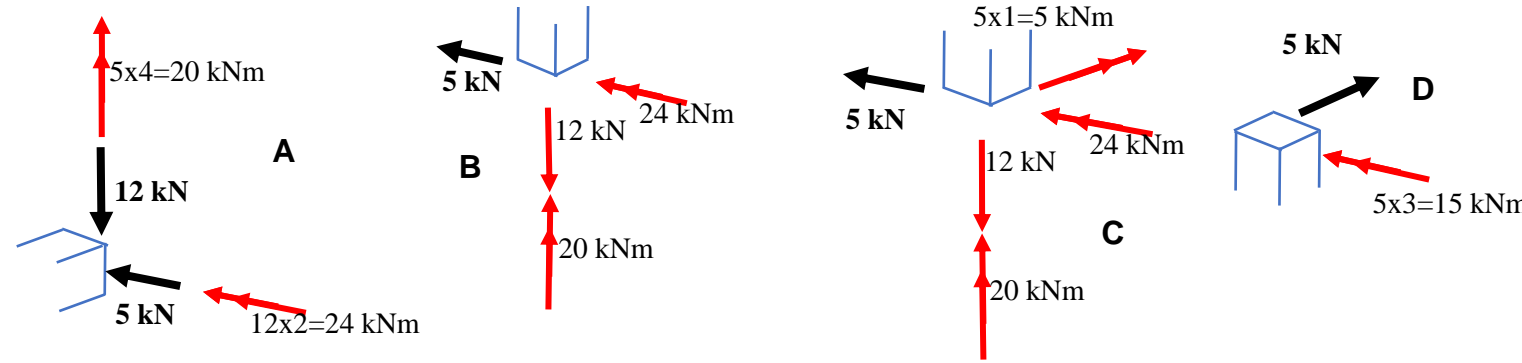
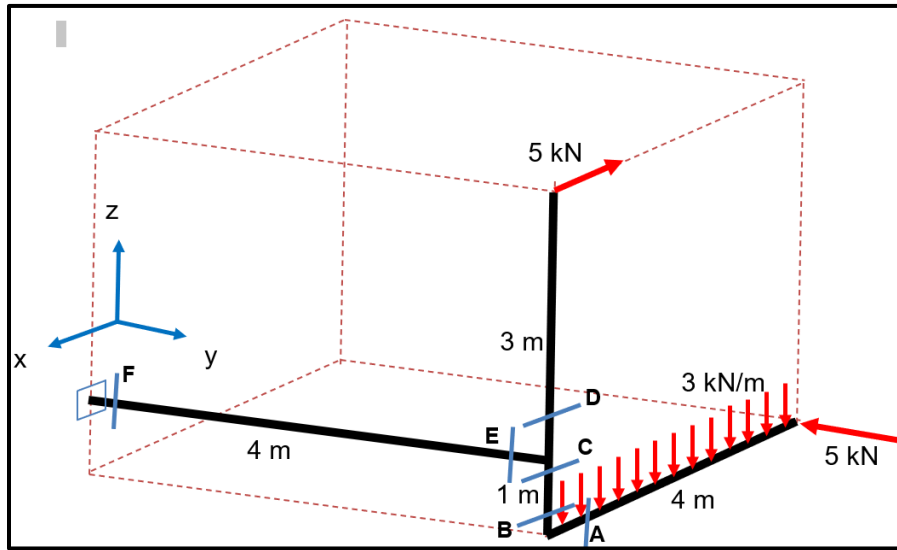

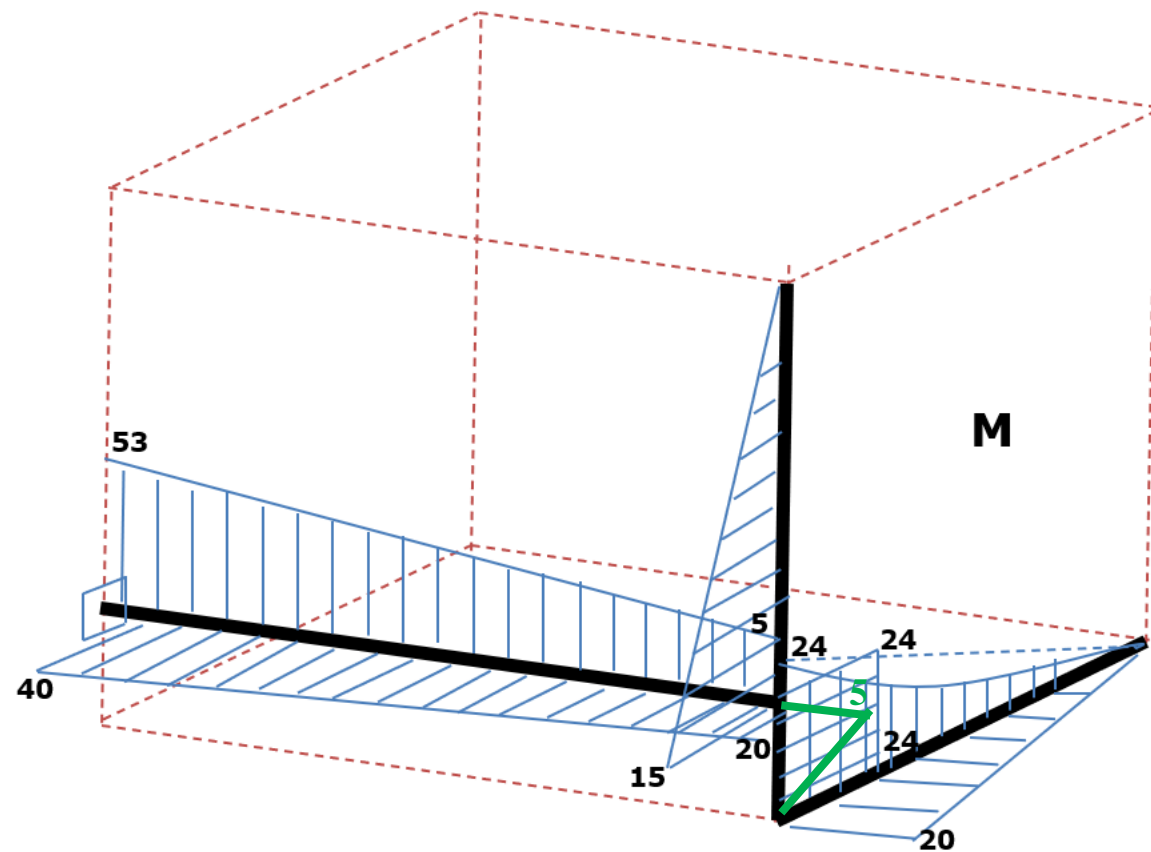
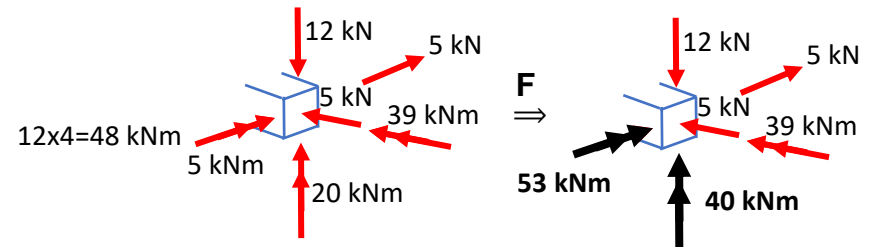
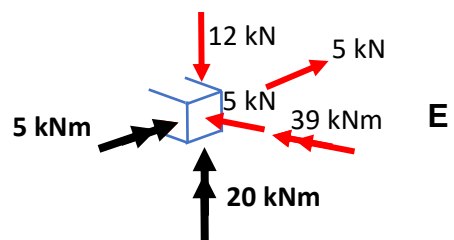
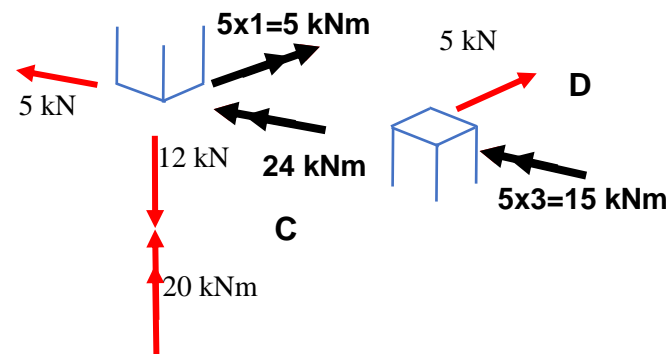
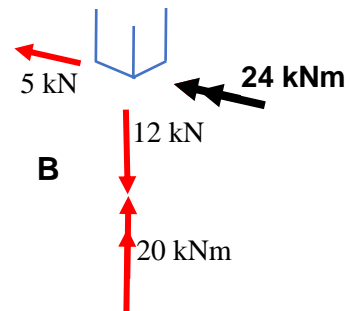
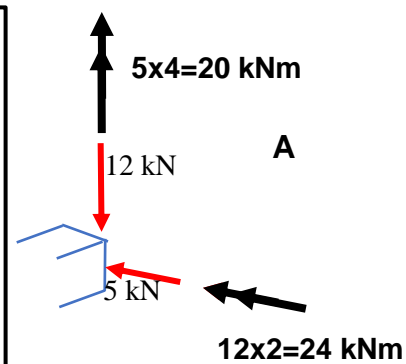
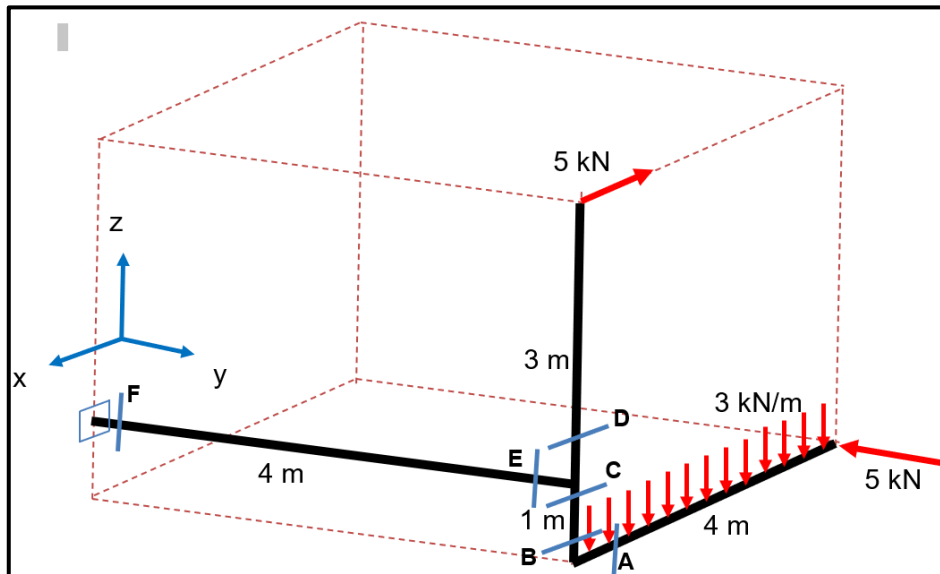

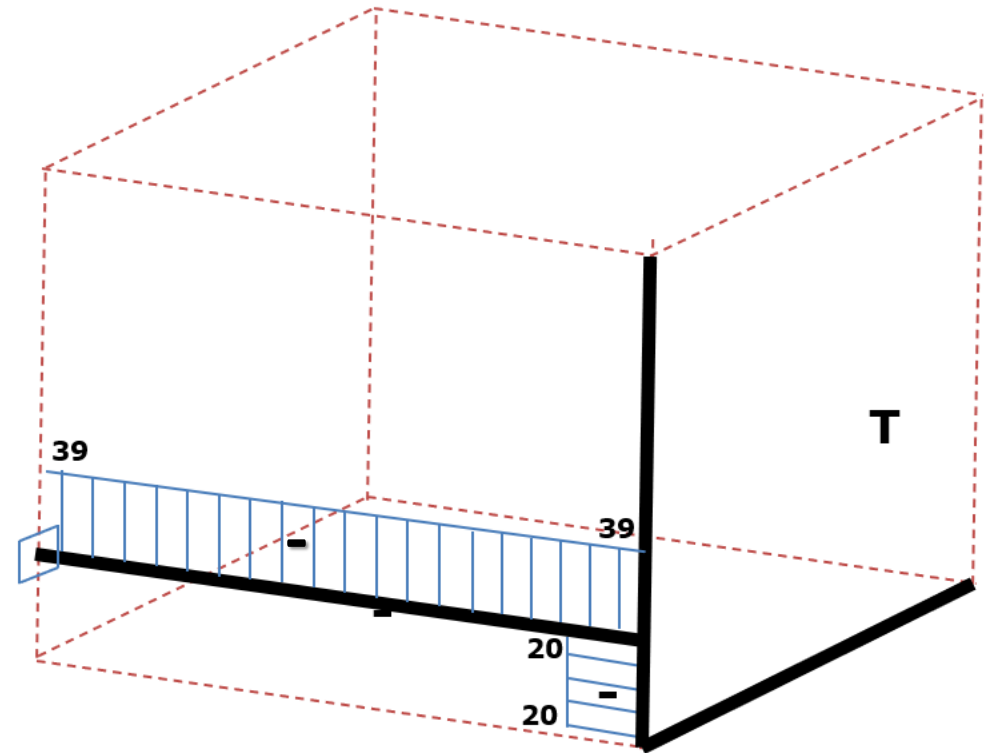
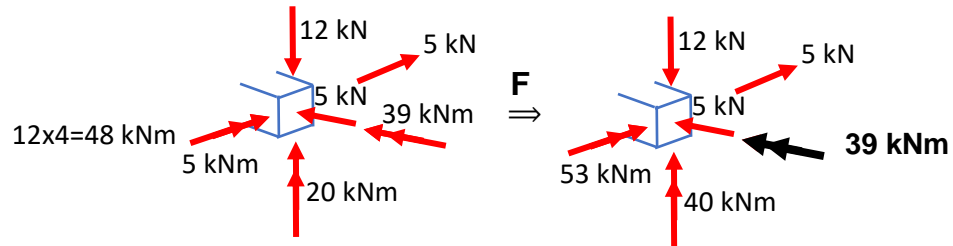
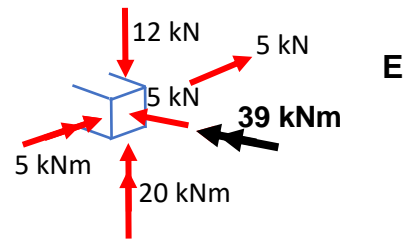
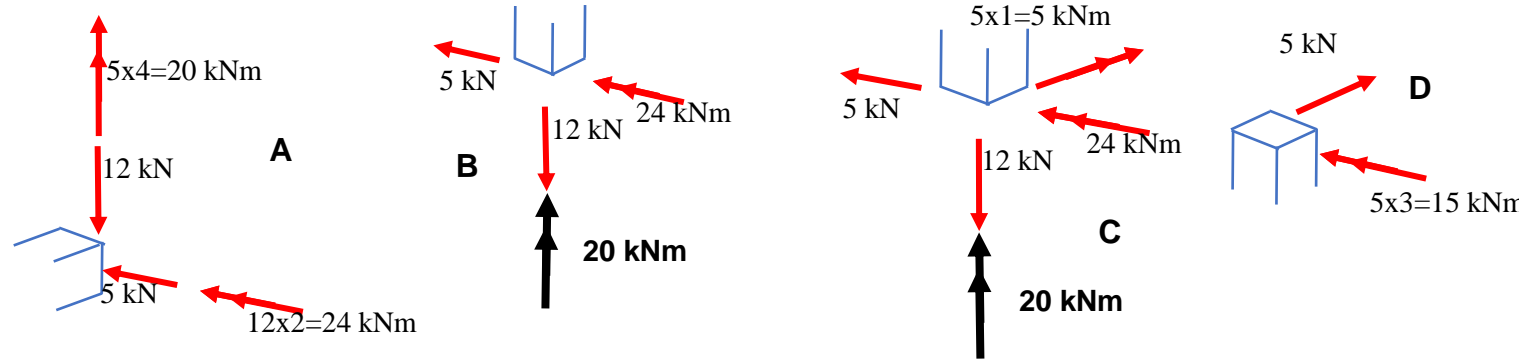
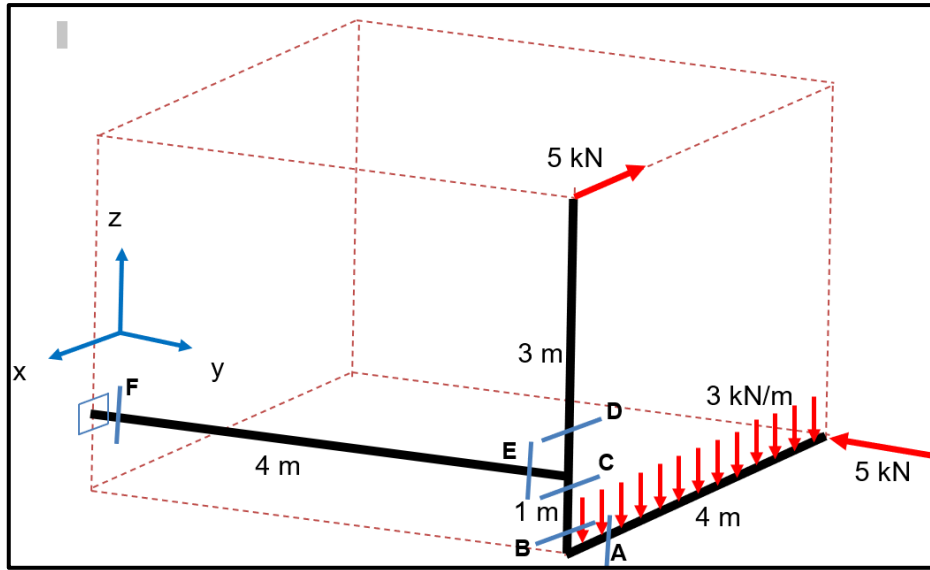

EXERCÍCIO 2. apostila Capítulo 5 página 174

Traçar os diagramas de esforços solicitantes da estrutura da figura

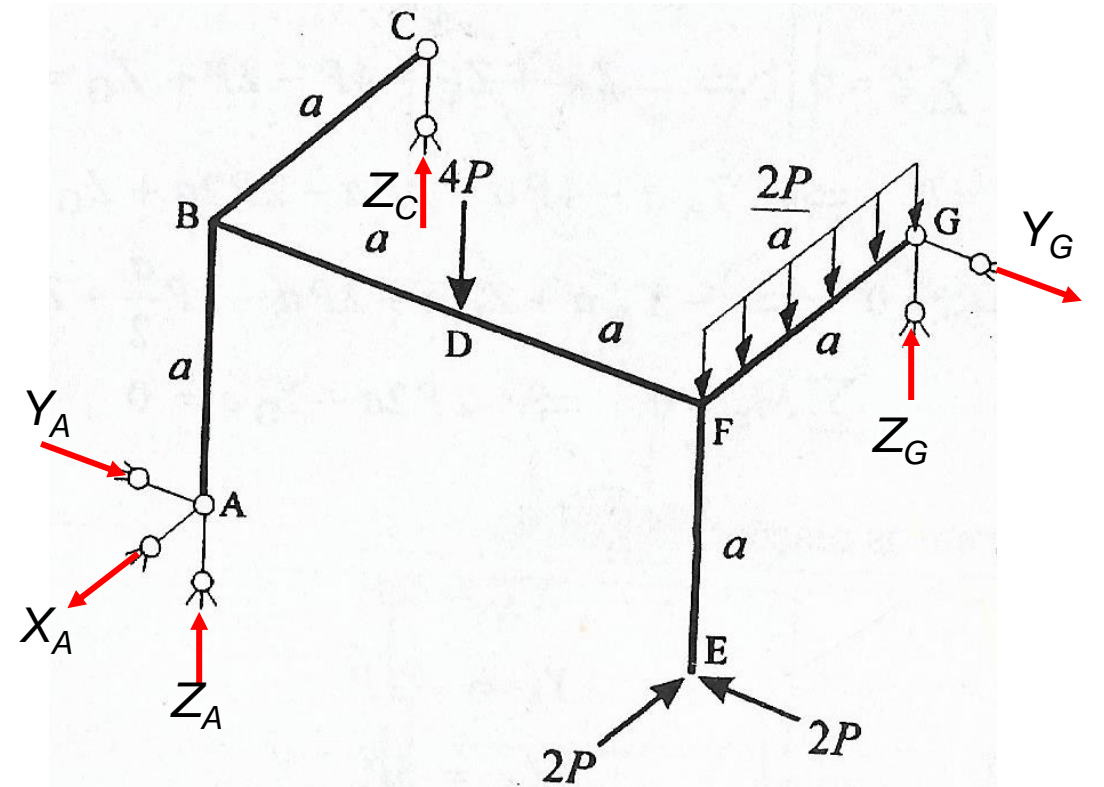
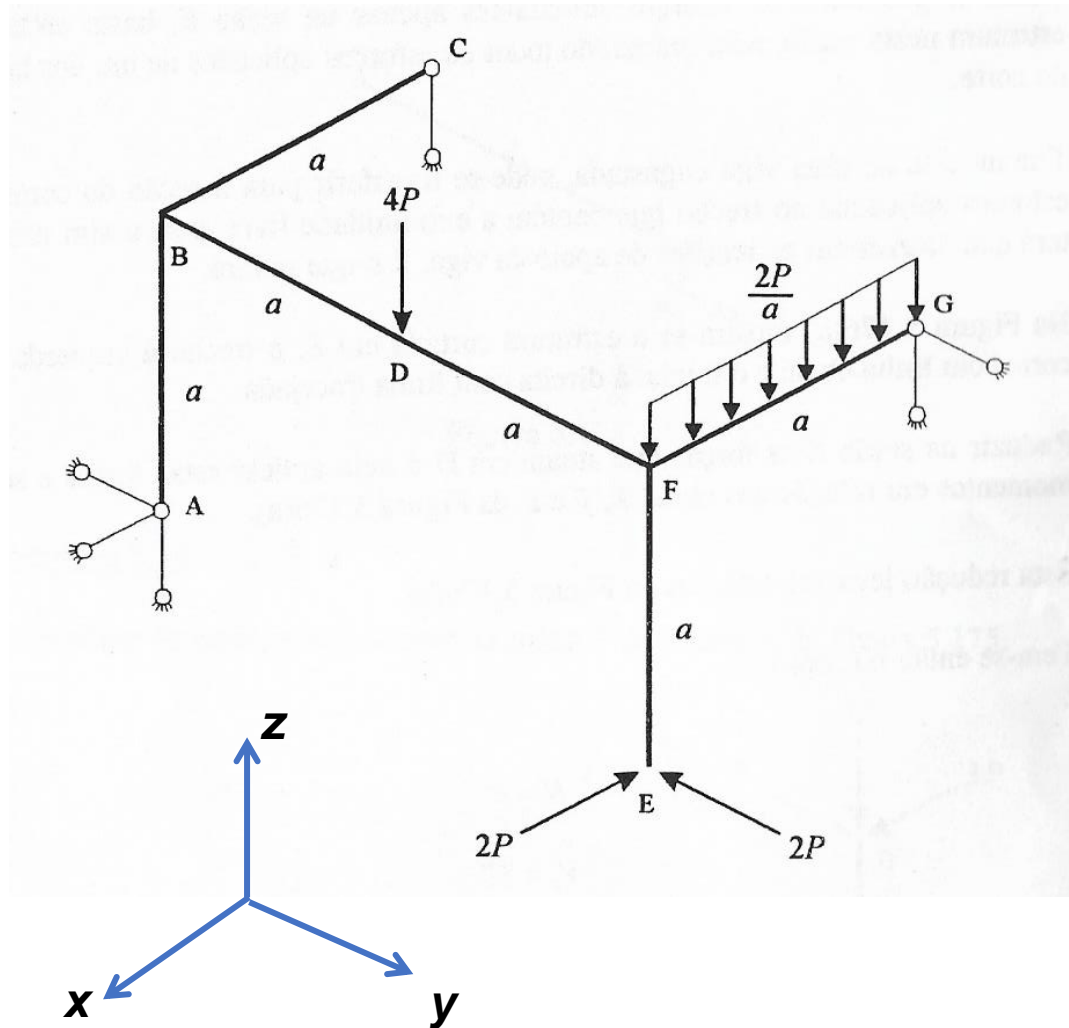

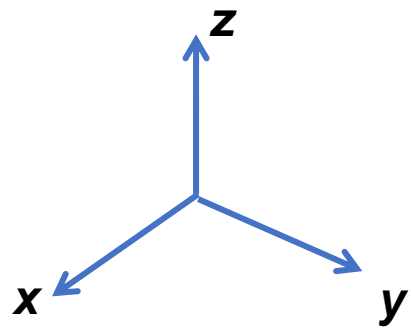
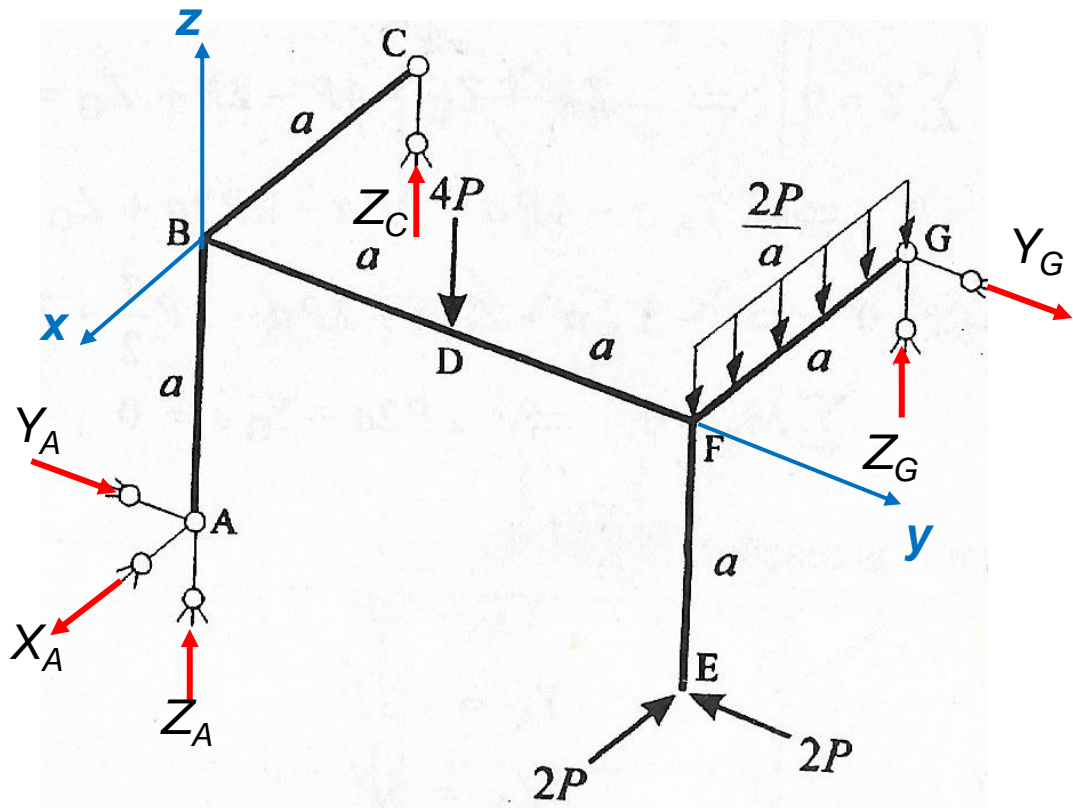

$$\sum X = 0 \Rightarrow X_A - 2P = 0$$

$$\sum Y = 0 \Rightarrow Y_A - 2P + Y_G = 0$$

$$\sum Z = 0 \Rightarrow Z_A + Z_C - 4P - 2P + Z_G = 0$$

$$\sum M_x = 0 \Rightarrow Y_A a - 4Pa - 2Pa - 2P2a + Z_G 2a = 0$$

$$\sum M_y = 0 \Rightarrow -X_A a + Z_C a + 2Pa - 2P \frac{a}{2} + Z_G a = 0$$

$$\sum M_z = 0 \Rightarrow 2P2a - Y_G a = 0,$$

de onde decorrem as reações

$$X_A = 2P$$

$$Y_A = -2P$$

$$Z_A = 5P$$

$$Z_C = -5P$$

$$Y_G = 4P$$

$$Z_G = 6P,$$

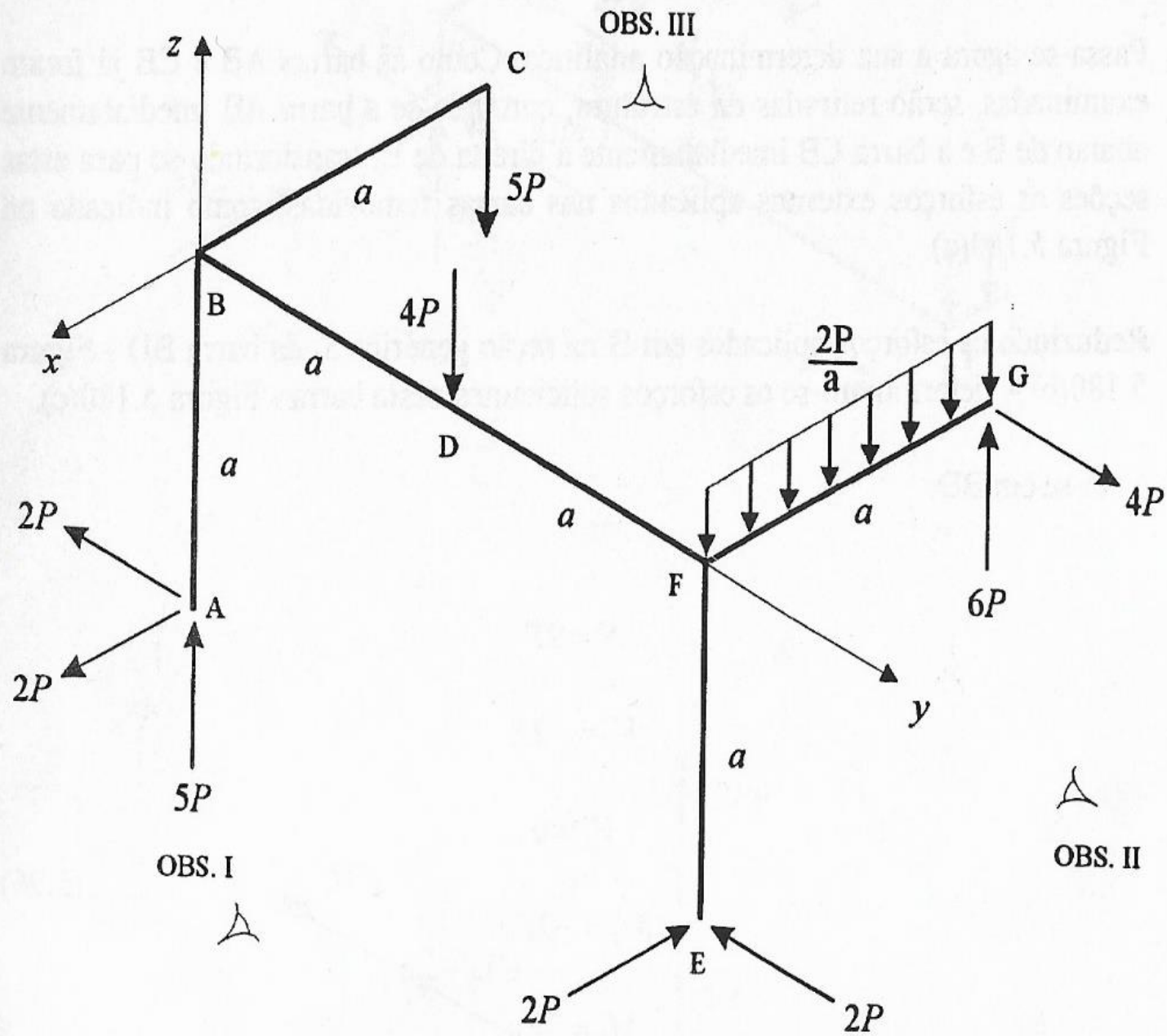

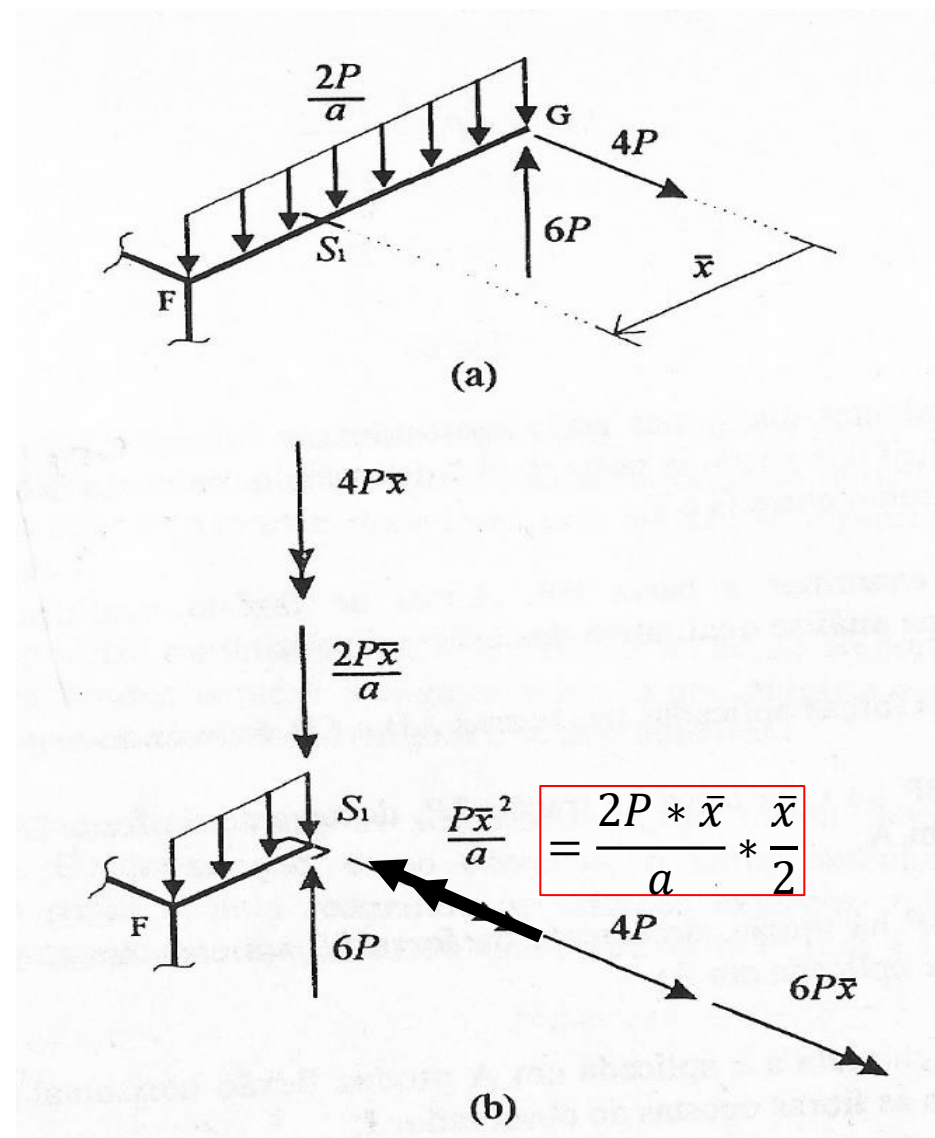
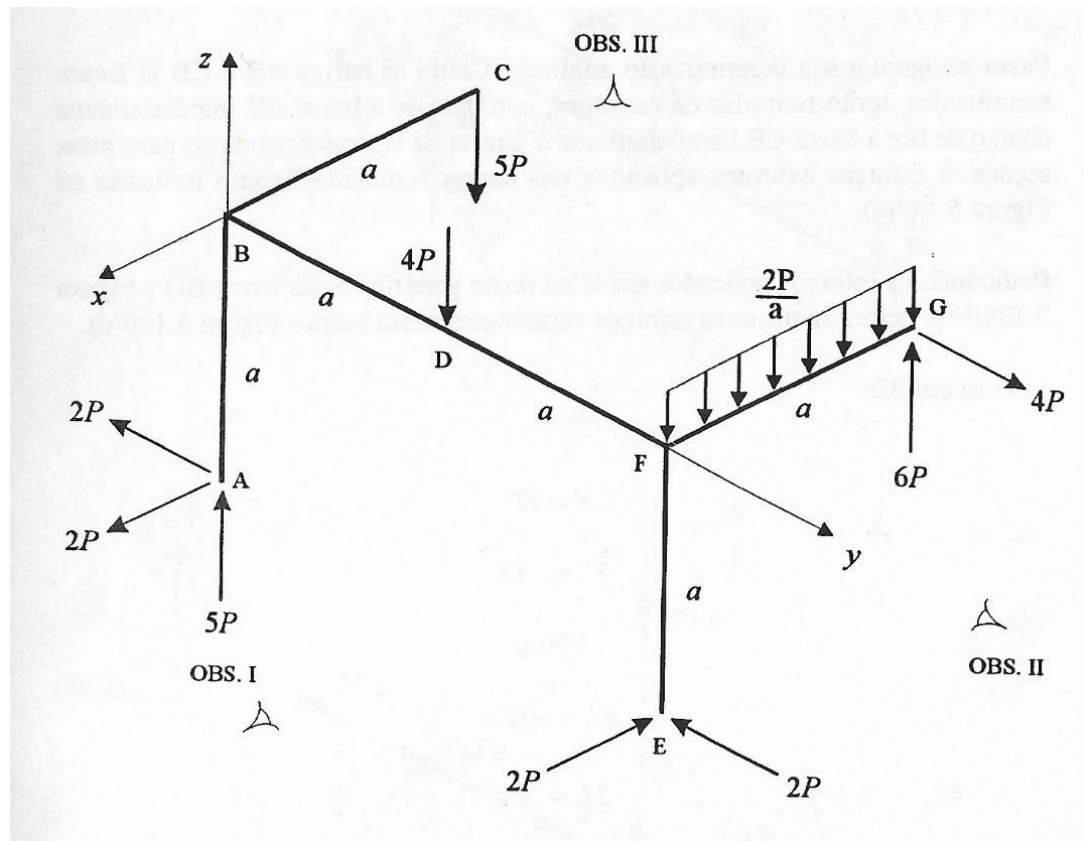

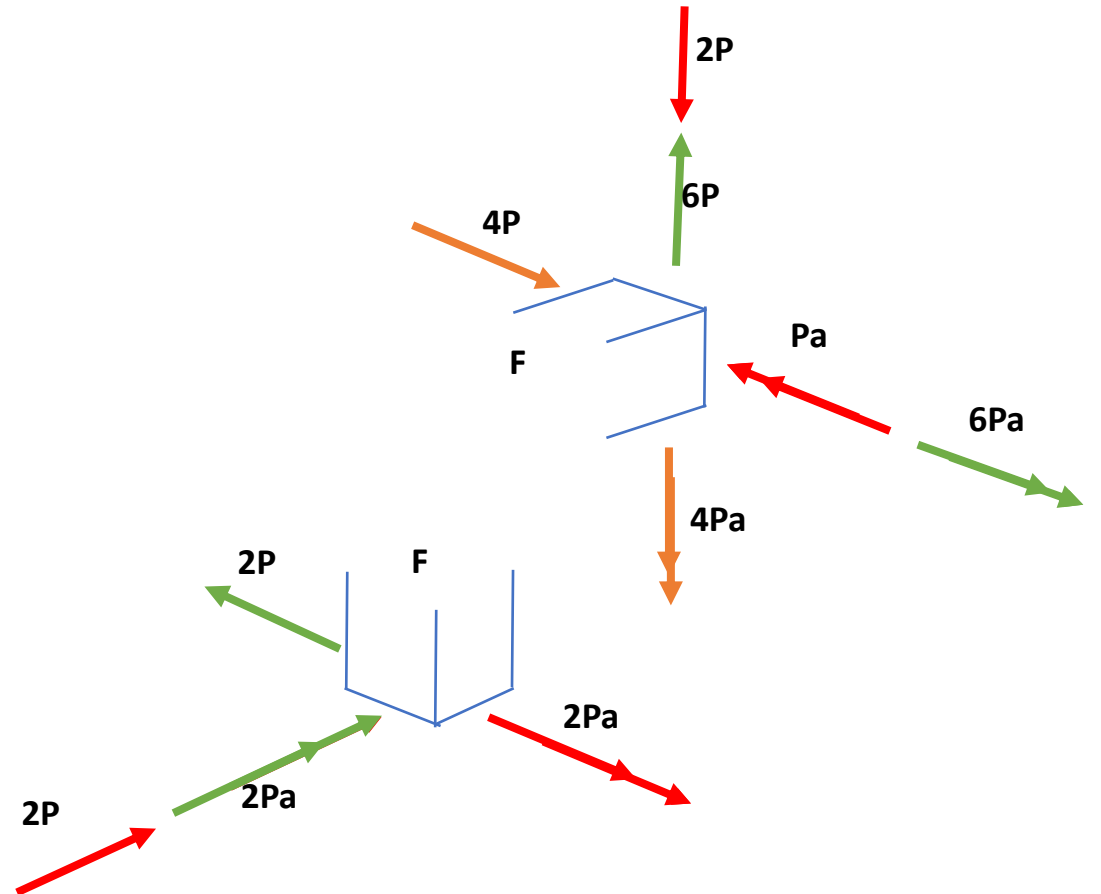
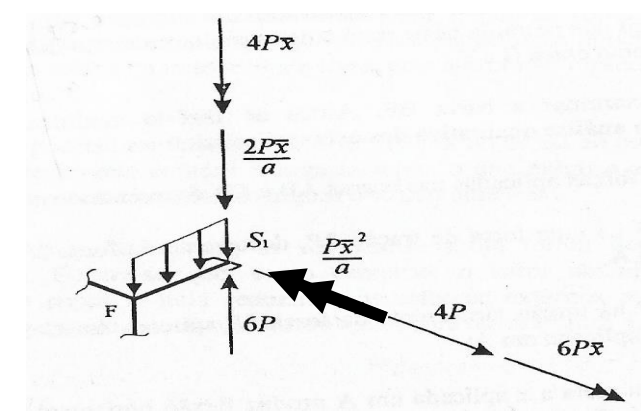
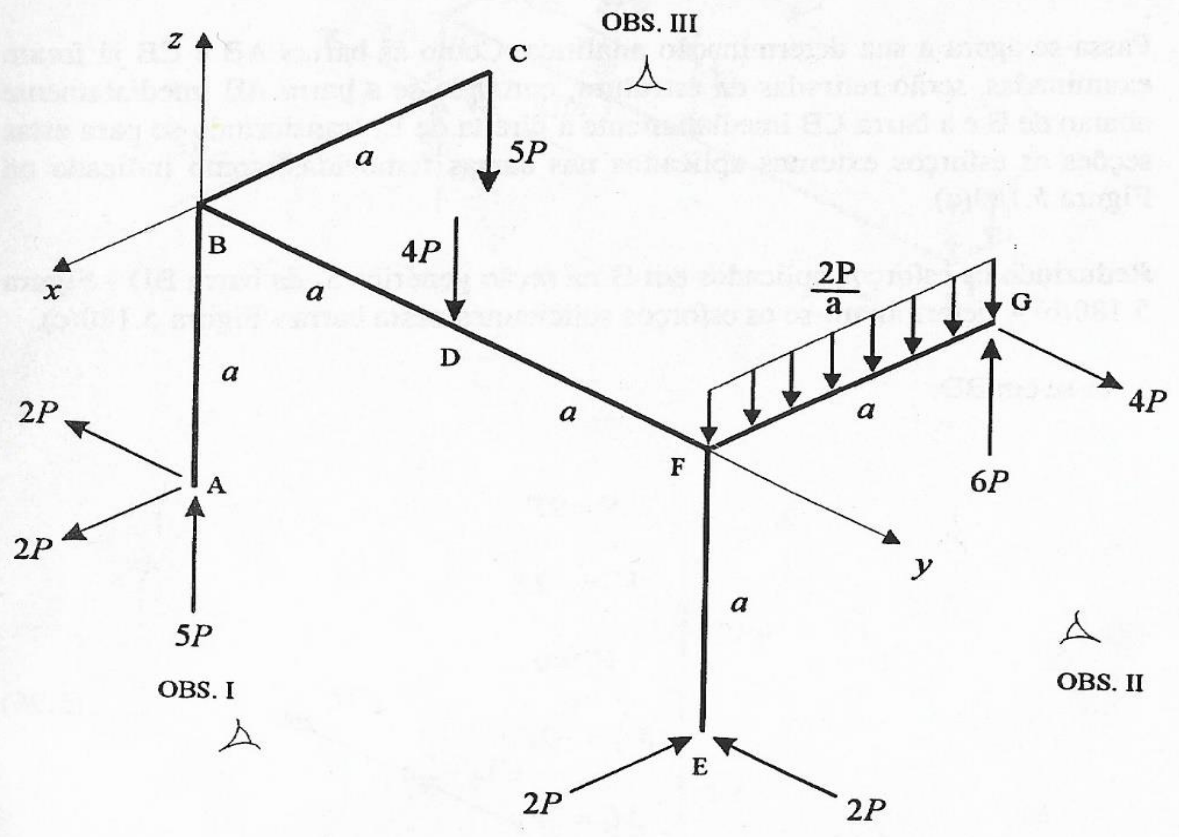

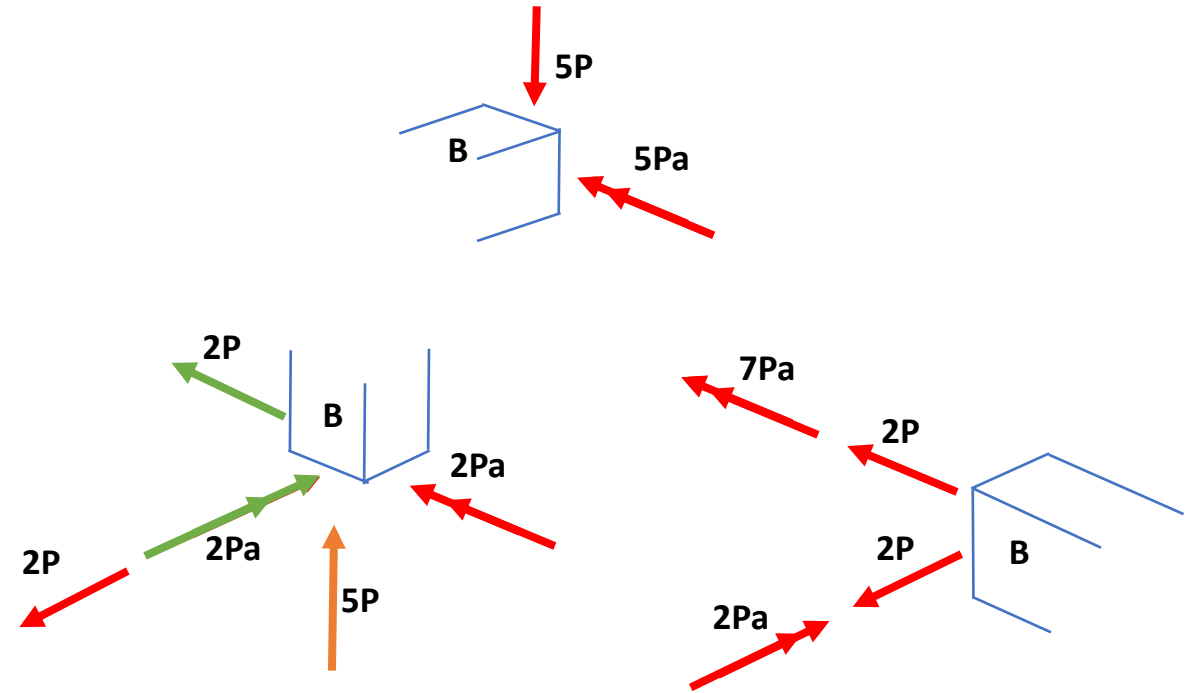
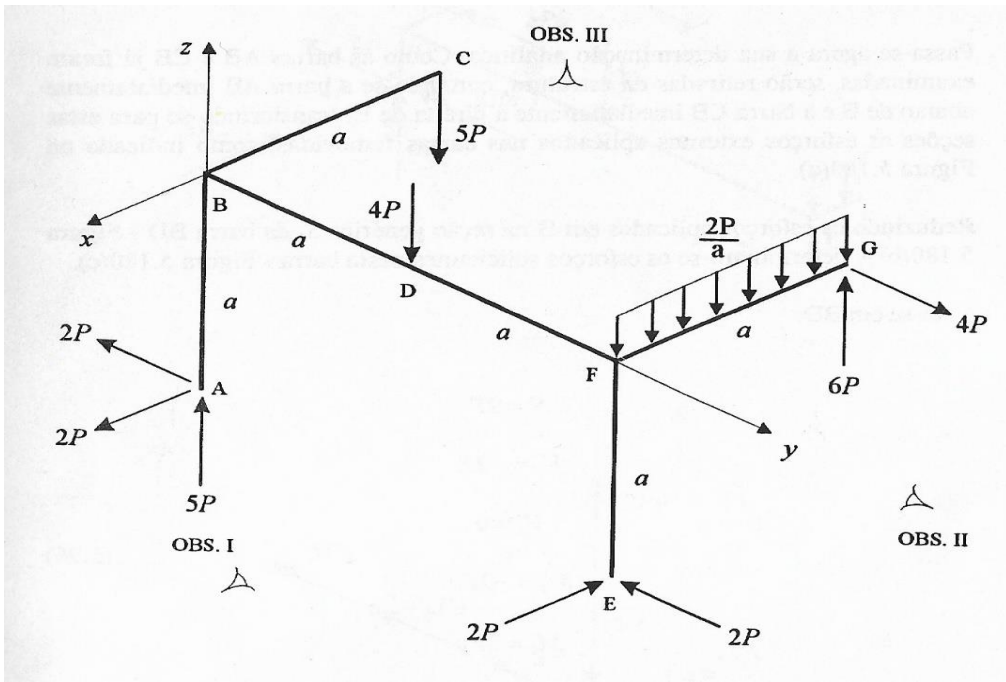

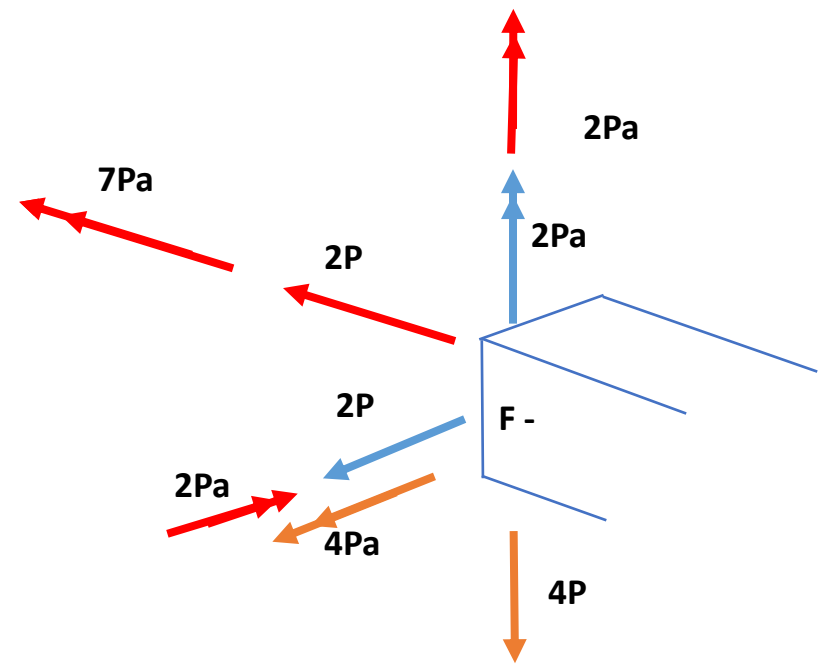
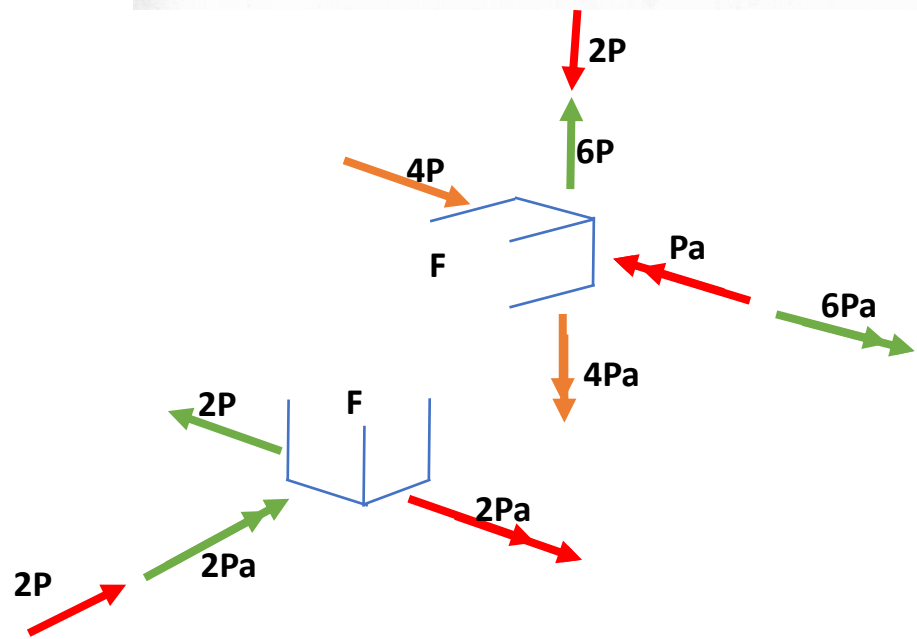
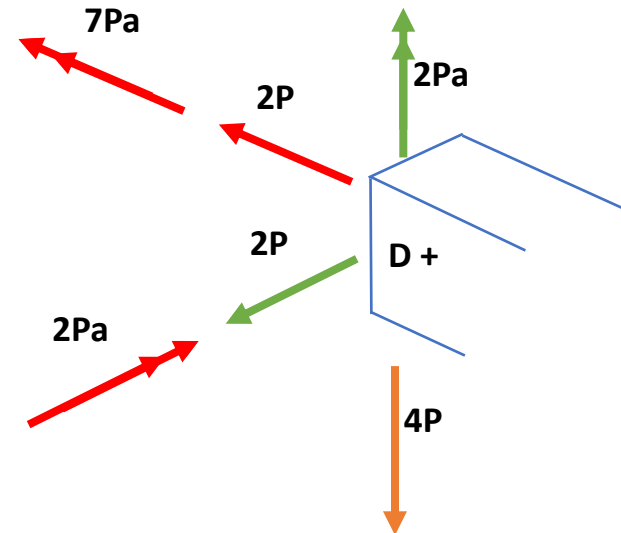
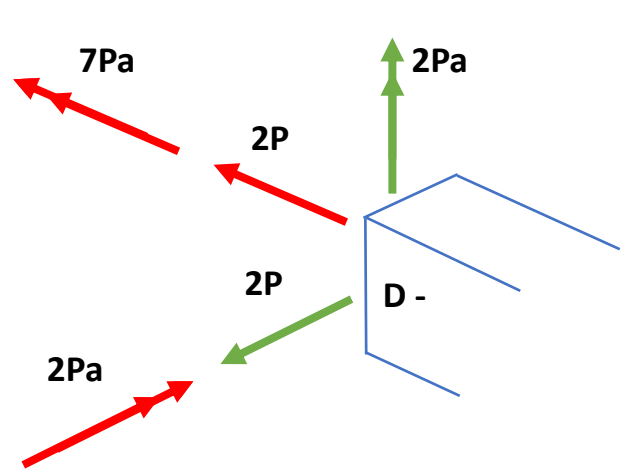
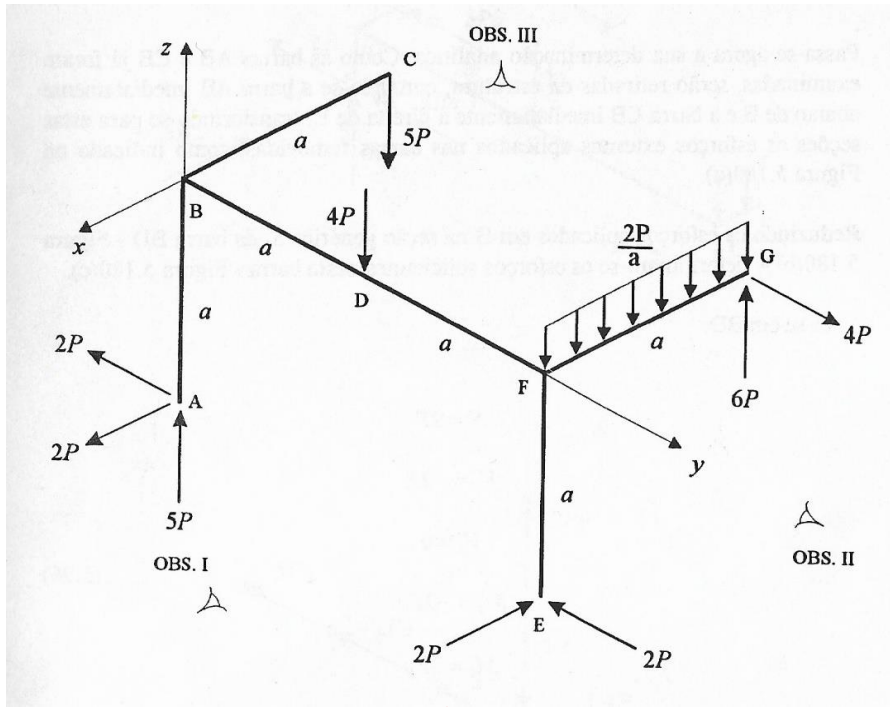

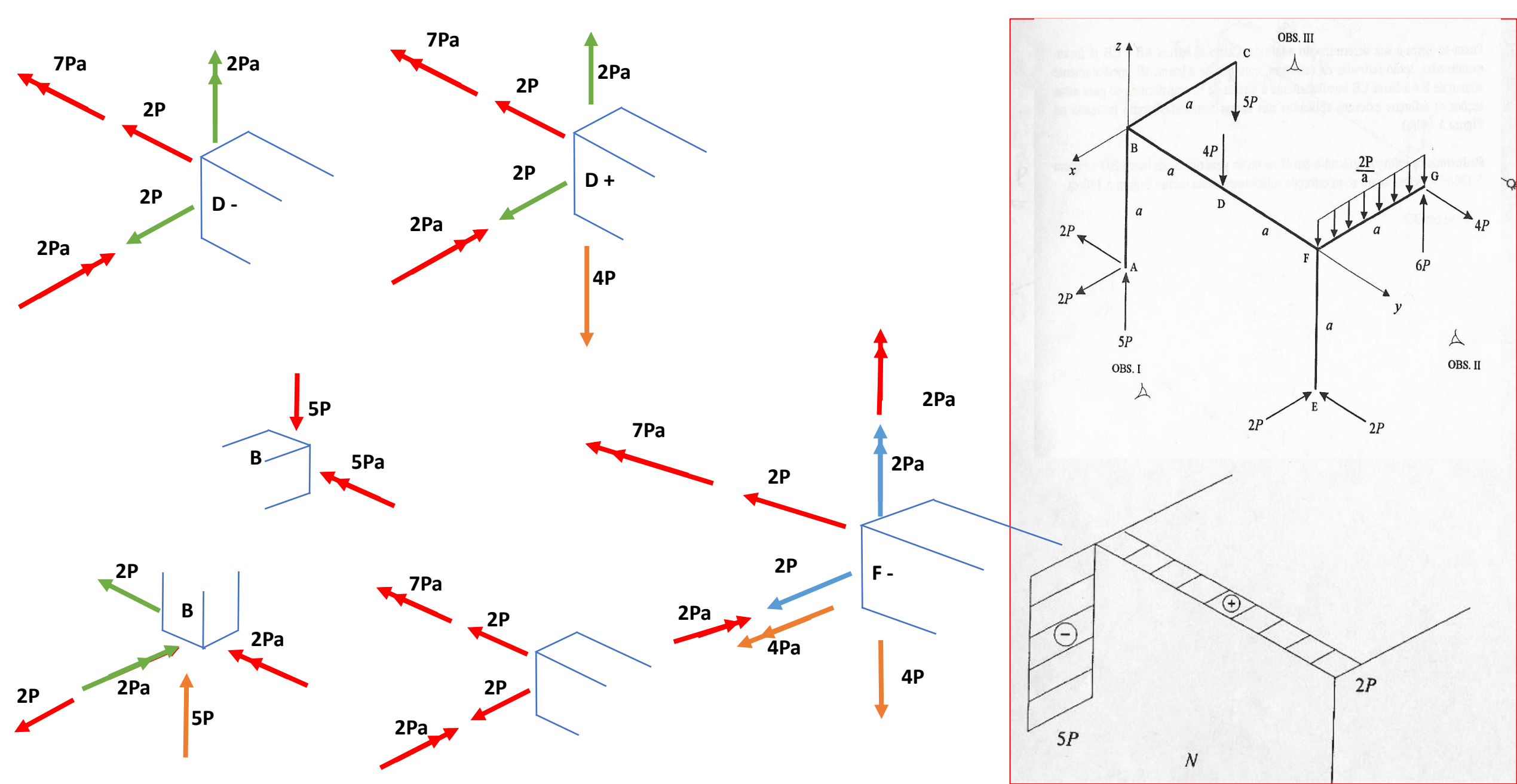

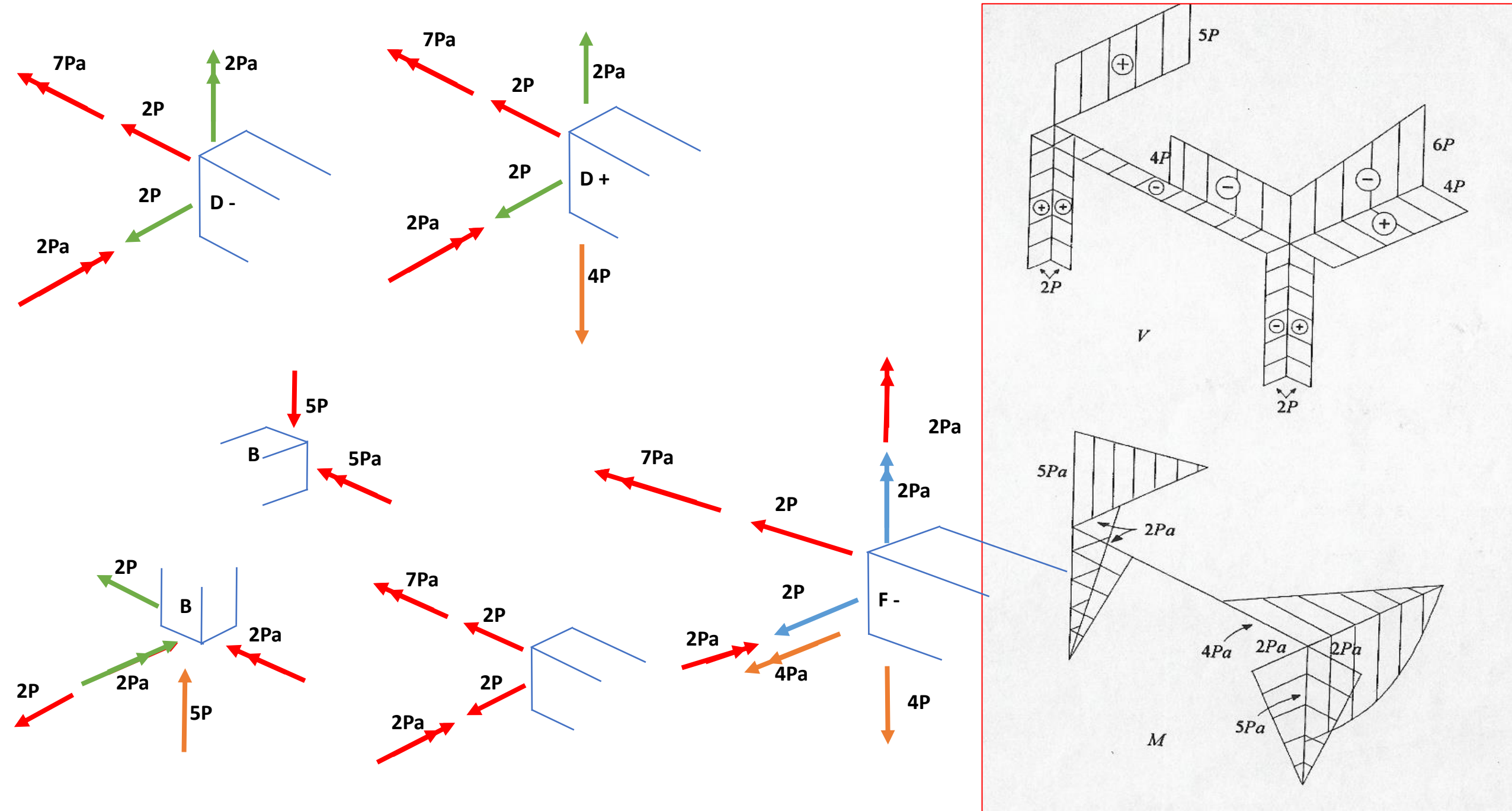

Fonte: Lindenberg Neto, H. Introdução à Mecânica das estruturas, apostila Epusp, São Paulo, 1997

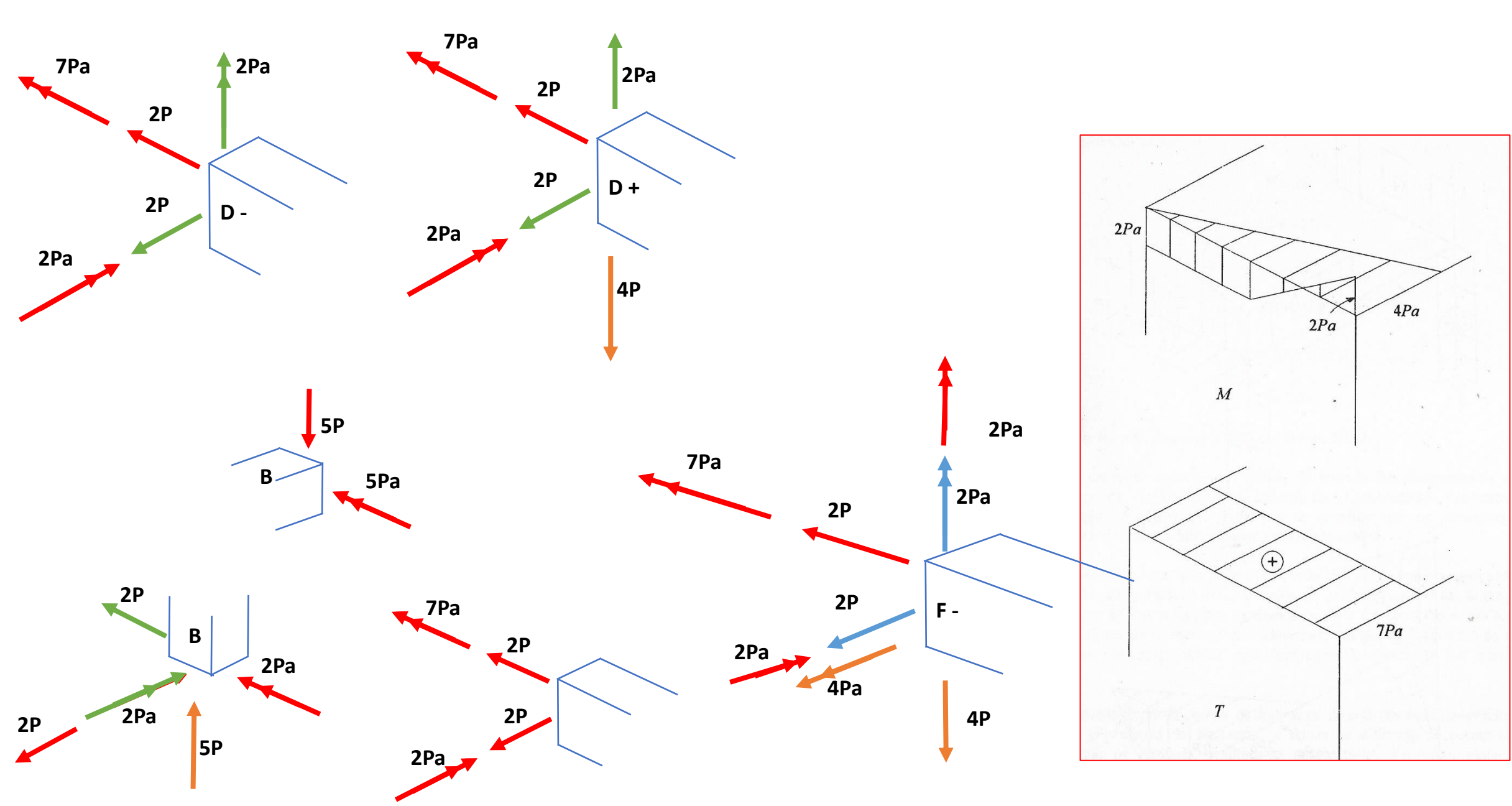

EXERCÍCIO 3.

Nº USP: _____ Nome: _____

Questão 1 (3,0 pontos) – Determinar os diagramas dos esforços solicitantes no trecho BC da estrutura espacial ABCD da figura. As barras AB, BC e CD são ortogonais entre si e estão na direção dos eixos. As forças ativas (aplicadas na direção dos eixos) são a força distribuída uniformemente variada de 0 a 2 kN/m em BC e as forças concentradas aplicadas na extremidade livre D. Considere os observadores em frente aos eixos.

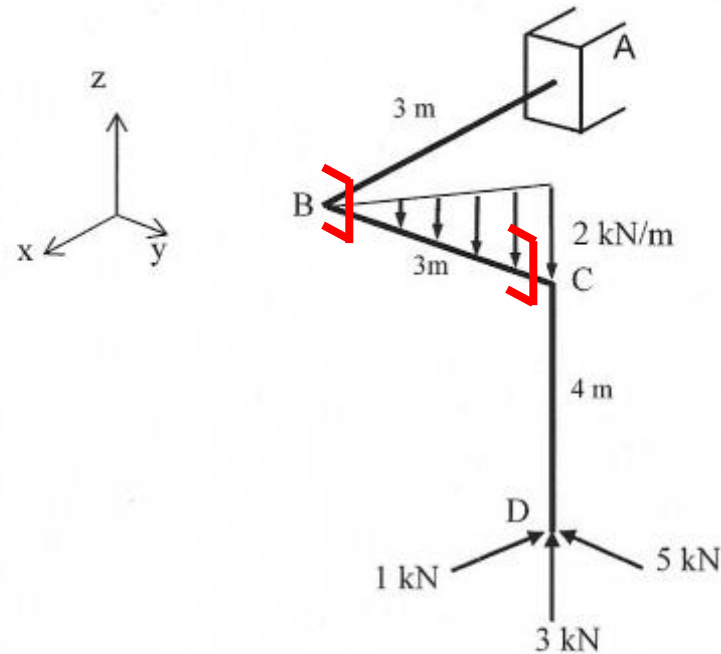

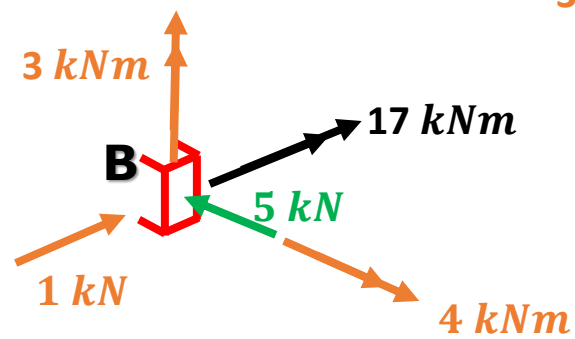
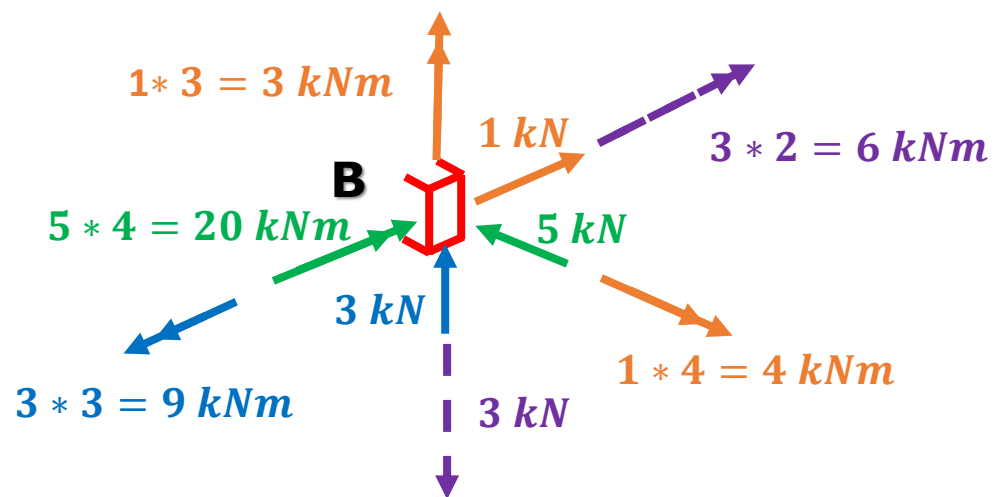
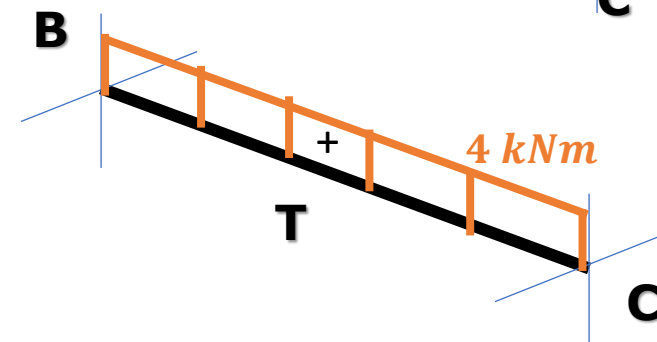
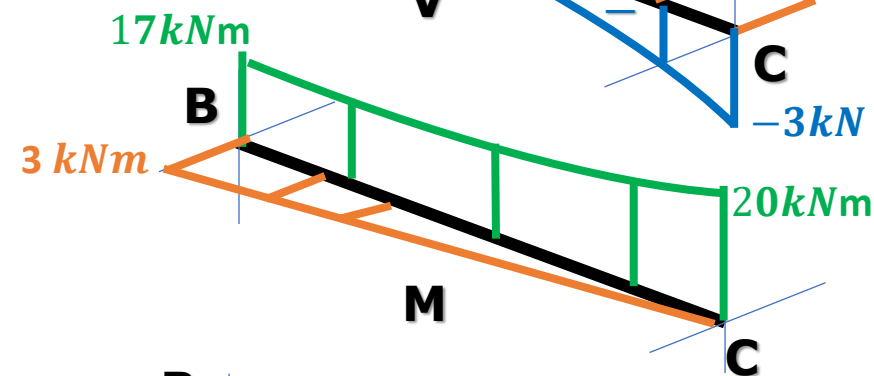
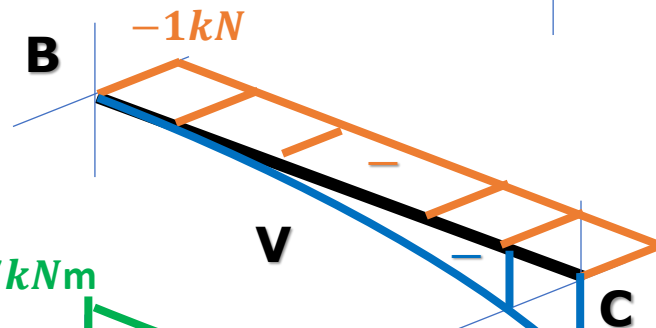
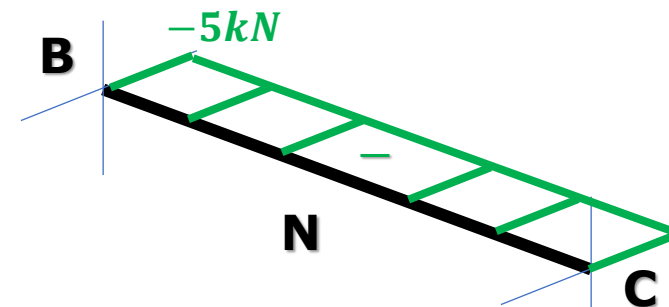
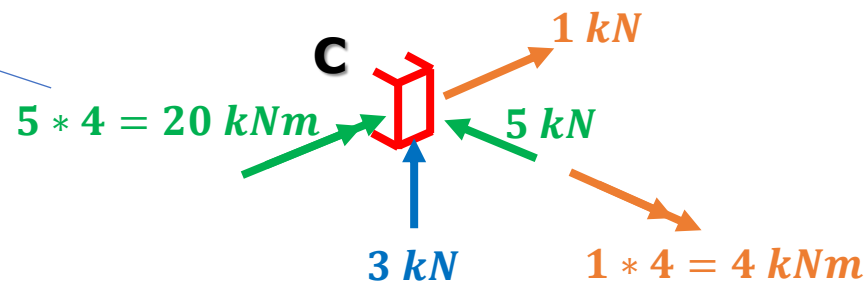
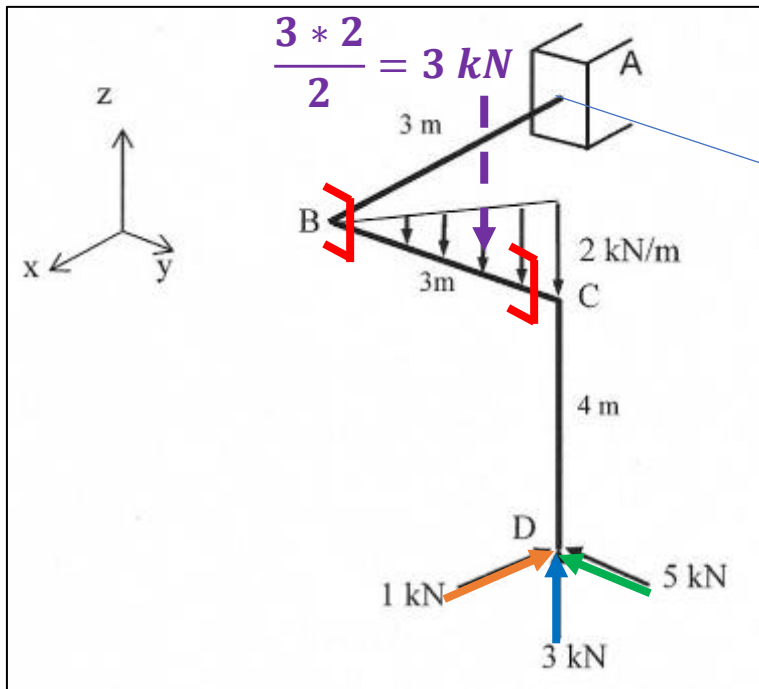

Nº USP: _____ Nome: _____

1ª Questão (3,5 pontos) A estrutura espacial ABCDEF da figura, engastada em A, está submetida a uma força de 10 kN (na direção z) na extremidade livre F, a uma força uniformemente variada (na direção x) de 1 kN/m (em F) a 2 kN/m (em E) e a uma força de 15 kN (na direção y) em D. Esboce os diagramas dos esforços solicitantes (N, V, M, T) no trecho CDEF. Os observadores estão situados defronte aos eixos.

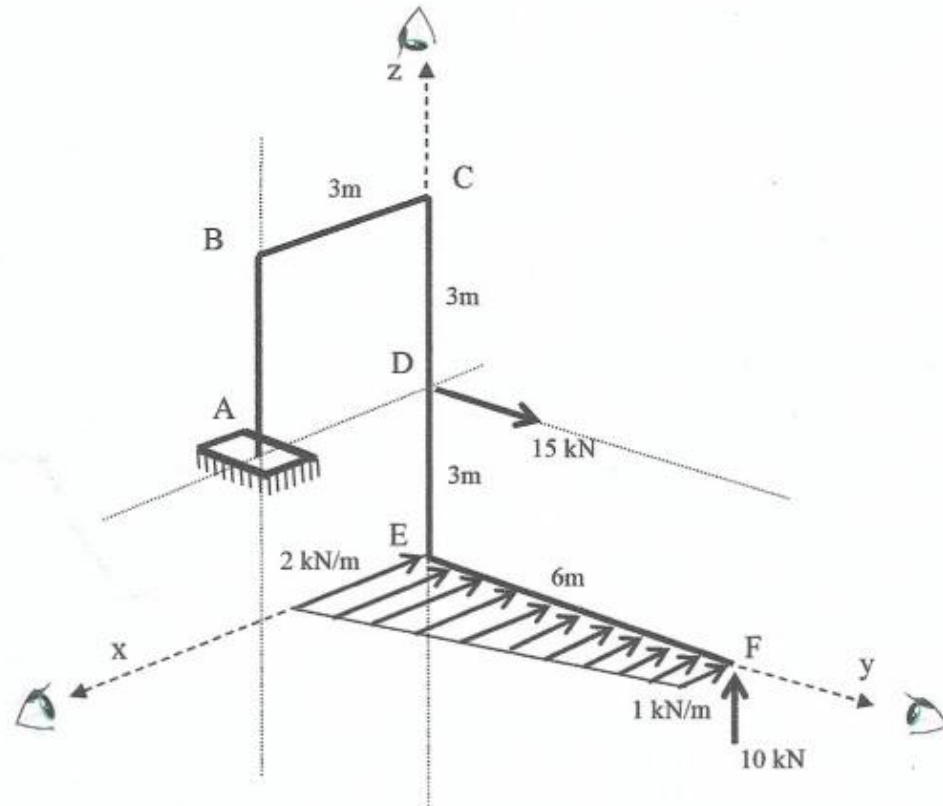

1. Secção E

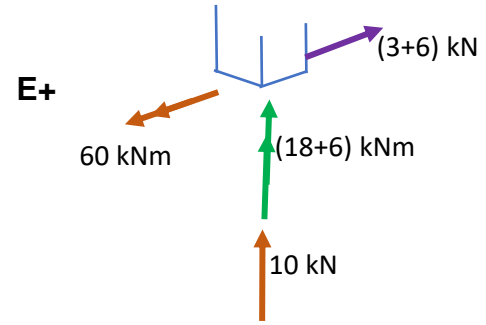
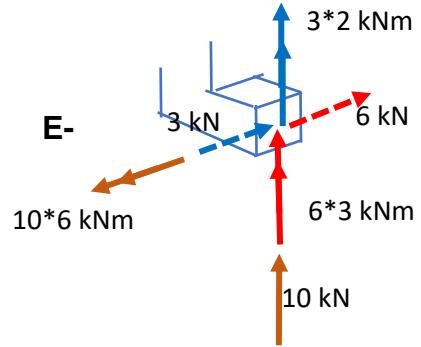

2. Secção D

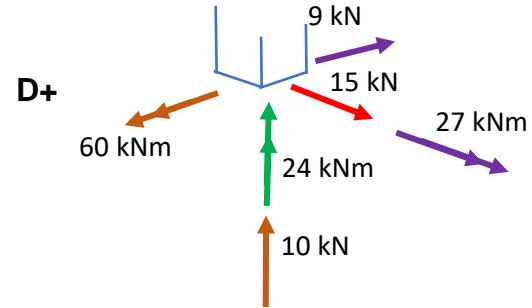
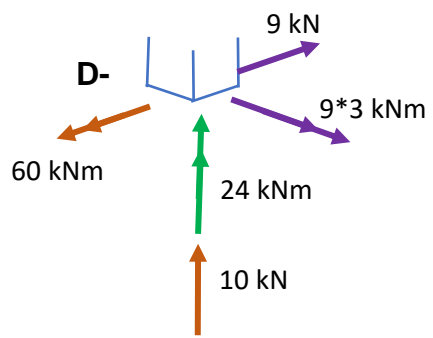

3. Secção C

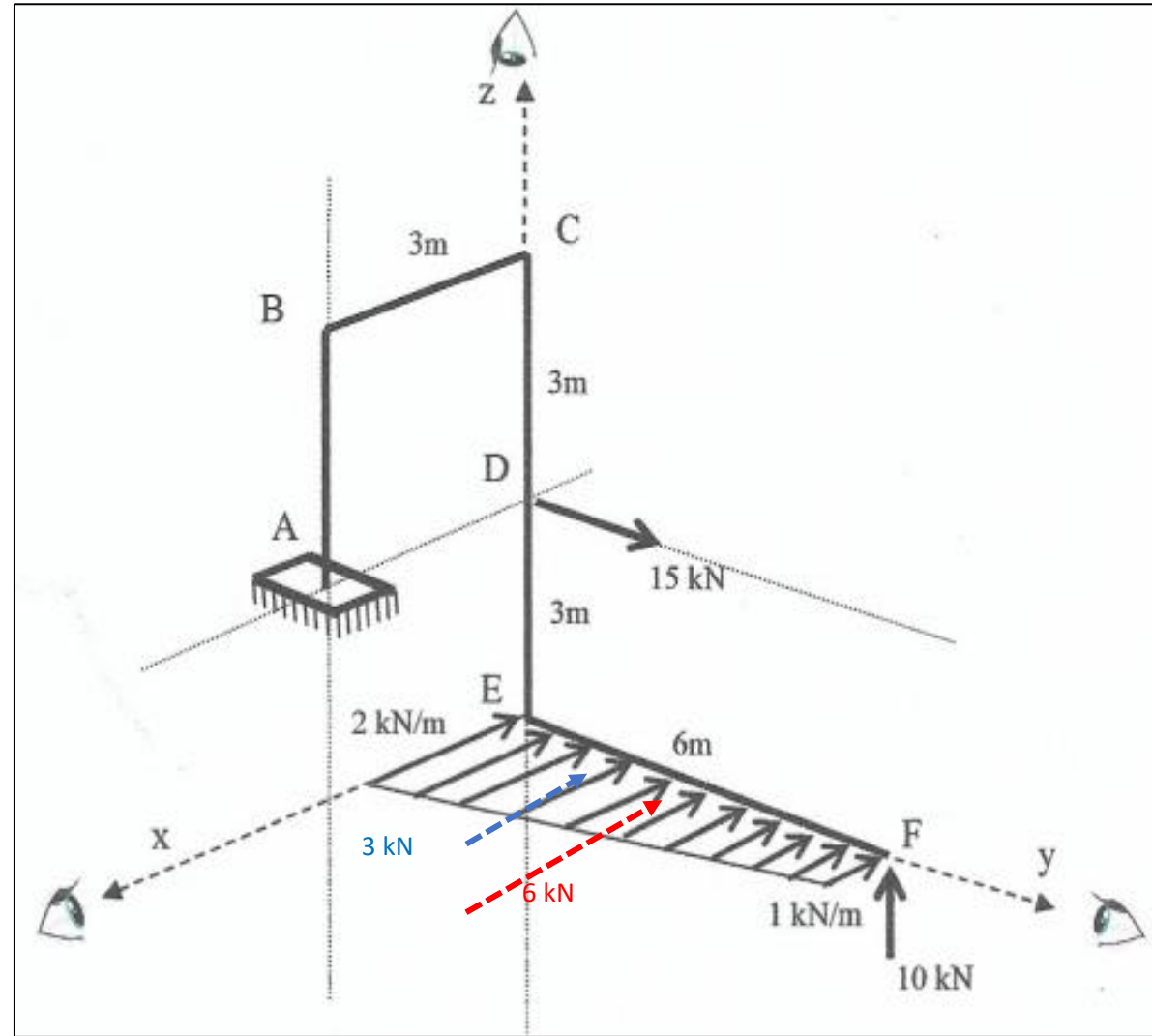
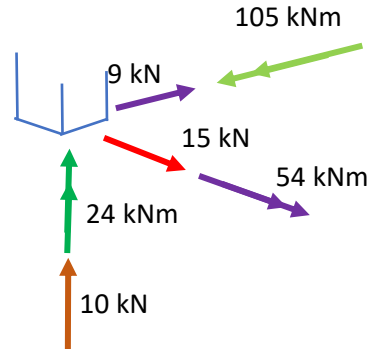
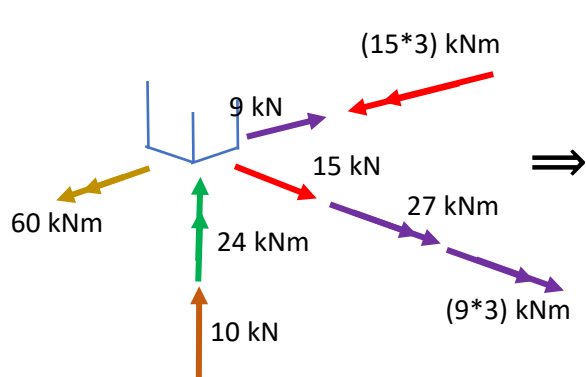

1. Secção E

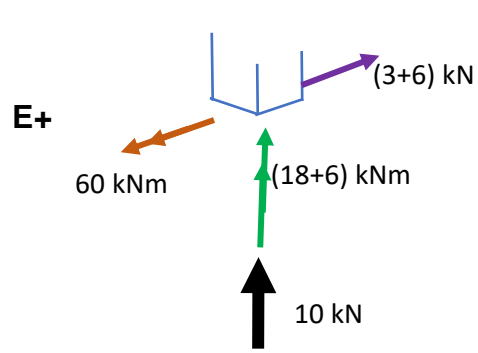
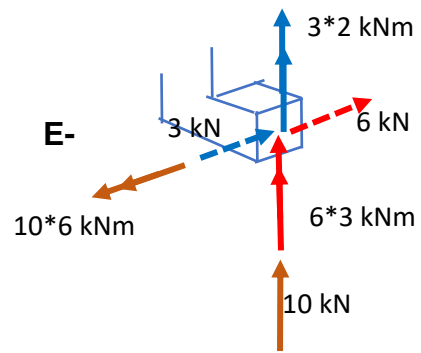

2. Secção D

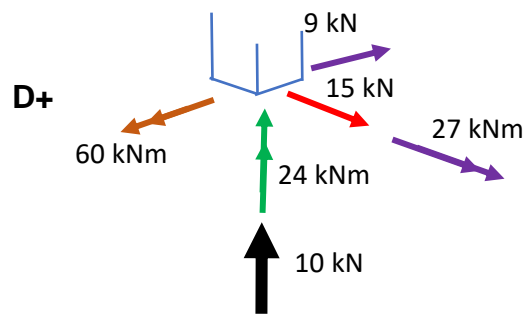
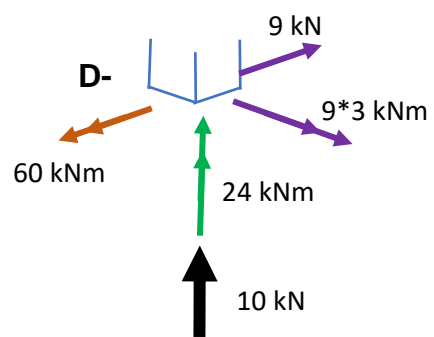

3. Secção C

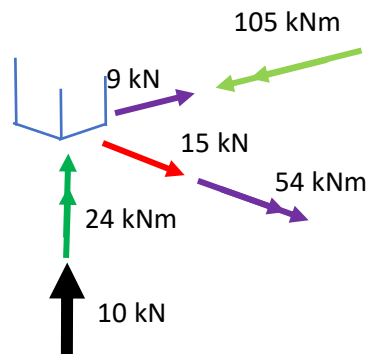
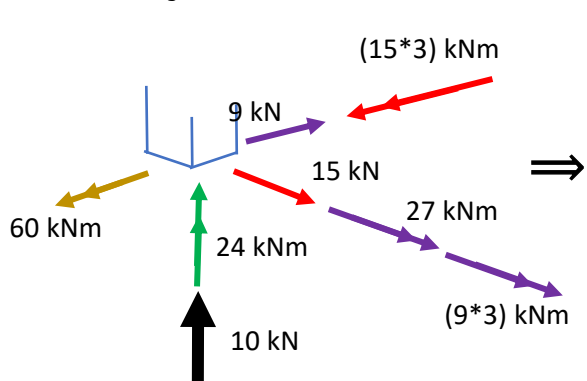

FORÇA NORMAL

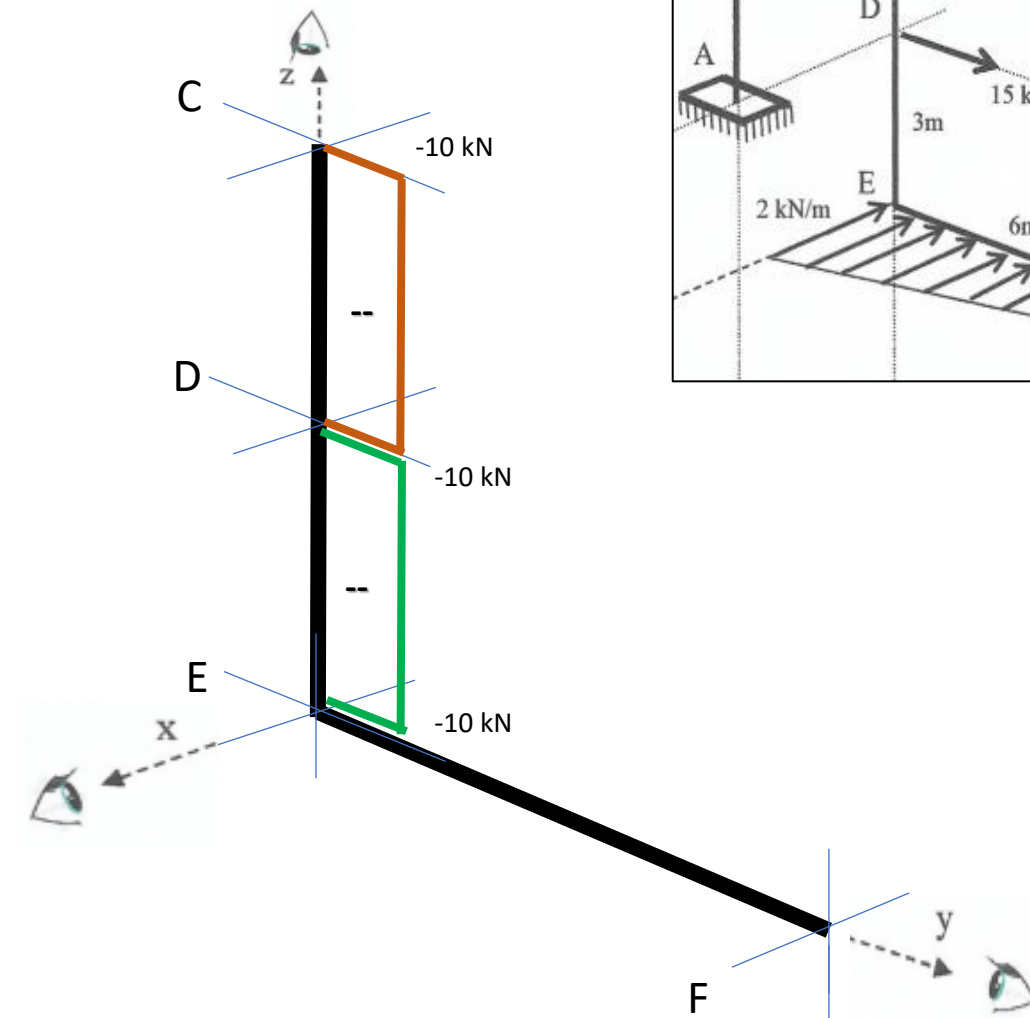

1. Secção E

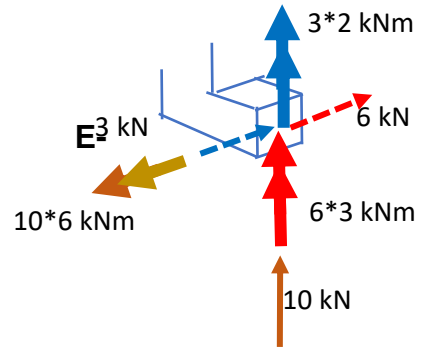

E+

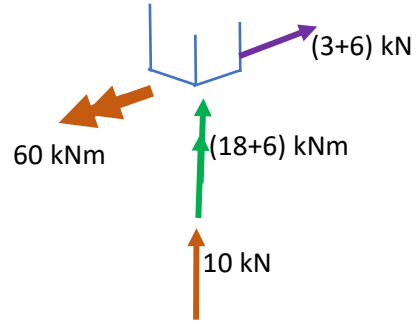

2. Secção D

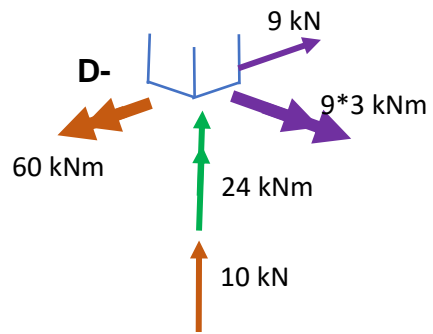

D+

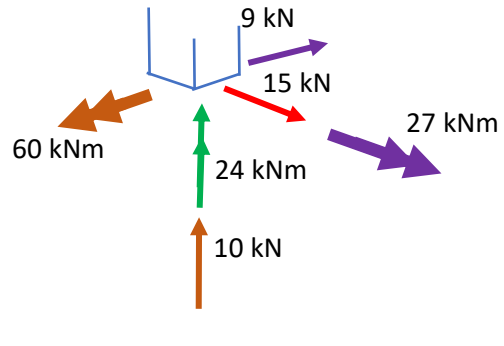

3. Secção C

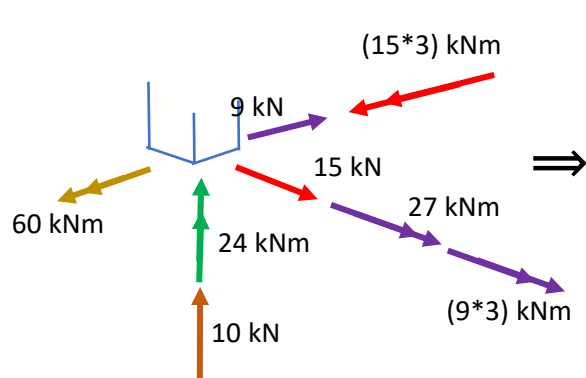

⇒

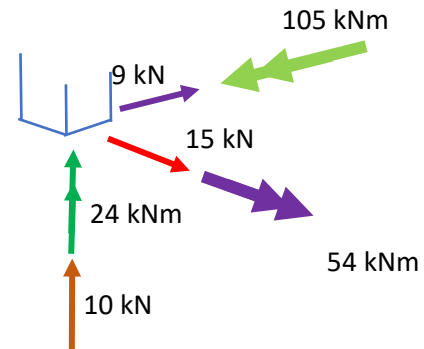

MOMENTO FLETOR

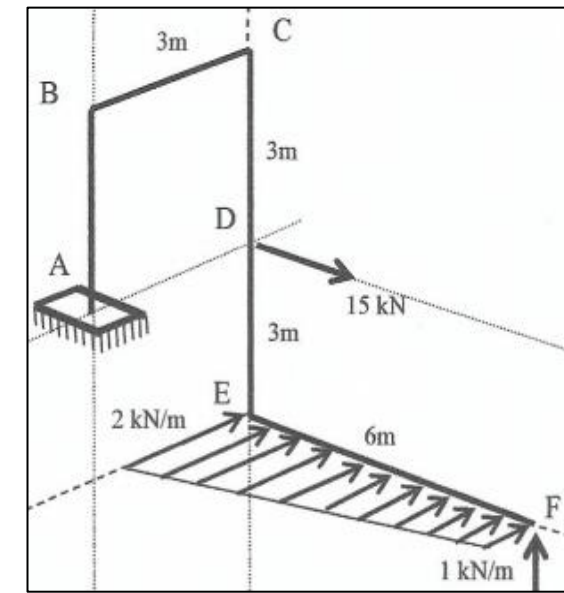
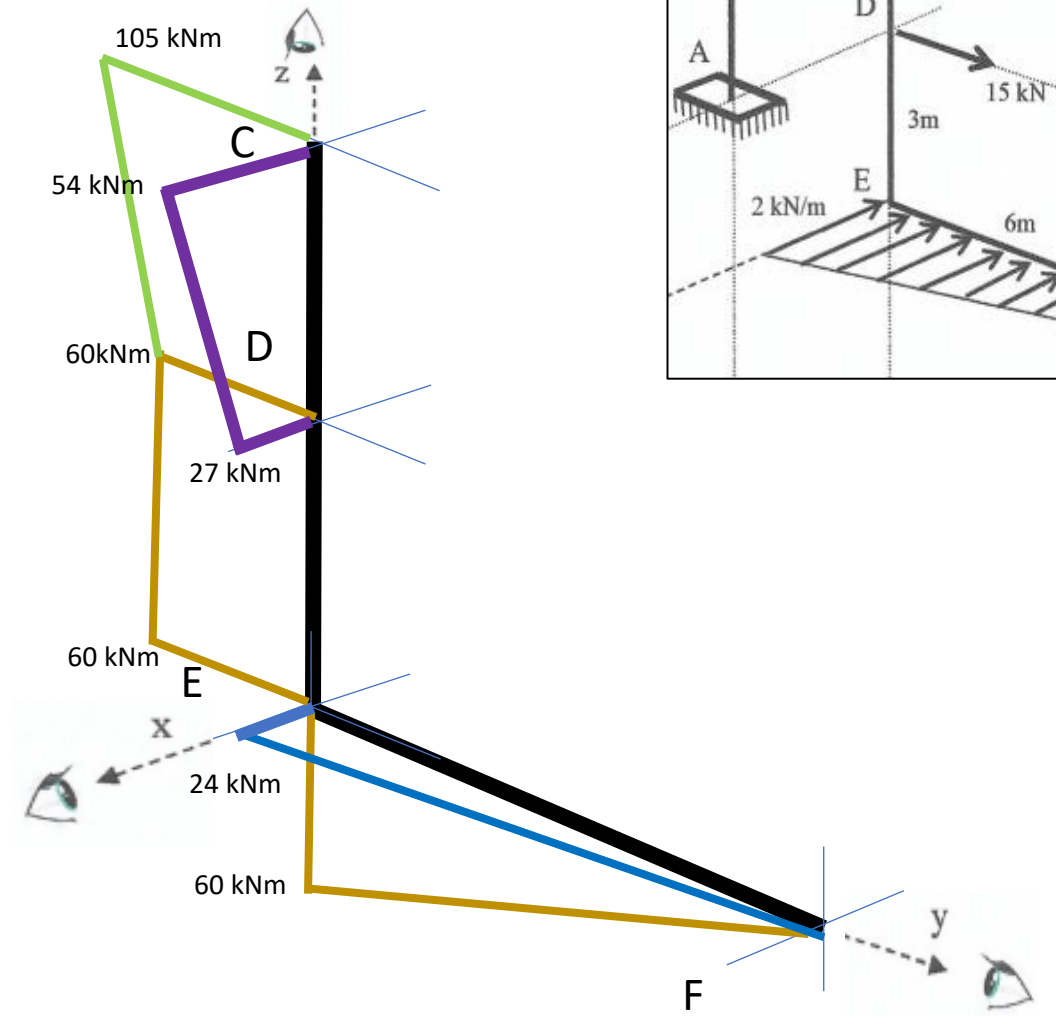

1. Secção E

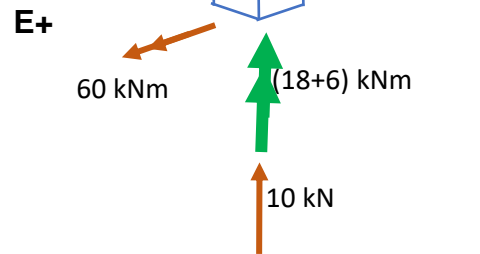
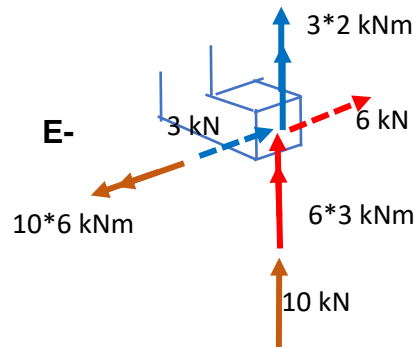

2. Secção D

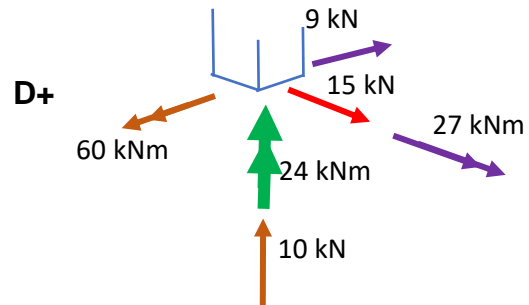
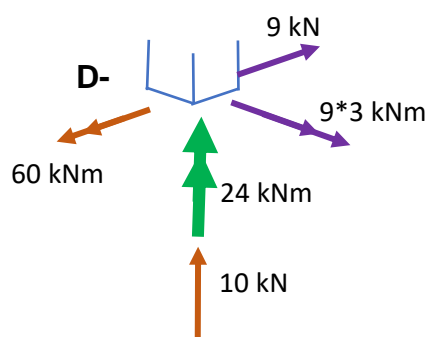

3. Secção C

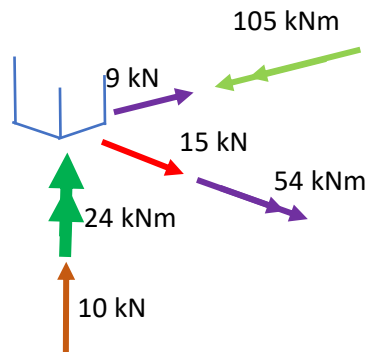
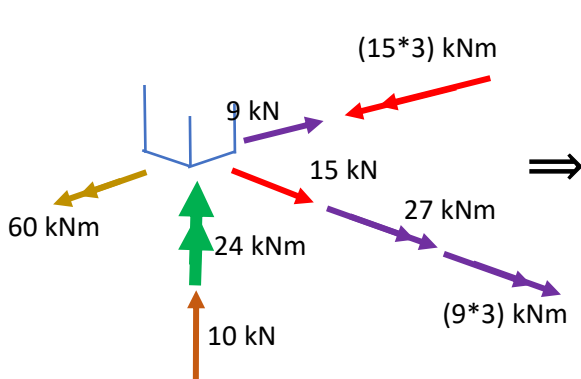

MOMENTO DE TORÇÃO

