

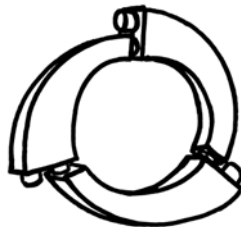

KTH Machine Design

10 Golden Rules in EcoDesign



Associate Professor, Dr. Conrad Luttrupp, [conrad@md.kth.se],
KTH Machine Design, SE-100 44 Stockholm, Sweden,
Phone: +46 8 790 7497 fax: +46 8 202287

First it must be stated that these 10 golden rules are not an invention made by the authors. It is a pedagogic summary of many of the guidelines that can be found in company guidelines and in handbooks of different origins. The Golden Rules, as presented in this chapter, are very generic and must be transformed and customised to be at real use in product development work. Guidelines in a company must be company and product specific and must be implemented by the product developers. The Golden Rules are NOT listed in any preference order.

- GR 1 Don't use toxic substances and arrange closed loops for necessary but toxic ones.
- GR 2 Minimise energy and resource consumption in production and transport through HOUSEKEEPING
- GR 3 MINIMISE energy and resource consumption in the usage phase, especially for products with most significant environmental aspects in the usage phase.
- GR 4 Promote repair and upgrading, especially for SYSTEM dependent products.
- GR 5 Promote LONG LIFE, especially for products with most significant environmental aspects OUT of usage phase
- GR 6 Use structural features and high quality materials to minimise WEIGHT not interfering with necessary flexibility, impact strength or functional priorities
- GR 7 Use better materials, surface treatments or structural arrangements to PROTECT products for dirt, corrosion and wear
- GR 8 PREARRANGE upgrading, repair and recycling through access ability, labelling, modules, breaking points, manuals
- GR 9 Promote upgrading, repair and recycling by using few, SIMPLE, recycled, not blended materials and no alloys
- GR 10 Use as FEW joining elements as possible and use screws, adhesives, welding, snap fits, geometric locking etc. according to the life cycle scenario.

Some designers have specific use for just a few of the rules. In these cases, on the other hand, they usually have a strong need for more product and activity focused design guidelines!

As stated earlier these 10 Golden Rules are generic rules. They are hardly intended for direct use in design work. For example the first rule "Don't use toxic.....". The customized set of rules can be:

- Identify which are the toxic substances inside your responsibility!
- Try to find a nontoxic substitute available not jeopardizing functionality and economy!
- Consider if closed loops be arranged or are there any established collecting-recycling systems for actual substance!

A connection to rule number 8 in this case can be:

- Label material A and try to make it as an easy accessible module!

Another connection can be to rule nr 9 and 10 the substitute of a toxic substance might be lead to a more complicated structure in order to achieve the modules and labels asked for.

- Provide instructions for the disassembly of the toxic and scarce substances in the product

This customization of the rules can preferably be made together with environmental expert as well as managers and market expertise.

A parallel can be made to living rules present in many cultures and religions, like "Thou shall not steal!"

This is easy to say but not very useful as guidance to someone who is a thief! For a kleptomaniac who would like to stop this habit, you have to give him customized rules like:

- Sew together your pockets
- Carry bags that can be seen thru
- Leave your overcoat at the shop entrance.
- Ask someone from the shop to accompany you during your stay in the shop

Some of these good advices in the 10 golden rules are contradictory to a certain extent. In most cases one cannot assign a winner. The best solution to be found to such a conflict is to implement a good guidance for compromises and to communicate the resulting view, e.g. in the dialogue between environmental experts, product developers, sales organisations and customers.

Precious materials can be an energy saver like gold plated connectors, making a conflict between GR 2, 3 7 and 9.

In-moulds in plastic parts can keep the weight down but at the same time by using precious metals, the product structure is getting more complex, making a conflict between GR 2, 6 and 9.

Saving energy often means lowering the weight of products but these savings must not jeopardise the functionality of the product. For example telephone receivers often have an inset of metal to give a more stable and solid impression. The same thing goes for razors, which often have an inlet of metal to lower vibrations and improve performance.

Lightweight cars, can be motivated by fuel consumption, but might denote danger at car accidents. Products, which have their most significant environmental aspect OUT of usage phase, like chairs, tables, stairs, bridges can benefit from more weight in order to lengthen life and lower the risk for damage and human injuries.

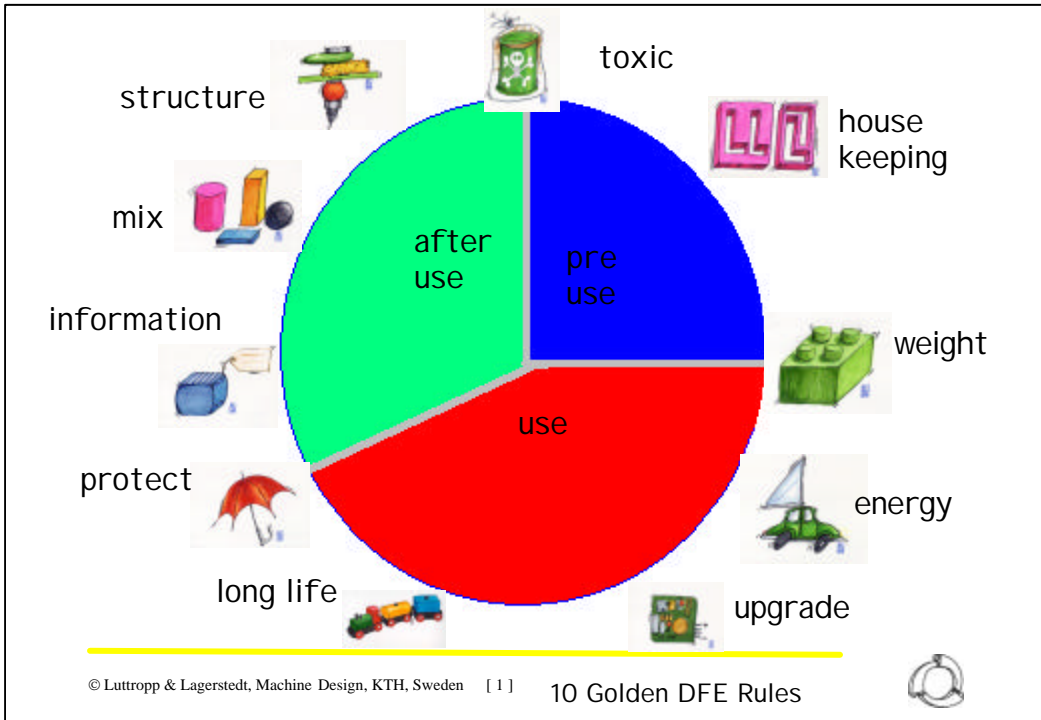

1

Don't use TOXIC substances and arrange closed loops for necessary but toxic ones.

© Luttrupp & Lagerstedt, Machine Design, KTH, Sweden [2] 10 Golden DFE Rules

Company and product specific white, grey and black lists can be at help as well as intelligent modules in recycling. Pollution of the environment is believed to lower biologic diversity and this is regarded as a threat against nature and human survival on earth. Some substances are identified as dangerous and one tries to take them out of the technical cycle e.g. Mercury, Lead, Cadmium. But a change of material can give new dangers not yet identified, as with the paint soluble in water. The paint soluble in water has shown to be dangerous due to poison contents taking care of mould with continuing danger to painters as result. Poisonous materials must be handled with great care at scrapping. Dangerous materials that cannot be avoided should be kept in strictly closed circles.

Some substances are identified as dangerous and one tries to take them out of the technical cycle e.g. Mercury, Lead, Cadmium. But a change of material can give new dangers not yet identified, as with the paint soluble in water. The paint soluble in water has shown to be dangerous due to poison contents taking care of mould with continuing danger to painters as result. Poisonous materials must be handled with great care at scrapping. Dangerous materials that cannot be avoided should be kept in strictly closed circles.



VOLVO Corporate Standard STD 1009,11

Drawn/issued by: 6957 H Jämtgård Issue: 8 Established: 2002-10-08 Page: 1(5)

NOT FOR NEW DESIGN AS OF 2002-10-01
This standard is valid when there is a reference to it.
"Not for new design" is only an indication to our design departments.

The English language version is the original and the reference in case of dispute.

Den engelska språkversionen är originalversion och skall åberopas i händelse av tvist.



Chemical substances whose use within the Volvo Group shall be limited

Volvo's grey list.

Orientation

This issue differs from issue 7 in that the standard no longer applies to new designs.

In case of new design, [STD 100-0000](#) shall be used.

This standard does not apply to the Volvo Car.

Kemiska ämnen vars användning skall begränsas inom Volvokoncernen

Volvos grå lista

Orientering

Den här utgåva skiljer sig från utgåva 7 genom att standarden ej längre gäller vid nykonstruktion.

Vid nykonstruktion skall [STD 100-0000](#) användas.

Den här standard gäller inte för Volvo Personbilar. För



2

Minimise energy and resource consumption in production phase and transport through HOUSEKEEPING.

© Luttropp & Lagerstedt, Machine Design, KTH, Sweden [4] 10 Golden DFE Rules

Transporting energy can be saved if the product is given a space saving structure and shape. See plastic cups or “knock down” furniture the IKEA-model.

Implementing ISO 14001 often put light on possible savings through housekeeping, like reducing and sorting waste, heat recovery, extended reuse, recycling of processing chemicals etc.

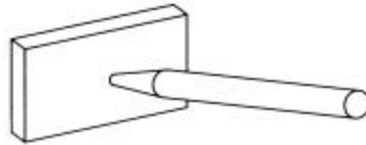
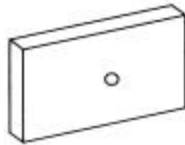
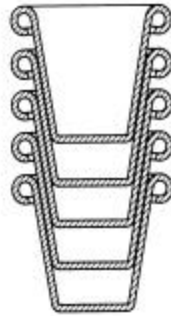

© Luttrupp & Lagerstedt, Machine Design, KTH, Sweden [5] 10 Golden DFE Rules



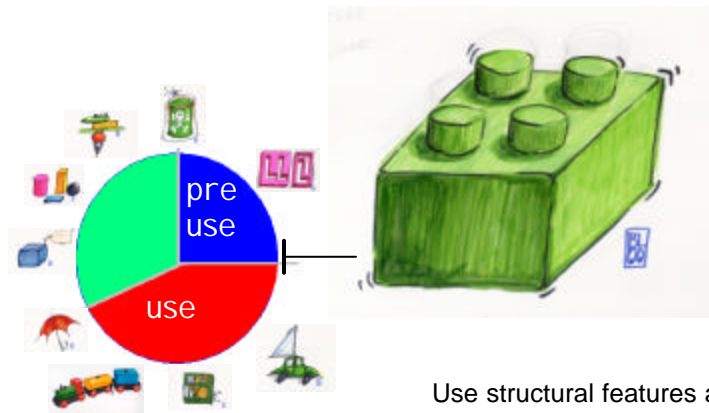

Use structural features and high quality materials to minimise WEIGHT ..in products...if not interfering with necessary flexibility, impact strength or functional priorities.



Saving energy often means lowering the weight of products but these savings must not jeopardise the functionality of the product. For example telephone receivers often have an inset of metal to give a more stable and solid impression. The same thing goes for razors, which often have an inlet of metal to lower vibrations and improve performance

One tries to save energy and this is especially interesting for products where the usage phase carry the most significant environmental aspects; refrigerators, cars, heated houses etc. For cars, which are also moving, it is also interesting to lower weight.

Lightweight cars, which can be motivated by fuel consumption but might denote danger at car accidents. Products, which have their most significant environmental aspect OUT of usage phase, like chairs, tables, stairs, bridges can benefit from more weight in order to lengthen life and lower the risk for damage and human injuries.

Isolation can motivate more weight in products in order to save energy during usage phase; refrigerators, heated houses etc.

Weight often can be saved through structural changes like reinforcements, rails, frames or folds but also by turning over to sophisticated and high strengths materials.

Higher weight can result in a more solid product with a longer life as result, which often is a benefit to the eco-cycle. If a product, on the other hand, has a short lifetime the weight should be as low as possible not to burden the eco-cycle unnecessary.

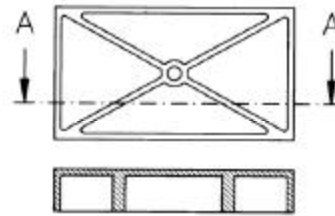
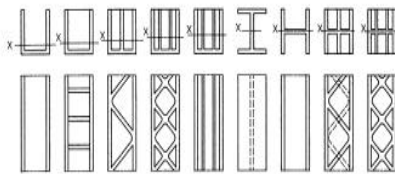
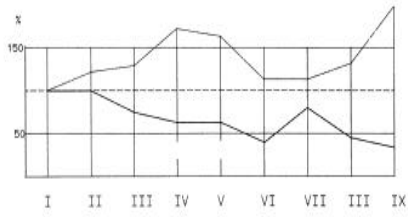

© Luttropp & Lagerstedt, Machine Design, KTH, Sweden [7]

10 Golden DFE Rules



MINIMISE energy and resource consumption in the usage phase, especially for products with most significant aspects in the usage phase.

4

© Luttropp & Lagerstedt, Machine Design, KTH, Sweden [8] 10 Golden DFE Rules

One tries to save energy and this is especially interesting for products where the usage phase carry the most significant environmental aspects; refrigerators, cars, heated houses etc. For cars, which are also moving, it is also interesting to lower weight.

Lightweight cars, which can be motivated by fuel consumption but might denote danger at car accidents. Products, which have their most significant environmental aspect OUT of usage phase, like chairs, tables, stairs, bridges can benefit from more weight in order to lengthen life and lower the risk for damage and human injuries.

Isolation can motivate more weight in products in order to save energy during usage phase; refrigerators, heated houses etc.



⑩ 0-50 7sec

⑩ max 85 km/h

⑩ range 50-70 km

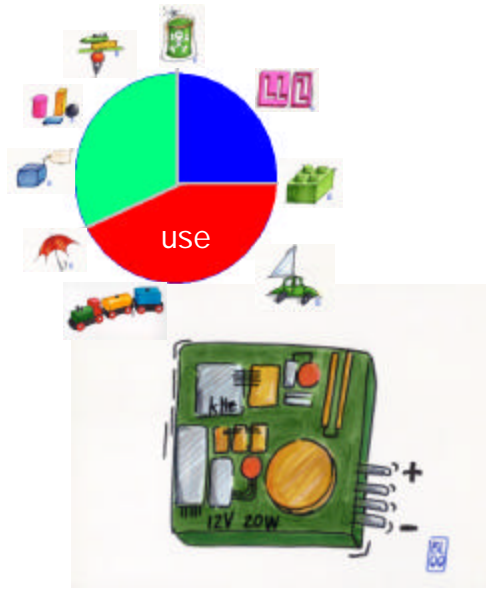

Promote repair and upgrading, especially for SYSTEM dependent products

5

© Luttrupp & Lagerstedt, Machine Design, KTH, Sweden [10] 10 Golden DFE Rules



System dependent products like cellular phones, computers etc. often need new electronics in a PCB or new software. The basic hardware, can many times be used much longer.

Change of functional demands and trends can make the service life of a product shorter than the real lifetime of the product. For example a hanger is used until it is broken! The suit or dress on the hanger will, sooner or later, be out of fashion and then reach the end of service life, even if there is nothing actually wrong with it.

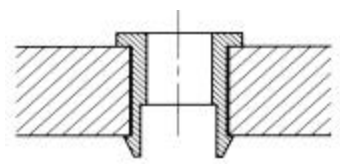
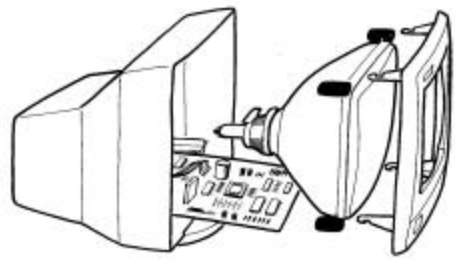
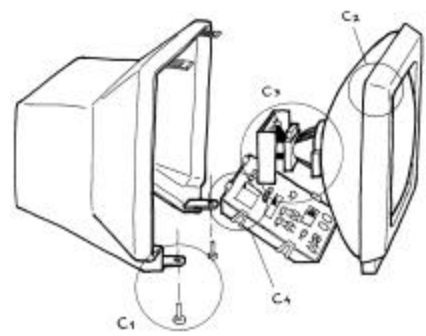

© Luttropp & Lagerstedt, Machine Design, KTH, Sweden [11] 10 Golden DFE Rules



Promote LONG LIFE for products.....
especially for products
with most significant
environmental aspects
OUT of usage phase.



6



© Luttropp & Lagerstedt, Machine Design, KTH, Sweden [12] 10 Golden DFE Rules



Lengthening life can be advantageous in the sense that scrapping is postponed but if new more environmentally friendly technique is available a premature scrapping can be motivated.

Higher weight can result in a more solid product with a longer life as result, which often is a benefit to the eco-cycle. If a product, on the other hand, has a short lifetime the weight should be as low as possible not to burden the eco-cycle unnecessary.



© Luttropp & Lagerstedt, Machine Design, KTH, Sweden [13]

10 Golden DFE Rules



Invest in better materials, surface treatments or structural arrangements to PROTECT products for dirt, corrosion and wear, giving long life and minimised maintenance.

7

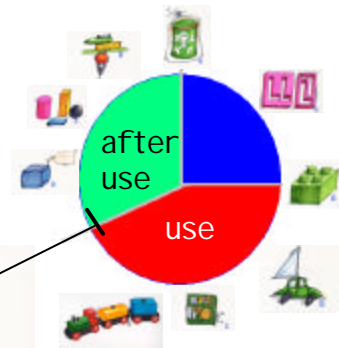

Material is often chosen due to esthetical values and/or customer preferences. This makes it hard to exchange certain materials into more environmentally friendly materials. A given materials mix can be hard to influence. ABS is often used as cover due to its protective surface qualities, PP is a cheap base plastic and PA is often used due to high wear and knock resistant properties. Chroming is used, often but not always, for the looks of it.

Surface treatments can lengthen life but also at the same time raise the environmental burden, this way forming a cost/benefit conflict.



© Luttropp & Lagerstedt, Machine Design, KTH, Sweden [15]

10 Golden DFE Rules



PREARRANGE upgrading,
repair and recycling trough
access ability, labelling,
modules, breaking points,
manuals.

8

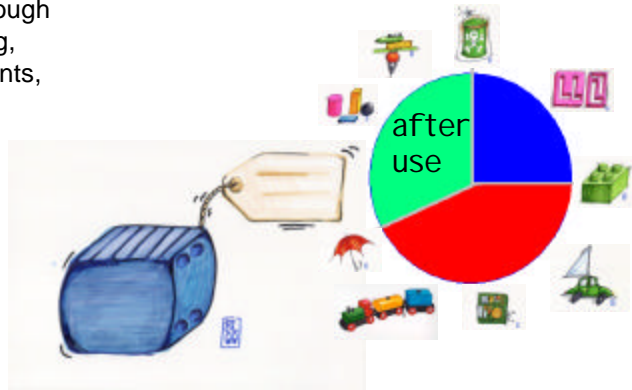

© Luttropp & Lagerstedt, Machine Design, KTH, Sweden [16] 10 Golden DFE Rules



Identifying is an important material property. This enhances the possibility of reuse and recycling, in end of life situations.

Good labels are necessary unless the sorting address is obvious as with metals, wood, paper etc. Alloys are often not labelled but should be, due to recycling activities.

Sometimes the interesting parts are difficult to access which raises the recycling/reuse costs.

For example the Swedish car manufacturer VOLVO, has a scrapping handbook for their latest models, enhancing the opportunity to make a cost effective car scrapping.

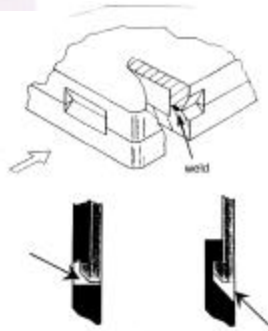

© Luttropp & Lagerstedt, Machine Design, KTH, Sweden [17]

10 Golden DFE Rules



9

Promote upgrading, repair and recycling by using few, SIMPLE, recycled, not blended materials and no alloys.



© Luttrupp & Lagerstedt, Machine Design, KTH, Sweden [18] 10 Golden DFE Rules



Material is often chosen due to esthetical values and/or customer preferences. This makes it hard to exchange certain materials into more environmentally friendly materials. A given materials mix can be hard to influence. ABS is often used as cover due to its protective surface qualities, PP is a cheap base plastic and PA is often used due to high wear and knock resistant properties. Chroming is used, often but not always, for the looks of it.

Extensive blending of materials and complicated materials chemistry makes identification more difficult and this complicates eco-cycling. Pure, clean and unmixed materials facilitate reuse and recycling.

Sometimes it is advantageous to increase the weight in a product in order to decrease the materials mix, to avoid a metal in-mould in a plastic part or to avoid the use of an alloy with toxic ingredients.

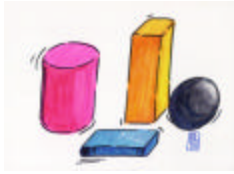

© Luttropp & Lagerstedt, Machine Design, KTH, Sweden [19]

10 Golden DFE Rules



10



Use as FEW joining elements as possible and use screws, adhesives, welding, snap fits, geometric locking etc. according to the life cycle scenario.

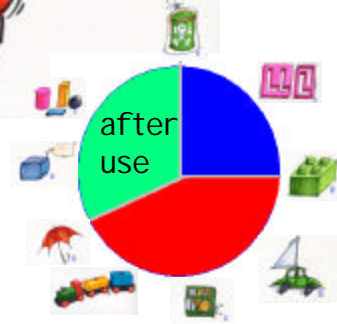

© Luttrupp & Lagerstedt, Machine Design, KTH, Sweden [20] 10 Golden DFE Rules



Many joints like screws, nuts, glue etc. can be avoided through structural arrangements. Remote controls are often arranged like hamburgers with two halves, which lock the rest of the contents inside after the assembly. An intelligent structure will simplify scrapping and recycling and if printed circuit boards and other important recycling parts are easily accessible, disassembly and sorting will be facilitated.

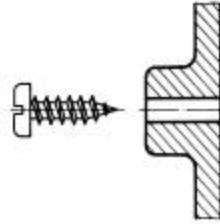
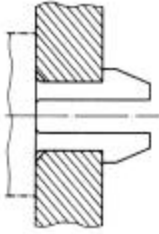
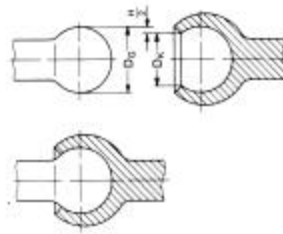
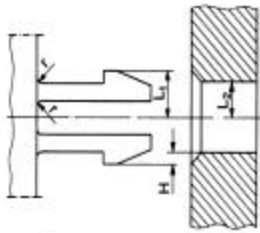

© Luttropp & Lagerstedt, Machine Design, KTH, Sweden [21]

10 Golden DFE Rules



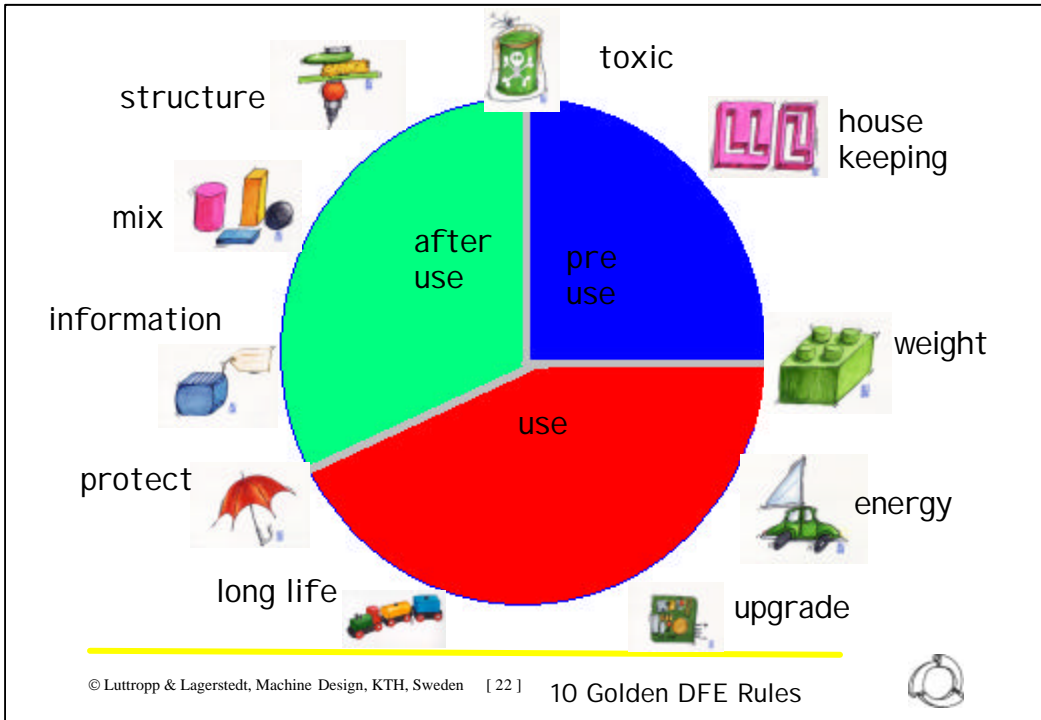



material

protect



10 GR



housekeeping



information/
structure

