

Q3 da Prova de Engenharia de PEF-2200
de 24.7.2014

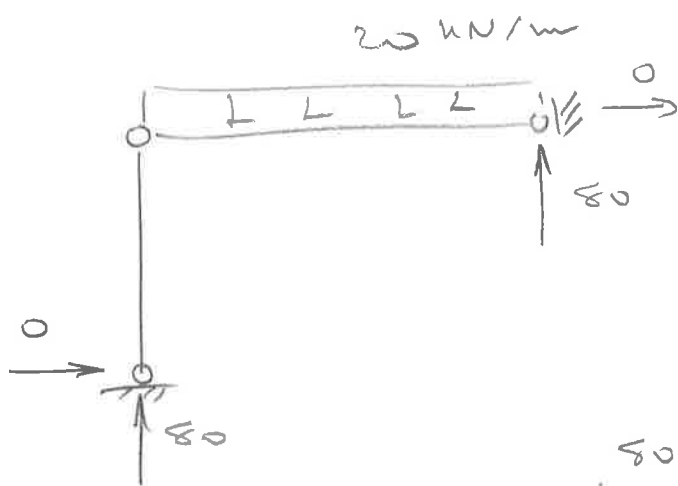

pothico trair m bed

vija en nalamy

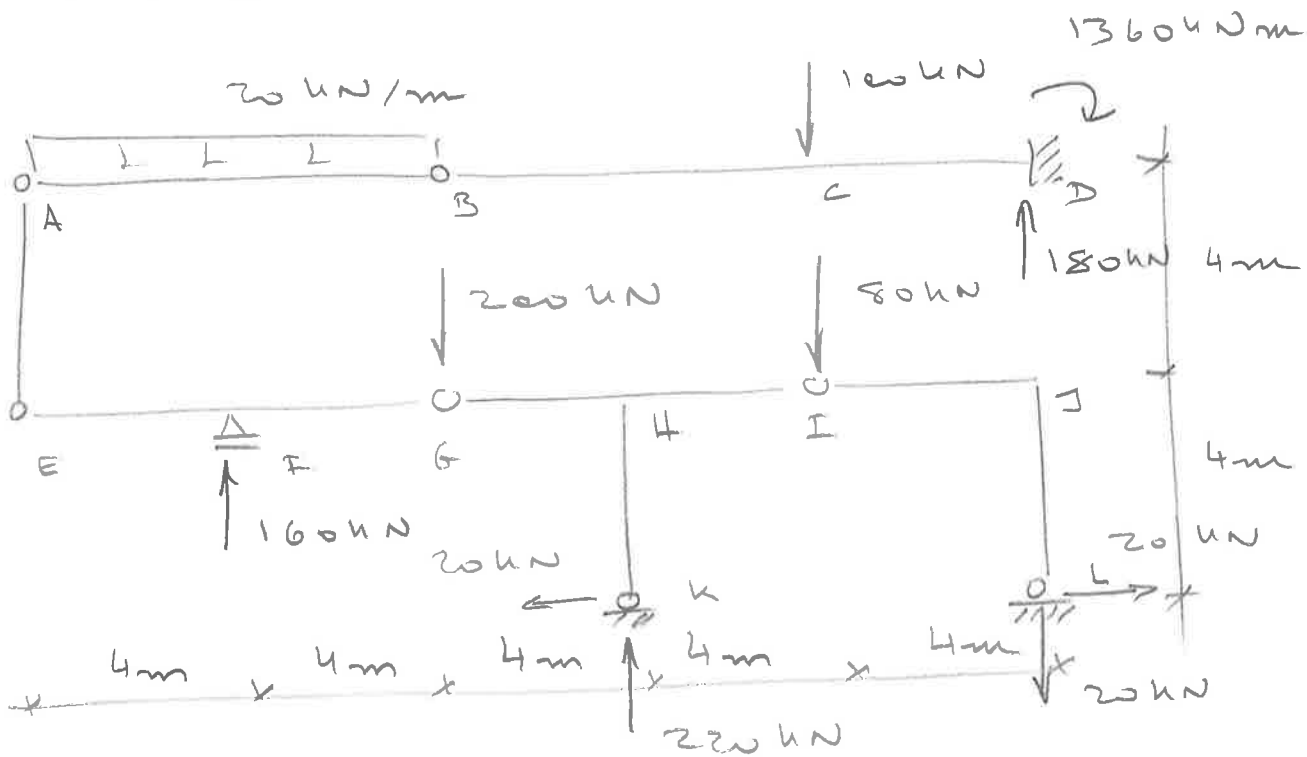
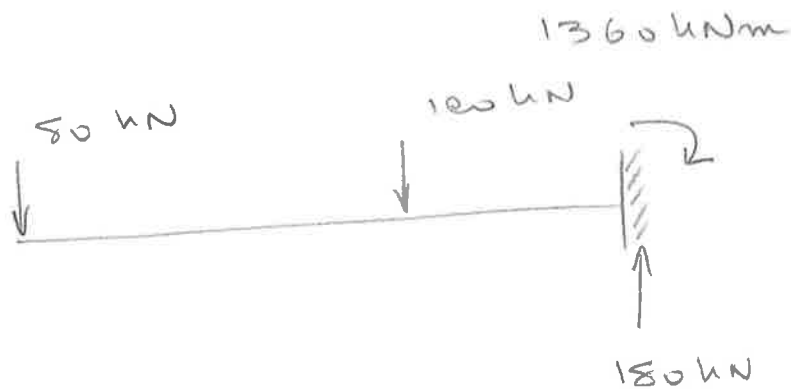

vija tringles mure a gorada
len nalamy a espur da

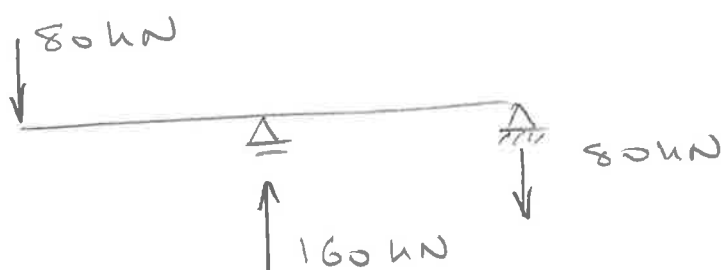

görsel olarak anlatıldı

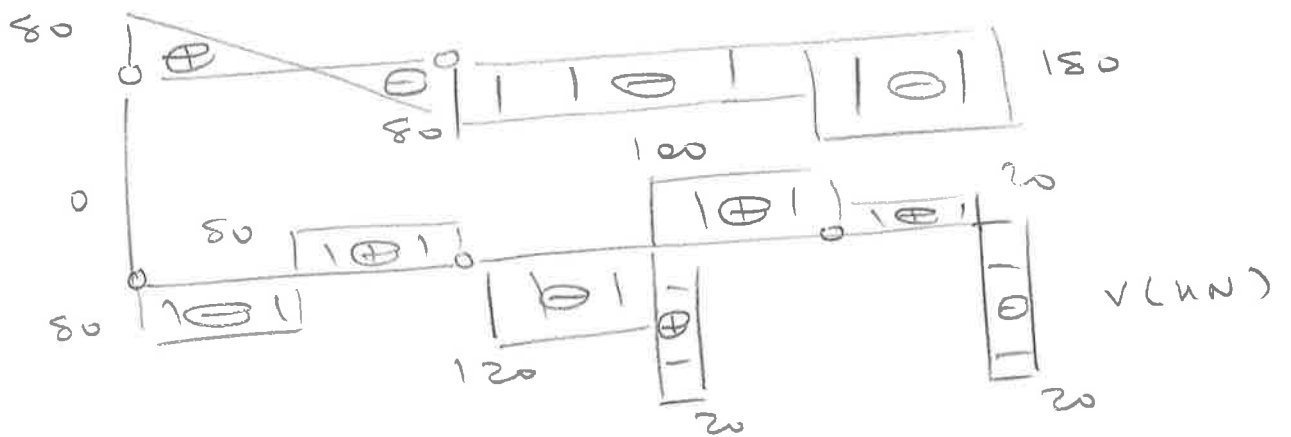
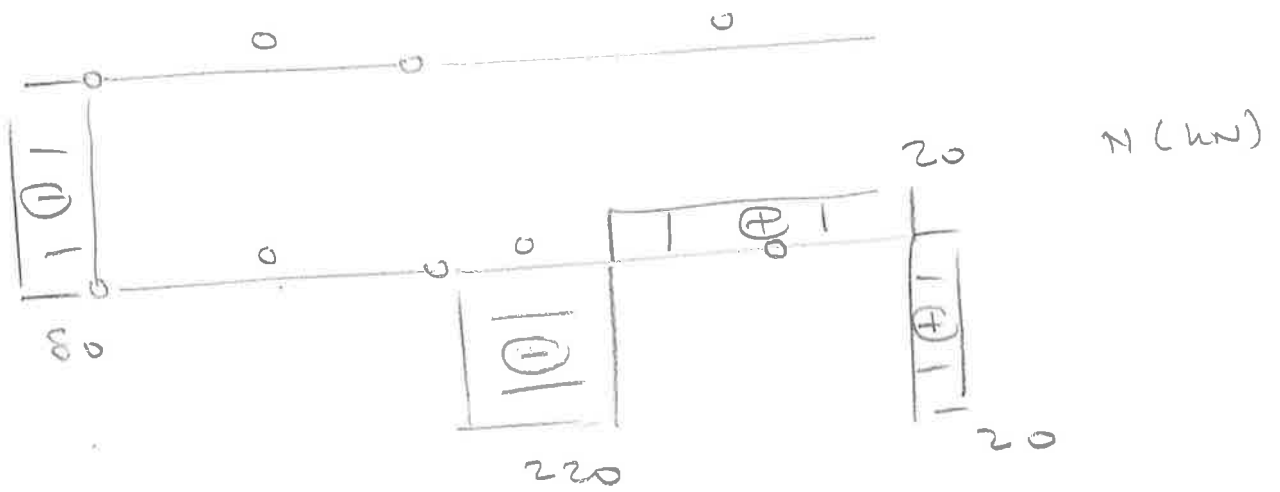
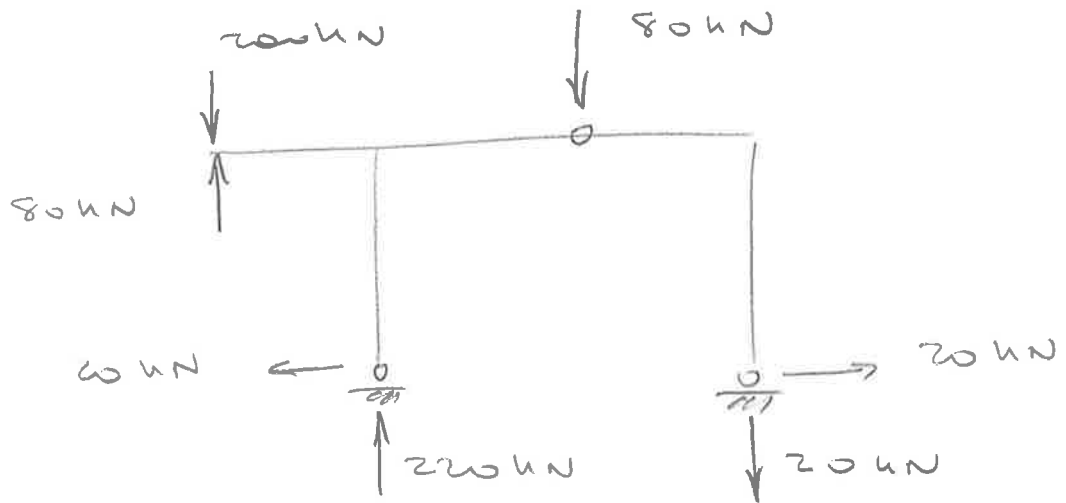

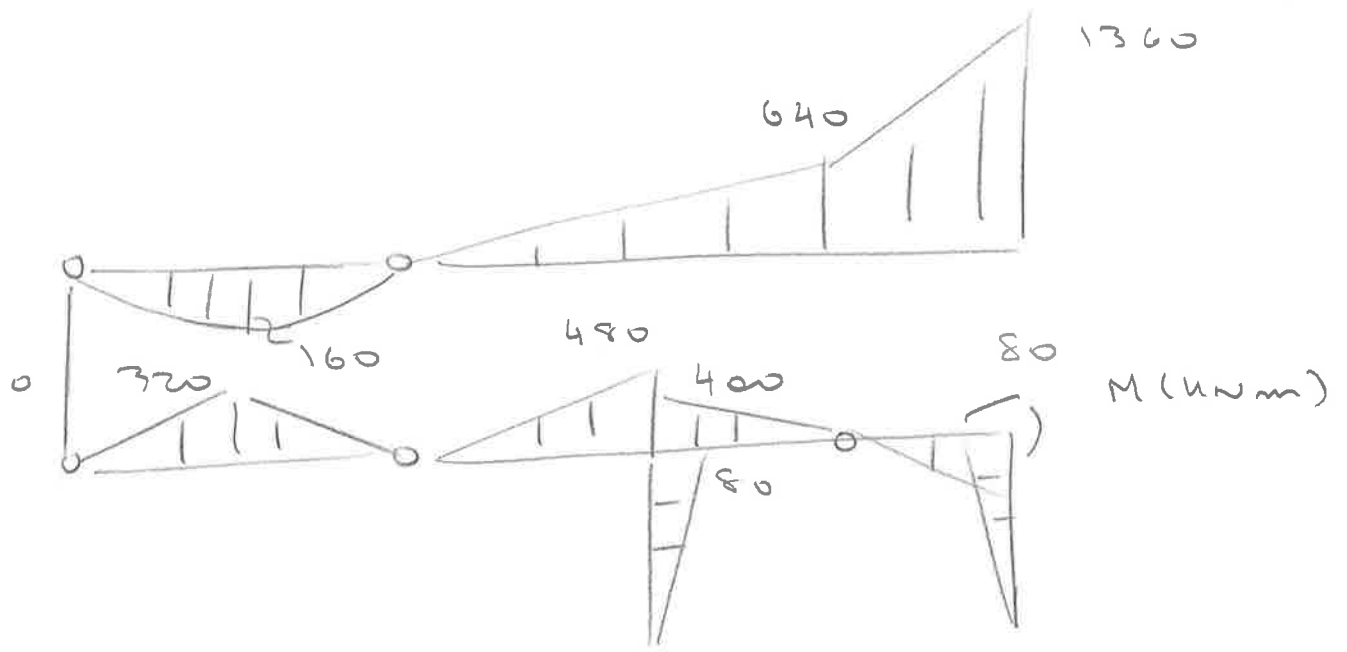

1 - 0,75

2 - N 0,5

V 0,75

M 1,0

3 - 0,5

Nº USP: _____ Nome: _____

3ª Questão (3,5 pts)

Dada a estrutura associada abaixo:

- 1) Decompor-na nas subestruturas que a formam, identificando o nome do sistema estrutural de cada uma dessas subestruturas;
- 2) Traçar os diagramas de esforços solicitantes de toda a estrutura;
- 3) Determinar as reações de apoio da estrutura associada.

