

A Coupled Mode Formulation by Reciprocity and a Variational Principle

SHUN-LIEN CHUANG, MEMBER, IEEE

Abstract—A coupled mode formulation for parallel dielectric waveguides is presented via two methods: a reciprocity theorem and a variational principle. In the first method, a generalized reciprocity relation for two sets of field solutions ($E^{(1)}, H^{(1)}$) and ($E^{(2)}, H^{(2)}$) satisfying Maxwell's equations and the boundary conditions in two different media $\epsilon^{(1)}(x, y)$ and $\epsilon^{(2)}(x, y)$, respectively, is derived. Based on the generalized reciprocity theorem, we then formulate the coupled mode equations. The second method using a variational principle is also presented for a general waveguide system which can be lossy. The results of the variational principle can also be shown to be identical to those from the reciprocity theorem. The exact relations governing the "conventional" and the new coupling coefficients are derived. It is shown analytically that our formulation satisfies the reciprocity theorem and power conservation exactly, while the conventional theory violates the power conservation and reciprocity theorem by as much as 55 percent and the Hardy-Streifer theory by 0.033 percent, for example.

I. INTRODUCTION

THE COUPLED mode theory has been very useful in the fields of integrated optics, semiconductor laser arrays or microstrip coupled transmission lines. A "conventional" coupled mode theory usually makes use of a perturbation theory to calculate the coupling coefficients [1], [2]. It has been recognized that a simple power conservation argument for the powers in individual waveguides leads to the fact that the two coupling coefficients K_{ab} and K_{ba} are complex conjugate of each other, which is generally not true if the guides are not identical [3]. A more rigorous approach has been recently proposed and very good numerical results have also been presented [3]–[5]. However, there is still considerable ambiguity about the reciprocity and the power conservation in the coupled mode theory. One knows that both the reciprocity relation and the power conservation are the two basic laws which must be obeyed and they are usually used in electromagnetics as necessary conditions to check the numerical accuracy [6], [7] of the results. The reciprocity relation is applied to the fields and is applicable to a lossy medium. Thus, most results derived from the reciprocity relations do not contain any complex conjugate quantities. If the medium is lossless, the complex conjugate of the permittivity ϵ^* equals to ϵ itself, one then applies the conjugate fields to the reciprocity relation. On the other hand, the power conservation deals with the power and, thus, the complex conjugate quantities are usually used.

Manuscript received April 11, 1986; revised June 4, 1986. This work was partially supported by NASA grant NAG 1-500.

The author is with the Department of Electrical and Computer Engineering, university of Illinois at Urbana-Champaign, Urbana, IL 61801.
IEEE Log Number 8611065.

The goal of this paper is to present new coupled mode equations and analytical relations for the coupling coefficients which follow the reciprocity theorem in a general lossy medium, and then the power conservation law if the medium becomes lossless. This new formulation removes the slight discrepancies of the power conservation encountered in a previous theory presented in [3], [5]. The analytical relation governing the coupling coefficients K_{ab} and K_{ba} is derived from a reciprocity relation for the fields instead of the power conservation law for the intensity. Thus, it is also applicable to any lossy (or gain) waveguide system.

The general reciprocity relation and the derivation of the new coupled mode equations are presented in Section II-A. A variational principle for a general lossy or lossless medium is presented in Section II-B while a previous method is limited to a lossless system [8]. We show that our formulation using the variational principle is identical to that of the formulation based on the reciprocity relation. In Section III, we derive the relation between the coupling coefficients and the propagation constants used in the coupled-mode equations. Note that this derivation is independent of the procedure in which one calculates those coupling coefficients and the propagation constants. We also show that the coupling coefficients and the propagation constants derived in Section II-A and Section II-B for the coupled mode equations do satisfy the reciprocity relation analytically. For a lossless case, the power conservation relation is derived from the reciprocity relation also. Finally, we present some numerical results and compare them with those of the previous theories. It is also demonstrated that an error of 55 percent in the power conservation using a previous theory [2] can occur unless the overlap integrals C_{pq} are taken into account properly. An error of 0.033 percent occurs using the Hardy-Streifer theory [3]–[5]. It is noted that the Hardy-Streifer theory, the theory of Haus *et al.* [8], and the present one give numerical results almost indistinguishable on the plots of propagation constants and coupling coefficients for the examples considered so far, although slight differences exist among the three theories.

II. FORMULATION

A. Coupled Mode Theory from a Generalized Reciprocity Theorem

In this section, we present a "generalized" reciprocity theorem for two sets of solutions ($E^{(1)}, H^{(1)}$) and ($E^{(2)},$

$H^{(2)}$) to Maxwell's equations in *two* media $\epsilon^{(1)}$ and $\epsilon^{(2)}$ respectively. Based on the generalized reciprocity theorem, we show by choosing various $\epsilon^{(1)}$ and $\epsilon^{(2)}$, and their corresponding field solutions, two exact relations for the conventional coupling coefficients K_{ab} and K_{ba} for two waveguides *a* and *b* can be derived in Cases A1 and A2. We then derive the coupled-mode equations in Cases A3 and A4. A different approach using the variational principle for waveguide systems will be presented in Section II-B, and identical results of the two approaches are also illustrated.

1. *A Generalized Reciprocity Theorem for Two Media $\epsilon^{(1)}(x, y)$ and $\epsilon^{(2)}(x, y)$* : Consider the first two Maxwell's equations in a medium $\epsilon^{(1)}(x, y)$

$$\nabla \times \mathbf{E}^{(1)} = i\omega\mu\mathbf{H}^{(1)} \quad (1a)$$

$$\nabla \times \mathbf{H}^{(1)} = -i\omega\epsilon^{(1)}\mathbf{E}^{(1)} \quad (1b)$$

where the fields $(\mathbf{E}^{(1)}, \mathbf{H}^{(1)})$ satisfy all the Maxwell's equations and the boundary conditions in the medium $\epsilon^{(1)}(x, y)$. For a different medium $\epsilon^{(2)}(x, y)$, the fields $(\mathbf{E}^{(2)}, \mathbf{H}^{(2)})$ satisfy a similar set of equations and also the boundary conditions in $\epsilon^{(2)}$. Following similar procedures for the Lorentz reciprocity theorem, we obtain

$$\begin{aligned} \nabla \cdot (\mathbf{E}^{(1)} \times \mathbf{H}^{(2)} - \mathbf{E}^{(2)} \times \mathbf{H}^{(1)}) \\ = i\omega(\epsilon^{(2)} - \epsilon^{(1)})\mathbf{E}^{(1)} \cdot \mathbf{E}^{(2)}. \end{aligned} \quad (2)$$

If we apply the above relation to an infinitesimal section Δz of a cylindrical geometry which is translational invariant in the z direction, we obtain

$$\begin{aligned} \frac{\partial}{\partial z} \iint (\mathbf{E}^{(1)} \times \mathbf{H}^{(2)} - \mathbf{E}^{(2)} \times \mathbf{H}^{(1)}) \cdot \hat{z} \, dx \, dy \\ = i\omega \iint (\epsilon^{(2)}(x, y) - \epsilon^{(1)}(x, y))\mathbf{E}^{(1)} \cdot \mathbf{E}^{(2)} \, dx \, dy \end{aligned} \quad (3)$$

where the divergence theorem has been used. A similar equation using the polarization vector has been derived before [1]. However, our interpretation using $\epsilon^{(2)}$ and $\epsilon^{(1)}$ instead of the polarization vector is slightly different and will be shown to be very useful. We note that the above relations are *exact* as long as the fields $(\mathbf{E}^{(1)}, \mathbf{H}^{(1)})$ satisfy the Maxwell equations and all the boundary conditions in the medium $\epsilon^{(1)}(x, y)$ and $(\mathbf{E}^{(2)}, \mathbf{H}^{(2)})$ in the medium $\epsilon^{(2)}(x, y)$, respectively. The above reciprocity relation is applicable to any two reciprocal media and is exact, while most reciprocity relations are applied to only one reciprocal medium with a polarization vector introduced and approximated using a perturbation approach. The advantage of using the above exact relation will be shown in the next few cases when applied to a coupled-waveguide system. The time convention $\exp(-i\omega t)$ will be adopted in this paper.

Case A1: We choose first

$$\epsilon^{(1)}(x, y) = \epsilon^{(a)}(x, y) \quad (4)$$

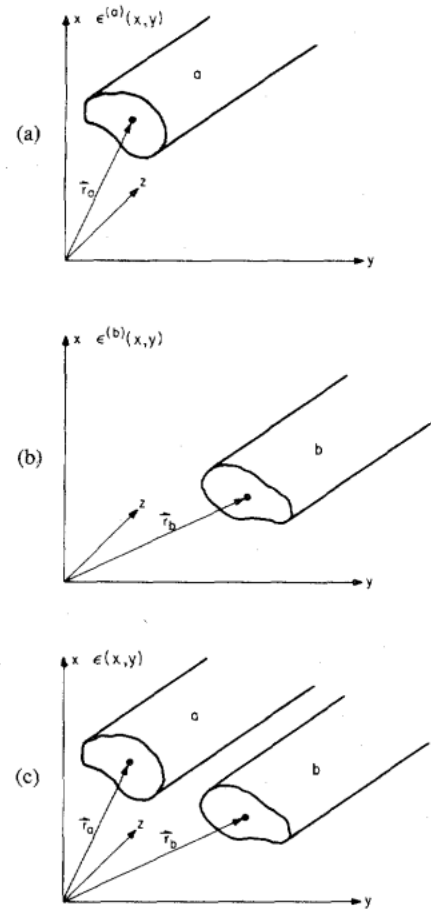

Fig. 1. Schematic diagrams for various media under consideration: (a) $\epsilon^{(a)}(x, y)$ with a single waveguide *a*. (b) $\epsilon^{(b)}(x, y)$ with a single waveguide *b*. (c) $\epsilon(x, y)$ with both waveguides *a* and *b*.

where $\epsilon^{(a)}(x, y)$ is a single waveguide *a* as shown in Fig. 1(a), and we choose the solutions to be a guided mode propagating in the $+z$ direction

$$\mathbf{E}^{(1)} = \mathbf{E}^{(a)+}(x, y) e^{i\beta_a z} = (\mathbf{E}_t^{(a)} + \hat{z}\mathbf{E}_z^{(a)}) e^{i\beta_a z} \quad (5a)$$

$$\mathbf{H}^{(1)} = \mathbf{H}^{(a)+}(x, y) e^{i\beta_a z} = (\mathbf{H}_t^{(a)} + \hat{z}\mathbf{H}_z^{(a)}) e^{i\beta_a z}. \quad (5b)$$

We then choose

$$\epsilon^{(2)}(x, y) = \epsilon^{(b)}(x, y) \quad (6)$$

and

$$\mathbf{E}^{(2)} = \mathbf{E}^{(b)-}(x, y) e^{-i\beta_b z} = (\mathbf{E}_t^{(b)} - \hat{z}\mathbf{E}_z^{(b)}) e^{-i\beta_b z} \quad (7a)$$

$$\mathbf{H}^{(2)} = \mathbf{H}^{(b)-}(x, y) e^{-i\beta_b z} = (-\mathbf{H}_t^{(b)} + \hat{z}\mathbf{H}_z^{(b)}) e^{-i\beta_b z} \quad (7b)$$

which are the guided modes propagating in the $-z$ direction for another waveguide *b* as shown in Fig. 1(b). Substituting the above two sets of solutions into the reciprocity relation (3), we obtain

$$\bar{K}_{ba} - \bar{K}_{ab} = \frac{1}{2}(C_{ab} + C_{ba})(\beta_b - \beta_a) \quad (8)$$

where

$$\bar{K}_{pq} = \frac{\omega}{4} \iint_{-\infty}^{\infty} \Delta \epsilon^{(q)} (\mathbf{E}_t^{(p)} \cdot \mathbf{E}_t^{(q)} - E_z^{(p)} E_z^{(q)}) dx dy \quad (9)$$

$$C_{pq} = \frac{1}{2} \iint_{-\infty}^{\infty} \mathbf{E}_t^{(q)} \times \mathbf{H}_t^{(p)} \cdot \hat{z} dx dy \quad (10)$$

and

$$\Delta \epsilon^{(q)}(x, y) = \epsilon(x, y) - \epsilon^{(q)}(x, y), \quad q = a, b \quad (11)$$

which are defined almost identically to those used in [3] except a constant factor of 4. The choice of the background $\epsilon(x, y)$ is not unique (in general). Here, it is chosen to be the coupled waveguide system (Fig. 1(c)) for convenience. One notes that \bar{K}_{pq} 's are the "conventional" coupling coefficients except for the z components in the last term of the integrand [2]. Note that Equation (8) is an exact relation as long as the field solutions for each waveguide system $\epsilon^{(a)}(x, y)$ and $\epsilon^{(b)}(x, y)$ are exact. For a slab waveguide structure, the exact solutions are known and the identity (8) can also be proved analytically since all the quantities \bar{K}_{pq} and \bar{C}_{pq} can be derived. That proof is mathematically laborious but straightforward, and will not be shown here. Equation (8) is also a very useful relation in checking the numerical accuracies of the "coupling coefficients" in the computer program. One sees clearly that in general $\bar{K}_{ba} \neq \bar{K}_{ab}$ when $\beta_b \neq \beta_a$. Equation (8) shows the precise relation that the difference between the coupling coefficients is equal to the difference between the two propagation constants multiplied by the average of the overlap integrals C_{ab} and C_{ba} . In the limit of extremely weak coupling $C_{ab}, C_{ba} \ll 1$, we have $\bar{K}_{ba} = \bar{K}_{ab}$, which is the reciprocity relation under the very weak coupling condition in a conventional analysis.

Case A2: We choose

$$\epsilon^{(1)}(x, y) = \epsilon^{(a)}(x, y) \quad (12)$$

$$\mathbf{E}^{(1)} = \mathbf{E}^{(a)+}(x, y) e^{i\beta_a z} \quad (13a)$$

$$\mathbf{H}^{(1)} = \mathbf{H}^{(a)+}(x, y) e^{i\beta_a z} \quad (13b)$$

and

$$\epsilon^{(2)}(x, y) = \epsilon^{(b)}(x, y) \quad (14)$$

$$\mathbf{E}^{(2)} = \mathbf{E}^{(b)+}(x, y) e^{i\beta_b z} \quad (15a)$$

$$\mathbf{H}^{(2)} = \mathbf{H}^{(b)+}(x, y) e^{i\beta_b z} \quad (15b)$$

Both fields are propagating in the $+z$ direction. We obtain from (3)

$$(\bar{K}_{ba}^t + \bar{K}_{ba}^z) - (\bar{K}_{ab}^t + \bar{K}_{ab}^z) = \frac{1}{2} (C_{ba} - C_{ab})(\beta_b + \beta_a) \quad (16)$$

where

$$\bar{K}_{pq}^t = \frac{\omega}{4} \iint \Delta \epsilon^{(q)} \mathbf{E}_t^{(p)} \cdot \mathbf{E}_t^{(q)} dx dy \quad (17a)$$

and

$$\bar{K}_{pq}^z = \frac{\omega}{4} \iint \Delta \epsilon^{(q)} E_z^{(p)} E_z^{(q)} dx dy. \quad (17b)$$

Note from (9):

$$\bar{K}_{pq} = \bar{K}_{pq}^t - \bar{K}_{pq}^z. \quad (17c)$$

(If only TE modes are excited, we have $E_z^{(p)} = 0$, $p = a, b$; thus, $\bar{K}_{pq}^z = 0$. Equations (8) and (16) will lead to $C_{ba}\beta_a = C_{ab}\beta_b$.) In general, relations between \bar{K}_{ab}^t and \bar{K}_{ba}^t , or \bar{K}_{ab}^z and \bar{K}_{ba}^z can also be derived from (8) and (16). In the following cases, we apply the reciprocity relation to the coupled waveguide medium $\epsilon(x, y)$ as shown in Fig. 1(c), and derive the new coupled mode equations.

Case A3: We choose

$$\epsilon^{(1)}(x, y) = \epsilon(x, y) \quad (18)$$

and

$$\mathbf{E}_t^{(1)} \approx a(z) \mathbf{E}_t^{(a)+}(x, y) + b(z) \mathbf{E}_t^{(b)+}(x, y) \quad (19a)$$

$$\mathbf{H}_t^{(1)} \approx a(z) \mathbf{H}_t^{(a)+}(x, y) + b(z) \mathbf{H}_t^{(b)+}(x, y) \quad (19b)$$

for the transverse components. The above relations are just the modal expansions in terms of the two guided modes in waveguides a and b . We also note that the above expansion is only an approximate set of solutions to the Maxwell equations in the coupled-waveguide medium $\epsilon(x, y)$ and the radiation mode has been neglected. Both waveguides a and b are assumed to support only a single TE (or TM) mode. The extension to a multiple mode waveguide is straightforward by including a summation over all the guided modes in each waveguide. The longitudinal components of the fields follow from Maxwell's equations for the waveguides

$$\mathbf{E}_z^{(1)} \approx a(z) \frac{\epsilon^{(a)}}{\epsilon} \mathbf{E}_z^{(a)}(x, y) + b(z) \frac{\epsilon^{(b)}}{\epsilon} \mathbf{E}_z^{(b)}(x, y) \quad (20a)$$

$$\mathbf{H}_z^{(1)} \approx a(z) \mathbf{H}_z^{(a)}(x, y) + b(z) \mathbf{H}_z^{(b)}(x, y). \quad (20b)$$

A derivation of the above two components in (20a) and (20b) is given in Appendix A. A similar relation has been given for the z -component of the polarization vector in [1], and used in [3]–[5]. The factors $\epsilon^{(a)}/\epsilon$ and $\epsilon^{(b)}/\epsilon$ in (20a) have been ignored in [8]. We think they should be kept for consistency with the Maxwell equations as shown in Appendix A.

For the second set of solutions, we choose the medium for a single waveguide a

$$\epsilon^{(2)}(x, y) = \epsilon^{(a)}(x, y) \quad (21)$$

and the guided mode solutions in the $-z$ direction

$$\mathbf{E}^{(2)} = \mathbf{E}^{(a)-}(x, y) e^{-i\beta_a z} \quad (22a)$$

$$\mathbf{H}^{(2)} = \mathbf{H}^{(a)-}(x, y) e^{-i\beta_a z}. \quad (22b)$$

We obtain from (3)

$$\begin{aligned} \frac{da(z)}{dz} + \frac{C_{ab} + C_{ba}}{2} \frac{db(z)}{dz} &= i(\beta_a + \tilde{K}_{aa}) a(z) \\ &+ i \left(\beta_a \frac{C_{ab} + C_{ba}}{2} + \tilde{K}_{ba} \right) b(z) \end{aligned} \quad (23)$$

where

$$\tilde{K}_{pq} = \frac{\omega}{4} \iint \Delta \epsilon^{(q)} (\mathbf{E}_t^{(p)} \cdot \mathbf{E}_t^{(q)} - \frac{\epsilon^{(p)}}{\epsilon} E_z^{(p)} E_z^{(q)}) dx dy. \quad (24)$$

To keep the same convention as in \bar{K}_{pq} , the order p, q for the definition of \tilde{K}_{pq} is reversed from that in [3], and for later use. It is straightforward to show that \tilde{K}_{pq} satisfies the same relation (8) as \bar{K}_{pq} by observing that

$$\tilde{K}_{pq} = \bar{K}_{pq} + \frac{\omega}{4} \iint \Delta \epsilon^{(q)} \frac{\Delta \epsilon^{(p)}}{\epsilon} E_z^{(p)} E_z^{(q)} dx dy \quad (25)$$

where the second term is symmetrical when we exchange p and q . Thus,

$$\tilde{K}_{pq} - \tilde{K}_{qp} = \bar{K}_{pq} - \bar{K}_{qp} = \frac{1}{2} (C_{pq} + C_{qp})(\beta_p - \beta_q) \quad (26)$$

which are exact relations.

Case A4: We choose

$$\epsilon^{(1)}(x, y) = \epsilon(x, y)$$

and $(\mathbf{E}_t^{(1)}, \mathbf{H}_t^{(1)})$ and $(\mathbf{E}_z^{(1)}, \mathbf{H}_z^{(1)})$ to be the same as in the first set of solutions (19)–(20) in Case A3. We use for the second set of solutions

$$\epsilon^{(2)}(x, y) = \epsilon^{(b)}(x, y) \quad (27)$$

$$\mathbf{E}^{(2)} = \mathbf{E}^{(b)-}(x, y) e^{-i\beta_b z} \quad (28a)$$

$$\mathbf{H}^{(2)} = \mathbf{H}^{(b)-}(x, y) e^{-i\beta_b z}. \quad (28b)$$

We obtain again from (3)

$$\begin{aligned} \frac{C_{ab} + C_{ba}}{2} \frac{da(z)}{dz} + \frac{db(z)}{dz} \\ = i \left(\beta_b \frac{C_{ab} + C_{ba}}{2} + \tilde{K}_{ab} \right) a(z) + i(\beta_b + \tilde{K}_{bb}) b(z). \end{aligned} \quad (29)$$

2. *Coupled Mode Equations:* Based on the results in Cases A3 and A4, we obtain the coupled mode equations

$$\bar{C} \frac{d}{dz} \begin{bmatrix} a(z) \\ b(z) \end{bmatrix} = iS \begin{bmatrix} a(z) \\ b(z) \end{bmatrix} \quad (30)$$

where the matrix elements for \bar{C} and S are

$$\bar{C}_{pq} = \bar{C}_{qp} = \frac{C_{pq} + C_{qp}}{2}$$

where

$$p, q = a, b \text{ (or } 1, 2) \quad (31)$$

$$S_{pq} = \tilde{K}_{qp} + \beta_p \left(\frac{C_{pq} + C_{qp}}{2} \right) \quad (32a)$$

$$= \tilde{K}_{pq} + \bar{C}_{pq} \beta_q \quad (32b)$$

and where C_{pq} and \tilde{K}_{pq} are defined in (10) and (24), respectively, and (26) has been used in (32). We note that $\bar{C}_{11} = \bar{C}_{22} = C_{11} = C_{22} = 1$, and the matrix \bar{C} is symmetric. The matrix S_{pq} is obviously symmetric following (32).

Let

$$\bar{c} = \frac{C_{ab} + C_{ba}}{2}.$$

We invert the matrix \bar{C} and obtain the coupled mode equations

$$\frac{da}{dz} = i\gamma_a a + iK_{ab} b \quad (33a)$$

$$\frac{db}{dz} = i\gamma_b b + iK_{ba} a \quad (33b)$$

where

$$\begin{aligned} \gamma_a &= \beta_a + [\tilde{K}_{aa} + (\beta_a - \beta_b)\bar{c}^2 - \tilde{K}_{ab}\bar{c}]/(1 - \bar{c}^2) \\ &= \beta_a + [\tilde{K}_{aa} - \tilde{K}_{ba}\bar{c}]/(1 - \bar{c}^2) \end{aligned} \quad (34a)$$

$$\begin{aligned} \gamma_b &= \beta_b + [\tilde{K}_{bb} + (\beta_b - \beta_a)\bar{c}^2 - \tilde{K}_{ba}\bar{c}]/(1 - \bar{c}^2) \\ &= \beta_b + [\tilde{K}_{bb} - \tilde{K}_{ab}\bar{c}]/(1 - \bar{c}^2) \end{aligned} \quad (34b)$$

$$\begin{aligned} K_{ab} &= [\tilde{K}_{ba} + (\beta_a - \beta_b - \tilde{K}_{bb})\bar{c}]/(1 - \bar{c}^2) \\ &= (\tilde{K}_{ab} - \tilde{K}_{bb}\bar{c})/(1 - \bar{c}^2) \end{aligned} \quad (34c)$$

$$\begin{aligned} K_{ba} &= [\tilde{K}_{ab} + (\beta_b - \beta_a - \tilde{K}_{aa})\bar{c}]/(1 - \bar{c}^2) \\ &= (\tilde{K}_{ba} - \tilde{K}_{aa}\bar{c})/(1 - \bar{c}^2) \end{aligned} \quad (34d)$$

where the first form in each equation is to compare with that in [3], and the second form is simplified after making use of (26) or (32b). One should know that although the matrices \bar{C} and S are both symmetric, $\bar{C}^{-1}S$ is not symmetric in general. That is, $K_{ab} \neq K_{ba}$, unless we have two identical waveguides. This does not violate the reciprocity theorem or the power conservation law as will be presented rigorously later.

B. Coupled Mode Theory From a Variational Principle Applicable to a Lossy Medium

Variational principle has been widely used to study the resonators, the waveguides or scattering from objects [9], [10]. A general variational formula for the propagation

constant γ of the coupled waveguide system $\epsilon(x, y)$ can be derived from two oppositely traveling modes of the system

$$\nabla_t \times \mathbf{E}^+ - i\omega\mu\mathbf{H}^+ = -i\gamma\hat{z} \times \mathbf{E}^+ \quad (35a)$$

$$\nabla_t \times \mathbf{H}^+ + i\omega\epsilon\mathbf{E}^+ = -i\gamma\hat{z} \times \mathbf{H}^+ \quad (35b)$$

$$\nabla_t \times \mathbf{E}^- - i\omega\mu\mathbf{H}^- = i\gamma\hat{z} \times \mathbf{E}^- \quad (36a)$$

$$\nabla_t \times \mathbf{H}^- + i\omega\epsilon\mathbf{E}^- = i\gamma\hat{z} \times \mathbf{H}^- \quad (36b)$$

Dot multiplying (35a) by \mathbf{H}^- and (35b) by \mathbf{E}^- , and adding the results, we obtain

$$\begin{aligned} \gamma &= \frac{\frac{1}{4i} \iint [\mathbf{E}^- \cdot (\nabla_t \times \mathbf{H}^+ + i\omega\epsilon\mathbf{E}^+) + \mathbf{H}^- \cdot (\nabla_t \times \mathbf{E}^+ - i\omega\mu\mathbf{H}^+)] dx dy}{\frac{1}{4} \iint (\mathbf{H}^- \times \mathbf{E}^+ + \mathbf{E}^- \times \mathbf{H}^+) \cdot \hat{z} dx dy} \\ &\equiv \frac{N}{D} \end{aligned} \quad (37)$$

where N and D denote, respectively, the numerator and the denominator in (37). A similar form to (37) has been derived in [8], [10]–[12], except that we keep \mathbf{H}^- , \mathbf{E}^+ , etc., in the denominator which will be shown to be necessary in the following case.

It is straightforward to show that (37) is a variational formula for the propagation constant γ by taking the first variation in γ , $\delta\gamma$, from the trial fields

$$\mathbf{E}^\pm = \mathbf{E}_0^\pm + \delta\mathbf{E}^\pm \quad (38a)$$

$$\mathbf{H}^\pm = \mathbf{H}_0^\pm + \delta\mathbf{H}^\pm \quad (38b)$$

where \mathbf{E}_0^\pm and \mathbf{H}_0^\pm are assumed to be the exact solutions. That is, using (35) and (36) for \mathbf{E}_0^\pm , \mathbf{H}_0^\pm and γ_0 , one finds

$$\delta\gamma = \frac{1}{D_0} \left[\delta N - \frac{N_0}{D_0} \delta D \right] = \frac{1}{D_0} [\delta N - \gamma_0 \delta D] = 0 \quad (39)$$

where N_0 and D_0 are the expressions in (37) evaluated using \mathbf{E}_0^\pm and \mathbf{H}_0^\pm . Thus any deviations of first order in $\delta\mathbf{E}^\pm$ and $\delta\mathbf{H}^\pm$ only result in errors of second order $(\delta\mathbf{E}^\pm)^2$ and $(\delta\mathbf{H}^\pm)^2$ in γ .

We choose the trial functions to be

$$\mathbf{E}_t^+ \approx a_1^+ \mathbf{E}_t^{(a)+} + a_2^+ \mathbf{E}_t^{(b)+} \quad (40a)$$

$$\mathbf{H}_t^+ \approx a_1^+ \mathbf{H}_t^{(a)+} + a_2^+ \mathbf{H}_t^{(b)+} \quad (40b)$$

for the transverse components of the fields propagating in the $+z$ direction. Here the subscript 1 refers to a , or waveguide a , and 2 for b for convenience. We also choose

$$\mathbf{E}_t^- \approx a_1^- \mathbf{E}_t^{(a)-} + a_2^- \mathbf{E}_t^{(b)-} \quad (41a)$$

$$\mathbf{H}_t^- \approx a_1^- \mathbf{H}_t^{(a)-} + a_2^- \mathbf{H}_t^{(b)-} \quad (41b)$$

for the transverse components of the fields propagating in the $-z$ direction. The longitudinal components are found

to be (Appendix A):

$$\mathbf{E}_z^\pm = a_1^\pm \frac{\epsilon^{(a)}}{\epsilon} \mathbf{E}_z^{(a)\pm} + a_2^\pm \frac{\epsilon^{(b)}}{\epsilon} \mathbf{E}_z^{(b)\pm} \quad (42a)$$

$$\mathbf{H}_z^\pm = a_1^\pm \mathbf{H}_z^{(a)\pm} + a_2^\pm \mathbf{H}_z^{(b)\pm} \quad (42b)$$

where a_1^+ , a_2^+ are, in general, independent of a_1^- and a_2^- . The variational formula can be put in a quotient of two quadratic forms

$$\gamma = \frac{\sum_{p,q} Q_{pq} a_p^- a_q^+}{\sum_{p,q} \bar{C}_{pq} a_p^- a_q^+} \quad (43)$$

where $p, q = 1, 2$ or a, b in a two-waveguide system. The matrix elements \bar{C}_{pq} are defined as (31). The derivation of the matrix elements Q_{pq} 's is more complicated and is given by

$$\begin{aligned} Q_{pq} &= \frac{1}{4} \iint \left[\omega \Delta \epsilon^{(q)} \mathbf{E}_t^{(p)-} \cdot \mathbf{E}_t^{(q)+} \right. \\ &\quad - \beta_q \mathbf{E}_t^{(p)-} \cdot \hat{z} \times \mathbf{H}_t^{(q)+} \\ &\quad - \beta_q \mathbf{H}_t^{(p)-} \cdot \hat{z} \times \mathbf{E}_t^{(q)+} \\ &\quad \left. + i \mathbf{H}^{(p)-} \cdot \nabla_t \times \left(\frac{\Delta \epsilon^{(q)}}{\epsilon} \mathbf{E}_z^{(q)+} \right) \right] dx dy \end{aligned} \quad (44)$$

where various relations such as those in Appendix A have been used. Using some vector identity and integration by parts for the last term in (44):

$$\begin{aligned} &\iint i \mathbf{H}^{(p)-} \cdot \nabla_t \times \left(\hat{z} \frac{\Delta \epsilon^{(q)}}{\epsilon} \mathbf{E}_z^{(q)+} \right) dx dy \\ &= \iint \omega \epsilon^{(p)} \frac{\Delta \epsilon^{(q)}}{\epsilon} \mathbf{E}_z^{(p)-} \mathbf{E}_z^{(q)+} dx dy. \end{aligned} \quad (45)$$

We simplify Q_{pq}

$$\begin{aligned} Q_{pq} &= \frac{1}{4} \iint \left[\omega \Delta \epsilon^{(q)} \mathbf{E}_t^{(p)-} \cdot \mathbf{E}_t^{(q)+} - \omega \Delta \epsilon^{(q)} \frac{\epsilon^{(p)}}{\epsilon} \mathbf{E}_z^{(p)-} \mathbf{E}_z^{(q)+} \right] \\ &\quad \cdot dx dy + \left(\frac{C_{pq} + C_{qp}}{2} \right) \beta_q \\ &= \bar{K}_{pq} + \bar{C}_{pq} \beta_q \\ &= S_{pq}. \end{aligned} \quad (46)$$

Thus it is clear that Q_{pq} is identical to S_{pq} .

The propagation constant γ of the supermode is determined from the variational formula (37). We thus take the partial derivative with respect to a_p^- regarding the amplitudes of the positive traveling waves a_q^+ to be independent of a_p^-

$$\frac{\partial \gamma(a_p^-, a_q^+)}{\partial a_p^-} = 0 \quad (47)$$

and obtain

$$\gamma \sum_q \bar{C}_{pq} a_q^+ = \sum_q Q_{pq} a_q^+ \quad (48)$$

where we have made use of (43) again.

Noting that

$$\frac{d}{dz} \rightarrow i\gamma$$

for the system mode, we obtain the coupled-mode equation

$$\bar{C} \frac{d}{dz} \begin{bmatrix} a_1 \\ a_2 \end{bmatrix} = iQ \begin{bmatrix} a_1 \\ a_2 \end{bmatrix} \quad (49)$$

which is identical to the coupled-mode equation (30) derived in Section II-A since $Q = S$. If one takes partial derivative with respect to a_q^+ in (47), one obtains identical results as (49) since both \bar{C} and Q are symmetric.

III. RECIPROCITY AND POWER CONSERVATION

Almost all the previous theories use the power conservation to find the relation between the two coupling coefficients K_{ab} and K_{ba} . That would lead to erroneous results since $K_{ab} \neq K_{ba}^*$, in general, if two waveguides are not identical. An approximate theory from a more rigorous approach indicates some clue to the reciprocity relation by a power conservation argument but the results still contain some small discrepancies [3]. The explanation given in [3] was that they are due to the neglect of the radiation modes. In this section, we show that reciprocal relations can indeed be satisfied *analytically* and the precise analytical relation of K_{ab} to K_{ba} can be obtained, and the radiation field can be ignored from the beginning. The relation derived here should be obeyed and our coupled mode theory does satisfy this analytical relation.

A. Reciprocity Relations

Let us apply the reciprocity relation (2) to the two waveguide system described by $\epsilon(x, y)$ (Fig. 2). We choose $\epsilon^{(1)}(x, y) = \epsilon^{(2)}(x, y) = \epsilon(x, y)$, and the two sets of solutions

$$E_i^{(1)} = a^{(1)}(z) E_i^{(a)+}(x, y) + b^{(1)}(z) E_i^{(b)+}(x, y) \quad (50a)$$

$$H_i^{(1)} = a^{(1)}(z) H_i^{(a)+}(x, y) + b^{(1)}(z) H_i^{(b)+}(x, y) \quad (50b)$$

and

$$E_i^{(2)} = a^{(2)}(z) E_i^{(a)-}(x, y) + b^{(2)}(z) E_i^{(b)-}(x, y) \quad (51a)$$

$$H_i^{(2)} = a^{(2)}(z) H_i^{(a)-}(x, y) + b^{(2)}(z) H_i^{(b)-}(x, y) \quad (51b)$$

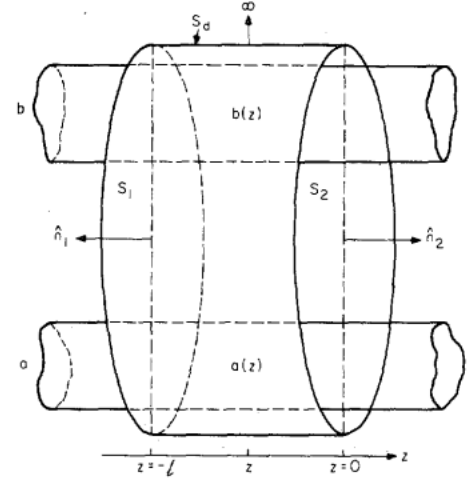

Fig. 2. Two parallel dielectric waveguides applied to the reciprocity relation. The surfaces S_1 and S_2 are normal to the \hat{z} -direction. The side surface S_d expands to infinity. The two sets of solutions used are: 1) $a^{(1)}(-l) = 0$, $b^{(1)}(-l) = V_0$, $a^{(1)}(0) =$ equation (55a), $b^{(1)}(0) =$ equation (55b). 2) $a^{(2)}(-l) =$ equation (60a), $b^{(2)}(-l) =$ equation (60b), $a^{(2)}(0) = U_0$, $b^{(2)}(0) = 0$.

for the transverse components where the radiation mode has been neglected.

The volume of integration is chosen to be bound by S_1 , S_2 , and S_d as shown in Fig. 2. Using the divergence theorem and the fact that the surface integral on the side S_d goes to zero because of the radiation condition, we obtain

$$\begin{aligned} & \iint_{S_1}^{z=-l} (\mathbf{E}_i^{(1)} \times \mathbf{H}_i^{(2)} - \mathbf{E}_i^{(2)} \times \mathbf{H}_i^{(1)}) \cdot \hat{z} \, dx \, dy \\ &= \iint_{S_2}^{z=0} (\mathbf{E}_i^{(1)} \times \mathbf{H}_i^{(2)} - \mathbf{E}_i^{(2)} \times \mathbf{H}_i^{(1)}) \cdot \hat{z} \, dx \, dy \quad (52) \end{aligned}$$

which leads to

$$\begin{aligned} & a^{(1)}(0) a^{(2)}(0) + \frac{C_{ab} + C_{ba}}{2} [a^{(1)}(0) b^{(2)}(0) + a^{(2)}(0) b^{(1)}(0)] \\ &+ b^{(1)}(0) b^{(2)}(0) \\ &= a^{(1)}(-l) a^{(2)}(-l) + \frac{C_{ab} + C_{ba}}{2} [a^{(1)}(-l) b^{(2)}(-l) \\ &+ a^{(2)}(-l) b^{(1)}(-l)] + b^{(1)}(-l) b^{(2)}(-l). \quad (53) \end{aligned}$$

We next consider these two sets of solutions to be the coupled mode equations with two boundary conditions satisfied respectively. One starts at $z = -l$ with the boundary conditions

$$(1) \quad a^{(1)}(-l) = 0 \quad (54a)$$

$$b^{(1)}(-l) = V_0 \quad (54b)$$

and the solutions of the mode amplitudes when propagating to $z = 0$ are

$$a^{(1)}(0) = V_0 i \frac{K_{ab}}{\psi} \sin \psi l e^{i\phi l} \quad (55a)$$

$$b^{(1)}(0) = V_0 \left[\cos \psi l + i \frac{\Delta}{\psi} \sin \psi l \right] e^{i\phi l} \quad (55b)$$

where

$$\Delta = \frac{\gamma_b - \gamma_a}{2} \quad (56)$$

$$\psi = \sqrt{\Delta^2 + K_{ab} K_{ba}} \quad (57)$$

$$\psi = \frac{\gamma_b + \gamma_a}{2} \quad (58)$$

The next set of solutions are the propagating modes in the $-z$ direction with the boundary conditions

$$(2) \quad a^{(2)}(0) = U_0 \quad (59a)$$

$$b^{(2)}(0) = 0 \quad (59b)$$

and the solutions when the mode propagates to $z = -l$ are

$$a^{(2)}(-l) = U_0 \left[\cos \psi l - i \frac{\Delta}{\psi} \sin \psi l \right] e^{i\phi l} \quad (60a)$$

$$b^{(2)}(-l) = U_0 \frac{iK_{ba}}{\psi} \sin \psi l e^{i\phi l} \quad (60b)$$

Substituting these field amplitudes (54), (55), (59), and (60) into the reciprocal relation (53), we obtain immediately the relation

$$K_{ba} - K_{ab} = \Delta(C_{ab} + C_{ba}) \quad (61)$$

which is the reciprocal relation that must be obeyed. Note that the above relation is exact and there is no complex conjugate operation involved here. It is applicable to lossy as well as lossless systems. Each quantity in (61) can be complex in general. Using our theory as derived in Section II, the quantities given by (34a)–(34d) do indeed satisfy the above reciprocal relation (61) analytically! The proof is straightforward by substitutions and making use of (26) for \tilde{K}_{ba} and \tilde{K}_{ab} . Interestingly, the above relation (61) is of the same form as (26) except that the propagation constants are the modified γ_a and γ_b instead of β_a and β_b for individual waveguides.

B. Power Conservations

We choose the first set of solutions to be

$$\mathbf{E}_i^{(1)}(x, y) = a(z) \mathbf{E}_i^{(a)+}(x, y) + b(z) \mathbf{E}_i^{(b)+}(x, y) \quad (62a)$$

$$\mathbf{H}_i^{(1)}(x, y) = a(z) \mathbf{H}_i^{(a)+}(x, y) + b(z) \mathbf{H}_i^{(b)+}(x, y) \quad (62b)$$

for $\epsilon^{(1)}(x, y) = \epsilon(x, y)$.

For the second set of solutions, we choose $\epsilon^{(2)}(x, y) = \epsilon^*(x, y)$. Since the medium is lossless, $\epsilon^* = \epsilon$, the com-

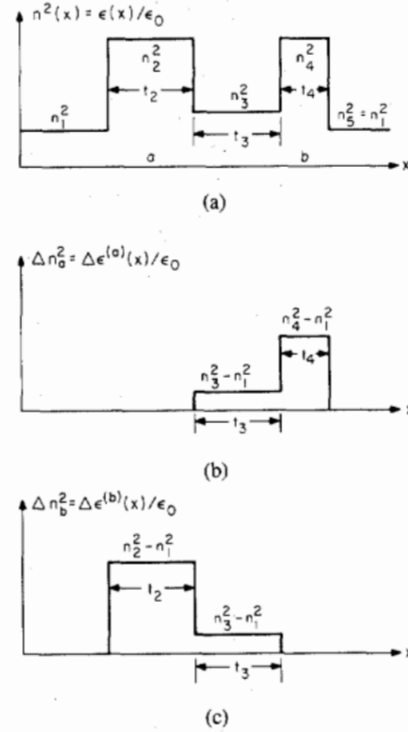

Fig. 3. (a) (b) (c) An illustrative example to show the two coupled waveguides under consideration. There also exists an external perturbation between the two waveguides.

plex conjugate fields are also solutions. We choose

$$\mathbf{E}_i^{(2)}(x, y) = a^*(z) \mathbf{E}_i^{(a)\pm}(x, y) + b^*(z) \mathbf{E}_i^{(b)\pm}(x, y) \quad (63a)$$

$$\mathbf{H}_i^{(2)}(x, y) = a^*(z) \mathbf{H}_i^{(a)\pm}(x, y) + b^*(z) \mathbf{H}_i^{(b)\pm}(x, y) \quad (63b)$$

making use of the z -inversion symmetry also. Substituting (62) and (63) into (52), we obtain

$$P(z = -l) = P(z = 0) \quad (64a)$$

where

$$P(z) = |a(z)|^2 + |b(z)|^2 + (C_{ab} + C_{ba}) \operatorname{Re}(a(z) b^*(z)) \quad (64b)$$

turns out to be the power guided by the two waveguides, where we have used relations such as

$$\begin{aligned} C_{ab} &= \frac{1}{2} \iint \mathbf{E}_i^{(b)} \times \mathbf{H}_i^{(a)} \cdot \hat{z} \, dx \, dy \\ &= \frac{1}{2} \iint \mathbf{E}_i^{(b)} \times \mathbf{H}_i^{(a)*} \cdot \hat{z} \, dx \, dy \end{aligned} \quad (65)$$

for a lossless system assuming one chooses \mathbf{E}_i and \mathbf{H}_i to be real, which is possible [13]. We note that since the distance l between the two surfaces S_1 and S_2 is arbitrary, (64a) leads to the fact that $P(z)$ should be constant independent of z , which is also obvious from the power conservation point of view. Using the boundary conditions

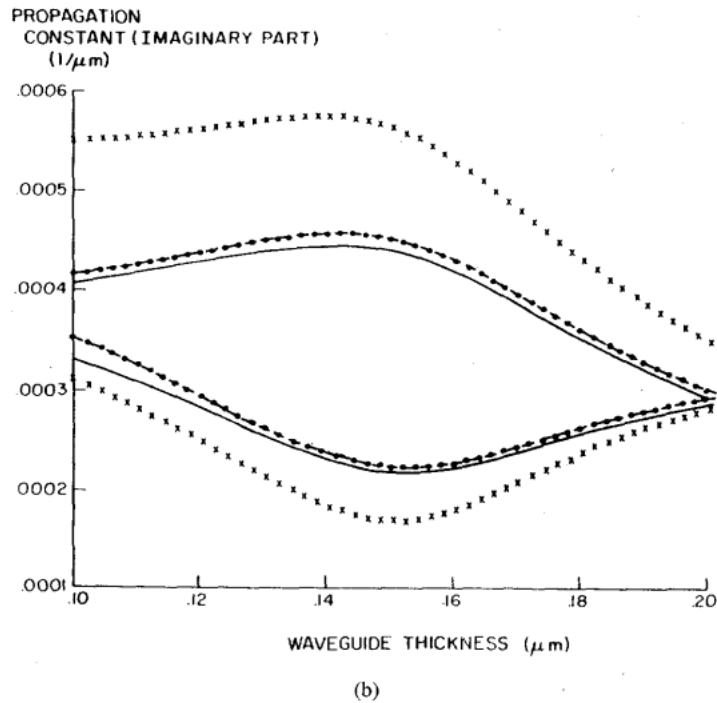
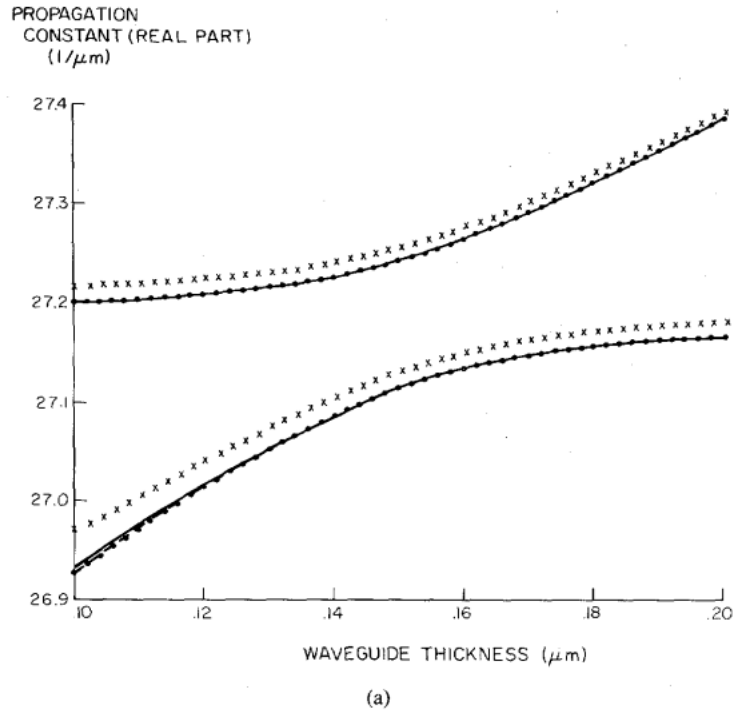

Fig. 4. The propagation constants for the coupled waveguides in Fig. 3: (a) the real parts, and (b) the imaginary parts of the propagation constants (1/μm) are plotted versus the thickness (μm) of waveguide *b*. The exact solution (solid line), our results (dashed line), and the results using [3] (dotted line) are almost on top of each other. The crosses are results using [2].

that $a(0) = 0$ and $b(0) = V_0$, we find [3]

$$P(z) = |V_0|^2 \left\{ 1 + \frac{K_{ab}}{\psi^2} [(K_{ab} - K_{ba}) + \Delta(C_{ab} + C_{ba})] \sin^2 \psi z \right\} = \text{constant.} \quad (66)$$

Thus the "power conservation violation factor" for excitation in waveguide *b* at $z = 0$

$$F_{b \rightarrow a} = \frac{K_{ab}}{\psi^2} [(K_{ab} - K_{ba}) + \Delta(C_{ab} + C_{ba})] \quad (67)$$

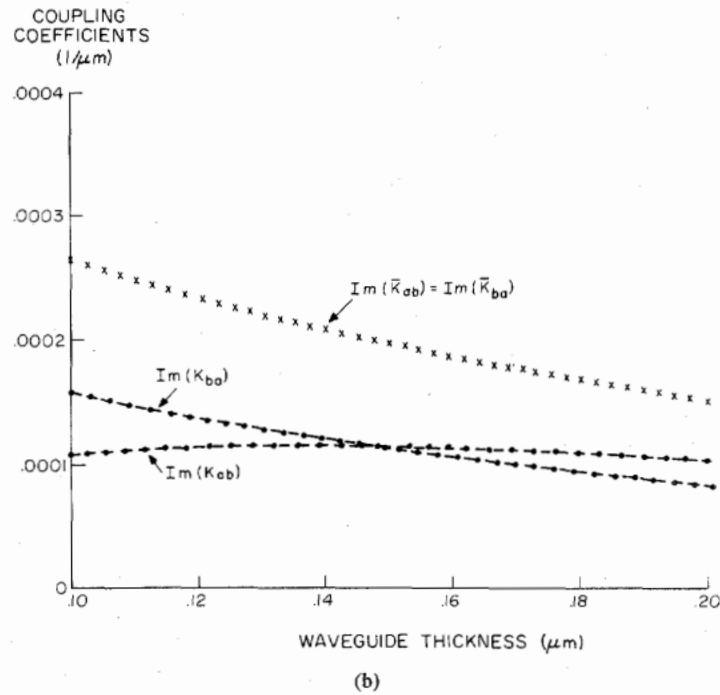
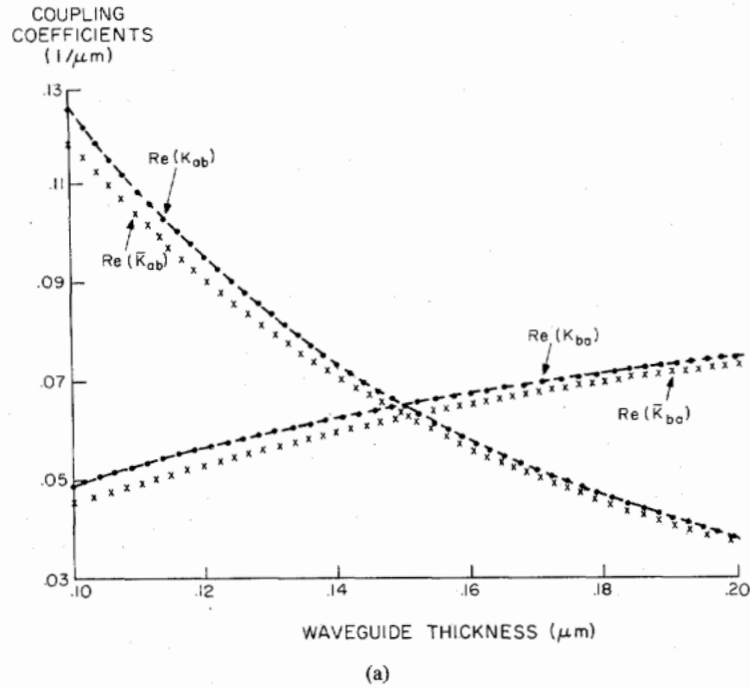

Fig. 5. (a) The real parts, and (b) the imaginary parts of the coupling coefficients K_{ab} and K_{ba} for the waveguide system in Fig. 3 are plotted versus the thickness (μm) of waveguide b . Our results (dashed lines) and the results using [3] (dotted lines) are on top of each other. The crosses are the results using [2].

should be zero. One sees clearly that this condition has been derived in the previous section using the reciprocity theorem which is more general for lossy as well as lossless cases. In deriving (67), one needs to restrict every quantity in (67) to be real for a lossless medium. Our new formulation presented in the previous sections does satisfy exactly these reciprocity conditions and power conservation, since the factor F is zero if we substitute all quantities in (34a)–(34d) into (67) and use (26). The fac-

tor F is an indication of the power conservation and the reciprocity relation. It can be used for the final numerical check of the consistency of the theory. Similarly, for an initial excitation in waveguide a at $z = 0$, one can define another factor

$$F_{a \rightarrow b} = \frac{K_{ba}}{\psi^2} [(K_{ba} - K_{ab}) - \Delta(C_{ab} + C_{ba})] \quad (68)$$

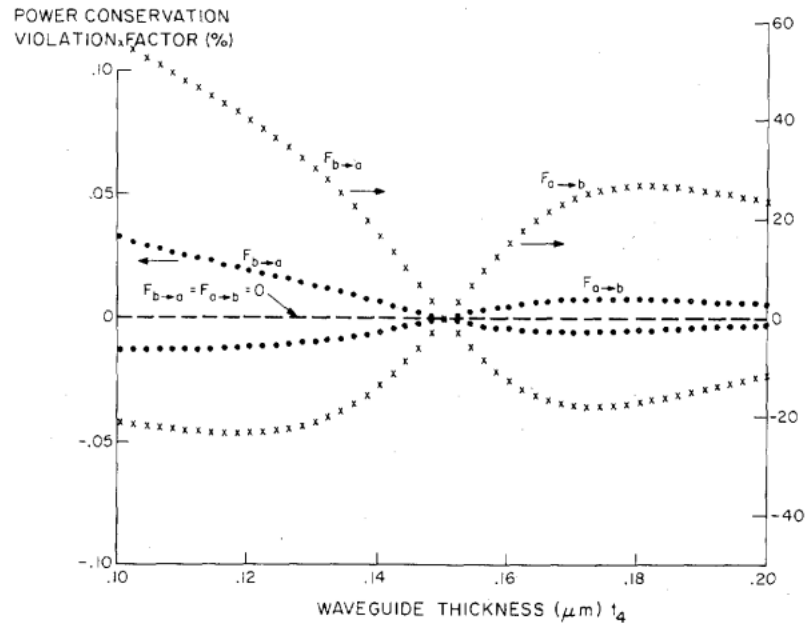

Fig. 6. The power conservation violation factors $F_{b \rightarrow a}$ and $F_{a \rightarrow b}$ for the three methods; our results (dashed line), the results using [3] (dotted lines) are shown using the left scale. The results using [2] (crosses) are shown using the right scale.

to check the numerical accuracy. The numerical results of these two factors in (67) and (68) using various methods will be presented in the next section.

IV. NUMERICAL RESULTS AND DISCUSSIONS

In this section, we consider an example from [3]. The coupled mode equations (33a) and (33b) with the expressions in (34a)–(34d) are used in the numerical calculations in this paper. The refractive index profile is shown in Fig. 3 where an external perturbation between the two planar waveguides also exists. We choose the index variation to be along the x direction, and for TE polarized waves, the electric field has only the y -component. The refractive indices are $n_1 = n_5 = \text{Re}(n_3) = 3.4$, $n_2 = n_4 = 3.6$ and an additional loss exists between two guides such that $n_3^2 - n_1^2 = i1.299 \times 10^{-3}$. The other parameters are $t_2 = 0.15 \mu\text{m}$, $t_3 = 0.4 \mu\text{m}$, $\lambda = 0.8 \mu\text{m}$, and t_4 varies from $0.1 \mu\text{m}$ to $0.2 \mu\text{m}$. The numerical results using an exact root-searching approach have also been shown as the solid lines in Fig. 4(a) and 4(b) for the real and imaginary parts of the propagation constants. (In [3], the “exact” numerical method combines a root searching approach assuming a lossless system to find the real parts of the propagation constants, and a perturbational approach for the imaginary parts when the loss is added. The final “exact” results in [3] are indeed very good compared with our exact root searching approach.) The results of the theory in this paper are shown as the dashed lines, and the results using that in [3] are shown as the dotted lines. We see clearly that all three methods agree very well with each other. The results of a conventional method [2] are also shown as the crosses which deviate more from the exact solutions especially for the imaginary parts of the propagation constants.

In Fig. 5(a) and 5(b) we compare both the real and the imaginary parts of the coupling coefficients using our method and the methods in [2] and [3]. It is clear that our results do agree very well with those using the method in [3] with a different approach, which has been checked with the “exact” numerical results presented in [3]. We note that our results satisfy the reciprocity and power conservation analytically and, thus, the factors $F_{b \rightarrow a}$ and $F_{a \rightarrow b}$ in (67) and (68) are zero while the F 's of the method in [3] still contain a small discrepancy which is around 0.033 percent at a maximum value at $t_4 = 0.1 \mu\text{m}$, and the F 's of the method in [2] yield a maximum power discrepancy of 55 percent at $t_4 = 0.1 \mu\text{m}$ (instead of only about 20 percent as claimed in [3]). Detailed calculations of the two power conservation violation factors are shown in Fig. 6 (assuming the lossless case, i.e., $\text{Im}[n_3^2 - n_1^2] = 0$) where $F_{b \rightarrow a}$ and $F_{a \rightarrow b}$ for the method in [3] are shown (the dotted lines) in the left scale. The results are within 0.033 percent. The results using [2] (crosses) show in the right scale that $F_{a \rightarrow b}$ for excitation in waveguide a has an error of power conservation of 21 percent at $t_4 = 0.1 \mu\text{m}$, and $F_{b \rightarrow a}$ for excitation in waveguide b has a value of 55 percent. Our results (the dashed line) for $F_{b \rightarrow a}$ and $F_{a \rightarrow b}$ are always zero or within the round off errors in the computer, and the power conservation is indeed satisfied.

One should also note that the relations using the reciprocity and power conservation laws are necessary conditions, not sufficient conditions, for the accuracy of the numerical results [7]. They usually serve as checks, not direct proofs, of the numerical solutions to the Maxwell equations.

V. CONCLUSIONS

A new coupled mode formulation has been described via two methods: a generalized reciprocity relation and a

variational principle. Both give the same results. Exact analytical relations governing the coupling coefficients \tilde{K}_{ab} and \tilde{K}_{ba} (also K_{ab} and K_{ba}) and the propagation constants of individual waveguide β_a and β_b (γ_a and γ_b) are derived. These relations are used to show that our formulation does satisfy the reciprocity theorem and the power conservation analytically. Numerical results compared with the exact solutions and a previous method [3] which contains a slight discrepancy show that our new formulation should be very useful and self-consistent. We hope this paper will also clarify the reciprocity relation for the coupled waveguides.

APPENDIX A

DERIVATION OF (20a) AND (20b)

For the guided modes, we have

$$\nabla_t \times \mathbf{E}^{(a)+} - i\omega\mu\mathbf{H}^{(a)+} = -i\beta_a\hat{z} \times \mathbf{E}^{(a)+} \quad (\text{A1})$$

$$\nabla_t \times \mathbf{H}^{(a)+} + i\omega\epsilon^{(a)}\mathbf{E}^{(a)+} = -i\beta_a\hat{z} \times \mathbf{H}^{(a)+} \quad (\text{A2})$$

and a similar set of equations for $\epsilon^{(b)}$, $\mathbf{E}^{(b)+}$, $\mathbf{H}^{(b)+}$, and β_b . For the coupled-waveguide medium, we have

$$\nabla_t \times \mathbf{E} - i\omega\mu\mathbf{H} = -i\gamma\hat{z} \times \mathbf{E} \quad (\text{A3})$$

$$\nabla_t \times \mathbf{H} + i\omega\epsilon\mathbf{E} = -i\gamma\hat{z} \times \mathbf{H}. \quad (\text{A4})$$

Breaking the equation into the transverse and longitudinal components, we have

$$\begin{aligned} \mathbf{E}_z &= \frac{1}{-i\omega\epsilon} \nabla_t \times \mathbf{H}_t = \frac{1}{-i\omega\epsilon} (a(z)\nabla_t \times \mathbf{H}_t^{(a)+} \\ &\quad + b(z)\nabla_t \times \mathbf{H}_t^{(b)+}) \\ &= a(z) \frac{\epsilon^{(a)}}{\epsilon} \mathbf{E}_z^{(a)+} + b(z) \frac{\epsilon^{(b)}}{\epsilon} \mathbf{E}_z^{(b)+} \end{aligned} \quad (\text{A5})$$

which is (20a) in the text. A similar procedure can be applied to \mathbf{H}_z and leads to (20b).

REFERENCES

- [1] H. Kogelnik, "Theory of dielectric waveguides," in *Integrated Optics*, T. Tamir, Ed., 2nd ed. New York: Springer-Verlag, 1979, ch. 2.
- [2] H. F. Taylor and A. Yariv, "Guided wave optics," *Proc. IEEE*, vol. 62, pp. 1044-1060, 1974.

- [3] A. Hardy and W. Streifer, "Coupled mode theory of parallel waveguides," *J. Lightwave Technol.*, vol. LT-3, pp. 1135-1146, 1985.
- [4] A. Hardy and W. Streifer, "Coupled modes of multiwaveguide systems and phase arrays," *J. Lightwave Technol.*, vol. LT-4, pp. 90-99, 1986.
- [5] A. Hardy and W. Streifer, "Coupled mode solutions of multiwaveguide systems," *IEEE J. Quantum Electron.*, vol. QE-22, pp. 528-534, 1986.
- [6] S. L. Chuang and J. A. Kong, "Wave scattering and guidance by dielectric waveguides with periodic surfaces," *J. Opt. Soc. Amer.*, vol. 73, pp. 669-679, 1983, and Addendum, *J. Opt. Soc. Amer.*, vol. 73, pp. 1823-1824, 1983.
- [7] S. L. Chuang and J. A. Kong, "Wave scattering from a periodic dielectric surface for a general angle of incidence," *Radio Sci.*, vol. 17, pp. 545-557, 1982.
- [8] H. A. Haus, W. P. Huang, S. Kawakami, and N. A. Whitaker, "Coupled-mode theory of optical waveguides," *J. Lightwave Technol.*, this issue, pp. 16-23.
- [9] H. A. Haus and M. N. Islam, "Application of a variational principle to systems with radiation loss," *IEEE J. Quantum Electronics*, vol. QE-19, pp. 106-117, 1983.
- [10] L. Cairo and T. Kahan, *Variational Techniques in Electromagnetism*. London, England: Blackie and Son, 1965.
- [11] R. F. Harrington, *Time-Harmonic Electromagnetic Fields*. New York: McGraw-Hill, 1961.
- [12] H. Haus, "Electron beam waves in microwave tubes," in *Proc. Symp. Electronic Waveguides*, Apr. 8-10, 1958, pp. 89-132.
- [13] R. E. Collin, *Foundations for Microwave Engineering*. New York: McGraw-Hill, 1966, sect. 3.9.



Shun-Lien Chuang (M'82) was born in Taiwan in 1954. He received the B.S. degree in electrical engineering from National Taiwan University in 1976, and the M.S., E.E., and Ph.D. degrees in electrical engineering from the Massachusetts Institute of Technology in 1980, 1981, and 1983, respectively.

While in graduate school, he held research and teaching assistantships, and also served as a recitation instructor. He conducted research at Schlumberger-Doll Research in Ridgefield, CT, during the summers of 1981 and 1982 and also in 1983 as a member of the professional staff. He is now an Assistant Professor in the Department of Electrical and Computer Engineering at the University of Illinois at Urbana-Champaign. He is conducting research in electromagnetics, integrated optics, and semiconductor devices including superlattice photodetectors and microwave transistors. He teaches courses on Electromagnetics and Solid State Electronic Devices. He has been cited several times in the list for Excellence in Teaching. He recently developed a new graduate course on *Integrated Optics and Optoelectronics*.

Dr. Chuang is a member of the Optical Society of America, Sigma Xi, and the American Physical Society.