

# **GEOPHYSICAL METHODS IN GEOLOGY**

Prof. G. R. Foulger & Prof. C. Peirce

## Overview

1. The course text book is:

*An Introduction to Geophysical Exploration*, by P. Kearey, M. Brooks and I. Hill, 3rd edition Blackwell Science, 2002, ISBN0632049294, cost new ~ £30.

For the Michaelmas Term you will be expected to read and study Chapters 1, 6 & 7.

For the Easter Term you will be expected to read and study Chapters 3, 4 & 5.

Your lecturers will assume that you know the material therein and you will be tested on it, even if it has not been covered in lectures and practicals. You are therefore *strongly advised* to purchase this book. The library holds copies of this text and copies of earlier versions which are very similar and would act as a suitable substitute.

2. Throughout the year you are expected to spend a total of 200 Student Learning and Activity Time (SLAT) hours on this module. There will be 3 staff contact hours per week for 20 weeks during the year, making a total of 60 hours. You are thus expected to spend an additional 140 hours on homework, background reading, revision and examinations. As a rule of thumb you will be expected to spend at least 3 hours a week on this module in addition to contact hours in lectures and practicals.

3. You are expected to spend some of your self-study SLAT hours reading additional material, e.g., books, scientific papers, popular articles and web pages, to broaden your knowledge. In tests and examinations, evidence for reading outside of lecture and practical handouts and the course textbook is required in order to earn 1st class marks. You will find suggestions for suitable books and web pages in the course notes.

4. You will get the most out of lectures and practicals if you have done the relevant recommended reading previously.

5. If you miss lectures and/or practicals through illness or for any other reason, it is your responsibility to make up the work missed and you will be expected to have done so for any assessment based upon it.

6. It is important to realise that, at this stage in your university career, courses are not “curriculum based” and examinations will not solely test narrowly and precisely defined blocks of information 100% of which have been presented during classroom hours. The function of the staff contact hours is to underpin, support, and broadly guide your self-study work. It is your responsibility to acquire a good knowledge and understanding of the subject with the help of the staff contact hours. This will require that you do not limit your learning activities solely to attending lectures and practicals.

## Background reading

*Compulsory:*

Keary, P., M. Brooks and I. Hill, *An Introduction to Geophysical Exploration*, 3rd edition Blackwell Science, 2002, ISBN0632049294.

## MICHAELMAS TERM

### GRAVITY & MAGNETICS

#### Schedule for staff contact time

Week 1	Gravity lecture, practical, use of gravimeter
Week 2	Gravity lecture, practical, use of gravimeter
Week 3	Reading week - no lecture or practical
Week 4	Gravity lecture, practical, use of gravimeter
Week 5	Gravity lecture, practical, use of gravimeter
Week 6	Gravity lecture, practical, use of gravimeter
Week 7	Magnetics lecture, practical, use of magnetometer
Week 8	Magnetics lecture, practical, use of magnetometer
Week 9	Magnetics lectures (2), practical, use of magnetometer
Week 10	No lecture, finish up of magnetics practical.

#### Assessment

The Michaelmas term will be assessed summatively as follows:

1. Gravity: Long Valley Caldera exercise (gravity problem #7 in practical booklet), section a). This will carry 7.5% of your final module mark. Deadline for handing in: 5.15 pm, Monday, 22nd November.
2. 1. Gravity: Long Valley Caldera exercise (gravity problem #7 in practical booklet), section b). This will carry 7.5% of your final module mark. Deadline for handing in: 5.15 pm, Monday, 29th November.
3. Magnetics: Essay (magnetics problem #4 in practical booklet). Deadline for handing in: 5.15 pm, Monday, 6th December. This essay will carry 5% of your final module mark.

Work should have a submission cover sheet stapled to the front and be handed in by posting through the appropriate letter box outside the Department office.

Short formative tests (which do not count towards your final mark) will be held at the beginning of most lectures, and will enable you to test yourself on the material taught in the previous lecture.

#### Additional recommended books

- Parasnis, D.S., *Principles of applied geophysics*, Chapman & Hall, 1996.
- Reynolds, J.M., *An introduction to applied and environmental geophysics*, Wiley & Sons Ltd., 1997.
- Dobrin, M.B. and C.H. Savit, *Introduction to Geophysical Prospecting*, 4th Edition, McGraw-Hill, 1988.
- Telford, W.M., L.P. Geldart, R.E. Sheriff and D.A. Keys, *Applied Geophysics*, 2nd Edition, Cambridge University Press, 1990.
- Fowler, C.M.R., *The Solid Earth*, Cambridge University Press, 1990.

## TABLE OF CONTENTS

### GRAVITY

<b>1. Introduction to gravity</b> .....	<b>1</b>
<b>2. Basic theory</b> .....	<b>1</b>
<b>3. The global gravity field</b> .....	<b>2</b>
<b>4. Units</b> .....	<b>3</b>
<b>5. Measurement of gravity on land</b> .....	<b>3</b>
5.1 <i>On the Earth's surface</i> .....	3
5.2 <i>In boreholes</i> .....	7
<b>6. Measurement of gravity on moving platforms</b> .....	<b>8</b>
6.1 <i>Sea surveys</i> .....	8
6.2 <i>Air surveys (accuracies ~ 1-5 mGal)</i> .....	8
6.3 <i>Space measurements</i> .....	8
<b>7. The gravity survey</b> .....	<b>10</b>
<b>8. Reduction of observations</b> .....	<b>11</b>
<b>9. Examples</b> .....	<b>15</b>
9.1 <i>A gravity survey of Iceland</i> .....	15
9.2 <i>Microgravity at Pu'u O'o, Hawaii</i> .....	15
<b>10. Gravity anomalies</b> .....	<b>16</b>
10.1 <i>Bouguer anomaly (BA)</i> .....	16
10.2 <i>Free-Air anomaly (FAA)</i> .....	16
10.3 <i>Isostasy</i> .....	16
<b>11. Rock densities</b> .....	<b>18</b>
11.1 <i>Introduction</i> .....	18
11.2 <i>Direct measurement</i> .....	18
11.3 <i>Using a borehole gravimeter</i> .....	18
11.4 <i>The borehole density logger (gamma-gamma logger)</i> .....	19
11.5 <i>Nettleton's method</i> .....	19
11.6 <i>Rearranging the Bouguer equation</i> .....	19
11.7 <i>The Nafe-Drake curve</i> .....	20
11.8 <i>When all else fails</i> .....	20
11.9 <i>Example</i> .....	20
<b>12. Removal of the regional - a suite of methods</b> .....	<b>21</b>
12.1 <i>Why remove a regional?</i> .....	21
12.2 <i>Removal of the regional by eye</i> .....	21
12.3 <i>Digital smoothing</i> .....	21
12.4 <i>Griffin's method</i> .....	21
12.5 <i>Trend surface analysis</i> .....	21
12.6 <i>Spectral analyses</i> .....	22
12.7 <i>Caveat</i> .....	22
<b>13. Pre-processing, displaying and enhancing gravity data</b> .....	<b>22</b>

13.1	<i>Why pre-process gravity data?</i>	22
13.2	<i>Gravity reduction as a process</i>	22
13.3	<i>Removal of the regional</i>	22
13.4	<i>Wavelength filtering</i>	22
13.5	<i>Directional filtering</i>	22
13.6	<i>Vertical derivative methods</i>	23
13.7	<i>Isostatic anomalies</i>	23
13.8	<i>Maximum horizontal gradient</i>	23
13.9	<i>Upward and downward continuation</i>	23
13.10	<i>Presentation</i>	24
<b>14.</b>	<b>Interpretation, modelling and examples</b>	<b>24</b>
14.1.	<i>The Parametric method</i>	24
14.2.	<i>Direct methods, or "forward modelling"</i>	25
14.3.	<i>Indirect interpretation (or inverse modelling)</i>	27
<b>15.</b>	<b>Applications of gravity surveying and examples</b>	<b>27</b>
15.1.	<i>Local structure</i>	27
15.2	<i>Regional structure</i>	27
15.3.	<i>Tests of isostasy</i>	27
15.4.	<i>Mineral exploration</i>	27
15.5	<i>Global surveys</i>	28
15.6	<i>Other applications</i>	28
15.7	<i>Long Valley caldera, California</i>	28

## 1. Introduction to gravity

<http://www.earthsci.unimelb.edu.au/ES304/>

Gravity and magnetic prospecting involves using passive potential fields of the Earth, and the fieldwork is thus fairly simple. It is not necessary to fire shots, for example. However, as a result, the end product is fundamentally different too. Seismic prospecting can give a detailed picture of Earth structure with different subsurface components resolved. Gravity and magnetic prospecting, on the other hand, is affected by the fact that the measured signal is a composite of the contributions from all depths and these can only be separated if independent information is available, e.g. from geology or boreholes.

It is convenient to study gravity prospecting before magnetic prospecting because the latter is analogous but more complex. Also, once the formulae for gravity calculations have been grasped, the more difficult equivalent magnetic formulae are more easily understood.

Gravity prospecting can be used where *density contrasts* are present in a geological structure, and the usual approach is to measure *differences in gravity* from place to place. In gravity prospecting we are mostly interested in lateral variations in Earth structure, because these involve lateral variations in density. Gravity prospecting was first applied to prospect for salt domes in the Gulf of Mexico, and later for looking for anticlines in continental areas. Gravity cannot detect oil directly, but if the oil is of low density and accumulated in a trap, it can give a gravity low that can be detected by gravity prospecting. Anticlines can also give gravity anomalies as they cause high or low density beds to be brought closer to the surface.

Nowadays, gravity surveys conducted to search for *oil* are broad regional studies. The first question to be answered is, *is there a large and thick enough sedimentary basin to justify further exploration?* Gravity prospecting can answer this question inexpensively because sedimentary rocks have lower densities than basement rocks. Gravity prospecting can be done over land or sea areas using different techniques and equipment.

Gravity prospecting is only used for *mineral* exploration if substantial density contrasts are expected, e.g., chromite bodies have very high densities. Buried channels, which may contain gold or uranium, can be detected because they have relatively low density.

## 2. Basic theory

Gravity surveying may be conducted on many scales, e.g., small scale prospecting, regional marine surveys and global satellite surveys. The fundamental equation used for mathematical treatment of the data and results is Newton's Law of Gravitation:

$$F = \frac{Gm_1m_2}{r^2}$$

$F$  = force

$m_1, m_2$  - mass

$r$  = separation distance

### 3. The global gravity field

If the Earth were a perfect sphere with no lateral inhomogeneities and did not rotate,  $g$  would be the same everywhere and obey the formula:

$$g = \frac{GM}{r^2}$$

This is not the case, however. The Earth is inhomogeneous and it rotates. Rotation causes the Earth to be an *oblate spheroid* with an eccentricity 1/298. The polar radius of the Earth is ~ 20 km less than the equatorial radius, which means that  $g$  is ~ 0.4% less at equator than pole. At the equator,  $g$  is ~ 5300 mGal (milliGals), and a person would weigh ~ 1 lb less than at the pole.

The best fitting spheroid is called the *reference spheroid*, and gravity on this surface is given by the International Gravity Formula (the IGF), 1967:

$$g_{\phi} = 9.780318(1 + 5.3024 \times 10^{-3} \sin^2 \phi + 5.9 \times 10^{-6} \sin^2 2\phi)$$

where  $f$  = geographic latitude

Definition: The *geoid* is an *equipotential surface* corresponding to mean sea level. On land it corresponds to the level that water would reach in canals connecting the seas.

The geoid is a conceptual surface, which is warped due to absence or presence of attracting material. It is warped up on land and down at sea.

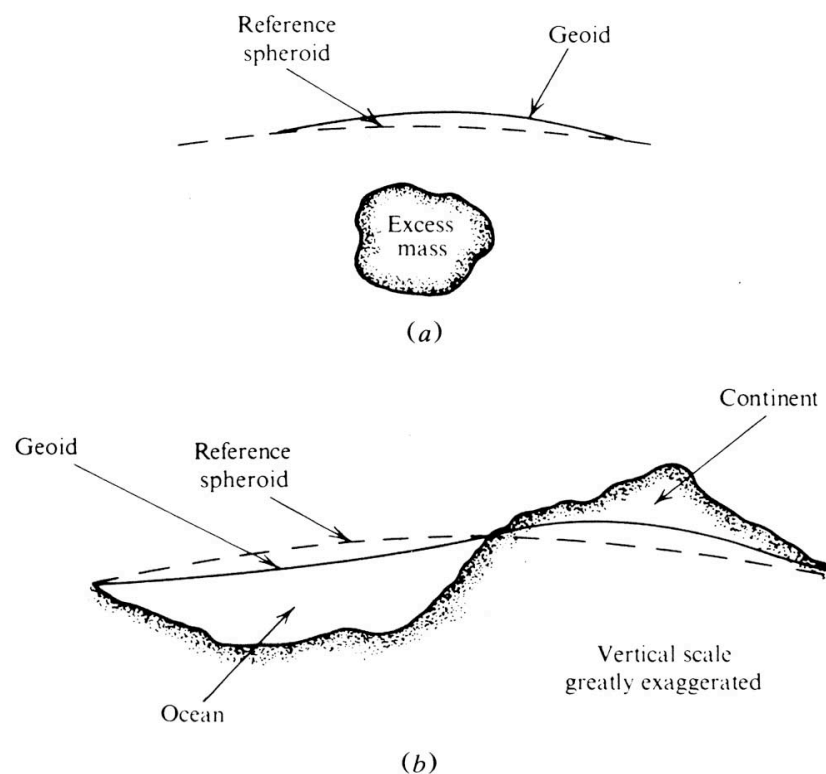

*The relationship between the geoid, the spheroid, topography and anomalous mass.*

The concept of the geoid is of fundamental importance to geodetic surveying, or plane surveying, because instruments containing spirit levels measure heights above the geoid, not heights above the reference spheroid. It is important to surveyors to know the geoid/spheroid separation, known as the geoid height, as accurately as possible, but in practice it is often not known to a metre.

#### 4. Units

1 Gal (after Galileo) =  $1 \text{ cm s}^{-2}$

Thus,  $g$  (at the surface of the Earth)  $\sim 10^3$  Gals

Gravity anomalies are measured in units of milliGals.  $1 \text{ mGal} = 10^{-3} \text{ Gals} = 10^{-5} \text{ m s}^{-2}$

Gravity meters, usually called gravimeters, are sensitive to  $0.01 \text{ mGal} = 10^{-8}$  of the Earth's total value. Thus the specifications of gravimeters are amongst the most difficult to meet in any measuring device. It would be impossible to get the accuracy required in *absolute* gravity measurements quickly with any device, and thus field gravity surveying is done using *relative* gravimeters.

#### 5. Measurement of gravity on land

##### 5.1 On the Earth's surface

<http://www-geo.phys.ualberta.ca/~vkrav/Geoph223/Gravity-Acquisition.htm>

Relative gravimeters are used, which have a nominal precision of  $0.01 \text{ mGal}$ . It requires a lot of skill and great care to use them well. The results are measurements of the differences in  $g$  between stations. There are two basic types of gravimeter:

Stable gravimeters. These work on the principle of a force balancing the force of gravity on a mass, *e.g.*, the Gulf gravimeter. The equation governing its behaviour is:

$$F = k(x - x_0) = mg$$

where  $x_0$  is the unweighted length of the spring,  $x$  is the weighted length of the spring and  $k$  is the spring constant. These instruments must have long periods to be sensitive. This is not convenient for surveys, as it means that it takes a long time to measure each point.

The Gulf gravimeter comprises a flat spring wound in a helix, with a weight suspended from the lower end. An increase in  $g$  causes the mass to lower and rotate. A mirror on the mass thus rotates and it is this rotation that is measured. The sensitivity of these gravimeters is  $\sim 0.1 \text{ mGal}$ . They are now obsolete, but a lot of data exist that were measured with such instruments and it is as well to be aware that such data are not as accurate as data gathered with more modern instruments.

Unstable gravimeters. These are virtually universally used now. They are cunning mechanical



devices where increases in  $g$  cause extension of a spring, but the extension is magnified by mechanical geometry. An example is the Wordon gravimeter, which has a sensitivity of 0.01 mGal, and is quite commonly used.



*A Wordon gravimeter*

The Wordon gravimeter is housed in a thermos flask for temperature stability, but it also incorporates a mechanical temperature compensation device. It is evacuated to eliminate errors due to changes in barometric pressure. It weighs about 3 kg and the mass weighs 5 mg. Vertical movement of the mass causes rotation of a beam, and equilibrium is restored by increasing the tension of torsion fibres.

<b>Advantages</b>	<b>Disadvantages</b>
no need to lock the mass	may not be overturned because it contains an open saucer of desiccant which can spill
no power is needed for temperature compensation	only has a small range ( $\sim 60$ mGal) and thus must be adjusted for each survey, though a special model with a range of 5500 mGal is available

Another example of an unstable gravimeter is the LaCoste-Romberg:

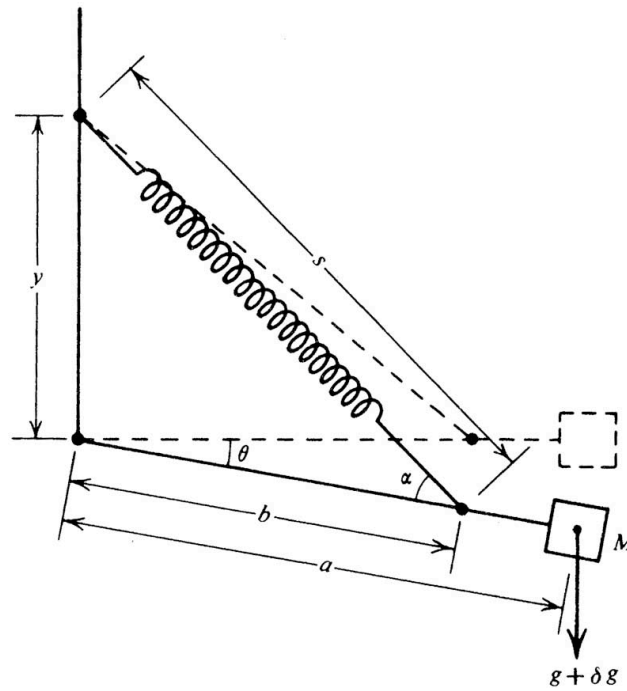

*Schematic showing the principle of the LaCost-Romberg gravimeter.*

A weight is hung on an almost horizontal beam supported by inclined spring. The spring is a “zero-length” spring, *i.e.* it behaves as though its unweighted length is zero. Deflections of the beam are caused by small changes in  $g$ , which cause movement of a light beam. This is restored to zero by an adjustment screw. The innovation of incorporating a zero length spring causes great sensitivity, as follows. Sensitivity is described by the equation:

$$\text{sensitivity} = \frac{mas^2}{kbzy}$$

where  $m$  = mass,  $a$ ,  $b$ ,  $y$ ,  $s$  = dimensions of the mechanism (see figure),  $k$  = the spring constant and  $z$  = the unweighted length of the spring. Sensitivity can be increased by:

- increasing  $M$ ,  $a$  or  $s$ , or
- decreasing  $k$ ,  $b$ ,  $z$  or  $y$

In practice,  $z$  is made very small. In addition to making the instrument very sensitive, it also has the undesirable effect of making the period of the instrument longer, so there is still a wait for the instrument to settle when taking readings.

#### Calibration of gravimeters

Calibration is usually done by the manufacturer. Two methods are used:

1. Take a reading at two stations of known  $g$  and determine the difference in  $g$  per scale division, or
2. Use a tilt table

All gravimeters drift because of stretching of the spring etc., especially the Wordon gravimeter. This must be corrected for in surveys.

Advantages	Disadvantages
wide range	Needs power to keep it at constant temperature. A temperature change of $0.002^{\circ}\text{C} = 0.02 \text{ mGal}$ error. It uses a lot of charge and takes hours to warm up.
0.01 mGal sensitivity	mass must be clamped during transport
very quick to use	

It is important to understand the difference between *accuracy*, *precision* and *repeatability* in surveying of all kinds.

*Accuracy* is how close the measurement is to the truth. This can only be assessed by comparing the measurement to a more accurate one.

*Precision* has two meanings:

- a) It may indicate the smallest division on a measurement scale (the engineer's definition), or
- b) it may indicate the statistical error in a measurement, *e.g.*, the root mean square (RMS).

*Repeatability* is the consistency between repeated measurements of the same thing.

Absolute gravimeters. Absolute gravity may be measured using (relatively) portable, sensitive (0.01 mGal) instruments recently developed. A mass is allowed to drop, and it is timed between two points using laser interferometry. The falling mass is a reflecting corner cube. Corner cubes have the property that a light beam entering them will be reflected back along the same path. The corner cube is enclosed in an evacuated lift to eliminate air resistance, and a seismometer is used to detect accelerations of the base due to seismic noise. Corrections are made for this noise. The mass is dropped up to many thousands of times in order to measure  $g$  at a single station.

[http://www.agu.org/eos\\_elec/99144e.html](http://www.agu.org/eos_elec/99144e.html)

The outputs of the instrument are fed into a computer which calculates the RMS solution. The measurement of 1 station takes  $\sim 1$  day, and needs a concrete base and mains power, since several hundred watts of power are needed. These instruments are still under development, and are not yet suitable for conventional surveys.

[http://www.agu.org/eos\\_elec/99144e.html](http://www.agu.org/eos_elec/99144e.html)

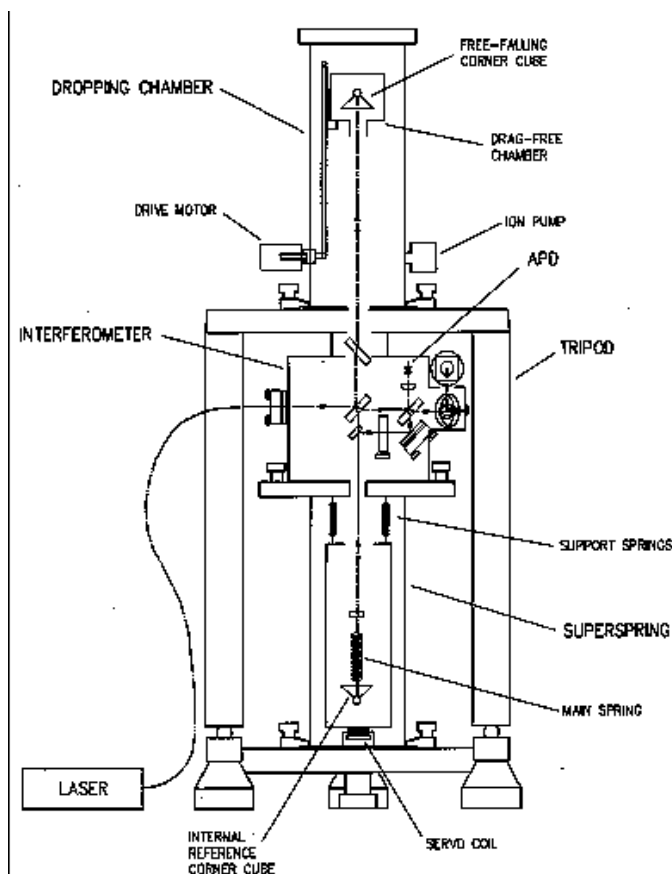

*Schematic of an absolute gravimeter*

Advantages	Disadvantages
accurate	needs a lot of power
no drift corrections needed	takes a long time to make a reading
different surveys, especially inter-continental surveys, can be accurately tied together. This used to be done by flying long loops with a Wordon 5400-mGal range gravimeter and tying back to pendulum-measured absolute gravity reference stations	instrument is not portable
sensitive to height changes of $\sim 3$ cm and thus can be used for tectonic studies, e.g. earthquake prediction	

### 5.2 In boreholes

Gravity was first measured in boreholes in the 1960s. Now Esso and U.S. Geological Survey (USGS)/LaCoste-Romberg gravimeter types are available to do this. They have sensitivities of  $\sim 0.01$  mGal. Temperature control is important because of the geothermal gradient. Meters must also allow for deviations from the vertical of boreholes. The USGS/LaCoste-Romberg meter can be levelled up to 6.5 degrees off vertical and is kept at  $101^\circ\text{C}$  by a thermostat. Thus it will not work at temperatures higher than this. It takes  $\sim 5$  minutes to make a reading.

These measurements are important for determining densities. Borehole gravimeters are the best borehole density loggers in existence. They are sufficiently sensitive to monitor reservoir depletion as water replaces oil.

## 6. Measurement of gravity on moving platforms

### 6.1 Sea surveys

Measurement of gravity at sea was first done by lowering the operator and the instrument in a diving bell. This is no longer done because it is slow and expensive. Now two methods are used:

#### 1. Lowering the meter onto the sea floor (~ 0.1 mGal accuracy)

The meter is operated by remote control. Gulf and LaCoste-Romberg gravimeters are adapted for this. Errors arise due to wave motion at the surface, which decrease with depth. It is better if the instrument is placed on rock and not mud. It is necessary to know accurately the water depth and for this a pressure gauge gives a readout on the same panel as the gravity reading. This method is used to study gravity anomalies of small extent, *e.g.*, salt domes. The sensitivity of these gravimeters is ~ 0.1 mGal. It is very expensive to survey in this way, as the ship must stop for each reading.

#### 2. The meter onboard ship (recently improved from ~ 2 mGal to 0.2 accuracy)

This is fundamentally difficult because the ship experiences accelerations up to 10% of  $g$  (100,000 mGal). The *horizontal* motions are compensated for by mounting the meter on a gyroscopically-controlled stable platform. The *vertical* motions are compensated for by averaging over a long period, and by damping the meter heavily, *e.g.*, by using a meter with a 5-minute natural period. This results in long-period anomalies only being measured, *i.e.* a heavily damped meter functions as a low-pass filter. The accuracy achieved depends on the state of the sea, however. Sea states of 4 or more make errors much larger. Gulf, LaCoste-Romberg, Bell and Askania meters are available for such work.

### 6.2 Air surveys (accuracies ~ 1-5 mGal)

Problems due to the acceleration of aircraft have not yet been completely solved, but rapid progress is being made with the advent of the Global Positioning System (GPS). Reasonably good regional surveys have been achieved, where accuracies of a few mGal have been demonstrated. Airborne gravity surveying has the potential to greatly reduce the expense of gravity surveys but how usable the results are is controversial. Some workers have checked airborne results with land results and report discrepancies much larger than the “official” errors, which suggests that the true *accuracy* of these surveys is worse than the calculated *precision*, a common situation in science.

### 6.3 Space measurements

Determining the gravity field of the Earth from space involves measuring the height of a satellite above sea level by *radar altimetry*. A series of satellites have been used, including Skylab (which currently has “mission completed” status), GEOS3, SEASAT, Geosat, ERS1

and ERS2. SEASAT until recently had given the most and best data. It was launched in 1978, into a circular orbit with an altitude of 800 km. It circled the Earth 14 times each day and covered 95% of the Earth's surface every 36 hours.

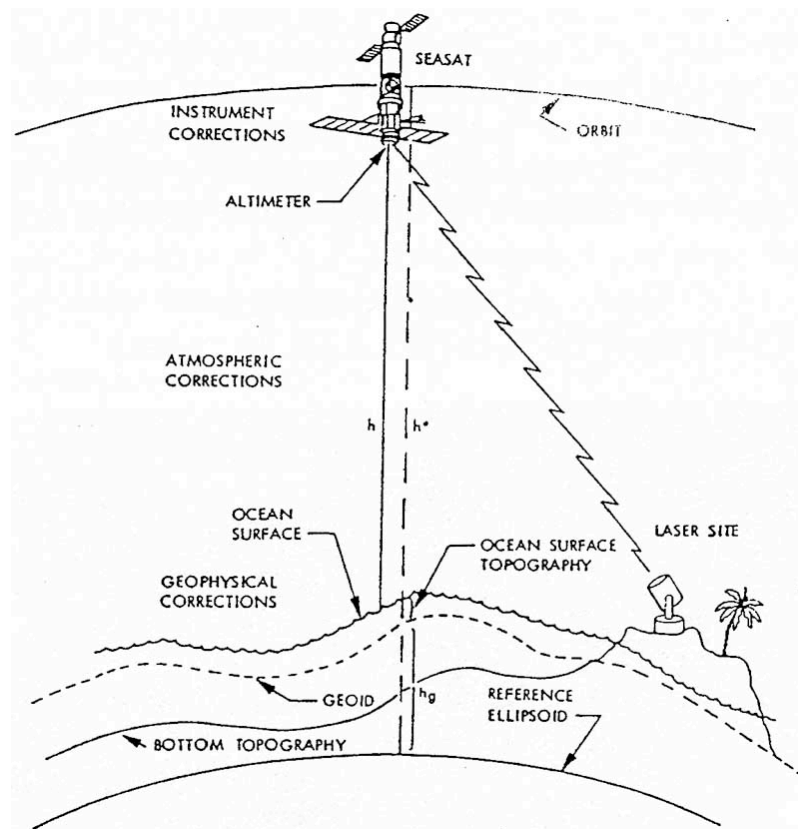

*Schematic of SEASAT principles of operation*

The position of SEASAT in three dimensions was continually tracked by laser sites whose co-ordinates with respect to the spheroid are known. The satellite continually transmitted a radar signal which bounced off the sea surface. The two-way travel time was measured.

- $h^*$  was derived from tracking,
- $h$  was measured by the satellite, and
- $h_g$ , the geoid height, was calculated

The “footprint” of the radar beam on the surface of the sea was 2-12 km wide, and this represents the diameter of the “points” that were measured. The precision of measurement was 10-20 cm. The gravity fields returned were used to study variations in the Earth's mass and density distribution, since these are related directly to geoid topography.

The “footprint” of the ERS satellites, launched in the 1990s, is at the kilometer level, representing a big improvement over SEASAT.

It is important to know the global gravity field of the Earth for:

1. Study of features on the scale of tectonic plates, *e.g.* subducting slabs,
2. Satellite orbits,

3. Determining the geoid height to tie geodetic surveys, and linking GPS-measured heights to elevations above sea level,
4. Calculating the deviation of the vertical, for connecting continental surveys, and
5. Missile guidance and satellite navigation.

Recent modern advances in gravimeters include the addition of direct digital readouts, which speed up measurements, and the use of GPS navigation in the case of moving platforms. This has greatly improved the accuracy of the Eötvös correction, reducing the error from this source from  $\sim 2$  mGal to 0.2 mGal. Reasonable gravity fields on regional scales are now available for most of the Earth via the Internet, so it is becoming less important for oil companies to do their own surveying.

A discussion of the comparative accuracies of various survey methods may be found in:

[http://www.geo.utexas.edu/courses/468k/Clark%20Wilson%20Lectures/Potential%20Fields%20Leading%20Edge%20%20articles/Fairhead\\_2002.pdf](http://www.geo.utexas.edu/courses/468k/Clark%20Wilson%20Lectures/Potential%20Fields%20Leading%20Edge%20%20articles/Fairhead_2002.pdf)

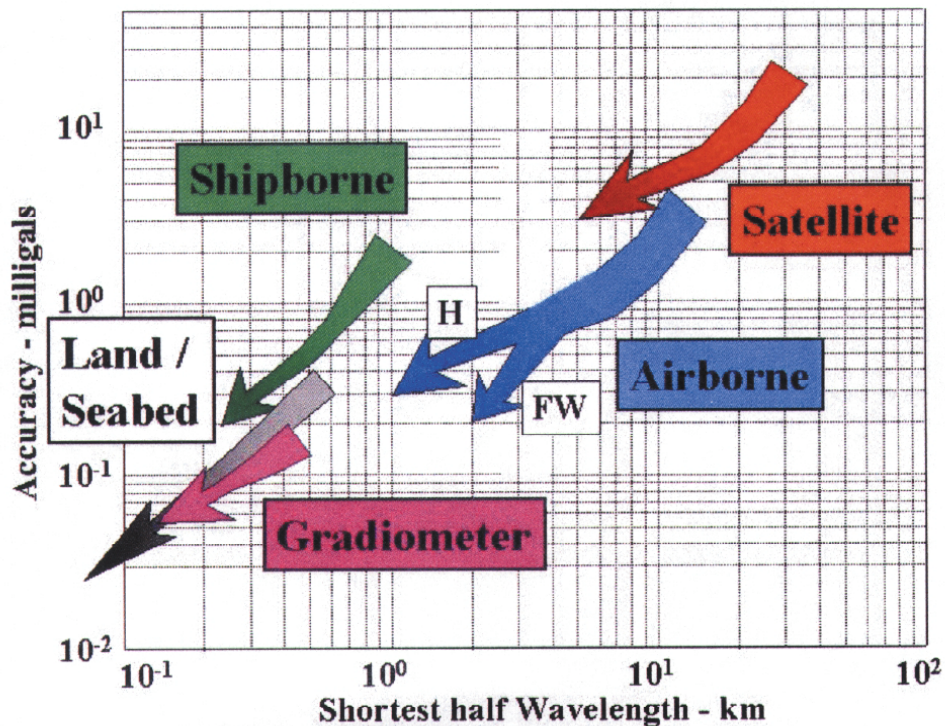

*Relative accuracies of different methods of surveying gravity*

## 7. The gravity survey

The following factors must be considered in designing a survey:

1. If it is desired to tie the survey to others, the network must include at least one station where absolute  $g$  is known.
2. The station spacing must fit the anomaly scale.

3. The heights of all stations must be known or measured to 10 cm.
4. Latitudes must be known to 50 m.
5. Topography affects the measurements, thus it is best to locate the stations where there is little topography.
6. Access is important, which often means keeping stations to existing roads or waterways if there are no roads.
7. In the design of the gravity survey, station spacing and accuracy are most important. It is important to realise that no amount of computer processing can compensate for poor experiment design. This wise adage applies for all geophysics, and not just gravity surveying. Linear features may be studied using one or more profiles, two-dimensional features may require several profiles plus some regional points, and for some special objectives, *e.g.*, determining the total subsurface mass, widely-spaced points over a large area may be appropriate.

### Method

The following field procedure is usually adopted:

1. Measure a base station,
2. measure more stations,
3. remeasure the base station approximately every two hours.

If the survey area is large, time can be saved by establishing a conveniently sited base station to reduce driving. This is done as follows:

Measure: base 1 → new base station → base 1 → new base station → base 1

This results in three estimates of the difference in gravity between base 1 and the new base station. From this, gravity at the new base station may be calculated.

The new base station can then be remeasured at two-hourly intervals instead of base 1. This procedure may also be used to establish an absolute base station within the survey area if one is not there to start with.

During the survey, at each station the following information is recorded in a survey log book:

- the time at which the measurement is taken,
- the reading, and
- the terrain, *i.e.*, the height of the topography around the station relative to the height of the station.

Transport during a gravity survey may be motor vehicle, helicopter, air, boat (in marshes), pack animal or walking. In very rugged terrain, geodetic surveying to obtain the station heights may be a problem.

## **8. Reduction of observations**

It is necessary to make many corrections to the raw meter readings to obtain the gravity anomalies that are the target of a survey. This is because geologically uninteresting effects are



significant and must be removed. For example, gravimeters respond to the changing gravitational attraction of the sun and moon, and sea and solid Earth tides. Earth tides can be up to a few cm, and 0.01 mGal, the target precision, corresponds to 5 cm of height.

### 1. Drift

A graph is plotted of measurements made at the base station throughout the day. Drift may be non-linear, but it has to be assumed that it is be linear between tie backs for most surveys. The drift correction incorporates the effects of instrument drift, uncompensated temperature effects, solid Earth and sea tides and the gravitational attraction of the sun and moon.

### 2. Calibration of the meter

This is a number provided by the manufacturer, that translates scale readings into mGal.

$$(actual\_reading + drift - base\_reading)calibration = g_{sta} - g_{base}$$

### 3. Latitude correction

This is needed because of the ellipticity of Earth.  $g$  is reduced at low latitudes because of the Earth's shape and because of rotation:

$$lat\_correction = g_{sta} - g_{\phi}$$

### 4. Elevation (Free Air) correction

It is necessary to correct for the variable heights of the stations above sea level, because  $g$  falls off with height. It is *added*:

$$FAC = \frac{2g}{r} = 0.3086mGal / m$$

### 5. Bouguer correction

This accounts for the mass of rock between the station and sea level. It has the effect of increasing  $g$  at the station, and thus it is *subtracted*. The formula for the Bouguer correction on land is:

$$\begin{aligned} BC &= 2\pi G\rho h \\ &= 4.185 \times 10^{-5}\rho \\ &\sim 0.1 \text{ mGal/m} \end{aligned}$$

where  $h$  = height above sea level and  $\rho$  = density. This is also the formula for an infinite slab of rock. The Bouguer correction is subtracted on land, but at sea it must be *added* to account for the lack of mass between the sea floor and sea level:

$$BC_{sea} = 2\pi G(\rho_{rock} - \rho_{water})h$$

where  $h$  = water depth.

It is possible to combine the Free Air and Bouguer corrections:

$$BC \& FAC = \left[ \frac{2g}{r} - 2\pi G\rho \right] h$$

## 6. Terrain corrections

The effect of terrain is always to *reduce* observed  $g$ . This is true for a mountain above the station and a valley below the station, which both cause  $g$  to be reduced. Terrain corrections are done by hand using a transparent graticule, or by computer if a digital terrain map is available. The graticule is placed on a map and the average height of each compartment estimated. A “Hammer chart” is then used to obtain the correction. This chart gives the correction for a particular distance from the station. It has been worked out assuming a block of constant height for each compartment. Other charts are available, e.g., the Sandberg tables, which provide for larger terrain differences and assume sloping terrain.

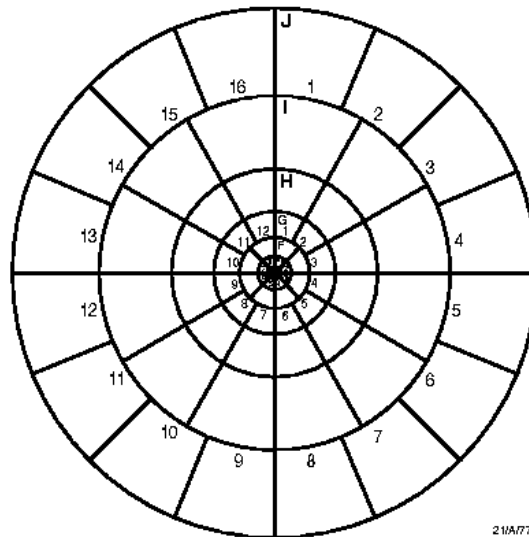

*A graticule*

Terrain corrections are now done with digital terrain maps and a computer program if possible, as doing the work by hand is very time-consuming and involves a lot of repetition.

## 7. Tidal correction

This is necessary for:

- ultra-accurate surveys where it is not sufficiently accurate to absorb the effect of the sun and moon in the drift correction, and
- if gravimeter drift is low and the base station tie backs were made with a similar period as the tides.

Tides occur both in the solid Earth and the sea. The latter is important for marine surveys. The period of the tides is about 12 hrs. The amplitude of the gravitational effect of the solid Earth tides is up to  $\sim 0.3$  mGal throughout the day at a fixed point on Earth.

Ultra-accurate gravity surveying, sometimes called micro-gravity, seeks changes in anomalies of the order of hundredths of mGal. Such surveys are conducted to look for changes in height with time (e.g., over an inflating volcano or a subsiding oil rig) or changes in density of the rocks in exploited reservoirs or beneath active volcanoes. For such surveys it may be necessary to make the tidal and sun/moon corrections explicitly. In modern computer gravity reduction programs, these effects can be automatically calculated.

### 8. Eötvös correction

Movement in an EW direction will invalidate the IGRF and this must be taken into account. Movement E will decrease  $g$  and movement W will increase it. The magnitude of the correction that must be made is  $\sim 0.1$  mGal per knot EW, and thus this correction is important for marine and air surveys.

$$EC = [75.03V \sin \alpha \cos \phi + 0.04154V^2] 10^{-3}$$

where  $EC$  = Eötvös correction in mGal,  $V$  = speed in knots,  $\alpha$  = the vehicle heading and  $\phi$  = latitude.

### 9. Errors

As with all geophysical surveys, errors limit survey accuracy. In deciding how accurate the survey is required to be it is necessary to decide how far to go with the corrections.

a) The reading error. This can be large for an inexperienced operator.

b) The drift error. This can be reduced by frequent tie backs. In surveys where very high accuracy is required, the sun, moon, solid Earth and sea tide corrections may be made separately for the instant the reading was made. Under these circumstances, extrapolation to a base station reading made at a different time is not accurate enough. The drift error can also be reduced by making several measurements at each station at different times and averaging. This will yield an estimate of the repeatability of the readings.

c) The meter calibration constant. This will introduce a systematic error if it is incorrect. It is generally only known to 1 part in  $10^4$ .

d) Subtraction of  $g_\phi$ . Gravity is supposed to be reduced to *sea level* (i.e. to the geoid), not to the spheroid. However, the IGRF gives absolute gravity at the reference spheroid. This is not a problem as long as the geoid-spheroid separation is the same over the survey area, i.e., there is no “geoid gradient”. In large areas this assumption may not be valid and the error due to this is known as the “indirect effect”. The error from errors in the measured latitude is  $\sim 0.01$  mGal/10 m.

e) FAC, BC. For these corrections the station height needs to be known accurately. The FAC and BC combined amount to  $\sim 0.2$  mGal/m. Thus an error of 5 cm in height gives an error of about 0.01 mGal. The height of stations is usually got by making gravity measurements at existing benchmarks and spot heights and reading the heights off a map. Levelling to get heights is very expensive. Geodetic barometer heights are only accurate to  $\sim 5$  m (= 1 mGal). The GPS can be used, and various modes of operation are available. The accuracy in vertical height obtainable using the GPS is proportional to the logarithm of the amount of work involved.

### f) Terrain corrections

These may be very large in mountainous areas. For example, in the Himalaya they may amount to 80 mGal. There is a problem with knowing the density of a layer several km thick, and where the corrections are huge the Hammer compartments are too coarse. The Hammer

corrections are also unequal for different compartments for a cylinder of constant height and density, and thus there are unequal errors for given terrain heights. A method is needed where compartments have equal corrections, e.g. 4 mGal. A digital terrain database can fulfill these requirements, and this can also solve the problem of the huge amount of work needed to make terrain corrections, 95% of which is duplication.

g) Rock density. It is difficult to assess the density of bulk rock *in situ*, and this may be the largest source of error.

h) The Eötvös correction. The main source of error in this is knowing the speed and bearing of the ship or aeroplane. Error in the Eötvös correction was the limiting error in sea and air surveys before the advent of the GPS, which provided an order of magnitude improvement in the accuracy of such surveys.

i) Satellite measurements. Errors in the known position of the satellite produce by far the largest errors. The known position of SEASAT was improved over what could be measured by minimising the RMS of measurements made at crossover positions in the orbit.

## 9. Examples

### 9.1 A gravity survey of Iceland

<http://www.os.is/~g/skyrslur/OS-93027/skyrsla.pdf>

The whole of the 450 x 300 km island of Iceland was surveyed 1967 - 1985, with the assistance of the US military. Gravity is of importance to the military because it is needed for accurate missile guidance.

The project involved 1610 gravity stations covering the whole island at 10-km spacings. Station locations, elevations and gravity readings were required at each. 46 absolute gravity base stations were used, which were tied to stations in the USA and Scandinavia. Because Iceland is an island both land and sea topography and bathymetry measurements were needed.

Problems included the need for accurate bathymetry of the surrounding seas, in order to make the Bouguer and terrain corrections, and the difficulties of making measurements on the icecaps where ice accumulation and ablation continually changes the surface elevation. Road transport in Iceland is limited and so much travelling had to be done by helicopter and snowmobile, which was expensive, time-consuming and dangerous.

The whole project was a massive effort - the terrain corrections alone took years to do.

### 9.2 Microgravity at Pu'u O'o, Hawaii

[http://geopubs.wr.usgs.gov/prof-paper/pp1676/pp1676\\_10.pdf](http://geopubs.wr.usgs.gov/prof-paper/pp1676/pp1676_10.pdf)

Microgravity surveying involves making repeated, super-accurate gravity surveys together with geodetic surveys for elevation, in order to seek mismatches between changes in elevation and changes in gravity. The mismatches can be interpreted as changes in the mass distribution

beneath the surface. This method has been applied to various active volcanoes in an effort to detect the movement of magma and gas in and out of chambers, thereby contributing to volcanic hazard reduction.

This method was applied to Pu'u O'o, which is a flank vent of Kilauea, Hawaii. Changes in gravity were correlated with eruptive behaviour. Extremely accurate elevation measurements were made by levelling, along with explicit corrections for Earth tides, in contrast to the usual procedure of absorbing these in a single drift corrections. Multiple measurements were made with more than one gravimeter at each station. The objective was to achieve  $\sim 0.01$  mGal precisions, corresponding to 3 cm elevation changes.

It was concluded from the study that mass changes were occurring beneath the summit of Kilauea that were much smaller than the erupted mass. This suggests that the summit reservoir is simply a waypoint for the magma, and large quantities of magma pass through from deeper levels to supply a single eruption.

## 10. Gravity anomalies

### 10.1. Bouguer anomaly (BA)

The equation for the Bouguer anomaly is:

$$BA = g_{obs} - g_{\phi} + FAC \pm BC + TC(\pm EC)$$

The BA is equivalent to stripping away everything above sea level. It is the anomaly most commonly used in prospecting.

### 10.2 Free-Air anomaly (FAA)

$$FAA = g_{obs} - g_{\phi} + FAC(\pm EC)$$

The FAA may be thought of as squashing up all the mass above sea level into an infinitesimally thin layer at sea level, and measuring gravity there. The FAA is mostly used for marine surveys and for investigating deep mass distribution, *e.g.*, testing theories of isostasy.

### 10.3 Isostasy

*Isostasy* is the study of how loads, *e.g.*, mountain belts on the Earth's surface, are compensated for at depth. The study of isostasy dates from  $\sim 1740$  when an experiment was done to measure the deviation of the vertical due to Andes. The deviation was found to be much smaller than predicted from the height and density of the Andes. It was suggested that a compensating mass deficiency lay beneath the mountains. The same results were found for the Himalaya. There, the astronomical distance between two sites, corrected only for the Himalaya, was found to be different from the terrestrially-surveyed distance.

This led to the application of Archimedes principle to the Earth's outer layers. There are two

basic theories, the Airy and the Pratt theories. Both were based on the concept that a rigid *lithosphere* overlies a viscous *asthenosphere*.

It is important to understand that the lithosphere and the asthenosphere are not the same as the crust and mantle.

<http://www.geolsoc.org.uk/template.cfm?name=lithosphere>

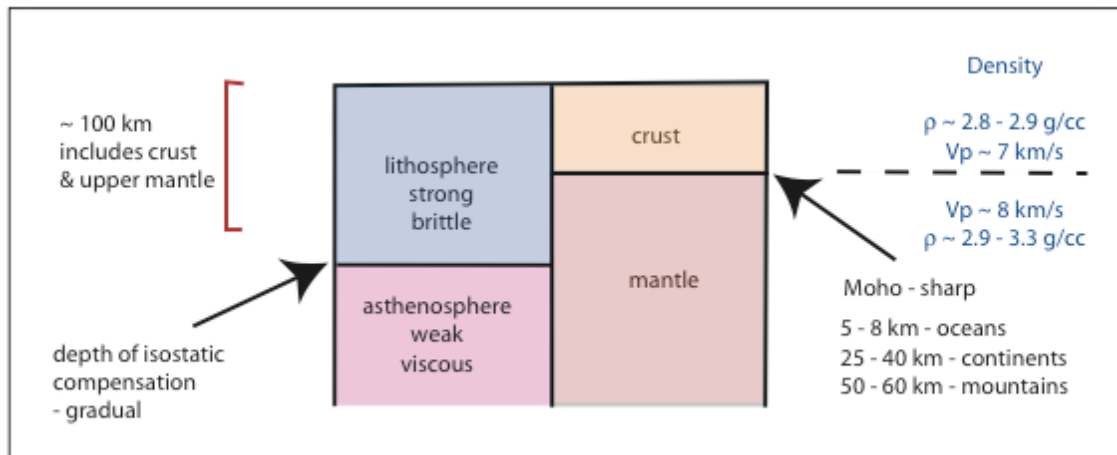

*Schematic comparing the crust, mantle, lithosphere and asthenosphere*

The lithosphere/asthenosphere boundary is the depth of isostatic compensation, whereas the crust/mantle boundary is defined as the Mohorovicic discontinuity, a seismic discontinuity where the velocity jumps from roughly 7 km/s to roughly 8 km/s. Scientists are guilty of using the terms lithosphere, asthenosphere, crust and mantle rather loosely, and even defining them in terms of geochemistry, petrology etc., but the definitions given above are the original ones.

The Airy hypothesis is governed by the equation:

$$r = \frac{h\rho_c}{\rho_s - \rho_c}$$

The Pratt hypothesis is governed by the equation:

$$\rho(h + D) = \text{constant}$$

Gravity anomalies can be used to test if an area is in isostatic equilibrium, since there the FAA should be approximately zero. Examples of places where this has been done are the mid-Atlantic ridge and the Alps. However, gravity anomalies cannot decide between the Airy and the Pratt hypotheses. Seismic refraction studies can give additional information, but they cannot detect the depth of compensation. Many broad features appear to be in approximate isostatic equilibrium. In some cases this appears to be due to variations in the thickness of the crust, *e.g.*, the Rocky Mountains, which implies Airy compensation. In other cases

compensation may result from there being low density rocks in the upper mantle, e.g., the E African Rift, ocean ridges, which implies Pratt compensation.

These theories lead to the concept of the isostatic anomaly:

$$\text{Isostatic anomaly} = \text{Bouguer anomaly} - \text{predicted effect of the root}$$

–ve isostatic anomaly = unexpected mass deficiency (i.e., too much root)

+ve isostatic anomaly = insufficient root

This is an oversimplification, however, as the presence of geological bodies means that the isostatic anomaly is rarely exactly zero. An example is over Fennoscandia, where there is a –ve isostatic anomaly because the compensation of the Pleistocene icecap is not yet dispersed. The land there is still rising at 0.5 cm/yr, and 200 m more of rising is needed before equilibrium is reached.

Isostatic compensation is an overly-simple idea, however, since:

- compensation may not occur only directly beneath the load. Because the lithosphere has strength, it can flex and distribute the load over laterally extensive areas.
- because of plate tectonics, the Earth is constantly being driven out of equilibrium.

#### Interpretation of satellite geoid warp data

The geoid warp is directly related to lateral variations in density and topography. SEASAT gave data which were translated into the FAA.

## **11. Rock densities**

### *11.1 Introduction*

The use of gravity for prospecting requires density contrasts to be used in interpretations. Rock densities vary very little, the least of all geophysical properties. Most rocks have densities in the range 1,500-3,500 kg/m<sup>3</sup>, with extreme values up to 4,000 kg/m<sup>3</sup> in massive ore deposits.

In sedimentary rocks, density increases with depth and age, *i.e.*, compaction and cementation. In igneous rocks, density increases with basicity, so granites tend to have low densities and basalts high densities.

### *11.2 Direct measurement*

The sample is weighed in air and water. Dry and saturated samples are measured.

### *11.3 Using a borehole gravimeter*

This is only possible if a borehole is available in the formation of interest. The density in the interval between the measurements is calculated using the equation:

$$g_1 - g_2 = 0.3086h - 4G\rho h$$

(FA term)    (2 x Bouguer term)

Where  $g_1$  and  $g_2$  are two measurements at points in the borehole separated by a vertical distance  $h$ . Twice the Bouguer term must be used because the slab of rock between the two points exerts downward pull at the upper station and an upward pull at the lower station. Thus:

$$\rho = \frac{0.3086h - \Delta g}{4\pi Gh}$$

#### 11.4 The borehole density logger (gamma-gamma logger)

This consists of a gamma ray source (*e.g.*, Co<sub>60</sub>) and a Geiger counter. The Geiger counter is shielded by lead so only scattered gamma radiation is counted. The amplitude of scattered radiation depends on the electron concentration in the rock, which is proportional to density (empirically calibrated). The gamma rays are scattered by rock in the borehole walls. The tool is held against the rock walls by a spring. This works well if the rock walls are good, but poorly if the rock is washed out, which can be a problem in soft formations. The maximum penetration is  $\sim 15$  cm and the effective sampled volume is  $\sim 0.03$  m<sup>3</sup>, which can be a problem if this small volume is unrepresentative of the formation. It is accurate to  $\sim 1\%$  of the density, and so accurate that the borehole log is irregular and must be averaged over a few tens of m to get values suitable for gravity reduction.

#### 11.5 Nettleton's method

This involves conducting a gravity survey over a topographic feature, and reducing the data using a suite of densities. The one chosen is that which results in an anomaly that correlates least with the topography. This method has the advantage that bulk density is determined, not just the volume of a small sample.

The disadvantages are:

- only near surface rocks are sampled, which may be weathered, and
- the topographic feature may be of different rock to rest of area, and may actually exist because of that reason.

#### 11.6 Rearranging the Bouguer equation

If the variation in gravity over the area is small, we may write:

$$BA = BA_{ave} + \delta BA$$

$BA$  = Bouguer anomaly at station,

$BA_{ave}$  = average BA over whole area,

$\delta BA$  = small increment of BA.

The standard Bouguer anomaly equation is:



$$BA = g_{obs} - g_{\phi} + FAC - BC + TC$$

thus:

$$\begin{aligned} g_{obs} - g_{\phi} + FAC &= BA_{ave} + \delta BA + BC - TC \\ &= \rho(0.04191h - \frac{TC}{2000}) + BA_{ave} + \delta BA \end{aligned}$$

for Hammer charts using  $\rho = 2,000 \text{ kg/m}^3$

This is an equation of the form  $y = mx + c$  if  $\delta BA$  is small. If the line is plotted:

$$g_{obs} - g_{\phi} + FAC : 0.04191h - \frac{TC}{2000}$$

it should yield a data distribution in the form of scatter about a straight line. A line can be fitted to this using least squares, and this will have a gradient of  $\rho$ .

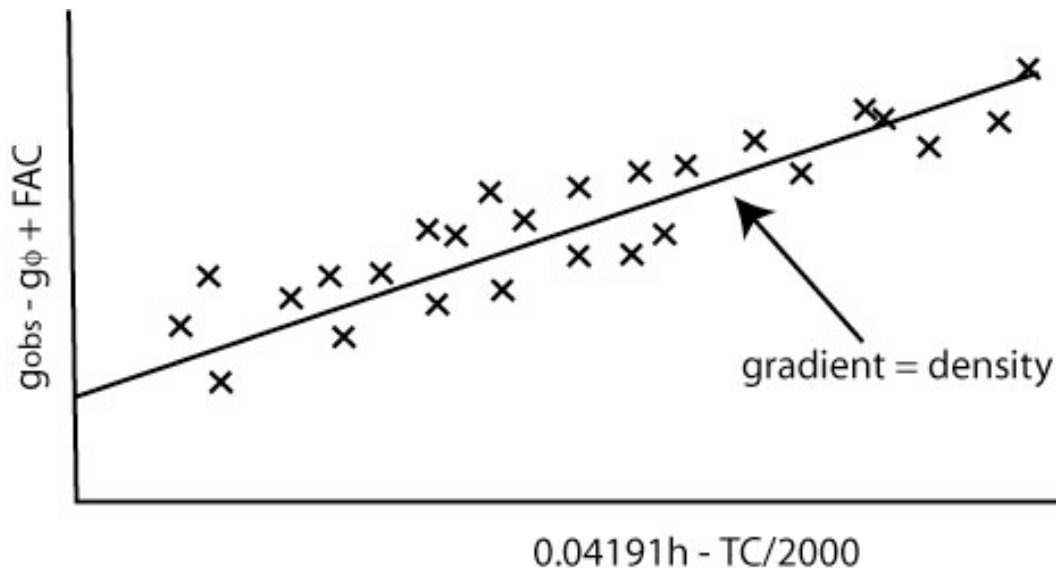

*Rearranging the Bouguer equation*

### 11.7 The Nafe-Drake curve

This is an empirical curve relating seismic velocity to density. It is probably only accurate to  $\pm 100 \text{ kg/m}^3$ , but it is all there is for deep strata that cannot be sampled.

### 11.8 When all else fails

Look up tabulated densities for the same rock type.

### 11.9 Example

An example of a survey where density was particularly important is the case of sulphur exploration at Orla, Texas. There, density of the rocks in the region were measured both from samples and in boreholes. The dominant lithologies were limestone, dolomite, sand, gypsum, salt and anhydrite.

Gravity was a suitable prospecting technique because there were substantial variations in the densities of the lithologies present, in the range 2,500 - 3,000 kg/m<sup>3</sup>. Density was measured using

- drill cuttings and cores,
- in boreholes using neutron borehole logs (a porosity well log which measured mainly hydrogen density) combined with lithologs,
- gama-gamma logs, and
- borehole gravimeters.

The densities were used to model surface gravity using fairly complex geological models, and the results were used to decide whether mining should proceed at promising locations.

A full report containing the details of this work is available at:

[http://www.igcworld.com/PDF/sulfur\\_seg\\_ref8.pdf](http://www.igcworld.com/PDF/sulfur_seg_ref8.pdf)

## **12. Removal of the regional - a suite of methods**

### *12.1 Why remove a regional?*

The deeper the body the broader the anomaly. The interpreter may wish to emphasise some anomalies and suppress others, *e.g.*, shallow anomalies are important to mineral exploration, and deep anomalies are important for oil exploration. One survey's signal is another's noise. The effects of shallow bodies may be considered to be near surface noise, and the effects of deep bodies, known as the regional, may be caused by large-scale geologic bodies, variations in basement density or isostatic roots. These must be removed to enable local anomalies to be interpreted. The problem lies in separating out the two effects, and it is not strictly possible to do this without effecting what is left.

### *12.2 Removal of the regional by eye*

This may be subjective.

### *12.3 Digital smoothing*

Get a computer to do what would otherwise be done by eye.

### *12.4 Griffin's method*

This involves calculating the average value of  $\Delta g$  at points surrounding the point under investigation.  $\Delta g$  is then subtracted from the value of gravity at the point. This procedure is subjective and the result depends on the circle radius.

### *12.5 Trend surface analysis*

This involves fitting a low-order polynomial of the form:

$$A_r = A_0 + A_1x + A_2y + A_3xy + A_4x^2 + \dots$$

If the surface is smooth, it may be assumed to be a “regional”.

### *12.6 Spectral analyses*

This can be used to remove long-wavelength components from the gravity field.

### *12.7 Caveat*

Mathematically objective methods should not be applied uncritically without physical insight. All enhancing of gravity data must be justifiable.

## **13. Pre-processing, displaying and enhancing gravity data**

These tasks have been made much easier in recent years by the availability of powerful computers, topography databases and vast amounts of gravity data available, *e.g.*, over the Internet.

### *13.1 Why pre-process gravity data?*

Some techniques for filtering and displaying gravity data in a variety of ways can reveal anomalies that are not visible in the original data. The deeper the body the broader the anomaly (but remember, that it does not follow that the broader the anomaly the deeper the body). The effects of shallow bodies create near surface noise, and the effects of deep bodies may be considered to be a “regional” trend of no interest. For these reasons, the analyst may wish to emphasise some anomalies and suppress others. The problem is to separate out the two effects without significantly distorting the signal of interest required.

### *13.2 Gravity reduction as a process*

Gravity reduction itself enhances anomalies. For example, gravity reduction may be done with or without terrain corrections.

### *13.3 Removal of the regional*

This process was discussed above.

### *13.4 Wavelength filtering*

This method may be helpful but artifacts can be created, and bodies of interest may have contributions from different wavelengths. Thus each survey must be looked at individually – there are no rules of thumb. Removing the regional is really a simple form of this process.

### *13.5 Directional filtering*

This is useful for enhancing second-order effects if the dominant tectonic trend is in one direction, and cleaning up data with artificial trends in a preferred direction, *e.g.*, as a result of

navigation of ship tracks having polarised errors.

### *13.6 Vertical derivative methods*

#### 1. The second vertical derivative

The second vertical derivative has certain properties because gravity falls off as  $r^{-2}$ , the 1st derivative falls off as  $r^{-3}$  and the second derivative as  $r^{-4}$ . Thus, the second vertical derivative:

- a) enhances shallower effects at the expense of deeper effects,
- b) can completely remove the regional,
- c) can determine the sense of contacts, and
- d) can be used to determine limiting depths (the “Smith rules”).

A problem is that it enhances noise, and thus must be done carefully.

An example of enhancement of shallow anomalies is the Los Angeles Basin, California and an example of suppression of the regional is the Cement field, Oklahoma.

#### 2. The first vertical derivative

This has a similar effect to the second vertical derivative in emphasising features related to gradients in the field rather than the field itself. It suffers less from noise enhancement than the second vertical derivative and has an additional interesting use because it gives the magnetic field, if it is assumed that the strength and direction of magnetisation is constant. “Pseudomagnetic anomalies” can be calculated in this way, and compared with real magnetic maps to see if bodies identified by gravity surveying are also magnetic or if magnetic material is present that is not related to density variations. For example, basic plutons have high density/high magnetisation and silicic plutons tend to have low density/low magnetisation.

Errors: Because derivatives enhance noise, they can be used to detect data outliers and blunders, which stand out as large anomalies in derivative maps.

### *13.7 Isostatic anomalies*

These remove the effect of the isostatic root. It makes little difference what isostatic model is used.

### *13.8 Maximum horizontal gradient*

In the case of near-vertical geological boundaries, the maximum horizontal gradient lies over the boundary. This provides a different way of viewing the data, which has the potential for revealing otherwise unnoticed features.

### *13.9 Upward and downward continuation*

This is useful in gravity because upward continuation suppresses the signals due to small, shallow bodies, just as taking the second derivative enhances them. It is most useful when applied to magnetic data for:

- a) upward continuing measurements made at ground level so they may be compared with

- aeromagnetic data, and  
 b) determining the depth to the basement.

Downward continuation is problematic because noise will blow up exponentially, and if the data are continued down past some body, a meaningless answer will result. Thus, this process must be done carefully, using low-noise data, and in a known situation.

### 13.10 Presentation

Much variety is available regarding presentation nowadays. In the past the results were simply presented as contour maps. Modern presentation methods include contour maps, colour, shaded gray, shaded relief maps, side-illuminated and stereo-optical maps. Several different types of geophysical data may also be draped onto the same figure.

## 14. Interpretation, modelling and examples

Interpretation relies heavily on the formulae for simple shapes. Methods for interpretation may be divided into two approaches:

**1. Direct (forward) methods.** Most interpretation is of this kind. It involves erecting a model based on geological knowledge, *e.g.*, drilling, or parametric results, calculating the predicted gravity field, and comparing it to the data. The body may then be changed until a perfect fit to the data is obtained.

**2. Indirect methods.** These involve using the data to draw conclusions about the causative body, *e.g.*, the excess mass, the maximum depth to the top. Some parameters may be calculated, but the full *inverse problem i.e.*, calculating the body from the anomaly, is inherently *non-unique*.

### The ambiguity problem

This is the intrinsic problem that gravity interpretation not unique. Although for any given body, a unique gravity field is predicted, a single gravity anomaly may be explained by an infinite number of different bodies, *e.g.*, spheres and point masses. Because of this dilemma, it is most important use constraints from surface outcrop, boreholes, mines and other geophysical methods. The value of gravity data is dependent on how much other information is available.

There are three basic interpretation approaches, and all may be used together to study a single dataset:

### 14.1. The Parametric method

This involves approximating bodies to simple shapes, or combinations of simple shapes, and measuring features of the gravity anomaly to obtain body parameters. Parameters that can be obtained include:

#### 1. The maximum depth to the top of the body

Note that the true depth to the top of body is always shallower because real bodies have

finite sizes. For example, if the anomaly is due to a mass that is approximately a point or line mass, then:

$$z \cong x_{1/2}$$

where  $z$  is the depth to the top and  $x_{1/2}$  is the width of the anomaly from its peak to the position where it has only half its maximum value. There are similar formulae for other bodies, *e.g.*, down-faulted slabs. Knowing a few of these enables the interpreter to make instant assessments from gravity maps. It is not possible to estimate the *minimum* depth to the top of a body, but fortunately it is the *maximum* depth that is important for making drilling decisions.

## 2. Excess mass

An estimate may be obtained without making assumptions about the shape of the body. Gauss' flux theorem states for the total gravitational flux from a body:

$$\sum \Delta g \Delta s = 4\pi GM$$

where  $s$  is the area. It is assumed that half of the flux comes out of the surface:

$$\sum \Delta g \Delta s = 2\pi GM$$

To get the actual tonnage, the densities must be known.

## 3. The nature of the upper corners of the body

The location of the inflection point, *i.e.*, the point where the horizontal gradient changes most rapidly, is dependent on the nature of the upper corners of the body. An example of the application of this useful fact is that if the second horizontal derivative of the gravity field is taken, it is possible to distinguish granite intrusions from sedimentary basins. This is useful because the two often occur together, and give gravity anomalies that look superficially similar.

## 4. Approximate thickness

A rough estimate may be got for this using a rearrangement of the slab formula:

$$t = \frac{\Delta g}{2\pi G \Delta \rho}$$

The *actual* thickness is always larger if the body is not infinite.

### *14.2. Direct methods, or "forward modelling"*

This involves setting up a model, calculating the gravity anomaly, comparing it with the observed data and adjusting the model until the data are fit well. The initial model may be obtained using parametric measurements and/or geological information. Simple shapes may be tried first, and analytical equations are available for these. These have been derived from Newton's Law. Formulae of this kind are useful because they approximate to many simple bodies, and irregular bodies can be approximated to the sum of many simple bodies.

Examples:

- the point mass: salt domes.
- the infinite horizontal cylinder: buried channels
- the horizontal sheet: a narrow horizontal bed
- the infinite sheet: faulted sills
- the infinite slab: – the SLAB FORMULA: broad structures e.g., faults, the edges of large intrusions
- the vertical cylinder: volcanic plugs, salt domes

More sophisticated forward modelling usually necessitates the calculation of gravity over irregular bodies. There are two methods for doing this. The *graticule method* which is a hand method that is now obsolete, and the *computer method*, which is based on the same principles. (It is interesting to note that, before the advent of electronic, digital computers, data analysts were known as “computers”.)

A typical computational approach is as follows. For two-dimensional modelling, the body cross-section is approximated to a polygon. The polygon is assumed to be infinite in the third direction. This works reasonably if one horizontal dimension is greater than twice the other. If this is not the case, the end effects must be corrected for. This is known as “two-and-a-half-dimensional modelling”. So-called “two-and-three-quarters-dimensional modelling” is the same as 2.5D but one end correction is “longer” than the other, *i.e.*, it is assumed that the profile does not pass through the middle of the body.

Three-dimensional bodies must be defined by contours, and these contours are approximated to polygonal layers. The effects of these layers at each contour are calculated and summed. Another method involves modelling the body as an assemblage of vertical prisms. Three-dimensional modelling is rarely needed because most problems can be addressed by profiles.

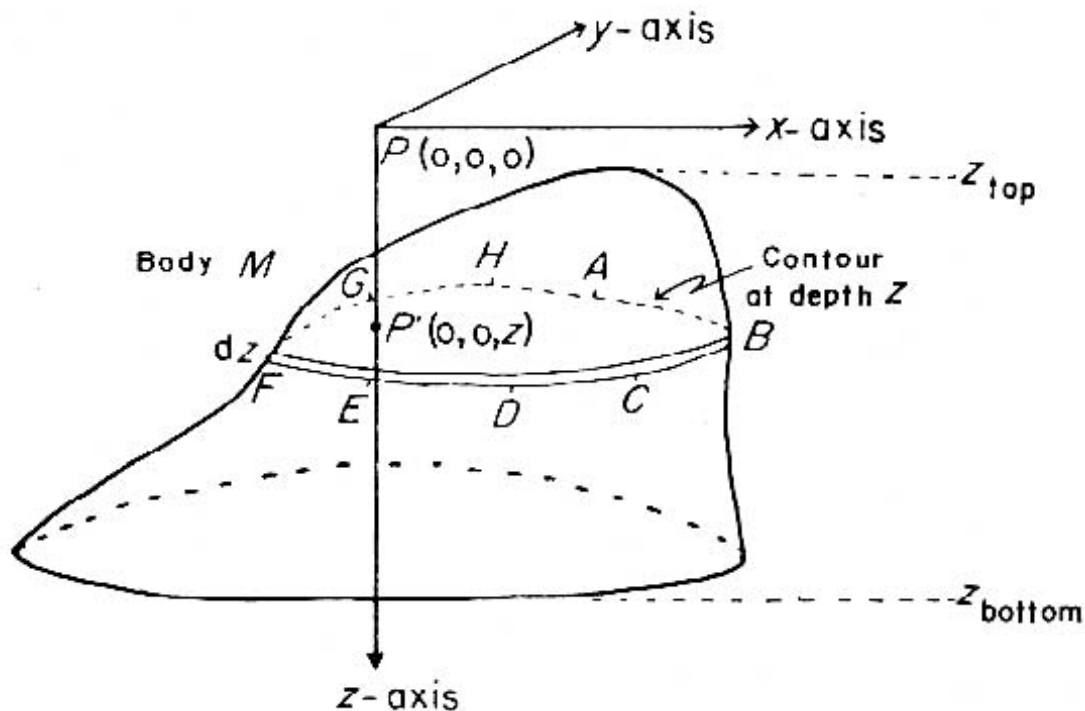

*Schematic illustrating gravity modelling of three-dimensional bodies.*

### *14.3. Indirect interpretation (or inverse modelling)*

The nature of the body is calculated automatically by computer, from the data. Because of the ambiguity problem, this is only possible if limits are placed on variables (*e.g.*, density, the spatial nature of body) so the range of possible solutions is severely restricted. A large number of methods are available. It may be done by varying the density only, varying the thickness of an assemblage of layers or by varying the co-ordinates of the body corners.

Inverse modelling is on the increase because of the rapid increase in availability of gravity data, the need for more automatic interpretation methods and the widespread availability of fast and convenient desktop computers. It is unlikely to replace forward modelling by humans, however, because of the ambiguity problem and the need for using sound judgment, geological knowledge, and experience in establishing realistic models.

## **15. Applications of gravity surveying and examples**

### *15.1. Local structure*

In prospecting for oil, gravity surveying used to be the most important geophysical technique. It has now been superseded by seismic reflection surveying. Gravity measurements are always routinely made, however. Some examples of gravity surveys are surveying salt domes, where gravity remains an important method, and reconnaissance of sedimentary basins. The Bouguer anomaly map generally shows a circular low because salt has low density. Examples are the “Way dome” in the Gulf of Mexico and the Grand Saline dome, Texas.

### *15.2 Regional structure*

Gravity surveying has greatly contributed to our understanding of the subsurface structure of Cornwall and Devon. There is a chain of gravity lows in this part of the country, which are interpreted as granite intrusions. This is supported by the fact that Dartmoor, Bodmin moor and the other moors in SW England are outcrops of granite. A similar structure exists in the northern Pennines, where there are alternating intrusions and fault-controlled sedimentary basins. Such surveys are often conducted for academic purposes or early-stage exploration. Another example is the gravity survey of Owens Valley, California. Features of note are the sharp, linear, steep gradient across the mountain slope and individual lows within Owens Valley itself.

### *15.3. Tests of isostasy*

Examples of places where isostasy has been tested using gravity surveying are the mid-Atlantic ridge, and the Alps.

### *15.4. Mineral exploration*

Gravity is not used extensively, but it can be used to estimate the tonnage of a previously discovered ore body. Very small anomalies must be worked with, perhaps < 1 mGal in total



amplitude. It requires a very accurate survey to detect such small anomalies so careful attention must be paid to the error budget. An example is the Pine Point lead-zinc body in Canada, which has an amplitude of only 1 mGal. Such surveys are often accompanied by electrical and/or magnetic surveys.

### 15.5 Global surveys

Usually satellite data are used for such large-scale work. The Free-Air anomaly over the whole of N America shows a huge regional high. This shows that the integrated amount of mass there is anomalously high. Conversely, the Free-Air anomaly map shows that there is a huge mass deficiency on the E America passive margin.

The SEASAT Free-Air gravity anomaly map is highly correlated with sea floor topography and geoid height. It revealed many new tectonic features, especially in the south Pacific, where little marine geophysics has been done.

### 15.6 Other applications

Repeated gravity surveying is a method for studying neotectonics, *i.e.*, current active tectonics. Topographic heights can be measured to  $\pm 3$  cm by very accurate gravity surveying. Gravity is used in geodetic surveying to measure geoid height, and gravity maps are used for satellite tracking and missile guidance. The latter use explains why gravity maps are classified in some countries, *e.g.*, Turkey.

### 15.7 Long Valley caldera, California

Long Valley is a “restless caldera” in eastern California. Eruptions have occurred there several times during the last few thousand years. It is currently of socio-economic importance to California so it is closely monitored for possible hazards by the US Geological Survey.

It is most famous for the cataclysmic eruption that occurred 760,000 years ago that produced the 600-km<sup>3</sup> Bishop Tuff which was deposited over more than half of the present-day USA. This falls into the category of a super-eruption.

It now contains a resurgent dome which experiences ongoing inflation, and it is seismically active, generating earthquakes up to  $\sim$  magnitude 6. Its subsurface structure has been studied using many methods including seismic tomography. Mammoth Mtn., an isolated volcanic cone on the southwest corner of the caldera, is remarkable because it is degassing hundreds of tonnes of CO<sub>2</sub> per day, which is killing large areas of forest.

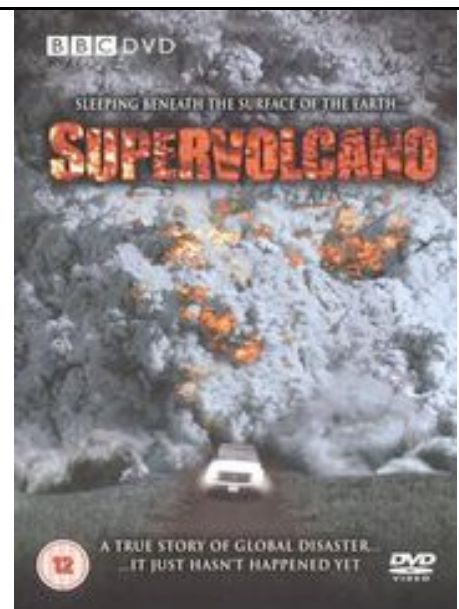

“Supervolcano”, a BBC DVD, running time 118 min

Long Valley caldera and the surrounding region shows a remarkable variety of interesting gravity anomalies. In 1988 the US Geological Survey used it as a textbook example to compare the appearances of different types of gravity map. They generated the complete Bouguer map, the Bouguer map without terrain corrections, the Free-Air gravity map, high- and low-pass filtered maps and many others, which are published in the textbook by Dobrin and Savit (1988).

The caldera itself is characterised by an oval anomaly about 30 mGal in amplitude. Much of this is without doubt caused by low-density Bishop Tuff filling the huge void in the Earth's surface caused by the great eruption 760,000 years ago. Perhaps the most important unanswered question about Long Valley is, however, whether there is currently a magma chamber beneath it, and if so, how large it is and how deep.

Can the gravity field help us to answer these questions?

For more information on Long Valley caldera, visit the US Geological Survey website at <http://lvo.wr.usgs.gov/>

# TABLE OF CONTENTS

## MAGNETICS

<b>1. Introduction .....</b>	<b>1</b>
<b>2. Basic concepts.....</b>	<b>1</b>
<b>3. The Earth's geomagnetic field.....</b>	<b>3</b>
<b>4. Rock magnetism.....</b>	<b>5</b>
4.1 <i>Kinds of magnetism in minerals</i> .....	5
4.1.1 Diamagnetism .....	5
4.1.2 Paramagnetism.....	6
4.1.3 Ferromagnetism.....	6
4.1.4 The Curie temperature .....	6
4.2 <i>Types of magnetism</i> .....	6
4.2.1 Induced magnetism.....	6
4.2.2 Remnant magnetism .....	6
4.3 <i>Induced and remnant magnetism</i> .....	7
4.4 <i>Rock susceptibility</i> .....	7
<b>5. Instruments for measuring magnetism .....</b>	<b>8</b>
5.1 <i>Observatory instruments</i> .....	8
5.2 <i>Magnetic balance</i> .....	8
5.3 <i>Flux-gate magnetometer</i> .....	8
5.4 <i>Proton precession magnetometer</i> .....	9
5.5 <i>Overhauser effect proton magnetometer</i> .....	10
5.6 <i>Optical pump (or alkali vapour) magnetometer</i> .....	11
5.7 <i>Magnetic gradiometer</i> .....	11
5.8 <i>the SQUID system</i> .....	12
<b>6. Magnetic surveys .....</b>	<b>12</b>
6.1 <i>Land surveys</i> .....	12
6.2 <i>Air surveys</i> .....	13
6.3 <i>Sea surveys</i> .....	14
6.4 <i>Examples</i> .....	15
<b>7. Data display .....</b>	<b>15</b>
<b>8. Data interpretation.....</b>	<b>16</b>
8.1 <i>Problems and errors in interpretation</i> .....	16
8.1.1 Magnetisation.....	16
8.1.2 Ambiguity .....	17
8.1.3 Narrow, deep dykes.....	17
8.2 <i>Approaches to interpretation</i> .....	17
8.2.1 Qualitative interpretation.....	17
8.2.2 Parametric interpretation.....	18
8.2.3 Forward modelling.....	19
8.2.4 Inverse modelling.....	19

8.2.5 Data enhancement .....	20
<b>9. High-resolution magnetic surveys.....</b>	<b>21</b>
<b>10. Examples.....</b>	<b>22</b>
10.1 Mineral exploration.....	22
10.2 Oil industry.....	23
10.3 The search for structure in sedimentary sequences.....	23
10.4 Geothermal exploration.....	24
10.5 Archaeological research.....	24
10.6 Regional structure .....	24

## 1. Introduction

<http://www.earthsci.unimelb.edu.au/ES304/MODULES/MAG/main.html>

In principle, magnetic surveying is similar to gravity, i.e., we are dealing with potential fields. There are three fundamental differences, however:

- we are dealing with *vector* fields, not scalar. We cannot always assume that the magnetic field is vertical as we can for gravity.
- magnetic poles can be *repulsive or attractive*. They are not always attractive as in gravity.
- the magnetic field is dependent on *mineralogy*, not bulk properties. Thus, what may be a trivial (to us) change in composition can have a large effect on the magnetic field.

Magnetic measurements are simple to make and reduce, but very complicated to understand and interpret. Magnetic surveying is the oldest method of geophysical prospecting, but has become relegated to a method of minor importance because of the advent of seismic reflection surveying in the last few decades. In terms of line-km measured each year, however, it is the most widely-used survey method. The great problems involved in interpreting magnetic anomalies greatly limits their use.

Magnetic prospecting is used to search for oil and minerals, for archaeology research and for searching for hazardous waste. The prime targets are the depth to basement (i.e., the thicknesses of sedimentary sequences), igneous bodies, kimberlite pipes, hydrothermal alteration (geothermal) and archaeology, e.g. fire pits, kilns and disturbed earth. Very recently, there has been a resurgence in interest in magnetic surveying because of the advent of extremely high-resolution surveys that can reveal structure in sedimentary sequences.

## 2. Basic concepts

Near to a bar magnet, magnetic flux exists. Field lines are revealed by iron filings which will orient parallel to lines of force that follow curved paths from one pole to another. The Earth behaves as a giant magnet.

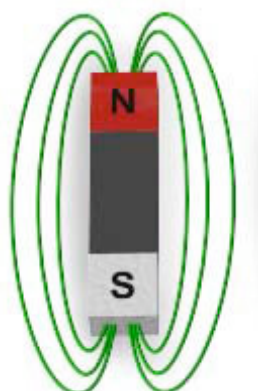

*Field lines around a bar magnet*

So-called *north-seeking* poles are +ve, and are south poles. Poles always occur in pairs, but sometimes one is a very long distance from the other and can be ignored in modelling.

Some basic parameters and variables used in magnetics are:

### Magnetic force $F$

This is the force between two poles. It is attractive if the poles are opposite and repulsive if the poles are the same.

### Intensity of induced magnetisation $I$

If a body is placed in a magnetic field it will acquire magnetisation in the direction of the inducing field. The intensity of induced magnetisation,  $I$ , is the induced pole strength per unit area on the body placed in the external field.

### Magnetic susceptibility $k$

This is the degree to which a body is magnetised.

### Magnetic units

In practical surveying, the gamma ( $\gamma$ ), which is the same as the nanoTesla (nT), is used:

$$1 \gamma = 10^{-9} \text{ Tesla (or Weber/m}^2 \text{ – SI unit)}$$

The strength of the Earth's field is about 50,000  $\gamma$ . Typical anomalies have amplitudes of a few 100  $\gamma$ . The desirable field precision is usually 1  $\gamma$ , or  $10^{-5}$  of the Earth's total field. This contrasts with gravity, where desirable field precision is 0.01 mGal, or  $10^{-8}$  of the Earth's field.

### Inducing magnetisation

The true behaviour of induced magnetisation may be investigated by placing a sample in a coil.  $B = \mu H$  until the sample is *saturated*, after which further increase in  $H$  produces no further increase in  $B$ . When  $H$  is returned to zero, some magnetisation still remains. This is called *remnant magnetisation*. This pattern continues and forms a *hysteresis loop*. It shows how a sample can stay magnetised after the magnetising force is gone.

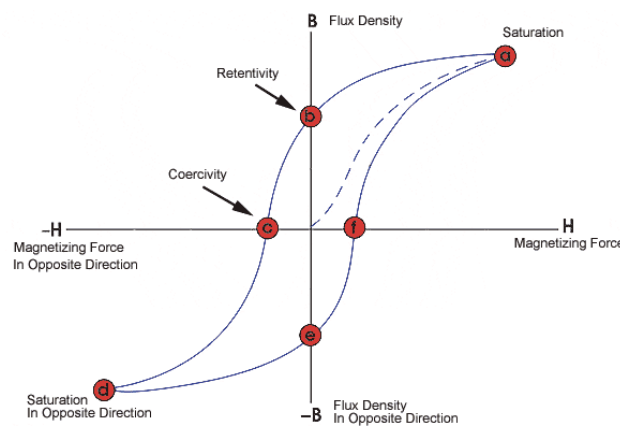

*A hysteresis loop*

<http://www.ndt-ed.org/EducationResources/CommunityCollege/MagParticle/Physics/HysteresisLoop.htm>

Magnetic parameters are analogous to gravity parameters:

- mass (scalar) corresponds to intensity of magnetisation (vector)
- density corresponds to susceptibility

### 3. The Earth's geomagnetic field

<http://geomag.usgs.gov/intro.html>

The Earth's magnetic field is more complicated than a simple dipole. It consists of:

#### a) the main field

This approximates to a non-geocentric dipole inclined to the Earth's spin axis. It can be modelled as polar and equatorial dipoles. A simple dipole is a good approximation for 80% of the Earth's field. The remainder can be modelled as dipoles distributed around the core/mantle boundary.

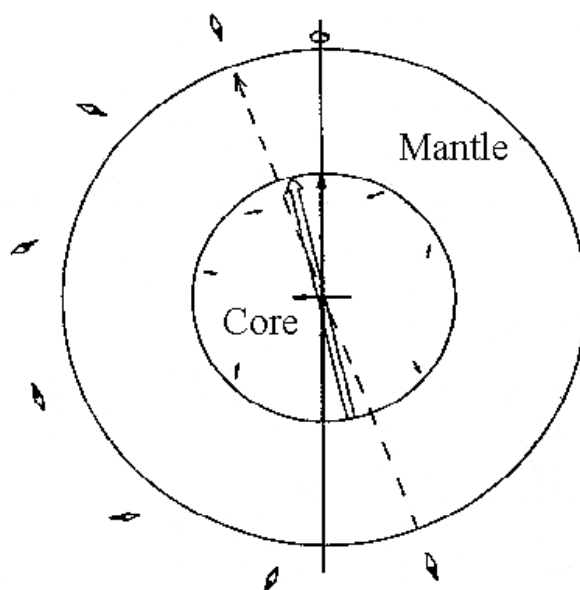

*Modelling the Earth's magnetic field with dipoles*

The origin of the Earth's field is known to be 99% internal and to be generated by convection in the liquid outer core, which drives electric currents. It cannot be due to magnetised rocks because it must be deep, and rocks lose all magnetisation above the Curie temperature. The Curie temperature for magnetite is  $578^{\circ}\text{C}$ , whereas the temperature of the core is probably  $\sim 5,000^{\circ}\text{C}$ .

#### b) the external field

This accounts for the other 1% of the Earth's field. It is caused by electric currents in ionized layers of the outer atmosphere. It is very variable, and has an 11-year periodicity which

corresponds to sunspot activity. There is a diurnal periodicity of up to  $30 \gamma$ , which varies with latitude and season because of the effect of the sun on the ionosphere. There is a monthly variation of up to  $2 \gamma$  which is the effect of the moon on the ionosphere. Superimposed on this are micropulsations which are seemingly random changes with variable amplitude, typically lasting for short periods of time.

Magnetic storms are random fluctuations caused by solar ionospheric interactions as sunspots are rotated towards and away from the Earth. They may last a few days and have amplitudes of up to  $1,000 \gamma$  within  $60^\circ$  of the equator. They are more frequent and of higher amplitude closer to the poles, *e.g.*, in the auroral zone. The possibility of magnetic storms must be taken into consideration in exploration near the poles, *e.g.*, in Alaska.

### c) local anomalies

These are caused by magnetic bodies in the crust, where the temperature is higher than the Curie temperature. These bodies are the targets of magnetic surveying.

### Mathematical treatment of main field

The terms used are:

**F** = total field

**H** = horizontal component

**Z** = vertical component

**I** = inclination

**D** = declination

In surveying,  $\Delta H$ ,  $\Delta Z$  or  $\Delta F$  can be measured. It is most common to measure  $\Delta F$ . Measurement of  $\Delta H$  and  $\Delta Z$  is now mostly confined to observatories.

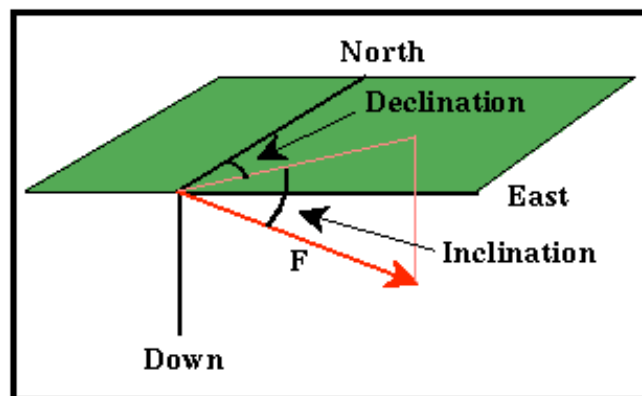

*Components of the Earth's field*

### Secular variations in the main field

These are very long period changes that result from convective changes in the core. They are monitored by measuring changes in **I**, **D** and **F** at observatories.

The Earth's field is also subject to *reversals*, the last of which occurred at 0.7 Ma (i.e., 0.7



million years ago). They appear to be geologically sudden, not gradual, and their frequency is very variable. They are used for palaeomagnetic dating. This is done by comparing the sequence of reversals in the field area of interest to the known, dated, geological record of reversals.

#### Theories on the origin of the Earth's field

In about 1600 W. Gilbert absolved the pole star of responsibility for the Earth's magnetic field. A century later, Halley rejected magnetized surface rock as the source because the field changes with time. He suggested that there is a magnetised sphere within the Earth. Early in the 20th century, Einstein described the origin of the Earth's magnetic field as one of the fundamental unsolved problems in physics.

<http://www.ocean.washington.edu/people/grads/mpruis/magnetics/history/hist.html>

It is now believed that the Earth's magnetic field is generated by a kinematic fluid dynamo. Fluid flowing across field lines in the Earth's liquid outer core induces the magnetic field. That the Earth's outer core is liquid was shown by earthquake seismology, which revealed that shear waves are not transmitted by the outer core. A material that does not transmit shear waves is the definition of a fluid. Thus modern earthquake seismology provided the critical information necessary to explain this phenomenon that had puzzled scientists for four centuries.

It has been shown that the Earth's field would decay for realistic Earth properties, and this resulted in several decades of highly complex mathematical debate and the development of physically-reasonable numerical models that predicted a sustained magnetic field. Two-scale dynamo models suggested that very small-scale fluid motions are important. These models could not be tested numerically until recently. The mathematical arguments were inconclusive and experiment was impractical. In the last few years, numerical modelling work initially suggested that a chaotic field would result. However, the addition of a solid inner core (also known for several decades from earthquake seismology) to the models stabilised the predicted field. After 40,000 years of simulated time, which took 2.5 months of Cray C-90 CPU time, a reversal occurred, which was a big breakthrough.

See: Glatzmaier, G.A. and P.H. Roberts, A three-dimensional self-consistent computer simulation of a geomagnetic field reversal, *Nature*, 377, 203-209, 1995, and News & Views article in the same issue.

<http://www.es.ucsc.edu/~glatz/geodynamo.html>

## **4. Rock magnetism**

### *4.1 Kinds of magnetism in minerals*

#### 4.1.1 Diamagnetism

In diamagnetic minerals, all the electron shells are full, and there are no unpaired electrons. The electrons spin in opposite senses and the magnetic effects cancel. When placed in an external field, the electrons rotate to produce a magnetic field in the opposite sense to the applied. Such minerals have negative susceptibilities,  $k$ . Examples of such materials are

quartzite and salt. Salt domes thus give diamagnetic anomalies, i.e., weak negative anomalies.

#### 4.1.2 Paramagnetism

Paramagnetic minerals are ones where the electron shells are incomplete. They generate weak magnetic fields as a result. When placed in an external field, a magnetic field in the same sense is induced, i.e.,  $k$  is positive. Examples of materials that are paramagnetic are the 20Ca - 28Ni element series.

#### 4.1.3 Ferromagnetism

Ferromagnetic minerals are minerals that are paramagnetic, but where groups of atoms align to make domains. They have much larger  $k$  values than paramagnetic elements. There are only three ferromagnetic elements – Iron, Cobalt and Nickel. Ferromagnetic minerals do not exist in nature. There are three types of ferromagnetism:

- *pure ferromagnetism* – all the domains align the same way, producing strong magnetism.
- *ferrimagnetism* – In the case of ferrimagnetic minerals, the domains are subdivided into regions that are aligned in opposition to one another. One direction is weaker than the other. Almost all natural magnetic minerals are of this kind, e.g., magnetite ( $\text{Fe}_2\text{O}_3$ ), which is the most common, ilmenite, titanomagnetite and the oxides of iron or iron-and-titanium.
- *antiferromagnetism* – antiferromagnetic minerals have opposing regions that are equal. An example is haematite ( $\text{Fe}_2\text{O}_3$ ). Occasionally there are defects in the crystal lattice which cause weak magnetisation, and this is called *parasitic antiferromagnetism*.

#### 4.1.4 The Curie temperature

This is the temperature of demagnetisation. Some examples of Curie temperatures are:

- Fe 750°C
- Ni 360°C
- magnetite 578°C

The majority of anomalies in the crust result from magnetite, and so knowledge of the Curie temperature and the geothermal gradient can give information on the depth range of causative bodies.

### *4.2 Types of magnetism*

#### 4.2.1 Induced magnetism

This is due to induction by the Earth's field, and is in the same direction as the Earth's field. Most magnetisation is from this source. It is important to appreciate that since the Earth's field varies from place to place, the magnetic anomaly of a body will vary according to its location.

#### 4.2.2 Remnant magnetism

This is due to the previous history of the rock. There are various types:

#### **4.2.2.1 Chemical remnant magnetization (CRM)**

This is acquired as a result of chemical grain accretion or alteration, and affects sedimentary and metamorphic rocks.

#### **4.2.2.2 Detrital remnant magnetisation (DRM)**

This is acquired as particles settle in the presence of Earth's field. The particles tend to orient themselves as they settle.

#### **4.2.2.3 Isothermal remnant magnetism (IRM)**

This is the residual magnetic field left when an external field is applied and removed, *e.g.*, lightning.

#### **4.2.2.4 Thermoremanent magnetisation (TRM)**

This is acquired when rock cools through the Curie temperature, and characterises most igneous rocks. It is the most important kind of magnetisation for palaeomagnetic dating.

#### **4.2.2.5 Viscous remnant magnetism (VRM)**

Rocks acquire this after long exposure to an external magnetic field, and it may be important in fine-grained rocks.

### *4.3 Induced and remnant magnetism*

The direction and strength of the present Earth's field is known. However, we may know nothing about the remnant magnetisation of a rock. For this reason, and because in strongly magnetised rocks the induced field dominates, it is often assumed that all the magnetisation is induced. The true magnetisation is the vector sum of the induced and remnant components, however.

The remnant magnetisation be measured using an Astatic or Spinner magnetometer, which measure the magnetism of samples in the absence of the Earth's field.

### *4.4 Rock susceptibility*

These are analogous to density in gravity surveying. Most rocks have very low susceptibilities. The susceptibility of a rock is dependent on the quantity of ferrimagnetic minerals. *In situ* measurements of rock susceptibility may be made using special magnetometers but it is more common to measure a sample in the laboratory, *e.g.*, using an induction balance. The sample is placed in a coil, a current is applied and the induced magnetisation is measured. It is usual to quote the strength of the field applied along with the result. If the applied field was very much greater than the Earth's field, the value obtained may not be suitable for interpreting magnetic anomalies.

Another method of obtaining the susceptibility of a rock is to assume that all the magnetisation is due to magnetite. The volume percent of magnetite is multiplied by the susceptibility of magnetite. This method has produced good correlation with field

measurements.

Susceptibility ranges over 2-3 orders of magnitude in common rock types. Basic igneous rocks have the highest susceptibilities since they contain much magnetite. The proportion of magnetite tends to decrease with acidity, and thus  $k$  tends to be low for acid rocks such as granite. The susceptibility of metamorphic rocks depends on the availability of  $O_2$  during their formation, since plentiful  $O_2$  results in magnetite forming.

Sedimentary rocks usually have very low  $k$ , and sedimentary structures very rarely give large magnetic anomalies. If a large magnetic anomaly occurs in a sedimentary environment, it is usually due to an igneous body at depth.

#### Common causes of magnetic anomalies

Dykes, folded or faulted sills, lava flows, basic intrusions, metamorphic basement rocks and ore bodies that contain magnetite all generate large-amplitude magnetic anomalies. Other targets suitable for study using magnetics are disturbed soils at shallow depth, fire pits and kilns, all of which are of interest in archaeological studies.

Magnetic anomalies can be used to get the depth to basement rocks, and hence sedimentary thickness, and to study metamorphic thermal aureoles.

## **5. Instruments for measuring magnetism**

### *5.1 Observatory instruments*

These are similar to field instruments, but measure all three components of the field.

<http://www.awi-bremerhaven.de/Geosystem/Observatory/>  
<http://www.dcs.lancs.ac.uk/iono/samnet/>

### *5.2 Magnetic balance*

Magnetometers were originally mechanical, but after World War II they were replaced by flux-gate instruments, rendering the magnetic balance now obsolete. However, a lot of data exist that were collected using magnetic balances. An example is the Schmidt magnetic balance. A magnet pivots about a point that is not the centre of gravity. The torque of the Earth's magnetic field balances with the gravity effect at the centre of gravity. The angle of pivot is a function of the magnetic field, and is measured by a light beam that is projected onto a scale. This changes between measuring stations and thus the magnetic balance is a *relative* instrument.

### *5.3 Flux-gate magnetometer*

This was originally developed for detecting submarines in World War II. It is used a lot for aeromagnetic work because it makes continuous measurements. The construction of this instrument involves two coils wound in opposition. A current is passed through to induce magnetisation. A secondary winding measures the voltage induced by the induced magnetisation. In the absence of the Earth's field these two cancel out. An AC current is

applied that saturates the cores in opposition in the absence of the Earth's field. The Earth's field reinforces one core and opposes the other. This causes the voltages induced in the secondary coils to get out of step. The result is a series of pips whose height is proportional to the ambient field. The precision is better than  $0.5 - 1 \gamma$ .

This instrument has the following disadvantages:

- it is not an absolute instrument and it is liable to drift,
- it is insufficiently accurate for modern work.

For these reasons it has now been largely superseded by the proton precession and alkali vapour magnetometers for land and sea work. It is still used in boreholes, however.

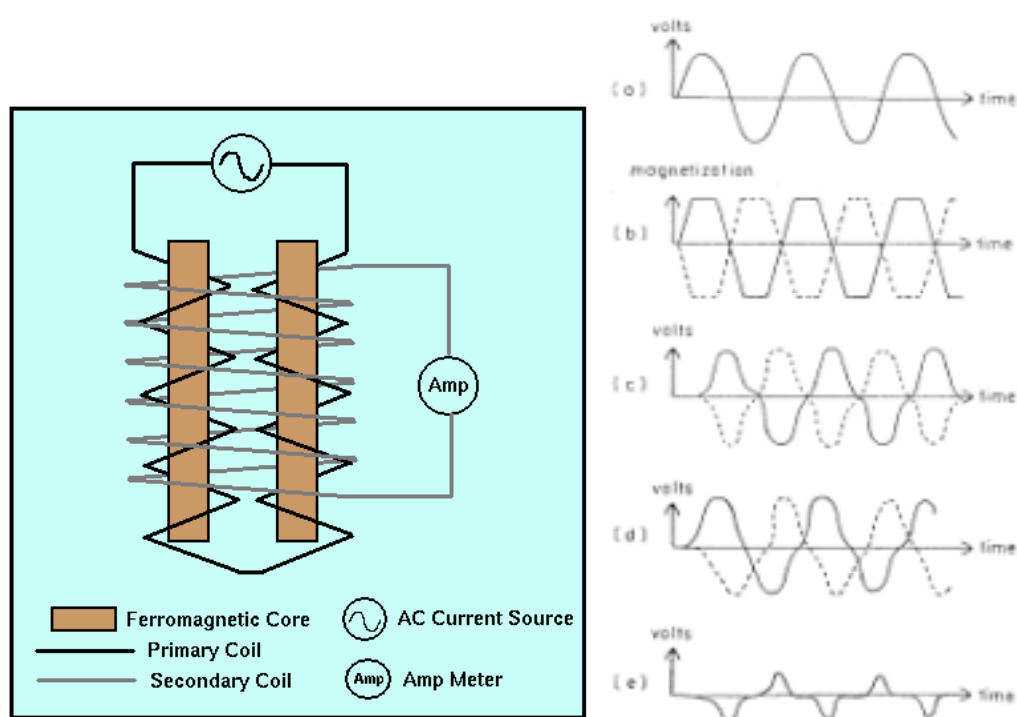

*Schematics showing design of flux-gate magnetometer and principles of operation*

#### *5.4 Proton precession magnetometer (free-precession magnetometer)*

This instrument resulted from the discovery of *nuclear magnetic resonance*. Some atomic nuclei have magnetic moment that causes them to precess around the ambient magnetic field like a spinning top precesses around the gravity field. Protons behave in this way. The magnetometer consists of a container of water or oil, which is the source of protons, around which a coil is wound. A current is applied so a field of 50-100 oersteds is produced. The container must be oriented so this field is not parallel to the Earth's field. The current is removed abruptly, and the protons precess as they realign to the Earth's field. The precession frequency is measured.

When the current is applied, it takes the protons 2-3 seconds to fully align, and this follows

an exponential relationship. The current is cut off abruptly compared with the period of precession (*e.g.*, over 50 ms). It takes time for the precession to build up after the applied field has been removed. This then decays exponentially. About 50,000 cycles are measured and this gives an accuracy of 1 cycle in 50,000, *i.e.*  $1 \gamma$ . It takes about 1/2 second to count 50,000 cycles. The strength of the measured signal is about 10 mV (10 microvolts).

Most proton precession magnetometers have a precision of  $1 \gamma$  but models are available that have precisions as good as 0.1 or  $0.01 \gamma$ .

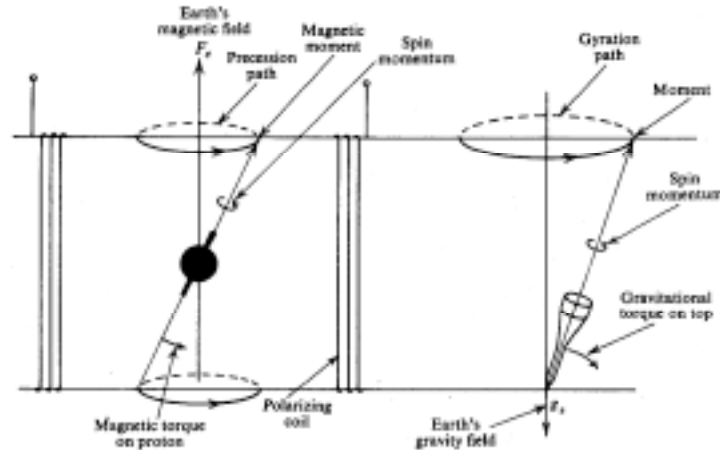

*Proton precession and spinning-top analogy*

Advantages offered by proton precession magnetometers include:

- great sensitivity,
- they measure the total field,
- they are absolute instruments,
- they do not require orientation or levelling like the flux-gate magnetometer,
- there are no moving parts like the flux-gate magnetometer. This reduces power consumption and breakdowns.

The disadvantages include:

- each measurement takes several seconds. This is a great disadvantage for aeromagnetic work,
- field gradients that are so large that they are significant within the bottle will cause inaccurate readings or no sensible reading at all,
- they do not work in the presence of AC power interference, *e.g.*, below power lines.

With the proton magnetometer, surveys are very simple and quick.

### *5.5 Overhauser effect proton magnetometer*

This magnetometer uses a proton-rich fluid with paramagnetic ions added. The paramagnetic ions resonate at a frequency called the *free-electron* resonant frequency, which is in the VHF radio frequency range. A saturating VHF signal is applied. The nuclear spin of the protons is

polarized as a result of interaction with the electrons. This is the equivalent to magnetic polarization in the proton-precession magnetometer. In the case of the Overhauser effect, the polarization is continuous and thus the proton precession signal changes continuously with the ambient magnetic field.

The Overhauser effect proton magnetometer has the following advantages over the proton precession magnetometer:

- it produces a continuous effect. Less time is needed to make a measurement and it can thus sample more rapidly – up to 8-10 readings per second may be made,
- the signal strength is 1-10 mV, so the signal-to-noise ratio is better than for proton precession magnetometers.

### 5.6 Optical pump (or alkali vapour) magnetometer

This device dates from the 1960s. It is used if sub- $\gamma$  sensitivity is needed, *e.g.* for sedimentary targets and for measuring magnetic gradients directly. It consists of a cell of helium, cesium, rubidium or some alkali-metal vapour which is excited by light from a source of the same material. The energy states of the electrons of the alkali metal atoms are affected by magnetic fields. In the presence of the light, the depopulation of energy states by light absorption and movement to higher states will be unequal. The repopulation to lower states by emission of energy will be equal for all states and thus unequal populations in the various energy states result. This is the *optically-pumped* state, and the gas is more transparent like this. The transparency is measured, and gives a precision of 0.005  $\gamma$  in the measurement of the strength of the Earth's field.

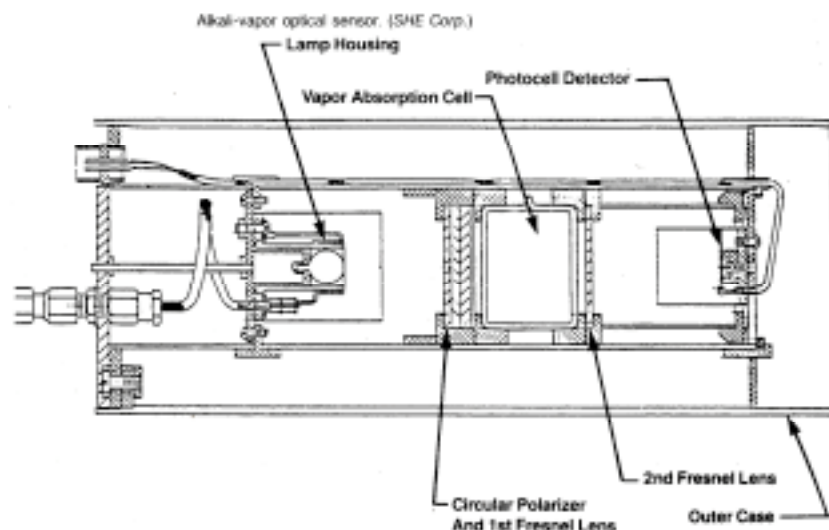

*Alkali vapour magnetometer*

### 5.7 Magnetic gradiometer

It is possible to measure either the vertical or horizontal gradient using two optical pumping devices separated by fixed distances. This may be done on land with an instrument carried by hand, or from a helicopter or ship. The advantages of this type of instrument are:

- diurnal variation corrections are not necessary, and
- shallow sources with steep gradients are accentuated compared with deep sources with gentle gradients.

### *5.8 the SQUID system*

SQUID stands for Superconducting QUantum Interference Device. It has a high sensitivity, and is used to measure both the direction and magnitude of the Earth's field. Thus three components are needed. It has a sensitivity of  $10^{-5} \gamma$ . The response is flat at all frequencies, and thus it can measure a changing magnetic field also, from DC to several 1,000 Hz. This instrument operates at liquid helium temperatures. It is physically large and thus not very portable. Some uses include magnetotelluric measurements, measurements of drift of the Earth's field and laboratory measurements for remnant and induced magnetization of rock samples.



*A SQUID magnetometer*

## **6. Magnetic surveys**

Magnetic surveys either directly seek magnetic bodies or they seek magnetic material associated with an interesting target. For example, magnetic minerals may exist in faults or fractures.

### *6.1 Land surveys*

These are usually done with portable proton precession magnetometers. Profiles or networks of points are measured in the same way as for gravity. It is important to survey perpendicular to the strike of an elongate body or two-dimensional modelling may be very



difficult. It is necessary to tie back to the base station at 2-3 hour intervals, or to set up a continually-reading base magnetometer. This will give diurnal drift and detect magnetic storms. The operator must:

- record the time at which readings were taken, for drift correction,
- stay away from interfering objects, e.g., wire fences, railway lines, roads,
- not carry metal objects e.g., mobile phones, and
- take multiple readings at each station to check for repeatability.

Reduction of the observations is much simpler than for gravity:

### 1. The diurnal correction

This may be up to 100  $\gamma$ . Observatory data may be used if the observatory is within about 100 km and no major magnetic bodies occur in between, which might cause phase shifts in the temporal magnetic variations. A magnetic storm renders the data useless.

### 2. Regional trends

These are corrected for in the same way as for gravity, i.e., a linear gradient or polynomial surface is fit to regional values, and subtracted. The UK regional gradient is 2.13  $\gamma$ /km N and 0.26  $\gamma$ /km W. Another method is to subtract the predicted IGRF (International Geomagnetic Reference Field) which is a mathematical description of the field due to the Earth's core. There are several such formulae to choose from, all based on empirical fits to observatory or satellite data.

The other corrections made to gravity readings are not necessary in magnetic surveys. In particular, small elevation changes have a negligible effect on magnetic anomalies, and thus elevation-related corrections are not needed for most surveys.

## *6.2 Air surveys*

Most magnetic surveying is aeromagnetic surveying, and it may be done with either aeroplane or helicopter. Helicopters are more suitable for detailed or difficult access areas, though aeroplanes are cheaper. Usually a proton magnetometer is towed behind the helicopter, and thus discrete measurements are made. The magnetometer is then called the *bird*. It may also be mounted as a tail stinger on planes because of problems with sensor motion and cable vibrations that result from higher speeds. Wingtip mounting is also available. If the instrument is housed inboard, it is necessary to correct for the magnetic effect of aeroplane. It is also possible to measure vertical and longitudinal gradients and often several magnetometers are flown to maximise the use of the flight. Aeromagnetic surveying is not useful for surveys where great spatial accuracy or very dense measurements are required.

The use of aeromagnetic surveying is limited by navigation which is a first order problem for such surveys. Before the widespread use of the GPS this was done by radio beacon e.g., Loran or aerial photography. Photography is not a solution sometimes, however, e.g., over jungles or the sea where there are no landmarks. Doppler navigation was sometimes used. This involves radio beams that are bounced off the ground both before and aft of the aircraft. This gives the speed of the aircraft accurately. The recent advent of the GPS has enabled aeromagnetism to be used more widely for sea surveys. Prior to the GPS, navigation accuracy was often no better than 100 m.

The layout of the survey depends on target scale and anomaly strike. Usually a criss-cross pattern of perpendicular flight paths is adopted. The lines perpendicular to strike are more closely spaced, and the *tie lines* at right angles to these may be typically at 1/4 or 1/10 the density.

The optimum design of lines has been examined analytically to determine the optimum spacing for a given anomaly width. The difference in anomaly deduced from lines with spacings of 0.5 and 0.25 miles is illustrated by a study of one of the largest sulphide deposits in Canada:

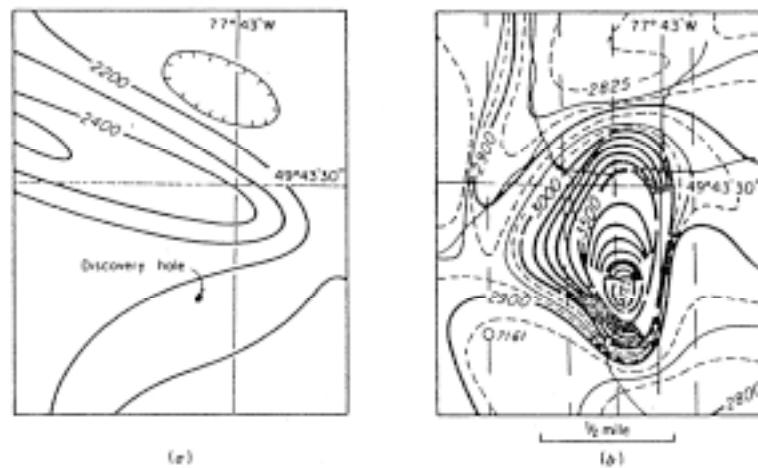

*Results from sparse and dense flight lines*

The flight height is typically 200 to 1,000s of feet, and should remain as constant as possible. For oil reconnaissance, the most interesting feature is generally deep basement structure. In this case, high surveys are flown, typically above 1000', to effectively filter out the signals from small, shallow bodies.

Diurnal drift and other errors, *e.g.*, variable flying height can be averaged out by:

- minimising the RMS of the line crossover measurement differences, or
- fitting a high-order polynomial to each line and eliminating the differences completely.

This procedure is similar to that applied to the SEASAT data and is a technique used in geodetic surveys. A fixed ground magnetometer is used to monitor for magnetic storms. Aeromagnetic surveys have the major advantages that they are very cheap, can cover huge areas, and can filter out shallow, high-frequency anomalies. This latter is also the major disadvantage of aeromagnetic surveying for prospecting for shallow bodies within mining range. Onboard computers for quasi-real time assessment of the data are becoming more common, as it is important to make sure the data are satisfactory before demobilising.

### 6.3 Sea surveys

The instrument is towed behind the ship at a distance of up to 500 m to avoid the magnetic

effect of ship. It is then known as the *fish*. The instrument is made buoyant and a proton magnetometer is usually used. The sampling frequency is typically 4-20 s, giving measurements spaced at intervals of 8-16 m if the ship speed is 4-6 knots. GPS navigation is almost universally used now. Loran navigation was most common in the past.

Sea magnetic surveys are generally conducted at the same time as a seismic survey. The ship's course is optimised for the seismic survey and it is thus usually non-optimal for the magnetic survey. There may also be problems making the diurnal correction if the ship is more than 100 km from land. Under these circumstances the diurnal correction may have to be done by tie-line analysis. Recently, the longitudinal gradient is frequently measured and used, and has caused great improvement in the usefulness of marine magnetic data for oil exploration.

#### 6.4 Examples

Good examples to study to gain familiarity with the application of magnetic surveying to studying a range of geological problems include:

- the combination of sea and land survey data and tectonic interpretation done in the Eastern Mediterranean and Near East. For details, see: <http://www.gii.co.il/html/ground/GravityNew/1.pdf>
- the use of magnetic anomalies to deduce the tectonic evolution of the North Atlantic. For original paper, see: Nunns, A. G. (1983), Plate tectonic evolution of the Greenland-Scotland ridge and surrounding regions, in *Structure and Development of the Greenland-Scotland Ridge*, edited by M. H. P. Bott, Saxov S., Talwani, M. & Thiede, J., pp. 1-30, Plenum Press, New York and London.
- correlation of volcanic features, *e.g.*, Long Valley caldera, with the regional magnetic field in California.

### 7. Data display

As with all geophysical data, outliers must be removed before turning to modelling and interpretation work. Algorithms are available for this, or the geophysicist can do it by brain.

It may be desired to interpolate all the measurements onto a regular grid in the case of aeromagnetic data which are not uniformly measured. It is critical to maintain the integrity of the data when this is done. For example, if contouring at 5  $\gamma$  intervals, each data point should fit the raw measurements to within 2.5  $\gamma$ .

Contour maps are the most common, but generating them without degrading the data nor introducing statistically unsupported artifacts is not simple. Decisions that must be taken in designing the final map are:

- contour interval (*e.g.* 0.25  $\gamma$ ),
- sampling interval (*e.g.* 75 m),
- height (*e.g.*, mean-terrain clearance of 150 m),
- spacing of flight lines,
- geomagnetic reference surface to subtract,

- % of data samples to contour,
- interpolation method (*e.g.*, minimum curvature with bicubic spline refinement).

### Aeromagnetic data

Displaying the data as offset profiles is common.

High frequencies attenuate out at great height. Very quiet, smooth aeromagnetic maps characterize sedimentary basins with deep basement. A lot of high frequency anomalies indicate shallow anomalous bodies that may be ore or igneous rocks. It is important to find the depth of bodies in sedimentary regimes. An irregular basement is often truncated by erosion, and thus the depth corresponds to the thickness of the sedimentary sequence. Abrupt changes in magnetic character may reflect boundaries between magnetic provinces, or a basement fault. The strike of the magnetic trend indicates the structural trend of area.

Using processing methods such as upward and downward continuation, the magnetic field can be calculated at any height. It may be helpful to display the data as they would look had the survey been made at a higher elevation, thereby filtering out high-frequency anomalies due to small, shallow bodies.

## 8. Data interpretation

### *8.1 Problems and errors in interpretation*

#### 8.1.1 Magnetisation

This may not be uniform, but the interpreter is usually obliged to assume it is. Large anomalies tend not to reflect major lateral changes in structure, as they do in gravity, rather lateral changes in rock susceptibility. In the example illustrated below, a lateral change in susceptibility gives a 3000  $\gamma$  anomaly. Elsewhere, a basement ridge 1000' high gives only a 120  $\gamma$  anomaly. The basement ridge is important for assessing the oil potential of the sedimentary basement, but the change in susceptibility is of no consequence.

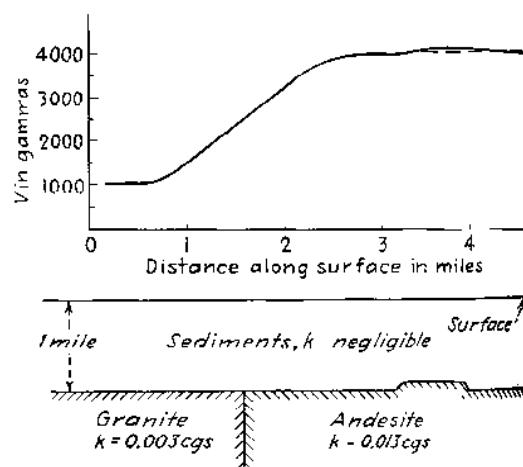

*Comparison of magnetic effect of lateral susceptibility change in basement with effect of structural feature on basement surface.*

### 8.1.2 Ambiguity

The ambiguity problem is the same for magnetic surveying as it is for gravity. There is ambiguity between size and distance. In the case of magnetics the problem is much worse, as there are many other ambiguities, *e.g.*, between the direction of the body magnetisation and the dip of the Earth's field.

### 8.1.3 Narrow, deep dykes

It is difficult to resolve the width of narrow, deep dykes.

## *8.2 Approaches to interpretation*

There are five basic approaches:

1. qualitative
2. parametric
3. forward modelling
4. inverse methods
5. data enhancement

### 8.2.1 Qualitative interpretation

Much interpretation of magnetic maps may go no further than this. For example, deducing the presence or absence of a fault or the position of the edge of a sedimentary basin may be more important and more confidently established than its detailed geometry. Such issues may be settled from visual inspection of the map only.

It is important to be careful not to intuitively assume that magnetic topography equates to physical topography. Magnetic topography reflects the lithology, not the dimensions of bodies. Because there are +ve and -ve poles, and also because the magnetic field is a vector field, there are +ve and -ve parts of magnetic anomalies. It would be intuitive to suppose that a single pole would produce an anomaly of one sign, but even this is not so. Even a buried -ve pole with no +ve pole nearby, the horizontal and total magnetic fields have a +ve anomaly on one side and a -ve anomaly on the opposite side. The vertical magnetic field alone, like gravity, has an anomaly of one sign.

The magnetic fields over a sphere magnetised like a dipole change radically with orientation of the dipole. If all the magnetization is induced, *i.e.*, in the direction of the Earth's field, the anomaly will vary with different inclinations of the Earth's field.

In the case of a buried dyke, there is the added complication that the orientation of the dyke can vary too. Evolutionary trends may be discerned in the forms of the anomalies as the dip of the magnetisation and the dip of the dyke are altered separately. If the dyke is magnetized by the Earth's field, in the southern hemisphere the anomalies are reversed. This illustrates the fundamental point that the anomaly resulting from a body looks different according to where you are because the direction of the Earth's field varies with position.

In the case of dykes, many anomalies look rather similar, and if the orientation of the dyke with respect to magnetic north, and its width/depth ratio are changed, many geological scenarios can be found that fit a given set of observations well. It is an interesting fact that, in the case of a dyke, if the size of the body doubled, and the depth of burial is doubled, the anomaly scales and stays proportionally the same.

Two- and three-dimensional bodies can be distinguished in plan view. Two-dimensional bodies have strike. Bodies may be approximated to two-dimensional bodies if the width:length ratio is 1:10 or greater. This contrasts with the gravity case where a width:length ratio of 1:2 is adequate for the two-dimensional approximation to be made. More examples are given in the textbook *Applied Geophysics* by Telford and others.

In a given situation, various candidate bodies can be explored qualitatively. Possible bodies can be approximated to simple shapes, *e.g.*, an elongate ore body can be approximated to a horizontal dipole, a basement ridge can be approximated to a horizontal cylinder and a faulted sill can be approximated to a slab with a sloping end.

#### The Pole distribution/lines of force method

The body is drawn, poles added and lines of force sketched. From these, the qualitative shape of the anomaly may be estimated.

#### 8.2.2 Parametric interpretation

This can give a reasonable, ball-park body to serve as starting model for computer modelling. Formulae have been derived to give estimates of the maximum depth, *e.g.*, for a uniformly magnetized body. For example, for a sphere:

$$z = 2w_{1/2}$$

where  $z$  is the depth to the centre and  $w_{1/2}$  is the half width.

For a horizontal cylinder:

$$z = 2.05w_{1/2}$$

#### Peter's methods

These were developed to interpret anomalies caused by dykes, and involve making elaborate measurements from the anomaly to estimate the width and depth to the top, and the magnetization.

#### The Vacquier method

Vacquier investigated criteria for estimating the depth to the top of vertical prisms from anomaly gradients. The method applies to  $\Delta F$  and is thus useful as this is the most common type of data. It involves measuring gradients and referring to tables corresponding to different body shapes and orientations with respect to magnetic north.

#### The Werner method

This is also designed for dykes, and involves measuring the value of  $\Delta F$  at various points. Unknowns, *e.g.*, the position of the dyke, the depth, the width etc. are solved for using

#### *10.4 Geothermal exploration*

Magnetic prospecting has been applied successfully to Yellowstone and the Cascades, U.S.A., to map the depth to the Curie isotherm. The method has been little used in Iceland, however, where geothermal resources are exceptionally important.

##### A high-resolution survey of the Dixie Valley, Nevada

Dixie Valley is an important geothermal resource currently under exploitation. Knowledge of the details of subsurface faults is important as geothermal fluid distribution is aquifer-controlled. A high-resolution magnetic survey conducted using a helicopter that could fly close to the ground and close to mountain sides yielded spectacular results after sophisticated data processing techniques had been applied to them. Details of this project can be found at:

[http://pubs.usgs.gov/of/2002/ofr-02-0384/ofr-02-0384\\_508.pdf](http://pubs.usgs.gov/of/2002/ofr-02-0384/ofr-02-0384_508.pdf)

<https://www.uwsp.edu/geo/projects/geoweb/participants/dutch/VTrips/FairviewPeak.HTM>

<http://geothermal.marin.org/GEOpresentation/sld058.htm>

#### *10.5 Archaeological research*

A spectacular survey in a mid-American country recently discovered numerous huge basalt artifacts buried only a few metres deep. Over 100 anomalies were detected and 20 were excavated. Archaeological digs are very expensive, whereas geophysics can cover very large areas quickly and cheaply. Also, digging destroys the material of interest, whereas geophysical studies are non-destructive. Geophysical surveys have become almost a standard feature of archaeological investigations.

#### *10.6 Regional structure*

##### The Montereian Hills, Montreal, Canada

An aeromagnetic survey showed magnetic anomalies that coincide with discrete hills that are actually outcropping igneous plugs. Two similar anomalies were found that were not associated with hills and these were interpreted as plugs that do not reach the surface to form hills, i.e., buried intrusions. The intrusions were modelled as vertical cylinders and the fit to the measured data was improved when the variable flight height of the aircraft was taken into account. The aeroplane had to climb when it flew over the hills.

simultaneous equations.

#### The Naudy method

Also developed to study dykes, the anomaly is separated into symmetrical and asymmetrical parts. These are correlated with a large set of master curves. The highest correlation gives the correct answer.

#### Hutchinson's method

This may be applied to dykes, scarps and thin beds. It is similar to Naudy's method, but can deal with more types of body.

### 8.2.3 Forward modelling

#### **8.2.3.1 Gay's master curves**

These comprise a series of curves for dykes of various dips, strikes, intensity of magnetisation, depth or width. The interpreter superimposes graphs of  $\Delta F$  onto these and chooses the curve that fits best. When the general nature of the body has been guessed, more detailed interpretation may follow. The use of master curves is now obsolete.

#### **8.2.3.2 Computer modelling**

As for gravity, various programs are available for both two- and three-dimensional modelling. Examples are:

- the Talwani method, where a body is modelled as a set of prisms of polygonal cross section. Two- and three-dimensional versions are available.
- a program similar to the Talwani gravity program is available for three-dimensional models, where the body is modelled as a stack of layers defined by contours.
- two- and three-dimensional methods for modelling in the frequency domain are also available.

It is also possible, and usually simpler, to use simple trial-and-error programs which use the expression for a magnetic anomaly over a semi-infinite slab with sloping end. The body points are input, the anomaly is calculated, compared with the observed, and the body is altered until a good fit is obtained.

It is generally assumed that all the magnetisation is induced, though sometimes it is important to include remnant effects, *e.g.*, in the case of a large igneous body that cooled when the Earth's field was very different from today's field.

### 8.2.4 Inverse modelling

It is important to reduce the number of variables, otherwise an infinite number of models results. If the source geometry is known, calculation of the distribution of magnetisation is a linear inverse problem because potential is a linear function of the magnitude of the source.

#### **8.2.4.1 the matrix method**

The source is divided into cells and a computer program solves for the best set of magnetisations. If there are more data than cells, a least squares fit is obtained.



### **8.2.4.2 The “Divide by the Earth” filter**

This method can be used for forward or inverse modelling.

### **8.2.4.3 Determining the best direction of magnetisation**

If the source geometry is known, the direction of magnetisation can be calculated. This has been applied to Pacific seamounts to calculate the Cretaceous polar wandering curve.

### **8.2.4.4 Determining the best source geometry**

This can be done if the magnetisation is known, but it is a non-linear inverse problem. Two approaches may be used:

- begin with a starting model close to the truth and approximate the refinements needed to a linear problem,
- linear programming. Divide the source region into many small cells whose number exceeds the number of data. This is used with constraints to find the magnetisation of each cell.

### **8.2.4.5 Calculation of the depth to the top or bottom of the source**

The top of the source may be the bottom of a sedimentary basin. The bottom of a source may be the Curie isotherm, which is useful for geothermal exploration or locating a lithological change. The bottom is much more difficult to obtain because the bottoms of bodies give a much smaller signal than the tops. Study of these aspects may be done by looking at power spectra.

## 8.2.5 Data enhancement

Being able to see features of interest in magnetic maps may be critically dependent on data enhancement. A suite of methods is available:

### **8.2.5.1 Reduction to the pole**

This involves transforming the anomaly into the one that would be observed if the magnetization and regional field were vertical (i.e., if the anomaly had been measured at the north magnetic pole). This produces symmetric anomalies which are visually easier to interpret and centred over the causative bodies. This may be done in the spatial or the frequency domain. An example of where it might have been useful is the Wichita Mountain area, Oklahoma. A NW-trending high is centred beneath the Wichita Mountain range. No igneous rocks exist there though, and the high was found to be due to a linear deposit of gabbro three miles wide on the SW slope of mountains.

### **8.2.5.2 Upward/downward continuation**

This may be used for either magnetics or gravity. It is another method to find the depth of bodies causing anomalies. If a magnetic field is downward continued, this amounts to calculating what the field would look like at a lower level. Downward continuation is unstable

because it blows up noise. Conversely, upward continuation involves calculating what the field would be at a higher level. The upward continuation process is problem-free. If the field is first downward continued and then upward continued back again, the same field should result. This breaks down if the field has been downward continued to a level that lies within the body causing the anomaly. In this case an unstable field results. This method can be used to determine the depth of the magnetic bodies responsible for the anomalies.

### **8.2.5.3 Pseudogravity transformation**

This method involves calculating the equivalent gravity field for a magnetic field, and then interpreting this gravity field.

### **8.2.5.4 Vertical and horizontal derivatives**

The 1st and 2nd vertical derivatives (i.e. gradients) accentuate short-wavelength (i.e., shallow) anomalies. They accentuate the edges of anomalies. This may be done in either the spatial or the frequency domain.

### **8.2.5.5 Attenuation of terrain effects**

The removal of terrain effects is important in young volcanic terrains. It is very difficult though, as the magnetisation differs from place to place. One approach is to correlate the magnetic anomalies with topography and assume that they are related only if they are correlated. It is also possible to calculate the spectral effect of the topography.

### **8.2.5.6 Wavelength filtering**

This is based on the assumption that the wavelength is related to the depth of the body. This assumption breaks down if a long-wavelength anomaly is caused by a broad, shallow body. It is a question of elephants with legs. Short-wavelength anomalies are always caused by shallow bodies, but long-wavelength bodies may be caused by either deep or shallow bodies. Put another way, the maximum depth of a body may be deduced from the wavelength but not the minimum depth. Directional filtering can also be used as for gravity.

## **9. High-resolution magnetic surveys**

Very recently, high-sensitivity, high-resolution aeromagnetic surveying to delineate structure in sediments has been pioneered. It has been found that bacteria exist that metabolise hydrocarbons and excrete magnetite. Also, chemical reduction of iron oxides by seeping hydrocarbons produces magnetite. The amount varies and anomalies are produced. For example, faults show up in high-resolution magnetic maps because of the different sequences on either side and because of fluids moving up the faults and redistributing minerals. Non-linear, sediment-sourced signatures have been correlated with specific layers and depths, *e.g.*, at the Morecombe gas fields in the E Irish Sea.

Important points to remember are:

- Data acquisition: refinements, *e.g.*, decreasing the line spacing, can have dramatic

effects. Typical survey specifications are:

survey factor	conventional	high res
line spacing	2-5 km	< 1 km
tie spacing	5-10 x line	3 x line
precision	0.1 $\gamma$	0.005 $\gamma$
system noise	2 $\gamma$	< 0.2 $\gamma$
navigation	$\pm$ 200 m	$\pm$ 5 m
flying height	> 300 m	80 m

- Processing: There is a problem that very few data exist on the magnetic intensities of sedimentary rocks. Variations of  $\pm 10 \gamma$  have been measured in wells, and it is thus necessary to survey to 10% of this.
- Imaging: The application of various image processing techniques, e.g., lateral illumination from different directions, may produce impressive results.
- Interpretation: Courage is needed to correlate anomalies across lines. The principle of least astonishment must be applied. This stage of the work relies heavily on pattern recognition and spatial correlation of anomalies to geological structure. In most cases, linear, sediment-sourced magnetic signatures have been found to originate with faults.

Examples of places where useful results have been obtained are off the NW coast of Australia and off the coast of Norway. This is leading to a resurgence in aeromagnetic work. At the moment it is a very new field, modelling methods have not yet been developed, and an empirical interpretive approach still used.

## 10. Examples

### 10.1 Mineral exploration

Magnetic surveying in this context equates to the search for magnetite. Magnetite tracers often disclose the location of other minerals. The objective is to determine the depth and structure of mineral-bearing bodies.

#### Iron prospecting – the Northern Middleback Range, South Australia

Large magnetic anomalies do not coincide with areas where iron exists in economic quantities. This illustrates the general rule that magnetic anomalies cannot be used to assess the size or economic value of the resource. This factor caused some spectacular failures in the method early on, when it was assumed that the magnetisation was proportional to the amount of iron present. Much iron ore exists as haematite ore bodies. The most sensible approach is to locate areas where magnetic anomalies are large, and then to survey the area using gravity to find the best ore bodies. This is not always the case, however, and it depends on the mineralogy of the ore whether the magnetic anomalies have a positive correlation with economic deposits or not.

Other minerals that may be prospected with magnetic surveying include nickel, copper and

gold, because these are often associated with magnetite.

#### The Dayton ore body, Nevada

This is an example of where a magnetic anomaly *is* associated with the ore body. The magnetic anomaly is actually associated with a granodiorite intrusion that folded and fractured sedimentary rocks and allowed ore to be deposited. Such capricious situations are not uncommon in geology. Logic leads you to expect something and you find it, but it later transpires that it was there for some other reason.

#### Kimberlite pipes

Kimberlite is an ultrabasic rock that contains magnetite and ilmenite, and may thus be detected by magnetic surveying.

#### Sulphide veins in the Bavarian Forest

A magnetic profile with a double peak was found and compared with the susceptibility of near-surface rocks and the percentage weight of magnetic constituents along the profile. The anomaly was interpreted as two veins. An offset discovered between the magnetic anomaly and the susceptibility profile is interpreted as being due to lateral variation in the magnetisation.

### *10.2 Oil industry*

Up to quite recently magnetic surveying was used to determine the depth to the basement only (i.e., it wasn't much use at all). However, this was in general accurate to ~5%. Magnetic results can also show topographic trends in the basement that may be relevant to the structure in the sediments above. Some oilfields have been discovered almost entirely because of the magnetic field, usually if the production is from porous serpentinite which has a high susceptibility compared with surrounding sediments. Sometimes oil exists in sediments draped over a basement high.

Magnetic surveying may be useful in basalt-covered areas, where seismic reflection won't work, e.g., the Columbia River Basalt province, Washington State, U.S.A. There, the approach used is to combine magnetotelluric measurements, which are powerful to give the vertical structure, with gravity and magnetics, which are powerful to give lateral variations.

#### The basement depth in the Bass Straits, Australia

This was prospected using an aeromagnetic survey. The data could also have been measured from a ship. The magnetic survey was done before anything else. The interpreted depth to the basement showed that a basin existed – the Bass basin. The nearby Gippsland basin was previously known. Seismic lines were subsequently shot and large quantities of gas accumulations found that are now used to power Sydney and Melbourne.

### *10.3 The search for structure in sedimentary sequences*

This is a new field and is leading to a resurgence in magnetic work. It has been made possible because of the advent of high-resolution/high-sensitivity surveys.

# **GEOPHYSICAL METHODS IN GEOLOGY**

## **GRAVITY & MAGNETICS**

### **PRACTICAL WORK**

G. R. Foulger

## GRAVITY

$$G = (6.670 + 0.006) \times 10^{-11} \text{ N m}^2 \text{ kg}^{-2} (=10^{-10} \times 2/3)$$
$$1 \text{ milligal (mGal)} = 10^{-5} \text{ m s}^{-2}$$

NOTE: ALL GRAVITY CALCULATIONS THAT ARE DONE IN UNITS OF MGAL MUST MAKE ALLOWANCES FOR THIS RELATIONSHIP BETWEEN MGAL AND SI UNITS

1. Use of a Lacoste-Romberg gravimeter. Students will use the gravimeter in groups of 5. A measurement will be taken at the top of the stairs, one on the 1st floor and a third measurement on the ground floor. The difference in scale reading on the gravimeter must be multiplied by the instrument calibration factor (1.05824 mGal/scale division) in order to convert it to mGal.

The height differences between the floors may be calculated using the equation for the reduction in gravity with height (the "Free-Air" correction). This equation is:

$$\text{FAC} = 0.3085h \text{ mGal}$$

where FAC is the difference in gravity in mGal and h is the height difference in metres.

Write a brief (~ 1/2-page) description of how to use a gravimeter.

2. The gravity anomaly due to a horizontal infinite sheet, density  $\rho$ , thickness  $t$ , is given by:

$$A = 2\pi G\rho t \times 10^5$$

This is known as the slab formula. Calculate the thickness of the following types of rock required to give gravity anomalies of 1 mGal and 10 mGal, assuming the surrounding rocks are metamorphics with a density of  $2750 \text{ kg m}^{-3}$ :

- (i) granite ( $2650 \text{ kg m}^{-3}$ )
  - (ii) triassic sandstone ( $2350 \text{ kg m}^{-3}$ )
  - (iii) recent sediment in buried channel ( $1750 \text{ kg m}^{-3}$ )
3. Calculate the gravity profile across a point mass of  $1.5 \times 10^{12} \text{ kg}$  situated at a depth of 1 km. Compute anomaly values at the following horizontal distances from the point vertically above the point mass: 0.00, 0.25, 0.50, 0.75, 1.00, 1.50, 2.00, 3.00, 5.00 km. The formula for the point mass is  $A = \mathbf{GMz/r^3}$ . Plot the profile from  $-5.00$  to  $+5.00$  km.  
  
What would be the effect on the gravity anomalies of (i) doubling the mass of the body, and (ii) increasing the depth to the centre of the body?
  4. (a) Contour the gravity map provided at intervals of 1 mGal and draw a profile across the anomaly.  
(b) Assuming the anomaly to be caused by a body in the form of a point mass or sphere, determine the depth to the point (or centre of the sphere) using (i) the half-width, and (ii)

the ratio of maximum anomaly to maximum gradient. If these two estimates agree, what does this mean? If they do not agree, what does that mean?

The relevant formulae are:

$$z = 1.305 x_{1/2}$$

$$z = 0.86 \frac{A_{\max}}{|A'_{\max}|}$$

(c) Determine the mass deficiency from the point mass formula. In order to do this, use the value of the gravity anomaly immediately above the center of the body. If the anomaly is caused by a salt dome of density  $2000 \text{ kg m}^{-3}$  emplaced within sediments of density  $2550 \text{ kg m}^{-3}$ , determine (i) the volume of salt, (ii) the mass of salt, and (iii) the depth to the top of the salt dome.

Useful formulae are:

volume = mass deficiency/density contrast

mass = volume x density

volume of a sphere =  $(4/3)\pi r^3$

5. The gravity contours in the figure show a portion of a large survey made over a base metal property in New Brunswick. Remove the regional. Given that there are ore-grade sulphides in the area, interpret the residual and estimate the excess mass. The relevant formula is:

$$2\pi GM = \sum \Delta g A$$

where  $M$  is the excess mass,  $\Delta g$  is the gravity anomaly and  $A$  is the area. Assuming the country rock is sedimentary with a density of  $2500 \text{ kg m}^{-3}$ , and the sulphides are galena, estimate the actual tonnage of ore in the area.

6. Analyze the gravity map of southwest Britain. There are several large gravity lows e.g., over Bodmin Moor and Dartmoor, which are attributed to granite batholiths there. Approximating these batholiths to spheres, estimate the depths to their bottoms. Assume that the density contrast between the granite and the country rock is  $150 \text{ kg m}^{-3}$ .

Comment on the geological realism of your answer. Critique the method you have used. One way in which the analysis could be improved would be to use the formula for a vertical cylinder:

$$\Delta g = 2\pi G\rho(L + S_1 - S_2).$$

This formula cannot be easily solved for L since it is a quadratic in L. It is more easily done using Excel. In your own time, use this formula with Excel, or by other means, to estimate the depth to the bases of the SW Britain granite intrusions. Compare the result with the results you got using the formulae for the sphere and comment.

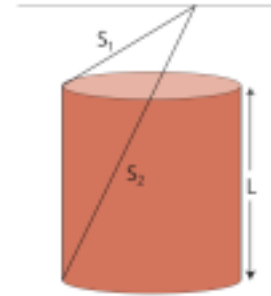

7. Can modelling of the main gravity anomaly associated with Long Valley caldera help to determine if a partially molten magma chamber lies beneath? If so, can gravity modelling determine the depth and size of this hypothesised chamber? Attempt to answer these questions by applying modeling methods that you have learned in the practical course so far.

You are provided with a Bouguer gravity map of Long Valley caldera, a gravity map with tectonic features draped, and a schematic geological cross section. In addition, you may assume the following densities:

- post-caldera lavas and fill  $2,000 \pm 50 \text{ kg/m}^3$
- top  $\sim 1$  km of country rock  $2,400 \pm 50 \text{ kg/m}^3$
- Bishop Tuff  $2,300 \pm 50 \text{ kg/m}^3$
- country rock at 1 – 10 km depth  $2,600 \pm 50 \text{ kg/m}^3$
- basement and congealed magma density about the same as surroundings
- partially molten magma  $2,700 \pm 50 \text{ kg/m}^3$
- country rock below  $\sim 10$  km  $2,800 \pm 50 \text{ kg/m}^3$

Below are suggestions for approaches you can try. In addition to these, use your ingenuity and deductive skills to develop new reasoning and modelling approaches. This may require finding out about other, supporting data, that have been gathered and analysed to reveal information about the subsurface structure. Take uncertainties into account in your work. Use the results you obtain to build a picture of the gravity effects of the subsurface structures.

Your write up should comprise two parts:

- a) A section showing clearly how you have done each different analysis, and
- b) A section comprising:
  - a statement of the problem
  - a description of the results
  - a discussion of the results
  - a short description of gravity work that is currently being done in the Long Valley caldera, as part of the ongoing research work there (you must research this yourself)
  - conclusions

Section b) should be word-processed, contain subheadings and not exceed 3 pages of 12-point type.



### Some suggested analysis approaches

1. Investigate the nature of the caldera ring fault. Draw a gravity profile across it (e.g. along profile A and/or B and use this to draw profiles of the first and second derivatives. What is the sense of the fault? Does this agree with the schematic geological cross section?
2. Assuming the gravity anomaly associated with the caldera rim is caused by a downfaulted low-density slab-like mass of rock, estimate the depth to the centre (i.e., the maximum depth to the top) of the structure using the formula for the limiting depth of a fault:

$$d = \frac{1}{\pi} \frac{A_{\max}}{A_{\max}}$$

3. Using the slab formula, the schematic geological cross section and the densities given above, estimate the total gravity anomaly expected for the layers above the hypothesised partially molten magma chamber, taking into account uncertainties. Compare your estimate with the total gravity anomaly observed.
4. Use the formula for a sphere to estimate the expected gravity anomaly for the hypothesised magma chamber.
5. Use the formula linking the depth to the centre of a buried sphere to the anomaly half width to estimate the width of the expected anomaly for the hypothesised magma chamber.
6. There are two circular gravity lows in the northern part of the caldera, and a gravity high centred on the SE edge of the resurgent dome. Estimate the depth to the centres (i.e., the maximum depth to the top) of the causative structures, e.g., using the formulae appropriate for a point source. A suggested line along which a profile might be drawn is C. Might one or more of these represent a shallow accumulation of magma?

## MAGNETICS

1. Use of a proton precession magnetometer. Students will use the magnetometer in groups of 5 to detect an iron-rimmed buried mineshaft behind the Department.

Write a brief (~ 1/2-page) description of how to use a proton precession magnetometer.

2. You are given a set of theoretical values of the magnetic anomaly across a dyke. Plot the magnetic profile from the readings given. Use a horizontal scale of 1 cm : 10 m, and a vertical scale of 1 cm : 25 gamma.

With reference to Figs. 1 and 2, draw tangents to your profile, on both the steeper and gentler flanks, which have the maximum anomaly gradients, and half the maximum gradients. Measure from your profile:

$X_{1-P1}$	$X_{P1-M}$
$P (X_{P2-P1})$	$X_{2-B1}$
$X_{B1-M}$	$B (X_{B2-B1})$
$X_{1-2}$	$F_1$
$F_2$	$t_1$
$t_2$	$X_{1-B1}$

Note:  $X_{1-P1}$  means  $X_{1-X_{P1}}$  etc. P and B are known as “Peter’s length” for the steeper and gentler flanks respectively.

Use these values to plot points on each of the four charts in Figs. 3-6. Read off these charts values for  $\theta$  and  $b/d$  ( $\theta$  is a composite angle involving the dips of magnetisation of the Earth’s field and the body and the dip of the body.  $b$  is the width of the dyke and  $d$  is the depth to the top).

Because this method is extremely sensitive to small inaccuracies in plotting, it is likely that you will find that only one or two of your points will plot on the grids.

Use your values for P, B and  $b/d$  to make 2 estimates of the depth  $d$  to the top of the dyke, using the charts in Fig. 7. The curved lines indicate the values of  $b/d$  (chart A) and  $\theta$  (chart B). Plot a point on each using your values of  $\theta$  and  $b/d$ , and read of a value on each horizontal axis. This value is Peter’s length in depth units, i.e., Peter’s length=value x  $d$ . Calculate  $b$ , the width.

Find the intensity of magnetisation  $J'$  of the dyke using the chart in Fig. 8. Plot a point on the chart using your values of  $\theta$  and  $b/d$ , and read the corresponding value off the vertical axis.  $[d\Delta F/dx]_{\max}$  is the maximum gradient of your magnetic profile,  $f=1$  and  $\sin\delta = 1$ .

**Magnetic data: Total magnetic field across a dyke**

distance, m	$\Delta F, \gamma$
-120	145.9
-100	171.7
-80	204.3
-60	238.8
-40	250.0
-20	204.3
0	111.5
20	0.48
40	-91.8
60	-135.9
80	-137.5
100	-127.1
120	-114.4

3. Sketch the rough form of the anomalies listed below by sketching lines of force, as illustrated in the figure:  
Horizontal and vertical magnetic anomalies of (a) an east-west dyke and (b) a sill terminated by an east-west fault, with directions of magnetisation:
  1. vertically downwards (normal in the N. hemisphere)
  2. vertically upwards (reversed in the N. hemisphere)
  3. horizontal northwards (normal in the N. hemisphere)
  4. horizontal southwards (reversed in the N. hemisphere)
  
4. Essay: *Write a short essay on magnetic measuring instruments, indicating to which kind of surveying each is most suitable.*

Your essay should comprise no more than two A4 sides of handwritten text. Diagrams may be drawn on accompanying sheets.

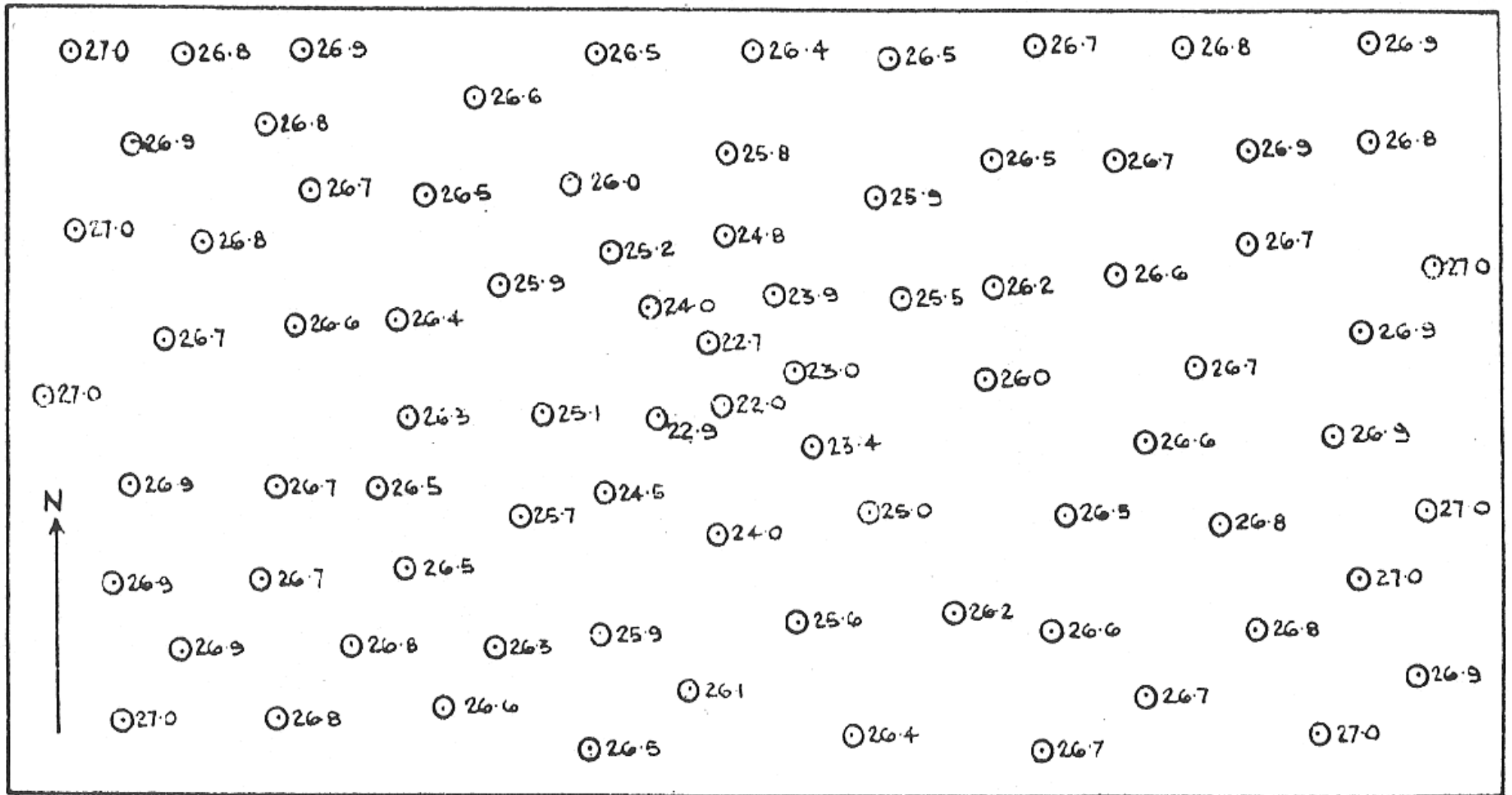

0 1 km.

Gravity values in mGal

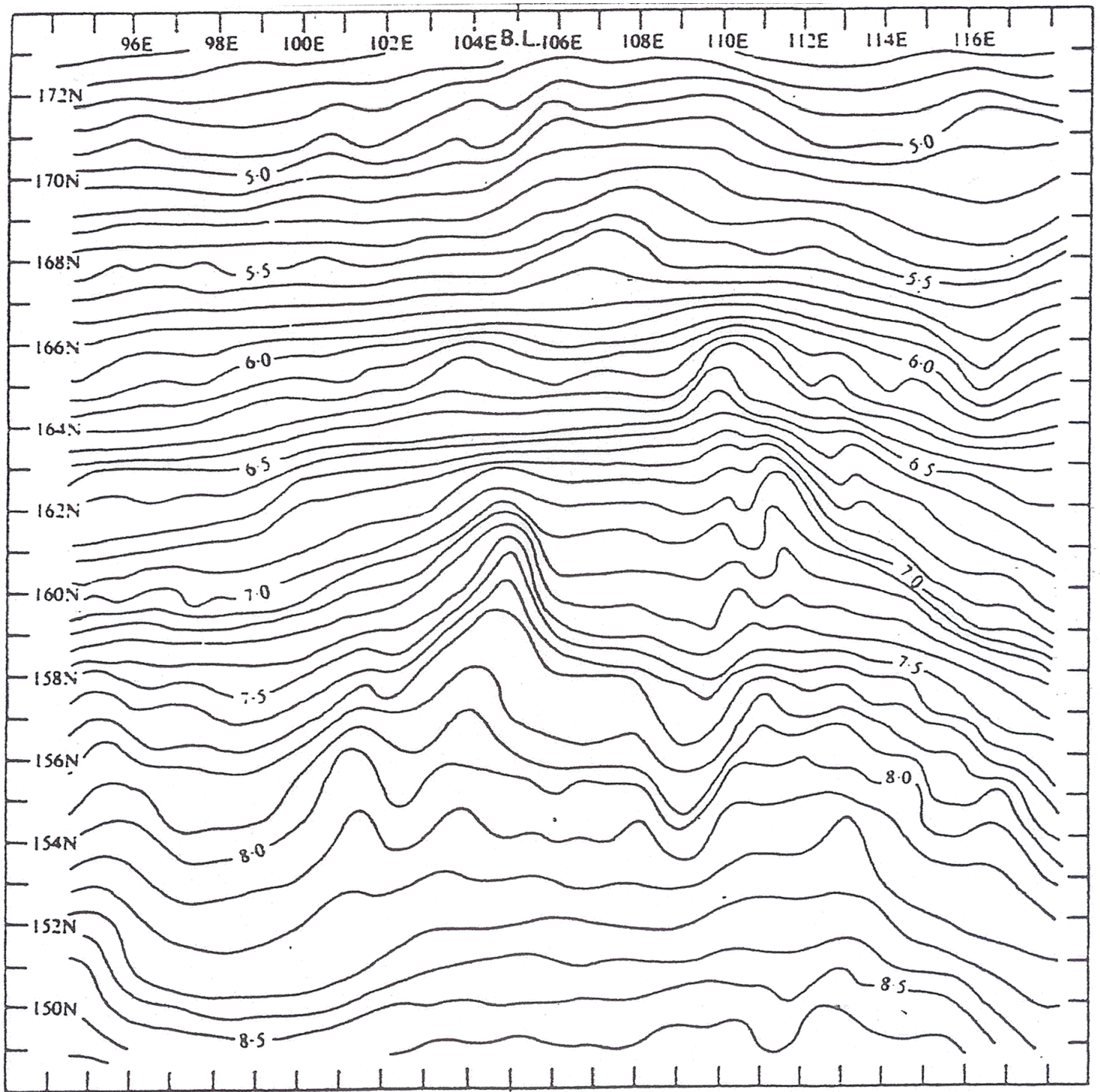

Bouguer gravity contours, Southern New Brunswick. Contour interval 0.1 mGal

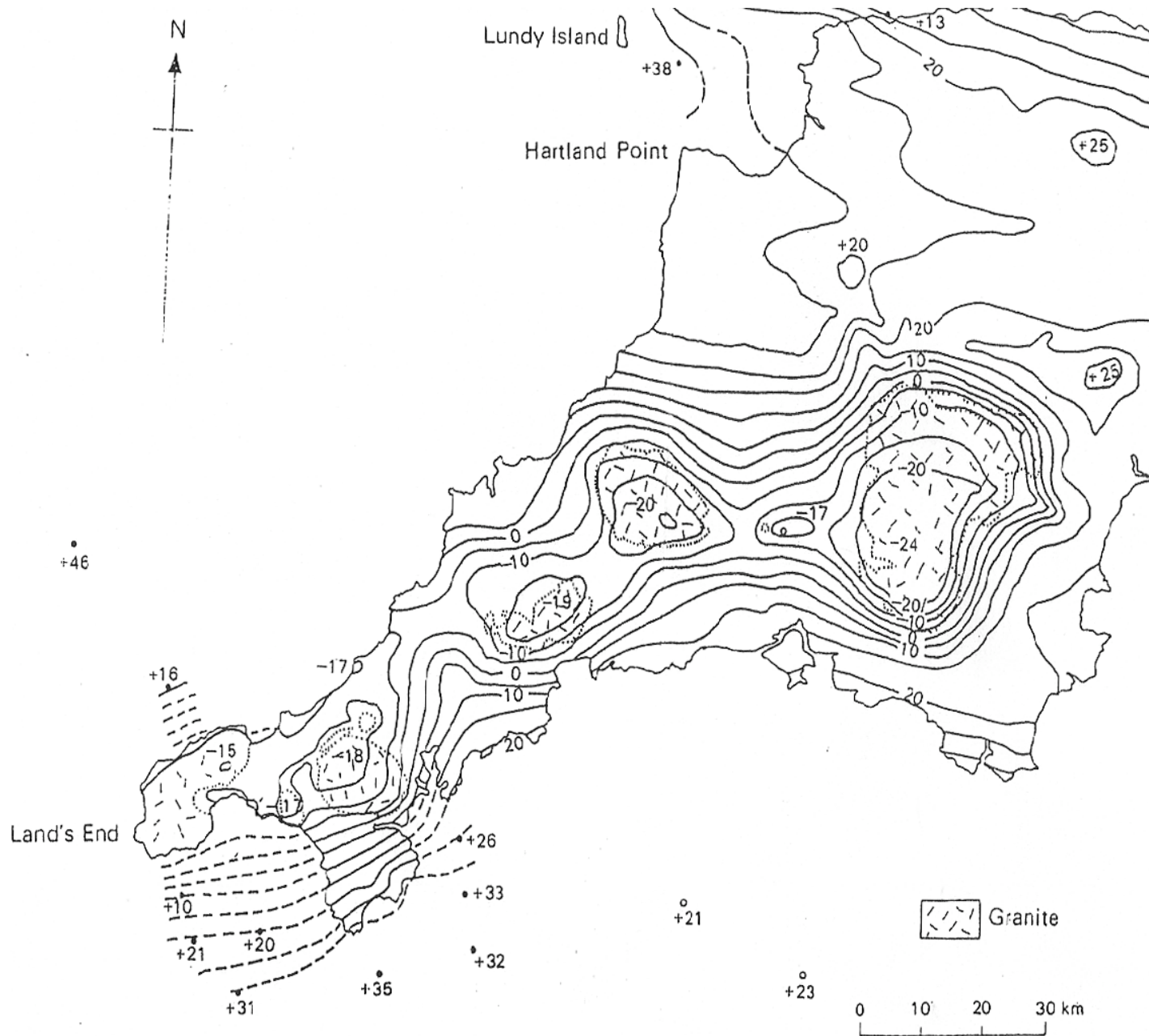

Gravity map of southwest Britain

# LONG VALLEY CALDERA BOUGUER GRAVITY

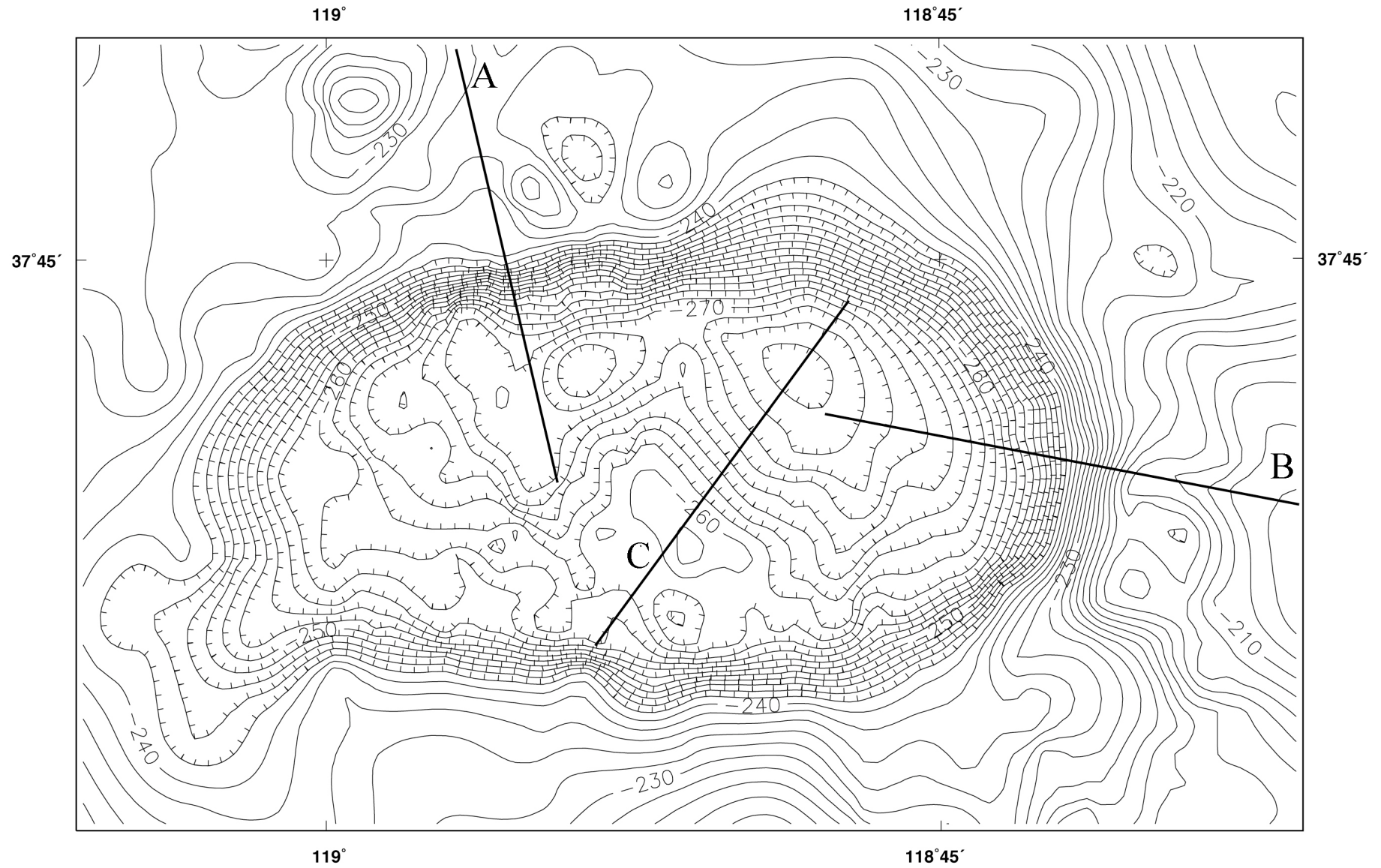

Map courtesy of Bob Jachens, US Geological Survey, 2005



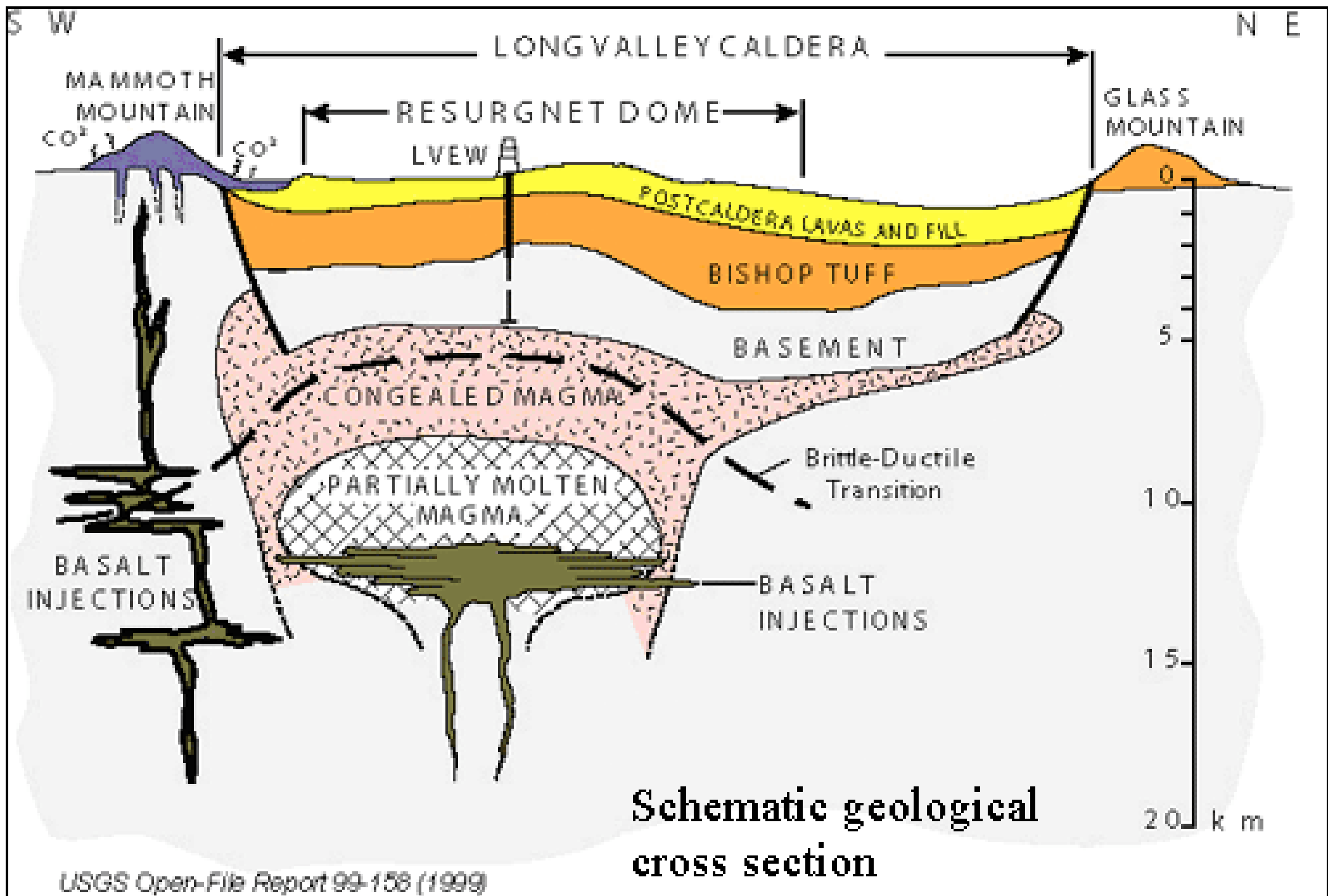



# LONG VALLEY CALDERA BOUGUER GRAVITY

Tectonic features  
draped

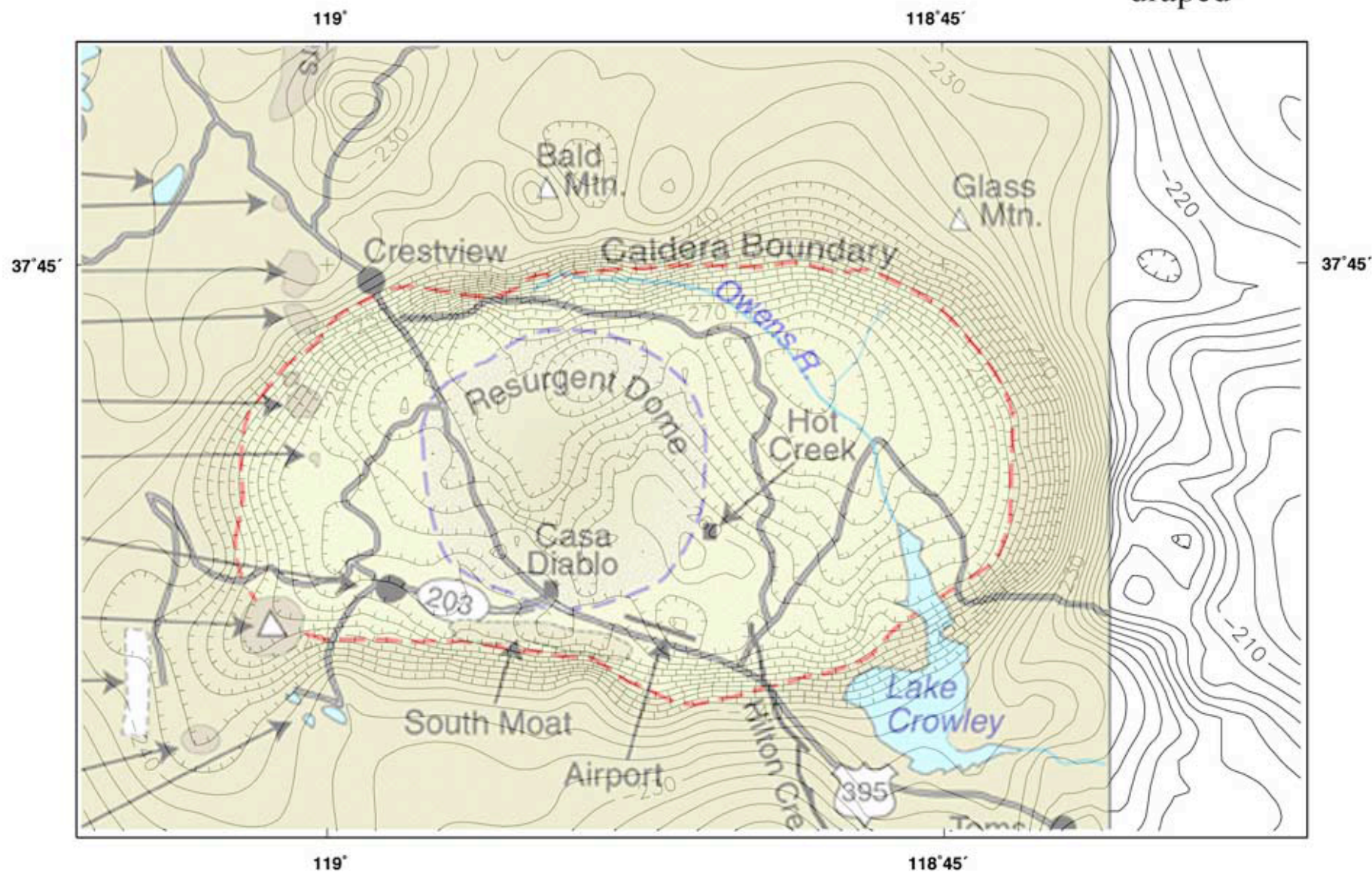



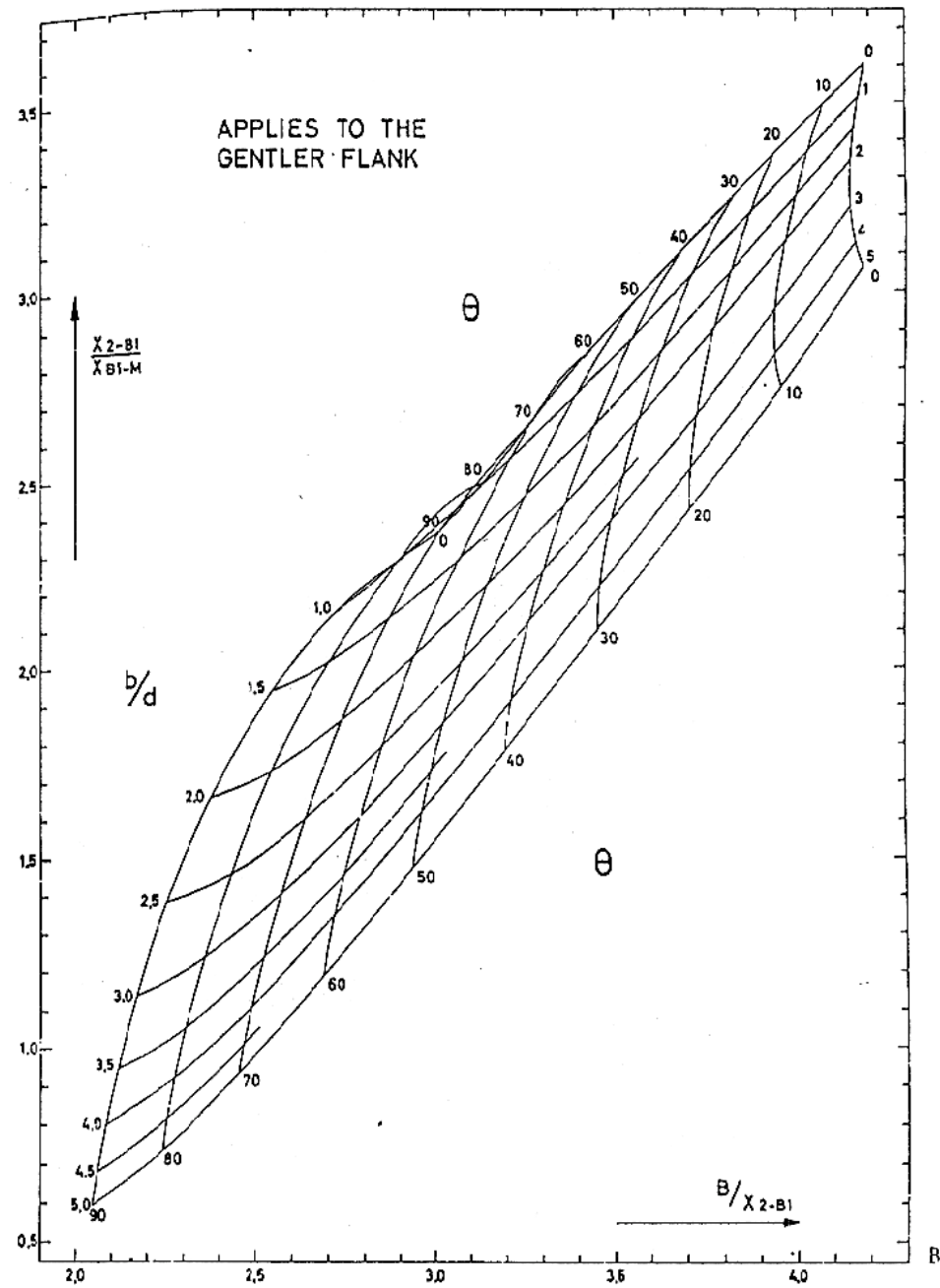
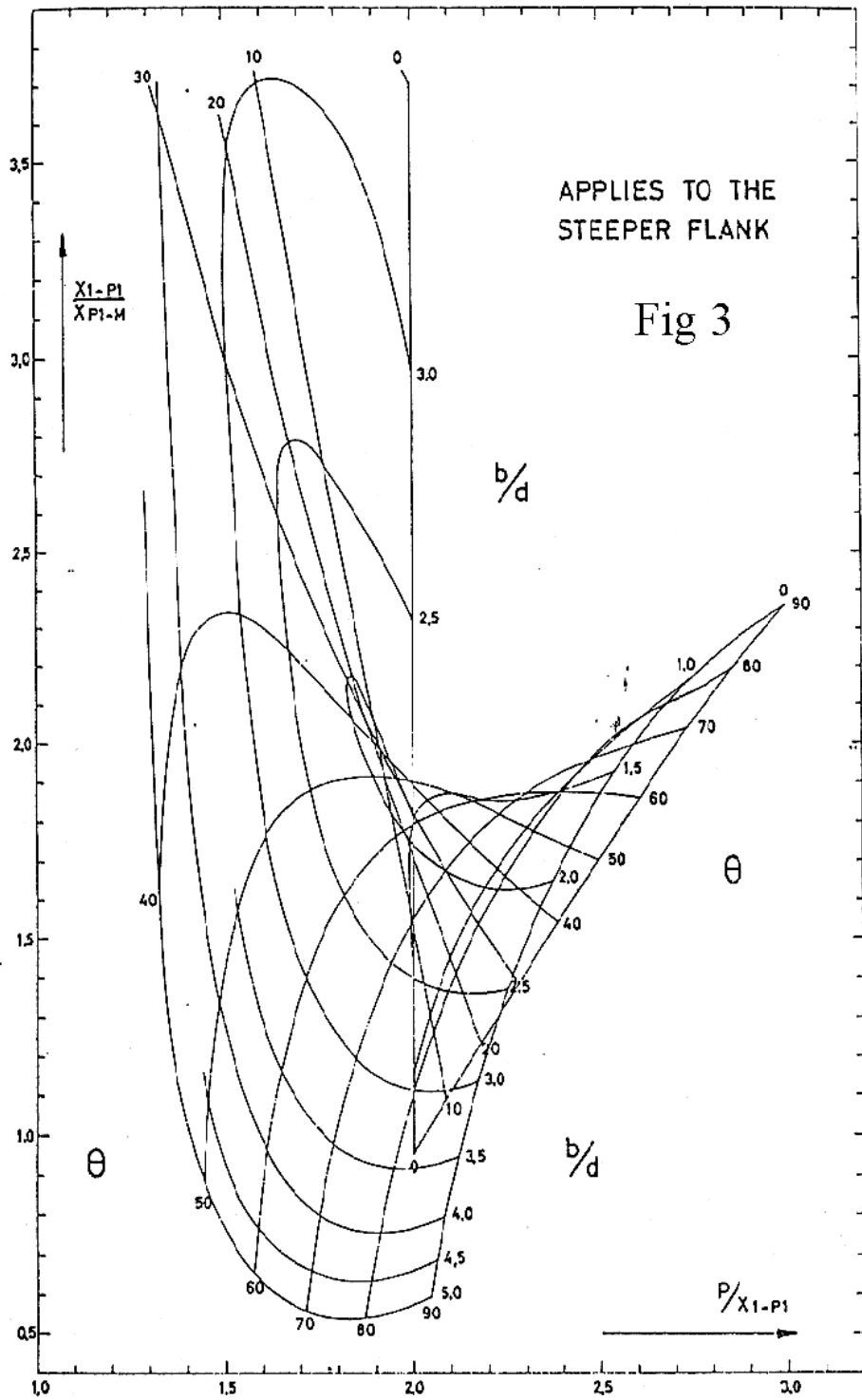

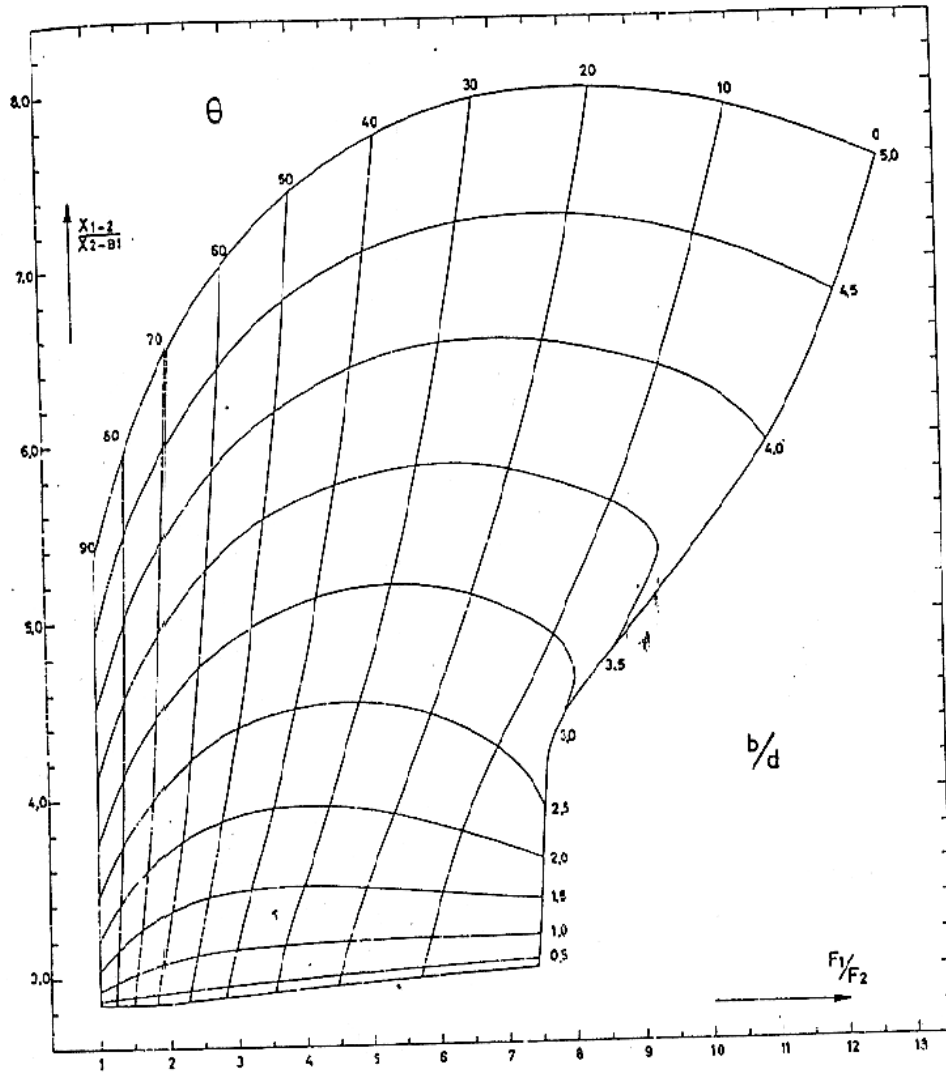

Fig 5

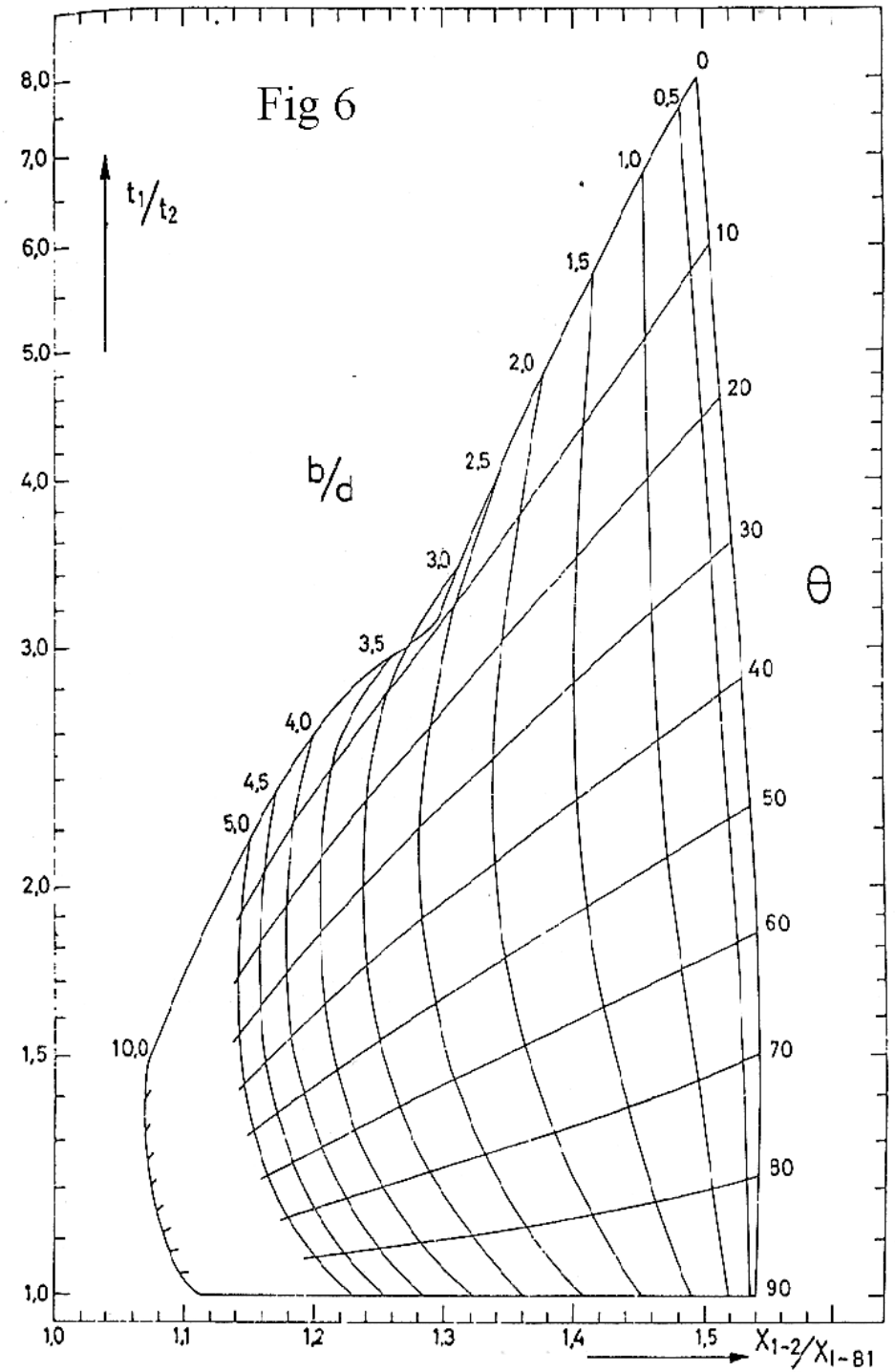

Fig 6

Chart A

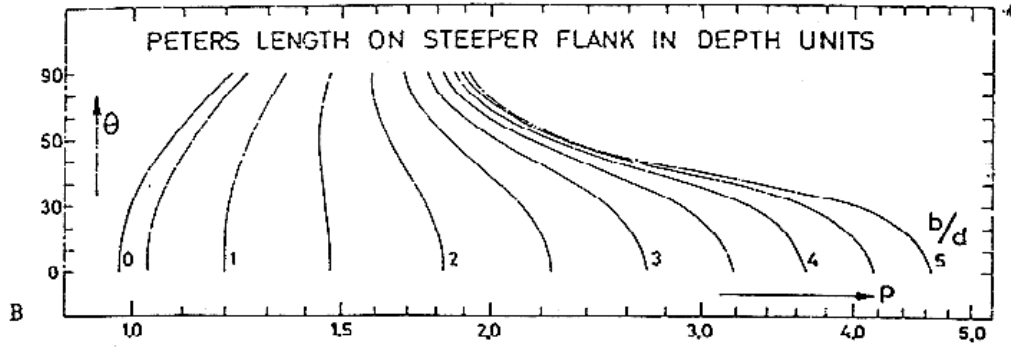

Chart B

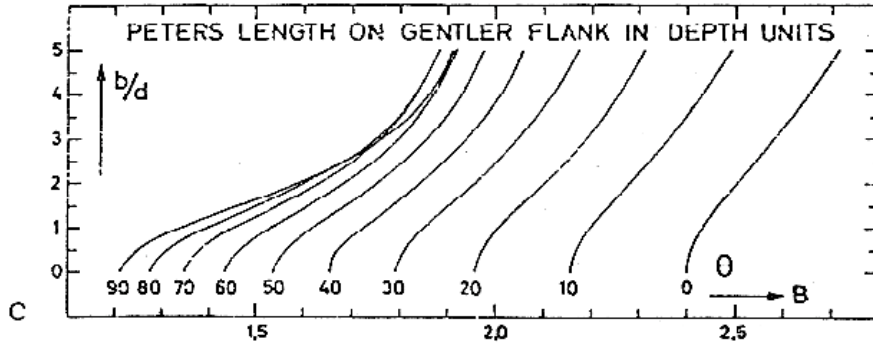

Fig 7

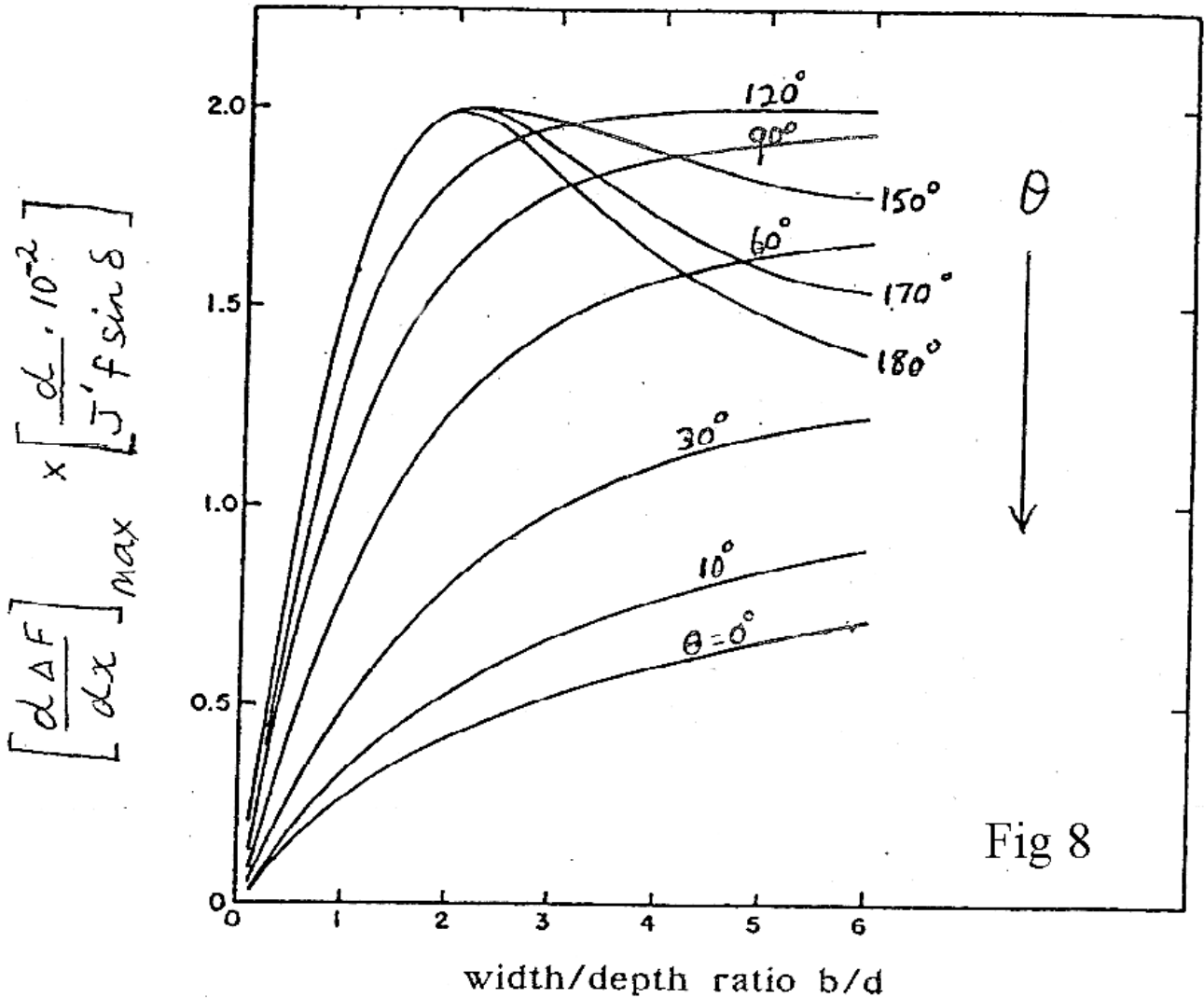

Fig 8

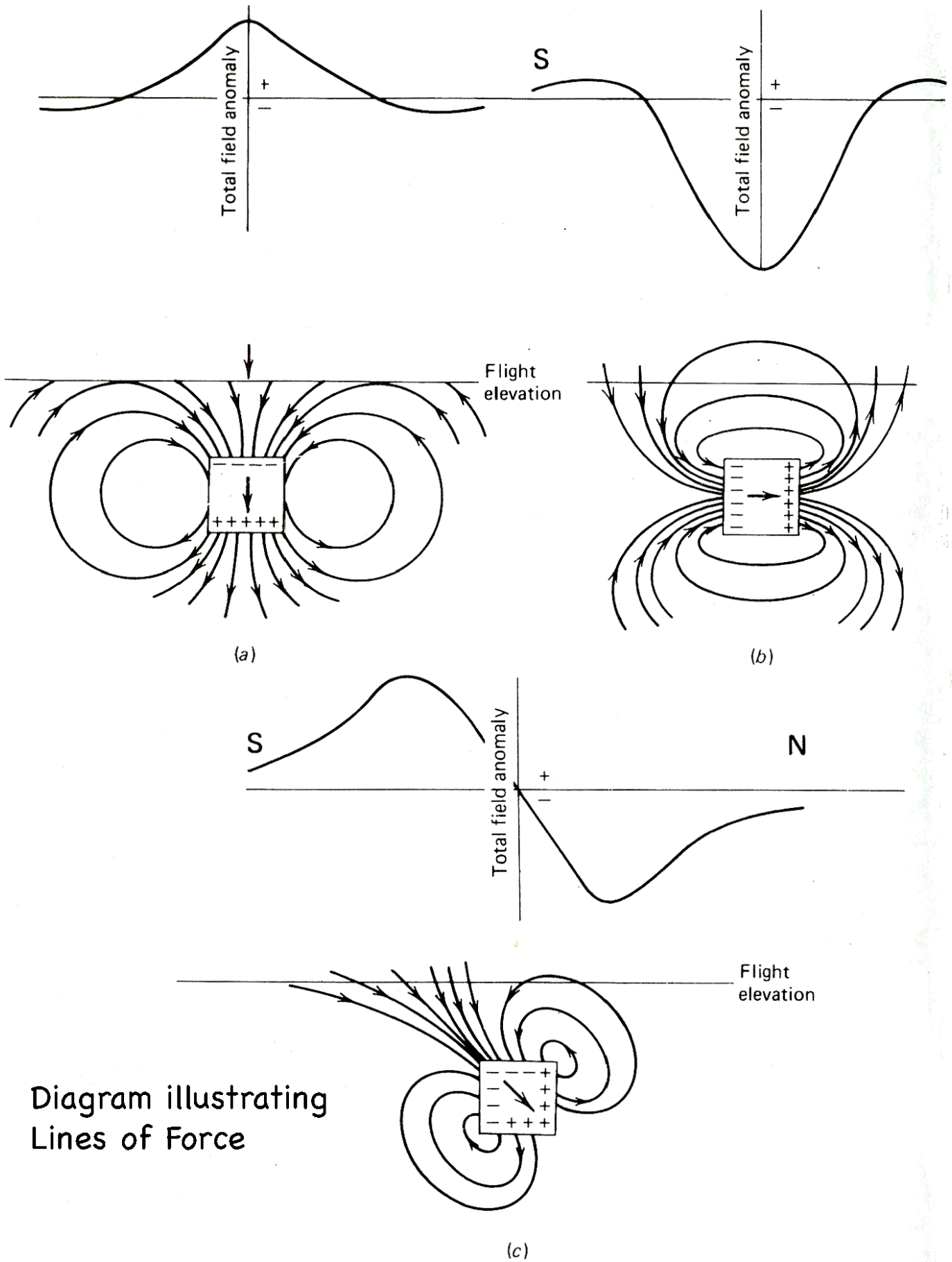

Diagram illustrating Lines of Force

Total-field anomalies observed when flight line is perpendicular to axis of buried body with square cross section elongated perpendicular to page: (a) at north magnetic pole; (b) at magnetic equator; (c) at magnetic latitude of 26.6°N. All magnetization is induced. Anomaly is positive when the field of the buried body reinforces the earth's field and is negative when the field opposes the earth's field.