

I) Infecção o Básico
II) Patogênese do HIV
III) Antivirais

BMM0450 -2021

Paolo Zanotto
pzanotto@usp.br

Viral pathogenesis



- *Pathogenesis*: the process of producing a disease
- Two components of viral disease:
 - Effects of viral replication on the host
 - Effects of host response on virus and host

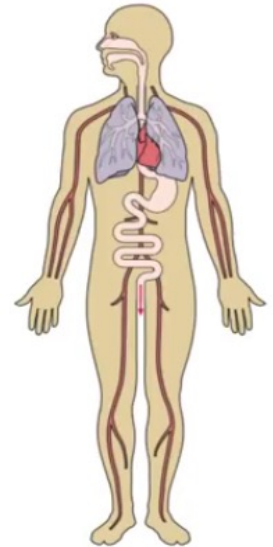

Patogênese e imunidade. A maior parte dos sintomas não são causados pelo vírus mas pela reação do sistema imune do portador à infecção viral. Por exemplo, citocinas liberadas pela mucosa pulmonar durante a infecção por Influenza causa febre associada à gripe. Maior parte dos sintomas e danos são causados pela resposta imune.

Three requirements for a successful infection

- Enough virus
- Cells accessible, susceptible, permissive
- Local antiviral defense absent or overcome

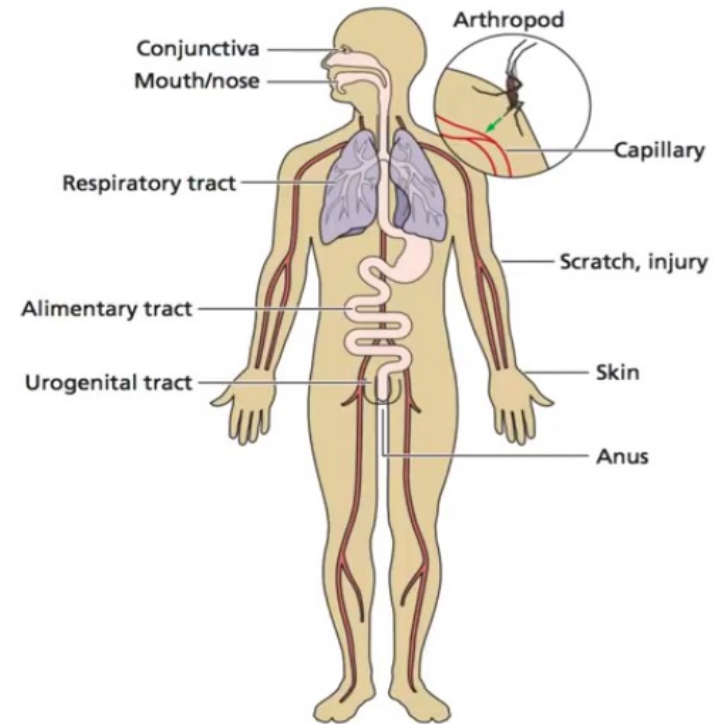

Na figura ao lado são mostrados os sítios de entrada de vírus.

Portais de Entrada de vírus no nosso sistema

Sítios principais: Pele e Mucosas.

Gaining access: site of entry is critical

The human body presents only a **limited spectrum** of entry sites for viral infection.

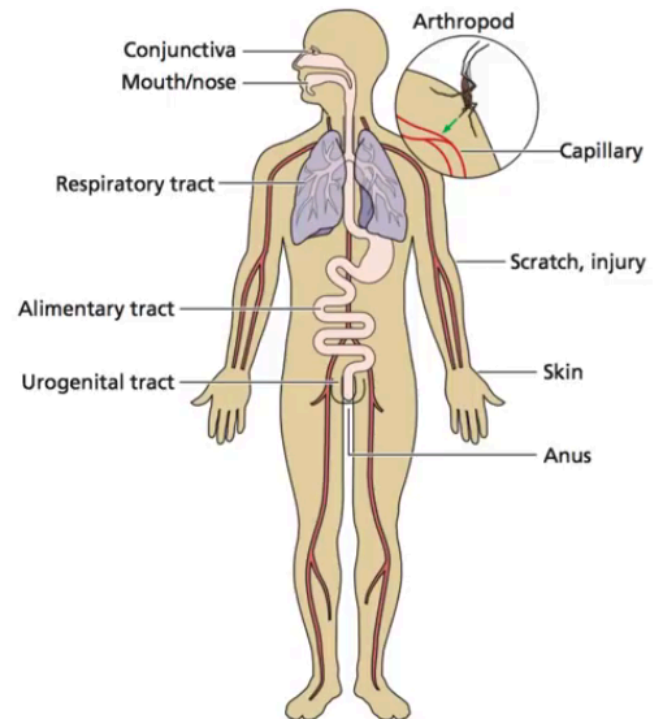

Sistema Respiratório.

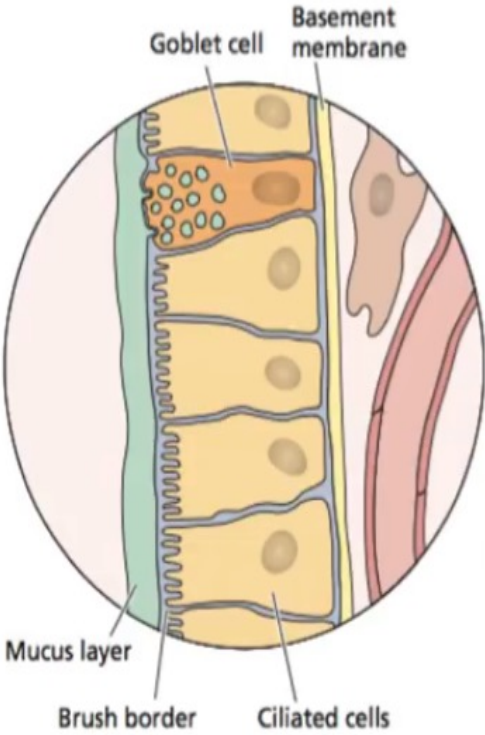

Site of reproduction	Clinical manifestation	Virus
	Rhinitis (common cold)	Rhinovirus Coronavirus Parainfluenza virus Respiratory syncytial virus Influenza virus Adenovirus Herpes simplex virus Epstein-Barr virus
Pharyngitis		
Laryngitis		
Tracheitis	Parainfluenza virus Respiratory syncytial virus Influenza virus Adenovirus Measles SARS MERS	
Bronchitis		
Bronchiolitis		
Bronchopneumonia		

Alimentary tract

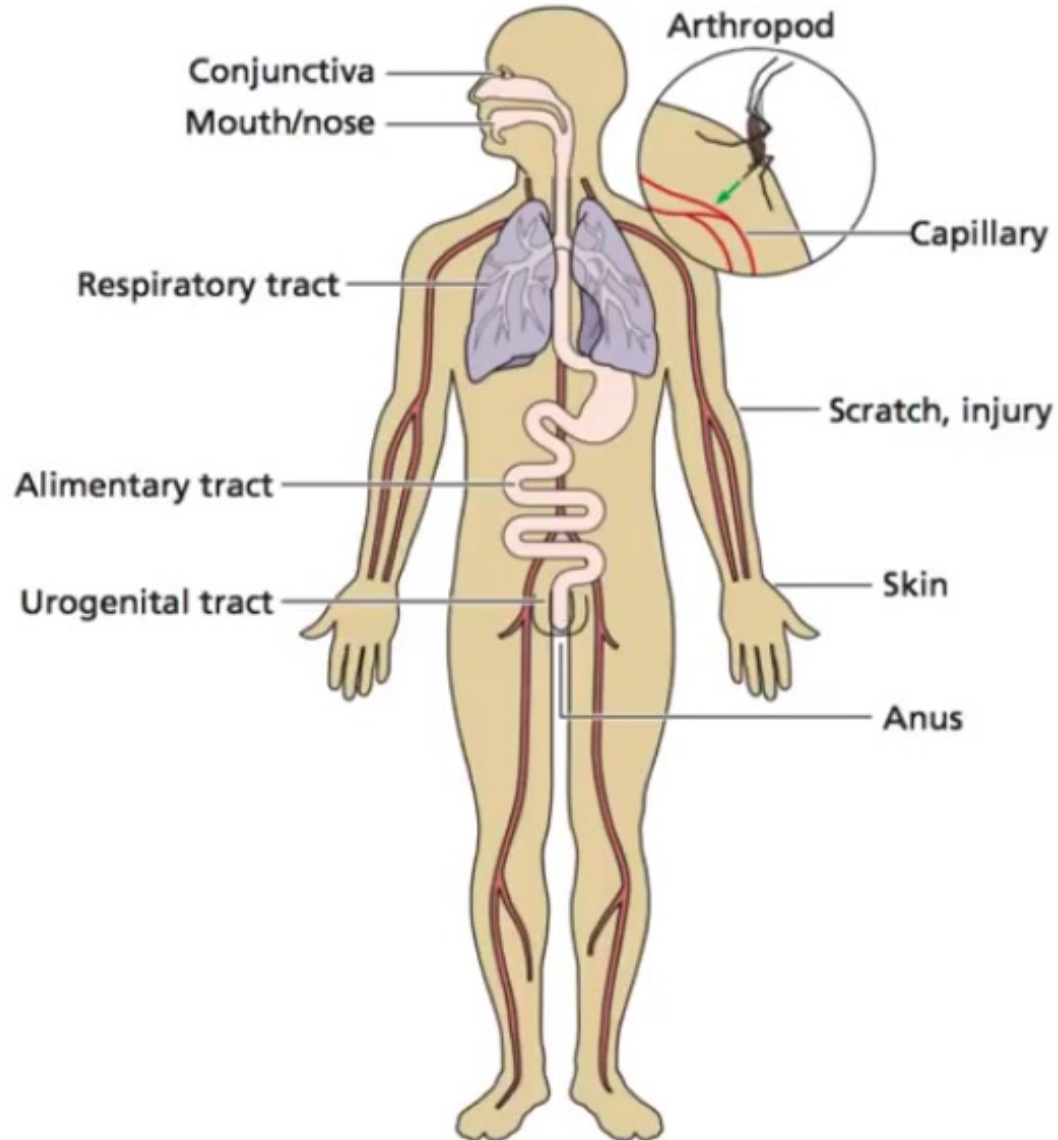

Eye

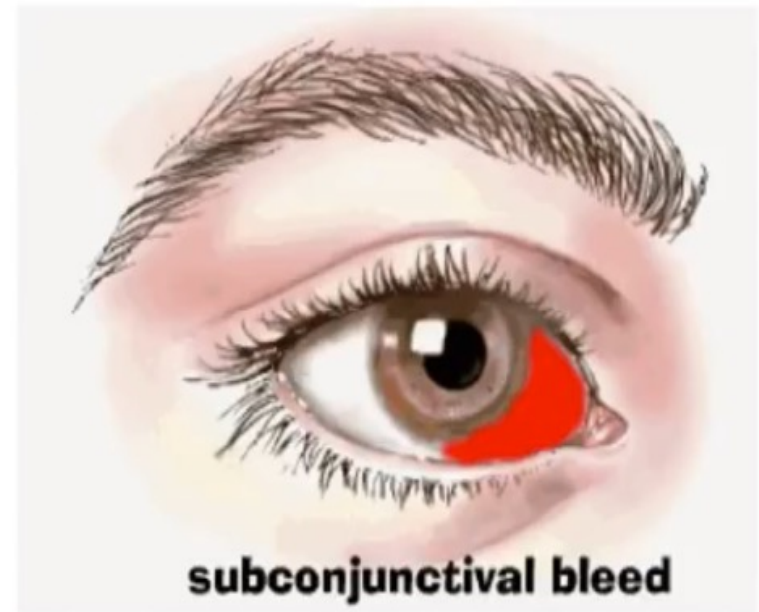
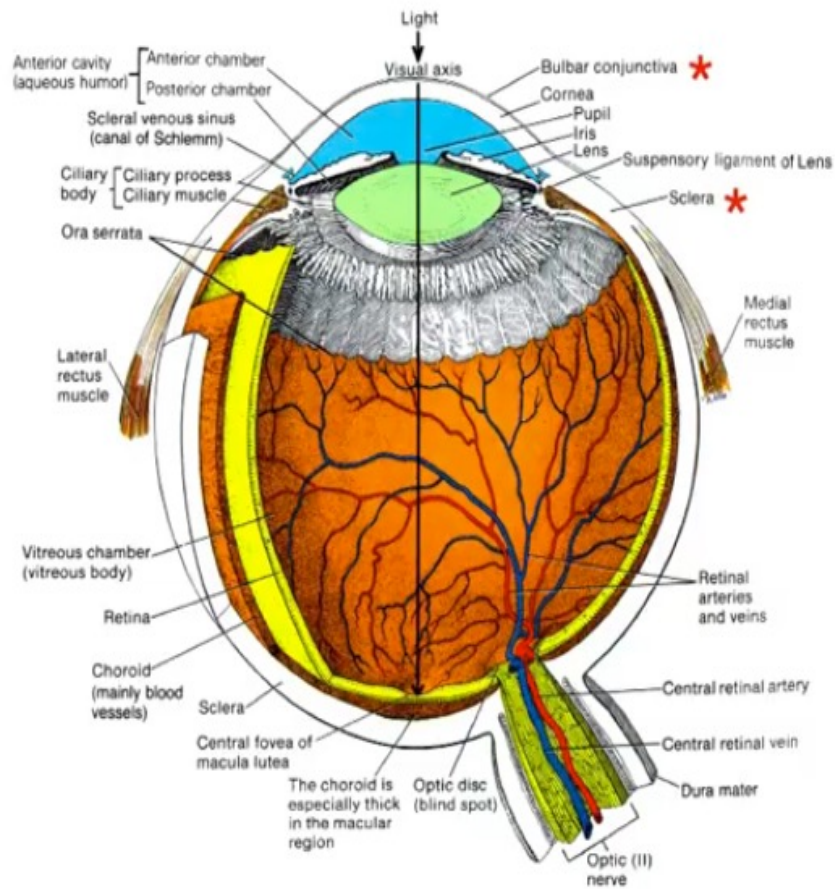

- **Infecção ocular.** Vírus (enterovírus, por exemplo) infectam os olhos, primariamente as membranas que revestem o olho: a Conjuntiva e a Esclerótica. Herpes podem causar cegueira por causar uma resposta imune `a infecção da Conjuntiva e a Esclerótica que afetam a córnea.

Hematogenous spread

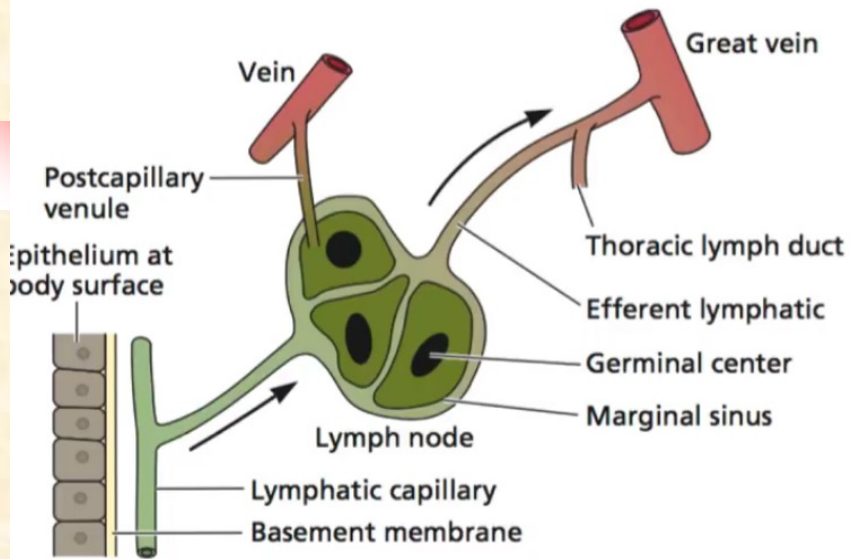

Viremia

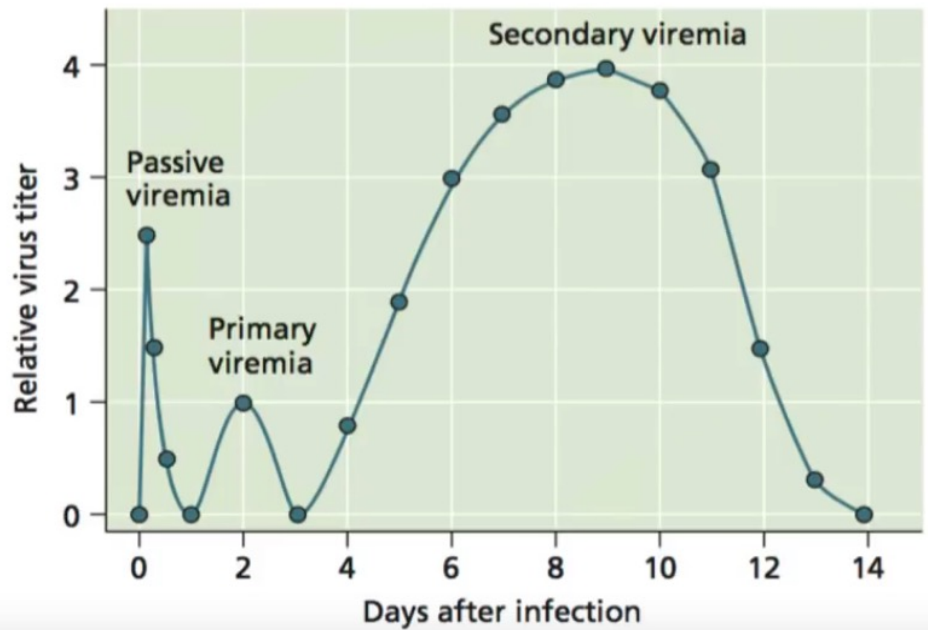

Viral spread

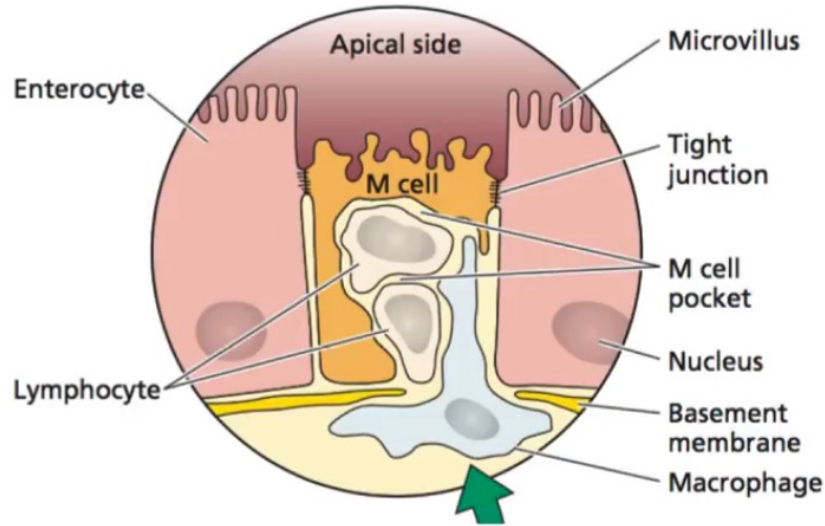

Viral spread

- After replication at the site of entry, viruses may remain **localized**: virus spreads within the epithelium and is contained by tissue structure and immune system
- Some viruses spread beyond the primary site: **disseminated**; if many organs are infected, **systemic**
- Physical and immune barriers must be breached

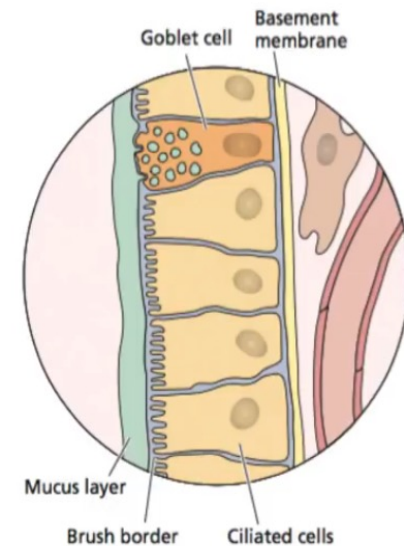

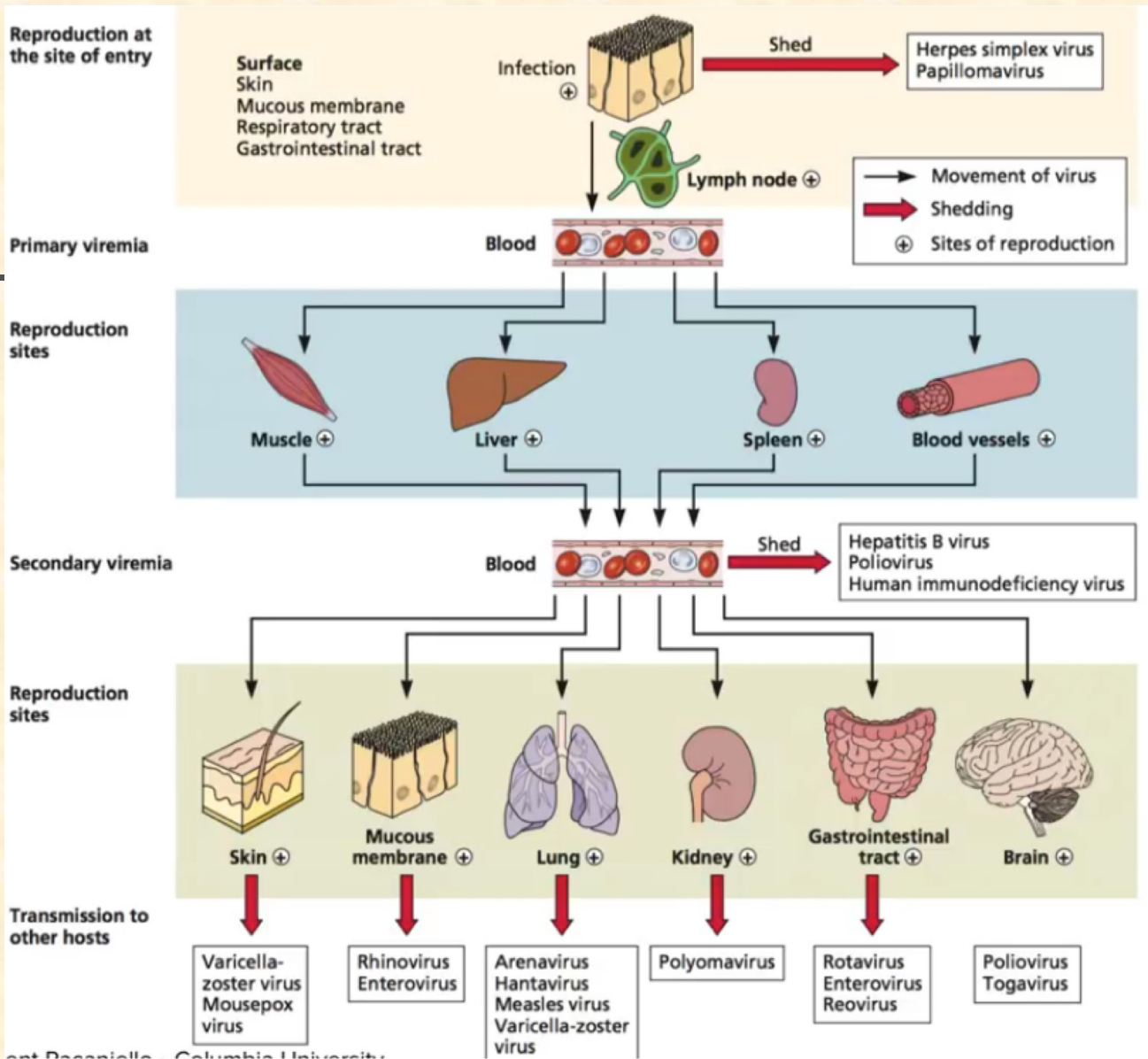

Resumo de infecção sistêmica. A doença característica de cada vírus é função da escolha de tecido(s) infectado(s) (lembre de tropismo viral!!!).

Tissue invasion

Pericyte
(glial cell in CNS) Neuron

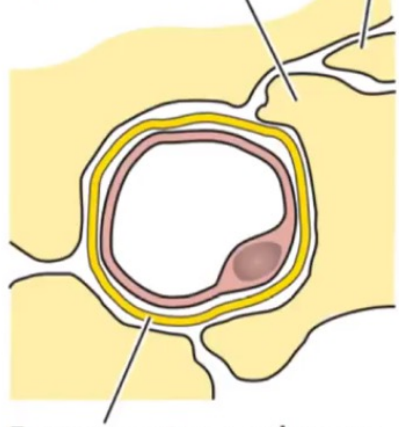

Basement membrane

Capillary

CNS, connective tissue,
skeletal & cardiac
muscle

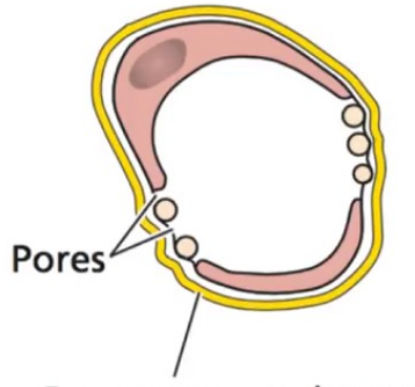

Pores

Basement membrane

Venule

Renal glomerulus,
pancreas, ileum, colon

Parenchymatous
cells

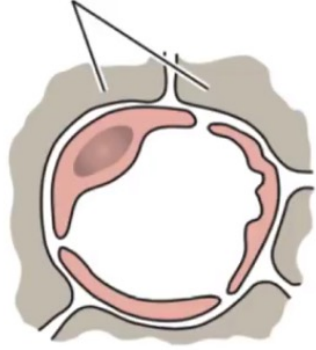

Liver, spleen, bone
marrow, adrenal glands

Sinusoid

Blood-brain junction

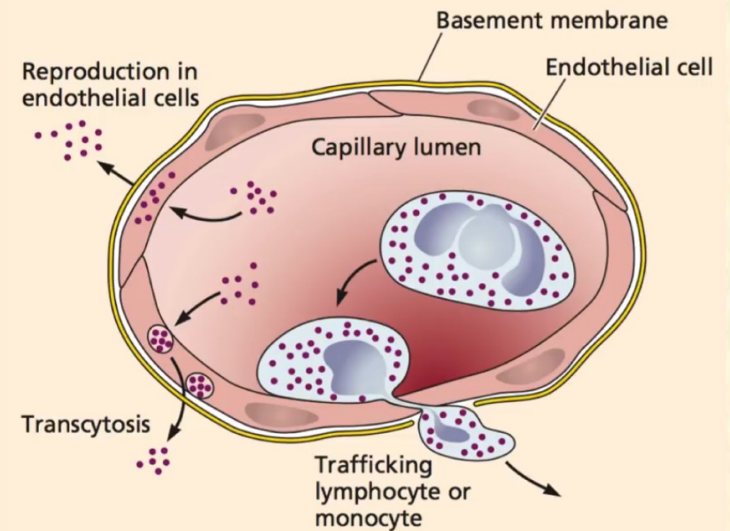

Infections of the CNS

- **Neurotropic** virus can infect neural cells; infection may occur by neural or hematogenous spread from a peripheral site
- **Neuroinvasive** virus can enter the CNS after infection of a peripheral site
- **Neurovirulent** virus can cause disease of nervous tissue
- HSV: low neuroinvasiveness, high neurovirulence
- Mumps: high neuroinvasiveness, low neurovirulence
- Rabies: high neuroinvasiveness, high neurovirulence

Neural spread

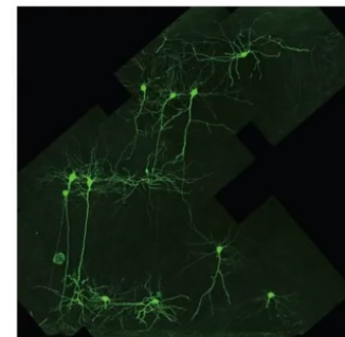
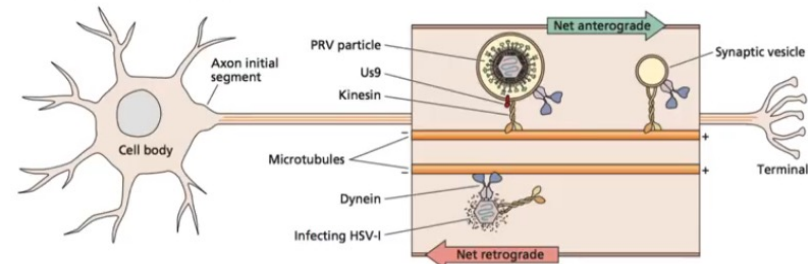
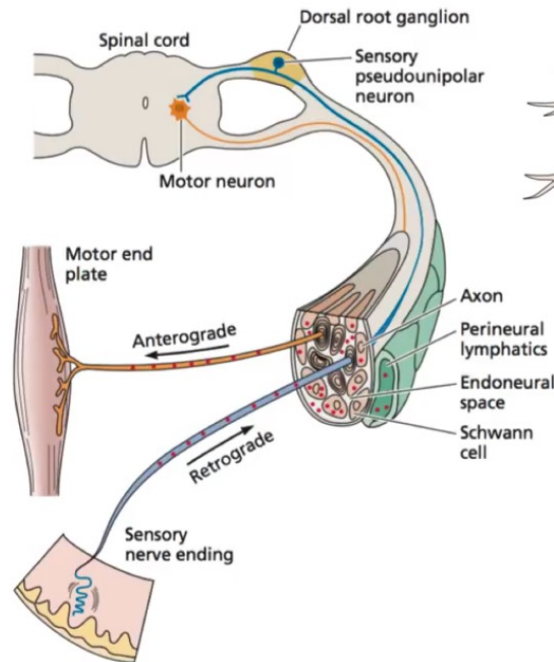

Tissue tropism

- The spectrum of tissues infected by a virus
 - Enterotropic, neurotropic, hepatotropic
- Ranges from limited to pantropic
- Some determinants: Susceptibility, permissivity, accessibility, defense

Virus shedding

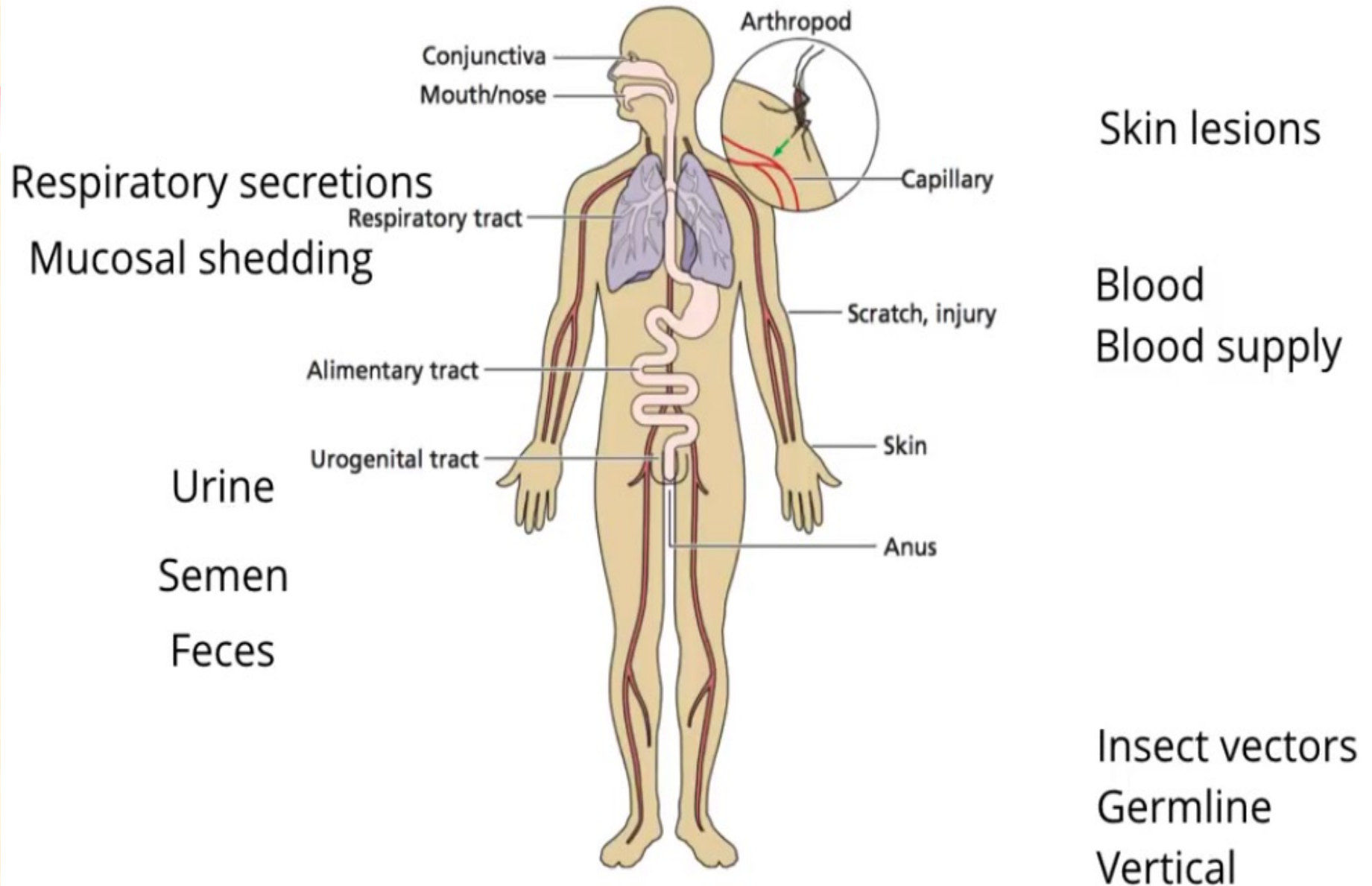



Human Immunodeficiency Virus

An Overview



Human Immunodeficiency Virus

- Acquired Immunodeficiency syndrome first described in 1981
- HIV-1 isolated in 1984, and HIV-2 in 1986
- Belong to the lentivirus subfamily of the retroviridae
- Enveloped RNA virus, 120nm in diameter
- HIV-2 shares 40% nucleotide homology with HIV-1
- Genome consists of 9200 nucleotides (HIV-1):
 - gag core proteins - p15, p17 and p24
 - pol - p16 (protease), p31 (integrase/endonuclease)
 - env - gp160 (gp120:outer membrane part, gp41: transmembrane part)
- Other regulatory genes ie. tat, rev, vif, nef, vpr and vpu



Replication

- The first step of infection is the binding of gp120 to the CD4 receptor of the cell, which is followed by penetration and uncoating.
- The RNA genome is then reverse transcribed into a DNA provirus which is integrated into the cell genome.
- This is followed by the synthesis and maturation of virus progeny.

HIV particles

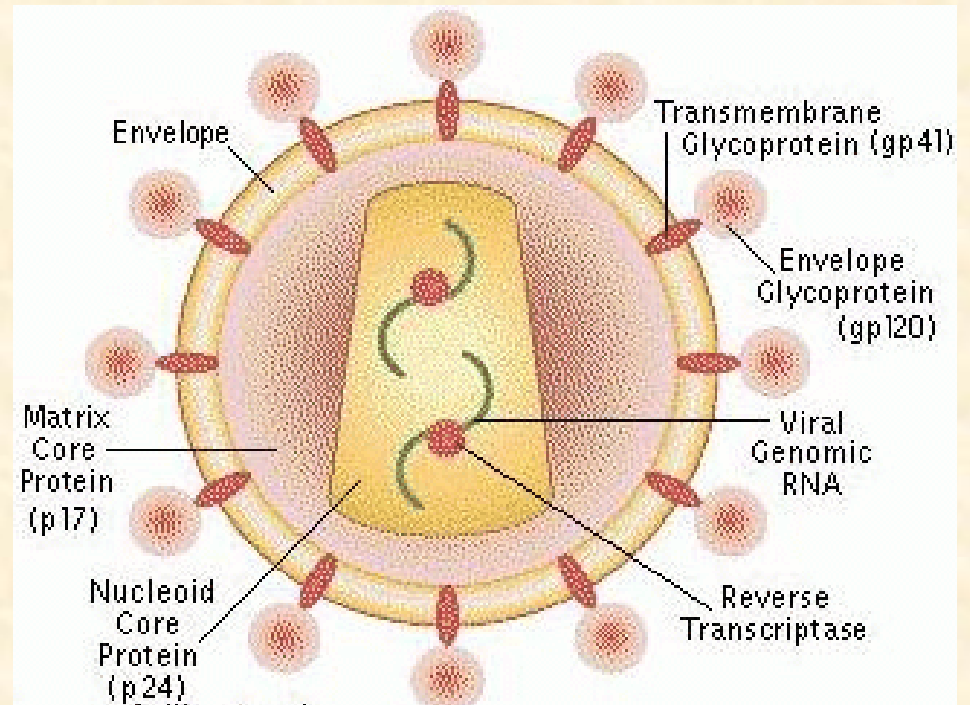

Schematic of HIV Replication

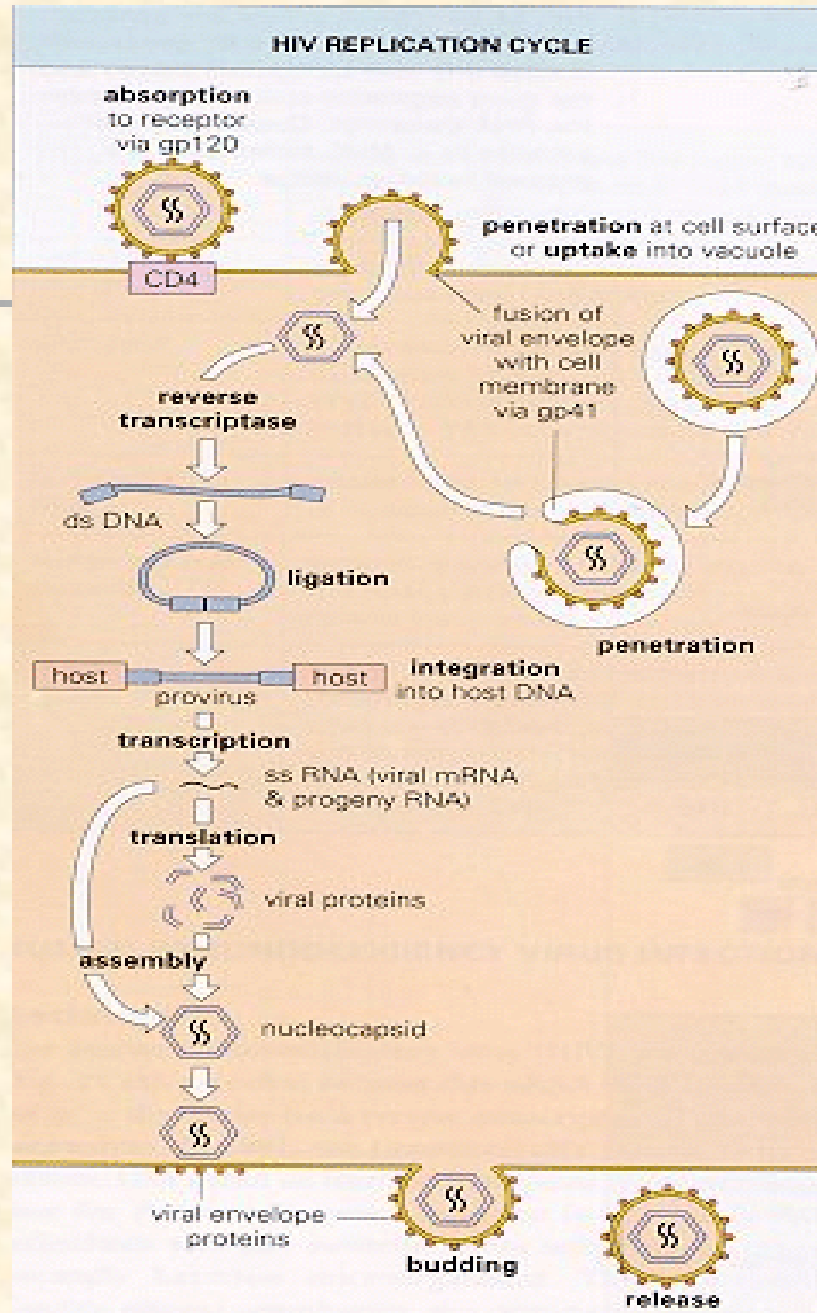

HIV Genome

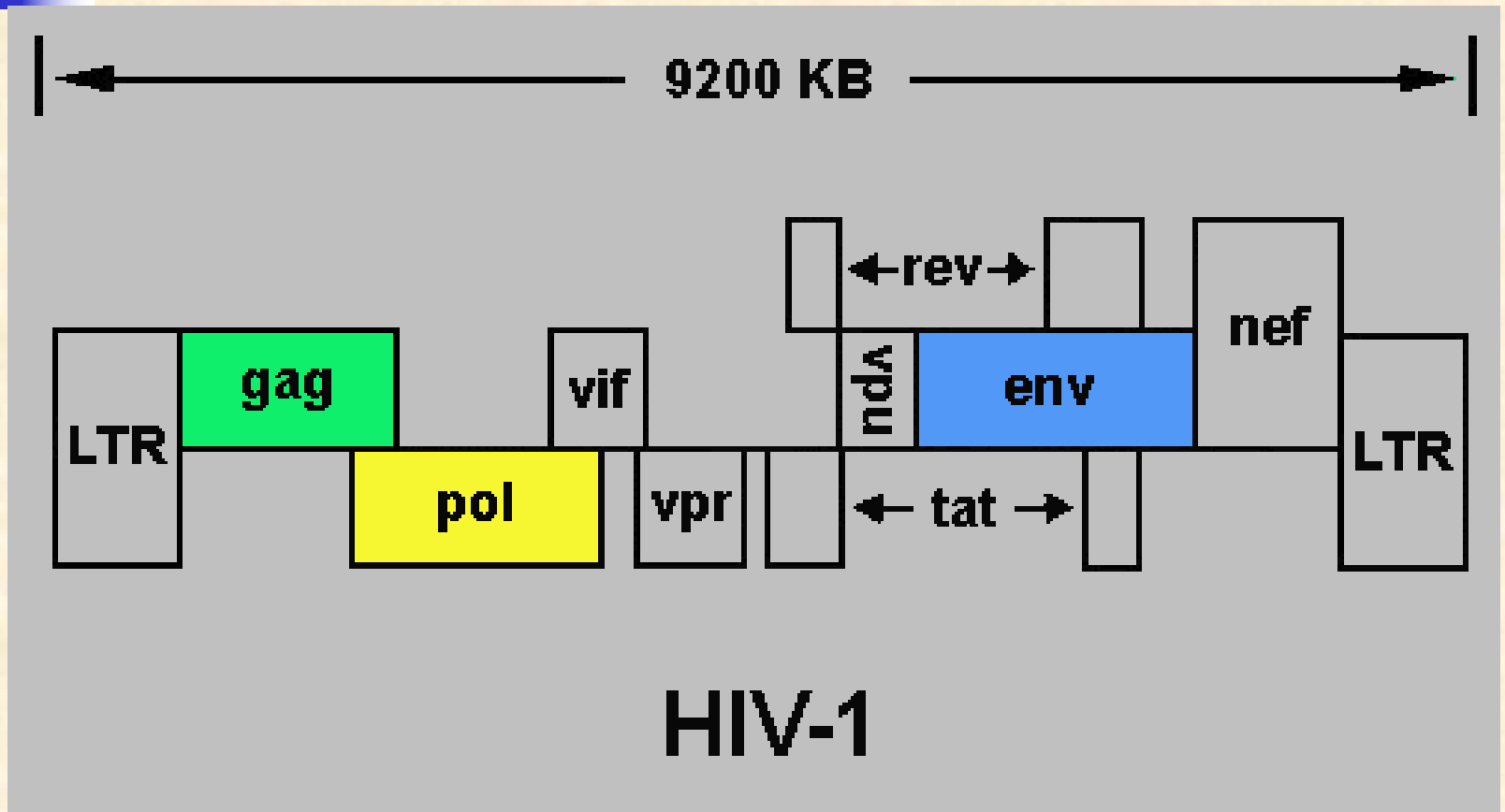

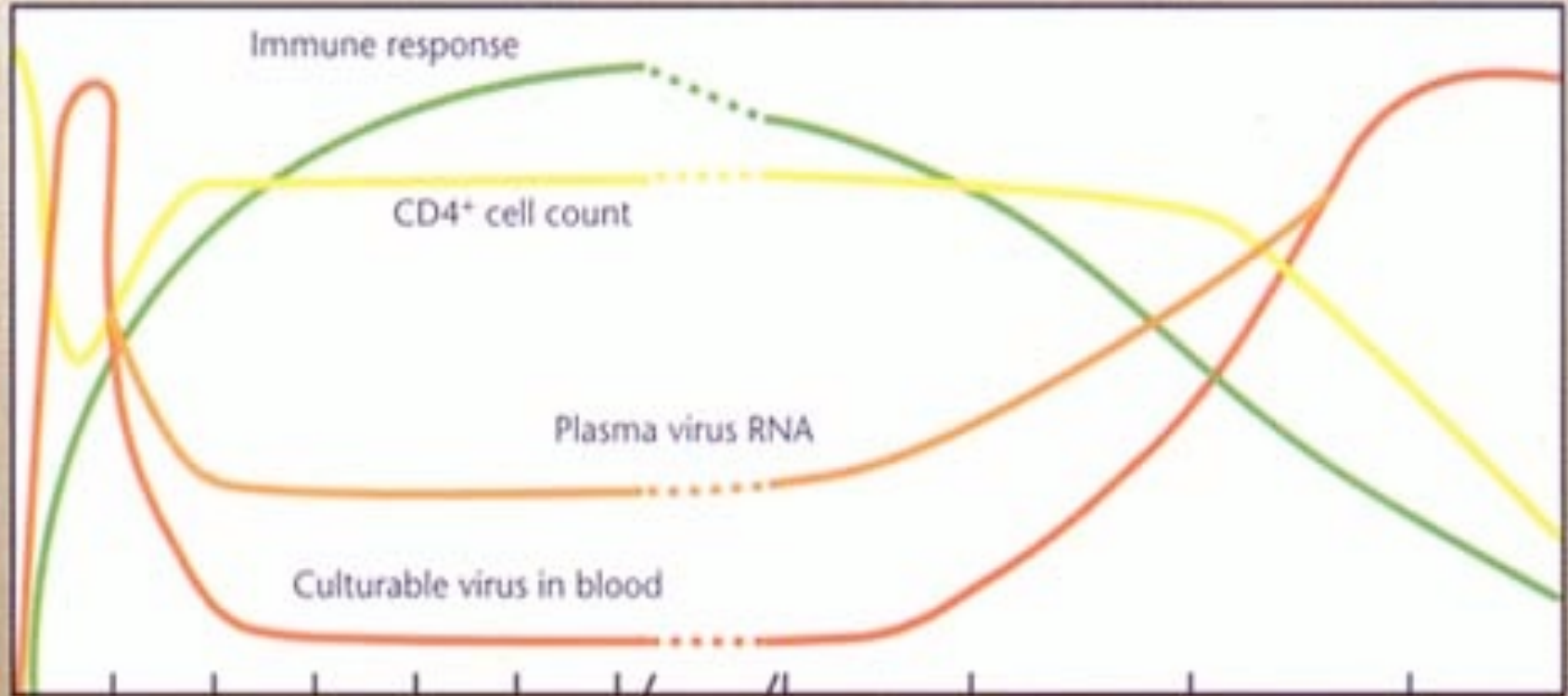

Months →

Years →



Symptoms

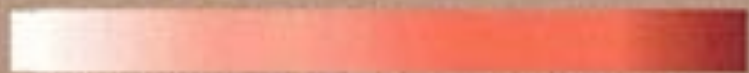

Symptoms



HIV Pathogenesis

- The profound immunosuppression seen in AIDS is due to the depletion of T4 helper lymphocytes.
- In the immediate period following exposure, HIV is present at a high level in the blood (as detected by HIV Antigen and HIV-RNA assays).
- It then settles down to a certain low level (set-point) during the incubation period. During the incubation period, there is a massive turnover of CD4 cells, whereby CD4 cells killed by HIV are replaced efficiently.
- Eventually, the immune system succumbs and AIDS develop when killed CD4 cells can no longer be replaced (witnessed by high HIV-RNA, HIV-antigen, and low CD4 counts).



Clinical Features

1. Seroconversion illness - seen in 10% of individuals a few weeks after exposure and coincides with seroconversion. Presents with an infectious mononucleosis like illness.
2. Incubation period - this is the period when the patient is completely asymptomatic and may vary from a few months to a more than 10 years. The median incubation period is 8-10 years.
3. AIDS-related complex or persistent generalized lymphadenopathy.
4. Full-blown AIDS.



Opportunistic Infections

Protozoal pneumocystis carinii (now thought to be a fungi),
toxoplasmosis, crytosporidosis

Fungal candidiasis, crytocooccosis
histoplasmosis, coccidiomycosis

Bacterial Mycobacterium avium complex
atypical mycobacterial disease
salmonella septicaemia
multiple or recurrent pyogenic bacterial infection

Viral CMV, HSV, VZV, JCV



Opportunistic Tumours

- The most frequent opportunistic tumour, Kaposi's sarcoma, is observed in 20% of patients with AIDS.
- KS is observed mostly in homosexuals and its relative incidence is declining. It is now associated with a human herpes virus 8 (HHV-8).
- Malignant lymphomas are also frequently seen in AIDS patients.

Kaposi's Sarcoma





Other Manifestations

- It is now recognised that HIV-infected patients may develop a number of manifestations that are not explained by opportunistic infections or tumours.
- The most frequent neurological disorder is AIDS encephalopathy which is seen in two thirds of cases.
- Other manifestations include characteristic skin eruptions and persistent diarrhoea.



HIV half-lives

- Activated cells that become infected with HIV produce virus immediately and die within one to two days.
- Production of virus by short-lived, activated cells accounts for the vast majority of virus present in the plasma.
- The time required to complete a single HIV life-cycle is approximately 1.5 days.
- Resting cells that become infected produce virus only after immune stimulation; these cells have a half-life of at least 5-6 months.
- Some cells are infected with defective virus that cannot complete the virus life-cycle. Such cells are very long lived, and have an estimated half-life of approximately three to six months.
- Such long-lived cell populations present a major challenge for anti-retroviral therapy.

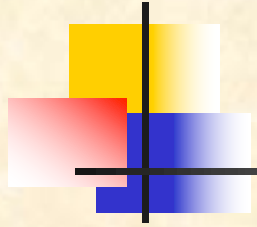

Antiviraais

HIV-1 half-lives

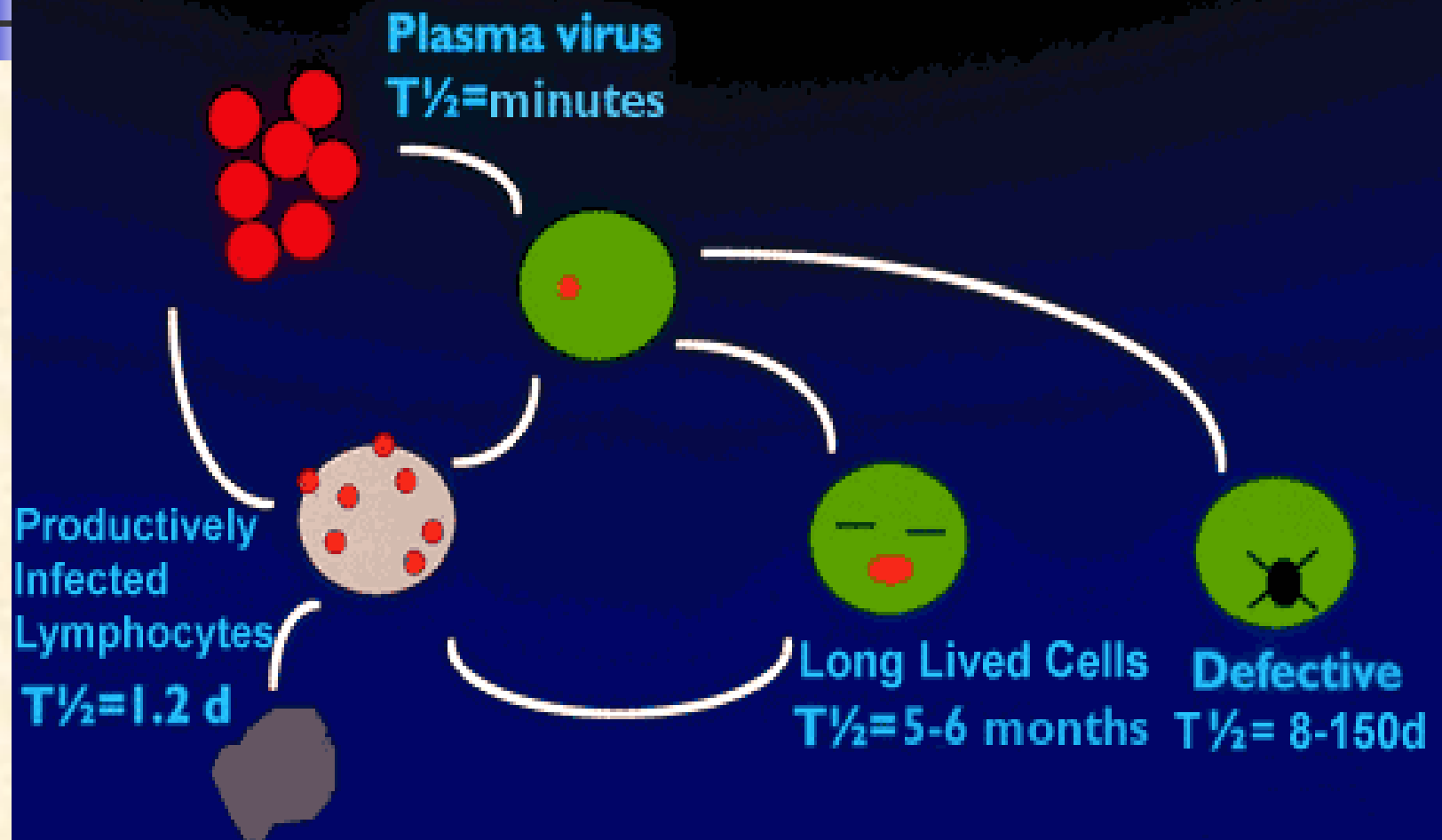

Estimated half-life of HIV-1 infected cells

Finzi & Siliciano, Cell 93:665, 1998

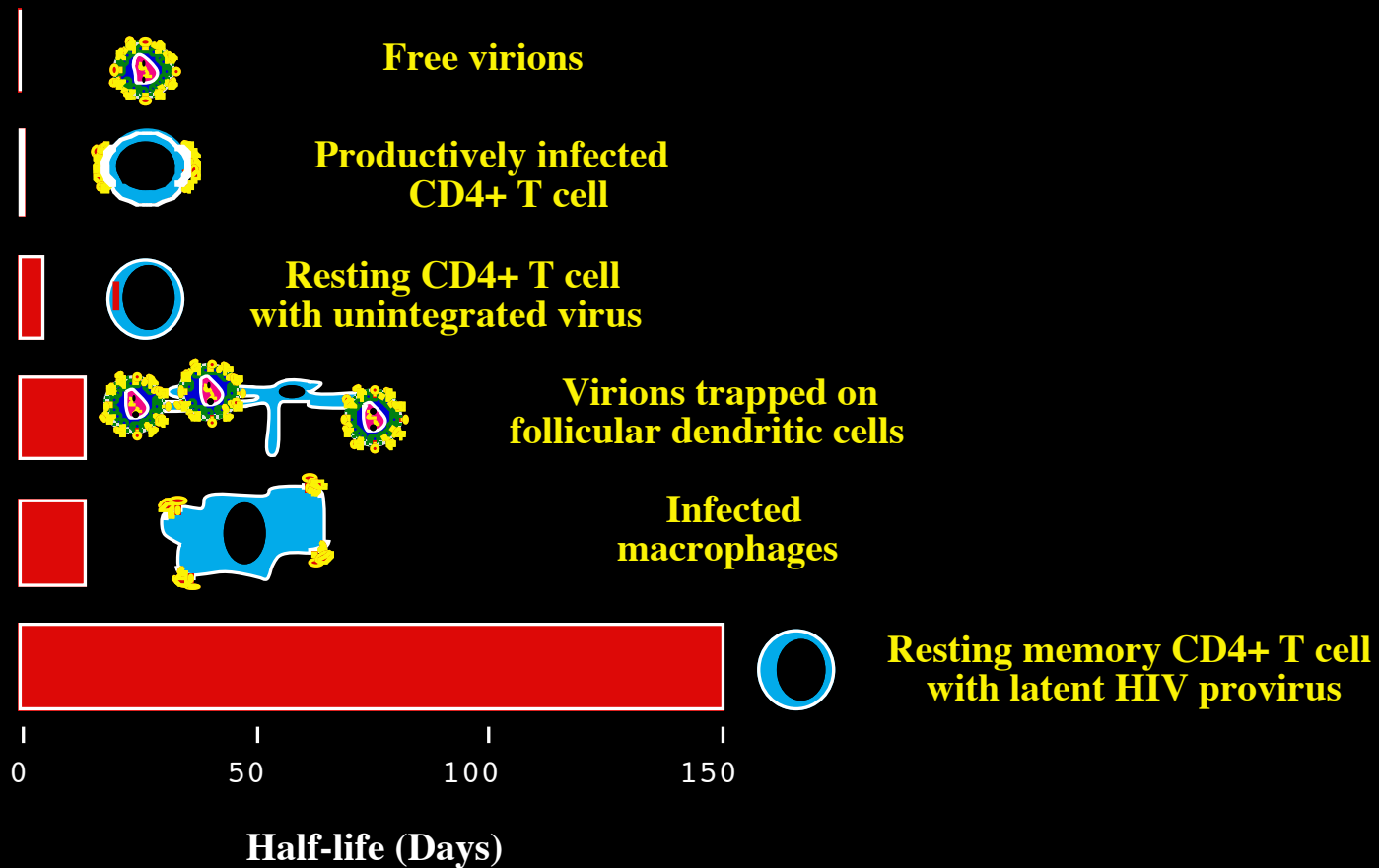

HIV lifecycle and antivirals

Reverse transcriptase blockers
nucleoside analogs: AZT, 3TC, d4T
non-nucleosides: delaviradine,
nevirapine

Protease blockers
e.g., indinavir,
ritonavir

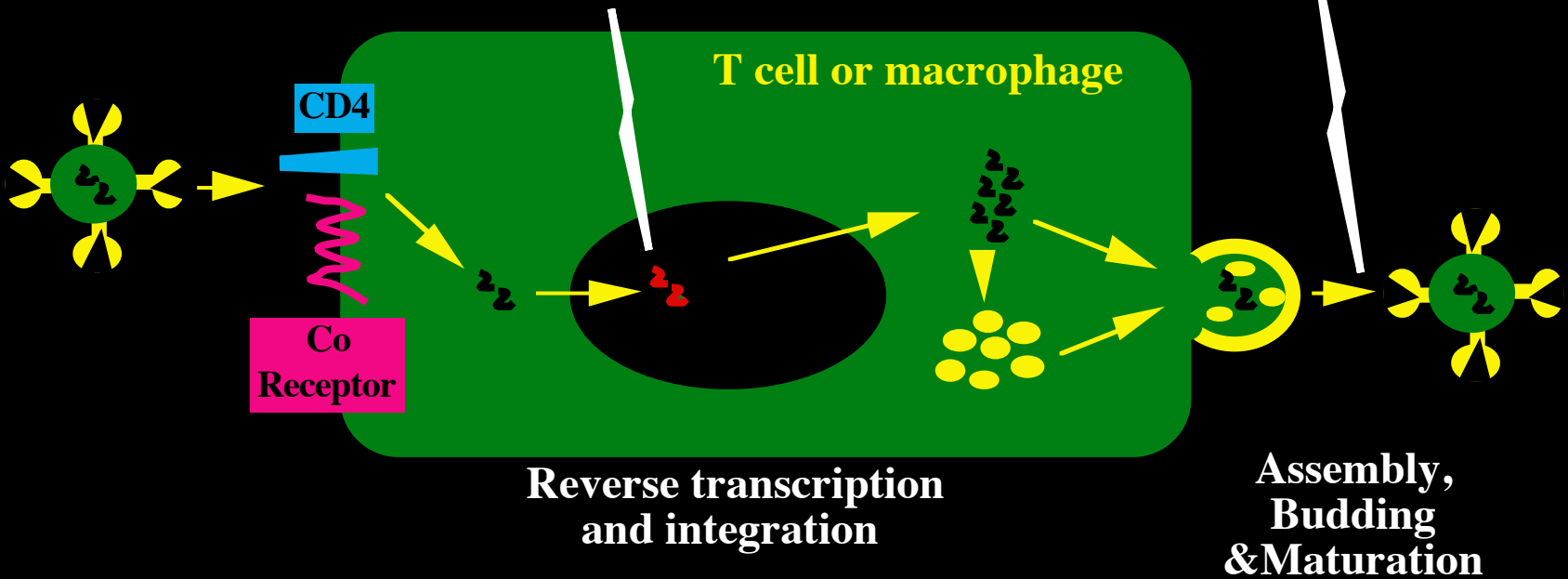

AZT Structure

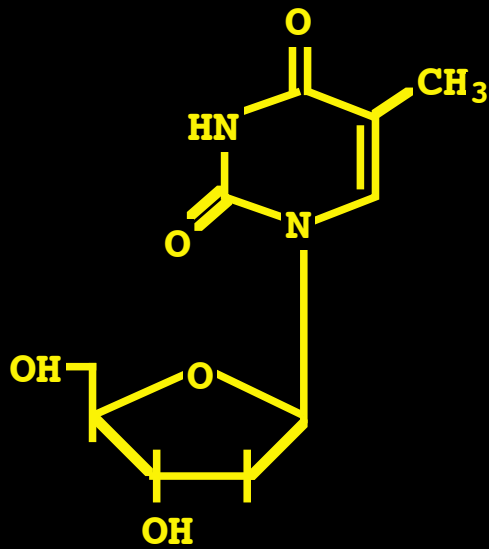

Thymidine

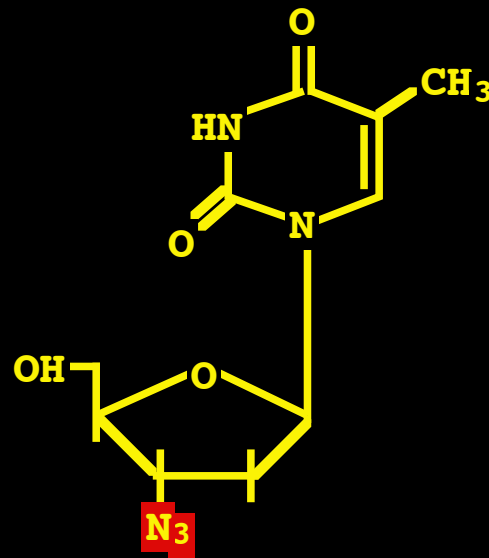

AZT

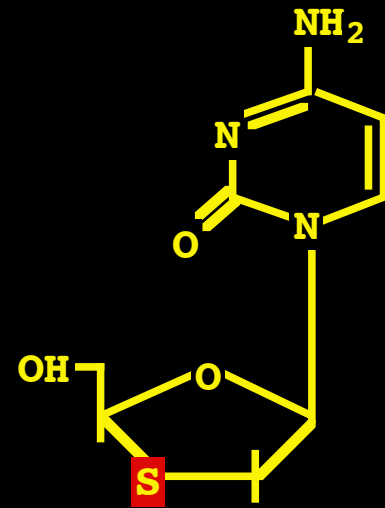

3TC

Nevirapine Structure

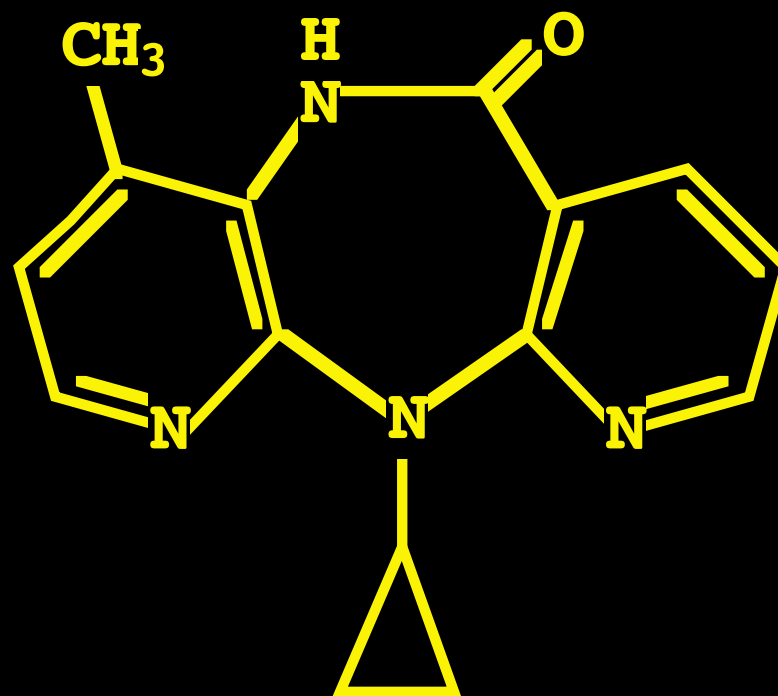

Protease + VX-478

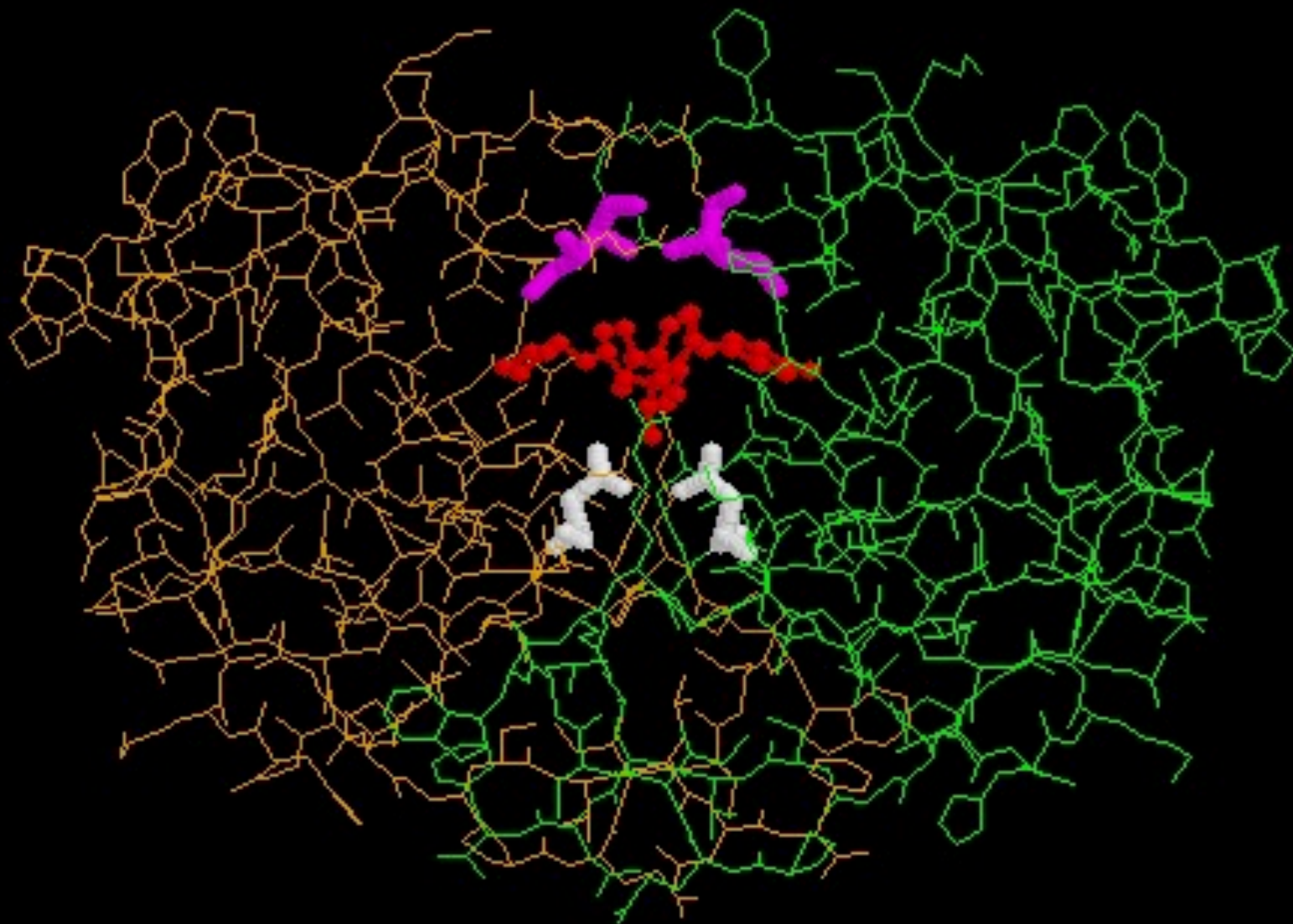

PROGRESSION TO AIDS/DEATH

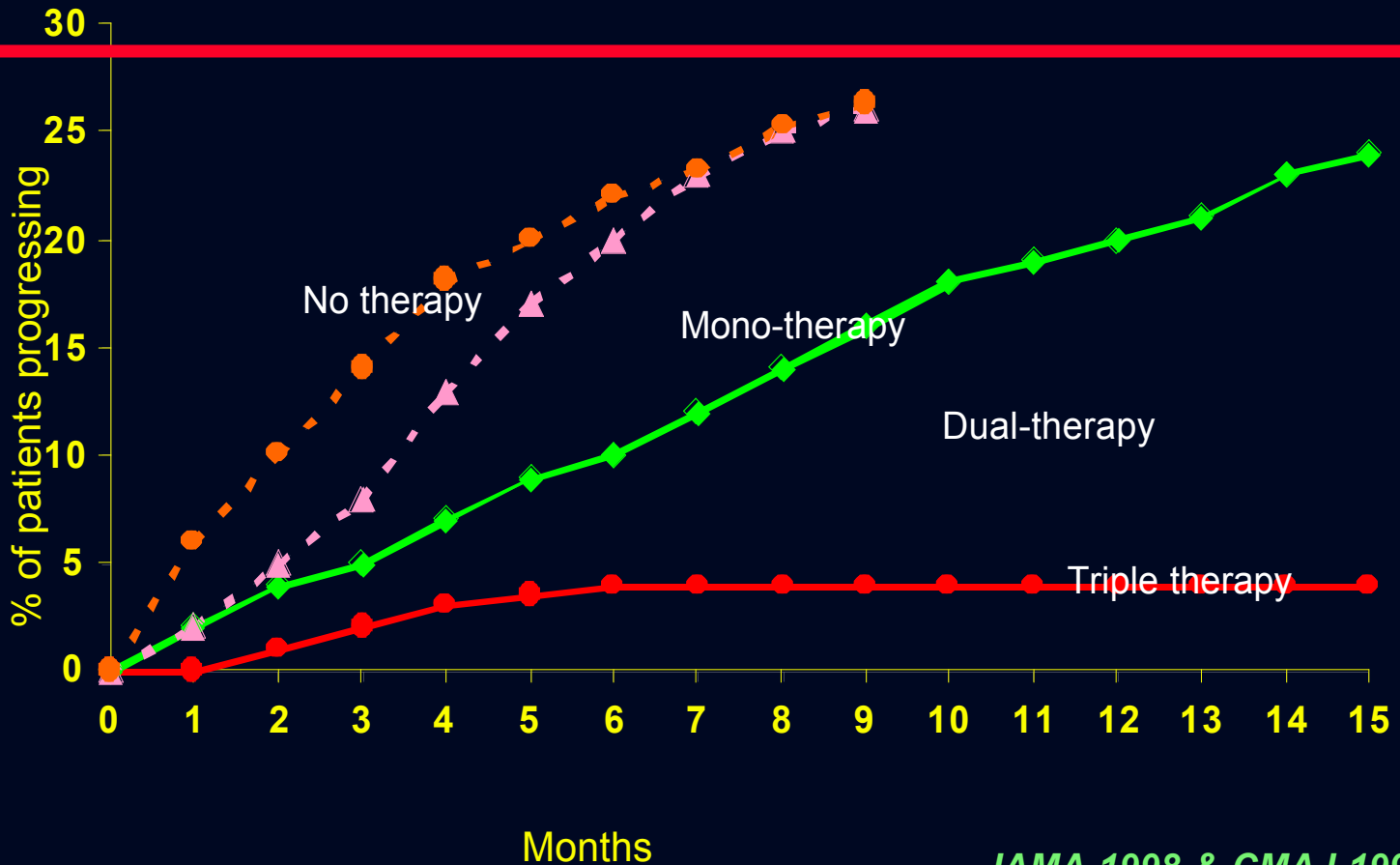

JAMA 1998 & CMAJ 1999



Laboratory Diagnosis

- Serology is the usual method for diagnosing HIV infection. Serological tests can be divided into screening and confirmatory assays. Screening assays should be as sensitive whereas confirmatory assays should be as specific as possible.
- **Screening assays** - EIAs are the most frequently used screening assays. The sensitivity and specificity of the presently available commercial systems now approaches 100% but false positive and negative reactions occur. Some assays have problems in detecting HIV-1 subtype O.
- **Confirmatory assays** - Western blot is regarded as the gold standard for serological diagnosis. However, its sensitivity is lower than screening EIAs. Line immunoassays incorporate various HIV antigens on nitrocellulose strips. The interpretation of results is similar to Western blot it is more sensitive and specific.

ELISA for HIV antibody



Microplate ELISA for HIV antibody: coloured wells indicate reactivity

Western blot for HIV antibody

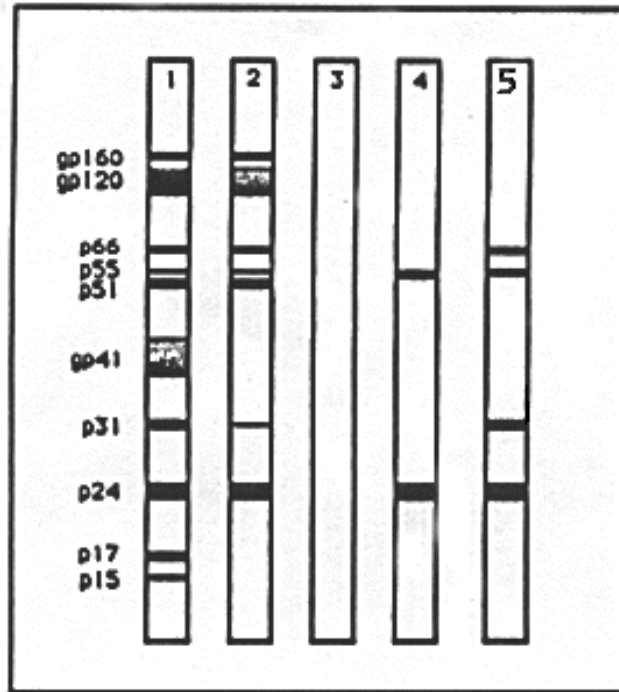

Figure:

Examples of reactions by an HIV-1 Western blot:

1. Positive control (strong)
2. Positive control (weak)
3. Negative control
4. Indeterminate profile
5. Indeterminate profile (highly suggestive)

- There are different criteria for the interpretation of HIV Western blot results e.g. CDC, WHO, American Red Cross.
- The most important antibodies are those against the envelope glycoproteins gp120, gp160, and gp41
- p24 antibody is usually present but may be absent in the later stages of HIV infection



Other diagnostic assays

- It normally takes 4-6 weeks before HIV-antibody appears following exposure.
- A diagnosis of HIV infection made be made earlier by the detection of HIV antigen, pro-DNA, and RNA.
- However, there are very few circumstances when this is justified e.g. diagnosis of HIV infection in babies born to HIV-infected mothers.



Prognostic tests

Once a diagnosis of HIV infection had been made, it is important to monitor the patient at regularly for signs of disease progression and response to antiviral chemotherapy.

HIV Antigen tests - they were widely used as prognostic assays. It was soon apparent that detection of HIV p24 antigen was not as good as serial CD4 counts. The use of HIV p24 antigen assays for prognosis has now been superseded by HIV-RNA assays.

HIV viral load - HIV viral load in serum may be measured by assays which detect HIV-RNA e.g. RT-PCR, NASBA, or bDNA. HIV viral load has now been established as having good prognostic value, and in monitoring response to antiviral chemotherapy.



Treatment

- Zidovudine (AZT) was the first anti-viral agent shown to have beneficial effect against HIV infection. However, after prolonged use, AZT-resistant strains rapidly appears which limits the effect of AZT.
- Combination therapy has now been shown to be effective, especially for trials involving multiple agents including protease inhibitors. (HAART - highly active anti-retroviral therapy)
- The rationale for this approach is that by combining drugs that are synergistic, non-cross-resistant and no overlapping toxicity, it may be possible to reduce toxicity, improve efficacy and prevent resistance from arising.



Anti-Retroviral Agents

- Nucleoside analogue reverse transcriptase inhibitors e.g. AZT, ddI, lamivudine
- Non-nucleoside analogue reverse transcriptase, inhibitors e.g. Nevirapine
- Protease Inhibitors e.g. Indinavir, Ritonavir
- HAART (highly active anti-retroviral therapy) regimens normally comprise 2 nucleoside reverse transcriptase inhibitors and a protease inhibitor. e.g. AZT, lamivudine and indinavir. Since the use of HAART, mortality from HIV has declined dramatically in the developed world.



Prevention

- The risk of contracting HIV increases with the number of sexual partners. A change in the lifestyle would obviously reduce the risk.
- The spread of HIV through blood transfusion and blood products had virtually been eliminated since the introduction of blood donor screening in many countries.
- AZT had been shown to be effective in preventing transmission of HIV from the mother to the fetus. The incidence of HIV infection in the baby was reduced by two-thirds.
- The management of health care workers exposed to HIV through inoculation accidents is controversial. Anti-viral prophylaxis had been shown to be of some benefit but it is uncertain what is the optimal regimen.
- Vaccines are being developed at present but progress is hampered by the high variability of HIV. Clinical trials for several vaccines are in progress.

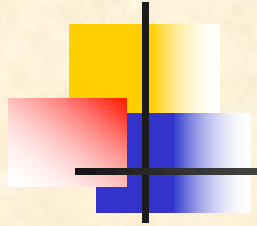

Até Logo!