

**As Moléculas do MHC
(Major Histocompatibility Complex)
e
Apresentação de Antígenos para Linfócitos T**

Vera Calich
2021

No processo de Diferenciação Linfócitos B expressam BCR e Linfócitos T TCR

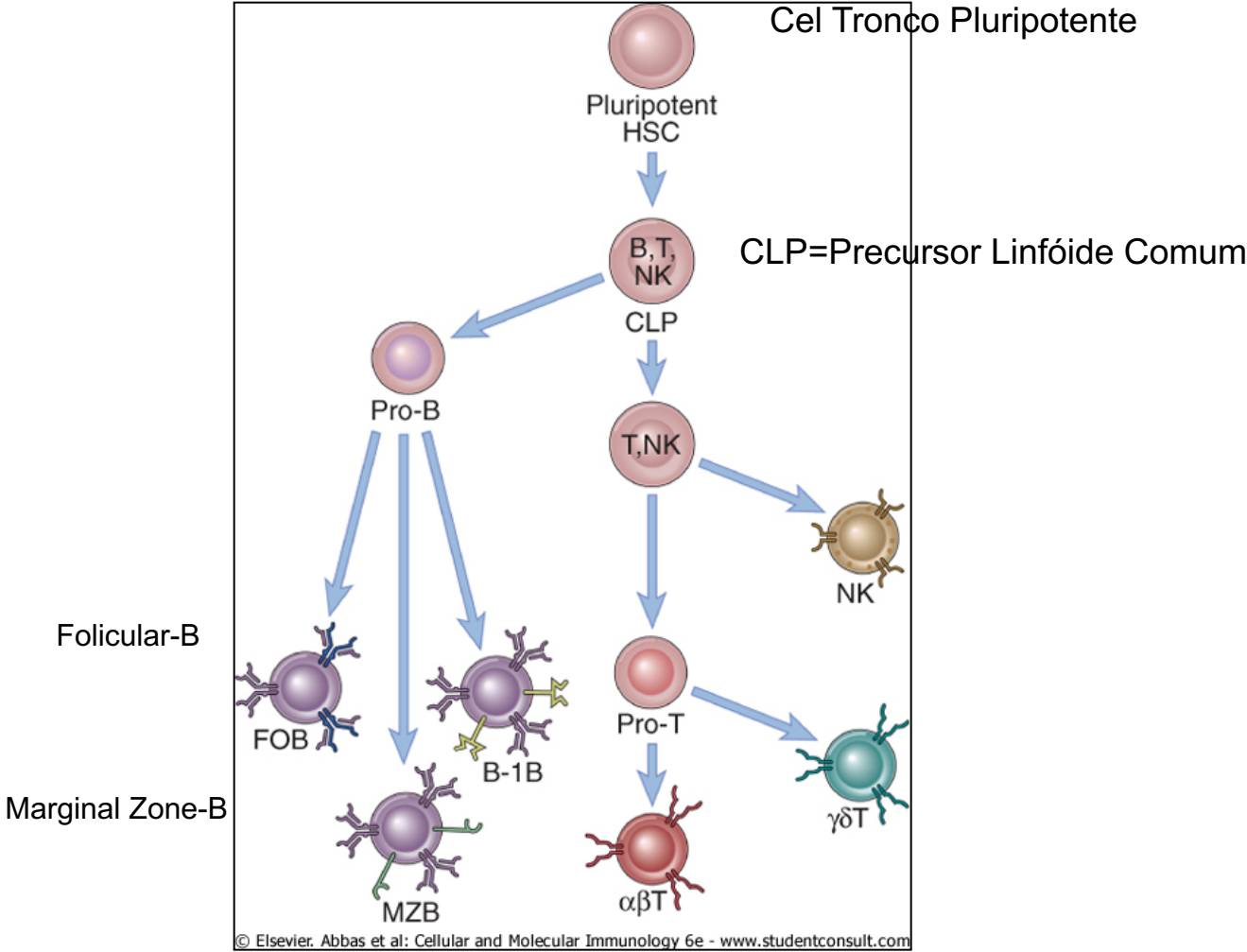

Grupos de Receptores que Reconhecem Antígenos

BCR {
Imunoglobulina (Ig) de Membrana do Linfócitos B (IgM e IgD de membrana)
Interagem **diretamente** com prots, lipídeos e polissac. solúveis, ou na mb cel

TCR {
Proteína de membrana de 2 tipos : $\alpha\beta$ ou $\gamma\delta$
Reconhece peptídeos apresentados por molecs do MHC das APCs
“reconhece no contexto do MHC”

Estrutura esquemática do BCR e do TCR

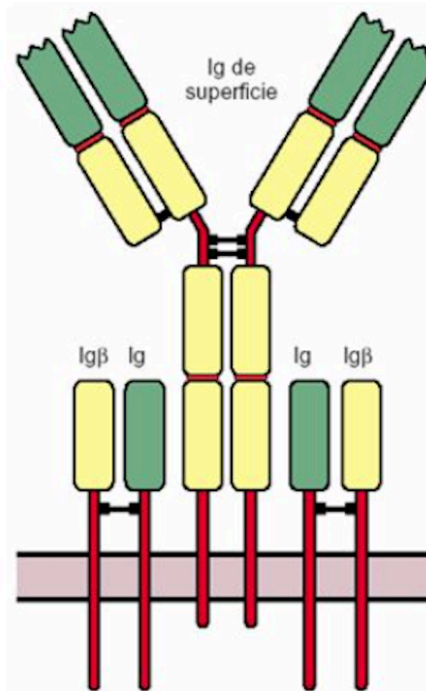

BCR (LB)

$10^9 - 10^{11}$
Receptores
Diferentes

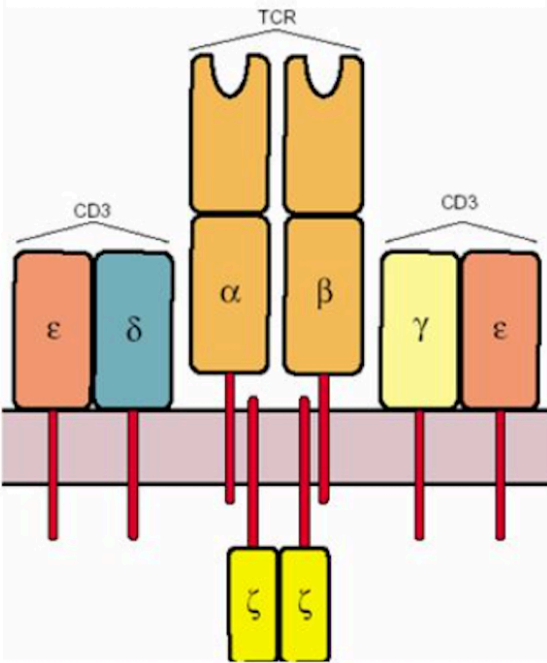

TCR (LT)

No timo, os linfócitos T passam a expressar o TCR.
Há 2 tipos de TCRs ($\alpha\beta$ ou $\gamma\delta$)

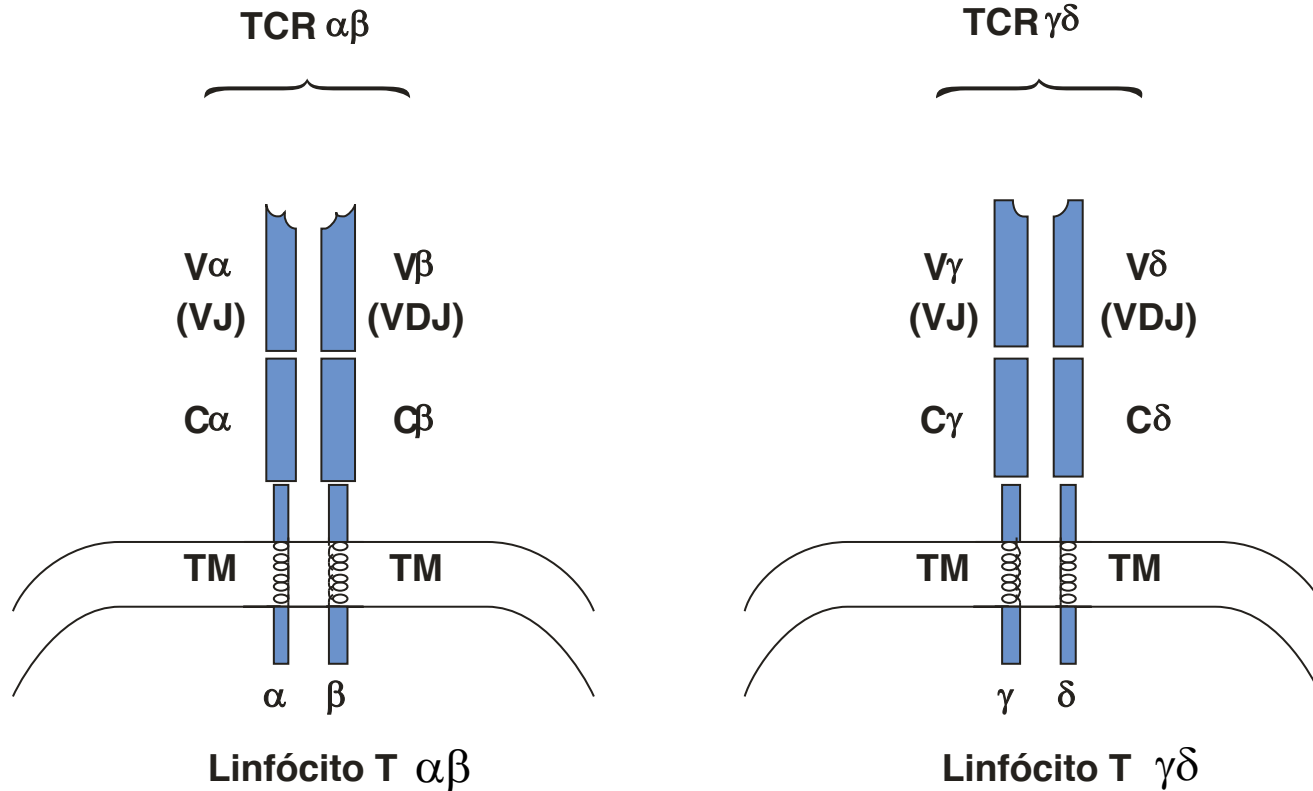

Maturação e Seleção de Linfs T $\alpha\beta$ (CD4+, CD8+) e T $\gamma\delta$ no Timo (do córtex para a medula)

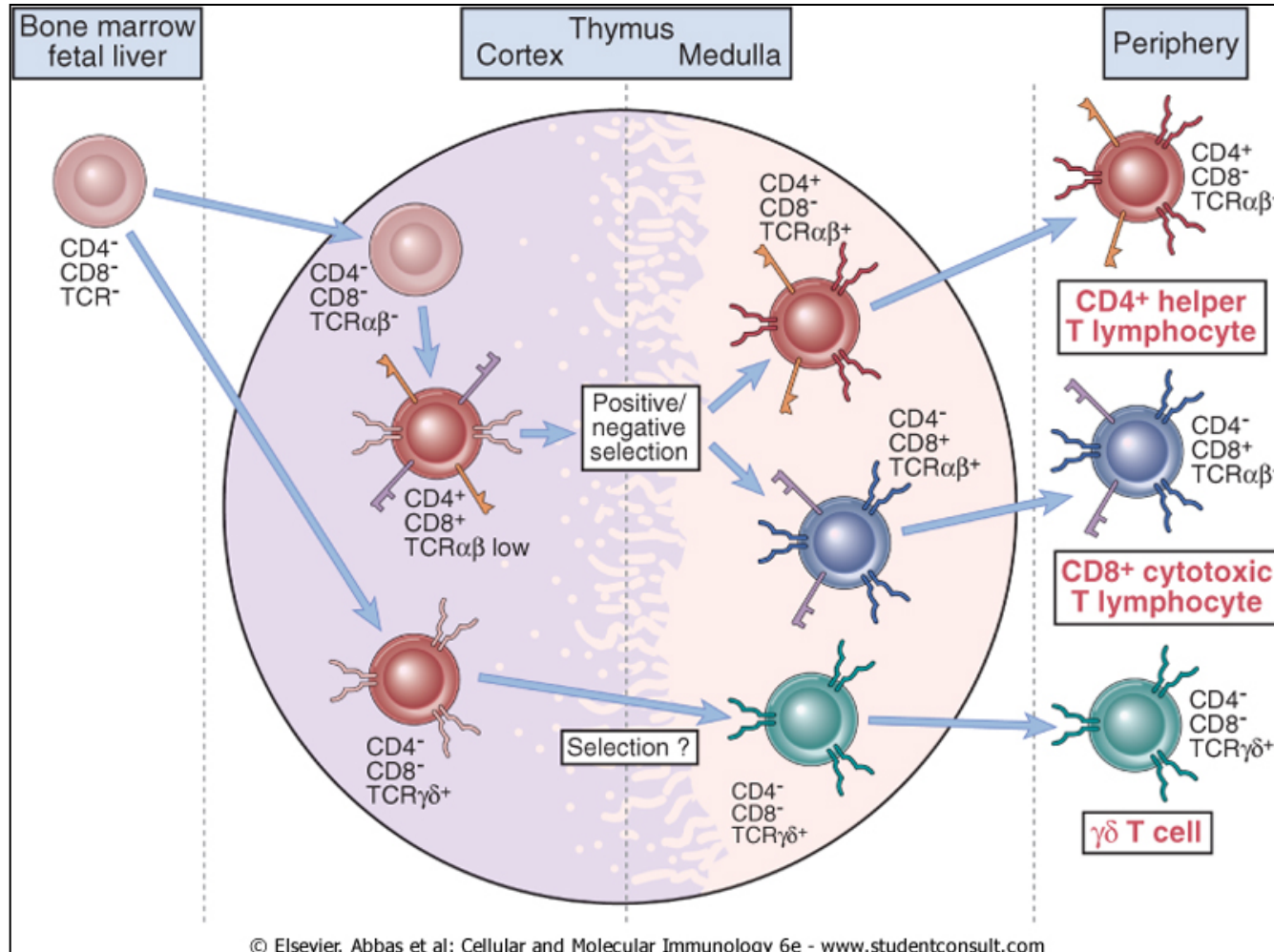

Reconhecimento de Ags por Linfócitos T e B

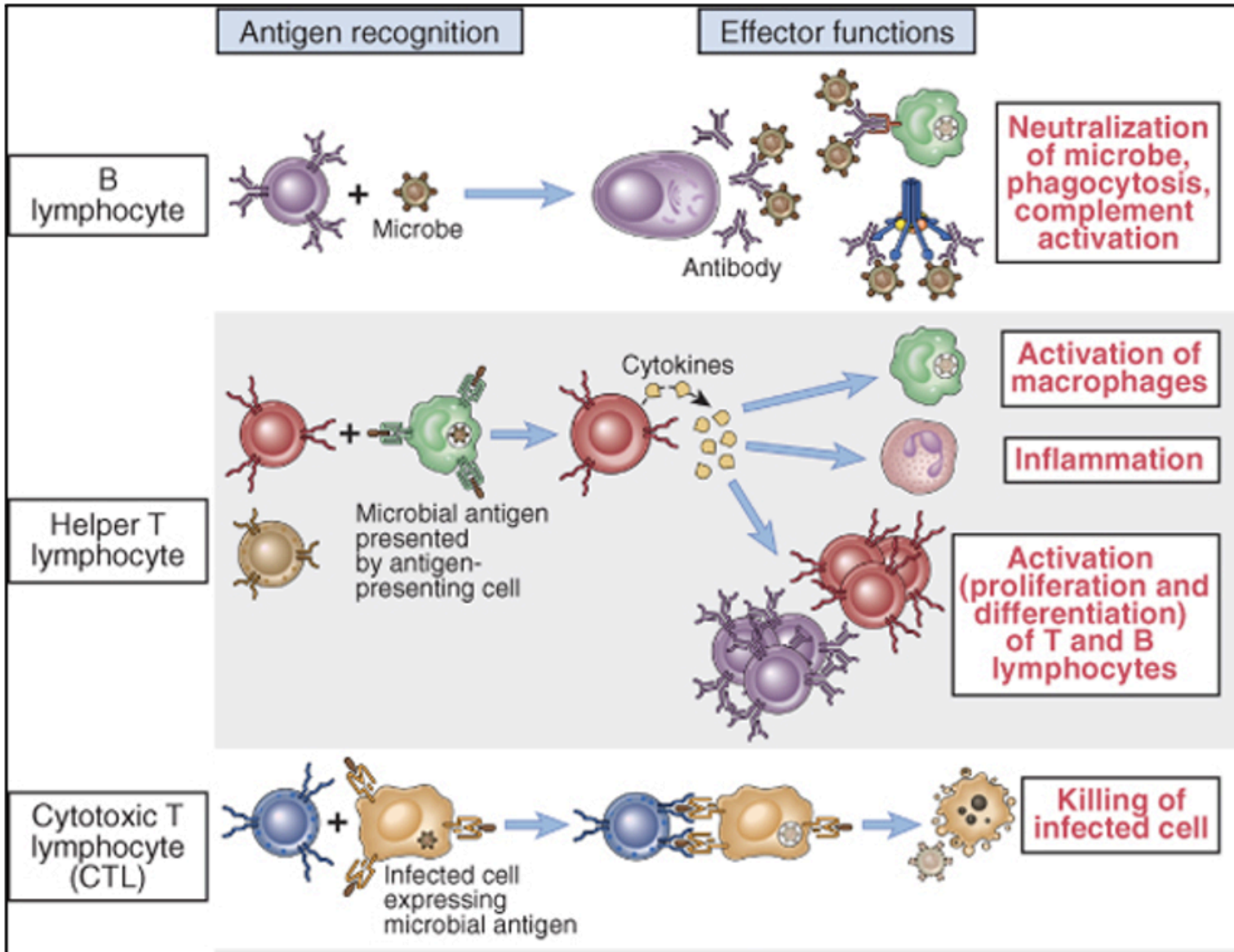

A CÉLULA DENDRÍTICA É CENTRAL PARA A APRESENTAÇÃO DE AGS E ATIVAÇÃO DE CELS T

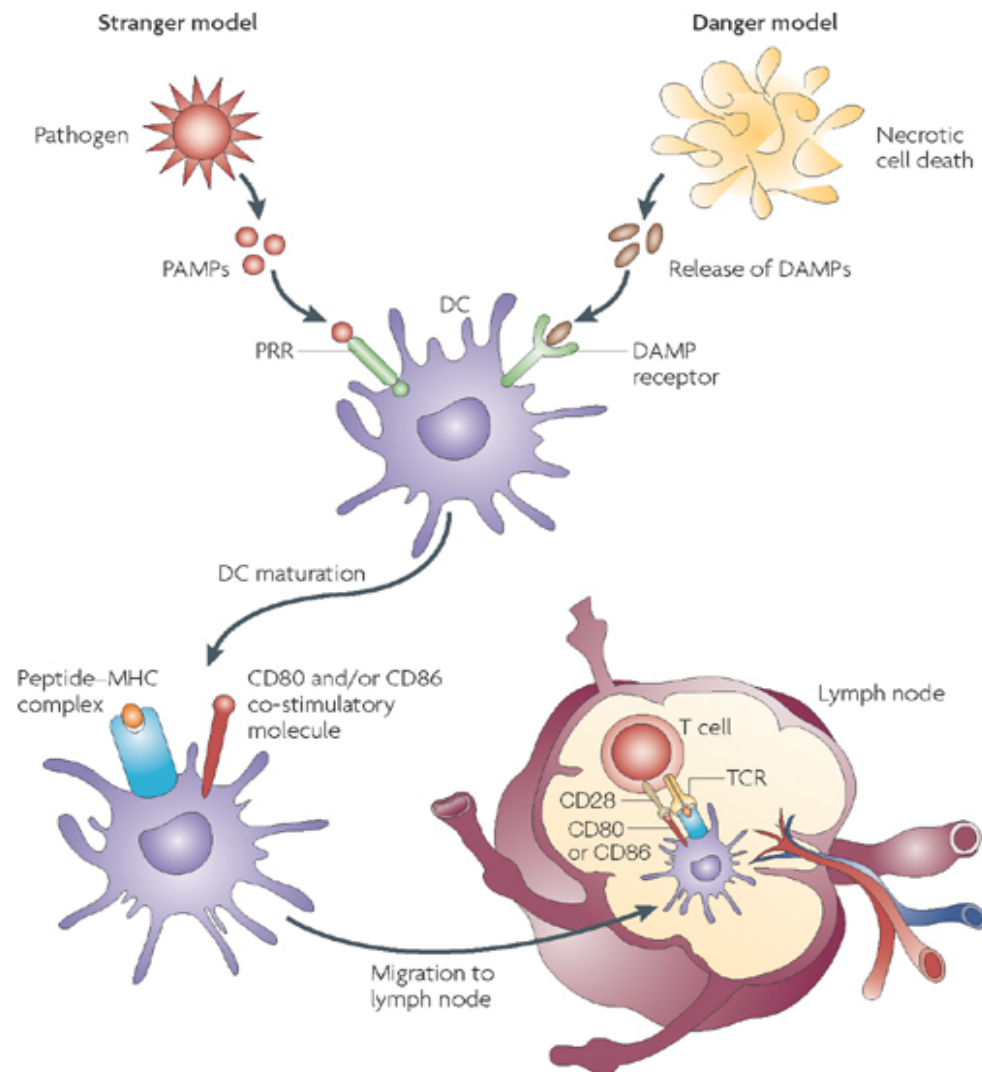

Fases da ativação de linfócitos T DC4+ e T CD8+

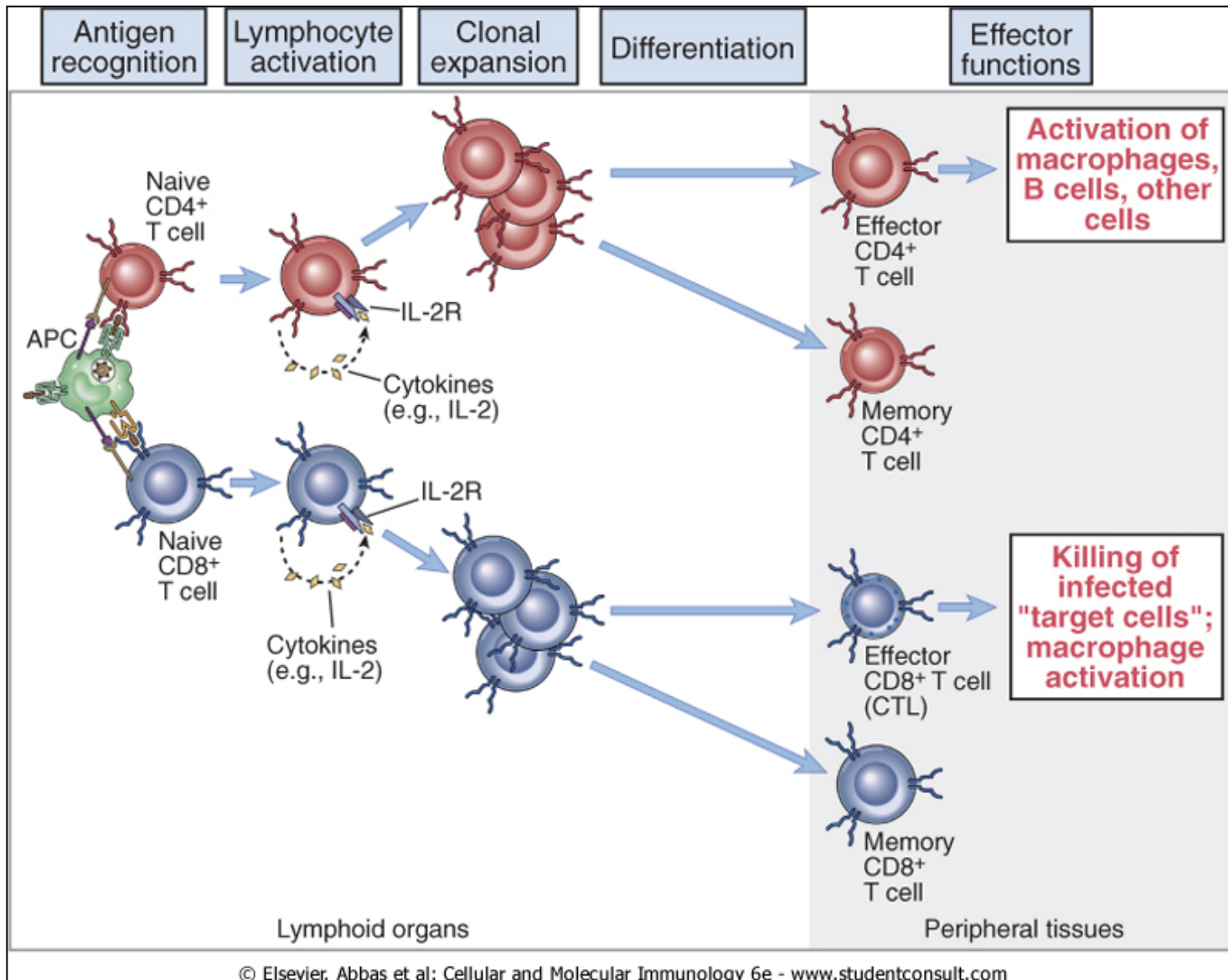

Ativação de linfócitos T **virgens e efetores** precisa que os peptídeos sejam apresentados por células apresentadoras de Ags (APCs)

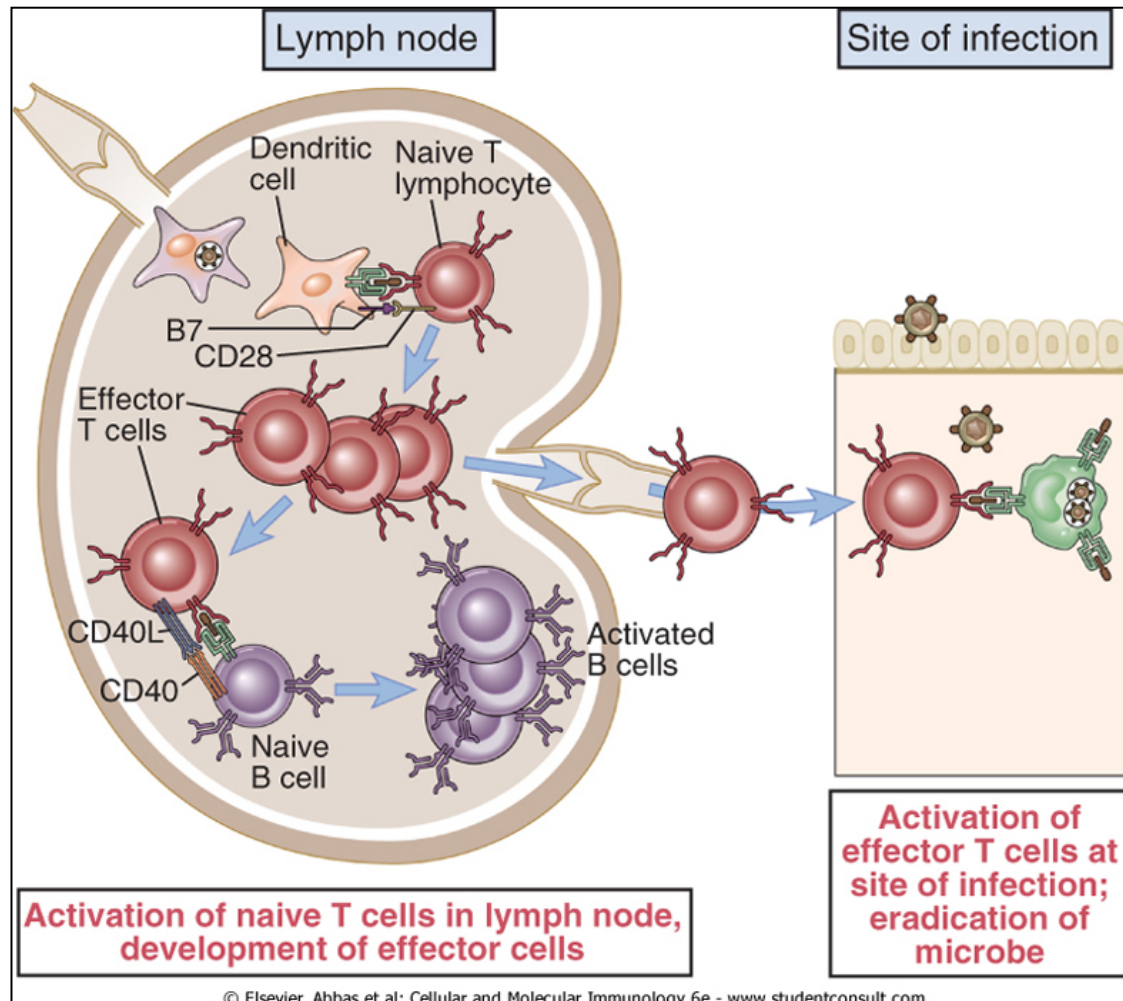

O TCR reconhece os peptídeos no contexto de moléculas do MHC

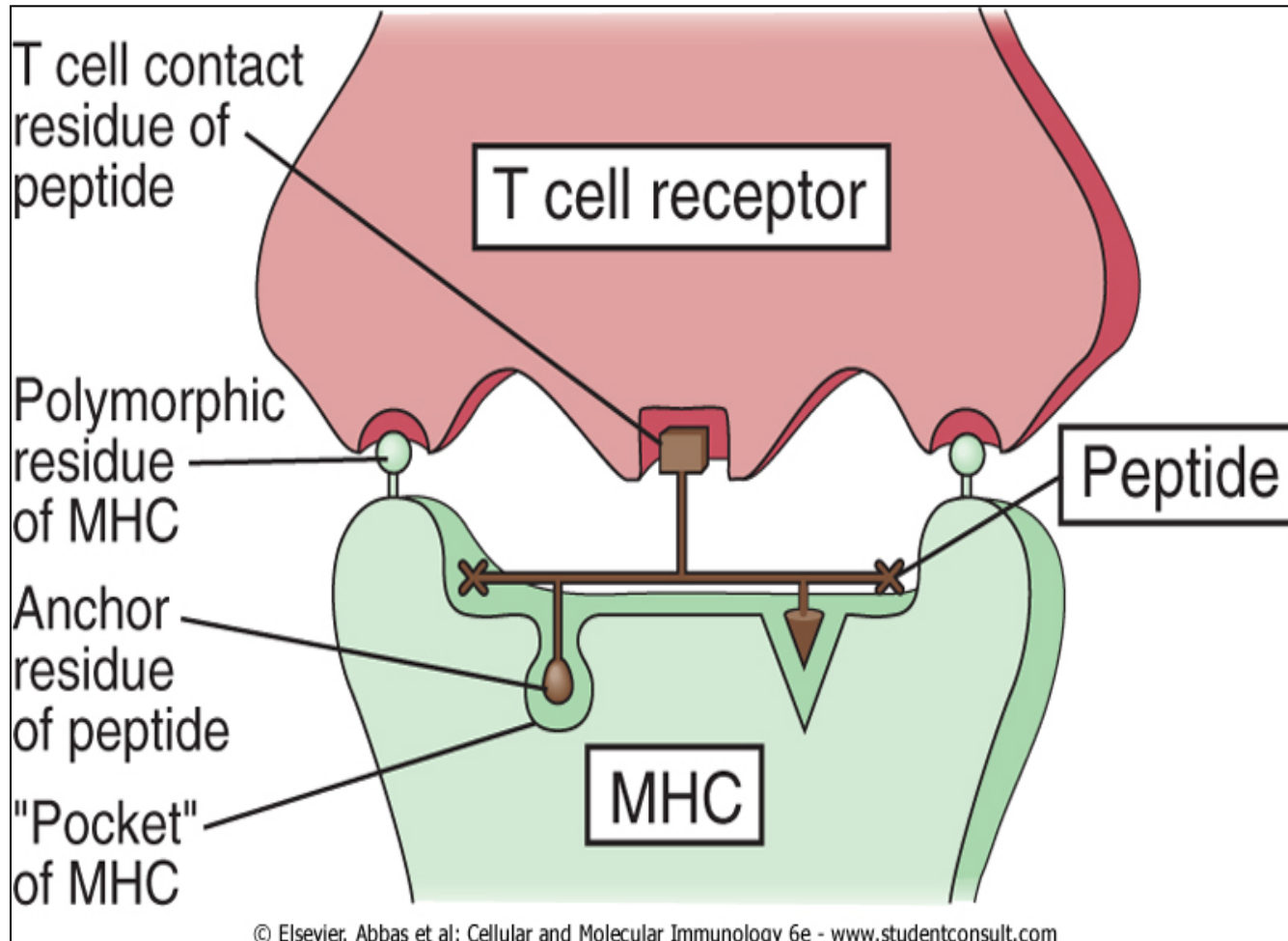

MHC=Major Histocompatibility Complex
CHP= Complexo Principal de Histocompatibilidade

Complexo MHC Descrito Através de Estudos sobre a Rejeição de Enxertos

Posteriormente: O MHC controla a Resposta Imune

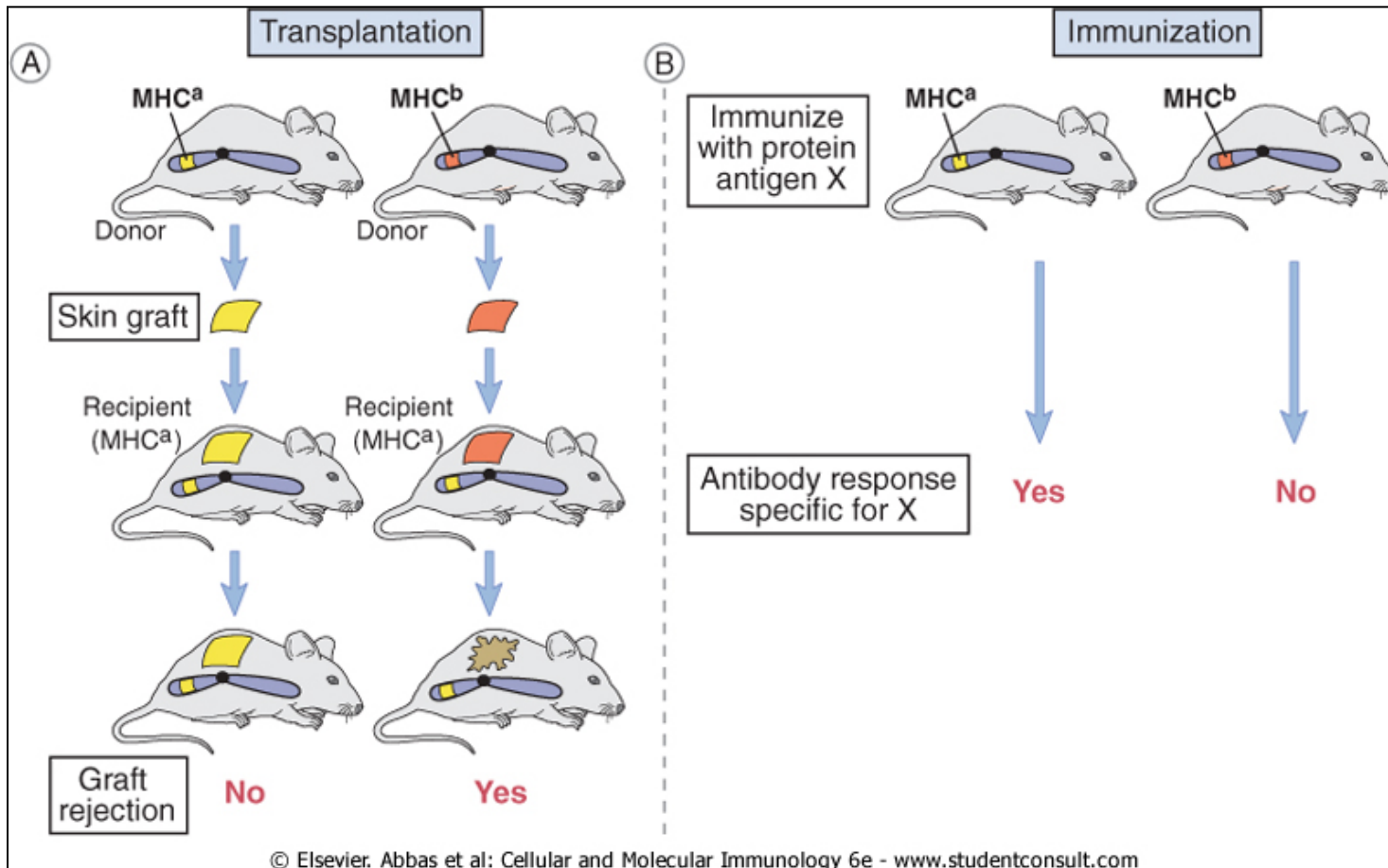

Há Duas Famílias de Moléculas do MHC:

MHC de Classe I (Apresentam peptídeos para linfs T CD8+)

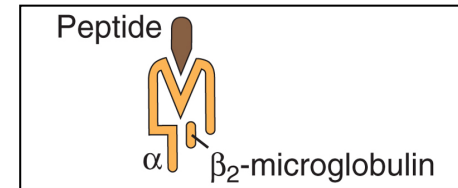

MHC de Classe II (Apresentam peptídeos para linfs T CD4+)

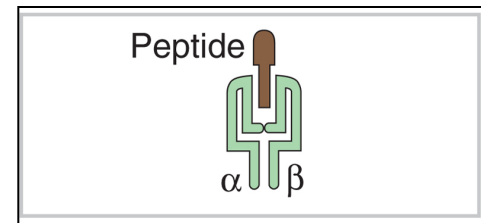

APC apresenta Ags para
Cels TCD4+ via MHC-cl II
e
Cels T CD8+ via MHC cl-I

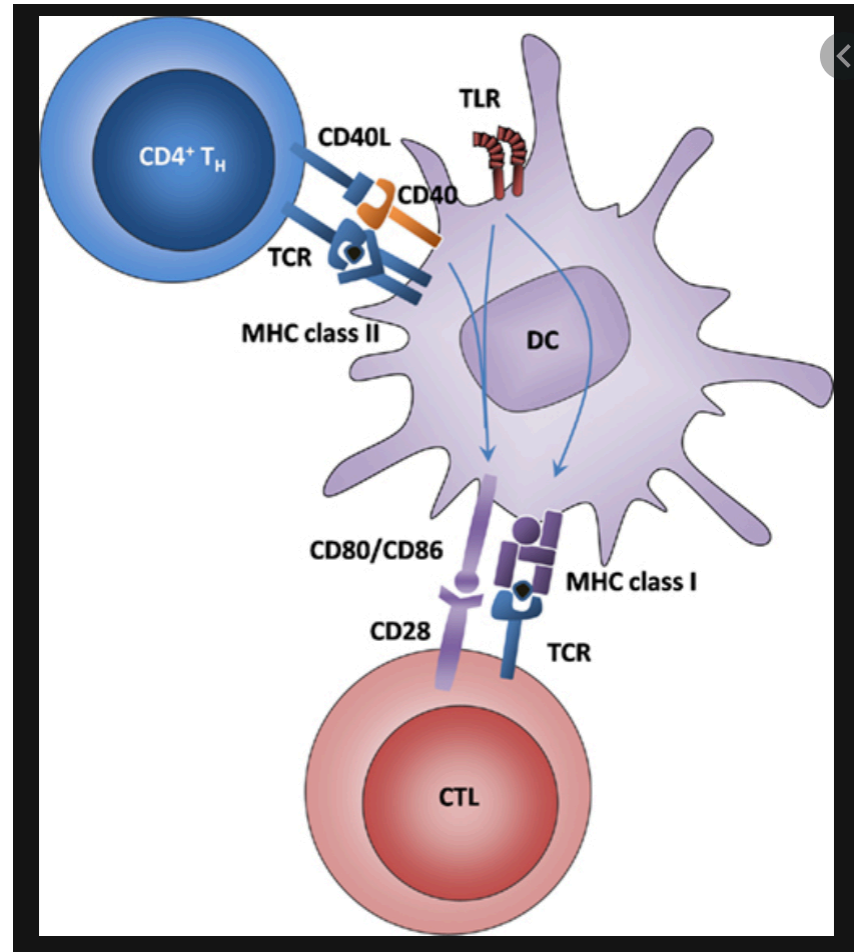
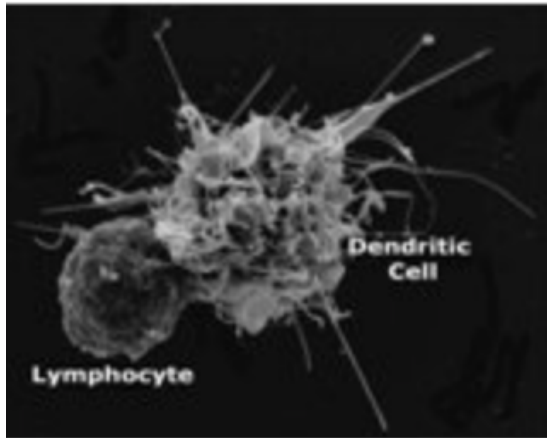

MHC de Classe I

Estrutura Esquemática e por Cristalografia de Raio X

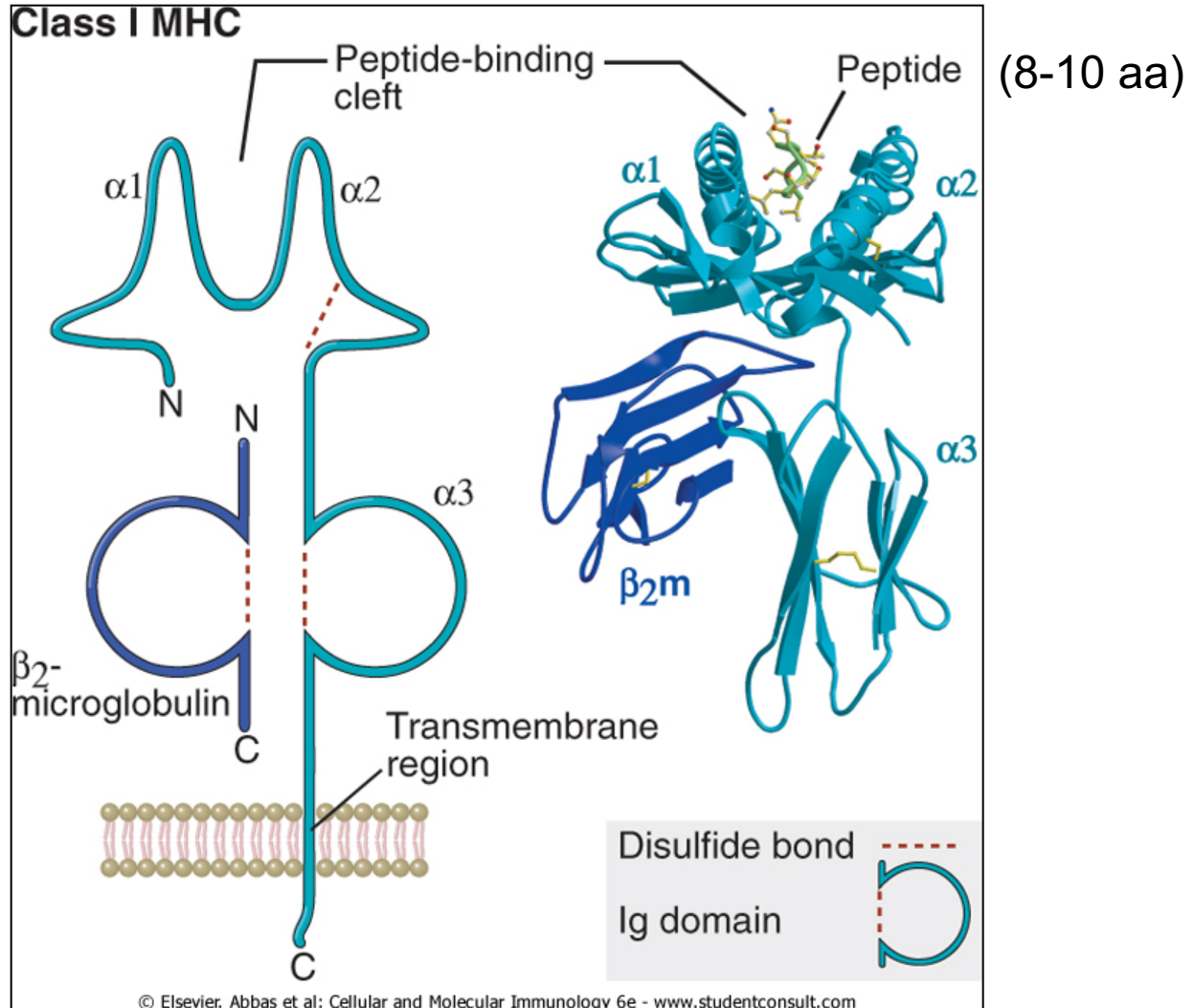

MHC de Classe II

Estrutura Esquemática e por Cristalografia de Raio X

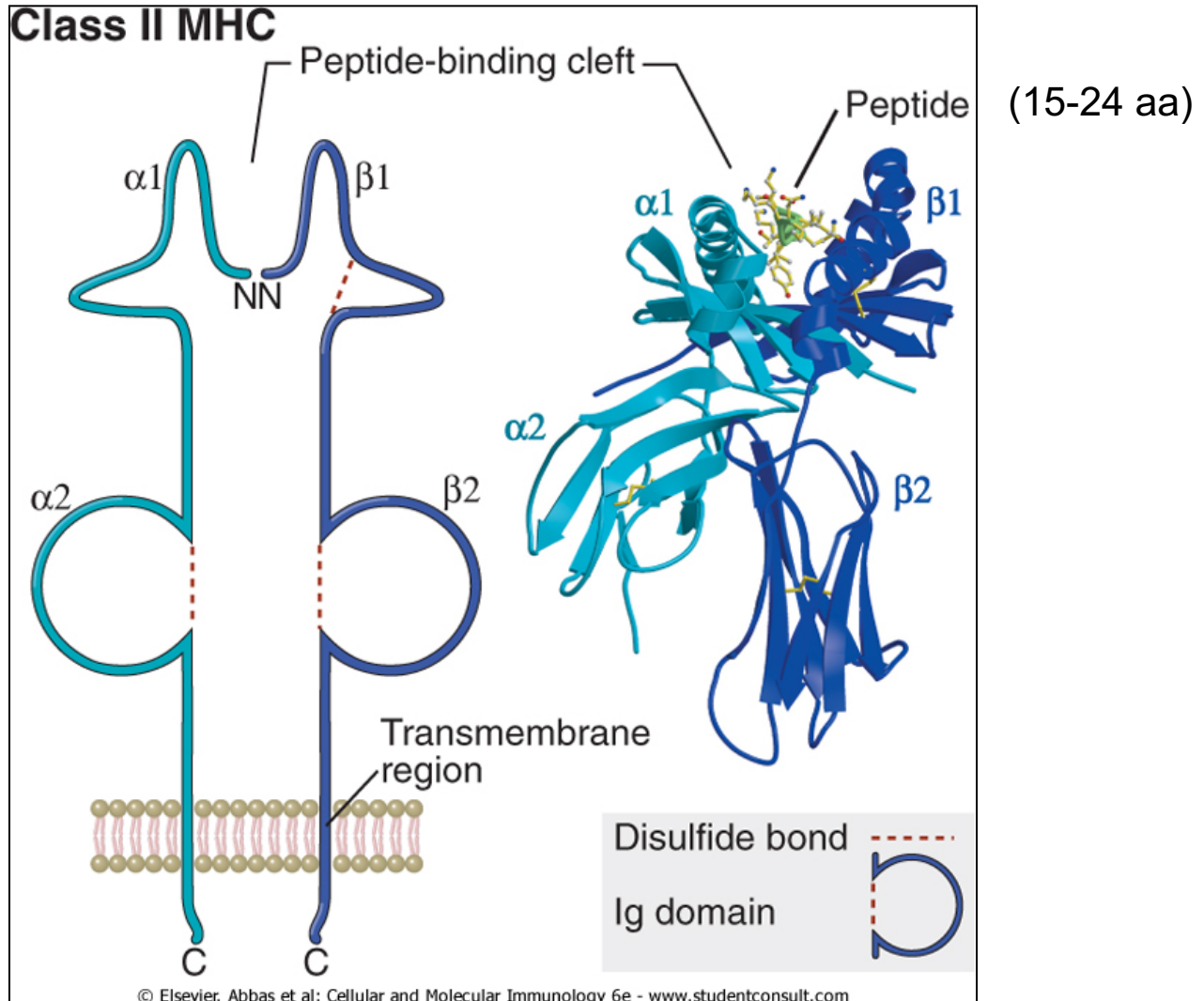

Mapa Genético do Complexo MHC Humano (Sistema HLA) e do Camundongo (Sistema H2)

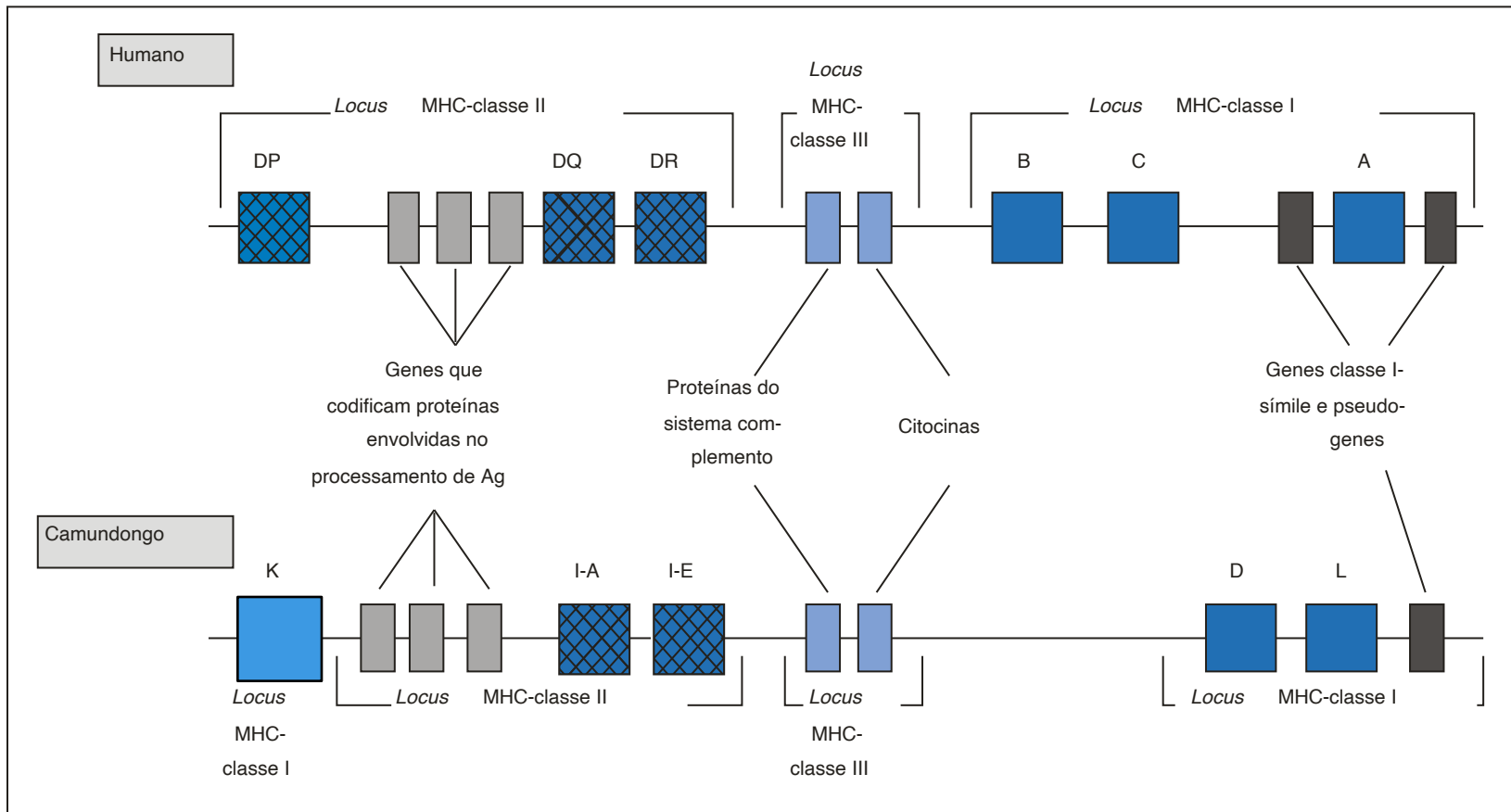

Características das Moléculas e Genes do MHC

1- Co-dominantes (híbrido expressa os dois genes)

2- Polimórficos (muitos genes diferentes na população)*

3- Expressão diferenciada

CI-II: Cels Dendríticas, Cels B, Macrófagos

CI-I: Todas as células nucleadas

4- A fenda do MHC é promíscua: liga vários peptídeos semelhantes

5- Apresentam peptídeos próprios e estranhos

6- Em DCs ativadas a taxa de desligamento do peptídeo é baixa

7- Em DCs ativadas o número de molecs do MHC é alta

* **HLA-A, -B e -C**, cada um dos quais com 649, 1029 e 350 alelos

Aumento da Expressão de Moléculas do MHC Classe II por IFN- γ Produzido por Célula NK ou Cel T CD4+

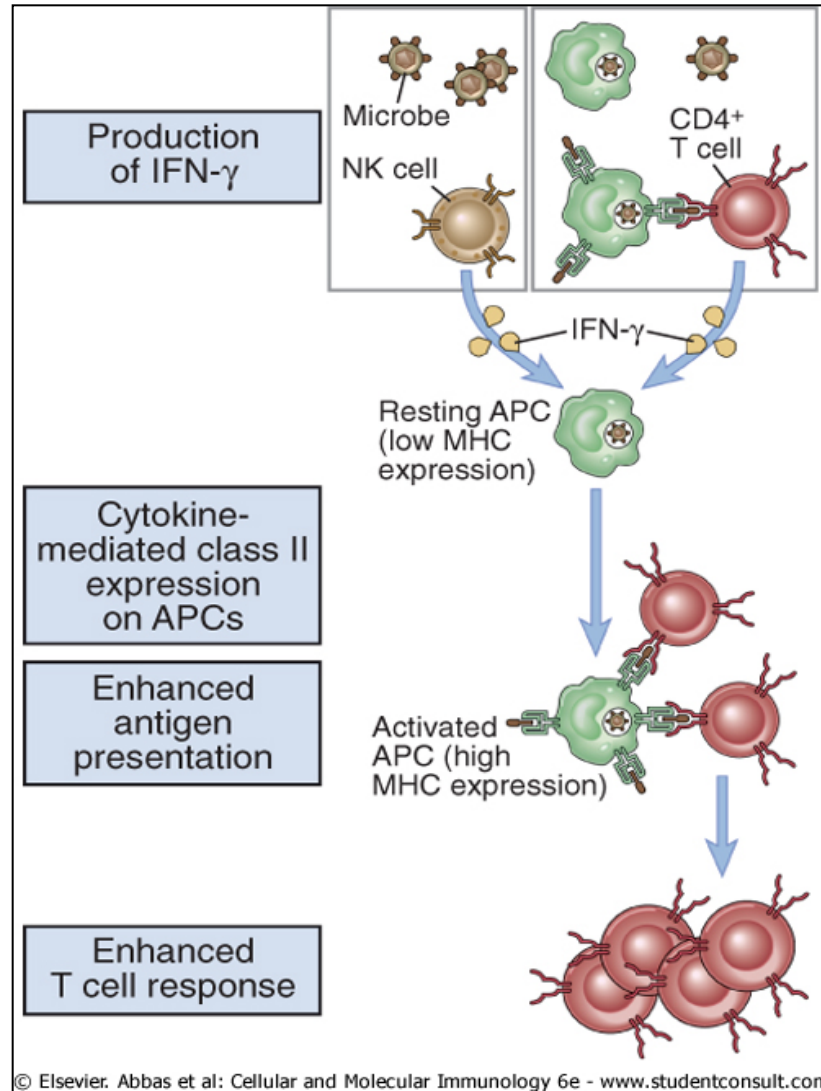

As Células Apresentadoras de Antígenos (APCs) são Necessárias para a Ativação de Linfócitos T

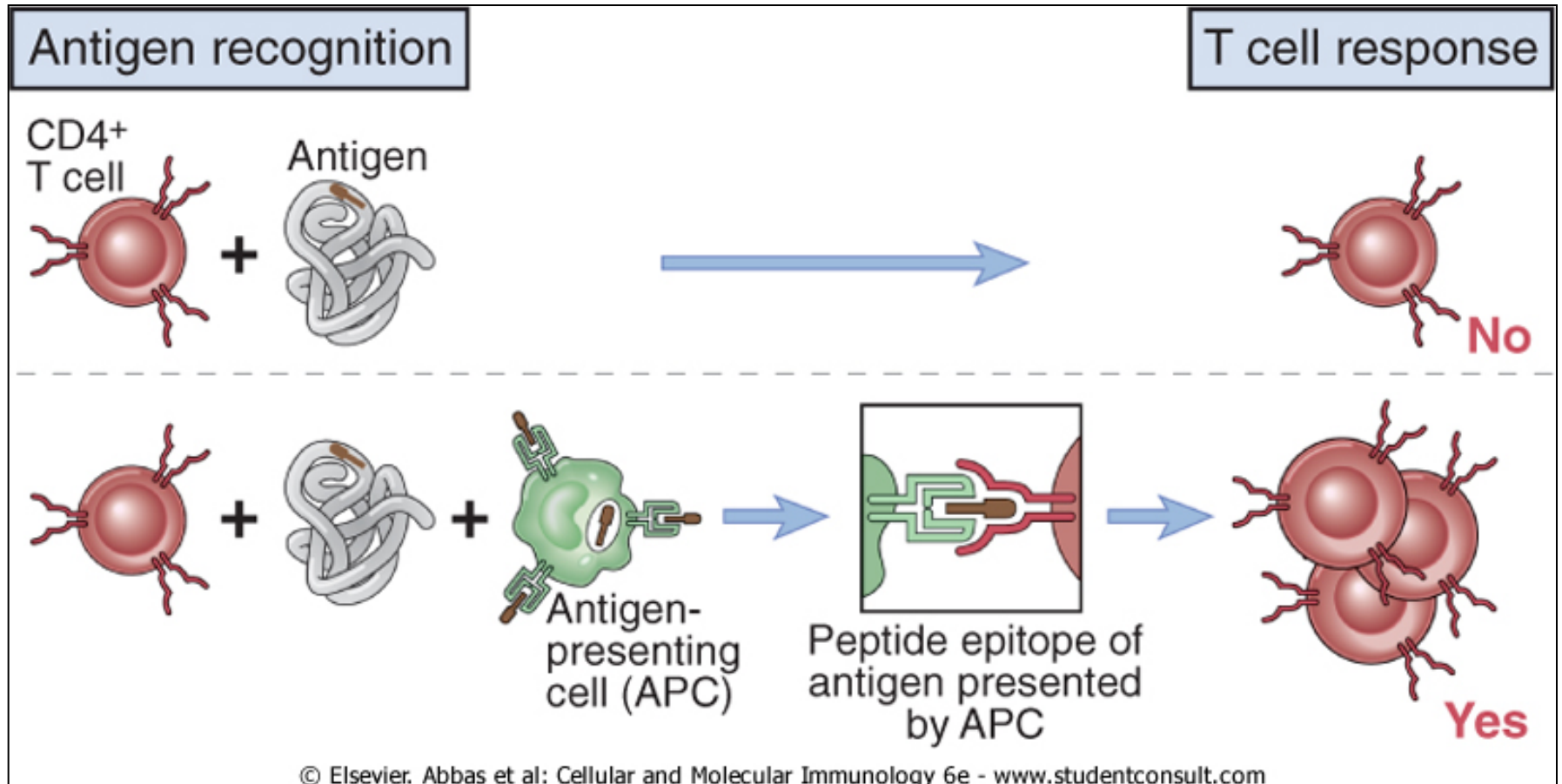

© Elsevier. Abbas et al: Cellular and Molecular Immunology 6e - www.studentconsult.com

Células Dendríticas: As APCs Profissionais

A- Em cultivo:
microscopia óptica

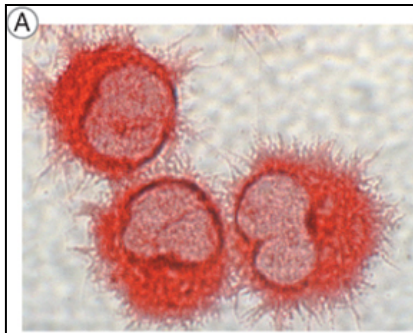

B- Microscopia
de Varredura

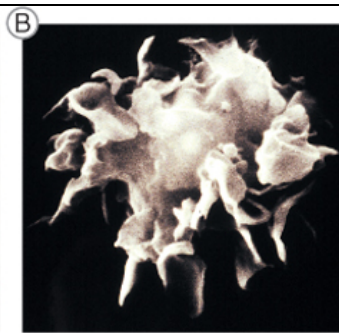

C- Esquema DCs da Pele:
Células de Langerhans

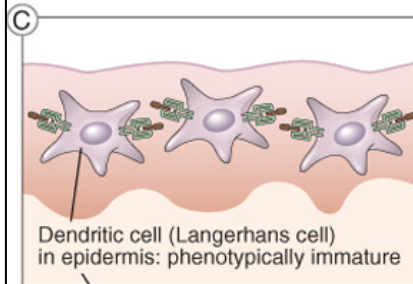

E- Esquema DCs de LN:

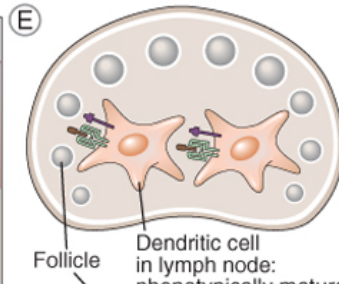

D-Células de Langerhans:
Histologia da Pele

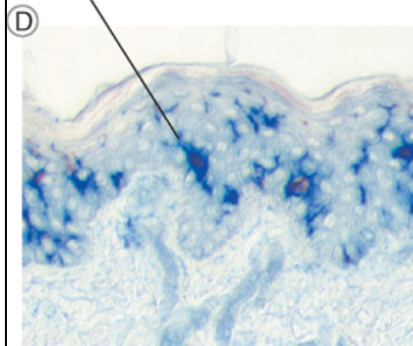

F- Histologia: DCs de LN
Região Paracortical

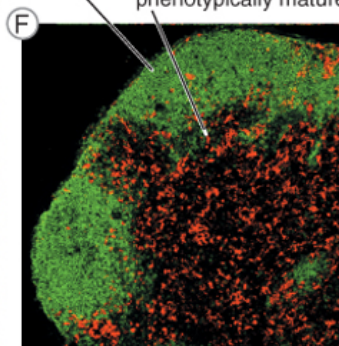

© Elsevier, Abbas et al: Cellular and Molecular Immunology 6e - www.studentconsult.com

Apresentação de Ags no LN (via cutânea, gastro-intestinal e respiratória) e Baço (via venosa)

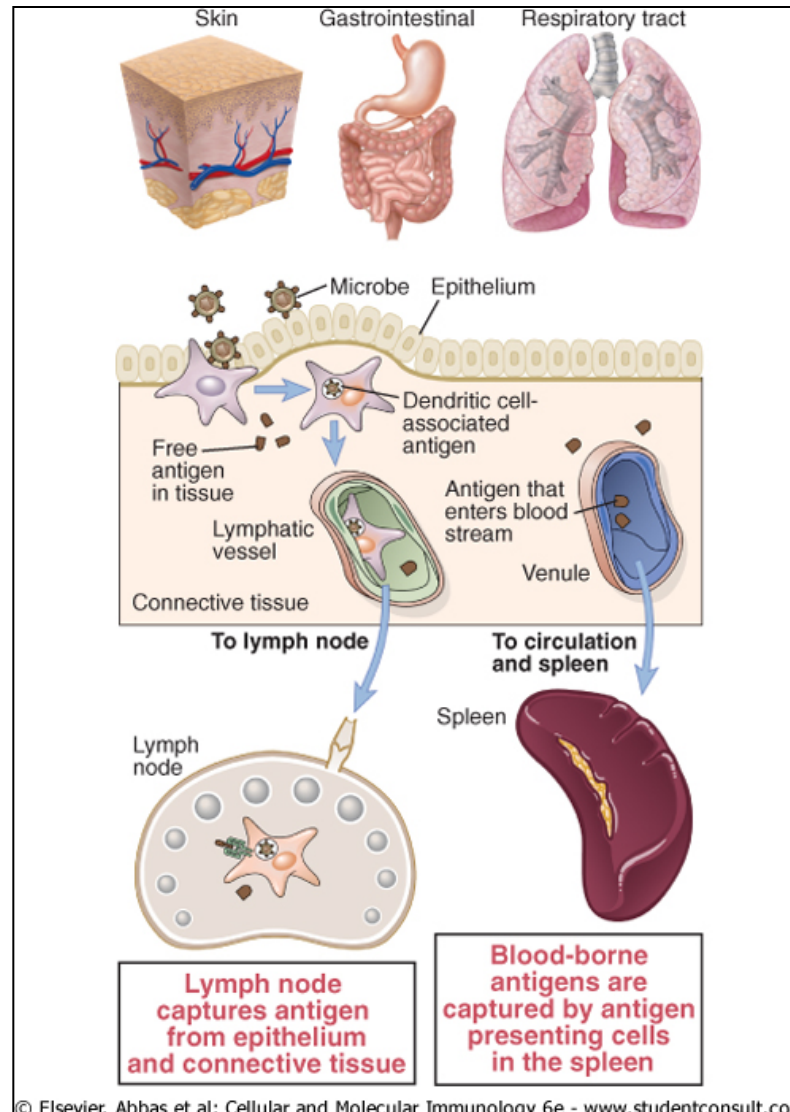

Maturação das DCs após Captura de Antígenos

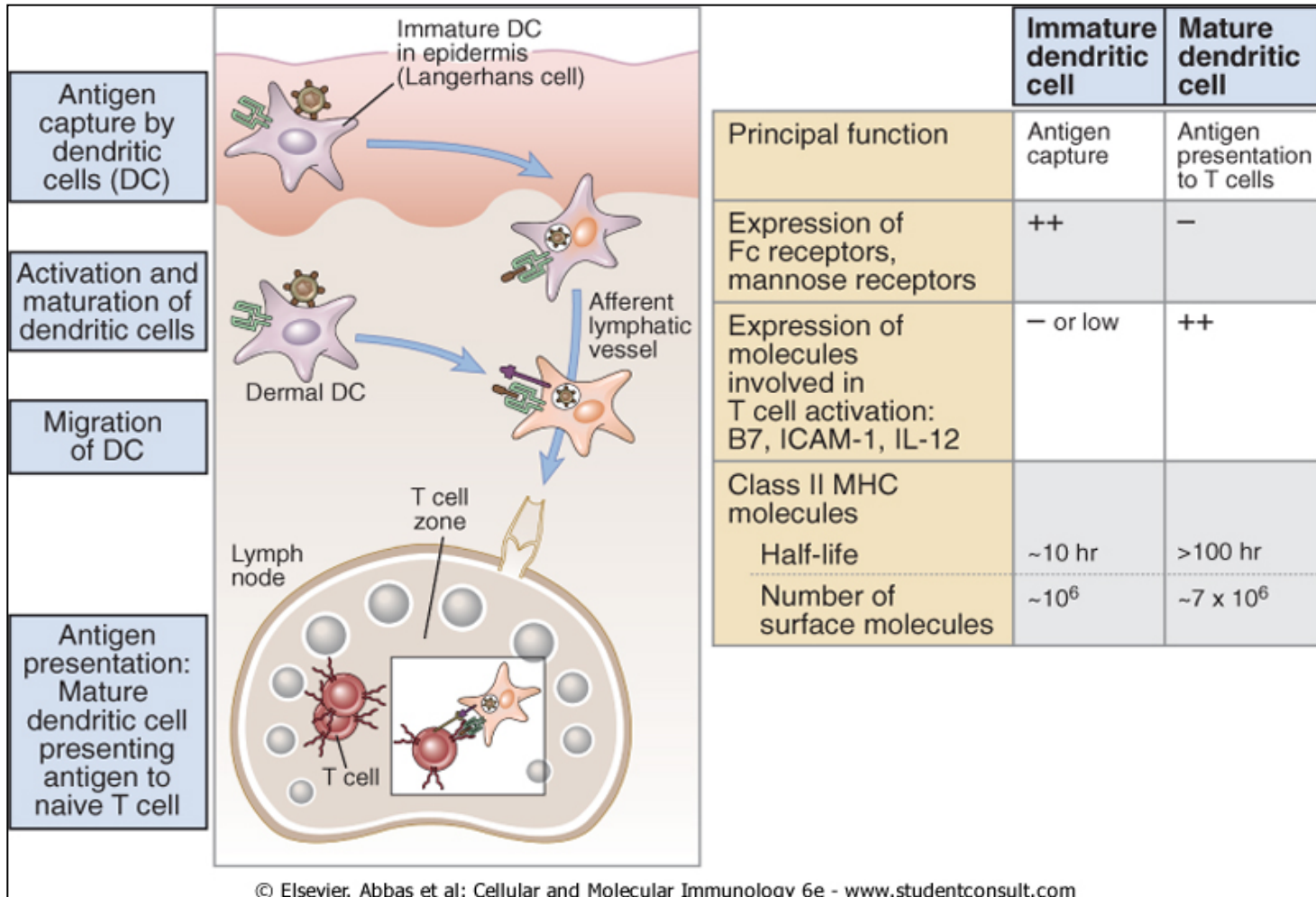

Diferentes Tipos de APCs

Dendritic cell

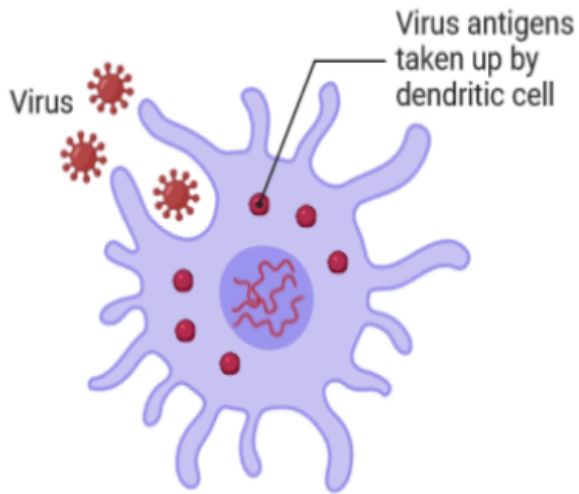

Viruses infecting dendritic cell

Macrophage

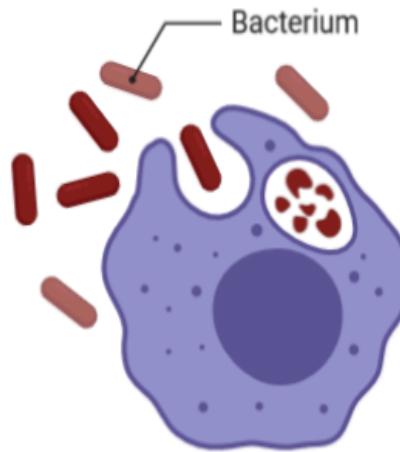

Bacteria infecting macrophage

B cell

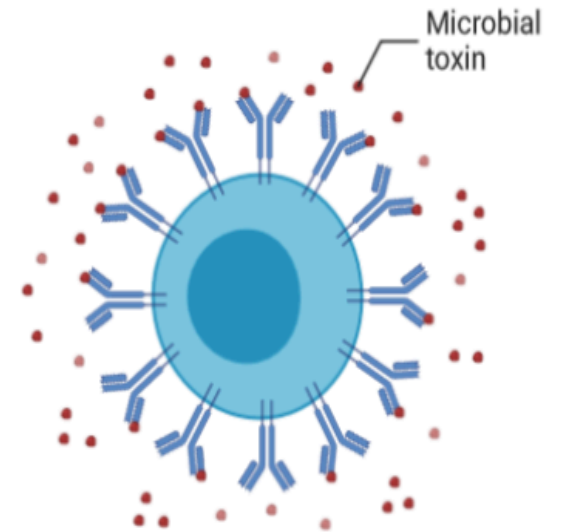

Microbial toxins binding to B-cell receptors

APCs Profissionais e Não-Profissionais

Professional APCs

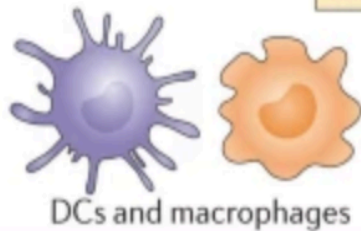

DCs and macrophages



B cells

Key features

- Phagocytic
- Express receptors for apoptotic cells, DAMPs and PAMPs
- Localize to tissues
- Localize to T cell zone of lymph nodes following activation (DCs)
- Constitutively express high levels of MHC class II molecules and antigen processing machinery
- Express co-stimulatory molecules following activation

Key features

- Internalize antigens via BCRs
- Constitutively express MHC class II molecules and antigen processing machinery
- Express co-stimulatory molecules following activation

Atypical APCs

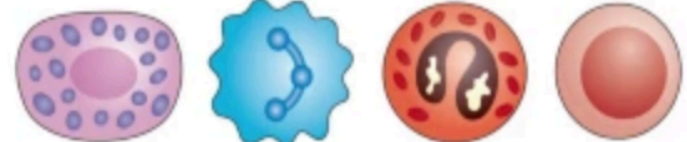

Mast cells

Basophils

Eosinophils

ILC3s

Key features

- Inducible expression of MHC class II molecules
- Antigen-presenting functions limited to specific immune environments (especially type 2 immune settings)
- Lack of compelling evidence that they can activate naive CD4⁺ T cells in an antigen-specific manner

Outras APCs Não-Profissionais

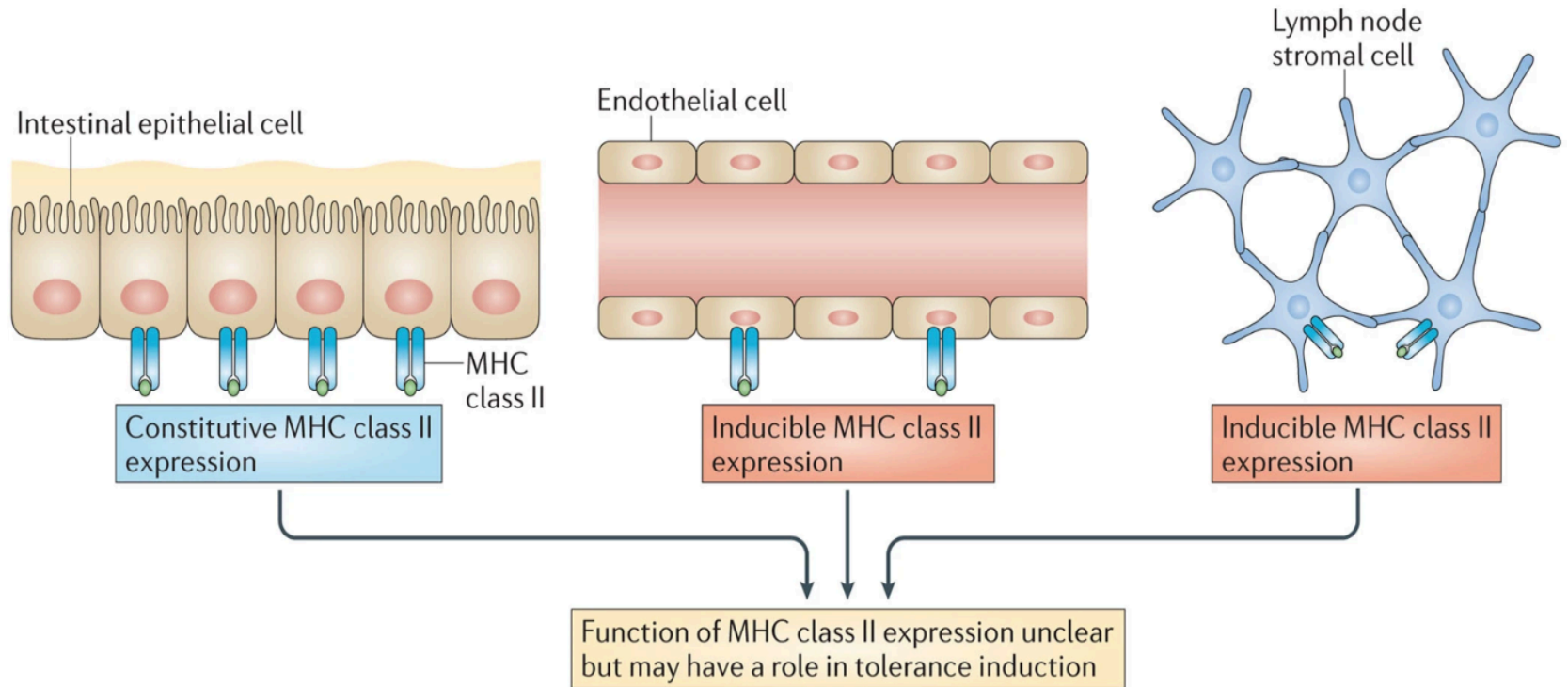

Nature Reviews | Immunology

Processamento de Antígenos Exógenos (MHC Cl II) para Linfs TCD4+ e Endógenos (MHC Cl I) para Linfs TCD8+

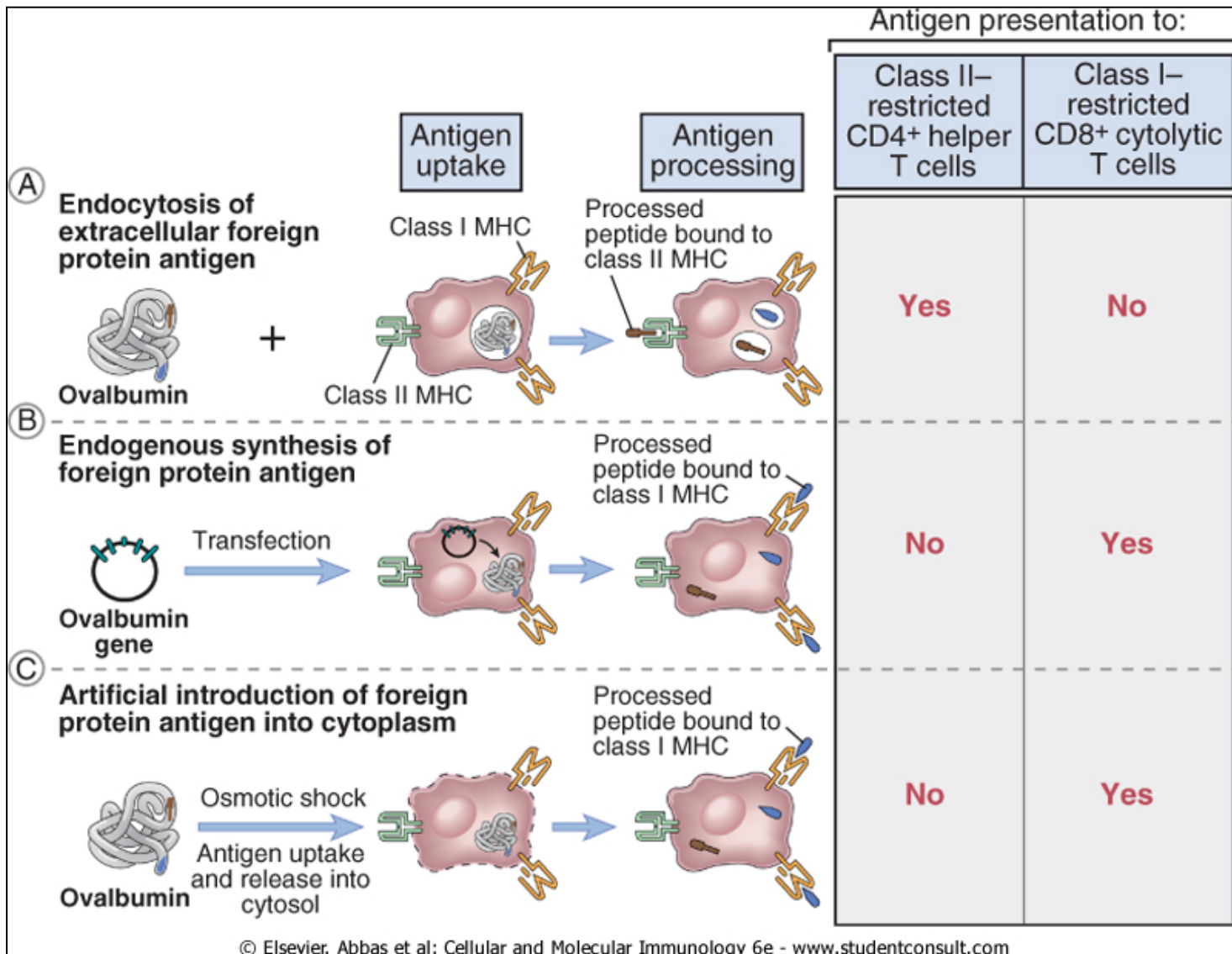

Processamento e Apresentação de Ags por MHC Classe II

Antígeno Exógeno - Ativação de Cels T CD4+

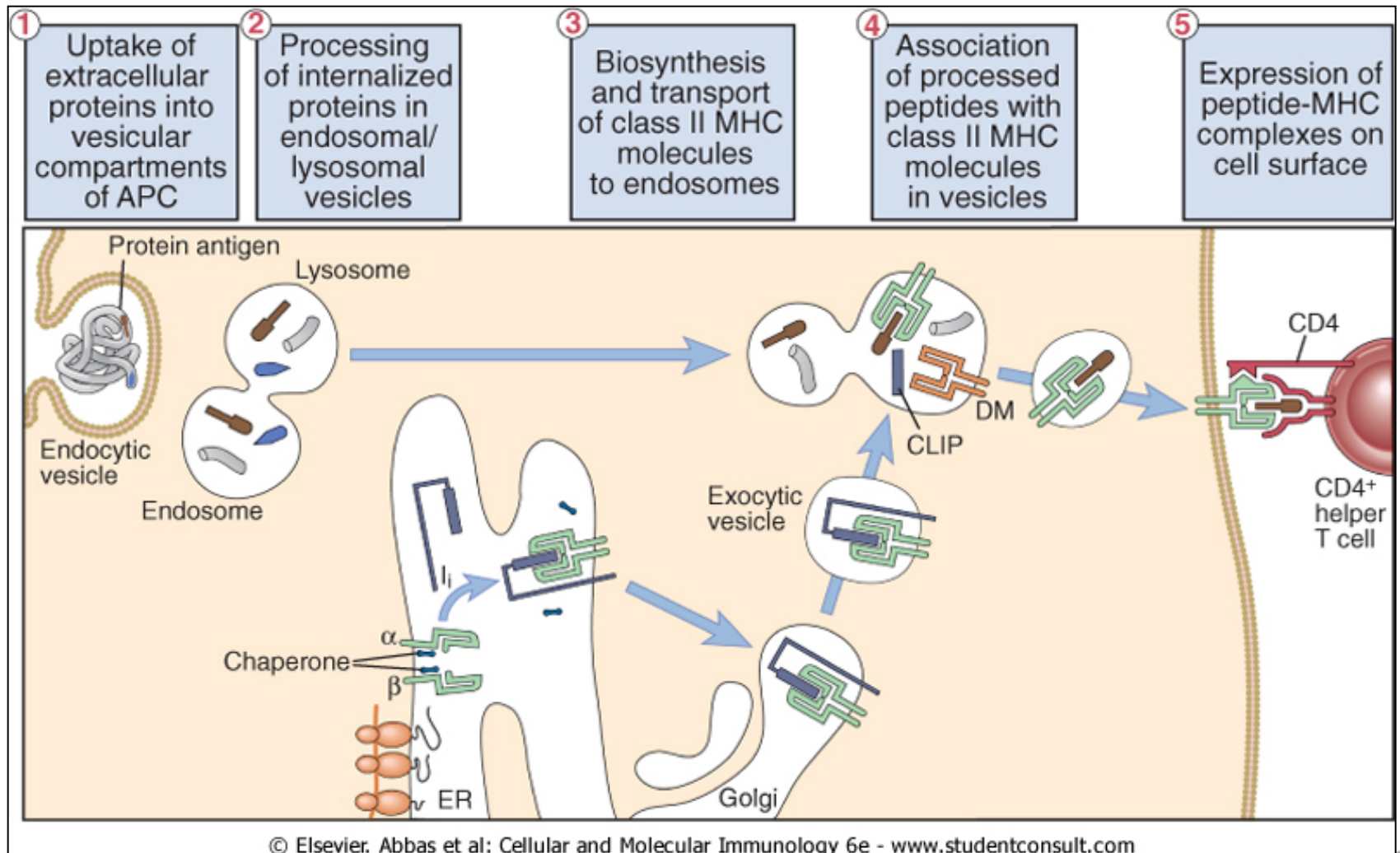

Invariant Chain-Protege o MHC no RE e Golgi

Processamento e Apresentação de Ags por MHC Classe II

Enzimas proteolíticas digerem a Cadeia Invariante e a molec. DM remove o clip para o acesso do peptídeo

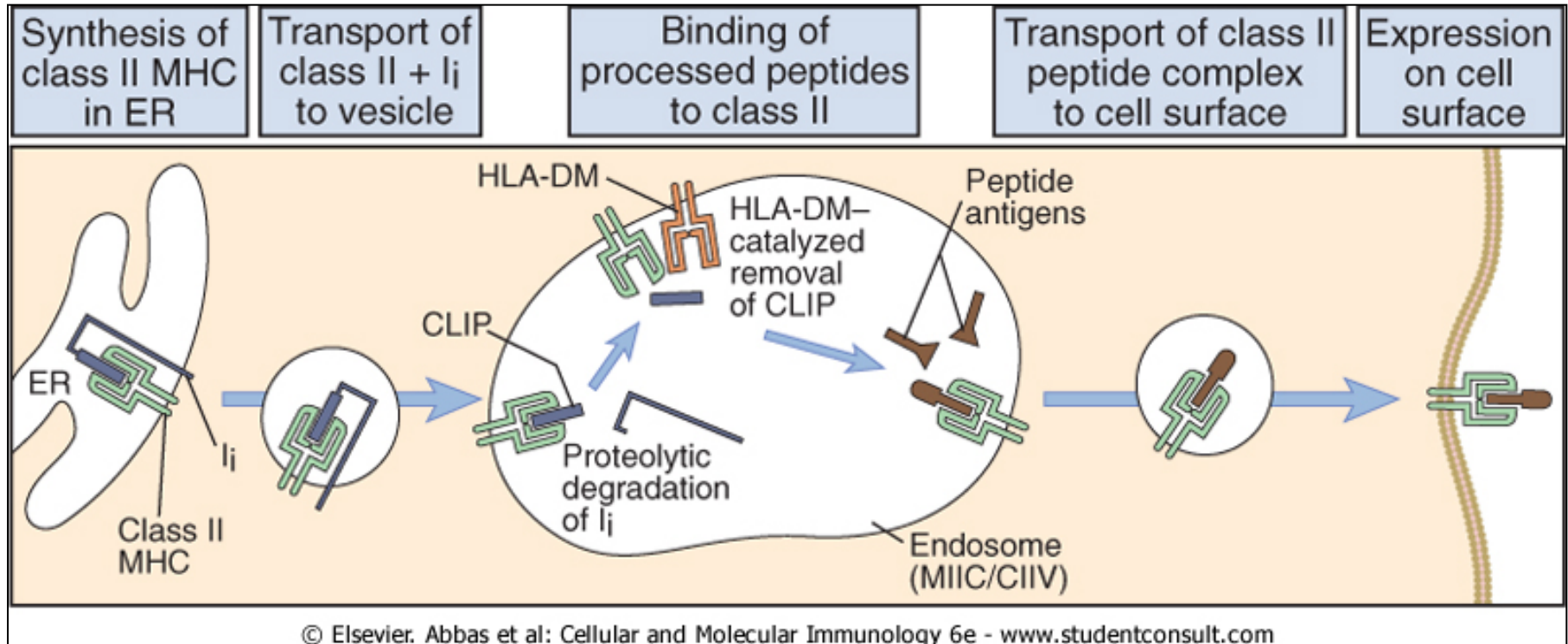

Processamento e Apresentação de Ags por MHC Classe I

Antígeno Endógeno - Ativação de Cels T CD8+

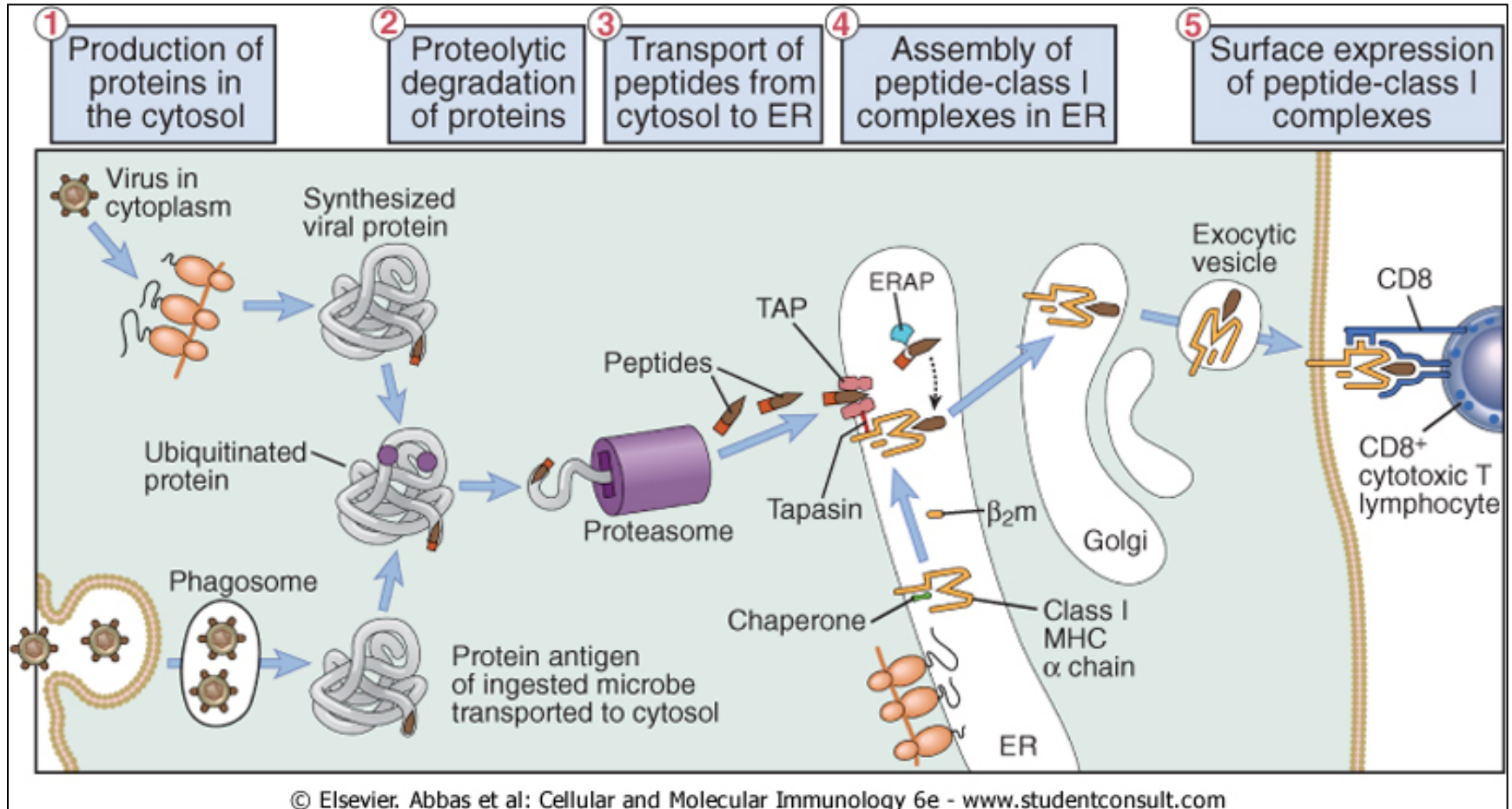

Os Vírus Inibem a Expressão de MHC de Cl-I

Apresentação Cruzada de Ags por DCs após Infecção Viral (via Cl-I e Cl-II)

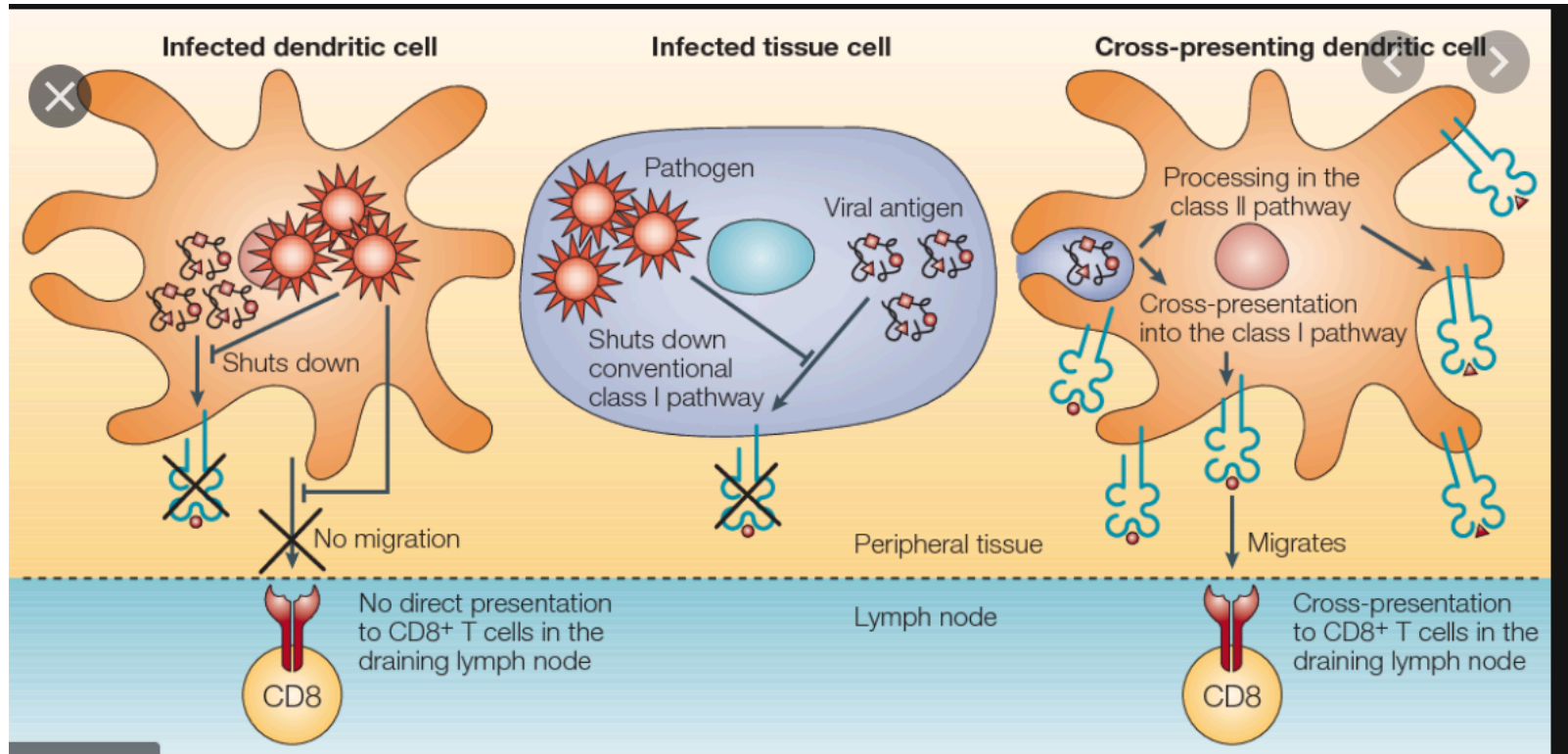

Apresentação Cruzada de Ags por DCs para Cels T CD8+ ("Cross Presentation")

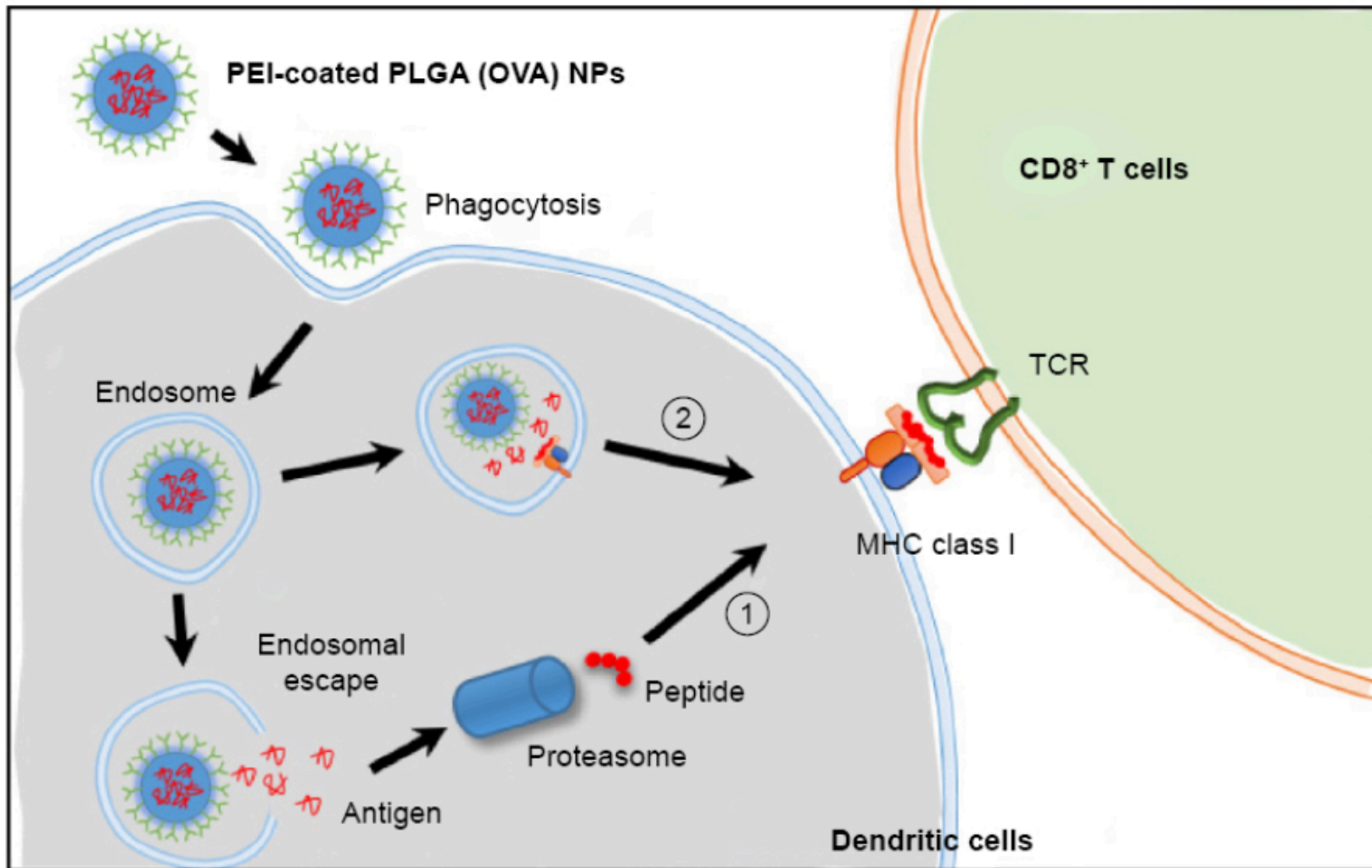

Vias Intracelulares para Apresentação Cruzada de Ags por DCs para Cels T CD8+ (“Cross Presentation”)

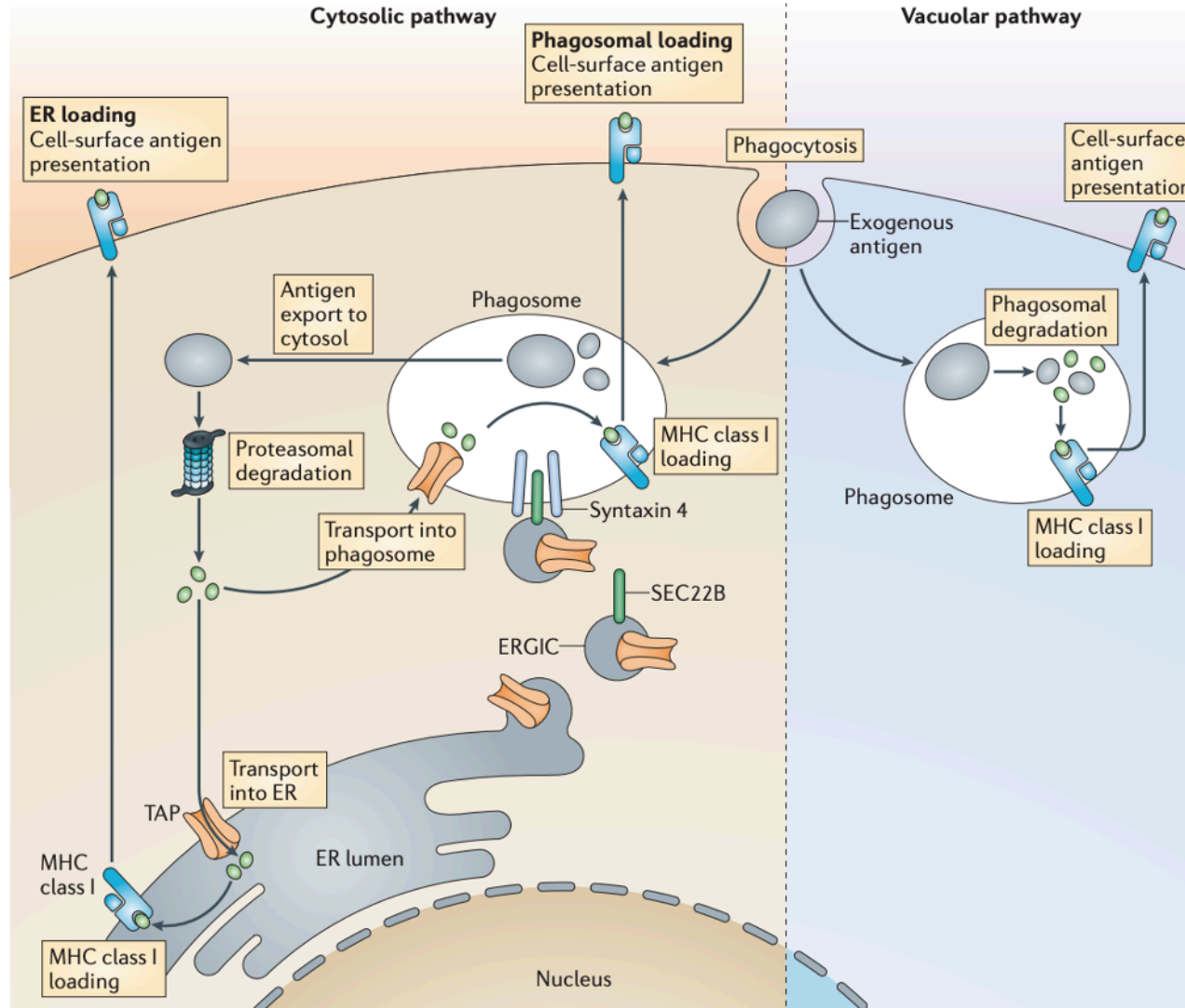

(Syntaxin 4 Regula o tráfico de proteínas (TAP e MHC CI-1) para a membrana do fagossoma)

O Processamento de Antígenos Gera Múltiplos Peptídeos

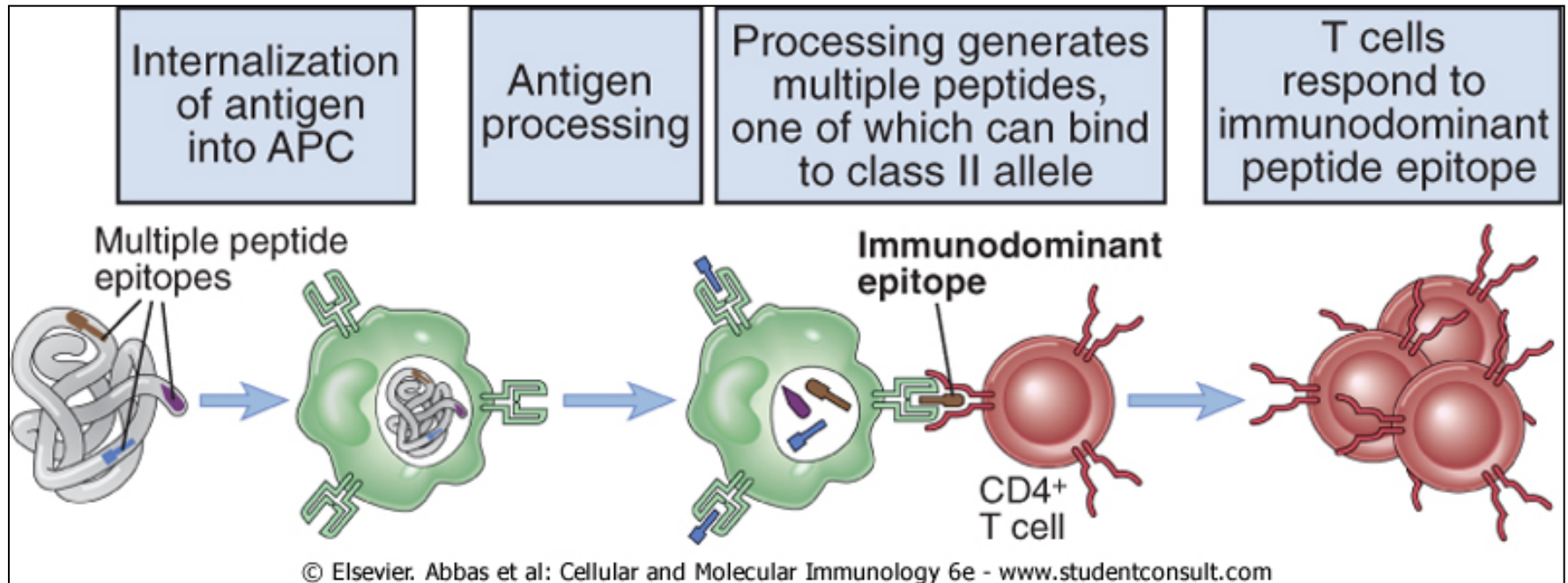

A Célula T Reconhece Antígenos Estranhos

(a maioria das cels T autorreativas foram deletadas no timo)

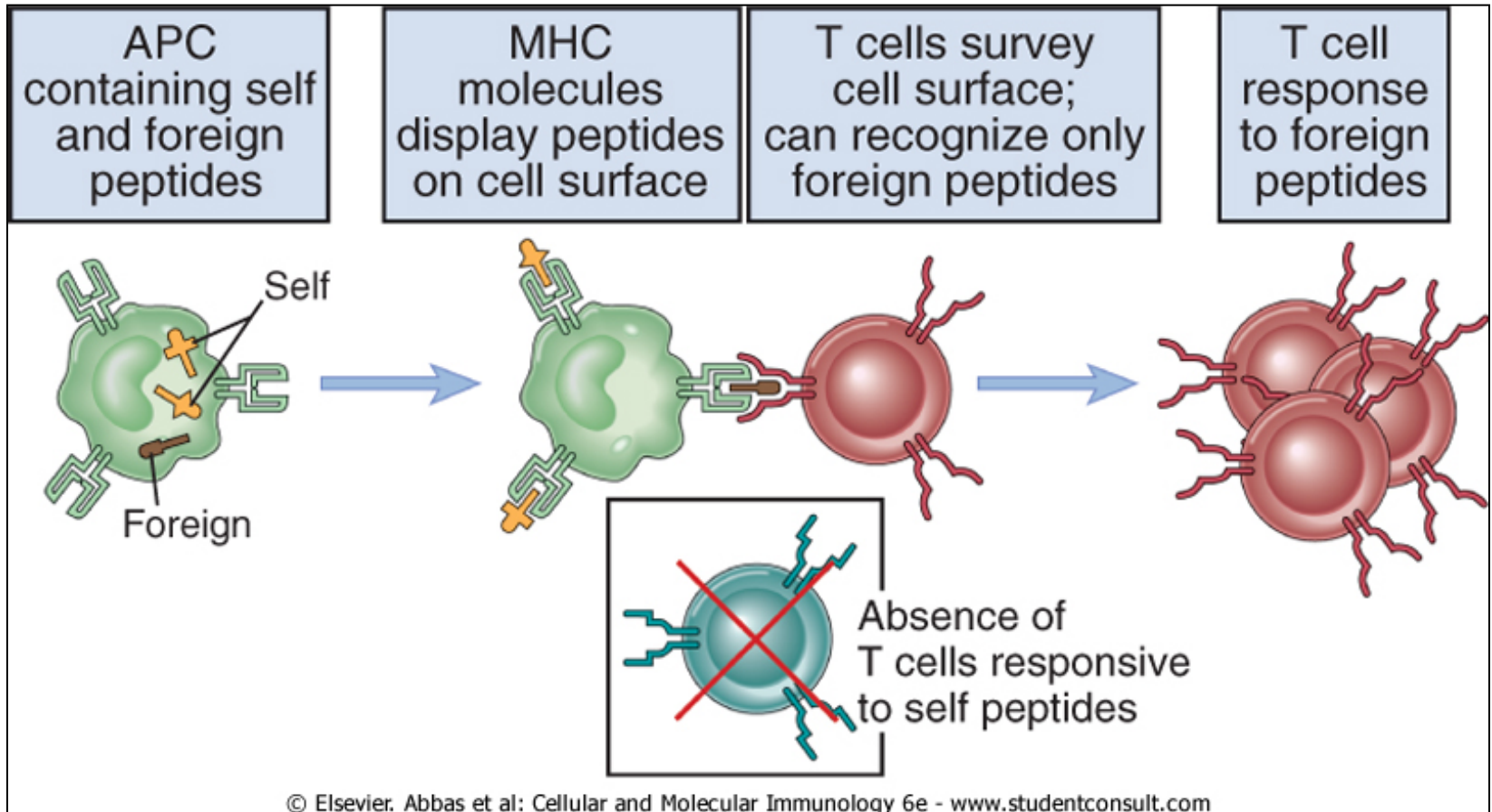

Apresentação de Antígenos para Diferentes Sub-populações de Linfócitos Induz Atividades Efetoras Diversas

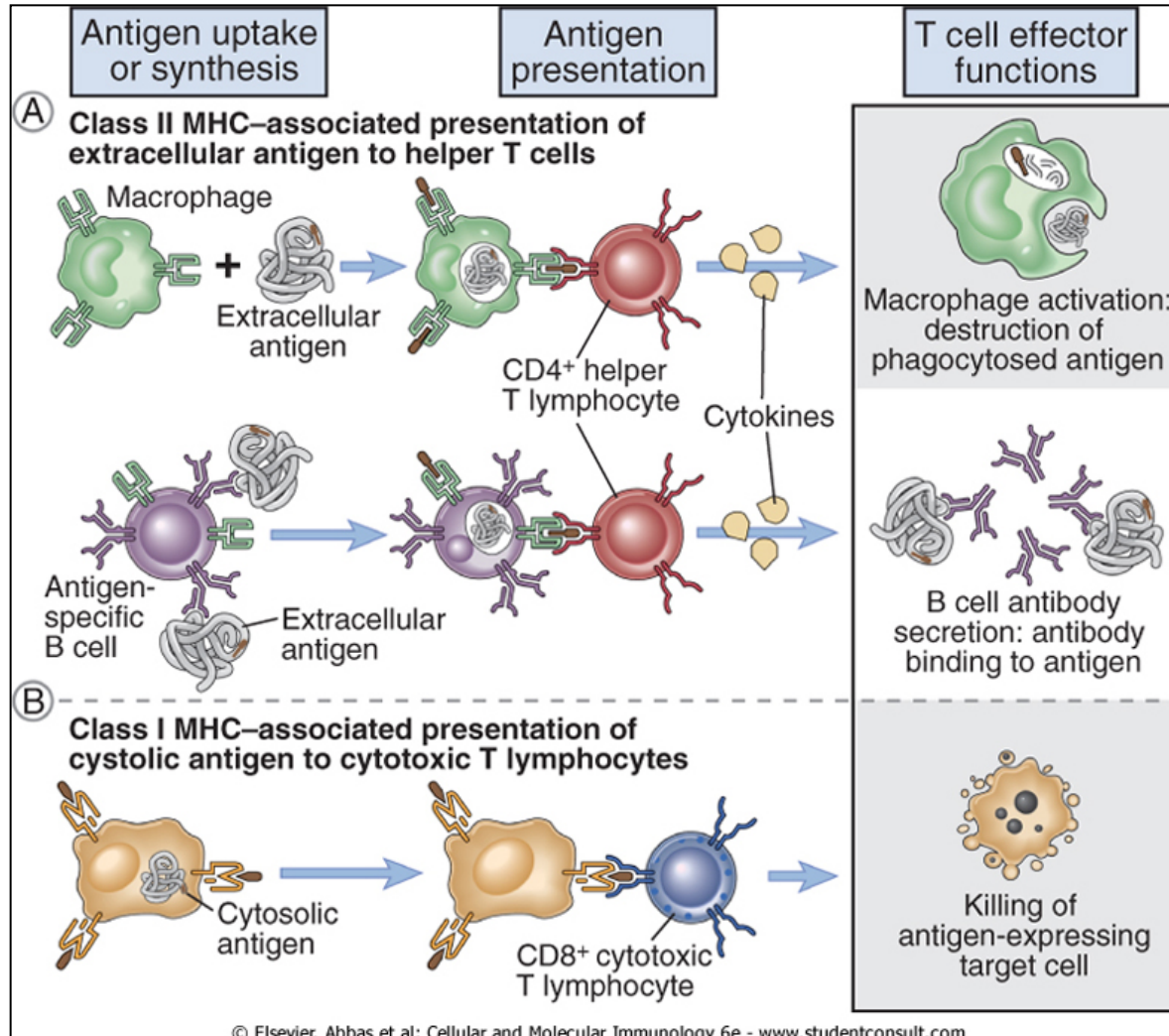

A Ativação de DCs e a Apresentação de Ags Determina a Diferenciação de Sub-Grupos de Cels T CD4+

