

Regression Discontinuity

- Assignment based on a cutoff score
- Second best design
- Theory and Unbiased Inference
- Can be widely used
- Analysis is tricky
- Need to use more often

Regression Discontinuity

Resource allocation can be by a merit score, need (or risk) score, first come..., date of birth

How prevalent are allocation mechanisms like this in a given society?

Some first examples in health are ...

RD is the design for such circumstances

What is it; and why does it have this name?

Need to learn the language of an assignment variable, cutoff and outcome

Real Examples of RD

Buddelmejer & Skoufias - Progresas in Mexico

Ludwig & Miller - Head Start on High School graduation

No Effect

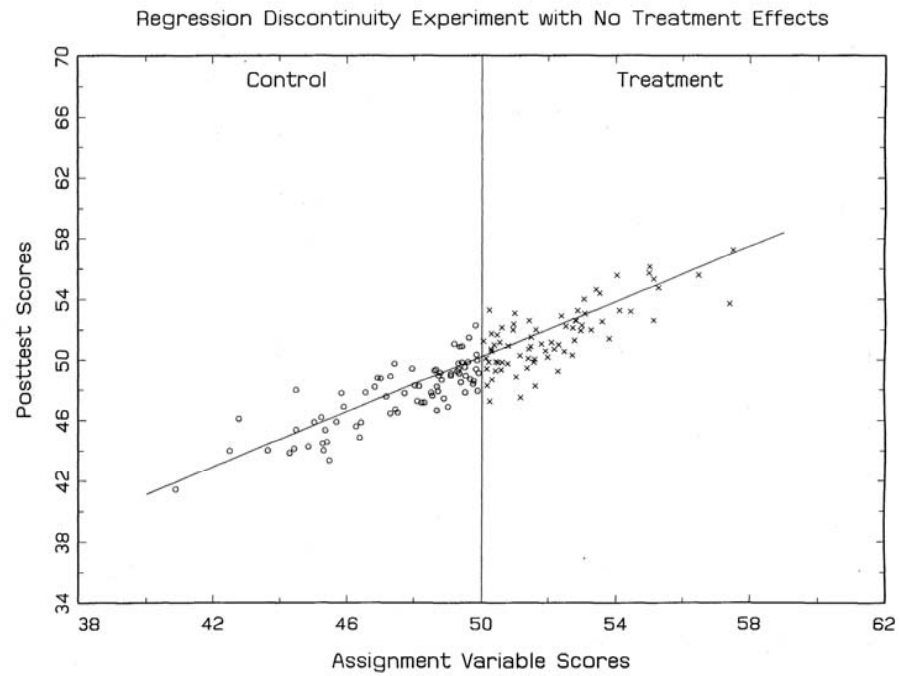

Clear Effect

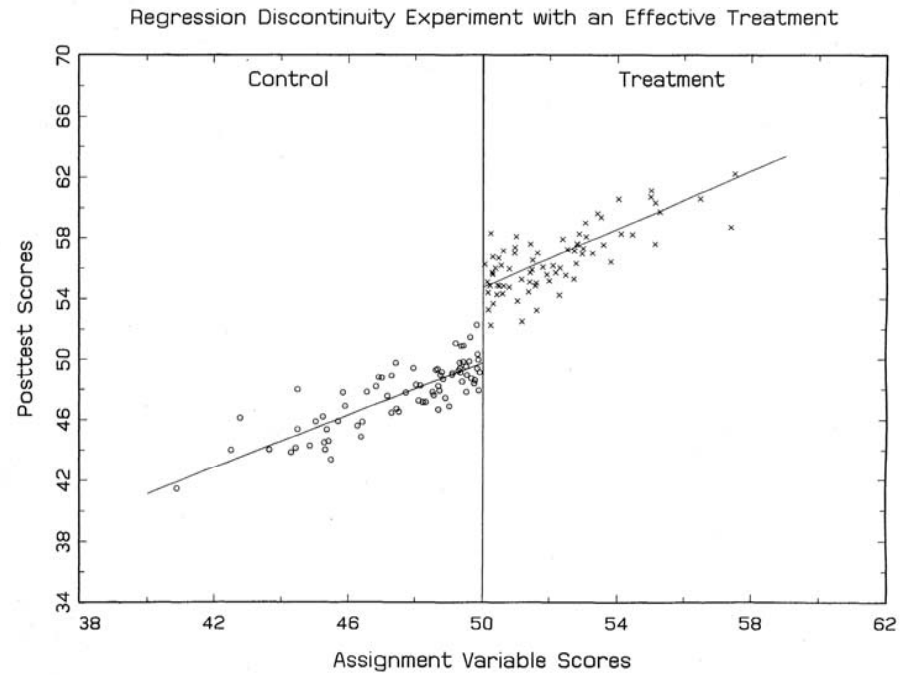

Ways of thinking about RD 1

Thinking of it as a randomized exp at cutoff--

advantages of this for functional form assumptions;

but it also assumes pure chance which side of cutoff;
dense sampling there; LATE acceptable

What does a randomized experiment look like when graphed as a scatterplot (next slide)?

Ways of thinking about RD 2

as a completely known assignment process, again like experiment;

This is the way proofs have been offered

heavy dependence on functional form but harder to model scores on assignment if greater range

little treatment misallocation

Not easy to get beyond LATE

The Two Great Problems of RD

- Misspecified functional form of assignment on outcome - Seaver & Quarton
- Social and political dynamics of cutoffs leading to fuzzy discontinuities--Irish school leaving example.

Three more Minor Problems

- External Validity--ATE vs LATE
- Statistical Conclusion Validity--Power relative to an experiment
- Implementability--even less well known than random assignment

Nonlinearities in RDD

- In a regression discontinuity design, we measure the size of the effect as the size of the discontinuity in regression lines at the cutoff:

The size of the discontinuity at the cutoff is the size of the effect.

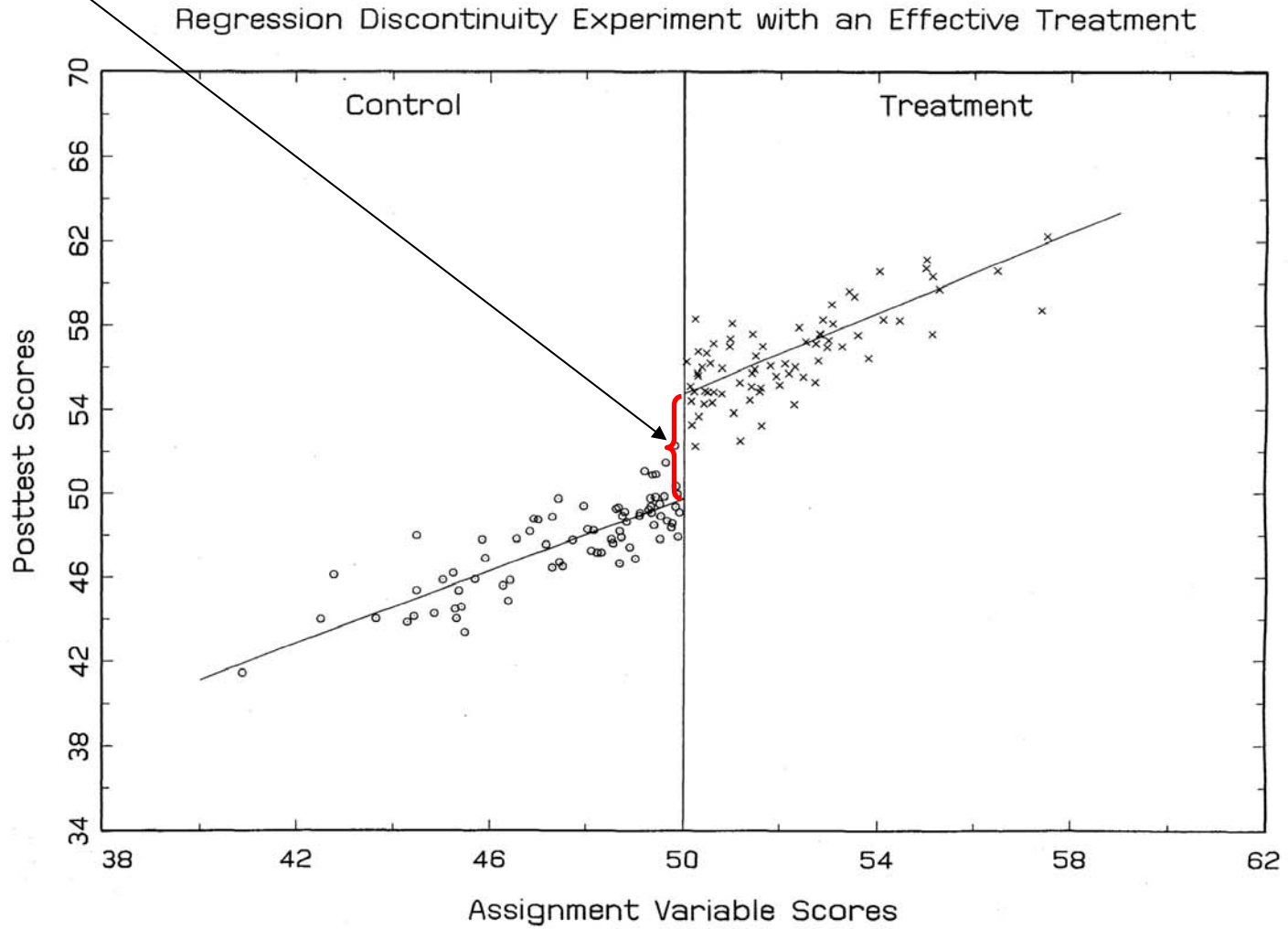

Nonlinearities in Functional Form

- Anything that affects the size of that discontinuity other than treatment is a threat.
- In the example, we assumed the relationship between assignment and outcome was linear—regressions are straight lines.
- But functional form can be nonlinear due to:
 - Nonlinear Relationships between the assignment variable and the outcome
 - Interactions between the assignment variable and treatment.

Functional Form

- Put more technically, effects are unbiased only if the functional form of the relationship between the assignment variable and the outcome variable is correctly modeled
- Consider first the example of a nonlinear relationship between the assignment variable and the outcome variable:

Here we see a discontinuity between the regression lines at the cutoff, which would lead us to conclude that the treatment worked. But this conclusion would be wrong because we modeled these data with a linear model when the underlying relationship was nonlinear.

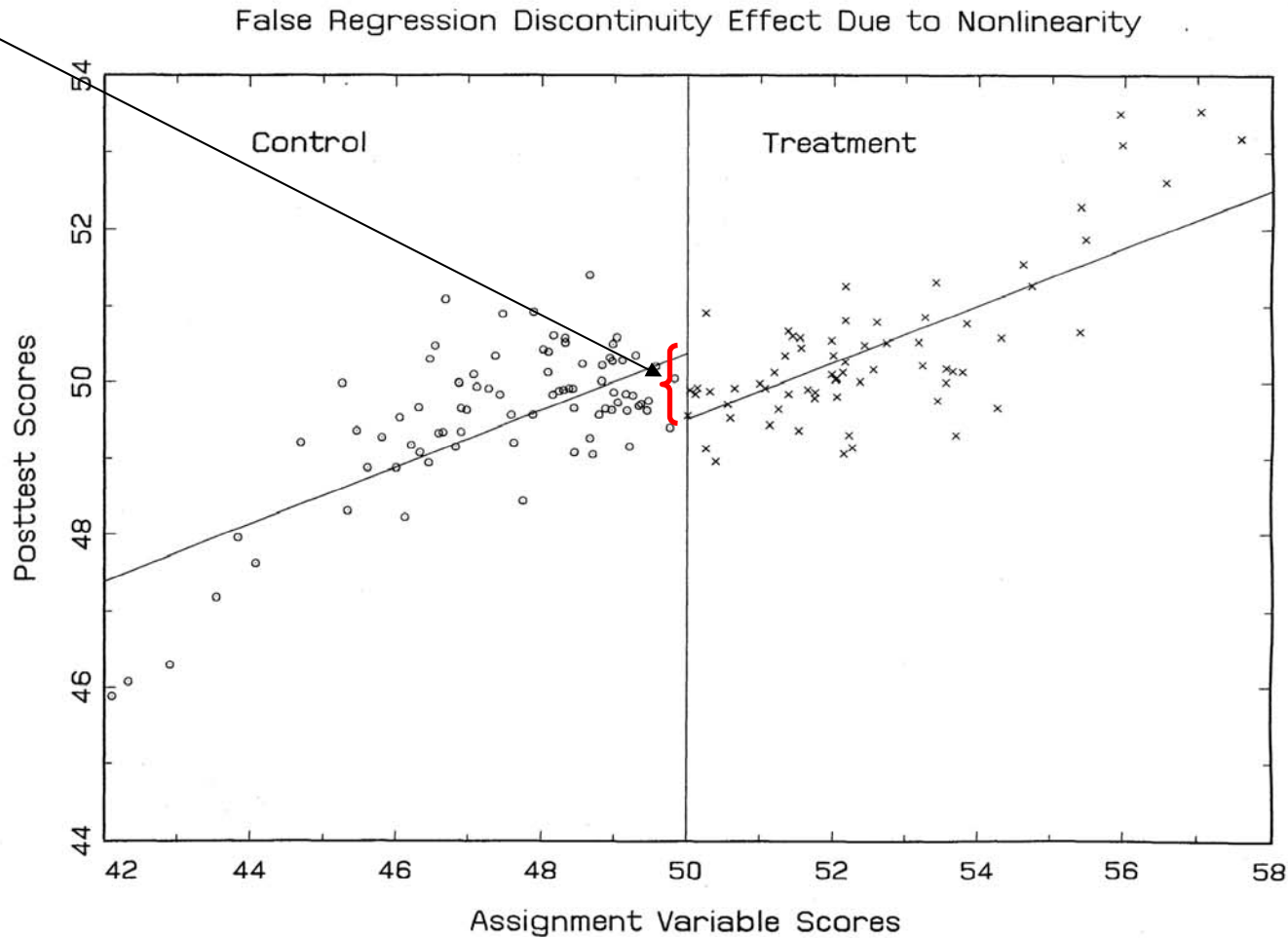

If we super-impose a nonlinear regression line¹ onto the data, a line that seems to match the curves in the data pretty well, we see no discontinuity at the cutoff anymore, and correctly conclude that the treatment had no effect.

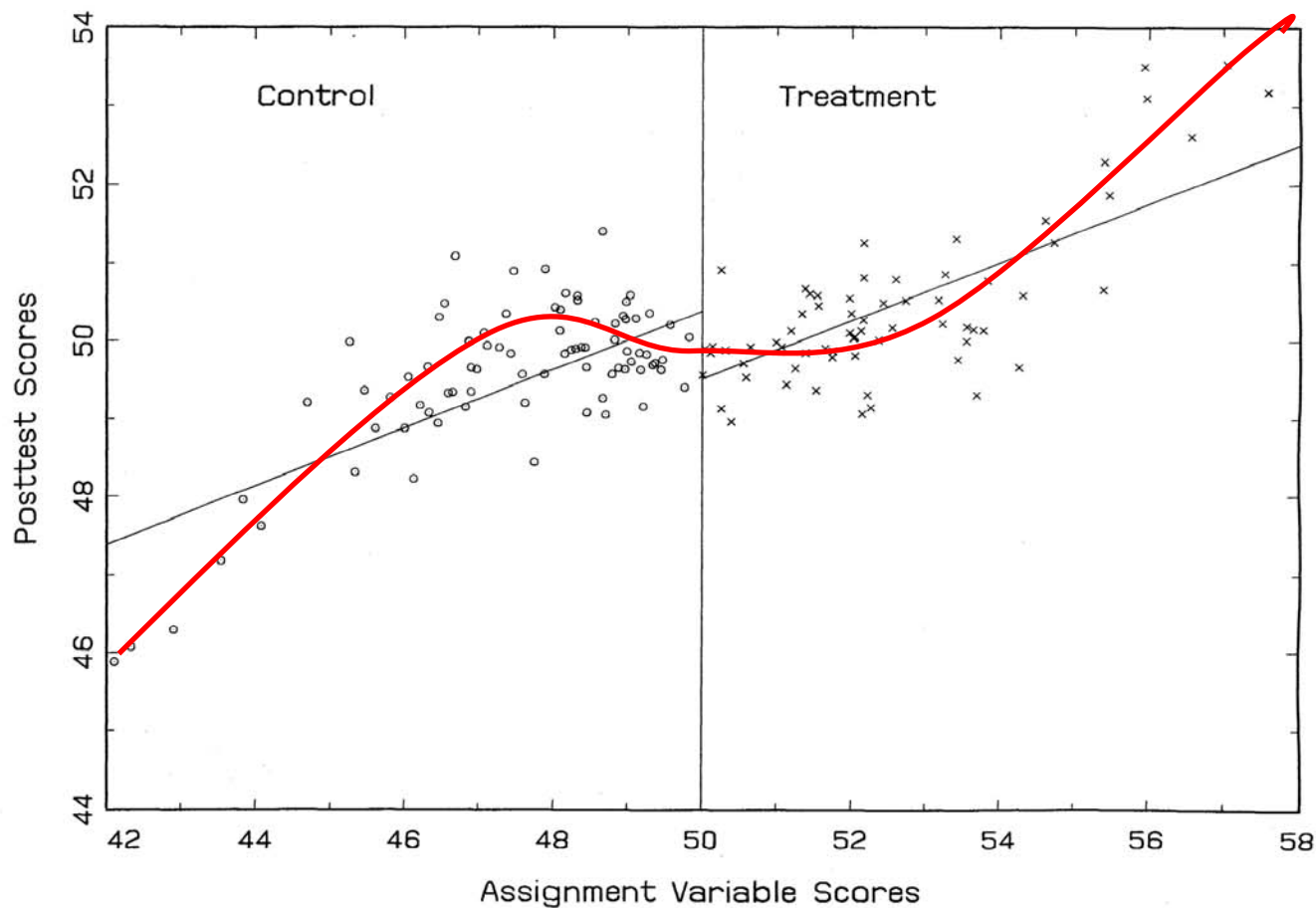

¹ In this case, a cubic function (X^3)

Functional Form: Interactions

- Sometimes the treatment works better for some people than for others
 - For example, it is common to find that more advantaged children (higher SES, higher pretest achievement scores) benefit more from treatment than do less advantaged children.
- If this interaction (between the assignment variable and treatment) is not modeled correctly, a false discontinuity will appear:

Here we see a discontinuity that suggests a treatment effect. However, these data are again modeled incorrectly, with a linear model that contains no interaction terms, producing an artifactual discontinuity at the cutoff...

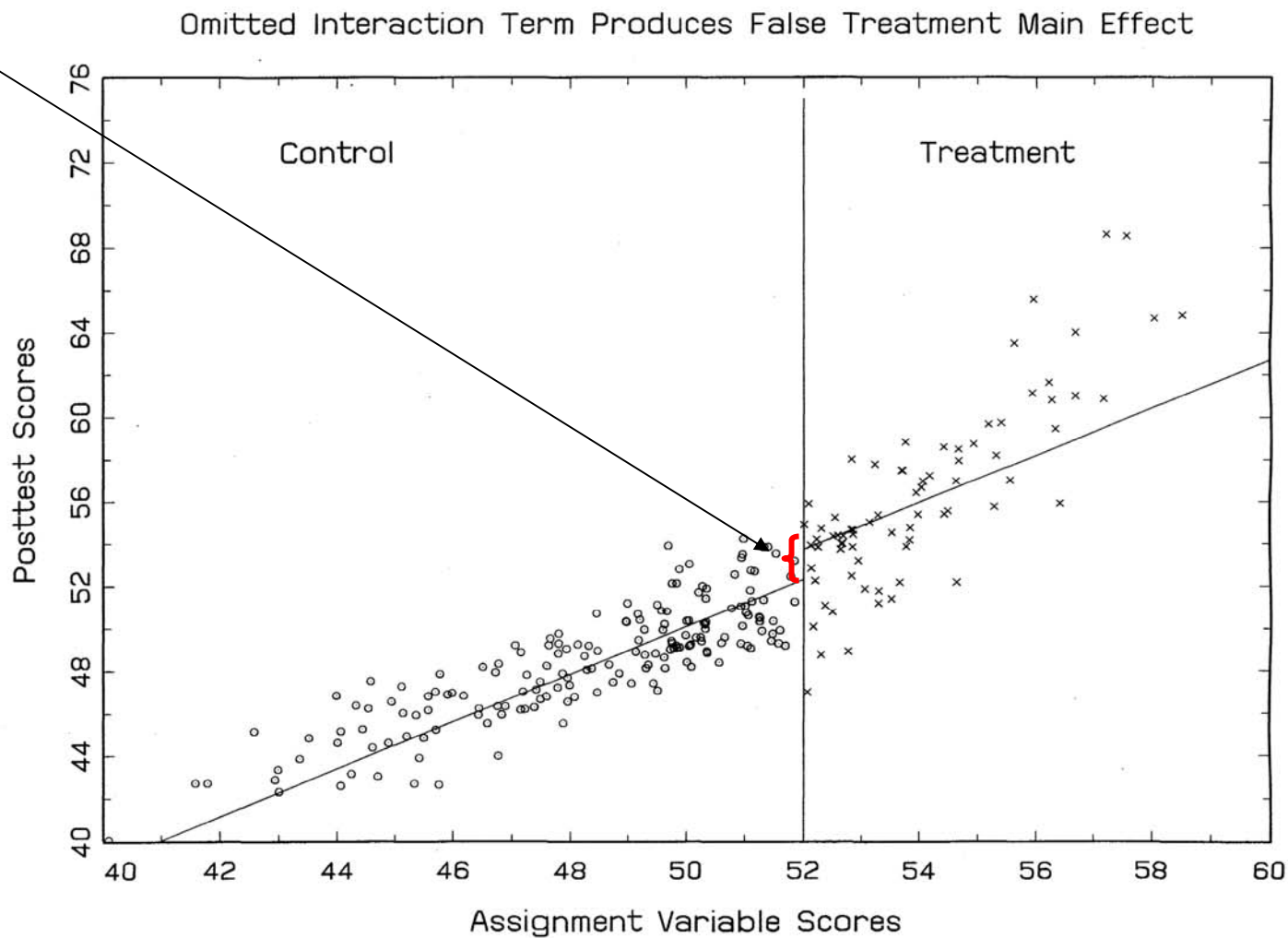

Fig 7-10

If we superimpose the regression lines that would have been obtained had an interaction term been included, we would find no discontinuity at the cutoff...

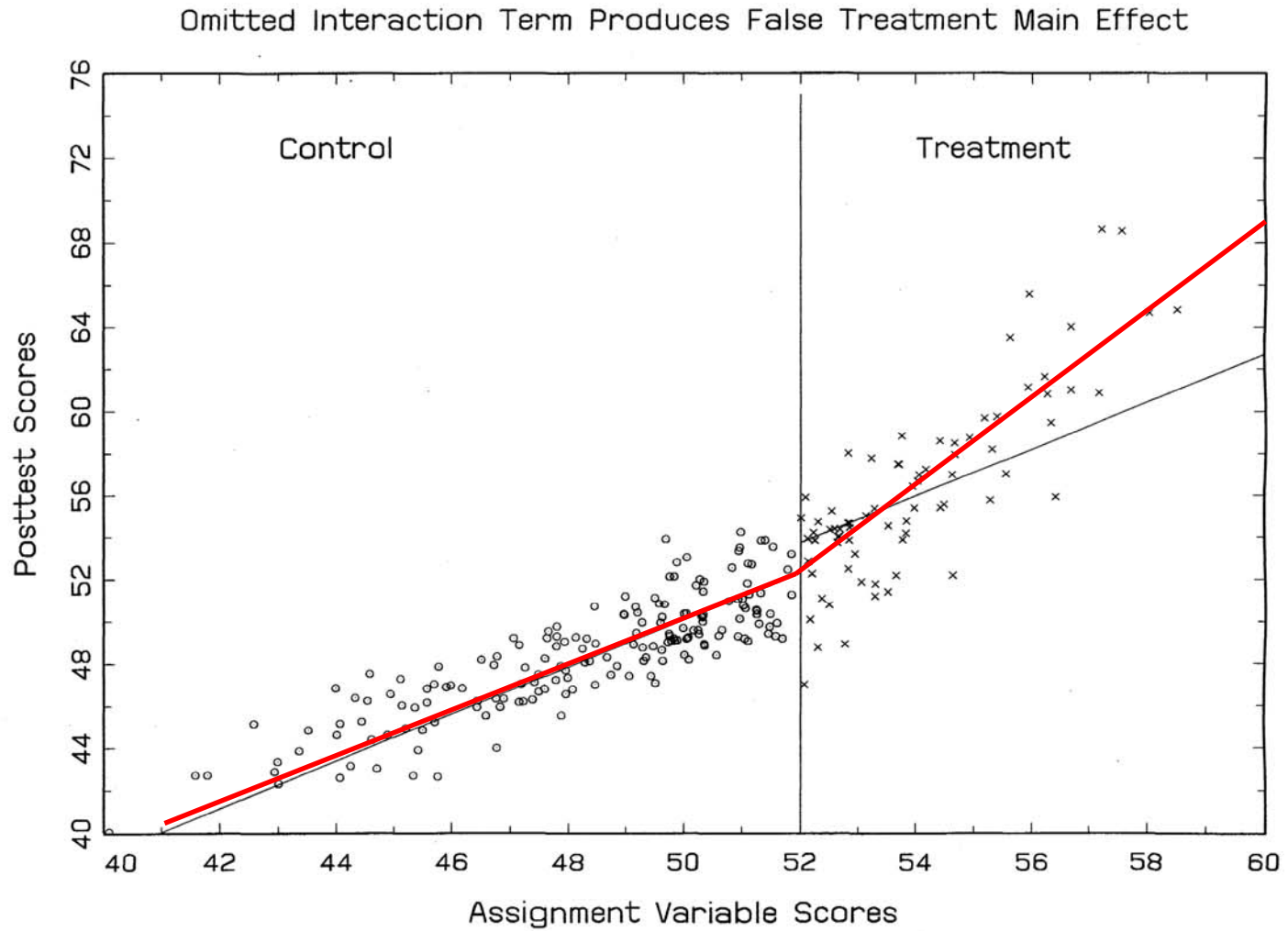
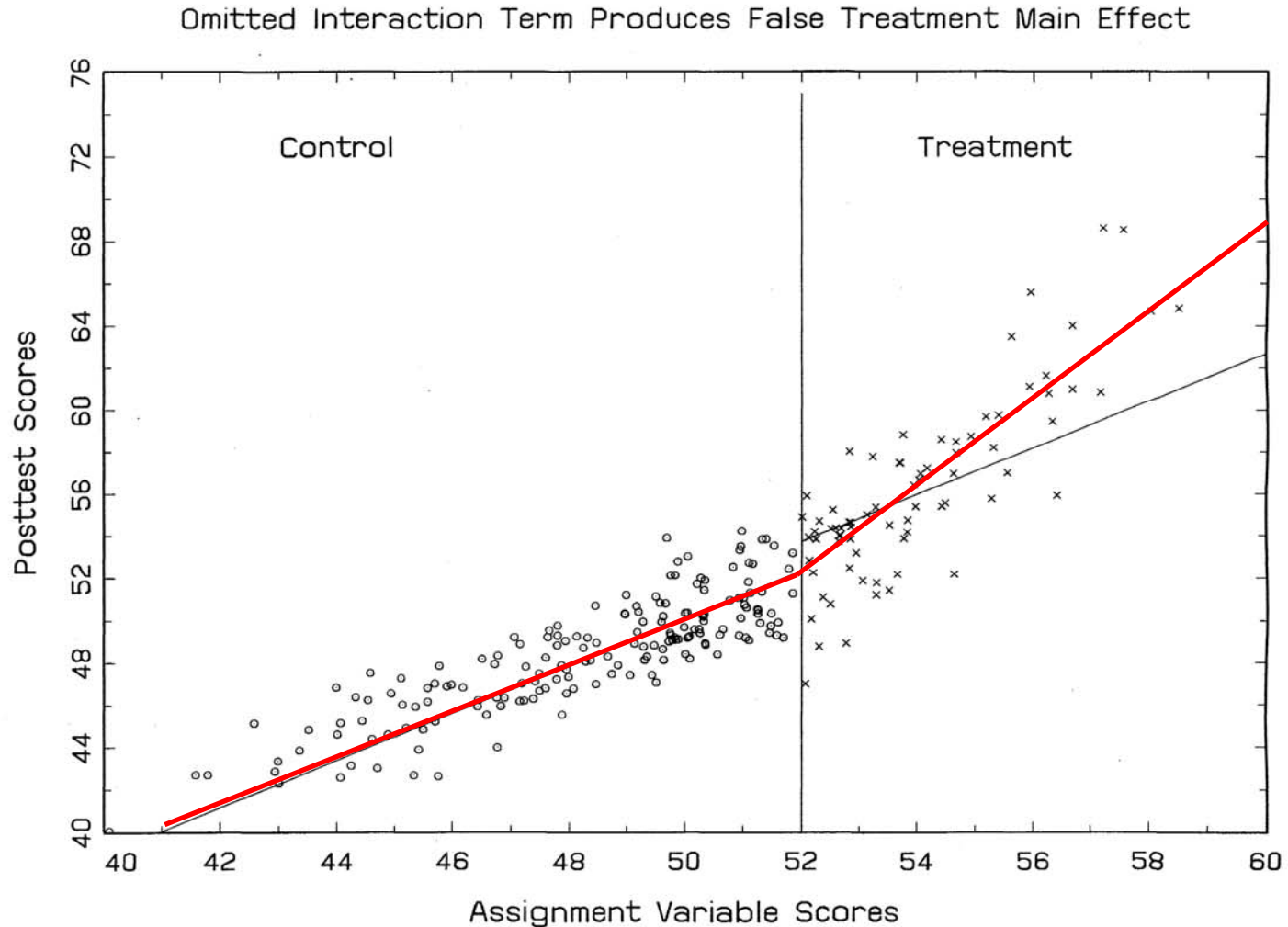
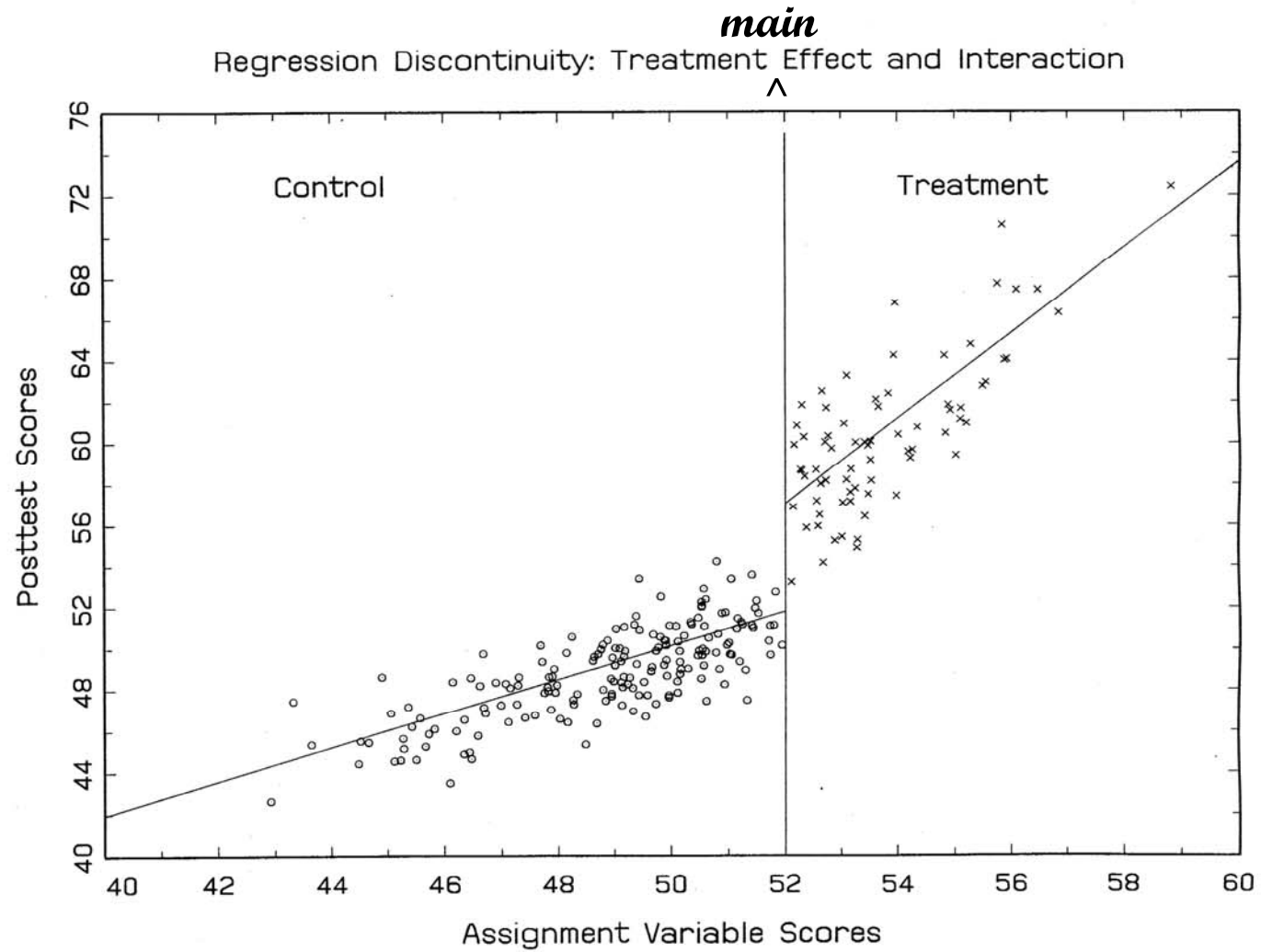

Fig 7-10

The interpretation of this example is important to understand. The title of the graph says “false treatment *main effect*”. However, the treatment did have an *interaction effect*: Treatment helped children with higher scores on the assignment variable more than children with lower scores on the assignment variable...



Here we see an example where the treatment had both a main effect and an interaction effect, correctly modeled.



How to Detect Nonlinearities

- Visual Inspection of relationship between assignment and outcome prior to treatment (e.g., if archival data is used).
- Visual Inspection of the Graph
- Computer Programs (e.g, Cook and Weisberg)
- Analysis: Overfitting the model (more on this later).

Analysis of RDD

- The basic analysis is a simple Analysis of Covariance (ANCOVA) with the assignment variable as the covariate:

$$Y_i = \hat{\beta}_0 + \hat{\beta}_1 Z_i + \hat{\beta}_2 (X_i - X_c) + e_i$$

- Where
 - Y is the outcome
 - $\hat{\beta}_0$ is the intercept
 - Z is the treatment dummy variable (1,0)
 - X is the assignment variable
 - X_c is the cutoff (to estimate the effects of treatment at the cutoff)
 - $\hat{\beta}_2$ predicts outcome from assignment
 - $\hat{\beta}_1$ is the estimate of treatment effect
 - e is a random error term

Analysis of RDD: Kind of Outcome

- If the outcome variable is continuous, then an ordinary regression equation can be used.
- If the outcome is dichotomous (e.g., pass-fail), then use a logistic regression, but the equation is the same (see Berk and Rauma, 1983)

Adding Nonlinear Terms to the Model

- Include nonlinear functions of the assignment variable in the equation, for example:

$$Y_i = \hat{\beta}_0 + \hat{\beta}_1 Z_i + \hat{\beta}_2 (X_i - X_c) + \hat{\beta}_3 (X_i - X_c)^2 + e_i$$

- There are many such nonlinear functions, so selecting the correct one is crucial

Adding Interaction Terms to the Model

- One can also add interactions between treatment assignment (Z) and the assignment variable (X), for example:

$$Y_i = \hat{\beta}_0 + \hat{\beta}_1 Z_i + \hat{\beta}_2 (X_i - X_c) + \hat{\beta}_3 Z_i (X_i - X_c) + e_i$$

Adding Nonlinear and Interaction Terms to the Model

- And one can add both nonlinear and interaction terms to the model:

$$Y_i = \hat{\beta}_0 + \hat{\beta}_1 Z_i + \hat{\beta}_2 (X_i - X_c) + \hat{\beta}_3 (X_i - X_c)^2 + \hat{\beta}_4 Z_i (X_i - X_c) + \hat{\beta}_5 Z_i (X_i - X_c)^2 + e_i$$

- As you can imagine, the model can get quite large.
- Though it may seem complex, all this can easily be done in SPSS, and all the relevant terms can easily be defined with simple SPSS Compute statements.

How Do You Know Which Terms to Add?

- If you did a pretest run of the design (before treatment was begun), use that data to model the baseline functional form.
- Visually inspect the data for clues about what form seems likely.
- Use available programs for curve fitting in order to explore possible functional forms (e.g., Cook & Weisberg, 1994)

Adding Terms, Continued

- When in doubt, start by overfitting the model:
 - Add more polynomial and interaction terms than you think are needed, and then eliminate the nonsignificant ones (from higher order to lower order).
 - When in doubt, keep terms in the equation; such overfitting will yield unbiased estimates, but will reduce power the more nonsignificant terms are kept.

Adding Terms, Continued

- Sensitivity Analyses: Do substantive conclusions vary with different assumptions about which terms to add?
- If sample size is large, split the sample in half randomly:
 - Develop the model on one half
 - Cross-validate the model on the other half.

State Pre-K Example

- Pre-K available by birth date cutoff in 38 states, here scaled as 0 (zero)
- 5 chosen for study and summed here
- How does pre-K affect PPVT (vocabulary) and print awareness (pre-reading)

Issues in RDD analysis

1. Incorrect specification of functional form
 2. Misallocation of treatment
 3. Inadequate statistical power
 4. Limited generalization of effects
- Use state pre-K evaluation to demonstrate methods for addressing interpretative threats.

Issue 1: Misspecification of Functional Form

Issue 1: Misspecification of Functional Form

- Correct specification of the regression line of assignment on outcome variable
- Best case scenario – regression line is linear and parallel (NJ Math)

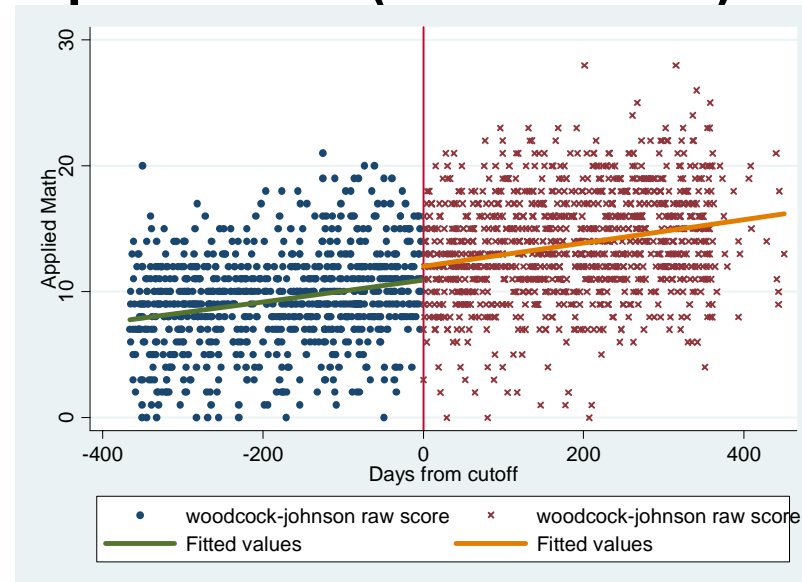

Issue 1: Misspecification of Functional Form

- Sometimes, form is less clear
Example: Oklahoma Print Awareness

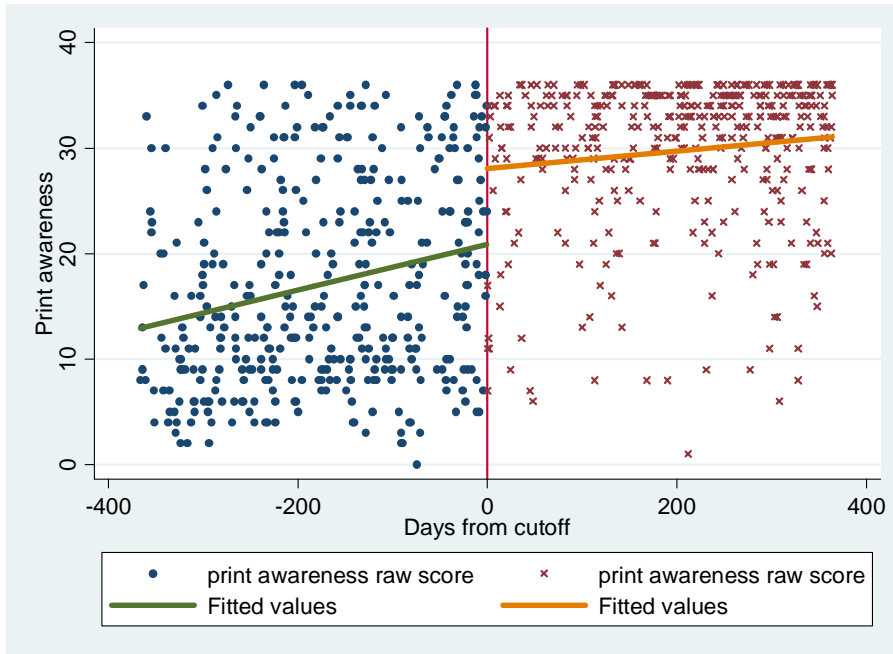

Linear plot

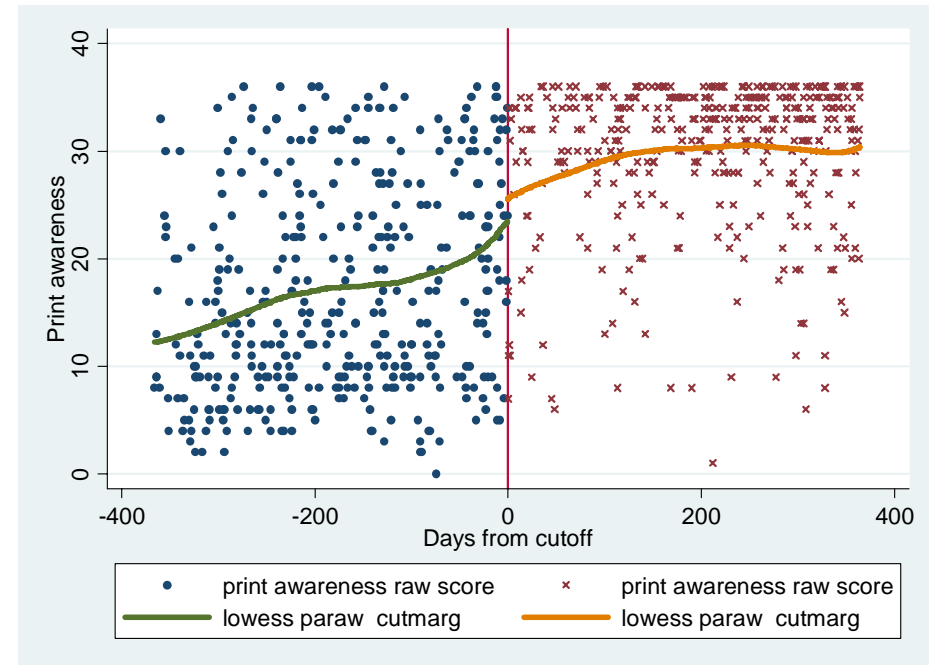

Lowess plot

Issue 1: What to do (1)

- Graphical approaches

Graphical analysis (New Jersey PPVT)

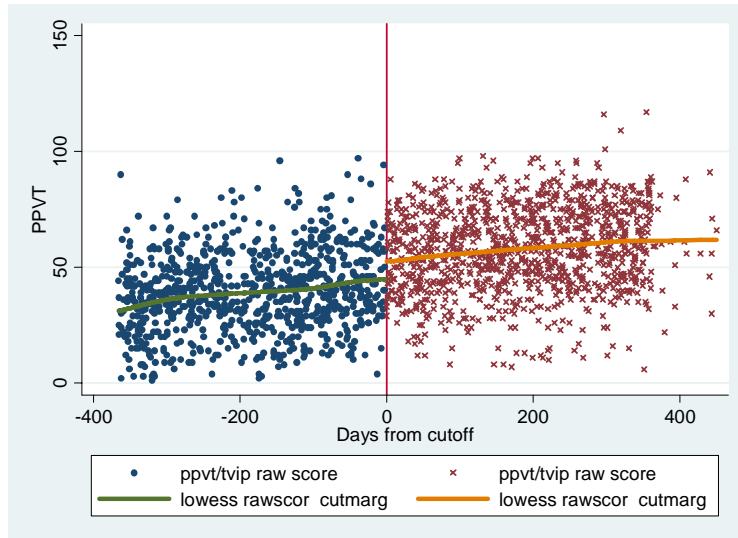

Lowess

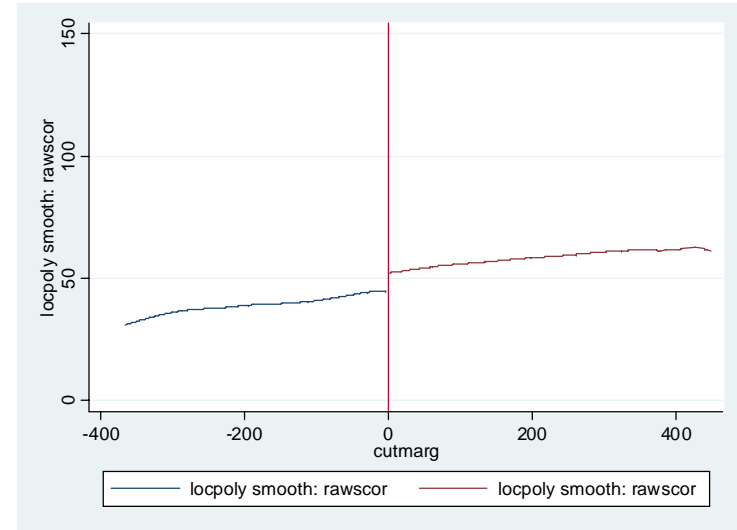

Local Linear Regression (LLN)

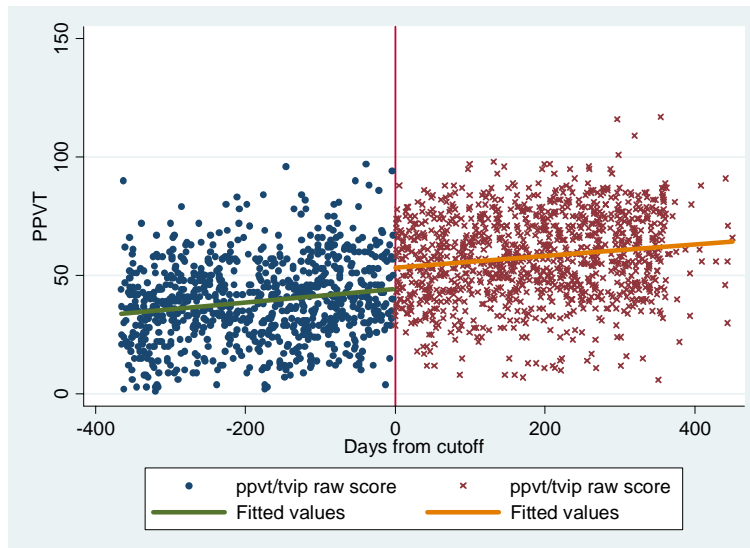

Regression

Issue 1: What to do (2)

- Parametric approaches
 - Alternate specifications and samples
 - Include interactions and higher order terms
 - Linear, quadratic, & cubic models
 - Look for statistical significance for higher order terms
 - When functional form is ambiguous, overfit the model (Sween 1971; Trochim 1980)
 - Truncate sample to observations closer to cutoff
 - Bias versus efficiency tradeoff

Issue 1: What to do (3)

- Non-parametric approaches
 - What are non-parametric approaches?
 - Eliminates functional form assumptions
 - Performs a series of regressions within an interval, weighing observations closer to the boundary
 - Use local linear regression because it performs better at the boundaries
 - What depends on selecting correct bandwidth?
 - Key tradeoff in NP estimates: bias vs precision
 - How do you select appropriate bandwidth?
 - Ocular/sensitivity tests
 - Cross-validation methods
 - » “Leave-one-out” method

Issue 1: What to do (4)

- State-of-art is imperfect
- So we test for robustness and present multiple estimates

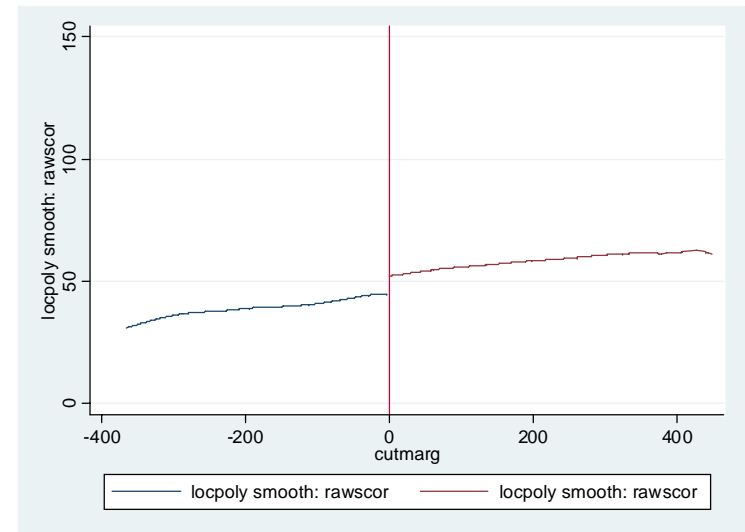

NJ PPVT LLR Plot

	Parametric estimates				Non-Parametric estimates	
	Linear	Quadratic	Cubic	6 months	30 BW	40 BW
	(1)	(2)	(3)	(4)	(5)	(6)
New Jersey PPVT	5.71* (1.44)	5.37* (2.02)	5.26 (2.72)	4.98* (1.93)	8.09* (3.86)	7.96* (2.64)

Issue 1: What to do (4)

- Another example
- Where function appears to be cubic

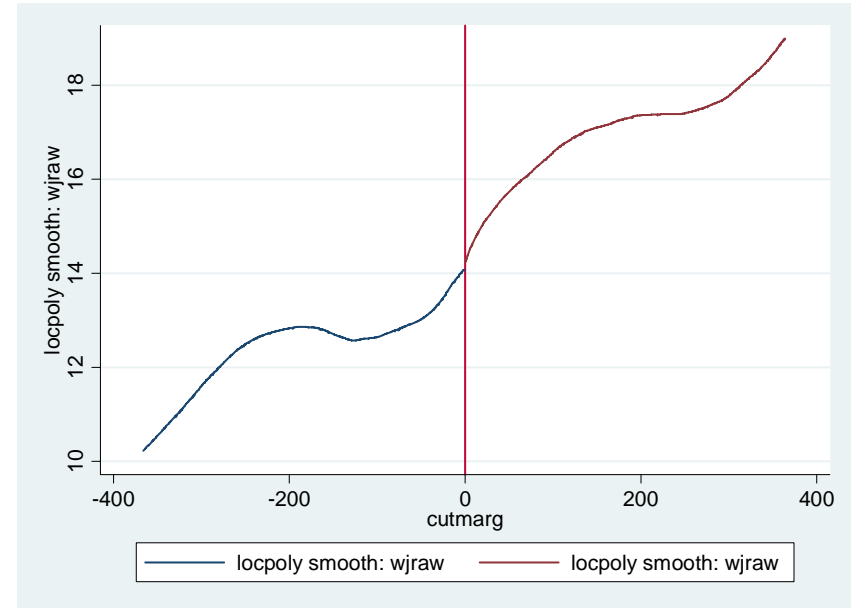

	Parametric estimates				Non-Parametric estimates
	Linear	Quadratic	Cubic	6 months	40 BW
Oklahoma Print Awareness	21.01* (3.52)	15.55* (4.84)	9.25 (6.91)	.465 (9.70)	4.78 (9.91)

Issue 1: What to do (5)

- Move to a tie breaker experiment, with both RD and random assignment around cutoff

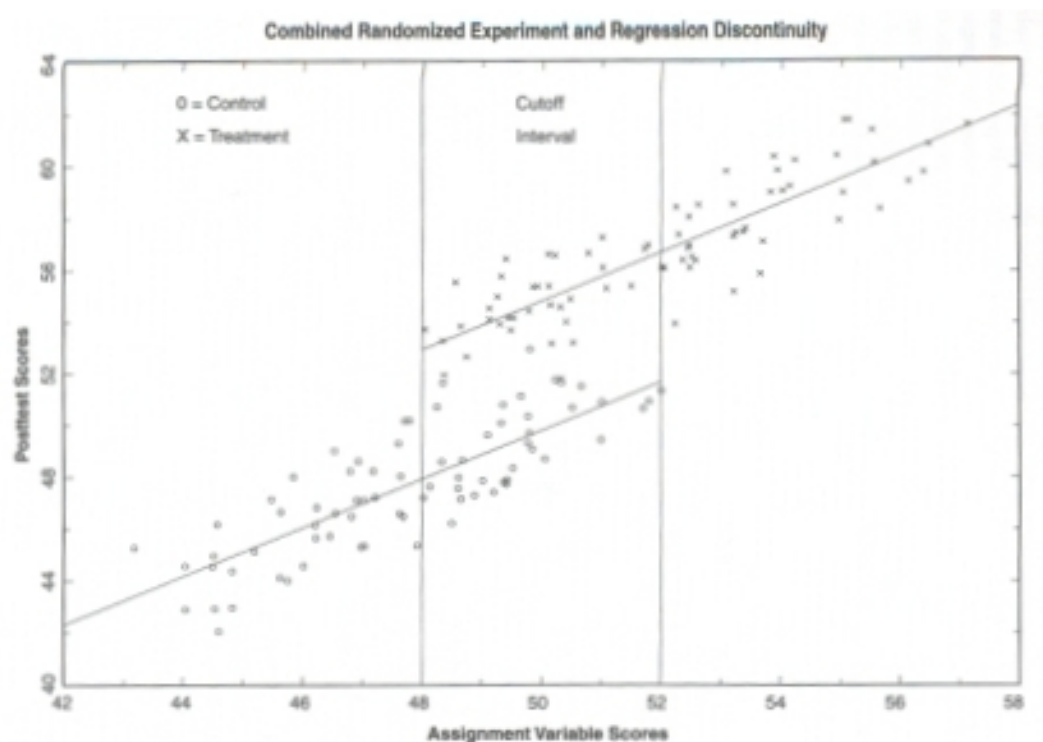
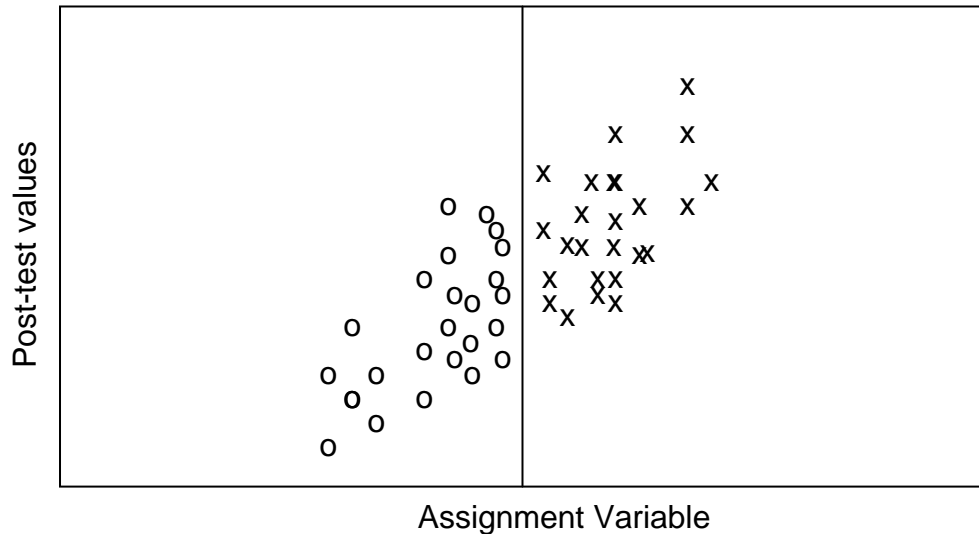

FIGURE 7.13 Combined randomized experiment and regression discontinuity.

Issue 1: What to do (6)

- Sample as densely as possible around the cutoff and curtail at the tails



Issue 1: What to do (7)

- Estimation through design
 - Cohort Comparison: becomes an almost independent estimate of the counterfactual functional form of the missing treatment group

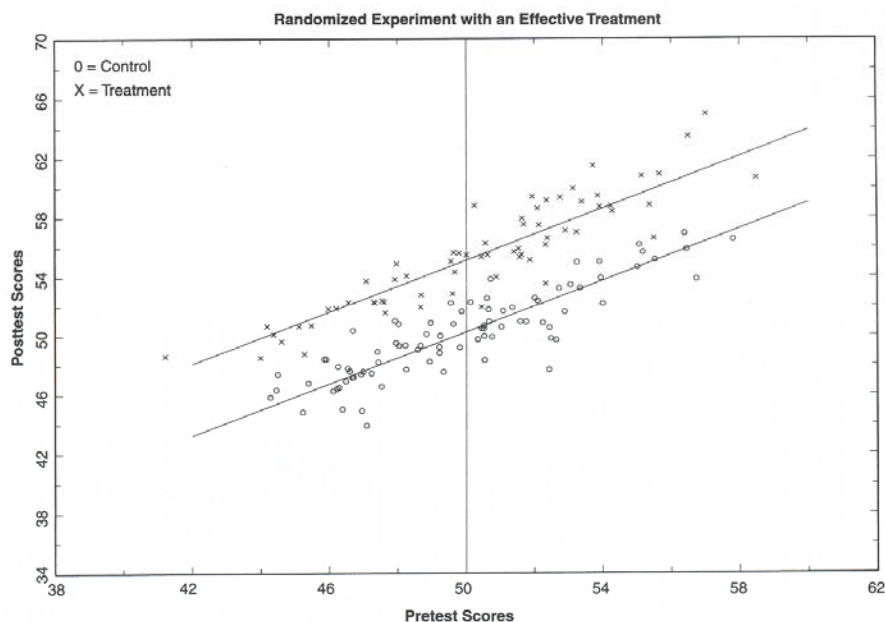

- Other design RDD features: pretests, nonequivalent dependent variable

Issue 1: Misspecification of functional form

- Summary of What to Do
 - Graphical analyses
 - Alternative specification and sample choices in parametric models
 - Non-parametric estimates at the cutoff
 - Present multiple estimates to check for robustness
 - Move to tie-breaker experiment around the cutoff
 - Sample densely at the cutoff
 - Use pretest measures

Issue 1: Misspecification of functional form

- We recommend:
 - Include tie-breaker experiment near the cutoff
 - Add pretest if you can
 - Sample densely around the cutoff
 - Provide estimates for alternative specifications and samples
 - Pray for parallel and linear relationships

Issue 2: Misallocation of Treatment

Issue 2: Misallocation of Treatment

- Misallocation occurs when assignment rule fails to induce all participants into proper treatment condition

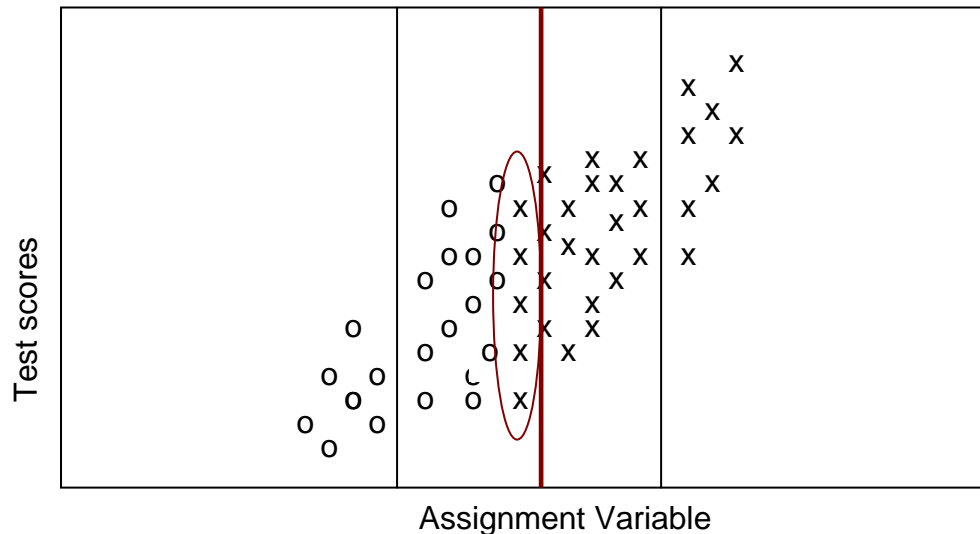

- Professional practice in assignment--note same thing can happen in experiments

Example: The Irish School Leavers Examination

- An exam is given to determine who continues in school and who leaves, the decision being made using a cutoff
- The exam is graded by graders who are aware of the cutoff and the consequences.
- Graders showed a marked reluctance to assign exam scores just below the cutoff point:

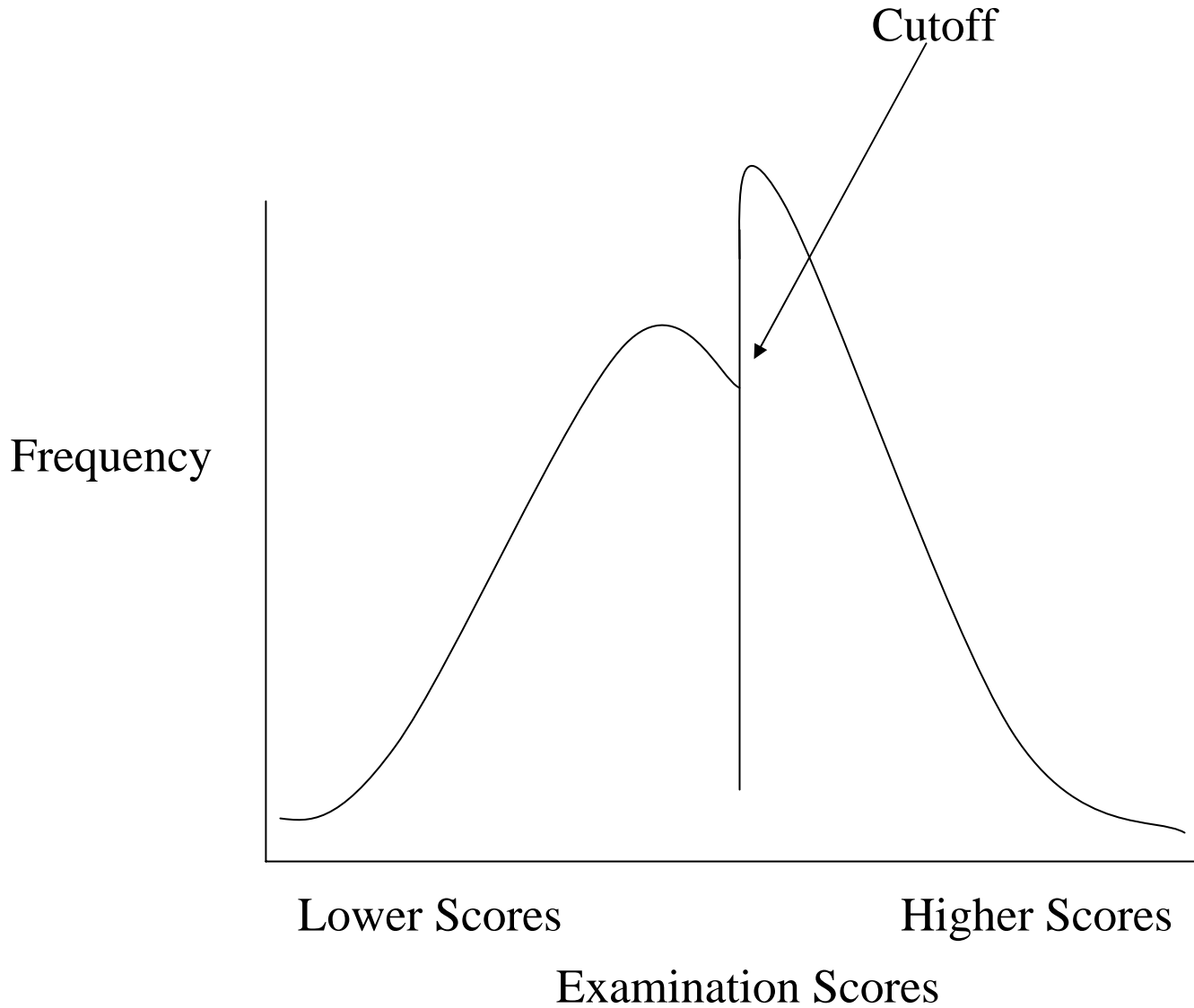

We would expect that examination scores would be normally distributed, but due to grader reluctance to assign scores just below the cutoff, the distribution is not normal. This can lead to nonlinearities between assignment and outcome.

Issue 2: What to do? (1)

- Observe misallocation in the data

States	Fuzzy cases
Michigan	2%
New Jersey	4%
Oklahoma	4%
South Carolina	1%
West Virginia	8%

Issue 2: What to do (2)

- Alternate samples
 - Full sample estimates
 - Restricted sample estimates (omit suspect cases and observe sensitivity of estimates)

Issue 2: What to do (3)

- RDD as an instrumental variable
 - Provides causal estimates if instrument is correlated with treatment and not with errors in the outcome.
 - Proof: Hahn, Todd, and van der Klaauw, 2001
 - Examples: Angrist & Lavy, 1999; Jacob and Lefgren, 2004a, 2004b; van der Klaauw, 2002

Issue 2: What to do

- Multiple estimations

		Full sample	Restricted sample	Instrumental Variable
	% Fuzzy	(8)	(9)	(11)
Michigan PPVT	2%	-2.20 (3.64)	-1.91 (4.15)	-2.75 (4.53)
West Virginia PPVT	8%	2.75 (2.23)	3.66 (2.39)	2.42 (1.94)
Michigan Print Awareness	2%	25.21* (3.48)	24.98* (3.58)	22.14* (3.11)
West Virginia Print Awareness	8%	22.25* (3.59)	24.49* (3.50)	20.15* (2.98)

Summary of Analytic Plan for Handling Assumptions 1 and 2

Parametric approaches (1)

	Function al form	Parametric models in		
		Linea r	analyses Quad	Cubi c
	(1)	(2)	(3)	(4)
PPVT	Quad	0.33 (2.49)	-1.91 (4.15)	-3.18 (5.62)
Student covariates		Yes	Yes	Yes
Fuzzy cases		No	No	No

Analytic plan: Parametric approaches (2)

	Function al form	Parametric models used in analysis			
		Linear	Quad	Cubic	6 mnt h s
	(1)	(2)	(3)	(4)	(5)
PPVT	Quad	0.33 (2.49)	-1.91 (4.15)	-3.18 (5.62)	-3.74 (6.10)
Student covariates		Yes	Yes	Yes	Yes
Fuzzy cases		No	No	No	No

Analytic plan: Non-parametric approaches

	Function al form	Parametric models used in analysis				Non- parametric estimates by bandwidth	
		Linear	Quad	Cubic	6 mnths	50 BW	75 BW
		(1)	(2)	(3)	(4)	(5)	(6)
PPVT	Quad	0.33 (2.49)	-1.91 (4.15)	-3.18 (5.62)	-3.74 (6.10)	-4.99 (4.40)	-1.66 (3.91)
Student covariates		Yes	Yes	Yes	Yes	No	No
Fuzzy cases		No	No	No	No	No	No

Analytic plan: Misallocation (1)

	Function al form	Parametric models used in analysis				Non-parametric estimates by bandwidth		OLS estimates	
		Linear	Quad	Cubic	6 mnths	50 BW	75 BW	Full (ITT)	Restri cted (TOT)
	(1)	(2)	(3)	(4)	(5)	(6)	(7)	(8)	(9)
PPVT	Quad	0.33 (2.49)	-1.91 (4.15)	-3.18 (5.62)	-3.74 (6.10)	-4.99 (4.40)	-1.66 (3.91)	-2.20 (3.64)	-1.91 (4.15)
Student covariates		Yes	Yes	Yes	Yes	No	No	Yes	Yes
Fuzzy cases		No	No	No	No	No	No	Yes	No

Analytic plan: Misallocation (2)

	Function al form	Parametric models used in analysis				Non-parametric estimates by bandwidth		OLS estimates by		IV estimates with and without covariates	
		Linear	Quad	Cubic	6 mnths	50 BW	75 BW	Full sampl e (ITT)	Restri cted sampl e (TOT)	IV 1 (TOT)	IV 2 (TOT)
	(1)	(2)	(3)	(4)	(5)	(6)	(7)	(8)	(9)	(10)	(11)
PPVT	Quad	0.33 (2.49)	-1.91 (4.15)	-3.18 (5.62)	-3.74 (6.10)	-4.99 (4.40)	-1.66 (3.91)	-2.20 (3.64)	-1.91 (4.15)	-1.51 (4.88)	-2.75 (4.53)
Student covariates		Yes	Yes	Yes	Yes	No	No	Yes	Yes	No	Yes
Fuzzy cases		No	No	No	No	No	No	Yes	No	Yes	Yes

Analytic Plan: Outcomes

	Functiona l form	Parametric models used in analysis				Non-parametric estimates by bandwidth		OLS estimates		IV estimates with and without covariates	
		Linear	Quad	Cubic	6 mnths	50 BW	75 BW	Full sampl e (ITT)	Restric ted sample (TOT)	IV 1 (TOT)	IV 2 (TOT)
	(1)	(2)	(3)	(4)	(5)	(6)	(7)	(8)	(9)	(10)	(11)
PPVT	Quad	0.33 (2.49)	-1.91 (4.15)	-3.18 (5.62)	-3.74 (6.10)	-4.99 (4.40)	-1.66 (3.91)	-2.20 (3.64)	-1.91 (4.15)	-1.51 (4.88)	-2.75 (4.53)
Math	Linear	2.03* (0.56)	2.25* (0.90)	2.47 (1.29)	1.91* (0.87)	2.99* (0.86)	2.35* (1.02)	2.07* (0.55)	2.03* (0.56)	1.87* (0.51)	1.82* (0.48)
Print awareness	Linear	24.98* (3.58)	21.58* (5.68)	21.75 (7.77)	21.79* (5.58)	19.31* (5.993)	22.19* (5.155)	25.21* (3.483)	24.98* (3.578)	22.23* (3.185)	22.14* (3.105)
Student covariates		Yes	Yes	Yes	Yes	No	No	Yes	Yes	No	Yes
Fuzzy cases		No	No	No	No	No	No	Yes	No	Yes	Yes

Analytic Plan: Final estimates

	Functional form	Parametric models used in analysis				Non-parametric estimates by bandwidth		OLS estimates		IV estimates with and without covariates	
		Linear	Quad	Cubic	6 mnths	50 BW	75 BW	Full sample (ITT)	Restricted sample (TOT)	IV 1 (TOT)	IV 2 (TOT)
	(1)	(2)	(3)	(4)	(5)	(6)	(7)	(8)	(9)	(10)	(11)
PPVT	Quad	0.33 (2.49)	-1.91 (4.15)	-3.18 (5.62)	-3.74 (6.10)	-4.99 (4.40)	-1.66 (3.91)	-2.20 (3.64)	-1.91 (4.15)	-1.51 (4.88)	-2.75 (4.53)
Math	Linear	2.03* (0.56)	2.25* (0.90)	2.47 (1.29)	1.91* (0.87)	2.99* (0.86)	2.35* (1.02)	2.07* (0.55)	2.03* (0.56)	1.87* (0.51)	1.82* (0.48)
Print awareness	Linear	24.98* (3.58)	21.58* (5.68)	21.75 (7.77)	21.79* (5.58)	19.31* (5.993)	22.19* (5.155)	25.21* (3.483)	24.98* (3.578)	22.23* (3.185)	22.14* (3.105)
Student covariates		Yes	Yes	Yes	Yes	No	No	Yes	Yes	No	Yes
Fuzzy cases		No	No	No	No	No	No	Yes	No	Yes	Yes

Issue 3: Inadequate statistical power

Issue 3: Inadequate statistical power

- Need adequate power for estimating regression line on both sides of the cutoff
 - RCTs more efficient than RDD by a factor of about 2.73 (Goldberger 1972b)

Issue 3: Inadequate statistical power

- Intuition

- In a randomized experiment, with treatment effect

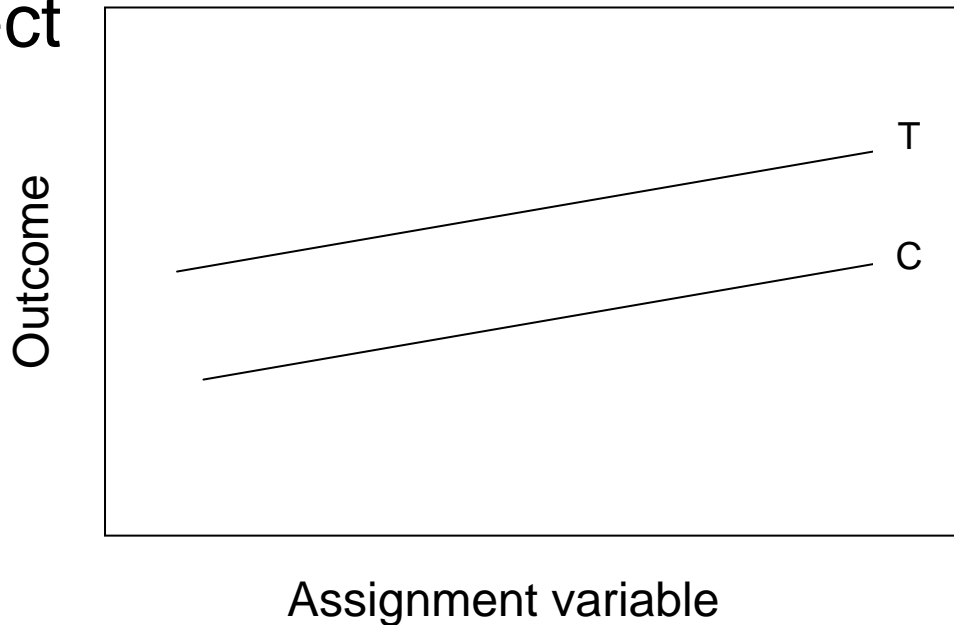

Issue 3: Inadequate statistical power

- Intuition

- In RDD, use cutoff for allocating treatment

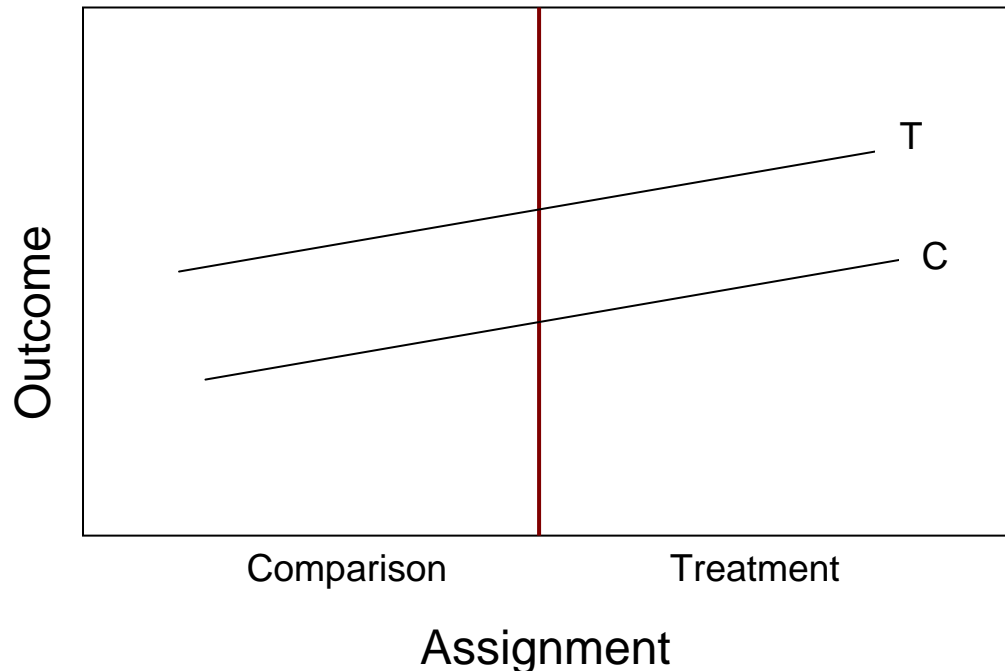

Issue 3: Inadequate statistical power

- Intuition

- But you don't observe some observations in RDD

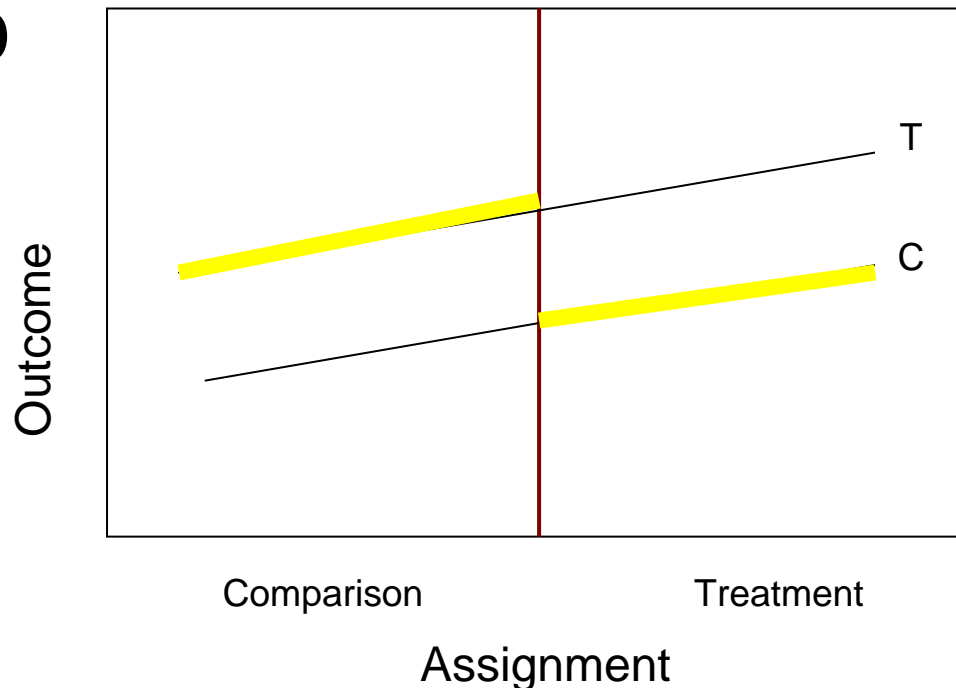

Issue 3: Inadequate statistical power

- Intuition
 - So you have reduced power in RDD because you have fewer observations

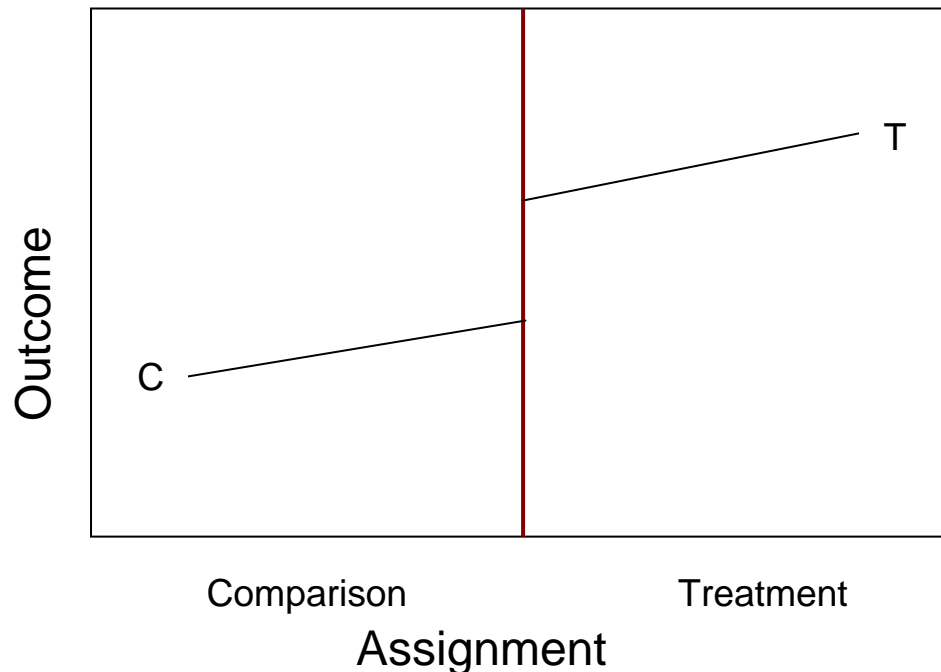

Issue 3: Inadequate statistical power

- Special issue for gifted learners: cutoff tends to be at the end of distribution

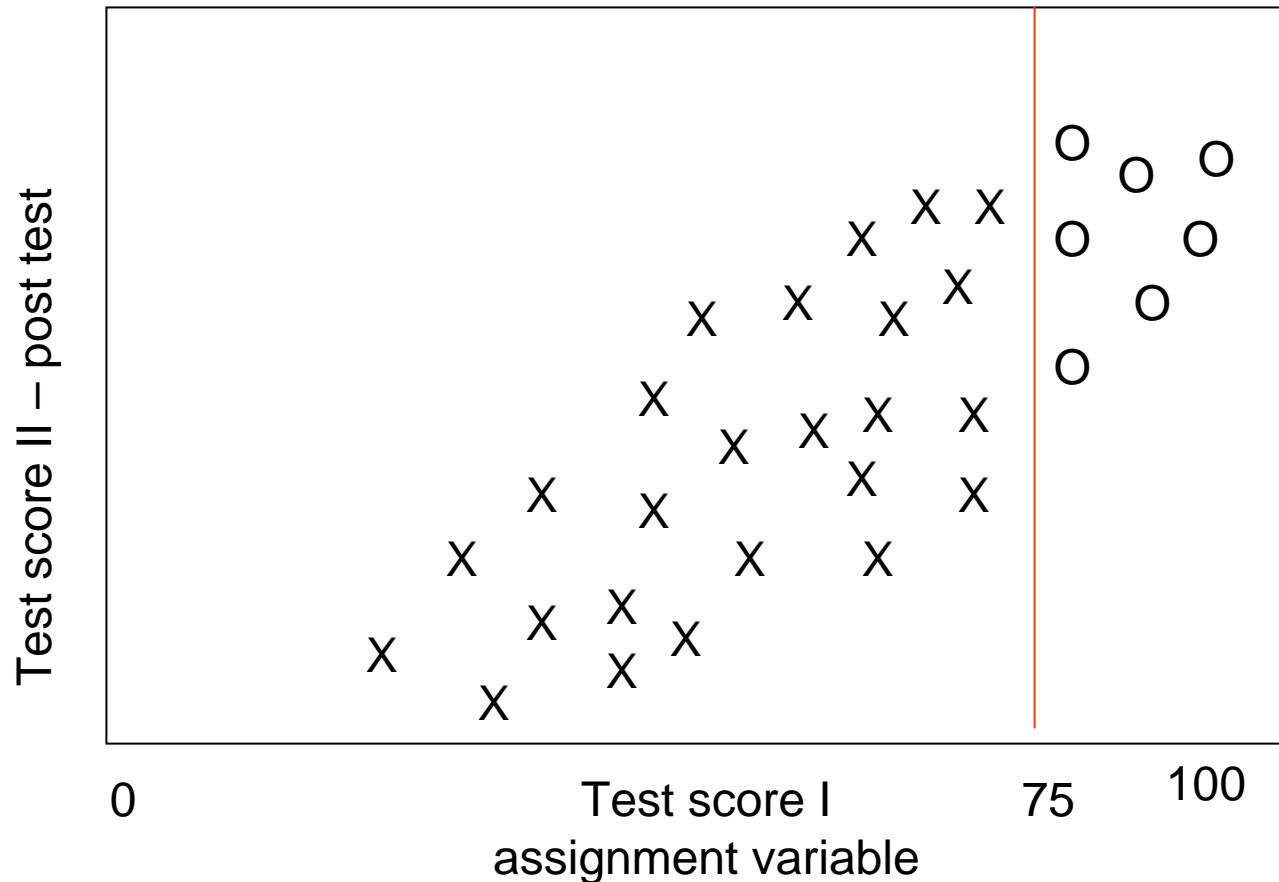

Issue 3: What to do (1)

- Place cutoff at the center of the *achieved sample*

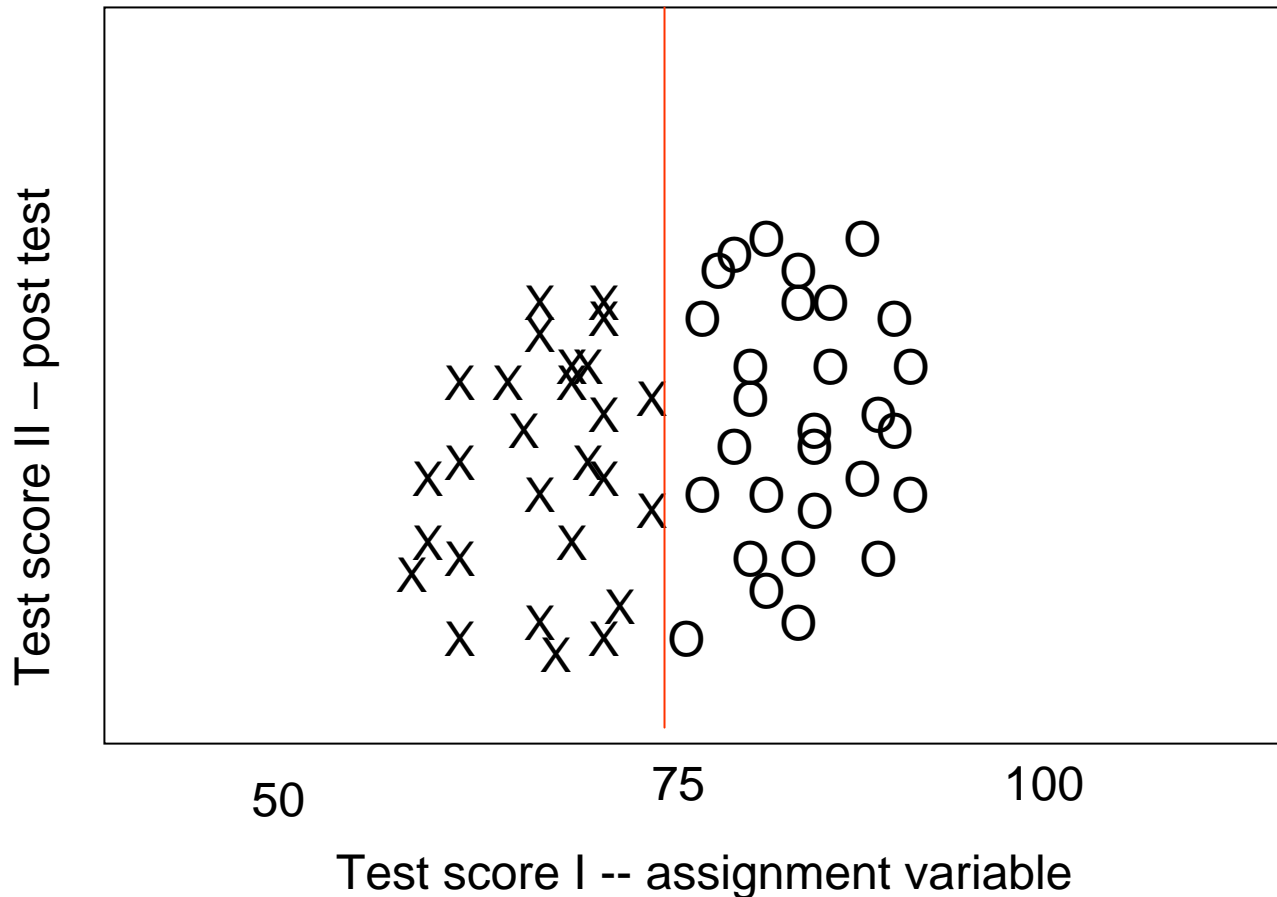

Issue 3: What to do (2)

- Add more cases near the cutoff

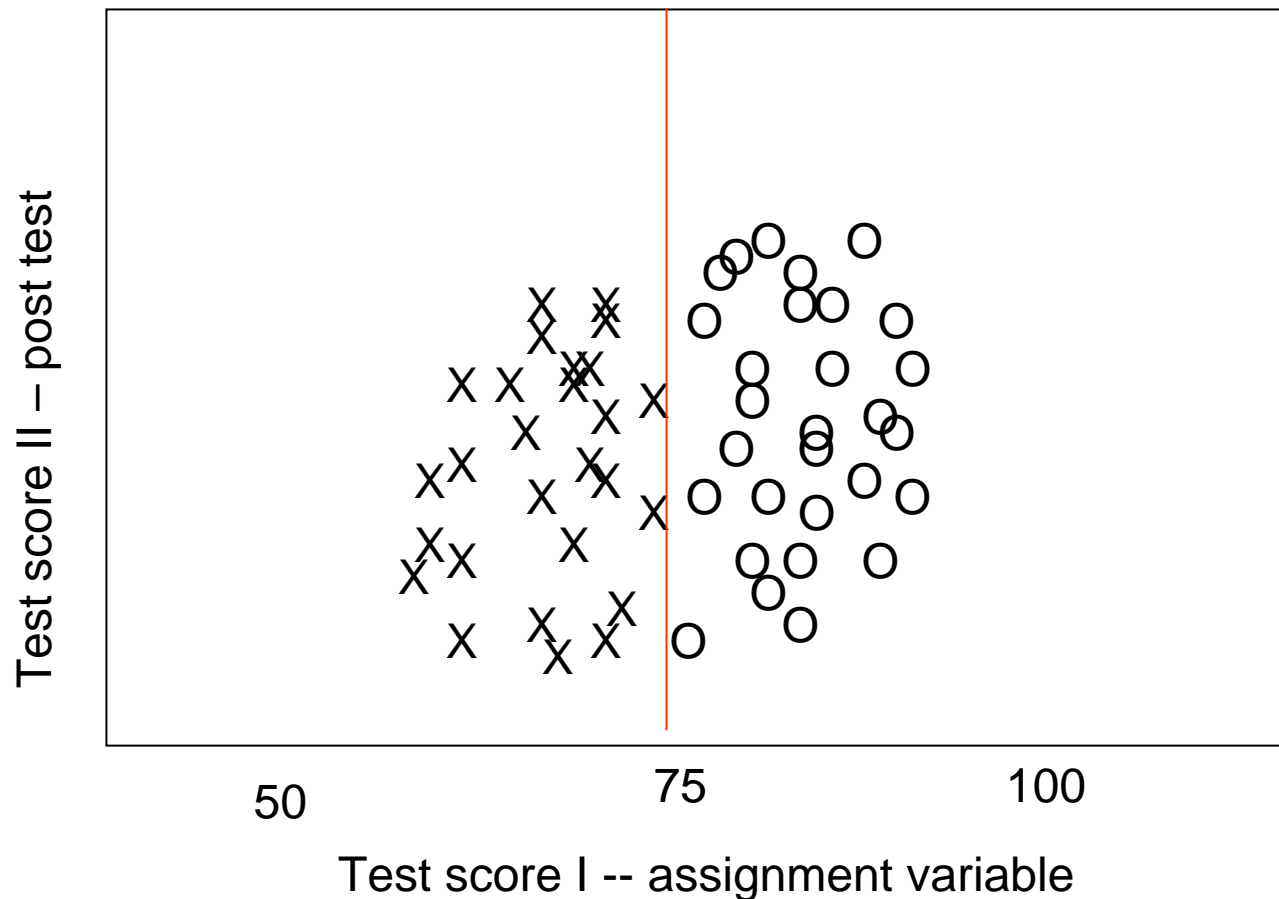

Issue 3: What do (3)

- Use design elements to add power
 - Pretest observations
 - Random assignment at cutoff

Issue 4: Limited Generalization

Issue 4: Limited Generalization

- 3 Issues
 - What do achieved samples of persons, settings, times, treatments, causes and effects “represent”?
 - How can the causal knowledge achieved in study be extrapolated to people, settings, times and variants of the cause and effect different from those sampled?
 - How to generalize beyond the local average treatment effect?

Issue 4: Limited Generalization

Parallel and linear relationships are best for generalization

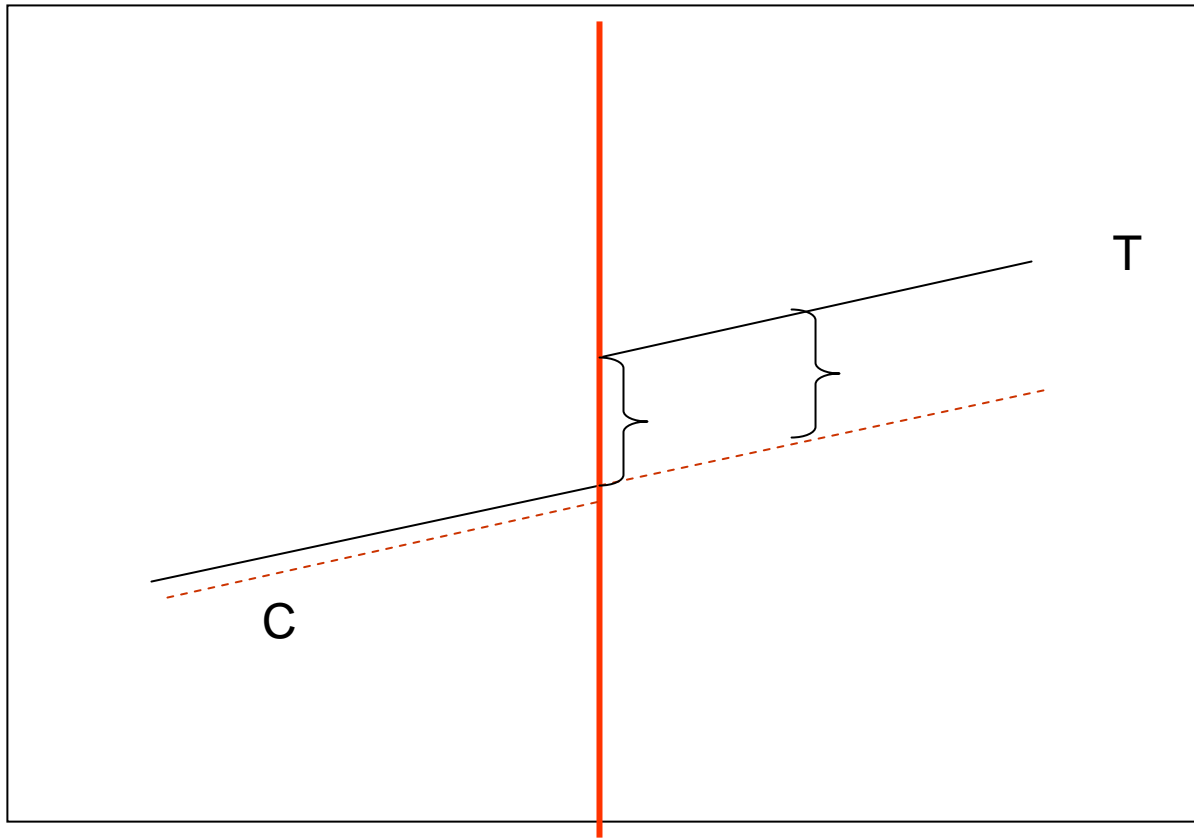

Issue 4: Limited Generalization

Better if there is a pretest ...

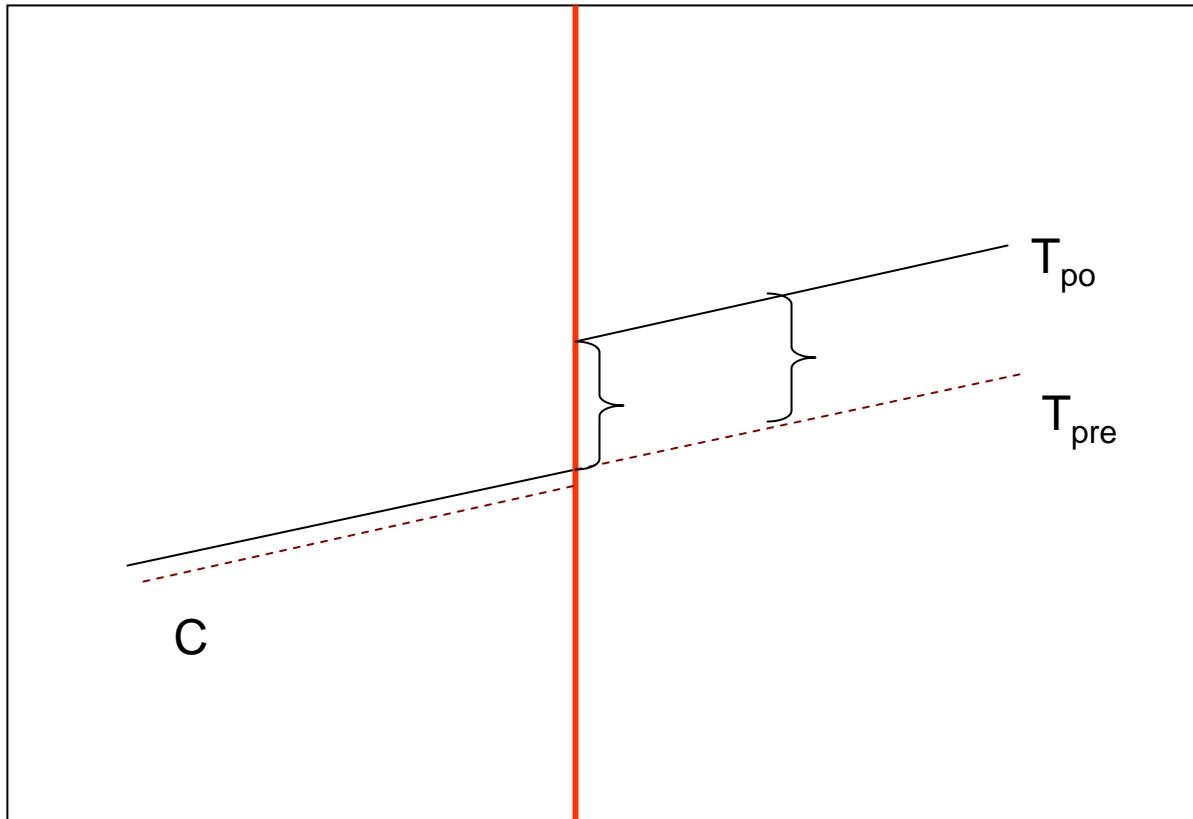

Issue 4: Limited Generalization

If functional form was *known*, we could also generalize...

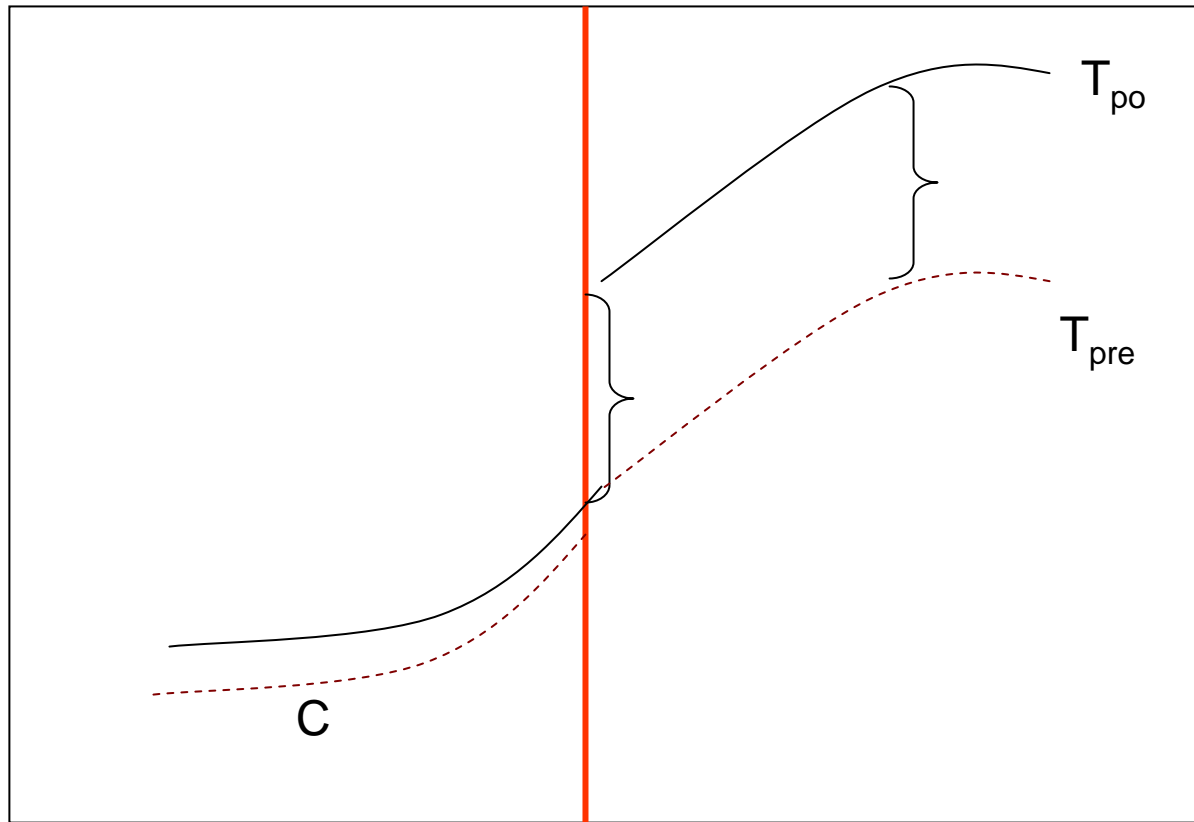

Issue 4: Limited Generalization

A pretest would also really help here ...

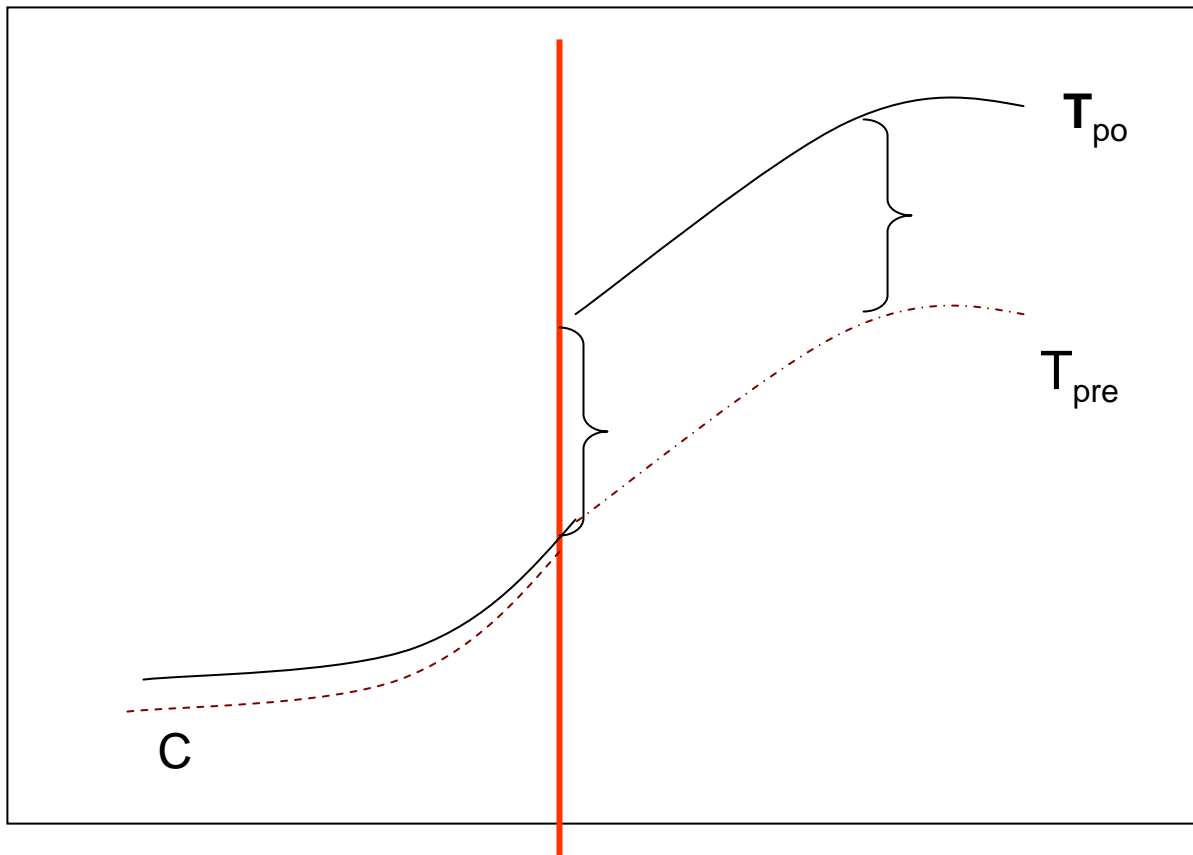

Issue 4: Limited Generalization

Harder if there is uncertainty about functional form

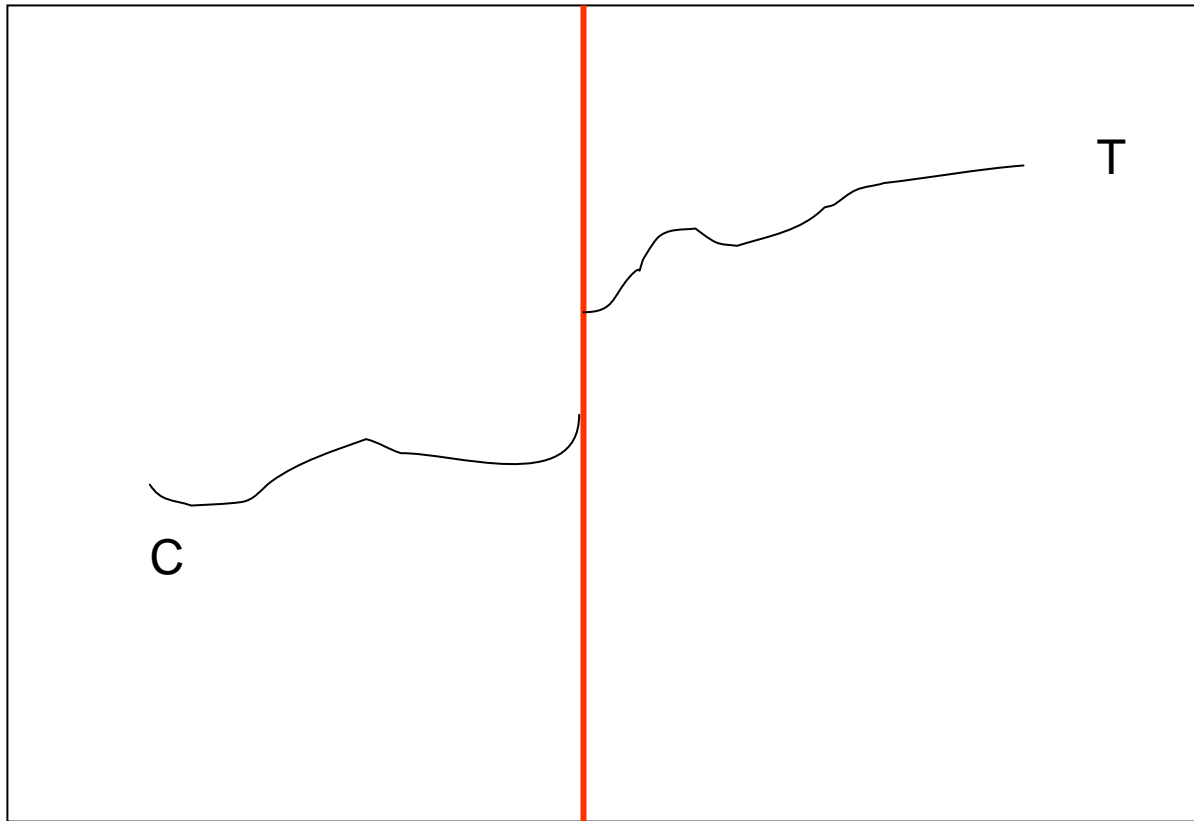

Issue 4: Limited Generalization

Harder if there is uncertainty about functional form \rightarrow Only local average treatment effect is estimated

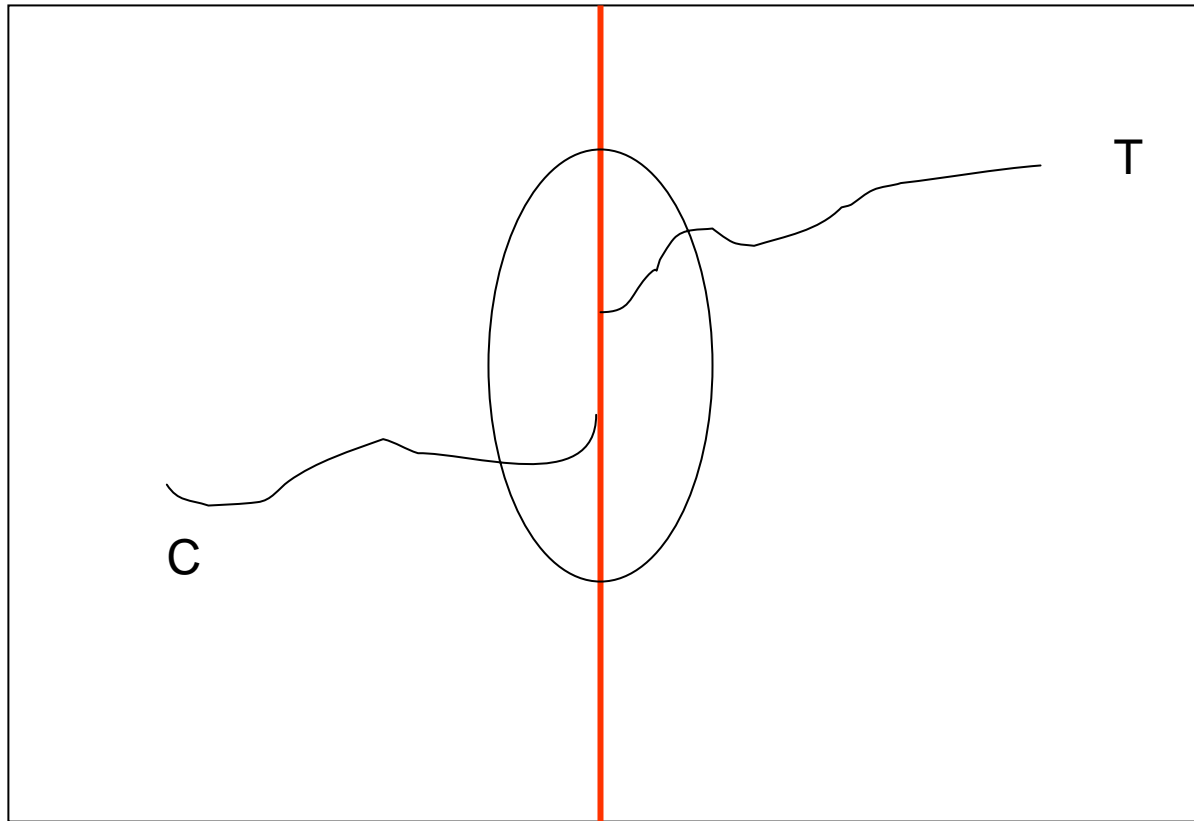

Issue 4: What to do (1)

1) Use multiple cutoffs, and recenter to unique cutoff

Cutoff dates for state pre-K programs

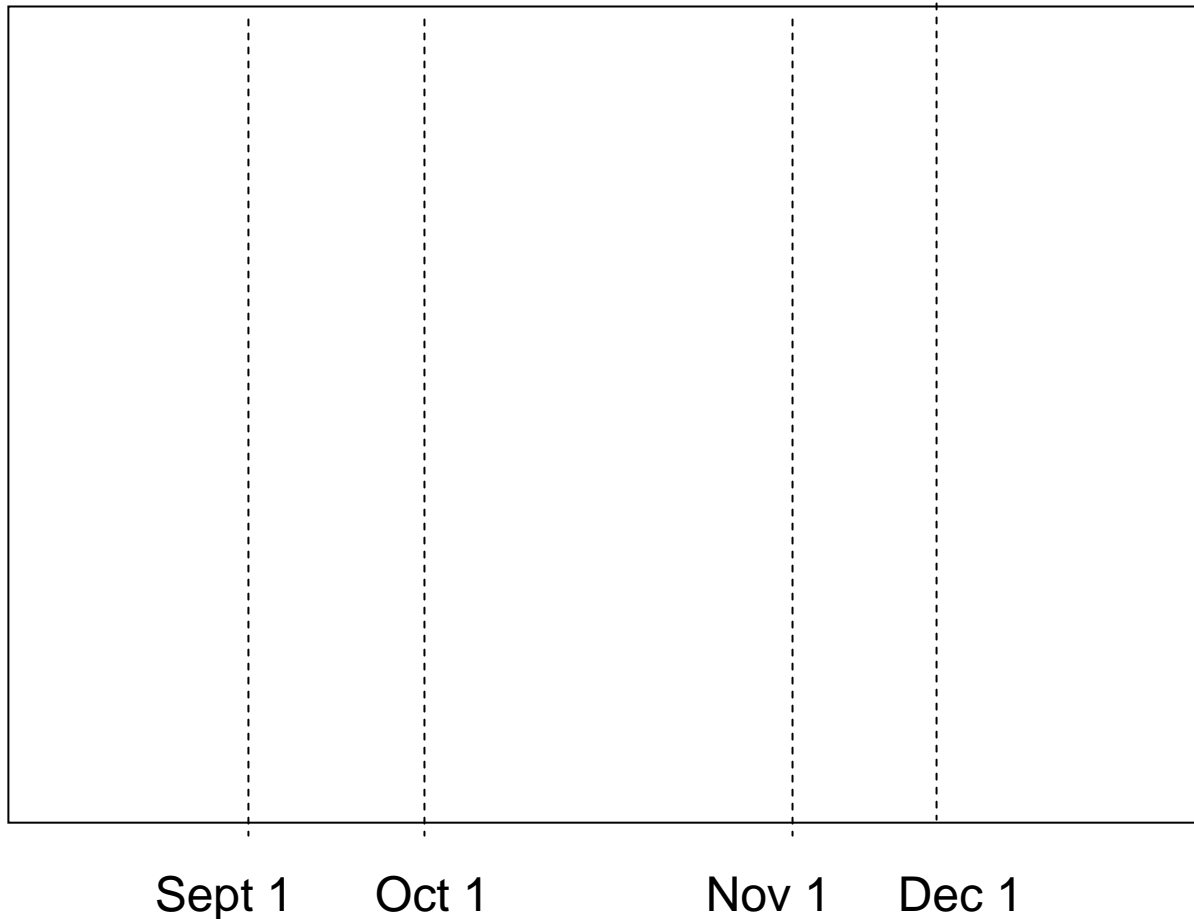

Issue 4: What to do (1)

1) Use multiple cutoffs, and recenter to unique cutoff

Cutoff dates for state pre-K programs

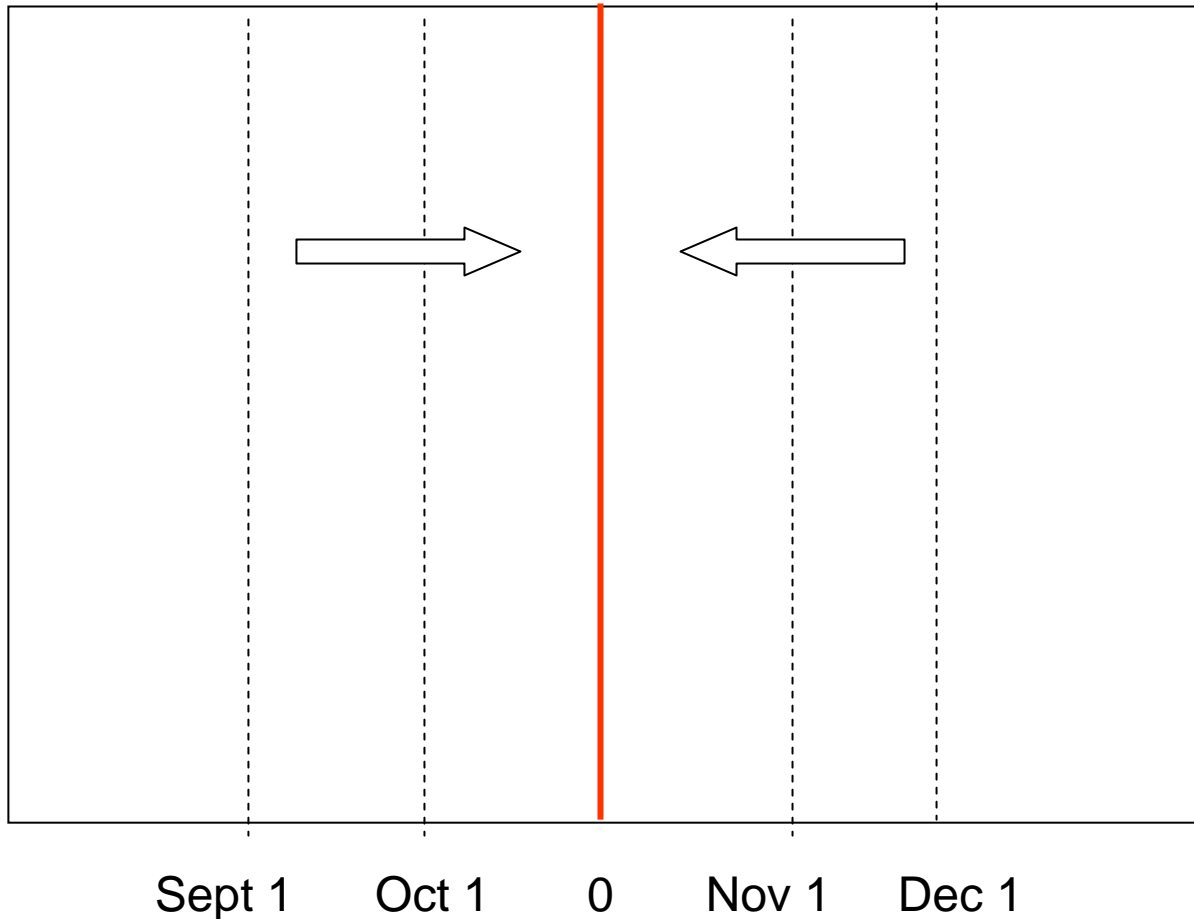

Issue 4: What to do (2)

2) Use multiple assignment variables, and multiple cutoffs

Multiple assignment variables for Reading First RDD

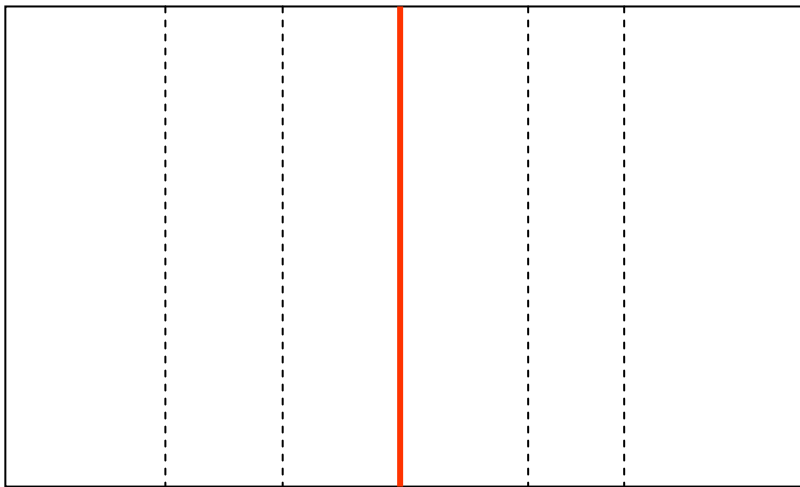

Assign v: % receiving free lunch

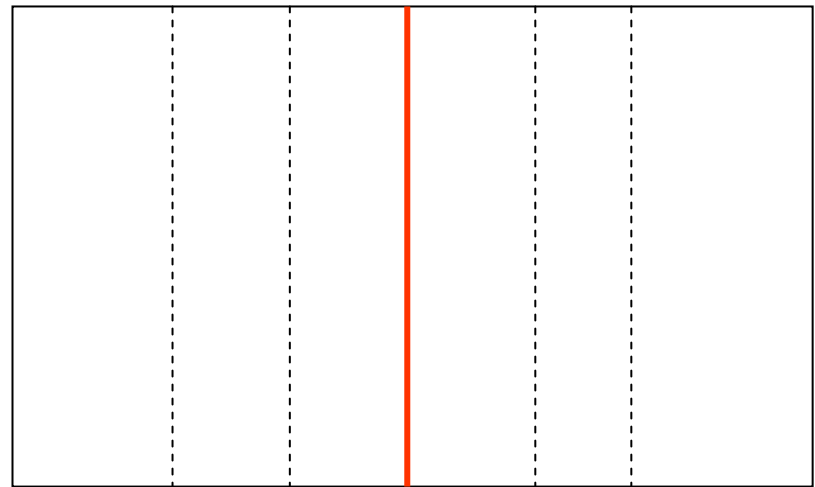

Assign v: test score performance

Issue 4: What to do

- Benefits
 - Improve generalization across the distribution of the assignment variable
 - Improve generalization across multiple assignment variables
 - Improve generalization across heterogeneous samples

State of the art today for using non-parametric statistics in RD

- NP procedures in RD are dominant in economics
- Some empirical and theoretical justification for choosing local linear smoother
- Key issue for NP estimates in RD → choosing appropriate bandwidth, esp when observations are sparse around cutoff
 - Ocular/sensitivity tests
 - Cross-validation methods
- Need multiple estimates and a lot of judgment!

Opportunities to Use RDD More Often (Will Shadish)

- Anytime treatment is assigned by cutoff, RDD can be used
- Cutoff based assignment occurs often in education
 - Assignment to special education
 - Assignment to remedial training
 - Assignment to a meritorious award (Dean's list)
- So the key is to keep your eyes open for cutoff-based assignment opportunities
 - that are naturally occurring in the world, or
 - that would be acceptable to administrators or teachers who might be reluctant to consider random assignment

Exclusion Criteria as Cutoffs

- Anytime inclusion/exclusion criteria are used for admitting participants to a randomized or nonrandomized experiment, RDD can be added to that design to increase power.
- For example, suppose you are implementing a program to reduce weight among obese children in a school
 - You use a cutoff on body mass index (BMI) as an inclusion criterion.
 - Instead of discarding those below the BMI cutoff, continue to measure their outcomes, too. They are then “control group” subjects.
 - Graphically:

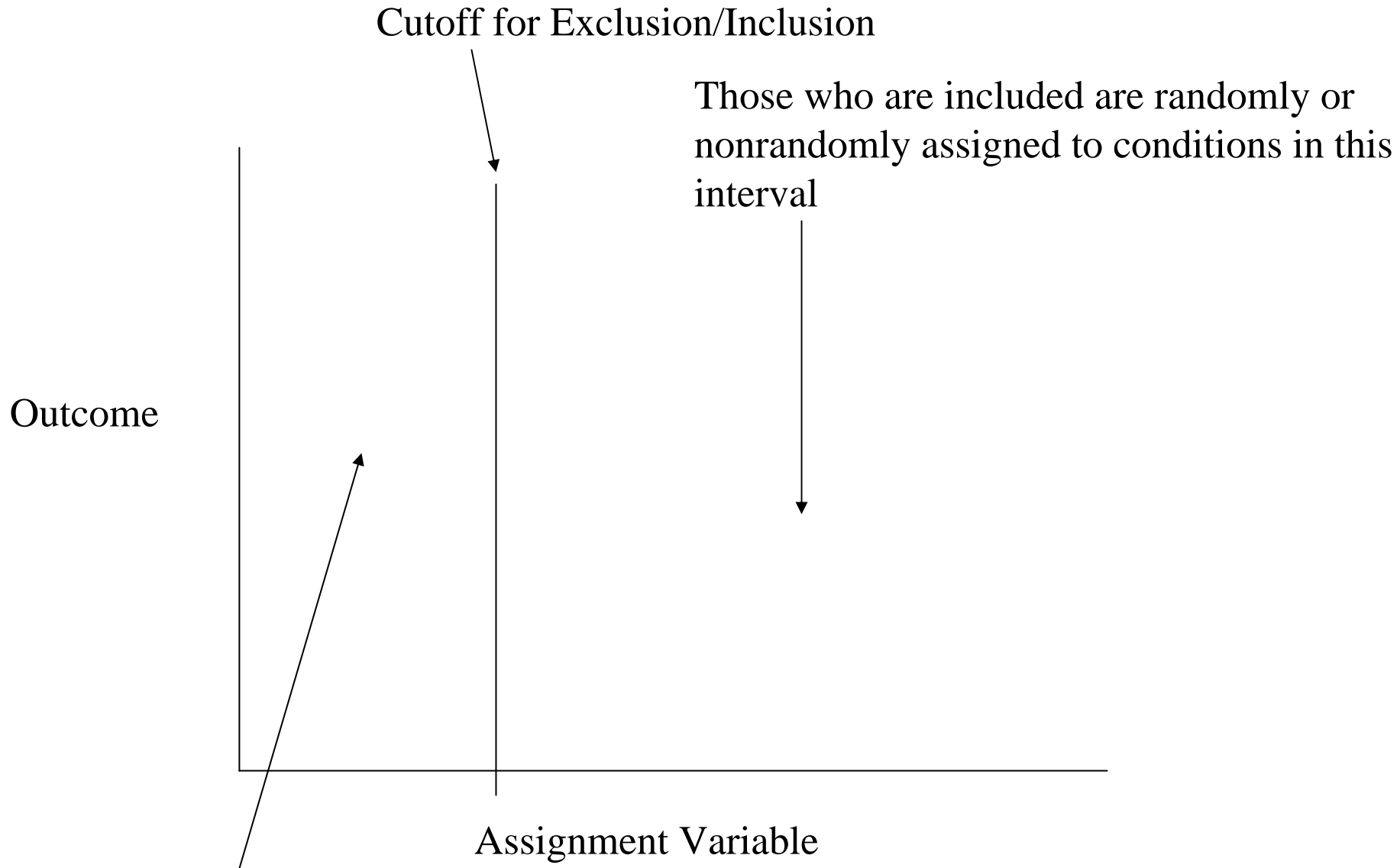

In this interval, instead of discarding those who were not eligible, continue to measure their outcome, yielding a regression discontinuity design

Booster Studies

- In a randomized or nonrandomized experiment
 - Identify a cutoff on the outcome variable below which you would say the person was not successfully treated.
 - Give those below the cutoff a booster treatment.
 - The result is an RD design
- Especially useful when the evaluator has been called in after the program has been implemented, and everyone has been given the program.
 - Propose a booster for the worst performers
 - Turns a very poor study into an RD

Advantages

- With randomized designs:
 - Keeping those you would have discarded increases the power of the study
 - And it may help you model functional form because you have a greater range on the assignment variable
- With nonrandomized designs:
 - One may be able to improve the internal validity of the nonrandomized experiment, though this is not fully clear.

More on Combining RDD with RE or QE

- If you can randomly assign in the interval, the design is more powerful, and you can do just one analysis that includes everyone.
- Sometimes it is more acceptable to allow nonrandom assignment within that interval
 - Self-Selection into the Interval
 - Administrator or Teacher Discretion to Assign Students in the Interval
- If you allow nonrandom assignment in the interval
 - It is best to exclude those in the interval (or do it both ways)
 - The larger the interval, the worse the RDD estimate will be

Empirical Validation of RD (Tom Cook)

- Aiken, West et al.
- Buddelmeyer & Skoufias
- Black, Galdo & Smith
- Why Buddelmeyer was lucky & Black et al. careful
- Why experiments are still to be preferred: fewer and more transparent assumptions, greater power and more credibility

Beyond the Basic RD Design

Pretest RD function - Jacob & Lefgren/Lohr

Comparison RD function - Reichardt

Non-Equivalent Outcome function - Trochim

Replicated Treatment RD Design - Campbell

Trickle Down Design - Black, Galdo & Smith