



# CHAPTER 11

## Beneficiation – Comminution

Sponsored by:

**Lycopodium**

# SPONSOR PROFILE



Through pioneering the introduction of modern process plants and associated technologies to remote and logistically challenging locations, Lycopodium Minerals Pty Ltd has developed a successful track record in developing and commissioning major resource projects worldwide.

Since its establishment in 1992, Lycopodium has become a leading international engineering and project management consultancy, with an enviable reputation for providing technically innovative and cost-effective engineering solutions. They are focused on the evaluation and development of projects in the fields of minerals processing, materials handling and infrastructure.

Lycopodium Minerals has undertaken studies and projects across a broad range of commodities including gold (free, gravity, refractory, preg robbing), base metals (concentrators, hydrometallurgy), iron ore, uranium, rare earths and industrial minerals. Their resume of projects reflects diversity in not only commodity, but client background, technology, scale of operation and geographical location, having completed work in Australia, Africa, Asia and Europe.

Over the past 20 years, Lycopodium's commitment to consistently delivering to client expectations has helped foster strong working relationships and ongoing repeat assignments with their international client base.

Lycopodium believes its success is a function of the success of its clients' projects and is focused on always leaving a positive legacy in respect to the environment, safety and community in which they work.

Contact Lycopodium for assistance in any of the following areas:

## Projects

- Project management
- feasibility study management
- estimating, planning and scheduling

- project controls and reporting
- contract management
- procurement and logistics management
- inspection and expediting
- quality assurance/quality control
- financial evaluations
- client representation.

## Engineering

- Conceptual through to detailed design
- across all disciplines: earthworks, civil
- structural, mechanical, piping
- electrical, instrumentation, control
- systems, automation and infrastructure.

## Process

- Metallurgical test work design
- management and interpretation
- process selection
- process modelling
- simulations and mass balancing
- design specification
- flow sheet development
- plant audits
- debottlenecking evaluations.

## Construction

- Construction management
- HSEC and IR management
- social risk management
- shutdown planning and management
- precommissioning and testing
- commissioning
- operations ramp-up
- optimisation.

# CHAPTER CONTENTS

---

Introduction	218
How to use this chapter	218
Recent cost movements	218
A short history	219
Early times	219
Current technology	219
Circuit considerations	219
Typical comminution calculations	220
Classical Bond approach	220
SMCC approach	220
JKSimMet approach	222
Test work methods and other approaches	222
Cost analysis and optimisation – mine to mill	225
Fragmentation	226
Higher energy blasting	228
Finer fragmentation	228
Example of process integration and optimisation	228
Primary crushing circuits	229
Equipment selection	229
Types of primary crushers	230
Equipment costs	232
Circuit capital costs	232
Secondary and tertiary crushing circuits	232
Application	232
Equipment selection and circuit simulation	233
Chamber selection	233
Determining capacity	233
Wear compensation	233
Crushing plant process design	234
Equipment costs	236
Circuit capital costs	236
High-pressure grinding roll-based circuits	237
Technology motivators	237
Application guidelines	237
Processing considerations	238
Equipment selection	238

Equipment costs	239
Circuit capital costs	240
Vibrating screens	240
Screen operating principles	240
Screen selection – wet and dry	241
‘C’ factor	242
‘M’ factor	242
‘K’ factor	242
‘Q’ factor	243
Screen selection – size	243
Screen costs	247
Semi-autogenous and autogenous milling	247
Mill selection	247
Drive selection	249
Equipment costs	251
Circuit capital costs	251
Rod and ball milling circuits	252
Equipment costs	253
Hydrocyclone classification	253
Closed-circuit grinding applications	253
Sizing and selection	253
Capital costs	254
Operating costs	254
Pebble crushing	254
Crushing duty	254
Crusher selection	254
Equipment costs	254
Fine and ultra-fine milling circuits	255
Stirred mills	255
Ball mills	256
Stockpiles and reclaim systems	256
Equipment procurement	257
Operating costs	257
Cost estimate methodology	257
Scope of estimate	257
Power	258
Consumables	258
Contributors	258
References	258
Further reading	260

# CONTRIBUTORS

---

First edition text by: R Dudgeon, R D Trinder, G W Lockwood, M Noakes, G B Siddall and P Bailly

Revised and updated by:

**Greg Lane** FAusIMM, Chief Technical Officer, Ausenco [Introduction; Typical comminution calculations; Primary crushing circuits; Secondary and tertiary crushing circuits; High-pressure grinding rolls based circuits; Semi-autogenous and autogenous milling; Pebble crushing; Operating costs]

**Chris Bailey** MAusIMM, JKTech [Typical comminution calculations]

**Katie Barns**, Xstrata Technologies [Fine and ultra-fine milling circuits]

**Adrian Dance** FAusIMM, Metso Process Technologies [Cost analysis and optimisation – mine-to-mill]

**John Fleay**, Ausenco Minerals and Metals [Primary crushing circuits; Secondary and tertiary crushing circuits; Semi-autogenous and autogenous milling]

**Rajiv Kalra**, Citic [Fine and ultra-fine milling circuits]

**Sarma Kanchibotla**, Metso Minerals Australia [Cost analysis and optimisation – mine-to-mill]

**Stefan Kirsch** MAusIMM, Polysius [High-pressure grinding rolls based circuits]

**Toni Kojovic** MAusIMM, JKTech [Typical comminution calculations]

**David La Rosa** MAusIMM, Metso Process Technologies [Cost analysis and optimisation – mine-to-mill]

**Graham W Lockwood**, Metso Minerals Australia [Vibrating screens]

**David Maxton** MAusIMM, Humboldt Wedag [High-pressure grinding rolls based circuits]

**Chris Memaris**, eand Consulting [Equipment procurement]

**Chris Morley**, Ausenco Minerals and Metals [High-pressure grinding rolls based circuits]

**Stephen Morrell** MAusIMM, SMCC Pty Ltd [Typical comminution calculations]

**Joe Pease** MAusIMM, Xstrata Technologies [Fine and ultra-fine milling circuits]

**Brian Putland** MAusIMM, Orway Mineral Consultants Pty Ltd [Typical comminution calculations; Semi-autogenous and autogenous milling]

**Frank Shi**, JKTech [Typical comminution calculations]

**Bernie Siddall** FAusIMM, Orway Mineral Consultants Pty Ltd [Typical comminution calculations; Semi-autogenous and autogenous milling]

**Paul Staples**, Ausenco Minerals and Metals [Semi-autogenous and autogenous milling]

**Per Svedensten**, Sandvik [Secondary and tertiary crushing circuits; Vibrating screens]

**Roy Trinder**, Metso Minerals Australia [A short history; Primary crushing circuits; Secondary and tertiary crushing circuits; Pebble crushing]

**Walter Valery** FAusIMM, Metso Process Technologies [Cost analysis and optimisation – mine-to-mill]

**Stan Wong**, FLSmidth Krebs [Hydrocyclone classification]

Note: Many contributors to this chapter on comminution and classification are listed above. The contributions were sourced between 2007 and 2010 and the affiliation shown is that at the time of the author's contribution. There was considerable cross-fertilisation of content and substantial editing was required to summarise over 400 pages of input from the authors.

# Beneficiation – Comminution

---

## INTRODUCTION

The purpose of this chapter is to provide assistance to metallurgical and engineering practitioners who are evaluating options for comminution circuits. The information contained in this chapter is only sufficient to provide a preliminary assessment of capital and operating costs and enable an experienced practitioner to rank options at a concept or option study level of accuracy. Technical data on equipment and circuit selection are provided to assist in the development and comparison of flow sheet options.

Because many authors provided the content of this chapter, it covers a range of experienced practitioners' experiences and vendor data. This information was provided in good faith and considered accurate at the time of preparation (Q4 2010). The data are not complete and do not substitute for consultants' advice.

This chapter summarises the following aspects of comminution circuit option assessment:

- potential effects of mine operation on the operation of comminution circuits
- typical comminution circuit calculations to determine comminution power draw
- equipment selection and equipment cost data for the most common comminution unit processes
- issues associated with equipment selection
- comminution circuit capital and operating cost considerations and approximations.

### How to use this chapter

The information in this chapter pertains to either the cost of a specific item of equipment, eg a ball mill, or to the direct cost of a unit process, eg a grinding circuit. The following terms are used to define capital costs:

- equipment cost – typically the cost of equipment ex works, excluding spares, but including drives and electric equipment to the local panel
- direct cost – cost of a unit process including all disciplines such as earthworks, structural steel, buildings, platework, equipment, electric work, pipework and other labour and materials required to bring the unit process to a state ready for precommissioning
- indirect cost – cost of owners' works, engineering, procurement, construction and project management

(EPCM), including temporary facilities for the EPCM contractor

- project contingency – allowances for the level of project definition and scope definition.

Equipment costs provided by vendors were given in good faith and any comparison between vendors on the basis of the cost presented here should not be used as a basis of vendor preference or selection.

The costs of individual discipline components of a cost estimate are not defined for the concept level capital cost estimate and are not discussed in this chapter. These discipline components include the individual costs of earthworks, civils, buildings, structural steelwork, platework, instrumentation and electrics and water and power reticulation.

For the level of accuracy of the estimates calculated using the data in this chapter, the indirect costs will be about 25 to 30 per cent of direct costs and the project contingency about 15 to 30 per cent, depending on the nature of the scope of estimate.

Other matters not discussed in this chapter that should be considered in compiling a capital cost estimate include escalation, risk assessment, taxes, freight and other general matters that vary from project to project and time to time.

### Recent cost movements

Over the ten years to 2004, movements in US\$ equipment costs were reasonably well tracked by small increases in the prices' indices. In 2004, the increasing demand for commodities saw an increase in worldwide demand that sharply increased price escalation. Thus, while escalation from 1995 to 2003 typically ran at two to three per cent per annum, escalation in 2004 to 2007 increased to 15 to 20 per cent per annum. Recent changes in the international exchange rates, equipment demand-supply relationships and the advent of new suppliers have made developing relationships between 2005 and 2010 more difficult. Since the global financial crisis (GFC), equipment costs have, in some cases, dropped (returned to approximately 2006 levels). However, as demand changes it is expected that 'abnormal' escalation may occur, necessitating adjustment to the 'rules-of-thumb' presented in this chapter.

Various escalation databases are available. For example, data can be purchased from Chemical Engineering at [www.che.com](http://www.che.com).

## A SHORT HISTORY

Lynch and Rowland (2005) discuss the history of comminution. A brief outline is presented in 'Early times', and more recent developments are then discussed.

### Early times

The breaking and shaping of rock was one of the earliest human occupations. Until well into the 19th century, nearly all rock was broken laboriously by hand. Eli Whitney Blake developed the first successful jaw crusher around 1850 and the gyratory (conical) crusher followed soon after. Comparative tests, costs and experience have established the gyratory crusher as suitable for large-capacity applications and the jaw crusher for more modest primary crushing. Both types have been in use for over 100 years.

The jaw crusher was adapted from simple squeezing devices. Older methods of reducing rock were all variations of existing processes. The stamp battery drops weights to cause crushing by simulating heavy hammer blows. The much earlier *arrastra*, a mill in which heavy stones were dragged in a circular path over the ore by animal power, came from the very early method of grinding grain between two rubbing stones.

The tumbling or tube grinding mill was a 'true invention' and first appeared on the mining scene in the late-19th century. Fine grinding of ores to release minerals then became part of almost every mining flow sheet.

Crushing was, of course, necessary to provide the impact energy required for fine grinding mills to work efficiently. Early plants sometimes incorporated roll crushers to produce fine feed. However, this was at a high price from a maintenance and wear point of view, and rod mills found application in many circuits as a coarse intermediate grinding stage between crushing and final ball milling. Now that secondary, tertiary and quaternary cone crushers are available and can operate in closed circuits with vibrating screens to produce fine feeds, both rod mills and conventional roll crushers are rare in mineral processing plants.

### Current technology

Tremendous progress was made in the 20th century in the refinement of crushing and milling circuits, although the reduction mechanisms have not altered greatly up to the present. Rather, the technology and techniques have been refined to produce the most efficient machinery and circuits.

The latest commercially applicable techniques have focused on either the reduction of the number of crushing stages required in a plant, or improving

energy efficiency. Plant simplification has been achieved by incorporating very large-diameter tumbling mills called autogenous grinding (AG) and semi-autogenous grinding (SAG) mills. SAG mills contain up to, and occasionally exceed, 20 per cent volume fill of steel grinding media. These mills did not reduce the energy cost of grinding or the cost of metal liner wear but decreased the number of reduction stages and simplified the layout, and thus reduced the maintenance cost of the mineral processing plant. Grinding mills with motors up to 28 MW are now being installed in projects such as Minas Conga and Toromocho in Perú.

Since the mid-1980s, high-pressure grinding rolls (HPGR) and similar bed compression crushers (eg vertical roller mills) have been introduced to crushing and grinding circuits. They were initially introduced for cement and clinker comminution and in diamond ore processing where the value of the diamonds or low ore abrasiveness offsets the initial high tyre wear. Advances in tyre technology, higher machine capacity than cone crushers and improved energy efficiency over SAG mill-based circuits have seen HPGR use spread to harder and competent ore applications. The Cerro Verde and Boddington projects were the first large-scale (>100 000 t/d) applications of a comminution circuit consisting of a primary gyratory crusher, secondary cone crushers, HPGR and ball mills.

In spite of considerable research, mathematical modelling and carefully conducted tests in the laboratory and pilot plants, information is still incomplete regarding crushing and milling as a science. Therefore, machine selection is a combination of theory and empirical field data.

### Circuit considerations

Due to the mechanical limitations of crushing machines, it is not currently possible to produce one crusher to handle run-of-mine (ROM) lump ore and produce a final product ready for mill feed in a single stage. This must be done in separate crushing stages as each type of machine has a specific reduction ratio (ratio between the feed lump to the product lump size).

In conventional ball mill grinding plants, it is necessary to have a primary crushing stage followed by secondary (and in some cases tertiary and quaternary) crushing to produce a feed size small enough to suit the operating characteristics of the grinding mill. In most cases, the second- and third-stage crushers are cone crushers, but tertiary and quaternary crushers can be replaced by HPGR. In an AG circuit there is a need for only single-stage crushing; that is, a primary jaw or gyratory crusher, producing a coarse product as the feed to the mill.

In all cases, crushers and grinding mills are mounted in concrete and steel structures with classification devices (screens and/or hydrocyclones), slurry

pumps, ancillary conveyors, drives, chute work, etc. The refinement of this infrastructure depends on the requirements of the project, so the final cost of the comminution circuit varies greatly. For example, for a crushing circuit, the total cost of the facility including infrastructure ranges between two and four times the cost of the individual equipment.

**TYPICAL COMMINUTION CALCULATIONS**

A critical component of establishing the capital cost of a comminution circuit is determining the energy and power requirements of the comminution process to be applied to the ore. This section summarises and provides references for the main methods used in comminution circuit design in Australia.

**Classical Bond approach**

The most established technique for determining size reduction performance in comminution machines is by applying Bond’s equations (Bond, 1961) or some adaptation of them such as described by Rowland (1972). There are three parts to Bond’s approach:

1. determining the comminution characteristics of the ore by laboratory tests
2. applying equations to predict the specific energy of the full-scale comminution machines
3. applying equations to predict the power draw of the full-scale comminution machines.

Subsequently, the throughput of the comminution machine can be predicted by dividing the predicted power draw by the predicted specific energy. Given that Bond published his equations in 1961, it is not surprising that they relate to crushers, rod and ball mills, as these were the dominant comminution machines of the day. Hence, AG and SAG mills were not specifically catered for.

*Specific energy*

Bond’s general equation for the specific energy requirement to reduce a feed with a specified F80 to a product with a specified P80 is given in Equation 11.1:

$$W = W_i \left( \frac{10}{\sqrt{P}} - \frac{10}{\sqrt{F}} \right) \tag{11.1}$$

where:

- W specific energy
- W<sub>i</sub> work index
- P 80 per cent passing size for the product (P80)
- F 80 per cent passing size for the feed (F80)

The work index (W<sub>i</sub>) was defined by Bond as the ‘... comminution parameter which expresses the resistance of the material to crushing and grinding’. In practice, W<sub>i</sub> has to be determined from plant data or by conducting grinding tests in which W, P and F are measured. If plant data are available, Equation 11.1 is rearranged with the work index referred to as the operating work index (OW<sub>i</sub>), as in Equation 11.2:

$$OW_i = \frac{W}{10 \left( \frac{1}{\sqrt{P}} - \frac{1}{\sqrt{F}} \right)} \tag{11.2}$$

Where plant data are not available the work index has to be determined from laboratory milling tests. Bond developed rod and ball mill laboratory tests for this purpose. Bond assumed that the net energy consumption per revolution of the test mills remained constant.

Further information on the Bond approach is provided by Bond (1962), Blaskett (1969), Levin (1989), Rowland (1972, 1973, 1975, 1978), Steane and Hinckfuss (1979), Rowland and Kjos (1980), Forsund *et al* (1988) and Morrell (2004b).

The introduction of AG and SAG mills prompted significant adaptation of Bond’s approach (eg Barratt and Allan, 1986), whereby circuit-specific energy was factored from Bond-calculated-specific energy, according to Equation 11.3:

$$\text{kWh/t (AG/SAG)} = f_{\text{sag}} \times \text{kWh/t (Bond)} \tag{11.3}$$

where:

f<sub>sag</sub> ‘efficiency’ factor related to the type of AG/SAG mill circuit and rock hardness

kWh/t (Bond) kWh/t predicted by Bond’s equations

*Power draw*

Bond (1961) published an initial power draw equation for a rotating mill, which was modified in 1962 to provide the power draw relationship in Equation 11.4:

$$\text{kW} = 12.262 D^{2.3} L \rho \phi J (1 - 0.937J) (1 - 0.1/2^{9-10\phi}) \tag{11.4}$$

where:

- D internal diameter in metres
- L internal length in metres
- φ fraction of critical speed
- J volume fraction of ball charge
- ρ bulk density of steel balls (t/m<sup>3</sup>)

**SMCC approach**

In some ways the approach of SMCC Pty Ltd mirrors that of Bond, as it contains a general equation for determining the specific energy to grind rock from a coarser distribution to a finer one, as well as work indices related to the strength of the rock. Unlike Bond’s approach, where three work indices were defined for particular equipment (crushing, rod milling and ball milling) plus at least seven ‘efficiency’ factors, the following technique uses only two indices related to ‘coarse’ and ‘fine’ ore properties with only one efficiency factor. ‘Coarse’ in this case is defined as spanning the size range from P80 of 750 μm up to P80 of the product of the last stage of crushing prior to grinding. ‘Fine’ covers the size range from P80 of 750 μm down



to P80 sizes typically reached by conventional ball milling (ie about 45 μm). The choice of 750 μm as the division between ‘coarse’ and ‘fine’ particle sizes was determined during the development of the technique and was found to give the best overall results across the range of plants in the author’s (S Morrell) database. Implicit in the approach is that size distributions are parallel and linear in log-log space.

The work index covering grinding of coarse sizes is labelled  $M_{ia}$ . The work index covering grinding of fine particles is labelled  $M_{ib}$ .  $M_{ia}$  values are provided as a standard output from an SMC Test® (Morrell, 2004a), while  $M_{ib}$  values can be determined using the data generated by a conventional Bond ball mill work index test ( $M_{ib}$  is not the Bond ball work index). Both of these tests are readily available from mineral processing laboratories around the world.

The general size reduction equation (Morrell, 2004b) is shown in Equation 11.5:

$$W_i = M_{ia} 4 (x_2^{f(x_2)} - x_1^{f(x_1)}) \quad (11.5)$$

where:

- $M_i$  work index related to the breakage property of an ore (kWh/t); the index is labelled  $M_{ia}$  for grinding from the product of the final stage of crushing to a P80 of 750 μm (coarse particles) and  $M_{ib}$  for size reduction from 750 μm to the final product P80 normally reached by conventional ball mills (fine particles)
- $W_i$  specific comminution energy at pinion (kWh/t)
- $x_2$  80 per cent passing size for the product (μm)
- $x_1$  80 per cent passing size for the feed (μm)

Equation 11.6 (Morrell, 2006a, b) shows:

$$f(x_i) = -(0.295 + x_i/1\,000\,000) \quad (11.6)$$

### Specific energy

The total specific energy at pinion ( $W_T$ ) to reduce in size crusher product to final product is given by Equation 11.7:

$$W_T = W_a + W_b \quad (11.7)$$

where:

- $W_a$  specific energy to grind coarse particles
- $W_b$  specific energy to grind fine particles

Implicit in this approach is the assumption that the grinding-specific energy is independent of the processing route and is believed to be applicable to all tumbling mills in the following circuit configurations: crush-rod-ball; crush-ball; crush-HPGR-ball; AG and ball (AB); SAG and ball (SAB); AG, ball and pebble crusher (ABC); SAG, ball and pebble crusher (SABC); and single-stage AG/SAG circuits.

For coarse-particle grinding, Equation 11.5 is written as:

$$W_a = KM_{ia} 4 (x_2^{f(x_2)} - x_1^{f(x_1)}) \quad (11.8)$$

where:

- K 1.0 for all circuits that do not contain a recycle pebble crusher and 0.95 where circuits do have a pebble crusher
- $x_1$  P80 in μm of the product of the last stage of crushing before grinding
- $x_2$  750 μm
- $M_{ia}$  coarse ore work index and is provided directly by the SMC Test®

For fine particle grinding, Equation 11.5 is written as:

$$W_b = M_{ib} 4 (x_3^{f(x_3)} - x_2^{f(x_2)}) \quad (11.9)$$

where:

- $x_2$  750 μm
- $x_3$  P80 of final grind in μm
- $M_{ib}$  provided by data from the standard Bond ball work index test using Equation 11.10 (Morrell, 2006):

$$M_{ib} = \frac{18.18}{P_1^{0.295} (Gbp) (P_{80}^{f(P_{80})} - F_{80}^{f(F_{80})})} \quad (11.10)$$

where:

- $M_{ib}$  fine ore work index (kWh/t)
- $P_1$  closing screen size in μm
- Gbp net grams of screen undersize per mill revolution
- P80 80 per cent passing size of the product in μm
- F80 80 per cent passing size of the feed in μm

Note that the Bond ball work index test should be carried out with a closing screen size that gives a final product P80 similar to that intended for the full-scale circuit.

This approach gives the predicted specific energy for the tumbling mill component of the circuit, but does not provide the specific energy of the AG/SAG mill in a multi-stage circuit unless it is a single-stage AG/SAG mill. To calculate the AG/SAG mill-specific energy, a proprietary method is used, based on the general relationship in Equation 11.11:

$$S = f(DW_i, \phi, J, A_r, F80, K, P) \quad (11.11)$$

where:

- S specific energy at the pinion
- F80 80 per cent passing size of the feed
- $DW_i$  drop weight index
- P ore density
- J volume of balls (per cent)

$\phi$	mill speed (per cent of critical)
$A_r$	function of mill aspect ratio
K	function whose value depends on whether a pebble crusher is in-circuit

### Power draw

Unlike Bond's tumbling mill model, which uses the 'classical' view of the motion of the charge, the SMCC equations use that proposed by Morrell (1996a, 1996b) where the charge shape is modelled as a series of concentric shells. Morrell's equations relate to both ball steel and rock media and can therefore be used for AG, SAG and ball mills. They can also be used for grate and overflow discharge conditions, but unlike Bond who tackled this by a correction factor, Morrell explicitly described the effect of the discharge mechanism on the mill charge and hence on the influence on the power draw. This model is used in JKSimMet software for analysis and simulation of comminution and classification circuits.

The classical power equations are discussed by Daniel, Lane and Morrell (2010).

### JKSimMet approach

Research at the Julius Kruttschnitt Mineral Research Centre (JKMRC) over the past four decades has resulted in the creation of mathematical models of various comminution and concentration devices used in mineral and coal beneficiation. To use the JKSimMet comminution modelling and simulation software, the general form of the model must be tailored to match the specific application. This is achieved by adjusting the model parameters, which are of two types: those dependent on ore characteristics and those dependent on machine characteristics.

In general, the ore-specific parameters are determined by laboratory tests.

For optimisation studies, machine-dependent parameters are calculated by non-linear least-squares fitting techniques from plant survey data. However, for design studies, sampling the plant is not possible, so machine-dependent parameters are 'borrowed' from other operations. Consultants such as JKTech Pty Ltd and others, together with mining companies have established databases of these parameters suitable for most design situations.

The most recent AG/SAG model in JKSimMet incorporates an operating database in the form of regression relationships between machine parameters (breakage rates and discharge characteristics) and operating variables (ball load, ball size, mill speed, etc). Thus, when using this model for design purposes, machine parameters, which are the 'average' of the JKMRC database, are applied. Models are available for most comminution and classification devices.

Details of the ore-specific test procedures and the models summarised here are given in Napier-Munn *et al* (1996).

The models require the following data:

- feed size distribution
- machine parameters (dimensions and fitted or estimated model parameters)
- ore-specific parameters from the JK Drop Weight Test (JKDWT) or SMC Test<sup>®</sup> (A, b and  $t_{10}$ ).

Once the data are assembled, the proposed flow sheet is constructed in JKSimMet and the data entered. In most design projects, the feed rate is specified in required tonnes per annum. After adjustments for availability, the feed rate is reduced to the required t/h for JKSimMet.

The actual simulation design procedure varies with the equipment in question. Bailey *et al* (2009) provides useful data for a large SAG mill-based circuit.

As with any method of interpreting comminution laboratory test results, JKSimMet modelling and simulation is subject to limitations. These fall into two groups: limitations of the mathematical models, and the quality of the model parameters and the data on which they are based. Simulation is only one tool in the metallurgist's tool box and should not be used in isolation. The design process uses a convergence of results derived by various methods, to which JKSimMet simulation can make an important contribution.

### Test work methods and other approaches

There are many approaches to comminution circuit test work for engineering design and geometallurgical modelling for ores, including various impact tests, tumbling tests and abrasiveness tests. Some of the more relevant tests for SAG mill and HPGR-based circuits are discussed below.

#### JK Drop Weight Test

In the standard data reduction procedures, the JKDWT results from testing five size fractions over a wide specific energy range (0.1 to 2.5 kWh/t), which are used to calibrate two parameters in the JKMRC breakage model (see Equation 11.12).

$$t_{10} = A(1 - e^{-b.Ecs}) \quad (11.12)$$

where:

$t_{10}$  size distribution 'fineness' index defined as the progeny per cent passing one tenth of the initial mean particle size

Ecs specific comminution energy (kWh/t)

A and b are the ore impact breakage parameters determined from JKDWT results (Napier-Munn *et al*, 1996).

The index  $A*b$  has become well-known in the mining industry as a reliable indicator of impact ore hardness, and essentially describes the rate at which fines are produced ( $t_{10}$ ) for a set amount of specific comminution energy (Ecs). This relationship is illustrated graphically in Figure 11.1 for a nominal 10 mm particle of hard copper ore.

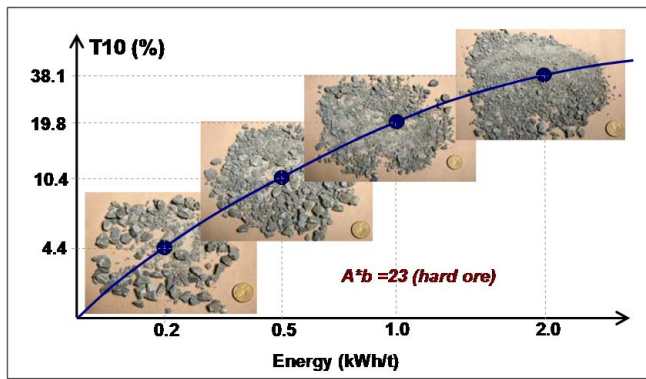

FIG 11.1 - Relationship between fines produced and specific breakage energy for a single particle size (hard ore).

The value of Equation 11.12 is embedded in the JKSimMet comminution models, which rely on  $t_{10}$  to generate a full size distribution, given the relationships between  $t_{10}$  and  $t_n$ -family curves established from the JKDWT database (Narayanan and Whiten, 1988). That is, the model only needs to know the  $E_{cs}$  and the ore parameters  $A$  and  $b$  to generate the product size distribution for a given breakage event.

However, since Equation 11.12 is used to fit the JKDWT data with one set of  $A$  and  $b$  parameters for all particle sizes, this typically results in a scattered plot due to the particle size effect, as illustrated below by the Mt Coot-tha quarry data. Banini (2000) fitted these data with one set of  $A$  and  $b$  parameters for all particle sizes (Figure 11.2).

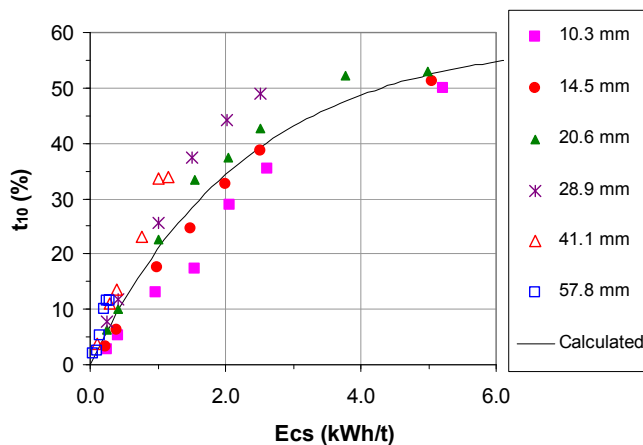

FIG 11.2 - JK breakage model (Equation 11.12) fitted to the data of Mt Coot-tha quarry material with one set of model parameters  $A$  and  $b$  for all sizes.

This ‘average’ set of  $A$  and  $b$  parameters used in the AG/SAG model assumes that particles of different sizes would be broken in the same way when subjected to the same impact energy. However, this assumption is questionable, particularly in an AG/SAG mill where the feed may contain particles from 200 mm down to less than 1 mm. Although the JKDWT has become an industry standard in ore characterisation, the device has limitations in meeting the emerging needs of comminution research.

Recognising this deficiency, the JKMRRC comminution research team developed a new breakage model incorporating the effect of particle size, and a new breakage characterisation testing device called the JK rotary breakage tester (JKRBT). The JKRBT allows rapid testing of particle breakage under high-energy single-impact and low-energy repetitive-impact conditions. The latter is believed to be the dominant breakage mechanism in AG/SAG mills (Djordjevic, Shi and Morrison, 2004). Existing devices such as the JKMRRC drop weight tester, are not suitable for performing repetitive impacts since they are too time-consuming.

#### JK rotary breakage tester and new breakage model

A new JKMRRC breakage model was based on a theoretical approach described in Vogel and Peukert (2004), considering a generalised dimensional analysis proposed by Rumpf (1973) and a detailed fracture mechanical model based on Weibull (1951) statistics. This model describes the breakage index  $t_{10}$  (per cent) in relation to the material property, particle size and net cumulative impact energy, as shown in Equation 11.13 (Shi and Kojovic, 2007):

$$t_{10} = M\{1 - \exp[-f_{mat} \cdot x \cdot k(E_{cs} - E_{min})]\} \quad (11.13)$$

where:

- $M$  (%) maximum  $t_{10}$  for a material subject to breakage
- $f_{mat}$  (kg/J/m) material breakage property
- $x$  initial particle size
- $k$  successive number of impacts with the single impact energy
- $E_{cs}$  (J/kg) mass-specific impact energy
- $E_{min}$  (J/kg) threshold energy

The first measurements of  $E_{min}$  at the JKMRRC were reported by Morrison, Shi and Whyte (2006). This work led to the formulation of a model form for the probability of breakage, degree of breakage and likely progeny size distribution, based on the standard JKMRRC impact breakage model (Napier-Munn *et al*, 1996) and the work of Vogel and Peukert (2003) with modifications suggested by Shi and Kojovic (2007). From this preliminary work it appeared that a test was required that could rapidly subject many particles to cumulative damage in order to develop a proper breakage probability curve for each ore. The JKRBT is well suited for this application.

The new model takes a form similar to the JKMRRC prior art breakage model (see Equation 11.12), but with particle size and breakage properties incorporated explicitly in the model. It is not surprising to discover that Equation 11.12 can be derived from fundamental breakage mechanics. Parameters in the new model can be converted back to the  $A \cdot b$  value that has traditionally been used as a rank of ore hardness in the JKMRRC model, using the relationship in Equation 11.14:

$$A \times b = 3600 M f_{mat. x} \quad (11.14)$$

where:

3600 constant used for unit conversion

Equation 11.14 gives the size-specific A\*b values. The overall A\*b value can be taken as an average of all particle sizes tested. This continuity feature of the new breakage model means that the comminution models under development at the JK MRC will work with the existing ore characterisation data, since the independent variables incorporated in the new breakage model are all available in the JK DWT database. Therefore, JK DWT data acquired by mining companies over many years remain relevant.

Figure 11.3 shows the fitting result of the new model to the same Mt Coot-tha quarry data, as shown in Figure 11.2. This comparison suggests that the present breakage model has a fundamentally better structure for describing the effect of particle size on the breakage distribution function.

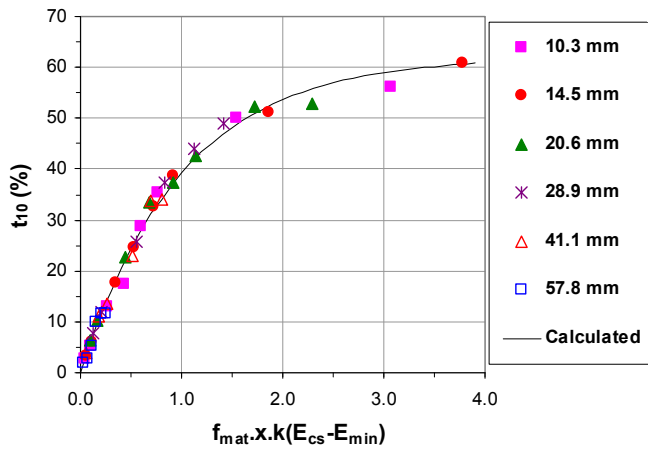

FIG 11.3 - New breakage model (Equation 11.13) fitted to 42 measured points from JK drop weight tests on Mt Coot-tha quarry material.

The JK RBT uses a rotor-stator impacting system, in which particles gain kinetic energy while they are spun in the rotor, as shown in Figure 11.4. They are then ejected and impacted against the stator, causing particle breakage. The industrial unit can treat particles from 1 to 45 mm at specific energy levels from 0.01 to 3.3 kWh/t.

*MacPherson's approach*

MacPherson (1989) realised it was impracticable to collect sufficient bulk samples and processed them in a pilot mill to determine the full range of grindability variability for large orebodies. His approach was developed based on processing 150 kg of ore to investigate the probable changes in grindability.

The test method develops a work index that is adjusted based on empirical equations and used in the Bond formula to determine the specific energy of an AG or SAG mill. The test is now rarely used for Australian projects.

*Orway Mineral Consultants' approach*

Orway Mineral Consultants Pty Ltd (OMC) adopted a method for comparing differing circuits, based on a consideration of the total power involved in the comminution process. As such, it is necessary to consider a standard feed (F80) size and a standard product (P80) size. Ancillary equipment power, such as crusher no-load, motor-pinion drive train losses and conveying system power, is excluded from the analysis.

The power necessary for the flow sheet is compared to the Bond ball mill work index-based power that is theoretically needed to affect comminution from feed to product. The ratio of the two is referred to as  $f_{SAG}$  (Equation 11.3).

In the following example, the standardised parameter values of F80 = 150 mm and P80 = 75 μm were adopted.

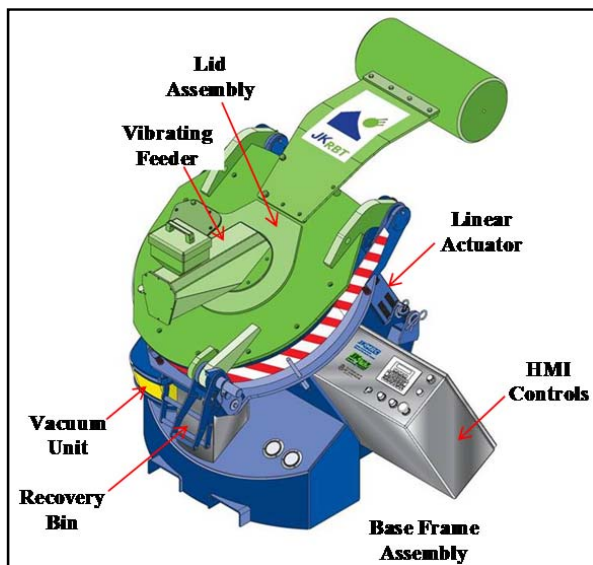

FIG 11.4 - JK rotary breakage tester device.

Thus, when analysing the performance of the SAG mill, the analysis assigns values to:

- Bond-calculated ball-mill-specific energy to P80 = 75 μm
- Bond-calculated-specific crushing energy from standard F80 to SAG mill feed F80
- SAG mill-specific energy at the pinion, from simulation, database or actual performance.

The sum of these values is divided by the equivalent Bond-specific energy, uncorrected, to arrive at  $f_{SAG}$ . Similarly, for an SABC circuit, the ball-milling-specific energy requirement is calculated, and the recycle crushing power is split across the whole feed tonnage to give the specific energy per tonne of ore. The efficiency defined by  $f_{SAG}$  is independent of product size and if known can be used to estimate the specific energy for any grind size typical of SAG mill circuits.

Methods have been developed using correlations from the large OMC database for calculating  $f_{SAG}$  for SAG circuits treating primary crushed ore. The determination of  $f_{SAG}$  uses inputs from a combination of high (Advanced Media Competency Test and JK DWT) and low (Bond ball mill work index) breakage energy comminution test work results. The correlations use ore characterisation data from the standard suite of comminution tests and real plant or pilot data.

*Semi-autogenous grinding power index approach of SGS*

The SAG power index (SPI) (Bennet *et al*, 2000) is loosely the SAG/AG equivalent of the Bond ball mill work index. It is obtained from laboratory testing from as little as 2 kg of ore. To determine the SAG/AG-specific energy requirement for a given block of ore, SGS MinnovEX uses the SPI energy relationship, given in Equation 11.15:

$$\text{kWh/t}_{SAG/AG} = K (\text{SPI } 1/\sqrt{T80})^n \tag{11.15}$$

where:

K and n constants

As with Bond’s third theory, the SPI-mill-specific energy relationship is based on a ‘standard’ circuit. In this case, the standard circuit is where the SAG/AG mill is fed with ore that has a nominal F80 of 150 mm (± 30 mm), in closed circuit with a trommel or screen, without a pebble crusher. Deviations from the standard circuit require the use of adjustment factors.

The goal was to model the energy requirements of SAG/AG circuits first and then separately account for the effect of a pebble crusher. This decoupling of the SAG/AG performance from pebble crushing makes it much easier to isolate, quantify and account for the often variable specific energy contribution of pebble crushers.

The two adjustment multipliers that apply to the SPI energy relationship are:

$A_1$  feed size (when the F80 is more than 30 mm different from 150 mm)

$A_2$  pebble crushing  
SGS’s database of benchmarked circuits provides typical ranges of each adjustment multiplier.

*Starkey’s approach*

According to Starkey (reported at [www.sagdesign.com](http://www.sagdesign.com)), the SAGDesign test was created in 2002 to address a number of perceived technical shortcomings in the SPI test. While these shortcomings were not important if the test was used for scoping studies, they were very important if the test was to be used for circuit design. For example, the size of the media was too small in the SPI mill and very hard ore could not be ground to completion because it was too hard. In addition, it was a mistake to leave the fines in the mill after each cycle. The fines ‘cushioned’ the grinding and artificially extended the grinding time in the SPI mill so it was non-linear relative to power required. Also, the SPI test used a constant weight at 2 kg. This resulted in a vastly under-loaded SPI mill when heavy sulfide or iron ores were tested. The SAGDesign mill uses constant ore volume. The final improvements in the SAGDesign test were to set the speed and load to optimum commercial conditions. Speed was increased from 70 to 76 per cent of critical, and the load was decreased from 30 per cent to 26 per cent by volume, by reducing the steel load from 15 per cent for the SPI test to 11 per cent for the SAGDesign test. It is important to duplicate commercial conditions in the test mill.

Determination of the SAG mill-specific energy is carried out along similar lines to the SPI method, but in a larger mill with coarser feed and larger balls.

*Levin’s approach*

The grindability of fine materials, such as sands or rougher concentrates requiring regrinding, cannot be determined using the standard Bond grindability test. The Levin test (Levin, 1984) uses the Bond standard test mill for a batch grind test rather than in lock cycle method, used in the Bond test. An equivalent energy per minute, denoted by E, was developed for this purpose. The E value was calculated from the average result of the Bond standard grindability tests on various materials, and was determined to be  $1425 \times 10^{-6}$  kWh min.

**COST ANALYSIS AND OPTIMISATION – MINE TO MILL**

Research and industrial experience in the past decade has shown that drill and blast results (such as fragmentation, muck pile shape, movement and damage) affect the efficiency of downstream processes and therefore the overall profitability of the mining operation (Kanchibotla *et al*, 1998a, b; Simkus and Dance, 1998; Valery *et al*, 1999; Hart *et al*, 2000; Hart *et al*, 2001; Karageorgos *et al*, 2001;

Lam *et al*, 2001; Morrell *et al*, 2001; Strohmayer *et al*, 2001; Valery *et al*, 2001; Dance *et al*, 2006; McCaffery *et al*, 2006; Renner *et al*, 2006; Tondo *et al*, 2006; Dance *et al*, 2007). The ‘mine to mill’ or process integration and optimisation approach involves identifying and understanding the leverage each process has on downstream processes (eg the effect of drill and blast results on load and haul, crushing and grinding processes). That leverage is then used to maximise the overall profitability of the operation rather than just the individual processes. A schematic indicating the main variables and parameters with this approach is shown in Figure 11.5.

The effects of fragmentation, higher energy blasting and finer fragmentation on crushing and grinding are discussed below.

### Fragmentation

In most modern metalliferous operations, the ore undergoes at least three stages of breakage or comminution:

1. blasting – to prepare the ore for excavation and transport

2. crushing – to improve the ore’s handling characteristics and prepare it for grinding
3. grinding – usually undertaken in two stages (with AG/SAG milling as the primary operation).

Table 11.1 shows the general relationship between energy requirements and cost for the three stages of comminution, while Figure 11.6 shows the breakdown of operating costs for a typical open pit gold mine.

The energy requirements and operating costs above clearly suggest that drill and blast is the most inexpensive form of energy required to break rock, followed by crushing. In the process integration and optimisation (PIO) approach, this leverage is exploited and the amount of breakage achieved in both blasting and crushing is maximised to relieve the mill of as much new breakage as possible. In essence, the breakage is moved back in the production chain where the energy requirements are lower and cheaper.

Figure 11.7 illustrates the concept presented in Table 11.1. The stages of comminution are shown from left to right. The first stage of blasting reduces the *in situ* block size of 2 m (for example) down to the

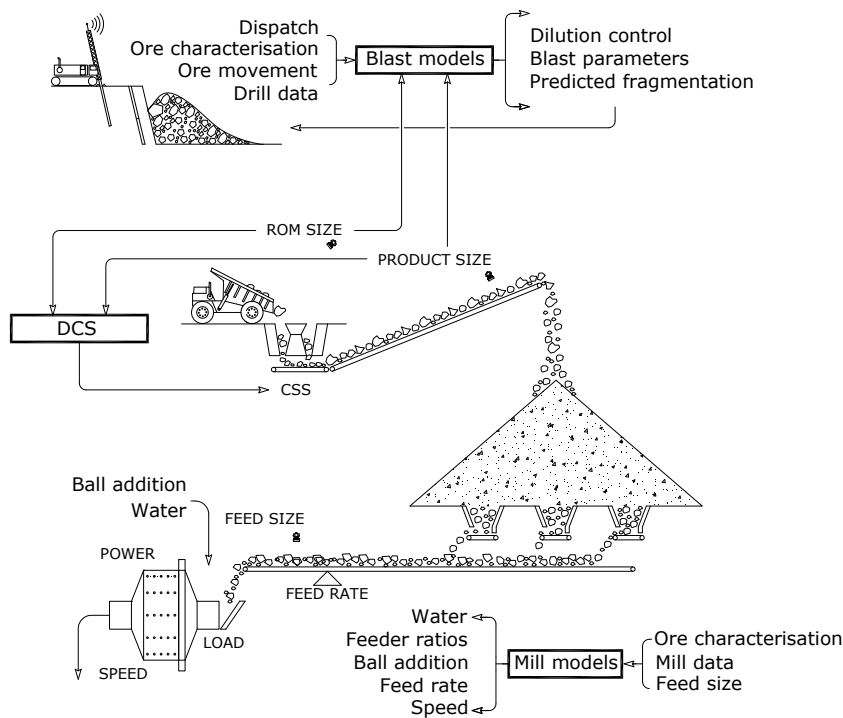

FIG 11.5 - Main variables involved in the integration and optimisation of a typical comminution process.

TABLE 11.1  
Relative energy and cost of comminution stages.

Comminution stage	Specific energy (kWh/t)	Cost (\$ per tonne ore)	Energy factor (1 = blasting)	Cost factor (1 = blasting)
Drill and blast	0.1 - 0.25	0.1 - 0.25	1	1
Crushing	1 - 2	0.5 - 1.0	4 - 20×	2 - 10×
Grinding	10 - 20	2 - 5	40 - 200×	8 - 50×
Total	11 - 22	2.6 - 6.25	–	–

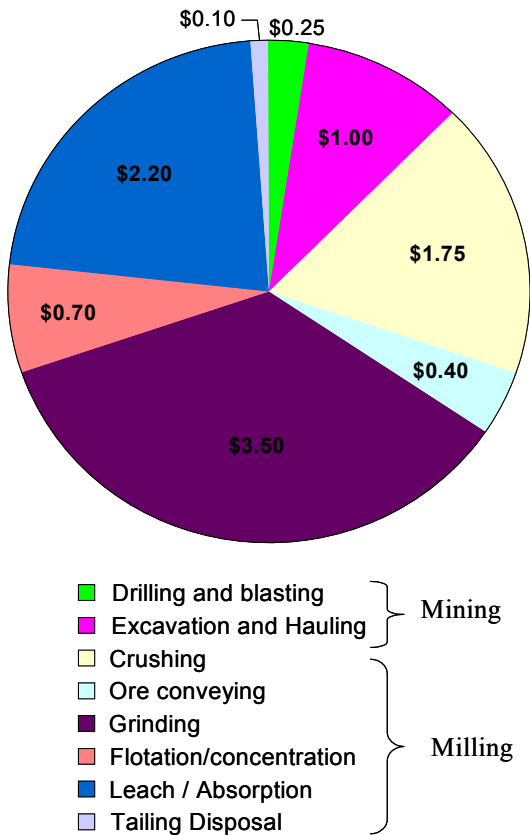

FIG 11.6 - Breakdown of operating costs (\$/t) in a typical open pit gold mine.

ROM fragmentation size of 500 mm. This is followed by crushing down to 150 mm, and then grinding down to 100 or 75  $\mu$ m. (Fine grinding can take this size reduction down to as low as a few micrometres, but the economics of this are not considered here.) Blasting reduces the *in situ* block size significantly, while crushing and grinding

require increasing amounts of energy (represented here in kWh/t) to produce a finer product. The result is an exponential increase in the specific energy required to continue the size reduction process.

Figure 11.7 illustrates the increasing cost-per-tonne associated with finer comminution stages. The cost-per-tonne to reduce material to crusher feed size by blasting is relatively low, but builds exponentially as the particle size becomes smaller. The cost curves are far more variable due to the combination of fixed and operating costs.

To maximise the benefit of this relatively low-cost, more-efficient comminution stage, drill and blast designs are modified to reduce the top size and increase fines in ROM ore fragmentation (Figure 11.8). A reduction in top size will improve the ease of excavation

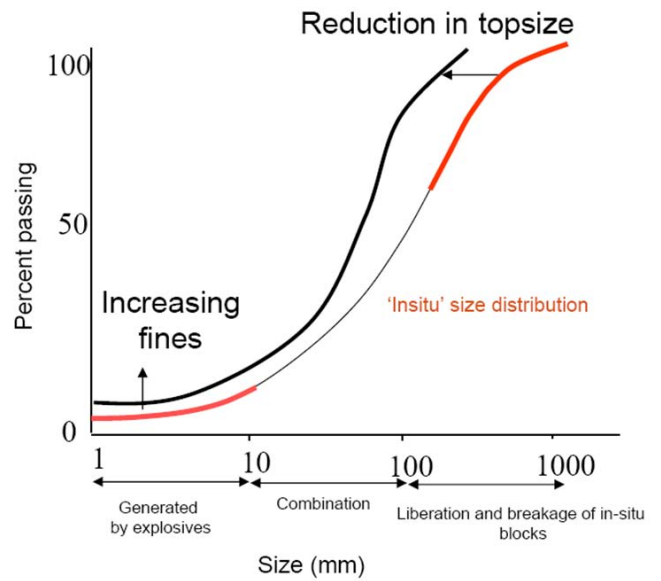

FIG 11.8 - Changes in size distribution sought through blasting.

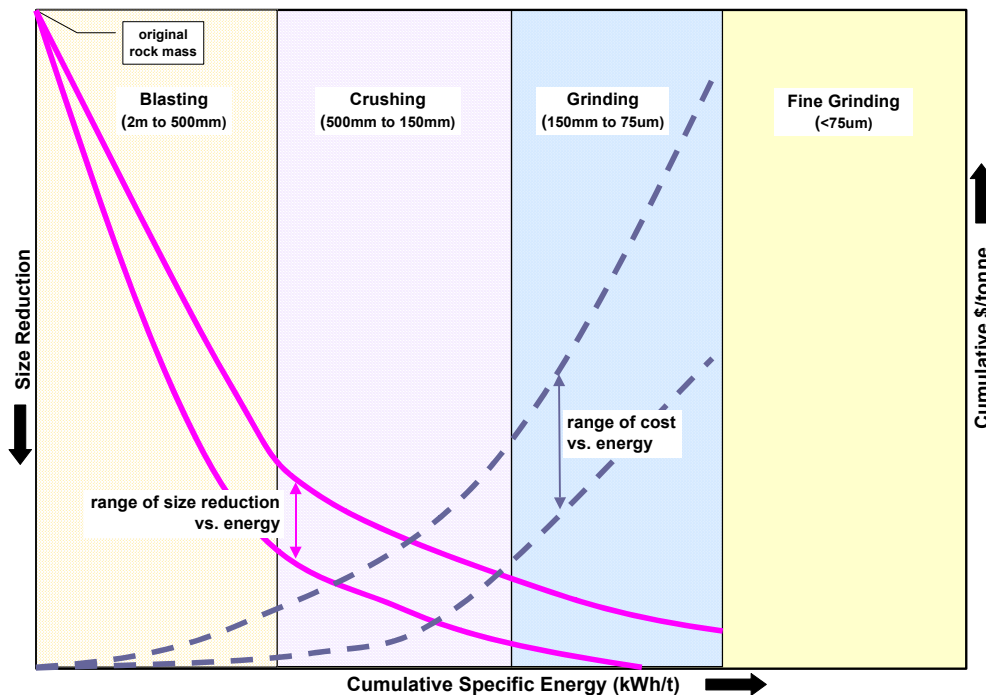

FIG 11.7 - Schematic of comminution stage size and cost versus energy consumption.

and transport within the mine, and also allows the primary crusher gap to be reduced, generating material that needs less breakage in the mill. With a reduced top size, the crusher can be choke-fed without the risk of blockages, as this promotes more inter-particle breakage and produces more fines. The increase in the proportion of fines (defined here as material smaller than the grate size of the mill) should pass freely through the mill and require no further breakage.

**Higher energy blasting**

Possible negative effects of higher energy blasting include blast movement and effect of blast damage.

The direction and magnitude of blast movement depends on factors such as:

- bench geometry
- characteristics of free face/s
- delay timing
- energy distribution
- initiation pattern.

Traditional grade control procedures do not take into account the post-blast-induced movements and the ore and waste are excavated based on preblast markings. This can result in significant dilution and ore loss (Figure 11.9).

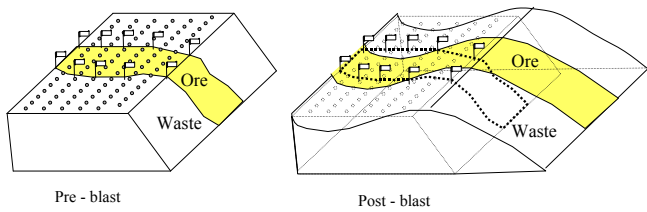

FIG 11.9 - Dilution and ore loss due to blast movement.

The effect of ore loss and dilution on the overall profitability of a mining operation can be significant, especially for gold mining operations. Taylor *et al*

(1996) reported that dilution levels could be reduced significantly with proper blasting procedures as well as by accounting for blast-induced movements when implementing ore control.

Some damage to the rock mass is inevitable during the blasting process, but there is a large incentive to limit this damage.

**Finer fragmentation**

There are considerable advantages to operating a crushing and grinding circuit with a finer and more consistent feed. Adjustments can be made to the operating conditions to focus on finer material and at the same specific energy (kWh/t) to achieve higher throughput or lower power-draw (or both) (Figure 11.10). When crushers and mills are fed a wide range of feed sizes, the task required of them becomes considerably more complicated and challenging. Ultimately, comminution equipment operates best when faced with a narrow feed-size range.

**Example of process integration and optimisation**

This example is taken from an open pit gold mine where the ore is subjected to blasting, crushing and grinding, flotation and leaching (Grundstrom *et al*, 2001). The strategy was to increase the SAG mill throughput, identified as a bottleneck, by modifying the ROM fragmentation with as many fines (<10 mm) as possible, along with a reduction in top size. The blast design was modified by reducing the hole burden and spacing and increasing the energy level. Blast designs, fragmentation and mill throughput are compared in Table 11.2.

The high-energy blast increased mill throughput by 14 per cent, compared to historical practice. The main reasons for this increase in mill throughput are:

- additional fines (<10 mm) in the ROM, generated by the new designs

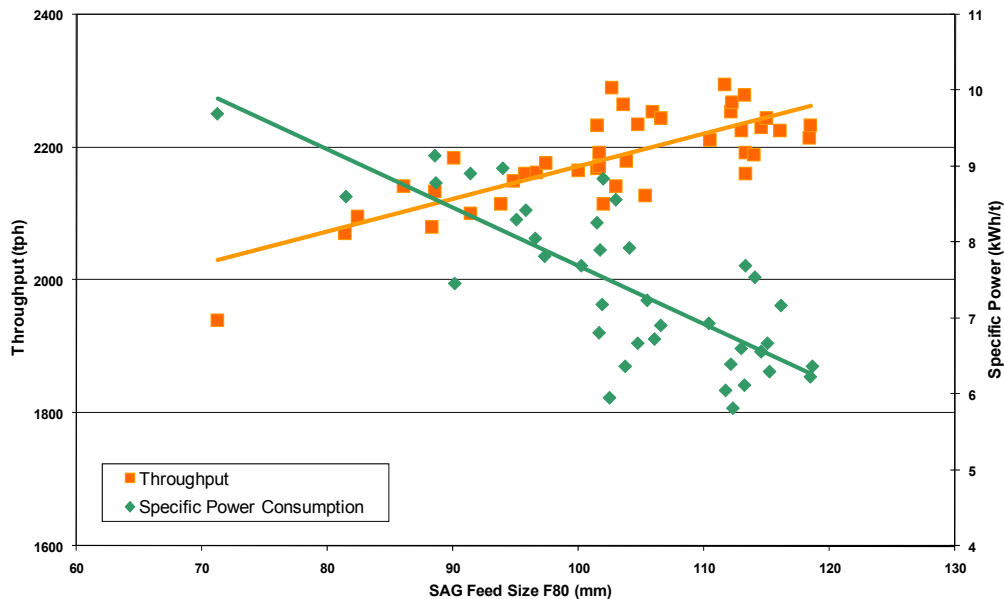

FIG 11.10 - Example of effect of SAG feed size F80 on throughput and specific energy (from Hart *et al*, 2001).



- reduced closed side setting and choke feeding of the primary crusher.

To demonstrate the economic incentives not clearly shown in Table 11.2, costs were applied to each process involved and a number of scenarios were compared in terms of their effect on operating profit or the ‘bottom line’. Before discussing the simulation results, a few definitions are given below.

**TABLE 11.2**  
Comparison of blast designs and resulting mill throughput.

	Current	Mine to mill design	Change (%)
Hole diameter (mm)	200	229	
Bench height (m)	10	10	
Burden (m)	5.3	4.5	
Spacing (m)	6.3	5.5	
Hole depth (m)	10.6	10.5	
Column height (m)	5.3	5.3	
Stemming height (m)	5.3	5.2	
Subdrill (m)	0.6	0.5	
Powder factor (kg/t)	0.24	0.4	65
Drill and blast cost (\$/t)	0.18	0.29	61
<b>Fragmentation</b>			
Top size (m)	1.5	1	
Oversize (+600 mm) (%)	6	1	
Fines (-10 mm) (%)	9	15	
Mill throughput (t/h)	673	767	14

Profit per tonne of broken ore is the difference between the price it commands and the costs to produce it. It can be estimated as:

$$\text{Profit} = \text{revenue} - \text{operating cost} - \text{fixed cost}$$

where:

revenue                      unit value × throughput  
operating cost              unit operating cost × throughput  
fixed cost                      cost of capital and overheads

Other definitions are:

unit value                      (grade × recovery × unit price) / (1 + dilution)  
unit operating cost          unit cost of (drilling + blasting + loading + hauling + crushing + grinding + liberation ...)

The financial simulations, summarised in Table 11.3, used indicative costs with the following assumptions:

- The grinding circuit was the bottleneck in this operation.

- The finer ROM from the mine to mill blast was expected to improve the diggability and excavator maintenance, and reduce the loading and hauling costs by two per cent (from current \$0.85/t to \$0.83/t).
- No additional capital expenditure or overheads were required for the additional throughput.
- The ratio of fixed plus overhead cost to variable operating costs was assumed as 50:50.
- The head grade was 3 g/t and the price of gold US\$600/oz.
- Annual figures were estimated based on 85 per cent mill availability.
- Current dilution was ten per cent.
- Three scenarios were considered:
  1. mine to mill style blasts with no change the dilution level
  2. without additional grade control procedures, modified designs increased dilution by 20 per cent (ie from ten to 12 per cent)
  3. additional grade control procedures doubled the grade control costs but reduced dilution by ten per cent from the current levels (ie from ten to nine per cent).

The financial simulations illustrate that the simple approach to minimise the cost of each subprocess may not result in an optimal solution for the total operation.

## PRIMARY CRUSHING CIRCUITS

This section presents equipment selection and costs, types of primary crushers and circuit capital costs.

### Equipment selection

To enable proper selection of primary crushing equipment, the following basic data are required:

- abrasion index (if available)
- bulk density and/or specific gravity of the material
- crushing work index or A\*b value
- description of the ore to be crushed (ie rock type, description of geology, mineralogy and visual experience)
- grading of the ROM feed material
- product size, either maximum final crushed product size as feed to the milling circuit, or alternatively, an 80 per cent passing figure (P80)
- special ore characteristics, such as moisture content and adhering clays
- special plant considerations, such as ROM bin size to suit the type of feed trucks, internal surge bins if required, preferences for type of equipment, site topography and minimum conveyor belt widths and conveying angles
- uniaxial compressive strength (UCS).

This information allows a crushing flow sheet to be rapidly designed, and budget cost to be determined.

TABLE 11.3  
Example of process integration approach on overall profitability.

Item	Current design	Mine to mill design		
		No change in dilution	Increase in dilution	Additional grade control and reduced dilution
Drilling and blasting (\$/t)	\$0.18	\$0.29	\$0.29	\$0.29
Excavation and hauling (\$/t)	\$0.85	\$0.83	\$0.83	\$0.83
Grade control (\$/t)	\$0.20	\$0.20	\$0.20	\$0.40
<i>Total – mining</i>	<i>\$1.23</i>	<i>\$1.32</i>	<i>\$1.32</i>	<i>\$1.52</i>
Crushing (\$/t)	\$0.20	\$0.18	\$0.18	\$0.18
Ore conveying (\$/t)	\$0.40	\$0.40	\$0.40	\$0.40
Grinding (\$/t)	\$2.20	\$1.93	\$1.93	\$1.93
<i>Total – crushing and grinding</i>	<i>\$2.80</i>	<i>\$2.51</i>	<i>\$2.51</i>	<i>\$2.51</i>
Throughput (t/h)	673	767	767	767
Increase (%)		14	14	14
<i>Total – operating (\$/t)</i>	<i>\$4.03</i>	<i>\$3.83</i>	<i>\$3.83</i>	<i>\$4.03</i>
Fixed + overheads (\$/t)	\$4.03	3.54	3.54	3.54
<i>Total – overall</i>	<i>\$8.06</i>	<i>7.36</i>	<i>7.36</i>	<i>7.56</i>
Dilution (%)	10	10	12	9
Average grade (g/t)	3.0	3.0	3.0	3.0
Recovery (%)	80	80	80	80
Gold recovered (g/t)	2.18	2.18	2.14	2.20
Total cost (\$/g)	\$3.69	\$3.37	\$3.44	\$3.44
Unit price (\$/g, @\$600/oz)	\$19.29	19.29	19.29	19.29
Revenue (\$/t of ore)	\$42.09	42.09	41.34	42.48
Profitability (\$/t of ore)	\$34.03	34.73	33.98	34.92
Added profit (\$/a)		\$4 M	\$0.3 M	\$5 M

In Australia, the crushing equipment supply companies available that can provide this service include:

- Crushing and Mining Equipment (CME)
- FLSmidth
- Metso Minerals (Australia) Limited
- Sandvik Mining and Construction
- Terex Jaques
- Thyssen-Krupp.

Various engineering and consulting offices also provide specialised professional services.

### Types of primary crushers

Primary crushers are divided into two major categories: jaw crushers and primary gyratory crushers.

Depending on crushability and abrasiveness of the ore, roll sizers are sometimes used; however, they will not be covered in this chapter. For a hard rock plant, a jaw crusher is considered when the feed capacity of a plant is not above approximately 750 t/h, and the

ROM plant feed size is limited according to the feed opening of the crusher and does not generally exceed 1 m. A gyratory primary crusher is selected when unit capacities extend above 750 t/h to greater than 7000 t/h and larger feed lumps can be handled.

### Jaw crushers

Jaw crushers are divided into two types according to whether they use single- or double-toggle mechanisms. This description indicates the mechanical means by which the moving jaw plate is operated and both have distinct operating functions and advantages. Most mining installations have traditionally used double-toggle crushers due to their perceived ability to crush hard and tough materials with relatively low wear rates. Single-toggle crushers have the advantages of lower capital cost and a distinct feeding action in the crushing chamber suitable for ores that are difficult to nip.

While regarded in the past as higher consumers of liner wear metal, modern single-toggle crushers have

largely overcome this disadvantage, and perceptions in the mining industry are changing. In recent years, many more single-toggle than double-toggle crushers have been installed.

A typical single-toggle cross-section with the major parts listed is shown in Figure 11.11.

Jaw crushers are sized by the feed opening of the machine. This varies between suppliers, but a typical range of sizes starts at a feed opening of 440 mm × 630 mm and progresses up to a maximum of 1600 mm × 2000 mm. As the size of the feed opening increases, so does the capacity that is processed through the crusher. The capacity of a crusher is governed not only by this machine size but also by the discharge gap setting between the fixed jaw and the moving jaw (discharge setting).

Manufacturers’ tables for a range of jaw crushers indicate the capacities through those crushers at the various settings for a given control material. An initial selection of a crusher is made using these tables. The other major consideration is that the maximum anticipated lump size in the ROM feed is not more than 80 per cent of the feed opening dimension.

Other tables provided by the manufacturer indicate the product grading of a primary jaw crusher discharge for the various settings of the crusher. The grading of material from a crusher always contains some material larger than the crusher setting.

The primary jaw crusher is the first major plant item in a milling flow sheet and evens out the cyclic feeding of either trucks or loaders bringing raw material to the plant. To accomplish this, the cycle times of the loading equipment and size and capacity of that loading equipment are ascertained so an adequate ROM holding bin can be provided. In all jaw crusher operations a ROM feed bin and an initial primary feeding device are needed to ensure a constant stream of material is fed to the plant.

This feeder is typically a variable flow rate feeder. Typically, this is either apron pan type or a vibrating type. Between the feeder and the jaw crusher a grizzly machine is interposed to bypass material naturally occurring in the ROM feed that is already finer than the discharge setting of the jaw crusher. Primary vibrating feeders accomplish this by incorporating the grizzly as part of the machine. However, a separate vibrating or static grizzly is used with apron feeders. Removal of the fine material often containing sticky ores and clay is necessary to avoid build-up and blocking in the jaw crusher, unnecessary wear and the overall detrimental effect of having to process material that is already at product size, with the consequent loss of jaw crusher capacity.

Typically, a primary jaw crushing installation comprises a ROM hopper, with a hopper support structure. A feeder incorporating a grizzly is mounted underneath. The grizzly has a gravity bypass chute to allow fine material to bypass the jaw crusher, and oversize from the feeder to report by gravity directly into the jaw crusher. Jaw crusher product is finally combined with grizzly bypass product on a common conveyor belt and transported to the next stage of the process.

There is a preference for double-toggle machines for material with UCS >200 MPa.

*Gyratory crushers*

Primary gyratory crushers are available in different sizes. Manufacturers’ tables provide size range, and for each machine the maximum designed power, motor speed, gyrations and range of capacities at various discharge settings and eccentric throws. Primary gyratory crushers are used in high-capacity applications, which are usually not below 800 t/h. As the product sizing at a given setting from a primary gyratory crusher is smaller than that of a jaw crusher, gyratory crushers are often used in conjunction with SAG and fully AG grinding circuits to produce high-

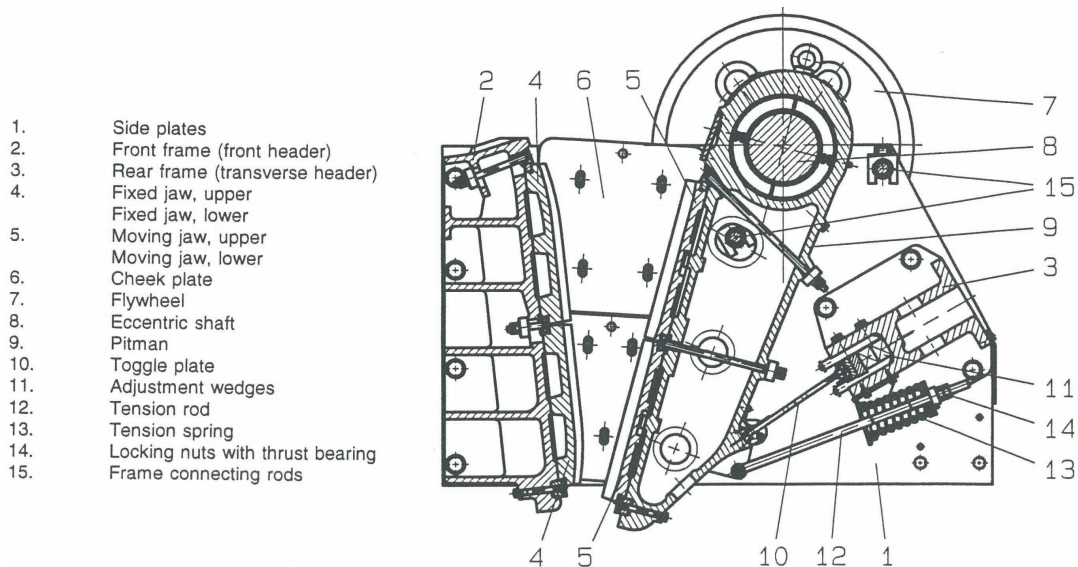

FIG 11.11 - Single-toggle jaw crusher.

capacity and finer feed sizing needed for AG/SAG milling. The model designation refers to the width of the feed opening followed by the diameter of the crusher head in inches: therefore, 60 × 89 is a 60 inch (1520 mm) wide feed opening and a head diameter of 89 inches (2260 mm).

Gyratory crushers can be mounted on crawlers or walking suspensions to make them semi-mobile for in-pit use. With this type of installation, an apron feeder usually elevates the feed to the primary crusher hopper, thus avoiding the need for the discharge surge box and feeder.

While providing a very efficient means of crushing, the high initial and installation costs means gyratory crushers are used only in the highest capacity plants.

### Equipment costs

Table 11.4 provides typical indicative budget prices for a range of jaw and gyratory crushers. Prices are indicative only and subject to confirmation, in Australian dollars ex an Australian capital city seaport, excluding motors and drives, but including typical mining duty options.

TABLE 11.4  
Primary crusher budget prices (c 2007).

Crusher type	Cost (A\$)
<b>Jaw crushers</b>	
C100 (750 × 1000 mm)	300 000
C125 (950 × 1250 mm)	600 000
C160 (1200 × 1600 mm)	850 000
<b>Primary gyratory crushers</b>	
54 × 74 in	3 900 000
60 × 89 in	5 500 000

### Circuit capital costs

The total direct costs for crushing circuits (ie crushers, supporting structure, retaining walls, lubrication and cooling circuits, conveyors and all associated civils, structurals, pipework and electrics) can be determined to an order of magnitude by applying a factor to the installed major equipment costs. However, the factor used can be affected by many design considerations, such as:

- discharge arrangement
- feed arrangement (apron feeder versus direct feed)
- geotechnical issues: for example, the foundation costs, which can be significantly affected
- maintenance and crane arrangements
- number of tipping points
- ROM pad requirements: for example, the size of the ROM pad and natural slope of the site can significantly affect the costs of the retaining wall
- size of feed bin.

The cost factors presented are for average conditions. The costs include works from crusher feed to the discharge from a conventional conical stockpile stacking conveyor.

To determine the direct cost (excluding EPCM and other indirect costs), the total cost of the crushing circuit equipment (including all sundry equipment in the crusher area such as conveyors, sump pumps, scrubbers and rock breakers) is multiplied by a factor. For large gyratory crusher circuits the factor is between 2.5 and 3.5. For small jaw crushing circuits the factor may be in the range 2.0 to 2.5.

The installed equipment cost can be calculated from the ex works cost by assuming that the installation cost is 15 per cent of the on-site cost of the equipment. Freight cost should also be included in the installed equipment cost for this purpose to reflect the location of the project. Freight is typically between five and 15 per cent of ex works equipment cost.

## SECONDARY AND TERTIARY CRUSHING CIRCUITS

Types and applications of crushers for secondary and tertiary crushing are discussed in this section.

### Application

A secondary crusher handles all the primary crushed material, whether from a primary gyratory or primary jaw crusher. It has a sufficiently large feed opening to be able to receive the largest piece of ore that is likely to be produced from the primary crusher to meet the specified design criteria of the circuit.

For secondary and tertiary crushing, cone or impact crushers are generally used (see separate section on HPGR). Impact crushers are only applicable to soft and relatively non-abrasive ores and as such have limited applications (eg Jobson, 2004). The cone crusher is the main secondary crusher used in hard rock mining.

### Circuit balance

To balance all the stages in a crushing circuit, the individual machines must be operated at optimum settings. There is an optimum setting for each crusher and an optimum number of stages required to maximise plant reduction ratio-based on specific characteristics of the material being crushed. Overloading the crusher does not increase production, but is counterproductive as it decreases the life of the crushing components. Ideally, the top size feed should receive four to five impact blows during its progress through the crushing chamber. This is a combination of reduction at the upper zone of the liners as well as the parallel zone. The crusher is fed so it operates at or near continuous full load power capability. Operating the crusher at too narrow a setting decreases capacity and increases wear. Too wide an opening in proportion to top size feed prevents crushing in the upper zone and the crusher draws excessive power. Power drawn per tonne of

crusher feed is not in itself a measure of productivity. Efficient use of power through proper application of the cavity, in respect to feed and product requirements, will determine the optimum production per power drawn.

### Cone crusher selection

Manufacturers' tables provide the capacities for all sizes of standard and short head crushers with their range of capacities at various discharge settings. The size of a crusher is based on the capacity, feed size and minimum discharge setting recommended for a specific machine, within the ranges specified. These capacity ratings are based on a control feed such as limestone and need to be verified for the ore being processed. The machine suppliers usually do this verification; however, the charts provide a useful preliminary guide. Additional tables, which indicate cone crusher product grading, are useful to assist with design and selection of further downstream crushing and screening equipment.

### Equipment selection and circuit simulation

This section highlights both the individual equipment operating principles and equipment interactions in a flow sheet. Process simulation software is an important tool for this task. More information about process simulation can be found in King (2001) and Lynch (1977). It is important for the software user to have specific product knowledge and is well informed about process simulations' benefits and dangers. In many cases it is important that the user is also well informed about the limitations of the software, as knowing the limitations of the software is more important than knowing the possibilities.

### Cone crusher operating principles

Rock breakage is achieved by crushing the material between two rigid surfaces, as shown in Figure 11.12 (Evertsson, 2000).

Rock is fed from the top of the crusher into the crushing chamber. The crusher is normally adjusted

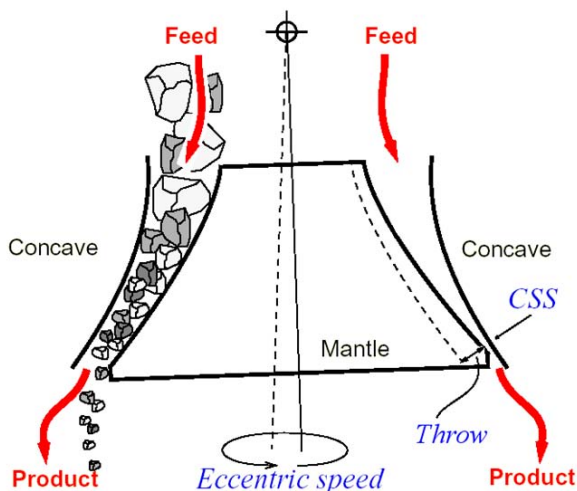

FIG 11.12 - Principle of a cone crusher (courtesy C M Evertsson).

by the closed side setting (CSS) and eccentric throw; both are shown in Figure 11.12. CSS is defined as the smallest distance between the mantle and concave in the closed position. It is adjusted by changing the relative vertical position of the concave and mantle; raising the mantle toward the chamber decreases the CSS. Adjusting the CSS affects both gradation (size distribution) and capacity. Adjusting the throw mainly affects the crusher capacity.

Apart from the adjustment of the vertical position there must also be a system for handling uncrushable tramp material like grinding balls that might accidentally enter the crushing circuit. This system must quickly separate the mantle and concave to protect the crusher from destructive forces.

### Chamber selection

The crusher can normally be equipped with a range of different mantle and concaves. The combination of the two is normally called the chamber. For chamber selection the feed material top-size plays an important role. Chambers normally range from coarse to fine, which indicates the feed size they can handle. A finer chamber can be used with a smaller CSS but, on the other hand, cannot handle large top-size. For correct operating conditions it is normally recommended that the selected chamber should be as fine as possible; that is, a chamber should be selected with slightly larger feed opening size than the expected feed top-size. Selecting a coarser chamber makes generating the same reduction more difficult, and might also cause uneven wear in the chamber. It is often tempting to select a chamber depending on its nominal capacity. This is not favourable, as capacity should instead be achieved by selecting the correct crusher and eccentric throw.

To solve the problem of a small percentage of the feed forcing the selection of a coarser chamber, a new chamber design has been developed by Sandvik AB (Silfver *et al*, 2006).

### Determining capacity

The capacity of a cone crusher is determined by the amount of material that can pass the narrowest section of the chamber. The section is called the choke zone. The choke zone is determined by viewing a horizontal cross-section of the crushing chamber. The choke zone will always be the level at the minimum cross-section. The vertical position of the choke zone varies with the type of chamber. Normally the choke zone is near the outlet on coarser chambers and is further up on finer chambers.

### Wear compensation

During operation, the chamber will wear as some of the manganese steel is removed from the mantle so the concave eventually needs replacement. The removal of material must be compensated to keep the desired

CSS. There are two methods for determining the CSS: stopping the feed to the crusher then manually dropping a piece of lead into the crusher and stopping the feed and raising the mantle until it touches the concave. The second method is only available on crushers with hydraulic mantle adjustment and has the advantage that it can be done very easily from the crusher control system. The Sandvik setting regulation system (ASRi) has a self-learning algorithm that, after a few calibrations, learns the wear-rate so it can automatically adjust the crusher setting. A disadvantage of hydraulic gap control system is that the clamping force is reduced and this can reduce the size of very competent rock. In many applications it is essential to closely monitor the wear since it will increase the CSS and thereby decrease the amount of reduction.

### Impact crusher operating principles

In mining operations, impact crushers are normally viewed as crushers for aggregates and softer material. Installations of vertical shaft impact crushers have been successful where a fine product is required (Lindqvist, in press). The impact crusher tends to produce more fines than a cone crusher and will, therefore, make the following mill stages work more effectively since less size reduction is needed.

Vertical shaft impact (VSI) crushers use a central rotor to throw the rock material into either a bed of rock or a metal wall, as shown in Figure 11.13. In the first case the crusher generates the rock bed during operation. Material that is thrown out of the rotor will stay on a constructed shelf in the crusher and thereby form a bed of material. This means that the impact of the rock will not affect any wear parts in the crusher. Instead, the impact will break either the rock coming with speed from the rotor, or one or more rocks in the material bed.

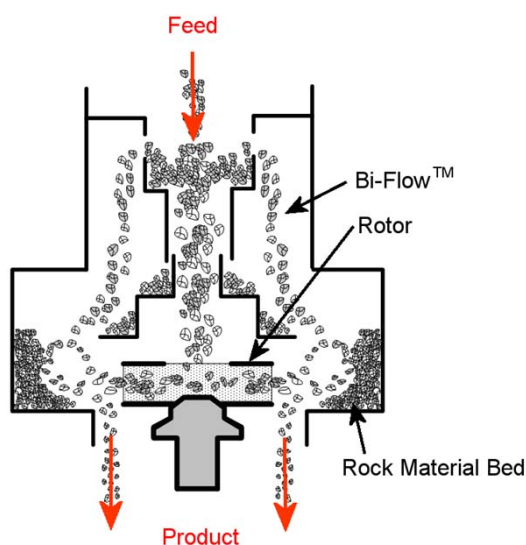

FIG 11.13 - Principle of vertical shaft impact crushing (courtesy M Bengtsson).

Compared to cone crushers, an important limitation of the VSI crusher is the maximum feed size. The rock

must be crushed in at least two, and often three, stages before entering a VSI.

The second type of impact crusher is the horizontal shaft impact (HSI) crusher. This is probably the most common type of crusher on the world market. It is mainly used for softer materials like limestones and is not applicable to hard rock mining. The crusher is sensitive to wear and will only be efficient for low-abrasive materials. However, where it is applicable it is a very good crusher mainly because of its high reduction ratio.

### Crushing plant process design

Designing the process is more than just selecting the machines. Crushing process design must combine the different crushing stages. There are two main configurations of crushing stage circuits: open and closed.

In open-circuit operation, the material only passes the crusher once; no oversize material is recirculated to the crusher. Open-circuit operation has the advantage of typically requiring smaller equipment sizes and being easy to balance. The downsides of open circuit are poor top-size control and coarser product. Two types of open circuits are shown in Figure 11.14.

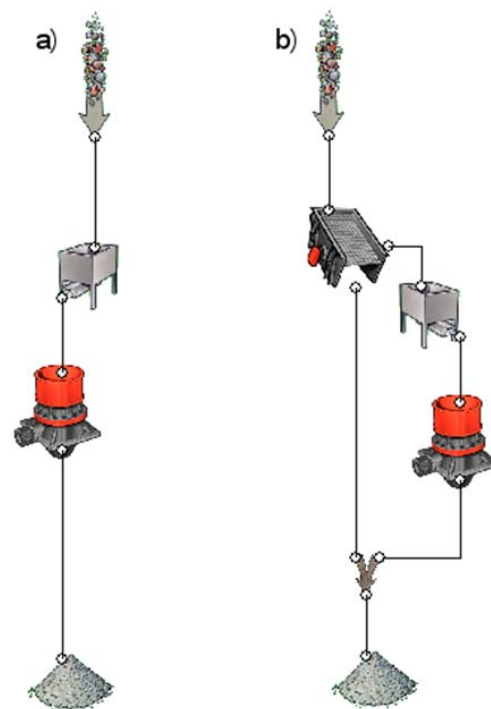

FIG 11.14 - Two types of open circuits: (a) everything through crusher; (b) bypass fine material.

Closed circuits can be designed in many ways. The main idea is to recirculate oversized material and recrush it. The layout of this type of crushing stage is, therefore, more complex and it is more difficult to calculate equipment performance and load. Equipment performance will depend very much on the performance of surrounding equipment. Two examples of closed circuits are shown in Figure 11.15.

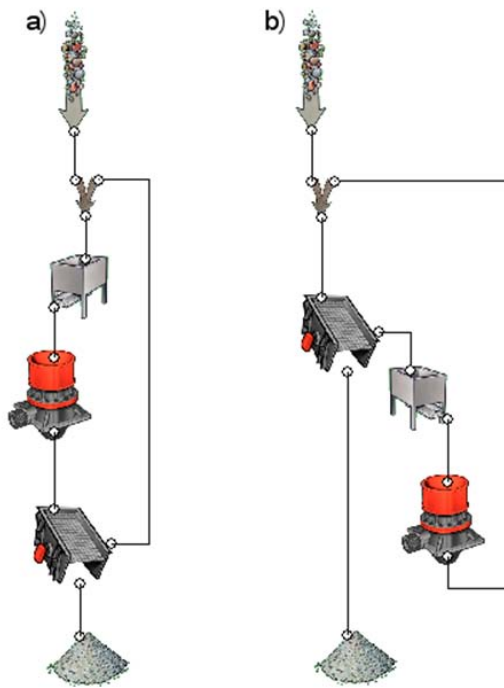

FIG 11.15 - Two closed circuits: (a) screening after crusher (forward closed); (b) screening before crusher (reverse closed).

The crushing stages should be configured to produce the final product as efficiently as possible. It is, therefore, very important to consider the process following the crushing plant. Crushers are generally more energy-efficient than grinding mills. The energy component of the total production cost will, in many cases, be lower if the product from the crushing plant is finer.

*Process simulation*

Process simulation is an iterative calculation of the equipment performance. Since the equipment performance depends on the feed material, the calculation has to be repeated until equilibrium is reached. Depending on the process layout this might require anything from a handful of repeated calculations to somewhere near 100 (for closed circuits) (Svedensten, 2007).

The material properties of the rock should be determined by testing and estimation. The material gradation (size distribution) is very often estimated, especially when it comes to primary crusher feed material. Contaminants and moisture content are usually also estimated. Variations in ore characteristics are common, particularly with depth for open pit operations, and it is often also very useful to change some of the rock material parameters to make sure the plant will be robust against unexpected changes.

When the feed material has been defined the process can be designed. Different software packages apply different approaches to process design, ranging from just equipment performance simulation to checking the process and how pieces of equipment interact. It is, therefore, important that the user knows what the

software does and what assumptions are made. Some packages use fixed product gradation profiles for each crusher-based on the crusher settings, rather than breakage and classification functions to generate the product size distribution.

*Circuit balancing*

Choke-feeding crushers requires that the crusher feeder and discharge screen have sufficient capacity to meet maximum crusher flow rates. The principle, illustrated in Figure 11.16, is an important consideration in flow sheet simulation. In Figure 11.6, the screen will not be overloaded when the crusher is operated. The peak load of the screen in this case is 96 per cent.

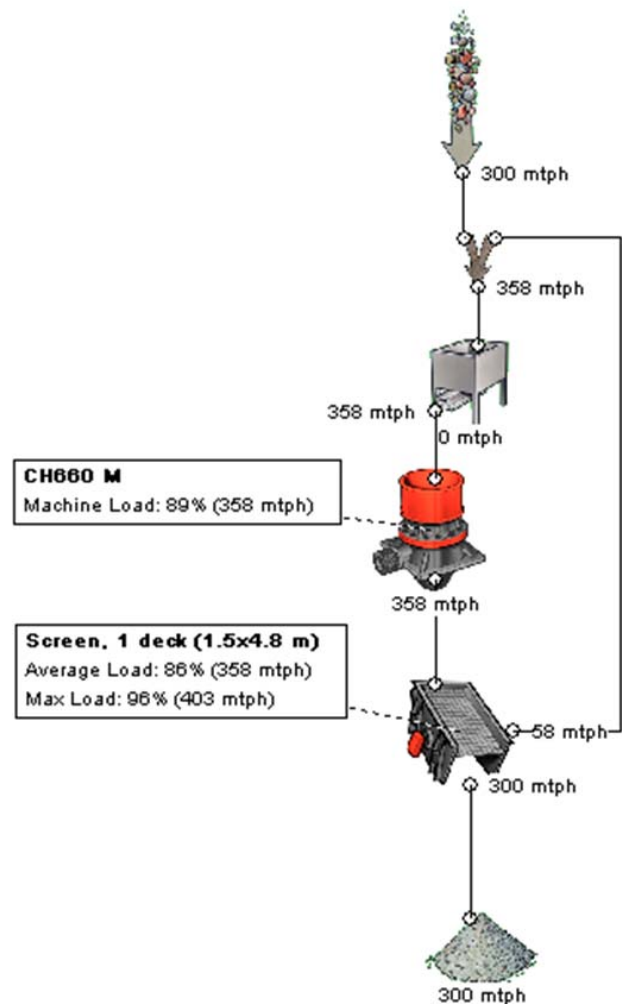

FIG 11.16 - Well-balanced circuit (screen shot from PlantDesigner® crushing and screening simulation software by Sandvik AB).

For crusher simulation and circuit modelling using software, there are a few things to consider:

- How is the gradation or product-sizing curve generated and how does it relate to the feed and crusher adjustment?
- Most models use a standard gradation curve; good software should adjust this curve for feed and crusher adjustment. The best solution is to apply a breakage and classification function (as per JKSimMet).

- The software should answer whether the modelled crusher configuration will work in the given application, whether the crusher is able to handle the given feed and whether it can be operated at this CSS.
- It is important to know whether there is a difference in predicted performance if the equipment is used in a closed or open circuit.
- The performance characteristics of screen models used for a crushing plant simulation; for example, it is important to understand which factors are used to calculate the load and how they are affected when the feed material changes.

By knowing the model structure and calculation methods it is easier for the user to analyse the results. The user will also know how to handle certain situations where it is obvious that the software will have trouble predicting the correct result.

### Equipment costs

Two approaches to estimating crusher costs are presented in this section.

#### *Metso Minerals (Australia)*

Table 11.5 provides typical third-quarter 2007 indicative budget prices for a range of cone crushers. The prices

TABLE 11.5

Cone crusher budget prices (courtesy of Metso Minerals, c 2007).

Crusher type	Cost (A\$)
HP300	\$450 000
HP500	\$950 000
HP800	\$1 700 000
MP800	\$2 500 000
MP1000	\$3 500 000

are indicative only and subject to confirmation by Metso Minerals (Australia). Prices are in 2007 Australian dollars ex an Australian capital city seaport, excluding motors and drives, but including typical mining duty options.

#### *Sandvik AB*

To indicate the 2007 cost for buying a crusher, a short-list of Sandvik crushers is presented in Table 11.6 and vertical crushers in Table 11.7. The prices are estimates from an Australian port and without motor and drives.

TABLE 11.7

Vertical impact crusher budget price range (courtesy Sandvik AB).

Main application	Crusher	Weight (kg)	Capacity <sup>a</sup> (t/h)
Tertiary and downstream	CV115	6 000	10 - 50
	CV116	9 500	51 - 121
Price range A\$150 000 - 400 000	CV117	9 500	122 - 192
	CV118	11 700	193 - 250
	CV128	14 826	251 - 444
	CV129	14 826	445 - 600

a. Capacity is presented as nominal values and is speed dependent. Presented values are the extreme selection of these parameters. Values are calculated using bulk density of 1.6 t/m<sup>3</sup>. Capacity will also depend on feed material properties like moisture and particle size distribution.

### Circuit capital costs

The total direct costs for multi-stage crushing circuits (ie crushing stations, lubrication, screening stations, cooling circuits, conveyors and all associated civils, structural, pipework and electrics) can be determined to a conceptual level of accuracy by applying a factor to the major equipment costs (including conveyor

TABLE 11.6

Budget price range of cone crushers (courtesy Sandvik AB).

Main application	Crusher	Installed power (kW)	Weight (kg)	Capacity <sup>a</sup> (t/h)
Secondary crushers Price range A\$300 000 - 1 000 000	CS420	90	7 070	70 - 168
	CS430	150	12 700	91 - 344
	CS440	220	19 790	195 - 601
	CS660	315	35 490	318 - 1050
Tertiary and downstream crushers with coarse chambers may also be used in secondary applications Price range A\$250 000 - 2 500 000	CH420	90	5 570	27 - 128
	CH430	150	9 470	48 - 208
	CH440	220	14 820	90 - 395
	CH660	315	24 020	162 - 662
	CH870	500	58 000	280 - 1512
	CH880	600	70 000	309 - 2128

a. Capacity is presented as nominal values. The crusher capacity will depend on chamber selection, throw and CSS. Presented values are the extreme selection of these parameters. Values are calculated using bulk density of 1.6 t/m<sup>3</sup>. Capacity will also depend on feed material properties like moisture and particle size distribution.



component costs). However, the factor used can be affected by:

- circuit throughput
- final product size
- interstage stockpile and/or bin capacity
- number of crushing stages
- style of the circuit.

For small plants (0.5 Mt/a) with no or minimal interstage storage, the factor can be as low as 2 to 2.5. For high-capacity and complex circuits with crusher feed bins and feeders to maximise availability, the factor can be as high as 4.

## HIGH-PRESSURE GRINDING ROLL-BASED CIRCUITS

HPGR technology has its genesis in coal briquetting in the early 20th century. However, it was not until the mid-1980s that it was adopted for comminution applications, when it was applied in the cement industry treating relatively easily crushed materials. Since then its use has spread to the diamond and iron ore sectors where it is now widely applied, and more recently has found increasing acceptance in hard rock minerals processing, as shown in Figure 11.17.

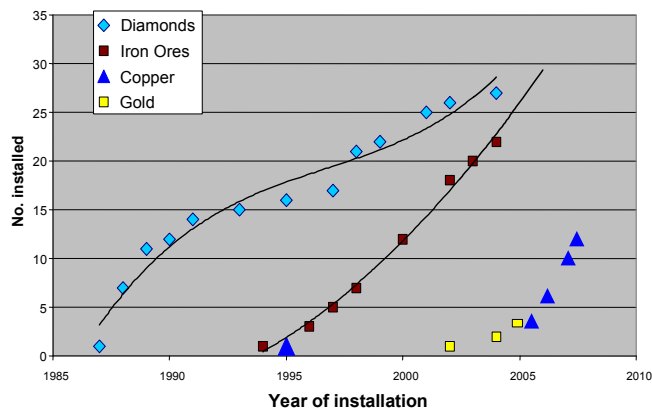

FIG 11.17 - High pressure grinding roll population in the minerals sector (courtesy of Polysius AG) (Klymowsky *et al*, 2006; Morley, 2005, 2006a, 2006b).

One reason for the caution displayed in the hard rock sector in adopting HPGR technology was the general lack of definition of flow sheet and circuit design requirements and the absence of any significant benchmark operations. This matter was addressed in detail by Morley (2006b) and is the subject of this section.

### Technology motivators

The motivating factors for the use of HPGR technology in the minerals extraction sector are:

- differential comminution for improved liberation and recovery of diamonds and coarse gravity-recoverable precious metals
- improved metallurgical performance in downstream operations

- increased comminution energy efficiency, leading to reductions in power demand and grinding media consumption.

### Application guidelines

At the current stage of development of HPGR technology and circuit design, a HPGR-based comminution plant will typically be more expensive to install than the equivalent conventional SAG-based plant. To be viable, therefore, the HPGR-based plant must incur lower operating costs (typically through reduced power demand and grinding media consumption), leading to the return of the incremental capital costs over an acceptable payback period.

Test work will determine the response and amenability of a particular ore to HPGR treatment, but other project-specific factors will determine its commercial viability, including the following:

- Capital cost differential tends to decrease (in percentage terms) as the size of the plant increases (the economies-of-scale effect), so that HPGR will typically be more easily justifiable for large-scale operations.
- Operating cost differential increases with ore competency and cost of electricity, thus reducing the payback period for the incremental capital cost.
- Energy-efficiency benefits of HPGR increase with the coarseness of the primary grind, as proportionally less energy is consumed in the less-efficient ball milling stage.

In summary, HPGR will be more easily justifiable with high plant throughput and long project life, competent abrasive ore, costly electricity and a coarse grind. The greater the number of these factors that apply to a project, the greater will be the likelihood that HPGR will be an attractive proposition.

The guidelines above are relevant primarily to greenfields hard rock applications in which energy efficiency has a major influence. For other categories, different considerations apply, as follows.

- In heap-leach operations in which comminution energy is a less significant factor, HPGR can be justified (Klingmann, 2005) by improved metallurgical performance ascribed to the phenomenon of micro-cracking of the HPGR progeny particles, which promotes penetration of leach liquors.
- In brownfields applications, HPGR has a small power footprint ( $m^2/kW$ ), making it suitable for debottlenecking conventional circuits for additional throughput and/or a finer grind (Mular and Mosher, 2006).
- In diamond processing, the differential comminution characteristics of HPGR improve recoveries (Maxton, Morley and Bearman, 2003). This behaviour applies equally to coarse gravity-recoverable gold (Pyke *et al*, 2006).

The following discussion assumes that the amenability of the ore to HPGR treatment has been demonstrated by appropriate test work. It assumes the suitability of HPGR for the project has been established by a cost-benefit analysis or trade-off study so that a HPGR-based circuit can be taken as both technically practical and commercially attractive.

### Processing considerations

Having established that HPGR is a suitable technology for a given application, it is then necessary to consider some additional factors when designing a suitable flow sheet.

#### Flake formation

The product from a HPGR is typically in the form of a compacted flake (Figure 11.18), the competency of which is a function of the ore characteristics and moisture content and of the operating pressure of the HPGR. Generally, hard primary ores generate fragile flakes while softer ores (eg kimberlites) produce relatively competent flakes.

Flake competency is not an indication of the suitability of HPGR for any given ore. Instead, it provides an indication of downstream processing requirements, specifically whether a separate de-agglomeration step is required before further processing. This must be determined as part of any test program before circuit design commences, and manufacturers have developed standard in-house tests for just this purpose.

#### Feed top size

For hard rock applications, it is generally accepted that, to minimise the likelihood of stud breakage, HPGR feed should be as fine as possible and the top size should not exceed the expected operating gap. This will normally demand a closed-circuit crushing operation upstream to ensure this top size is positively controlled. For softer materials, this rule can be relaxed. For example, some kimberlite operations successfully treat an open-circuit secondary crushed product with a top size-to-gap ratio of about 1.8 - 2.0, using studded rolls, as shown in Figure 11.19.

As a guide, the operating gap can be taken as about 2.0 - 2.5 per cent of the roll diameter for full-fines feed

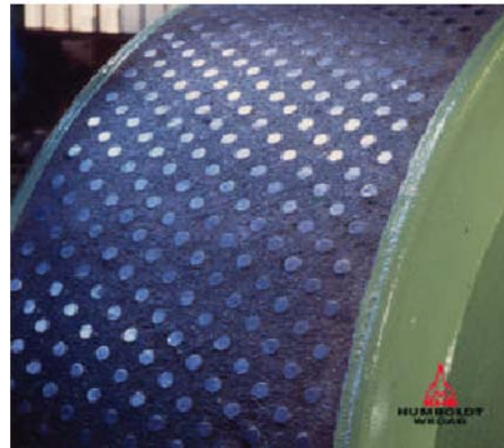

FIG 11.19 - Studded tyre (courtesy of KHD Humboldt Wedag).

and 1.5 - 2.0 per cent for truncated feeds, as discussed for feed bottom size.

#### Feed bottom size

The capacity of a HPGR is a strong function of the feed bulk density and, therefore, the bottom size. Throughput is significantly higher with a full-fines feed than with a truncated feed; that is, with the fines removed. Despite the reduced unit capacity, there are some potential benefits to operating with a truncated feed (Morley, 2006a).

#### Circuit options

HPGR-based circuit design for hard ore processing is similar to options for other crusher types. The only departures are where multiple-pass or edge-recycle flow sheets are used to increase size reduction without stage screening. This is possible and sometimes effective with compression crushers like HPGR, but not with contact crushers such as cone crushers.

#### Equipment selection

Based on supply cost alone the equipment may appear capital-intensive relative to competing technologies. This is partly because the initial supply cost includes the first set of tyres for the rolls. It is important to note that a significant proportion of the operating cost for the first year of production is tied up in the cost of the first set of tyres. This cost is an operating expense, but



FIG 11.18 - High pressure grinding roll product flake (courtesy of Amplats Potgietersrus).

it is generally capitalised according to conventional accounting practices. A set of standby rolls is also required as part of the initial purchase in addition to the first set of tyres. The standby rolls provide the strategic spares for the HPGR and ensure that rapid exchange of the rolls is possible. The tyres on the standby set are also an operating cost. With this knowledge, care must be taken to apportion costs correctly into the respective capital and operating streams without inadvertently overstating the operating cost in the first few years of production. This statement is particularly relevant at a conceptual study level, where the finer detail of the breakdown between the capital and operating budget is generally not addressed.

Depending on the application, the overall operating cost can be very competitive once liner and media consumption and other maintenance expenses associated with competing technologies are taken into account. When the production rate is relatively low there can be certain niche applications for the technology. These are likely to be when additional metallurgical benefits, such as improved metal recovery due to the formation of micro-fractures, are demonstrated as part of the HPGR test work phase.

#### *Data required*

Access to standard ore physical property data, such as the UCS, crushing work indices, JK appearance function and Bond abrasion index, are useful to the equipment supplier in predicting HPGR response. However, at no stage are any of the results from these tests used in the calculation to size the equipment.

Laboratory- and pilot-sized HPGRs are available at a limited number of commercial laboratories and research institutes. Laboratory-sized units are useful for undertaking spatial evaluations of the orebody across different geological and mining domains. For each major ore type, a minimum of five batch tests is required to characterise the response of the material to the key HPGR process variables. These are pressing force, roll speed and feed moisture content. Key parameters generated during the test program include:

- product size distribution
- specific energy consumption (kWh/t)
- specific throughput (t.s/h.m<sup>3</sup>).

In a pilot-sized unit the minimum batch time required to achieve steady state, and thus generate a reliable data set, is about 15 seconds. With this constraint, the minimum sample weight per batch will be 150 to 250 kg. As a result, the total sample size required to complete the five characterisation tests would range from 750 to 1250 kg, depending on the density of the ore.

In most applications, the HPGR is operated in closed circuit with product classification usually by wet or dry screening. In this situation a closed circuit (locked cycle) test is also required. An additional 200 to 350 kg of sample will be required for this purpose, again

depending on the density of the ore. If the HPGR is operated in closed circuit with product screening, then classification at approximately 3 mm is considered to approach the lower limit for the technology.

#### *Key equipment required*

A spare set of rolls complete with shafts (×2), bearings (×4) and tyres (×2) will be required to minimise the time to exchange worn rolls. This also fulfils the requirement for keeping strategic spares for these critical components. If multiple HPGRs are used only one spare set of rolls will be required to fulfil the rapid interchange function between worn and new rolls. Thus, the cost of the strategic spares, as a percentage of the overall supply cost, will decrease considerably. It is also prudent to have at least one spare gearbox and one spare main motor available in close proximity to the operation, given the lead time for supply of these items.

The feed chute is an integral component of the HPGR supply. Each manufacturer has its own design. The main role of the feed chute is to distribute the material evenly across the width of the rolls to minimise the potential for roll skew and to position the ore flow to minimise turbulent wear at the roll surface. The correct distribution of ore is achieved by an internal regulating gate. The position of the gate can be adjusted online if required, although once set during commissioning it is rarely changed. The regulating gate can also be adjusted to change the nipping angle, and thus increase or decrease the HPGR capacity (within certain limits), if variable-speed drives cannot be justified.

A HPGR should be operated with choke feed conditions for optimal performance. Choke feeding helps to maximise the operating gap at a given roll speed, since the weight of the ore directly above the operating gap helps open the gap, particularly at higher roll speeds where slippage at the surface of the rolls can occur. A suitable hopper above the HPGR must be used to achieve choke-feed conditions. The hopper should be designed so that the minimum residence time is approximately 90 seconds. The main HPGR feed bin can be used for this function, but doing this can present some additional risk, since the potential for tramp metal to enter the HPGR undetected is increased. The HPGR supplier will generally provide a functional specification for the design of the feed hopper, but this item is usually manufactured and procured locally to reduce the supply cost.

#### **Equipment costs**

Figure 11.20 provides an overview of HPGR equipment cost in 2007 - 2008 (checked again in 2012 with similar cost outcome). The average cost figures shown are based on global HPGR installations. Country-specific conditions that affect packing, shipment, etc are not considered. The current cost figures shown are projected for investments in the year 2007 - 2008.

For desktop studies or prefeasibility studies, the equipment costs given in Figure 11.20 provide ample

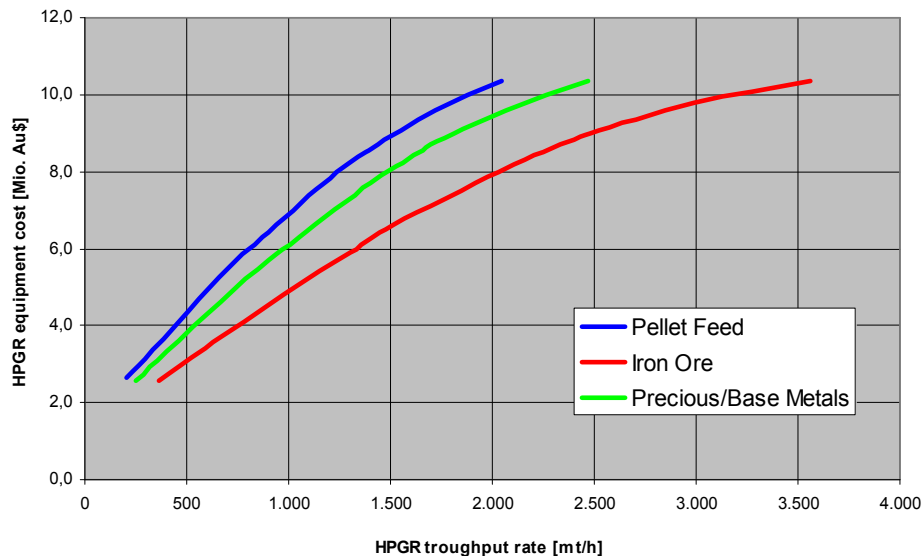

FIG 11.20 - High pressure grinding roll feed rate versus high pressure grinding roll equipment cost (Capex).

accuracy. For feasibility studies, the specific conditions of the particular application must be considered. Thus, more specific technical and commercial calculations, as well as HPGR test work, must be carried out to achieve accurate data.

The basic scope of supply for the HPGRs is shown in Figure 11.21. The HPGRs are ready for operation including monitoring and control systems, two 'stud lining' rollers, feed hoppers including feeding gates to ensure even feed presentation, hydraulic pressure units, lubrication systems, inching drives, access platforms, special tools, two drive trains consisting of planetary gearboxes, safety couplings, Cardan shafts, main drive motors, variable-speed drives (VSDs) and transformers. Also included are engineering services for a complete HPGR design, plus installation drawings and operation manuals.

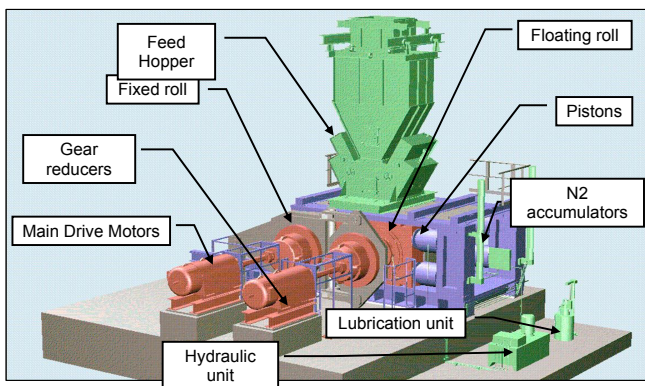

FIG 11.21 - Scope of supply for high pressure grinding roll cost estimation.

The equipment cost in Figure 11.20 excludes:

- civil work and structural steel to support the HPGRs
- engineering, both basic and detailed
- equipment for sampling and materials handling, including stockpiles, surge bins, feeders, conveyors and chutes
- installation and commissioning of the equipment.

### Circuit capital costs

To assess the installation cost of HPGRs for feasibility studies on major projects in the mining industry, a factor of approximately 1.4 to 1.6 should be applied to the HPGR equipment cost, shown in Figure 11.20. While the capital cost of the HPGR installation alone may be estimated using a factor of 1.4 to 1.6, the costs of other facilities need to be considered, including:

- dust extraction and collection
- feed and recycle conveyors
- feed bins
- screening facilities.

The largest variable cost with any given HPGR is determined by the size of the feed bin or stockpile and dust extraction system. If these unit processes are not included, the costs of the conveyors, screens and HPGR facility are approximately 2.2 times the ex works HPGR cost; including a large bin with 30-minute residence time and dust extraction system causes the multiplier to increase to approximately three.

### VIBRATING SCREENS

There are two main applications for screens: process screening and final product production (Soldinger Stafhammar, 2002). The first type separates the rock to provide the crushers with oversize material. The second type separates the crushed material into one or more products that need no further processing in the crushing plant.

### Screen operating principles

Vibrating screens include horizontal, inclined and banana-shaped screens. Screen motions also vary: linear, circular, or elliptical strokes are used. The amplitude of the motion can also be altered. Horizontal screens are normally used with linear motion. For inclined or banana screens, circular or elliptical motion

is typically used. The reason for using linear motion on horizontal screens is that the motion both conveys the material forward and stratifies it.

Stratification is the process where larger particles move upwards while smaller particles move downwards. This process can only take place if the bed of material is thick enough. Otherwise the particles bounce on the screen media and efficiency is reduced. Keeping a particle bed that allows for stratification and good contact between the particles and screen media is, therefore, essential for a good screening result.

As the smaller particles reach the bottom of the material bed they pass through apertures. Depending on the open area of the screen, the opportunity for passage will vary. Open area is defined as the percentage of holes in the screen media. The type of motion and amplitude (also called 'stroke') will also affect the rate of passage. Smaller stroke will suit smaller separation sizes. The longer the material stays on the screen deck, the higher the probability the particles will pass through the apertures. On the other hand, longer time on the screen also means lower transport velocity, which results in thicker bed depth and a higher need for stratification. Transport velocity is determined by stroke, motion direction and speed. Thus, there is a need to trade off stratification and passage, as both are necessary to achieve a satisfactory screening result.

Banana screens provide a solution to this problem. The banana screen media incline decreases from start to end. It starts with a rather steep incline, which then gradually decreases. This forms a bent 'banana' shape.

In most cases, a single deck is enough to screen material with good accuracy. Sometimes, when a smaller fraction needs to be screened from coarse material, it is useful to use a 'relief deck'.

To determine the screen performance a number of different calculation methods are used. Traditionally, the Allis-Chalmers method has been dominant in mining applications (Allis Chalmers, undated). Most methods are based on a number of calculation factors that depend on screen operating conditions. They are normally multiplied together and compared to the amount of material expected to pass through the screen deck. This comparison results in a load figure. In the Allis-Chalmers calculations the load is then used to determine the efficiency. Efficiency is defined as the ability of the screen to remove undersize material.

### Screen selection – wet and dry

Although only a relatively small cost item in the plant, vibrating screens provide an essential function as they ensure separations and quantities at selected sizes are available for distribution to various sections of the plant. It is, therefore, important that a vibrating screen is correctly selected for efficient plant operation.

Vibrating screen selection is influenced by a number of variables and, therefore, the final selection often depends on the experience of the person making the recommendations.

The calculations described here are not suitable for the following applications:

- carbon-in-pulp (CIP) process screens
- desliming
- drain and rinse
- jig product screens
- SAG mill screens.

### Steps for screen selection

To determine the size of the vibrating screen there are several factors to consider. Screen election starts by considering whether a double-deck screen has any advantage when only a single separation is required. A better appreciation of how this affects the decision is obtained by considering the example of a feed analysis showing a high proportion of large lumps in the feed. In such cases a top deck screen surface is used as a relief deck to scalp off the oversize, thereby protecting the bottom deck from damage.

Another example is the case of a screen required to have a 12 mm cut point receiving –150 mm feed. Providing the feed analysis is suitable; a double deck is selected with the top deck acting as a relief deck, which results in choosing a smaller size screen.

Care must be taken not to choose a top deck aperture that too closely approaches the bottom deck aperture. This causes an abundance of near-size particles to discharge onto the bottom deck, eliminating the larger pieces, which provide a scrubbing effect that assists the screening action. Either an inclined circular motion screen or a horizontal linear motion screen is typically used for sizing. However, the normal preference is to use inclined screens for dry screening and horizontal screens for wet screening. For dry screening with limited headroom and cut points greater than 32 mm, a linear motion screen sloped at 5 or 10°, with a mechanism line of action of 50 or 55° should be chosen.

The steps to screen selection are given by the following equation:

$$A = \frac{T}{C_n}$$

where:

- |                |   |
|----------------|---|
| A              | area of screen surface required   |
| T              | metric t/h of feed to the screening deck  |
| C <sub>n</sub> | metric t/h that one square metre of screen surface can be fed, while effectively removing the undersize particles |

$$C_n = C \times M \times K \times Q$$

All factors in the equation for C<sub>n</sub> are described below.

**'C' factor**

The 'C' factor, or capacity curve (shown in Figure 11.22) is an empirical value of the amount of feed in t/h that 1 m of screen surface can handle for different size cut points. These size cut points are based on a feed containing 25 per cent oversize and 40 per cent passing holes that are half the size of the opening in the screen surface.

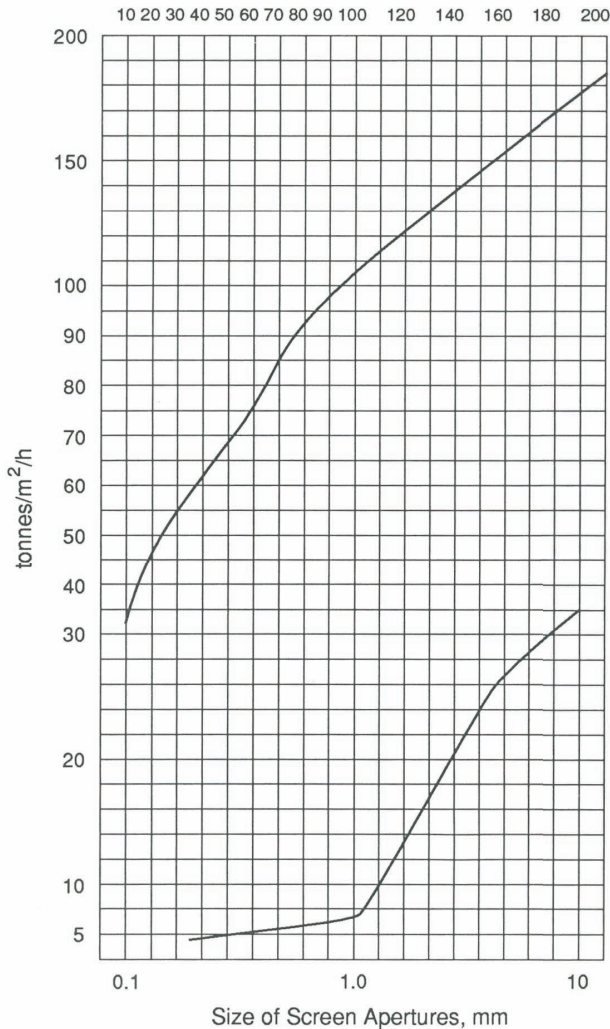

FIG 11.22 - Correction factor 'C'.

The 'C' factor is also based on:

- estimated screening efficiency of 90 per cent
- handling material bulk density of 1.6 t/m<sup>3</sup>
- open area in screen surface of 50 per cent for 1.6 t/m<sup>3</sup> material and 60 per cent for 0.8 t/m<sup>3</sup> material
- square opening or equivalent round opening screen surface.

**'M' factor**

Expressed as percentage of feed to the screening deck that is larger than the opening in the deck, the 'M' factor (oversize curve, Figure 11.23) compensates for the difference in the percentage oversize at which the 'C' factor was established (25 per cent) and the actual application. The 'M' compensates for how easy or difficult it is for the fines to sift through the bed

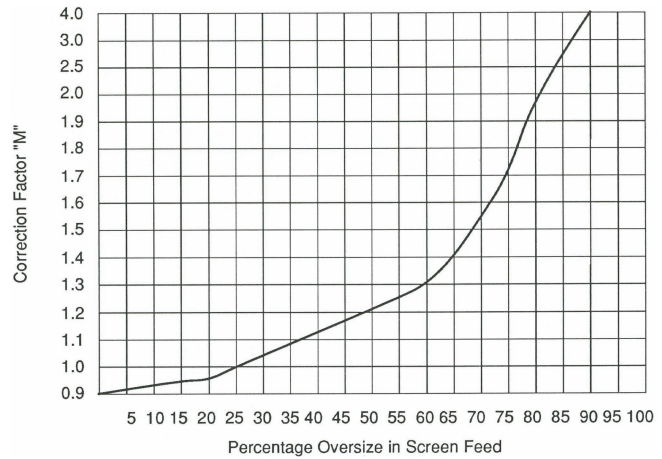

FIG 11.23 - Correction factor 'M'.

of material. The principle of screening is to agitate the feed so that the fine particles sift through the bed (stratification) and present themselves to the opening in the screen surface, either to pass through or over the screen.

Not all applications have the same gradation of material. Material coarseness or fineness determines how the fines sift through the bed of material.

**'K' factor**

Expressed as the percentage of feed offered to the screening dock that is one-half the size of the opening in the screen surface, the 'K' factor (half-size curve, Figure 11.24) compensates for the difference in the percentage half size at which the 'C' factor was established (40 per cent) and the actual application. Material gradation will determine whether this will be a high or low degree of probability of separation. Depending on how coarse or fine the material is, it may be easy or difficult for the undersize to pass through the screen surface openings. The smaller the particle is compared to the opening size (high percentage of half size), the greater the probability. Conversely, the larger the particle is compared to the opening size (low percentage of half-size), the smaller the probability.

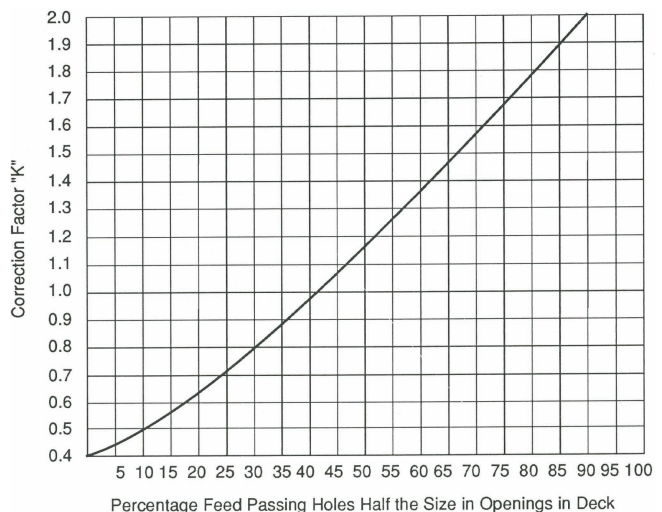

FIG 11.24 - Correction factor 'K'.

**‘Q’ factor**

The ‘Q’ factor (additional factor affecting ‘C’ capacity) corrects for the difference in the value of ‘C’ due to any variance between the conditions under which the ‘C’ factor was established and the specific application. It is the product of two or more ‘Q’ factors:

$$Q = Q1 \times Q2 \times Q3 \text{ etc}$$

Table 11.9 and Table 11.10 show ‘Q’ variances and their correction factors. Definitions for parameters shown are:

- bulk density – weight of one cubic metre of material in its ‘loose state’
- particle shape – ‘C’ factor, based on dry, free-flowing particles such as sand and gravel with uniform cubic shape; this correction is made for slabby elongated particle shapes
- screening surface opening – correction for round or slotted openings
- screening surface open area – ‘C’ factor established for 50 per cent open area in the screening surface for 0.8 to 1.6 t/m<sup>3</sup> material and 60 per cent open area for up to 0.8 t/m<sup>3</sup> material; any variance may be compensated for by the ratio of percentage area available to these base values:

$$Q4 = \frac{\% \text{surface area available}}{\% \text{surface area base}}$$

Wet or dry screening affects the ‘Q’ factor. The ‘C’ capacity was based on dry screening; in many applications increased screenability is obtained by adding water to the feed prior to its introduction to the screen and through a series of high-pressure sprays above the deck surface. The value of increased screenability depends on the opening, type of screen surface and amount of water used. The increase in value when using spray water decreases as the screen surface opening approaches 25 mm and a correction for using water at an opening of 25 mm or more is considered negligible. On openings smaller than 5 mm its effect is reduced due to open area and water surface tension. When dry screening (no spray), Q = 1.

Surface moisture affects ‘Q’. The film of moisture adhering to the exposed surface of a particle affects the ease or difficulty with which it is screened. Surface moisture is expressed in percentage weight. ‘C’ capacity was established for dry material with not more than three per cent surface moisture. Only the surface moisture has any effect on screenability of material. Total moisture is made up of inherent and surface moisture. Inherent moisture is contained inside the material or particle and has no effect on screenability. Dense material, such as trap rock or iron ore, may have a total moisture of eight per cent with only three per cent surface moisture, while lignite (lowest form of coal) may have a total

moisture of 18 to 25 per cent with three per cent surface moisture, as shown in Table 11.8. Variances in ‘Q’ correction factors are shown in Table 11.9 and banana-screen correction factors are shown in Table 11.10.

**TABLE 11.8**  
Effect of moisture on ‘Q’ factor.

Moisture content	Surface moisture ‘Q’
Up to 3%	1.00
Damp quarried or stockpiled material with 3 - 6% surface moisture	0.85
Damp quarried sand and gravel, coal, iron ore, etc with greater than 6% surface moisture, but not greater than 9%	0.75
When wet screening	1.00

Note: Greater than six per cent surface moisture, depending on the ‘stickiness’ or the clay content, may dictate using wet screening.

Once the factors have been determined, the area required can be calculated by the formula  $A = T/Cn$ . This area is based on 90 per cent screening efficiency, with no more than ten per cent undersize material in the oversize. Greater capacities can be obtained, but only at a sacrifice in efficiency. Where a customer specifically requests maximum efficiency (95 per cent), an additional 20 per cent screening area should be added to the calculated screen area.

The area required for each deck of a multiple-deck screen is calculated and the width and length of the screen are selected to create an area equal to, or greater than, the deck area calculated. Calculated deck area is the net effective area, taking into consideration area loss due to clamp bars, centre hold bars and longitudinal support bars, plus area loss where particles pass from one deck to another. With multiple decks, the deck with the greatest screening area requirement governs the selected width and length.

**Screen selection – size**

The slope on inclined screens changes travel rate and capacities, as well as the resultant opening, so they are different from a testing sieve. The standard slope is 20°. If reduced slopes are used, capacities must also be reduced if screening efficiency is to be maintained, as shown in Table 11.11.

Several combinations of widths and lengths may give the area needed. To make the proper choice, select the width that maintains proper bed-depth for efficient screening. If the required area is greater than the net effective area available from Table 11.12, multiple screens are used in parallel. If installation limitations restrict multiple screens in parallel and it is desired to put units in series, enough area could be available. However, the bed depth may be more than is acceptable

TABLE 11.9  
'Q' factor variances and corrections.

Q correction factor	Q1 bulk density (kg/m <sup>3</sup> )	Q2 screen surface opening (type)	Q3 particle shape	Q4 % surface area	Q5 wet screening (opening mm)	Q6 % surface moisture (dry screening)
1.40	2240	–	–		1 - 3	–
1.30	2080	–	–		–	–
1.25	2000	Rect. 4 to 1 slot	–		5 - 6.5	–
1.20	1920	Rect. 3 to 1 slot	–		8 - 12.5	–
1.15	1840	Rect. 2 to 1 slot	–		–	–
1.10	1760	–	–		14.5 - 22.5	–
1.00	1600	Square	Dry cubic		Dry screening	Up to three or wet screening
0.90	1440	–	–		–	–
0.85	1360	–	–		–	3 - 6
0.80	1280	Round	–		–	–
0.75	1200	–	–		–	6 - 9
0.50	800	–	–		–	–
0.25	400	–	–		–	–

Notes: 'C' factor was established for base values of 50 per cent open area in screening surface for 0.8 - 1.6 t/m<sup>3</sup> material and 60 per cent open area for up to 0.8 t/m<sup>3</sup> material; compensate for variances by ratio of percentage area available to these base values.  $Q = (\text{percentage surface area available}) / (\text{percentage surface area base})$ .

Rect. = rectangular. Do not interpolate between values given.

– = no data.

TABLE 11.10  
Banana screen correction factors.

Feed passing cut point (%)	Correction factor Q7	Feed passing cut point (%)	Correction factor Q7
5	1.09	55	1.46
10	1.13	60	1.50
15	1.16	65	1.54
20	1.20	70	1.57
25	1.24	75	1.61
30	1.28	80	1.65
35	1.31	85	1.69
40	1.35	90	1.73
45	1.39	95	1.76
50	1.43		

TABLE 11.11  
Capacity factors according to screen slope.

Slope reduction	Rated (or %) capacity
2½° less	90 - 92.5
5° less	80 - 85
7½° less	70 - 75
10° less	60 - 65

for efficient screening, thus reducing efficiency of separation.

The size and number of screens required is estimated by following the guidelines in Table 11.11. Calculated capacities are conservative, but due to inconsistencies in the screenability of materials, even under similar conditions, such estimations are considered approximate and should be used as a guide and not as a guarantee that they will apply to any particular case.



TABLE 11.12  
Net effective screening area (m<sup>2</sup>).

Screen size (m)	Top deck	Second deck	Third deck	Screen size (m)	Top deck	Second deck	Third deck
0.6 × 1.2	0.55	0.5	0.45	1.8 × 3.0	5.11	4.6	4.14
0.6 × 1.8	0.84	0.75	0.68	1.8 × 3.6	6.13	5.5	4.97
0.9 × 1.8	1.4	1.25	1.12	1.8 × 4.2	7.15	6.44	5.8
0.9 × 2.4	1.85	1.67	1.5	1.8 × 4.8	8.18	7.36	6.62
0.9 × 3.0	2.3	2.1	1.85	1.8 × 6.1	10.2	9.2	8.28
0.9 × 3.6	2.8	2.5	2.25	2.1 × 3.6	7.24	6.52	5.87
0.9 × 4.2	3.25	2.9	2.64	2.1 × 4.2	8.45	7.6	6.85
0.9 × 4.8	3.7	3.35	3.0	2.1 × 4.8	9.66	8.7	7.8
1.2 × 1.8	1.95	1.75	1.58	2.1 × 6.1	12.08	10.87	9.78
1.2 × 2.4	2.6	2.34	2.1	2.4 × 4.2	10.69	9.62	8.66
1.2 × 3.0	3.25	2.92	2.64	2.4 × 4.8	11.15	10.03	9.03
1.2 × 3.6	3.9	3.5	3.15	2.4 × 6.1	13.94	12.55	11.29
1.2 × 4.2	4.55	4.1	3.69	2.4 × 7.3	16.42	14.78	13.3
1.2 × 4.8	5.2	4.68	4.2	3.0 × 4.8	13.68	12.3	11.08
1.5 × 2.4	3.35	3.0	2.7	3.0 × 6.1	17.38	15.65	14.08
1.5 × 3.0	4.2	3.76	3.4	3.0 × 7.3	20.8	18.72	16.85
1.5 × 3.6	5	4.5	4.06	3.6 × 4.8	16.56	14.9	13.4
1.5 × 4.2	5.85	5.27	4.74	3.6 × 6.1	21.04	18.94	17.04
1.5 × 4.8	6.7	6.02	5.4	3.6 × 7.3	25.18	22.66	20.39
1.5 × 6.1	8.36	7.53	6.77	4.2 × 6.1	24.34	22.03	
1.8 × 2.4	4.1	3.68	3.3	4.2 × 7.3	29.13	26.36	

### Example of screen selection

Screen selection involves a series of steps. The order for completing the steps is given later in this section; however, in summary, the steps include:

- define duty
  - material and feed rate the screen will be expected to handle
  - results the user expects
  - limitations, including physical characteristics and customer preference
- establish considerations, which include
  - desired product
  - feed specifications – type, weight, size, t/h, etc
  - inclined or horizontal
  - percentage efficiency required
  - screening surface requirements
  - wet or dry screening application
- draw a simple diagram based on feed rate and sieve analysis
- determine factors for each deck
  - capacity (C)/m<sup>2</sup> (Figure 11.22)
  - oversize (M) correction factor (Figure 11.23)
  - half-size (K) correction factor (Figure 11.24)
  - 'Q' correction factors, as applicable (Tables 11.9 and 11.10)
- determine screen area for each deck
- select screen width and length
- check bed depth.

The steps are examined in sequence below.

#### Step 1 – define duty

- Feed is 280 t/h of –38 mm crushed stone weighing 1.6 t/m<sup>3</sup>.
- Three products desired: +25, 25 × 10 and 10 × 0.
- Customer needs commercially perfect screening efficiency (ie 95 per cent efficiency).
- Customer needs clean, square opening to produce saleable products and recommends:
  - –25 mm square top deck (8 mm diameter wire)
  - –10 mm square opening second deck (4 mm diameter wire).
- Water sprays can be used to accelerate passage of undersize.

- Sieve analysis of feed is:
  - –100 per cent passing 38 mm
  - –90 per cent passing 25 mm
  - –68 per cent passing 12.5 mm
  - –60 per cent passing 10 mm
  - –41 per cent passing 5 mm.
- Head room is no problem and an inclined screen is acceptable.

**Step 2 – determine screen area on each deck**

$$A = T/C_n$$

where:

A area of screen surface required

T t/h feed to screening deck

$$C_n = C \times M \times K \times Q$$

$$Q = Q_1 \times Q_2 \times Q_3, \text{ etc}$$

**Step 3 – determine capacity C**

Capacity per square metre (C) for each deck is estimated from Figure 11.22.

Top deck, 25 mm square opening: C = 53

Bottom deck, 10 mm square opening: C = 33.

**Step 4 – determine oversize correction factor M**

Oversize correction factor M for each deck is estimated from Figure 11.23 using percentage of feed to each deck that is larger than deck opening.

Top deck, 10% oversize (10% + 25) = 0.94

Bottom deck:  $\frac{84 \text{ t/h (oversize)}}{252 \text{ t/h (feed to second deck)}}$ , or

$$\frac{30\% \text{ (per cent oversize)}}{90\% \text{ (per cent feed to 2nd deck)}} = 33.3\%,$$

and from Figure 11.23 = 1.05.

(Refer to Step 1 for sieve analysis of feed and Step 2 for values used in formulas.)

**Step 5 – determine half-size correction factor K**

Half-size correction factor K for each deck is determined from Figure 11.24 using percentage of feed to each deck that is one-half the size of deck opening.

Top deck, 68% half size (68% –12.5 mm) = 1.58

Bottom deck:  $\frac{41\% - 5 \text{ mm}}{90\% \text{ (feed to bottom deck)}}$ , or

$$\frac{0.41 \times 280 \text{ (half size t/h)}}{252 \text{ t/h (feed to bottom deck)}} = 45.5\%$$

or from Figure 11.24 = 1.11.

(Refer to Step 1 for sieve analysis of feed passing 12.5 and 5 mm.)

**Step 6 – determine correction factor Q**

$Q = Q_1 \times Q_2 \times Q_3, \text{ etc}$  (refer to 'Q' correction factors).

For the example:

Q1 for bulk density:  $1.6 \text{ t/m}^3 = 1.0$

(Step 1, for bulk density –1.6 t/m<sup>3</sup>)

Q2 for square opening = 1.0

(Step 1, for opening requirement)

Q3 for dry cubic particle = 1.0

(Crushed stone, Step 1, is a dry cubic product)

Q4 for screen surface open area (both decks)

Q4 (top deck) =  $58/50 = 1.16$

Q4 (bottom deck) =  $51/50 = 1.02$

(Refer to Step 1 for openings and wire diameters)

Q5 for wet screening

Q5 (top deck) for 25 mm square = 1.10

Q5 (bottom deck) for 10 mm square = 1.20

(Refer to Step 1, for wet screening recommendation)

Q6 for surface moisture

Both decks = 1.00

(Refer to Step 1 for wet screening recommendation)

Q7 banana-screen factor (Refer Table 11.10).

**Solutions:**

QT (top deck)  $1.0 \times 1.0 \times 1.0 \times 1.16 \times 1.10 \times 1.0 = 1.28$

QB (bottom deck)  $1.0 \times 1.0 \times 1.0 \times 1.02 \times 1.20 \times 1.0 = 1.22.$

**Step 7 – solutions for screen area each deck**

$$\frac{T}{C_n} = \frac{T}{(C \times M \times K \times Q)}$$

$$\text{Top deck: } AT = \frac{280}{53 \times 0.94 \times 1.58 \times 1.28} \times 1.2^a$$

$$AT = 3.3 \text{ m}^2$$

$$\text{Bottom deck: } AB = \frac{252}{33 \times 1.05 \times 1.11 \times 1.22} \times 1.2^a$$

$$AB = 6.44 \text{ m}^2$$

**Step 8 – select screen width and lengths**

The bottom deck has the greatest area requirement (6.44 m<sup>2</sup>); refer to Table 11.12 for the nearest size screen to this, ie 1.8 × 4.2 double-deck screen.

Top deck effective area = 7.15 m<sup>2</sup>

Bottom deck effective area = 6.44 m<sup>2</sup>.

**Step 9 – bed depth**

An evaluation of screening area required for a given application is not complete without checking the depth of material that is being transported along the deck. A good rule-of-thumb is to not exceed four times the aperture size for the depth of bed at the discharge end for material with a bulk density of 1600 kg/m<sup>3</sup>. Where

a. 20 per cent added to calculation because customer specified maximum efficiency of 95 per cent.

the depth of the bed exceeds these limits, screening efficiency is reduced even though the screening area requirements have been satisfied by calculation.

The bed depth formula is :

$$D = \frac{277 \times T}{S \times W \times B}$$

where:

- D bed depth at discharge end (mm)  
 T t/h feed at the discharge end  
 S feed rate of travel on the deck (m/s); circular motion screens sloped at 20° (with flow rotation) = 0.5 m/s  
 W effective width of screen = actual width (m) – 0.15 (m)  
 B bulk density of feed (kg/m<sup>3</sup>)

For counterflow rotation reduce travel rate by ten per cent.

Linear motion screens (horizontal) = 0.23 m/s

Banana-screen slope 25° to 15° = 0.6 m/s.

### Screen costs

Table 11.13 summarises the budget prices (2007) for Multi-Flo banana and Rip1-Flo screens.

## SEMI-AUTOGENOUS AND AUTOGENOUS MILLING

A history of the development of AG/SAG mills is covered in the proceedings of the SAG milling conferences convened by the University of British Columbia in Vancouver in 1986, 1991, 1996, 2001, 2006 and 2011. The papers in these proceedings outline the development of mill sizing and selection processes, project development, operations and maintenance. Principal issues in SAG mill selection and circuit design is discussed below.

### Mill selection

The test work, modelling methods and calculations described in previous sections are aimed at determining the specific energy required to grind the feed material. Once that is calculated, the design throughput determines the amount of power required in the circuit to grind the ore according to the equation:

$$\text{tonnes milled} \times \text{specific energy} \\ (\text{energy required in kWh/t}) = \text{power required (kW)}$$

When the power demand is known and aspect ratio decided, mill sizes can be estimated.

TABLE 11.13  
Screen budget pricing.

Screen size (W × L)	Linear motion low-head horizontal and Multi-Flo banana screens		Inclined circular motion Rip1-Flo screens	
	Single deck	Double deck	Single deck	Double deck
1.2 m × 4.8 m	90 000	122 000	75 000	120 000
1.8 m × 4.8 m	98 000	177 000	96 000	140 000
1.8 m × 6.1 m	175 000	225 000	150 000	184 000
2.4 m × 4.8 m	145 000	195 000	135 000	163 000
2.4 m × 6.1 m	187 000	345 000	160 000	200 000
2.4 m × 7.3 m	225 000	370 000	230 000	280 000
3.0 m × 4.8 m	150 000	298 000	N/A	N/A
3.0 m × 6.1 m	270 000	398 000	199 000	290 000
3.0 m × 7.3 m	305 000	440 000	260 000	320 000
3.0 m × 8.5 m	330 000	480 000	N/A	N/A
3.6 m × 6.1 m	324 000	473 000	N/A	N/A
3.6 m × 7.3 m	360 000	490 000	N/A	N/A
3.6 m × 8.5 m	396 000	570 000	N/A	N/A
4.2 m × 6.1 m	340 000	568 000	N/A	N/A
4.2 m × 7.3 m	390 000	680 000	N/A	N/A

Notes: Low-head and Multi-Flo pricing includes motor and modular polyurethane screen surfaces.

Rip1-Flo screen pricing includes motor(s) and woven wire screen surfaces.

N/A = not applicable.

*High or low aspect ratio?*

High-aspect mills dominate as primary mills in two-stage, high-throughput applications. Aspect ratios of length/diameter (L/D) around 0.5 are common. For lower throughput and single-stage applications, L/D ratios ranging from 0.5 to 1.6 are used, with 1.0 - 1.6 more common. The critical determinant of SAG mill diameter is to allow for sufficient area on the mill discharge end such that adequate grate open area is installed to allow transport of the maximum slurry flow. AG and SAG mills are equipped with discharge grates to retain media, while allowing slurry to pass. Slurry flow through the grates can become a constraint, which, if exceeded, will lead to slurry pooling in the mill and loss of power. Total grate open area increases with increased diameter, favouring high-aspect mills for high-flow situations.

High-aspect mills in open circuit undertake primary grinding duty with a lower specific-energy input and produce a coarser transfer size to the secondary stage of grinding than low-aspect mills. The high-aspect SAG mill is, therefore, better suited to processing large capacities through a single grinding line.

A high-aspect mill has a higher throughput and coarser product than a low-aspect mill operating in open circuit with the same operating conditions (ball load, percentage-critical speed and power draw, etc).

Burgess (1989) summarised the features of high-aspect mills:

- best suited to two-stage SAG/ball mill circuits
- can accept larger, thicker liners
- can handle harder ores due to higher impact forces
- discharge more efficiently
- do not overgrind and retain fines
- are more expensive than low-aspect mills
- are not restricted in feed size, and can accept large feed from a gyratory crusher
- take longer to install than low-aspect mills.

*Mill features*

Currently, 42 ft (12.2 m) is the maximum AG/SAG mill size, with motor power at around 28 MW. However, larger units are currently in design. Ball mills are available up to 8.5 m in diameter (about 27 ft) and 22 MW, but with current support and motor technology, there is no over-riding constraint on mill sizes.

The single-pinion power limit has remained at around 7 to 8 MW (11 000 hp) for some years. Single motor twin-pinion or dual motor dual-pinion drives are thus limited to 14 - 16 MW depending on application, although large mills to 20 MW twin-pinion and 28 MW quad-pinion are being considered. Beyond that, a wrap-around, also referred to as ring motor or gearless mill drive (GMD), is considered up to about 35 MW.

Above 35 MW, motor cooling efficiency may become a limiting factor with the present technology.

Lining systems have advanced in recent years to facilitate rapid change-out. SAG mills generally have steel liners, but rubber or combined steel-rubber systems are acceptable for AG mills.

Care is required in selecting the discharge system. High wear can be experienced in the pans behind the grates when pebbles are discharged and curved or other angled profiles have been introduced in SABC applications to minimise wear. The grate and pebble port design will typically evolve over the project life, with an adequate model used for initial design.

Mill support systems can be either trunnion-mounted or shell-supported; however, most installed mills are trunnion-supported.

*Trommel versus screens*

The method of protecting the mill discharge pump from tramp oversize and of sorting pebbles for recycle crushing is an important decision. Trommels are widely used in Australia and screens in North America.

A trommel provides a convenient slurry removal device, typically operating at a cut of 12 to 20 mm. However, fines can adhere to oversize because of incomplete washing if the trommel is too small. The fines and associated moisture can cause packing and ring-bounce problems in recycle pebble crushers (if installed). SABC circuits typically use horizontal vibrating screens to maximise dewatering, prior to pebble crushing.

Screens suffer from preferential wear at the point of discharge from the mill to the extent that a standby screen is normally provided via a sliding rail device. Screen area can be a problem for cuts finer than 14 mm for large-throughput circuits. Screen installation will also add height to the mill centreline, increasing the installation cost of the mill.

*Mill size*

A first-pass mill shell size is obtained from the equation:

$$(D)^x = kW \times D/L \times C$$

where:

- D mill diameter (m)
- kW power draft required
- D/L diameter/length ratio

Power range (kW)	x	C
180 - 1800	3.70	0.25
2000 - 4000	3.48	0.25

The power equation below provides a useful approximation:

$$\text{Power} = c \times w \times g \times N \text{ (kW)}$$

where:

c	0.833
w	weight of mill charge (t)
g	distance from centre of mill to the centre of gravity of the charge
N	mill speed (rev/min)

The g factor approximates to 0.3D for a 30 per cent mill load. Most slurries exhibit a load density of 2.15 t/m<sup>3</sup> in SAG mode or 2.3 t/m<sup>3</sup> in AG mode, and the ball load has a bulk density of approximately 4.64 t/m<sup>3</sup>.

Sizing of the mill motor should allow for the increased power draw caused by:

- fully worn liners
- increased ball charge
- increased slurry density
- increased speed if variable-speed.

More accurate prediction can be obtained from mill vendors or by using the Morrell's equations (eg Morrell, 1996a, 1996b, 2004a, 2004b).

### Drive selection

AG/SAG and ball mills are normally supplied with drive trains, comprising a pinion driving an external ring gear. Over the past decade, the application of pinion-driven mills has extended to dual-pinion designs as demand for higher mill powers has risen. There are several motor and drive combinations available, depending on starting requirements and variable-speed capability.

As mills have increased in size, the power limitations of pinions and ring gears have necessitated the use of gearless ring motor drives in the upper range of mill sizes. However, the economic evaluation of large multi-pinion and ring motor drive systems has led to a number of conflicting outcomes, typically hinging on the differential in mill availability, based on the downtime associated with mill gear alignment and maintenance for multi-pinion systems. The assessment of mill availability, in turn, depends on the validity of individual project data.

#### *Fixed-speed drive*

Fixed-speed drive systems are most often applied to ball mills and some AG/SAG mills whose operation will not be adversely affected by ore variability. At high power ratings, the options are generally limited to synchronous motors with clutches, and wound rotor motors with secondary liquid resistance starters.

Synchronous motors can be applied at high power ratings to either single- or twin-pinion drives. Twin-pinion drives require a complex system to share load between the clutches and motors. Synchronous motors with clutches are more expensive than wound rotor drive systems.

Wound rotor motors can also be applied at high power ratings to either single- or twin-pinion drives.

The drive delivers power to the pinion through a main gearbox. A liquid resistance starter provides the starting torque. Twin-pinion designs provide good load sharing characteristics due to the use of electrically similar motors and a common electrolyte tank for starting.

#### *Variable-speed drive*

Variable-speed drive systems are typically applied to AG/SAG mills due to factors including operating efficiency, reduced operating and maintenance costs and ease of commissioning. In many cases, the challenge for large twin-pinion AG/SAG mills is to achieve an acceptable level of variable speed control, while maintaining cost and reliability targets.

The quality of the power supply is a critical issue in considering motors and drives for grinding mills. For example, if voltage fluctuations are common and outages relatively frequent, gearless ring motors are not considered appropriate. Slip energy recovery (SER) drives also require a stable power supply to operate effectively. Thus, information on the quality of the supply is needed to facilitate decisions.

Typically, variable-speed ball mills are considered only where there is a need to limit the grind size and where ores are highly variable. Examples include the feed to a complex base metal flotation plant or where the cost of power is high and significant savings can be achieved by turning down the ball mills when processing soft ores at constant tonnage. In gold mining, available capacity presents an opportunity to mill higher tonnages, and overgrinding tends to result in higher leach recoveries. Thus, the need for fine control on ball mill speed is probably absent. The most basic form of variable speed operation can be achieved by using a wound rotor motor and a secondary liquid resistance starter (LRS). The LRS is typically used as the starting device, and can be used to obtain limited speed variation. The slip energy of the motor is dissipated as heat in the LRS, and is proportional to the reduction in speed of the motor from its maximum speed. Circulation pumps and electrolyte to water heat exchangers remove the heat to maintain the operating temperature of the LRS.

The drive has the following advantages:

- high availability
- lowest capital cost option
- proven on twin-pinion applications.

The drive has the following disadvantages:

- large power losses as heat and hence increased electric power cost
- small operating speed range; however, it is adequate for mill motor control.

#### *Slip energy recovery drive*

SER drive systems use the same major equipment as the LRS option, with high-speed wound rotor induction motors and secondary liquid-resistance

starters operating through speed-reduction gearboxes and a pinion-ring gear system. However, instead of dissipating power continuously in the LRS as heat, the SER system returns the energy back into the power system.

The modern version of the SER drive system, the rotor drive, is able to both recover power from the motor and inject it into the rotor circuit. This enables the drive to vary the motor speed both subsynchronously and hyper-synchronously. The rotor drive offers a simple system that is robust against power dips and has reduced load on start-up.

The SER rotor drive has the following advantages:

- high availability
- high power factor and constant torque
- highest efficiency (drive losses are only on recovery power)
- low capital cost
- proven for twin-pinion applications.

#### *Variable voltage variable frequency drive*

The variable voltage variable frequency (VVVF) system uses medium-speed, squirrel-cage induction motors operating through speed-reduction gearboxes and a pinion-ring gear system. The mill is started, accelerated to speed and continuously operated under the control of the VVVF drive.

The VVVF drive has the following advantages:

- good power factor that minimises power factor correction capacitor costs
- high availability
- inching drive not required
- lower cost squirrel-cage motors.

The VVVF has the following disadvantages:

- higher capital cost than the SER
- limited track record for twin pinions.

Some vendors are supplying advanced high-power VVVF drive systems, which use small low-speed synchronous motors with fewer poles than the other synchronous drive systems. These systems are cheaper than other synchronous drive options, but more capital intensive than the SER-gearbox-wound rotor drive systems.

#### *Cyclo-converter drive*

The cyclo-converter (CCV) and synchronous low-speed motor drive systems use six or eight pole synchronous motors driven by a cyclo-converter. The cyclo-converter produces harmonics, and the power factor is poor. Static power factor correction and harmonic filtering are required.

The CCV drive has the following advantages:

- high availability
- lower maintenance

- proven load sharing twin-drive system for twin-pinion.

The CCV drive has the following disadvantages:

- high power system fault level required for satisfactory operation
- higher capital cost than the SER
- higher harmonics requiring filters
- lower overall efficiency
- poor power factor, requiring static correction.

#### *Gearless motor drives*

As mills have increased in size, the use of gearless ring motor drives in the upper range of mill sizes has become more common. Due to their considerable capital expense, gearless drives are usually applied at the upper end of the mill size range where ring gear and pinion capability are exceeded; currently this limit would be approximately over 16 MW for SAG mills and over 18 MW for ball mills.

These drives are based on cyclo-converters and require a conditioned power supply and preferably a limited temperature range in the surrounding environment. Harmonic vibration potential in the surrounding structures should also be carefully analysed. An advantage of a gearless drive is its inherently variable speed. However it is typically the most expensive option by several million dollars.

The drive has the following advantages:

- frozen charge protection
- high availability
- low maintenance
- mill positioning control
- wide speed range.

The drive has the following disadvantages:

- higher harmonics requiring filters
- highest capital cost
- nearly all GMDs installed in the past 15 years have experienced structural or electric issues that have caused substantial downtime
- poor power factor, requiring static correction.

#### *Load commutated inverter*

Load commutated inverter (LCI) drives with synchronous motors have found acceptance overseas, but have not been installed to date in Australia (Tost and Frank, 1996).

#### *Drive cost comparison*

A comparison of the SER rotor drive with gearless and CCV twin-pinion system, on a cost and timing basis, was provided by Morgan *et al* (2001) and is shown in Table 11.14. The use of gearless drives increases the length of project construction schedule and incurs significant additional commissioning costs for motor vendor representatives (>\$1 M per drive).

**TABLE 11.14**  
Comparative drive systems for 13 MW semi-autogenous grinding mill (Morgan *et al*, 2001).

	Dual slip energy recovery rotor drive	Gearless drive	Dual cyclo-converter low-speed synch
Overall system efficiency (%)	93.1	92.7	92.7
Overall installed motor cost (US\$ M)	1.9	4.18	3.42
Harmonic filtering required	No	Yes	Yes
Install and commissioning time (weeks)	2	12	6
Mill gear lubrication	Yes	No	Yes
Clutches or shearpins essential?	No	No	Yes
Water-cooled semi-conductors	No	Yes	Yes
Inbuilt inching capability	Yes	Yes	Yes
No. of critical auxiliary motors	0	18	4
Variable speed backup system	Yes	No	No
Fixed-speed backup system	Yes	No	No
Heavy lift crane (+50 t)	No	Yes	Yes
No. of critical semi-conductors	12	72	72
Plant water required	No	Yes	Yes

A recent evaluation (2006) for a 13 MW twin-pinion SAG mill indicated the cost differential between twin-pinion and gearless drive systems was in excess of \$6 M plus commissioning and vendor costs (up to \$2 M per mill).

### Equipment costs

Grinding mill equipment purchase costs are affected by factors including:

- Size – generally small mills are more expensive per unit of power than large mills. This tends to reduce over 2 MW of power, at which costs are increasingly proportional to installed power.
- Type of mill – SAG mills tend to be more expensive than ball mills due to the greater diameter mill end castings and increased complexity of items such as grate discharge liners and pulp lifters.
- Ball charge – mills designed for very low or no ball charge, such as AG mills, tend to be more expensive per unit of installed power, as the mill shell required to draw the power is larger than with higher ball charges.
- Aspect ratio – as the diameter of a mill increases, costs also increase. A low-aspect mill is typically lower cost than a high-aspect mill. However, several other factors need to be considered, as discussed elsewhere, when determining the optimum mill selection.
- Drive configuration – there are numerous drive configurations such as single-pinion, dual-pinion, combiflex and gearless drives. In general, mills with less than 16 MW of power are installed with pinion drives.

- Market conditions – current market conditions are very tight for mills, and significant price escalation has occurred recently. Market conditions following publication could result in the cost guidelines provided below rapidly becoming outdated.

Table 11.15 provides a general estimate of mill equipment costs (inclusive of drive and lubrication system). However, the above specific factors can have a significant effect on the cost of individual mills and should be considered to more accurately predict mill price. Smaller mills follow similar cost multipliers, but the multiplier increases with small mills, particularly when less than 2 to 3 MW.

**TABLE 11.15**  
Approximate semi-autogenous grinding and ball mill capital costs (Q2, 2010).

Mill type	Installed power (US\$ M/MW)
SAG mill – 8 < pinion drive < 16 MW	1.1 - 1.3
Ball mill – 8 < pinion drive < 16 MW	0.9
Mill with ring motor (generally drives larger than 16 MW)	About 1.4

### Circuit capital costs

The total direct costs for milling circuits (ie mills, lubrication and cooling circuits, pumps and hydrocyclones, and all associated civils, structural work, pipework and electrics) can be determined to a conceptual level of accuracy by applying a factor to the major equipment costs. The factor can be affected by:

- maintenance crane selection (gantry, portal, semi-portal, tower, mobile crane)
- location and whether the circuit is inside a building
- complexity of other equipment in the milling circuit – a simple circuit such as a ball mill closed with a pump and hydrocyclone will have a lower install factor than, for example, an SABC circuit with dual pebble crushers, cooling circuits and conveyors
- geotechnical issues – foundation costs can be significantly affected by geotechnical issues; the factors presented below are for average conditions
- level of detail of mechanical equipment – several rules-of-thumb have been used in the industry to determine total direct costs from mechanical equipment costs; typically, these factors are applied to the complete installed equipment costs (ie including all minor equipment like sump pumps and ancillary hydraulic packs); during preliminary cost estimation, it is common for a lot of this equipment to be missed from the equipment list and, hence, factored costs can be underestimated.

Table 11.16 provides a general estimate of the factor that can be applied to mill equipment costs to estimate the total circuit direct costs for mill circuits. The above specific factors can have a significant effect on the cost of individual mill circuits and should be considered to more accurately predict the price of specific circuits.

**TABLE 11.16**  
Total circuit direct cost factors to apply to milling circuit equipment costs.

Basis of estimate	Factor
Mill costs only	2.2
Total equipment costs	1.8
Total installed equipment costs	1.6

To facilitate an estimation of total circuit direct costs with varying levels of equipment cost information, factors have been provided to apply to the following:

- mill equipment cost only – this factor applies to the unit equipment cost for the mill or mills, not including any other equipment or installation costs; this factor should be used where only very preliminary mill sizing is available
- total equipment costs – this factor applies to the unit costs of all equipment in the milling circuit including pumps, hydrocyclones, hydraulic packs, compressors and maintenance cranes; again, the equipment costs do not include any installation labour component
- total installed equipment costs – as above, but including the labour costs for installing the equipment.

### Rod and ball milling circuits

This section presents some of the features of circuits containing rod mills and ball mills.

#### Rod mills

At present, the maximum length of rods is 6.3 m, which is limited by rod quality and resistance to bending. In turn, this limits the maximum mill length to 6.5 m. The L/D ratio should not be less than 1.25 to avoid rod tangles. However, the typical ratio is between 1.4 and 1.6. Applying these rules, the maximum mill diameter is approximately 4.5 m. The mill speed is usually restricted to <65 per cent of critical to avoid cataracting the rods, resulting in a maximum power draw of about 1500 kW. Flow constraints limit maximum throughput to less than 600 t/h per unit.

The feed size to a rod mill is typically that of the secondary crusher product, about 80 per cent passing 30 mm. The mill usually operates in open circuit, and the product passes to a second stage of grinding in a ball mill. High efficiency usually depends on culling worn, broken rods and charging with fresh rods, with the adverse consequence of increased downtime.

Mills are sized by the power they are required to deliver. Similar calculations to those used for ball milling are needed to determine the mill size or number of units. Overflow discharge is normal for wet grinding; however, centre and peripheral discharge units are produced.

#### Ball mills

Ball mills may have grate or overflow-type discharge arrangements. An overflow mill of the same external dimensions draws a little less power than a grate discharge, but is used more for fine product grinds. Hence, the question of using grates revolves around the need to remove coarser heavy particles (eg gold) efficiently. In overflow configuration, unless a retaining ring is fitted, bearing diameter influences the maximum ball charge attainable. In large-diameter mills this can approach 30 per cent by volume.

L/D ratios range from above 2.0 for fine-grinding mills to 1.0 for avoidance of fines; typically they are around 1.3 - 1.6.

It is usual to run ball mills at a fixed speed between 70 and 78 per cent of critical. There is a trend to using the variable speed capabilities of ring motors for larger installations. Increasing speed leads to higher power draw at the expense of increased liner wear.

A wide choice of lining systems exists. Single-stage grinding units and abrasive ores typically use rubber liners or steel-capped lifter bars and rubber shell plates. For larger sizes, and in secondary grinding applications, steel wave liners are used.

Ball size is dictated by feed top size and desired product size. For a tertiary crushed feed, 90 to 100 mm



balls are used, compared to 50 to 80 mm when grinding typical SAG mill discharge. Increasing the proportion of small balls allows a finer product with an accepted limit of 25 mm unless special conditions are adopted, as discussed in the section on fine and ultra-fine grinding.

Wet grinding classification is almost universally achieved using hydrocyclones (see hydrocyclone section). It is normal to classify between stages in two-stage grinding systems and grind only the hydrocyclone underflow in the second stage.

Flow limits exist in both grate and overflow ball mills at high capacity, and suppliers should be consulted for advice in this area.

Support systems can be either trunnion-mounted or shell-supported. Most installed mills are trunnion-supported.

**Equipment costs**

This section presents some costs of rod mills, ball mills and circuit costs.

*Rod mills*

Rod mills between 1 and 1.5 MW were priced at between US\$1.5 M and US\$2.5 M per MW of motor power in 2010, depending on source and vendor. The wide variation in cost reflects the cost differential between western and Chinese supply.

*Ball mills*

Ball mill costs depend on the vendor, motor power and source of supply. Small mills (<1 MW) can cost as much as US\$2.5 M/MW, or more. Very large mills (16 MW) can cost as little as US\$0.8 M/MW.

*Circuit capital costs*

Rod and ball mill circuit capital costs (for mills of approximately 1.5 MW) can be approximated by:

- mill cost ex works = installed mill, power MW × 1.5
- total equipment cost = mill cost ex works × 1.5
- total direct costs = total equipment costs × 1.5.

For costs of larger ball mills refer to earlier sections on SAG milling.

**HYDROCYCLONE CLASSIFICATION**

Hydrocyclones are used in many and various duties in mineral processing flow sheets. There are wide ranges of sizes, styles and fittings, however, and the focus of this section is to provide a basis to specify and cost hydrocyclones for a given closed-grinding circuit application. A general description of how a hydrocyclone works is included to provide background to the discussion of process and hydrocyclone geometry variables. The mechanism for selecting a hydrocyclone for an application includes the cyclone cut size (D50) and its relationship to P80 as the key separation parameter. Important radial manifold design options for new projects and hydrocyclone maintenance and

materials considerations are identified. Included for reference are costings for typical mineral processing hydrocyclone applications and graphs for hydrocyclone size determination.

**Closed-circuit grinding applications**

One of the most prevalent hydrocyclone applications in a concentrator is to classify grinding mill discharge. This can be discharge from a SAG/ball mill circuit, or from a primary, secondary, regrind or other auxiliary ball milling circuit. Depending on the application and mineral liberation of the ore, the hydrocyclone will typically achieve an overflow product size ranging from P80 of 300 µm to P95 of 25 µm in closed-circuit grinding duties.

Table 11.17 illustrates the relationship between D50 and passing size.

TABLE 11.17

Multiplier to convert percentage passing in overflow to D50.

Required overflow size distribution or % passing of specified micron size	Multiplier (to be multiplied with specified size in µm) to obtain D50
P99 or 99%	0.54
P95 or 95%	0.73
P90 or 90%	0.91
P80 or 80%	1.25
P70 or 70%	1.67
P60 or 60%	2.08
P50 or 50%	2.78

**Sizing and selection**

To select the appropriate hydrocyclone, the solids concentration and size distribution, particle and liquid specific gravities, solids tonnage and slurry flow rate need to be identified. The liquid and slurry viscosities and particle shape also influence hydrocyclone selection.

Hydrocyclones come in a variety of sizes or diameters. Typically, the greater the hydrocyclone diameter, the coarser the separation. Each size hydrocyclone has a base D50 using standard operating conditions and a ‘typical’ geometry (Arterburn, 1976). The D50 (base) shown in Figure 11.25 is valid with the following conditions:

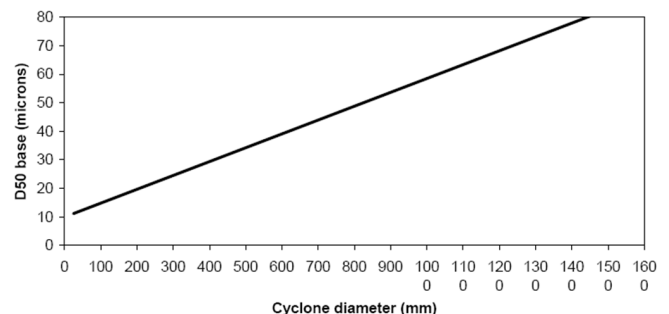

FIG 11.25 - D50 for typical hydrocyclones.

- feed concentration – <1 wt% per cent solids
- feed liquid – water at 20°C (viscosity 1 cp)
- feed solids – spheres of 2.65 specific gravity
- hydrocyclone geometry – standardised hydrocyclone with vortex finder 30 per cent of hydrocyclone diameter, feed orifice seven per cent of feed chamber area, cone of 20° for larger hydrocyclones, cylinder section included and vertical mount
- pressure drop – 70 kPa.

### Capital costs

Figure 11.26 shows approximate capital costs, based on 2010 data. The standard manifold arrangement and its costing will vary from design to design to suit specific process and design conditions. The hydrocyclone manifold comes standard with the following equipment:

- air-actuated isolation valves and local control cabinets
- feed distributor
- hydrocyclones
- overflow and underflow launders with wear resistant lining
- service platform.

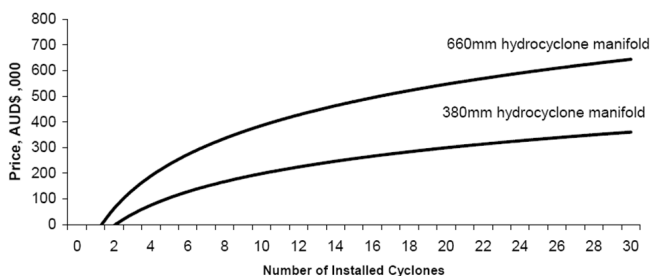

FIG 11.26 - Costs of hydrocyclone manifolds for hydrocyclone sizes of 660 mm and 380 mm.

In some instances, the capacity of the same hydrocyclone diameter can vary between different manufacturers, which will determine the manifold size and cost.

### Operating costs

The most common operating costs for hydrocyclones are replacement of wear liners in the hydrocyclone and labour to refit liners. It is essential to determine the wear pattern in the hydrocyclone because it will typically be higher in the lower section than upper sections. Therefore, it is an advantage to install evenly-wearing liners (eg ceramic in lower sections and rubber in upper sections) to retain smooth surfaces throughout the hydrocyclone interior.

Wear rates vary and depend substantially on the abrasiveness of ore treated. As various concentrators experience different hydrocyclone wear rates, it may not be easy to generalise about operating cost. However, an estimate would be between one and four cents per tonne of new feed.

## PEBBLE CRUSHING

The use of cone crushers to reduce oversize material from SAG mills has become more prevalent. Pebble crushing increases the throughput of SAG milling circuits and is particularly pertinent for competent ore processing. Most new SAG circuits treating competent ore incorporate pebble crushing into the flow sheet.

### Crushing duty

This crushing duty is extremely arduous as it entails the reduction, usually in open circuit, of extremely hard, usually quite rounded material containing no fines to assist with AG crushing in the cone crusher cavity. The throughput of a pebble circuit can fluctuate with variation in ore hardness, so this variability needs to be taken into account during crusher selection. Reduction ratios in pebble crushers are usually as high as possible, with large mill discharge grate openings, and minimum crusher discharge settings that maximise the overall milling circuit operation. Additionally, some of the SAG mill ball charge is ejected with the pebbles. Even though protection magnets and other detection systems are installed before the cone crusher, the balls enter the crushing chamber, creating undue stress and reducing the life of crushing components.

### Crusher selection

Certain design criteria are applied when selecting pebble crushers. First, pebble crushers need to be designed as fully hydraulic machines with large automatic tramp release systems. They must have the ability to be hydraulically cleared in the event of bogging and adjusted under load. All these operations should be monitored using an automation package and/or remote operator control. The crusher must operate in the mill circuit 24 hours per day. Therefore, to minimise mill circuit downtime, spare head and bowl assemblies are highly recommended to expedite crusher liner changes. If large variations in feed capacities are envisaged, it is also recommended that a surge bin and surge bin feeder system are included before the crusher to enable a uniform load to be fed to the crusher. The pebble feed needs to be passed through multiple stages of magnets for removal of tramp metal (mill balls). The pebble feed should also pass at least one metal detector. Pebble discharge from SAG mill trommels or screens is often pulpy, so wash-water needs to be adequate for removal of any adhering fines, otherwise this will affect the pebble crusher operation and component lifetime.

### Equipment costs

Pebble crushing equipment costs are discussed in the section on cone crushers.

### Circuit capital costs

The cost of pebble crushing circuits is dependent on the complexity of the design, including the size and number of pebble crushers, pebble bin capacity and location,

and whether closed- or open-circuit crushing is used. Typically, the minimum cost is approximately twice the cost of the pebble crusher and associated feeders. However, this can increase to four times the cost of the installed equipment if large bins and complex flow sheets and layout are used.

**FINE AND ULTRA-FINE MILLING CIRCUITS**

This section discusses stirred mills, including the Vertimill® and the IsaMill for fine and ultra-fine milling. Ball mills are briefly noted.

**Stirred mills**

Fine and ultra-fine grinding in the metalliferous industry has become widespread. It is an integral part of the initial plant design and has been incorporated in many upgrades in progress because new thinking and technologies require fine grinding to maximise economic return. Higher gold and base metal prices have also helped.

A 1 µm change in P80 can require an extra 30 to 60 per cent milling power with sub-10 µm ore. It is imperative that the grade and recovery benefits of the system are well understood. An example is understanding the grade or recovery gained when ore is reduced from 7 to 6 µm.

For leach processes, the final mill product must have a tighter control on the size distribution, especially at coarser size fractions.

Types of available stirred media grinding equipment are:

- low-speed stirrer such as the Vertimill®, which uses tip screw speeds of approximately 4 m/sec
- high-speed stirrer such as the stirred media detritor (SMD), which uses tip speeds of approximately 10 m/s (the IsaMill uses tips speeds of approximately 20 m/s).

*Vertimill®*

The tower mill, shown in Figure 11.27, was first installed in the mineral processing industry commercially in 1979.

Typical feed sizes are around F80 of 100 to 300 µm and typical product sizes are P80 of 15 to 100 µm using commercial media size between 10 and 32 mm. Finer grinding requires the use of finer media sizes.

Vertimill® models are available in standard units ranging from 10 to 2300 kW. The capital cost of a fully installed 2.3 MW Vertimill is approximately A\$12 to 15 M (2012 costs).

*IsaMill*

The IsaMill uses a horizontal shaft media agitator fitted with discs that have staggered holes for the slurry to pass through. Media ranges from prepared fine slag through to sand media and high-density MT1 Keramax ceramic by Maggoteaux. In operation, the mill is 70 to 80 per cent filled with media, which



FIG 11.27 - Metso Vertimill®.

is stirred at high speed up to the stirrer tip speed of about 20 m/s. New feed passes through eight different grinding chambers between the discs and then an internal classifier or centrifuge at the end of the mill. At the end, media is returned to the grinding discs and slurry discharged, as shown in Figure 11.28. The mill operates full and pressurised, with average retention time of 30 to 60 seconds. The IsaMill is compared with other mills in Table 11.18.

TABLE 11.18  
Comparison of power intensities and media.

	Power intensity (kW/m <sup>3</sup> )	Media size (mm)	Number (balls/m <sup>3</sup> )	Surface area (m <sup>2</sup> /m <sup>3</sup> )
Ball mill	20	20	177 000	222
Tower mill	40	12	818 000	370
IsaMill	300	2	176 500 000	2200

Notes: ball mill is 5.6 m D × 6.4 m L at 2.6 MW; tower mill is a 2.5 m D × 2.5 m L at 520 kW; IsaMill is an M3000 mill, 1.1 MW motor with 3 m<sup>3</sup> grinding shell.

Mill sizes up to 3 MW in a single unit are available and are operated in open circuit.

The capital cost of the IsaMill should be compared with conventional grinding on a fully installed basis.

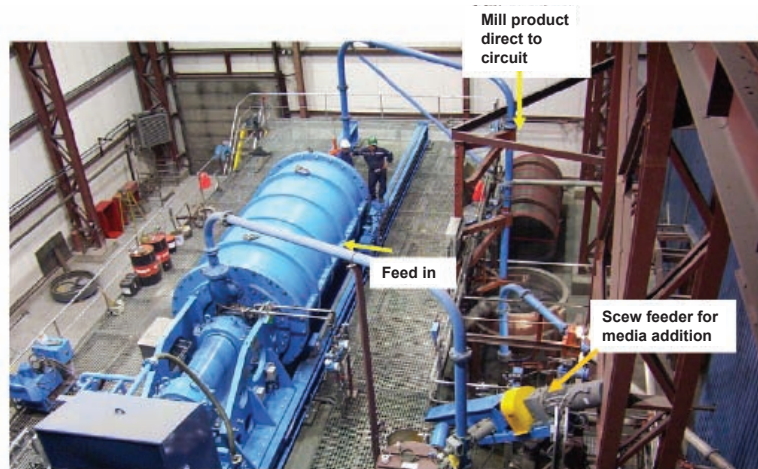
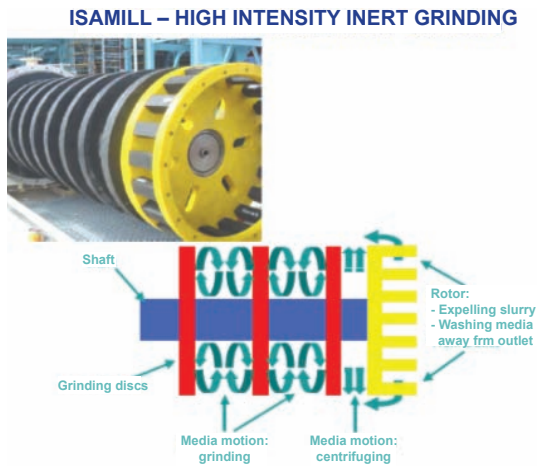

FIG 11.28 - IsaMill.

It is not appropriate to apply a standard 'installation factor' to equipment cost, since the installation factor for the IsaMill is lower than conventional mills. To achieve the high power intensity, the IsaMill is precision engineered from high-alloy steels. It also contains its own internal classifier. This gives a small footprint installation, small crane requirements and no need for closed-circuit hydrocyclones, resulting in a lower installation factor.

Figure 11.29 shows a 3 MW IsaMill installation. An indicative fully installed capital cost of this installation in 2011 dollars is A\$15 M. This includes everything within the area marked by an ellipse:

- commissioning
- crane
- electrics, instrumentation and control system
- feed and discharge pump boxes, pumps, etc
- foundation and steelwork installation
- media system
- mill, motor, gearbox, initial operating consumables
- precyclone installation (used in this case to increase mill throughput).



FIG 11.29 - IsaMill installation.

### Ball mills

Ball mills, in regrind duty, typically operate in the speed range of 11 to 24 rev/min depending on mill diameter, at speeds of 67 to 77 per cent of critical. High grinding efficiency has been recorded when running at lower critical speeds. Liners can be steel or rubber; magnetic liners have been successfully applied to fine grinding of iron ores in Brazil.

Mill feed sizes (80 per cent passing) range from 200 to 45  $\mu\text{m}$  and products from 44 to 20  $\mu\text{m}$ . The types of material processed includes siliceous gold ore, iron ore and various sulfide concentrates.

The capital costs are similar to those discussed for primary ball mills in the section 'Rod and ball milling circuits'.

### STOCKPILES AND RECLAIM SYSTEMS

Stockpiles and reclaim systems are an integral part of a comminution circuit.

The capital cost of a stockpile and reclaim system depends on design and application and can be one of the following. These are listed in order of increasing capital cost (for a given capacity):

- small-capacity (say 20-minute) bin with a reclaim slot feeder
- elevated single-stacking conveyor over a conical stockpile with apron feeder, vibrating feeder or belt feeder style ore reclaimers
- luffing and slewing stacker with reclaim
- elevated tripper or shuttle distribution systems above an extended stockpile with apron feeder ore reclaimers
- travelling stacker with integrated bucket wheel reclaimer.

Integrated stacker/reclaimers are only applicable to materials with low abrasive properties.

Dust abatement, through the use of stockpile covers, also adds to the capital cost of the stockpile.

At a conceptual level, a simple stockpile and reclaim system has a capital cost of approximately \$8 M to \$10 M per 100 000 t total volume (of which approximately 25 per cent will be live), including stacker conveyor, reclaim feeders and SAG mill feed conveyor.

**EQUIPMENT PROCUREMENT**

Several issues that may affect the estimation of the costs of milling are discussed in this section.

A mill or mill drive failure can end up costing the owners more than the mill in terms of lost production. Lost production costs can be of the order of the total plant capital cost depending on the type of failure, because more production is concentrated into fewer items of milling equipment. Therefore, the risk associated with mills and mill drives is disproportionate to the ratio of mill cost to plant cost. Accepting the premise that the owners’ main responsibility in developing a project is to manage the trade-off between risk and reward, then a hands-on management approach by the owners is warranted for equipment such as mills.

There are several approaches available to the owners to manage risk. They range from the owners relying on contractual instruments and agents to manage risk, to full owner intervention in the procurement process from specification to handover. The model selected by the owners is beyond the scope of this section; however, it should be clear that probability of failure or poor performance is inversely proportional to the quality of the equipment purchased.

Equipment quality is a function of both design and manufacture. The design affects not only the integrity of the equipment but also the ease of manufacturing the equipment. Therefore, reviewing the design of a mill or drive forms part of the quality process. The preceding steps to design, development and vendor selection also affect the quality of the end-product. Once the design is reviewed and accepted, the focus then turns to maintaining the design intent through manufacturing, installation and commissioning. The quality assurance process can then be considered in two parts: premanufacturing and post-design.

The cost for the premanufacturing component of the quality assurance process is a function of the equipment. Specifications, vendor selection and design reviews of mills follow well-established processes and can be done as a fixed price provided the mill is based on a standard design. In the case of gearless drives, the process is more complicated as the two options currently available are fundamentally different from each other. Design review for gearless drives involves more specialist knowledge and measurement data from similar equipment. A rule-of-thumb for estimating the premanufacturing review costs is 0.5 to 1.5 per cent of the capital cost of the equipment, depending on the extent to which the design pushes the ‘envelope of experience’.

The costs for post-design quality assurance are also not clear-cut. If the owners take a hands-on approach, the cost will be greater than it would, if the owners rely on bureaus, as the owners will have to move their own people to the location where the equipment will be built. Furthermore, the experience of the vendor and the subsuppliers also can affect cost. A problem at one subsupplier can use up an enormous amount of resources from both vendor and owners to ensure that this problem does not compromise the project schedule. In general, a quality surveillance program will cost approximately three per cent of the capital equipment cost. However, examples abound in which this cost doubles because of mistakes and unforeseen matters.

An initial budget of three to four per cent of the capital cost of the equipment for the owners’ quality review is a reasonable start for any project involving mills. Targeting the use of the funds to areas in which risk is greatest is then the next item on the owners’ agenda.

**OPERATING COSTS**

Comminution circuit operating costs can be divided into:

- people
- power
- consumables (wear parts)
- maintenance materials (non-wear parts).

**Cost estimate methodology**

The operating cost estimate developed from a number of sources is summarised in Table 11.19.

**TABLE 11.19**  
Derivation of comminution plant operating costs.

Cost category	Source of cost data
Power	Consumption from equipment load list and assumed power cost
Grinding media	Consumption from models and database, unit prices from market
Crusher liners	Consumption and unit prices from vendors
Mill liners	Consumption from models and database, unit prices from market

**Scope of estimate**

The scope of this operating cost estimate includes:

- costs of operation of the comminution circuit, from stockpile discharge to hydrocyclone overflow; there are no allowances for other areas of the plant
- costs associated with direct operation of the comminution circuit, including grinding media and crusher/mill liners
- costs of power-based on the assumptions stated in this chapter.

Excluded from the operating cost estimate are:

- costs for all process and management areas outside the comminution facility
- labour
- maintenance materials (typically up to five per cent of equipment cost)
- operations, metallurgical and maintenance management.

## Power

The power requirements for the plant are developed from the electric load list, generated as part of the mechanical equipment list. The load study on which the power costs are based calculates a power draw given the installed equipment power (excluding installed standby equipment) and a utility factor to allow for intermittently running equipment. Power consumption has then been derived from the power draw and plant operating hours.

Power increases at the ratio of approximately 1:2:4 for a typical three-stage crushing plant comprising primary, secondary and tertiary crushing, respectively.

Grinding circuit power is a function of ore characteristics and grind product size. In addition to the grinding power, approximately 15 per cent additional power is consumed by ancillaries (cyclone feed pumps, lube systems, etc).

## Consumables

The largest plant consumables are major wear items such as crusher, HPGR and mill liners and steel grinding media. Expected consumption is usually estimated based on the ore abrasion index, vendor experience and historical data (2010 costs).

- 2.4 m × 1.65 m HPGR tyres approximately US\$1.7 M new and US\$1 M refurbished
- 600 kW crusher liners about US\$35 000/set
- grinding media costs approximately US\$1300/t
- SAG and ball mill steel liners approximately US\$2/kg.

Steel media consumption can be calculated using Bond's formula with a 0.6 multiplier and typically about 0.06 kg/kWh. Mill liner wear-rates are about ten per cent of the media consumption rate.

## CONTRIBUTORS

Many contributors to this chapter on comminution and classification are listed at the start of this chapter in alphabetical order of affiliation. The contributions were sourced between 2007 and 2012 and the affiliation shown is that at the time of the author's contribution. Major contributions are noted in the chapter where practical; however, there was considerable cross-fertilisation of content and substantial editing was required to summarise over 400 pages of input from the authors.

## REFERENCES

- Allis Chalmers**, undated. *Vibrating Screen, Theory and Selection* (Allis Mineral Systems).
- Arterburn**, R A, 1976. The sizing of hydrocyclones, Krebs Engineers [online]. Available from: <[http://www.flsmidth.com/~media/PDF%20Files/Liquid-Solid%20Separation/Hydrocyclones/Sizing\\_select\\_cyclones.ashx](http://www.flsmidth.com/~media/PDF%20Files/Liquid-Solid%20Separation/Hydrocyclones/Sizing_select_cyclones.ashx)>.
- Bailey**, C, Lane, G, Morrell, S and Staples, P, 2009. What can go wrong in comminution circuit design?, in *Proceedings Tenth Mill Operators' Conference*, pp 143-149 (The Australasian Institute of Mining and Metallurgy: Melbourne).
- Banini**, G A, 2000. An integrated description of rock breakage in comminution machines, PhD thesis, University of Queensland (JKMRC), Brisbane.
- Barratt**, D J and Allan, M J, 1986. Testing for autogenous and semiautogenous grinding: A designer's point of view, *Minerals and Metallurgical Processing*, May, pp 65-74.
- Blaskett**, K S, 1969. Estimation of the power consumption in grinding mills, in *Proceedings Ninth Commonwealth Mining and Metallurgy*, 3, pp 631-649.
- Bond**, F C, 1961a. (Revised 1962), *Crushing and Grinding Calculations* (Allis-Chalmers).
- Bond**, F C, 1961b. Crushing and grinding calculations, *British Chemical Engineering*, part I, 6(6):378-385; part II, 6(8):543-548.
- Dance**, A, Valery Jnr, W, Jankovic, A, La Rosa, D and Esen, S, 2006. Higher productivity through cooperative effort: A method of revealing and correcting hidden operating inefficiencies, in *Proceedings SAG*, Vancouver, volume 4, pp 375-390.
- Dance**, A, Valery, W, Jankovic, A, La Rosa, D and Esen, S, 2007. Maintaining the benefit – How to ensure mine to mill continues to work for you, in *Proceedings Ninth Mill Operators' Conference*, pp 215-222 (The Australasian Institute of Mining and Metallurgy: Melbourne).
- Daniel**, M, Lane, G and Morrell, S, 2010. Consolidation and validation of several tumbling mill power models, in *Procemin 2010, Proceedings Seventh International Mineral Processing Seminar*, pp 83-92.
- Djordjevic**, N, Shi, F and Morrison, R, 2004. Determination of lifter design, speed and filling effects in AG mills by 3D DEM, *Minerals Engineering*, 17:1135-1142.
- Evertsson**, C M, 2000. Cone crusher performance, PhD thesis, Chalmers University of Technology, Sweden.
- Forsund**, B, Norkyn, I, Sankvik, K L and Winther, K, 1988. Sydvarangers 6.5 m diameter × 9.65 m ball mill, in *Proceedings XVI International Mineral Processing Congress* (ed: E Forssberg), pp 171-183.
- Grundstrom**, C, Kanchibotla, S, Jankovich, A and Thornton, D, 2001. Blast fragmentation for maximising the SAG mill throughput at Porgera gold mine, in *Proceedings 27th Annual Conference on Explosives and Blasting Technique*, pp 383-399 (International Society of Explosives Engineers: Cleveland).
- Hart**, S, Dioses, J, Gelfi, P, Clementis, B, Valery Jnr, W and Dunne, R, 2000. Cadia Mines – Reflections after one year's operation, presented to *2000 SME Annual Meeting*, Salt Lake City, 28 February - 1 March.
- Hart**, S, Dioses, J, Gelfi, P, Clements, B, Valery, W and Dunne, R, 2001. Cadia Mines – Reflection after one year's operation, presented to *SME Conference*, Denver.

- Jobson, G**, 2004. Case study – Pegasus Gold Australia, very fine crushing and screening – The Mt Todd Experience, presented to IIR Crushing and Grinding Conference, Townsville, March.
- Kanchibotla, S S, Morrell, S, Valery, W and O’Loughlin, P**, 1998a. Exploring the effect of blast design on throughput at KCGM, in *Proceedings Mine to Mill Conference*, pp 153-158 (The Australasian Institute of Mining and Metallurgy: Melbourne).
- Kanchibotla, S S, Valery, W and Morrell, S**, 1998b. Modelling fines in blast fragmentation and its impact on crushing and grinding, in *Proceedings Explo ’99*, pp 137-144 (The Australasian Institute of Mining and Metallurgy: Melbourne).
- Karageorgos, J, Skrypniuk, J, Valery Jnr, W and Ovens, G**, 2001. SAG milling at the Fimiston Plant (KCGM), in *Proceedings SAG 2001*, Vancouver, 1 p.
- Karageorgos, K, Burford, B, Valery Jnr, W, Rohner, P, Johnson, N W and Morrell, S**, 1996. Copper concentrator autogenous grinding practices at Mount Isa Mines Limited, in *Proceedings International Conference on Autogenous and Semiautogenous Grinding Technology*, Vancouver, pp 145-163.
- King, R P**, 2001. *Modeling and Simulation of Mineral Processing Systems* (Butterworth-Heinemann: Oxford).
- Klingmann, H L**, 2005. Soledad Mountain project, flowsheet development and benefits of the HPGR, Golden Queen Mining Co Ltd feasibility study.
- Klymowsky, R, Patzelt, N, Knecht, J and Burchardt, E**, 2006. An overview of HPGR technology, in *Proceedings Fourth International Conference on Autogenous and Semi-Autogenous Grinding Technology* (eds: Allan, Major, Flintoff, Klein and Mular), vol IV, pp 11-26 (Department of Mining Engineering, University of British Columbia: Vancouver).
- Lam, M, Jankovic, A, Valery Jnr, W and Kanchibotla, S S**, 2001. Increasing SAG mill circuit throughput at Porgera gold mine by optimising blast fragmentation, in *Proceedings SAG 2001*, Vancouver, 1 p.
- Levin, J**, 1984. A proposed test for the determination of the grindability of fine materials, Council for Mineral Technology, South Africa.
- Levin, J**, 1989. Observations on the Bond standard grindability test and a proposal for a standard grindability test for fine materials, *Journal of the Southern African Institute of Mining and Metallurgy*, (1):89.
- Lindqvist, M**, in press. Energy considerations in compressive- and impact crushing of rock, *Minerals Engineering*.
- Lynch, A J**, 1977. *Mineral Crushing and Grinding Circuits* (Elsevier Scientific Publishing Company).
- Lynch, A J and Rowland, C A**, 2005. *The History of Grinding* (Society for Mining, Metallurgy and Exploration: Littleton).
- MacPherson, A R**, 1989. Autogenous grinding – 1987 update, *CIM Bulletin*, 82:75-82.
- Maxton, D, Morley, C T and Bearman, R**, 2003. A quantification of the benefits of high pressure rolls crushing in an operating environment, *Minerals Engineering*, 16(9):827-838.
- McCaffery, K, Mahon, J, Arif, J and Burger, B**, 2006. Batu Hijau – Controlled mine blasting and blending to optimise process production at Batu Hijau, in *Proceedings SAG 2006*, Vancouver, vol 2, pp 372-393.
- Morgan, J, Roper, G, Maneuco, C and Elanasinghe, S**, 2001. Advanced technology variable speed mill drives with hyper synchronous capability, in *Proceedings International Conference on Autogenous and Semiautogenous Grinding Technology*, Vancouver, vol II, p 142.
- Morley, C T**, 2005. The case for high pressure grinding rolls, in *Proceedings Randol Innovative Metallurgy Forum*, pp 15-30 (Randol International Ltd: Golden).
- Morley, C T**, 2006a. High pressure grinding rolls – A technology review, in *Proceedings SME Conference* (ed: S K Kawatra).
- Morley, C T**, 2006b. Flowsheets for HPGR, in *Proceedings Fourth International Conference on Autogenous and Semi-Autogenous Grinding Technology* (eds: Allan et al), vol IV, pp 172-189 (Department of Mining Engineering, University of British Columbia: Vancouver).
- Morrell, S**, 1996a. Power draw of wet tumbling mills and its relationship to charge dynamics, part 1: A continuum approach to mathematical modelling of mill power draw, *Transactions of the Institution of Mining and Metallurgy*, 105:C43-C53.
- Morrell, S**, 1996b. Power draw of wet tumbling mills and its relationship to charge dynamics, part 2: An empirical approach to modelling of mill power draw, *Transactions of the Institution of Mining and Metallurgy*, 105:C54-C62.
- Morrell, S**, 2004a. Predicting the specific energy of autogenous and semiautogenous mills from small diameter drill core samples, *Minerals Engineering*, 17(3):447-451.
- Morrell, S**, 2004b. An alternative energy-size relationship to that proposed by Bond for the design and optimisation of grinding circuits, *International Journal of Mineral Processing*, 74:133-141.
- Morrell, S**, 2006a. Design of AG/SAG mill circuits using the SMC Test, in *Proceedings International Autogenous and Semi Autogenous Grinding Technology*, Vancouver, vol IV, pp 247-266.
- Morrell, S**, 2006b. Rock characterisation for high pressure grinding rolls circuit design, in *Proceedings International Autogenous and Semi Autogenous Grinding Technology*, Vancouver, vol IV, pp 267-278.
- Morrell, S, Valery Jnr, W, Banini, G and Latchireddi, S**, 2001. Developments in AG/SAG mill modelling, in *Proceedings SAG 2001*, Vancouver, 1 p.
- Morrison, R D, Shi, F and Whyte, R**, 2006. Modelling of incremental rock breakage by impact – For use in DEM models, *Minerals Engineering*, 20:303-309.
- Mular, M and Mosher, J**, 2006. A preproduction review of PT Freeport Indonesia’s HPGR project, in *Proceedings Fourth International Conference on Autogenous and Semi-Autogenous Grinding Technology* (eds: Allan et al), vol IV, pp 62-79 (Department of Mining Engineering, University of British Columbia: Vancouver).
- Napier-Munn, T J, Morrell, S, Morrison, R D and Kojovic, T**, 1996. *Mineral Comminution Circuits: Their Operation and Optimisation* (Julius Kruttschnitt Mineral Research Centre: Brisbane).
- Narayanan, S S and Whiten, W J**, 1988. Determination of comminution characteristics from single particle breakage tests and its application to ball mill scale-up, *Transactions of the Institution of Mining and Metallurgy*, 97:C115-C124.

- Pyke, P, Johansen, G, English, D, Lane, G, Hayward, T and Gardula, A, 2006.** Application of HPGR technology in processing of gold ores in Australia, in *Proceedings Fourth International Conference on Autogenous and Semi-Autogenous Grinding Technology* (eds: Allan *et al*), vol IV, pp 80-93 (Department of Mining Engineering, University of British Columbia: Vancouver).
- Renner, D, La Rosa, D, DeKlerk, W, Valery Jnr, W, Sampson, P, Bonney Noi, S and Jankovic, A, 2006.** Anglogold Ashanti Iduapriem mining and milling process integration and optimisation, in *Proceedings SAG 2006*, Vancouver, volume 1, pp 249-264.
- Rowland, C A, Jnr, 1972.** *Grinding Calculations Related to the Application of Large Rod and Ball Mills* (Allis-Chalmers).
- Rowland, C A, Jnr, 1973.** Comparison of work indices calculated from operating data with those from laboratory test data, in *Proceedings 10th International Mineral Processing Congress*, pp 47-61 (Institution of Mining and Metallurgy: London).
- Rowland, C A, Jnr, 1975.** The tools of power: How to evaluate grinding mill performance using the Bond work index to measure grinding efficiency, in *Proceedings AIME Annual Meeting*, Arizona.
- Rumpf, H, 1973.** Physical aspects of comminution and a new formulation of a Law of Comminution, *Powder Technology*, 7:145-159.
- Shi, F and Kojovic, T, 2007.** Validation of a model for impact breakage incorporating particle size effect, *International Journal of Mineral Processing*, 82:156-163.
- Silfver, R, Bern, R, Trulsson, C, Loven, B and Nilsson-Wulff, T (Sandvik), 2006.** A shell for a gyratory crusher as well as a gyratory crusher, AU2006225776, WO2006101432, US2006219830, and more (Sandvik AB).
- Simkus, R and Dance, A, 1998.** Tracking hardness and size: Measuring and monitoring ROM ore properties at Highland Valley Copper, in *Proceedings Mine to Mill Conference*, pp 113-120 (The Australasian Institute of Mining and Metallurgy: Melbourne).
- Soldinger Stafhammar, M, 2002.** Screening of crushed rock material, PhD thesis, Chalmers University of Technology, Sweden.
- Steane, R A and Hinckfuss, D A, 1979.** Selection and performance of large diameter ball mills at Bougainville Copper Ltd, Papua New Guinea, in *Proceedings 11th Commonwealth Mining and Metallurgical Congress*, Hong Kong, pp 577-584.
- Svedensten, P, 2007.** Crushing plant performance, PhD thesis, Chalmers University of Technology, Sweden.
- Taylor, S L, Gilbride, L J, Daemen, J J K and Mousset-Jones, P, 1996.** The impact of blast induced movement on grade dilution in Nevada's precious metal mines, in *Proceedings Fifth International Symposium on Rock Fragmentation by Blasting – Fragblast 5* (ed: B Mohanty), pp 407-413 (Balkema: Rotterdam).
- Tondo, L A, Valery Jnr, W, Peroni, R, La Rosa, D, Silva, A, Jankovic, A and Colacioppo, J, 2006.** Kinross' Rio Paracatu Mineração (RPM) mining and milling optimisation of the existing and new SAG mill circuit, in *Proceedings SAG 2006*, Vancouver, vol 2, pp 301-313.
- Tost, H and Frank, W, 1996.** Comparisons of twin drive alternatives using Fimiston as an example, in *Proceedings SAG '96*, Vancouver, vol 3, pp 504-520.
- Vogel, L and Peukert, W, 2004.** Determination of material properties relevant to grinding by practicable lab-scale milling tests, *International Journal of Mineral Processing*, 74S:329-338.
- Weibull, W, 1951.** A statistical distribution function of wide applicability, *Journal of Applied Mechanics*, 9:293-297.

## FURTHER READING

- Angove, J E and Dunne, R C, 1997.** A review of standard physical ore property determinations, in *Proceedings World Gold '97*, p 139 (The Australian Institute of Mining and Metallurgy: Melbourne).
- Anon, 1976.** *Nordberg Process Machinery Reference Manual*, first edition, pp 11-1 to 11-13 (Rexnord Inc Process Machinery Division).
- Atasoy, Y, Brunton, I, Tapia-Vergara, F and Kanchibotla, S, 1998.** Implementation of split to estimate the size distribution of rocks in mining and milling operations, in *Proceedings Mine to Mill Conference*, pp 227-234 (The Australasian Institute of Mining and Metallurgy: Melbourne).
- Atasoy, Y, Valery Jnr, W and Skalski, A, 2001.** Primary versus secondary crushing at St Ives (WMC) SAG mill circuit, in *Proceedings SAG 2001*, 1 p, Vancouver.
- Bennett, X, Dobby, G and Kosick, X, 2000.** Advances in SAG circuit design and simulation applied to the miner block model, in *Proceedings SAG 2001*, p 221.
- Bolu, M, Bouma, P and Paterson, J, 1984.** Rod mill grinding for improved gravity recovery at the Canada tungsten scheelite concentrator, *SME-AIME Annual Meeting*, Los Angeles, February, preprint, pp 84-132.
- Burgess, D, 1989.** High or low aspect – Which one?, in *Proceedings SAGSEM'89* (ed: N D Stockton), p 144 (Murdoch University: Perth).
- Dance, A, 2001a.** The importance of primary crushing in mill feed size optimisation, presented to *SAG 2001*, University of British Columbia, Vancouver.
- Dance, A, 2001b.** The benefits of mine-mill integration, presented to IPMM-2001: Intelligent Processing and Manufacturing of Materials, Vancouver.
- Dance, A, 2003.** Closing the loop – Using actual concentrator performance to determine the true value of ore sources, presented to CIM Annual General Meeting, Montreal.
- Dance, A, 2004.** Remove the disturbance: Stabilising SAG mill tonnage through proper feed preparation, presented to SME Annual Meeting, Denver.
- Hart, S, Valery Jnr, W, Clements, B, Reed, M, Song, M and Dunne, R, 2001.** Optimisation of the Cadia Hill SAG mill circuit, in *Proceedings SAG 2001*, Vancouver, 1 p.
- Kanchibotla, S, 1994.** Models for assessing the blasting performance of explosives, PhD thesis, University of Queensland (JKMRC), Brisbane.
- Lawson, V, Carr, D, Valery Jnr, W, Burford, B, Pease, J and Man, Y, 2001.** Evolution and optimisation of the copper concentrator autogenous grinding practices at Mount Isa Mines Limited, in *Proceedings SAG 2001*, Vancouver, 1 p.
- Levin, J, 1992.** Indicators of grindability and grinding efficiency, *Journal of the Southern African Institute of Mining and Metallurgy*, 92(10):283-289.
- Mainza, A and Powell, M S, 2006.** RoM ball mills – A comparison with AG/SAG milling, in *Proceedings International Autogenous and Semi Autogenous Grinding Technology*, Vancouver, vol II, pp 314-325.



- McGee, S, Mosher, J, Richardson, M, David, D and Morrison, R, 2001.** SAG feed precrushing at ASARCO's Ray concentrator: Development, implementation and evaluation, in *Proceedings International Autogenous and Semi Autogenous Grinding Technology*, Vancouver, vol I, pp 234-247.
- Morley, C T, 2003.** HPGR in hard rock applications, *Mining Magazine*, 189(3):118-127.
- Morrell, S, 1993.** Power draw of wet tumbling mills, PhD thesis, University of Queensland, Brisbane.
- Morrell, S and Kojovic, T, 1996.** The influence of slurry transport on the power draw of autogenous and semi-autogenous mills, in *Proceedings Second International Conference on Autogenous and Semi-Autogenous Grinding Technology*, Vancouver, pp 378-389.
- Morrell, S and Morrison, R D, 1996.** AG and SAG mill circuit selection and design by simulation, in *Proceedings SAG '96*, Vancouver, vol 2, pp 769-790.
- Morrell, S, Shi, F and Tondo, L, 1997.** Modelling and scale-up of high pressure grinding rolls, in *Proceedings XX International Mineral Processing Congress*, Aachen, pp 129-140.
- Morrell, S and Valery Jnr, W, 2001.** Influence of feed size on AG/SAG mill performance, in *Proceedings SAG 2001*, Vancouver, 1 p.
- Mosher, J and Alexander, D J, 2002.** Sampling high throughput grinding and flotation circuits, in *Proceedings SME Mineral Processing Plant Design, Practice and Control Conference*, pp 63-76 (Society for Mining, Metallurgy and Exploration: Littleton).
- Motz, J C and Beerkircher, G, 1992.** *New Cone Crusher Designs*, chapter 20.
- Motz, I C, 1978.** *Crushing, Mineral Processing Plant Design, Comminution Theory and Practice*, chapter 11 (SME-AIME: New York).
- Mular, A L and Bhappu, R B, 1978.** *Mineral Processing Plant Design*, pp 62-63 (Port City Press: Baltimore).
- Nelson, M, Valery Jnr, W and Morrell, S, 1996.** Performance characteristics and optimisation of the Fimiston (KCGM) SAG mill circuit, in *Proceedings SAG 2001*, Vancouver, pp 233-248.
- Nielsen, K, 1998.** Economic optimisation of the blasting-crushing-comminution process in a low-grade iron ore (taconite) operation, in *Proceedings Mine to Mill Conference*, pp 135-138 (The Australasian Institute of Mining and Metallurgy: Melbourne).
- Rowland, C A, 1988.** Diameter factors affecting ball mill scale-up, *International Journal of Mineral Processing*, 22:95-104.
- Rowland Jnr, C A and Kjoss, D M, 1978.** (Revised 1980), Rod and ball mills, *Mineral Processing Plant Design* (eds: A L Mular and R B Bhappu), Chapter 12, pp 239-278 (Society for Mining, Metallurgy and Exploration: Littleton).
- Scott, A and McKee, D J, 1994.** The inter-dependence of mining and mineral beneficiation processes on the performance of mining projects, in *Proceedings AusIMM Annual Conference*, pp 303-308 (The Australasian Institute of Mining and Metallurgy: Melbourne).
- Siddall, G B and White, M, 1989.** The growth of SAG milling in Australia, in *Proceedings Advances in Autogenous and Semiautogenous Grinding Technology* (eds: A L Mular and G E Agar), p 169 (University of British Columbia: Vancouver).
- Thornton, D M, Kanchibotla, S S and Esterle, J S, 2001.** A fragmentation model to estimate ROM size distribution of soft rock types, in *Proceedings 27th Annual Conference on Explosives and Blasting Technique*, pp 41-53 (International Society of Explosives Engineers: Cleveland).
- Valery Jnr, W, 2004.** Process integration and optimisation in aggregates production, presented to the Second International Seminar on Construction Aggregates, Campinas, Brazil, 25 - 28 October.
- Valery Jnr, W, Jankovic, A, La Rosa, D, Dance, A, Esen, S and Colacioppo, J, 2007.** Process integration and optimisation from mine-to-mill, in *Proceedings International Seminar on Mineral Processing Technology*, India, pp 577-581.
- Valery Jnr, W, Kojovic, T, Tapia-Vergara, F and Morrell, S, 1999.** Optimisation of blasting and sag mill feed size by application of online size analysis, presented to the IRR Crushing and Grinding Conference, Perth, 29 - 31 March.
- Valery Jnr, W, La Rosa, D and Jankovic, A, 2004.** Mining and milling process integration and optimisation, presented to the SME 2004 Conference, Denver, 23 - 25 February.
- Valery Jnr, W, Morrell, S, Kojovic, T, Kanchibella, S and Thornton, D, 2001.** Modelling and simulation techniques applied for optimisation of mine to mill operations and case studies, presented to the VI Southern Hemisphere Conference on Minerals Technology, Rio de Janeiro, Brazil, 27 - 30 May.
- Walters, S and Kojovic, T, 2006.** Geometallurgical mapping and mine modelling (GEMIII) – The way of the future, in *Proceedings SAG 2006*, Vancouver, vol IV, pp 411-425.