



ESCOLA POLITÉCNICA DA UNIVERSIDADE DE SÃO PAULO

# **PMR 3203**

Profa. Izabel Machado





# Introdução

Processos de deposição e alterações superficiais

DESACOPLAR O MATERIAL DA SUPERFÍCIE !!!

Superfícies: contato com o meio , contato com outro elementos mecânicos

Microestrutura , topografia, composição

Óleos : modificadores de atrito e pressão

Textura

Contato em engrenagens.



# Recobrimentos ou Revestimentos (superfícies)

## Coating

- ✓ São utilizados para obter :
- ✓ Redução de desgaste, atrito e/ou corrosão
- ✓ Controle da condutividade térmica
- ✓ Filtragem espectral de radiação eletromagnética
- ✓ Controle de sinais eletrônicos e eletro-mecânicos
- ✓ Variam entre  $10^{-9}$  m a  $10^{-3}$  m de espessura
- ✓ Múltiplos componentes e arranjos espaciais



# Recobrimentos ou Revestimentos (superfícies)

- ❖ Tipos de recobrimentos
- ❖ Aplicações
- ❖ Processos de deposição
- ❖ Propriedades mecânicas



# Recobrimentos ou Revestimentos (superfícies)

## ❖ Tipos de recobrimentos

### ❖ Metálicos

❖ Zn, Cr, Ag, Au, Cu...

### ❖ Cerâmicos

❖ Óxidos ( $ZnO$ ,  $Al_2O_3$ ,  $TiO_x$ )

❖ Carbonetos ( $NbC$ ,  $TiC$ ,  $SiC$ )

❖ Nitretos, Boretos...

### ❖ Poliméricos

❖ PVA

❖ PU

❖ Resina acrílica



[\\_JMhttp://produto.mercadolivre.com.br/MLB-679742179-400gr-corante-em-po-para-fabricaco-de-tinta-para-impressora-](http://produto.mercadolivre.com.br/MLB-679742179-400gr-corante-em-po-para-fabricaco-de-tinta-para-impressora-)

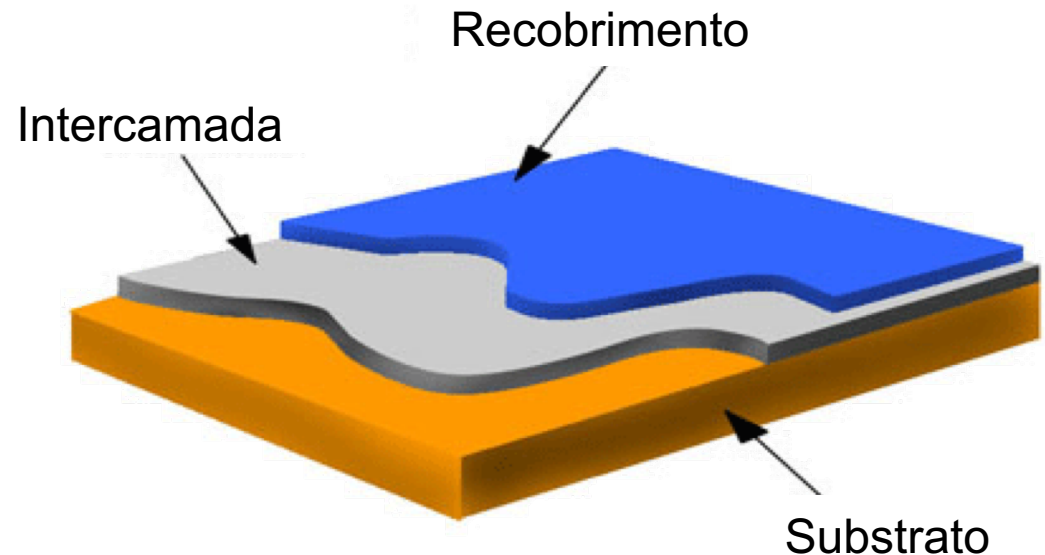

[http://www.globalspec.com/learnmore/materials\\_chemicals\\_adhesives/industrial\\_sealants\\_coatings/industrial\\_coatings](http://www.globalspec.com/learnmore/materials_chemicals_adhesives/industrial_sealants_coatings/industrial_coatings)



# Recobrimentos ou Revestimentos (superfícies)

## ❖ Tipos de recobrimentos - Exemplos

### Galvanoplastia

- Adquirir resistência a corrosão;
- Adquirir proteção contra a oxidação;
- Apresentar maior durabilidade;
- Aumentar a resistência da peça;
- Ampliar a espessura da peça;

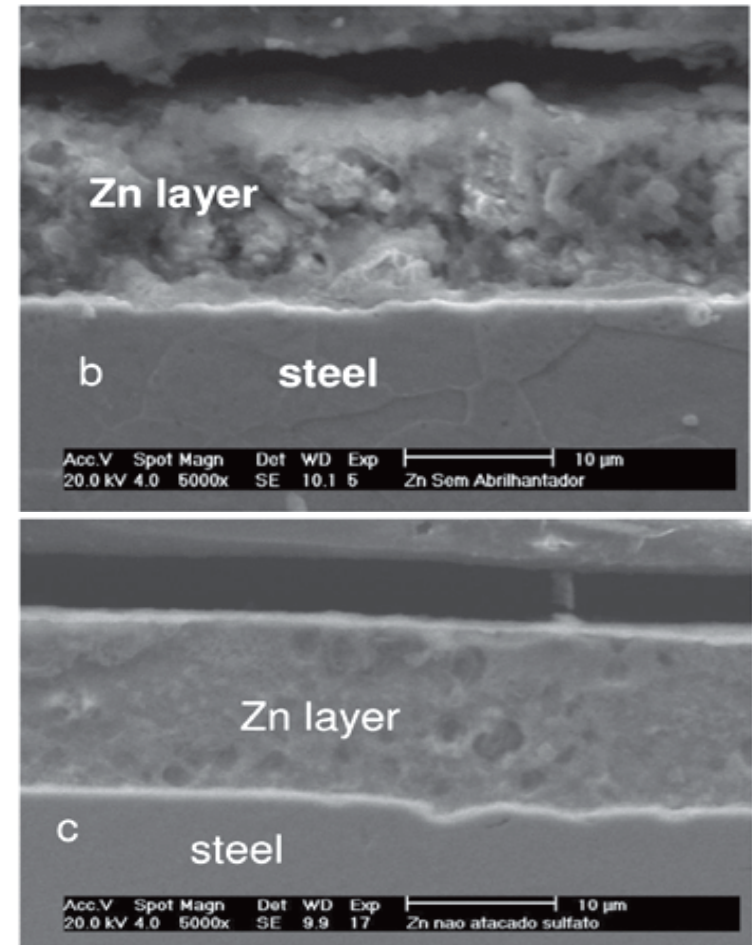

[http://www.scielo.br/scielo.php?script=sci\\_arttext&pid=S0103-50532007000600010](http://www.scielo.br/scielo.php?script=sci_arttext&pid=S0103-50532007000600010)

<https://www.manualdaquimica.com/fisico-quimica/galvanoplastia.htm>

❖ Aspersão térmica - Exemplos

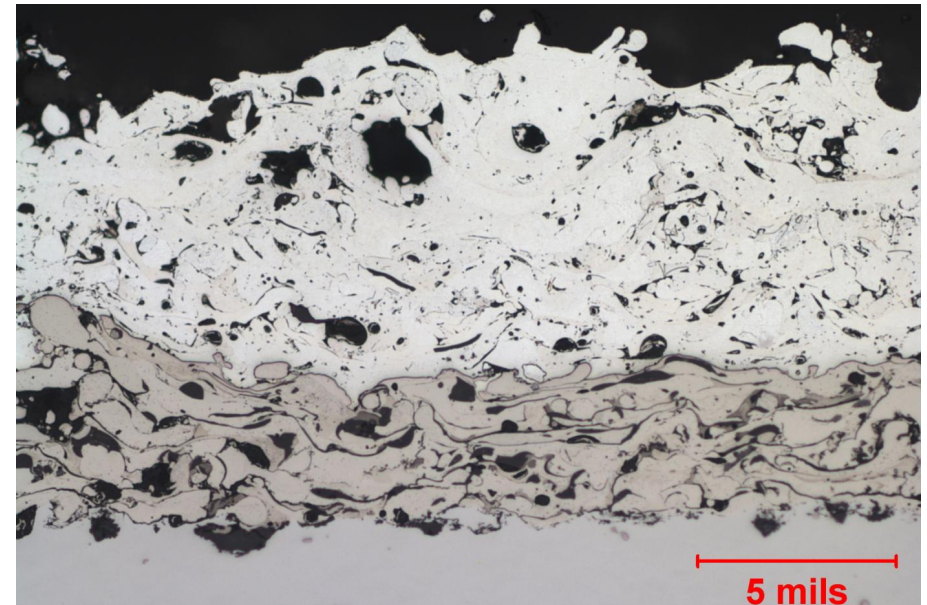
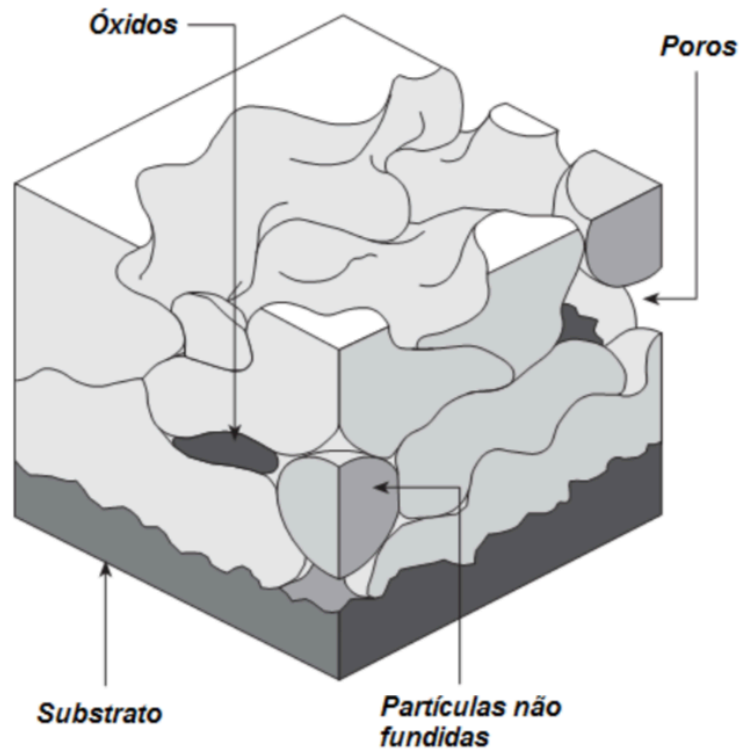

<https://www.imrtest.com/tests/thermal-spray-coating-analysis>

Figura 2. Corte transversal mostrando os constituintes de uma camada aspergida termicamente [6]



# Aplicações de Recobrimentos

❖ Proteção a oxidação e corrosão



❖ Redução de desgaste e atrito



❖ Resistência térmica



❖ Agente bactericida



❖ Componentes eletrônicos

❖ Sistemas eletro-mecânicos

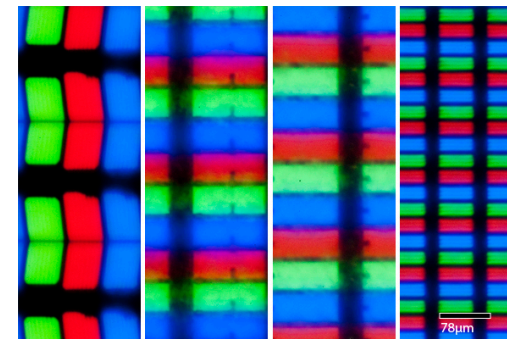

Ionbond (2015)

<http://prometheus.med.utah.edu/~bwjones/2010/06/apple-retina-display>





# Recobrimentos: Redução de Atrito

## ❖ Lubrificantes sólidos

### ❖ Teoria do baralho de cartas

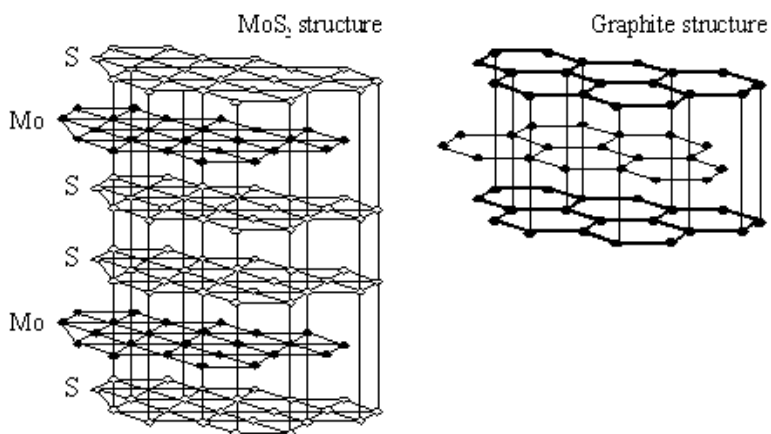
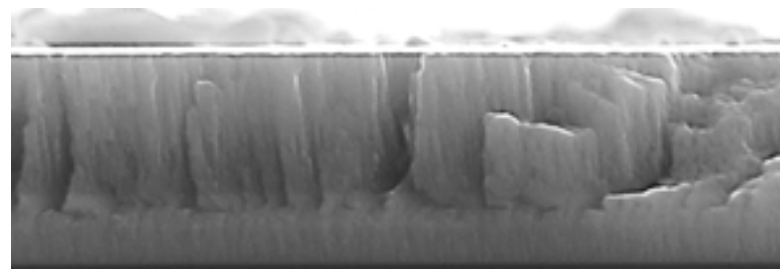

<http://www.tribology->

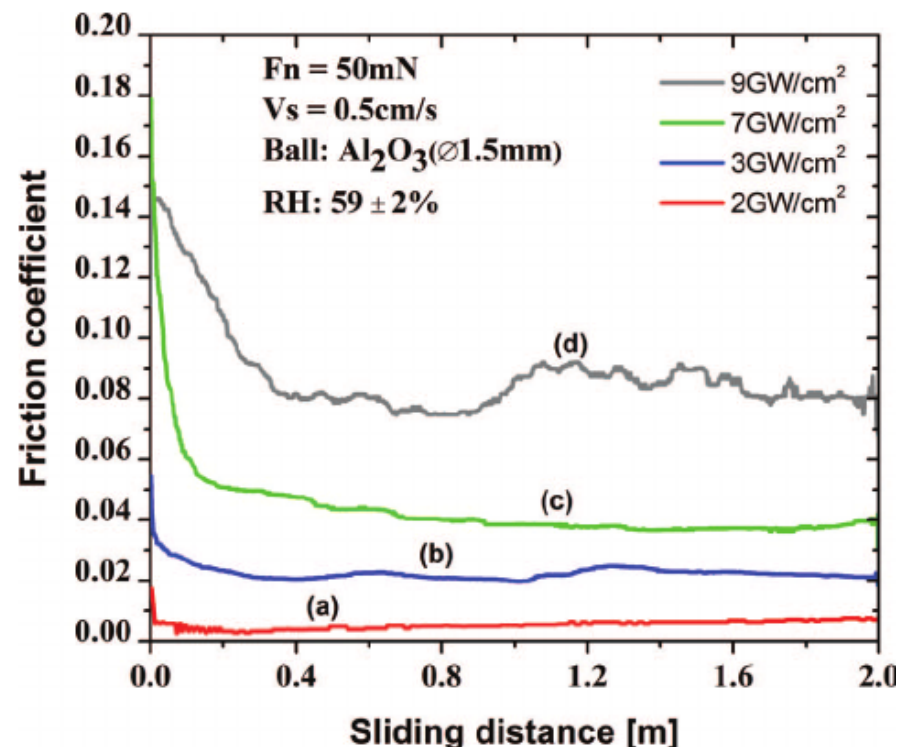
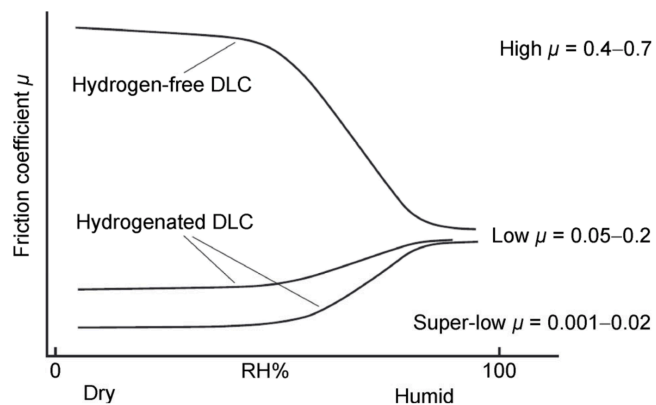

[https://www.researchgate.net/publication/272314519\\_Impact\\_of\\_laser\\_power\\_density\\_on\\_tribological\\_properties\\_of\\_Pulsed\\_Laser\\_Deposited\\_DLC\\_films/figures?lo=1](https://www.researchgate.net/publication/272314519_Impact_of_laser_power_density_on_tribological_properties_of_Pulsed_Laser_Deposited_DLC_films/figures?lo=1)



# Recobrimentos: Redução de Atrito

## ❖ Lubrificantes sólidos

### ❖ Formação de tribocamada

### ❖ Passivação de superfícies

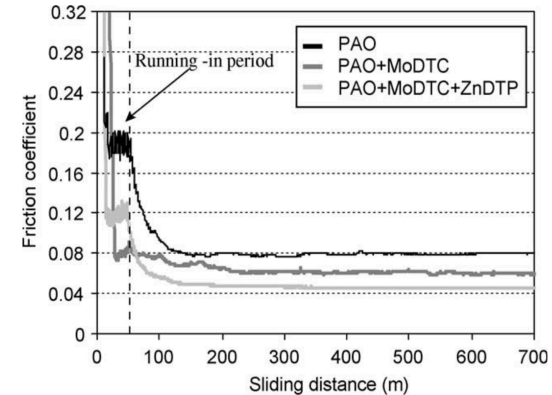

[https://www.researchgate.net/publication/222546572\\_Boundary\\_lubrication\\_mechanisms\\_of\\_carbon\\_coatings\\_by\\_MoDTC\\_and\\_ZDDP\\_additives](https://www.researchgate.net/publication/222546572_Boundary_lubrication_mechanisms_of_carbon_coatings_by_MoDTC_and_ZDDP_additives)

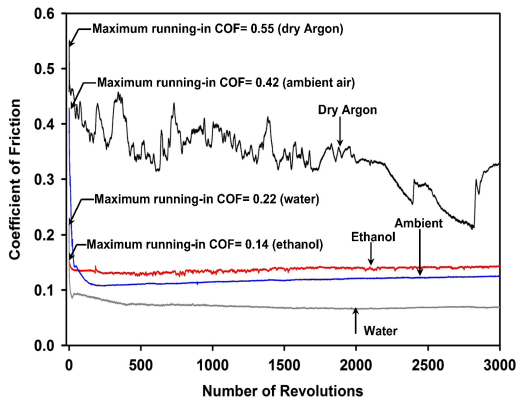
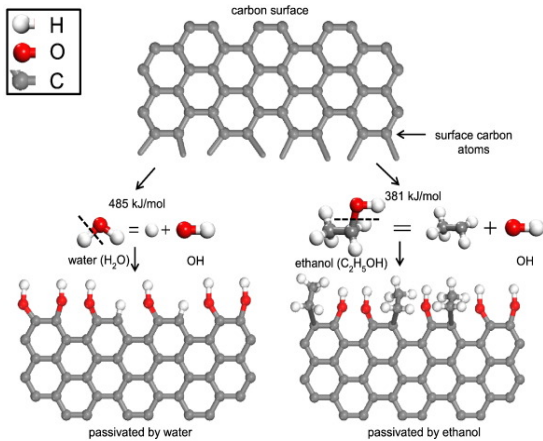

<http://www.sciencedirect.com/science/article/pii/S0257897214006203#f0005>

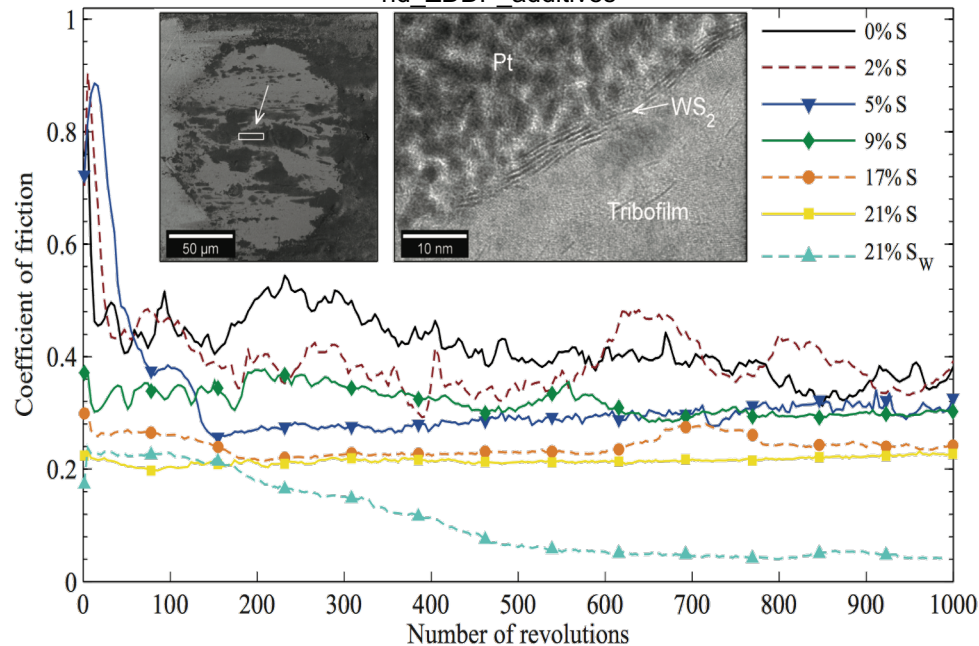

<https://uu.diva-portal.org/smash/get/diva2:754210/FULLTEXT01.pdf>



## Recobrimentos: Ferramentas

- ❖ Recobrimentos típicos: TiN, CrN, WC, NbC, ta-C
- ❖ Alta dureza (> 20GPa)
- ❖ Alto módulo de elasticidade (> 300GPa)
- ❖ Deposição por PVD ou CVD
- ❖ Baixa espessura (< 10 µm)
- ❖ Alta tensão residual

$$Q = \frac{kWL}{H}$$

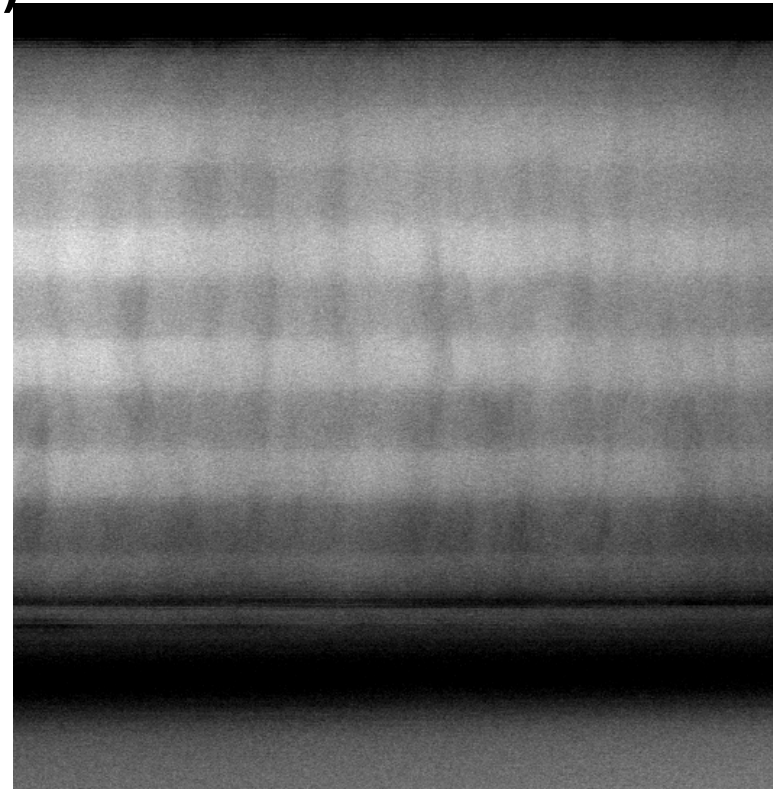

<http://www.sciencedirect.com/science/article/pii/S0254058415300158>



# Recobrimentos: Desgaste

un-shrouded blades

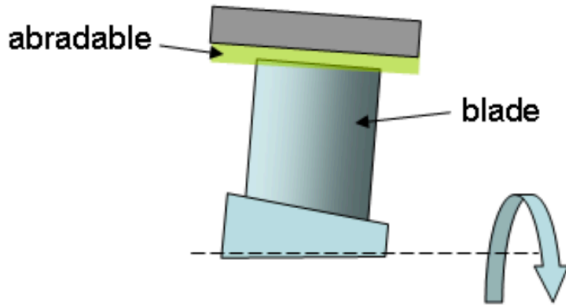
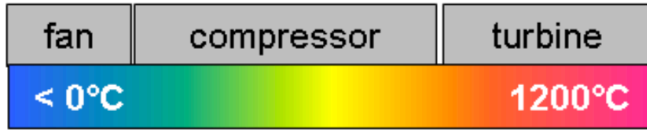

BLADE TIP VELOCITY: 30-410 m/s  
 RATE OF INCURSION: 2 to 2000 μm/s  
 SHROUD TEMPERATURE: 20 to 1100°C

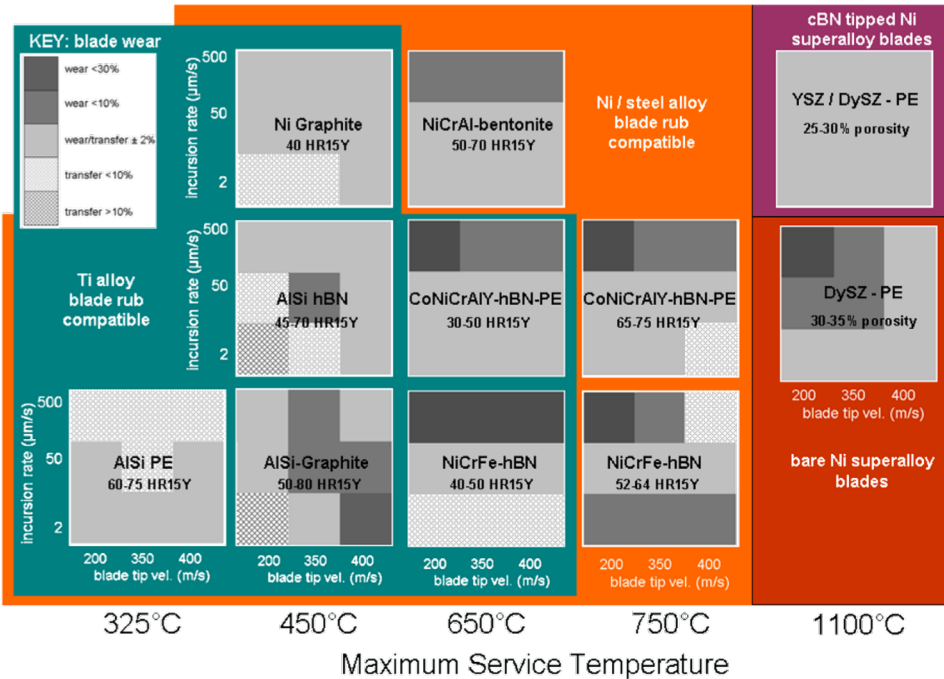
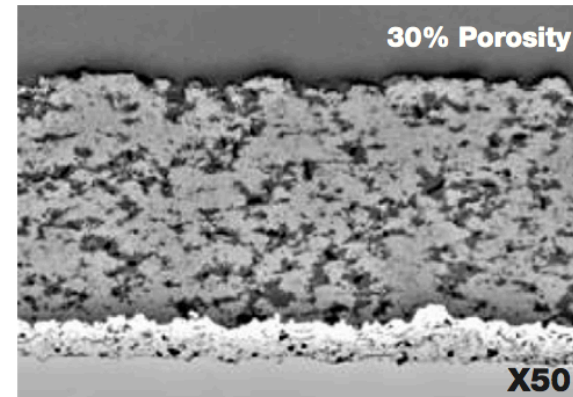
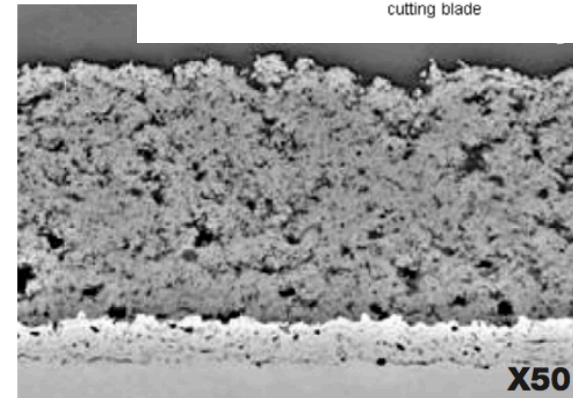
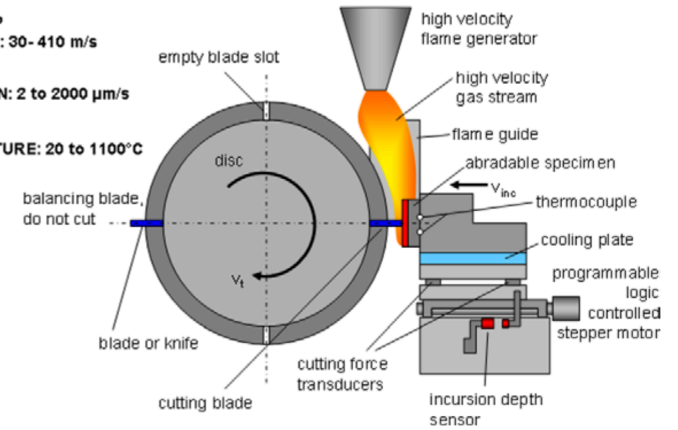

[https://www.oerlikon.com/2FecomaXL%2Ffiles%2Foerlikon\\_ThermallySprayedAbradableCoatings\\_2012.10.pdf%26download%3D1&usg=AFQjCNH6vlw7BRyslazBS1FngcXzIVs7DA](https://www.oerlikon.com/2FecomaXL%2Ffiles%2Foerlikon_ThermallySprayedAbradableCoatings_2012.10.pdf%26download%3D1&usg=AFQjCNH6vlw7BRyslazBS1FngcXzIVs7DA)



# Recobrimentos: Filtros ópticos

## ❖ Filtros dicróicos

Espelho **dicróico** é um **filtro** de cores, usado para selecionar a luz que passa em uma pequena faixa de cores e refletir a luz de uma cor determinada



<http://www.sherlan.com/bandpass-filters.html>

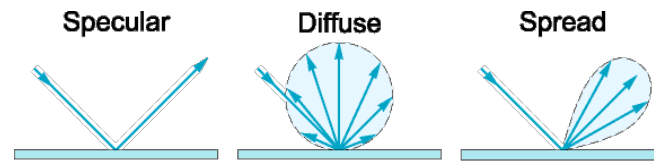

Fig. 3.2 Specular, diffuse, and spread reflection from a surface.

<http://www.dfisica.ubi.pt/~hgil/fotometria/HandBook/ch03.html>

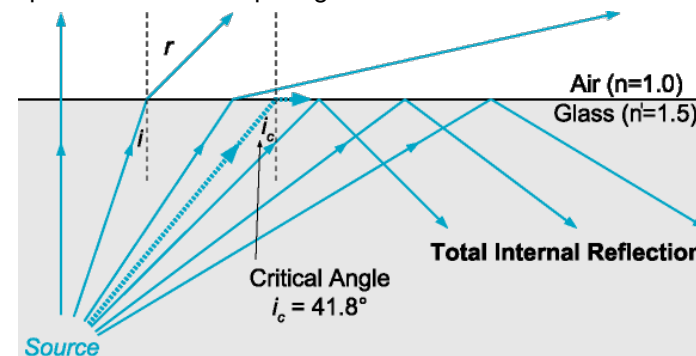

Fig. 3.5 Refraction and total internal reflection.

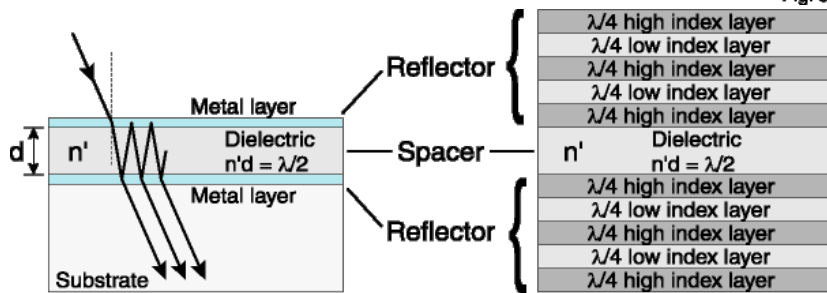

Fig. 3.7 A thin film metal interference filter and an all dielectric interference filter.

<http://www.dfisica.ubi.pt/~hgil/fotometria/HandBook/ch03.html>

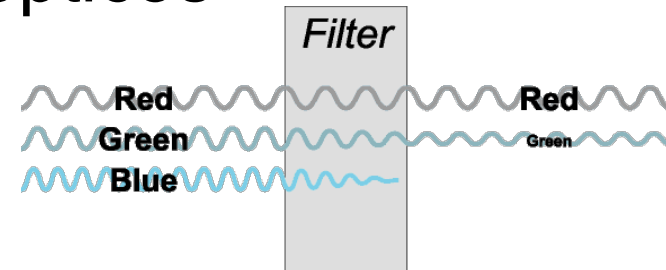
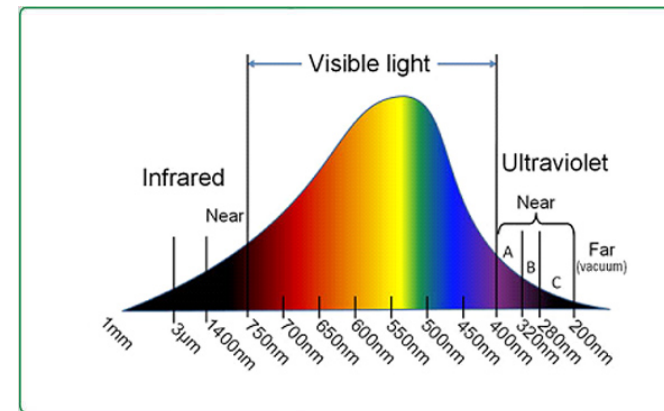
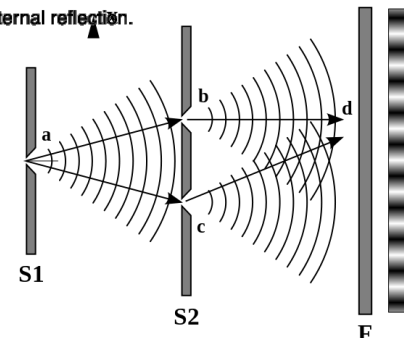

Fig. 3.3 Transmission through an optical filter.



<https://www.go-ttv.com/optical-filters/>



<https://alemdainercia.wordpress.com/2016/02/16/fisica-moderna-interferencia-e-difracao-de-luz/>

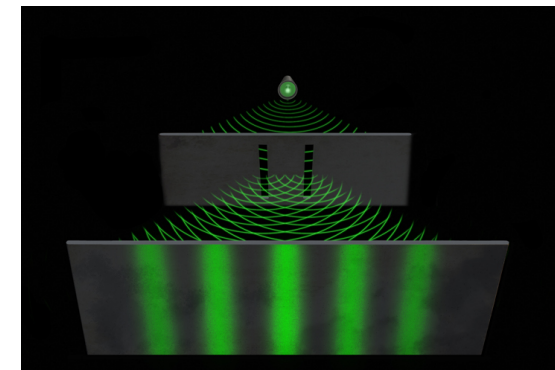



# Recobrimentos: Filtros ópticos

## ❖ Filtros dicróicos



<http://www.sherlan.com/bandpass-filters.html>

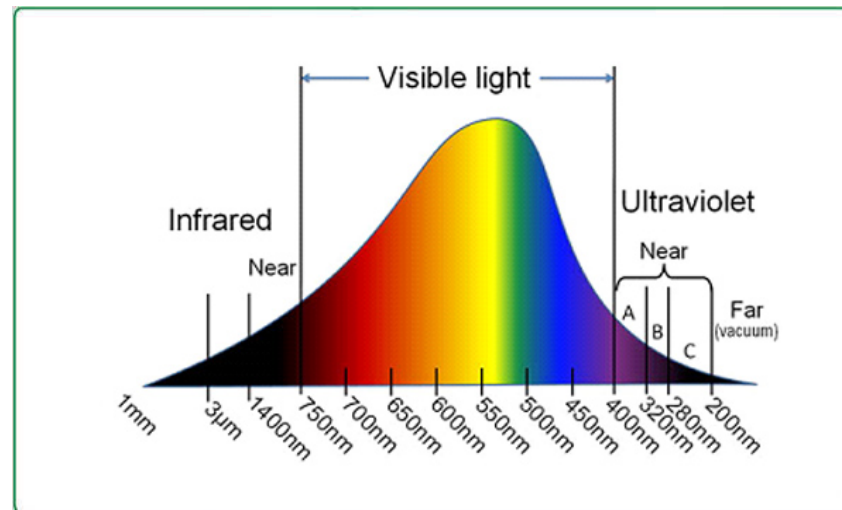

<https://www.go-ttv.com/optical-filters/>

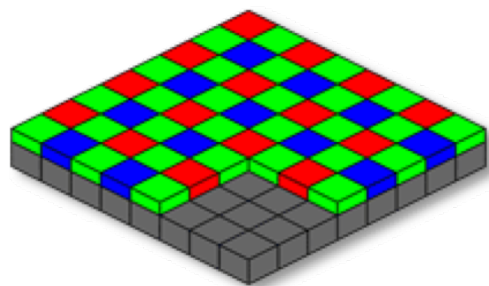

Color Filter Array Sensor

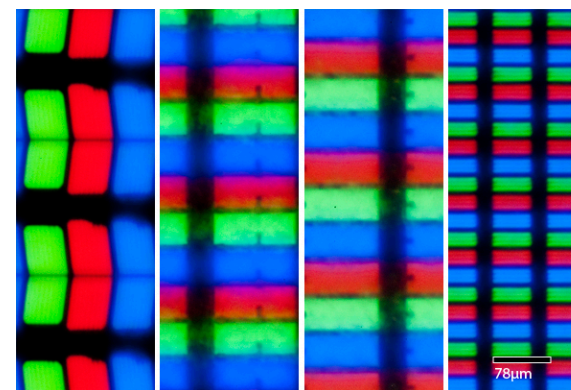
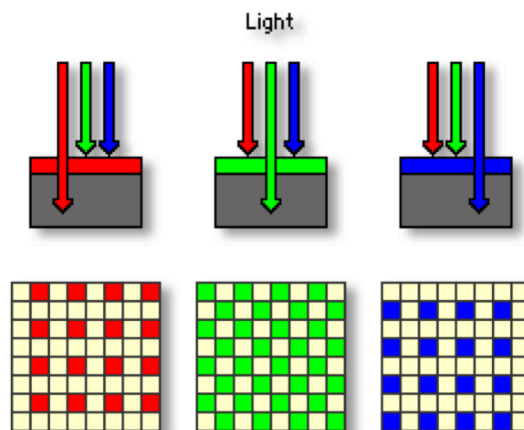

<http://prometheus.med.utah.edu/~bwjones/2010/06/apple-retina-display/>

© 2003 Vincent Bockaert [123di.com](http://www.123di.com)

<https://fotobellarte.wordpress.com/category/funcionamento>



## Recobrimentos: Outros

### ❖ Baseados em Carbono (NanoTubos, NanoDiamantes)

- ❖ Bio-compatíveis
- ❖ Baterias e capacitores

(a)

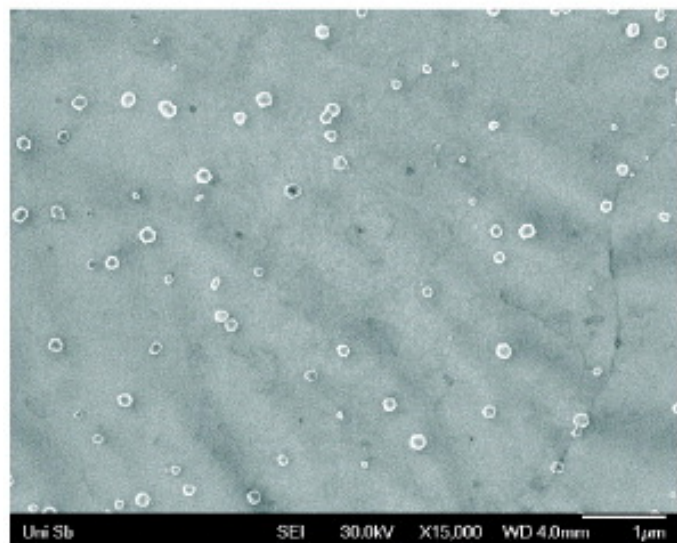

(b)

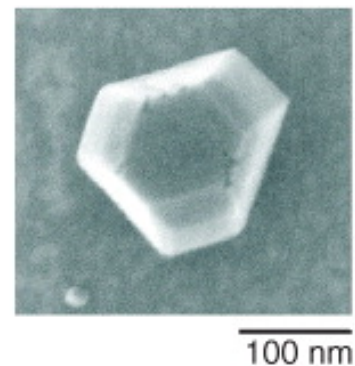
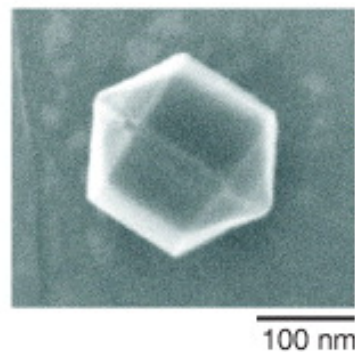

<http://iopscience.iop.org/article/10.1088/1367-2630/13/2/025012/meta>

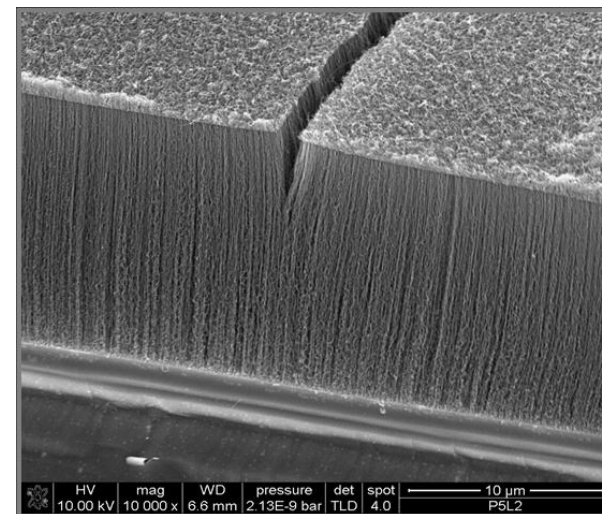

<https://www.ifw-dresden.de/de/institute/institut-fuer-komplexe-materialien/abteilungen/mikro-und-nanostrukturen/molecular-nanostructures/carbon-nanotubes-i/>

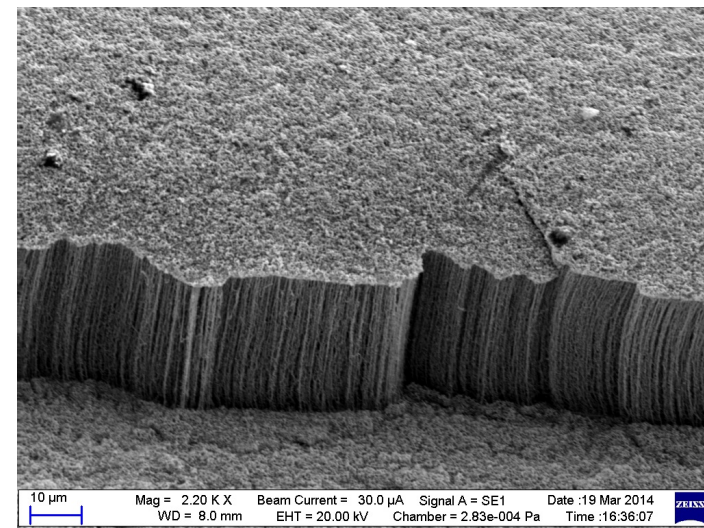

<http://users.ecs.soton.ac.uk/apl08r/adamplewis/>



# Recobrimentos: Outros

## ❖ Recobrimentos bactericidas e bio-compatíveis

### ❖ Dopados por Ag e Cu

a) Uncoated

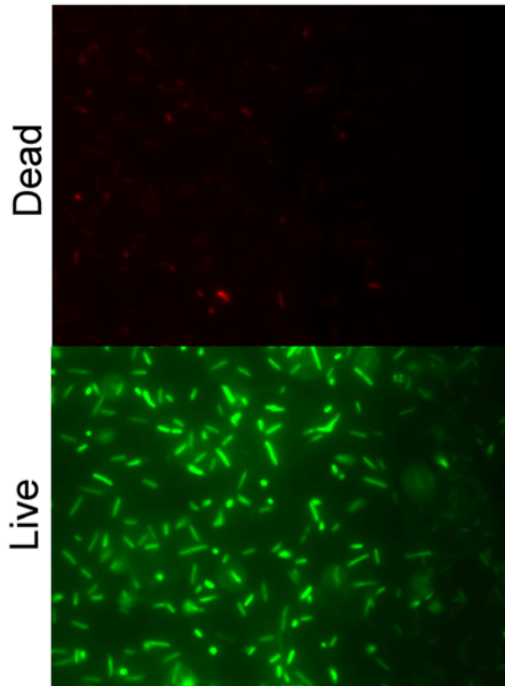

b) Ag-DLC

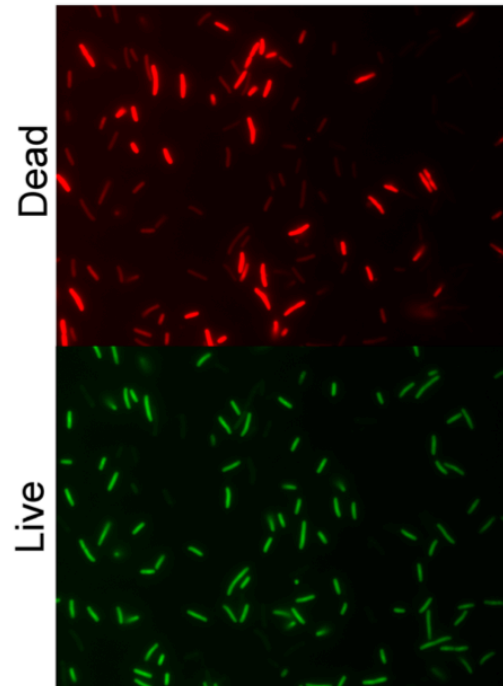

<http://avs.scitation.org/doi/10.1116/1.4871435>

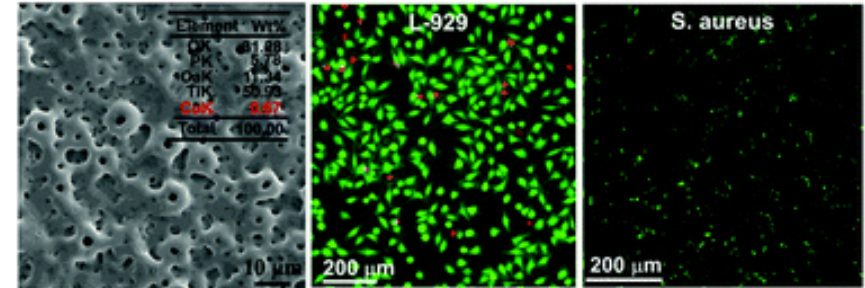

<http://pubs.rsc.org/en/Content/ArticleLanding/2016/TB/c6tb00563b#!divAbstract>

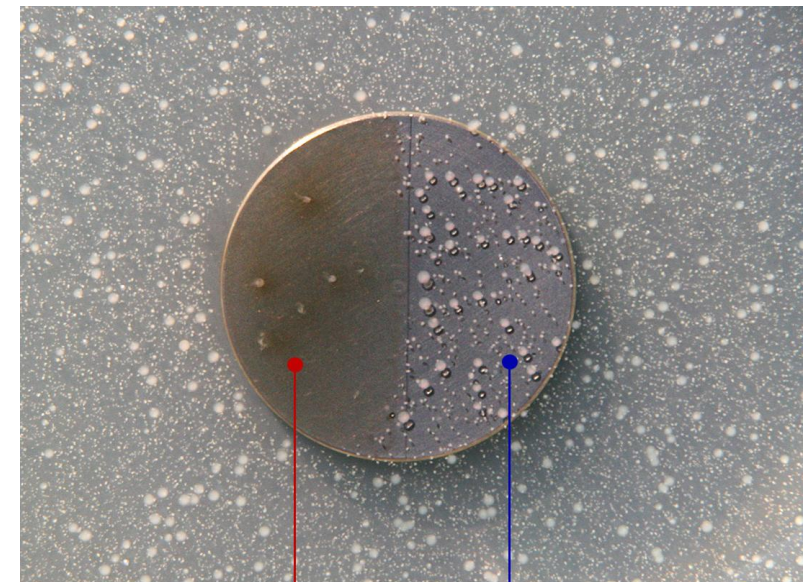

Antibacterial Coated Material: Ti Al6 V4 Bacterium: E-Coli Non-Coated

<http://www.artworldmedical.com/antibacterial.html>





## Processos de deposição

### ❖ Eletrodeposição

- ❖ Espessos
- ❖ Densos
- ❖ Homogêneos
- ❖ Imersão
- ❖ Precursor sólido ou líquido



<http://www.hypeness.com.br/2011/07/audi-r8-cromado/>

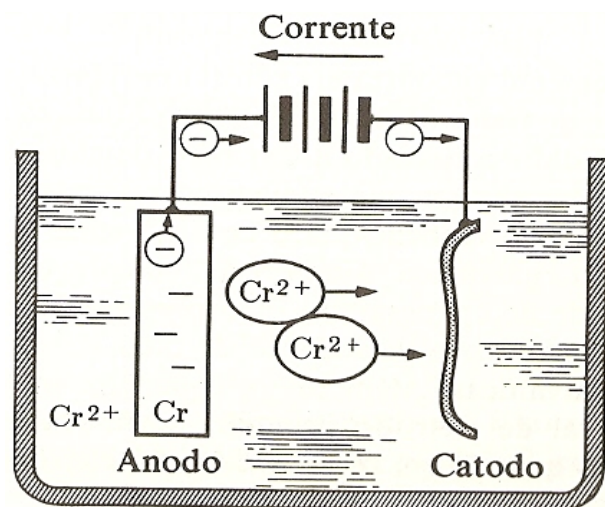

<http://www.ebah.com.br/content/ABAAABYGkAl/corrosao>



<https://www.mobly.com.br/aparador-viterbo-cromado-vidro-incolor-64101.html>



# Recobrimentos ou Revestimentos (superfícies)

## ❖ Tipos de recobrimentos - Exemplos

**Galvanoplastia** é uma técnica industrial que utiliza a eletrólise em meio aquoso para cobrir uma determinada peça metálica com outro metal. O objetivo é obter uma ou mais das vantagens a seguir:

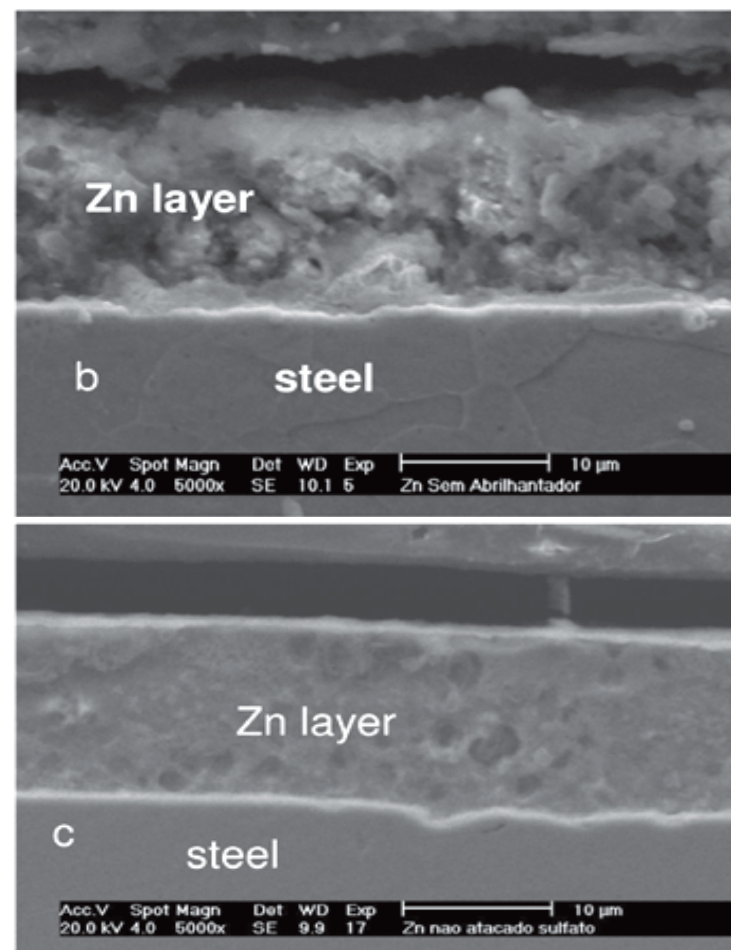

[http://www.scielo.br/scielo.php?script=sci\\_arttext&pid=S0103-50532007000600010](http://www.scielo.br/scielo.php?script=sci_arttext&pid=S0103-50532007000600010)

<https://www.manualdaquimica.com/fisico-quimica/galvanoplastia.htm>



# Processos de deposição

## ❖ Laser

❖ Espessos

❖ Densos

❖ Linha de visão

❖ Precursor sólido ou líquido

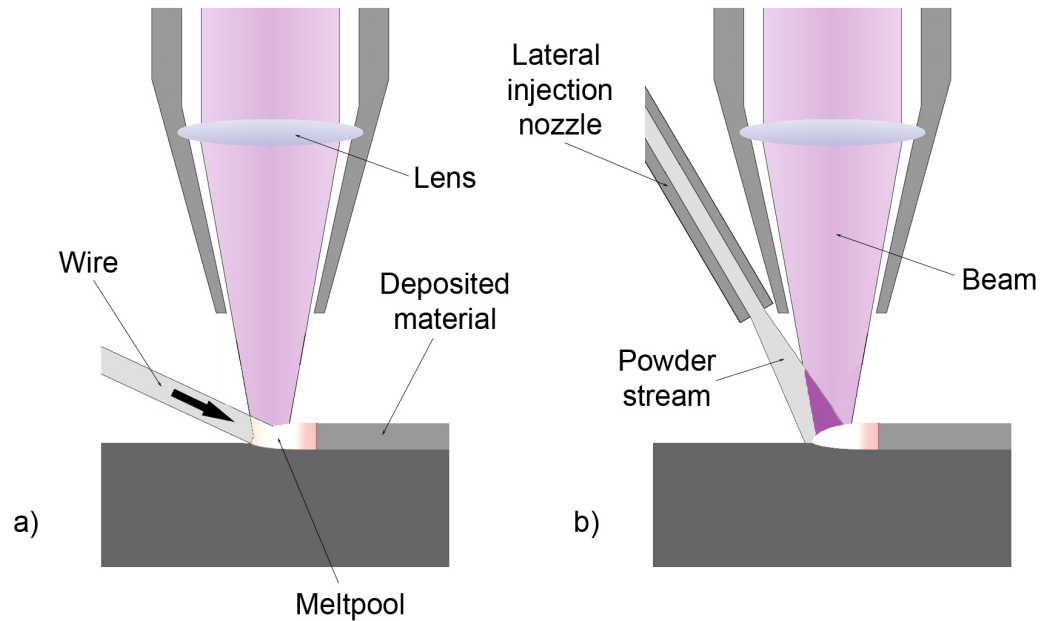

[https://en.wikipedia.org/wiki/Cladding\\_\(metalworking\)](https://en.wikipedia.org/wiki/Cladding_(metalworking))



<http://www.castolin-eutectic-oiltec.com/services/laser-cladding-services>



<http://www.ogj.com/articles/print/volume-105/issue-34/drilling-production/special-report-lasers-used-to-clad-strengthen-nonmagnetic-steel-equipment.html>



# Processos de deposição

- ❖ **Aspersão térmica**
  - ❖ **Espessos**
  - ❖ **Porosos**
  - ❖ **Heterogêneos**
  - ❖ **Alta temperatura**
  - ❖ **Linha de visão**
  - ❖ **Precursor sólido**

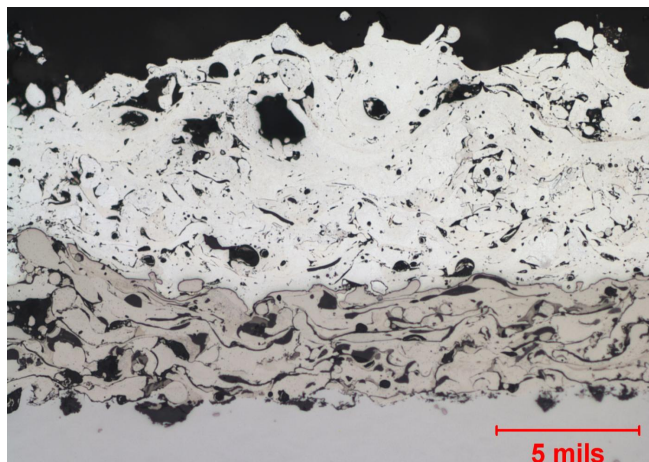
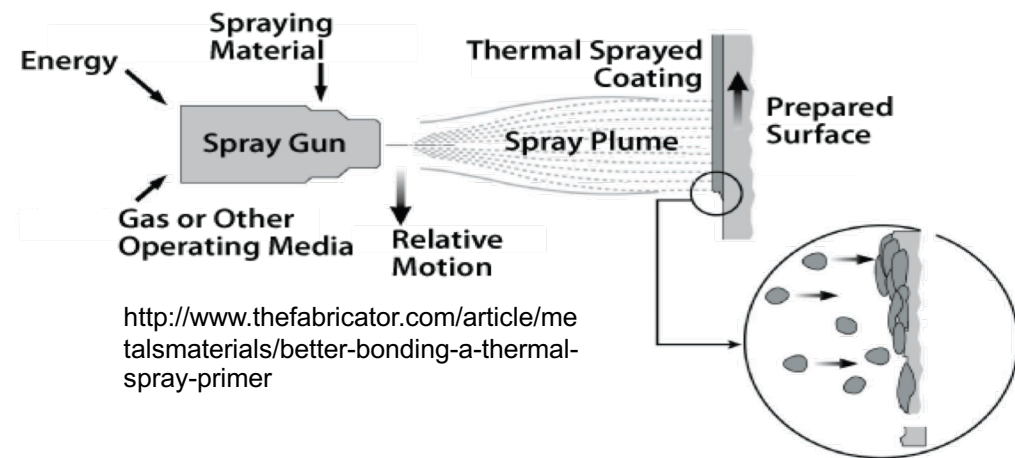

<https://www.imrtest.com/tests/thermal-spray-coating-analysis>

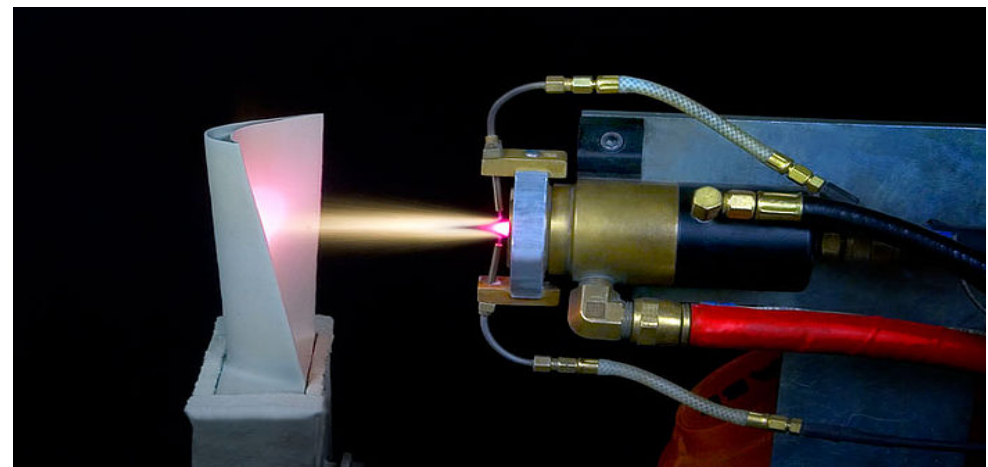

<https://www.vividinc.com/thermal-coatings-1>



# Processos de deposição

## Recobrimento Metálico por Aspersão Térmica

- ✓ A técnica de aspersão térmica consiste no depósito em um substrato devidamente preparado utilizando de partículas finamente divididas, sendo estas metálicas ou não, na condição fundida ou semi-fundida, formando uma camada superficial. A energia para a deposição é advinda de uma tocha ou um arco elétrico, aquecendo as partículas e atirando-as sobre o substrato através de um gás comprimido. As camadas formadas possuem estrutura lamelar, com a presença de óxidos e poros. Estas camadas conferem ao material proteção de natureza mecânica (desgaste), química (corrosão) e física (calor e eletricidade).

E. M. Mazzer & C. R. M. Afonso / Revista Eletrônica de Materiais e Processos /  
ISSN 1809-8797 / v.7.2 (2012) 123 – 130



# Processos de deposição

## Recobrimento Metálico por Aspersão Térmica

O número de técnicas de aspersão térmica para recobrimento metálico é variado, dependendo da aplicação requisitado. Elas são classificadas principalmente pela fonte de calor utilizada no processo, podendo ser por processos elétricos ou por combustão, de uma maneira geral. Os tipos principais de processos de recobrimento e suas siglas são listados como segue:

- FS – Flame Spraying (aspersão a chama oxi-gás com material de adição na forma de pó ou arame);
- HVOF – High Velocity Oxy-Fuel flame spraying (aspersão a chama oxigênio-combustível de alta velocidade com material de adição na forma de pó);
- D-gun – Detonation-Gun spraying (aspersão por detonação); • TWAS - Twin Wire Arc Spraying (aspersão térmica por arames gêmeos).
- PS – Plasma Spraying (aspersão a plasma);
- AS – Arc Spraying (aspersão a arco elétrico); • LS – Laser Spraying (aspersão a laser);
- CS – Cold Spraying (aspersão a frio).



✓ Aspersão térmica

Aspersão por arco elétrico



Figura 3. Ilustração de equipamento de aspersão por arco elétrico [8]

Processo de aspersão por HVOF

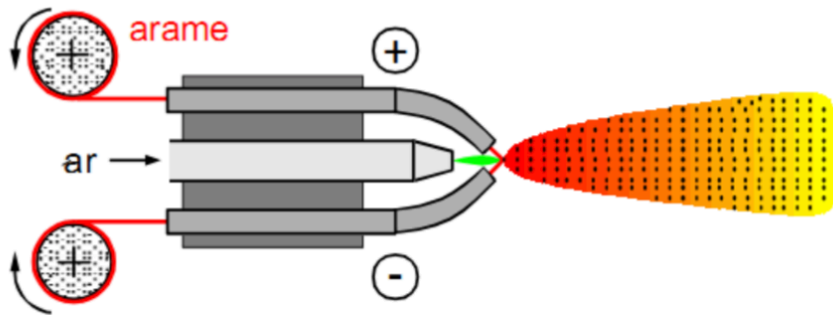

Figura 4. Ilustração do funcionamento básico de um equipamento de HVOF de terceira geração [6]

Aspersão a plasma

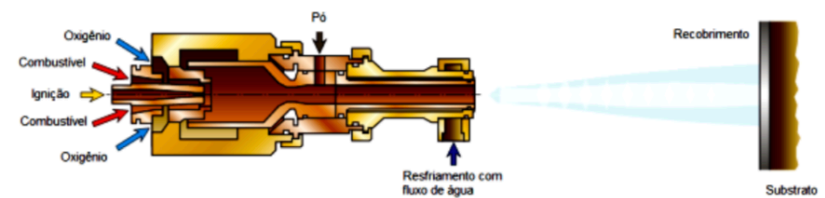

Figura 5: Ilustração do equipamento de aspersão a plasma

[11]

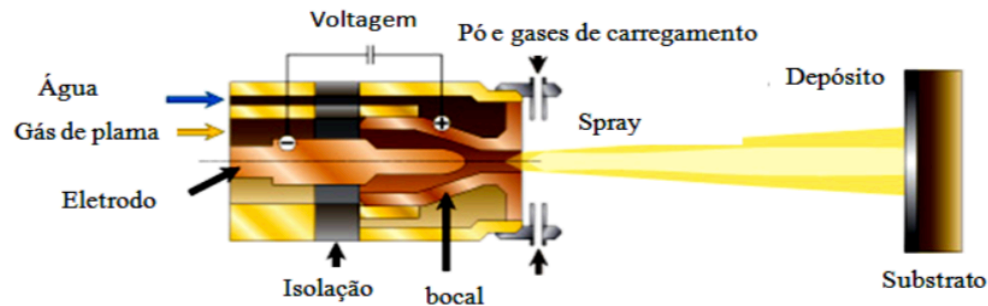

# Processos de deposição

- ❖ **Deposição física de vapor (PVD)**
  - ❖ **Densos**
  - ❖ **Homogêneos**
  - ❖ **Finos**
  - ❖ **Baixa temperatura**
  - ❖ **Linha de visão**
  - ❖ **Precursor sólido**

O processo PVD (Deposição física de vapor) é uma tecnologia utilizada para a **deposição de filmes metálicos finos sobre diversos tipos de substratos**. O processo é realizado, **sob vácuo**, aonde os metais a serem depositados (tais como zircônio, titânio, cromo) são evaporados. Graças a **energia cinética** e ao diferencial de potencial aplicado sobre a peça a ser recoberta, os íons metálicos são atraídos para a superfície do objeto a ser recoberto, onde se condensam, juntamente com um gás de processo, formando o revestimento desejado.

O **PVD** é particularmente indicado para aqueles produtos inovadores e de qualidade que necessitam atender elevados padrões ( **resistência a abrasão, ao risco, a corrosão, dureza superficial, etc** ) e permite ainda obter uma vasta gama de cores.





# Processos de deposição

## ❖ Deposição física de vapor (PVD)

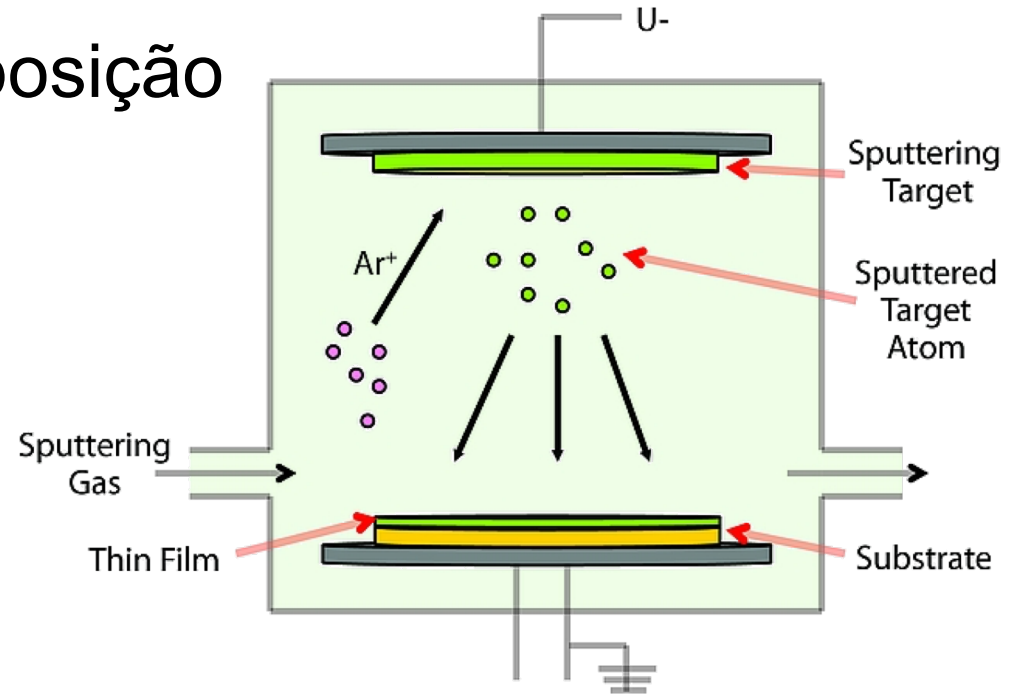
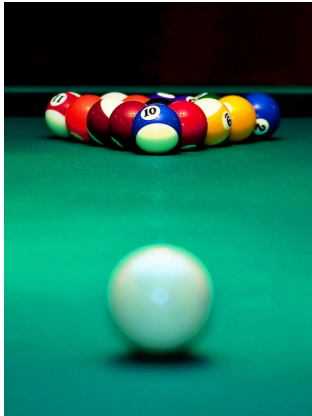

<http://www.sigmaldrich.com/materials-science/material-science-products.html?TablePage=108832720>

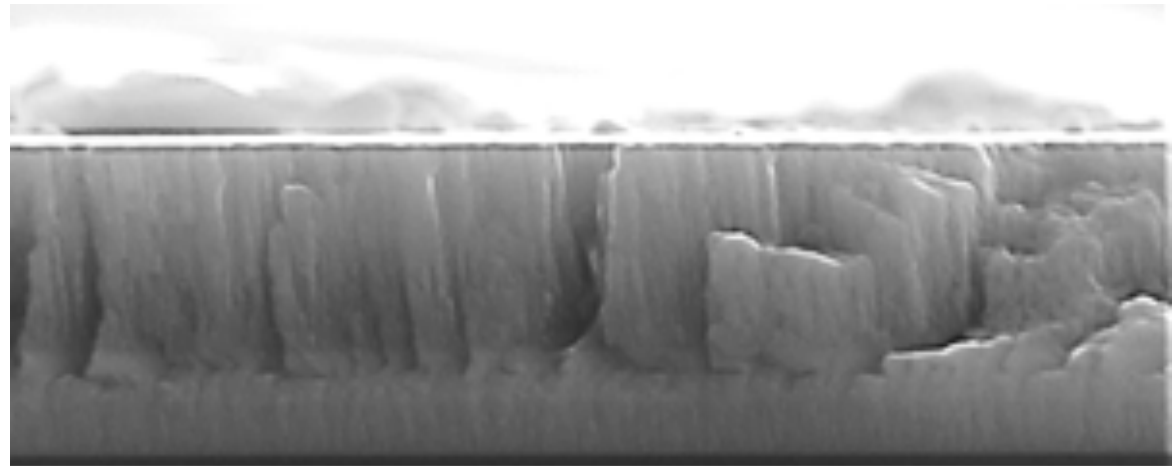
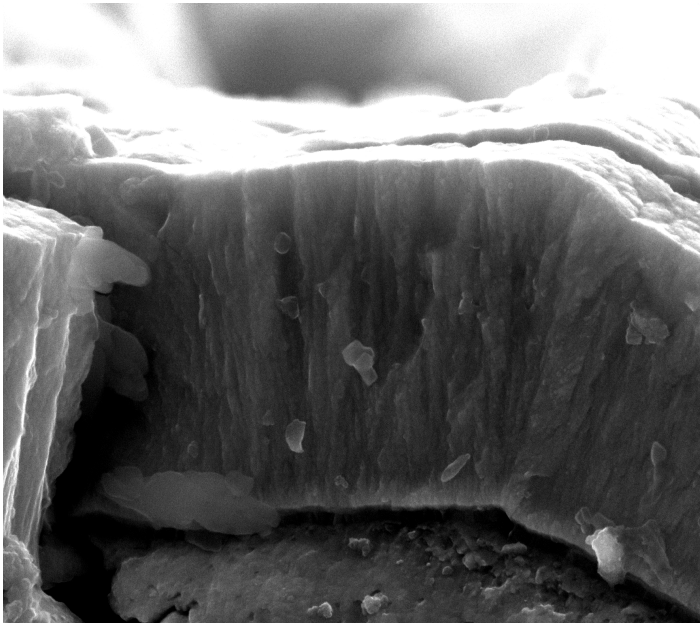



## Processos de deposição

### ❖ Deposição química de vapor (CVD)

- ❖ Cerâmicos
- ❖ Densos
- ❖ Homogêneos
- ❖ Alta temperatura
- ❖ Finos
- ❖ Imersão
- ❖ Precursor gasoso

**Deposição química em fase vapor** ou **CVD** (*chemical vapour deposition*) é um processo versátil para construção de filmes sólidos, revestimentos, fibras, componentes monolíticos, entre outros materiais. Essa tecnologia é usada na indústria de semicondutores e outros componentes eletrônicos, em componentes ópticos e optoeletrônicos, fotossensíveis e revestimentos.

No processo de CVD ocorre a formação de um filme fino sólido pela deposição atômica ou molecular, em uma superfície aquecida, sendo o sólido resultante de uma reação química onde os precursores estão na fase de vapor. No processo de CVD as espécies depositadas são átomos ou moléculas ou a combinação desses.



# Processos de deposição

## ❖ Deposição química de vapor (CVD)

- ❖ Cerâmicos
- ❖ Densos
- ❖ Homogêneos
- ❖ Alta temperatura
- ❖ Finos
- ❖ Imersão
- ❖ Precursor gasoso

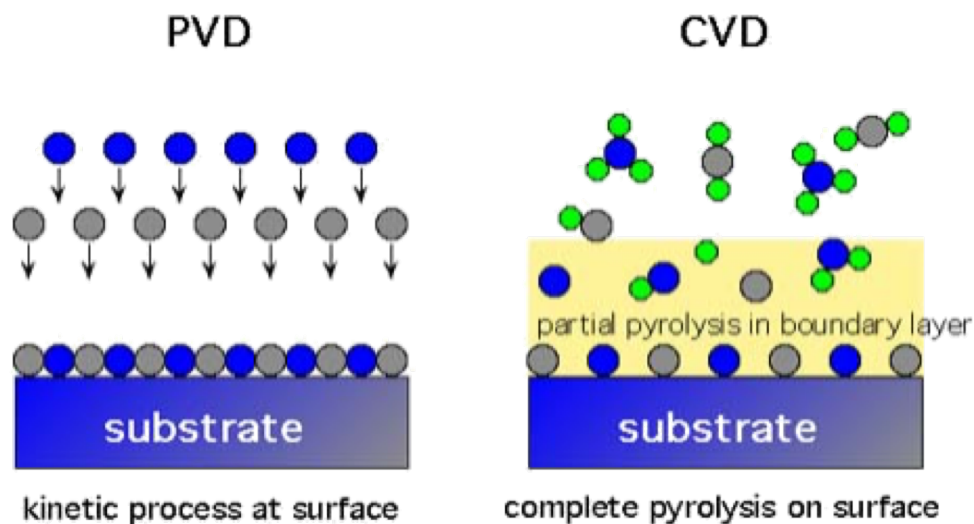

<https://www.withfriendship.com/user/svaruna/Chemical-vapor-deposition.php>

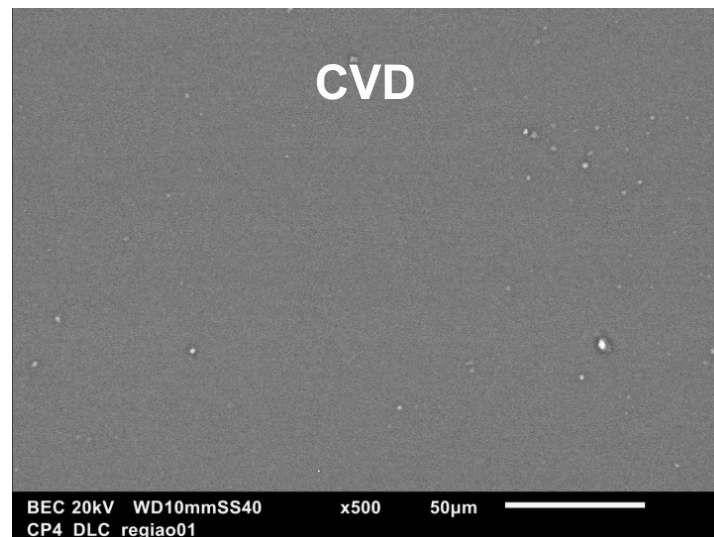
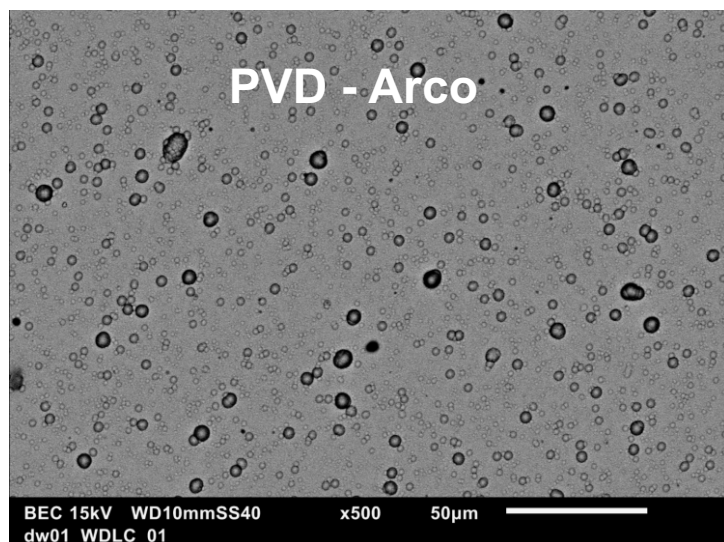



# Processos de deposição

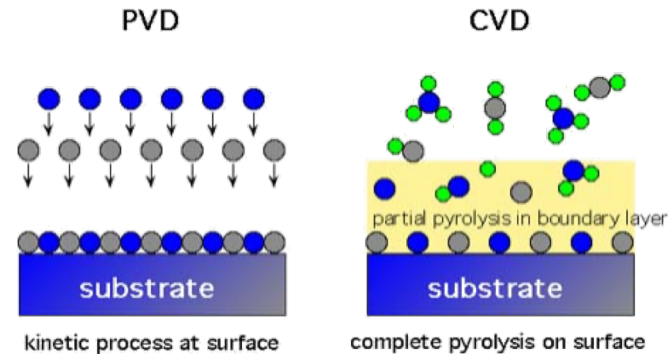

**CVD:** usa gases ou precursores em estado vapor e o filme depositado a partir de reações químicas sobre superfície do substrato.

**PVD:** vaporiza o material sólido por calor ou sputtering e recondensa o vapor sobre a superfície do substrato para formar o filme fino sólido.

- . Filmes CVD: melhor cobertura de degrau.
- Filmes PVD: melhor qualidade, baixa concentração de impurezas e baixa resistividade

<https://www.ccs.unicamp.br/novosite/ie521/files/2013/08/PVD-I.pdf>



# Processos de deposição

<https://www.youtube.com/watch?v=c4Sic1DRXJI>



<https://www.youtube.com/watch?v=c4Sic1DRXJI>



## Processos de deposição

- ❖ **Processos por deposição de vapor (PVD/CVD)**
  - ❖ **Composição variável**
    - ❖ **Diferentes elementos**
  - ❖ **Melhorar as características**
    - ❖ **Adesão, resistência ao desgaste**

Intercamada

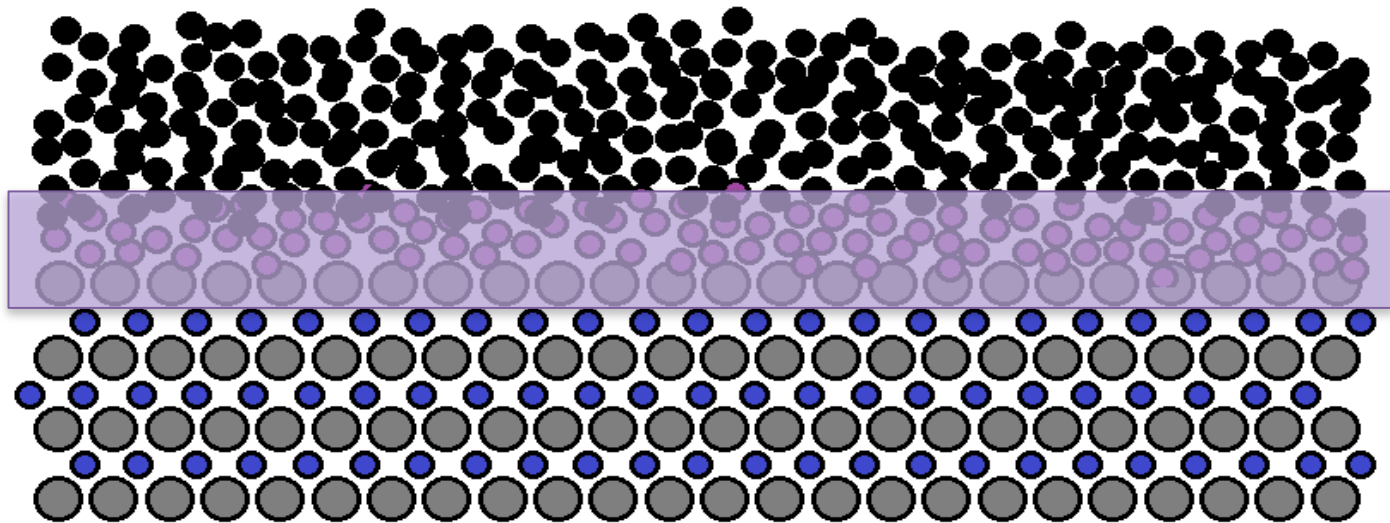



## Processos de deposição

- ❖ Processos PVD/CVD
  - ❖ Composição variável
    - ❖ Diferentes elementos

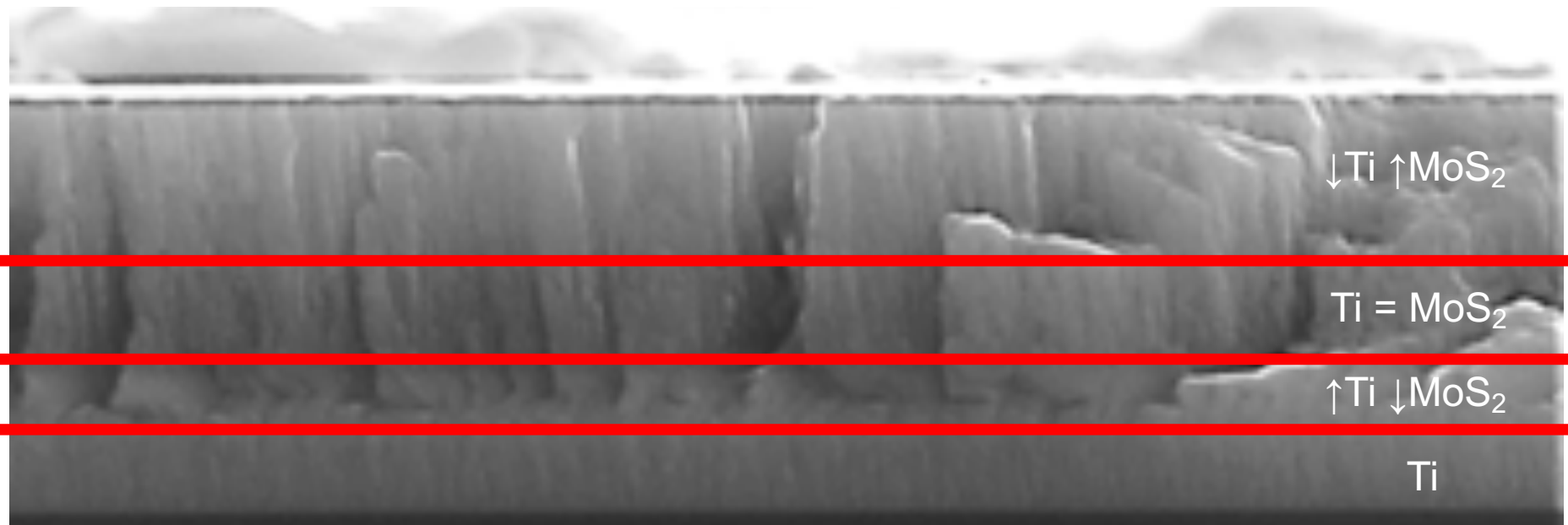



# Processos de deposição

## ❖ Processos PVD/CVD

### ❖ Composição variável

### ❖ Diferentes elementos

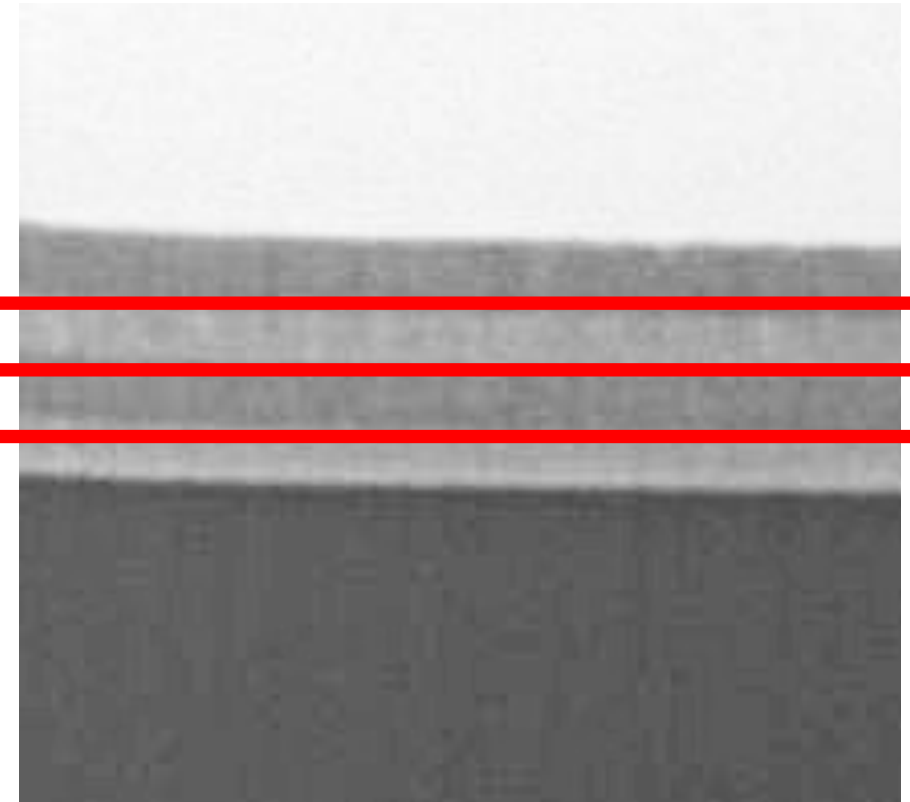
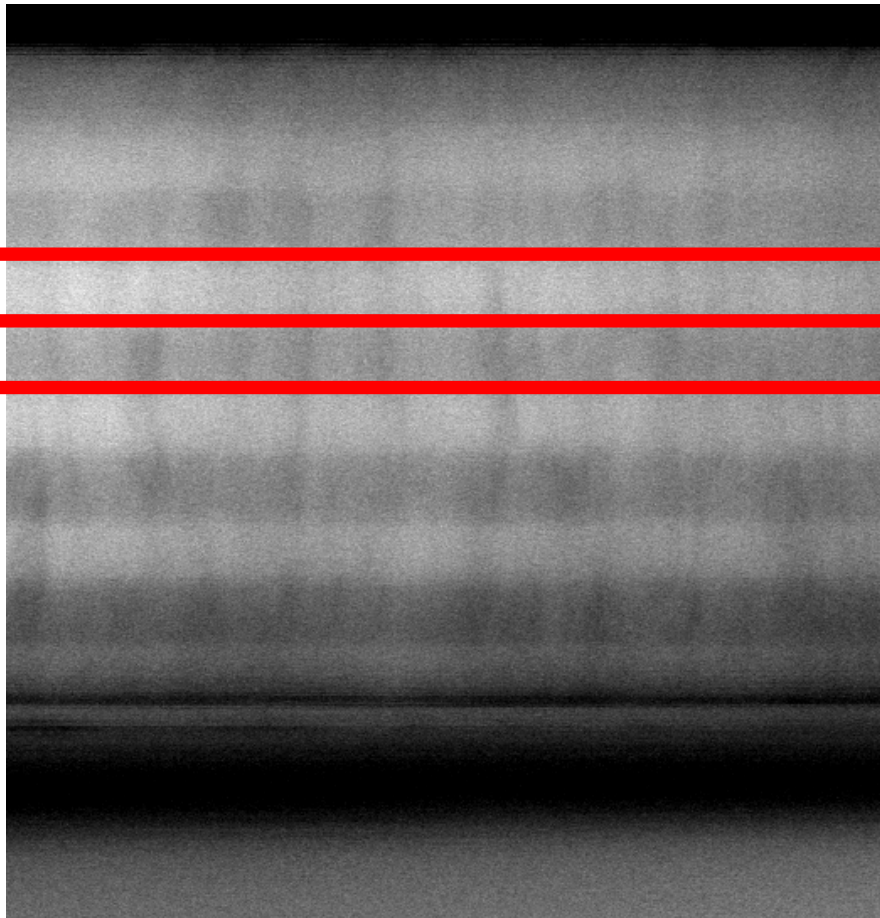

<http://www.sciencedirect.com/science/article/pii/S0254058415300158>





# Processos de deposição

## ❖ Processos PVD/CVD

### ❖ Morfologia

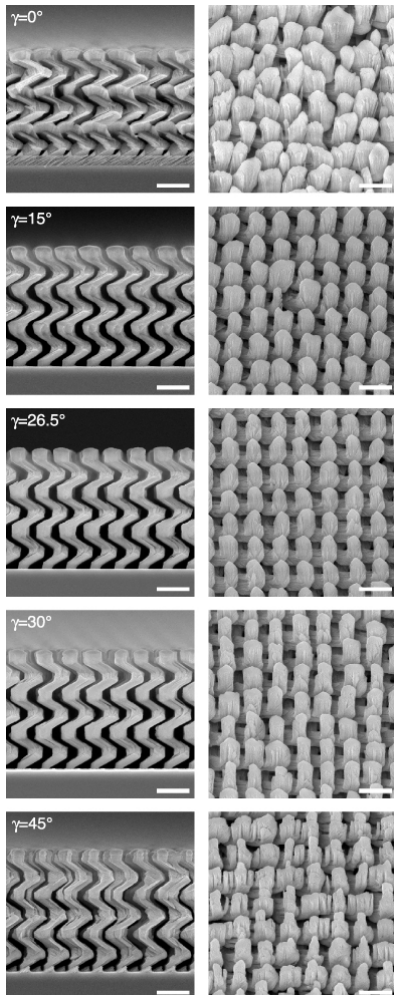

<http://iopscience.iop.org/article/10.1088/0957-4484/19/41/415203>

Multilayer  
Bond layer (Cr)  
Base Material

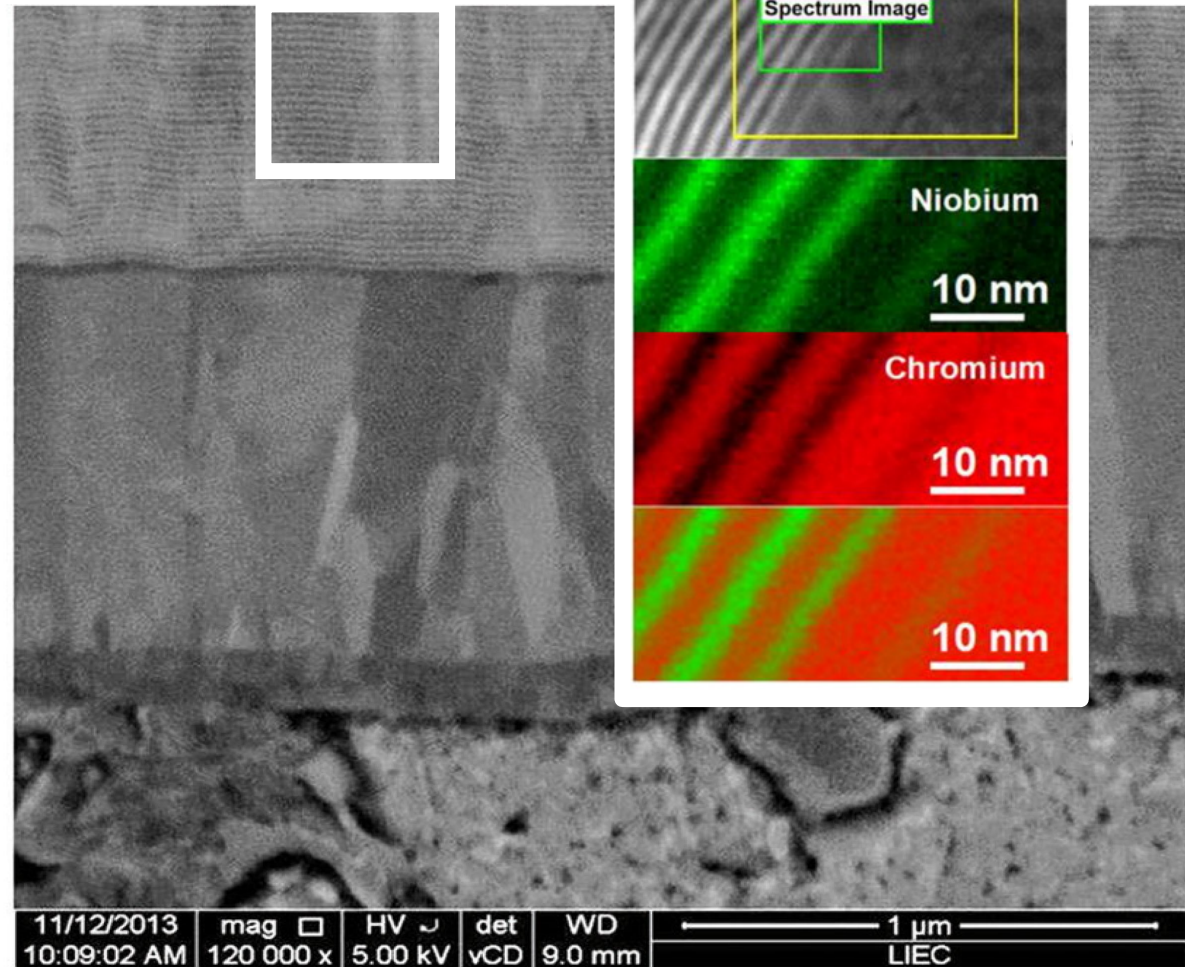

[http://www.scielo.br/scielo.php?script=sci\\_arttext&pid=S1516-14392017000100200&lng=en&tling=en](http://www.scielo.br/scielo.php?script=sci_arttext&pid=S1516-14392017000100200&lng=en&tling=en)



## Defeitos

Figura 5- Tipos de defeitos relacionados com o crescimento de filmes depositados por arco catódico. É possível observar da esquerda para direita exemplos de defeitos em forma de flocos (a), de cone (b e c), de buraco de agulha (*pin hole*) (d), vazios (e) e defeitos gerados por presença de irregularidades na superfície (f).

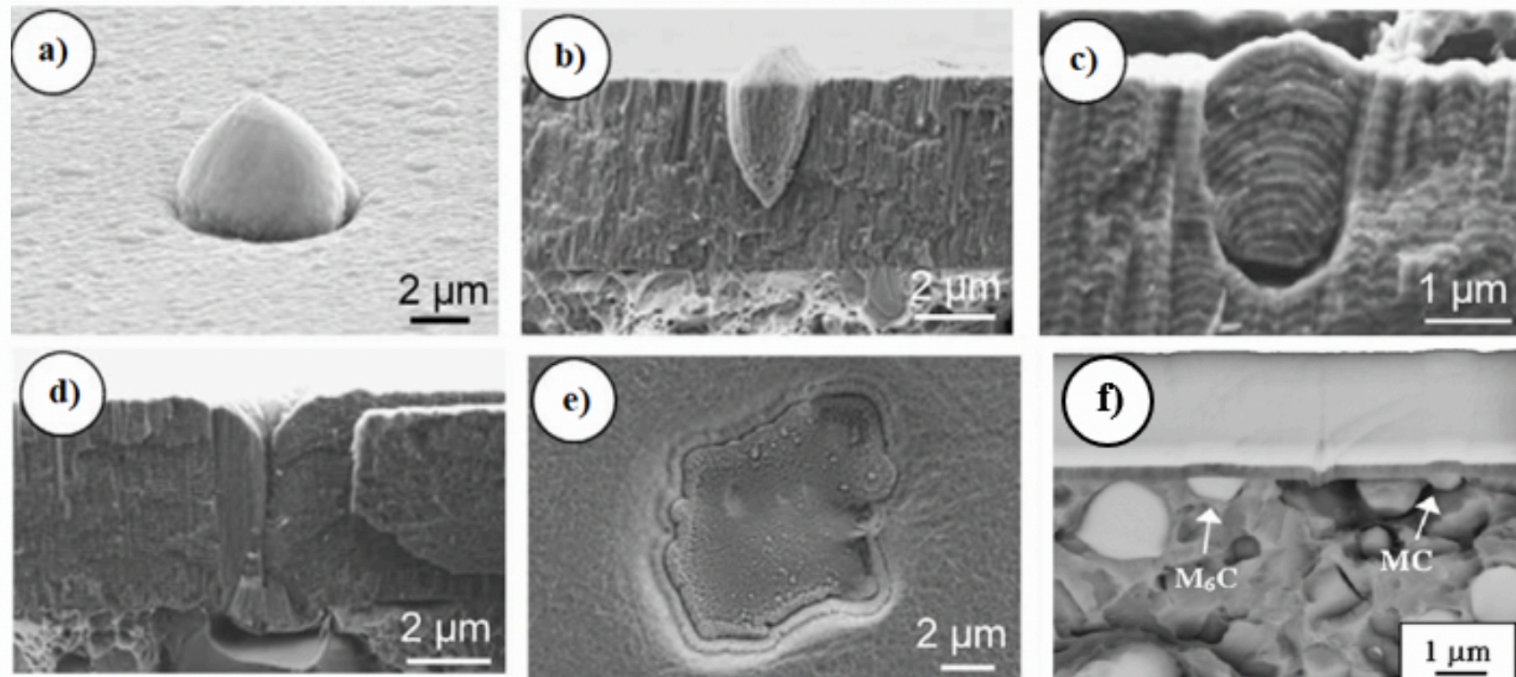

Fonte: Adaptado de [Harlon](#); [Bexell](#); [Olsson](#) (2009); [Panjan et al.](#), (2009)

Transição do comportamento mecânico das micropartículas em um revestimento WC/C durante ensaios de riscamento. Cassiano Ferreira Bernardes

# Defeitos

Figura 31 - Imagem obtida por MEV da microestrutura heterogênea do revestimento WC/C: a) Seção transversal do revestimento mostrando um macropartícula; b) Superfície do revestimento.

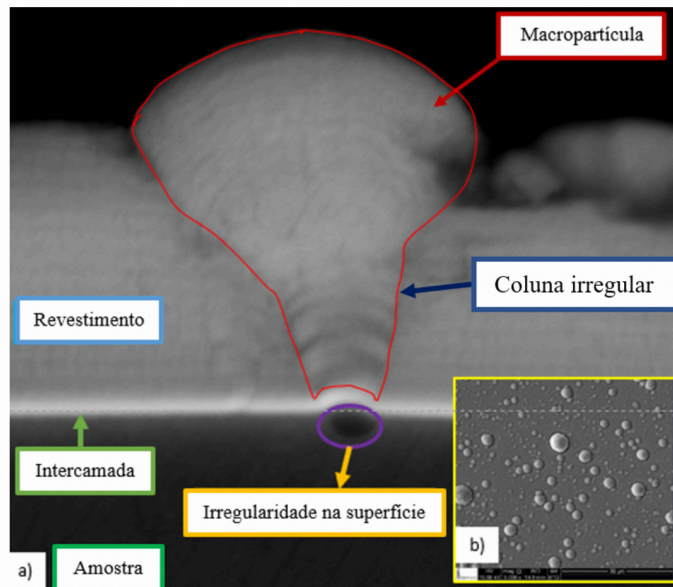

Fonte: Próprio autor

Figura 38 – Evolução do comportamento da macropartícula no tempo para o ensaio de riscamento: a) Carga normal 1 mN e b) Carga normal 100 mN

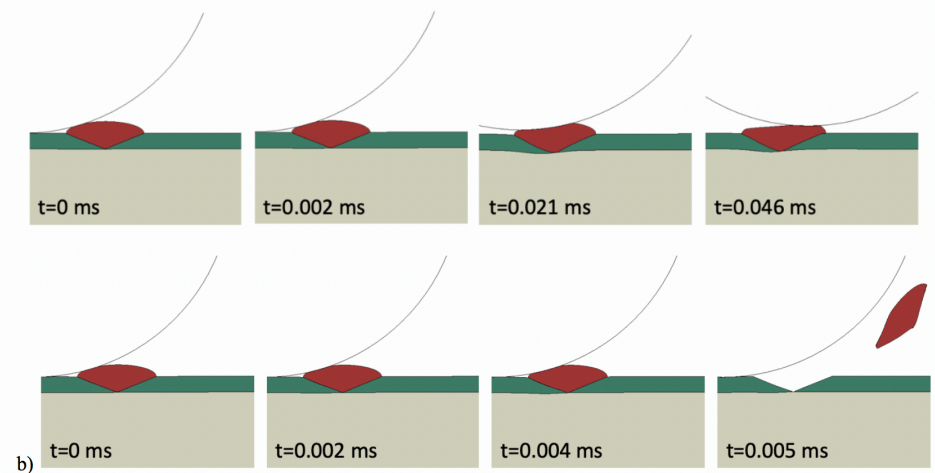

Fonte: Próprio Autor

Transição do comportamento mecânico das micropartículas em um revestimento WC/C durante ensaios de riscamento. Cassiano Ferreira Bernardes



## Processos de deposição

### ❖ Tensão residual

❖ Dureza

❖ Falha

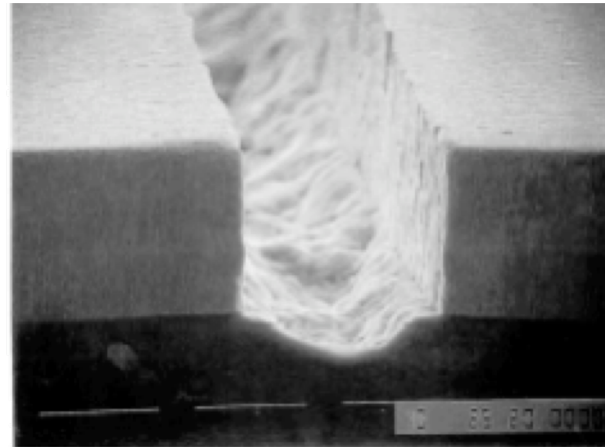

E. Harry, A. Rouzaud, M. Ignat, P. Juliet, Thin Solid Films 332 (1998) 195-201.

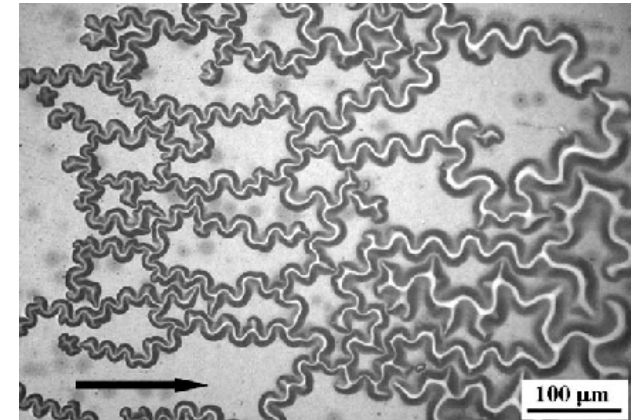

[https://www.researchgate.net/publication/229230748\\_Buckle\\_morphologies\\_of\\_wedge-shaped\\_Fe\\_films\\_quenched\\_by\\_silicone\\_oil\\_during\\_deposition](https://www.researchgate.net/publication/229230748_Buckle_morphologies_of_wedge-shaped_Fe_films_quenched_by_silicone_oil_during_deposition)

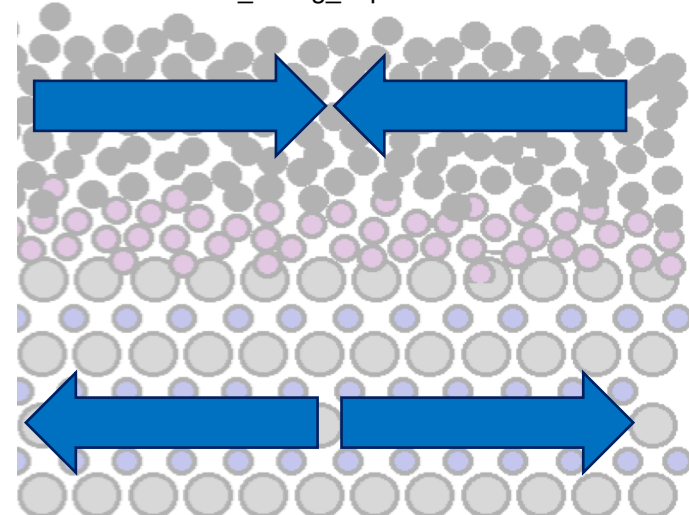
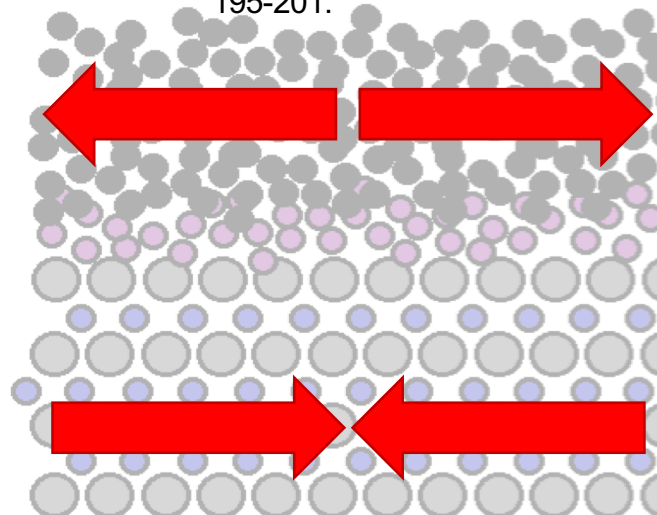



# Caracterização dos Recobrimentos

- ❖ Módulo elástico: até 600+ GPa
- ❖ Dureza: até 70+ GPa
- ❖ Tenacidade a fratura: 0.1 a 7 MPa m<sup>1/2</sup>

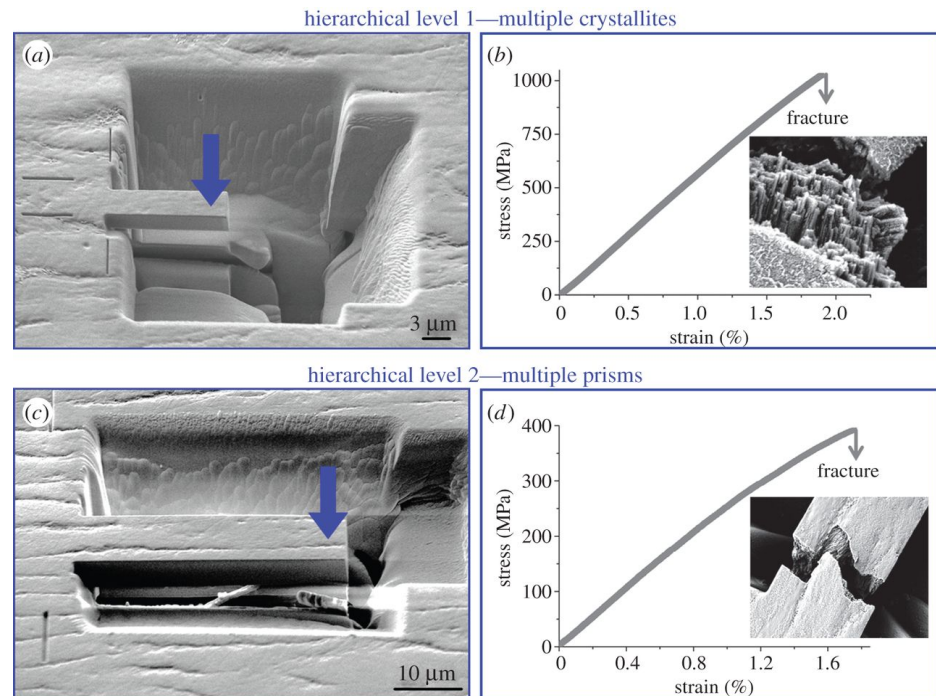
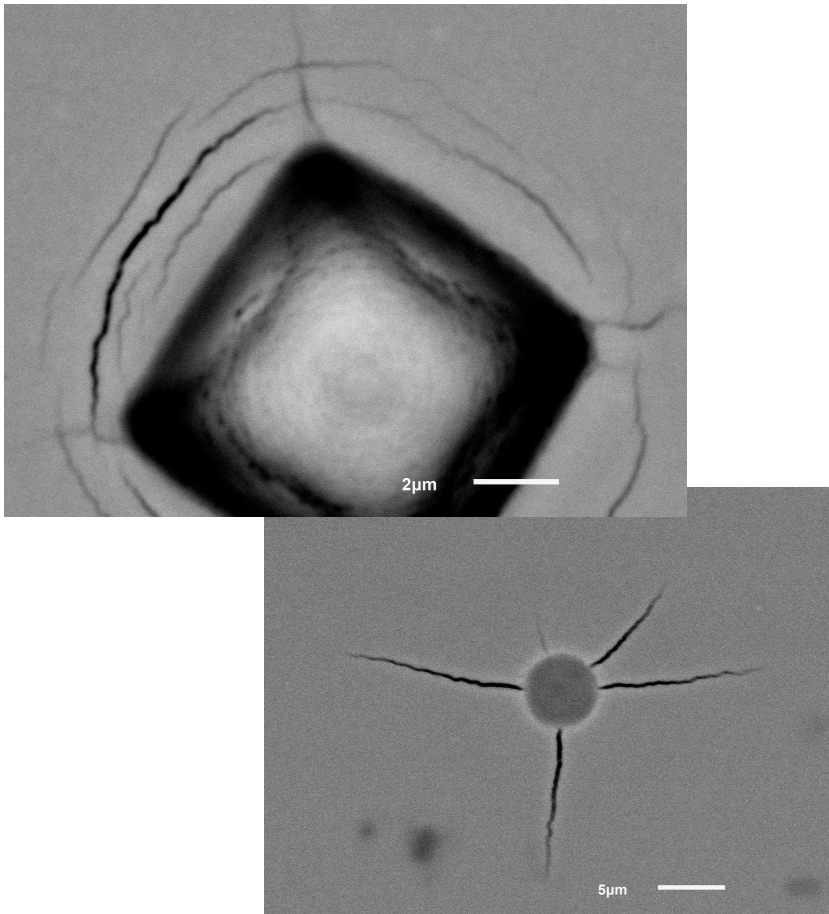
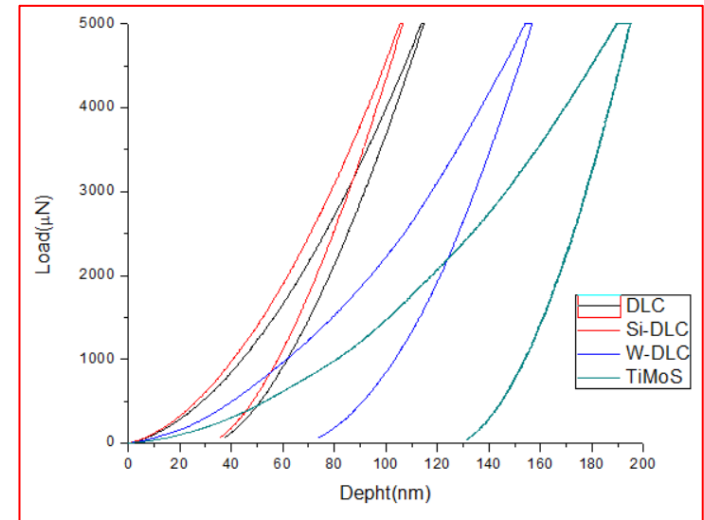



# Caracterização dos Recobrimentos

## ❖ Nano-indentação

- ❖ Método indireto
- ❖ Baixo custo
- ❖ Influência da rugosidade
- ❖ Influência do substrato

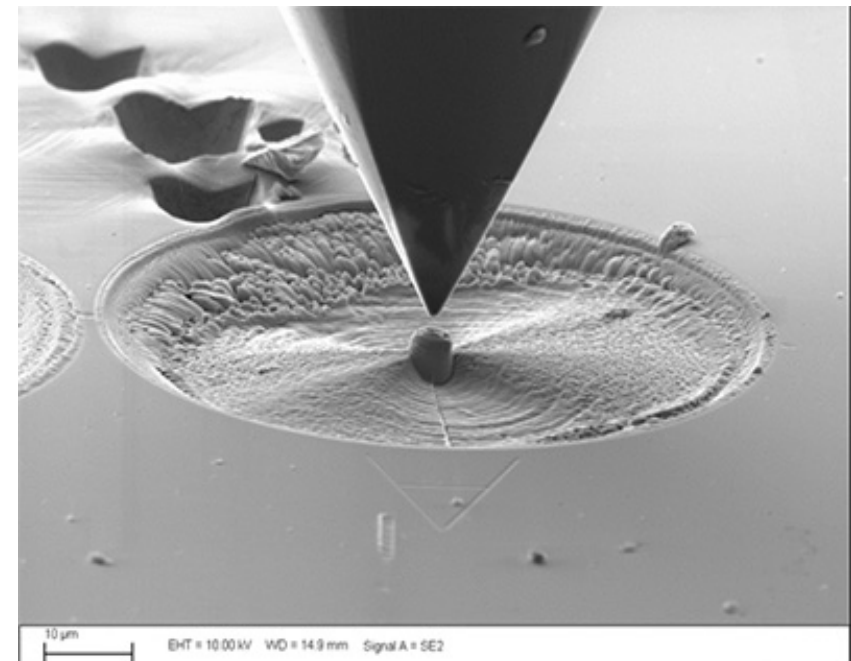
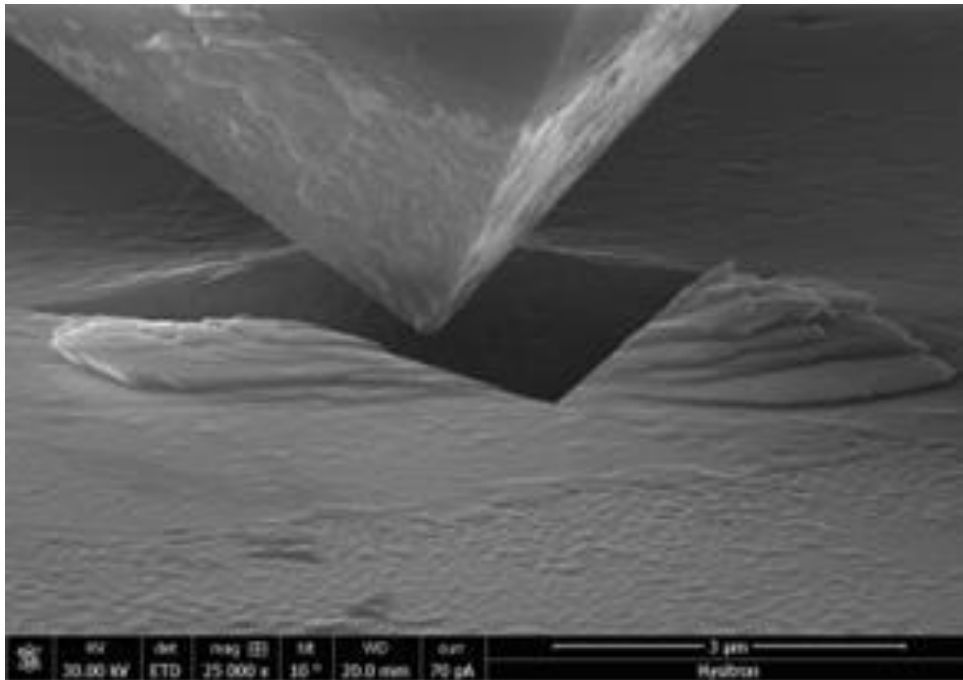
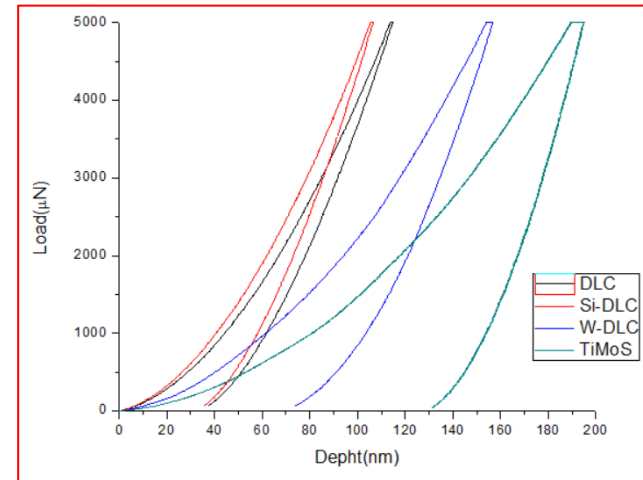

<http://www.blue-scientific.com/picoindenter/>



# Caracterização dos Recobrimentos

## ❖ Ensaio de flexão

### ❖ Método direto

### ❖ Alto custo

### ❖ Influência do corte

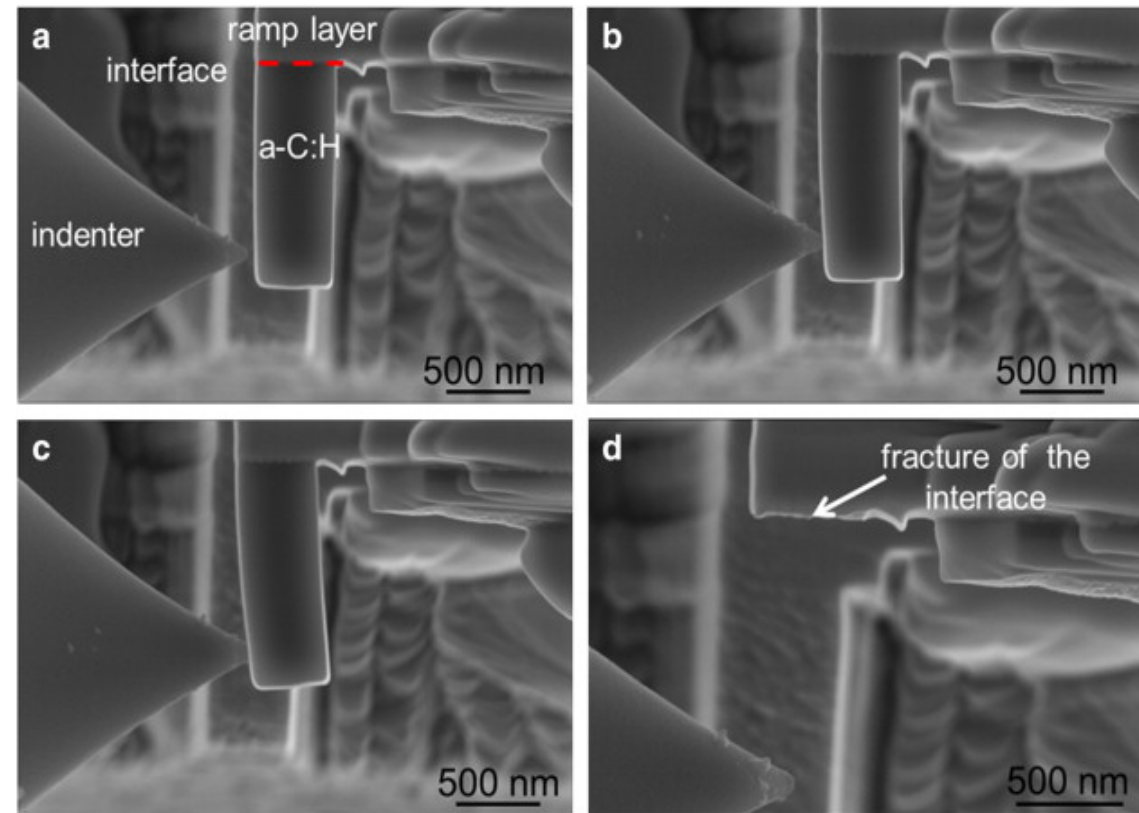

<http://www.sciencedirect.com/science/article/pii/S0040609012010681>

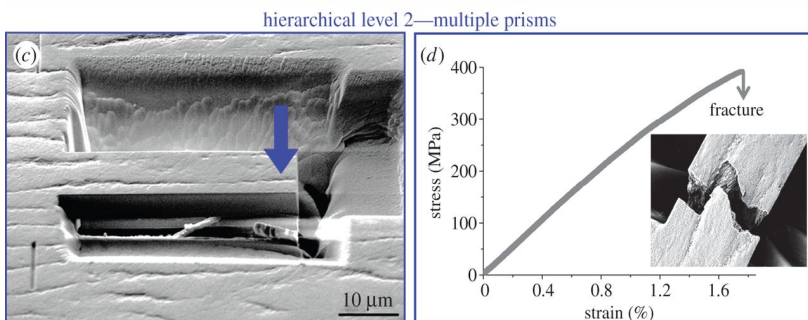
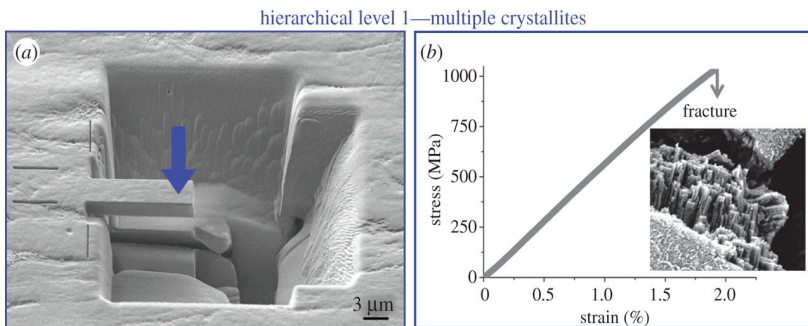

<http://rsta.royalsocietypublishing.org/content/373/2038/20140130>



# Caracterização dos Recobrimentos

ESCOLA POLITECNICA DA UNIVERSIDADE DE SÃO PAULO



❖ Tenacidade a fratura: 0.1 a 7 MPa m<sup>1/2</sup>

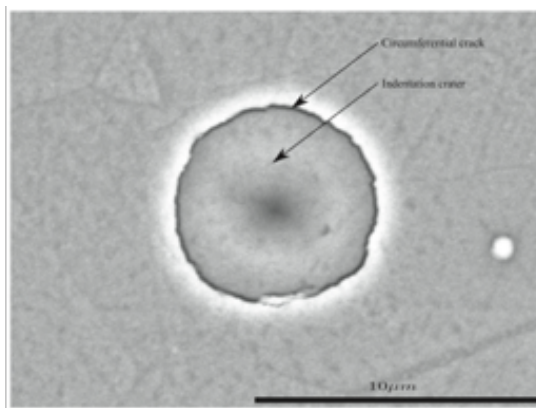
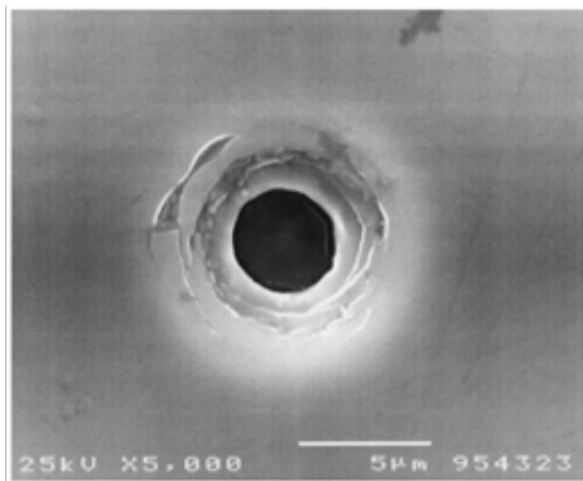
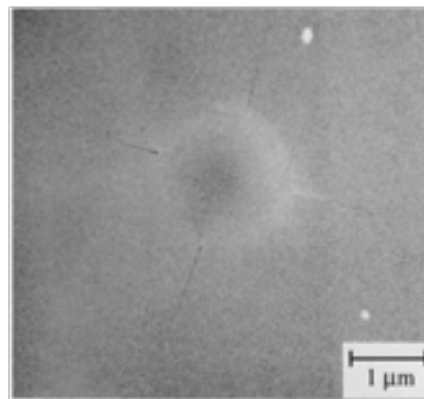
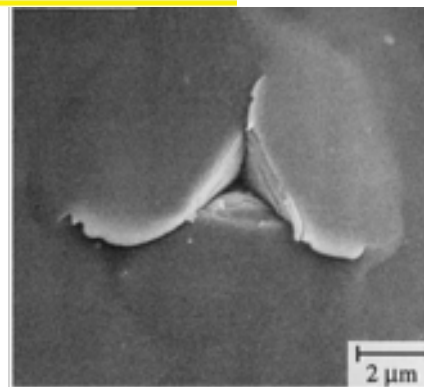
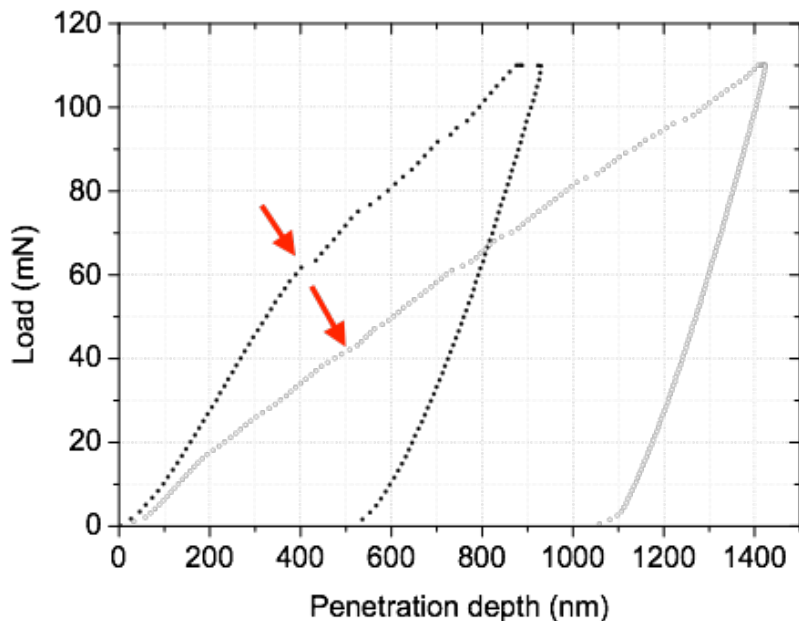

S. Steffensen et al. Intl. J. of Solid and Struct. 50 (2013) 3406

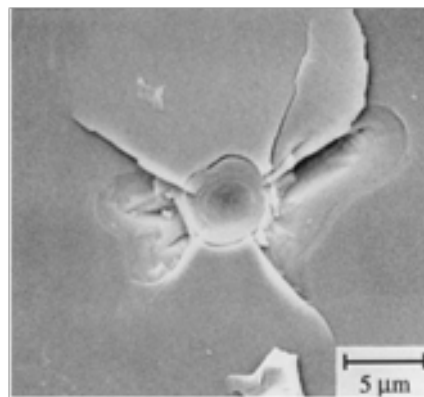





# Caracterização dos Recobrimentos

❖ Tenacidade a fratura:  $0.1$  a  $7 \text{ MPa m}^{1/2}$

$$K_{IC} = \left[ \left( \frac{E}{(1 - \nu^2) 2\pi C_R} \right) \left( \frac{U}{t} \right) \right]^{1/2}$$

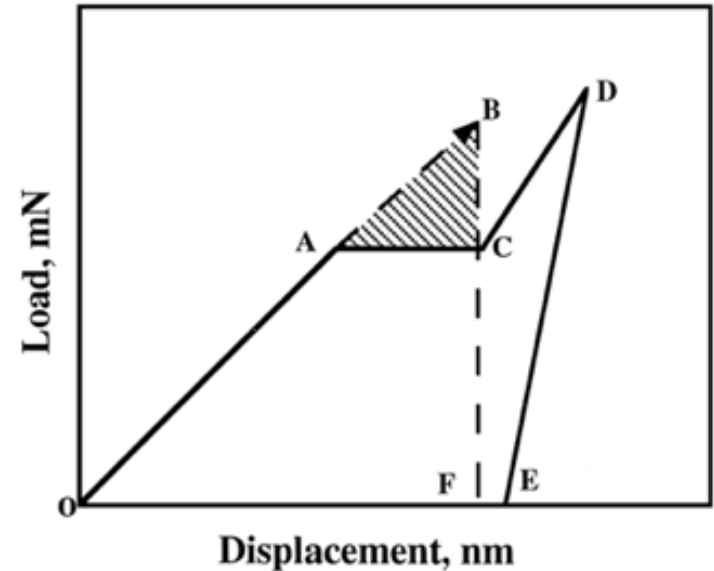

X. Li, B. Bhushan, Thin Solid Films 315 (1998) 214

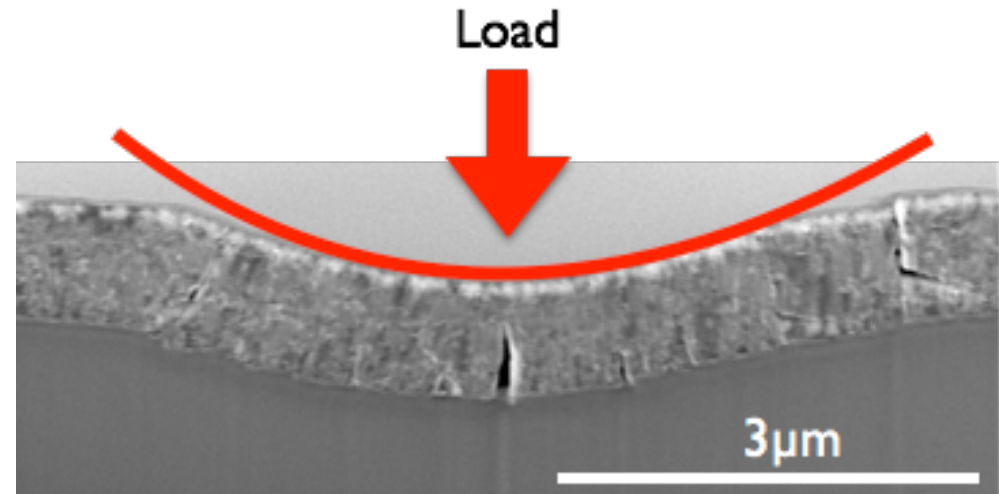
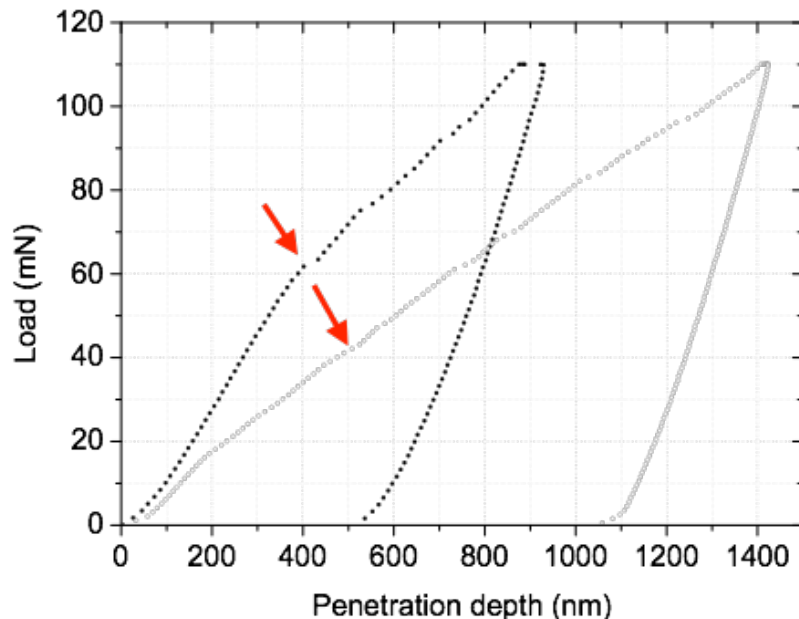



Table 2.1. Comparative typical characteristics of some of the main coating methods.

	Gaseous State Processes					Solution Processes		Molten or Semi-Molten State Processes		
	PVD	PAPVD	CVD	PACVD	Ion Implantation	Sol-Gel	Electro-Plating	Laser	Thermal Spraying	Welding
Deposition rate (kg/h)	Up to 0.5	Up to 0.2	Up to 1	Up to 0.5		0.1–0.5	0.1–0.5	0.1–1	0.1–10	3.0–50
Coating thickness or treatment depth (μm)	0.1–1000	0.1–100	0.5–2000	1–20	0.01–0.5	1–10	10–500	50–2000	50–1000	1000–10,000
Component size	Limited by chamber size					Limited by solution bath		May be limited by chamber size		
Substrate deposition or treatment temperature (°C)	50–500	25–500	150–12,000	150–700	50–200	25–1000	25–100	200–2000	100–800	500–1200
Substrate material	Metals, ceramics, polymers	Metals, ceramics	Metals, ceramics	Metals, ceramics	Metals, ceramics, polymers	Metals, ceramics, polymers	Metals, ceramics, polymers	Metals		
Pretreatment	Mechanical/chemical	Mechanical/chemical plus ion bombardment	Mechanical/chemical	Mechanical/chemical plus ion bombardment	Chemical plus ion bombardment	Grit blast and/or chemical clean	Chemical cleaning and etching	Mechanical and chemical cleaning		
Post-treatment	None	None	Substrate stress relief	None	None	High temperature	None/thermal treatment	None/substrate stress relief	None	
Uniformity of coating	Good	Good	Very good	Good	Line of sight	Fair/good	Fair/good	Fair	Variable	Variable
Bonding mechanism	Atomic	Atomic plus diffusion	Atomic	Atomic plus diffusion	Integral	Surface forces		Mechanical/chemical/ metallurgical		

**Coatings Tribology**  
 Properties, Mechanisms, Techniques and Applications in Surface Engineering

Kenneth Holmberg  
 Allan Matthews

INCLUDES FREE REFERENCE ENGINEERING SERIES, No. 02



## Informação complementar :

### Recobrimentos ou Revestimentos (partículas)

- ✓ A solução de recobrimento é adicionada no leito fluido de produto. A solução de recobrimento cobre as superfícies das partículas durante a mistura.
- ✓ Uma cobertura de 100 % das superfícies é raramente obtida com este processo uma vez que a distribuição não pode ser controlada. Os graus de recobrimento usuais estão entre 70 e 95%. Entretanto, isto é absolutamente suficiente para a maioria das aplicações.

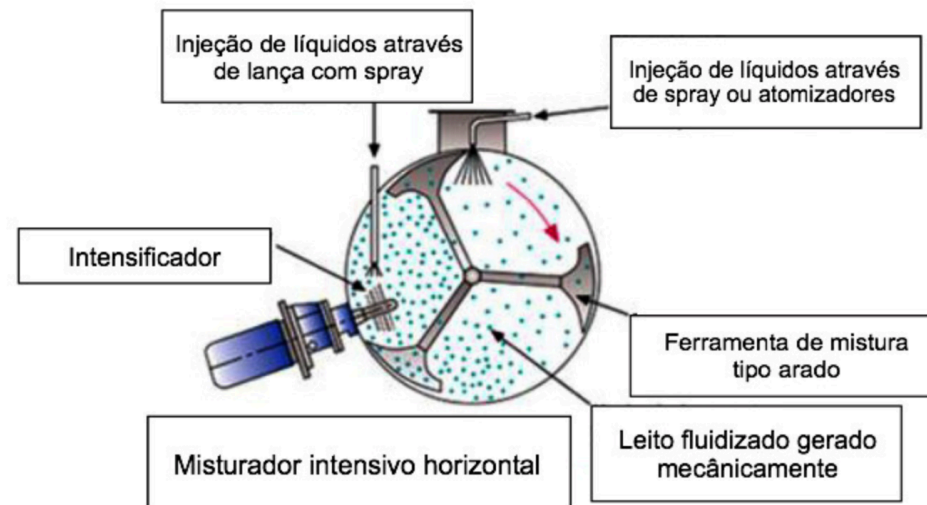

<http://protea.com.br/portfolio/revestir>



Atividade:

Descreva exemplos da aplicação de recobrimentos para aplicação em :

1. Sistemas Mecânicos
2. Robótica



## Agradecimentos

**Dr Newton Kiyoshi Fukumasu** por ceder material para esta aula de recobrimentos de PMR 3301