

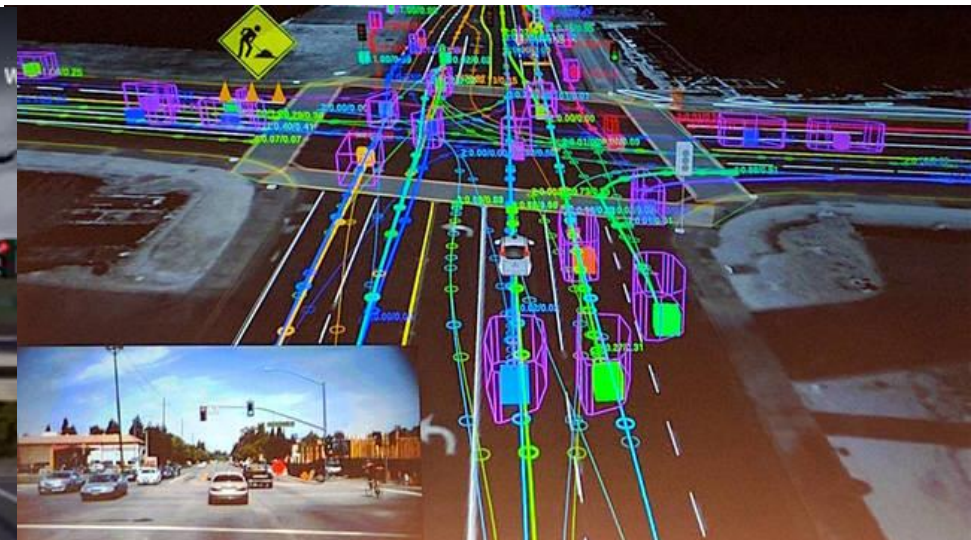

## - Veículos Autônomos

### Aula 2 – Sensores, Hardware e Software

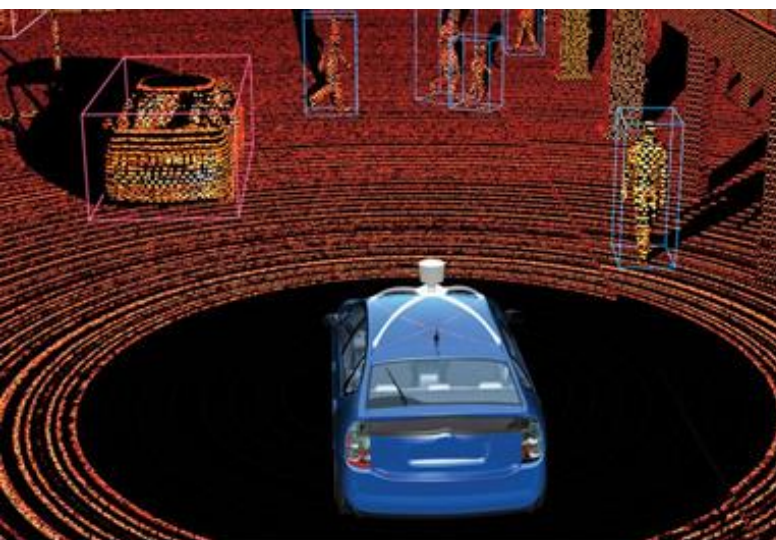

# Na aula 1 buscamos responder:

- Quais são os tópicos mais quentes que o engenheiro de veículos autônomos deve conhecer?
- Quais são as principais taxonomias relacionadas com veículos autônomos?
- O que é a percepção?
- Como é o processo de planejamento e tomada de decisão?

# Recapitulando – níveis de automação



Condução manual, sem automação



Assistência à condução:

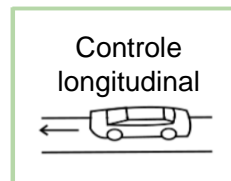

Controle longitudinal

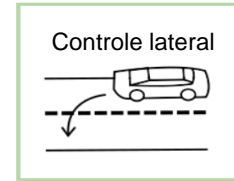

Controle lateral

(uma das funções)



Automação parcial:

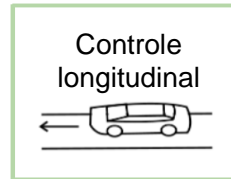

Controle longitudinal

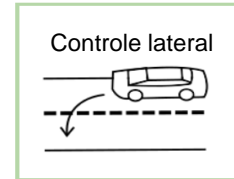

Controle lateral

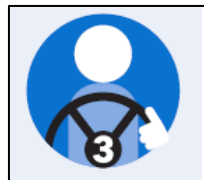

Automação condicional:

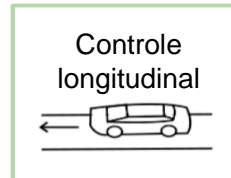

Controle longitudinal

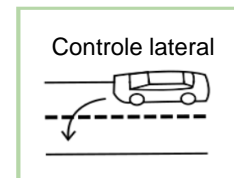

Controle lateral

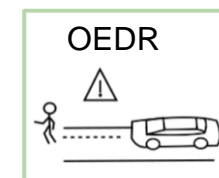

OEDR



Automação elevada:

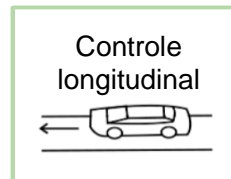

Controle longitudinal

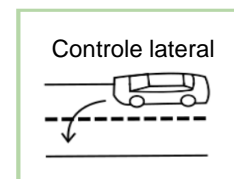

Controle lateral

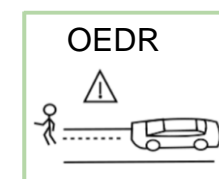

OEDR

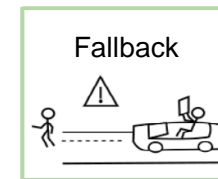

Fallback



Automação completa:

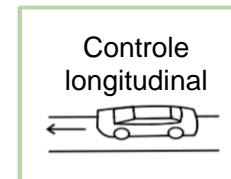

Controle longitudinal

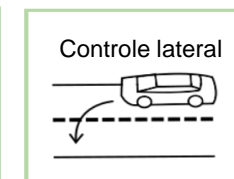

Controle lateral

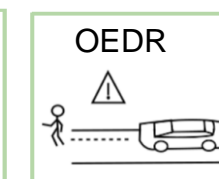

OEDR

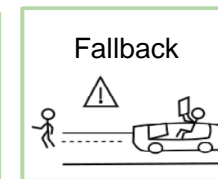

Fallback

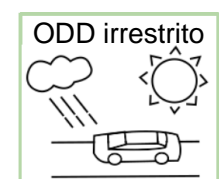

ODD irrestrito

# Os objetivos da Aula 2 são os seguintes:

- Especificar os sensores de percepção do veículo autônomo
- Analisar a configuração de Hardware do veículo autônomo
- Modelar a dinâmica lateral e longitudinal do veículo autônomo

# Parte 1 - Sensores

- Arquitetura geral do veículo autônomo

# Arquitetura geral de um veículo autônomo

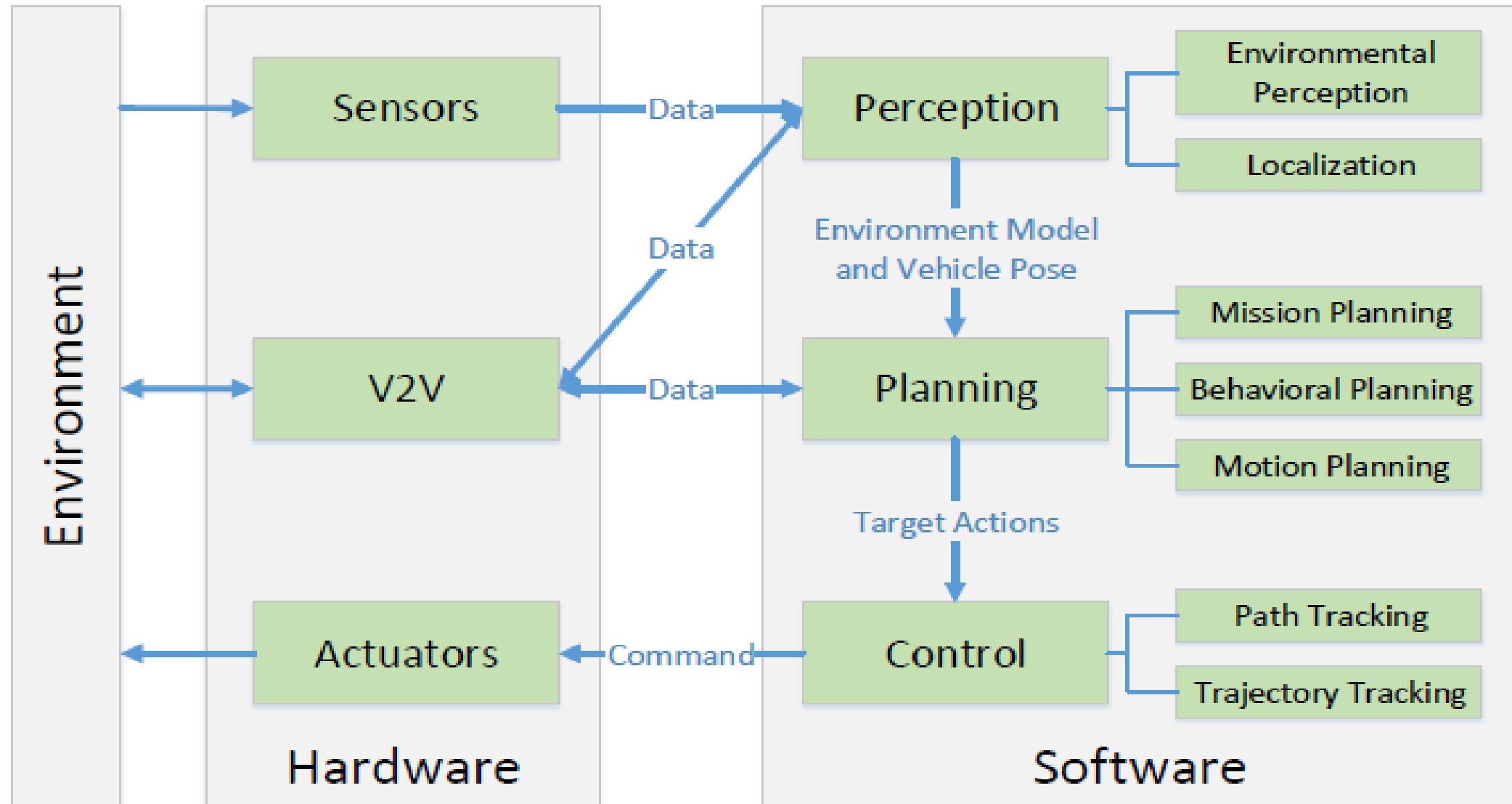

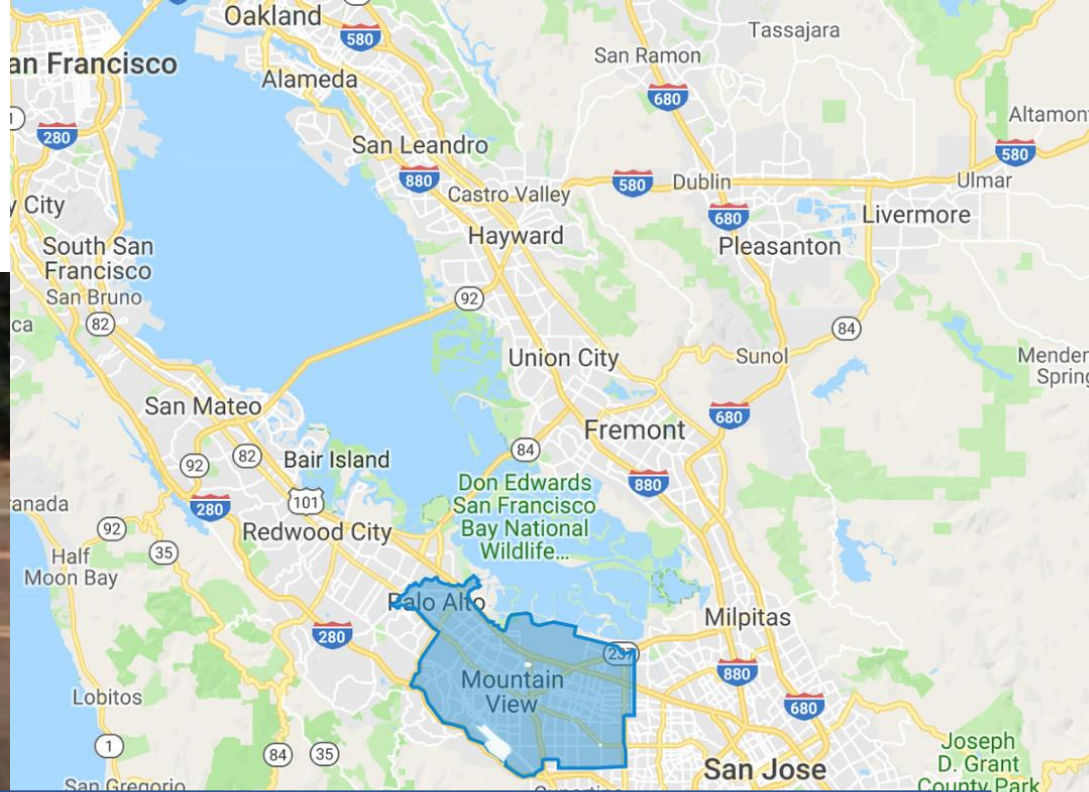

# Tarefa 1: explorar a região destacada no mapa com o Street View e observar a qualidade da via, intersecções, semaforização e sinalizações.

**Waymo** tem a permissão do DMV da Califórnia para operar no modo “*full driverless car*” em Mountain View, Sunnyvale, Los Altos, Los Altos Hills e Palo Alto. Essa região foi escolhida por ficar próximo do **Google X Lab** e a sede do Alphabet. A permissão inclui operação diurna e noturna e velocidade máxima de 104 km/h. No Estado da Califórnia, atualmente existem 60 empresas realizando testes com 300 veículos autônomos que possuem a licença do DMV. (Diverge, 2018: <https://www.theverge.com/2018/10/30/18044670/waymo-fully-driverless-car-permit-california-dmv>)

# Quiz 1: Quantos tipos de sensores embarcados de percepção este em este Veículo Autônomo ?

# 6 tipos de sensores embarcados para a percepção

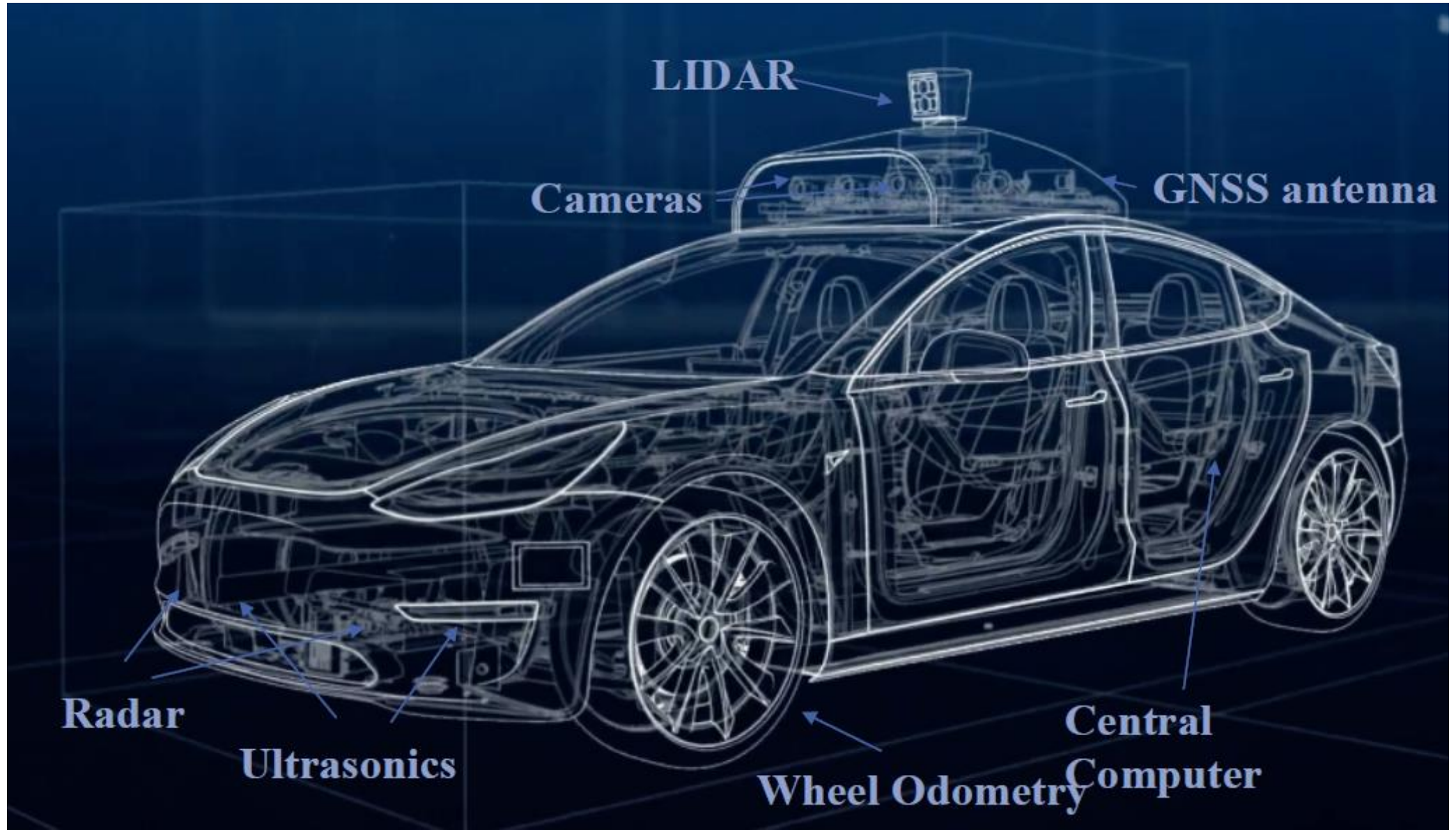



# 6 tipos de sensores embarcados para a percepção

Camera



LIDAR



RADAR

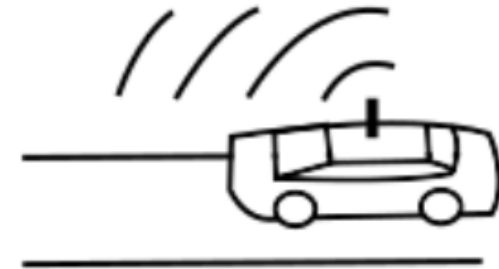

Ultrasonics

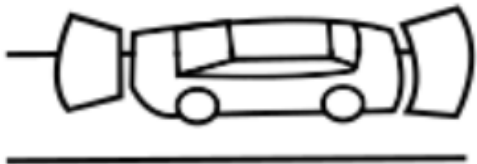

GNSS/IMU



Wheel  
Odometry



# Sensor para percepção CÂMERA

Camera



(JABIL OPTICS)



Mono Camera  
(Continental )



Stereo Camera  
(Continental )

# Tipos de Câmeras

Camera

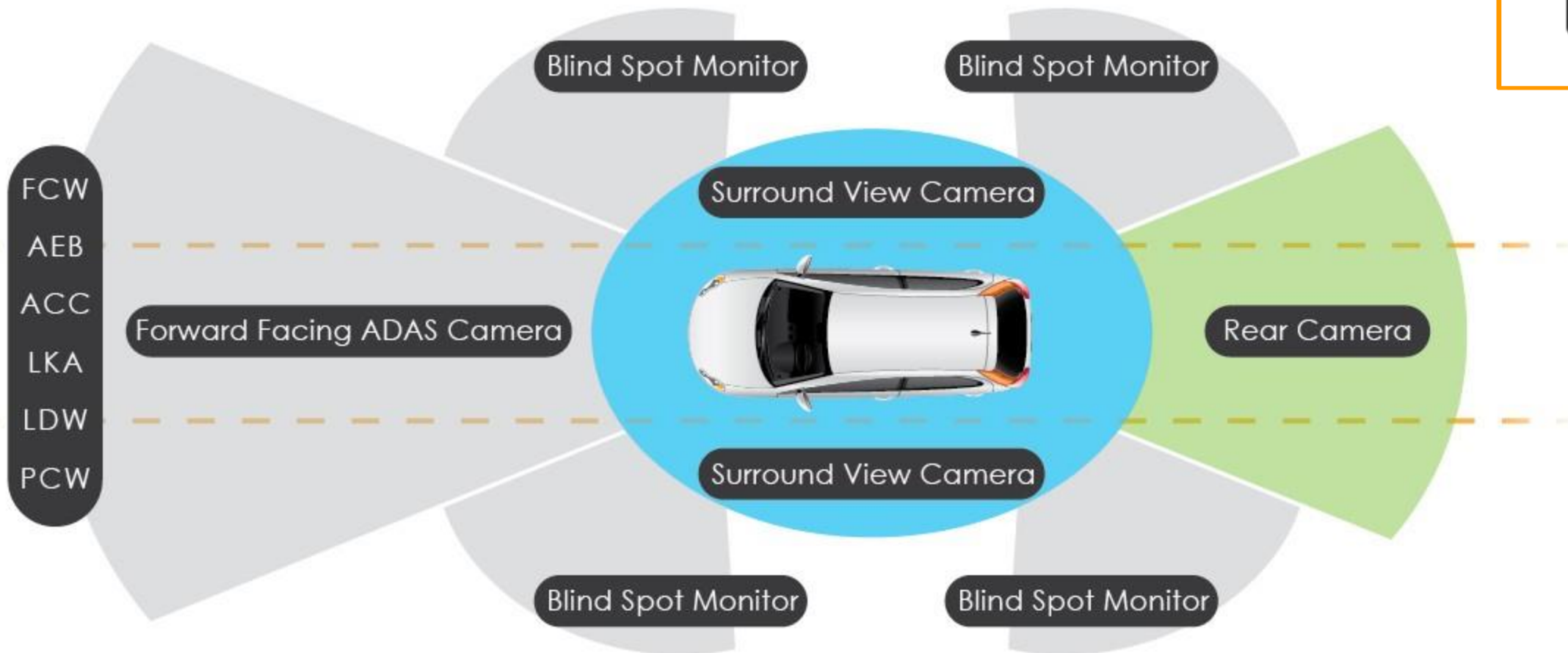

(JABIL OPTICS – AUTOMOTIVE CAMERAS)

# Funcionalidades de Segurança

Camera



- Forward collision warning (FCW)
- Lane departure warnig (LDW)
- Lane keeping assist and Centering (LKA/LC)
- Traffic sign recognition (TSR)
- Intelligent heading control (IHC)
- Automatic Emergency Braking (AEB)
- Traffic Jam Assist (TJA)
- Pedestrian collision warning (PCW)
- Eletronic mirror replacement (blind spot monitoring)

# 1. CÂMERA

Camera



- É um sensor essencial para perceber corretamente o ambiente
- Parâmetros de especificação:
  - Resolução (número de pixels)
  - Mono ou estéreo
  - Campo de visão (FOV)
  - Faixa dinâmica (nível de contraste entre preto e o branco)

# Características técnicas da câmera:

- Sensor de imagem CMOS – HD com 1 a 2 megapixels
- Mono ou estéreo
- 4 a 8 câmeras gera uma visão 360°
- Faixa dinâmica superior a 130 dB (imagem clara mesmo contra luz)
- Codificação 24bits com interface para Processador de Imagem (ISP)
- Taxa de aquisição de 30 quadros/s
- ECU centralizado para processamento de imagem
- Compressão H.264 de baixa latência

Camera



## **Funcionalidades:**

- Identificar trajetória
- Detectar obstáculos
- Classificação de objetos

# Arquitetura centralizada do sistema de captura de imagens

Camera



- Captura de imagem
- Compressão de imagem
- Vídeo streaming

**Cameras**



- Decodificação de imagem
- Correção da lente
- Transformação top-view
- Transcodificação do vídeo streaming
- Overlay
- Image streaming

**Camera ECU**



- Decodificação de imagem
- Agregação da imagem
- Image display

**Computador Central**

# Exemplo de smart camera utilizado em V.A.

- 132dB HDR Imager (Vx6640)
  - 1280x960, up to 60fps
- Companion Chip (STV0991)
  - ARM R4 @ 500MHz
  - No external RAM/Flash
  - AutoSAR, FreeRTOS, SafeRTOS\*
  - HDR ISP and adv. graphics processor
  - MJPEG, H.264 (Profile Level 4.1)
  - HW-timestamp, 802.1AS-2011, 802.1Q-2011
  - Transport Protocols (incl. HW-timestamp)
    - RTP over UDP (RFC 3550)
    - RTP A/V over UDP (RFC 3551)
    - AVTP (IEEE 1722a)
  - Built-in Video Analytics
    - Optical Flow
    - Edge Detection



(Fierce Electronics)

Camera



FoV para câmeras de média distância: **70° a 120°**

FoV para câmeras de longa distância: **~35°**



# Exemplo de *merge* de sinais de vídeo de quatro câmeras para produzir uma visão 360°

Camera

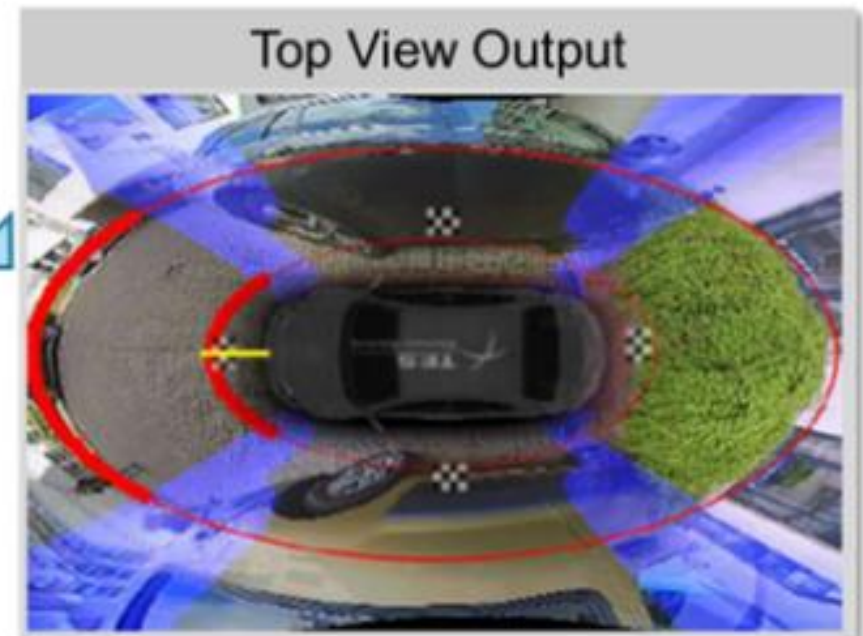
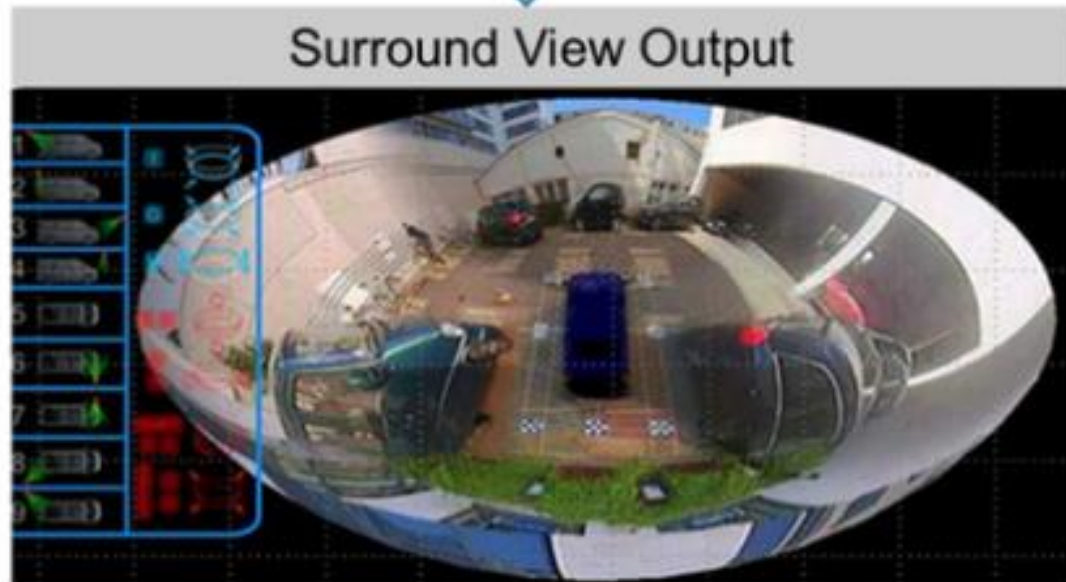

(TES Electronic Solution)

# Aplicação das câmeras frontais

Camera



- Cobrem distâncias médias e longas (**100 a 250** metros)
- Possuem algoritmos para detectar automaticamente objetos, classificar e determinar a distância
- Podem identificar pedestres e ciclistas, carros, faixas, pilares de pontes, e bordas das vias. Alguns algoritmos são capazes de reconhecer sinalização de tráfego e semáforos.
- Câmeras para **médias distâncias** são usadas para detectar tráfegos transversais, pedestres, acionar freios em situação de emergência, reconhecer faixas e semáforos
- Câmeras para **longa distância** são usados para reconhecer sinalizações de trânsito, controle de distância com o carro à frente e controle de guiagem.

# MFC500 - Continental



## Technical Specifications

- Dimensions: 88 x 70 x 38mm
- Mass: < 200g
- Field of View: hor. up to 125° (effective) / vert. up to 60° (effective)
- Temperature Range: -40° up to +95° (full operational)
- Power Dissip.: <7 W
- Supply Voltage: 12V

# Tesla AUTOPILOT



<https://www.youtube.com/watch?v=tIThdr3O5Qo>

# LINKS para explorar

[http://www.mcnex.com/eng/page/sub2\\_02.html](http://www.mcnex.com/eng/page/sub2_02.html)

<https://www.ambarella.com/applications/automotive/>

<http://www.ti.com/lit/ug/tiducr4a/tiducr4a.pdf>

<https://www.foresightauto.com/quadsight>

<https://www.samsung.com/semiconductor/minisite/exynos/products/automotiveprocessor/exynos-auto-v9/>

<https://www.nxp.com/products/processors-and-microcontrollers/arm-processors/s32v2-vision-mpus-/vision-processor-for-front-and-surround-view-camera-machine-learning-and-sensor-fusion:S32V234>

<https://www.qualcomm.com/products/qualcomm-snapdragon-602-automotive-platform>

<https://www.renesas.com/eu/en/solutions/automotive/soc/r-car-h3.html>

<https://www.nhtsa.gov/equipment/driver-assistance-technologies>

# Sensor para percepção LIDAR

LIDAR

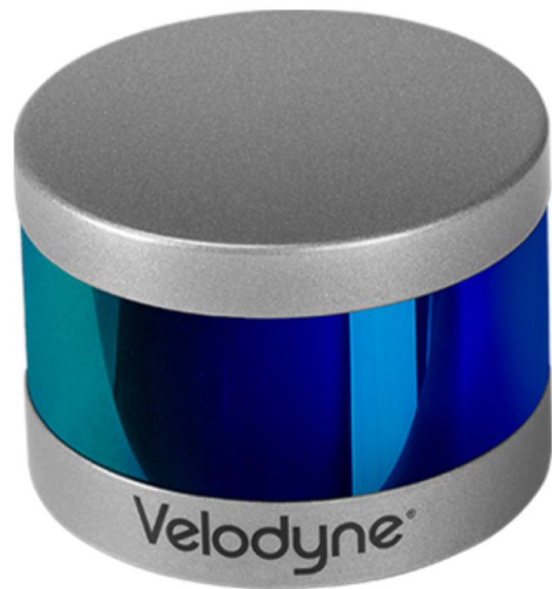

# Sensor para percepção - LIDAR

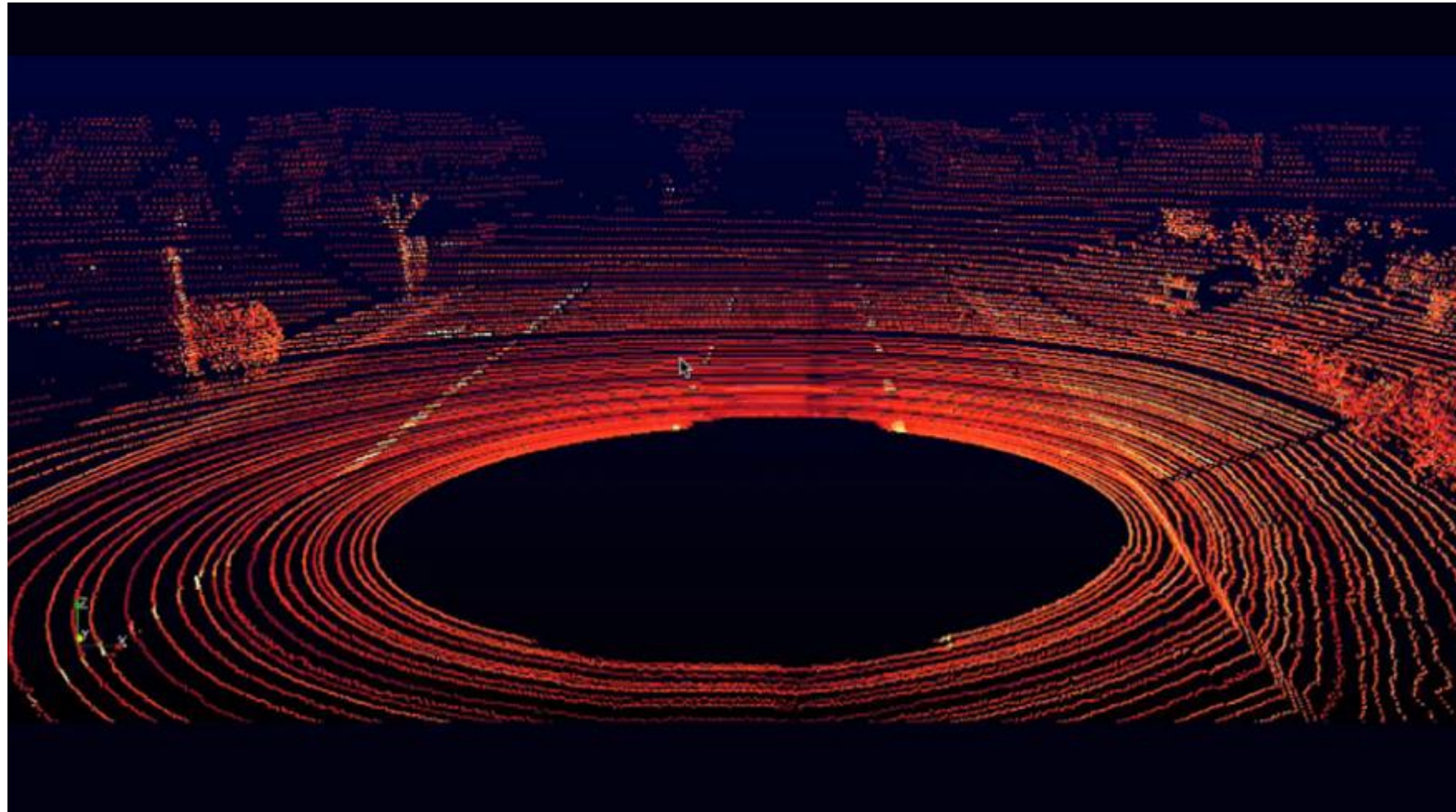

LIDAR



[https://www.youtube.com/watch?time\\_continue=20&v=VoMhX1et7Yo](https://www.youtube.com/watch?time_continue=20&v=VoMhX1et7Yo)

# Sensor para percepção - LIDAR

LIDAR



- **L**ight **I**maging, **D**etection **A**nd **R**anging
- Emite feixe de laser que é refletido de volta quando encontra um objeto
- Mede a distância de objetos estacionários e em movimento
- Constrói uma imagem tri-dimensional dos objetos detectados
- Utiliza um detector extremamente sensível capaz de medir a luz refletida
- O estado da arte na tecnologia de detecção utiliza o diodo SPAD (Single-Photon Avalanche Diode)



# Principle

1. Emit pulsed IR light



Emitter

Photon

2. Sense reflected signal

Sensor

Target

(Gert Rudolph, 2017)

distance

Measured distance

$$\text{Measured distance} = \frac{\text{Photon travel time}}{2} \times \text{Speed of light}$$

(Gert Rudolph, 2017)

LIDAR



# Principais elementos do LiDAR

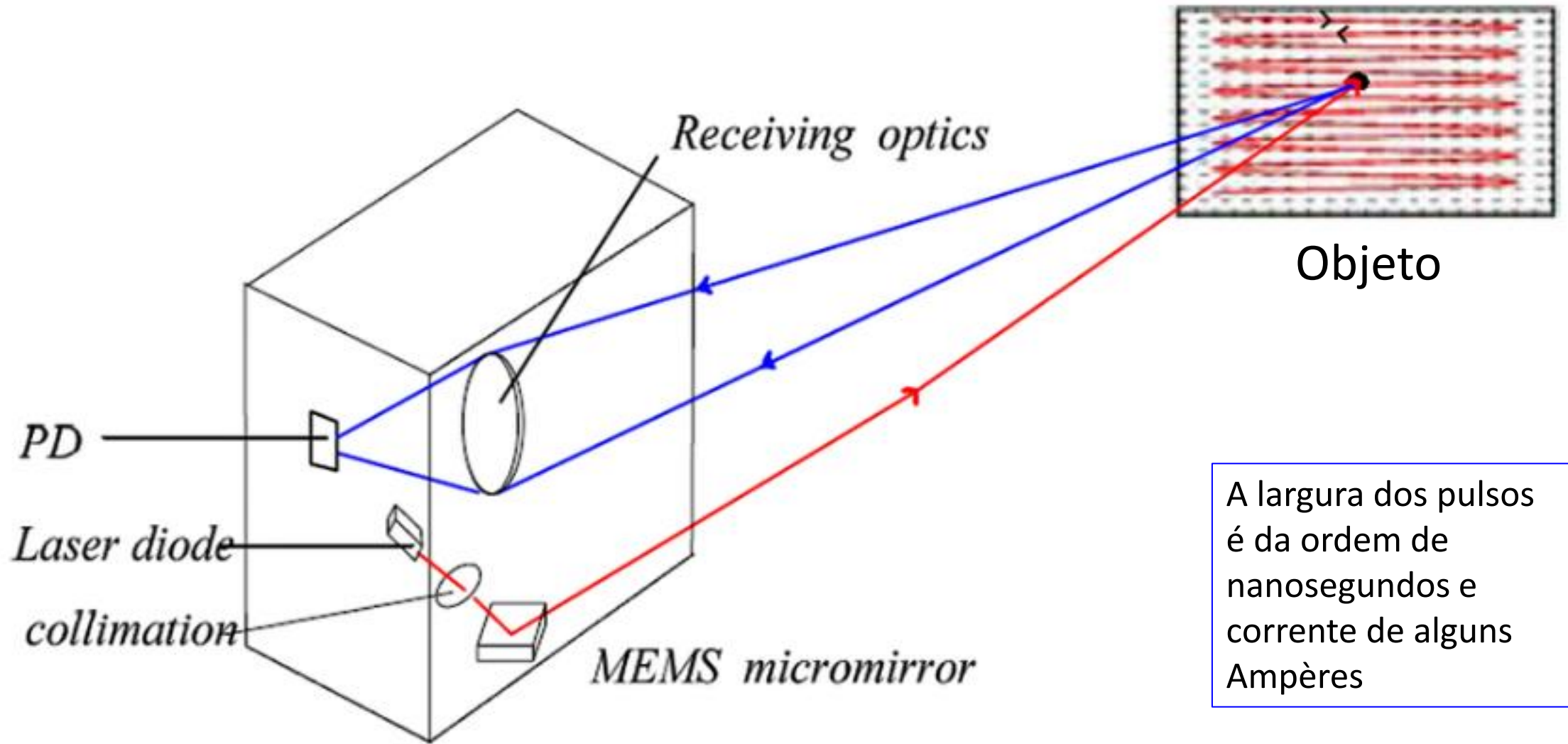

A largura dos pulsos é da ordem de nanosegundos e corrente de alguns Ampères

LiDAR baseado na tecnologia do micro espelho MEMS

## Exemplo de especificação de LiDAR – HDL-64E



- 5 – 20 Hz *frame rate*
- 2.2 *million points per second*
- 64 *lasers/detector*
- 360 *degree field of view*
- 0.08 *degree angular resolution*
- 2 *cm distance accuracy*
- 50 *m range for pavement*
- 120 *m range for cars*
- Laser: 905 nm, *~ 10 ns pulse*
- 300 – 1200 *RPM spin rate*

(mid to long range)

Sensor	HDL-64E	HDL-32	Puck	Puck LITE	Puck Hi-Res	Puck 32MR	Ultra Puck	Alpha Puck
								
Range	Up to 120m	Up to 100m	100m	100m	100m	120m	200m	Up to 300m <sup>5</sup>
Range Accuracy	Up to ±2 cm (Typical) <sup>4</sup>	Up to ±2 cm (Typical) <sup>1</sup>	Up to ±3 cm (Typical) <sup>1</sup>	Up to ±3 cm (Typical) <sup>1</sup>	Up to ±3 cm (Typical) <sup>1</sup>	Up to ±3 cm (Typical) <sup>1</sup>	Up to ±3 cm (Typical) <sup>1</sup>	Up to ±3 cm (Typical) <sup>1</sup>
# of Lines	64	32	16	16	16	32	32	128
Horizontal FoV	360°	360°	360°	360°	360°	360°	360°	360°
Vertical FoV	26.9°	41.33°	30°	30°	20°	40°	40°	40°
Horizontal Resolution	0.08° – 0.35°	0.08° – 0.33°	0.1° – 0.4°	0.1° – 0.4°	0.1° – 0.4°	0.1° – 0.4°	0.1° – 0.4°	0.1° – 0.4°
Vertical Resolution	0.4°	1.33°	2.0°	2.0°	1.33°	0.33° (min)	0.33° (min)	0.11° (min)
Points Per Second (Single Return Mode)	~ 1,300,000	~ 695,000	~ 300,000	~ 300,000	~ 300,000	~ 600,000	~ 600,000	~ 2,400,000
Points Per Second (Dual Return mode)	~ 2,200,000 <sup>5</sup>	~ 1,390,000	~ 600,000	~ 600,000	~ 600,000	~ 1,200,000	~ 1,200,000	~ 4,800,000
Refresh Rate	5-20 Hz	5-20 Hz	5-20 Hz	5-20 Hz	5-20 Hz	5-20 Hz	5-20 Hz	5-20 Hz
Operating Voltage	12V - 32V	9V – 18 V	9V – 18 V	9V – 18 V	9V – 18 V	10.5V – 18 V	10.5V – 18 V	9V – 28 V
Power Consumption	60 W (Typical) <sup>2</sup>	12 W (Typical) <sup>2</sup>	8 W (Typical) <sup>2</sup>	8 W (Typical) <sup>2</sup>	8 W (Typical) <sup>2</sup>	10 W (Typical) <sup>2</sup>	10 W (Typical) <sup>2</sup>	< 30 W (Typical)
Weight (without cabling)	~ 28 lbs. (12.7 Kg)	~1.0 kg	~830 g	~590 g	~830 g	~925 g	~925 g	~3.5 kg
Operating Temp	-10°C to +60°C <sup>3</sup>	-10°C to +60°C <sup>3</sup>	-10°C to +60°C <sup>3</sup>	-10°C to +60°C <sup>3</sup>	-10°C to +60°C <sup>3</sup>	-20°C to +60°C <sup>3</sup>	-20°C to +60°C <sup>3</sup>	-20°C to +60°C <sup>3</sup>
Storage Temp	-40°C to +85°C	-40°C to +105°C	-40°C to +105°C	-40°C to +105°C	-40°C to +105°C	-40°C to +85°C	-40°C to +85°C	-40°C to +85°C
Output	UDP packets over Ethernet	UDP packets over Ethernet	UDP packets over Ethernet	UDP packets over Ethernet	UDP packets over Ethernet	UDP packets over Ethernet	UDP packets over Ethernet	UDP packets over Ethernet
Ethernet Connection	100 Mbps	100 Mbps	100 Mbps	100 Mbps	100 Mbps	100 Mbps	100 Mbps	1000 Mbps
GPS Timesync	\$GPRMC	\$GPRMC + \$GPGGA	\$GPRMC + \$GPGGA	\$GPRMC + \$GPGGA	\$GPRMC + \$GPGGA	\$GPRMC + \$GPGGA	\$GPRMC + \$GPGGA	\$GPRMC + \$GPGGA
Laser	903nm Class 1 eye safe	903nm Class 1 eye safe	903nm Class 1 eye safe	903nm Class 1 eye safe	903nm Class 1 eye safe	903nm Class 1 eye safe	903nm Class 1 eye safe	903nm Class 1 eye safe
Water Resistance	IP67	IP67	IP67	IP67	IP67	IP67	IP67	IP67



## Velodyne LiDAR

### ULTRA Puck

High Resolution Real-time LiDAR for Autonomous Systems

- Campo de visão (FoV) horizontal de **360°**
- Campo de visão vertical de **40°** (-25° a 15°)
- Alcance de **200m**
- Resolução vertical de **0,33°**
- Resolução horizontal (azimuth): **0,1° a 0,4°**
- **32 canais**
- Precisão de medição de distância: **± 3cm**
- Frame rate: **5Hz a 20Hz**
- Conexão Ethernet: **100Mbps**
- Protocolo: **UDP**

- Consumo: 10W
- Alimentação: 10,5 a 18V
- Dimensões: **100mm x 87mm**
- Peso: 925g
- Encapsulamento: IP67
- 3D Datapoints:
  - 600.000 (single return mode)
  - 1.200,000 (dual return mode)

<https://velodynelidar.com/vlp-32c.html>

# Sensor para percepção RADAR

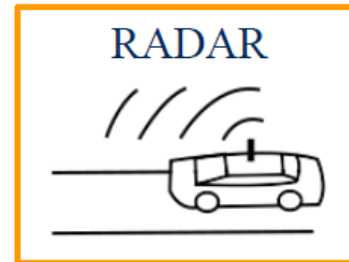

“O RADAR funciona mesmo em **condições adversas** como chuva, neve, gelo e névoa”



# Sensor para percepção - RADAR

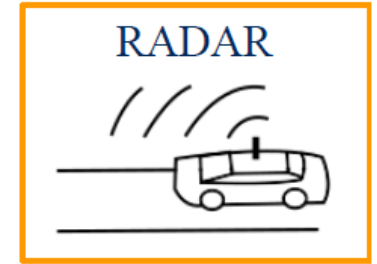

- **Radio Detection And Ranging (RADAR)**
- Emite sinal de rádio na frequência de **24GHz** ou **77GHz**
- Em 77GHz consegue medir a distância e velocidade com elevada precisão



# Três tipos de RADAR

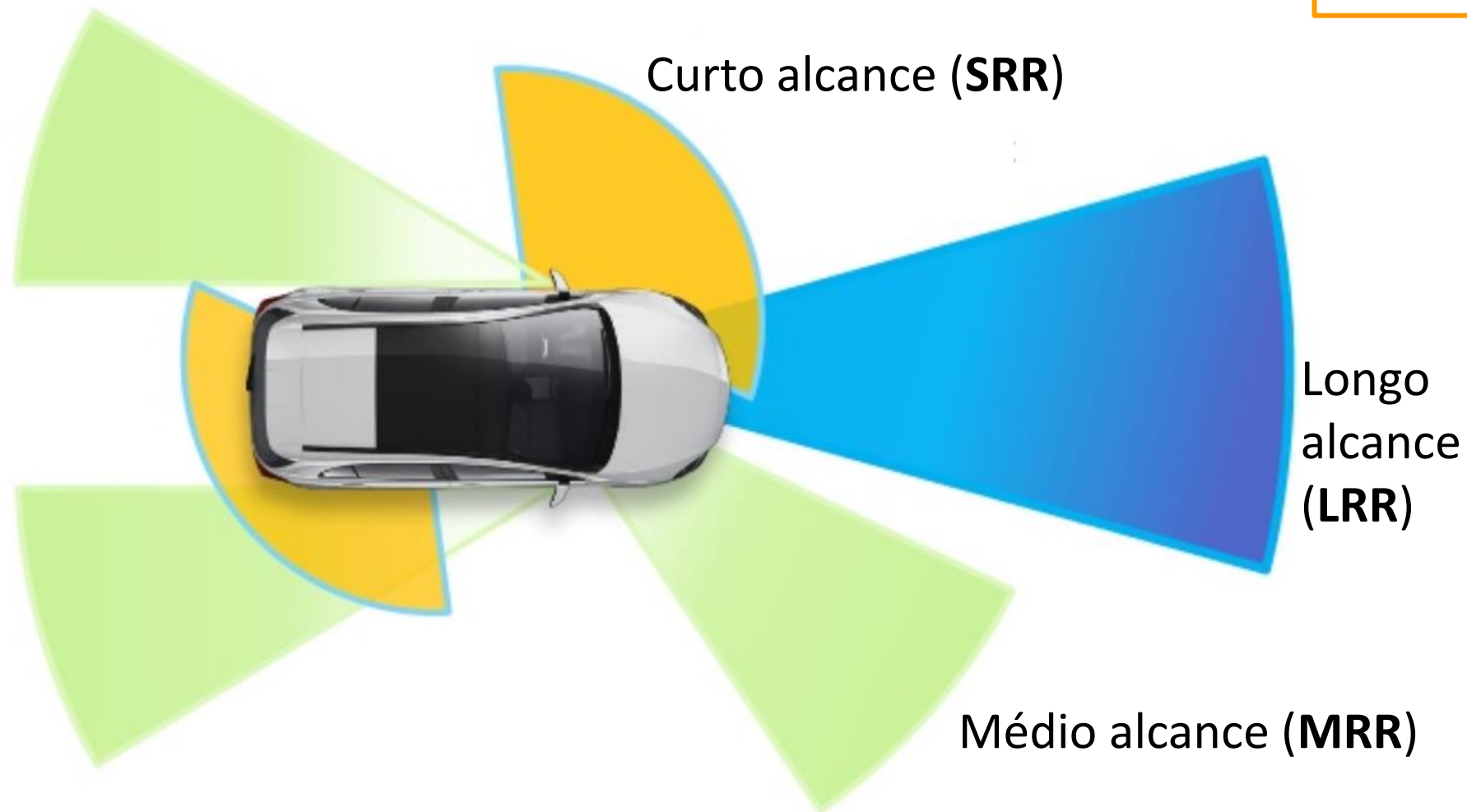
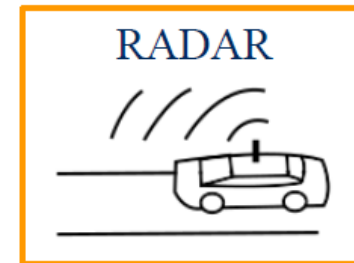

## RADAR de curto alcance (SRR)

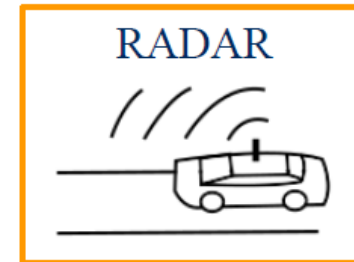

- Em geral utiliza frequência de **24GHz**
- Ângulo de 80° e alcance de aproximadamente 30m

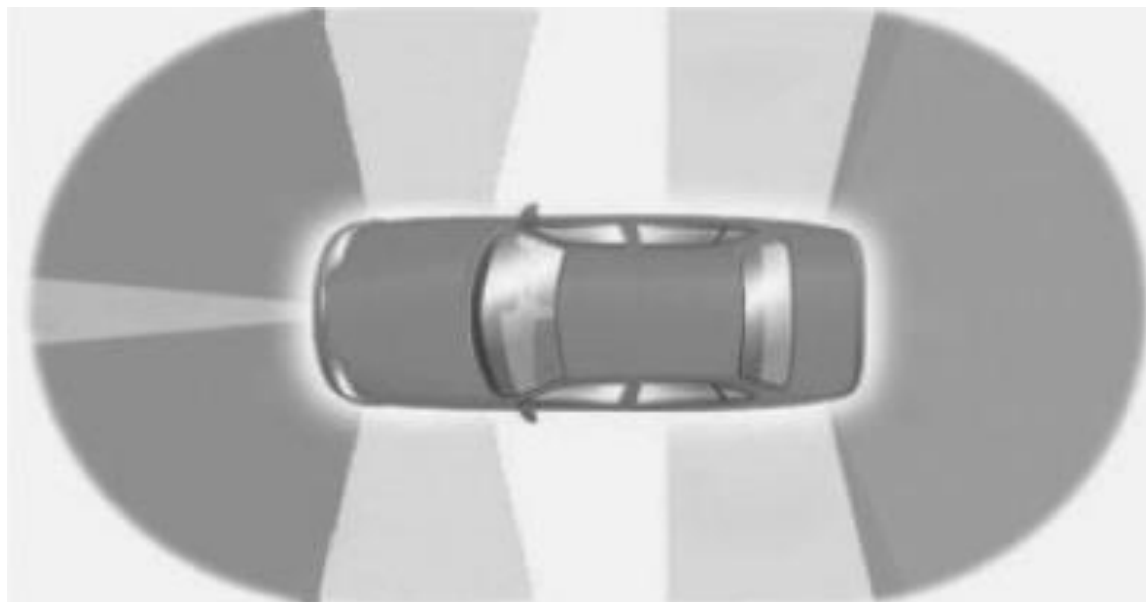

### APLICAÇÕES:





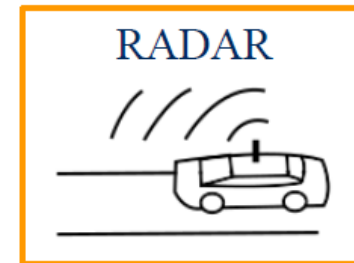

- Suporte ao ACC com Sto and Go
- Alerta de colisão
- Mitigação de colisão
- Monitoramento de zona cega
- Assistência ao estacionamento
- Assistência à mudança de faixa
- Alerta de colisão traseira

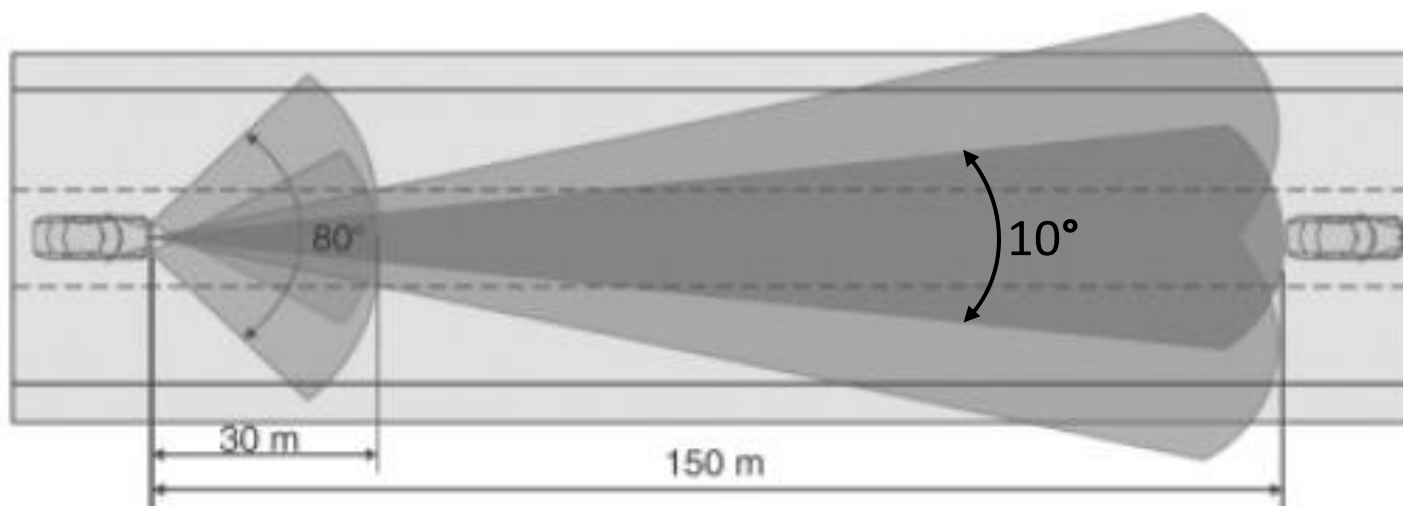
## RADAR de longo alcance (LRR)

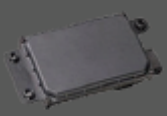
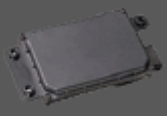

- Em geral utiliza frequência de **77GHz**
- Ângulo de **10°** e alcance de aproximadamente **150m**
- Provê informações sobre a **situação do tráfego** à frente do veículo
- É fundamental para o acionamento do **freio de emergência** em alta velocidade. Mede de distância, ângulo e velocidade radial dos outros veículos



Manufacturer	RADAR	Frequency	Min Range	Target	Max Range	Accuracy Range Range Rate Angle	Update Rate	MidRange/ Long Range	Horizontal FOV	Vertical FOV	Power	Voltage	Mass	Tracking Targets	
	Electronically Scanning, Multi-Ranging, Automotive Radar.														
	9.21.21	76.5 GHz	1m	10db	>174m	0.5m 0.12m/s 0.5°	≤50ms	60m/174m	Long Range	±10°	4.2°-4.75°	<12W	8V-16V, 24V < 1 min	575g	64
				0db	>100m				Mid-Range	±45°					
				10db	>60m										
0db				>50m											
	Electronically Scanning, Multi-Ranging, Automotive Radar, Provides Individual Detections, Disabled Tracker Grouping, Merging, and Filtering.														
	9.21.15	76.5 GHz	1m	10db	>174m	0.5m 0.12m/s 0.5°	≤50ms	60m/174m	Long Range	±10°	4.2°-4.75°	<12W	8V-16V, 24V < 1 min	575g	64
				0db	>100m				Mid-Range	±45°					
				10db	>60m										
0db				>50m											
	Electronically Scanning, Multi-Ranging, Automotive Radar, Lower Detection and Improved Detection Algorithms, Disabled Tracker Grouping, Merging, and Filtering, Over USB to Ethernet Interface.														
	2.5	76.5 GHz	1m	10db	>174m	0.5m 0.12m/s 0.5°	≤50ms	60m/174m	Long Range	±10°	4.2°-4.75°	<12W	8V-16V, 24V < 1 min	575g	64
				0db	>100m				Mid-Range	±45°					
				10db	>60m										
0db				>50m											
	Rear and Side Detection System, Single-beam mono-pulse radar. Typically Used for Cross Traffic Alert (CTA) and Blind Spot Detection. Detection data only, no tracking.														
	SRR2	76.5 GHz	0.5m		80m	-50 (Closing) to ±10m/s (Opening)	≤50ms	80m	±75°	±5°	7W	8V-16V, 24V < 1 min	380g	N/A	
	Automotive Radar with Flexible System Integration, Multi-Sensor Data Fusion, Vehicle/Customer Application Can Be Embedded														
	SMS UMRR Type 29	24 GHz	1m	Ped	50m	Typ. < ±2.5% Or < ±0.25m	≤50ms	160m	±18°	±4°	3.7W	7V-32V	330g	32/64	
				Car	160m										
	Automotive Radar with Flexible System Integration, Multi-Sensor Data Fusion, Vehicle/Customer Application Can Be Embedded														
	SMS UMRR Type 30	24 GHz	1m	Ped	40m	Typ. < ±2.5% Or < ±0.25m	≤50ms	90m	±35°	±5°	3.7W	7V-32V	295g	32/64	
				Car	90m										
	Automotive Radar with Flexible System Integration, Multi-Sensor Data Fusion, Vehicle/Customer Application Can Be Embedded														
	SMS UMRR Type 31	24 GHz	1m	Ped	20m	Typ. < ±2.5% Or < ±0.25m	≤50ms	45m	±50°	±5°	3.7W	7V-32V	295g	32/64	
				Car	45m										

# Radar automotivo - NXP



<https://www.youtube.com/watch?v=FjDn1DWfRjI>

# Sensor para percepção SONAR ULTRASÔNICO

Ultrasonics

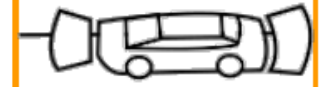

# Sensor para percepção – SONAR ULTRASONICO

Ultrasonics

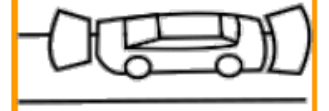

- Medição de curta distância em qualquer condição de tempo
- Solução ideal para função de estacionamento automático
- É robusto à iluminação e chuva
- Parâmetros de comparação:
  - Faixa de operação
  - Campo de visão (FoV)
  - Custo

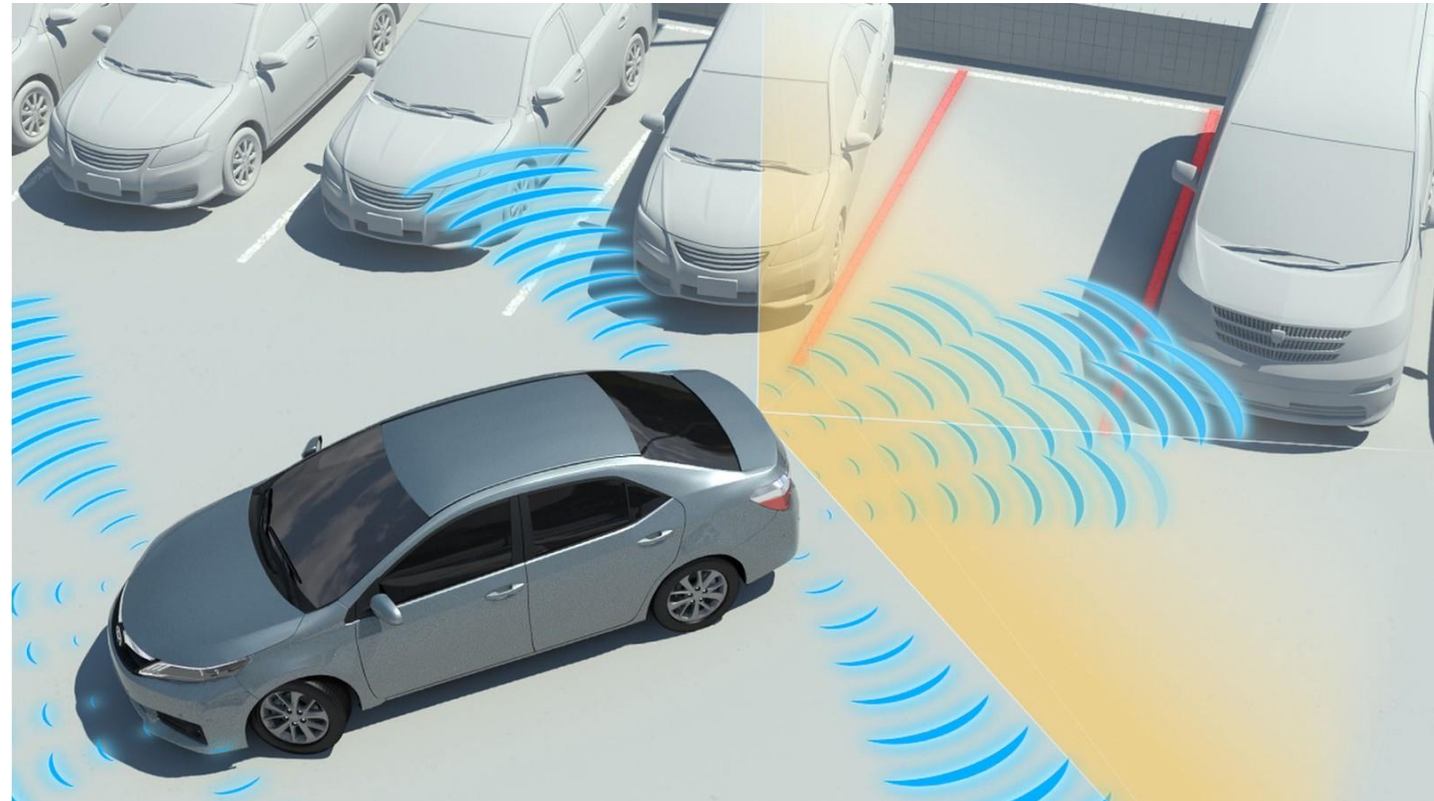

# Sensor para percepção Posicionamento Global (GNSS) e Sistema Inercial (IMU)

GNSS/IMU

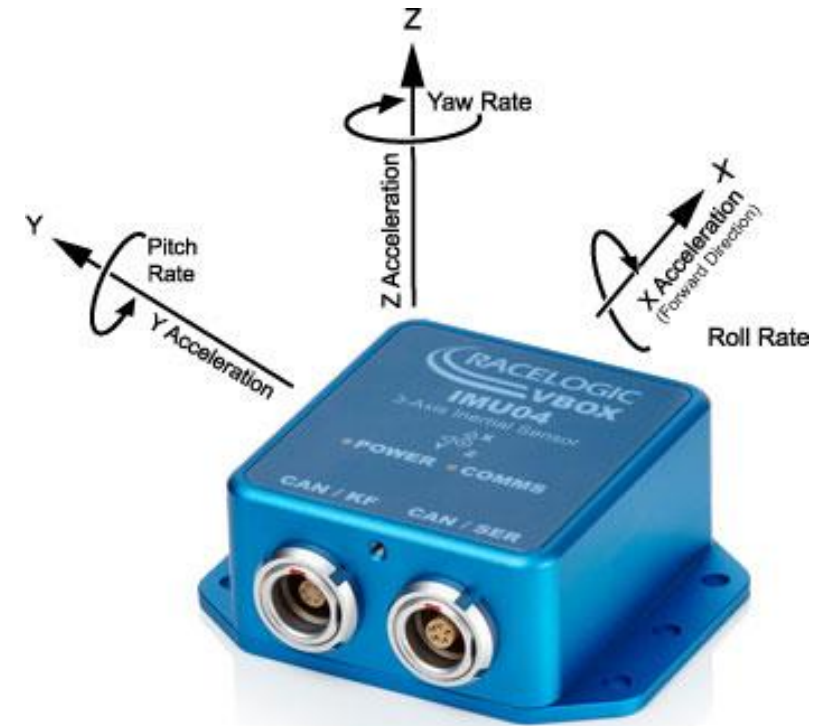



## Porque precisamos combinar os dois sensores?

- A precisão do GPS é da ordem de 3 ~ 30m (95% do tempo)
- O IMU tem boa precisão para curtas distâncias, mas acumula erros (*drift*)
- A solução foi combinar os dois sensores (fusão sensorial)
- Para se chegar a uma precisão da ordem de centímetros é necessário ainda fazer um casamento (*matching*) da localização obtida com um mapa e fotografias aéreas e fotografia do entorno (prédios por exemplo).

# Posicionamento global por satélites

## Sistemas em operação

GNSS/IMU



(EUA)

(EU)

(Rússia)

(China)

	<b>GPS</b>	<b>GALILEO</b>	<b>GLONASS</b>	<b>BeiDou</b>
First launch	1978	2011	1982	2007
Full Operational Capability	1995	2018-19	2011	2020
Number of satellites	32	30	31	35
Orbital planes	6	3	3	3
Access Scheme	CDMA	CDMA	FDMA/CDMA	CDMA
Current Status	31 operational	16 operational + 4 in validation phase	24 operational	15 operational satellites, full coverage on Asia pacific region

# Posicionamento global por satélites (GPS/GNSS)



24 satélites em 6 órbitas

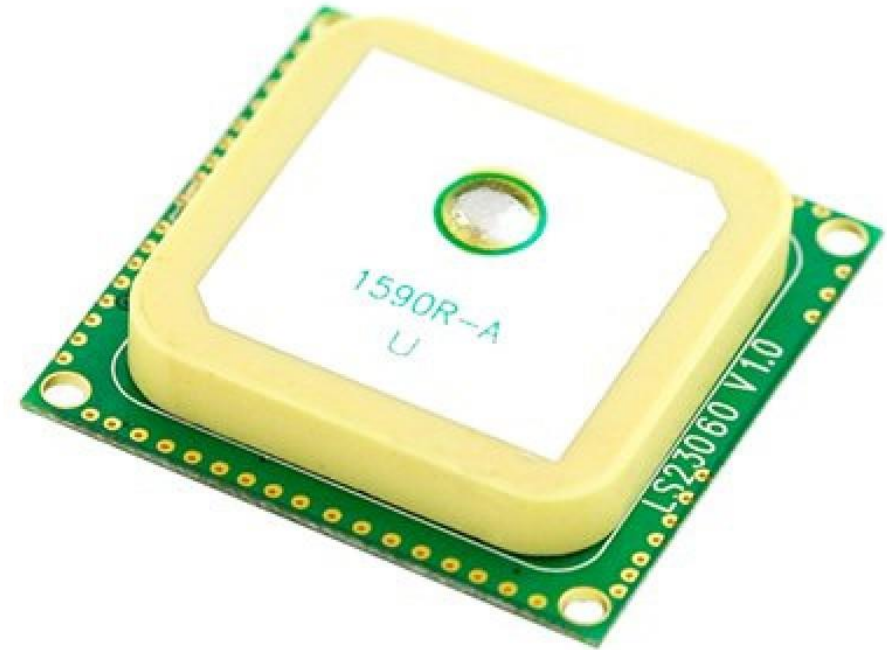

**GPS Receiver**  
**LS20031 66 Channels 5 Hz**  
**( 3 m accuracy)**

# Inertial Measurement Unit (IMU)



- Aceleração (x, y, z)
- Rotação (roll, pitch, yaw)

# GPS and IMU Integration

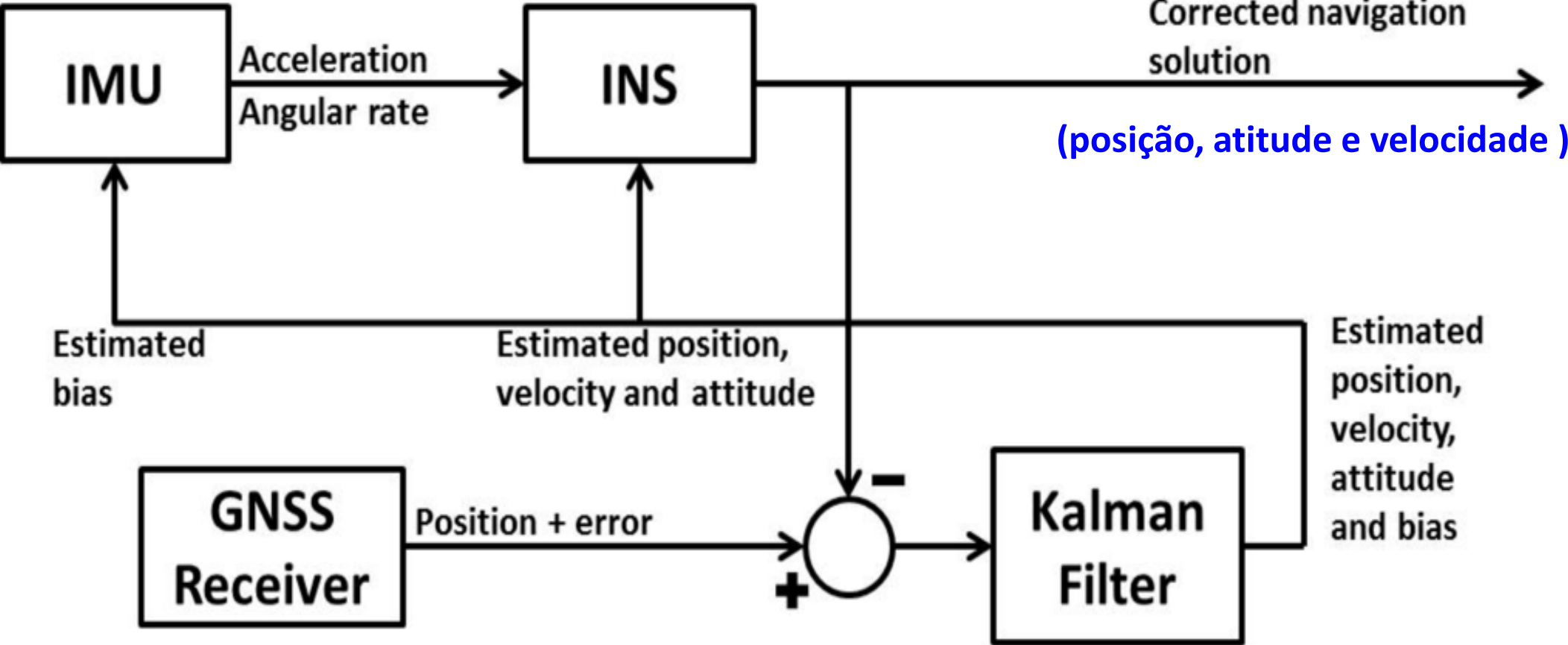

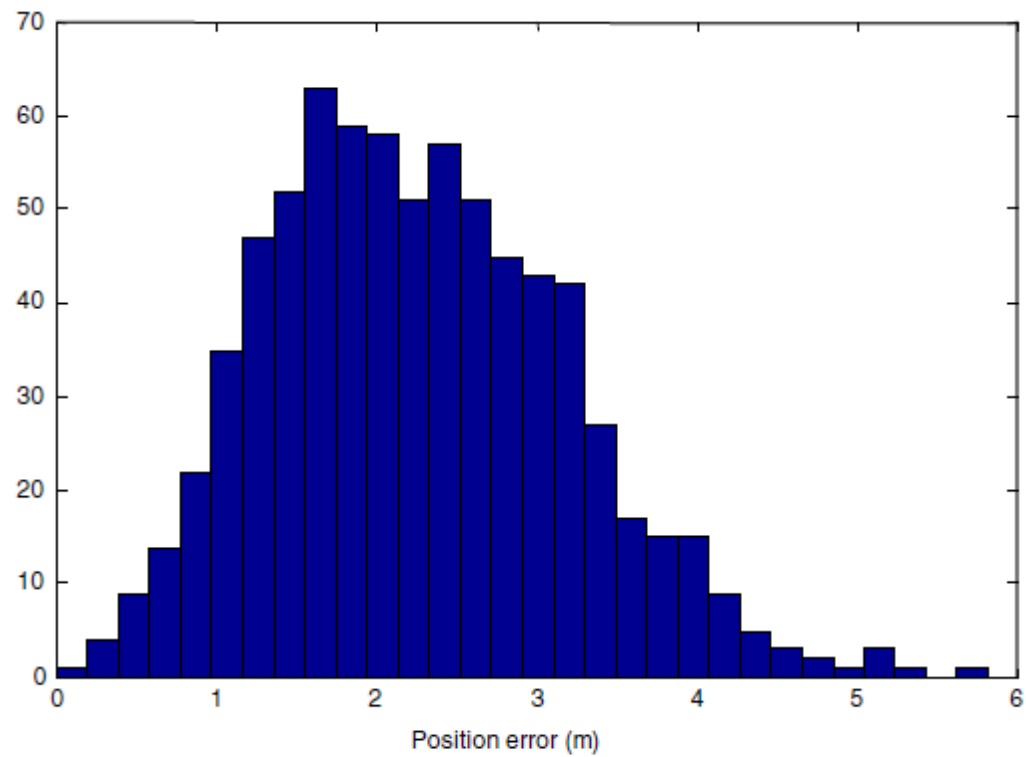

Fig. 5. Histogram of the position error of the non-filtered GPS signal.

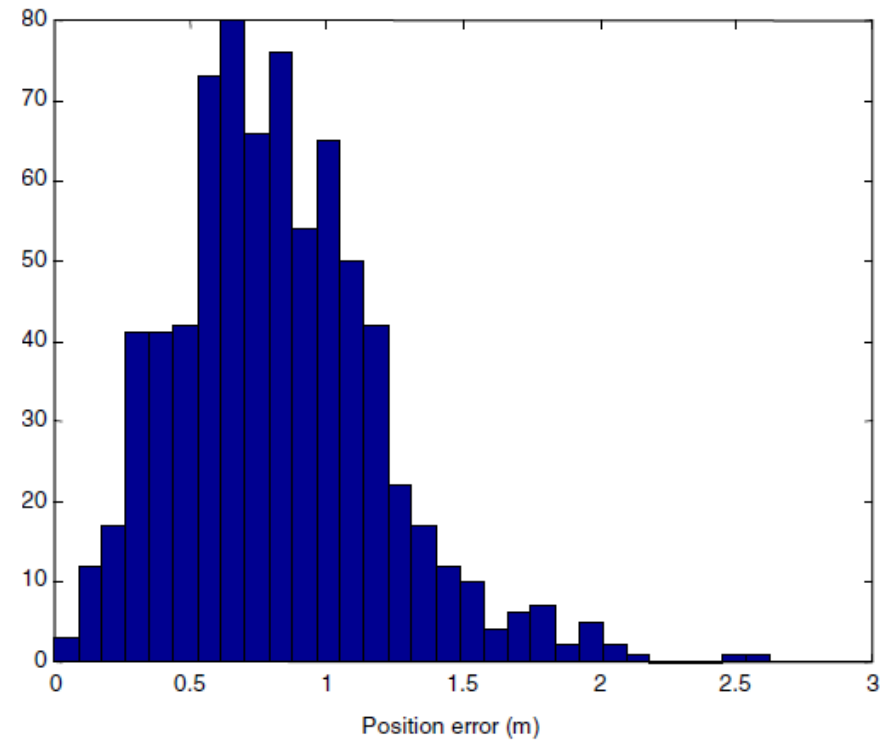

Fig. 6. Histogram of the position error of the GPS/IMU filtered signal.

**Table 3**  
Performances of the multisensor filter

	GPS data	GPS/IMU fusion	Improvement
p.e.a. (m)	2.23	0.82	63.2%
p.e.s.b. (m)	0.96	0.38	60.3%
95% c.l. (m)	3.92	1.49	62.0%

(Caron, 2004)

# Sensor para percepção

## Odômetro

Wheel  
Odometry



- Mede a velocidade de rotação das rodas
- Essa informação é usada para calcular a velocidade do veículo e a orientação do carro

# Exemplo de sistema de localização: Plataforma de veículo autônomo da Univ. Carnegie Mellon

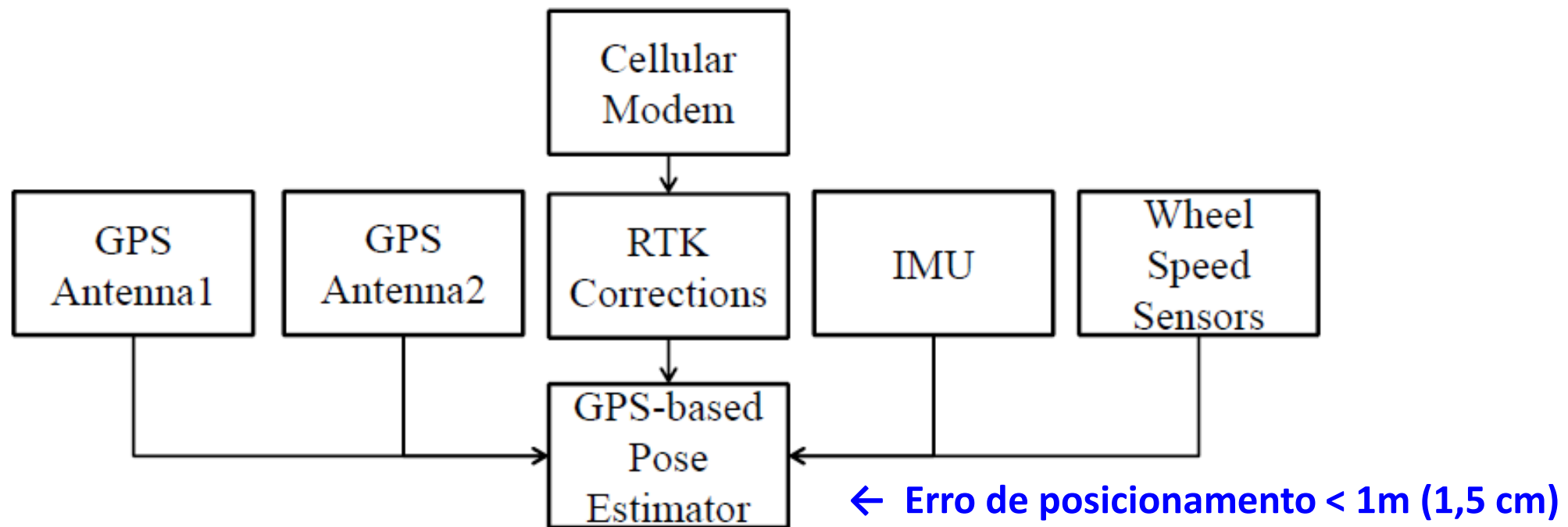

Fig. 6: The design of the autonomous vehicle global localization system



# Sensores para percepção

## Resumo

Camera



LIDAR



RADAR

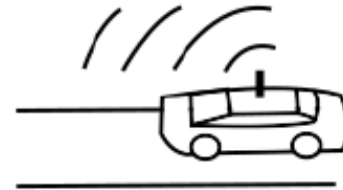

Ultrasonics

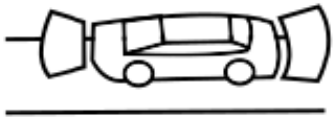

GNSS/IMU



Wheel  
Odometry



Para processar todos os dados dos sensores ...

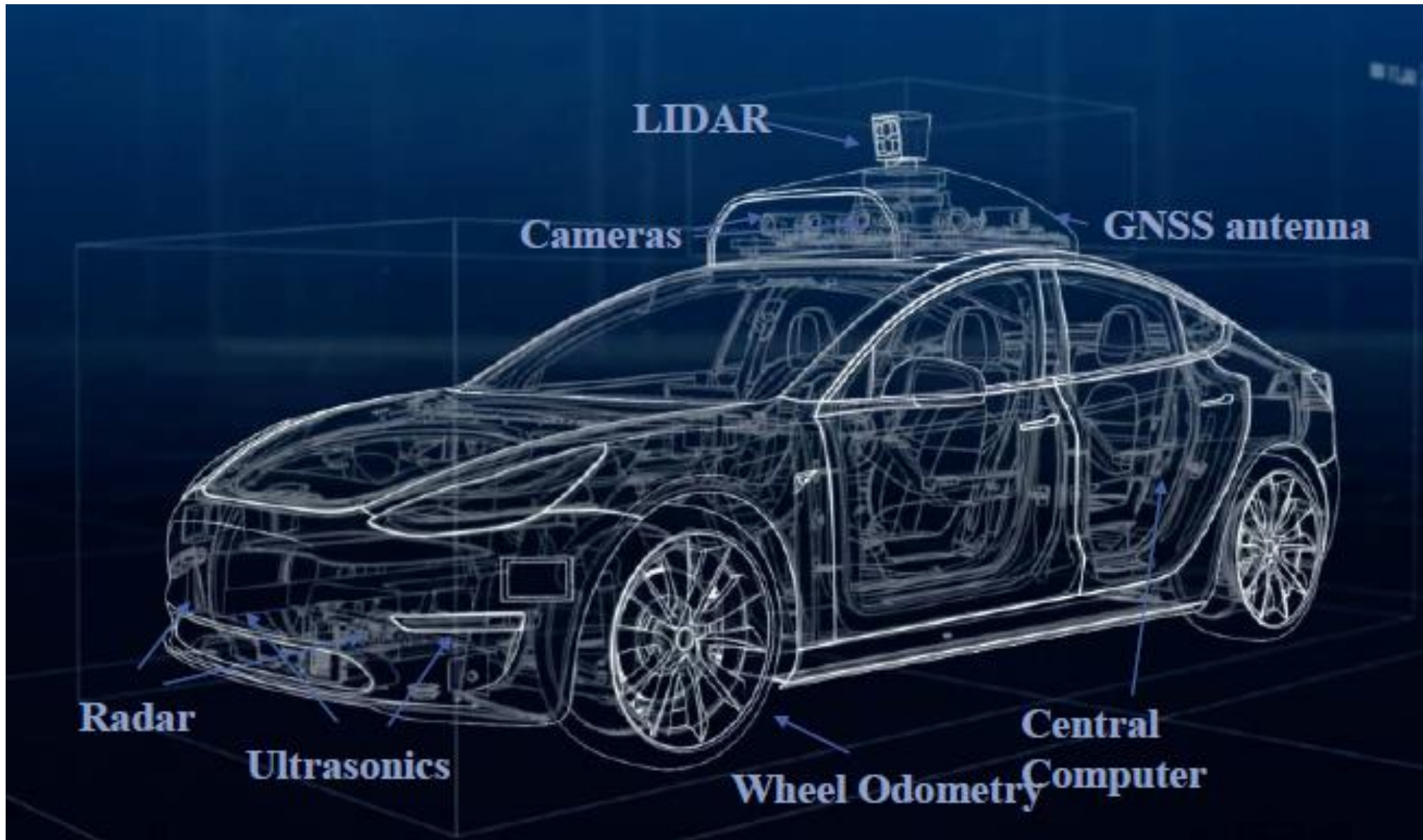

# Exemplo de arquitetura do sistema computacional

## Plataforma de veículo autônomo da Univ. Carnegie Mellon

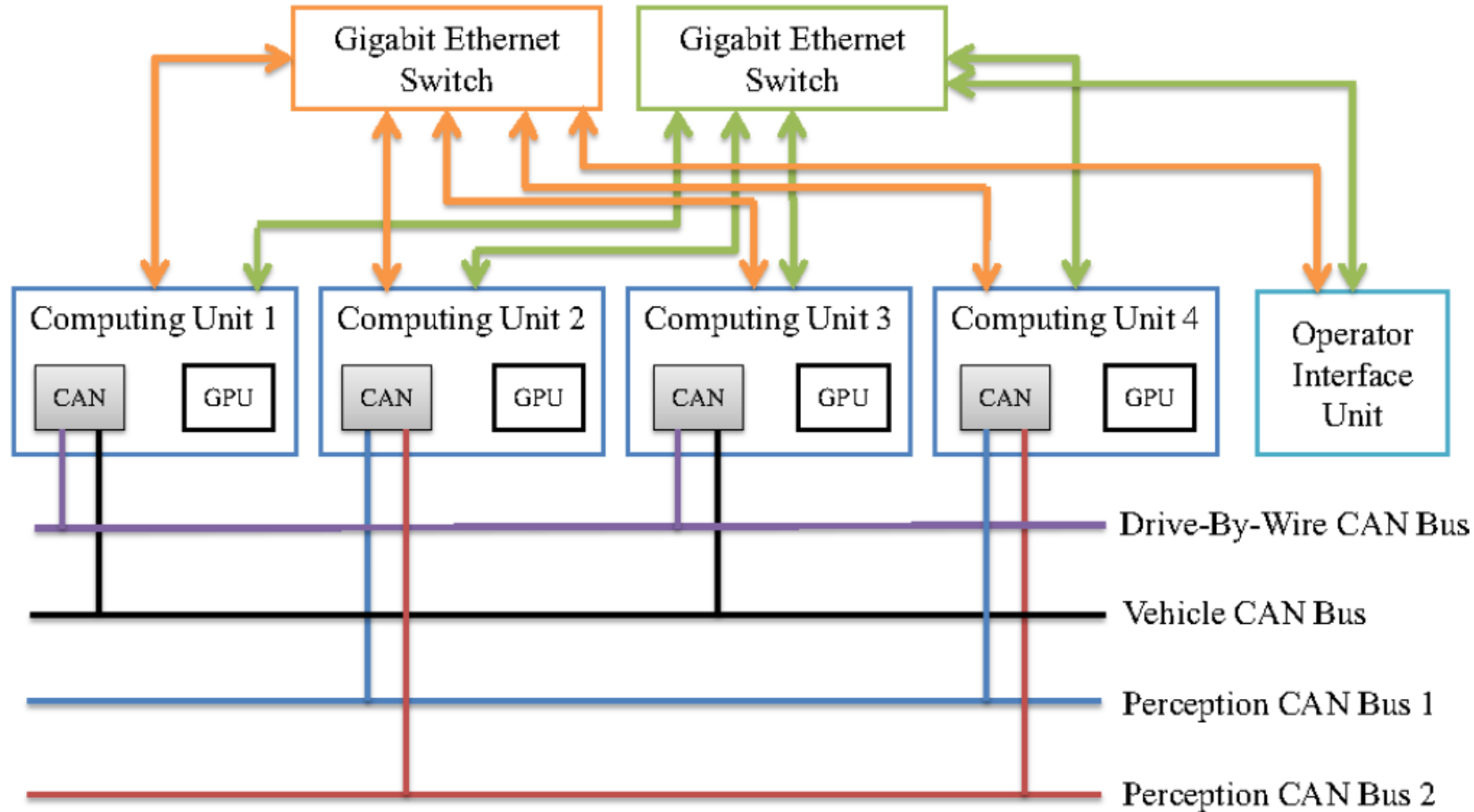

# Arquitetura de software do veículo autônomo da Univ. Carnegie Mellon

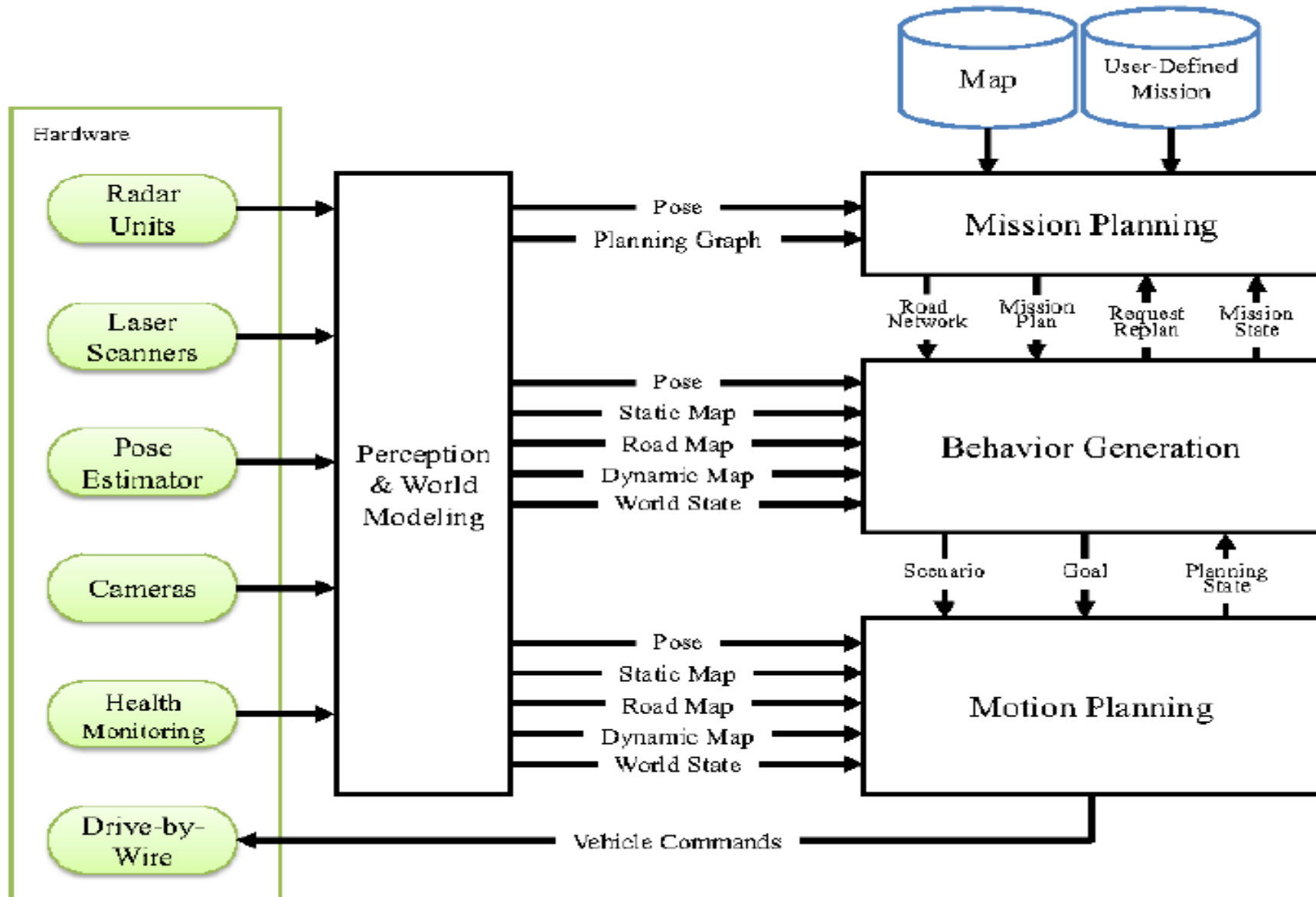

(Wei, 2013)

# Detalhes do compartimento do sistema computacional



Normal



Aberto

# Interface do Usuário do veículo autônomo da Univ. Carnegie Mellon



Interior do carro autônomo



Console central

# Interface do Usuário do veículo autônomo

- Interface do Usuário (UI) do veículo autônomo tem grande importância.
- Deve proporcionar uma comunicação suave entre o operador humano e o sistema de direção automática (ADS)
- UI deve prover ao operador humano a habilidade de cooperar com o carro em 4 níveis:
  - Nível de **missão** (seleção de destino / rota preferencial)
  - Nível de **comportamento** (*behavior*) (preferências do usuário, p.ex. faixa)
  - Nível de **execução** (chaveamento para o modo autônomo)
  - Nível de **acesso remoto** (via App de smartphone, p. ex. *parking* e *pick-up*)

# Computador de bordo para veículos autônomos



- Coleta de dados de todos os sensores
- Comunicação com os ECUs
- Processamento das atuações

DRIVE AGX – In-Vehicle AI Computer

- DRIVE AGX Xavier (Nível 2/3)
- DRIVE AGX Pegasus (Robotaxi)

<https://developer.nvidia.com/drive/drive-agx>



# Processamento de imagens, detecção de objetos e mapeamento

## HARDWARE DEDICADO:

- GPUs
- FPGAs
- ASICs



## Titan X (GM200)

- 28nm [Maxwell GPU](#) with
- 12GB of GDDR5 Hynix RAM,
- 1GHz clock speed,
- 336GB/s memory bandwidth,
- 8 billion transistors,
- 3,072 CUDA cores,
- 7TFLOPS (single precision) and
- 0.2TFLOPs (double precision) performance, and a
- PCIe 3.0 x16 interface.

# Projeto de configuração de Hardware

Vamos assumir a menos de indicação em contrário que:

- Desaceleração agressiva =  $5 \text{ m/s}^2$
- Desaceleração confortável =  $2 \text{ m/s}^2$

# Exercício 1 - qual a distância necessária para o carro parar?

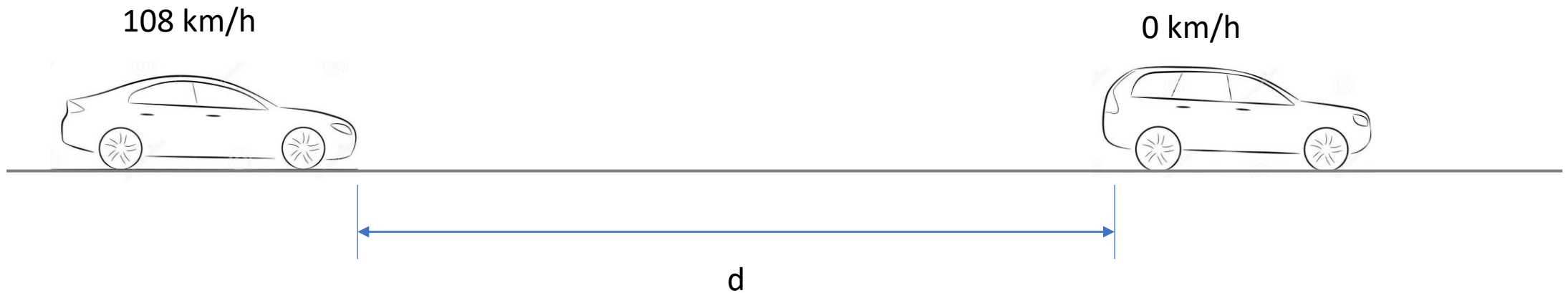

- a) 60 m
- b) 70 m
- c) 80 m
- d) 90 m
- e) 100 m

A distância necessária para parar é dada por:

$$d = \frac{v^2}{2a}$$

$a$  = desaceleração máxima;  $v$  = velocidade

## Em geral, temos dois ambientes de operação

Parâmetro	Tráfego Rodoviário	Tráfego Urbano
Velocidade	Elevada	Baixa - média
Volume	Baixo - elevado	Médio - elevado
Número de faixas	2 a 4	2 a 6
Outras características	Poucas curvas graduais, confluências	Muitos retornos e intersecções

# Análise do tráfego rodoviário

De forma geral, é preciso considerar três tipos de manobras:

- Frenagem de emergência
- Manutenção da velocidade
- Mudança de faixa



# Análise do tráfego rodoviário: frenagem de emergência

No caso de trânsito parado à frente, é necessário **parar a tempo**:

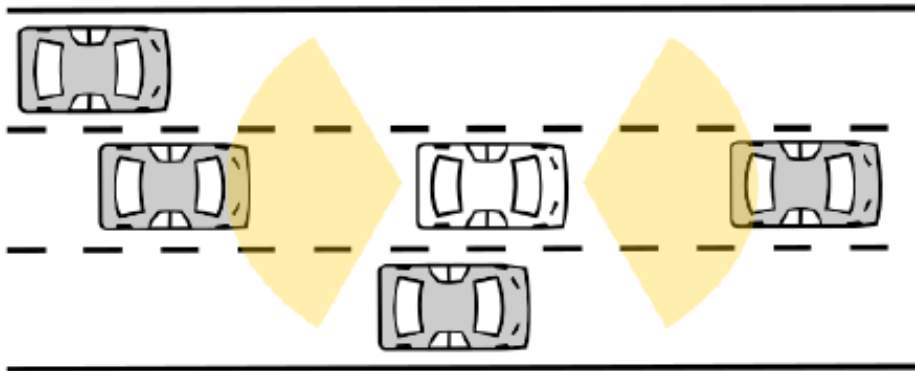

## Cobertura longitudinal:

- Assumindo uma velocidade de 120Km/h
- Precisaremos de distância de 110m para parar o carro
- Pelo menos 150 a 200m

# Análise do tráfego rodoviário: frenagem de emergência

No caso de trânsito parado à frente, é necessário parar a tempo ou **mudar de faixa**:

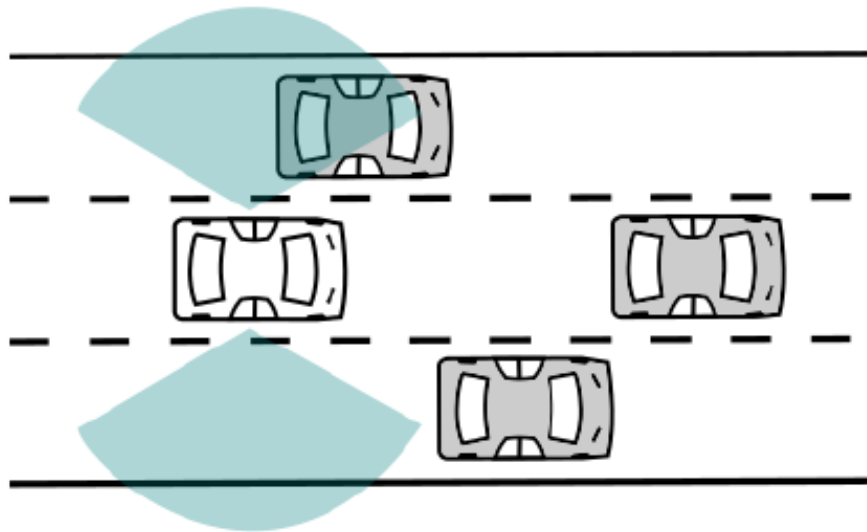

## Cobertura lateral:

- Pelo menos as faixas adjacentes para mudar de faixa em segurança.

# Análise do tráfego rodoviário: manutenção de velocidade

A velocidade relativa é tipicamente menor que 30km/h:

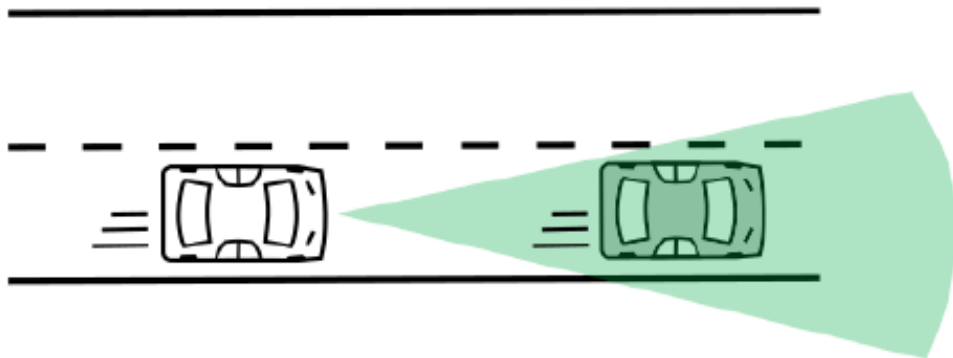

## Cobertura longitudinal:

- Pelo menos 100m à frente
- Como ambos veículos estão em movimento não há necessidade de ver longe como no caso de frenagem de emergência



# Análise do tráfego rodoviário: manter velocidade na confluência

A velocidade relativa é tipicamente menor que 30km/h:

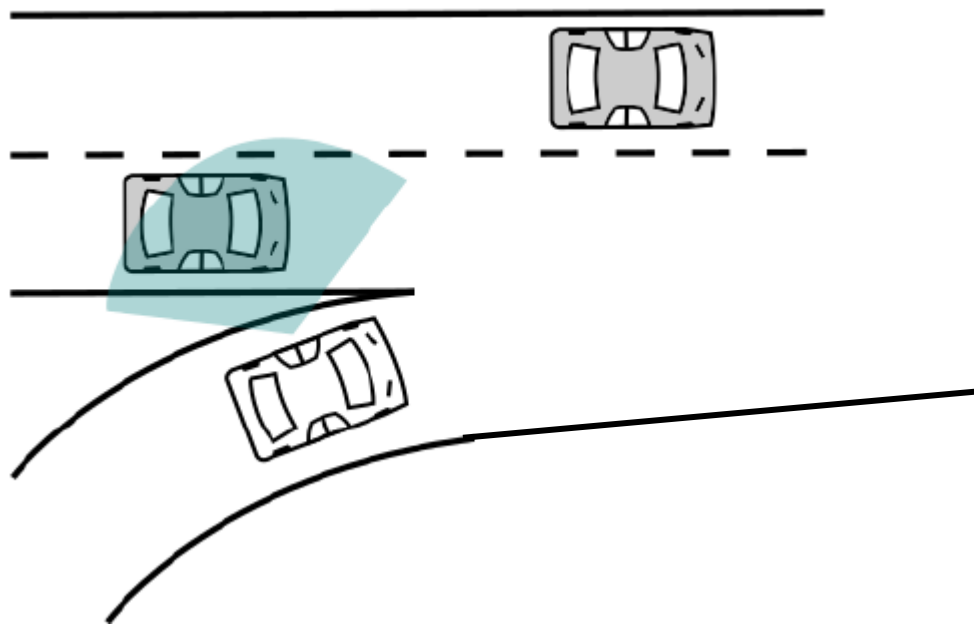

## Cobertura lateral

- Detecção de veículo na faixa adjacente

## Análise do tráfego rodoviário: mudança de faixa (1/3)

Vamos considerar mudança para faixa da direita como mostrado:

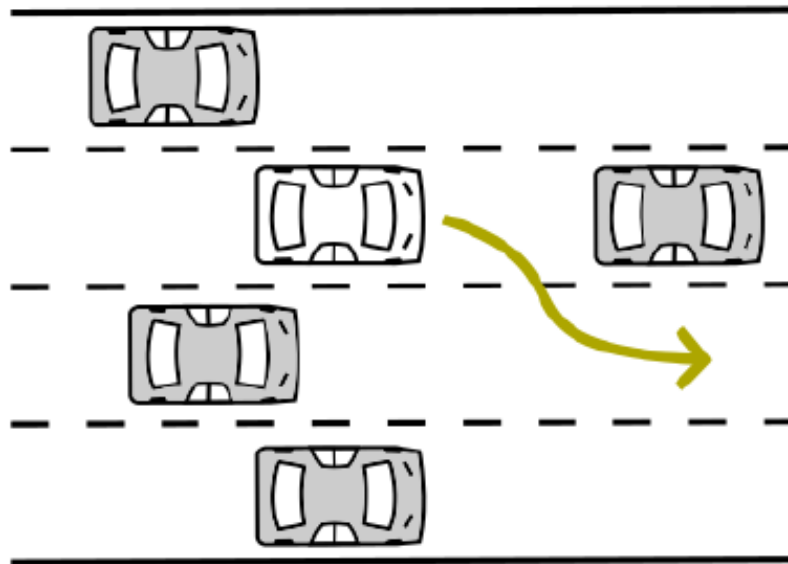

Faixa desejada

## Análise do tráfego rodoviário: mudança de faixa (2/3)

Cobertura longitudinal:

- necessário visão à frente para manter distância segura e
- necessário visão à ré para ver o que o carro de trás está fazendo

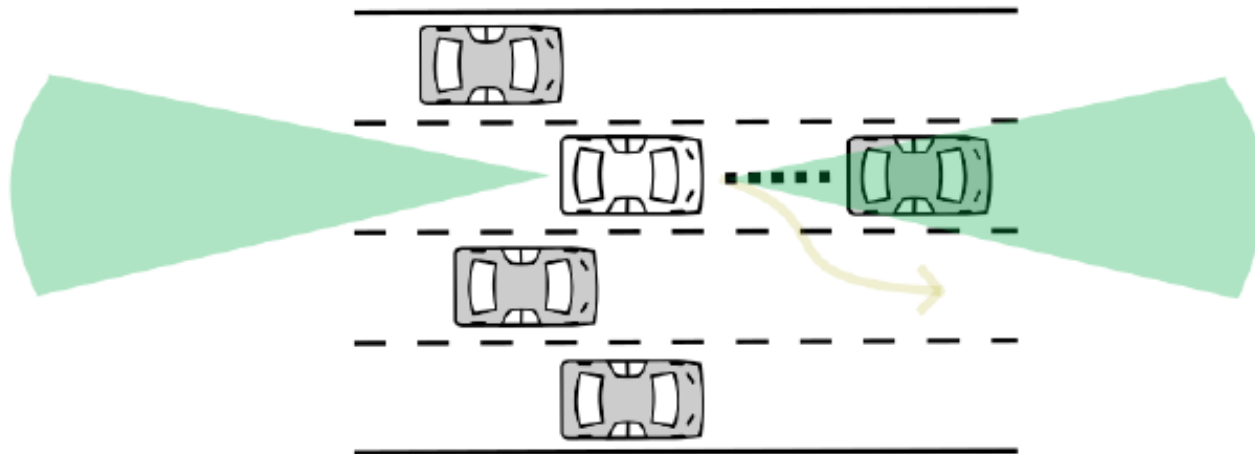

## Análise do tráfego rodoviário: mudança de faixa (3/3)

### Cobertura lateral:



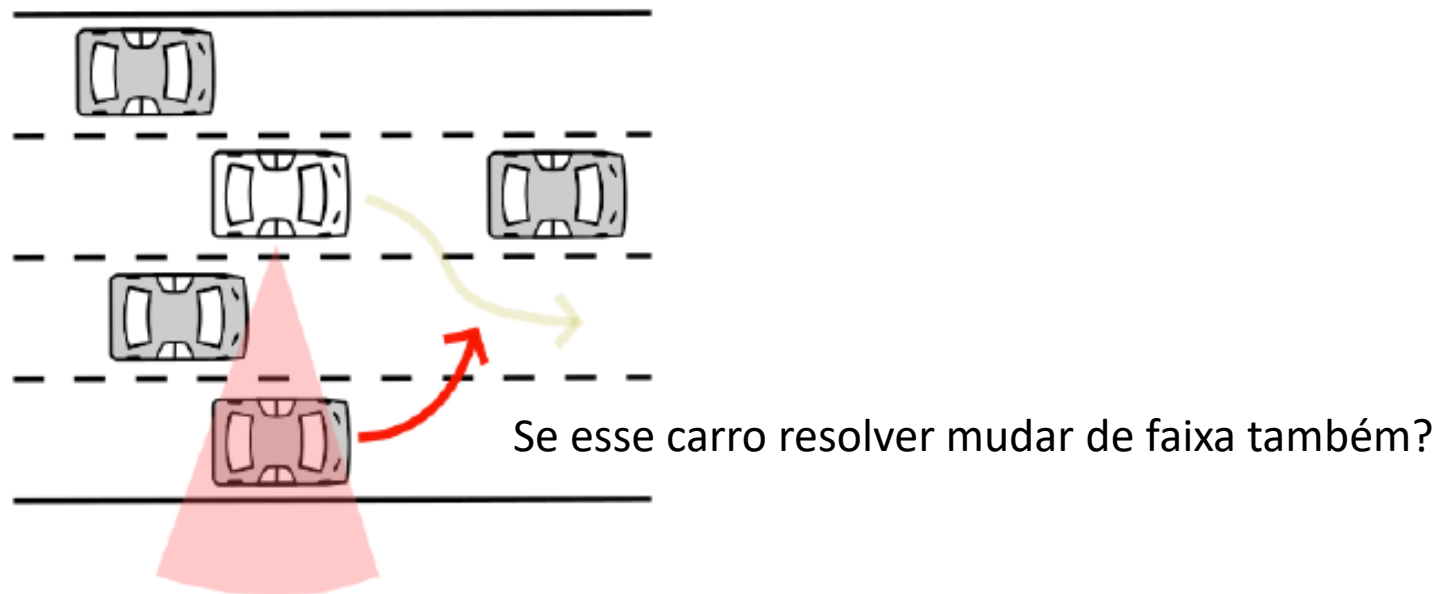

- necessário visão da faixa adjacente, mas também da subsequente
- necessário uma cobertura maior



# Análise do tráfego rodoviário: cobertura geral

## Cobertura longitudinal e lateral:

- necessário visão do entorno conforme mostrado abaixo para realizar as diferentes manobras no tráfego rodoviário



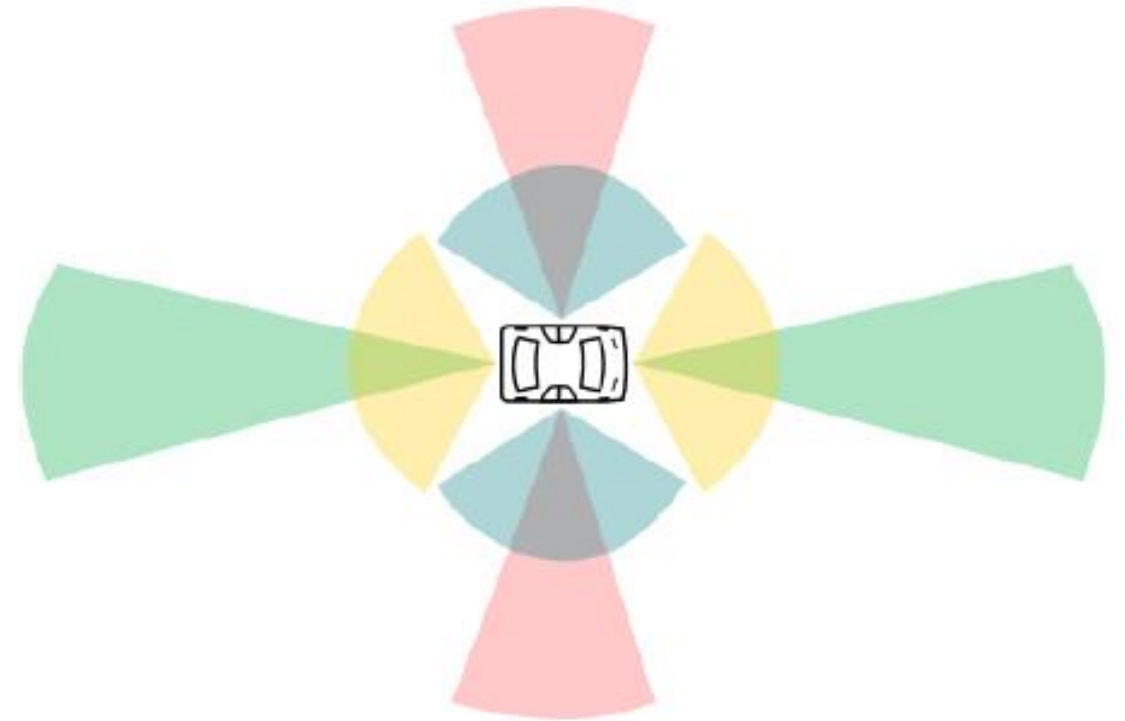

-  Frenagem de emergência
-  Frenagem de emergência, manutenção de velocidade, mudança de faixa
-  Manutenção de velocidade, mudança de faixa
-  Mudança de faixa



# Análise do tráfego rodoviário: cobertura geral

## Cobertura longitudinal e lateral:

- necessário visão do entorno conforme mostrado abaixo para realizar as diferentes manobras no tráfego rodoviário

-  Frenagem de emergência
-  Frenagem de emergência, manutenção de velocidade, mudança de faixa
-  Manutenção de velocidade, mudança de faixa
-  Mudança de faixa

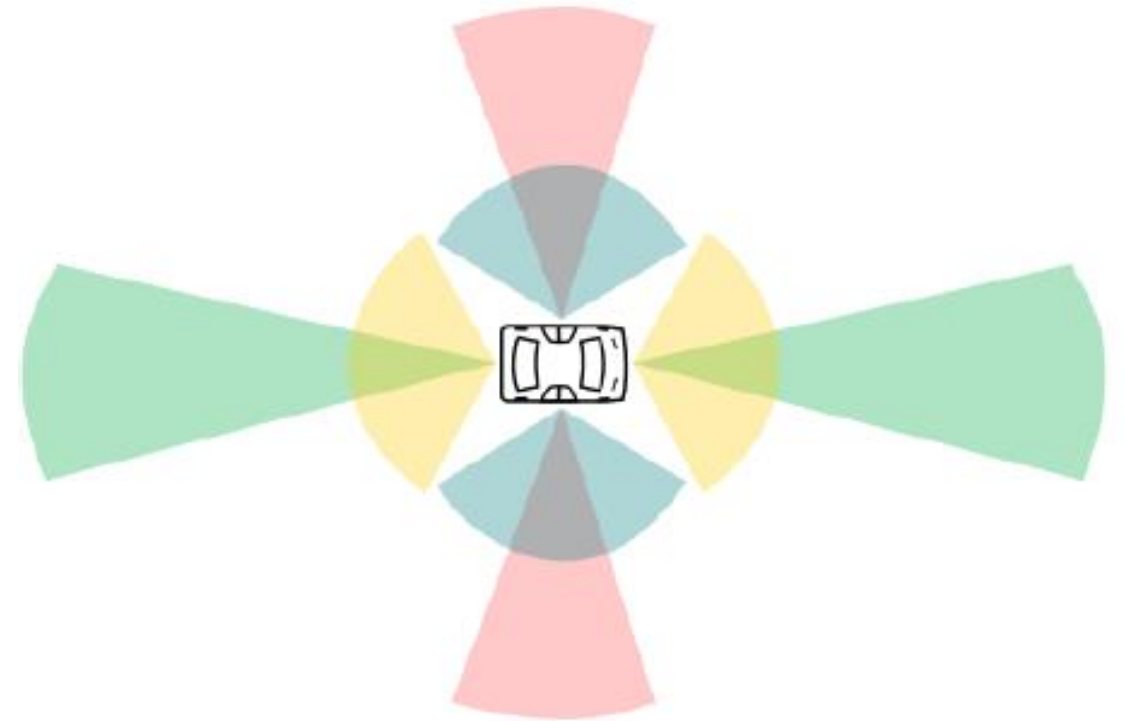

# Análise do tráfego urbano

De forma geral, é preciso considerar seis tipos de manobras:

- Frenagem de emergência
- Manutenção da velocidade
- Mudança de faixa
- Ultrapassagem
- Retorno, cruzar a intersecção
- Passar pela rotatória



Similar à análise de tráfego rodoviário

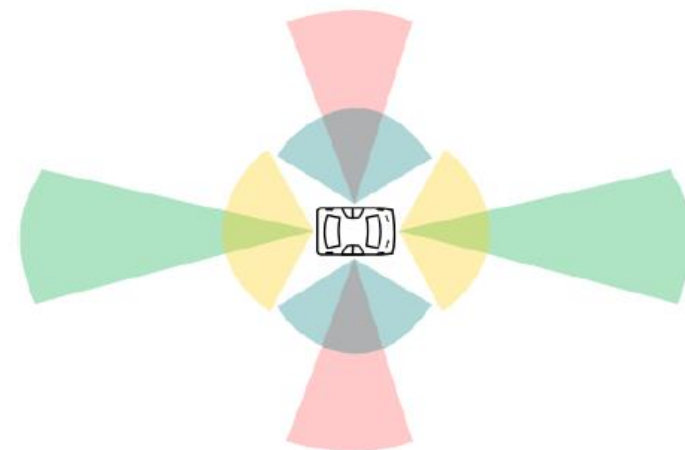

# Análise do tráfego urbano: ultrapassagem

## Cobertura longitudinal:

- Para ultrapassar um veículo parado ou em movimento, é necessário detectar o tráfego no sentido oposto antes do ponto de retorno à própria faixa.

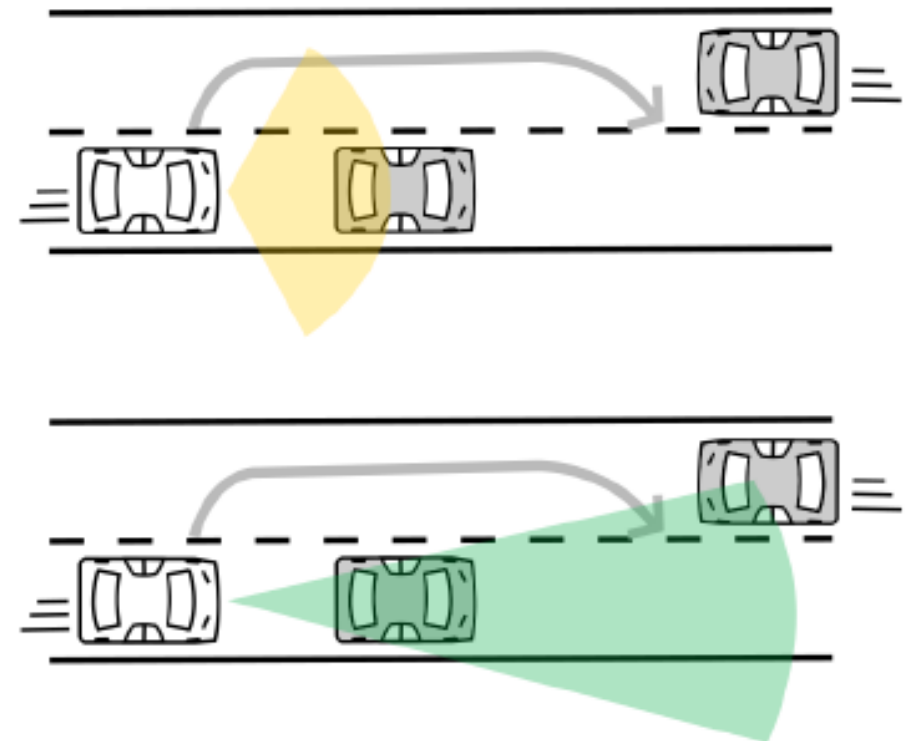



# Análise do tráfego urbano: ultrapassagem

## Cobertura lateral:

- É necessário observar sempre as faixas adjacentes
- Necessário também observar as faixas subsequentes às adjacentes para verificar se estão se movendo para a faixa adjacente pretendida.

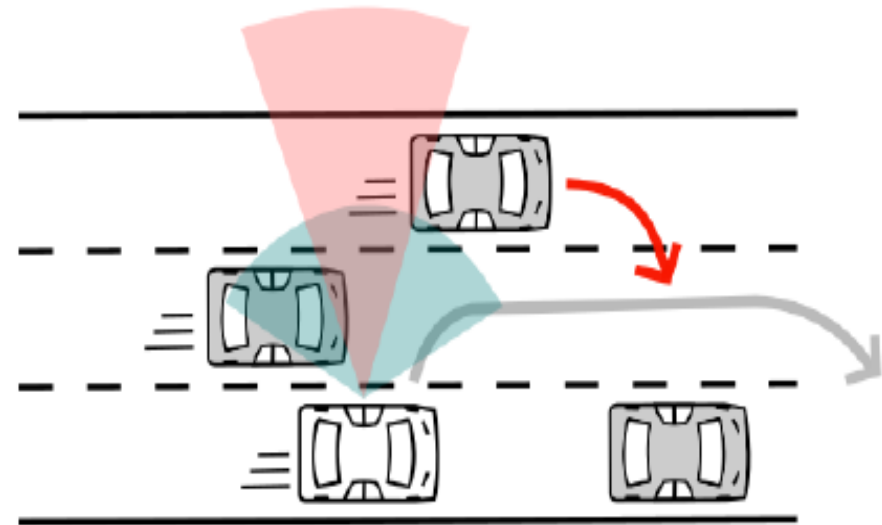

# Análise do tráfego urbano: Intersecção

- É necessário observar além da intersecção para identificar veículos se aproximando, pedestres atravessando e se a faixa encontra-se livre para prosseguir
- Requer um sensoriamento quase omnidirecional para ter uma visão para todos os ângulos da intersecção.

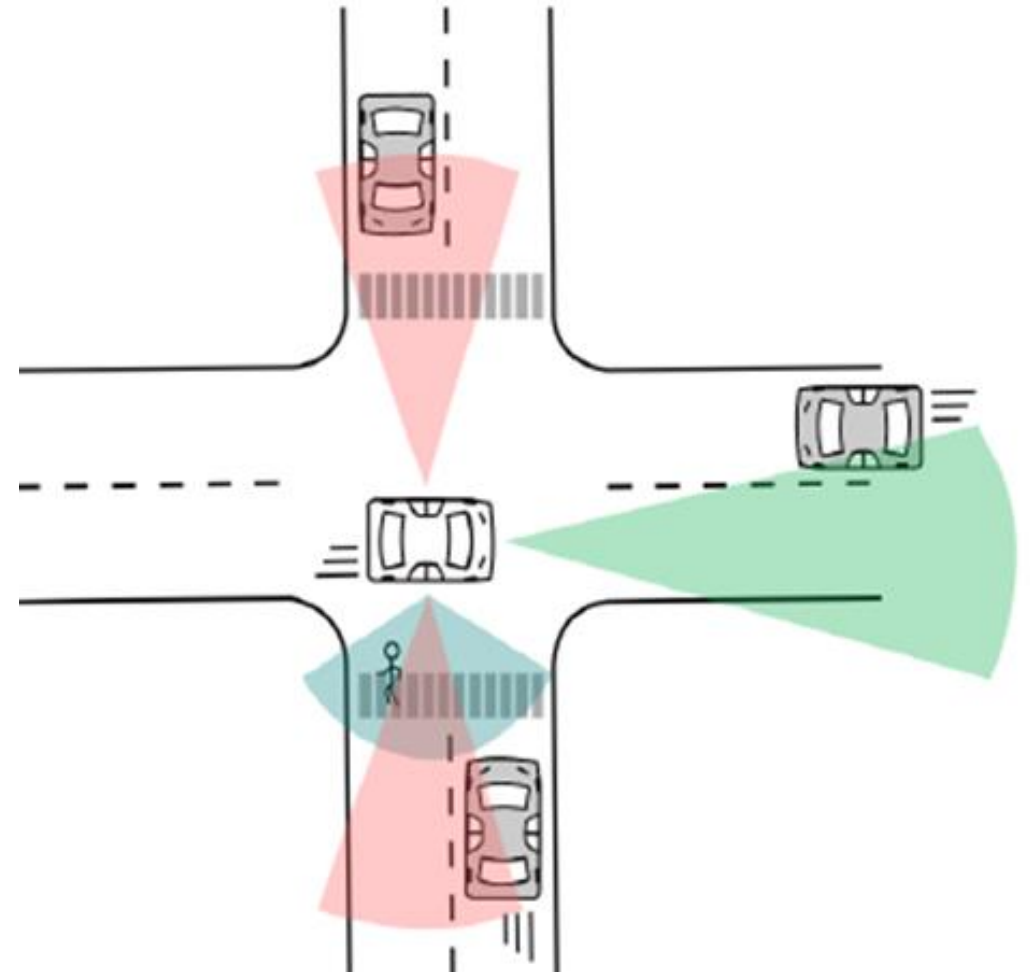

# Análise do tráfego urbano: Rotatória

## Cobertura Lateral:



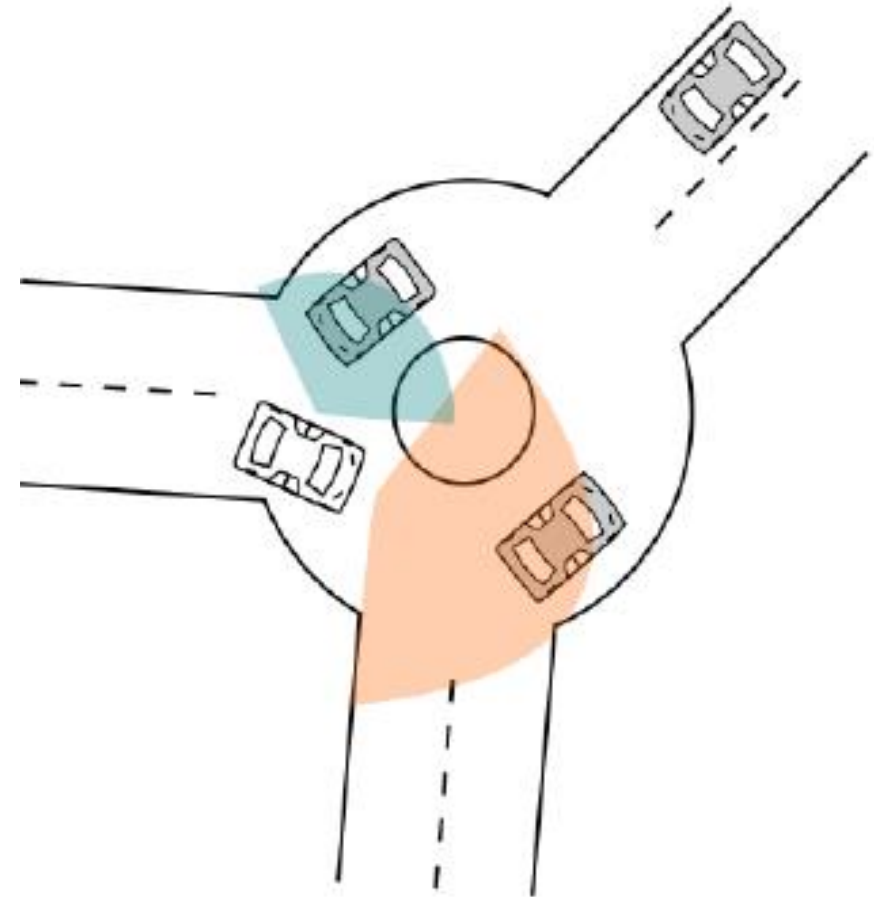

- Os veículos trafegam mais lentamente que o usual, necessitando de uma cobertura de menor alcance

## Cobertura Longitudinal:

- Devido ao formato circular da rotatória, necessita de um campo de visão maior(FoV)



# Análise do tráfego urbano: Cobertura geral

-  Parada de emergência, ultrapassagem
-  Parada de emergência, manutenção de velocidade, mudança de faixa, ultrapassagem, intersecção e rotatória
-  Ultrapassagem, intersecção
-  Ultrapassagem, intersecção
-  Rotatória

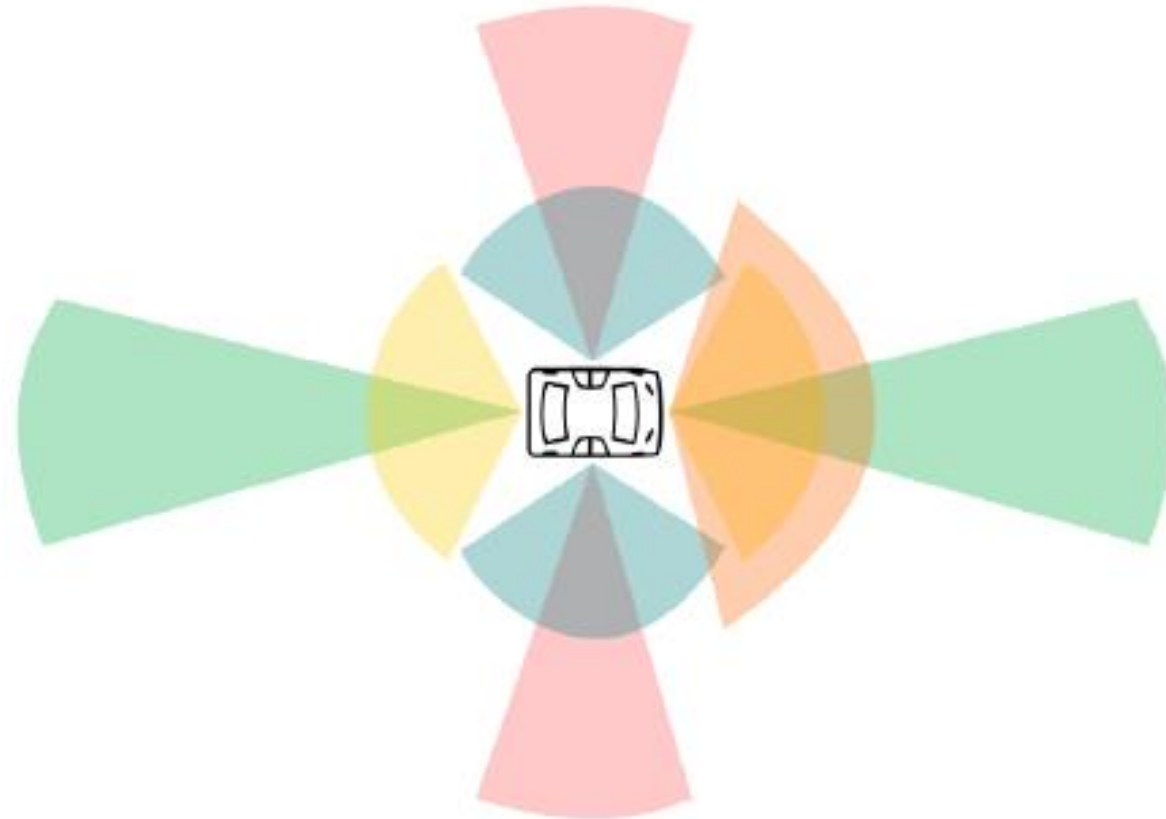

# Alcance dos sensores

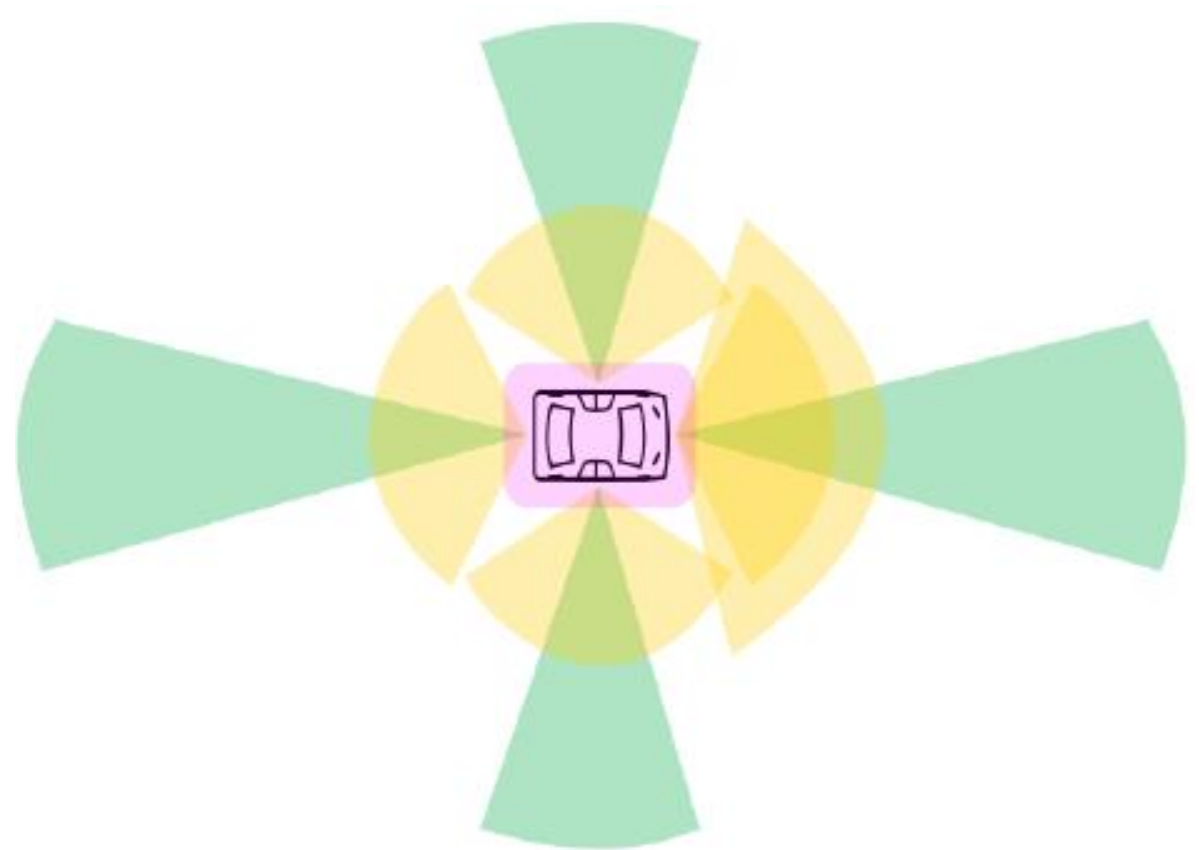
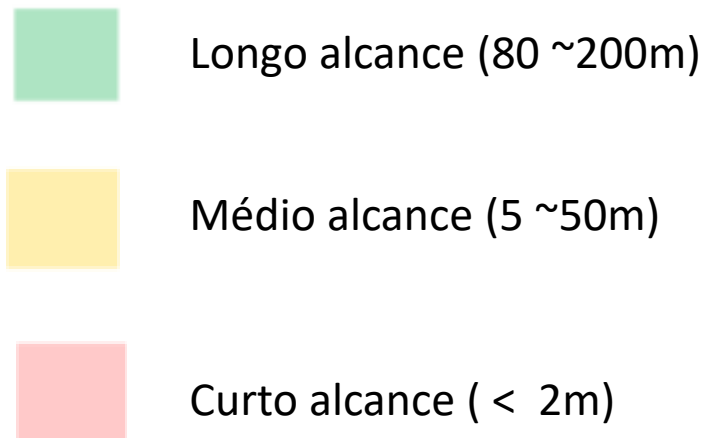

# Arquitetura de Software

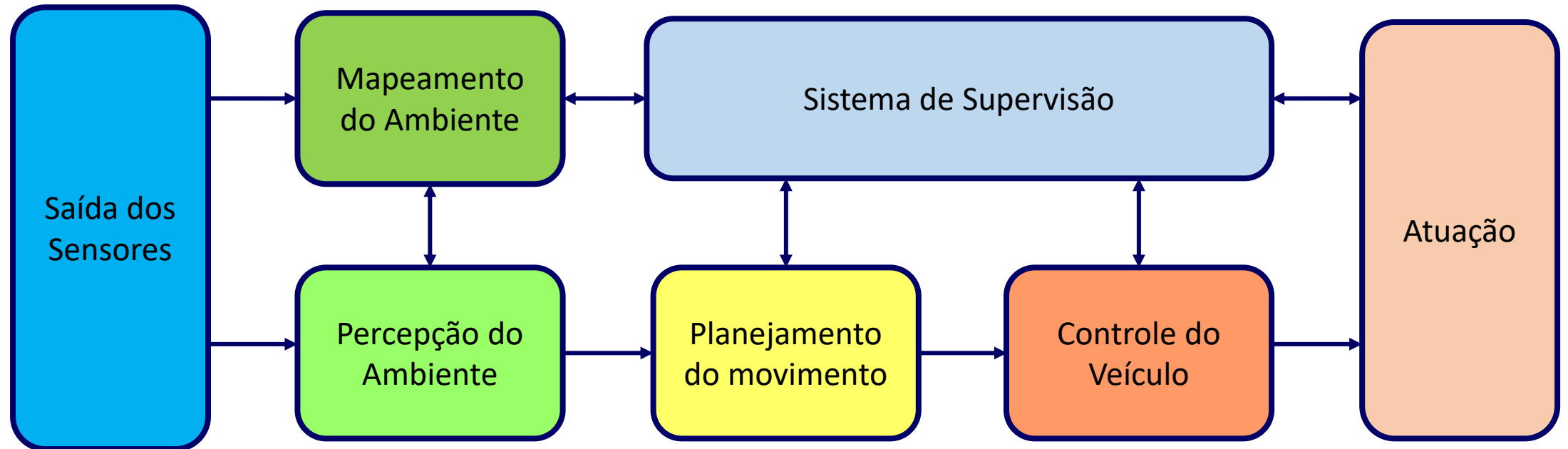

# Arquitetura de Software – Percepção do ambiente

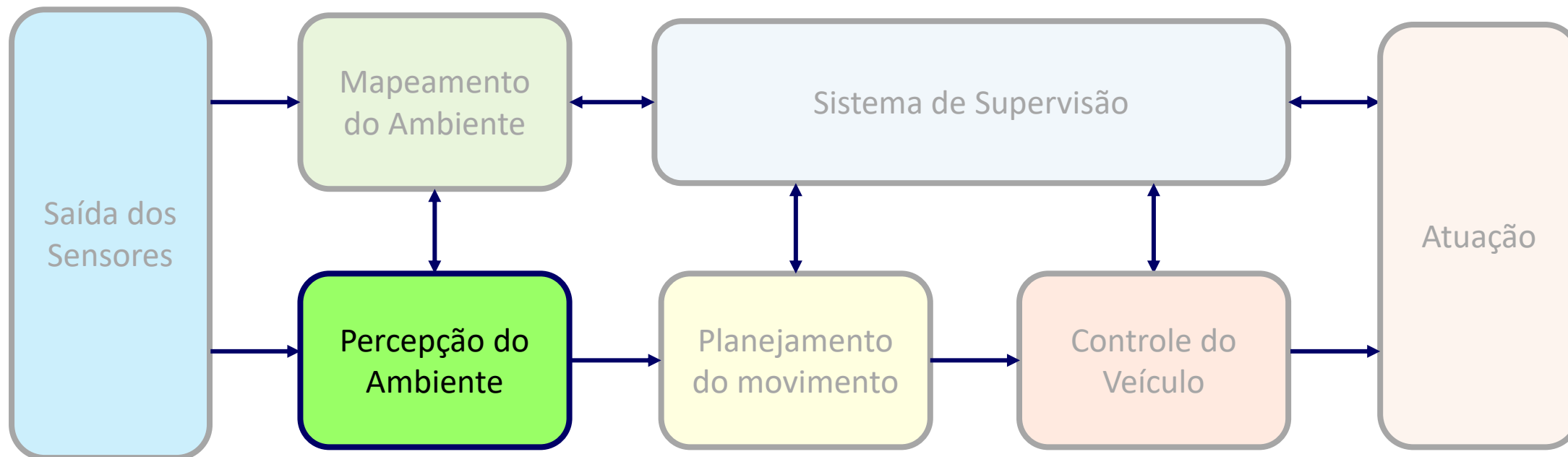

# Arquitetura de Software: Percepção do ambiente

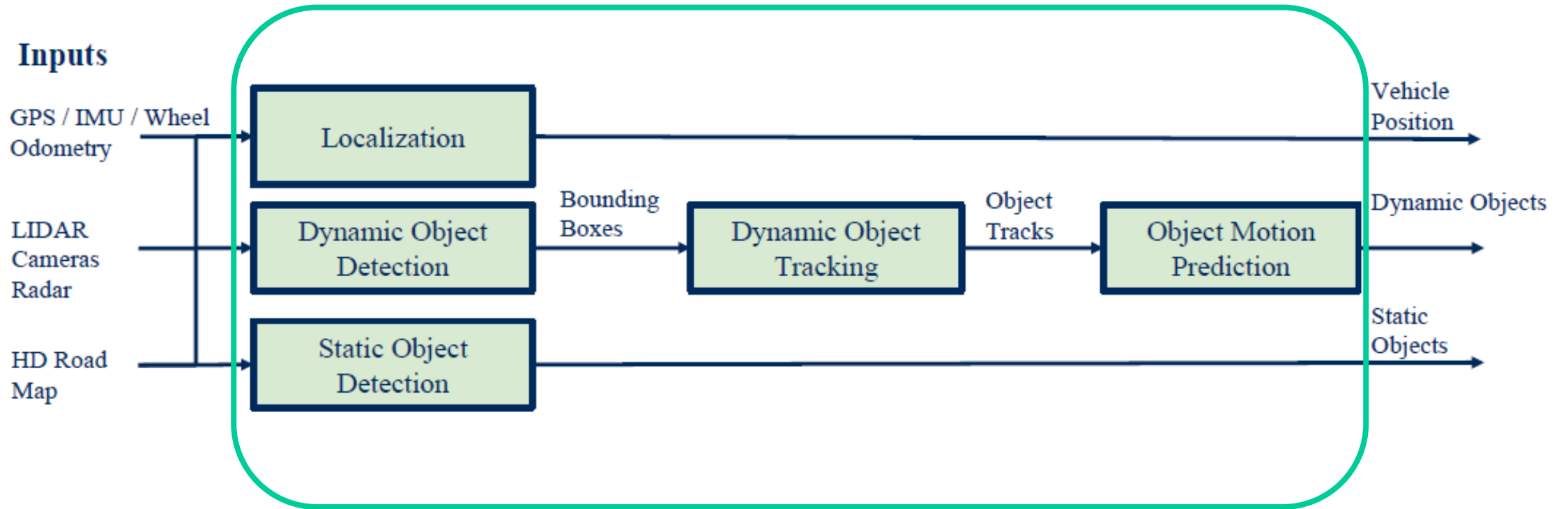



# Arquitetura de Software: Mapeamento do ambiente

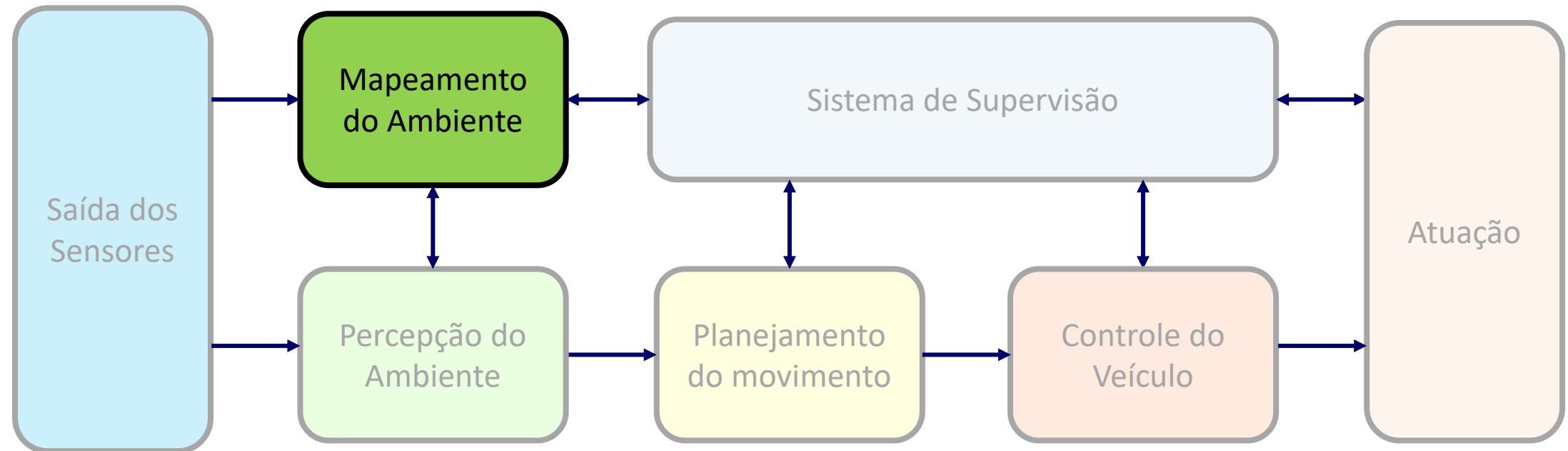

# Arquitetura de Software: Mapeamento do ambiente

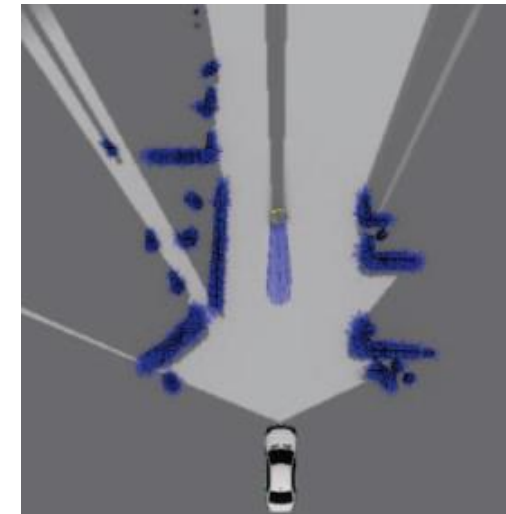
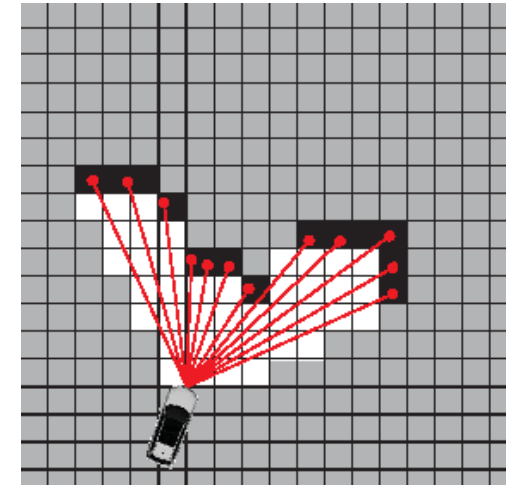
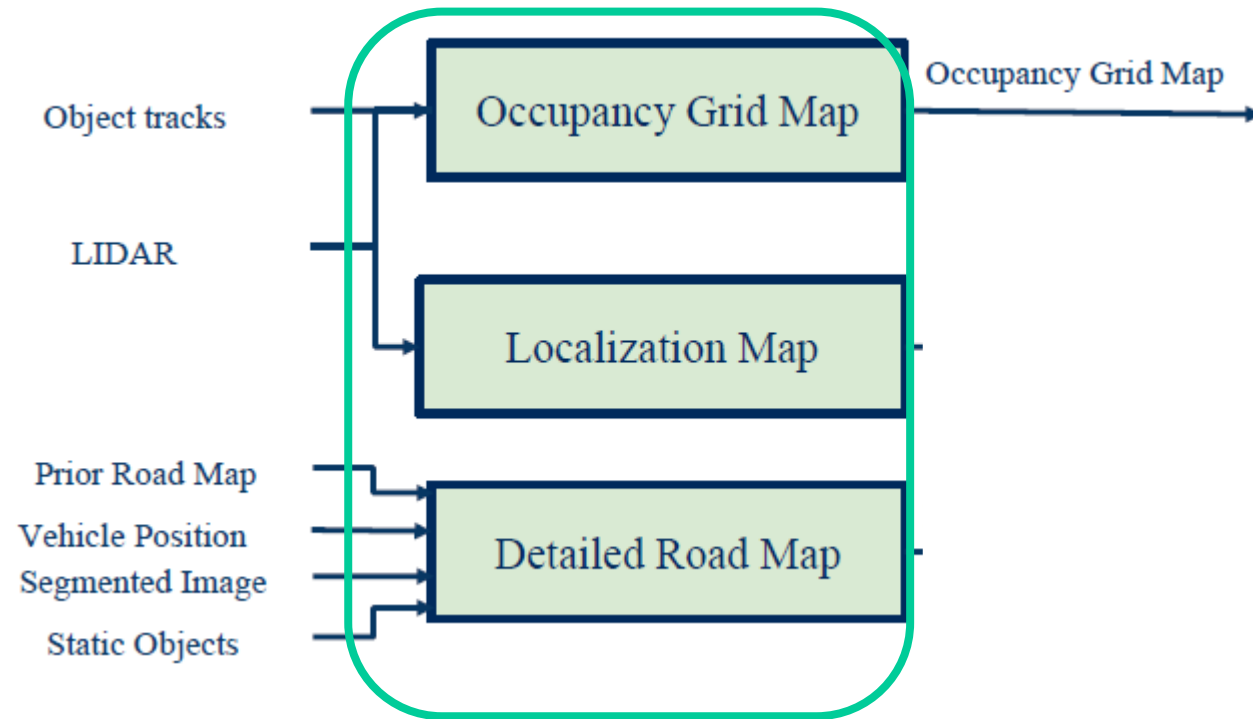

# Arquitetura de Software: Mapeamento do ambiente

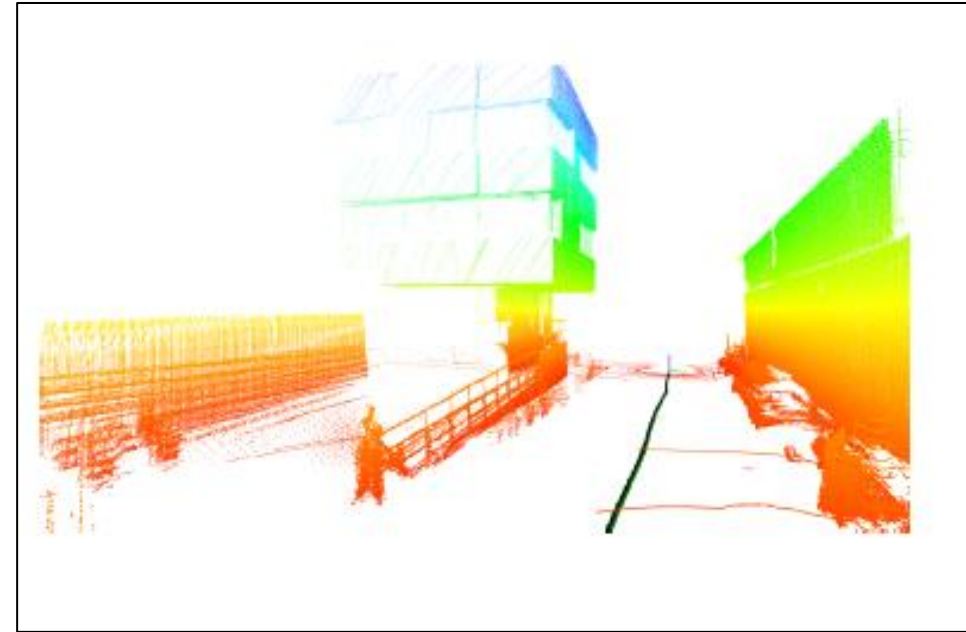
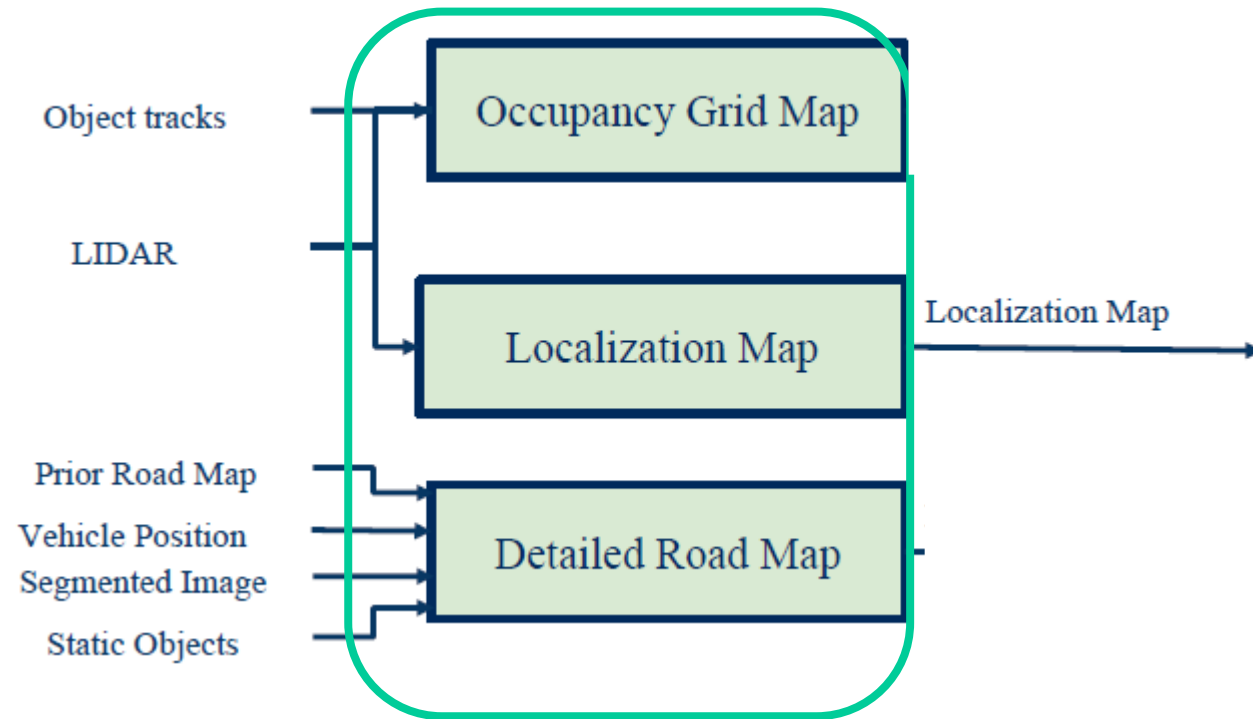

# Arquitetura de Software: Mapeamento do ambiente

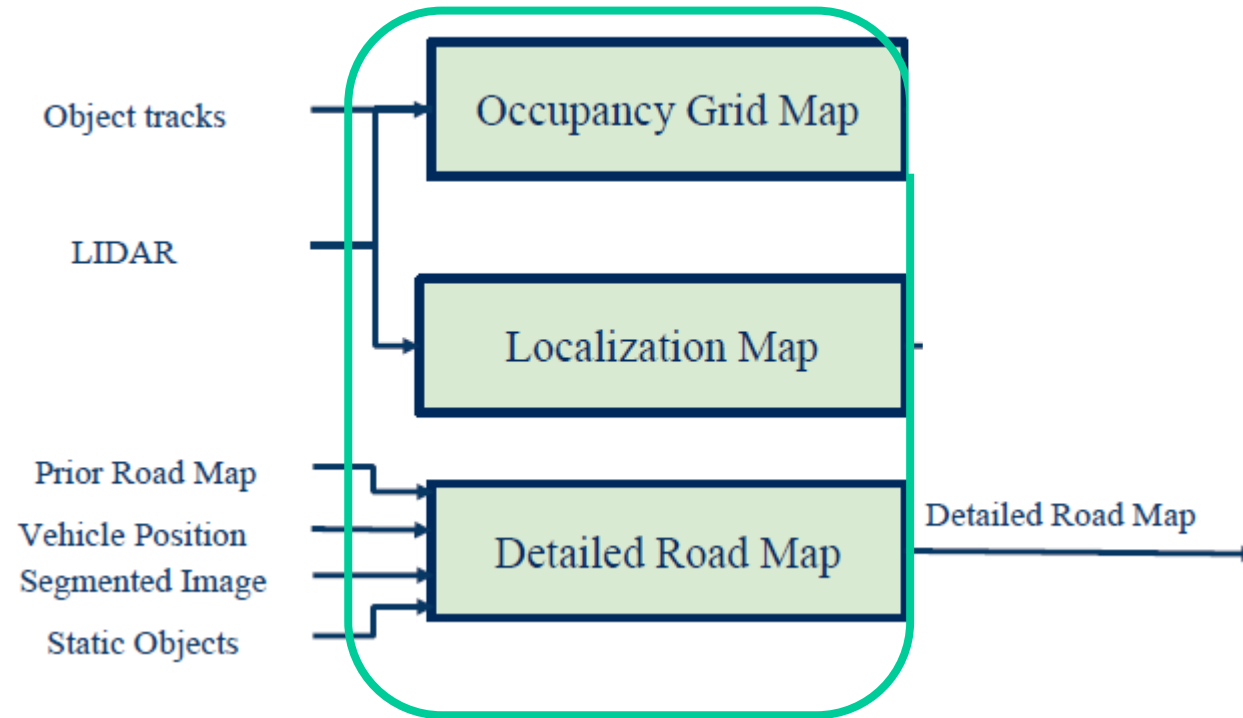

# Arquitetura de Software: Planejamento do movimento

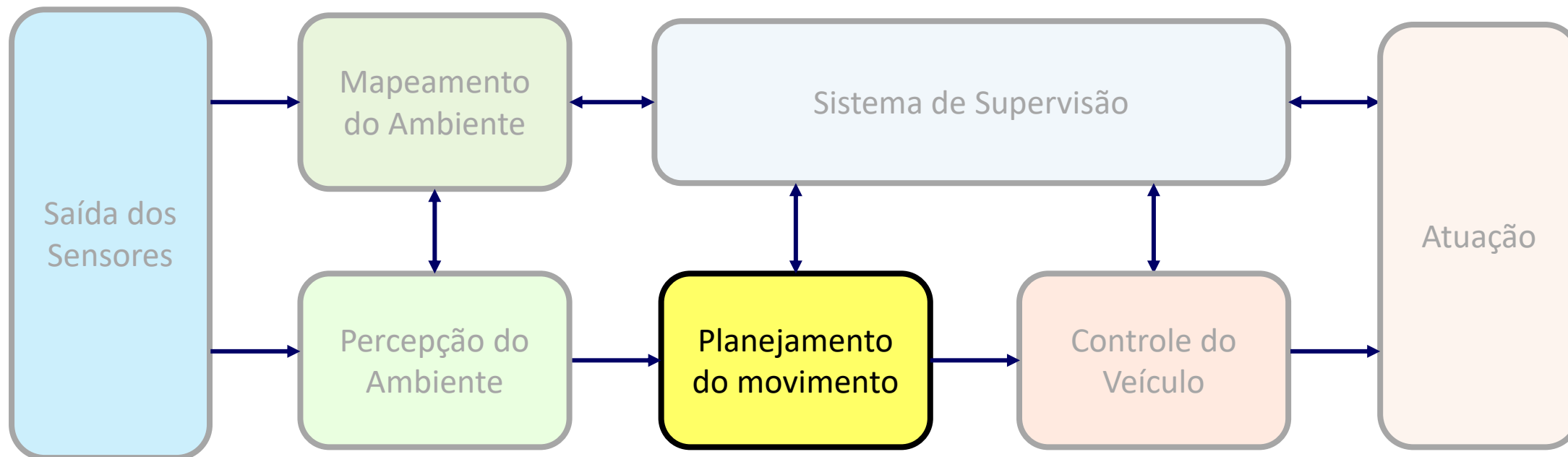

# Arquitetura de Software: Planejamento do movimento

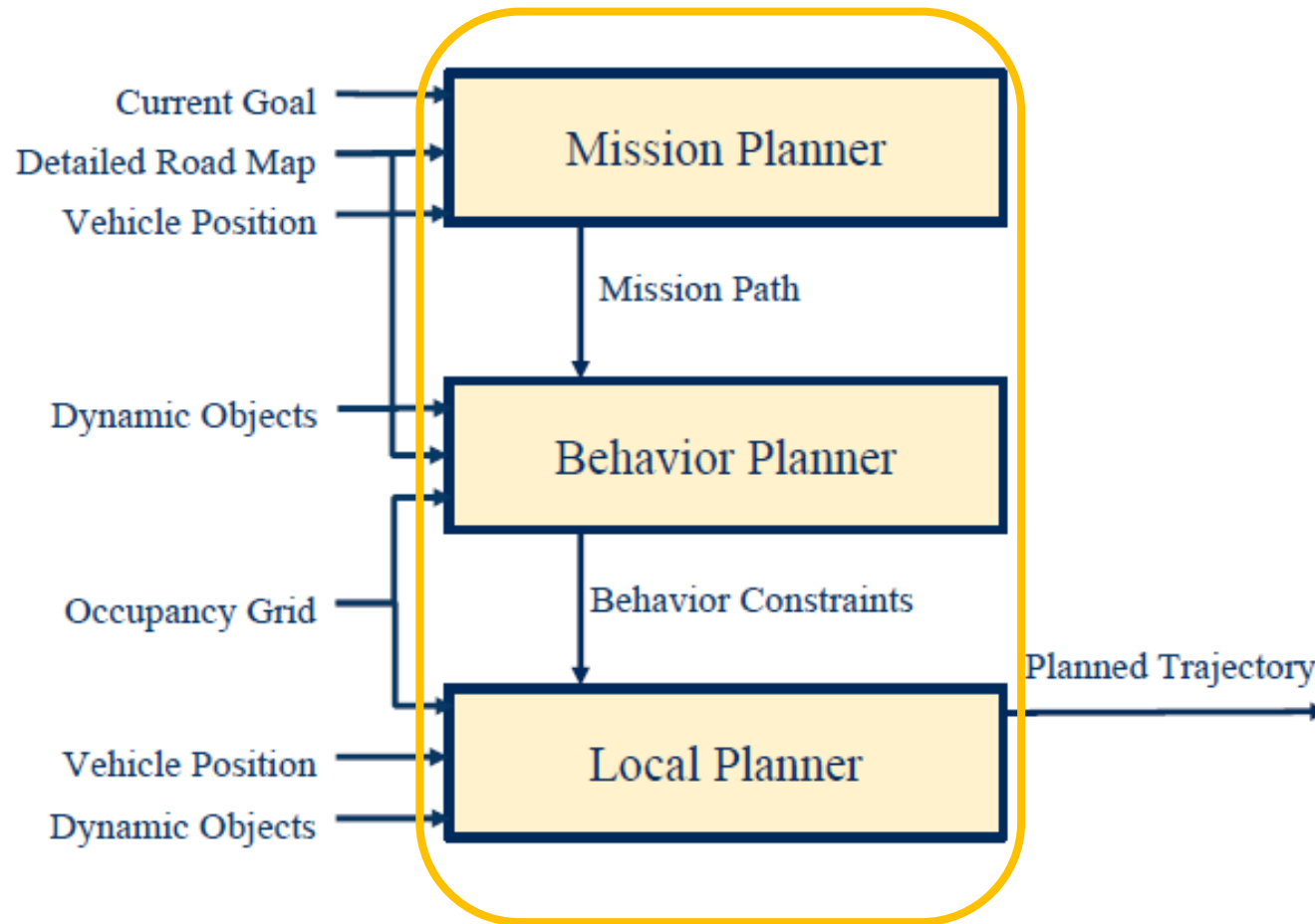

# Arquitetura de Software: Planejamento do movimento

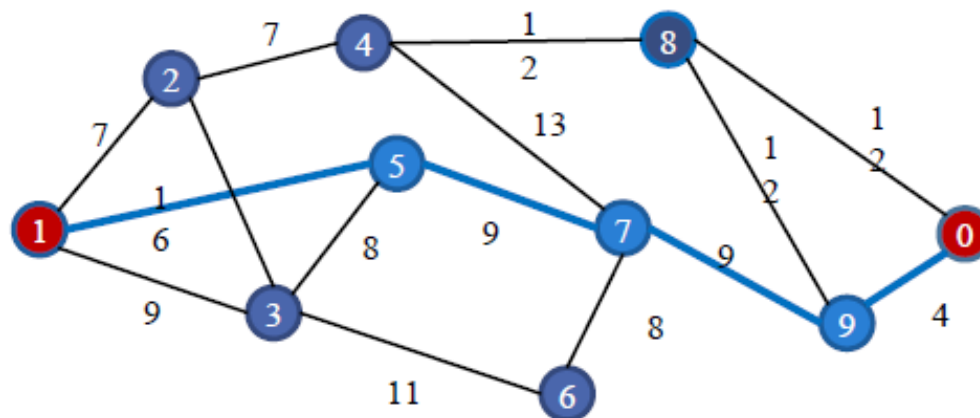
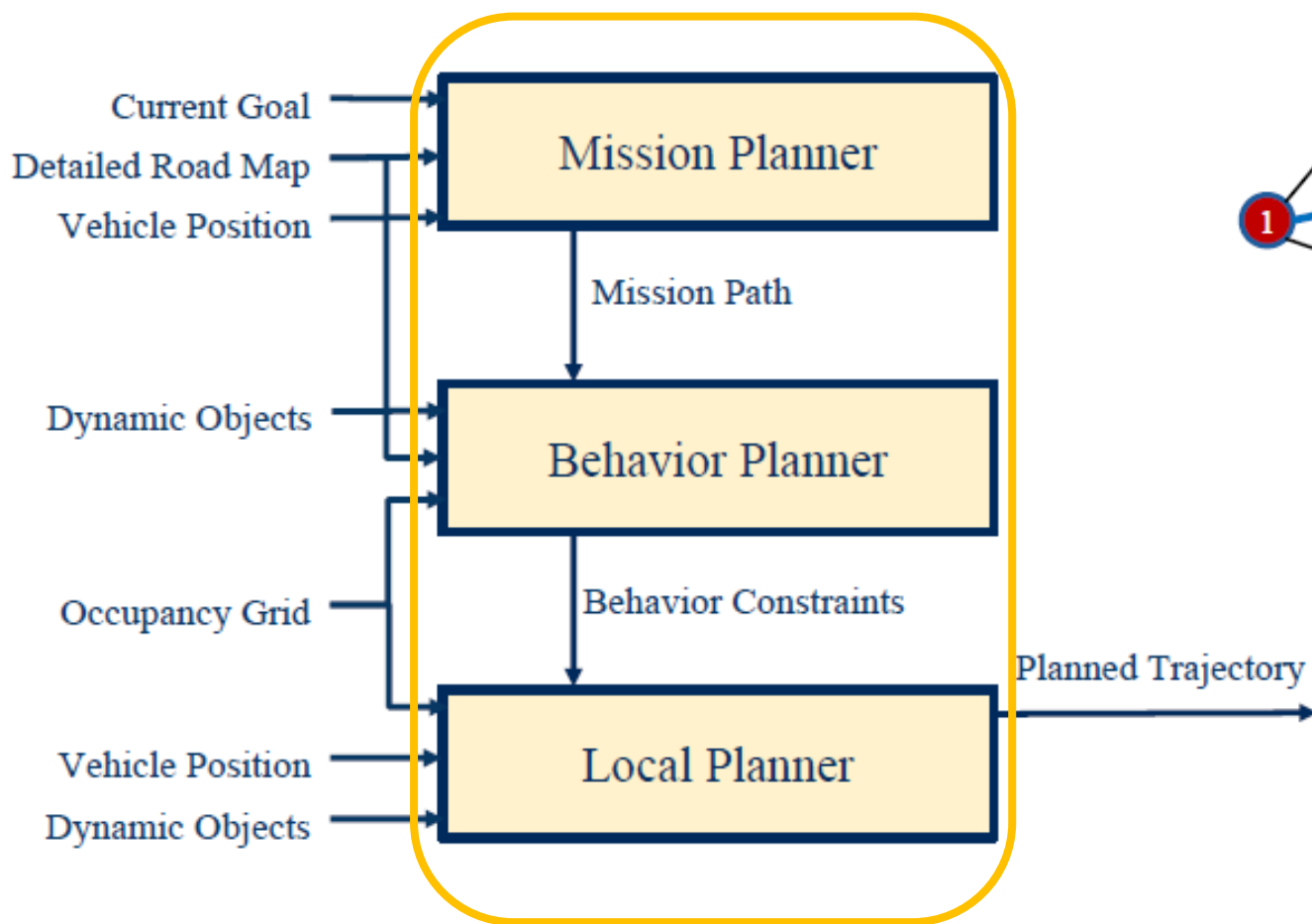

# Arquitetura de Software: Planejamento do movimento

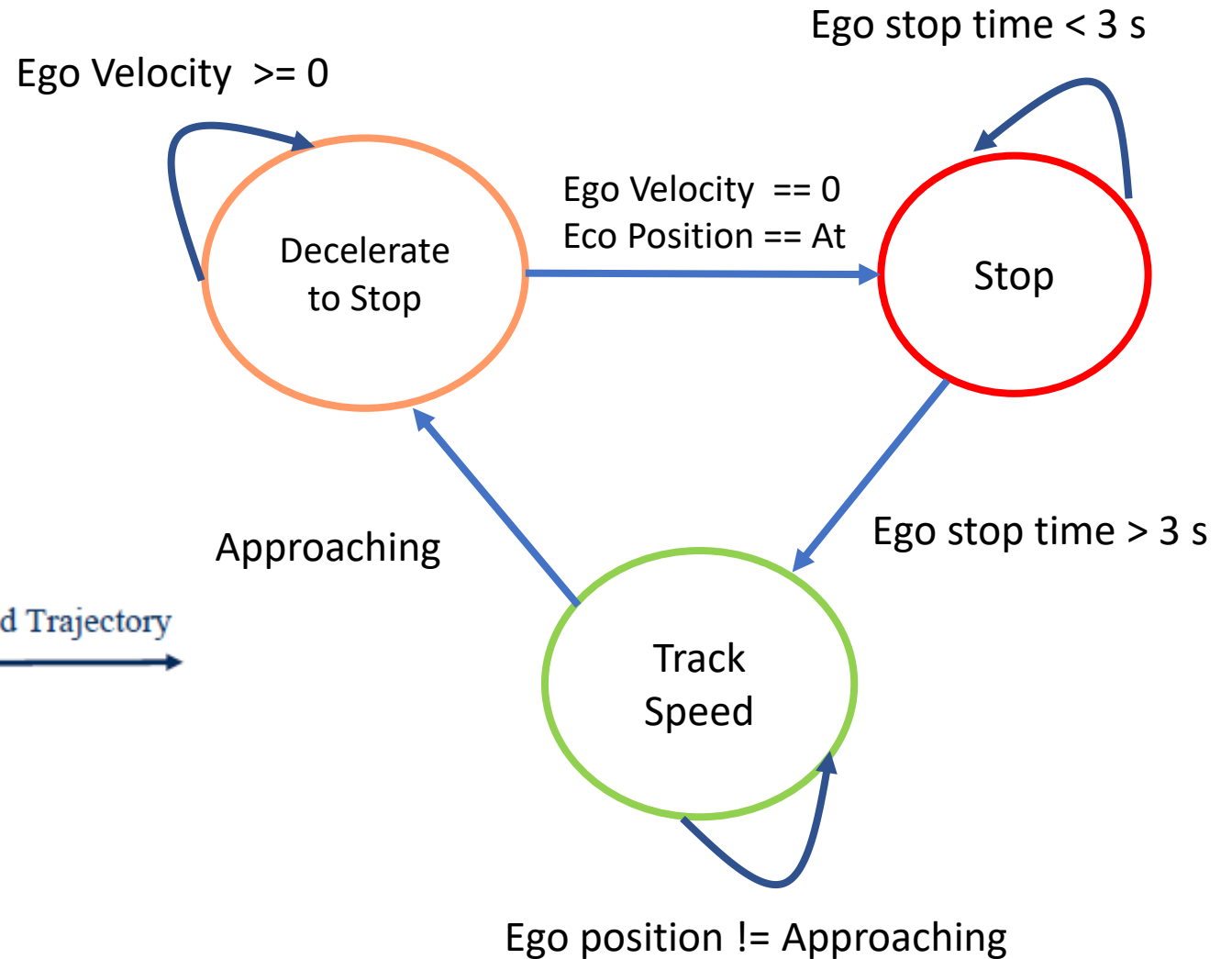
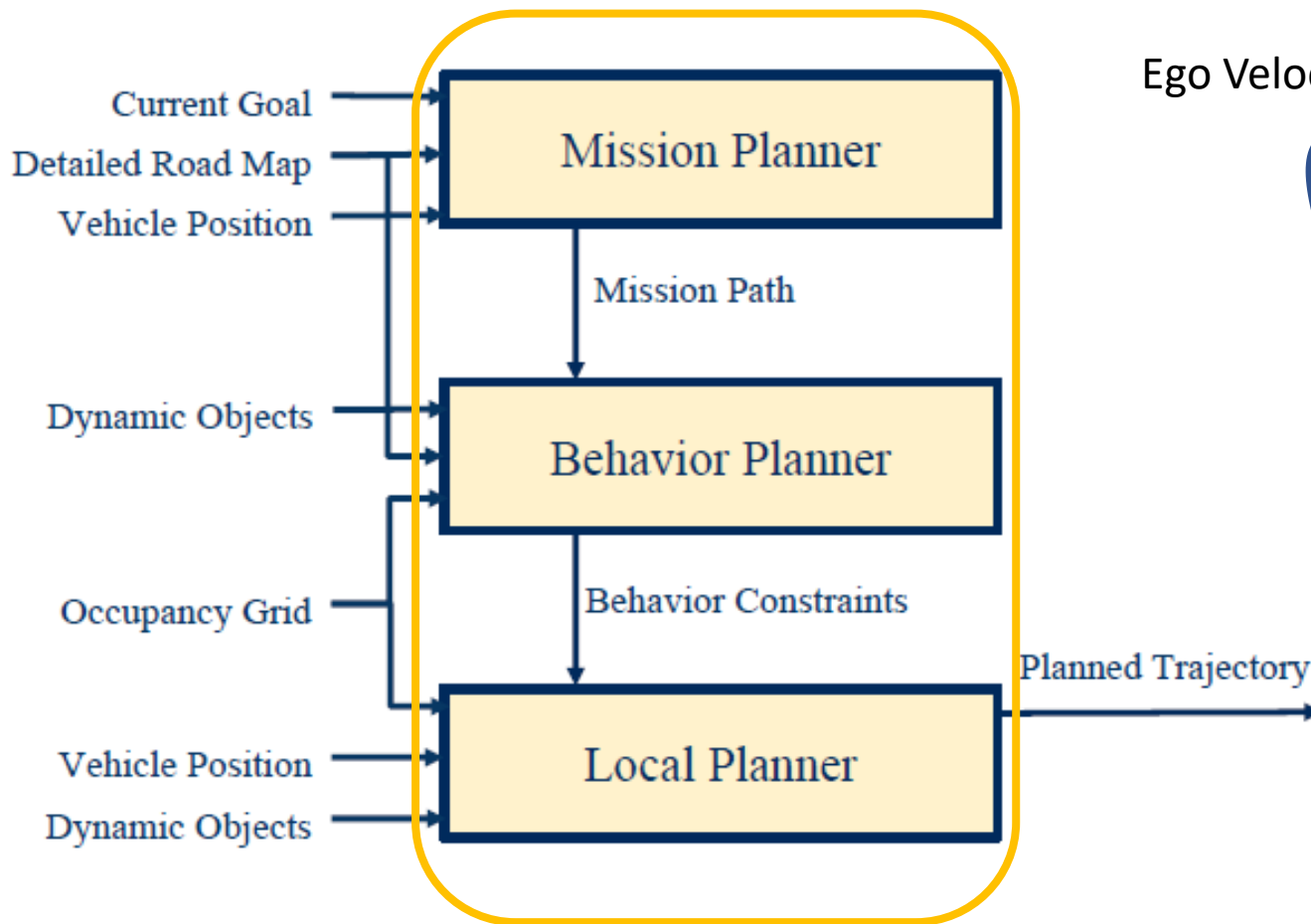



# Arquitetura de Software: Planejamento do movimento

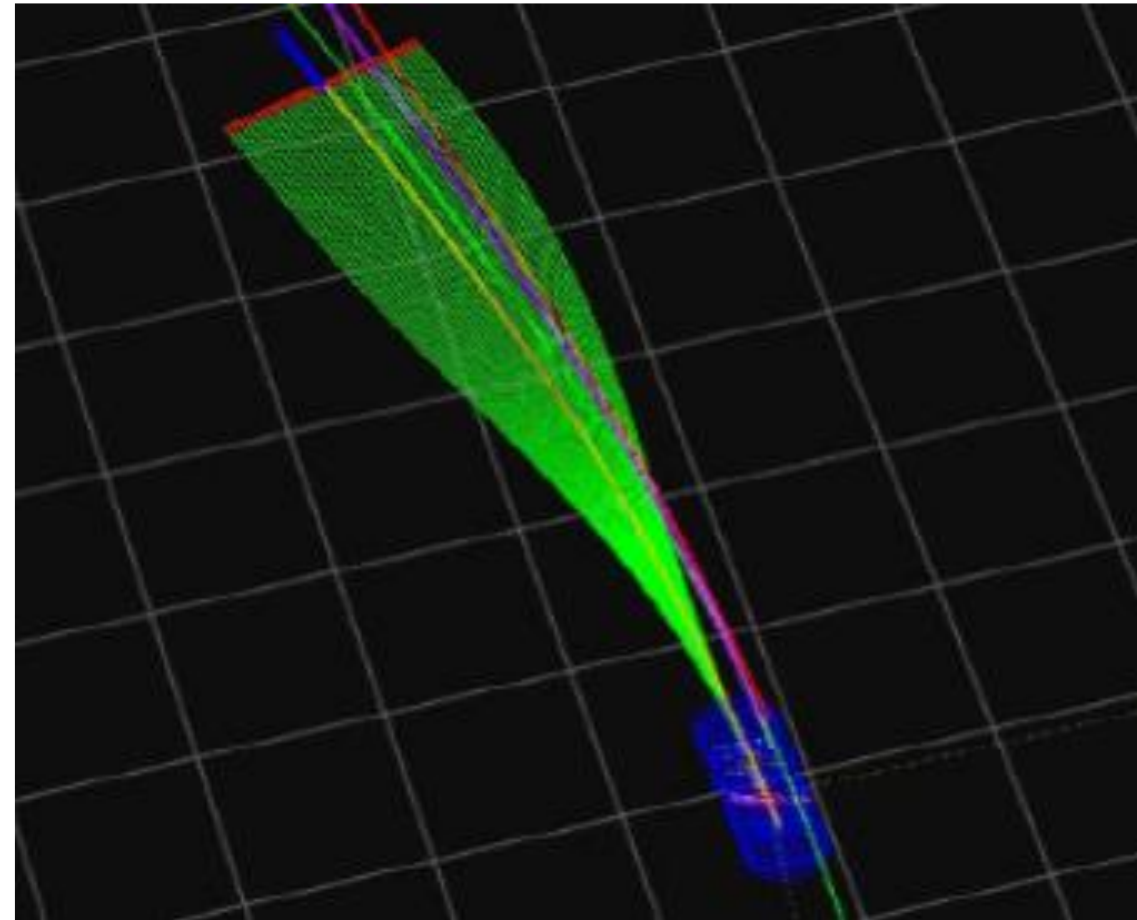
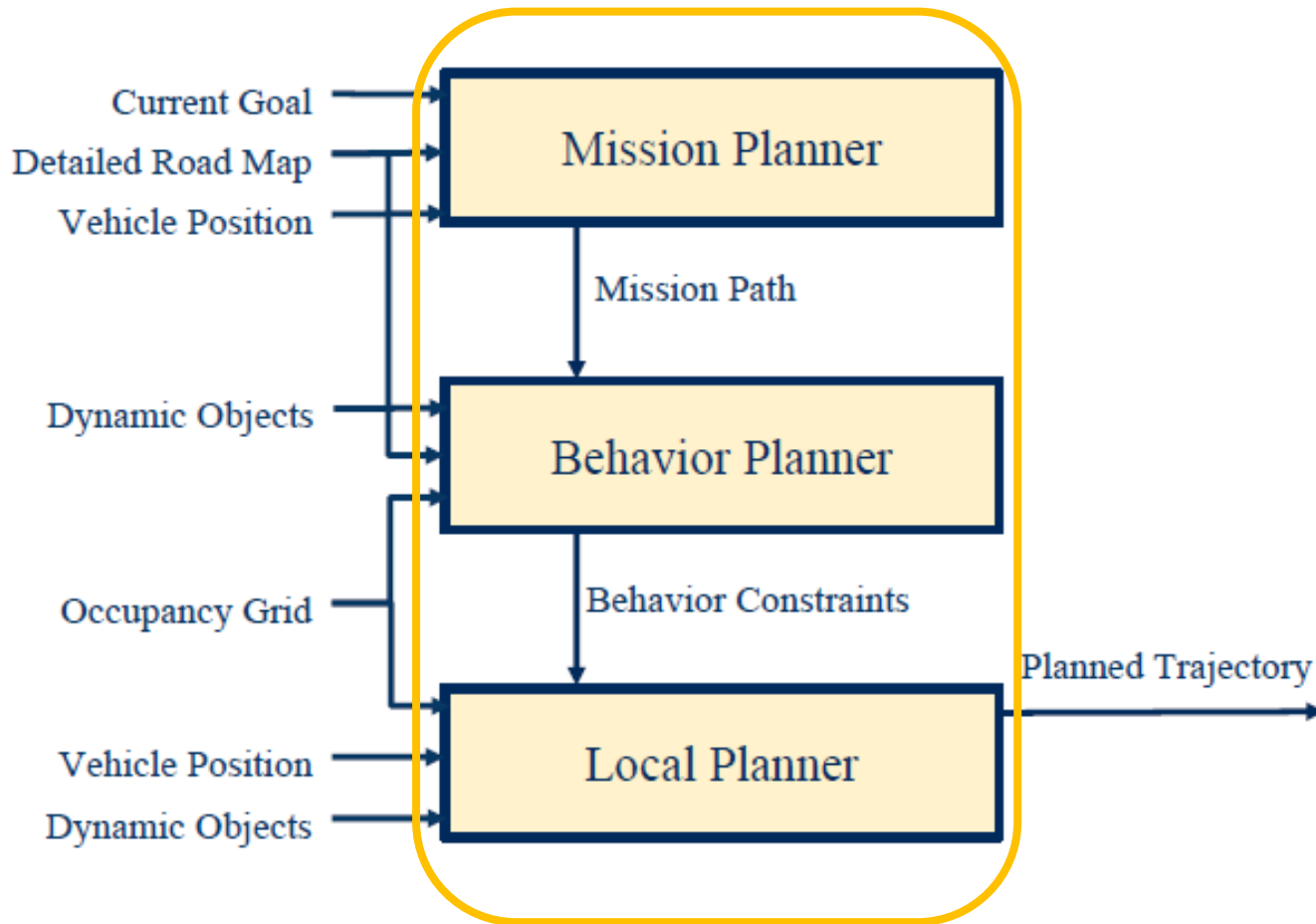

# Arquitetura de Software: Controle do Veículo

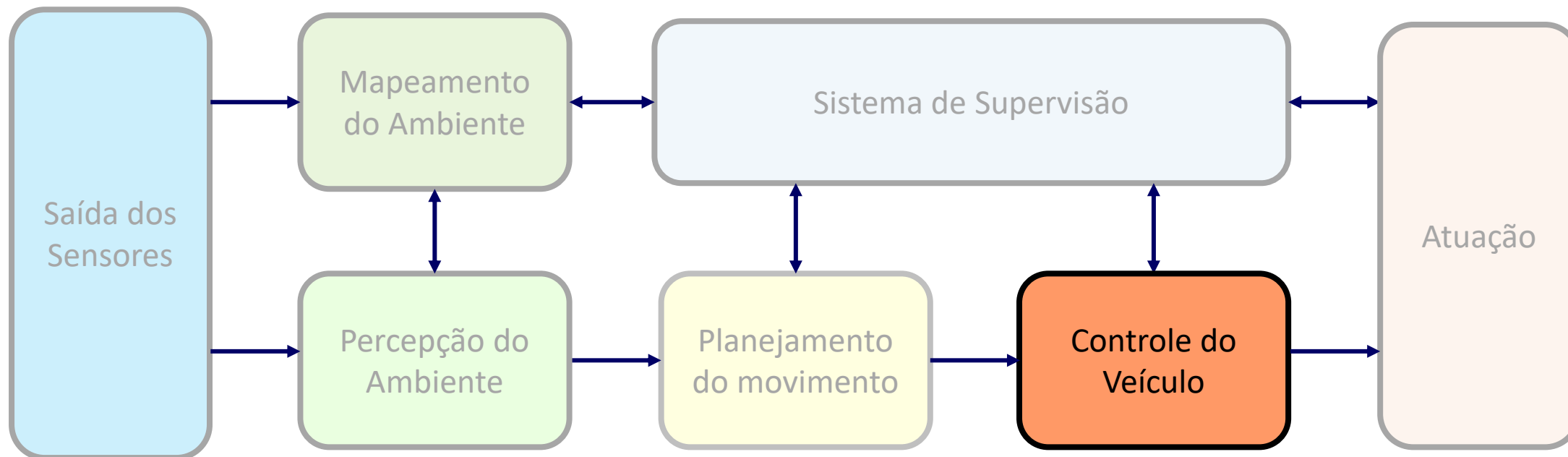

# Arquitetura de Software: Controle do Veículo

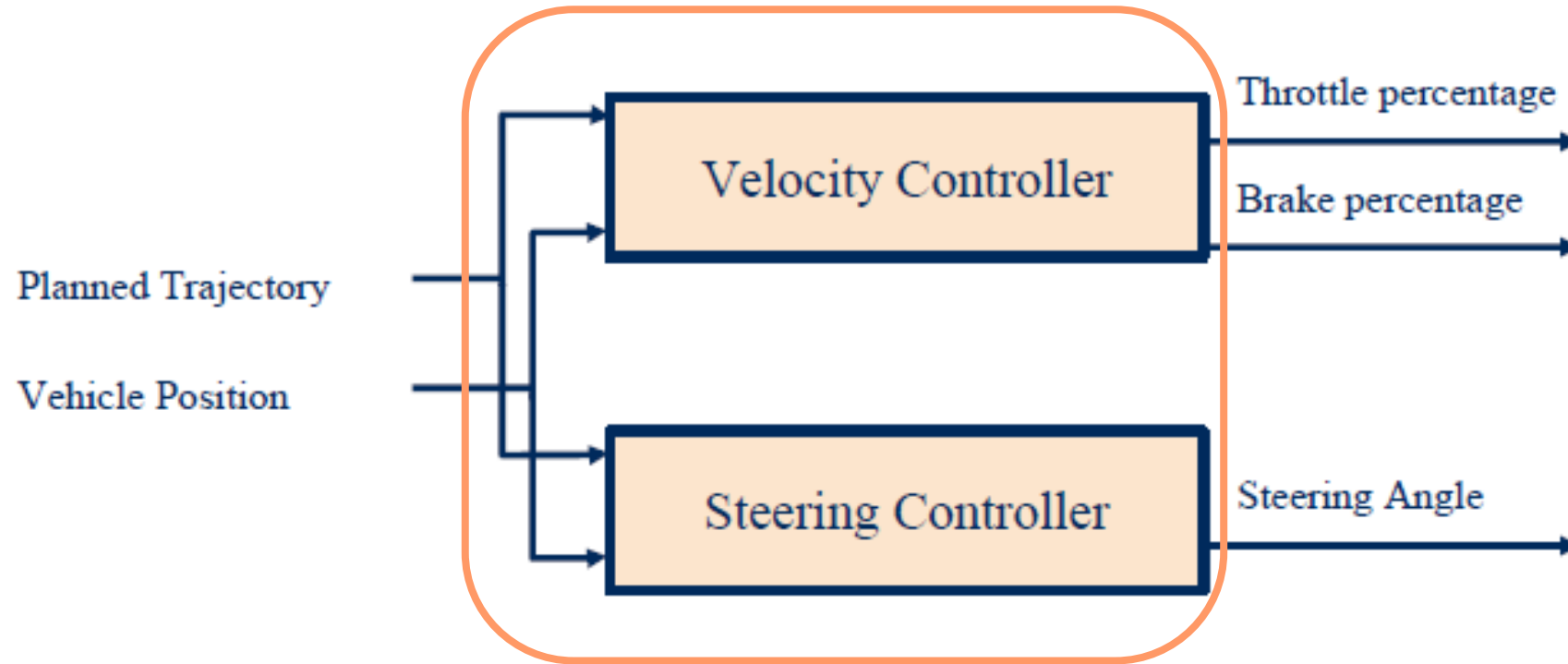

# Arquitetura de Software: Controle do Veículo

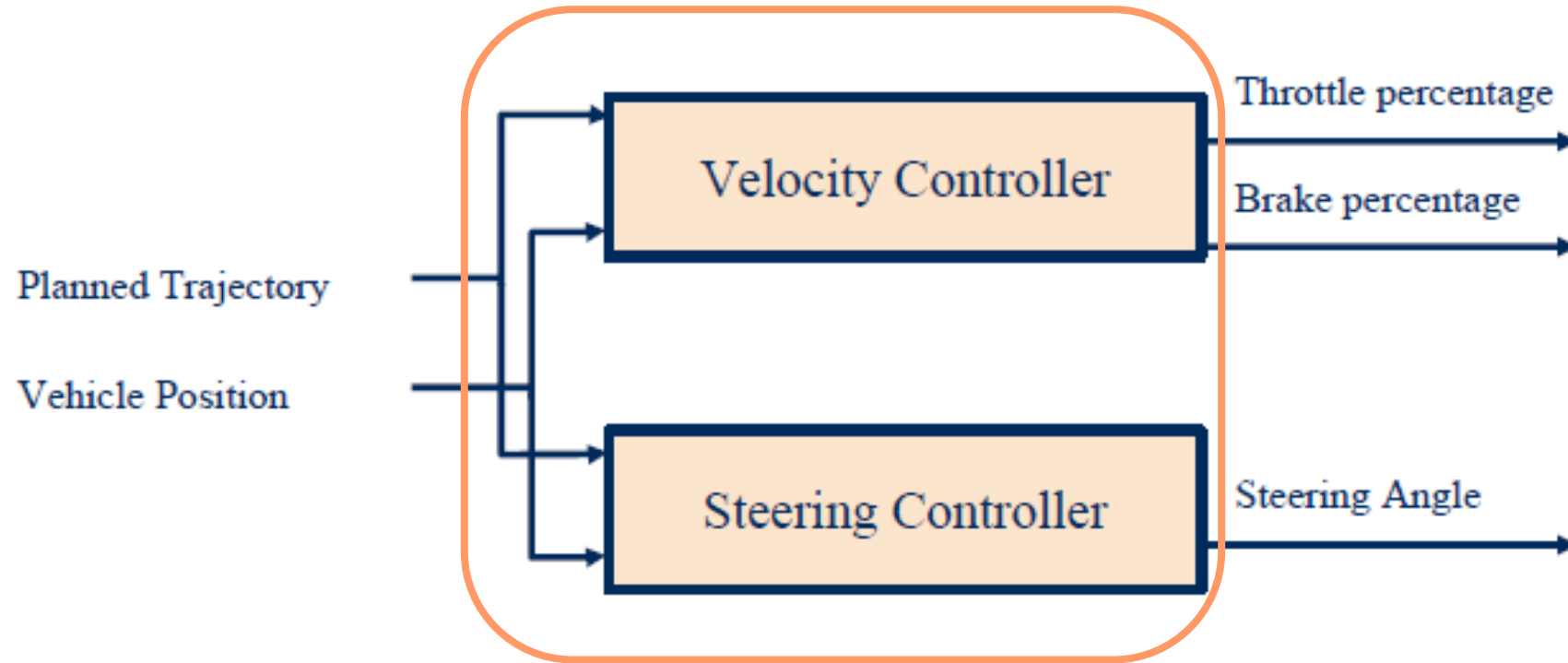

# Arquitetura de Software: Sistema de supervisão

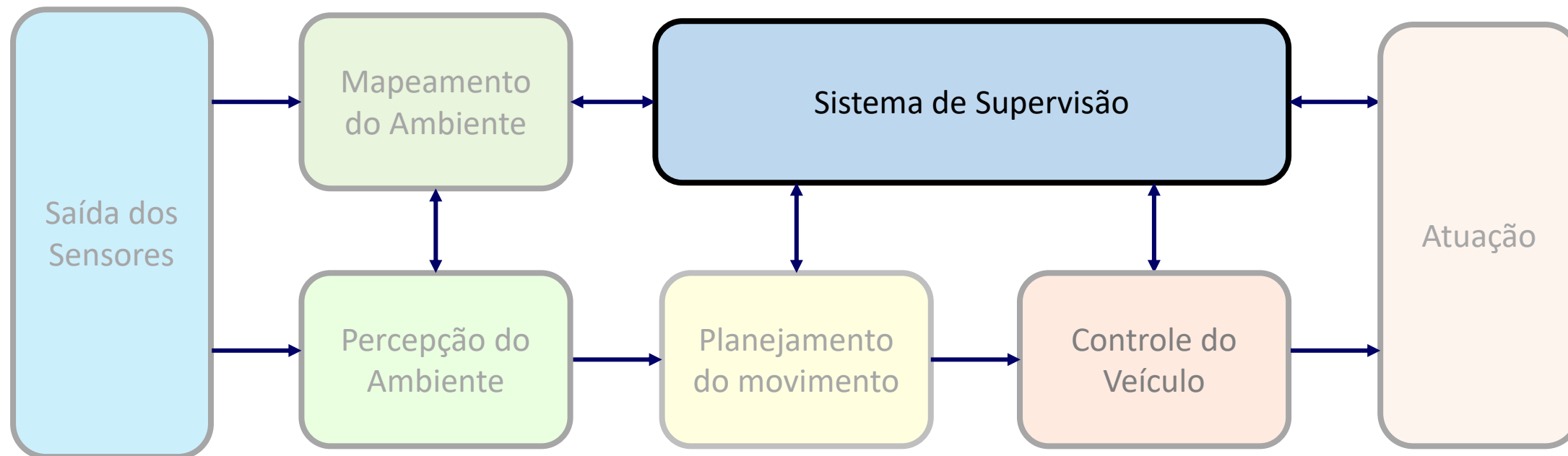

# Arquitetura de Software: Sistema de supervisão

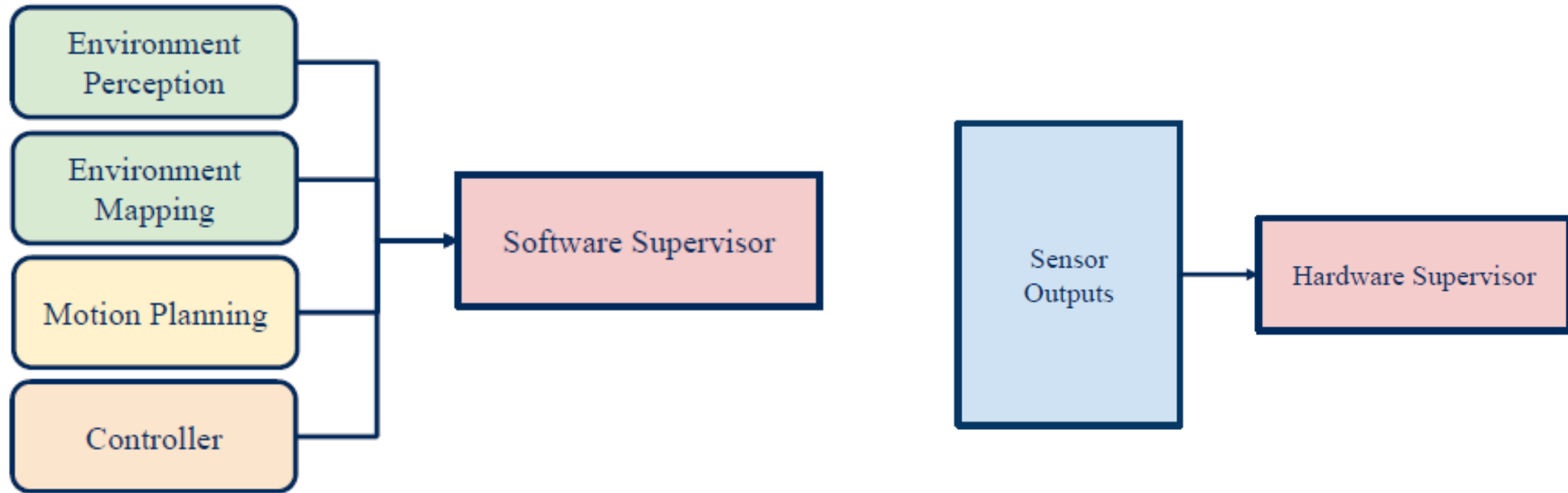

# Tipos de mapas de representação do ambiente

- Localização do veículo no ambiente
  - Nuvem de pontos
- Evitar colisão com objetos estáticos
  - Mapa de ocupação
- Planejamento de trajetórias
  - Mapa detalhado da via

## Point cloud or Feature Map (Localization Map)

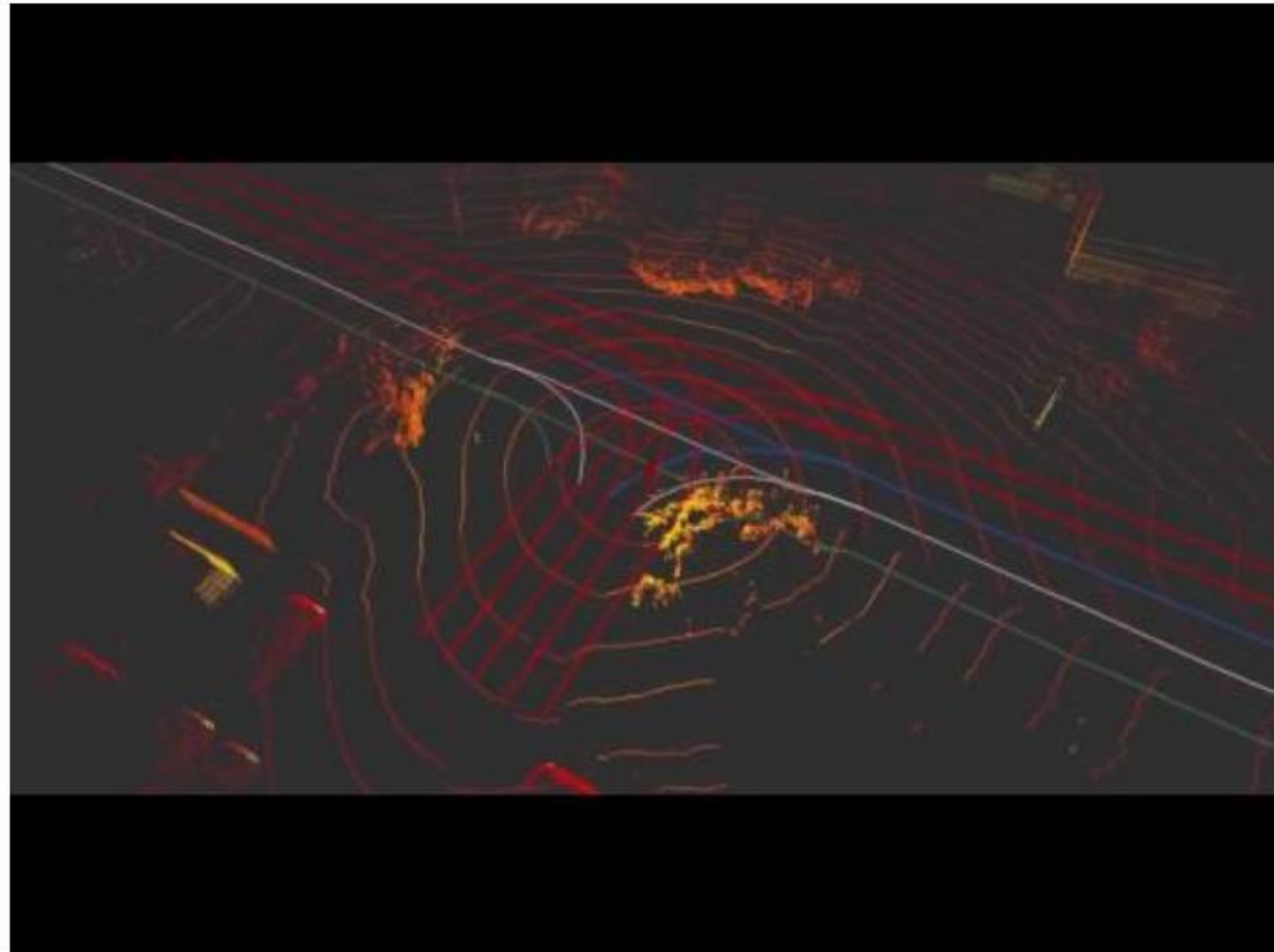



# Occupancy Grid

- Discretized fine grain grid map
  - Can be 2D or 3D
- Occupancy by a static object
  - Trees and buildings
- Curbs and other non drivable surfaces
  - Dynamic objects are removed

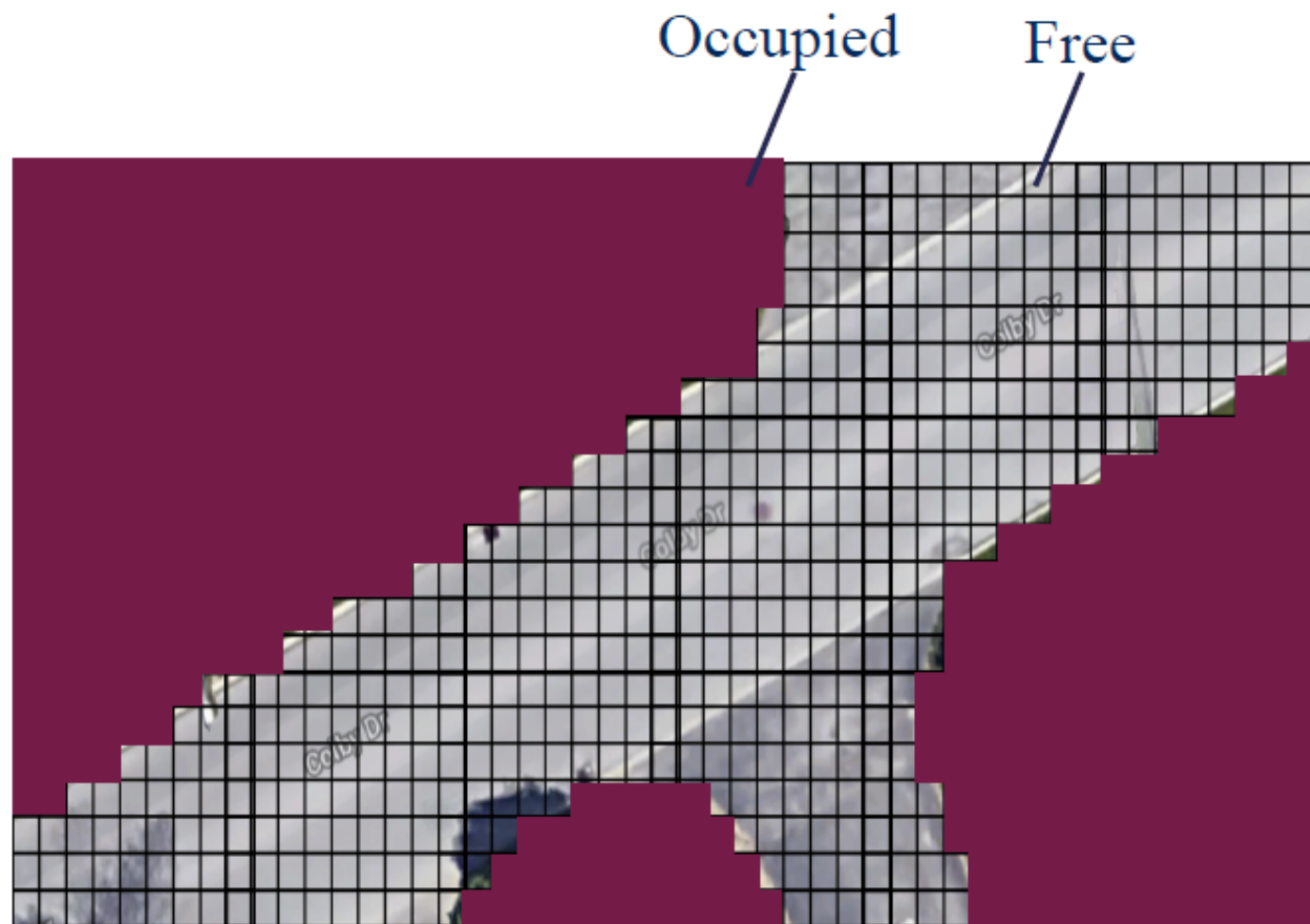

# Occupancy Grid Map

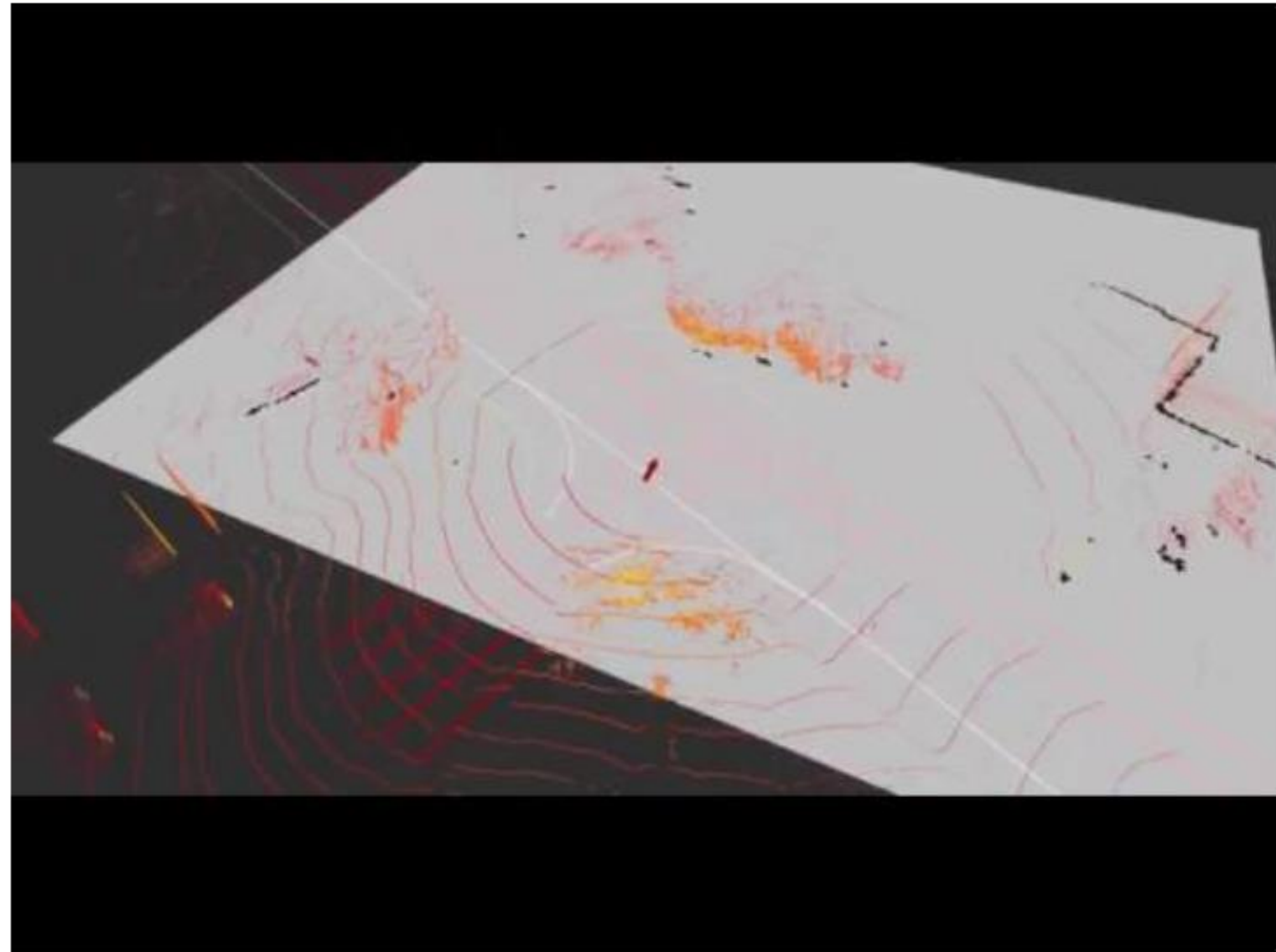

# Detailed Roadmap

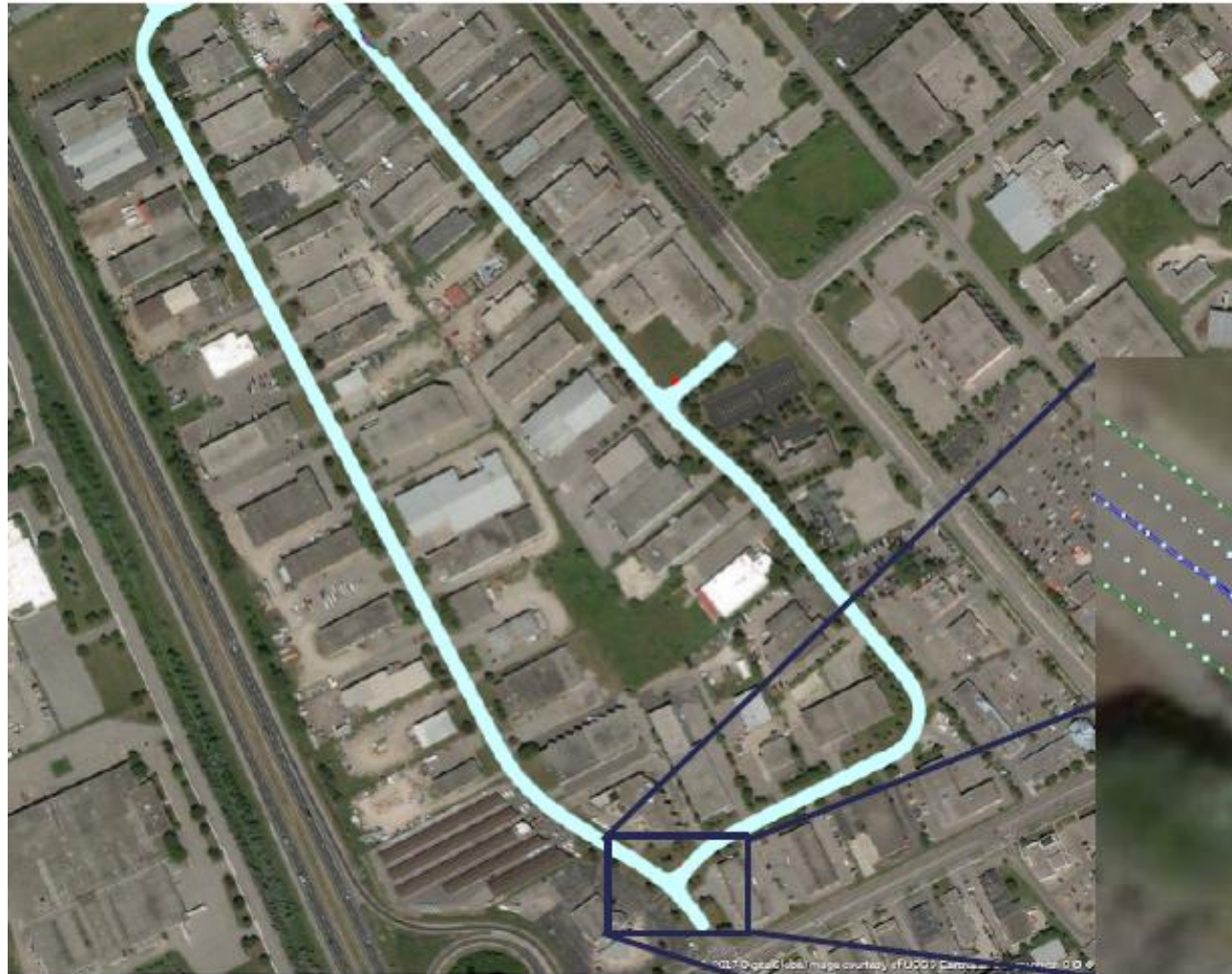

Traffic regulation Lane Boundaries



# Detailed Roadmap

