

Criação do Cubo



v1

f1

(0, 0, 0)



```
mvsf(1,1,1,1,0.0,0.0,0.0);  
mev(1,1,1,1,2,1,1,1,1,10.0,0.0,0.0);
```

Criação do Cubo

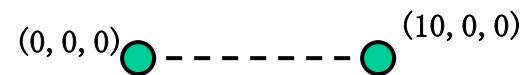
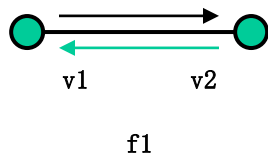

```
mev(1,2,1,1,3,1,1,1,1,10.0,0.0,10.0);
```

Criação do Cubo

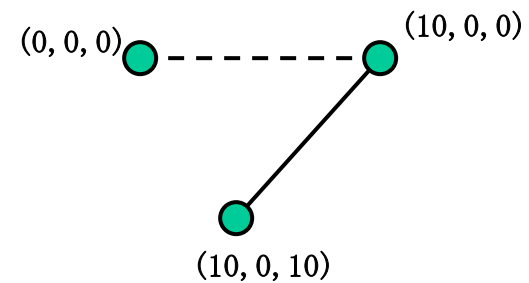
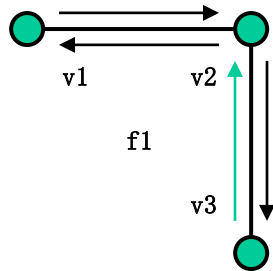

```
mev(1,3,2,2,4,1,1,1,1,0.0,0.0,10.0);
```

Criação do Cubo

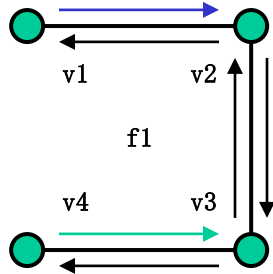

— Nova Face
— Face Original

`mef(1,1,4,2,3,1,1,1,2);`

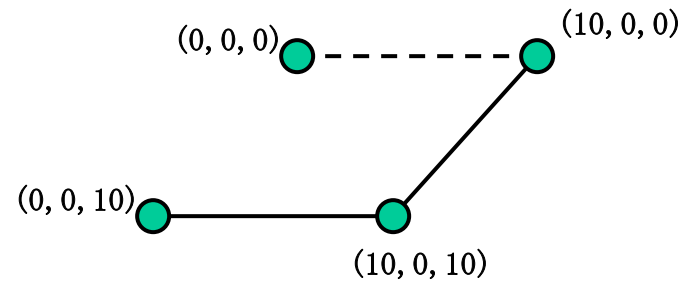

Criação do Cubo

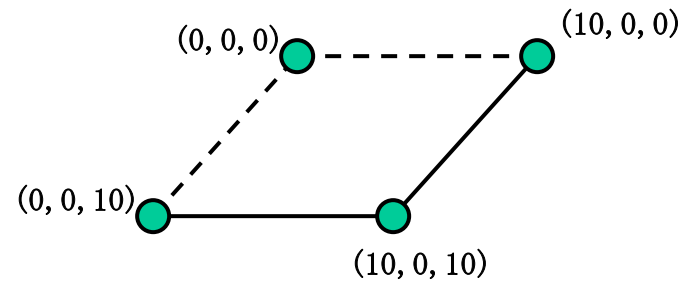
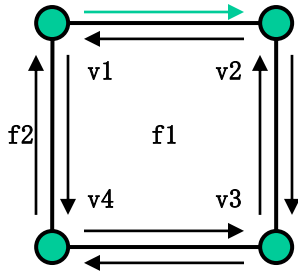

`mev(1,1,2,2,5,2,2,1,1,0.0,10.0,0.0);`

Criação do Cubo

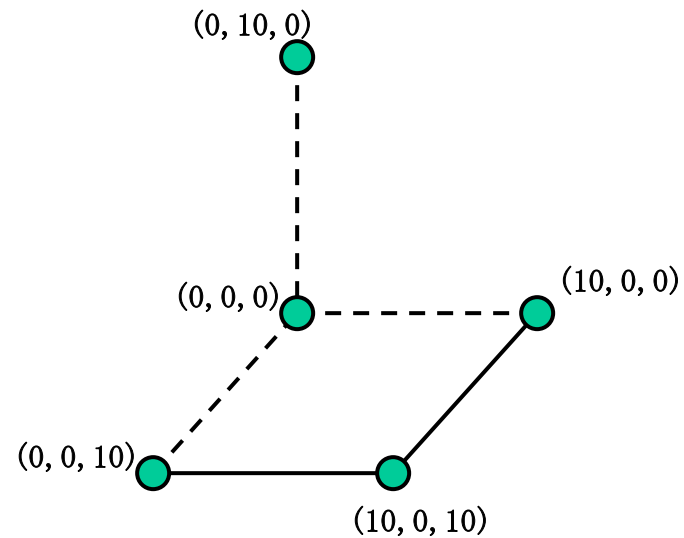
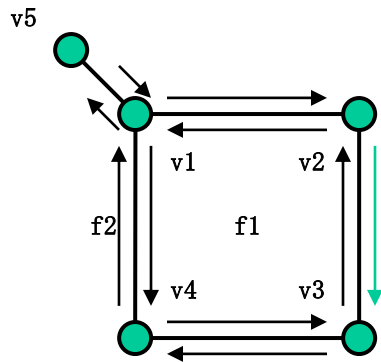

`mev(1,2,3,3,6,2,2,1,1,10.0,10.0,0.0);`

Criação do Cubo

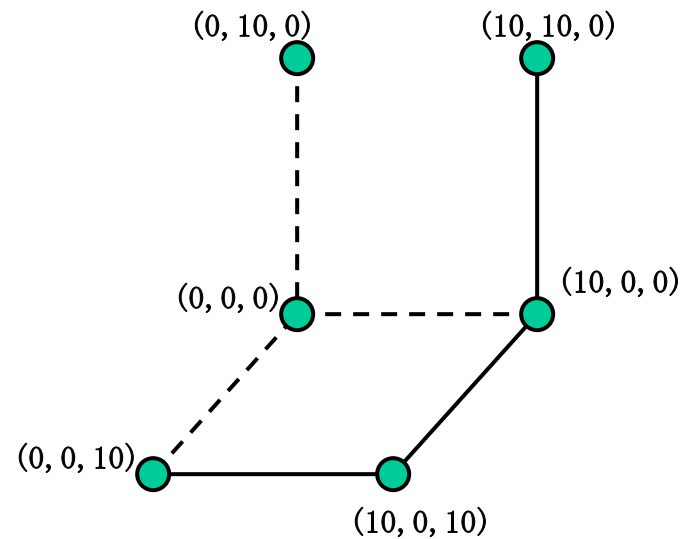
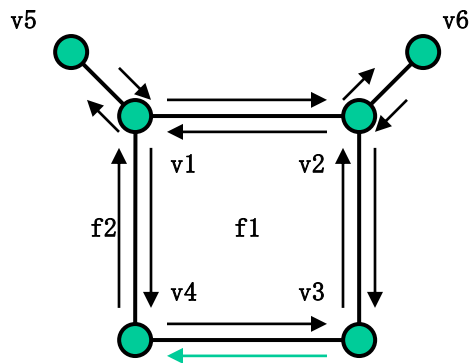

mev(1,3,4,4,7,2,2,1,1,10.0,10.0,10.0);

Criação do Cubo

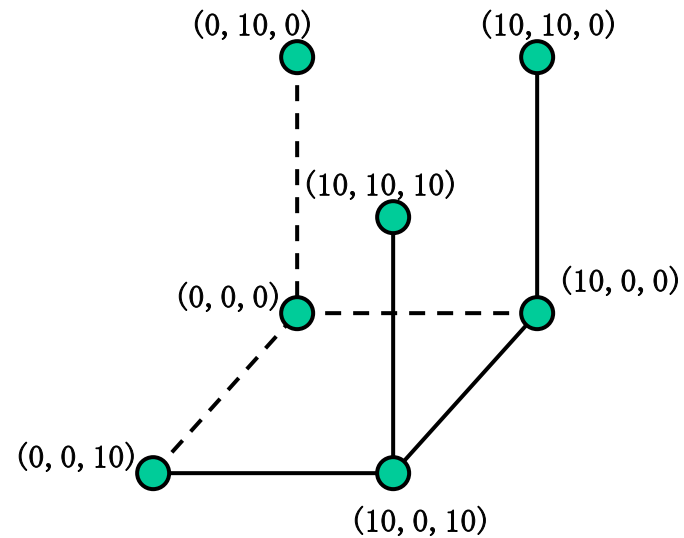
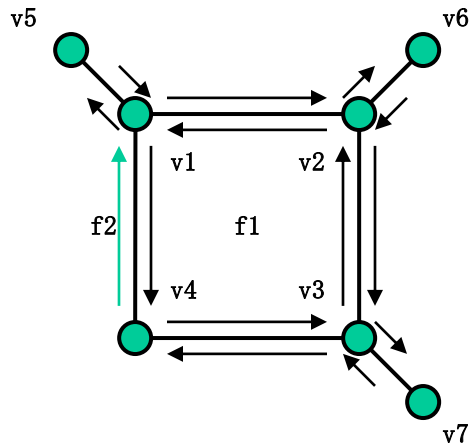

`mev(1,4,1,1,8,2,2,1,1,0.0,10.0,10.0);`

Criação do Cubo

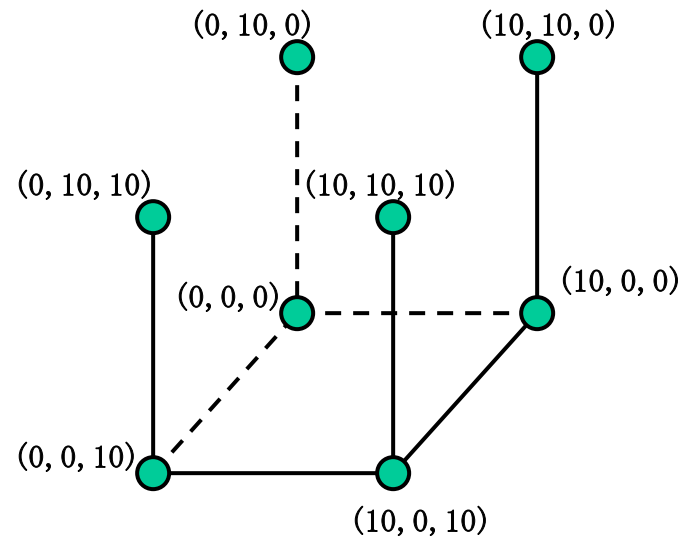
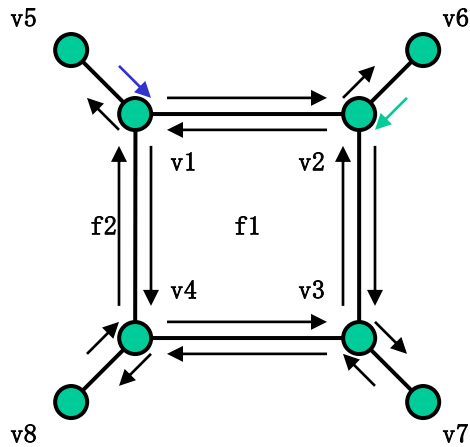

- Nova Face
- Face Original

mef(1,5,6,1,2,2,2,2,3);

Criação do Cubo

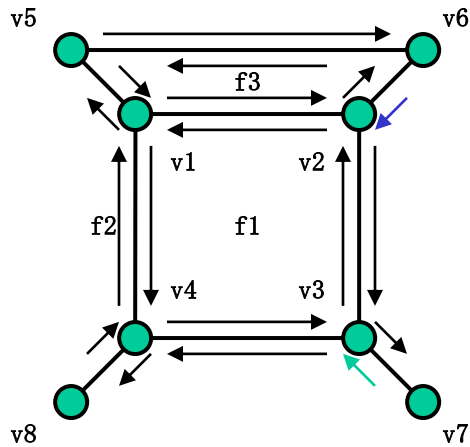

- Nova Face
- Face Original

`mef(1,6,7,2,3,2,3,2,4);`

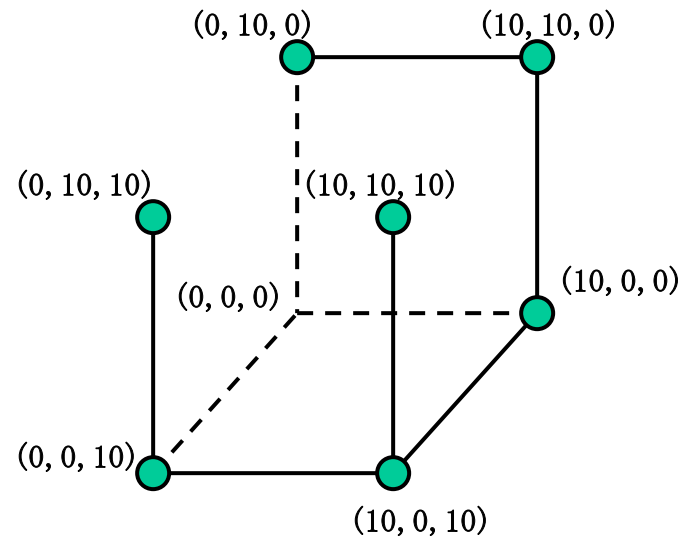

Criação do Cubo

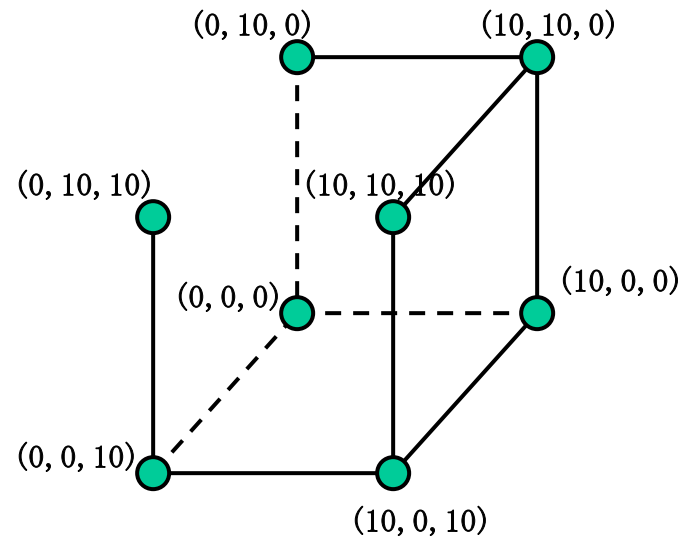
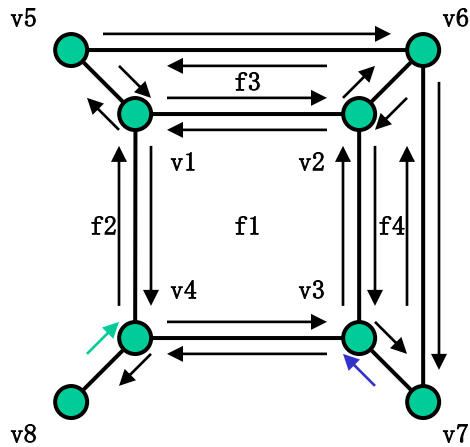

- Nova Face
- Face Original

mef(1,7,8,3,4,2,4,2,5);

Criação do Cubo

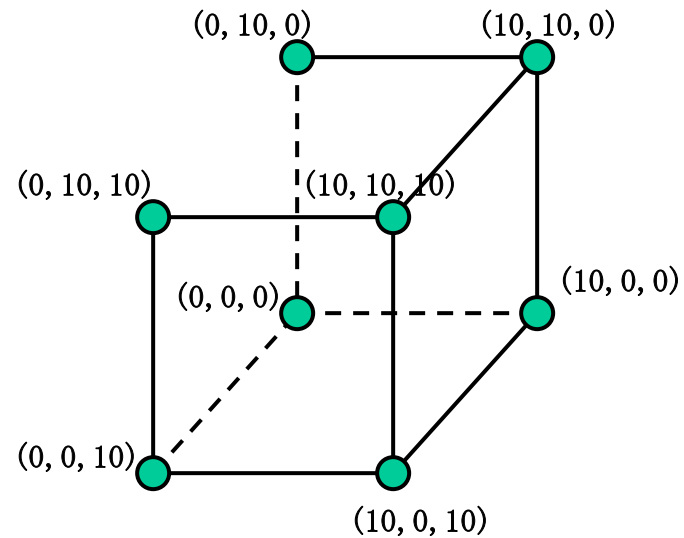
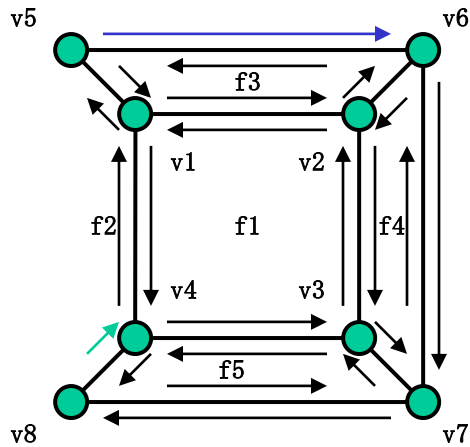

- Nova Face
- Face Original

`mef(1,8,5,4,6,2,5,3,6);`

Criação do Cubo

