

Análise de Alimentos II

Espectroscopia atômica

Prof^a Dr^a Rosemary Aparecida de Carvalho



Pirassununga/SP
2018

Espectrometria de Emissão Atômica

1

- Teoria envolvida
- Tipos de espectrometria de emissão

2

- Equipamento: ICP

3

- Aplicações

1. TEORIA

- ✓ Baseia-se na propriedade dos átomos ou íons (no estado gasoso) de, quando excitados, **emitir** radiações com comprimento de onda característicos nas regiões do UV-Vis (180 – 800 nm)

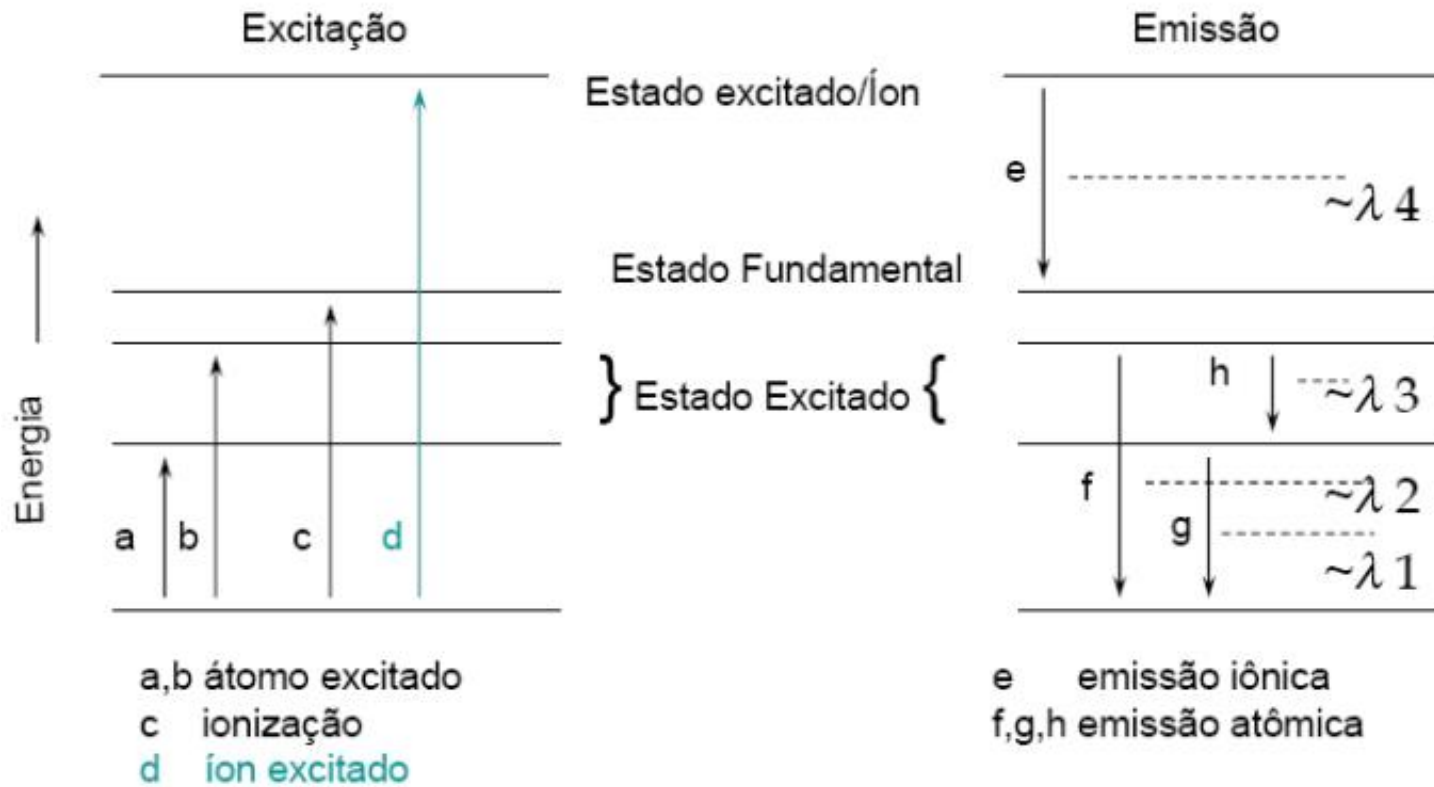
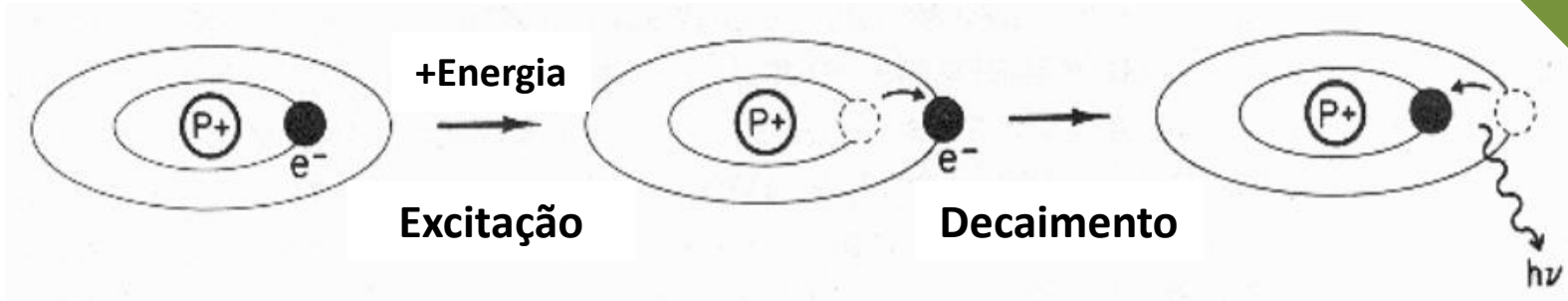



Tipos de Espectrometria de Emissão Atômica

- ✓ Arco ou centelha (*Spark* ou *Arc*)
- ✓ Chama (*Flame Atomic Emission Spectrometry* – FAES)
- ✓ **Plasma**
- ✓ *Laser-induced breakdown* (LIBS) – Tecnologia nova





Espectrometria de Emissão Atômica baseada em plasma

✓ Plasma:

“Mistura gasosa condutora de eletricidade, que contém uma concentração significativa de cátions e elétrons”

✓ Plasma de Argônio:

- Espécies condutoras: Íons argônio e elétrons

| Solid | Liquid | Gas | Plasma |
|--|--|--|--|
| Example Ice H_2O | Example Water H_2O | Example Steam H_2O | Example Ionized Gas $H_2 \rightarrow H^+ + H^+ + 2e^-$ |
| Cold $T < 0^\circ C$ | Warm $0 < T < 100^\circ C$ | Hot $T > 100^\circ C$ | Hotter $T > 100,000^\circ C$ > 10 electron Volts |
|  |  |  |  |
| Molecules Fixed in Lattice | Molecules Free to Move | Molecules Free to Move, Large Spacing | Ions and Electrons Move Independently, Large Spacing |



Tipos de plasma

- ✓ Corrente direta (*Direct-current plasma* – DCP)
- ✓ Microondas (*Microwave-induced plasma* – MIP)
- ✓ **Plasma induzido (*Inductively-coupled plasma* – ICP)**

2. EQUIPAMENTO

Plasma induzido (*Inductively-coupled plasma – ICP*)

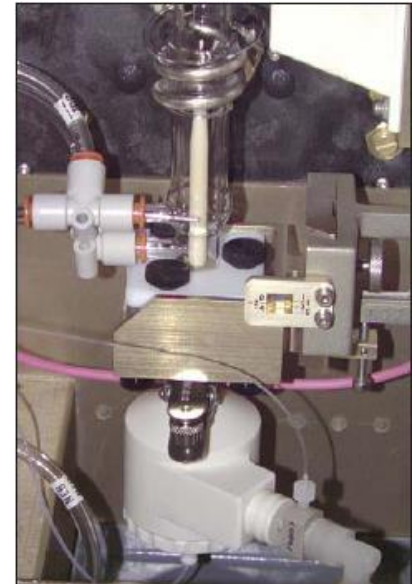

2.1. Fluxograma de funcionamento

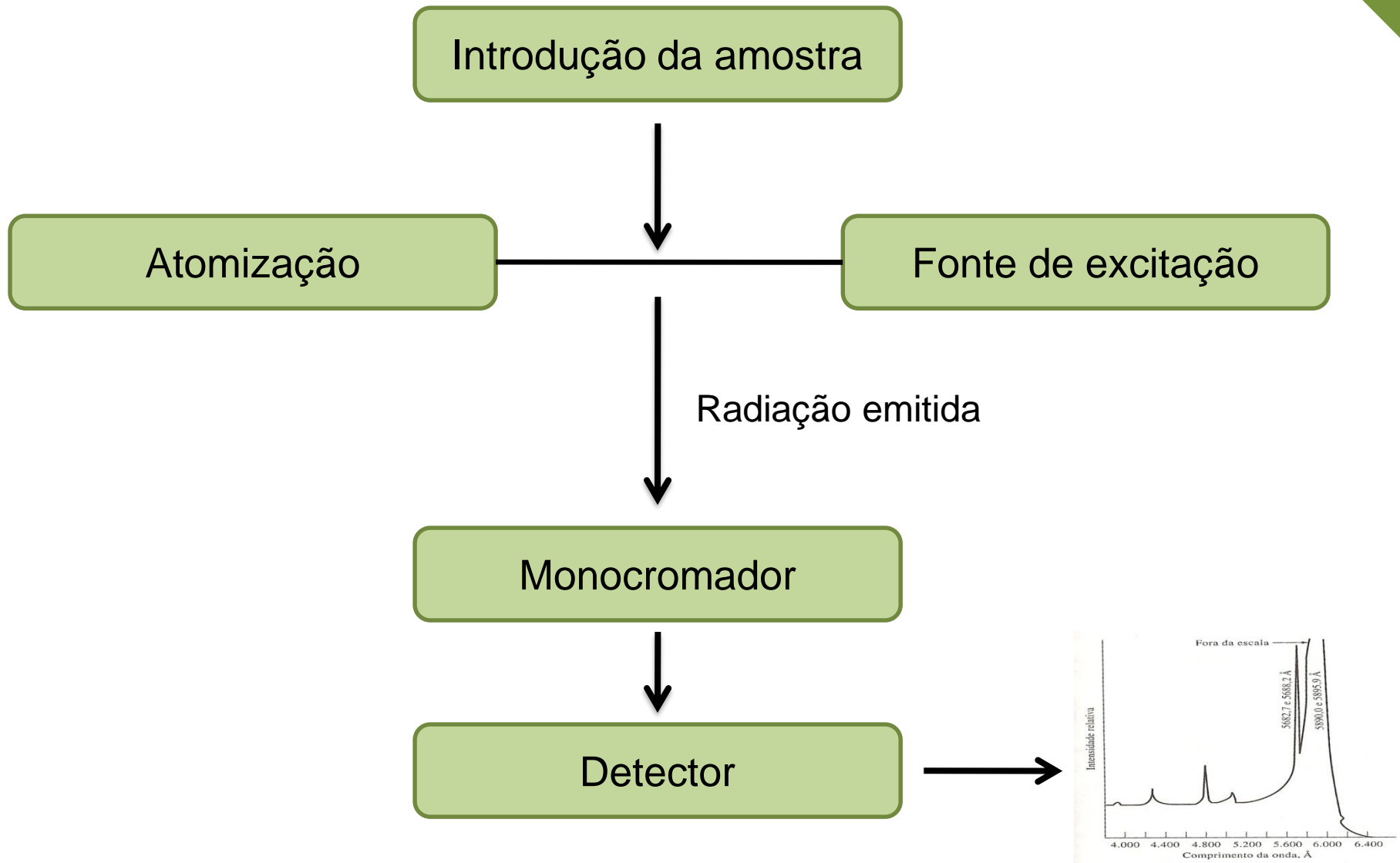

a) Introdução da amostra

✓ Soluções

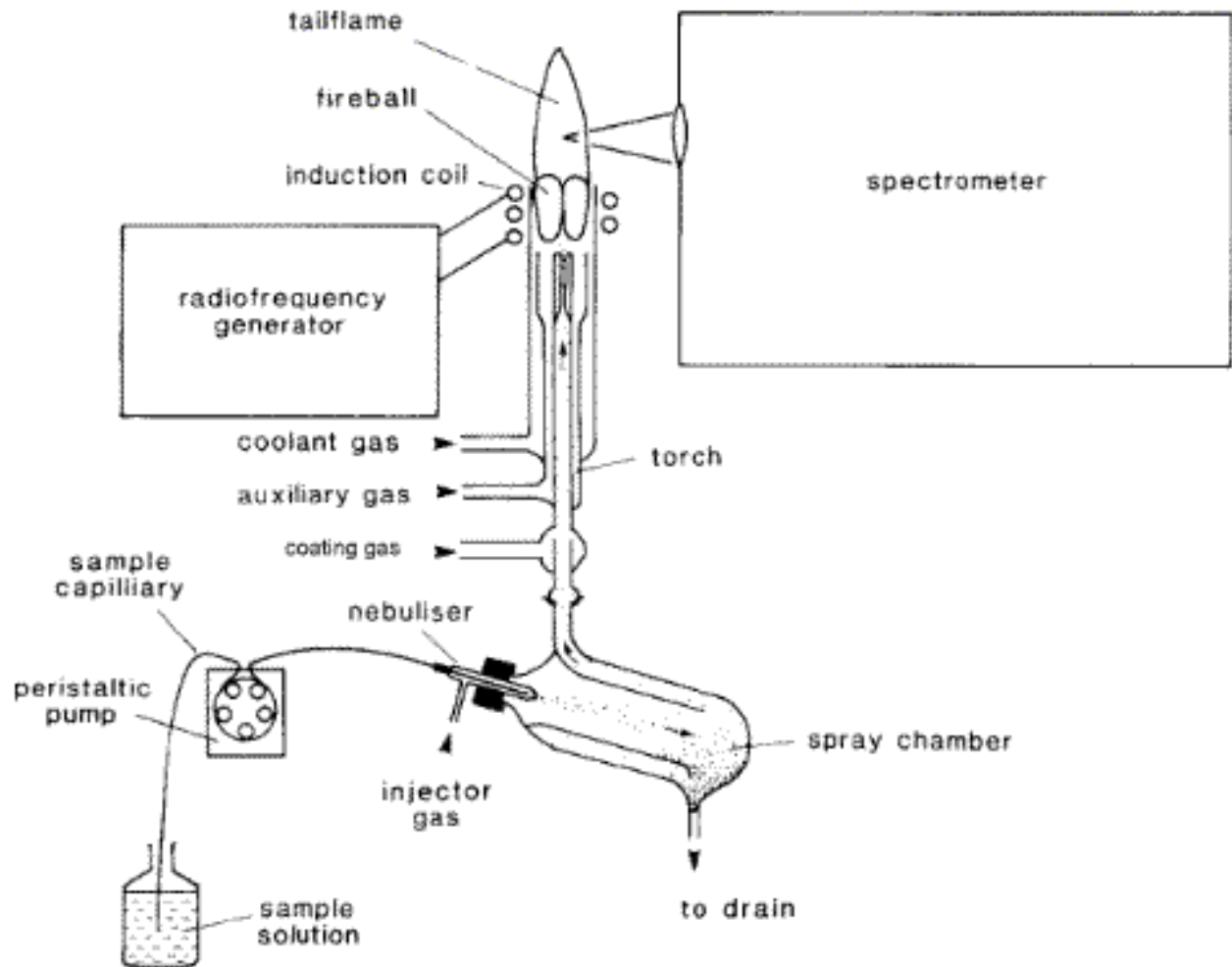

a) Introdução da amostra

✓ Sólidos

Vaporização Eletrotérmica

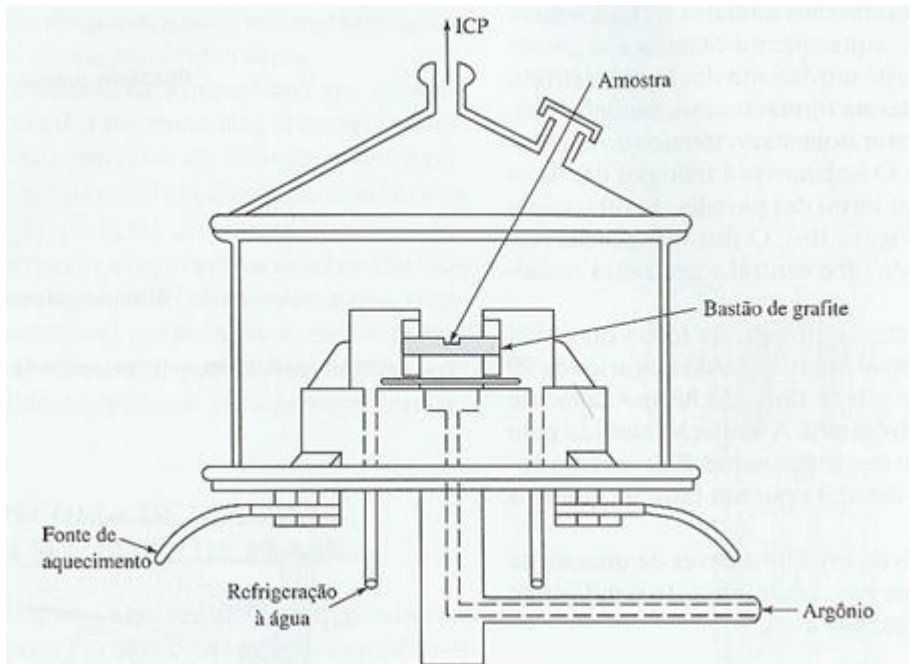

Ablação - Laser

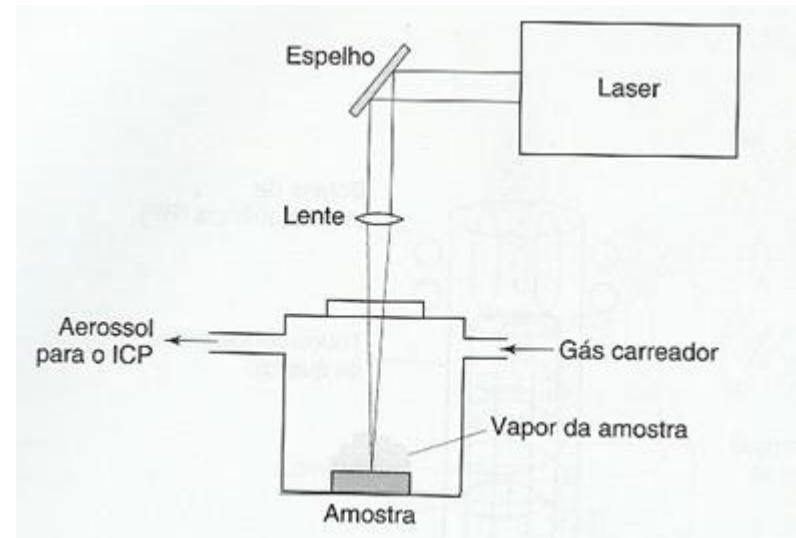

b) Atomização e excitação:

- ✓ Atomização: **Plasma induzido**

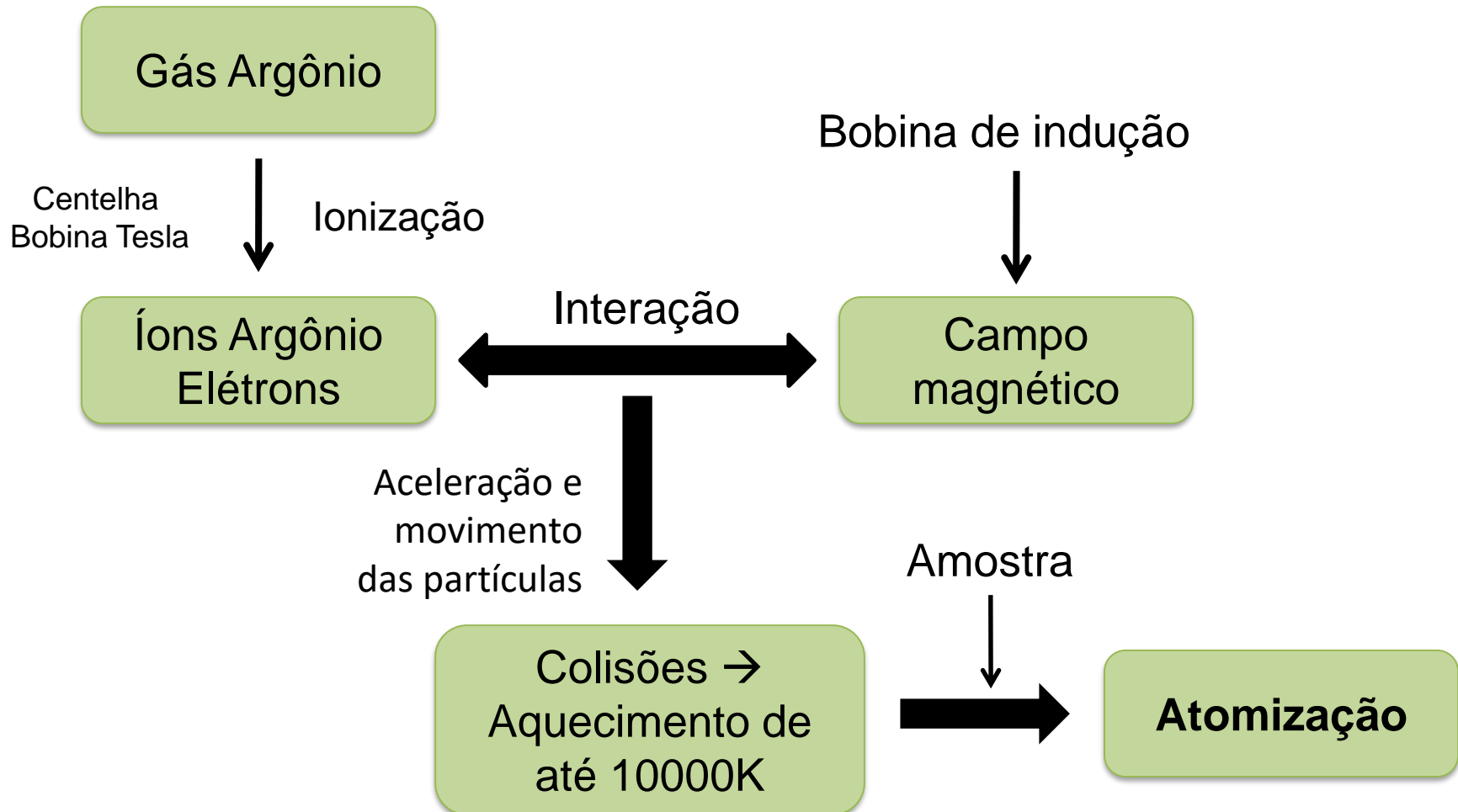

✓ Processo de formação do ICP

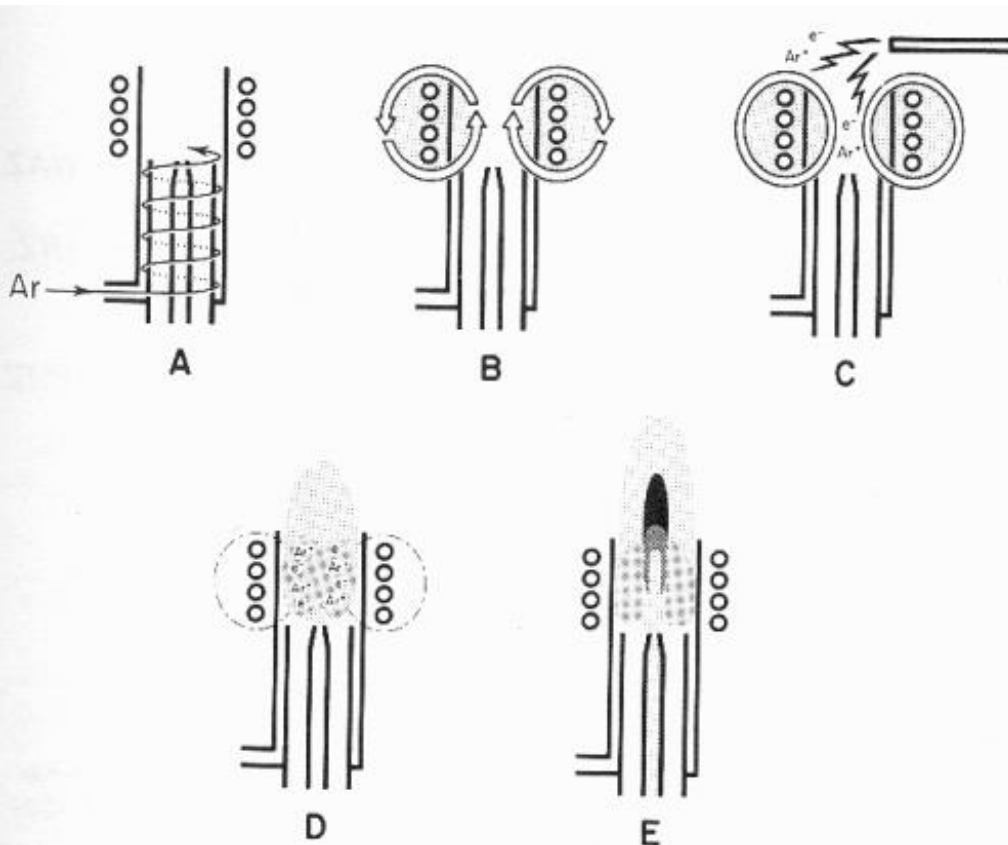

A – Entrada de Ar

B – Aplicação de campo de rádio-frequência (RF), 27 ou 40 Mhz

C – Geração de alguns elétrons livres (Bobina de Tesla)

D – Efeito cascata

E – Plasma

✓ Fonte de plasma induzido: Tocha



Foto 4 - Plasma de Hélio sendo produzido pela bobina na câmara menor. Podemos perceber a cor verde do plasma de Hélio.

b) Atomização e excitação:

- ✓ Fonte de excitação: **Plasma induzido**

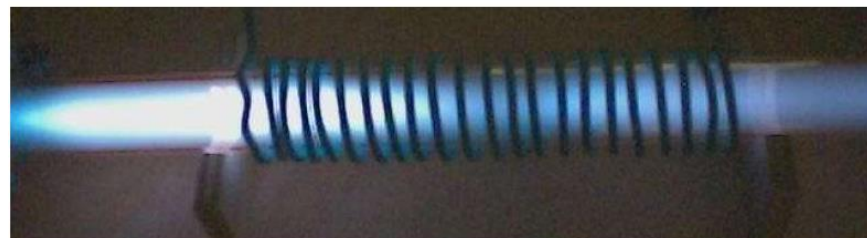
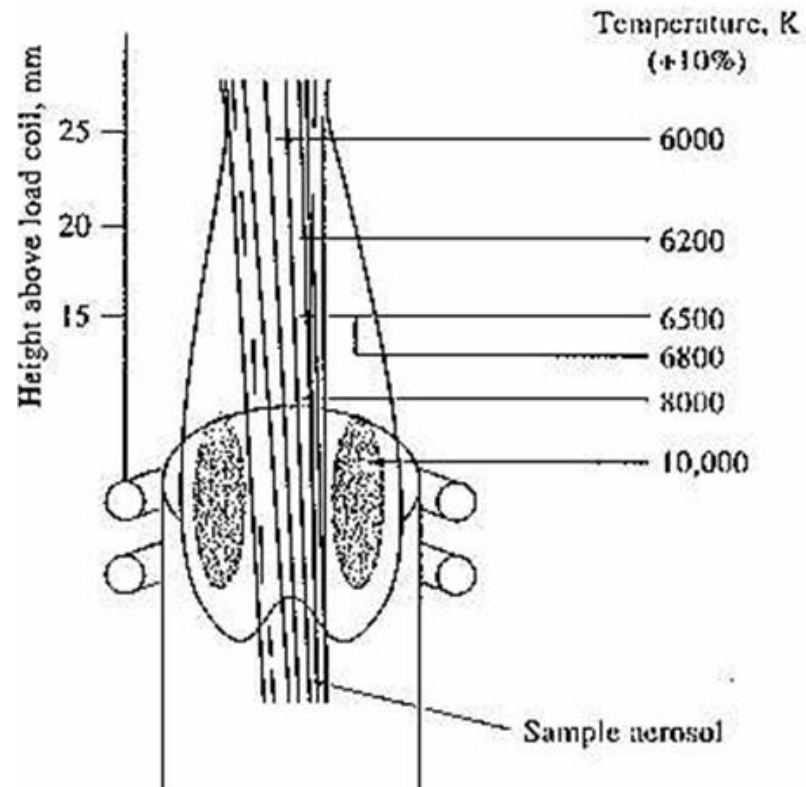
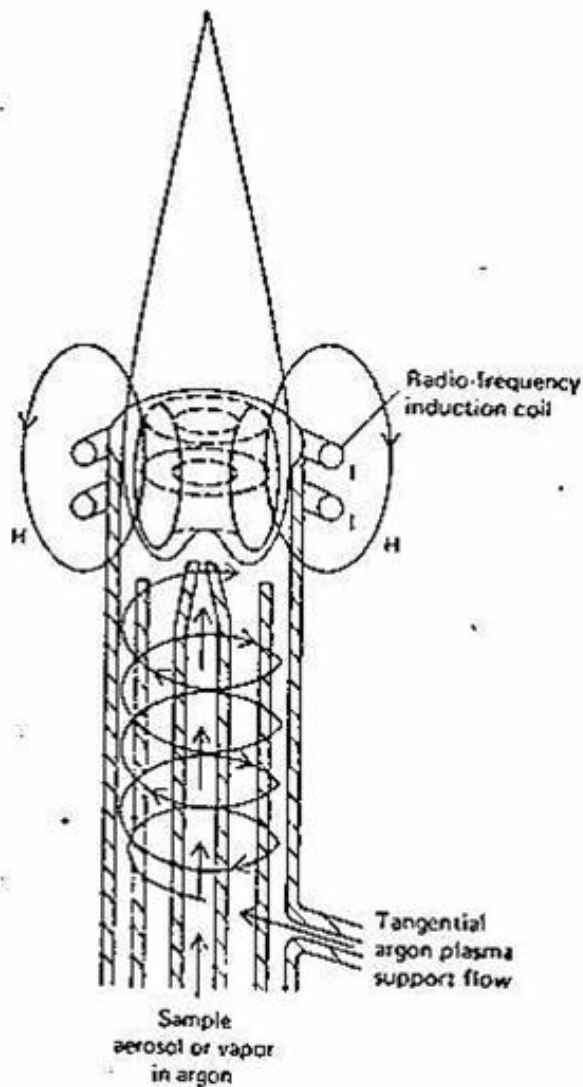
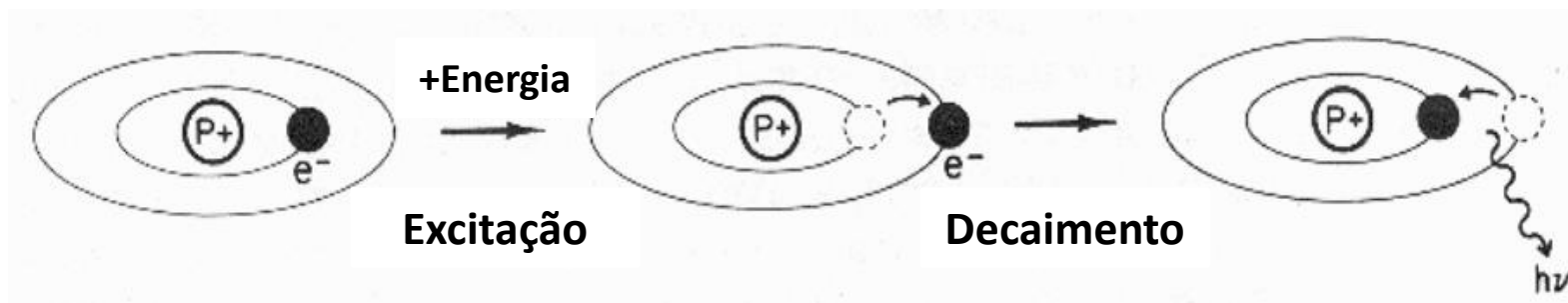

Monocromador

Radiação emitida

Detector

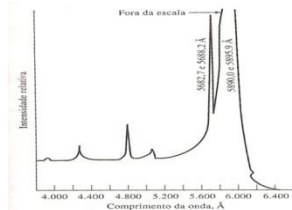

2.2. Tipos de espectrofotômetros para fontes de plasma

✓ Instrumentos para espectroscopia de emissão:

- Sequencial
 - Multicanal simultâneo
 - de transformada de Fourier
- Mais utilizados

a) Simultâneo

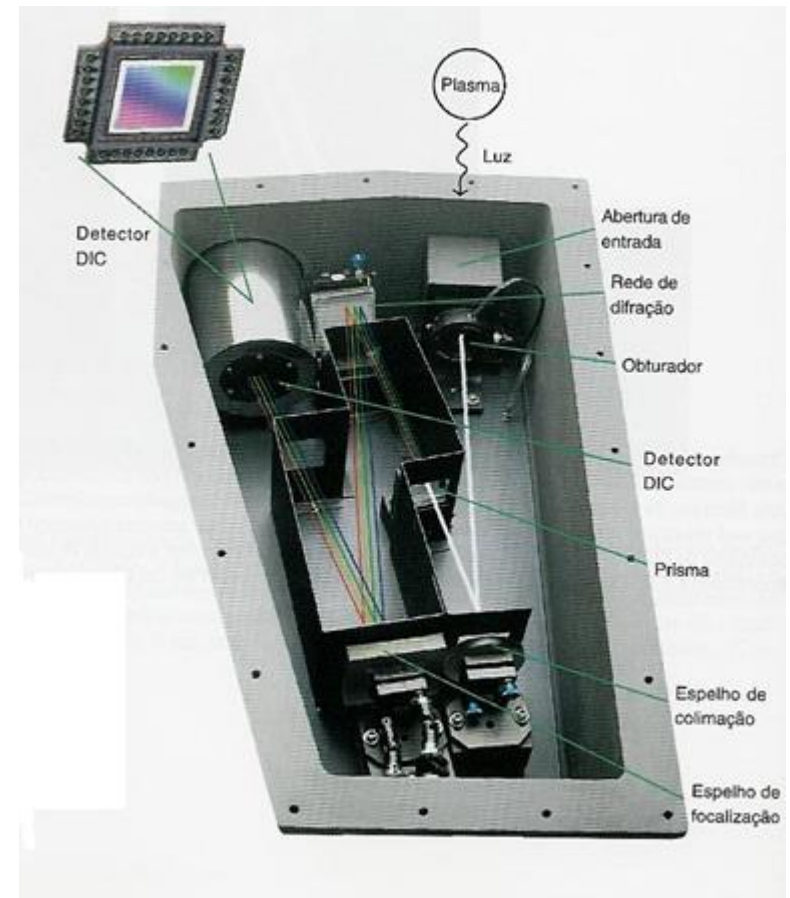
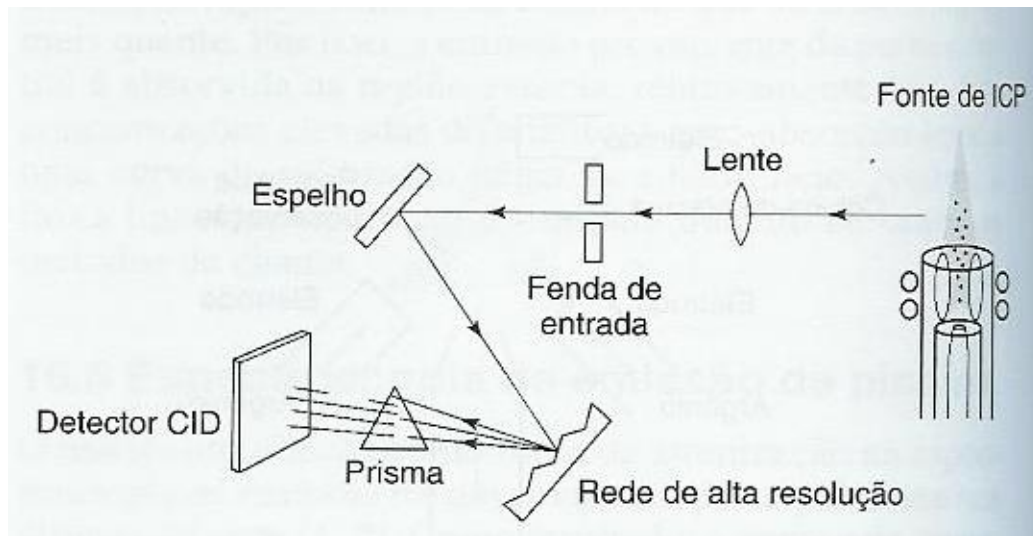

✓ Simultâneo

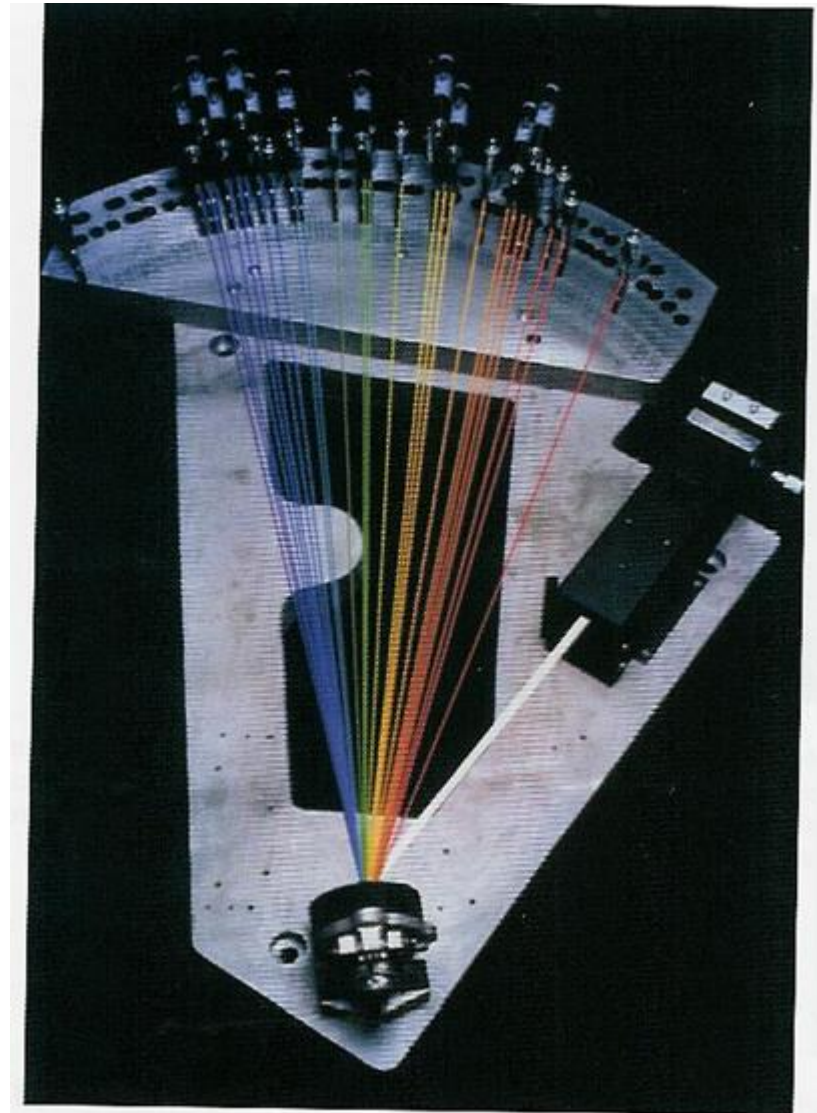
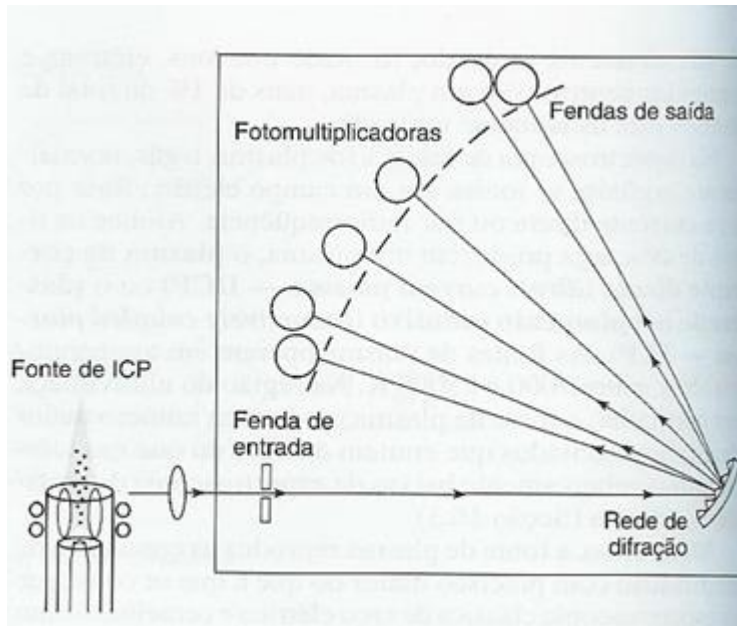

b) Sequencial

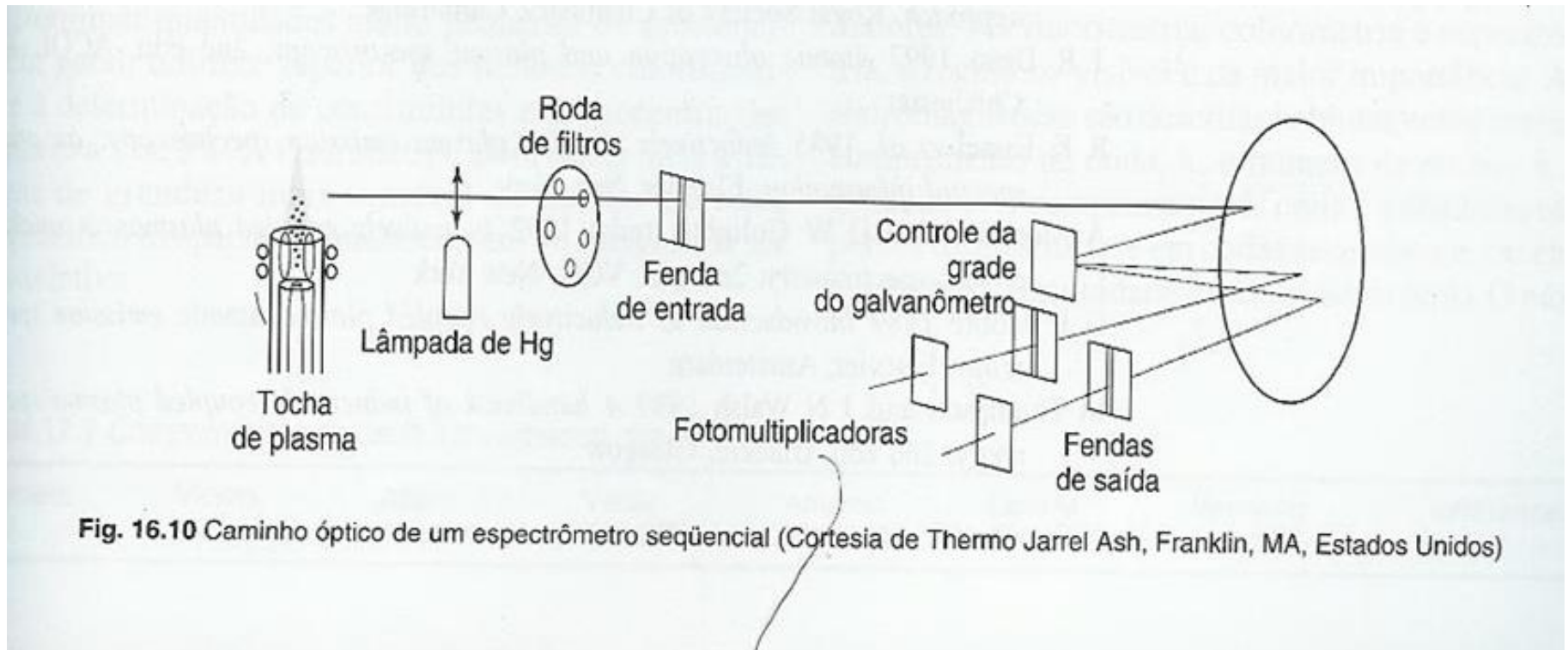

Fig. 16.10 Caminho óptico de um espectrômetro seqüencial (Cortesia de Thermo Jarrel Ash, Franklin, MA, Estados Unidos)