

Curvas motor Diesel

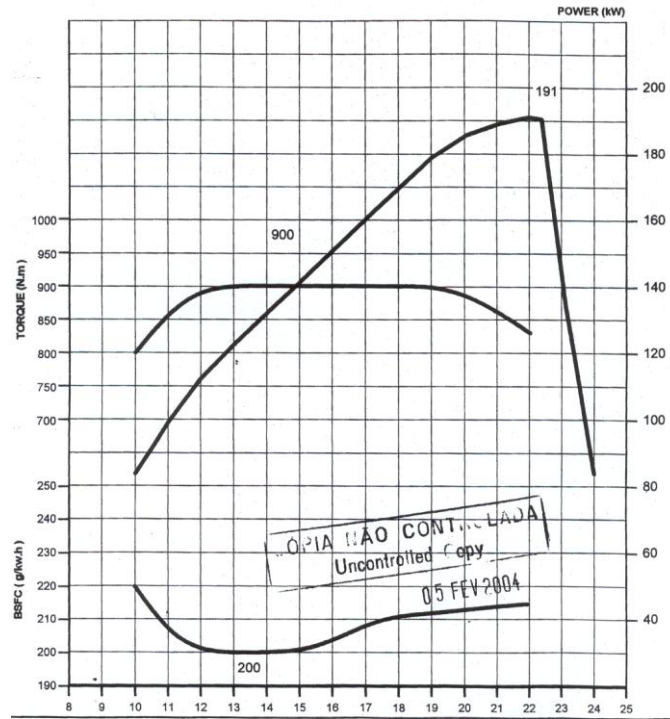

Motor mapeado em torque

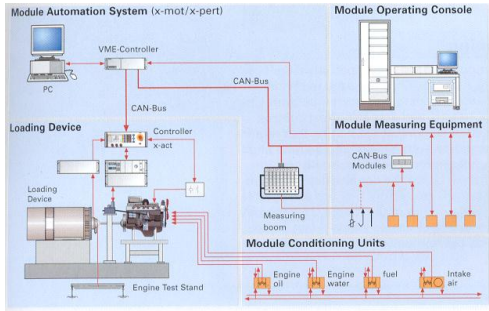

dinamômetro

Tração 4

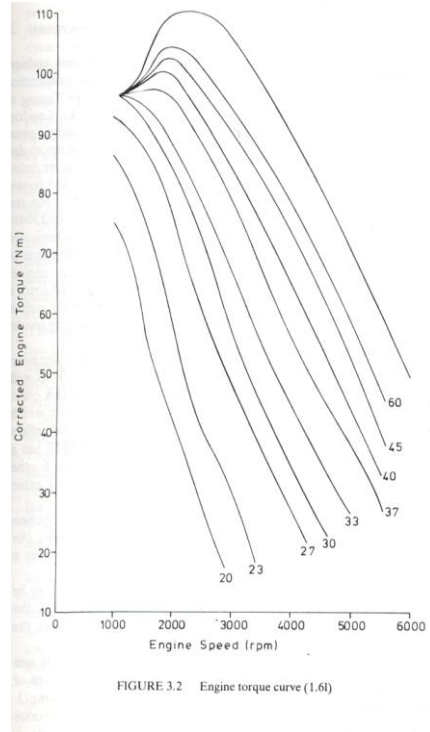
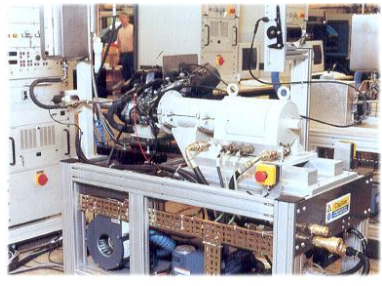

FIGURE 3.2 Engine torque curve (1.6l)

Motor mapeado em potência



dinamômetro

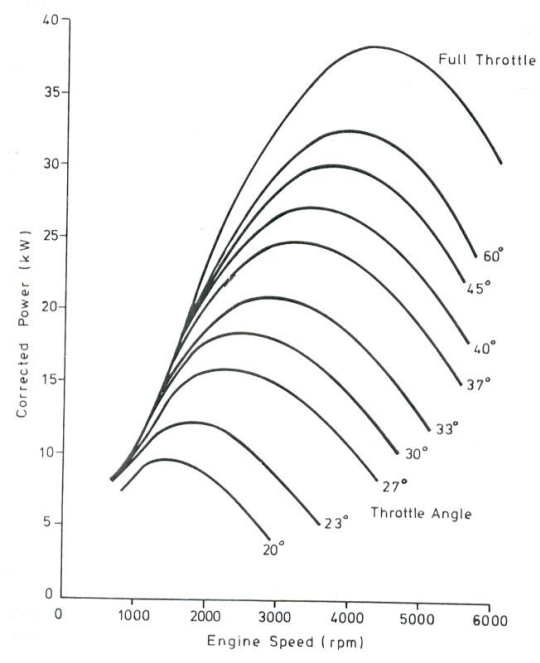

FIGURE 3.3 Engine power curves for 1.6l engine

Tração 5

Motor mapeado em consumo específico

Tração 6

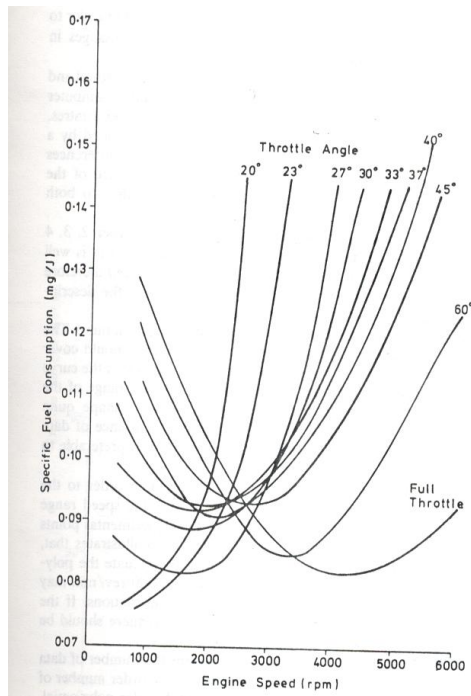

FIGURE 3.4 Specific fuel consumption of 1.6l engine

Motor mapeado

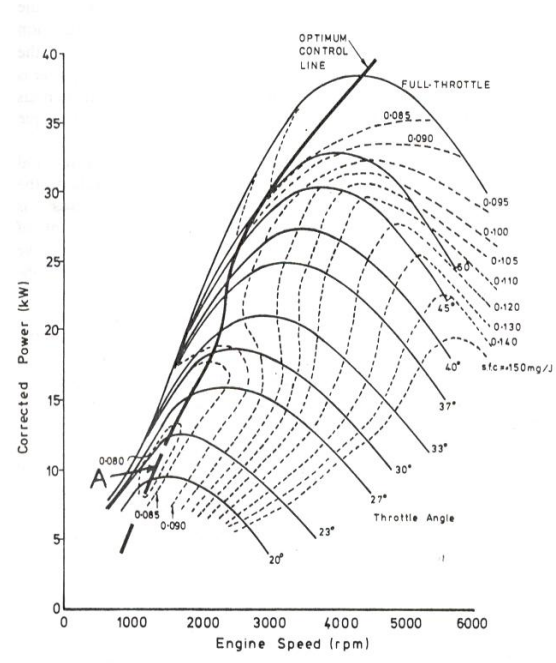
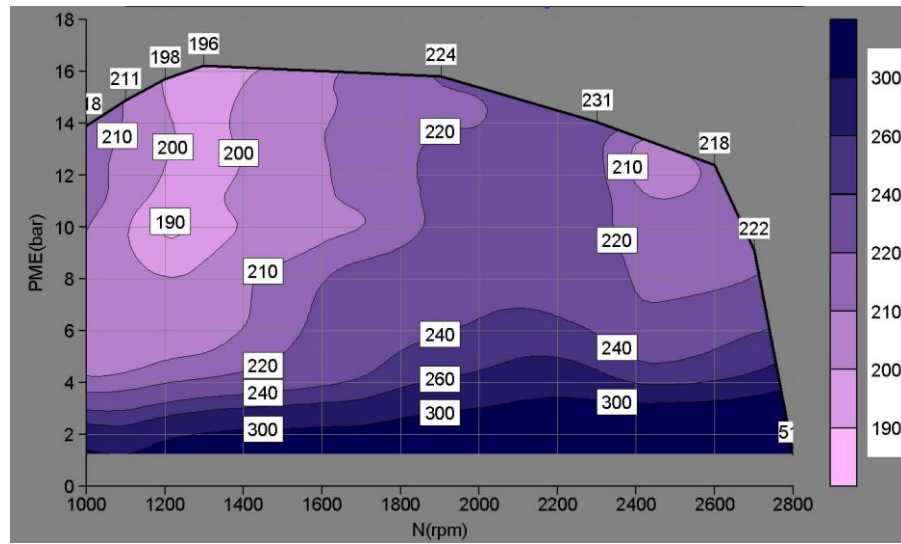
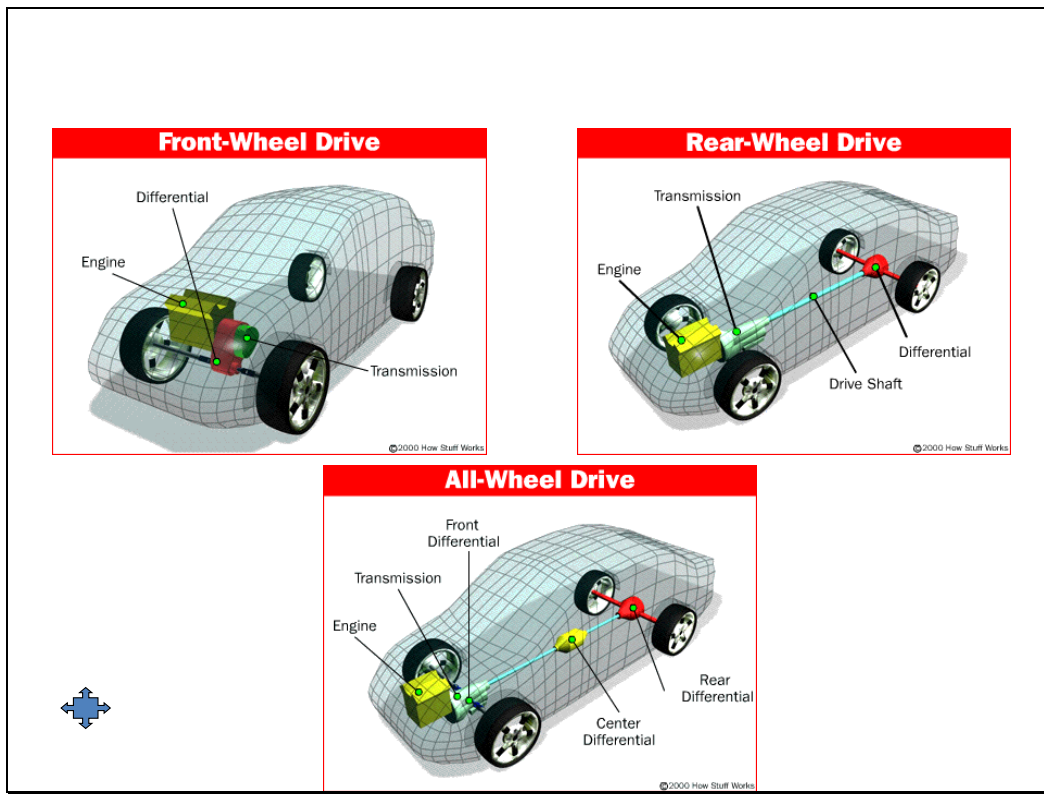

FIGURE 3.5 Characteristics of 1.6l engine

Tração 7

Motor mapeado





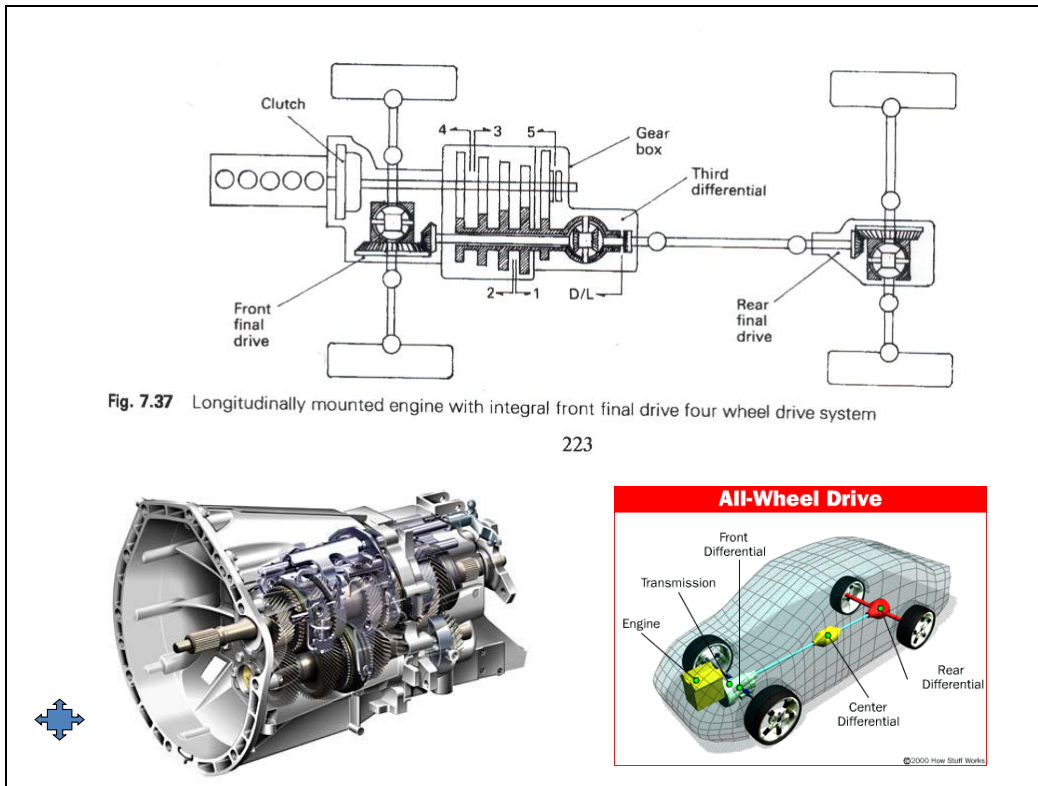

CLUTCH - EMBREAGEM

Single clutch

embreagem

Embreagem explodida

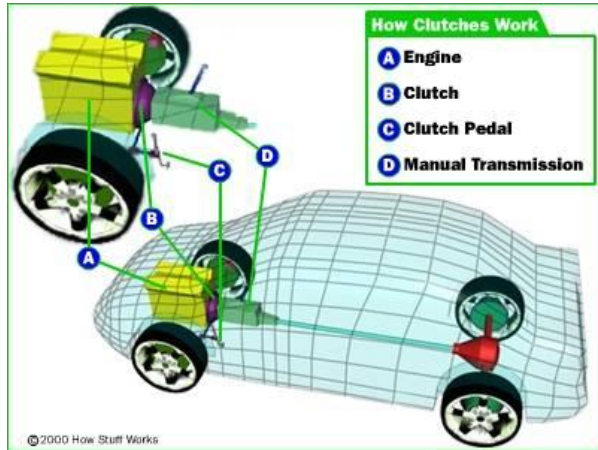

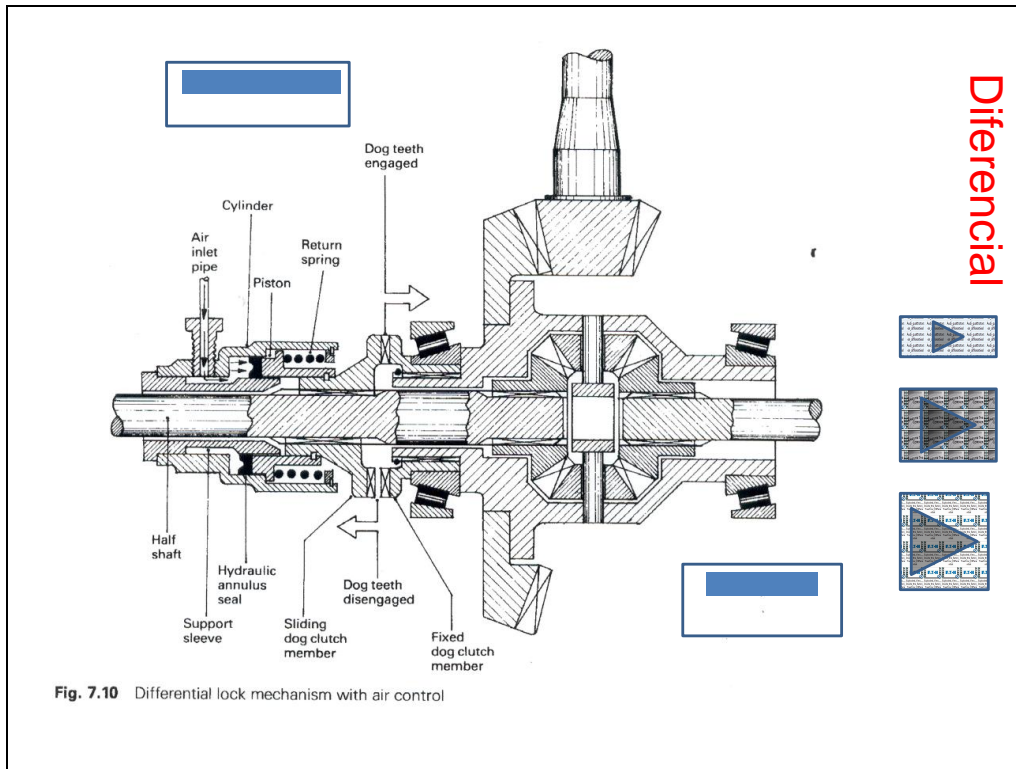

Transmissão 4 x 4

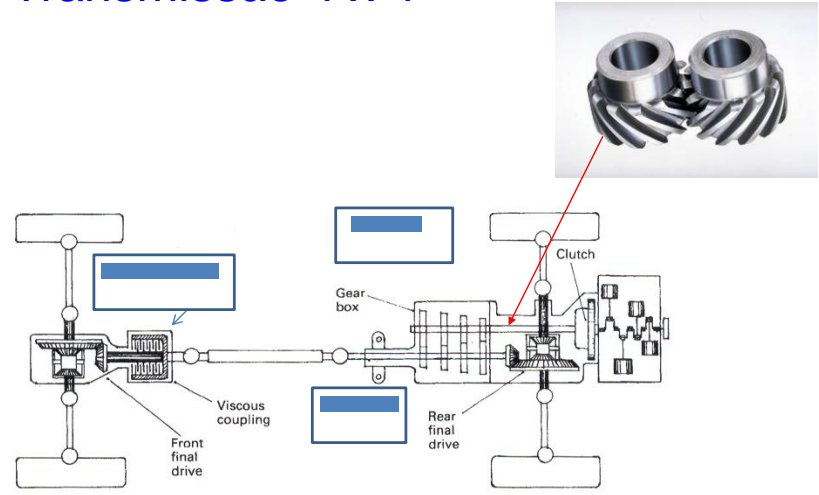
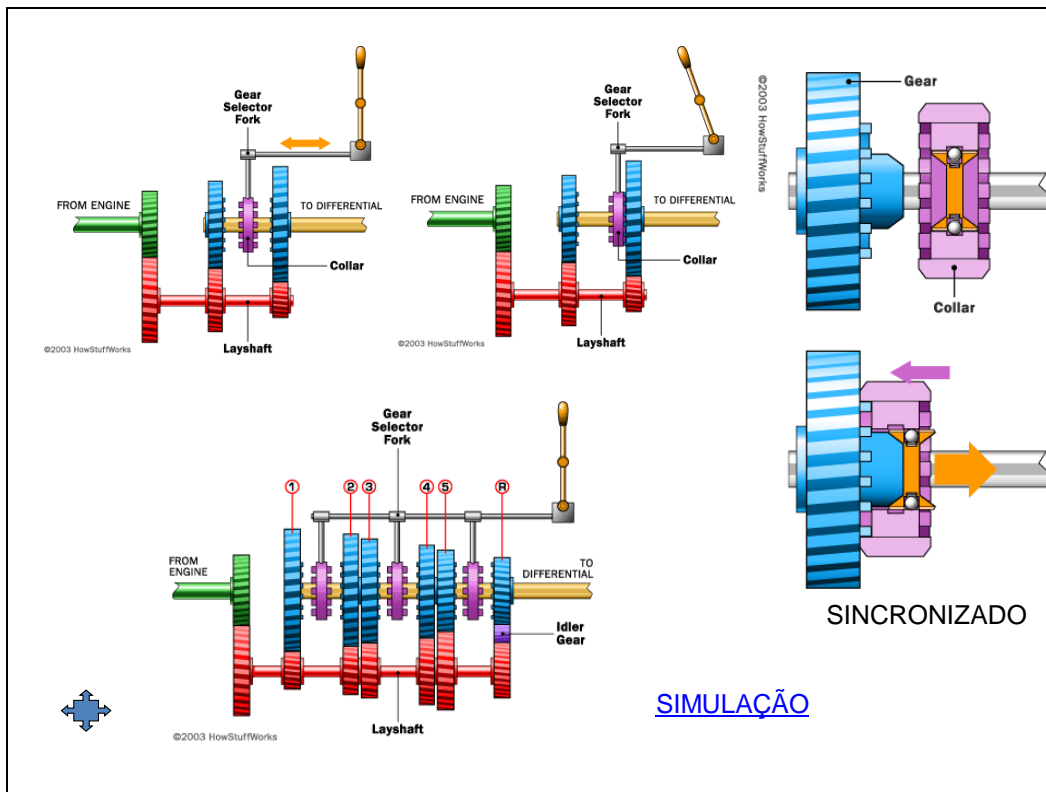
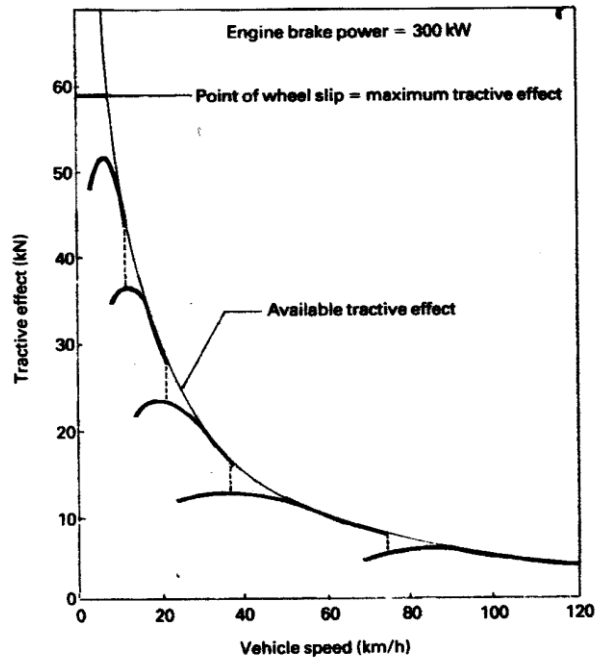

Fig. 7.40 Rear mounted engine four wheel drive system

Tração 8



Curva tangente
exponencial



Tração 10

Diagrama dente de serra com faixa econômica e faixa de alto torque
Otimização da transmissão

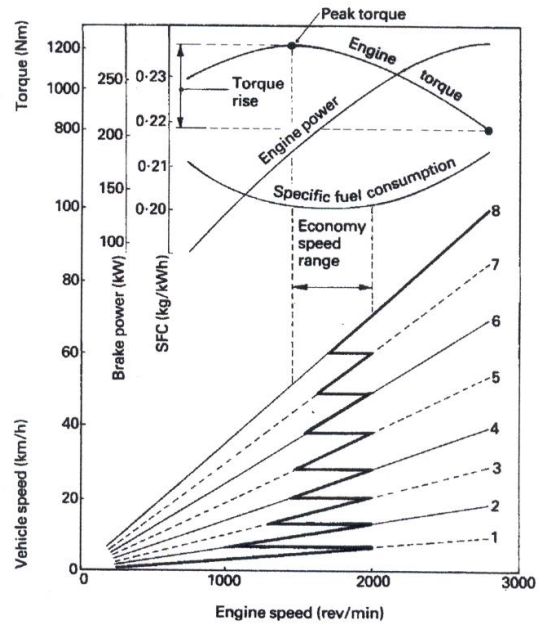
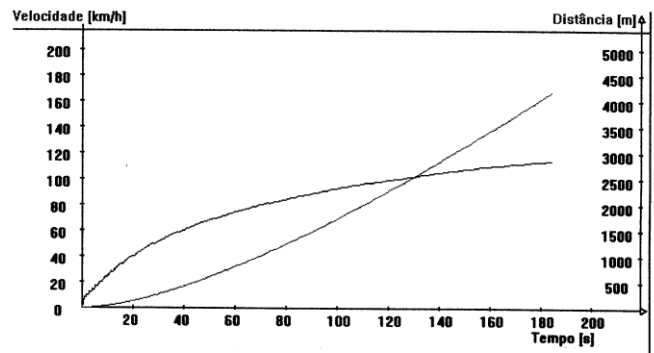
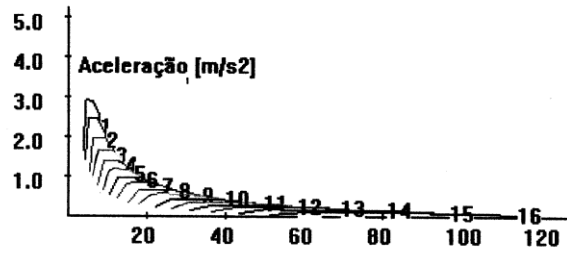

Fig. 3.2 Engine performance and gear split chart for an eight speed gearbox

Advance vehicle technology - Heinz Heisler

Tração 12

Câmbio
de 16
marchas



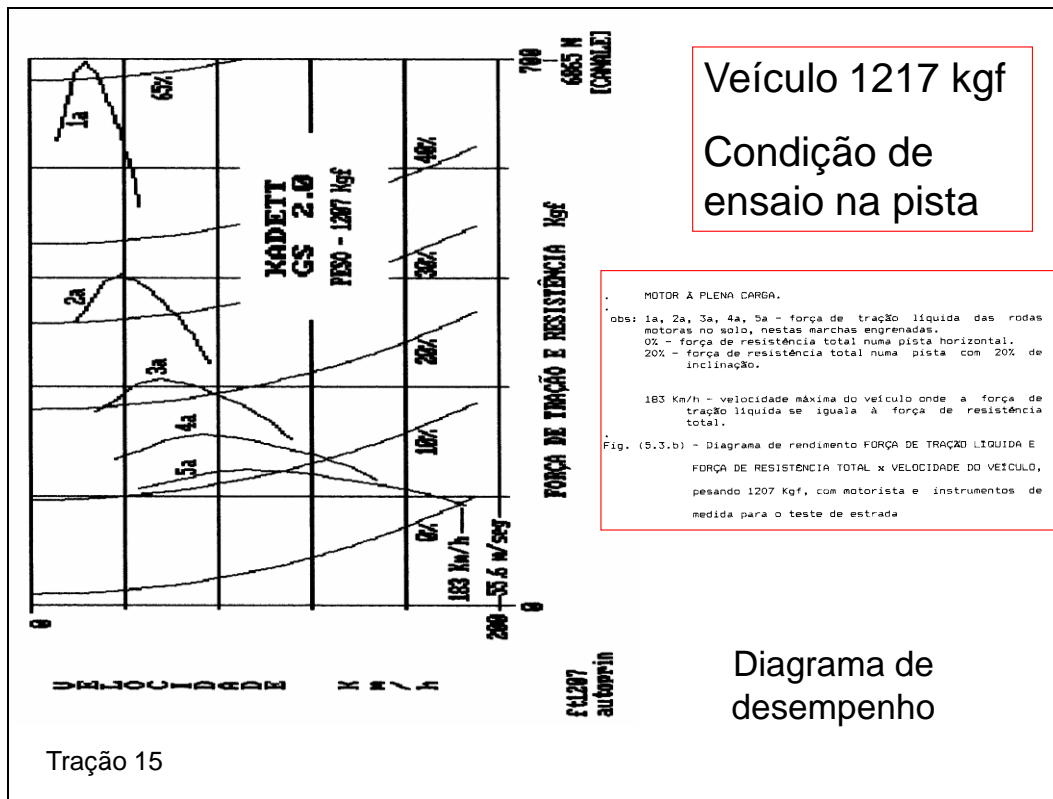

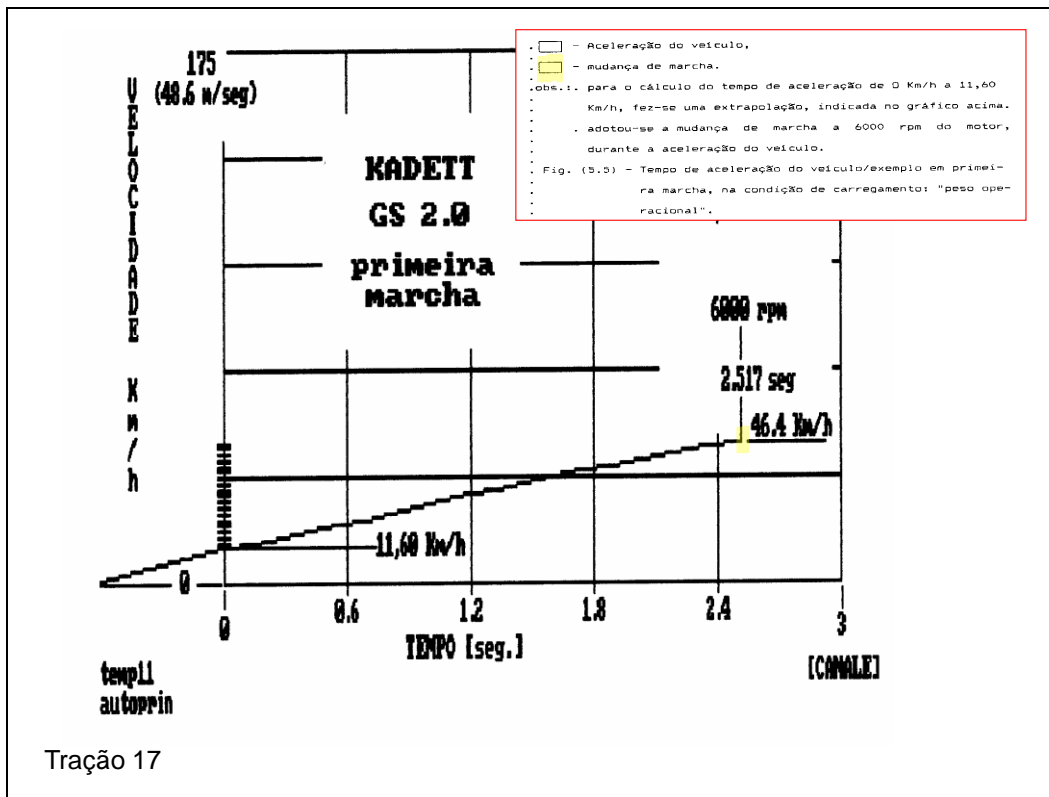

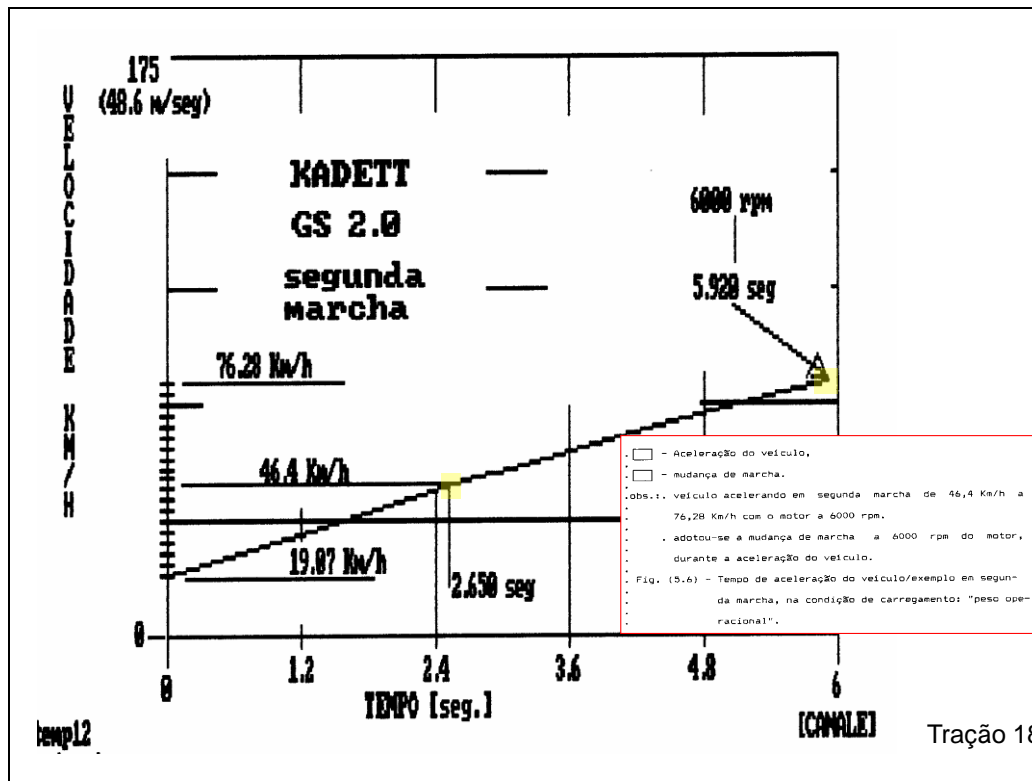

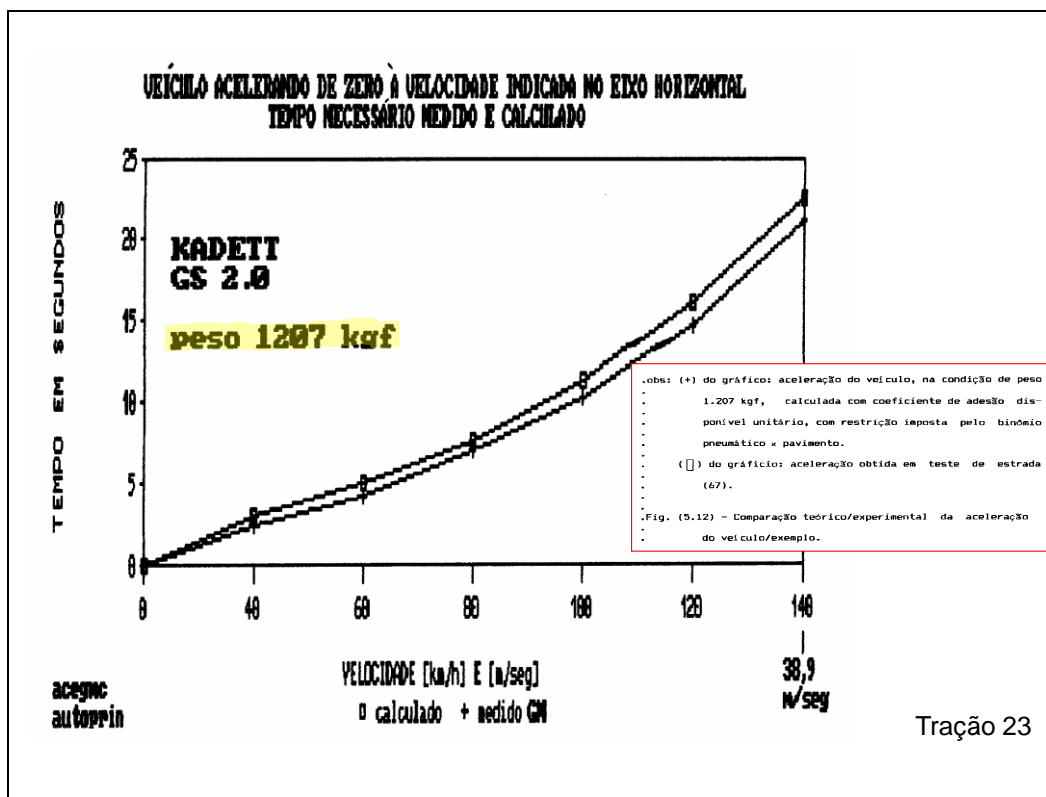

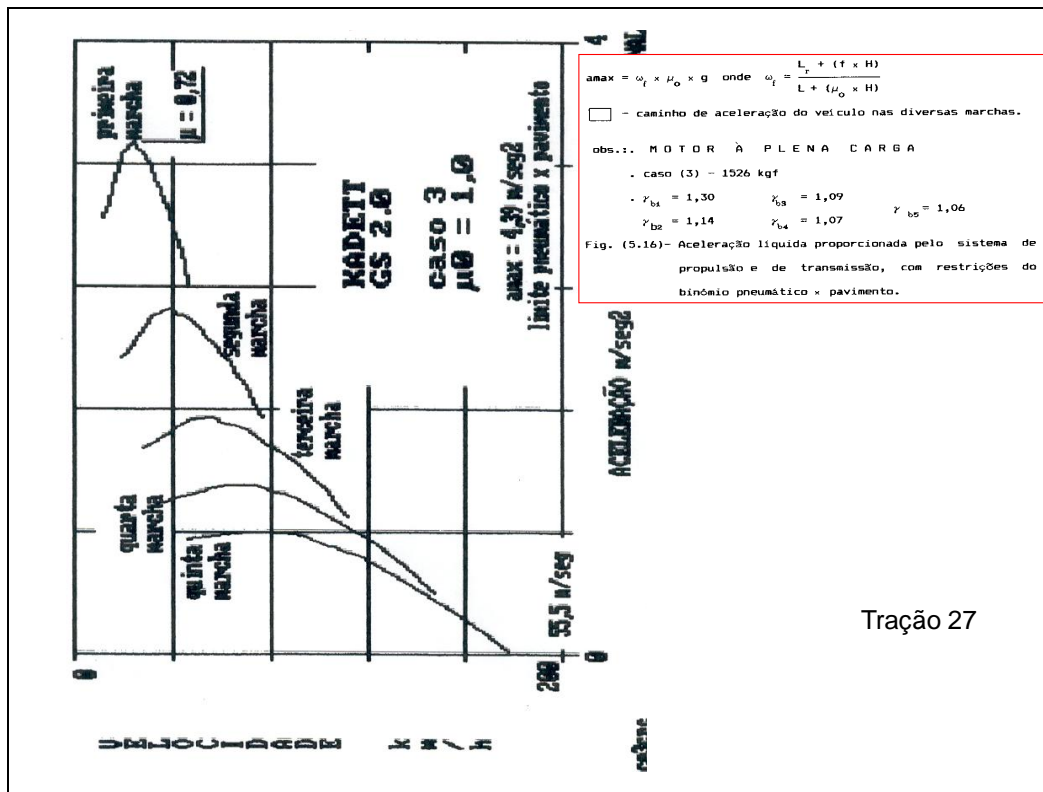

Tração 27

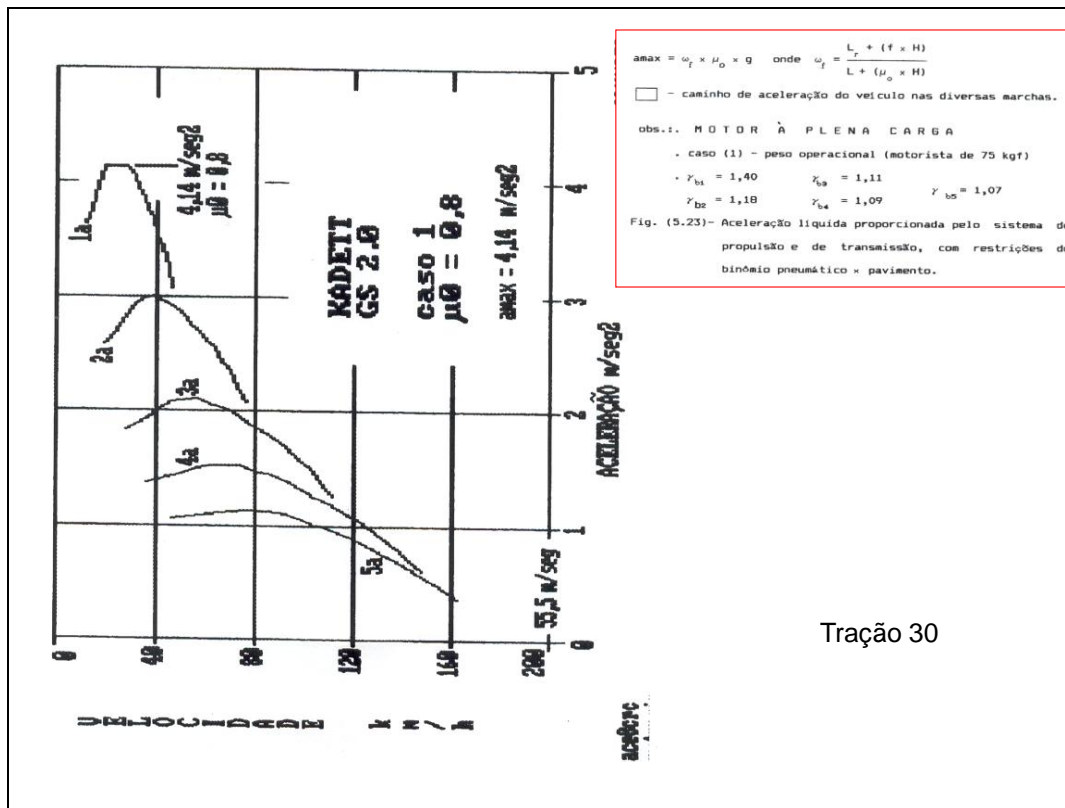

Tração 30
