

# Modulação em Largura de Pulso Inversor Monofásico em Ponte Completa

José Roberto B. de A. Monteiro

Escola de Engenharia de São Carlos  
Universidade de São Paulo

23 de abril de 2018



Inversor Monofásico em Ponte Completa

Tipos de Modulações

Modulação em Largura de Pulso Simples

Modulação em Múltiplos Pulsos

Modulação em Múltiplos Pulsos Combinada a Pulso Simples

Modulação Senoidal



## Inversor Monofásico em Ponte Completa

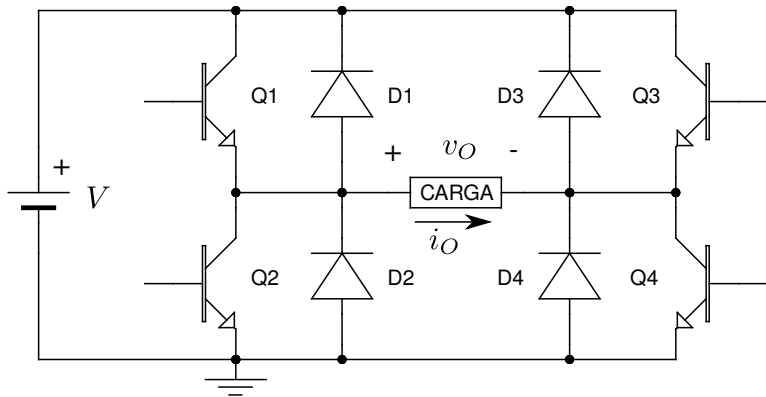

## Tipos de Modulações

- ▶ Modulação em Largura de Pulso Simples
- ▶ Modulação em Múltiplos Pulsos
- ▶ Modulação em Múltiplos Pulsos Combinada a Pulso Simples
- ▶ Modulação Senoidal

## Modulação em Largura de Pulso Simples

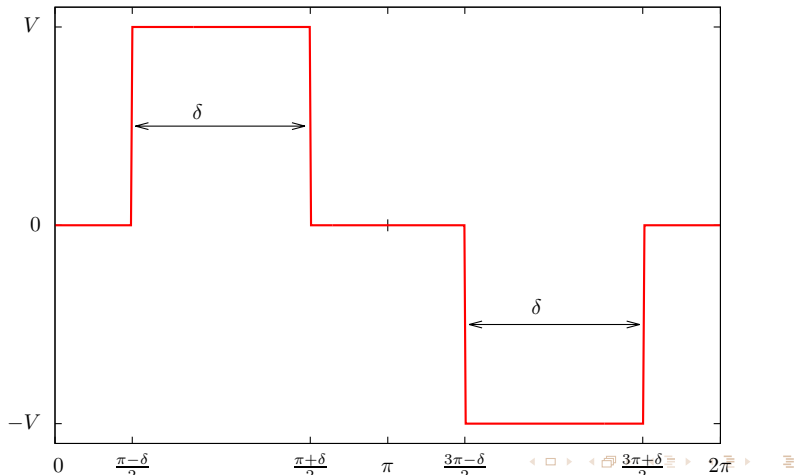

## Modulação em Largura de Pulso Simples

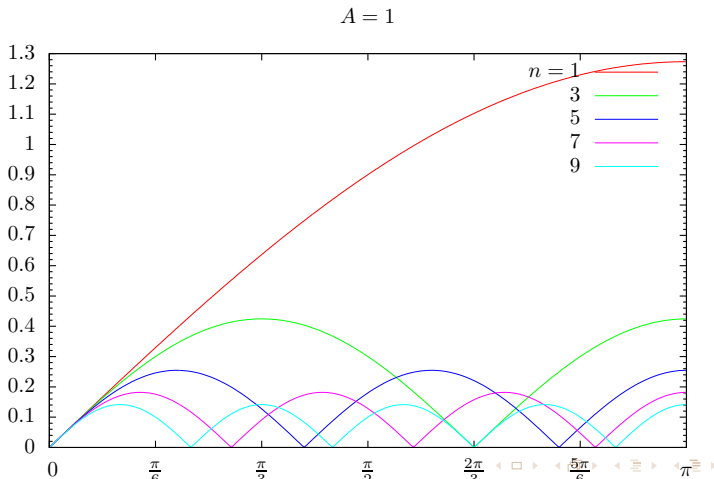

# Modulação em Múltiplos Pulsos

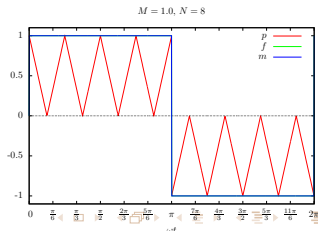
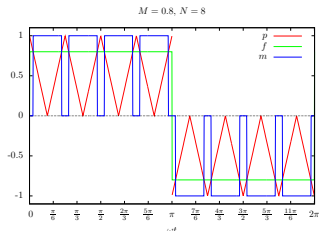
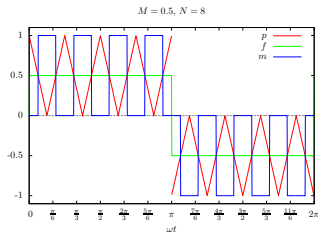
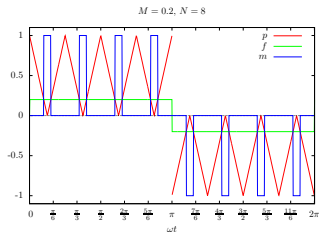

# Modulação em Múltiplos Pulsos

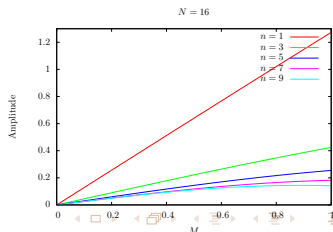
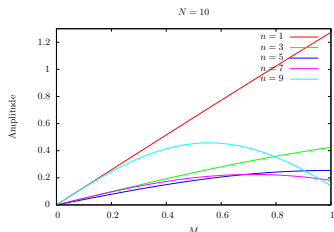
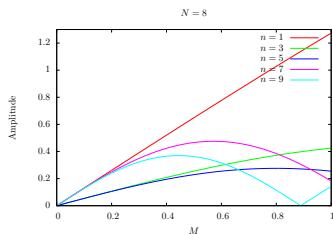
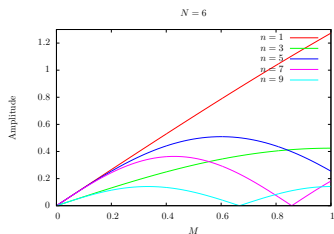



# Modulação em Múltiplos Pulsos Combinada a Pulso Simples

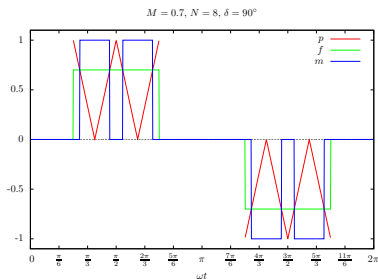
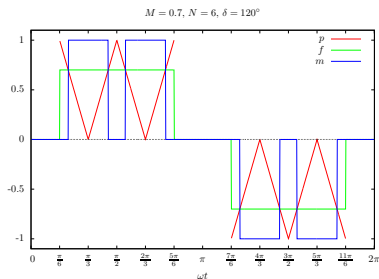

# Modulação em Múltiplos Pulsos Combinada a Pulso Simples

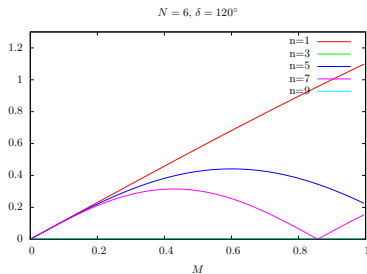
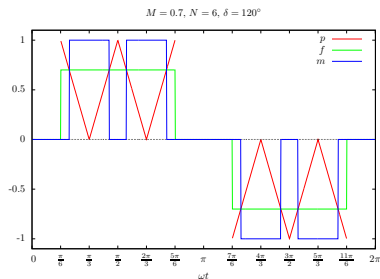

# Modulação em Múltiplos Pulsos Combinada a Pulso Simples

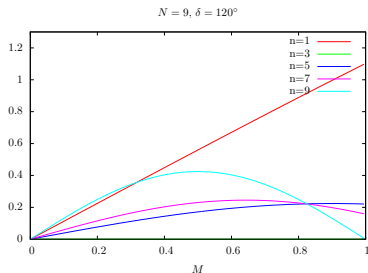
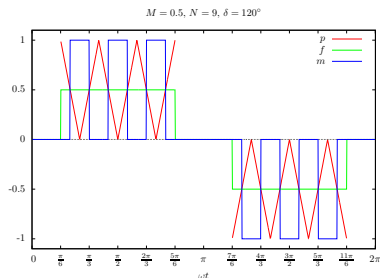

# Modulação em Múltiplos Pulsos Combinada a Pulso Simples

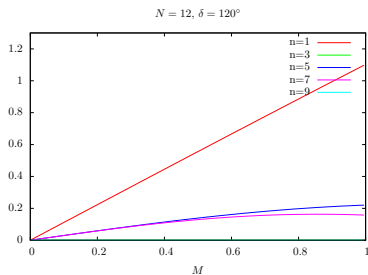
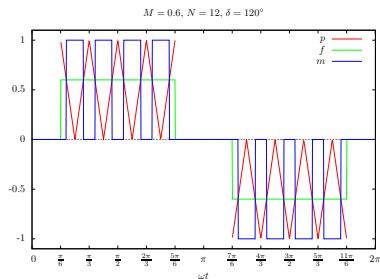

# Modulação em Múltiplos Pulsos Combinada a Pulso Simples

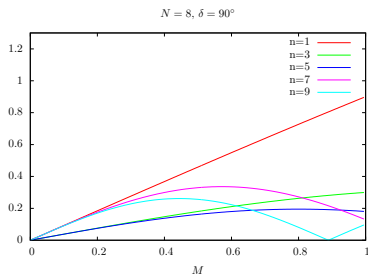
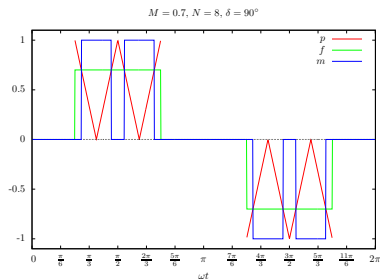

# Modulação em Múltiplos Pulsos Combinada a Pulso Simples

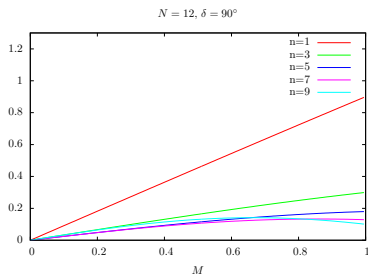
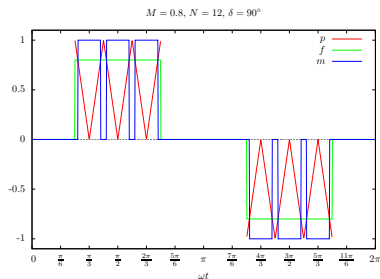

# Modulação Senoidal

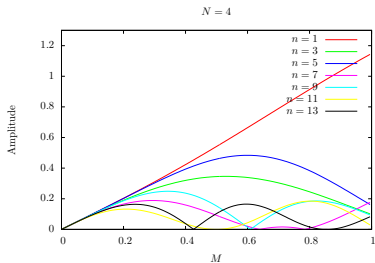
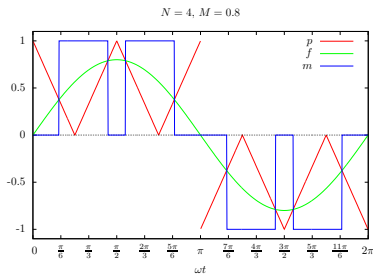

# Modulação Senoidal

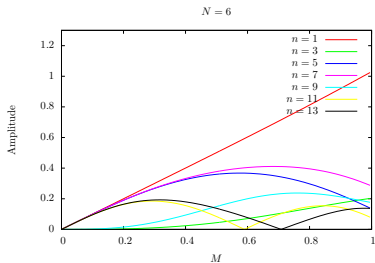
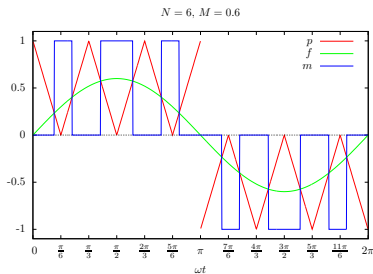



# Modulação Senoidal

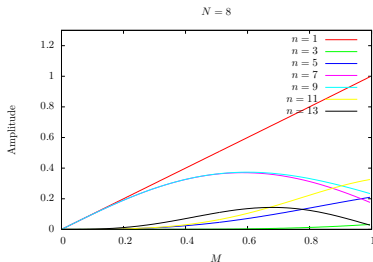
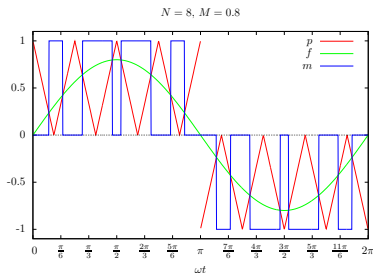

# Modulação Senoidal

