



STATUS AND RECENT DEVELOPMENT IN DESIGN, MANUFACTURING AND PERFORMANCE OF TBMs

M. Eng. Dipl. Ing. Tobias Wiedenmann

HERRENKNECHT AG – geotechnics, research and development

ITS GETTING CLOSER AT GROUND SURFACE. THE FUTURE IS UNDERGROUND.

- natural and artificial (infrastructural) barriers and obstacles often complicate today's development of mobility and transport
- tilled ground surface for example in cities and natural obstacles like mountains or waterways often avoid further developments of the unearthy traffic infrastructure
- increasing need of underground infrastructure constructions



SOFT SOIL - TUNNELLING

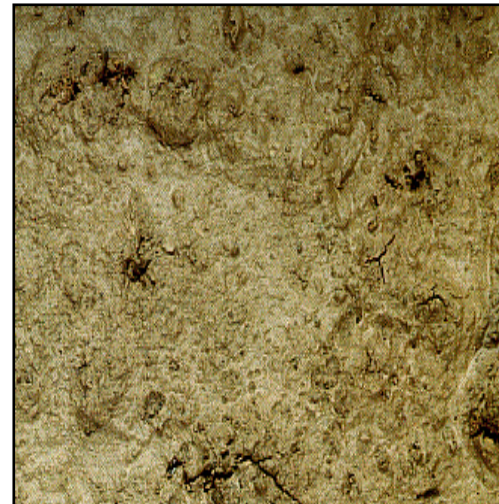

SHIELDED MACHINES SM. APPLICATION RANGE.

DAUB:

„Shield machines are employed in loose soils with or without groundwater, in the case of which generally the subsoil surrounding the cavity and the face have to be supported. The characteristic feature of these machines is the type of face support.“

2 principle tunneling methods in soft ground
with full face excavation:

- Earth-Pressure-Balanced (EPB-Shield)
- Slurry-Shield (Hydro-Shield/Mixshield)

ACTIVE FACE SHIELDED MACHINES. CLASSICAL APPLICATION RANGE OF EPB AND HYDRO.

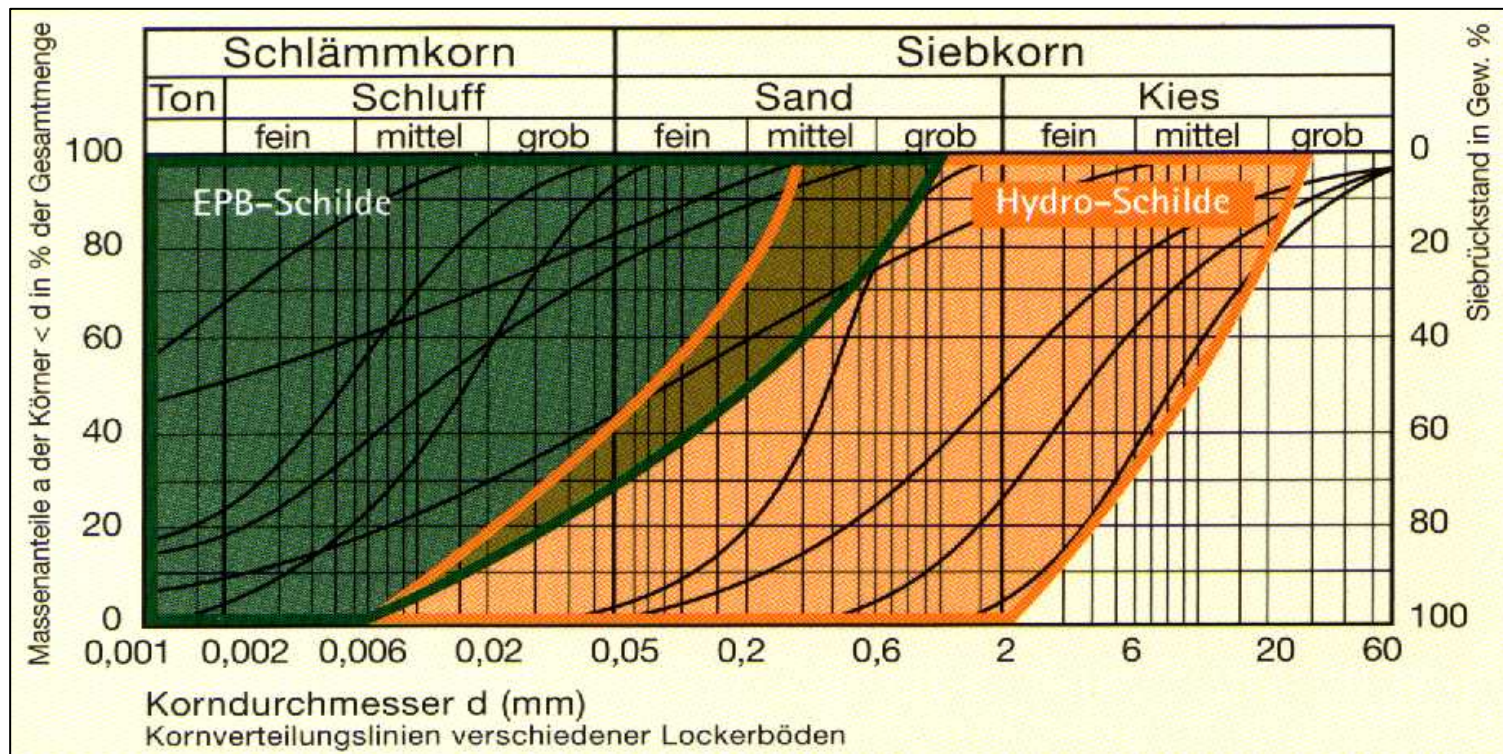

SHIELD MACHINES SM. CLASSICAL APPLICATION RANGE OF EPB AND HYDRO.

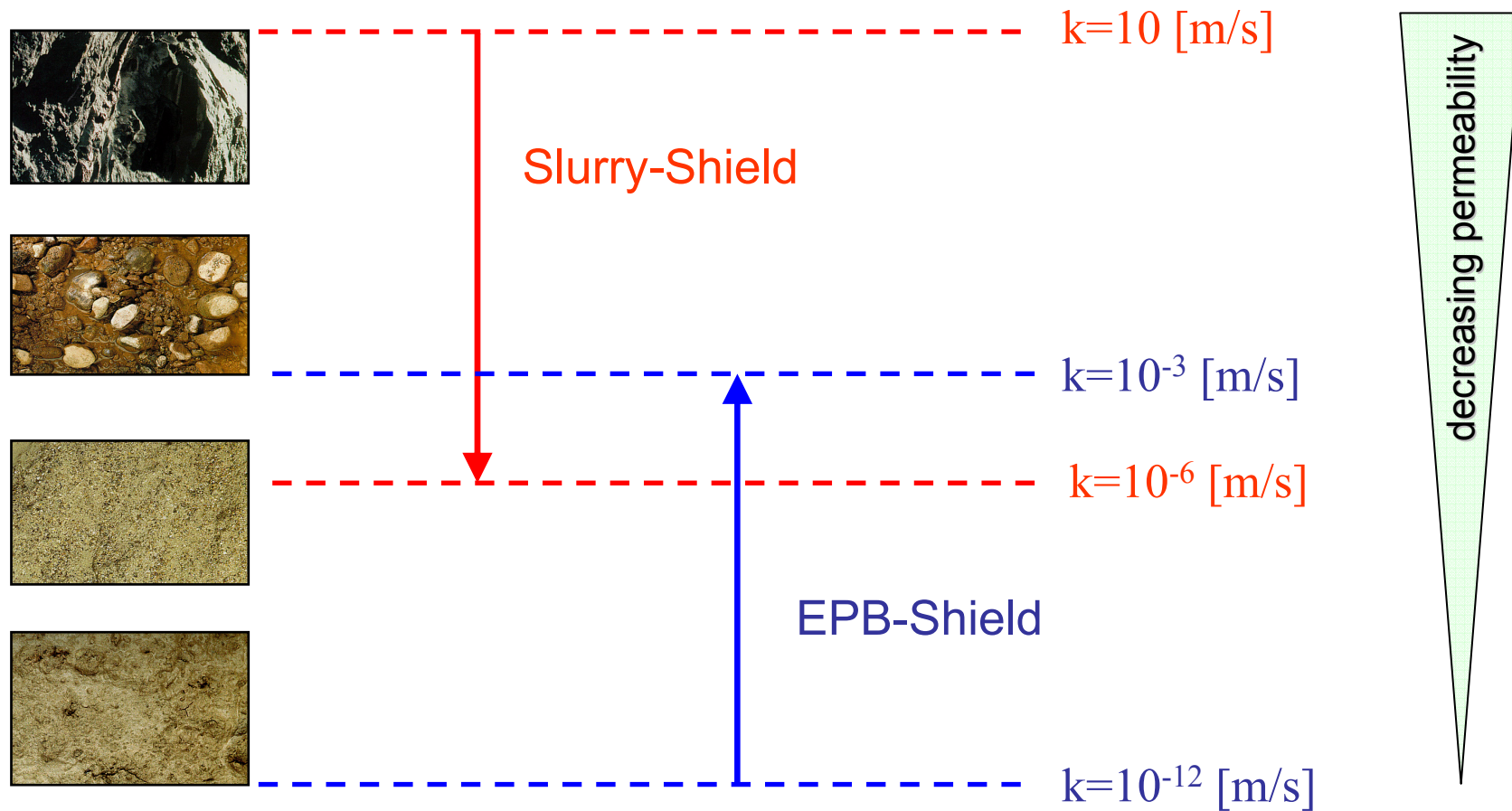

SHIELD MACHINES SM. APPLICATION RANGE OF EPB AND HYDRO. WITH ADDITIVES.

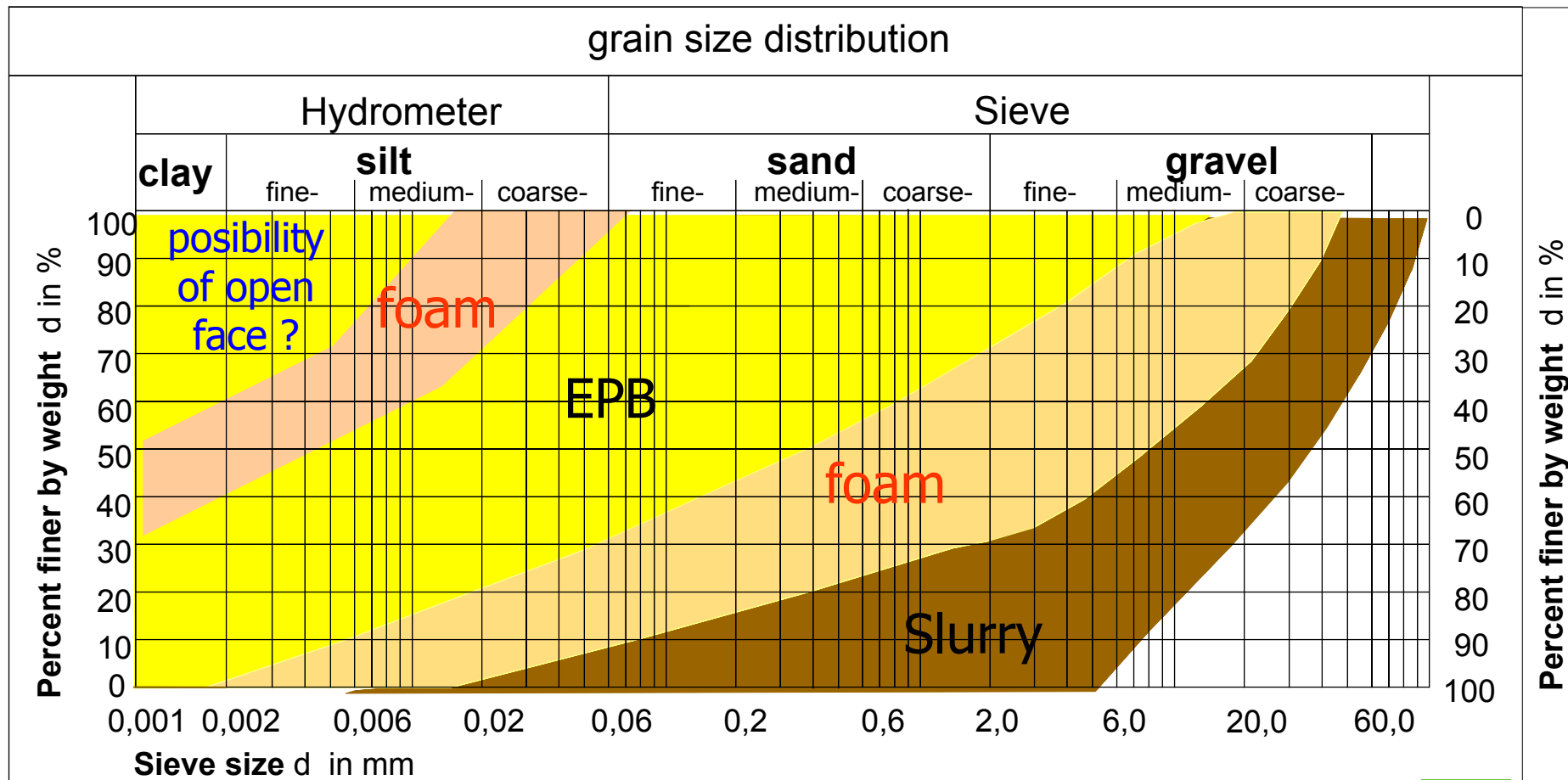

EPB – SHIELDS. WITH EARTH PRESSURE THROUGH COHESIVE GROUNDS.

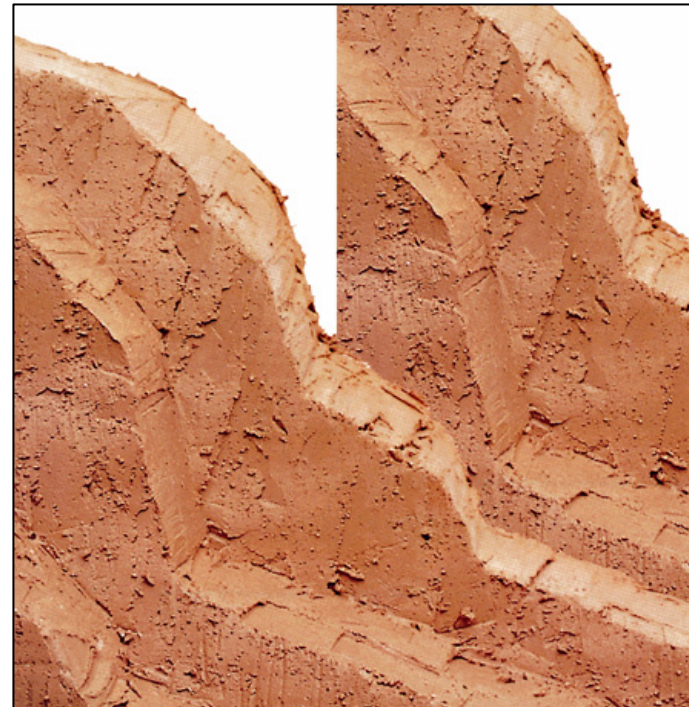

EPB – SHIELD. THE OPERATION PRINCIPLE.

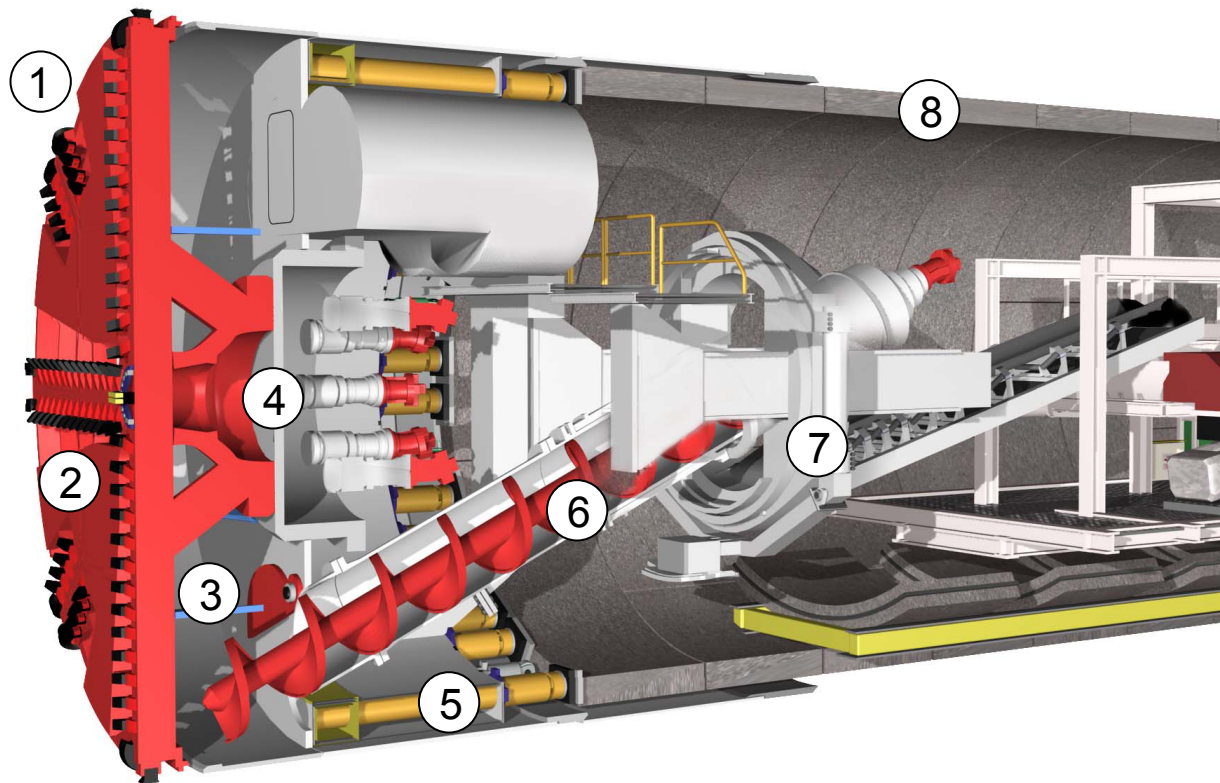

1. tunnelface
2. cutterhead
3. excavation chamber
4. bulkhead
5. thrust cylinders
6. screw conveyor
7. segment erector
8. segment lining

EPB-SHIELD. SUPPORT OF TUNNEL FACE.

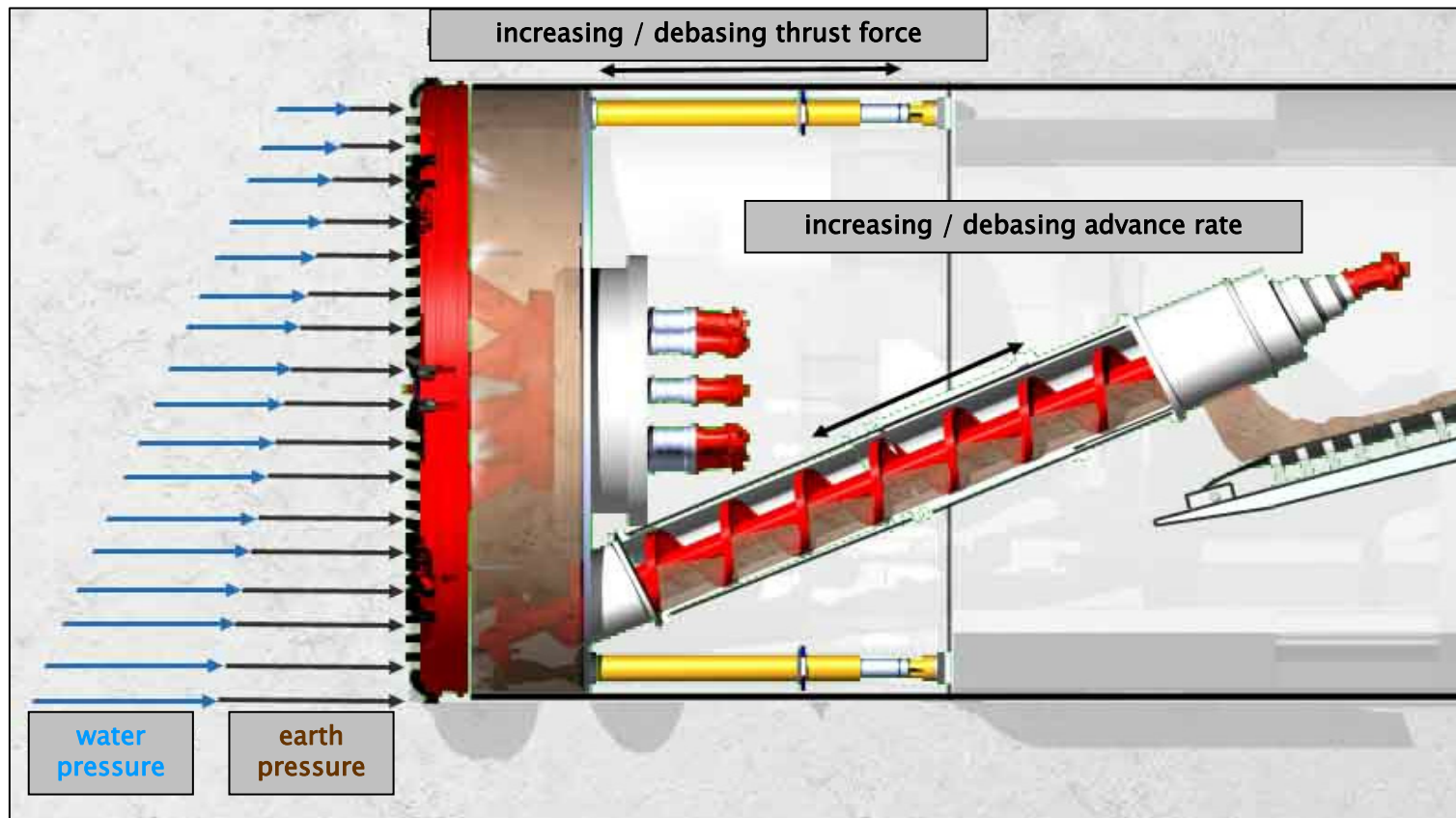

EPB-SHIELD. FOUR MODI. EXCAVATION METHOD: OPEN TO CLOSED.

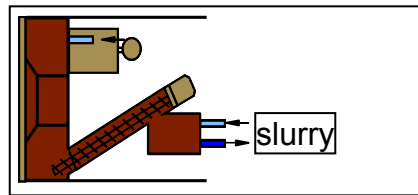

slurry mode

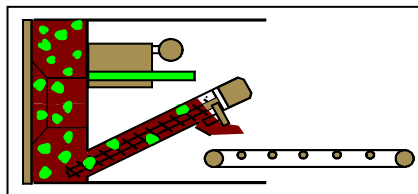

closed mode

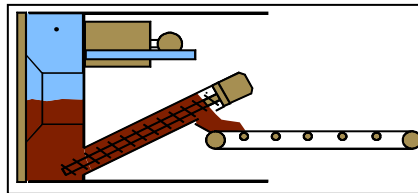

semi closed mode

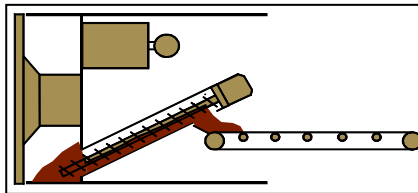

open mode

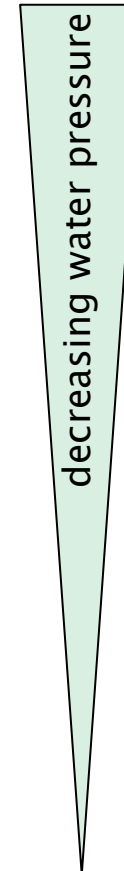
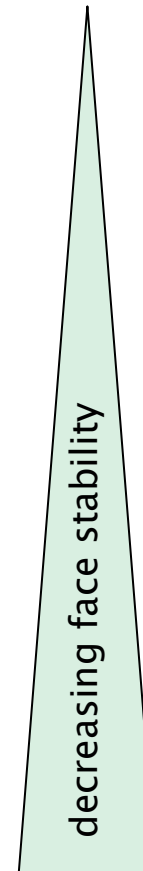

EPB-SHIELD. MODE: SLURRY / CLOSED.

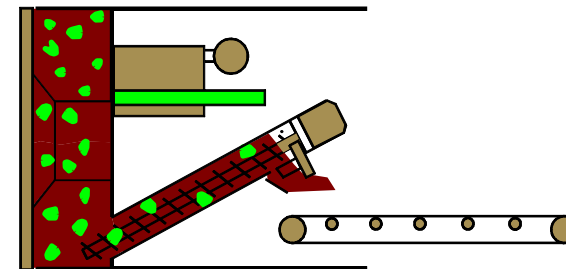
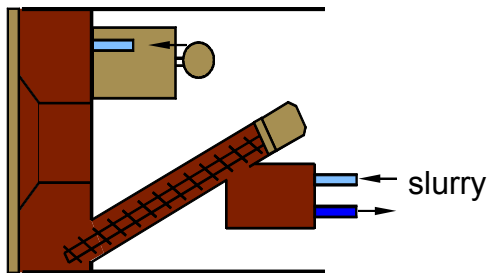

EPB-SHIELD. MODE: SEMI CLOSED / OPEN.

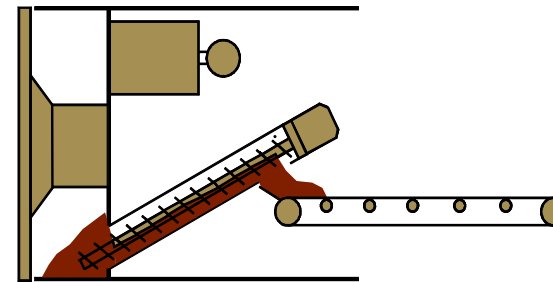
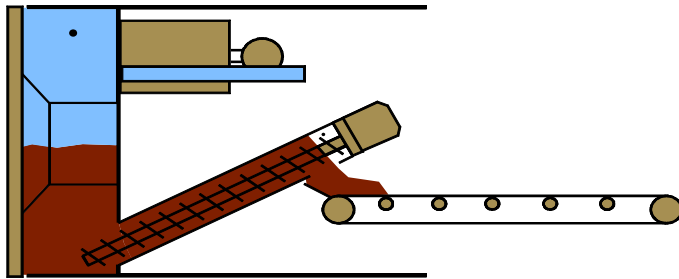

HERRENKNECHT MIXSHIELDS. HIGH SECURITY IN NON COHESIVE AND HETEROGENOUS GROUNDS.



MIXSHIELDS. THE OPERATION PRINCIPLE.

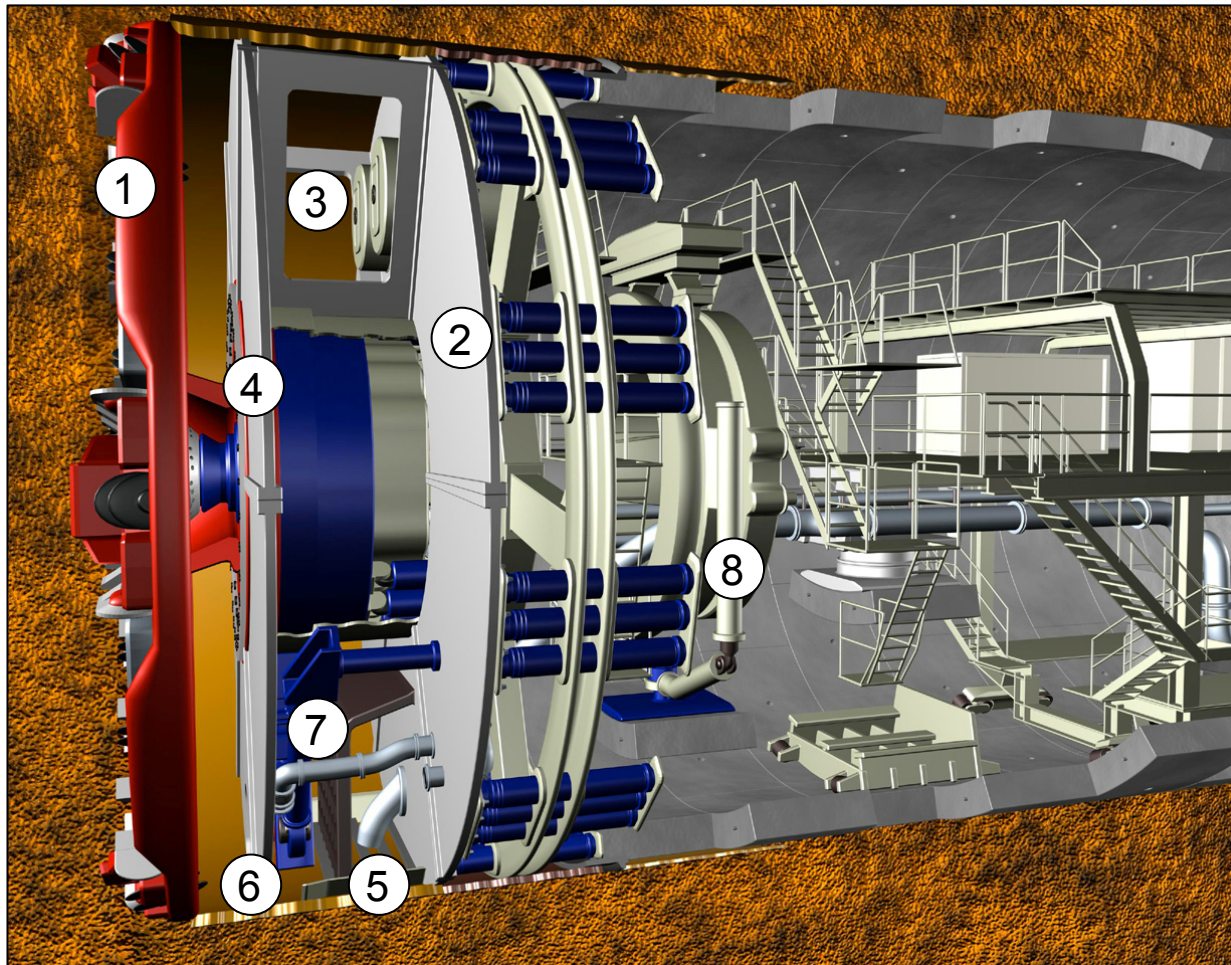

1. cutterhead
2. bulkhead
3. compressed air
4. submerged wall
5. slurry line
6. stone crusher
7. feed line
8. segment erector

MIXSHIELDS. THE OPERATION PRINCIPLE.

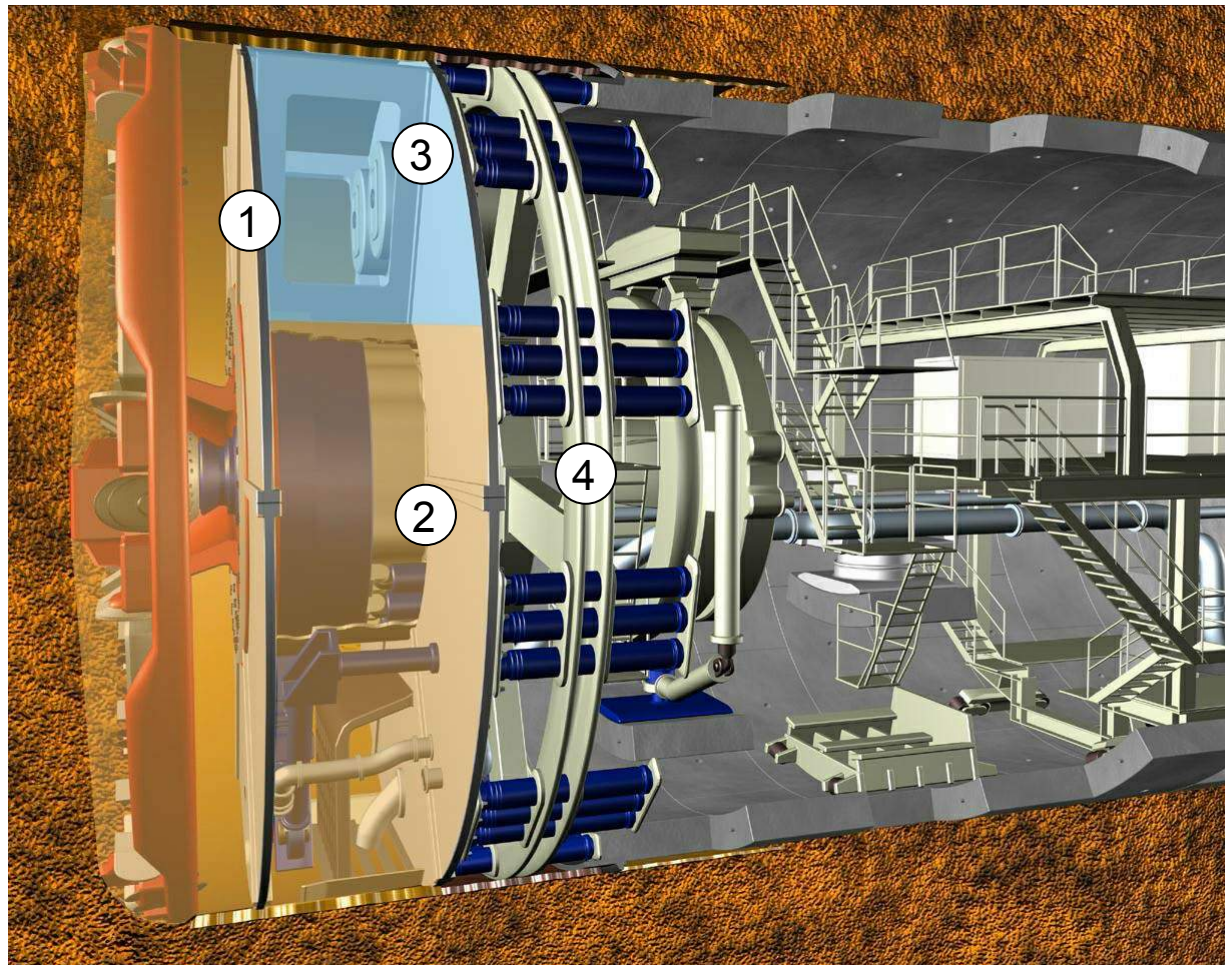

- 1. submerged wall
- 2. working chamber
- 3. compressed air
- 4. bulkhead

HARD ROCK - TUNNELLING

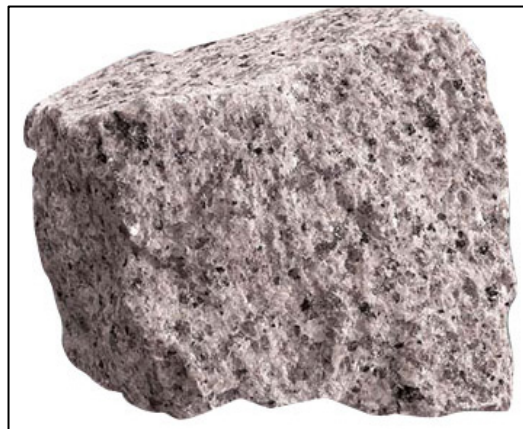

SINGLE SHIELD TBM. THE OPERATION PRINCIPLE.

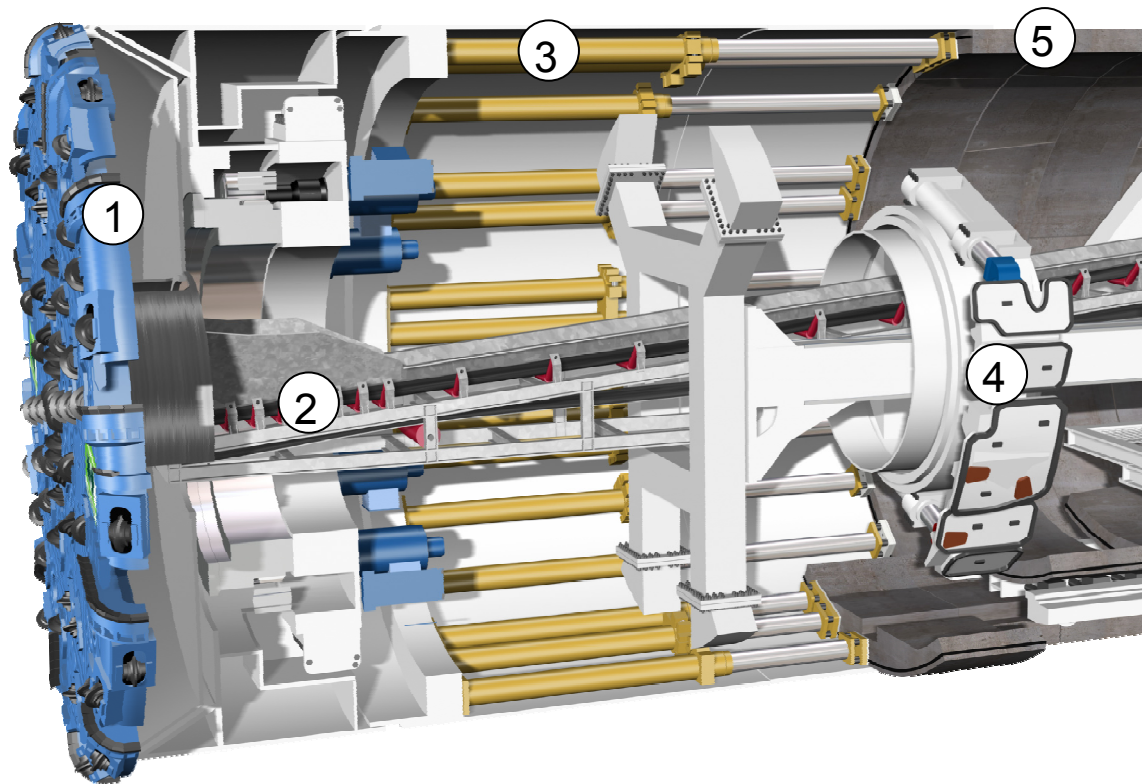

1. cutterhead
2. belt conveyor
3. thrust cylinders
4. segment erector
5. segment lining

SHIELDMACHINES. SEGMENT LINING.

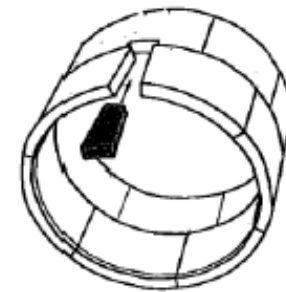

SHIELDMACHINES. SEGMENT LINING.

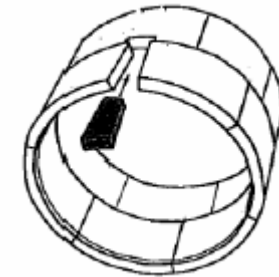

- factory made precast segments, manufactured under controlled conditions
- directly static sustainable after completion of the ring
- circular cross section offers static advances. → “moments are overlapped by normal forces”
- directly waterproof (after completion of the ring)
- standard sealing: water pressures up to 9 bar
- neopren sealing: sealing function for 100 years and more

TÜBBINGAUSBAU. SEGMENT GEOMETRY.

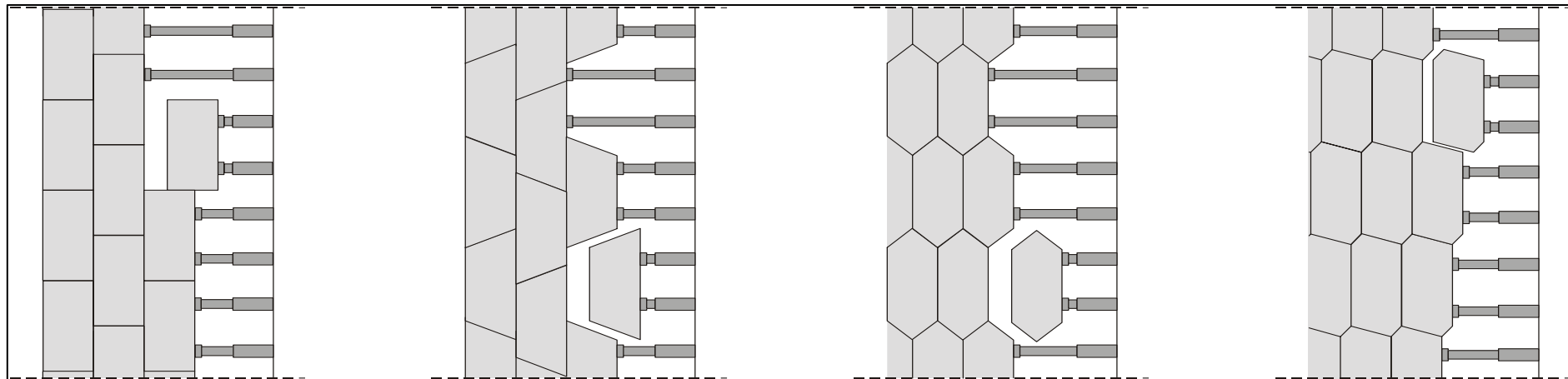

rectangular
segment

trapezoidal
segment

hexagonal
segment

spiral
segment

GRIPPER TBM. THE OPERATION PRINCIPLE.

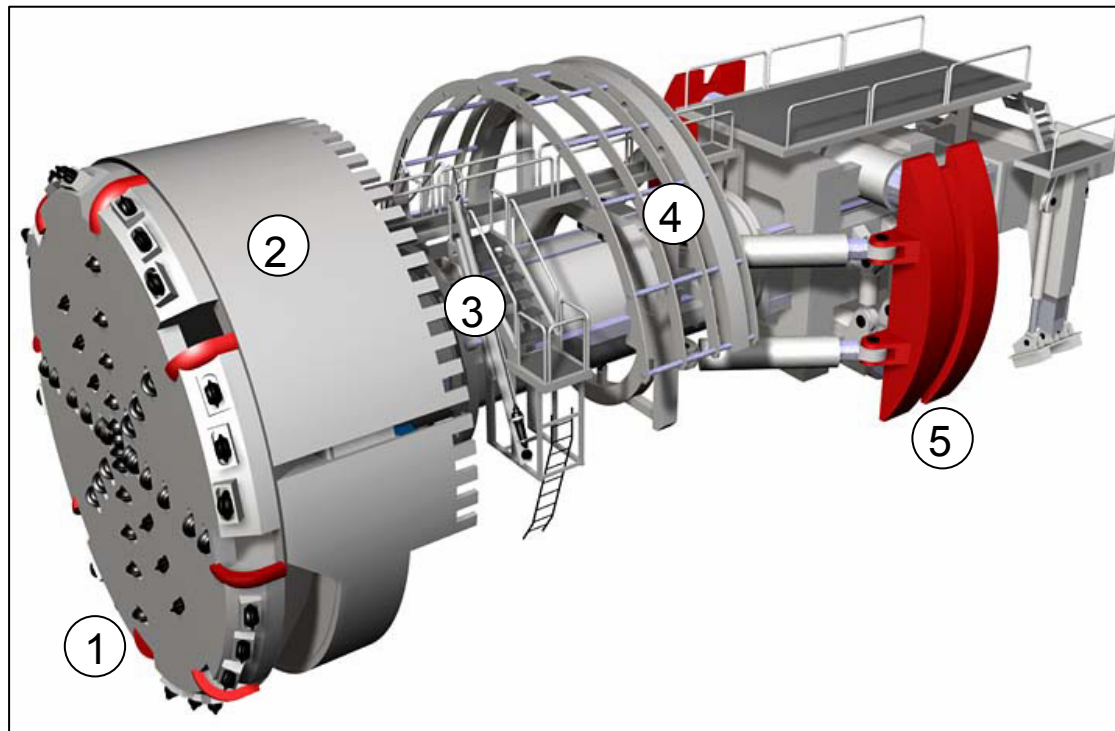

1. cutterhead
2. small crown shield
3. drillings
4. wire mesh erector
5. gripper shoes

GRIPPER TBM. STEELARCHES, STEELMESHES, SPRAYED CONCRETE.

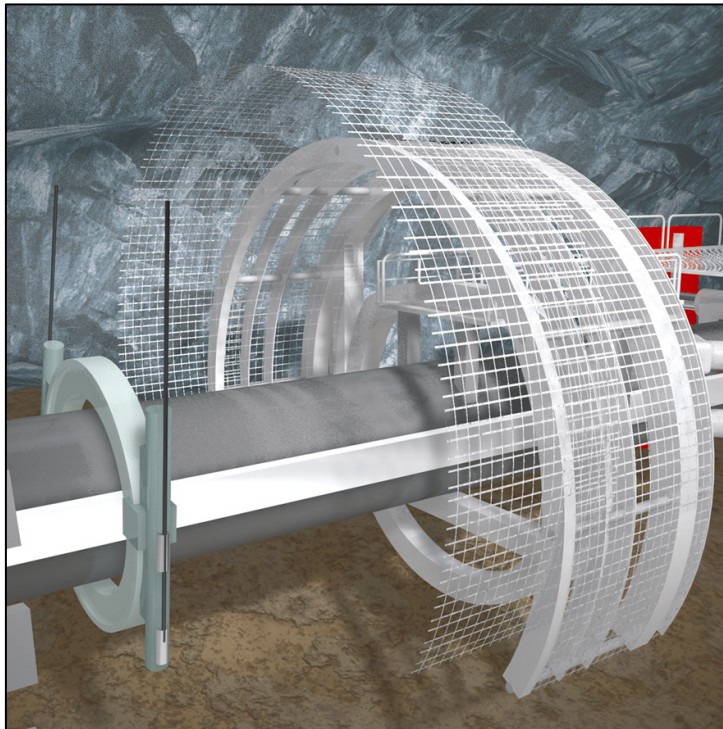

- the steel mesh erector positions the steel meshes and the steelarches over the anchor drillings, which avoid larger collapses into the tunnel behind the crown shield

GRIPPER TBM. STEELARCHES, STEELMESHES, SPRAYED CONCRETE.

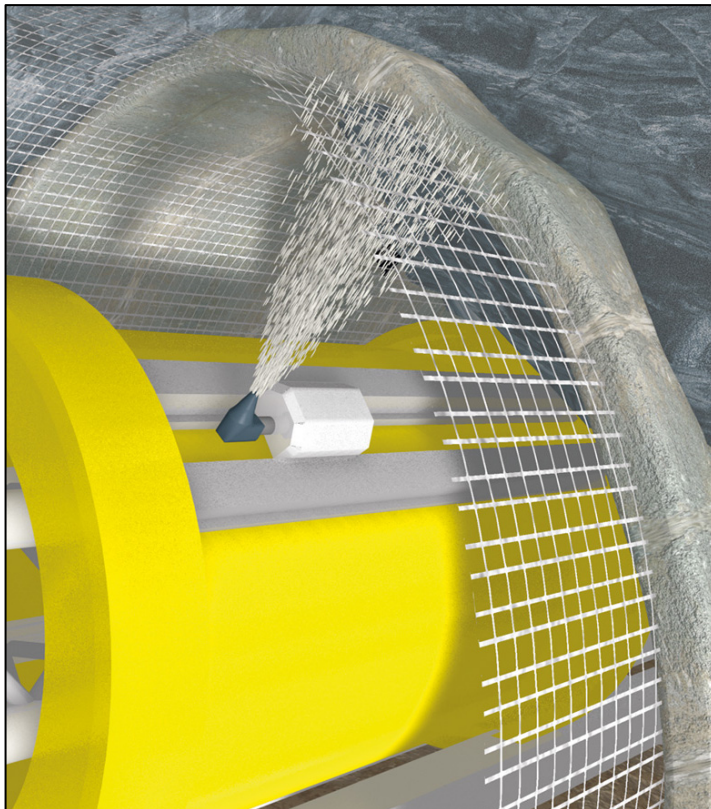

- concrete nozzle manipulator about 60 m behind the cutterhead for avoiding dust pollution on neuralgic machine components



DOUBLE SHIELD TBM. ALLROUND MACHINE TYPE FOR HARDROCK CONDITIONS.

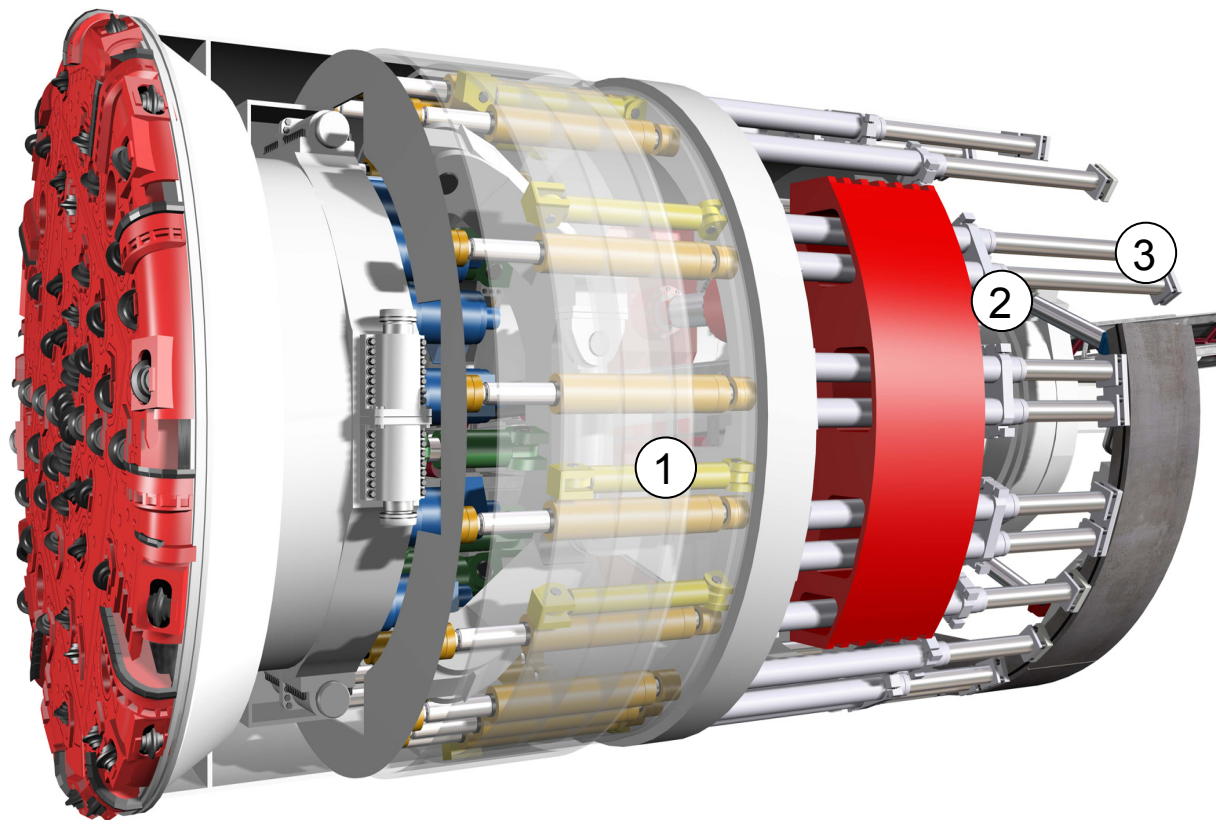

1. telescopic shield
2. gripper shoe
3. thrust cylinders

DESIGN PARAMETERS FOR TUNNELBORINGMACHINES.

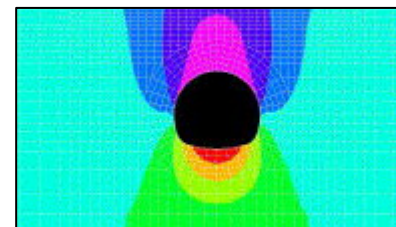
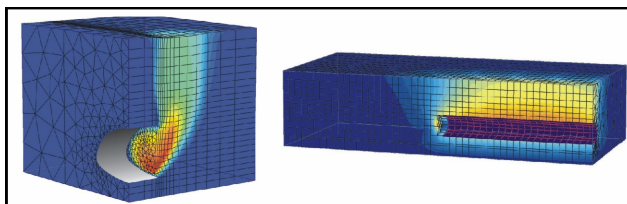
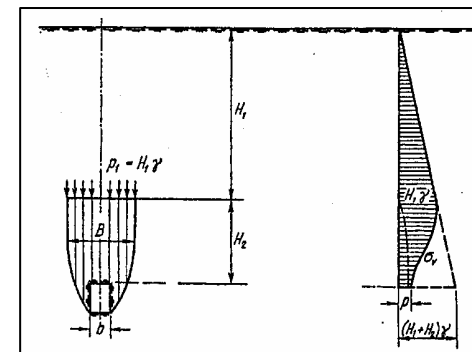
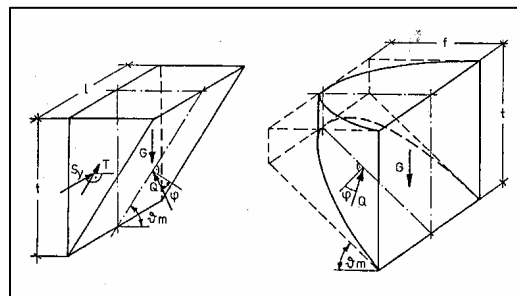
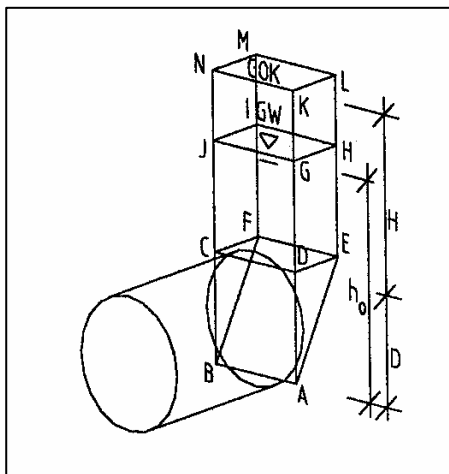

GEOTECHNICS. GROUND RISK IN RELATION TO EXPLORATION.

Ground risk in relation to extent of preliminary geotechnical investigation

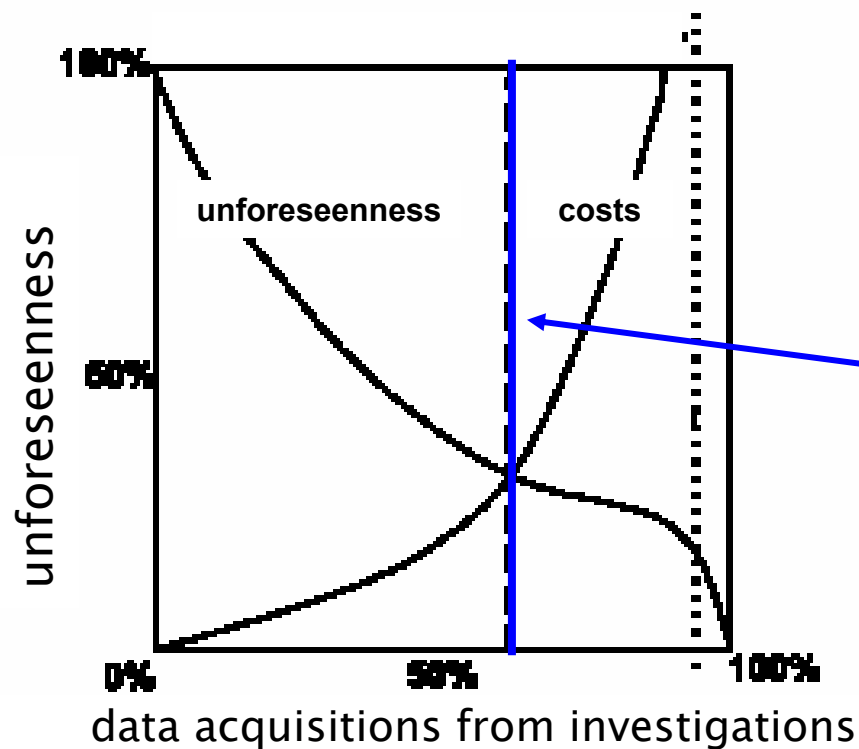

practical limit of
data acquisition:

for every project, the
optimal effort in
relation to economy
and unforeseenness has
to be found !

GEOTECHNICS. INFLUENCE OF GEOLOGY AND HYDROGEOLOGY.



GEOTECHNICS. INFLUENCE OF GEOLOGY AND HYDROGEOLOGY.

Important soil parameters for TBM concept in soft ground

- grain size distribution
- unit weight γ
- inner angle of friction φ
- cohesion c
- permeability k
- groundwater condtion
- clay mineralogy
- Atterbergs limits w_l , w_p , w
- quartz content
- elastic modulus E_c
- lateral earth pressure coefficient K_0
- OCR
- etc.

GEOLOGY + HYDROGEOLOGY

GEOTECHNICS

design of shield structure

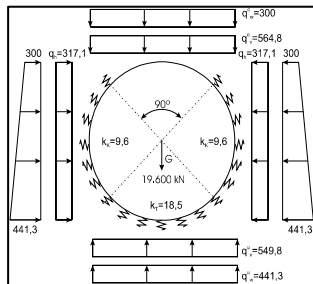

torque calculation

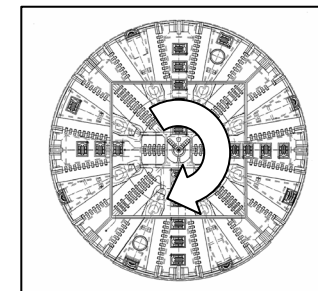

thrust force calculation

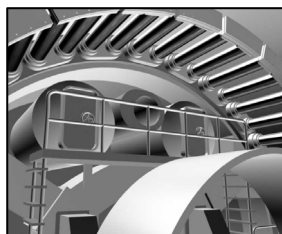

wear prognosis

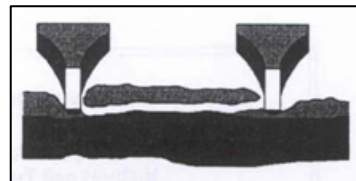

support pressure calculation

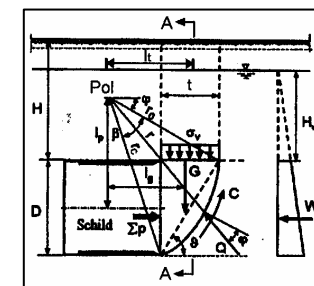

DESIGN PARAMETERS AND DESIGN CRITERIA.

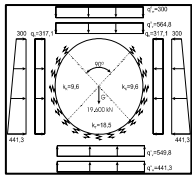

design of shield structure:

- analytical methods: – full load approach
– arching theory
- numerical methods: – FEM

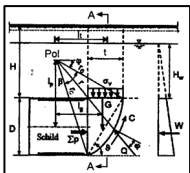

support pressure calculation:

- analytical methods: – DIN 4085
– Jancsecz etc.
- numerical methods: – FEM

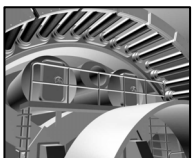

thrust force calculation:

- analytical: balance of all external and internal forces

DESIGN PARAMETERS AND DESIGN CRITERIA.

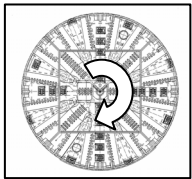

torque calculation:

soft soil: experience, empirical
calculation methods

hard rock: CSM modell etc.

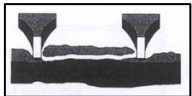

wear prognosis:

soft soil: experience, empirical
calculation methods

hard rock: CSM modell
NTNU modell
Sanio / Ewendt
etc.

SHIELD MACHINES. SUPPORT PRESSURE ESTIMATION.

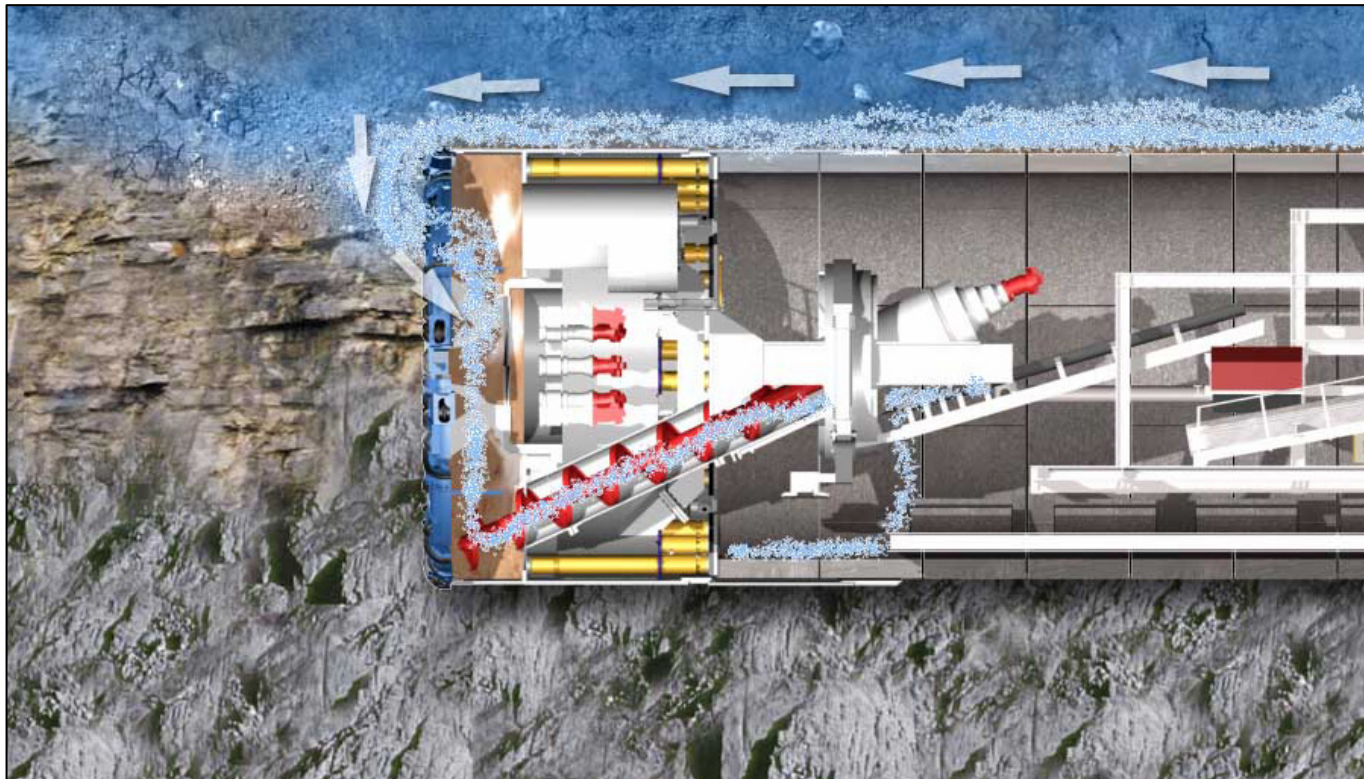

SHIELD MACHINES. SUPPORT PRESSURE.

support pressure:

- to maintain tunnel face stability in shield tunnelling the pressure of the support mediums should be in balance with the outer earth and water pressure.

earth pressure:

- analytical calculation of earth pressure based on 3-d arching effect and tunnel face deformation not possible

water pressure:

- consideration of hydrostatic pressure / perched water / tidal water levels

SHIELD MACHINES. SUPPORT PRESSURE. MODELS FOR COHESIVE & NON – CHESIVE SOILS.

Non-cohesive models:

- application in coarse and mixed grained soils.
- fracture along slip plane in excavation chamber
- elastic failure

cohesive models:

- application in cohesive soils
- fracture in a spatial zone under continuous deformation
- plastic failure

SHIELD MACHINES. SUPPORT PRESSURE. ANALYTIC MODELS.

Nr.	Berechnungsmodell	Bruchkörper	Art	Gleitfläche	Überdeckung
Für nicht-kohäsive Böden					
1	Mitteldruckverfahren von Balthaus	-	2D	-	X
2	Verfahren von Krause	Halbkreis	2D	Gekrümmt	-
3	Verfahren von Krause	Viertelkreis	2D	Gekrümmt	-
4	Verfahren von Krause	Halbkugel	3D	Gekrümmt	-
5	Verfahren von Murayama	Log. Spirale	2D	Gekrümmt	X
6	Verfahren von Murayama (Phillip)	Log. Spirale	3D	Gekrümmt	X
7	Verfahren von Anagnostou/Kovari	Erdkörper nach Horn	3D	Eben	X
8	Verfahren Jancsecz	Erdkörper nach Jacsecz	3D	Eben	X
9	Verfahren nach DIN 4085	Erdkörper nach Piaskowski / Kowalewski	3D	Gekrümmt	X
10	Verfahren von Mohkam	Log. Spirale	3D	Gekrümmt	
Für kohäsive Böden					
10	Mit Stabilitätsfaktor nach Jancsecz	Atkinson & Mair	3D	Eben	X
11	Mit Totalspannungen	-	3D	-	X

Praxisrelevante Verfahren

practical relevant methods

Tab. 3.1: Übersicht über die Berechnungsverfahren für kohäsive und nicht-kohäsive Böden

SHIELD MACHINES. SUPPORT PRESSURE. TUNNEL FACE STABILITY.

Failure monolith:

- method with real failure body
(DIN 4085 based on
Piakowski/Kowalwski)
- method with soil wedge „pseudo-
spatial“
(Jancsecz and Anagnostou/Kovari or
Horn)

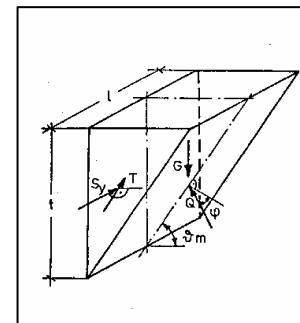
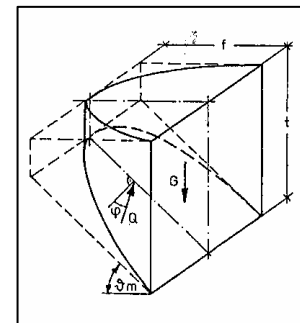

SHIELD MACHINES. SUPPORT PRESSURE. TUNNEL FACE STABILITY. EXAMPLE: JANCSCZEZ MODEL.

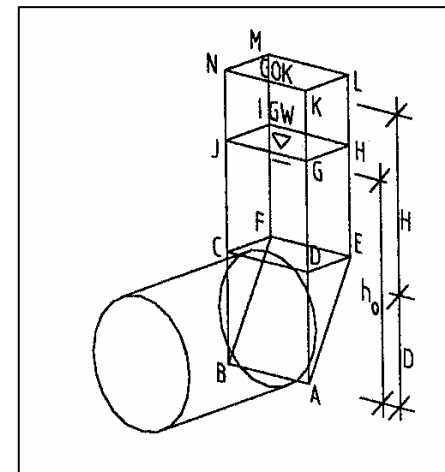
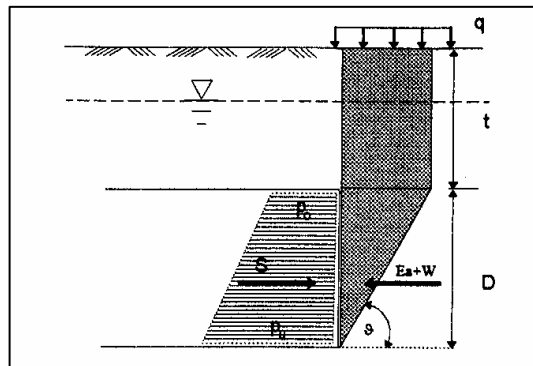

Calculation method:

- Determination based on consideration of balance of forces
- with a composite, spatial failure model (rectangular soil column and soil wedge) based on Horn.
- Failure according to Mohr – Coulomb

DESIGN PARAMETERS AND DESIGN CRITERIA. EPB - CUTTERHEAD.

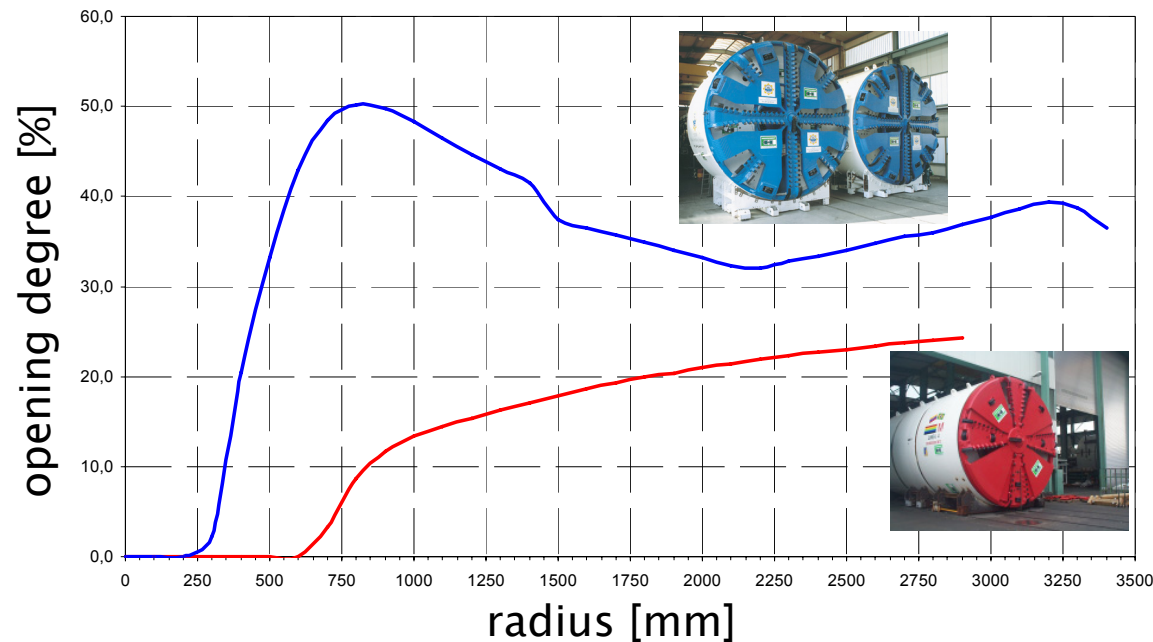

layout cutterhead in rather non cohesive soil conditions

layout cutterhead in rather cohesive soil conditions

DESIGN PARAMETERS AND DESIGN CRITERIA. MIXSHIELD - CUTTERHEAD.

cutterhead design and opening degree in relation to excavated ground,
mechanical tunnel face supporting function, material flow...

geology:
sand and gravel

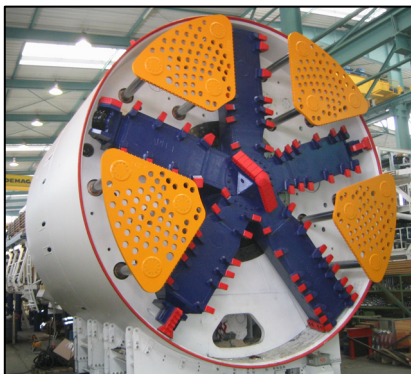

geology:
sand, silt, clay



„hard rock
Mixshield“



GEOTECHNICS. SOIL RECOMMENDATION.

EPB - Shield

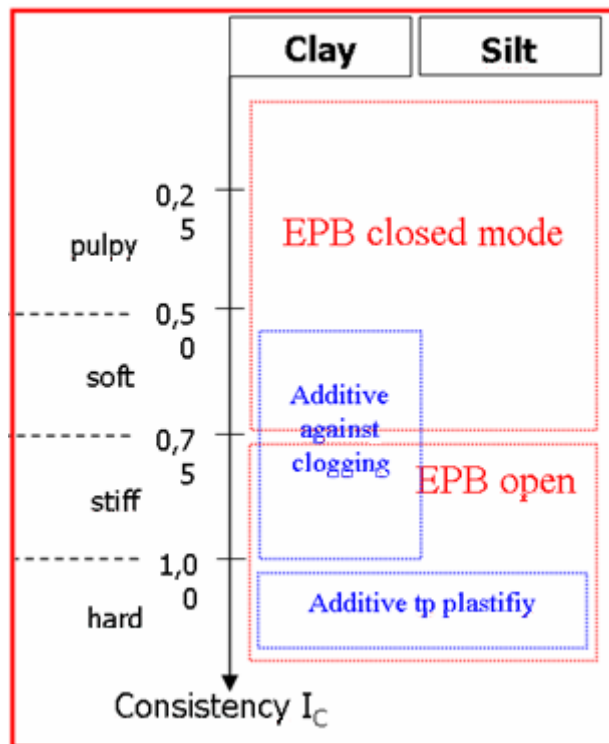

MIX - Shield

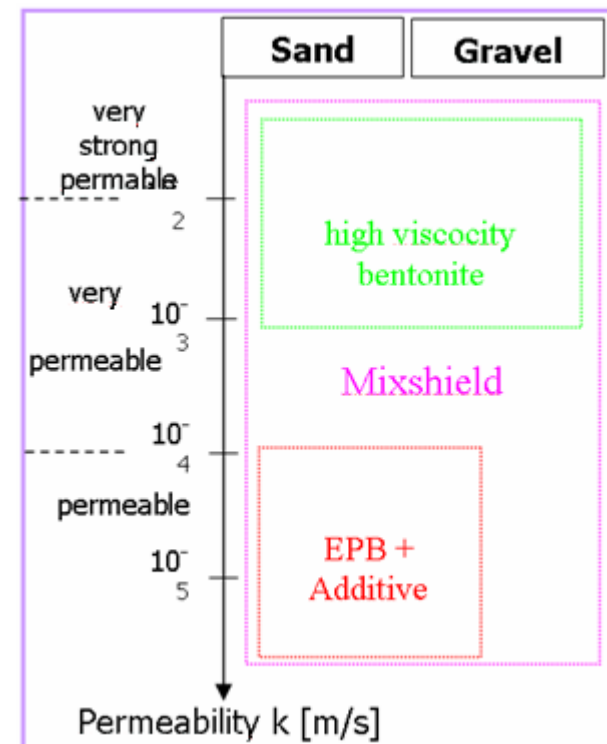

GEOTECHNICS. SOIL RECOMMENDATION. EPB.

Soil recommendation for EPB-mode:

- cohesive and plastic
- soft to stiff consistency
- small inner angle of friction
- low permeability

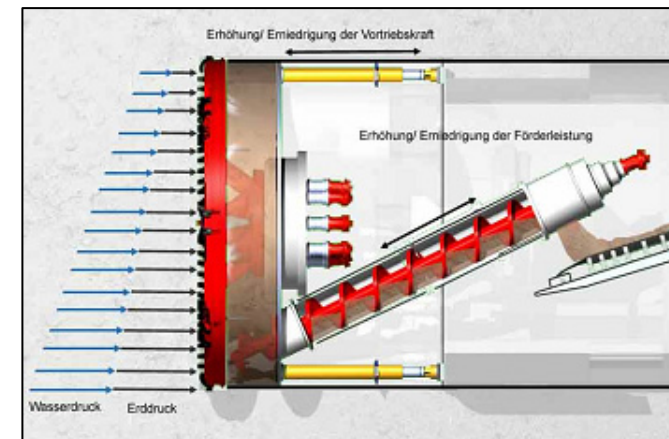
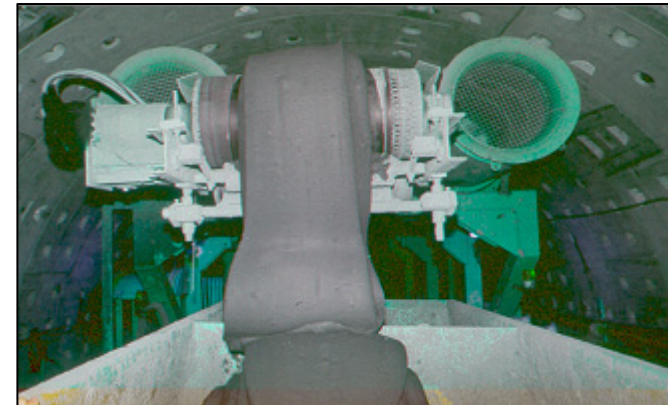

EPB-SHIELD. CONDITIONING. FOAM.

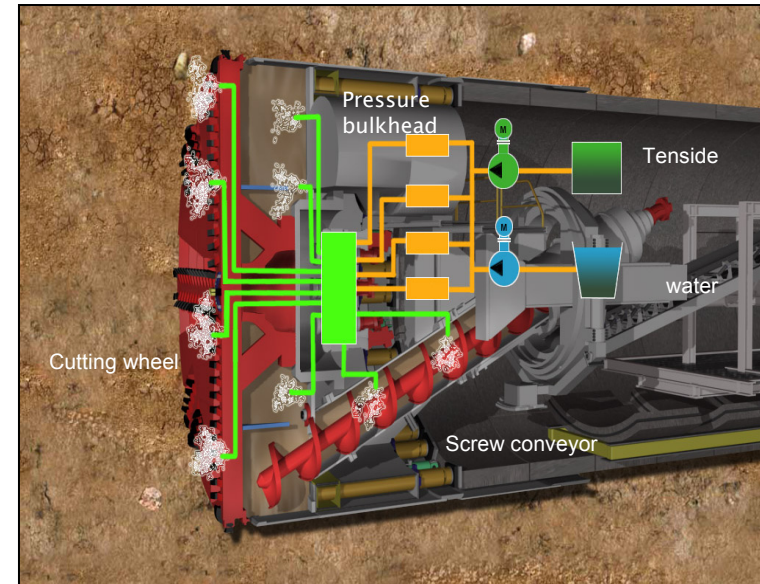

FOAM. PROPERTIES.

Properties of foaming:

- creating plasticity
- short term cohesion
- lower angle of friction
- lower permeability



FOAM. ADVANTAGES.

soft soil	hard rock
<ul style="list-style-type: none">▪ reduction of friction angle of soil▪ short term cohesion of soil▪ plasticity and lower permeability of soil▪ lower wear▪ lower torque▪ short term stabilisation of face▪ lower clogging▪ soil structuring	<ul style="list-style-type: none">▪ reduction of dust▪ reduction of choking disc cutters, clean disc and faster changing possible▪ greater cooling effect with foam than with water▪ lower wear, abrasion▪ lower torque

FOAM. CONDITIONING IN SOFT SOIL.



- low cohesive sand

- short-term cohesion via foam



FOAM. CONDITIONING IN HARD ROCK.

- foam for structuring



FOAM. DIFFERENT FOAMS.

Different foams have different characteristics:

- foaming capacity
- stability
- anti-clay capacity
- rheological impact (liquefaction / stiffening)
- drying-up capacity

„wet foam“

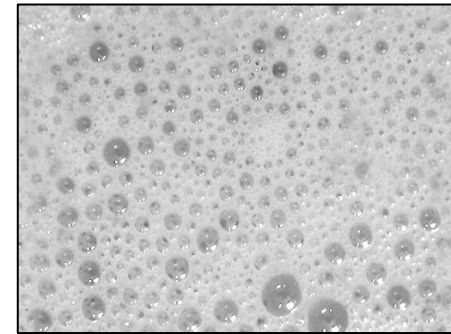

„dry foam“



FOAM. GENERATION.

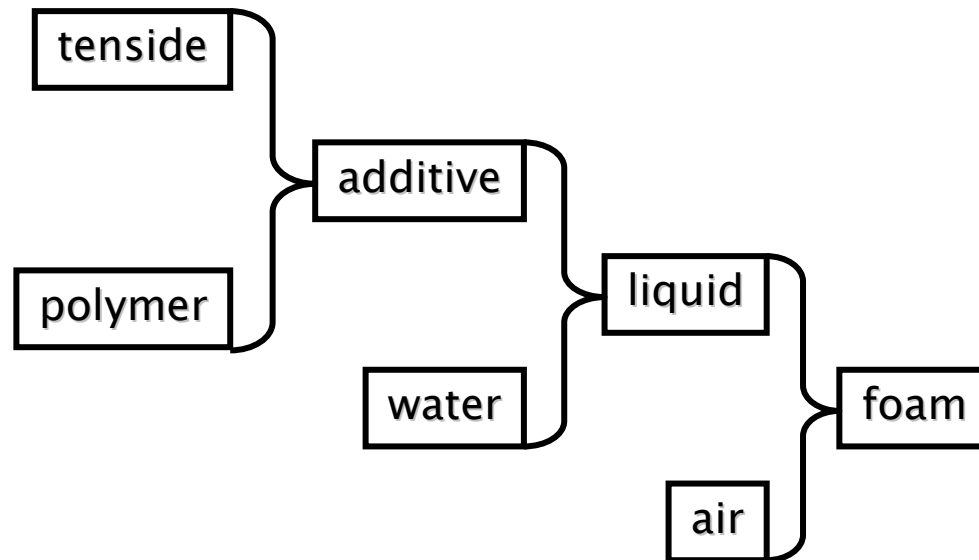

FOAM. FOAM INJECTION RATE.

Foam Injection Rate (FIR):

- FIR regulates amount of foam
- FIR correlates with pore volume
- $FIR = \text{volume foam} / \text{volume soil}$
- FIR correlates with advance rate

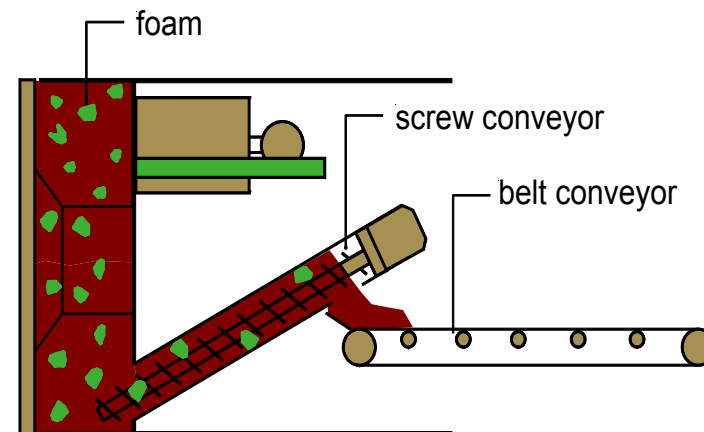

FOAM. FOAM EXPANSION RATE.

Liquid: additive (2 – 5%)
water (95 – 98%)

Foam Expansion Rate (FER):

- FER regulates quality
- low FER = wet foam
- high FER = dry foam
- FER = volume foam/volume liquid

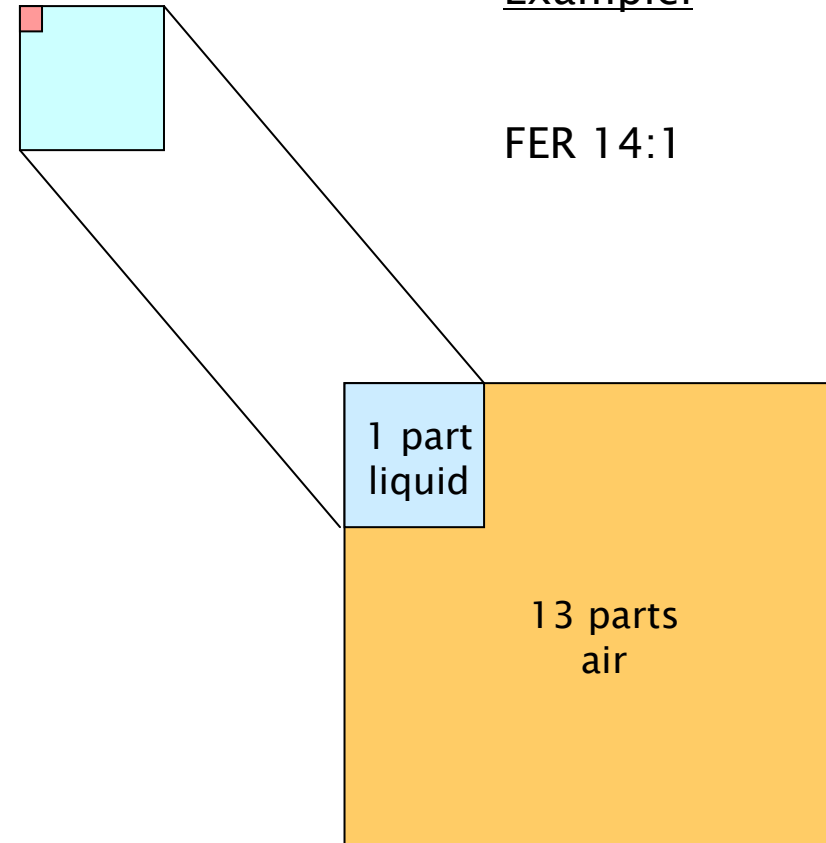

FOAM. CLOGGING. ANTI – CLAY – ADDITIVE.

Use of Anti-clay-Additives in clay as well as in silt & sand:

- Problem
 - adhesion on steel surface
 - cohesion of greater clay lumps

- Conclusion
 - clogging of cutting wheel
 - clogging of screw conveyor or excavation chamber



Solution: addition of anti – clay additives

FOAM. CLOGGING. PREDICTION OF CLOGGING RISKS.

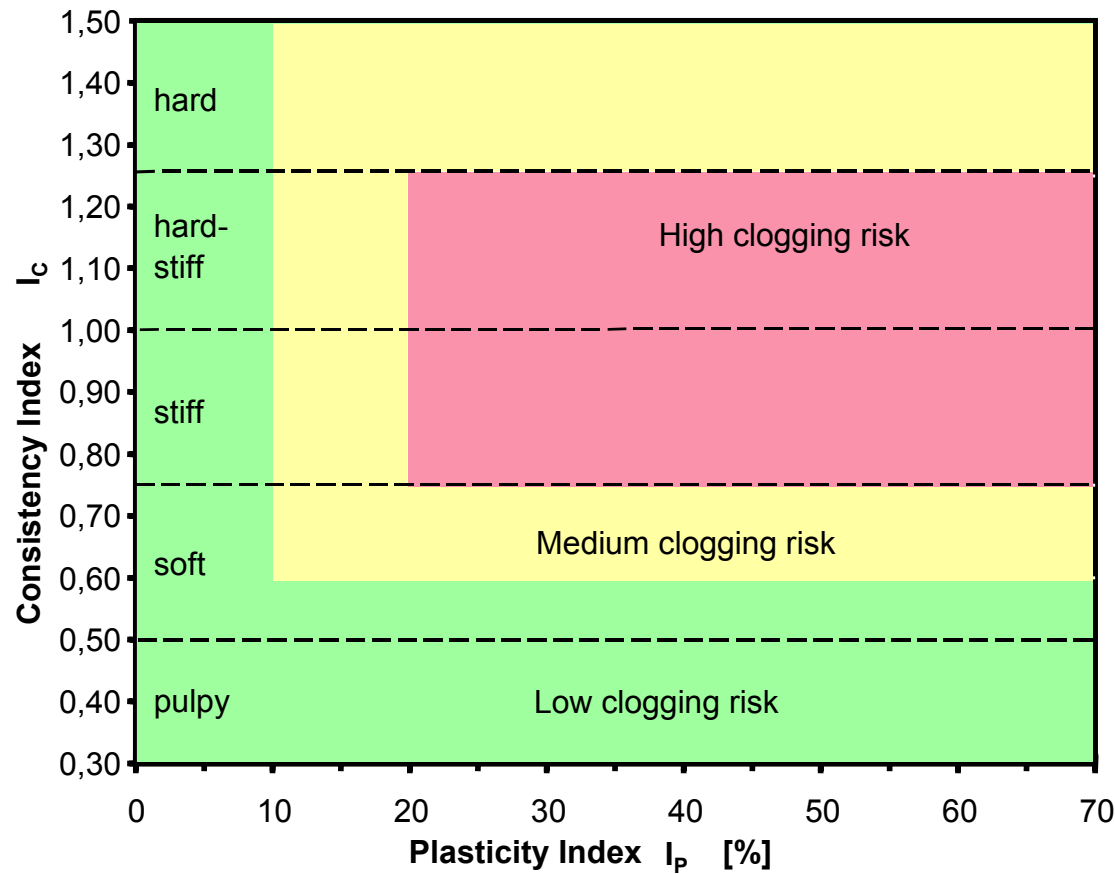

$$I_c = (w_L - w) / (w_L - w_p)$$

$$I_p = w_L - w_p$$

HYDROSHIELD / MIXSHIELD. SLURRY SUSPENSION.

principle role:

- 1.) transport medium for excavated soil
- 2.) support medium for „active face support“



HYDROSHIELD / MIXSHIELD. SLURRY CHARACTERISTICS. BASIC ROLE.

principle characteristics:

- creates an impermeable membrane so that slurry can develop adequate confinement pressure to ensure face stability
- the viscosity of the slurry must allow a high velocity in the pipes for adequate mucking
- slurry should limit wear by reducing friction
- slurry should reduce sticking and flocculation in fine soils
- slurry must allow for easy separation/mud treatment
- slurry must be confirm with environment restriction

HYDROSHIELD / MIXSHIELD. FILTER CAKE.

Thickness of filter cake:

- 4% loose bedding
- 5% medium dense bedding
- 6% dense bedding



HYDROSHIELD / MIXSHIELD. MUD TREATMENT.

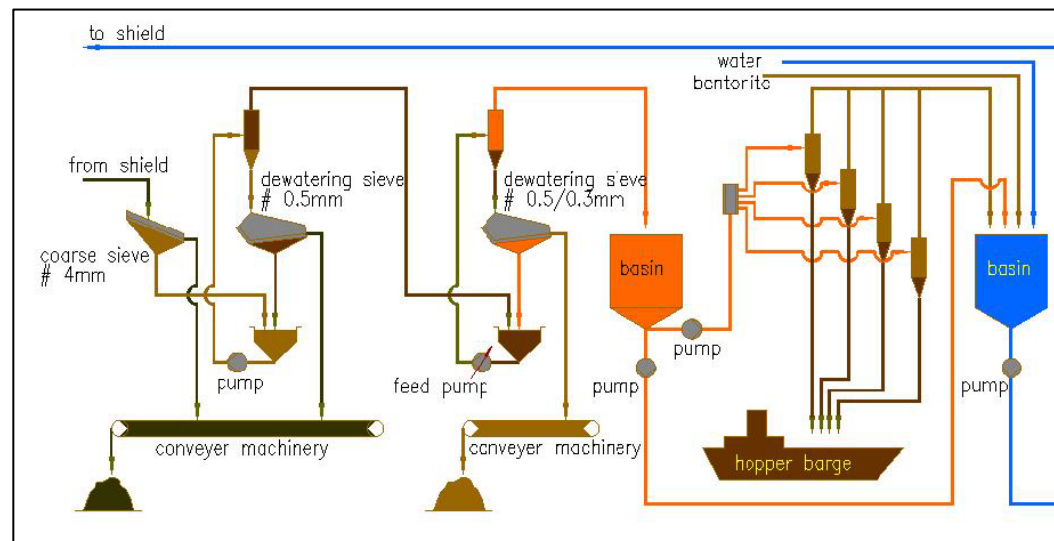

HYDROSHIELD / MIXSHIELD. MUD TREATMENT. SEPARATION PLANT.



HYDROSHIELD / MIXSHIELD. MUD TREATMENT. SIEVE ANALYSIS.

EXAMPLE: Sieve analysis of a slightly clayey, intensive sandy clay

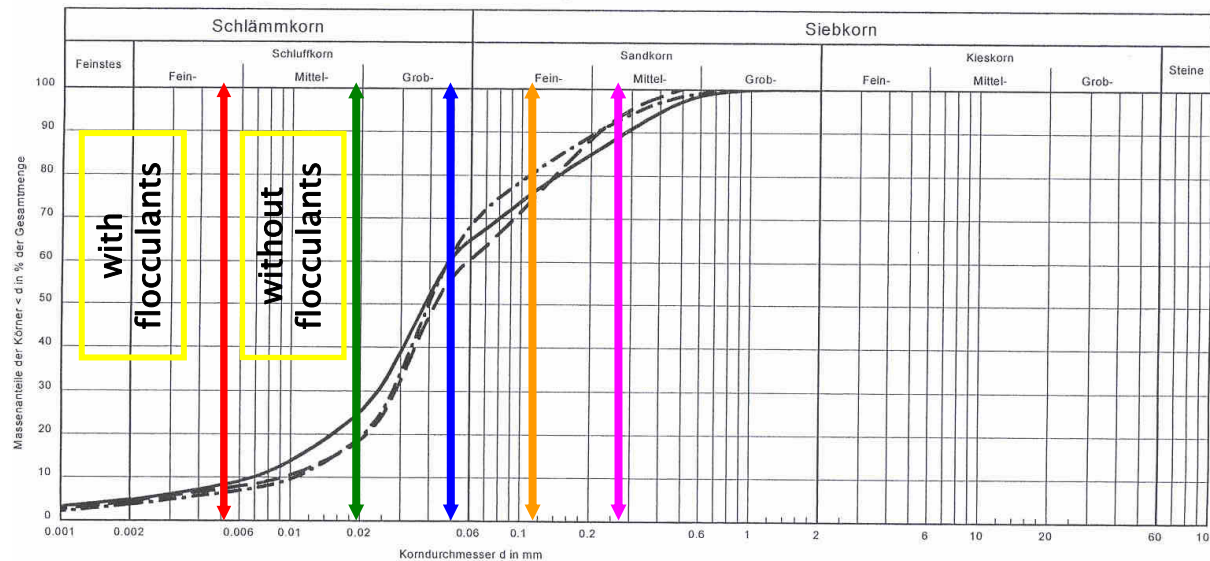

1st sieve

2nd sieve

1st cyclone level

2nd cyclone level

centrifuge

HYDROSHIELD / MIXSHIELD. MUD TREATMENT. SEPARATION PLANT.

sieve / dewatering screen:



cyclone:

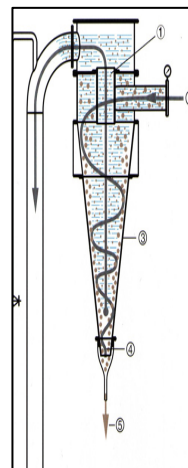

Details of hydrocyclon:

- 1. Overflow nozzle
- 2. Feed slurry
- 3. Wear protection
- 4. Underflow nozzle
- 5. Underflow
- 6. Overflow

HYDROSHIELD / MIXSHIELD. MUD TREATMENT. SEPARATION PLANT.

centrifuge:



filter press:

SPECIAL CHALLENGE OF LARGE SCALE TBM's



S-300: M30 Madrid, Spanien



S-317: Shanghai, China

S – 300, M 30 – MADRID. CHALLENGE IN DEVELOPMENT, SECURITY AND A VERY ROUGH OPERATING SCHEDULE.





Madrid M30 roadtunnel with inspection- and escapeways under the main deck.

Mounting of M30.

World largest EPB – Shield Ø15.2 m.

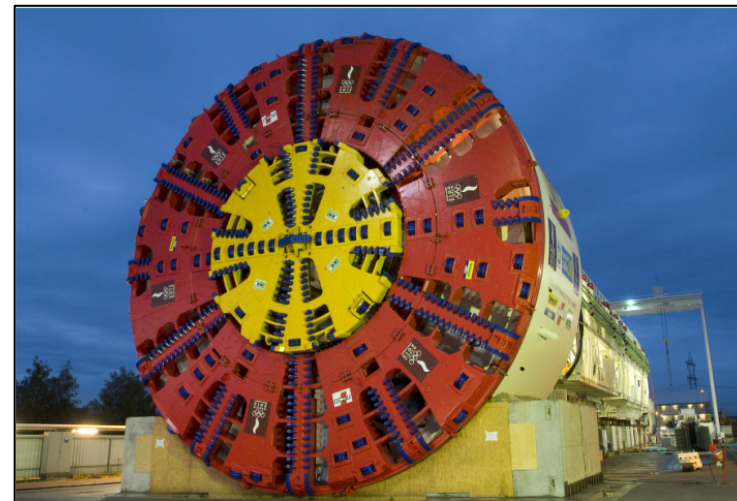

S – 300: M 30. MADRID. SPAIN. GEOLOGY.

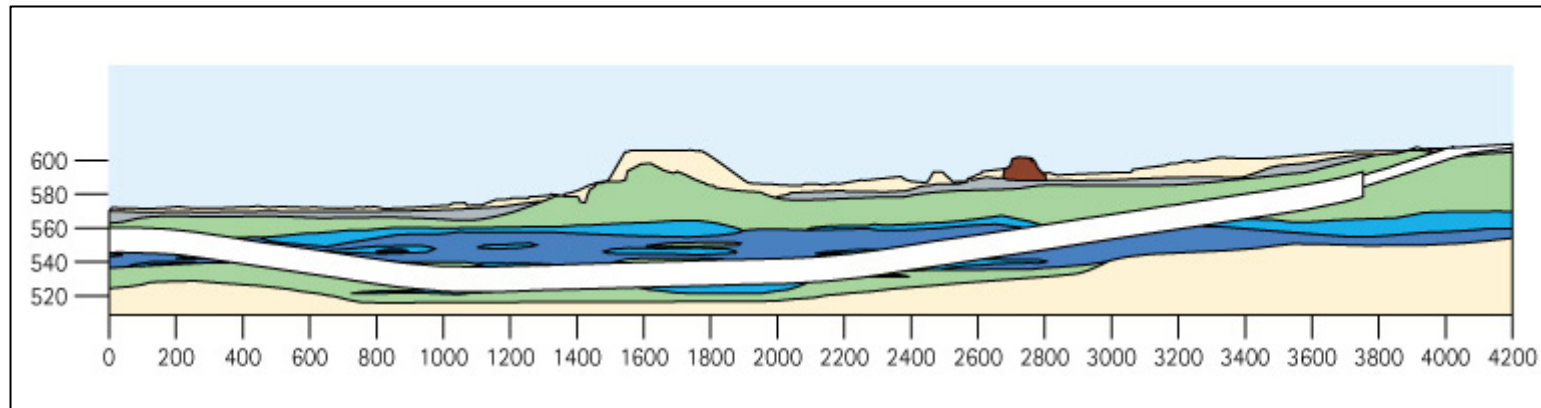

original designation	geological classification	particle size distribution	share trace [%]
Penuelas verdes y grisaceas	silty clay, green and green-grey, with layers of sandy silt	gravel 1% sand 11% fine portion 88%	38
Penuelas + Yesos	penuela with interleaves of gypsum white-grey, portion of gypsum variable between 0–5 up to 50%	gravel 6% sand 13% fine portion 81%	38
Yesos masivos	gypsum white-grey with layers of silty clay grey hard., low resistance	gypsum > 50%	24

S – 300: M 30. MADRID. SPAIN

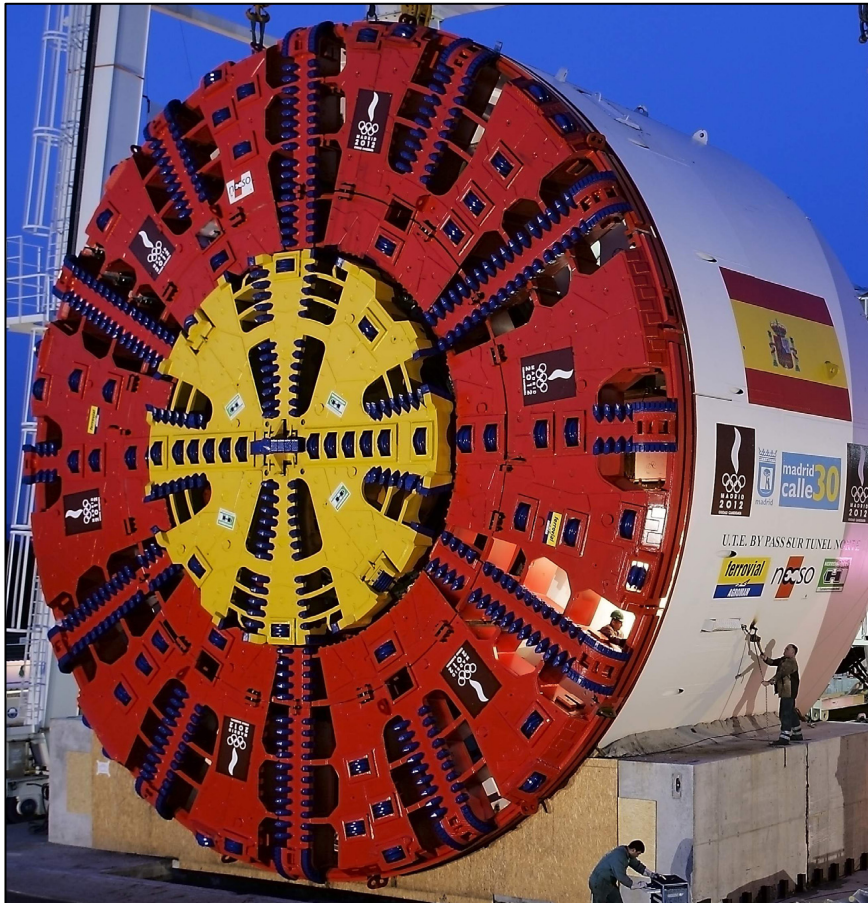

S-300 | M 30 Madrid
| Spain



EPB – Shield

Diameter: 15.200 mm

Tunnel length: 3.650 m

Cutterhead power: 12.000 kW

Geology: penuela, sand,
gypsum

Customer: Necso
Ferrovial-
Agroman S.A.

M 30. MADRID.

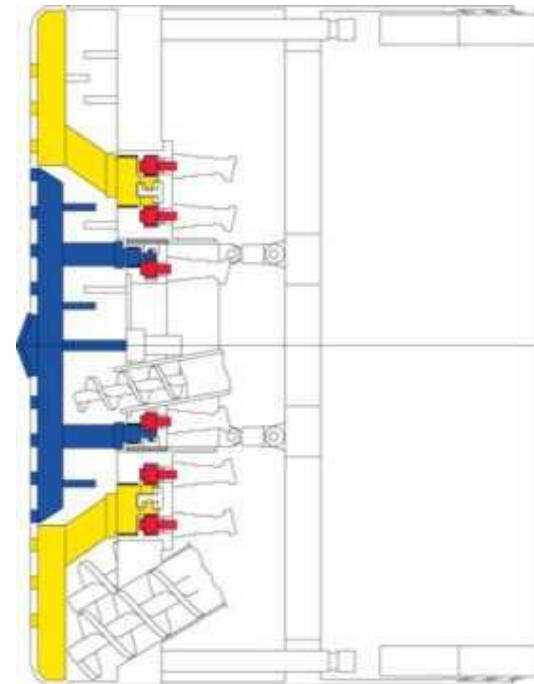
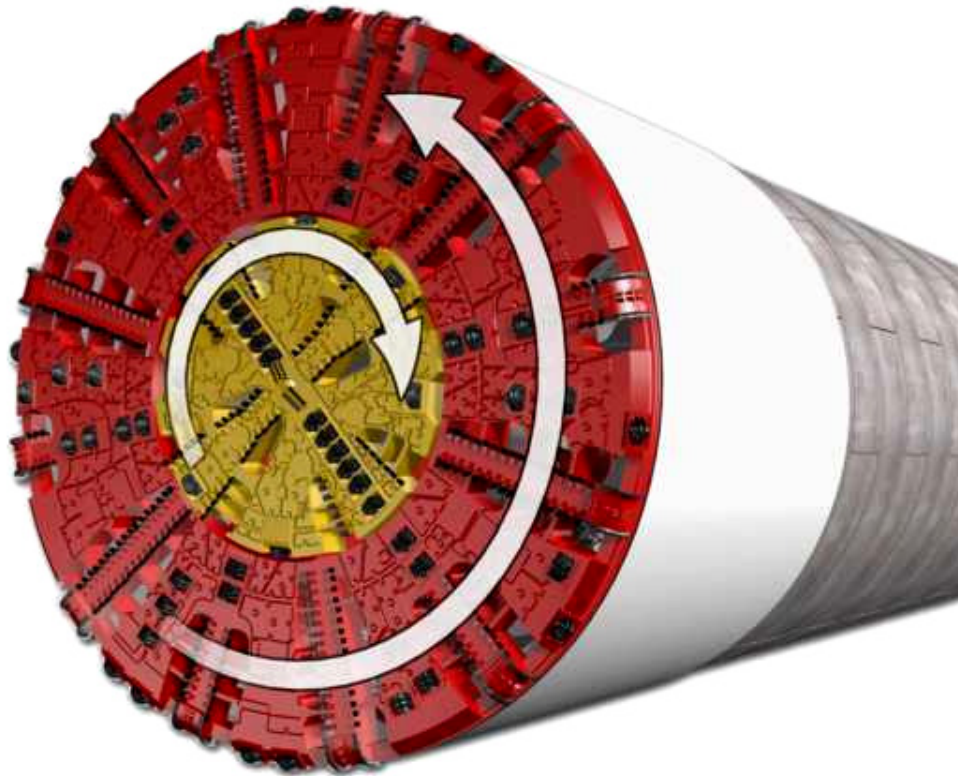

- assembly of 60 drive units for the internal and external cutterheads.
- torque reduction by divided cutterhead with opposite directional rotation

LARGEST EVER INSTALLED TORQUE.

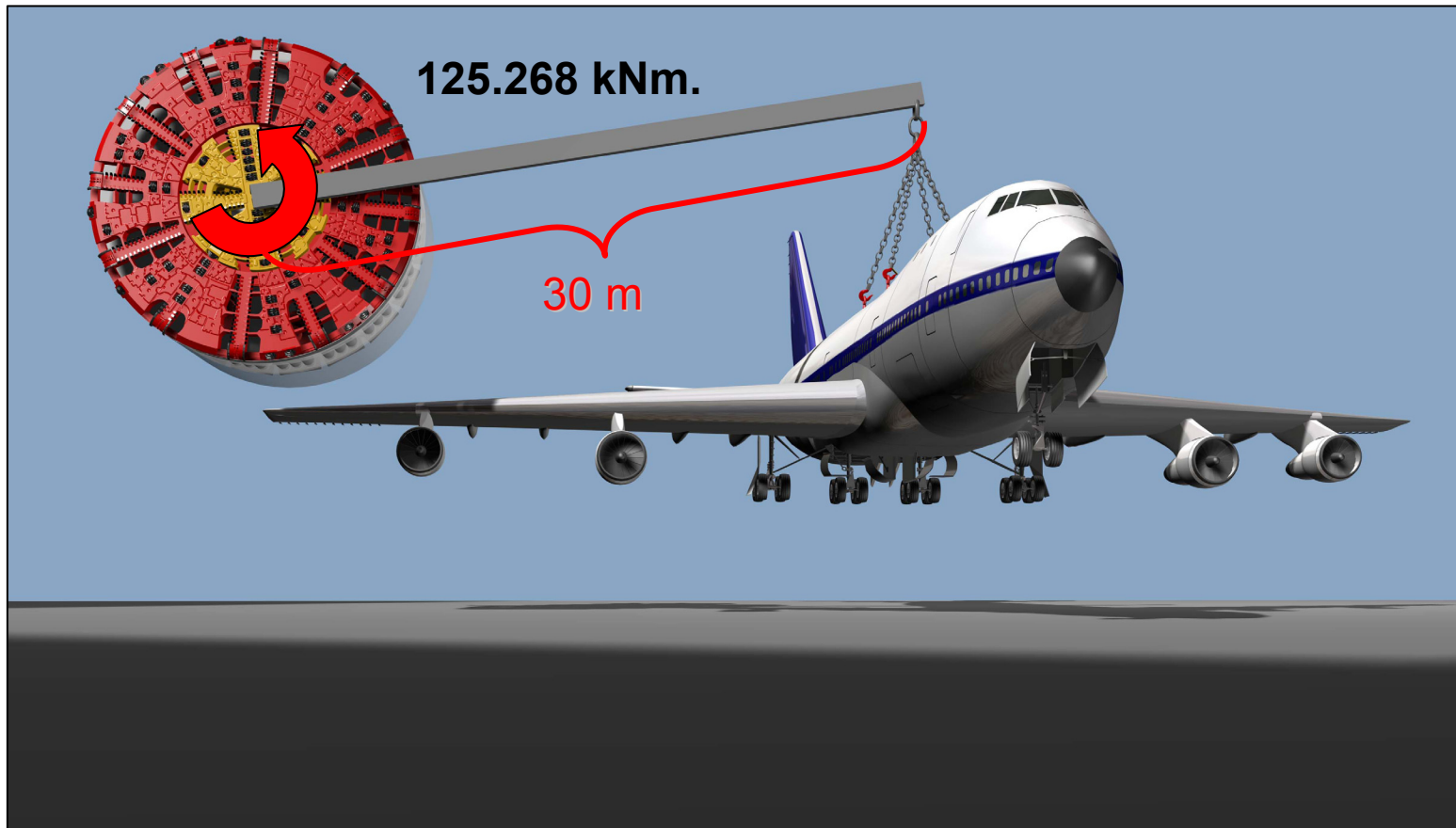

CHALLENGE SOIL MATERIAL TRANSPORT.

- 3 screw conveyors for maximum possible soil material transport...

calculation example:

- Logistics at 35 m/day advance:
 - 90 trucks for segments
 - 18 trucks for concrete
 - 810 truck for muck transport
- $\Sigma = \sim 1000$ trucks / day

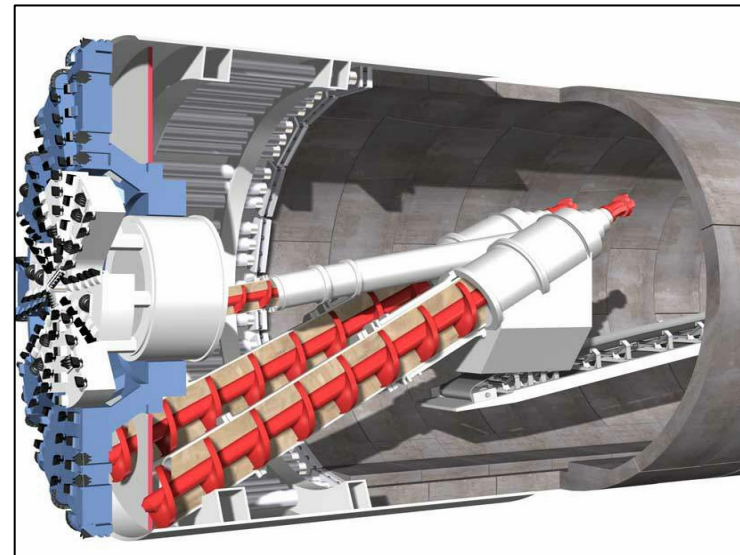

S – 300: M 30. MADRID. SUPERLATIVES.

- tunnel length: 3.650 m
- advance time for hole 3.650 m:
8 month (about 15 m per day)
- best daily advance:
36 m (18 rings)
- Best weekly advance:
188 m (94 rings)

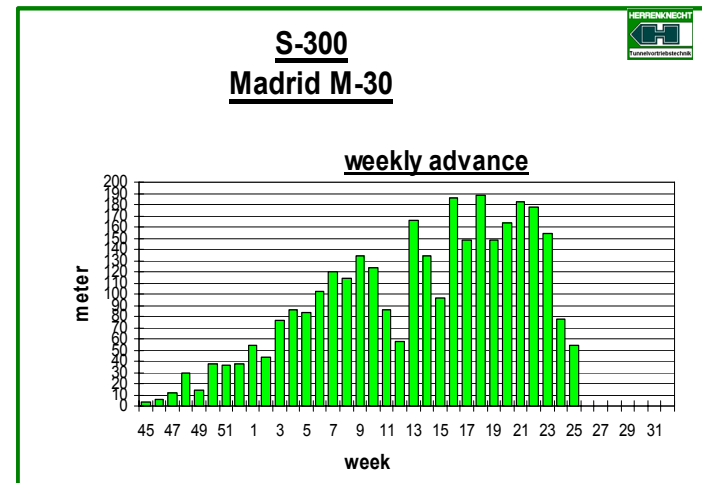

3,650 METERS IN 8 MONTH.

MAX. ADVANCE RATE PER MONTH: 758 METER.



S – 317: SHANGHAI, CHANGJIANG TUNNEL & BRIDGE CONSTRUCTION DEVELOPMENT CO. LTD.

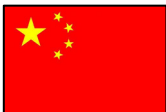

S – 317: SHANGHAI, CHANGJIANG TUNNEL & BRIDGE CONSTRUCTION DEVELOPMENT CO. LTD. ALIGNMENT.

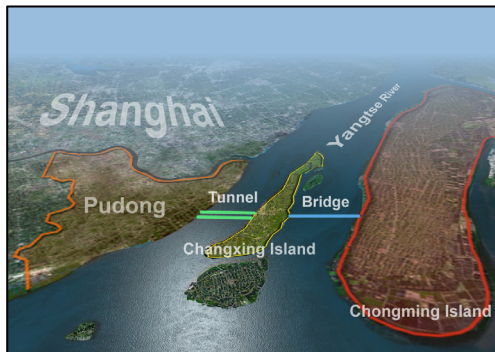

- 2 parallel bored tunnels:
 - Inside Diameter: 15,000 mm.
 - Tunnel length: 7,170 m each
- Yangtze River Crossing: Maximum overburden above tunnel axis: 65 m

- Connection between Pudong and Changjiang.
- 2 Double-deck road tunnels:
 - Upper level: 2 lanes + rescue lane.
 - Lower level: service + safety

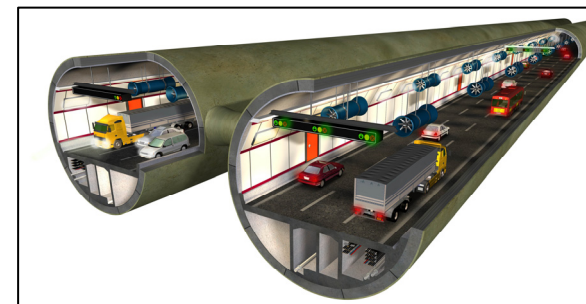

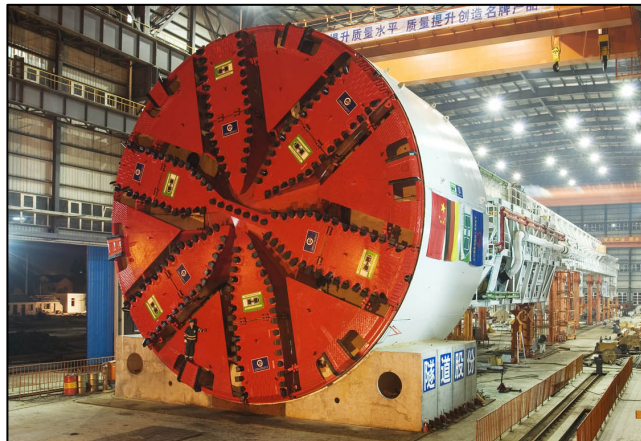

S-317 and S-318 | Changjiang Under River Tunnel | Shanghai | China



2 Mixshields

Shield diameter: 15,430 mm

Cutterhead power: 3,500 kW

Tunnel length: 7,170 m each

Geology: Sand, clay, shell debris

End user: Shanghai Changjiang Tunnel & Bridge Construction Co., Ltd.

S – 317: SHANGHAI, CHANGJIANG TUNNEL & BRIDGE CONSTRUCTION DEVELOPMENT CO. LTD. ALIGNMENT. GEOLOGY.

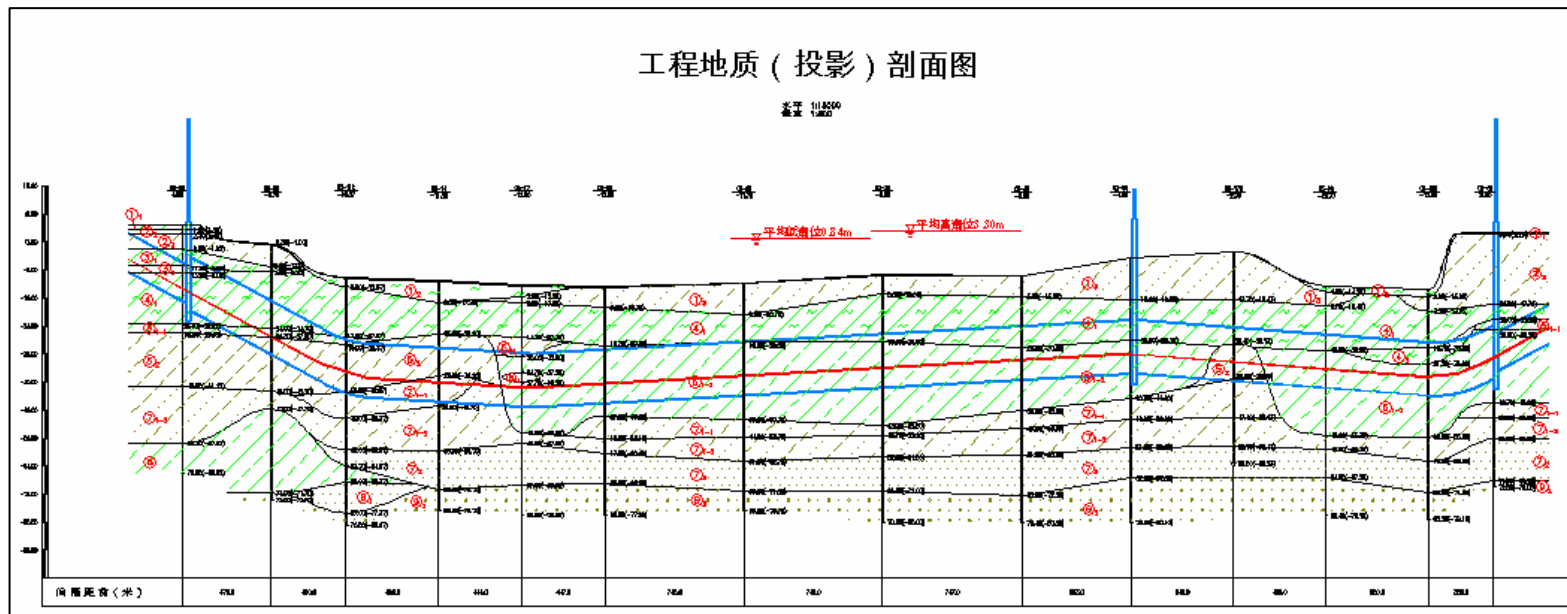

- very soft silty clay with thin sand layers.
- clay laminated with few thin silt layers, contains some shell debris.
- very soft clay laminated with thin silty sand, contains shell debris. Grey sandy silt

THE CHALLENGE:

- River crossing.
- High groundwater pressures.
- Adhesive soil conditions.
- Long tunnel drives.
- Application of currently largest TBMs world-wide.



EFFICIENT SOFT GROUND TUNNELLING WITH ELECTRONIC WEAR DETECTION SYSTEM.

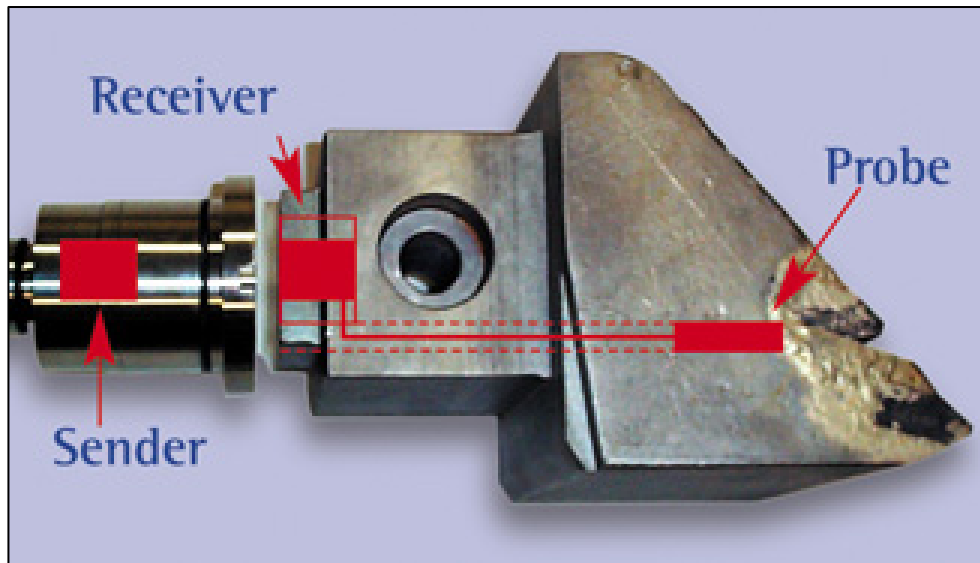

- Actual information about cutting tool wear.
- Economical tool change.
- Limited damage on steel structure.



ACCESSIBLE CUTTING WHEEL SPOKES. TOOL CHANGE IN FREE AIR.

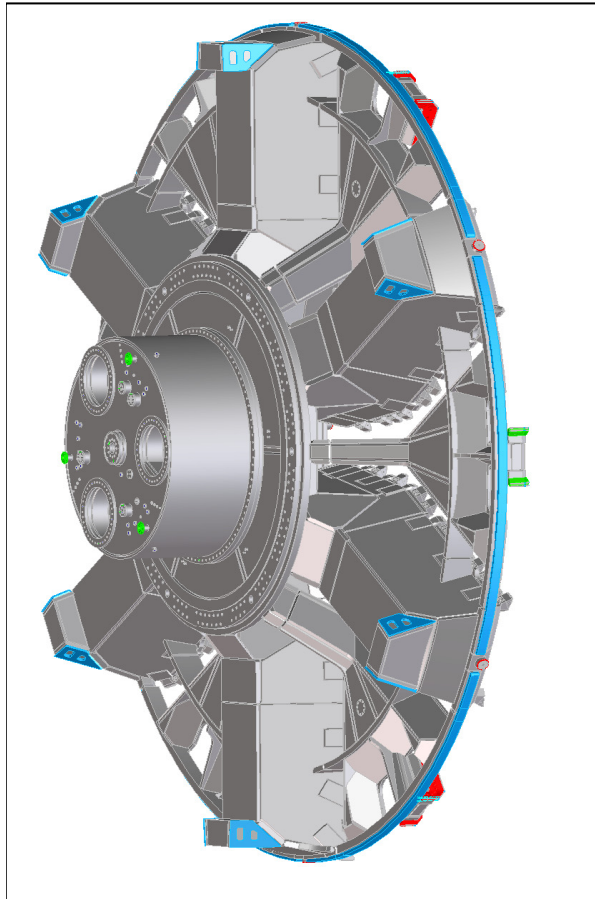

ACCESSIBLE CUTTING WHEEL SPOKES. TOOL CHANGE IN FREE AIR.

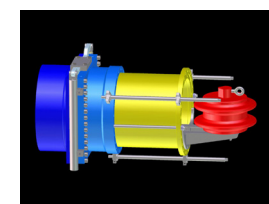
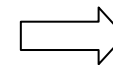
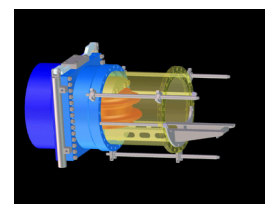
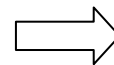
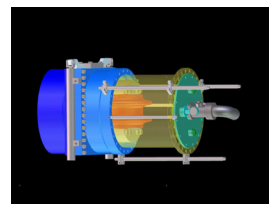
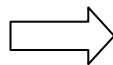
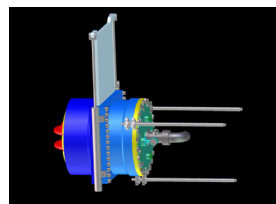
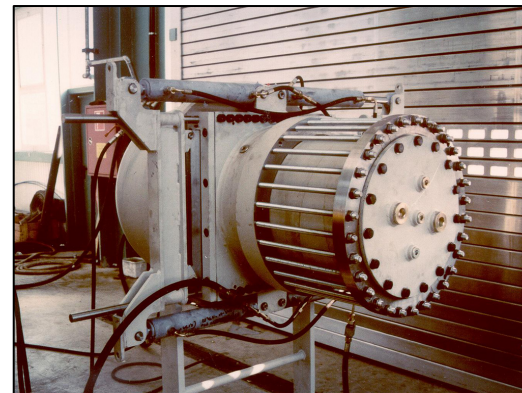
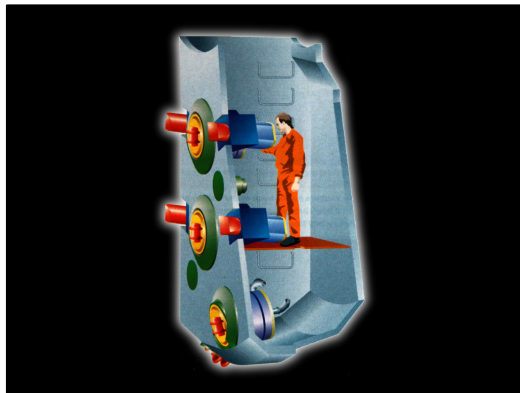

FAST AND SECURE TUNNELLING.

- Lining segment production close to jobsite for just in time delivery
- Best weekly performance:
110 m (55 rings)
- Ø weekly performance:
61 m (31 rings)



INNOVATIVE DEVELOPMENTS. TIMBY- TUNNEL IMMERGE BY HERRENKNECHT AND BOUYGUES - TIMBY.

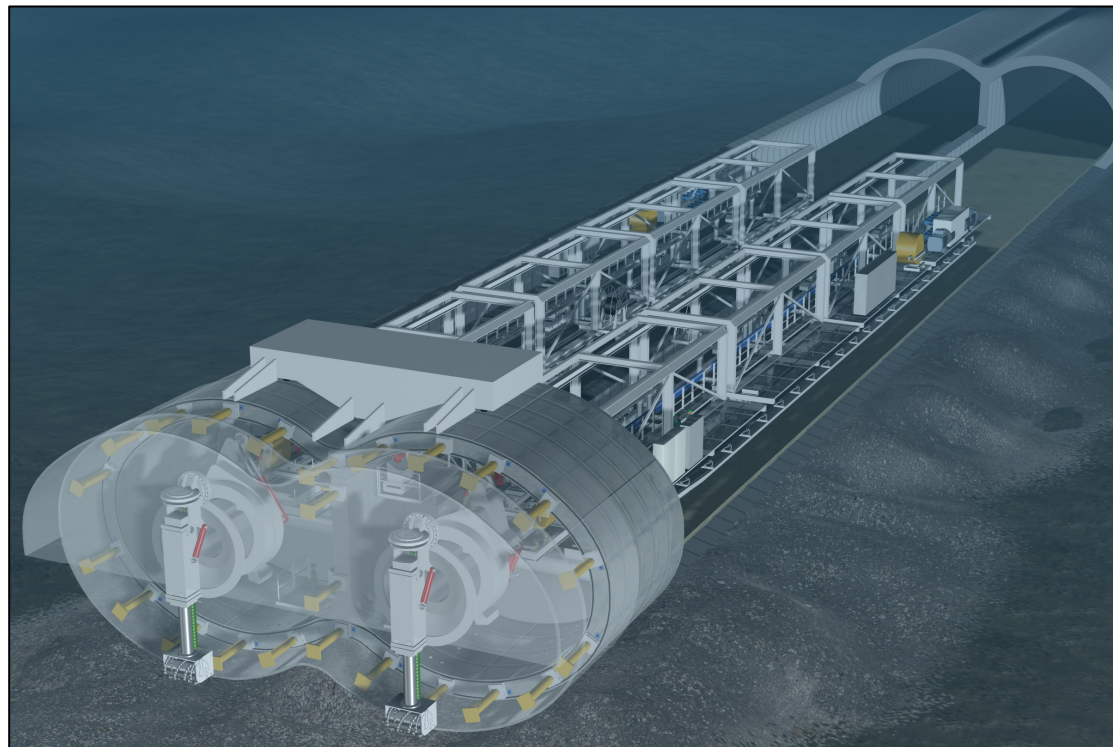

mechanical excavation alternative to immersed tunnel procedure



TIMBY- TUNNEL IMMERGE BY HERRENKNECHT AND BOUYGUES.

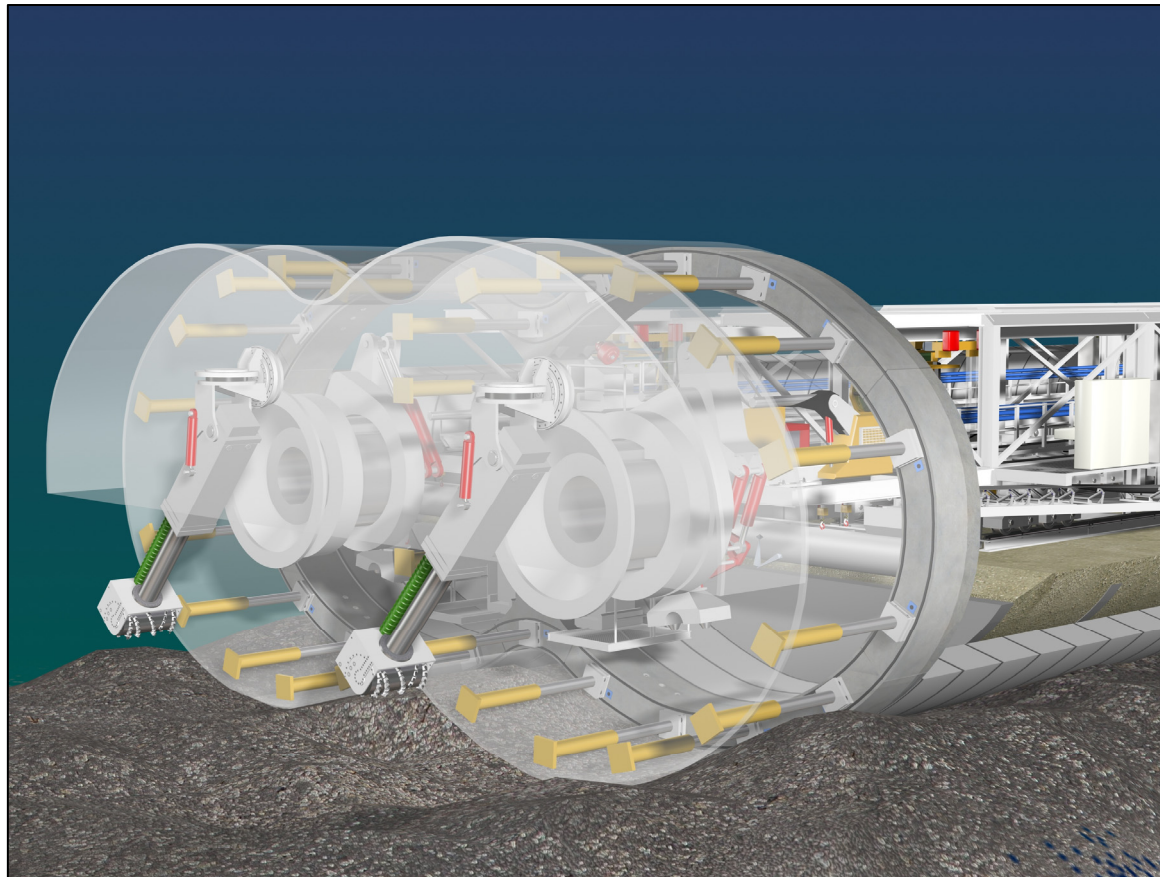

TIMBY:

combination of tunnel
excavation and
prestressing

IMMERSED TUNNELS. CONVENTIONAL METHOD.

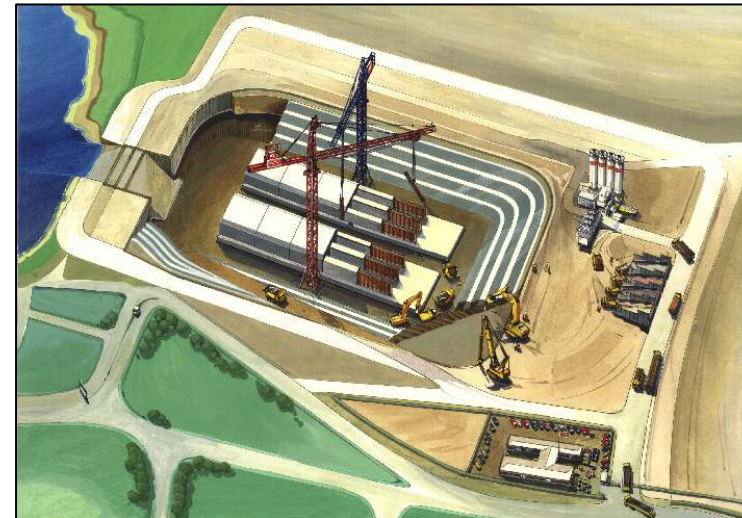

- large spaces at the river shore necessary
- excavation of dry dock necessary
- complex dewatering necessary
- annoyance of the water traffic
- etc.



IMMERSED TUNNELS. CONVENTIONAL METHOD.

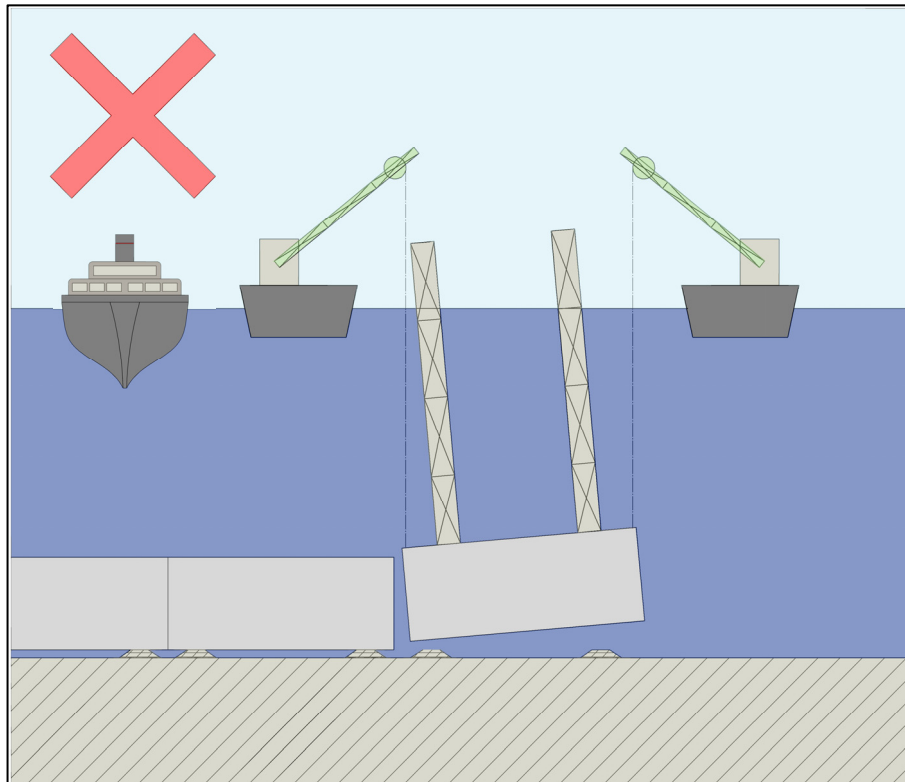

annoyance of the water traffic:

- during immersion
- during kneeling
- manifold actions in relation to discontinuous excavation.

IMMERSED TUNNELS. TIMBY.



no disturbance of the
waterway...

many diameter types
possible...

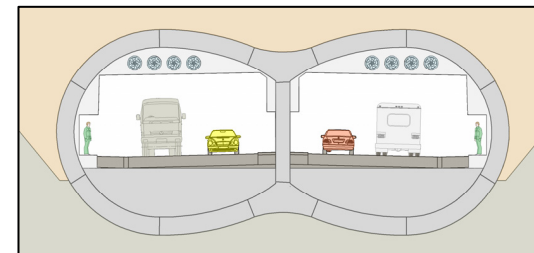
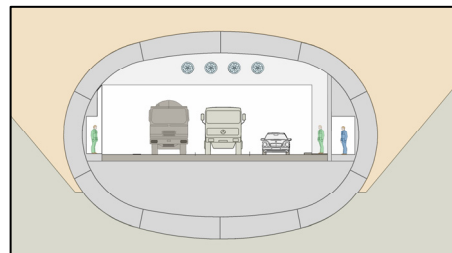

IMMERSED TUNNELS. TIMBY.

pre - stressed segment
ring...

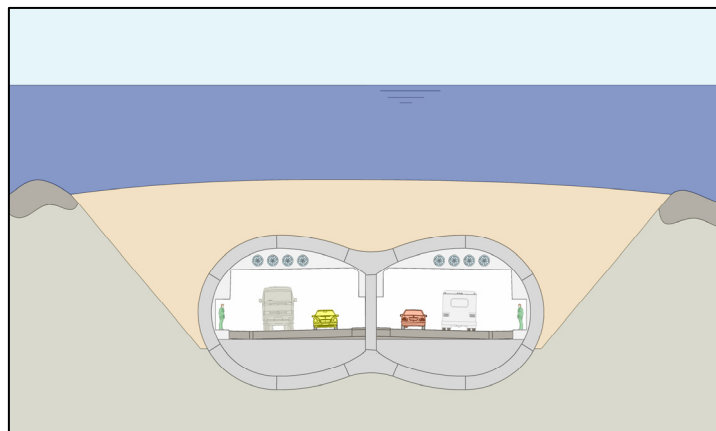
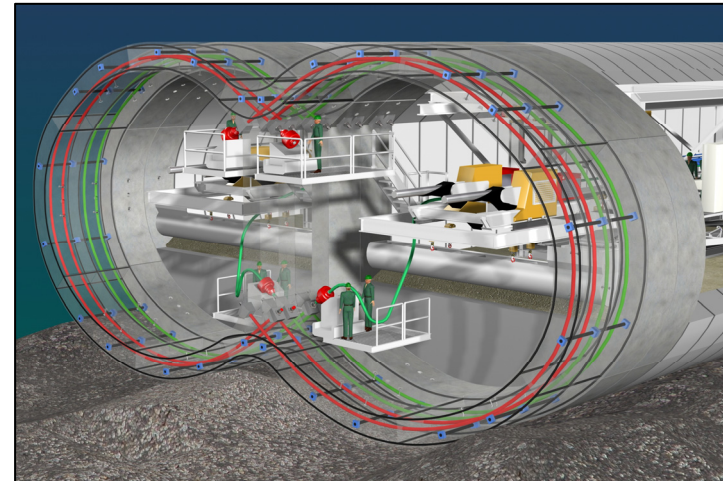

superimposed load against
bouyancy...

IMMERSED TUNNELS. TIMBY.

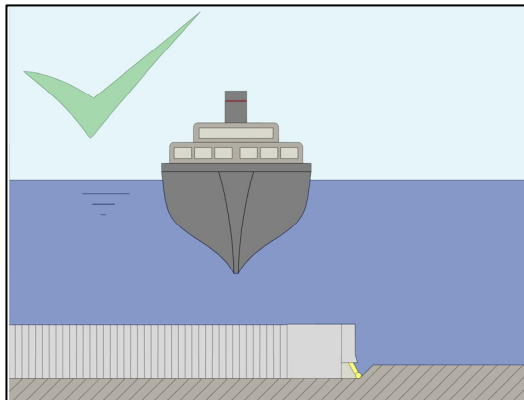

- no disturbance to the water traffic
- tunnel logistics through finished tunnel tube
- use of common technique
- continous excavation
- etc.

A photograph of two workers in a dark tunnel. They are wearing red high-visibility safety suits and hard hats. One worker is standing on the left, and the other is kneeling on the right, holding a camera or light. In the center of the tunnel is a large, circular structure with a textured, concentric pattern, possibly a tunnel boring machine cutterhead or a large pipe. The scene is dimly lit, with the workers' lights illuminating the structure and the tunnel walls.

**THANK YOU FOR YOUR
ATTENTION...**