



SEL 0449 - Processamento Digital de Imagens Médicas

Aula 1 - Introdução

Prof. Dr. Marcelo Andrade da Costa Vieira

mvieira@sc.usp.br

O QUE É?

Processar uma imagem significa modificar as informações contidas nessa imagem sob vários aspectos, de modo que o resultado seja uma imagem ou informações extraídas dela.



PROCESSAMENTO DE IMAGENS

- Interpretação humana (visualização)
- Armazenamento
- Transmissão
- Representação
- Extração de Informações
- Visão Computacional



Dados Geométricos 3D

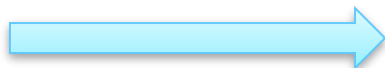

Computação Gráfica



Imagem 2D

Imagem 2D



Processamento de
imagens

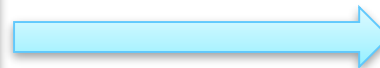

Imagem 2D

Imagem 2D



Visão Computacional

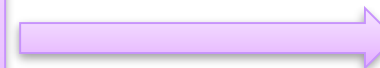

Dados Geométricos 3D

Processamento de Imagens

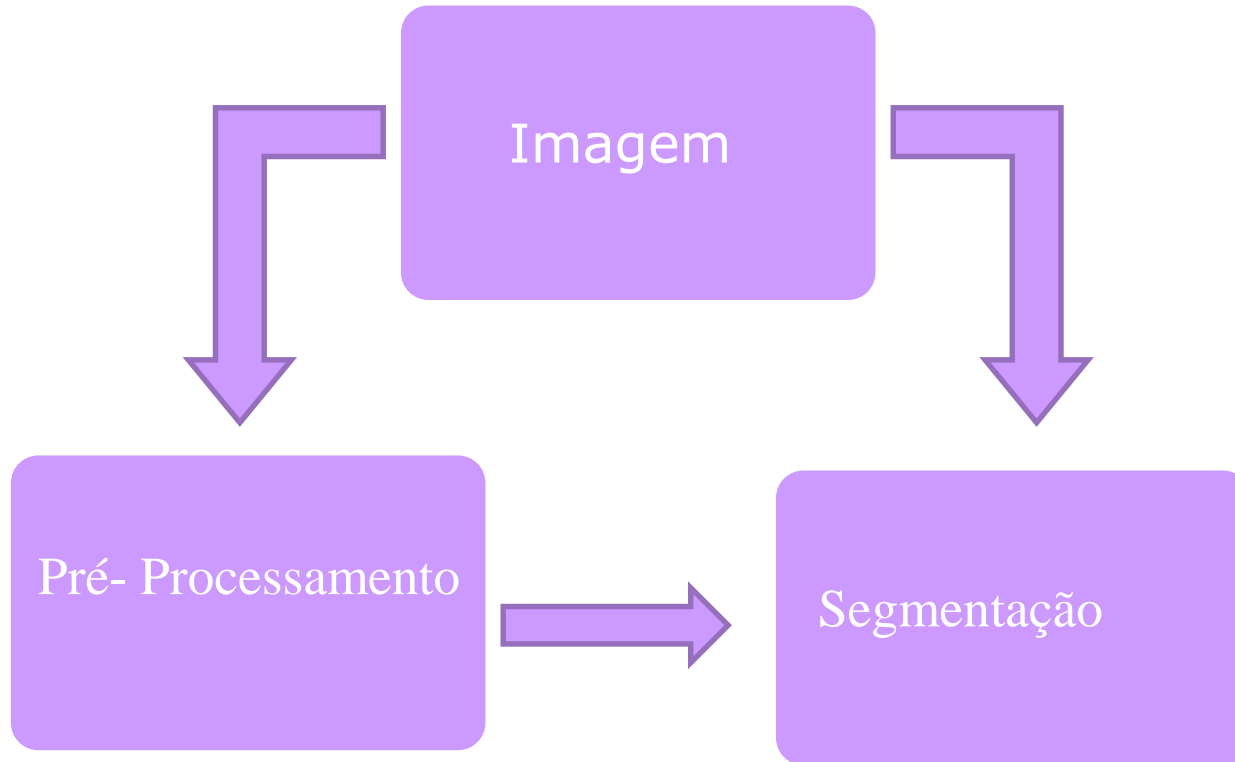

Processamento de Imagens

Filtros



Imagem Ruidosa



Segmentação
de Fronteira

Visão Computacional

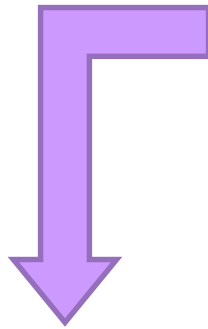
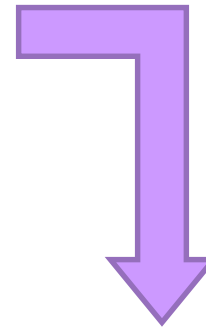
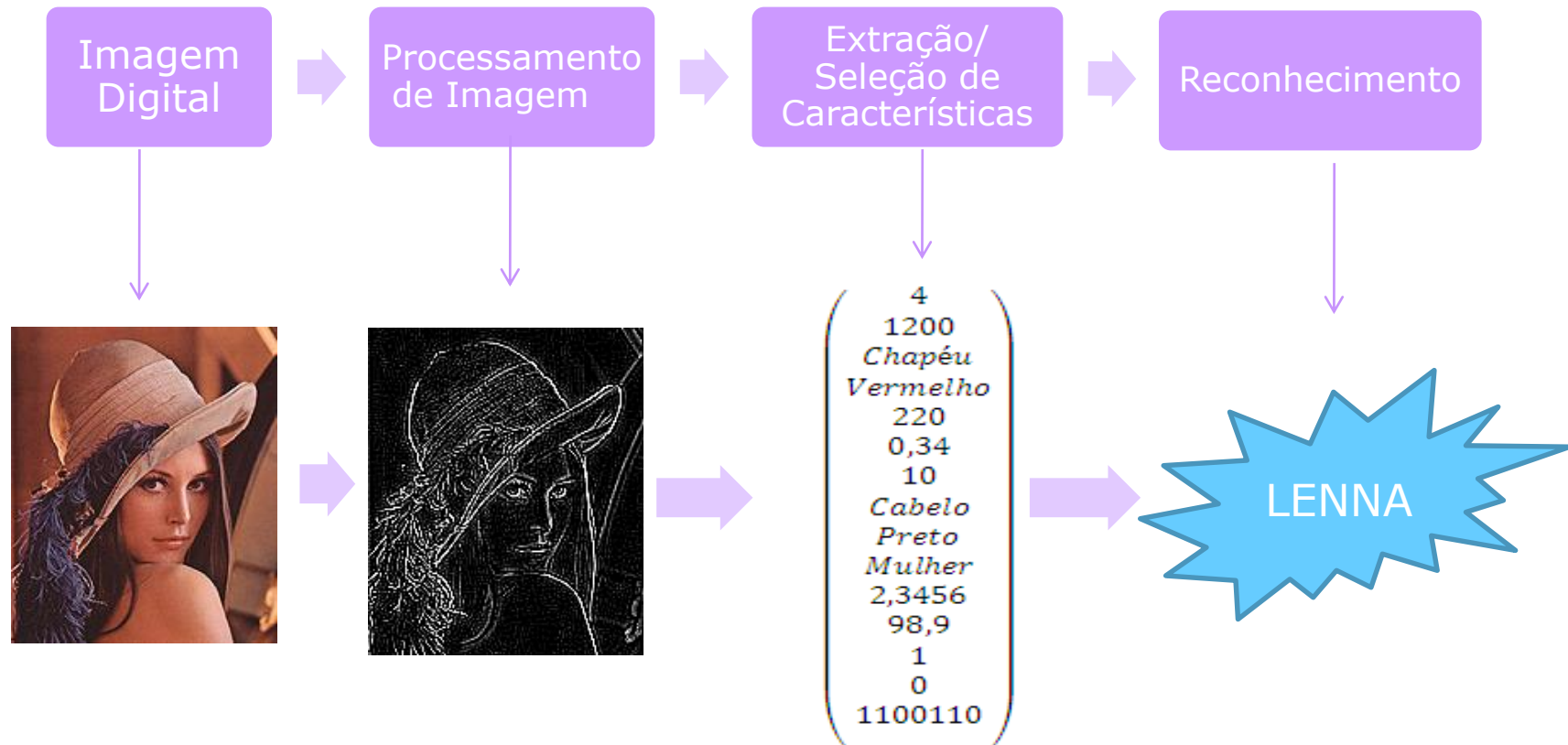

PROCESSAMENTO DE IMAGENS

As saídas desses processos geralmente são imagens

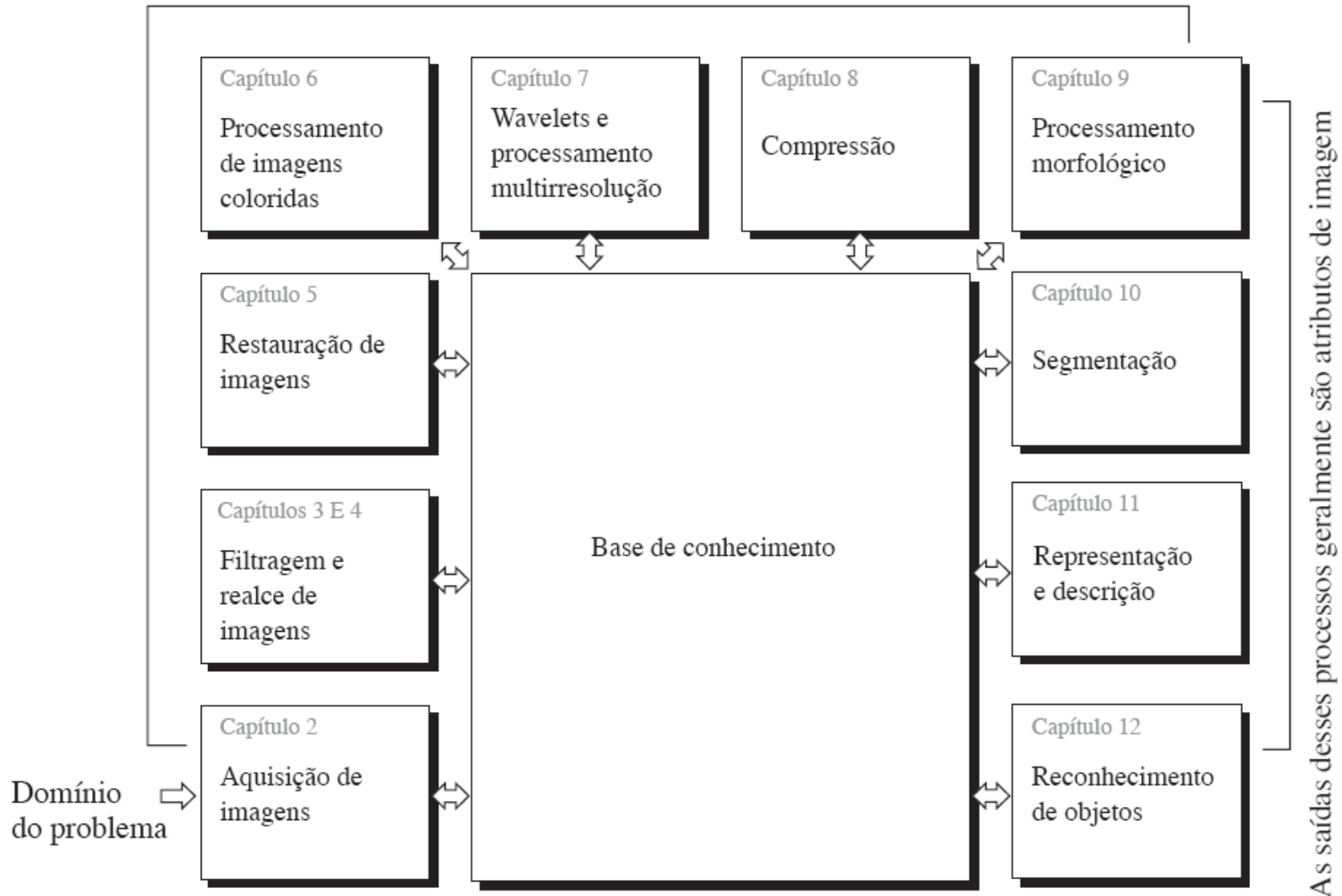

- 
- Principais exemplos de aplicações de processamento de imagens digitais:
 - Imagens baseadas em radiação (espectro eletromagnético)
 - Imagens baseadas em energias acústicas, ultrasônicas e eletrônicas
 - Imagens sintéticas usadas para modelamento e visualização, geradas por computador.

Espectro eletromagnético de acordo com a energia de um fóton

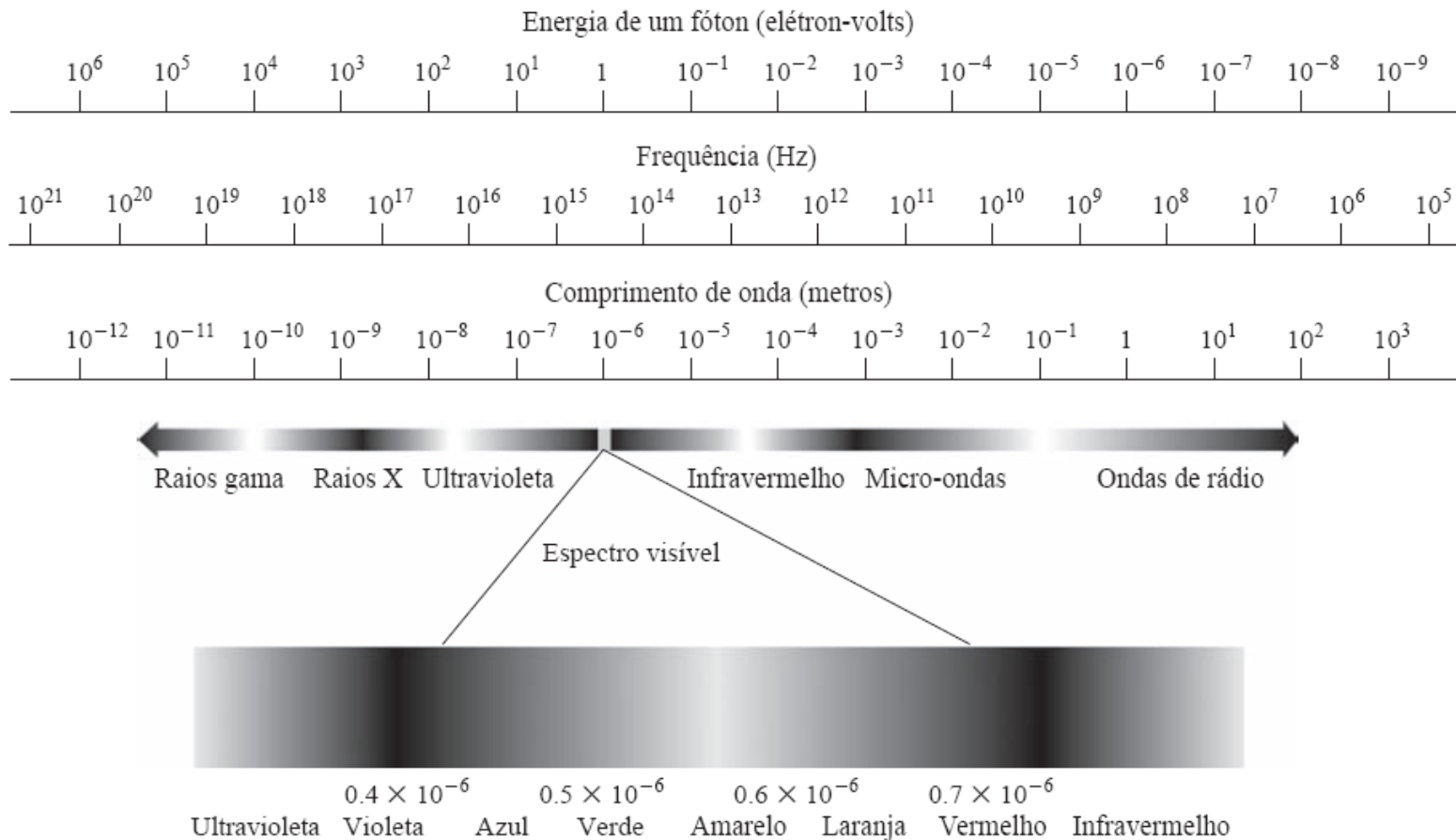

Espectro Eletromagnético

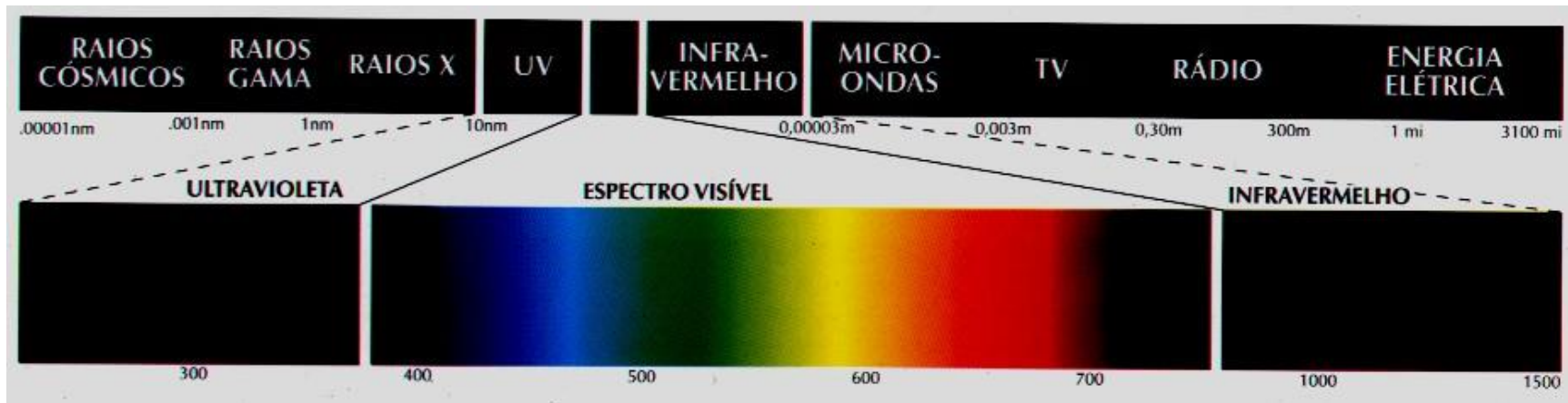

Espectro Eletromagnético

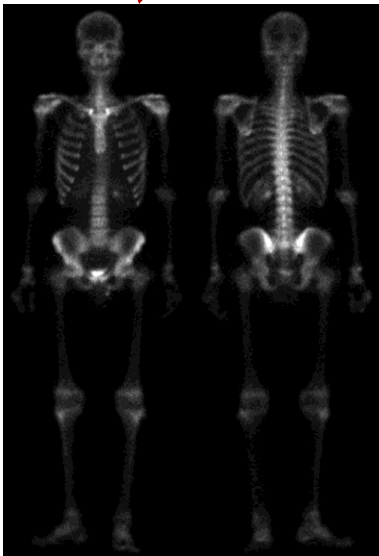
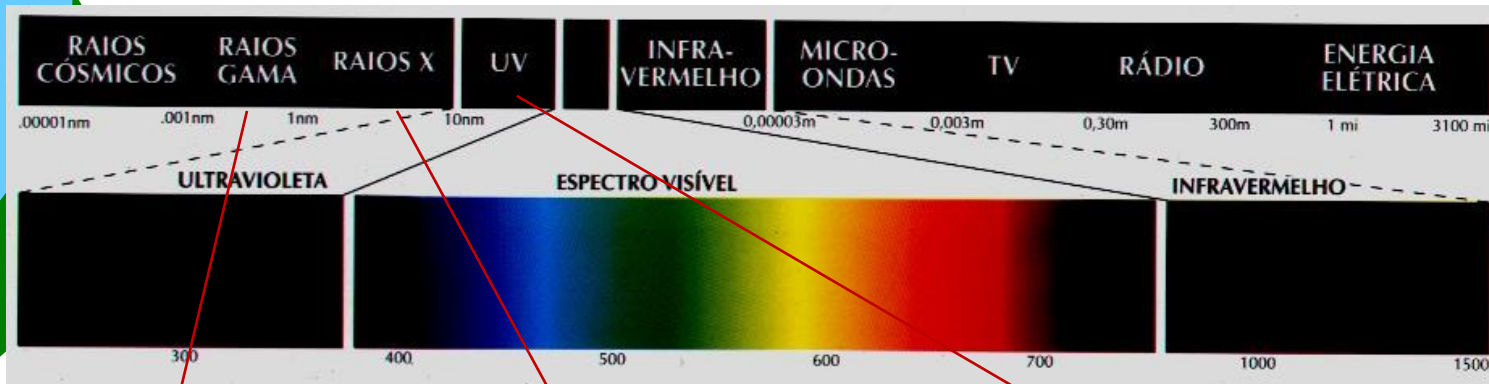

Medicina Nuclear

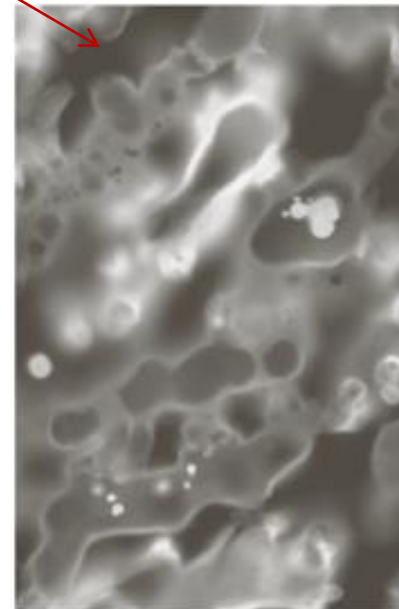

Análise da qualidade do milho.

Espectro Eletromagnético



Imagem de satélite de Washington D.C.



Radar (Montanhas do Tibet)

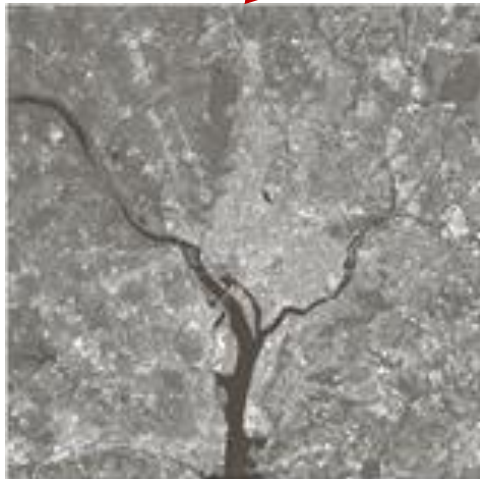
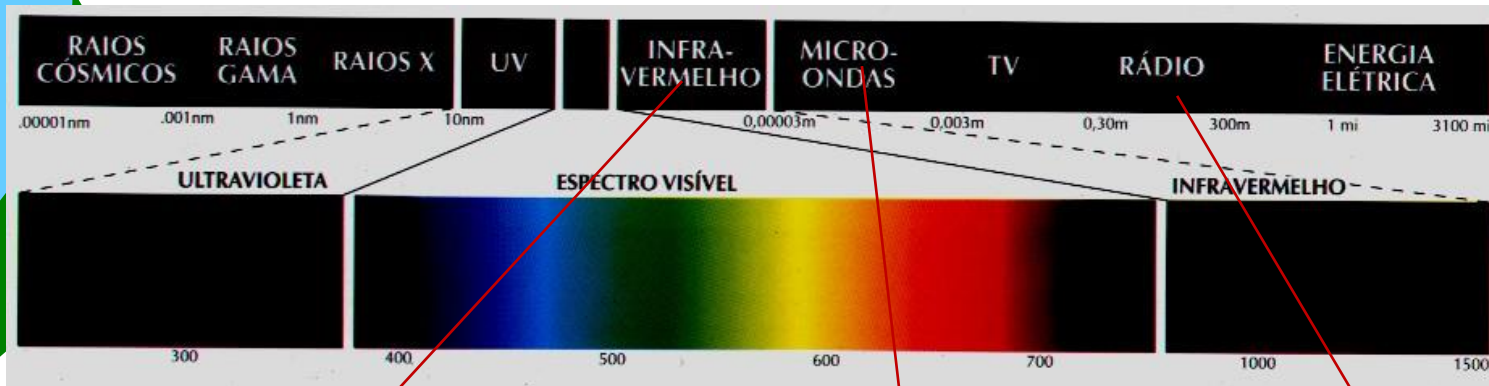
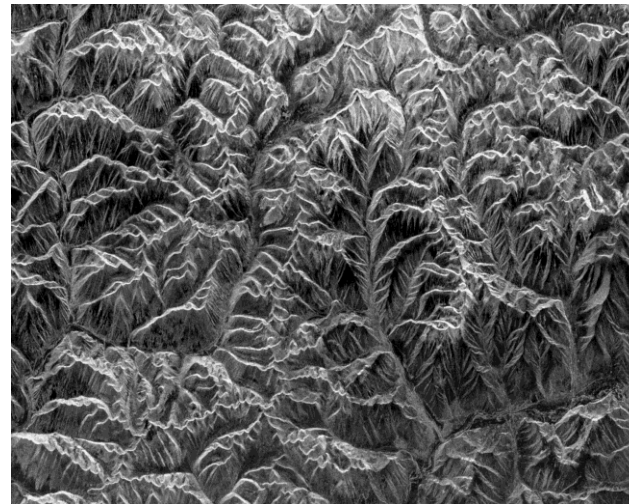

Ressonância Magnética

Espectro Eletromagnético

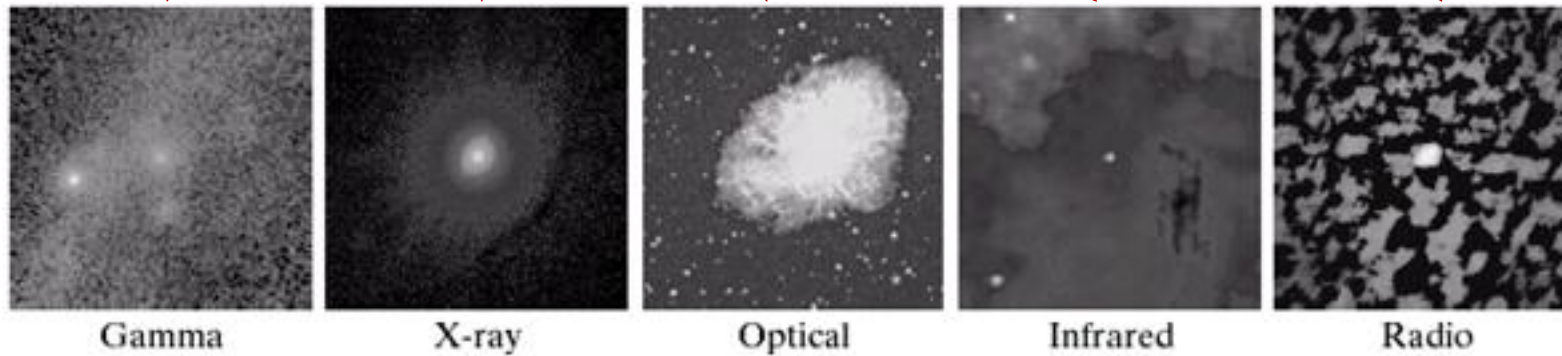
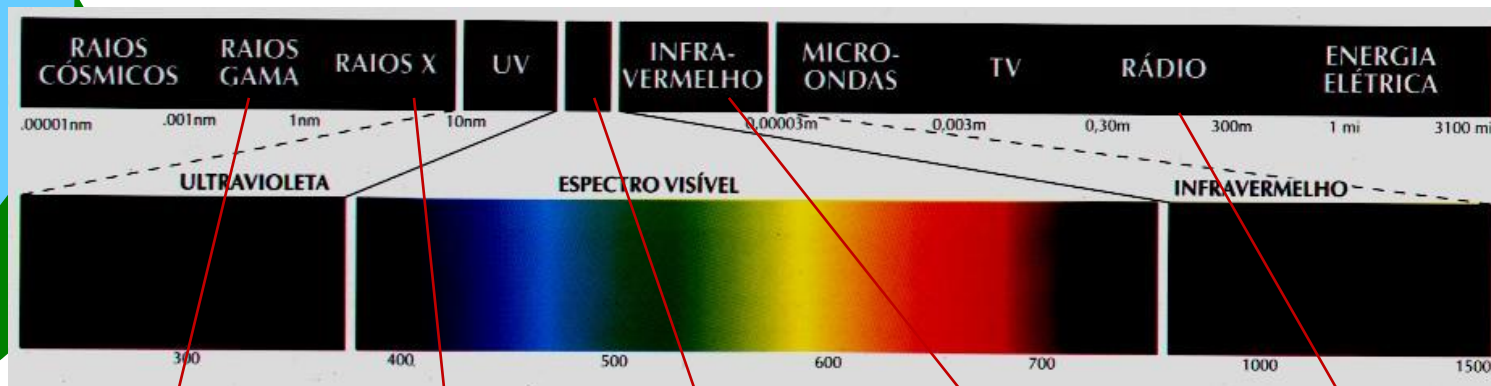

Imagens de um mesmo Pulsar geradas com diferentes frequências.

Espectro Eletromagnético

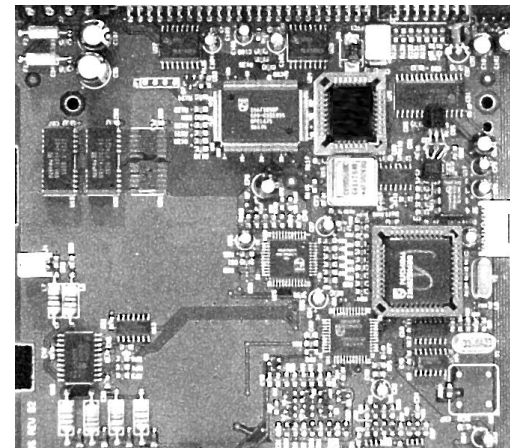
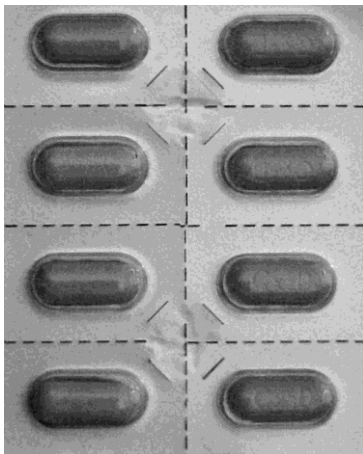
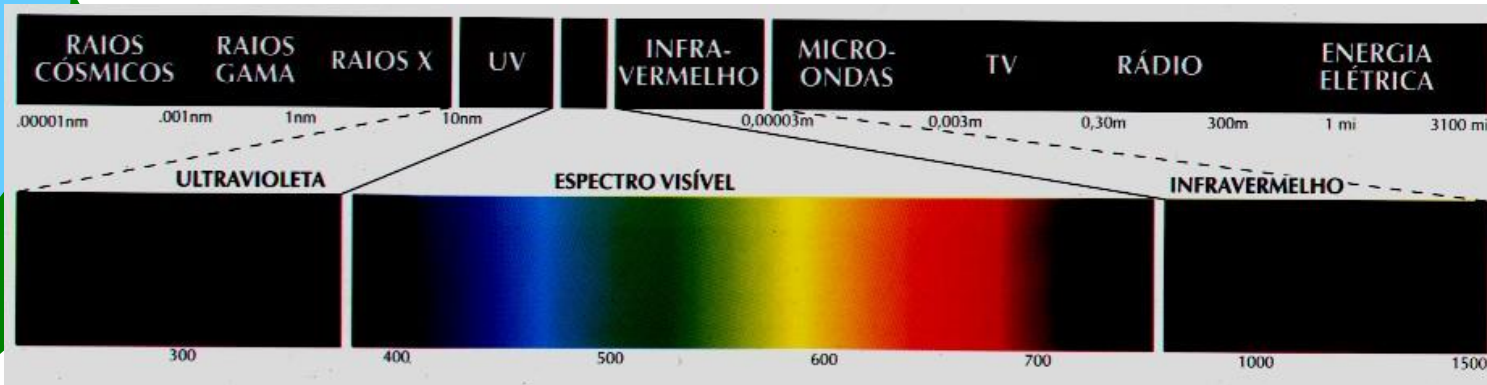

Imagens no Espectro Visível

Modalidades de Imagens Médicas

- Imagens por Raios X
 - Convencional
 - Tomografia Computadorizada
 - Mamografia Digital
 - Tomossíntese Digital
- Imagens por Raios γ
 - Medicina Nuclear
- Ressonância Magnética Nuclear
- Ultrassonografia



Raios-X – Roentgen 1895



Produção dos raios X

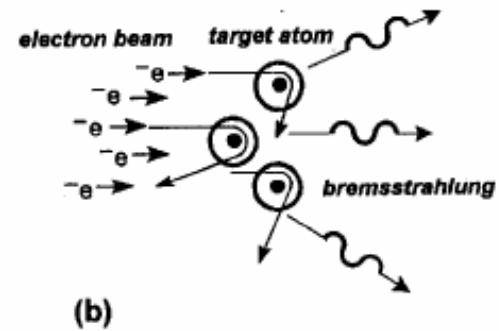
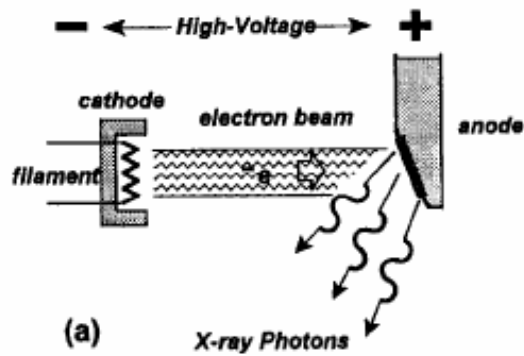

Formação de uma Imagem Radiográfica

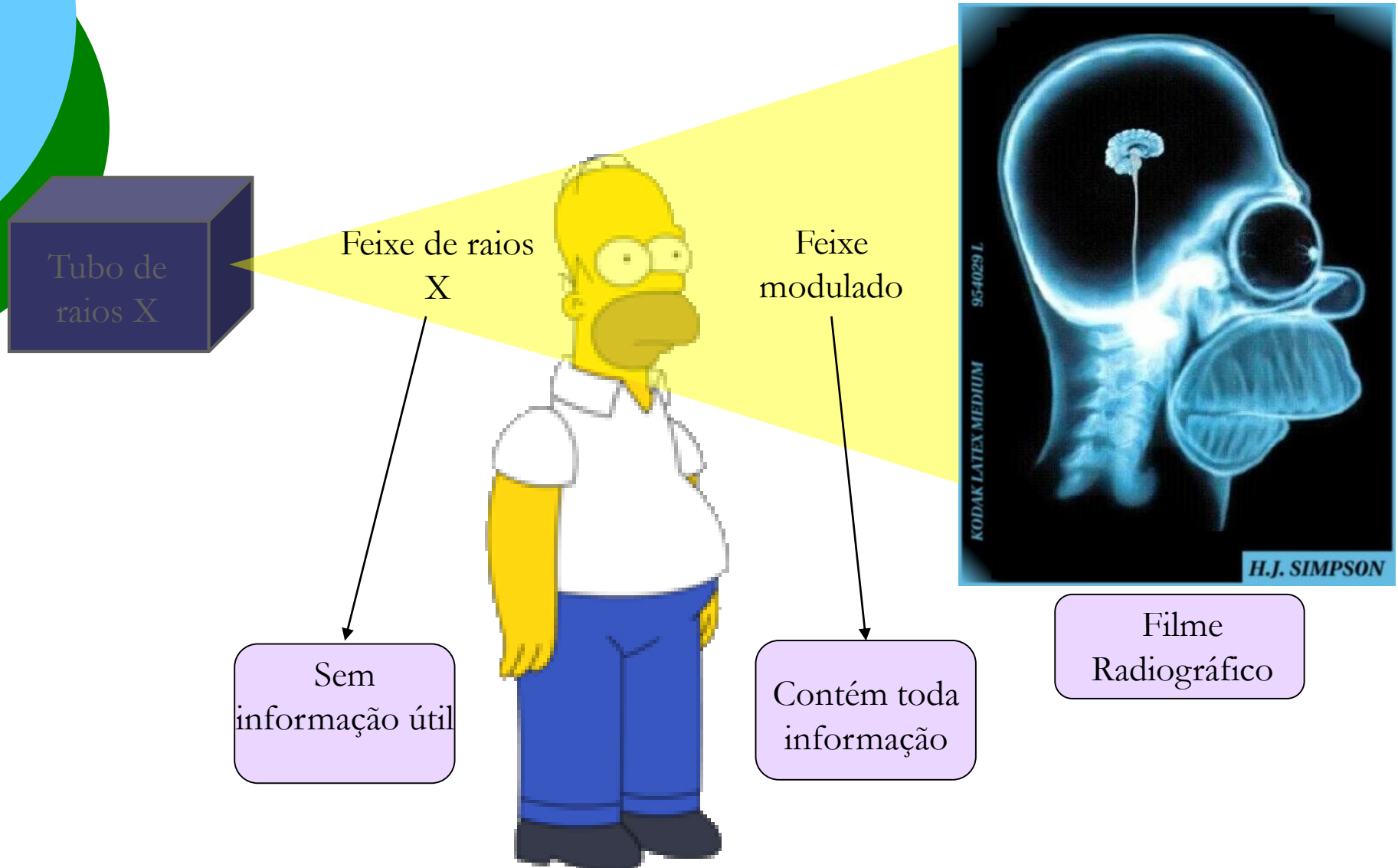

Formação de uma Imagem Radiográfica

Composição \neq

Espessura \neq

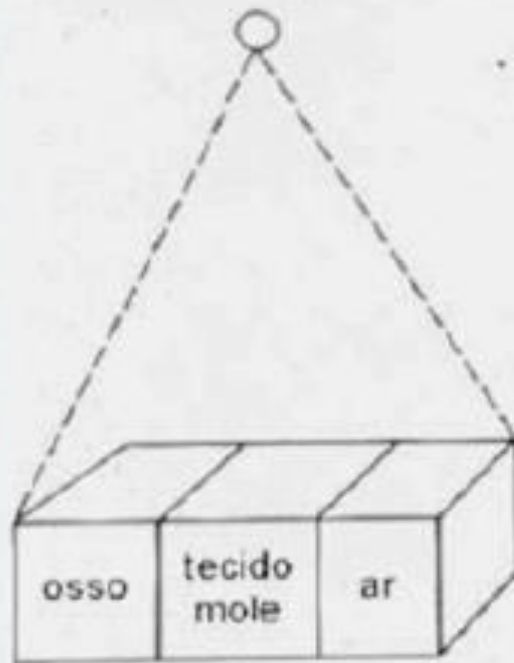

A

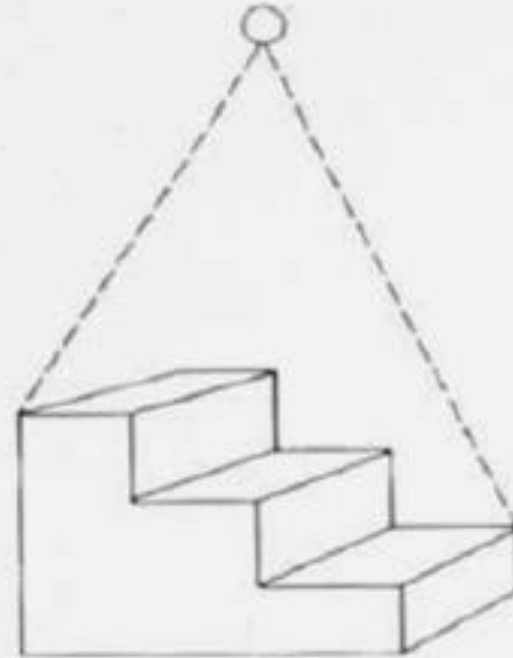

B



radiografia



Raios-X



Raios-X

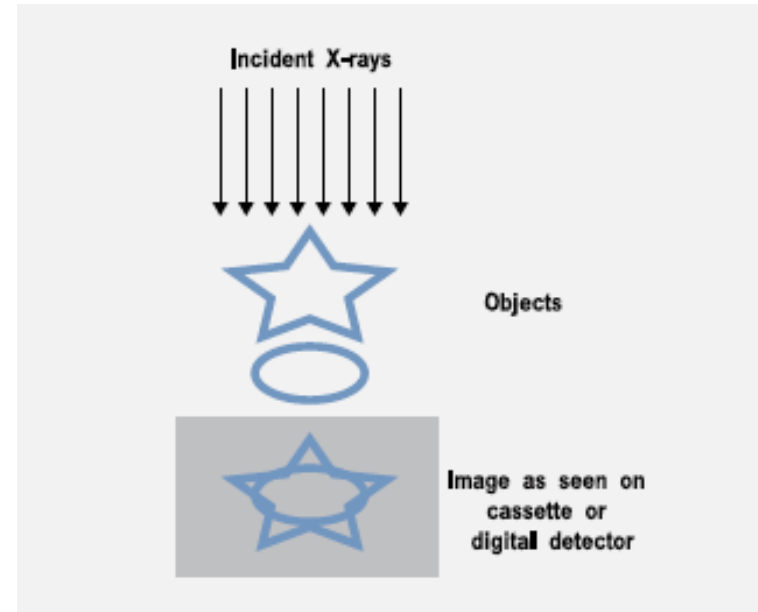
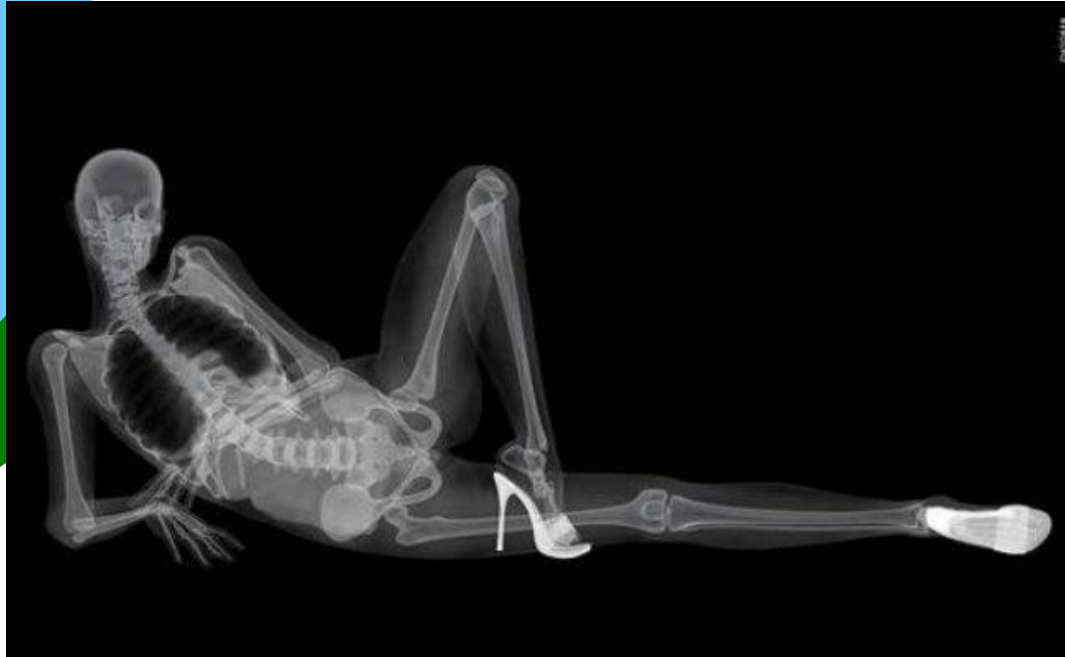

- Baixo custo
- Alto contraste para ossos
- Baixo contraste para tecidos moles
- Exposição à radiação ionizante
- Alto ruído quântico
- Imagem 2D (superposição de estruturas)

Tomografia Computadorizada (CT)

- É utilizado um aparelho de raios X com feixe colimado em forma de leque que gira em torno do paciente, fazendo radiografias transversais da região.
- Estas imagens são processadas matematicamente para se estimar os valores das intensidades no interior do corpo humano gerando os cortes tomográficos (reconstrução).

Tomografia Computadorizada (CT)

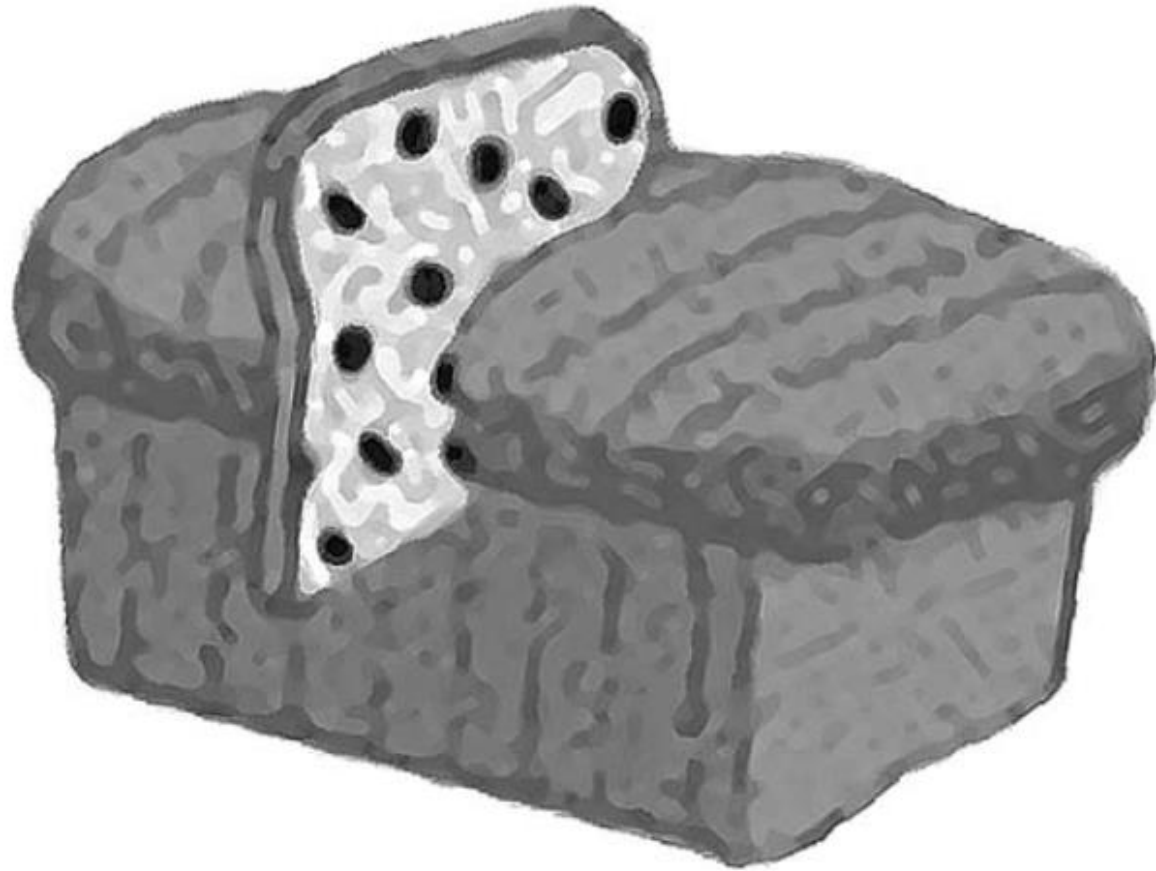

Tomografia Computadorizada (CT)



Tomografia Computadorizada (CT)

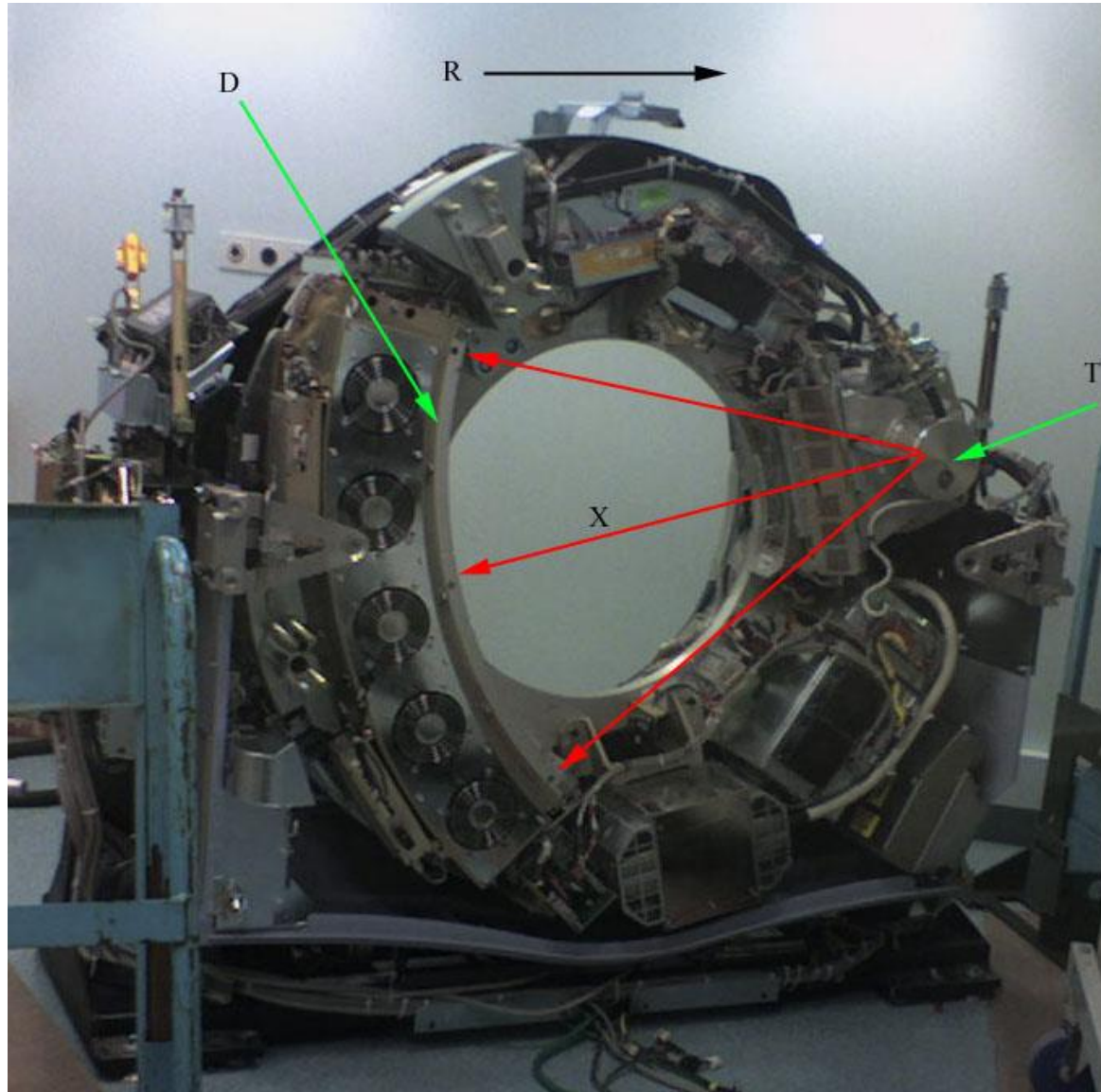

Tomografia Computadorizada (CT)

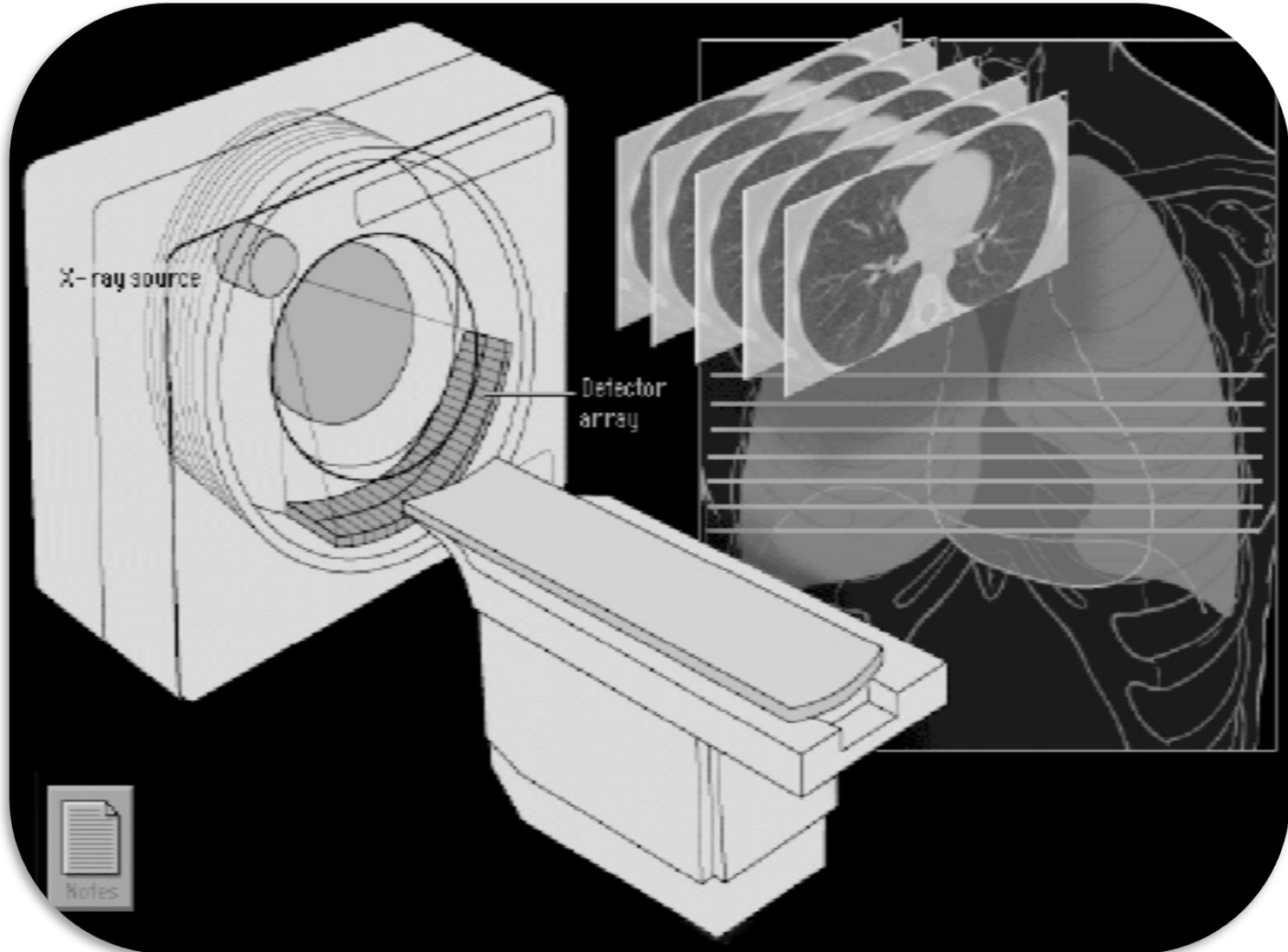

Tomografia Computadorizada (CT)

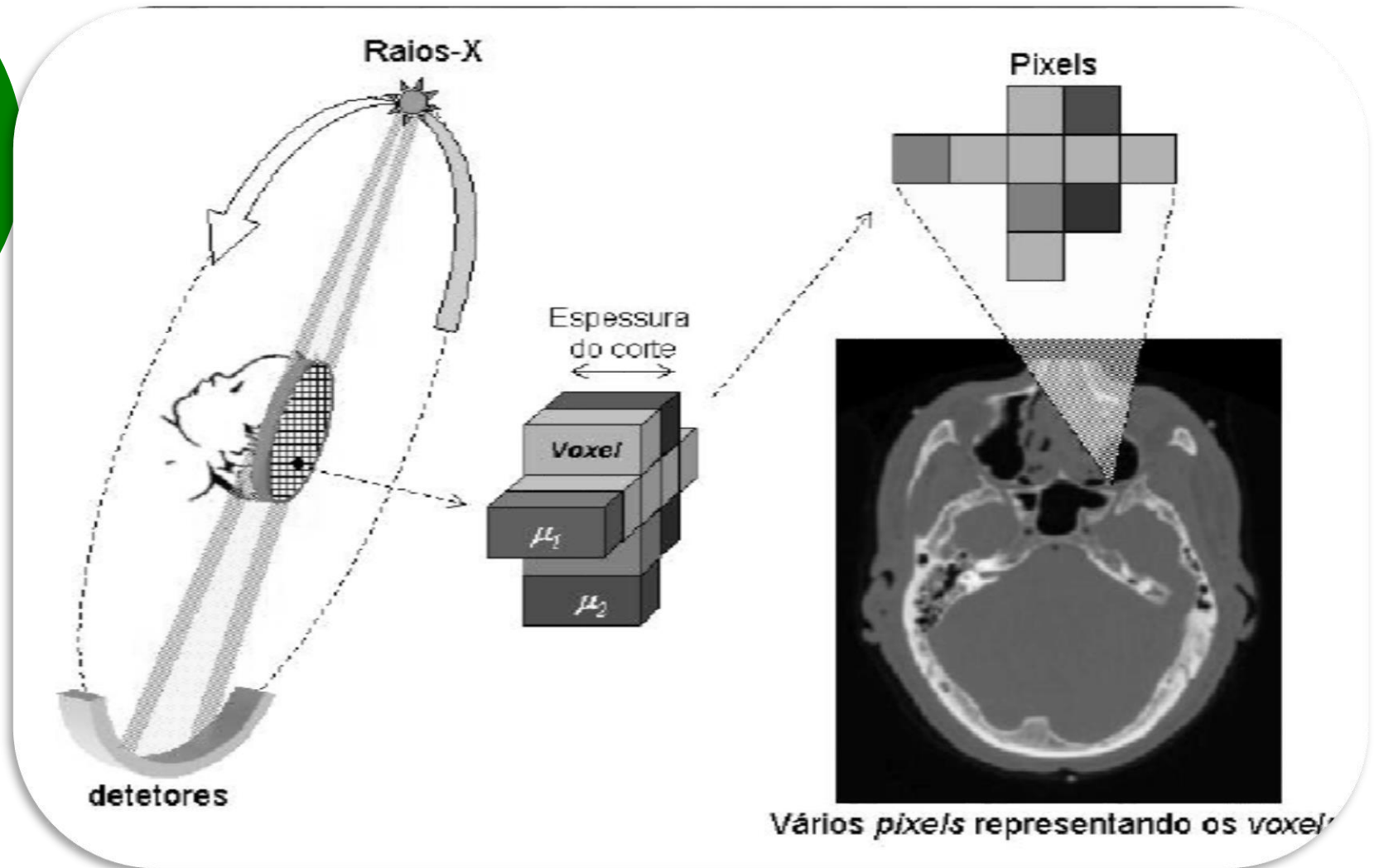

Tomografia Computadorizada (CT)

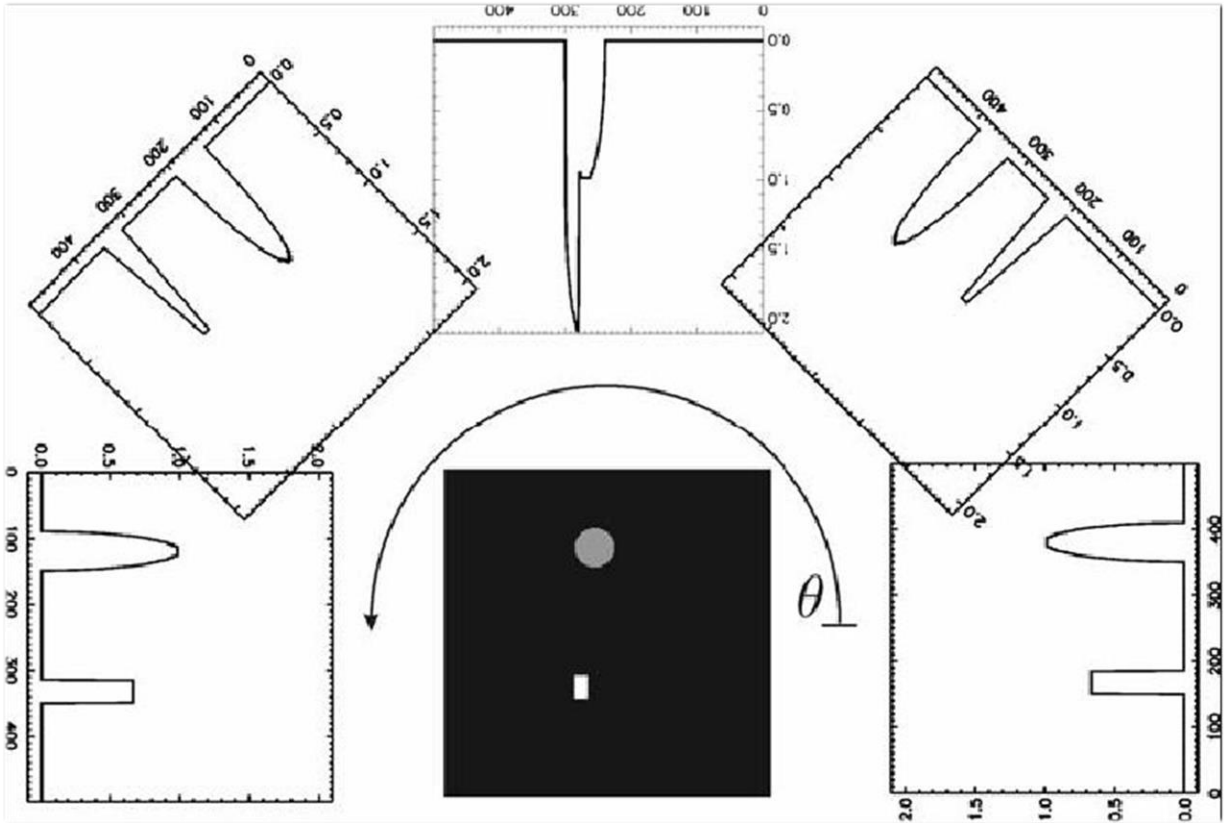

1 Projection

2 Projections

4 Projections

1000 Projections

Tomografia Computadorizada (CT)



- Imagens de seções transversais do corpo vivo



- Alta exposição à radiação ionizante
- Custo elevado

Mamografia



– Alvo de molibdênio

– Filtro de molibdênio,
alumínio ou ródio



Base do filme

Emulsão

Écran

Crânio-Caudal

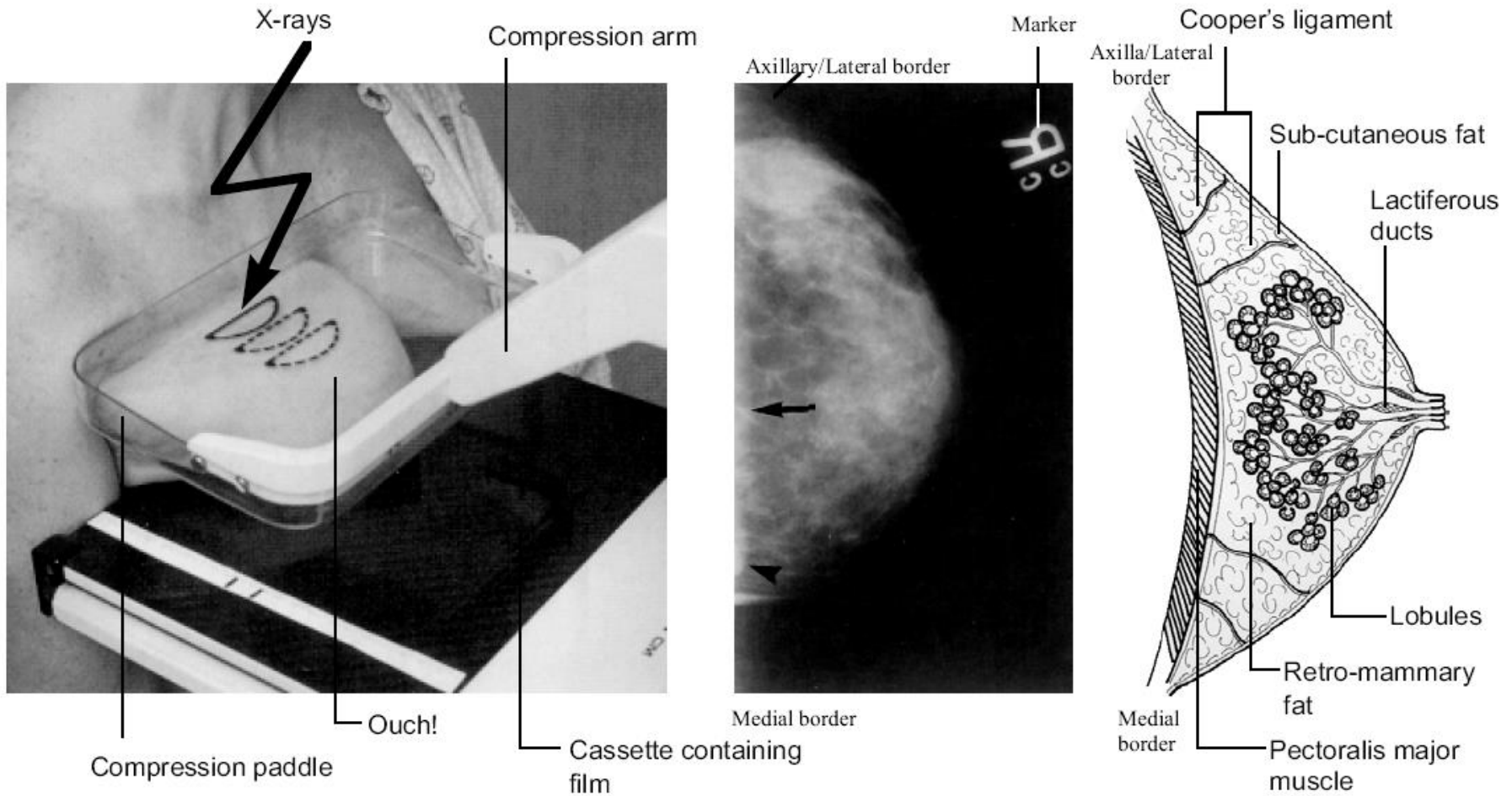

Médio-Lateral Oblíqua

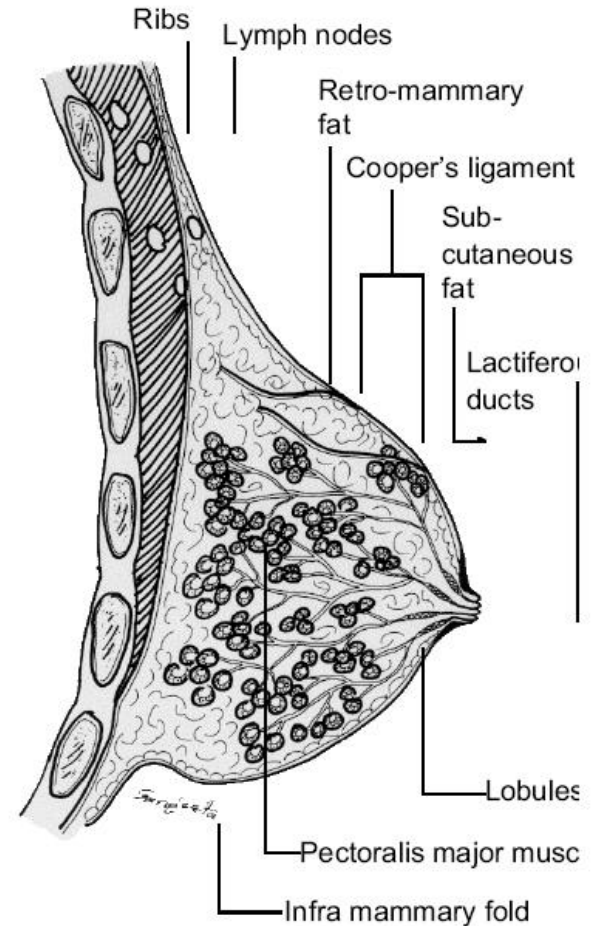
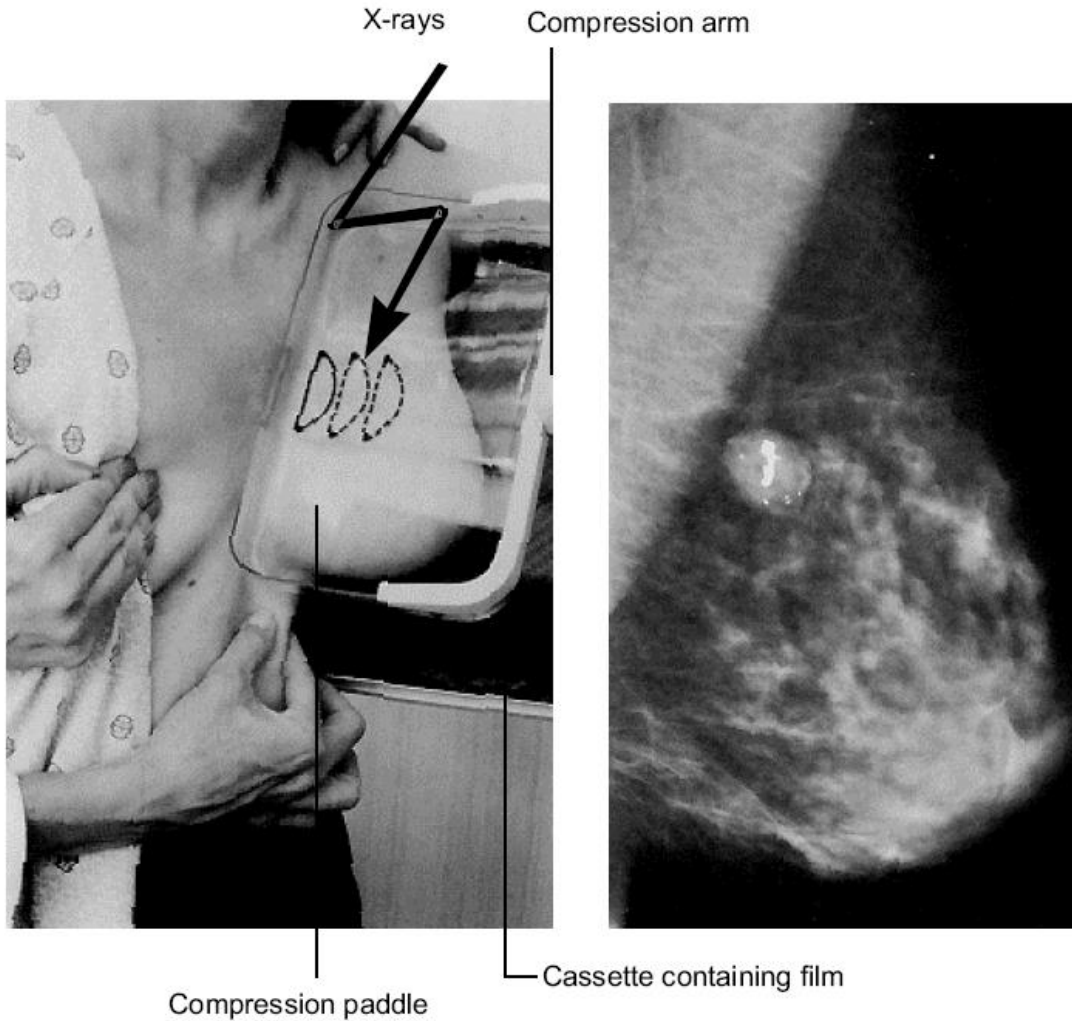

Mamografia

- Baixo custo
- Imagens de alta resolução
- Compressão da mama
- Ruído quântico
- Exposição à radiação



No Girlfriend, it's not noticeable at all!

Medicina Nuclear

- Análise funcional
- Raios Gama
- Alto custo
- Exposição à radiação

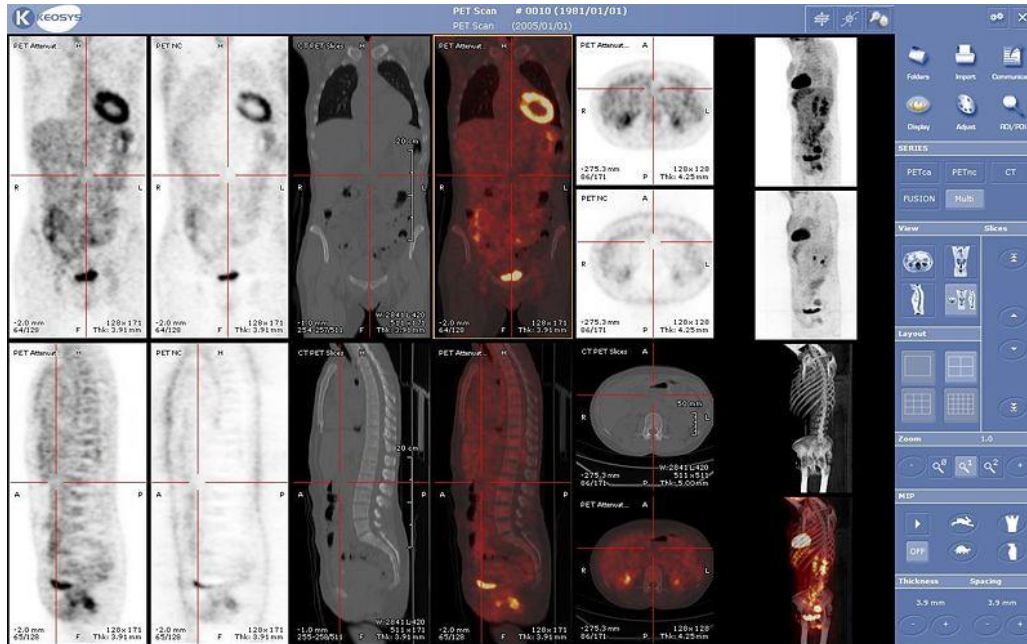
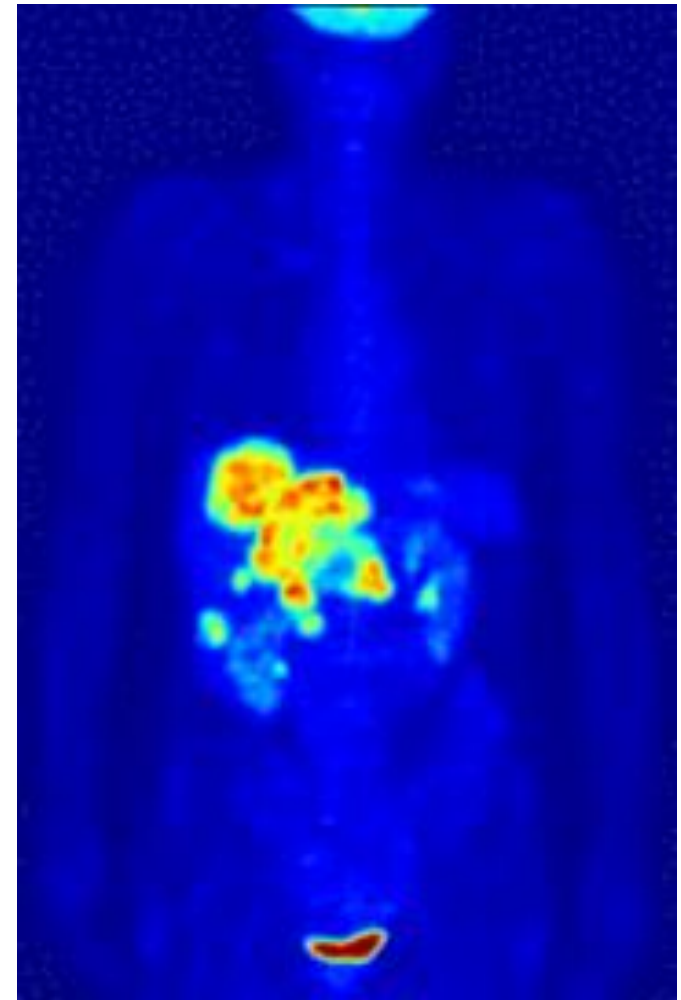
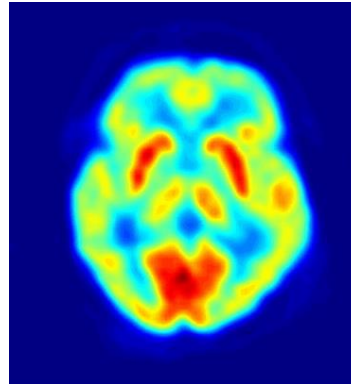

Ressonância Magnética Nuclear

- Interação do núcleos dos átomos (em campos magnéticos estáticos) com ondas de rádio
- Os *spins* dos núcleos dos átomos tem movimento aleatório, mas ficam alinhados se submetidos a um campo magnético

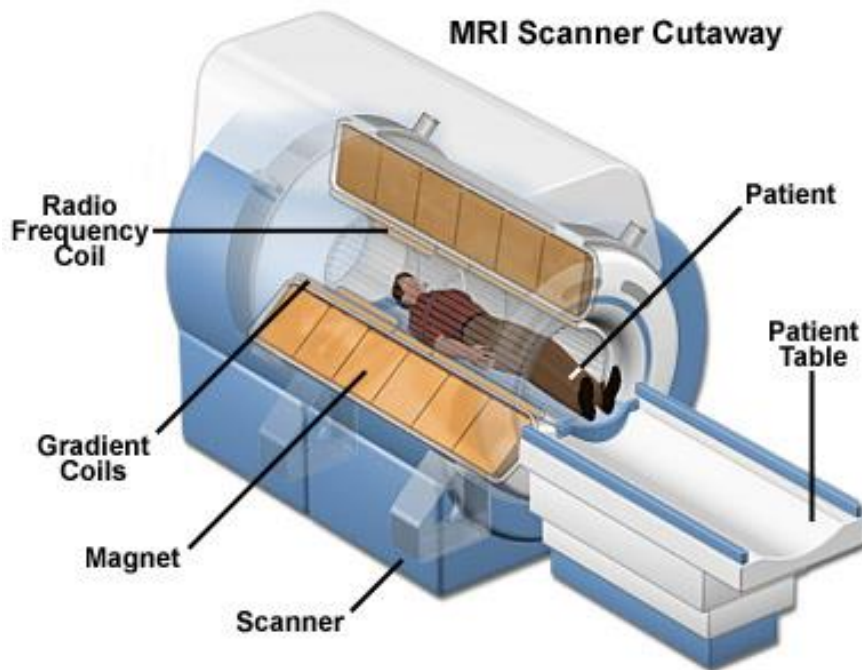

Ressonância Magnética Nuclear

- A interferência com ondas de rádio (MHz) gera ressonância, que absorve e emite uma quantidade de energia que depende da natureza do átomo.
- Um dos átomos mais sensíveis à variação magnética é o hidrogênio;
- O corpo humano é composto de aproximadamente 85% de água e cada molécula de água, contém 2 átomos de Hidrogênio e 1 de Oxigênio;

Ressonância Magnética Nuclear

- ↑ • Excelente visualização de tecidos moles
- ↑ • Imagens de alta resolução
- ↓ • Alto custo
- ↓ • Desconforto do paciente

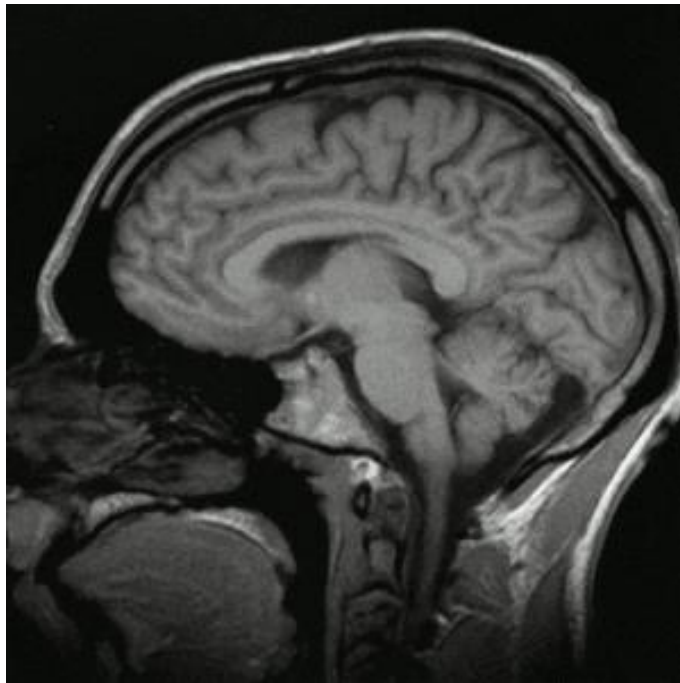

Ultrassonografia

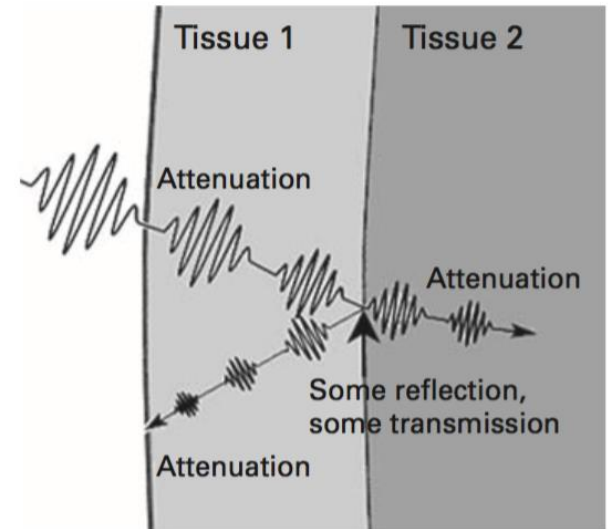
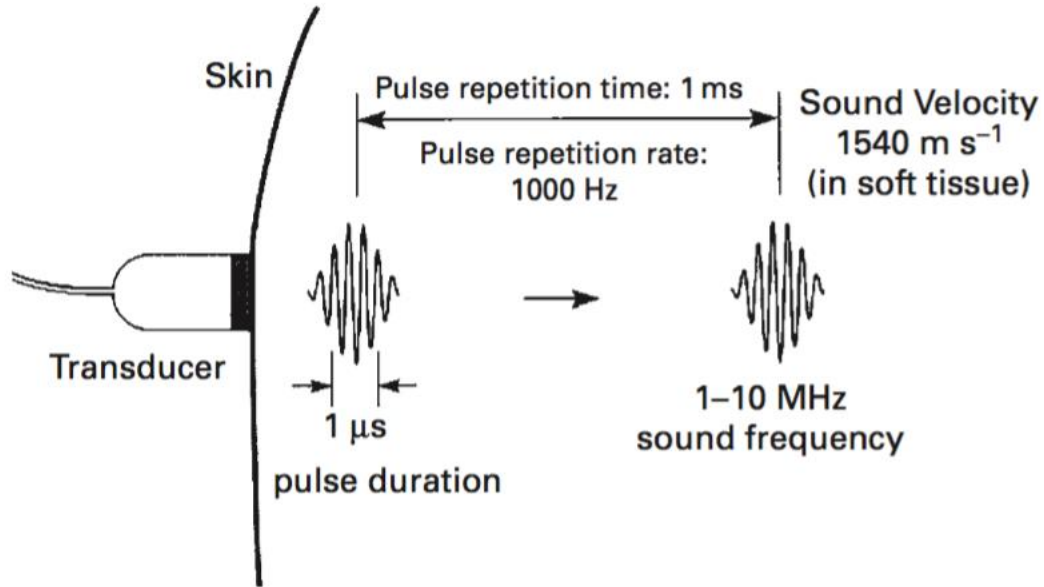

Ultrasonografia



Ultrassonografia

- Baixo custo
- Não invasivo

- Alto ruído e imagens com baixa resolução

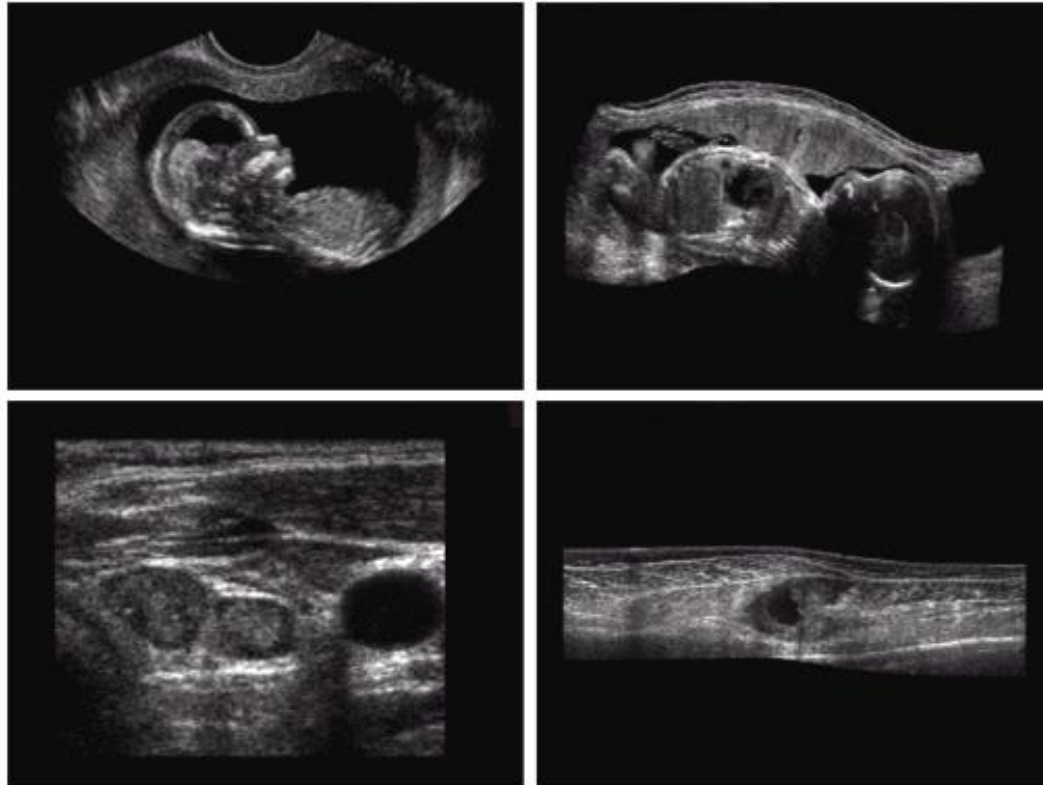

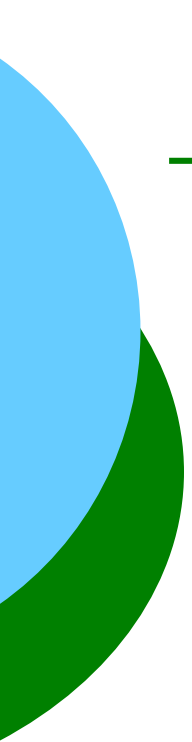

FIM