



# Ultrassom em biomedicina

**Theo Z. Pavan**

**Universidade de São Paulo, FFCLRP, Departamento de Física**

# MRI

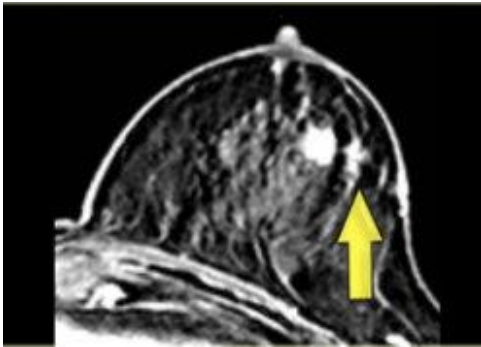
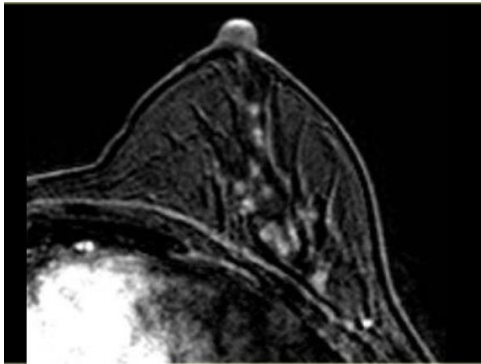

# Mamografia

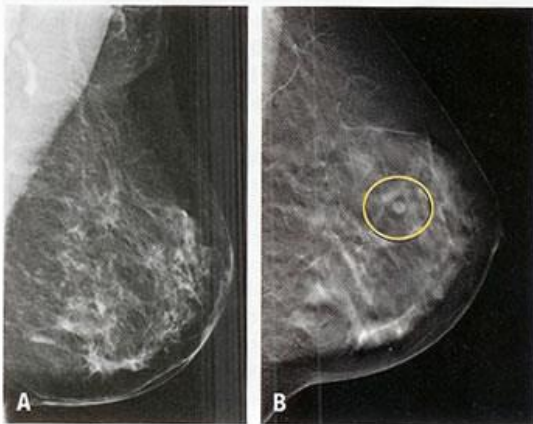

# PET/CT

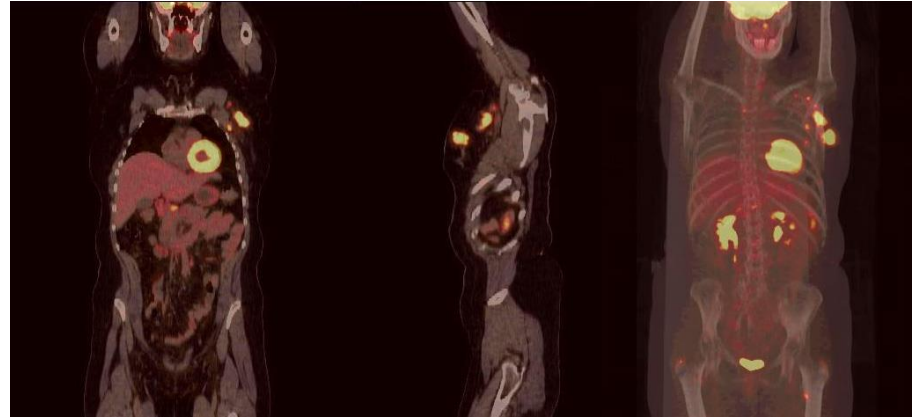

# Ultrassom

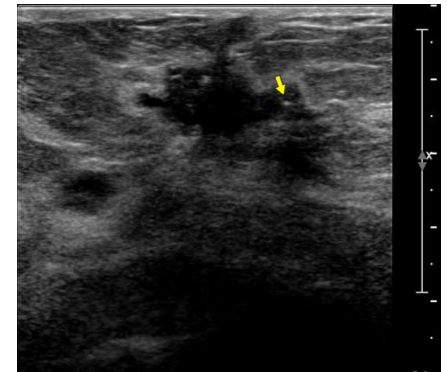
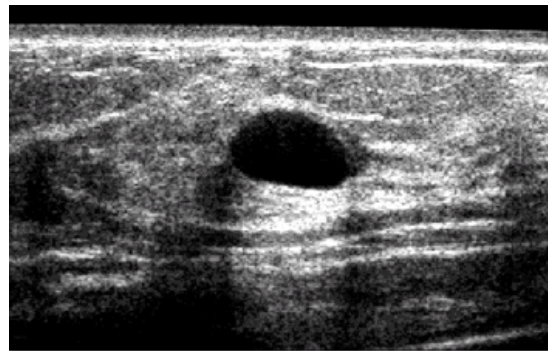

# Aula introdutória

🌀 **Capítulos de 1 a 3.**

🌀 Essentials of Ultrasound Physics – James A. Zagzebski.

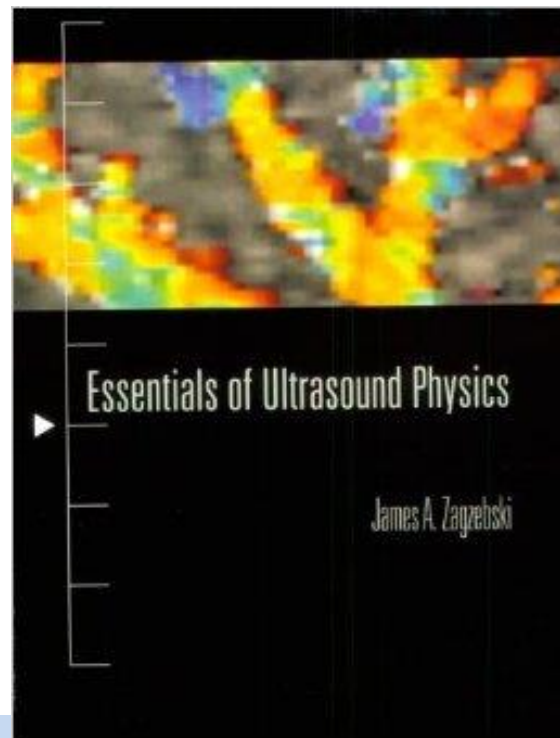

# Ultrassom

Som audível

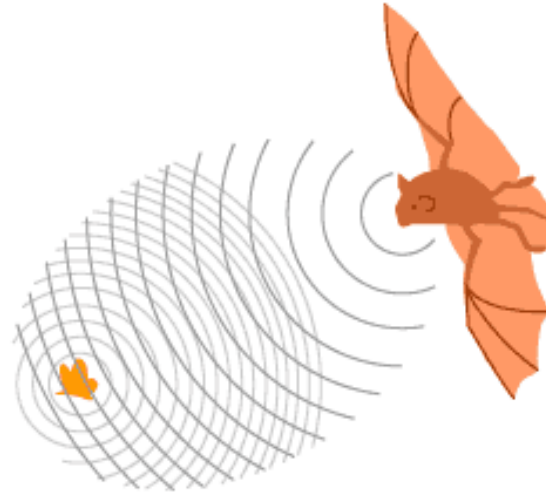
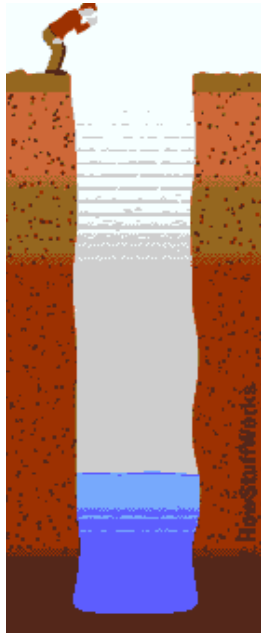

Ultrassom ~ kHz

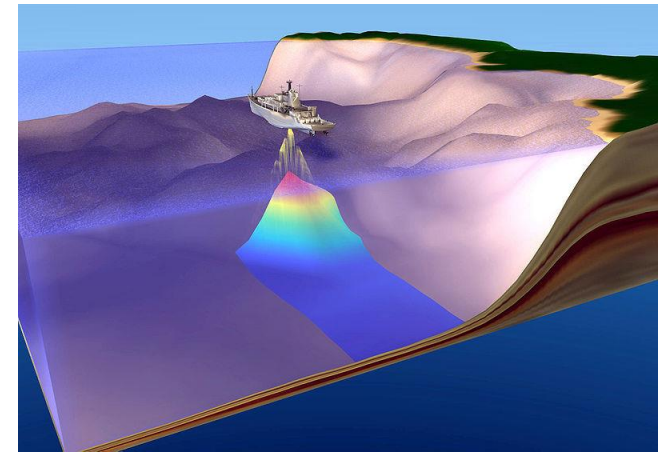

 **Ultrassom diagnóstico 1 a 15 MHz.**

# Ultrassom

A ultra-sonografia, ou ecografia, é um método diagnóstico que aproveita o eco produzido pelo som para ver em tempo real as reflexões produzidas pelas estruturas e órgãos do organismo



Aparelho de ultra-som

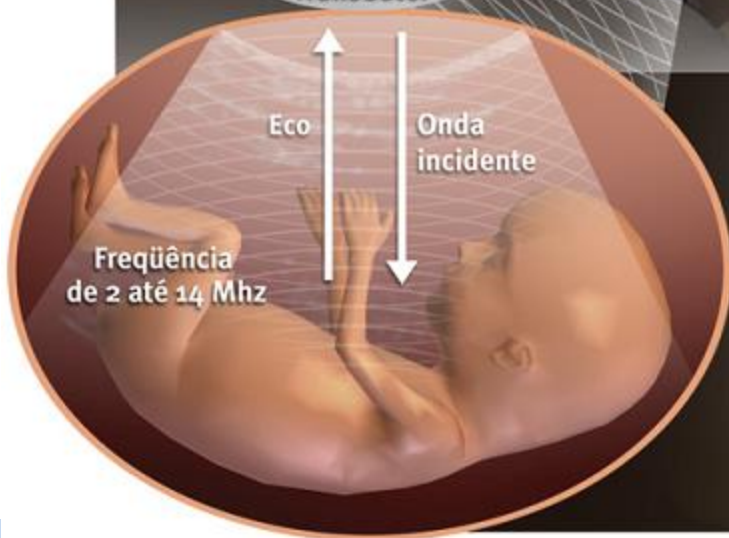

Os ecos gerados são interpretados através de computação gráfica. Quanto maior a frequência, maior a resolução obtida

Ecografia



# Princípio de aplicação





# O potencial do Ultrassom em Biomedicina?

---

- É um método qualitativo e quantitativo pouco invasivo;
- Tem uma vasta aplicação nas mais diversas áreas de diagnóstico clínico;
- É de baixo custo;
- Portátil;
- Resolução submilimétrica.
- Não faz uso de radiação ionizante;
- É uma área que apresentou grande avanço tecnológico recentemente.

# Algumas limitações

- 🌀 Órgãos que apresentam gases ou estrutura óssea não são adequadamente imageadas.
- 🌀 Por isso, apenas certas janelas estão disponíveis para examinar alguns órgãos como o cérebro e o coração.
- 🌀 Depende da habilidade do operador.
- 🌀 Alguns pacientes e situações não permitem obtenção de imagens. Exemplo: paciente obesos.



- ☞ No final dos anos 1800, **Lord Rayleigh** publicou sua famosa obra: **"the Theory of Sound"**. Dita como a primeira descrição matemática das ondas acústicas.
- ☞ Lazzaro Spallanzani, um biólogo italiano, demonstrou em 1794 que a habilidade dos morcegos de navegar com precisão no escuro era através de ecos de um som inaudível de alta frequência.
- ☞ Primeira grande descoberta para evolução do ultrassom pulso eco: descoberta **do efeito piezelétrico pelos irmãos Curie**.
- ☞ Outro fato importante: **Titanic em 1912**. Primeira patente de um Sonar depositada um mês depois.



# Histórico

- ☞ Primeira Guerra, em 1914, impulsionou a evolução do SONAR (Sound Navigation and Ranging).
- ☞ Com o surgimento da eletrônica de potência, Paul Langevin (aluno de Curie) desenvolveu SONAR submarino em 50 kHz.
- ☞ Em seus experimentos, Lengevin observou peixes mortos e dor ao colocar a mão em frente ao feixe.
- ☞ Primórdios do ultrassom em biomedicina foi dedicado a terapia.

# Histórico - Terapia

- Na década de 1940 foi usado para destruir tecido cerebral.
- Chegou a ser tratado como remédio para qualquer doença : asma, incontinência urinária, artrite, etc...
- Introduzido na fisioterapia.



Úlcera gástrica

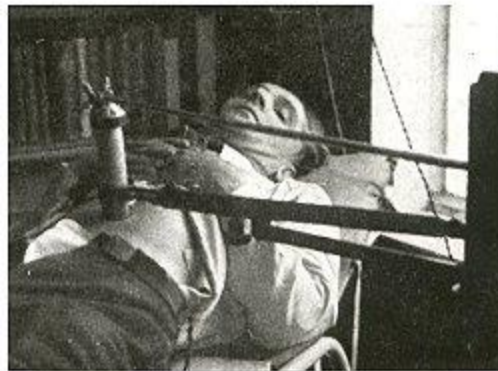

Artrite

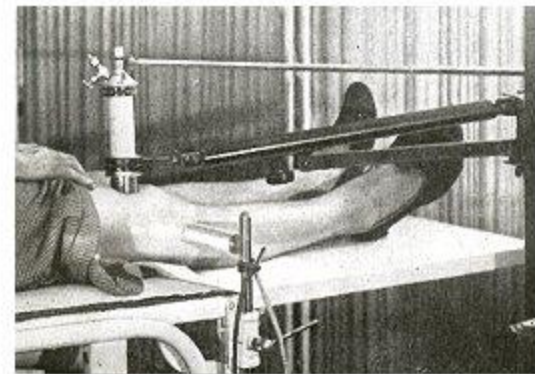

# Histórico – Detectores de falha em material

- Técnica de detecção de falhas em material proposta pelo russo Sokolov.
- Americano Floyd Firestone desenvolveu o primeiro equipamento.

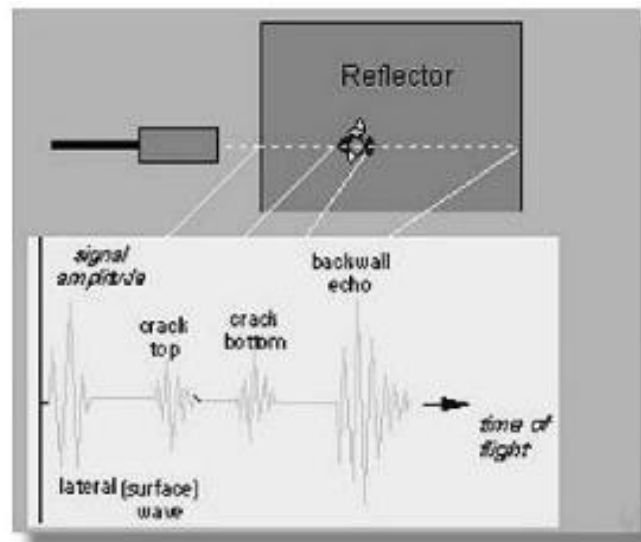

# Histórico- Possível técnica de diagnóstico

- **Karl Theo Dussik, médico austríaco propôs obtenção de imagens do cérebro por transmissão.**

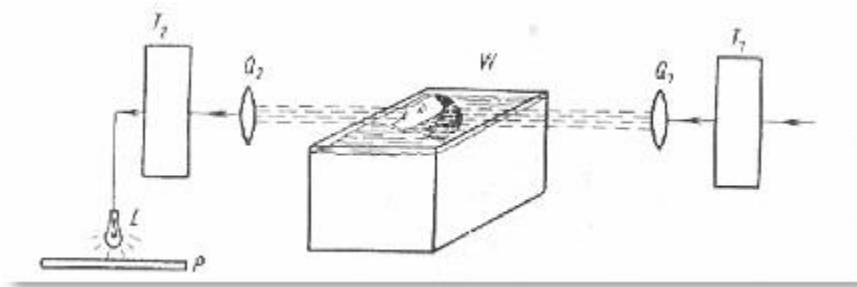

T1 -- ultrasonic generator, Q1-- transmitter, Q2 -- receiver, T2 -- converter amplifier, W – waterbath, L -- light, P -- photographic/ heat-sensitive paper \*

**Primeira tentativa em cérebro pode ter sido um erro estratégico que atrasou a evolução do método de imagem.**

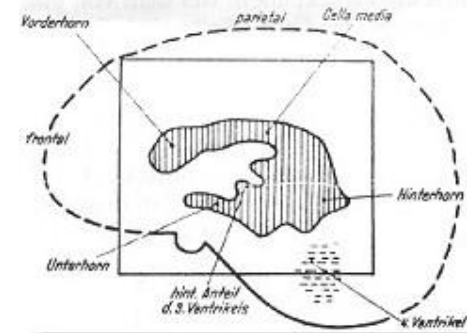
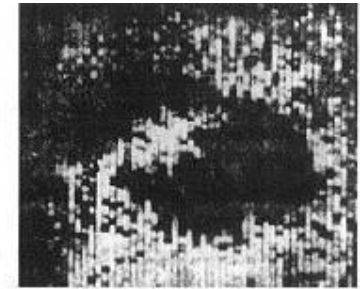

The hyperphonogram was thought to depict the ventricles

- ⌘ A partir do trabalho de Dussik, muitas outras abordagens para medicina foram feitas em outros países (Japão, Alemanha, Suécia, EUA).
- ⌘ Grande maioria trabalhou somente com sinais unidimensionais.
- ⌘ Detecção de pedra em vesícula, detecção de movimentos do coração (ecocardiograma), etc.



## Echographic Visualization of Lesions of the Living Intact Human Breast\*

J. J. WILD† AND JOHN M. REID†

(Department of Electrical Engineering, University of Minnesota, and St. Barnabas Hospital, Minneapolis, Minn.)

\* This investigation was supported by a research grant from the National Cancer Institute, Department of Health, Education, and Welfare, U.S. Public Health Service.

† Dr. Wild and Mr. Reid are presently Director and Chief Electronic Engineer, respectively, of the Medico-Technological Research Department of St. Barnabas Hospital, Minneapolis, Minn.

Received for publication October 5, 1953.

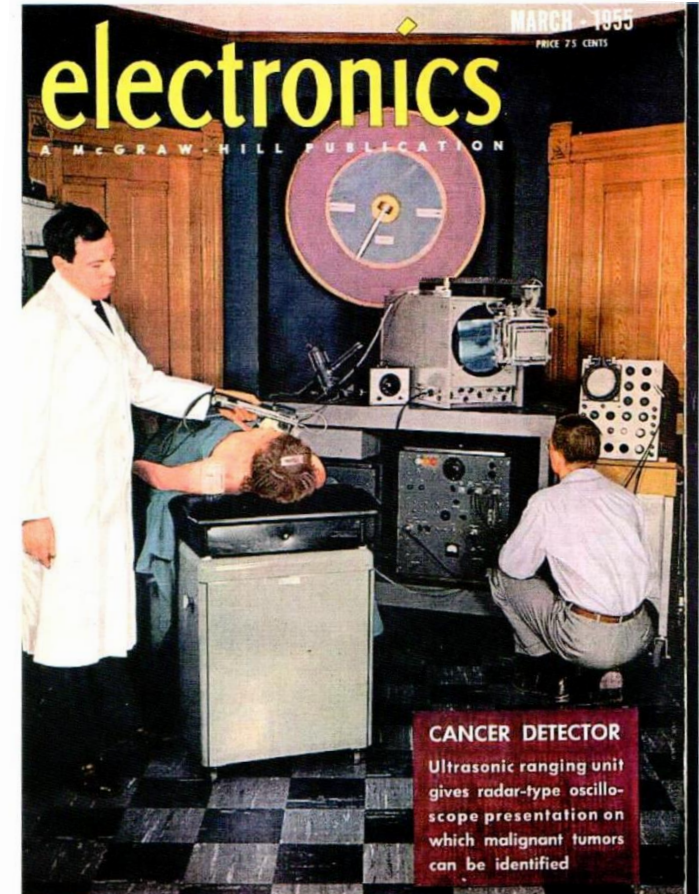
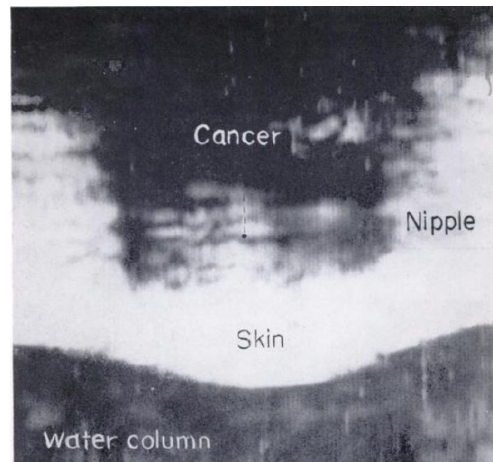

**Figure 1.9** Dr. John J. Wild scans a patient with a handheld, linearly scanned 15-MHz contact transducer. John Reid (later Professor Reid) adjusts modified radar equipment to produce a B-scan image on a large-diameter scope display with a recording camera (courtesy of J. Reid, reprinted with permission of VNU Business Publications).

# Transdutores





# Elementos piezelétricos

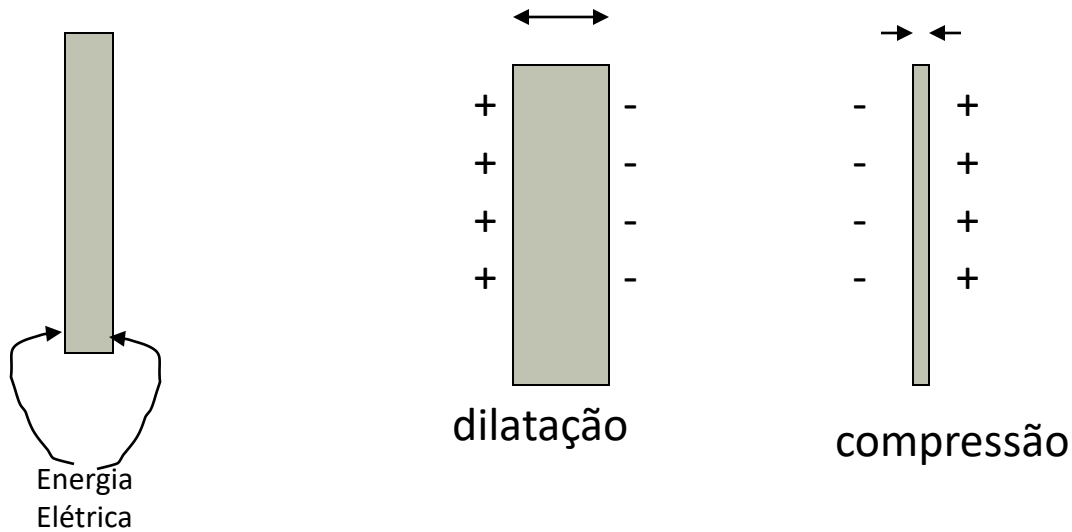

**Descoberto pelos irmãos Pierre e Jacques Curie, na França, em 1880**

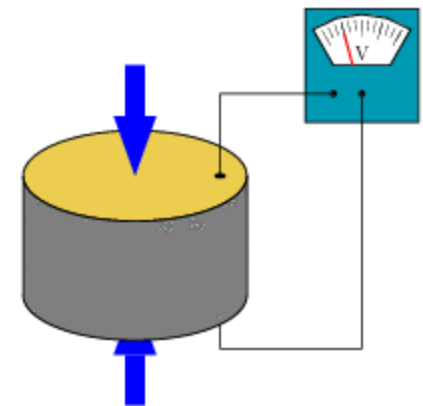
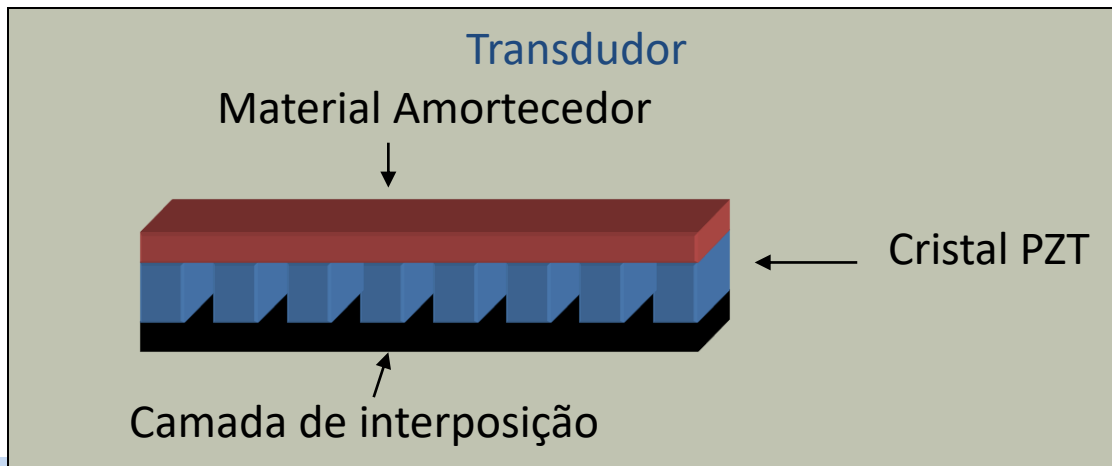

# Propagação da onda de ultrassom

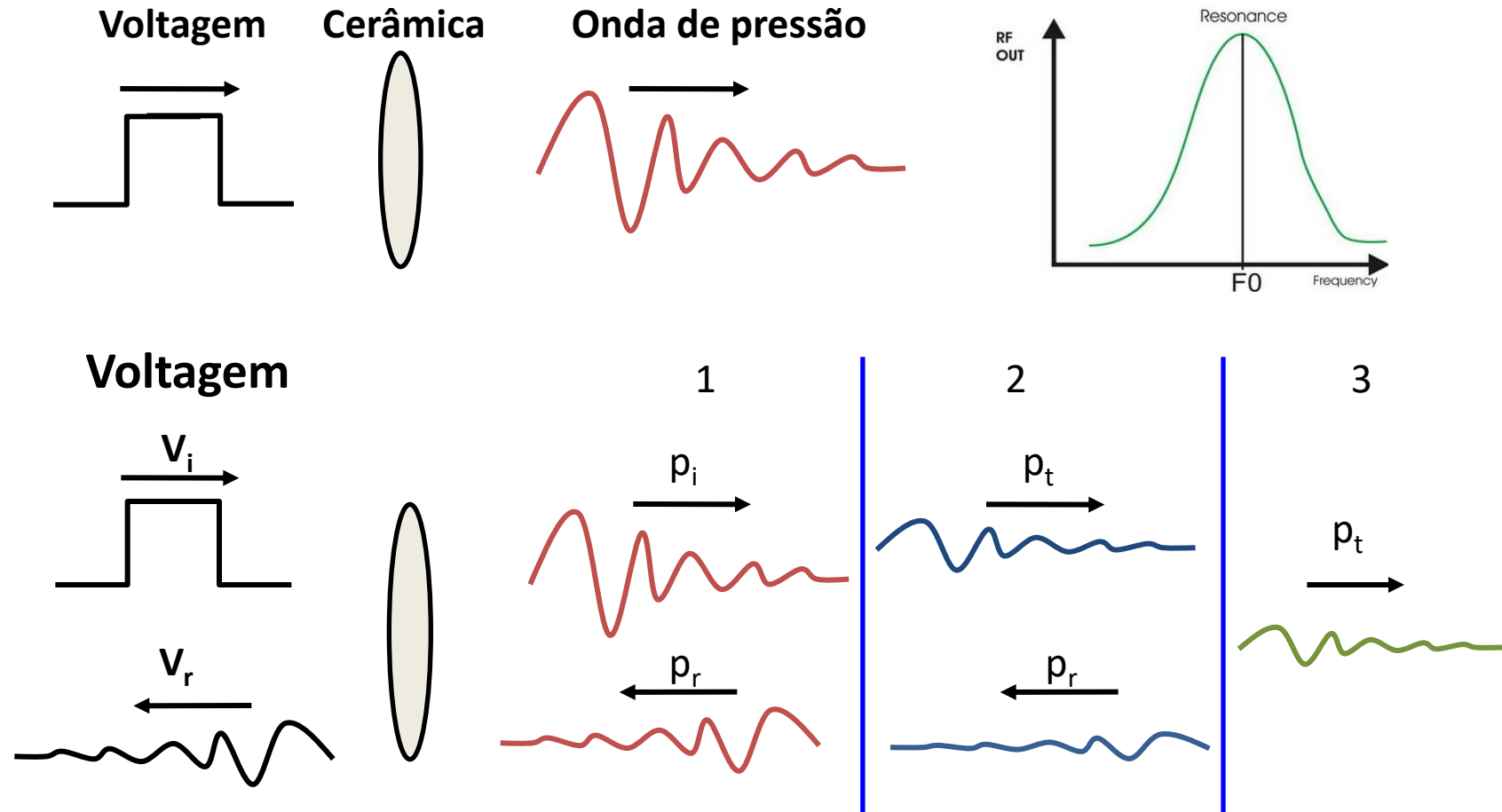

# Ondas longitudinais vs. transversais

## Onda Longitudinal

Fonte e Mola movem-se  
esquerda ---- direita



Direção do transporte de energia

## Onda Transversal

Fonte e Mola movem-se  
para cima e para baixo

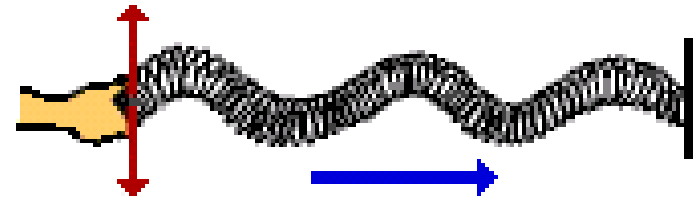

Direção do transporte de energia

A direção do movimento das partículas do meio é a mesma da fonte que gera a perturbação.

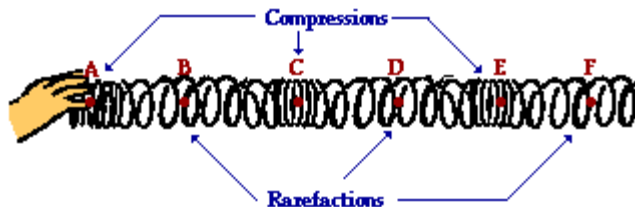

 Som é uma onda longitudinal.

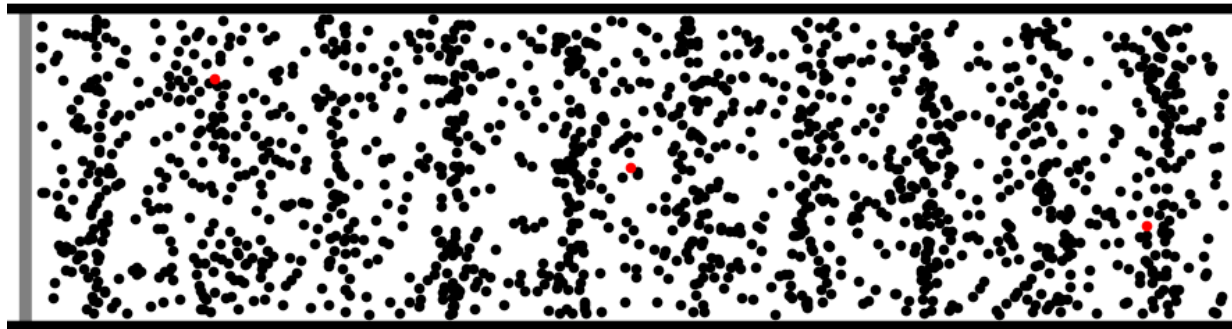

©2011. Dan Russell

# Velocidade - Ondas em cordas

$$v = \sqrt{\frac{F}{\mu}}$$

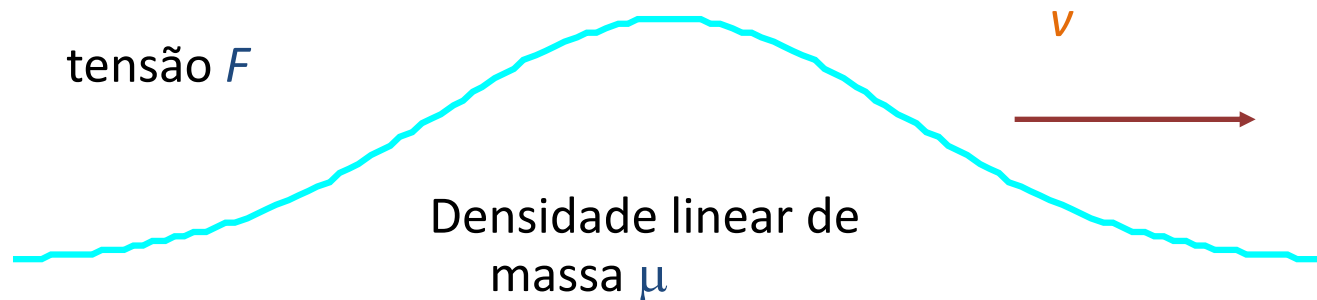

- Aumentando a tensão, aumenta-se a velocidade.
- Aumentando a massa da corda, diminui-se a velocidade.
- Estes fatos **dependem apenas na natureza do meio**, e não na amplitude, frequência, etc da onda.

# Velocidades de ondas longitudinais

 A velocidade de ondas longitudinais tem uma forma similar ao caso de uma onda transversal

$$v = \sqrt{\frac{\text{fator elástico}}{\text{fator de inercia}}}$$

$$v = \sqrt{\frac{B}{\rho}}$$

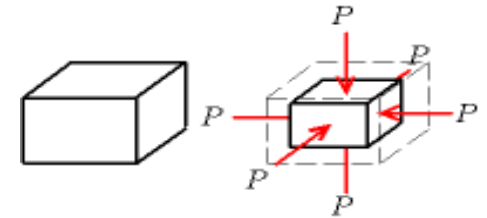

$$B = - \frac{\Delta P}{\Delta V / V}$$

O som é uma onda de pressão

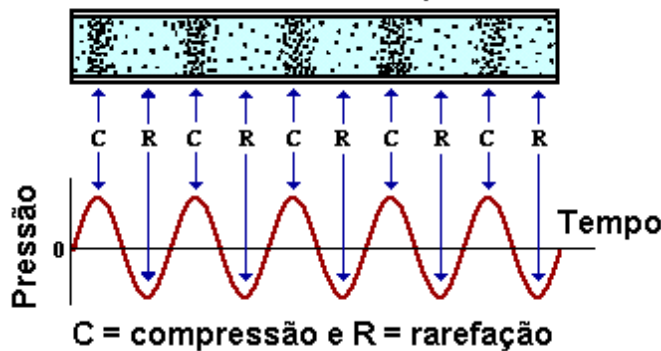

- $\rho$  é a densidade;
- $B$  é o módulo volumétrico.

# Velocidade de propagação do Ultrassom

$$V = (B/\rho)^{1/2}$$

**B** → módulo volumétrico

**$\rho$**  → densidade material

<b>Gordura</b>	<b>1450 m/s</b>
<b>Água</b>	<b>1480m/s</b>
<b>Tecido mole</b>	<b>1540m/s</b>
<b>Osso</b>	<b>4100 m/s</b>

**O Ultrassom diagnóstico é ajustado com  $v=1540$  m/s**

# Pressão e intensidade

- Para quantificar a **“força”** de uma onda é preciso analisar a **pressão acústica**.
- Regiões de compressão aumento na pressão.
- Regiões de rarefação diminuição na pressão.
- Pressão atmosférica  $\rightarrow 10^5$  Pa
- Pressão acústica   
ultrassom diagnóstico  $\rightarrow \sim 10^6$  Pa



# Pressão e intensidade

- Intensidade é a energia média transportada por unidade de área em um certo período de tempo.
- Em algumas situações, por exemplo quando discutirmos **efeitos biológicos do ultrassom**, a **intensidade acústica** é muito útil.

$$I = p^2/\rho c$$

**A Intensidade é proporcional ao quadrado da pressão.**

# Bioefeitos e intensidade

**Grande parte dos equipamentos de ultrassom são pulsados do tipo pulso-eco.**

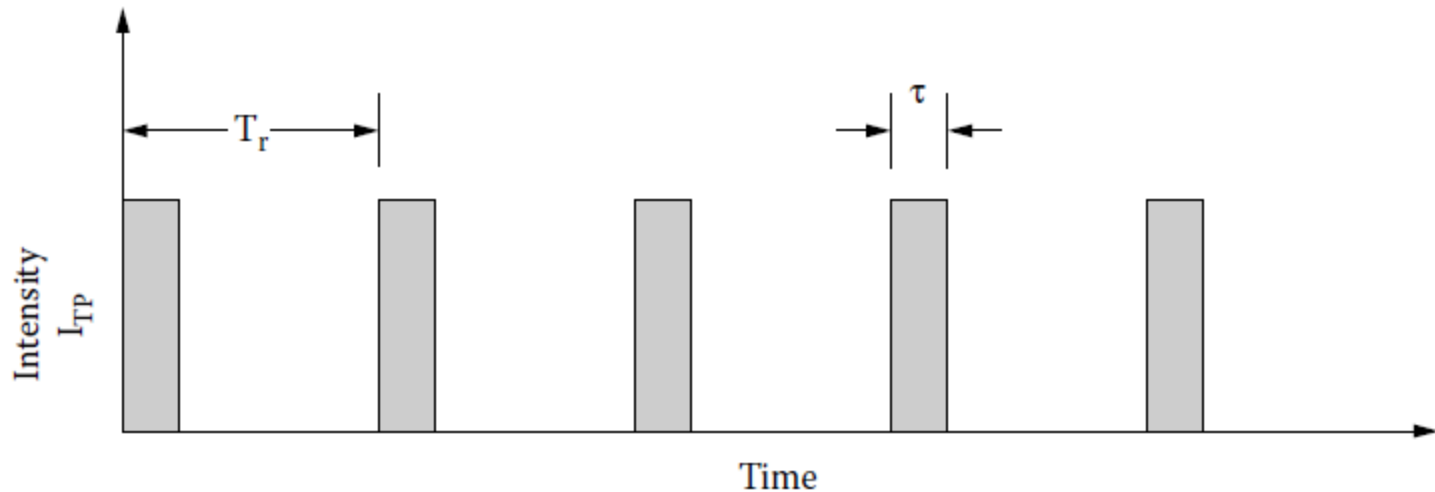

$\tau/T_r =$  pulse duration/pulse repetition period  
= duty cycle

$I_{TP}$  = temporal peak intensity,

$I_{TA}$  = temporal averaged intensity =  $(\tau/T_r) I_{TP}$

# Bioefeitos e intensidade

---

- 🌀 A intensidade em um pulso de ultrassom não é espacialmente uniforme.
- 🌀 Para se falar de bioefeitos é preciso especificar qual definição é usada.
- 🌀 Por exemplo:
  - **Intensidade média espacial e média temporal.**
  - **Intensidade de pico espacial e média temporal.**

# Intensidade

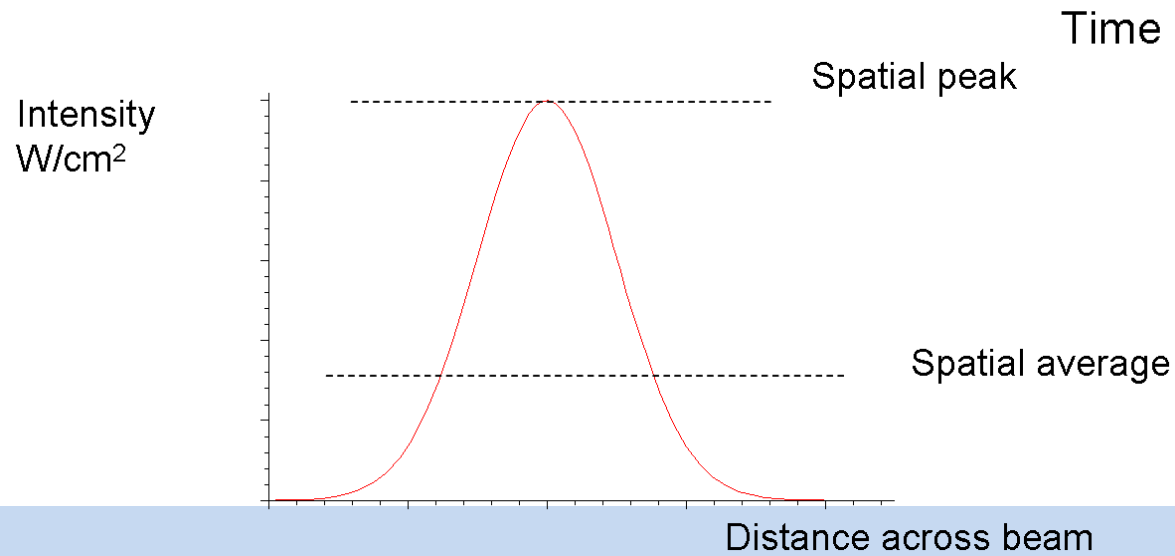
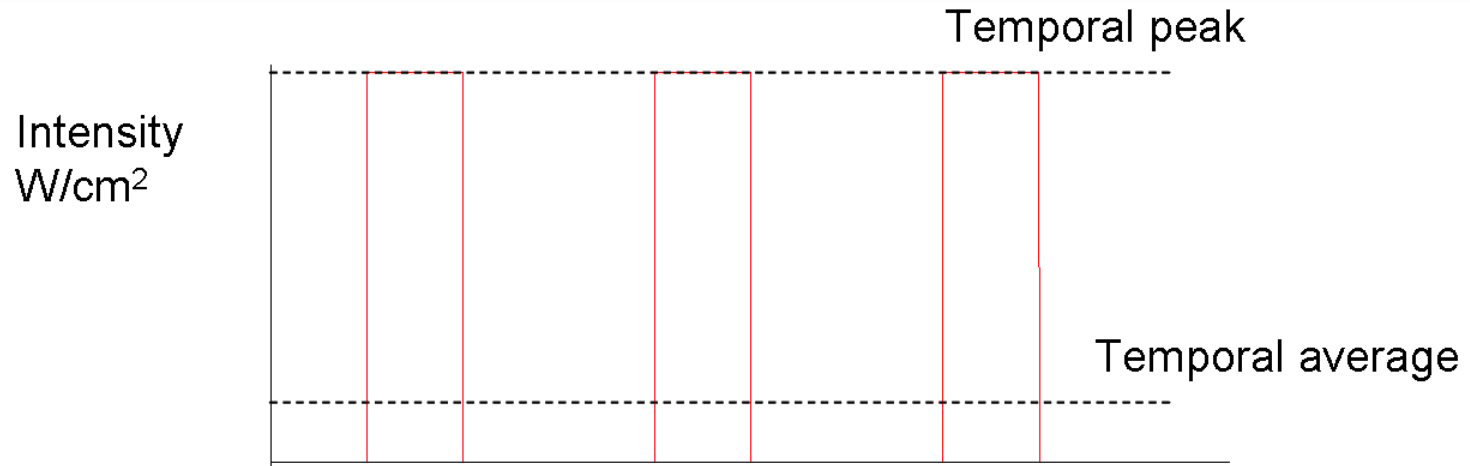

# Impedância acústica (**Z**)

---

- ⌘ Grandeza análoga à resistência elétrica.
- ⌘ Sendo a diferença de pressão (**p**) devido a passagem da onda análoga à diferença de potencial elétrico.
- ⌘ Velocidade adquirida pelas partículas (**u**) no meio é análoga a corrente elétrica.

$$Z = p/u$$

# Impedância acústica ( $Z_a$ )

O eco só surge quando o feixe de ultrassom passa por dois meios com diferentes impedâncias.

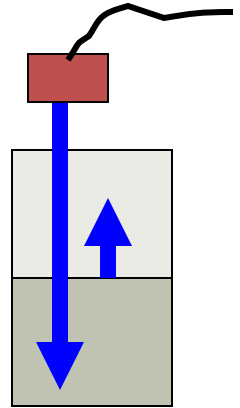

🌀 **Z** - impedância acústica

🌀  **$\rho$**  - densidade do meio

🌀 **V** - velocidade do som nesse meio

$$Z = \rho \cdot v$$



# Interação das ondas de Ultrassom

---

Podem ser absorvidas e se transformarem em calor, podendo ser usadas para o tratamento de certas patologias.

Podem ser refletidas de forma:

- **Especular** – nesse caso se a incidência é perpendicular, a maioria das ondas incidentes volta à fonte de ultrassons.
- **Difusa** - o feixe refletido se espalha por todas as direções.

Podem ser espalhadas

Podem ser transmitidas

# Reflexão - incidência perpendicular

$$\frac{p_r}{p_i} = \frac{z_2 - z_1}{z_2 + z_1}$$

$$\frac{I_r}{I_i} = R_i = R_A^2 = \left( \frac{z_2 - z_1}{z_2 + z_1} \right)^2$$

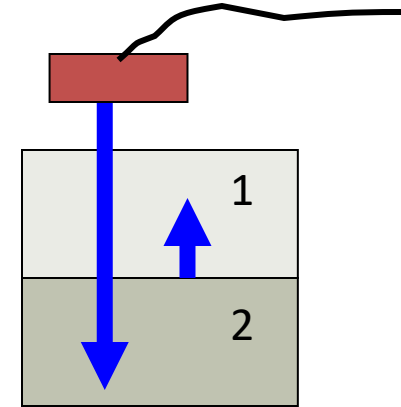

**$P_r$  = Pressão Refletida**

**$P_i$  = Pressão Incidente**

**$I_r$  = Intensidade Refletida**

**$I_i$  = Intensidade Incidente**



# Impedância acústica

Body Tissue	Acoustic Impedance ( $10^6$ Rayls)
Air	0.0004
Lung	0.18
Fat	1.34
Liver	1.65
Blood	1.65
Kidney	1.63
Muscle	1.71
Bone	7.8

**Rayl  $\rightarrow$  kg/(m<sup>2</sup>.s)**

**Homenagem a Lord Rayleigh**

# Exemplos de reflexão especular

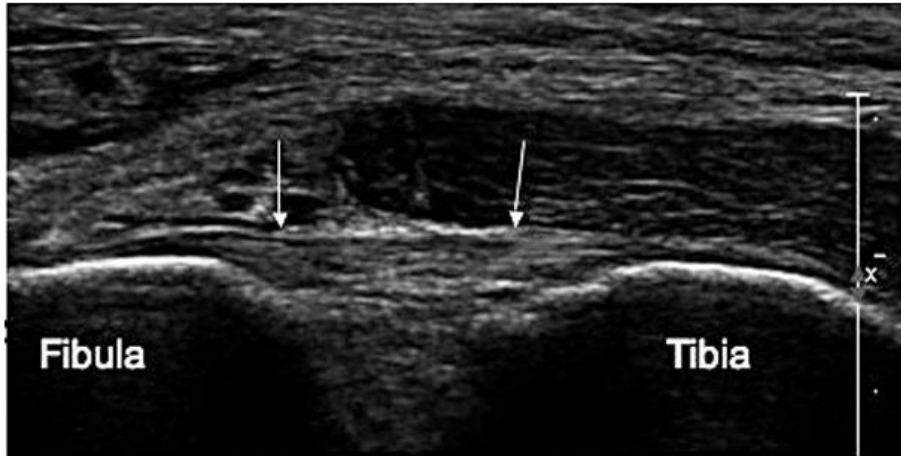
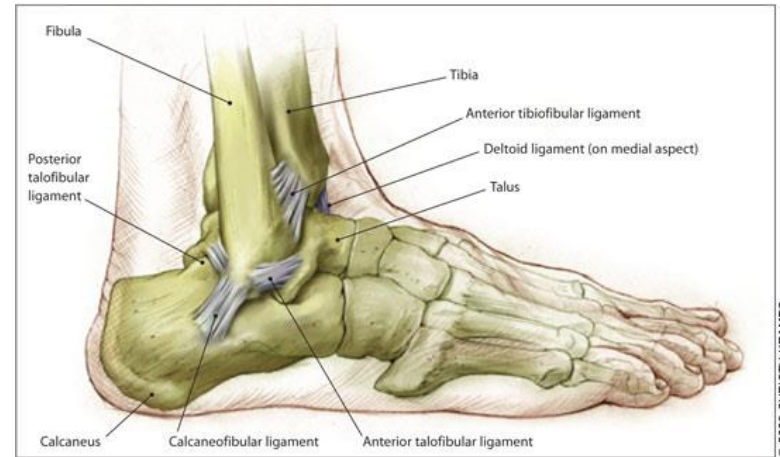

Fig. 17a: Normal anterior tibiofibular ligament stretched between the distal tibia and fibula seen as a well defined fibrillar structure.  
Image 32 of 37

CLOSE X



© 2006 CHRISTY KRAMES

## Distal radioulnar joint

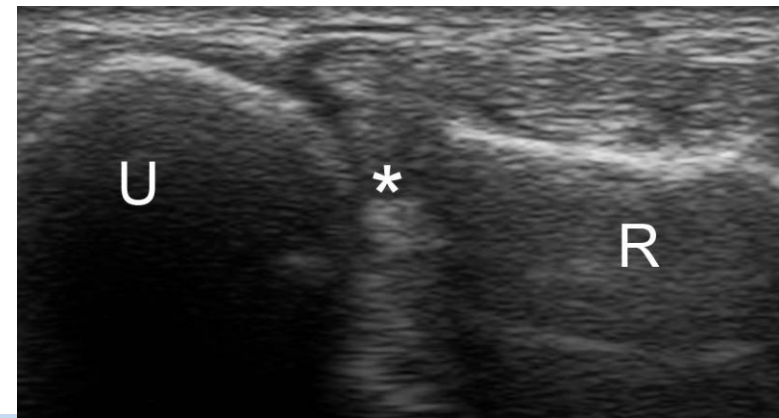
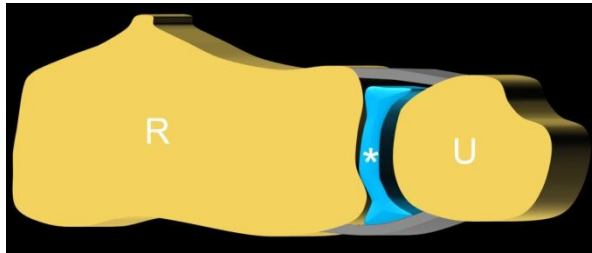

# Incidência não perpendicular

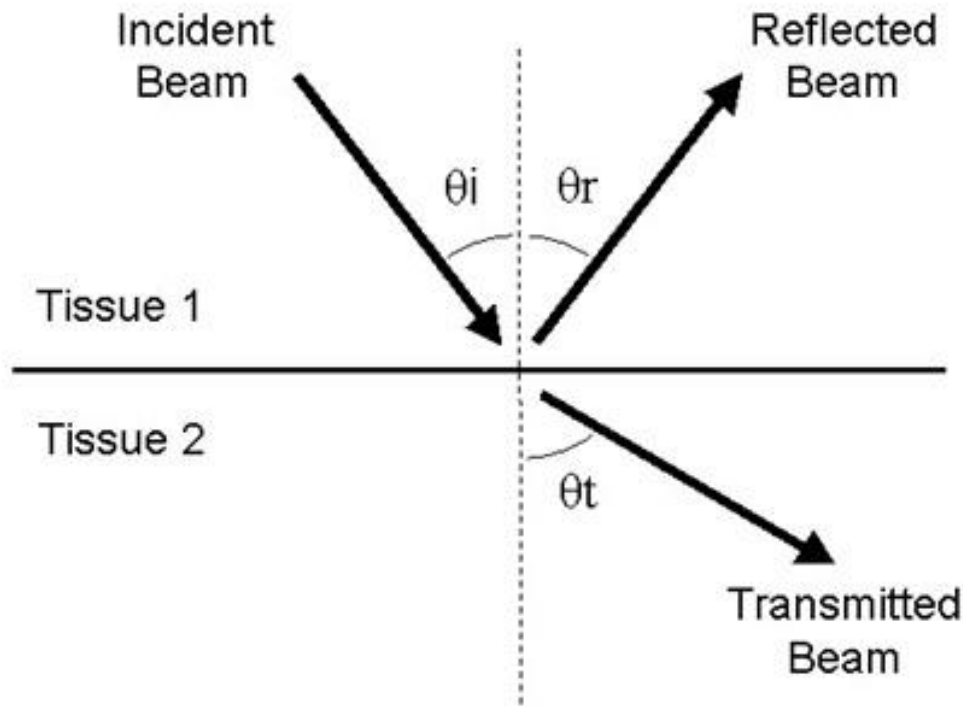

$$R = \frac{p_r}{p_i} = \frac{Z_2 \cos \theta_i - Z_1 \cos \theta_t}{Z_2 \cos \theta_i + Z_1 \cos \theta_t}$$

$$T = \frac{p_t}{p_i} = \frac{2Z_2 \cos \theta_t}{Z_2 \cos \theta_i + Z_1 \cos \theta_t}$$

$$\frac{I_r}{I_i} = \left( \frac{Z_2 \cos \theta_i - Z_1 \cos \theta_t}{Z_2 \cos \theta_i + Z_1 \cos \theta_t} \right)^2$$

$$\frac{I_t}{I_i} = \frac{4Z_2 Z_1 \cos \theta_i}{(Z_2 \cos \theta_i + Z_1 \cos \theta_t)^2}$$

# Reflexão difusa

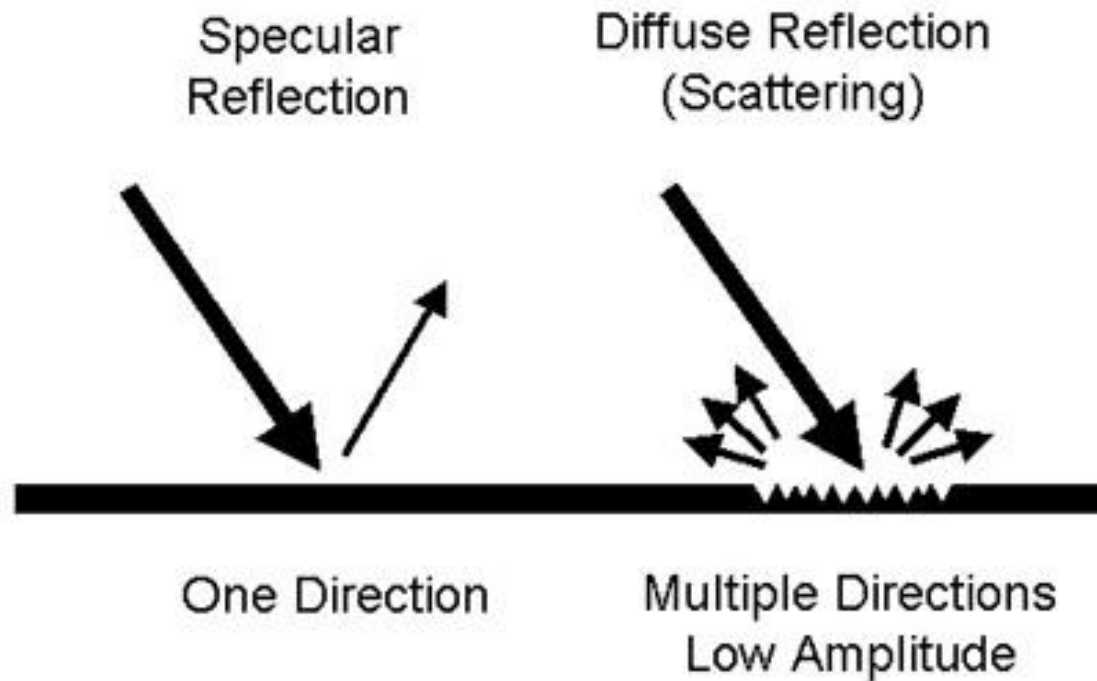

# Exemplo

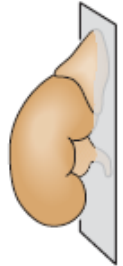
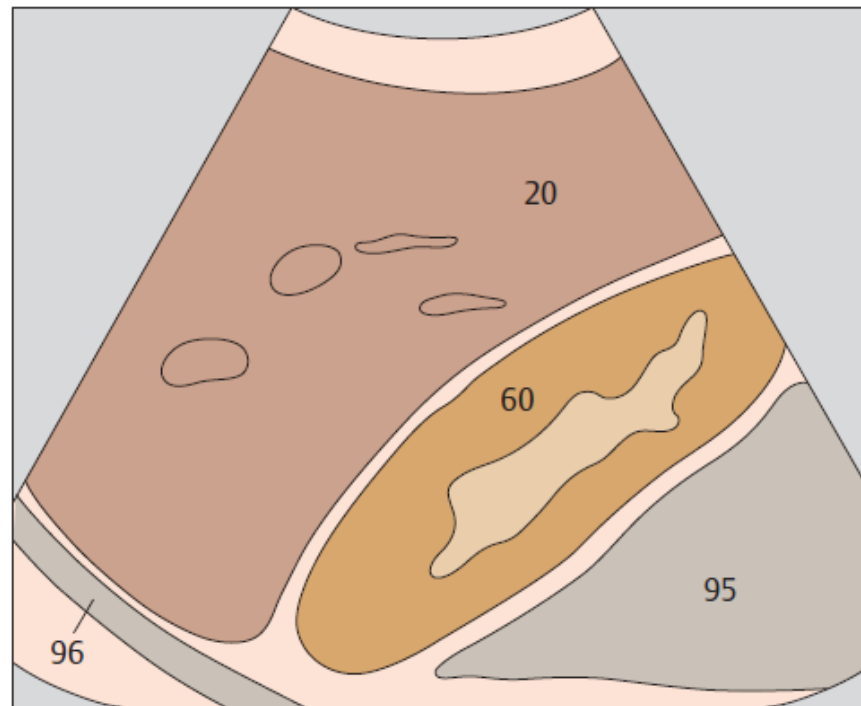
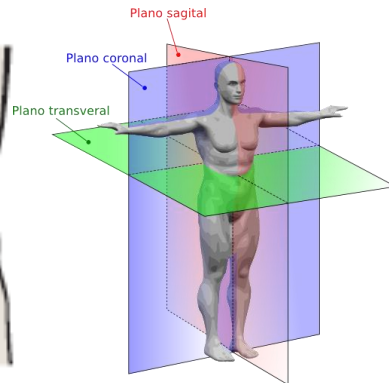
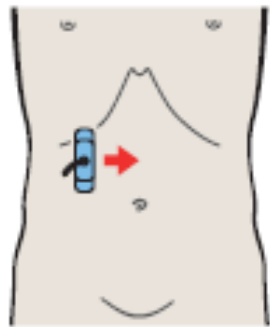
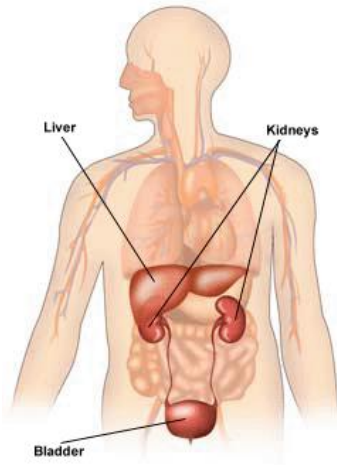

- |                               |                        |
|-------------------------------|------------------------|
| <b>20</b> Right lobe of liver | <b>60</b> Right kidney |
| <b>95</b> Psoas muscle        | <b>96</b> Diaphragm    |

# Reflexão difusa e especular

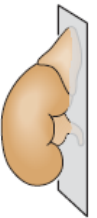
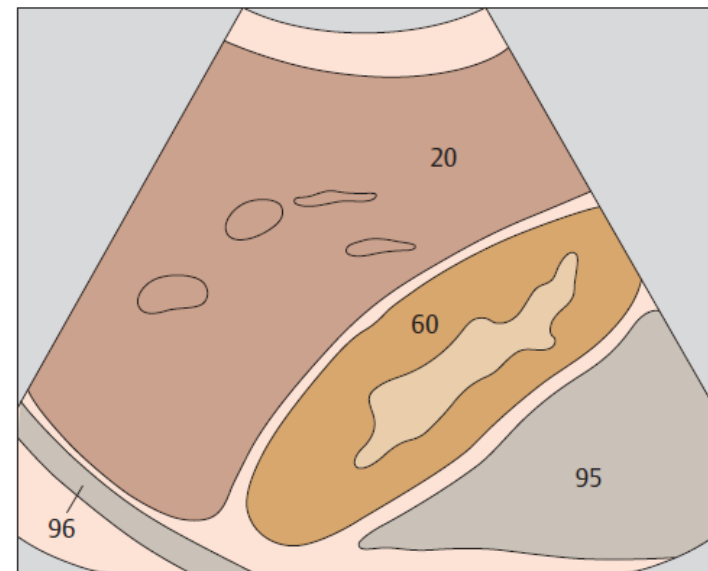
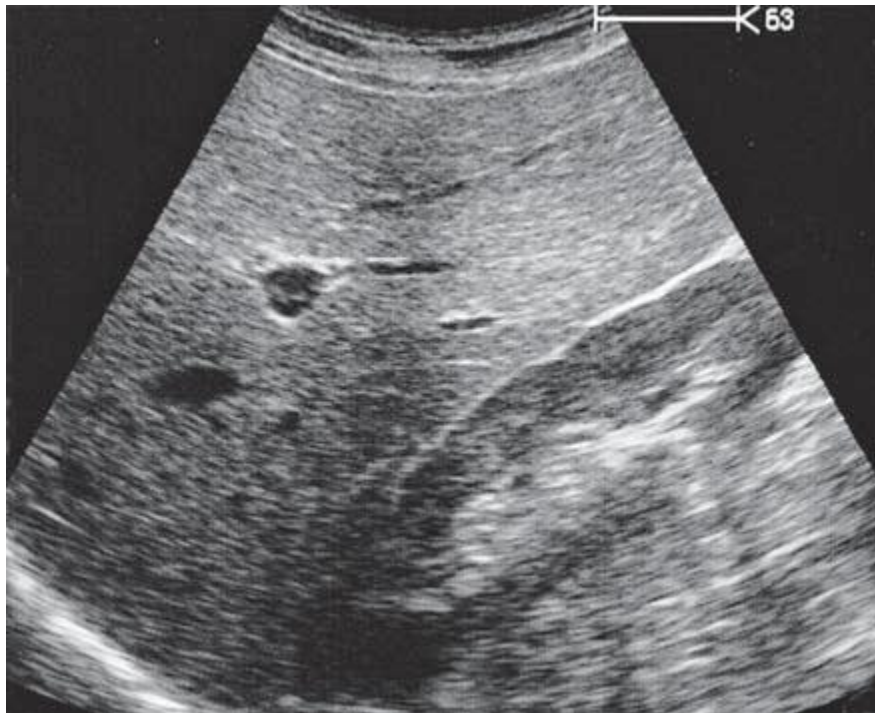

- |    |                     |    |              |
|----|---------------------|----|--------------|
| 20 | Right lobe of liver | 60 | Right kidney |
| 95 | Psoas muscle        | 96 | Diaphragm    |

# Reflexão difusa e especular

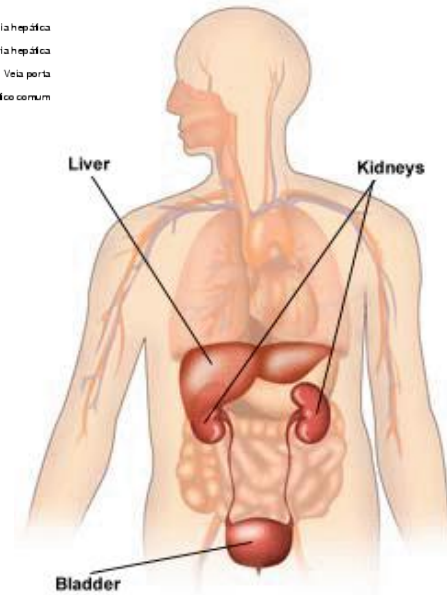
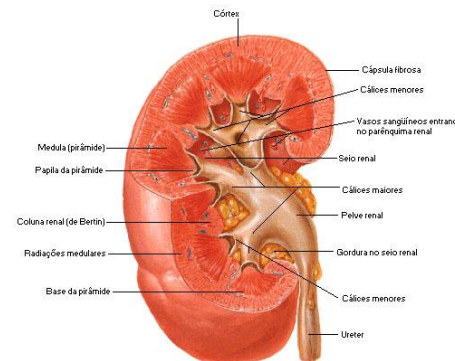
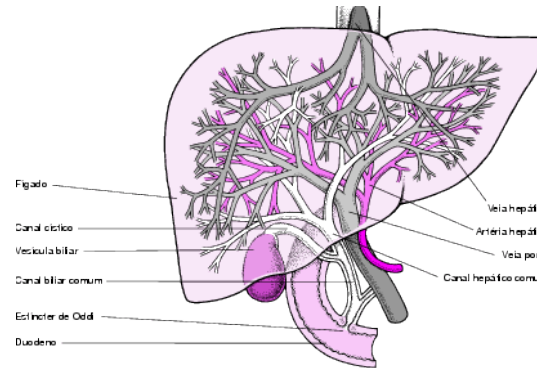
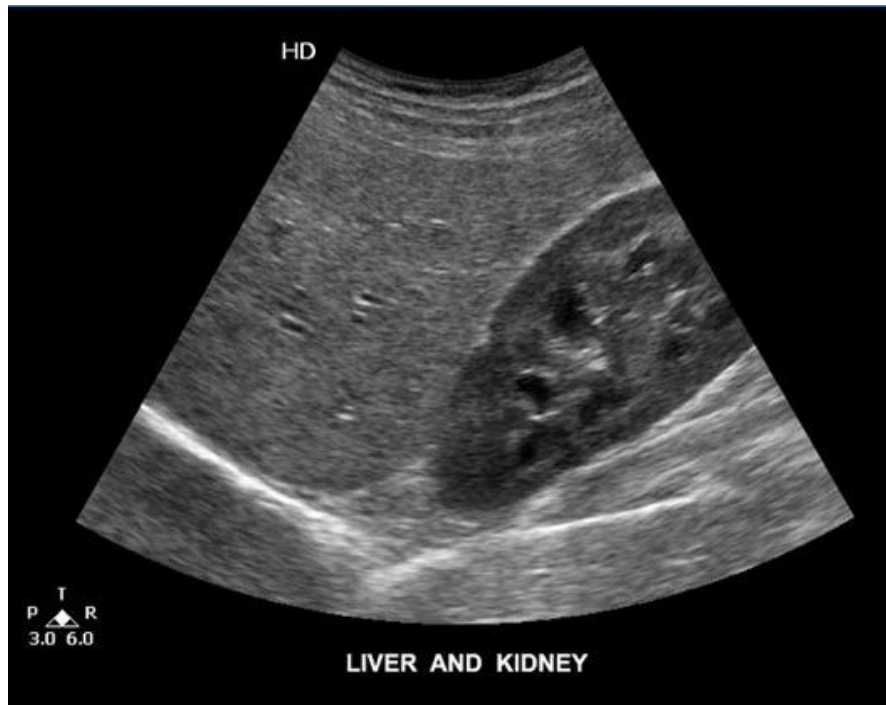

# Eco de espalhadores

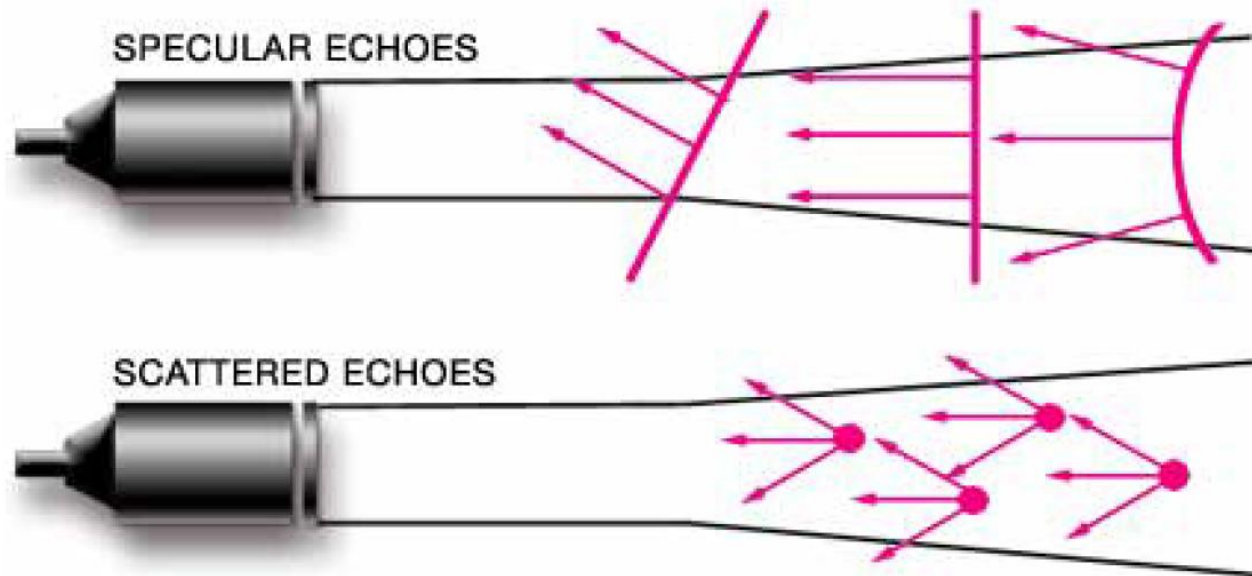

- Fonte de ecos mais importante para imagem de US.
- Espalhamento ocorre para objetos com dimensão da mesma ordem de grandeza do comprimento de onda
- Não depende do ângulo de sonificação.



# Ecos de espalhadores

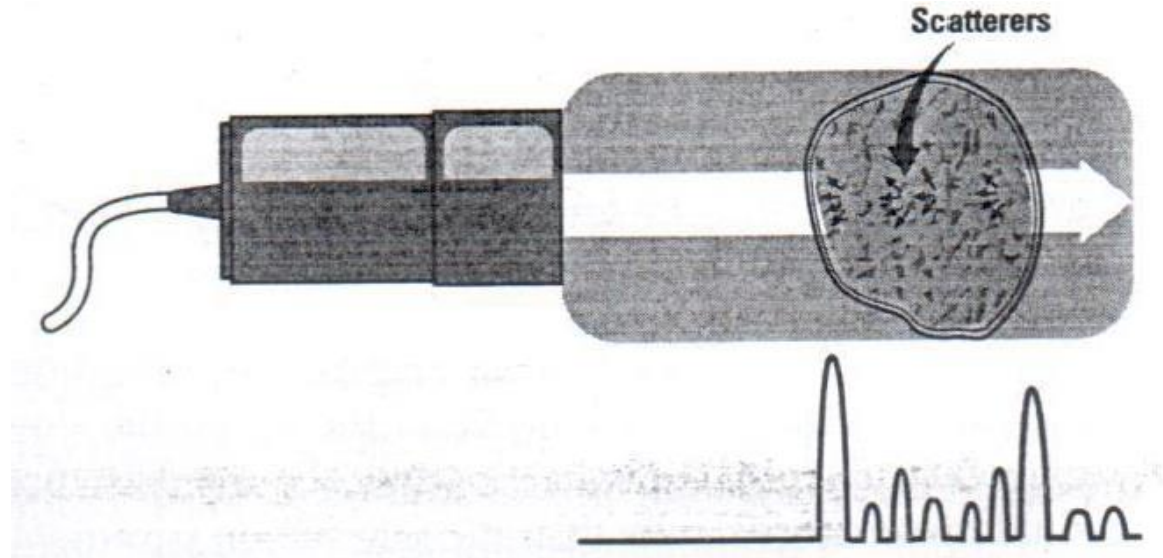

## Regiões Hiperecoicas

Aumento no nível de espalhamento

## Regiões Hipoecoicas

Diminuição no nível de espalhamento

# Eco de espalhadores

## Cisto



## Fibroadenoma



## Carcinoma - IDC



# Espalhadores Rayleigh

- Esse termo é usado quando os espalhadores são bem menores que o comprimento de onda.
- Exemplo: glóbulos vermelhos.
  - $f = 5 \text{ MHz}$   $\lambda = 0,3 \text{ mm}$
  - Glóbulos vermelhos:  $8 \text{ }\mu\text{m}$
- Espalhamento Rayleigh depende inversamente da quarta potência do comprimento de onda. Aumenta com a frequência.

# Exemplos espalhadores Rayleigh

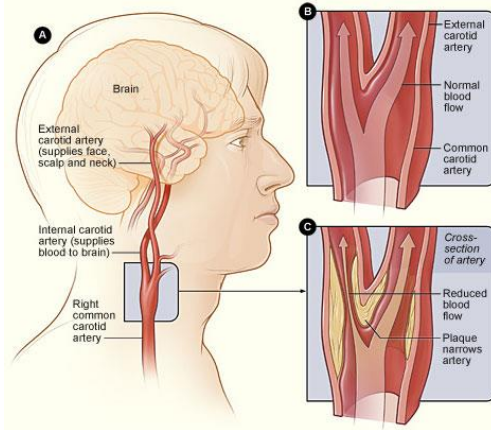

**10-MH**

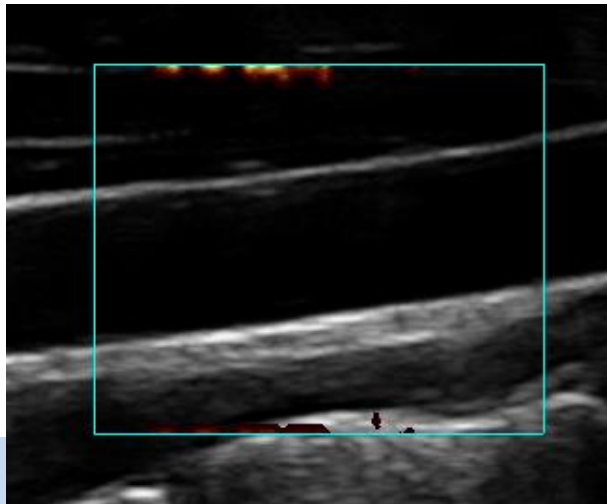

**40-MH**

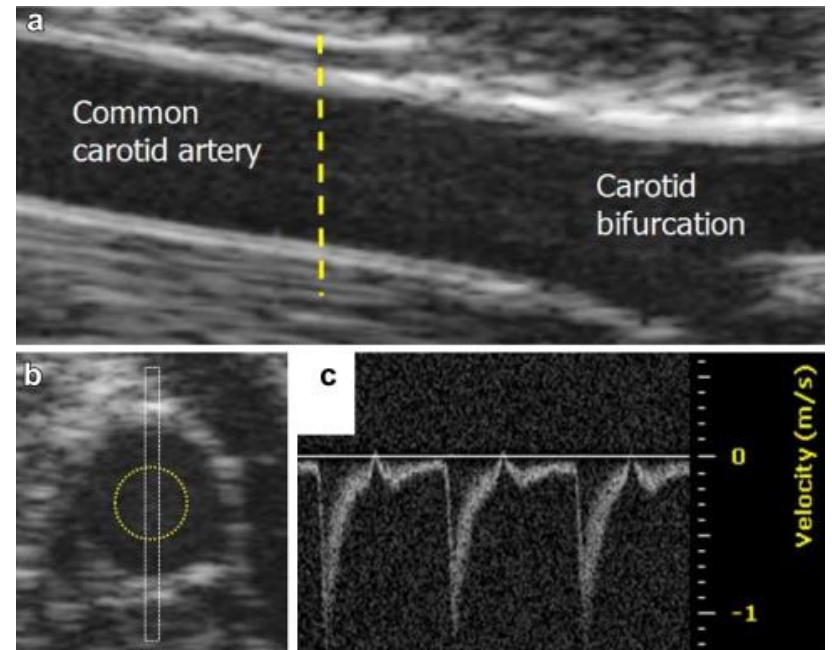

## Reflexão e espalhamento

## Absorção

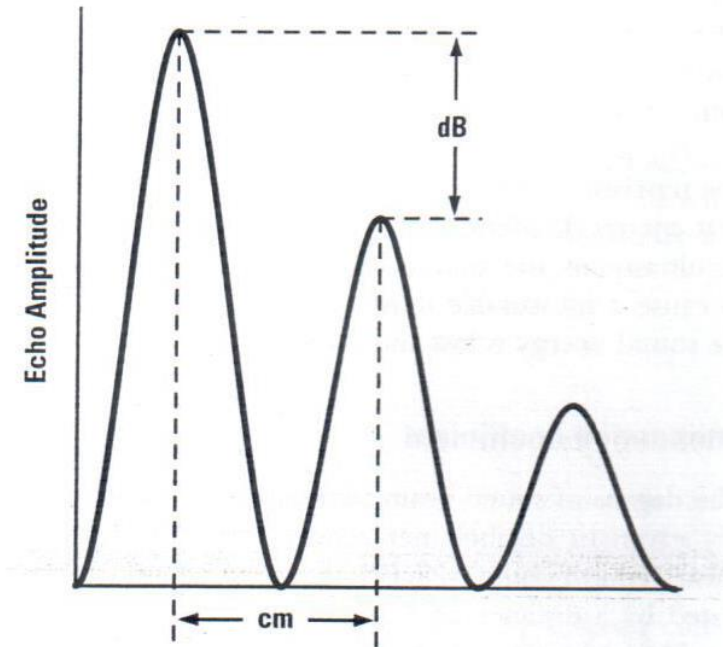
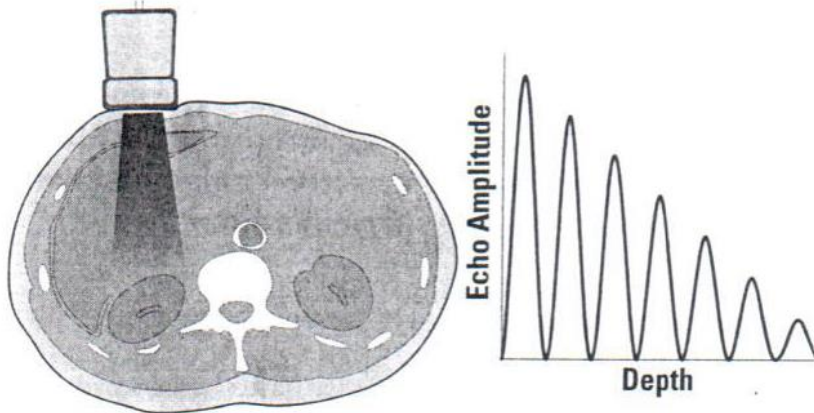

- ❧ Criado por conveniência, para expressar a razão de dois números com diferenças grandes.
- ❧ Homenagem ao cientista Alexander Graham Bell, inventor, entre outras, do telefone.
- ❧ Se  $a$  e  $b$  são dois níveis de potência, então a razão *bel* é: *Nível de Potência* =  $\log_{10} (a/b)$  [Bel].

# Notação Decibel

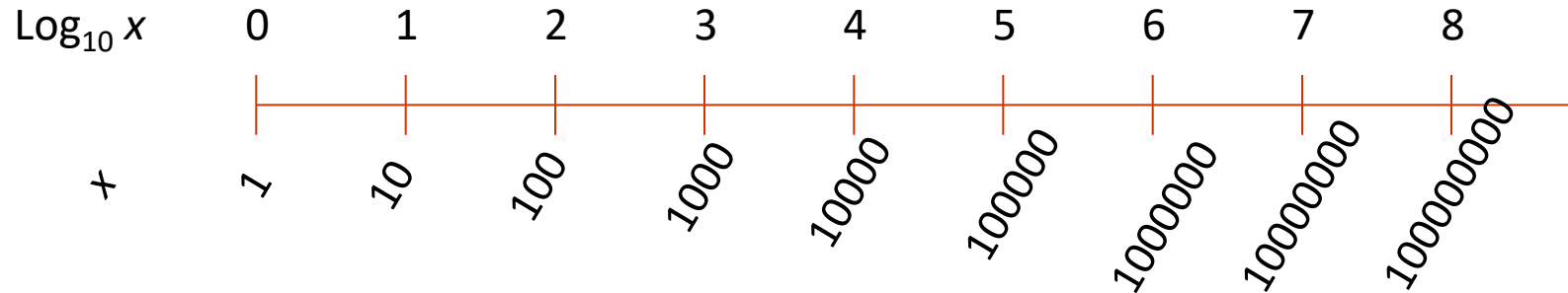

**Criado por conveniência, para expressar a razão de dois números com diferenças grandes.**

**Se  $a$  e  $b$  são dois níveis de potência, então a razão *bel* é: *Nível de Potência* =  $\log_{10} (a/b)$  [Bel].**

# Atenuação - Decibel

**Nível Relativo de Intensidade =  $10 \log (I_1 / I_2)$**

**Nível Relativo do Sinal =  $20 \log (A_1 / A_2)$**

**Coeficiente de  
atenuação**

$$\alpha = \frac{20}{d} \log \left( \frac{A_0}{A} \right)$$

**O grau de atenuação do feixe sonoro é dado em:  
dB/cm**

$$p(z) = p(z = 0)e^{-\alpha z} \quad \alpha = \frac{1}{z} \ln \left[ \frac{p(z = 0)}{p(z)} \right]$$

$$\alpha(\text{dB/cm}) = 20(\log_{10} e)\alpha(\text{np/cm}) = 8.686\alpha(\text{np/cm})$$



# Coeficiente de atenuação

Body Tissue	Attenuation Coefficient (dB/cm at 1MHz)
Water	0.002
Blood	0.18
Fat	0.63
Liver	0.5-0.94
Kidney	1.0
Muscle	1.3-3.3
Bone	5

# Atenuação - Frequência

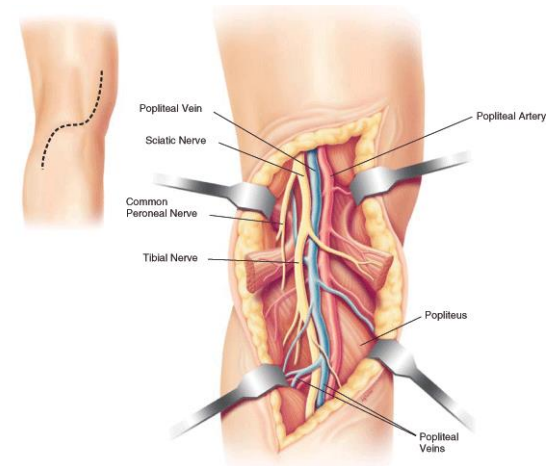
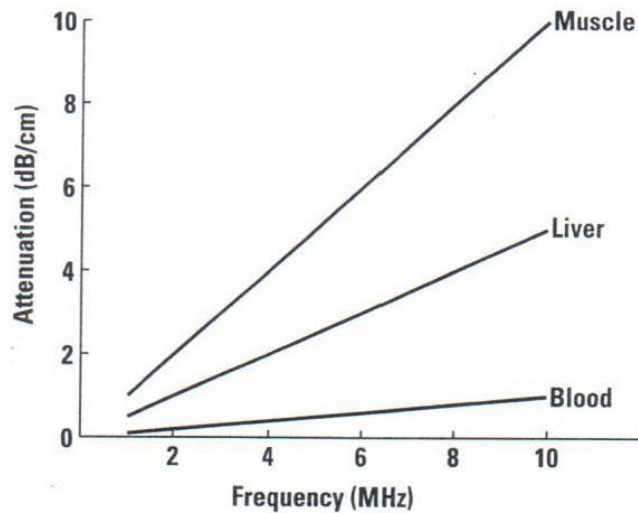

*ScN-Sciatic nerve, PA - Popliteal artery*

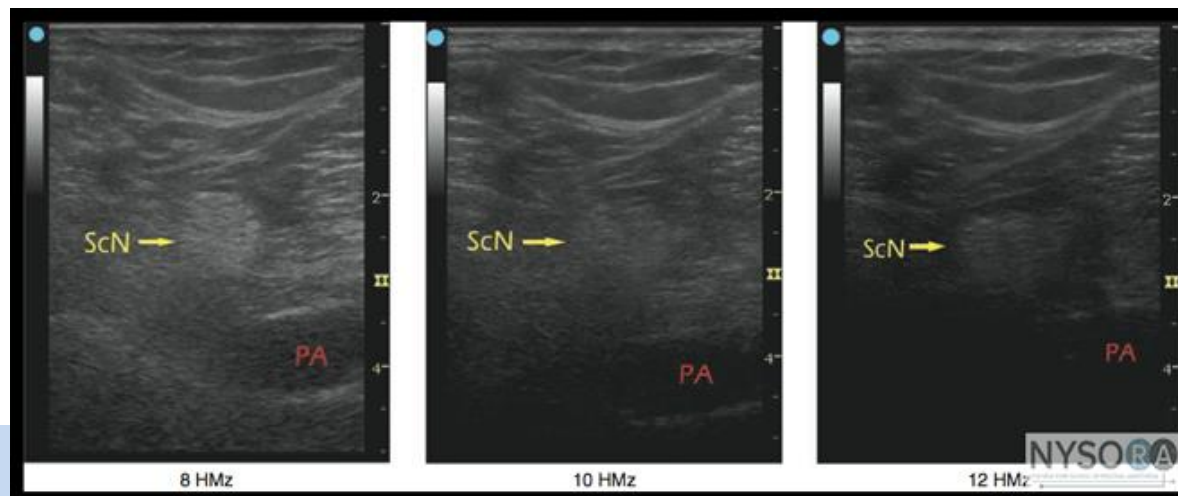

# Ultrassom pulso-eco

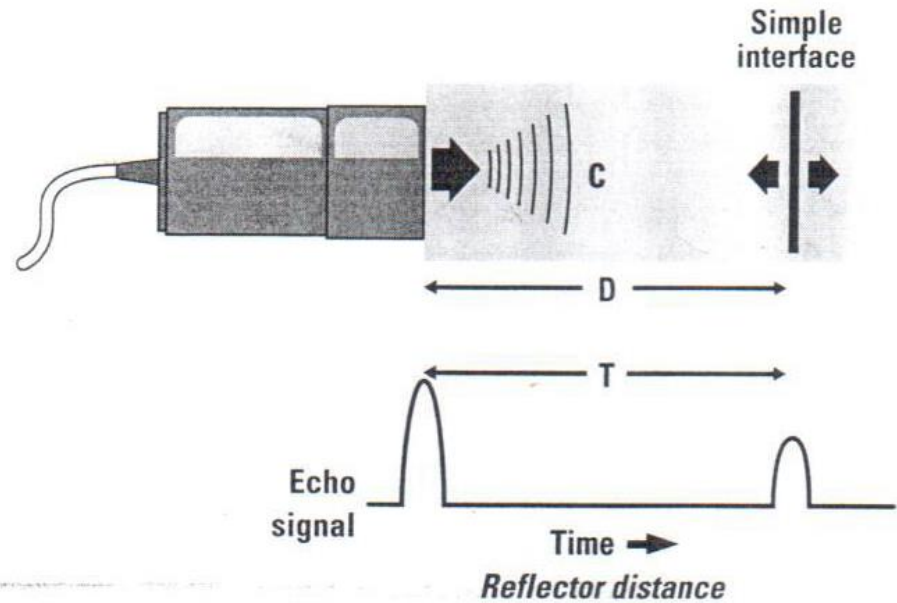
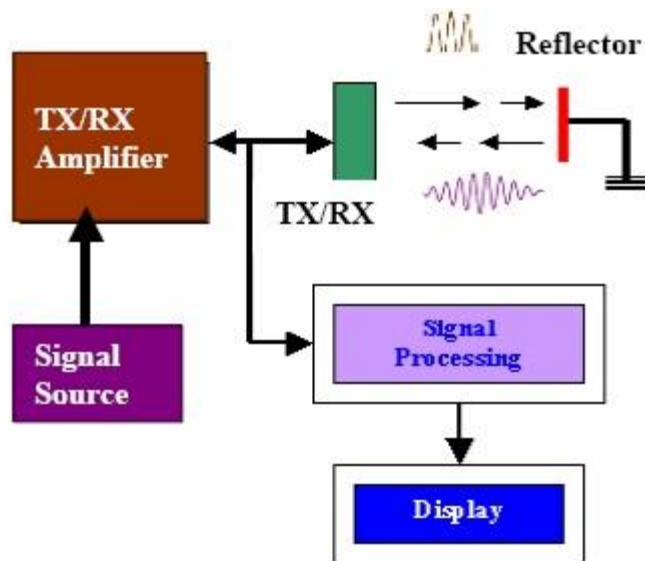

# Pulso-eco Calculando distâncias

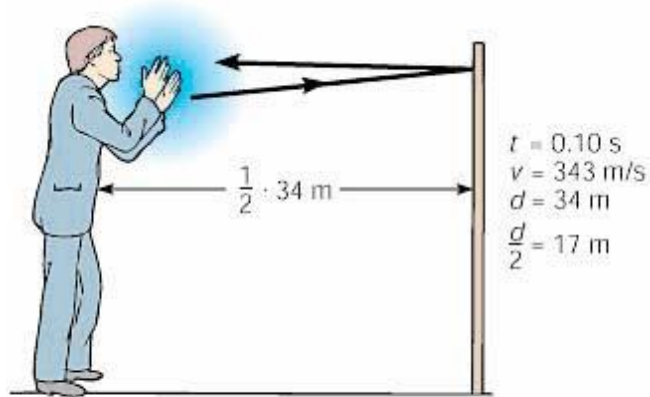

A

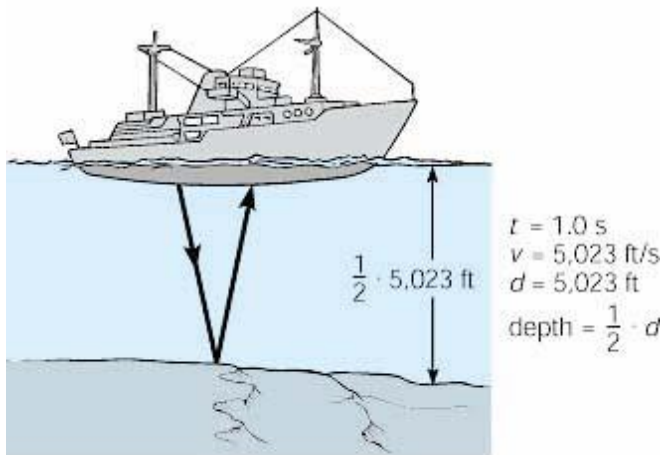

B

Table 3-1. Pulse-echo travel time for various reflector distances in soft tissue (speed of sound = 1540 m/s)

Distance to reflector	Pulse-echo travel time
1 cm	13 $\mu\text{s}$
5 cm	65 $\mu\text{s}$
10 cm	130 $\mu\text{s}$
20 cm	260 $\mu\text{s}$

# Formação da Imagem

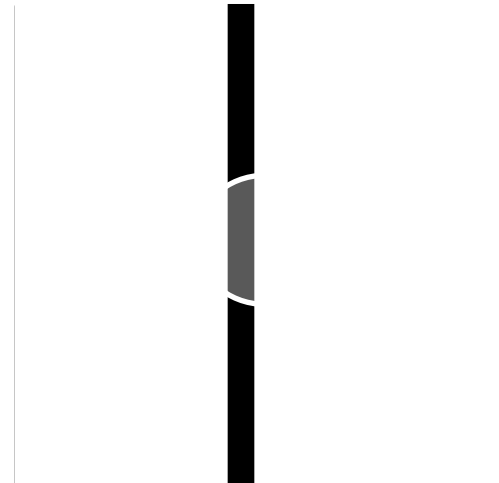
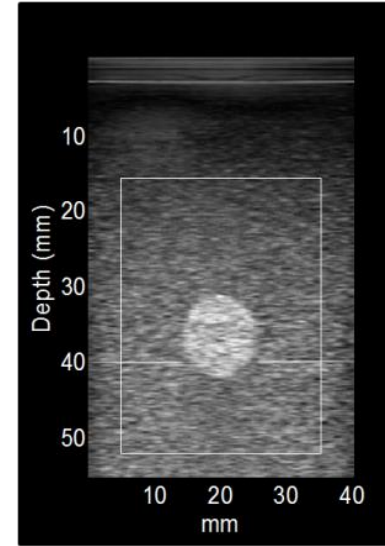
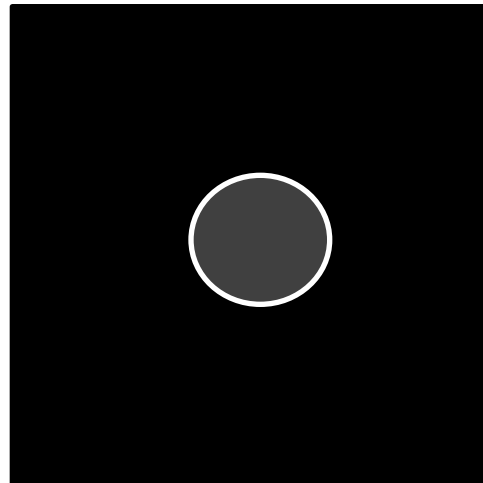
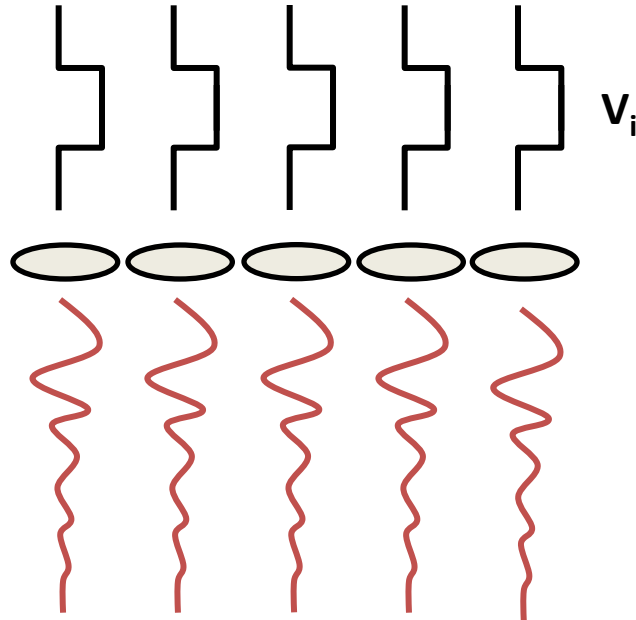
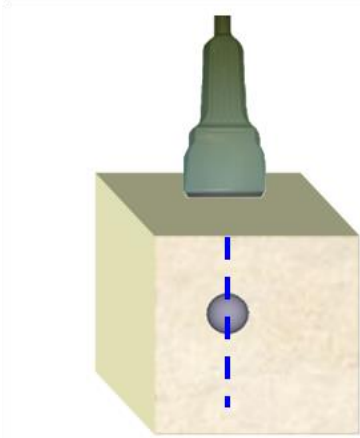

# Varredura

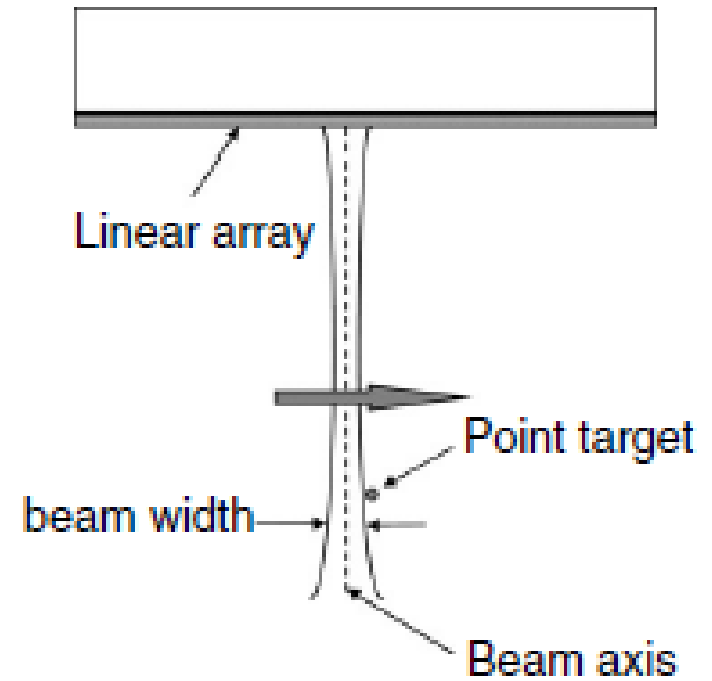
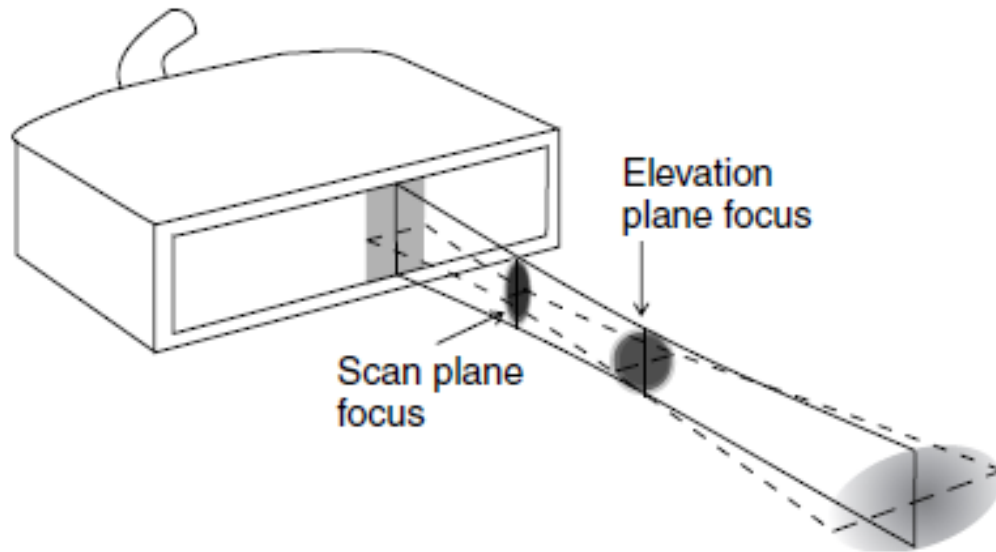

# PRF – Frequência de Repetição dos Pulsos

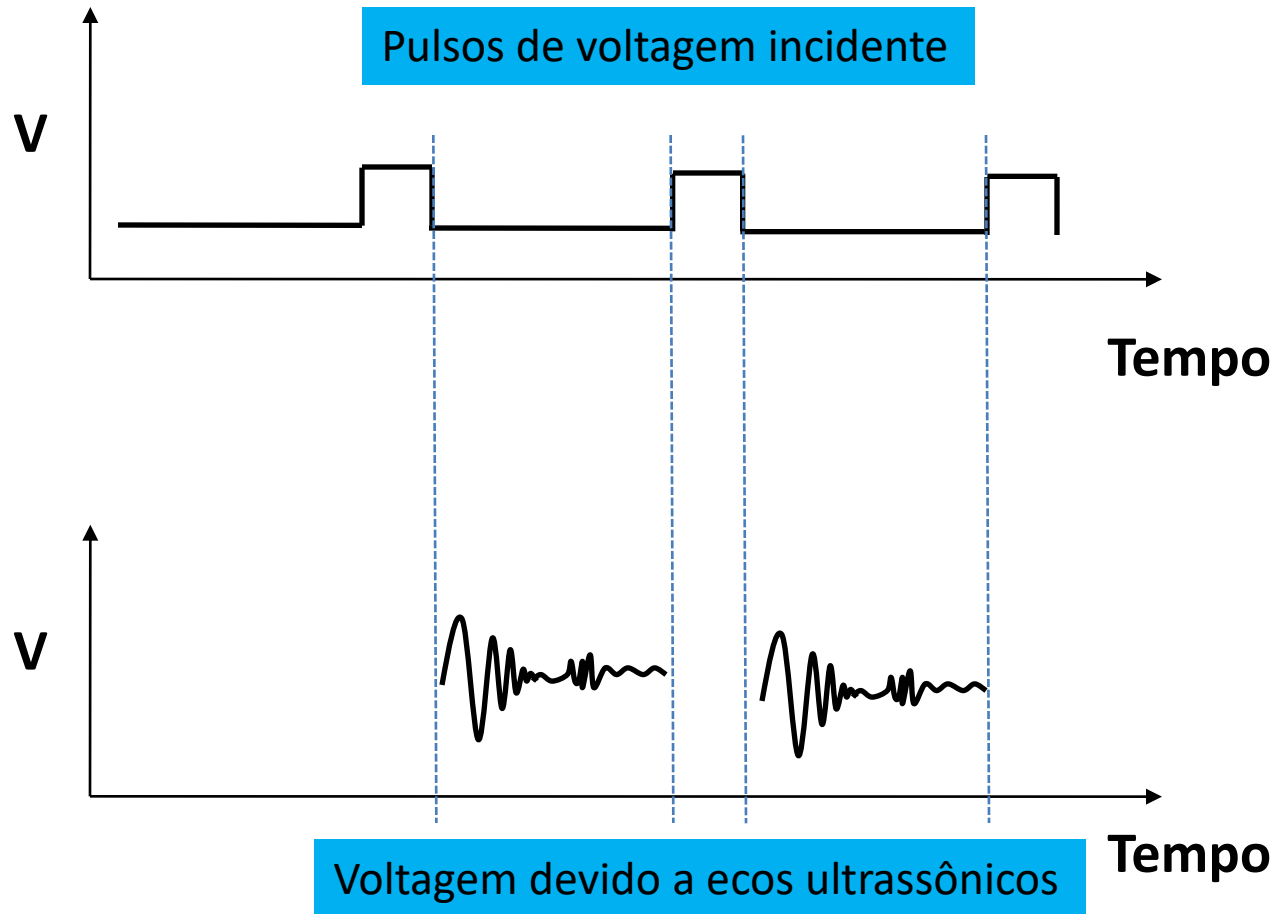

# PRF → 7 cm de profundidade

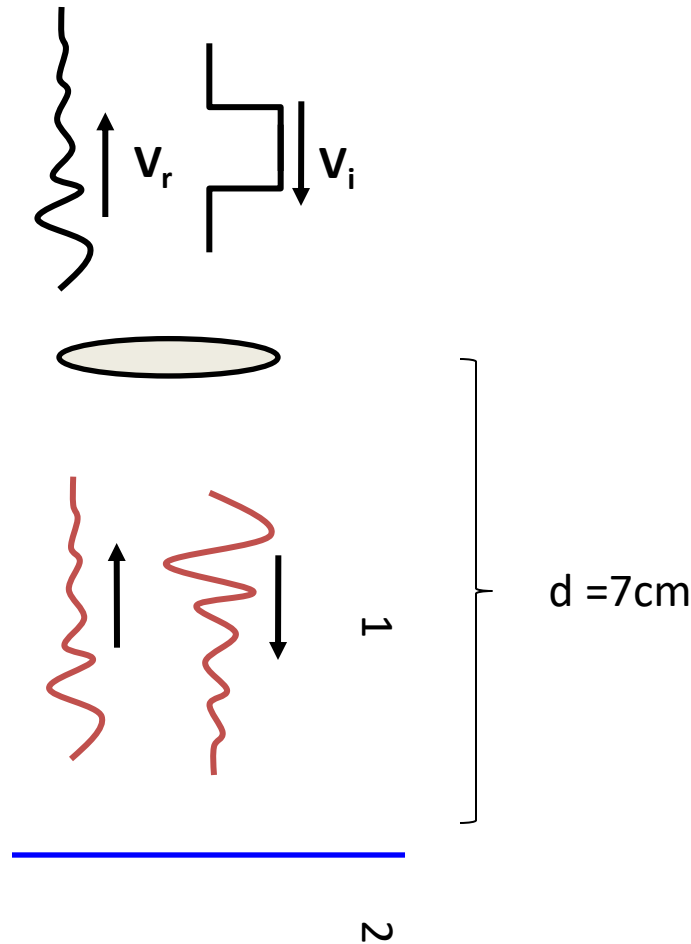

Velocidade do som  $c = 1540\text{ m/s}$

$$\Delta t = \frac{2d}{c}$$

$$PRF = \frac{1}{\Delta t} = \frac{1540}{2 \cdot 0,07} = 11\text{ kHz}$$

11.000 linhas/segundo



# Formação da Imagem

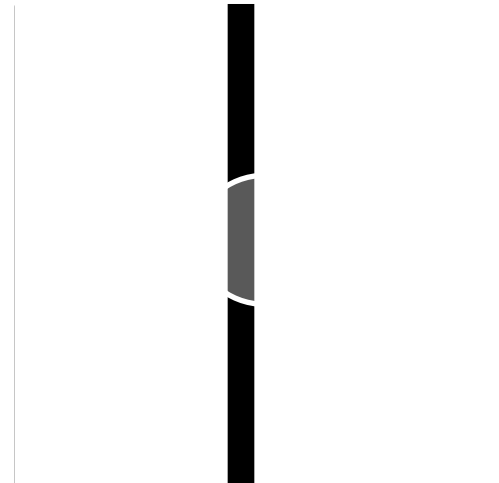
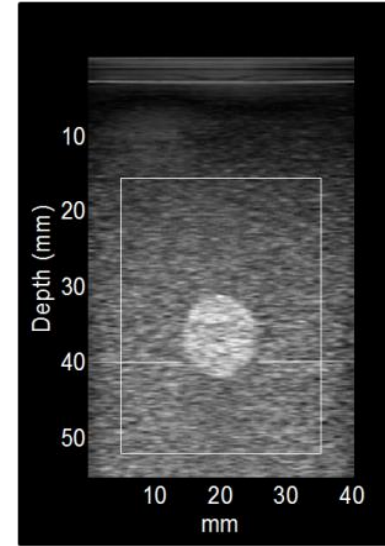
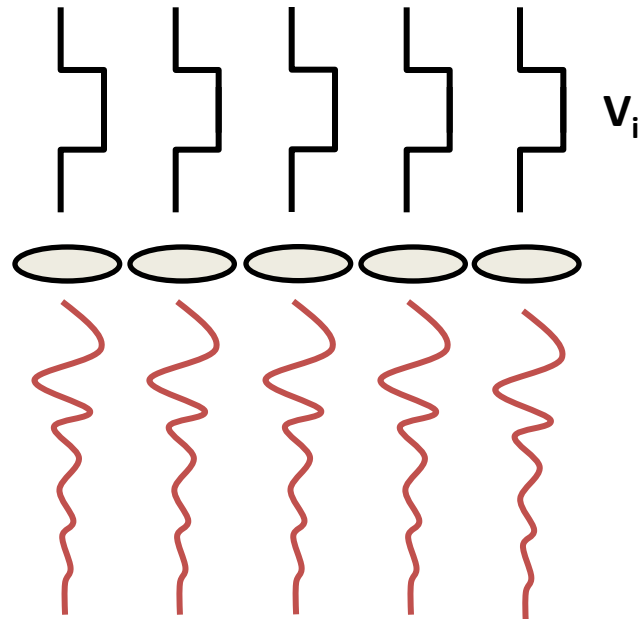
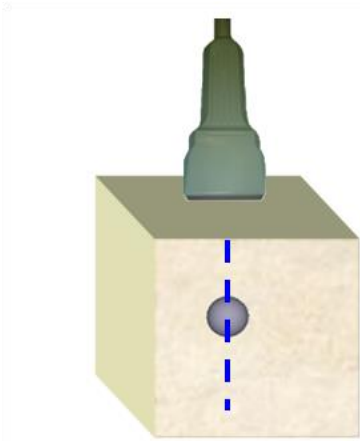

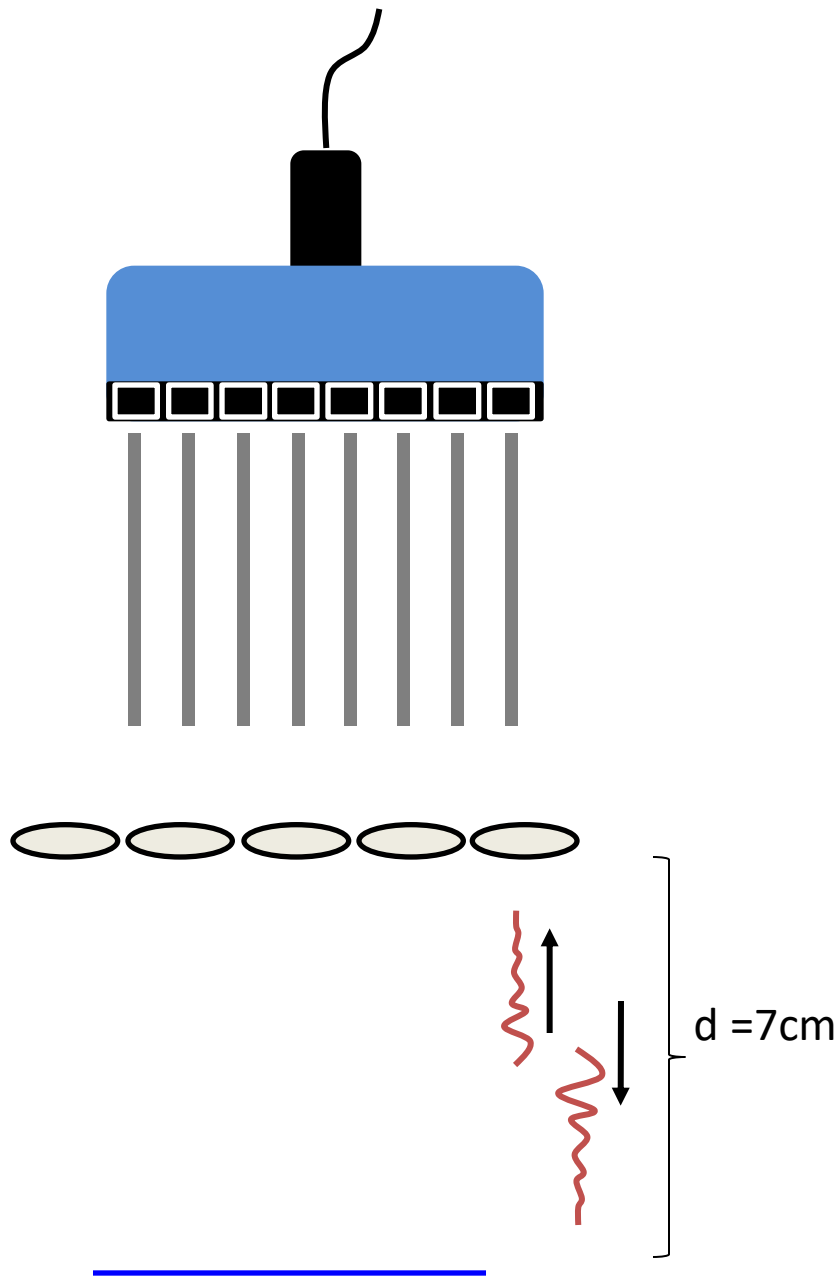

$$c = 1540 \text{ m/s}$$

Número de cerâmicas  $N = 128$

$$\Delta T = \frac{N \cdot 2d}{c}$$

$$FPS = \frac{1}{\Delta T} = \frac{1540}{128 \cdot 2 \cdot 0,07} = 86 \frac{\text{Frames}}{\text{Segundo}}$$

# Parâmetros do Ultrassom

<b>Frequência</b>	<b>2-15 MHz</b>
<b>Velocidade de Propagação</b>	<b>1400 – 1700 m/s</b>
<b>Frequência de repetição do pulso</b>	<b>2-10 kHz</b>
<b>Ciclos por pulso</b>	<b>1-3</b>
<b>Duração do pulso</b>	<b>0,5-3 <math>\mu</math>s</b>
<b>Comprimento espacial do pulso</b>	<b>0,1-1 mm</b>
<b>Intensidade espacial máxima</b>	<b>0,01-100 mW/cm<sup>2</sup></b>
<b>Coeficiente de atenuação</b>	<b>0,2-5 dB/cm – 1 MHz</b>

# Resolução Espacial **Axial**

**Depende de:**

**-Duração do pulso de ultrassom**

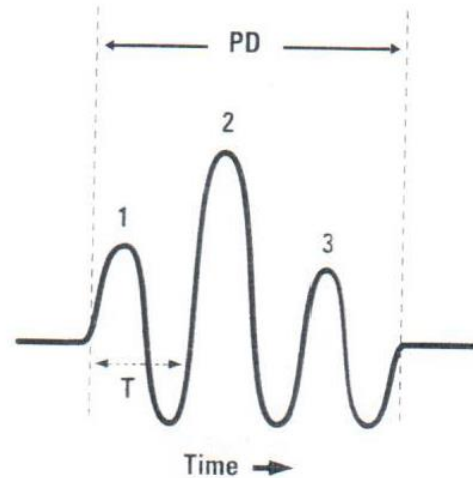
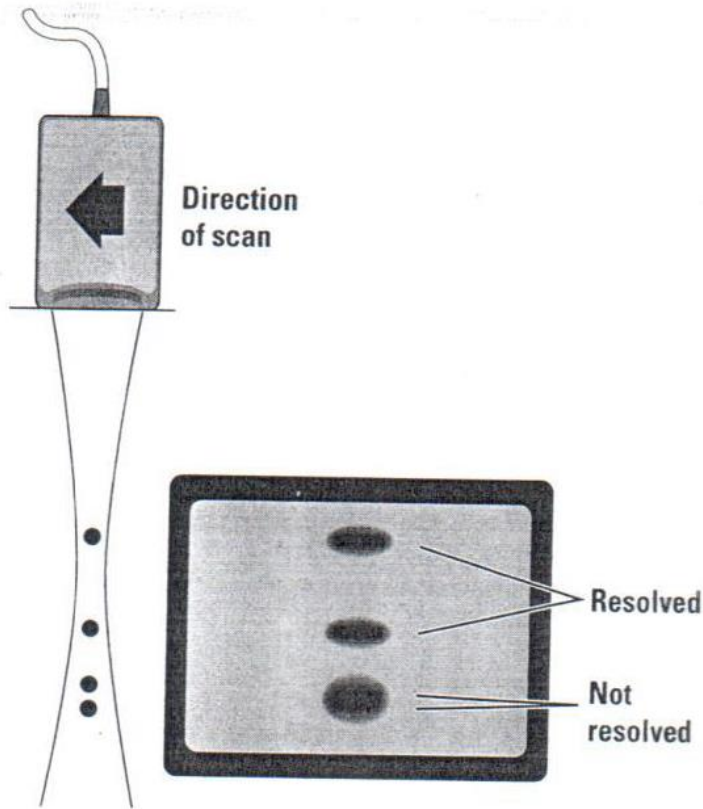

$$PD = \frac{N_c}{f(\text{MHz})} \mu\text{s}$$

# Resolução Espacial

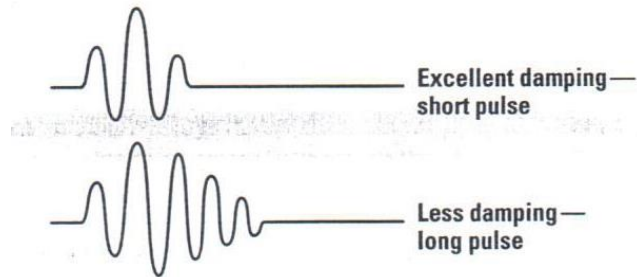
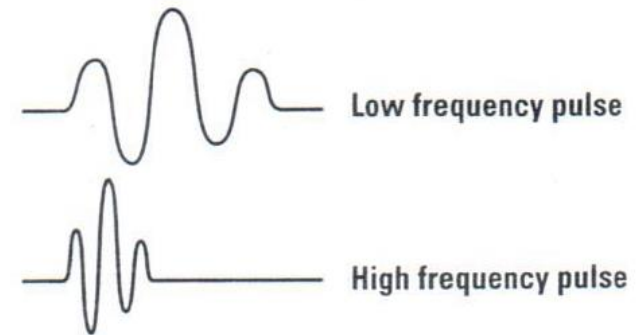
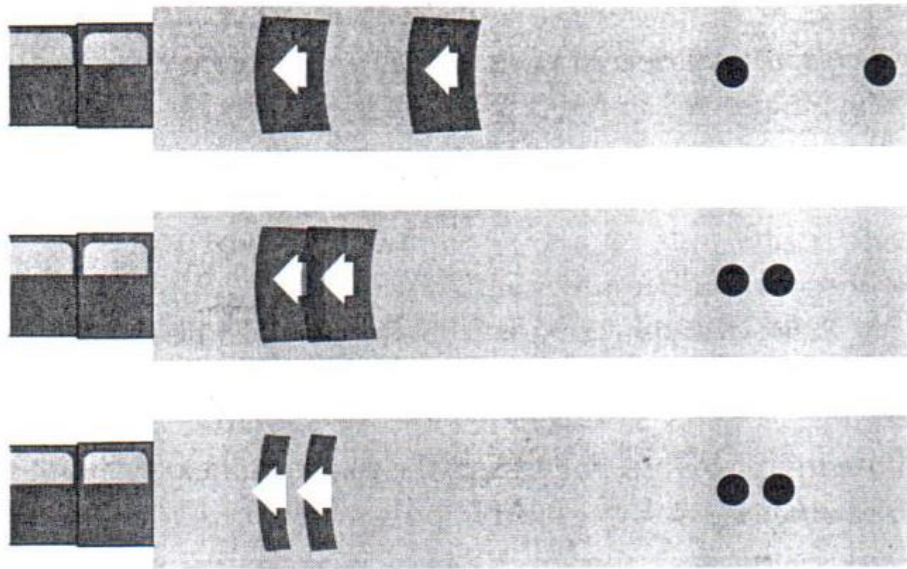

$f$ (MHz)	$\lambda$ (mm)
2	0.77
5	0.31
10	0.15
15	0.1

# Resolução Axial (RA)

$$RA = \text{comprimento do pulso} / 2$$

- $\Delta x = v \cdot \Delta t$
- $\Delta x = 1.540 \text{ m/s} \cdot 10^{-6} \text{ s} = 1,54 \text{ mm}$
- objetos separados por uma distância menor que 0,77 mm não podem ser distinguidos.

# Resolução Espacial **Lateral**

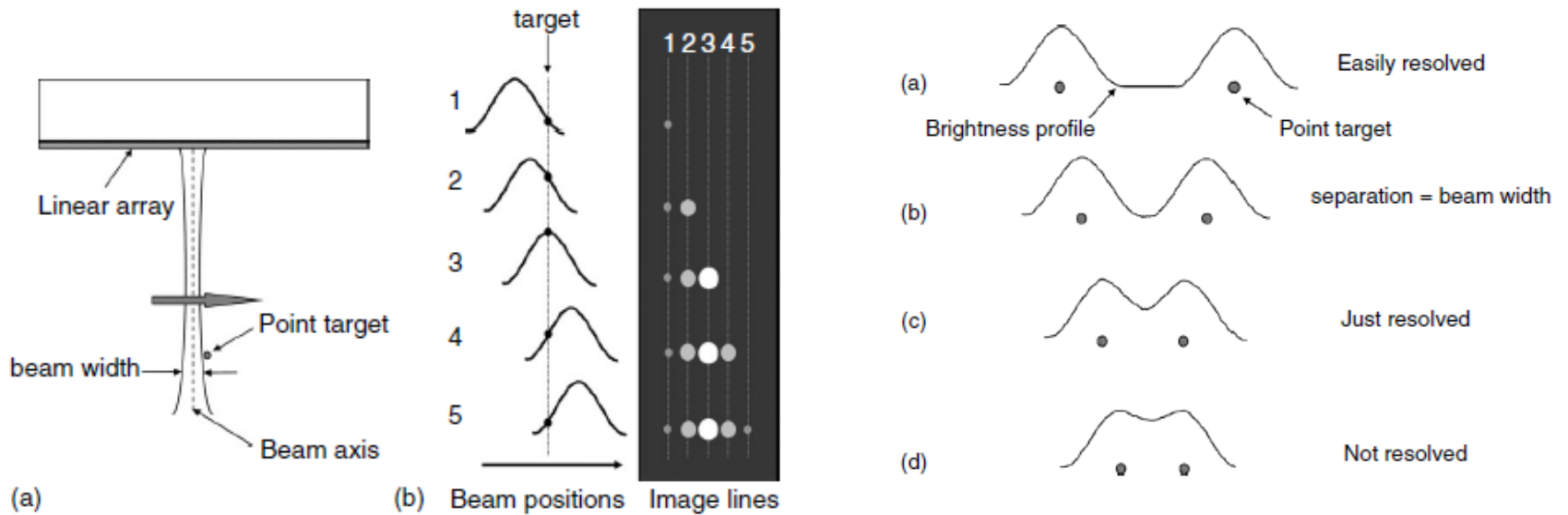

# Resolução Lateral (RA)

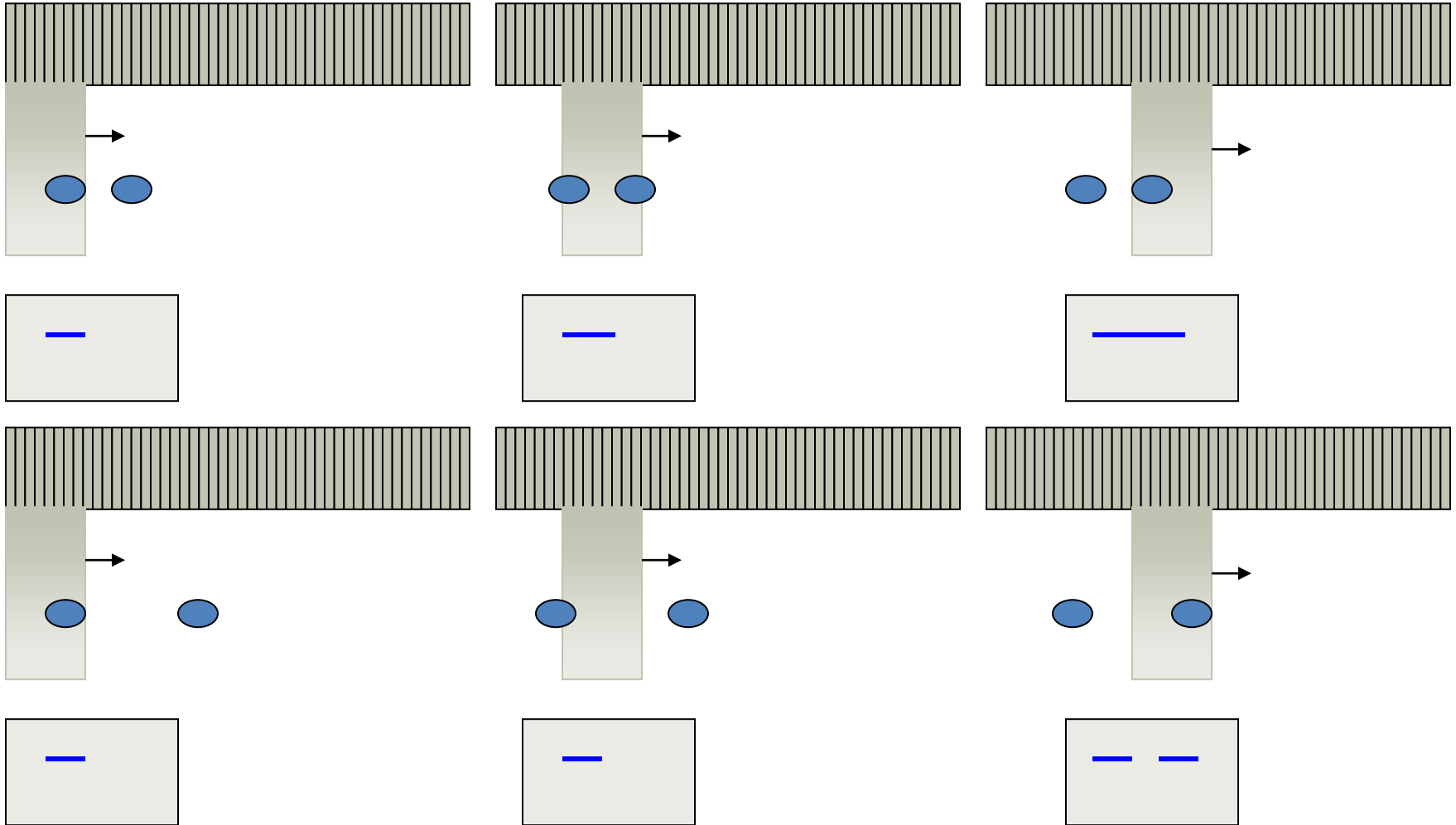



# Resolução

**Comp. Espacial do pulso**

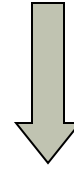
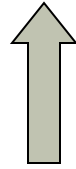

**Resolução axial**

**Ciclos por pulso**

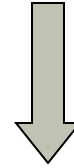
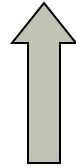

**Resolução axial**

**Frequência**

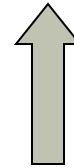
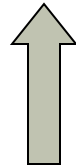

**Resolução axial**

**Frequência**

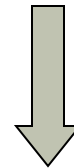
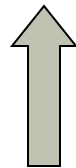

**Profundidade da imagem**

**Largura do feixe**

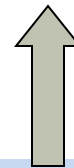
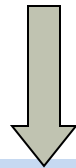

**Resolução Lateral**

# Fonte sonora

## Princípio de Huygens

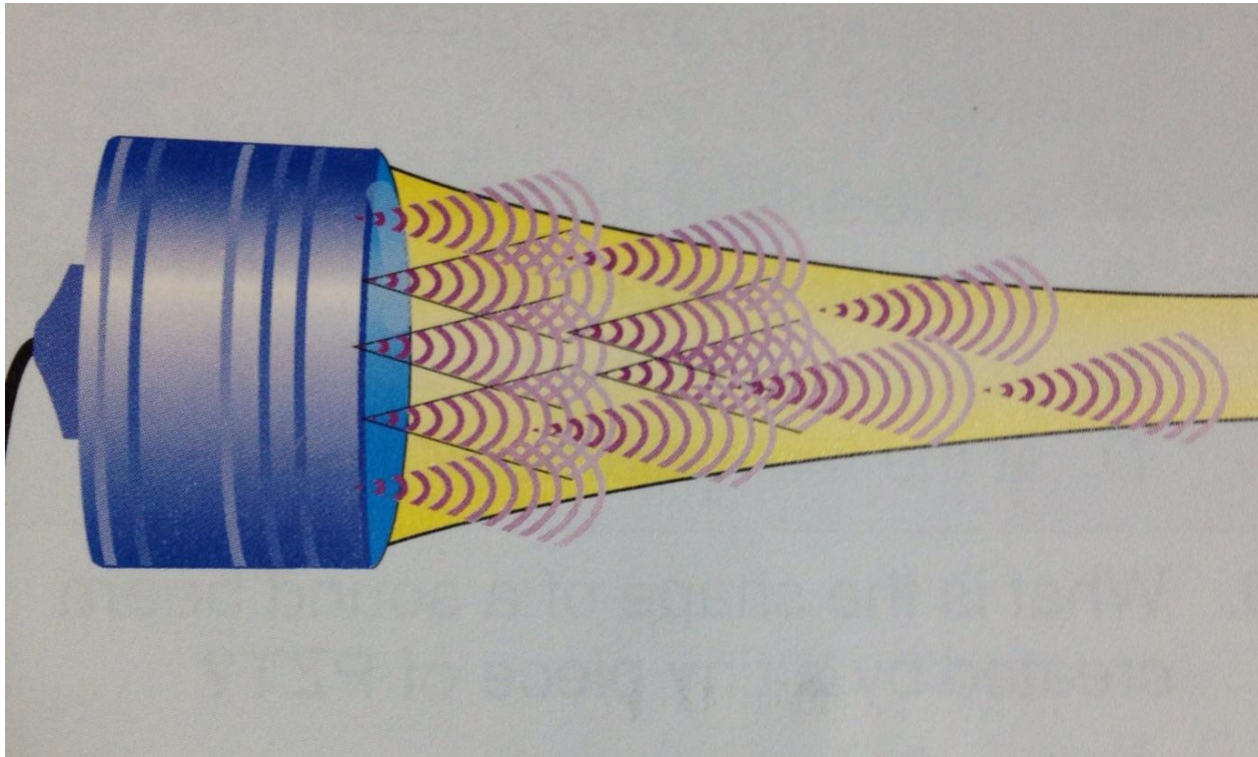

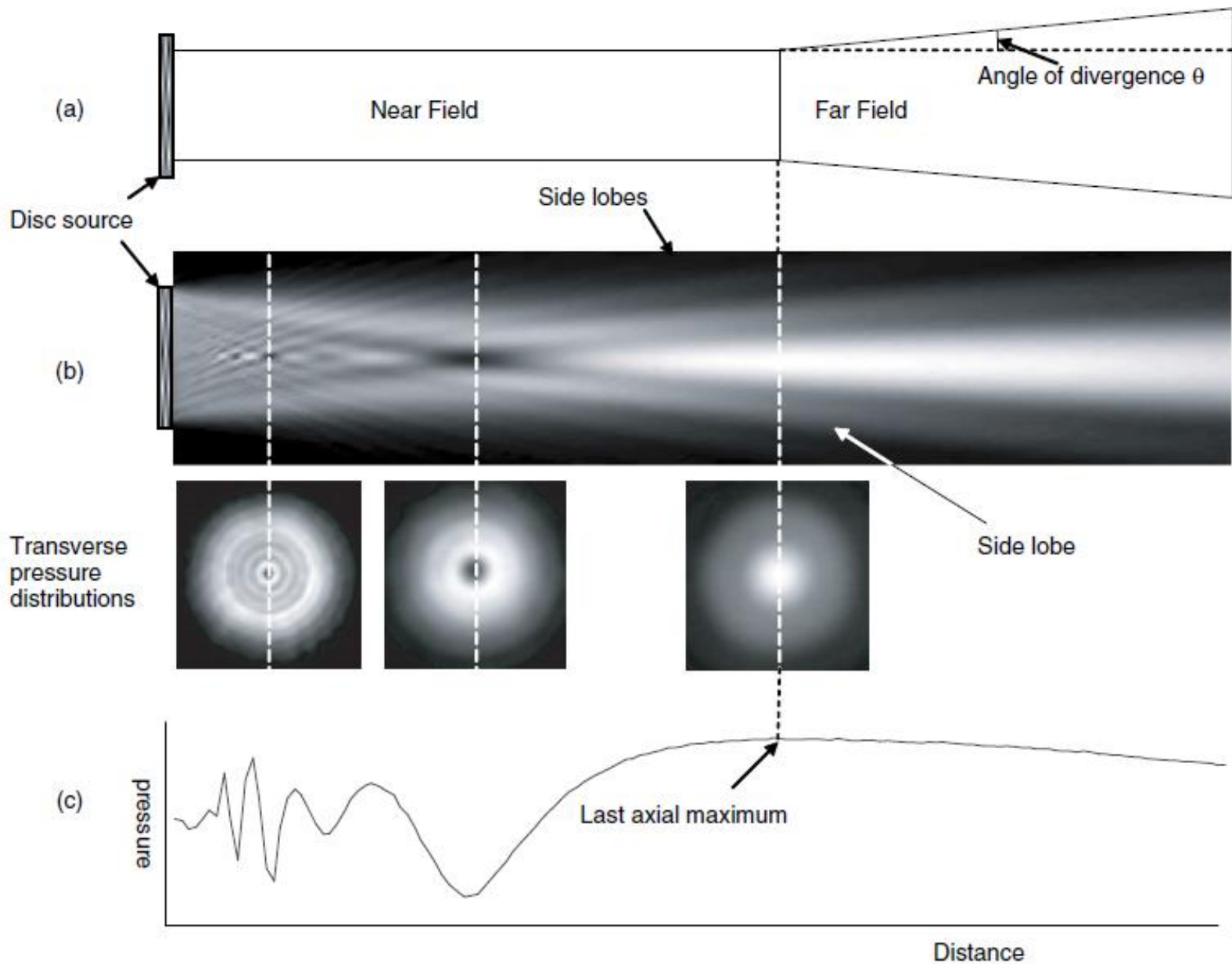

**Fig. 2.15** The ultrasound beam from a plane disc source consists of a near field, in which the pressure distribution is complex, and a far field, in which it is more uniform.

# Características do feixe acústico

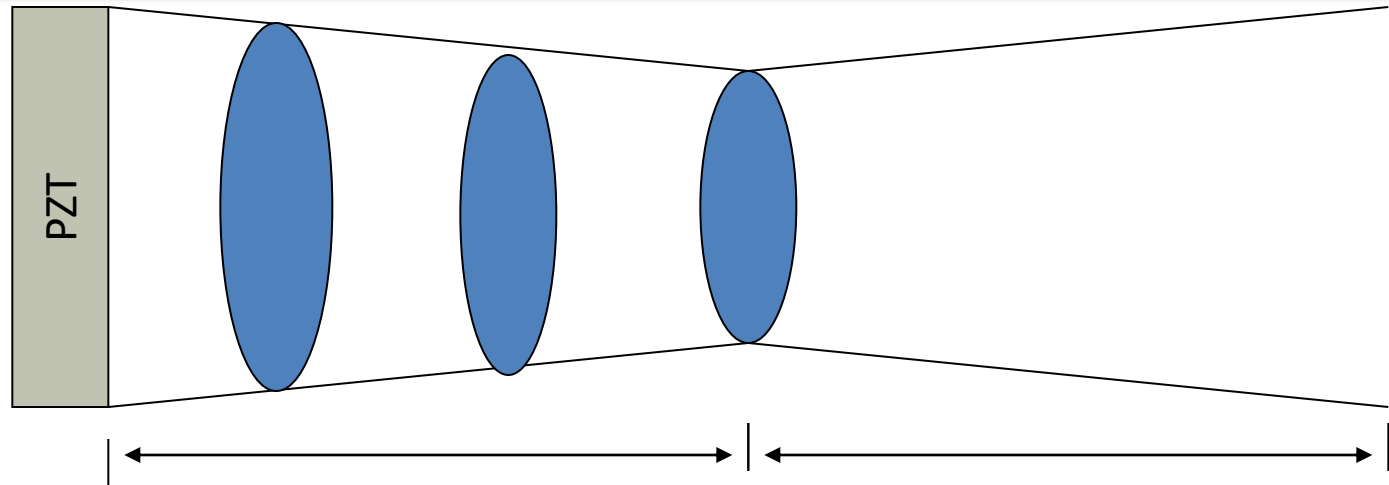

**Campo Próximo**  
**Zona de Fresnel**

**Campo Distante**  
**Zona de Fraunhofer**

$$z_0 = \frac{a^2}{\lambda}$$

↑ Frequência => ↑ Zona de Fresnel

$z_0 \rightarrow$  Dimensão do campo próximo ---  $a \rightarrow$  Raio do disco

# Características do feixe acústico

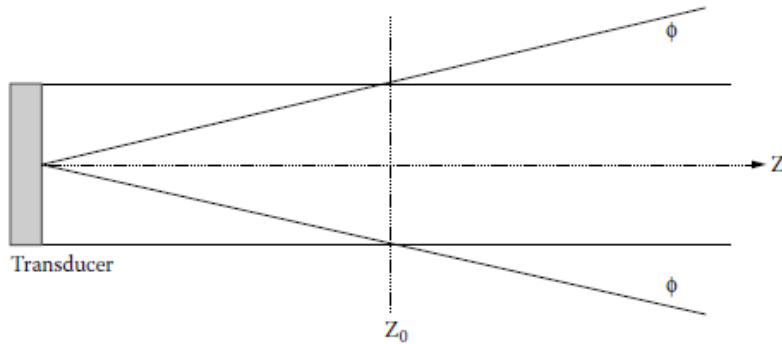

$$\phi = \sin^{-1} (0.61(\lambda/a))$$

$$z_0 = \frac{a^2}{\lambda}$$

FIGURE 3.16 Idealistic representation of the beam behavior of a single-element piston transducer.

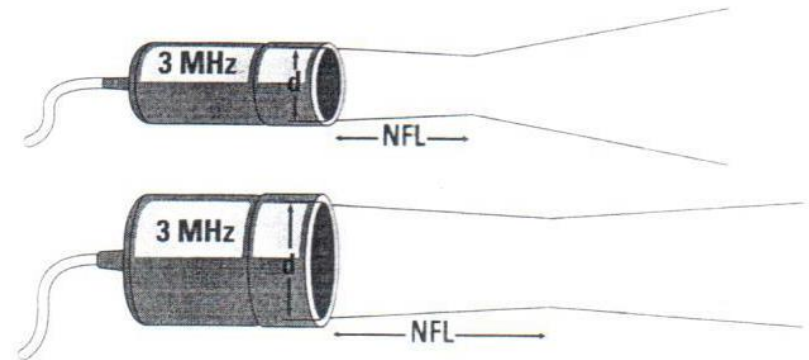
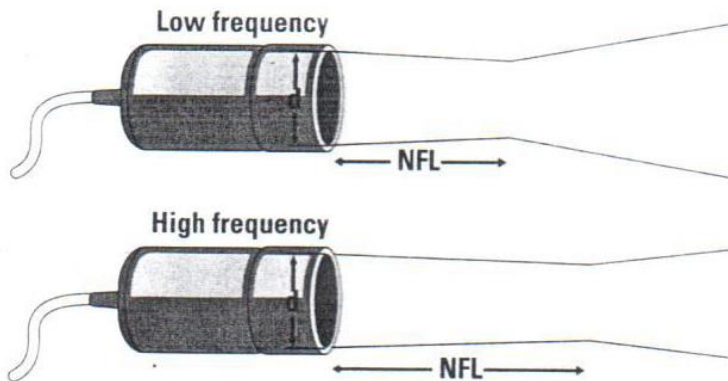



# Transdutores matriciais

---

**Arrays: Compostos de 100 a 300 elementos separados.**

**Vantagens:**

**→ Varredura eletrônica.**

**→ Possibilita focar eletronicamente o feixe acústico.**

# Formação do feixe acústico

## Transdutores matriciais

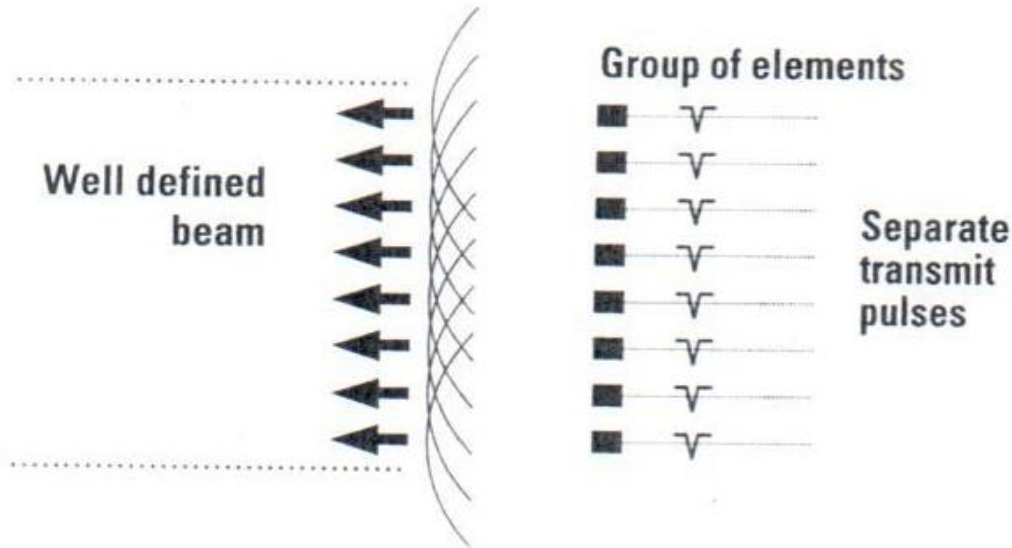
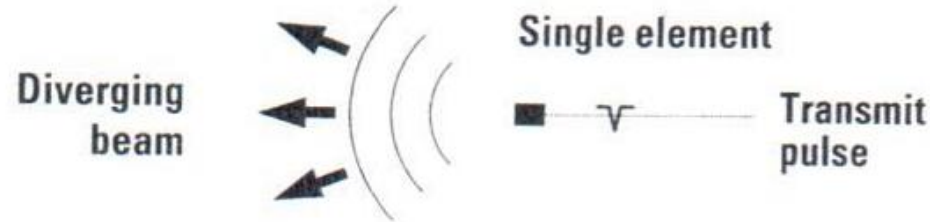

# Formação do feixe acústico Transdutores matriciais

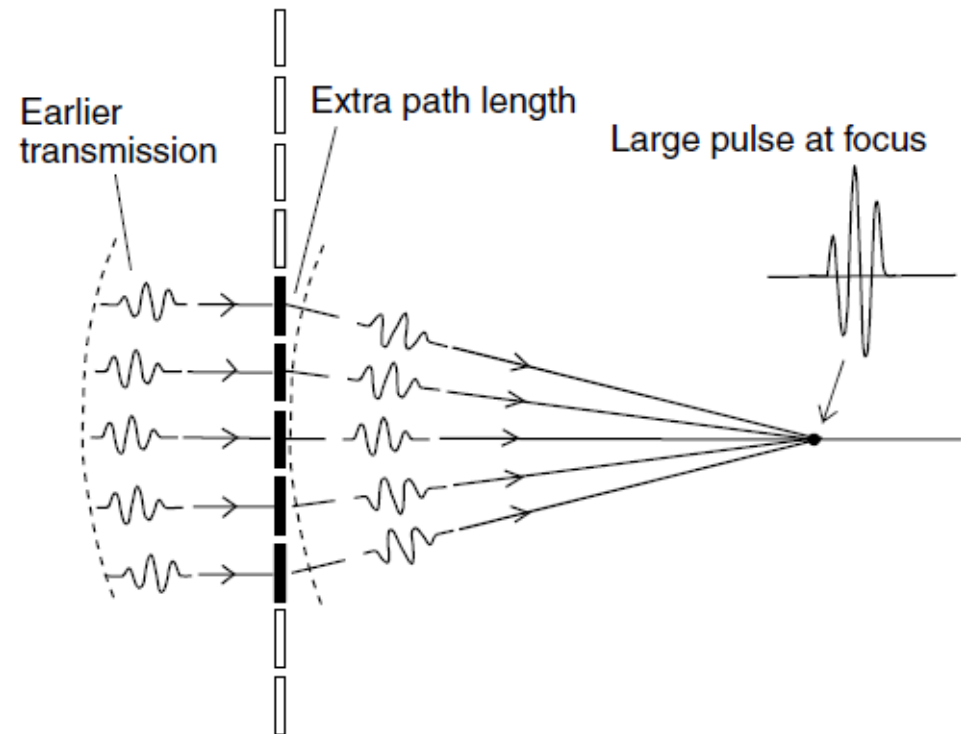
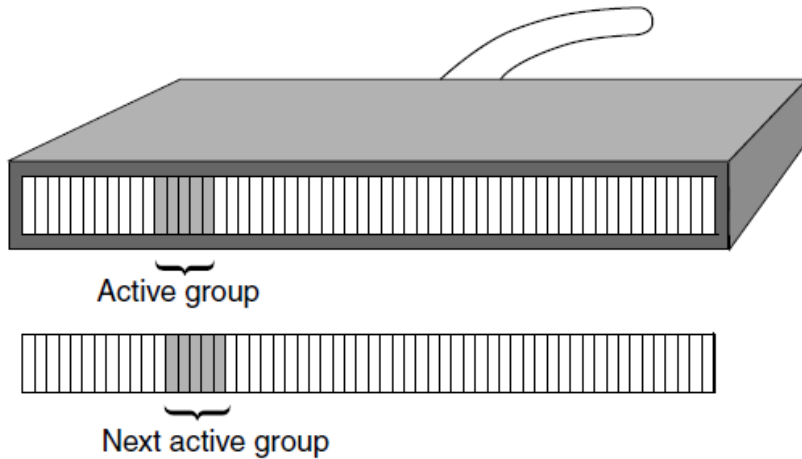



# Formação do foco

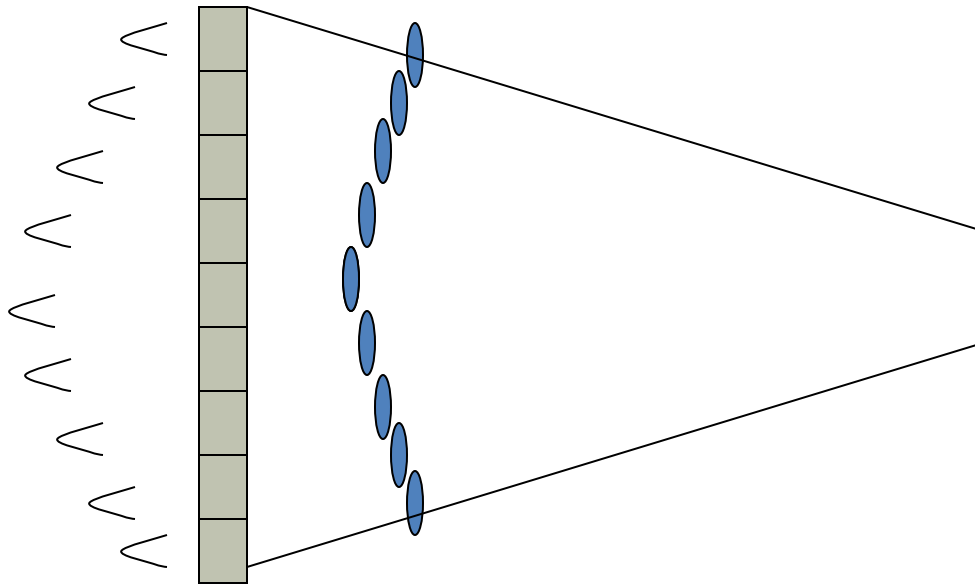

## Beamforming de emissão

# Carótida

**Tx → 64 Elementos**

**Rx → 32 Elementos**

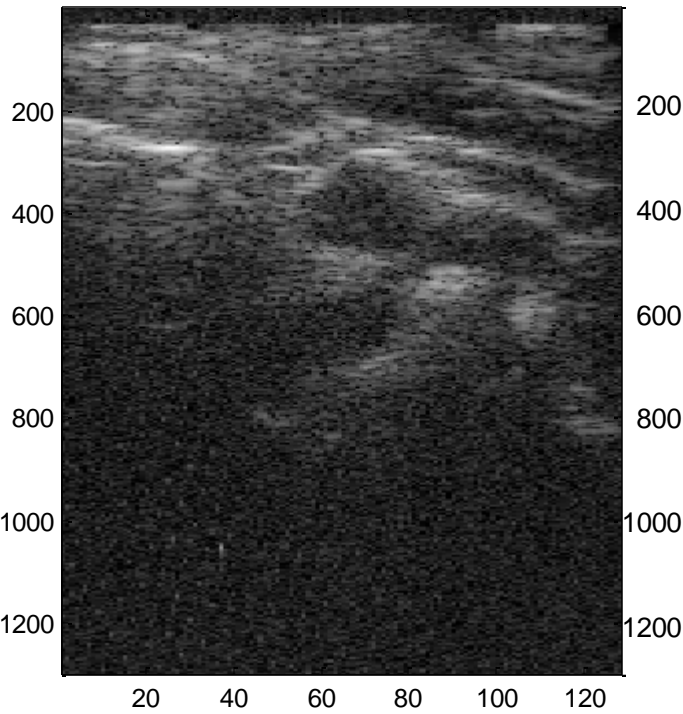

**Tx → 64 Elementos**

**Rx → 1 Elemento**

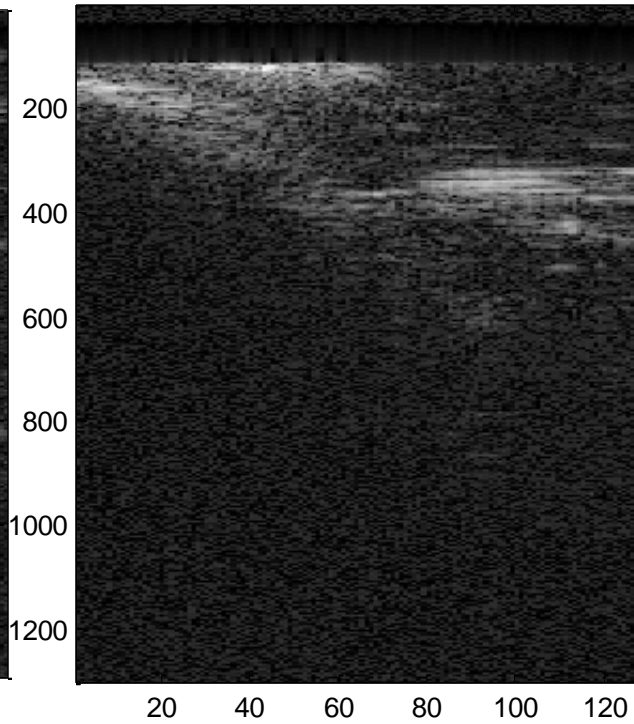

**Tx → 1 Elemento**

**Rx → 1 Elemento**

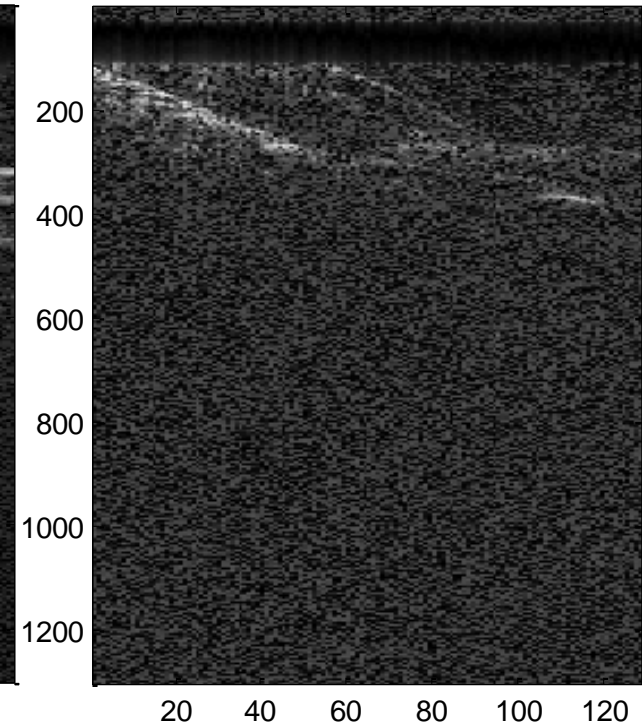

# Beamforming de recepção

## Beamforming Dinâmico

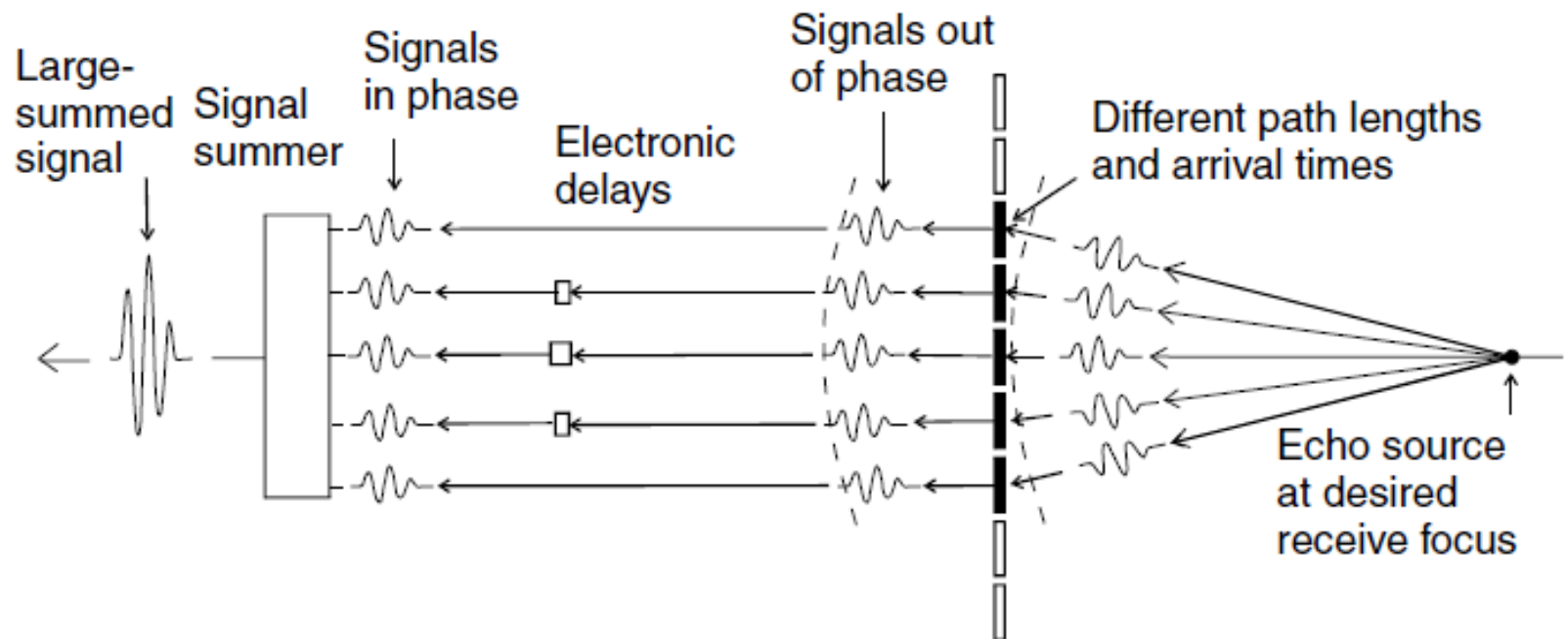

# Atraso e soma

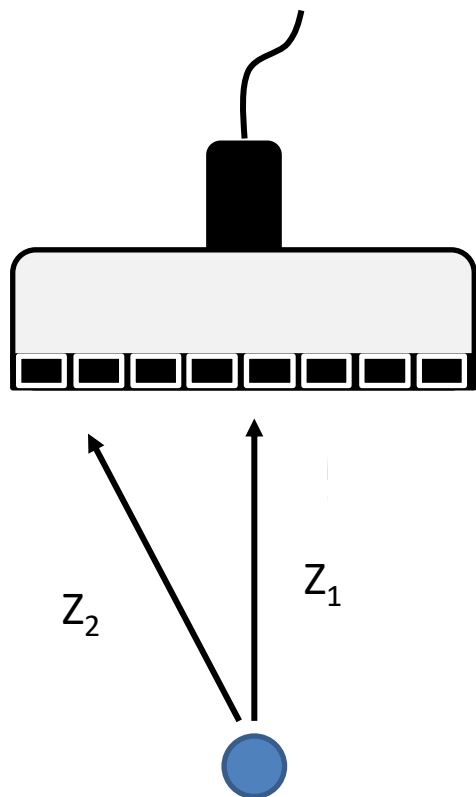

Sinal entregue

Sinal atrasado

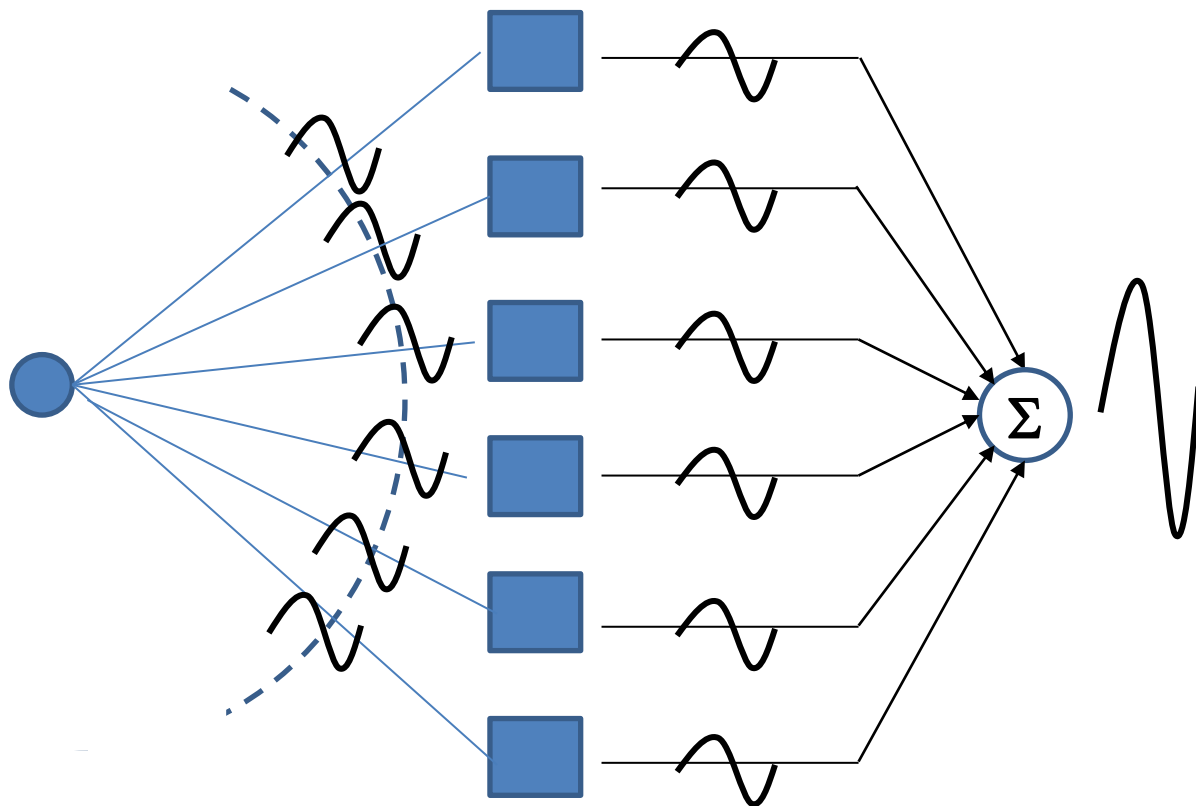

# Beamforming de recepção

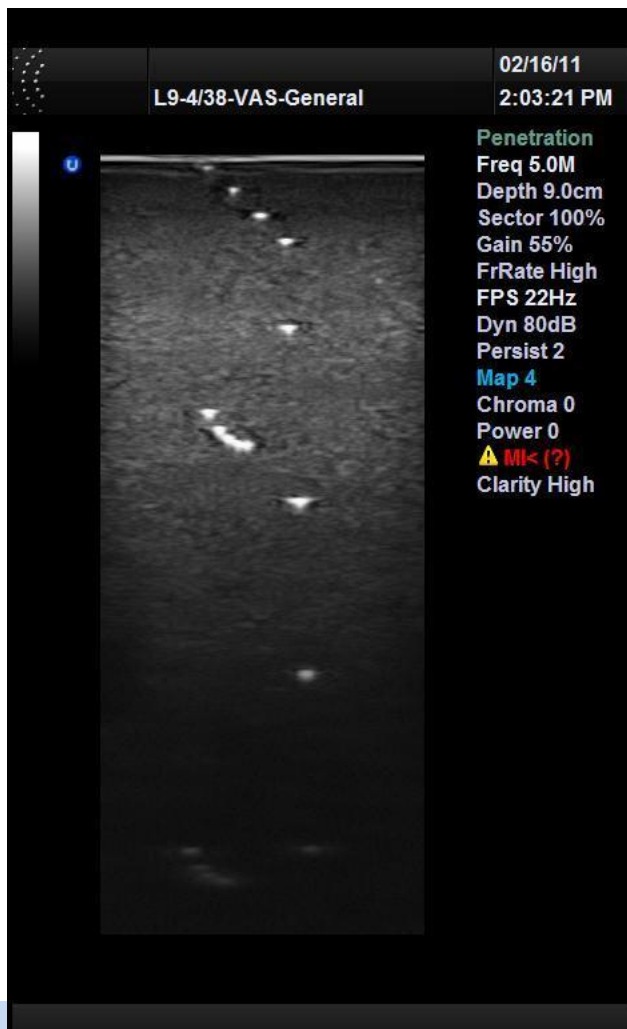

Focused TX Beamformed RX

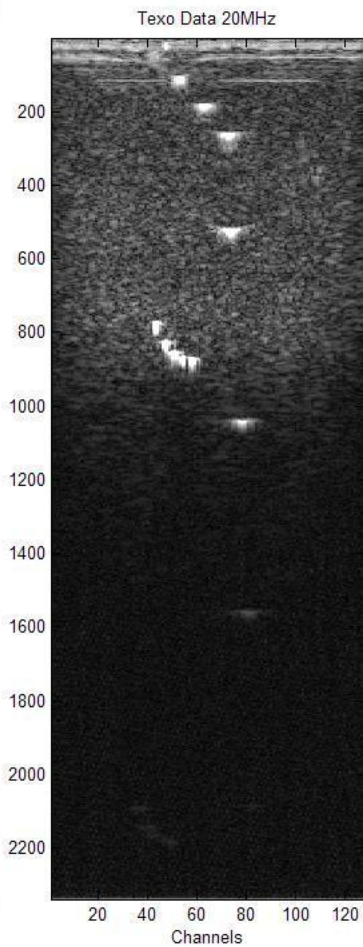

Plane TX Beamformed RX

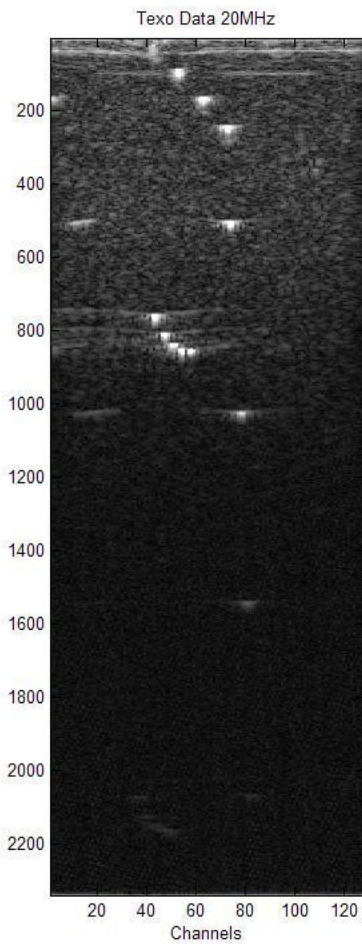

Plane TX raw RX

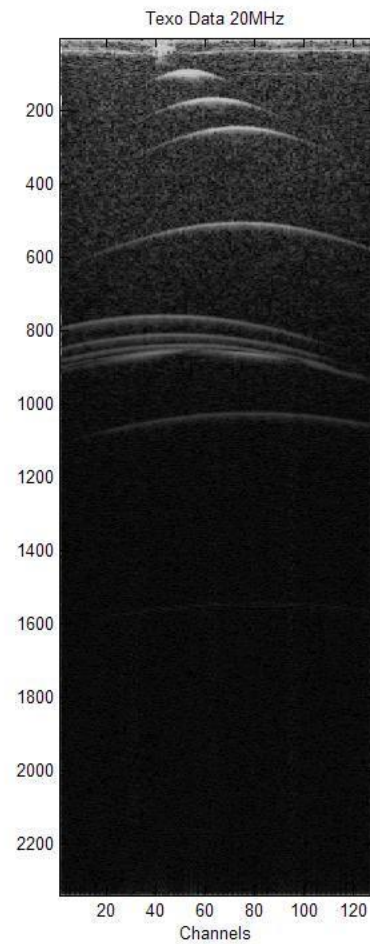

# Formação do Feixe acústico

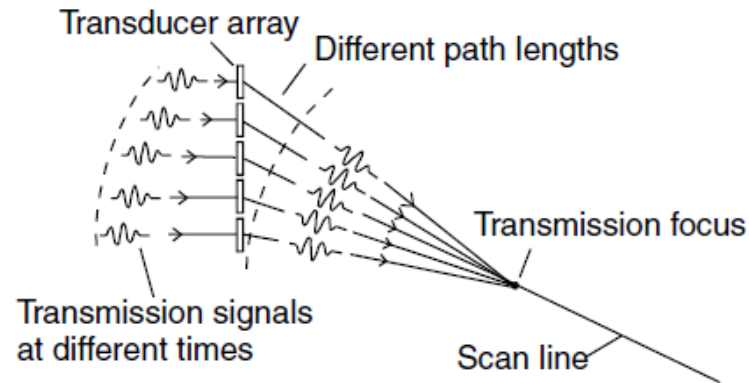
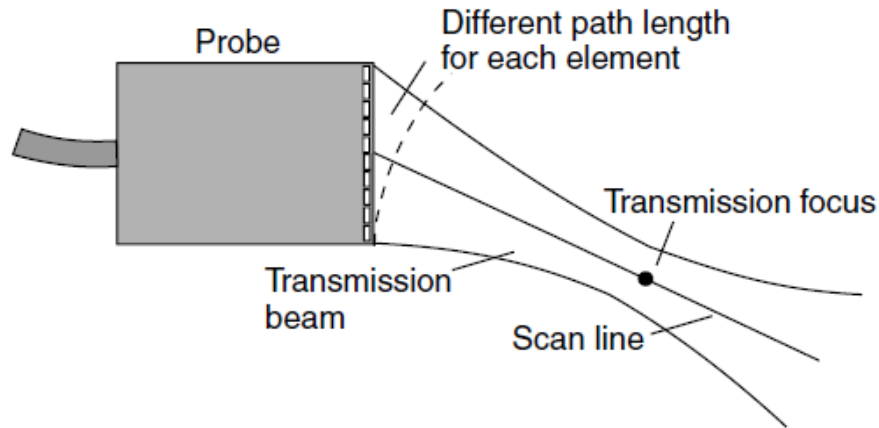

# Transformando o eco em informação

---



**Amplificar**



**Compensar**



**Comprimir**



**Demodular**



**Rejeitar**

# Ganho recepção

- 🌀 Amplificação é necessária porque o sinal que chega ao transdutor é muito baixo.
- 🌀 Primeiro estágio → Pré-amplificação.
  - Amplificar ecos bem baixos. Geralmente circuitos o mais próximo possível do transdutor.
- 🌀 Ganhos controláveis pelo usuário
  - Ganho geral → Para todas as profundidades.
  - TGC → Para compensar atenuação (depende da profundidade).



# TGC – Time Gain Control

**Compensar a atenuação!**

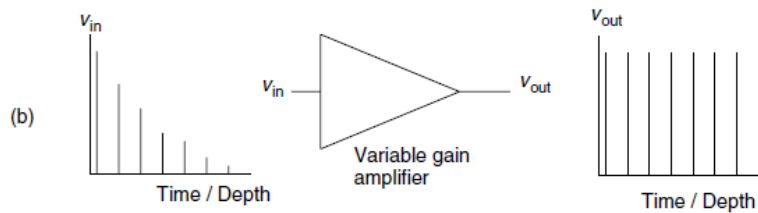
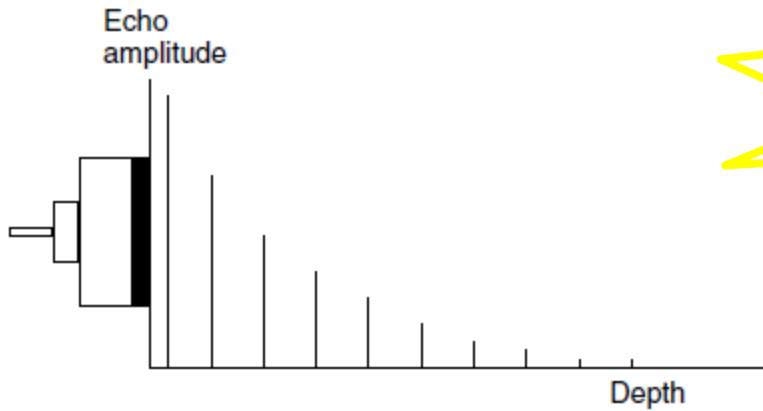

**Fig. 4.4** Time-gain compensation (TGC). (a) The gain applied by the TGC amplifier increases with time after transmission to compensate for the greater attenuation of echoes from larger depths. (b) After TGC, echoes from similar interfaces should be equal in amplitude regardless of depth.

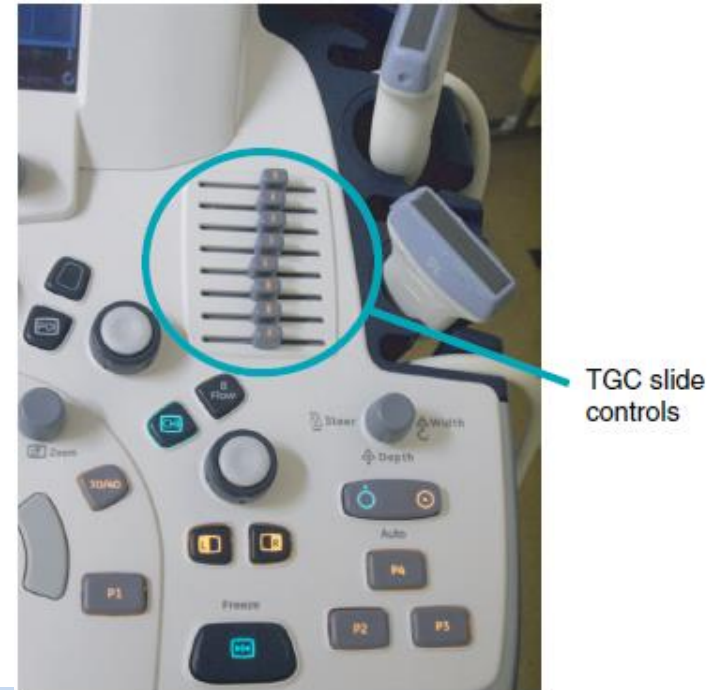



# Dynamic Range ou Alcance Dinâmico

---

- **O ser humano tem uma capacidade de ver e ouvir sinais extremamente baixos (cochicho ou uma pequena estrela na escuridão) até sinais extremamente altos (som de roque ou objetos a luz do sol)**
- **Ou seja tem um alto alcance dinâmico. (Razão entre o maior e menor valores detectáveis)**
- **A variação na amplitude dos sinais de eco é muito alta! Alto alcance dinâmico.**
- **Computador tem baixo alcance dinâmico (usualmente 256 tons).**

# Alcance Dinâmico

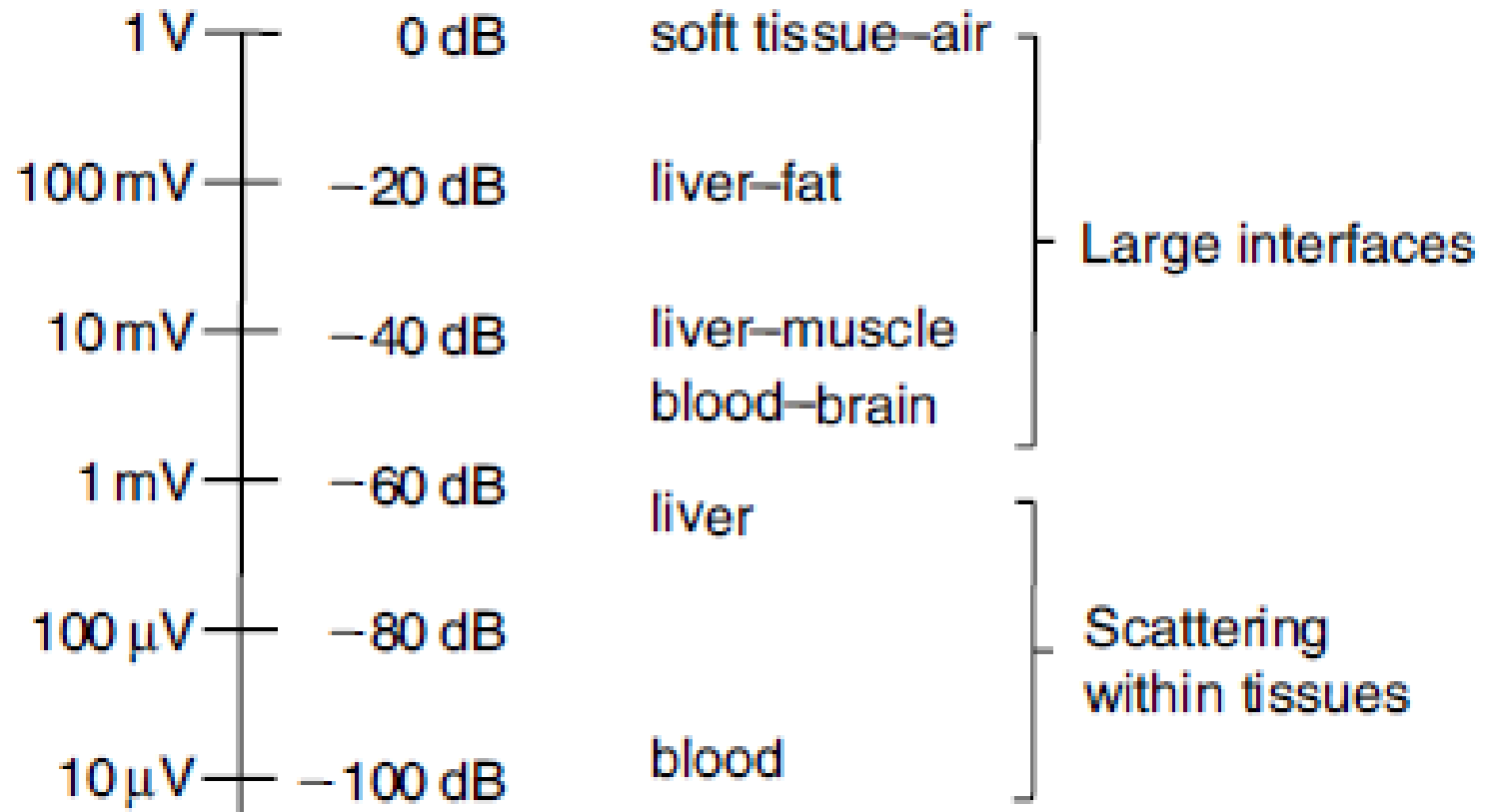

# Compressão logarítmica

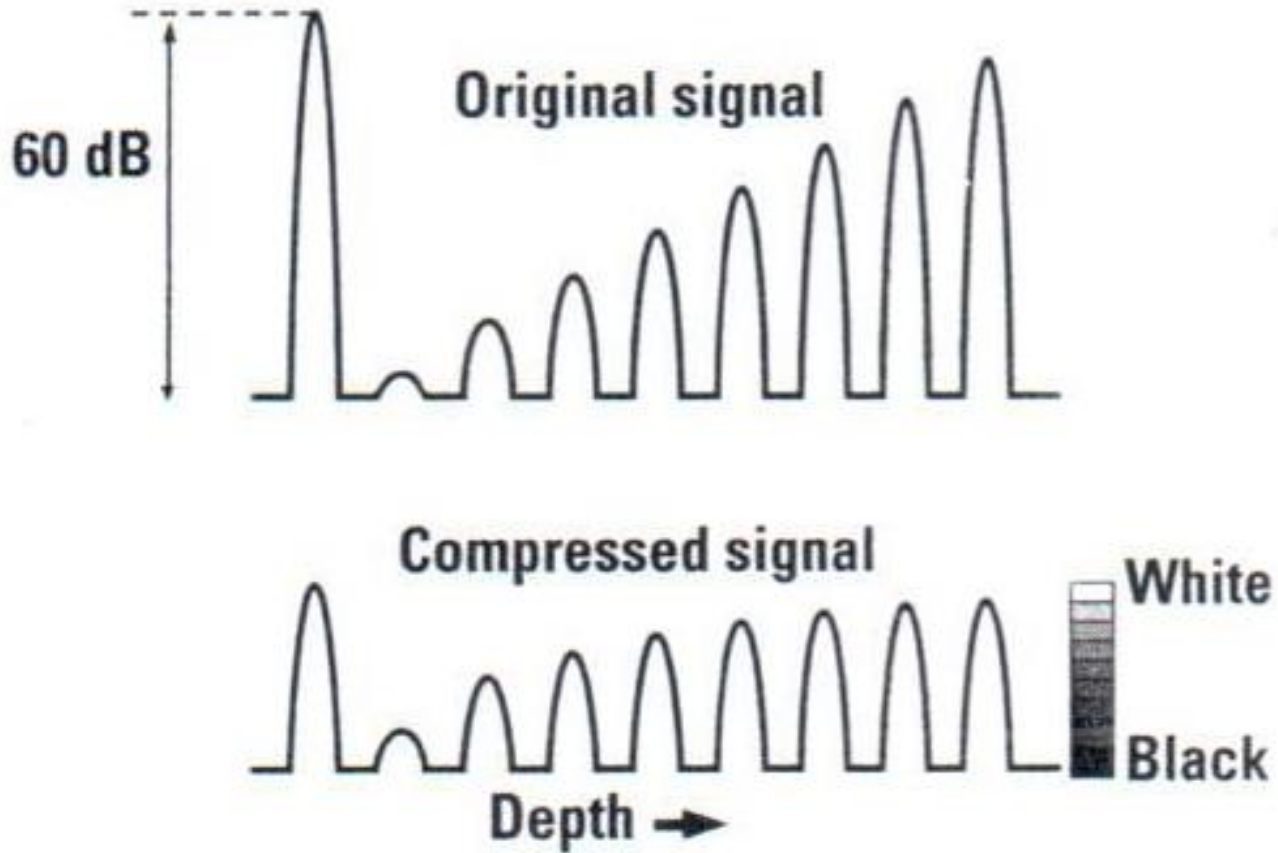

# Compressão logarítmica

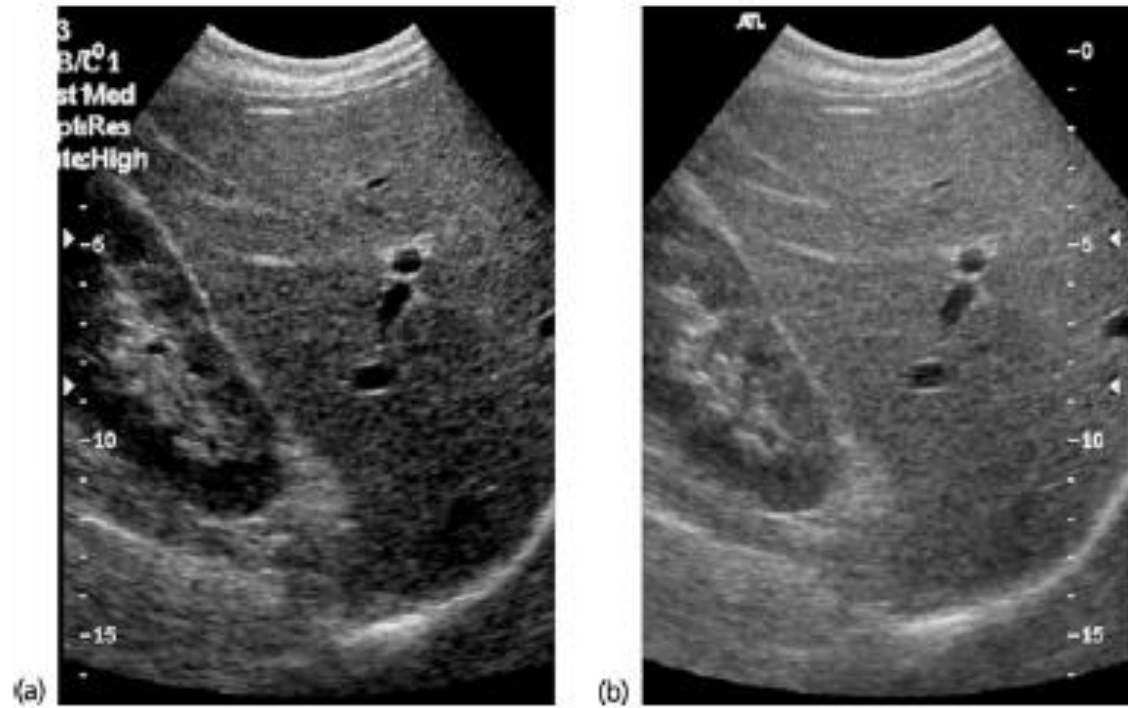

**Fig. 4.8** Increasing the dynamic range setting from (a) 40 dB to (b) 80 dB increases the gain for small echoes, making it easier to detect irregularities in the texture of the liver.

# Imagem RF

Sinal de eco ou RF



Imagem obtida a partir dos sinais de RF

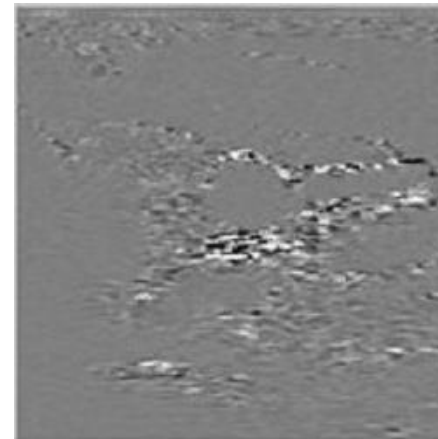

# Transformada de Hilbert Detecção de envelope



Imagem RF

Histogram



Imagem Modo B

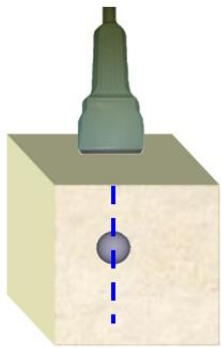

# Envelope - Hilbert transform



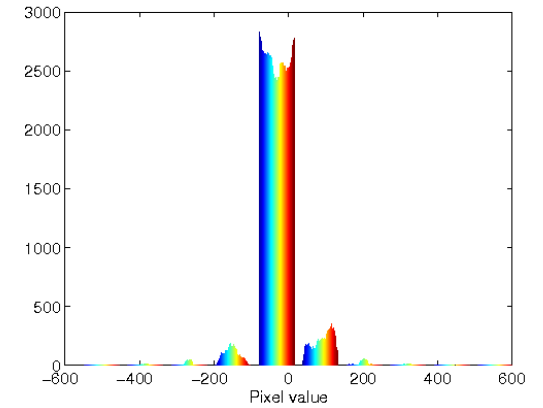
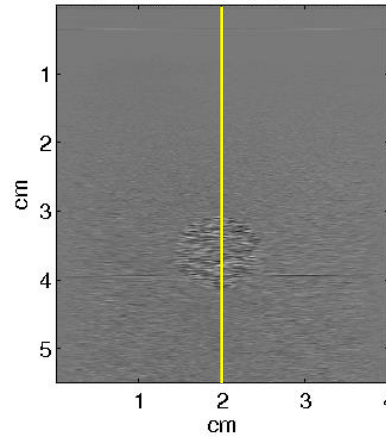
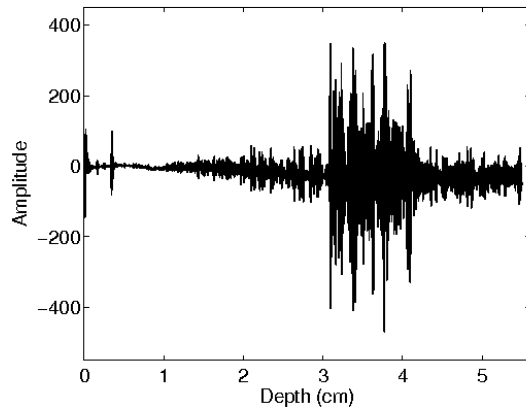
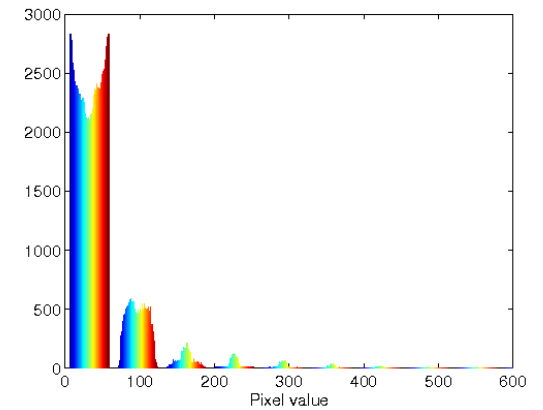
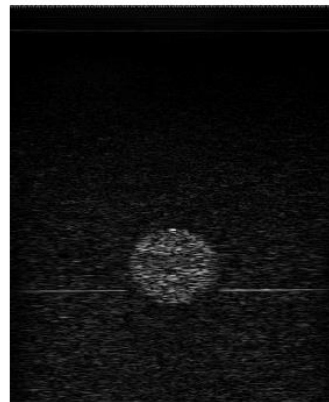
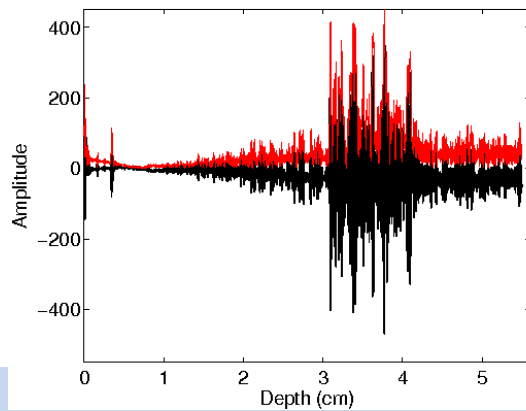
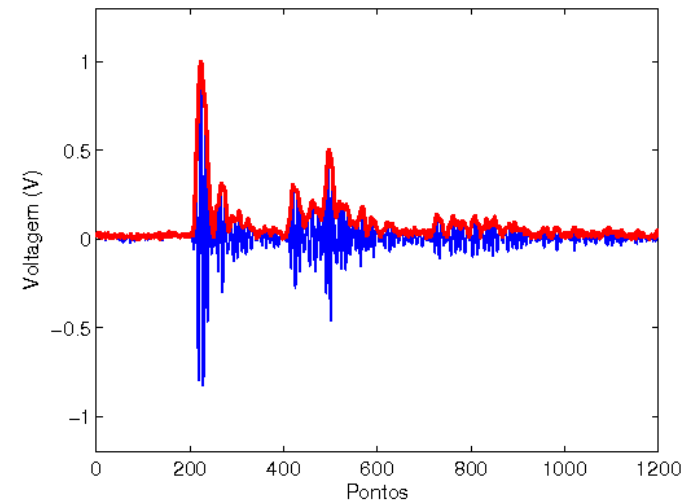
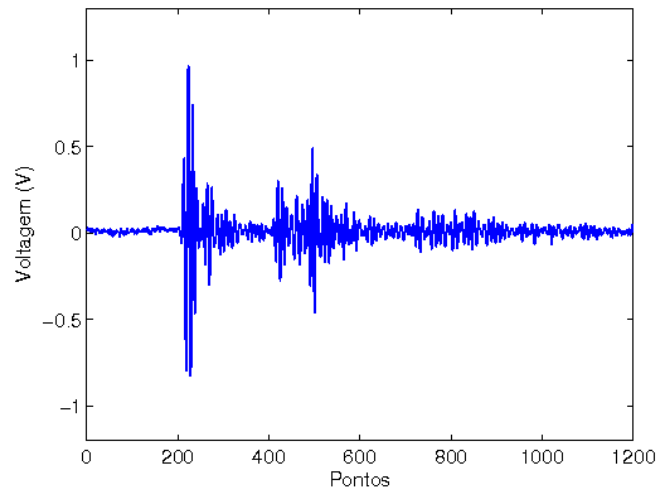

# Demodulação de amplitude

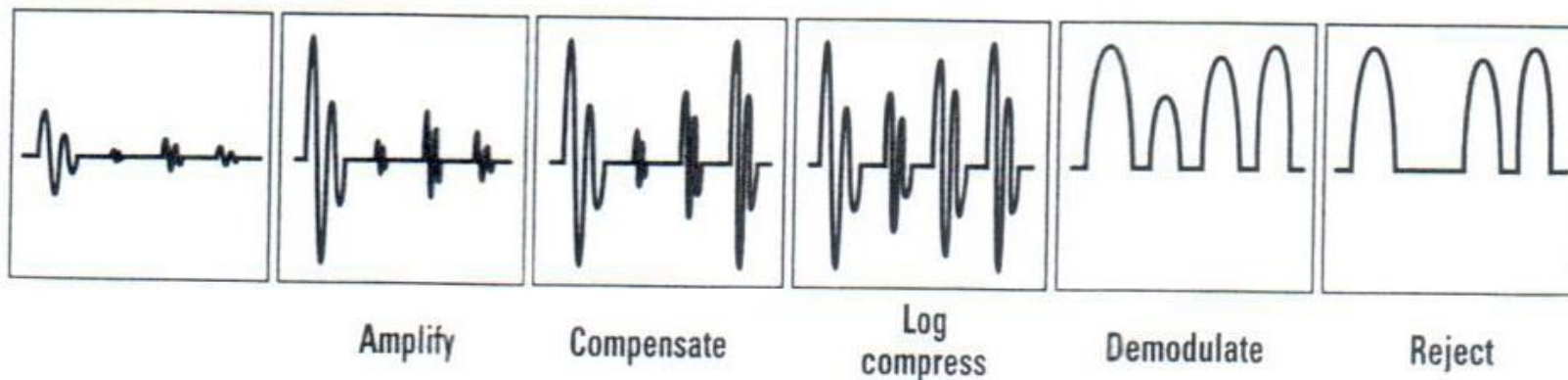
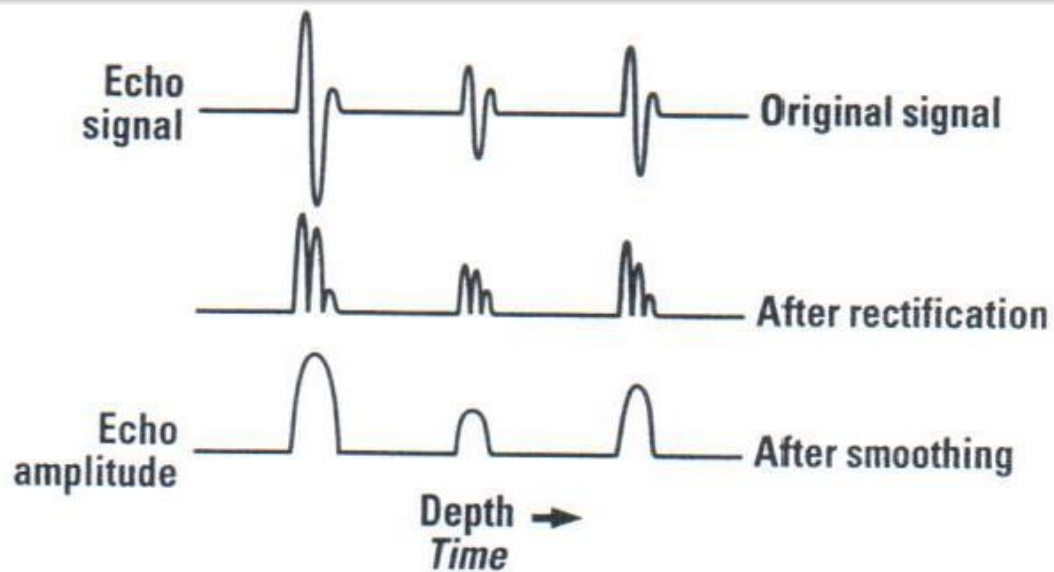

# Equipamento de ultrassonografia

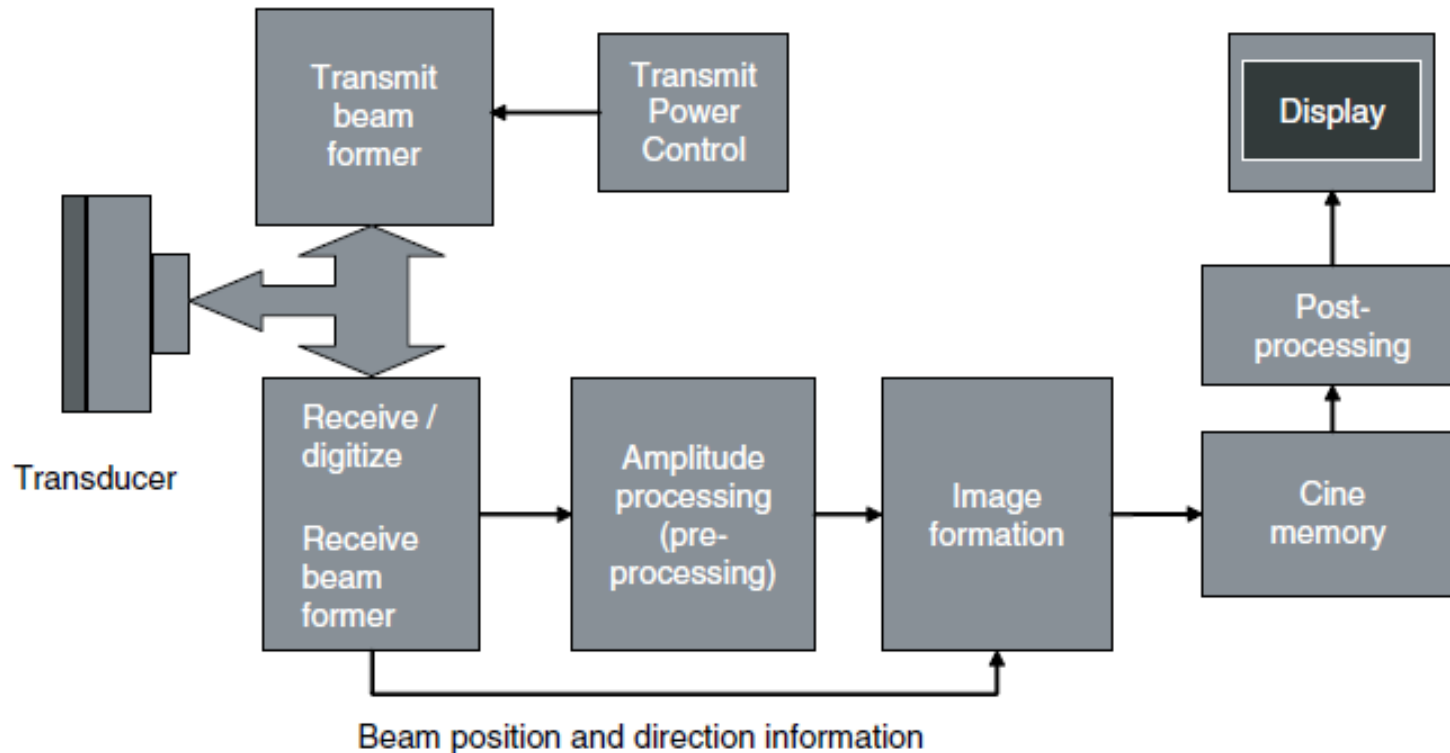

# Modos de apresentar os resultados

---

 Modo A (Amplitude)

 Modo B (Brightness)

 Modo M (Movement)

# Ultrassom Diagnóstico 3D

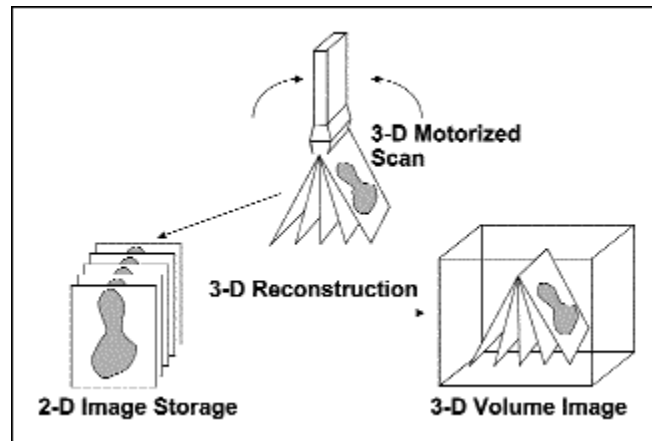
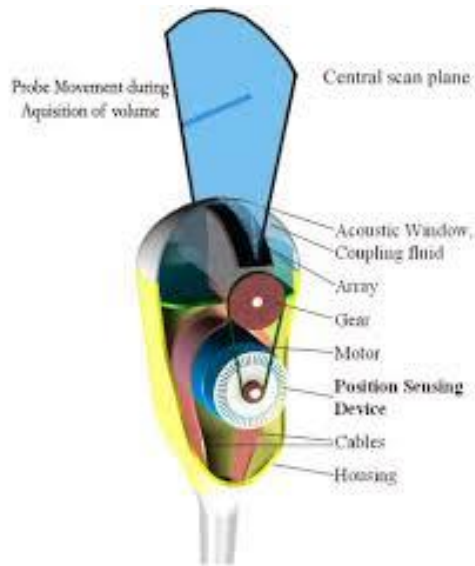

# Ultrassom Diagnóstico 3D



Siemens



MobiSante



GE



# Doppler

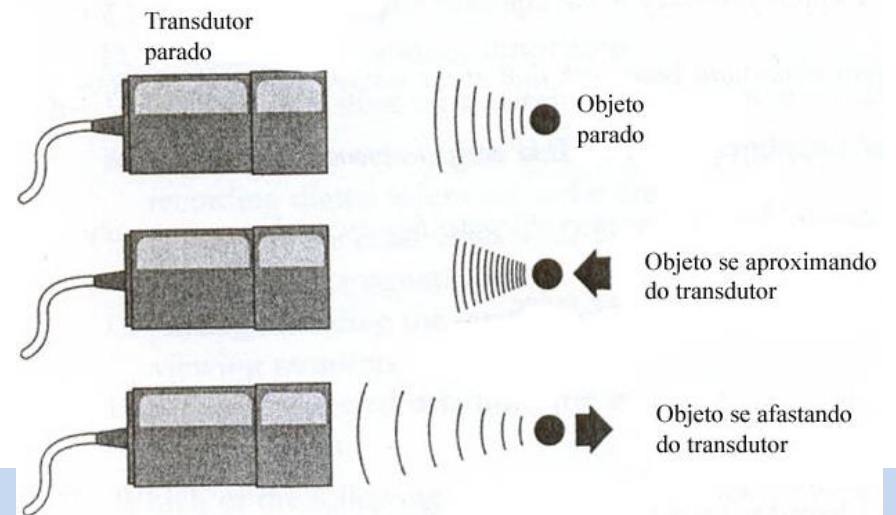
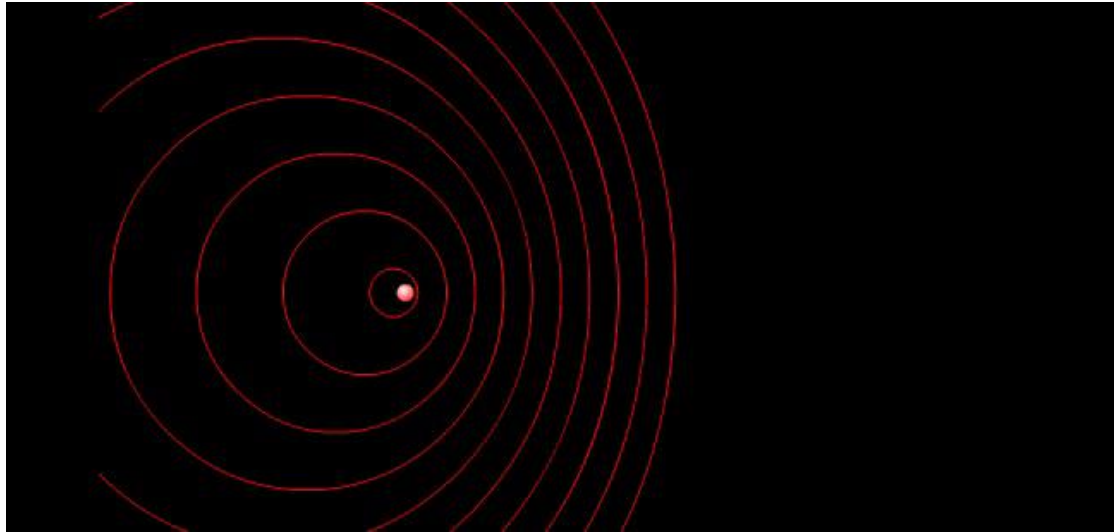

# Imagem Color-Doppler

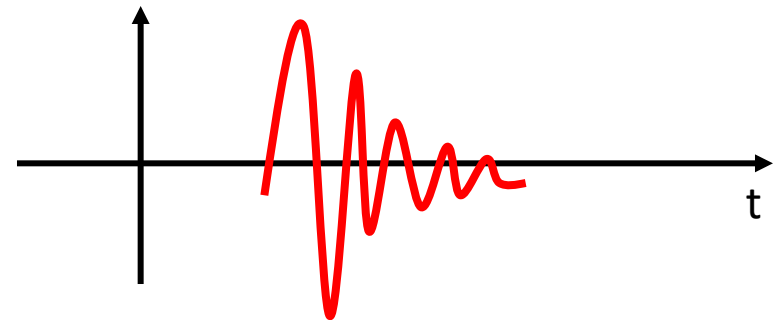
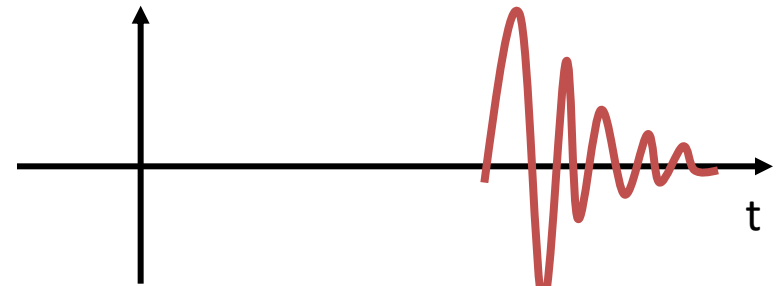
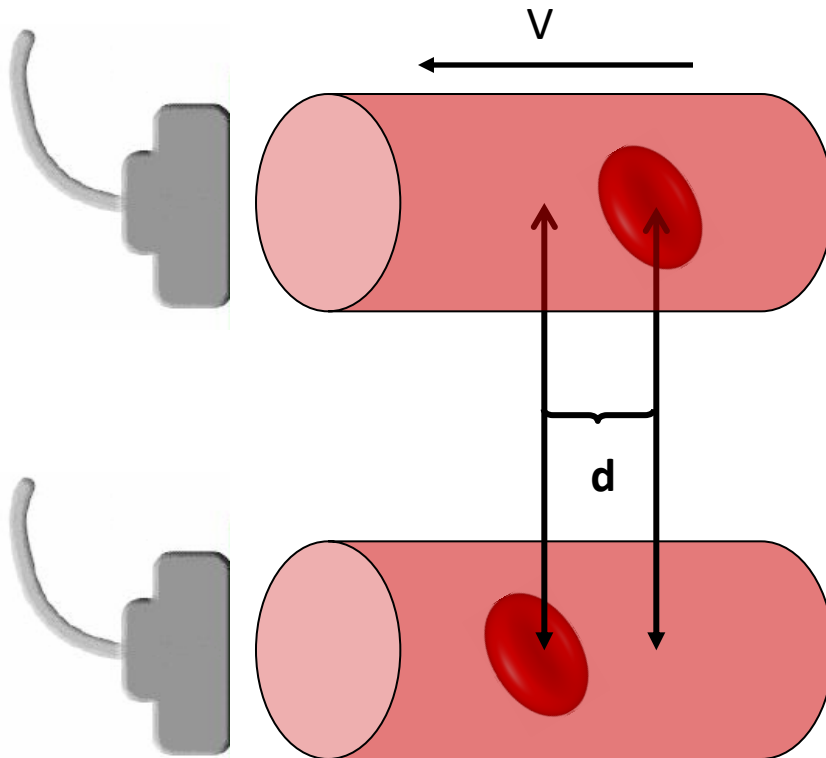



# Modo Doppler

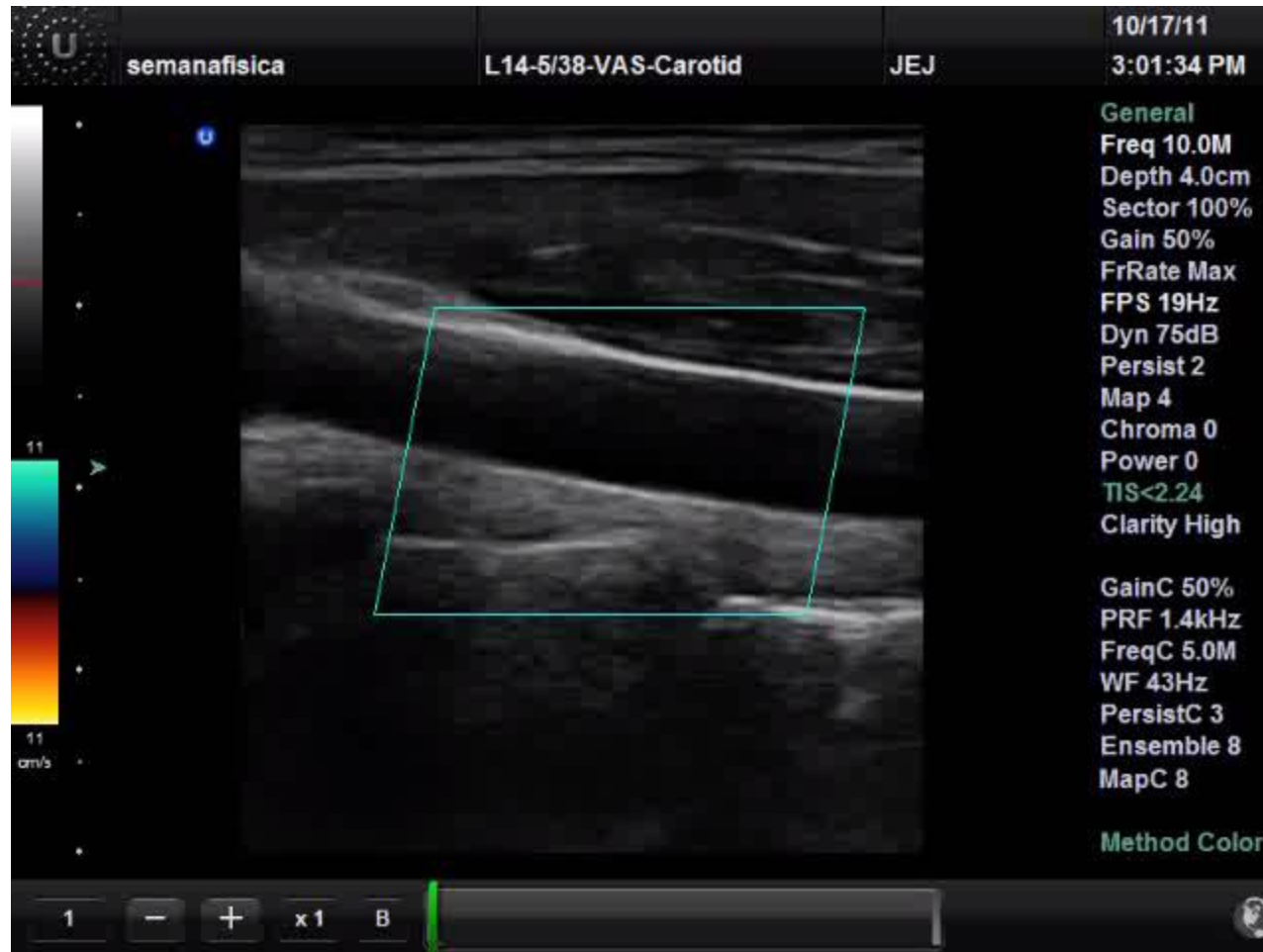



# Exemplo de aplicação - Ecocardiografia

- É um exame usado rotineiramente no diagnóstico e acompanhamento de pacientes com suspeita ou alguma desordem conhecida no coração.
- Quem fez algum check-up sabe disso 😊
- Dentre os exames mais usados em cardiologia.
- Informações anatômicas (forma e tamanho), capacidade de bombeamento, localização de danos em tecidos, função cardíaca, entre outras.

# Anatomia básica do coração

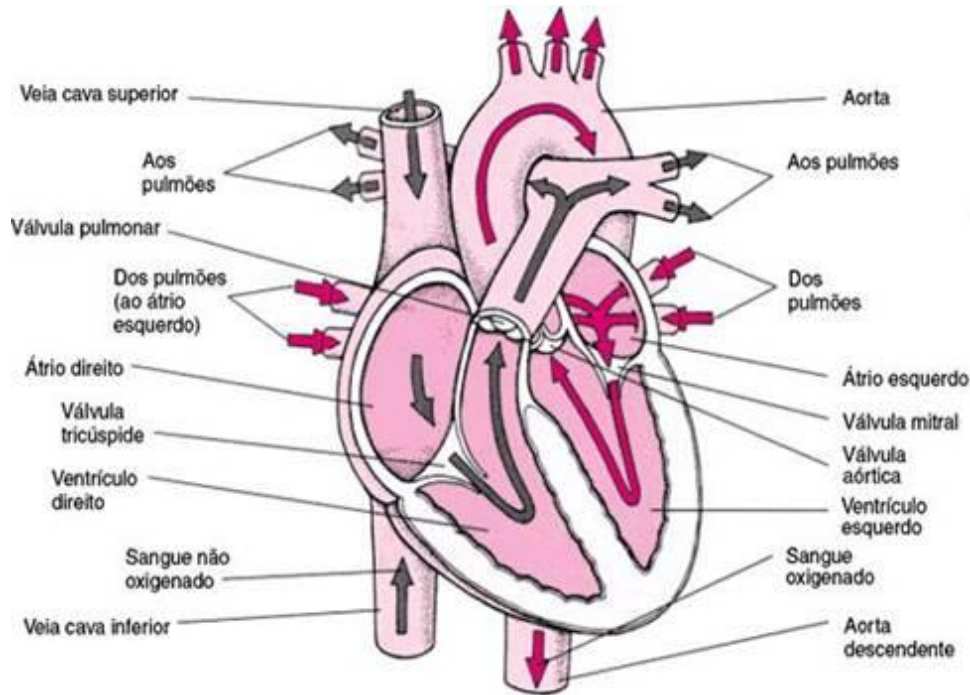

Átrios → Cavidades responsáveis por armazenar sangue.

Ventrículos → Cavidade de onde o sangue é bombeado a todo corpo.

Diástole → Fase de repouso, na qual o coração é preenchido por sangue.

Sístole → Fase de contração, na qual o sangue é bombeado.

# Anatomia básica do coração

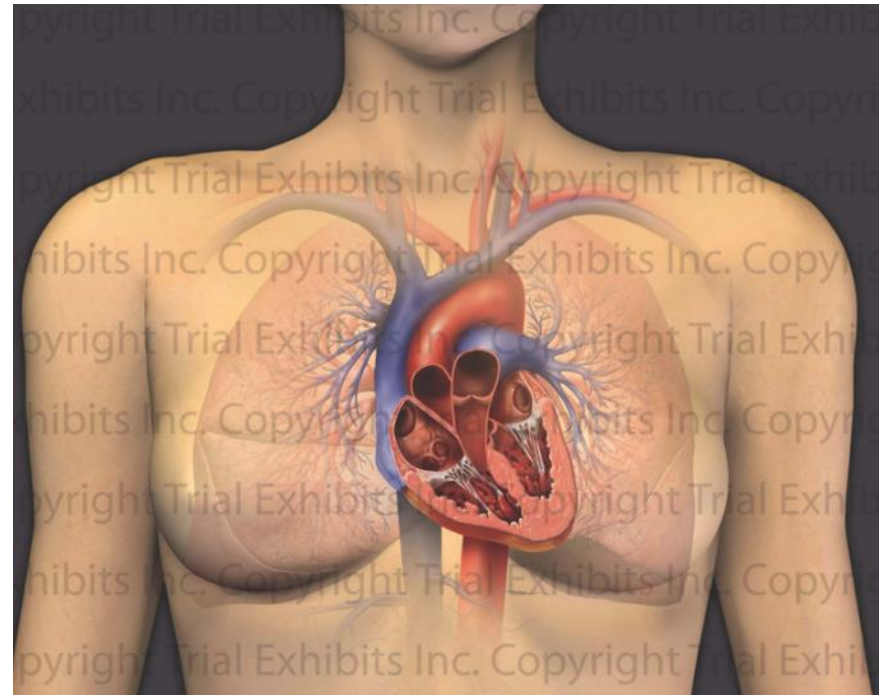
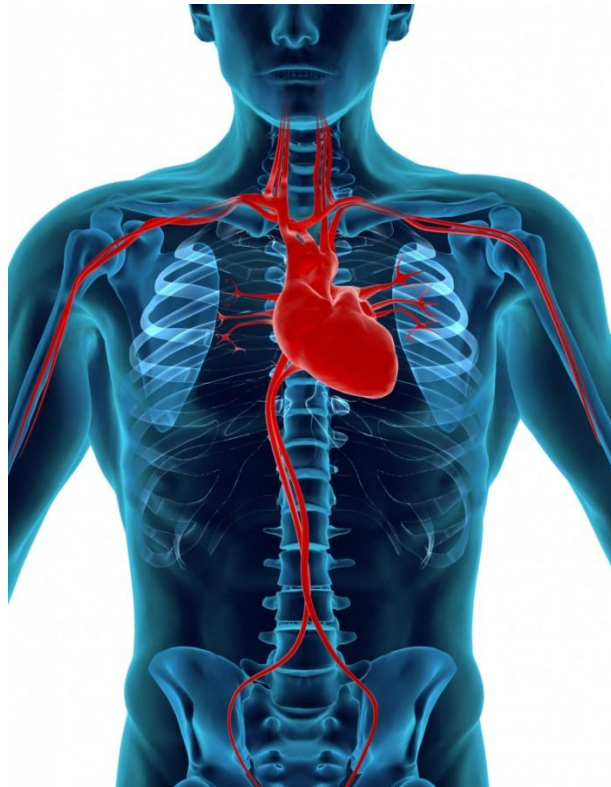

# Anatomia básica do coração

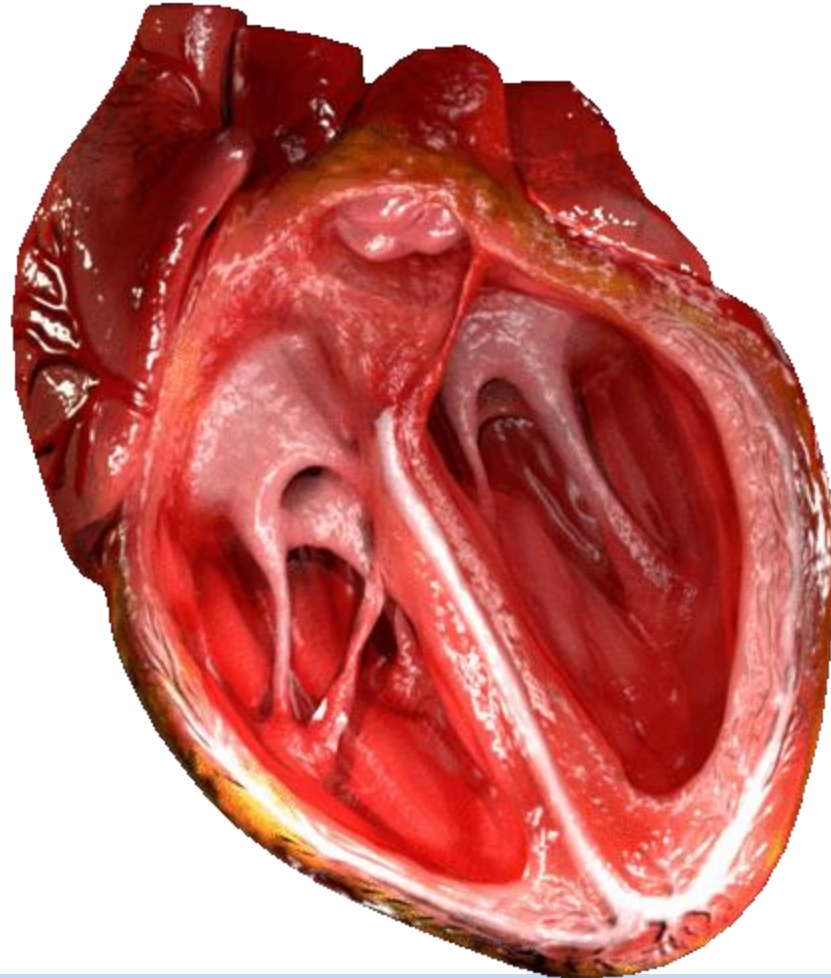

# Ecocardiografia

## Posição apical



Figure 44

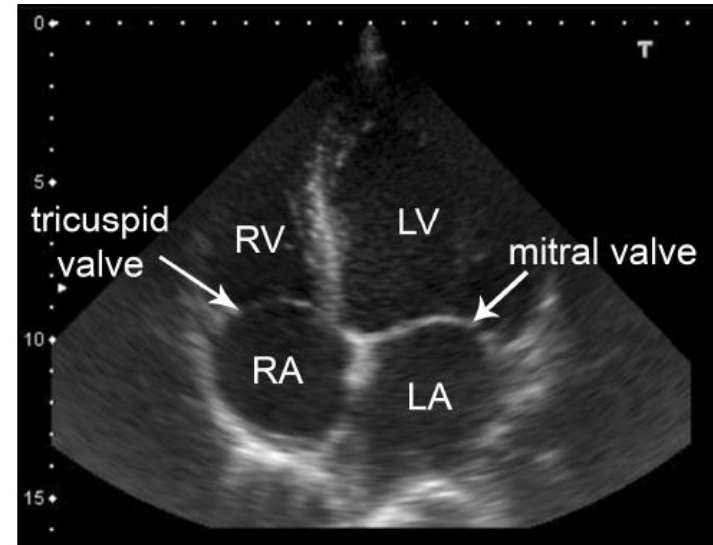

Figure 45

<https://calsprogram.org/manual/volume3/Section28/Ultrasonound/03-US2EmergencyUSTechniques13.html>



# Ecocardiografia

 Mostrar vídeo:

<https://www.youtube.com/watch?v=5czv-c1uUnw>

<https://www.youtube.com/watch?v=CIJewMLUQkU>

# Ecocardiografia

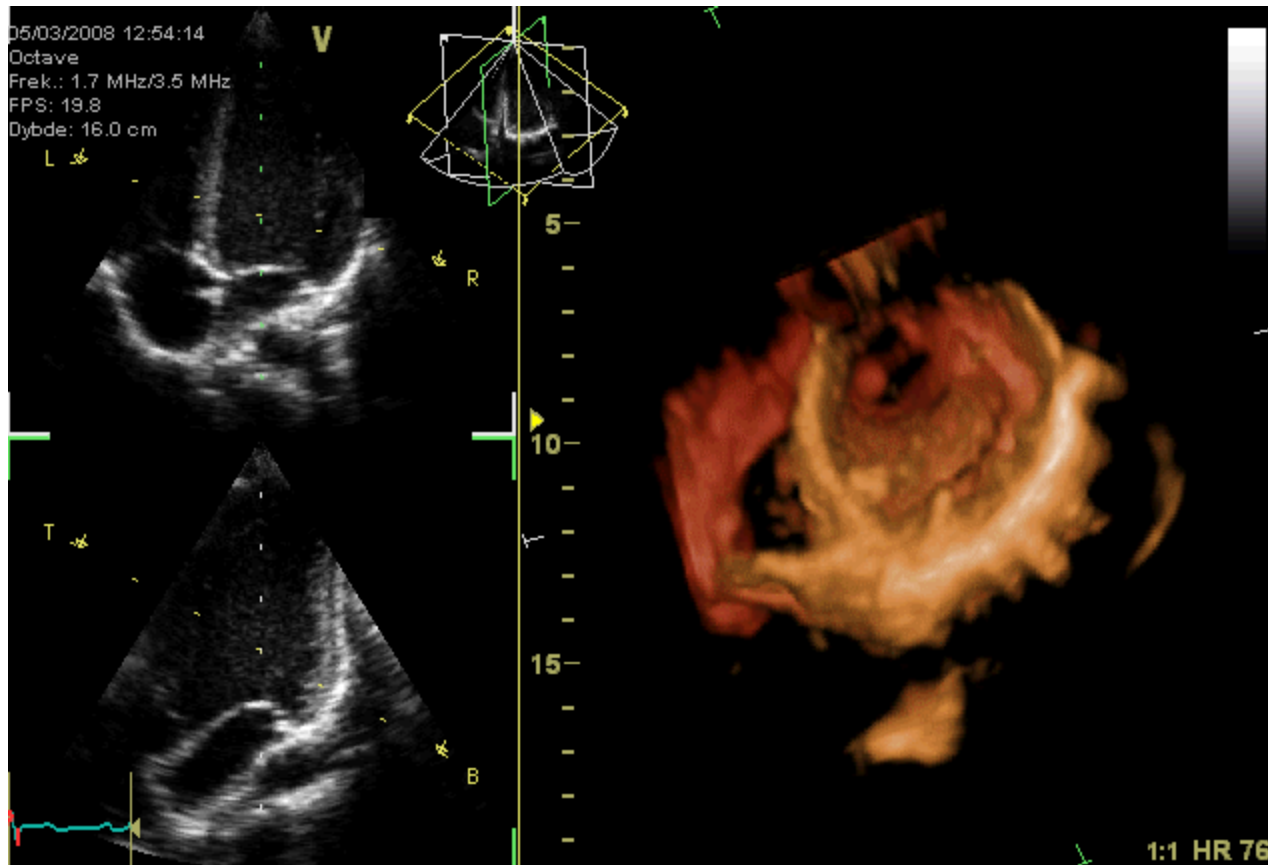



# Ecorcardiografia Doppler

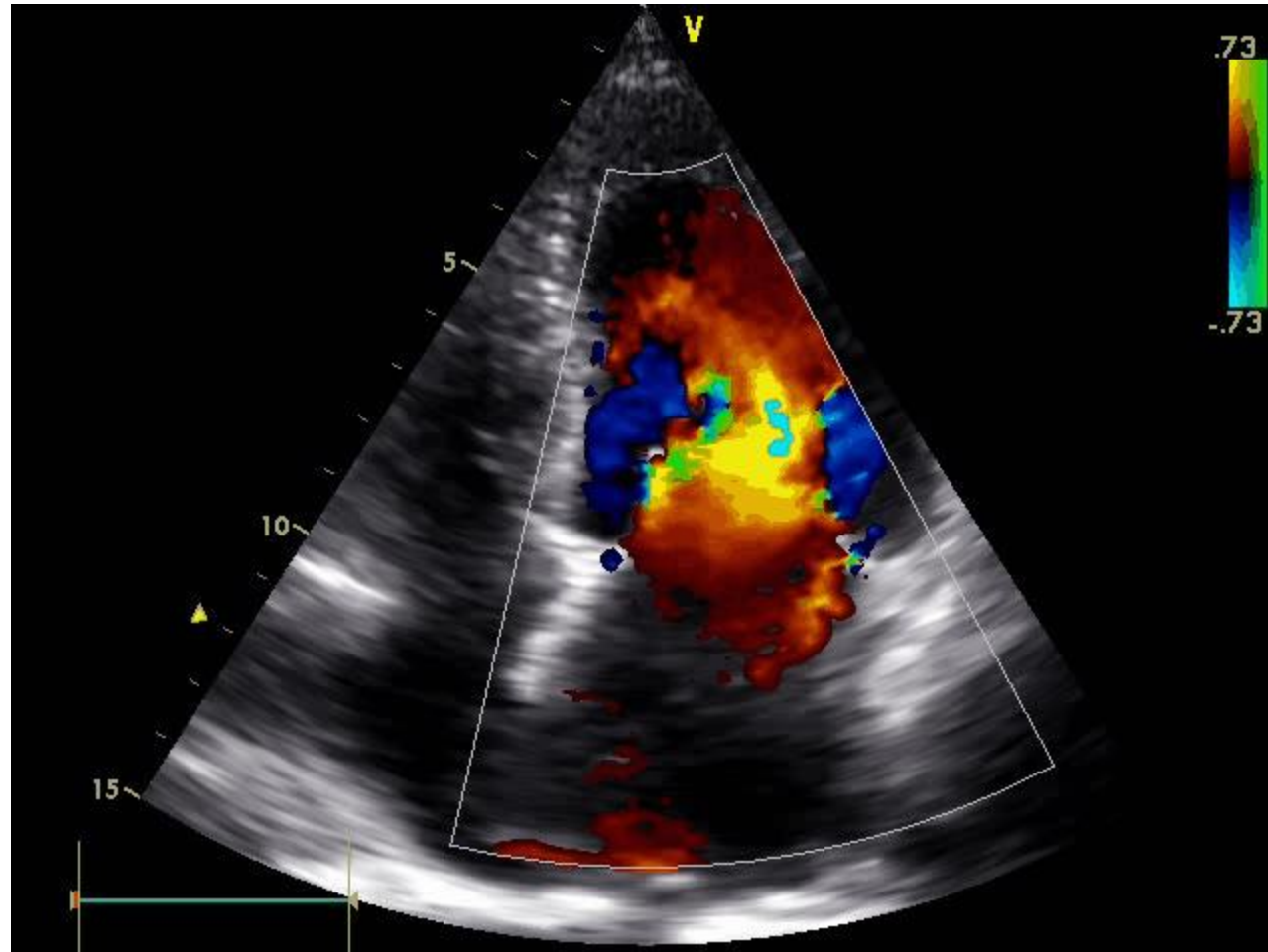

## Imagem Funcional do Cérebro

