

SEM0540

Elementos de Automação

Introdução a Sistemas
Hidráulicos e Pneumáticos

Prof. Dr. Thiago Boaventura
tboaventura@usp.br

Prof. Dr. José Guilherme Sabe
equitron@equitron.com.br

São Carlos, 19/06/18



Conteúdo



- Princípios básicos
- Circuito e componentes básicos
- Aplicações
- Exemplos

Hidráulica



- Introdução e princípios básicos
- Circuito e componentes básicos
- Aplicações

Pneumática



- “Take-home messages”
- Bibliografia

Conclusão

Conteúdo



- **Princípios básicos**
- Circuito e componentes básicos
- Aplicações
- Exemplos

Hidráulica

Pneumática

Conclusão

Fluidos

Hidráulica

Pneumática

Conclusão

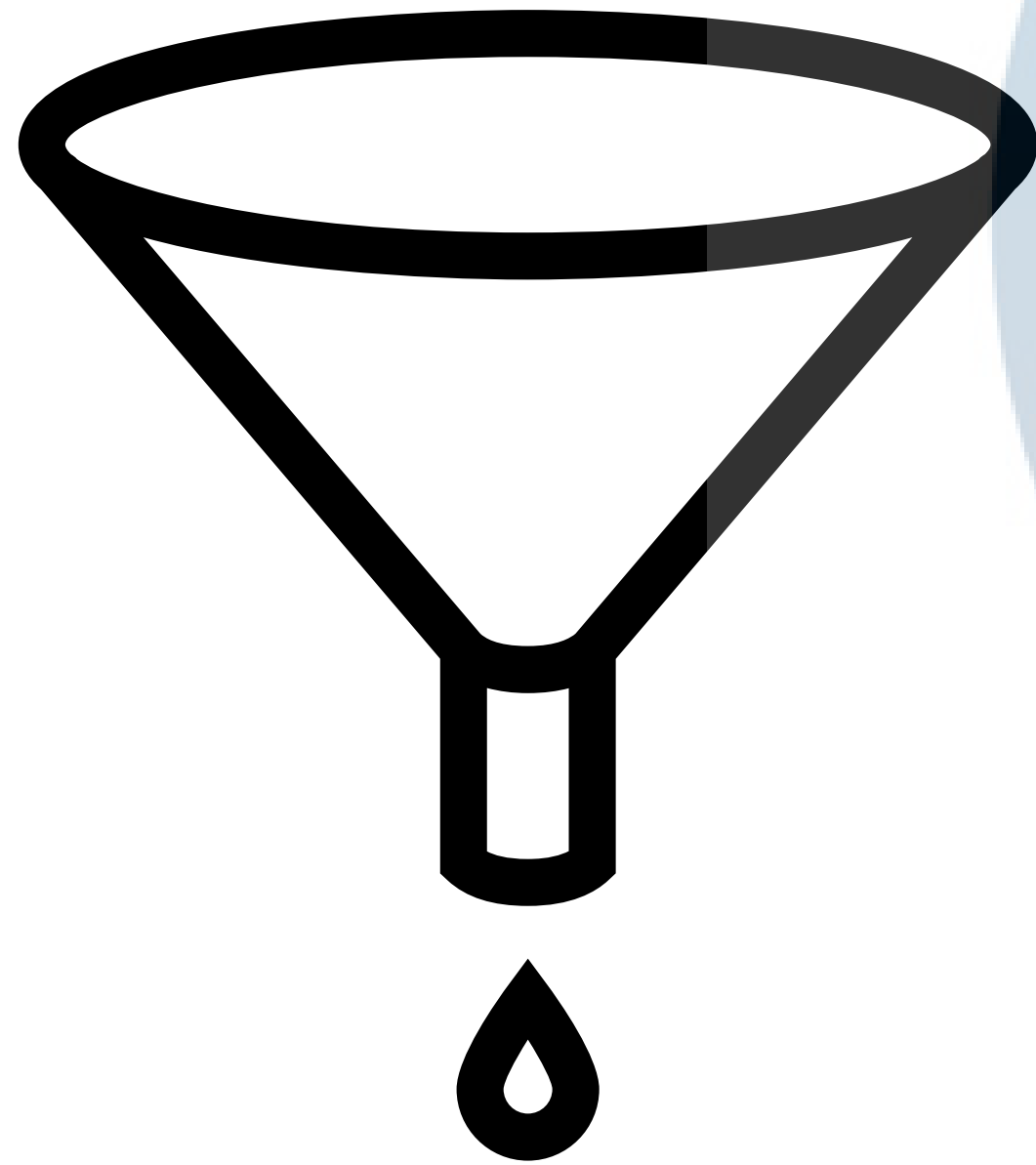

Escoam



Óleo mineral



Água

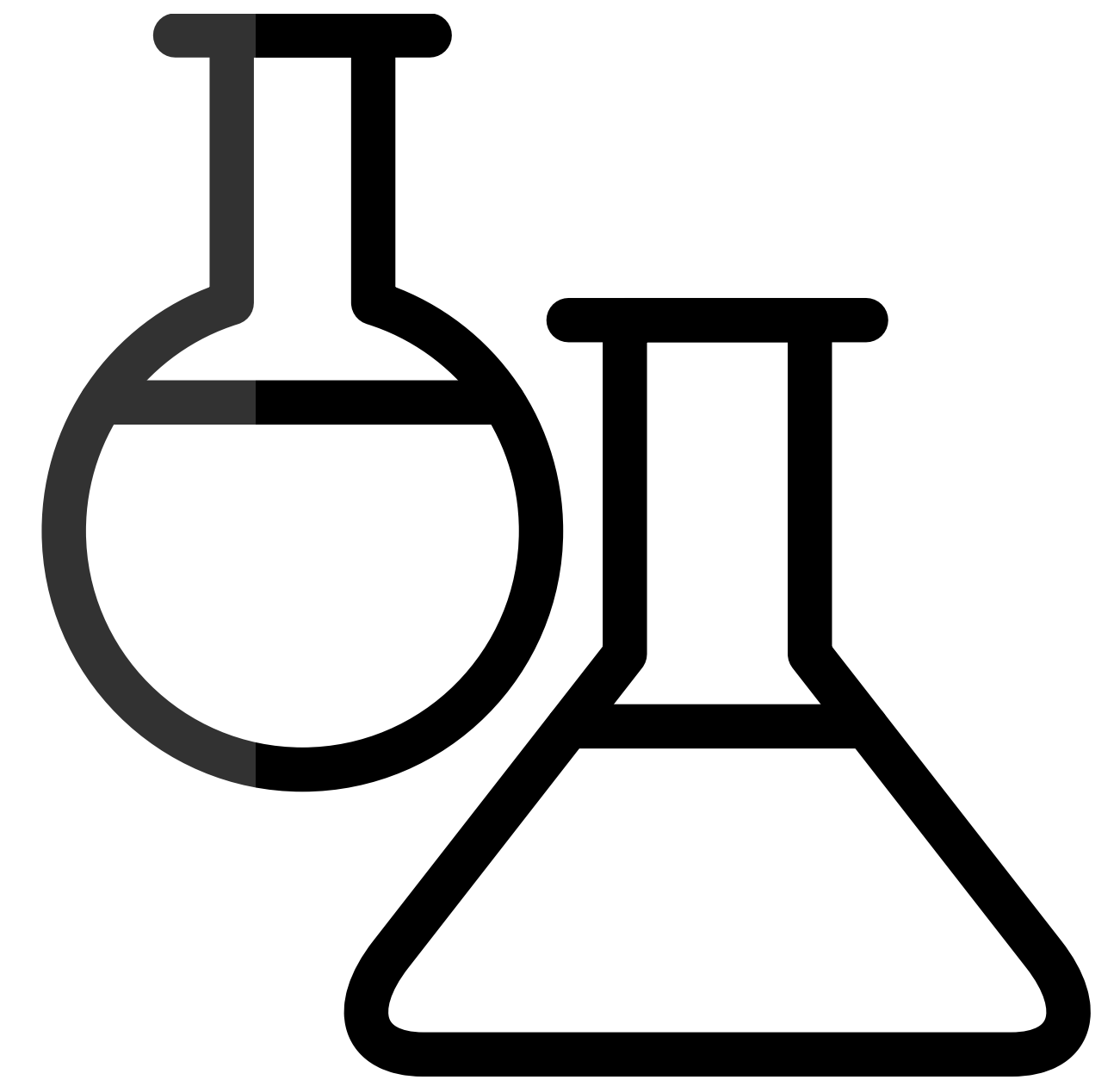

Deformam-se

Óleo mineral — Prós e contras

Hidráulica



Lubrificante



**Temperaturas
de operação**

Pneumática



**Baixa condutividade
térmica**



Inflamável

Conclusão

Água — Prós e contras

Hidráulica



Não poluente



Baixo Custo



**Baixa
Compressibilidade**

Pneumática



Corrosão



**Congelamento e
evaporação**



**Vazamentos
Internos**

Conclusão

Pressão

$$P = \frac{F}{A}$$

$$p = mv$$

[Pa]

$$\left[\frac{N}{m^2} \right]$$

[bar]

$$1 \text{ bar} = 10^5 \text{ Pa}$$

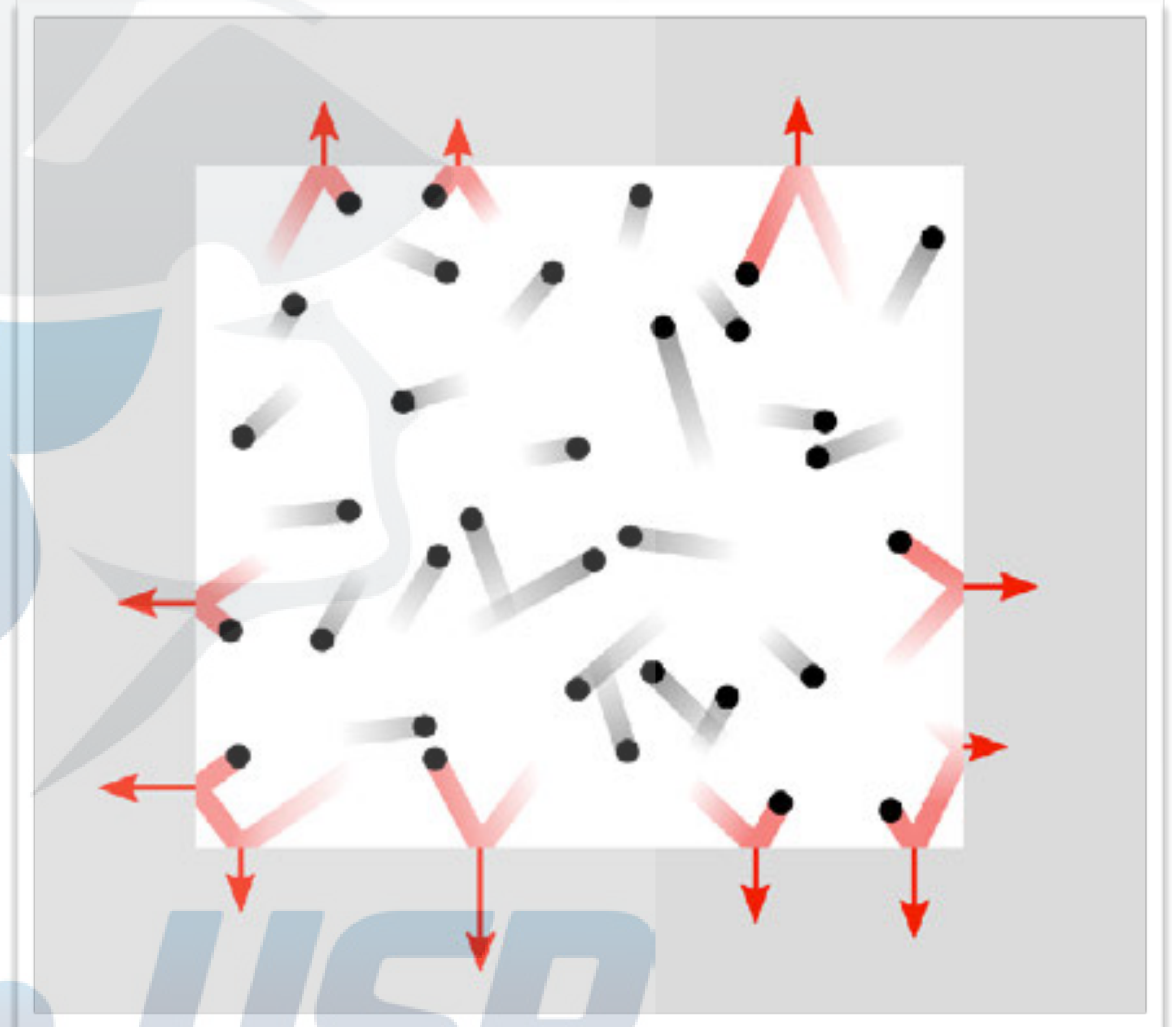

Princípio de Pascal

$$P_A = P_B \Rightarrow \frac{F_A}{A_A} = \frac{F_B}{A_B}$$



Blaise Pascal
1623 — 1662

$$P = \frac{F}{A}$$

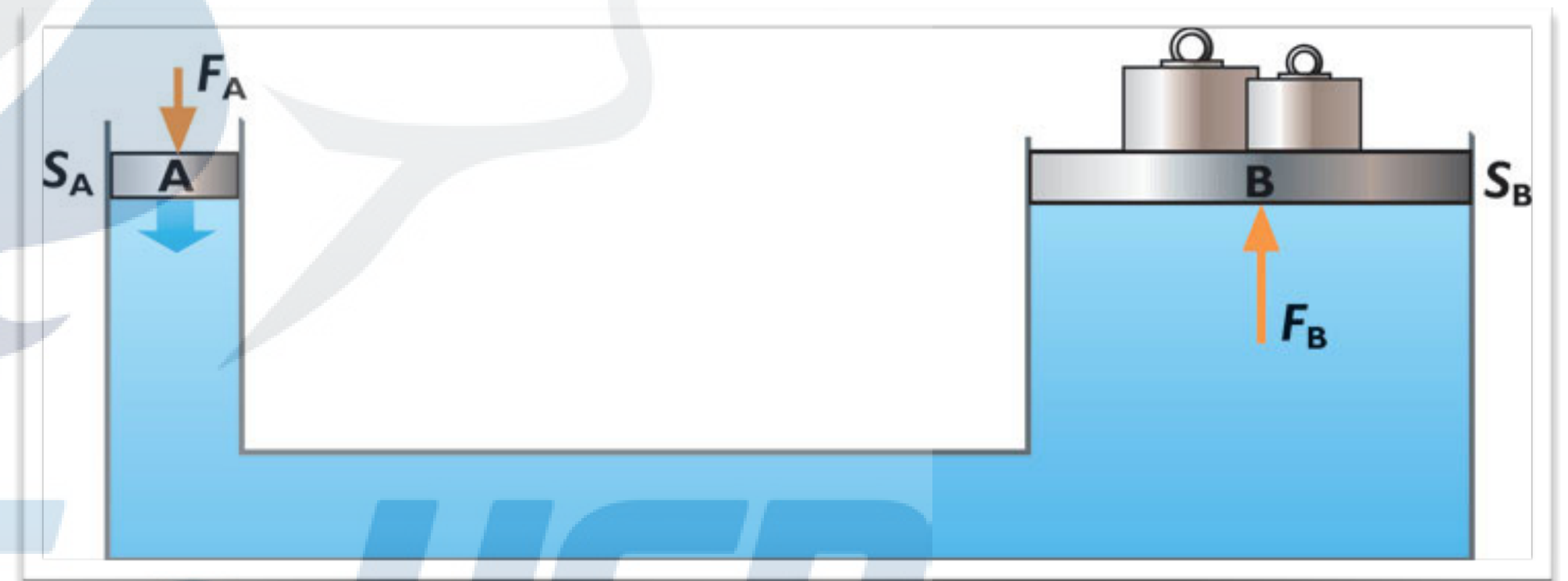

wikipedia

Vazão volumétrica

$$Q = \frac{\Delta V}{\Delta t} \quad \left[\frac{m^3}{s} \right] \quad \left[\frac{l}{min} \right]$$



$$1.500 \frac{m^3}{s} = 1.5 \cdot 10^6 \frac{l}{s}$$

$$11.000 \frac{m^3}{s} = 11 \cdot 10^6 \frac{l}{s}$$

POTÊNCIA

=

ESFORÇO

X

FLUXO



Mecânico

=

FORÇA

X

VELOCIDADE

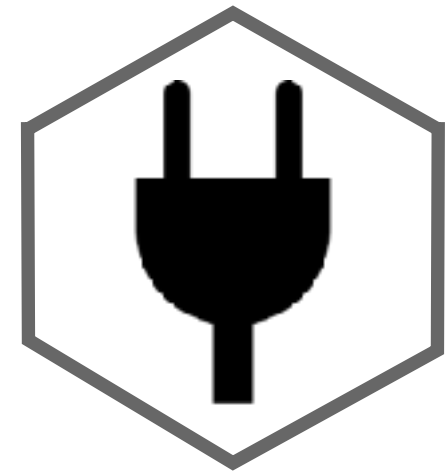

Elétrico

=

TENSÃO

X

CORRENTE



Fluidos

=

PRESSÃO

X

VAZÃO

EESC • USP

POTÊNCIA = **ESFORÇO** **X** **FLUXO**

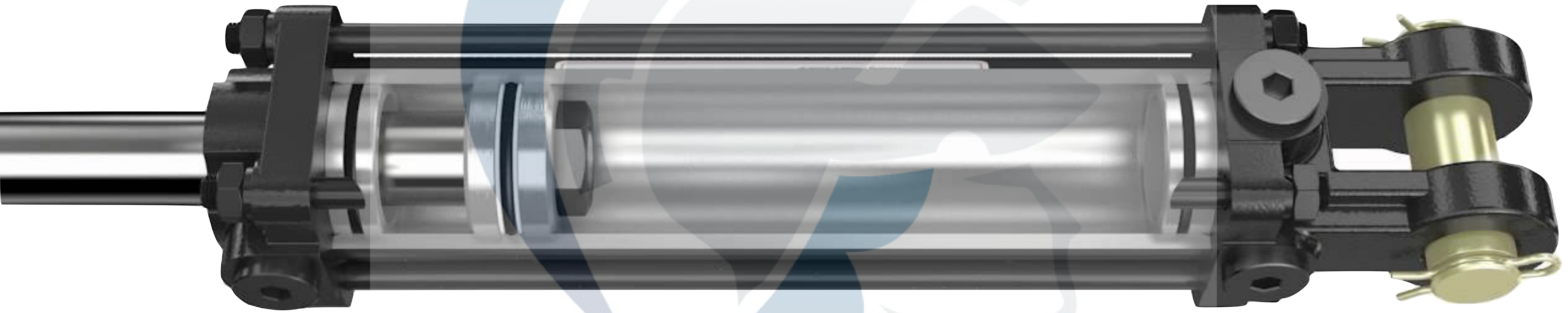

Fluidos

= **PRESSÃO** **X** **VAZÃO**

EESC • USP



Princípio de Bernoulli

"Se a **velocidade** de uma partícula de um fluido **aumenta** enquanto ela se escoia ao longo de uma linha de corrente, a **pressão** do fluido deve **diminuir** e vice-versa"



Daniel Bernoulli
1700 – 1782

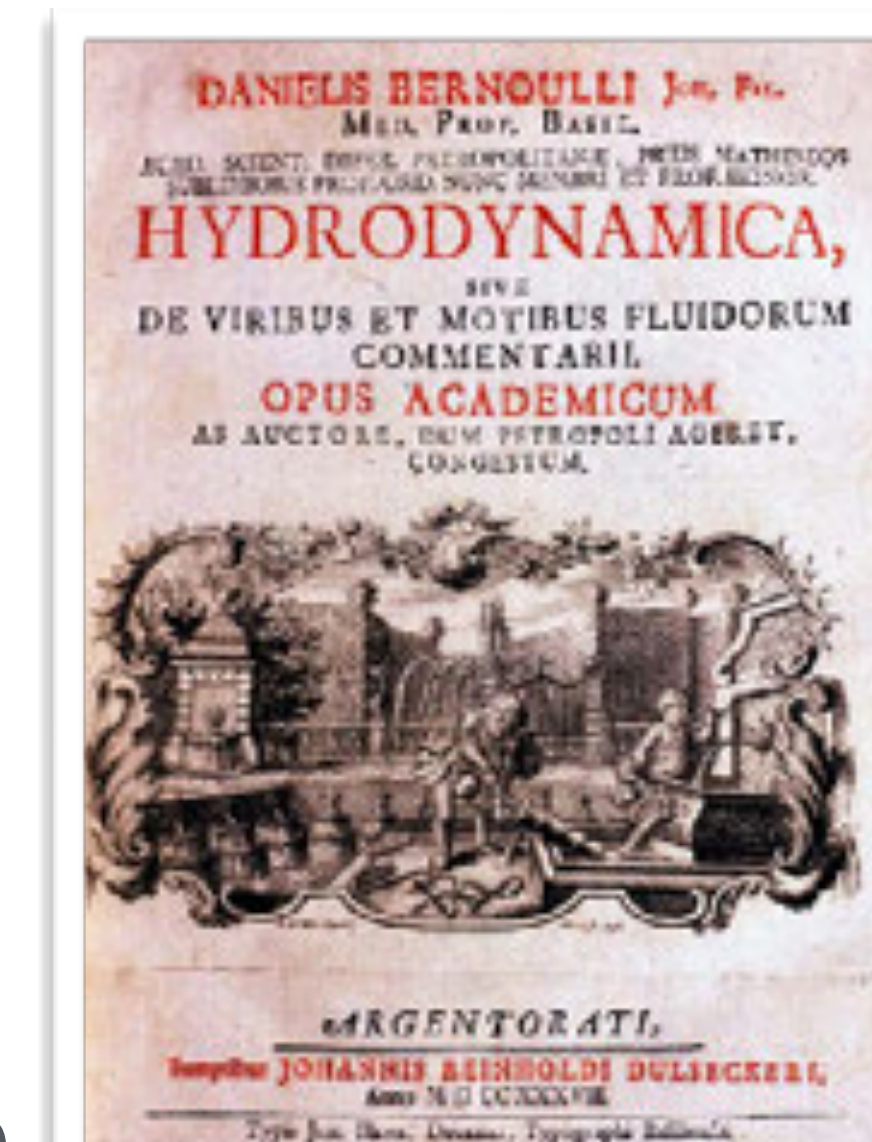
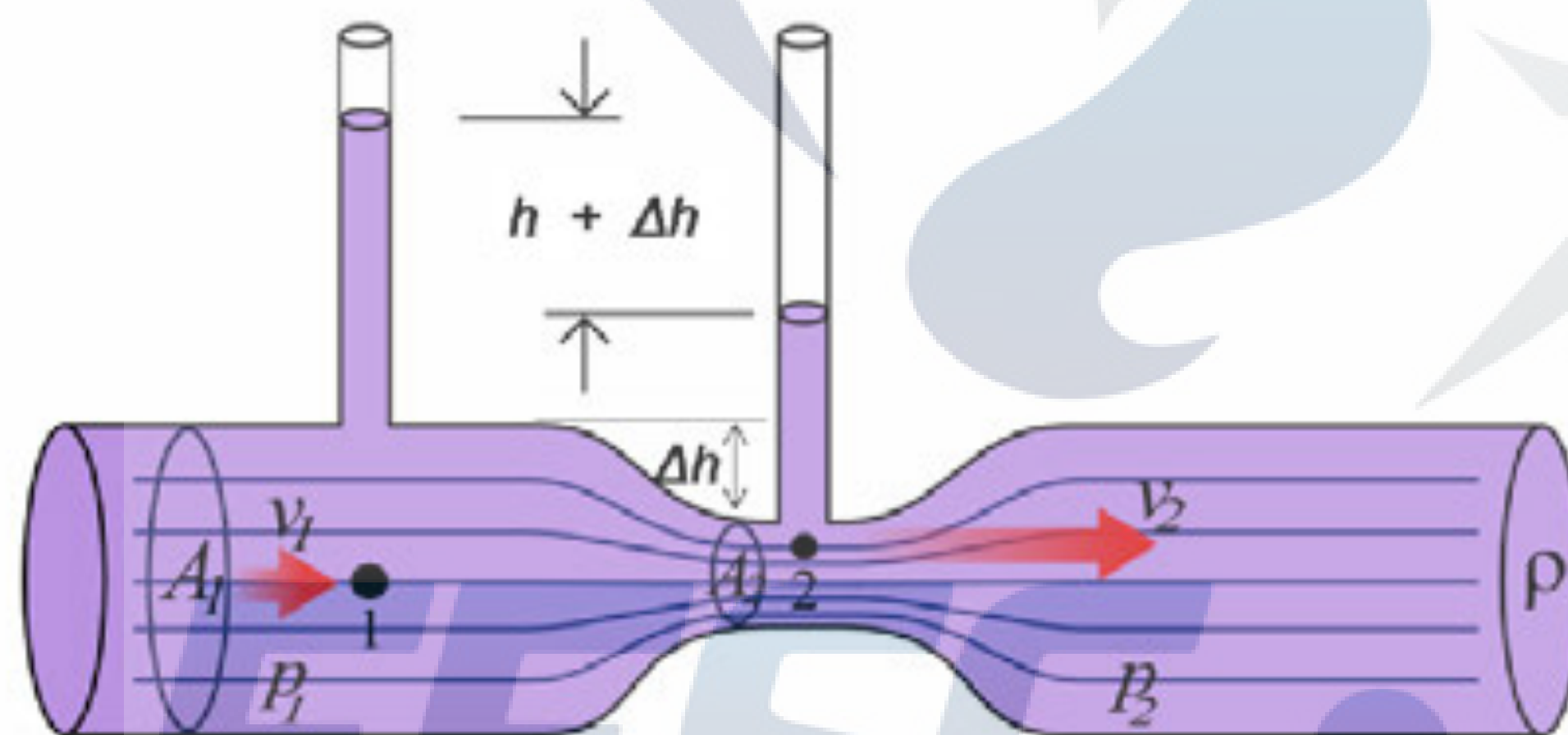

1739

Hidráulica — Vantagens e desvantagens

Hidráulica



Potência/Peso



Rápidos



Autolubrificados

Pneumática



Alto custo inicial



Baixo rendimento

Conclusão

Conteúdo



- Princípios básicos
- **Circuito e componentes básicos**
- Aplicações
- Exemplos

Hidráulica

Pneumática

Conclusão

Circuito básico

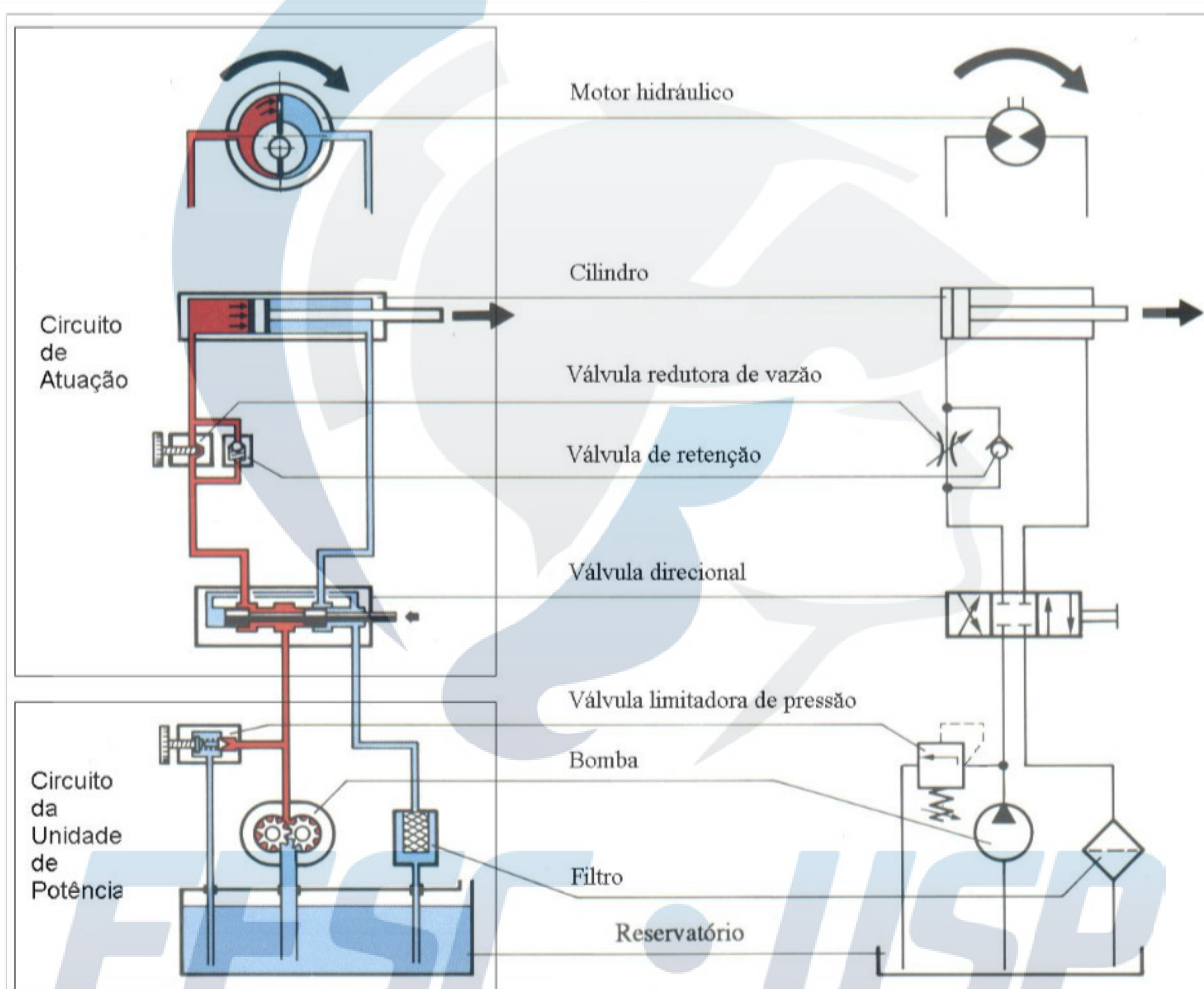

Unidade de potência

Hidráulica

Pneumática

Conclusão

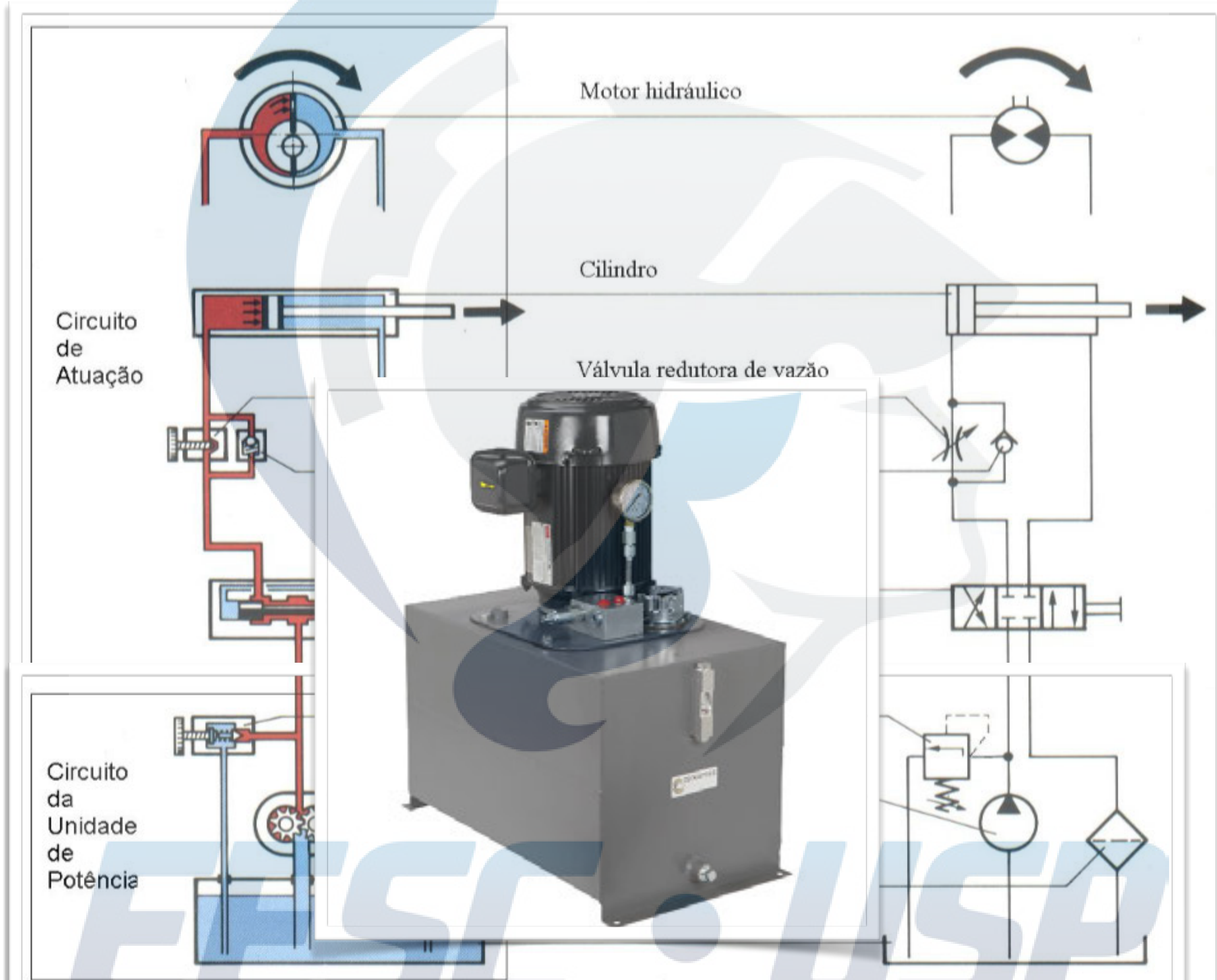

Unidade de potência

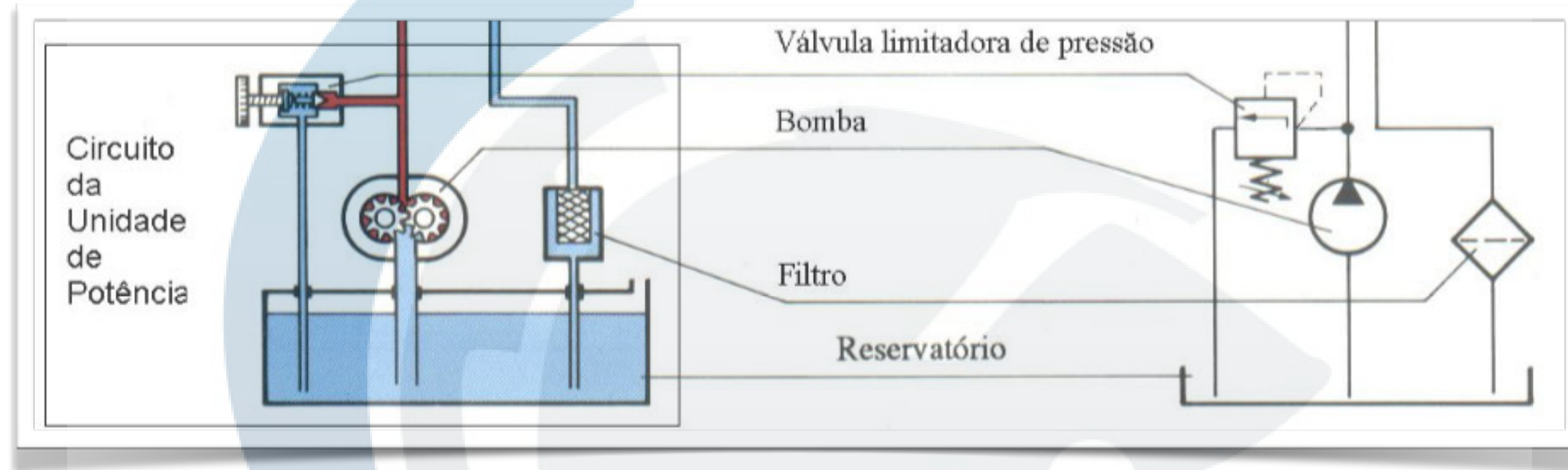

Reservatório



Unidade de potência

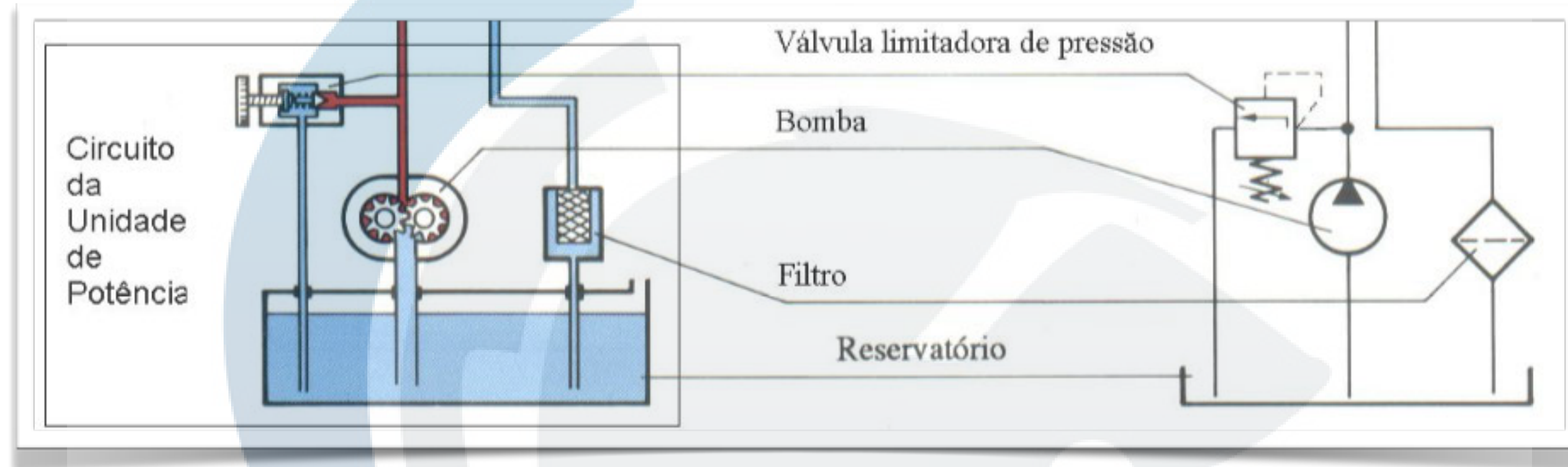

Bomba

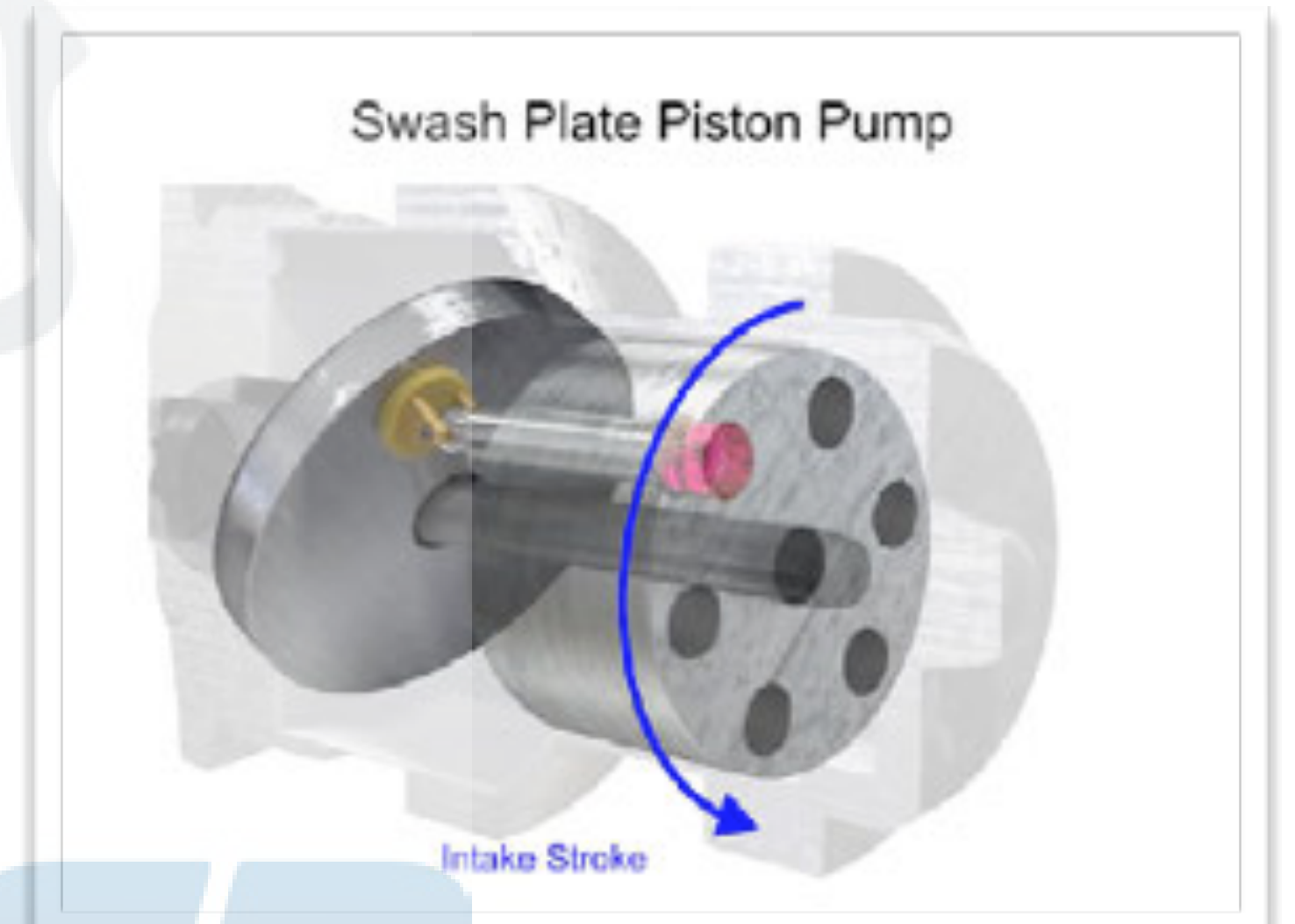
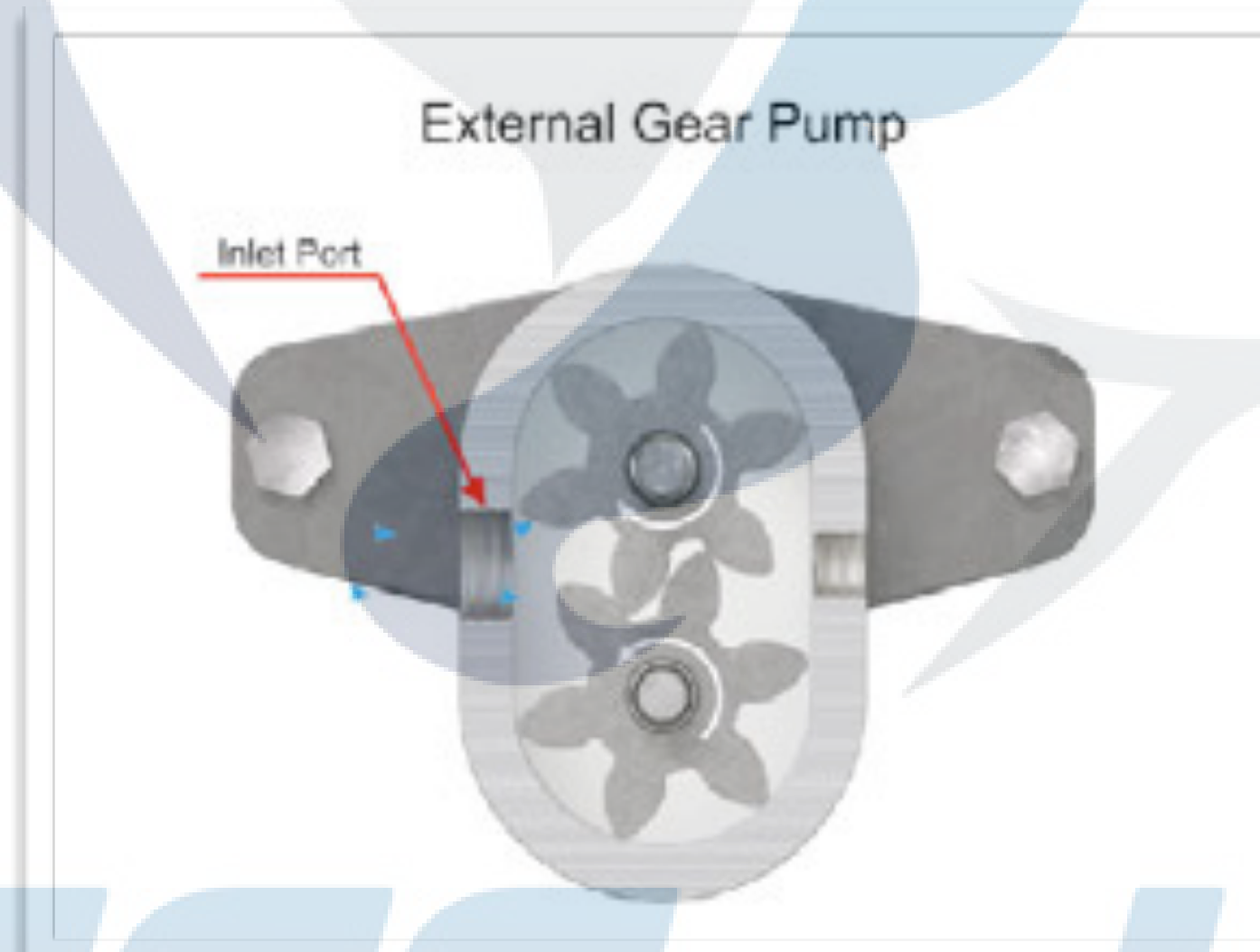
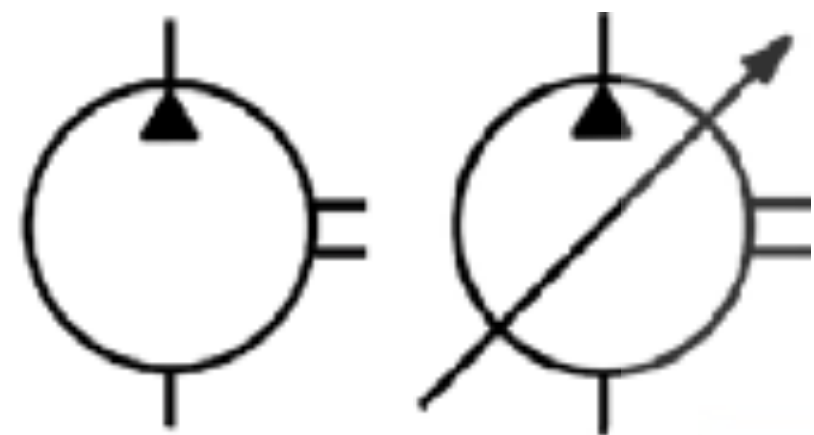

Unidade de potência

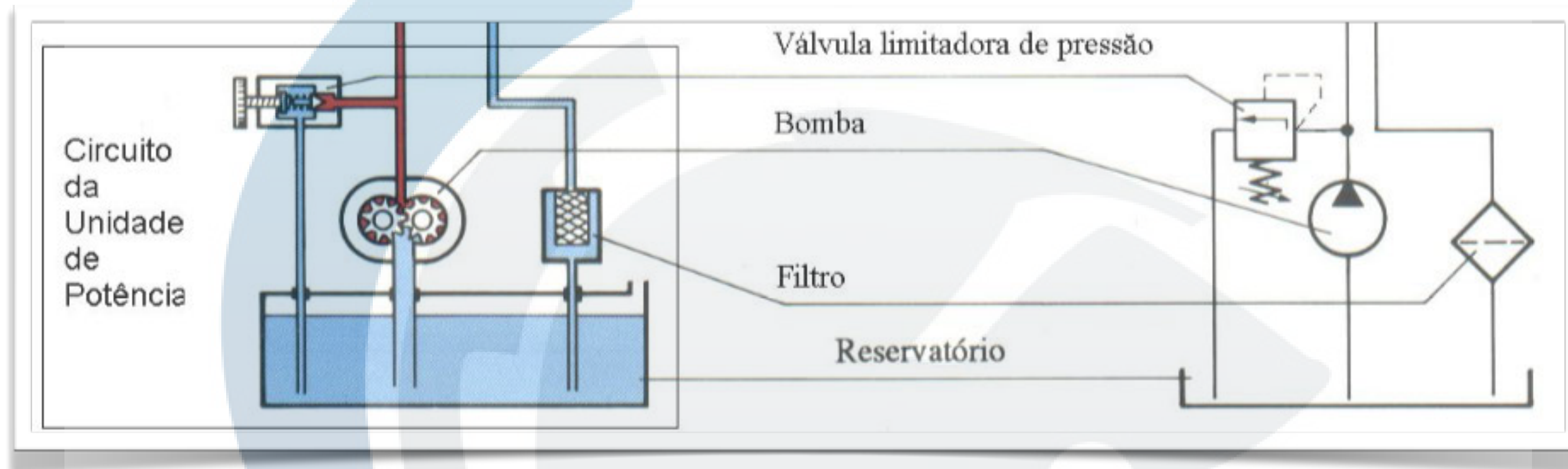

Válvula de alívio

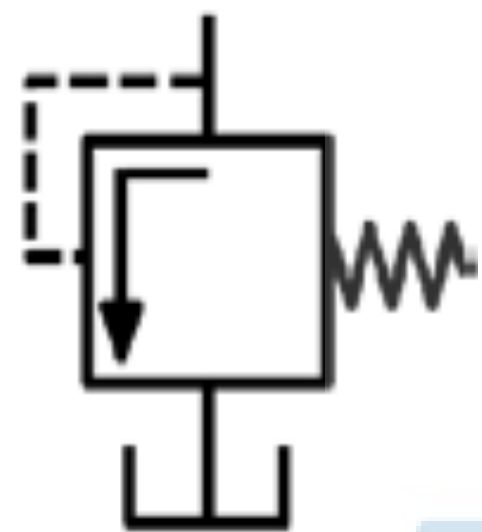

Unidade de potência

Hidráulica

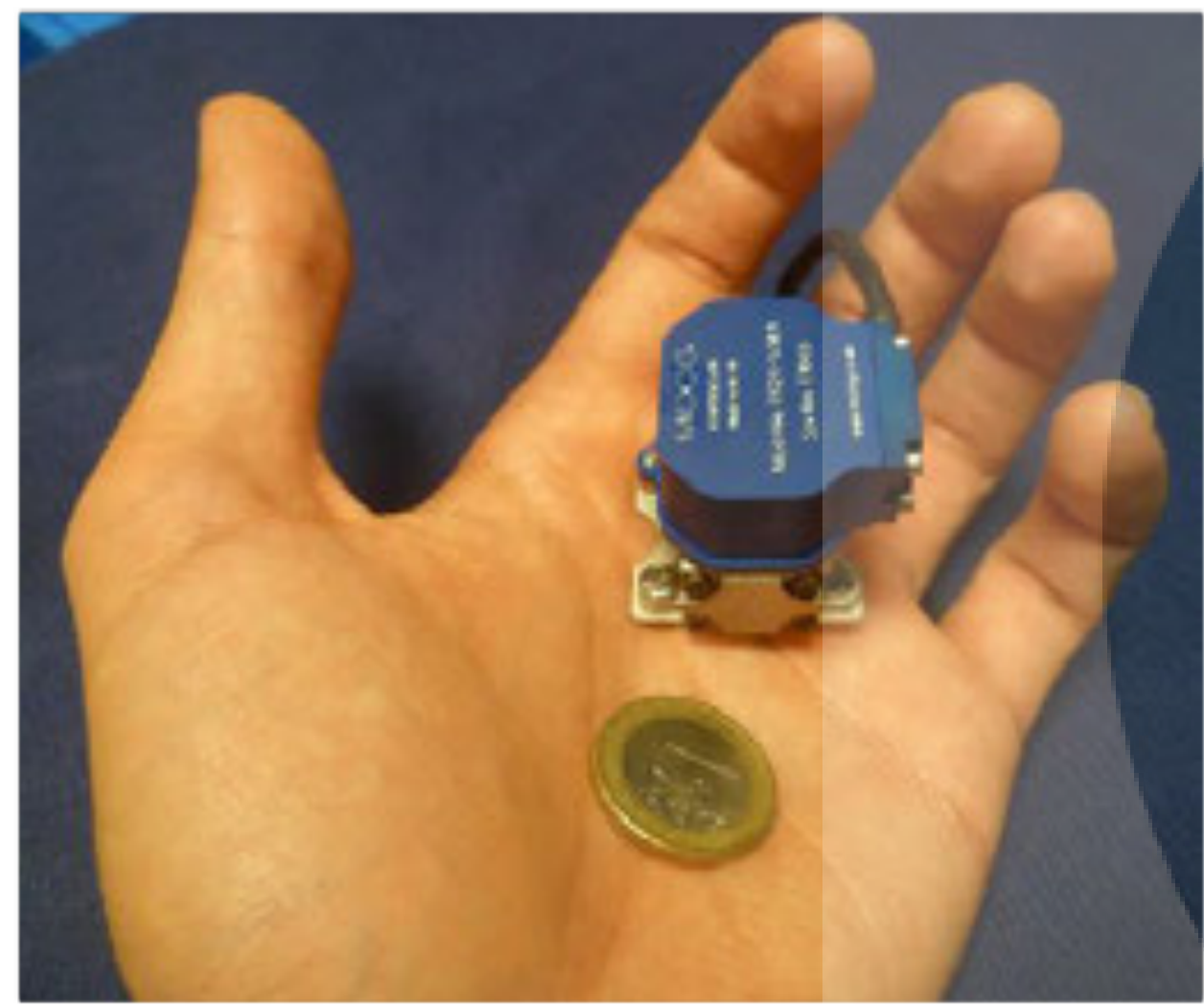

Pneumática

Filtro

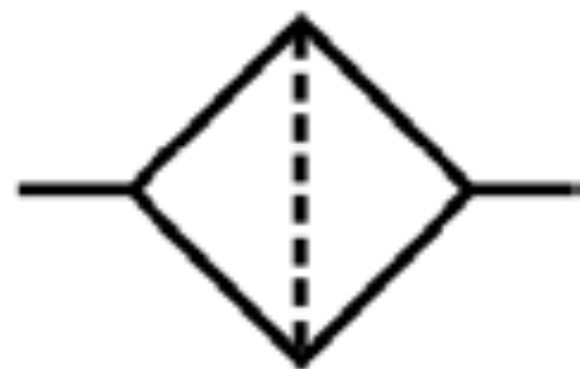

Conclusão

Unidade de potência

Hidráulica

Pneumática

Conclusão

Motor elétrico



Resfriador

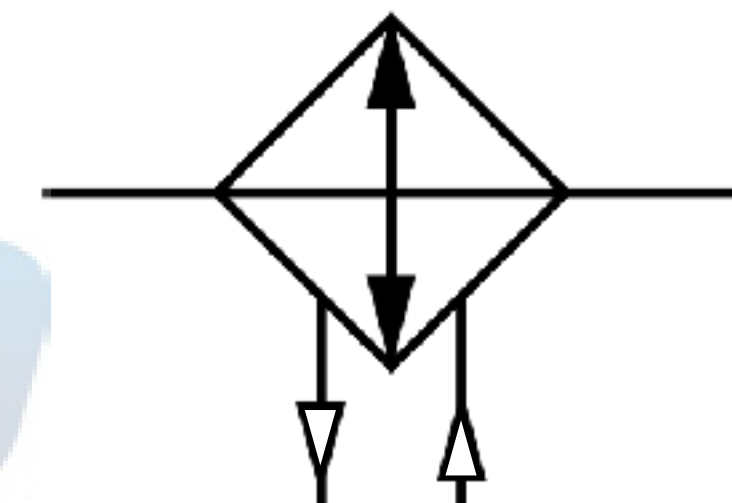
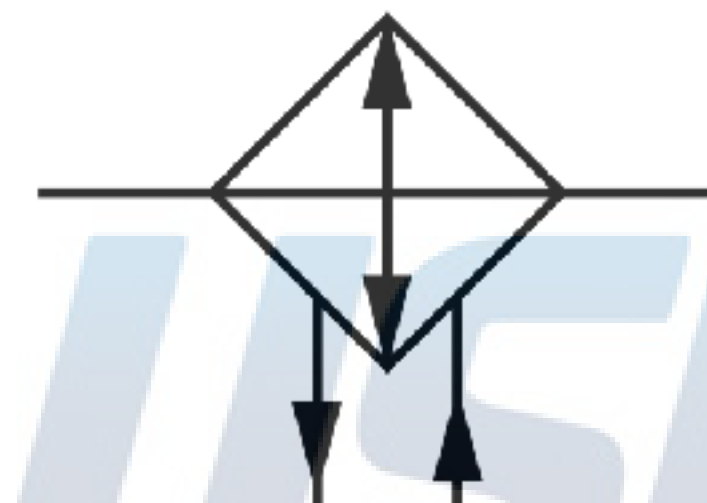

Circuito de atuação

Hidráulica

Atuadores

Pneumática

Válvulas

Conclusão

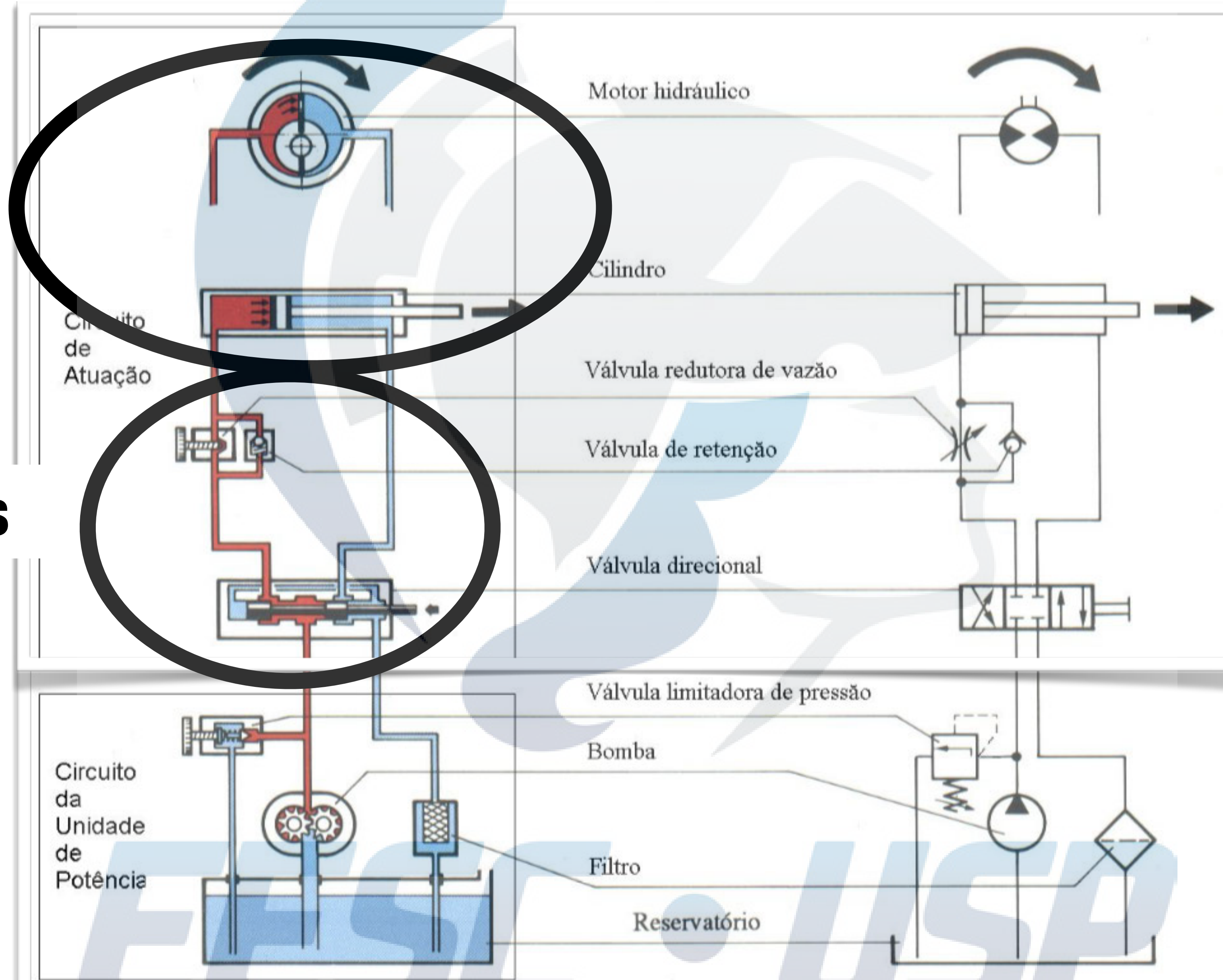

Circuito de atuação

Hidráulica

Pneumática

Conclusão

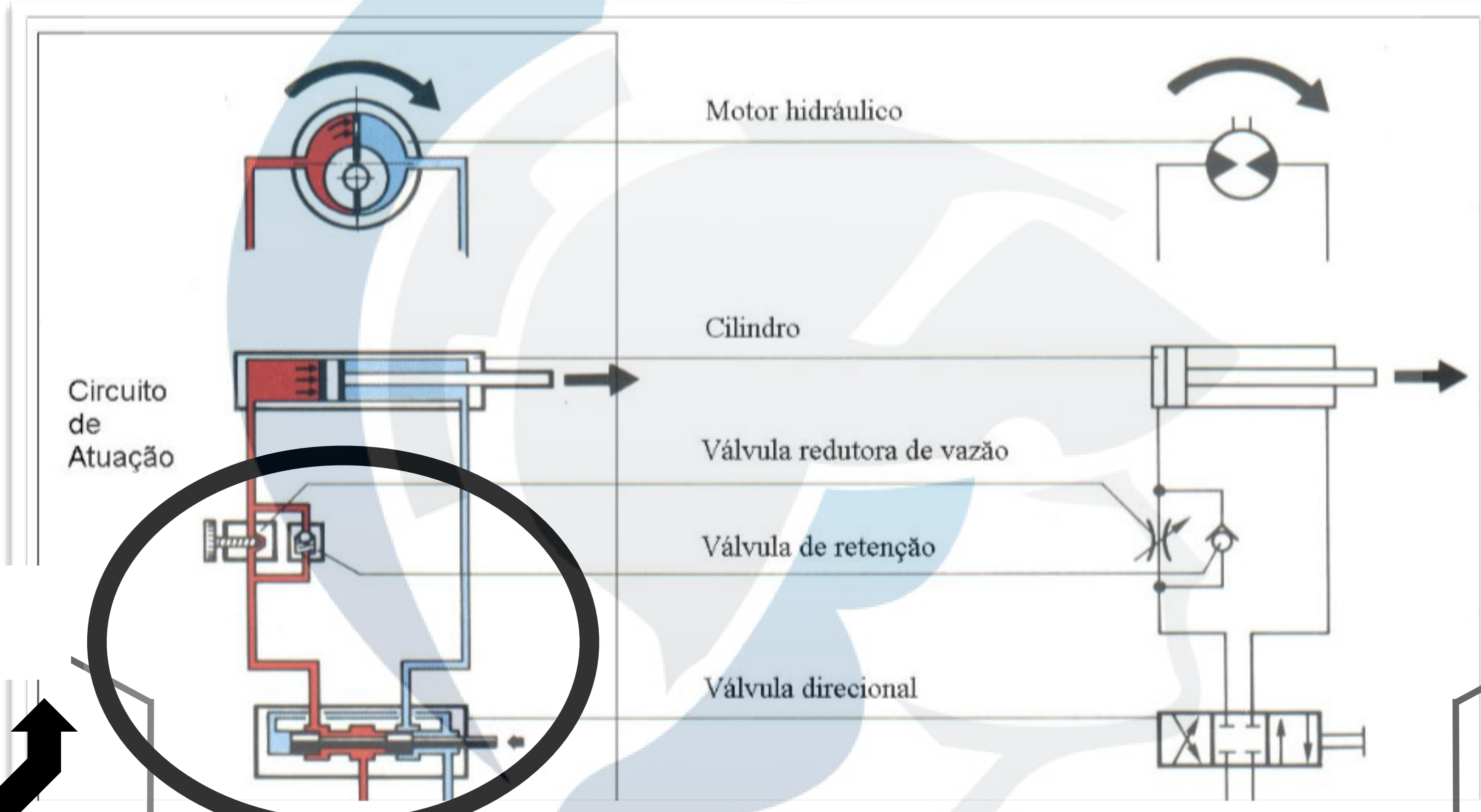

Válvulas

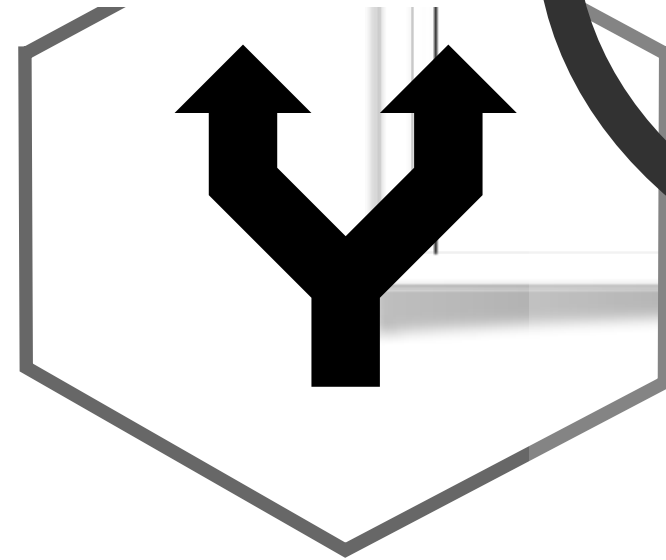

Válvulas de controle direcional

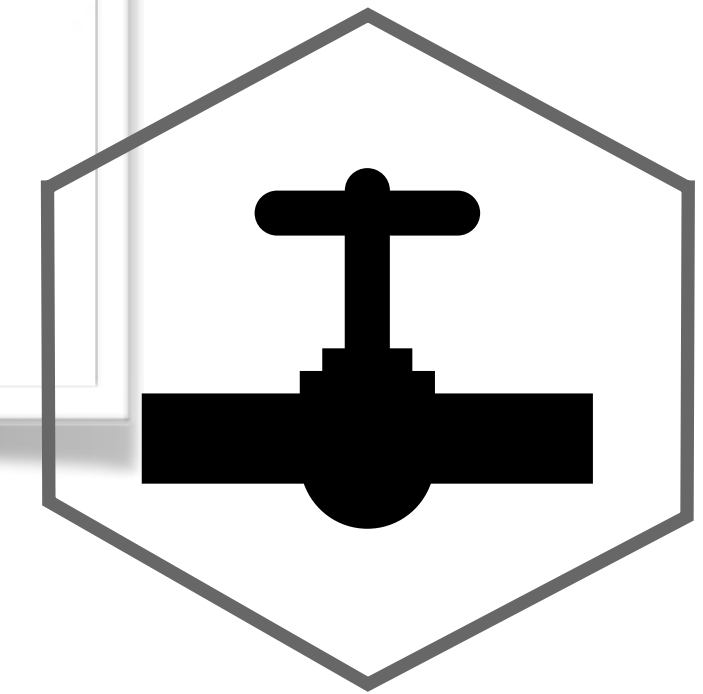

Válvulas auxiliares

Válvula auxiliares

Hidráulica

Pneumática

Conclusão



Simbologia

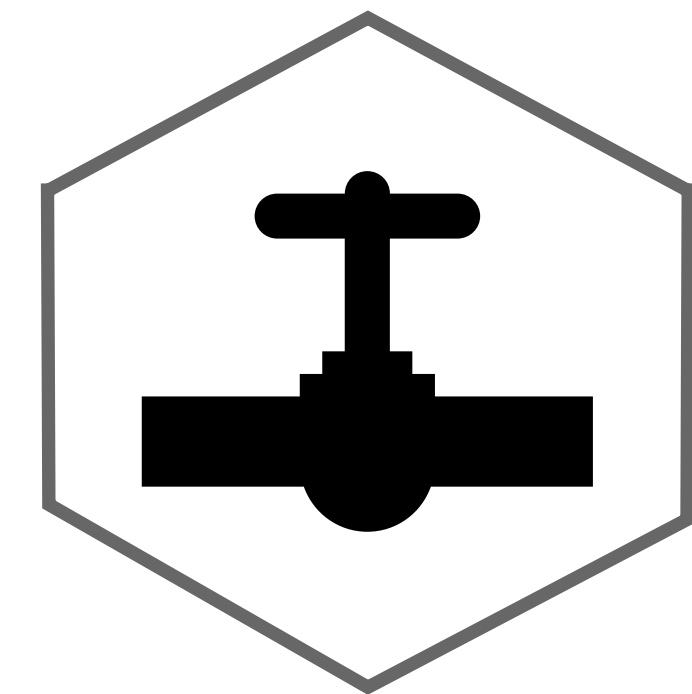
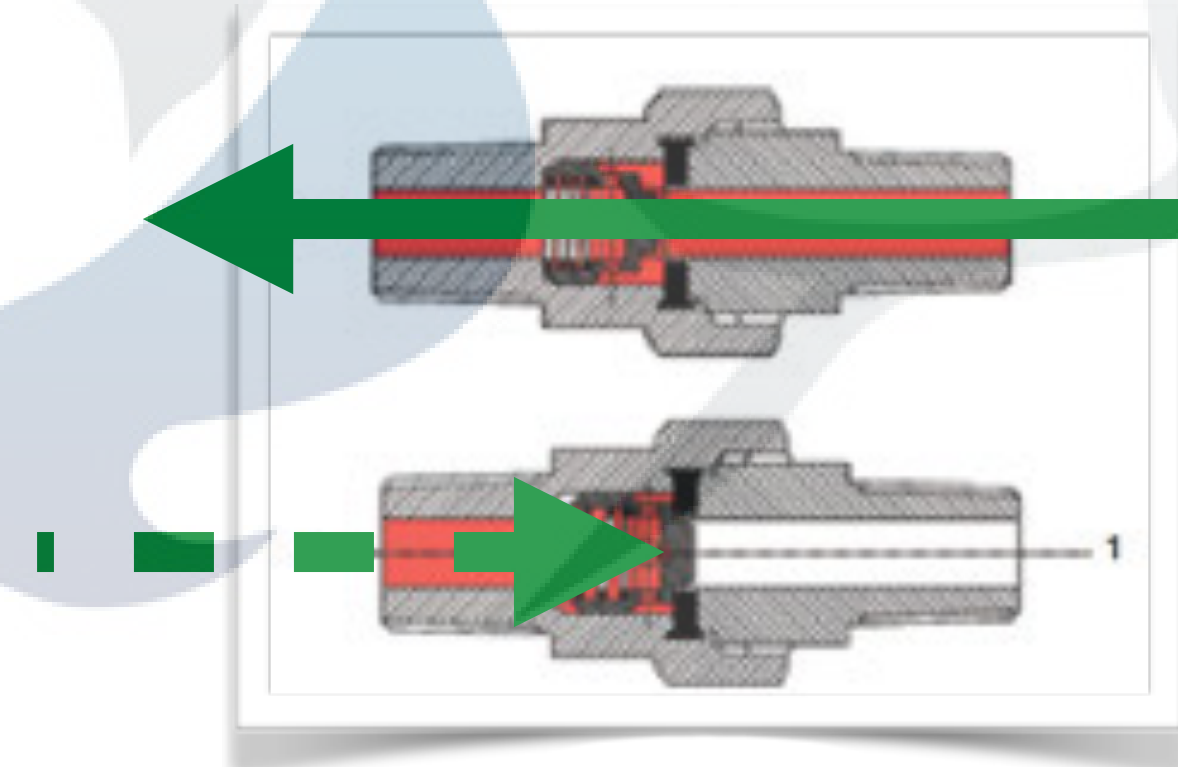
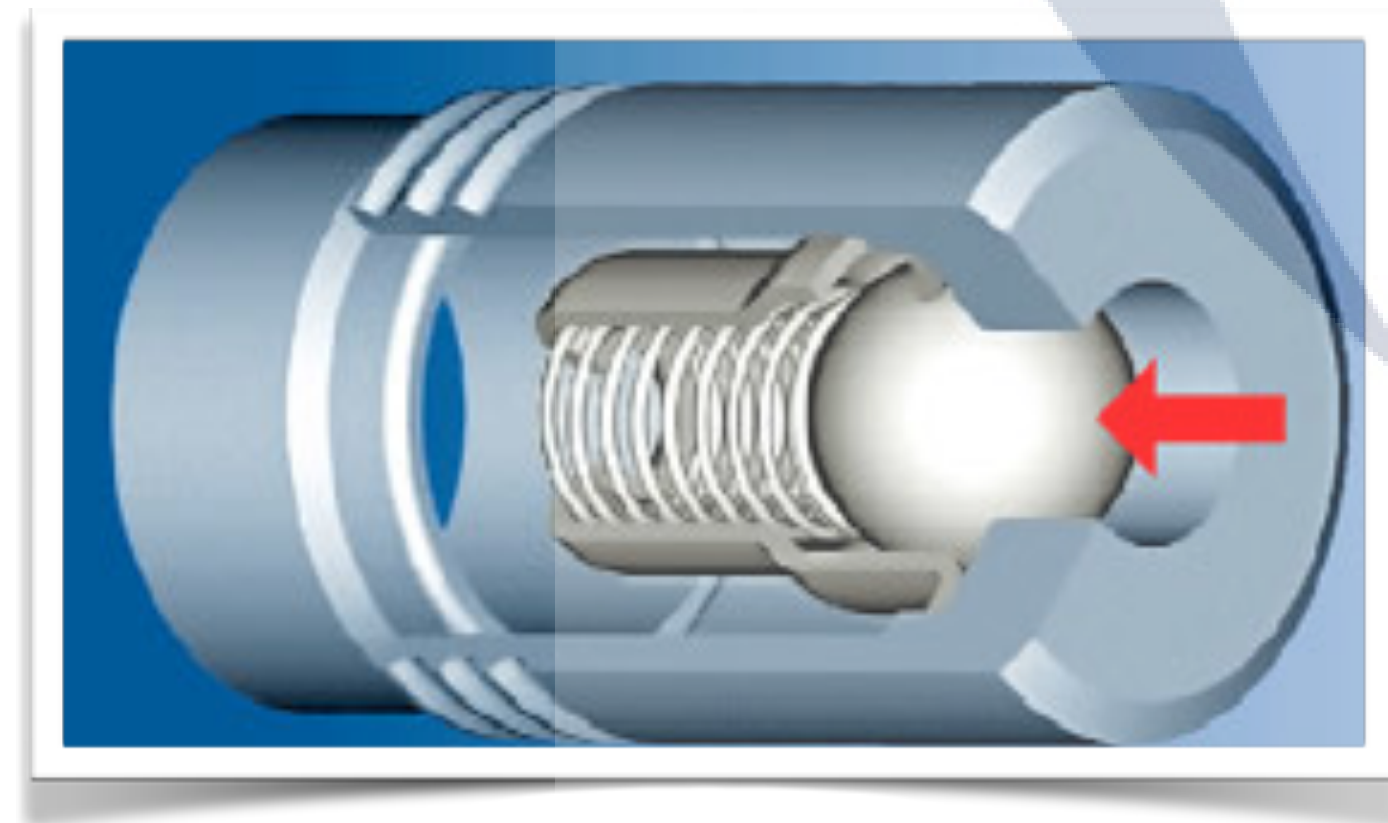

Válvulas auxiliares

Válvula auxiliares

Hidráulica

Pneumática

Conclusão

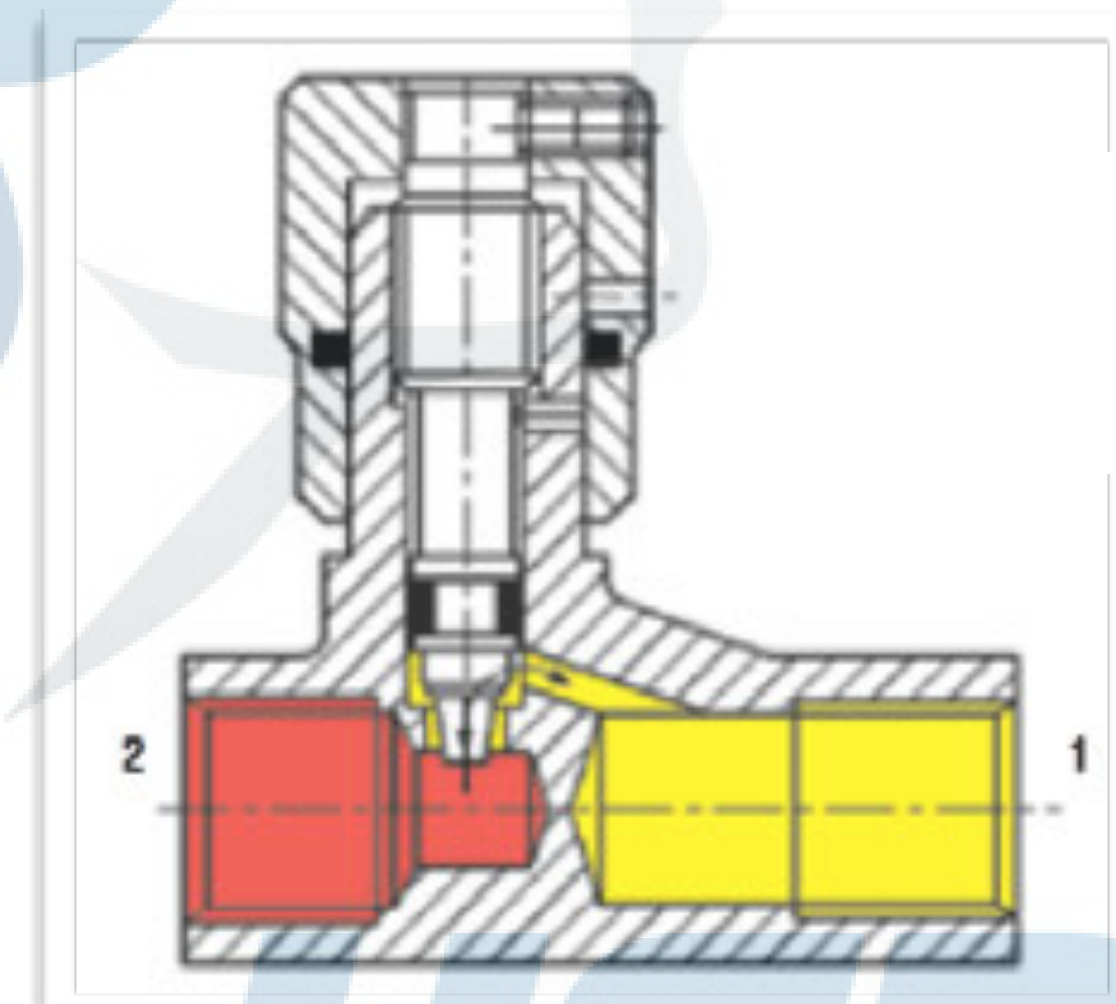

Válvulas direcionais

Hidráulica

Pneumática

Conclusão

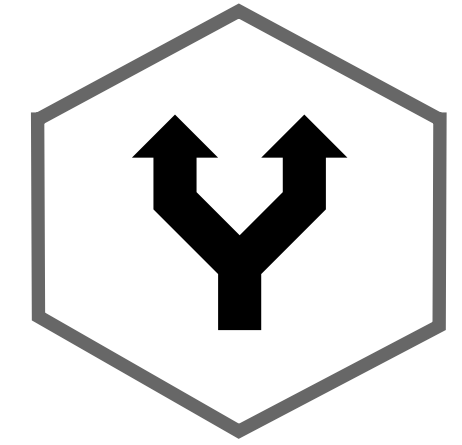

Válvulas direcionais

Hidráulica

Pneumática

Conclusão

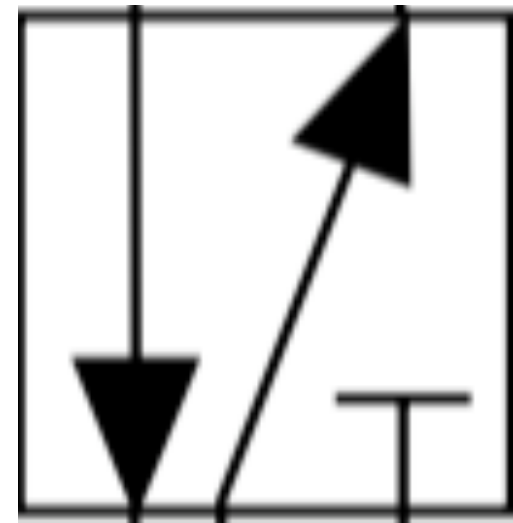

5 vias
(portas)



Posição 2

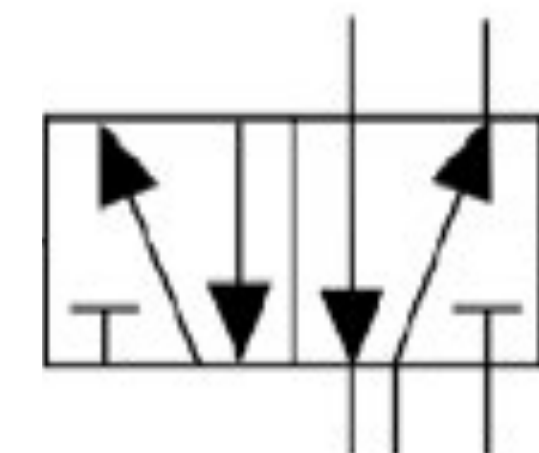
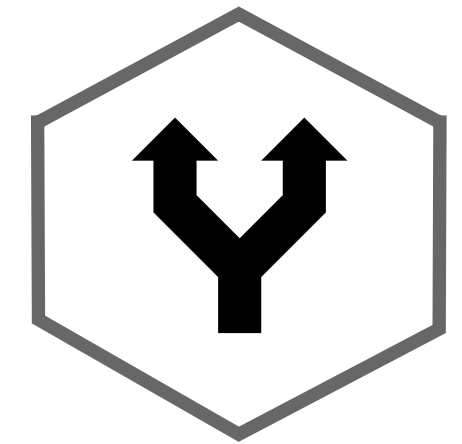
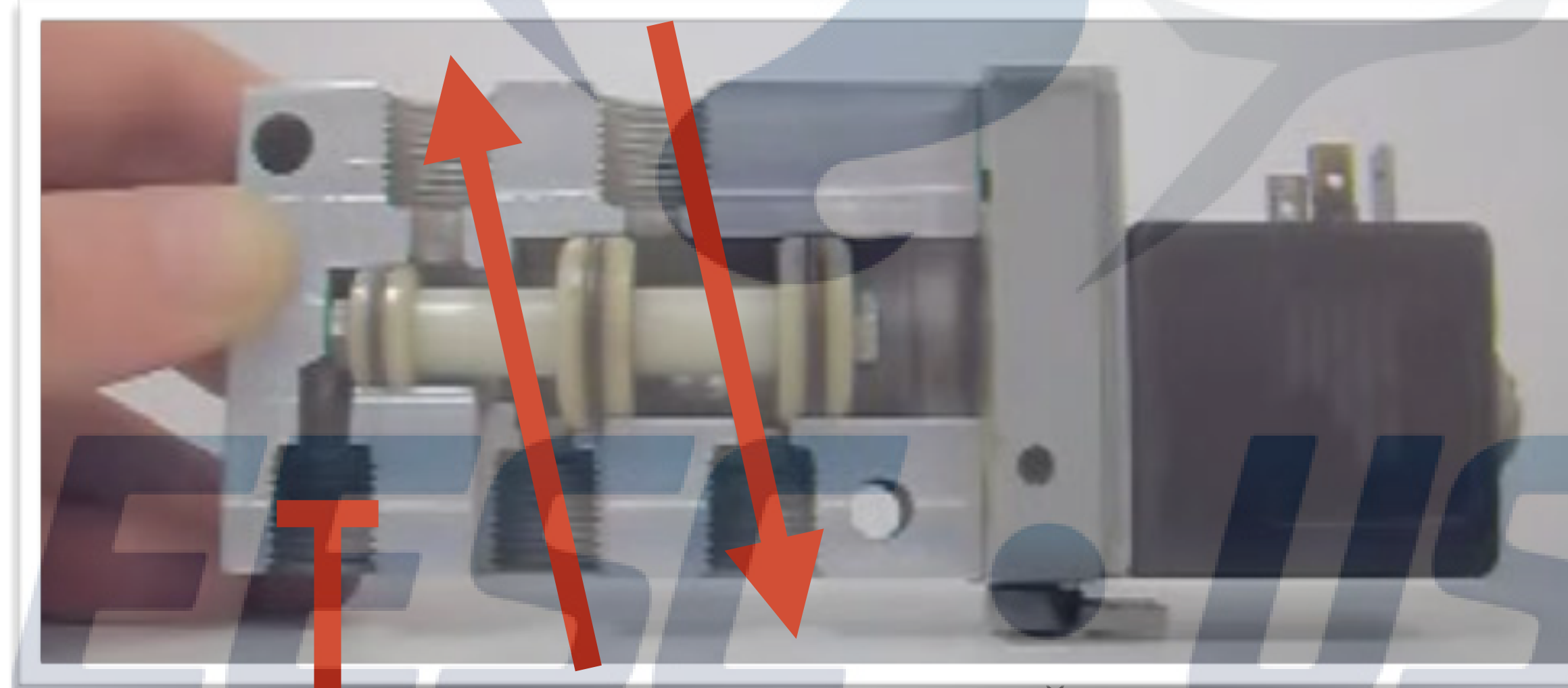

Simbologia

Válvula direcional 5/2

Válvulas direcionais

Hidráulica

Pneumática

Conclusão

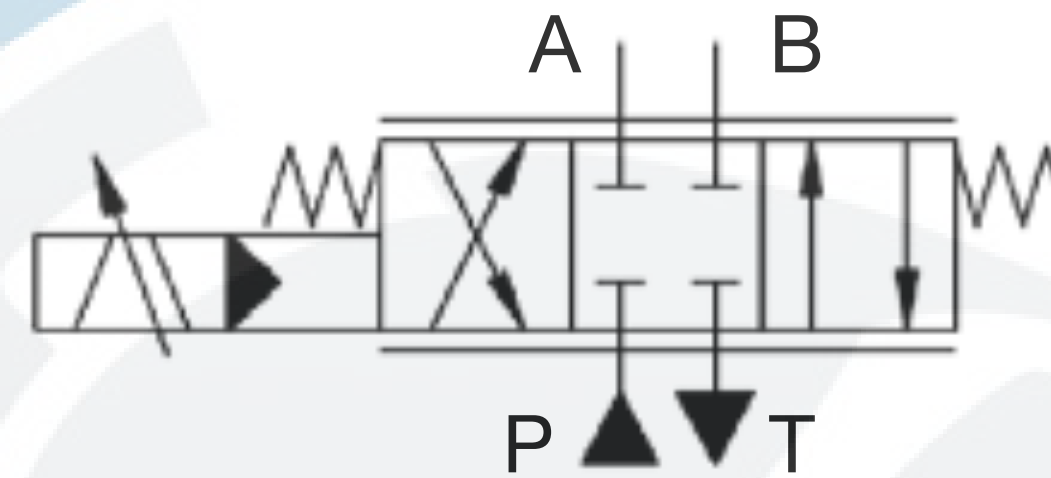
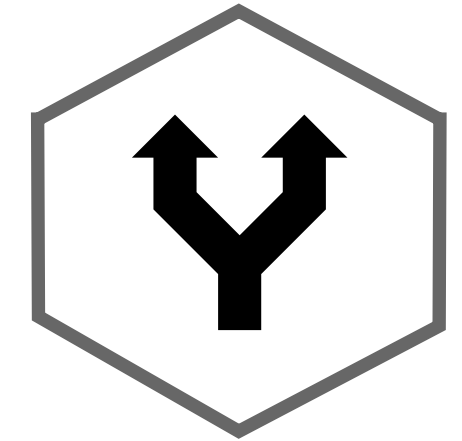

4/3 acionada por **duplo solenóide** e centralização por mola

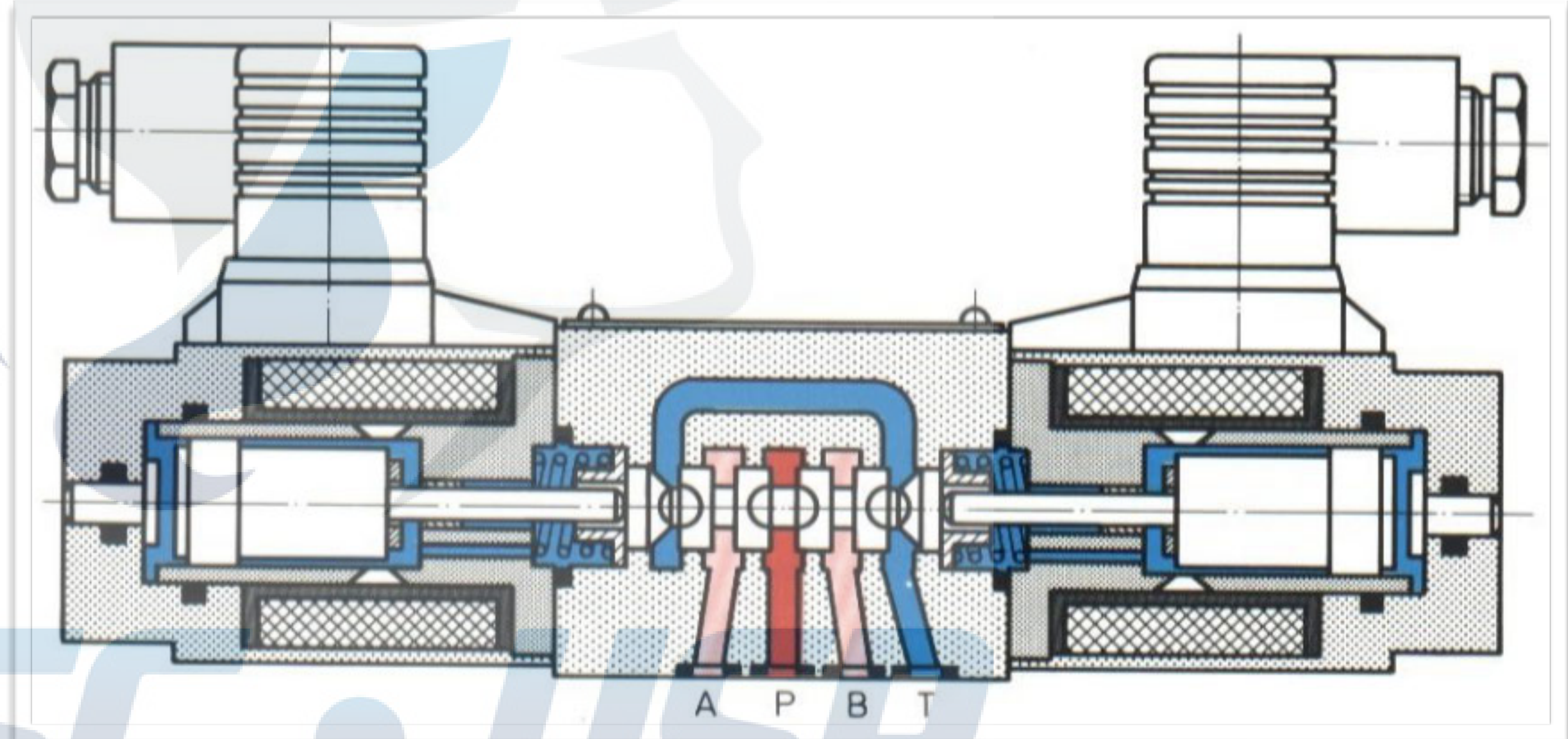
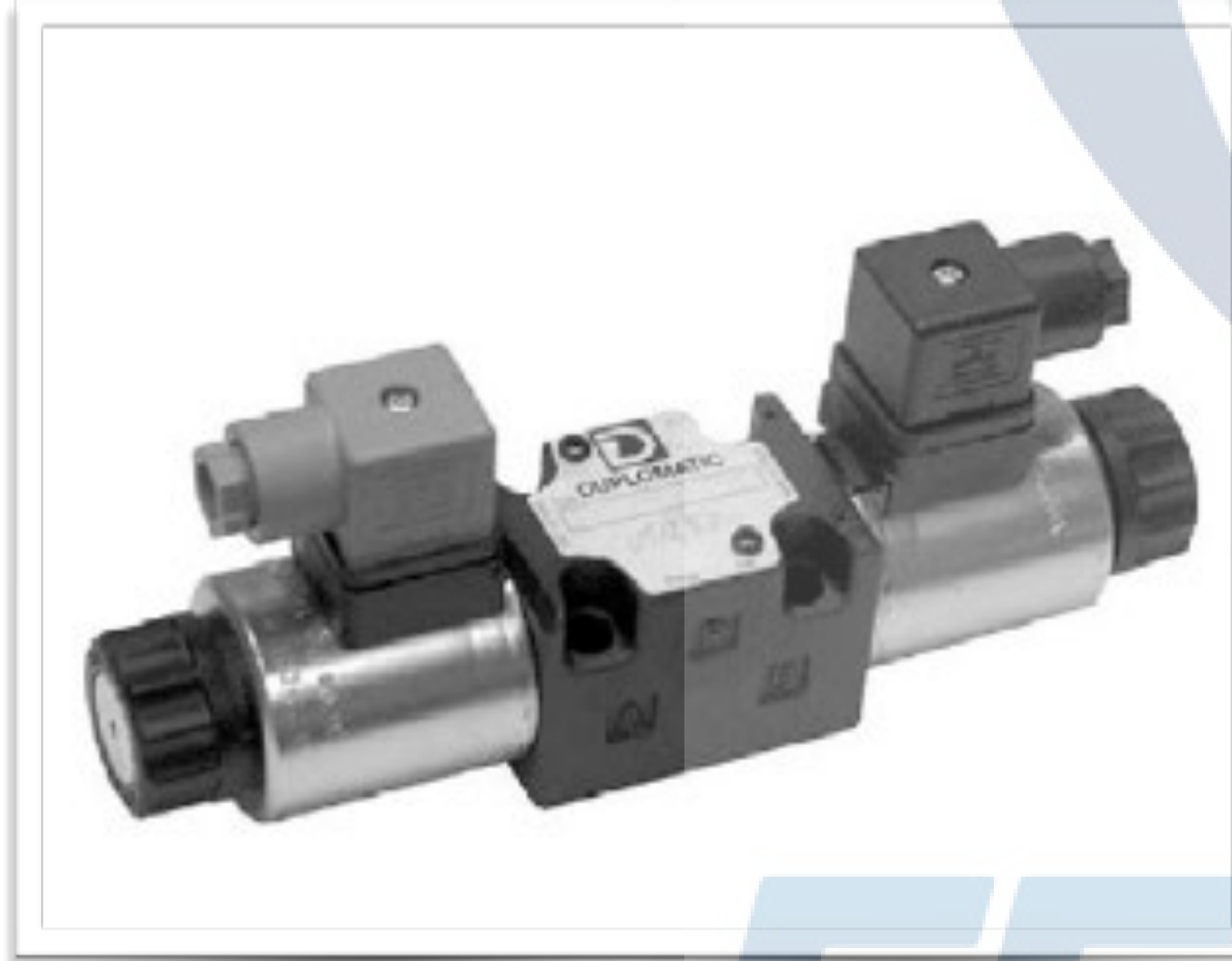

Válvulas direcionais

Hidráulica

Pneumática

Conclusão

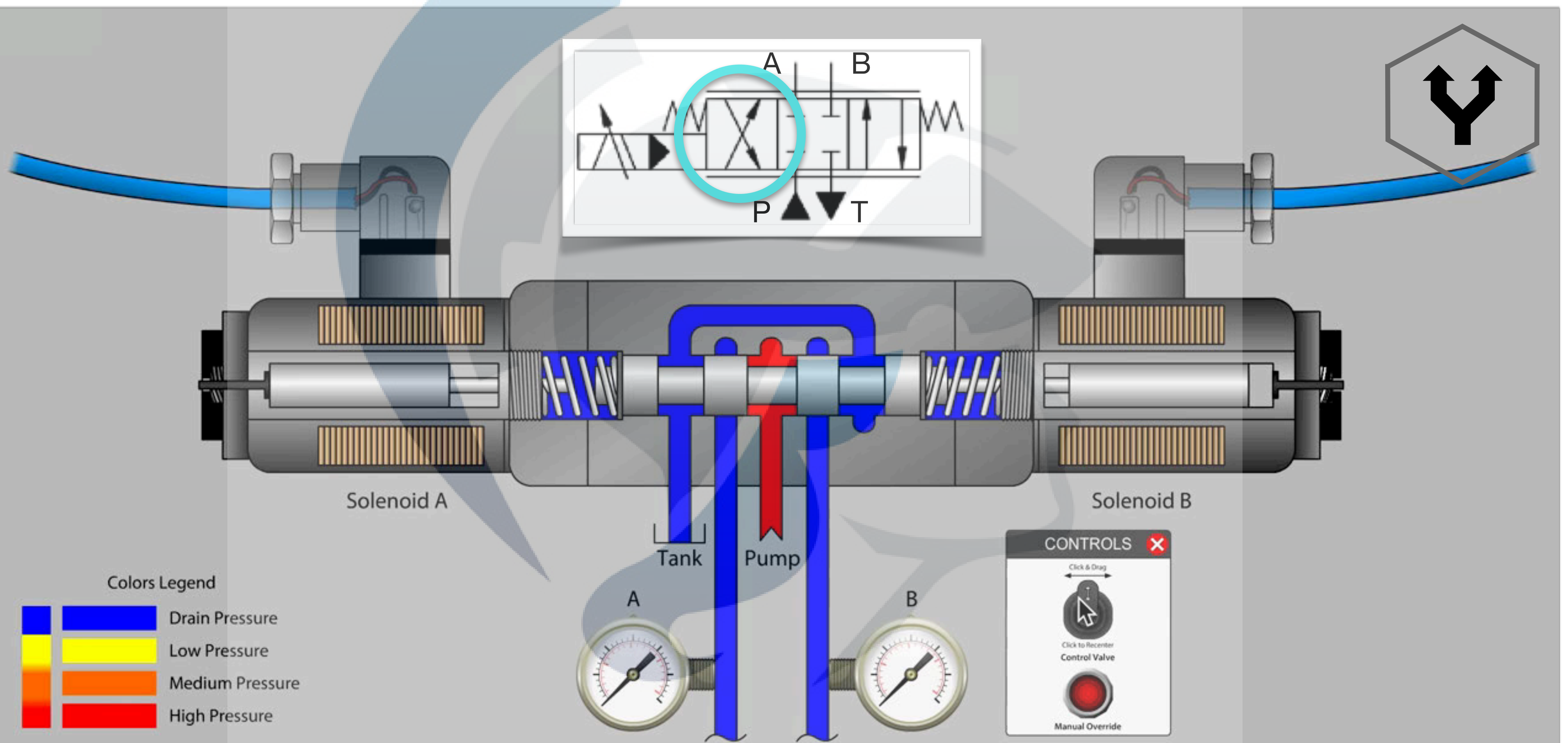

[LunchBoxSessions.com]

Válvulas — Identificação das vias

	Norma DIN 24300			Norma ISO 1219		
Pressão	P			1		
Utilização	A	B	C	2	4	6
Escape	R	S	T	3	5	7
Pilotagem	X	Y	Z	10	12	14

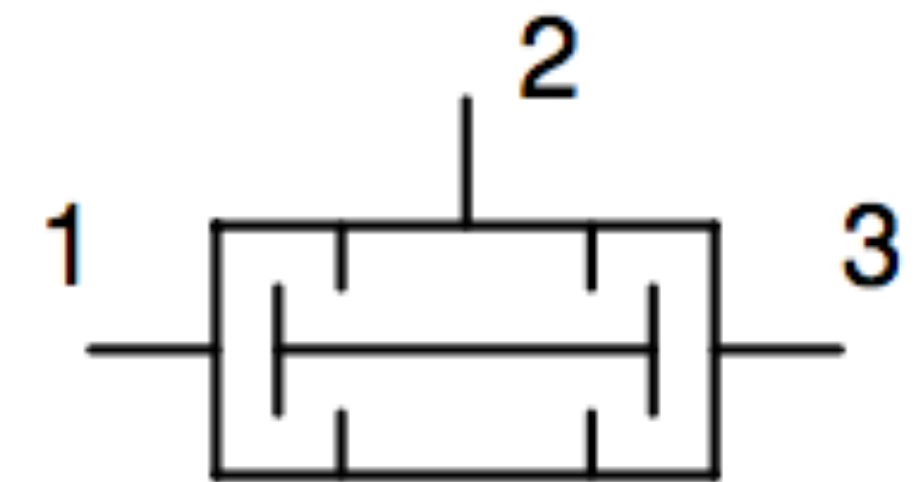
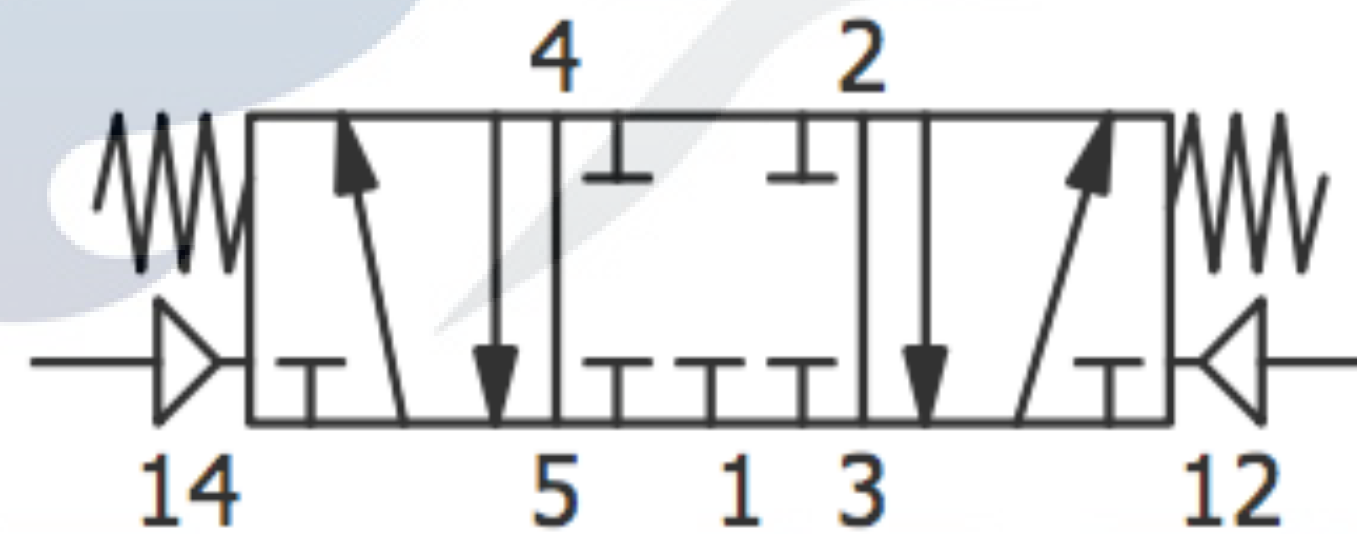
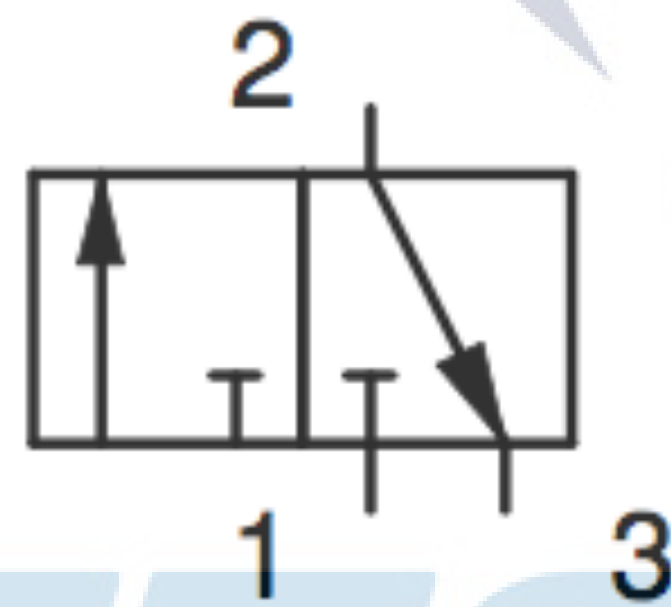
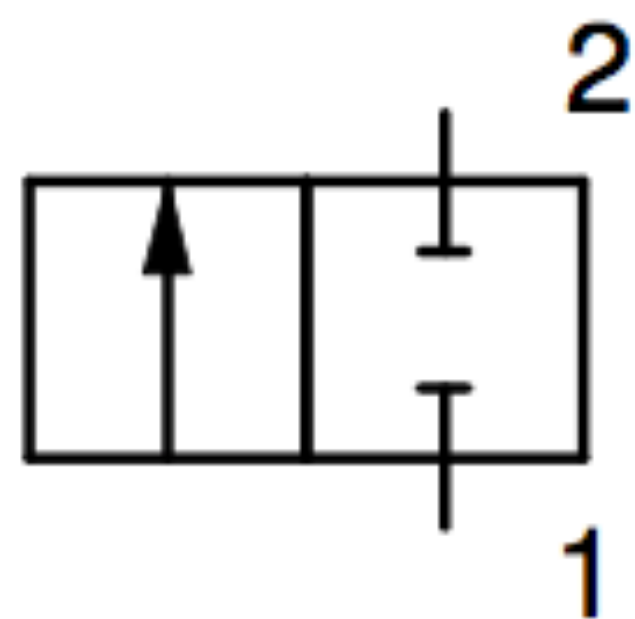

Válvulas — Identificação das vias

Hidráulica

Pneumática

Conclusão



Válvulas — Identificação das vias

Hidráulica

Pneumática

Conclusão

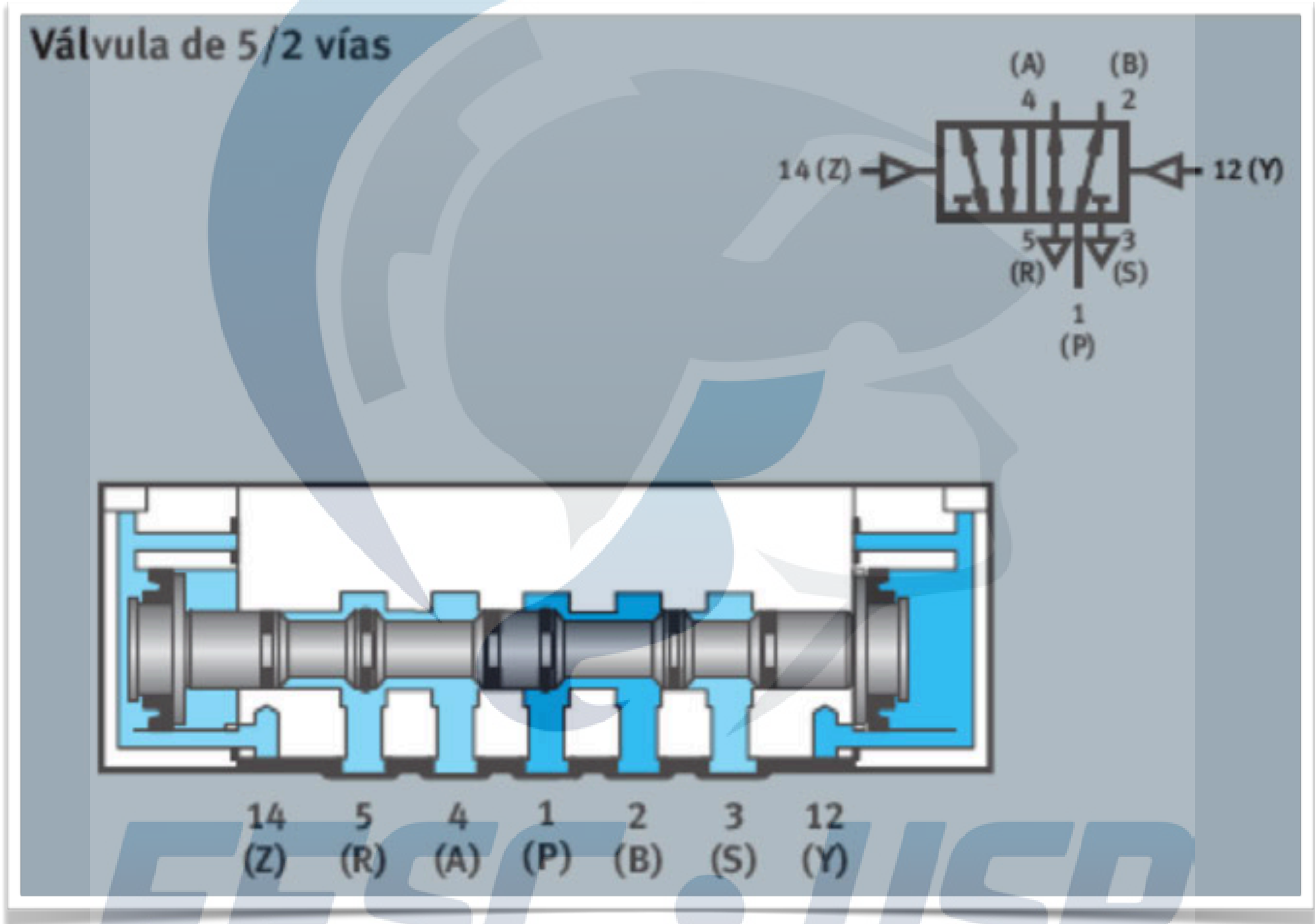

Válvulas direcionais

Hidráulica

Pneumática

Conclusão

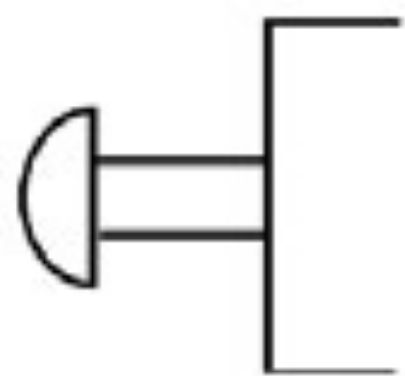
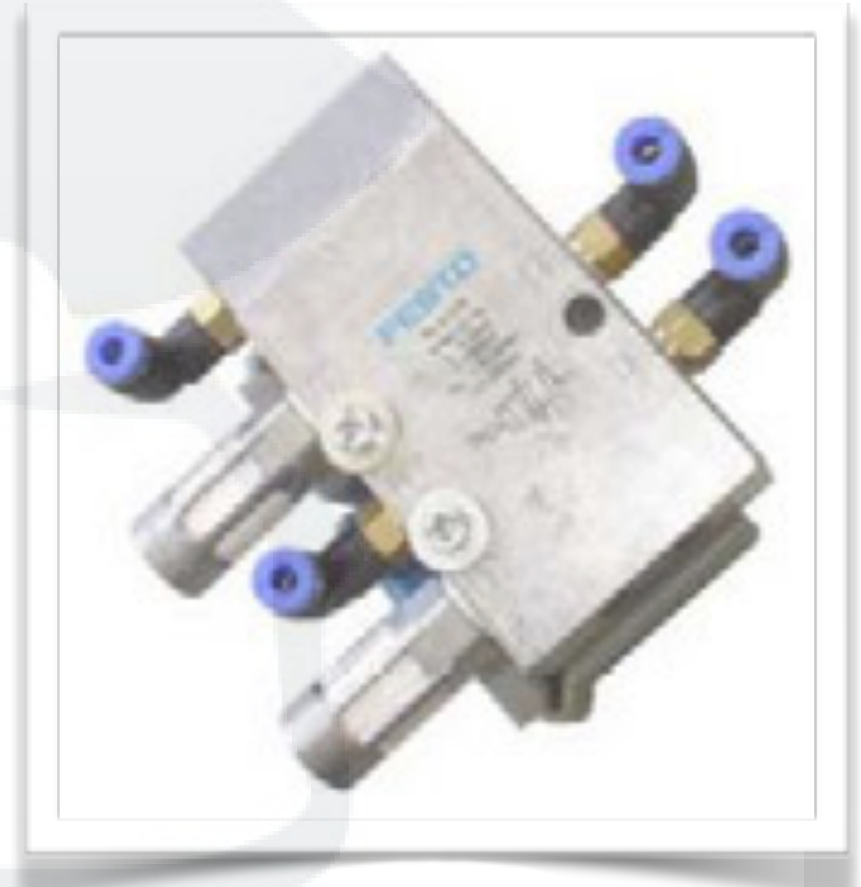
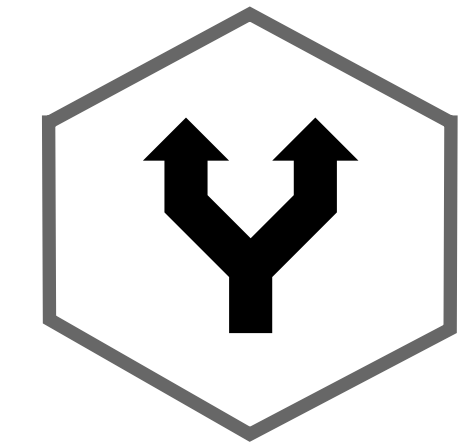

Simbologia



Simbologia

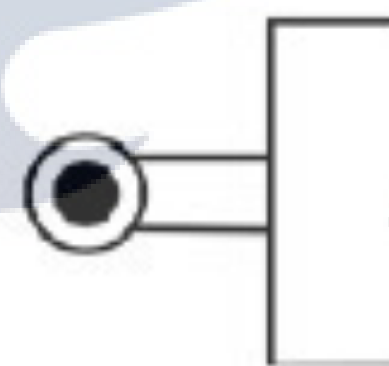

Simbologia



Simbologia

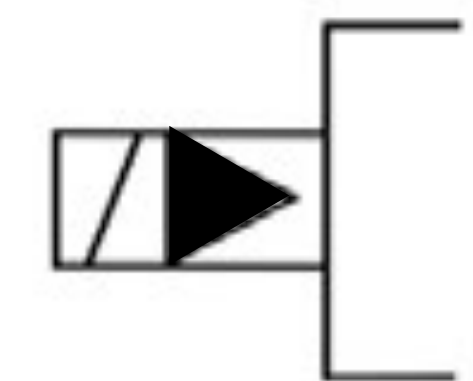

Simbologia

Válvulas direcionais

Hidráulica

Pneumática

Conclusão

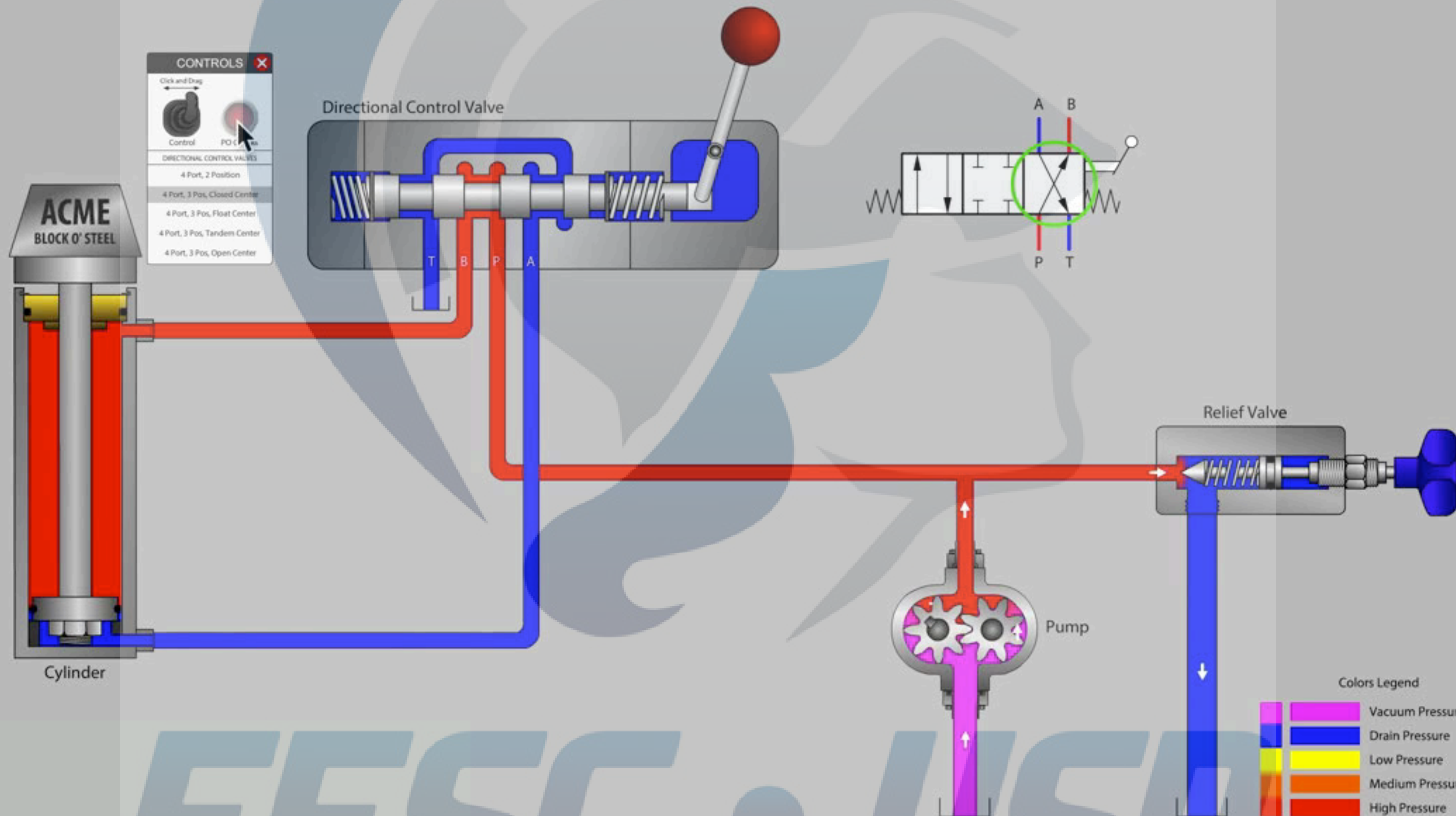

Válvulas on/off

Hidráulica

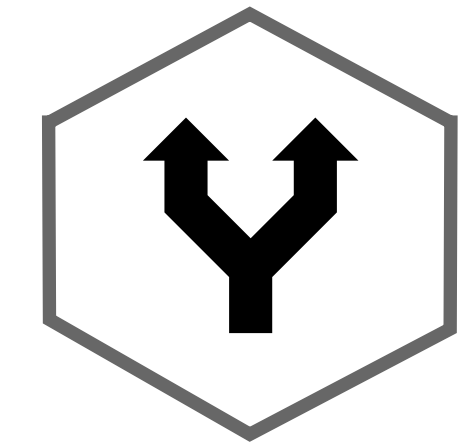
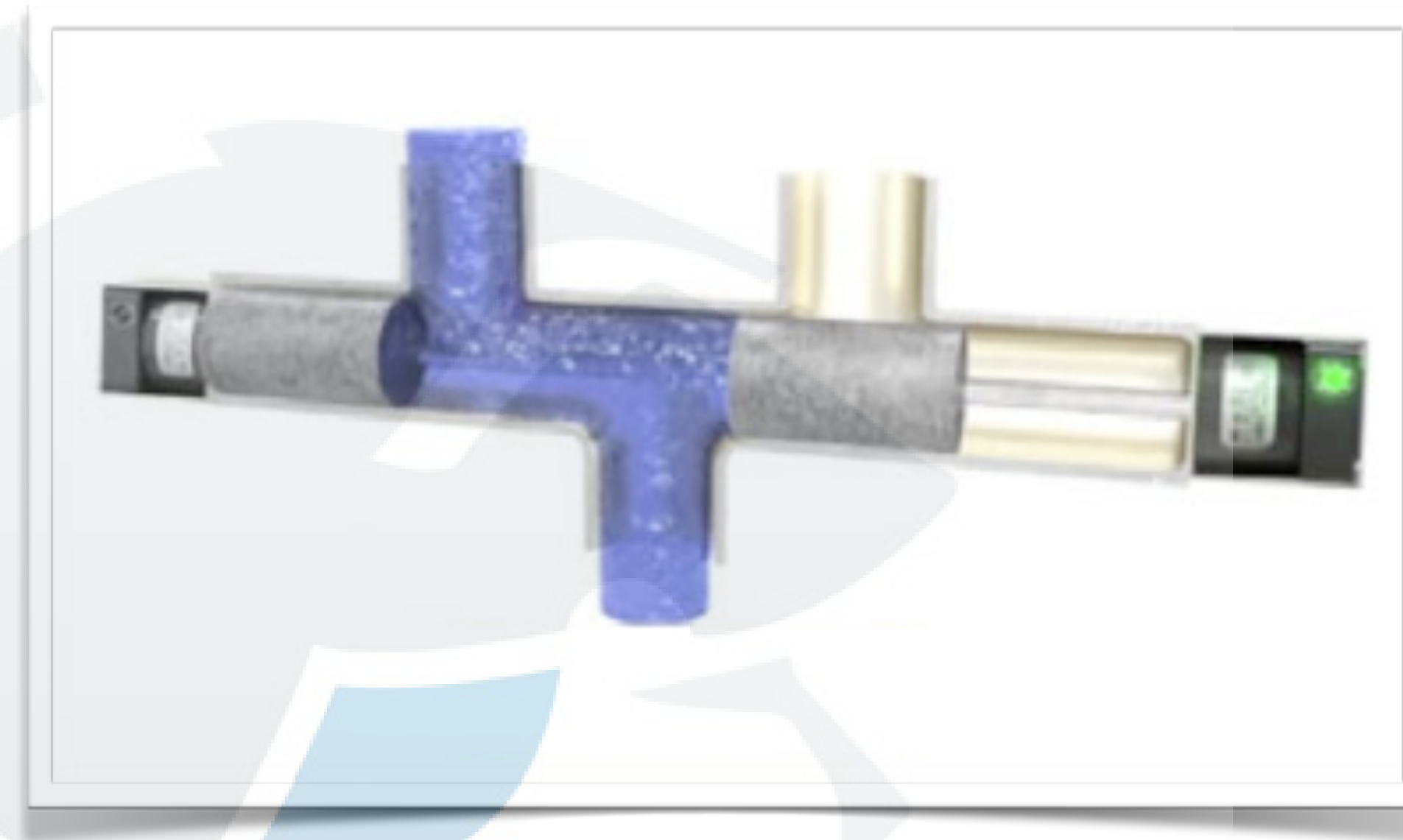
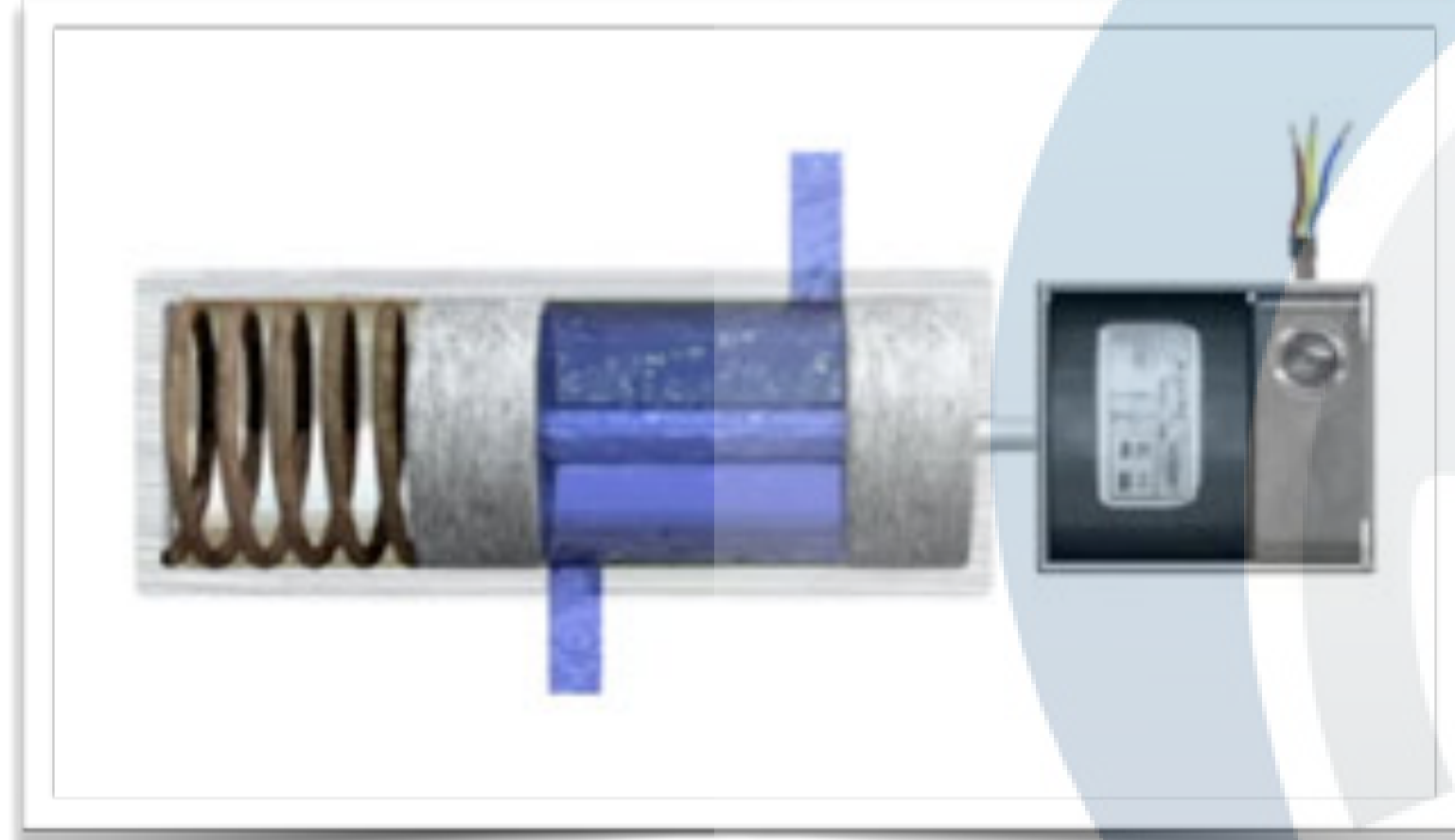

Pneumática



Baixo custo



Design simples

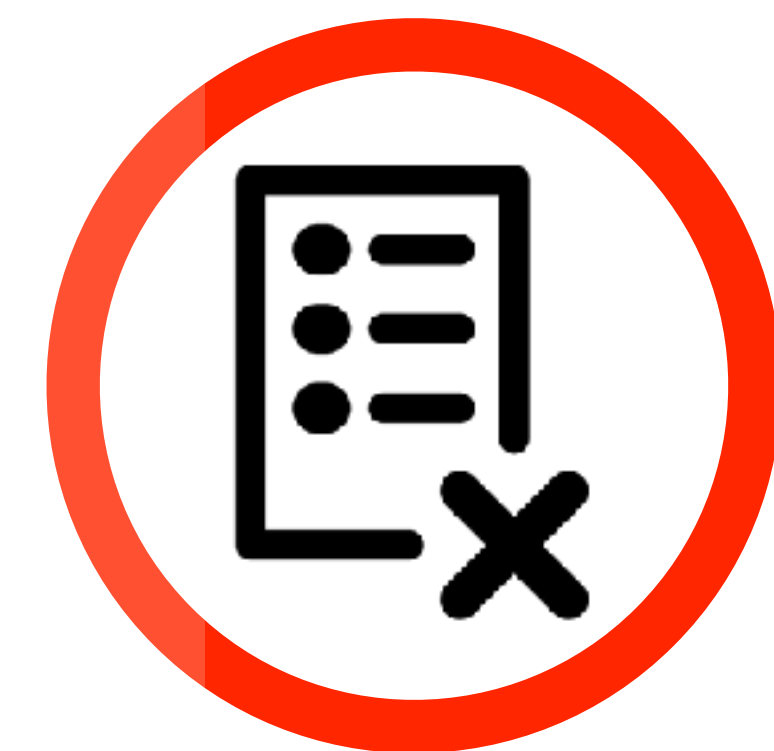

Inflexibilidade

Conclusão

Válvulas proporcionais

Hidráulica

Pneumática

Conclusão

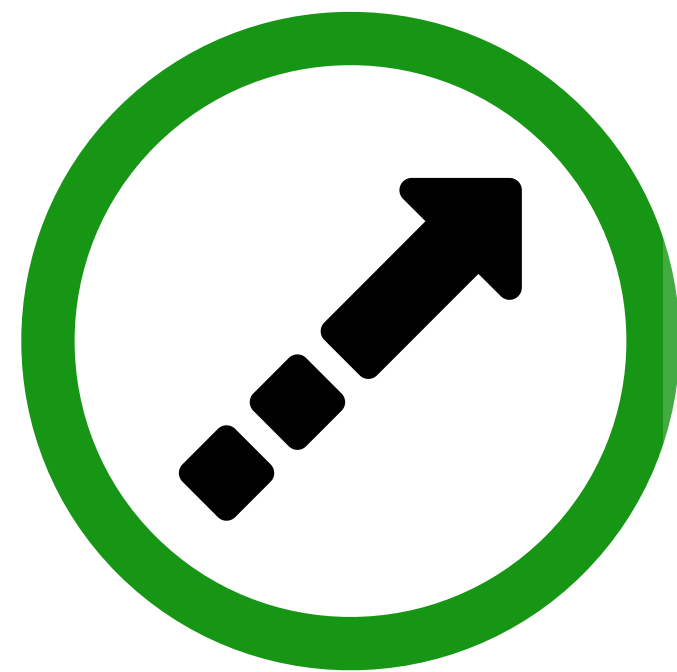
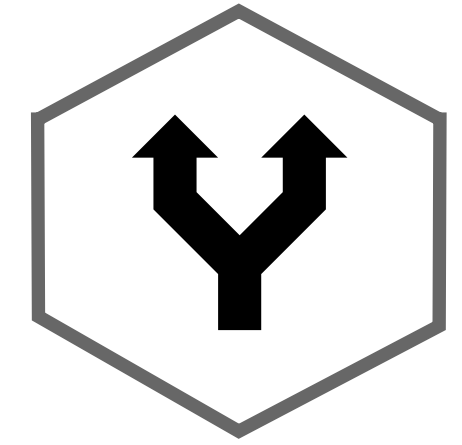
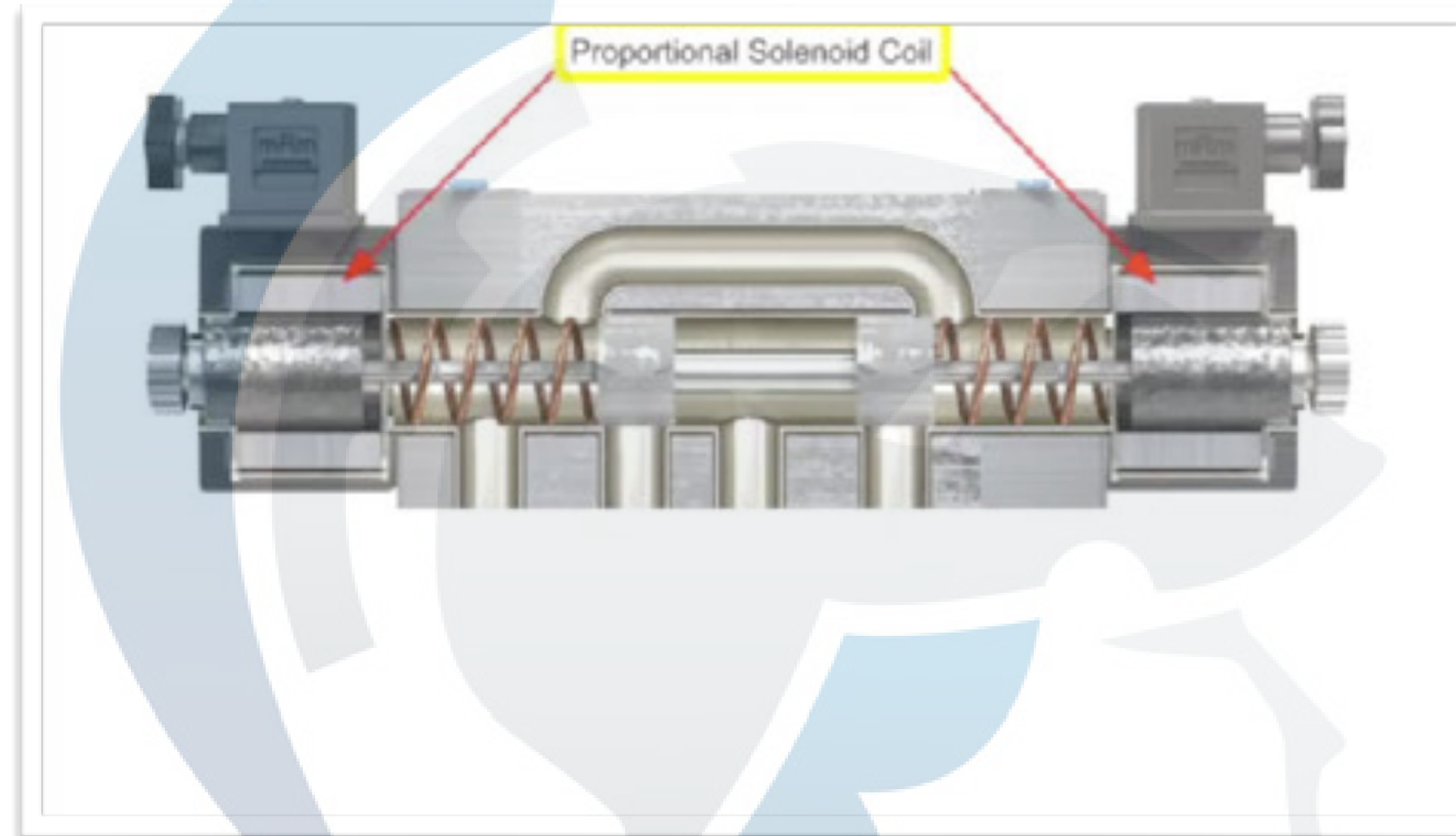

Aceleração gradual



Versatilidade



Baixa Precisão



Largura de banda limitada

Servo válvulas

Hidráulica

Pneumática

Conclusão

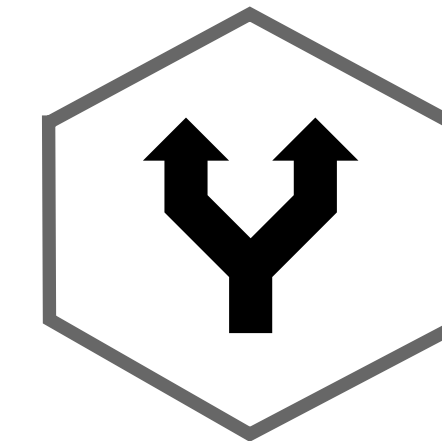
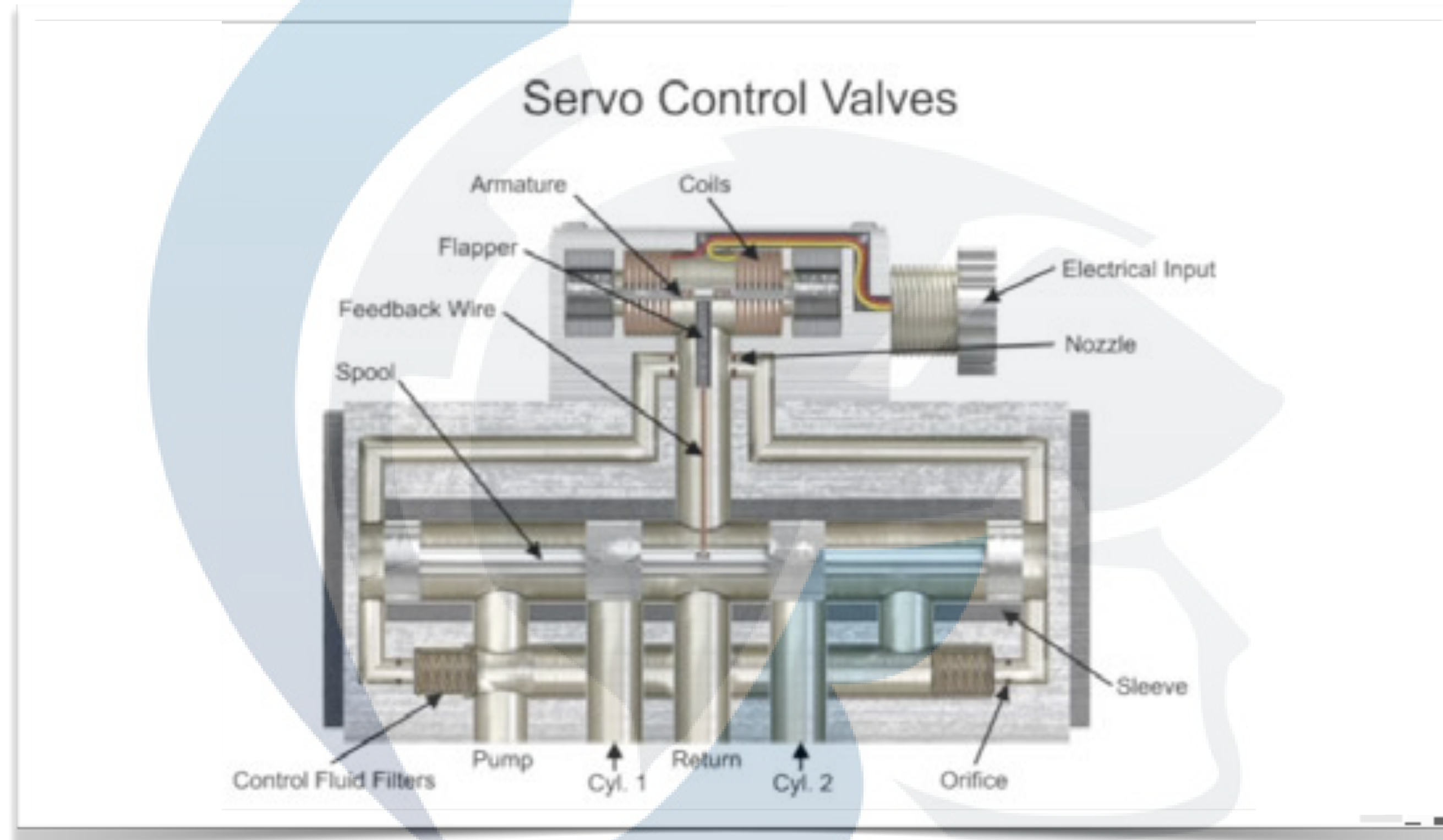

Alta precisão



Largura de banda elevada



Alto custo

Circuito de atuação

Atuadores

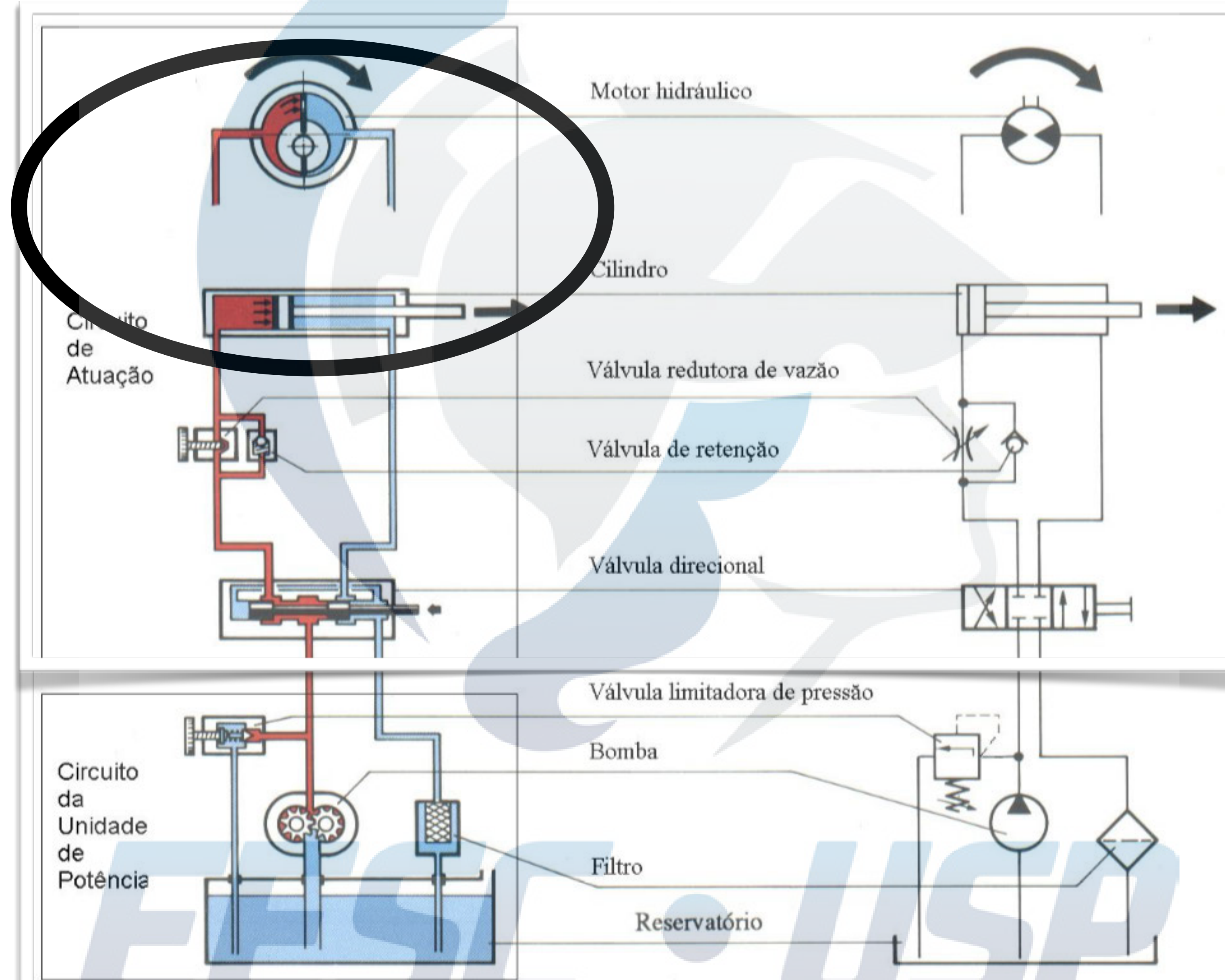

Hidráulica

Pneumática

Conclusão

Atuadores

Hidráulica

Pneumática

Conclusão

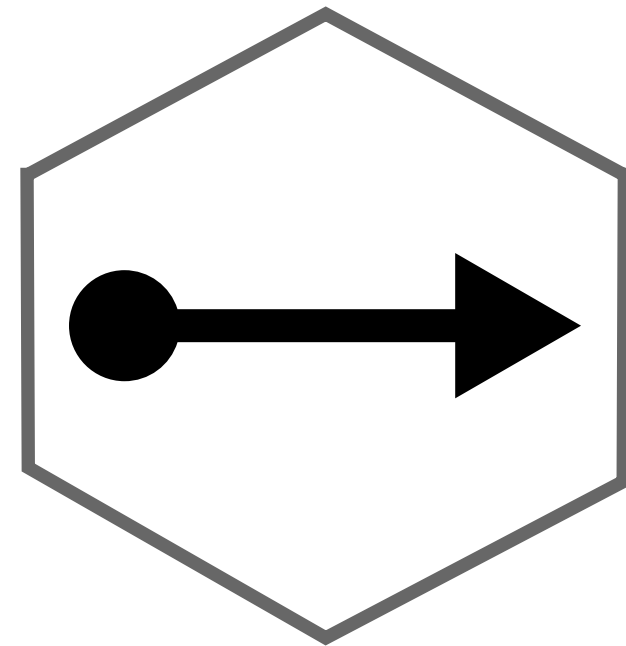

Lineares



Oscilantes



Rotativos

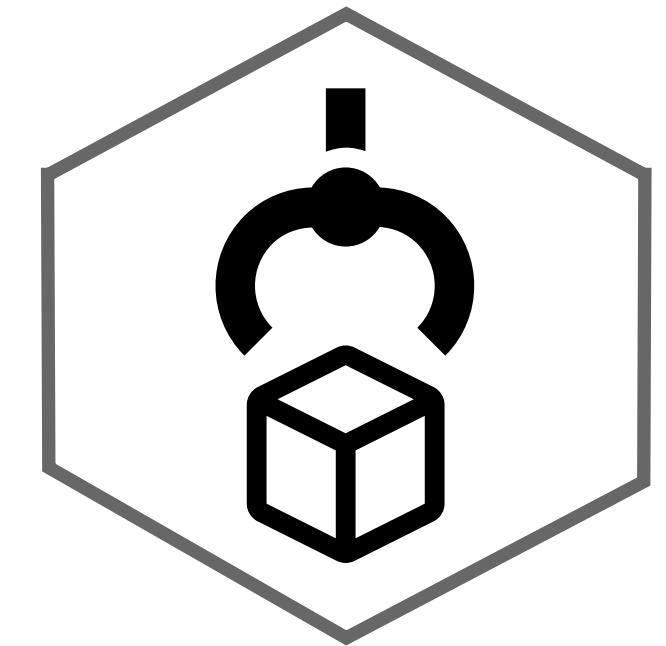

Especiais

Cilindros hidráulicos

Hidráulica

Pneumática

Conclusão

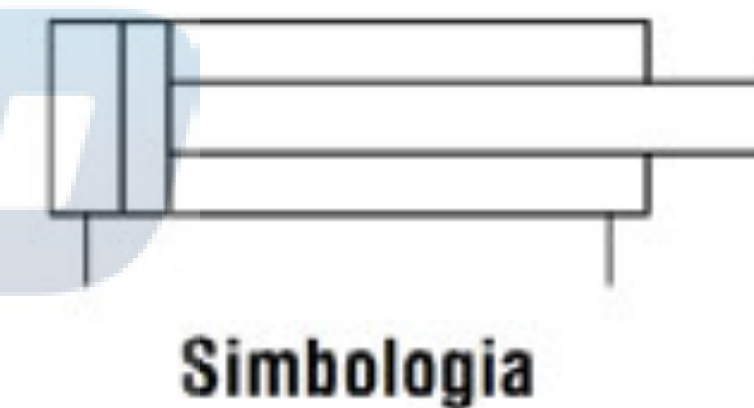
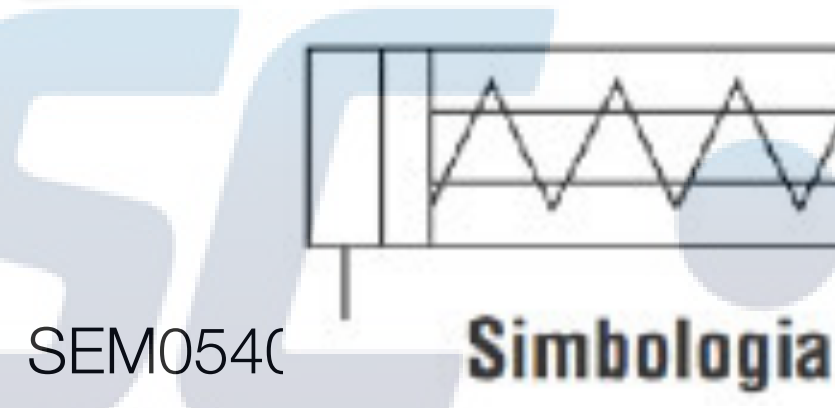
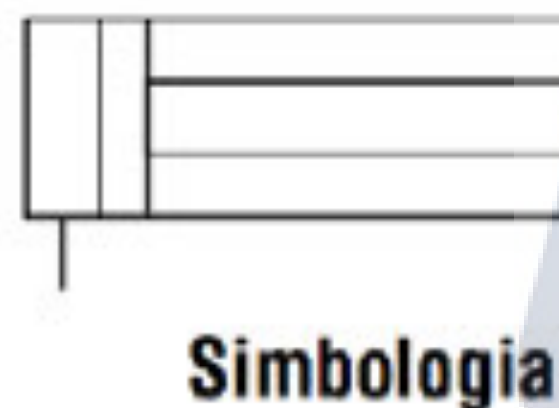
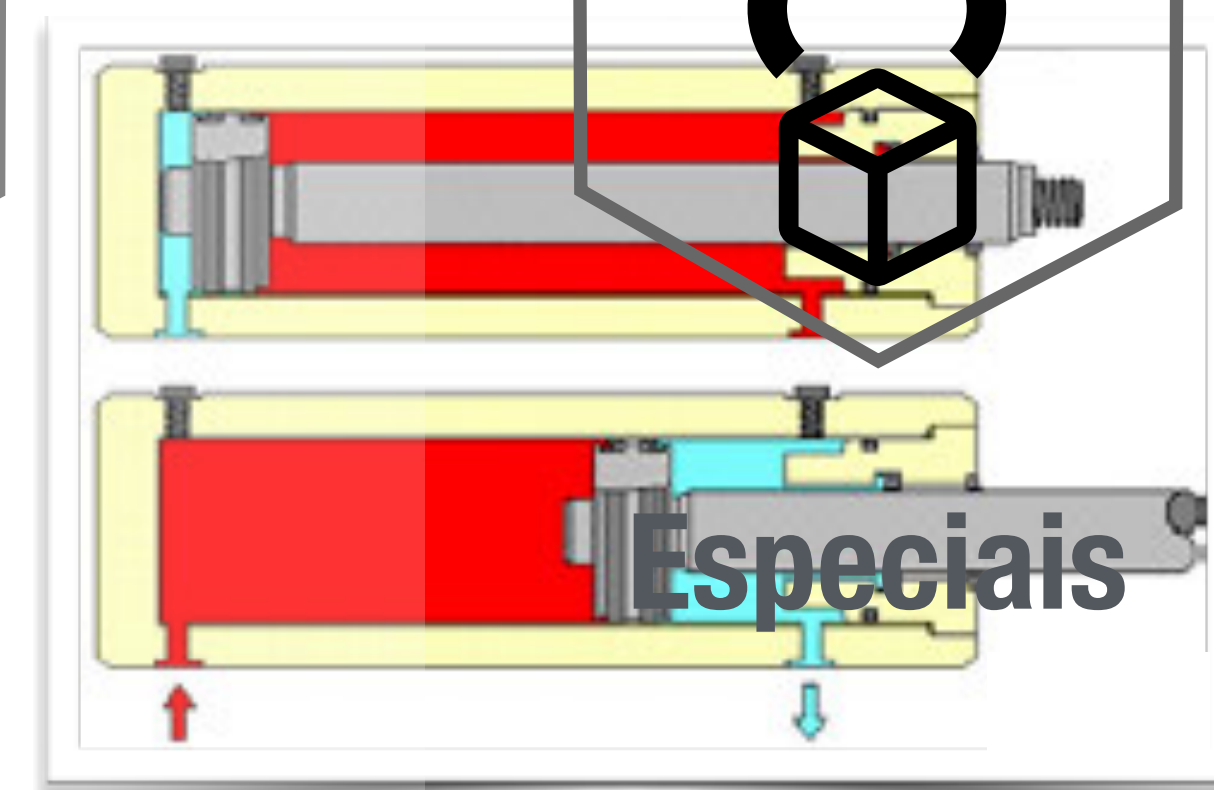
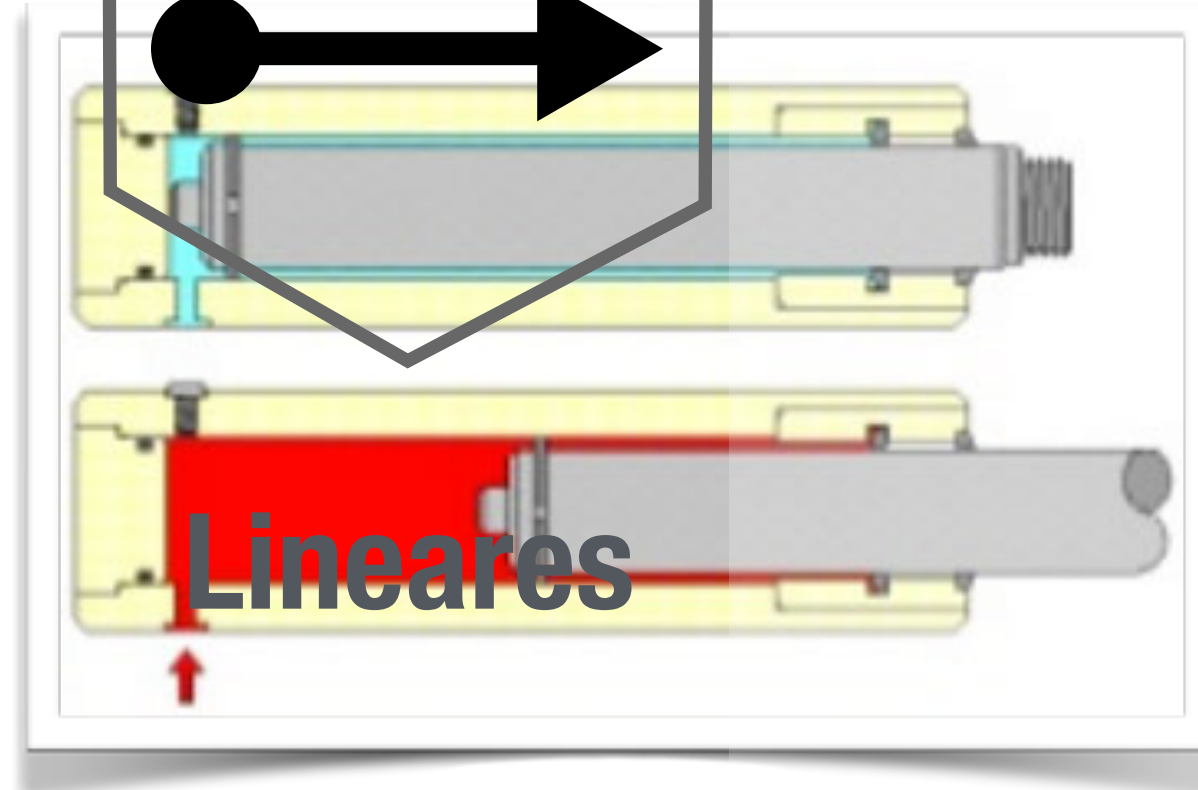
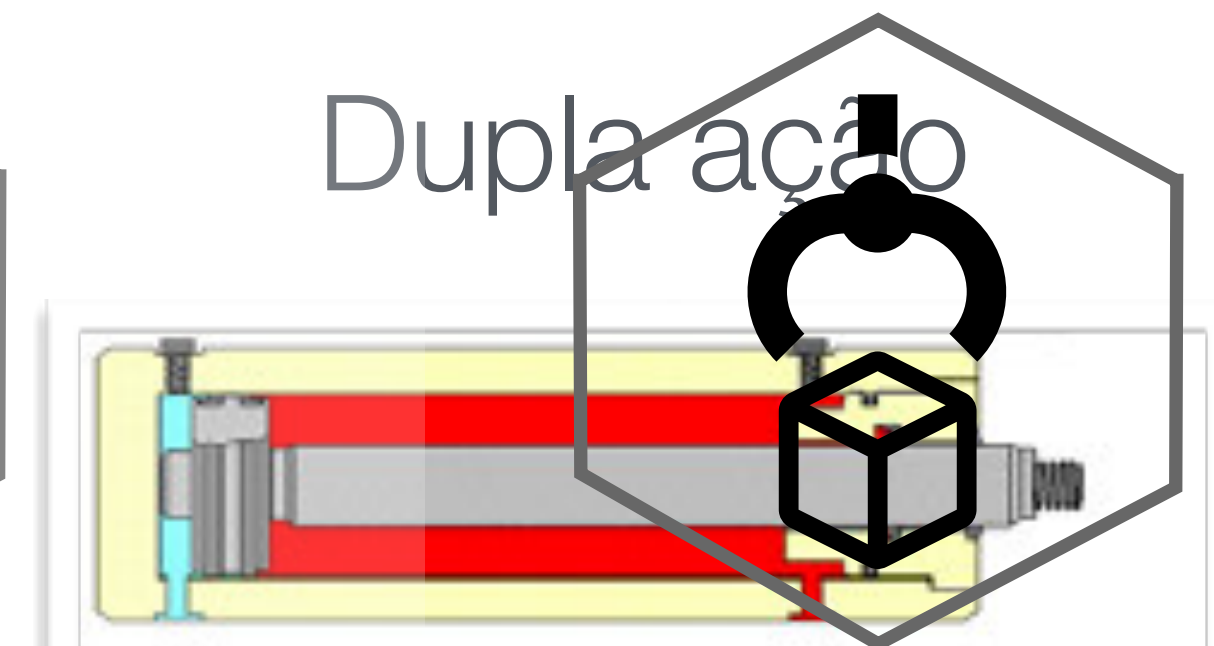
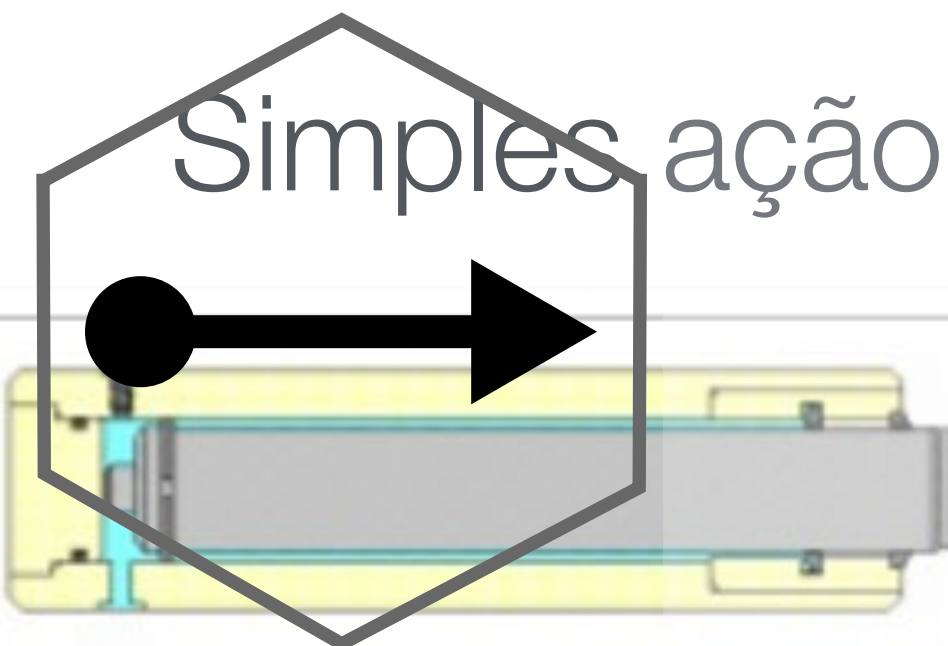

Cilindros hidráulicos

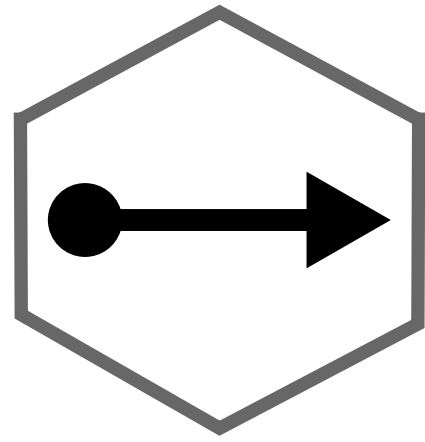

Hidráulica

Pneumática

Conclusão



Haste dupla

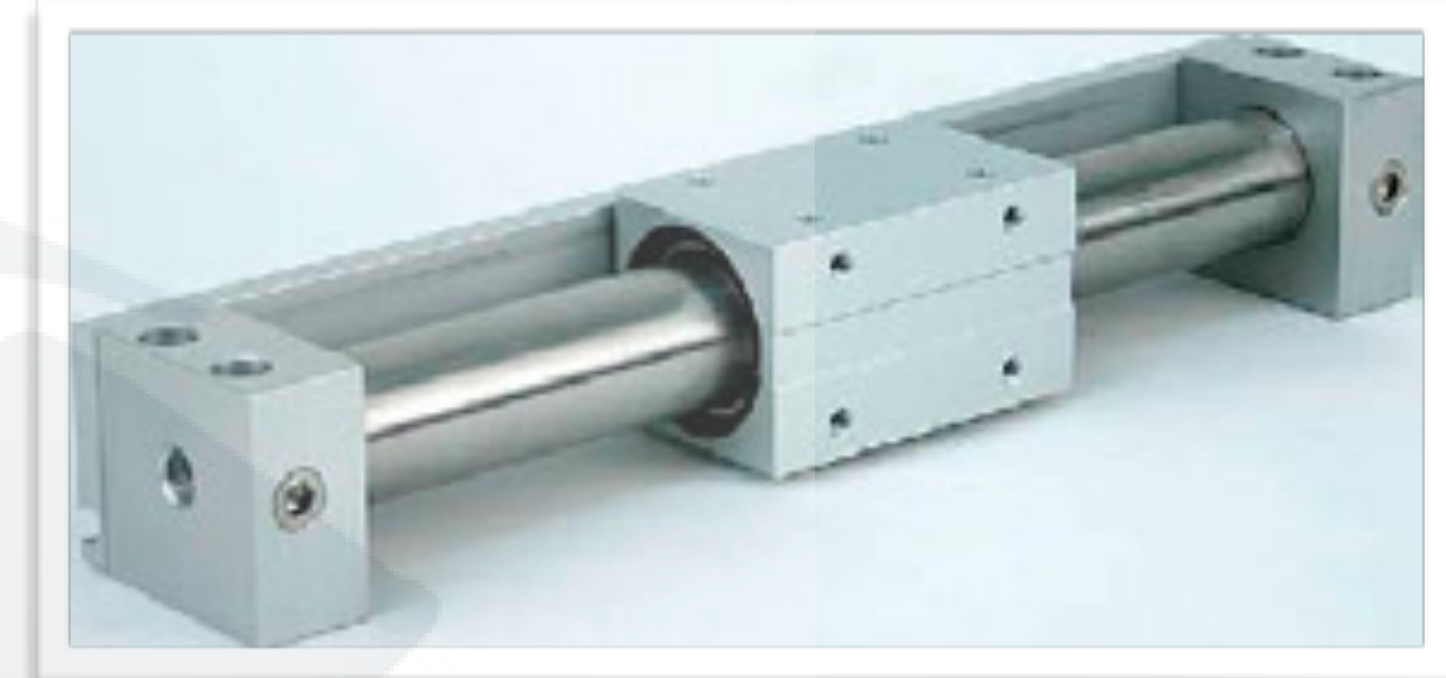

Sem haste

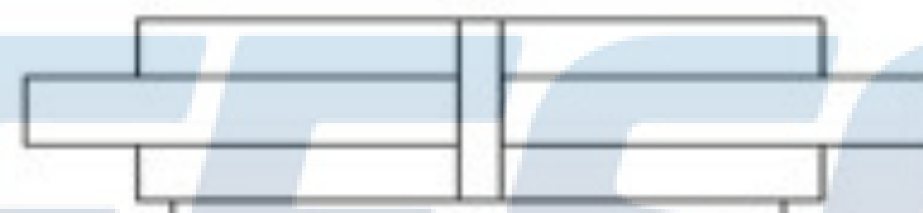
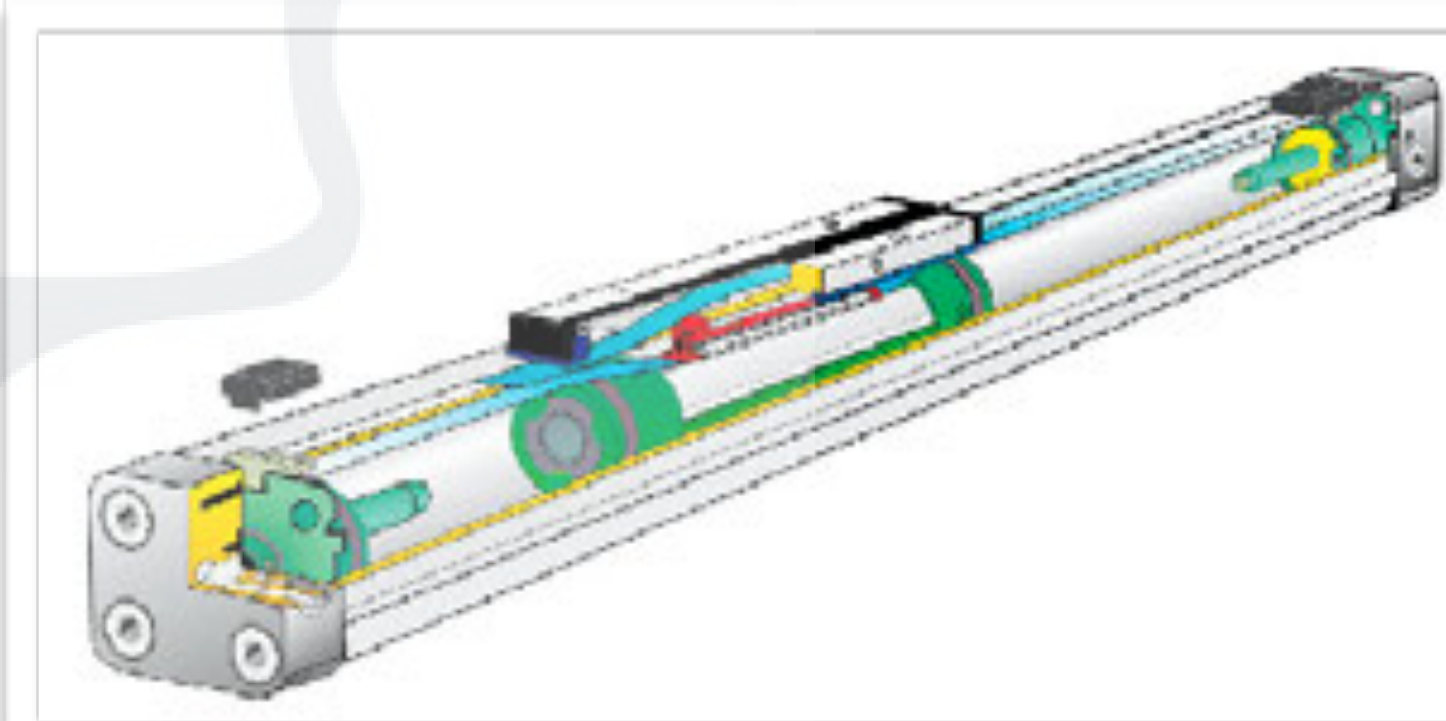
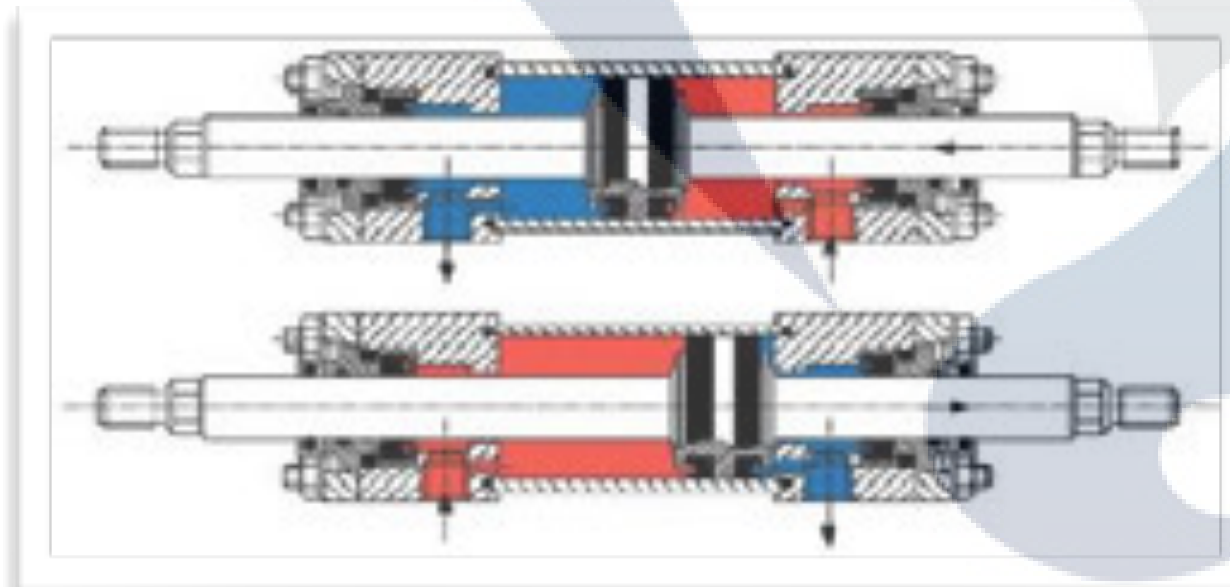

Simbologia

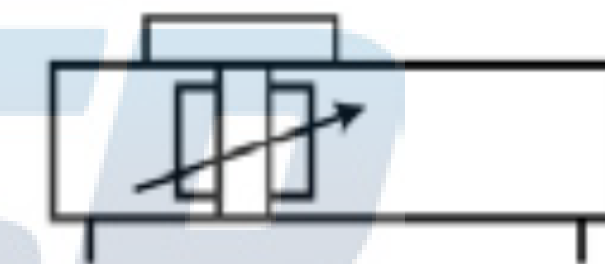

Simbologia

Osciladores hidráulicos

Hidráulica

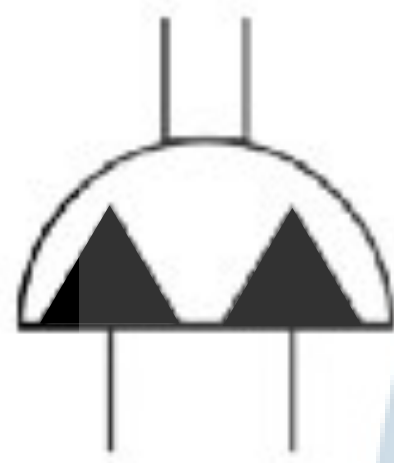
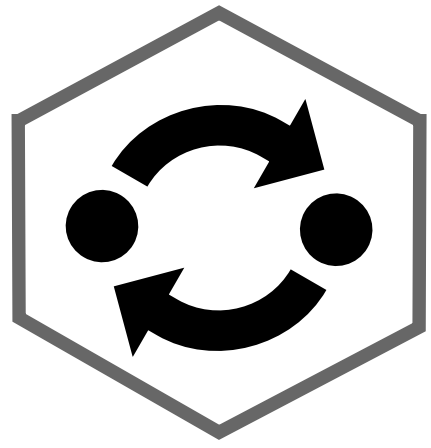

Simbologia

Pneumática

Conclusão

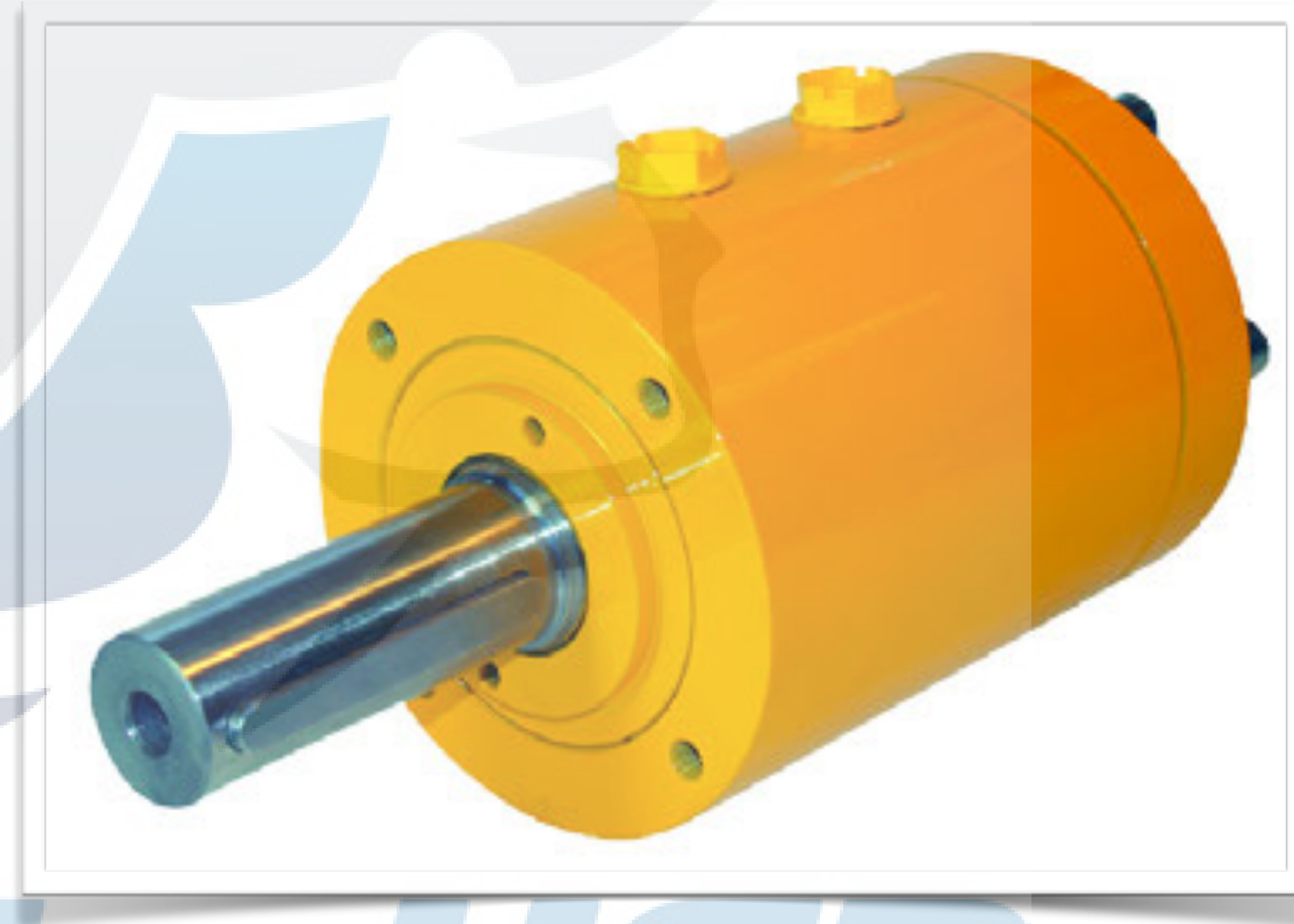
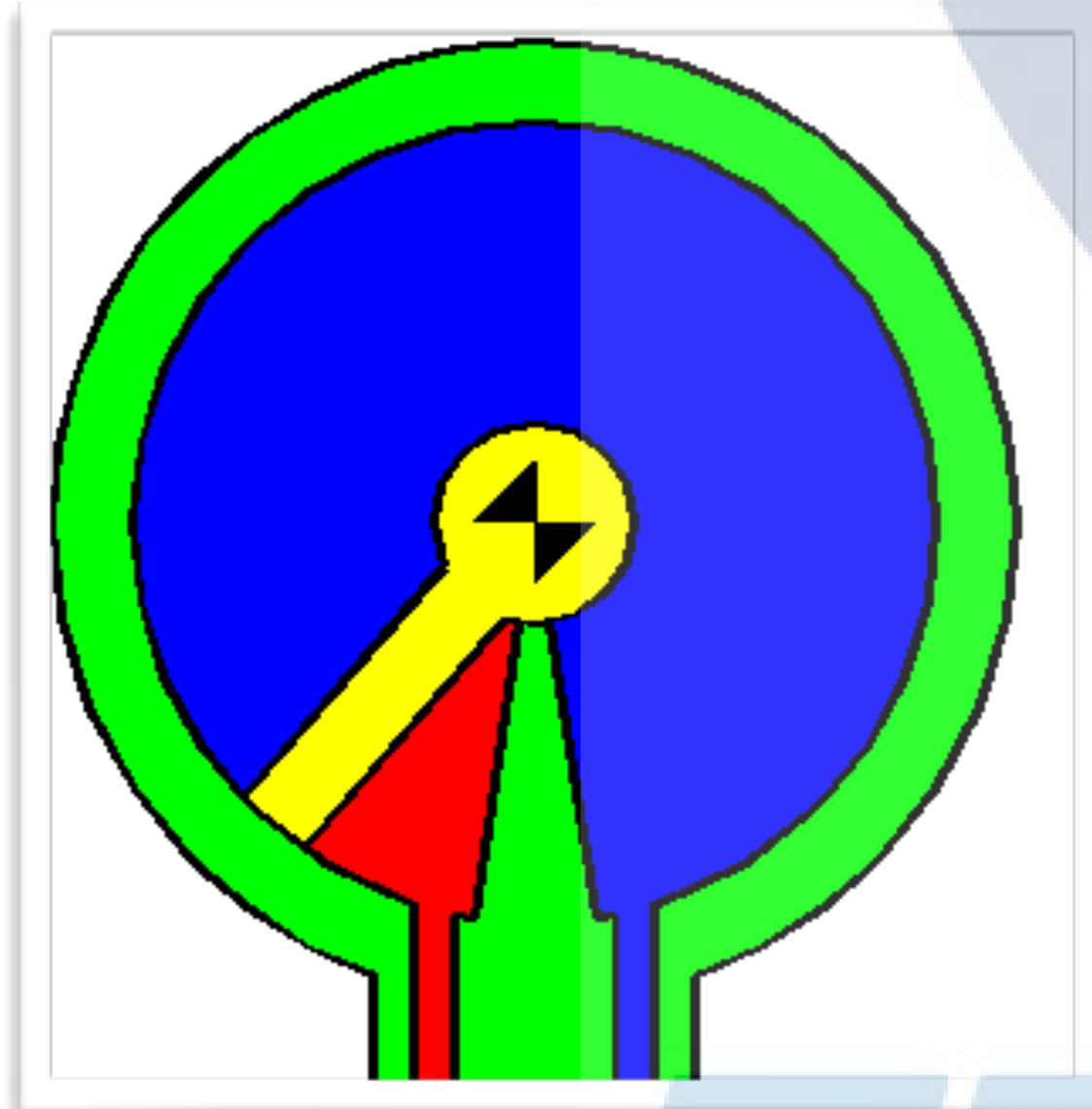

Osciladores hidráulicos

Hidráulica

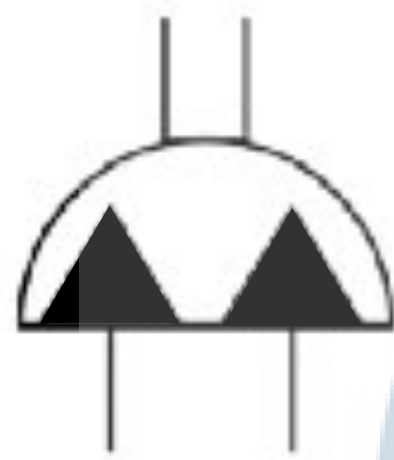
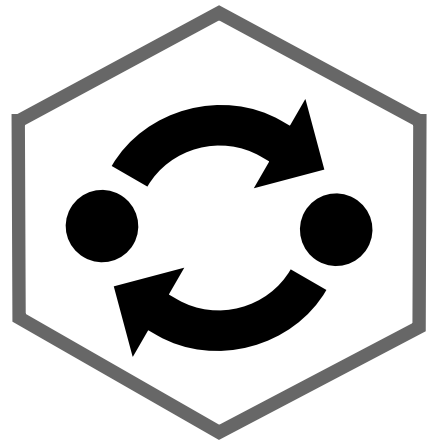

Simbologia

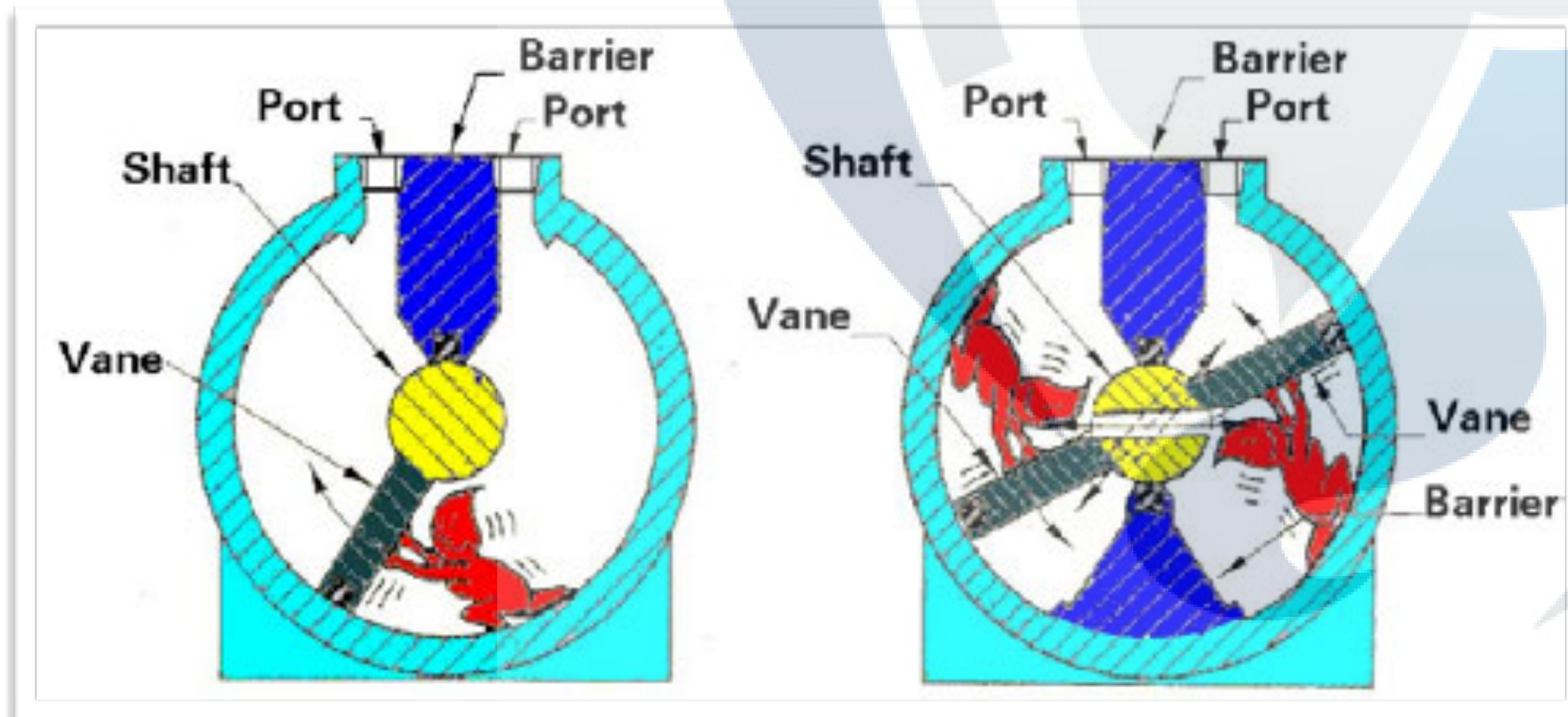

Palhetas

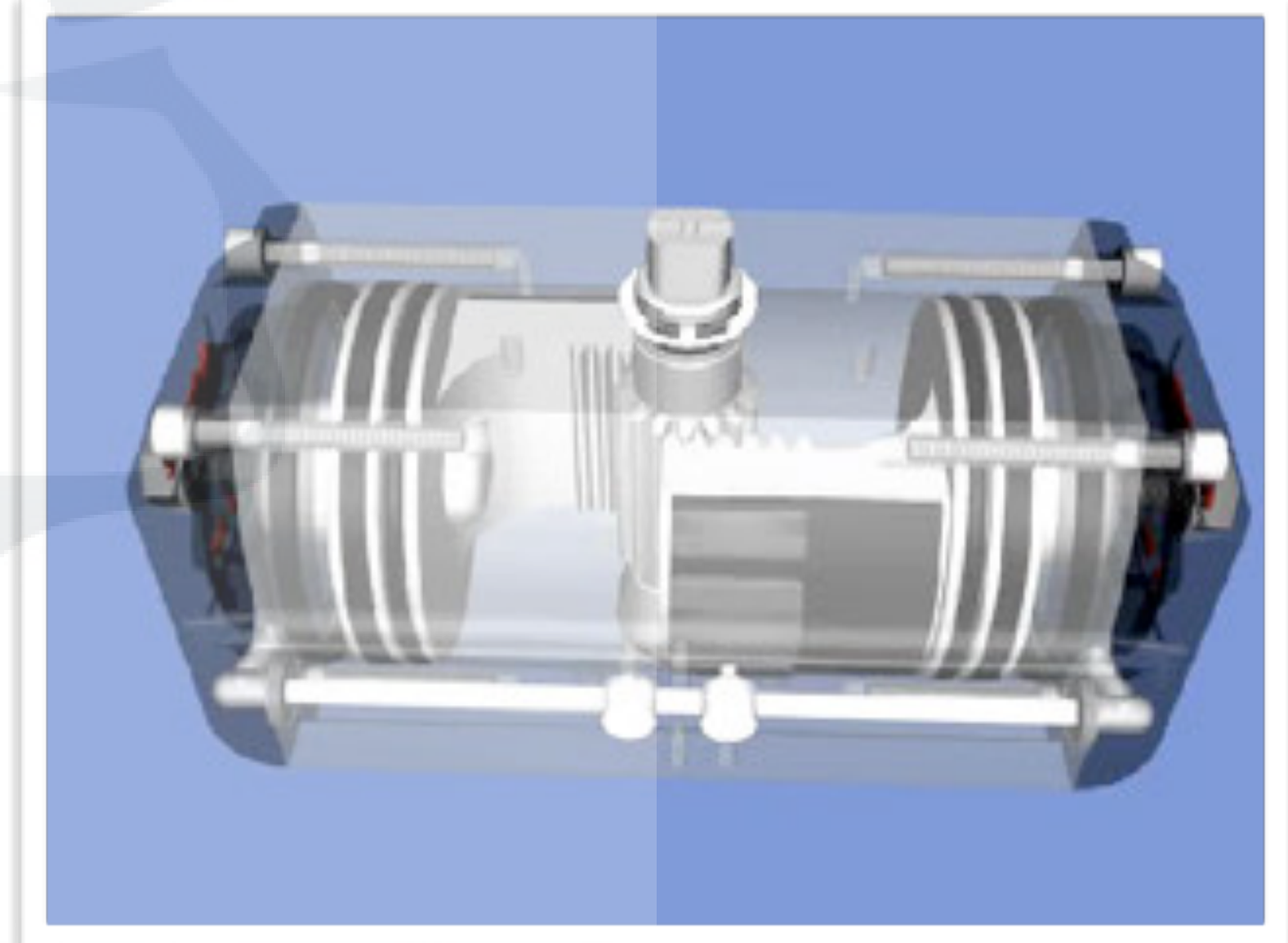

Cremalheira e pinhão

Pneumática

Conclusão

Motores hidráulicos

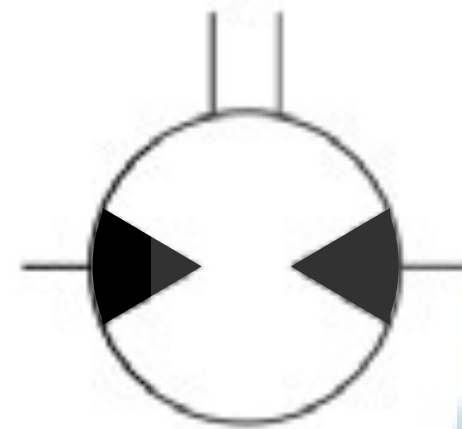
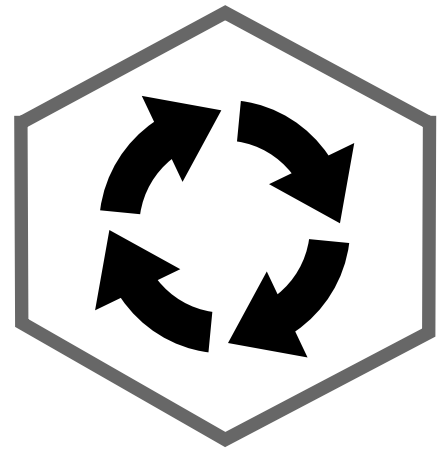

Simbologia

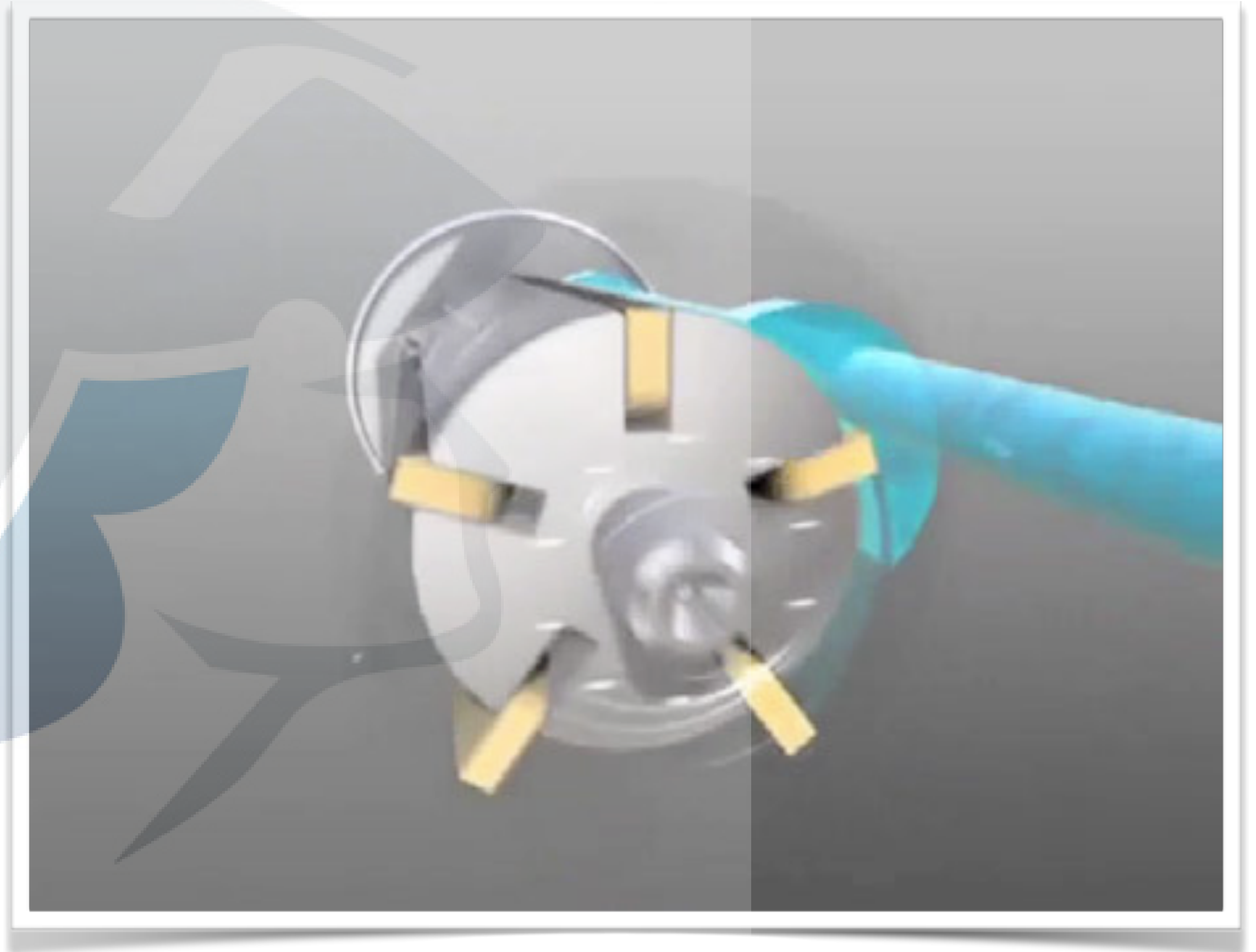

Hidráulica

Pneumática

Conclusão

Motores hidráulicos

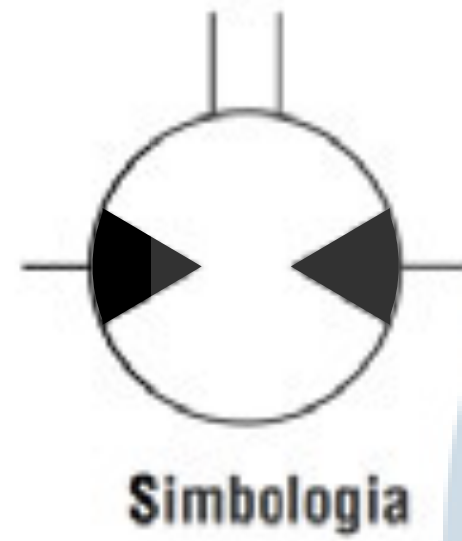
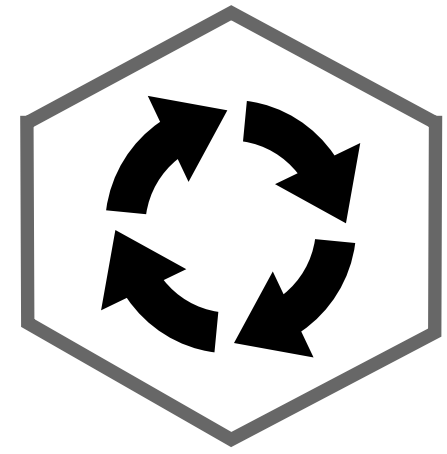

Densidade de
potência



Carga máxima
estática

Hidráulica

Pneumática

Conclusão

Atuadores especiais

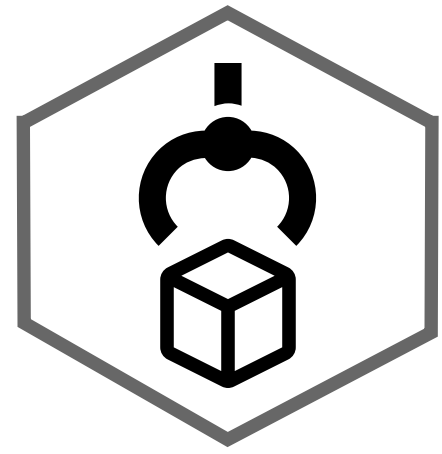

Hidráulica

Pneumática

Conclusão

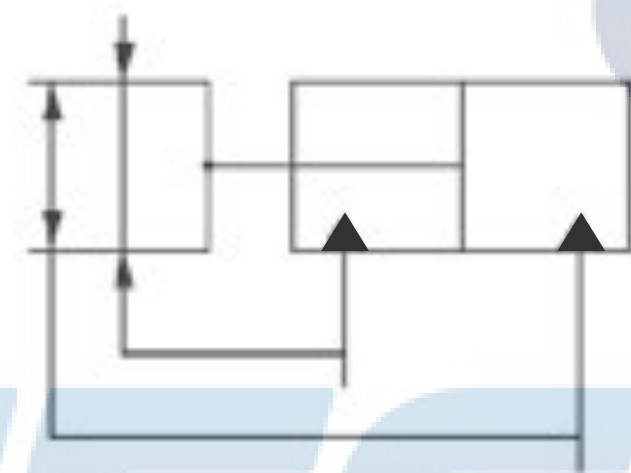
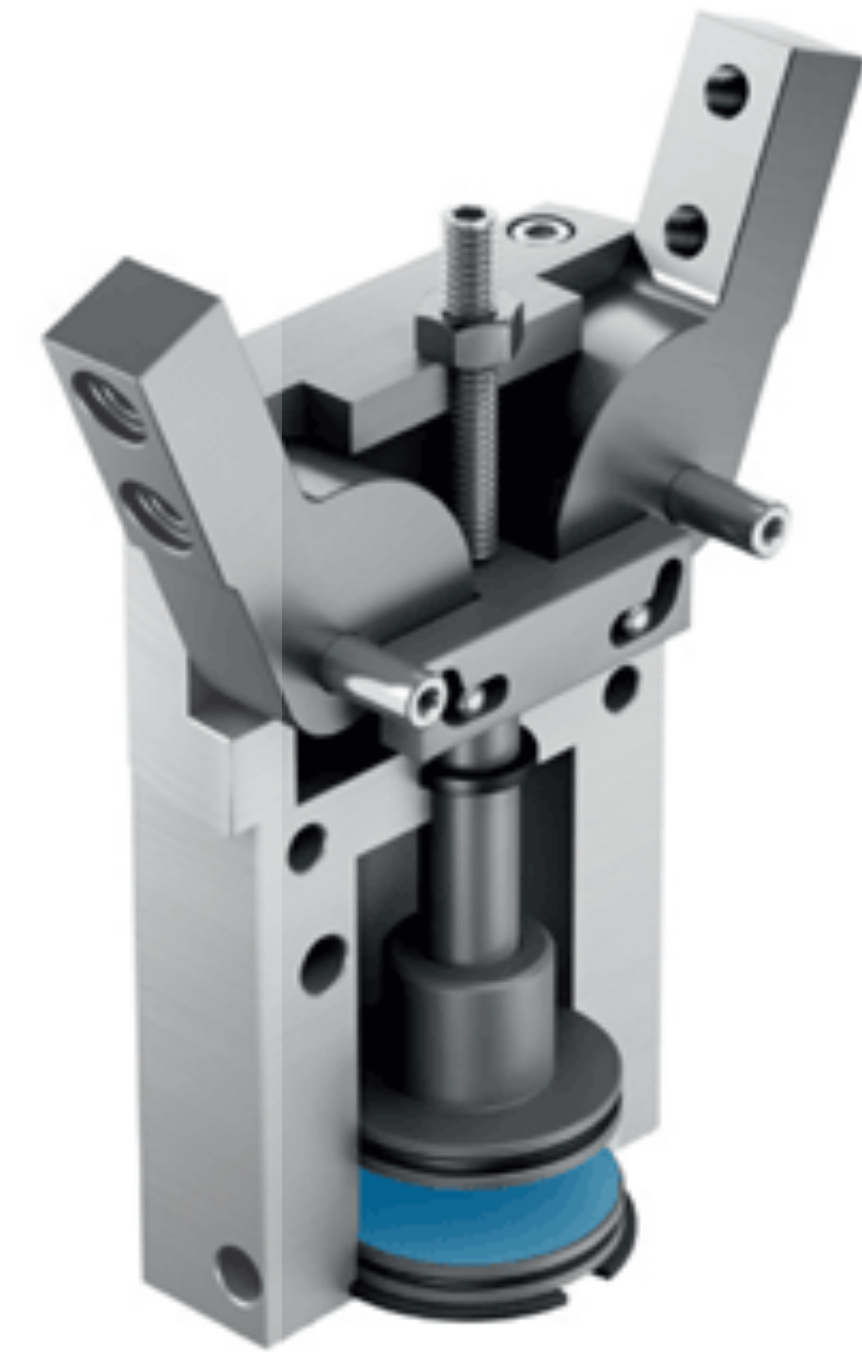
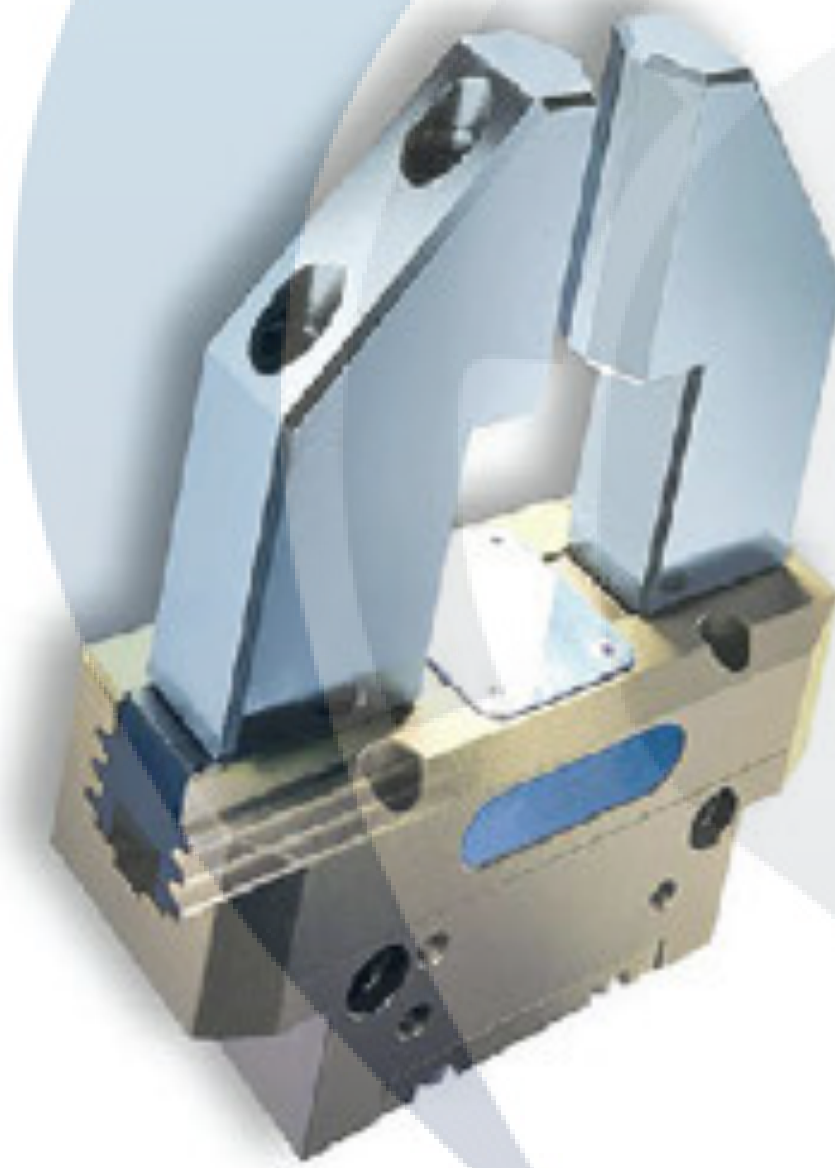

Simbologia

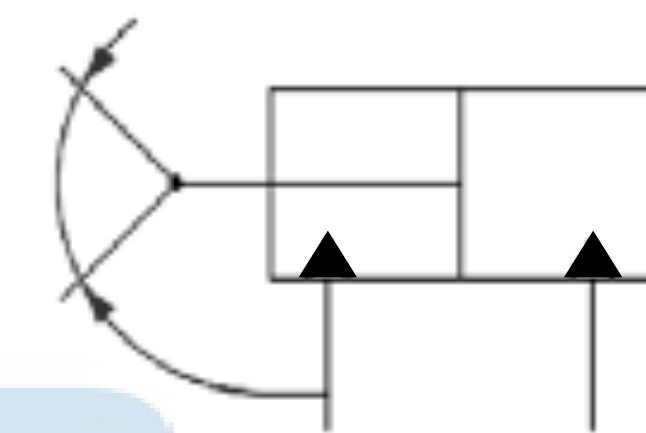

Simbologia

Conteúdo



- Princípios básicos
- Circuito e componentes básicos
- **Aplicações**
- Exemplos

Hidráulica

Pneumática

Conclusão

Hidráulica na indústria

Hidráulica

Pneumática

Conclusão

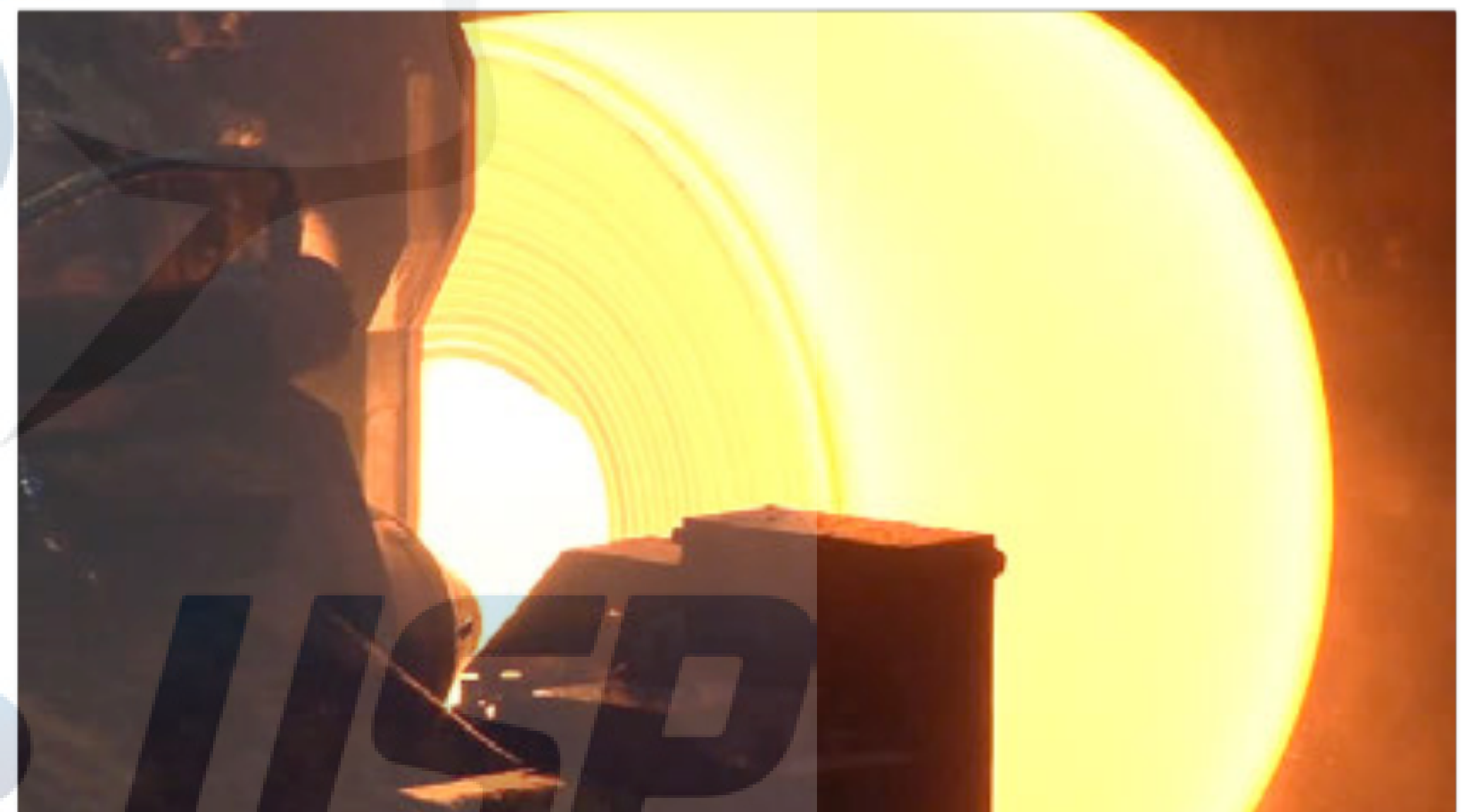
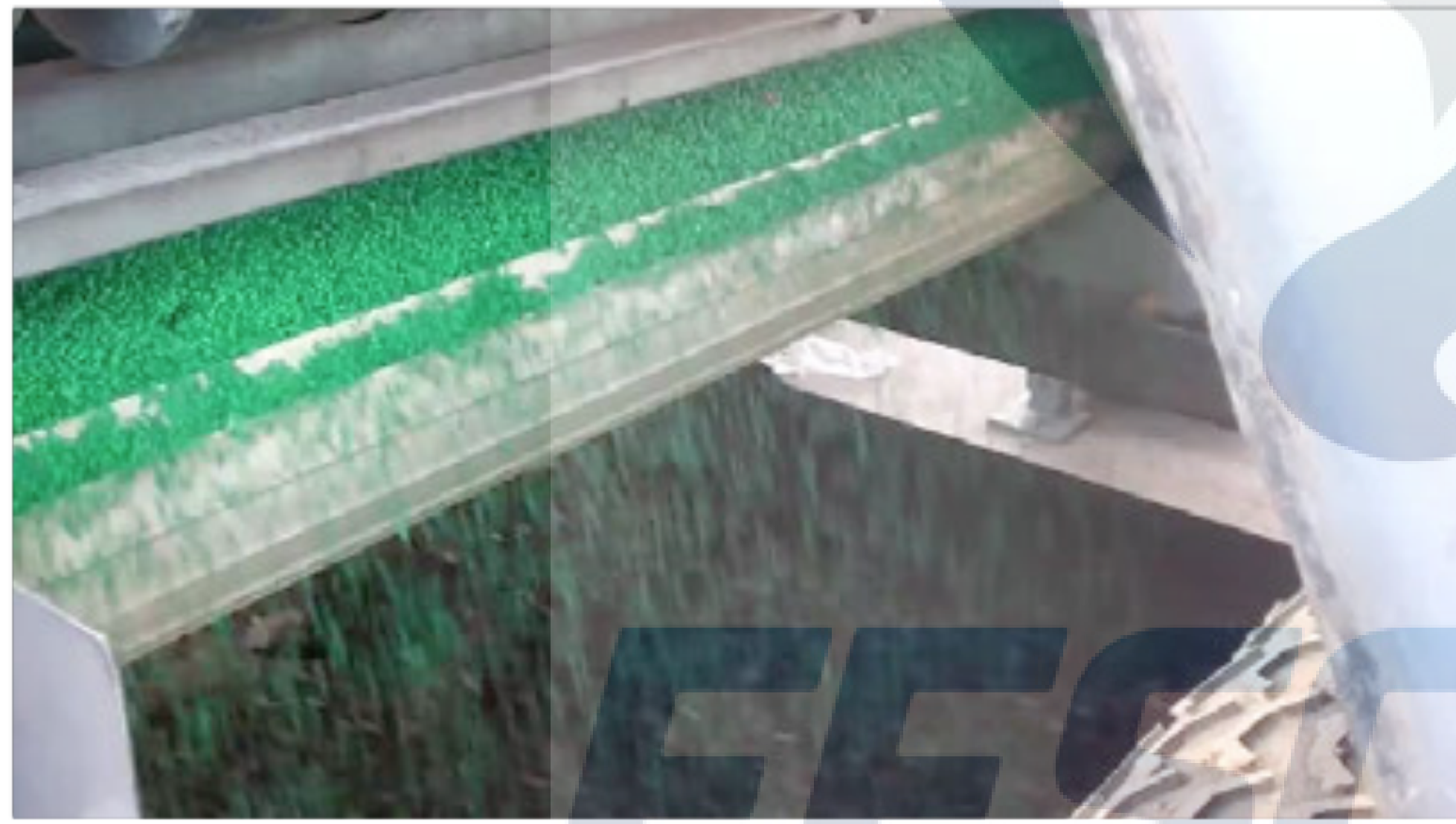

Hidráulica móvel

Hidráulica

Pneumática

Conclusão



Hidráulica na construção

Hidráulica



4x

Pneumática



Conclusão

Hidráulica na demolição

Hidráulica

Pneumática

Conclusão



2x

Hidráulica na mineração

Hidráulica

Pneumática

Conclusão



Hidráulica no campo

Hidráulica

Pneumática

Conclusão



Hidráulica nos carros

Hidráulica

Pneumática

Conclusão



Hidráulica nos aviões

Hidráulica

Pneumática

Conclusão



Hidráulica na robótica

Hidráulica



Pneumática



Conclusão

Hidráulica na robótica

Hidráulica

Pneumática

Conclusão

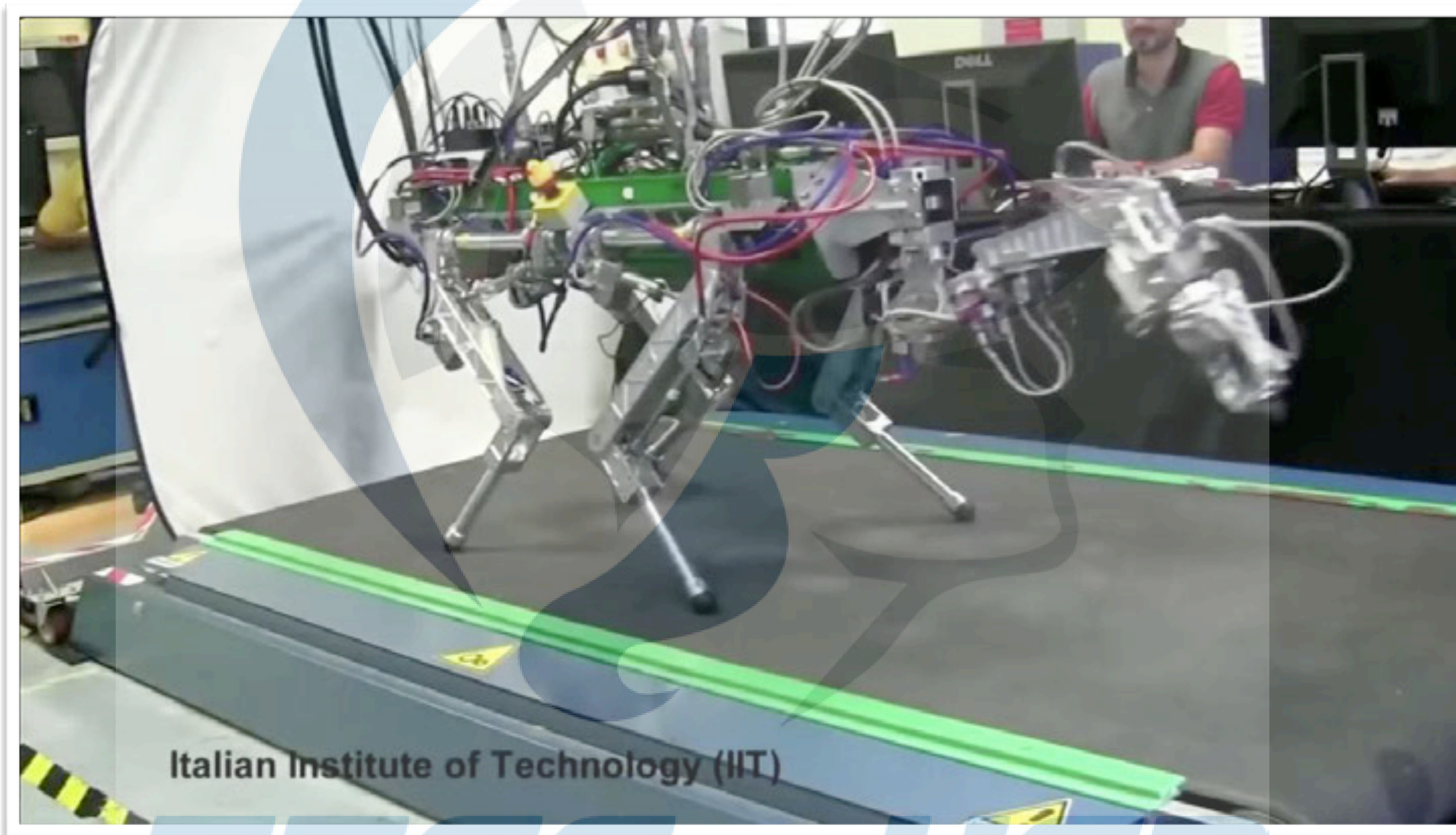

Conteúdo



- Princípios básicos
- Circuito e componentes básicos
- Aplicações
- **Exemplos**

Hidráulica

Pneumática

Conclusão

Circuito hidráulico #1

Um cilindro de ação dupla de avançar, mediante o acionamento da alavanca de uma válvula direcional. Soltando-se a alavanca, o cilindro deve retornar a sua posição inicial.

Circuito hidráulico #1

Hidráulica

Pneumática

Conclusão

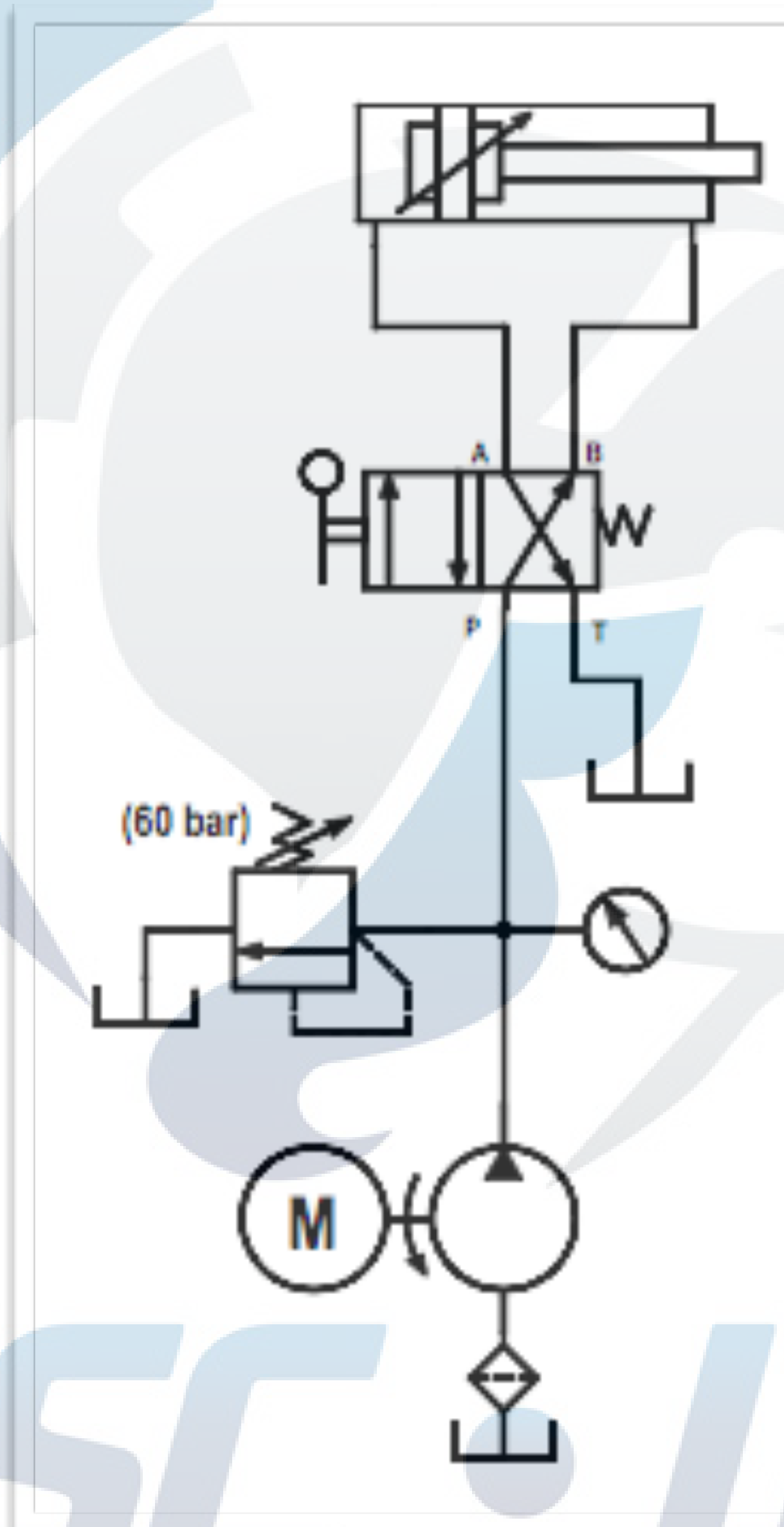

Circuito hidráulico #3

O eixo de um motor hidráulico reversível deve girar em ambos os sentidos de rotação e parar, sob o comando de uma válvula direcional.

Circuito hidráulico #3

Hidráulica

Pneumática

Conclusão

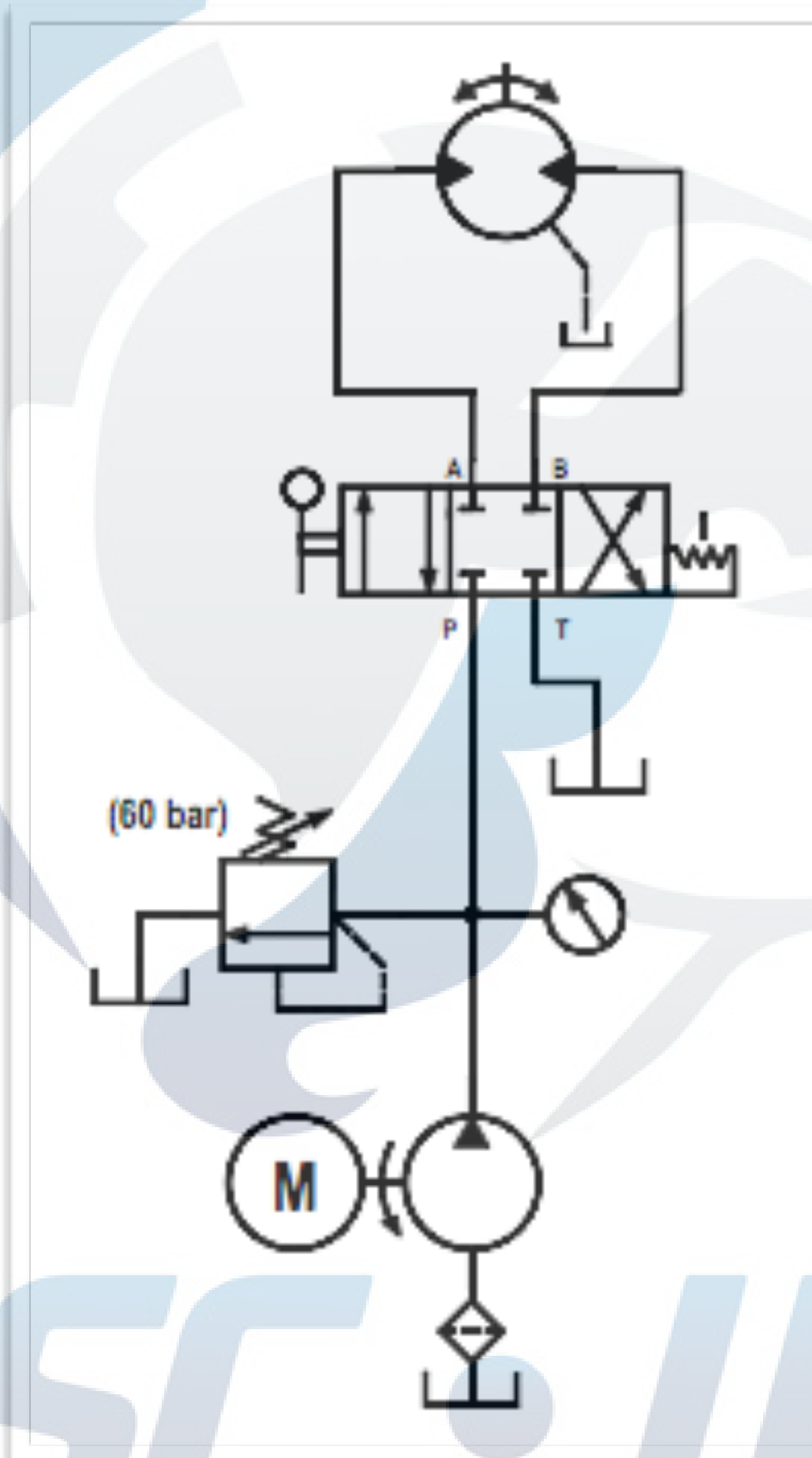

Circuito hidráulico #4

Por meio de um circuito regenerativo, um cilindro hidráulico, com diferencial de áreas de 2 para 1, deve se movimentar apresentando forças e velocidades iguais, tanto no avanço como no retorno

Circuito hidráulico #4

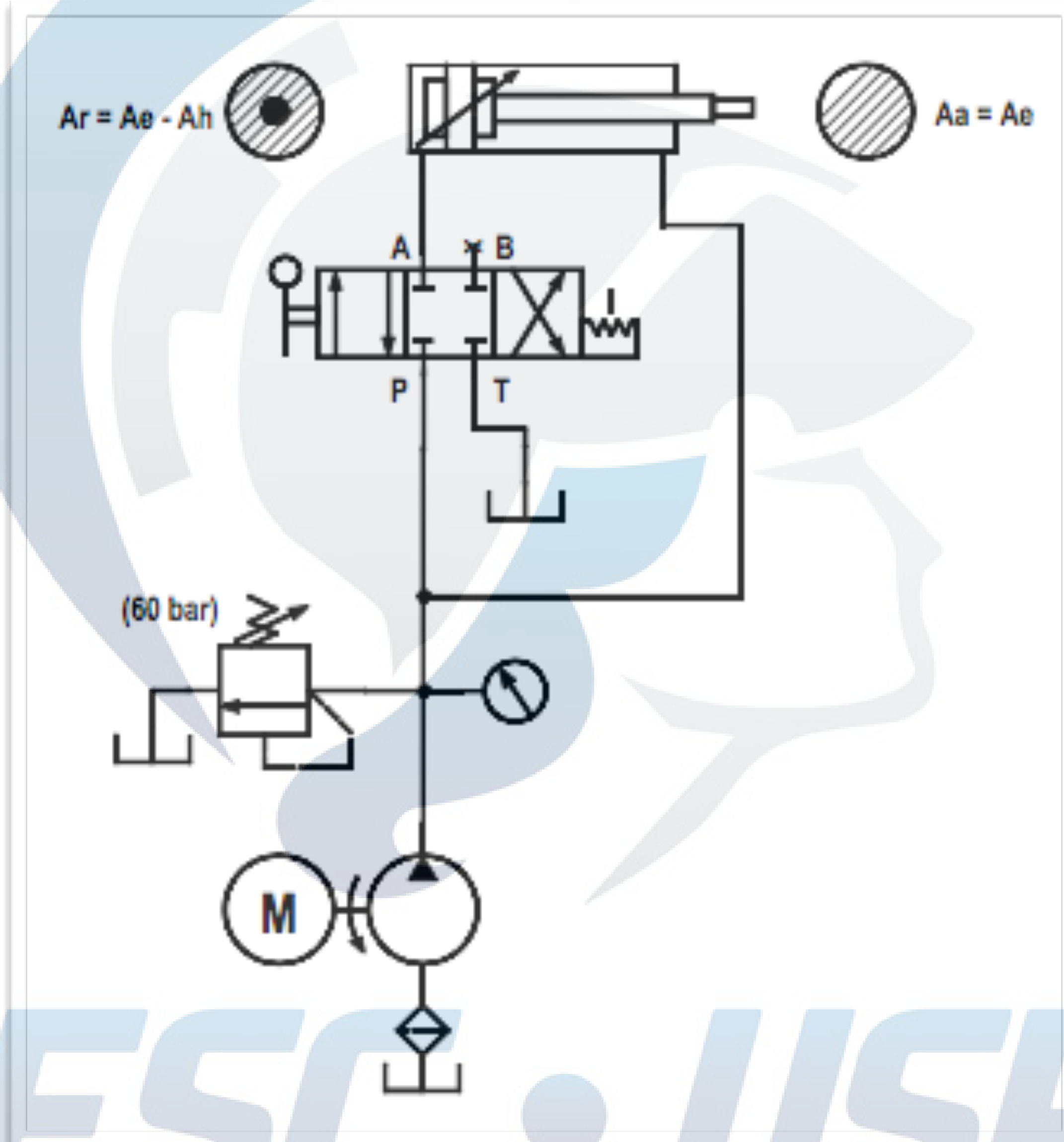

Conteúdo

Hidráulica



- **Introdução** e princípios básicos
- Circuito e componentes básicos
- Aplicações

Pneumática

Conclusão

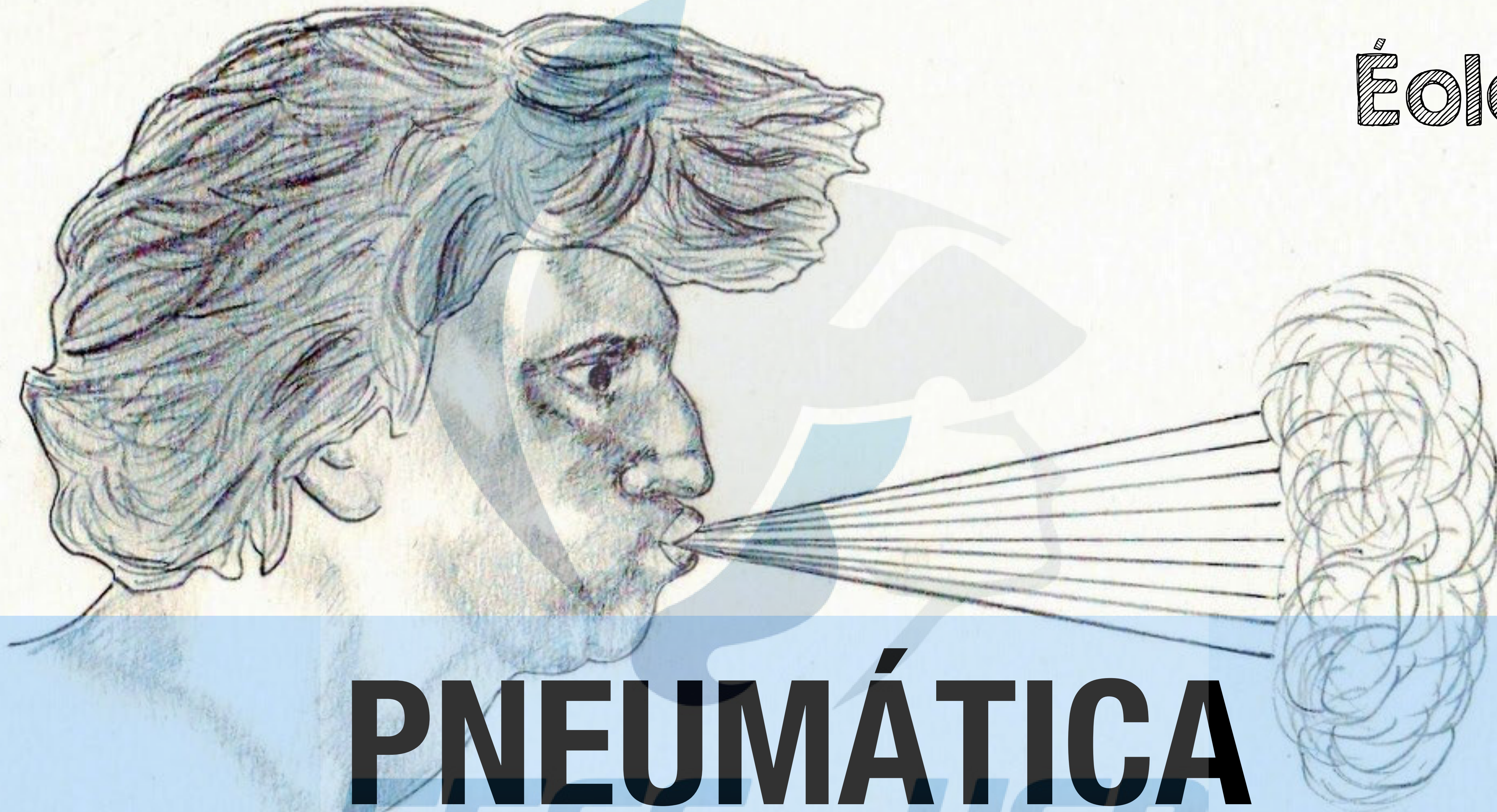

PNEUMÁTICA

Pneumática

Hidráulica

Pneumática

Conclusão



PNEUMA + THIKE

“fôlego, sopro” + “arte, técnica”

Ciência e tecnologia que trata do uso do **ar** ou gases neutros como meio de **transmissão de potência.**

Pneumática

Hidráulica

Pneumática

Conclusão

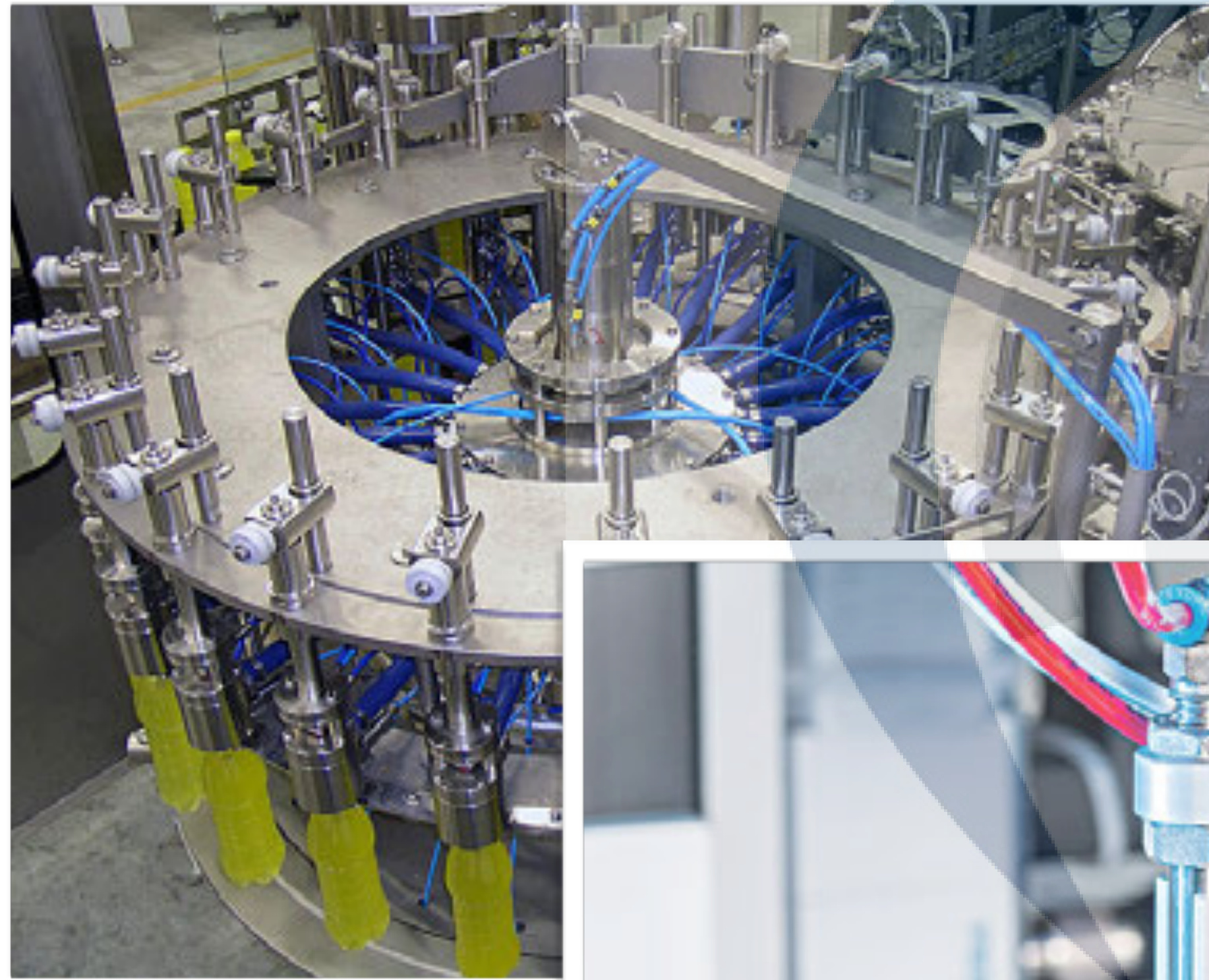

Os primórdios da pneumática

Ctesíbios: o “pai da pneumática”

Alexandria, 270 a.c.

Hero: o discípulo

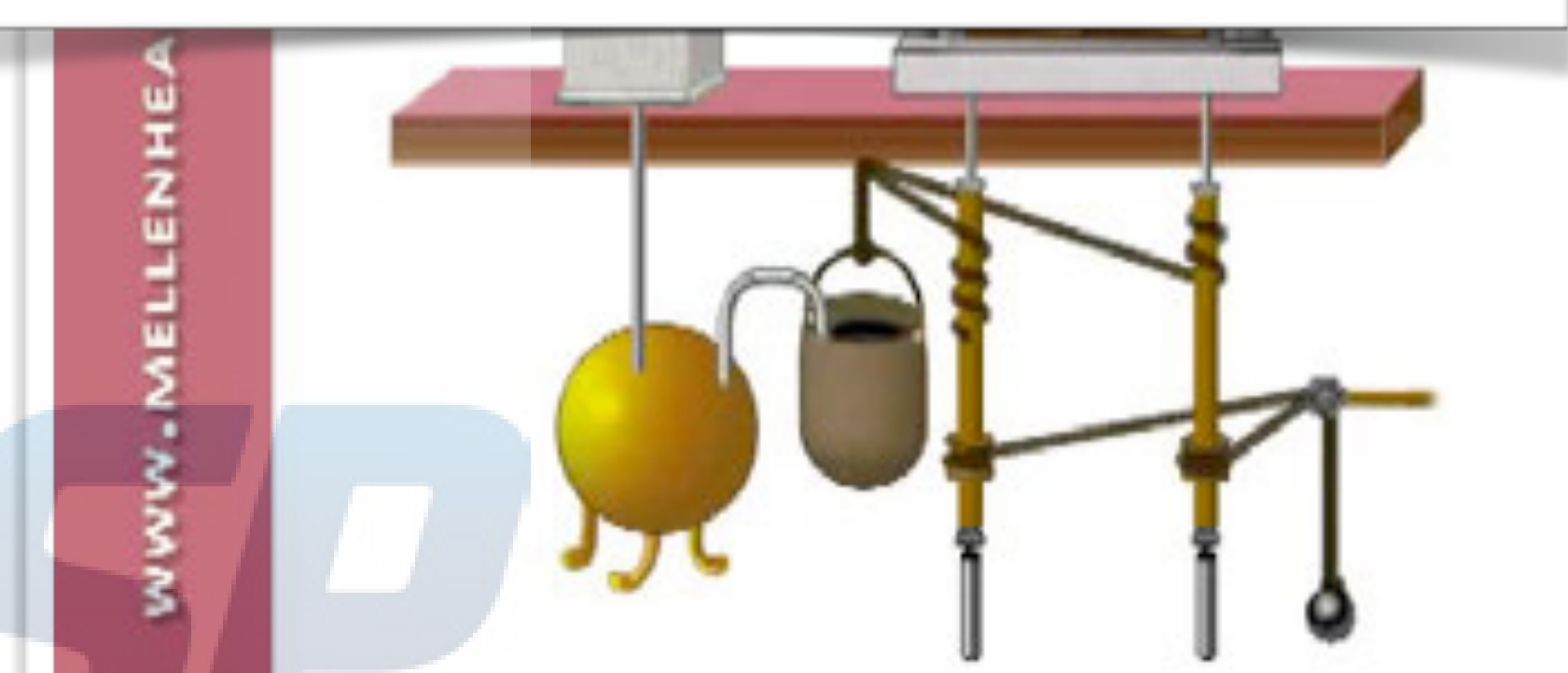
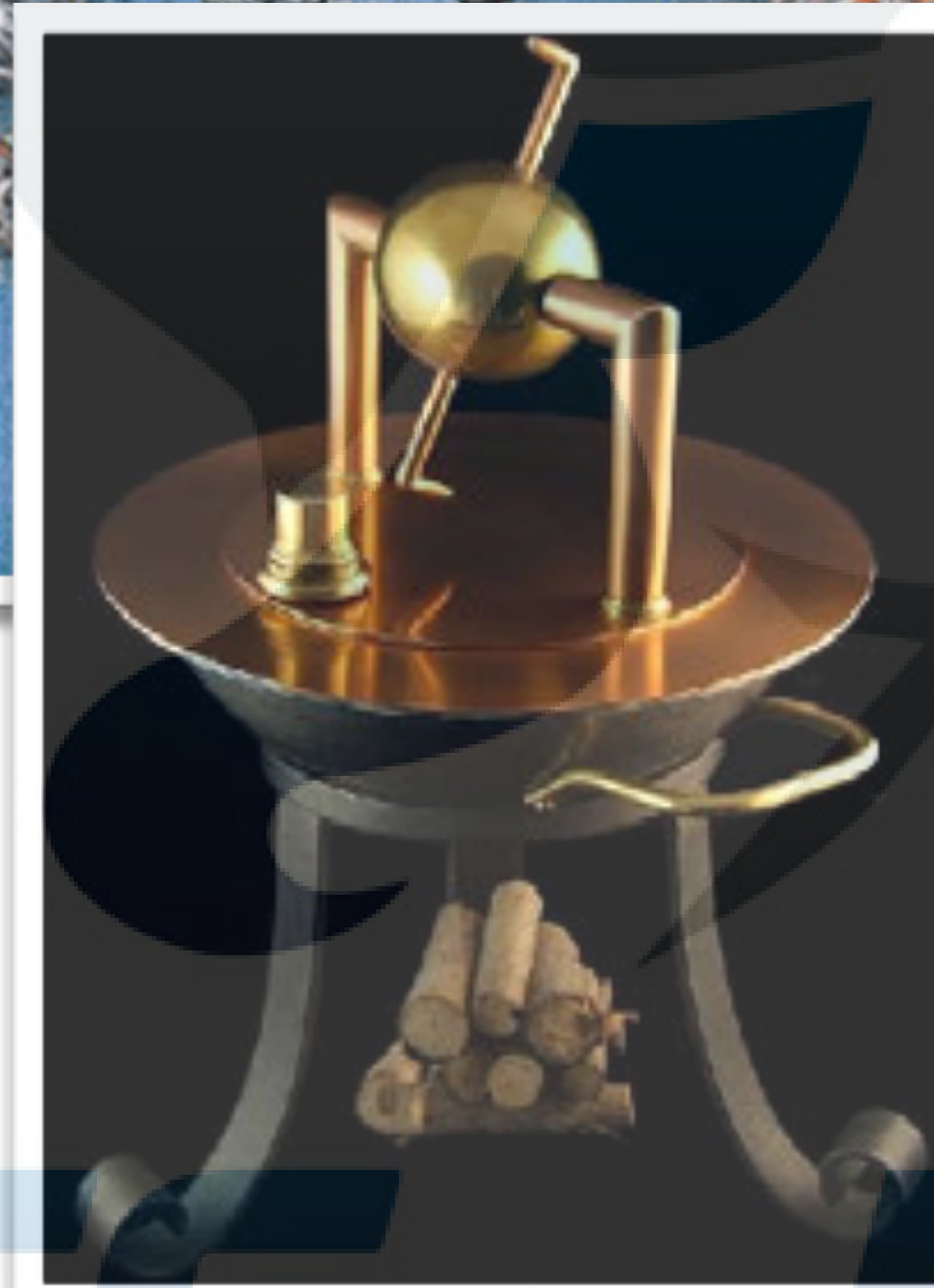
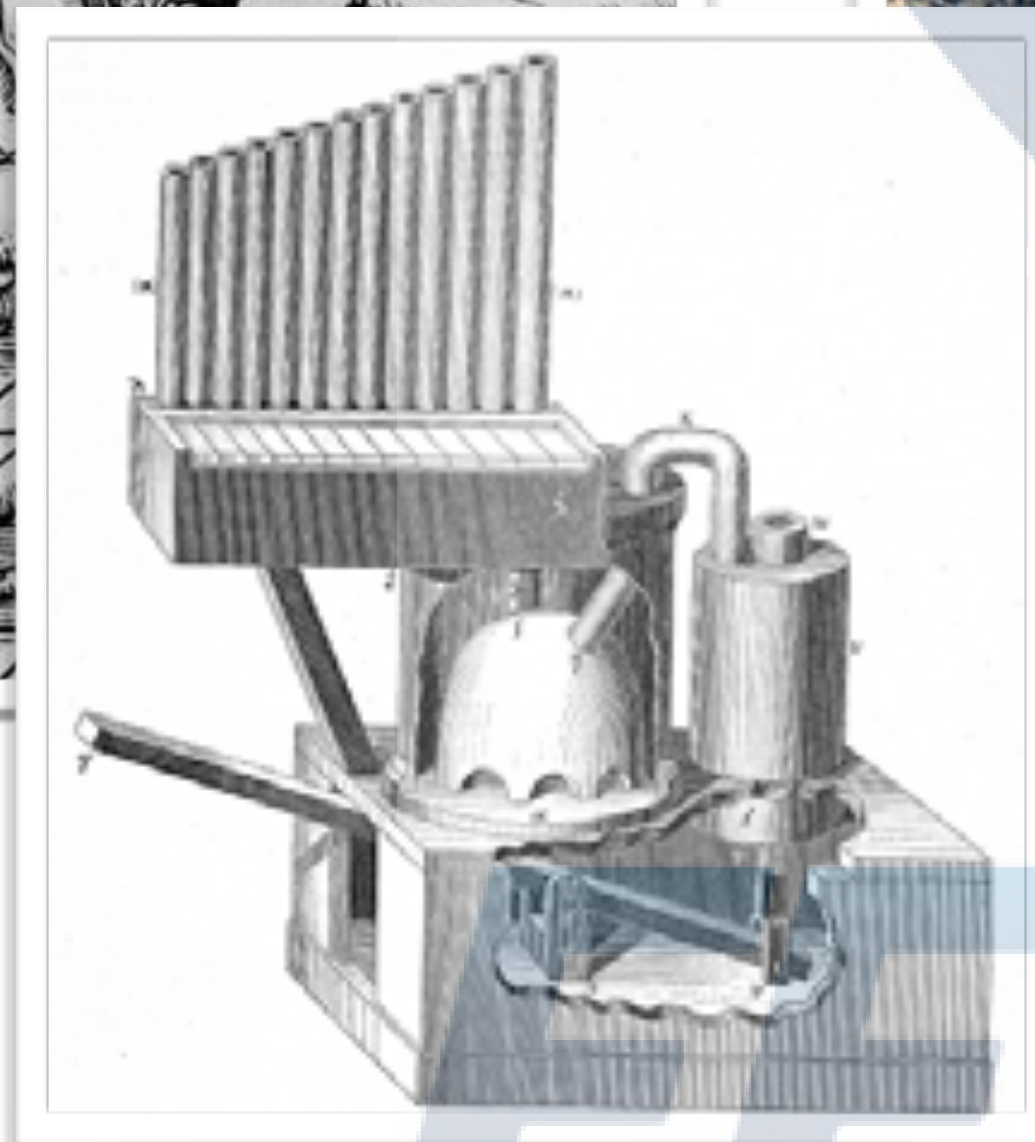
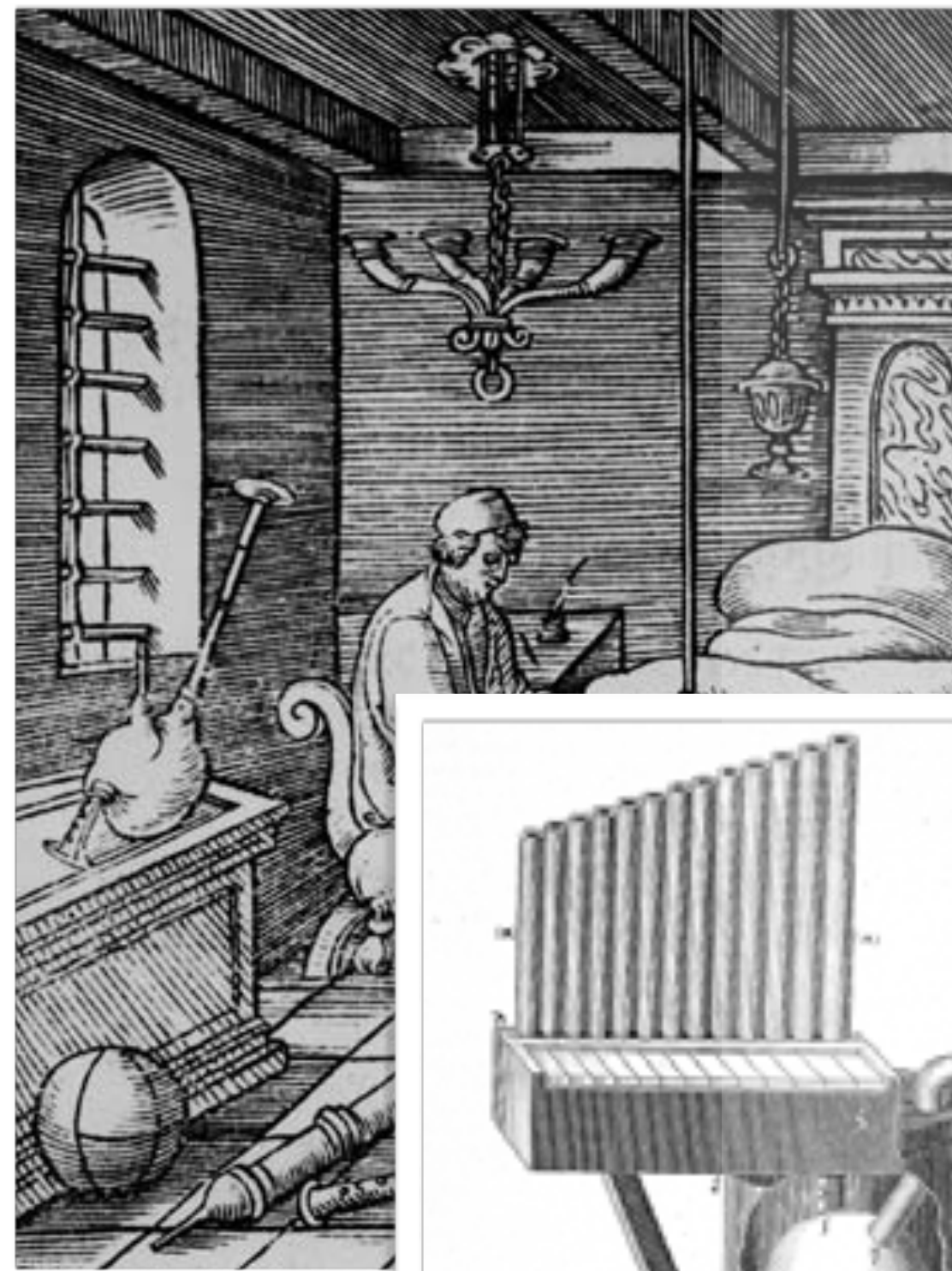

Hidráulica

Pneumática

Conclusão

Os primórdios da pneumática

James Watt: a primeira máquina a vapor automatizada



Revolução Industrial

1736 — 1819

$$1 \text{ W} = 1 \frac{\text{J}}{\text{s}}$$

Pneumática no séculos XVI e XVII

Hidráulica

Pneumática

Conclusão



Francis Bacon
(1561 — 1626)

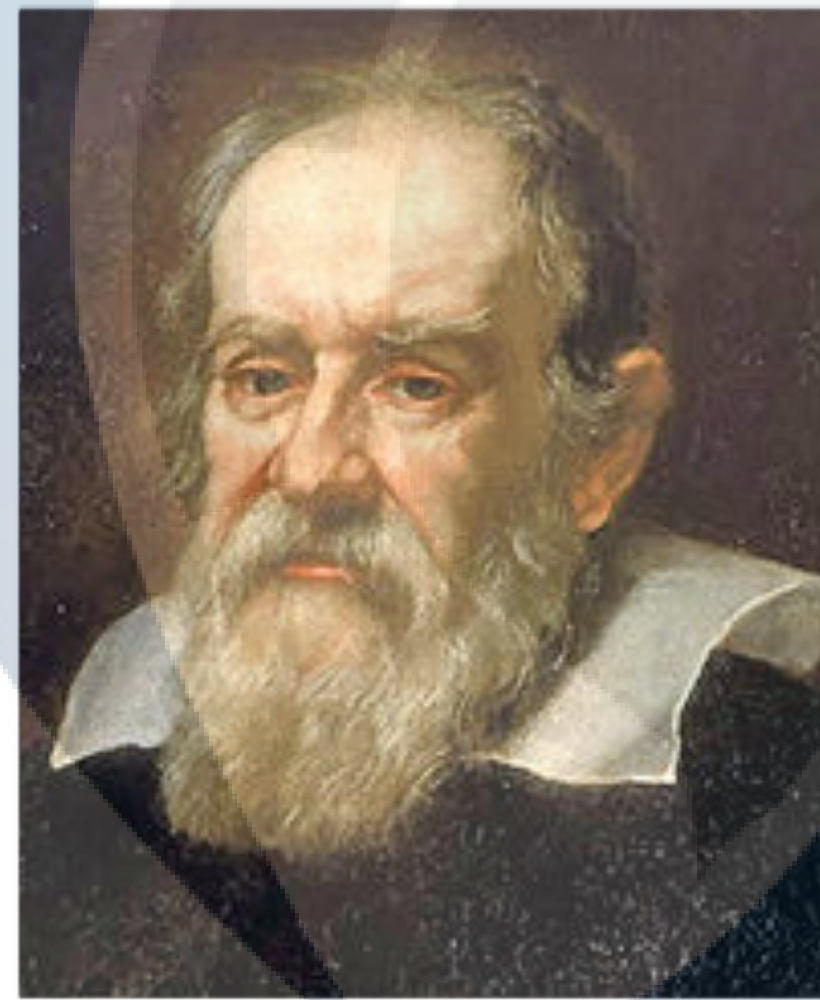

Galileu Galilei
(1564 — 1642)



Otto von Guericke
(1602 — 1686)



Robert Boyle
(1627 — 1691)

Conteúdo

Hidráulica



- Introdução e **princípios básicos**
- Circuito e componentes básicos
- Aplicações

Pneumática

Conclusão

Ar: um fluido!

Hidráulica

Pneumática

Conclusão



Escoam



Deformam-se



Pressão

$$P = \frac{F}{A}$$

$$[Pa] \quad \left[\frac{N}{m^2} \right]$$

$$[bar] \quad 1 \text{ bar} = 10^5 Pa$$

$$PV = nRT$$

Lei dos gases ideais

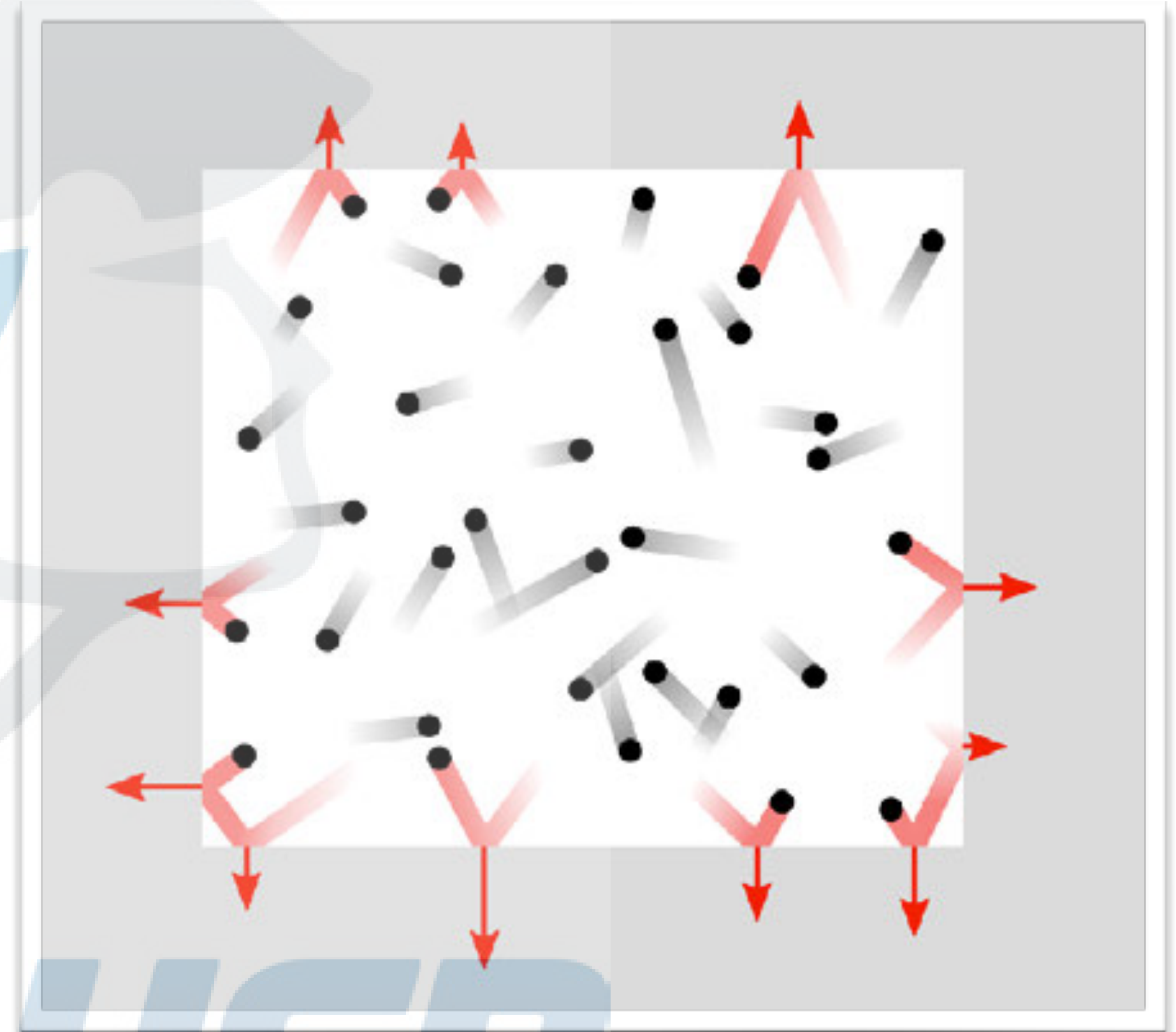

Compressibilidade do ar

Hidráulica

Pneumática

Conclusão

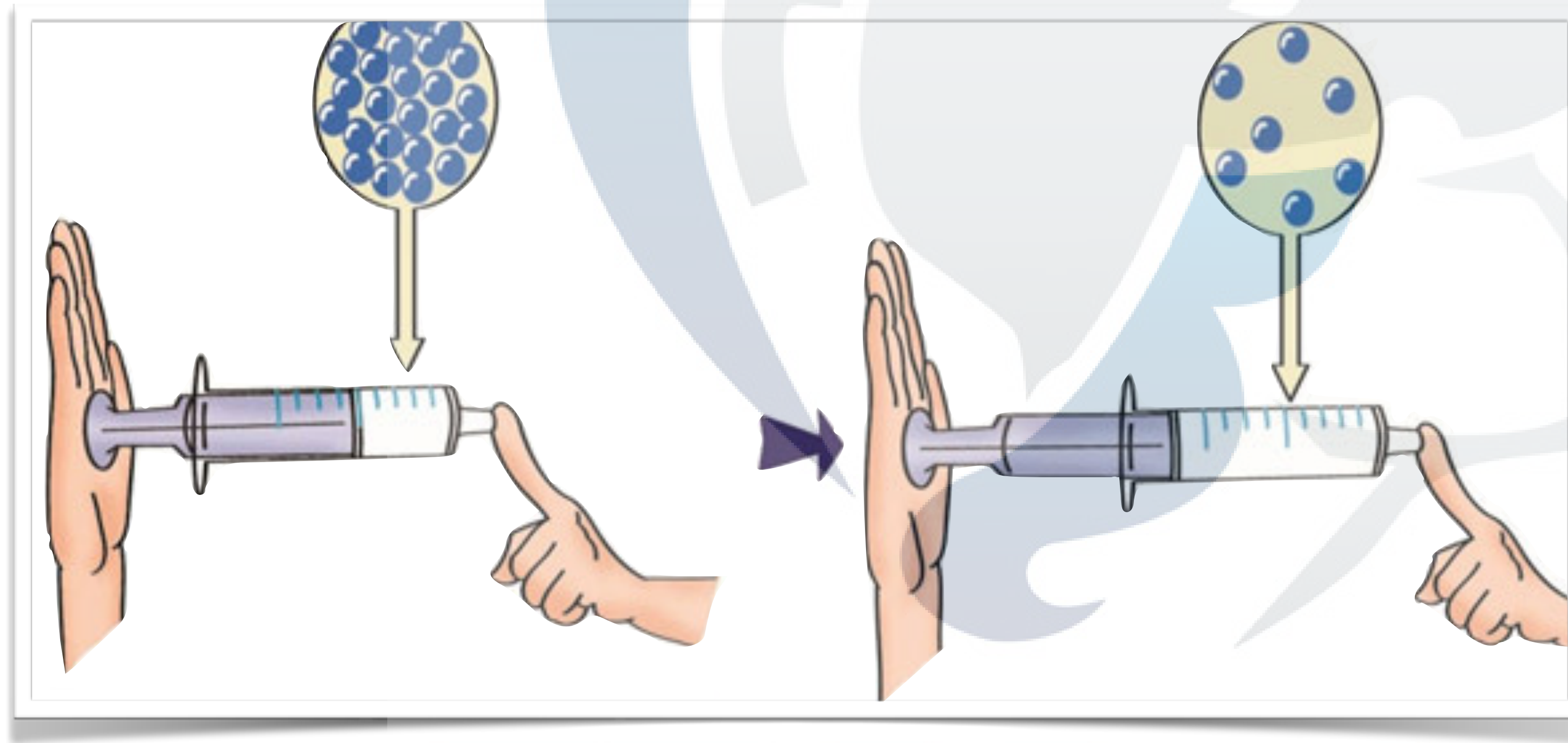

$$\frac{P_1 V_1}{T_1} = \frac{P_2 V_2}{T_2}$$

Velocidade do som

Hidráulica

Pneumática

Conclusão

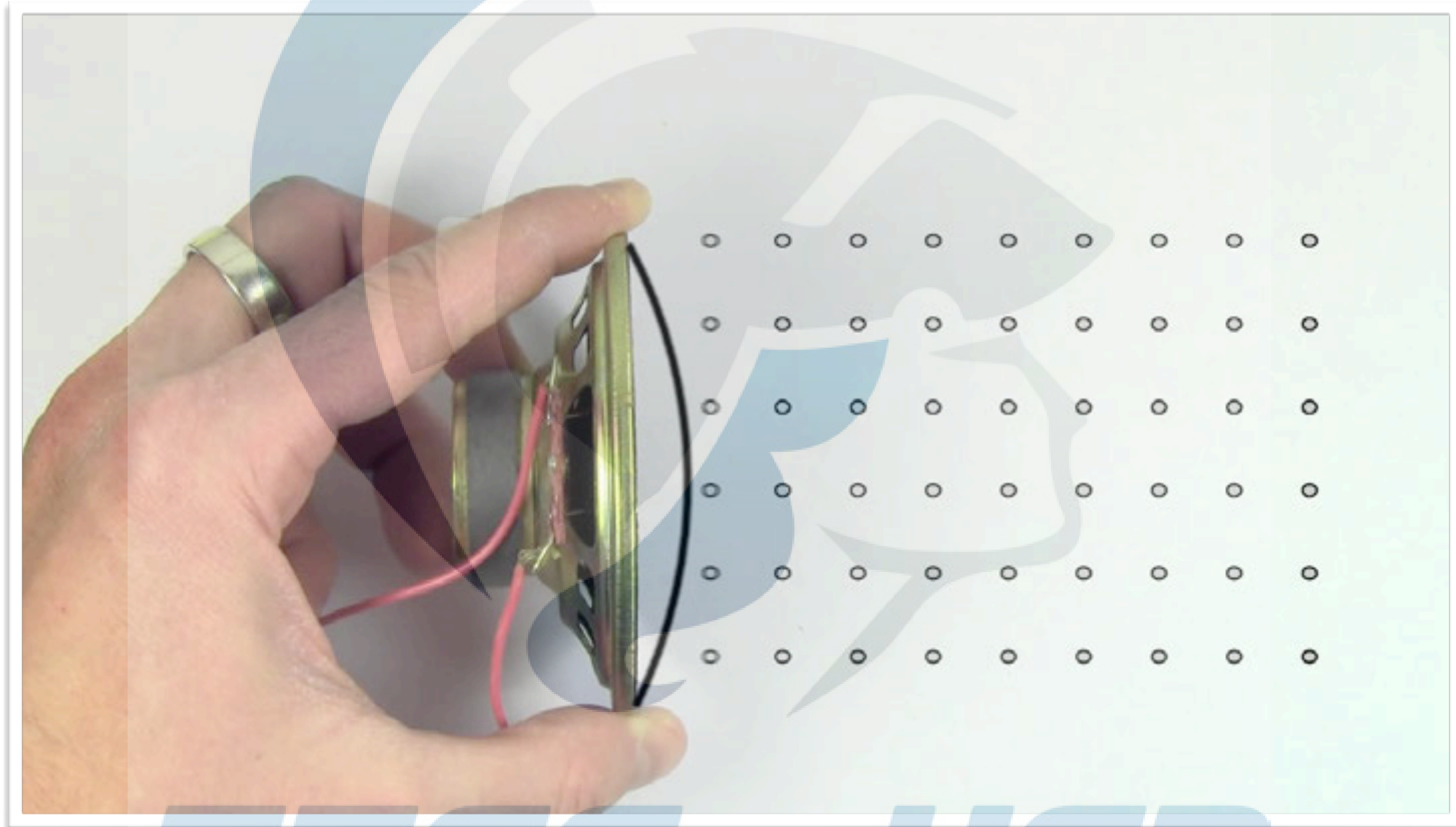

Velocidade do som

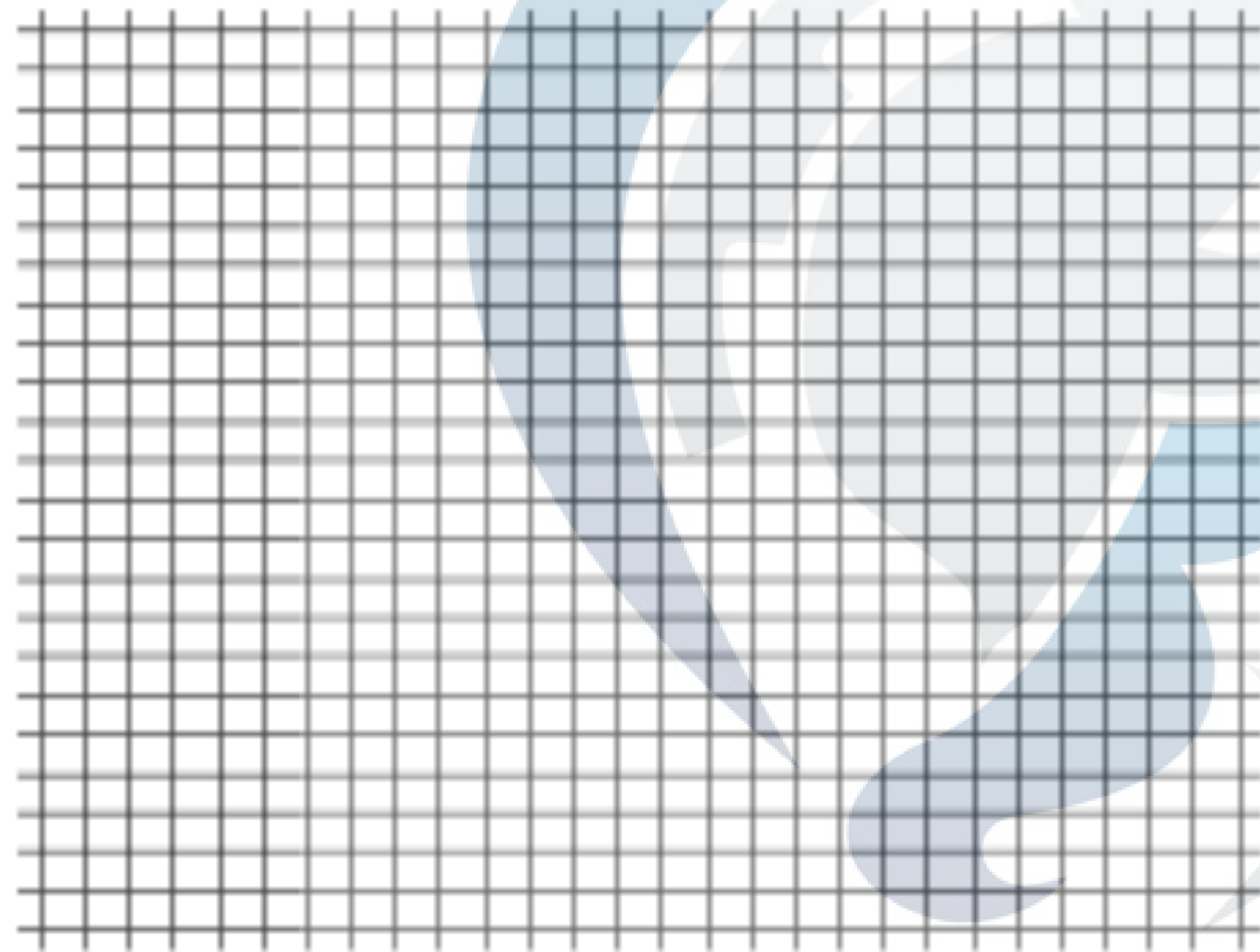

No ar, depende da:



Representa um **limite** na **velocidade** de propagação de ondas de **pressão**

Ondas de compressão

Velocidade do som

Hidráulica

Pneumática

Conclusão



Vazão em válvulas

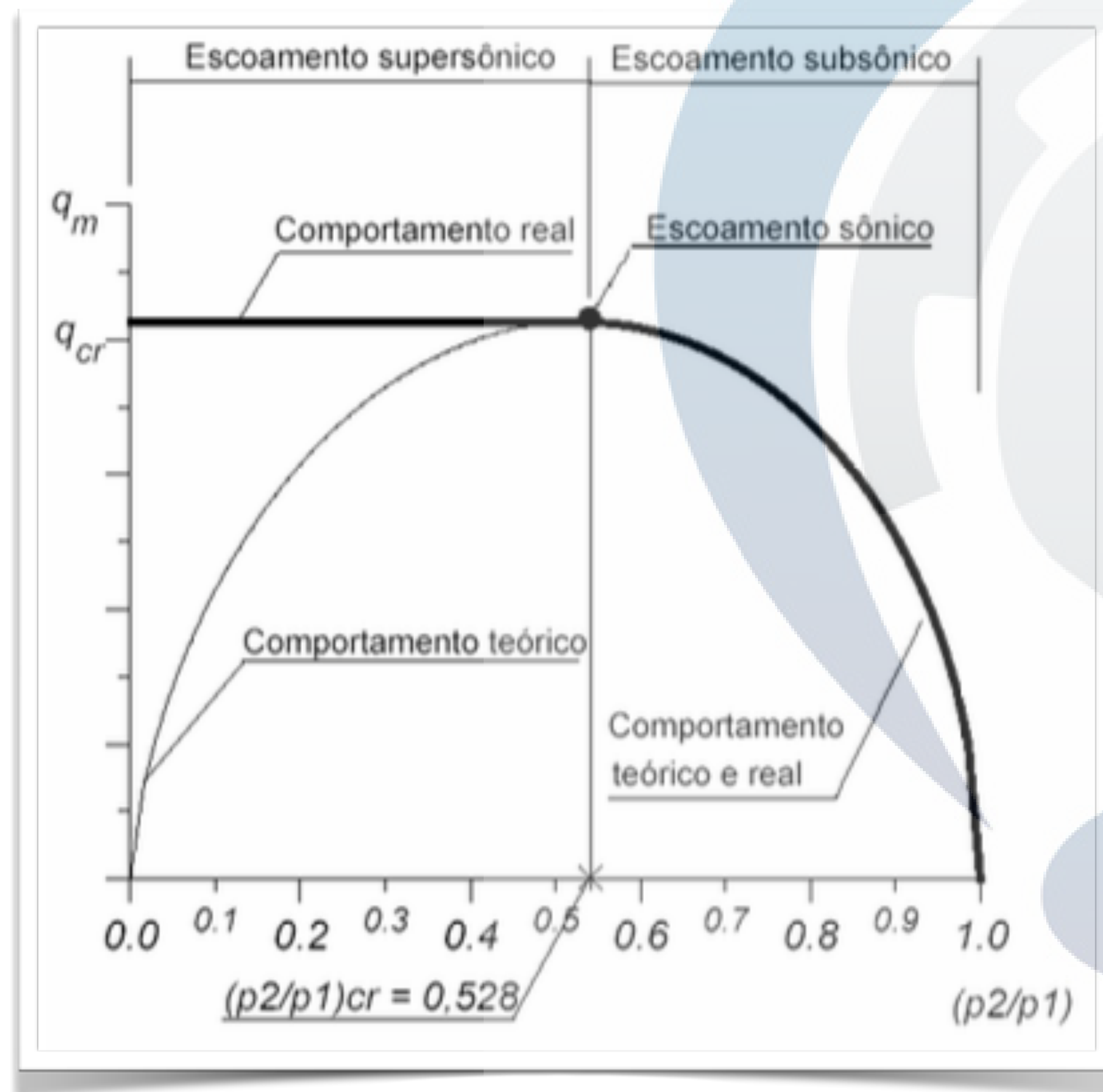

A **máxima** vazão mássica que pode passar através de qualquer área ocorre à **velocidade do som!**

Vazão em válvulas

fenômeno da
saturação

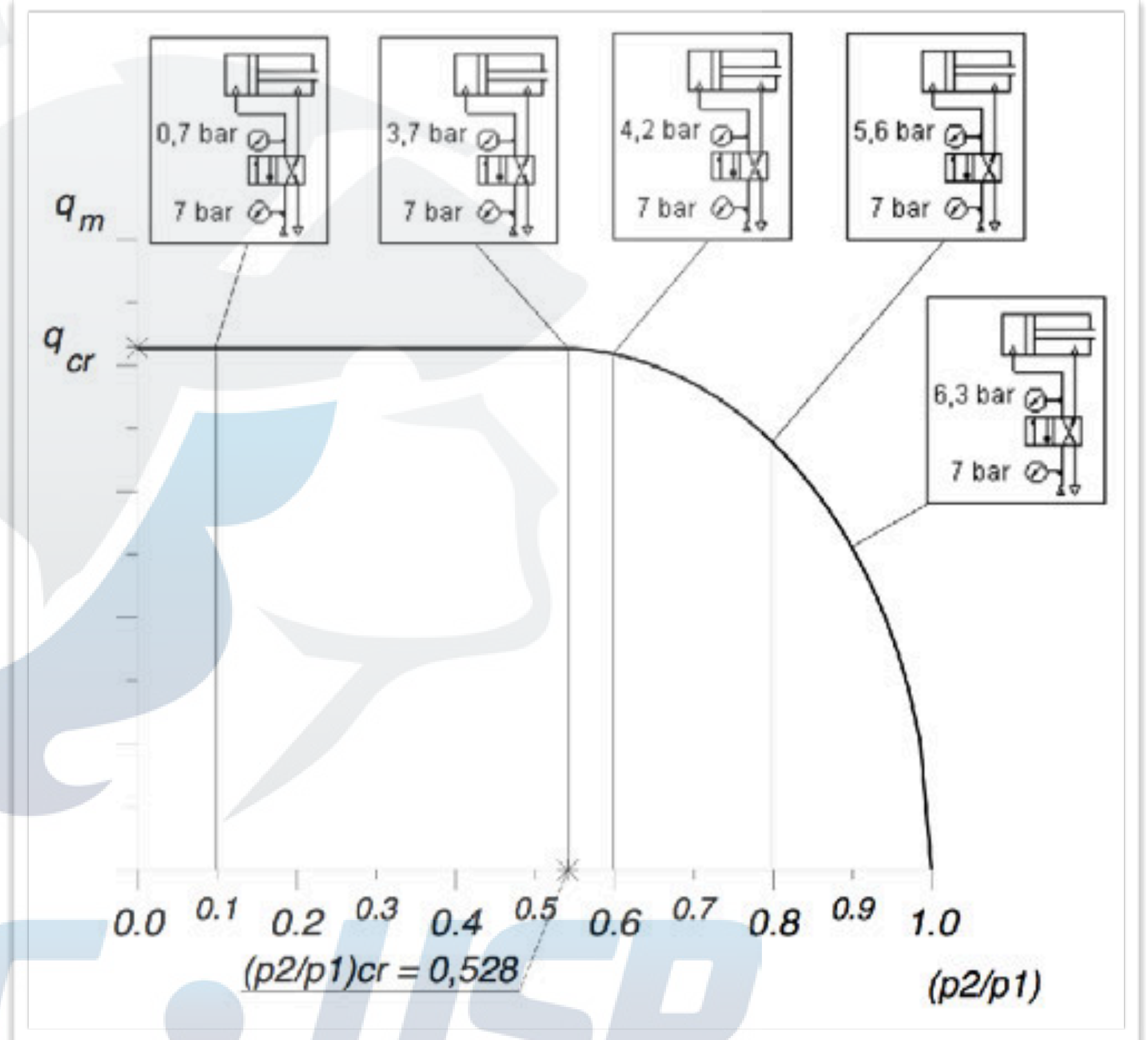

Vazão em válvulas

Hidráulica

Pneumática

Conclusão

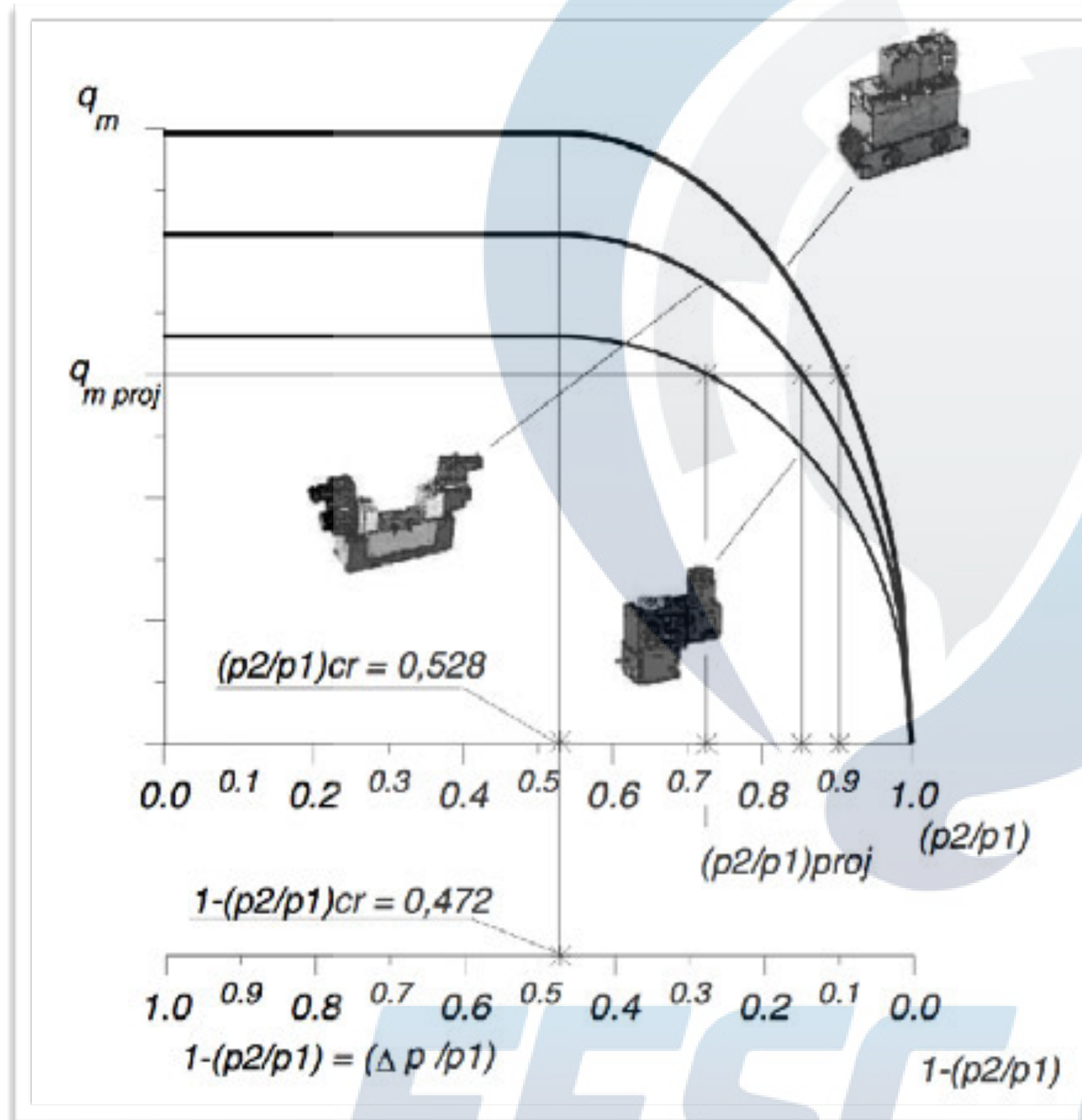

$$b = \left(\frac{p_2}{p_1} \right)_{cr}$$

na prática:

$$0,2 < b < 0,45$$

Vantagens da pneumática

Hidráulica

Pneumática

Conclusão



**Acessibilidade
do fluido**



Limpeza

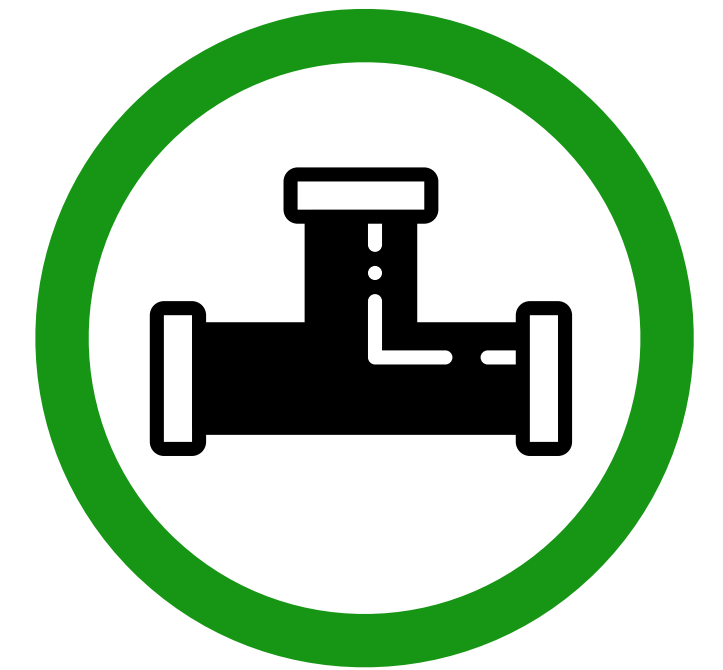

Distribuição



Custos



Segurança

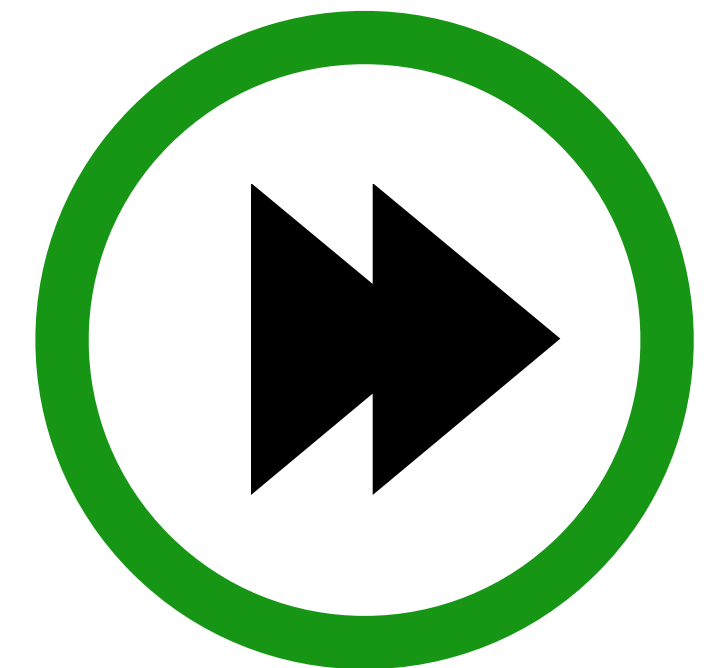

Velocidade

Desvantagens da pneumática

Hidráulica

Pneumática

Conclusão



Compressibilidade



Força limitada



Poluição sonora

Conteúdo

Hidráulica



- Introdução e princípios básicos
- **Circuito e componentes básicos**
- Aplicações

Pneumática

Conclusão

Circuito básico

Hidráulica

Pneumática

Conclusão



Compressor



Reservatório de ar comprimido



Filtro regulador e lubrificador



Cilindro

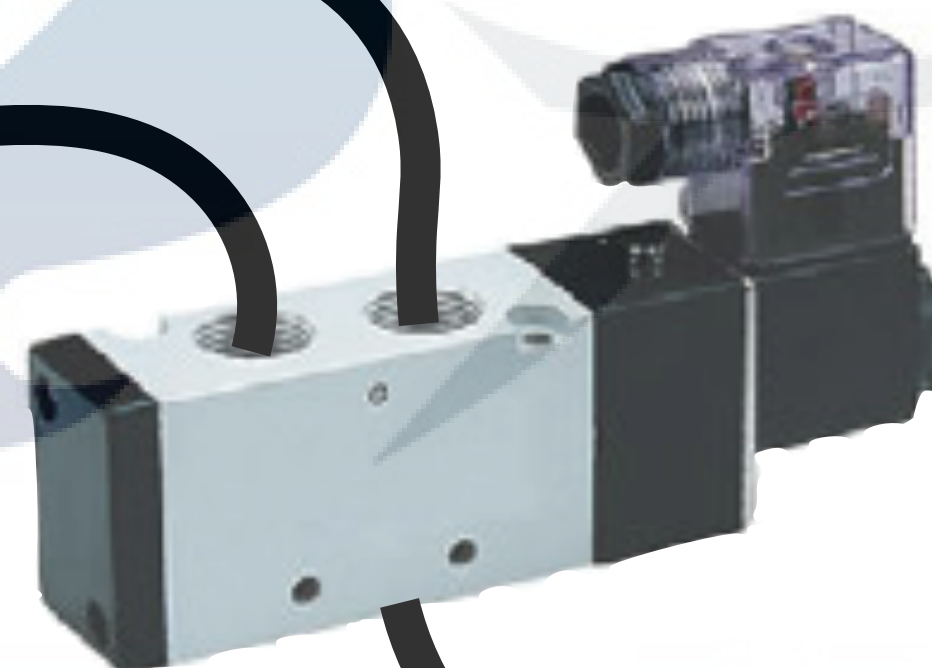

Válvula

Produção e condicionamento

Atuação

Suprimento de ar

Hidráulica

Pneumática

Conclusão

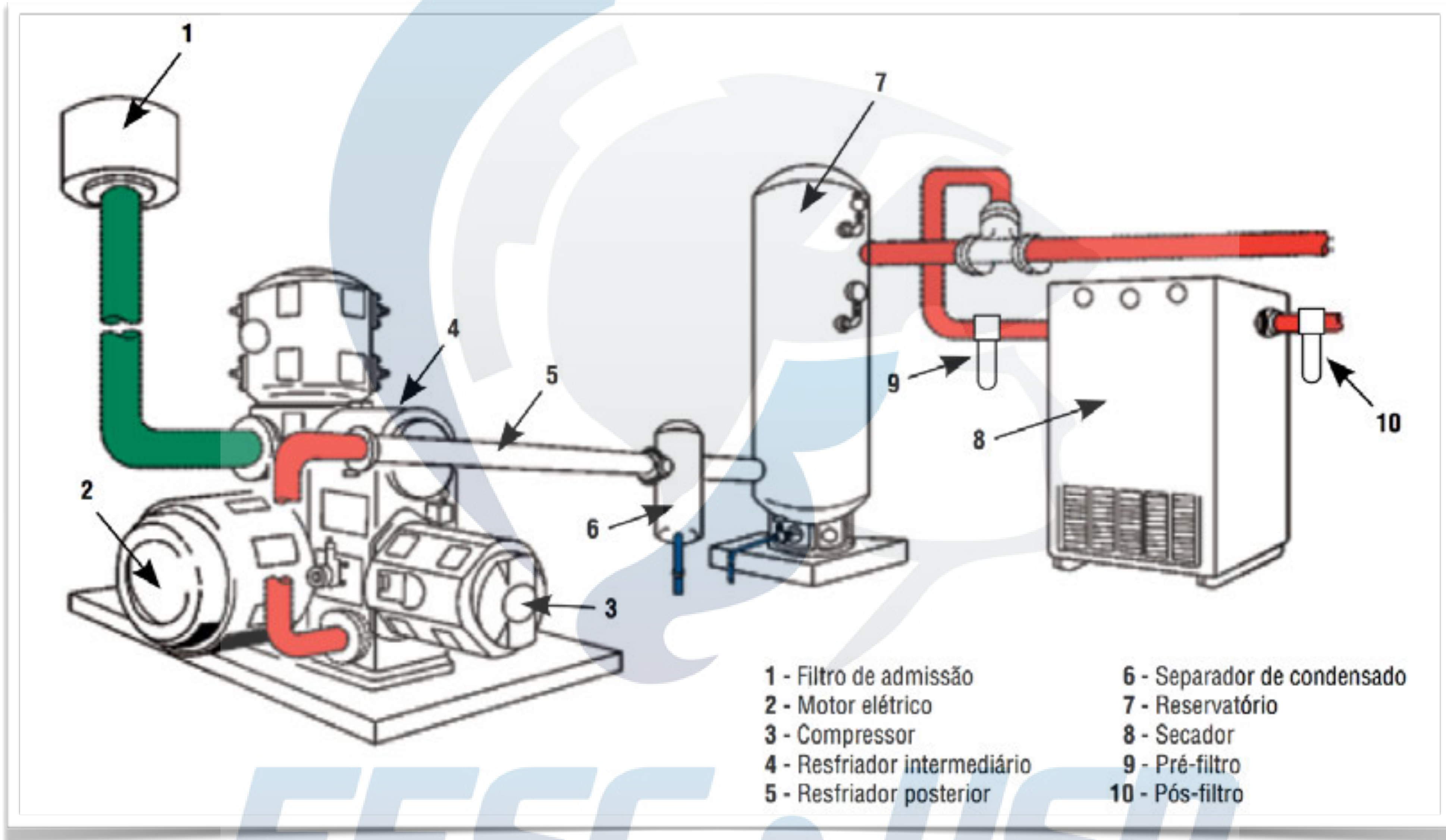

Suprimento de ar

Hidráulica

Pneumática

Conclusão

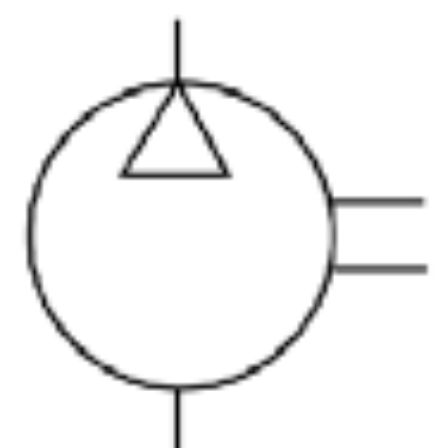
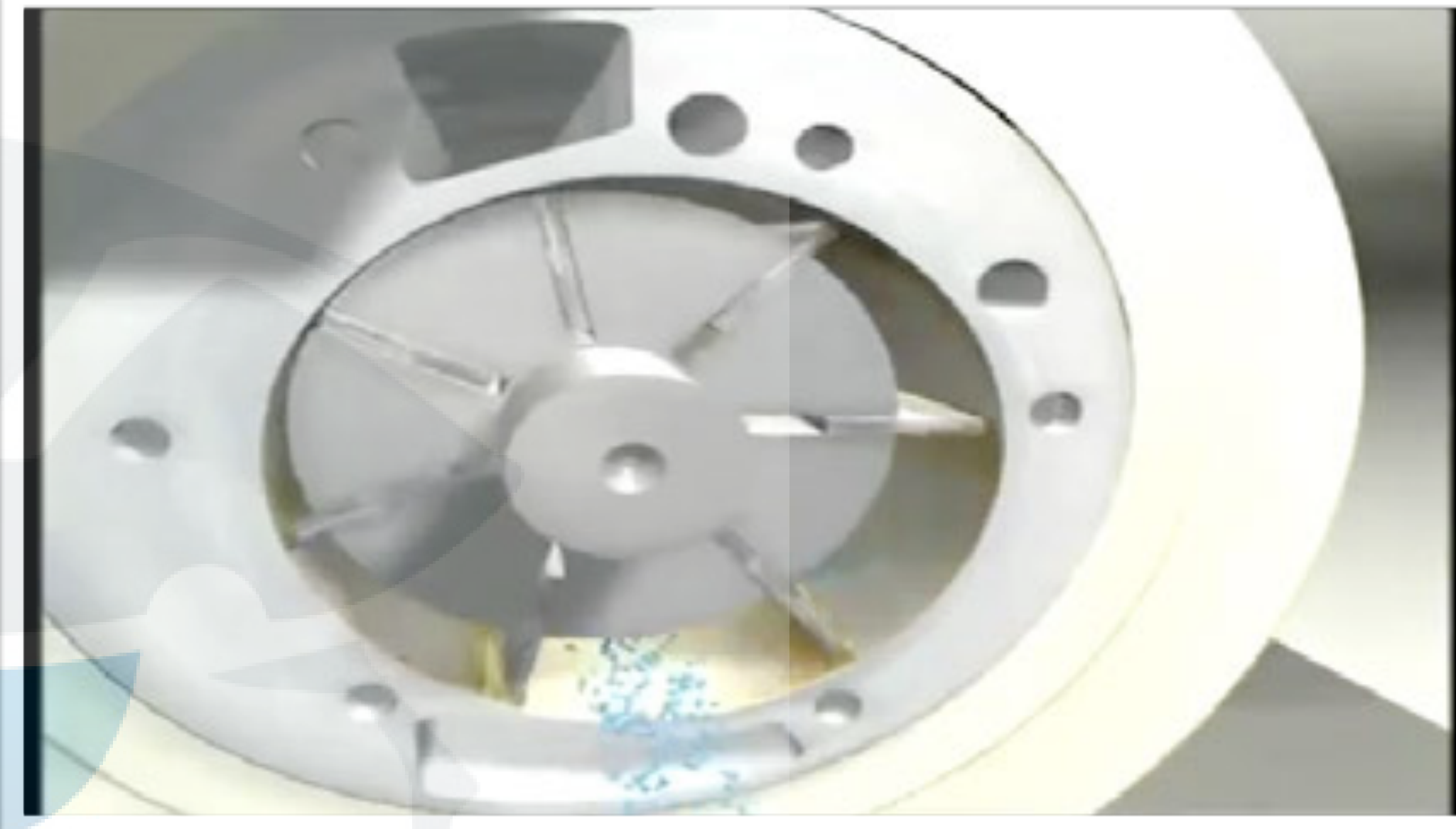
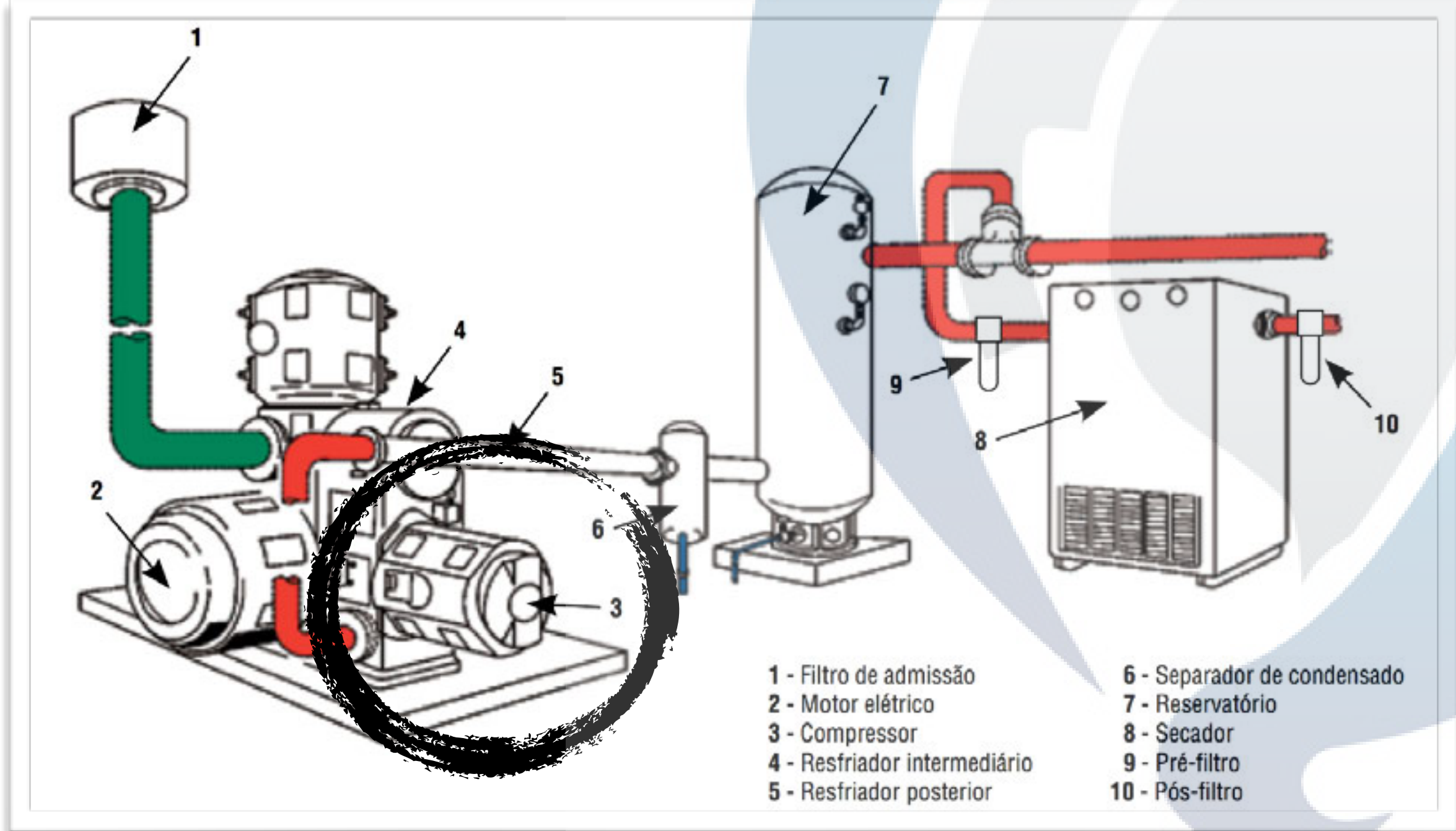

Simbologia

Suprimento de ar

Hidráulica

Pneumática

Conclusão

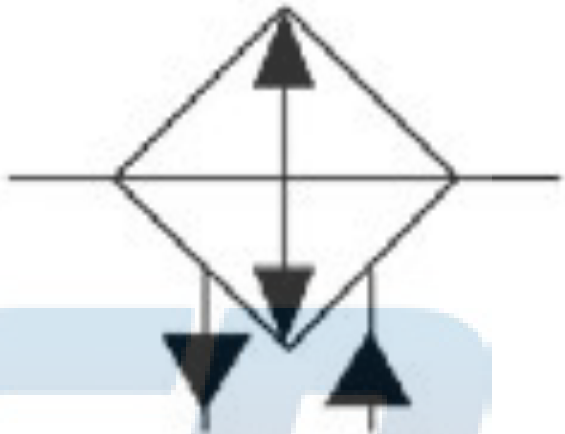
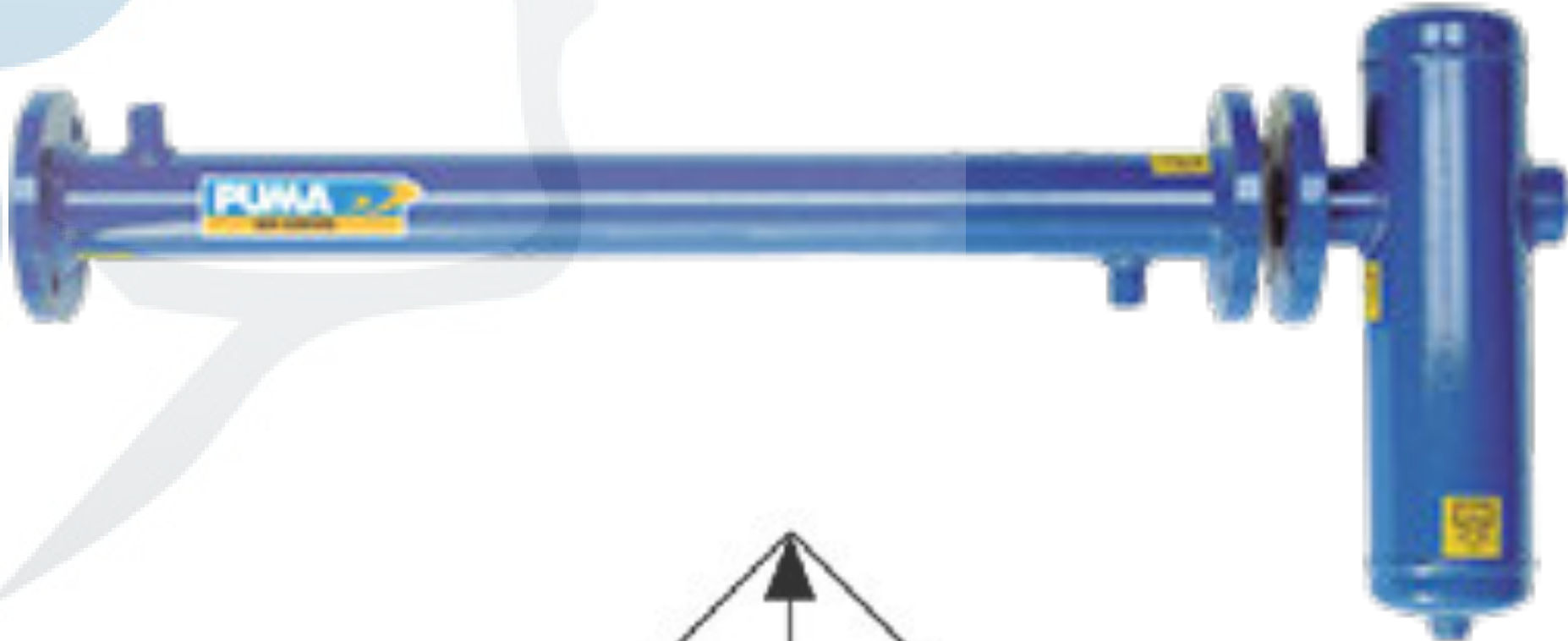
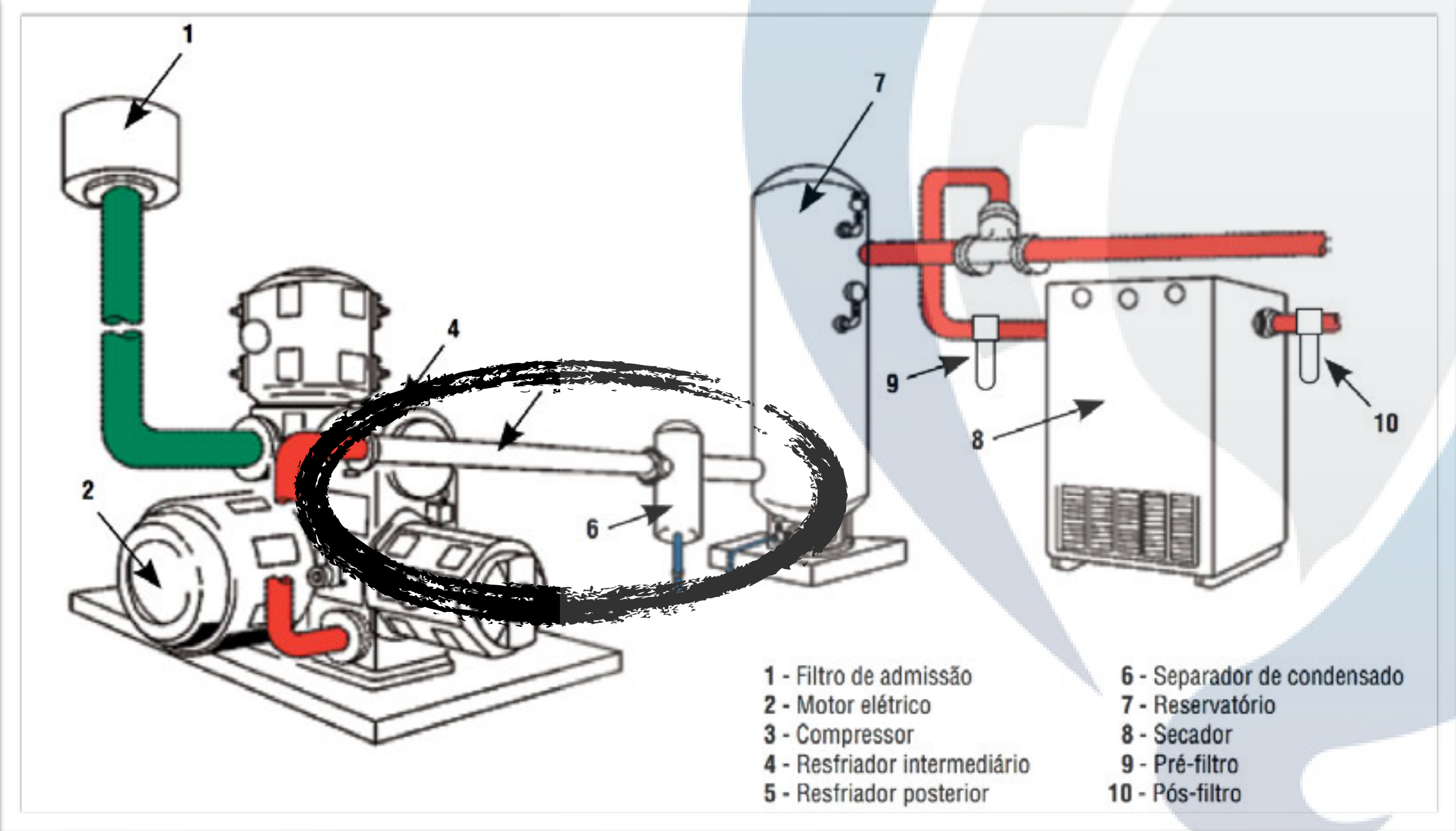

Simbologia

Suprimento de ar

Hidráulica

Pneumática

Conclusão

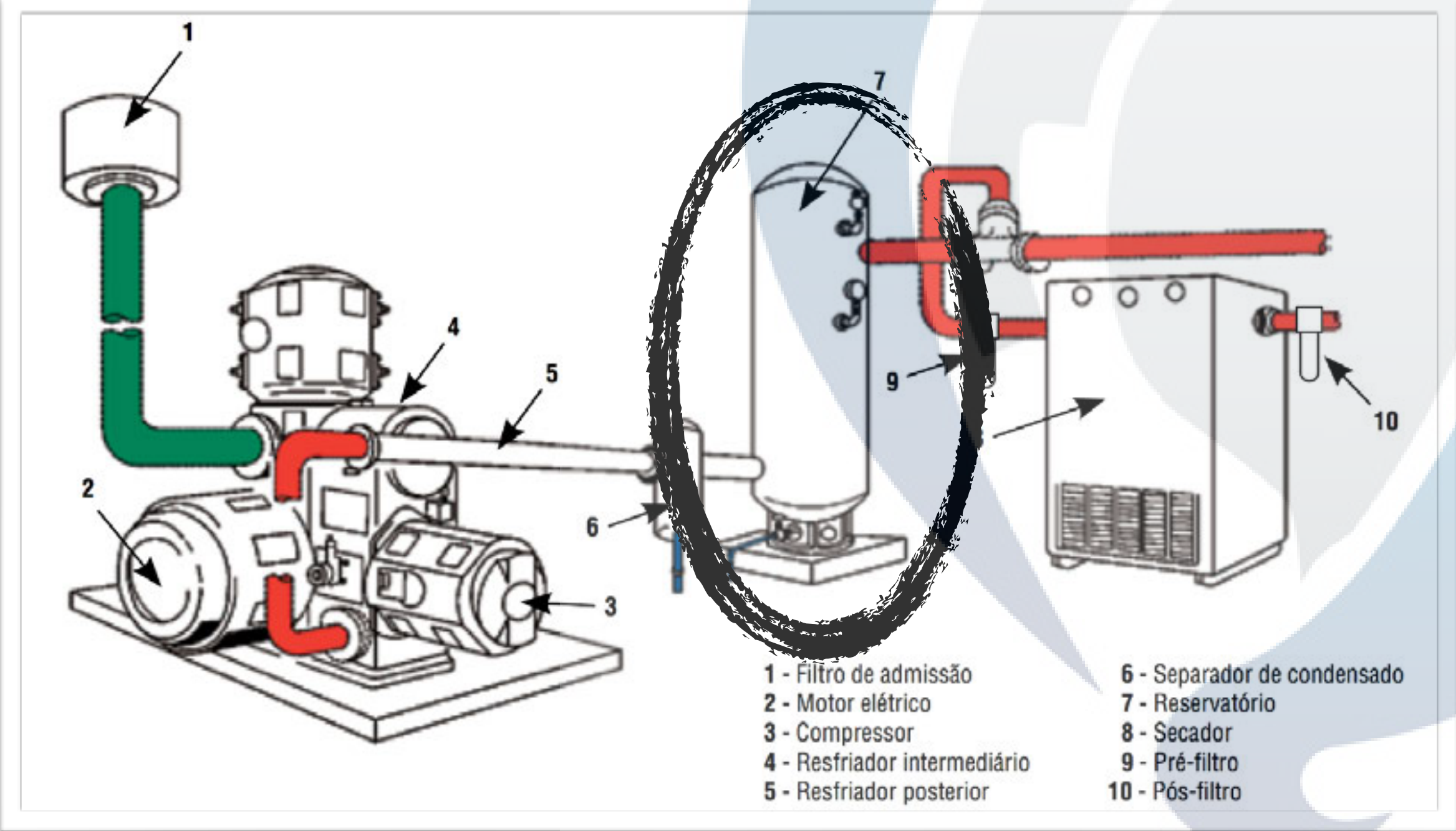

Simbologia

Suprimento de ar

Hidráulica

Pneumática

Conclusão

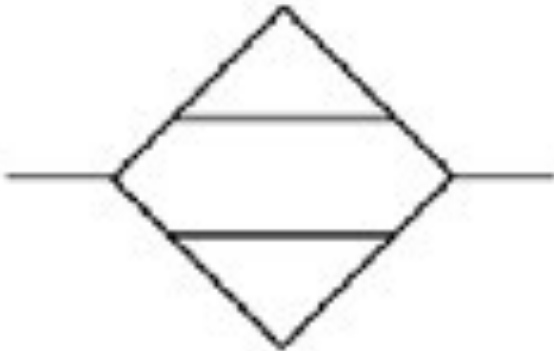
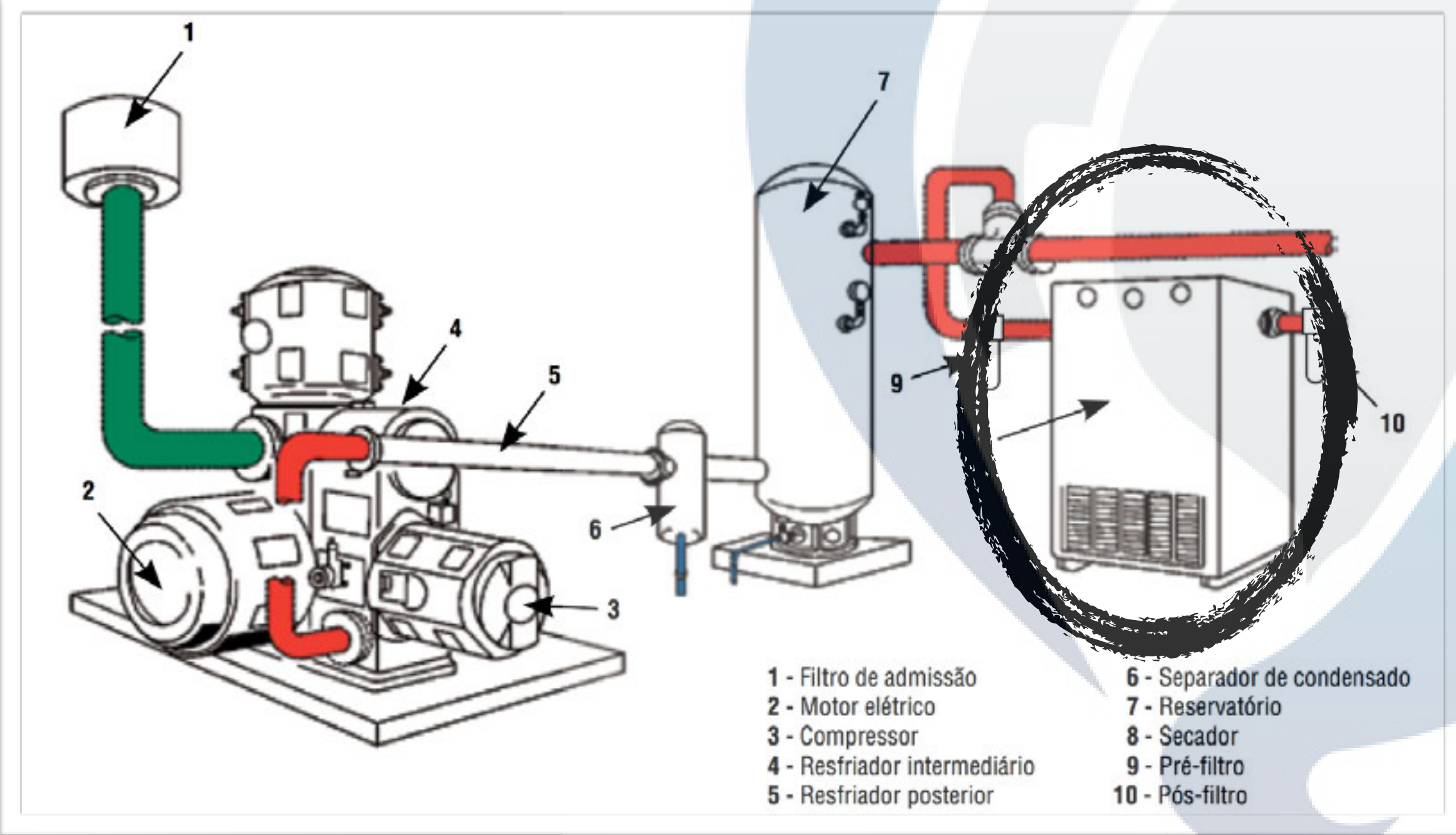

Simbologia

Rede de distribuição

Hidráulica

Pneumática

Conclusão

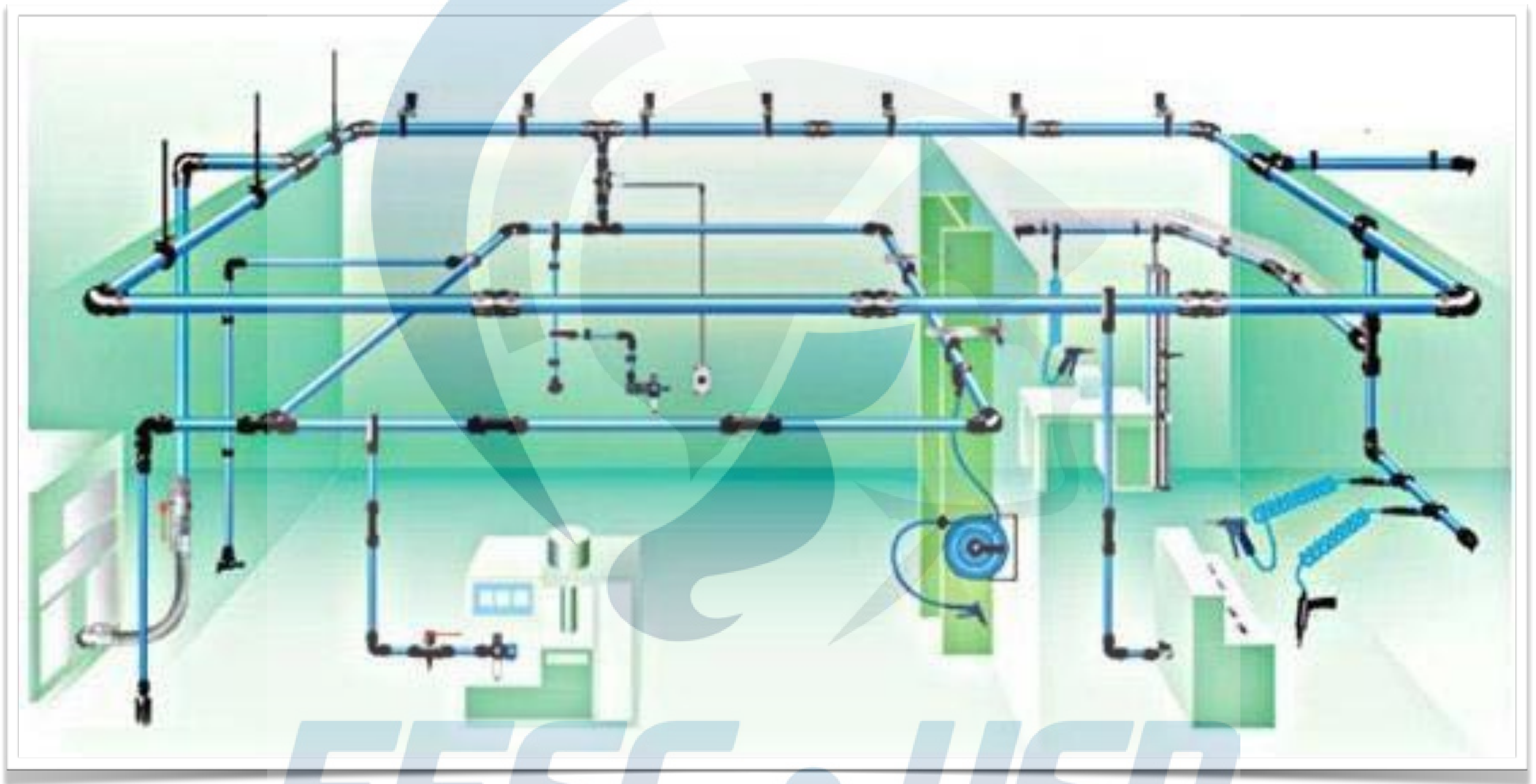

Rede de distribuição

Hidráulica

Pneumática

Conclusão

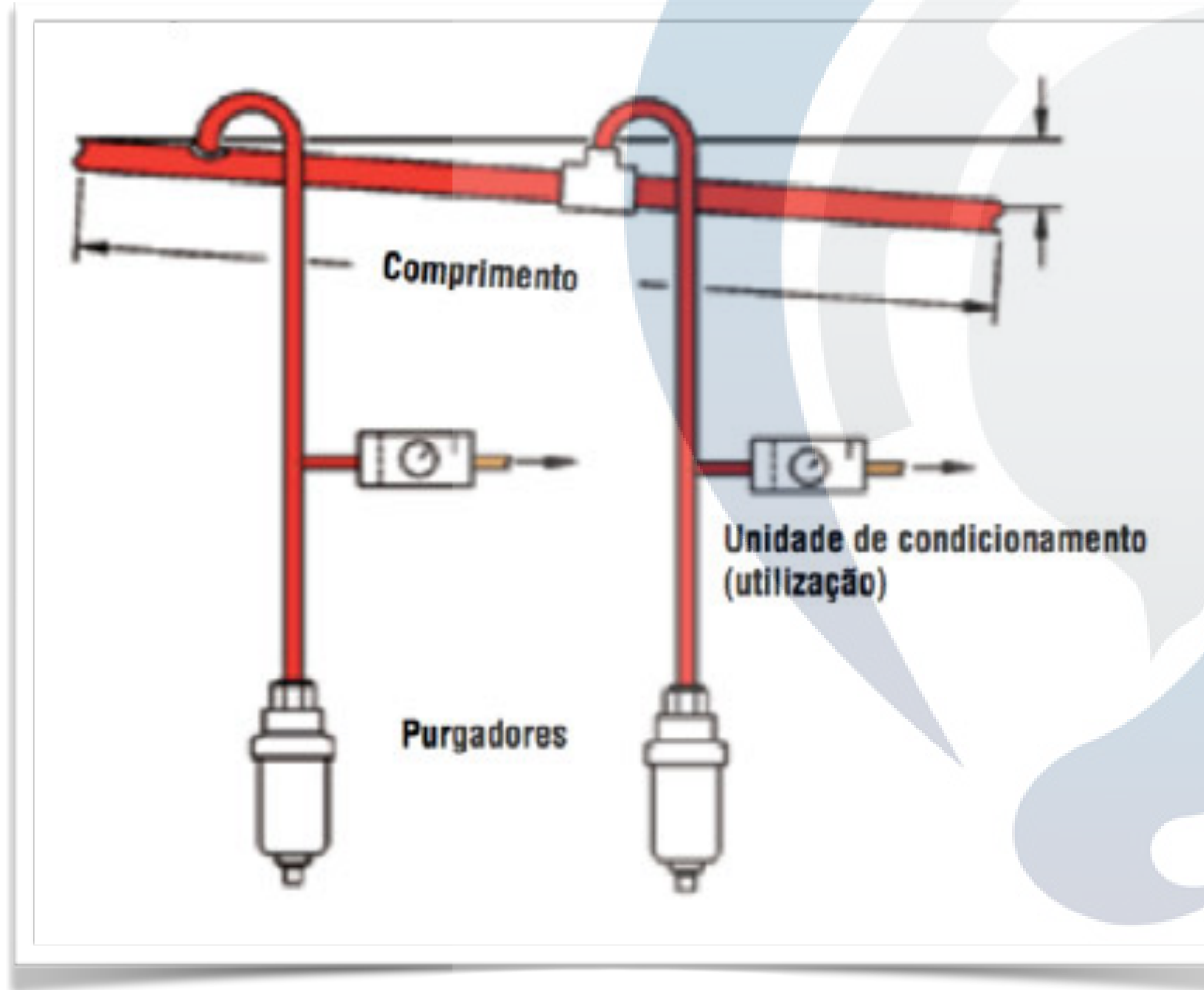

Simbologia

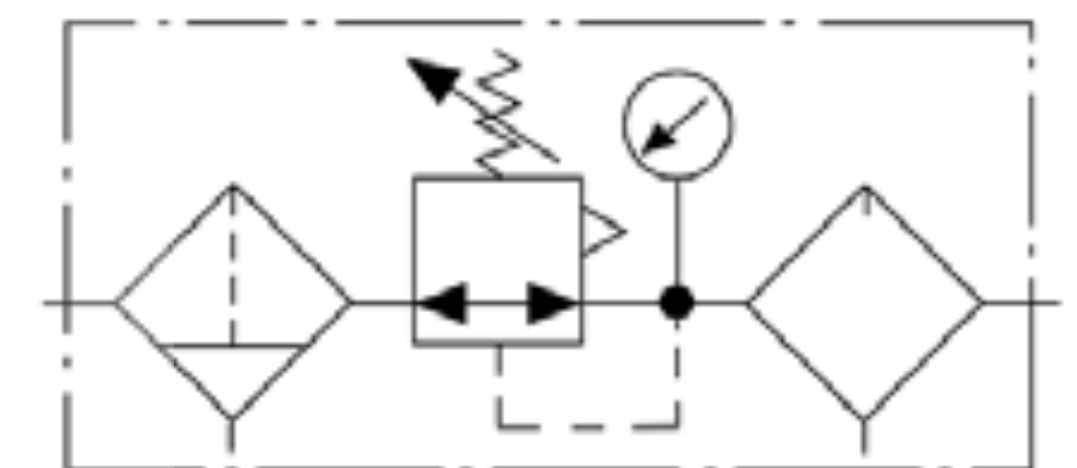

Válvulas

Hidráulica

Pneumática

Conclusão



Válvulas

Hidráulica

Pneumática

Conclusão

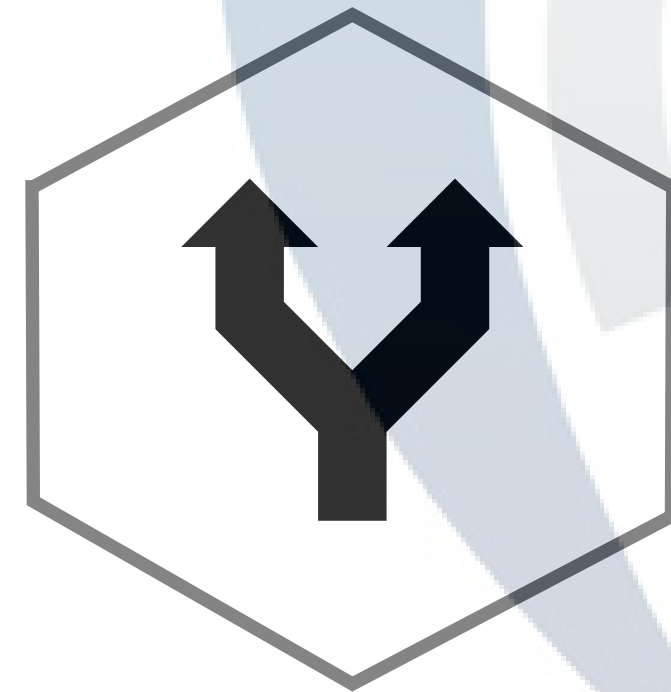

Válvulas de controle direcional



Válvulas auxiliares

Válvulas direcionais

Hidráulica

Pneumática

Conclusão

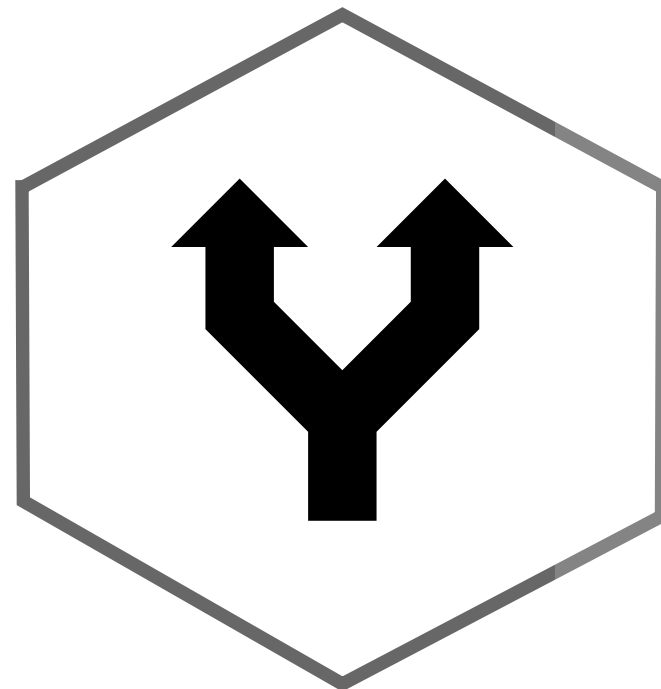

Válvulas de controle direcional

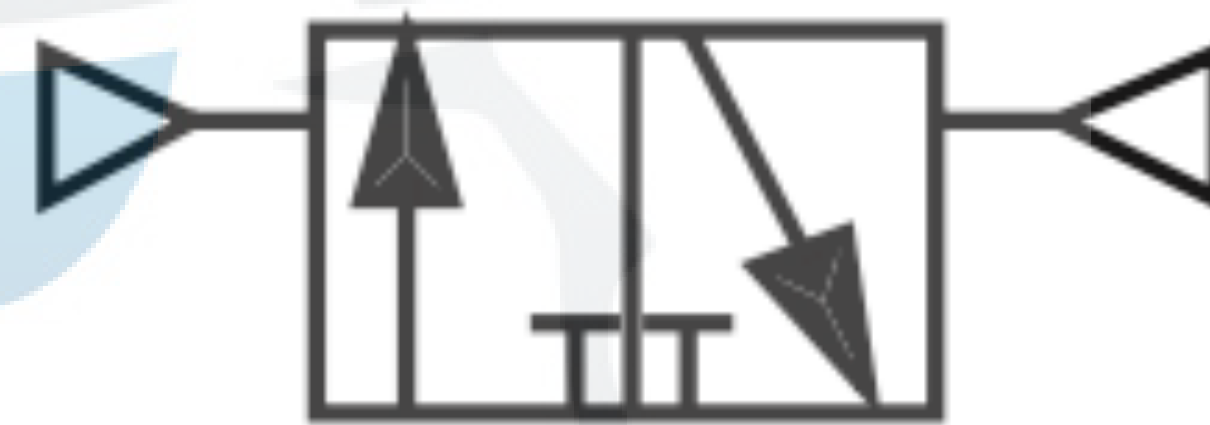

Pilotagem pneumática

Válvulas direcionais

Hidráulica

Pneumática

Conclusão

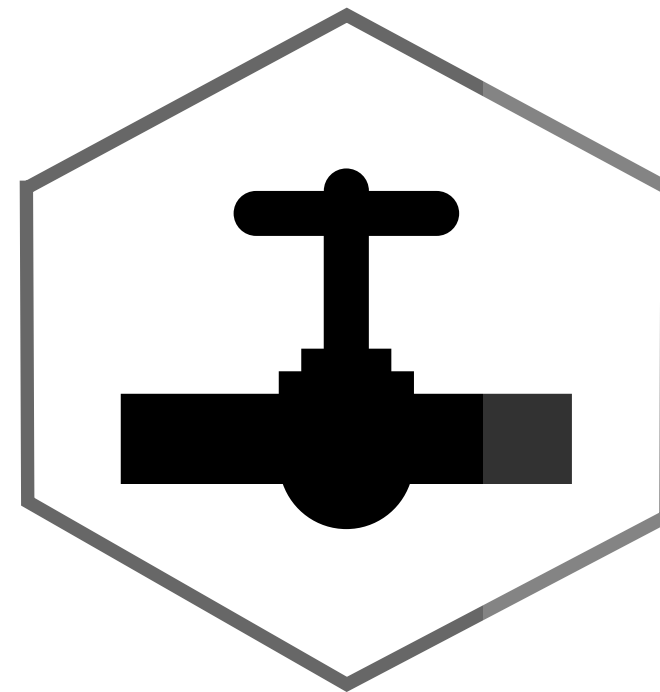
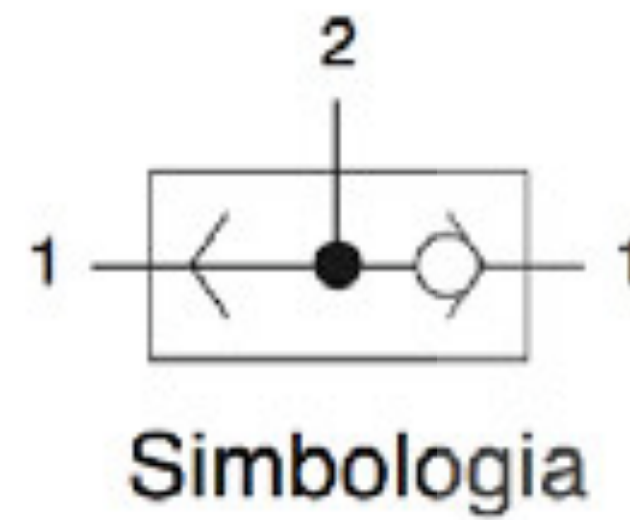

Válvulas
auxiliares

Válvula de isolamento (Elemento “OU”)

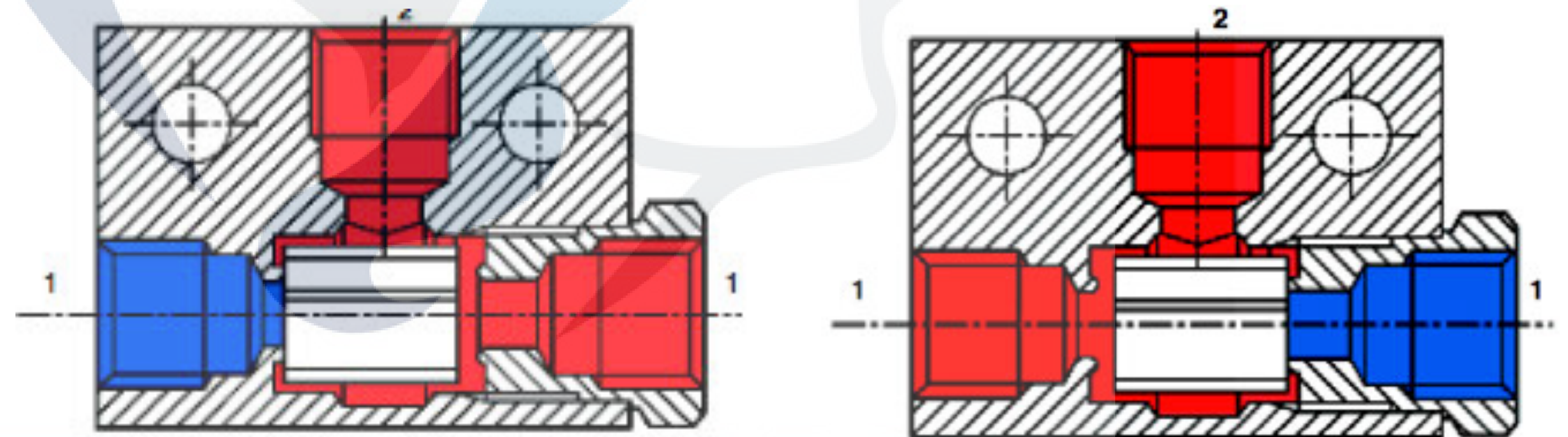

Válvulas direcionais

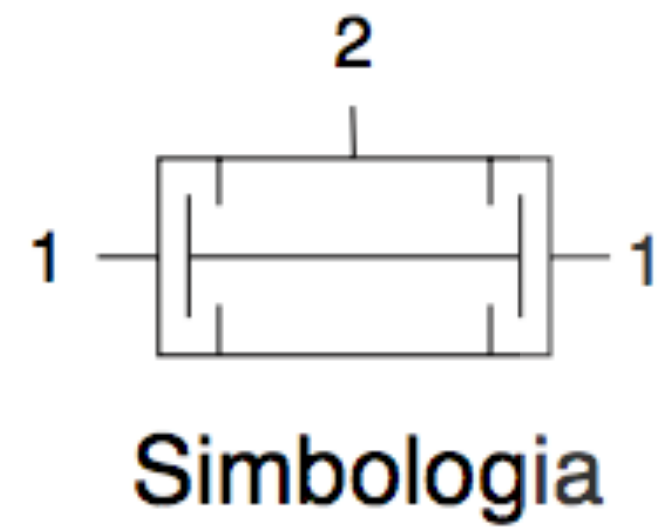

Válvulas auxiliares

Válvula de simultaneidade (Elemento “E”)

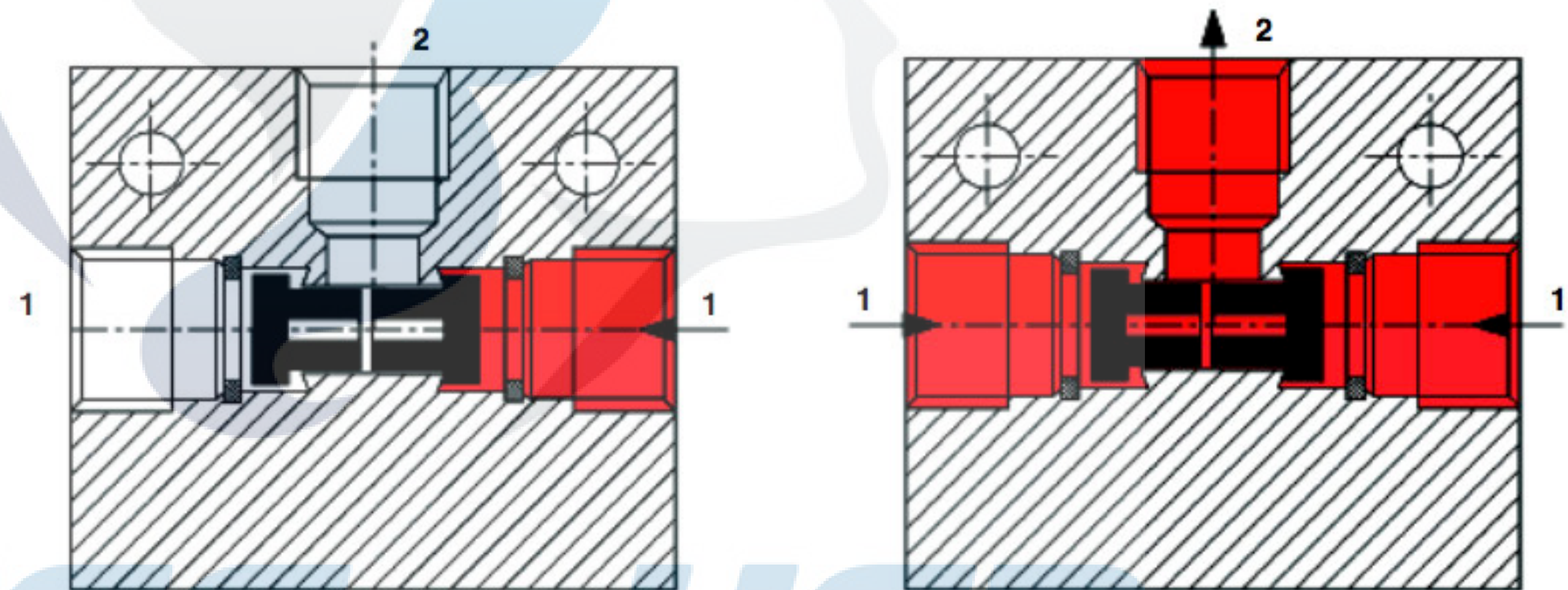

Atuadores pneumáticos

Hidráulica

Pneumática

Conclusão

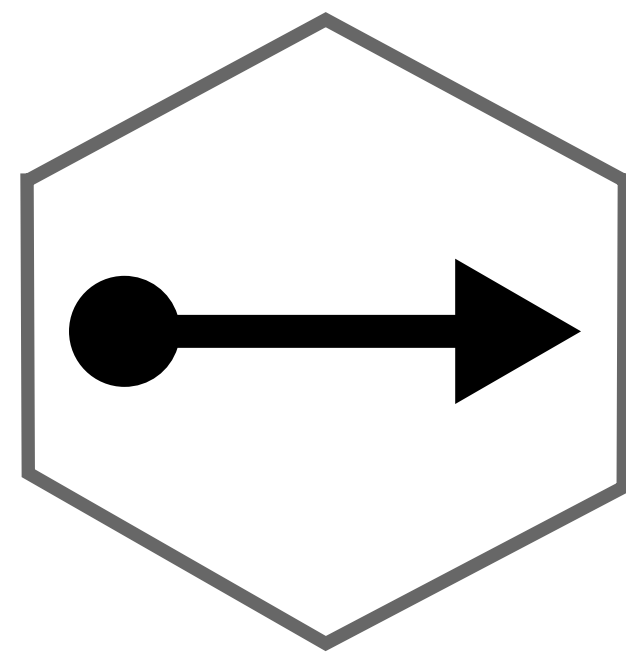

Lineares



Oscilantes

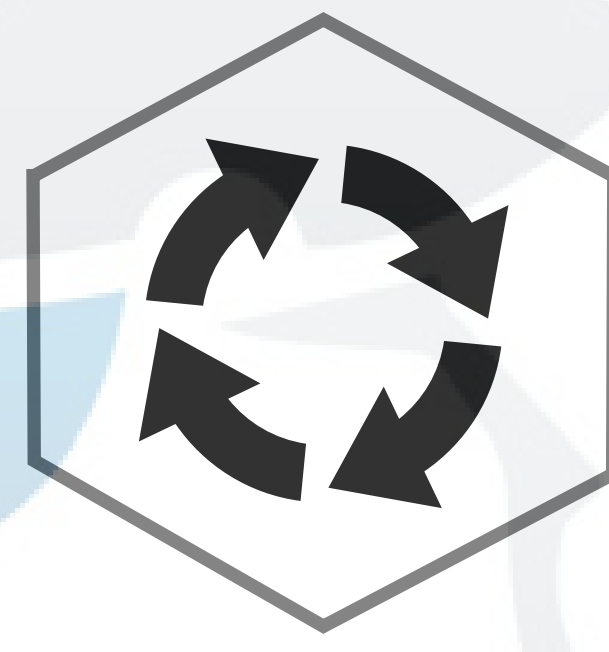

Rotativos

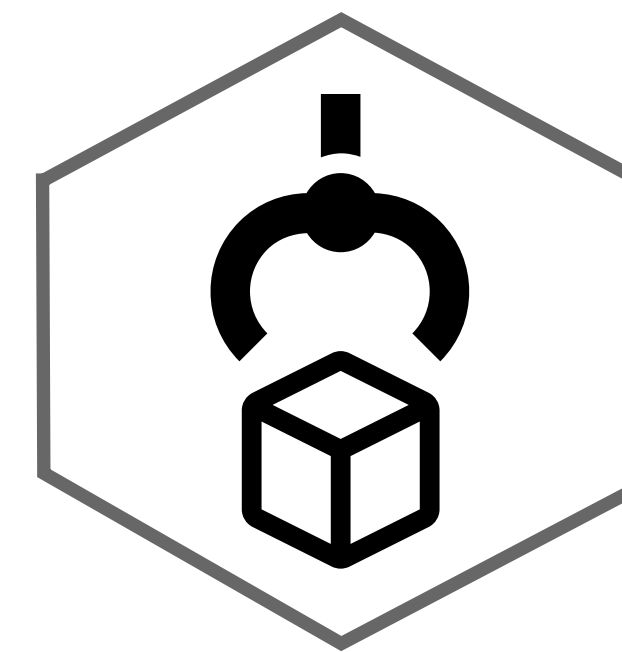

Especiais

Cilindros pneumáticos

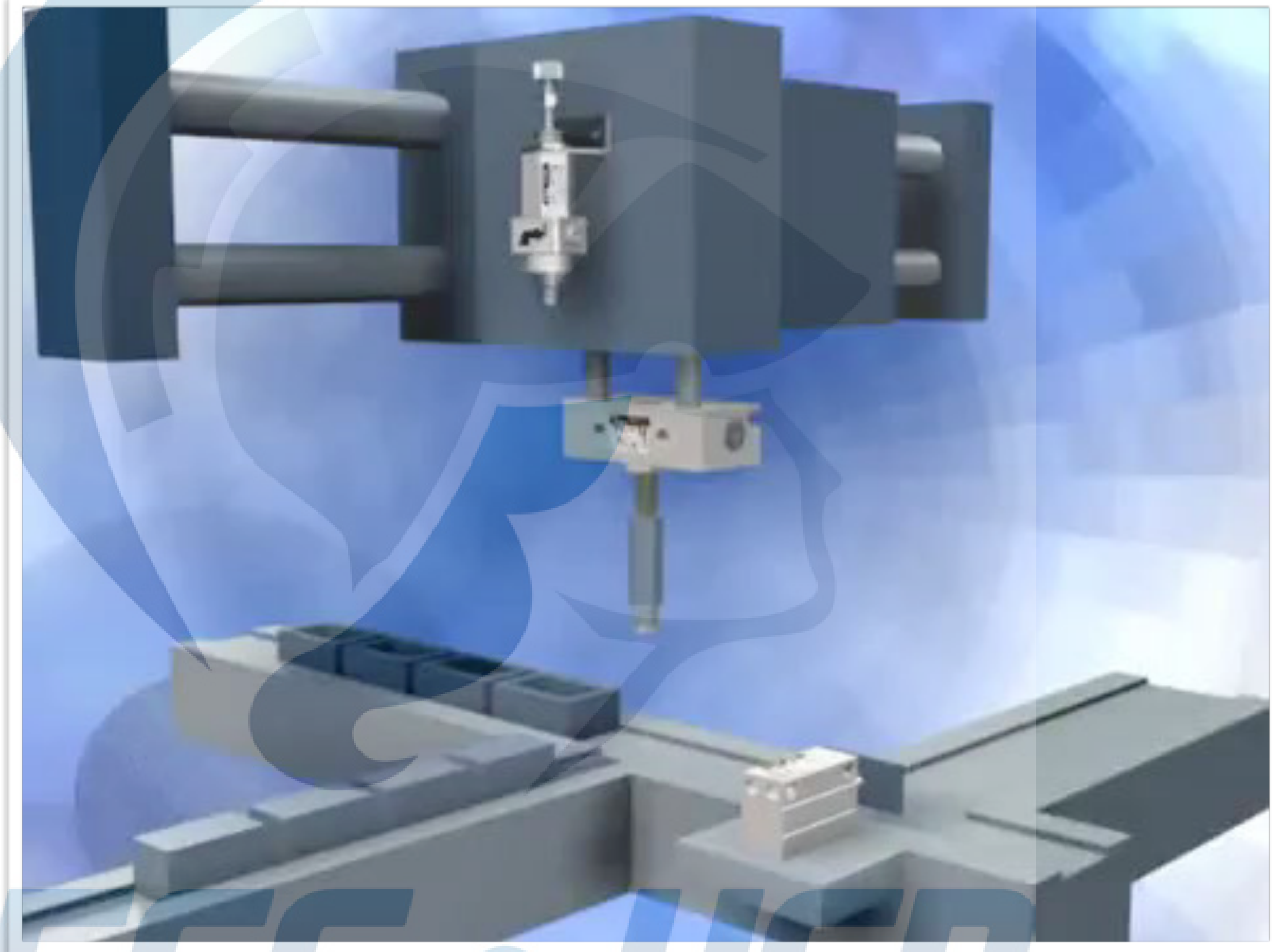
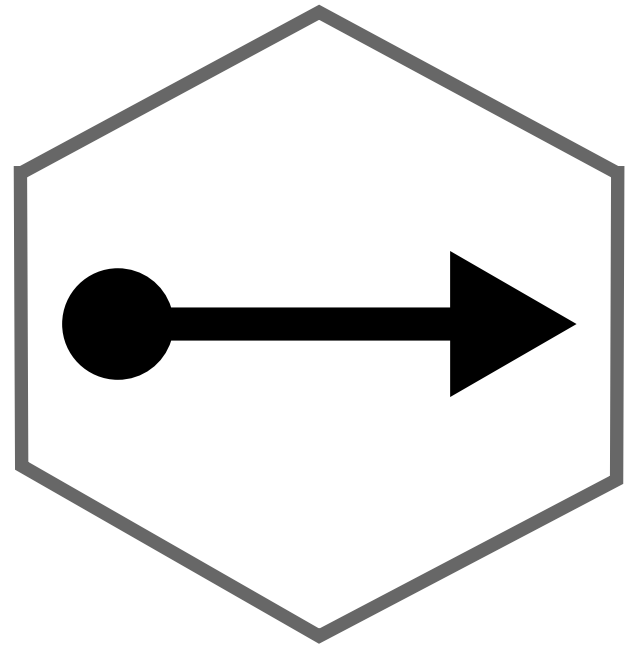

Hidráulica

Pneumática

Conclusão

Cilindros pneumáticos

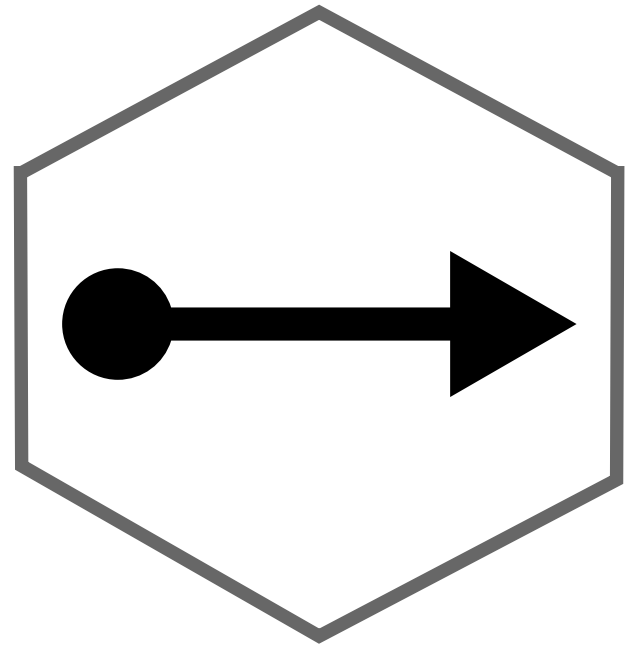

Hidráulica

Pneumática

Conclusão

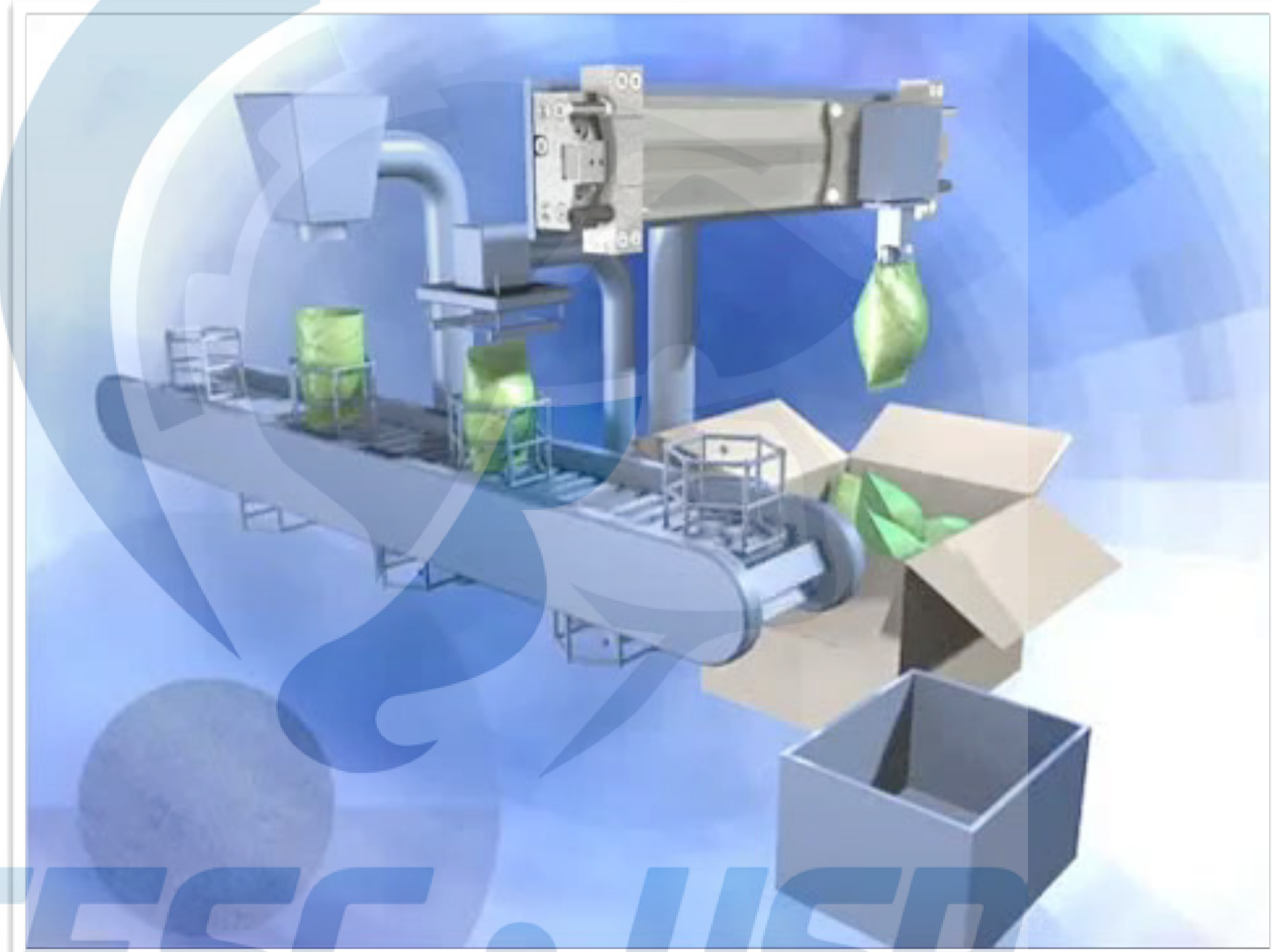

Osciladores pneumáticos

Hidráulica

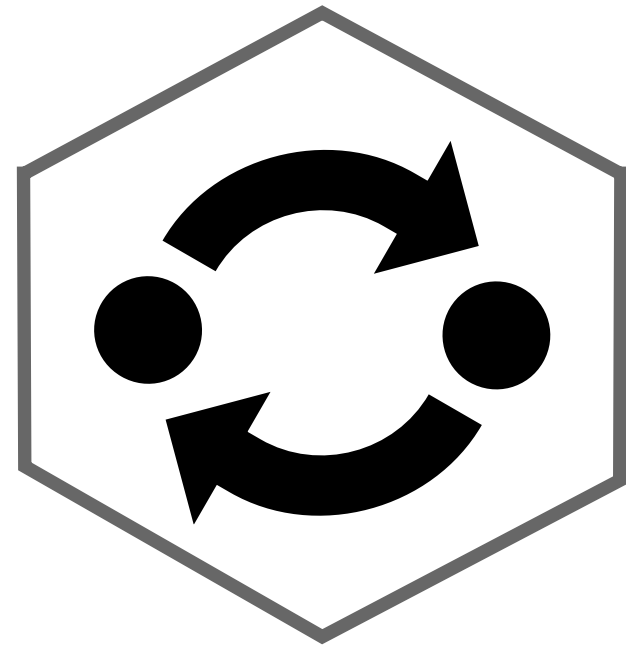

Simbologia

Pneumática

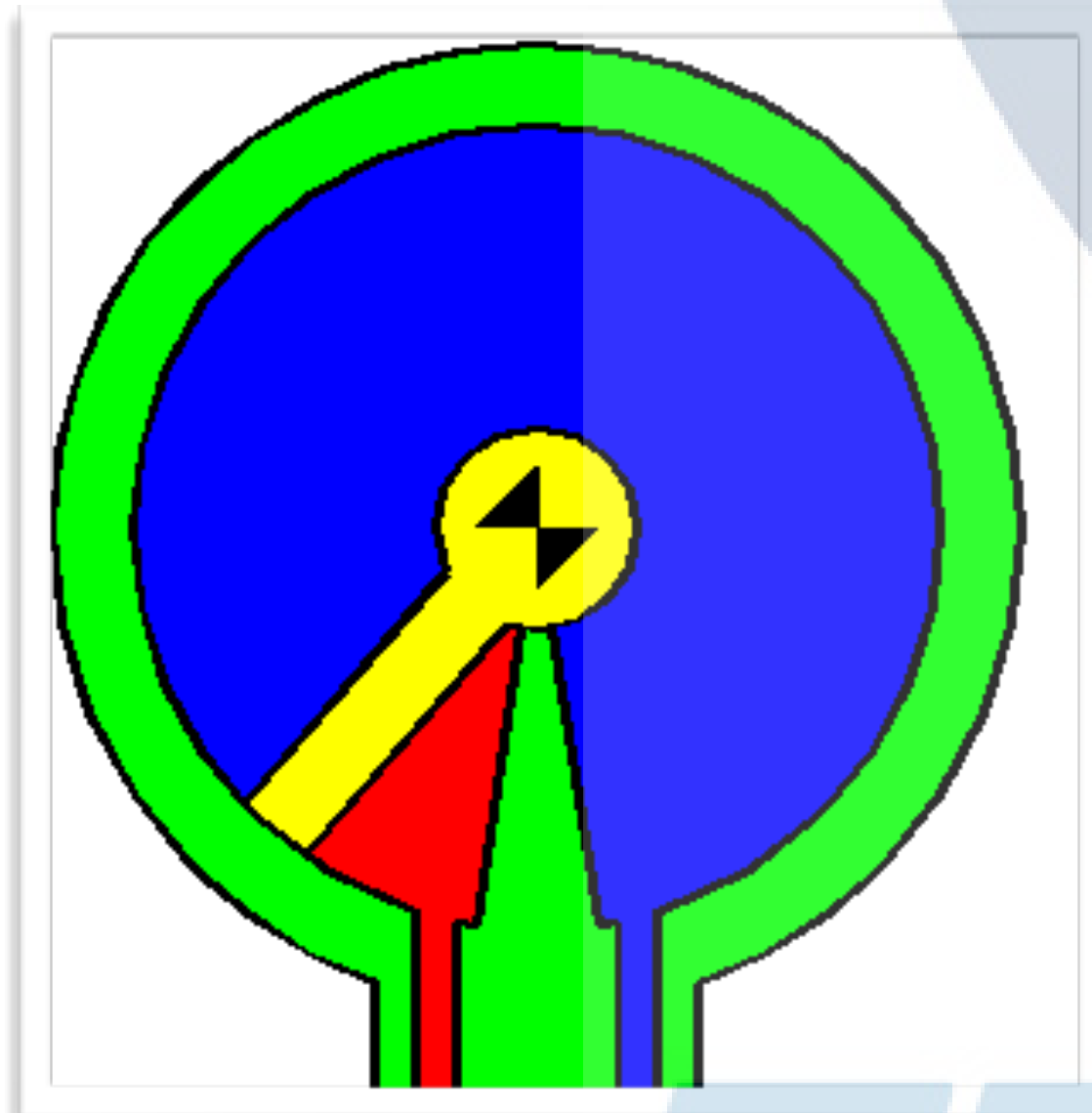

Conclusão

Osciladores pneumáticos

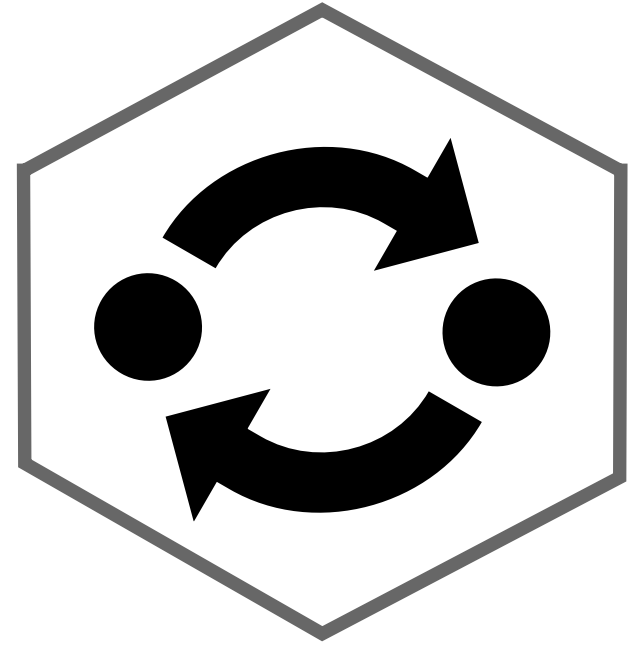

Simbologia

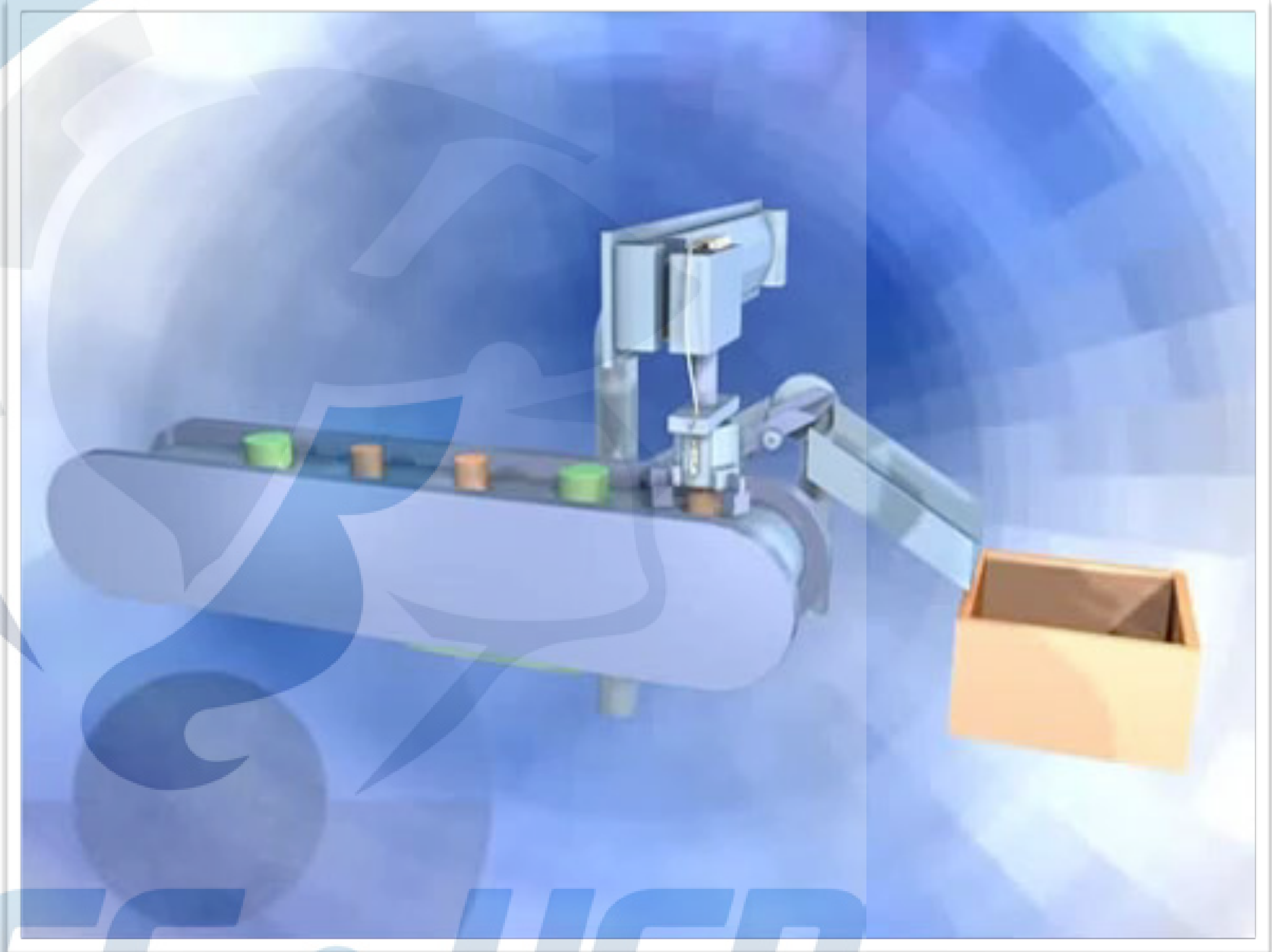

Hidráulica

Pneumática

Conclusão

Osciladores pneumáticos

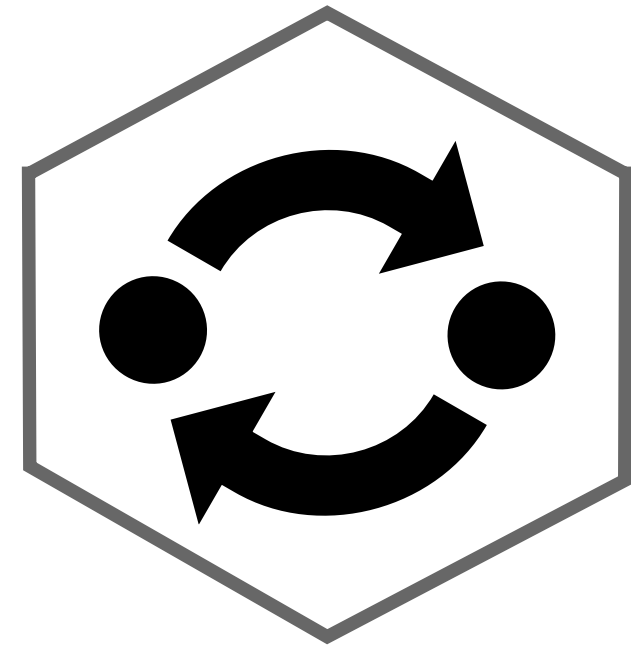

Simbologia

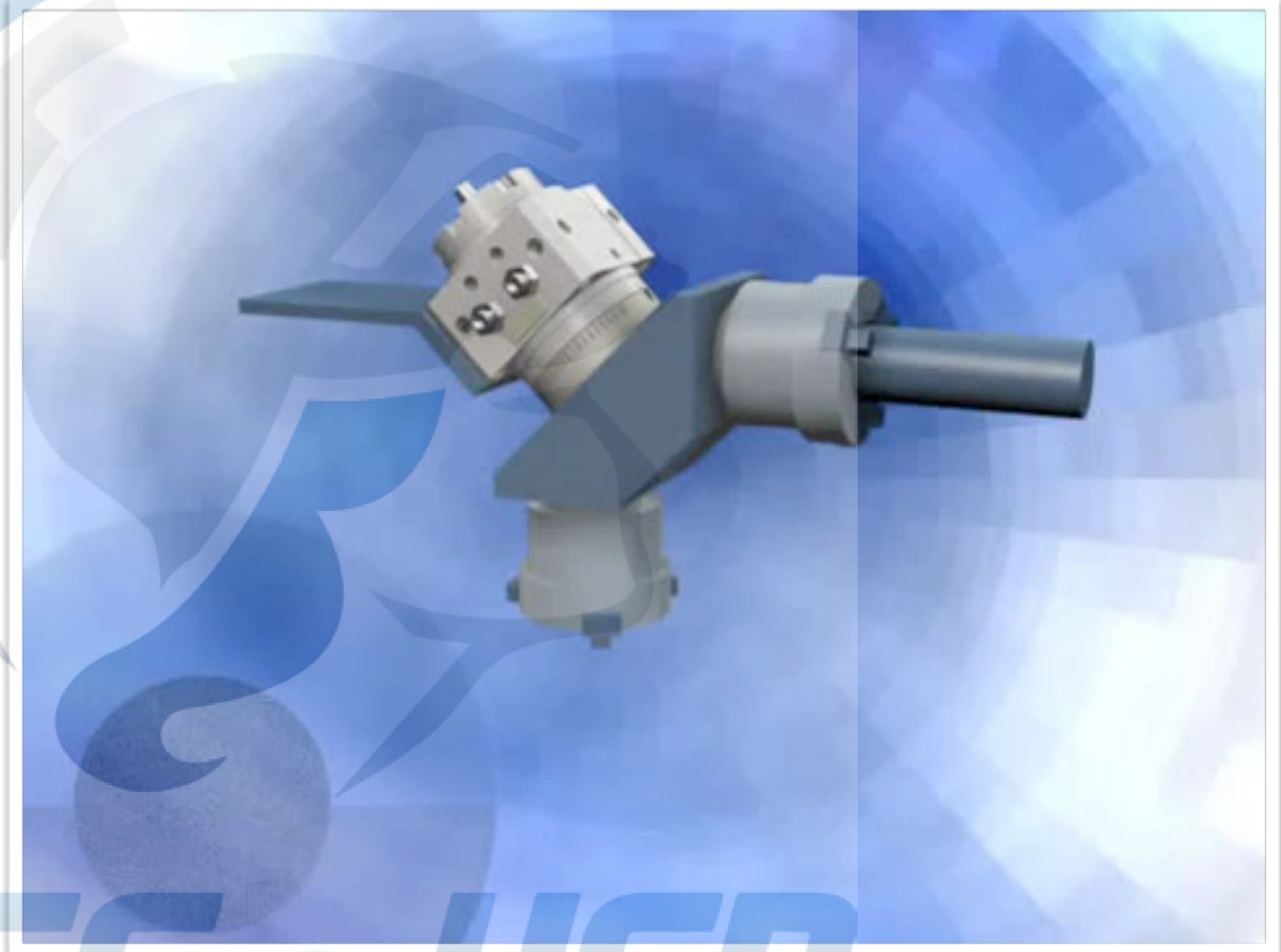

Hidráulica

Pneumática

Conclusão

Motores pneumáticos

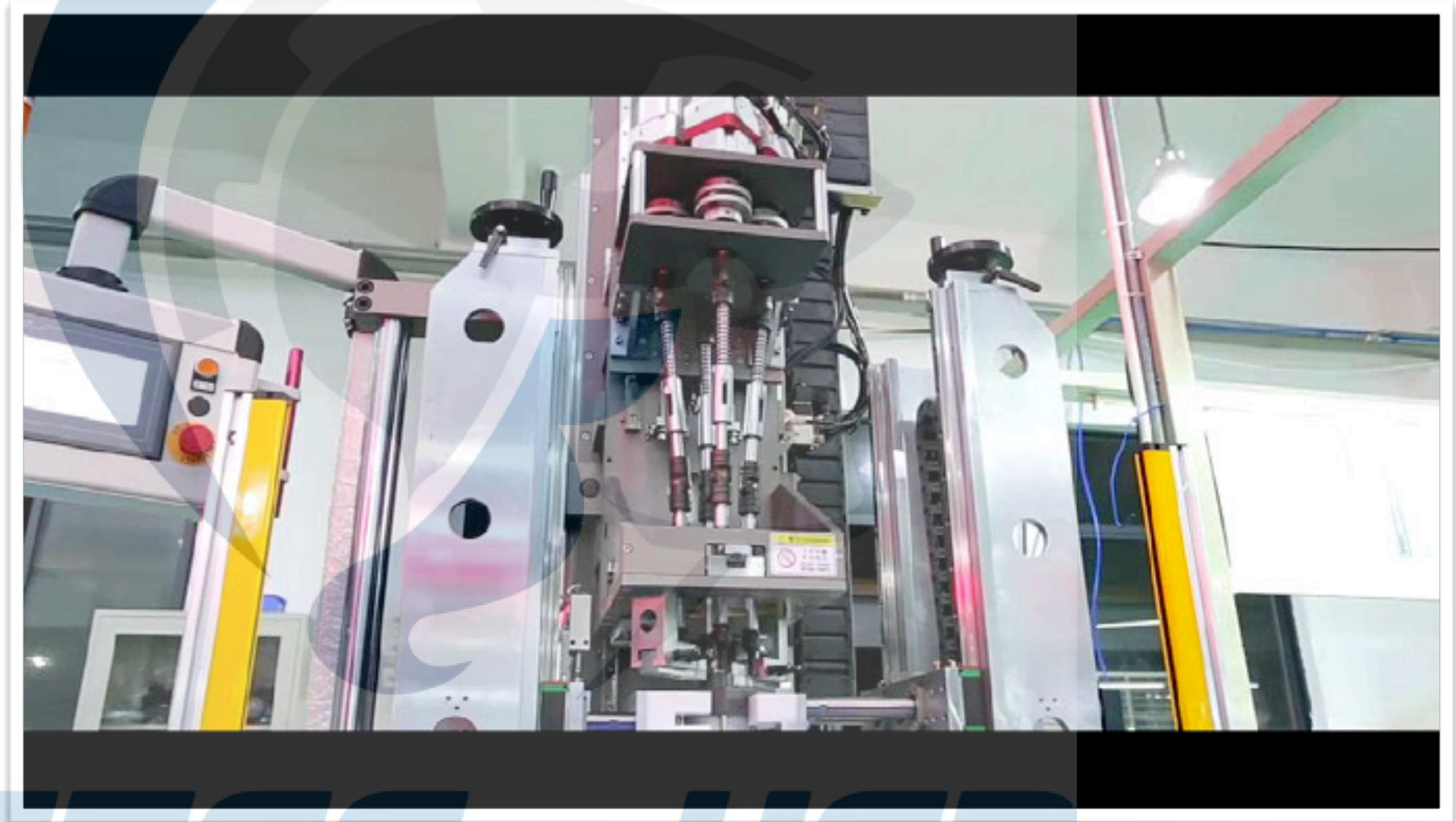
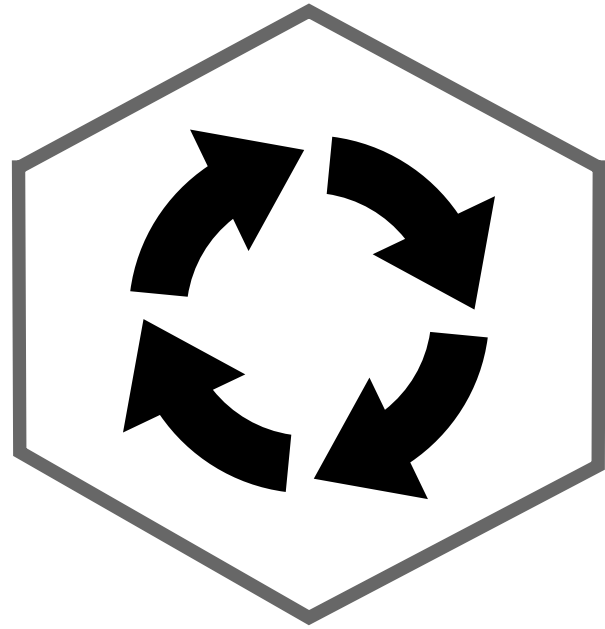

Hidráulica

Pneumática

Conclusão

Motores pneumáticos

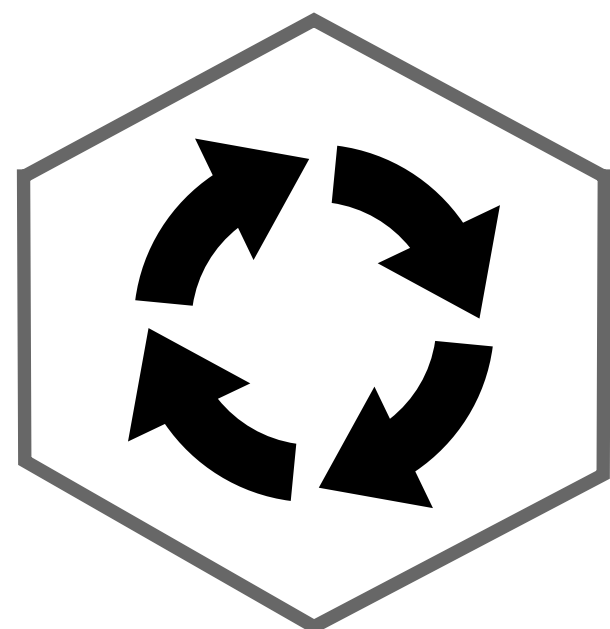

Hidráulica

Pneumática

Conclusão

Motores pneumáticos

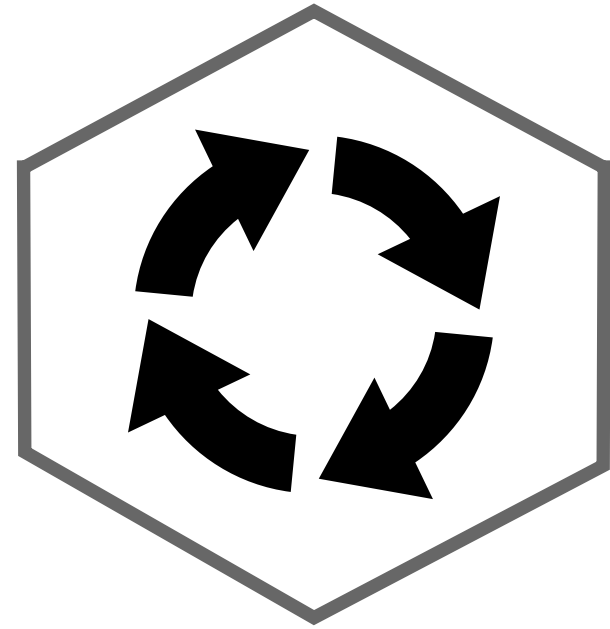

Hidráulica

Pneumática

Conclusão

Motores pneumáticos

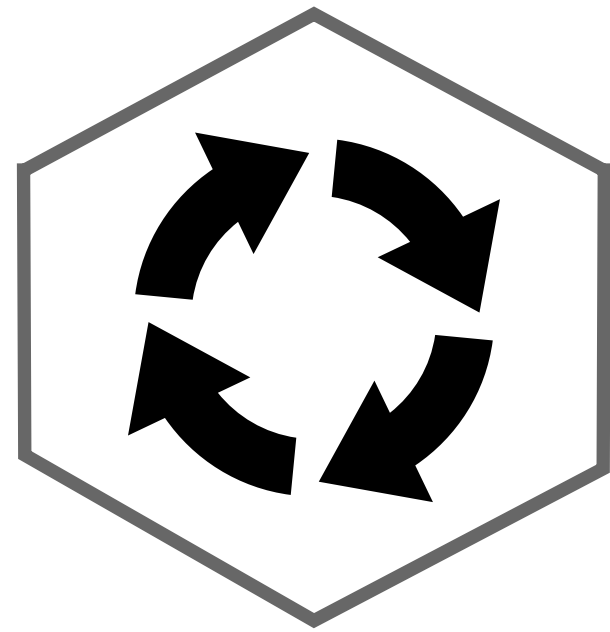

Simbologia



Menor dimensão
e peso



Carga máxima
estática

Hidráulica

Pneumática

Conclusão

Atuadores especiais

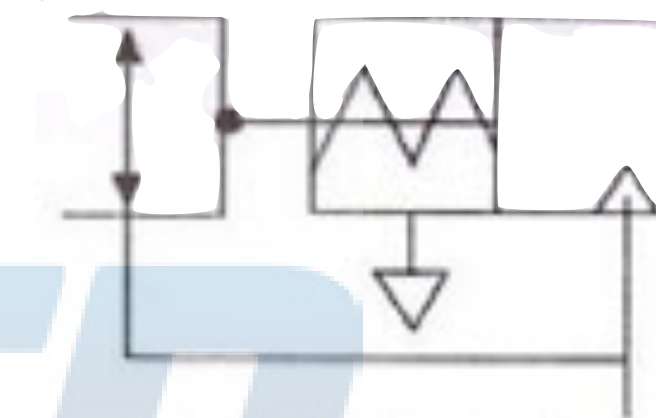
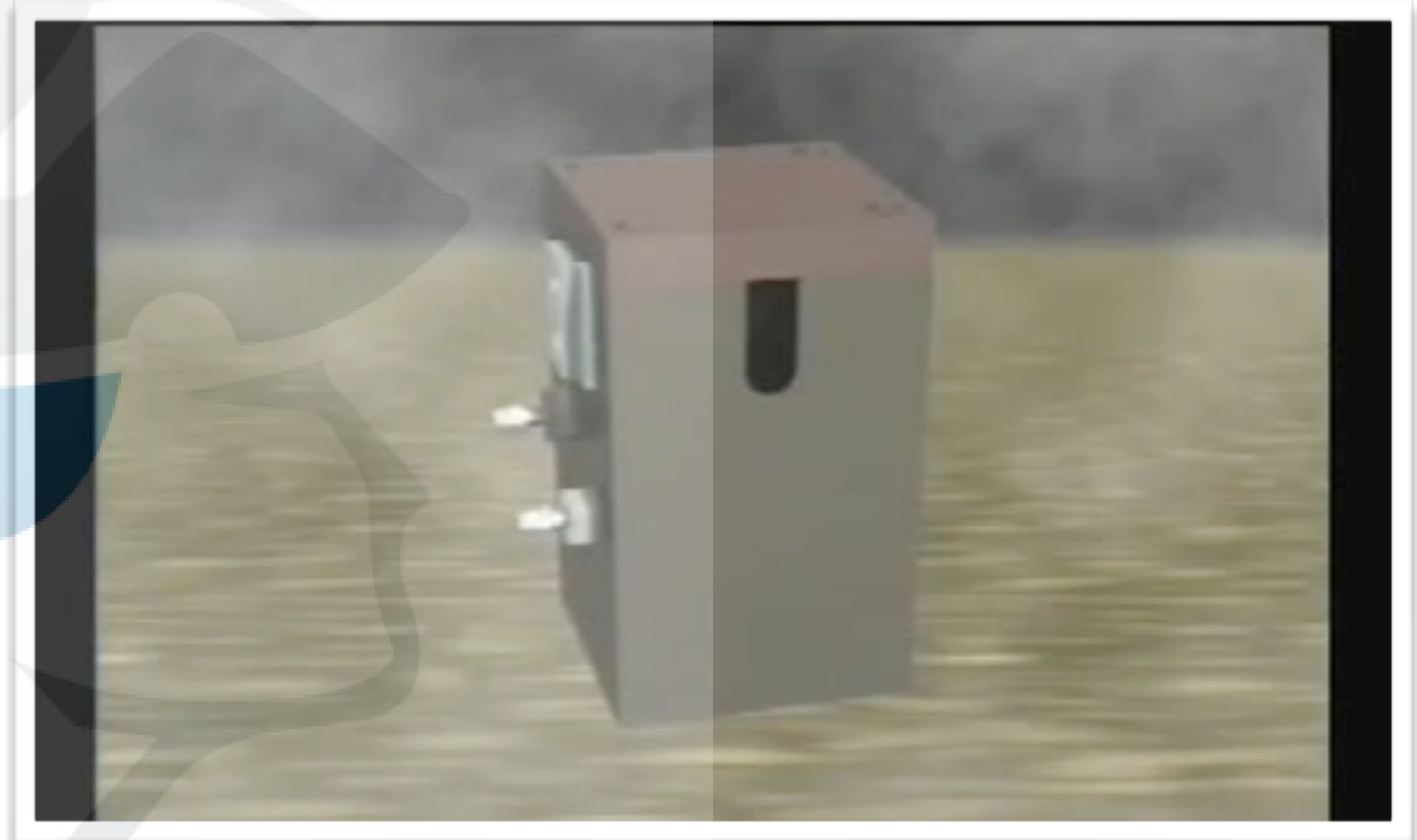
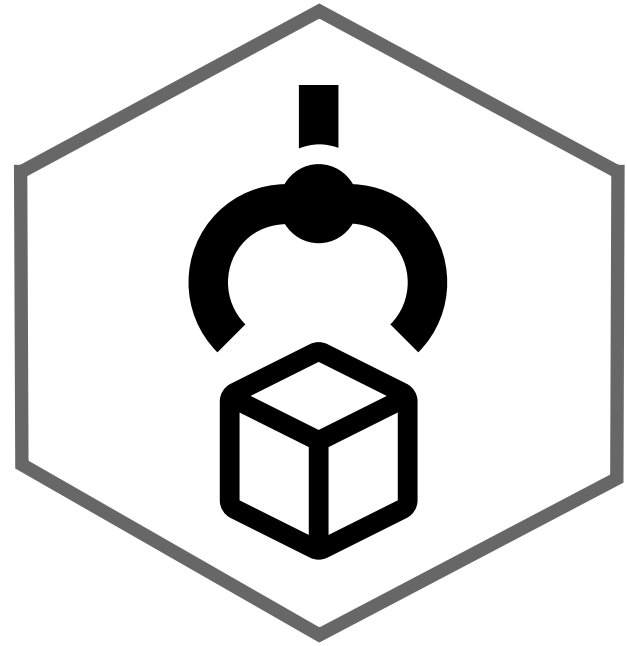

Simbologia

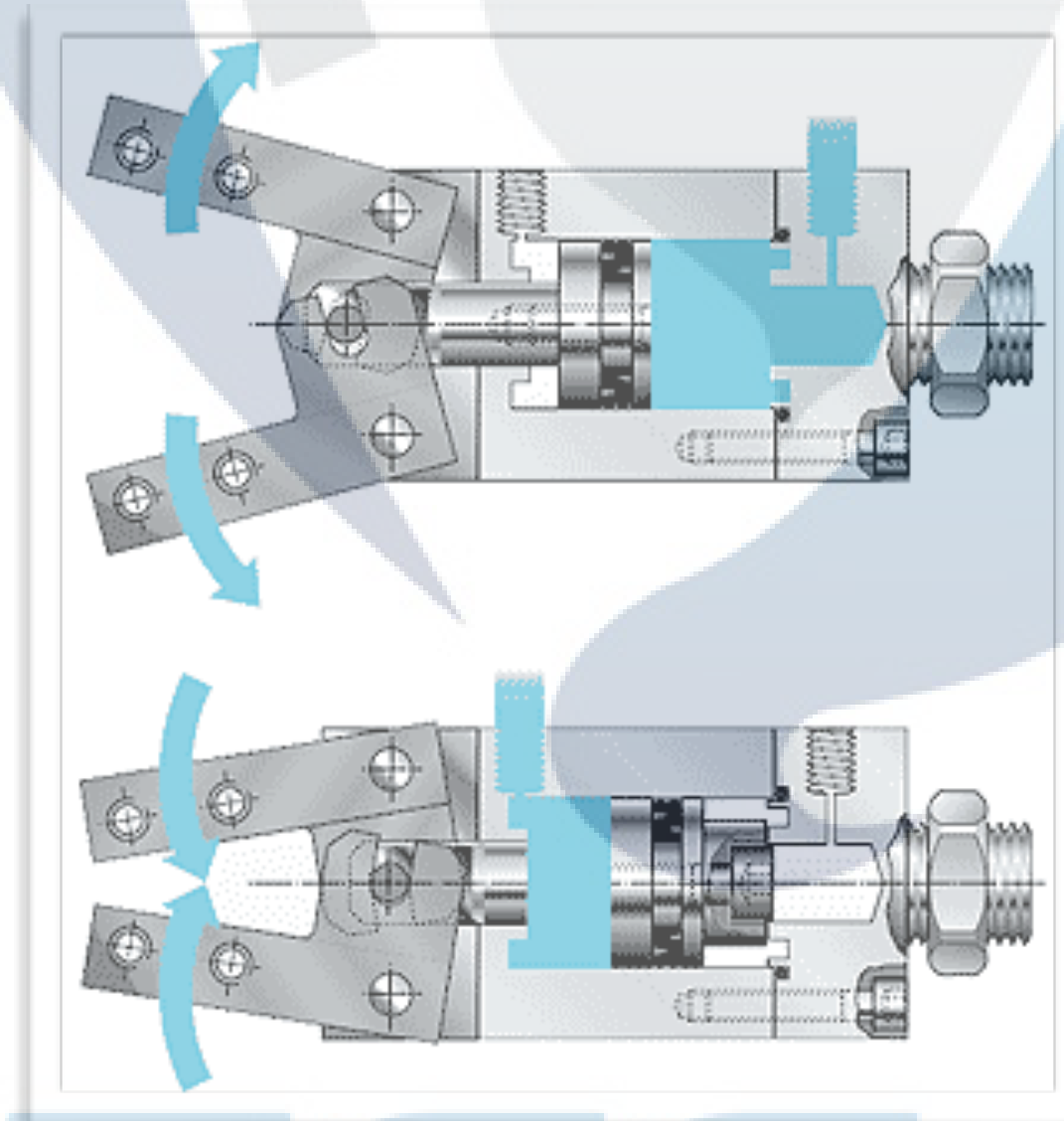

Hidráulica

Pneumática

Conclusão

Atuadores especiais

Hidráulica

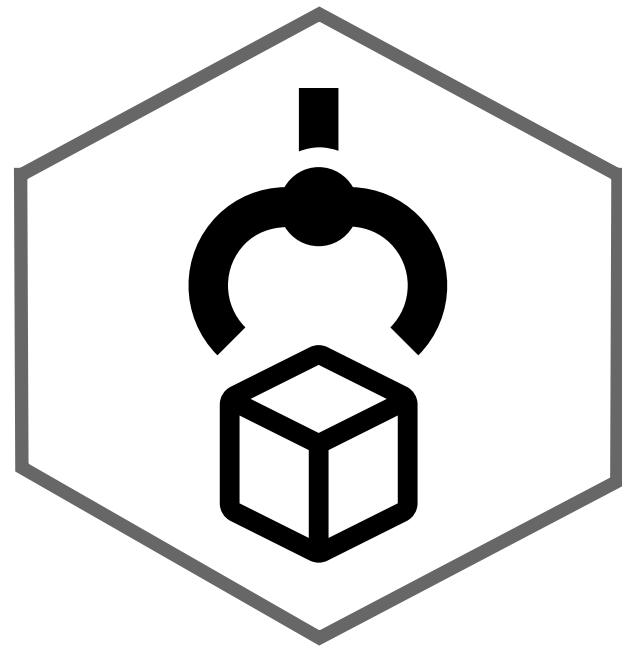

Pneumática

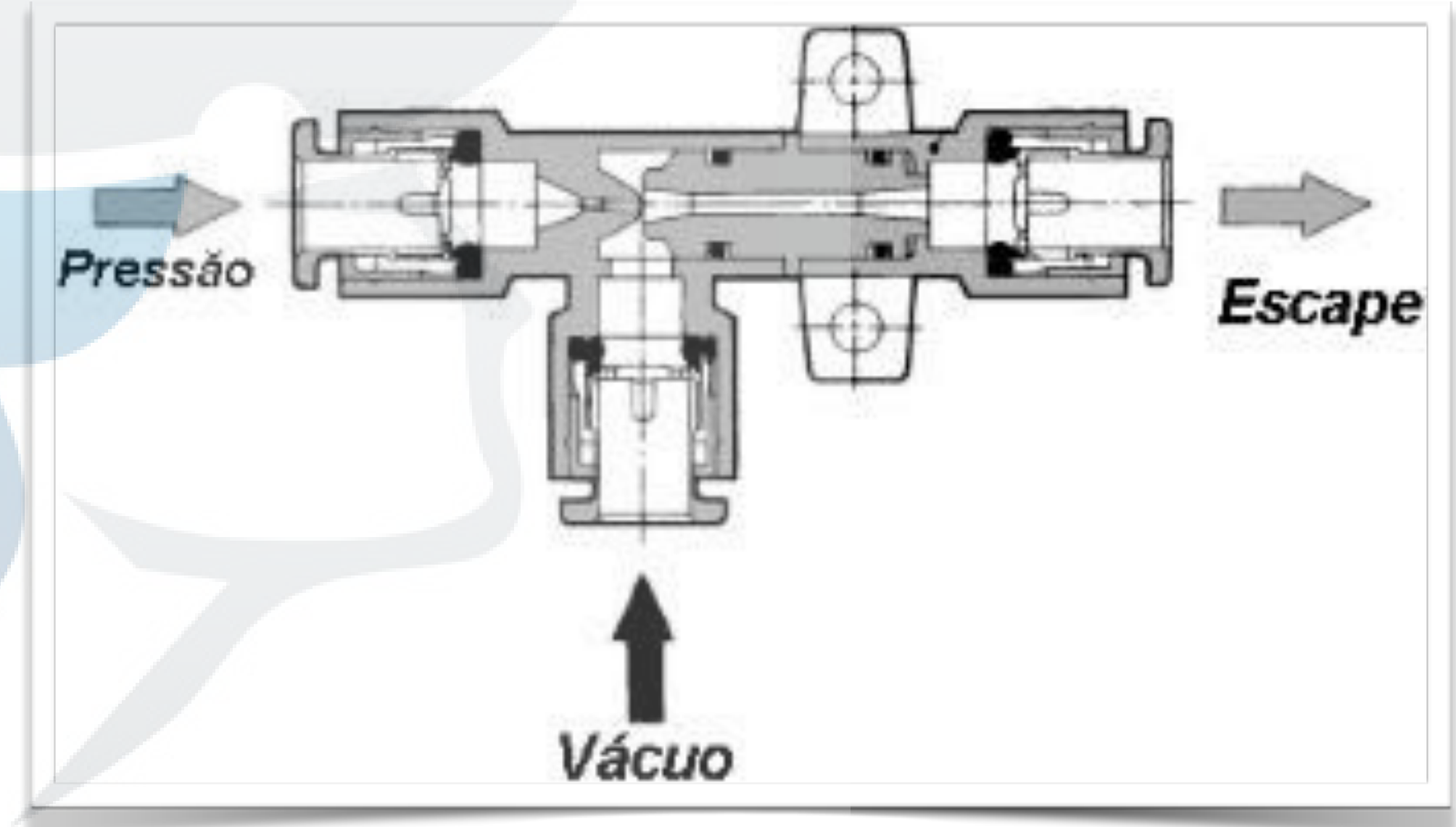

Conclusão

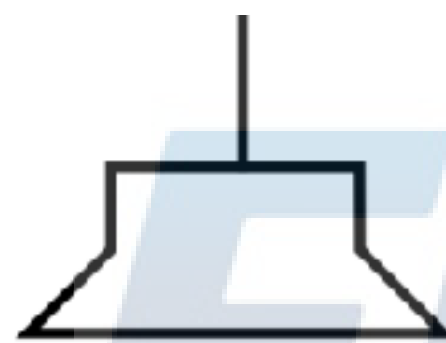

Simbologia

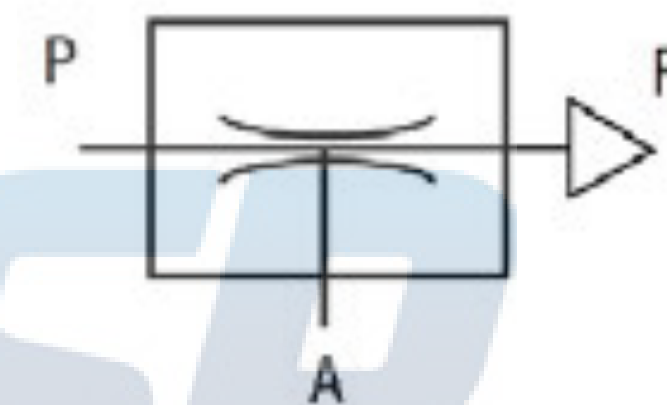

Simbologia

Atuadores especiais

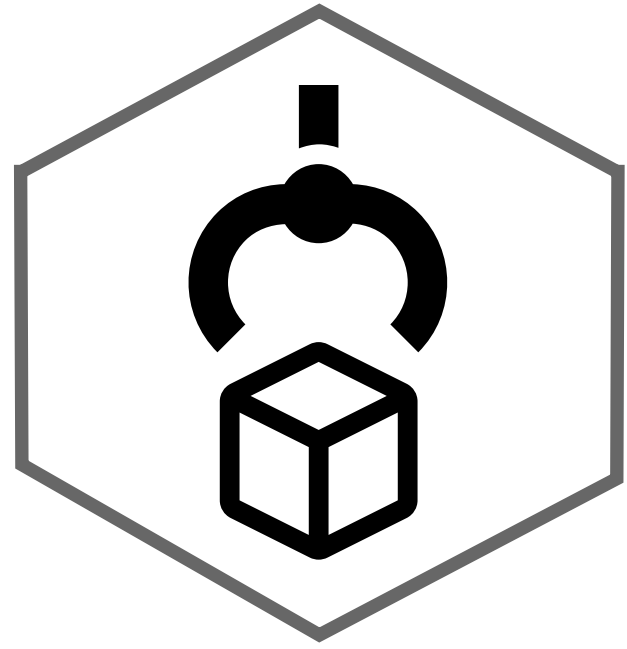

Hidráulica

Pneumática

Conclusão

Conteúdo

Hidráulica



- Introdução e princípios básicos
- Circuito e componentes básicos
- **Aplicações**

Pneumática

Conclusão

Pneumática na automação industrial

Hidráulica

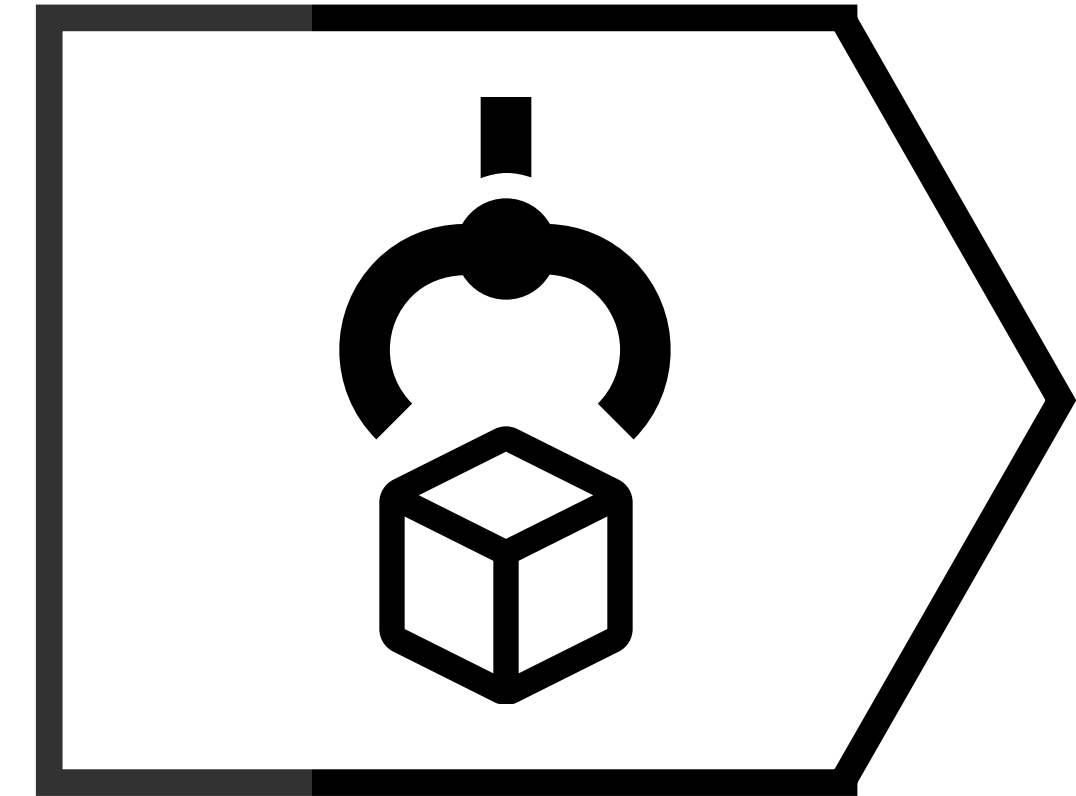
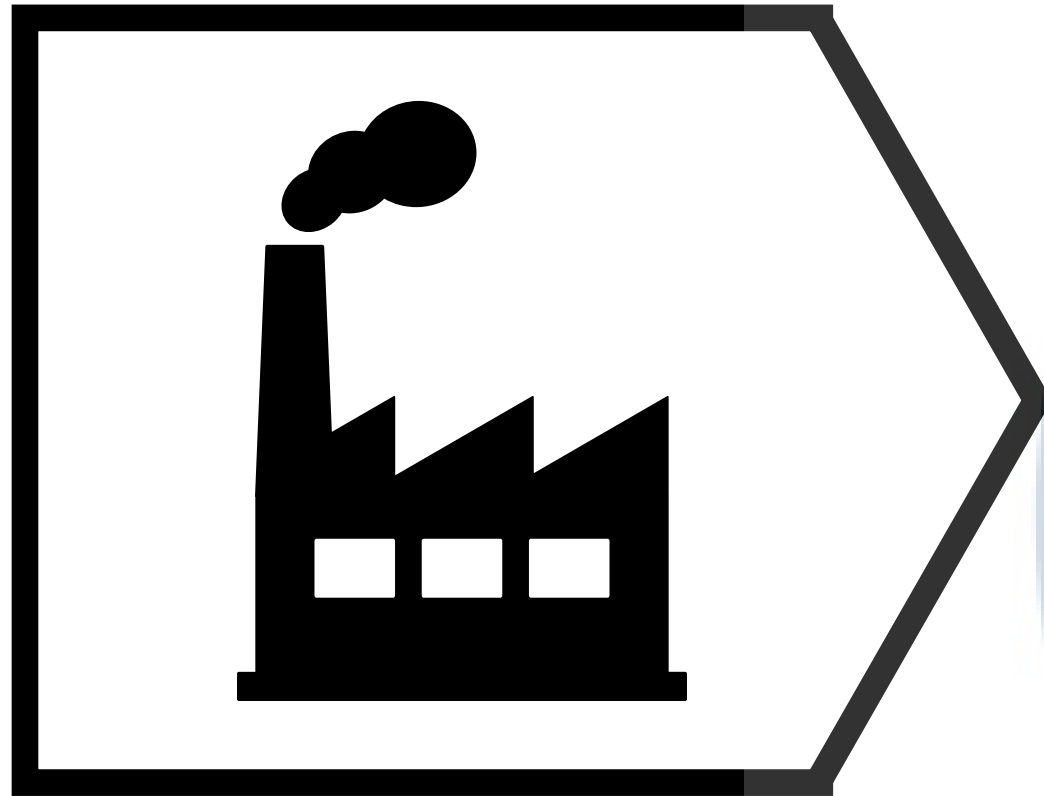

Pneumática

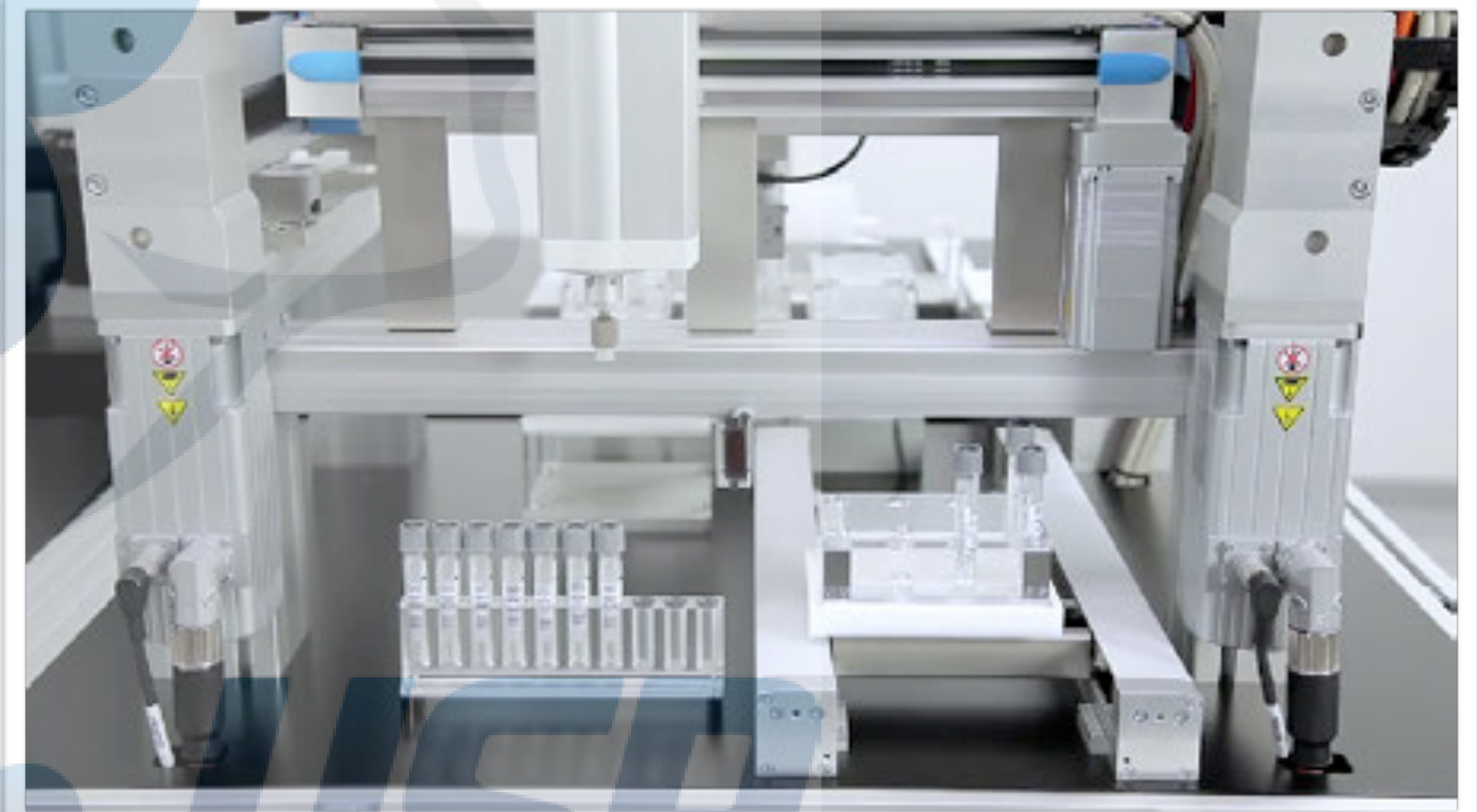

Conclusão

Pneumática na automação industrial

Hidráulica

Pneumática

Conclusão

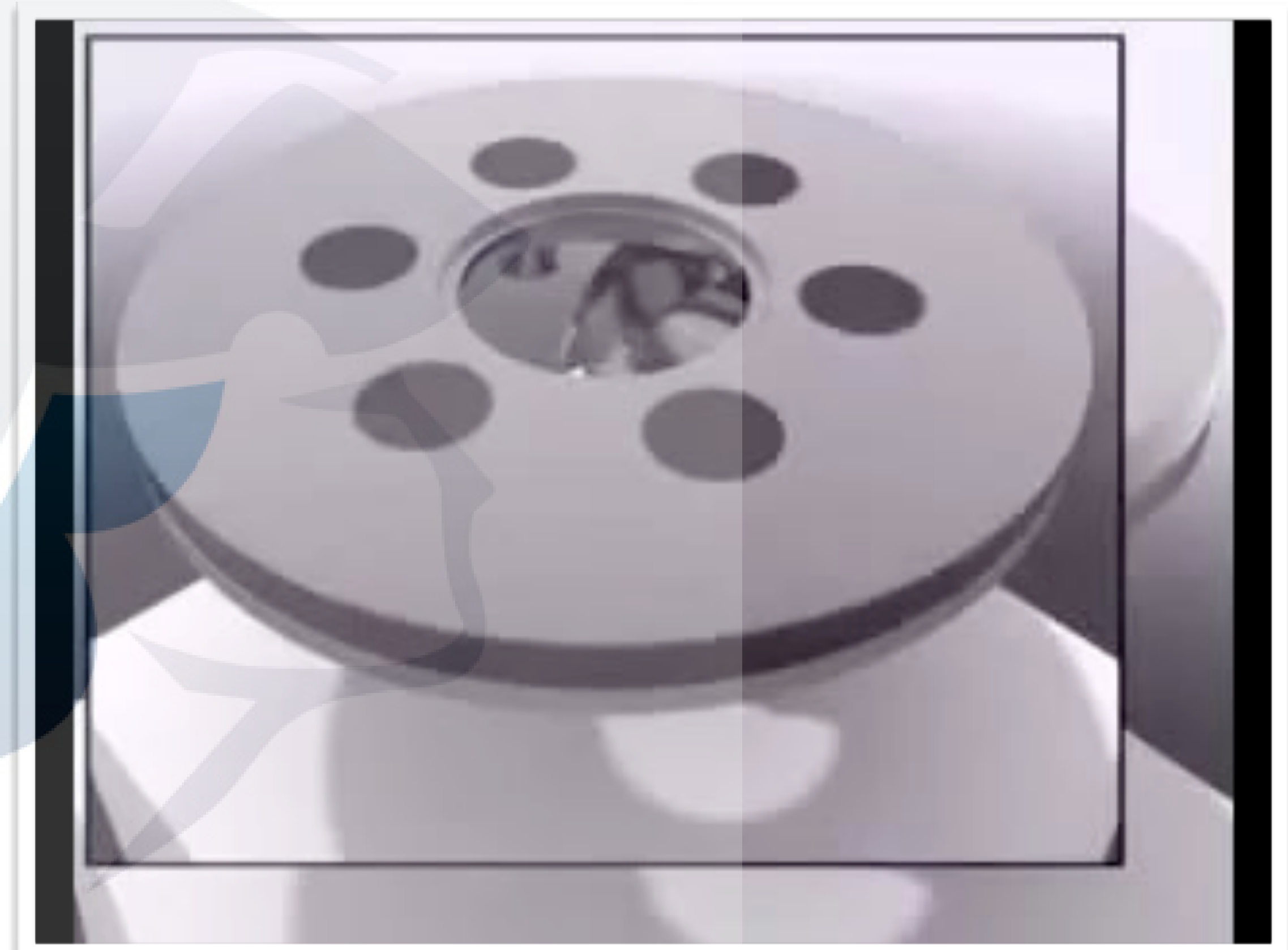

Pneumática na automação industrial

Hidráulica

Pneumática

Conclusão



Pneumática na automação industrial

Hidráulica

Pneumática

Conclusão



Conteúdo

Hidráulica

Pneumática



- “Take-home messages”
- Bibliografia

Conclusão

Prós e contras — Hidráulica

Hidráulica

Pneumática

Conclusão



Potência/Peso

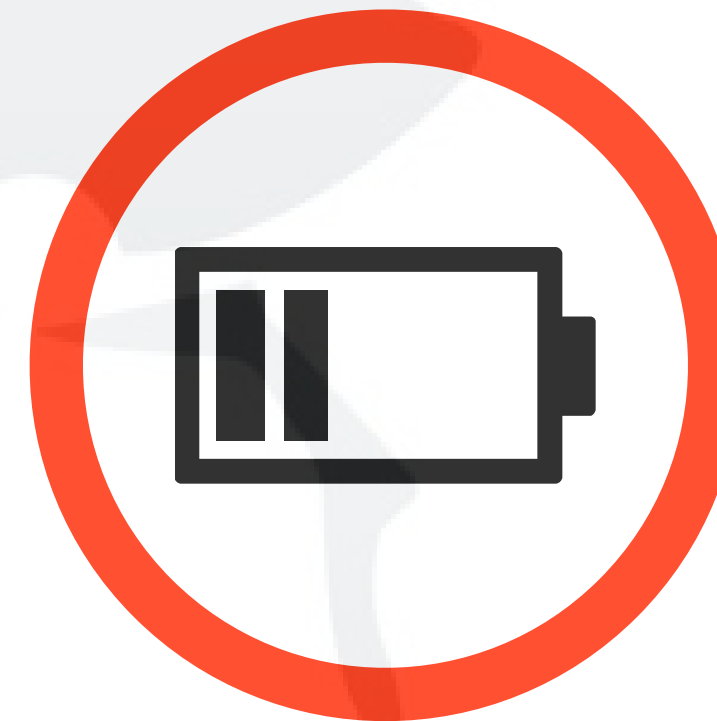

Baixo rendimento

Prós e contras — Pneumática

Hidráulica



**Acessibilidade
do fluido**



Limpeza



Compressibilidade

Pneumática



Custos



Velocidade



Força limitada

Conclusão

Campos de aplicação em automação

Hidráulica

Pneumática

Conclusão

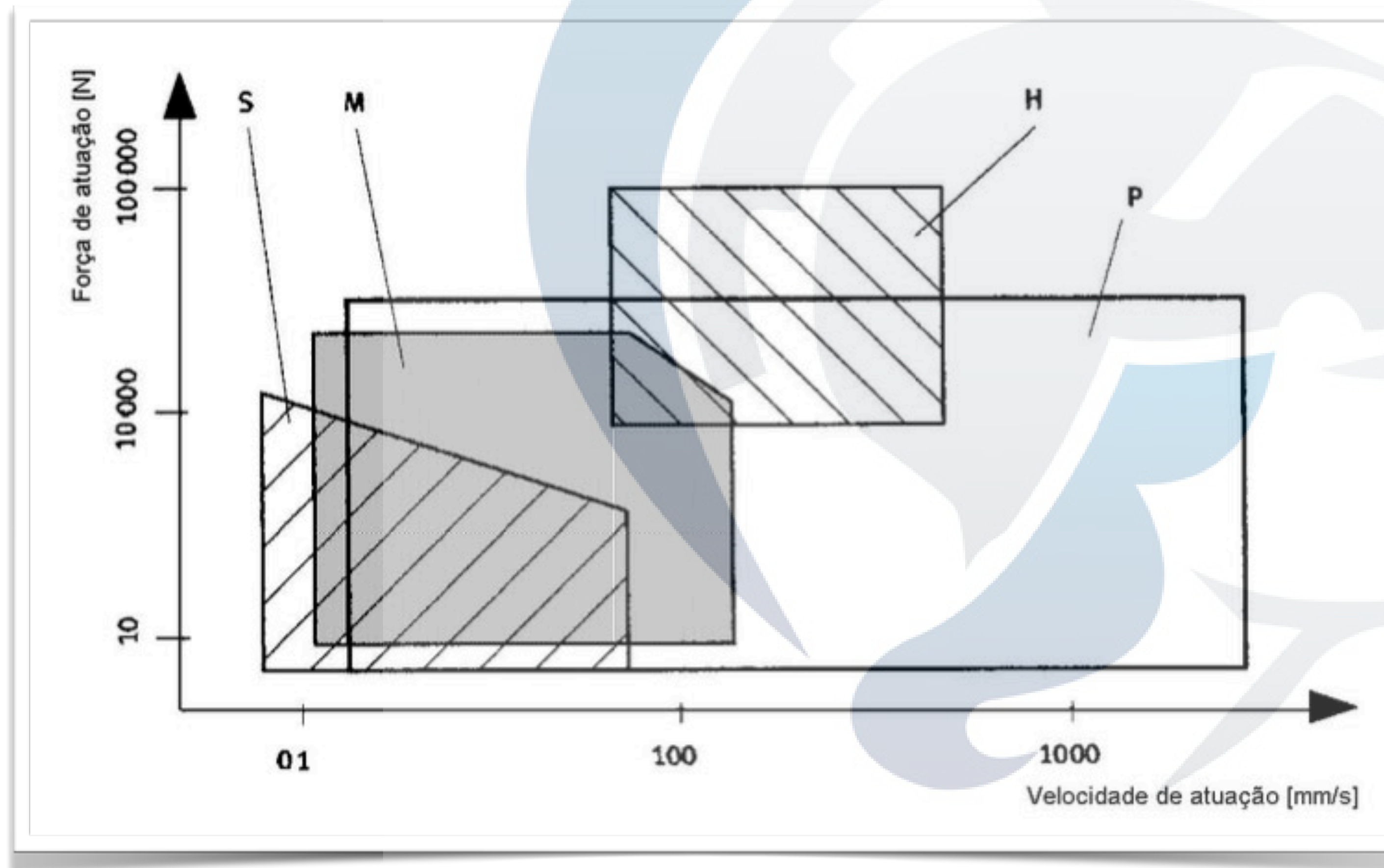

- (H)** sistemas hidráulicos
- (M)** conjuntos motor elétrico-fuso
- (P)** pneumática
- (S)** motor de passo

(HESSE, 2000)

Referência bibliográfica

“

De Negri, V.J. “PARTE II - Sistemas Pneumáticos para Automação”. LASHIP, UFSC, 2001.

”

Festo Didactic, Apostila “Painel simulador de Hidráulica Industrial e Eletro-hidráulica”.

That's all Folks!

EEESC • USA