

Deterministic Finite Automata

And Regular Languages

Deterministic Finite Automaton (DFA)

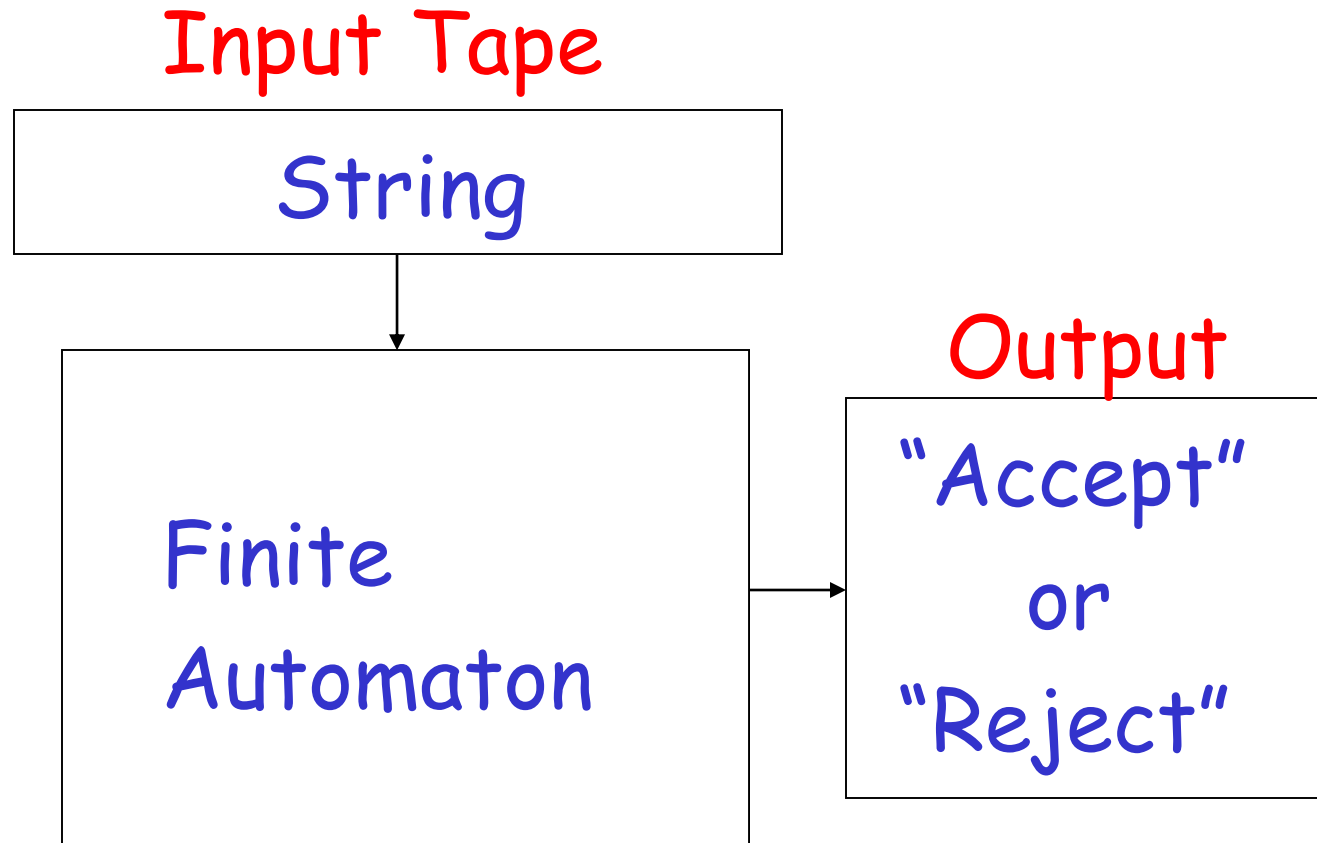

Transition Graph

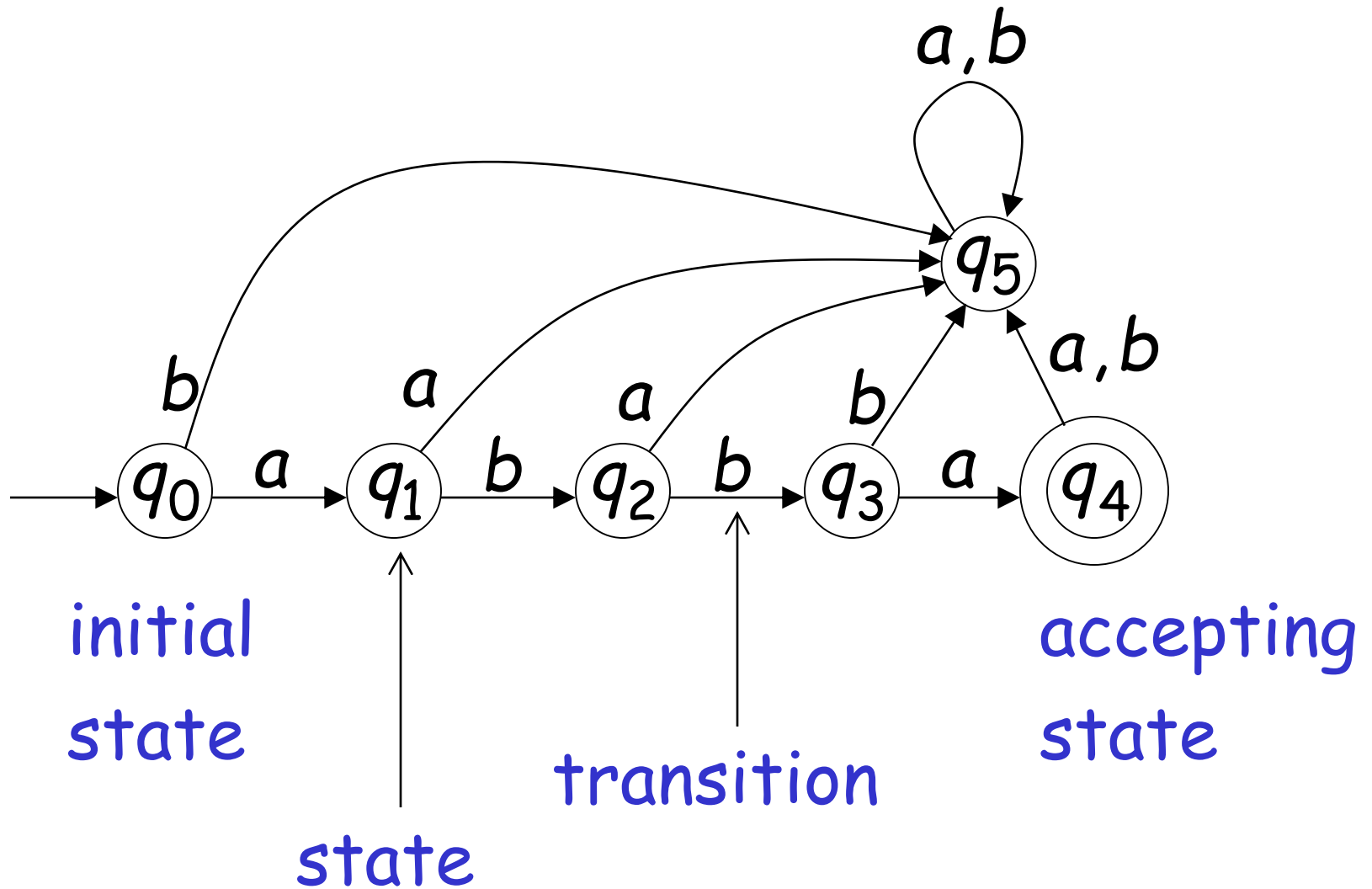

Alphabet $\Sigma = \{a, b\}$

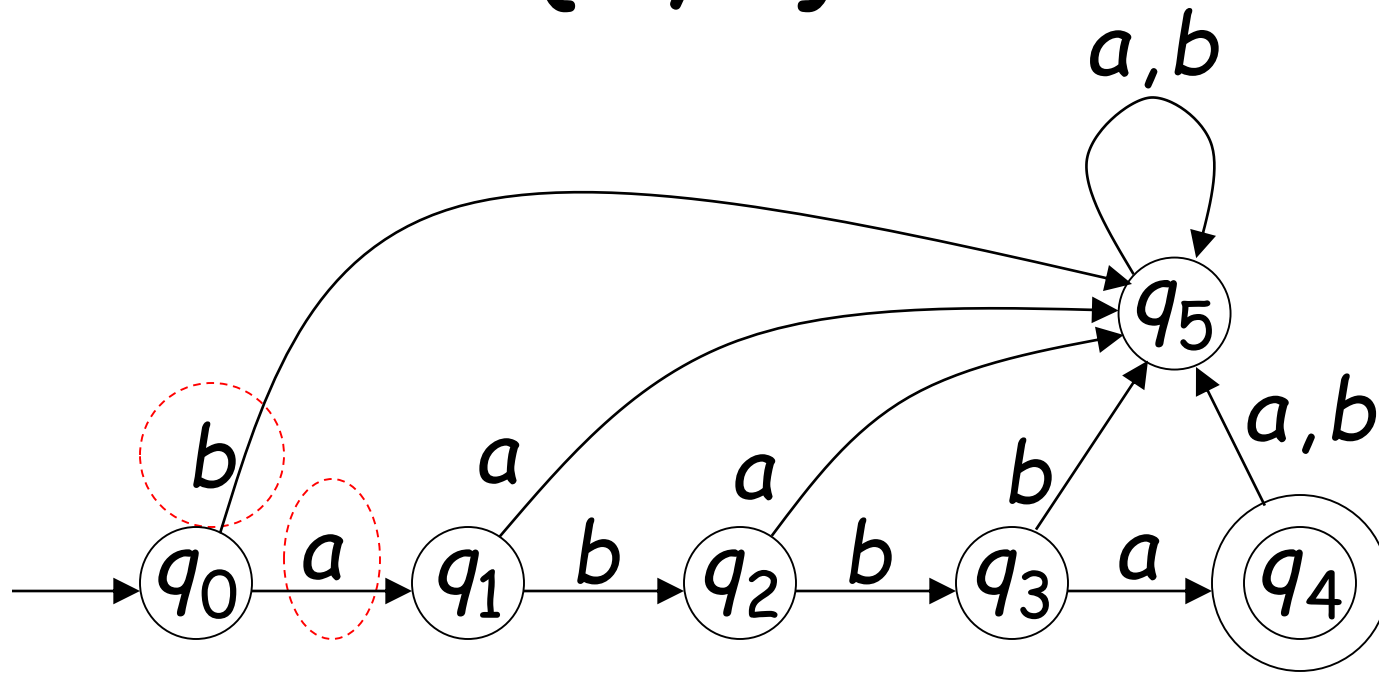

For every state, there is a transition for every symbol in the alphabet

Initial Configuration

Input Tape

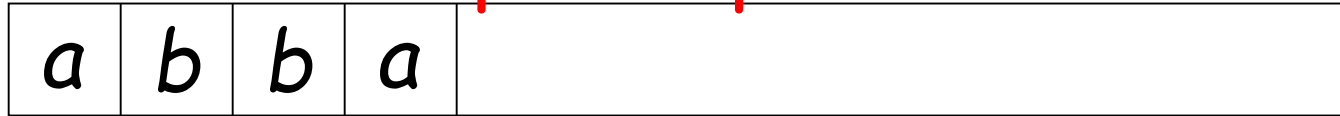

Input String

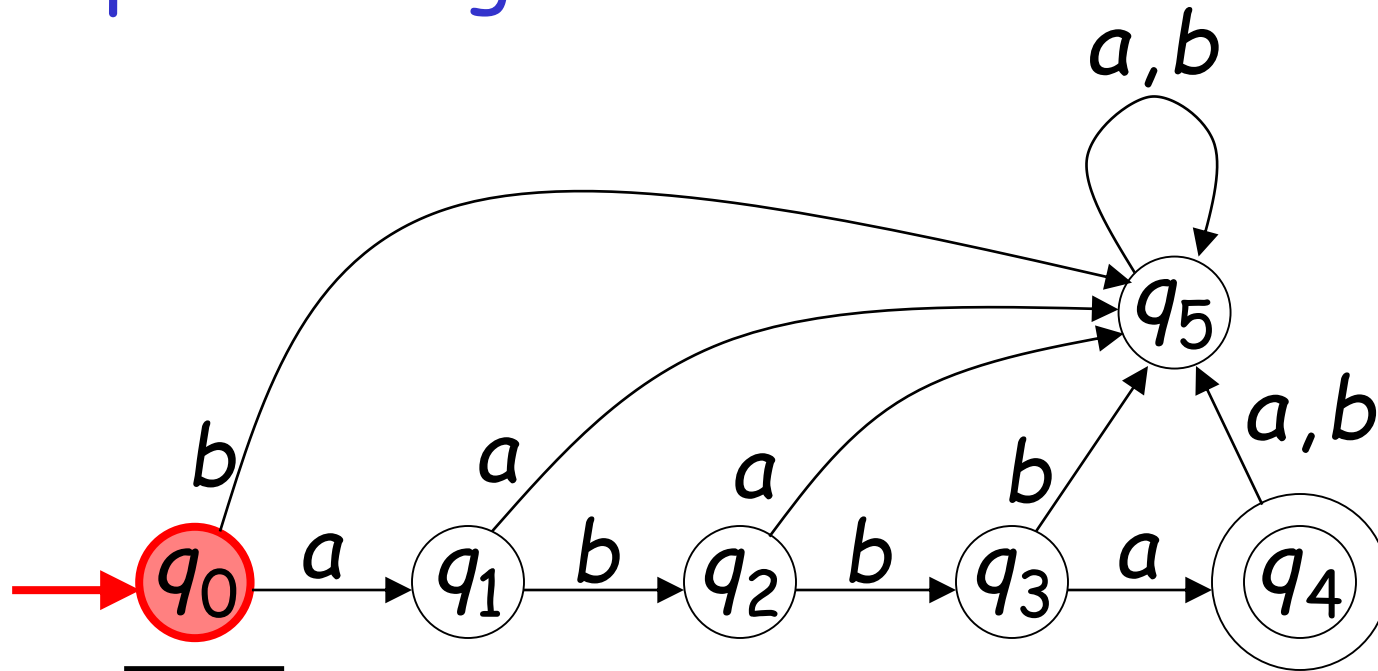

Initial state

Scanning the Input

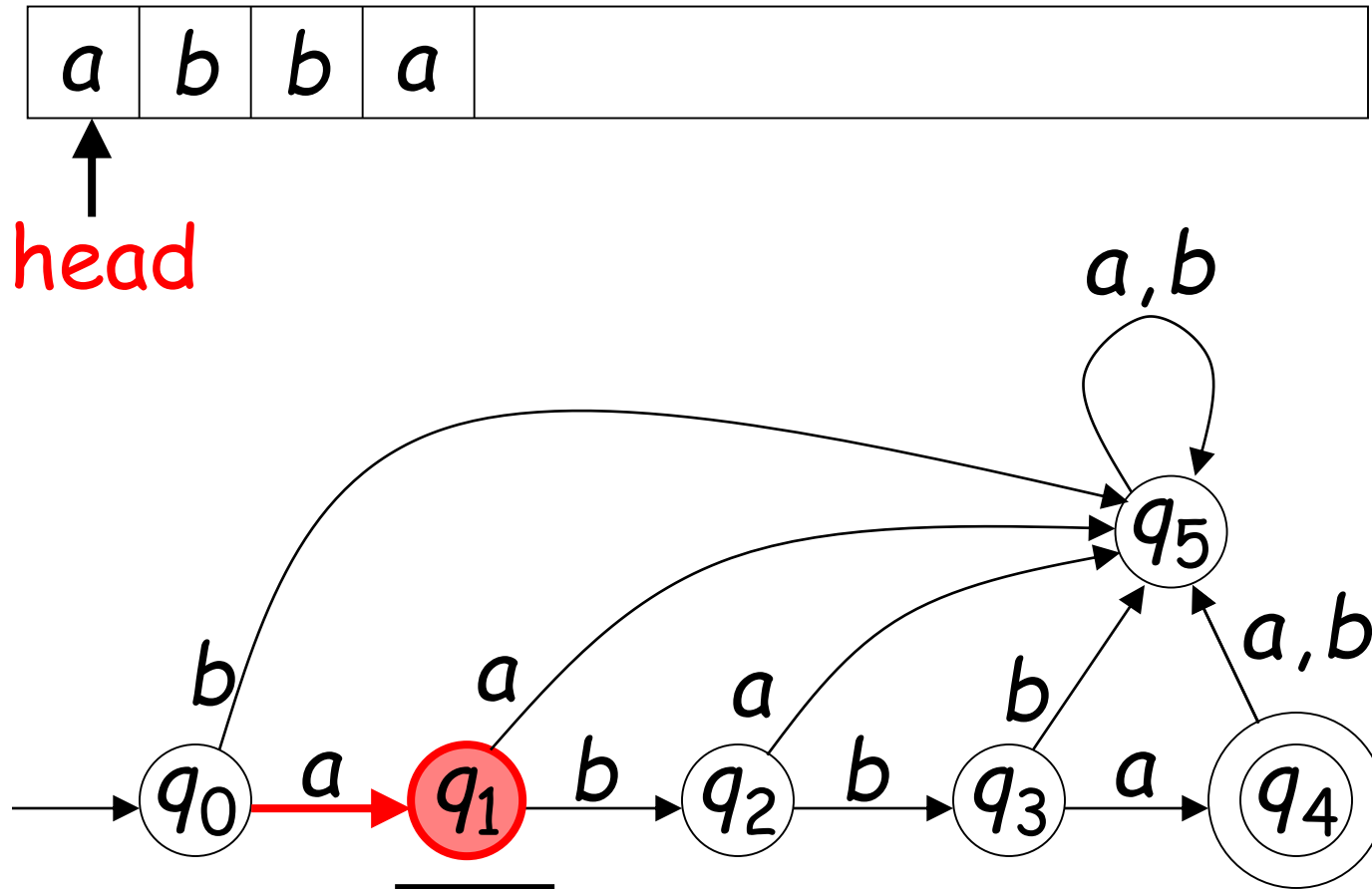

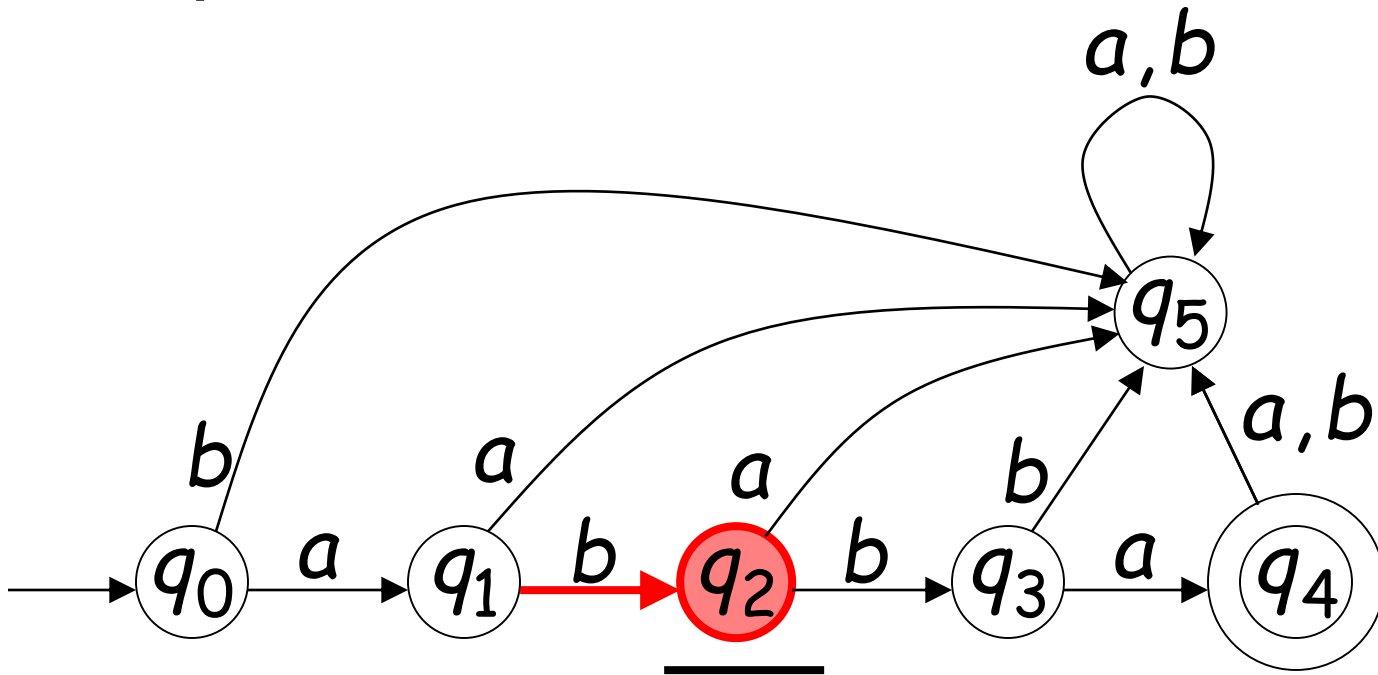
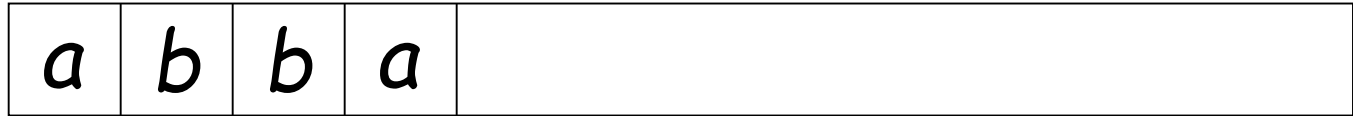

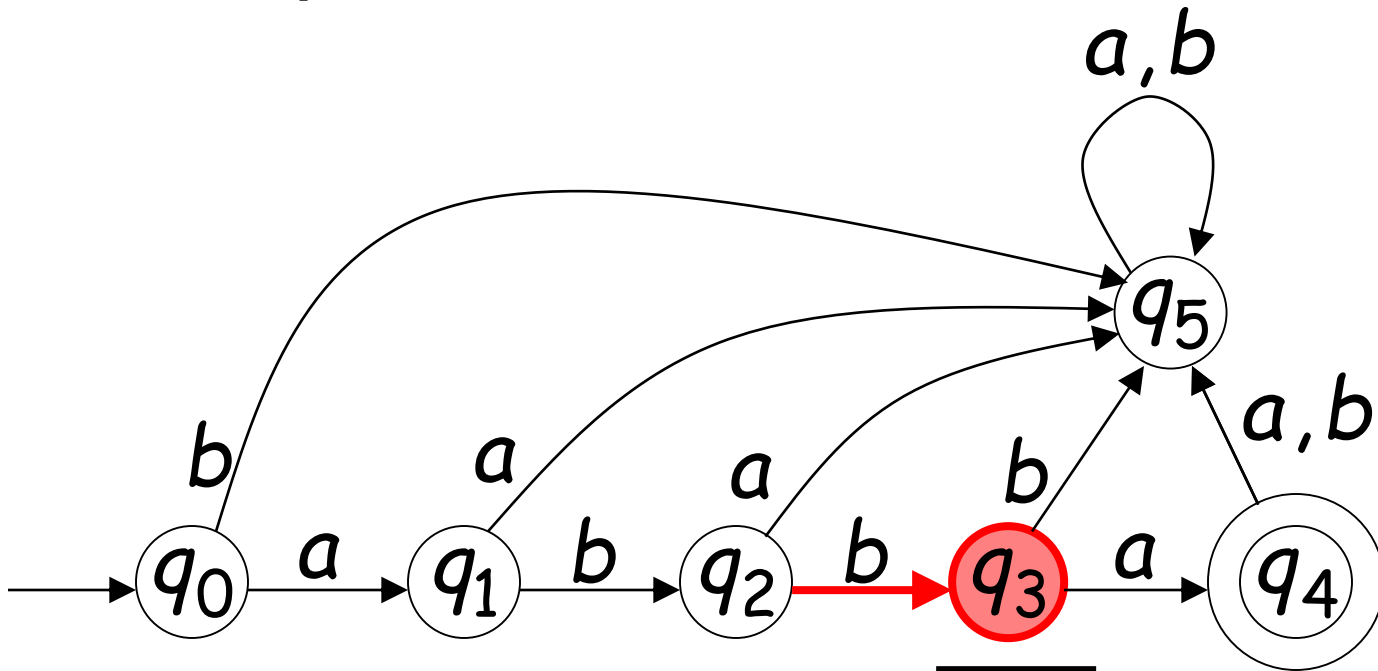
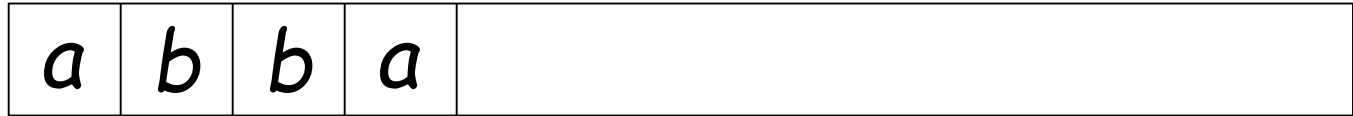

Input finished

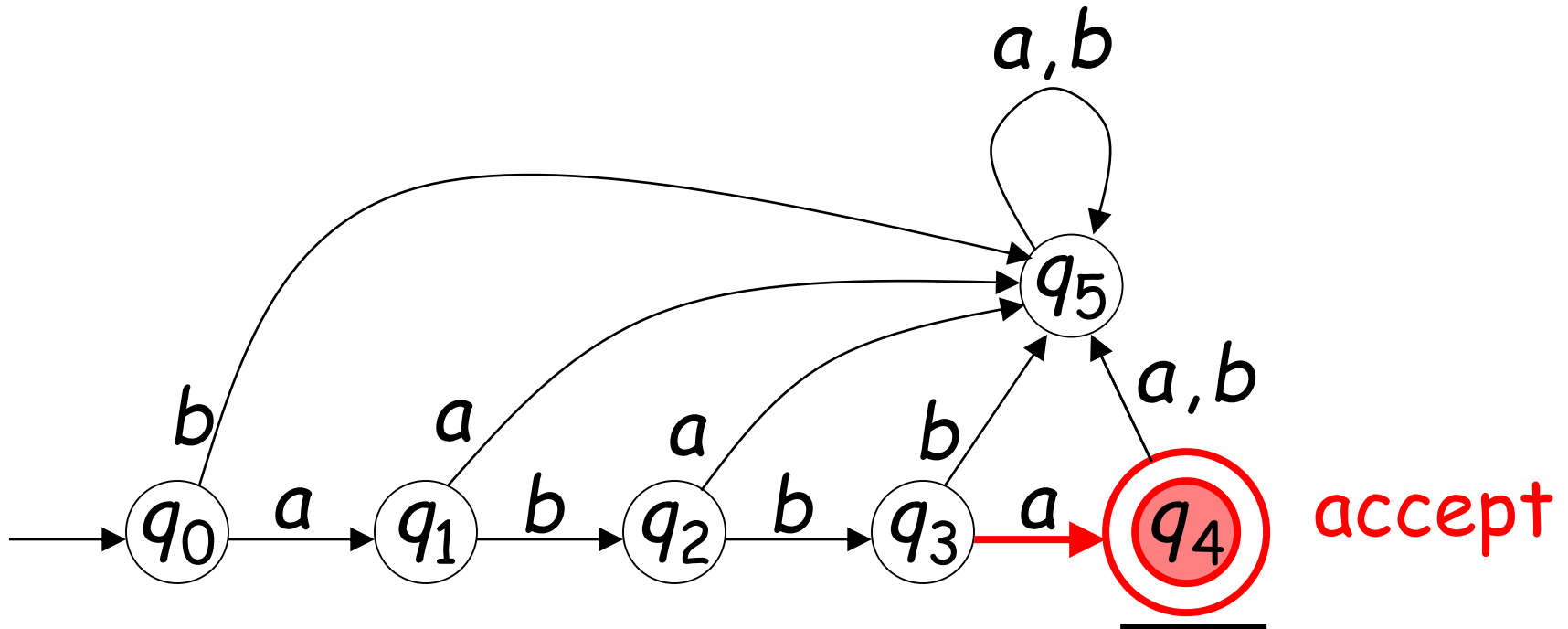

Last state determines the outcome

A Rejection Case

a	b	a	
---	---	---	--

Input String

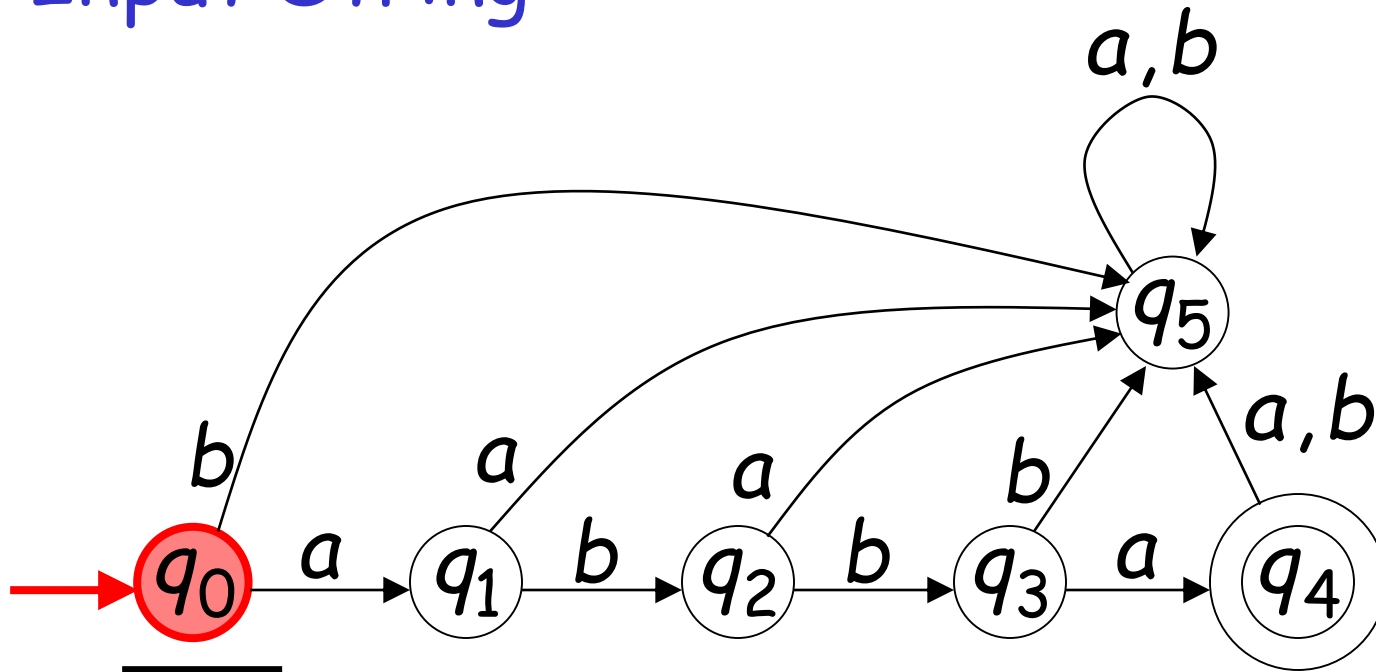

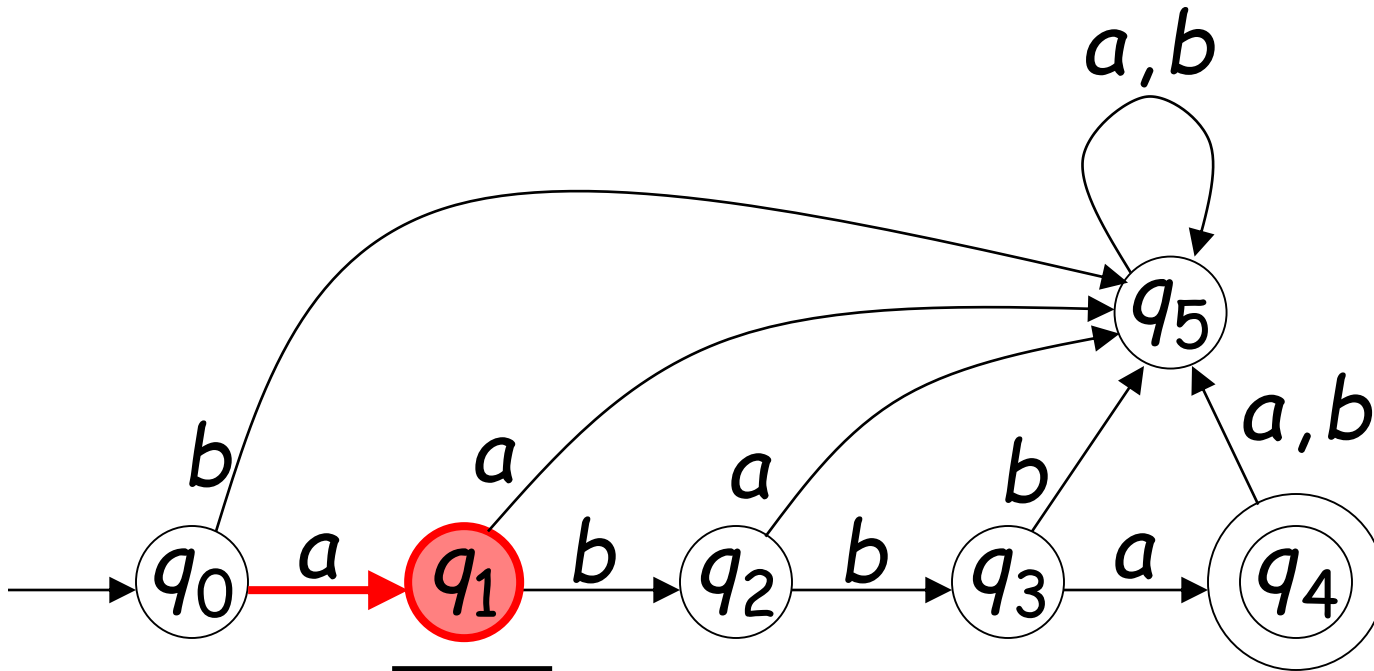
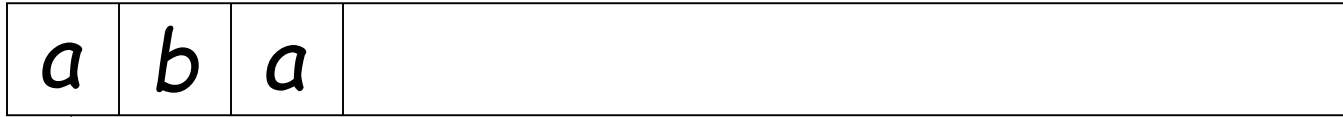

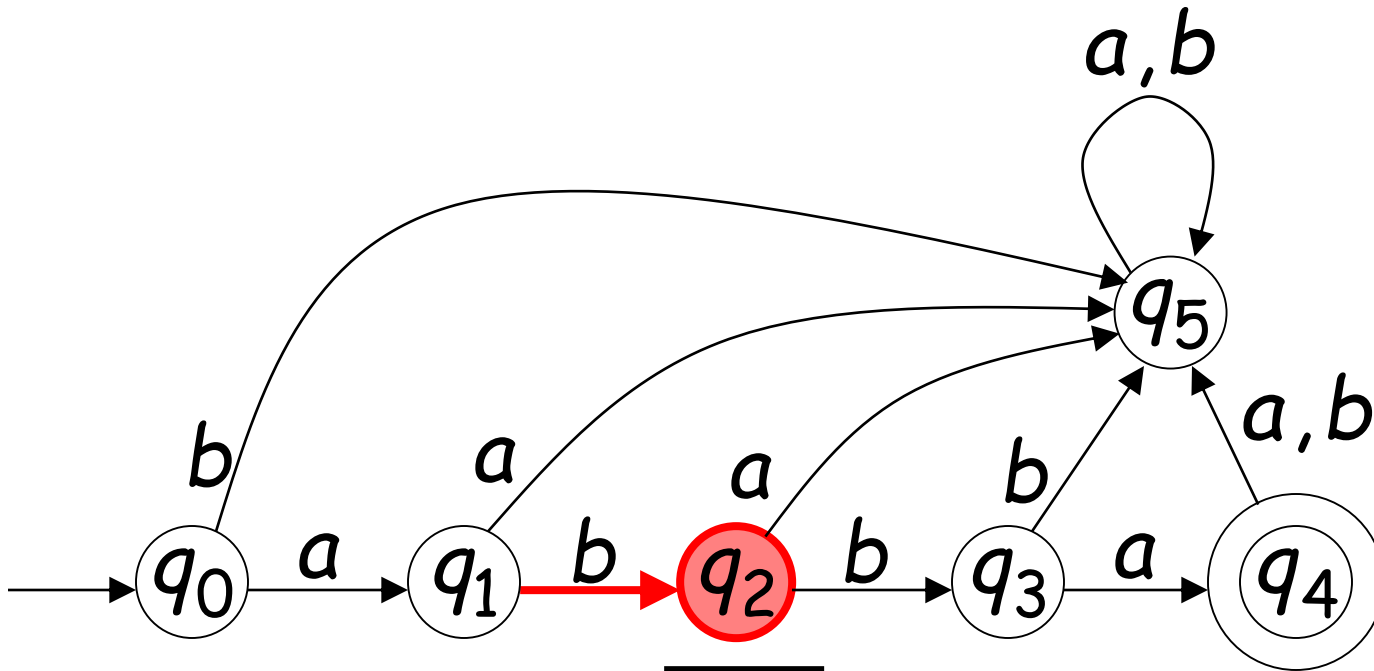
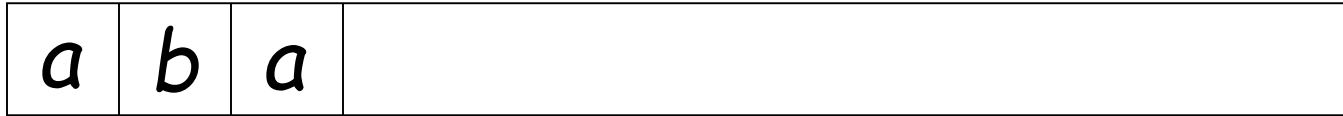

Input finished

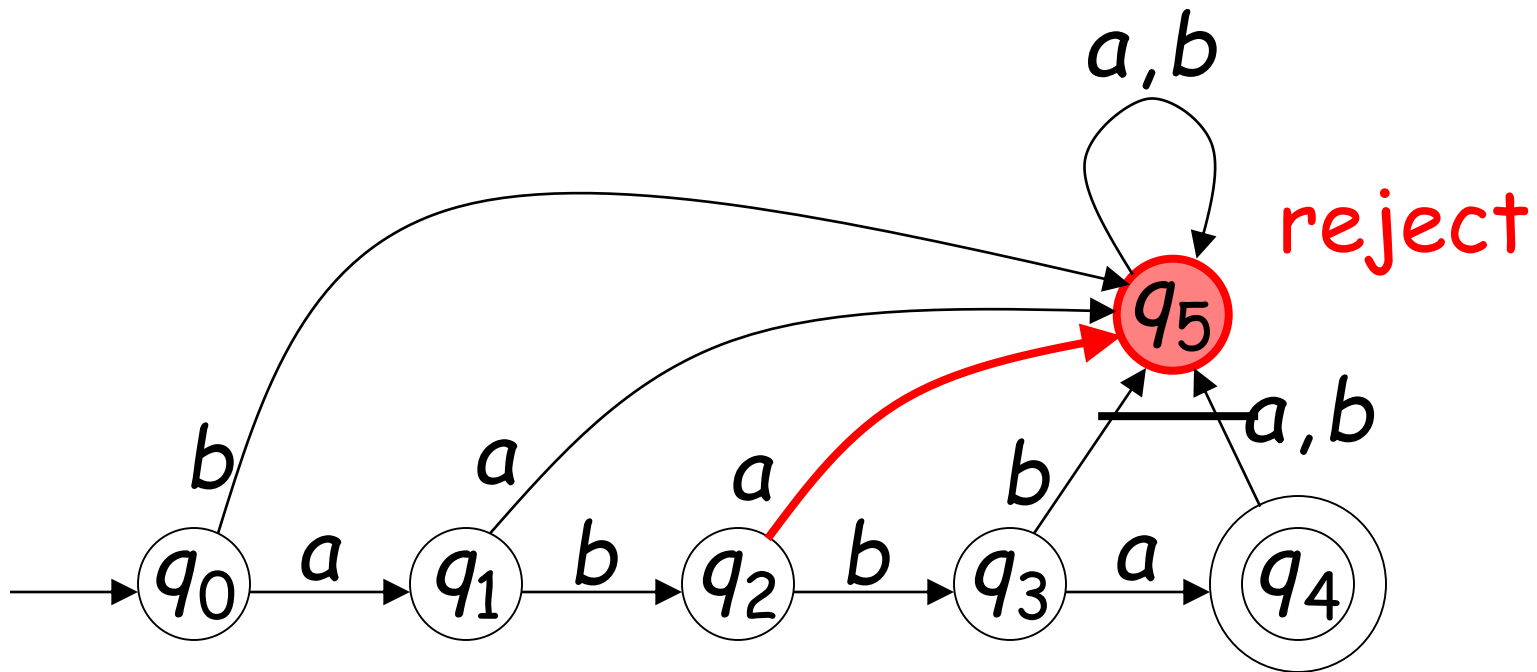

Last state determines the outcome

Another Rejection Case

Tape is empty

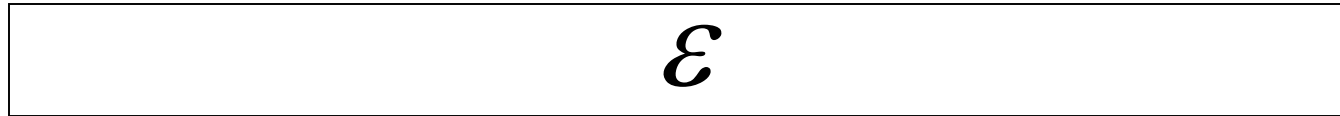

Input Finished (no symbol read)

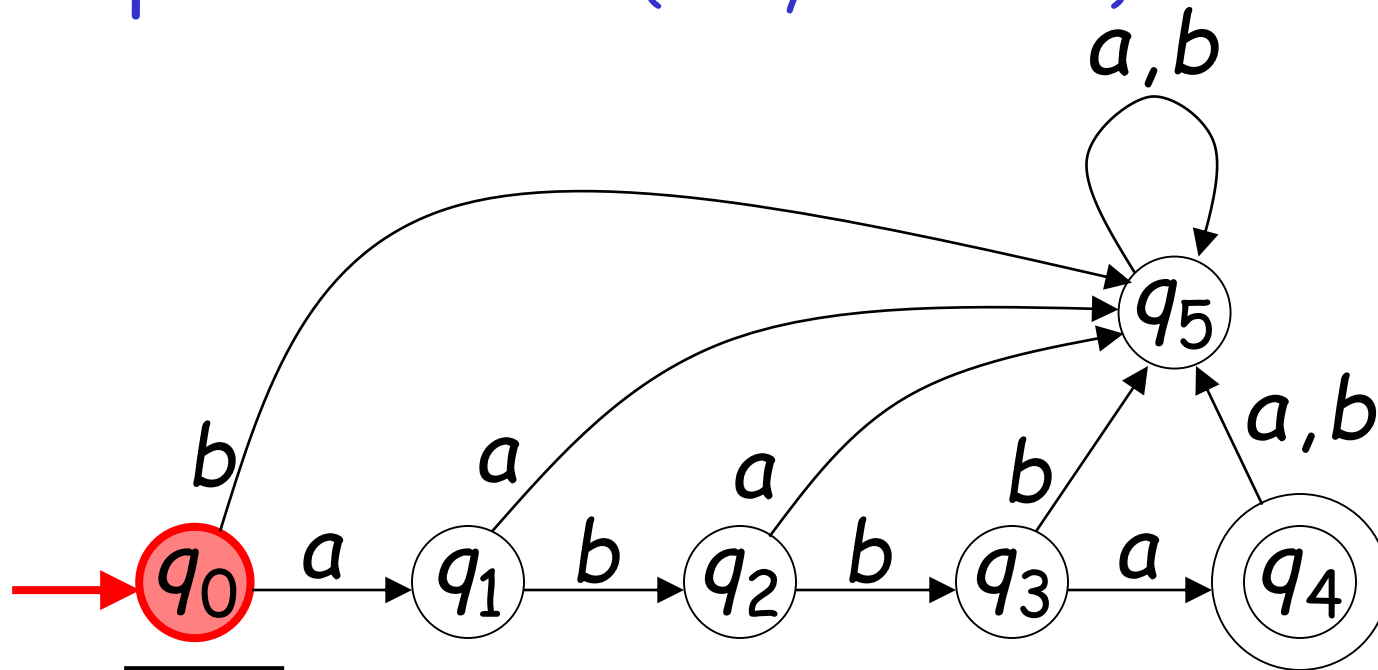

reject

This automaton accepts only one string

Language Accepted: $L = \{abba\}$

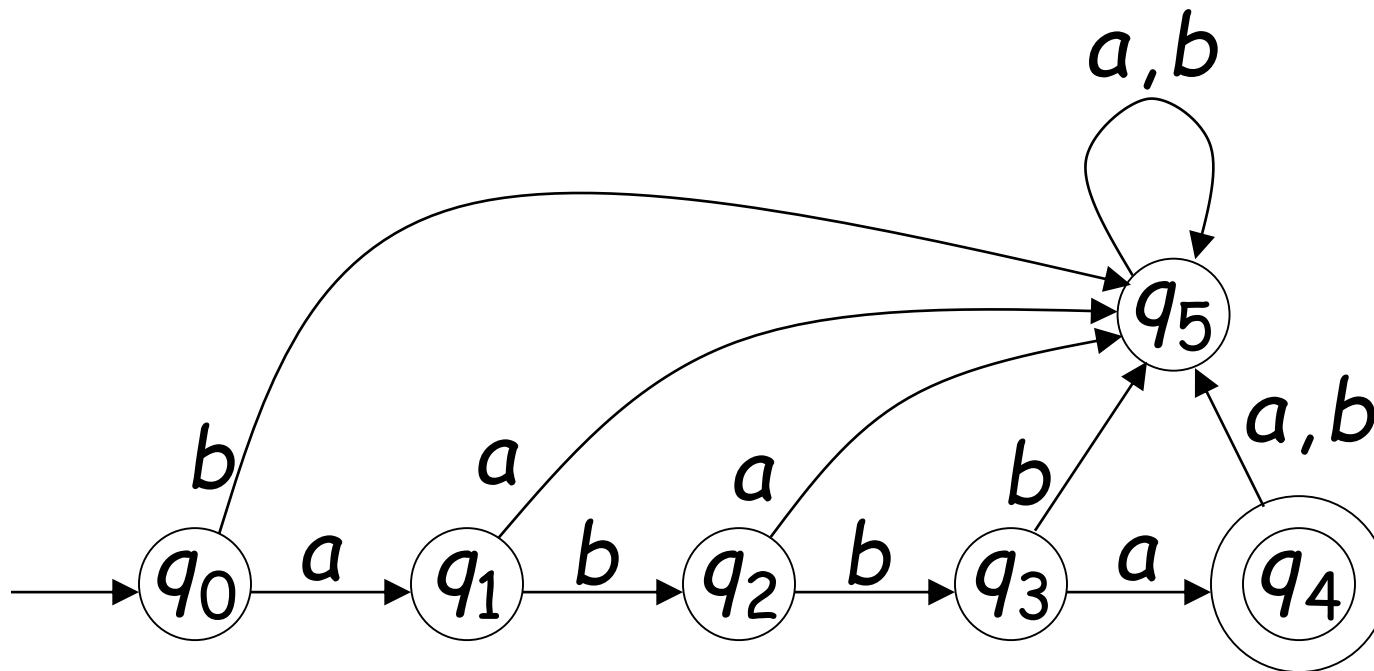

To accept a string:

all the input string is scanned
and the last state is accepting

To reject a string:

all the input string is scanned
and the last state is non-accepting

Another Example

$$L = \{\varepsilon, ab, abba\}$$

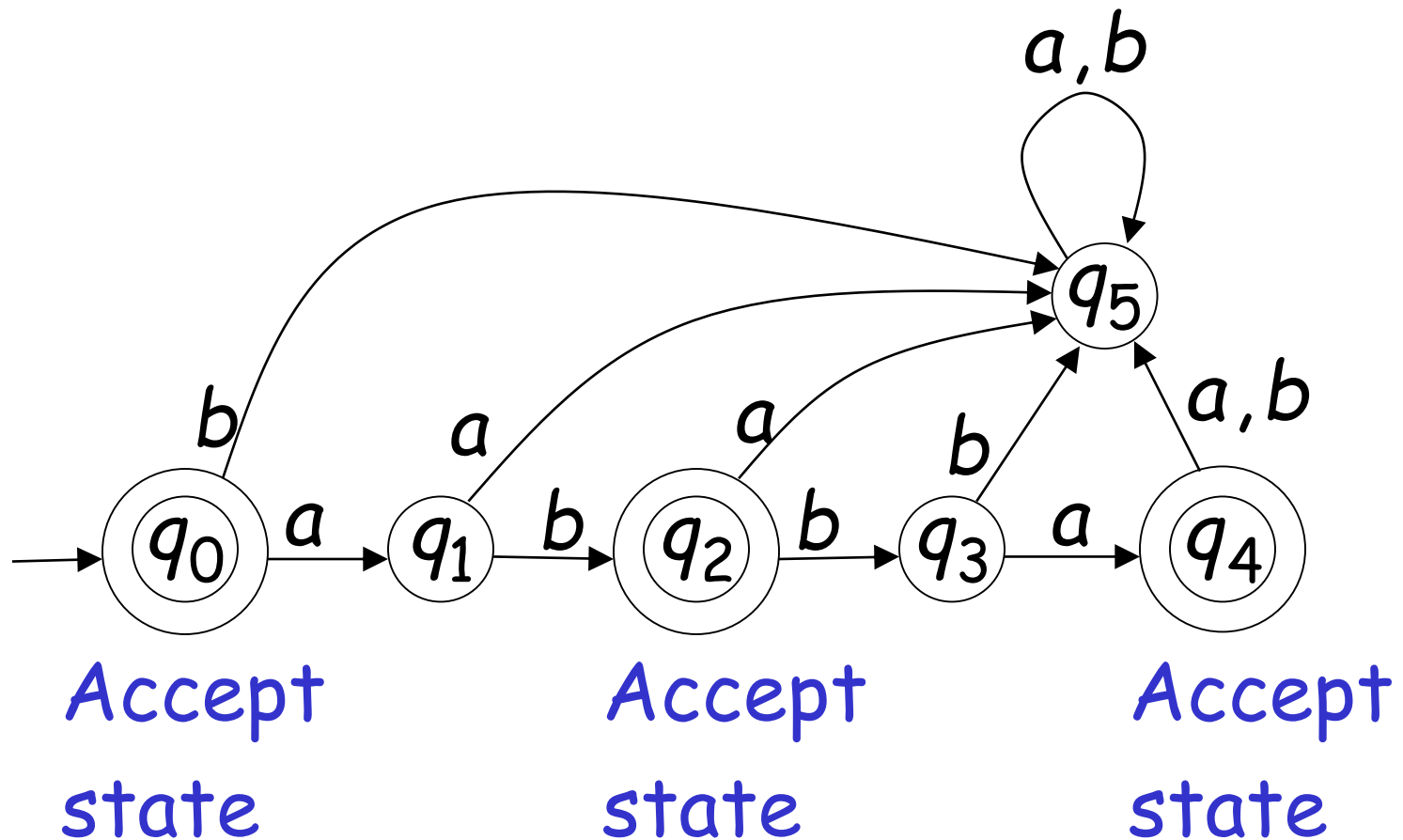

Empty Tape

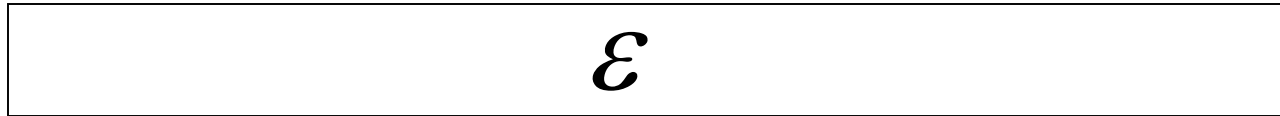

Input Finished

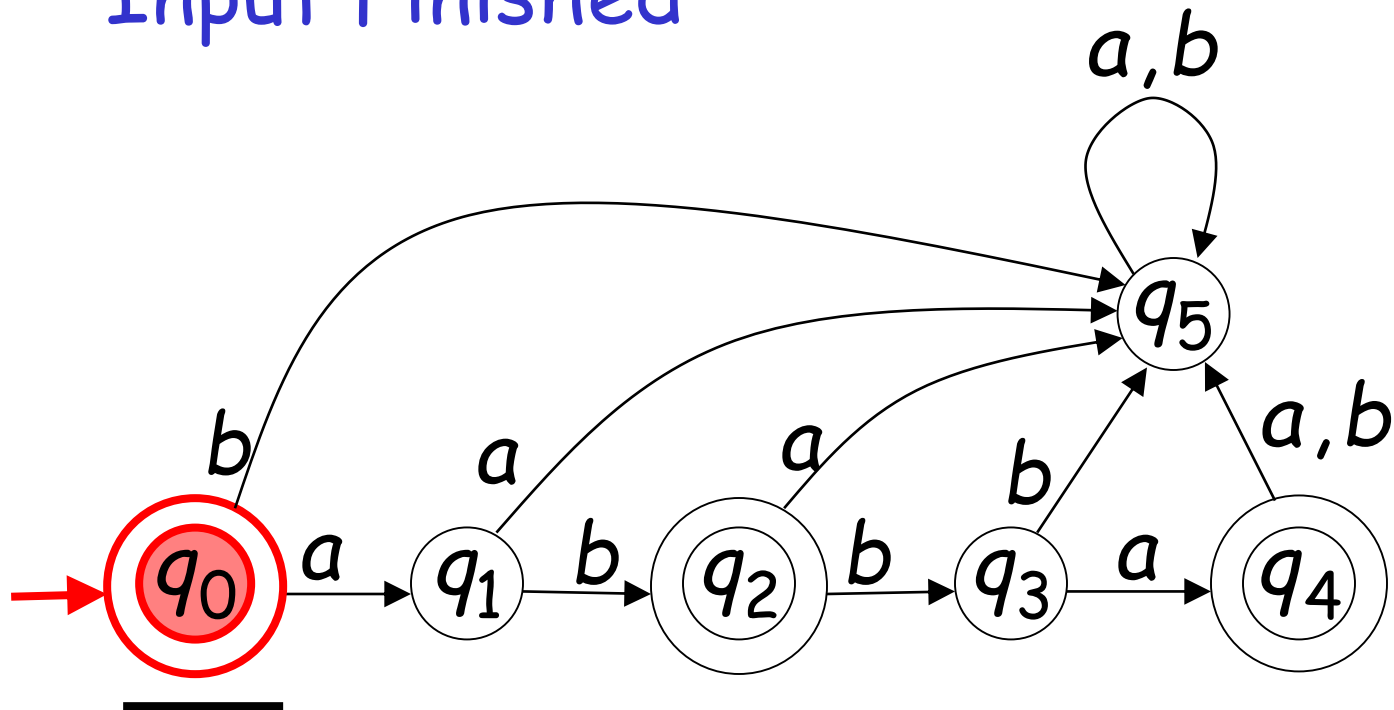

accept

Another Example

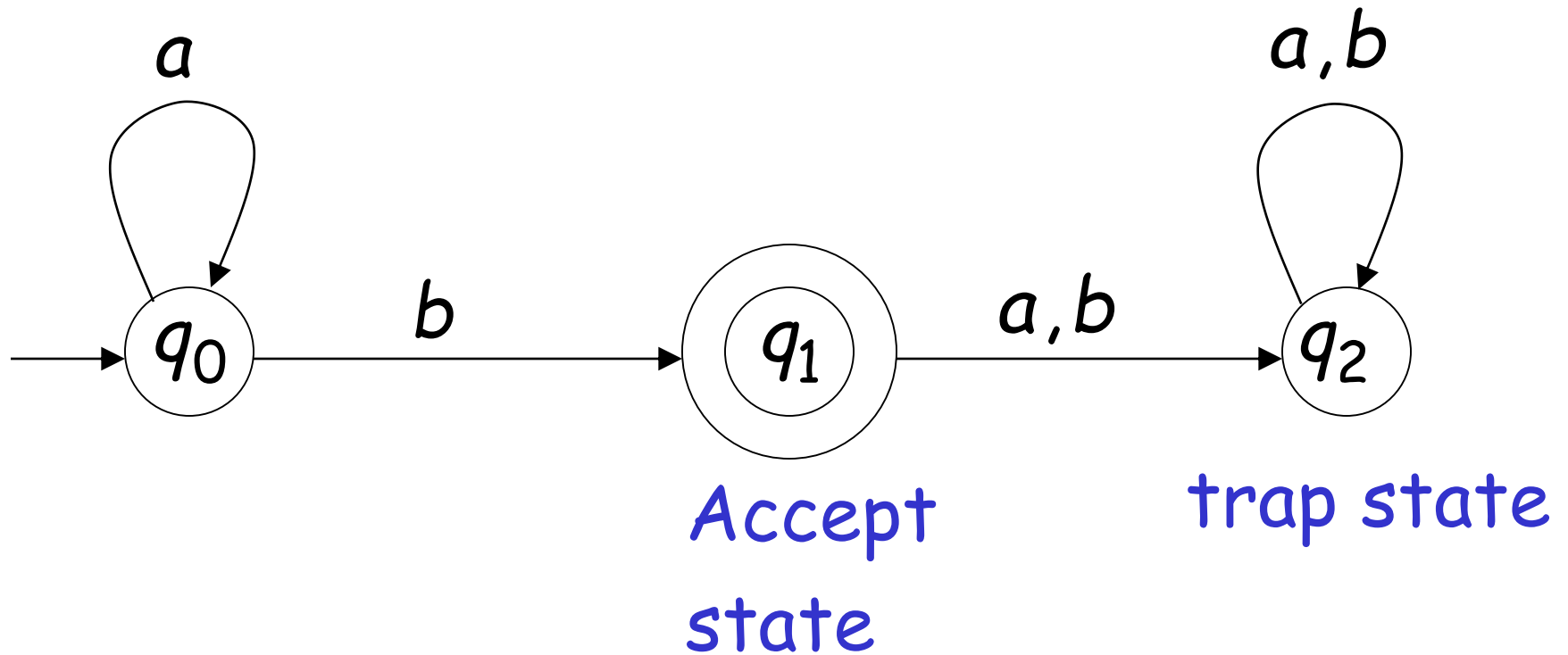



Input String

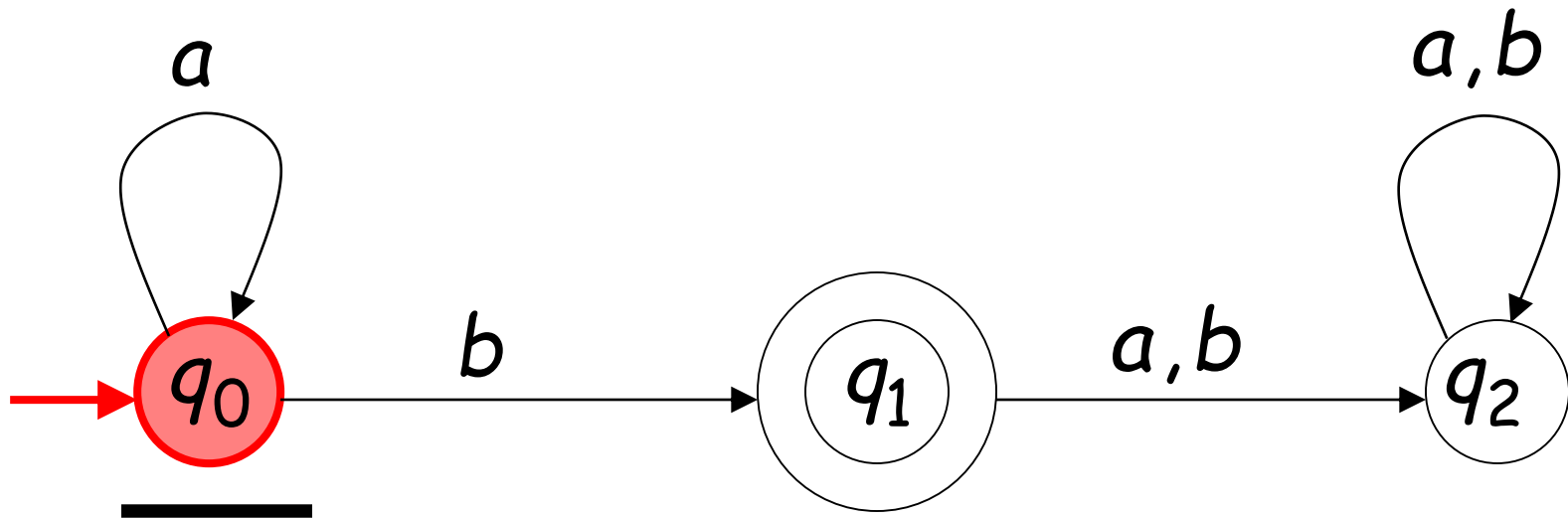

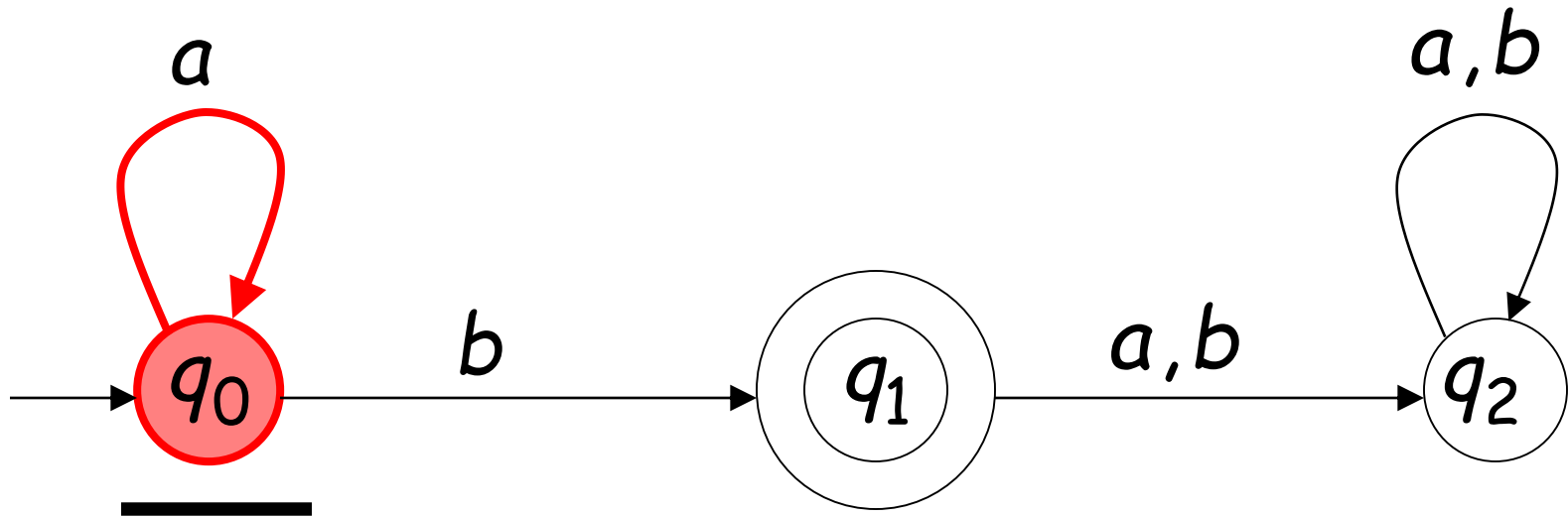

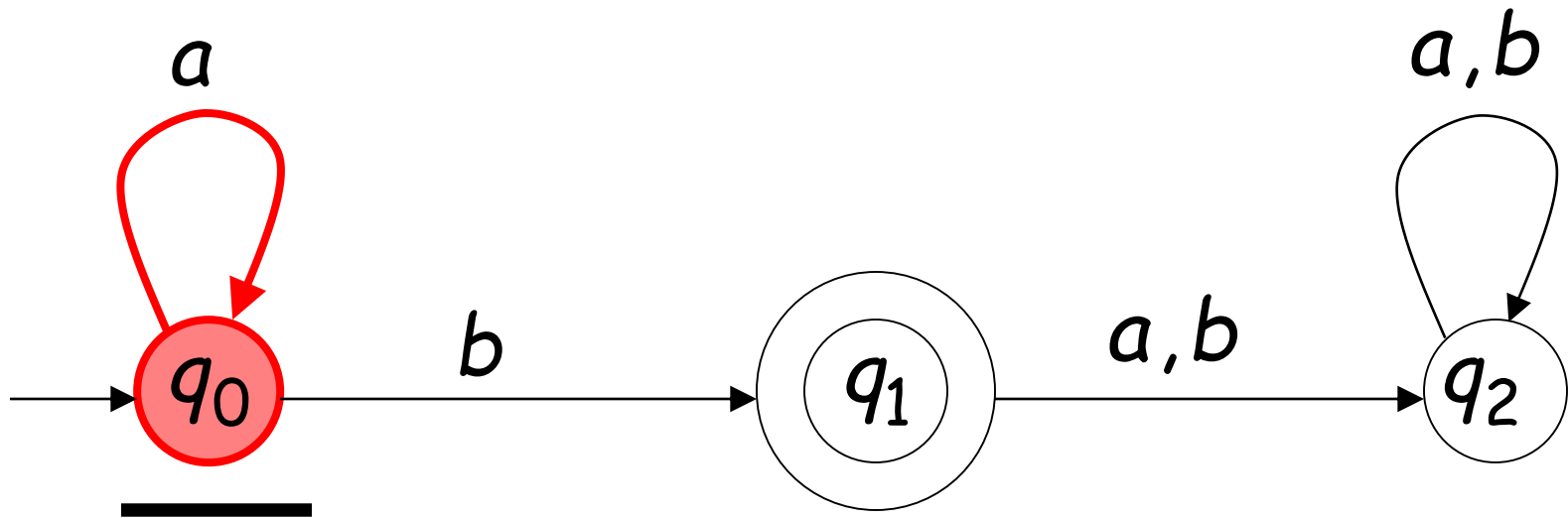

Input finished

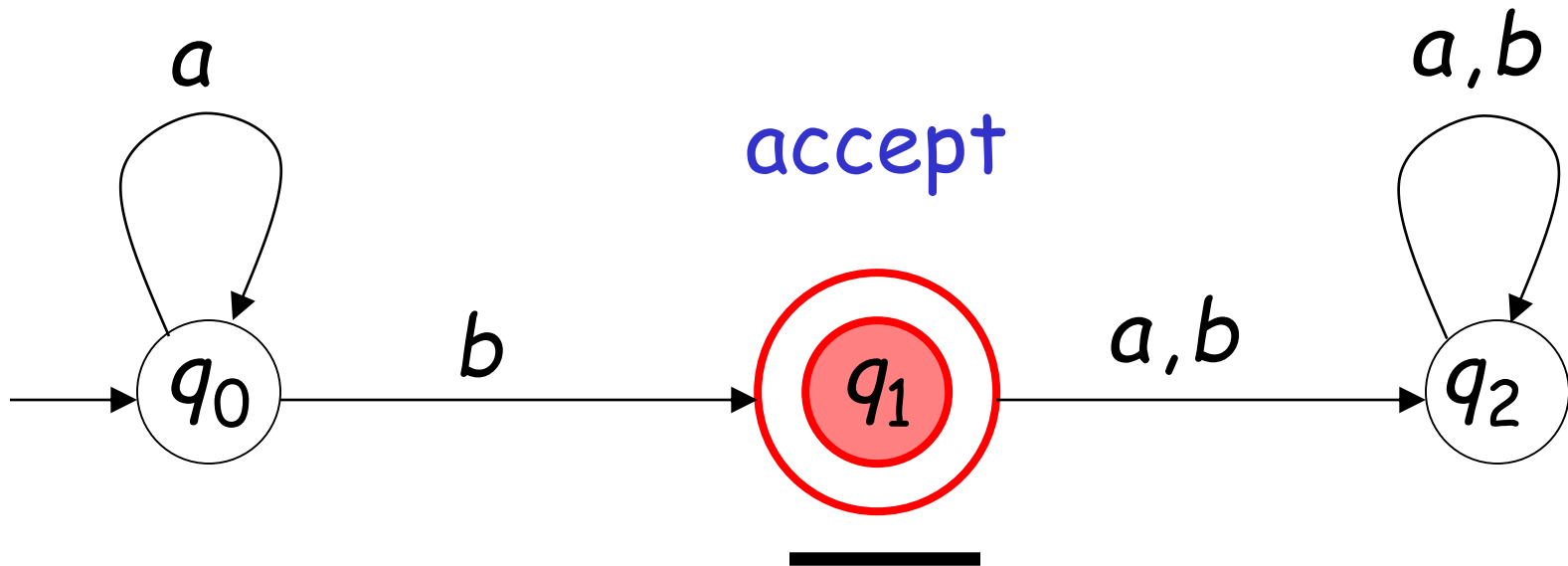

A rejection case



Input String

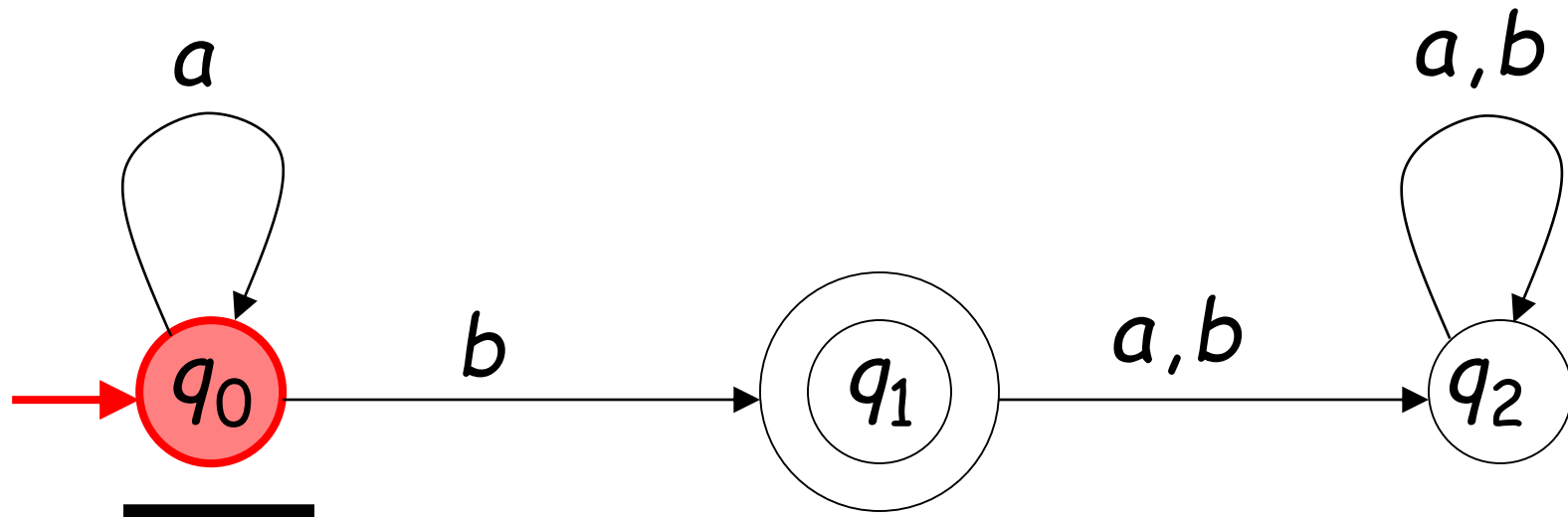

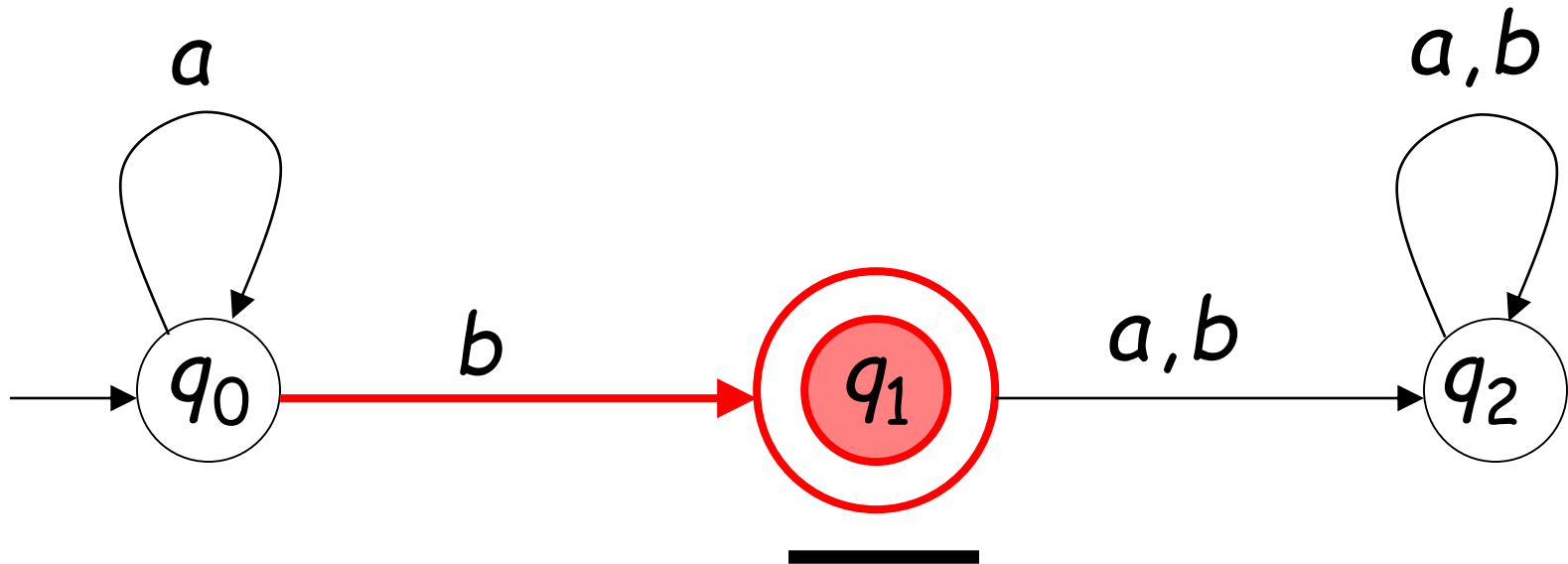
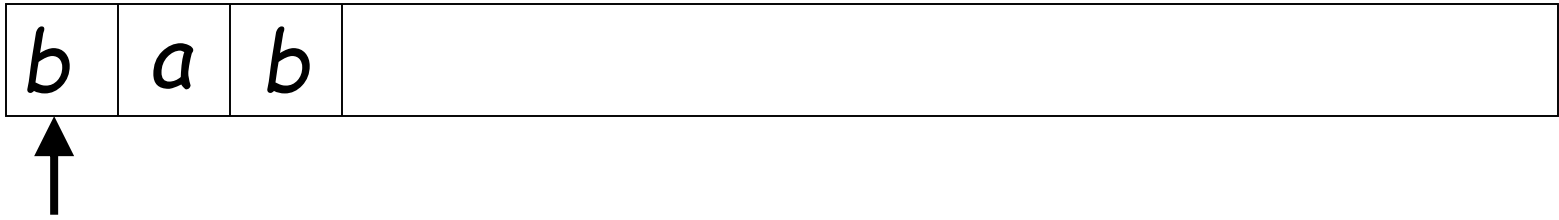

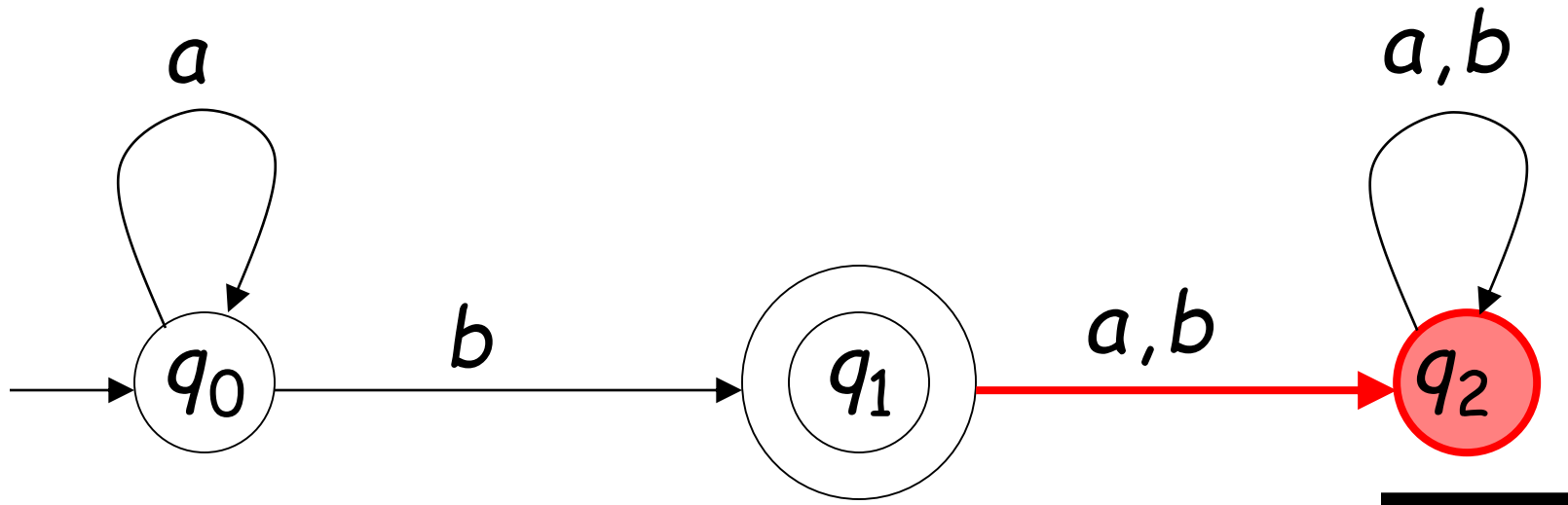

Input finished

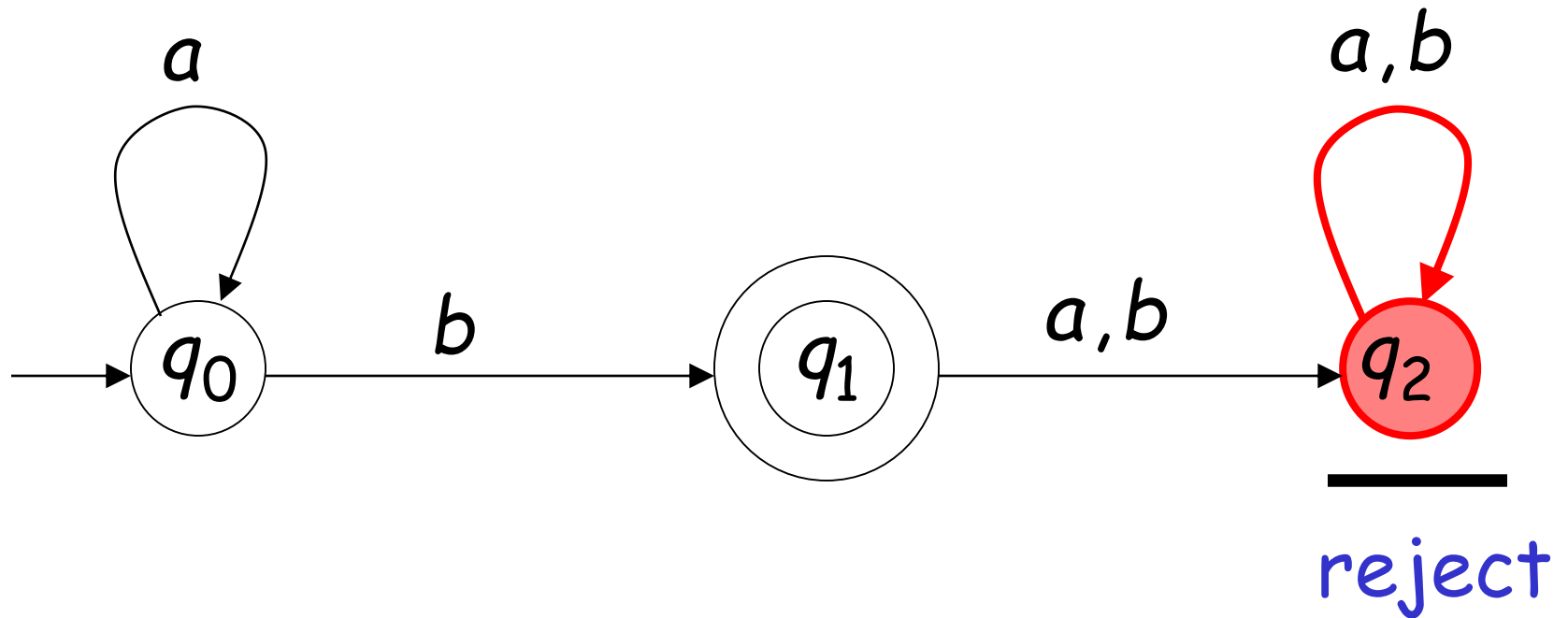
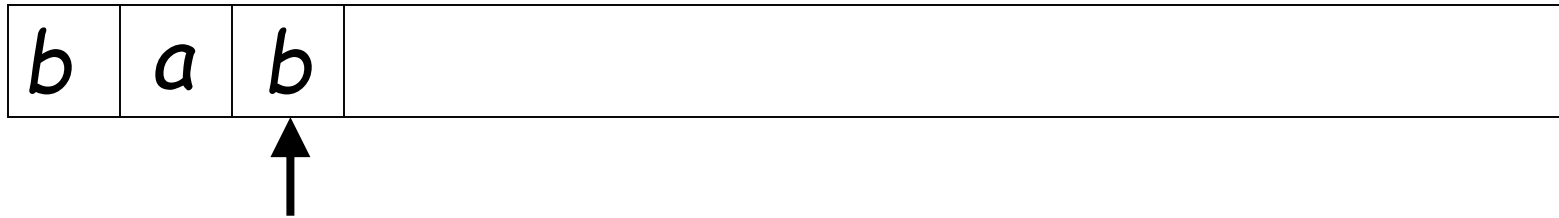

Language Accepted: $L = \{a^n b : n \geq 0\}$

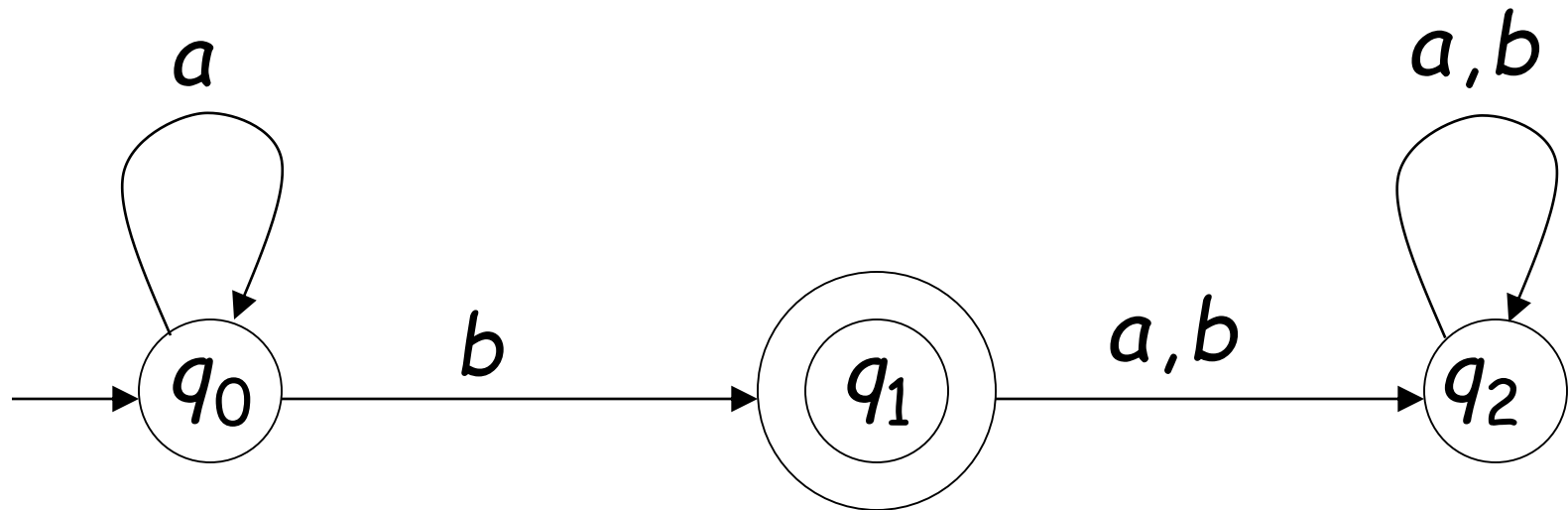

Another Example

Alphabet: $\Sigma = \{1\}$

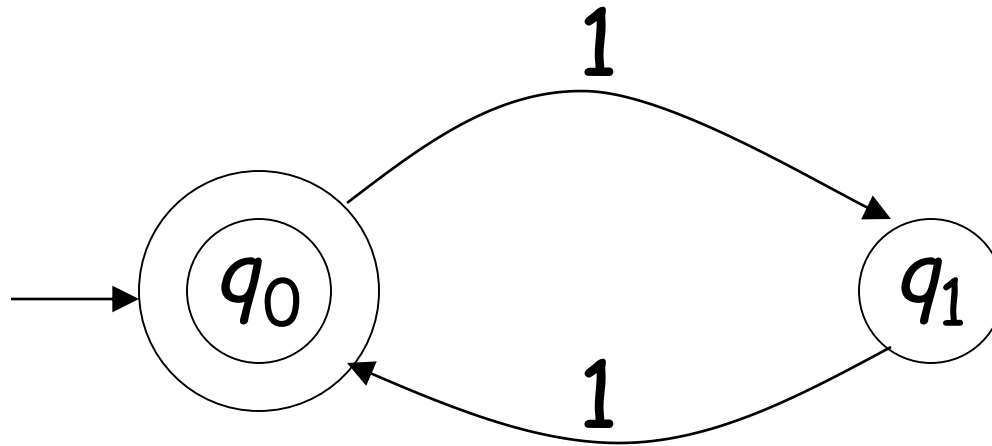

Language Accepted:

$$\begin{aligned} \text{EVEN} &= \{x : x \in \Sigma^* \text{ and } x \text{ is even}\} \\ &= \{\varepsilon, 11, 1111, 111111, \dots\} \end{aligned}$$

Formal Definition

Deterministic Finite Automaton (DFA)

$$M = (Q, \Sigma, \delta, q_0, F)$$

Q : set of states

Σ : input alphabet $\varepsilon \notin \Sigma$

δ : transition function

q_0 : initial state

F : set of accepting states

Set of States Q

Example

$$Q = \{q_0, q_1, q_2, q_3, q_4, q_5\}$$

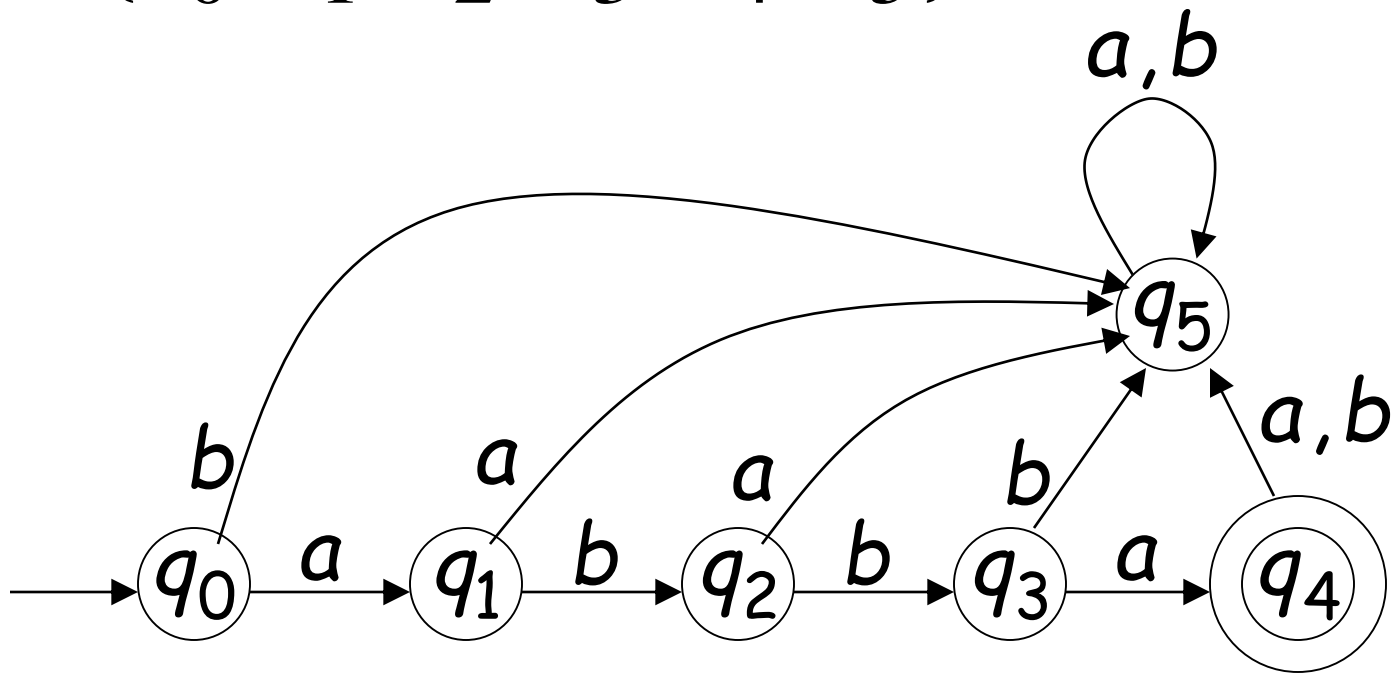

Input Alphabet Σ

$\varepsilon \notin \Sigma$: the input alphabet never contains ε
empty string

Example

$$\Sigma = \{a, b\}$$

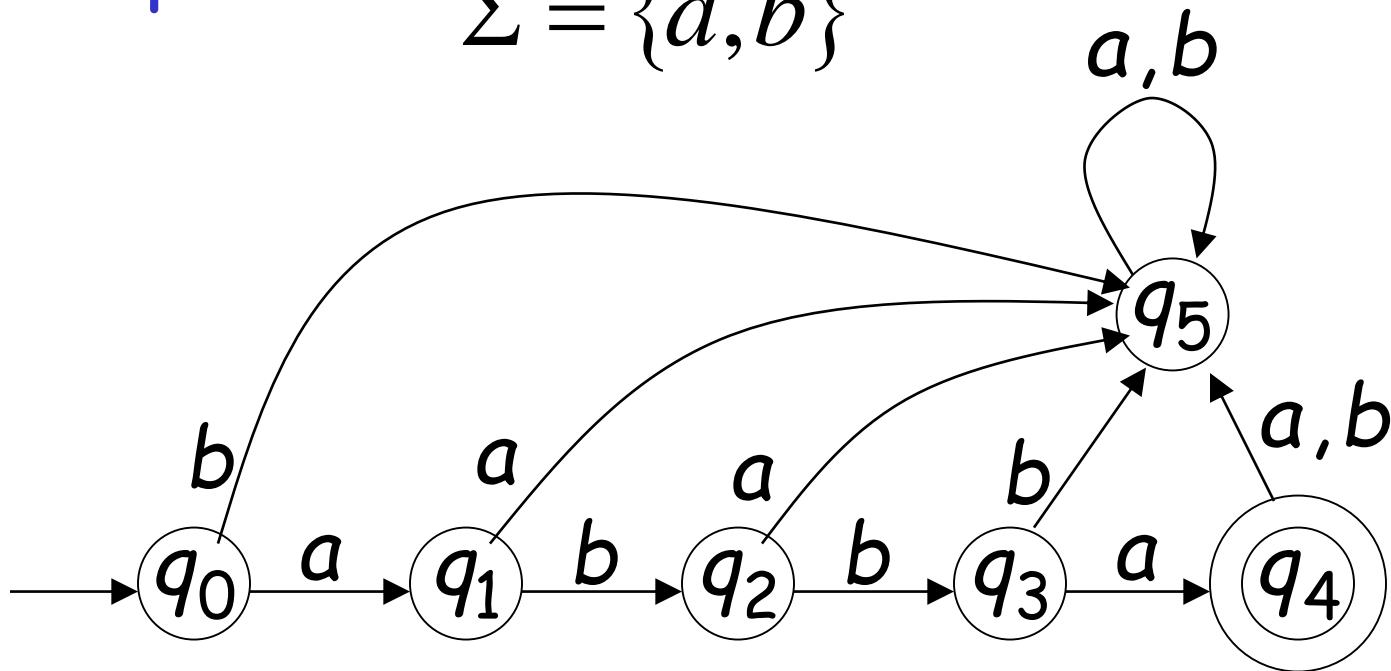

Initial State q_0

Example

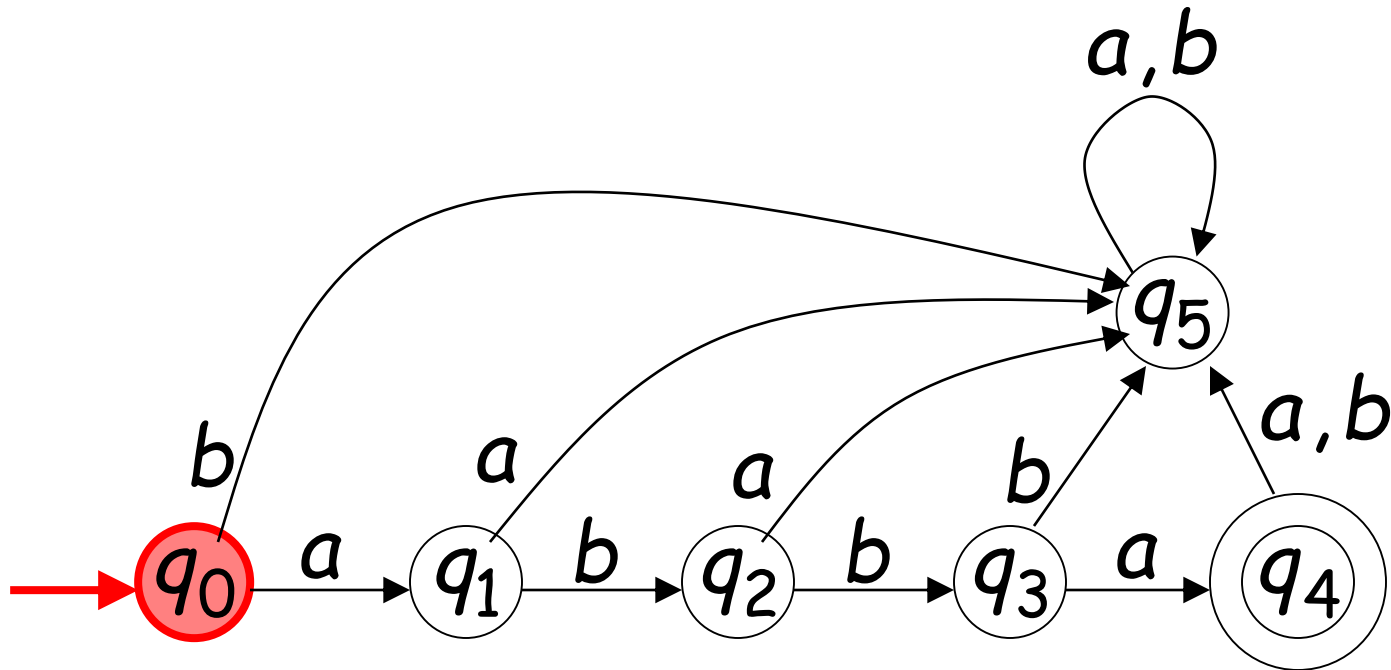

Set of Accepting States $F \subseteq Q$

Example

$$F = \{q_4\}$$

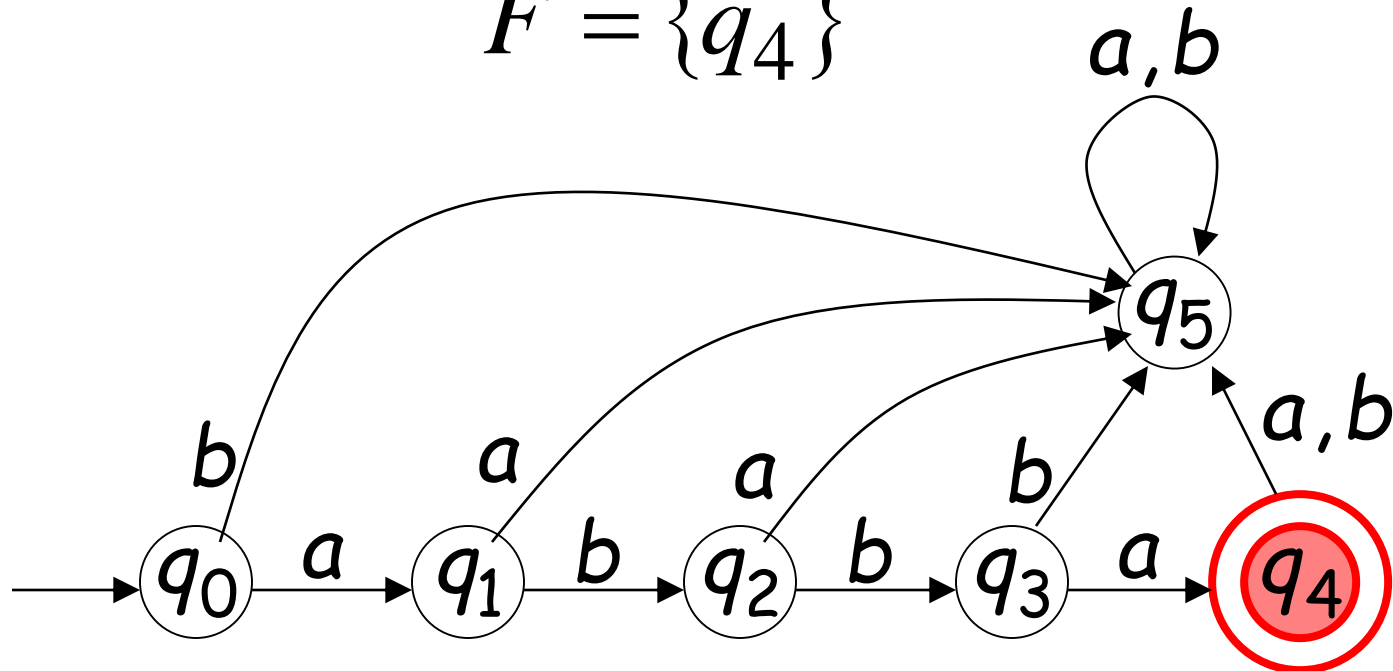

Transition Function $\delta : Q \times \Sigma \rightarrow Q$

$$\delta(q, x) = q'$$

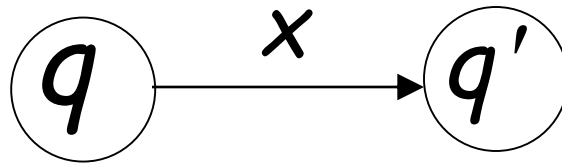

Describes the result of a transition
from state q with symbol x

Example:

$$\delta(q_0, a) = q_1$$

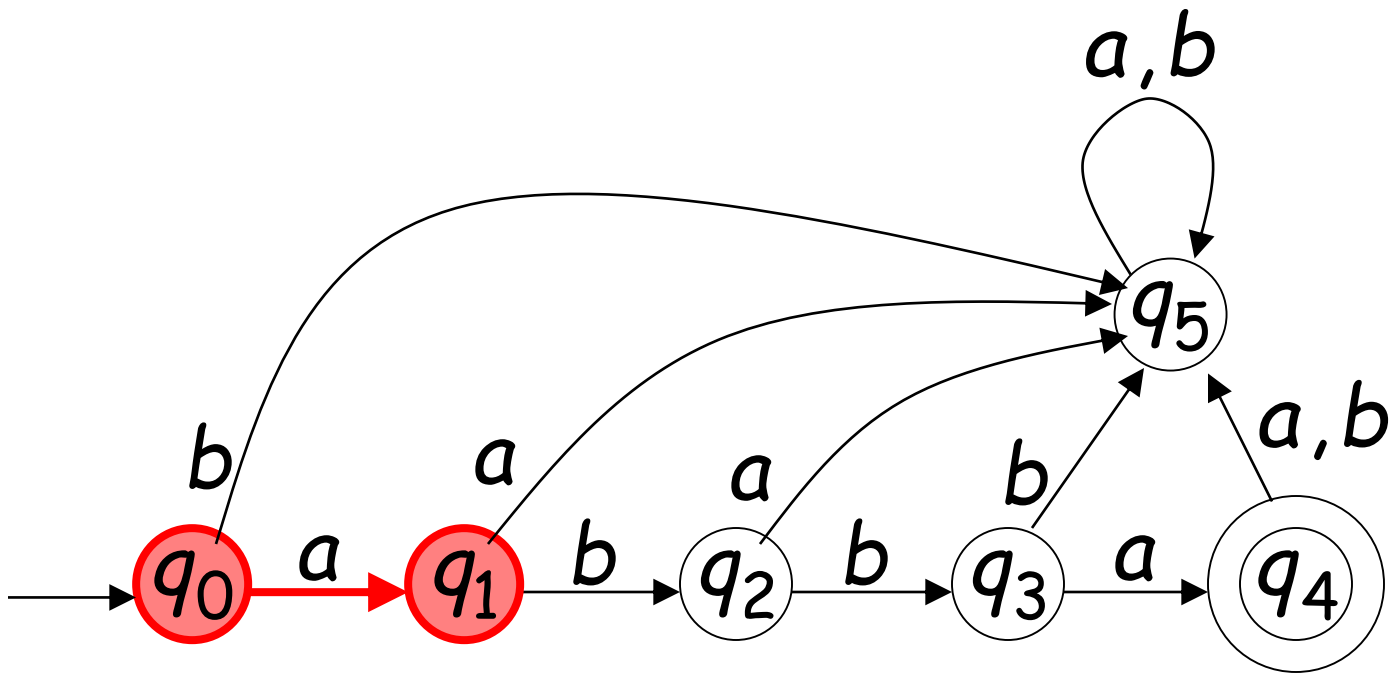

$$\delta(q_0, b) = q_5$$

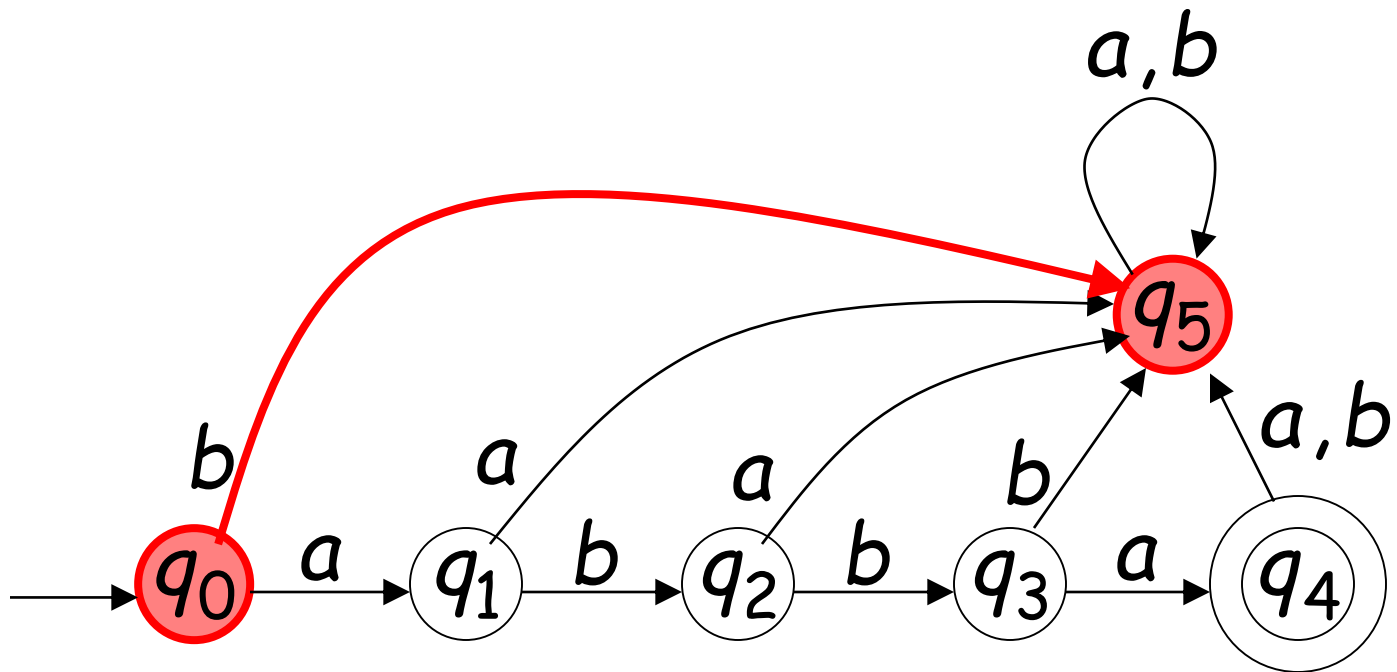

$$\delta(q_2, b) = q_3$$

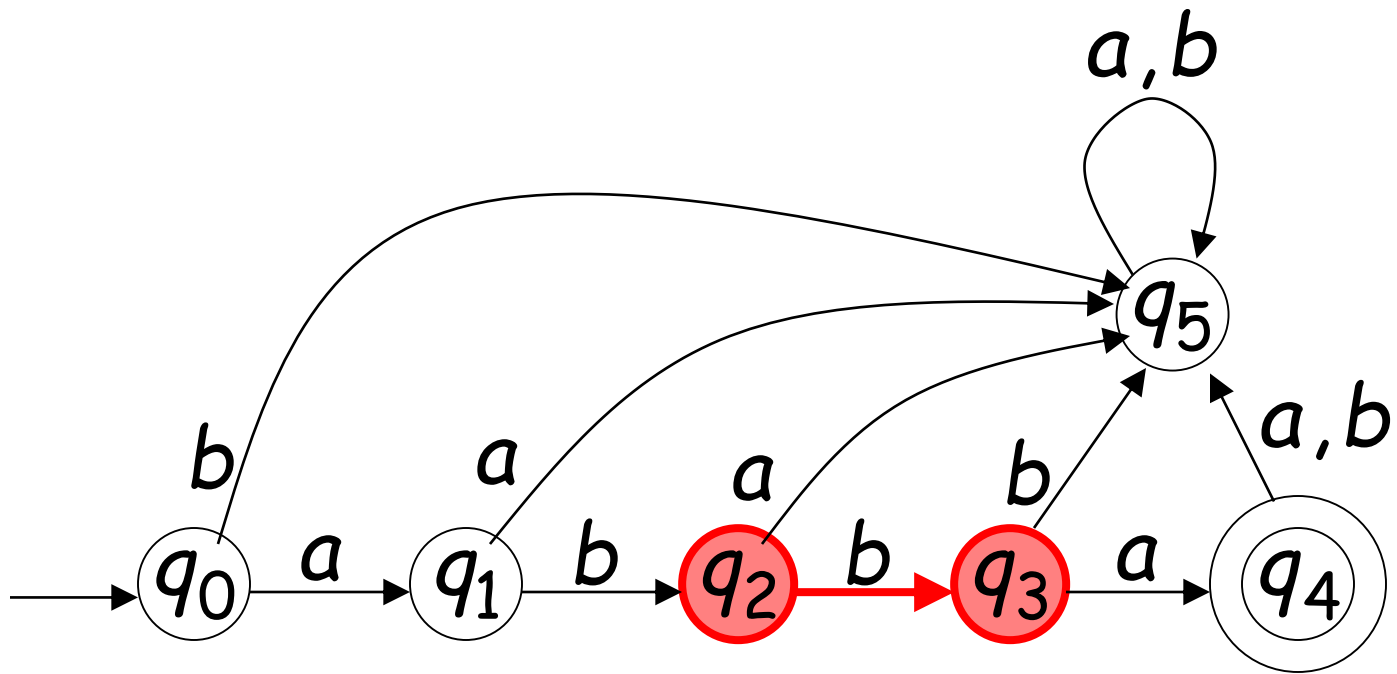

Transition Table for δ

states

δ	symbols	
	a	b
q_0	q_1	q_5
q_1	q_5	q_2
q_2	q_5	q_3
q_3	q_4	q_5
q_4	q_5	q_5
q_5	q_5	q_5

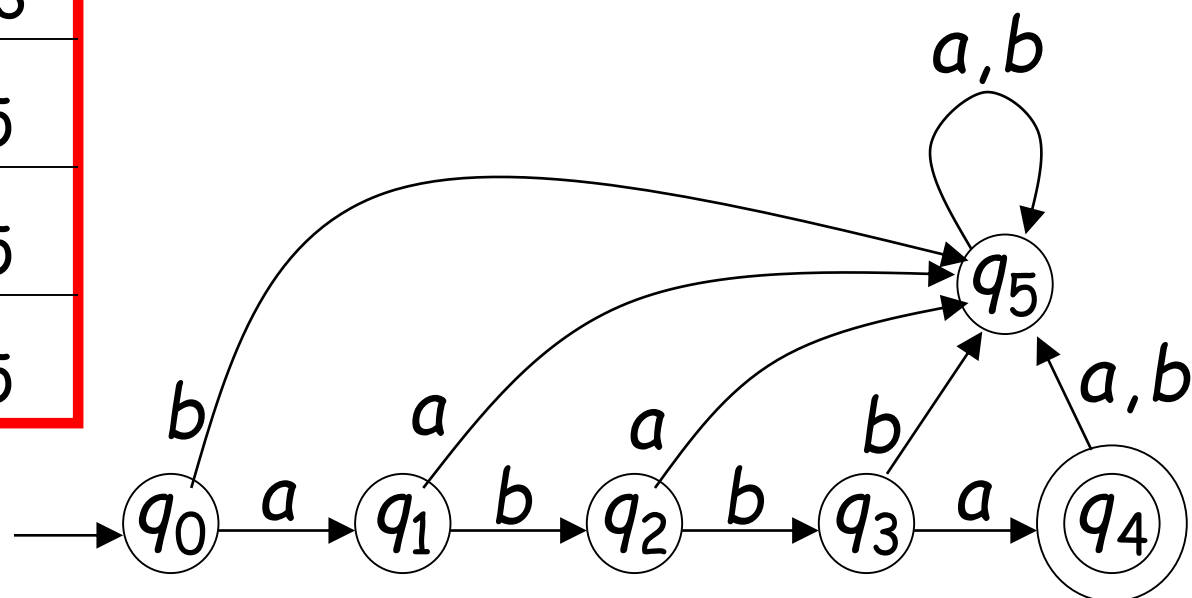

Extended Transition Function

$$\delta^* : Q \times \Sigma^* \rightarrow Q$$

$$\delta^*(q, w) = q'$$

Describes the resulting state
after scanning string w from state q

Example: $\delta^*(q_0, ab) = q_2$

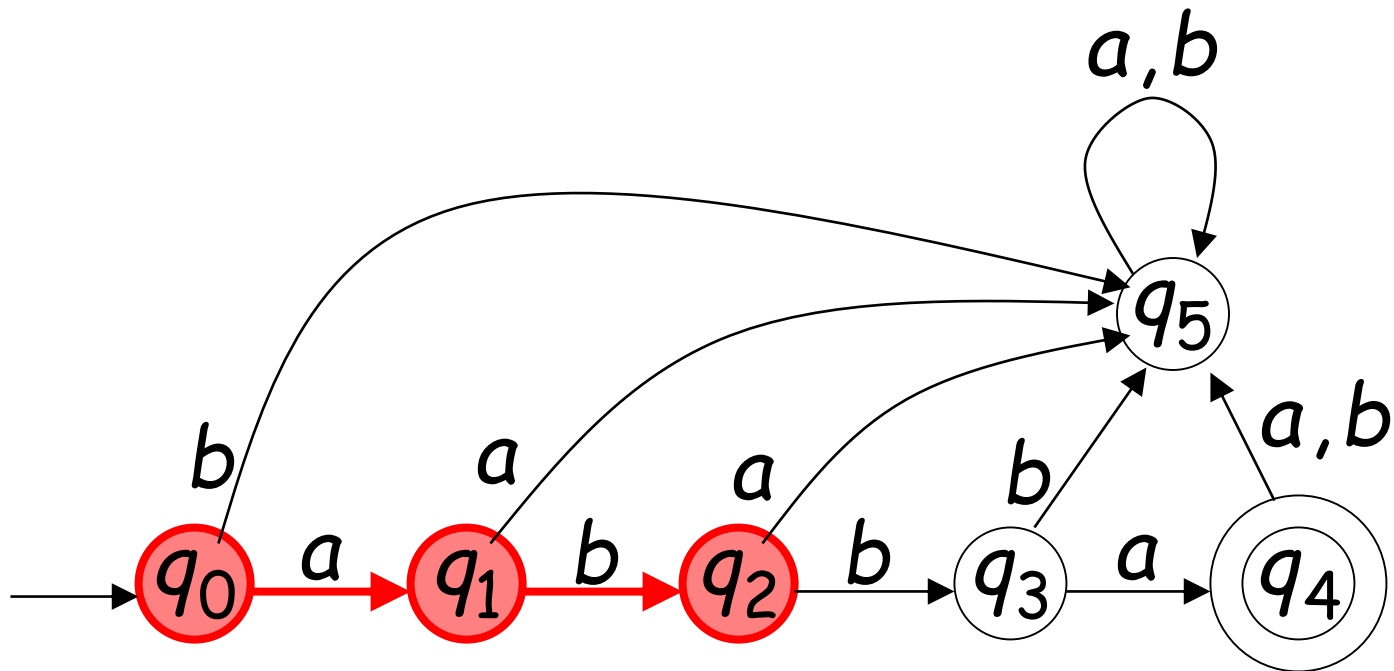

$$\delta^*(q_0, abbbaa) = q_5$$

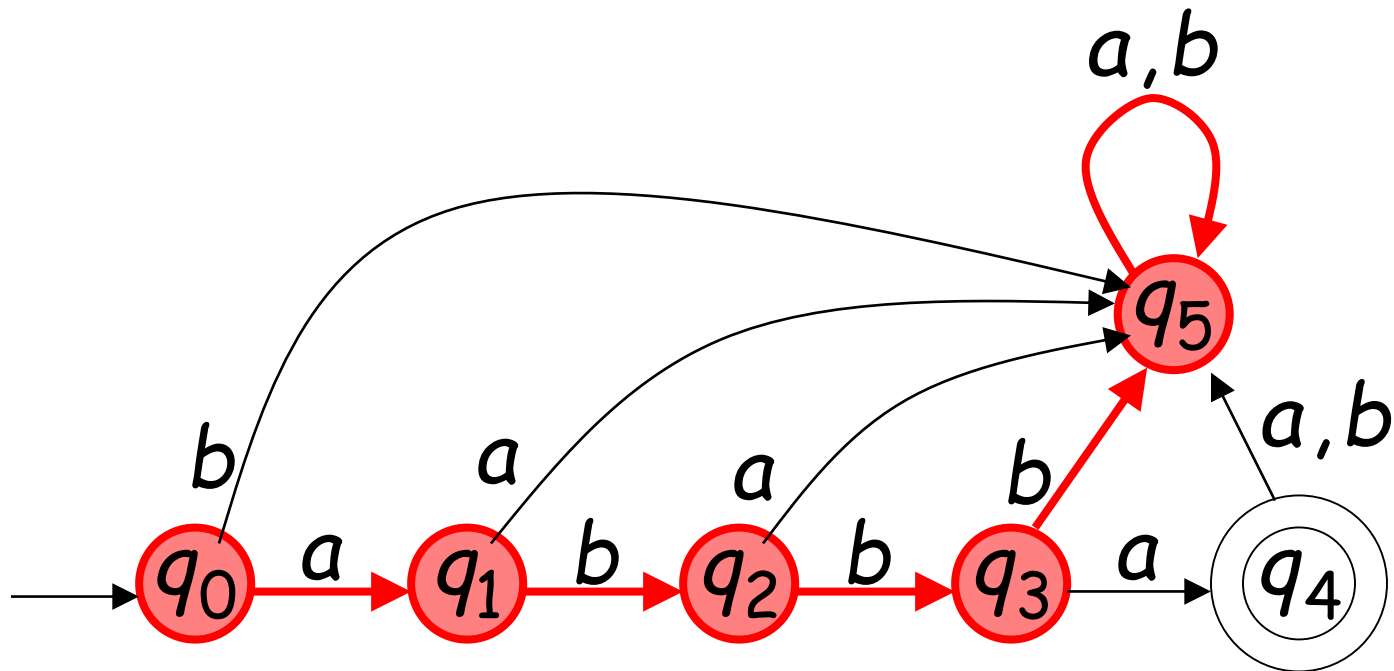

$$\delta^*(q_1, bba) = q_4$$

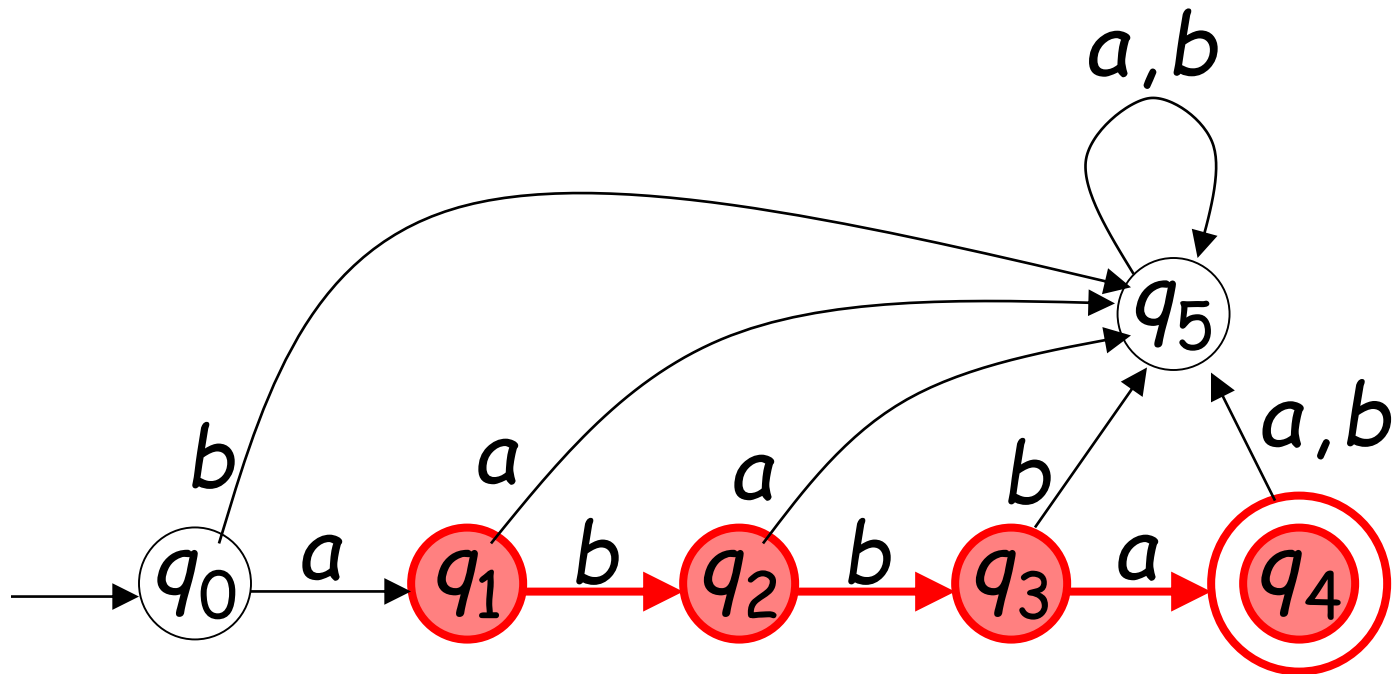

Special case:

for any state q

$$\delta^*(q, \varepsilon) = q$$

In general: $\delta^*(q, w) = q'$

implies that there is a walk of transitions

$$w = \sigma_1 \sigma_2 \Lambda \sigma_k$$

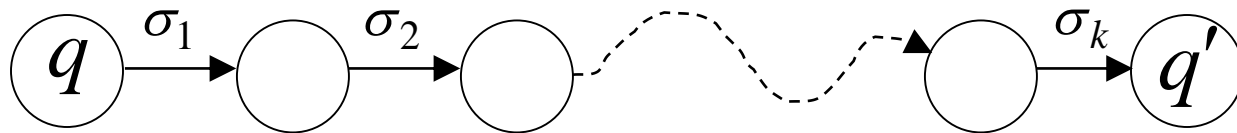

states may be repeated



Language Accepted by DFA

Language accepted by DFA M :

it is denoted as $L(M)$ and contains all the strings accepted by M

We also say that M recognizes $L(M)$

For a DFA $M = (Q, \Sigma, \delta, q_0, F)$

Language accepted by M :

$$L(M) = \{w \in \Sigma^* : \delta^*(q_0, w) \in F\}$$

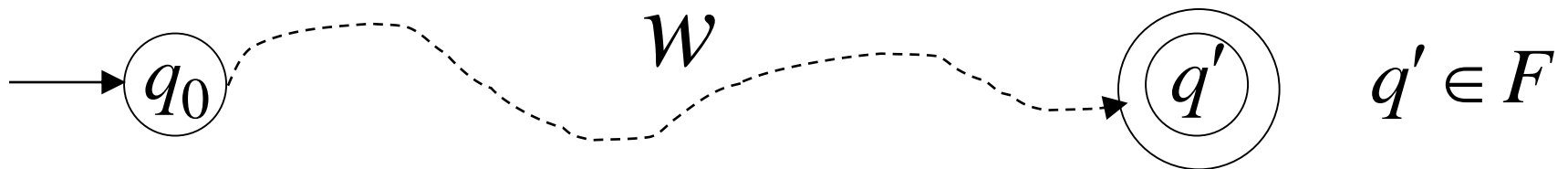

Language rejected by M :

$$\overline{L(M)} = \{w \in \Sigma^* : \delta^*(q_0, w) \notin F\}$$

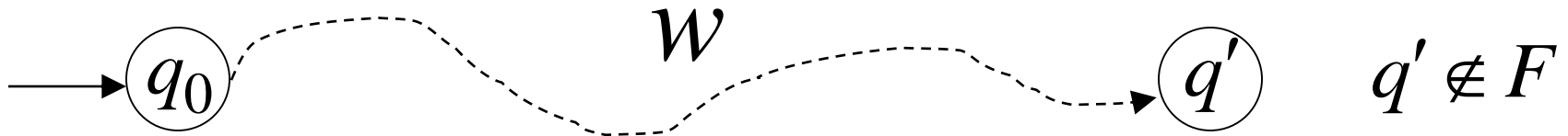

More DFA Examples

$$\Sigma = \{a, b\}$$

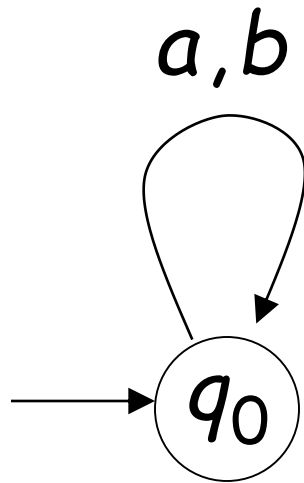

$$L(M) = \{ \}$$

Empty language

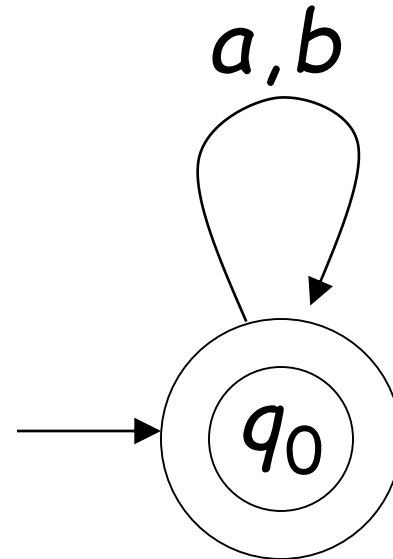

$$L(M) = \Sigma^*$$

All strings

$$\Sigma = \{a, b\}$$

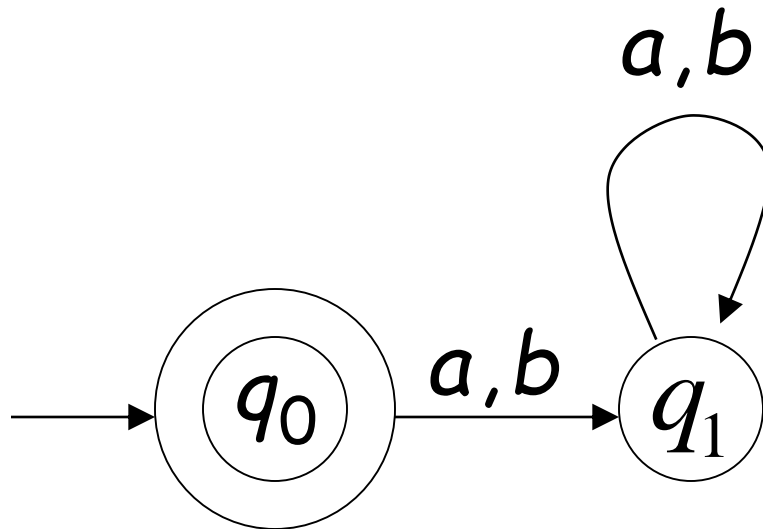

$$L(M) = \{\varepsilon\}$$

Language of the empty string

$$\Sigma = \{a, b\}$$

$L(M) = \{ \text{all strings with prefix } ab \}$

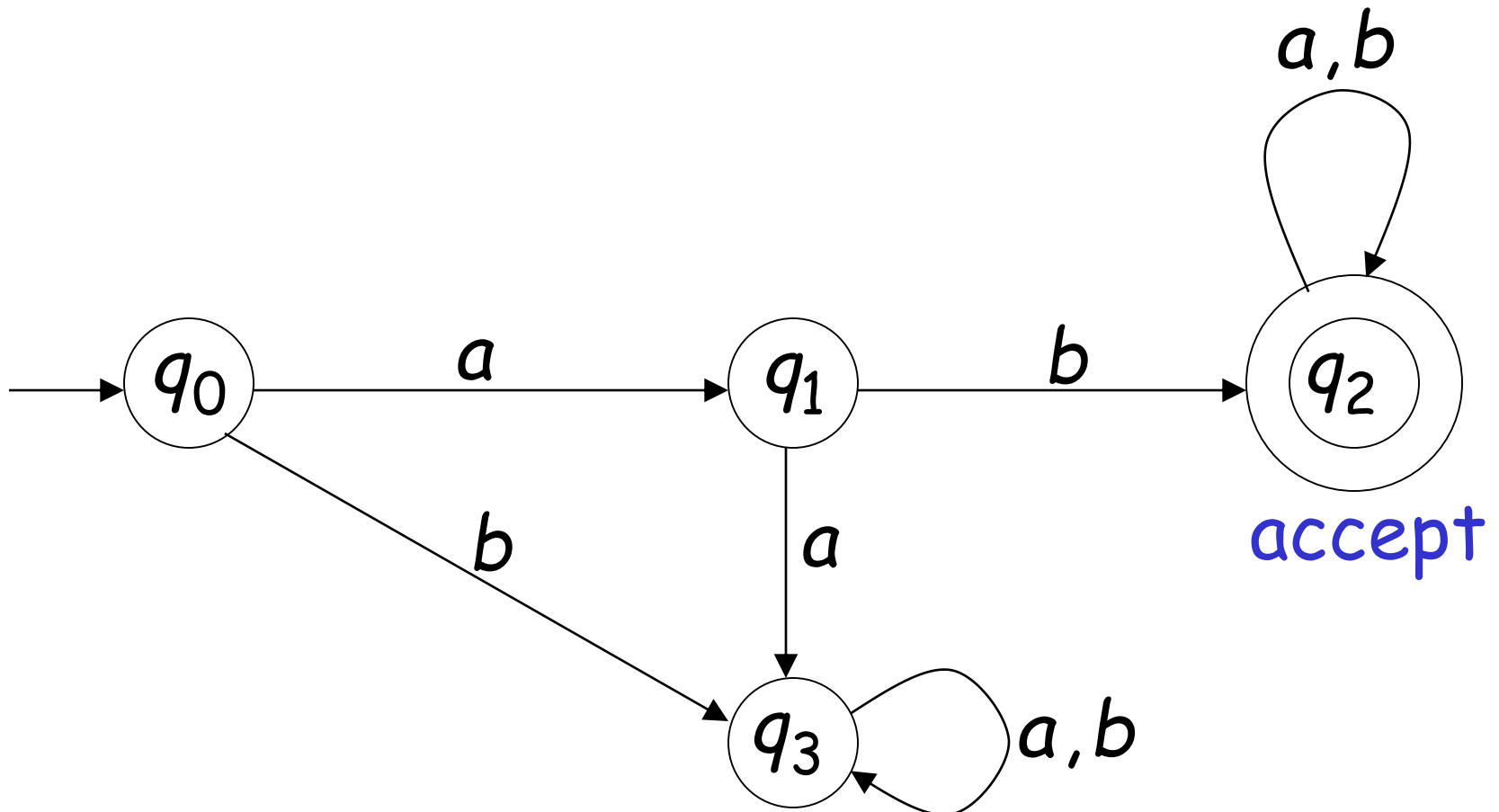

$L(M) = \{ \text{all binary strings containing} \\ \text{substring } 001 \}$

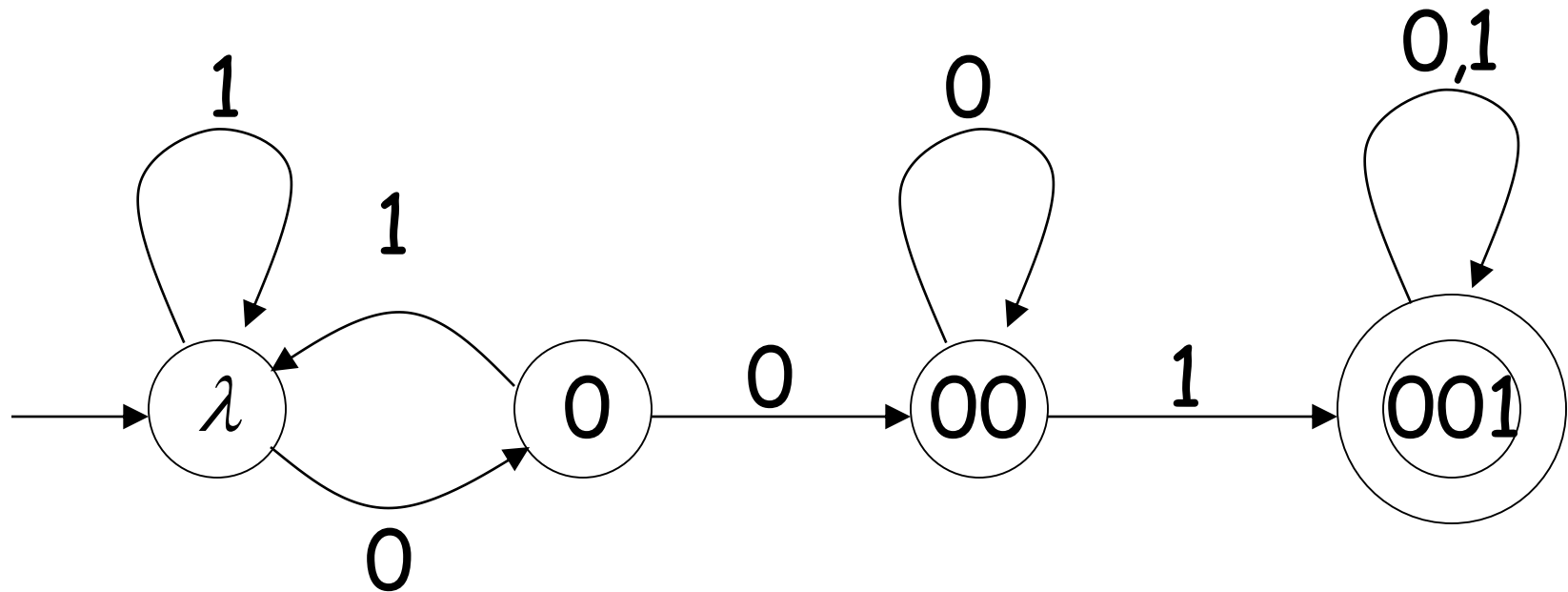

$L(M) = \{ \text{all binary strings without substring } 001 \}$

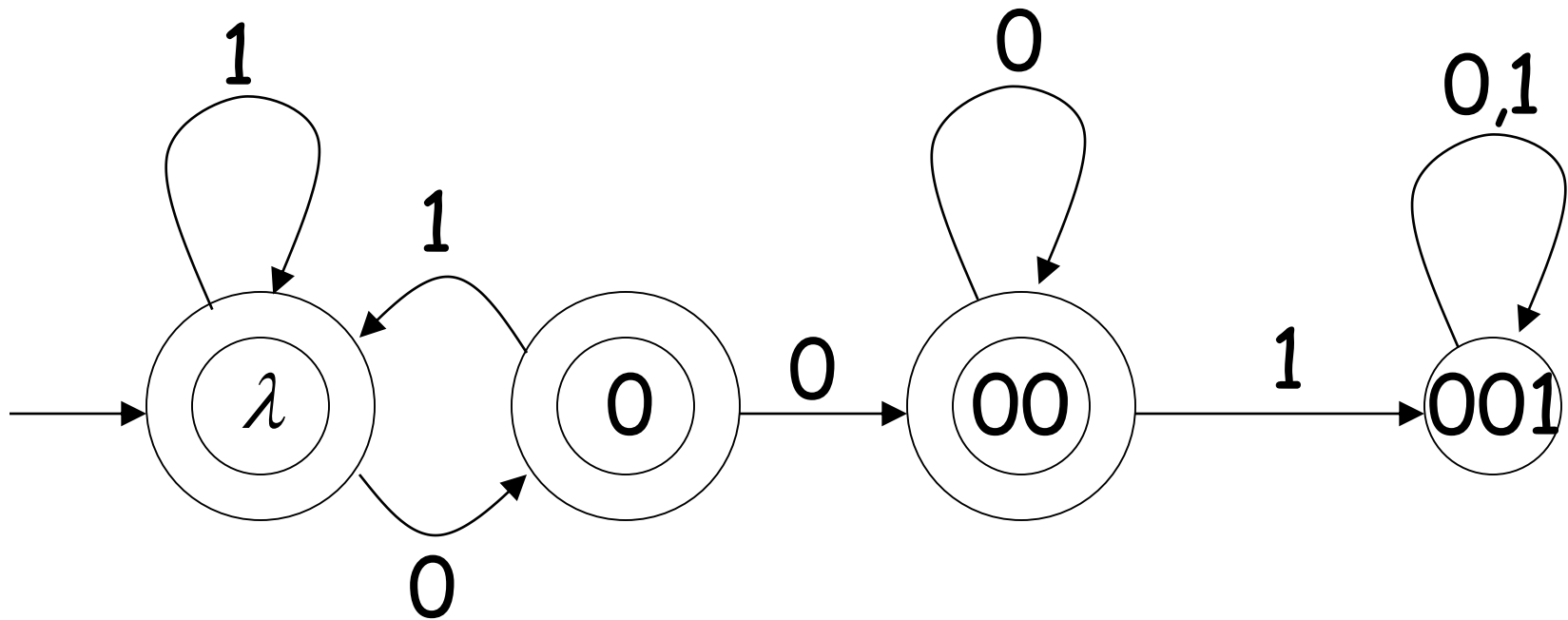

$$L(M) = \{awa : w \in \{a,b\}^*\}$$

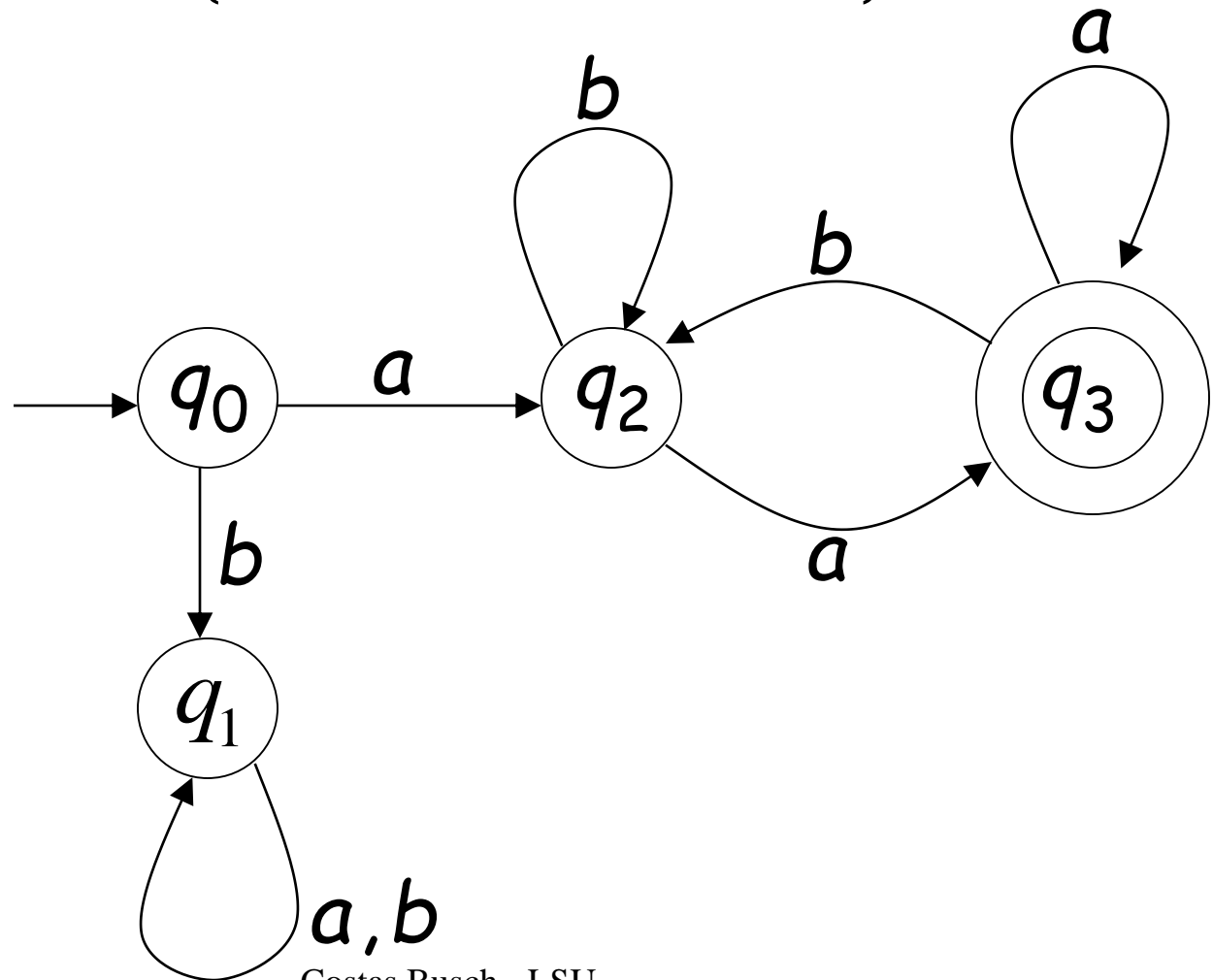

Regular Languages

Definition:

A language L is **regular** if there is a DFA M that accepts it ($L(M) = L$)

The languages accepted by all DFAs form the family of **regular languages**

Example regular languages:

$\{abba\}$ $\{\lambda, ab, abba\}$

$\{a^n b : n \geq 0\}$ $\{awa : w \in \{a, b\}^*\}$

$\{ \text{all strings in } \{a, b\}^* \text{ with prefix } ab \}$

$\{ \text{all binary strings without substring } 001 \}$

$\{x : x \in \{1\}^* \text{ and } x \text{ is even}\}$

$\{\}$ $\{\varepsilon\}$ $\{a, b\}^*$

There exist DFAs that accept these languages (see previous slides).

There exist languages which are not Regular:

$$L = \{a^n b^n : n \geq 0\}$$

$$\text{ADDITION} = \{x + y = z : x = 1^n, y = 1^m, z = 1^k, \\ n + m = k\}$$

There are no DFAs that accept these languages

(we will prove this later)