

Seminário IES **LIGHTING DESIGN. PROCESSO DE PROJETO**

Shoshanna A. Segal

IALD, LEED-AP BD&C
Principal
Luminous Flux, LLC

Tradução Livre: **Paulo Scarazzato**
Arquiteto, Prof, Dr.
CAU. IAB, ANTAC, IES, CIE, CIBSE, SLL

Resultados do Aprendizado

Ao final do seminário você deverá ser capaz de ...

- Identificar os objetivos de um design de iluminação de qualidade.
- Descrever o processo de projeto adotado
- Analisar as ferramentas utilizadas para organizar um projeto de iluminação
- Identificar como um projeto de iluminação se relaciona com o projeto de arquitetura e os demais projetos complementares



Lighting Design. Processo de projeto

O que estamos fazendo?

- Quais são os objetivos do projeto de iluminação?

Como o fazemos?

- O que é o processo de análise e tomada de decisão?

Que ferramentas devemos utilizar?

- Como são organizados os desenhos, a documentação e outros tipos de comunicação?

Quando o fazemos?

- Como o cronograma do projeto e suas respectivas fases se relacionam e afetam nosso trabalho?

Como nosso “produto se relaciona com os demais projetos?

- Quais as questões de coordenação / integração que precisamos ter em mente e como é que a colaboração realmente funciona?

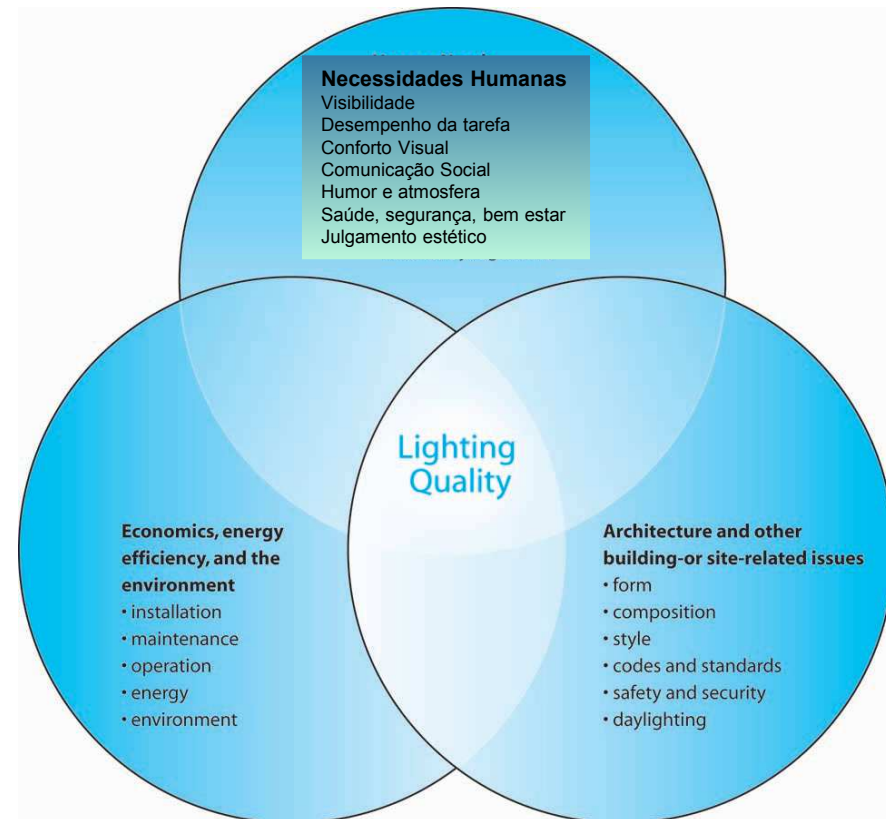

© Illuminating Engineering Society of North America



O que estamos fazendo?

Quais são os objetivos de um projeto de iluminação?

- *Satisfazer necessidades visuais*



Pequeno ofuscamento, iluminação de tarefa adequada



Image courtesy of Archronica Architects, New York, New York
Lighting Designer: Randy Sabedra
Project: Eleftheros Tipos Media

O que estamos fazendo?

Quais são os objetivos de um projeto de iluminação?

- Satisfazer necessidades visuais*
- Atender normas*



Consumo de iluminação 8 w/m²



Image courtesy of Brad Anderson/Architectural Photography Inc.
Project: COFRA/Good Energies
Architect: Perkins + Will, NY

O que estamos fazendo?

Quais são os objetivos de um projeto de iluminação?

- Satisfazer necessidades visuais*
- Atender normas*
- Revelar a Arquitetura*



Distribuição das luminárias destaca formas arquitetônicas



Image courtesy of Peter Paige
Project: AP NY

O que estamos fazendo?

Quais são os objetivos de um projeto de iluminação?

- Satisfazer necessidades visuais*
- Atender normas*
- Revelar a arquitetura*
- Integrar-se à Iluminação Natural*



A iluminação natural está sendo usada como fonte funcional ou decorativa nesta imagem?



Image courtesy of Stephen Lees

O que estamos fazendo?

Quais são os objetivos de um projeto de iluminação?

- Satisfazer necessidades visuais*
- Atender normas*
- Revelar a arquitetura*
- Integrar-se à Iluminação natural*
- Favorecer a Sustentabilidade*



Projeto LEED Platinum



Image courtesy of Ken Douglas / © Illumination Arts
Lighting Design: Illumination Arts

O que estamos fazendo?

Quais são os objetivos de um projeto de iluminação?

- Satisfazer necessidades visuais*
- Atender normas*
- Revelar a arquitetura*
- Integrar-se à Iluminação natural*
- Favorecer a Sustentabilidade*
- Atender às exigências do cliente*



Image courtesy of Adrian Wilson/Interior Photography, Inc.
Project: Moët Hennessey
Architect: TPG Architects

O que estamos fazendo?

Quais são os objetivos de um projeto de iluminação?

- Satisfazer necessidades visuais*
- Atender normas*
- Revelar a arquitetura*
- Integrar-se à Iluminação natural*
- Favorecer a Sustentabilidade*
- Atender às exigências do cliente*
- Possibilitar manutenção*



Project: Reece School, NYC
Architect: Platt, Beyard, Dovell, White

O que estamos fazendo?

Quais são os objetivos de um projeto de iluminação?

- Satisfazer necessidades visuais*
- Atender normas*
- Revelar a arquitetura*
- Integrar-se à Iluminação natural*
- Favorecer a Sustentabilidade*
- Atender às exigências do cliente*
- Possibilitar manutenção*
- Possibilitar controles*



Os sistemas de iluminação também abrigam dispositivos mecânicos e elétricos



O que estamos fazendo?

Quais são os objetivos de um projeto de iluminação?

- Satisfazer necessidades visuais*
- Atender normas*
- Revelar a arquitetura*
- Integrar-se à Iluminação natural*
- Favorecer a Sustentabilidade*
- Atender às exigências do cliente*
- Possibilitar manutenção*
- Possibilitar controles*
- Propiciar Flexibilidade*



Sistemas de controle de iluminação que possibilitem mudanças nas necessidades dos usuários



Image courtesy of Peter Paige
Project: AP NYC

O que estamos fazendo?

Quais são os objetivos de um projeto de iluminação?

- Satisfazer necessidades visuais*
- Atender normas*
- Revelar a arquitetura*
- Integrar-se à Iluminação natural*
- Favorecer a Sustentabilidade*
- Atender às exigências do cliente*
- Possibilitar manutenção*
- Possibilitar controles*
- Propiciar Flexibilidade*
- Considere o tempo de vida do sistema*

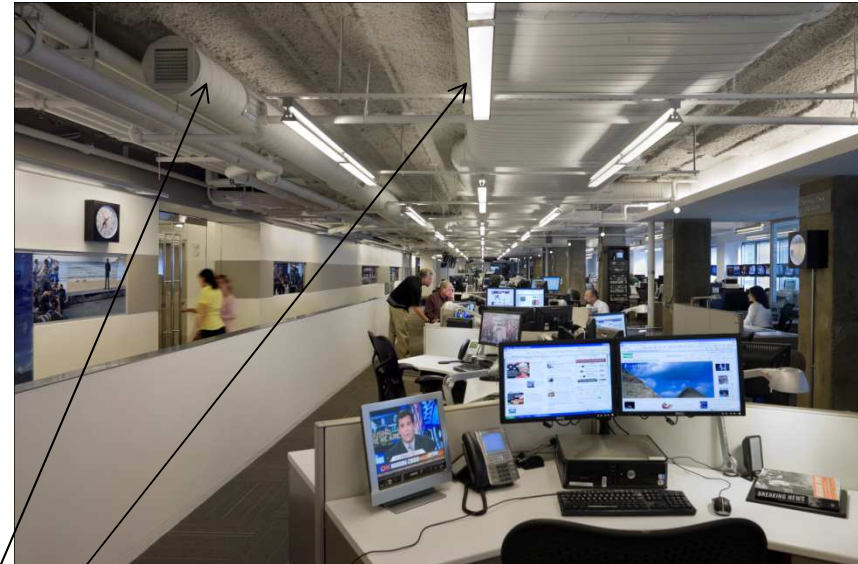

Image courtesy of Randy Sabedra
Project: U.S. Customs House

O que estamos fazendo?

Quais são os objetivos de um projeto de iluminação?

- Satisfazer necessidades visuais*
- Atender normas*
- Revelar a arquitetura*
- Integrar-se à Iluminação natural*
- Favorecer a Sustentabilidade*
- Atender às exigências do cliente*
- Possibilitar manutenção*
- Possibilitar controles*
- Propiciar Flexibilidade*
- Assegure compatibilidade com outros sistemas*



Integração entre iluminação artificial e ar condicionado



Project: AP, DC
Architect: Gensler, DC

O que estamos fazendo?

Quais são os objetivos de um projeto de iluminação?

- Satisfazer necessidades visuais
- Atender normas
- Revelar a arquitetura
- Integrar-se à Iluminação natural
- Favorecer a Sustentabilidade
- Atender às exigências do cliente
- Possibilitar manutenção
- Possibilitar controles
- Propiciar Flexibilidade
- Assegure compatibilidade com outros sistemas
- **Comunique as intenções do projeto**



Este projeto se valeu da iluminação natural periférica e a distribuição luminosa representada ilustra a necessidade de iluminação artificial suplementar.



Como o fazemos? Questões esquemáticas

Como vamos de uma ideia às instalações finalizadas?

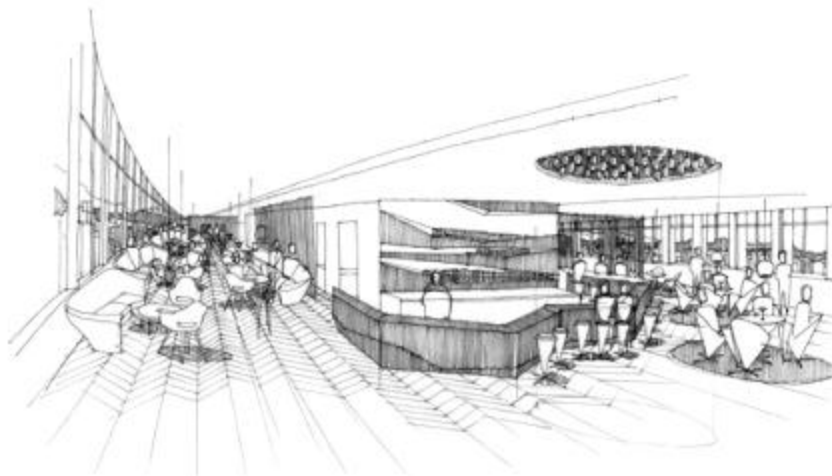

Desenho conceitual



Instalação finalizada



Sketch courtesy of Tom Dixon Design research Studio, www.designresearchstudio.net
Project: Aetna Lighting Design: Horton Lees Brogden Lighting Design
Architect: Perkins+ Will, CT
Image courtesy of Peter Brown/Woodruff Brown Architectural Photography

Como o fazemos? Questões esquemáticas

Funções do Edifício

Que atividades precisam ocorrer no interior do edifício/dos pavimentos?



Top image courtesy of Jessica Paul/KCJP
Project: Dalton School Architect: Peter Matthews
Mid Image: iStockphoto
Bottom Image: Project: Advanced Healthcare

Como o fazemos? Questões esquemáticas

Funções do Edifício

Que atividades precisam ocorrer no interior do edifício/dos pavimentos?



Níveis de Ocupação

Como os focos visuais são balanceados com um uso criterioso, tanto com relação (iluminação natural e iluminação artificial)?

Como os níveis de ocupação e atividades afetam o uso?

As variáveis de exigências visuais são baseadas na ocupação?



Top: iStockphoto
Bottom: Veer Images

Como o fazemos? Questões esquemáticas

Funções do Edifício

Que atividades precisam ocorrer no interior do edifício/dos pavimentos?

Níveis de Ocupação

Como os níveis de ocupação e atividades afetam o uso?

As variáveis de exigências visuais são baseadas na ocupação?

Exigências Normativas

Há exigências normativas ou níveis de iluminação relacionados ao uso do espaço ou função?

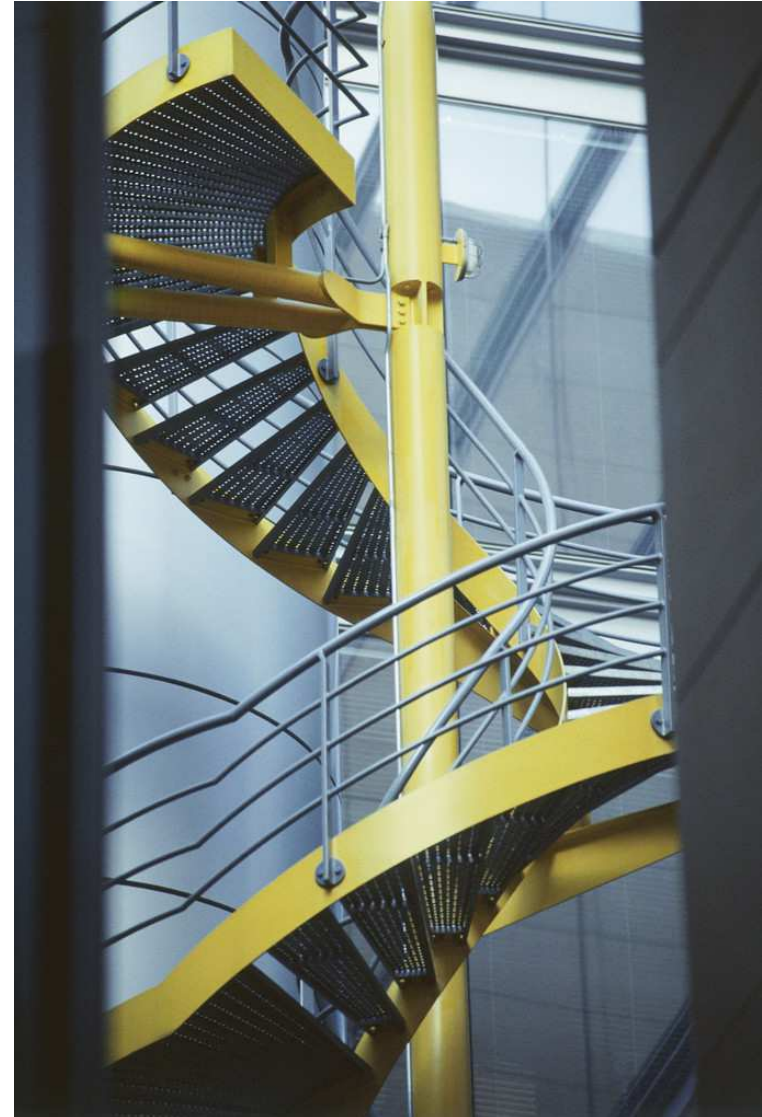

Como o fazemos? Questões esquemáticas

Funções do Edifício

Que atividades precisam ocorrer no interior do edifício/dos pavimentos?

Níveis de Ocupação

Como os níveis de ocupação e atividades afetam o uso?

As variáveis de exigências visuais são baseadas na ocupação?

Exigências Normativas

Há exigências normativas ou níveis de iluminação relacionados ao uso do espaço ou função?

Influência na Escolha de Lâmpadas e Luminárias

Critério

As fontes de luz elétrica são usadas durante o dia?

Somente à noite?

Como essas questões afetam nosso critério de escolha das fontes de luz, lâmpadas e luminárias?

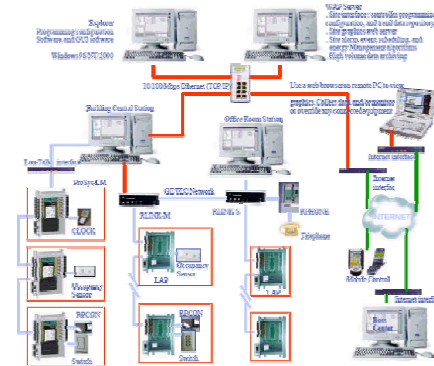
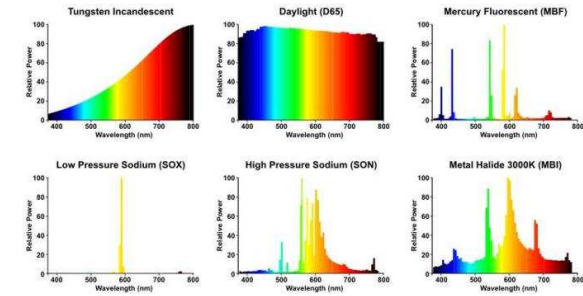

Top: Image courtesy of G.E. Lighting
Middle: Image courtesy of G.E. Lighting
Bottom: Jiaying Meiyao Lighting Technology Co., Ltd.

Como o fazemos? Questões esquemáticas

Outras considerações:

Sistemas de Avaliação e Certificação

*O projeto pretendo obter ser
certificação de eficiência energética
e/ou sustentabilidade?*

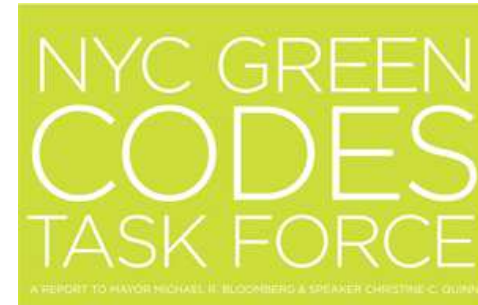

breeam



Como o fazemos? Questões esquemáticas

Outras considerações:

Sistemas de Avaliação e Certificação

O projeto pretendo obter ser certificação de eficiência energética e/ou sustentabilidade?

Parâmetros Orçamentários

Existem fatores de custos ou outras realidades econômicas que devem ser considerados?

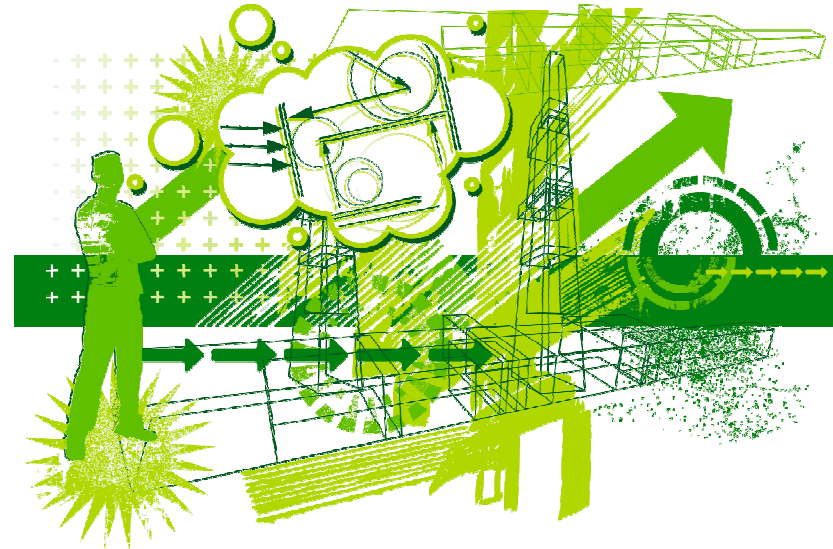

Como o fazemos? Questões esquemáticas

Outras considerações:

Sistemas de Avaliação e Certificação

O projeto pretendo obter ser certificação de eficiência energética e/ou sustentabilidade?

Parâmetros Orçamentários

Existem fatores de custos ou outras realidades econômicas que devem ser considerados?

Algo mais?

Algum outro tópico a ser explorado?



Top: Image courtesy of Erco, Inc.

Bottom: Project: Heiffer International Headquarters – Image courtesy of Tim Hursley
Architect: Polk Stanley Wilcox Architects

Como o fazemos? Questões esquemáticas

... e ainda mais algumas questões

Tipos de Espaços?

Padrões ou características comuns entre ambientes?

Pés-fireitos e materiais de acabamento?



Top: Image © Jeff Goldberg/Esto Architect: Perkins + Will
Bottom Image: Eduard Hueber ArchphotoInc.com

Iluminância Pretendida e Níveis de Contraste

Quantidade de luz?
Luz suficiente?



Iluminância Pretendida e Níveis de Contraste

Depende



Iluminância e Visibilidade



Aumento nos níveis de iluminação podem superar alguns obstáculos visuais, mas não todos.



Image courtesy of Flickr

Contraste e Visibilidade

Contrastes Extremos inibem a visibilidade



Unifromidade extrema inibe a focagem



Images courtesy of Hayden McKay

Considere a Luz do Dia

Com único membro da equipe de projeto focado principalmente nas questões sobre visibilidade, contrastes e refletâncias, o lighting designer deve estar preparado para promover a integração da luz do dia ao seu projeto.

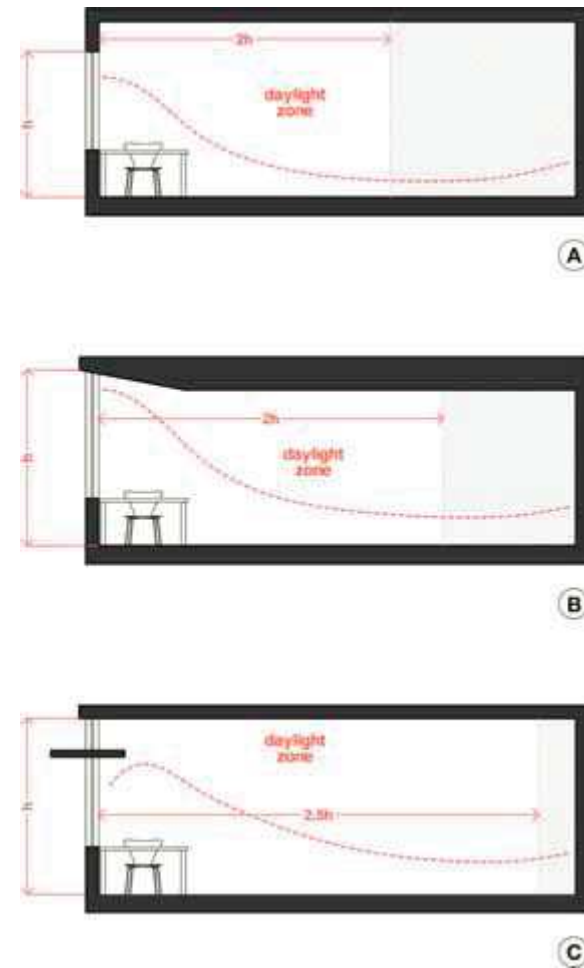

Images courtesy of Tanteri + Assoc.

Iluminância e Visibilidade

E	1	20/200
F P	2	20/100
T O Z	3	20/70
L P E D	4	20/50
P E C F D	5	20/40
E D F C Z P	6	20/30
F E L O P Z D	7	20/25
D E F P O T E C	8	20/20
L E F O D P C T	9	
F D P L T C E O	10	
P E Z O L C F T D	11	



Carta para medição da acuidade visual desenvolvida por Hermann Sneller em 1862

Iluminância e Comportamento

O que o ambiente visual nos revela ...



... sobre comportamento social adequado?



Left: www.indoorsphoto.ru
Right: © Brian Park Photo

Iluminância: Valores recomendados

Category	Recommended Illuminance Targets (lux)			Some Typical Application and Task Characteristics	Visual Performance Description			
	Visual Ages of Observers (years) where at least half are							
	<25	25 to 65	>65					
Interior and exterior applications	A	0.5	1	2	<ul style="list-style-type: none"> • Dark adapted situations • Basic convenience situations 	<p>Orientation, relatively large-scale, physical (less-cognitive) tasks</p> <p>Visual performance is typically not work-related, but related to dark sedentary social situations, senses of safety and security, and casual circulation based on landscape, hardscape, architecture, and people as visual tasks.</p>		
	B	1	2	4	<ul style="list-style-type: none"> • Very-low-activity situations 			
	C	2	4	8	<ul style="list-style-type: none"> • Slow-paced situations • Low-density situations 			
	D	3	6	12	<ul style="list-style-type: none"> • Slow-to-moderate-paced situations • Moderate-to-high-density situations 			
	E	4	8	16				
	F	5	10	20	<ul style="list-style-type: none"> • Moderate-to-fast-paced situations 			
	G	7.5	15	30	<ul style="list-style-type: none"> • High-density situations • Some indoor very subdued circulation situations 			
	H	10	20	40	<ul style="list-style-type: none"> • Some indoor social situations 			
Interior and exterior	I	15	30	60	<ul style="list-style-type: none"> • Congested and significant outdoor intersections, important decision-points, gathering places, and key points of interest • Some indoor social situations • Some indoor commerce situations 			
Interior and exterior applications	J	20	40	80		<p>Common social activity and large and/or high-contrast tasks</p> <p>Visual performance involves higher-level assessment of landscape, hardscape, architecture, and people and can be work related.</p>		
	K	25	50	100				
	L	37.5	75	150	<ul style="list-style-type: none"> • Some outdoor commerce situations • Some indoor social situations 			
	M	50	100	200	<ul style="list-style-type: none"> • Some indoor commerce situations 			
	N	75	150	300				
	O	100	200	400				
	P	150	300	600	<ul style="list-style-type: none"> • Some indoor social situations • Some indoor education situations • Some indoor commerce situations • Some indoor sports situations 			
	Q	200	400	800	<ul style="list-style-type: none"> • Some indoor education situations • Some indoor commerce situations 			
	R	250	500	1000	<ul style="list-style-type: none"> • Some indoor sports situations • Some indoor industrial situations 			
	S	375	750	1500				
Interior and exterior applications	T	500	1000	2000	<ul style="list-style-type: none"> • Some sports situations 	<p>Small-scale, cognitive visual tasks</p> <p>Visual performance is work- or sports-related, close and distant fine inspection, very small detail, high-speed assessment and reaction.</p>		
	U	750	1500	3000	<ul style="list-style-type: none"> • Some indoor commerce situations • Some indoor industrial situations 			
	V	1000	2000	4000				
	W	1500	3000	6000	<ul style="list-style-type: none"> • Some sports situations • Some indoor industrial situations • Some health care procedural situations 			
	X	2500	5000	10000	<ul style="list-style-type: none"> • Some health care procedural situations 			
	Interior applications	Y	5000	10000	20000		<ul style="list-style-type: none"> • Some health care procedural situations 	<p>Visual performance is of the highest order in respective fields of health care, industrial, and sports.</p>



Iluminância: Valores recomendados

Category	Recommended Target Illuminances, lux			Typical Application and Task Characteristics
	Visual Age of Observer (years of age)			
	at least half the observers are <25	25 to 65	at least half the observers are >65	
A	0.5	1 interior and exterior applications	2	<ul style="list-style-type: none"> • Dark adapted situations • Basic convenience situations • Very-low-activity situations
B	1	2 interior and exterior applications	4	
C	2	4 interior and exterior applications	8	<ul style="list-style-type: none"> • Slow-paced situations • Low-density situations
D	3	6 interior and exterior applications	12	<ul style="list-style-type: none"> • Slow-to-moderate-paced situations • Moderate-to-high-density situations
E	4	8 interior and exterior applications	16	
F	5	10 interior and exterior applications	20	
G	7.5	15 interior and exterior applications	30	<ul style="list-style-type: none"> • Moderate-to-fast-paced situations • High-density situations • Some indoor very subdued circulation situations
H	10	20 interior and exterior applications	40	

Orientation, relatively large-scale, physical (less-cognitive) tasks

Visual performance is typically not work-related, but related to dark sedentary social situations, senses of safety and security, and casual circulation based on landscape, hardscape, architecture, and people as visual tasks.



Iluminância: Valores recomendados



Project: NYU Stern School of Business
© Eduard Hueber ArchphotoInc.com

Códigos Energéticos

TABLE 9.3.1.2
Lighting Power Densities Using the Space-by-Space Method
Space-By-Space Method Lighting Power Density (LPD)

Common Space Types*	LPD (W/ft ²)	Building Specific Space Types (Continued)	LPD (W/ft ²)
Office-enclosed	1.1	Fire Stations	
Office-open plan	1.1	Fire Station Engine room	0.8
Conference/ Meeting/ Multipurpose	1.3	Sleeping Quarters	0.3
Classroom/ Lecture/ Training	1.4	Post Office - Sorting Area	1.2
For Penitentiary	1.3	Convention Center - Exhibit Space	1.3
Lobby	1.3	Library	
For Hotel	1.1	Card File & Cataloguing	1.1
For Performing Arts Theater	3.3	Stacks	1.7
For Motion Picture Theatre	1.1	Reading Area	1.2
Audience/ Seating Area	0.9	Hospital	
For Gymnasium	0.4	Emergency	2.7
For Exercise Center	0.3	Recovery	0.8
For Convention Center	0.7	Nurse station	1.0
For Penitentiary	0.7	Exam/Treatment	1.5
For Religious Buildings	1.7	Pharmacy	1.2
For Sports Arena	0.4	Patient Room	0.7
For Performing Arts Theater	2.6	Operating Room	2.2
For Motion Picture theatre	1.2	Nursery	0.6
For Transportation	0.5	Medical Supply	1.4
Atrium-first three floors	0.6	Physical Therapy	0.9
Atrium-each additional floor	0.2	Radiology	0.4
Lounge/Recreation	1.2	Laundry-Washing	0.6
For Hospital	0.8	Automotive - Service/Repair	0.7
Dining area	0.9	Manufacturing	
For Penitentiary	1.3	Low Bay (<25 ft Floor to Ceiling Height)	1.2
For Hotel	1.3	High Bay (>25 ft Floor to Ceiling Height)	1.7
For Motel	1.2	Detailed Manufacturing	2.1
For Bar Lounge/Leisure Dining	1.4	Equipment room	1.2
For Family Dining	2.1	Control room	0.5
Food Preparation	1.2	Hotel/ Motel Guest Rooms	1.1
Laboratory	1.4	Dormitory - Living Quarters	1.1
Restrooms	0.9	Museum	
Dressing/Locker/Fitting Room	0.6	General Exhibition	1.0
Corridor/Transition	0.5	Restoration	1.7
For Hospital	1.0	Bank/Office - Banking Activity Area	1.5
For Manufacturing Facility	0.5	Religious Buildings	
Stairs - active	0.6	Worship-pulpit, choir	2.4
Active Storage	0.8	Fellowship Hall	0.9
For Hospital	0.9	Retail [For accent lighting see 9.3.1.2.1.(c)]	
Inactive storage	0.3	Sales area	2+1.7
For Museum	0.8	Mall Concourse	1.7
Electrical/ mechanical	1.5	Sports Arena	
Workshop	1.9	Ring Sports Area	2.7
		Court Sports Area	2.3
		Indoor Playing Field Area	1.4
Building Specific Space Types			
Gymnasium/ Exercise Center		Warehouse	
Playing Area	1.4	Fine Material Storage	1.4
Exercise Area	0.9	Medium/Bulky Material Storage	0.9
Courthouse/ Police Station/ Penitentiary		Parking Garage - Garage Area	0.2
Courtroom	1.9	Transportation	
Confinement Cells	0.9	Airport - Concourse	0.6
Judges Chambers	1.3	Air/Train/Bus - Baggage Area	1.0

ACCEPTABLE PRACTICE FOR COMMERCIAL BUILDINGS **TABLE 805.4.2**

TABLE 805.4.2
INTERIOR LIGHTING POWER

BUILDING OR AREA TYPE	ENTIRE BUILDING (W/ft ²)	TENANT AREA OR PORTION OF BUILDING (W/ft ²)
Auditorium	NA	1.6
Bank/financial institution ^a	NA	2.0
Classroom/lecture hall ^b	NA	1.6
Convention, conference or meeting center ^a	NA	1.5
Corridor, restroom, support area	NA	0.8
Dining ^a	NA	1.4
Exercise center ^a	1.4	1.1
Exhibition hall	NA	3.3
Grocery store ^c	1.9	2.1
Gymnasium playing surface	NA	1.9
Hotel function ^a	NA	2.4
Industrial work, <20 ft ceiling height	NA	2.1
Industrial work, ≥20 ft ceiling height	NA	3.0
Kitchen	NA	2.2
Library ^a	1.5	1.8
Lobby—hotel ^a	NA	1.9
Lobby—other ^b	NA	1.0
Mall, arcade or atrium	NA	1.4
Medical and clinical care ^{b, d}	1.6	1.6
Museum ^b	1.6	1.6
Office ^b	1.3	1.5
Religious worship ^a	2.2	3.2
Restaurant ^a	1.7	1.7
Retail sales, wholesale showroom ^d	1.9	2.1
School	1.5	NA
Storage, industrial and commercial	0.6	1.0
Theaters—motion picture	1.1	1.0
Theaters - performance ^a	1.4	1.5
Other	0.6	1.0

For SI: 1 foot = 304.8 mm, 1 W/ft² = W/0.929 m².
NA = Not Applicable.

a. Where lighting equipment is specified to be installed for decorative appearances in addition to lighting equipment specified for general lighting and is switched or dimmed on circuits different from the circuits for general lighting, the smaller of the actual wattage of the decorative lighting equipment or 1.0 W/ft² times the area of the space that the decorative lighting equipment is in shall be added to the interior lighting power determined in accordance with this line item.

b. Where lighting equipment is specified to be installed to meet requirements of visual display terminals as the primary viewing task, the smaller of the actual wattage of the lighting equipment or 0.35 W/ft² times the area of the space that the lighting equipment is in shall be added to the interior lighting power determined in accordance with this line item.

c. Where lighting equipment is specified to be installed to highlight specific merchandise in addition to lighting equipment specified for general lighting and is switched or dimmed on circuits different from the circuits for general lighting, the smaller of the actual wattage of the lighting equipment installed specifically for merchandise, or 1.0 W/ft² times the area of the specific display, or 3.9 W/ft² times the actual case or shelf area for displaying and selling fine merchandise such as jewelry, fine apparel and accessories, or china and silver, shall be added to the interior lighting power determined in accordance with this line item.

d. Where lighting equipment is specified to be installed, the smaller of the actual wattage of the lighting equipment, or 1.0 W/ft² times the area of the emergency, recovery, medical supply and pharmacy space shall be added to the interior lighting power determined in accordance with this line item.

ENERGY CONSERVATION CONSTRUCTION CODE OF NEW YORK STATE 75



Densidade de Potência de Iluminação (DPI_L)



O Departamento de Energia dos EUA (DOE) fornece software gratuito e ferramentas online para localizar DPI_L e códigos energéticos estaduais

Brasil: Portaria INMETRO nº 372/2010, disponível em:

<http://www.inmetro.gov.br/legislacao/rtac/pdf/RTAC001599.pdf>



www.energycodes.gov



Integração: Iluminação Natural e Iluminação Artificial



Esta integração requer que o projeto de iluminação especifique como e quando as luminárias deverão ser energizadas.

Estas luminárias precisam estar sempre energizadas durante o dia?



Image courtesy of Acuity Brands
Photo: Hewitt Garrison Architectural Photography

Integração: Iluminação Natural e Iluminação Artificial

Componentes de um Sistema de Sistema de Iluminação artificial integrado à Iluminação Natural

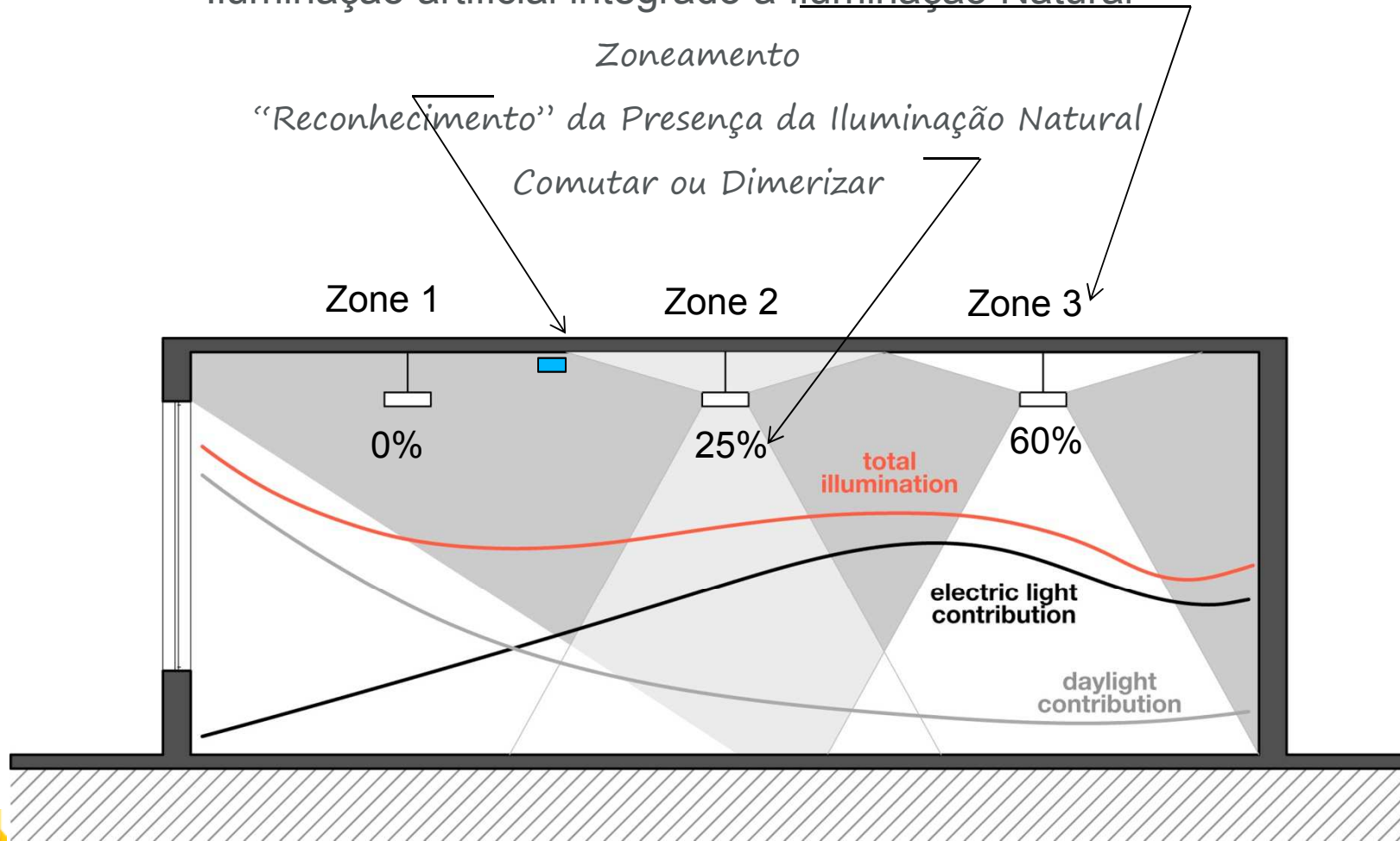

Image courtesy of Tanteri + Associates

Integração: Iluminação Natural e Iluminação Artificial

A escolha de outro tipo de luminária poderia melhorar a transição?



OU uma janela diferente poderia eliminar a necessidade de luminárias na área de transição?



Energia Zero e Expectativas Realistas

“O Compromisso AIA 2030 é uma iniciativa nacional (EUA) crescente que oferece uma estrutura consistente, com métricas simples e um formato de relatório padronizado para ajudar as empresas a avaliar as decisões de design que podem impactar o desempenho energético de um projeto individual. Para efetivamente cumprir as metas de redução de energia em 2030, temos que aplicar os princípios de design sustentável para cada projeto, desde o seu início até a conclusão e início de operação da obra acabada, e não apenas daqueles que os clientes desejam ver certificados.....O arquiteto deve ter uma visão mais ampla a respeito de um design realmente sustentável.

<http://www.aia.org/about/initiatives/AIAB079544>



Images courtesy of Kevin Van Den Wymelenberg

Energia Zero e Expectativas Realistas

Que medidas os profissionais de projeto podem adotar de imediato para melhorar tanto o desempenho energético como a integração com a iluminação natural?



Image courtesy of Kevin Van Den Wymelenberg

Sensores de Iluminação Natural. Tipos e Aplicações

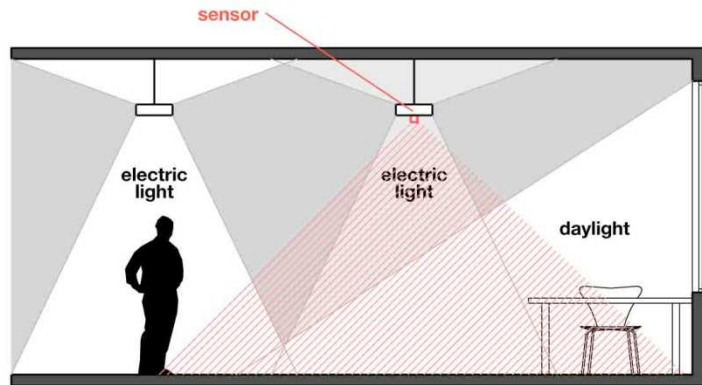

A

CIRCUITO FECHADO:
SINAL DO SENSOR AFETADO PELAS
FONTES DE LUZ CONTROLADAS

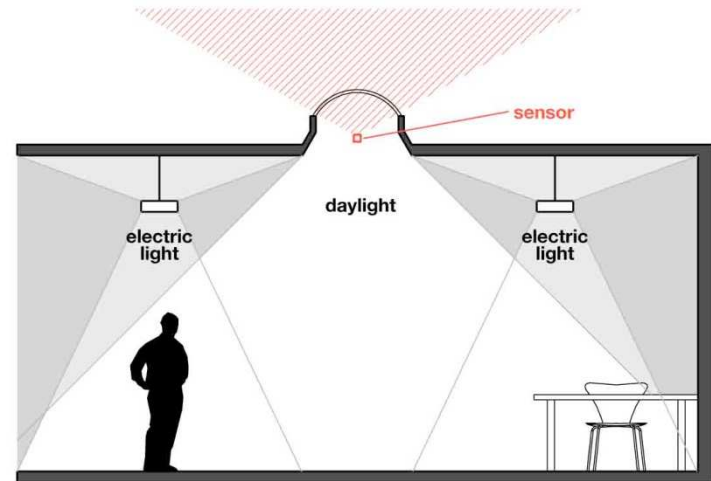

B

CIRCUITO ABERTO:
SINAL DO SENSOR NÃO AFETADO
PELAS FONTES DE LUZ CONTROLADAS

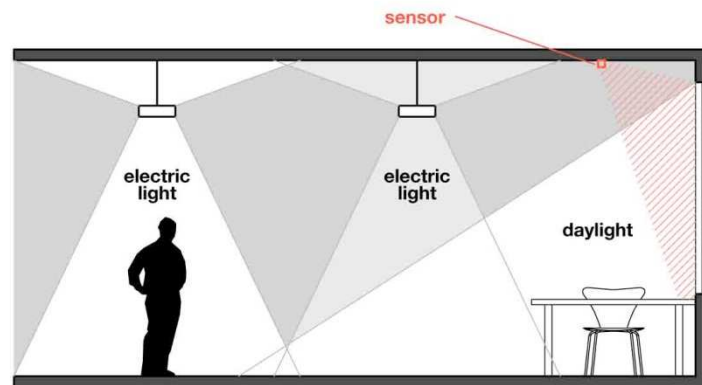

C

CIRCUITO ABERTO / VARIAÇÃO A:
SINAL DO SENSOR PODE OU NÃO AFETADO
PELAS FONTES DE LUZ CONTROLADAS



Sensores de Iluminação Natural. Tipos e Aplicações

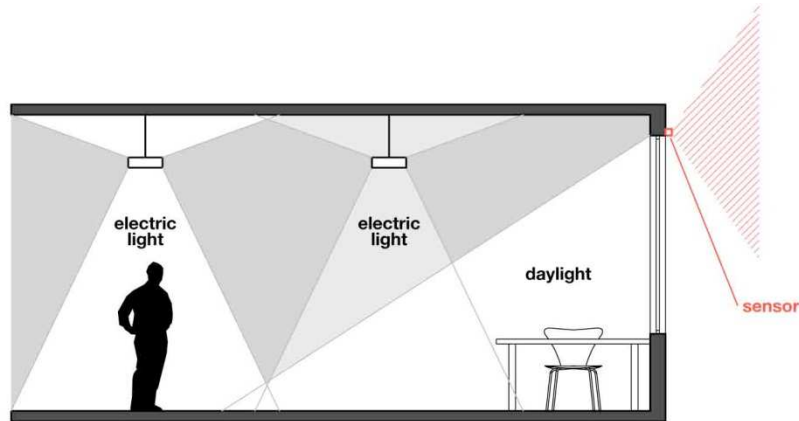

D

CIRCUITO ABERTO:
SINAL DO SENSOR NÃO AFETADO
PELAS FONTES DE LUZ CONTROLADAS

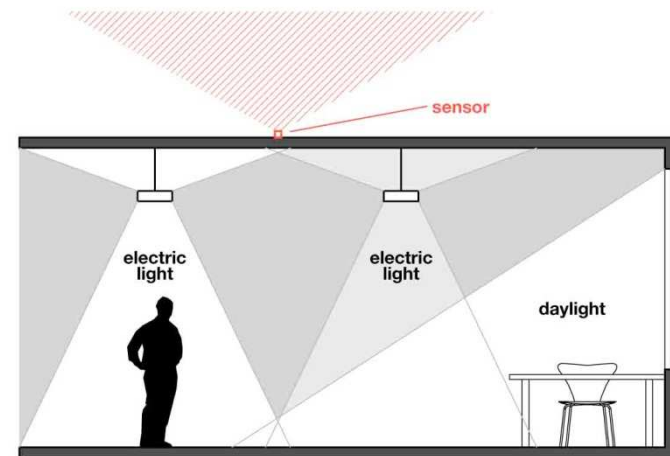

E

CIRCUITO ABERTO:
SINAL DO SENSOR NÃO AFETADO
PELAS FONTES DE LUZ CONTROLADAS

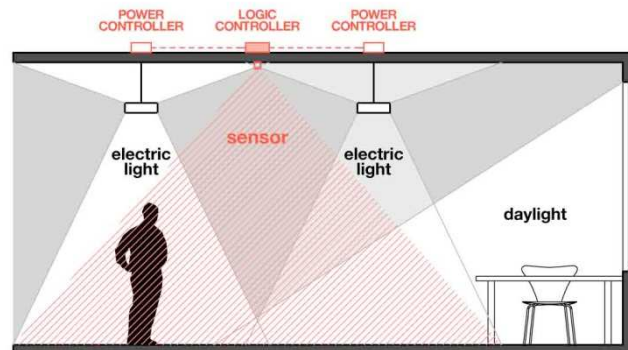

F

CIRCUITO FECHADO:
SINAL DO SENSOR NÃO AFETADO
PELAS FONTES DE LUZ CONTROLADAS



Relatório Esquemático

Area	Target Light Level (footcandles)	Source	SF	MaxW /sf	ASHRAE / IESNA 90.1 2004 Whole Building	Control Type	Total Watts per Space	Ceiling Type	\$/sf*	Special Requirements	Comments
EXTERIOR											
Plaza	1-5 FC	Ceramic Metal Halide, fluorescent		0.2	Building Grounds-Plaza	Timeclock		N/A			Tradable
Stairs	5 FC	"		1	Building Grounds - Stairways	Timeclock		N/A	\$3.00	Emergency Egress	"
Sidewalks	1 FC	"		1 W/LF	Building Grounds - Walkways	Timeclock		N/A	\$15.00		"
Landscape	1-5 FC	"		0.2	Building Grounds - Special Feature	Timeclock		N/A	\$10.00		"
Main Entrances	5-10 FC	"		30 W/LF	Building Entrances and Exits	Timeclock		TBD	\$10.00	Emergency Egress	"
Upper Façade		"		0.2	Building Facades	Timeclock		N/A	\$10.00		Non-Tradable
Lower Façade		"		5 W/LF	Building Facades	Timeclock		N/A	\$10.00		Non-Tradable
Loading Dock	5-10 FC	Metal Halide Compact Fluorescent		0.5	Loading Areas for emergency vehicles	Timeclock		N/A	\$8.00		Non-Tradable
Exterior Stairs	5 FC	"		20W/L F	Building Entrances and Exits	Timeclock		N/A	\$10.00	Emergency Egress	Tradable
Exterior Terraces	1-20 FC	CMH, CFL		0.2	Building Grounds-Special Feature Areas	Timeclock		N/A	\$10.00	Place of Assembly?	Tradable
GROUND FLOOR											
Main Entry Lobby	10-15 FC	Linear Fluorescent, Halogen		1.6	Performing Arts Theatre	Preset Dimming/Timeclock		TBD	\$15.00	Decorative Element Allowance	Decorative Fixt @ Bars
Grand Spiral Stair	5 FC Steps	Halogen, Linear Fluorescent		1.6	"	"		N/A	\$20.00	Decorative Element Allowance	
Theatre Lobbies	10-15 FC	Halogen, Linear Fluorescent		1.6	"	"		TBD	\$20.00	Decorative Element Allowance	Decorative Fixt @ Bars
Theatre Auditorium	5-10 FC	Halogen / LED		1.6	"	DMX Dimming		TBD	\$20.00	Special Effect RGB	Possible Chandelier
Governors Reception	20-30 FC	Halogen, Linear Fluorescent Compact		1.6	"	"		TBD	\$10.00	Decorative Element Allowance	Decorative Pendants
Box Office	35-50 FC	Fluorescent		1.6	"	Switch		TBD	\$4.00		
Restrooms	35FC	Linear and Compact Fluorescent		1.6	"	Keyless Switch		TBD	\$4.00		
BOH Corridors	30-30 FC	Linear and Compact Fluorescent		1.6	"	"		TBD	\$2.00		
Dressing Rooms	20-75 FC	Fluorescent and Incandescent		1.6	"	Switch/Dimmer		TBD	\$3.00		
Scenery Transfer	35-50 FC	Fluorescent and Halogen		1.6	"	Switch		TBD	\$2.00		



Desenvolvimento do Projeto

O que estamos fazendo?

TORNA-SE

Como isto funcionará?



Desenvolvimento do Projeto

Expandido a partir de dados da Etapa Esquemática

- *Propicia detalhes adicionais*
additional detail
- *Começa a explorar quais os aspectos serão coordenados com outros projetos*

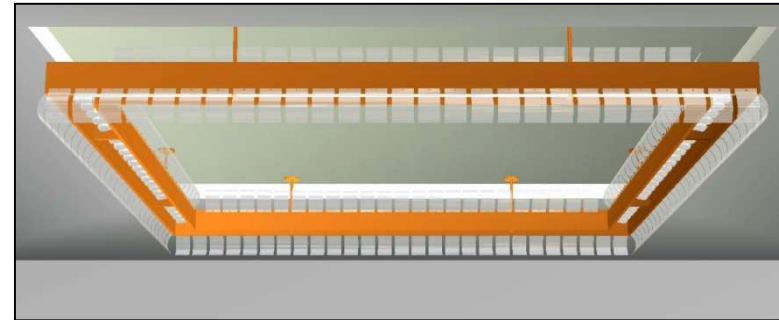

Rendering da Proposta



Luminária Instalada

Desenvolvimento do Projeto

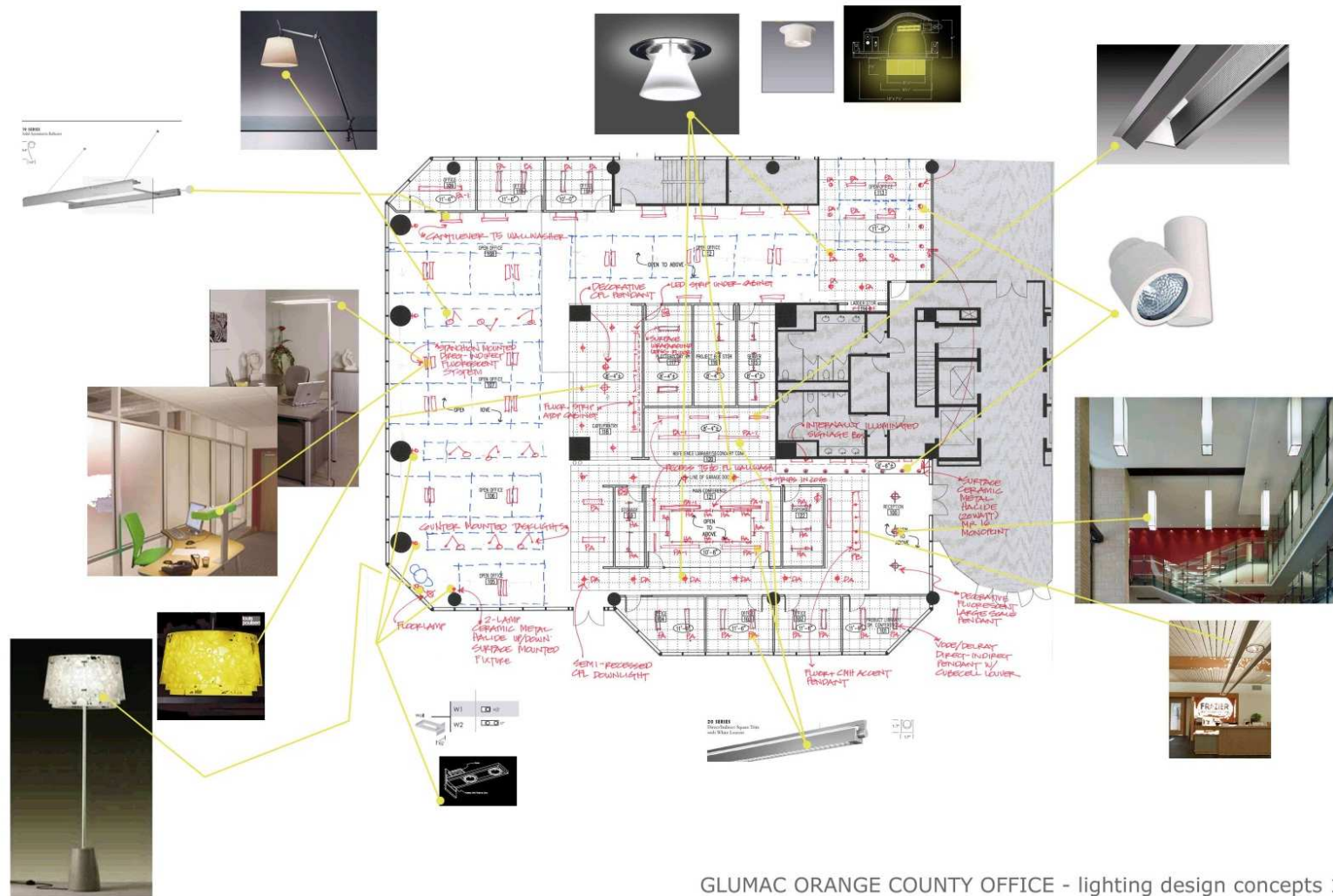

GLUMAC ORANGE COUNTY OFFICE - lighting design concepts 10-14-09



Cortesia da imagem: Carlos Inclan/Glumac

Desenvolvimento do Projeto



Projeto: Igreja do Jubileu, Roma
Richard Meier, Architetto

Desenvolvimento do Projeto



Estabeleça uma hierarquia visual



Cortesia da imagem: Sheri L. Koetting, MSLK Design www.mslk.com

Desenvolvimento do Projeto



Trate as superfícies verticais



Cortesia da Imagem: Erco, Inc.

Desenvolvimento do Projeto



© Bob Perzel Fotografia

Use repetição para estabelecer ritmo

Desenvolvimento do Projeto



Proporcione pausas visuais



© RMA Photography, Inc.

Desenvolvimento do Projeto



Não negligencie a cintilação



Desenvolvimento do Projeto

As luminárias são classificadas em função do padrão de luz por elas emitido.

Direct: 90-100% downward

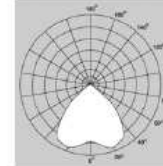

Photo: Courtesy of OSRAM SYLVANIA



Semi-direct: 60-90% downward; 10-40% upward

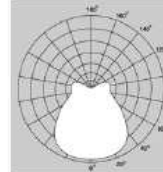

Photo: Randall Perry



Semi-indirect: 10-40% downward; 60-90% upward

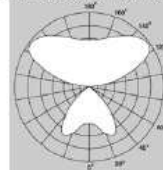

Photo: Courtesy of Lightolier



Indirect lighting: 90-100% upward

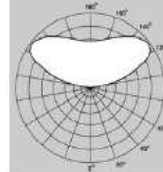

Photo: Courtesy of Litecontrol



General diffuse: 40-60% downward; 40-60% upward

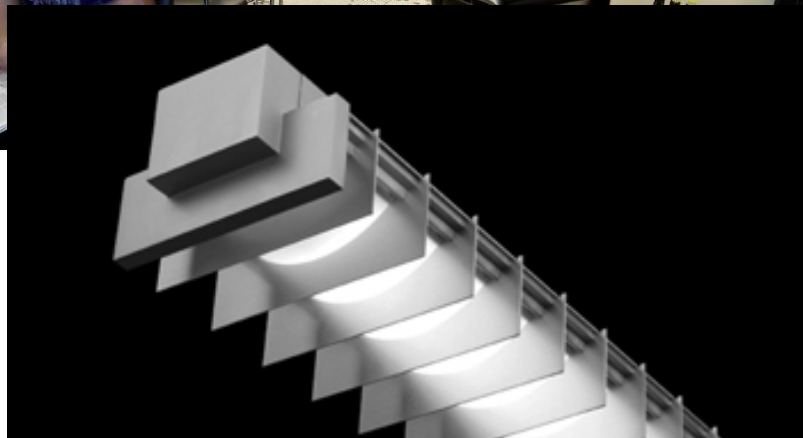
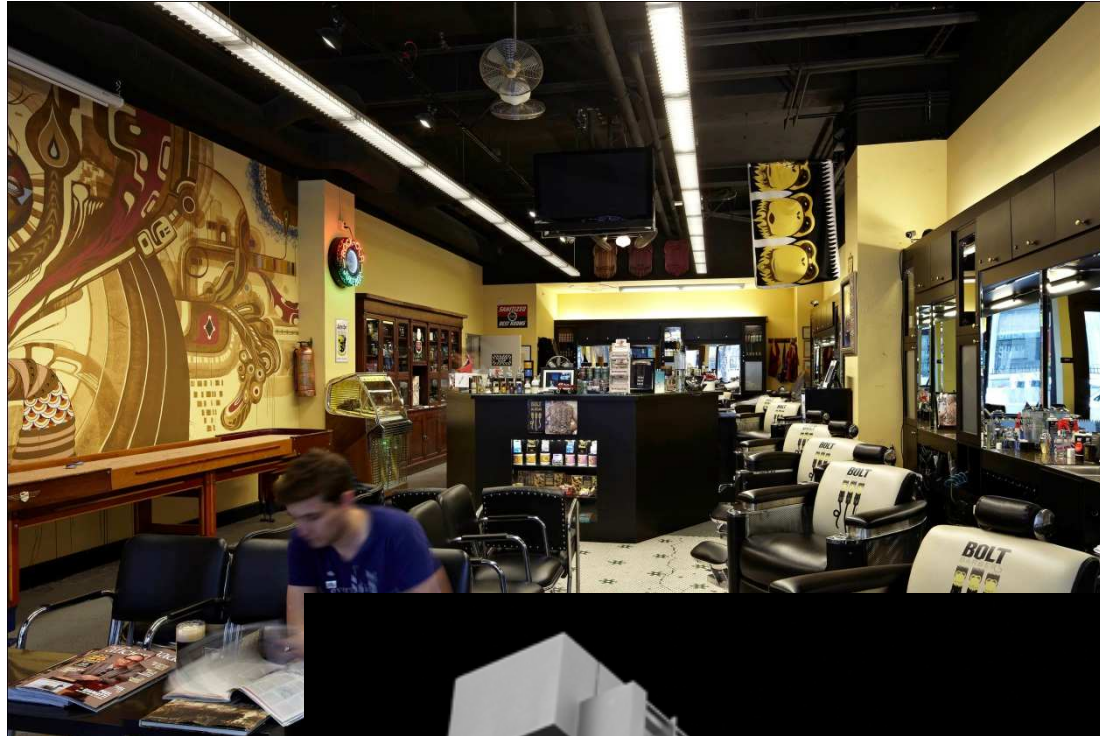

Photo: Courtesy of Kichler Lighting



Cortesia da s Imagens NYSERDA

Desenvolvimento do Projeto



Direto

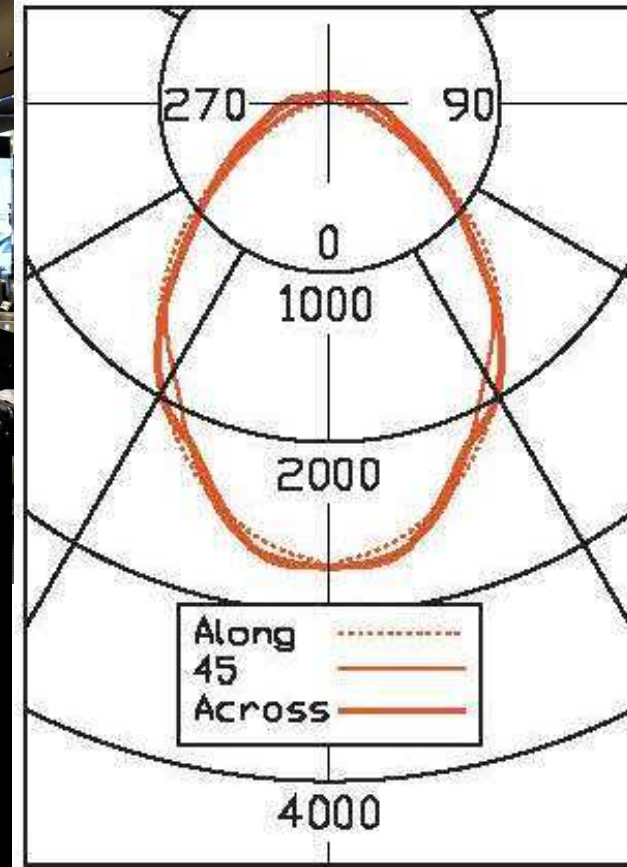

Desenvolvimento do Projeto

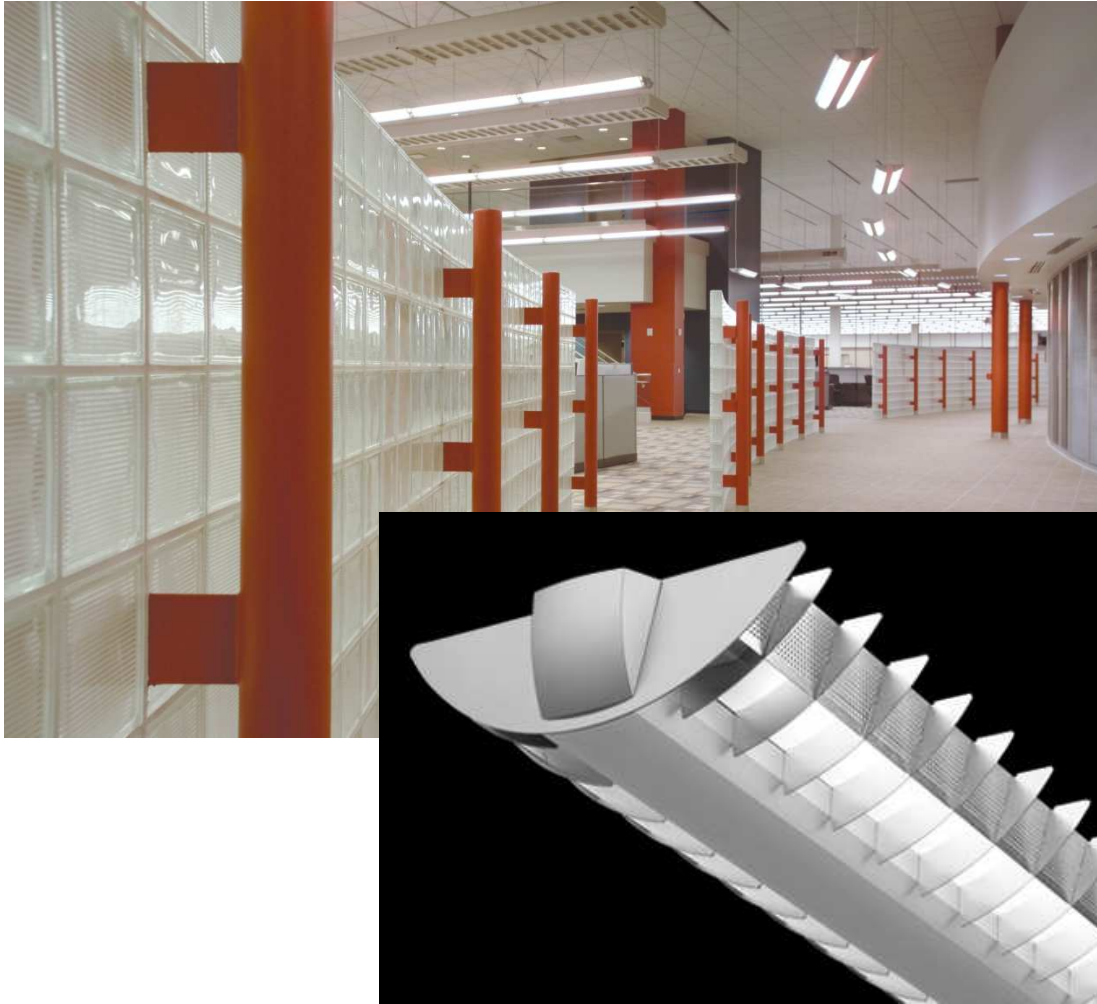

Semi-Direto

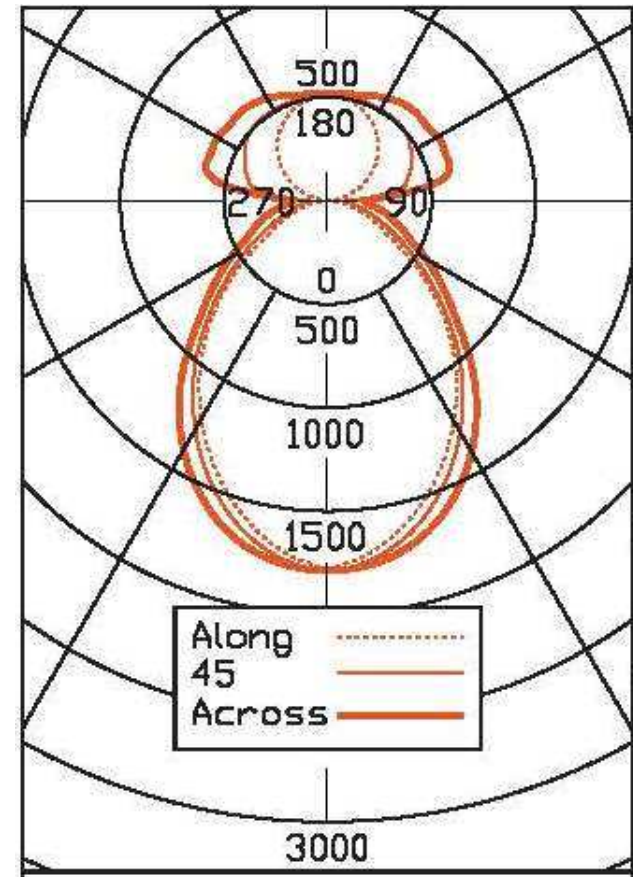
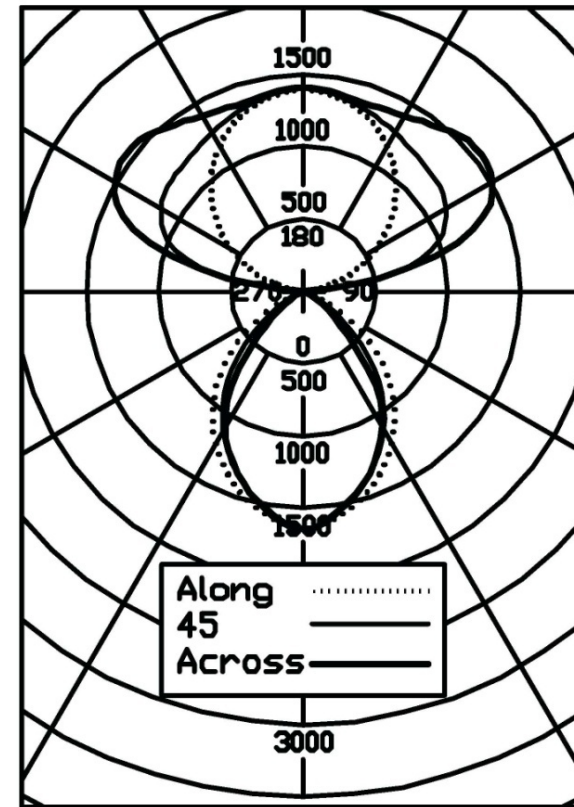

Image mMark Boisclair

Desenvolvimento do Projeto



Semi-Indireto



Desenvolvimento do Projeto

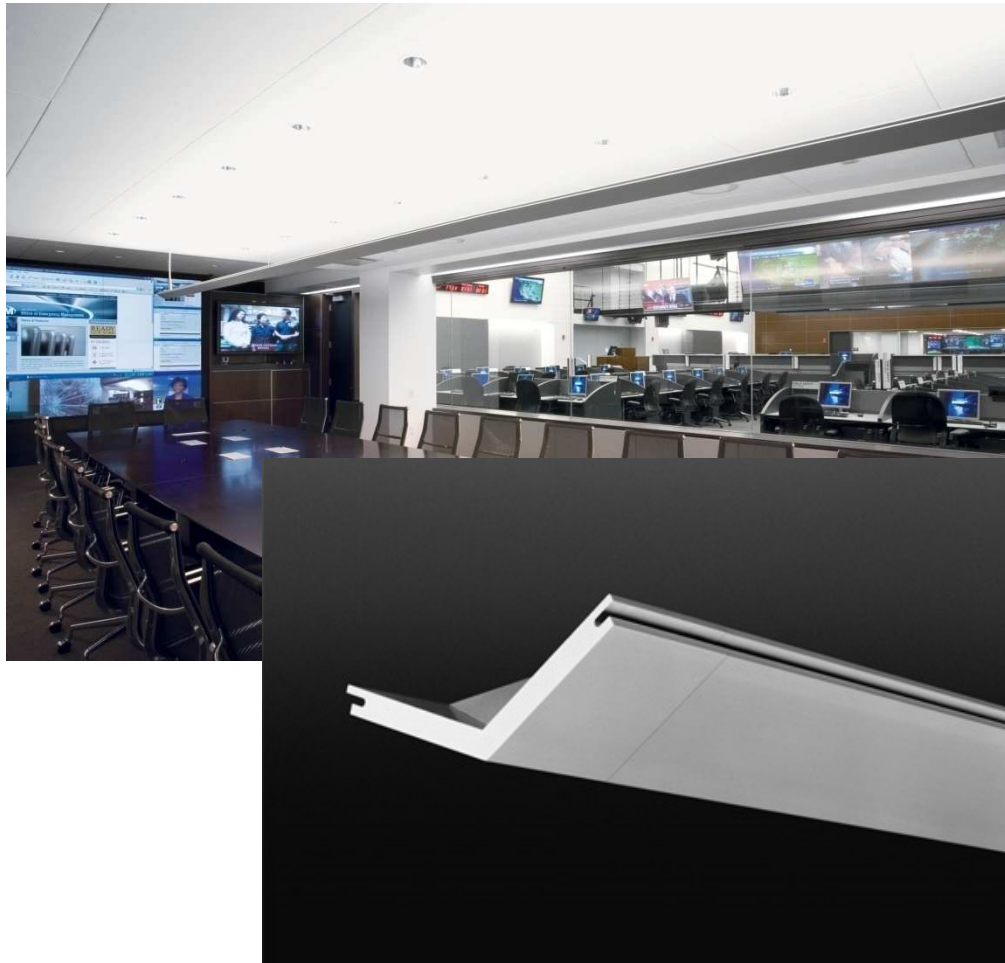

Indireto



Imagem Elliott Kaufman

Desenvolvimento do Projeto



Diffuso

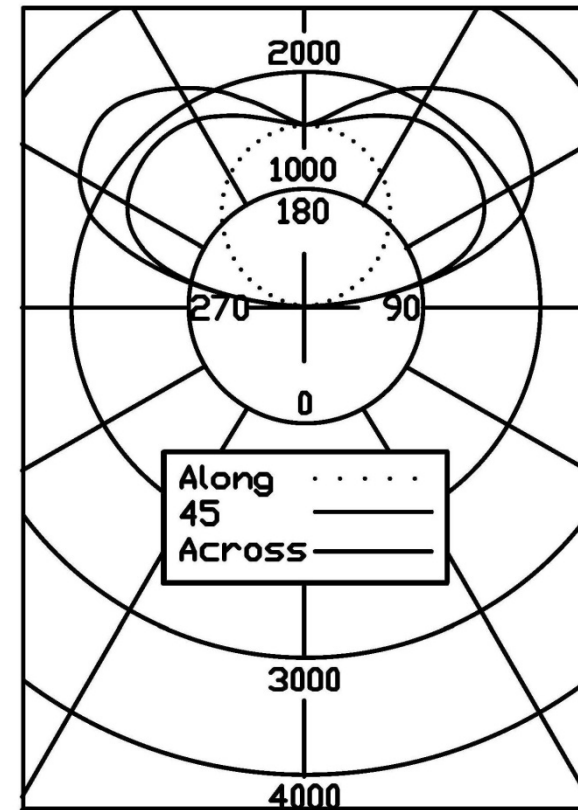
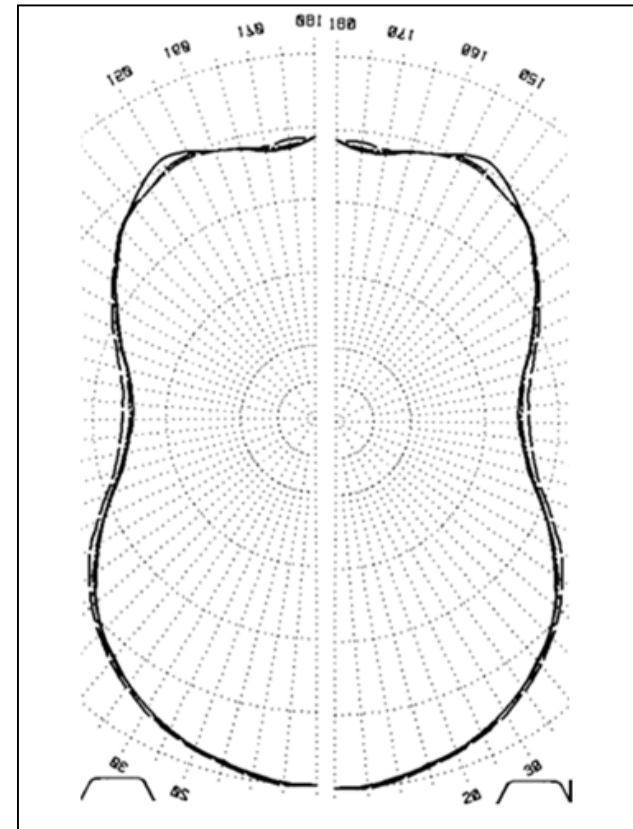

Desenvolvimento do Projeto

Influências na Escolha de Luminárias:

- *Imagens Prévias*
- *Técnica*
- *Distribuição*



Projeto: Conde Nast Cafeteria

Desenvolvimento do Projeto

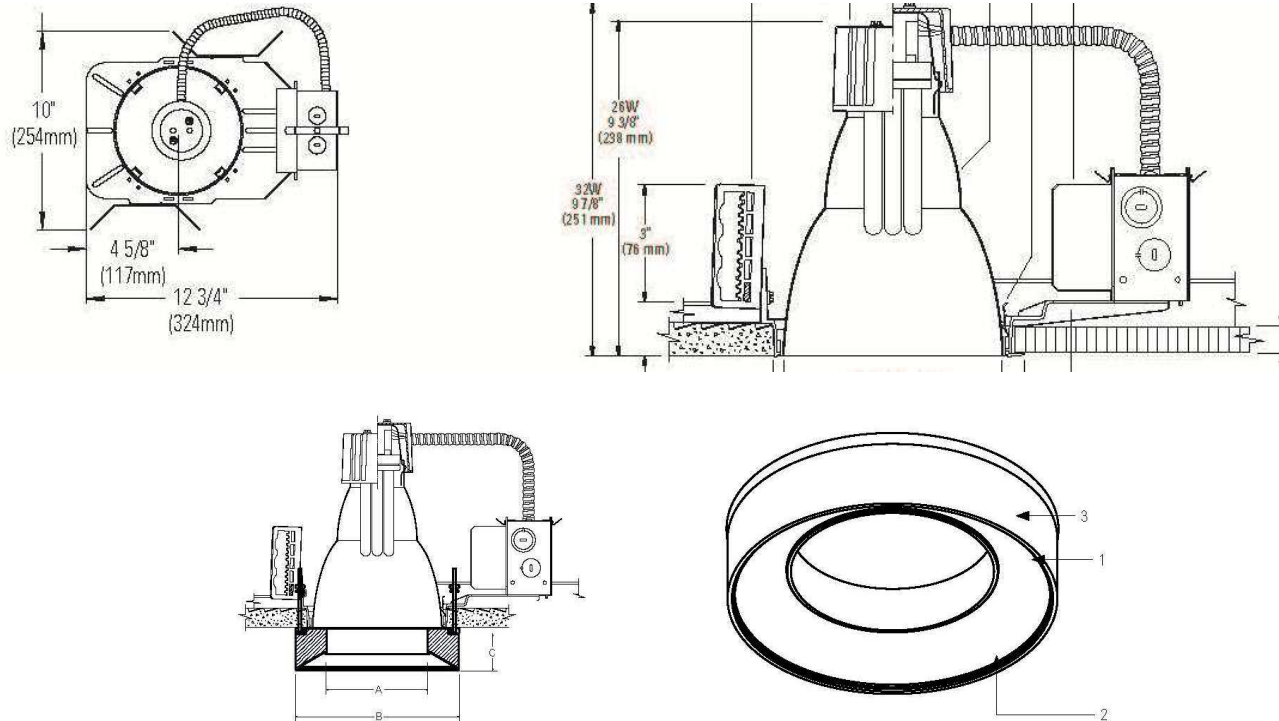

Qual luminária é a melhor escolha? Por quê?



Cortesia das imagens Philips Lightolier

Desenvolvimento do Projeto

Eficiência da Luminária:

Luminária para FC, aberta, tipo downlight 1 X 32 w, lâmpada na vertical



Page 2 of 2

26W Quick Calculator

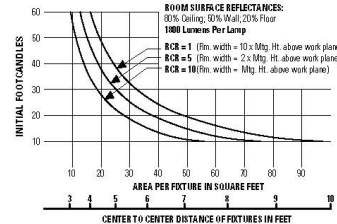

This quick calculator chart determines the number and spacing of 1 ft. x 26W TTT units with Comfort Clear™ reflector, for any level of illumination.

Spacing Ratio = 1.0

REPORT NO. LS11402

LIGHT TOLLIER RECESSED FLUORESCENT LUMINAIRE, WITH COMFORT CLEAR™ REFLECTOR

ONE 26 WATT CPFL 6E LAMP

DATA FOR IES LAMP-805

LUMEN OUTPUT = 1800 LMS.

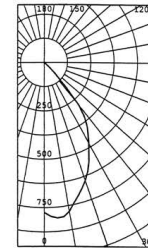

**EFFICIENCY = 81.1%*

DATE: 4-23-99

DIE TYPE DIRECT

LUMINOUS DIAMETER: 8.000

THIS REPORT BASED ON LM-1 AND OTHER PERTINENT IES PROCEDURES.

Coefficients of Utilization

ROOM CAVITY RATIO	EFFECTIVE FLOOR CAVITY REFLECTANCE = .20											
	80					70						
	50	30	10	50	30	10	50	30	10	50	30	10
1	50	30	10	50	30	10	50	30	10	50	30	10
2	50	49	47	50	48	47	48	47	46	47	46	45
3	47	45	44	47	45	44	46	44	43	44	43	42
4	45	42	40	44	42	40	43	41	40	42	41	40
5	42	39	37	42	39	37	41	39	37	40	38	36
6	40	37	35	39	37	35	38	36	34	37	36	34
7	37	34	33	37	34	32	36	34	32	35	33	31
8	35	32	30	34	32	30	34	31	30	33	31	29
9	33	30	28	32	30	28	32	29	28	31	29	27
10	31	28	26	30	28	26	30	27	26	29	27	25

32W CFL Open Downlight

6" Aperture Triple Tube Vertical Lamp

32W Quick Calculator

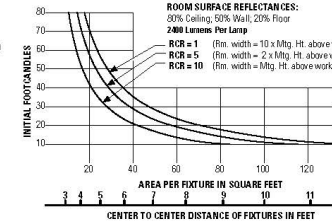

This quick calculator chart determines the number and spacing of 1 ft. x 32W TTT units with Comfort Clear™ reflector, for any level of illumination.

Spacing Ratio = 1.1

REPORT PREPARED FOR: LIGHT TOLLIER 04-27-1999

REPORT NO. LCL 494-99

DESIGN: C.F. LUMENS

LAMPS: 1 PFC32 LUMENS: 2400

DESCRIP: 6" DIA X 10" HT RECESSED DOWNLIGHT

WITH COMFORT CLEAR™ REFLECTOR, VERTICAL LAMP

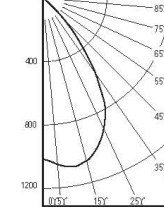

**EFFICIENCY = 52.7%*

DATE: 4-27-99

DIE TYPE DIRECT

LUMINOUS DIAMETER: 6.000

THIS REPORT BASED ON LM-1 AND OTHER PERTINENT IES PROCEDURES.

Coefficients of Utilization

ROOM CAVITY RATIO	EFFECTIVE FLOOR CAVITY REFLECTANCE = .20											
	80					70						
	50	30	10	50	30	10	50	30	10	50	30	10
1	59	59	57	59	57	56	56	55	54	54	53	52
2	56	54	53	55	54	52	54	52	51	52	51	50
3	53	51	50	53	51	49	51	49	48	49	48	47
4	51	48	47	50	48	46	49	47	46	47	46	45
5	48	46	44	48	45	44	47	45	43	46	44	43
6	46	43	42	46	43	41	45	43	41	44	42	41
7	44	41	39	43	41	39	43	41	39	42	40	39
8	41	38	37	41	38	37	41	38	37	40	38	36
9	39	36	35	39	36	35	39	36	34	38	36	34
10	35	32	31	35	32	31	35	32	30	34	32	30

Desenvolvimento do Projeto

Eficiência da Luminária:

Luminária para FC, aberta, tipo downlight 1 X 32 w, lâmpada na vertical

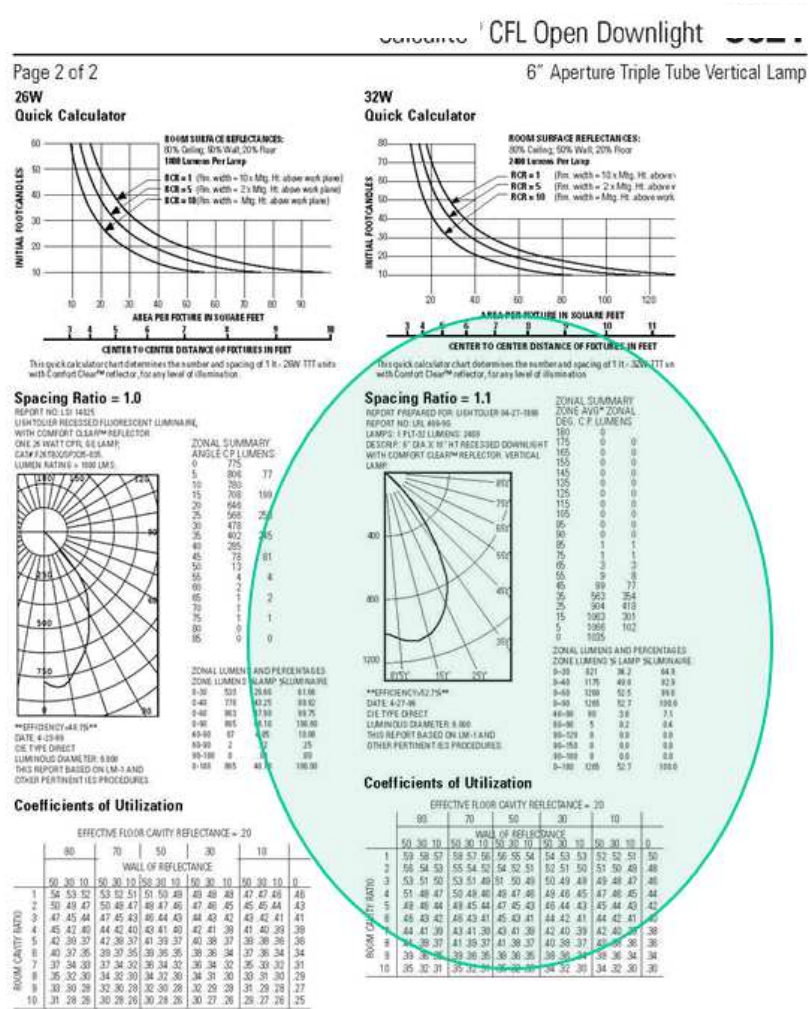

Desenvolvimento do Projeto

Eficiência da Luminária:

*Luminária para FC,
aberta, tipo downlight
1 X 32 w, lâmpada na
vertical*

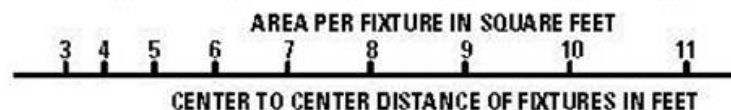

This quick calculator chart determines the number and spacing of 1 ft. - 32W TTT un with Comfort Clear™ reflector, for any level of illumination

Spacing Ratio = 1.1

REPORT PREPARED FOR
REPORT NO: LRL 499-96
LAMPS: 1 PLT-32 LUMENS: 2400
DESCRIP.: 6" DIA X 10" HT RECESSED DOWNLIGHT
WITH COMFORT CLEAR™ REFLECTOR. VERTICAL
LAMP.

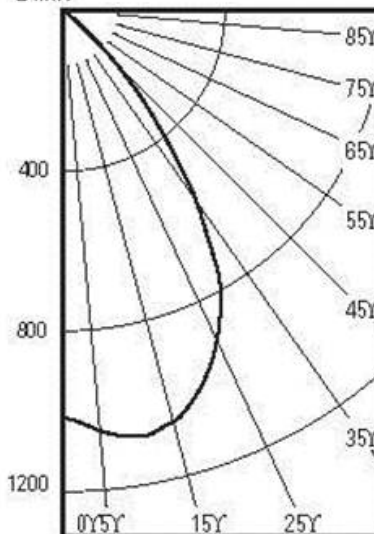

EFFICIENCY=52.7%
DATE: 4-27-99
CIE TYPE DIRECT
LUMINOUS DIAMETER: 6.000
THIS REPORT BASED ON LM-1 AND
OTHER PERTINENT IES PROCEDURES.

ZONAL SUMMARY

ZONE	AVG* DEG.	ZONAL C.P.	LUMENS
180	0		
175	0	0	
165	0	0	
155	0	0	
145	0	0	
135	0	0	
125	0	0	
115	0	0	
105	0	0	
95	0	0	
90	0	0	
85	1	1	
75	1	1	
65	3	3	
55	9	8	
45	99	77	
35	563	354	
25	904	418	
15	1063	301	
5	1066	102	
0	1035		

ZONAL LUMENS AND PERCENTAGES

ZONE	LUMENS	% LAMP	% LUMINAIRE
0-30	821	34.2	64.9
0-40	1175	49.0	92.9
0-60	1260	52.5	99.6
0-90	1265	52.7	100.0
40-90	90	3.8	7.1
60-90	5	0.2	0.4
90-120	0	0.0	0.0
90-150	0	0.0	0.0
90-180	0	0.0	0.0



Desenvolvimento do Projeto

Eficiência da Luminária:

Luminária para FC, aberta, tipo downlight 1 X 32 w, lâmpada na vertical

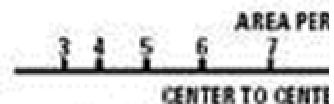

This quick calculator chart determines ti with Comfort Clear™ reflector, for any h

Spacing Ratio = 1.1

REPORT PREPARED FOR: LIGHT TOWER 04-27
 REPORT NO: URL 499-96
 LAMPS: 1 FLT-32 LUMENS: 2400
 DESCRIP: 1" DIA X 10" HT RECESSED DOW WITH COMFORT CLEAR™ REFLECTOR, VER LAMP.

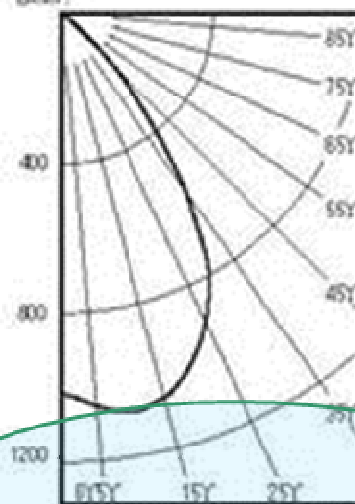

****EFFICIENCY=52.7%****
 DATE: 4-27-99
 CIE TYPE DIRECT
 LUMINOUS DIAMETER: 6.000
 THIS REPORT BASED ON LM-1 AND OTHER PERTINENT IES PROCEDURES.

****EFFICIENCY=52.7%****

DATE: 4-27-99

CIE TYPE DIRECT

LUMINOUS DIAMETER: 6.000

THIS REPORT BASED ON LM-1 AND OTHER PERTINENT IES PROCEDURES

145	0	0
135	0	0
125	0	0
115	0	0
105	0	0
95	0	0
90	0	0
85	1	1
75	1	1
65	3	3
55	8	8
45	99	77
35	563	354
25	904	418
15	1063	301
5	1066	102
0	1005	

ZONAL LUMENS AND PERCENTAGES			
ZONE	LUMENS X LAMP	% LAMP	% LUMINAIRE
0-00	971	40.2	64.8
0-40	1175	48.9	92.9
0-60	1260	52.5	99.8
0-90	1265	52.7	100.0
40-90	90	3.8	7.1
60-90	5	0.2	0.4
90-120	0	0.0	0.0
90-150	0	0.0	0.0
90-180	0	0.0	0.0



Desenvolvimento do Projeto

Eficiência da Luminária:

Luminária para FC, aberta, tipo downlight na vertical com filtro decorativo em vidro

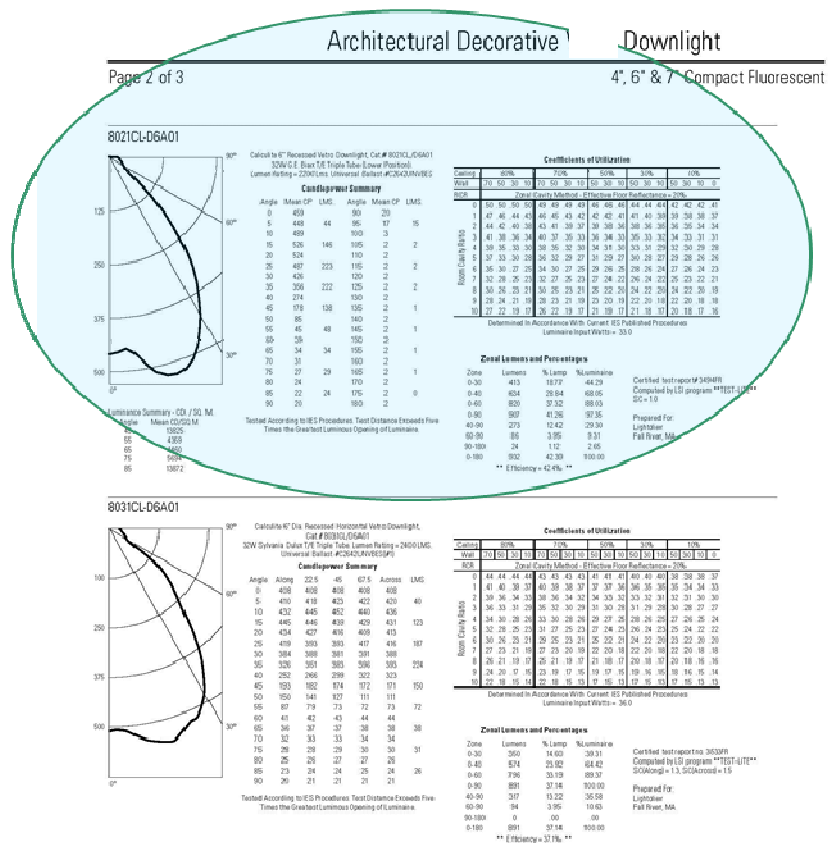

Desenvolvimento do Projeto

Architectural Decorative

Eficiência da Luminária:

Page 2 of 3

4", 6"

Luminária para FC, aberta, tipo downlight 1 X 32 w, lâmpada na vertical com filtro decorativo em vidro

8021CL-D6A01

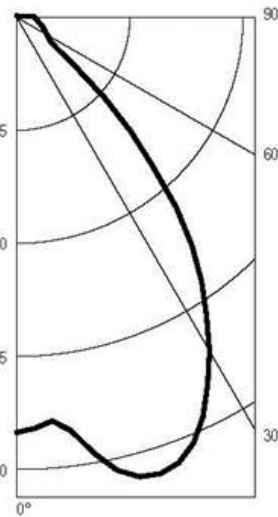

Calculate 6" Recessed Vetro Downlight, Cat # 8021CL/D6A01
32W G.E. Biax T/E Triple Tube (Lower Position).
Lumen Rating = 2200 Lms. Universal Ballast #C2642UNVBES

Candelperformance Summary

Angle	Mean CP	LMS	Angle	Mean CP	LMS
0	459		90	20	
5	448	44	95	17	15
10	489		100	3	
15	526	146	105	2	2
20	524		110	2	
25	487	223	115	2	2
30	426		120	2	
35	356	222	125	2	2
40	274		130	2	
45	178	138	135	2	1
50	85		140	2	
55	45	48	145	2	1
60	39		150	2	
65	34	34	155	2	1
70	31		160	2	
75	27	29	165	2	1
80	24		170	2	
85	22	24	175	2	0
90	20		180	2	

Luminance Summary - CD./SQ. M.

Angle	Mean CD/SQ. M.
45	13825

Tested According to IES Procedures. Test Distance Exceeds Five Times the Greatest Luminous Opening of Luminaire.

Coefficients of Utilization

Ceiling	80%				70%				50%				3
	70	50	30	10	70	50	30	10	50	30	10	50	
Wall	Zonal Cavity Method - Effective Floor Refle												
RCR	Zonal Cavity Method - Effective Floor Refle												
0	50	50	50	50	49	49	49	49	46	46	46	46	44
1	47	46	44	43	46	45	43	42	42	42	41	41	41
2	44	42	40	38	43	41	39	37	39	38	36	38	38
3	41	38	36	34	40	37	35	33	36	34	33	35	35
4	39	35	33	30	38	35	32	30	34	31	30	33	33
5	37	33	30	28	36	32	29	27	31	29	27	30	30
6	35	30	27	25	34	30	27	25	29	26	25	28	28
7	32	28	25	23	32	27	25	23	27	24	22	26	26
8	30	26	23	21	30	25	23	21	25	22	20	24	24
9	28	24	21	19	28	23	21	19	23	20	19	22	22
10	27	22	19	17	26	22	19	17	21	19	17	21	21

Determined In Accordance With Current IES Publish
Luminaire Input Watts = 33.0

Zonal Lumens and Percentages

Zone	Lumens	% Lamp	% Luminaire	Cer
0-30	413	18.77	44.29	Cer
0-40	634	28.84	68.05	Con
0-60	820	37.32	88.03	SC
0-90	907	41.26	97.35	Prej
40-90	273	12.42	29.30	Ligt
60-90	86	3.95	9.31	Fall
90-180	24	1.12	2.65	
0-180	932	42.39	100.00	

** Efficiency = 42.4% **

0-180 932 42.39 100.00

** Efficiency = 42.4% **



Desenvolvimento do Projeto

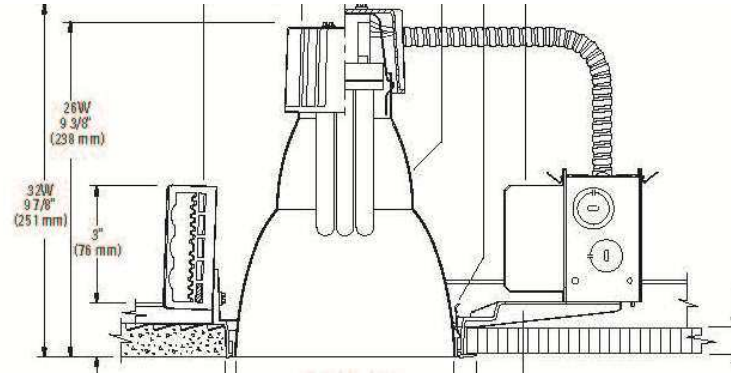
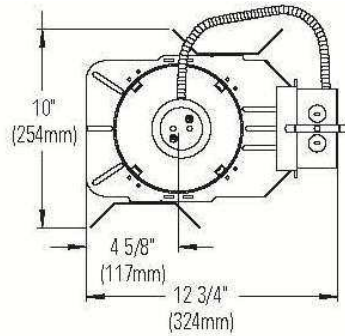

Luminária aberta – downlight – 52.7% de eficiência

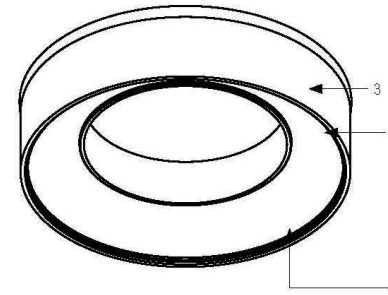
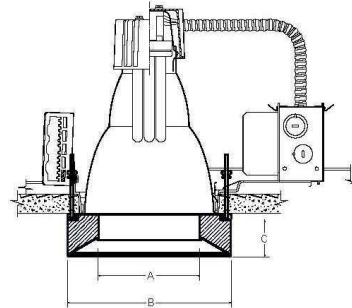

Luminária sem embutida – downlight – 42.4% de eficiência



Desenvolvimento do Projeto

Eficiência do projeto não é o mesmo que eficiência energética

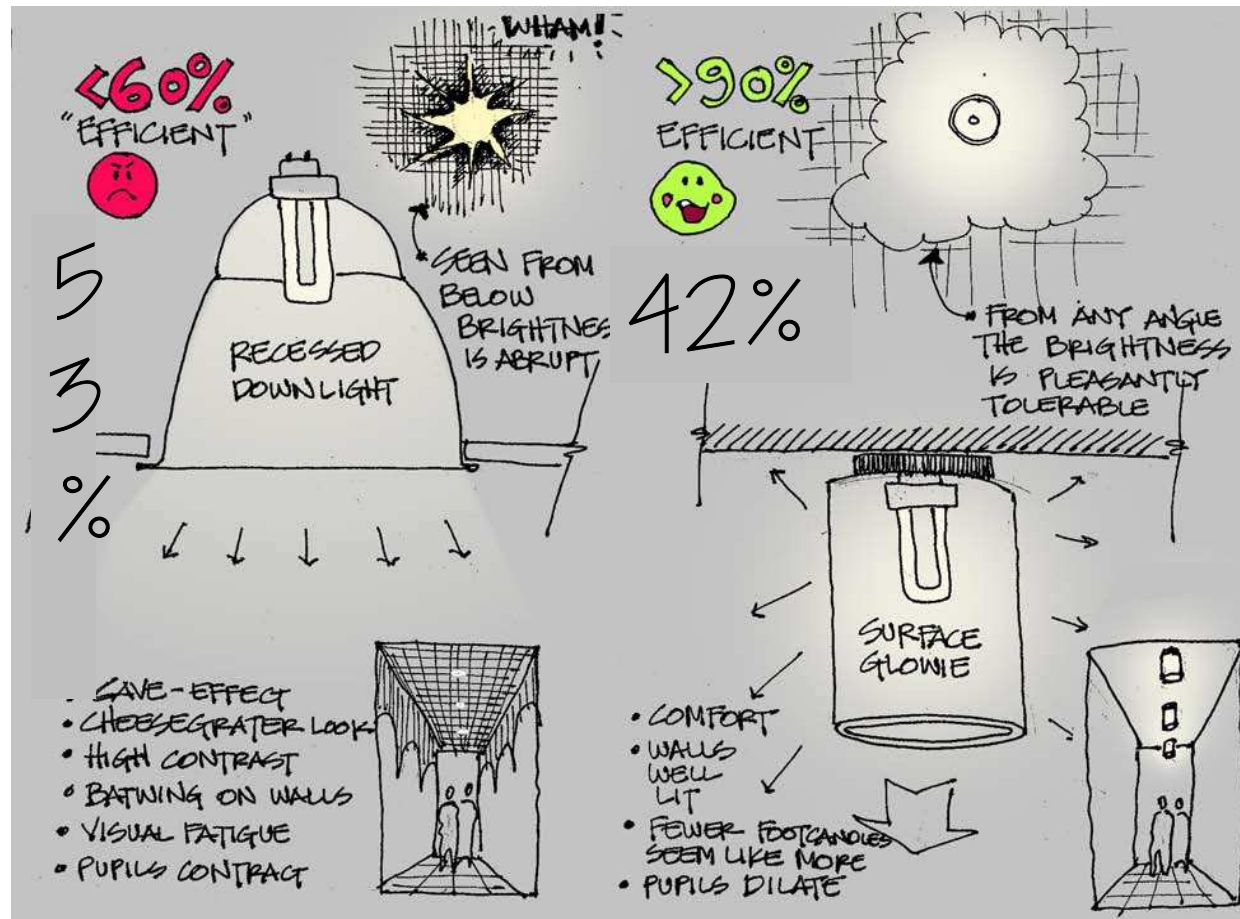

Cortesia da imagem: Carlos Inclan

.... A menos que....

Desenvolvimento do Projeto



*Downlights em espaços
com formas
arquitetônicas dinâmicas
podem aumentar e
atrari focos*

*Focos aleatórios e superfícies
verticais escuras*



Solução adequada?



Imagem da Esquerda:: Santa Cruz Tenerife Concert Hall
Architect: Calatrava

Desenvolvimento do Projeto

A experiêncai visual é o subjetiva. Portanto, caracterizações objetivas não podem descrever adequadamente o desempenho do projeto

A integração com a luz do dia pode requerer iluminação artificial suplementar para balancear os níveis de contraste.



Cortesia da Imagem: Barbara Erwine

Desenvolvimento do Projeto

Como vamos juntar tudo isso?



Imagem superior © Jeff Goldberg/ESTO

Desenvolvimento do Projeto

Impacto da Ocupação
Controle
Escolha de Lâmpadas e
Luminárias

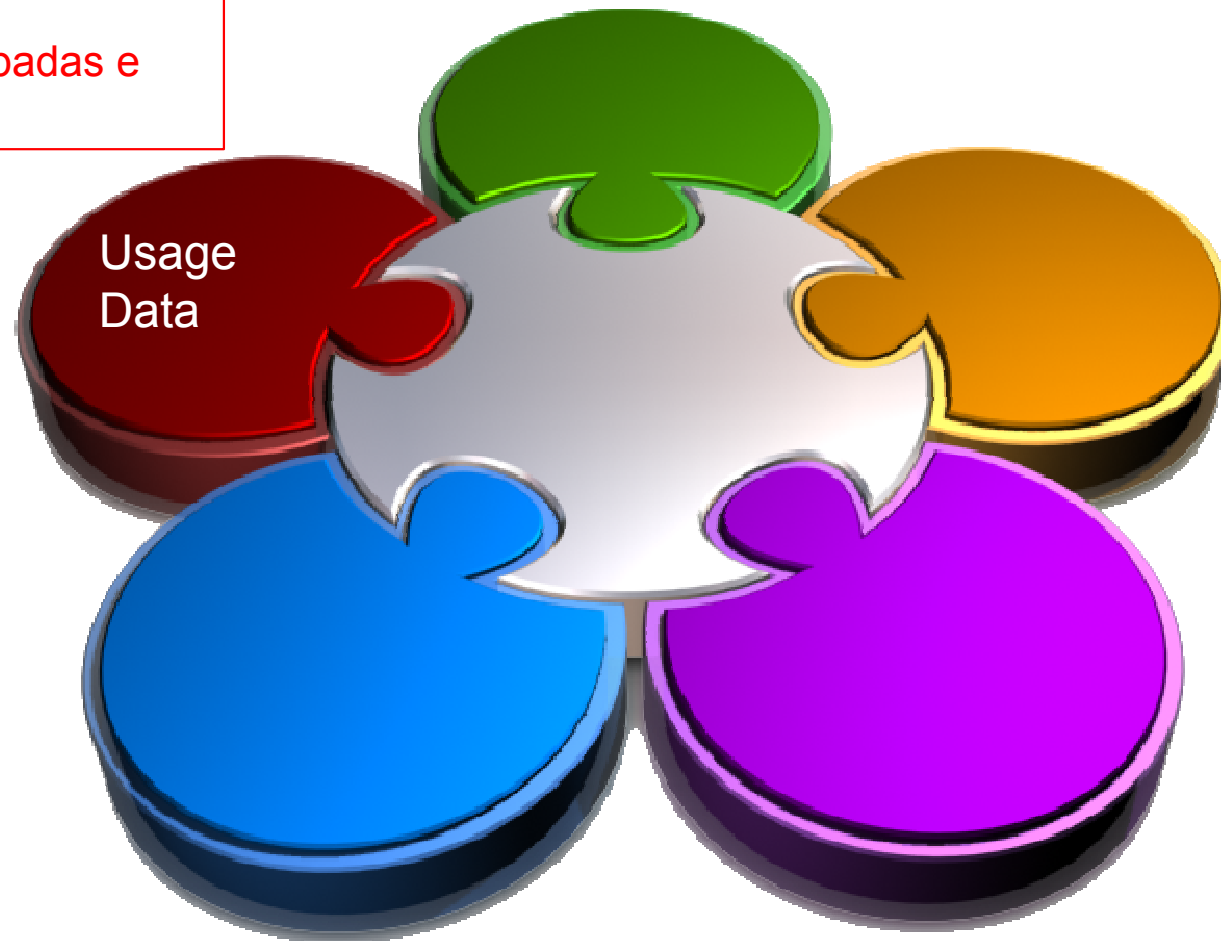

Desenvolvimento do Projeto

Quando o espaço está ocupado ou vago?

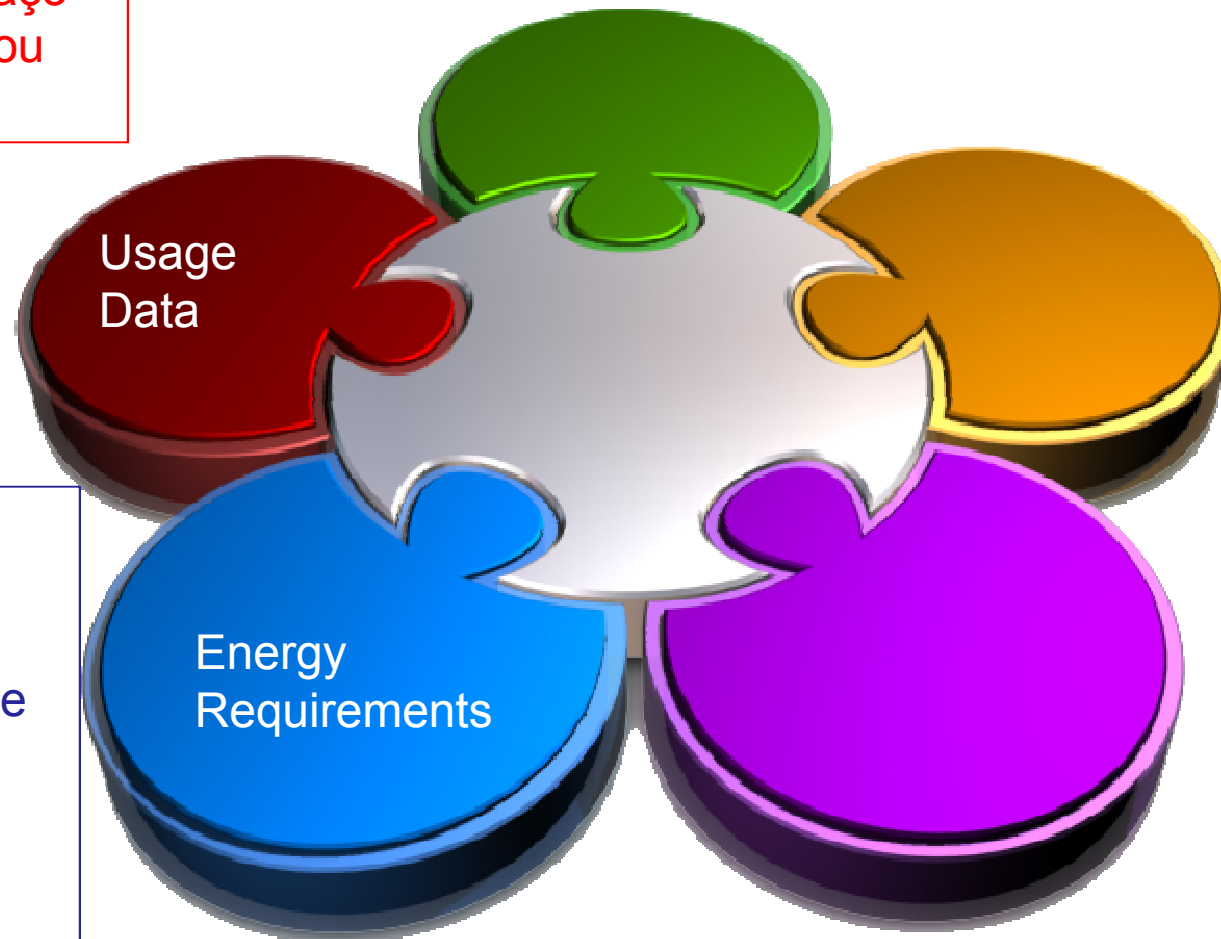

Impacto de exigências normativas.
Necessidade de controles?
Escolha de Lâmpadas e Luminárias?



Desenvolvimento do Projeto

Quando o espaço está ocupado ou vazio?

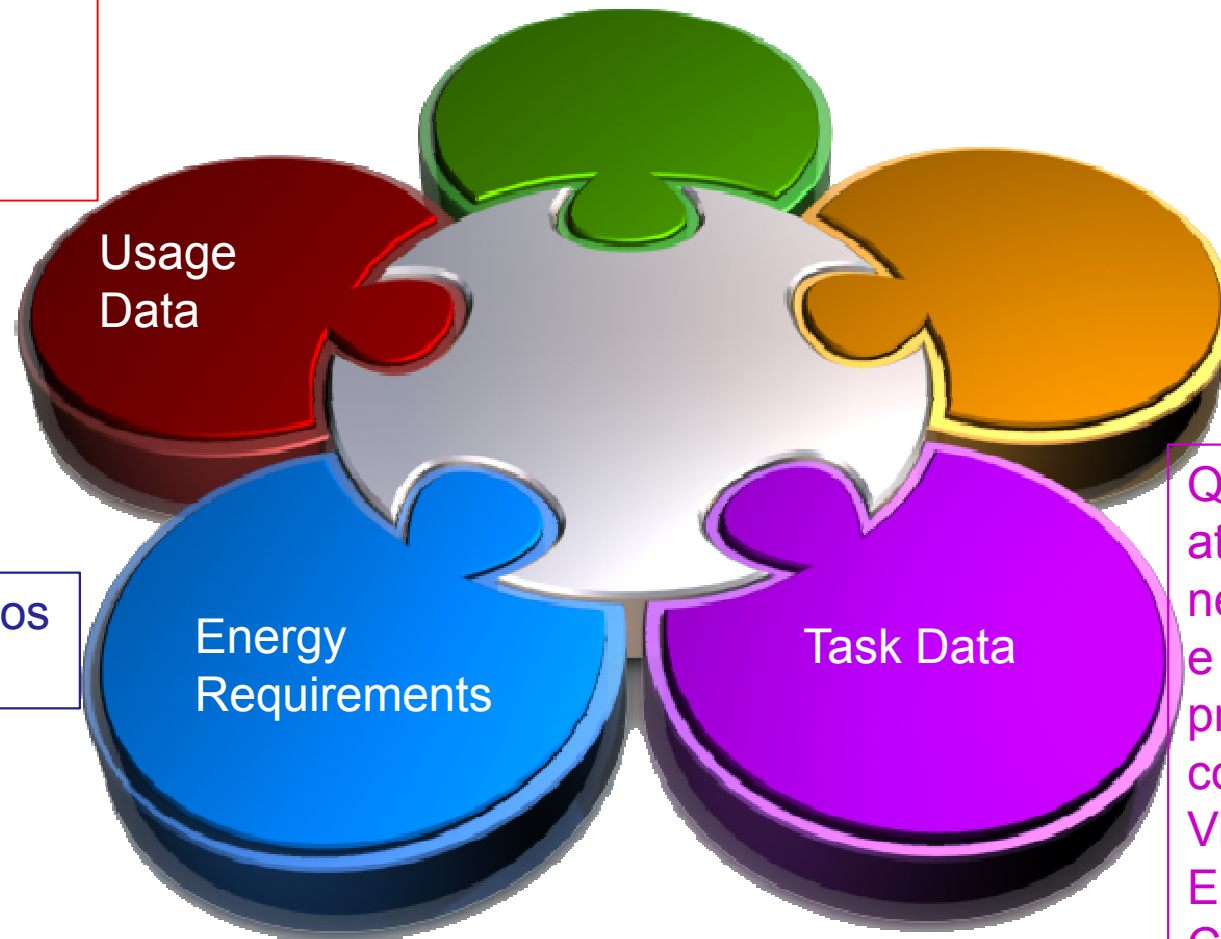

Quanto podemos usar?

Que atividades nele ocorrerão e que precisam ser consideradas?
Visual?
Emocional?
Carga?
Atmosfera?



Desenvolvimento do Projeto

Quando o espaço estará ocupado ou vazio?

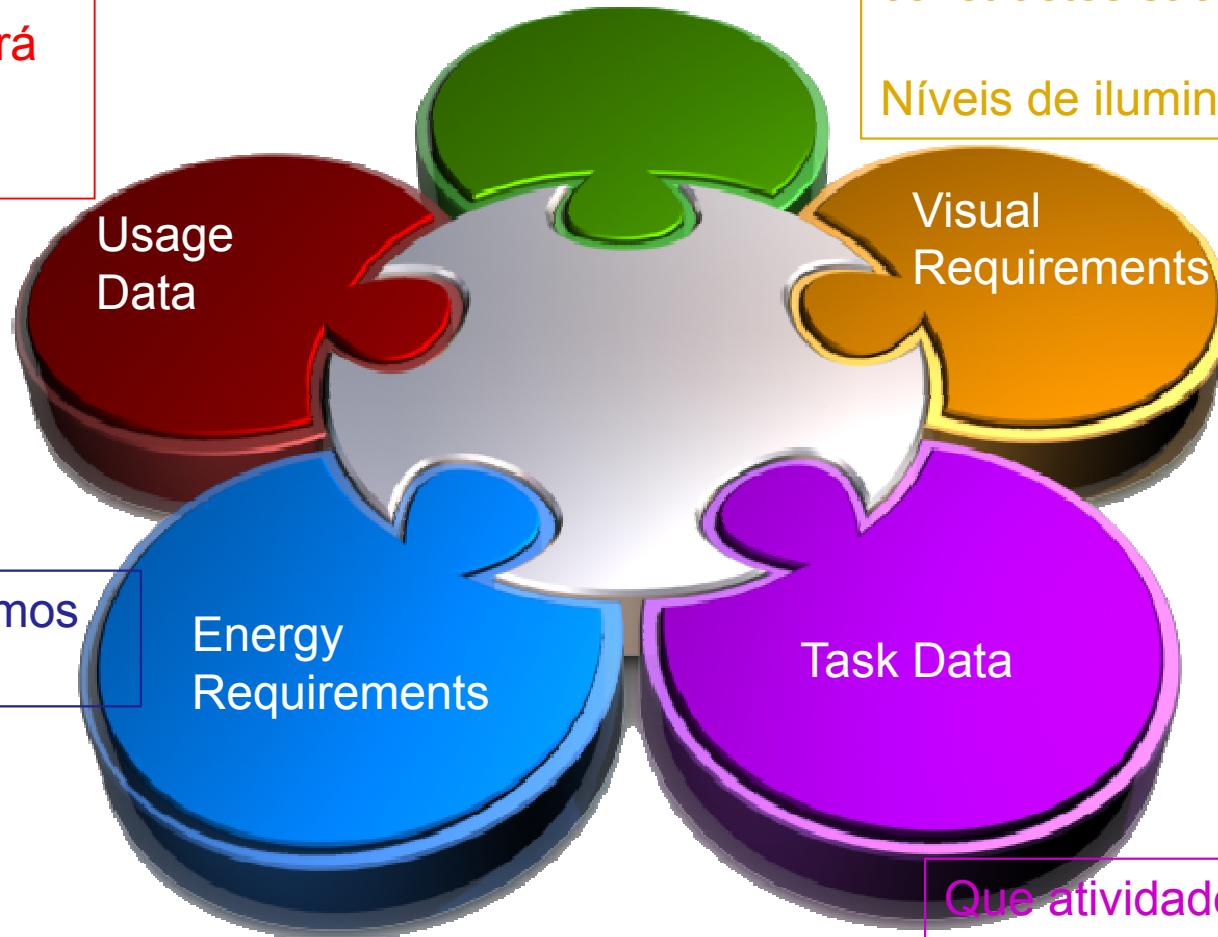

Que luz e níveis de contrastes são apropriados?

Níveis de iluminâncias?

Quanto podemos usar?

Que atividades nele ocorrerão e que precisam ser consideradas?



Desenvolvimento do Projeto

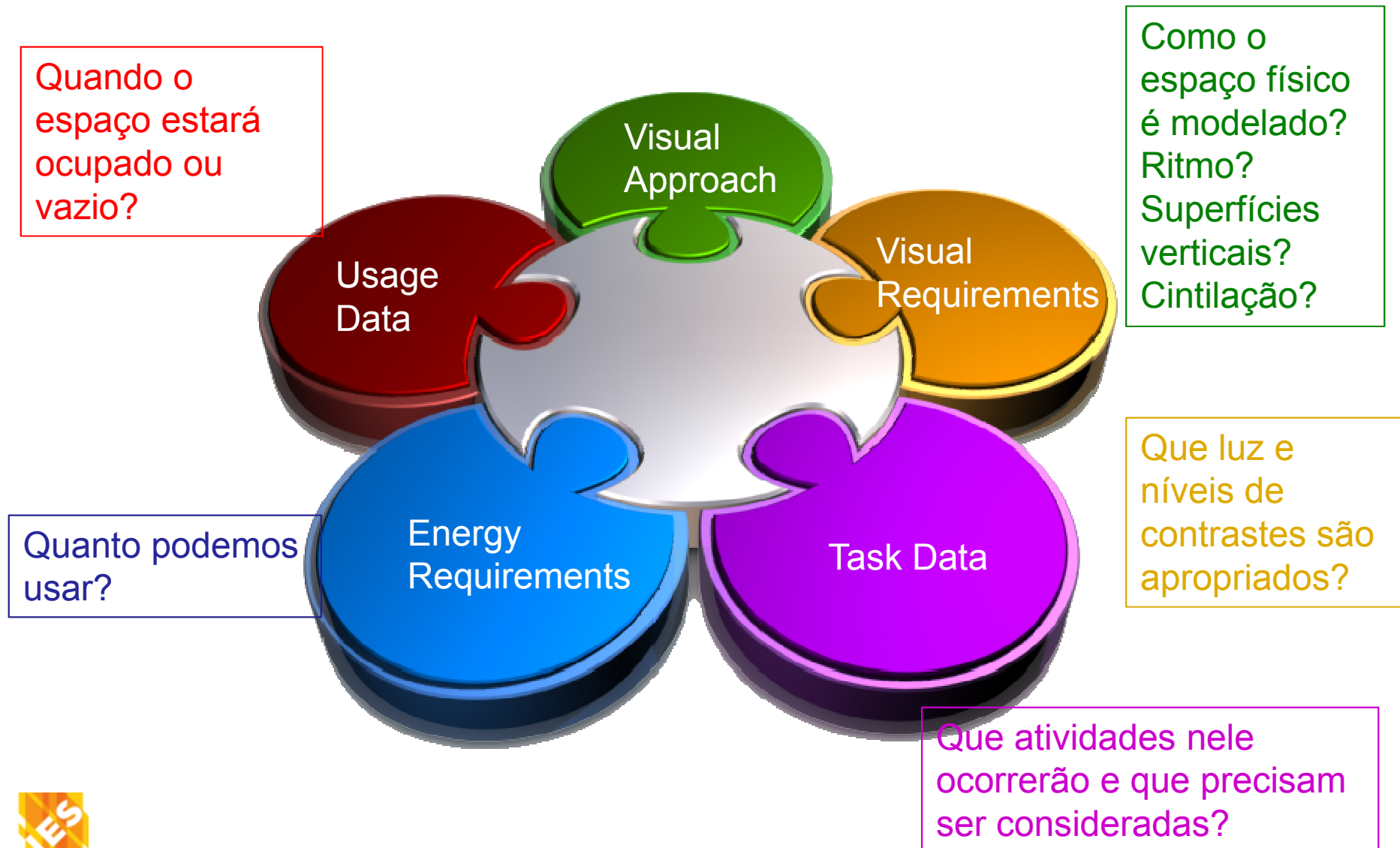

Desenvolvimento do Projeto

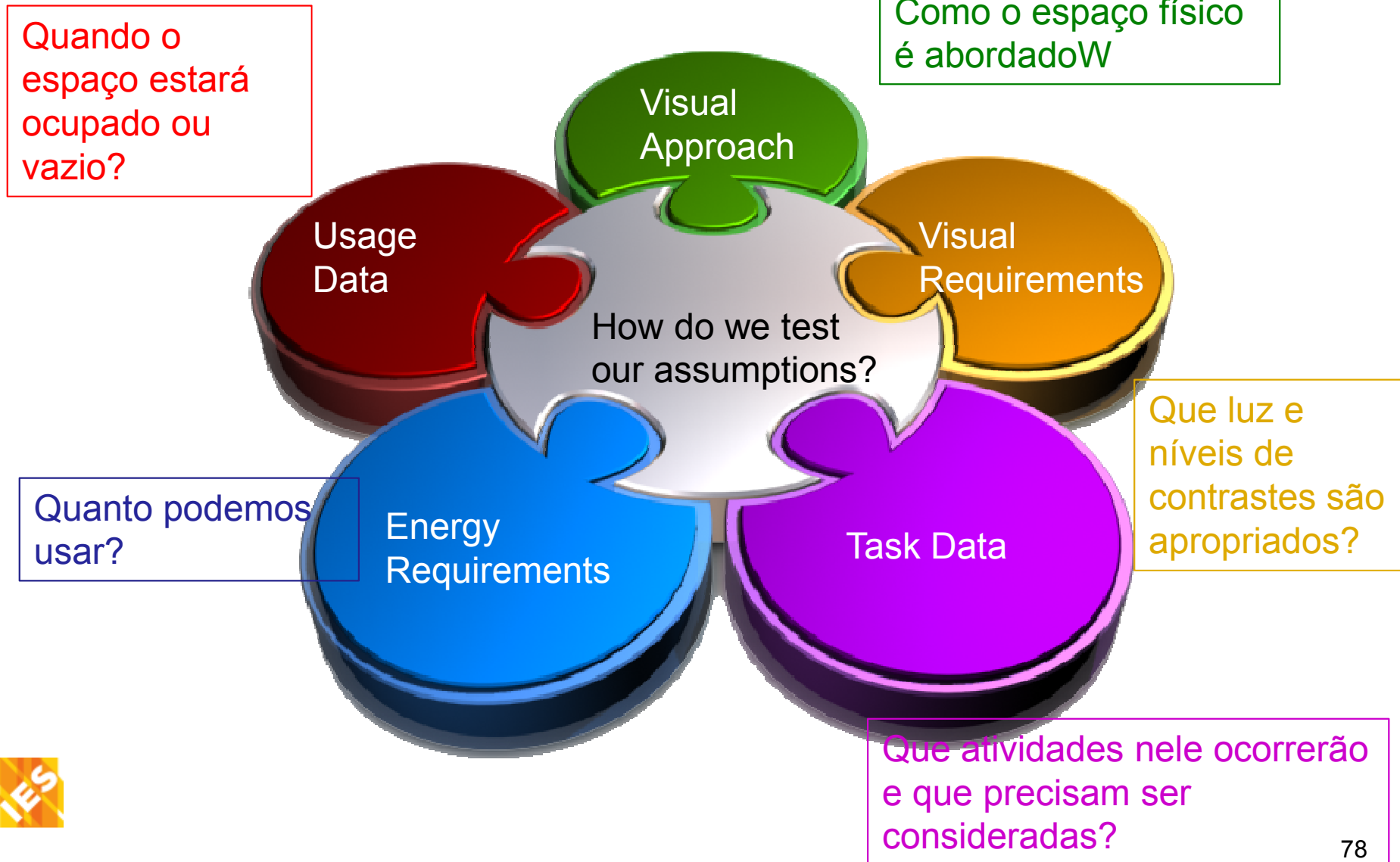

Desenvolvimento do Projeto

Cálculos digitais e renderização podem ajudar na tomada de decisões

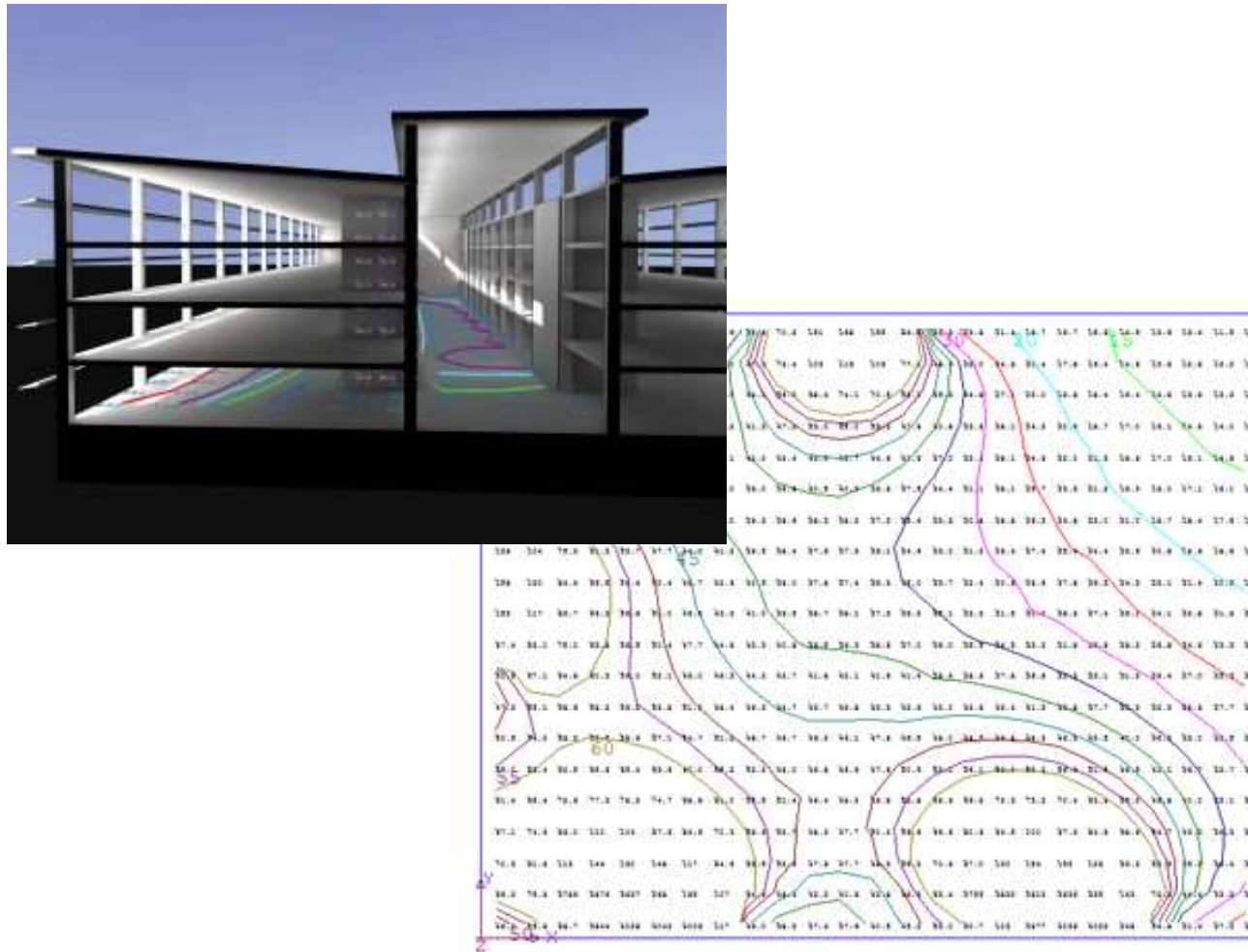

Cortesia das imagens : Lighting Analysts, Inc.

Documentação do Projeto

Memorial Explicativo

Layouts

Especificações

Tabelas

Diagramas de Controles

Detalhes

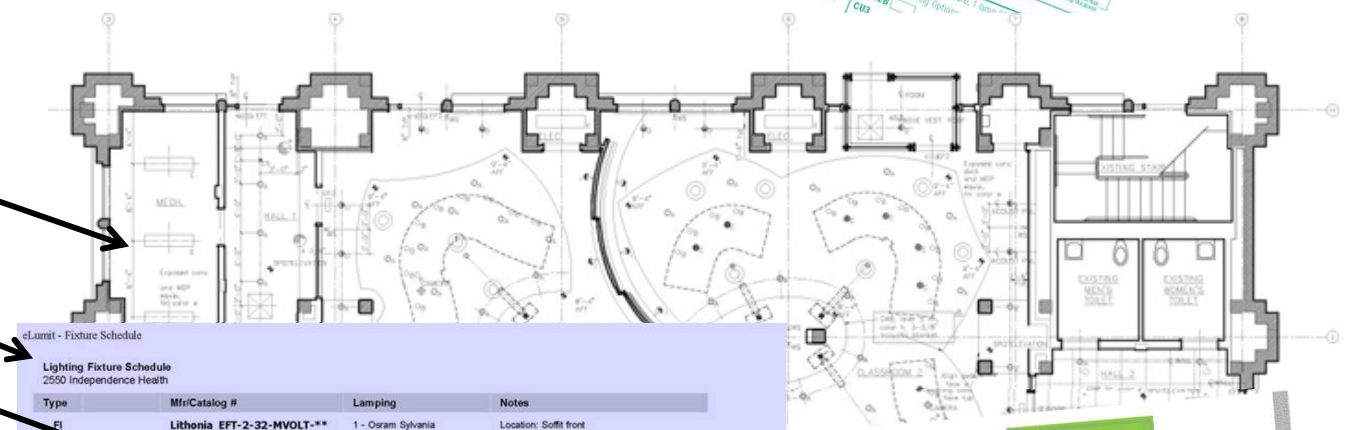
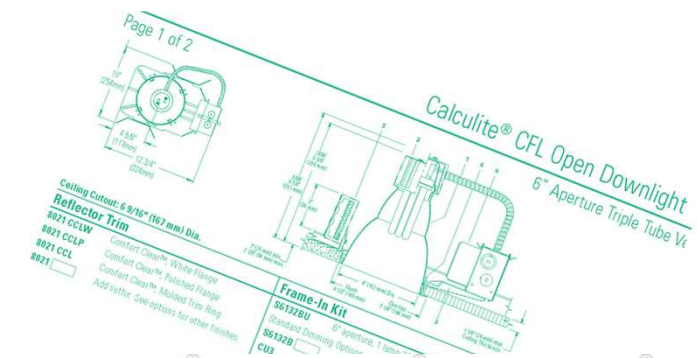

eLumit - Fixture Schedule

Lighting Fixture Schedule
2550 Independence Health

Type	Mfr/Catalog #	Lamping	Notes
F1	Lithonia EFT-2-32-MVOLT-* Description: Surface mounted 2-lamp linear fluorescent strip/light with acrylic tube and stainless steel hardware.	1 - Osram Sylvania F03/B30/PSECO High output T8 lamp rated for 3100 initial lumens	Location: Soffit front Mounted to vertical face of soffit as shown on arch'd drawings.
F2	LiteMakers VT18wRG-PS-P Description: Pendant mounted compact fluorescent jelly jar with ribbed prismatic glass globe and per-metal shield. Conduit stem mounts directly to covered junction box	1 - PLC-ALTO-18W830/4P 18w Quad Compact fluorescent lamp	Location: throughout Confirm stem length prior to release for production.
F3	LiteMakers VT418wRG-PS-P Description: Pendant mounted compact fluorescent jelly jar chandelier with (4) ribbed prismatic	4 - Philips PLC-ALTO-18W830/4P 18w Quad Compact fluorescent lamp	Location: throughout Confirm stem length prior to release for production.

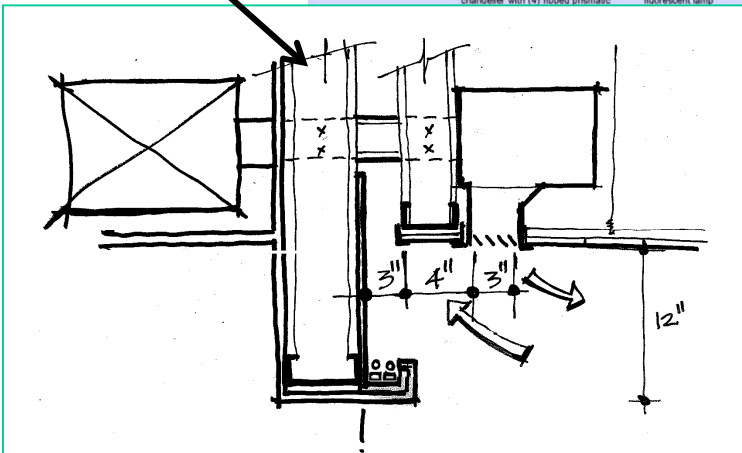

Documentação do Projeto

Abordagem Tradicional

- Plantas
- Cortes
- Elevações
- Tabelas
- Modelos 3D

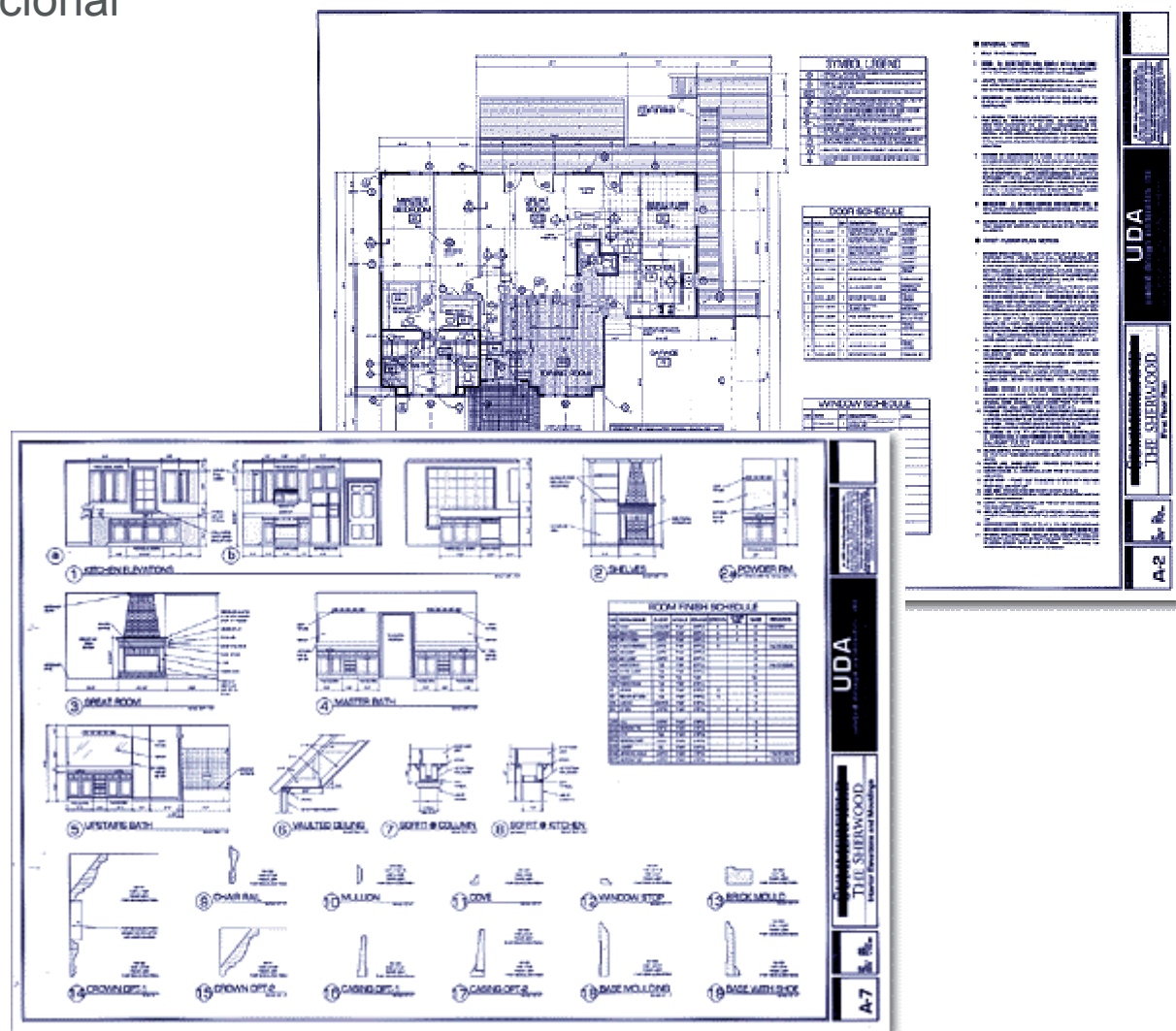

Documentação do Projeto

Abordagem BIM

- Base de Dados
- Edições Simultâneas editing
- Checagem de Conflitos
- Fontes de Materiais

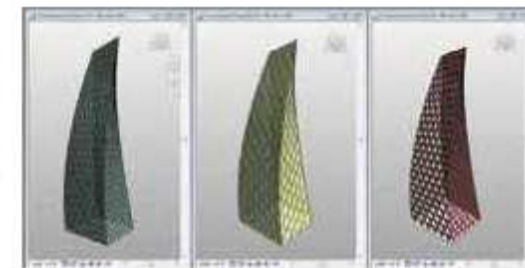
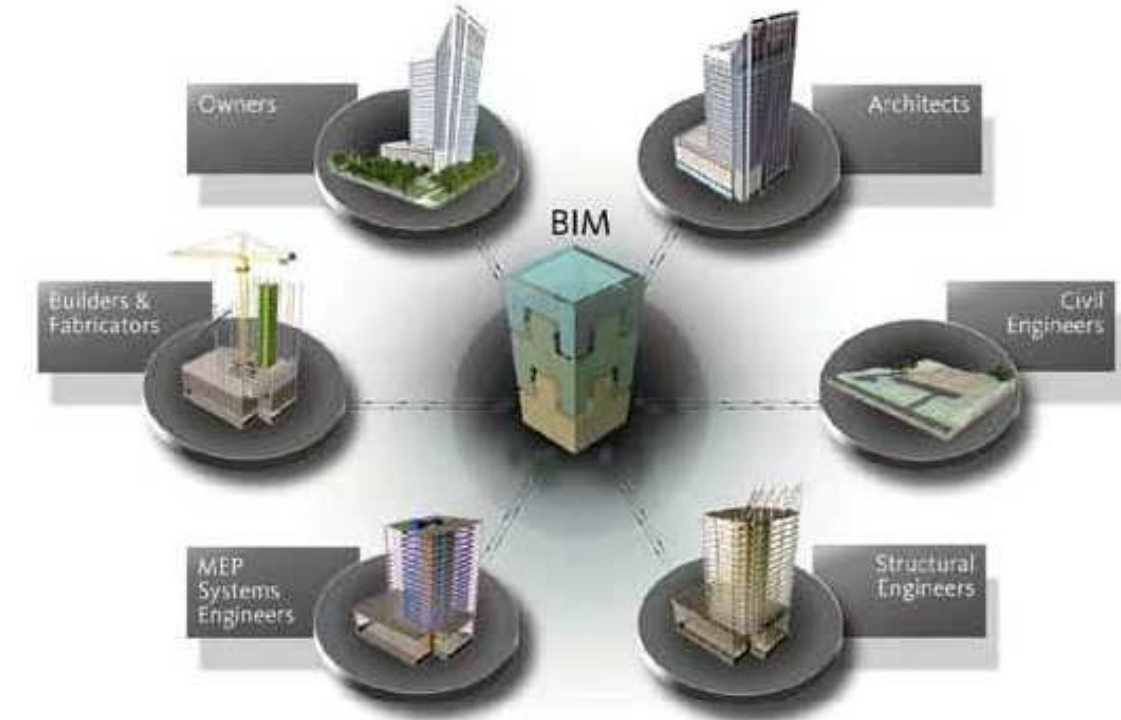
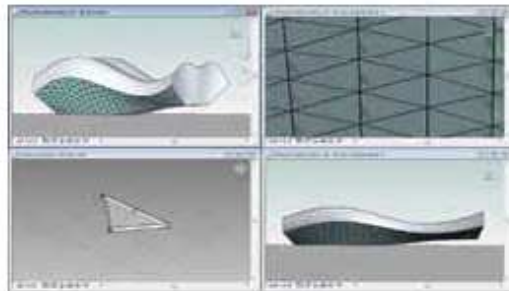

O processo continua...

... com Documentos de Contratação (DC)

e

Gerenciamento da Construção (GC)

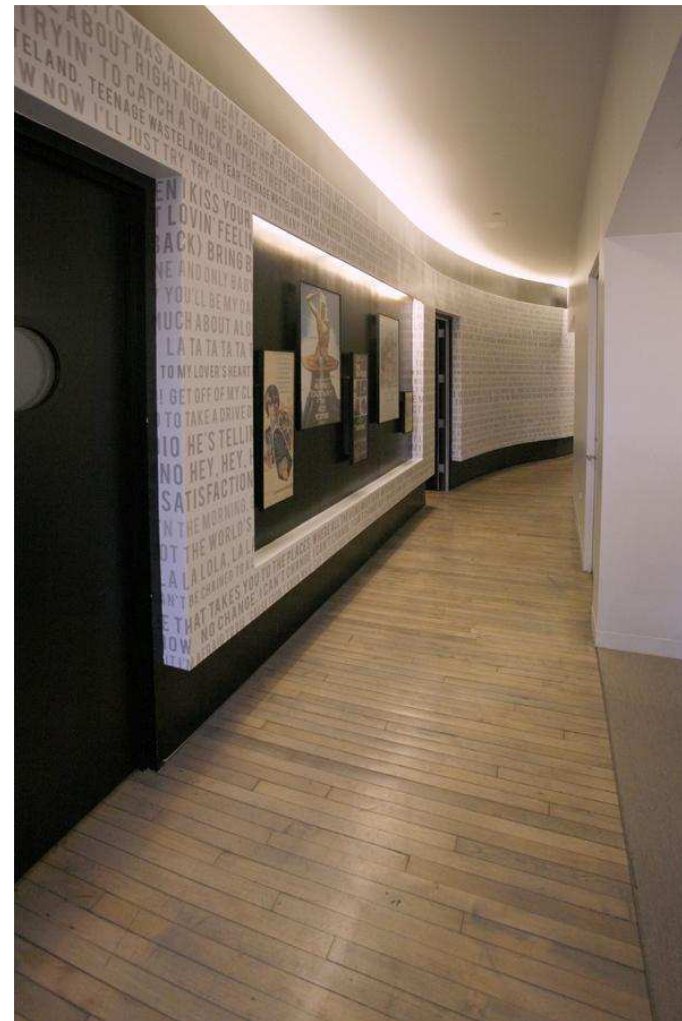

ABKO Music and Records
RS Lighting Design

Lighting Design.Processo de Projeto

Perguntas?

