



Bus Rapid Transit Planning Guide

June 2007

Developed through the support of:

The William and Flora Hewlett Foundation
Global Environment Facility /
United Nations Environment Programme
Deutsche Gesellschaft für Technische
Zusammenarbeit (GTZ) GmbH

Editors: Lloyd Wright
Researcher
Bartlett School of Planning,
University College London

Walter Hook
Executive Director
Institute for
Transportation & Development Policy



Published by: Institute for
Transportation & Development Policy
127 W. 26th Street, Suite 1002
New York, NY 10001
USA

3rd edition, June 2007

Cover photos: Front cover:
Bogotá's TransMilenio;
Photo by Karl Fjellstrom
Back cover:
Bogotá's TransMilenio;
Photo by Lloyd Wright

Layout: Klaus Neumann, SDS, G.C.

Contents: The editors the Bus Rapid Transport Planning Guide take full responsibility for the contents of the document. The sponsoring organisations are not responsible for any errors or omissions resulting from the publication of this document.



Bus Rapid Transit Planning Guide

June 2007

Contributing authors:

(in alphabetical order)

- ▶ César Arias, A & Y Consultores Cia. Ltda.
- ▶ Angélica Castro, TransMilenio SA
- ▶ Wagner Colombini Martins, Logit Engenharia Consultoria
- ▶ Paulo Custodio, Public transport consultant
- ▶ Juan Carlos Diaz, Akiris Consultants
- ▶ Karl Fjellstrom,
Institute for Transportation & Development Policy (ITDP)
- ▶ Dario Hidalgo, Booz Allen Hamilton
- ▶ Walter Hook,
Institute for Transportation & Development Policy (ITDP)
- ▶ Michael King, Nelson / Nygaard Consultants
- ▶ Lin Wei, Kunming Urban Transport Institute
- ▶ Todd Litman, Victoria Transport Policy Institute (VTPI)
- ▶ Gerhard Menckhoff, World Bank consultant
- ▶ Peter Midgley, World Bank consultant
- ▶ Carlos F. Pardo,
GTZ Sustainable Urban Transport Project (SUTP)
- ▶ Edgar Enrique Sandoval, Public transport consultant
- ▶ Pedro Szasz, Public transport consultant
- ▶ Geetam Tiwari, Indian Institute of Technology – Delhi
- ▶ Jarko Vlasak, Business strategy consultant
- ▶ Luis (Pilo) Willumsen, Steer Davies Gleave
- ▶ Lloyd Wright, University College London and Viva
- ▶ Sam Zimmerman, The World Bank Group

Preface

“We wander for distraction, but we travel for fulfillment.”

– Hilaire Belloc, writer, 1870–1953

The ability to access jobs, education, and public services is a fundamental part of human development. An efficient and cost-effective public transport system essentially connects people to daily life. For many cities, though, effective public transport has been forgone, leaving mobility needs exclusively in the hands of private vehicles and uncoordinated paratransit operators. These cities have been largely unprepared for the consequences, including severe traffic congestion, air and noise pollution, accidents, and the loss of a sense of community. A high-quality public transport system remains an indispensable element in creating a city where people and community come first.

Bus Rapid Transit (BRT) is increasingly recognised as amongst the most effective solutions to providing high-quality transit services on a cost-effective basis to urban areas, both in the developed and developing world. The growing popularity of BRT as a viable solution to urban mobility underscores the success of initial efforts in cities such as Curitiba, Bogotá, and Brisbane. By allowing cities to provide a functional network of public transport corridors, BRT permits even low-income cities to develop a high-quality mass transit system that serves the public’s daily travel needs.

However, BRT is not just about transporting people. Rather, BRT represents one element of a package of measures that can transform cities

into more liveable spaces. Integration of BRT with non-motorised transport, progressive land-use policies, and car-restriction measures forms part of a sustainable package that can underpin a healthy and effective urban environment. In this sense, BRT represents one pillar in efforts to better urban quality of life for all segments of society, and especially in providing greater equity across an entire population.

The Bus Rapid Transit Planning Guide has been the culmination of over five years of efforts to document and improve the state of the art in cost-effective public transport solutions for cities. This current document is the third edition of the Planning Guide. The production of new versions in a short span of time is indicative of the pace by which the BRT concept is growing and evolving. The first two versions of the Planning Guide were developed by Lloyd Wright and published through the Sustainable Urban Transport Project (SUTP) of the German Technical Cooperation (GTZ). This new edition has been expanded to include inputs from a wide range of professionals with direct experience in implementing actual systems. Further, as new projects have been implemented, the base of knowledge on issues such as route design, information technology, fare collection options, and BRT vehicles has expanded significantly.

This Planning Guide first provides an overview of the BRT concept, including its definition and historical development. The Planning Guide then proceeds to give a step-by-step description of the BRT planning process. The

Planning Guide encompasses six major components in BRT planning: I. Project preparation; II. Operational design; III. Physical design; IV. Integration; V. Business plan; and VI. Evaluation and implementation. In total, there are 20 different chapters covering a comprehensive set of planning issues including communications, demand analysis, operational planning, customer service, infrastructure, modal integration, vehicle and fare collection technology, institutional structures, costing, financing, marketing, evaluation, contracting, and construction planning. Finally, this publication also lists a range of information sources that can assist a city's BRT planning efforts.

The BRT Planning Guide is intended as a guidance document for a range of parties involved in delivering public transport services to urban areas. Municipal planning professionals and planning consultants will particularly benefit from the step-by-step documentation of the BRT development process. However, non-governmental organisations and civic organisations involved in transport, environment, and community development will likewise find this information of use in realising their objectives. Additionally, other stakeholders, including business groups, regional and national governmental agencies, and international development organisations are also key partners who will benefit from knowledge on the BRT option.

The BRT Planning Guide was originally developed principally for officials in developing-nation cities, and most of the expertise

presented here has been developed in the cities of developing nations. Given that the most successful applications of BRT to date have been from cities such as Bogotá, Curitiba, and Guayaquil, developed nations have much to learn from the developing world. Further, as energy security and the spectre of climate change have become topics of increasing global concern, providing effective public transport should be a fundamental objective for all cities, regardless of a nation's economic designation.

BRT alone will not solve all the myriad of social, environmental, and economic challenges facing our various urban centres across the globe. However, BRT has shown to be an effective catalyst to help transform cities into more liveable and human-friendly environments. The appeal of BRT is the ability to deliver a high-quality mass transit system within the budgets of most municipalities, even in low-income cities. BRT has proven that the barrier to effective public transport is not cost or high technology. Planning and implementing a good BRT system is not easy. This guide aims to make the task a little easier. The principal ingredient, however, is not technical skill: It is the political will to make it happen.

Lloyd Wright

University College London (UCL) and Viva

Walter Hook

Institute for Transportation & Development Policy (ITDP)

Acknowledgements

The development of this Bus Rapid Transit Planning Guide has benefited from the experiences of cities and professionals from around the world. In many respects, BRT owes its existence to the creativity and determination of Jaime Lerner, the former mayor of Curitiba (Brazil) and the former governor of the state of Paraná. Curitiba marked a vital first step in understanding a customer-based view of public transport provision. Former Mayor Lerner and his municipal team used a great deal of creativity in developing a “surface metro” system that was the forerunner of BRT.

Subsequently, the leadership of former Bogotá Mayor Enrique Peñalosa resulted in the development of the Bogotá TransMilenio system in the late 1990s. The Bogotá system proved the applicability of BRT in even the largest and most complicated urban settings. Further, former Mayor Peñalosa has gone on to be a worldwide ambassador of sustainable urban transport. Together, the stories of Curitiba and Bogotá are now the basis for more and more cities engaged in urban transformation led by BRT and a package of other sustainable transport measures.

It is no coincidence that many of the persons involved with this BRT Planning Guide have played a central role in planning and implementing BRT systems around the world. The experience of planners from Brazil, Colombia, and elsewhere has helped to dramatically improve the quality of this third edition of the BRT Planning Guide.

This guide has drawn most heavily on the team that designed Bogotá’s TransMilenio system. The consulting firm Akiris, especially Juan Carlos Diaz, have helped to draft the sections of the Planning Guide on project preparation, communications, and technology. Under the guidance of Luis (Pilo) Willumsen, staff from Steer Davies Gleave contributed inputs to the demand analysis and operations sections. Jarko Vlasak formerly helped lead the team that developed the business and institutional structure for TransMilenio, and he has provided inputs on these topics to the Planning Guide. Angélica Castro, the current Managing Director of TransMilenio SA, and other members of Bogotá’s public BRT company, TransMilenio SA, also

provided many highly useful ideas and inputs. Further, the former director of TransMilenio, Edgar Enrique Sandoval, has applied his experience to provide a wide spectrum of suggestions to the Planning Guide. Likewise, Dario Hidalgo, formerly the Deputy Director of TransMilenio and now with the firm of Booz Allen Hamilton, has assisted with an array of inputs, including insights into initial project development.

Pedro Szasz, a world leading transport engineer who played a key role in helping TransMilenio reach its current unrivalled capacity and speed, contributed greatly to the sections on operational and design issues. Likewise, the inputs and ongoing interactions from Brazilian consultants such as Wagner Colombini (Logit Engenharia), Paulo Custodio, and Arthur Szasz have provided invaluable insights to this Planning Guide.

César Arias, who played a key role in developing the Quito BRT system and is now doing the same in the city of Guayaquil, has provided inputs from BRT development in these cities. Likewise, Hidalgo Nuñez and Cecilia Rodriguez of Quito’s Department of Transport have provided much assistance in documenting Quito’s experiences.

For Asia, valuable lessons emerged from our partnership with the Guangzhou Municipal Technology Development Corporation under the Guangzhou Construction Commission, and from the Energy Foundation’s Beijing Office. Special recognition should also be extended to Lin Wei and the entire team from the city of Kunming who developed China’s first BRT project. Additionally, the inputs of Dr. Jason Chang and Kangming Xu have helped to document early experiences in China and Taiwan. In India, Dr. Dinesh Mohan and Dr. Geetam Tiwari of the Indian Institute of Technology in Delhi are at the forefront of efforts there, and many elements of this guide result from the richness of their inputs. With particular attention to the integration of pedestrian access and small vendors into the station environment, Dr. Tiwari has provided insights for this Planning Guide. Recognition must also be extended to DKI Jakarta and the valuable lessons learned during the development of the TransJakarta BRT system.

In Africa, the city of Dar es Salaam has embarked upon a path to prove that a high-quality public transport system is possible even in cities with limited financial resources. The rise of the Dar es Salaam BRT system may well spur on similar efforts across the African continent. Interactions with Raymond Mblinyi and Asteria Mlambo of the Dar es Salaam Project Management Unit, along with the team from Logit Engenharia provided invaluable guidance on issues appropriate to working in the African context.

The Planning Guide has benefited not only from leading developing-nation experiences but also from the growing level of interest in BRT in Australia, Western Europe, Japan, and North America. A similar compendium of experiences developed under the United States Transit Cooperative Research Program (TCRP) has been a rich source of world-wide experiences in BRT. Sam Zimmerman, now with the World Bank, and Herbert Levinson, an independent transport consultant, have been leading these efforts and have helped to provide insightful contributions to this Planning Guide.

Heather Allen and the entire team at the International Union of Public Transport Operators (UITP) have helped to share the experiences of their membership in order to strengthen this Guidebook. François Rambaud of French Research Centre on Transport and Urbanism (CERTU) has also been most helpful in noting BRT developments in France, as has been Werner Kutil of Veolia Transport. Appreciation is also extended to Dave Wetzel, the Vice Chair of Transport for London (TfL), who has contributed greatly to innovative financing strategies such as the concept of a Land Benefit Levy (LBL).

Additionally, efforts to raise awareness of the BRT option have been furthered by several US-based organisations, including the US Federal Transit Administration (USFTA), the American Public Transport Association (APTA), and WestStart-CALSTART. The team of Dennis Hinebaugh, Georges Darido, and Alasdair Cain at the National BRT Institute at the University of South Florida have been quite gracious in providing data and images for this Planning Guide. Also, Bill Vincent of Breakthrough Technologies has been an inspirational

lead for BRT in the US and elsewhere, and has helped to develop one of the most effective videos on BRT to date. Kate Blumberg of the International Council on Clean Transportation (ICCT) contributed many insights on air quality and fuel technology for this Planning Guide. At the city level, the efforts of officials in Brisbane, Nagoya, Ottawa, and Rouen have also made a significant difference in furthering the BRT concept.

Several international transport professionals are working to ensure that concepts like BRT are integrated within the local context. Michael King of Nelson/Nygaard Consultants is the principal author of the Planning Guide's section outlining the integration of BRT with pedestrian access. Todd Litman of the Victoria Transport Planning Institute (VTPI) gave major contributions to the sections on BRT integration with land use planning and BRT within a framework of transit-oriented development (TOD). The VTPI remains a valuable resource within the sustainable transport movement. Also, through co-operation with Nancy Kete, Lee Schipper, and the entire team at the Embarq programme of the World Resources Institute (WRI), and the Center for Sustainable Transport in Mexico City, valuable insights have been gained.

Several international organisations are now at the forefront of making BRT a mainstream option for cities worldwide. The World Bank and the Global Environment Facility (GEF) have teamed up to support BRT initiatives in a range of cities, including Hanoi, Lima, Mexico City, and Santiago. Gerhard Menckhoff, a World Bank consultant, has been particularly instrumental in this process, and he has made substantial contributions to many elements of this Planning Guide. Likewise, Peter Midgley, a former World Bank transport specialist, who has been a pioneer in forming the BRT concept, also provided assistance to this Planning Guide. Other World Bank staff who are closely involved in making BRT projects a reality include Mauricio Cuéllar, Pierre Graftieux, and Shomik Mehndiratta. Further, Cornie Huzienga and his team at the Clean Air Initiative for Asian Cities (CAI-Asia) are working to improve air quality of Asian cities through the

promotion of measures such as BRT. Efforts in Asia are also assisted through the Environmentally-Sustainable Transport (EST) programme of Kazunobu Onogawa, Choudhury Mohanty, and others at the United Nations Centre for Regional Development (UNCRD).

This most recent version of the Planning Guide would not have become a reality without the vision and support of several key organisations. The Hewlett Foundation stands out as one of the principal catalyst organisations making BRT possible in countries such as Brazil, China, and Mexico. Much appreciation must be extended to Joseph Ryan and Hal Harvey of the Hewlett Foundation for their belief in BRT as a sustainable option for developing-nation cities. Likewise, Sheila Aggarwal-Kahn and Lew Fulton of the United Nations Environment Programme (UNEP) worked with the Secretariat of the Global Environment Facility (GEF) to also make both a substantive and a financial contribution to this document's publication. Additionally, Manfred Breithaupt and the Sustainable Urban Transport Project (SUTP) of GTZ have played a pivotal in supporting the development of the first two versions of this Planning Guide. Likewise, GTZ has also given support to this third edition as well as continues to support BRT

knowledge dissemination through workshops and training courses.

Finally, much has been learned by turning the ideas of BRT into on-the-ground realities. Most of the valuable lessons presented here resulted from the persistence and patience of key people often in often difficult situations. Several key staff members at the Institute for Transportation & Development Policy (ITDP) have been at the forefront of bringing direct technical assistance to developing cities pursuing sustainable transport options. From ITDP's team, Oscar Diaz played a critical role in collecting information about TransMilenio; likewise, John Ernst's work in Jakarta, Eric Ferreira's work in Brazil, Karl Fjellstrom's work in China and Tanzania, and Aimee Gauthier's work in Dakar and South Africa, was the basis for many of the insights shared here. A special thanks is also extended to Klaus Neumann who provided the design and formatting of this document.

In total, the Bus Rapid Transit Planning Guide is the sum of some of the most experienced minds that are striving to improve public transport conditions worldwide. The contents of this Planning Guide give the reader a revealing look at the promise and latest accomplishments of Bus Rapid Transit systems.

Acronyms

AEI	Access Exchange International	IDA	International Development Association
AIJ	Activities Implemented Jointly	IEA	International Energy Agency
APTA	American Public Transport Association	ICT	Information and communications technologies
AfDB	African Development Bank	IFC	International Finance Corporation
ALS	Area Licensing Scheme	IPCC	Inter-governmental Panel on Climate Change
ADB	Asian Development Bank	ITDP	Institute for Transportation & Development Policy
AGV	Automatic Guided Vehicle	ITS	Intelligent Transportation Systems
AVL	Automatic Vehicle Location	JBIC	Japanese Bank for International Co-operation
BNDES	Banco Nacional de Desenvolvimento Econômico e Social (Brazilian National Development Bank)	JICA	Japanese International Co-operation Agency
BOT	Build-Operate-Transfer	JI	Joint Implementation
BRT	Bus Rapid Transit	JIT	Just-in-time
CH ₄	Methane	KfW	Kreditanstalt für Wiederaufbau (German Bank for Reconstruction)
CIDA	Canadian International Development Agency	kph	Kilometres per hour
CO	Carbon monoxide	LVT	Land-value taxation
CO ₂	Carbon dioxide	LOS	Level of service
CFD	Car-free day	LPG	Liquid Petroleum Gas
CBD	Central business district	LRT	Light Rail Transit
COE	Certificate of entitlement	LBL	Location Benefit Levy
CER	Certified Emission Reduction	MRT	Mass Rapid Transit
CAI	Clean Air Initiative	NBRTI	National Bus Rapid Transit Institute
CDM	Clean Development Mechanism	NO _x	Nitrogen oxides
CNG	Compressed Natural Gas	N ₂ O	Nitrous oxide
COP	Conference of the Parties	NGO	Non-governmental organisation
DANIDA	Danish International Development Agency	NMT	Non-motorised transport
dB	Decibel	OMV	Open market value
DLT	Development Land Tax	O-D	Origin-Destination
DFID	UK Department for International Development	OECD	Organisation for Economic Co-operation and Development
ERP	Electronic Road Pricing	O ₃	Ozone
EIA	Environmental Impact Assessment	PM	Particulate matter
EST	Environmentally-Sustainable Transport	PCU	Passenger car units
EU	European Union	pphpd	Passengers per hour per direction
EOI	Expression of Interest	PC	Personal computer
GEF	Global Environmental Facility	PDA	Personal digital assistant
GST	Goods and services tax	PRT	Personal Rapid Transit
GTZ	Deutsche Gesellschaft für Technische Zusammenarbeit (GTZ) (German Technical Cooperation)	PV	Photovoltaic
HCBS	High-Capacity Bus System	PPQ	Por el País que Queremos (For the Country that We Want)
HOV	High-occupancy vehicle	PPP	Public-private partnership
IADB	Inter-American Development Bank	PSA	Public service announcement
IBRD	International Bank for Reconstruction and Development	PT	Public transport

PTTF	Pune Traffic & Transportation Forum
QIC	Quality incentive contract
RATP	Régie Autonome des Transports Parisiens (Paris Regional Public Transport Agency)
RF	Registration fee
SMS	Short message service
SOx	Sulphur oxides
Sida	Swedish International Development Agency
SUMA	Sustainable Urban Mobility in Asia
SUTP	Sustainable Urban Transport Project
TOR	Terms of Reference
TDM	Transportation Demand Management
TOD	Transit-Oriented Development
TfL	Transport for London
TRB	Transportation Research Board
TVR	Transport sur Voie Reservée (Transport on Reserved Lane)
UITP	International Association of Public Transport
UNCRD	United Nations Centre for Regional Development
UNCED	United Nations Conference on Environment and Development
UNDP	United Nations Development Programme
UNEP	United Nations Environment Programme
UNFCCC	United Nations Framework Convention on Climate Change
US AID	United States Agency for International Development
US EPA	United States Environmental Protection Agency
US FHWA	United States Federal Highway Administration
US FTA	United States Federal Transit Administration
US NCHRP	United States National Cooperative Highway Research Program
US TCRP	United States Transit Cooperative Research Program
UCL	University College London
VTPI	Victoria Transport Policy Institute
VOCs	Volatile organic compounds
WBCSD	World Business Council for Sustainable Development
WRI	World Resources Institute

Contents

Executive Summary	1
Introduction	10
I. Project Preparation	34
1. Project initiation	35
2. Public transport technologies	47
3. Project set-up	92
4. Demand analysis	124
5. Corridor selection	154
6. Communications	189
II. Operational Design	212
7. Network and service design	213
8. System capacity and speed	244
9. Intersections and signal control	278
10. Customer service	316
III. Physical Design	342
11. Infrastructure	343
12. Technology	406
IV. Integration	462
13. Modal integration	463
14. TDM and land-use integration	520
V. Business Plan	546
15. Business and institutional structure	547
16. Operational costs and fares	576
17. Financing	613
18. Marketing	665
VI. Evaluation and Implementation	686
19. Evaluation	687
20. Implementation plan	718
Resources	744
Annexes	753
A.1: BRT system comparisons	754
A.2: Consultant directory	779
A.3: Templates for consultant solicitation	793
A.4: List of financing organisations	797
A.5: Template for concession contract	801
References	805

Executive Summary

Public transport is a critical means by which citizens can effectively access goods and services across the expanse of today's cities. Bus Rapid Transit (BRT) has been found to be one of the most cost-effective mechanisms for cities to rapidly develop a public transport system that can achieve a full network as well as deliver a rapid and high-quality service. While still in its early years of application, the BRT concept offers the potential to revolutionise the manner of urban transport.

Bus Rapid Transit (BRT) is a *high-quality bus-based transit system that delivers fast, comfortable, and cost-effective urban mobility through the provision of segregated right-of-way infrastructure, rapid and frequent operations, and excellence in marketing and customer service*. BRT essentially emulates the performance and amenity characteristics of a modern rail-based transit system but at a fraction of the cost. A BRT system will typically cost 4 to 20 times less than a tram or light rail transit (LRT) system and 10 to 100 times less than a metro system.

To date, “full BRT” systems encompassing almost all high-quality service features have been developed in Bogotá (Colombia) and Curitiba (Brazil). Other leading developing-nation systems include Guayaquil (Ecuador), Jakarta (Indonesia), and Pereira (Colombia). In the developed world, high-quality systems have been implemented in Brisbane (Australia), Ottawa (Canada), and Rouen (France). In total, approximately 40 cities on six continents have implemented “BRT” systems, and an even greater amount of systems are either in planning or construction. The elements that constitute the BRT concept include high-quality infrastructure, efficient operations, effective and transparent business and institutional arrangements, sophisticated technology, and excellence in marketing and customer service.

The Bus Rapid Transit Planning Guide details the steps within the six major planning areas for delivering a successful BRT system. These planning areas include: 1. Project preparation; 2. Operational design; 3. Physical design; 4. Integration; 5. Business plan; and 6. Evaluation and implementation.



Fig. 1
Bogotá TransMilenio BRT system.

Photo courtesy of TransMilenio SA

1. Project preparation

Project initiation

A new public transport system does not create itself. Somewhere, some how, someone must act as the catalyst to set out a dramatic new vision for a city's public transport system. This catalyst for change may be a political official, a non-governmental organisation, or simply a concerned citizen. Ultimately, though, **political leadership** must take upon the task of turning a vision into a realisable project. The most successful BRT systems to date have been initiated and led by charismatic political leaders, such as former Mayors Jaime Lerner of Curitiba and Enrique Peñalosa of Bogotá.

Public transport technologies

BRT is not the only mass transit option available to a city. Metro rail, light rapid transit (LRT), monorail, suburban rail, and standard bus systems are all options that municipal leaders may consider. There is no one single right or wrong technology since much depends on the local circumstances. The factors affecting the technology choice include capital costs (infrastructure and land costs), operational costs, design and implementation considerations, performance, and

economic, social and environmental impacts. The rise of BRT as an effective option relates mostly to its relatively *low infrastructure costs* and ability to *operate without subsidies*. BRT's ability to be implemented within a short period (1-3 years after conception) also has proven to be a significant advantage. The flexible and scalable nature of BRT infrastructure also means that the systems can be cost-effectively adapted to a range of city conditions.

Project set-up

Once the decision has been made to develop a BRT system, forming a project team will be amongst the first activities. The project team will likely consist of both local government officials and outside consultants, and will involve a range of skilled positions, including administrators, financial specialists, engineers, designers, and marketing and communications professionals. In general, a BRT project can be planned within a period of **12 to 18 months**. A BRT plan will generally cost in the range of **US\$1 million to US\$3 million**, depending on the complexity and size of the city as well as the extent to which outside consultants are required. The financing of BRT planning activities can be gained through a variety of sources, including local and national transport budgets, international and regional development banks, and the Global Environment Facility (GEF).

Fig. 2
Quito Ecovía line.
Photo by Lloyd Wright



A BRT project will likely encompass a multi-phase process since it would be unrealistic to build a complete network in a single, brief period. The size of the initial phase will depend upon many factors, but generally a project's first phase should capture enough passengers to establish the new system on a sound financial basis. Generally it will encompass one to two major corridors for a total of 15 to 60 kilometres of exclusive busways as well as 40 to 120 kilometres of feeder services.

Demand analysis

A city's demand profile for daily trips provides the basis for designing the BRT system. Understanding the size of customer demand along the corridors and the geographical location of origins and destinations permits planners to closely match system characteristics to customer needs. The BRT Planning Guide presents two options for estimating customer demand: 1.) Quick *assessment method*; 2.) Assessment with a *full transportation model*. As its name suggests, the "quick assessment method" allows cities to roughly estimate demand in a relative short period of time and within a modest budget. In this case, basic traffic counts are combined with boarding and alighting surveys of existing public transport services. The likely demand for the new BRT system will be roughly equal to the existing public transport ridership along the corridor plus a percentage of new passengers from private vehicles (*e.g.*, perhaps a 10 percent shift from private vehicles, depending on local circumstances).

However, if a city already possesses the basis for documenting trips through a full transportation demand model, then such a model can provide a level of detail that will produce a more precise demand estimation. Using one of the recognised transport modelling software packages in conjunction with surveys, counts, and analysis will give greater certainty in the likely ridership but will also require more time and resources to complete.

Corridor selection

Corridors are generally chosen based on a range of factors, including *customer demand*, network advantages, roadway characteristics, ease of implementation, costs, political considerations,

and social equity. In a project's first phase, the chosen corridor(s) will likely serve popular origins and destinations in order to prove the technology as well as achieve financial sustainability from the outset. However, project developers may wish to avoid the densest and most difficult corridors in the first phase since the technical and political risks can be quite high.

A standard BRT lane requires approximately **3.5 metres of width** while stations are generally 2.5 metres to 5.0 metres wide. A standard busway with a single lane in each direction will require from 10 to 13 metres of road width. A system utilising express services and therefore passing lanes at stations may require 20 metres of road width just for BRT usage. While narrow roadway segments in historical centres and business districts can restrict BRT design, many solutions exist to overcome roadway limitations. Some of these solutions include use of median space, expanding roadway width, transit-only streets ("transit malls"), fixed guideways, grade separation, and operation in mixed traffic lanes. In general, system designers have found solutions even in the most spatially constrained environments, such as the historical centre of Quito.

Communications

A failure to communicate the new public transport plan to key stakeholders and the general public can greatly undermine the ultimate viability of the project. Misunderstandings and misconceptions can be quite common at the outset of a project. Those organisations and individuals who feel threatened by the new system may act to hinder or even halt the project's progress and ultimate implementation. As the initial step in a communications plan, a **stakeholder analysis** of all persons and entities affected by the new system should be completed. Such stakeholders may include existing public transport operators, taxi owners and drivers, car owners, retailers, environmental and other civic organisations, governmental agencies, and the traffic police. Strategies should be developed to address the possible concerns that could be expressed by these groups. A strategy should also be established for communications with the news media, including newspapers, radio, and television. Finally, the planning and design process can particularly benefit from the



Fig. 3
Curitiba BRT system.

Photo courtesy of Volvo
Bus Corporation

direct inputs of citizens. Few individuals are more qualified to provide insight on customer needs than the customers themselves. A substantive **public participation** process in which ideas and recommendations are solicited from a range of citizens (e.g., public transport users, motorists) may be an effective means to a high-quality design.

2. Operational design

Network and service design

At the outset of the project, a few basic decisions regarding operational design will have profound ramifications on the quality of the service and the overall financial sustainability. To an extent, the system's business structure will be largely defined by whether to choose a **closed system** or an **open system**. A "closed system" implies that the corridor access is limited to a prescribed set of operators and a restricted number of vehicles (e.g., Bogotá and Curitiba). By contrast, an "open system" generally permits any existing operator to utilise the busway (e.g., Kunming, Taipei). To date, most open-type systems have been of somewhat lower quality than closed systems and have been prone to busway congestion, particularly at stations and intersections.

Another major initial operational decision involves whether to choose a *trunk-feeder* configuration or a *direct services* configuration. A “trunk-feeder” system allows smaller vehicles to be utilised in lower-density areas while the main corridors can operate more efficiently with larger, trunk-line vehicles. Although this configuration can lead to high system efficiencies, it can also mean that many customers will require a terminal transfer. By contrast, “direct services” will generally use a single vehicle to connect a residential area to the central districts of the city. Thus, direct services will help reduce the number of transfers required but potentially at the expense of operational cost efficiency. While to date direct services have been utilised within lower-quality open systems, the advent of new systems utilising “direct services” in a closed system offer the potential to deliver highly-flexible operating conditions and a high-quality service.

Unlike rail-based transit systems, BRT holds the advantage of easily accommodating a large number of route permutations. With multiple options at the disposal of the customer, the number of required transfers can be greatly reduced. *Express* and *limited-stop services* can be particularly popular with customers, especially when significant travel time savings are realised.

System capacity and speed

From a customer’s perspective, a car-competitive public transport service is one that competes in terms of total travel time, comfort, cost, and convenience. Thus, designing a BRT system to handle high passenger demand in a rapid manner is one of the pillars to delivering a car-competitive service. The capacity and speed characteristics of BRT are defining features that set it apart from conventional bus services.

To date, the highest-capacity BRT system serves approximately **45,000 passengers per hour per direction** (Bogotá’s TransMilenio). A standard BRT system without passing lanes for express services will provide a maximum of approximately 13,000 passengers per hour per direction. Most high-quality BRT systems achieve average commercial speeds of approximately **23 to 30 kilometres per hour**.



Fig. 4
Brisbane busway.

Photo courtesy of Queensland Transport.

Achieving a high-speed and high-capacity system depends on a range of operational design characteristics, including multiple stopping bays at stations, express and limited-stop services, articulated vehicles with multiple wide doorways, off-board fare collection and fare verification, platform level boarding, and optimum station spacing. In general, the bottleneck point for most BRT systems will be vehicle congestion at the stations. Mechanisms that help to de-congest the station area and lead to rapid boarding and alighting of passengers will likely return the greatest dividends in terms of speed and capacity.

Intersections and signal control

Intersections represent a critical point along any BRT corridor. A poorly designed intersection or a poorly timed signal phase can substantially reduce system capacity. Finding solutions to optimising intersection performance can do much to improve system efficiency.

There are normally design solutions which optimise the total time savings for all modes. In developing countries, where typically the number of passengers and the number of buses per hour is much higher, where intersections tend to be fewer, and where traffic signal maintenance is less reliable, BRT system designers tend to rely more heavily on *turning restrictions* to improve intersection performance. Turning movements for mixed traffic vehicles, though, can be accommodated through selective turning strategies.

The efficiency of the intersection will also be influenced by the *location of the BRT station*.

Stations located near the intersection may be more convenient at times for passengers, but a mid-block location may be preferred if mixed traffic will be turning at the intersection. Finally, priority traffic signal control can be option to consider in some circumstances.

Customer service

If a system is designed around customer needs and wants, then success is almost assured. If customer service issues are ignored, then failure is also almost assured. From the customer's perspective, small and simple measures that improve comfort, convenience, safety, and security are more important than sophisticated vehicle technologies or busway designs.

Many persons do not utilise public transport simply because they do not understand how the system works. *Clear signage* and system maps can do much to overcome the information barriers to usage. Electronic displays and digital voice announcements both within vehicles and stations can also ease system understandability.

Friendly, *professional staff* dressed in smart uniforms helps to create the right system image that bolsters customer confidence. High-quality illumination and the presence of *security personnel* can do much to encourage ridership, even during the late evening hours. The *cleanliness* and aesthetic appearance of the system infrastructure also sends a message regarding the customer friendliness of the system.

3. Physical design

Infrastructure

The system's design and engineering depends upon several key factors that will dictate the eventual form of the infrastructure. These factors include: cost, functional attributes, climatic and topological conditions, aesthetic attributes, and cultural preferences. The physical design and engineering of the system directly follows from the chosen operational and customer service characteristics. The corridor selected, expected capacities, and service options all influence the physical design.

The infrastructure design must encompass a wide range of system components, including *busways, stations, intermediate transfer*



stations, terminals, depots, control centres, traffic control signals, integration facilities, public utilities, and landscaping. The choice of asphalt or concrete as the busway material will hold long-term ramifications on performance and maintenance costs. In general, concrete will be required at station locations in order to maintain a level platform height. Stations must be designed not only for functional purposes but also customer comfort and convenience. Passive solar design techniques can do much to moderate outside temperatures. The profile of many BRT systems has been raised through creative architectural designs for the stations. Terminals must be properly sized to efficiently handle feeder-to-trunk transfers. Likewise, depot areas must be designed to handle a range of tasks including re-fuelling, cleaning, maintenance and repair, and vehicle parking. A control centre allows system controllers to ensure a timely service to the customer as well as the ability to respond to any problems or emergencies.

Unlike other public transport options, BRT's infrastructure costs are relatively affordable, even for a developing-nation city. In general, a BRT system will cost between *US\$1 million and US\$8 million per kilometre*. The actual capital cost of the system depends on a range of factors including the complexity of the street environment, the need for flyovers or underpasses, the number of busway lanes, and the need for property acquisition. Frequently costs escalate because when reconstructing a corridor the municipality will decide to address other

Fig. 5
BRT depot in Bogotá.
Photo courtesy of TransMilenio SA

infrastructure issues not directly related to the BRT project. If extensive road widening and property acquisition is required, the total cost can quickly escalate. Any expropriation of property must be handled in a transparent, open, and fair manner, especially if the confidence of the international finance community is to be retained. The typical cost components within a BRT project include busways, stations, transfer stations, terminals, depots, pedestrian infrastructure, bicycle and taxi integration facilities, control centre, and property acquisition.

Technology

Few decisions in the development of a BRT system invoke more debate than the choice of bus propulsion technology and bus manufacturer. However, it should always be remembered that BRT is far more than just a bus. The choice of bus technology is important, but not necessarily more so than the myriad of other system choices.

Vehicle technology options involve both the vehicle size as well as propulsion system. For high-demand corridors, 160-passenger articulated vehicles have become standard. Feeder vehicles from lower-density residential areas will typically range from small mini-buses or vans to standard-sized buses, depending on the demand profile of the area. Innovative new technologies and fuels have substantially reduced BRT vehicle emissions. EURO III vehicle emission levels are increasingly becoming the standard worldwide. Such clean vehicle technologies include

clean diesel, compressed natural gas, liquid petroleum gas, biofuels, hybrid-electric vehicles, and electric trolleys.

Fare collection and verification systems also represent a range of technology options that vary by cost and features. The versatility of smart card systems has prompted many leading BRT systems to adopt this technology option. However, there also exist many lower-cost technologies that provide excellent value to the customer. Magnetic-strip technology has long been utilised in leading metro systems world-wide. Additionally, simple coin-operated machines, as applied in Quito, have proven to be a robust and highly cost-effective solution.

Finally, through **intelligent transportation systems** (ITS) such as real-time information displays, customers gain vital system knowledge that makes journeys more efficient and less stressful. ITS also sometimes plays an important role in system management by giving the BRT authority the power to track and control the speed and location of operators.

4. Integration

Modal integration

BRT systems cannot be designed and implemented in isolation. Instead, such systems are just one element in a city's overall urban framework and set of mobility options. To be most effective, BRT should be fully integrated with all options and modes. By maximising the BRT system's interface with other options, system designers are helping to optimise the potential customer base. The BRT system does not end at the entry or exit door of the station, but rather encompasses the entire client capture area. If customers cannot reach a station comfortably and safely, then they will cease to be customers.

If it is not convenient or easy to walk to a BRT station, then customers will be discouraged from using the system. Providing a Safe Route To Transit is therefore the first step to providing an effective BRT service. High-quality **pedestrian access** can be defined through design factors such as directness and connectivity, aesthetics, ease of movement, legibility, safety, and security. Mapping the quality of pedestrian facilities around the BRT station is a basic first

Fig. 6
Pedicabs can be the perfect zero-emission feeder service.

Photo courtesy of INSSA



step to identify barriers and difficulties faced by the customer. Pedestrian-only zones, shared space, and covered walkways are some of the design solutions that can encourage a strong linkage between a community and the BRT service. In general, customers prefer secure at-grade crossings over pedestrian bridges and tunnels, although the latter can also be effective if designed properly.

Integrating the BRT system with *bicycle* usage can significantly increase the customer catchment area. Allowing bicycles to enter the BRT vehicle permits the customer to use the bicycle as a feeder service on both sides of their journey. Alternatively, secure bicycle parking facilities at stations gives customers the confidence to leave the bicycle at the station during the day. Integrating BRT with *taxis* can produce a win for both the taxi operators and the BRT system. Formal taxi parking facilities next to the BRT station provides each mode with a complementary set of customers. *Pedicabs* are increasingly seen as a clean taxi alternative, especially for connecting BRT to nearby residential areas.

Transportation demand management and land-use

A high-quality public transport system is the “carrot” to encourage car owners to try an alternative. *Transportation demand management* (TDM) measures are an effective “stick” to help further discourage car and motorcycle use. Such measures include congestion charging, parking fees, vehicle ownership fees, and day usage restrictions.

Finally, BRT should also be fully integrated with *land-use policies* in order to ensure the growth of transit-oriented development around stations. The location of shops, services, and residences within walking distance of stations can ensure that as the city grows, the BRT system will serve the mobility needs of new residents.

5. Business plan

Business and institutional structure

The best BRT systems achieve a high quality of service not only because of the “hardware”, (buses, stations, busways, and other infrastructure), but because BRT redefines the way public transport services are managed and regulated.

The infrastructure investments can help the transport authority to negotiate a better quality of service from private operators. Traditional bus services tend to either operate as a single public monopoly or as thousands of individually-owned and operated businesses. Neither of these business structures have proved satisfactory in terms of delivering high-quality, subsidy-free services.

The experiences to date indicates that giving appropriate roles to both the public and private sectors can lead to optimum results for both the customer and the operator. A privately operated system through a system of *competitively-tendered concessions* can provide the right set of incentives for profit and customer service. In conjunction with a strong oversight role by a public agency, this type of system can deliver a high-quality product to the customer.

Bogotá’s TransMilenio system provides one of the best examples of combining private sector competition with strong public oversight. In this case, there is much competition for the market but little of the competition in the market that can produce poor-quality service. Typically, concessioned *operators are paid by the number of kilometres* travelled rather than by the number of passengers. Further, operators can be penalised or awarded depending on their performance levels. Such incentives do much to focus operator efforts on providing a quality service.

A range of options exist over the institutional and regulatory arrangements presiding over the system. In some cases, focused *specialised agencies* are effective in catalysing a new type of public transport service for a city. Some cities such as Bogotá intentionally create new agencies or public companies to oversee the project’s development. Bypassing the established regulatory agencies helps to create a new system unbounded by past problems and restrictions.

Alternatively, a *single department* with responsibility over planning, infrastructure, and operational oversight helps ensure each component of the process is mutually compatible. A single agency approach also ensures that the system accountability is clearly defined.

In all cases, a strong hands-on role by the leading political official, a Mayor or a Governor, is

recommended. The direct involvement by the leading political official ensures that the project remains a priority and that any difficulties can be swiftly addressed.

Operational costs and fares

In the developing world, BRT systems should always be designed to function with no *operational subsidies* from the project's outset. By carefully understanding operational cost components and the expected revenues from an affordable fare level, a cost equation can be developed to the benefit of all.

If the expected passenger fare level is sufficient, then equipment items such as vehicles and even fare systems can be included as operational costs. Alternatively, equipment costs can be capitalised and included in the initial infrastructure budget financed by the public sector. The traditional components of operational costs include repayment of capital (*e.g.*, vehicle depreciation and cost of capital), fixed operating costs (*e.g.*, driver salaries, administrative costs, insurance), and variable operating costs (*e.g.*, fuel, parts, and maintenance).

The distribution of revenues relates closely to the business structure. Generally, an independently concessioned fare company will collect the passenger revenues. A “trustee” company will then distribute the revenues based on the previously agreed upon contractual arrangements. The parties that will likely receive a share of passenger revenues include trunk-line operators, feeder operators, a fare collection company, and possibly the public transport authority as well. A highly *transparent and accountable* revenue distribution system is imperative to ensuring the confidence and participation of all parties.

Financing

Financing is rarely an obstacle to implementing a successful BRT project. In comparison to other mass transit options, BRT's relatively low capital and operational costs puts the systems within the reach of most cities, even relatively low-income developing cities. Some developing-nation cities have actually found that loans and outside financing are unnecessary. *Internal municipal and national funding* may be sufficient to fully finance all construction costs.

However, in the event some financing is required to implement the system, many local, national, and international resources are available to interested cities. At the local level, existing transport budgets, congestion charges, parking fees, petrol taxes, and vehicle ownership fees are all possibilities. Additionally, cities can generate revenue from property development around stations and corridors as well as from system advertising and merchandising. *Private sector lending and investment* may also be options to consider. Private-Public Partnerships (PPPs) typically involve private firms funding all or part of infrastructure development in exchange for exclusive, long-term operational concessions. While PPPs have a mixed record of both successes and problems, such investment schemes will likely increasingly be an option for cities to consider.

Finally, *international development banks* have been increasingly interested in supporting BRT projects. The World Bank has been particularly active in financing BRT initiatives.

Marketing

While marketing BRT as a new public transport option to the public is not an easy task, the public is also rarely satisfied with current transit service. The negative stigma of existing bus systems may be a formidable barrier to overcome in selling any bus-based concept, but it is also creates an opportunity to bring change. The marketing strategy will likely begin with the appropriate branding of the system through the *system's name and logo*. System names such as TransMilenio, TransJakarta, TransMetro, and Rapid have done much to create a new image for bus-based transport.

The marketing plan will also include a *media strategy* involving promotions and announcements placed in newspapers, magazines, community flyers, radio, and even television. This media strategy may not only promote the new system, but also highlight public dissatisfaction with the existing system. A *public education plan* helps to describe the BRT concept to the public and to explain how the specific system will work. Information kiosks, demonstration stations, and direct community outreach may be some of the tools utilised by a city to introduce the new system.

6. Evaluation and implementation

Evaluation

In many respects, the success or failure of a system can be apparent from public reactions to the system. The customer's opinion is perhaps the single most important measure. However, to obtain an objective and quantifiable indication of a system's overall performance, a defined *monitoring and evaluation plan* is fundamental. The feedback from such a plan can help identify system strengths as well as weaknesses requiring corrective action. Projected environmental and social impact analysis may also be an important step in securing financing from an international development bank.

On-going performance indicators, such as passenger satisfaction levels, ridership numbers, on-time performance, and average travel times, will help system developers judge the system's value as well as suggest areas for improvement. Information collection will likely involve both real-time quantitative data as well as qualitative inputs from surveys.

Additionally, the system's impact on the economy, the environment, and the city's social well-being will indicate BRT's overall value to the city and may be the determining factor if further system expansion is to occur. *Economic impacts* can include both direct and indirect employment, shop turnover and sales, and property values. *Environmental impacts* will include local air quality improvements (*i.e.*, CO, NO_x, PM, SO_x), greenhouse gas emission reductions, and noise level improvements. *Social impacts* will encompass social equity issues, social interactions, and crime levels.

Implementation plan

The production of a BRT plan is not the end objective of this process. Without implementation, the planning process is a rather meaningless exercise. The final stage of the planning process should be the formal preparation for construction and full implementation.

The *construction plan* will address not only the physical work to be completed but the procedures to ensure the minimal disruption to the functioning of the city. The closing of roadways, the construction noise, and the blowing dust can all give the new system a negative first



impression to the population. Thus, organising the construction work in a city-friendly manner should be a top consideration.

A *contracting plan* will help to ensure that the entire process of legal and concession agreements take place in an open, transparent, and competitive environment. Many different types of contractual arrangements will be developed as the implementation process unfolds. Some of the parties to be contracted include consultants, trunk-line operators, feeder operators, fare collection company, fiduciary company, and construction firms. These contracts will specify the activities to be undertaken, the expected final products, the duration of the activity, and the means for receiving compensation.

Fig. 7

The ultimate test of any public transport system is the happiness of the customer.

Photo courtesy of TransMilenio SA

Introduction

“By far the greatest and most admirable form of wisdom is that needed to plan and beautify cities and human communities.”

—Socrates, Greek philosopher and dramatist, 469–399 BC

Effective public transport is central to development. For the vast majority of developing city residents, public transport is the only practical means to access employment, education, and public services, especially when such services are beyond viable walking and cycling distances. Unfortunately, the current state of public transport services in developing cities often does little to serve the actual mobility needs of the

population. Bus services are too often unreliable, inconvenient and dangerous.

In response, transport planners and public officials have sometimes turned to extremely costly mass transit alternatives such as rail-based metros. Due to the high costs of rail infrastructure, cities often can only construct such systems over a few kilometres in a few limited corridors. The result is a system that does not meet the broader transport needs of the population. Nevertheless, the municipality ends up with a long-term debt that can affect investment in more pressing areas such as health, education, water, and sanitation. Moreover, the probable need to subsidise the relatively costly rail operations can place a continuing strain on municipal finances.



Fig. 8
Bogotá's TransMilenio system clearly illustrates the potential of BRT to provide a metro level of quality in mass transit through BRT.

Photo courtesy of Volvo Bus Corporation

However, there is an alternative between poor public transport service and high municipal debt. Bus Rapid Transit (BRT) can provide high-quality, metro-like transit service at a fraction of the cost of other options (Figure 8). This BRT Planning Guide provides municipal

officials, non-governmental organizations, consultants, and others with an introduction to the concept of BRT as well as a step-by-step process for successfully planning a BRT system.

This introductory section to BRT includes the following topics:

- i. Defining BRT
- ii. History of BRT
- iii. Public transport in developing cities
- iv. Overview of the BRT planning process

i. Defining Bus Rapid Transit

“Cities are an invention to maximise exchange opportunities and to minimise travel... The role of transport is to help maximise exchange.”

—David Engwicht, writer and activist (1999, p. 19)

What is BRT?

Bus Rapid Transit (BRT) is a high-quality bus-based transit system that delivers fast, comfortable, and cost-effective urban mobility through the provision of segregated right-of-way infrastructure, rapid and frequent operations, and excellence in marketing and customer service. BRT essentially emulates the performance and amenity characteristics of a modern rail-based transit system but at a fraction of the cost. A BRT system will typically cost 4 to 20 times less than a light rail transit (LRT) system and 10 to 100 times less than a metro system.

The term “BRT” has emerged from its application in North America and Europe. However, the same concept is also conveyed around the world through different names, including:

- High-Capacity Bus Systems;
- High-Quality Bus Systems;
- Metro-Bus;
- Surface Metro;
- Express Bus Systems; and
- Busway Systems.

While the terms may vary from country to country, the same basic premise is followed: A high quality, car-competitive public transport service at an affordable cost. For simplicity, the term “BRT” will be utilised in this document to generically describe these types of systems. However, it is recognised that the concept and the term will undoubtedly continue to evolve. Several previous documents have also contributed definitions for BRT. These include:

BRT is “a flexible, rubber-tired rapid-transit mode that combines stations, vehicles, services, running ways, and Intelligent Transportation System (ITS) elements into an integrated system with a strong positive identity that evokes a unique image.”

(Levinson *et al.*, 2003, p. 12)

“BRT is high-quality, customer-orientated transit that delivers fast, comfortable and cost-effective urban mobility.” (Wright, 2003, p. 1)

BRT is “a rapid mode of transportation that can combine the quality of rail transit and the flexibility of buses” (Thomas, 2001).

All of these definitions set BRT apart from conventional bus services. In fact, the definitions tend to suggest that BRT has far more in common with rail-based systems, especially in terms of operating performance and customer service. Rather than represent a lower-quality upstart to rail interests, BRT is actually a compliment to what many urban rail systems have achieved to date. BRT has attempted to take the aspects of LRT and metro systems most cherished by public transport customers and make these attributes more accessible to a wider range of cities. The main difference between BRT and urban rail systems is simply that BRT can usually provide high-quality public transport services at a cost most cities can afford.

Today, the BRT concept is becoming increasingly utilised by cities looking for cost-effective transit solutions. As new experiments in BRT emerge, the state of the art in BRT will undoubtedly continue to improve. Nevertheless, BRT’s customer focus will likely remain its defining characteristic. The developers of high-quality BRT systems in cities such as Bogotá, Brisbane, Curitiba, Ottawa, Guayaquil, and Rouen astutely observed that the ultimate objective was to swiftly, efficiently, and cost-effectively move people rather than cars.

Features of BRT

BRT can be defined more precisely through an analysis of the features offered by the system. While few systems have achieved status as a complete BRT system, the recognition of the key characteristics can be invaluable to system designers and developers. The following is a list of features found on some of the most successful BRT systems implemented to date:

1. Physical infrastructure

- Segregated busways or bus-only roadways (Figure 9), predominantly in the median of the roadway;
- Existence of an integrated “network” of routes and corridors;
- Enhanced stations that are convenient, comfortable, secure, and weather-protected;
- Stations provide level access between the platform and vehicle floor;



Fig. 9
Segregated median busway in Seoul.

Photo courtesy of the Seoul Development Institute



Fig. 10
At-level platforms provide rapid boarding and alighting in Quito.
Photo by Lloyd Wright



Fig. 11
High-technology vehicle on Eindhoven BRT corridor.
Photo courtesy of Advanced Public Transport Systems (APTS)



Fig. 12
Wheel-chair friendly boarding in Beijing.
Photo courtesy of Kangming Xu

- Special stations and terminals to facilitate easy physical integration between trunk routes, feeder services, and other mass transit systems (if applicable);
- Improvements to nearby public space.

2. Operations

- Frequent and rapid service between major origins and destinations;
- Ample capacity for passenger demand along corridors;
- Rapid boarding and alighting (Figure 10);
- Pre-board fare collection and fare verification;
- Fare-integration between routes, corridors, and feeder services.

3. Business and institutional structure

- Entry to system restricted to prescribed operators under a reformed business and administrative structure (*i.e.*, “closed system”);
- Competitively-bid and wholly-transparent processes for awarding all contracts and concessions;
- Efficient management resulting in the elimination or minimisation of public-sector subsidies towards system operations;
- Independently operated and managed fare collection system;
- Quality control oversight from an independent entity / agency.

4. Technology

- Low-emission vehicle technologies (Figure 11);
- Low-noise vehicle technologies;
- Automatic fare collection and fare verification technology;
- System management through centralised control centre, utilising applications of Intelligent Transportation Systems (ITS) such as automatic vehicle location;
- Signal priority or grade separation at intersections.

5. Marketing and customer service

- Distinctive marketing identity for system;
- Excellence in customer service and provision of key customer amenities;
- Ease of access between system and other urban mobility options (such as walking, bicycles, taxis, paratransit, private motorised vehicles, etc.);
- Special provisions to ease access for physically-disadvantaged groups, such as children, the elderly, and the physically disabled (Figure 12);
- Clear route maps, signage, and/or real-time information displays that are visibly placed within stations and/or vehicles.

In a similar manner, Levinson *et al.*, (2003, p. 13) put forward seven principal components of BRT: 1. Runways, 2. Stations, 3. Vehicles, 4. Services, 5. Route Structure, 6. Fare Collection, and 7. Intelligent Transportation Systems. To

Informal transit service	Conventional bus services	Basic busways	BRT-lite	BRT	Full BRT
<ul style="list-style-type: none"> ➢ Non-regulated operators ➢ Taxi-like services ➢ Poor customer service ➢ Relatively unsafe / insecure ➢ Very old, smaller vehicles 	<ul style="list-style-type: none"> ➢ Publicly or privately operated ➢ Often subsidised ➢ On-board fare collection ➢ Stops with posts or basic shelters ➢ Poor customer service ➢ Standard bus vehicles 	<ul style="list-style-type: none"> ➢ Segregated busway / single corridor services ➢ On-board fare collection ➢ Basic bus shelters ➢ Standard bus vehicles 	<ul style="list-style-type: none"> ➢ Some form of bus priority but not full segregated busways ➢ Improved travel times ➢ Higher quality shelters ➢ Clean vehicle technology ➢ Marketing identity 	<ul style="list-style-type: none"> ➢ Segregated busway ➢ Typically pre-board fare payment / verification ➢ Higher quality stations ➢ Clean vehicle technology ➢ Marketing identity 	<ul style="list-style-type: none"> ➢ Metro-quality service ➢ Integrated network of routes and corridors ➢ Closed, high-quality stations ➢ Pre-board fare collection / verification ➢ Frequent and rapid service ➢ Modern, clean vehicles ➢ Marketing identity ➢ Superior customer service

Fig. 13
The quality spectrum of tyre-based public transport.

qualify as a BRT system, each of these factors must be enhanced to quality levels well beyond those of conventional bus services.

Local circumstances will dictate the extent to which the above characteristics are actually utilised within a system. Small- and medium-sized cities may find that not all of these features are necessary or feasible to achieve within cost constraints. Nevertheless, serving customer needs first is a premise that all cities, regardless of local circumstances, should follow in developing a successful public transport service.

Full BRT and standard BRT

The difficulty in providing a precise definition of BRT stems from the wide-variety of systems currently in operation. Rather than representing a discrete set of qualities, the various BRT systems form more of a spectrum of possibilities (Figures 13 and 14). A range of local factors affect the extent to which a complete package of BRT attributes are achieved. These factors may include local preferences and culture, population density, distribution of trips, climate, geography, topography, available financial resources, local technical capacity and knowledge, existing business and institutional structures, and, perhaps

most importantly, the degree of existing political will to implement a high-quality system.

Determining what qualifies as BRT is also likely to be more than the sum of a system’s quantitative characteristics. Certainly system capacity, average vehicle speeds, and network size are key determinants in providing a high-quality service. However, it must also be recognised that many key characteristics of excellence in public transport services are at least partially qualitative in nature. These characteristics may include: ease of accessing system, comfort of stations and vehicles, sense of system safety and security, legibility and clarity of system maps and signs, friendliness of staff and drivers, wide-spread recognition of system name and image, and overall cleanliness and professionalism. There is clearly more to public transport than simply moving people about. A successful BRT system does not simply move persons from point A to point B. A successful BRT system invokes a feeling of confidence to its users, creates a sense of community pride, and helps to transform the very nature of a city’s urban form. To date, too few public transport systems have achieved this level of impact on its citizenry.

This Planning Guide will observe a tiered approach to defining the BRT concept. The

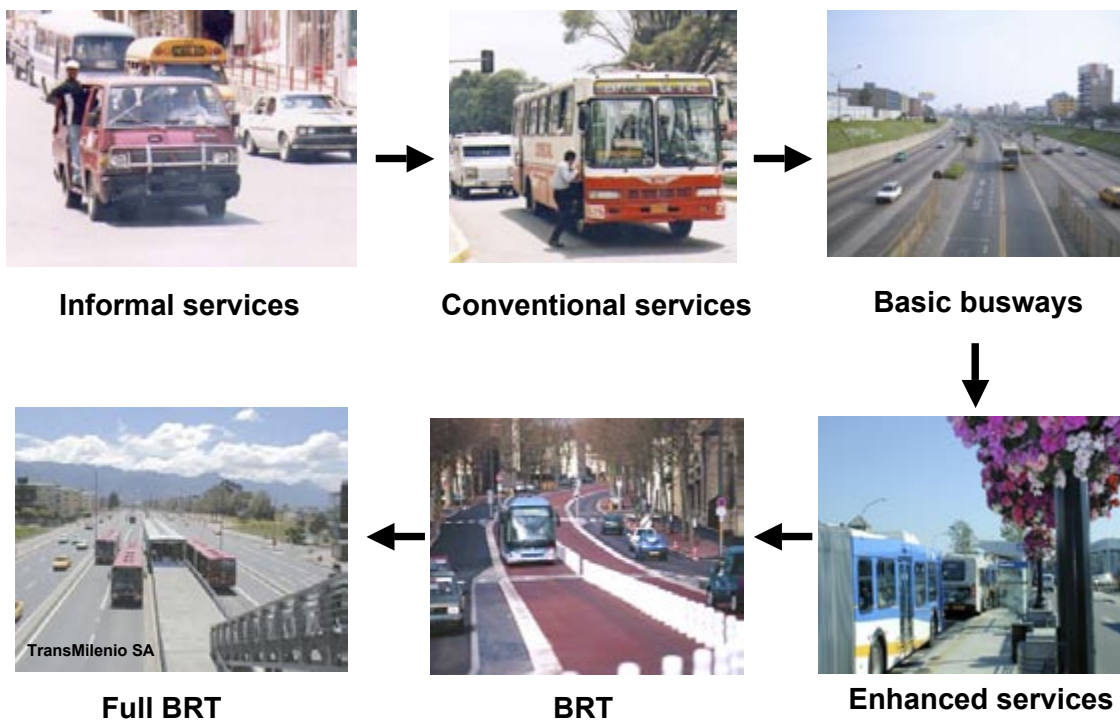


Fig. 14
Public transport evolution.

concept of “full BRT” will reside as the top tier. A system providing exemplary levels of public transport service and encompassing the most critical features of BRT will be recognised as achieving “full BRT” status. In this case, a “full” BRT system is defined as systems with the following minimum characteristics:

- Segregated busways or bus-only roadways over the majority of the length of the system’s trunk / city centre corridors;
- Location of the busways in the median of the roadway rather than in the curb lane;
- Existence of an integrated “network” of routes and corridors;
- Enhanced stations that are convenient, comfortable, secure, and weather-protected;
- Stations provide level access between the platform and vehicle floor;
- Special stations and terminals to facilitate physical integration between trunk routes, feeder services, and other mass transit systems (if applicable);
- Pre-board fare collection and fare verification;
- Fare- and physical-integration between routes, corridors, and feeder services;
- Entry to system restricted to prescribed operators under a reformed business and administrative structure (“closed system”);
- Distinctive marketing identity for system.

Based upon this strict definition, as of March 2007, there exists only two truly “full BRT” systems in the world:

- Bogotá (Colombia);
- Curitiba (Brazil).

This lack of a significant number of “full BRT” systems is in part due to the relatively recent nature of the BRT concept. It is also notable that “full BRT” has only occurred in the two cities with the highest levels of political commitment towards quality public transport.

Several existing systems, though, are quite close to being considered “full BRT” systems. The system in Goiânia (Brazil) just lacks the higher quality level of “full BRT”. If the multiple corridors in Quito (Ecuador) were combined into a seamless network, then this city too would likely qualify. If the systems in Brisbane (Australia) and Ottawa (Canada) eventually implemented off-board fare collection and fare verification, then these systems will certainly have all the qualities of “full BRT”. As the limited-corridor

systems in Guayaquil (Ecuador), León (Mexico), Mexico City (Mexico), and Pereira (Colombia) expand into complete networks, then these systems will also likely qualify. As Jakarta (Indonesia) makes its feeder services more fully integrated with its trunk services, then it too will be a full BRT system. Until such upgrades are made, though, all of these systems will remain under the general “BRT” heading.

In many ways, the idea of “full BRT” is similar to defining an “ideal” public transport service. However, the most appropriate type of system for a particular city is very much dependent on local circumstances. Thus, the concept of an “ideal” or “full” BRT system may not be the right solution for a given set of local conditions. The purpose of these BRT categorisations is merely to highlight differences between existing systems. These categorisations should not be construed as necessarily implying superiority of one BRT philosophy over another.

It is also recognised that the general “BRT” term is a fairly subjective notion, depending on the features chosen to define a system. For the purposes of this Planning Guide, the term “BRT” will be reserved to systems with the following characteristics:

- Segregated busways or bus-only roadways over the majority of the length of the system’s trunk / city centre corridors.

And, at least *two* of the following features:

- Existence of an integrated “network” of routes and corridors;
- Enhanced stations that are convenient, comfortable, secure, and weather-protected;
- Stations provide level access between the platform and vehicle floor;
- Location of the busways in the median of the roadway rather than in the curb lane;
- Pre-board fare collection and fare verification;
- Special stations and terminals to facilitate physical integration between trunk routes, feeder services, and other mass transit systems (if applicable);
- Fare-integration between routes, corridors, and feeder services;
- Entry to system restricted to prescribed operators under a reformed business and administrative structure (“closed system”);
- Distinctive marketing identity for system;

- Low-emission vehicle technologies (Euro III or higher);
- System management through centralised control centre, utilising ITS applications such as automatic vehicle location;
- Special physical provisions to ease access for physically-disadvantaged groups, such as children, the elderly, and the physically disabled;
- Clear route maps, signage, and/or real-time information displays that are visibly placed within stations and/or vehicles.

Table 1 provides a list of cities that currently qualify as possessing BRT systems.

In addition to these existing systems, there are numerous BRT projects both under construction and within the planning process. Many of these new systems may open as “full BRT” systems. Further, many existing BRT systems and busway systems are being extended and undergoing improvements, and these systems likewise may soon become “full BRT” systems (e.g., Jakarta and León). Tables 2 lists cities with BRT systems under construction.

In reality, there are currently more BRT systems under development than in existence. Again, this situation may say much about the significant recent upsurge in interest towards BRT systems. While such rapid expansion of BRT does pose difficulties in terms of ensuring the provision of quality technical support, the many cities involved means that there are multiple opportunities for experimentation and improvement to the existing notions of best practice. Table 3 lists cities with BRT systems in the process of being planned.

In addition to the new systems being developed as noted in Table 3, several of the existing BRT systems are in the process of extension and improvement. Table 4 therefore lists the existing systems that are currently undergoing major expansion.

As noted, the BRT concept invokes a range of both quantitative and qualitative attributes that together help to create a high-quality transit experience for the customer. Annex 1 of this document provides a comparative matrix of the many qualitative and quantitative attributes that define a BRT system. Similar type of information can also be found in several other publications including Menckhoff (2005), Levinson *et al.*, (2003), Rebelo (2003), and Mercielles (2000).

Table 1: Cities with BRT systems, as of March 2007

Continent	Country	Cities with BRT systems
Asia	China	Beijing, Hangzhou, Kunming
	India	Pune
	Indonesia	Jakarta (TransJakarta)
	Japan	Nagoya (Yurikamome Line)
	South Korea	Seoul
	Taiwan	Taipei
Europe	France	Caen (Twisto), Clermont Ferrand (Léo 2000), Lyon, Nancy (TVR line 1), Nantes (Line 4), Nice (Busway), Paris (RN305 busway, Mobilien, and Val de Marne busway), Rouen (TEOR), Toulouse (RN88)
	Netherlands	Amsterdam (Zuidtangent), Eindhoven, Utrecht
	UK	Bradford (Quality Bus), Crawley (Fastway), Edinburgh (Fastlink), Leeds (Superbus and Elite)
	Germany	Essen (O-Bahn)
Latin America and Caribbean	Brazil	Curitiba (Rede Integrada), Goiânia (METROBUS), Porto Alegre (EPTC), São Paulo (Interligado)
	Chile	Santiago (Transantiago)
	Colombia	Bogotá (TransMilenio), Pereira (Megabus)
	Ecuador	Quito (Trolé, Ecovía, Central Norte), Guayaquil (Metrovía)
	Guatemala	Guatemala City (Transmetro)
	Mexico	León (Optibus SIT), Mexico City (Metrobús)
North America	Canada	Ottawa (Transitway)
	United States	Boston (Silver Line Waterfront), Eugene (EmX), Los Angeles (Orange Line), Miami (South Miami-Dade Busway), Orlando (Lynx Lymmo), Pittsburgh (Busway)
Oceania	Australia	Adelaide (O-Bahn), Brisbane (Busway), Sydney (T-Ways)

Table 2: Cities with BRT systems under construction, as of March 2007

Continent	Country	Cities with systems under construction
Africa	Tanzania	Dar es Salaam
Asia	China	Jinan, Xi'an
Europe	France	Evry-Sénart, Douai, Clermont-Ferrand (Line 1 Lohr system)
	Italy	Bologna
Latin America and Caribbean	Colombia	Bucaramanga, Cali, Cartagena, Medellín
	Venezuela	Barquisimeto, Mérida (Trolmérida)
North America	United States	Cleveland
Oceania	Australia	Canberra
	New Zealand	Auckland (Northern Busway)

Table 3: Cities with BRT systems in the planning process, as of March 2007

Continent	Country	Cities with systems in the planning process
Africa	South Africa	Cape Town, Johannesburg, Port Elizabeth, Pretoria
	Other Africa	Accra (Ghana), Dakar (Senegal), Lagos (Nigeria)
Asia	China	Chengdu, Chongqing, Guangzhou, Shanghai, Shenyang, Shenzhen, Wuhan, Wuxi
	India	Ahmedabad, Bangalore, Delhi, Indore, Jaipur
	Taiwan	Chiayi, Kaohsiung, Taoyuan, Taichung, Tainan
	Other Asia	Bangkok (Thailand), Colombo (Sri Lanka), Haifa (Israel), Hanoi (Vietnam), Ho Chi Minh (Vietnam), Jerusalem (Israel)
Europe	France	Cannes, Montbéliard, Besançon, Lorient, Amiens, Metz, Nancy (Line 2), Caen (Line 2), Valenciennes/Pays de Condé, Nîmes, Le Havre
	UK	Cambridge, Coventry, Kent Thames-side, Leigh
Latin America and Caribbean	Colombia	Barranquilla, Soacha (Bogotá)
	Mexico	Aguas Calientes, Chihuahua, Guanajuato, Monterrey, Querétaro, Torreón, Zapopan
	Other Latin America and Caribbean	Lima (Peru), Managua (Nicaragua), Fort-de-France (Martinique, France), Posadas (Argentina), Rio de Janeiro (Brazil), San José (Costa Rica), Tegucigalpa (Honduras)
North America	Canada	Brampton, Calgary, Durham region, Edmonton, Mississauga, St. John, Toronto, Victoria, Winnipeg
	United States	Albany, Atlanta, Baton Rouge, Charlotte, Chicago, Denver, Detroit, El Paso, Fort Collins, Hartford, Houston, Louisville, Milwaukee, Minneapolis and St. Paul, Montgomery County, New York City, Reno, Sacramento, St. Petersburg, Salt Lake City, San Diego, San Francisco, San Jose, Seattle, South Brunswick, Tampa Bay
Oceania	Australia	Melbourne



Fig. 15
A rubber-tyred vehicle on an elevated track provides public transport services between the terminals of London Gatwick Airport.

Photo by Lloyd Wright

Table 4: Existing BRT systems undergoing expansions, as of March 2007

Continent	Country	Cities with BRT systems
Asia	China	Beijing
	Indonesia	Jakarta (TransJakarta)
	South Korea	Seoul
Europe	France	Paris (Mobilien)
Latin America and Caribbean	Brazil	Curitiba, Porto Alegre (EPTC), São Paulo (Interligado)
	Chile	Santiago (Transantiago)
	Colombia	Bogotá (TransMilenio)
	Ecuador	Quito (Trolé, Ecovía, Central Norte)
	Mexico	León (Optibus SIT), Mexico City (Metrobús)
North America	United States	Boston (Silver Line)
Oceania	Australia	Brisbane

There are also rubber-tyred, fixed guideway systems utilised at many airports, including Amsterdam Schipol, Frankfurt Airport, London Gatwick (Figure 15), Orlando Airport, and Osaka Kansai International. Depending on one’s definition of BRT, these systems could also be categorised as formal BRT systems. However, given the specialised nature of these systems, they are not treated as BRT in the context of this Planning Guide.

Basic busways

This Planning Guide will mostly concentrate upon systems meeting the described standards for “BRT” with the objective of promoting “full-BRT” systems. However, it is also recognised that there exists quality public transport systems which do not fully meet the definition of BRT. There are cities that have implemented basic “busway” corridors that, while do not meet the amenity and performance standards of BRT, have helped to improve travel times for residents. In many instances, these busway systems predated BRT and have contributed immensely to the development of the BRT concept. For example, the “Via Expresa” service in Lima (Peru) was a forerunner to many of the BRT systems in Latin America and elsewhere (Figure 16). Such services provide a basic level of service that at least provides priority to public transport vehicles, leading to potential savings in travel times.

In the United States, basic busways have been utilised along freeway corridors in order to provide rapid, express services from suburban areas into city centres. The lack of stops along these corridors has produced some of the highest recorded commercial speeds for bus service operations. In such examples, the median lanes of the freeway are given over to exclusive bus use. In other cases, these lanes are designated for “high-occupancy vehicle” (HOV) use only, and buses share the lanes with other multiple-passenger vehicles. Cities such as Los Angeles, New York, and Perth (Australia) all make use of some form of freeway priority measures of public transport. Table 5 provides a list of cities with basic busways services.

While these simple busways can result in improved travel times, they typically lack the other characteristics of BRT that are key to realising



Fig. 16
Lima's "Via Expresa" was a forerunner to the modern BRT system.

Photo by Dario Hidalgo

a high standard of customer service. In many instances, “open” busways, which allow all operators to enter, suffer from congestion with buses backing up near stations and intersections. Thus, many of the potential travel time benefits are effectively negated by inefficiencies.

The existence of a basic busway can help set the stage for later upgrades to BRT. Prior to the development of the TransMilenio system along Bogotá’s Caracas Avenue, the corridor featured a median busway. While the performance of this busway was poor due to uncontrolled



Fig. 17
Kunming is currently attempting to upgrade its basic busway into a BRT system.

Photo by Lloyd Wright

Table 5: Cities with basic busways, as of March 2007

Continent	Country	Cities with basic busways
Africa	Ivory Coast	Abidjan (Boulevard de la Republique)
	South Africa	Johannesburg (Soweto Highway)
Asia	China	Beijing (Qinghua Dong Road), Shejiazhuang, Shenyang
	Japan	Nagoya ("Key" Routes)
	Turkey	Ankara (Besevler-dikimevi), Istanbul (Taksim-Zincirlikuyu)
Europe	Belgium	Liege, Evry
	Italy	Genoa
	Spain	Madrid (Paseo de la Castellana)
	UK	Ipswich (Superoute 66), Runcorn
Latin America and Caribbean	Brazil	Belo Horizonte (Avenida Cristiano Machado), Campinas (Amoreiras), Manaus, Recife (Avenidas Caxangá, Joaquim Nabuco, Sul, and Herculano Bandeira), Rio de Janeiro (Avenida Brasil)
	Chile	Santiago (Avenida Grecia)
	Peru	Lima (Paseo de la República or "Via Expresa", Avenida Abancay, and Avenida Brasil)
	Trinidad and Tobago	Port of Spain
North America	United States	Los Angeles (San Bernardino Freeway, Harbor Freeway), New York City (Lincoln Tunnel), Philadelphia (Ardmore busway), Providence (East Side bus tunnel)
Oceania	Australia	Perth (Kwinana Freeway)

Fig. 18 and 19
While corridors such as the Los Angeles Metro Rapid service on Wilshire Boulevard (left photo) or the Vancouver

B-Line (right photo) may not be "full" BRT systems, they do represent an improvement for users.

Photos courtesy of the National Bus Rapid Transit Institute (NBRTI)

operations and severe congestion, the existence of the infrastructure set a precedent from which the new system could evolve. In a similar manner, the Kunming busway system is currently undergoing an upgrade towards BRT status (Figure 17). Thus, in many instances, busways may represent an early stage of development towards the realisation of a BRT system.

Enhanced bus services

In addition to busways, there exists another category of bus services that deserves special notice. This Planning Guide has made a segregated busway a requirement in order for a system to be labelled as a BRT system. However, there are several systems that possess many of the other qualities of BRT but do not have a significant busway component. In some instances, these systems may utilise bus lanes or even run amongst mixed traffic. These type of systems will be termed "Enhanced Bus Services". Some authors also refer to such systems as "BRT Lite". Most of these "Enhanced Bus Services" are found in developed nations, especially in Europe and North America. In the context of cities with low public transport usage and low-density development, the difficulty in procuring exclusive right-of-way for public transport vehicles can be significant.

Nevertheless, systems in Europe, North America, and elsewhere have added BRT-like enhancements to conventional bus services, and in the process, have achieved marked improvements in travel times and patronage (Figures 18 and 19). Such "Enhanced Bus Services" include systems in the cities of Hong Kong, Boston



(US), Las Vegas (US), London, Los Angeles, Oakland-San Pablo (US), Vancouver (Canada), and York (Canada). Table 6 provides a listing of some of the systems regarded as “Enhanced Bus Services”.

London’s bus network serves 5.4 million passenger trips each day, far exceeding the city’s underground metro system. London is one of the few cities in the world in which bus ridership has consistently risen over the past ten years (Figure 20). London’s success has been predicated upon four broad goals of service quality: 1. Frequency (“turn up and go” service with waits of 12 minutes or less); 2. Reliability (enforced bus lanes); 3. Comprehensiveness; and 4. Simplicity. To accomplish these goals, London has

Box 1: Bus lanes or busways

Bus lanes and busways are quite different in design and effectiveness. While some well-demarcated and well-enforced bus lane systems in developed nations have succeeded (e.g., London), in general, bus lanes alone, particularly those situated in the curb lane, do little to enhance the effectiveness of public transport. Bus lanes are street surfaces reserved primarily for public transport vehicles on a permanent basis or on a specific hourly schedule. Bus lanes are not physically segregated from other lanes. While the lanes may be painted, demarcated, and sign-posted, changing lanes is still feasible. In some cases, bus lanes may be shared with high-occupancy vehicles, taxis, and/or non-motorised vehicles. Bus lanes may also be open to private vehicle usage near turning points.

Busways are physically segregated lanes that are permanently and exclusively for the use of public transport vehicles. Entrance to a busway can only undertaken at specific points. The busway is segregated from other traffic by means of a wall, curbing, cones, or other well-defined structural feature. Non-transit vehicles are generally not permitted access to a busway although emergency vehicles often also may utilise the lane. Busways may be at surface level, elevated, or underground, but if located on a mixed traffic arterial tend to be in the median of the roadway. BRT systems typically consist of busway infrastructure.

Table 6: Cities with Enhanced Bus Services (“BRT-Lite”), as of Jan. 2007

Continent	Country	Cities with enhanced bus services
Asia	China	Hong Kong
Europe	UK	London
	Italy	Trieste
	Netherlands	Almere
Latin American and Caribbean	Puerto Rico (US Commonwealth)	San Juan (Río Hondo Connector)
North America	United States	Alameda and Contra Counties (AC Transit Rapid Bus), Albuquerque (Rapid Ride), Boston (Silver Line Washington Street), Chicago (NEBR), Denver (16th Street Mall), Honolulu (City / County Express), Kansas City (MAX), Las Vegas (MAX), Los Angeles (Metro Rapid Wilshire Boulevard), Phoenix (RAPID), Santa Clara (VTA)
	Canada	Gatineau, Halifax, Quebec City (Metrobus), Montreal (STM R-Bus 505), Vancouver (B-Line), York (Viva)

implemented many BRT-type features within a conventional bus service:

- Accessible low-floor vehicles for fast boarding and alighting;
- Pre-board fare collection in central areas;
- Real-time information displays at stations;
- Quality incentive contracts with concessioned operators;
- Enhanced driver training;
- Priority lane measures.



Fig. 20
London's use of camera-enforced bus lanes and off-board fare payment has improved system performance considerably.

Photo by Lloyd Wright

While London has not strictly implemented busways, the frequent use of well-demarcated and enforced bus lanes has helped to increase average speeds and overall reliability. Hong Kong has achieved many of the same successes as London with priority bus lanes, integrated fare structures with other mass transit options, incentive-based contracts with concessioned operators, and higher-quality vehicles.

AC Transit's "Rapid Bus" in the San Francisco Bay Area and the "Viva" service in York have set high standards in terms of customer service and performance. Both the AC Transit "Rapid Bus" and the York "Viva" systems utilise innovations such as queue-jumper lanes and signal priority at intersections to give to transit vehicles priority over other traffic. The Viva system has also installed fare machines at stations to facilitate pre-board fare collection. Thus, these systems have done much to replicate many of the features of BRT but in situations where segregated busways are not yet possible.

Likewise, the new MAX system in Las Vegas utilises the Civis vehicles that were originally popularised in French systems. Las Vegas has attempted to employ an optical guidance system for docking vehicles at the system's modernistic stations.

As many of these enhanced systems exemplify, whether a system is termed "BRT" or not may be less relevant than the quality of the service provided and the degree to which continual improvement is achieved. Most conventional bus services can be upgraded substantially by considering some of the low-cost customer service enhancements that are evident in BRT systems. Further, in many instances, these "Enhanced Bus Services" may well be upgraded to BRT status with the later addition of exclusive busways. The second phase of the York Viva system calls for the development of exclusive busways.

However, there are limitations to the extent that technology-based solutions alone will create a high-quality public transport service. Many of the enhanced bus services, especially in the US, rely upon expensive vehicle technology alone to create a new system image. New vehicles, though, will do little to encourage new ridership if other changes, such as priority access, are not

also addressed. High technology is not a substitute for the political leadership required to give a clear priority to public transport. Enhanced bus services must thus avoid the risk of placing flair over substance in terms of providing real value to the customer.

What BRT is not

BRT has little in common with conventional bus services. For much of the world, conventional bus services are slow, infrequent and inconvenient, uncomfortable, and distinctly lacking in status and service. Systems invoking small, cosmetic changes to conventional services are unlikely to reap the benefits witnessed in the best BRT systems to date. Bus services carry a long-standing negative stigma regarding poor operational performance and inadequate customer service. "Public transport" often brings with it the same connotation of unpleasantness as "public toilets" can. Overcoming this negative image requires a complete revamping of every aspect of service and operational performance. The "BRT" banner should not be expropriated to systems that make only a marginal effort towards performance improvement.

BRT should also not be confused with "bus lanes". In many cities, a lack of enforcement has rendered bus lanes to be grossly ineffective (Figures 21 and 22), particularly when located in the curb lane. In such instances, bus lanes are a token gesture to public transport customers, and have made only a small difference in service quality. Box 1 discusses the differences between busways and bus lanes in more detail.

Temporary parking by taxis and delivery vehicles can do much to degrade the usefulness of the bus lane. In such cases, buses will likely just cease to make use of the lanes (Figures 23 and 24).

In other instances, bus lanes have been regularly enforced and do provide a discernible service improvement. For example, the colour coding and camera enforcement of the London bus lanes have served to maximise the usefulness of the lanes. However, due to the unavoidable conflicts from turning vehicles and limitations in narrow street configurations, even well-managed bus lanes will unlikely ever match the efficiency of a full busway. Further, enforcement by traffic police can wane with time and new political ad-



Fig. 21 ▲
A “bus-only” street in San José (Costa Rica) is invaded by private vehicles.

Photo by Lloyd Wright

ministrations. The bus lanes in Bangkok worked reasonably well when first introduced in 1973, but in a short time the traffic police decided not to enforce private vehicle intrusions and thereby rendered the scheme ineffective.

ii. History of BRT

“If you want to make an apple pie from scratch, you must first create the universe.”

—Carl Sagan, scientist and writer, 1934–1996

The predecessors to BRT

BRT’s history resides in a variety of previous efforts to improve the public transport experience for the customer. While the modern era of BRT development is credited to the opening of Curitiba’s system in 1974, there were several efforts prior to Curitiba that helped to establish the idea. Further, BRT has also benefited greatly from applications of high-quality urban rail systems. In many respects, BRT has borrowed concepts from light rail and metro rail systems in order to provide a quality customer experience but at a lower cost than traditional rail systems.

The origins of the BRT concept can be traced back to 1937 when the city of Chicago outlined plans for three inner city rail lines to be converted to express bus corridors. Exclusive



Fig. 22 ▲
The view from the front of a Mexico City bus travelling in a “bus-only” lane.

Photo by Lee Schipper



Fig. 23 ◀ and 24 ▼
In cities diverse as Sydney (left photo) and São Paulo (photo below), the intent of bus lanes are thwarted by constant invasions from delivery vehicles, taxis, and other obstructions.

Left photo courtesy of Todd Litman; Right photo by Lloyd Wright



busway plans were developed for several other cities in the US, including: Washington, DC (1955-1959), St. Louis (1959), and Milwaukee (1970) (Levinson *et al.*, 2003).

However, actual implementation of bus priority measures did not occur until the 1960s with the introduction of the “bus lane” concept. In 1963, counter-flow express bus lanes were introduced in the New York City area. A year later, in 1964, the first “with-flow” bus lane was implemented in Paris.

In 1966, the first dedicated median busways appeared in the US (in St. Louis) and in Belgium (in Liege) as a result of converting tram systems to bus use. The first high-speed busway was constructed in the United States in 1969 with the opening of the first 6.5-kilometre section of the Shirley Highway Busway in Northern Virginia (Figure 25). In 1971, the city of Runcorn (UK) opened a busway corridor which also acted as a catalyst for new town development.

The first developing-nation busway was developed in Lima (Peru) with the 1972 introduction of a basic, dedicated busway known as “Via Expresa”. The Via Expresa covers a distance of 7.5 kilometres, and still provides an effective, albeit basic, service to the area. The arrival of the first “bus-only” street was also in 1972 with the conversion of London’s Oxford Street from

a major traffic route to a bus-and-taxi only street. One year later in 1973, the 11-kilometre El Monte busway was developed in Los Angeles (Figure 26).

Modern BRT systems

“When you have little money, you learn to be creative.”

—Jaime Lerner, former Mayor of Curitiba

BRT’s full promise was not realised, though, until the arrival of the “surface metro” system developed in Curitiba (Brazil) (Figure 27). The first 20-kilometres of Curitiba’s system was planned in 1972, built in 1973, and opened for service in 1974. In conjunction with Curitiba’s other advancements with pedestrian zones, green space, and innovative social programmes, the city became a renowned urban success story across the world. Ironically, Curitiba initially aspired to constructing a rail-based metro system. However, a lack of sufficient funding necessitated a more creative approach. Thus, under the leadership of Mayor Jaime Lerner, the city began a process of developing busway corridors emanating from the city centre. Like many Latin American cities at the time, Curitiba was experiencing rapid population growth. Beginning at a level of some 600,000 residents in the early 1970s, the city now has over 2.2 million inhabitants.

In much of Latin America, private sector operators had dominated the public transport market. However, left uncontrolled and unregulated such operators did not meet the needs of commuters in terms of comfort, convenience, or safety. Lacking the resources to develop either a rail-based transit system or a car-based urban form, Mayor Lerner’s team created a low-cost yet high-quality alternative utilising bus technology. Today, Curitiba’s modernistic “tubed” stations and 270-passenger bi-articulated buses represent a world example. The BRT system now has five radial corridors emanating from the city core. Construction of a sixth corridor is now underway through funding provided by the Inter-American Development Bank (IADB). Currently, the Curitiba system features 65 kilometres of exclusive busways and 340 kilometres of feeder services. The system annually attracts hundreds of city officials from other

Fig. 25

The Shirley Highway busway in Arlington (US) was amongst the first median busway efforts.

Image courtesy of the US TCRP Media Library.



Fig. 26

An advertisement attempting to lure motorists out of their cars for the El Monte busway in Los Angeles.

Image courtesy of US TCRP media library.



municipalities, all seeking to study the organisational and design features that have shaped Curitiba's success. The success of Curitiba's BRT system has propelled the career of Jaime Lerner, the political backer of the original concept, as he has been twice elected as Mayor and twice elected as Governor of the state of Paraná in Brazil.

The oil crisis of the early seventies put pressure on many governments to find quick ways to improve public transport. Thus, the 1970s represented a relative flurry of activity regarding early busways. The potential for busways to encourage public transport usage was recognised in the United States through reports by the National Cooperative Highway Research Program (NCHRP) in 1973 and 1975. These reports highlighted the benefits of bus use on highways as a form of rapid commuting. Likewise, the publication in 1976 of busway design guidelines by the Paris transit operator, Régie Autonome des Transports Parisiens (RATP), helped to propel busway interest in France. With Curitiba serving as example, several other Brazilian cities followed this model with basic systems being deployed in São Paulo (1975), Goiânia (1976), Porto Alegre (1977), and Belo Horizonte (1981) (Meirelles, 2000). The São Paulo BRT system is currently the largest in the world with 142 kilometres of exclusive busways serving over two million passenger-trips each day.

With the development of these early systems, the World Bank also came to recognise the potential of busways through its 1975 urban transport policy paper. Subsequently the World Bank went on to finance the first busway in Africa (in Abidjan, Ivory Coast) in 1977. The city of Pittsburgh (United States) also opened its first busway in 1977.



Fig. 27

Under the leadership of former-Mayor Jaime Lerner, Curitiba became a world leader in effective public transport.

Photo courtesy of Volvo Bus Corporation

Despite Curitiba's success and relative fame within the transport planning profession, the overall replication of the BRT concept stalled over the next decade. As the first oil crisis receded, governmental interest with public transport began to wane. At the same time, short-sighted private bus operators, enjoying stable or increasing ridership, resisted BRT system developments for fear of losing the benefits of minimal taxation and weak regulation. Nevertheless, the 1980s did see the advent of the first "guided busways". As an alternative to a planned light rail system, the city of Essen (Germany) opened its guided system in 1980 (Figure 28). This innovation uses side guide wheels to control



Fig. 28 ◀◀

In 1980, Essen became the first system using a mechanical guidance system.

Photo courtesy of the TCRP Media Library

Fig. 29 ◀

Quito's "Trole" line provided an early example of BRT in Latin America.

Photo by Lloyd Wright



Fig. 30
The BRT systems in Rouen (photo above) and other cities of France have introduced many new features, especially high-technology vehicles and guidance systems.
 Image courtesy of Connex

Fig. 31
In just a few years time, Bogotá planned and constructed the first phase of its world-leading BRT system.
 Photo courtesy of TransMilenio SA



vehicle movement within a track roughly the width of a bus. Adelaide (Australia) followed with a guided busway of its own in 1986. Eventually, the guideway concept did make it to a few other cities, including the UK cities of Ipswich (1995), Leeds (1995), and Bradford (2002) as well as the Japanese city of Nagoya (2002). However, due to the relatively high cost of the guided busway infrastructure, the concept has seen relatively little further adoption.

It was only in the late 1990s that BRT's profile became more widely known. By the late 1990s, many bus operators in Latin America faced a crisis of declining ridership due to competition from private motor vehicles and informal sector

minibuses, and this moderated the resistance to change. In 1996, Quito (Ecuador) opened a BRT system using electric trolley-bus technology (Figure 29). Quito then added its "Ecovía" corridor in 2001 and its "Central Norte" corridor in 2005. Beyond Latin America, the 1990s saw the first interest in BRT in Asia. In 1999, Kunming developed the first median busway system in China. Taipei (Taiwan) also has developed a median busway system with the first put into place in 2001. Likewise, renewed interest from developed-nation cities also sparked in the late 1990s with new systems being implemented in Vancouver (Canada) in 1996, Miami (US) in 1997, and Brisbane (Australia) in 2000.

In France during the late 1990s, innovations in vehicle technology produced a blurring of the distinction between BRT and light rail. Vehicles such as the Civis by Irisbus and the TVR (Transport sur Voie Reservée) by Bombardier have utilised a rounded body and covered wheels to produce a highly-sophisticated product. The systems in Caen (2002), Clermont-Ferrand (2001), Lyon (2004), Nancy (2001), and Rouen (2000) have utilised these types of vehicles (Figure 30). The "TEOR" BRT system in Rouen is particularly sophisticated through the use of an optical guidance system.

The Bogotá transformation

Even by the 1990s, though, BRT was not seen as a serious mass transit option capable of full rail-like service. BRT was more of a niche market for small- and medium-sized cities (e.g., Curitiba) or as a lower-quality alternative for a few isolated corridors (e.g., São Paulo). Transport engineers widely believed that BRT could not comfortably serve more than 12,000 passengers per direction per hour per lane at any reasonable speed. However, the advent of the "TransMilenio" BRT system in Bogotá has now radically transformed the perception of BRT around the world (Figure 31). As a large-sized city (7.0 million inhabitants) and a relatively dense city (240 inhabitants per hectare), Bogotá has provided the proof that BRT is capable of delivering high-capacity performance for the world's megacities.

The main ingredient in Bogotá was a visionary Mayor, Enrique Peñalosa, who recognised that

the timely delivery of a quality mass transit network could not be achieved through expensive rail technologies. Instead, Mayor Peñalosa and his team examined the experiences of cities like Curitiba, Goiânia, and Quito, and concluded that BRT could work for Bogotá as well. In the course of just a few short years, the first phase of Bogotá's TransMilenio system came to fruition with a launch in December 2000. As of March 2007, the TransMilenio system encompasses 84 kilometres of trunk corridors and 420 kilometres of feeder routes. At this time, the system is moving over 1.2 million passenger-trips per day. By the time the entire system is completed in 2015, an estimated five million passenger-trips per day will be served over a trunk network of 380 kilometres.

Simultaneously, Bogotá has implemented many complementary measures that support public transport usage. These measures include 300 kilometres of new cycleways, pedestrian and public space upgrades, a Sunday closing of 120 kilometres of roadway to private motorised vehicles (Figure 32), and the world's largest car-free weekday. Additionally, Bogotá has implemented car restriction measures through parking restrictions and a programme that only permits peak-hour vehicle use on certain days, based on one's license plate number.

Today, with both Bogotá and Curitiba acting as catalytic examples, the number of cities with actual BRT systems or with systems under development is quite significant. Most new BRT systems owe a direct lineage to the experiences of these two cities.

The influence of the Curitiba experience has directly assisted the launching of BRT initiatives in other cities, such as Seoul (2004) and Beijing (2005). Further, in 1998, the Administrator of the United States Federal Transit Agency (USFTA), Gordon Linton, visited the Curitiba BRT system. Based on the findings of this visit, a national BRT initiative was launched in the United States. For many US cities, the combination of high automobile ownership and low-density sprawl development has made the development of rail systems difficult from a standpoint of financial viability. Today, the US BRT programme of the USFTA encompasses 17 demonstration/partner cities. In November



Fig. 32
Bogotá hosts a range of innovative transport and public space measures, including a closing of streets to car traffic on Sundays.

Photo by Lloyd Wright

2005, the 17-kilometre Orange Line opened in Los Angeles. Further, three high-quality BRT systems are being constructed, in Eugene, Cleveland, and Las Vegas. The extent to which these new systems can encourage mode switching from cars to public transport will determine how successful BRT can be in the context of car-dependent nations such as the US.

Like Curitiba, Bogotá's influence has been felt far and wide across the globe. Since TransMilenio's inception in 2000, Bogotá has hosted both major public transport conferences as well as specialised technical missions from a range of

Fig. 33

Over 1,000 transport professionals from more than 30 countries have travelled to Bogotá to experience the TransMilenio system.

Photo courtesy of Fundación Ciudad Humana



cities (Figure 33). In part due to visits to Bogotá, the following cities have undertaken BRT efforts: Barranquilla, Bucaramanga, Cali, Cartagena, Guatemala City, Guayaquil, Juarez, Lima, Managua, Medellín, Mexico City, Panama City, Pereira, Querétaro, San José, Santiago, Soacha, Accra, Dar es Salaam, Delhi, Guangzhou, and Jakarta. Clearly, a few highly successful efforts, such as Bogotá and Curitiba, can have profound ramifications around the globe.

iii. Public transport in developing cities

“The newly motorising countries can see what a mess the North has made and how inefficient are its very large investments in a transport system that fails to deliver health, social equity and regional equity. It is possible for a newly motorising country to leapfrog the last 40 years of European and the last 70 years of North American transport development and move directly into a sustainable strategy that genuinely conserves resources, reduces pollution and pays great attention to the poorest when disbursing scarce cash.”

—John Whitelegg, author and lecturer, (1997, p. 220)

For much of the world’s population, public transport is a necessary evil that must be endured rather than appreciated. For many individuals and families, the ultimate goal is to one day afford individual motorised transport, either in the form of a motorcycle or automobile. The state of public transport implies discomfort, long waits, risk to personal safety, and restrictions on movement. Customer satisfaction with the myriad of informal and formal vans, mini-

buses, and full-sized buses that ply developing city streets is typically extremely low.

Under such conditions, it is not surprising that such services are losing passengers at alarming rates. The private vehicle continues to make gains in virtually every city. If present trends continue, public transport may have a rather doubtful future. As incomes rise in developing nations, private vehicles are gaining usage while public transport’s ridership is almost universally declining. A selection of developing cities indicates that public transit systems are typically losing in the area of between 0.3 and 1.2 percentage points of ridership each year (Table 7) (WBCSD, 2001).

The reasons for public transport’s demise are not difficult to discern (Figures 34 through 37). Poor public transport services in both the developed and developing world push consumers to private vehicle options. The attraction of the private car and motorcycle is both in terms of performance and image. Public transport customers typically give the following reasons for switching to private vehicles:

1. Inconvenience in terms of location of stations and frequency of service;
2. Failure to service key origins and destinations;
3. Fear of crime at stations and within buses;
4. Lack of safety in terms of driver ability and the road-worthiness of buses;
5. Service is much slower than private vehicles, especially when buses make frequent stops;
6. Overloading of vehicles makes ride uncomfortable;
7. Public transport can be relatively expensive for some developing-nation households;

Table 7: Changes over time in daily average public transport trips, selected cities (includes bus, rail, and paratransit)

City	Earlier Year				Later Year			
	Year	Population (million)	Public Transport Trips/day	Percent of all Trips	Year	Population (million)	Public Transport Trips/day	Percent of all Trips
Mexico	1984	17.0	0.9	80	1994	22.0	1.2	72
Moscow	1990	8.6	2.8	87	1997	8.6	2.8	83
Santiago	1977	4.1	1.0	70	1991	5.5	0.9	56
Sao Paolo	1977	10.3	1.0	46	1997	16.8	0.6	33
Seoul	1970	5.5		67	1992	11.0	1.5	61
Shanghai	1986	13.0	0.4	24	1995	15.6	0.3	15
Warsaw	1987	1.6	1.3	80	1998	1.6	1.2	53

Source: WBCSD, 2001



Fig. 34, 35, 36, and 37
Public transport options in today's developing-nation cities are often quite poor (photos clockwise from top left):

1. *Dar es Salaam*

(photo by Lloyd Wright)

2. *Dhaka*

(photo by Karl Fjellstrom)

3. *Manila*

(photo by Lloyd Wright)

and

4. *Santo Domingo*

(photo by Lloyd Wright)

8. Poor-quality or non-existent infrastructure (e.g., lack of shelters, unclean vehicles);
9. Lack of an organised system structure and accompanying maps and information make the systems difficult to understand; and
10. Low status of public public transport services.

However, the demise in public transport is not pre-ordained. BRT is public transport's response to this decline, with an attempt to provide a car-competitive service. Recent BRT experience demonstrates that it is possible to ensure urban mobility which is independent from ever-increasing car congestion, thereby generating considerable economic and environmental benefit.

With the introduction of the TransMilenio BRT system in Bogotá, public transit ridership has actually increased in that city. Although the system had only opened two of its 22 planned lines in December 2000, the system achieved an immediate 6 percent of transport mode share. Private vehicle usage declined from 18 percent of daily trips in 1999 to 14 percent in 2001 (Como Vamos Bogotá, 2001). A more detailed study along the TransMilenio corridor indicates that the system captured nearly 10 percent of trips that would have been otherwise

undertaken by private vehicle. (Steer Davies Gleave, 2003). Curitiba's BRT system witnessed a similar increase when initially opened, and was able to increase ridership by over 2 percent a year for over two decades, enough to maintain the public transport mode share when every other Brazilian city was witnessing significant declines.

BRT attempts to address each of the identified deficiencies in current services by providing a rapid, high quality, safe and secure public transport option.

iv. Overview of the BRT planning process

"Plans are nothing; planning is everything."

—Dwight D. Eisenhower,
former US President, 1890–1969

This BRT Planning Guide seeks to help build the institutional and technical capacity of developing city municipalities that are interested in achieving improved public transport services. This section provides an overview of the structure and contents of a BRT plan. While these planning elements have been extracted from some existing BRT plans, it must be recognised that planning practices vary greatly by location

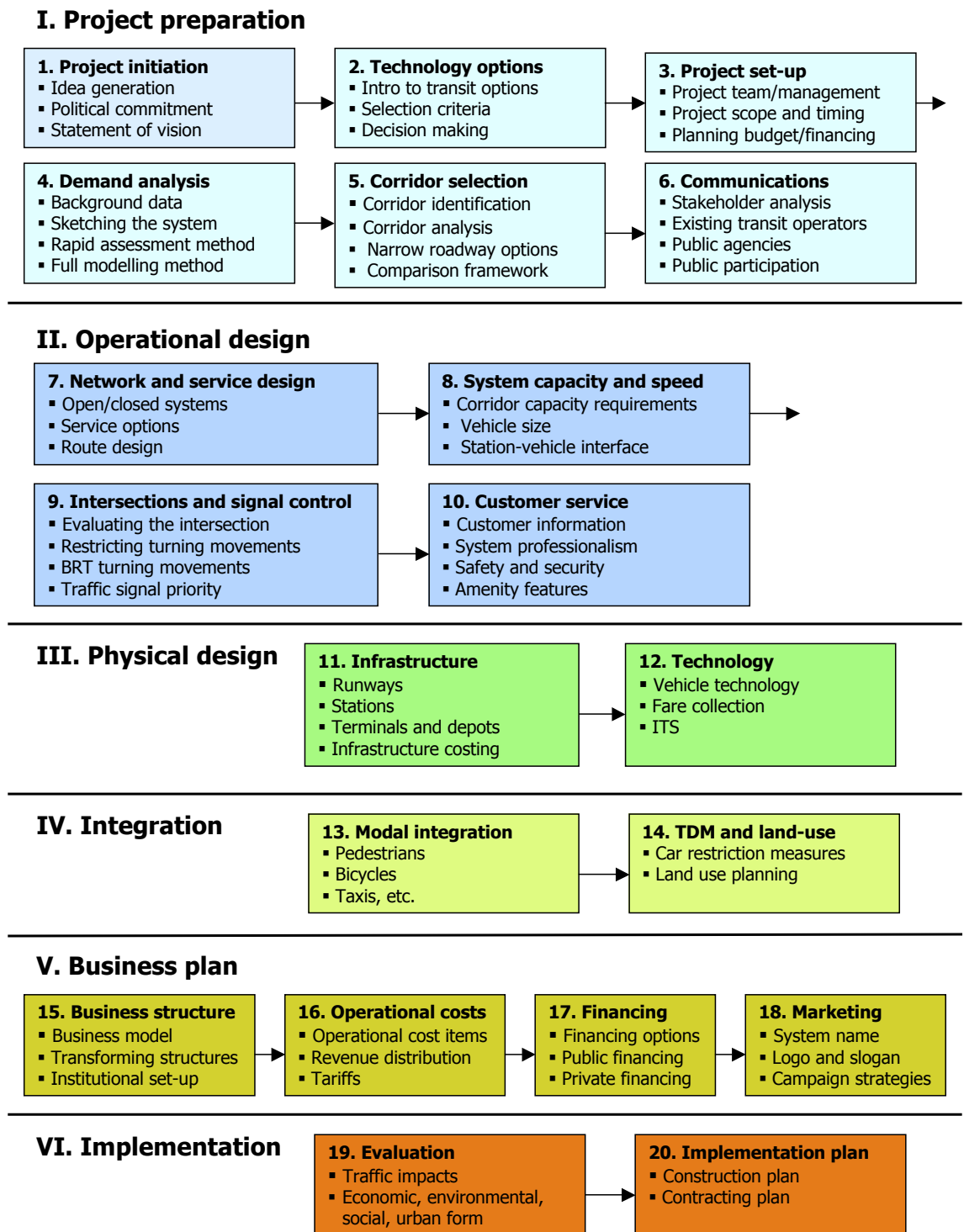
and circumstances. Thus, actual BRT plans in a particular city may necessitate other elements which are not discussed in this Planning Guide.

Outline of the planning process

The exact nature of any city's BRT plan depends greatly on local circumstances. Most plans are a combination of rational analysis and advocacy

for a particular set of solutions and interventions. Frequently a "pre-feasibility" study is largely an advocacy tool to give the public and decision-makers a general idea of what BRT might look like in their city as they consider various options, while a feasibility study would be a more serious analysis of the viability of BRT once a preliminary decision has been

Fig. 38
Overview of the BRT
planning process



made. The less secure the political commitment, the more important the plan is as an advocacy tool. The stronger the political commitment, the more urgent is the need for the planners to provide accurate information to decision-makers about how to implement the project successfully in a timely manner.

Promoters of BRT must enter into whatever planning process exists in a particular city. The content and order of the planning process may be partly determined by code and law. In some cities transportation master plans are powerful legal documents, in other cases they are a meaningless compendium of various projects being pushed by different promoters, and in other cases there is no transportation master plan. Some cities and financial institutions may require a detailed “cost-benefit analysis” before public funds can be expended; others may have entirely ad hoc off-budget mechanisms for financing major projects.

Ideally, a BRT plan should grow out of an earlier transportation master planning process, which in turn grew out of an integrated urban development plan. The transportation planning process should start with an analysis of the level of existing and projected future transport demand in all major corridors, and should then proceed to an analysis of alternatives for addressing these mobility and access needs with the greatest benefit and the least cost, within the constraints of available resources. Ideally, this process should be done with extensive stakeholder participation throughout.

In very few cities, however, is the transportation planning process ideal. Objective, rational assessment of alternatives is the exception rather than the rule. In many developing country cities, BRT was largely unknown until recently, so having BRT emerge out of a rational transportation master planning process was unlikely. Furthermore, most transportation plans are developed as the result of support from the promoters of a specific public transport technology. Resources for an objective analysis of alternatives are rarely available. As a general rule, though, proponents of BRT would benefit from a wholly transparent and rational planning process.

If several competing mass transit proposals are already in active discussion, it will be insufficient

to merely prepare a basic appraisal of the potential feasibility of BRT. A realistic estimate of BRT ridership and modal shift potential will need to be coupled with a thorough analysis of the alternatives presented, including an analysis of the soundness of the data and the methodologies used. In the developed world there is a formal certification process that is emerging for such proposals, but in the developing world the proposals of project proponents are rarely subjected to rigorous scrutiny.

Most of the planning information presented in this guide will be most useful once decision makers have already decided that a BRT project should go forward. However, the following chapter on transport technology aims to assist with a rough assessment of likely alternative proposals.

An overview of the entire BRT planning process is provided in Figure 38. This planning template is based upon BRT planning documents from several cities. Not all cities need to follow this process, but it is hoped that the planning template will help reduce the amount of time required to move from the conceptual phase through to implementation. The sharing of BRT planning documents from other cities also presents an opportunity to greatly reduce planning costs. A focused BRT planning process can be reasonably completed in a period of 12 to 18 months.

Figure 38 identifies five major activities in the realisation of a BRT plan:

1. Project preparation;
2. Operational design;
3. Physical design;
4. Integration;
4. Business plan;
5. Evaluation and implementation.

This guidebook will detail the content of each of these planning activities.

The planning stages outlined in this guide are presented in roughly chronological order. However, BRT planning is an iterative process. There is significant interaction between the different stages, and many activities must be undertaken simultaneously. For instance, the financial analysis should influence infrastructure and technology decisions, and routing decisions should impact busway design options. In this sense, each topic should be addressed in

Table 8: Constituent planning components

Planning component	Description
Pre-feasibility study	Early study to document options for improving the city’s public transport conditions.
Feasibility study	The feasibility study attempts to prove the financial, institutional, and physical viability of a particular transit option; this stage frequently involves a “cost-benefit analysis”.
Transport demand modelling	Existing transport demand is documented on the major city corridors of interest.
Stakeholder analysis and communications plan	At the outset, a communications plan for key stakeholders such as existing transit operators should be conducted.
Conceptual study <ul style="list-style-type: none"> • Operations • Infrastructure • Modal integration • Technology • Business and institutional structure • Costing and financing • Impact analysis 	The conceptual plan is a rapid overview of each major planning component. The idea is to quickly cover each aspect of the plan in order to gain a general sense of the project prior to committing further planning resources.
Detailed BRT plan <ul style="list-style-type: none"> • Operations • Infrastructure • Modal integration • Technology • Costing 	The core of the BRT planning process consists of the design and technical specification process. Likewise, detailing the business and institutional structures, along with detailed cost analyses, is key to ensuring the system’s financial viability.
Business and institutional plan	This plan establishes the structural relationship between the public and private sectors. The business plan helps to ensure that the system is financially viable from an operational standpoint.
Detailed engineering design	Once the body of the BRT plan is approved, then a highly detailed analysis of each physical component is conducted; every metre of busway infrastructure is designed in detail.
Financing plan	As a complete cost analysis is completed, the exact financing requirements become known and can be fully addressed.
Marketing plan	The marketing plan involves developing the system’s name, logo, and outreach campaign.
Impact analyses	Once the final technical plan is approved, more precise analyses of traffic, economic, environmental, social, and urban impacts can be undertaken.
Implementation plan	As the project moves toward implementation, construction contracts and timelines must be developed.

an iterative manner. Different scenarios may be attempted until an optimum solution is reached.

Proper planning brings with it an array of well-proven benefits, including reduced costs, increased efficiency in system delivery, and greater confidence in the form and nature of the final product. However, a point can be reached where additional planning can be counter-productive. If a city explores all alternatives, technologies, alignments, contractual mechanisms, and design issues, the resulting delay may mean that a new system will never be realised. With any political administration, there is but a brief window of opportunity to lead a project to actual implementation. A high-quality, thorough investigation that merely results in a non-implemented study is a failure. Thus, one of the most important recommendations is to plan with a bias towards implementation, with an eye towards spelling out the key decisions that the Mayor or Governor must make and in what time frame, rather than planning for the absolutely ideal solution.

BRT planning components

"Would you tell me which way I ought to go from here?" asked Alice.

"That depends a good deal on where you want to get," said the Cat.

"I really don't care where" replied Alice.

"Then it doesn't much matter which way you go," said the Cat.

(Alice’s Adventures in Wonderland, 1865)

—Lewis Carroll, novelist and poet, 1832–1898

In reality, the idea of a “BRT plan” is a misnomer. There are likely to be multiple plans that each addresses a particular aspect of the project. The term “BRT plan” is used as an over-arching concept representing the compendium of all these individual planning components. Table 8 lists some of the most common planning components within an overall BRT plan.

Pre-feasibility study

The pre-feasibility work is frequently conducted for cities in the exploratory phase of assessing public transport improvement options. The pre-feasibility study may thus only include BRT as one of many different public transport options. In many cases, groups initiating the pre-

feasibility work will orientate the study contents towards obtaining eventual political support for a public transport improvement initiative.

The pre-feasibility period may include some of the following types of activities:

- Identification of major transit corridors;
- Summary of previous demand figures and mass transit studies;
- Rough estimates of potential benefits of a new transit system (impacts on traffic, economy, environment, social equity, and urban form);
- Missions and technical visits to existing systems in other cities;
- Production of simulation videos or models to show how a new system may look in the local context.

Thus, the pre-feasibility stage typically does not involve a great deal of design or analytic work. However, the outcome will likely determine whether a transit improvement project gains political momentum.

Feasibility study

In many instances, a feasibility study may be required to justify the expenditure of public funds on the project. A cost-benefit analysis is one of the principal tools used to justify the use of public funds. Clearly, though, to conduct such an analysis, more detail on the potential transit project must be known. Some of the factors that will require determination include:

- Approximate size of project (*e.g.*, length of transit corridors);
- Projected passenger demand using the new system;
- Initial cost estimates;
- Estimates of economic savings from system (time savings, reduction of petrol use, emission reductions and health benefits, etc.).

Clearly, the determination of these factors will require a certain amount of analysis and investigation. However, the feasibility study is not an in-depth BRT plan. Instead, approximate estimations are utilised to produce reasonably accurate results to help the decision-making process. The objective of the feasibility study is to determine if a project is warranted under the local conditions.

The feasibility work may also involve analysis of a variety of alternative public transport options,

including enhanced bus services, BRT, light rail transit (LRT), and elevated / underground rail metro technology. Each technological option is tested to the local operational conditions, design needs, and financing capacity. While some cities may restrict the analysis to a single public transport option, testing all options through a rigorous comparative process may provoke the type of competition resulting in the most appropriate choice. It is no accident that project developers almost always deliver a verdict of “feasible” for the particular technology being proposed. Personal biases and financial incentives can deliver a feasibility study that is less than completely objective and transparent. Ultimately, allowing such biases undermines the credibility of the public transport project, regardless of its merits. An honest and open process is the best way to instil long-term confidence in the project and ensure that public funds are used in the most appropriate manner.

A full BRT plan, by contrast, should include all the information necessary to successfully implement the system.

Transport demand modelling

The projection of passenger demand figures will affect a range of system sizing decisions. Chapter 4 of this document outlines different techniques for determining passenger demand, including both full modelling and other more economical techniques.

Stakeholder and communications plan

A new mass transit system implies a number of dramatic changes, including changes to the form of a city, the competitiveness of the local economy, and the structure of transit operations and employment. For many, any such dramatic change is viewed with concern or even outright opposition. Developing a communications strategy for key groups, such as existing transit operators, car owners, and government agencies, is fundamental to ensuring an informed decision-making process. Chapter 6 discusses the nature of an effective communications strategy for a BRT project.

Conceptual study

Public transport planning is more often an iterative process rather than a linear, step-by-step

Fig. 39

The conceptual phase involves providing an overall vision of the future system.

Illustration courtesy of Lane Transit District (Eugene, US)



procedure. Committing extensive planning resources to detailed design prior to establishing the basic conceptual outline can result in needless and costly duplication of efforts. If a city was to only proceed sequentially, then it is possible a great deal of detailed work may have to later be re-done when it is determined the situation dictates a different approach. For example, a costing analysis may prove that initial design characteristics are inconsistent with the expected budget. Answering basic questions about the nature of the system can do much to focus the subsequent analysis and planning. Thus, the development of a conceptual study is a highly cost-effective early activity.

Decisions made on these types of items will help to shape the detailed planning process as well as inform all parties of the effort required to produce the full plan. The conceptual study will also help give political officials a better perspective on the direction of the project. In some instances, the results of the conceptual study may define the contents of the “Terms of Reference” for consulting contracts related to the plan’s development.

The conceptual study will likely be completed in a matter of just a few months. It is essentially a rapid overview of the entire planning process. However, a conceptual study can provide sufficient detail to allow political and technical decision-makers the ability to make big picture decisions on system size, costs, business structure, and features. Some of the initial issues

that are often raised during the conceptual phase include:

- Most likely corridors for mass transit operations;
- Best corridors for an initial project phase;
- Trunk-feeder services or direct services;
- Targeted service frequency;
- Targeted tariff levels for customers;
- Potential business and administrative structures for system;
- Estimates of expected capital costs;
- Estimates of expected operating costs;
- Understanding of potential financing sources;
- Level of cooperation expected from private sector operators;
- Listing of all major stakeholder groups, organisations, and individuals;
- Potential design characteristics (stations, busways, terminals, vehicles, fare collection systems, etc.).

The issues raised in the overview study should be seen as initial concepts and not immovable decisions that are forever fixed. Clearly, later circumstances and new information may well necessitate in alterations from the earlier decisions noted in the conceptual study. However, the conceptual study is a worthwhile head start on the overall project.

Detailed BRT plan

The detailed BRT plan is the principal focus of this Planning Guide. Over the course of one year or more, all aspects of project development

are thoroughly covered within a detailed BRT plan. Chapters 7–14 of this Planning Guide provide more detail on the nature of the detailed BRT plan as well as the many design options available to city officials. This portion of the planning encompasses operational design, physical design, and integration with other transport modes.

Business and institutional plan

Finding the right balance of roles for both the public sector and the private sector greatly affects the long-term financial and operational viability of the system. This plan establishes the structural and contractual nature of the relationship between the public and private sectors. A detailed examination of expected operational costs will help determine whether the estimated customer demand and tariff levels can produce a system without the need for operational subsidies. Much of the effort in the business plan is to devise the right set of incentives to ensure private sector operators are motivated to provide a quality level of service to the customer. Chapters 15 through 18 of this Planning Guide discuss different aspects of the Business Plan.

Detailed engineering design

Once all physical aspects of the BRT plan are determined, the detailed engineering work can commence. Utilising specialised software design tools, the engineering team will design in detail each physical aspect of the system. In some instances, each distinct metre of the busway infrastructure will receive its own design treatment. The detailed engineering design will later be used as the basis of bid documents for different infrastructure components.

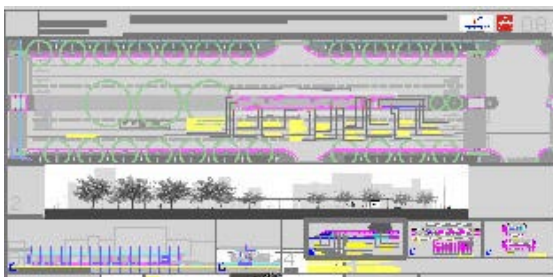


Fig. 40

The detail engineering design will involve designing and mapping every infrastructure component.

Graphic courtesy of the Municipality of Barranquilla (Colombia)

Financing plan

As the details of the physical design requirements become known, cost analyses will indicate the amount of capital required for system construction. Unlike other public transport technology options, BRT is reasonably affordable to most cities. Nevertheless, some cities may look to outside financing sources as an option to consider. Chapter 17 of this Planning Guide outlines the variety of financing options available to cities interested in developing a BRT system.

Marketing plan

Perhaps one of the most important decisions in a system's development is the name and marketing image of the system. The right promotional strategy will greatly influence the public's perception of the system and the ultimate level acceptance and ridership. Chapter 18 of this Planning Guide discusses different BRT marketing strategies.

Impact analysis

At the outset of the project, developers likely estimated the system's impact on the economy, traffic levels, environment, social equity, and urban development. Once the system is fully planned, it is worthwhile to revisit these estimates. A more accurate set of impact projections is possible once all design and planning components are completed. A detailed impact analysis will give decision-makers the confidence to fully commit to system construction. Further, once a system is operational, an evaluation plan is useful for assessing the system's performance and for identifying areas of improvement. Chapters 19 discusses issues related impact analysis and project evaluation.

Implementation plan

The principal objective of any transit planning process is not to merely to produce a plan. Rather, the extensive planning effort should be focussed upon delivering an actual system. In order to prepare for the construction process, an implementation plan encompassing timelines, construction plans, and contracting procedures should be developed. Chapter 20 of this Planning Guide outlines the typical steps in an implementation plan.

Part I – Project Preparation

CHAPTER 1



Project initiation

CHAPTER 2



Public transport technologies

CHAPTER 3



Project set-up

CHAPTER 4



Demand analysis

CHAPTER 5



Corridor selection

CHAPTER 6



Communications

1. Project initiation

“Never doubt that a small group of thoughtful, committed citizens can change the world. Indeed it is the only thing that ever has.”

—Margaret Mead, anthropologist, 1901–1978

Despite the existence of a few exceptional examples in the world today, a transformation of public transport conditions is a relatively rare event. Such events do not magically arrive in a city. Catalysing public and political will towards changing existing public transport conditions is perhaps the most important activity discussed in this Planning Guide. Strong political will underscored by strong public desire for an improved public transport system is a combina-

tion for a rapid and successful project. Without either of these factors, it is unlikely a project will survive the myriad of challenges posed by special interest groups opposed to the new endeavour. With both political will and public support, it is unlikely a successful new vision can be stopped.

This chapter outlines a few mechanisms to help groups interested in catalysing a project to improve a city’s urban transport system. This chapter also cites examples of how some cities have achieved political commitment for a project and how that support has been translated into a wider vision for a transformation of public transport operations. The topics discussed in this chapter are:

- 1.1 Project catalyst
- 1.2 Political commitment
- 1.3 Statement of vision
- 1.4 Barriers to transit improvement
- 1.5 Benefits

1.1 Project catalyst

“To accomplish great things, we must not only act but also dream. Not only plan but also believe.”

—Anatole France, writer, 1844–1924

Before a customer boards a new system, before a new line is constructed, and before a plan is developed, a person or a group of persons must decide that action is required to improve a city’s public transport system. The inspiration may come from a private sector operator, a civil servant, a political official, a civic organisation, or even just a concerned citizen. Nevertheless, without someone acting as a catalyst, a city’s public transport potential will likely go unrealised.

The inspiration for a new public transport vision may stem from reading about alternatives, seeing a photo, visiting other cities, or a person simply asking “what if”. In many cases, the catalyst may unfortunately originate from the dire conditions of public transport in much of the world today. As public transport conditions descend to depths of poor customer service, extreme levels of discomfort and insecurity, and

official neglect, the issue can become a principal topic of public discourse. In too many cases, corrective actions are only undertaken once conditions become truly unbearable.

Because most top officials do not generally utilise public transport, the difficult conditions can be removed from the current political

Fig. 1.1
The Los Angeles Bus Riders Union has proven that people power can catalyse more progressive policies.

Photo courtesy of the Bus Riders Union



agenda. Instead, the impetus may fall upon public transport users and citizen groups who are closer to the day-to-day realities. In some instances, public transport users have formed

their own organisations to demand improved conditions. In Los Angeles, the Bus Riders Union has successfully launched several campaigns to convince decision makers to expand

Box 1.1: BRT support organisations

A few of the organisations involved in BRT development are described below.

Institute for Transportation & Development Policy (ITDP)

ITDP is a US-based NGO that has worked on sustainable transport issues in developing nations for over 20 years. ITDP has lent direct technical assistance to several cities seeking to develop BRT systems, including the cities of Accra, Cape Town, Dakar, Dar es Salaam, Delhi, Guangzhou, Jakarta, Managua, and Quito. ITDP often enters cities at an early stage to help build the political confidence to proceed with an actual project.
<http://www.itdp.org>



Energy Foundation (EF)

EF is a partnership of major donors interested in solving the world's energy problems. EF has been particularly involved in promoting BRT efforts in China, and has established a BRT resource centre in Beijing. Through EF's efforts, BRT projects are completed or underway in several cities including Beijing, Chengdu, and Hangzhou.
<http://www.efchina.org>



World Resources Institute (EMBARQ)

The EMBARQ programme of the WRI has sought to support BRT efforts in several targeted cities including Shanghai, Mexico City, and Porto Alegre. With funding from the Shell Foundation, EMBARQ forms partnerships with local organisations and helps devise sustainable transport strategies.
<http://www.embarq.wri.org>



GTZ Sustainable Urban Transport Project (SUTP)

GTZ's SUTP promotes sustainable transport through information dissemination, especially by way of the "Sustainable Transport Sourcebook". GTZ has been particularly instrumental in providing a BRT training course to various cities. The course allows cities to build BRT capacity as well as initiate thought on local design options.
<http://www.sutp.org> and <http://www.sutp.cn>



Clean Air Initiative for Asian Cities (CAI-Asia)

The Clean Air Initiative for Asian Cities (CAI-Asia) works to improve the air quality of Asian cities. In December 2005, CAI-Asia launched a US\$5 million programme called Sustainable Urban Mobility in Asia, which will promote sustainable transport initiatives, such as BRT. SUMA is supported through funding from the Swedish International Development Agency (Sida), the Asian Development Bank (ADB), and others.
<http://www.cleanairnet.org/caiasia>



bus priority lanes as well as to modernise the vehicle fleet (Figure 1.1)

In other instances, environmental organisations have led the charge due to the unsustainable nature of existing conditions, especially when private vehicle usage begins to overwhelm a city's streets and greatly harm the area's air quality. Box 1.1 notes a few of the organisations that have worked to improve urban transport conditions in the cities of developing countries.

In a similar manner, groups affected by deteriorating urban conditions, such as physicians, air quality professionals, tourism specialists, and police, may also play a contributing role in propagating the need for change. Additionally, university researchers and staff can provide the technical evidence of the costs of existing conditions as well as be the source of new ideas. In Delhi (India), staff from the Indian Institute of Technology have been leading the way with the city's new BRT system.

Likewise, the existing conditions for drivers, conductors, and transport owners may stimulate a search for a better model. In many instances, the private sector interests delivering public transport services in developing-nation cities struggle to make a living. Through awareness of successful models in cities such as Bogotá and Curitiba, private operators can see that forming an integrated network and providing a higher level of service can indeed lead to greater profit. Thus, the inspiration for change may well be initiated from the private sector.

The news media may also play a prominent role in raising awareness on existing conditions. Articles, images, and film of poor-performing public transport services can help to coalesce public opinion around the need for change. Further, articles and video on the successes in other cities may stimulate many to ask why the same could not be done in their own city.

Finally, international organisations can play a vital role in facilitating information sharing between projects as well as facilitating direct financial and technical assistance to cities. Such organisations can help to share experiences, raise awareness amongst local groups, and build the local capacity for a new project to take hold. International non-governmental organisations such as the Institute for Transportation & Devel-



opment Policy (ITDP), the Embarq programme of the World Resources Institute (WRI), and the Energy Foundation have been instrumental in providing cities with both the inspiration for change and the tools to achieve it (Figure 1.2).

The international private sector is also now playing an increasing role in raising awareness of mass transit options. For example, Volvo is now partnering with municipalities in nations such as India to build the capacity for options such as BRT (Hindu Business Line, 2006). While clearly private firms have their own commercial incentives for favouring one technology over another, these firms help can help to put forward ideas within the context of a competitive marketplace.

Bi-lateral agencies such as the German Technical Cooperation (GTZ), the Swedish International Development Agency (Sida), and the United States Agency for International Development (USAID) all have helped to facilitate public transport initiatives in developing-nation cities.

International funding organisations such as the Global Environment Facility (GEF) and the Hewlett Foundation likewise are key catalysts in this process. Further, international financing organisations such as the World Bank and the regional development banks not only help to financially support projects but often work to raise awareness and provide supportive guidance.

Additionally, international organisations such as the Clean Air Initiative (CAI), the United Nations Centre for Regional Development (UNCRD), the United Nations Development

Fig. 1.2
The Energy Foundation helps build BRT capacity in China through seminars and outreach.

Photo by Lloyd Wright

Programme (UNDP), and the United Nations Environment Programme (UNEP) have also provided assistance to cities on sustainable transport issues. Municipalities thus have a plethora of international resources at their disposal to undertake a public transport improvement initiative. In many cases, it is merely a matter of contacting the right individuals to make such co-operation available.

From the concerned individual to a local civic organisation to universities and the news media and to international groups, there are a range of parties able to spark change towards improved urban transport. Any city can take advantage of these linkages to catalyse change. However, to date, most cities have not taken such a transformative step. While the gulf between problem recognition to construction of a modern mass transit system seems quite daunting, particularly to developing-nation cities, this chasm can be overcome with the array of resources now available to cities. Very often, it requires just one individual to provide the initial spark.

1.2 Political commitment

“I have never learned to tune a lute or play upon a harp, but I can take a small and obscure city and raise it to greatness.”

—Themistocles, Athenian statesman, 525–460 BC

Ultimately, though, a project concept must enter the political mainstream in order to move towards official development. A leading politi-

cal official must make a strong commitment to overhauling the city’s public transport system. Political will and commitment are probably the most critical and fundamental components in making a new system a reality. Outside groups can certainly help to create the right conditions for project consideration, but as a public good, public transport requires political support to become a reality.

While almost all political officials will claim to hold strong political will and commitment to public transport, the reality is often quite different. Is an official willing to give priority road space to public transport over private vehicles? Will the official risk upsetting powerful lobbying groups such as existing transit operators and private motorists? Will the official seek out the best technical help they can find, and the best financial resources to make a project happen? Convincing officials to say yes to each of these questions is the basis of establishing project commitment. “Political will” are just words until backed up by tangible evidence of a serious intent to fully implement a project.

1.2.1 Political officials

“In Spanish we have this saying that it doesn't cost anything to dream. So I say let's play. Let's just imagine how you want your home to be. How you want your kids to live. Do you want to walk or drive to get bread? That's the basis of thinking about cities. We have not given



Fig. 1.3 and 1.4

Former Mayors who transformed their cities with BRT:

1. *Enrique Peñalosa of Bogotá (left photo); and*
2. *Jaime Lerner of Curitiba (photo above).*

Left photo courtesy of Por el País que Queremos (PPQ);
Right photo courtesy of the Jaime Lerner Foundation

enough thought to how we live. We have left too many of these decisions to others."

—Enrique Peñalosa, former Mayor of Bogotá

The creation of a political environment suitable to introducing a new mass transit system can depend upon many factors. There is no set amount of time required or set series of events. In the case of cities such as Bogotá and Curitiba, the election of dynamic mayors who entered office with a new vision was the determining factor. Both former Mayor Enrique Peñalosa of Bogotá and former Mayor Jaime Lerner of Curitiba came to office with a strong intent to improve public space and transport (Figures 1.3 and 1.4). They also possessed a base knowledge on these topics and brought with them highly trained professionals as their core staff. In such instances, the progression towards system planning happens almost immediately.

In other instances, a long period of persuasion and information gathering will precede the commitment. Naturally, the more senior the political figure leading the cause, the more likely the official's influence can lead to action. Thus, mayors and governors are the logical targets for gaining political support. In many cases, as in Jakarta and Dar es Salaam, key local politicians can quickly realize that BRT can help them politically, because it can show results within their administration. In some developing cities, support from national ministry officials may also be necessary for project approval. The role of national officials may be particularly required in capital cities.

In many instances, a mayor or governor will lack the necessary background on transport or urban planning issues. It requires confidence to grapple with a wide-spread transformation of the public transport system. In such cases, building the trust of the decision maker and giving them the necessary confidence to implement such a seemingly far-reaching proposal will be key. Political officials will be averse to risk with key constituencies, such as car owners and transit operators, unless the issue is a core part of their platform.

Further, mayors and governors are busy individuals juggling an array of issues and interests. The amount of time these officials can devote to a studied consideration of a public transport

transformation is limited. For this reason, it may be more effective to target the top advisors of the mayor or governor. Such individuals may be able to give the idea greater attention, and then subsequently they would be in a position to make a trusted recommendation to the top political official.

However, even in the absence of support at the highest levels, a strategy to begin influencing officials at lower levels may still merit effort. Fortunately, there are many other starting points within the city's political and institutional environment. Deputy mayors, deputy governors, and councillors are also relevant positions from which a project can be launched. Amongst such officials it may be more likely to find a specialist with a background in transportation, environmental issues, urban planning, or other related fields. In such cases, the learning curve will likely be less.

Another useful starting point can be unelected officials holding key positions within municipal institutions. Directors and staff within departments of planning, public works, environment, health, and transportation all will likely play a role in any eventual project. Without the support of such officials and staff, institutional inertia can delay and weaken implementation. Further, these officials often have a direct relationship with top elected officials. During their daily or weekly briefings with elected officials, technical staff can prompt a discussion of public transport options. A concept being supported by both citizen's groups and departmental directors will stand a better chance of approval by a mayor than a project being pursued by just one outside group.

The best strategy is actually to approach all relevant officials, both elected and unelected, who may be influential on public transport. Even if an official is unlikely to become an overt supporter of a mass transit initiative, eliminating the threat of overt opposition is equally important. Thus, an initial pre-emptory session with the potential opposition can be vital to reducing any strongly-negative repercussions. Much care must be given to the manner in which the issue is presented to any given audience. In fact, the key points to be stressed will likely vary from one official to another given their different starting points and initial understanding of mass transit options.

One common and rather unfortunate complication is the existence of opposing political parties in key positions overseeing the project. For example, if the local government control is held by one political party while the regional or national government is held by another party, then cooperation may be lacking in making the project a reality. The lack of cooperation between national and local officials has delayed implementation of the Bangkok BRT project. While local government will typically have direct implementation responsibility, approval from the national government could be required for either budgetary or legal reasons.

The duration of the political administration's time in office is also another key factor to consider. If a mayor or governor has only a short time remaining prior to an election, then such officials may be reluctant to embark upon any bold initiative. The risk of alienating any potential voting groups can over-ride any political boost that a project announcement could entail. Further, once an incumbent takes a strongly favourable position on a mass transit option, this position may imply an equal and opposite reaction from the opposition candidates.

For these reasons, catching a political official at the earliest stages of their time in office provides the best chance for achieving commitment to implementation. Often, a major selling point for mayors and governors of an option such as BRT is that it can be built easily within a single term of office, helping to establish the politician's

career. It may also be effective to introduce mass transit options even prior to officials taking office. Providing information to staff within the major political parties can be a worthwhile investment of time and effort. Identifying potential future leaders and establishing a mentoring relationship with them can be equally useful.

1.2.2 Awareness raising mechanisms

“Nobody made a greater mistake than he who did nothing because he could only do a little.”

—Edmund Burke, philosopher, 1729–1797

There are several different mechanisms available to help alert political officials to the potential of different public transport improvement options. These mechanisms include:

- Site visits to successful public transport systems;
- Tour of own city's existing public transport services;
- Visits from successful Mayors;
- Basic information provision on options;
- Videos on public transport improvement examples;
- Simulation video of a potential system in the particular city;
- Physical models of public transport options;
- Pre-feasibility study.

These various mechanisms are not mutually exclusive, as several different information techniques can be combined to build a case on the need for change. Frequently, all it takes to generate political interest is to provide fairly basic information to mayors and other decision makers.

In most cases, however, firm political resolve only comes after the chief decision maker visits a successful system like Bogotá or Curitiba to see it and understand it for themselves. “Seeing is believing” is completely true in the case of BRT and other effective public transport options. Usually the decision makers are also accompanied by senior technical staff that will be responsible for implementing the project. Members of the city's media as well as existing public transport operators may also participate in the visit. By speaking directly with technical staff and political officials in cities with existing systems, perspective system developers can understand the possibilities in their own cities (Figure 1.5). Experiencing a high-quality system in a relatively low-income city such as Guayaquil

Fig. 1.5
International visitors gain many insights by speaking with TransMilenio technical staff in Bogotá.

Photo by Lloyd Wright



also shows city officials that a system is possible regardless of local economic conditions. In many instances, the process to develop a new public transport system can seem quite overwhelming at the outset. Seeing systems in practice and walking through the development process can do much to dispel uncertainties and fears. At the same time, care should be exercised not to give the wrong impression that project implementation is always easy, fast, and problem free.

Surprisingly, political officials and even municipal technical staff can be relatively unfamiliar with public transport in their own city. Given the background and income levels of such persons, many will utilise their own private vehicle for transport. In the case of top elected officials, their only view of daily transport issues may be from the back of a chauffeur-driven luxury vehicle (Figure 1.6). Thus, public transport systems are frequently conceptualised and designed by individuals with relatively little actual familiarity with the daily realities of transit travel.

Organising a tour of the public transport conditions in an official's own city can be an eye-opening experience for the official. In cities such as Bogotá, Delhi, Johannesburg, and São Paulo officials have either made a point to regularly utilise public transport and/or have required



Fig. 1.6

The only perspective many decision makers have on transport is based on a chauffeur driven ride to work each day.

Photo by Lloyd Wright

staff to use public transport for certain periods of time (Figures 1.7 and 1.8).

Testimonials from one political official to another may sometimes be appropriate. Visits to cities by prominent former mayors such as Enrique Peñalosa and Jaime Lerner have been sponsored by international organisations to help catalyse local actions. Showing how mayors and governors who delivered high-quality systems have tended to win subsequent elections can also be quite motivating to local officials.

Advances with information and communications technologies (ICT) have put the power of sophisticated visual and software tools in the hands of most municipalities. Visual renderings of stations, vehicles, and runways can do much to excite political officials over the possibilities (Figure 1.9). Videos on high-quality public transport systems in cities such as Bogotá,

Fig. 1.7 and 1.8

Leading political officials such as former Mayor Enrique Peñalosa of Bogota (photo below) and South African Minister of Transport, Jeff Radebe, make a special effort to experience public transport for themselves.

Left photo courtesy of PPQ.

Right photo courtesy of the South African Ministry of Transport





Fig. 1.9
A rendering of the proposed BRT system in Dar es Salaam, using a combination of digital photography and graphic design software.

Image courtesy of Luc Nadal and ITDP

Brisbane, and Curitiba provide an accurate visual display of the options to decision makers. Likewise, the digital video technology is now available to simulate how a new system would actually operate in a city of interest. Being able to “virtually ride” the new system at an early stage in the planning process cannot only work to stimulate political commitment but it can also help planning staff with design considerations. In a similar manner, small models of vehicles, stations, and runways all help to give political officials a hands-on feel with the possibilities (Figure 1.10).



As noted in the Introduction to this Planning Guide, a pre-feasibility study is also an effective mechanism to build initial interest towards public transport improvement. The pre-feasibility work can include the identification of major corridors for mass transit development, early estimates of potential benefits (economic, environmental, social, etc.), and approximations of expected costs. This work will be of a fairly superficial level but will at least give decision makers a degree of confidence in a possible project direction. The faster and more compelling this early vision of the new system, the easier it will be for decision makers to build the necessary political commitment to move forward. This early vision will be needed to persuade the public and interested parties to support the project, and to guide the information gathering process.

The techniques to achieving project commitment are varied, and can depend greatly upon the local context, but the principal aim is to get the chief decision maker to make a public commitment to implement a major transformation of the public transport system, and to create a sense of expectation amongst the public.

1.3 Statement of vision

“If you want to build a ship don’t drum up the men to fetch the wood, allocate the jobs and divide the work, but teach them the yearning for the wide open sea.”

—Antoine de Saint-Exupéry, writer and aviator, 1900–1944

As has been stressed, political leadership is probably the single most important factor in realising a successful public transport project. Without such leadership, the project will not likely have sufficient momentum to survive the inevitable challenges from opposition groups and special interests. Further, without leadership, it is significantly more difficult to galvanise public opinion towards supporting a new outlook on public transport.

An initial vision statement from the political leadership marks an important first step in mak-

Fig. 1.10

Small-scale models, as shown here with a proposed terminal facility in Quito, helps give decision makers a three-dimensional understanding of the physical infrastructure.

Photo by Lloyd Wright

ing the case for improved public transport. This political announcement provides a broad-based perspective on the general goals of the proposed system. This statement gives a direction and mandate for the planning teams and will also be used to stimulate interest and acceptance of the concept with the general public.

The vision statement should not be overly detailed but rather describe the form, ambitions and quality of the intended project. Thus, the statement will set the agenda for the ensuing planning activity. Examples of the type of phrases that can form part of the vision statement include:

- “Provide a high-quality, cost-effective public transit system that will ease congestion, reduce contamination, and ensure public confidence in the city’s transit service.”
- “Establish a fast, comfortable, economic, and car-competitive mass transit system that will serve the mobility needs of all segments of the city’s population, even current owners of private vehicles.”
- “By developing a modern public transport system for the twenty-first century, the city will become increasingly competitive, attract more investment and tourism, and ultimately stimulate the economy and job creation.”
- “Place over 80 percent of the city’s population within 500 metres of a mass transit corridor.”
- “Provide a one-ticket service that will allow a person to travel to any point of the city in less than 30 minutes with no delays from congestion.”

While this initial vision statement will be quite broad in scope, the message can become more detailed and specific as the project progresses. Subsequent pronouncements can detail more precisely costs, travel times, and amenity features of the new service.

The announcement should be placed within an overall press and media strategy for the project. The press and media organisations should be thoroughly briefed about the vision being put forward. These organisations should also be given a basic overview of the various mass transit options and their potential for the city. In some cases, press visits to cities with existing systems can help reinforce the positive attributes of the project.

1.4 Barriers to transit improvement

“The great tragedy of science—the slaying of a beautiful hypothesis by an ugly fact.”

—Thomas Huxley, biologist and writer, 1825–1895

The case for improving public transport quality would seem to quite strong. The economic, environmental and social benefits are actually quite well documented (Litman, 2005a). However, major public transport improvement initiatives are actually quite rare. The barriers to public transport improvement often overwhelm the call to action. Understanding the likely obstacles to be faced allows project developers to devise strategies for countering this opposition.

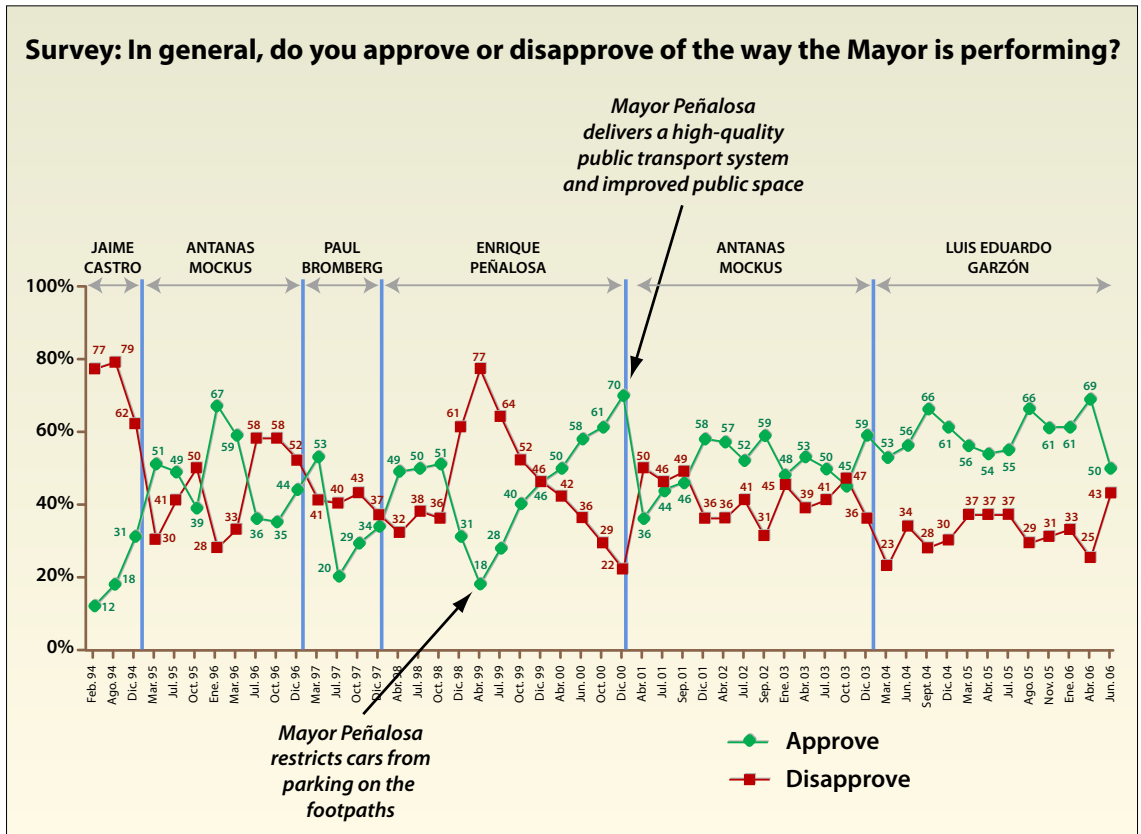
Some of the most significant barriers include:

- Lack of political will;
- Governance;
- Opposition from key stakeholders (existing public transport operators, motorists, etc.);
- Political and institutional inertia;
- Institutional biases;
- Lack of information;
- Poor institutional capacity;
- Inadequate technical capacity;
- Insufficient funding and financing;
- Geographical / physical limitations.

Political will is by far the most important ingredient in making a public transport initiative happen. Overcoming resistance from special interest groups and the general inertia against change is often an insurmountable obstacle for mayors and other officials. However, for those public officials that have made the commitment, the political rewards can be great. The political leaders behind the BRT systems in cities like Curitiba and Bogotá have left a lasting legacy to their cities, and in the process, these officials have been rewarded with enormous popularity and success. To achieve this success, a great deal of political capital was expended to convince project detractors, the mass media, and the general public.

Many political officials may be reluctant to undertake a BRT project due to the perceived risks, especially in relation to upsetting powerful special interest groups. Motorists and existing public transport operators will tend to resist such change. Thus, political officials may end up playing it safe by avoiding any type of major public transport initiative that will risk

Fig. 1.11
Approval ratings of
Bogotá Mayors



alienating specific stakeholders. However, when officials take the perceived low-risk path of inaction, the ensuing political rewards will certainly be diminished.

The trajectory of the popularity of former Mayor Enrique Peñalosa makes for an interesting comparison (Figure 1.11). Mayor Peñalosa implemented transport and public space changes in Bogotá that was a major shock for many persons. Under Mayor Peñalosa laws preventing persons from parking on the footpaths were enforced for the first time. Outraged motorists led a campaign to impeach Mayor Peñalosa. At this point in his term in office, Mayor Peñalosa suffered through one of the lowest popularity rankings recorded by a Bogotá mayor. However, subsequently, something rather miraculous occurred. As Mayor's vision and projects came into reality, the public responded in quite a positive manner. With the new cycle ways, the improvements in public space, and the TransMilenio BRT system, citizens could see the transformation of a city. By the time, Mayor Peñalosa finished his three-year term, he ended with the highest popularity ratings ever recorded by a Bogotá mayor.

It is quite likely that a political official with less drive and passion for public space and sustainable transport would have reversed course at the first sign of upset motorists. Instead, the risk taken by Mayor Peñalosa to transform the city and the public transport system resulted in significant political rewards and international fame.

While automobiles may represent less than 15 percent of a developing city's transport mode share, the owners of such vehicles represent the most influential socio-political grouping. The idea of prioritising road space to public transport may appear to be counter to the interest of private vehicle owners. However, in reality, separating public public transport vehicles from other traffic may often improve conditions for private vehicles. However, motorists may only understand this benefit once the system is operating. Prior to the project, car owners may only see BRT as an intruder that is stealing road space.

Existing public transport operators will likely also view BRT as a threat to their interests and livelihood. In cities such as Quito (Ecuador), the existing operators took to violent street

demonstrations to counter the development of the BRT system. The government ultimately called in the military to disperse the protests after the operators shut down public transport in the city for four days. Likewise, in other cities the private transit operators have pressured political officials through recall efforts and intense lobbying.

However, it should be noted that the threat to existing operators may be more perceived than real. In most cases, an effective outreach effort with the operators can help dispel unfounded fears. In reality, existing operators can gain substantially from BRT through improved profitability and better work conditions. The existing operators can effectively compete to win operational concessions within the proposed BRT system. In Bogotá, the existing operators launched seven different strikes to protest the development of TransMilenio. Today, many of these same operators are shareholders of concessionaire companies in TransMilenio, and these operators have seen a significant increase in profits. Few, if any, would want to revert back to the previous system.

The professional staff within municipal agencies may also represent a barrier to public transport improvement. Such staff often do not utilise public transport as the primary means to travel. Instead, municipal officials are part of a middle class elite who have the purchasing power to acquire a private vehicle. Thus, the professionals who are responsible for planning and designing public transit systems frequently do not use public transit. This lack of familiarity with user needs and realities can result in less than optimum public transport design. Such staff may also unwittingly give funding and design preference to individual motorised travel since this mode is the one with which they are most familiar.

Despite the rise of global information networks, a lack of knowledge of options like BRT remains a very real barrier. The long period of time between the development of the system in Curitiba and the realisation of BRT by other cities is evidence of this information shortfall. Through the assistance of international agencies and non-governmental organisations, awareness of BRT has risen sharply in recent years.

Visits to Bogotá by city officials from Africa and Asia have helped to catalyse new BRT projects. Nevertheless, many developing cities still do not have the basic information required to develop a transit improvement initiative.

The lack of information at the municipal level often occurs in direct correlation with the lack of human resource capacity. The transport departments of many major developing cities must cope with a wide array of issues with only a handful of staff. The lack of institutional and technical capacity at the local level inhibits the ability of agencies to consider projects even when general awareness of the opportunity is present.

Financing can also be an issue with public transport projects, although it tends to be less of an issue with lower-cost options such as BRT. Access to capital and the cost of capital can be real constraints, especially for more costly forms of public transport infrastructure. Additionally, the lack of resources to sustain any sort of operational subsidy means that systems must be largely designed to be financially self-sustainable.

Various local conditions, such as urban, geographical and topographical factors, can also present barriers to implementation. For instance, extremely narrow roadways and steep hills can pose design challenges. However, in general, there are technical solutions to each one of these issues. Local conditions require local solutions, which ultimately makes each project unique in its own way.

All of the barriers and challenges noted in this section can be overcome. Nevertheless, for many municipalities, these issues greatly dampen the ability to initiate a project. Project champions will need to provide answers to each of these barriers that represent a threat to project acceptance.

1.5 Benefits

“Nothing is ever done until everyone is convinced that it ought to be done, and has been convinced for so long that it is now time to do something else.”

—F.M. Cornford, author and poet, 1874–1943

Perhaps the best answer to critics of public transport initiatives is the overall benefit that such initiatives bring to a city and the quality

Table 1.1: The benefits of public transport initiatives

Factor	Impacts / indicators
Time savings benefit to transit users	<ul style="list-style-type: none"> • Labour productivity • Quality of life
Time savings benefit to mixed traffic vehicles	<ul style="list-style-type: none"> • Labour productivity • Delivery efficiency for goods and services
Fuel savings from public transport operations	<ul style="list-style-type: none"> • Reduced fuel expenditures for public transport operators • Reduced fuel expenditures for vehicles in mixed traffic • Reduced dependency on imported fuel or reduced usage of domestic supply
Air quality improvements (reduced emissions of CO, NO _x , PM, and SO _x)	<ul style="list-style-type: none"> • Human health • Preservation of built environment • Preservation of natural environment • Labour productivity
Greenhouse gas emission reductions	<ul style="list-style-type: none"> • Global environment
Noise and vibration reductions	<ul style="list-style-type: none"> • Human health • Labour and educational productivity • Built environment
Other environmental improvements	<ul style="list-style-type: none"> • Reduced solid and liquid wastes • Reduced impacts on flora and fauna
Transit system employment	<ul style="list-style-type: none"> • Construction employment • Operational employment Commercial sector • Property values • Shop sales • Employment generation
Amenity benefits to transit passengers	<ul style="list-style-type: none"> • Comfort of passengers • Prestige of system Social benefits • Reductions in crime and social problems in area • Sociability of street environment • Equity for low-income groups • Increased civic pride and sense of community
City image	<ul style="list-style-type: none"> • City-wide pride • Tourism
Urban form	<ul style="list-style-type: none"> • More sustainable urban form, including densification of major corridors • Reduced cost of delivering services such as electricity, sanitation, and water
Political	<ul style="list-style-type: none"> • Delivery of mass transit system within one political term • Delivery of high-quality resource that will produce positive results for virtually all voting groups

of life of its inhabitants. In many cases, these benefits can be directly quantified to produce results in monetary terms. In other cases, the qualitative benefits can also be assessed within a logical framework.

Table 1.1 outlines some of the direct benefits that public transport improvements have provided to cities. Beyond these benefits, though, there exist multiplier impacts that can further increase the value to a municipality. For example, public transport projects can lead

to reduced public costs associated with vehicle emissions and accidents. Such impacts include costs borne by the health care system, the police force, and the judicial system. In turn, by reducing these costs, municipal resources can be directed towards other areas such as preventative health care, education, and nutrition.

Methodologies for estimating the economic, environmental and social impacts of BRT are included in later sections of this Planning Guide.

2. Public transport technologies

“For a successful technology, reality must take precedence over public relations, for nature cannot be fooled.”

—Richard P. Feynman, physicist, 1918–1988

Choosing the type of public transport technology for a city can be a highly polemical process. Given the various interest groups involved and the substantial private sector contracts at stake, the process can become quite politicised. However, making the decision within a rational framework is the only way to ensure that the customer is truly served. This chapter attempts to provide such a framework, as well as offer a discussion on each decision variable.

The choice of public transport technology will affect travel times, personal transport expenditures, and commuter comfort and safety. The choice will also dramatically affect municipal finances and a city’s economic efficiency. Ulti-

mately, the selection will shape a city’s urban form and the very lifestyle of its inhabitants. Thus, an objective and effective evaluation process is an essential part of responsible and coherent decision making.

While this Planning Guide focuses upon BRT, it is only one of many different public transport options. For many cities, BRT is a highly cost-effective option for delivering a full system network that provides customers with a car-competitive public transport service. However, there are also conditions in which metro rail, light rail transit, and even conventional bus services may be the more appropriate technology choice. This chapter sets forward some of the key considerations in making a decision on the type of public transport system. Ideally, cities can establish a healthy competition between different technology options in order to ensure the most appropriate option is selected.

The topics discussed in this chapter include:

- 2.1 Introduction to public transport technologies
- 2.2 Criteria in technology section
 - 2.2.1 Cost
 - 2.2.2 Design and implementation
 - 2.2.3 Performance
 - 2.2.4 Impacts
- 2.3 Technology decision making

2.1 Introduction to public transport technologies

“The technologies which have had the most profound effects on human life are usually simple.”

—Freeman Dyson, physicist, 1923–

2.1.1 Public transport typologies

Public transport in its broadest sense refers to collective passenger services. It can thus include the assortment of both the paratransit and formal services found in cities around the world. Public transport thus encompasses shared taxis, mini-vans, conventional bus services, BRT, water-based services, and rail-based services. *More specifically, Mass Rapid Transit (MRT) is a collective urban passenger service that operates*

at high levels of customer performance, especially with regard to travel times and passenger carrying capacity. Mass rapid transit can achieve reduced travel times through the provision of widely accessible networks, higher speed vehicles, exclusive right-of-way infrastructure, special limited-stop or express services, efficient fare collection systems, and/or faster boarding and alighting techniques. Higher carrying capacities may be achieved through larger vehicles, multiple sets of vehicles (*i.e.*, a bus platoon or a train), and/or more frequent service.

Box 2.1 defines the major categories of public transport typologies. There is a wide range of permutations possible with each technology. Some LRT systems may blur the boundaries

with the definition of a metro when LRT is utilised on grade-separated infrastructure. Likewise, some BRT systems have segments that go underground or on elevated structures. Nevertheless, Box 2.1 provides a general typology for public transport technologies. The continued innovation from public transport developers is likely to mean that these definitions will also continue to evolve.

Box 2.1: Types of public transport technologies

Bus Rapid Transit (BRT) – Bus-based technology typically operating on exclusive right-of-way lanes at the surface level; in some cases underpasses or tunnels are utilised to provide grade separation at intersections or in dense city centres.

Light Rail Transit (LRT) – Electric rail-based technology operating either as a single rail car or as a short train of cars, typically on exclusive right-of-way lanes at the surface level with overhead electrical connectors.

Trams – Trams can also be considered a type of LRT, but typically utilise smaller-sized carriages and may share road space with other forms of traffic.

Underground metro – A heavy rail transit system operating on grade separated tracks that are located principally underground.

Elevated rail transit – A rail transit system operating on grade separated tracks that are located principally on an aerial structure; elevated systems can also be considered a form of metro.

Suburban rail – A heavy rail transit system operating on exclusive right-of-way tracks that are located principally at the surface level but generally grade separated; typically carries passengers between suburban and urban locations; differs from other urban rail systems by the fact that carriages are heavier and the distances travelled are usually longer.

Personal Rapid Transit (PRT) – A rail- or wheel-based system carrying passengers in small Automatic Guided Vehicles (AGV); PRT typically operates on exclusive right-of-way lanes that may also be grade separated.

Bus Rapid Transit (BRT) is thus just one of the many public transport technology options. Additionally, there are a range of rail-based public transport systems that are possible, including underground metros, elevated rail systems, Light Rail Transit (LRT), and trams (Figures 2.1 through 2.6). No one of these options is inherently correct or incorrect. Local conditions and local preferences play a significant role in determining the preferred system type.

Additional types of public transport technologies are also possible. While monorail and maglev train technologies could be considered a form of elevated rail transit, these technologies are also distinctive enough to be considered as separate public transport categories. Monorail technology has been in existence for the past forty years with particular implementation experience in Japan. Some new monorail systems are still being built, such as the Las Vegas monorail, which opened in 2004.

Maglev technology is quite new and holds the potential to increase vehicle speeds considerably. The only current passenger application of maglev is found in Shanghai (China), where speeds of over 400 km per hour are reached on a 30-kilometre line between the city and its new international airport. However, at a cost of over US\$300 million per kilometre, the technology is unlikely to be replicated elsewhere for the foreseeable future. Further, for many transport professionals, maglev technology is seen more as a competitor of air travel for inter-city travel rather than a practical solution within the urban public transport sector. Nevertheless, maglev represents an interesting new technology that may have future applications.

Personal Rapid Transit (PRT) is another relatively new phenomenon that is being developed as an option in lower-density developed cities. PRT utilises Automatic Guided Vehicles (AGV) that avoid the need of a driver, and thus help developed cities to reduce their relatively high labour costs in public transport operations. These vehicles may be either rubber tyre- or rail-based, and are somewhat small in size with each vehicle carrying in the range of two to six passengers. The idea behind PRT is to combine the flexibility of taxi services with the automation of fixed-track systems. A PRT system offers the



Fig. 2.1, 2.2, 2.3, 2.4, 2.5, and 2.6

Rail transit comes in a variety of forms.

Photos:

1. Hong Kong subway

(Photo courtesy of Hong Kong MTR)

2. Bangkok elevated Skytrain

(Photo by Lloyd Wright)

3. Osaka monorail

(Photo by Lloyd Wright)

4. Hankyu suburban rail system

(Photo by Lloyd Wright)

5. Strasbourg LRT system

(Photo by Manfred Breithaupt)

6. Bucharest tram

(Photo by Lloyd Wright)



▼ Fig. 2.7

Personal Rapid Transit (PRT) attempts to combine aspects of both public and private transport vehicles.

Image courtesy of ULTra

potential to provide each customer with their own personal routing option, and thus leading to more point-to-point travel. The systems also combine the privacy of smaller vehicles with the advantages of a public system. The challenge for these systems is to deliver a product that is cost competitive with conventional public transport options. To date, only a few experimental systems have been developed (Figure 2.7). For these reasons, PRT is not presented in any further detail in this document.



2.1.2 Rail versus road

The innovation demonstrated by certain technology firms has in many ways already rendered traditional definitions obsolete. The distinctions between rail and road are increasingly being blurred by technologies that cross both realms (Figures 2.8 through 2.11). For example, the Mexico City and Paris metro systems utilise rubber-tyred vehicles, but these systems clearly give the appearance of full rail technology. The Translohr vehicle being developed for new systems in Clermont-Ferrand (France), L'Aquila (Italy), Mestre-Venice (Italy), and Padua (Italy) is a rubber-tyred tramway operating within a dedicated track. The "Transport sur Voie Reservée" (TVR) systems, developed in such cities as Caen and Nancy in France, utilise modern, rubber-tyred vehicles that operate both on and off a dedicated runway. Finally, the modernistic Civis by Irisbus is a rubber-tyred vehicle with a rounded-front and covered wheels that produces a distinctive LRT-like appearance. Such vehicles are utilised by systems in cities such as Rouen (France) and Las Vegas (US). With its enclosed stations and dedicated lanes, the Bogotá BRT system in many ways more closely

resembles a metro system than a conventional bus system. As these examples demonstrate, the line between rail and road can be quite fine and perhaps somewhat irrelevant. Whether a system is called BRT or LRT or metro perhaps matters less than whether the system meets the needs of the particular customer.

Given that mass transit implies a certain level of both capacity and speed, some systems are technically better described by the more general term of "public transport" than "mass transit". Whether a system qualifies as "mass transit" is dependent both on the nature of the technology and the circumstances of the particular city. Trams and at-grade LRT systems typically carry less than 12,000 passengers per hour per direction (pphpd) and thus are perhaps more precisely defined as "public transport" technologies. Bogotá's BRT system carries as many as 45,000 pphpd and thus would likely be considered a mass transit system. However, many other BRT systems operate in cities with much lower demand and speed characteristics, and thus would likely not be considered "mass transit". Metro and elevated rail systems are capable of operating at both high speeds and high capacities,



Fig. 2.8, 2.9, 2.10, and 2.11
All these images are of rubber-tyred vehicles, making the distinction between rail and road somewhat irrelevant. Photos clockwise from upper left:

1. Mexico City subway

(Photo by Lloyd Wright)

2. Translohr vehicle in Padova (Italy)

(Photo courtesy of Groupe LOHR)

3. Civis bus in France

(Photo courtesy of NBRTI)

4. TVR vehicle in Nancy (France)

(Photo by Klaus Enslin)

and thus typically qualify for the “mass transit” term. However, there are cases of metro systems operating at relatively low capacities, such as in Delhi and Kolkata, in which the “mass transit” term may not apply (Figure 2.12). The following discussion on public transport technologies will not distinguish precisely between the semantics of “mass transit” technologies and “public transport” technologies. Instead, it is recognised that the “most appropriate” technology is the one which best meets the needs of the customers within the context of their own local conditions.

2.2 Criteria in technology selection

“Western society has accepted as unquestionable a technological imperative that is quite as arbitrary as the most primitive taboo: not merely the duty to foster invention and constantly to create technological novelties, but equally the duty to surrender to these novelties unconditionally, just because they are offered, without respect to their human consequences.”

—Lewis Mumford, historian and architectural critic, 1895–1990

The decision to select a particular technology depends upon many factors. Costs, performance characteristics, local conditions, and personal preferences have historically all played a role in the decision-making process. This section will outline some of the factors that should be considered in selecting the type of mass transit system for a city.

In recent years, significant debate amongst transport professionals has occurred on whether BRT or rail-based solutions are the most appropriate. Such competition between systems can actually be healthy as it implies an environment in which all technologies must strive to improve. A rigorous evaluation process will help ensure that a city makes the most appropriate choice.

The planning and decision-making process can be defined so that the ultimate outcome reflects the goals and objectives of the city in conjunction with the current and projected trends. Figure 2.13 outlines this process. The goals and objectives will likely in part reflect the vision statement developed by the political leader. Additionally, objectives regarding quality of life and city image will likely be part of the evalua-



Fig. 2.12
Rush hour on the Delhi metro.
Photo courtesy of ITDP

tion. Demographic trends will help to indicate the transport service levels required to meet the future form of the city.

As the decision-making process enters actual comparisons between different public transport technologies, a framework for objectively evaluating each criteria should be clearly articulated. The evaluation process will likely begin with the widest number of options under consideration. As the evaluation proceeds, increasing levels of detailed analysis will be utilised to narrow the choices. Figure 2.14 illustrates this relationship between the number of alternatives and the level of detail in the analysis.

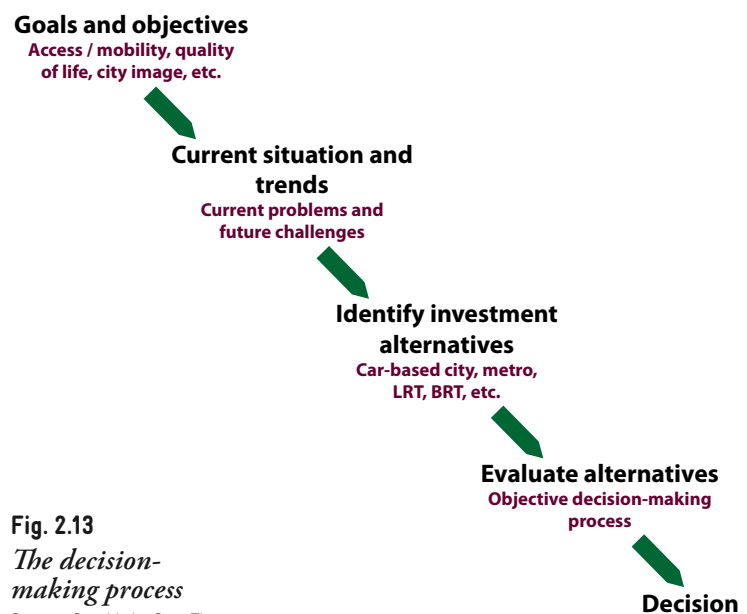
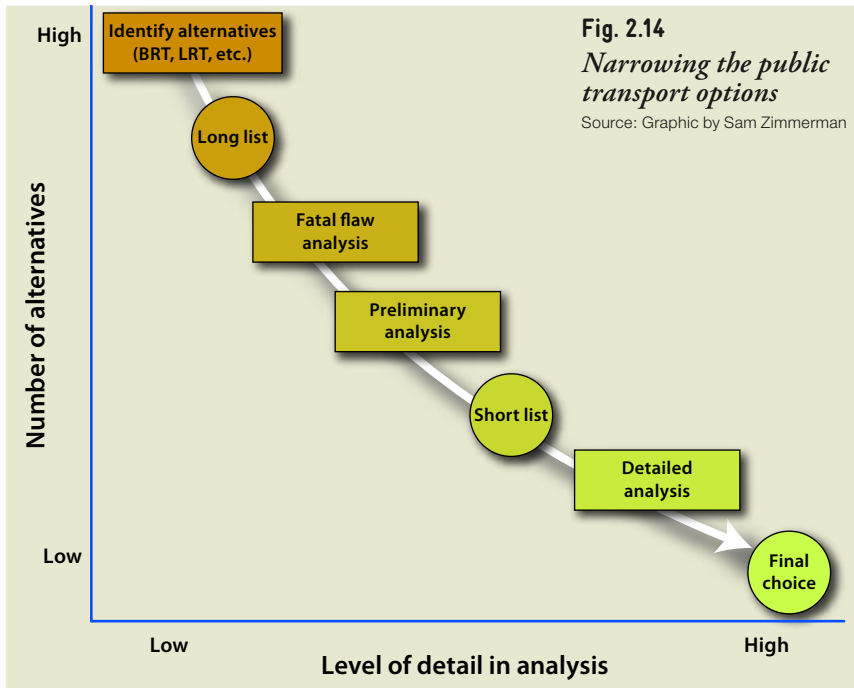


Fig. 2.13
The decision-making process
Source: Graphic by Sam Zimmerman

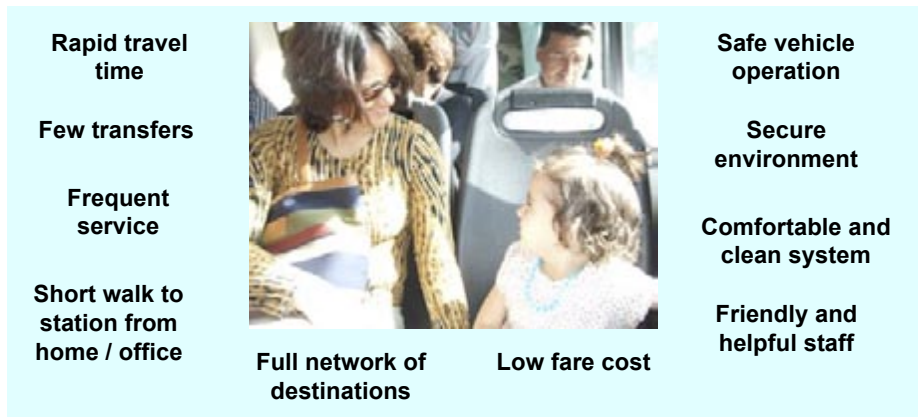


irrespective of potentially better alternatives. Public transport technology decisions can thus become a self-fulfilling prophecy based upon political or personal preferences rather than customer needs.

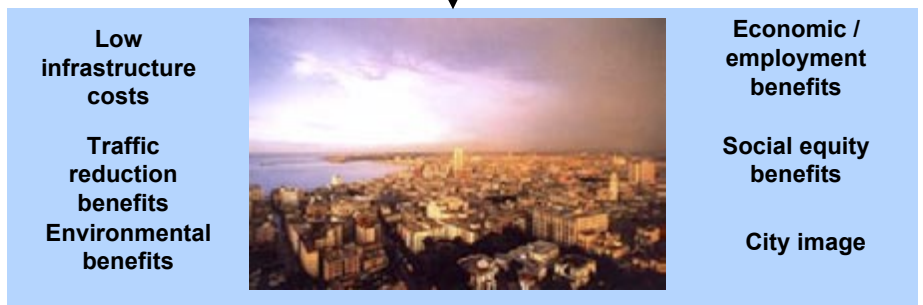
In reality, a top-down approach that begins with a technology focus is perhaps not the ideal. It is much preferred to define desired public transport characteristics prior to selecting a particular technology. By understanding customer needs with respect to fare levels, routing and location, travel time, comfort, safety, security, frequency of service, quality of infrastructure, and ease of access, system developers can define the preferred type of service without bias toward any particular technology (Figure 2.15). Thus, much of the planning noted in this Planning Guide can actually be conducted without committing to one type of technology over another. In this scenario, the public transport technology is one of the last issues to be introduced in the decision-making process. Such a customer-orientated approach will likely have the best chance of producing a public transport service that can effectively compete with the private automobile.

“Feasibility” studies and “cost-benefit” analysis may be utilised to determine in detail the financial viability of a particular option. In instances where only a single technology is considered, it is not uncommon for “feasibility” studies to almost always deliver a verdict of “feasible”,

Step 1. Design a system from customer’s perspective



Step 2. Evaluate customer-driven options from municipality perspective



Step 3. Decision

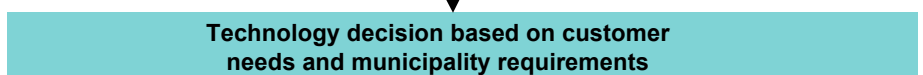


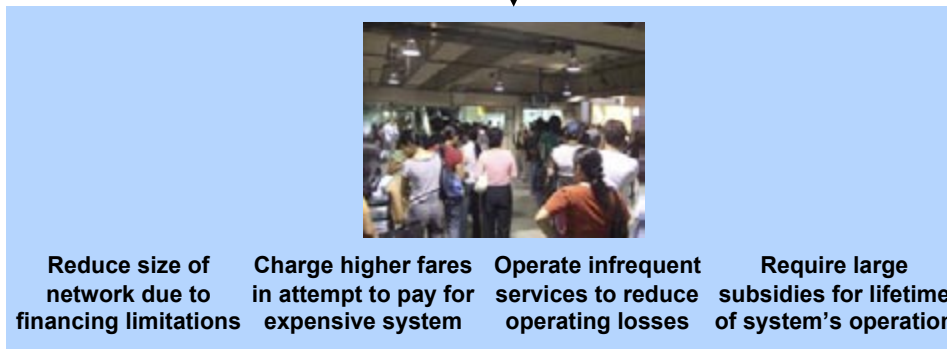
Fig. 2.15
Customer-oriented design: Shaping the technology around the customer.
Source: Graphic by Lloyd Wright

Step 1. Choose technology

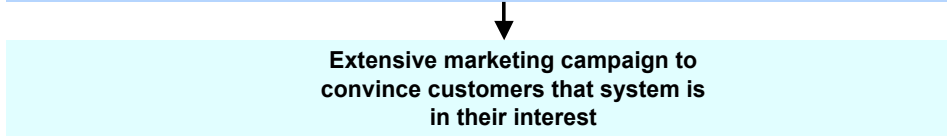


Fig. 2.16
Technology-driven design: Making the customer adapt to a technology.
Source: Graphic by Lloyd Wright

Step 2. Fit city to the technology



Step 3. Force customer to adapt to technology



In practice, though, a political official or technical official will often state a preference for a particular technology at the outset. Such a choice may reflect an official's own personal experiences or may simply be the result of a convincing lobbying effort from interest groups or a salesperson of a particular technology (Figure 2.16). In such instances, the service is effectively being designed around a technology rather than the customer. If a technology requires a certain passenger flow to be cost-effective, then the corridors and routes will be designed around this characteristic. Clearly, though, what is good for a particular technology may not be ideal for the city residents as a whole.

In 1985, the then President of Peru made an afternoon flyover of the city by helicopter. From this vantage point, the President hastily selected a corridor for a new rail system. Unfortunately, the selected corridor did not match well with the actual demand for public transport services. The city spent an estimated \$300 million from 1986 through 1991 to build and equip the first 9.8 kilometres of a planned 43-kilometre system (Menckhoff, 2002). High costs, poor location,

and revised passenger estimates meant that the construction of the unused system was stopped, but the continued maintenance of the mothballed system is still a costly burden (Figure 2.17).

In other instances, a public transport system may be designed around the wishes of a property developer or a construction firm. The

Fig. 2.17
Except for the occasional llama, the "Tren Eléctrico" in Lima serves no actual customers.

Photo courtesy of Gerhard Menckhoff



Table 2.1: Factors in choosing a type of public transport technology

Category	Factor
Cost	Capital costs (infrastructure and property costs) Operating costs Planning costs
Planning and management	Planning and implementation time Management and administration
Design	Scalability Flexibility Diversity versus homogeneity
Performance	Capacity Travel time / speed Service frequency Reliability Comfort Safety Customer service Image and perception
Impacts	Economic impacts Social impacts Environmental impacts Urban impacts

integration between the MRT3 and LRT2 rail systems in Manila require customers to make long walks through three shopping complexes. The intent of the interchange is not orientated towards customer convenience but rather towards maximising shop sales. In such cases, the desirability and usability of the public transport system is severely undermined. If instead the system is developed entirely around the wants and needs of the public transport customer, ultimately the greatest number of persons will benefit.

Thus, the choice of public transport technology should be based on a range of considerations with performance and cost being amongst the most important. As suggested, these requirements are ideally derived from an objective analysis of the existing and projected situation. Table 2.1 outlines categories of the characteristics that can help shape a city’s decision towards the most appropriate type of public transport technology.

This chapter attempts to provide an objective review of each of these characteristics. Again, no one public transport solution is the right solution for all cities. The local circumstances and

public policy objectives play a significant role in selecting the most appropriate public transport solution for any city.

2.2.1 Costs

“While real trolleys in Newark, Philadelphia, Pittsburgh, and Boston languish for lack of patronage and government support, millions of people flock to Disneyland to ride fake trains that don’t go anywhere.”

—Kenneth T. Jackson, historian

2.2.1.1 Capital costs (infrastructure and property costs)

For most developing-nation cities, the infrastructure costs will be a pre-eminent decision-making factor. Such cities often face a borrowing cap which acts as a ceiling to the total amount of borrowing that can be undertaken, based upon lending regulations set by institutions such as the International Monetary Fund and the World Bank. The lending capacity is often a function of the amount of loans currently outstanding as well as the level of debt relative to gross domestic product (GDP). Additionally, lending in the transport sector will have a direct impact on a city’s ability to borrow for all critical functions, including such areas as water, sanitation, education, and health care. Thus, the decision on a city’s public transport system will have broad ramifications affecting many facets of overall development.

Infrastructure costs

The exact capital cost of a system will depend upon many local factors, including:

- Local labour costs;
- Competitiveness of construction industry;
- Quality of management and organisational capabilities;
- Local physical conditions (topology, soil conditions, water tables, etc.);
- Design and safety requirements;
- Financing costs;
- Local content versus imported content of technology;
- Requirements to retire existing vehicle fleets;
- Levels of import duties;
- Property prices and level of expropriation required for system development;
- Level of competitiveness and openness in the bidding process.

Infrastructure cost comparisons

While it is possible to compare capital costs with other cities, the actual investment level will depend upon the nature of local conditions. Table 2.2 provides a sampling of capital costs from several different cities and several different mass transit technologies. In making such comparisons, one must take extra precaution that one is comparing the same set of cost factors.

For instance, one technology bid may consider rolling stock (vehicles) to be part of capital costs while another bid may place the item in operating costs. Further, in some cases, systems may capitalise spare parts and regular maintenance activities while the more conventional treatment would be to expense such items under operating costs. For the purposes of developing a decision-making matrix between system types, one must be strict in categorising each cost type consistently. Any cost comparison should also ideally bring costs to a common base year in terms of currency values. Real rather than nominal cost values should be used when possible.

Table 2.2 indicates that BRT systems are typically in the range of US\$500,000 per kilometre to US\$15 million per kilometre, with most systems being delivered for under US\$5 million per kilometre. By comparison, at-grade trams and light rail transit (LRT) systems appear to be in the range of US\$13 million to US\$40 million per kilometre. Elevated systems can range from US\$40 million per kilometre to US\$100 million per kilometre. Finally, underground metro systems seem to range from US\$45 million per kilometre to as high as US\$350 million per kilometre. The significant size of the various ranges again indicates the local nature of costing. Additionally, the range depends upon the individual features sought within each system (e.g., quality of stations, separation from traffic).

The infrastructure cost per kilometre of system in conjunction with the likely financing capacity for the system will determine the overall size of the eventual public transport network. One of the most fundamental determinants of system usability to the customer is the extent of the overall network. A few kilometres of high technology will likely not coerce commuters into becoming customers. A limited system of only a few kilometres will mean that most of a person's essential destinations are not reachable

Table 2.2: Capital costs for different mass transit systems

City	Type of system	Kilometres of segregated lines (km)	Cost per kilometre (US\$ million/km)
Taipei	Bus rapid transit	57.0	0.5
Quito (Ecovía Line)	Bus rapid transit	10.0	0.6
Porto Alegre	Bus rapid transit	27.0	1.0
Las Vegas (Max)	Bus rapid transit	11.2	1.7
Curitiba	Bus rapid transit	57.0	2.5
São Paulo	Bus rapid transit	114.0	3.0
Bogotá (Phase I)	Bus rapid transit	40.0	5.3
Tunis	Tram	30.0	13.3
San Diego	Rail trolley	75.0	17.2
Lyon	Light rail transit	18.0	18.9
Bordeaux	Light rail transit	23.0	20.5
Zurich tram	Tram	NA	29.2
Portland	Light rail transit	28.0	35.2
Los Angeles (Gold Line)	Light rail transit	23.0	37.8
Kuala Lumpur (PUTRA)	Elevated rail	29.0	50.0
Bangkok (BTS)	Elevated rail	23.7	72.5
Kuala Lumpur Monorail	Monorail	8.6	38.1
Las Vegas	Monorail	6.4	101.6
Mexico City (Line B)	Metro rail	24.0	40.9
Madrid (1999 extension)	Metro rail	38.0	42.8
Beijing Metro	Metro rail	113.0	62.0
Shanghai Metro	Metro rail	87.2	62.0
Caracas (Line 4)	Metro rail	12.0	90.3
Bangkok MRTA	Metro rail	20.0	142.9
Hong Kong subway	Metro rail	82.0	220.0
London (Jubilee Line ext.)	Metro rail	16.0	350.0

by the system. When systems form a complete network across the expanse of a city, then the ability to function without using a private vehicle is considerably higher.

Figure 2.18 presents a graphical way of looking at the trade-off between infrastructure costs and network length. This figure is based on actual cost values for the Bangkok elevated rail system (Skytrain), the Bangkok subway system (MRTA), the proposed Bangkok BRT system (Smartway), and a proposed LRT system. As expected, the lower capital costs of BRT and LRT systems favour the development of a more extensive system at an equal cost.

From the customer's perspective, a full network serving most major origins and destinations

Fig. 2.18
Four systems at the same cost.¹⁾



426 kilometres of BRT



40 kilometres of LRT



14 kilometres of elevated rail



7 kilometres of subway

Fig. 2.19 ▼
The Zurich tram system covers almost the entirety of its urban area, making it one of the world's few rail-based systems with such widespread service provision.

Image courtesy of City of Zurich



is fundamental to system usability. A system consisting merely of few kilometres or a single corridor makes the system relatively unusable to most customers. Forcing a customer to live, work, and fulfil all major daily activities in one corridor is typically an unrealistic assumption. Once a person opts for a private car to fulfil some trips, then the convenience and sunk cost of vehicle ownership will typically imply that virtually all trips by public transport are forgone.

A BRT system will likely permit a city to build a network 4 to 20 times more extensive than a tram or light rail system if the same budget is applied to both technologies. Thus, for most developing-nation applications, BRT is capable of providing more value for the given investment. However, some cities are capable of delivering

¹⁾ Assumes a total investment of US\$1 billion to each system. Projected Bangkok BRT costs at US\$2.34 million per kilometre. Hypothetical LRT system estimated at US\$25 million per kilometre. Reported cost for Bangkok Skytrain (elevated rail) of US\$72.5 million per kilometre. Reported cost of Bangkok MRTA (subway) of US\$142.9 million per kilometre.

a rail-based system covering much of the urban area. The tram system in Zurich (Switzerland) is one of such examples (Figure 2.19). A Zurich resident can access virtually all points in the city through the expansive tram system, although the system is also augmented by bus services. In reality, though, few cities have the resources of Zurich to implement a rail-based system across the entire urban area. The most recent extensions to the system cost approximately US\$28 million per kilometre (Husler, 2005).

There are certainly examples of very costly BRT systems as well. The section of the Boston Silver Line BRT system that goes under the Boston harbour required an investment of US\$312 million per kilometre. However, anytime tunnelling is involved in a complex urban or aquatic environment the cost will be extreme. The same holds true for a rail line in the same circumstances. The main point being made in Table 2.2 is that BRT will generally cost 4 to 20 times less than a tram or LRT system and 10 to 100 times less than an elevated or underground rail system, assuming a BRT system that predominantly operates at street level. Of course, a more accurate comparison for any given situation can be gained by conducting an appropriate detailed feasibility study in which all relevant technology options are objectively compared.

Robustness of cost projections

The relative robustness of capital cost projections is also an important consideration. Higher-cost options tend to demonstrate greater disparity between projected and actual costs. As the estimated budget increases, a greater range of variables may tend to create uncertainty in the figures. This disparity translates into greater financial risk for those undertaking the project. Table 2.3 illustrates the tendency for certain public transport projects to under-estimate expected costs and to over-estimate the number of expected passengers.

There may be a variety of reasons for the under-estimation of public transport projects, including economic self-interest, technological complexity, and psychological factors. Project developers may under-estimate costs in order to win initial commitment to the project; the underestimation may particularly occur when there is no penalty or risk for doing so (Flyvbjerg

Table 2.3: Cost overruns and passenger projections of public transport projects

Project	Cost Overrun (%)	Actual traffic as a percentage of predicted traffic, opening year
Washington metro	85	NA
Mexico City metro	60	50
Tyne and Wear metro	55	50
Kolkata metro	NA	5
Miami metro	NA	50
Sao Paulo metro line 5	NA	9
Brasilia metro	NA	3

Source: Flyvbjerg, B., Bruzelius, N., and Rothengatter, W. (2003); Custodio (2005)

et al., 2003). Projects that require tunnelling, elevated structures, and advanced technology probably also incur greater cost variance due to the relative project complexity that is related to the occurrence of unforeseen events and costs. Allport (2000, p. S-23) notes that “metros are a different order of challenge, cost and risk.” Additionally, overly-optimistic projections may also be due to psychological preferences for more grandiose and image-driven options.

Systems based in rail technology have suffered some of the most significant problems regarding cost escalation. The 17-kilometre Kolkata metro required 22 years to build and had its budget revised upward on 14 different occasions (Economist, 2006a). Kuala Lumpur has had a particularly difficult history with its multiple rail systems. The PUTRA rail system incurred debts of US\$1.4 billion after only three years of operation. The STAR system likewise ran up over US\$200 million in debts after its first five years of operation. Both these systems went bankrupt and required nationalisation. The Kuala Lumpur monorail system also has had some difficulty, requiring eight years of construction and only reaching half its originally projected ridership after its first two years of operation. The nine-kilometre number 5 Metro Line of São Paulo cost US\$700 million to construct and was projected to carry 350,000 passengers per day. In reality, the system now just handles approximately 32,000 passengers

per day. The Brasilia metro cost a staggering US\$1.2 billion to construct and carries just 10,000 passengers per day. The feasibility study projected more than 300,000 passengers per day (Custodio, 2005).

Low infrastructure costs are perhaps the chief advantage of BRT systems. The advent of BRT is in many cases bringing a mass transit option to cities that would likely be decades away from affording a rail transit option. Dar es Salaam (Tanzania) is currently moving ahead with plans for a BRT system involving a first phase network of 21 kilometres. Per capita GDP is just US\$1,200 per year in this rapidly growing city of 4 million inhabitants. And yet, the combination of World Bank support with local financial resources has placed a BRT system within the city's reach. If BRT was not an option for Dar es Salaam, the city would potentially not be able to financially support a formal public transport system within this century.

While the experience to date has indicated that the most severe infrastructure costing problems have occurred with rail systems, there is no reason the same problems could not occur with BRT or other technologies. The same incentives for project developers to underestimate costs could occur with any public transport technology. The only real difference with BRT is the degree of scale. Even if the project goes terribly wrong, the total cost exposure of the city is an order of magnitude less. When a large rail project goes terribly wrong, the very financial foundation of an entire municipality can come into question.

It should also be noted that in some instances, LRT systems may be relatively close to BRT in infrastructure costs, especially when vehicle costs are compared equally. If existing rail corridors are present and available for use, then property and construction costs for options like LRT can be dramatically reduced. Further, there are metro rail systems that have been delivered at remarkably competitive cost levels. The Madrid metro stands out as one of the most well-managed and cost-effective public transport projects to date. Through innovations such as 24-hour construction scheduling, Madrid substantially reduced construction equipment costs. Madrid also benefited from relatively soft soil conditions due to the clay base under the city. This unique

set of physical conditions facilitated less costly tunnelling. Thus, the actual basis for comparison is quite dependent on local conditions. One must thus use much caution in comparing infrastructure costs between different cities.

Land and property acquisition costs

In addition to the system's physical infrastructure, land acquisition along corridors can be a major cost item in some systems. Land may be required for a variety of purposes, including:

- Rights to road space;
- Rights to underground or aerial space;
- Entry and exit points to stations;
- Terminal sites;
- Depot areas for maintenance and vehicle storage;
- Road widening to mitigate impacts on mixed traffic.

In many systems, land purchases may not be necessary. The legal designation of road space, underground areas, and aerial space may be considered public property in such instances. However, this designation varies considerably by local jurisdiction. Thus, there is no general rule favouring land and property costs for either rail or road public transport options. Either technology may involve considerable requirements for land and property acquisition or none at all.

Whether a system requires land and property acquisition will have profound impacts on the overall capital expenditures. The world's most costly public transport project to date has been the Jubilee Line extension to the London tube system. The 16-kilometre extension came to total of US\$350 million per kilometre. Much of this astronomical figure was due to the procurement of private land and property in areas such as the Canary Wharf business district. However, other technology options like BRT can also involve costly land and property purchases. While the construction costs of the first phase of the Bogotá BRT system totalled approximately US\$5.3 million per kilometre, the second phase has increased to as much as US\$15.9 million per kilometre for the most costly segment. This increase was in large part due to land and property purchases. The city decided to widen some roadways during Phase II in order to maintain the number of mixed-traffic lanes along the BRT corridor.

There are likewise many examples of more economical systems, such as the Madrid metro or the Quito BRT Ecovía line, where little to no land acquisition was required. Given the ramifications of potential land and property purchases, planning a system that minimises acquisition requirements can be a wise strategy. Of course, much depends on local circumstances that may well be beyond the control of project developers.

2.2.1.2 Operating costs

The long-term financial sustainability of a public transport project is highly dependent upon the on-going operating costs of the system. These costs can include vehicle amortisation, labour, fuel, maintenance, and spare parts. If a system requires on-going subsidies, the financial strain can end up affecting the effectiveness of both the municipal government and the public transport service to the customer. The level of operating costs will often also be related to the expected fare levels of the service, and thus will ultimately affect affordability and issues of social equity.

Operating cost categories

The exact components of operating costs will vary somewhat depending on the technology. However, table 2.4 provides a general listing of these types of costs.

Labour costs represent perhaps the greatest difference between systems in developed nations and systems in developing nations. Whereas labour can represent between 35 percent and 75 percent of operating costs in Europe and North America, the labour component of developing-nation systems may be well less than 20 percent.

This difference has greatly shaped the direction of public transport in each context. Systems such as light rail transit (LRT) have proven

Table 2.4: Operating cost categories for public transport

Category	Elements
Repayment of Capital	<ul style="list-style-type: none"> • Vehicle depreciation • Cost of capital
Fixed Operating Costs	<ul style="list-style-type: none"> • Driver / conductor salaries • Fare collection salaries • Information staff salaries • Security staff salaries • Mechanic salaries • Salaries of administrative personnel and supervisors • Other administrative expenses • Insurance
Variable Operating Costs	<ul style="list-style-type: none"> • Fuel / electricity • Spare parts • Lubricants and other service items • Maintenance

quite popular in developed nations, in part due to the reduced need for operating staff. With multiple rail vehicles being operated by one driver, the labour cost per customer is greatly reduced. In contrast, the relatively low labour costs in developing city applications means that there is less penalty for modes requiring more operating staff. Further, for social reasons, maintaining or even increasing employment is often a fundamental objective of public transport projects in the developing-city context.

In developing cities, the lower impact of wages on total costs means that these costs can be overwhelmed by the other components. Porto Alegre (Brazil) offers a unique opportunity to directly compare urban rail and BRT operating costs. The city has both types of systems operating in similar circumstances. The TrensUrb rail system requires a 70 percent operating subsidy for each passenger trip. By contrast, the city’s BRT system has a comparable fare structure, but operates with no subsidies and in fact returns a profit to the private sector firms operating the vehicles (Figures 2.20 and 2.21).

Fig. 2.20 and 2.21
Porto Alegre operates both a BRT system and an urban rail system. While each passenger trip on the rail system requires a 70 percent subsidy, the BRT system is entirely subsidy free from an operational standpoint.

Photos by Lloyd Wright



Fig. 2.22
Low ridership and several operational mishaps have dropped the bonds on the Las Vegas Monorail to junk status.

Photo courtesy of iStockphoto



In the developed cities of North America and Western Europe, rail solutions, particularly LRT, are now being implemented with increased frequency. The divergent technology paths between developing and developed cities do not suggest one solution is better or more appropriate than another. Instead, it perhaps merely reflects different local circumstances and cost structures.

Even in developed nation conditions, though, rail systems can represent a significant financial risk. The current financial crisis with the Las Vegas monorail system is indicative of the type of risks higher-cost transit systems can face (Figure 2.22). The system loses approximately US\$70,000 per day, which includes shortfalls to both existing operating costs and debt serving for the US\$650 million system (6.4 kilometre line). In 2005, the system lost a total of US\$20 million in part due to revenue shortfalls (Sofradzija, 2005). In early 2006, the system raised the cost of a one-way fare to US\$5, which

marginally raised total revenues while simultaneously reducing the number of passengers. By March 2006, the company's bond status dropped to the junk level.

Thus, in many instances, BRT may compete quite strongly even on a basis of operating costs in the developed-nation context. In an extensive study of different US systems, it was found that from a sample 26 BRT systems, the operating costs were the same or less than comparable light rail systems (Levinson *et al.*, 2003a).

Vehicle costs

Vehicle or rolling stock costs may be considered either a capital cost or an operating cost, depending in part on the technology and in part on the local circumstances. For road-based systems, such as BRT, the convention has been to regard vehicles as an operating cost that will be amortised through the life of the vehicle, which is typically ten years. By contrast, rail systems tend to include the rolling stock as part of the initial capital cost. Rail vehicles will also tend to maintain a longer useful life with service periods of 20 years or longer. However, there are exceptions to the conventions on designating vehicles and rolling stock as either operating or capital costs. Some BRT systems may treat some or all of vehicle costs as a capital cost, particularly in instances where the maintenance of a low fare structure is important. Likewise, some rail systems, such as the Bangkok subway, have treated the rolling stock as an operating cost in order to move more cost items to the private sector operator.

The vehicle costs between the different technologies vary considerably, although the different useful lifetimes and carrying capacities of the vehicle types tend to balance out this difference. Today, a high-quality articulated BRT vehicle in

Fig. 2.23
A metro rail car arrives in Bangkok from Germany.

Photo courtesy of the Bangkok MRTA Company



Latin America costs in the area of US\$200,000 to US\$250,000. Rail vehicle costs vary considerably depending on the technology but will typically cost in excess of US\$2 million.

Bus-based systems tend to benefit from the economies of scale generated by the great number of buses operating in cities today. Thus, the cost of maintenance staff and spare parts tends to be lower for such systems when compared to more specialised technologies. However, in large cities with extensive rail networks, economies of scale may be reached in purchasing spare parts and maintaining a well-trained repair team.

Buses can be manufactured in a wide range of locations, with most countries possessing some form of vehicle assembly. By contrast, there are only a few major rail manufacturers in the world today (e.g., Alstom, Bombardier, Hitachi, and Siemens). The scale required to erect local rail manufacturing is unlikely to be achieved in most developing nations. Instead, manufacturing (and the associated employment) will be based in a developed nation such as France, Canada, Japan, or Germany. When a city such as Bangkok purchases its rail metro vehicles, the carriages arrive almost fully fabricated (Figure 2.23).

Comparisons of fuel costs depend upon the technology utilised for the public transport vehicles. Rail-based systems are typically fully electrified and thus the cost structure depends on the local cost of electricity generation. BRT vehicles operate on a range of fuel types, including diesel, compressed natural gas (CNG), liquid petroleum gas (LPG), diesel hybrid-electric technology, hydrogen fuel cells, and electricity (electric trolley-buses).

Operating costs and service scalability

Cost-effective public transport services are not just designed for the highest peak demand periods. Systems must possess a certain degree of scalability and flexibility in order to be able to cost-effectively serve both peak and non-peak periods. Vehicles operating during non-peak periods with just a fraction of their potential customer demand create unprofitable conditions. Thus, the depth of the non-peak low can do much to undermine overall profitability.

Conventional bus systems, BRT, and LRT utilise smaller vehicle sizes and thus can be more adaptable to incremental changes in demand.

By contrast, longer train sets have somewhat less flexibility in matching supply and demand. Simply decreasing the frequency of the service is not an ideal solution. The sporadic offering of service during off-peak periods means that the system is less useful and less dependable to the entire customer base.

Farebox recovery

A common calculation used to compare operating cost performance for public transport is known as “farebox recovery”. To what extent do fare revenues cover the system’s operating cost? Systems that recover more income from fare revenues than the costs of their operations are able to operate without any public subsidy. The avoidance of a public subsidy is of particular importance in developing nations where local resources are often unable to cope with the demands of a costly public transport system. As noted, subsidies to public transport operations can crowd out investment to other vital areas such as education, healthcare, water and sanitation. Gregory Ingram of the World Bank notes this concern with (Ingram, 1998, p. 7):

“The construction costs of Metros in developing countries are so high that they crowd out many other investments... Most systems have operating deficits that severely constrain local budgets, as in Pusan and Mexico City.”

This crowding out effect is particularly pronounced in the case of the Guadalajara (Mexico)

Fig. 2.24
Despite absorbing much of the city's budget, the Guadalajara Metro has achieved only a fraction of its ridership target.

Photo by Ivan Romero



Box 2.2: Operating subsidies in Manila

Manila (The Philippines) operates three elevated light rail corridors in its metropolitan region. The LRT1, LRT2, and MRT3 lines operate independently although there are interchange points where customers can change from one corridor to another (after paying a new fare). The lines are all operated by public companies.

Even putting aside the construction costs, the system has proven to be a significant drain on government budgets. The LRT2 line brings in approximately 600,000 pesos (US\$12,000) in gross

revenues each month (Avendaño, 2003). However, the electricity costs alone total 1.6 million pesos (US\$32,000) and the other operational costs add another 1 million pesos (US\$20,000).

Another line, the MRT3, has fared even worse. Despite operating at crush capacity levels, the MRT3 still loses approximately US\$126 million per year. By late 2005, the MRT-3 operating company was unable to pay creditors, suppliers, and contractors (Bautista, 2005). For the same amount that Manila spends in one year for rail operational subsidies, it could build an entire BRT network.



Fig. 2.25 and 2.26
Manila's MRT-3 (left photo) and LRT-2 (right photo) have been beset by severe

operational revenue shortfalls, which have strained both system and municipal finances.

Photos by Lloyd Wright

metro system. The system consumes 40 percent of the municipality's budget in order to move approximately 120,000 passengers per day (Figure 2.24). The original feasibility studies predicted an average ridership of 400,000 passengers per day (Custodio, 2005). Likewise, the three elevated rail lines in Manila all place heavy operating subsidies on the government budget (Box 2.2).

Historically, systems with high ridership levels tend to come to closer to achieving subsidy-free operations. High-capacity metro systems in cities such as Hong Kong, London, Santiago, and São Paulo largely operate without operational subsidies, especially when other income, such as property development, is included. However, for the most part, metro and other rail-based systems are not able to fully recover operating costs from fare revenues. In lower-density cities, such as cities in the US, this lack

of farebox recovery is understandable due to the costly nature of public transport service across a widely dispersed customer base. The necessity of operational subsidies does not mean that these systems have failed. In many instances, the public transport system is rightly seen as a vital public service that should be supported through general tax revenues. Others have also argued that the subsidies to public transport are significantly less than the overall subsidies given to car-based infrastructure (Litman, 2005a).

The advantages of avoiding operational subsidies, though, are not insignificant. In addition to the on-going cost burden to the city and subsequent impacts on other potential investments, subsidies consume management resources and can be prone to misappropriation. Additionally, subsidies require a complex control strategy in order to avoid inciting incentives counter to the delivery of good customer

service. Implementing a system that will require subsidies without end also raises issues of inter-generational equity. A commitment to subsidies into the indefinite future places a potentially heavy burden on future generations. Further, the necessity of subsidies does create an image problem for systems; many citizens and decision-makers will view a subsidised system as a burden on public resources. The perception of a system “not paying for itself” can undermine overall support to public transport.

Developing-city BRT systems often operate without subsidies. The combination of relatively high passenger demand in conjunction with scale economies and low labour costs creates a fortuitous set of conditions for profitability. Revenues cover all BRT operating costs in cities such as Bogotá, Curitiba, Guayaquil, Quito, and Porto Alegre. Further, the fare levels are often quite affordable with BRT; the customer fare is approximately US\$0.50 per passenger in Bogotá and is US\$0.25 in Quito and Guayaquil. The lack of subsidies also allows these cities to easily accommodate and manage private sector concessions on the corridors. Thus, not only are all operating costs recovered within the affordable fares, but a healthy profit is realised by the private operating companies.

2.2.2 Planning and management

“Plan for what is difficult while it is easy, do what is great while it is small. The difficult things in this world must be done while they are easy, the greatest things in the world must be done while they are still small. For this reason sages never do what is great, and this is why they achieve greatness.”

—Sun Tzu, Military strategist, 544–496 BC

2.2.2.1 Planning and implementation time

The window of opportunity for public transport is sometimes quite limited. The terms in office of key political champions may only be three to five years. If implementation is not initiated during that period, the following administration may well decide not to continue the project. In some instances the project may be cancelled just because the new administration does not want to implement someone else’s idea, regardless of the merits of the particular project. A longer development period also means that a host of other special interest groups will have more opportunity to delay or obstruct the process.

Ideally, a public transport project can be planned and implemented within a single political term. This short time span would provide an additional incentive, as the project’s initiator would want to finish the project in time to reap the political rewards.

Rail-based options and BRT have significantly different planning and implementation time horizons. Examples of planning and construction times vary greatly by local circumstances, but the duration from start to completion is significantly shorter for BRT. BRT planning typically can be completed in a 12 month to 18 month time horizon. The construction of initial corridors can generally be completed in a 12 month to 24 month period (Figure 2.27). About two-thirds of phase I (40 kilometres) of Bogotá’s TransMilenio system was planned and constructed within the three-year term of Mayor Enrique Peñalosa, and the remaining portion began operation within eight months of his leaving office. As the learning curve with BRT systems progresses, the actual planning time seems to be falling. Planning for the



Fig. 2.27 and 2.28
An initial BRT corridor may take 12 to 24 months to construct (left photo); by comparison a typical underground or elevated rail system will require from three to ten years (right photo).

Left photo by Lloyd Wright
 Right photo by Karl Fjellstrom

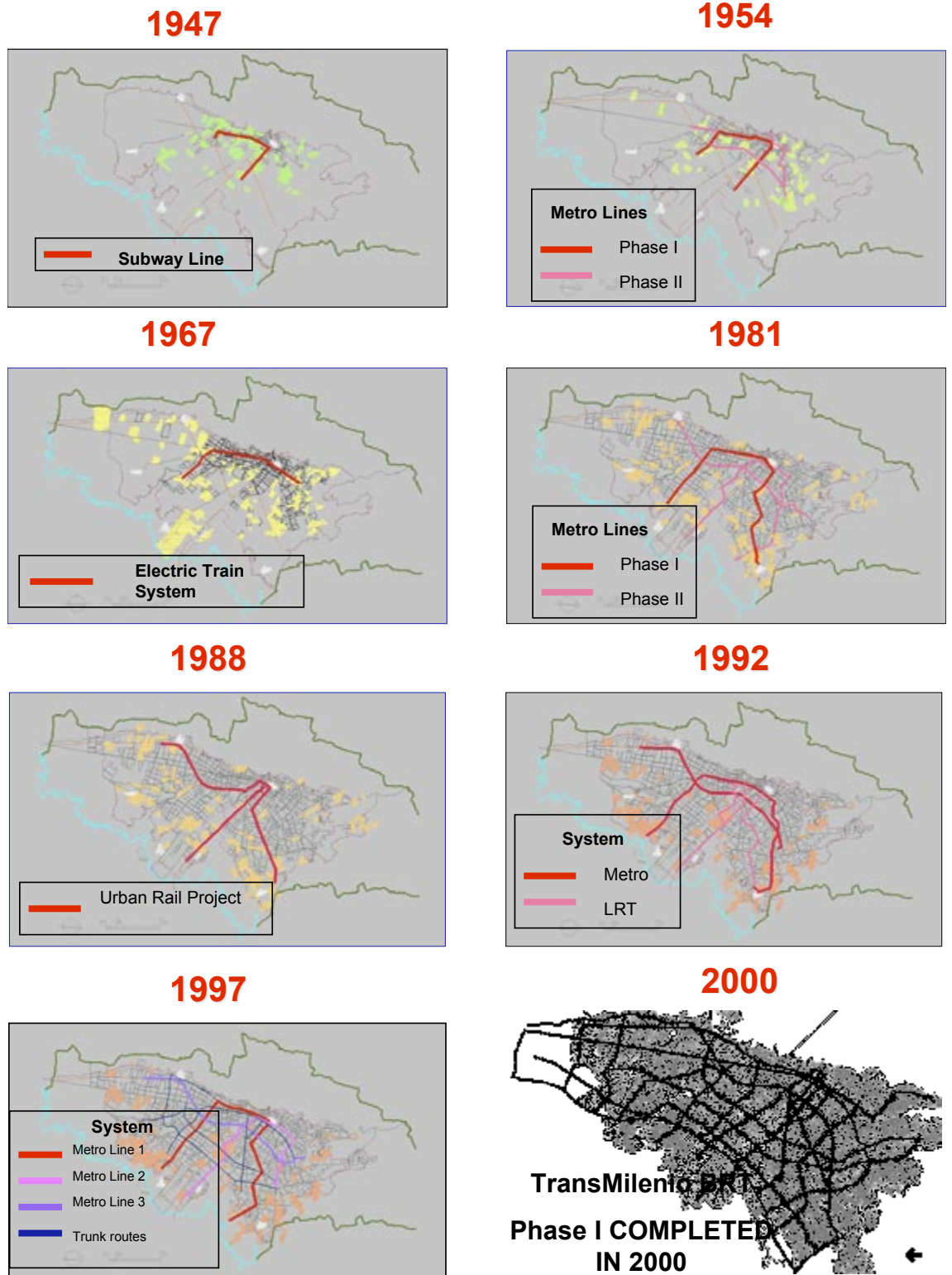


Fig. 2.29
For six decades various political administrations attempted to implement rail-based transit in Bogotá without success. The Peñalosa administration planned and implemented the TransMilenio BRT system in just three years.

Illustration courtesy of TransMilenio SA

16-kilometre phase I of the Beijing BRT system required just five months of effort.

By contrast, planning a more complex rail project will typically consume three to five years of time (Figure 2.28). Examples such as the Bangkok SkyTrain and the Delhi Metro show that construction can also require another three to five year time horizon.

Bogotá makes for an interesting case study as the city has pursued both rail-based options (metros and LRTs) and BRT. Bogotá spent over four decades developing metro and LRT plans (Figure 2.29). Not a single project advanced beyond the planning stage. In most cases, either sufficient financing was not available or the plan lost momentum with the change of political administrations. While the years of rail planning provided regular incomes to consulting firms, it did little to address the city’s growing transport crisis. BRT brought the first sense of implementation reality to the city’s public transport objectives. Mayor Peñalosa did in a single three-year term what could not be accomplished by fifty years of rail planning.

A longer construction phase can also mean more disruption to the functioning of the city. As portions of the city are under construction, road traffic and businesses will sometimes need to make inconvenient changes to their normal behaviour. The ensuing congestion and loss of sales caused by such disruption can do much to harm the goodwill that a public transport project can otherwise deliver. However, underground systems, such as metros, may have the advantage of less disruption at the surface level.

Obtaining the project financing can be another significant time delay. Most capital intensive technologies may require an additional amount of time in identifying financing sources and in negotiating the terms.

2.2.2.2 Management and administration

The degree of managerial and administrative oversight required by a public transport system is related to the relative complexity of the operations. Thus, cities choosing technically complicated and sophisticated technologies must be prepared for more complex managerial and administrative responsibilities. This added complexity may also imply more financial resources are required to oversee the operating supervision of the system. Allport (2000, p. S-19) points out that the level of managerial experience to oversee such complexity is sometimes difficult to find:

“Without high standards of operations, maintenance and administration [metros] will rapidly deteriorate... The culture, managerial standards and attitudes often found in bus companies and railway corporations of developing countries are unsuitable for a Metro.”

In 2004, Bangkok launched the operation of its subway system, the MRTA. In early 2005 a derailment occurred. The cause was at least partly attributable to human error and the lack of proper administrative controls.

However, partnerships with experienced vendors and management firms can help facilitate the local learning curve. Thus, if a more complex system is chosen, municipalities simply must ensure that the proper controls and expertise are in place.

Fig. 2.30
Phase I of TransMilenio (left illustration) consisted of 40 kilometres of exclusive busways. By the year 2015, the total system is expected consist of 380 kilometres of exclusive busways (right illustration).

Illustrations courtesy of TransMilenio SA



2.2.3 Strategic design considerations

2.2.3.1 Scalability

Scalability refers to the ability to match the size and scope of a system to the particular urban environment. More costly systems tend to require a relatively large scale to operate economically. The higher costs mean that relatively high passenger numbers are needed to financially sustain the system. For the same reasons, such systems may necessitate a larger network in order to operate effectively.

Further, scale is also an issue during the construction phase. Systems requiring expensive construction equipment and special expertise are more cost-effectively constructed with sufficient economies-of-scale. For example, if a city contracts tunnelling equipment and experienced construction teams, it might be relatively costly to construct just a short segment.

Systems that are scalable both in terms of its operations and construction thus give cities a bit more flexibility to match the system characteristics to the needs of the customer. With smaller-sized vehicles, BRT and LRT systems are well-attuned to meeting incremental changes in customer demand. Long sets of metro carriages are perhaps somewhat less flexible in this regard, but some systems, such as the Washington Metro, are able to reduce the number of carriages per rail set to better match off-peak requirements. Since construction techniques for BRT are not so different than normal roadway construction, the required economies-of-scale are far less acute than those for other types of systems. BRT has been developed in cities with populations of 200,000 to mega-cities with over 10 million inhabitants. Even relatively small system additions can be economically accommodated by BRT. Thus, BRT allows cities to have a public transport system that grows and evolves in close step with the demographic and urban form changes that occur naturally in a city. Figure 2.30 illustrates the planned system expansion taking place within the Bogotá TransMilenio system.

2.2.3.2 System flexibility

“It is not the strongest of the species that survive, not the most intelligent, but the one most responsive to change.”

—Charles Darwin, scientist, 1809–1882

Modern modelling and planning practices have greatly aided the objective of matching public transport design to customer needs. Unfortunately, even the best crafted plans cannot account for all eventualities. Customer preferences can be difficult to know with absolute certainty. The nature of a city’s urban form and demographics can change as social and economic conditions change. Thus, it is always preferable to have a public transport system that can grow and change with a city.

During the start-up phase of a new system, customer reactions and preferences are sometimes different than the original predictions indicated from modelling exercises. Demand in one area may exceed or fall short of expectations and require service adjustments. Alternatively, customer demand for express or limited stop services may be quite different from early projections. Routes may require adjustments to account for future changes in urban form.

The relative flexibility of BRT means that such changes can often be accommodated at a modest investment in terms of time and money. Changes to the Bogotá TransMilenio system were handled smoothly within the first weeks of opening the system. By contrast, routing and service changes to rail-based systems are far less adaptable. Once the expense and engineering effort of tunnelling and laying rail is made, the flexibility to make changes is rather limited. Thus, rail-based systems require a good deal more certainty in terms of the required demand and service preferences.

The combination of lower capital costs and greater scalability of BRT means that the system can preserve greater option value for future political administrations and future generations. Rather than committing a city to a prescribed path for the foreseeable future, BRT permits changes in city form, demographics, and public priorities to allow different options to be viable at a later date. Once a city has committed to an expensive technology option, both the psychological and the financial flexibility for making later changes can become limited.

BRT does not necessarily represent the endpoint in terms of a city’s ultimate transit choice. The relative flexibility of BRT means that other options are not closed to a city at a later time.



Van



Conventional bus



Metro



Trolley-bus



Tram

Fig. 2.31
Bucharest (Romania) has virtually every type of public transport system, but the end result of too much diversity can be customer confusion and poor integration.

Photos by Lloyd Wright

A city may elect to upgrade a BRT corridor with a rail-based option. This change may be in response to improved municipal financial conditions that allow a more capital intensive option to be implemented. The reasons for such a conversion may be related to increases in passenger demand or a desire to upgrade to a system with a higher perceived visual image. In either case, BRT provides the flexibility for such a conversion to take place. The segregated busways and high-quality stations of BRT may be directly transferable to another technology. Thus, the earlier BRT investment may not be lost entirely in the conversion process.

Of course, once a BRT system has been put in place a city may not consider a conversion to rail to be necessarily regarded as an upgrade. It is unlikely that residents of cities with high-quality BRT systems such as Bogotá, Curitiba, Guayaquil, and Pereira feel that they possess an inferior service. To date no developing city BRT system has converted to another technology option, although Curitiba has examined the possibility of a future conversion to LRT in some corridors.

The opposite of the flexibility inherent to BRT is the sense of permanence a system provides. Thus, more inflexible infrastructure, such as overhead rail and underground metro systems, encapsulate a stronger message to the population that the public transport system will be a permanent part of the city landscape. Once a city has embarked upon such a costly investment, there is frequently little psychological room to reverse course on a commitment to high-quality public transport.

2.2.3.3 Diversity versus homogeneity

In the past, the conventional wisdom for mass transit services implied that a wide diversity of public transport technologies in a city could be useful. Thus, there are cities such as Buenos Aires, Bucharest, and Paris that simultaneously possess virtually all types of transit technologies (metros, elevated rail, trams, trolleys, standard buses, mini-buses, etc.) (Figure 2.31). The idea behind this abundance of diversity is that each public transport technology can be matched with the corridor characteristics that best match the technology's optimum operating characteristics.

The costs of technology diversity

The reality, though, is often a plethora of services that are not integrated with each other and not understood by the majority of the population. Instead of serving the public in the most efficient manner, the variety of public transport technologies mostly just serve the interests of technology vendors. Physically integrating different technologies that involve separate grade levels (underground, surface level, elevated), boarding techniques, and customer flow levels can be challenging. More often, customers must make difficult and sometimes unpleasant walks between systems. Further, each technology possesses a distinctly different operating cost structure. Some systems operate without the need of public subsidy while others require a continued stream of public funding. Coordinating fare structures and distributing revenues in such an environment can be quite complex and require a high level of managerial and administrative skills. It is quite difficult to design a unified fare structure in such conditions. However, some cities, such as Seoul, have done well in providing a clear and integrated fare system across both rail and road technologies.

Operating several technology types also can imply higher maintenance costs than if a single technology is utilised. Different technologies mean different skills and personnel are needed for maintaining and operating each; there are fewer opportunities for synergies that reduce personnel costs. The various technologies will each likely require their own costly set of spare parts. Economies of scale are typically lost when purchasing multiple types of vehicles and components. Instead of one large order, smaller

orders of different technologies are needed. The opportunity for reduced pricing through bulk procurement is limited.

Additionally, the complexity of managing many technology type often results in a different public agencies being created for each service. An expanding bureaucracy can increase overall administrative costs, reduce coordination, and establish “turf” that is later politically difficult to efficiently consolidate. This administrative complexity can also breed an environment where corruption is more prevalent. As the number of contracts for different technologies expands, so does the opportunity for misappropriation.

While integration of different public transport technologies is an often stated goal, rarely is such integration achieved either physically or in terms of tariffs. In Kuala Lumpur (Malaysia), the Star, PUTRA, monorail, and KLIA systems all operate with different fare structures, despite intersecting at several points in the city. Customers must negotiate difficult transfers across inhospitable roadways in order to transfer from one system to another. Once the customer arrives at the other system, a new fare must be fully paid. Likewise, despite having developed its public transport system over three decades, Manila has yet to fare integrate its LRT1, LRT2, and MRT3 systems.

The justification for a diverse set of technologies has largely been based on the assumption that each mode (LRT, BRT, elevated rail, metro, etc.) had a fairly narrow band of operational viability. However, as will be shown later, many technologies can operate cost effectively across a fairly wide range of passenger demand.

Fig. 2.32, 2.33, and 2.34
Customer conditions with road-based public transport in Bangkok.

Left and middle photo by Lloyd Wright
Right photo by Carlos Pardo





Fig. 2.35 and 2.36
How the other half lives. Conditions on rail-based systems in Bangkok.

Photos by Lloyd Wright

Public transport investments and equity

The practice of selecting many different technologies of varying quality also creates serious equity issues within a city. High-capacity corridors serving commercial centres and business districts may receive more expensive, high-technology systems. In such cases, the served customers may tend to belong more to middle and higher-income groups. Lower-income areas can end up being served by lower-quality systems such as under-funded (or non-funded) paratransit and conventional bus systems. Thus, a sort of transport apartheid can emerge in which much of the public transport investment budget actually disproportionately serves higher-income groups. While such policies may be more an outgrowth of matching a technology to demand, the consequences for the population are no less unsettling.

The Bangkok MRTA subway system is one potential example of this phenomenon. The system has absorbed much of the recent city’s public transport budget, but serves only about one percent of daily public transport trips in the city. Further, these trips tend to be disproportionately serving middle and higher-income groups. By contrast, the city’s bus system serves approximately 96 percent of the daily public transport trips, but receive little funding support or basic customer amenities (Figures 2.32, 2.33, and 2.34). The difference in travel conditions between the under-funded road based system and the heavily subsidised rail-based system in Bangkok is quite dramatic (Figures 2.35 and 2.36). Likewise, the Kolkata metro is an often cited example of a costly system serving mostly higher-income groups while other public transport forms are left to a certain degree of neglect.

Table 2.5: Characteristics of highly-profitable airlines

Category	Product and operating features
Vehicle (aircraft)	Single type
Fares	Low, simple, and unrestricted
Distribution	Ticketless
Service	Single-class, high-density
Frequency	High
Punctuality	Very good
Staff	High productivity, high morale
Customer service	Friendly and responsive

Source: Adapted from Doganis (2001)

An alternative model

Perhaps the best example of how technological simplification can result in a multiple of benefits can be seen in today’s airline industry. The recent success of so-called “low-cost” or “no-frills” airlines can in part be tied to a fairly simplified business model. These airlines typically only maintain one type of aircraft, and thus have greatly reduced maintenance costs and spare part costs. The simplified operating environment also permits faster turn-around time between routes which leads to more revenues per passenger-vehicle kilometres. As a result such airlines (Southwest Airlines, JetBlue, GOL, EasyJet, and Ryan Air) have become leaders in terms of profitability and market

capitalisation (*i.e.*, value). The business model for these companies may in fact offer a host of lessons that may provide insights into how public transport can succeed. Table 2.5 summarises these characteristics.

While urban public transport is clearly quite different from the airline industry, there are a sufficient number of parallels to consider aspects of this model. Simplicity in conjunction with excellence in customer service can be a powerful combination.

In some extreme cases of population densities and topographical constraints, a city may indeed require multiple technologies to meet its public transport needs. However, these cases are relatively rare. If a single public transport technology can adequately serve a city's mobility needs, then the ensuing cost and managerial savings can be significant.

2.2.4 Performance

A system's performance characteristics will play a large role in determining customer usage levels. It does little good to have an economical system if nobody is willing to use it. The ability of a system to attract ridership is thus a prime decision-making determinant in selecting a public transport technology.

2.2.4.1 System capacity

Characteristics affecting system capacity

The ability to move large numbers of passengers is a basic requirement for mass rapid transit systems. This characteristic is particularly important in developing-nation cities where mode shares for public transit can exceed 70 percent of all trips. Passenger capacity is affected by several factors that can differ between types of public transport systems:

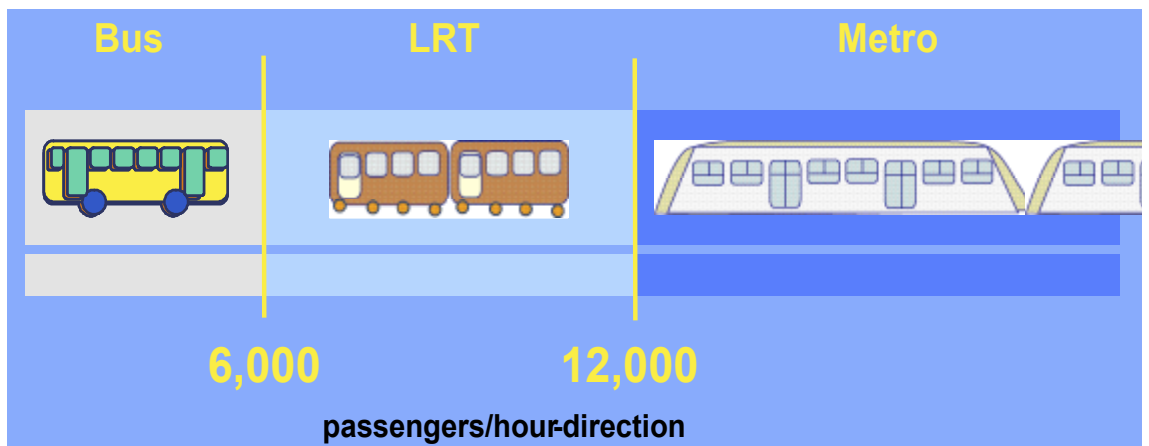


Fig. 2.37
Traditional view
of public transport
capacity.

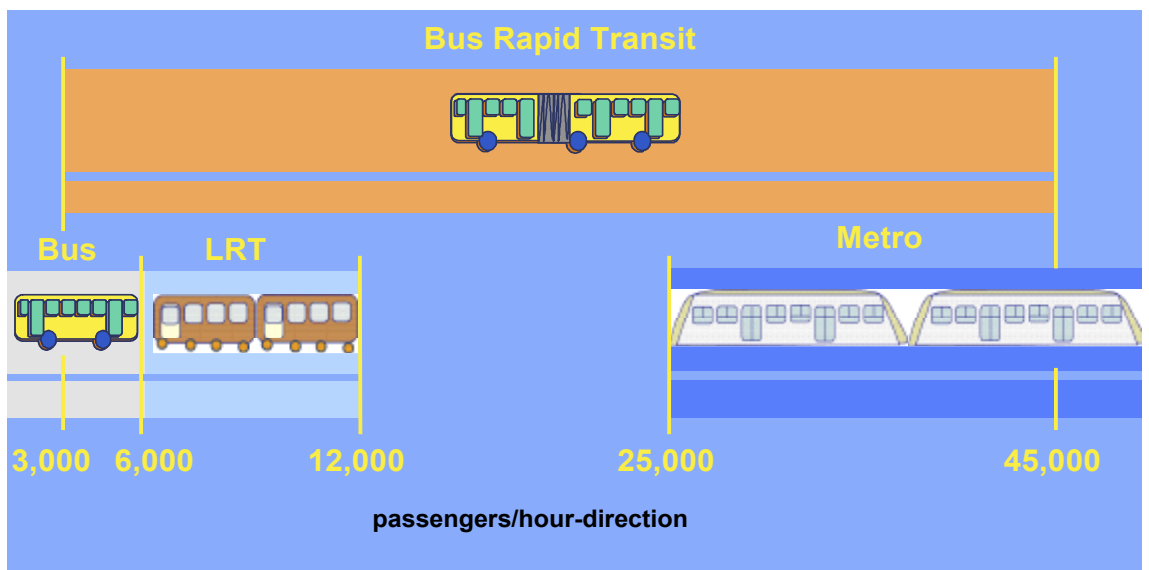


Fig. 2.38
New view of public
transport capacity.

- Size of vehicle (passengers per vehicle);
- Number of vehicles that can be grouped together;
- Headway between vehicles (amount of time that elapses between vehicles in safe operation);
- Availability of limited-stop or express services;
- Boarding and alighting techniques.

In many developed-nation cities, passenger capacity is a less vital issue as the lower density of the cities along with lower market shares for public transport creates less peak demand. By contrast, developing-nation cities often have both high population densities and high market share for public transport.

System capacity comparisons

Passenger capacity and infrastructure costs have traditionally been the most significant determinants in public transport technology decision making. Historically, a fairly strict set of technology capacity limitations has meant that buses, LRT, and metro rail operate only within rather narrowly defined circumstances (Figure 2.37). A corridor’s demand characteristics would thus largely determine the possible technology. A single arterial lane of cars can typically transport from 2,000 to 4,000 passengers per hour per direction (pphpd), depending on average passenger numbers per vehicle, velocities, and separation distance between vehicles. It was previously thought that bus services could only operate in a range up to about 5,000 to 6,000 pphpd. LRT could then cover demand up to approximately 12,000 pphpd. Anything over this level would require a metro or elevated rail system.

However, busways and BRT systems have begun to change this traditional view. With the Bogotá BRT system now achieving an actual peak capacity of 45,000 pphpd, a new capacity paradigm is being created. Figure 2.38 provides a pictorial view of this new view on each technology’s approximate current operating range.

Determining the appropriate technology from a passenger capacity standpoint actually requires attention to two different factors: 1. Maximum capacity; and 2. Cost-effective range of operational capacity. The first factor determines whether a technology possesses sufficient capacity to support the peak period on a given corridor. The second factor determines if the fluctuations between peak and non-peak periods

Table 2.6: Actual peak capacity, selected mass transit systems

Line	Type	Ridership (passengers/hour / direction)
Hong Kong Subway	Metro	80,000
São Paulo Line 1	Metro	60,000
Mexico City Line B	Metro	39,300
Santiago La Moneda	Metro	36,000
London Victoria Line	Metro	25,000
Buenos Aires Line D	Metro	20,000
Bogotá TransMilenio	BRT	45,000
São Paulo 9 de julho	BRT	34,910
Porto Alegre Assis Brasil	BRT	28,000
Belo Horizonte Cristiano Machado	BRT	21,100
Curitiba Eixo Sul	BRT	10,640
Manila MRT-3	Elevated rail	26,000
Bangkok SkyTrain	Elevated rail	22,000
Kuala Lumpur Monorail	Monorail	3,000
Tunis	LRT	13,400

fits into the range of cost-effectiveness for the technology.

Table 2.6 summarises capacities actually achieved on a different systems. “Actual” capacities are more typically revealing than “theoretical” capacities. It is true that some systems run at higher passenger densities, depending on cultural norms. Thus, one could differentiate between “crush capacities” and “nominal capacities”. For example, the Hong Kong and São Paulo systems as well as the Bogotá BRT system operate under fairly packed customer conditions. The Tokyo subway system has employed workers with white gloves whose job is to push passengers as tightly as possible into the carriages. Obviously, such packed conditions can distort capacity values. Nevertheless, this section provides only “actual” passenger capacity values in order to avoid the arbitrariness of comparing highly theorised values that may be manipulated to make one technology more attractive than another.

Figure 2.39 compares the range of passenger capacity for each technology measured against the range of capital costs. The ranges presented in Figure 2.39 are based on actual not theoretical data.

The different sized areas of the rectangles in Figure 2.39 are also revealing with regard to the relative risk and overall flexibility of each

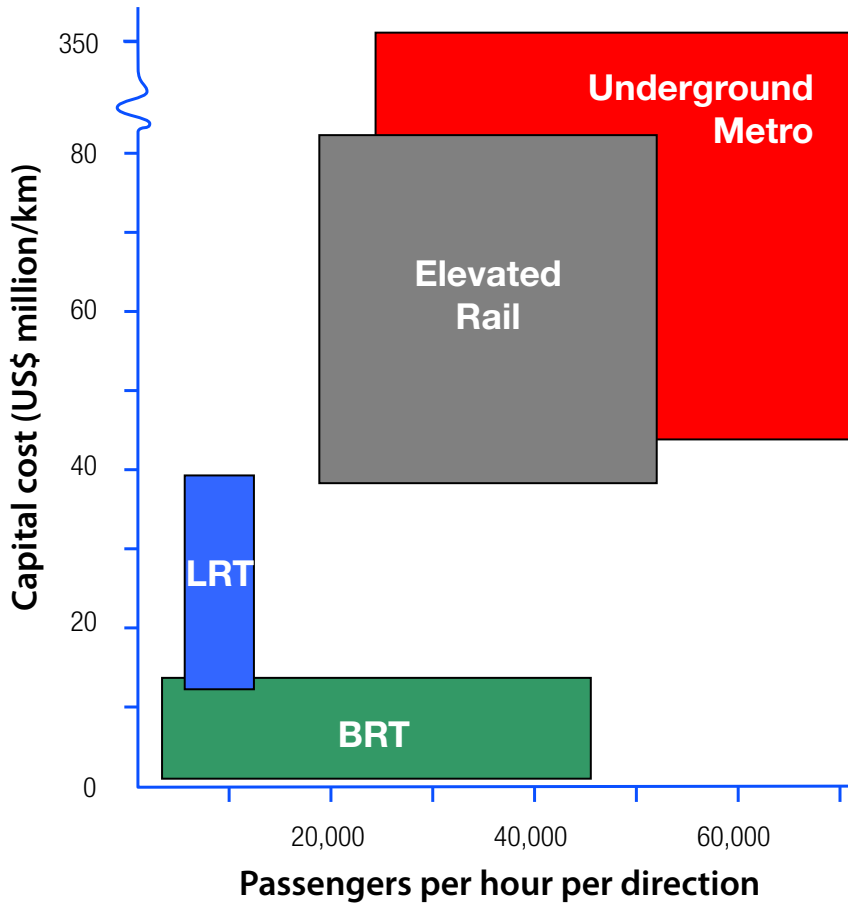


Fig. 2.39
Passenger capacity and capital cost for mass transit options.

transit technology option. Ideally, a technology will have a narrow band of possible capital cost levels (y-axis) and a wide band of profitable capacity operations (x-axis). In other words, a system that minimises costs and maximises the spectrum of profitable operating conditions provides the most cost-effective and flexible solution. The width of the range of capital costs (y-axis) can also be interpreted as an indication of the potential risk and uncertainty involved in implementing the particular project.

Metro and elevated rail capacities

Historically, passenger capacity has been the major advantage of underground metro systems and elevated rail systems. The combination of large, multiple-train sets and unencumbered fully-segregated infrastructure provides the conditions to rapidly move high volumes of customers. The metro systems in cities such as Hong Kong, New York, São Paulo, and Tokyo are capable of transporting well over 50,000 pphpd. No other public transport technology can match this level of service capacity.

Further, the efficiency of such systems when operating at high capacity levels produces highly cost-effective operations. The Hong Kong subway system has been financed entirely through passenger revenues and property development. The 88 kilometres of metro rail construction



Fig. 2.40
For cities such as Montpellier (France), LRT provides a good public image and can adeptly serve moderate peak demands (less than 12,000 pphpd).
 Photo courtesy of UITP

thus required no public financing. This result is principally due to the fact that the system achieves the highest passenger demand levels of any mass transit system in the world.

As noted earlier, though, such systems are significantly less cost effective at lower demand levels. Without very high peak demand and reasonably high non-peak demand, metro rail and elevated rail systems are unlikely to be able to achieve farebox recovery. Thus, these systems require a fairly particular operating window of passenger demand. For this reason, the most successful metro rail and elevated rail systems operate in the highest demand corridors of mega-cities.

LRT capacities

LRT applications are well suited to the demand conditions of US cities and medium-sized European cities. The given population densities and urban form of such cities imply that corridor demand rarely exceeds 10,000 pphpd (Figure 2.40). In such situations, metro rail or elevated rail would likely not be a cost-effective option.

When operating at street level, LRT is limited by intersections and safe distances between train sets. Unlike some busway applications, LRT switching and signalling systems do not support vehicles over-taking one another at station stops. This limitation restricts the ability of the system to offer the type of express services that make the high capacity figures on BRT systems like Bogotá possible. Allport (2000, p. 38) reinforces this point with:

“Typical at-grade LRT throughputs were about 4,000-6,000 passengers per hour compared to busway average of 15,000 at about the same commercial speed. There were no known LRT’s operating at-grade which approach the passenger carrying capacity of the existing Curitiba, Quito or Bogotá busways.

LRT achieves high speed by using a signalling system to avoid bunching, and by obtaining priority at traffic signals over other traffic; and it achieves high capacity by having large vehicles which take advantage of the signal cycles. In practice the distance between signals defines the maximum vehicle size, and the need to provide for crossing traffic limits the number of vehicles per hour. However,

LRT systems are operationally vulnerable to the everyday events that happen in the centre of developing cities. Whether this is junctions being partly blocked, or road maintenance work, or a breakdown, or an accident, while bus systems are often able to get round the problem (they can overtake, leave the busways etc), LRT is not.

We conclude that an LRT capacity of 10-12,000 pphpd at an operating speed of 20 kph is likely to be the limit to what is achievable.”

LRT systems are capable of higher capacities if the systems are grade separated. The Manila MRT3 line could be considered an LRT system by some definitions since it draws its electricity source from an overhead cable. The system is fully grade separated through an elevated structure and currently achieves an actual peak capacity of approximately 26,000 pphpd.

In general, though, capacity is not a major constraint for LRT systems since the principal application has been in the developed nations of Europe and North America. Cities in these nations rarely have public transport demand exceeding the limitations of an at-grade system.

BRT capacities

Concerns are sometimes raised whether bus-based options such as BRT can handle the passenger flows that are often required in denser, developing-nation cities. Bogotá’s Trans-Milenio system has done much to answer these concerns. Bogotá’s system currently moves an average actual peak capacity of 45,000 pphpd (Figure 2.41). Many BRT and busway systems in Brazil are capable of peak capacities ranging from 20,000 pphpd to nearly 35,000 pphpd. In the case of Bogotá, the high capacity figures are achieved principally through the following attributes:

1. Use of articulated vehicles with a passenger capacity of 160;
2. Stations with multiple stopping bays that can handle up to five vehicles per direction simultaneously;
3. Passing lanes at stations and double lanes on some runways in order to allow express and limited-stop vehicles to pass local services
4. Multiple permutations of routing options that include local, limited stop, and express services;



Fig. 2.41
The provision of multiple stopping bays and passing lanes at stations permits the Bogotá TransMilenio system to achieve high passenger capacity.

Photo by Carlos Pardo

5. Average vehicle headways per route of three minutes, and as low as 60 seconds during peak periods; and,
6. Station dwell times of approximately 20 seconds (achieved by use of at-level boarding and alighting, pre-board fare collection and fare verification, and three sets of large double doors on each vehicle).

The fact that Bogotá's TransMilenio functions well in a city of 7 million inhabitants with a population density of 240 inhabitants per hectare says much about BRT's potential in other mega-cities. However, to accommodate Bogotá levels of capacity, a system would have to make available sufficient road space for passing lanes at stations and/or double lanes per direction along the runways. In many cities, the physical space to implement this width of infrastructure is simply not available. Moreover, dedicating any amount of road space to exclusive use by public transport is often politically difficult, especially given the relative political strength of private motorists.

Systems such as Quito and Curitiba that utilise just one lane in each direction can reach capacities of approximately just 12,000 pphpd. However, Porto Alegre (Brazil) also has only one lane available in each direction but reaches capacities of over 20,000 pphpd through the clever use of multiple stopping bays and the platooning of vehicle movements. In general, though, a BRT

system or an LRT operating on a dedicated single lane will achieve the approximately the same capacity level. For most cities, these capacity levels are sufficient for the given demand. BRT is still an option of up to 45,000 pphpd, but only if Bogotá-type measures are taken.

Corridor capacity vs. network development

In reality, the debate over capacity can be a bit misleading. The capacity required on a particular corridor is principally determined by the population density along the corridor, the total catchment area for passengers, and the origin and destination profile of the residents. When a system consists of a network that covers the majority of central districts and main corridors, this catchment area typically extends to an area of between 500 metres and one kilometre around stations as well as the passenger traffic collected by feeder services. Thus, while the central areas of London and New York host dense populations, the extensive coverage of the system network distributes demand across many parallel and connecting lines. In London, the demand handled by the mass transit system does not exceed 30,000 pphpd. This lower capacity occurs not because there is little demand, but rather because the relatively large demand has been well-distributed around an overall network.

However, in cities such as Hong Kong and São Paulo, where a limited network is provided, capacities reach 60,000 pphpd and higher. In this sense, a limited network can become a self-fulfilling prophecy with respect to capacity. If a city can only afford a few metro lines, the passenger demand is drawn from a much wider area and thus creates a capacity requirement that only metros can fulfil. Hong Kong draws large numbers of passengers from Kowloon and the New Territories into a single metro line on Nathan Road. There are disadvantages to this approach. By requiring passengers to travel farther to enter the system, the system developers are making conditions less convenient to the customer, which will ultimately result in captive users seeking alternatives such as private vehicles. Also, when operating at a capacity of over 60,000 pphpd, the system is far less robust with respect to delays and technical problems. A two-minute outage in such a system can create extremely difficult conditions and backlogs.

Extending the Hong Kong subway system has been restricted due to the sole use of private capital for all infrastructure costs. Only the highest-demand corridors provide sufficient return on capital from passenger revenues to fully finance the infrastructure.

Distributing capacity across a full network of routes and corridors offers several benefits: 1. More convenient station access for customers; 2. More comfortable customer conditions; and 3. More manageable customer volumes. It is recognised that the extensive metro networks developed in London, New York, Paris, and Tokyo are not necessarily financially replicable in developing-nation cities. However, an important principle regardless of the technology chosen is to design a system with as much city-wide network coverage as possible. It is preferable from a customer standpoint to choose a less costly system that covers more origins and destinations than a costly system covering a more limited area.

2.2.4.2 Affordability

The customer tariff is related to operational costs and the level of subsidies (if any). Developing-nation public transport customers can be particularly price sensitive. A small difference in tariff levels can make a substantial difference in ridership levels. Thus, technologies that involve lower operating costs are perhaps more appropriate in such a context.

As noted earlier, BRT systems have achieved a certain amount of success in providing reasonable fare levels without the intervention of operating subsidies. Fares in the range of US\$0.25 to US\$0.70 are typical with the subsidy-free systems in Latin America. In some cases, though, conventional bus services may be able to deliver tariffs at just below these levels. Thus, in the case of Bogotá, the small difference in conventional bus fares to the BRT system can affect ridership in certain parts of the city. In other cities, such as Quito, the BRT system and the conventional bus system offer services at the same tariff level of US\$0.25.

Outside of the highest demand corridors, many metro rail systems must offer a subsidised fare level in order to achieve affordability within the local context. The Delhi Metro’s fare level of

12 rupees (US\$0.26) is subsidised at a level of approximately 90 percent. While this type of subsidisation can be appropriate in some circumstances, there are always questions over its long-term sustainability, especially in cities with many other investment requirements.

2.2.4.3 Travel time / speed

Travel time and operating speed are related but distinct concepts. From the customer standpoint, the actual door-to-door travel time is probably the more important variable rather than top speeds. Thus, one must also consider the time travelling to and from stations, the time spent walking from entry points to the vehicle platforms, and the time spent waiting for a vehicle. Equation 1 summarises each of the variables that contribute to calculating total travel time.

Equation 2.1: Total travel time

Total travel time	=	Travel time from origin to transit station
	+	Travel time from entering station to vehicle platform
	+	Vehicle waiting time
	+	Vehicle boarding time
	+	Vehicle travel time
	+	Vehicle alighting time
	+	Travel time from vehicle platform to station exit
	+	Travel time from station exit to final destination

The “commercial speed” of the vehicle is often more important than the “maximum speed”. The commercial speed represents the average speed including the dwell time at stations. Thus, a system with short distances between stations or with long boarding and alighting times will be comparatively penalised in terms of average speed. However, a system with significant distances between stations will mean that passengers spend more time walking to and from the stations to access destinations.

As surface modes, BRT and LRT are advantaged with relatively accessible entry and exit points. In contrast, metro and elevated rail

systems may require additional time to reach the platforms that are at a depth below the street or overhead. Further, the more costly systems sometimes imply that there is less coverage of the city's total area since it is not typically financially feasible to construct lines in all corridors. Thus, distances to arrive at a station may also require additional travel time or even an additional public transport trip on a feeder service.

However, once a passenger enters a vehicle, the commercial speed of metro rail systems and elevated systems can be significantly superior to either that of BRT or LRT. Underground and elevated metro systems generally reach average commercial speeds in the range of 28 to 35 kilometres per hour. LRT systems will generally achieve average commercial speeds in the range of 12 to 20 kilometres per hour. Commercial speeds for BRT systems are typically in the range of 20 to 30 kilometres per hour. These values will vary depending upon the number of intersections to be crossed, the extent to which signal prioritisation technologies are being utilised, and the separation distance between stations.

A comparison of light rail systems and BRT systems in the United States revealed higher average speeds for BRT in five of the six cities investigated (Figure 2.42). The US study noted the use of high-occupancy vehicle (HOV) lanes and the ability to augment local services with limited stop services as the reason for BRT's superior performance (US GAO, 2001). However, if special highway lanes with infrequent stops are not included in the analysis, BRT and

LRT will likely have fairly comparable average commercial speeds.

The provision of "limited stop" and "express" services in addition to "local" services can be a significant factor in reducing travel times. Limited stop services imply that the public transport vehicle will skip several stations between more major travel nodes. Express services imply that even more stations are skipped allowing the service to go between major points of origins and destinations. Local services typically involve stopping at each of the stations in a particular corridor. A few metro systems, such as the New York subway, do in fact have second sets of tracks to permit limited stop services. However, these services are relatively rare for metro and LRT systems for reasons of both cost and technical complexity. The ability to safely control passing at stations is difficult with high-frequency rail services. The ability to change directions and cross paths between two rail routes requires the somewhat costly grade separation of the two tracks, at least in most urban situations (Figure 2.43). The relative flexibility of BRT permits greater ease in developing passing lanes at stations. BRT systems in cities such as São Paulo and Bogotá operate with either passing lanes and/or second sets of exclusive busway lanes in order to permit more direct services.

The relative advantage of a particular public transport technology with respect to travel time depends greatly upon local circumstances and system design. Metros may produce the highest maximum velocities, but may entail longer access and departure times. BRT's ability to provide limited stop and express services can be quite advantageous, especially for customers travelling from areas outside the central districts.

2.2.4.4 Mode share

In theory, any type of public transport technology could be designed to serve most of the trips within a city. In practice, financial limitations prevent the construction of a full network across an entire metropolitan region. Thus, more costly technologies generally can only be cost justified

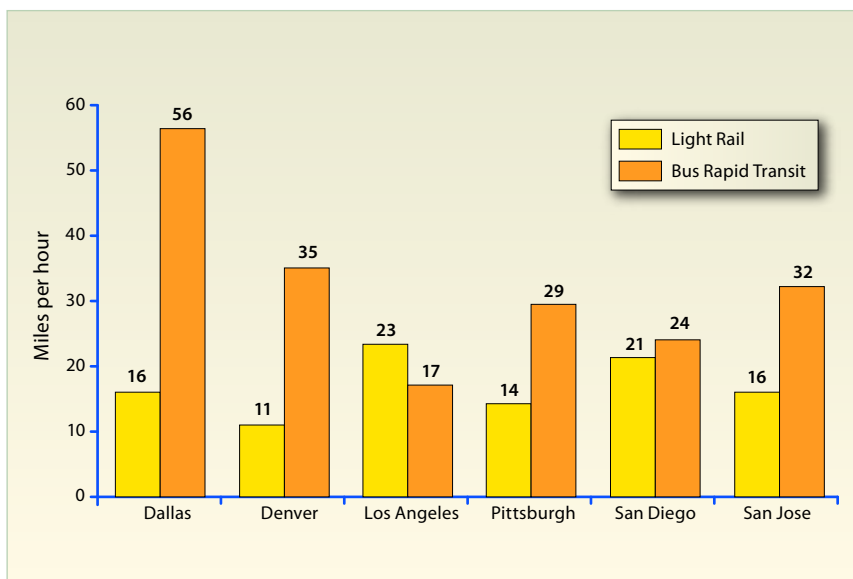


Fig. 2.42

A survey comparing US BRT systems with light rail systems showed that the BRT systems actually delivered higher average speeds.

Graph from US GAO (2001)



Fig. 2.43
As this image from the Osaka monorail indicates, in order for two intersecting rail corridors to cross in high-capacity urban conditions, grade separation is likely to be necessary.

Photo by Lloyd Wright

in a few corridors, and thus actually serve fewer overall numbers of passengers.

In cities that have both a metro system and a bus network, the metro generally only carries a small portion of the cities public transport ridership. Table 2.7 compares mode shares for several cities with both a metro and a bus network. While it is true that the peak capacity of metros and elevated rail systems surpass other modes, their ability to serve large overall numbers of passengers is limited due to cost reasons. Bus systems, as both a standard service and an enhanced BRT service, continue to serve as the principal public transport backbone of most cities. In cities with metros and/or elevated rail systems,

such as Mexico City and Bangkok, the numbers served by the rail systems are typically less than 15 percent of the daily trips (Table 2.7).

While metro systems often receive the largest share of public transport investment as well as political attention, the reality is that underfunded bus systems still carry the vast share of customers. This finding does not diminish the importance of high-capacity metro rail in serving key corridors. However, it may indicate that cities might also consider evaluating investment decisions based on passengers served.

Figures 2.44 through 2.47 illustrate the different treatment sometimes extended to bus services. Such examples perhaps demonstrate

Table 2.7: Mode share comparison

City	Bus	Metro	Train	Car	Motor-cycle	Taxi	Walk	Bicycle	Other
Bangkok ¹ , 2003	31.0	3.0	0	30.0	32.0	4.0	-	-	-
Beijing ² , 2000	15.0	2.0	0	16.0	2.0	6.0	33.0	26.0	-
Buenos Aires ³ , 1999	33.0	6.0	7.0	37.0	0	9.0	7.0	0	-
Caracas ³ , 1991	34.0	16.0	0	34.0	0	0	16.0	0	-
Mexico City ⁴ , 2003	63.0	14.0	1.0	16.0	-	5	-	-	-
Rio de Janeiro ⁵ , 1996	61.0	2.3	3.1	11.5	0.2	-	19.7	1.3	0.9
Santiago ⁶ , 2001	28.4	4.5	-	23.5	-	1.3	36.5	1.9	4.0
São Paulo ³ , 1997	26.0	5.0	2.0	31.0	1.0	0.0	35.0	0	-
Shanghai ² , 2001	18.0	2.0	0	4.0	2.0	2.0	44.0	28.0	-

Sources:
 1. OTP (2003)
 2. Xu, K. (2004)
 3. Vasconcellos, E. (2001)
 4. SETRAVI (2003)
 5. IplanRio (1996)
 6. Ciudad Viva (2003)

the relatively low status held by decision makers for road transport services. Despite often serving the majority of trips within a city, funding is typically quite scarce.

2.2.4.5 Service frequency

Travel time is also greatly affected by the frequency of the provided public transport service. Highly frequent service will imply lower average wait times for customers. Service frequency also affects the perception of the system's reliability and car competitiveness.

While a frequency of five to ten minutes may not seem long in relative terms, from the perspective of the passenger, wait times can have much (*i.e.*,

time between different train sets or vehicles approaching a station) is safety. However, today's switching technologies permit rail train sets to arrive within 60 seconds of one another. Bus-based systems are capable of safely maintaining even closer distances. Highly frequent service, though, can result in the "bunching" of vehicles, and thus ultimately result in delays and slower average speeds.

In practice, some technologies can be disadvantaged in terms of service frequency due to the local demand profile. For example, the popularity of LRT vehicles in North America and Europe is in part due to the ability to carry as many 400 passengers utilising just a



Fig. 2.44 and 2.45

The quality of the customer's experience varies greatly in Singapore depending on whether the rail system (left photo) or the bus system (right photo) is utilised. While the Singapore rail system has received orders of magnitude more investment, it

actually carries less than half as many passengers as the bus system, 1.2 million trips per day by rail and over 3 million trips per day by bus.

Left photo by Calvin Teo
Right photo by Karl Fjellstrom



Fig. 2.46 and 2.47

In Chengdu (China), despite private cars being used for only 3 percent of the trips (left photo), car-based infrastructure is being rapidly expanded, often at the expense of space for non-motorised users.

At the same time, bicycles represent a 43 percent mode share and the badly maintained bus system carries 10 percent of the trips (right photo).

Photos by Karl Fjellstrom

single driver. This characteristic helps to reduce labour costs, which are relatively high in these countries. However, the other side of this equation is that larger capacity vehicles tend to result in lower frequency of service, especially in North American cities with relatively low passenger numbers. The lower frequency is due to the need to adequately fill public transport vehicles in order to operate efficiently. Table 2.8 gives peak and non-peak service frequencies for some rail-based systems in the United States.

Table 2.8: Service frequency for rail-based systems

System	Peak frequency (minutes)	Non-peak frequency (minutes)
Denver Light Rail	3-6	9-26
Miami MetroRail	6	10-60
Portland MAX	5-13	13-33
St. Louis MetroLink	10	10-30
San Diego Trolley	9-15	15-30

The proper sizing of public transport vehicles can help keep service frequency in the range of two to five minutes throughout the day. BRT systems have been successful in maintaining both high service frequencies and system profitability. The higher frequencies are particularly feasible in developing cities where customer flows are relatively large.

2.2.4.6 Reliability

Reliability is related to the level of confidence one has in the public transport system’s ability to perform as expected. The concept of reliability is related to the previous discussions of travel time and service frequency, but can also refer to other system characteristics such as comfort and safety.

An unreliable service can create a high degree of personal stress if a customer does not know when or if a vehicle is going to arrive at a station. Unreliable services ultimately lead to non-captive users seeking more robust travel options, such as private vehicles.

Each type of public transport system has different characteristics with regard to reliability.

The frequency of service breakdowns, the rate at which disabled vehicles can be replaced, and the operational responsiveness to changes in demand all affect overall reliability. Metros, LRT, and BRT all have excellent records of reliability, particularly when compared to more conventional public transport services. Segregated right-of-ways help to better control service frequencies and headways between vehicles. Systems with complete grade separation, such as underground metros, have a particular advantage in terms of avoiding unforeseen incidents at mixed traffic intersections.

The relative flexibility of BRT vehicles to operate inside and outside of the segregated infrastructure allows immediate adjustments to breakdowns. Service can continue while repairs or removal are taking place. The breakdown of a metro or LRT vehicle can require additional time for remedial actions. Until the disabled vehicle is cleared from the system, there can be disruption to service.

Another consideration is the impact of extreme weather considerations on the system. Systems that are completely underground are immune to such affects, although a weather-related failure of the electricity supply can obviously have an impact. Ice on rails and busways can act to slow or even halt services.

2.2.4.7 Comfort

The level of comfort within a system depends upon many design characteristics that are somewhat independent of mass transit type. Station seating and protection from the elements are dependent on system design. Underground systems have the advantage of a better natural barrier from outside weather conditions. The interior design of the vehicles is again dependent upon design specifications, and can be of equal quality for either rail or BRT services. However, some types of trams may have a more narrow width which may limit design options and in some cases create a more squeezed environment for the customer.

Ride comfort is one potential area of significant difference between BRT vehicles and rail vehicles. Rail is typically credited with a smoother ride performance both during starts and stops as well as during full operation. A smoother ride

performance better permits value-added activities, such as reading, for the customer (Figure 2.48). However, not all rail systems provide the same ride quality. The Kuala Lumpur monorail technology actually delivers a somewhat “bumpy” travel experience. Additionally, older tram systems likewise may not provide an entirely smooth ride. Low-floor BRT vehicles can be susceptible to surface imperfections on the busway that will result in a “bumpier” ride. High-floor vehicles with ramped entry service can better mitigate this issue through dampening and improved suspension. With this type of BRT vehicle set-up in cities such as Bogotá, Curitiba, and Guayaquil, on-board activities such as reading are quite feasible. However, in general, the ride smoothness of rail vehicles is superior to that of BRT vehicles.

2.2.4.8 Safety

Segregated lanes for rail and BRT vehicles help to reduce the potential for accidents, and thus make such mass transit options relatively safer over more standard services. Grade separated services, such as underground metros, particularly benefit from avoiding such conflicts. Both BRT and LRT systems face potential risks when crossing intersections. The opening of the

Houston (US) LRT system has been met with a higher than expected accident rate between private vehicles and LRT vehicles. Likewise, the November 2005 opening of the Orange Line BRT system in Los Angeles resulted in intersection clashes between cars and the BRT vehicles. Private vehicle owners are often unaccustomed to the presence and operation of segregated public transport vehicles and may be unprepared for the implications.

Fully grade separated systems do incur other types of risks that may affect safety. The higher maximum speeds reached on underground and elevated systems implies that in the event of a mishap, there is a greater chance for serious injury and fatalities. Just before the launch of the Kuala Lumpur Monorail a spare wheel came loose and fell to the surface, striking a journalist who happened to be walking near the system (Figure 2.49). The resulting injury required hospitalisation. Likewise, the Las Vegas monorail also had parts fall to the street level during its first year of operation. Further, underground and elevated systems have added difficulty in evacuating customers during a system emergency. Passengers may be stranded several hours prior to being evacuated in a safe manner. However, in general, modern metro systems have an exemplary record of both reliability and safety.

2.2.4.9 Customer service

Customer service features are equally possible for both BRT and rail-based systems. Intelligent Transport Systems (ITS) that inform passengers of expected arrival times, clear maps and payment instructions, and friendly and helpful staff are not generally dependent on the type of public transport system.

However, the provision of customer service infrastructure may be related to the available capital investment. Systems with larger budgets may be better positioned to provide customer features such as comfortable seating, air conditioned vehicles and stations, and aesthetically pleasing environments. Conversely, systems requiring large track, station, and terminal investments may have little capital resources remaining to be attentive to customer comforts. The main station of the Tokyo Monorail is located on the third floor of a commercial building in central Tokyo. No lifts or escalators

Fig. 2.48
The smooth ride performance of rail-based systems makes add-value activities, such as reading or studying, easier to undertake.

Photo by Lloyd Wright





Fig. 2.49
A pedestrian was seriously injured when a part fell from the Kuala Lumpur monorail during its initial trials.
 Photo by Calvin Teo

are provided to access the station. Instead, prospective passengers must make a hike of three floors (Figure 2.50). Since the monorail services Haneda Airport, many passengers enter the system with large bags and suitcases, and thus have a difficult time reaching the station platform by stairs. The significant infrastructure budget of the system has restricted the developers' ability to provide customer amenities such as escalators.

2.2.4.10 Integration

The ability to transfer comfortably and easily between neighbourhood feeder services and trunk-line services is a major determinant in attractiveness of the overall system. Poorly executed transfer services often share some of the following characteristics:

- Long physical distances separate the two services involved in a transfer; for example, customers may have to cross a street to make the transfer;
- Transfer is conducted in an area unprotected from extreme weather conditions;
- Transfers are poorly timed so that long waiting periods are required; and,
- Customers must effectively pay twice for transferring between lines.

Transfers with such characteristics do little to foster customer good will. Conversely, a fare-free transfer conducted in a pleasant, safe, and controlled environment with a brief wait will minimise the undesirability of transferring.



Fig. 2.50
Despite being a premiere public transport system in the Tokyo area, the city centre station of the Tokyo monorail requires its passengers to make a three-story climb up stairways to access the station.
 Photo by Lloyd Wright

In theory, easy transfers are possible with any of the public transport technologies. In practice, the cost of facilitating transfers between systems with different physical, operational, and cost characteristics can be challenging. As noted earlier, bus services tend to be the backbone of most city public transport systems, even when a rail-based system is operating on major corridors. Mass transit systems must integrate with conventional bus services in order to continue services into lower-density neighbourhoods. Surface-based systems, such as BRT and LRT, thus have an immediate physical advantage in easing simpler at-grade transfers.

Grade-separated systems, such as underground or elevated systems, imply that transfers must traverse a vertical distance. While the physical discontinuity can be overcome with the use of stairways, escalators, and elevators, in some cases these transfers are quite physically difficult, especially for the very young, the elderly, and the physically disabled (Figure 2.51). Further, directing patrons from one system to another requires clear and visible signage. The facilitation of this type of coordination between two independently managed systems sometimes fails to occur. Allport (2000, p. S-6) notes these various difficulties with:

“Integration with the bus system is particularly necessary to metro viability, and often difficult to achieve.”

Despite these challenges, some metro systems have done quite well to overcome the physical

Fig. 2.51

Whenever this is a grade difference between public transport services, there will always be challenges in facilitating easy transfers, especially for the physically disabled.

Photo courtesy of UITP



differences and have designed effective integration stations. Hong Kong, Miami, Washington, and São Paulo have achieved some success in this area (Figures 2.52).

In addition to facilitating at-grade transfers with conventional bus systems, BRT systems tend to have an advantage in terms of operational and business integration. First, there is less economic discontinuity between feeder bus services and an exclusive busway. Both systems are based on bus vehicles and operate within relatively similar cost structures. In developing-nation cities, both feeder services and busway services typically operate without subsidies. Thus, finding a business model that allows smooth integration and shared infrastructure between feeder and trunk-line services is more easily facilitated.

Fig. 2.52

The Miami busway integrates closely with the city's elevated rail system.

Photo by Lloyd Wight



By contrast, matching a system requiring operational subsidies with another devoid of subsidies can be difficult in terms of distributing revenues. In such instances, developing an integrated business model can be more complex.

Second, some BRT systems are able to cleverly eliminate the distinction between feeder and trunk-line services. In cities such as Porto Alegre (Brazil), public transport vehicles from multiple routes utilise the same trunk-line corridor, but these vehicles then leave the busway to directly serve different feeder areas. In this arrangement, virtually all customers receive a direct trip into the city centre. Likewise, the city of Guangzhou (China) is developing a system along a similar premise. Operating rail-based systems into lower-density neighbourhoods is generally not economically viable.

Accommodating other types of feeder services is equally important. Arriving at the public transport station by taxi, by bicycle, or by walking, should also be considered in the system's design. Designing for these modes is relatively independent of public transport type. However, in some cases, underground systems may be able to provide more space for bicycle parking than median LRT and BRT systems. In all cases, terminal areas should provide sufficient space to include bicycle facilities. Permitting bicycles on-board the vehicle is a significant advantage for the customer who can then use the bicycle to arrive at the final destination. In narrow public transport vehicles, such as some tram systems, the ability to enter with a bicycle may not be physically possible.

2.2.4.11 Image and status

"A man who, beyond the age of 26, finds himself on a bus can count himself as a failure."

—Margaret Thatcher, former British Prime Minister, 1925–

The perceived image and status of the public transport system is a major determinant in attracting ridership, particularly from non-captive public transport users who have other alternatives. The best designed public transport system in the world becomes meaningless if customers do not find the system sufficiently attractive to use.

Rail-based systems traditionally have maintained an edge with regard to creating a modern



Fig. 2.53 and 2.54
Rail-based systems do not always offer superior aesthetic qualities. The systems in Cairo (left photo) and Bucharest (right photo) show problems of neglect and vandalism.

Left photo by Karl Fjellstrom
 Right photo by Lloyd Wright

and sophisticated image. Such an advantage becomes particularly important when attempting to attract ridership from car users. At the same time, the traditional image of the bus is relatively poor. Attracting middle-income and higher-income users to the bus can thus be difficult. Image issues, though, are not entirely restricted to bus technology. Older or poorly maintained rail-based systems may also evoke images that are not entirely favourable to attracting customers (Figures 2.53 and 2.54).

The image problem is most closely associated with bus technology. However, as has been noted, traditional bus services and BRT are two distinct types of service. BRT systems have done much to create a modern and unique identity. The modern tubed boarding stations

in Curitiba helped to make a dramatic new impression for the service. Modern vehicles that cover their wheels and emulate the rounded shape of LRT vehicles also help to create a new image (Figure 2.55).

To date, the success of BRT systems in cities such as Bogotá, Brisbane, and Curitiba has dispelled much of the image concerns. It has been noted that users in Bogotá do not say that they are “going to use the bus” but rather that they are “going to use TransMilenio.” The marketing of the system name and the quality of the service has been effective in creating a metro-like image.

Nevertheless, in developed cities of North America and Western Europe, the perception of BRT versus rail-based public transport is still a major decision-making consideration.



Fig. 2.55
Modern vehicles can give BRT systems a highly professional image. The vehicle in this photo is a Cibus bus and not a light rail vehicle.

Photo courtesy of US
 TCRP media library

2.2.5 Impacts

The characteristics of different public transport technologies can result in different impacts as measured by urban, economic, environmental, and social indicators. Since public transport is often used as a policy measure to achieve a variety of social goals, an analysis of each system's impact is a legitimate part of the technology evaluation.

2.2.5.1 Economic impacts

Economic impacts can include the public transport system's ability to foment economic growth, stimulate jobs, and encourage investment. A prized objective with public transport systems is to encourage transit-oriented development (TOD), which refers to the densification of development along corridors. If a public transport project is implemented successfully, the creation of densified corridors can help to increase property values as well as shop sales levels.

While the research linking public transport projects to property values and shop sales is still limited, the results to date indicate a positive correlation. Research from the San Francisco-Bay Area indicated a US\$1,578 property value premium for every 0.03 km closer a home is to a BART metro station (Lewis-Workman and Brod, 1997). Similarly, results from the Washington Metro system show a 2.4 percent to 2.6 percent premium in apartment rental prices for every 0.16 km closer to a station (Benjamin and Sirmans, 1996). Likewise, LRT systems have produced similar types of results. Evidence

suggests that the Portland MAX system has produced a US\$2,300 premium for homes located within 0.06 kilometres of the system (Dueker and Bianco, 1999). Additionally, Cervero and Duncan (2002a) found that homes near the San Diego LRT system increased in value by 2.1 percent to 8.1 percent depending on the distance from a station.

While there has been relatively little analysis of property impacts from BRT, there is some evidence to suggest similar positive impacts. The rows of high-rise development along the Curitiba busways are readily-visible indications of a relationship (Figure 2.56). Likewise, many commercial centres are now being developed along the Bogotá BRT corridors. In fact, Rodriguez and Targa (2004) found that apartment rental values in Bogotá increased by 6.8 percent to 9.3 percent for every five minutes closer the location was to a TransMilenio BRT station. Additionally, during a three-month period after the construction of the Brisbane (Australia) busway, land values along the corridor increased by 20 percent (Hazel and Parry, 2003).

It should be noted that there also exists studies that do not show property value increases from public transport development. For example, Cervero and Duncan (2002b) found no appreciable effects from either the Los Angeles Red Line metro or the city's enhanced bus services. A 1998 study of the Supertram in Sheffield (UK) likewise gave no indication of impacts on property values (Dabinett, 1998). Thus, the quality and local context of the development plays a key role in determining the level of benefit. Some authors have also asserted that the local development benefit from BRT may be less than that from rail options. This assertion is based upon the idea that BRT may be perceived as less permanent than rail infrastructure. The perception of permanence is quite important to property developers who would be at risk if a public transport project was later removed. To date, there is no actual data indicating that BRT is perceived as being less permanent. As noted above, the results from Brisbane and Bogotá indicate that like rail transit, BRT can produce development gains.

Employment generation is another economic measure of a project's impact. Public transport

Fig. 2.56
The high-rise development along the Curitiba BRT system illustrates the ability of public transport to focus city development.

Photo courtesy of the City of Curitiba



projects generate employment through the planning and construction phase, equipment provision (*e.g.*, vehicles), and operation. In developing cities, employment creation tends to be a fairly important factor. Projects that ultimately reduce employment levels, in comparison to previous transport services, are more politically difficult to pursue. By contrast, in the developed city context, labour costs represent a much larger component of operating costs, and thus are typically a target for reduction to the extent possible.

BRT construction can provide a high level of employment per input of investment. Metro construction also provides employment but much of the project expenditures go towards the expensive machinery required for the tunnelling activities. In Bogotá, the first phase of TransMilenio produced 4,000 direct jobs during construction. The operation of the first 40 kilometres of the system also provided 2,000 persons with long-term employment.

The fabrication of mass transit vehicles offers the potential not only for local employment gains but also the transfer of new technology to a nation. Major international bus manufacturers have established production facilities in BRT cities such as Curitiba, São Paulo, Pereira (Colombia), and Bogotá. The smaller economies-of-scales involved in bus manufacturing means that fabrication can be cost-effectively sourced to local sites. Rail-car production is generally not as transferable to the local level. The economies of scale with rail vehicle production imply that it is difficult to transfer fabrication from headquarter plants in countries such as Canada, France, Germany, Spain, and Japan. The importation of vehicles carries with it particular costs and risks, such as import duties and long-term currency fluctuations. Additionally, the importation of rail vehicles tends to create an awkward situation where tax funds in low-income nations are supporting employment and technology development in wealthier nations. However, at the same time, rail vehicles generally represent a higher order of technical sophistication, and this factor can be a consideration to countries interested in technology transfer opportunities.

All new public transport systems present both an opportunity and a threat in terms of opera-

tional employment. While in developed nations the reduction of employment through higher-capacity rail vehicles is a positive aspect in terms of reducing operational costs, this aspect can be a negative from the perspective of developing nations seeking to bolster employment. Likewise, BRT systems can imply a reduction of employment when many smaller vehicles are essentially being replaced by a larger articulated vehicle. In Bogotá this impact was mitigated by the fact that drivers are working shorter shifts in the new system (and making equal or better incomes). Previously a single driver would work as much as 16 hours per day. In the current system, more drivers share the same vehicle. Likewise, new employment was created through new positions related to fare collection, administration and management, and security.

All new mass transit systems, though, offer the potential to increase overall economic efficiency through reductions in congestion and subsequent gains through the supply chain. In the long term, such systems may be the backbone of improved economic growth. However, any short term negative impacts on employment levels must be handled with great sensitivity and concern.

2.2.5.2 Environmental impacts

All public transport options produce environmental impacts when displacing journeys that would be otherwise taken by individual motorised transport. Thus, the amount of expected ridership and the number of persons switching from private vehicles to public transport is a significant determinant in calculating environmental benefits. The ability of mass transit systems to encourage car users to switch to public transport depends on many factors, most notably cost and service performance. The convenience of car use makes for a challenging competitive environment. However, research in Bogotá indicates that approximately 20 percent of TransMilenio users formerly used private vehicles (TransMilenio, 2005).

The type of fuel utilised with the public transport vehicles also contributes to the overall environmental impacts. LRT and metro vehicles are almost always electrified. BRT vehicles may use a variety of fuel forms, including diesel, compressed natural gas (CNG), liquid-petroleum

gas (LPG), diesel hybrid-electric, and electricity. The Beijing BRT system utilises Euro III diesel. The Bogotá system currently uses a mix of both Euro II and Euro III vehicles. The Quito Trolé line is an electric trolley-bus system. The Los Angeles Orange Line utilises vehicles CNG technology. Brazilian cities now are looking more closely at adapting diesel hybrid-electric technology to BRT systems.

Electrified public transport systems produce no ambient emissions at the local level. By contrast, BRT systems powered by fossil fuels produce local emissions. Thus, rails systems are essentially emission free at the street level. However, the overall environmental performance of such systems depends on the type of fuel utilised to generate the electricity. Renewable sources such as biomass, hydro, solar, and wind are relatively clean, but these sources typically only constitute a small percentage of total electric generation. Natural gas is also a relatively clean energy source but the combustion process does produce emissions such as nitrogen oxides and carbon dioxide. Nuclear energy is not typically utilised in developing nations, but in any case, carries with it other types of serious waste issues. Finally, coal remains a major energy source for electricity generation, particularly in developing nations such as China, India, Indonesia, and South Africa. Coal combustion produces significant quantities of nitrogen oxides and sulphur oxides, which are precursors to acid rain. Coal combustion also produces as significant emissions of greenhouse gases. If coal is a major constituent of the electricity supply, total emissions from electrified public transport can exceed the emissions of vehicles powered directly by natural gas or clean diesel technology. While BRT vehicles can also be propelled by electricity, such vehicles more commonly utilise natural gas or clean diesel fuels. The amount of emissions from natural gas or clean diesel vehicles depends upon many factors including local geographic and topological features, fuel quality, and driving behaviour. BRT systems, even in developing nations, require fairly stringent emission levels, and typically are a dramatic improvement over the previous standard bus services. Nevertheless, natural gas vehicles and clean diesel vehicles do emit some amounts of

nitrogen oxides, carbon monoxide, particulate matter, and sulphur oxides at the local level. Additionally, these vehicles also contribute to greenhouse gas emissions.

Mass transit vehicles of all types also reduce emissions through smoother operations. With fewer station stops and fewer conflicts with mixed traffic vehicles, mass transit in dedicated corridors is less prone to operational inefficiencies.

Besides air emissions, public transport is also a contributing factor to the overall level of ambient noise in a city. Since one public transport vehicle is equal to 100 or more individual vehicles, the reduction in noise, like the reduction in air emissions, can be considerable if ridership is increased. Thus, public transport in general contributes to lower decibel levels in a city. Electrified systems, such as LRT, metros, and electric trolleys, are particularly quiet while in operation. However, rail and trolley systems can also produce excessive noise, especially during braking. The noise generated from braking can be particularly amplified inside tunnels, such as with metro systems. Noise from the BART metro system in the San Francisco Bay area regularly exceeds 100 decibels. However, the noise impact from underground systems tends to only affect passengers and staff and generally has little to no impact at the surface level. The maximum permitted noise level for BRT systems such as Bogotá is generally 90 decibels. In general, electrified systems, whether rail or trolley-buses, provide a quieter operating environment.

2.2.5.3 Social impacts

Social impacts refer to the ability of a new public transport system to help create more social equity within a city. Thus, this factor is related to previous discussions on affordability and employment creation, as well as social changes due to the new urban environment. Social impacts can also refer to changes in the safety and sociability of the streets.

Public transport's potential social impacts can thus include:

- Affordability of fares, especially for low-income groups;
- Creation of a social environment encouraging personal interactions;

- Attractiveness to all income segments of society and thus offering a meeting point of all income groups;
- Reduction in crime and insecurity in both the transit system and its surrounding environment.

The lower unsubsidised fare levels of BRT in developing cities can help make the public transport system accessible to a wider social audience. Of course, with subsidisation, fares on LRT and metro systems can likewise be made affordable to the majority of the population. The metro systems in Mexico City and Delhi, for example, employ significant fare subsidies in order to ensure accessibility. However, this subsidy implies that public funds must be taken away from other potential public services.

Public transport systems can also provide one of the few places in a city where all social groups are able to meet and interact. An affordable and high-quality system can attract customers from low-income, middle-income, and high-income sectors. This role as a common public good can be quite healthy in creating understanding and easing tensions between social groups.

The regeneration of an urban area due to public transport improvements can have multiple social benefits. As noted, the upliftment of an area creates employment and economic growth. Additionally, evidence suggests that public transport improvements can also reduce crime. In general, the more professional the public transport environment, the less likelihood there is of crime. Further, higher levels of surveillance also can act as a deterrent. Security cameras and emergency call buttons are often utilised in both BRT and rail-based systems.

The longer train sets used in rail-based systems will tend to create greater separation between the driver and most passengers. Also, the driver of a rail system is generally separated from the passengers by an enclosed wall. By contrast, the open nature of a bus allows greater awareness by the driver of any security problems arising in the vehicle. Nevertheless, many metro systems employ regular surveillance of rail cars by way of security personnel.

2.2.5.4 Urban impacts

Public transport systems have a major impact on the shape and quality of urban life. A new public transport system will wield a considerable influence over the physical form of a city. This impact occurs both directly through the infrastructure as well as indirectly through the development that occurs along the corridor as a result. In the long term, the system will even influence where people decide to live.

The Curitiba BRT system has helped to focus considerable development along the busway corridors. A planning ordinance that restricted high-rises to the corridors also helped to achieve the transit-oriented development. The transit-development linkage is so pronounced that one can see exactly where the busways are located even when flying over the city in a jet airplane, due to the density of commercial and residential buildings. In turn, this density helps the municipality in several ways. First, more development near the public transport stations means that more people will be able to access and utilise the system. Second, the higher urban density also implies that municipal costs associated with electricity and water connections are reduced. Connecting municipal services to more suburban locations can be several times more costly.

In comparison to individual motorised transport, public transport consumes far less of the public domain. Figures 2.57 and 2.58 illustrate the difference in space requirements between 60 private vehicles and 60 public transit customers.

As surface modes, BRT and LRT require use of public road space. With its fixed guideways LRT typically requires less road width than BRT. This space savings is especially true of the smaller tram vehicles. Metros, of course, consume the least amount of surface space with only the entrance and exit points protruding into the surface area. Elevated systems still consume space due to the need for support columns. Typically, systems such as the Bangkok SkyTrain require one lane of surface space to provide this infrastructure. Additionally, footpath space is typically also taken near stations in order to provide stairways and other access means to reach the elevated platforms (Figure 2.59).

The conversion of traffic lanes to public transport lanes can become highly politicised with

Fig. 2.57 and 2.58
These images compare the amount of space required to move the same number of persons by private vehicles (left photo) and by public transport (right photo).

Photos courtesy of the City of Muenster Planning Office



Fig. 2.59
The pillars supporting elevated systems, as shown here with the Bangkok Skytrain, can also consume a considerable amount of surface space, especially in the median and sometimes along footpaths.

Photo by Lloyd Wright



arguments both in favour and against the exclusive lanes. Given the higher number of passenger-trips served in a more space efficient manner, it can be argued that public transport deserves a prioritisation. Nevertheless, automobile users will likely complain that the exclusive public transport lanes will create congestion. However, an alternative view suggests that private vehicles can also gain from the loss of a lane. In many

developing cities, public transport and mixed traffic share the same road space. Conflicts arise because public transport and private vehicles have very different movement patterns. Public transport vehicles, especially informal mini-bus operations, will stop on a fairly random basis. Private vehicles, though, tend to travel directly between destinations. Thus, the random nature of the public transport vehicles will negatively impact the free flow preferences of the private vehicles. The separation of public transport from private vehicles can thus lead to greater order and flow rates for all vehicles.

The use of exclusive lanes by BRT and LRT also may result in an overall reduction in private vehicle use. The concept of “induced traffic” has been used to explain how roadway expansions seem to attract new traffic and ultimately do relatively little to deter congestion. Evidence from bridge and street closings in Great Britain and the United States indicates that a reduction in road capacity actually reduces overall traffic levels, even accounting for potential traffic transfers to other areas (Goodwin *et al.*, 1998). Thus, the empirical evidence suggests that giving exclusive road space to LRT and BRT will lead to reduced

private vehicle use and little to no overall change in congestion levels. The fact that underground metro systems do not consume road space may thus result in a reduced incentive for motorists to switch to public transport. Since the existing road will continue to be available, any motorists switching will create more space, which can in turn encourage more private vehicle use.

2.3 Technology decision making

“For every complex and difficult problem, there is an answer that is simple, easy, and wrong.”

—H. L. Mencken, journalist, 1880–1956

2.3.1 Comparative matrix

This chapter has attempted to provide an objective overview of the different public transport technologies. While this document outlines the planning process for the development of a BRT

system, it is recognised that rail-based systems can be the appropriate technology choice in many circumstances. There is no one correct technology. As this chapter has indicated, the decision depends upon an array of local factors.

Table 2.9 summarises the findings of this chapter and notes the circumstances that are best suited to each technology.

2.3.2 Appropriate technology roles

“The proud minister of an ostentatious court may frequently take pleasure in executing a work of splendour and magnificence, such as a great highway, which is frequently seen by the principal nobility, whose applause not only flatter his vanity, but even contribute to support his interest at court. But to execute a great number of little works, in which nothing that can be done can make any great appearance, or

Table 2.9: Public transport decision matrix

Technology	Demand requirements	Advantages	Disadvantages
Metro rail / elevated rail systems	High to very high passenger demand (30,000 to 80,000 pphpd)	<ul style="list-style-type: none"> • Superior image for city • High commercial speeds (28–35 kph) • Attracts discretionary public transport riders • Uses relatively little public space • Low local air emissions 	<ul style="list-style-type: none"> • Very high infrastructure costs (US\$45 million to US\$350 million per km) • May require operational subsidies • Poor revenue recovery during non-peak periods • Long development and construction times • Complex integration with feeder services
Light rail transit (LRT)	Moderate passenger demand (5,000 to 12,000 pphpd)	<ul style="list-style-type: none"> • Provides good image for city • Attracts discretionary public transport riders • Quiet ride performance • Can be fitted to narrow streets • Low local air emissions 	<ul style="list-style-type: none"> • Moderately high infrastructure costs (US\$15 million to US\$45 million) • May require operational subsidies • Limitations with respect to passenger capacity
Bus rapid transit (BRT)	Low to high passenger demand (3,000 to 45,000 pphpd)	<ul style="list-style-type: none"> • Relatively low infrastructure costs (US\$0.5 million to US\$14 million) • Often does not require operational subsidies • Good average commercial speeds (20–30 kph) • Ease of integration with feeder services • Moderately good image for city 	<ul style="list-style-type: none"> • Can carry with it the negative stigma of bus technology • Relatively unknown to many decision makers
Conventional bus services	Low passenger demand (500 to 5,000 pphpd)	<ul style="list-style-type: none"> • Low infrastructure costs • Relatively low operating costs • Appropriate for small cities with low demand 	<ul style="list-style-type: none"> • Poor service image • Often lacking in basic customer amenities and comfort • Regularly loses mode share to private vehicles

excite the smallest degree of admiration in any traveller, and which, in short, have nothing to recommend them but their extreme utility, is a business which appears in every respect too mean and paltry to merit the attention of so great a magistrate. Under such an administration, therefore, such works are almost always entirely neglected". (The Wealth of Nations)

—Adam Smith, economist, 1723–1790

The previous conventional wisdom within transport planning was to employ rail-based systems wherever it was financially possible to do so. This philosophy is tantamount to spending as much as possible on a given corridor, even if the same service is achievable with a lower-cost solution. This preference can result in rail systems dominating the most lucrative corridors with virtually no possibility of covering other areas of the city. In turn, this result can imply higher fares, multiple transfers within a single journey, difficulties in effective integration between modes, and a long-term commitment to subsidies and capital repayment.

However, as the discussion in this chapter has noted, there are circumstances where metro rail and elevated rail are entirely appropriate. These circumstances can include:

- A megacity environment with actual peak corridor demand exceeding 30,000 to 45,000 pphpd;
- Extremely tight structural densities or geographical constraints (e.g., a narrow strip of land bounded by water or a hillside) that do not permit use of the surface for dedicated public transport lanes; and,

- Availability of capital funding in the range of US\$45 million to US\$200 million per kilometre.

Likewise, there are many circumstances in which LRT systems are an appropriate technology choice. These circumstances include:

- Moderate corridor demand ranging from 5,000 pphpd up to 12,000 pphpd;
- Cities seeking an enhanced image through a visually attractive system; and,
- Availability of capital funding in the range of US\$13 mn to US\$40 million per kilometre.

These characteristics explain the prevalence of LRT systems in many North American and European cities.

Finally, BRT is increasingly being recognised as a sound technology option for a range of city conditions, and especially for developing-nation cities seeking both high-quality and a low-cost solution. BRT’s ability to operate profitably across a broad range of operating conditions and the relatively low costs of its infrastructure has made it an option worthy of consideration. Based on the experiences to date, the conditions most favourable to BRT are:

- Passenger demand ranging from 3,000 to 45,000 pphpd along a given corridor;
- Need for average commercial speeds over 20 kph;
- Cities seeking to avoid the need for operational subsidies; and,
- Availability of capital funding in the range of US\$1 million to US\$7 million per kilometre.

BRT’s broad set of profitable operating conditions has given the technology some versatility in terms of compatible public transport environments. BRT systems have fulfilled a range of roles in cities, including trunk services, feeder services to other transit technologies, and temporary solutions prior to rail upgrades. Table 2.10 outlines the different types of roles that BRT may assume within a city’s public transport strategy.

Bogotá has demonstrated that a densely-populated mega-city can in fact be quite well-served by BRT alone. With actual peak capacities of 45,000 pphpd the TransMilenio BRT system is compatible to many metro systems in terms of ridership capabilities.

Table 2.10: Potential BRT roles within an integrated mass transit strategy

Service type	Explanation
Principal mass transit service	BRT can serve as the principal mass transit technology for a city, covering all trunk-line corridors and providing feeder routes
Metro extension	BRT can provide an economical means to extend metro services to outer areas
Mass transit in-fill	BRT can provide an economical means of adding mass transit lines within a city that already has some rail-based corridors
Feeder service	BRT can provide a feeder service connecting with existing metro corridors
Future conversion	BRT can serve as an economical entry into a mass transit for a city while also allowing for the future conversion to rail

Nevertheless a range of cities with existing rail systems may find BRT a compatible addition to an integrated system. As noted above, employing multiple technologies does bring with it added costs and managerial complexity. However, for cities with existing rail infrastructure and few financial resources the choice may be either BRT or waiting decades for further system expansion. Some cities with existing rail-based systems are viewing BRT as an economical means to extend or augment their systems. Medellín (Colombia) and Beijing are both developing BRT corridors that will act in concert with an existing rail-based system. São Paulo uses BRT as a means to extend the reach of the metro system to satellite cities.

A city with few financial resources may wish to consider developing a full mass transit network with BRT prior to a limited rail-based corridor. Building a single, limited corridor of high technology does little to provide a meaningful network for those persons who depend upon public transport for their daily mobility needs. In time, if the desire to convert to rail is strong, then this possibility is always there as a future conversion option. For such cities, BRT can provide a quality network over the medium term and thus do much to relieve the pressures of congestion, contamination, and inadequate access.

As stressed throughout this chapter, though, the ultimate decision on a mass transit system should not be based on a particular type of technology. Instead, the needs of the customer should be paramount above all. Placing the needs of the customer at the centre of the design process is the one mechanism to ensure the most appropriate technology is chosen.

2.3.3 The myths and realities of BRT

As a relatively new public transport option, BRT remains unknown to many decision makers. With much of the experience to date focussed in a few Latin American cities, BRT has been surrounded by several myths and misunderstandings. Table 2.11 sets forward many of these issues. BRT is clearly not the ideal public transport solution in every instance, and in many cases, works best in conjunction with other options. Nevertheless, BRT is likely to be increasingly viewed as an option for consideration.

Table 2.11: The myths and realities of BRT

Myth	Reality
BRT cannot compete with the capacity of rail systems	Bogotá’s TransMilenio system moves 45,000 passengers per hour per direction while BRT corridors in São Paulo can also provide capacities over 30,000 passengers per hour per direction. Such capacity numbers are in fact larger than many rail-based systems including all LRT systems and many metro systems, such as the systems in London, Santiago, and Bangkok.
BRT is only appropriate for small cities with low population densities.	Bogotá is a mega-city of 7 million inhabitants with a population density of 240 inhabitants per hectare. In comparison, the population densities of selected Asian cities with rail-based systems are: Manila, 198 inhabitants per hectare; Bangkok, 149 inhabitants per hectare; Kuala Lumpur, 58.7 inhabitants per hectare (Newman and Kenworthy, 1999).
BRT requires a great deal of road space and cannot be built in narrow roadways	Design solutions exist for virtually every road space circumstance. Quito runs a BRT system through three-metre wide streets in its historical centre.
BRT cannot compete with rail options in terms of speed and travel time	Average commercial speeds for BRT systems generally are in the range of 20 to 30 kph. As a surface transit option, BRT reduces travel times through rapid access to stations and platforms. A US GAO study found that a comparison of BRT and LRT systems actually showed that BRT systems produced faster average speeds (US GAO, 2001).
BRT uses vehicles with rubber tyres which is an inferior technology; customers will never accept BRT	It is doubtful that anyone in Bogotá, Curitiba, Guayaquil, or Pereira feels that they have an “inferior technology”. The appearance of BRT stations, terminals and vehicles can all be made to appear as sophisticated and inviting as any rail option.
BRT cannot deliver the transit-oriented development and land use advantages of rail	One only needs to see the rows and rows of high-rise development that has occurred along Curitiba’s BRT corridors to realise that BRT can indeed deliver quality transit-oriented development (TOD).
BRT is fine as a feeder service, but it cannot serve main corridors	Yes, BRT can work economically as a feeder service or system extension service, and it can do so without requiring subsidies or prohibitively expensive fares. But the Latin American BRT systems have also proven that it functions perfectly well on relatively high-density mainline corridors.

3. Project set-up

"Begin with the end in mind."

—Stephen Covey, author and management consultant, 1932–

Once a leading political figure has made the decision to move ahead with the BRT project, the real planning process gets underway. It is also recognised, though, that other groups may move ahead with initial planning even when lacking a full political commitment. Thus, private sector groups or non-governmental groups may elect to develop more detailed feasibility and conceptual studies in order to gain political approval at a later junction. In reality, no two BRT planning processes are exactly alike, and gaining formal project approval can require a variety of approaches.

Even with a commitment from a leading political official, several legal steps may be necessary in order to formalise the project. Once these legal proceedings are completed, the process of forming a project team and developing a work plan can begin. The development of a planning budget and the full financing of the planning effort are also early activities. Finally, if outside consultants are to be utilised, the development of terms of references and contractual agreements is necessary to properly delineate the contracted activities.

Investments made early in properly structuring and organising the planning process can pay significant dividends later in terms of both the efficiency and effectiveness of the overall effort.

The topics to be presented in this chapter include:

- 3.1 Legal basis
- 3.2 Project team and management structure
- 3.3 Project scope and timing
- 3.4 Planning budget
- 3.5 Planning financing
- 3.6 Project phasing
- 3.7 Common planning mistakes

3.1 Legal basis

"Before beginning, plan carefully."

—Marcus T. Cicero, Roman orator, 106–43 BC

3.1.1 Statutory approval

In most cases, a statutory or legal mandate needs to be created prior to the project being officially recognised. This process then allows public funds to be disbursed towards the planning process as well as permits planning staff to be employed on the project. The actual authorisation process will vary depending upon local, provincial, and national laws and regulations. In some cases, city councils or provincial parliaments will need to give formal approvals before project expenditures can be realised. In other cases, the Mayor or Governor may have greater legal authority to approve project activities independently.

Of greatest importance is to maintain an open and transparent process throughout. If the project is not implemented in an entirely legitimate and pluralistic manner, long-term public and political support can be undermined. If the proper authorisation mechanisms are not followed, opposition groups may later use such improprieties as a means to stop the project. The proper legal mandate will also establish the BRT project as a city-wide priority.

Beyond an initial mandate to begin the planning process other authorisations might be needed as well. Authorisations may include the creation of a specialised agency or transformation of existing ones, approval of the project budget or loans, and modification or creation of laws, regulations, and policies regarding the funding, implementation, and operation of bus systems. Many of these authorisations will

require formal approvals from political bodies, such as the city council. This approval process can take considerable time and involve a substantial effort, so these requirements should be identified early in the process. Using existing legal frameworks is advised, rather than depending on changes for project implementation. Nevertheless, in some cases, preparing an adequate legal framework will be necessary.

3.1.2 Relationship to existing policies and plans

“Everyone who got where he is has had to begin where he was.”

—Robert Louis Stevenson, novelist and poet, 1850–1894

The vision for the new public transport system should also be consistent with the intent and objectives set forth in existing policies and plans related to transport, land use, and economic development. The lack of consistency with existing policies and plans may create an opportunity for project detractors to legally delay or block the initiative. Thus, in some cases, policies and plans may require additions or amendments to be seen as fully compatible with the new public transport initiative.

While BRT itself may not be explicitly noted in an existing master transport plan, stated objectives to improve public transport are most likely present. Drawing a connection between the new vision and the master plan is worthwhile to ensure overall integration of the new system with the existing direction of the city’s transport plan. If improved public transport is not a stated objective within the master plan or if BRT will somehow contradict existing objectives, then a review of the master plan may be in order.

Likewise, economic development and land-use plans should be examined for consistency with the proposed initiative. Typically, the reduction in congestion associated with a new public transport system will directly connect economic objectives to the BRT project. Existing land-use plans should make reference to transit-oriented development (TOD) and/or the densification of residential and commercial sites along key corridors. Such references would be consistent with the objectives of a BRT initiative.

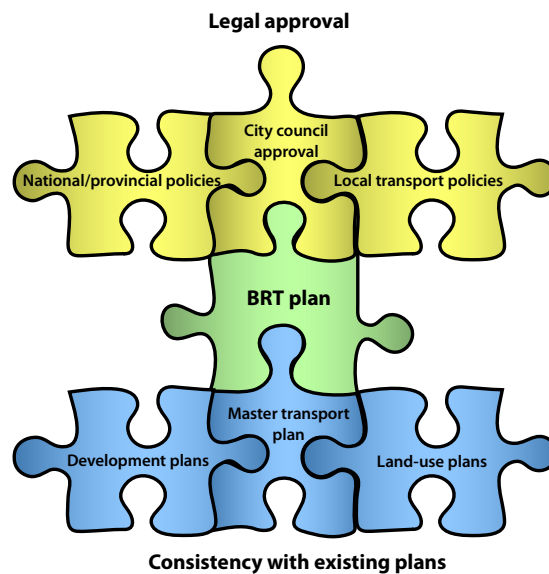


Fig. 3.1
To be approved by the required legal mechanisms, the proposed BRT project must succinctly fit with local, provincial, and national policies and plans.

Figure 3.1 outlines the importance of a BRT plan’s consistency with existing policies, plans, and authorisation processes.

3.2 Development team

“Teamwork is the ability to work together toward a common vision. The ability to direct individual accomplishments toward organizational objectives. It is the fuel that allows common people to attain uncommon results.”

—Andrew Carnegie, industrialist and philanthropist, 1835–1919

A new mass transit system for a city is not a small undertaking. It is unlikely to be achieved without staff dedicated full-time to the effort. Attempting to plan a BRT system while simultaneously juggling other planning duties will most likely not produce a high-quality or timely result. Thus, the organisation and selection of a dedicated BRT planning team is a fundamental step towards planning the system.

3.2.1 Development entity

“Talent wins games, but teamwork and intelligence wins championships.”

—Michael Jordan, former NBA basketball player

There are two different philosophies regarding the selection of a development entity for the new public transport initiative. On the one hand, some cities assign the project to one of the existing agencies with public transport responsibilities. Such an agency may have responsibilities regarding infrastructure (Public Works),



Fig. 3.2
Bogotá developed a new entity, TransMilenio SA, to oversee the development of the city's BRT system.

Photo by Lloyd Wright

regulation, or policy. The selected agency could also possibly have tangentially related responsibilities such as environment and air quality, health, or finance.

Other the other hand, some cities elect to create an entirely new organisational entity. The new entity may draw upon some existing agency staff, but in general would represent an entirely new team.

There are advantages to each option. Utilising an existing agency means that the development team would already possess a fairly insiders view of the current public transport situation. The existing relationship between the agency and transport operators could also be advantageous if a history of trust and co-operation is present. Further, by not creating a new entity, existing groups will not feel that their thematic “turf” has been expropriated. Also, any new organisation may have over-lapping responsibilities with the existing agencies, and thus this duplication can lead to confusion and administrative in-fighting.

An entirely new organisation offers the advantage of bringing a new perspective to the city's public transport system. It may be difficult for existing agencies to adequately think outside the box. Further, in some cases, the existing agencies may be to blame for the existing poor quality of public transport in a city. An entirely new entity will not feel as constrained by existing customs and existing biases. Additionally, the skills to deliver a successful BRT system

can be quite different than the skills required to regulate conventional services. BRT development tends to be significantly more customer oriented and more entrepreneurial in nature. Some cities find that only a clean break with the past through a new organisation will result in a dramatic improvement to the public transport system.

Cities may also decide not to decide on any final choice of agency supervision for the new system. Instead, the BRT planning process can be overseen by a temporary, ad-hoc team. The decision on the eventual organisational structure can be determined through the planning process itself. At the outset, a decision can be made that the planning team will essentially be disbanded once the work is completed.

There are examples of each type of approach. São Paulo and Santiago developed their new BRT efforts through existing organisations. São Paulo's new Interligado system was co-ordinated by the Secretary of Transportation, with the participation of the bus authority (SP-Trans) and the traffic authority (Institute of Traffic Engineering). São Paulo's organisational decision was likely influenced by the fact that Interligado was a priority project of the Mayor and strong institutions already existed.

Santiago created a BRT project office within the national Ministry of Transportation. This office co-ordinated efforts of the other contributing organisations. For example, the Secretary of Transport Planning (SECTRA) had responsibility over technical aspects. Santiago also formed a project committee consisting of cabinet level officials and other key leaders, including the Ministry of Housing, Ministry of Finance, and the President of the Santiago Metro. Santiago's structure perhaps reflects the strong nature of central government institutions in overall decision making.

By contrast, Bogotá, Lima, and Dar es Salaam have all created new entities to develop their systems. From the outset, Bogotá created a project office that reported directly to the Mayor. This project office also co-ordinated efforts with other city agencies. The project office eventually became the formal oversight agency for the implementation and operational management of the TransMilenio system (Figure 3.2). Other

Colombian cities have followed the same structure, especially as a result of laws that make a specialised agency compulsory in order to receive national grants. In a similar manner, Lima has also created a special project office, which has now transformed itself into a city agency called PROTRANSPORTE.

It is perhaps worthy to note that the most ambitious BRT plans have emanated from newly created project offices or agencies. Bogotá and the other Colombian cities stand out as high-quality BRT systems. By contrast, the São Paulo and Santiago systems are possibly further from being considered “full BRT”, especially when compared to Bogotá and other systems that were developed from a new institutional perspective. Thus, newly created entities may have an advantage in terms of being able to go well beyond established thinking and develop a public transport system of the highest quality.

3.2.2 Planning staff

“Creative thinking is not a talent, it is a skill that can be learnt. It empowers people by adding strength to their natural abilities which improves teamwork, productivity and, where appropriate, profit.”

—Edward de Bono, psychologist and physician

Depending on the intended timeline for planning and implementing the system, the initial number of full-time team members will likely vary from three to ten. As the project progresses, the size and specialties of the team will likely grow. Some of the initial posts to be filled may include:

- Project coordinator;
- Administrative support;
- Project accountant;
- Public education and outreach;
- Negotiator for discussions with existing operators;
- Liaison officer for international organisations;
- Finance specialist / economist;
- Transport engineer;
- Architect;
- Transport modeller;
- Design specialist.

There is a natural tendency to hire engineers first, as they are usually the people in charge of transport projects. Nevertheless, the team needs

to be interdisciplinary and must have the ability to interact with public officials and corporations, transport industry, media, interest groups and so on. It is preferred that the members of the team are ambitious and not risk averse.

Special care should be exercised in the selection of the project co-ordinator. This person needs to have excellent management and communications skills, extensive experience in the creation and consolidation of new ideas, and must be as close to the political leader of the project as possible. The project co-ordinator should be fully devoted to co-ordination and management activities. Forcing this person to also juggle technical tasks will likely detract from the project’s overall effectiveness.

In many instances, the team’s attention may predominantly focus on infrastructure and vehicles, rather than operations, fare systems, and customer service. This tendency is natural given that infrastructure and vehicles can consume the bulk of the likely investment. However, ignoring issues like operations and customer service will ultimately undermine the entire project.

In some cases, it may be possible to outsource some of these activities to consultancies. However, it is important to retain a certain degree of in-house technical competence in order to maintain a perspective that will allow for informed decision-making.

Fig. 3.3
Members of the Jakarta BRT team being briefed on the Quito system.

Photo by Lloyd Wright



Since BRT is a relatively new concept, it is sometimes difficult to find staff with extensive implementation experience. For this reason, some training and even study tours may be appropriate mechanisms to develop local technical capacity (Figure 3.3).

3.2.3 Consultants

“Attachment is the great fabricator of illusions; reality can be attained only by someone who is detached.”

Andrei Voznesensky, poet, 1923–

3.2.3.1 Appropriate role of consultants

Utilising consultants within a BRT project can be a cost-effective means to gain individuals with key specialties and direct BRT experience. The use of consultants allows skills to be brought on board without the cost and overhead of a full-time hire. Further, in many instances the particular skills may be only needed for one component of the project, and thus do not justify a full-time position.

Perhaps, more importantly, consultants help avoid the situation where cities are needlessly reinventing lessons already learned elsewhere. International consultants with significant BRT experience can help smooth the path from planning through to implementation. In all likelihood, such consultants have experienced many of the problems that will be faced by the local team and thus can propose effective solutions. A local team working in conjunction with experienced international professionals can

ideally result in a combination of world best practice and local context.

Of course, a city should not become over-dependent upon consultants. The local context is still best realised by local staff. The key decision-making points ultimately must be made by local officials. Consultants are one of several resources that lead to knowledge sharing.

A prudent strategy could involve building the capacity of local staff while simultaneously making selective use of consulting professionals. While Dar es Salaam officials had previous little experience with the BRT concept, the development of a core local team in conjunction with international consultants has proved to be a successful strategy (Figure 3.4).

Tracing the genealogy of recent BRT efforts reveals the influence of consulting expertise from previously successful projects. With Curitiba’s early success in BRT, Brazilian consultants were particularly involved with the subsequent initiatives in Quito and Bogotá. To this day, Brazilian consultants are closely tied to several new initiatives, including BRT projects in Cali, Pereira, Cartagena, Dar es Salaam, and Johannesburg. More recently, Bogotá’s highly acclaimed success has boosted the careers of those associated with TransMilenio. These consultants have been involved with a wide range of initiatives including projects in Cape Town, Lagos, Guatemala City, Lima, Mexico City, and Santiago. Consultancies from more developed nations have also made their impact with consultants from the US and Spain making substantive contributions to projects such as Bogotá and Lima. Thus, a BRT project may not only enrich a city with a new and efficient public transport system, it may also spawn a new local service industry catering to the exportation of BRT expertise.

3.2.3.2 Consultant selection and contracting

While some cities have developed well-designed systems without significant assistance from outside consultants, many cities find it advantageous to at least partially make use of persons with previous BRT experience. However, the procuring of consultant services can be difficult for municipalities with little knowledge of BRT consultant options. There can be a

Fig. 3.4
Dar es Salaam has successfully combined a full local team with international consultants.

Photo courtesy of Enrique Peñalosa



bewildering number of persons claiming BRT expertise. Given the myriad of BRT definitions and experiences, the perspectives and abilities of consultants can vary greatly. Thus, establishing a rational process for evaluating perspective consultants can help to ensure the municipality finds the right person(s).

Annex 2 of this Planning Guide provides a listing of some of the existing BRT consultants. Consultant selection should firstly be characterised by the process’ openness and transparency. Further, structuring the process to be as competitive as possible ensures that the project developers have done their utmost to find the most qualified candidate(s). While designing

an open, transparent, and competitive selection process may initially appear to be a time-consuming endeavour, the process can actually be relatively simple to implement.

Number of consulting contracts

As noted earlier, there really is not a single “BRT plan”. Rather, the BRT plan consists of a series of constituent plans that each represent a distinct component of the overall project. The expertise required to develop a marketing and communications plan is quite different from the expertise required to deliver detailed engineering designs. However, there are clearly trade-offs involved in determining the optimum number of contacts to be issued.

Single consultant contract

Multiple contracts with consultant specialists

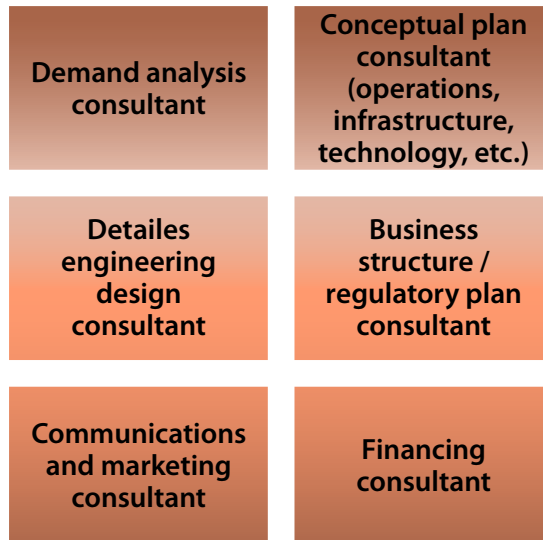


Fig. 3.5
Consulting services can either be structured through a single contract with a consortium of firms or through multiple contracts with specialist firms. Both structures have advantages and disadvantages that should be considered.

When deciding what to contract out, and into how many separate contracts, the following considerations should be weighed:

- Relative competence of private firms vis-à-vis the government in hiring the best experts;
- Possible conflicts of interest between the private contractors;
- Cost of planning;
- Project coordination.

At one extreme is the option of having the implementing government agency contract out a single consulting firm or consortium to deliver all components of the BRT plan (Figure 3.5). At the other extreme, a skilled public administra-

tor might create a team within the government agency itself, and hire dozens of individual experts and private firms for very specific tasks. Most BRT planning processes fall somewhere between these two extremes.

Single contract

A single firm holds the advantage of ensuring that all planning components are internally consistent. For example, if separate firms are contracted for the operational and infrastructure planning, there is a much higher chance that parts of the plans will be incompatible, even with regular cross-communication. A decision that optimises system operations may

be inconsistent with the funding available through the financing plan. By contrast, within a single firm, there is more likelihood that the team will develop a plan in which all parts fit closely together. Additionally, a single consulting contract is easier and less costly to manage and administer.

However, the simplicity of a single contract can compromise the overall quality of the delivered product. First, there are relatively few firms or individuals capable of delivering a quality plan for every aspect of a new public transport system. The requirement to hold expertise in every single aspect of public transport planning will limit the competitive field of possible consultants. Local firms who hold specialties in some areas (*e.g.*, engineering design and marketing), but not in other areas, may be especially disadvantaged by the single contract requirement. This lack of competition also tends to invariably increase costs.

Second, the project's quality can be compromised by firms attempting to deliver component areas where an adequate level of competence is not held. It is more productive to contract out project components to specialists who can provide greater depth to an individual topic.

Third, with ideas only coming from one source, the potential creativity and innovation being applied to the project will be limited. Different consultants tend to hold different philosophies on certain aspects of BRT design (*e.g.*, trunk-feeder designs versus direct service designs, smart cards versus lower-cost fare options). No one philosophy is inherently correct or incorrect, as local circumstances and preferences will ultimately dictate the path taken. With multiple consultants involved in the project, then this clash of ideas can spark a healthy debate in which all possibilities are more fully explored. Of course, such debates and discussions will tend to somewhat prolong the planning process, as each option put forward will require a degree of analysis.

Multiple contracts

For a skilled public administrator, having many smaller subcontracts of the very best experts only where needed to supplement government staff will yield much higher value for the money. One role that an international NGO can play is

to advise the government on how to minimise planning costs by hiring individuals with the specific skills that they need. The weaker the capacity of the government to implement the project on its own, then the greater will be the incentive to lump planning activities under the management of competent corporate entities. However, this choice will come at a cost. It will be much more expensive relative to the quality of the work. Some key questions are:

- Who is more likely to make a sound choice on the selection of quality sub-contractors?
- Which structure will better ensure internal coordination within the project?
- Which structure will minimise potential conflicts of interest?

The right answers will vary on a case by case basis.

Consultant consortiums

To an extent, the problems associated with a single consultant contract can be overcome through the formation of consultant consortiums. In this case, a grouping of individuals and firms with the correct mix of skills and specialties helps to create a well-balanced team. Additionally, the consortium structure allows the combination of international and local firms with each focussing upon their respective areas of specialty.

The consortium concept works well where the organisational resources are available to help facilitate the teaming of different consultants. International consultants are unlikely to possess detailed knowledge of the possible local firms and may have difficulty in determining the most appropriate partner. Facilitating the “marriages” between the different firms and individuals may require the presence of an independent facilitator who can help make introductions between the relevant parties. Invariably, though, skilled specialists who would likely contribute to a particular planning component will find themselves without a viable partner. Further, it is likely that only a handful of successful consortiums will arise, and thus limiting the extent of the competitiveness within the bidding process. Small- and medium-sized cities may have difficulty in encouraging consulting firms to make the effort in forming successful consortiums. The perceived value of a smaller project may not

be sufficient to warrant the investment in time to organise the consortium.

The emerging norm for BRT projects is to have the planning done by at least two or three contracts. It is typical that one firm, usually a planning and engineering firm with some modelling capacity, do the planning for the operations, technical specifications for the vehicle technology, and conceptual design for the infrastructure. This team might take the project all the way to the detailed engineering, but normally it takes the project as far as the detailed conceptual design. It is typical for a second firm, usually a management consultant, to manage the project, build the capacity of the government to implement and manage the operations, prepare the business plan, draft the terms of reference on the operating contracts, and prepare private sector bids. Typically there will be smaller contracts for other discrete elements, like legal support, planning bike lanes or public space in the corridor, public relations, etc.

However, on international projects, for the time being, these consortiums tend to be ad hoc, with many of the partners never having worked

together, and this can frequently lead to tension and confusion within the consortium. Inter-organizational contracts are rarely able to cover every eventuality, and contract enforcement across national boundaries is expensive and difficult.

Thus, the number of consulting solicitations to be issued will depend on the particular approach being taken. If government administrative capacity is weak and a competitive number of viable consortiums can be arranged, then the single contract approach may be an option. Alternatively, the work can be strategically separated into component-based contracts. In this case, the optimum number of consulting contracts will likely be that which encourages the appropriate use of specialist skills without fragmenting the planning into unmanageable pieces. Component areas which require close coordination should probably be placed together in a single contract. Areas that require discernibly different skill types should probably be separated. Table 3.1 lists a possible division of consulting contracts for a typical BRT project.

In all cases, at least three of the activities should be contracted to firms or individuals

Table 3.1: Segmentation of consulting contracts

Type of plan/study	Types of individuals / firms
Pre-feasibility study (if needed)	Local or international consultants with public transport experience; firm should independent of the other consultants
Feasibility study (if needed)	Local or international consultants with public transport experience; firm should independent of the other consultants
Demand analysis	Local firm with modelling experience or a consortium of local and international firms in which the international firm may provide the analytic framework and modelling expertise while the local firm is responsible for the survey work
Conceptual BRT plan and detailed engineering plan (includes corridor and route selection, operational, infrastructure, integration, and technology plans)	Consortium of both local and international firms; international firms with BRT experience would help develop plan framework while local firms would provide labour-intensive activities such as detailed engineering designs
Communications and marketing plan	Generally a local public relations firm with some possible inputs from international firms/individuals
Business structure and regulatory plan	Consortium of both local and international firms; international firm provides inputs on business/regulatory schemes used to date while local firm provides the local regulatory context
Financing plan	Local or international financing expert, or municipal agency
Impact evaluation	Local or international firm; firm should be independent from the other consultants

independent of the others. Namely, pre-feasibility, feasibility, and impact evaluation should all be conducted by firms or individuals with no ties to the other consultants. This independence removes problems with conflicts of interest. A firm that has a possible interest in the full consulting work would have an incentive to return a verdict of “feasible” within the early feasibility work, regardless of the potential project’s merits. Likewise, the evaluation of the plan’s potential impacts (traffic, environmental, economic, and social) should be conducted by someone with no vested interest in the plan.

It is also normally a good idea to separate the contract for the conceptual design from the business plan. An engineering firm doing the conceptual design under contract is not going to want to have to redesign the entire system if the business plan determines the first iteration is not financially feasible, but this is precisely what needs to happen. They might also have relationships with specific vehicle suppliers and have an incentive to write the technical specification to favour known suppliers who will provide kickbacks. Having a separate management consulting firm evaluate the financial feasibility, for which the vehicle cost and technical specification will be a key issue, provides a certain amount of checks and balances.

If an approach using multiple consulting contracts is utilised, then a communications framework should be established to ensure good dialogue between all parties. The municipality should make sure that all consultants are operating under a similar conceptual understanding of the project. Otherwise, problems may arise in terms of consistency and compatibility between the plan components.

Of course, cities may also elect to take upon many of these activities without the need of outside consultants. Thus, for some or all of the activities listed in table 3.1, consultants may not be required.

Expression of Interest (EOI)

Often, the first step in any competitive tendering process is to issue a call for “Expression of Interest” (EOI). The EOI document basically requests that all firms and individuals interested in bidding on the project submit a document stating their interest. The EOI should be

distributed as widely as possible to all potential consultants and firms. Since many consultants may have other commitments or interests, not all targeted firms will likely respond. The very best experts tend to gravitate to the projects with the best chance for success, and will need to be convinced that the project is worthy for them to be coaxed into bidding. Simply sending out the EOI will generally not be enough, but it is an important part of the process. Further, the EOI process helps the municipality to become aware of consultants not previously identified. Responses to the EOI may help municipal officials develop a shortlist of potential consultants who will then submit more detailed proposals. The EOI process permits a wide range of consultants to extend their interest without the necessity of a lengthy and costly formal proposal.

The EOI document itself will likely be fairly simple and short. Many EOIs are only 2 to 5 pages in length. In general, the contents of an EOI may include some of the following:

- Project title;
- Project description;
- Brief description of consultant remit and expected outputs;
- Estimated timeframe for consultant selection process, project initiation, and length of consultant activities;
- List of inputs requested from applying consultants (*e.g.*, previous experience in similar projects);
- Deadline for EOI submission;
- Submission details (length, format, etc.);
- Contact details.

Annex 3 of this Planning Guide provides a contract template for a typical EOI document.

The background information and the project description are sometimes issued separately as a background memorandum. The contents of the EOI should not be unduly detailed. If the EOI and later proposal requests are overly prescriptive, then there is little room for consultants to apply their expertise and propose more effective alternatives. Thus, these documents should merely set the project goals and objectives and leave creative aspects of project design to the actual planning process.

However, since the EOI may provide relatively little information about the prospective

consultant, municipalities may have difficulty in determining the short-listed firms. Experience on having worked on other BRT projects is a necessary but insufficient criterion for short list qualification. Many of the firms likely to bid will be huge planning and engineering firms which have worked on all sorts of projects all over the world, including what might be called BRT projects. The important consideration is less the firm than the resume of the project team that is concretely being proposed. Sometimes a firm with limited experience in BRT will pick up an extremely talented expert to lead their team, and this would be a stronger bid than a firm that has worked on many BRT systems but which is assigning inexperienced personnel to the specific project.

As BRT has grown in popularity, the number of self-proclaimed BRT experts has also grown, and as much additional research as possible should be done into the qualifications of the specific team being proposed. Interviewing some of the clients of the consultant's previous work, and asking around among other professionals about their reputation, may provide useful insights. The community of international BRT experts is sadly still very small, and information about fellow experts is easy to obtain. Evaluating the quality of previous plans may also be useful.

How many firms should be invited to participate in preparing more detailed bid documents? There is no single rule on the number of firms since much depends on the local capacity to evaluate detailed proposals. In some cases, a well-resourced municipality may be able to bypass the EOI stage and simply ask all interested parties to participate in submitting a full proposal. The more proposals submitted, the greater the potential for a highly-competitive contest. Generally, though, the municipality will only want to evaluate a manageable number of detailed proposals. Further, requesting proposals from individuals or firms with no experience or no chance of acceptance can be a drain on the time of both the municipality and the applicants. Thus, short-listing anywhere from three to seven firms for detailed proposals probably provides a sufficient level of competition without becoming unwieldy in administrative terms.

Terms of Reference (TOR)

The next phase of the contract solicitation process typically involves developing the Terms of Reference (TOR). The EOI merely sets forth a few generalities to solicit consultant interest. The TOR sets out the list of requirements from which the detailed proposals will be developed. While the TOR will not necessarily detail every activity to be undertaken in the planning process, it will note the specific outputs and products required. For example, the TOR could call for the delivery of specific plans, such as operational plans, infrastructure plans, architectural plans, detailed engineering plans, financing plans, and marketing plans, and the TOR will likely discuss the level of detail sought from the planning process. Nevertheless, a well-crafted TOR will leave open the possibility of creativity from the consultants in achieving these results. Some of the common topics listed in a TOR include:

- Project title;
- Detailed project description;
- Description of expected consultant outputs;
- Estimated timeframe for consultant selection process, project initiation, and length of consultant activities;
- Request for names, titles, and curriculum vitae (CVs) of consultant team-members;
- Description of consultant's relevant experience on past projects;
- Description of other evaluation categories (*e.g.*, use of local expertise);
- Deadline for EOI submission;
- Submission details (length, format, etc.);
- Scoring process for selecting consultant;
- Contact details.

Annex 3 of this Planning Guide provides a contract template for a typical TOR document.

The number of TORs should match the number of EOIs that were issued. Thus, each different consulting contract will have its associated TOR document.

Bid price

The proposed project cost will be one of the principal decision-making factors in choosing the consultant. However, it should not be the over-riding factor if other qualities, such as experience and staff qualifications, are not adequate. In some cases, cities may be legally bound to choose the lowest bid. This practice, though, can result in unsatisfactory results.

The amount of the bid prices can be derived either through open competition or through pre-set limits. Table 3.2 describes the options for determining consultant fees.

Table 3.2: Mechanisms for consultant bid prices

Mechanisms	Description
Fixed price	A single fixed price for consultant activities is pre-set; consultants only compete on experience and quality of TOR document
Fixed maximum price	A maximum price is pre-set; consultants compete on price to the extent that it does not exceed the maximum amount
Range of acceptable prices	A range of acceptable prices is established; consultants compete on price within this range
Open bidding	No pre-set amount or range of amounts is established; consultants compete in a completely open market

The particular mechanism chosen for the bid structure may depend in part on local legal requirements. In some cases, a fixed price bidding system may be required by law. However, by introducing some degree of competitively priced bidding, the municipality gains a better measure of the difference between the competing firms. Some cities may use a fixed maximum price or a range of acceptable prices in order to keep bids within the established budget. However, in such cases, all firms may simply bid the maximum amount or the median amount of the given range. Thus, any pre-set limits will tend to reduce competition and may increase actual costs over that which could be achieved in a truly competitive market.

An open bidding process can bring with it several benefits. First, without pre-set limits firms will tend to lower bid prices in order to effectively compete with others. Open bidding will tend to encourage innovation and creativity amongst the competing firms to find the most efficient manner of delivering a high-quality plan. Second, the range of bids received provides feedback to the municipality on the actual likely costs. With a pre-set value, firms will likely adjust their effort levels and the quality applied to the final product in order to achieve the fixed amount. Third, open bidding makes it easier to distinguish between different bids. The likely spread of bid values provides a more discernible gauge to evaluate the proposals.

Of course, the risk with open bidding is that all firms will bid an amount that exceeds the

maximum allotted budget. However, this over-bidding can provide valuable feedback to the municipality. It may be a sign that the municipality should consider revising the estimated budget, or it may imply that the scope of work should be reduced to more realistically reflect the available budget.

For circumstances in which over-bidding occurs and there is no room for an expansion of the budget, the TOR should include a clause invoking “no qualified response”. This clause signifies that none of the proposals met the project requirements and that a possible re-bid will be required. The “no qualified response” clause may also be invoked for other reasons, such as circumstances where none of the bidding firms have adequate experience. It is also possible that the bidding documents could spell out what happens in case the bids are over an undisclosed maximum. Bids over an undisclosed maximum need not necessarily be automatically disqualified. The TOR could specify that the bid price is not final but one consideration along with technical competence and other factors in the selection of a winning bidder. An over-bid might bring about a penalty but not necessarily a full disqualification. At this point, the winning bidder can be asked to resubmit the bid within the given budget.

Submittal deadlines

The deadline for the EOI and TOR submissions must be strictly adhered. If proposals even a few minutes late are accepted, then legal challenges from other aspiring firms and individuals may cause the entire project to become delayed or blocked.

Evaluation process and applicant scoring

Prior to issuing the EOI or TOR documents, the project developers should formally establish the decision-making process. Ideally, the decision-making criteria will be created in an open and transparent manner with inputs from a variety of sources. A committee of officials should be established to oversee the bid evaluation process. Placing all evaluation responsibilities with a single person can create unintended impressions.

The decision-making process for both the EOI and TOR should be as quantitative as possible. A scoring system for ranking firms and

proposals can be a useful mechanism for clear and consistent decision making. If the selection relies too heavily upon qualitative judgements, then the entire process can be open to arbitrariness and the possible appearance of impropriety. In some cases, highly qualitative decision making could be challenged by the losing applicants, and thus creating delays and additional costs. Table 3.3 provides an example of a scoring system used to evaluate consultant bid proposals.

Table 3.3: Sample scorecard for evaluating consultant proposals

Factor	Points value
Bid price	35
Project experience with BRT	20
Project experience with other transport initiatives	15
Qualifications of proposed project staff	15
Proposed methodology	10
Proposed time schedule	5
Total	100

Because there is no commonly accepted definition of BRT, and projects called “BRT” vary widely, it may be necessary to further qualify the type of BRT experience being sought, such as experience with “closed” BRT systems, or experience with BRT systems in developing countries. Experts that have previously only worked in the US may have no idea how to plan a system like Curitiba or Bogotá’s Trans-Milenio. If the BRT system being planned is likely to require restructuring of existing public transport routes, for instance, this is a different skill set than for a system which does not plan to alter existing bus routes.

The points allotted each category in table 3.3 are presented for demonstration purposes only. The actual relative value of each component will depend upon local circumstances and priorities. Further, if multiple consulting contracts are to be issued, then the scoring system will likely be tailored to the specific speciality being requested (e.g., marketing, demand modelling, operational planning, infrastructure design).

Phasing of contracts

Despite the best efforts to clearly articulate the project objectives in the contracts, misunderstandings can arise. In such cases, consultants may work in a project direction that differs from the intent of the project organisers. By phasing the consultant work, such misunderstandings can be corrected before a great deal of unnecessary effort is invested. The phased approach essentially requires the consultants to obtain municipal approval prior to moving to the next stage of the project. Rather than waiting until the final report is submitted to review the project, municipal officials review intermediate findings and give their approval or disapproval. Such project milestones should be explicitly stated in the contract.

Additionally, these types of problems can be avoided by maintaining a close dialogue between the consultant and municipality at all times. Weekly or even daily briefings can ensure that all parties are in agreement on the project direction. Figure 3.6 outlines the process for reviewing consultant outputs. Alternatively, municipal officials may even procure “supervisory consultants” who work principally to review and evaluate the work of the project consultants.

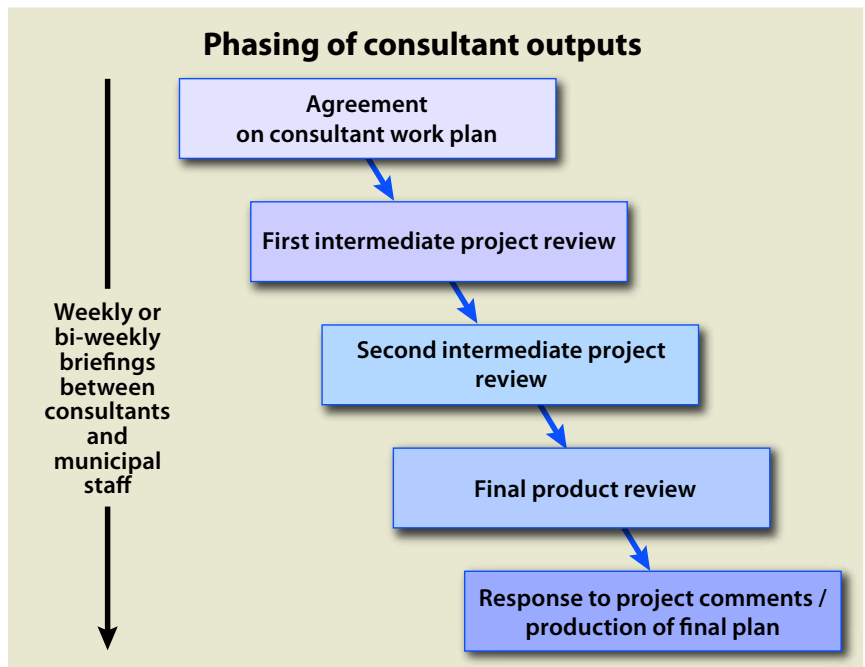


Fig. 3.6
Regular reviews and briefings by municipal staff over consultant progress helps to make sure all parties are in agreement over the project direction.

Penalties and incentives

Consultant contracts can be written to include penalty and incentive clauses to encourage good performance. Such clauses for planning work typically relate to the timely delivery of the product. However, incentives can also be applied to the quality and acceptability of the product. For example, a marketing firm can receive more compensation if the system logo or slogan is actually utilised by the BRT system.

The crafting of incentive language must be carefully considered. Ill-conceived performance clauses can produce unintended results. For example, rewarding the early completion of the work may create the incentive to rush through a poor-quality effort. In this case, it might be more advisable to just penalise a late delivery in conjunction with some form of incentive for plan quality.

Ultimately, the best defence against problems is to work with firms that already have a relationship with the government or that are interested in building a longer-term relationship that government. A government should establish longer-term relations with a few trusted firms with expertise in BRT. When problems arise, if the company believes that it has a future working with that government, it is much more

likely to be responsive and flexible to government needs. Planning and engineering firms must often make large up-front investments in order to undertake complex and detailed planning work. This investment is especially true in a new city where they may not have all the information and modelling data that they need. Firms with a longer-term interest in that city are therefore likely to provide better results.

3.2.4 Project management structure

Once the project becomes officially announced to the public, a clear project management structure should be firmly in place. While pre-project fact-finding activities may be sufficiently conducted with a few staff and/or consultants, the formal project should be given a definitive personnel structure at the outset. The specific organisational structure will vary with local circumstances, but in all cases the structure should reflect the importance given to a new public transport system for the city. Figure 3.7 gives an example of an organisational structure for the Rea Vaya BRT project in Johannesburg.

Perhaps most importantly, the top political official overseeing the project should nominally be placed as the project chairperson. In most cases, this position should be held by the mayor



Fig. 3.7
An example of a possible project management structure for a BRT project.

or governor. In the case of Johannesburg, the Executive Mayor has the ultimate oversight and leadership on the project. The lead City Councillor for the project (*i.e.*, Member of Mayoral Committee for Transportation) has the lead role in terms of overseeing day-to-day activities.

This type of direct leadership involvement helps ensure that the project remains a top priority throughout the development process. While the project chair will not be intimately involved in all system decisions, the top political official should make an effort to become involved through regular briefings and formal committee sessions. The Mayors overseeing the highly successful BRT projects in Bogotá and Curitiba made an effort to be involved in decision-making sessions and briefings at least once a week and sometimes even more frequently. This type of high-profile involvement helps keep the project's momentum moving decidedly forward.

The organisational structure in Figure 3.7 also shows both internal and external advisory committees. The internal advisory committee consists of other city departments or entities with some interest in the project. The external advisory committee consists of key outside stakeholders, including national and provincial governmental officials, public and private transport providers, trade and labour unions, commuter organisations, and local and international experts. Formal inclusion of all key stakeholders in the process can help ensure the necessary buy-in to make the project a reality. Giving a voice and ownership role to these groups will ideally create a spirit of shared commitment that will drive the project towards implementation.

The inclusion of related agencies (public works, transport, urban planning, finance, environment, and health) on the steering committee helps to ensure cooperation. At some point the support and knowledge of these organisations will likely prove invaluable. Further, the inclusion of these actors will help mitigate “turf” issues and facilitate inter-agency cooperation to the extent possible.

3.3 Project scope and timing

“Time is the scarcest resource and unless it is managed nothing else can be managed.”

—Peter Drucker, author and management consultant, 1909–2005

3.3.1 Work plan and timeline

Once a vision is set for the BRT system and an initial team is formed, a detailed work plan and timeline on how to achieve the vision will be necessary. By walking through each step of the process, municipal officials and the public will have a better idea of the scope of the project and the necessary activities to make it happen.

Invariably, cities underestimate the amount of time needed to complete a full BRT plan. A BRT plan can be reasonably completed in 12 to 18 months, but can take longer in cases of very large and complicated cities. However, as experience with BRT planning grows, some cities may be able to greatly reduce the required planning period, especially through cooperation with existing BRT cities and international consultants. The January 2006 launch of the Beijing BRT system was supported by just five months of planning effort. Of course, the actual duration of the planning process will depend greatly upon the complexity of the project and upon other local conditions.

Completing the work plan and timeline will help ensure that important elements such as public communication and education are not inadvertently left out. Sharing the work plan and timeline with politicians, press and the public will also help ensure that all parties have realistic expectations of progress with the project.

No matter how well one plans, though, unexpected events will also act to necessitate modifications. Thus, the work plan and timeline should be revisited and revised from time to time during the planning process. Figure 3.8 provides an example of a basic BRT timeline. In an actual project, a very detailed Gantt chart should be created so that each step is carefully evaluated from a timing perspective.

Figure 3.8: BRT Planning Process: Workplan and Timeline

Activity	Pre-project	Months 1-3	Months 4-6	Months 7-9	Months 10-12	Months 13-15	Months 16-18	
I. Project preparation								
1. Project initiation	■							
2. Transit technology selection		■						
3. Project set-up		■						
4. Demand analysis			■					
5. Corridor selection			■	■				
6. Communications			■					
II. Operational design								
7. Network and service design				■				
8. System capacity and speed				■	■			
9. Intersections and signal control				■	■			
10. Customer service plan					■			
III. Physical design								
11. Infrastructure					■	■		
12. Technology					■			
IV. Integration								
13. Modal integration					■			
14. TDM and land-use					■			
V. Business plan								
15. Business and institutional structure			■	■	■			
16. Operator costs and fares					■	■		
17. Financing plan				■		■	■	
18. Marketing plan						■	■	
VI. Evaluation and implementation								
19. Evaluation						■	■	
20. Implementation plan							■	

3.4 Planning budget

“A budget tells us what we can’t afford, but it doesn’t keep us from buying it.”

—William Feather, author, 1889–1981

The realistic scope and depth of the BRT planning process is largely determined by the available funding. However, the first step should be to determine the required amount based upon the projected activities. An estimated budget for the plan can be developed from the activities outlined in the work plan. The budget will include staff salaries, consultant fees, travel and study tours, resource materials, telecommunications, and administrative support. Some of these costs may be covered by existing budgets and overheads while other line items will need newly dedicated funding. Since the planning horizon is likely to encompass 12 to 18 months of time, any temporal cost escalations such as projected salary increases or inflationary trends should also be considered.

Budgets should be made as realistic as possible. Overly-optimistic projections will ultimately be compared unfavourably to actual results, which will be used by project opponents to undermine the project’s image. Unfortunately, projecting budgets is never an exact science. Unexpected and unforeseen events will undoubtedly arise which will create the need for budgetary adjustments. Thus, it is always wise to include a contingency amount that will help cover such unexpected costs. The contingency is often represented as a percentage of the projected total (e.g., 10 percent of the projected budget).

BRT planning costs have historically varied considerably, depending upon the scope and complexity of the project, as well as the degree to which in-house expertise is utilised in comparison to consultants. To plan the extensive TransMilenio system of Bogotá, a total of over US\$5.2 million was spent in the planning process. By comparison, using principally in-house

professionals, the municipality of Quito spent only approximately US\$300,000 to plan its smaller system. The recently inaugurated Phase I of the Beijing BRT system was planned from a budget of just US\$125,000. In general, though, planning costs will likely range from US\$1 million to US\$3 million.

Given the modest cost of BRT planning relative to other public transport options, cities should be careful not to under-invest in the planning process. As one BRT planner has noted:

“BRT is like performing heart surgery on your city’s clogged arteries. A city should not hire the cheapest surgeon it can find, it should hire the best surgeon it can find.”

Skimping on the provision of resources to the planning process, and rushing the process to ensure rapid implementation deadlines determined by political imperatives, may prove costly in the long run. Proper planning helps cities to avoid the basic mistakes that can be quite costly later. It is hoped that this BRT Planning Guide will help cities plan a BRT system at a lower cost and within a shorter time frame.

3.5 Funding and financing sources

“He that wants money, means, and content is without three good friends.”

—William Shakespeare, playwright, 1564–1616

Funding refers to the general provision of monetary resources to a project. Financing refers to the mechanism required to cover the difference between the available funding and the total amount required for the project. Financing may particularly refer to circumstances where there is an additional associated cost with procuring the funds (*e.g.*, interest-based loans). In the case of BRT planning, financing is usually not required at all. Even for relatively low-income countries and cities, a total planning cost of between US\$1 million and US\$3 million for a new public transport system may not be an insurmountable amount to be designated from local sources. Political commitment is likely to be a much greater determinant in whether to undertake the planning process rather than any fiscal limitations.

Local, provincial, and national entities are the logical starting point for identifying funding sources for BRT planning. However, the cost-effectiveness of BRT has also meant that many international sources are supportive of BRT planning efforts. Table 3.4 lists many of the possible funding sources for BRT planning.

Table 3.4: Potential funding sources for BRT planning

Funding source	Examples
Local government	New budget item Existing budget from Transport Department Existing budget from Planning Department Existing budgets from Departments of Environment, Economic Affairs, and Health
Provincial / state government	New budget item Existing budgets from Departments of Transport, Planning, Environment, Economic Affairs, and Health
National government	New budget item Existing budgets from Departments of Transport, Planning, Energy, Environment, Economic Affairs, and Health
Private sector	Private bus operators, land developers, fuel suppliers, vehicle manufacturers, etc.
Bi-lateral assistance agencies	DfID, GTZ, JICA, Sida, USAID
Bi-lateral export banks	JBIC, KfW, US TDA, US ExIm Bank, US OPIC
United Nations agencies	UNDP, UNEP, UNCRD, etc.
International environmental funds	Global Environment Facility (GEF)
Development banks	World Bank, IADB, ADB, etc.
Private foundations	Hewlett Foundation, Blue Moon Foundation, Shell Foundation, etc.

Annex 4 provides contact details for various types of bi-lateral agencies, international organisations, and private foundations.

3.5.1 Local, provincial, and national funding sources

3.5.1.1 Local government sources

In many instances, a municipality will hold sufficient to budgetary resources to plan a BRT project without any outside assistance. This situation is particularly true when the municipal leader is highly motivated towards a new public transport system.

The viability of self-funded efforts will also likely depend on the technical capacity of the government bodies charged with planning and designing the system. If the technical capacity is quite strong and if many staff members are already experienced with BRT, then much of the planning work may be conducted internally. In these cases, the planning costs may be covered through normal on-going budgets. Thus, the planning costs are effectively nominal. Quito illustrates the cost effectiveness of this approach with the Trolé corridor being planned internally for a cost of approximately US\$300,000. However, the lack of outside inputs may have contributed to some of the problems currently plaguing the Quito system. Thus, short-term cost effectiveness can carry with it significant long-term liabilities.

In other cities with little in-house technical capacity, external and/or international consulting expertise may be required. In these cases, the higher planning cost may make sole reliance on municipal funding more difficult.

Even if a city envisions the need for external funding, local, provincial, or national government contributions will likely be required. International organisations typically view local contributions as an indicator of a city's true seriousness towards actual implementation. Any city would likely accept a free BRT plan, but without any local commitment of funds there is little motivation to deliver a real project. Thus, many external funding sources require a significant local (or provincial or national) contribution. A 50 percent match is frequently the standard for receiving international planning funds.

3.5.1.2 Provincial and national sources

Additional funding inputs from provincial and national agencies may be another option that avoids the requirement of non-governmental funding. In some cities, provincial and national agencies may actually hold responsibility over BRT planning and implementation. Thus, in cities such as Cape Town, Bangkok, and Jakarta, provincial funding sources have provided the some of the impetus for BRT planning. In Colombia, the national planning agency has played a central role in exporting the Trans-Milenio concept to other cities.

Involving provincial and national agencies also brings with it other advantages in terms of accessing additional technical experience. Of course, each additional agency involved in the project can also imply increased managerial complexity and the potential for disagreements between parties, especially if the different levels of government are represented by different political parties.

3.5.1.3 Local private sector

In some instances, the local transport situation can deteriorate to the point where the private sector may take it upon themselves to seek an alternative. Private sector involvement may stem from local officials essentially abdicating their responsibility to manage and promote public transport. Clearly, private sector involvement will also feature a bit of self-interest in which the private sector parties expect the improved public transport system to deliver corporate profits.

Private bus operators may view a move to a BRT system as the principal means to improve their profitability. Operators may also be responding to increased competition from informal vans and mini-buses that are filling a market gap left by poorly organised and managed formal services. The development of BRT in Curitiba was likely the reason that Curitiba is the only major Brazilian city where “clandestinos” (informal vans) have not infringed upon the formal market. Thus, consortiums of private operators have led BRT planning efforts in several cities including San Salvador (El Salvador) and Santiago (Chile).

Other private parties may also have an interest in BRT development. In Manila (Philippines) a

local property development company has initiated BRT efforts in districts near business parks owned by the firm. A formal public transport system in this area would deliver value to the company through improved property values and better access for employees.

Private manufacturers may also have a vested interest in BRT. Vehicle manufacturers could benefit from the increased sales stemming from new BRT vehicles. For example, Volvo has launched an initiative in India to promote BRT development. Additionally, fuel suppliers may also see an advantage to BRT promotion if their product is likely to be chosen for improved environmental performance. In Dhaka (Bangladesh), a local supplier of compressed natural gas (CNG) has taken the lead to initiate BRT planning activities.

Based on these examples, municipalities may wish to form alliances with private sector associations that would be natural allies in BRT development.

3.5.2 International funding sources

The success of BRT has not been lost upon development banks and other international organisations. The lack of large capital debts and the lack of necessary operational subsidies mean that these organisations typically rank BRT as an option to promote and facilitate.

The plethora of international organisations now interested in BRT means that cities have a healthy supply of funding options. The international role is particularly relevant to the planning process. The mandate of many international organisations revolves around issues such as capacity building, information dissemination, and project facilitation. All of these issues are related to planning. Further, most international planning assistance arrives in the form of grants and not loans. Thus, planning funds typically do not carry any additional financing costs.

The international resources often also bring the additional advantage of allowing greater access to professionals with international BRT experience. An international organisation may hold a relationship with top BRT consultants, many of whom would not ordinarily be available or affordable to a particular city. A local government within a developing-nation city may have little

knowledge on which international consultant to trust with the project. International organisations will often be involved in multiple cities and thus be able to identify the best-performing consultants. Likewise, some leading experts will not work directly for municipal governments for fear of never getting paid. By contracting directly with the international organisation, the consultant will be more confident in accepting the assignment.

International organisations can also ensure that local and international consulting teams work as a united team. As noted earlier, local consultants possess the critical knowledge of the local context while international consultants may possess greater BRT experience. The local and international consultants may not work in a complementary manner if each group feels the other is inadequate either for the lack of local knowledge or for the lack of BRT experience. The presence of a respected international organisation, such as a bi-lateral agency or development bank, can mediate such differences and create greater team harmony and co-operation.

The main disadvantage of involving international funding sources can be the amount of effort required in the application process. The international organisations may require an extensive analysis of the city's transport history, assurances from all relevant agencies and departments, calculations of emission benefits, and a detailed framework connecting objectives to outputs. This process may also involve seminars and workshops to build capacity and sharpen the project premise. While this application process can actually be a useful part of project preparation, the amount of time and effort involved can slow overall project development. Further, several such applications may be necessary before receiving the support and commitment of an international organisation.

3.5.2.1 Multi-lateral organisations

Multi-lateral organisations such as the World Bank, regional development banks, and agencies of the United Nations often provide grants to support planning activities and initial demonstrations. Unlike loans, grant-type funding mechanisms do not require repayment. One such grant mechanism is the Global Environment

Facility (GEF). The GEF was created in 1991 to assist governments and international organisations in their goals of overcoming global environmental threats. Thus, GEF funds are utilised to address such issues as the degradation of international waters, biodiversity, global climate change, ozone depletion, and persistent organic pollutants (POPS). Through the global climate change programme and the GEF's Operational Programme number 11, transport is an eligible sector for funding. BRT projects qualify under article 11.10(a) of Operational Programme 11: "Modal shifts to more efficient and less polluting forms of public and freight transport through measures such as traffic management and avoidance and increased use of cleaner fuels."

To qualify for a GEF project, a municipality will need the support of its national GEF focal point, which is typically housed at either a national ministry of the environment or a national ministry of foreign relations. Additionally, the project will need one of the GEF's implementing agencies to champion and support the project through the application process. Eligible implementing agencies include the World Bank, the United Nations Development Programme (UNDP), the United Nations Environment Programme (UNEP), and regional development banks (e.g., African Development Bank, Asian Development Bank, Inter-American Development Bank). To date, the GEF has approved several BRT-related projects, including projects in Cartagena, Dar es Salaam, Hanoi, Lima, Mexico City, and Santiago, as well as multi-city initiatives in Colombia and China.

The size of a GEF grant depends on the type of application and the nature of the project. GEF funding mechanisms include:

1. Small Grants Programme (funds of less than US\$50,000)
2. Small and Medium Sized Enterprise Programme
3. Project Preparation and Development Facility (PDF)
 - PDF Block A (up to US\$25,000 for project preparation)
 - PDF Block B (up to US\$350,000 for project preparation)
 - PDF Block C (up to US\$1 million for project preparation)
4. Medium-Sized Projects (up to US\$1 million for project)
5. Full-Sized Projects (large grants of sometimes over US\$10 million)

In a large city or a multi-city project, a full-sized GEF project will likely be required. For this reason, the GEF transport projects in Hanoi, Lima, Mexico City, Santiago, Colombia, and China are all full-sized projects. Medium-sized cities such as Cartagena and Dar es Salaam have received funding as medium-sized projects (MSPs).

GEF resources are unlikely to directly finance infrastructure, but are useful in assisting with the planning process. Additionally, GEF funding can also be an effective means to attract complementary financing from other sources.

Other international organisations may also support BRT planning activities. For example, the United Nations Development Programme (UNDP) has played a role in developing BRT projects in Pereira (Colombia) and Cartagena (Colombia) through technical assistance activities. The Clean Air Initiative for Asian Cities (CAI-Asia) is also playing role in BRT development through its programme known as Sustainable Urban Mobility in Asia (SUMA). The SUMA programme is a US\$5 million grant-making facility made possible through resources from Sweden (Sida) and the Asian Development Bank (ADB). Likewise, the European Union (EU) possesses some of its own overseas development assistance funding. In some instances, EU funds have been applied to feasibility studies where European consortiums are positioned to capture the contracts.

Fig. 3.9
Multi-lateral organisations have been quite supportive of BRT projects to date. In many cases, grant funding is available to support planning activities.



While development banks are more closely associated with financing infrastructure, the project preparation grants have also been used. These grants are common when a later infrastructure loan is being considered. Cities such as Dar es Salaam (World Bank) and San José (Costa Rica) (IADB) have benefited from such grants.



Fig. 3.10
Bi-lateral agencies can also be a source of potential technical and financial support during the planning phase of the project.

3.5.2.2 Bi-lateral agencies

Additionally, bi-lateral agencies such the German Technical Cooperation (GTZ), the Japanese International Cooperation Agency (JICA), the Swedish International Development Agency (Sida), and the United States Agency for International Development (USAID) may be approached to assist on the provision of support and technical resources. GTZ has played a role supporting BRT development in such cities as Bangkok (Thailand), Buenos Aires (Argentina), Cartagena (Colombia), and Surabaya (Indonesia). Sida has assisted BRT awareness in Bangalore (India) and Dhaka (Bangladesh), and more recently, Sida has helped to fund the US\$5 million Sustainable Urban Mobility in Asia (SUMA) programme. USAID has been active with BRT support in Accra (Ghana), Dar es Salaam (Tanzania), Dakar (Senegal), Cape Town (South Africa), Johannesburg (South Africa), Delhi (India), Hyderabad (India), and Jakarta (Indonesia).

JICA has funded numerous master plans and transportation demand modelling projects in developing countries. Most often JICA, along with the Japanese Bank for International Cooperation (JBIC), encourage cities to procure Japanese rail-based technology or make use of Japanese construction firms for roadway projects (Figure 3.11). In Bogotá, JICA recommended the construction of a metro system and a large elevated roadway system (Figure 3.12). Fortunately, former Mayor Enrique Peñalosa rejected this vision and opted for the path of sustainable transport characterised by the city’s TransMilenio system, cycle ways, and pedestrian zones. However, some of JICA’s studies

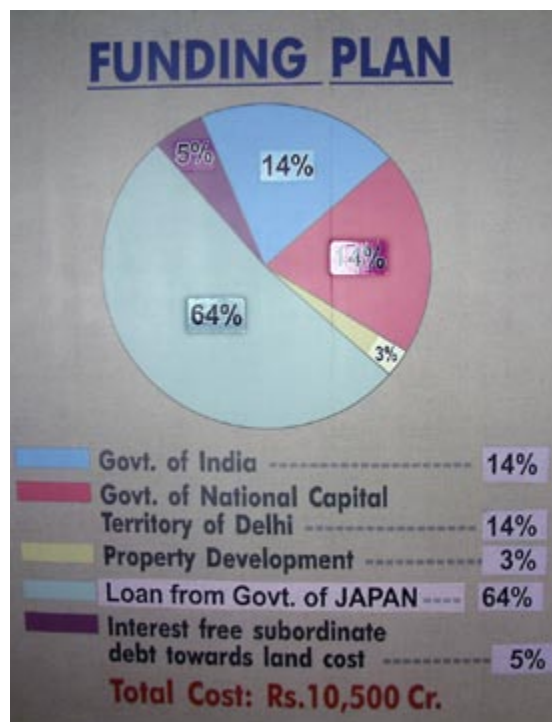


Fig. 3.11
With the assistance of JICA and JBIC, the Delhi metro benefited from concessionary loans from the Government of Japan.
Photo by Lloyd Wright



Fig. 3.12
A JICA drawing showing a vision for Bogotá with elevated roadways. Fortunately, Mayor Enrique Peñalosa rejected this vision and opted to build TransMilenio instead of elevated roads.

Image courtesy of the Municipality of Bogotá

and master plans have made reference to the possibility of BRT.

As the example of JICA indicates, cities must be careful when governments are practicing “tied” aid, in which the technology options are limited to firms only from a particular country. Thus, a city may be limited to selecting consultants of a particular nationality or using vehicles or fare equipment manufactured in a particular developed nation. Such practices may result in sub-optimal technology solutions. Additionally, such restrictions will dampen efforts to develop skills and manufacturing capabilities locally. BRT represents a practical means to encourage appropriate technology transfer and local manufacturing. A “tied” aid package may mean that developed-nation consultants and products take precedence over local sources.

3.5.2.3 Bi-lateral import-export banks

The link to exporting products from developed nations is even more explicit with bi-lateral import-export banks. These entities have been created mostly by governments in North America, Western Europe, Oceania, and Japan for the purpose of promoting the exportation of their own manufacturing goods and services. Examples of bi-lateral import-export banks include:

- German Kreditanstalt für Wiederaufbau (KfW);
- Japanese Bank for International Cooperation (JBIC);
- United States Export-Import Bank (EX-IM Bank);
- United States Overseas Private Investment Corporation (OPIC);
- US AID’s Housing Guaranteed Loan program.

As with the case with some bi-lateral aid, this type of “tied” contract can come at the expense of local production. Further, the exclusive use of one nation’s products will undoubtedly reduce overall competition and potentially result in a sub-optimum solution.

However, not all funding from bi-lateral import-export banks is quite so solidly tied to a particular manufacturer. Some bi-lateral import-export banks will extend funding for feasibility studies and planning work if their national firms have a chance of winning a contract, but there may not

be an absolute guarantee of their firms being given an automatic contract. Thus, bi-lateral import-export banks may still be an option even when fully competitive bidding is the preference of the city.

3.5.2.4 Private foundations

Private foundations such as the Blue Moon Foundation, Hewlett Foundation, the Shell Foundation, the Volvo Foundation, and the former W. Alton Jones Foundation have also been supporters of BRT activities. The Hewlett Foundation has supported BRT activities in Beijing (China), Rio de Janeiro (Brazil), São Paulo (Brazil), and Mexico City (Mexico). The Shell Foundation, through the World Resources Institute, is assisting BRT development in Mexico City and other cities both in Latin America and Asia. In some instances, these foundations may not directly fund planning work. Instead, some foundations focus on market preparation activities, such as workshops and other capacity-building exercises, in order to help cities make the decision to proceed with a BRT project.

3.5.3 Funding and financing examples

3.5.3.1 Bogotá, Colombia

As perhaps the premiere BRT system in the world today, Bogotá’s TransMilenio benefited from some of the best consulting assistance offered to date. Since few high-quality projects had been completed prior to TransMilenio, Bogotá essentially paid for the development of many ground-breaking concepts in the BRT field. With the experience of Bogotá now established and well-known, new projects have benefited from this knowledge. The planning costs of new projects have thus been substantially reduced due to Bogotá’s efforts. In total, the municipality of Bogotá invested approximately US\$5.2 million in the BRT planning process. While this amount seems costly, the Bogotá system is highly profitable, and requires no operating subsidies, nor subsidies for vehicle procurement.

Table 3.5 summarises the consultants utilised in the TransMilenio project and the sources of the consulting expenditures.

In Bogotá, the largest contract was for a management consultant firm (McKinsey) to provide overall project management as well as

Table 3.5: Planning costs for Phase I of Bogotá’s TransMilenio

Firm contracted	Amount (US\$)	Source
McKinsey & Co. (Strategic consultants)	3,569,231	United Nations Development Programme
Investment bank	192,308	Bogotá Department of Transport
Steer Davies Gleave (Technical consultants)	1,384,615	Bogotá Department of Transport
Landscape design consultants	115,385	Bogotá Department of Transport
Total	5,261,538	

set-up TransMilenio SA, the operating authority. McKinsey’s participation was funded by the municipality through an account with the United Nations Development Programme (UNDP). For almost three years, the Municipality of Bogotá held a technical assistance agreement with UNDP through which the municipality would pay into a UNDP account. These funds would then eventually be applied to international technical assistance. Since these funds were already committed, the municipality simply allocated the money to the BRT project.

The remaining consultant contracts were also supported by municipal funding. The planning, design, and engineering work (another US\$1.5 million) was paid for largely out of the ongoing budget allocations of the Municipality’s Department of Transportation. This work was contracted a leading international planning firm, Steer Davies Gleave. In turn, Steer Davies Gleave subcontracted some of this work to Brazilian experts from the firm of Logit. Due to the consulting team’s efforts, the TransMilenio system has proven to be fully self financing and even profitable and has represented a world best example. Thus, the large planning expenditures have helped to save the city financial resources into perpetuity.

3.5.3.2 Quito, Ecuador

Like Bogotá, Quito used ongoing budget resources to finance all of the planning. However, other than for one international UNDP expert brought in during Phase II, all of the planning and design work was done in-house by the Planning Department of the Municipality of Quito. The costs were much lower than in Bogotá, and are difficult to define precisely, as these costs were covered by the normal ongoing budget of the planning department. The total planning costs are estimated to be approximately US\$300,000.

While Quito represents an admirable effort for a city with limited resources, the exclusive use of in-house staff may have contributed to some of the system’s operating and financial difficulties. On the first BRT corridor, the “Trolé” line, the selection of electric trolleybus technology helped to minimise environmental impacts, but the technology has undermined overall system cost effectiveness. The use of electric trolley-buses and the accompanying required infrastructure meant that the total corridor costs came to approximately US\$5.1 million per kilometre. This amount represents a cost of nearly US\$4 million more than subsequent corridors that did not utilise electric trolley-bus technology. Since the Trolé line has not been entirely self financing, the corridor has remained in the hands of a public company. However, Quito is currently attempting to privatise this corridor.

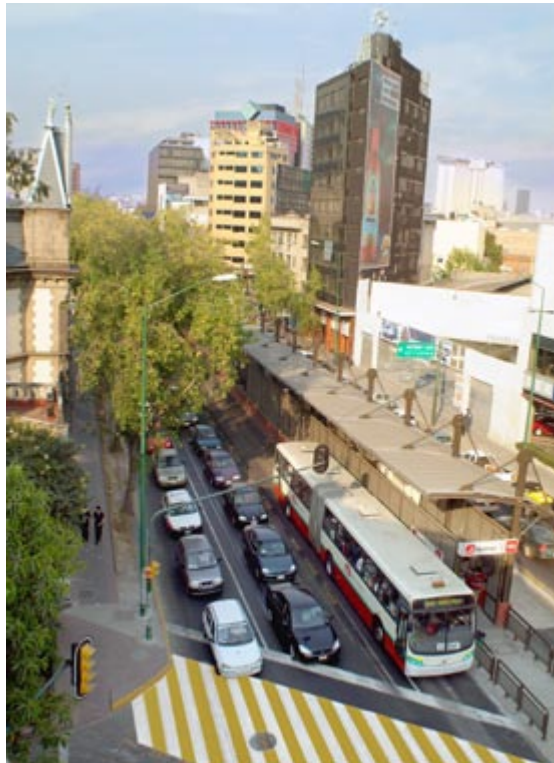
The two new corridors in Quito have also suffered from operational difficulties, especially with respect to the business structure. The concession contracts given to existing operators for the “Ecovía” and “Central Norte” lines have limited municipal control of system quality and effectiveness. Further, since none of Quito’s corridors are integrated with one another, the system offers little in terms of customer convenience. It is possible that many of the problems with Quito could have been avoided if the city gathered some inputs from the experiences of international experts. Quito is subsequently in the process of re-organising contractual arrangements along the “Ecovía” and “Central Norte” corridors.

3.5.3.3 Mexico City, Mexico

Planning for the Mexico City BRT system has attracted considerable international donor support. The total amount spent on system planning is estimated to be over US\$1 million. The

Fig. 3.13
The Metrobus system in Mexico City has benefited from the assistance of several international organisations, including the GEF, World Bank, WRI-Embarq, and ITDP.

Photo courtesy of Volvo Bus Corporation



detailed planning work for two BRT corridors in the Federal District and very preliminary analysis in the State of Mexico was financed by a World Bank-sponsored grant from the Global Environmental Facility (GEF). The Federal District used this money to hire local consultants to develop designs on the Insurgentes (Getinsa) and Eje 8 (Eteysa) corridors. The Shell Foundation and the Hewlett Foundation paid for international experts to review the Federal District plans. This international review process was largely managed by WRI-Embarq's Center for Sustainable Transport, along with support from ITDP to review pedestrian access issues.

The German Technical Cooperation (GTZ) funded the State of Mexico plans, which were developed by the consulting firm of "Cal y Mayor". In turn, ITDP funded international experts to review these plans, and to prepare a financing plan for the system. The State of Mexico has also contracted the Jaime Lerner Institute, the organisation headed by the former Mayor of Curitiba, to develop another pre-feasibility study on the system.

3.5.3.4 Delhi, India

In Delhi, approximately US\$500,000 has been spent on planning the Delhi High Capacity Bus System. The plan's financing has emanated from

three sources: the Delhi Government's general tax revenues, a grant from US AID to ITDP, and a general grant from the Volvo Foundation to the Indian Institution of Technology's Transportation Research and Injury Prevention Program (IIT TRIPP). The funds from the Delhi Government (approximately US\$300,000) were used to contract out to IIT TRIPP and several private planning firms.

In Delhi's case, most of the planning work has focussed on operational and detailed engineering design. Little to no initial investment has been made for demand analysis. As a result, the planned corridors may well do much to congest mixed traffic lanes without providing substantial time savings benefits to public transport customers. The "cost" of this design flaw will be in the form of congestion imposed on the mixed traffic (fuel consumption and time lost).

3.5.3.5 Jakarta, Indonesia

Jakarta's TransJakarta system was planned with funding principally from the provincial government (DKI Jakarta). The government contracted out three local consulting firms, Pamintory Cipta, Ernst and Young, and the University of Indonesia's Center for Transportation Studies (UI CTS) for different elements of the planning. With supplemental funding from US AID, ITDP has organised a review of the plans by international consultants. Additionally, the US AID funds have supported study tours



Fig. 3.14

The TransJakarta planning process was supported by a range of local and international organisations.

Photo by Karl Otta, courtesy of the GTZ SUTP Photo CD-ROM

for key staff, work on demand modelling, public relations activities, and NGO efforts to facilitate public participation.

3.5.3.6 Dar es Salaam, Tanzania

Dar es Salaam’s BRT planning efforts have been financed to date through four different sources. The largest share, approximately US\$1 million, is part of a World Bank loan package known as the Central Roads Corridor improvement project. An additional US\$500,000 has been awarded through a UNEP-sponsored GEF project that has been managed by ITDP. This GEF-funded component is focussing upon planning of the institutional and business model, capacity building, and non-motorized transport facilities. The Municipality itself is contributing US\$600,000 to the two-year planning process. Another US\$100,000 has been awarded through a US AID grant that is being managed by ITDP.

Dar es Salaam provides one of the best examples of how funding diversity can be the key to putting a project together. By approaching multiple sources, Dar es Salaam is not dependent on a single organisation. Further, since different funding sources tend to focus on different project aspects, this funding diversity also brings two other advantages:

1. Provides access to multiple sources of consulting expertise; and,
2. Ensures all aspects of the planning process are adequately addressed.

Building a synergistic package of funding sources should thus be a priority in any funding strategy.

3.5.3.7 China

In China, technical support for the first BRT system in Kunming came originally from the Swiss Government via the Zurich Sister City Project, with matching funds from general municipal government budget revenues. Technical support to Shejiazhuang came from municipal general budget revenues, with some loan funds from the World Bank. Subsequent technical support to Beijing, Chengdu, Xian, Jinan, Hangzhou, and Kunming stems from the Hewlett Foundation and the Energy Foundation, always with matching municipal funds for project staff and surveying work. Technical support to Guangzhou was originally provided



by the Rockefeller Brothers Fund, but more recently the project is being supported through the funding assistance of the Hewlett Foundation.

3.6 Project phases

“Those who plan do better than those who do not plan, even thou they rarely stick to their plan.”

—Winston Churchill, former British Prime Minister, 1874–1965

3.6.1 Benefits of project phasing

A BRT can be phased-in over several distinct periods or built in a massive single effort. Typically, cities choose to construct a system over a series of phases. The phased approach is necessitated for several reasons:

- Financing for the entire system may not be immediately available;
- Results from the initial phase can help improve the design in subsequent phases;
- The limited number of local construction firms may not be sufficient to construct a system across the entire city;
- Phased construction reduces the disruption that the construction process brings to city traffic flows.

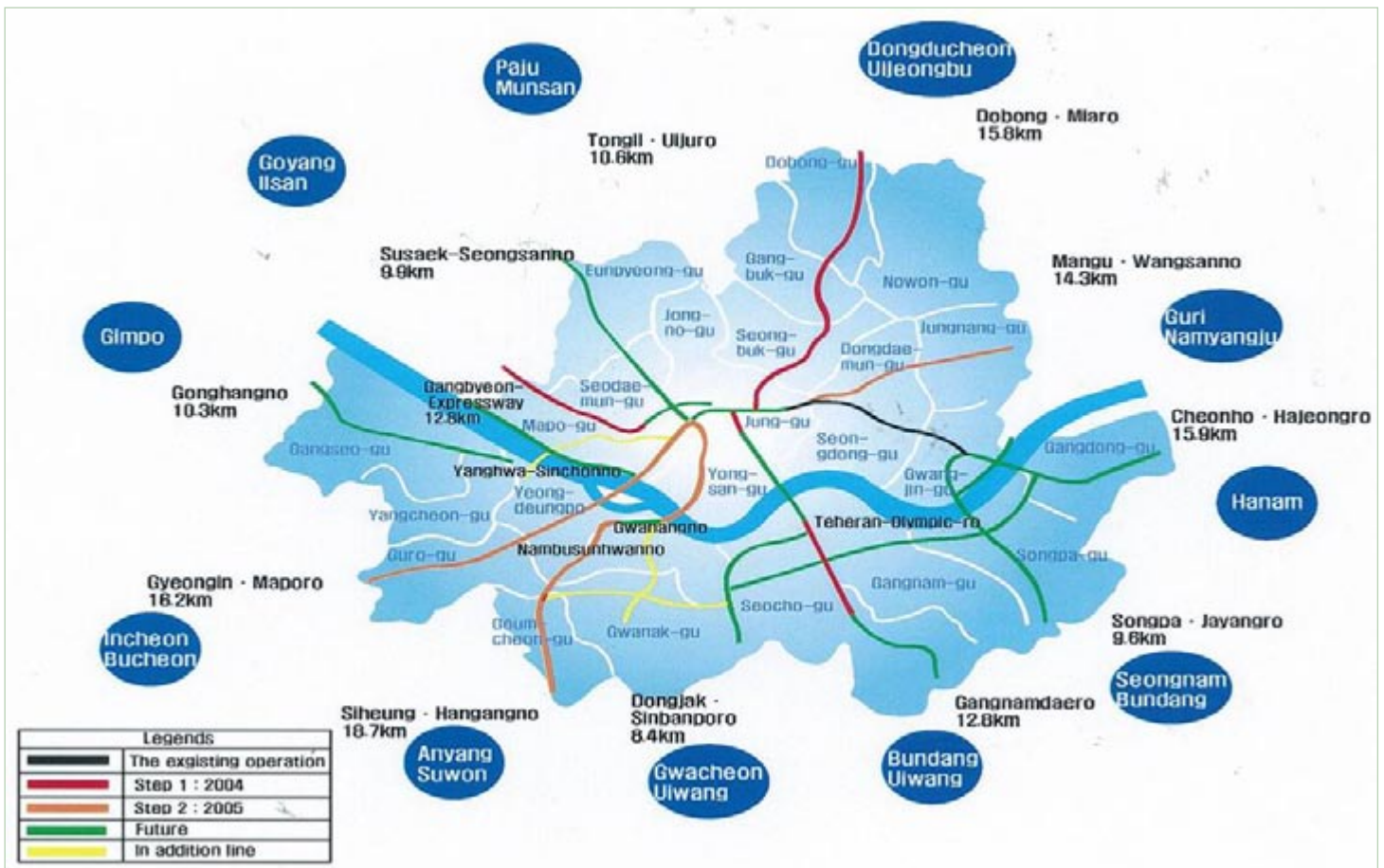
The initial vision of the overall system will likely evolve as circumstances change. However, the evolving nature of the urban landscape means that corridors and concepts may be altered, but in general, the overall concept will still be valid.

Fig. 3.15
Several new BRT projects in China, including the new corridor in Hangzhou (photo), have benefited from the assistance of the Energy Foundation.

Photo by Karl Fjellstrom



Fig. 3.16 and 3.17
Although the systems in Jakarta (top image) and Seoul (bottom image) are being constructed in multiple phases over several years, the system developers have put forward a full vision of the future system. Images courtesy of Transjakarta and the Seoul Development Institute.



The types of factors that may change over the development horizon of the project include:

- Demographic changes in population and population density;
- New property developments that significantly alter travel frequency around major origins and destinations;
- Cost factors for both infrastructure and operations.

Additionally, the lessons learned during the first phases of the system will undoubtedly affect future designs. The BRT development process should be one of constant improvement in order to best serve customer needs.

On the other hand, phased implementation will result in distinct types of operations coexisting with different rules, actors, and conditions. A large-scale adaptation of the new system across the majority of a city can reduce the confusion and inconsistencies created by a phased approach. While a large-scale approach is typically unlikely due to physical and budgetary constraints, some small and medium-sized cities may be able to actually deliver most of their entire network within a single phase.

3.6.2 A whole-system vision

Even when a system is to be built over a series of phases, it is still worthwhile to put forward a vision for the entire system (Figures 3.16 and 3.17). Such a vision may consist simply of a route map showing where all planned corridors are intended to be placed. Thus, even residents and stakeholders who will not immediately benefit from the initial phases of the system will see the long-term value for themselves.

Further, the establishment of an overall vision for a network will be seen as a legacy from the existing political administration to future administrations. If the concept of an entire network is firmly set, then there is less likelihood that future administrations will forgo implementation of the full system. The loss of political will is always a risk when moving from one political administration to the next. In many instances, the political instincts of the incoming administration are to jettison everything proposed by the previous administration.

A phased approach also should not be an excuse for an overly timid first phase. An extremely

limited initial phase may not produce the necessary results to justify further phases. BRT along just a single corridor may not attract sufficient passenger numbers to become financially sustainable. If the financial model fails in the first phase, there may never be a second phase. A single corridor strategy depends on people working, shopping, and living on the same corridor. This highly limited set of circumstances typically means that a single corridor simply cannot achieve sufficient customer flows. The limited usefulness of a one-corridor system will also dampen public support for the future system.

3.6.3 Evolution versus revolution

The issue here is whether to approach BRT by a strategy of “revolution” or “evolution”. A revolutionary approach implies that the city commits to a bold plan for an entirely new city-wide transport system. An evolutionary approach implies that the city begins developing its new system slowly, by implementing relatively small projects one by one. The revolutionary approach depends upon a highly motivated and charismatic political leader who can push through a wider vision. A revolutionary approach will implement all the aspects of a full BRT system at once. The evolutionary approach may only implement a limited system, and perhaps only a few BRT elements at once. It is more characteristic of municipal leaders with only a moderate amount of political interest towards public transport.

3.6.3.1 System quality and political motivation

Bogotá and Curitiba were successful with highly charismatic leaders who developed a revolutionary vision. The initial corridors of these systems were built in just a few years, and these corridors were of sufficient size to achieve financial sustainability even at the outset. Bogotá implemented virtually all elements of BRT in the first Phase of the project. Curitiba implemented most of the physical aspects of BRT in the early 1970s but many of the critical management elements of BRT emerged only gradually.

In contrast to a revolutionary approach, Jakarta initiated its BRT project with a limited single corridor of just 12.9 kilometres. The limited nature of the Jakarta system was further

exacerbated by the lack of integrated feeder services. Unsurprisingly, ridership on the initial corridor has been under expectations. Based on the observed examples of BRT to date, the scope and force of the initial vision will likely set the tone for the ultimate quality of the product.

3.6.3.2 Quality versus quantity

To an extent, many of the latest BRT systems have made trade-offs between system quality and quantity. The amount of resources expended per kilometre will ultimately affect the number of kilometres constructed at any given time. While BRT is far more cost effective than many other public transport technologies, there are still limits to infrastructure financing. Thus, cities that develop very high-quality projects may be effectively reducing the number of kilometres constructed, at least over the short to medium term.

Bogotá represents perhaps the highest quality BRT system developed to date. The clean, modern vehicles, aesthetically-pleasing architecture, and use of smart cards all work to produce a metro-like appearance to the system (Figure 3.18). To date, Bogotá has completed two of its project phases, which have spanned a period of 1998 to 2006. A total of 84.33 kilometres of exclusive busways have been created in this period. In the long term, Bogotá plans to construct some 380 total kilometres of busways. However, the high quality nature of the TransMilenio system translates into somewhat higher construction costs that limit the speed

at which financing for the system can be obtained. The overall length of the system directly affects ridership since a system's network of origins and destinations affect usability. Based on trip survey analysis from the year 2005, TransMilenio serves approximately 19 percent of the trips taken in the city. Non-BRT buses, minibuses, and vans still catered to approximately 51 percent of all trips. In TransMilenio's first year of full operation (2001), it served only approximately 6 percent of all trips (Como Vamos Bogotá, 2005). Thus, it is possible that the decision to build a very high quality system has somewhat reduced the speed at which a full network can be constructed.

In contrast to Bogotá's approach, cities such as Santiago, São Paulo, and Seoul are foregoing some of TransMilenio's quality for a more city-wide approach to system development. The Transantiago and Interligado systems are in some ways exchanging quality for quantity. Both Santiago and São Paulo have effectively decided to restructure and re-organise the entire city's bus system all at one time. The entire city network is being bid and concessioned all at once. These systems have tended to incorporate more of the existing bus operations into the new system, whereas, in Bogotá there is a sharp distinction between the BRT system (TransMilenio) and the non-BRT system (old, poor-quality buses and minibuses).

At the outset, only a relatively small portion of the overall network in Santiago, São Paulo, and Seoul is being converted to exclusive busways. In Santiago, only 22 kilometres of segregated busways are included in Phase I. Another 59 kilometres of roadway will receive some infrastructure improvements. However, the reach of Santiago's Phase I will extend beyond the upgraded roadways. Once leaving the busways and the upgraded roadways, the buses will travel on standard bus routes. Existing buses will also be incorporated into the system and integrated as feeder services.

At the same time, Santiago has foregone many of the attributes that would normally constitute a high-quality BRT system. The station infrastructure is somewhat modest in design and scale (Figure 3.19). Fare verification is done on-board the vehicles, and thus greatly reducing

Fig. 3.18
TransMilenio's excellence in service and design has produced a system of metro-like quality.

Photo by Shreya Gadepalli



stop efficiency and average vehicle speeds. Additionally, Santiago is utilising side-aligned stations that will cause buses to be negatively affected by turning mixed traffic.

To an extent, the systems in Santiago, São Paulo, and Seoul may be seen as hybrids between BRT and a standard bus service, akin to the definition of a “BRT lite” system given in the Introductory section of this Planning Guide.

While the approach taken by Santiago, São Paulo, and Seoul can be interpreted as a trade-off between quality and quantity, the actual motivations may be more due to the limits of sector reform in these cities. Bogotá and Curitiba benefited from highly-motivated mayors who revolutionised public transport services in their cities by wholly re-structuring the systems around the customer. In the case of Santiago, São Paulo, and Seoul, the degree of change is somewhat less so as to not affect the operations of existing fleet owners in a drastic fashion. The result of this approach, though, is a system that is far from the metro-level of quality achieved elsewhere. While Bogotá may require more time to create a full system network, the final product will clearly be car-competitive and attractive to the widest audience.

There are clearly political and technical reasons that new systems such as Santiago, São Paulo, and Seoul have embarked upon a different path than Bogotá. Neither approach is inherently correct or incorrect. Given the limits of financing resources and construction capabilities, there will always be the need to make some form of trade-off between quality and quantity. Political leaders and local officials must decide which path best fits with their political, cultural, social, and financial realities.



3.7 Common planning mistakes

"If at first you do succeed, try not to look too surprised."

—Anonymous

At the project's outset, the planning team should make much effort to observe the lessons learned to date from the previous BRT efforts. Both the successes and the failures of previous project should be noted. In many ways, the problems and mistakes encountered from past efforts may be even more instructive the successes. Recognising and avoiding the most common errors can save a city considerable time and resources.

Box 3.1 summarises some of the most common errors, as identified by leading BRT consultants. The remaining chapters of this Planning Guide will provide examples of each of these common errors.

It is almost always less costly to get a system right the first time, rather than attempting to correct problems later. Once operator contracts are signed, it becomes quite difficult and costly to negotiate later changes. Attempts to integrate Quito's three independently operated busway corridors have been thwarted due to the existing contractual arrangements. Likewise, retrofitting infrastructure can be both physically and financially difficult (although the nature of BRT infrastructure makes it easier to realise adjustments than most other forms of mass transit systems). In Brisbane, a miscalculation of

Fig. 3.19

The more basic station and infrastructure designs utilised in Transantiago have reduced costs and made the system more compatible with the city's standard bus operations.

Photo courtesy of Transantiago

Box 3.1: Most common BRT planning errors

1. System designed around a technology and not the customer
2. System designed around the existing operators and not the customer
3. Too little investment in the planning process
4. No competitive tendering of planning consultants
5. Too few full-time staff dedicated to planning the system
6. First phase is too limited in scope
7. No re-organisation of existing bus routes
8. No re-organisation of existing regulatory structures
9. Allowing all existing bus operators to use busway infrastructure, resulting in severe busway congestion
10. No competitive tendering of bus operators
11. No independent concession for fare collection
12. Public sector procurement of vehicles (instead of private sector procurement)
13. No provision for feeder services or direct services into residential areas
14. System built on low-demand corridor(s) to make construction easier
15. No provision of safe and quality access for pedestrians to stations
16. No provision for integration with other transport modes (e.g., bicycle parking, taxi stands, park and ride facilities)
17. No integration of BRT plan with land-use planning or provisions for transit-oriented development (TOD)
18. Under sizing vehicles and/or infrastructure for the given demand
19. Too few doorways in vehicles/station to facilitate rapid boarding and alighting
20. No communications plan, marketing campaign, or system branding to explain or promote the new system

demand and the use of standard-sized vehicles resulted in severe busway congestion at one major station (Figure 3.20). The subsequent retrofitting of a passing lane through the station area resulted in an additional cost of US\$11.4 million (Figure 3.21).

Bangkok proposed to construct its Phase I BRT system along the “Kaset Nawamin” corridor specifically because there was not traffic or congestion on the corridor (Figure 3.22). The lack of demand along the corridor was attractive because it meant that the BRT system would have no effect on mixed traffic flows. However, at the same time, there was virtually no public

transport demand either along the corridor. While building a high-technology BRT system along such a corridor might prove a testing ground for the concept, it would not likely be financially viable. Building a system only where it is easy to do so is unlikely to serve the interests of public transport users.

Bangkok’s long-term BRT plan also has given relatively little attention to customer convenience. The system calls for all corridors to terminate prior to arriving in the city centre (Figure 3.23). Additionally, the system routing forces most customers to make multiple transfers prior to even arriving at the final stop, which is



Fig. 3.20 and 3.21
Brisbane miscalculated demand at a major station resulting in significant busway congestion (left photo). The problem eventually had to be corrected through a somewhat costly retrofit of a passing lane at the station (right photo).

Photos courtesy of the Queensland Busway



Fig. 3.22
Bangkok proposed developing a BRT line along the Kaset Nawamin corridor expressly because there was little demand or traffic along the corridor.

Photo by Lloyd Wright

outside the principal city centre destinations. Once arriving at the periphery of the central area, customers are expected to either transfer to the rail system (which only serves a few corridors) or transfer to other options such as taxis.

The first phase of the Jakarta system and the demonstration phase of the Beijing system both suffered design problems that inhibited the performance of the systems. Jakarta's litany of initial problems included:

- Existing buses were allowed to continue operating in the mixed traffic lanes along the busway corridor, resulting in much congestion for private vehicles;
- Lack of competitive tendering for consulting services;
- Lack of competitive tendering for smart card system resulted in a non-functioning fare system;
- No feeder services were provided in conjunction with the relatively short Phase I corridor;
- A subsequent attempt to fare integrate the BRT and existing buses failed due to existing operators not accepting the transfer tickets;
- The public procurement of vehicles resulted in vehicles too small for the given demand;

- Station sizes were also too small for the given demand (Figure 3.24);
- A single vehicle doorway resulted in slow boarding and alighting times;

The problems associated with Beijing's demonstration phase included:

- Construction of busway in a corridor with little public transport demand (approximately 1,000 passengers per DAY);



Fig. 3.23
The proposed Bangkok BRT system of the Bangkok Metropolitan Administration (BMA) features a corridor plan that forces all customers to transfer to other modes prior to arriving in the city centre.

Image courtesy of the BMA



Fig. 3.24
Small vehicles, single-door entry, and under-sized stations all contributed to crowding problems on the Phase I corridor of TransJakarta.

Photo by Shreya Gadepalli (ITDP)

- The only segment of corridor which could have benefited from an exclusive busway was the one segment without an exclusive busway;
- Interior seating design of vehicle provided space for 1.5 customers, meaning that the 18.5 metre articulated vehicle had approximately the same passenger capacity as a 12 metre standard bus (Figure 3.25);
- The five-metre wide busways were quite wide for a standard bus lane but were insufficient for two lanes (Figure 3.26).

Fortunately, for both Jakarta and Beijing efforts in subsequent phases have helped to reverse or

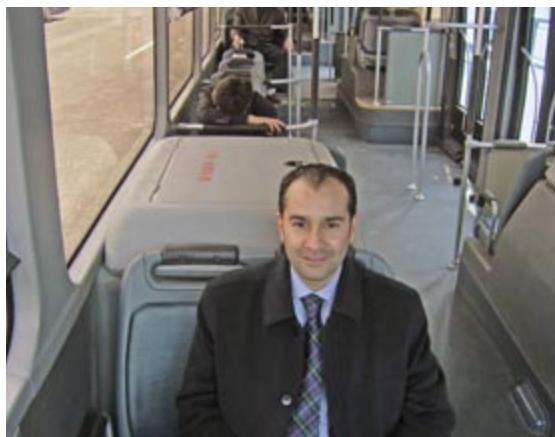


Fig. 3.25
The initial Beijing vehicles provided 2 seats that only had reasonable space for 1.5 persons.

Photo by Karl Fjellstrom

mitigate many of these problems. Nevertheless, problems in the initial phases can do much to damage a system's image for the future. A few BRT "failures" may do harm to the concept across an entire region. Thus, cities are encouraged to closely study the lessons learned to date.

Perhaps the most serious type of implementation problem relates to political continuity. There are a handful of projects that began in a promising manner and then collapsed either due to a lack of complete political will or because there was a change in leadership. In many cases, cities expend significant resources in sending delegations on study tours and hiring consultants to develop scoping studies. In the end, many of these projects are actually quite feasible, but the drive to move to actual planning never happens for many reasons.

In the latter part of 2002, the Western Cape Province (Cape Town) began a process to develop a BRT project. A large delegation of persons was sent to Bogotá for a study tour (Figure 3.27). The government identified a corridor, Klipfontein Road, and invested resources in the initial planning. A project video was even produced. International donors (US AID through ITDP) also contributed consulting resources to the initiative. However, when the leading political advocate moved to another portfolio within the Provincial government, there was a loss of momentum. Subsequently, the Province went through two other Transport Ministers in the course of three years. In many cases, new



Fig. 3.26
The five-metre wide corridor in Beijing was quite wide for a single lane busway but insufficient for two lane operation.

Photo by Karl Fjellstrom



Fig. 3.27
In November 2002, the Province of Western Cape (Cape Town) sent a large delegation to Bogotá. Subsequent political changes meant that no project materialised in Cape Town over the following five years.

Photo courtesy of Fundación Ciudad Humana

Mayors or Ministers will reject previous projects simply because they do not wish to complete a project started by another politician.

In a similar manner, project efforts have collapsed or have been seriously stalled in such cities as Dhaka (Bangladesh), Shanghai (China),

Hyderabad (India), Puebla (Mexico), and Virginia Beach (USA). In many cases, political and technical officials spent great resources in study tours and research. However, for one reason or another, the projects simply could not move beyond the basic first steps.

4. Demand analysis

“The essence of mathematics is not to make simple things complicated, but to make complicated things simple.”

—S. Gudder, mathematician

The analysis of the potential passenger demand for the planned BRT system is the technical foundation for most of the subsequent planning design work. Demand estimates are critical to designing the system, planning operations, and predicting the financial viability of the system. Knowing where and when customers require transport services will help to shape a system based first on customer needs.

Often, decision-makers will want to put a new BRT system on a wide road or a ring road where there is plenty of space, but where there is little or no demand. Other times, decision-makers will choose BRT corridors for political reasons, like putting one BRT corridor in each district, regardless of the relative importance of the corridor to riders, or locating the BRT system where its benefits would accrue to politically powerful people. While such factors will inevitably be a part of the decision-making process, BRT planners need to do their best to argue for a system that serves the most passengers in the best way possible. This requires proposing not only a single corridor but eventually a network of BRT routes. If the system does not form a network, ridership will be a fraction of its potential.

First, the system needs to be designed with enough capacity to handle a reasonable estimate of projected future demand while maintaining high vehicle speeds. This projected future demand should start with an analysis of existing public transport demand, and then expanded with reasonable expectations about passenger growth. To be conservative, the system needs to be designed with plenty of extra capacity, so from a design perspective, it is better to err on the side of over-estimating future passengers. Demand estimates can be fairly approximate at first, but the sooner the demand estimate can be made accurate, the better the design. If the system is designed with more capacity than it needs, it will be needlessly expensive and consume a needless amount of scarce right of

way that might otherwise be used for footpaths, bikeways, public space, parking or private vehicles. Alternatively, if capacity is too low, transit vehicles will be overcrowded, and the vehicle speeds might even be slower than current speeds even at very low levels of ridership, and thus alienating passengers. Any of these mistakes will significantly compromise the quality of service and the profitability of the system.

The demand estimate is also needed for optimising operations. Maybe a BRT system will keep the bus routes the same, but maybe the system would be much more profitable if they are significantly changed. Demand estimates will provide lots of information critical to optimising BRT service operations.

Finally, the demand estimate is critical for financial projections. For this, the demand estimates have to err on the conservative side, to be credible to banks and investors. The critical factor is that the banks and investors trust the estimates, and for this the greater the accuracy of the projection, and the more methodologically credible, the better.

When developing demand estimates, there is a trade-off between cost, accuracy, and timing. A detailed full demand modelling exercise will produce more accurate results, but developing a full traffic model can be time consuming and expensive. Planners often do not have the time or resources to build an entire model all at once. Rapid assessment techniques can produce acceptable accuracy fast and at a low cost. Partial modelling, of only the public transport system rather than the entire traffic system, will provide a better estimate of projected demand, while providing useful information for all sorts of operational issues. A full four-step traffic model will provide more accuracy, more robust estimates of traffic impacts, and better projections of possible modal shift, but cost more and take more time.

While the authority responsible for developing the BRT system should develop over time the capacity to do full multi-modal transport demand modelling, if this capacity does not already exist, it is unlikely that it can be developed at the same time that the agency is engaged in a politically time-bound BRT planning process.

In most developing countries, time and money are usually restricted at first, and local modelling capacity is limited. In such circumstances, it is better to develop the modelling capacity of the agency step by step, over time, so that the local partners learn how to collect and use the information, and so the design team will at least have at least some preliminary information about demand in a timely manner to influence critical early decisions.

Curitiba's BRT system was designed without any formal traffic modelling, so it can be done. However, Curitiba made certain design mistakes that compromised the system's efficiency, and which local leaders in Curitiba now regret. With today's modelling tools available, there is no excuse for repeating costly mistakes.

This chapter therefore outlines a step-by-step approach that provides gradually better demand analysis as the process evolves. The topics to be presented in this chapter include:

- 4.1 Background and situational analysis
- 4.2 Rapid demand assessment
- 4.3 Estimating demand without modelling
- 4.4 Estimating demand with a public transport model
- 4.5 Estimating demand with a full traffic model

While this chapter will narrowly focus on demand analysis, it is important to emphasise that a broader understanding of how the city's public transport system is woven into its existing demographic, economic, environmental, social, and political fabric. System planners may face all sorts of questions about how the system will affect different parts of a city, and different people within a city, and not every question can be answered by even the best traffic model. Even highly technical modelling ultimately relies heavily on the judgement of the planners. As such, it is useful to assemble a lot of basic data about the city. Section 4.1 discusses the basic demographic, economic, environmental, employment, and political information often collected prior to a full demand analysis.

Section 4.2 discusses a *rapid demand assessment*. Rapid demand assessment will provide an approximate idea of likely BRT demand on major corridors using only traffic counts and occupancy surveys in key locations, accompanied by some bus speed surveys. With this information alone, a skilled BRT planner may be able to come to a demand estimate within 20 percent of the actual demand upon completion of the system.

Section 4.3 discusses a methodology for estimating demand without modelling. In

cities where there is a clearly defined bus route structure, and the buses are reasonably well regulated, and routes reasonably well optimised, there is a way to *estimate demand without modelling* with reasonable accuracy. This estimation technique requires a very accurate set of route itineraries and boarding and alighting data from surveys at all the key stops.

Section 4.4 then explains how to develop a basic *public transport model*. The public transport model simulates only the public transport system, and requires in addition a passenger origin and destination survey. With a basic public transport model, most critical decisions about the BRT system and many critical operational decisions can be made, but where impacts of the system on mixed traffic and on modal shift can only be roughly estimated. Most BRT planners, including the team that designed TransMilenio, primarily used such a public transport model.

Finally, section 4.5 discusses the basics of developing a *multi-modal traffic demand model* for BRT. Such a model will provide full flexibility for testing multiple routing and pricing scenarios, a more robust estimate of plausible modal shift, emissions impacts, bus route optimisation, and a host of other useful tools.

4.1 Background and situational analysis

“You think that because you understand ONE you understand TWO, because one and one makes two. But you must understand AND.”

—Sufi proverb

A city’s public transit system is intimately woven into the existing demographic, economic, environmental, social, and political conditions. Understanding these conditions enables the BRT planner to better align the prospective public transit system with the local realities. Some of these data items will later be inputted into transportation models to project future needs. Other portions of this background information will help the planner view the proposed public transit system in its wider socio-economic context.

For instance, by understanding the major employment areas of the city, one can better project the location and times of the day when public transport will be required. Further, the relative economic purchasing power of the city’s inhabitants will later assist in developing a realistic tariff schedule. Demographic figures on population, population densities, and future population projections will be key inputs into the transportation modelling process. Trends in environmental conditions will help determine the sorts of air quality and noise objectives that the BRT system can help to achieve. Quantifying the social equity levels throughout the city may assist in recognising the districts that will most benefit from improved public transit services. Finally, mapping out the various political actors and the dates of upcoming elections can help establish realistic project timeframes. It is often difficult to gain political support for BRT initiatives if elections are relatively soon. However, if a political administration feels that there is sufficient time to demonstrate a tangible outcome, then the prospects for political commitment tend to be greater.

The type of background information to be collected can thus include:

- Population, population density;
- Overall economic activity (Gross Regional Product);
- Economic activity by social groupings;
- Employment levels (unemployment and underemployment);

- Environmental conditions;
- Social equity levels;
- Schedule of local, regional, and national elections.

These bigger picture issues can often shape a project in ways that a strict demand analysis cannot begin to encapsulate. Thus, a project team should also involve professionals who understand the urban and economic context of a city in addition to the local transport characteristics.

Geographical information systems (GIS) can be the ideal tool to integrate social-economic and environmental data with transport data figures. GIS software allows officials to overlay different data types upon one another. In turn, project staff can visualise transport demand figures simultaneously with other data types. Thus, the new public transport system can be prioritised in low-income areas and/or in locations with the most serious air quality problems.

4.2 Rapid demand assessment method

“Prediction is difficult, especially about the future.”

—Yogi Berra, former baseball player, 1925–

If a city has no previous history in mapping its transport demand through modelling software, then the appropriate initial step is the collection of basic travel data. By cataloguing the number of vehicles and customers within the existing bus and paratransit systems, system developers can develop a basis for estimating the required characteristics of the new system. A rapid assessment of existing conditions can be a cost-effective means by which cities can begin to build an analytic database evolving into more sophisticated analysis techniques.

In this sense, the rapid assessment method is not necessarily a distinct alternative to full transportation modelling. Instead, the rapid assessment method represents the first steps in a process that can later grow into full modelling. The same steps used in the rapid assessment method will provide the basis for a modelling exercise.

Analysing the existing public transport services and the conditions in which they operate is the first step in a rapid demand assessment. The principal data that needs to be collected is:

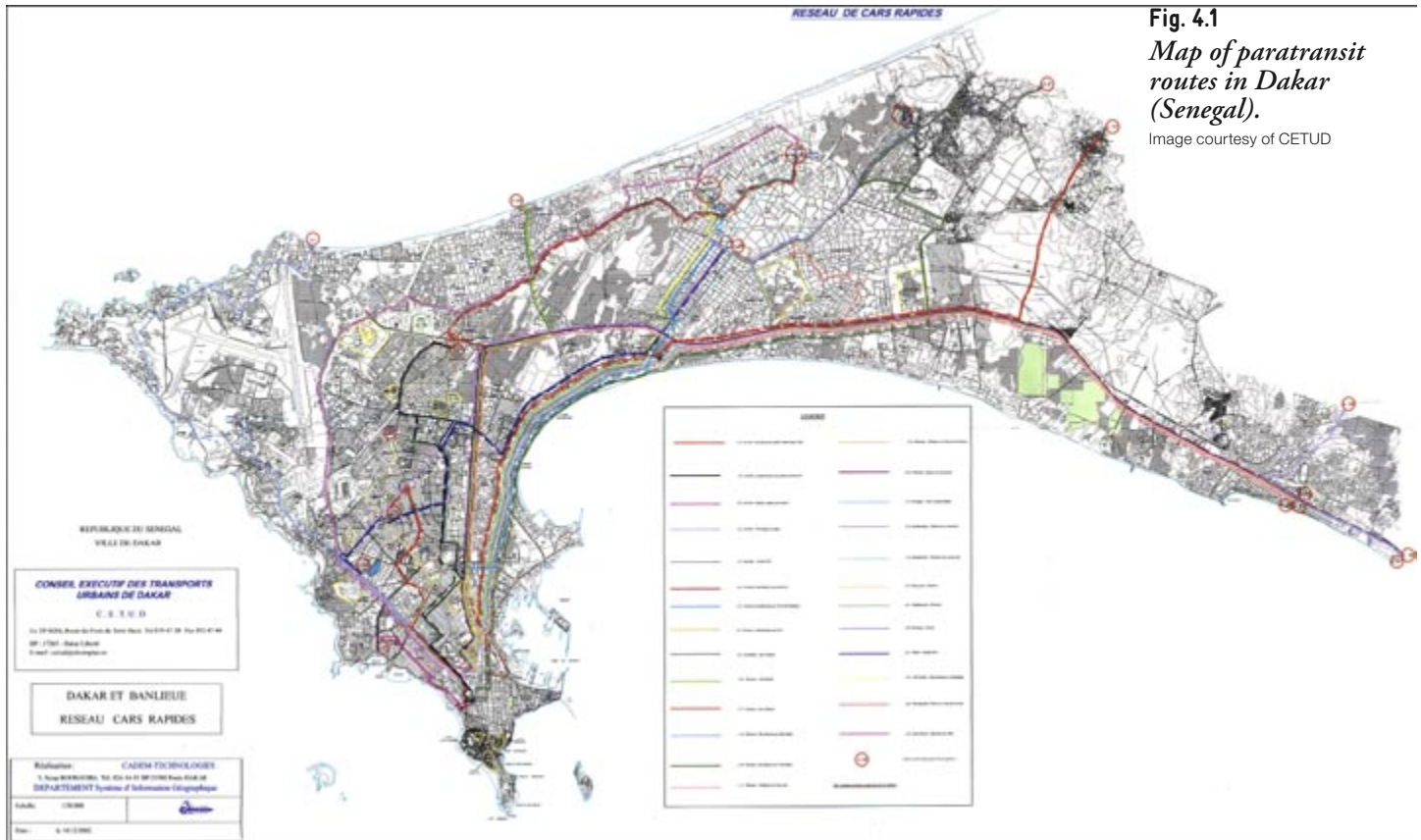


Fig. 4.1
Map of paratransit routes in Dakar (Senegal).
 Image courtesy of CETUD

1. The routes of current transit services
2. The number of passengers using each route
3. The transit vehicle speeds on each route

4.2.1 Route maps

“All you need is the plan, the road map, and the courage to press on to your destination.”

—Earl Nightingale, author, 1921–1989

Mapping the existing transit routes provides an initial indication of the areas with the greatest transit demand. While the roads which carry the most bus or paratransit routes do not always correspond to the highest number of public transport passengers on a given corridor, usually there is a strong correlation between large numbers of public transport routes and high passenger flows. If public transport routes are fairly well regulated, then municipal officials will likely already possess detailed route itinerary information through registration records. In some cases, a map of existing routes may also be available.

However, in many developing-nation cities, the majority of transit passengers may be served by paratransit operations that are weakly regulated. In such cases, there may be few records of specific transit routes. In other cases, registered

routes may bear little resemblance to the actual situation. Thus, an initial step may involve simply mapping the existing route structure of bus and paratransit services. Interviews with existing operators, and actually riding many itineraries may be a critical first step in this mapping process.

The map in Figure 4.1 is one of the first efforts to map the existing paratransit (Car Rapide and Ndiaga Ndiaye) in Dakar (Senegal). This activity is often a critical first step towards bringing such services into a transparent regulatory framework.

4.2.2 Traffic counts

With the basic route structure in hand, the next step in the rapid assessment process will be *traffic counts and bus occupancy surveys*. The number of buses (or other types of transit vehicles) combined with their estimated occupancy rates will already yield a crude estimation of a corridor’s existing demand. Sample surveys are listed in Annex 5.

The strategic selection of the points to conduct the traffic and occupancy survey will determine the extent to which the survey results will



Fig. 4.2
Effective traffic counts requires the right set of personnel and resources.

Photo courtesy of the Municipality of Osaka

represent the actual situation. Determining where to do traffic counts can be more of an art than a science, but some general rules can be applied.

Ideally, the survey locations will allow most trips to be easily captured with a minimum of resources and effort. If a city has a fairly clearly defined central business district (CBD), and most of the trips end in the CBD, then it is sometimes possible to do traffic counts at the entry points along a “cordon” around the CBD. For example, in Dar es Salaam, the entire CBD can only be entered through six major arterials, and few trips both originate and end within the

CBD. By conducting traffic counts at just these six entry points, it was possible to obtain rough CBD demand data for each major arterial as well as the collective totals.

If travel into an area is fairly concentrated along a single direction, perhaps from north to south or from east to west, then the conditions may allow an even more selective application of counts. Dakar, for example, is a peninsula, with the CBD at the end, and a simple “screen line” count, or several screen line counts may capture most daily commuting trips. With both cordon counts and screen line counts, the overall principle is the same, but the focus of the count location is different in order to match the predominant movement of travel.

Ideally, the counts will not just involve observation of buses and paratransit vehicles. There is also great value in also counting all vehicle traffic (e.g., cars, motorcycles, bicycles, trucks, pedestrians). Designers may face difficult choices regarding the allocation of scarce road right of way, and knowing the full mix of traffic, including non-motorized traffic, will be extremely helpful in making priorities.

With the data on private vehicle numbers, system developers will also be able to estimate the impact of mode switching on system demand. This data can also be later used to estimate the impact of the new system on corridor congestion levels. Additionally, if a decision is later made to utilise a full traffic demand model, then the existing data will be in a form that is readily adaptable to a more inclusive analytical package.

As the complexity of the counting process increases, though, the resources required to obtain an accurate count also increase (Figure 4.2). To identify all vehicles and produce a valid count across multiple traffic lanes, a counting strategy becomes vital. One option is to employ counting teams involving many persons at a single location in order to properly record all vehicle types in each of the lanes. Alternatively, video technology can be utilised to record traffic movement and



Fig. 4.3
The high flow rate of minibus taxi vehicles along the Soweto Highway in Johannesburg requires an organised counting strategy to get an accurate estimate of vehicles and occupancy levels.

Photo by Lloyd Wright

allow a more precise count at a later time. The video record allows quality control sampling to ensure the counting team is performing at a reasonable level of accuracy. With all counting strategies, the proper training of survey personnel should be conducted so that all participants have a common understanding of the task at hand.

4.2.3 Occupancy surveys

The number of vehicles is only one part of the demand equation. Knowing the average number of passengers in the vehicles at any given time period provides the other half of the demand input data. Given the diversity of possible vehicle sizes, the occupancy data should be categorised and collected by vehicle type. The survey should thus identify vehicles according to their seating numbers or maximum capacity numbers. For public transport and paratransit vehicles, some of the possible categorisations could include:

- 70-seat bus;
- 35-seat bus;
- 16-seat mini-bus (Figure 4.3);
- 7-seat vans.

Usually surveyors count each transit vehicle type and mark “full”, “3/4 full”, “1/2 full”, “1/4 full” or “empty.” By recording these two sets of data (vehicle type and occupancy level), the basis for a rough demand estimate is established. The average occupancy level is multiplied by the total number of vehicles for a given vehicle type over a stated time period. The smaller the time period interval, the finer the demand analysis becomes in identifying significant peak and non-peak periods. Thus, recording vehicle numbers in 15-minute intervals provides a

reasonably fine level of peak identification. A one-hour interval would provide less insight into peak and non-peak conditions.

4.2.4 Recording the data

The data on the number of vehicles and the occupancy levels can be collected separately or simultaneously. The ability to collect both data sets at the same time depends on the personnel or technical resources being applied to the survey, and the volume of traffic. If all vehicle types are being counted along with all occupancy levels, then the counting will likely require either a coordinated team approach or the use of video technology. The effectiveness of video technology in identifying vehicle occupancy levels will depend on the quality of the video technology and the placement of the camera.

If a formal transportation model is not being utilised in the rapid assessment approach, then the raw data will likely next be inputted into standard spreadsheet software like Excel. This data would likely then be used to produce summary tables and graphs (Figure 4.4). The data would likely be displayed for each direction of traffic movement across both peak and off-peak periods.

If the routing of each public transport vehicle can be determined either by numerical route numbers or signage on the vehicle, then vehicle counts and occupancy surveys can be done on a route-by-route basis. This technique will not only produce a total demand figure for a given corridor but also some indication of which routes are carrying the most passengers.

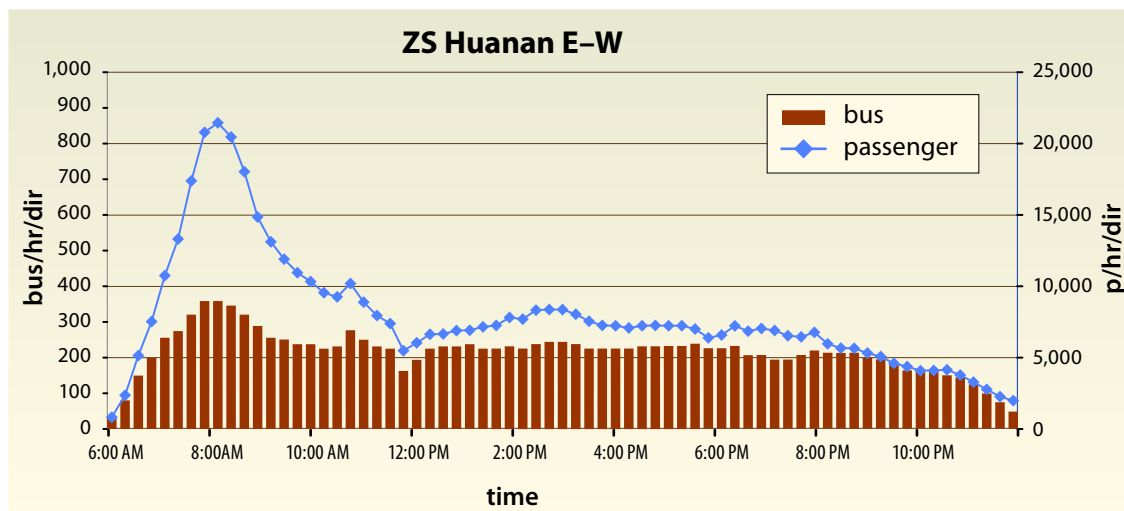


Fig. 4.4
Sample graph of vehicle and passenger movement in peak and off-peak periods

4.2.5 City-wide counts

Because in most cities, trips to the CBD are not the only important routings, and may not even be the most important trips for public transport passengers, it is usually insufficient to only do traffic counts in a cordon around the CBD. Further, some cities do not have a clearly defined CBD.

For this reason, normally one would do traffic counts at a larger selection of critical points around the city strategically chosen by local and international experts based on a rough estimate of those locations where most daily trips would pass. However, this selection process does not necessarily have to lead to a cost-prohibitive number of counting sites. For example, in the city of Dar es Salaam (population of approximately 4 million inhabitants) traffic counts in about 30 locations captured a large majority of the trips, and in Jakarta (population of approximately 9 million inhabitants) about 65 locations were sufficient. If trips are heavily peaked, then one way counts may be sufficient. Two-directional counts are best if the travel patterns do not exhibit clear-cut peak conditions.

4.2.6 Implications of demand results

By simply multiplying total transit vehicles at the peak hour with the average total passengers

per transit vehicle, project developers essentially possess a reasonable estimate of the likely size of total public transport demand on most of the main corridors. At this point, the most likely BRT corridors and routes become roughly evident. By approximately correlating this demand profile with specific public transport route itineraries, a crude estimate of the corridor segments with the heaviest passenger volumes is obtained. Effectively, planners are looking for an estimate of the “maximum load on the critical link”, usually measured in “passengers per peak hour per direction” (pphpd). The maximum load on the critical link is that section of the potential BRT corridor which is currently carrying the highest volume of existing public transport passengers (Figure 4.5).

A table ranking the corridors by passenger demand can greatly aid the corridor selection process. Customer demand is one of the key determinants in choosing the BRT corridor. As the corridor selection process moves forward, the most desirable corridors will likely undergo further analysis. This activity will include additional vehicle counts and occupancy surveys along that corridor. The other elements in corridor selection are discussed in Chapter 5 (*Corridor selection*).



Fig. 4.5
Demand mapping in Johannesburg helps to identify critical links.

Image courtesy of the City of Johannesburg.

With an estimate of the pphpd at the maximum load on the critical link, planners can already make some preliminary determinations about the nature of the prospective system. While these initial traffic counts will not directly imply how many passengers will use a new BRT system under different scenarios, the counts will provide some indication of how many transit passengers are currently using the corridor at the peak hour. Table 4.1 outlines a preliminary decision matrix that correlates a given passenger demand with the type of system. Further analysis and operational decision-making will ultimately determine which type of system is most appropriate.

As noted earlier, the results from the rapid assessment work can ultimately feed into a formal transportation model. The traffic counts and occupancy surveys can be used to potentially calibrate the model.

4.2.7 Counts of private vehicles

To the extent possible, private vehicles (cars, motorcycles, trucks, and others) and non-motorized trips (bicycles, pedestrians) should be included in the counting survey (Figure 4.6). The counting of private vehicles and non-motorized vehicles becomes important when difficult decisions need to be made about the allocation of scarce road right of way. First, the number and types of these vehicles can give an indication of the likely traffic impact of dedicating lanes to buses. Secondly, it will provide an early indication of how many passengers could potentially switch from private transport means to public transport.

Knowing the relative levels of private vehicles and public transport vehicles will be quite instructive in determining traffic impacts. If three quarters of the vehicles on a three lane road are buses, then a segregated busway is clearly justified. In fact, such a finding may well indicate that multiple-lane busways are justifiable; otherwise, bus passengers may experience delays due to bus congestion along a single lane. In conditions where public transport vehicles largely outnumber private vehicles, the separation of buses into a busway can actually free up space for the private vehicles. Thus, such conditions can ultimately achieve win-win results for both public transport users and private vehicle users.

Table 4.1: Typical solutions for different demand levels

Transit passengers per hour per direction	Type of BRT solution
Less than 2,000	Simple bus priority, normally without physical segregation, possible part-time bus lane
2,000 to 8,000	Segregated median busway used by direct services reducing the need to transfer
8,000 to 15,000	Segregated median busway used by trunk services requiring transfers but benefiting from fast boarding and operating speeds. Transit priority at intersections.
15,000 to 45,000	Segregated median busway, with overtaking at stops; possible use of express and stopping services. Use of grade separation at some intersections and some form of signal priority at others.
Over 45,000	This level of demand is very rare on existing bus systems. It is possible, however, to design a BRT system that would serve up to even 50,000 passengers per hour per direction. This can be achieved with full segregation, double busway, a high proportion of express services and multiple stops. This capacity could also be handled by spreading the load through two or more close corridors.

If the results show that relatively few of the road users are public transport vehicles, then the development of a busway will likely lead to an initial period of higher congestion levels for the private vehicles.

This information will also provide an important first clue as to how many passengers might switch from private cars or motorcycles as a result of the new BRT system. Such data will be important to estimating projected greenhouse

Fig. 4.6
Basic counts of private vehicles help to estimate the potential for mode shifting as well as indicate possible congestion impacts of the dedicated busways.

Photo by Lloyd Wright



gas emission impacts, which may be critical to eligibility for Global Environmental Facility (GEF) funding.

Projecting the modal shift of the project is so complex that simple techniques for making estimates may be nearly as reliable as detailed modelling. The experience of other cities lends some basis for prediction. In most reasonably well designed systems, some 5 percent to 20 percent of the motorists switch from private vehicles to BRT along a given corridor.

If the majority of the vehicles on the corridor are buses, then the traffic benefits of the project will be broadly distributed between both bus passengers and mixed traffic, but the modal shift impact will be less. If the majority of the vehicles on the corridor are private vehicles, then a busway will tend to have a stronger adverse impact on mixed traffic speeds, a stronger positive impact on bus speeds, and therefore a bigger potential modal shift impact.

Making a final determination about potential benefits of the system and potential mode shift requires additional information about current vehicle speeds and congestion points.

4.2.8 Mapping congestion points and vehicle speeds

While it is often easier to select BRT routes on wide roads, sometimes planners make the mistake of prioritising BRT on roads that have no congestion, thinking that this will also make it politically easier to implement. However, one of the major reasons BRT is more efficient than other systems is that the segregated right of way removes buses from traffic congestion. If there is no traffic congestion, then the segregated right of way is meaningless.

BRT systems should therefore be located not on the least congested routes, but on the most

congested routes if benefit to public transport passengers is to be maximised. Choosing congested roadways will also tend to encourage modal shifts from private vehicles to public transport.

Therefore, an important element of a rapid assessment is to look at existing bus speeds along the possible BRT corridors (Figure 4.7). This information will be critical to the calculation of benefits of the new system. If average bus speeds in a corridor are high (e.g., over 20 kph), shifting to a BRT system is not likely to bring a significant improvement in bus speeds. In such conditions, little mode shift from travel time improvements can be expected, although mode shifts may occur for other reasons, such as improved system image and comfort. If, on the other hand, speeds are very low (e.g., under 12 kph), then a BRT system can bring significant travel time improvements for passengers, and a higher level of modal shift from private vehicles and ordinary buses can be expected.

This point may appear obvious, but a surprising number of new BRT systems are being built on roads with little or no congestion in order to avoid political problems. The demonstration phase of the Beijing BRT system, for example, was built on a new road with no bus routes, no bus demand, and no congestion. On the part of the route where congestion was the most severe, the buses currently re-enter mixed traffic, removing any possible benefit of the BRT system. In Delhi, the new high capacity bus system (HCBS) being planned was initially only approved for that part of phase I corridor which is not congested, while the second part of Corridor I which passes through the old city faces greater political resistance for fear of worsening traffic congestion. Even in São Paulo, while many routes have exclusive lanes into the CBD, once the vehicles enter the city centre

Fig. 4.7
Existing bus speeds on three different potential BRT corridors in Guangzhou. A black line indicates links with average bus speeds below 10 kph, a red line indicates bus speeds from 10 kph to 15 kph, a yellow line indicates speeds from 15 kph to 20kph, and a blue line represents speeds greater than 20 kph. Physical separation of the busway in the short term will only yield benefits in the black, red, and yellow sections.

Image courtesy of ITDP





Fig. 4.8
São Paulo’s busways provide dedicated right-of-way to public transport outside the city centre, but once in the CBD most public transport vehicles no longer serve the area with priority treatment.

Photo by Lloyd Wright

most routes are forced to re-enter mixed traffic, undermining the benefits of the physical segregation at the most critical point (Figure 4.8). Normally, the CBD is the most congested part of a city. It is therefore of crucial importance that a new BRT system both serve and penetrate the congested CBD.

Table 4.2: Projected modal shift impact based on type of BRT corridor

Type of BRT Corridor	Projected Modal Shift Impact from private vehicles
Little congestion, buses > 30% of the vehicle fleet	5%
Some congestion, buses around 25% of vehicle fleet	10%
Many links congested, buses around 15% of vehicle fleet	15%
Very congested, few buses on the corridor	20%

Collecting information on existing bus speeds and mapping it is generally not very difficult. Many bus operators already collect this information or have it readily available. If not, if the bus route itinerary is known and the distances between stops are known, it is simply a matter of riding the key bus routes during the peak hour, taking the time at each stop, and by relating this time with the distance calculating the speed for each link.

Often, for GEF funding, a decision has to be made about projected modal shift impacts of a BRT system before the system is clearly defined. For such circumstances, the Table 4.2 is offered as a possible approach, based on observed impacts in BRT systems around the world. It combines the information about the vehicle mix on each corridor and the level of congestion on those corridors.

4.3 Detailed demand estimate without modelling

“Computers are useless. They can only give you answers.”

—Pablo Picasso, artist, 1881–1973

The first step in moving beyond the demand analysis already done in the rapid assessment method is to map a very detailed and accurate itinerary of all existing transit routes. Software employing geographical information systems (GIS) can be quite useful to this end. Perhaps this was already done in the pre-feasibility phase, but it is a good idea at this point to put these itineraries into a GIS program like Map-Info, AutoCAD or TransCAD. This mapping could be done on a paper map but it will save a lot of time doing the computations using a GIS system, and if the data is already geo-coded it will be easy to put the routes into a traffic model like TransCAD, EMME II, or Visum later on.

In some cities, where a significant share of transit demand is handled by paratransit vehicles, shared taxis, and other forms of collective transport that do not have fixed itineraries, this methodology will not work. In other cities, paratransit vehicles usually follow some reasonably predictable route between a well known origin and destination, and the basic itineraries can be estimated. In cities where the existing bus routes are all public buses that closely follow routes assigned by a transport

department or transit authority, mapping these bus routes may have already been done, and if it has not been done, it should be quite easy.

During the rapid assessment, the technical team should have already done a significant number of transit vehicle counts and bus occupancy surveys in strategic locations which will capture most of the transit demand in the city. Once the critical corridors have been selected, traffic counts and transit vehicle occupancy surveys should also have been completed in order to get a sense of the demand along the corridor. If this was not done before, it should be done now.

Fig. 4.9 and 4.10

Software packages such as MapInfo (above) and TransCAD (below) give the modelling process a user-friendly visual interface.

Images courtesy of MapInfo and TransCAD

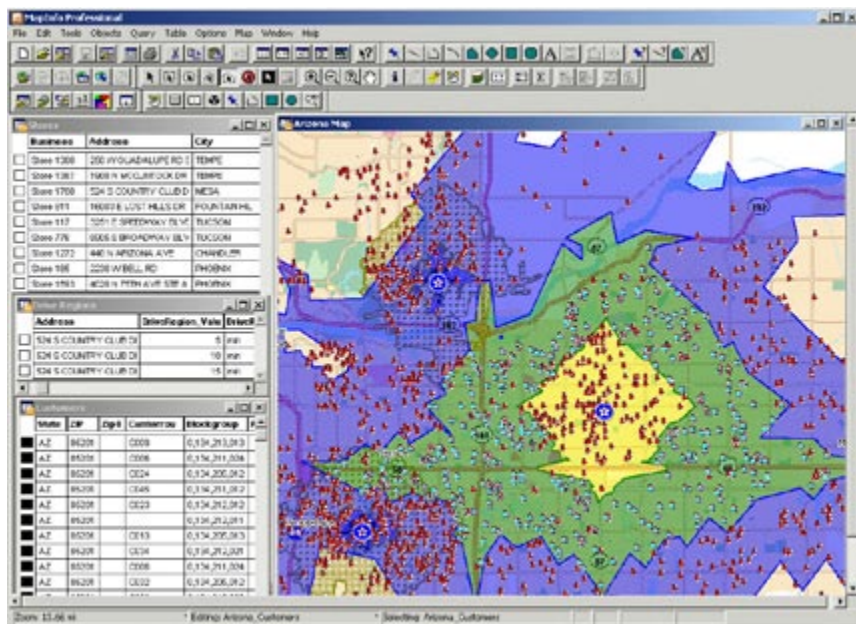


Fig. 4.11

A count of boardings and alightings at each station will be invaluable information in terms of prioritising corridors, sizing vehicles, and sizing stations.

Photo by Lloyd Wright

At this point, an additional survey should be conducted: a boarding and alighting survey on each public transport line (Figure 4.12). For this type of survey, surveyors should ride the entire length of each major transit line during the rush hour recording how many people are getting on and off the vehicle at each stop. At the same time, the speed of the vehicle can also be recorded. If GIS is used, and accurate distances are recorded in the itinerary, the surveyor simply needs to record the time of each stop, and then the speed can be calculated based on the distance.

The boarding and alighting survey will give a picture of how many passengers are on each bus line at different parts of their journey, some of which may be included in the proposed BRT corridor.

The projected boardings and alightings at each new BRT station will be useful data to allow designers to avoid station congestion. By aggregating the boarding and alighting data as in Figure 4.13, the station can be designed to

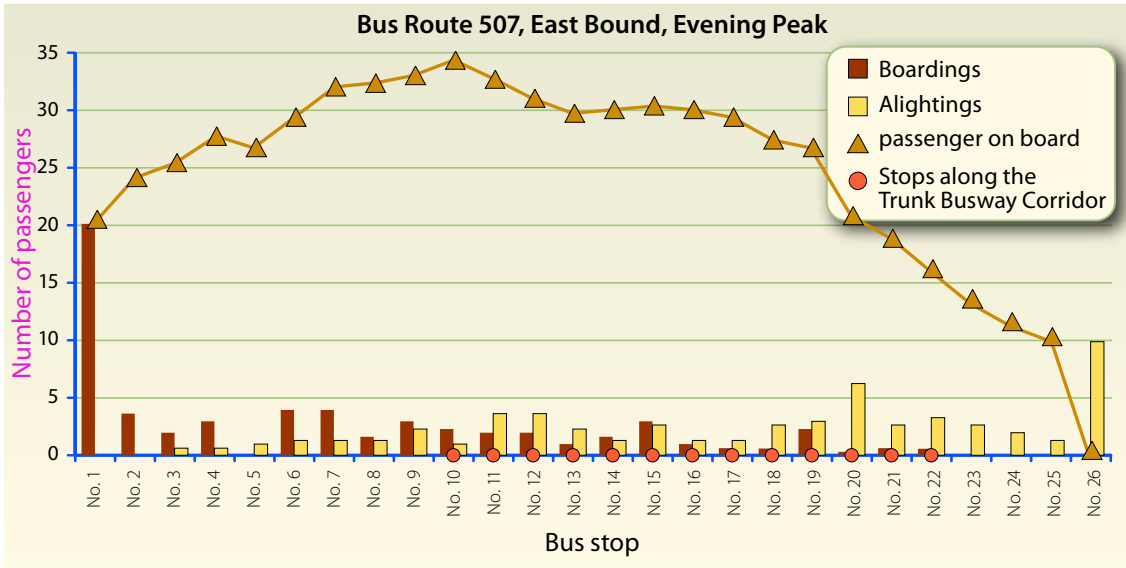


Fig. 4.12
Boarding and alighting survey results on bus route 507 in Guangzhou (China). The stops with yellow dots connected with a red line are stops along the new planned Zhongshan Road BRT system.

Image courtesy of ITDP

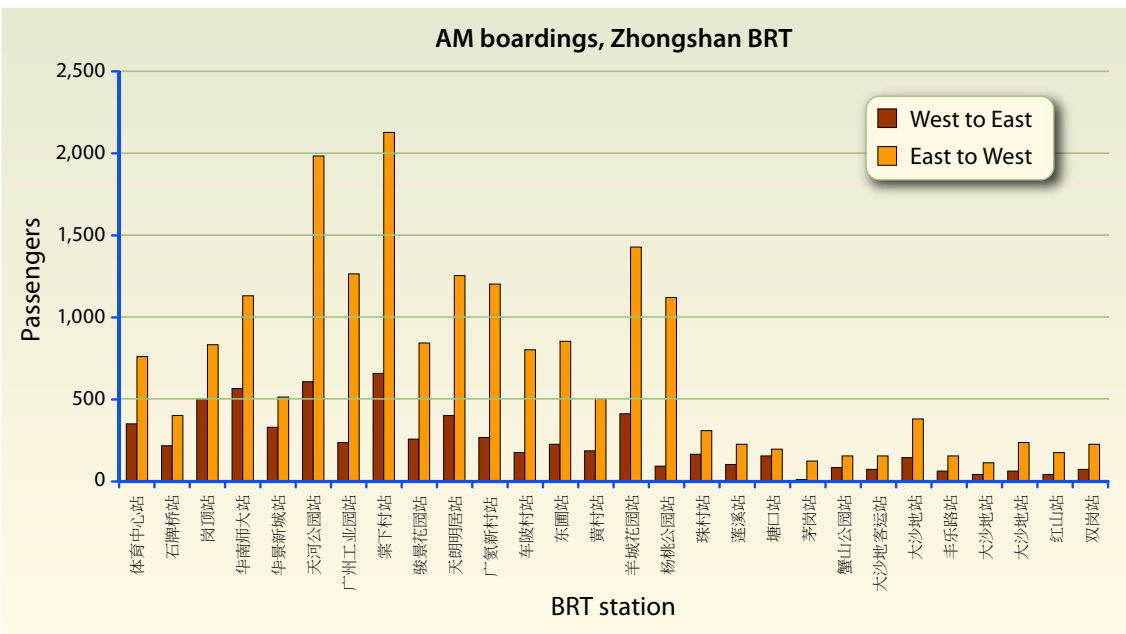


Fig. 4.13
Aggregate data for boardings and alightings

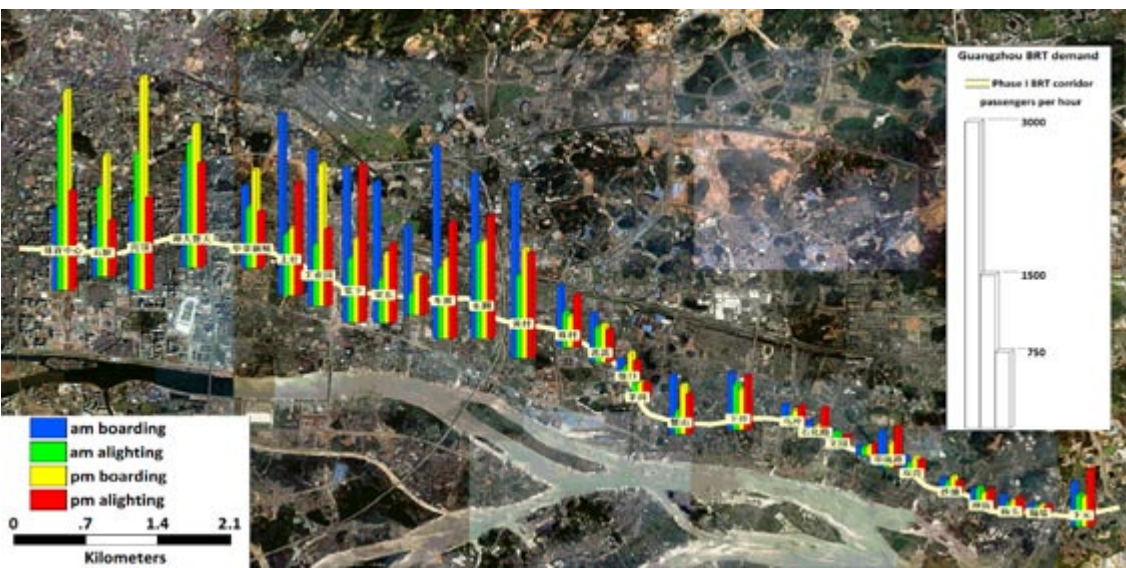


Fig. 4.14
Ridership by bus line by stop

are likely to be attracted from other modes. To get a robust estimate requires a traffic model, but an important clue will be the existing bus speed data. If existing public transport speeds are already at or above 26 kph, it can safely be assumed that the new system will not provide a significant time savings benefit. This lack of time savings will limit the number of new passengers attracted to the system, although customers may be attracted for other reasons (safety, security, comfort, fare price, etc.). The lower the existing public transport speeds, the higher the projected modal shift (Figure 4.17).

It is highly unlikely that short term modal shift will be more than 25 percent of the baseline demand from existing public transport trips, though to be conservative the system should be designed to accommodate an increase of 50 percent above existing public transport demand. However, there may be exceptions. If a city's bus system has all but collapsed, and there are a large number of difficult to count shared taxi trips, it may be that modal shift will be higher. In cases of such uncertainty, full demand modelling is recommended.

4.4 Estimating demand with a public transport model

“The best way to predict the future is to invent it.”

—Immanuel Kant, philosopher, 1724–1804

This section will describe how to build a basic traffic model that only models the public transport system. With this basic public transport model it will be possible to develop a much more robust estimate of the demand on the existing system. It will also enable the planning team to much more easily test the demand for different alternative scenarios for fares, small changes in the routes, as well as to optimise operational characteristics.

In many cities, some sort of traffic model will already exist, but in the developing world it is relatively rare to have the transit system already coded into a traffic model. Often if there is a traffic model, it is only usable for motor vehicles and has very limited capacity to model public transport systems. If a good traffic model already exists, it should be possible to simply put the public transport system and the proposed



Fig. 4.17

If existing public transport services are slow or inefficient, the upgrading to BRT will produce a significant shift in passengers to the new service.

Photo by Lloyd Wright

BRT scenario into the existing model. If not, the BRT team should start by modelling the public transport system first, which will be the most important information for BRT planning.

4.4.1 Choosing a modelling software

The first step in setting up a public transport model is to obtain traffic modelling software. The development of transportation modelling software has greatly aided the process of transport supply and demand projections. Software models today can greatly ease the modelling process and increase accuracy and precision. However, with an array of software products on the market, the transport planner can be left with an overwhelming set of options. Of course, there is no one software solution that is inherently correct. A range of variables will guide the software selection process. These variables include cost, familiarity of municipal staff and local consultants with a particular product, degree of user friendliness sought, degree of precision sought, and the overall objectives of the modelling task. The table below lists a few of the commonly used software packages that are on the market today.

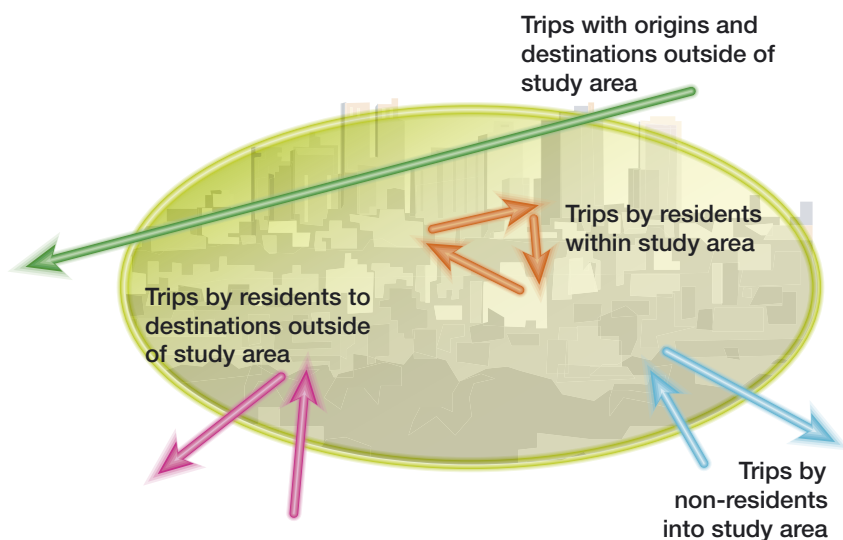
The strongest packages for general purpose planning and design of BRT systems are Emme/2, Cube/Trips and Visum with TransCad offering close capabilities. All of these are rather expensive packages but again, the most significant costs will be those of training

Table 4.3: Options for transport modelling software

Software name	Vendor	Comments
EMME / 2	INRO Consultants Inc.	Good general purpose
CUBE/ Trips	Citilabs	Good general purpose
TransCAD	Caliper Corporation	Good integration with GIS, easy to use
VISUM	Ptv/ITC	Good general purpose
AMSUN2		Microsimulation model useful for animations for intersection design
Paramics	SIAS	Microsimulation package, very useful animations for traffic design
VISSIM	Ptv	Microsimulation package, good animations, good integration with VISUM
QRS II	AJH Associates	Low cost but weaker on PT assignment
TMODEL	TModel Corporation	Low cost but weaker on PT assignment
SATURN	Atkins-ITS	Good for congested vehicle assignment, but no PT assignment

leading to effective use and familiarity with the package. Older and more sophisticated modellers like the flexibility of Emme/2, which allows them to easily write sub programs, called 'macros', but Emme/2 does not yet have a windows interface (it is under development), and its graphics capability is fairly weak. More and more consultants are now using Emme/2 in combination with other programs with better GIS capability, such as TransCAD. Saturn, TMODEL, QRS II, all either have no public transport assignment component or else are

Fig. 4.18
Representation of study area for analysis.



Source: Adapted from Ortúzar and Willumsen, 2002

fairly weak at modelling public transport demand, and are not recommended for BRT.

Amsun2, Paramics, and Vissim simulate trip making at a high level of detail, in particular vehicle-by-vehicle. These are very powerful packages to study priority at junctions and interactions and delays at stops. They should only be used for these purposes and in combination with the macro demand models listed above, as they are not appropriate for BRT route analysis.

4.4.2 Defining the study area and the zoning system

Normally, the study area for a BRT system will be the areas currently served by bus and paratransit services. If the decision maker has already pre-selected a particular corridor as the first BRT corridor, then the catchment area for this corridor will be the study area.

To analyse travel in the study area, the entire area, as well as some areas outside the study area, need to be divided into a number of zones (Figure 4.18). As all origin-destination data will be collected and coded to this zoning system, establishing these zones is an important first step. Usually the zones are based on census tracts or political subdivisions that have been used as the basis of any existing census information or previous origin and destination studies. Using census and other administrative zones that already exist in the city will increase the chance of compatibility with the overlaying of different data types.

The information needed for modelling, however, is not exactly the same as information needed by the census bureau, so some census zones are usually consolidated into bigger zones, and others are broken up into smaller zones. Traffic modellers are generally less concerned about information outside the study area. As a result, they tend to consolidate zones outside the study area into fewer, larger zones. This consolidation is a simple matter of adding up the data associated with each zone.

Typically, modellers need more detailed information in the city center and/or along the proposed BRT corridor. So typically, the modellers will break up census zones into smaller zones, using more detailed census data if available, or just dividing the zones using their judgement

based on aerial photographs (Figure 4.18). Sometimes, households and employment will be concentrated into some parts of a large zone and not others, and it is important to break up the zone to capture this geographical concentration. Selecting the size of the zones and the number of zones is a trade-off between accuracy, time, and cost. The size and number of zones will also depend in part on how the data was collected and how it will be used. For BRT systems, for a large city like Jakarta, roughly 500 zones were used to analyse the main relevant BRT corridors. In a smaller city like Dar es Salaam, only 300 zones were necessary for the main BRT corridor analysis, though for detailed traffic impact analysis the city centre was later broken into an additional 20 zones.

Table 4.4 lists the number of zones that have been developed for various cities. Note that cities such as London have multiple levels of zones that permit both coarse- and fine-level analyses.

These zones, and the road network, must be coded into the traffic model if it has not already been done. This process will not be described here in any detail, as it is a standard function of all traffic modelling, and is thoroughly described in the documentation of any commercially available traffic demand model. However, the basic points of this process are summarised below.

Data is usually entered into a traffic model either as a point, usually called a “node” which has a specific “x” and “y” coordinate, or as a “link”, which is a line connecting two nodes. Normally, each intersection and each major bend in a road is assigned a separate node. Nodes are usually numbered. Ideally, the x and y coordinates of each node should correspond to actual latitude and longitude. Making sure these nodes correspond to actual latitude and longitude is called “geocoding”. Geocoding will ensure that data from different sources are consistent.

Normally roads are broken up into different links. Links are usually named from their origin node and their destination node.

For example, in Dar es Salaam, there was already an existing GIS map. If no GIS map exists, then staff will have to utilise a Geographic Positioning System (GPS) device to record the coordinates of each of these points (Figure

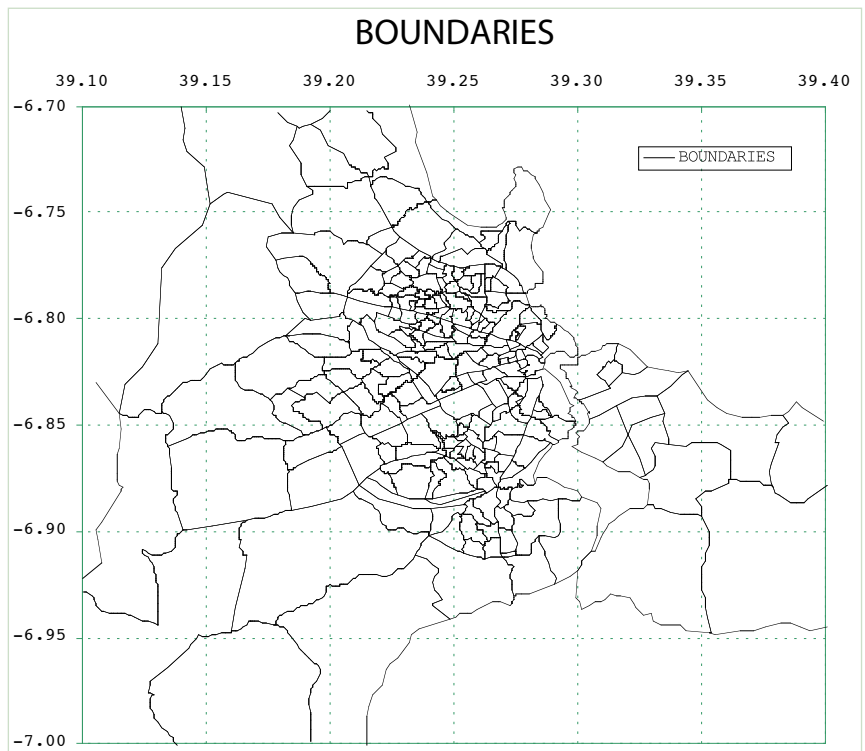


Fig. 4.19
Geographic area divided into zones for modelling purposes. Zoning system for Dar Es Salaam BRT feasibility study.

4.20). In Dar es Salaam, the team initially defined 102 nodes, and later increased it to 2,500 important nodes. By the end, the nodes represented most of the important intersections in the city. Each node will be recorded in a simple spreadsheet (Table 4.5).

By connecting these nodes, a series of links are defined that represent different roads. For example, in Dar es Salaam, Morogoro Road between Sokoine Drive and Samora Avenue, is

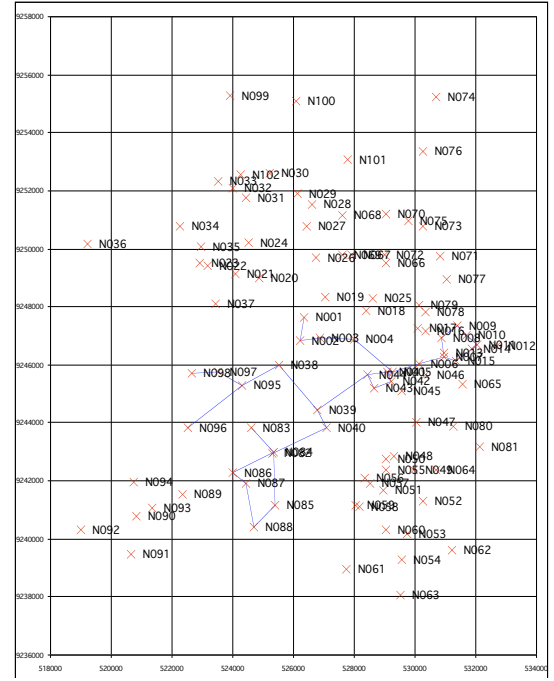
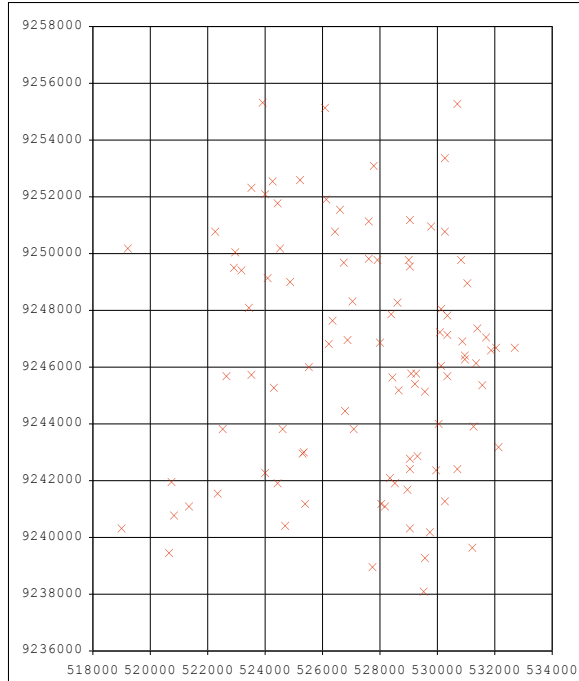
Table 4.4: Typical zone numbers for modelling studies

Location	Population (million)	Number of zones	Comments
Bogotá (2000)	6.1	800	BRT project
Jakarta (2002)	9.0	500	Normal zones
Dar es Salaam	2.5	300	BRT project
Cali	2.0	203	Normal zones
London (1972)	7.2	2,252 ~1,000 ~230 52	Fine level subzones Normal zones at GLTS GLTS districts Traffic boroughs
Marseille (2001)	1.5	562	Normal zones
Montreal Island (1980)	2.0	1,260	Fine zones
Ottawa (1978)	0.5	~120	Normal zones
Santiago (1986)	4.5	~260	Zones, strategic study
Washington (1973)	2.5	1,075 134	Normal zones District level

Source: Ortúzar and Willumsen (2002) and ITDP

Fig. 4.20
Nodes and links from the Dar es Salaam transit model used to design the DART system.

Images courtesy of the City of Dar es Salaam



a link (the link between the nodes Morogoro Road X Sokoine Drive and Morogoro Road X Samora Avenue). Link data can also be entered into the traffic model from an Excel spreadsheet (Table 4.6).

These links are generally further defined, based on the number of lanes and other characteristics, but for public transport planning it is not really necessary to further define at this point.

Zones are generally entered into a traffic model based on the nodes of all points that are needed to define the boundary. In an Excel spread

Table 4.5: Node coordinates in Dar es Salaam

Node identification number	X coordinate	Y coordinate
13	16340	26375
14	16835	26370
17	17212	26440
23	16433	26090
24	16835	26090
27	17339	26185
28	17580	26300
33	16435	25810
34	16835	26805
127	17110	26060
128	17540	25930
134	17285	25675

sheet, each zone will just look like a series of nodes defined by their x and y coordinates.

Once the data is entered into a model, the zone is actually represented by a special type of node called a “zone centroid”. This zone centroid is a node that is used to signify the average characteristics of the particular zone. In Dar es Salaam, for example, in addition to 2,500 nodes along roads, there were another 300 zone

Table 4.6: Link data for the traffic model (Dar es Salaam example)

Link	Node A	Node B	Two directional
1	13	14	Yes
2	14	17	Yes
3	13	23	Yes
4	14	24	Yes
5	17	27	Yes
6	23	24	Yes
7	24	127	No
8	127	27	No
9	27	28	No
10	23	33	Yes
11	24	34	Yes
12	33	34	Yes
13	28	128	No
14	128	134	No
15	134	34	No

centroid nodes. Trips are generated and attracted to these centroids. It is therefore important to know how these centroids are connected to the real network, in particular to stations in a new BRT design. Normally these zone centroids are in the middle of the zone, but if all the population is concentrated in one smaller part of a zone, it is better to move the zone centroid closer to the population concentration.

4.4.3 Origin-destination survey and matrix

“If you have to forecast, forecast often.”

—Edgar R. Fiedler, economist

The next survey required for constructing the public transport model is sometimes called an “on-board origin destination survey”. This survey is one of a family of surveys called “intercept surveys”, where individuals are interviewed about their origin and destination (where they began their trip and where they will end the trip).

4.4.3.1 Data collection

All the origin and destination information collected will be coded as between the zone centroids of two of these zones, and aggregated based on these zones. A trip between two zones is called an ‘origin-destination pair’, or OD pair. The table of all the trips between each OD pair by any given mode, in this case public transport, is called the OD matrix.

To conduct an on-board OD survey, public transport users are interviewed either on-board a bus or paratransit vehicle, (and in that case it is not an interception point but a section of a road between two intersections) or at stops and interchanges. Sometimes, with the cooperation of the police, paratransit passengers can be interviewed very efficiently by having the van driver pull over and allow the passengers to be interviewed. In Dar es Salaam, with the cooperation of the police, the planning team, wearing DART (Dar es Salaam Rapid Transit) shirts, stopped Daladalas (paratransit vehicles) and interviewed all of the passengers inside (Figure 4.21). Other data besides OD information can also be collected, if appropriate. Other useful information can include the fares paid and the services used, but the questions should be kept as simple as possible. Although it is tempting to ask about waiting times, these are seldom



accurately reported by individuals and are best estimated by another method.

On-board OD surveys of bus passengers are typically attempting to focus upon the passenger flows during the morning peak period. However, it can be difficult to avoid capturing non-peak trips as well, so normally data is collected for approximately four hours around the morning peak, and averages are taken or weighted.

The survey locations should correspond to the locations where the traffic counts were conducted earlier, if these points were chosen wisely. In the case of Dar es Salaam, the points where the origin destination surveys were conducted were the same 34 points of the original traffic counts. This precision was possible due to the assistance of the police to pull over the vehicles at particular locations. In Jakarta, the surveys were conducted on board the buses, so surveys were conducted along key links that corresponded as closely as possible to the points where previous traffic counts had been conducted.

4.4.3.2 Sample size

The sample size for intercept surveys depends on the accuracy required and the population of interest. The error for an intercept OD survey is a function of the number of possible zones that a passenger might travel to when passing through a particular point. As a simple rule, Ortúzar and Willumsen (2001) suggest the following table

Fig. 4.21

Collecting data on origins and destinations and fares paid from passengers using the Dar es Salaam “Daladalas” helped to define the operational characteristics of the proposed BRT system.

Photo by Lloyd Wright

for a 95 percent confidence in an error of 10 percent for given passenger flows:

Table 4.7: Sample size for origin-destination surveys

Expected Passenger flow (passengers/period)	Sample size (%)
900 +	10.0 %
700-899	12.5 %
500-699	16.6 %
300-499	25.0 %
200-299	33.0 %
1-199	50.0 %

Usually, on BRT corridors, the flows are much greater than 900, so 10 percent of the total passenger flow at any given survey point is a reasonable general rule. In the case of Dar es Salaam, the average passenger flow at the peak hour was around 10,000, so 1,000 passengers were surveyed at each point, or some 34,000 surveys. In Jakarta, 120,000 surveys were conducted, of which 20,000 were useless. Other survey data was not taken during the morning peak, so ultimately about 65,000 of the surveys were usable. This quantity was all that was possible with the budget available, and constituted roughly 3 percent of the peak hour flows. In Jakarta, the survey numbers were weighted based on the flows on the corridor.

Origins and destinations should be recorded as accurately as possible, for example as the nearest intersection or other key identifier. These locations then have to be attributed to the zone in which they are located, so the origin and destination can be coded to the zone centroids.

4.4.3.3 Error types

The data collection process is thus prone to two types of errors: measurement errors and sampling errors. Measurement errors arise from misunderstandings and misperceptions between the questions asked and the responses of the sampled subjects. Misinterpretation by the interviewer can result in the incorrect listing of a response. Frequently, during an OD survey, for instance, a person will identify the origin and destination of their trip, but neither the interviewee nor the surveyor are able to locate this location within any of the zones on a map. Sometimes surveyors will also not do the work responsibly and will make up answers. There may also be a degree of bias in which respondents answer questions in a manner that represents a desired state rather than reality.

Avoiding measurement errors is a complex process that requires a lot of local knowledge, and should start at the survey stage. One method is to ask the interviewee the best local landmark, and have the local staff identify as precisely as possible its location on a map. Another method is to have the interviewees pick their origin and destination from a pre-selected list of areas and sub-areas, and specific popular destinations. The latter method will probably avoid a lot of trouble and confusion, but will lose some subtlety regarding walking distances. In countries where street names and neighbourhoods are far from standardised, the latter method may be more effective.

Sampling errors occur due to the cost and feasibility of surveying very large sample sizes. Sampling errors are approximately inversely proportional to the square root of the number of observations (*i.e.*, to halve them it is necessary to quadruple the sample size) (Ortúzar and Willumsen, 2001).

4.4.3.4 OD matrices

Once each OD pair is coded to specific zone centroids, a separate OD matrix is created for each survey point. For each survey point and each direction, it is simply a matter of adding up the trips surveyed between each OD pair for the peak hour. This raw survey data will give you a preliminary OD matrix for each direction at each survey point. Table 4.8 outlines the general form of a two-dimensional trip matrix.

Table 4.8: General form for a two-dimensional trip matrix

Origins	Destinations					$\sum_j T_{ij}$
	1	2	3	...j	...z	
1	T_{11}	T_{12}	T_{13}	... T_{1j}	... T_{1z}	O_1
2	T_{21}	T_{22}	T_{23}	T_{2j}	T_{2z}	O_2
3	T_{ij}	T_{ij}	T_{ij}	T_{ij}	T_{ij}	O_3
...						
I	T_{i1}	T_{i2}	T_{i3}	T_{ij}	T_{iz}	O_i
...						
Z	T_{z1}	T_{z2}	T_{z3}	T_{zj}	T_{zz}	O_z
$\sum_i T_{ij}$	D_1	D_2	D_3	... D_j	... D_z	$\sum_{ij} T_{ij} = T$

Source: Ortúzar and Willumsen, 2001

Table 4.9: O-D matrices expanded by expansion factor

Point	Factor inicial	Sample	Passengers per peak hour	Daladala small	Daladala large
P 01 W1	12.9295302	298	3853.0		
P 01 W2	1.53046595	558	854.0		
P 02 W1	6.545655774	493	3227.008297	320.5	63.0
P 03 W1	5.833990702	515	3004.505212	68.0	68.0
P 03 W2	2.928214064	522	1528.527741	60.0	54.0
P 04 W1	14.87864833	619	9209.883319	409.5	95.5
P 06 W1	9.375530401	511	4790.896035	65.5	107.0
P 06 W2	4.431338691	358	1586.419251	83.0	62.5
P 07 W1	2.597194766	502	1303.791773	164.0	8.0
P 07 W2	9.968302596	449	4475.767865	210.0	16.0
P 09 W1	12.92116263	470	6072.946436	180.5	65.5
P 09 W2	6.609650125	485	3205.680311	181.0	47.5
P 10 W1	25.42999509	515	13096.44747	628.5	65.5

From Table 4.8, “ T_{11} ” indicates how many trips were made within zone 1. “ T_{ij} ” indicates the total surveyed trips between zone i and zone j . “ O_1 ” is the total origins in Zone 1, and “ D_1 ” is the total destinations in Zone 1.

This simple matrix is still not a full OD matrix for the whole city’s public transport trips during the peak hour. To get to that, the number of people surveyed needs to be related to the total number of transit passengers per direction per hour at each survey point. This process is called expanding the matrix. The total number of public transport passengers at the peak hour is taken from the data that was collected earlier at each of the same points using the transit vehicle occupancy surveys. For example, in Dar es Salaam, on some corridors 1,000 out of 10,000 hourly transit passengers per direction were collected on some corridors, which yields an expansion factor of 10. On this matrix, the observed OD trips need to be multiplied by 10 to get the total public transport trips at the peak hour. On other corridors, where 1,000 interviews were taken for only 6,000 passenger flows, the expansion factor is 6, so the surveyed OD trips need to be multiplied by six. Each separate matrix needs to be expanded by its appropriate expansion factor, as indicated in Table 4.9.

Because the point of each OD survey was chosen to pick up a discrete set of OD pairs, each individual OD matrix will largely cover a different part of the city. So the individual matrices will have some OD pairs with actual values, and some OD pairs with zero trips (Table 4.10 and Table 4.11).

Table 4.10: OD Matrix #1 East Bound Morogoro Road and United Nations Intersection

Origins	Destinations					$\sum_j T_{ij}$
	1	2	3	4	5	
1	4	10	6	0	0	O_1
2	12	4	2	0	0	O_2
3	16	5	12	0	0	O_3
4	3	2	0	0	0	O_i
5	0	0	0	0	0	O_z
	D_1	D_2	D_3	D_4	D_5	Total

Table 4.11: OD Matrix #2 South Bound Old Bagamoyo Road and United Nations Intersection

Origins	Destinations					$\sum_j T_{ij}$
	1	2	3	4	5	
1	0	0	0	12	15	O_1
2	0	0	3	15	20	O_2
3	5	2	15	8	10	O_3
4	0	0	0	6	11	O_i
5	0	0	5	12	10	O_z
	D_1	D_2	D_3	D_4	D_5	Total

Table 4.12: OD Matrix Dar es Salaam

Origins	Destinations					$\sum_j T_{ij}$
	1	2	3	4	5	
1	4	10	6	12	15	O_1
2	12	4	3	15	20	O_2
3	16	5	15	8	10	O_3
4	3	2	0	6	11	O_i
5	0	0	5	12	10	O_z
	D_1	D_2	D_3	D_4	D_5	Total

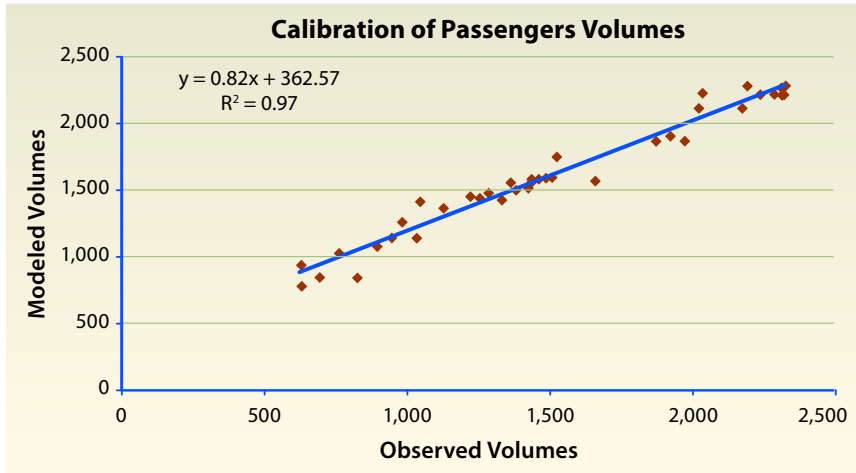


Fig. 4.22
Modelled versus observed passenger volumes in Jakarta.

Graphic courtesy of Remi Jeanneret

To develop the full OD matrix for transit trips in Dar es Salaam, a simple estimate would be to take the maximum value for any OD Pair in any observed survey. Others believe taking the average of the observed trips. For illustration purposes in Table 4.12, the values from the previous two tables have been combined to form a complete OD matrix (assuming that only two points are surveyed).

This methodology is used to avoid double (or triple) counting of some trips. This double counting may happen because some journeys

may have been intercepted by more than one survey station, either potentially or in the sample. In this case, steps must be taken to avoid exaggerating their importance in the matrix by weighting those cells appropriately, for example taking the average value of duplicated cell entries. For more details, consult Ortúzar and Willumsen (2001). On the other hand, sometimes people may go in very different directions to reach the same endpoint, so using this method will undercount the total demand.

4.4.3.5 Validation

Due to these distortions, along with measurement and sampling errors, it is usually necessary to undertake corrective actions. A validation process is typically done at the conclusion of the data collection process in order to provide a degree of quality control.

Validation is usually accomplished by looking at OD pairs route by route, and doing an informal trip assignment, assigning the OD trips to specific public transport routes, and comparing the aggregate total trips to the aggregate trip counts developed from the occupancy surveys and transit vehicle counts (Figure 4.22).

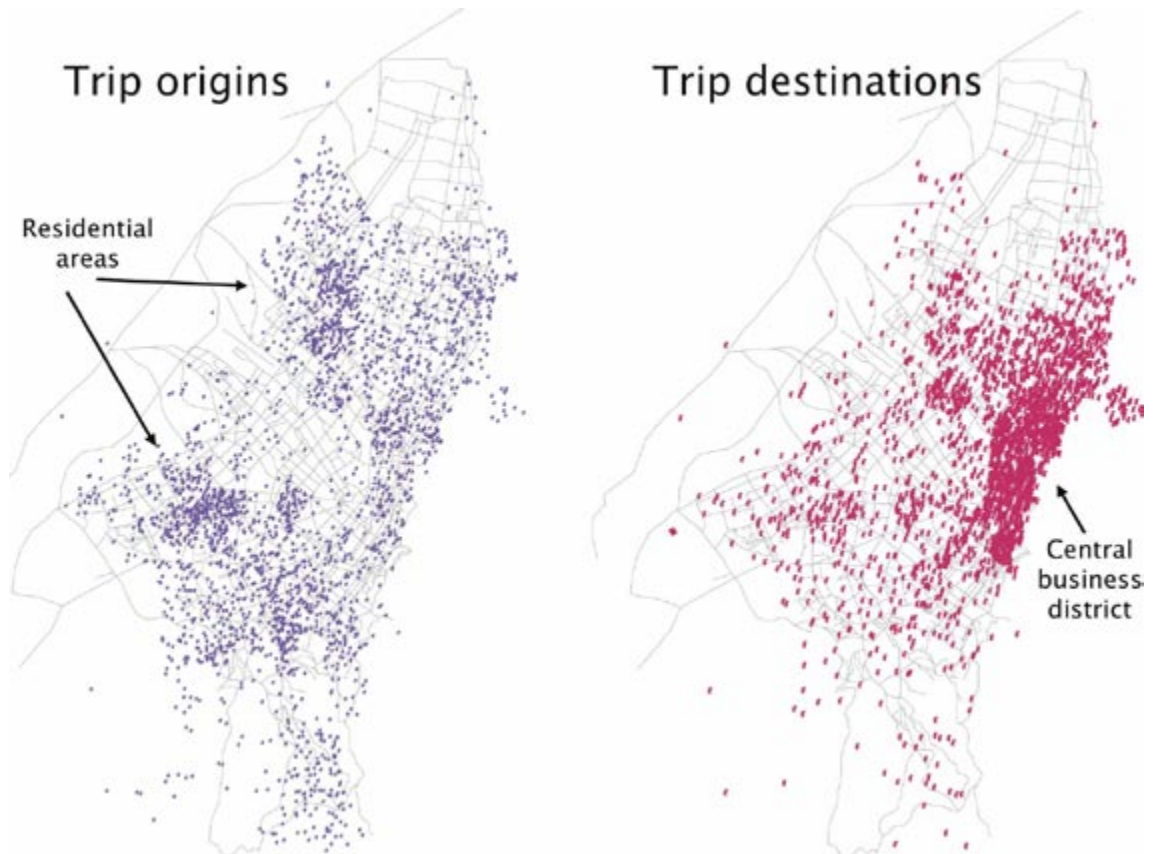


Fig. 4.23
Origin-destination map for Bogotá.

Image courtesy of TransMilenio SA

Once the OD matrix has been cleaned and calibrated, the OD matrix can be input into the traffic model, and the testing of different scenarios can begin. The OD matrix can also be used to generate an origin-destination map that gives decision-makers an overall view of the density of origins and destinations in the city. The OD map will frequently illustrate the extent to which trips are distributed or are centralised within the city. The OD map of Bogotá shows that there is a heavy concentration of trip destinations to the centre of the city (Figure 4.23)

4.4.4 Outputs of the public transport model

“I have not failed. I’ve just found 10,000 ways that won’t work.”

—Thomas Edison, inventor, 1847–1931

Once the road system and the OD matrix are input into the traffic model, different scenarios for the BRT system can be tested. While the output from the public transport model will be used at various points throughout this guide, for the time being it will be used to generate demand estimates for specific BRT system scenarios.

The first step is generally to take a look at the existing public transport demand on all major corridors throughout the city at the peak hour. These results should now show a much more

accurate estimate of total existing public transport demand on all the major corridors in the city. This result is a valuable tool for prioritising which corridors should be included in the BRT system. Figure 4.24 is a picture of the total existing transit demand on all of the major corridors in Jakarta.

These total demand estimates, or “desire lines”, tell how many public transport passengers are currently on each major corridor. It still does not say anything about how many public transport passengers will be on a specific BRT system.

When first coding the existing public transport system into the model, the following additional information was required:

- Vehicle capacity (total standing capacity is all that is used);
- Public transport (this will be a series of links; each direction needs to be coded separately because sometimes bus routes do not go and return on the same roads);
- Specific location of the bus stops (for most of the network, just assume the bus stops are at the intersections, but the BRT corridor nodes should be added specifically at the bus stop, and the links between the bus stops should be broken into separate links);

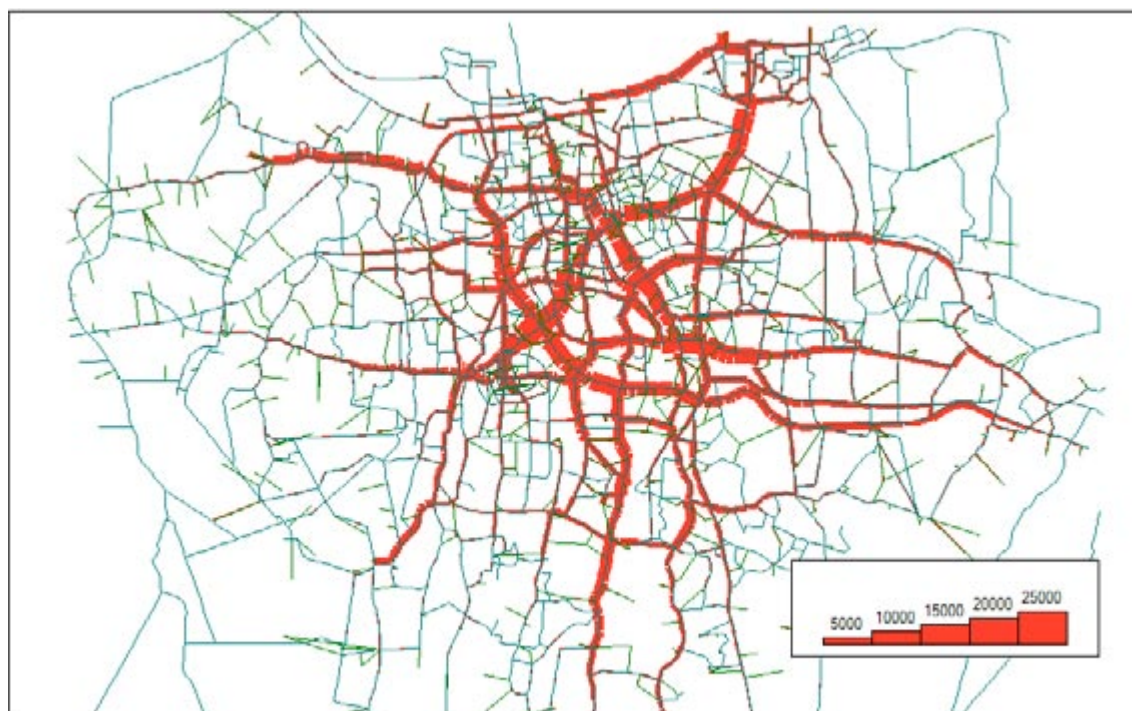


Fig. 4.24
A graphical illustration of demand volumes (also known as “desire lines”) from Jakarta.

Image courtesy of ITDP

- Speed on each link (this will be taken from the bus speed and boarding and alighting survey);
- Bus fare (usually the models allow fare * distance and if there is a flat fare leave the distance blank);
- Bus frequency;
- Value of time (there are various ways of calculating this value, but in practice this value is based either on interviews with bus passengers or 50 percent of the hourly wage rate for the typical bus passenger).

At this point, the scenario to be tested should be carefully defined. In the case of TransJakarta, the scenario was essentially defined through a decision taken by the Governor. The Governor's design decision was as follows:

- TransJakarta would go from Blok M to Kota station with 24 stops at specific locations;
- TransJakarta would have fully segregated lanes and of certain design;
- TransJakarta would charge a flat fare of Rp. 2,500 (US\$0.30);
- There would be no feeder buses and no (functional) discount transfers from any existing routes;
- Ten existing bus lines travelling between Blok M and Kota would be cut; all other bus routes would be allowed to continue to operate in the mixed traffic lanes at curbside bus stops;
- 54 buses were procured to operate in the system.

When coding this BRT scenario into the public transport model, there is a small difference

between coding a new BRT link and coding just any other bus route. The main difference is that normally, in order to test some unique elements of the BRT system, the BRT link will be coded as an entirely new road link with special BRT characteristics, rather than assuming that it is a bus line operating on an existing road link that is open to transit vehicles and other vehicles. This new BRT link in the model will only be coded for use by a specific BRT vehicle that may be a new vehicle category that does not already exist. In the case of Jakarta, these vehicles are only used on the BRT system. This special coding of the BRT link is also required to give this route special fare characteristics, such as the possibility of free transfers between routes when the system expands to more than one route.

Thus, coding a new BRT route is no different than coding any public transport route, except:

- The bus speed will be higher than for routes on the mixed traffic links. The BRT bus speed must be calculated specifically based on the system's design, and how to do this is laid out elsewhere in this guide, but it is generally between 20 and 29 kph;
- Some new bus stop locations will be created, which will affect walking times;
- Bus frequencies will be specific to the number of buses and the bus speed;
- If a lane of mixed traffic is being removed from the existing link, the definition of the characteristics of that link will need to be changed to reflect the loss of a lane. This change will only be necessary for running the full traffic model in the future;
- It may be necessary to adjust downward the bus speeds for all the bus routes that are running in the mixed traffic lanes. If there is only a public transport model, this will only be an estimated impact. If there is a full transportation demand model, the model will help calculate this impact.

After defining the new BRT links and assigning it a new BRT route with the characteristics reflecting the political decision, the projected demand for this specific scenario can be calculated (Figure 4.25).

In the case of Jakarta, the projected demand on Corridor I for the scenario determined by the Governor was tested. Based on the lack of a feeder system and the unwillingness to cut

Fig. 4.25
Demand estimate for TransJakarta Corridor I, Scenario I.
Image courtesy of ITDP



bus routes that ran parallel to the new BRT system, it was known that the demand on the new system would not be very high. It was also known that because one mixed traffic lane had been removed, while few of the buses in the mixed traffic lanes had been removed, mixed traffic lanes would be more congested. However, due to the lack of a full traffic model, the precise scale of this impact was not known. The planning team therefore encouraged the Governor to add more feeder buses with free transfers onto the trunk system, and to cut more existing bus routes.

Note that this demand estimate assumed that the new BRT system will only get the trips from existing public transport trips. It did not assume that any trips would be attracted from other modes, as the public transport model alone did not have the capacity to provide much of an answer to this question. Nevertheless, this analysis produced a very good conservative first estimate of the likely demand.

To include some possible modal shift from private vehicles, it is usually sufficient to simply add 25 percent to the demand, but this modal shift impact will vary based on the difference between the bus speeds on the new BRT system and the mixed traffic speeds that can reasonably be expected after the BRT system opens. The greater the shift in relative speeds, the greater the projected modal shift. In Jakarta, for example, the political decision to allow many buses to continue in the mixed traffic lanes was certain to add to congestion in the mixed traffic lanes. This situation created a lot of controversy initially, but it did lead to a significant modal shift impact. According to surveys of passengers, roughly 20 percent had shifted from private cars, motorcycles, and taxis.

In Bogotá, where a well designed system actually decongested the mixed traffic lanes, the modal shift impact in the first phase was a modest 10 percent of private vehicle users to the BRT system (Steer Davies Gleave, 2003). Most public transport users moved to BRT since many directly competing routes by existing operators were eliminated. However, the slightly lower price of existing operators has meant that a number of customers have continued using these services in cases where they still operate.

As the system has expanded, approximately 20 percent of current BRT customers are former private vehicle users.

With this demand estimate, planners are better able to assess whether the physical designs proposed will have sufficient capacity to handle the projected demand, whether stations will congest, and whether or not the system is likely to be profitable or operate at a loss.

4.5 Estimating demand using a full traffic model

"Those who have knowledge, don't predict. Those who predict, don't have knowledge."

—Lao Tzu, philosopher, 6th century BC

Most BRT systems in the developing world have been planned using only a public transport model, without having the full transportation system modelled. The lack of full modelling occurs because such modelling is only in its infancy in most developing countries, and it takes time to build up the data and the skills and resources to develop a full traffic system demand model. Nonetheless, the tools provided by the full transport demand model are very useful to BRT planning, and if time and resources allow, developing a full traffic demand model is worthwhile.

4.5.1 Overview

With a full traffic model, you will have a much better sense of “potential” passengers on the BRT system that currently may be taking motorcycles, private cars, bicycles, or walking. Planners will also get a much more complete understanding of congestion on different points of the network, and a much better capacity to assess the projected traffic impacts of the new BRT system.

Guidelines for how to build and operate a full traffic demand model is beyond the scope of this guide. However, some basic information on traffic modelling is included here to give BRT planners a general overview of how these models work, and some specific examples of where they are relevant to BRT planning.

Modelling is a simplified representation of real world systems that allows projections of future conditions. Transportation modelling is quite commonly utilised to determine expected

demand and supply conditions that will help shape decisions on future infrastructure needs and supporting policy measures. Modelling helps project future transport growth as well as allows planners to run projections across many different scenarios.

However, it should be noted that transportation models do not solve transport problems. Rather, the models are tools that provide decision-makers with information to better gage the impacts of different future scenarios. The type of scenarios considered and the type of city conditions desired are still very much the domain of public policy decision-making.

While complex mathematical relationships underpin transportation models, the basic premise behind the modelling analysis can be presented in an understandable form to a wide audience. Figure 4.26 outlines the classic four-stage transport model. This model still serves as

the basis for the various software products that today enable effective transport modelling.

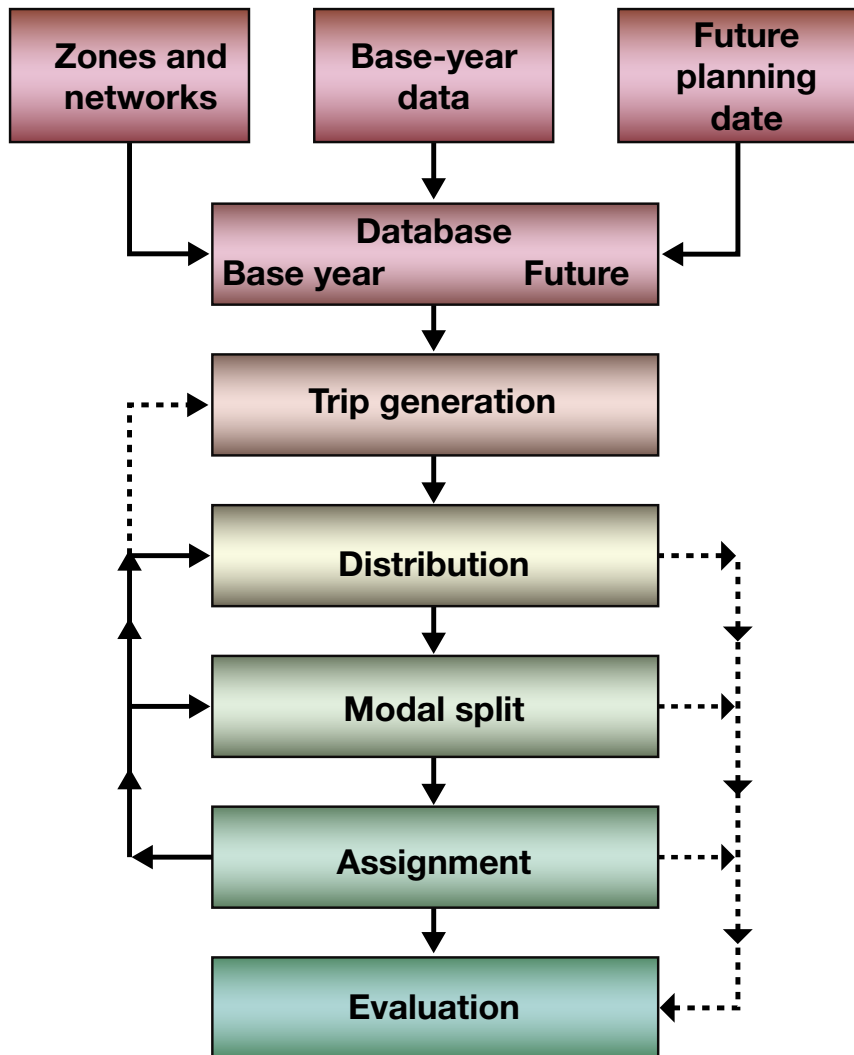
The **Trip Generation** stage deals essentially with demand growth issues. Thus far, this chapter has only considered how much demand the BRT system will probably have when it opens, but does not provide much guidance regarding longer term demand trends. Normally, long-term public transport usage will be influenced by growth of population, income and vehicle ownership. These changes are captured by the best trip generation models. If these elements of growth are expected to be different in different parts of the city, then it is worth developing at least a simple set of trip generation models. If, on the other hand, there is urgency in BRT design and growth is expected more or less uniformly throughout the urban area, then perhaps a very simple trend extrapolation model could be used.

The **Trip Distribution** stage consider situations where the new BRT mode will change the origin or destination of trips, for example by making some schools or shopping areas more accessible than others. In the case of work trips, any re-distributional effect may take some time but shopping and social trips may react more quickly. As BRT schemes can be implemented more rapidly than rail schemes, there may be a case for postponing any consideration of trip redistribution until the system is actually operational.

The **Mode Split or Choice** stage considers the potential for attracting to BRT current users of other modes, in particular private vehicle users. Again, the likelihood of this depends on how much better the new system will be compared to existing services. If car ownership is low (say below 8 percent) and the change in ride quality is not that different, it may be possible to design a BRT system without considering explicitly a mode choice model. A rough estimation by an experienced planner of how many people would transfer from car would be sufficient. On the other hand, in some cases it is necessary to have a good grasp on this mode transfer figure to size the system and estimate de-congestion benefits.

The Assignment stage is in most large cities essential and requires a good public transport model and also a model of the interaction with the rest of the traffic.

Fig. 4.26
Representation
of standard
transport model.



4.5.2 Additional data needs

Much of the data required for the full traffic demand model will have already been collected during the initial analysis period. It is fairly common for transport departments to do traffic counts, and if recent traffic counts exist in reasonable locations, this data should be usable. If counts for all vehicles were not done earlier, they need to be done now to calibrate the traffic model.

Secondly, when the road network is coded into the traffic model, it is no longer enough to simply identify existing road links, but the definitions of these links (how many lanes, etc.) becomes important. Furthermore, all existing alternative modes such as commuter rail lines, subway lines, etc. must be coded into the model.

Also, at this point, demographic data for each zone defined earlier becomes important, such as population by zone, employment by zone, average income by zone, vehicle ownership by zone, etc. This information is usually obtained from census data. Historical growth rates in population and employment by zone are the best first indicator of the likely growth rate of future trips in specific locations. Knowing household incomes and motor vehicle ownership levels will help indicate whether most people will take the bus regardless of the price, or whether they will switch to a car or motorcycle. Mapping the income levels throughout the city will also help to define price elasticities and target lower income beneficiaries, both important to developing the fare structure. Thus, traffic models are usually built up from demographic data on population, employment, and vehicle ownership.

Finally, for full traffic demand modelling, the planning team will need to conduct a full household origin destination survey. This survey is necessary since the team will only initially have estimates of origins and destinations for public transport trips. By contrast, the full transportation model will require OD matrices for all modes, including walking trips and private vehicle trips.

Surveying all members of a household regarding individual travel practices (destinations, mode choice, reasons for mode choice, travel expenditures, etc.) provides a very complete picture of where people are going, when, and sometimes

why. This process is called *trip generation*. Likewise, work place surveys can also be an effective mechanism. Unfortunately, household and work place surveys are probably the most costly of the O-D techniques. As a result, sometimes shortcuts are taken. Home interviews are the best way to obtain information on trips made per household, vehicle ownership data, linked journeys and overall levels of expenditure in transport.

The number of observations is constrained by financial and human resources. While the statistically desirable sample size for household surveys may be that represented in Table 4.13 (Bruton, 1985), the reality of what is possible is often quite different.

Table 4.13: Sample sizes recommended in traditional home interview surveys

Population of area	Sample size (dwelling units)	
	Recommended	Minimum
Under 50,000	1 in 5	1 in 10
50,000 – 150,000	1 in 8	1 in 20
150,000 – 300,000	1 in 10	1 in 35
300,000 – 500,000	1 in 15	1 in 50
500,000 – 1,000,000	1 in 20	1 in 70
Over 1,000,000	1 in 25	1 in 100

Source: Bruton (1985) in Ortúzar and Willumsen (2001)

In some locations, it may be very difficult (and expensive) to gain access to certain types of households or even define them unambiguously.

In general terms, if no household survey data has already been conducted, one would like to collect at least some 1,000 home interview surveys and preferably 3,000 in order to obtain a broader picture of household demand. The trip data from these interviews will then be combined with that from intercept surveys to obtain a more accurate trip pattern in the study area.

4.5.3 Detailed modelling for BRT

“The analysis of the thing is not the thing itself.”
—Aaron Allston, novelist

Market segmentation can be a key issue in deriving good modelling results. Different people react in different ways to changes in the transport system. Even the same person may behave in different ways when travelling to work, on

business or during leisure time. These differences affect design when considering the service during peak (mostly journey to work and education) and off-peak periods (mostly shopping, social and recreational trips). The proper segmentation of data can be costly since it requires more carefully collected data and greater detail in the modelling process. However, the benefits of segmentation can be a system well-tailored to the needs of the customer.

4.5.3.1 Trip generation

The data collected in the previous section will serve as the key inputs into the modelling process. The first stage of the process consists of utilising demand models to define trip generation characteristics. Specifically, the model attempts to match the total number of origins for a given area to specific destinations. Quite often trips are categorised by classifications such as trip purpose, time of day, and person type. Trip purpose may include the following:

- Work;
- Education;
- Shopping;
- Social and recreational;
- Personal business;
- Accompanying others;
- Other.

Of these, the first two are never omitted but sometimes all the others are grouped under the catch-all category of “other purposes”.

Classification by time of day may differentiate between morning peak, evening peak, and off-peak periods. Classification by person type typically focuses upon personal characteristics such as income level, car ownership levels, household size, and household structure. These personal characteristics along with other factors such as residential density play a role in determining the number of trips produced per household. The selected transport model will utilise these factors to calculate an estimated number of trips.

4.5.3.2 Trip distribution

The next stage of the modelling process involves obtaining the base year demand matrix for all the categories (or segments) of users. As with the public transport OD survey data presented previously, the OD data from the household

survey should be coded to each zone, collated, and formed into a full OD matrix for each separate mode. By using the household survey data to obtain the OD matrix, some of the risks of double counting or undercounting that arise with an on-board transit OD survey can be avoided, so the OD matrix should generally be more reliable, so long as the survey size is large enough and sufficiently free of errors.

Because of sampling limitations it is very likely that the resulting matrix will be very sparse; in other words, most cells will have no trips in them. Some of these zeros will be there because the intercept surveys could never interview trip makers making that journey (there was no survey point that intercepted that particular O-D pair). Others may simply be zero because that journey was not observed in the sample.

In these cases, it may be desirable to in-fill some of these empty cell values with a synthetic estimate of the number of trips. The most often used synthetic method for matrix estimation is the Gravity Model (see Ortúzar and Willumsen, 2001). This can be calibrated from the observed data, ideally home interviews as they capture trips of all possible lengths.

Since models are used to project the impacts of future scenarios, one also must consider how to represent expected changes in the number of trips. The gravity model is also useful in this context as it takes into account the changes in travel costs. Ultimately, the trip distribution model should be calibrated and validated for accuracy. For example, the model should be able to reasonably replicate the base year distributions in order to show that it is relevant to the area being studied.

4.5.3.3 Modal split

From a policy point of view, perhaps the most important stage in the transport modelling process is the selection of mode choice for the different trips. Determining the number of trips to be made by public transport, non-motorised options, and private motorised options will have a profound impact on future municipal investments. The factors that affect mode choice can be summarised into three groupings (Ortúzar and Willumsen, 2001):

1. Characteristics of the trip maker

- Car availability and car ownership
 - Possession of driving license
 - Household structure (young couple, couple with children, retired, singles, etc.)
 - Income
 - Residential density
2. Characteristics of the journey
 - Trip purpose (work, school, shopping, etc.)
 - Time of day when the journey is taken
 3. Characteristics of the transport facility

Quantitative:

 - Relative travel time (in-vehicle, waiting and walking times by each mode)
 - Relative monetary costs (fares, fuel and direct costs)
 - Availability and cost of parking

Qualitative:

 - Comfort and convenience
 - Reliability and regularity
 - Protection, security

The mode choice model will typically include these factors in estimating levels of usage between different modes. Segmentation will be, of course, very important. One should only include choices that are really available to each type of user. For instance, driving a car is only optional to those in households that have a car available. In some cases, travellers with a car provided by their company are in effect captive to that mode, as they have no choice.

If it has been decided that the BRT design must consider customers attracted from other modes, mode choice modelling will be essential. However, this is a specialised undertaking usually requiring good modelling techniques and trained specialists. If it is not possible to conduct a full modelling process, then it may be appropriate to make a simplified assumption about potential demand increases due to mode shift. This shift is unlikely to represent more than 5 to 20 percent of the demand in the new system.

4.5.3.4 Assignment

The previous stages in the modelling process focussed primarily on the demand side of public transport services. The “assignment” stage is where the supply of public transport services are matched with these demand conditions. Within a BRT system, the assignment stage also helps to identify usage levels amongst different routing and service options. For instance, it is quite

useful in planning terms to know the number of passengers who will be utilising express routes versus local routes.

In order to accurately model public transport route choice, it is necessary to represent the network with a good degree of realism. Centroids and centroid connectors should be used to represent access times to stations. Moreover, there is always an additional time to reach the right platform in a BRT or metro system. Transfer times and waiting times for the next available service should also be represented in the generalised cost of travelling along a particular route. People dislike transferring services because of the uncertainty involved, so there is usually a transfer penalty to consider in addition to the time spent changing services.

Fares should also be accurately represented and this may prove very tricky in some cases. If there is no fare integration, each change of service will involve paying a new fare. This additional cost may be represented as a “boarding charge”. If the fare has an element proportional to distance, this amount must be added to the journey. For integrated and zonal fares the issues may be more complex to handle but most modern software can cope if skilfully used.

It is important to adopt a realistic assignment model for public transport. This is particularly important when dealing with corridors where many bus routes converge. If all bus services have similar operating speeds (a common occurrence on a corridor) earlier models will tend to allocate all trips to the service with the highest frequency. In reality, people will probably choose the first bus that comes along, and thus allocating trips to services perhaps in proportion to frequency rather than “all-or-nothing” to the highest frequency service. Contemporary software packages, especially those developed and tested for high public transport usage like Emme/2, Cube/Trips and VISUM, perform better in this respect.

Equilibrium conditions within assignment are achieved when each passenger has been assigned the most efficient routing based upon inputs factors such as monetary costs and time of travel. Equilibrium is very important in dealing with private vehicle assignment but has an equivalent representation in public transport route choice.

Congestion effects may take place because buses are very crowded and users will experience losses in comfort (increases in generalised costs) similar to driving under congested conditions. An additional problem arises when passengers cannot board a bus (or metro, LRT vehicle) because it is full and must then wait for the next service. The first of these problems (crowding) is easier to model accurately than the second one but both may be important in replicating current conditions.

For the purpose of designing a new BRT system, one should try to avoid excessive crowding and delays to passengers because they cannot board a bus. Therefore, congested public transport assignment should be less of an issue for design purposes. In any case, congested public transport assignment is tricky and requires good use of a suitable software platform; it should not be attempted without at least a minimum of experience.

4.5.3.5 Evaluation

The previous modelling stages have combined supply and demand factors to develop an overall simulation of a city’s transit services. The final stage of the process is to evaluate the robustness of the particular solution being proposed by the model. Hopefully, the model will produce equilibrium conditions that lead to a single identifiable solution for the given input factors. In evaluating the model, several iterations are run in order to determine if the model results converge to an equilibrium point. If several iterations produce such a convergence, then the proposed solution is considered to be sufficiently robust. The lack of a convergence implies that changes in the model structure may be necessary before proceeding.

4.5.4 Assessment of the feasibility of the system

Once some sort of transit or traffic model has been developed, and a clear scenario for the BRT system has been defined, it should be possible to make a preliminary assessment of the general feasibility of the system.

A good litmus test of whether a new BRT system makes sense is to compare the existing generalized cost of some popular trips (origin-destination pairs) as it exists before the BRT

system, and what they might be with the new BRT system serving those trips. As a proxy for cost savings, the value of time savings can be utilised. However, it should be recognised that time savings is just one of the many reasons for encouraging public transport usage. Other factors include environmental benefits, fuel cost savings, urban design benefits, and social benefits. Further, time savings may be realised not just by public transport passengers but by private vehicle users as well.

Equation 4.1 Generalised time cost

The generalised time cost GC of travelling between two points using one or more bus services can be described as follows:

$$GC = a * IVT + b * WTM + c * WAT + d * TTM + e * NTR + f * FAR$$

Where

- IVT** is the time in minutes spent in the bus(es)
- WTM** is the total waiting time to board the bus
- WAT** is the total walking time to and from bus stops
- TTM** is the time spent transferring from one service to another, if any
- NTR** is the total number of transfers required for the journey, if any
- FAR** is the total fare paid for the whole journey

The factors *a*, *b*, *c*, *d*, *e* and *f* are parameters representing the weight attached to each of these elements in the journey. This generalised cost can be represented in time or money units. For example, by dividing the whole formulation by *f* the generalised cost would be measured in money units. It is more advantageous to divide the formulation by *a* and then measure generalised costs in (in-vehicle) time units.

A good starting point to investigate how much better the new system will be is to assume that *b*, *c* and *d* to be twice as big as *a* and that *e/a* is about 3 minutes¹⁾.

This provisional formulation could then be written as:

$$GC = IVT + 2 WTM + 2 WAT + 2 TTM + 3 NTR + \alpha * FAR$$

In this case, α is equal to f/a and is often interpreted as the inverse of the Value of Time (savings)²⁾. The generalised costs in this case would be measures in generalised in-bus minutes.

It would be desirable to consider this relationship and sketch how a new BRT system would reduce the generalised cost of travel for a set of relevant origin-destination pairs. This calculation could be accomplished using information already available on existing services, fares, frequencies and travel times compared with a new system that may have faster travel times on a trunk corridor but require transfers and perhaps longer walking times. This would give an idea of how much faster the buses should operate on the trunk corridor to compensate most travellers for the need to add one or more transfers.

For example, if one is considering the introduction of a trunk and feeder system that will replace a number of direct services, one can make the following estimation to check whether this scenario is going to improve travel to users. One can assume that the feeder services will have similar performance to the current services but perhaps a higher frequency for the relevant OD pair. For example, one can assume that waiting time will be reduced by 2 minutes

each way and that walking time will remain the same. The trunk and feeder service may require an average of, say, 1.5 transfers per trip where beforehand there was none. Each transfer will require additional waiting time for the new service (say 2 minutes each), so the original savings in waiting time will be lost. The trunk road will have to provide an overall time saving of 3 times 1.5 minutes (4.5 minutes) to be better than the old system, provided the fares remain the same. Therefore, unless one can provide an average time savings on the trunk route of 5 minutes it will not be worthwhile to introduce a trunk and feeder service. These calculations would have to be repeated for a number of representative journeys to support a decision one way or another.

The existing public transport system may be used to identify some key corridors where significant elements of demand will concentrate. Direct observations of the number of buses with a reasonable estimation of their passengers at peak periods would enable an initial sizing of the new system. This determination can be achieved in a short period of time and without detailed information on Origin-Destination patterns.

¹⁾ Research results agree that walking, waiting and transfer times are between 1.5 and 3 times as onerous as in-bus times, the precise values depending on cultural and local conditions like the weather. Similarly, the need to transfer is perceived by users as adding a notional 3 to 6 minutes to their journey.

²⁾ An initial estimate for α could well be the length of working time required to earn one unit of currency, for example how many minutes it takes the average earner to earn US\$1. The average earner in question is the type of user the new BRT is trying to benefit most. For example, if the average wage rate per hour for the population of interest is US\$2, then α is 30 minutes per dollar.

5. Corridor selection

“Look at every path closely and deliberately, then ask ourselves this crucial question: Does this path have a heart? If it does, then the path is good. If it doesn't, it is of no use.”

—Carlos Castaneda, author, 1925–1998

The choice of BRT corridors, and the specific roads on which to build the BRT system, will not only impact the usability of the BRT system for large segments of the population but will also have profound impacts on the future development of the city. The principal determining factor in corridor selection is the level of public transport demand, which was considered in Chapter 4 (*Demand analysis*). This chapter first discusses the different roadway and design options that indicate the suitability of BRT for a particular corridor. Second, this section will discuss options for BRT through narrow right-of-way corridors. Third, a cost-benefit model will be presented to quantitatively evaluate the merits of a particular corridor.

Though a corridor's importance will vary with circumstances, the choice of a particular roadway as part of a BRT network should be prioritised through the following considerations:

1. Maximise the number of beneficiaries of the new BRT system
2. Minimise the negative impacts on general traffic
3. Minimise operational costs
4. Minimise implementation costs
5. Minimise environmental impacts
6. Minimise political obstacles to implementation
7. Maximise social benefits, especially to lower-income groups.

Even though a new mass transit system will have profound impacts on the commuting patterns and quality of life of a city's inhabitants, officials sometimes make key decisions based on purely political criteria with relatively little forethought to the consequences. Thus, this section seeks to provide a rationale framework for corridor and routing decision making. While political concerns are legitimate, they can often lead to poor results if technical issues are not also considered. A detailed comparative analysis of each of the factors discussed in this chapter gives project developers the best chance at producing a cost-effective and useful public transport service.

The contents of this chapter are:

- 5.1 Corridor identification
- 5.2 Analysing corridor options
- 5.3 Options for narrow roadways
- 5.4 Framework for comparing corridors
- 5.5 Length of corridors
- 5.6 Number of corridors
- 5.7 Station and lane placement

5.1 Corridor identification

“Many roads lead to the path, but basically there are only two: reason and practice.”

—Bodhidharma, Buddhist monk, 6th century

The starting point for corridor decisions is the demand profiles generated during the analytical process outlined in Chapter 4 (*Demand analysis*). This process helped to identify the daily commuting patterns in both spatial and temporal terms.

5.1.1 High-demand areas

Clearly a key consideration is to minimise travel distances and travel times for the largest segment of the population. This objective will typically result in corridor siting near major destinations such as work places, universities and schools, and shopping areas. The demand profiles and origin-destination (O-D) results

from the earlier traffic counting and modelling will ideally guide corridor decision making.

In addition to reviewing the results of the demand analytic work, other key indicators assisting corridor decisions include the location of:

- Existing services;
- Central business district (CBD) (Figure 5.1);
- Educational centres;
- Large commercial centres;
- Business parks and industrial areas;
- Areas of rapid urbanisation.

In this early phase of corridor selection, all options should be fully explored. Rather than immediately discarding certain corridors for political reasons or for lack of sufficient road width, system developers should try to think outside the existing conventional wisdom. Closing down possibilities too early can result in unforeseen network connections being lost. The proposed BRT system should both complement existing land use patterns as well as reflect the future aspirations of city leaders, planners, and citizens.

Further, system developers should not just focus only on likely Phase I corridors. Certainly a city-wide BRT system will likely be implemented over a series of phases, encompassing several years of distinct efforts. However, developing a full city map of all potential future corridors can be useful for several reasons. First, it is difficult to evaluate the usefulness of a particular corridor without visualising its future connectivity with other parts of the city. Secondly, decision makers and donor agencies are often willing to tolerate a Phase I system that is not entirely viable financially if a Phase II has already clearly been articulated that will bring the project into full financial feasibility. Third, developing a full BRT map can be quite useful from political and marketing standpoints to ensure public support over the long term.

5.1.2 Major arterials

While BRT systems sometimes utilise all types of roads, BRT trunk corridors are usually located on primary arterial roads serving central business districts and other popular locations, while feeder bus routes (if any) will tend to serve secondary arterials and some local streets. Primary arterials are usually those roads which



serve long distance trips within the city, and secondary arterials usually serve a mix of longer distance and shorter trips. BRT is rarely put on limited access highways which are primarily designed for intercity travel and usually difficult to access. BRT trunk routes are frequently located usually on primary arterials because:

- Population densities are generally highest near major arterials;
- Major arterials tend to serve medium and longer distance intra-municipal trips, which are ideal for BRT;
- In developing countries, only major arterials form clear and logical connections with other major arterials to form an integrated network;
- Major arterials tend to have a concentration of existing bus or paratransit routes; and,
- Arterials also tend to host a concentration of major destinations such as businesses and shopping areas.

The choice of primary arterial roads may also provoke less concern about noise and traffic impacts since these roadways already have a significant presence of motorised vehicles. It is generally the aim of BRT systems to achieve high-speed services, and high speeds on residential streets or dense commercial streets are generally incompatible with pedestrian safety. Choosing roads with existing concentrations of public transport vehicles also means that locating these vehicles in an exclusive lane will help to decongest the remaining mixed traffic lanes.

Fig. 5.1

As this image of central Bogotá indicates, central business districts are a logical part of any complete BRT network.

Photo courtesy of Oscar Diaz and Por el País que Queremos (PPQ)

5.1.3 Secondary roads

“Do not go where the path may lead, go instead where there is no path and leave a trail.”

—Ralph Waldo Emerson, author and poet, 1803–1882

Secondary roads often hold the advantage that they are more “traffic calmed” for effective busway conversion. In some cases, a secondary road may be entirely converted to BRT use, with access being prohibited to private vehicles. The feasibility of such an approach depends upon existing use patterns in the area. If the area is largely commercial, then the busway may co-exist quite well, especially since it will provide a concentration of customers for the businesses. Historical centres may also require this approach since the narrow roadways may not permit both exclusive transit lanes and mixed traffic use. Cities such as Bogotá, Curitiba, and Quito have decided that certain portions of their BRT corridors will only cater to public transport customers and non-motorised traffic (Figures 5.2 and 5.3). Many key destinations, such as historical centres, do not possess an arterial infrastructure, but such areas nevertheless should be a priority of public transport service.

However, if there are no parallel roads, individuals and businesses may require private vehicle access to their properties along a public transport corridor. Truck deliveries are critical to the survival of small shops, for example. Such conflicts can generally be resolved with the

establishment of access hours during non-peak periods, but this approach is not always possible. A remaining solution is to legally expropriate such properties for public purchase, but such purchases can be quite costly as well as sometimes politically disruptive.

In general, though, secondary roads are considered more commonly as feeder routes. Feeder routes generally operate in mixed traffic like normal bus services. Since extensive residential sites are located along secondary roads, providing services to these areas becomes essential to operating a viable system.

5.2 Analysing corridor options

“Success is a journey, not a destination.”

—Ben Sweetland, author

5.2.1 Measuring road width and available right of way

A logical starting point for analysing corridor options is to record the road and right-of-way width throughout each potential corridor. While road and right-of-way widths may be constant for long stretches of a corridor, fluctuations can occur. For example, as corridors enter denser central districts and historical centres, less road width may be available. Likewise, at certain intersections and interchanges, there may more or less road space available.

The roadway width and the right-of-way width can be graphically noted in a plot of width against corridor location. Figure 5.4 shows such

Fig. 5.2 and 5.3
Major arterials are not the only options for BRT corridors. Cities such as Bogotá and Quito have made use of narrow roadways in the city centre to give exclusive access for public transport and pedestrians.

Left photo by Shreya Gadepalli
Right photo by Lloyd Wright



a plot for a proposed BRT corridor in Hyderabad (India). The band in yellow shows the central district of the city, where roadway and right-of-way widths are quite narrow.

In addition to noting physical dimensions along a roadway, an initial survey should also note other features, such as the present condition of the median area and pedestrian areas. Is the median a relatively open area or does it possess significant infrastructure (such as sculptures or utility poles) or greenery (such as large trees)? Are the pedestrian paths adequate for providing access to a public transport system or do they likely require widening? Are there difficult intersections along the corridor, such as roundabouts with fountains or artwork? In many cases, there are practical solutions to these challenges, but an initial survey can do much to categorise the major issues that will require further consideration.

5.2.2 BRT runway widths

There are no hard rules regarding the necessary road width. Successful BRT systems have been built in areas where the entire road width is only 3 metres (e.g., portions of the Quito historical centre). In an ideal situation, the roadway width will support a median station, one or two BRT runways, two mixed traffic lanes, and adequate space for pedestrians and cyclists (Figure 5.5). As noted earlier, many major arterials will fit this description. Much of Quito’s Ecovía (Figure 5.6), Trolé, and Central Norte corridors are based on this configuration.

A standard vehicle lane is typically 3.5 metres in width. However, lanes can be as narrow as 3.0 metres; and a narrower lane will tend to reduce

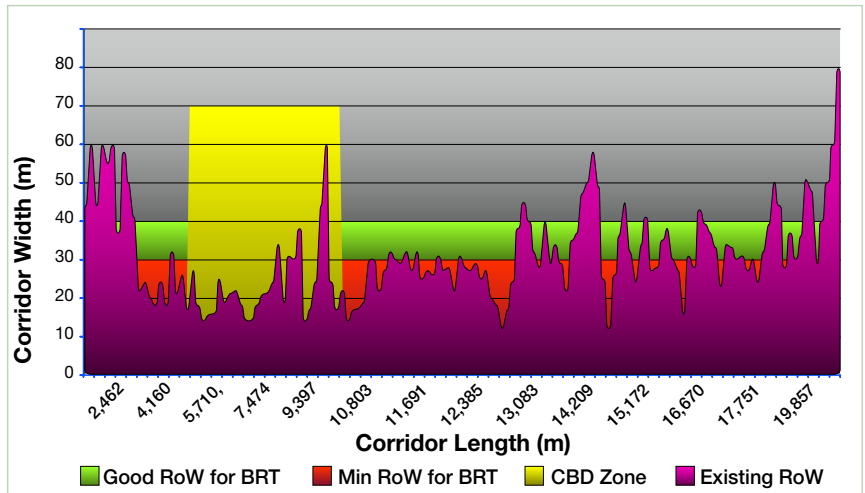


Fig. 5.4
Mapping roadway and right-of-way widths is a basic first step in analysing a corridor for BRT potential. This example shows issues with narrow widths in the central district of Hyderabad (India).

Image courtesy of ITDP

speeds and the risks of serious accidents. A BRT vehicle and many trucks are typically 2.6 metres in width while a standard car is approximately 2.2 metres in width.

The two mixed traffic lanes provide several advantages. If a car breaks down or if a taxi stops for a passenger or if there is a very slow moving vehicle, other vehicles can go around such obstacles by using the second lane. In this sense, a second lane more than doubles the amount of road capacity provided by a single lane.

However, in the right circumstances, traffic systems can also function quite well with only a single BRT lane and a single mixed traffic lane. Rouen (France) operates its BRT system on a 14 metre-wide street in this fashion (Figure 5.7).

The problem with vehicle breakdowns is solved by a semi-permeable barrier between the BRT lane and the mixed traffic lane. Typically the divider is such that vehicles can not infringe upon the BRT lane. In Rouen, road bumps

Fig. 5.5
A typical roadway configuration for a BRT corridor.

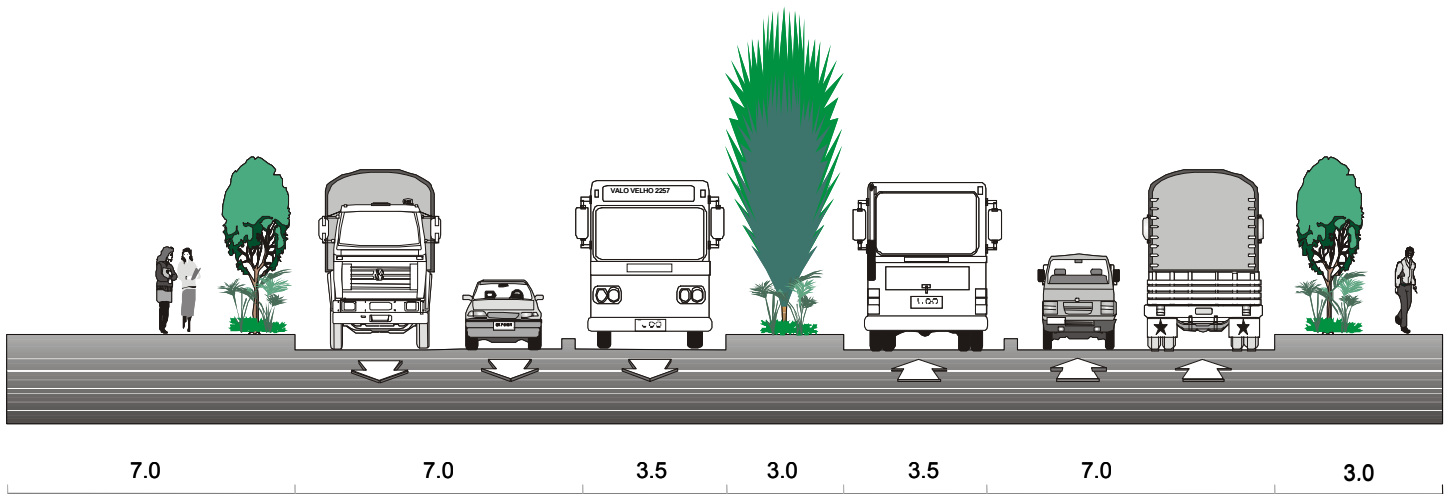




Fig. 5.6
The Ecovía corridor in Quito provides an example of a standard BRT road configuration.
Photo by Lloyd Wright

along with the brightly painted BRT lane still deter unauthorised use of the BRT space, but the semi-permeable nature of the bump allows vehicles to enter in case of blockage in the mixed traffic lane.

The Guayaquil Metrovía system also employs a system with just a single mixed traffic lane through the central portions of the city. However, in this case, a non-permeable barrier is utilised to separate the busway from the mixed traffic lane. The degree of physical separation can be culturally driven; much depends on the likely behaviour of motorists. If motorists are likely to violate a semi-permeable barrier and regularly infringe upon the busway, then a city may have no choice but to employ a non-permeable barrier. In Guayaquil, the system

Fig. 5.7
BRT corridors can also function adequately with the provision of only a single lane of mixed traffic, as shown in this example from Rouen (France).
Photo courtesy of TCRP photo library



planners decided to prioritise public transport over private vehicles, given the limited spatial arrangements.

As the experiences of Guayaquil, Quito, and Rouen clearly demonstrate, narrow road space is not an insurmountable obstacle to developing a BRT system. In some instances, a limited road space can actually be seen as a positive attribute from the standpoint of reversing “induced traffic”. If the BRT system is built in entirely unused right-of-way, there is no spatial incentive for mode switching from private vehicles. Research from road closings indicates that a certain percentage of vehicle traffic simply disappears when road space is no longer available (Goodwin *et al.*, 1998). This phenomenon, known as “traffic evaporation” or “traffic degeneration”, occurs due to motorists balancing travel time against the available options. Thus, many motorists may switch to public transport or other alternatives as a reaction to the more limited road space. An outgrowth of these findings has been a realisation that overall traffic levels can remain roughly the same before and after changes in road widths.

5.3 Options for narrow roads

“We will either find a way, or make one.”

—Hannibal, military commander and politician,
247 BC–183 BC

Areas with narrow road widths, such as central business districts (CBDs) and historical centres, present many challenges to BRT developers. The density of activity and architectural nature of these areas may imply less road space is available for a surface-based public transport system. At the same time, CBDs and historical centres are prime destinations for customers and thus such areas should be included in the system’s network. Without access to central destinations, the entire system becomes considerably less useful to the potential customer base.

In general, there are at least ten different solutions to designing BRT system through an area with extremely narrow road widths:

1. Median busway and single mixed-traffic lane (*e.g.*, Rouen, France)
2. Transit malls and transit-only corridors
3. Split routes (two one-way services on parallel roads)



Fig. 5.8, 5.9, and 5.10
Transit malls, as applied in Zurich (top left photo), Bogotá (top right photo), and Pereira (bottom right photo), are both a viable corridor option as well as an attractive addition to the urban environment.

Zurich and Bogotá photos by Lloyd Wright
 Pereira photo courtesy of the Municipality of Pereira

4. Use of median space
5. Road widening
6. Grade separation
7. Fixed guideway
8. Single-lane operation
9. Staggered stations / elongated stations
10. Mixed-traffic operation

5.3.1 Median busway and single mixed-traffic lane

As noted earlier, Rouen has had success with operating a median busway on a roadway with just one lane reserved for mixed traffic in each direction. A semi-permeable barrier between the busway and the mixed traffic lane allows private vehicles to encroach temporally onto the busway in case of lane obstruction. Guayaquil has successfully implemented a single lane option, even with an impermeable barrier between the busway and the mixed traffic lane.

This solution assumes a corridor has available right of way of at least 14 metres for vehicles plus an appropriate amount of space for pedestrians. Additional space is also required in areas with stations, which likely require at least another 2.2 metres of width.

This solution permits BRT operations to largely operate without a significant change to service levels. The system functions in a similar fashion to BRT operations on corridor sectors with wider right of way. However, this option is only viable where available road space is at least 14 metres. Further, this option requires either a cultural climate or an enforcement mechanism that prevents private vehicles from abusing access to the busway space. It will be easier to implement if the BRT vehicle frequencies are high, so that the lane does not appear empty.



An empty BRT lane will be very tempting to cyclists, motorcyclists, taxis, and other vehicles.

5.3.2 Transit malls and transit-only corridors

There may be an opportunity in some instances to restrict a segment's access to only public transport vehicles. Private cars, motorcycles, and trucks are banned either entirely from the corridor segment or during public transport operating hours. A transit mall is a commercial corridor segment in which only public transit and non-motorized traffic are permitted. More broadly, a transit-only corridor is any such segment, whether in a commercial area or a residential area.

Transit malls are frequently an effective solution when a key corridor only has two lanes of road

Fig. 5.11 and 5.12
In Pittsburgh (left photo) and Ottawa (right photo), entire roadways are devoted exclusively to BRT operation.

Photos by Lloyd Wright



space available. Thus, segments with only seven metres of road space could be appropriate for a transit mall. However, a one-way transit mall can operate on as little three metres of space, as is the case with the “Plaza del Teatro” segment of the Quito Trolé.

Transit malls are particularly appropriate when the public transport service enhances commercial activity and integrates well into the existing land-use patterns. In such cases, the transit mall creates a calmed street environment void of traffic congestion. Transit malls permit a maximum number of customers to access shops and street amenities. Thus, transit malls typically reside in locations where shop sales are quite robust. The lack of mixed traffic encourages an environment friendly to pedestrians and street activity.

Examples of successful transit malls include central Zurich where the tram system provides easy access to shops, offices, and restaurants

(Figure 5.8). Likewise, the Avenida Jimenez corridor of Bogotá’s TransMilenio system represents a high-quality example of merging urban regeneration with a BRT system (Figure 5.9). In a similar manner, the 16th Street Mall in Denver (US) combines a bus-only corridor with an attractive pedestrian space.

Transit-only corridors, though, are not just restricted to central business and shopping districts. For example, some busways are essentially limited access roadways restricted to bus use. The West Busway in Pittsburgh moves through a bus-only corridor in largely residential areas (Figure 5.11). Likewise, portions of the Transitway service in Ottawa operate through residential destinations on an exclusive busway (Figure 5.12). In both the cases of Pittsburgh and Ottawa, the busways run along corridors with significant green space. Thus, there are no residential driveways entering



Fig. 5.13
The narrow right-of-way space and high passenger volumes at the Quito “Plaza del Teatro” station have necessitated the physical separation of the busway and the pedestrian space.

Photo by Lloyd Wright



Fig. 5.14
The volume of pedestrians along London’s Oxford Street is such that the street may be better utilised as a pedestrian-only area.

Photo by Lloyd Wright

directly onto the corridor. Otherwise, these schemes would likely not be viable.

The open interaction between pedestrians and the transit service on a typical commercial transit mall will impact the travelling velocity of the system. Otherwise, accidents can occur or the system will dampen the usefulness of the public space. Thus, use of a transit mall design will likely reduce the average vehicle speed and thus increase transit times for passengers crossing the district. However, the “Plaza del Teatro” segment of the Quito Trolé avoids this problem by physically separating the pedestrian area from the busway (Figure 5.13). While this separation reduces the risk of accidents, it also makes the streetscape less socially pleasant to pedestrians.

In instances where pedestrian movement along a transit mall is quite high, then the presence of transit vehicles can become detrimental to the overall quality of the street. Conditions on the Oxford Street corridor in London have become difficult due to the pedestrian volume exceeding the provided footpath space (Figure 5.14). In this case, the space given to public transport vehicles (and taxis) may be better allocated entirely to pedestrians. Thus, at certain pedestrian volumes a street may be better utilised as a “pedestrian mall” rather than a “transit mall”.

Perhaps the greatest challenge in making transit malls and other transit-only corridors work is access for delivery vehicles and local residents. The desire by some merchants to have round-the-clock delivery access is both a political and technical obstacle to implementing a transit mall. The loss of on-street parking and direct customer access by private vehicles may also be a worry for some merchants. In general, the experience to date has indicated that transit malls and pedestrian malls both tend to improve shop sales and property values. Thus, while merchants do tend to object to vehicle restrictions at the outset:

“...they virtually never campaign for the abandonment of a scheme once it has come into operation. It is notable that, once a scheme has been put in place, traders are often the main people to voice a desire to extend its boundaries or period of operation” (Hass-Klau, 1993, p. 30).



A common solution is to establish delivery access for shops during non-transit hours. Thus, merchants are able to move large goods during the late evening and early morning hours. Smaller goods can typically be delivered at any time by carts and delivery services operating from the pedestrian area (Figure 5.15).

If the area is largely residential, then conflicts are usually with individuals seeking private vehicle access to their properties and parking. Such conflicts can sometimes be resolved with the establishment of nearby parking garages and access during non-operating hours of the public transport system. In both the cases of residential access and shop deliveries, the successful achievement of a transit mall is likely to require careful political negotiation.

5.3.3 Split routes

As an alternative to the transit mall, cities frequently consider splitting each direction of public transport service between two different (typically parallel) roads. The public transport system thus operates as two one-way links with each busway operating along the curb-side of the street. In this case, one lane of mixed traffic can typically be retained.

The chief advantage of splitting the route is the impact on mixed traffic, parking and truck deliveries. Private vehicles retain some form of direct access to corridor properties. Also, this

Fig. 5.15
Non-motorised delivery systems, as shown here in Santiago, can help make a transit malls viable for local shop owners.

Photo by Lloyd Wright

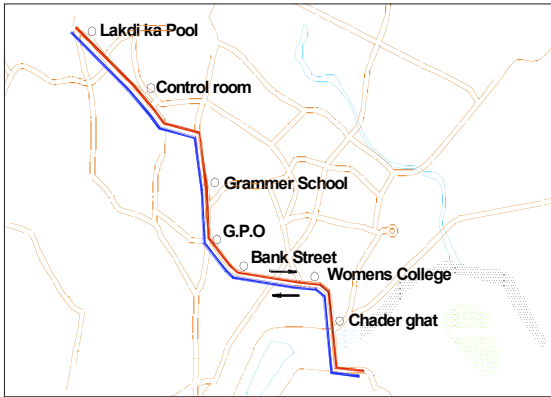


Fig. 5.19 and 5.20
Hyderabad also considered both single corridor and split route options, but in the end Hyderabad suspended its BRT efforts due to concerns over roadway space in the city centre.
 Images courtesy of ITDP

5. Permit customers to easily change directions if necessary
6. Allow easier direct transfers when two corridors cross one another.

In the development of its new “DART” BRT system, the city of Dar es Salaam is designing a busway through its relatively narrow city centre. The city has considered both the transit mall and split route options. Figures 5.17 and 5.18 illustrate the two options.

In the end, the Mayor preferred the transit mall configuration because it looks more like a metro system. Also, the technical team felt the transit mall would work as there were fairly low volumes of mixed traffic on the road that would be reconfigured for public transport and pedestrian only access.

The developers of the proposed Hyderabad BRT system also considered both the transit mall and split route options for services through the city’s central district. Figures 5.19 and 5.20 illustrate the two options.

In this case, the city decided neither option satisfactorily resolved their spatial limitations. The political pressures to retain road space for private vehicles ultimately undermined the project. At this point in time, Hyderabad’s BRT plans have been shelved due to the space issue as well as due to an alternative proposal from a metro consortium. Hyderabad’s experience clearly demonstrates the sensitivity of road space allocation decisions. For more information on road space allocation issues, Litman (2005) is a useful overview document.

5.3.4 Use of median space

Adverse traffic impacts will obviously be minimised if the new BRT system adds additional

capacity to an existing road, and does not have to convert an existing lane of traffic to an exclusive bus lane. In the case of Bogotá, for example, most but not all of the TransMilenio BRT system was built in the medians of an extremely wide existing right of way that had been cleared of encroachments in the 1960s. The new BRT system in most corridors therefore did not reduce the number of lanes for mixed traffic.

In many cities of the developing world, roads exist where the right of way is much wider than the existing road. The median of the VDN corridor in Dakar (Senegal) holds the potential for BRT lanes (Figure 5.21). Certainly in such cases, BRT can be built with no adverse impact on the mixed traffic. Normally, such roads are scheduled for widening by national or regional authorities, and it is critical for BRT planners to

Fig. 5.21
The VDN corridor in Dakar will likely make use of available right-of-way space in the median to construct the BRT lanes.
 Photo courtesy of ITDP





Fig. 5.22 and 5.23
Jakarta managed to minimise the system's impact on median trees through careful design.

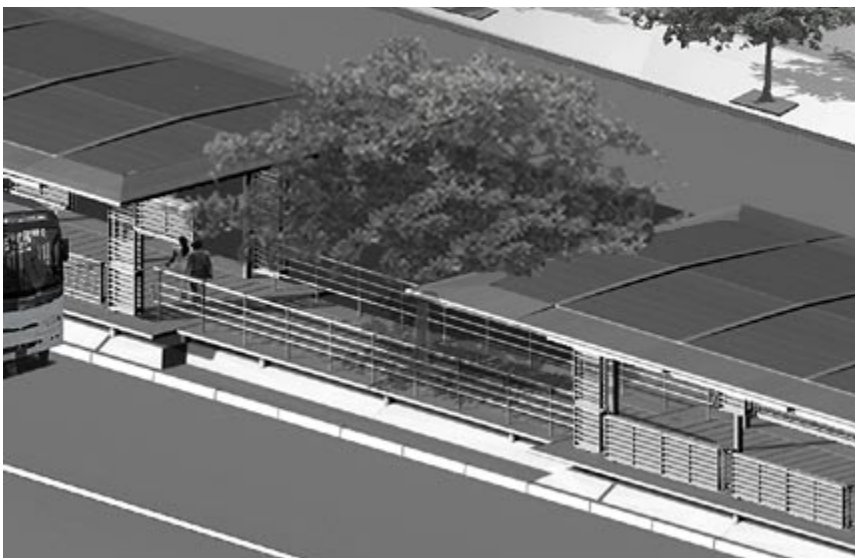
Left photo by Karl Otta, courtesy of the GTZ SUTP CD-ROM; Right photo by Karl Fjellstrom

coordinate BRT development efforts with any national road development initiatives.

However, use of existing medians can create other types of problems. A median may represent one of the few urban areas with greenery. In some instances, the trees planted in the median will be assets highly appreciated by civic and environmental organisations, public officials, and the general public. Accommodating the beautiful trees along the Sudirman Corridor in Jakarta meant that the BRT system had to minimise its impact on the median area (Figure 5.22). Some stations can even be built around the trees and thus providing an attractive environment to customers (Figure 5.23). In many cases, the BRT system can actually enhance green space by providing a protective buffer against mixed traffic pollution. However, access to median space for roadway purposes can be limited due to the need for green space preservation.

Fig. 5.24
Station design can even be predicated upon the preservation of existing greenery.

Image courtesy of the Municipality of Barranquilla (Colombia)



5.3.5 Road widening

If a usable median space is not available and the existing roadway proves to be insufficient, then widening the road could be an option to consider. In cases where unused land or development of low intrinsic value borders a proposed corridor, then road widening could be a viable solution.

However, in central districts widening roads can be quite difficult for political, financial, and architectural reasons. Purchasing properties along dense corridors with office towers is likely to be prohibitively expensive. Further, any expropriation process can be wrought with social and legal difficulties. For more discussion on land acquisition, see Chapter 17 (*Financing*).

Additionally, any road widening in a historical centre will likely face opposition from groups wishing to preserve the architectural nature of the area. Ensuring that the new public transport system is physically congruent and complementary to the surrounding area should be a priority for system designers. Intruding upon the cultural fabric of an area by replacing architecture with roadway is not likely to be consistent with this objective.

Phase II of the Bogotá TransMilenio system has seen extensive road widening and property acquisition along its new “Norte-Quito-Sur” corridor (Figure 5.25). While the existing roadway was actually sufficiently wide for both BRT and mixed traffic lanes, the municipality wished to retain the same number of mixed traffic lanes after the BRT system goes into operation. However, the amount of expenditures on land acquisition has pushed up the corridor’s cost consider-

Fig. 5.25
Road-widening along the “Norte-Quito-Sur” corridor in Bogotá did much to increase the total infrastructure cost.

Photo by Carlos Pardo



ably. Phase II of TransMilenio represents a near tripling of costs over the system’s Phase I. In this case, the cost of road widening should perhaps be compared to using the same funds to simply extend the system to other needed corridors.

By contrast, selective land purchases in bottleneck points away from the central districts can make sense. Away from central areas, land prices are more affordable and there are likely to be fewer conflicts with historical buildings and infrastructure. In particular, areas with undeveloped land, parking lots, derelict buildings and/or illegal encroachments are clearly more cost-effective acquisition targets than areas with high-rise office towers and luxury apartments.

However, land cost should not be the only criteria when making land acquisition decisions. If land value is the only decision factor, then road widening will tend to impact lower-income groups more adversely than others. While it may be economically optimal to widen roads through a poor neighbourhood when building a BRT system, mechanisms for compensating poor families with only informal claims to their land will often be weak. The forced relocation

of such families will cause severe hardships that should be avoided. Thus, some social criteria should also be included in any decision making on land acquisition or property expropriation.

5.3.6 Grade separation

Underground or elevated BRT systems may make sense for short segments where there is little other option for connecting key sectors. However, over a longer distance, such infrastructure does much to erode BRT’s cost advantage against other transit technologies.

Fig. 5.26 and 5.27
Construction of an underground segment to the Quito Trolé at the Villa Flor area helped to significantly reduce customer travel times.

Photos by Lloyd Wright



Grade separation can make sense for BRT in the following circumstances:

- Roundabouts;
- Congested intersections;
- Segments of dense, central areas.

One advantage of BRT over some forms of rail transit is the ability to change from surface-based travel to underground or overhead travel within relatively short distances. The ability of BRT vehicles to negotiate incline changes lends itself to this type of flexibility.

Grade separation can dramatically improve average commercial speeds and travel times. The Quito Trolé system retroactively constructed an underpass at one of the more congested roundabouts in the system (Figures 5.26 and 5.27). The “Villa Flor” underpass immediately reduced terminal to terminal travel times by approximately 10 minutes (from 55 minutes to 45 minutes). The elimination of the discontinuities from the roundabout had a ripple effect through the operation of the system and thus produced this larger-than-expected time savings.

The use of grade separation also brings with it safety improvements as public transport vehicles are no longer vulnerable to accidents at intersections. During the opening phase of the Houston LRT system in 2003 and the Los Angeles Orange Line (BRT line), both systems incurred several initial accidents between the public transport vehicles and cars. Motorists may be unaccustomed to the presence of the public transport system and thus traffic violations (such as turning on a red light) can become major accidents. While such accidents would likely occur even without the new public transport system, the events tend to become major media stories when involving a public transport vehicle. The resulting bad publicity can harm the overall image of the system and dampen enthusiasm

with potential new users. The use of an underpass at an intersection essentially eliminates this risk.

Likewise, grade separation removes the dangers to pedestrians from

transit vehicles. The separation allows the vehicles to travel at normal speeds through areas that would otherwise require speed reductions for safety reasons.

The use of an underpass at an intersection does carry with it restrictions on the location of the nearby station. In such instances, the station would typically be located away from the intersection at a point where the busway again rises to the surface level. However, there are exceptions to this restriction as the Quito Villa Flor station is actually below and inside the roundabout.

If the intersection involves two intersecting BRT corridors on perpendicular routes, then the underpass could complicate interchange options. Nevertheless, there are solutions even to this set of circumstances that can permit both grade separation and ease with customer transfers (Figure 5.28).

If the bypassed segment is larger than a simple intersection or roundabout, then a tunnel may be required rather than just an underpass. Systems in Seattle (US) and Boston (US) both

Fig. 5.28
By placing fare collection and the station entrance at the surface level, this design utilises an escalator system to allow customers to access the underground platform.

Image courtesy of Logit Engenharia

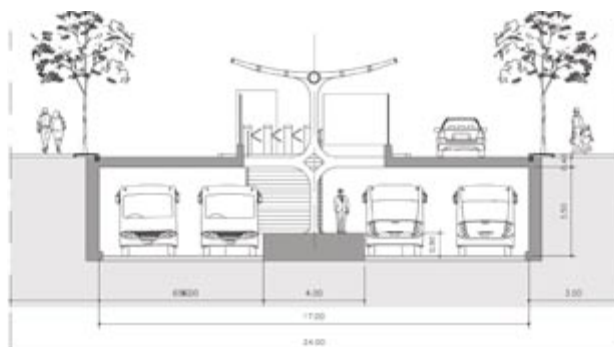


Fig. 5.29
The “Big Dig” in Boston included priority infrastructure for BRT.

Photo courtesy of the TCRP photo library

make use of tunnelling to avoid dense city centre infrastructure (Figures 5.29). The Seattle Bus Tunnel is actually in the process of being converted to an LRT tunnel. In the case of Boston, tunnelling is used along the Waterfront segment of the Silver Line BRT system as well as to permit the vehicles to traverse under the city’s bay. The advent of these various experiments with underground BRT segments has made the terms “surface metro” and “BRT” no longer synonymous, and thus has continued to blur the previous distinctions between rail-based and rubber tyred-based systems.

Elevated BRT systems are also a possibility. Short-distance use of flyovers to avoid congested intersections is being considered in the current planning of the Bangkok BRT system. In case of two-lane flyovers, the BRT system would gain complete use of the flyover infrastructure, leaving mixed traffic to negotiate the intersection at the surface level. While this design would be unpopular with motorists, it does much to improve the relative travel time advantage of the transit system. In the case of four-lane flyovers, the overpass would have sufficient space for both dedicated transit lanes and a mixed traffic lane in each direction. Flyovers share the same complications with underpasses in terms of location of boarding and alighting stations. Stations are likely to be located away from the intersection at a point where the busway is level with the street surface.

In general, flyovers are likely to be a less favourable solution than an underpass, especially given the negative aesthetic impact such visual intrusions have upon an urban area. Unlike underpasses, though, flyovers do avoid complications regarding water drainage.



Fig. 5.30
The Yurikamome line in Nagoya utilises an elevated roadway structure to avoid any conflicts with street level traffic.

Photo by Lloyd Wright

Longer elevated segments in the manner of a monorail or elevated rail system are also possible. The Nagoya Yurikamome Line is a 10 kilometre elevated BRT system, serving a key residential and commercial corridor as well as linking with the city’s regional rail and metro systems (Figure 5.30). The elevated stations along the corridor are accessed through escalators and elevators. At one point, a concourse takes passengers directly from the BRT station to the Nagoya Dome sporting facility. The elevated nature of the system means that there are no delays along the route due to mixed traffic or intersection signalling. However, at approximately US\$22 million per kilometre, the Yurikamome line is one of the world’s most expensive BRT corridors.

São Paulo also began constructing an elevated busway in the 1980s, which is likely to be completed finally in 2007. The “Furo Fila” elevated busway is being constructed over a river. Like other segments of the São Paulo busway system, the Furo Fila corridor does not penetrate the



Fig. 5.31 and 5.32
Quito makes extensive use of underpasses at major intersections, and as the experience of Quito shows, such underpasses are not always prohibitively expensive.

Photos by Lloyd Wright

city centre, so the time savings resulting from the elevation will not be that significant. Nonetheless, having already made the investment, Mayor Serra had the outer part of the corridor redesigned as a surface BRT, and decided to complete the system by 2007. Problems of passenger evacuations during vehicle breakdowns, increased construction and maintenance costs, and other issues can limit the applicability of elevated corridors.

Thus, grade separated solutions (underpasses, tunnels, overpasses/flyovers, and elevated corridors) do offer substantial speed and safety advantages. The cost of these structures, though, can do much to undermine the cost advantage of BRT relative to rail systems. Thus, cities employing such infrastructure may find a rail system to be of a similar cost. However, the new Quito “Central Norte” BRT line has achieved grade separation at a remarkably economic price. Virtually every major intersection along the central stretch of the corridor features a BRT underpass (Figure 5.31). The average cost

for this infrastructure was a rather economical US\$1 million per underpass (Figure 5.32). Using calculations of time savings benefits to public transport customers and reduced congestion impacts on mixed traffic, the Quito underpasses have delivered a swift return on investment. Further, the approximate US\$1 million per underpass did not appreciably affect the overall infrastructure cost of the corridor. Thus, in the developing-nation context, where construction costs may be significantly lower, grade separation could be a valid option to consider in the right circumstances.

5.3.7 Fixed guideways

Since a BRT vehicle is typically 2.6 metres in width, it is possible that a lane just slightly wider than this amount could suffice. Under normal operating conditions, a driver will require a road width of approximately 3.5 metres to safely maintain position within the lane, and 3 meters at the station, since the driver must pull adjacent to the boarding platform in any case. However, if a vehicle is physically restrained by a guidance mechanism, then a lane width of 2.7 metres is possible.

Physical guidance systems are employed on BRT systems in Adelaide, Bradford, Essen, Leeds, and Nagoya. A side-mounted guidance wheel maintains the vehicle’s position within the lane (Figures 5.33 and 5.34). A slight trench in the roadbed has also been used reasonably successfully in the Netherlands for short sections. Likewise, optical or magnetic guidance systems are also possible.

Thus, in instances when reducing lane width by approximately 0.9 metres is of great value, then a fixed guideway system can be an option to consider. Guidance systems also provide other advantages, such as safer vehicle operation and higher operating speeds. The chief disadvantage is the added infrastructure cost associated with the side-wheel and the guidance track.

Some cities, such as Bangkok, are only considering the guidance system in areas with extremely narrow road widths. For example, stations constrain road space due to the floor width of the station. Bangkok is thus considering mechanical guidance only at the station area. Fixed guidance at the station also provides the



Fig. 5.33 and 5.34
Nagoya’s elevated BRT line utilises a mechanical guidance system to reduce the required roadway width.

Photos by Lloyd Wright



advantage of accurately aligning the vehicle to the station doorways.

5.3.8 Single-lane operation

In some special cases, a short stretch of narrow busway could be operated with a single lane. Thus, a single lane would provide service to both directions on an alternating basis. To ensure that two vehicles would not try to use the one-lane segment at the same time, a special traffic control system is usually employed.

Single-lane operation is being studied for applications in Seoul and Eugene (Figure 5.35). This option works best when limited to just short road segments and bus frequencies are low. As the length of the one-lane operation is increased, the greater is the possible disruption to operation of the overall system. This option is also not likely to be viable in systems with high vehicle frequencies and high passenger demand.

However, in some circumstances, single-lane operation can be used to overcome obstacles spanning short road segments. A single-lane tunnel or bridge or a narrow historical street may appear as insurmountable obstacles and therefore cause planners to forgo an otherwise ideal corridor. Single-lane operation can be an option to consider in such situations.

5.3.9 Staggered stations / elongated stations

The physical placement of the stations and the physical dimensions of the stations can be manipulated to reduce spatial width requirements. The station area is likely to be the critical point in terms of width along the corridor. This area must not only accommodate the width of the runways but also the floor width of the station. As noted above, road widening and fixed guideways are options for addressing spatial constraints in the station areas. However, in many instances, these options may not be either possible or sufficient to overcome the spatial limitations. Altering the station placement or design may thus be another option for overcoming the spatial constraints of station areas.



5.3.9.1 Staggered stations

Historically, the roadway configuration for the BRT stations has taken one of two different options. In one case, a single station in the roadway median can act to serve both directions

▲ Fig. 5.35 Eugene has considered single lane operation for portions of its proposed corridor.

Image courtesy of Lane Transit District

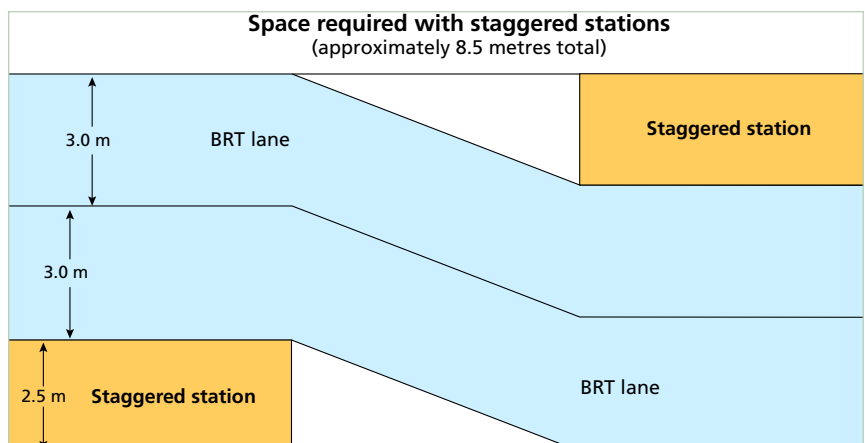
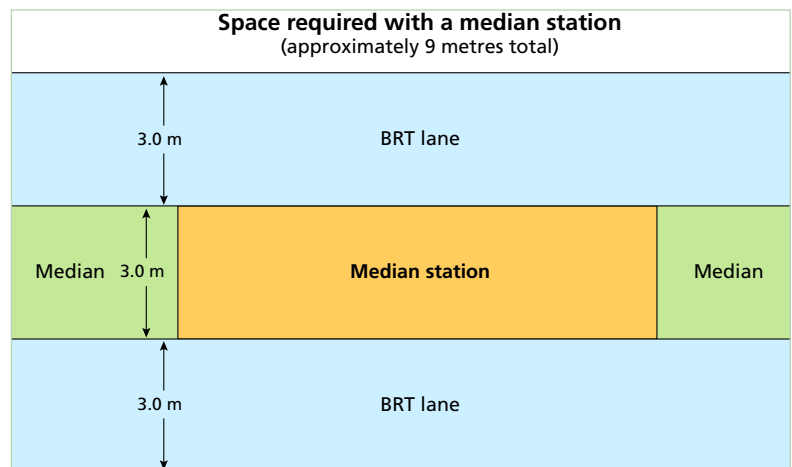


Fig. 5.36 and 5.37
Relative space requirements for roadway configurations with median stations and staggered stations.

of corridor travel (Figure 5.36). Alternatively, stations can be split with a different station serving each direction of travel (Figure 5.37). This second option, the staggering of stations for each direction, will likely provide a marginal space savings in terms of road width. The station will only have to accommodate approximately half as many passengers for a single direction, and thus a reduction in width is possible.

While requiring a somewhat wider floor area, the single station in the median is by the most useful in terms of customer convenience and system design. With a single station serving both directions, customers are able to change directions by simply crossing the station platform. Separated stations will require either complicated connecting infrastructure (underground pedestrian tunnels or overhead pedestrian bridges) or a more costly fare system to recognise customers leaving and re-entering the system from nearby stations. Additionally, building two

stations instead of a single median station will tend to increase overall construction costs.

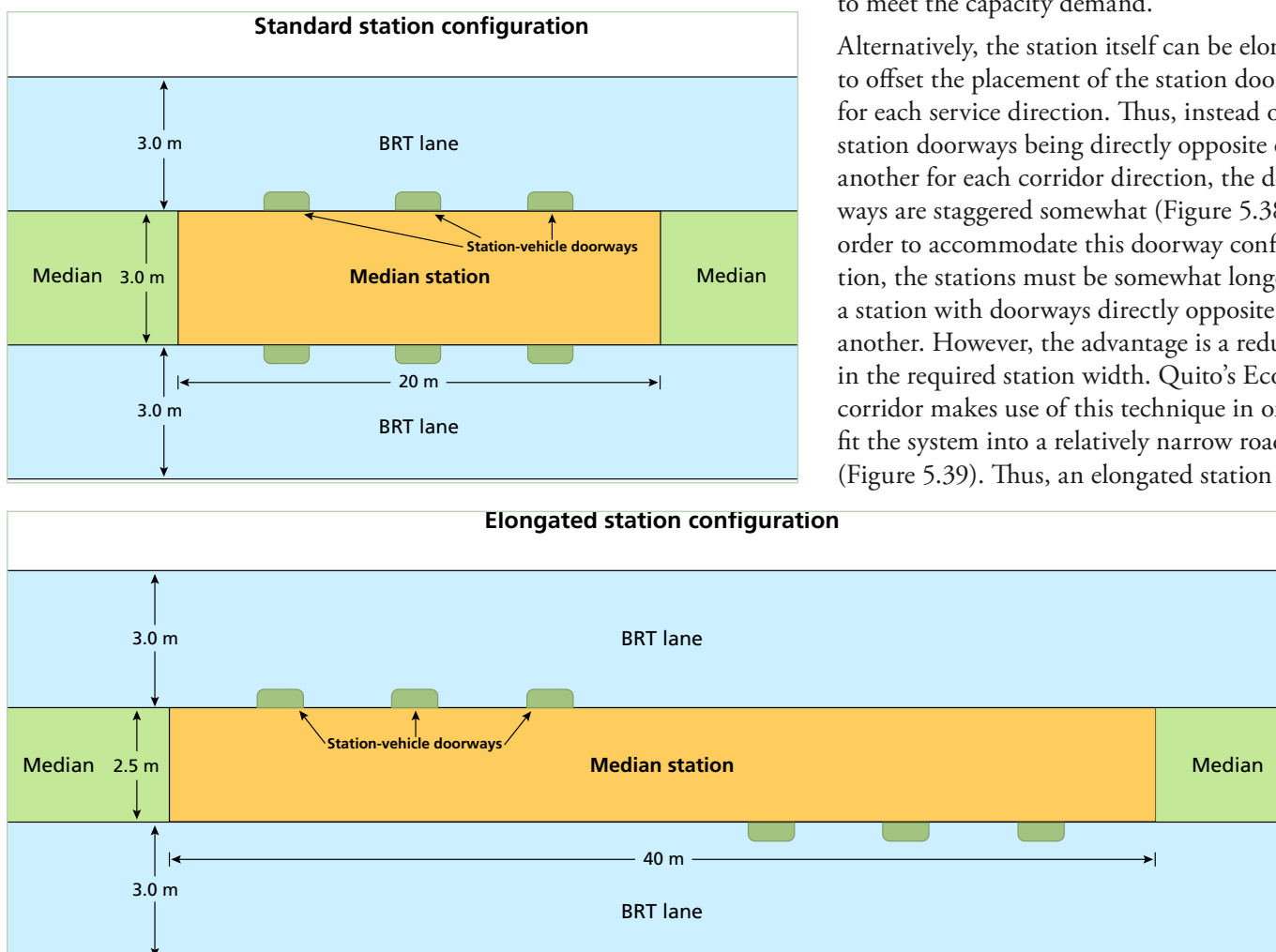
Thus, the marginal width gained from a staggered configuration usually is not a significant benefit in comparison to the operational disadvantages associated with this type of arrangement.

5.3.9.2 Elongated stations

The required width of a station is largely a function of the projected peak passenger volume. The peak number of boarding and alighting passengers will determine how much station floor space will comfortably accommodate all customers. With a median station configuration, there is the possibility that two vehicles will stop at the same time, and thus exacerbating the peak station load. If the station doors for each direction are situated opposite one another, then space will be at a premium with a simultaneous arrival of vehicles for each direction. In such cases, the station width must be increased to meet the capacity demand.

Alternatively, the station itself can be elongated to offset the placement of the station doors for each service direction. Thus, instead of the station doorways being directly opposite one another for each corridor direction, the doorways are staggered somewhat (Figure 5.38). In order to accommodate this doorway configuration, the stations must be somewhat longer than a station with doorways directly opposite one another. However, the advantage is a reduction in the required station width. Quito's Ecovía corridor makes use of this technique in order to fit the system into a relatively narrow roadway (Figure 5.39). Thus, an elongated station con-

Fig. 5.38 and 5.39
Comparison of a standard and elongated station configuration.



figuration allows a fairly narrow station with the favoured median station location.

5.3.10 Mixed traffic operation

As perhaps a last option to narrow road space, a BRT system can operate in mixed traffic for certain segments of a corridor. If the corridor is not congested and future congestion can be controlled, or if the political will to restrict mixed traffic access is simply not present, then a temporary mixing of BRT vehicles with traffic may be unavoidable. However, if the link is congested, then this choice will have a detrimental impact on travel times, system control, and the overall system image.

Near the Usme terminal of the Bogotá Trans-Milenio system, the BRT vehicles operate in mixed traffic lanes. This design choice is due to two factors: 1. Limited road space (two lanes in each direction) and limited right of way; and 2. Relatively light mixed traffic levels. Since the Usme terminal area does not see high congestion levels, the BRT system co-exists with the mixed traffic in a way that does little to affect public transport operations. In this case, the mixed traffic operation has a negligible impact on system performance.

By contrast in Beijing, the BRT segment with mixed traffic is near the famous Forbidden City portion of the corridor, and this area incurs both considerable mixed traffic congestion as well as fairly high public transport ridership. The result is a significant negative impact on the travel time performance of the BRT system (Figure 5.40). However, Beijing is currently examining options to widen the roadway in this area and/or create a transit mall prohibiting mixed traffic access. As BRT was a new concept to Beijing, the initial political confidence did not exist to deliver a fully segregated solution at the project's outset.

Mixed traffic operation can also become necessary when a BRT vehicle must traverse around a flyover or other obstacle. The plethora of flyovers in Bangkok will likely make this type of lane crossing necessary within the system design. As the BRT vehicle moves to the centre median, it must temporarily mix with cars descending from the flyover. While this set of circumstances is undesirable from a travel time and system control standpoint, the congestion usually does



not occur at the bottleneck or flyover, but prior to it. Providing public transport vehicles with separated facilities up to the flyover will allow them to jump the queue with little detriment to overall travel time.

Thus, short and selected points of mixed traffic operation can likely be tolerated without undermining the functionality of the entire system. However, longer periods of mixed traffic operation can render the BRT system as indistinguishable from a standard bus system. The impact of such a design is not just on the performance and operational control, but also on the psychological image of the system. The exclusive, priority lane given to a BRT vehicle is the principal physical feature that sets it apart as a higher-quality form of transport. The segregated lane is what allows customers to develop a “mental map” of the system in their minds. Removing this segregation from significant portions of the system greatly diminishes the metro-like nature of BRT and makes it far less attractive to discretionary riders.

5.4 Framework for comparing corridors

“The only relevant test of the validity of a hypothesis is comparison of prediction with experience.”

—Milton Friedman, economist, 1912–2006

The initial step in the corridor selection process has been identifying areas with key origins and destinations. A survey of corridor characteristics in these areas then helps to inform decision

Fig. 5.40
Beijing operates its BRT system along mixed traffic lanes at a crucial segment of the corridor, and thus travel times and system control are negatively affected.

Photo by Karl Fjellstrom

Table 5.1: Factors comparing potential BRT corridors

Factor	Impacts / indicators
Time savings benefit to transit users	<ul style="list-style-type: none"> • Labour productivity • Quality of life
Time savings benefit to mixed traffic vehicles	<ul style="list-style-type: none"> • Labour productivity • Delivery efficiency for goods and services
Fuel savings from transit operations	<ul style="list-style-type: none"> • Fuel expenditures
Fuel savings from mixed traffic vehicles	<ul style="list-style-type: none"> • Fuel expenditures
Air quality improvements (CO, NO _x , PM, SO _x)	<ul style="list-style-type: none"> • Human health • Preservation of built environment • Preservation of natural environment • Labour productivity
Greenhouse gas emission reductions	<ul style="list-style-type: none"> • Global environment
Noise and vibration reductions	<ul style="list-style-type: none"> • Human health • Labour and educational productivity • Built environment
Urban development considerations	<ul style="list-style-type: none"> • Streetscape improvements • Transit-oriented development • Property values, shop sales, etc.
Social considerations	<ul style="list-style-type: none"> • Equity for low-income groups
Planning and infrastructure costs	<ul style="list-style-type: none"> • Planning costs • Infrastructure costs
Political considerations	<ul style="list-style-type: none"> • Time required for political approval • Time required for construction

makers on the feasibility of BRT operations. In the next step, as the potential BRT corridor is identified, project developers may wish to attempt to quantify the relative benefits of each corridor.

This section thus presents a framework for evaluating different corridors. By using such a framework, project developers can roughly rank each corridor in terms of quantitative and qualitative benefits.

Table 5.1 summarises the potential factors comprising a comparative analysis of corridor qualities.

In many instances, it is possible to monetarise the factor. Monetarisation can allow a cost-benefit analysis to be conducted across many different factors. Factors such as “time savings” can be calculated in a fairly straight-forward manner.

By contrast, factors such as street sociability or traffic safety are more difficult or problematic to monetarise. However, qualitative factors can still play a role in the corridor and route

selection process. The Quito Municipality chose the “Seis de diciembre” corridor for its Ecovía line in part because of the presence of a children’s hospital. The contamination from existing fleet of older buses created a serious air quality problem within and around the hospital. The new Ecovía corridor allowed all such vehicles to be displaced from the area, and thus the new system created a healthier environment for the hospital’s patients. If the corridor selection was based on only one parameter, such as time savings, then the value of the children’s health would not have been part of the decision-making process.

Thus, the final disposition of any corridor under consideration will likely be the product of both a quantitative and a subjective analysis. Corridors can be potentially scored by a weighted ranking, with the weighting based on the relative importance a city gives to each factor.

5.4.1 Time savings benefits to public transport passengers

The relative benefits of one corridor over another corridor will be mainly a function of the affected passenger demand on the corridor, and the degree to which the public transport service and the urban conditions are improved. Public transport service improvements result from reducing congestion delays and boarding and alighting delays. Thus, the worse the congestion and the larger the number of existing bus passengers along the corridor, the higher will be the benefit of implementing a BRT system. The economic impacts from these effects are typically calculated through time savings analysis.

To calculate the time savings benefits to public transport customers, then estimations on passenger numbers and vehicle speeds, both before and after the new system, are required. The average vehicle speeds will directly relate to the amount of travel time for a particular journey. Equation 5.1 provides a framework for calculating the passenger time savings.

Equation 5.1 Passenger time savings

$$\text{Total time savings} = P * (T_p - T_f)$$

P = number of passengers

T_p = present travel time

T_f = future travel time

Because benefits will vary quite a lot not only between corridors but within corridors, it is

necessary to add up the benefits on each link in the corridor. These benefits will also likely vary according to the time of day and the day of the week. A calculation of this type is most readily accomplished with the assistance of a traffic model. However, a simple spreadsheet analysis with inputted survey data can also suffice. The more complete time savings formula is given in Equation 5.2.

Equation 5.2 Detailed time savings calculation

$$\text{Total time savings} = \sum_i \sum_h P_{ih} * \Delta H_h * (T_{p_{ih}} - T_{f_{ih}})$$

Where:

i = link

h= period (morning peak, off peak, night, etc.)

P_{ih} =passenger flow on the link (pas/hour)

ΔH_h = duration of period h in hours

T_{p_{ih}} = present travel time on link i period h

T_{f_{ih}} = future travel time on link i period h

P_{ih}*ΔH_h produces the total number of passengers on a particular link during a particular period. This value multiplied by the estimated time savings yields per link produces the total number of hours saved to public transport passengers. This value can then be multiplied by a monetary value of time, or it can be left in the form of hours saved.

The existing transit vehicle speeds and passenger counts should have been collected during the demand analysis work noted in Chapter 4 (*Demand analysis*). Likewise, the boarding and alighting surveys during this analytic phase should have produced values for both peak and non-peak periods.

Future average vehicle speeds and passenger demand will depend on the system’s design. If value for future average vehicle speed is not known, then as a first approach, the off-peak speed for the present transit system may be used as a conservative estimate. Future passenger volumes should be based on a combination of existing passenger volumes in conjunction with the size of any expected mode shifting.

5.4.2 Time savings benefits to general traffic

Corridor selection will have a significant impact on whether a BRT system can improve mixed traffic flow, have no impact on it, or make it much worse. The three most important indicators of the likely impacts are the current traffic mix, the available right of way relative to the existing road, and the possible behavioural and travel changes of motorists once the new public transport system is in place.

5.4.2.1 Current traffic mix

Normally, for a BRT system to be considered an option, there is likely to be significant congestion on at least part of the corridor. As a general rule, the greater the current contribution of public transport vehicles to the current congestion problem, the greater will be the chance that a new BRT system will actually decongest the mixed traffic lanes. If current congestion is caused primarily by private motor vehicles, the risks are high that the new BRT system will not significantly improve the situation, at least in the short run (Figures 5.41 and 5.42).



Fig. 5.41 and 5.42
An exclusive busway on the road left (Dallas) will likely make congestion for mixed traffic worse. An exclusive busway on the road right (Bangladesh) would make mixed traffic less congested.

Left photo by Richard Stouffer (iStockphoto)
 Right photo by Karl Fjellstrom

In developing countries, public transport vehicles frequently have a disproportionate impact on congestion relative to private vehicles. This impact occurs because of higher bus volumes, because the vehicles often stop and go at undesignated bus stops, and because the vehicles sometimes stop two and even three abreast to pick up passengers. Bringing these public transport operators into a new BRT system therefore frequently offers the opportunity to decongest mixed traffic lanes even if a full lane or two becomes exclusively used by buses. In such cases, the new BRT system can easily produce a somewhat counterintuitive result: *Taking away road space and giving a priority lane to public transport can actually give motorists more space and produce less overall congestion.*

The specific congestion impact of the BRT system will depend on which transit vehicles are incorporated into the new BRT system, and which are excluded. The more transit trips that can be incorporated into the BRT system, the less adverse impact the remaining transit trips will have on the mixed traffic lanes.

5.4.2.2 Methodology for estimating impacts on mixed traffic

As a rough estimate, one can calculate the likely impact of a planned exclusive busway on mixed traffic in the following manner. The existing traffic flow at the most congested point of the road (based on traffic counts) should be converted to passenger car units (PCUs) for each available road lane. If the road lanes are not delineated, then this PCU conversion should be done for every 3 metres of road width.

Normally, lanes with a width of 3.0 to 3.5 metres can handle approximately 2,000 PCUs per hour. The more the PCUs over 2,000 per lane, the more congested the road will become.

This level of existing congestion should then be compared to the scenario with the BRT system in place. Some of the current public transport vehicles will be relocated onto the new BRT system, and others will remain in the mixed traffic lanes. All the vehicles that will not be incorporated into the BRT system, including the buses not incorporated into the system, then need to be converted into PCUs, and allocated to the remaining number of lanes (or 3 metre road widths). Table 5.2 provides an example of this type of analysis.

If the PCUs of the BRT scenario are higher than the PCUs of the pre-BRT scenario, then the new BRT system will tend to increase congestion of the mixed traffic lanes. If it is lower, it will lead to lower congestion levels. Because the PCUs of buses are generally double that of private cars and taxis, and eight times as high as motorcycles, the more buses in the existing traffic stream that are relocated to the new BRT system, the greater will be the degree to which the remaining mixed traffic lanes are decongested. A more detailed and accurate calculation of traffic congestion impacts can be obtained through a traffic software model.

Once the level of traffic is estimated for both the baseline case and the BRT case, then the amount of time savings for occupants of mixed traffic lanes can be calculated. Box 5.1 provides an overview of the time savings calculation.

5.4.3 Implementation costs

In general, the more complicated the physical aspects of a corridor, the more costly the planning and construction will be. Any of the following infrastructure components along a proposed corridor can cause costs to escalate:

- Road widening;
- Use of median;
- Relocation of utilities;
- Underpass or tunnel;
- Flyover, overpass, or elevated segment;
- Bridges;
- Large roundabouts.

Road widening can be particularly costly, especially when any property acquisition is factored into the equation.

At the same time, the necessity of these types of infrastructure components should not

Table 5.2: PCU calculation for BRT scenario

Vehicle type	Traffic volume	Average passengers per vehicle	Total passengers	PCU equivalent	PCU total
Cars	1,200	2.5	3,000	1.00	1,200
Taxis	500	1.2	600	1.00	500
Motorcycles	170	48.0	8,160	2.00	340
Remaining buses	300	1.5	450	0.25	75
Total	2,170	–	12,210	–	2,115

Box 5.1: Calculating time savings for vehicle occupants in general traffic

On some critical sections (i) present general traffic volume on peak periods (j), will exceed the road’s capacity, by certain amount: DSij. The total general traffic prejudice on that point “i” is then estimated by equation 5.3.

Equation 5.3 Time savings for general traffic

$$TGC_j = \sum_i (\Delta S_j * T_{cong_{ij}}^2 / 2 * K_i) * n_{p_i}$$

i = point of evaluation where one of the following effects takes place:

1. The point is the bottle neck of the corridor
2. The point is not the bottle neck, but future capacity (after BRT) will fall below present peak volume

j = some specific peak hour. There are normally two peak periods, a morning peak and an evening peak. A velocity survey for cars will more accurately identify the peak periods.

TGCj = Total time savings for general traffic

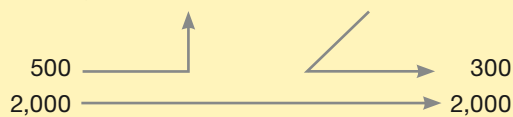
ΔS_j = the amount of change on capacity to the new scheme. This value will be negative value if there is a reduction in capacity; this value will be positive if there is an increase in capacity.

$T_{cong_{ij}}$ = duration of the congestion period being considered. The peak period can be better estimated by traffic velocity surveys that show when travel times increase more drastically. Usual values are around 0.5 to 3 hours.

K_i = reflects a group of factors derived form network analysis and demand elasticity.

It should be noted that reductions of capacity on two successive nearby points are not independent. However, usually the more congested point should be considered the important one.

Example:



If for example on this case of two connected points A and B, B has a greater capacity reduction than A, then we should consider that:

$K_B = 1$ and

$K_A = 500 / (500 + 2000) = 0.2$ because the 2000 will in each way be congested on point B.

n_{p_i} = average number of passenger per pcu.

automatically negate a corridor option. As Quito has demonstrated, in some cases, underpasses and complicated roundabouts can be handled without extravagant costs. If a corridor is of significant importance to providing a complete set of origins and destinations, then it can be worth a bit of engineering effort in finding a cost-effective solution to infrastructure challenges. However, corridors with highly complex physical challenges, even if vital to the overall transit network, may not be the best choice for a project’s first phase. Development and construction teams will undergo a learning process from one phase to the next. A physically easier initial corridor may hone the technical capacity needed to take on more challenging corridors.

By contrast, simply converting a mixed traffic lane to a BRT runway without any of these complications can reduce both planning and infrastructure costs. Corridors with a concrete base instead of asphalt may particularly make BRT implementation a less costly endeavour. However, corridors should not be selected principally based upon ease of construction. In many cases, such “easy” corridors do not host significant demand. The proposed Kaset Narawin BRT corridor in Bangkok was selected expressly because it has no congestion issues. Officials felt that the BRT system would thus have no negative impacts on mixed traffic in this corridor. Unfortunately, there is also extremely limited public transport demand in

the corridor as well. The corridor will eventually connect with residential areas, but through the Kaset Narawin portion there will be relatively little customer value.

Likewise, several Chinese cities are contemplating placing BRT runways along ring roads. Again, much of the reasoning is related to the existing right-of-way space and the relative ease of construction. However, customer access to a ring road station (both in terms of horizontal and vertical distances travelled) can be difficult. Building these “easy” infrastructure projects may eventually undermine the BRT concept. A BRT system with few customers may seem to operate quite smoothly, but it will not be cost effective and unlikely to move public opinion to support future expansion.

5.4.4 Political considerations

While this chapter has stressed the need for a rational decision-making process, it is recognised that corridor and route decisions are frequently based on far more subjective rationale with sometimes little analytical consideration. Some past decision-making rationale have included:

- “On this corridor we will have a metro one day... so we should choose another.”
- “The President or another important official lives on this corridor... so we should avoid... or we should build here.”
- “This corridor may not have much demand but it has a lot of space... so we will build it here.”
- “Connecting these locations will be an important symbol of integration.”

Such capricious decision-making not grounded in analysis of actual travel demand can result in costly mistakes that do little to support a quality service for the customer (*e.g.*, Lima’s Tren Eléctrico). At the same time, it is recognised that political considerations can be quite appropriate in augmenting technical data. In fact, democratically elected officials have a responsibility to utilise their judgements in making determinations between different sets of costs and benefits. Some of the key instances requiring political inputs include:

- Preference to place initial corridors in a high visibility location in order to promote the BRT concept more widely;

- Preference to locate corridors initially in low-income communities in order to promote greater social equity;
- Avoidance of corridors that may conflict with other infrastructure plans or with other governmental entities;
- Avoidance of corridors requiring extensive re-organisation of many existing formal and informal public transport operators.

A purely technical analysis of the corridor attributes can miss some of the more subtle political considerations that may greatly affect the project’s viability.

However, the existence of competing infrastructure plans or a complex operator environment does not mean a corridor should not be considered at all. There may be solutions to these difficulties or there may still be much reason to consider such corridors for a later project phase.

Frequently, the most difficult problem is that the corridors with the highest existing public transport volumes have already been included in a master plan for a future metro project. Decision makers are reluctant to plan a BRT on a future metro corridor in the fear of foreclosing the possibility of future national government funds for a metro. In such cases, it is usually best to first propose putting BRT in the corridor as a temporary measure, to be upgraded to metro or light rail at some unspecified future date. This rationale was utilised successfully with TransJakarta Corridor I as well as in Kunming and Curitiba. The low infrastructure costs of a BRT system can make it a fairly effective transitional technology to a future rail system. Further, the BRT infrastructure can actually help physically prepare the area for the future rail corridor. For example, an LRT system will require a right of way similar to that of a BRT system. Likewise, an elevated rail system will require median space for support columns.

In other cases, the political environment may simply not permit BRT consideration in a future metro corridor, even if the metro line is unlikely to be realised in any foreseeable time horizon. The next best solution is to select a corridor that will complement the planned metro system. The BRT systems under consideration in Guangzhou (China), Ahmedabad (India), and Delhi, and some BRT lines in São Paulo, have

been intentionally planned outside of potential future metro corridors. However, these BRT systems have been expressly designed to provide complementary integration with the planned rail systems.

Political inputs can be particularly appropriate when cultural or social issues are at stake. In Hyderabad, the presence of a Muslim graveyard on both sides of the road creates an unfortunate bottleneck on the main highway bisecting the city from the northwest to the southeast. An engineering solution may call for expropriating parts of the graveyard for road widening. However, for a Hindu-dominated government to relocate this graveyard would likely be both politically and socially dangerous. Thus, a reasoned political judgement may be needed to curtail any discussion of road widening.

In Jakarta, the initially planned routing of the Second BRT corridor would lead it directly through the Senen Bus Station. However, this design would have required the removal of several hundred street vendors who are illegally occupying public space but are nonetheless organised into a sort of mafia. Several policemen were killed trying to relocate the vendors, and the decision was made to select a sub-optimal route. This political obstacle will cost the new BRT system approximately 25,000 passengers a day. The Senen station example is not unique as many developing-nation arterials are illegally encroached upon by both the rich and politically connected, as well as the poor and desperate. Political negotiation to reclaim these areas for the BRT system can often add significant delays and increase the risk of turmoil.

It may also be advisable in Phase I not to disrupt too many existing public transport routes that are not going to be incorporated into the new system. Negotiations with existing transit operators are a delicate part of BRT planning, and it is generally advisable not to take on the entire private sector transit industry all at once. Corridors with a large number of existing separate bus operators will make the negotiations for reforming the system a lot more complex than corridors where there are only a small number of operators. This consideration was a determining factor with the Insurgentes corridor in Mexico City, and is also a factor in the planning of the Dar es Salaam system.

5.4.5 Social considerations

Social considerations may be a leading determinant in corridor decision making. Public transport systems perform many key social functions in a city and have often played a central role in regeneration efforts. Political leaders and project developers may thus seek to target areas that would most benefit from a public transport investment.

Focussing an initial phase upon a low-income community can produce several economic and social equity benefits. The new public transport system will connect these residents to jobs and public services in the city's central areas. The system itself will also likely produce both direct and indirect employment opportunities for the community. Recent studies from Bogotá indicate that the significant reductions in travel costs resulting from TransMilenio have greatly expanded the potential job market for lower income residents, increasing employment and wages among lower income groups.

A new public transport system can also do much to attract investment into lower income areas. Additionally, the presence of the system can instil a sense of pride and community into areas that previously felt abandoned and ignored. For these reasons, Bogotá purposefully located its initial BRT corridor in between the central area and the lower-income south of the city.

Access to BRT can also increase land values, which can be a double edge sword for the poor. Recent studies indicate that TransMilenio led to significant increases in property values in areas served by a TransMilenio feeder bus. For poor families without land title, the benefits of lower transportation costs may be lost to higher rents. It is therefore a good idea to prioritise efforts to give poor families land title in planned BRT corridors so that the resulting property value increases can be captured by the families instead of by land speculators.

At the same time, there are also social and environmental reasons for including middle- and upper-income communities within a project's early phases. While Bogotá did target the lower-income south of the city, the Mayor also intentionally included a corridor extension into the more affluent north of the city. The wealthier areas of a city are obviously the locations of higher vehicle ownership. Thus, from

Fig. 5.43
Bogotá's TransMilenio system has successfully attracted users from a wide spectrum of the society.

Photo by Lloyd Wright



the standpoint of shifting car users to public transport, there is greater emission and congestion reduction potential in targeting car-owning households. Further, Mayor Enrique Peñalosa of Bogotá also saw significant social benefits from encouraging greater interactions between economic classes. Peñalosa has noted that: “A public transport system may be the only place that the rich and the poor interact with one another.” In terms of propagating understanding and awareness between social groups, a high-quality public transport system can thus be a potential social unifier within a city (Figure 5.43). Having the new system also serve higher income groups also helps to encourage political buy-in to the system by influential families.

Social and equity issues may also be central to loan pre-requisites from major international financing organisations. Most development institutions, such as the World Bank, justify investments in terms of poverty alleviation. Thus, ensuring that a reasonable number of BRT passengers are below median income is important to linking the system to broader goals of poverty alleviation.

5.4.6 Multi-criteria analysis for corridor selection

As noted throughout this section, the final selection of a corridor will ultimately be made by a political decision-maker, who will likely

incorporate political and social considerations into the decision. Nevertheless, an analytic framework can contribute much to this process. A cost-benefit analysis incorporating the benefits from time savings, fuel savings, and environmental improvements can do much to help shape the eventual decision. Quantifying these benefits will also improve the project's attractiveness to many financial institutions.

As the name implies, a cost-benefit analysis calculates the ratio of a project's benefits to its costs. The larger this ratio, the more attractive a project is likely to be to decision makers and financing organisations. Equation 5.4 provides the framework for calculating the cost-benefit ratio.

Equation 5.4 Cost-benefit ration

$$BC = (B_{tp} + B_{tm} + B_{fp} + B_{fm} + B_e) / C_i$$

With,

- BC** = Total benefit cost ratio
- B_{tp}** = Time savings for transit passengers
- B_{tm}** = Time savings to occupants in mixed-traffic vehicles
- B_{fp}** = Fuel savings to transit vehicles
- B_{fm}** = Fuel savings to mixed-traffic vehicles
- B_e** = Environmental benefits
- C_i** = Implementation cost.

Box 5.2 provides an example of a multi-criteria analysis using two of the factors presented in this section.

Box 5.2: Calculating the benefit to cost ratio

As a simplified example of this calculation, the table below presents a hypothetical example of time savings benefits for BRT vehicles and mixed-traffic vehicles. The “weighting” factor indicates how much consideration is given to each stakeholder group (transit users and car users). In this first case, each group is given an equal weighting.

Table Time-savings benefits, Scenario 1

Corridor	Time-savings benefits			Cost	Benefits to cost ratio
	BRT	Cars	Total		
Weighting	1	1			
A	50	-6	44	10	4.4
B	2	0	2	5	0.4

In the above scenario, corridor A attracts a high-volume of ridership. The benefits awarded to transit users in this case will greatly exceed the costs to car users. Corridor B is a low-ridership area but with little congestion and therefore no time impact on car users. In this case, the time benefit to transit users is quite small. From these two options, the benefit to cost ratio for corridor A is 11 times greater than the same ratio for corridor B. Thus, from a time savings perspective, corridor A would be the chosen corridor.

If political officials were concerned about reactions from car owners, then the weighting for this group might be increased to five. However, as the table below indicates, even this amount of prioritisation to car interests would not change the overall result.

Table Time-savings benefits, Scenario 2

Corridor	Time-savings benefits			Cost	Benefits to cost ratio
	BRT	Cars	Total		
Weighting	1	5			
A	50	-6	20	10	2.0
B	2	0	2	5	0.4

However, if officials were particularly worried about car owner reactions and therefore gave a priority weighting of 10 to private vehicles, then the result would change.

Table Time-savings benefits, Scenario 3

Corridor	Time-savings benefits			Cost	Benefits to cost ratio
	BRT	Cars	Total		
Weighting	1	10			
A	50	-6	-10	10	-1.0
B	2	0	2	5	0.4

In this scenario, corridor A would be a less desirable choice than corridor B. However, with the low benefit ratio for transit users, corridor B would risk doing little to promote the future prospects of BRT development in the city.

An expanded benefits table could be constructed to also factor in impacts from fuel savings and environmental improvements.

5.5 Corridor length

“Time is the longest distance between two places.”

—Tennessee Williams, dramatist, 1911–1983

Once the principal corridors have been selected, the question arises over the optimum length of the corridors. In general, passenger demand will tend to fall as the distance from the city centre destinations increases. At a certain point, the demand will become insufficient to maintain profitable operations and the justification for infrastructure investment in an exclusive busway may become more difficult. Additionally, beyond a certain point, other services, such as feeder services, may become more economically practicable. Finally, farther out it is likely that congestion will be less severe, making segregated lanes less necessary. Thus, the corridor service may continue but beyond this point the service will operate in mixed traffic and not with the benefit of an exclusive busway.

In systems utilising feeder services, the decision on where to terminate the exclusive busway (*i.e.*, trunk corridor) may depend in part on the availability of land for a terminal site (Figure 5.44). A terminal is required to facilitate the transfers between feeder and trunk line operations. Additionally, depots for vehicle parking and maintenance are normally located near the terminal site in order to facilitate rapid and cost-effective entry of the vehicles into service. Given the relatively large amount of land required for terminal and depot sites, property

acquisition costs will likely be a major part of the decision on where to locate the sites. Social considerations may also play a role in the length of a corridor. If low-income communities at the city’s periphery are to be targeted for service for social equity reasons, then the corridor may be extended to cater to these groups. Thus, while passenger demand will be a principal determinant, other factors such as terminal and depot siting as well as social considerations, will also play a part in determining the length of a busway corridor.

The starting point, though, for determining the corridor length will likely be a cost-benefit analysis related to passenger demand. Once the optimum corridor length is determined based on passenger demand, then the decision can be adjusted to account for other factors such as terminal and depot siting as well as social equity factors.

The basis for the cost-benefit analysis of corridor length is typically the time savings generated by the exclusive busway. Once the exclusive busway no longer provides a net time savings benefit in comparison to the construction costs, then the point has been reached when the exclusive busway is no longer cost justifiable. As the number of passengers fall with the distance from the city centre, the total time savings benefit is reduced. Further, since congestion levels will also likely fall with distance from the city centre, the travel time advantage of an exclusive busway will likewise fall. Table 5.3 provides an example of



Fig. 5.44
The availability of land for terminal and depot space can be a consideration of the end point for a specific corridor.

Photo courtesy of TransMilenio SA

a cost and benefit results plotted against a corridor’s length.

Of course, this time savings benefit will tend to increase over time as congestion worsens. Since a BRT system is likely to last a long time, it is standard practice to roughly estimate the likely congestion along the corridor in the next ten to twenty years rather than simply assuming that current congestion conditions will prevail long into the future.

In the example given in table 5.3, the corridor would end after segment “H” if the decision was based only on benefit to cost considerations. After segment “H”, the benefit to cost ratio falls below a value of 1.0, meaning that the costs of extending the exclusive busway corridor outweigh the time savings benefits.

5.5.1 Feeder service length

If feeder services are to be employed in the system, then length of these services would likely be based on a similar cost-benefit analysis as well as several other considerations, such as social-equity factors. Since feeder services typically employ smaller vehicles and do not require exclusive busways, the cost of extending the feeder service is principally based on operating costs such as fuel and driver salaries. At a certain distance from the terminal site, a feeder service will cease to be economically viable as the passenger demand drops below a certain value.

However, in many cases, feeder services may be extended into lower-density areas for reasons of

social equity reasons. Some communities may have no other transport services, and the existence of feeder services may be vital for connecting people to employment opportunities and social services such as education and healthcare. In these cases, though, formal feeder services may be just one of many options to connect residents to major transport corridors. As will be discussed in Chapter 13 (*Modal integration*), other options such as bicycles, pedicabs, and taxi services may also be options to consider for linking the system to areas with lower population densities.

5.6 Number of corridors

“There are several paths one can take, but not every path is open to you.”

—Claire Bloom, actress, 1931–

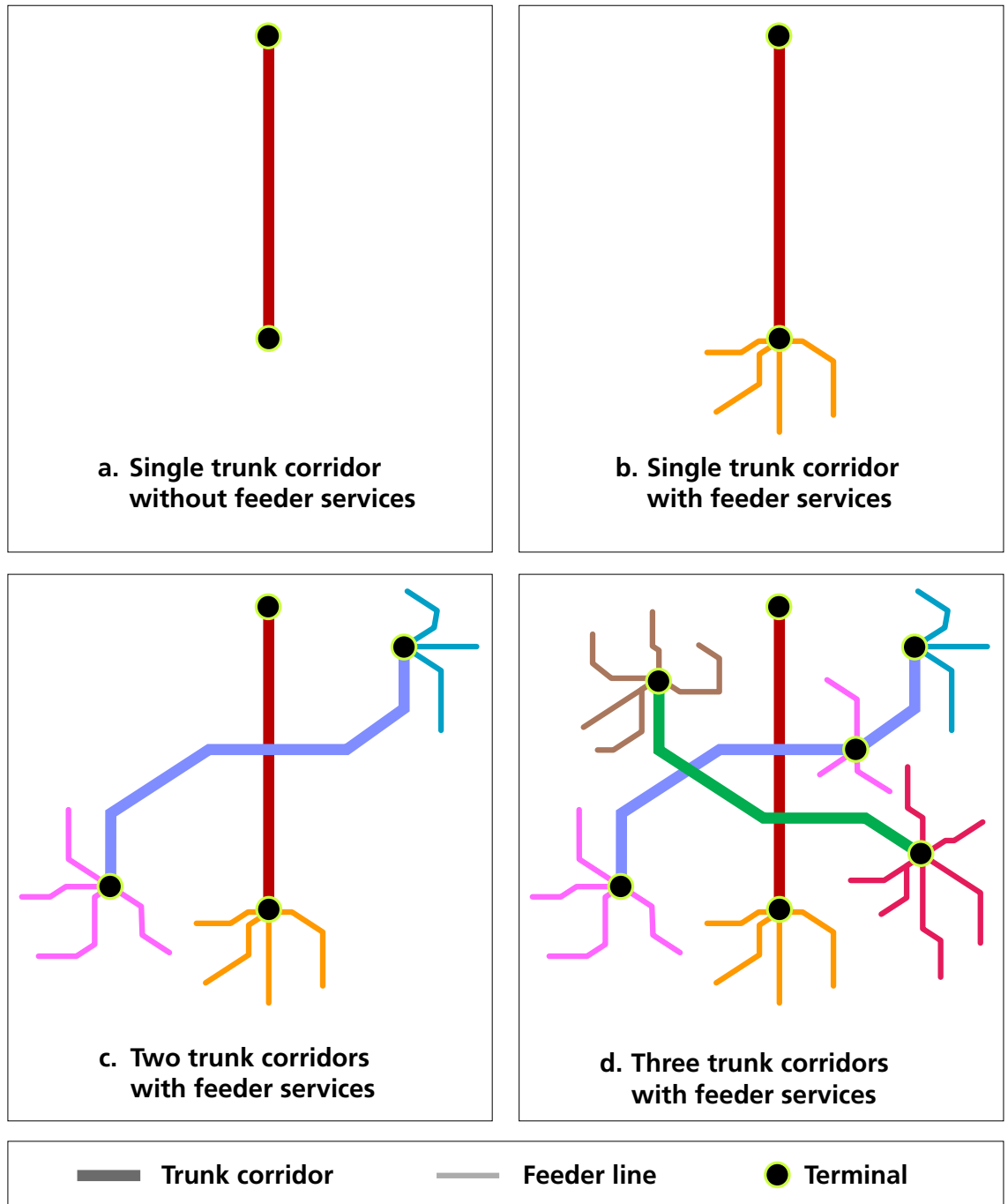
A second corridor in the initial plan does not simply translate into a doubling of the possible destinations. Rather, the math of public transport corridors tends to behave in an exponential manner. The math of transport corridors means that one plus one does not equal two but is instead equal to four. This result is due to the added permutations of trips possible with each leg of the corridor. Figure 5.45 illustrates the progression of increasingly greater destination possibilities that are achieved by adding each new corridor.

Clearly, scenarios (a) and (b) in Figure 5.45 provide the customer with relatively few destination options. In these instances, many customers will continue to use their existing transport

Table 5.3: Benefit-cost analysis of corridor length

Corridor segment	Length of segment (km)	Demand along segment (x 1000)	Time savings (minutes)		Cost		Benefit / km	Benefit / cost ratio (B / C)
			Total	/ km	Total	/ km		
A	3.0	13.0	6.0	2.00	5	1.67	26.00	15.61
B	2.0	12.0	4.0	2.00	4	2.00	24.00	12.00
C	1.5	13.0	5.0	3.33	3	2.00	43.33	21.67
D	3.0	11.0	4.0	1.33	4	1.33	14.67	11.00
E	1.8	9.0	1.2	0.67	2	1.11	6.00	5.40
F	3.1	7.5	2.5	0.81	4	1.29	6.05	4.69
G	2.3	6.0	0.5	0.22	3	1.30	1.30	1.00
H	1.5	4.5	0.6	0.40	2	1.33	1.80	1.35
I	3.1	3.0	1.0	0.32	5	1.61	0.97	0.60
J	1.9	2.2	0.2	0.11	3	1.58	0.23	0.15

Fig. 5.45
The impact of adding more corridors.



options, even if they spend some of their travel time on the new transit system's single corridor. However, scenarios (c) and (d) begin to provide a service that will compete quite well with other modal options. In these scenarios, many customers will be able to fulfil all their travel needs within the new BRT system. If only scenarios (a) or (b) are followed in the project's first phase, then there will be a high degree of risk regarding the system's future.

5.7 Station and lane placement

"The three most important things in real estate are location, location, and location."

The location of the segregated busway within a specific roadway is a design decision that holds more options than might be immediately apparent. The lanes may be placed in the median or along the sides of the road. Additionally, both lane directions could be placed on the same side of the roadway. In some cases, the busway may

be given the entire roadway space, as is the case with transit malls.

5.7.1 Median lanes and stations

The most common option is to locate the busway in the centre median or in the centre two lanes (Figure 5.46). This configuration reduces turning conflicts to the right (in countries that drive on the right-hand side of the street). The median location also permits a central station to serve both busway directions. A single station reduces infrastructure costs in comparison to the construction of separate stations for each direction. The median-based station also allows for easier integration between busway routes, particularly when two routes cross on perpendicular streets. It is far simpler to link two median stations by way of tunnels or bridges than trying to link four stations along the sides of the roadway. In the case of busways along the sides of the roadway or with staggered stations in the busway median, the difficulties in providing pedestrian infrastructure that connects all the possible transfer permutations can be quite difficult (Figure 5.47). An alternative is to provide a full set of route permutations that connects each



Fig. 5.46

A median busway with a single median station has become the standard for high-quality BRT systems.

Photo courtesy of TransMilenio SA

possible routing from each station. However, when attempting to connect all permutations, the route structure becomes unrealistically complicated with just a single set of crossing intersections (Figure 5.48).

As noted earlier, the use of a single median station is far more conducive to ease of transfers.

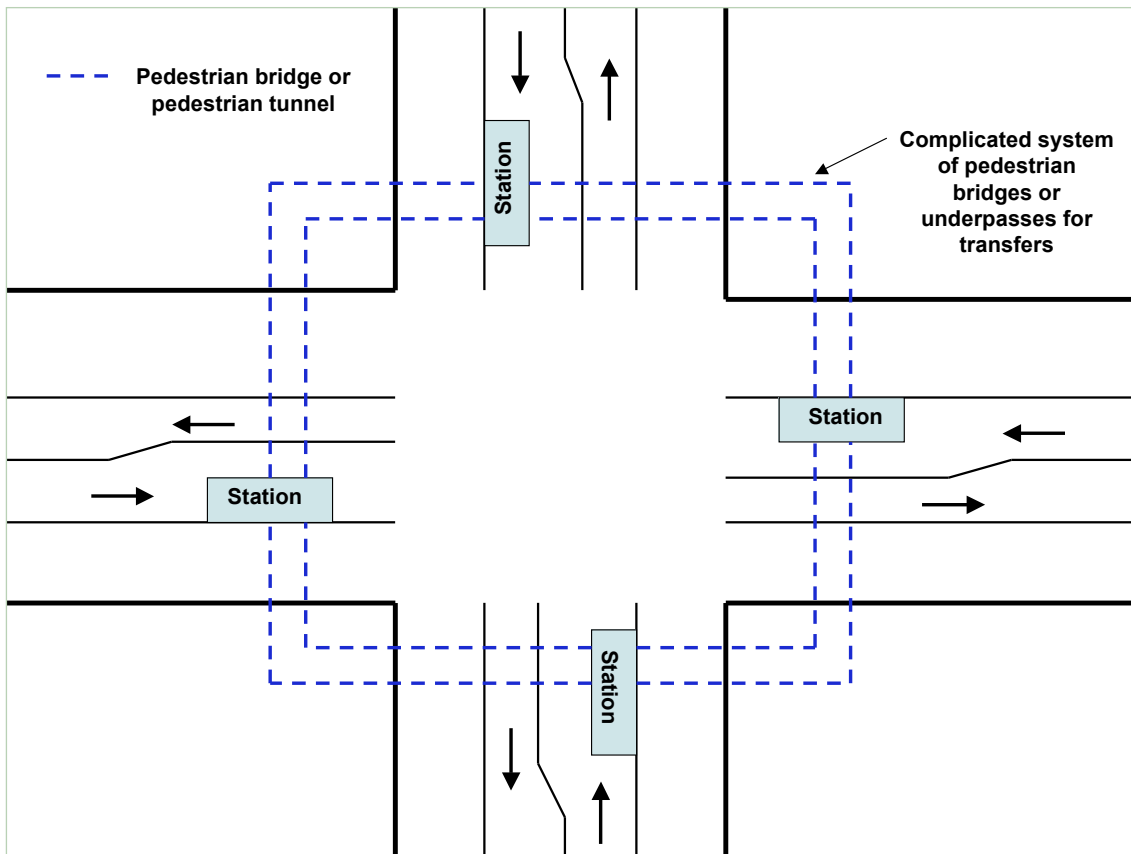


Fig. 5.47

Split stations and side aligned stations make customer transfers quite difficult. An elaborate set of bridges or underpasses would be required to make closed transfers possible in such an arrangement.

Fig. 5.48

An alternative means of connecting split and side-aligned stations is to provide a full set of route permutations.

However, the required number of permutations becomes excessive, even for just a single intersection.

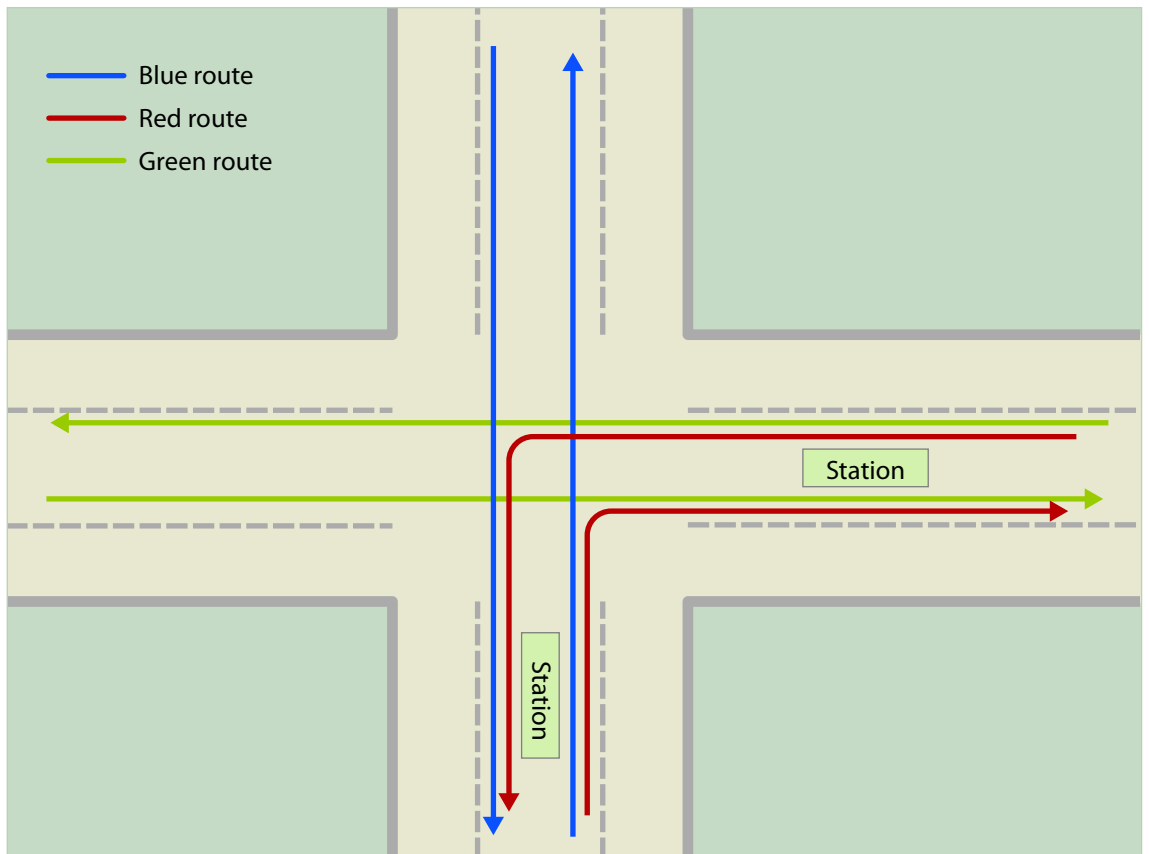
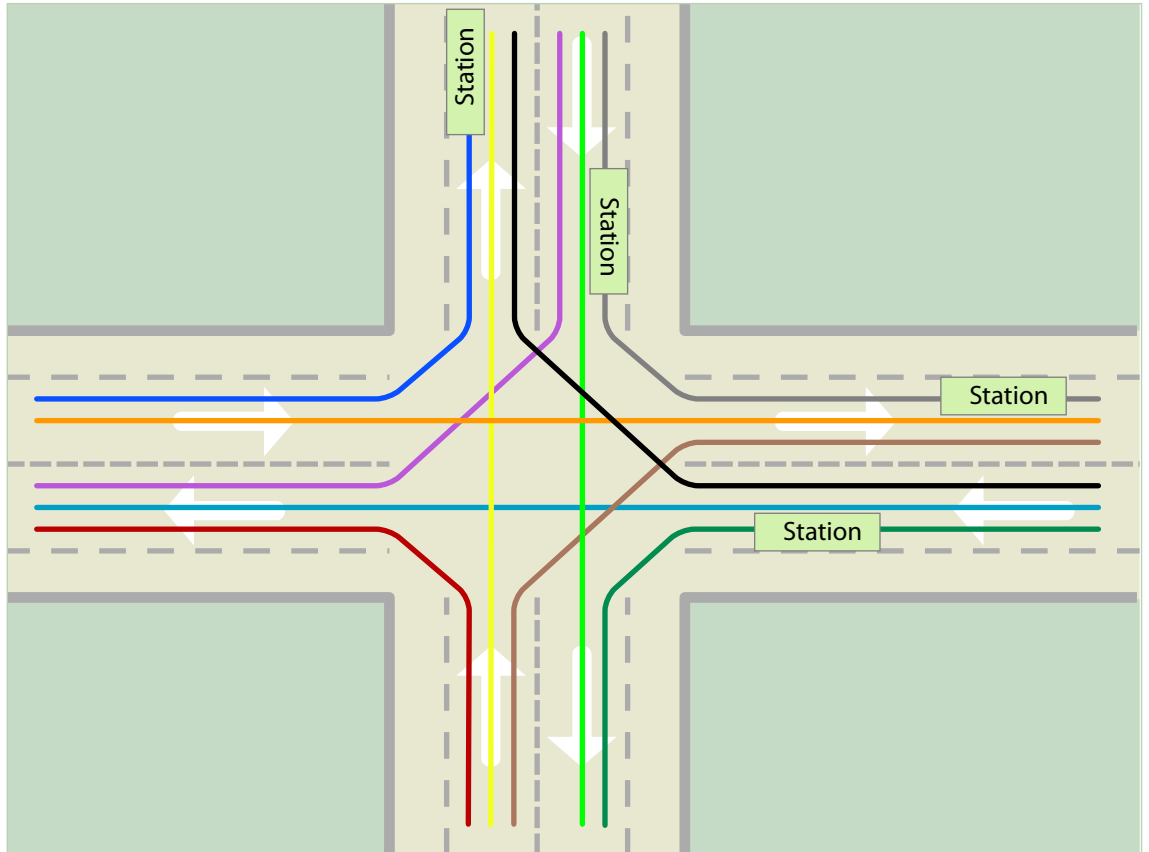


Fig. 5.49

Median stations permit easier platform transfers and multiple route permutations.

A median station permits customers to select multiple routing options from a single station platform. Figure 5.49 provides the same number of possible route permutations as that shown in Figure 5.48. However, the use of a median station greatly simplifies the route combinations.

5.7.2 Curbside stations

While typical to find typical bus lanes at the curbside, it is rare for BRT to place the busway on the sides of the roadway (Figure 5.50). BRT systems generally do not utilise this configuration primarily because of the conflicts with turning traffic, stopping taxis, delivery vehicles, and non-motorized traffic (Figure 5.51). Such conflicts will greatly inhibit the system’s capacity. Achieving capacities over 5,000 passengers per hour per direction is quite difficult if turning vehicles are frequently interfering with busway operations. Curbside busways create the potential for the entire busway to be stopped due to a single taxi picking up a passenger, a policeman temporarily parking, an accident, or a turning



▲ **Fig. 5.50**
Curbside bus lanes are quite common in conventional bus systems, but often fail due to traffic congestion and poor enforcement.

Photo by Lloyd Wright



► **Fig. 5.51**

In this image from Quito, the Trolé BRT vehicle is operating in an “exclusive” curbside lane, but is blocked by merging traffic from a side street. A median busway would largely avoid these types of conflicts.

Photo by Lloyd Wright



vehicle trapped behind high pedestrian crossing volumes. Such a configuration also creates difficulty when trying to allow free-flow transfers between perpendicular lines. To do so, one would have to construct a rather elaborate set of overhead or underground pedestrian passages to keep the system closed off. Alternatively, passengers could be forced to walk across busy intersections and pay a second fare to enter a different corridor.

◀ **Fig. 5.52**
In many respects, the Hangzhou system is a well-designed and modern busway system. However, the choice of curbside stations limits flexibility integrating future routes and corridors.

Photo by Kangming Xu (<http://www.brtchina.org>)

However, customers will clearly not want to pay twice merely to change directions.

For systems with just a single corridor, the curbside stations do not inhibit transfers since there are no other corridors for transfers to take place. However, systems that start with just a single corridor first phase, almost invariably grow to incorporate more parts of the city. Thus, the problems associated with curbside stations can become evident once the additional corridors are constructed and transfers become necessary. Hangzhou has developed an impressive phase I busway system that includes very modern vehicles and stations. However, the choice of curbside stations will likely create future limitations with the system (Figure 5.52).

5.7.3 Busway-only corridors

“Bus-only” or “transit mall” corridors are effective options in giving complete priority to public transport. Such corridor segments are typically employed in central areas where space restrictions limit the ability to share space between both public transport and private vehicles. In such cases, transit malls can greatly contribute to high-quality public space for pedestrians.

Fig. 5.53

An exclusive busway runs under the Mater Hill Hospital in Brisbane.

Photo courtesy of Queensland Transport



Fig. 5.55

In suburban locations, Brisbane is able to fully segregate its busway to the side of an existing roadway.

Photo courtesy of Queensland Transport

Cities such as Bogotá and Quito employ bus-only corridors in selected locations. Likewise, Brisbane, Denver, Ottawa, and Pittsburgh also have developed bus-only corridors (Figures 5.53 and 5.54).

5.7.4 Multiple lanes along corridor side

While side-aligned busways generally fail due to turning conflicts with mixed traffic, placing multiple busway lanes along the side of the roadway can work for certain roadway segments. If a roadway is bordered by green space (e.g., a large park), water (e.g., ocean, bay, lake, or river frontage), or open space, then there may be no turning conflicts for long distances, in which case side alignment may actually be preferable to median alignment.

The Miami busway system places lanes for both busway directions along the same side of the roadway. In Brisbane, busways connecting suburban locations pass along relatively open areas where fully segregated infrastructure alongside the existing roadway is possible (Figure 5.55).

Fig. 5.54

Public transport vehicles are given exclusive use of Denver's 16th Street Mall.

Photo courtesy of NBRTI



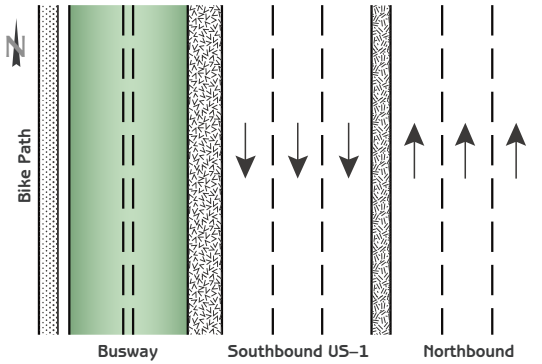


Fig. 5.56
The Miami busway is situated entirely along one side of a major expressway.

Image courtesy of the US FTA

In the case of Miami, non-intersection turning movements for private vehicles are not allowed along the corridor (Figure 5.56). In Orlando (US), the central Lymmo system occupies two of the three downtown lanes (Figure 5.57). Mixed traffic is given only a single one-way lane. In this configuration, access to shops on the BRT side is limited to the hours that the system is not operating. Thus, shops must make vehicle deliveries in the late evening.

5.7.5 “With-flow” and “counter-flow” options

In addition to the different roadway configurations, system designers can opt for either “with flow” or “counter-flow” bus movements. “With flow” means that the vehicles operate in the same direction as the mixed traffic in the adjoining lanes. “Counter flow” means that the vehicles operate in the opposite direction of mixed traffic. “Counter flow” is sometimes used if the doorways on the existing buses require the bus to drive on a certain side. Obviously, it is preferable to derive the vehicle design from the optimum busway design, but this situation is not always possible. “Counter flow” set-ups do have a potentially serious problem with increased pedestrian accidents. Pedestrians can be unaccustomed to looking in the direction of the counter flow lane and thus cross unknowingly into a dangerous situation.

Counter-flow bus lanes are used in various conventional bus systems around the world (Figure 5.58). Often, counter-flow designs are employed to discourage private vehicles from entering the



Fig. 5.57
The Orlando Lymmo system utilises two of the three lanes available in the city’s central district.

Photo by Lloyd Wright



Fig. 5.58
A counter-flow bus lane as utilised in the central business district of Johannesburg.

Photo by Lloyd Wright

Fig. 5.59
Quito briefly employed counter-flow design on its “Ecovia” line since the initial vehicles had doorways on the wrong side.

Photo by Lloyd Wright





Fig. 5.60, 5.61, and 5.62
Curitiba utilises a variety of roadway configurations. Each street's design depends upon the local circumstances.

Left and right photos by Lloyd Wright
 Centre photo courtesy of URBS and the Municipality of Curitiba

bus lane. However, the counter-flow lane may simply result in busway congestion if private vehicles nevertheless decide to enter the area.

Counter-flow systems are generally not employed in BRT systems, particularly due to concerns over pedestrian safety. Quito briefly utilised counter-flow movements for its "Ecovía" corridor since its only available vehicles possessed doorways on the wrong side (Figure 5.59). However, once the new vehicles arrived from the manufacturer, Quito converted the corridor back to "with-flow" movements.

5.7.6 *Mixing different configuration options*

Like many other design decisions associated with BRT, there is no one correct solution to roadway configuration. Much depends upon the local

circumstances. Additionally, it may be possible to use several different configurations in a single system. Curitiba, Brazil uses centre lanes, both lanes on the side, and streets exclusively for BRT (Figures 5.60, 5.61, and 5.62). Curitiba essentially tailors the roadway configuration to the particular situation on the given road segment.

In most cases the only limitation is to keep the doorway on the same side, so that one has the flexibility to use the same buses on multiple lines. However, even this caveat has been circumvented in some cases; Eugene, Porto Alegre and São Paulo utilise buses with doorways on both sides to allow maximum flexibility (Figures 5.63 and 5.64).



Fig. 5.63
São Paulo utilises buses with doorways on both sides of the vehicle in order to service both median and curbside stations.

Photo by Lloyd Wright



Figure 5.64
Vehicles with doorways on both sides permits Eugene to share a single lane for both directions at a station.

Image courtesy of Lane Transit District

6. Communications

“The greatest compliment that was ever paid me was when someone asked me what I thought, and attended to my answer.”

—Henry David Thoreau, author, 1817–1862

Communications play an essential role in planning, implementing and operating a BRT system. Communications also play a role in attracting riders to use the system. Developing a communications plan can be as important as any other critical activity like road engineering, transportation demand modelling, or project financing. A comprehensive communications plan facilitates the interaction between project leaders and the various stakeholders involved in the process, namely, transport providers, passengers, and the general public. The communications plan is a helpful tool for facilitating a revision of entrenched ideas, notions, and perceptions regarding public transport. An advisor to the planning team for the Mexico City Metrobus has emphasised:

“Do not spend any money testing emissions or fuel / drive train combinations and fuel economy; spend everything you can on outreach” (Lee Schipper, 2003).

Overcoming the challenges and problems associated with a BRT system does not simply

involve building new roads, buying new vehicles, restructuring operational methods, or modifying organisational models. Changing the general public’s notions and perceptions about public transportation during the transformation process is fundamental to building project support.

Effective transport planning is not conducted in isolation. In many instances, insights from the public, civic organisations, existing operators, private sector firms, and other governmental entities are more relevant than merely relying upon planning staff and consultants. Systems should be designed around the needs and wants of the customer. All subsequent details with regard to technology and structure can follow from this simple focus upon the customer. As noted previously, bus systems today are often losing mode share because customer concerns about convenience, safety, and comfort are not being addressed. In developing-nation cities, existing transport operators represent another key group that can provide insights into the design process, especially with regard to costs and the final business structure of the system.

This chapter provides some preliminary guidance to help the BRT team develop an effective communications strategy and public participation process. The contents of this chapter include:

- 6.1 Stakeholder analysis
- 6.2 Communications strategy
- 6.3 Public participation processes

6.1 Stakeholder analysis

“Alone we can do so little; together we can do so much.”

—Helen Keller, deaf-blind author and activist, 1880–1968

6.1.1 Stakeholder identification

The first step to developing an effective communications strategy is to identify the key stakeholders. Typically, the most significant barrier to the implementation of a BRT system is neither technical nor financial in nature, but political. While firm political will is necessary to overcome the many political obstacles, a good communications strategy can significantly minimise

political opposition and increase public support for the project, and improve the quality of the final BRT system.

The pre-planning period is the time to begin identifying key groups and organisations that should be included in the planning and development of the system. Specific agencies, departments and political officials will all have varying opinions and interests with regard to developing a new public transport system. Non-governmental and community-based organisations are often important resources to draw upon as well. Organisations that might be included in the stakeholder identification process include:

- Existing transport operators, and operators’ and drivers’ associations (formal and informal);
- Proponents of competing or complimentary rail projects;
- Motorists and their organisations;
- Construction industry and other potential industry supporters;
- Customers (including current public transport users, car owners, non-motorised transport users, students, low-income groups, physically disabled, elderly);
- Municipal public transport departments;
- Municipal environmental departments;
- Municipal health departments;
- Municipal urban development and public works departments;
- Roads agency;
- Economic development agencies;
- Business and merchant associations;
- Resident associations;
- Traffic and transit police;
- Relevant national agencies;
- Public transport experts and consultants;
- Non-governmental organisations;
- Community-based organisations;
- Ward and district councils;
- News media (television, radio, newspapers, etc.).

Public transport stakeholders are often categorised as either Public Targets (users, general population) or Private Targets (service providers, drivers, and employees). Public Targets, also known as Passive Targets, consist of service users/consumers and the general public, while Private Targets, or Active Targets, include agents actively involved in the provision or regulation of transportation services, either in the public or the private sector (Pardo, 2006).

A stakeholder analysis should seek to understand what are the main concerns of each group, their interest in the project, and their ability to influence, either positively or negatively, the development of the project (technically called their “resources” and “mandates”).

The inclusion and active participation of many interested parties is a simple way of avoiding

much of the potential opposition to project development down the road. No one stakeholder group should be allowed to hold the project hostage, or compromise the public interest. On the other hand, participation should also not be conducted in a token manner. If agencies or groups feel that their inputs are not being considered seriously, then again the same counter-productive reactions may occur. More importantly, stakeholder groups can significantly help to improve the quality of the project. Each stakeholder has a unique view on public transport issues and holds the potential to contribute to an improved final product.

6.1.2 Stakeholder positions

In general terms, stakeholders’ positions may be summarised as is shown in the Figure 6.1. A stakeholder can be in the position of fully supporting a project or completely opposed to it. Nevertheless, all these positions must be taken into account in a stakeholder analysis, since the goal of doing this exercise is to know what each stakeholder thinks about a project, and to know what each stakeholder can do to promote it or to stop it. It is also important to note that the stakeholder analysis is a tool for knowing the population, rather than “convincing them” of one aspect or the other of BRT.

Table 6.1 lists the various stakeholders potentially affected (negatively or positively) by a BRT initiative as well as the possible position taken by the stakeholder. Actual positions by these stakeholders will clearly depend upon the local context.

A full analysis will likely include the following elements:

- Stakeholder identification;
- Interests and motivations of stakeholder;
- Likely position to be taken on project;
- Resources and mandates;
- Perceived problems;
- Solutions to perceived problems.

By going through this analytical process, a strategy can be crafted which addresses the concerns of each stakeholder. Table 6.2 outlines a partial stakeholder analysis that was conducted for a public transport project in Palmira.

Fig. 6.1
Spectrum of stakeholder positions

Support

Moderate support

Neutral

Moderate opposition

Opposition

Table 6.1: BRT stakeholders and expected project position

Stakeholder	Possible position
Municipal departments	
Department of Planning	Possibly a supporter of transit priority measures but the reaction will vary by individual predisposition
Department of Transport	Some staff may prefer rail transit while others will see BRT as a good opportunity for bus sector reform
Department of Public Works	Some engineers may have a preference for rail or car-based infrastructure projects, but a busway project could be of interest
Department of Health	Likely to be highly supportive of measures that reduce accident victims and improve air quality
Department of Environment	Likely to be highly supportive of measures that reduce air contamination and noise
Department of Sports and Recreation	Likely to be highly supportive of measures that reduce air contamination
Department of Commerce / Economic Affairs	Concern will be expressed over economic impacts, but likely to be persuadable if given sufficient evidence
Traffic police	Sometimes un-supportive of transit priority projects; may see such projects as creating additional congestion for mixed traffic
Private Sector	
Existing transit operators	Deeply suspicious of any changes from the status quo; will require a concerted information campaign to persuade, can be an important opponent of the system if not properly addressed.
Rail project proponents	May be most serious source of opposition to a BRT project, or may support a BRT project integrated with their network.
Construction industry	Generally highly supportive
Real estate industry	May or may not be supportive
Chamber of Commerce	Likely to be quite persuadable if the right economic case on congestion relief can be made
Car dealerships, petrol stations, car repair shops	Opposed to any initiatives that may contribute to a reduction in vehicle ownership
Insurance industry	Highly supportive of measures that reduce accidents and improve overall health
Retail shops	Concern will be expressed over impacts on sales
Telecommunications, water, and sewer companies	Will be concerned about any possible displacement of their utility lines.
Large industrial and business complexes	Will be supportive if project helps improve employee access and reduces congestion hindering current deliveries
Public services	
Schools and universities	Supportive if improves student access; research staff can help to plan project and document its impacts
Hospitals	Likely to be supportive if potential use of priority lane improves response times by emergency vehicles
Civil Society	
Environmental NGOs	Highly supportive of measures that reduce pollution and noise
Community-based organisations	Highly supportive of measures to improve safety and the aesthetic quality of street
International NGOs and foundations	Highly supportive of cities creating best practice examples with potential for replication elsewhere
User groups	
Car owners	Concerned about loss of road space for private vehicles
Public transport users	Highly supportive of BRT-type improvements
Physically disabled persons	Supportive if appropriate access is provided

Table 6.2: Stakeholder analysis table for public transport project in Palmira

Group	Interests	Resources & mandates	Problems perceived
Passengers	To have a reliable low-cost public transportation system	<ul style="list-style-type: none"> • Willingness to pay for reliable bus transportation 	<ul style="list-style-type: none"> • Poor reliability of bus transportation • Drivers do not drive carefully • Frequent accidents • Frequent passenger injuries • Frequent breakdowns • Drivers are rude
Non-passengers	Reduction of traffic jams	<ul style="list-style-type: none"> • Some willingness to use bus system if reliable 	<ul style="list-style-type: none"> • Frequent traffic jams
Bus Drivers' Union	Better working conditions for bus drivers	<ul style="list-style-type: none"> • Strong influence on bus drivers; membership is 100% • To represent the interests of its members in collective bargaining 	<ul style="list-style-type: none"> • Low salaries • Extended working shifts • Vehicles in poor condition • Streets and roads in poor condition
Public Bus Company	To provide an essential, safe, cost-efficient public service	<ul style="list-style-type: none"> • Fleet of buses • Operating budget, including municipal subsidy • To provide an essential, safe, cost-efficient public service 	<ul style="list-style-type: none"> • Vehicle fleet is old • Buses are poorly maintained • Fares charged cover only 75% of operating costs • Decrease in demand • Many passenger complaints
Public Works Department	Improve roads in Palmira	<ul style="list-style-type: none"> • Annual operating budget allocated by City Council/Mayor • To build and maintain adequate roadways within Palmira city limits (including far-away neighbourhoods) 	<ul style="list-style-type: none"> • Roads are in poor condition • Budget is insufficient • Increasing traffic congestion
Mayor of Palmira	<ul style="list-style-type: none"> • To have a reliable low-cost public transportation system • Decreased congestion 	<ul style="list-style-type: none"> • Commands popular support • Has veto power over City Council decisions • To serve the best interests of the City of Palmira • To serve as chief executive and city manager 	<ul style="list-style-type: none"> • Increasing congestion. • Many citizen complaints about transportation system
Palmira City Council	<ul style="list-style-type: none"> • Decreased congestion • To have a reliable public transportation system 	<ul style="list-style-type: none"> • Approves and has oversight of annual Palmira budget • To serve the interests of the residents of Palmira • To make the final decision regarding all projects presented to be financed by the Palmira budget 	<ul style="list-style-type: none"> • Increasing congestion

Source: <http://www.iadb.org>

6.1.3 Existing public transport owners and staff

"And it should be realised that taking the initiative in introducing a new form... is very difficult and dangerous, and unlikely to succeed. The reason is that all those who profit from the old order will be opposed to the innovator, whereas all those who might benefit from the new order are, at best, tepid supporters of him."

—Niccolo Machiavelli, political philosopher, 1469–1527

6.1.3.1 Public transport owners

Typically, the most difficult negotiations for developing a BRT system will be with the existing transit operators. Change is never easy and

likely will be resisted regardless of the benefits of the intended change.

This set of circumstances is typically true for BRT and existing transit operators. BRT can improve profits and working conditions for existing operators and drivers. However, in many countries, the sector is unaccustomed to any official involvement, oversight, or taxation, and operators often carry a distinct distrust of public agencies. In cities such as Belo Horizonte (Brazil), São Paulo (Brazil), and Quito (Ecuador) proposed formalisation of the transport sector has sparked violence and civil unrest. In Quito, the existing operators blocked the functioning of the new Trolé system. Finally, the military was ordered into the situation in order to restore order (Figures 6.2, 6.3, and 6.4).



Existing transit operators may be quite sceptical of any change, especially when the change may have ramifications on their own profitability and even viability. In many cities the private transit operators have pressured political officials through recall efforts and intense lobbying. However, it should be noted that the threat to existing operators may be more perceived than real. The existing operators can effectively compete to win operational concessions within the proposed BRT system. Fleet operators and owners typically gain through the synergies of network development that produce improved profitability.

Thus, the existing operators can come to view BRT as a positive business opportunity and not as a threat to their future. How this key sector comes to view the concept, though, largely depends on the circumstances and manner in which BRT is introduced to them. The municipality will wish to carefully plan an outreach strategy that will build a relationship of openness and trust with the existing operators. At

least one planning staff member should be dedicated permanently to liaison activities with the existing operators. In some instances, this position may best be filled by a former transit operator or another person who holds personal credibility with the operators.

In many cases, an effective outreach effort with the operators can help dispel unfounded fears. Visits to cities with existing BRT systems can be quite appropriate for private transport operators

Fig.s 6.2, 6.3, and 6.4
Existing operators in Quito violently protested the 1995 opening of the Trolé system. The week of unrest only ended after the intervention of the Ecuadorian military.

Photos courtesy of El Comercio



Fig. 6.5
Victor Raul Martinez, owner of TransMilenio operating company Si99, talks to a delegation from Johannesburg.

Photo courtesy of Lloyd Wright

(Figure 6.5). Many of the fears that the operators may hold about BRT can be successfully dispelled with a first-hand view of a system. Further, private operators are probably most convinced by speaking directly with operators in other cities which have already experienced a conversion from conventional services to BRT. Discussions between different private operators are thus a very effective mechanism to create an atmosphere of support and trust.

That being said, it is critical that the political leader of the BRT project not allow the former transit operators to hold hostage the public interest. Developing the new system will inevitably require difficult and contentious negotiations with transit operators. Allowing the new system to be defined by the narrow interests of the transit operators can significantly compromise good quality public transit service.

6.1.3.2 Drivers, conductors, and other existing staff

“Finding a good bus driver can be as important as finding a good musician.”

—Reba McEntire, singer, 1955–

The transit company owners, though, are not the only persons directly affected by the re-organisation of the sector. Employees, such as drivers, conductors, and mechanics, will all be quite concerned about how the changes will affect their livelihood. Since these workers are

typically from low-income communities, any employment or income impacts will carry with them considerable social equity concerns.

The most common concern of the employees will be any job loss or reduction in wages stemming from a conversion to BRT. Since BRT vehicles typically hold greater customer capacity than existing transit vehicles, drivers and other employees will fear that there will be a significant reduction in employees. A single articulated bus will have a capacity of 160 passengers while a standard minibus or midi-bus may only hold a capacity of 16 to 35 passengers. Thus, a new BRT vehicle may end up replacing anywhere from 5 to 10 existing vehicles. With the spectre of potential job retrenchments, the drivers themselves may take to the streets to protest against the development of a BRT system (Figure 6.6).

However, any negative employment impacts from BRT re-organisation are often offset by



Fig. 6.6
Public transport workers in Cuenca (Ecuador) protest against regulatory changes.

Photo courtesy of El Comercio



other factors and new employment opportunities. Quite often, existing drivers may work very long hours in order to make a marginal income. In many developing-nation cities, a driver will essentially rent the vehicle from an owner for a fixed daily fee. The driver thus has an incentive to work as long as possible in order to recoup this daily investment. As will be seen with the BRT business model later in this Planning Guide, the incentive to work excessive hours is eliminated with BRT. Instead drivers make a fixed salary and work a more rational shift schedule. Thus, instead of a single driver worker a single 16-hour shift, the new system may employ four different drivers to work four 6-hour shifts. Further, the efficiencies gained from BRT operations typically mean that the drivers will gain a higher income even within the reduced working hours. Additionally, the BRT system will bring with it improved work conditions, health care, training, uniforms, and other benefits (Figures 6.7, 6.8, and 6.9).

BRT re-structuring will likely not only bring with it “better” jobs but also “more types” of jobs. There are many types of employment that existing systems may simply not include in their operational make-up. For example, existing services may not include any security staff, or existing drivers may double as fare collection staff. There may be only a minimum of maintenance and administrative staff in an existing operation. With the conversion to BRT, all these unfilled or under-filled positions are fully formalised (Figures 6.10 and 6.11). Thus, the creation of new positions can also do much to mitigate any potential job reductions elsewhere.

For these reasons, many new BRT systems have actually increased and not decreased employ-

ment. Nevertheless, it is not inconceivable that a set of circumstances could arise in which job reductions may occur. Given the sensitivity of transit-sector employment, it is highly recommended that cities foresee these possible circumstances and take strong measures to mitigate employment impacts. If some employment reduction cannot be avoided, at the very least cities should implement remedial actions such as re-training programmes and job placement support.

6.1.4 Rail interests

After transit operators, the next most likely opposition to a BRT project are competing project proponents, frequently proponents of an alternative rail-based technology. Ideally, the selection of an appropriate mass transit technology should follow a rational weighing of alternative costs and benefits of different systems, and the best alternative for each corridor established and grounded in a master plan for an integrated long term mass transit network. In such cases, BRT and rail interests may both be providing critical links in a network, and be mutually supportive.

Fig. 6.7, 6.8, and 6.9
The upgrading to BRT brings with it many workplace benefits to the system’s staff, including locker and shower facilities, lounges, and recreational areas.

Photos by Lloyd Wright

Fig. 6.10 and 6.11
Formalising the public transport system brings with it new employment opportunities that were previously not part of the operations. Security staff (left photo) and maintenance workers (right photo) may be some of the new positions created.

Left photo by Carlos Pardo
 Right photo by Lloyd Wright



In other cases, however, particularly when a middle income city is developing its first mass transit system, there is likely to be competition for the most profitable mass public transport corridors. Well-funded rail project proponents will sometimes disseminate misinformation about BRT which can be highly convincing to decision makers and highly damaging to public support.

Determining how to situate a new BRT project with respect to previously developed rail proposals on high demand corridors is often one of the most difficult political decisions the BRT proponent will need to make. Ultimately, if corridors can be found that will be financially viable and likely to yield political acceptance of BRT with less opposition than other corridors, certainly these corridors might be considered in phase I. Because BRT systems can be built quickly, rapid implementation of a good BRT system is the most important thing.

If a BRT system is being introduced in competition with a rail project in a similar corridor, it is generally a good idea to call on government officials to conduct an open and transparent alternatives analysis, where both project proponents make public the detailed plans. BRT proponents must be ready to provide the public with accurate facts about the potential of their own proposal, but they also must demand full public disclosure of competing proposals, and be ready to challenge the often exaggerated claims of competing proposals. Metro, tram, or monorail proponents might make very public claims that they will require no government subsidies, will attract large numbers of motorists from their cars, and take away no road space from private motorists. BRT proponents must be ready to challenge these claims. Chapter 2 on

transit technology options provides some materials that should give planners some reasonable expectations about the possibilities of competing transit technologies.

6.1.5 Motorists

While lobby groups representing automobile interests can sometimes create powerful political opposition to BRT implementation, their opposition should not be taken for granted. Providing motorists and their organizations with accurate information about the planned BRT project and its projected impact on motorists can sometimes turn a misinformed opposition into a supporter. Motorists are generally not happy about traffic congestion and feel something should be done. Some motorists may be looking for a high quality alternative to driving for at least some trips. Most motorists support mass transit, if only in the hope that it will be used by others. In some cases, BRT will actually improve private motor vehicle travel.

While in the developed world automobile owners may represent a majority of the population, in developing countries, automobile owners may represent less than 15% of the population. The political power of motorists is disproportionate to their numbers, however, because they usually include the wealthiest, most influential socio-political grouping. The degree to which private motorists are organised varies greatly from country to country. Sometimes BRT projects have been implemented with little resistance from motorists, and other times motorists have raised significant concerns, often through the media. Some private motorists will view BRT development as an expropriation of their own transport infrastructure, while others will be

enthusied about the development of a high-quality mass transit alternative.

The idea of prioritising road space to public transport may appear to be counter to the interest of private vehicle owners. However, sometimes separating public transit vehicles from other traffic will improve conditions for private vehicles. Since public transit vehicles stop more frequently, and may represent the majority of vehicles on the road in some countries, the separation of these vehicles from mixed traffic can actually improve flows for all.

The specific impact on mixed traffic will depend on local circumstances. This impact can be predicted in advance. Getting accurate information to the motoring public can prepare motorists with reasonable expectations about the new system. If the system has been designed well, it is likely that there will be minimal adverse impacts to motorists, and sometimes there will actually be positive impacts. If the new system really does create negative impacts for motorists, then project proponents should be ready for this and prepare a campaign to justify the project anyway on equity or environmental grounds (Figure 6.12).

6.1.6 Public transport users

Existing public transport customers are obvious allies in gaining the political will to push a transit improvement project forward. Public transport users are likely to be the single most forceful group with the most to gain from improved services. Unfortunately, in many cases, public transport users are not well-organised into strong lobbying groups. However, when public transport users do join together as a single voice, their influence can be significant. The Bus Riders Union of Los Angeles has been successful in gaining the notice of public transport decision makers (Figure 6.13).

In cities such as Quito, passenger demonstrations have proved to be a counterpoint to the demands of the private operators. Passenger groups may protest against fare increases while private operators request such increases in order to provide a better service. To a certain extent, such tensions can stimulate a healthy debate. However, in other cases, it can lead to political gridlock and violence (Figures 6.14 and 6.15).



6.1.7 Municipal departments

With any new project, deciding which government agency or agencies will be in charge of the project, or if a new agency needs to be created, is likely to be a contentious process. Agencies and their staff that are excluded from the planning and development process may react in ways that will be detrimental to eventual implementation. Some groups may interpret their exclusion as evidence that the new transit project is counter to their interests. Excluded agencies may also feel threatened that their domain of responsibility and influence is being eroded. In such instances, the excluded

Fig. 6.12
Staff of the TransJakarta BRT system disseminate information to motorists about the new system.

Photo courtesy of ITDP

Fig. 6.13
The Bus Riders Union of Los Angeles has proven to be a powerful voice of change in improving public transport conditions.

Photo courtesy of the Bus Riders Union



organisations may oppose and even obstruct the project development process. This is especially relevant since local authorities have many legal and administrative tools to stop the project. If they are properly addressed in future steps of the pre-planning process, they can use these tools to contribute to the project's success.

Most contentious is generally the role of the regulatory body responsible for the existing public transport operators. Often the allocation of route licenses and operating licenses generates both licit and illicit revenues for government officials, and the potential loss of these revenues is frequently a major concern to the regulatory body. If this same agency is given responsibility for the BRT project, it may be that the agency itself is covertly attempting to undermine the project. A powerful mayor, backed by public interest groups, can generally overcome these problems with enough political will.

6.2 Developing a communications strategy

“The greatest problem in communication is the illusion that it has been accomplished.”

—George Bernard Shaw, playwright, 1856–1950

Communications on a BRT project has two components. First, a strategy is needed for communicating with direct stakeholders, or “active targets”, including:

- Public transport operators;
- Other government agencies involved or affected by the project;
- Internal project team.

Secondly, a strategy is needed for communicating with the general public, or “public targets”.

Normally at the very beginning of a project, it is advisable to release general information to both stakeholders and the general public about what BRT is. Since BRT is a relatively new concept, it is quite likely that few of the stakeholders will have a detailed understanding. Information about the successful systems in cities such as Bogotá and Curitiba usually serves this purpose well. Speaking engagements and press briefings from representatives of existing BRT systems are frequently good mechanisms to begin public understanding (Figure 6.16). Inviting key stakeholders and media representatives on study tours of cities with successful BRT systems has also been an effective way to further the education process (Figure 6.17).

A political announcement that a BRT project is underway is an important milestone in a BRT project. Once the political leadership announces that a BRT project will be built, there will immediately be much public interest in the project. Thus, well before this announcement is made, a full communications strategy should be well articulated. The likely reactions of all the major stakeholders should be considered prior to placing the public spotlight on the project.

6.2.1 Setting up the communications team

One of the first full-time employees selected for a project should be a communications director. Communications within the project team will be a principal determinant in the effectiveness and efficiency of the planning process, and communications with outside stakeholders can be determinant in whether the project is approved for full implementation.

Fig. 6.14 and 6.15

Proposed increases in bus fares in Quito lead to violent protests.

Left photo by Alfredo Lagla
Right photo by Diego Pallero
Photos courtesy of El Comercio





Fig. 6.16
Former Bogotá Mayor Peñalosa discussing the political advantages of TransMilenio with Jakarta Vice Governor Budihardjo, 2001.

Photo courtesy of ITDP

Given the different levels of communications, several spokespersons could be appropriate, especially when differentiating between internal and external communications. As a high-profile public project, the main political leader (whether it is the Mayor or Governor) will have a significant stake in the project's progress and outcome (Figure 6.18). Thus, the political leader may designate a specific spokesperson to handle the critical lines of communications, especially with regards to the news media. This spokesperson will be empowered to answer questions on behalf of the political leader with regard to the project. The political leader and their appointed representative are generally responsible for ongoing communications with the project steering committee as well as mayor stakeholder groups such as the news media.

The project spokesperson may be a communications expert or it may be one of the departmental directors overseeing the planning. The chosen person should have a strong command of the project details as well as a high degree of verbal communications skills. The official spokesperson or spokespersons for the project will be the public face of the project, necessitating public statements before television, radio, and other media outlets.



Fig. 6.17
TransMilenio staff explaining the system to Jakarta Governor Sutiyoso, 2003.

If a project spokesperson is not clearly named by the political leaders, then multiple persons related to the project may be placed in positions to provide information to the public and other stakeholders. However, without a carefully scripted set of replies to media and public inquiries, then the communications message can be inconsistent, and worse, sometimes incorrect. Ultimately, this lack of a communications strategy leads to confusion amongst the stakeholders and reduces public confidence in the project.

Internal communications amongst the project team and the project steering committee also need to be carefully managed. If communications are infrequently provided, then steering



Fig. 6.18
As suggested by the amount of news media attention given to the project, the Jakarta BRT initiative had significant political ramifications for Governor Sutiyoso.

Image courtesy of ITDP

committee members will feel disenfranchised from the project. In such cases, obtaining project approvals to proceed at specific milestone points will be more difficult. Providing regular project updates to all, either through verbal or electronic mediums, helps to ensure everyone remains involved and informed.

For some critical stakeholder groups, such as existing public transport operators, the project team may designate a person to specifically handle those communications on a full-time basis. This sector-specific spokesperson will likely remain in close contact with the political leader to ensure the direction of the stakeholder relationship remains consistent with official policy.

The information campaign targeted at the general public is generally best led by competent public relations professionals. In a large municipality, a press office may also play a role in this process. However, given the importance of a new public transport system to a city, procuring a professional public relations team with an outside perspective is usually the recommended course. Some of the activities to be undertaken by the public relations team will include:

- Preparation of press materials;
- Organizing press conferences;
- Development of a media strategy.

Social scientists may also be part of the public relations team, especially when there are sensitive issues that have been shown in the stakeholder analysis (for example, the concern for job loss from existent operators).

In the case of TransMilenio, the Director of the TransMilenio Project was a direct appointee of the Mayor, and was empowered to speak on all matters related to TransMilenio on the occasions when the Mayor himself was unavailable. He was assisted by project staff, and also by time and effort donated by a large bank for a public relations campaign. This individual summarised his communications activities with:

“As Director of the TransMilenio Project, I dedicated a great deal of my time to discussing the new transportation system and explaining its benefits to political, business, and religious leaders as well as other associations and interest groups. I attended a number of round

table discussions, panels, and conferences. I was also interviewed by different media, prepared official press statements, and attended several debates and forums in order to discuss the issues” (de Guzmán, 2005).

In the case of TransJakarta, no official spokesperson was designated, and the public received conflicting information from the Department of Transportation and the head of the TransJakarta Task Force. However, prior to the system launch, the Governor did hire a consulting firm to organise press events and also to design and disseminate television and radio advertising. NGOs also played a key role in TransJakarta in both disseminating information about the project, as well as criticising mistakes being made by the planning team.

In the case of Delhi, a professional public relations firm was contracted out by the project team headed by the Indian Institute of Technology.

In the case of Dar es Salaam, the project management unit had a project director responsible for managing the project as well as a project coordinator, who was responsible for communicating with all the key stakeholders. The ultimate spokesperson for the project, however, was initially the Mayor.

A budget for publicity and advertising should be assigned, and every other resource available should be used to increase marketing opportunities.

6.2.2 Promotional materials

Promoting the new BRT system with both private interests and the general public generally requires the development of some fairly standard promotional materials. While this material should be crafted to particular political needs, certain materials are fairly standard:

- Branding and logo;
- Images of the new system;
- Three dimensional models;
- Route map;
- Simulation videos.

The system branding, logo, and slogan should be crafted with great care and marketing insight by a professional marketing firm. Chapter 18 of this Planning Guide provides more detail on the development of a full marketing package.



Fig. 6.19
This rendering of a proposed BRT station in Las Vegas helps to convey a positive and modern image to the public and helps relate the new system to the local community.

Image courtesy of the City of Las Vegas

Because the general public will likely have relatively little knowledge of BRT, a package of visual materials may be an effective mechanism for introducing the concept. *Visual renderings* of the new system are a standard part of any public relations campaign. The better the quality of the rendering, the more useful it is for public relations. Some excellent renderings of the planned Las Vegas BRT stations show how the system will incorporate traditional neon signs evoking the glamour of Las Vegas connect the planned system with a sense of municipal pride (Figure 6.16). Showing people how their city can be transformed by the new BRT system can generate lots of enthusiasm and a strong desire on the part of the public to see the project implemented.

With the advent of affordable and user-friendly software, such visual renderings can be accomplished fairly quickly at a modest cost. In most cases, the special enclosed stations with pre-board fare collection as well as the modern vehicles make BRT a visually appealing option, especially to developing-nation residents accustomed to sub-standard bus services. Thus, sophisticated renderings of the system can do much to stimulate public enthusiasm for the project.

Three dimensional models can also be quite effective ways of explaining to both the public and to stakeholders how the BRT system is likely to work, and giving them a sense of what it might look like (Figure 6.20).

The future route map is a fundamental part of the BRT public relations campaign. The route map creates a sense among stakeholders that the new system is indeed likely to be implemented (Figures 6.21). Getting a mayor or a governor to publish a future proposed route map for a BRT system, particularly a route map that has a similar appearance to a metro map, will be a

Fig. 6.20
Three-dimensional model of the new Dar es Salaam BRT system.

Photo courtesy of ITDP



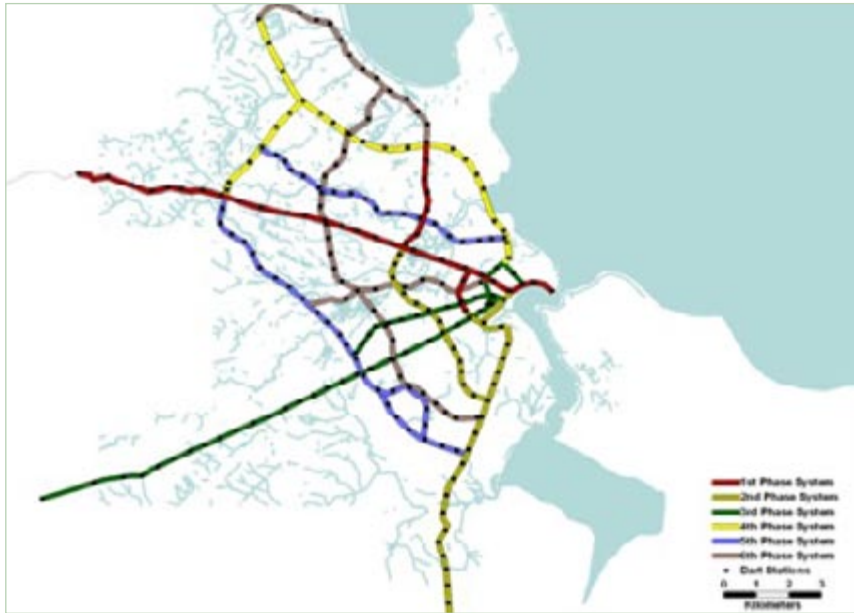


Fig. 6.21
First full future corridor map for the DART system, Dar es Salaam.
 Courtesy of Logit Engenharia

signal of political seriousness, and create a sense of project inevitability which will be critical to winning over the general public. The route map shows commuters how they will benefit from the new system. For this reason, it is important to not only indicate the Phase I routes but also the likely routing for the entire completed network.

Finally, it is increasingly viable to economically produce a simulation video about the problems with the current transportation system and the proposed future BRT system. TransMilenio of Bogotá made a series of short videos about the future BRT system that aired on national television. Such videos often discuss the current conditions faced by public transport users and provide a visual portrayal of the future system. A successful technique is to trace the movements of customers as they make their way through the system. A successful video will allow the public to gain a sense of what it would feel like to ride on the new BRT system.

6.2.3 Communications strategy for active targets

“Active targets” or “private targets” refer to those stakeholders with direct financial interest or direct planning involvement in the project. These stakeholders will likely have an intimate engagement with the entire planning process. Frequent and detailed communications with these groups will be essential to avoid creating opposition and delays to the project. As a

minimum within any BRT initiative, tailored communications strategies should be devised for three critical active targets:

1. Existing public transport service providers;
2. Local authorities; and the
3. Internal project team.

6.2.3.1 Existing transportation service providers

The communications strategy with key private stakeholders serves two crucial functions. First, targeted messages to these groups can help dispel concerns and preoccupations that could evolve into resistance to the project. Thus, these communications can help pre-empt potential future obstacles to implementation. Second, communications with these groups can lead to better design and execution based on their own observations and recommendations.

In the process of transforming a city’s public transportation system, existing transport service providers are key agents. Although they may become obstacles to the transformation process, they can also represent an important group of supporters if handled properly. The operators stand a very good chance of realising a significant improvement in their long term profitability from the new system. Being able to communicate effectively with all the people involved in their operation (business leaders, bus owners, bus drivers, and administrative personnel) is essential. These operators also possess critical system information, and securing their support will make the planning process much easier. Addressing their concerns is also crucial to the viability of the system in the long term (Figure 6.22).

The communications team should strive to get existing service providers involved in the transformation process in order to minimise their opposition to change. Transportation service providers are not usually organised as a homogeneous coalition. In fact, there are several agents with several distinct interests within the transportation industry. It is necessary to investigate and analyse the interests of each identified agent, their concerns and resources. For instance, the driver’s interests are different from those of a bus owner, while the latter also differ from the interests of executive managers or administrators of transport companies. Moreover, when

one encounters unions or coalitions, the interest group’s leader may have different interests than the group’s individual members.

Just as engineers carry out technical designs and economists plan financial strategies, a team of specialists in strategic analysis, communications, and negotiation processes must lead all discussions with existing transport service providers. In Bogotá’s case, a team of eight people was assembled featuring economists, lawyers, psychologists, sociologists, and negotiation experts. This team was in charge of handling discussions with existing transport service providers during a period of two years.

The team members’ first task should be to learn everything there is to know about a city’s transportation industry, in order to create a socio-political map. A *socio-political* map is a tool which provides profiles of all key agents in the transportation industry, be it individuals, companies, or groups. It is quite helpful for analysing each agent’s particular concerns and its implications. The map should feature background information, interests and positions in the process, associations, dealings, strengths, and weaknesses. Gaining a deep understanding of the way a city’s transportation industry operates is essential when trying to transform it. Becoming an expert is the only way in which one can trace the correct path towards change and develop the according strategy.

In TransMilenio’s case, a dossier with profiles of each one of Bogotá’s seventy transportation companies was created. The files included their background, history, relevant documents, names, routes, and financial statements, among other details. The files also included information on transportation interest groups, associations, and each one of their respective leaders. At the end of the research period it could be said that the team knew better the industry and company details than the industry members.

Once the socio-political map is in place and the stakeholder analysis has been developed, a detailed communications plan and strategy must be laid out. The plan should be used as a flexible guide, as constant revision and updating will be needed. The plan should list all required activities and the person responsible for their execution as well as the respective due dates,



Fig. 6.22

The public transport sector as it appeared prior to TransMilenio in Bogotá. Engaging the existing operators and demonstrating the benefits of an improved system is fundamental to making a BRT project happen.

Photo by Lloyd Wright

duration, and correlation, as this information is needed to develop an activity critical path. With this plan, it will be easier to control the work team’s activities as well as monitoring all progress towards achieving the desired results and goals.

Direct interaction and discussions between the project managers and existing transportation service providers are indispensable. However, this activity is a time consuming task that requires constant attention. The process involves attending interest group meetings and various union assemblies, as well as holding discussions with all of the transportation service providers’ executive management teams and boards of directors. Attending the aforementioned events is important because the subject matter being discussed is vital to the existing transportation

Fig. 6.23

Dar es Salaam BRT project team leaders discuss the proposed DART BRT system with an association of Daladala owners.

Photo courtesy of ITDP



service providers and to the project, in its own right. Also, direct conversations create an atmosphere of trust, commitment, and transparency among the parties involved. This interaction in turn, provides Project Managers with deeper understanding of the other parties' motivating factors, interests, positions, and aspirations. Also employing the direct discussion method excludes all unnecessary intermediaries and avoids any interest group agendas or political mediation (Figure 6.23).

All subject matter should be studied carefully prior to discussion. Also, a team member should be made responsible for keeping minutes that summarize the main issues discussed at every meeting.

The communications strategy should be developed around a select number of key themes. In Bogotá's case, the main messages developed included:

1. Industry failure

"The transportation industry in Bogotá has failed to keep up with industry changes in other cities and other industries. Currently, the transportation industry employs obsolete technology and uses outdated employment practices, financial plans, and management strategies." The aforementioned tendencies were constantly explained, in depth, at forums and assemblies. Finally, members of the transport industry, themselves, realised the nature of the crisis and concluded that change was necessary, at least for a group of managers that generated a critical mass.

2. Urban form and efficiency

"A transportation system, as a fundamental public service, significantly affects a city's structure and functioning. Transportation service providers are not always conscious of the great impact their businesses have on people's daily lives. An outdated, unorganized, poorly run transportation industry affects each citizen's quality of life negatively. City mayors and public officials must intervene in the transformation process, in order to assure the greater good is being served." This message should strive to explain the reasons behind the city's intervention in transforming the industry.

3. Social well being

"Society's well being is above that of any individual. This basic civic concept conveys the fact that the transformation process is taking place to serve society's interests, which supersede those of a select few, like incumbent transport service providers. This concept will set a precedent for future discussions with members of the transportation industry. It will make it clear to them that imposing those conditions, which solely favour their interests and aspirations, is not acceptable."

4. Inevitability of industry transformation

"Change *will* happen, whether incumbent service providers participate in the process or not, and even if they challenge it. A social modernisation process that sets out to appropriately meet society's needs is inevitable. Opposing such change will imply taking on higher risks and costs than cooperating with and being part of the process." This was a key message in the communications with the industry, because it sent a message that they could be a key partner but that they were not going to be delaying the overall goal.

5. Opportunity

"Within every crisis lies an opportunity. This message suggests that in every crisis some may suffer, but others, who seize available opportunities successfully, can emerge from the crisis in a stronger position." The message invites people to choose whether they want to come out of the transformation process as victims or as winners.

All of the communication plans' activities, discussions, and negotiations, should be carried out following a strict professional practice standard. It is best to follow one of the many available negotiation strategies instead of allowing personal feelings to steer the process.

Discussions with existing transport service providers should be educational. Project success depends on whether or not the industry can change its way of thinking, professional practices, and operating methods.

While direct discussions are an effective instrument in achieving this purpose, trips abroad to view other transportation systems can be an excellent complement. This way, operators can

witness actual examples of alternative and successful operating systems first hand. The operators should also be made aware of means that might help them make all the required changes, such as training on financial analysis, human resources management, and customer service.

6.2.2.2 Local authorities

New projects of this nature will clearly need some approval from at least one level of government, be it city, state, or federal. Communicating effectively with government officials will allow the project to run smoothly and will prevent internal opposition.

The objective is to receive the necessary project approval, construction permits, debt consent, legal faculties, and financial resources from governmental entities in order to complete the project. One must also seek permission to make any changes or adjustments deemed necessary.

Interaction with government officials demands specialised professionals, familiar with all formalities and procedures, so that approvals and permits can be obtained from the competent government agencies. It can be useful to hire specialised lawyers and individuals with political insight of the city's key players and their respective interests, positions, and aspirations.

Socio-political mapping should be done again, this time focused on city norms, procedures, formalities, processes, requisites, waiting times, and competent agencies. The socio-political map is an essential tool in guaranteeing the project's success as quickly as possible. Even extraordinary projects have failed because they could not effectively deal with the bureaucratic apparatus. A plan listing required activities, responsible parties, due dates, estimated duration, interrelation, will help in tracing the project's critical path. It will also prove to be an indispensable tool for monitoring, controlling, and executing tasks or activities.

The communications plan must revolve around trying to secure as much political support as possible, both from the party in power and the opposition. The new system must be portrayed as a city project, as its design, development, and completion might take several years, with different stages of development possibly taking place under several administrations. One

must always keep in mind that the project does not solely consist of building an initial set of corridors, stations, or roadways, but rather, that its main focus is creating a comprehensive citywide system. Employing long-term forward thinking from the project's inception is important, so that future expansion permits and budget approvals can be incorporated into the urban development plan, making room for the project's future growth.

In Bogotá's case, approval was secured for a fifteen year plan that included earmarking a significant percentage of a petrol tax to finance the new system. A deal with the national government was also signed whereby it agreed to finance the 60 percent of project's cost for eight years. The deal was extended later for an additional seven years, and allowed systems expansion. In Transantiago's case, in Chile, a legal and financial structure that would integrate all bus, feeder, and corridor networks to the city's Metro system was achieved.

6.2.2.3 Internal project team

Creating a new BRT authority and new private bus operators does not simply involve filling a corporate charter or opening a bank account; it primarily entails putting a team of capable individuals together.

Internal communications serve the purpose of getting the work team on the same page when it comes to supporting the project's vision and mission statement. It allows the work team to share a modern urban philosophy, designed around modern transportation systems and the concept of public space.

The project director's individual leadership is not enough. The director must get the work team to believe the dream is achievable, if hard work and a sense of urgency are in place. Provoking social changes requires effort and involves overcoming numerous obstacles and opposition forces. Also, figuring out all the details associated with the implementation of a new transportation system demands creative ideas and critical thinking. Success depends on putting together a creative, cohesive, professional and dedicated work team.

Sufficient resources and time should be dedicated to selecting the members of the project

team. Having highly qualified and experienced individuals is an asset, but intangible qualities such as being open minded, creative, optimistic, forward looking, and not afraid of change are probably of even greater importance.

Work should be divided among multidisciplinary teams, as transportation systems are very complex, and can encompass legal, judicial, economic, engineering, and sociological aspects among others. The key to a successful system transformation lies in employing a collective creative process.

As noted earlier, developing a BRT system is a full-time job. Team members cannot be expected to deliver a quality system if they have numerous other project responsibilities. Focusing the minds of everyone on the task at hand is one of the principal organisational tasks of the project director. In Bogotá's case, aside from constant teamwork regular planning sessions were held on both Mondays and Fridays in order to review progress and plan next steps. Subject matter used in these sessions was often more conceptual than evaluative or practical. There was a continual effort to instil a uniform city concept and urban philosophy that would inspire the work team and be reflected in their efforts.

6.2.3 Communications strategy for the general public

"It is insight into human nature that is the key to the communicator's skill. For whereas the

writer is concerned with what he puts into his writing, the communicator is concerned with what the reader gets out of it."

—William Bernbach, advertising executive, 1911–1982

The communications strategy for the general public ("public targets") is quite different from the strategy for "active targets" in both its aims and its objectives. The purpose of the public communications strategy is to:

- Educate the public about the benefits of the new system;
- Prepare the public for the difficulties they are likely to face during construction and the transition;
- Win ridership for the system when it opens;
- Isolate critics and strengthen the hand of the project designers in the negotiation process;
- Develop a mechanism for ongoing consumer input.

The development of a communications strategy for the general public is more frequently handled by public relations professionals, but generally this is still led by the BRT authority or the project office. Whether the public relations strategy is led by a public relations office in the Mayor's office, or by a private firm contracted to the Mayor's office or the BRT authority, information about the project to be released to the general public must be carefully developed and scrutinised before being released to the public.

Establishing a schedule for when the media can reasonably expect further detailed system information should be a principal first step. Usually, because the preparation of the plans is done under contract, the general timing of the release of new reports is known, and press briefings and public hearings can be planned accordingly.

The general public will have little prior knowledge of the BRT concept, and thus basic educational materials and campaigns will be required. The instruction process requires the use of specialised media with the capacity to reach target audiences. The language used must communicate instructions precisely, accurately and as simple as possible to target individuals and communities. If possible, easy to understand illustrations should be used. These communications should also include relevant contact information for persons seeking further details.

Fig. 6.24
Street campaign organised for TransJakarta helps to build awareness for the new BRT system in a lively and engaging manner.

Photo courtesy of ITDP





Fig. 6.25
Creative approaches to public outreach, such as through mimes and entertainers, can be a highly-effective mechanism for disseminating information in a memorable manner.

Photo by Lloyd Wright

Information is effectively passed on to target audiences through television, radio and printed press. The agency in charge of promoting the project should regularly supply the press with images, maps, written press releases, and statements from authorised personnel, so that this information can be released to the general public at an opportune time.

However, direct outreach, while sometimes costly, is probably the most effective in delivering a memorable message. Given the array of commercial messages the public receives on a daily basis, it can be quite difficult for the new public transport system to compete for attention. Street campaigns and personal contact directly with the public can raise awareness of the system beyond the normal level of commercial marketing (Figure 6.24).

In Bogotá's case, the city utilised a programme known as "Mission Bogotá" to conduct personal outreach to members of the public. The city employed more than 300 young people from low-income communities to serve as outreach ambassadors for the proposed system. The campaign began six months before TransMilenio

was commissioned and it mainly took place at bus stations and aboard regular buses, but also included civic gathering places and local schools. At these locations, the outreach team of Mission Bogotá would discuss the project directly with the public and personally answer any questions or concerns. The programme also made use of many highly creative forms of outreach mimes, comedians, and puppets. Many cities now utilise these techniques to impart transport information in a congenial and light-hearted manner (Figure 6.25).

Bogotá officials also made a special effort to target children as a principal outreach group. Children are often more receptive to new information than adults and can thus become real champions of a new public transport system. Effectively communicating a project to children through in-school outreach initiatives may also be the best mechanism to ultimately reach parents and other adults. Children are often quite excited to explain new information to others. In Bogotá, the communications team organised educational materials and encouraged activities such as drawing contests. The communications team also prepared jigsaw puzzles and



Fig. 6.26
Before the system was launched, Transantiago has already posted a website informing all stakeholders of the system's characteristics.

Lego-style toy buses for use in schools. Brochures, magazines, and videos were developed in order to provide educators with appropriate educational tools.

Additionally, key social actors and organisations may be appropriate for a targeted outreach. Civic, business, and community organisations represent potential first-mover adaptors who can be influential in mainstreaming a new project. Direct, individual sessions with the leadership of these organisations as well as with the membership itself can reap many dividends in terms of educating the wider public.

Educating the general public and public transportation users is a gradual process, which must be carefully planned and executed in order to be successful. Logical messages must be repeated until they have been learned and successfully adopted.

The educational process should not only seek to modify habits and customs, but it should also aspire to encourage civic values like respect. Examples of some of the value-driven messages can include:

- Wait in line out of respect for those who arrive first;
- Offer seats to a pregnant woman out of respect for the life she is carrying;
- Offer seats to the old and young to ease their comfort;
- Refrain from vandalism and show respect for public goods;
- Place litter in a trash receptacle and maintain the quality of the system;
- Do not smoke out of respect for the health of others.

The educational campaign's budget must be calculated during the project's initial stages in order to assure that it is allocated with the required financial resources. Expert consultants should be considered for many of these activities.

The stronger the hand of the system designers in relation to existing bus operators, the better deal they will be able to negotiate for the public. In the case of TransMilenio, the communications team issued press releases almost on a daily basis not only about the future system, but also illustrating the many problems with the status quo. Whenever a pedestrian was killed by a private bus operator, or a private bus operator crashed due to poor vehicle maintenance, another press release would be issued. This generated a lot of political pressure on the private operators to reform the system.

A system website can also be a useful tool in terms of both disseminating basic information as well as acting as a feedback tool with future customers. The website should contain a list of Frequently Asked Questions (FAQ) for the system in order to quickly address the most common inquiries. The website may also have a form for users' questions about the system, and it should be revised and answered (if possible, also published in the website itself) as frequently as possible (Figure 6.26).

6.3 Public participation processes

"Tell me and I'll forget. Show me and I'll remember. Involve me and I'll understand."

—Confucius, philosopher, 551–479 BC

Communications are not only important in terms of obtaining public approval of the project but also provide the design insights of the people who will be using the system. Public inputs on likely corridors and feeder services can be invaluable. Incorporating public views on design and customer service features will also help ensure that the system will be more fully accepted and utilised by the public. Professional planners and engineers obviously do play a key role in system design, but often such "professionals" do not frequently use public transport systems, and thus do not possess some of the design insights of the general public. Some cities are now requiring public officials to use public transport

each day so as to retain a better understanding of the daily realities.

Managing and fostering wide public involvement can be a challenge to agencies and departments unaccustomed to public processes. Non-governmental organisations sometimes are better equipped to manage such processes. Alternatively, consultants are also a possibility. Third party management of the public participation process can also be an effective mechanism to achieve an independent and objective viewpoint on design issues. In some cases, community members may be more comfortable expressing opinions to local organisations rather than exclusively to public officials.

Though public participation may sometimes seem a superficial approach that will have little effect in the project's success, it is a key element in the long term. For instance, if people's concerns are not addressed properly or a particular group is unsatisfied with the process, there can be negative effects such as vandalism, riots or legal measures taken against the system and its development. The communications process is one step towards achieving this goal, but there are other permanent tasks from the project's management which can ensure a more "integrative" approach at the system's planning and development.

Once the project is in place, one of these actions is to include a representative of the general public in the system's Board of Directors, who can be appointed by a relevant municipal authority, the system management or the public itself. This step will ensure that all users' are "represented" in the decisions that are being taken regarding the system. The position of the public representative should be open to election on a periodic basis.

Various mechanisms can be utilised to facilitate participation from community members. These mechanisms include:

- Neighbourhood information sessions;
- Interviews with specific NGOs and community-based organisations;
- Town hall meetings;
- Focus groups;
- Polling of existing public transport passengers;
- Telephone outreach;



Fig. 6.27

Public participation session in Manila for a project supported by USAID.

Photo by John Ernst

■ Website and email communications.

Each of these options carry with them different cost implications. In general, the more personal the participation process, the more costly it will be. However, in comparison to other system components, expenditures on public participation processes will be modest. Further, the design and operational advice gained from actual public transport users can be invaluable to the system's long-term performance.

Individual sessions directly with user groups or other interested organisations are amongst the most productive in terms of information gathering. Under the leadership of a skilled facilitator, these sessions can be particularly illuminating (Figure 6.27).

A somewhat more specialised participation technique is known as focus groups. This technique can improve knowledge about the population which will take part (active or passive) in the BRT project. It is similar to a group interview, in which specific topics (focus points) are addressed by a person moderating the discussion between participants.

The focus group interview is a means to recollect briefly but in depth, a significant volume of qualitative information. It is based on a discussion with a group of people, who are guided by an interviewer to express their knowledge and opinion regarding specific topics. In the case of BRT, the focus group can revolve around user satisfaction, characteristics of the system,

proximity to work and study, safety issues, health issues and perceived performance of the system. Focus groups usually have the following methodological characteristics:

- Consists of 6 to 12 people;
- Sessions require around two hours of time.

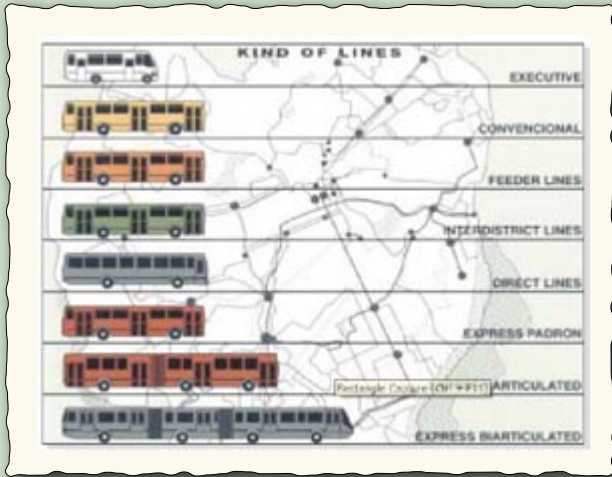
The typical procedure for a focus group is as follows:

- Introduction of the topic by the moderator;
- Instructions on the dynamics of the meeting;
- Emphasis on the objective being to understand the group's experiences and impressions;
- Development of the interview: starting with general themes and then introducing the specific topic of the meeting, focussing on the most important issues;
- Closing of the interview: summarising the findings and checking notes taken during the meeting.

To achieve a greater success of a focus group, it should be developed by professionals in social sciences who are external to the project management and organisation, but they must have detailed information of the system's characteristics. It is also important to note that a focus group is not a tool to persuade people, but rather to know their points of view in order to address them appropriately in system planning and in the communications campaign.

Part II – Operational Design

CHAPTER 7



Network and service design

CHAPTER 8



System capacity and speed

CHAPTER 9



Intersections and signal control

CHAPTER 10



Customer service

7. Network and service design

“Always design a thing by considering it in its next larger context—a chair in a room, a room in a house, a house in an environment, an environment in a city plan.”

—Eliel Saarinen, architect, 1873–1950

The starting point for the design process should not be the infrastructure or the vehicles. Instead, the system should be designed to achieve the operational characteristics that are desired by the customer. From the customer’s perspective, some of the most important factors affecting their choice of travel modes are whether the service will take them where they want to go and how long it takes.

This chapter addresses the system’s coverage across the wider network of a city’s principal origins and destinations. Additionally, this chapter discusses the various factors that affect the system’s convenience and ease of use. Does

the trip involve many difficult transfers or can one access desired destinations within a single routing? If transfers are necessary, will they involve cumbersome walks across intersections and grade separations or are the transfers easily facilitated across a platform protected from adverse weather?

In some instances, operational decision-making can involve trade-offs. The most economical and efficient system may impose transfers on customers while direct services may prove to be more costly. Providing the most effective service frequently requires a significant change in how existing public transport operators work, but changing the status quo for operators can often be politically difficult. Balancing the various factors between customer service, cost efficiency, and operator relations requires a full understanding of the operational options and their implications.

The topics discussed in this chapter are:

- 7.1 Open systems versus closed systems
- 7.2 Trunk-feeder services versus direct services
- 7.3 Route design

7.1 “Open” versus “closed” systems

“Sometimes we stare so long at a door that is closing that we see too late the one that is open.”

—Alexander Graham Bell, inventor, 1847–1922

The degree to which access is limited to prescribed operators and vehicles can have a significant impact on vehicle speeds, environmental impacts, and the system’s aesthetic qualities. On one extreme, there are busways that are essentially high-occupancy vehicle lanes (HOV). In this case, access is granted to any vehicle carrying over a certain number of passengers. Bus corridors such as Avenue Blaise Diagne in Dakar, Oxford Street in London and the Verazano Bridge in New York allow both buses and taxis. The Ottawa Transitway permits both urban BRT vehicles as well as inter-city bus services. Conversely, the Bogotá and Curitiba systems limit access to only prescribed BRT operators and special BRT vehicles.

If there are no restrictions on operator access or the types of vehicles, the busway may perform inefficiently. As more vehicles enter the busway, the resulting congestion at stations and intersections will greatly reduce average speeds and thus increase customer travel times. Limiting access to an optimum number of operators and vehicles can help to ensure system capacity and speeds are maximised and maintained over time. However, placing restrictions on operator access generally requires changing the way the public transport sector is regulated and managed. While such a re-organisation can be a positive development, it often requires a great deal of political will and political leadership.

Emergency vehicles, such as ambulances, are generally permitted access on most BRT systems (Figures 7.1 and 7.2), whether it is an open or closed system. This public service provides an additional motivation for approving a BRT project, especially since many rail options are not be compatible with emergency vehicles. In

Fig. 7.1 and 7.2
In cities such as Quito, the exclusive busways also permit emergency vehicles to avoid traffic delays and respond more quickly to those in need.
 Photos by Lloyd Wright



many cities, mixed traffic congestion significantly inhibits emergency access and delivery. By facilitating rapid emergency services for the injured and critically ill, the BRT system is in effect helping to save lives.

Some cities also permit “official” vehicles to utilise the busway. This usage may include presidential and ministerial motorcades as well as travel for low-ranking public officials (Figure 7.3). The justification for such usage can be somewhat questionable. Certainly, for the highest ranked officials, such as the national president or prime minister, the exclusive busway does allow for potentially safer movements, which can be important in nations where terrorism or other security threats may exist. The usage by lower-ranking officials is harder to justify and can ultimately have a highly detrimental impact on system speeds and capacity. In Quito, sometimes the expropriation of busway space even extends to public utility vehicles, such as garbage trucks (Figure 7.4). While it is understandable that utility companies would like to take advantage of rapid access on the busway, the presence of such vehicles can do much to hinder proper BRT operation.

Fig. 7.3
When usage of the exclusive busway by lower-ranking governmental officials becomes common place, then there can be negative impacts on the efficiency of the system.
 Photo by Lloyd Wright



7.1.1 Defining “open” and “closed” systems

Systems that limit access to prescribed operators are known as “closed systems”. Typically, this access is granted through a competitive selection process. In general, the highest-quality examples of BRT, such as Bogotá and Curitiba, utilise a closed system structure. In these cases, private companies compete for the right to provide public transport services under a process of competitive tendering. The number of operating companies and the number of vehicles utilised will largely be a product of optimising customer conditions. These systems also only permit vehicles with highly-defined specifications to operate on the corridor.

By contrast, systems that have implemented a busway system without any sector reform or any exclusivity are known as “open systems”. In such cases, any operator that previously provided collective transport services will retain the right to provide services within the new busway. In

Fig. 7.4
In Quito, even garbage trucks take advantage of the exclusive busway.
 Photo by Lloyd Wright





Fig. 7.5
Kunming employs an “open” BRT system, using segregated busways but with few routing or structural reforms.

Photo by Lloyd Wright

an open system, operators will largely continue to run the same routes as they did previously. Thus, the operators will tend to utilise the busway infrastructure whenever it coincides with their previous routing, and they will likely also operate parts of their existing routes without busway infrastructure. The systems in the cities of Kunming, Porto Alegre, and Taipei operate as open systems (Figure 7.5). Most cities with lower-grade BRT systems, or simply basic busways, utilise an open system structure.

In general, a closed structure is more conducive to efficient operations. Since the number of operators and the number of vehicles are rationally selected and carefully controlled, a closed system tends to be designed around the optimum conditions for customer movement. Further, a closed structure frequently implies that a competitive structure is in place that provides operator incentives regarding service quality.

Open systems tend to be designed principally around the preferences of existing operators, and thus not necessarily around the optimum conditions for customers. Open systems have

the advantage that they do not require any fundamental changes in the regulatory structure of the existing bus services. Open systems are particularly prevalent in cities where the political will does not exist to re-organise the bus system. Since bus operating companies may represent powerful political interests, public officials may decide that maintaining the status quo will cause the least amount of discomfort to existing operators. Thus, with the exception of a bit of new infrastructure in the form of a basic busway, an open system may be otherwise indistinguishable from a standard bus service.

In reality, the division between “closed” and “open” systems is not as clearly delineated as suggested above. Some “open” systems may still exclude charter buses, school buses, airport access buses, minibuses, or intercity buses. Systems may undergo some relatively minor reforms that may partially limit operator access. In some cases, such as the Quito “Central Norte” corridor, the business structure may be partially reformed. The operational concession for the Central Norte line essentially permitted all existing operators to participate in the new busway. However, to operate on the Central Norte corridor, only vehicles of a specific type are allowed. The shift to larger, articulated vehicles did help to rationalise services in the corridor, despite the lack of complete business reform. Thus, systems such as the Central Norte may represent a partially closed system that reaps some benefits from marginal reform.

7.1.2 Impacts on operations

Perhaps the most telling difference between an open and closed system is the impact on average vehicle speeds and customer travel times. Without any rationalisation of existing services, an open system can lead to severe congestion on the busway, though a poorly planned closed system can also become congested. A closed system will tend to operate high-capacity vehicles that will likely result in service being provided every three minutes. An open system may consist of many smaller vehicles all tightly bunched with little spacing between them. Thus, while a closed system can produce average commercial speeds of 25 kph or higher, an open system will likely produce considerably slower speeds. Also, to date, some open systems have



Fig. 7.6 and 7.7

Bogotá originally operated an “open” busway system (left photo), but the resulting congestion did little to help customers. By contrast, the development of the “closed” TransMilenio system along the same corridor has proven to dramatically improve travel times and customer comfort.

Left photo courtesy of TransMilenio SA
Right photo by Lloyd Wright

been implemented without improving the quality of the vehicles utilised.

The allowed vehicle types will also greatly affect several performance indicators including boarding and alighting times and station congestion levels. A single small bus with a very small door can badly congest an exclusive BRT lane, and for this reason such buses are incompatible with high speed, high capacity BRT systems. Specifying maximum vehicle age and maintenance practices can also affect performance. Breakdowns contribute to corridor congestion. Thus, weak regulatory control over the vehicle fleet is incompatible with consistent high-speed,

high-capacity, and high-quality service. Tight regulation of emissions, operating speeds, and noise are also important to protecting the environmental quality of the corridor.

Prior to developing its TransMilenio system, Bogotá actually operated a median busway on its “Avenida Caracas” corridor. The “Avenida Caracas” busway operated as an open system, permitting all existing operators to utilise the infrastructure. The result was excessive busway congestion and average commercial speeds of approximately 10 kph (Figures 7.6 and 7.7). The busway was partially effective in improving conditions for mixed traffic but did little to improve travel conditions for transit passengers.

Likewise, the existing busways in Lima (Vía Expresa, Avenida Abancay, and Avenida Brasil) as well as the BRT systems in Kunming, Porto Alegre, São Paulo, and Taipei are also open systems and are also subject to congestion (Figures 7.8 and 7.9).

Fig. 7.9

Likewise, average speeds on the open Taipei system also are affected by busway congestion.

Photo courtesy of Jason Chang



7.2 Trunk-feeder services versus direct services

“A straight path never leads anywhere except to the objective.”

—Andre Gide, novelist, 1869–1951

Providing public transport service to all major residential and commercial sectors of a city can

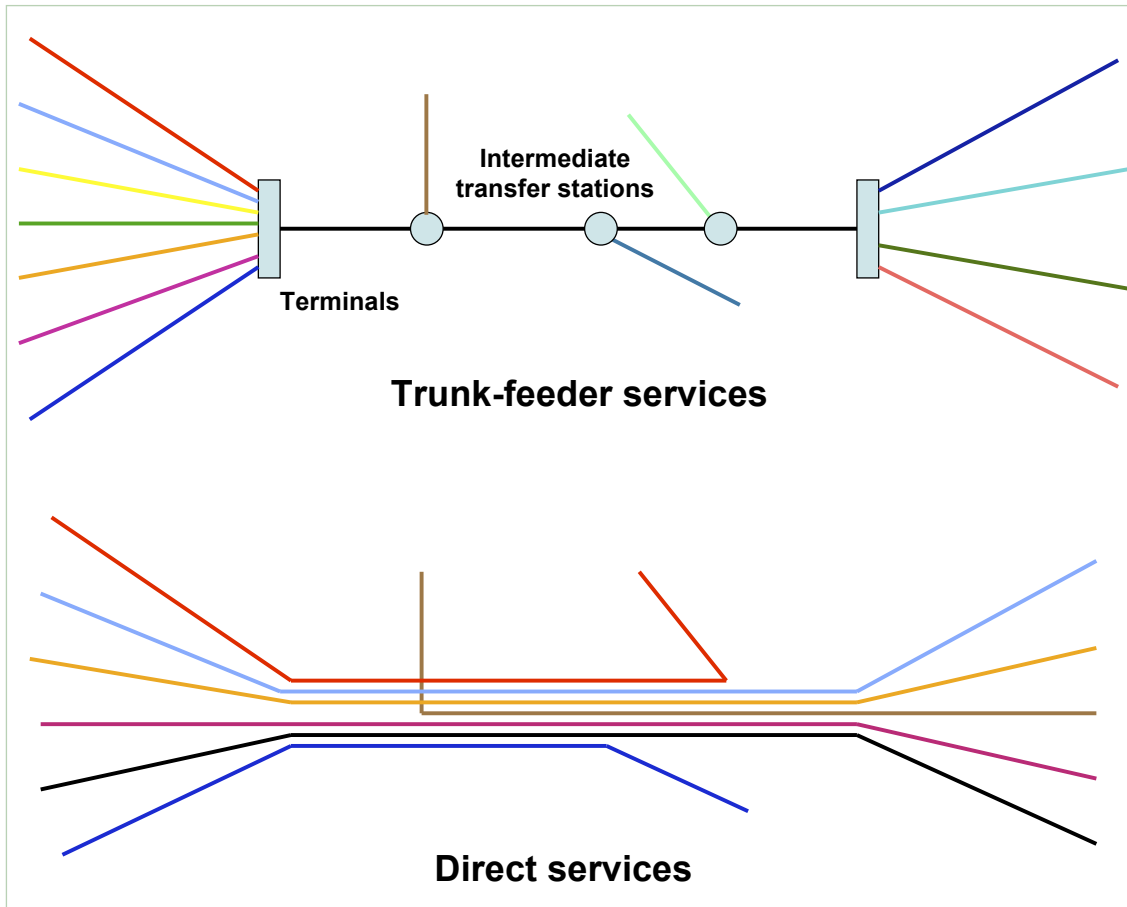


Fig. 7.10
Illustrative comparison between trunk-feeder services and direct services.

be challenging from a standpoint of system efficiency and cost effectiveness. Serving the densest portions of the city often requires a high-volume of high-capacity vehicles, while lower-density residential areas may be most economically served with smaller vehicles. However, at the same time, customers generally prefer not be forced to transfer between vehicles as transfers impose a cost in both time and convenience. The question for BRT system planners is how to balance these varying needs and preferences. Smaller residential areas do not have to be sacrificed from the system. A well-designed system can accommodate a range of population densities in order to achieve a true “city-wide” service.

In general, there are three options in terms of the overall service structure:

1. Trunk-feeder services;
2. Direct services;
3. Mix of trunk-feeder services and direct services (“hybrid” services).

Trunk-feeder services utilise smaller vehicles in lower-density areas and utilise larger vehicles

along higher-density corridors. The smaller vehicles thus “feed” passengers to the larger “trunk” corridors. Many passengers utilising a trunk-feeder system will need to make a transfer at a terminal site. Direct services will have less need for feeder vehicles and transfers, generally taking passengers directly from their origin to a main corridor without the need for a transfer. Figure 7.10 illustrates the difference between trunk-feeder services and direct services.

7.2.1 Trunk-feeder services

Trunk-feeder services utilise smaller vehicles from residential areas to provide access to terminals or transfer stations, where customers transfer to larger trunk vehicles (Figure 7.11). High-quality BRT systems, such as the systems in Bogotá, Curitiba, and Guayaquil, have so far all tended to employ trunk-feeder services. Typically, the feeder service vehicle will operate on mixed-traffic lanes while the trunk vehicles will operate on exclusive busways. In many respects, the concept of trunk-feeder services is similar to the practice of hub-and-spoke operations as utilised by the airline industry.

Fig. 7.11

In trunk-feeder systems, such as Bogotá's TransMilenio, customers change from feeder vehicles (green vehicle on the left) to trunk vehicles (red vehicle on the right) at terminal sites.

Photo by Shreya Gadepalli



7.2.1.1 Advantages of trunk-feeder services

Operational efficiency

The major advantage of trunk-feeder services is the ability to closely match supply and demand, depending on the characteristics of the local area. Trunk-feeder services can increase the number of passengers per vehicle. The amount of passengers carried relative to the capacity of the vehicle (*i.e.*, the load factor) is a principal determinant in the profitability of the system. The improved load factor also makes possible a reduction in the fleet size required by a factor of three or more, reducing busway congestion and air emissions from the vehicles.

Systems with direct services will generally use a uniform vehicle size to provide services in both residential areas and higher-density trunk corridors. By contrast, trunk-feeder services use smaller vehicles to collect passengers in lower-demand residential area. The smaller vehicles are less costly to purchase and operate, and these vehicles can more cost-effectively provide a frequent service. If a large vehicle is employed in a low-density area, then either: 1.) The frequency between vehicles will be long; or, 2.) The large vehicle will operate with few passengers, making for expensive operations per passenger carried. If service frequency to peripheral areas is poor and customer waiting times are long,

then many passengers will seek alternatives. In such circumstances, paratransit services may flourish while the formal bus system will receive little ridership. On the trunk corridors, a trunk-feeder service will operate larger-sized vehicles, which can provide a much higher capacity with fewer vehicles.

The efficiency gained from increasing load factors by closely matching vehicle sizes to customer demand can be significant, especially if the current system is operating with high vehicle volumes and low load factors.

Service quality

Trunk-feeder services are typically coupled with “closed system” business structures. Since most standard bus systems do not utilise trunk-feeder services, the conversion to the trunk-feeder option is typically accompanied by bus sector reform. Thus, the selection of the trunk-feeder option can also catalyse other important structural changes in concessions, contracting, and operational control.

7.2.1.2 Disadvantages of trunk-feeder services

Time loss due to transfers

The principal disadvantage of trunk-feeder services is the requirement for some passengers to transfer vehicles at one or more points in

their journey (Figure 7.12). The process of transferring can be an undesirable burden for passengers, as it takes time and creates inconvenience. For a customer with baggage or with a small child, a transfer can make the journey physically difficult. In some cases, a person may elect to utilise a different travel mode if the transfer process is too cumbersome. Customers will particularly dislike transferring if they are travelling a relative short distance. In such instances, the time lost in the transfer can be equal to or greater than the actual time required to travel to the destination.

Additionally, customers tend to penalise “waiting time” more severely than “travel time”. Thus, even if a vehicle operating in direct services incurs a longer overall travel time due to traffic congestion, the perception of the waiting time with a trunk-feeder transfer may make that service seem longer.

Distance travelled

The act of travelling from a residential area to a transfer station may also imply a significant detour from the intended destination. This detour factor not only affects customer travel times but also affects the efficiency of operations. The amount of additional fuel consumed is directly proportional to the length of the detour. Figure 7.13 illustrates the potential detour factor.

Infrastructure costs

Another disadvantage of a trunk-feeder service is the need to construct transfer terminals or



Fig. 7.12
The walk between a feeder stop and the trunk station can act as a disincentive to use public transport for many.

Photo by Carlos F. Pardo

intermediate transfer stations. These facilities typically involve multiple platforms and pedestrian infrastructure facilitating access between the different routes and services. Thus, these transfer stations will likely be more costly to construct than a standard station that does not facilitate transfers. Additionally, there are maintenance and operational costs associated with these facilities.

The main economic costs associated with a trunk-feeder service will be the amount of travel time delay due to transfers and the additional cost of building, operating, and maintaining the transfer facilities.

However, it should be recognised that not all passengers will require a transfer when utilising a trunk-feeder service. In Bogotá, approximately

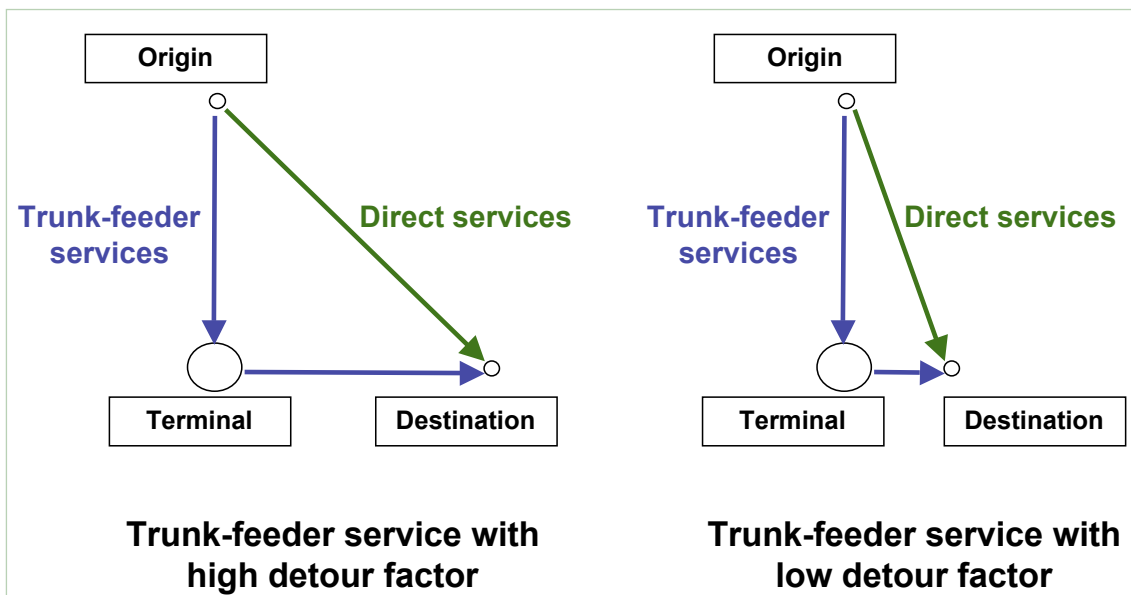


Fig. 7.13
Detour factor and trunk-feeder services.

50 percent of passengers enter the system from the feeder services. The other 50 percent of passengers enter the system along one of the trunk corridors. Additionally, not all passengers from feeder routes enter a trunk corridor, as some trips can be conducted entirely within a feeder route.

Further, the amount of time and inconvenience associated with a transfer depends greatly on the design of the transfer area. A well-designed transfer may simply involve a few metre walk across a platform to a waiting vehicle. In this case, the time and inconvenience penalty will be relatively small. By contrast, a transfer involving a walk across a busy intersection and a long wait at another station will be considerably more costly from the customer’s standpoint.

7.2.2 Direct services

As the name implies, “direct services” carry a passenger directly from a residential area to a main-line corridor. Direct services are employed in several cities, including Kunming, Nagoya, Porto Alegre, São Paulo, and Taipei. In these cities, the BRT vehicles may only utilise an exclusive busway for one portion of the route. The vehicles typically operate on an exclusive busway in central areas, where demand is higher. For other portions of the route, the vehicle will likely operate in mixed-traffic lanes.

7.2.2.1 Advantages of direct services

Time savings

The principal advantage of direct services is that fewer passengers should require transfers between routes. The same vehicle carries the passenger from a residential area into the trunk corridor. Some passengers may still require transfers if they are travelling to a different trunk corridor, but overall, fewer transfers should be required. Direct services can save travel time in two ways: 1.) Reduction in waiting times at transfer stations; 2.) Potentially more direct routing to a destination. If the direct services provide a shorter and more direct route, there will likely also be some operational cost savings from reduced fuel usage.

Infrastructure costs

Systems employing direct services also forgo the need to construct terminals and intermediate

transfer stations. Some interchange stations for trunk-line to trunk-line transfers may still be required. Thus, the total economic benefit of direct services will be the travel time savings plus the infrastructure savings of terminals and intermediate transfer stations.

7.2.2.2 Disadvantages of direct services

Operational efficiency

The primary disadvantage with direct services is that a single vehicle size must be used throughout the entire bus route, while passenger demand along the route may vary widely. The operator will have to choose a vehicle size that will be optimal for some part of the trip but not for other parts of the trip. The vehicles utilised by direct services are often smaller than articulated, trunk vehicles and larger than feeder mini-buses. This size compromise may imply the vehicles are not optimally designed for either location.

As a result, on trunk roads, there are likely to be a larger number of smaller vehicles operating at lower capacity than would be optimal. A lower number of passengers per vehicle will tend to increase the cost per passenger of providing the service. At very high vehicle volumes inside a BRT system, this will tend to lead to vehicle congestion and slowing bus speeds and lower system capacity. On feeder routes, the vehicles may have less manoeuvrability than mini-buses. In turn, this lack of manoeuvrability may delay average speeds as the vehicles attempt to operate on narrow streets and sharp corners.

Average speeds and total travel time

Thus, the time savings gained through avoiding transfers can be negated with inefficiencies elsewhere. The slower operating speeds, due to congestion, can more than offset the customer’s time advantage from avoiding a transfer. While customers may avoid the physical inconvenience of transferring vehicles, they do not necessarily arrive more swiftly to their destination. Figures 7.14 and 7.15 illustrate the bunching of buses that may occur with direct service systems.

Meanwhile, on low demand suburban routes, the chosen vehicle type may be too large to efficiently serve the area. This vehicle will either operate nearly empty, requiring more fuel and more vehicles than are actually required, or else the



Fig. 7.14 and 7.15
To date most of the systems with direct services have suffered from congestion and bus “bunching”, such as the systems in São Paulo (left photo) and Taipei (right photo). However, the congestion problems are likely due to such systems being “open” in their operational structure.

Left photo courtesy of Paulo Custodio
 Right photo courtesy of Jason Chang

vehicle operator will tend to cut back on service, leading to long waiting times for passengers.

The perceived time savings gained through the lack of a transfer can also be negated through fare handling and other operational procedures. Most existing direct services tend to employ on-board fare collection and verification (e.g., Kunming, São Paulo, Seoul, and Taipei). This activity can considerably delay boarding and alighting and result in long dwell times at stations. In turn, this delay will significantly increase total travel times for passengers.

Vehicles

Direct services may also imply additional costs for vehicles and/or compromises in the location of the station. Direct services operated on a median busway with median stations will require doors on both side of the vehicle. Doorways on one side of the vehicle will likely be of a wide, high-floor design providing direct access to formal trunk-line stations. Doorways on the other side of the vehicle will be smaller, stair-accessed entry points to be used when the vehicle is operating in mixed traffic lanes. When operating in low-demand areas, passengers are boarding and alighting at a curb-side shelter and not at a median station. Providing doorways on both sides of a vehicle involves an additional cost. This cost is not just the additional cost of the doorways but also the structural reinforcement required when more of the vehicle’s carriage is open space. Figure 7.16 provides a schematic layout of a vehicle with two-sided doorways.

The lower load factors for direct services may also imply more vehicles are required since the

same number of passengers must be moved with fewer passengers per vehicle. However, direct services may gain some economies of scale if all vehicles are identical. In contrast, a trunk-feeder system will always require the purchase of at least two vehicle types: 1. Larger, trunk vehicles; and 2. Smaller, feeder vehicles.

Additionally, since direct services imply that some large and expensive vehicles will be operating in mixed traffic conditions, this type of operation can increase accident risks as well as likely insurance costs.

Infrastructure

While direct services may avoid the cost of some infrastructure components such as transfer

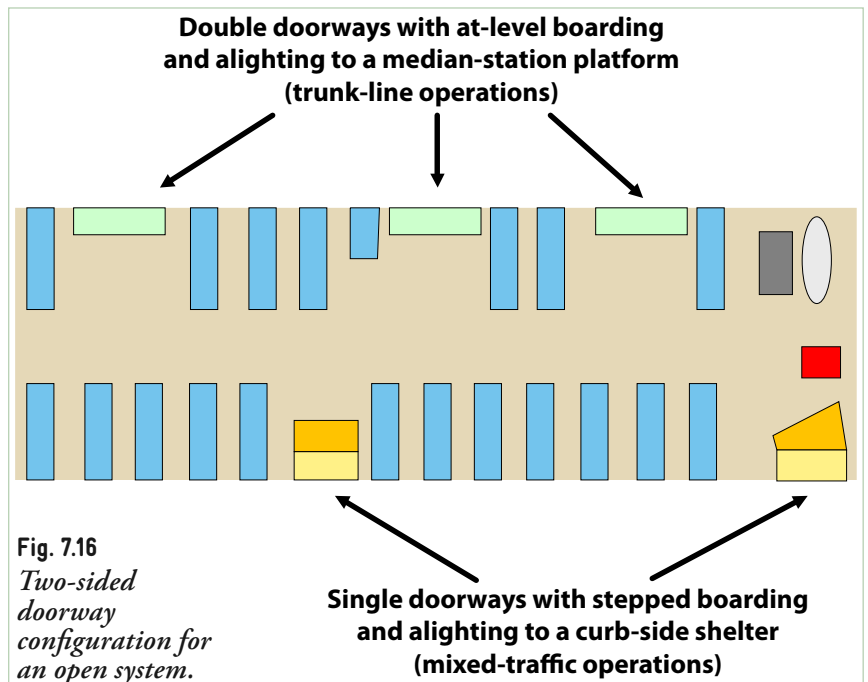


Fig. 7.16
Two-sided doorway configuration for an open system.

Fig. 7.17

The use of side-aligned stations on systems such as the Central Norte corridor in Quito can force difficult transfers between routes.

Photo by Lloyd Wright



terminals, other components may be more costly. Some systems utilise direct services with single-sided doorways. In order to accommodate both median and curbside stations, these systems employ side-aligned stations at the median. This design ensures that passengers will always board and alight on the same side of the vehicle. Figure 7.17 shows the Quito Central Norte line with side-aligned stations in the median.

This configuration carries with it several disadvantages from a cost and customer service perspective. First, unlike a central median station, the curbside stations imply that two different stations must be built for each direction of travel. The doubling of the number of stations constructed will likely increase costs. Also, splitting the stations for each direction makes transfers to other corridors quite difficult. Customers are no longer able to easily change directions during a trip, and most often this configuration implies that customers will have to walk across intersections to change corridors. A single median station allows easier platform transfers between corridors. In effect, the side-aligned stations make the routes function more as a series of independent corridors, rather than a fully integrated system.

Additionally, stations for direct service systems must often handle long queues of waiting vehicles due to the nature of the operations. In order to accommodate this quantity of vehicles, either longer station platforms are required or multiple

platforms will need to be provided. The longer stations and/or platforms may increase infrastructure costs as well as increase the amount of required right of way. Passengers also frequently are not sure where along a platform to wait, and must race up or down the platform when their vehicle arrives. However, this last problem can be avoided by giving each different route a different sub-stop area along the platform.

Impact on mixed traffic congestion

One of the main reasons traffic authorities decide to shift to trunk and feeder bus route systems is to reduce adverse impacts of bus traffic on mixed traffic. If direct services require more buses to accommodate the same passengers on congested trunk corridors, then the BRT system itself is likely to require more right-of-way to accommodate this higher bus volume to avoid congestion. This consumption of space may adversely impact the right-of-way available to mixed traffic, or to non-motorised facilities.

Customer friendliness and quality of service

Direct services may also tend to increase system complexity and therefore reduce a customer's understanding of the system. Since the number of routes may proliferate with direct services, the system map tends to look less like a metro system with clearly defined trunk corridors. Instead, the system can appear as a complex web that may only be understood by regular customers. In most systems with direct services, system maps are not even provided at stations or within

vehicles. Thus, occasional customers are not able to form a “mental map” of the system as clearly as a system with a straight-forward set of trunk corridors. The net effect of this complexity can be a substantial barrier to entry for discretionary riders and others who do not invest the time in learning the system.

Direct services have also traditionally delivered a lower level of service quality. The lack of off-board fare collection, formal stations, and aesthetically pleasing infrastructure has meant that these systems are perceived more as bus systems rather than mass transit systems. However, there is likely no reason that a system utilising direct services could not be built to the same quality standards of a trunk-feeder system.

7.2.2.3 Direct services in a closed system

Most direct services have historically tended to utilise an “open” system business structure. Systems such as São Paulo’s Interligado and Seoul’s busways have been able to reap the benefits of exclusive busway operation while reducing transfers for customers. These open systems have permitted improved operational performance without completely reforming the business structure of existing operators. However, inadequacies in station and associated operational design have often led to busway congestion and slower travel times for customers.

By contrast, a relatively new concept is operating direct services within a closed system. In this case, the numbers and types of vehicles are closely controlled by the regulatory agency or system management company. The bunching of vehicles, which tends to occur with direct services in open systems, can be avoided through appropriately sized infrastructure and closely controlled operations.

Although existing systems with direct services have tended to deliver lower-quality standards than trunk-feeder systems, there is no reason why the same amenity features cannot be given to direct services. For example, most systems with direct services require on-board fare collection and fare verification. This practice can considerably delay dwell times at stations. Direct services within a closed system could employ off-board fare collection on high-demand corridors and on-board fare collection with elec-

tronic ticketing in low-demand corridors, where there are fewer boarding passengers to cause stopping delays. Such systems can use pre-paid boarding stations even off the trunk corridor in locations like train stations or shopping malls, where a large number of passengers are likely to be boarding and alighting. The proposed Guangzhou system plans three such off-corridor BRT stations as part of the first phase.

This dual fare system would require the additional cost of having fare collection and fare verification equipment both on the vehicles and also in the stations. This type of system would also require special vehicles with doors on both sides.

Normally, for direct services in a closed system, a determination is made as to which existing bus routes will be brought under the management authority of the new BRT system in order to operate within the new system. This decision-making process will also determine which existing bus routes will continue to operate in mixed traffic lanes, and thus operate outside of the management structure of the new BRT system. This determination is typically made based on the frequency of buses on the particular route in the corridor, and the percentage of the route overlap on the corridor. If too few routes are brought into the new BRT system, the buses outside the BRT system will contribute significantly to mixed traffic congestion. Once this determination is made, all of the buses operating on those routes will have to be replaced with “flexible vehicles” (*i.e.*, vehicles with doorways on two sides).

The pre-paid boarding stations and physically separated busways are then only constructed on the trunk corridors where traffic congestion is a problem and where high volumes of boarding and alighting passengers justify the cost of pre-paid boarding stations.

While this new concept is yet to be fully implemented, the developers of the proposed Ahmedabad and Guangzhou BRT systems are investigating the possibility of a closed system operated through direct services. The idea is to help as many passengers as possible to make their entire trip without transferring, and to remove the need for constructing transfer terminals. These systems also mitigate the need for fundamental changes in the route licensing structure and concession agreements with existing operators.

Fig. 7.18

Vehicles operating on the proposed BRT system in Guangzhou will move directly from an exclusive busway to feeder routes, and thus greatly reduce the need for passenger transfers.

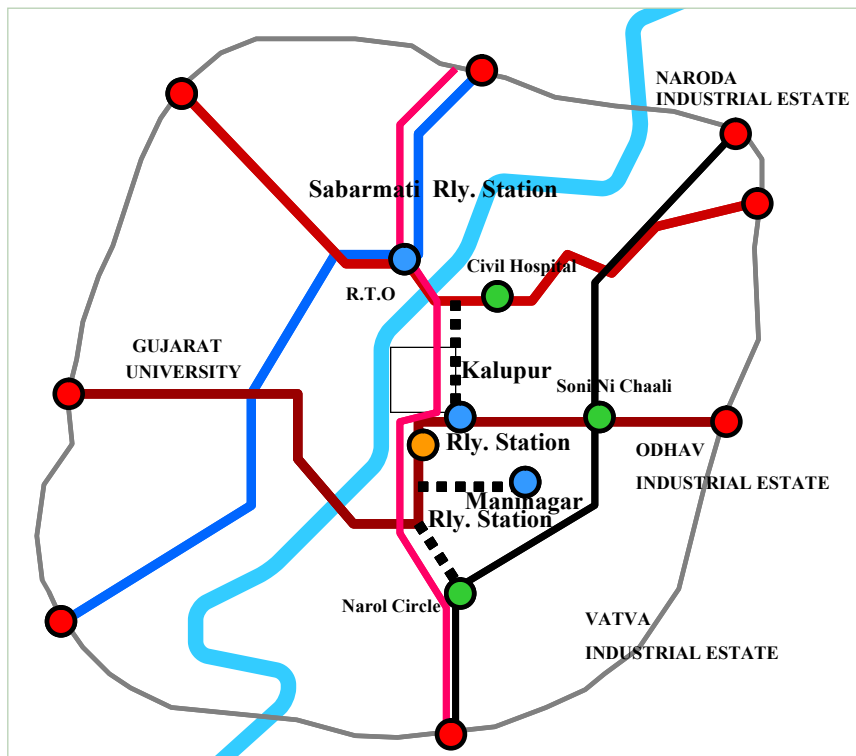
Image courtesy of ITDP



Fig. 7.19

The flexibility of direct services matches the realities of the restricted right-of-way space in Ahmedabad. Vehicles on the proposed BRT system will move directly between segregated busways and mixed traffic lanes.

Image courtesy of ITDP and CEPT



However, the lack of structural reform can also be an impediment to higher-quality services.

Figure 7.18 provides a map of the proposed Guangzhou system. All the existing bus routes illustrated in Figure 7.18 will be allowed to operate along the BRT trunk corridor. The physically segregated busways and pre-paid boarding stations will only be built on the trunk corridor illustrated in green.

Figure 7.19 outlines the concept being examined for Ahmedabad. In parts of the city centre, the

roadway is narrow and volumes of bicycles and motorcycles are quite high, and thus making fully segregated busways politically difficult in Phase I. Nevertheless, even in some areas without segregated busways, pre-paid boarding stations are being recommended anyway due to high passenger volumes. The flexible vehicle concept makes it possible to use these measures only where they are required.

While this operating model has many advantages, there are three main disadvantages of direct services within a closed system:

- Larger vehicle fleet requirement compared to a trunk-feeder system;
- Longer average waiting times if the shift to the new system is accompanied by the user of higher-capacity “flexible vehicles” operating at lower service frequencies;
- Less kilometres of segregated busways means that the system seems less “metro-like” in appearance.

However, direct services within a closed system could be a very appropriate solution in many circumstances, especially when there is much advantage to be gained from avoiding customer transfers.

7.2.3 Mix of trunk-feeder services and direct services

Trunk-feeder services and direct services are not mutually exclusive. A system developer could elect to use different services in different sectors of the city, depending on the local

circumstances. In areas that give way to low-density residential plots, then a trunk-feeder service can be employed. In areas with less variability in corridor population density, then direct services could be employed.

In some ways, Curitiba has implemented a system that features aspects of both trunk-feeder services and direct services. Curitiba’s “Rede Integrada de Transporte” (RIT), *Integrated Transport Network*, encompasses a range of vehicle and route types (Figure 7.20). Curitiba currently operates trunk-feeder routes in five major corridors of the city, and a sixth corridor is currently being planned. The red-coloured vehicles operating on the exclusive busways are known as “Express Buses”.

At the same time, Curitiba also operates several other types of services that directly link some areas to the city centre without needing to first travel to a trunk corridor. A “Rapid Bus” is a silver coloured vehicle that connects major destinations with few stops in between; these routes are known as “Direct Lines”. These buses operate in mixed traffic lanes but also connect passengers to the trunk corridors. Curitiba also operates “Interdistrict Lines” that connect neighbourhoods through direct routes without having to travel first to the city centre. These green vehicles provide a time-savings service by avoiding a significant detour for passengers wishing to travel from one residential neighbourhood to another. Curitiba’s orange feeder buses then connect individual neighbourhoods to terminal sites where passengers can transfer to the other types of services.

Within the RIT system, passengers are able to make transfers without additional payment. Curitiba also operates conventional bus services (yellow-coloured buses) as well as specialised services in mini-buses (white-coloured buses). Some of these specialised services include:

- *Inter-hospital services* – Provides direct services between the city’s different hospitals;
- *Tourist services* – Provides services to popular tourist destinations;
- *City centre services* – Provides services to various destinations within the city centre area.

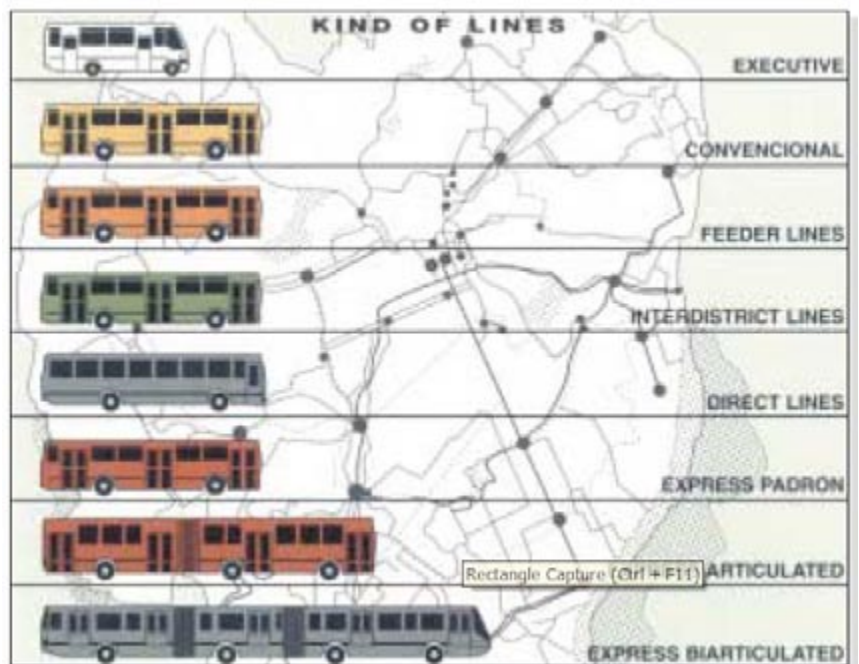
Curitiba also provides an excellent example of how the colour-coding of the buses can help facilitate better system clarity for customers.

The Curitiba does not strictly utilise any examples of direct services since none of the non-express buses enter the exclusive busways. All of the “Inter-district” and “Direct” lines essentially just utilise mixed-traffic lanes. However, these direct express lines operate outside the Curitiba busway only because Curitiba’s system did not provide the passing lanes at station stops that are needed to accommodate express bus services. One major trunk corridor in Curitiba is currently being reconstructed to have passing lanes, and in this corridor the direct express services will be brought inside the busway. The intent of these services is quite similar to that of direct services: To provide direct routes between destination pairs that are not covered by the trunk-line services.

The advantages of the Curitiba approach are the flexibility it allows planners to match different urban and demographic conditions. The main disadvantage of this tiered approach is the relative complexity it presents to the customer, and especially to occasional users and new users. Figure 7.21 provides a system map with just Curitiba’s trunk routes and a system map with direct and inter-district routes. While the left map is fairly readily understandable, the right map requires a bit more of a studied view. As opposed to a metro-like approach, such as Bogotá, Curitiba’s system structure is perhaps less immediately understandable to an outsider.

Fig. 7.20
Curitiba attempts to maximise system efficiency by utilising a wide-range of vehicle and routing types.

Image courtesy of the Municipality of Curitiba



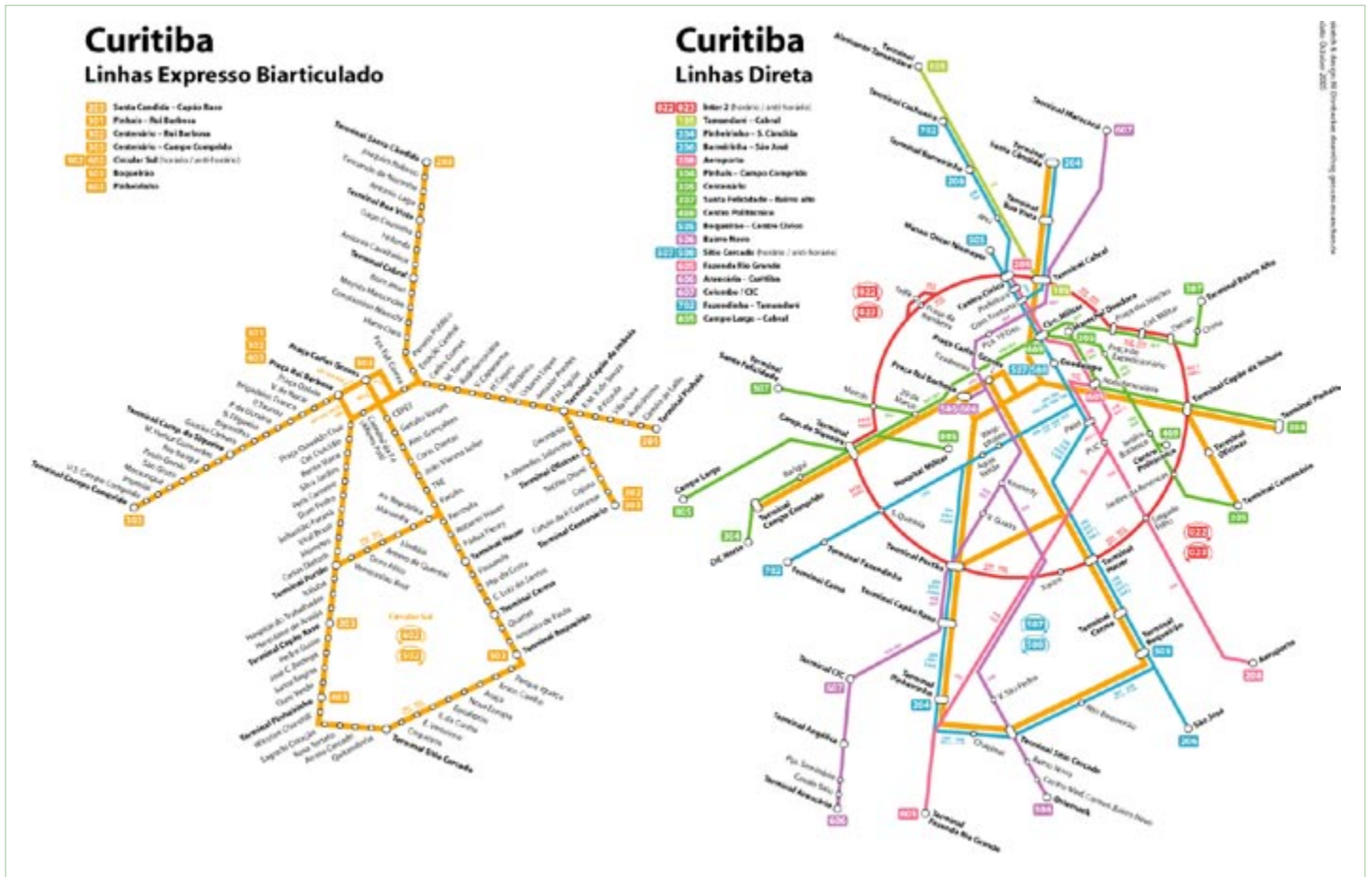


Fig. 7.21
 Curitiba's BRT route map. The advantage of Curitiba's system is its high flexibility, but it can appear somewhat complicated to customers.

Image courtesy of the Municipality of Curitiba

7.2.4 Decision framework

"It is the framework which changes with each new technology and not just the picture within the frame."

— Marshall McLuhan, educator and social reformer, 1911–1980

Neither trunk-feeder services nor direct services are inherently a correct or incorrect design option. Either of these options can be effective in the right circumstances. This section discusses some of the factors that can help determine the optimum choice. The best solution will match the local distribution of origins and destinations and the local demographic characteristics.

Further, a system can change from one service type to another as conditions also change. In

many cases, direct service BRT systems have been a transitional phase to a trunk and feeder system. Both Bogotá and Curitiba essentially operated direct services prior to their transition to trunk-feeder services. Curitiba shifted its bus routes to a trunk-feeder system in the early 1960s, and only built exclusive busways in the 1970s. In São Paulo, while there have been problems of implementation due to resistance from bus companies, there are detailed plans for shifting all the bus routes on major arterials from direct services to trunk-feeder services. While some of the current corridors have exclusive bus lanes, some of them do not. São Paulo plans to build free transfer facilities at key locations.

Table 7.1: Comparison of trunk-feeder services and direct services

Factor	Trunk-feeder services in closed system	Direct services in open system	Direct services in closed system
Travel time	Time penalty incurred for requiring transfer, but speed and capacity along the trunk busway is maximised	Time saved in avoiding transfers, but “bunching” of vehicles along busway will increase travel time	Allows BRT authority to control busway congestion while also gaining the time savings benefits from fewer transfers
Operational efficiency	Matches supply and demand very closely; produces high efficiency even when there are significant variances in population density between corridors and residential areas	Compromise between high-demand areas and low-demand areas may reduce overall efficiency; however, gains are realised if route distance is short	Compromise between high-demand areas and low-demand areas may reduce overall efficiency; however, gains are realised if route distance is short
Infrastructure	Requires construction of terminals and intermediate transfer facilities	Avoids cost of terminals but may require more costly stations	Avoids costs of terminals
Vehicle types	Trunk routes typically restricted to large vehicles; feeder routes typically employ standard sized buses or smaller	Often little standardisation of vehicles; vehicles may require doorways on both sides	BRT authority can standardise the vehicles; vehicles must be capable of both on and off busway operation and thus may require doorways on both sides
Capacity	High passenger flow rates can be handled efficiently with trunk-feeder services	The bunching of vehicles and on-board fare payment inhibit system capacity	Capacity will be somewhat lower than for trunk-feeder systems as vehicle sizes will be somewhat smaller
System image / customer friendliness	Metro-like route structure makes for customer-friendly system	Lack of clear route maps and plethora of routes can create customer confusion	Potentially more complex than a trunk-feeder system but more organised than an open system

7.2.4.1 Summary comparison of services

Table 7.1 provides a summary comparison of the advantages and disadvantages of each service type.

7.2.4.2 Optimum conditions for each service type

This section has detailed the advantages and disadvantages of trunk-feeder and direct services. The complex list of variables involved is not likely to be easily analysed through a cost-benefit analysis. Instead, system developers may need to make qualitative judgements based on their own local conditions. This final subsection outlines a few general decision-making rules that may help facilitate the best fit with the local situation.

A trunk-feeder service within a closed system is likely to be effective under the following conditions:

- Main corridors have relatively high demand;

- Population densities between different areas of the city are significantly different;
- Distances between the city centre and the feeder areas is relatively far, *e.g.*, over 10 kilometres in length.

In general, a direct service within an open system is not recommended. However, such a system could be a transitional step to a more formalised closed system.

A direct service within a closed system is likely to be effective under the following conditions:

- Main corridors have relatively low demand;
- Population densities between different areas of the city are not significantly different;
- Distances between the city centre and feeder areas are relatively short, *e.g.*, less than 10 kilometres.

However, as has been stressed throughout this section, there is no single correct option; the best service type depends significantly on local circumstances. System developers may also elect

to develop a mix of both trunk-feeder routes and direct service routes.

7.3 Route design

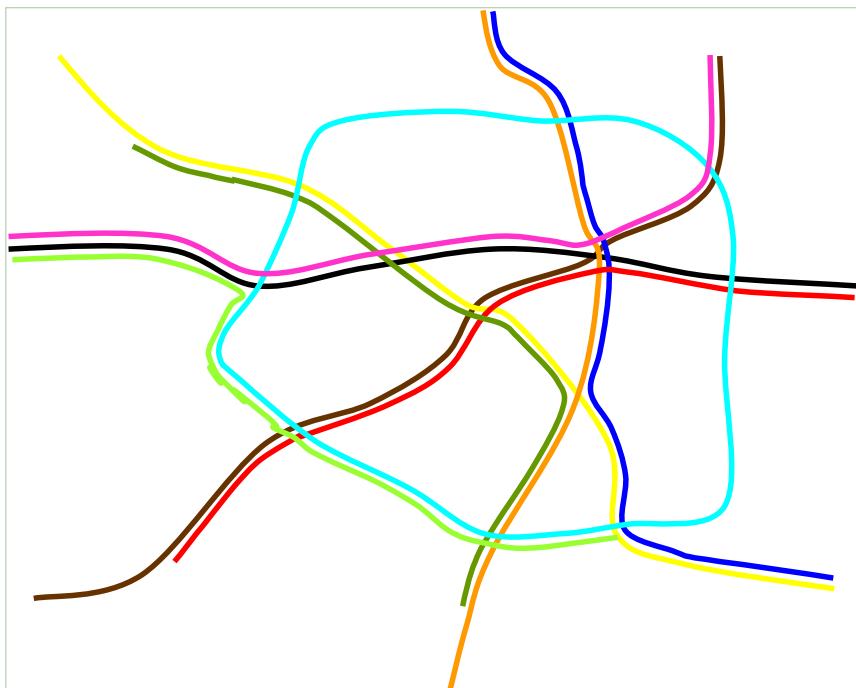
“A route differs from a road not only because it is solely intended for vehicles, but also because it is merely a line that connects one point with another. A route has no meaning in itself; its meaning derives entirely from the two points that it connects. A road is a tribute to space. Every stretch of road has meaning in itself and invites us to stop.”

—Milan Kundera, novelist, 1929–

The choice of the BRT corridors only provides a macro-level view of where a system will operate. Within a given set of corridors, vehicles will serve particular routes. The route selection process within and between corridors determines many operational characteristics that will directly impact customer travel times and convenience.

No system will likely be able to provide a route network that caters to every possible permutation of origins and destinations. Transfers between routes will be inevitable for some origin-destination combinations. However, a well-designed routing system can optimise travel times and convenience for the largest number of journeys, and significantly reduce operating costs.

Fig. 7.22
BRT and the synergies of route permutations



The relative flexibility of BRT in comparison to other public transport options means that routes and services can be tailored quite closely to customer needs. The system can be designed to minimise travel times for the greatest number of passengers. Routing options, such as local, limited-stop, and express services, permit an array of permutations that maximise system efficiency and minimise travel times for customers. Both passengers and operators can benefit from adjusting public transport services to more closely match existing demand. An effective route network can be achieved through the following design principles:

1. Minimising the need for transfers through efficient routing permutations;
2. Providing local, limited-stop, and express services within the BRT system;
3. Shortening some routes along a corridor to focus on high-demand sections.

Customers typically prefer to have choices and options. Providing alternative routing options serves several objectives, including good customer service, reduced travel times, and increased system capacity.

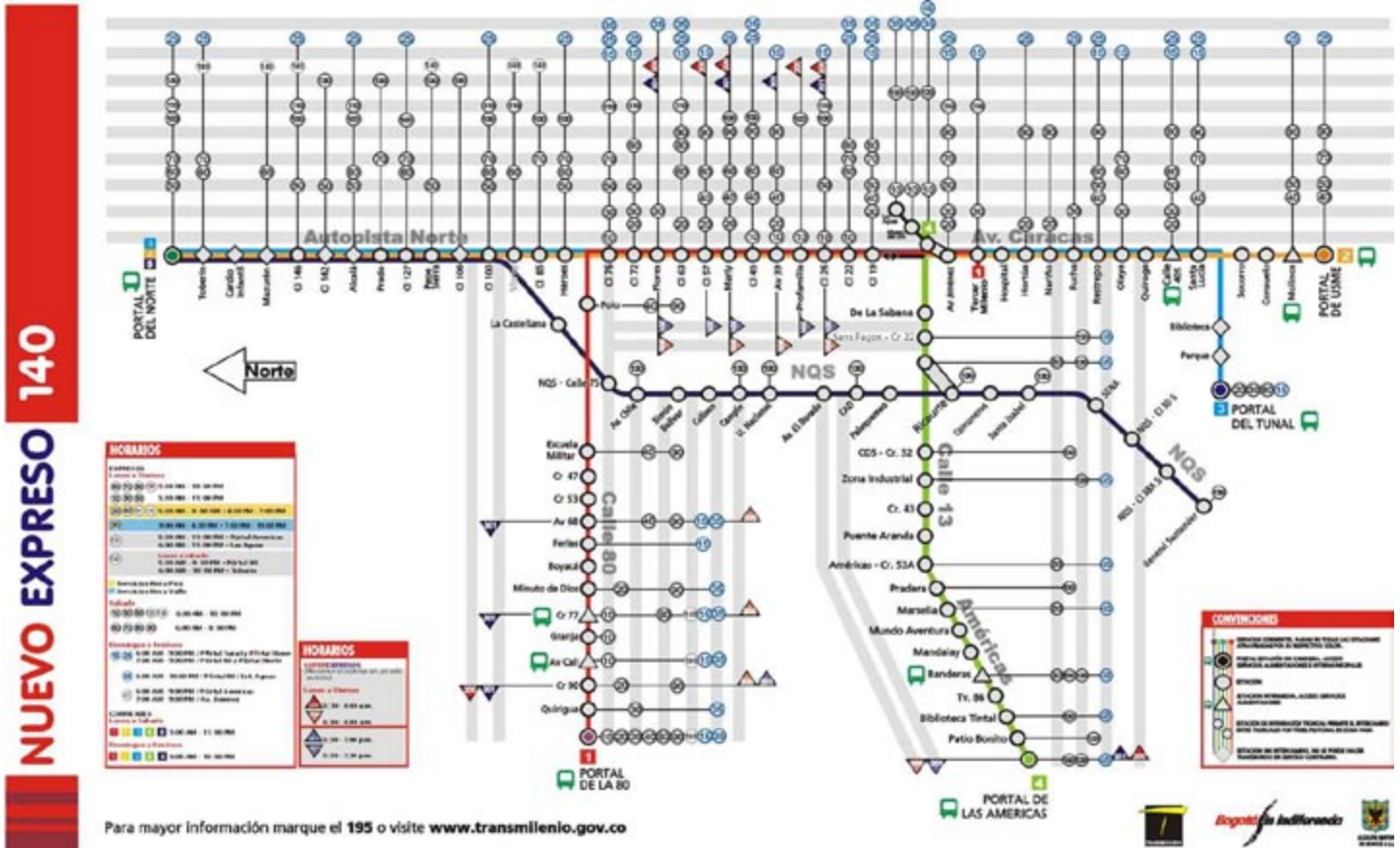
7.3.1 Route network

“A system is a network of interdependent components that work together to try to accomplish the aim of the system. A system must have an aim. Without the aim, there is no system.”

—W. Edwards Deming, statistician, 1900–1993

BRT is unique as a public transport system in terms of its flexibility with routing options. The ability of rubber-tyred vehicles to change lanes and directions at will allows any number of potential routing permutations. By contrast, rail-based vehicles are limited to set tracks and can only make line switches in low-frequency circumstances.

The most immediate advantage of multiple route permutations is the avoidance of transfers for passengers and the subsequent savings in travel times. If a passenger has several route options from which to choose, then the likelihood of a required transfer is lessened. Additionally, more efficient passenger movements also equate to more efficient system operations. Further, as the need for transfers is minimised or even eliminated, the cost implications for complex



▲ Fig. 7.23
The Bogotá TransMilenio system offers a large number of route permutations to maximize customer convenience, but the end result can be a fairly complex route map.
 Image courtesy of TransMilenio SA

transfer stations are reduced. Figure 7.22 is an illustration of the type of routing options possible with BRT systems. Bogotá's TransMilenio system has been one of the most successful BRT systems to exploit the power of multiple route permutations. Customers at a single station may have as many as ten different routes from which to choose, including local and limited-stop services.

Bogotá's routing complexity can also be somewhat bewildering to new and occasional users. Due to the large number of route permutations, Bogotá's system map is fairly complex (Figure 7.23). Rather than showing different coloured lines for each route, Bogotá must list the route numbers that service each stop. A map user must essentially follow the numbers through the

While the customer and operational benefits of the Bogotá routing permutations are clear, there is one potential drawback in terms of system complexity. As the number of routing permutations increase, the operational complexity to manage such a system becomes significant. Bogotá's TransMilenio system benefits from satellite location technology and a sophisticated control centre to ensure the vehicle movements operate smoothly. Without such technology, it is unlikely that a system of this complexity level could function well.



Fig. 7.24 ▶
The complexities of the TransMilenio routing system can be a bit perplexing to customers.
 Photo by Carlos F. Pardo

system to determine which route is most appropriate for their journey (Figure 7.24). Given the number of routes in the system, if TransMilenio attempted to fully colour-code its maps, then the ensuing tangle of lines would likely also confuse customers. Further, there would not be a sufficient number of distinguishable colours to show the various TransMilenio routes in such a map.

Despite such complexities, the minimisation of transfers and options given to customers makes systems with multiple routing permutations quite convenient to passengers.

More recently, TransMilenio has divided its system into coloured zones (Figure 7.25). A passenger will identify the destination by relating it to zonal colour. In term, the passenger can consult individual routing maps to determine which route option within their zonal colour will be the most efficient. As has been the case with TransMilenio, a city with a complex routing structure will likely experiment with various display options to determine which provides the customer information in the most user-friendly manner.

7.3.2 Transfers

The impact of transfers on ridership cannot be underestimated. Transfers are often one of the main reasons discretionary riders will elect not to use a system. Further, if the transfers involve any form of physical hardship, such as stairs, tunnels, or exposure to rain, cold, or heat, then the system’s acceptability is even more compromised.

7.3.2.1 Types of transfers

Not all transfers are created equally. On one extreme are transfers involving lengthy walks across intersections and other obstacles while being unprotected from rain and wind. At the other extreme are transfers involving a simple few metre walk across a comfortable, safe, and weather-protected platform. Which of these two types of transfers are possible depends much on the infrastructure design and the route design.

In reality, there is a spectrum of possible of transfer arrangements. Figure 7.26 illustrates the different types of transfer options.

The most desirable option is obviously to avoid transfers altogether for the vast majority of customers. Thus, level 1 in Figure 7.26 underscores the importance of utilising good system and route design to eliminate the need for transfers. Level 2 is recognition that some transfers may be necessary but that the use of multiple sub-stops at stations can permit customer-friendly platform transfers.

As the type of transfers become more difficult beyond level 2 transfers, then the system will likely begin losing some discretionary customers (*i.e.*, customers who have other mobility options such as private vehicles). A level 3 transfer implies that a customer must physically walk from one corridor to another (typically around an intersection area). However, in level 3 the walk is within a closed and protected environment, such as a pedestrian overpass or a tunnel. Further, in level 3, the transfer still occurs without

Fig. 7.25
With an ever-growing number of routes, the most recent TransMilenio system map has foregone showing individual routes and instead divides the system into several colour-coded zones.
 Image courtesy of TransMilenio SA.





**Level 1: No transfer necessary
(Good route design)**



**Level 2: Platform transfers
(High customer convenience)**



**Level 3: Grade separated in closed environment / fare integrated
(Less convenience)**



**Level 4: Grade separated in open environment / fare integrated
(Less convenience)**



**Level 5: Grade separated in open environment / fare compatible
(Inconvenient)**



**Level 6: Grade separated and fare separated
(Inconvenient)**



**Level 7: Physical barriers to transfer and fare separated
(Poor customer service)**

any penalty payment or the need to go through another fare verification process.

With levels 4 and 5, the customer must make a transfer in an “open” environment, meaning that they must physically leave the confines of one system and then enter another. There are two clear disadvantages to this approach. First, the customer will likely have to cross an intersection and also undertake the inconvenience of walking up and down stairways or escalators. A customer with a small child or with several shopping bags may find the physical nature of this transfer prohibitively difficult. Second, customers must re-verify their fare medium since they are entering from outside the system. The re-verification process can involve several possible delays and queues.

The Seoul integrated transit system is an example of a type 4 transfer. Customers entering a bus must swipe their smart card with an on-board card reader. The same customers must remember to swipe their cards again upon exiting.

Then, if a person wishes to continue the journey using the city’s metro system, the card is swiped upon entering and exiting the metro system. In each case, customers must remember to swipe their smart card as well as incur a delay due to a queue at a card reader. However, the Seoul system is fully “fare integrated”. With a fare integrated system the total fare charged to the customer is based on the total distance travelled. A customer is not charged a new “entry” fee into the system. In Seoul, the smart card technology allows a quantity to be deducted primarily on a distance basis. However, the distance covered when using the metro rail system is charged at a higher rate than when using the BRT system.

The difference between a type 4 transfer and a type 5 transfer is the difference between “fare integration” and “fare compatibility”. Whereas fare integration allows a customer to avoid paying an additional entry fee into the second system, fare compatibility does not. With fare compatibility, a customer can use the same fare

Fig. 7.26
Types of transfers

medium, such as the same smart card, but must essentially pay for an entirely new fare when entering the second system. Fare compatibility does not imply that there is any distance-based consideration in determining the fare for a journey that encompasses two different systems. For example, in Tokyo, there are two different metro rail systems: 1. Tokyo Metro; and 2. Toei Metro. It is possible to purchase a smart card that can be utilised on both systems. However, when transferring from one system to another, a customer must effectively pay two separate fares. Thus, fare compatibility allows some convenience in terms of using a single fare payment

method, but the fares are not fully integrated and this lack of integration means that customers will likely pay more.

By the time that one reaches transfer levels 6 and 7, any discretionary customers will generally opt not to utilise the public transport system. At levels 6 and 7, there is neither physical nor tariff integration between different systems. Customers must not only pay twice but also must endure a difficult physical environment to walk from one system to another. Level 7 is the most difficult with actual physical barriers making transfers at the same station area almost impossible. For example, in Kuala Lumpur the KL Sentral station hosts both PUTRA LRT operations and the KL Monorail operations. However, to walk from one to another implies a 20 minute walk through multiple changes in grade and an unpleasant parking lot environment. Likewise, changing from an intersecting PUTRA LRT line and a STAR LRT line in Kuala Lumpur is also a challenging experience. The three different rail systems in Kuala Lumpur were not designed with much consideration for customer convenience in transfers (see levels 6 and 7 in Figure 7.26).

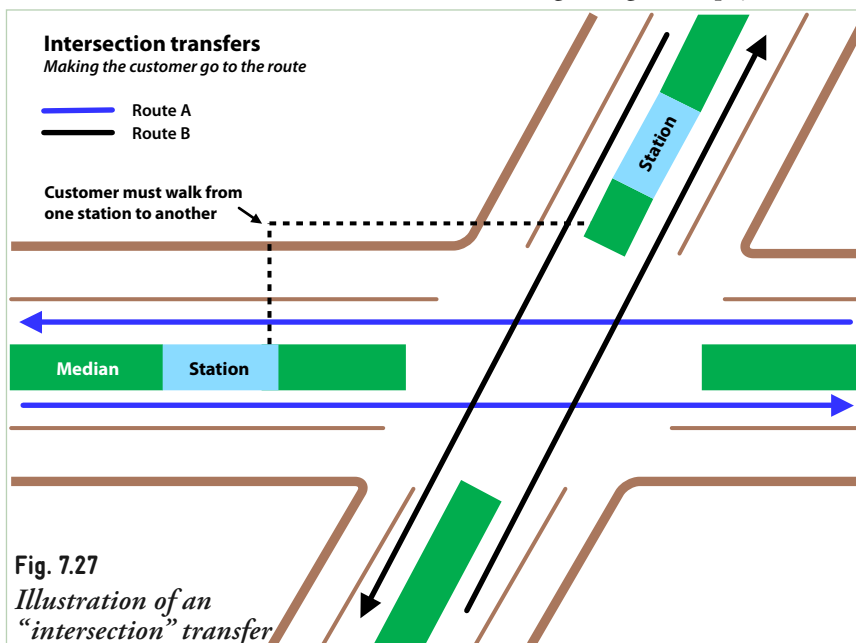


Fig. 7.27
Illustration of an "intersection" transfer

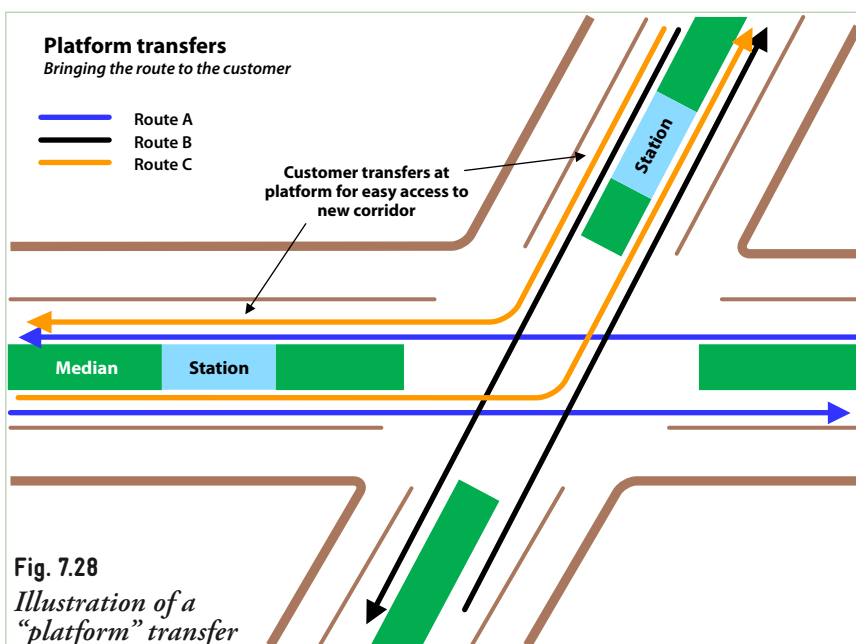


Fig. 7.28
Illustration of a "platform" transfer

7.3.2.2 Facilitating platform transfers

As indicated from the options given in Figure 7.26, if a transfer is necessary, then a platform transfer in a safe and pleasant closed environment is the preferred option. A platform transfer essentially brings the vehicle (and the route) to the customer. By contrast, an intersection transfer means that a customer is traversing the distance of an intersection to access the intersecting route. While the physical hardship of an intersection transfer can be eased through a pedestrian tunnel or overpass, it is always less desirable than a simple platform transfer. In this case, the system is forcing the customer to go to the route, rather than the other way around.

To achieve a platform transfer, an intersecting corridor must be connected by way of the routing system. Figures 7.27 and 7.28 illustrate the routing circumstances that either force an intersection transfer or permit a platform transfer.

Thus, the simple addition of a new route in Figure 7.28 provides much transfer convenience to the customer.

7.3.3 Local, limited stop, and express services

7.3.3.1 Local services

The most basic type of public transport service along a corridor is typically known as “local service”. This term refers to stops being made at each of the major origins and destinations along a route. “Local services” imply that no stops are skipped along a route. Thus, while local services provide the most complete route coverage along a corridor, such services also result in the longest travel times.

Single track metro systems and simple, single lane BRT systems like TransJakarta and RIT Curitiba typically have few options but to operate only local services. There are no provisions within the narrow infrastructure of these systems for vehicles to pass one another.

In comparison to conventional bus services, the local services of a BRT system are considerably more efficient. In many developing-nation cities, public transport services operate on a “hail and ride” basis. The bus will effectively stop whenever hailed by a customer, whether the customer is at a bus shelter or not. The bus may stop every few metres if requested. This situation is particularly true when operator income is based on the number of passengers carried. While this practice will reduce walking distances to access a bus, the net effect of all passengers controlling stopping location greatly increases overall travel time for everyone. For minibuses, because there are fewer passengers, the number of such stops is minimised, and once the minibus is full it may not stop at all. This can often lead to very fast travel speeds, but it can also mean that some passengers during peak periods can wait a long time until a minibus is willing to stop, and the service is highly unpredictable.

By contrast, BRT stations only alight and board passengers at designated stations. Further these stations are separated by enough distance to minimise stop times while at the same time are close enough to be accessed by most persons in the area. A typical range of distances is between 300 metres and 700 metres. By avoiding short stopping distances, the overall travel time is reduced due to higher average vehicle velocities.

The location of BRT stations will follow from the origin and destination modelling conducted

earlier. Major destinations such as commercial centres, educational institutions, and large employers will all influence the location. Additionally, an array of other factors, such as road configuration, will also play a determinant role in choosing a cost-effective location that best serves the customer.

7.3.3.2 Limited-stop services

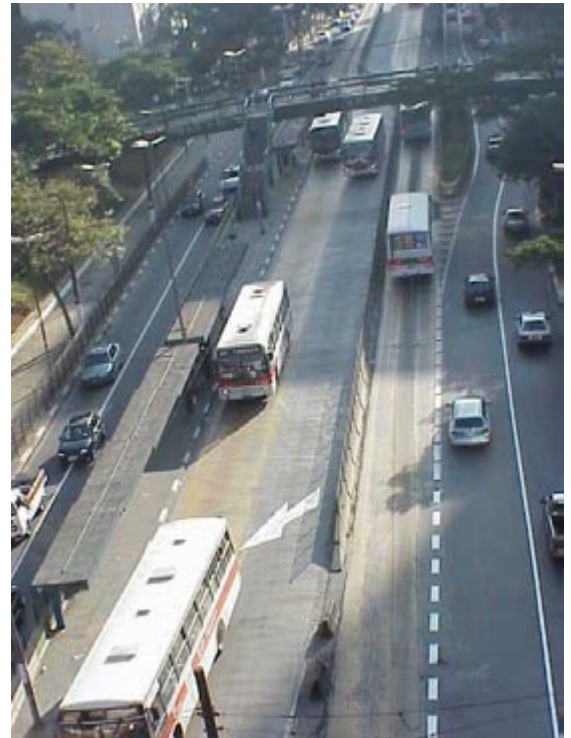
Single lane BRT systems with only local services have significant disadvantages. Most importantly, at high passenger volumes, they have much lower capacity and speed. Typically, the vast majority of passengers will get on and off at a few major stations. A few passengers, however, will get off at less used stations. For many passengers, stopping at each intermediate station adds significantly to the overall travel time with relatively little commercial benefit to the system operators. Thus, both passengers and operators can benefit from the provision of services that skip intermediate stops.

BRT’s relative flexibility means that “limited-stop services” or “skipped-stop services” can be accommodated. The number of station stops to be skipped depends on the demand profile. Major station areas with the largest customer flows may be the most logical stops retained in a limited-stop service. However, the system can employ multiple limited-stop routes in order to ensure travel times are minimised for the largest number of customers. Thus, limited-stop routes can differ by the stations served as well as by the number of stations skipped by the service. Some routes may skip 3 or 4 stations while other routes may skip double that number.

Well-designed stations can permit customers to transfer from a local service to a limited-stop service. Thus, even if a customer does not reside near a limited-stop station, he or she can transfer to a more rapid service after just a few stops in a local-service vehicle. In some instances, customers may find it advantageous to go beyond their desired stop in a limited-stop vehicle and then return a few stations by way of a local service. The principal idea is to give the maximum flexibility to the customer in order to reach the destination in the most convenient manner.

Fig. 7.29 and 7.30
Passing lanes at stations as practiced in Bogotá (left photo) and São Paulo (right photo) allow for the provision of express and limited stop services, which deliver significant travel time savings to customers.

Left photo courtesy of TransMilenio SA
 Right photo courtesy of Booz Allen Hamilton



The main advantages of limited-stop and express services are thus:

- Time savings for vehicles and passengers using limited-stop services;
- Reduction of saturation (*i.e.*, congestion) at stations that have been skipped, meaning smaller stations can be built in some locations
- Increase in overall capacity of system.

However, these services also introduce some challenges for system managers:

- Some passengers may experience increased waiting times; as more lines are added, the frequency on each line will be reduced;
- More complicated system from both the standpoints of system management and customer understandability;
- Requirement of passing lanes at stations.

While limited-stop services do provide much amenity value to customers, these services do introduce greater complexity to the management of the system. The coordination of vehicles on the same corridor with different travel characteristics can be a challenge. Limited-stop services are thus best implemented in conjunction with vehicle tracking technology that permits a central control team to oversee and direct vehicle movements.

The provision of limited-stop services also implies particular infrastructure requirements.

In order to skip stops, the limited-stop vehicles must be able to pass intermediate stations. Thus, sufficient road space must be available for either a second set of exclusive busway lanes or the provision of a passing lane at by-passed stations (Figures 7.29 and 7.30). These requirements mean that cities employing limited-stop services will incur greater system complexity and higher infrastructure costs. Chapter 8 (*System capacity and speed*) discusses how passing lanes can be fitted for even relatively narrow right of ways.

Some cities with single lane busways also utilise limited stop and express services. The vehicles pass by way of the opposing lane. The Quito Trolé and the Beijing Qinghua Dong Road busway both make use of this technique. In general, though, overtaking by way of the opposite lane is not recommended. There are obvious safety issues involved with such an approach (Figure 7.31). The risk of a head-on collision between rapidly approaching vehicles is a real possibility. Further, this arrangement can only be done in conjunction with side-aligned stations, which create other types of operational problems.

Another technique is to time services so that limited-stop or express services only catch up with the local services at the terminal point of a route. Thus, an express service may begin ten minutes behind a local service, and this

starting time difference ensures that the express service does not overtake the local service. This technique is quite commonly applied to urban rail systems in Japan, such as the Hankyu service in Osaka. The applicability to BRT, though, is likely to be limited. Unless a corridor is relatively short, the starting time difference between local and express vehicles would have to be quite significant (e.g., 10 minutes). This difference is probably too large to accommodate the required vehicle frequencies for BRT systems in the high-capacity corridors of many developing-nation cities.

7.3.3.3 Express services

Another type of limited-stop service is known as an “express service”. Express services skip all stations between a peripheral area and a central core area. Thus, express services are an extreme form of limited-stop service.

Express services function quite well when the origin of the trip is a high-demand area that is some distance from the city centre. If population densities are such that vehicles reach capacity at peripheral areas, then it can be efficient to transport these passengers directly to central locations. In many cases, the trip origin for an express service will be a transfer terminal where demand from numerous feeder services has been consolidated.

The reduced travel time of express services can be a major enticement to curb the growth of private motorised vehicles in the city’s periphery. In many developing cities, low-income communities are often located at such peripheral locations, and thus, the provision of express services can be way of achieving greater equity within a system.



Express feeder buses can also work well to connect a large residential area a considerable distance from the transfer terminal (Figure 7.32). TransJakarta, for instance, has introduced express non-stop feeder buses from a suburban shopping mall to one of the TransJakarta stations.

7.3.4 Shortened routes

Even within BRT systems that only allow for local stops, it is possible to adjust the service to better meet the demand by having some bus routes turn around before reaching the final terminals. The same corridor can host several routes of varying lengths.

Ideally, the highest-frequency of service will be provided on the highest-density section of the corridor. Thus, rather than operating a route across the entire length of a corridor, the service can focus mostly on the higher-demand portions. A single corridor may be split into two or more routes covering a different portion of the

Fig. 7.31
By allowing vehicles to overtake in the opposing lane, there are obvious risks of a serious collision as evidenced in Beijing.

Photo by Lloyd Wright

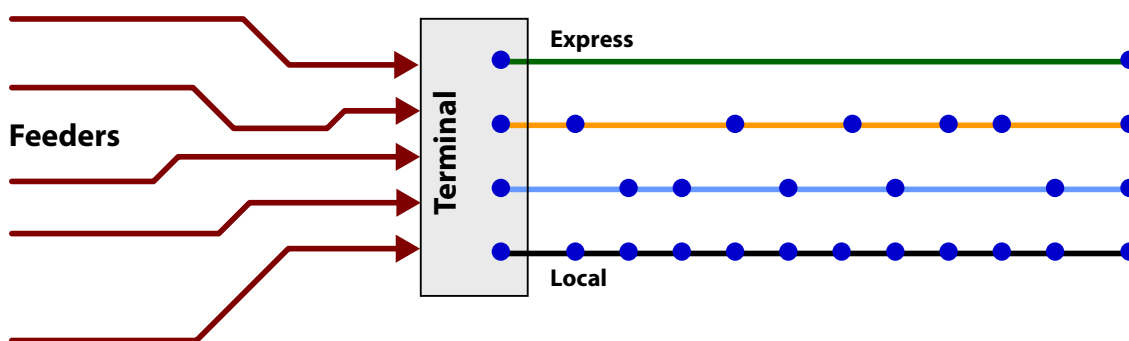


Fig. 7.32
Schematic of feeder lines supporting local and express services from a single terminal.

customer regarding the approaching vehicle. Customers using the Trolé system, only have a few moments of time to recognise which route is approaching the station. A small plaque in the windscreen of the bus is the only indication of the route. The sight-line to see this plaque is quite obscured due to the station infrastructure. No pre-announcement is made nor is there any digital display indicating which route is approaching the station. Such lack of customer informational support can cause much stress and confusion amongst passengers.

In general, the shortened route should not be terminated at the highest-demand point in the system. These stations are already stressed by the quantity of passengers and the intensity of customer movements. Further, since these stations tend to be located in the densest portion of the urban area, there are fewer opportunities to efficiently turn around the vehicles. Thus, the route termination / vehicle turning point should be at least one or two stations removed from the busiest station.

This type of route programming will typically reduce overall operational costs by up to 10 percent. In order to accommodate a shortened route option, the planning process should provide sufficient flexibility with regarding:

- Providing places where buses can make u-turns within the BRT system; and,
- Designing the station areas with sufficient extra capacity to allow for service adjustments.

Adequate programming of bus services even within a system of all local services can reduce operational costs by up to 10 percent. The public transport modelling process can help to forecast corridor and station passenger demand, and thus help determine the optimum form of the shortened routes. Through this process, the multiple corridor routes for Jakarta have been determined, as given in Table 7.2.

Box 7.1 summarises the savings the Jakarta routing proposal produces in terms of the size of the required vehicle fleet.



7.3.5 Decision factors in route selection

As with corridor selection, the most basic principle for route selection is to focus upon serving the majority of passengers in the most efficient manner possible. Thus, system planners will aim to serve the most common origin-destination pairs in the most rapid and direct manner. This objective particularly implies the avoidance of transfers for the majority of passengers. The basis for this selection therefore is the public transport modelling work that should supersede the route selection.

Beyond the first emphasis on serving the demand profile in the most direct manner, there may be other decision criteria. The physical

Fig. 7.35

Some vehicles make a u-turn movement in the city centre of Bogotá in order to begin a new route direction.

Photo by Lloyd Wright



Fig. 7.36

A vehicle making a u-turn at the end of a corridor in Curitiba.

Photo courtesy of the Volvo Bus Corporation

Box 7.1: Calculating fleet reduction from shortened routes

Shortened routes focussing on higher-demand central areas will contribute to high operating efficiencies. These efficiency gains will help reduce the number of vehicles required to serve the corridor. The graphic below illustrates the demand profile along the length of a corridor.

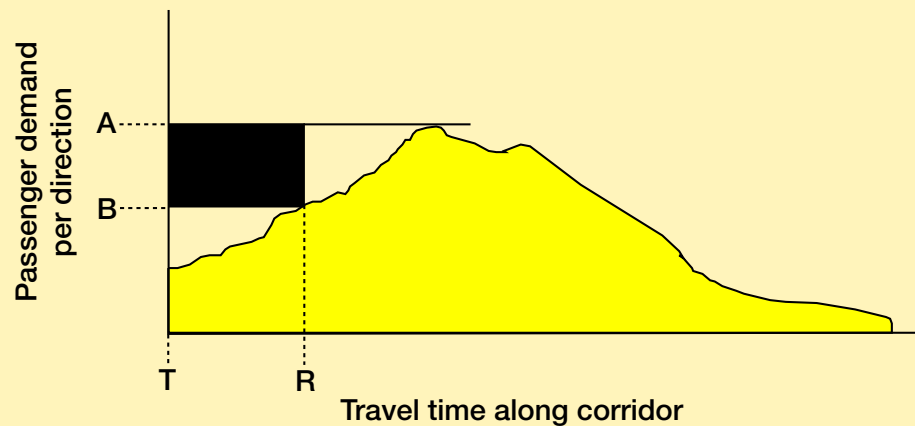


Fig. 7.37
Offering the option of shortened routes along a corridor can help reduce vehicle fleet requirements.

Image courtesy of Pedro Szasz

In the figure above, most of the corridor’s demand occurs in the central areas. Under a full corridor route, all vehicles would commence from point T. However, if vehicles were to operate a shortened route beginning from point R, then the number of vehicles required to serve the corridor will be reduced. This fleet reduction is calculated as:

$$\text{Fleet reduction} = [2 * (R - T) * (A - B)] / C$$

Example:

A = 15,000 passengers/hour

B = 10,000 passengers/hour

R – T = 10 minutes (uni-directional time) = 10/60 hours

C = 150 pas/bus (vehicle capacity)

$$\text{Fleet reduction} = [2 * (10/60) * (15,000 - 10,000)] / 150 = 11 \text{ vehicles}$$

nature of the corridors will also affect route selection. In some cases, turning from one corridor to another may be difficult to traffic or physical constraints. Ultimately, the number of route permutations and services added is limited by two factors: 1. Congestion on busway due to number of services; and 2. Confusion amongst customers regarding the overwhelming number of permutations.

As a quick general rule, the first priority for routing efficiency gains is ensuring a transfer-free option is available for customers travelling between any two major corridors that intersect. As a next step, significant efficiency gains can be

achieved along any corridor by simply operating one local service and one limited-stop service focussed upon the highest demand stations.

This simple division into two services will likely significantly improve the average speed and overall capacity of the system. Adding express services between the main transfer terminal and the city centre would likely be the next line to add. Even if demand is completely uniform, if bus frequency is sufficiently high, this concept can be extended and more express lines can be used, with speed and capacity gains for the system. Figure 7.38 summarises the process of building up an effective route structure.

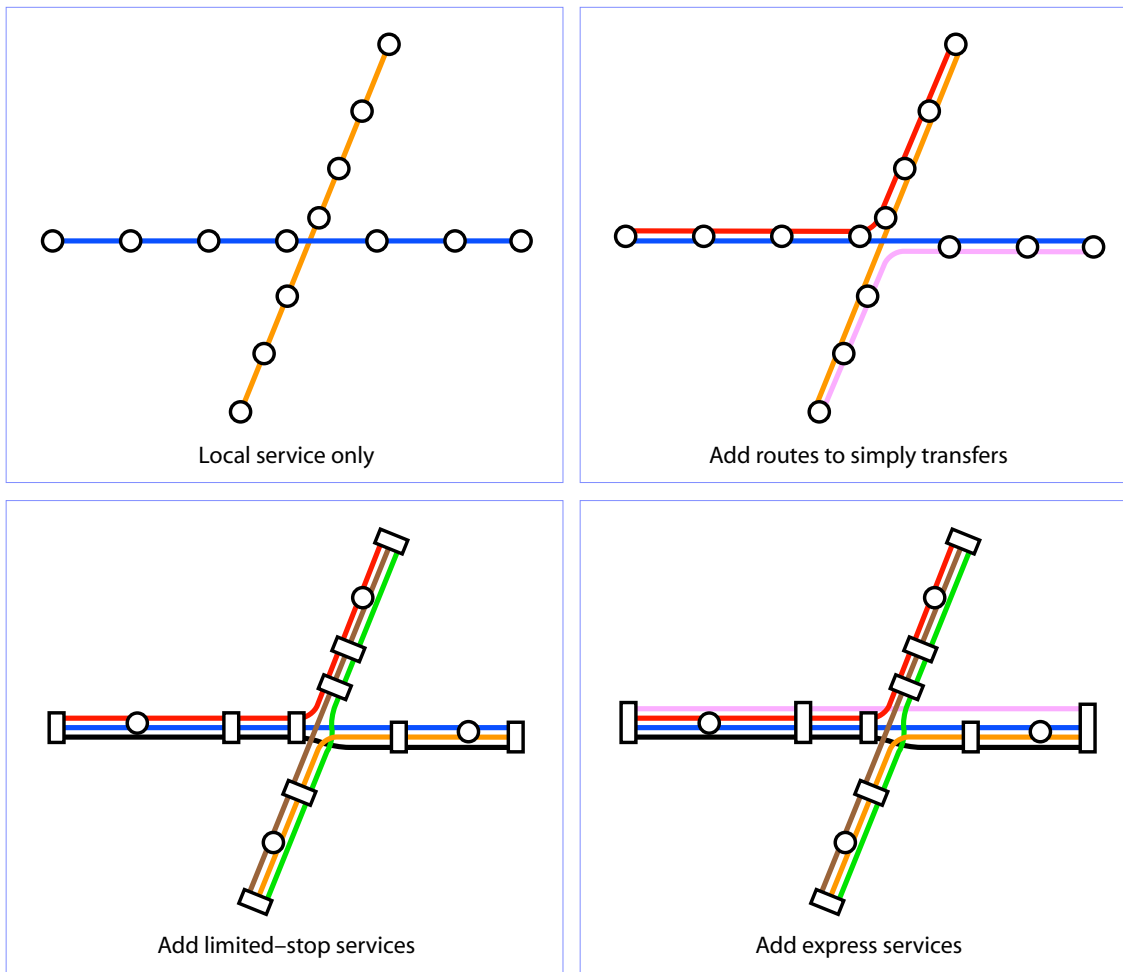


Fig. 7.38
Route-building process

The nature and organization of express and local services will depend on the nature of demand and where it is concentrated. Fully optimising public transport services makes it possible to find the right balance between local and express services which minimises the generalised trip cost for the most passengers. To do it properly requires a public transport system model, as described in Chapter 4 (*Demand analysis*).

Splitting services within a BRT corridor between local, limited stop, and express options, can dramatically increase the speed and capacity of a BRT system. This splitting of services is one of the key secrets to the high capacity and speed that was achieved with Bogotá’s TransMilenio system. Getting the right mix of local and express services, however, is both difficult and critical in high demand systems.

7.3.6 Feeder routes

Connecting residential areas to the main BRT corridors is almost always essential to establishing a financially-sustainable public transport system. If a system only consists of major destinations with viable connections to trip origins, then customers will face difficulties in accessing the system. In high-quality BRT systems such as Bogotá and Curitiba, approximately one-half of system boardings originate from feeder services.

As this chapter has indicated, there are two service structures for linking main corridors to residential areas:

- Trunk-feeder services;
- Direct services.

This section provides an overview of choosing feeder routes within a trunk-feeder service. However, cities implementing systems with direct services will also need to give much consideration to how the route network extends into residential areas.

7.3.6.1 Selecting feeder routes

Normally, when a BRT system is built, many of the traditional bus and paratransit routes are removed from the corridor. The traditional routes generally operated both along the trunk corridor and off the corridor. The first step in identifying feeder routes is to look at those traditional bus and paratransit routes, and assign to feeder vehicles to those parts of the traditional routes that are not along the new BRT corridor. The traditional routes, however, are unlikely to be entirely optimal, and it is likely that new routes will need to be created using the data from the traffic model. Just as the demand analysis from Chapter 4 shaped the location of the trunk-line corridors, passenger demand profiles should also underpin feeder route selection. Both major residential areas and secondary commercial roadways are typically the focus of feeder services.

For distances beyond 500 metres from a trunk-line station, many customers will likely prefer a feeder service. Although some developing-nation cities report considerably longer walking distances for citizens to access public transport, these persons are often captive customers with few other options. Moreover, the footpath

conditions in such cities are generally not of a high quality. Thus, the 500-metre rule should be one of the guiding principles in selecting feeder routes.

In most cases, the areas around the system's trunk terminals are a priority for feeder services. The terminal location will likely be chosen in part due to the nearby passenger capture area. Terminals are also the easiest place to facilitate transfers from feeder vehicles to trunk-line vehicles.

However, intermediate feeder opportunities should not be ignored. Very often secondary corridors that run perpendicular to the trunk corridor are fertile areas for customer demand. In such cases, some form of an intermediate transfer station must be provided to facilitate the feeder to trunk transfer.

The location of feeder services may also be influenced by social considerations. Low-income communities may be located in peripheral areas with poor road infrastructure. Smaller feeder vehicles are likely the only option for a system to access such areas effectively (Figure 7.39). Cities may elect to particularly emphasise feeder



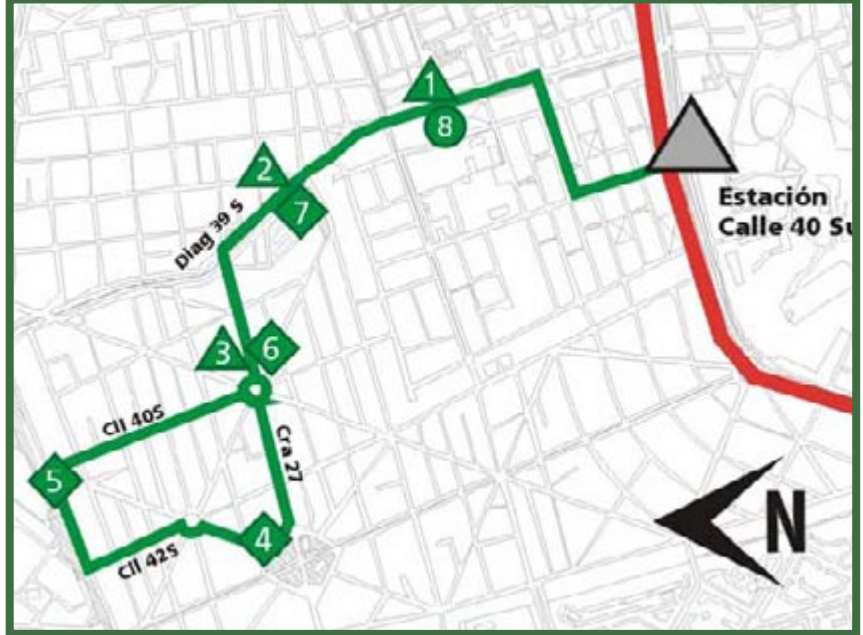
Fig. 7.39
Smaller feeder vehicles are likely to be required in order to penetrate many low-income residential areas that may have a limited road network.

Photo by Shreya Gadepalli

Loop route



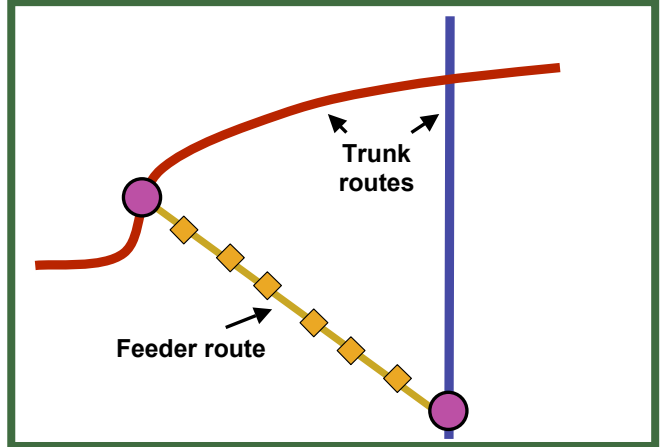
Straight/loop hybrid route



Straight roundtrip route



Feeder route connecting two trunk routes



connections for the poorest areas in order to better link such citizens to services and employment opportunities.

The overall length of feeder services will depend upon demand patterns and the relative population density of residential areas. The population density of a feeder area may be two to four times lower than the population density along a trunk corridor. Since feeder services are generally expected to deliver at least half of a system’s ridership, the length of the total feeder routes may actually need to be two to four

times greater than the length of the total trunk corridors.

The physical shape of a feeder route will depend upon local street configurations and demand profiles. However, in general, feeder routes tend to take upon one of these type of forms:

- Loop route (Figure 7.40);
- Straight roundtrip corridor (Figure 7.41);
- Combination of single corridor and loop route (Figure 7.42);
- Single corridor connecting two trunk corridors (Figure 7.43).

Fig. 7.40, 7.41, 7.42, and 7.43

Examples of different feeder route configurations in Bogotá.

Images courtesy of TransMilenio SA

The loop route can be efficient from the standpoint of minimising duplication of services. The loop route maximises the area being covered by the feeder service (Figure 7.40). Rather than travelling “out and back” on the same corridor, the loop route allows the feeder vehicle to serve a new customer base along the entire length of the route. Thus, in some cases, operators earning revenues based on the number of passenger boardings may prefer a loop route.

However, a loop route has many disadvantages from a customer standpoint. Passengers boarding at the earliest portion of the loop route will have the longest travel time to arrive at the transfer terminal. Ironically, many of these passengers will actually reside closer to the terminal than passengers with a much shorter travel time. The reverse is also true for passengers returning to their residence. Passengers at the end of the loop line will have the longest travel time in order to travel from the terminal to their home. However, again, these passengers will likely reside much closer to the terminal than passengers with much shorter journeys. Thus, loop routes can create long and frustrating detour factors for many customers.

Loop routes can also create inefficiencies for operators. Along a loop route, passengers will be both boarding and alighting at each station. Thus, in terms of payment control and passenger counts, the task is more complex.

By contrast, a single corridor operating on an “out and back” routing avoids most of these difficulties (Figure 7.41). On the trip away from the terminal, most customers will be alighting. On the return leg, most customers will be boarding. Further, the length of time to the transfer terminal is directly proportional to a person’s proximity to the terminal. However, a single roundtrip corridor will cover an area in a more limited fashion than a loop route. Thus, the out and back routing is not as cost effective in terms of covering a given area.

A reasonable compromise is to combine both the out and back routing with a loop routing (Figure 7.42). The loop route configuration would be attached to the end of straight roundtrip portion of the route. Thus, passengers living along the loop portion of the route are not heavily penalised with a large detour factor relative

to the overall length of the route. At the same time, the addition of the loop improves the area coverage of the route and thus improves overall cost-effectiveness.

Perhaps the most effective feeder route structure, though, is a route directly connecting two different trunk corridors (Figure 7.43). In this case, the service retains the straight-line time efficiency of a single roundtrip corridor, but the cost-efficiency is improved with relatively uniform demand across the entire corridor length. In this configuration, customers will board and alight all along the corridor since there is a key destination (*i.e.*, a trunk-corridor station) at both ends of the corridor.

Of course, the actual optimum feeder service for any given situation will depend on many local factors, including the demand profile and the structure of the road network.

7.3.6.2 The dangers of ignoring feeder services

Can a BRT system operate only on major corridors without any supporting feeder services? Some cities have attempted to implement a busway system without providing either feeder services or direct services into residential areas. Typically, this arrangement occurs when a city wishes to implement a limited experiment on a major corridor during a BRT project’s first phase. By doing so, the municipality can avoid addressing many of the complicated issues related to existing informal operators who service residential areas. The municipality can also avoid the complications related to the integration of services. However, the results to date on such an approach have not been entirely positive.

Jakarta (Indonesia) inaugurated its TransJakarta BRT system in January 2004 with an initial Phase I corridor of 12.9 kilometres. The system in this corridor consists of a single-lane median busway (Figure 7.44). The corridor is largely composed of business and shopping oriented destinations with few residential origins. The municipality tried to designate some pre-existing privately operated perpendicular routes as official feeder buses, and to give these bus passengers a discount on the BRT system, but the discount tickets were

not honoured by the private bus operators, leading in effect to a ‘trunk’ system without a ‘feeder’ system.

The city also elected to allow the existing bus operators to continue operating in the mixed traffic lanes. While the system enjoys popular support and significantly reduces the travel time for trips along the corridor, it poorly serves many other transit passengers using the corridor. The limited BRT system carries 65,000 passengers per day and about 3,000 passengers per hour per direction at peak times. The continued operation of the existing operators in the reduced confines of the mixed traffic lanes has also exacerbated overall traffic congestion levels (Figure 7.45). As the system expands, these problems will be reduced, but a system of feeder buses would certainly have significantly increased demand and reduced mixed traffic congestion.

Jakarta’s experience with the first phase of the TransJakarta system provides several lessons regarding the importance of feeder services and coordination with existing services. The lack of feeder services has created three troubling outcomes in Jakarta:

- Mixed first impression of BRT;
- Insufficient demand for a financially-viable BRT system;
- Increase in overall congestion levels.

While initial reaction to Jakarta’s Phase I was mixed, many negative articles in the press and much consternation from private vehicles users could have been avoided.



Fig. 7.44
Phase I of the TransJakarta system provided a reasonable quality trunk service.

Photo courtesy of ITDP



Fig. 7.45
The lack of feeder services and the continued operation of existing services in the mixed traffic lanes exacerbated traffic congestion.

Photo courtesy of ITDP

8. System capacity and speed

“Speed provides the one genuinely modern pleasure.”

—Aldous Huxley, writer, 1894–1963

“There is more to life than increasing its speed.”

—Mahatma Gandhi, political leader, 1869–1948

Designing a BRT system to comfortably handle high passenger demand in a rapid manner is one of the pillars to delivering a car-competitive service. Since customers do not like to wait at stations and terminals, providing highly frequent services with a minimum of transfers must also be a principal design objective.

The capacity, speed, and service frequency of BRT systems are defining features that set it apart from conventional bus services. This

chapter on operational planning thus addresses decisions affecting these basic parameters:

1. Sufficient system **capacity** to handle expected passenger demand;
2. Service **speeds** that minimise travel times;
3. **Frequency** of service to minimise waiting times.

However, high-capacity and high travel speed can be conflicting concepts. As the number of vehicles and passengers increase, the opportunity for bottlenecks and operational problems multiply. Identifying all the critical elements that may inhibit high-capacity and high-speed service is an important step towards effective design. This chapter outlines the design features that can enable a system to achieve both high capacity and high speed.

The topics discussed in this chapter are:

8.1 Calculating capacity requirements

8.2 Vehicle size

8.3 Station-vehicle interface

8.4 Multiple stopping bays and express services

8.5 Convoying

8.6 Station spacing

8.1 Calculating capacity requirements

“An optimist will tell you the glass is half-full; the pessimist, half-empty; and the engineer will tell you the glass is twice the size it needs to be.”

—Anonymous

8.1.1 Design objectives

Once the BRT corridors and routes have been determined and once the basic service options have been selected, optimising conditions to handle the expected passenger demand in the most rapid manner possible becomes a design priority. System designers should aim to satisfy three general objectives:

1. Meet current and projected passenger demand;
2. Achieve average vehicle speeds of 25 kph or higher;
3. Minimise door-to-door travel times for customers.

8.1.1.1 High-capacity operations

In many cities, the provision of high-capacity capabilities is the principal design consideration. Recent experiences have firmly demonstrated that high-capacity operations can be achieved with BRT at a considerably lower cost than rail options.

However, in many cities with lower levels of demand on their main corridors, high capacity is not needed, and designing a high-capacity system may impose needless operating and capital costs on the city. Large vehicles, for example, are not always needed, and can even be detrimental to system performance. Inappropriately large vehicles will either operate with few passengers or result in infrequent service. In such instances, smaller vehicles will both improve profitability as well as better meet customer preferences, such as high-frequency services.



Fig. 8.1 and 8.2
Designing a system along corridors with demands exceeding 30,000 passenger per hour per direction (left photo, Bogotá) is quite different from designing for systems with less than 3,000 pphpd (right photo, Orlando).

Left photo by Carlos F. Pardo
 Right photo by Lloyd Wright

The demand analysis and modelling process will help quantify existing public transport demand as well as provide projections of expected system growth. A system should be designed for expected capacities at least one to two decades into the future. The size of the growth cushion will depend upon how fast a city’s population and mobility needs are increasing. For example, in some rapidly urbanising Chinese cities, growth rates of up to 25 percent are being realised over relatively short periods. In such instances, a growth cushion of 50 percent or higher may be appropriate for sizing the system’s capacity requirements. In other regions that are already highly urbanised, such as Latin America, growth rates are much less. In cities of Latin America, a growth cushion of 25 percent would likely be adequate. A detailed modelling exercise will produce more precise growth estimates, and thus can be particularly useful in situations with high growth rates.

The specific design solutions to achieve high capacity will vary widely for different levels of demand. For example, a theoretical BRT system that only needs to handle a demand of 5,000 passengers per peak hour per direction (pphpd) will be significantly different than a system requiring over 30,000 pphpd (Figures 8.1 and 8.2). For example, a lower-demand system, where most of the demand is concentrated at two nodes at the beginning and the end, and faces bottlenecks only at one bridge and one intersection, and operates the rest of its route down an uncongested interstate highway, may only require an exclusive bus lane across the bottleneck and signal priority at the intersection. With these simple measures the capacity, speed, and total travel time targets can be achieved. Of

course, providing an exclusive busway along the entire corridor creates the appearance of a more metro-like system that will likely be better perceived and understood by the greater population.

A high-demand corridor in a mega-city will require a different set of planning tools than those required for low-demand areas. In high-demand areas, full busway corridors are likely to be essential to removing the congestion delays that inhibit system capacity and speed.

8.1.1.2 High-speed operations

Busway systems can be designed to operate at high capacities, but in some cases, high demand designs have also produced relatively slow commercial speeds. Prior to the Bogotá TransMilenio system, the simple busway on the Avenida Caracas corridor was able to move over 30,000 passengers per hour per direction (pphpd), only marginally less than the current BRT system in the same corridor. However, due to significant congestion, the vehicles only averaged 10 kph. By comparison, the TransMilenio BRT system operates at an average commercial speed of approximately 27 kph.

8.1.1.3 Rapid travel times

In general, customers are not particularly aware of capacities or average speeds. These issues are of importance to operators and the administrative agency, but to customers the only number of importance will be the length of time to go from their trip origin to their trip destination.

Designing a high-capacity and high-speed BRT system does not guarantee that door-to-door travel times for customers are minimised. High-capacity and high-speed services can be achieved simply by eliminating all the stops along a BRT

corridor, and having service run only between the two terminals. Metro systems are often designed with very long distances between station stops in order to increase average speeds and capacity. However, this decision has an adverse impact on door-to-door travel times, as customers will now have much further to walk to reach the nearest public transport station.

The system's design therefore has to be optimised not only in terms of speed and capacity but also in terms of minimising door-to-door travel times for the majority of passengers.

8.1.2 Defining terms

Achieving rapid, high-capacity operations is built upon many inter-dependent design components. This section defines terms that represent the building blocks for these components. The elements that support efficient customer and vehicle movements ultimately determine the speed and capacity performance of the system.

8.1.2.1 Station saturation

Understanding the *saturation level* of a station is a basic starting point in achieving high capacities and high speeds. The saturation level of a station refers to the percentage of time that a vehicle stopping bay is occupied. The term saturation is also used to characterise a roadway, and in particular, the degree to which traffic has reached the design capacity of the road.

When engineers talk about the capacity of a road or a BRT system, they will give a capacity for an acceptable *level of service*, rather than for the maximum number of vehicles or passengers that could pass through a road or a system. After a certain point, the lane or BRT system

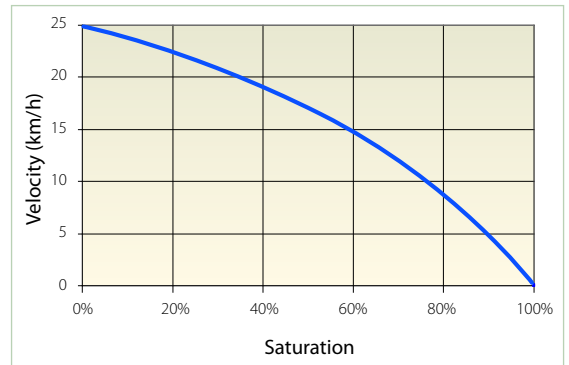


Fig. 8.4
Impact of saturation on vehicle velocity.

becomes congested. With congestion, the total flow of vehicles is still increasing, but the vehicles are going slower and slower, so that the level of service declines.

Commonly, for mixed traffic, a level of saturation of ($x=$) 0.85 is considered acceptable. Below a saturation level of 0.85, increases in traffic will have only a minimal impact on average speeds, and the level of service is acceptable. Once saturation levels exceed 0.85, there is a dramatic drop in speeds.

However, with BRT stations, there is no clear break point. Because bus activity is complex and irregular, stations can sometimes become congested even at low saturation levels of 0.1 to 0.3.

In general, stations should be at less than 40 percent saturation or else the risk of congestion increases significantly. The impact of stopping bay saturation on speed is shown in Figure 8.4.

Rather than a clear point at which the system collapses, station saturation tends to lead to a gradual deterioration of service quality. For this reason, the optimum level of station saturation is not clear. Some studies argue that the optimum should be around 0.30, but saturation levels as high as 0.60 can be tolerated in specific locations if this condition is not general throughout a BRT corridor. However, for saturation levels above 0.60, the risk of severe congestion and system breakdown is considerable.

A low saturation level or a high level of service means that there are no vehicles waiting in queue at a stopping bay. A high saturation level means that there will be long queues at stopping bays. For saturation levels over one ($x > 1$), the system is unstable with queues increasing until the system does not move.

Fig. 8.3
Relationship between travel time and saturation levels

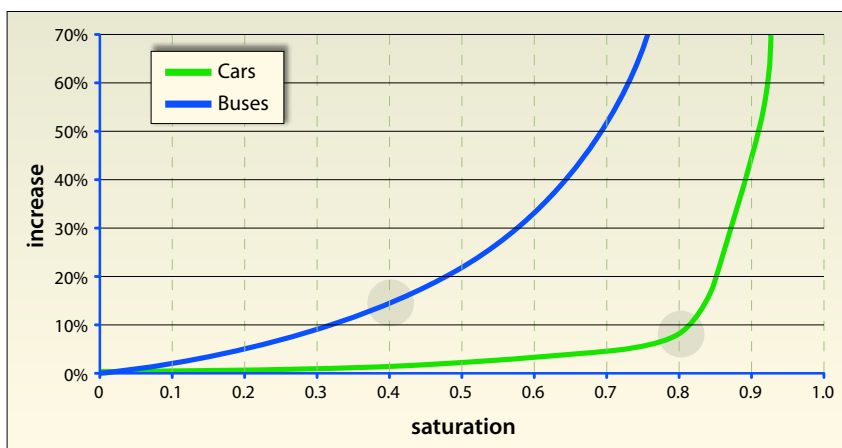




Fig. 8.5
The use of multiple stopping bays and passing lanes in Bogotá helps minimise bus congestion.

Photo courtesy of Oscar Diaz and Por el País que Queremos (PPQ)

8.1.2.2 Stopping bay

A *stopping bay* is the designated area in a BRT station where a bus will stop and align itself to the boarding platform. In the first BRT systems, each station had only one stopping bay. A key innovation of Bogotá’s TransMilenio system was that more capacity and speed could be obtained if at each station, instead of having just one stopping bay, there were multiple stopping bays (Figure 8.5).

By adding more stopping bays, the saturation level of each stopping bay could be kept to a maximum value of 0.40. TransMilenio strives to keep the maximum variation in the saturation value at no more than 0.10 between stations, so the values should not vary from a range of 0.35 to 0.45.

The “Calle 76” station of the TransMilenio system illustrates the importance of accurately projecting passenger movements and station saturation levels. Originally, this critical station was planned for a saturation level of 0.40. However, many more people chose to transfer at this station than was anticipated. While the planners predicted 32 passengers would be boarding and

alighting during the peak hour, in fact, 75 are currently boarding and alighting. The present saturation level on that station is approximately 0.65. There are some queues and delays of up to 1.5 minutes, but just at this station. If the saturation level continues to rise further, this problem could lead to system gridlock.

8.1.2.3 Service frequency and headways

The *service frequency* refers to the number of buses per hour. The waiting time between

Fig. 8.6
Service frequency and the potential impact on vehicle velocity.

Source: Steer Davies Gleave

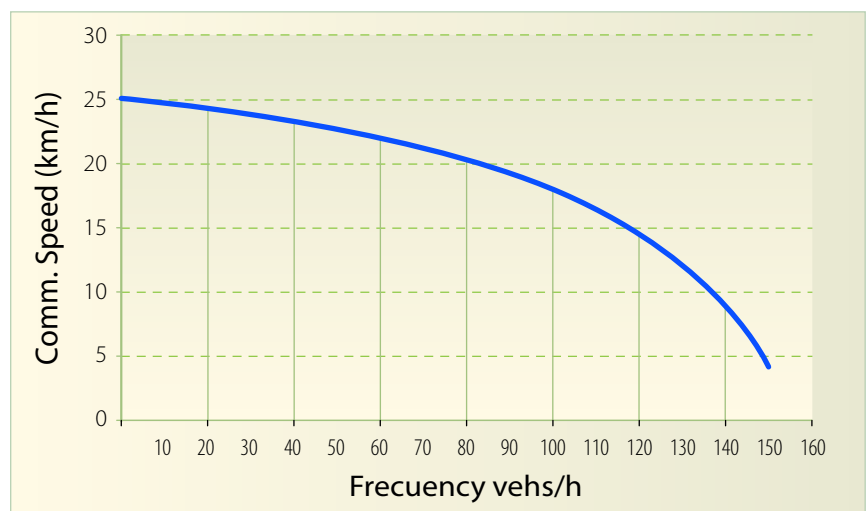




Fig. 8.7 and 8.8
The perception of a relatively empty busway next to heavily-congested mixed traffic lanes, as seen in these images of Quito (left photo) and Hangzhou (right photo), can create political pressures.

Left photo by Lloyd Wright
 Right photo by Kangming Xu

vehicles, which is roughly the same idea, is known as the *headway*. In general, it is desirable to provide frequent services in order to reduce customer waiting times. Customers often perceive waiting times to be much longer than the actual duration.

On the other hand, if headways are very low, and frequency is high, the danger of stopping bay congestion and slower speeds increases. Figure 8.6 illustrates the relationship between service frequency and congestion. Thus, a key objective is to minimise customer waiting by balancing the impact of headways on stopping bay saturation.

Service frequency varies between different cities with BRT based on demand, but in general, one of the key innovations of TransMilenio was dramatically increasing service frequency by reducing delays at the stations. A vehicle will pass any given point on TransMilenio's corridors every 20 seconds. Peak frequencies of 60 seconds to 90 seconds are now quite common on BRT systems. However, frequency per stopping bay tends to be around one minute.

When services become infrequent, the impact is not only on waiting passengers. Car drivers in traffic congestion will become frustrated from seeing an empty busway beside them. In turn, motorists will complain that the road is being under-utilised. Such complaints ultimately undermine political support for future busways (Figures 8.7 and 8.8). While a headway of a few minutes may not seem like a lot of time, the sight of a busway with a vehicle only passing every few minutes can appear to be empty most

of the time. In Quito, pressure from motorist organisations led the national police to open-up exclusive busway corridors to mixed traffic for a period of time in 2006. This conversion occurred despite the fact that each busway lane was moving 3 to 4 times the volume of passengers as a mixed traffic lane. Nevertheless, the perception of an empty busway next to heavily congested mixed traffic lanes can create political difficulties.

Non-peak frequencies are likely to be longer due lower passenger demands. However, if non-peak headways are excessively long, the system's viability will be undermined. To a waiting passenger, five minutes can seem like a long time, especially if one is in a hurry to arrive at the destination. At headways of ten minutes or longer, passengers will no longer regard the system as a metro-like service. Instead, at this point, passengers will tend to view the system as a timetable service.

On the other hand, if frequencies are too high relative to demand, the profitability of the system will suffer. Service during weekends may also tend to follow non-peak frequencies. However, weekend services may also require peak and non-peak schedules, depending upon local circumstances. For example, weekend markets and sporting events may necessitate higher frequency services.

8.1.2.4 Load factor

The *load factor* is the percentage of a vehicle's total capacity that is actually occupied. For



Fig. 8.9
Due to unexpectedly high demand, the Avenida Caracas corridor in Bogotá sometimes suffers from overcrowding at peak periods.
 Photo by Carlos F. Pardo

example, if a vehicle has a maximum capacity of 160 passengers and an average use of 128 passengers, then the load factor is 80 percent (128 divided by 160). The actual load factor of any BRT system is determined by the frequency of the vehicles and the demand. The load factor can be changed by changing the frequency of the services or changing the routes of competing services.

While systems with high load factors tend to be more profitable, generally, it is not advisable to plan to operate at a load factor of 100 percent. At a 100 percent load factor the vehicle is filled to its recommended maximum capacity. Such conditions are not only uncomfortable to passengers, but also create negative consequences for operations. At 100 percent capacity, small system delays or inefficiencies can lead to severe over-crowding conditions.

The desired load factor may vary between peak and non-peak periods. In the Bogotá TransMilenio system, typical load factors are 80 percent for peak periods and 70 percent for non-peak periods. However, as ridership levels are increasing in Bogotá, over-crowding is an increasing concern (Figure 8.9).

Systems can also sometimes operate at a load factor exceeding 100 percent. Such a level implies that passengers are more closely packed than the maximum recommended levels. This situation is sometimes known as the “crush capacity” of a system. While such extreme



Fig. 8.10
The Manila LRT1 and MRT3 systems are managed to operate almost constantly at crush capacity, making usage somewhat unpleasant.
 Photo by Lloyd Wright

capacities can be expected in some unusual circumstances (e.g., immediately after special events such as sporting events or concerts), it is not desirable to regularly overcrowd vehicles.

Due to operational cost reasons, some rail systems are forced to operate at an almost continuous state of crush capacity. The frequencies of the LRT1 and MRT3 systems in Manila are timed to maximise the load factor at all times of the day (Figure 8.10). Due to the subsidies required for operation, the Manila system operators are forced to minimise costs through high load factors. However, in the long term, such conditions simply encourage public transport users to switch to private vehicles.

8.1.2.5 Dwell time

The amount of *total stop time per vehicle* will affect the system’s overall efficiency. The amount of time that any given vehicle is occupying a given stopping bay is known as the *dwell time*. Total stop time per vehicle is the contribution to stopping bay saturation that each vehicle adds. The dwell time consists of three separate delays: *boarding time*, *alighting time*, and the *dead time*. Some of the factors affecting dwell time include:

- Passenger flow volumes;
- Number of vehicle doorways;
- Width of vehicle doorways;
- Entry characteristics (stepped or at-level entry);
- Open space near doorways (on both vehicle and station sides);
- Doorway control system.

BRT systems are able to operate metro-like service in large part due to the ability to reduce total stop time to 20 seconds or less. A conventional

bus service often requires over 60 seconds for stop time, though the specific time will be a function of the number of passengers and other factors. In general, dwell times may be somewhat higher during peak periods than non-peak periods. The increase during peak periods is due to the additional time needed to board and alight the higher customer volumes.

The dwell time is one major element affecting average commercial speed. Every second of delay at the stopping bay leads to a deterioration of average speed. However, there are also two other elements of vehicle stopping that affects speed and travel time. The rate of vehicle deceleration, when approaching a stopping bay, and the rate of acceleration, when departing a stopping bay, are also key factors. The deceleration and acceleration rates often involve a trade-off between speed and customer comfort, as well as the ability to properly align the vehicle to the stopping-bay interface.

An abrupt deceleration will cause passengers to lunge forward, making reading or other travel-time activities quite difficult. The impact on standing passengers can be particularly jarring. Likewise, a rapid deceleration can cause the driver to misalign the vehicle with the platform, making boarding and alighting difficult. While BRT operations are not likely to ever be as

smooth as a well-operated rail systems, improvements in vehicle technology and operational practices can minimise the discomfort of slowing and stopping.

8.1.2.6 Renovation factor

The *renovation factor* is defined as the average number of passengers that are on a vehicle divided by the total boardings along a given route. For example, if 50 is the average number of people on a vehicle at any given time going from point A to point B, but 200 people are boarding the bus between these points, then the renovation factor is 25 percent. The lower the renovation factor, the higher the usage rate of the vehicle, regardless of the vehicle's physical attributes. In this respect, a high number of boardings and alightings increases the effective capacity of the vehicle.

Corridors with very low renovation factors are extremely profitable because the same number of total paying passengers can be handled with many fewer buses. For example, the new Insurgentes corridor in Mexico City has recorded renovation factors of 20 percent, which means that five times more people getting on and off the vehicle as there are people on the vehicle at any given time (Figure 8.11).



Fig. 8.11
The Insurgentes corridor in Mexico City.

Photo by Bill Vincent,
Breakthrough Technologies

8.1.3 Calculating corridor capacity

8.1.3.1 Basic calculation

Equation 8.1 shows the basic relationships between the main factors that affect the capacity of a BRT system: vehicle capacity, load factor, service frequency, and the number of stopping bays. The renovation factor will not be affected by the system design, but it is important to keep in mind when calculating capacity.

Equation 8.1 Basic formula for corridor capacity

$$\text{Corridor capacity (pphpd)} = \text{Vehicle capacity (passengers/vehicle)} \times \text{Load factor} \times \text{Service frequency (vehicles/hr)} \times \text{Number of stopping bays}$$

Table 8.1 below shows sample corridor capacities for a range of common scenarios. By varying only the vehicle capacity and the number of stopping bays per station, it shows just how powerful these two factors are in determining system capacity. The values in this table are merely examples; the actual potential capacities for a given city will vary depending on a variety of local circumstances.

The values presented in table 8.1 above are possible values, but Equation I tells little about how these values were achieved, or how they might be achieved in another city. These values assume that the vehicles operate on a segregated,

Table 8.1: BRT corridor capacity scenarios

Vehicle capacity ¹⁾ (passengers)	Load factor	Vehicle frequency per hour per stopping bay	Number of stopping bays per station	Capacity flow (passengers per hour per direction)
70	0.85	60	1	3,570
160	0.85	60	1	8,160
270	0.85	60	1	13,770
70	0.85	60	2	7,140
160	0.85	60	2	16,320
270	0.85	60	2	27,540
70	0.85	60	4	28,560
160	0.85	60	4	32,640
270	0.85	60	4	55,080
160	0.85	60	5	40,800
270	0.85	60	5	68,850

Table 8.2: Sample values from existing BRT systems

Factor	Typical range
Vehicle capacity, standard-sized bus	60 – 75 passengers
Vehicle capacity, articulated bus	140 – 170 passengers
Vehicle capacity, bi-articulated bus	240 – 270 passengers
Load factor, peak period	0.80 – 0.90
Load factor, non-peak period	0.65 – 0.80
Headways per stopping bay, peak period	1 – 3 minutes
Headways per stopping bay, non-peak period	4 – 8 minutes
Dwell time, peak period	20 – 40 seconds
Dwell time, non-peak period	17 – 30 seconds
Number of stopping bays	1 – 5 stopping bays

median-aligned busway with at-level boarding. Values will be lower for curbside busways where there are significantly more turning conflicts with other vehicles. Further, if the vehicles have stepped passenger entry instead of at-level entry, longer headways will be necessary to handle the additional dwell times.

The number of stopping bays also affects the type of busway infrastructure. Unless operating in a controlled convoy, stations with two or more stopping bays will require passing lanes or double sets of busway lanes. As the number of stopping bays increase to four or more, then it is likely that double sets of lanes will be required along the entire length of the busway. Otherwise, congestion will likely occur.

Below are some sample values for a variety of factors affecting BRT passenger capacity. Table 8.2 summarises these values.

The sample values represent the findings from a survey of existing BRT systems. However, they are presented for purely demonstrational purposes. The actual figures for a given set or circumstances are highly dependent upon local factors. To

¹⁾ Standard-sized bus (12 metres): 70 maximum passengers. Articulated bus (18.5 metres): 160 maximum passengers. Bi-articulated bus (24 metres): 270 maximum passengers.

calculate the actual capacity of a specific system being designed in a different city, the following far more complex formula is generally used. To understand the entirety of this formula will require considerable explanation.

8.1.3.2 Detailed capacity calculation

The capacity calculation given above (equation 8.1) above does not detail the precise inter-relationships between different design factors, such as vehicle size, dwell times, and renovation factors. Determining the actual capacity of a proposed system requires understanding these relationships. For example, as the number of boardings and alightings increase, dwell times will tend to increase and capacity will be repressed. Further, the equation does not account for the additional capacity benefits gained from limited-stop and express services.

A more detailed capacity formula is thus given as follows:

Equation 8.2 Capacity formula

$$C_o = \frac{N_{sp} * X * 3,600}{\left[\frac{T_d * (1 - Dir)}{C_b} + (Ren * T1) \right]}$$

Where:

C_o = Corridor capacity (in terms of passengers per peak hour per direction or pphpd)

N_{sp} = Number of stopping bays

X = Saturation level

3,600 = Number of seconds in an hour

T_d = Dwell time

Dir = Percentage of vehicles that are limited-stop or express vehicles

C_b = Capacity of the vehicle

Ren = Renovation rate

$T1$ = Average boarding and alighting time per passenger

The saturation rate shows the amount of time that a stopping bay is occupied by vehicles. In order to ensure an acceptable level of service, the saturation rate must be carefully selected. An acceptable level of service is typically defined as the ability to achieve an average commercial speed of 25 kph. The general assumption for achieving this level of service is a saturation of approximately 40 percent ($X = 0.4$) or less. Thus, for the purposes of the examples presented in this

chapter, the saturation level will be set at 0.4. The corridor capacity equation thus becomes:

Equation 8.3 Calculating corridor capacity

$$C_o = \frac{N_{sp} * 1,440}{\left[\frac{T_d * (1 - Dir)}{C_b} + (Ren * T1) \right]}$$

where, from the previous equation:

$$X = 0.4$$

$$0.4 * 3,600 \text{ seconds} = 1,440 \text{ seconds}$$

This formula is the calculator that will be used throughout the rest of the chapter to calculate the impacts of different design changes on corridor capacity. Each part of this equation will be broken down into its various sub-parts in order to develop a better understanding on how each component affects corridor capacity.

8.1.4 Designing for rapid, high-capacity services

A system will only move as quickly as its slowest point. Identifying this weak link in the system is the foundation for improving capacity and travel times. In general, one of three critical factors will represent the bottleneck point on a public transport system:

- Passenger delays in boarding and alighting;
- Vehicle congestion at stations;
- Vehicle congestion at intersections.

In most cases, the critical factor in developing a rapid, high-capacity system will be de-congesting the station areas. The fact that BRT systems are now able to reach speeds and capacities comparable to all but the highest capacity metro systems is principally due to dramatic improvements in vehicle capacity at stations. Other factors are also important to reaching these speed and capacity goals, but none are as important as stopping bay congestion. Designing an effective BRT system requires a thorough understanding of the causes of stopping bay delay and how to solve them. Many existing BRT systems are burdened with slow operating speeds due to incorrect demand projections at particular stations. Poorly designed stations can lead to peak-hour vehicle queues that stretch for several hundred metres. For optimum performance, each stopping bay should be designed and dimensioned to the specific demand at that bay.

The specific factors that will most likely affect customer and vehicle flows are:

- Size of the vehicle;
- Vehicle-stopping bay interface;
- Number of stopping bays at each station;
- Number of express and local bus services;
- Frequency of stations;
- Load factor per vehicle;
- Intersection design;
- Station design (station size, characteristics of pedestrian access, number of turnstiles, etc.).

The remaining sections of this chapter will review the various techniques that can be utilised to overcome these potential bottleneck points.

8.2 Vehicle size

“Size matters not. Look at me. Judge me by my size, do you? Hmm? Hmm. And well you should not.”

—Yoda (Star Wars)

Most decision makers unfamiliar with BRT systems assume that the secret to a high-capacity and high-speed system lies in the procurement of larger vehicles. While larger vehicles are one contributing factor, they are rarely the principal component in realising rapid, high-capacity services. Station efficiency is more likely to be the critical factor in optimising system operations. However, the size and design of the vehicle will be an important decision factor, especially in terms of ensuring customer convenience and comfort.

8.2.1 Vehicle size options

As has been noted, system designers have many vehicle size options. The right vehicle size is not always the largest vehicle. The main advantage

Table 8.3: Trunk corridor vehicle options

Vehicle type	Vehicle length (metres)	Capacity (passengers per vehicle)
Bi-articulated	24	240 – 270
Articulated	18.5	120 – 170
Standard	12	60 – 80
Mini-bus	6	25 – 35

of larger vehicles stems from reductions in operating costs, especially driver labour costs per passenger carried. However, in lower-demand corridors, these large vehicles also tend to mean lower frequency, and hence longer waiting times for passengers. Table 8.3 summarises the standard vehicle sizes available to system developers.

Increasingly, the 18.5-metre articulated vehicle is becoming the standard for BRT systems (Figure 8.12). To date, only the Curitiba system has utilised the larger bi-articulated vehicles. There are several reasons for the current dominance of the articulated vehicles (160 passenger capacity) over the bi-articulated vehicle (270 passenger vehicle):

- Large numbers of articulated vehicle orders have produced cost savings through economies-of-scale in manufacturing;
- Currently only a few manufacturers offer a bi-articulated vehicle, and thus limiting the power of competition during the bid process;
- Heavier weight of bi-articulated vehicles reduces fuel efficiency and ability to accelerate rapidly;
- Length of bi-articulated vehicles (24 metres) can create difficulties with regard to available length of right-of-way at stations.



Fig. 8.12
The 18.5-metre articulated vehicle has become standard in many BRT applications.

Photo by Kangming Xu (<http://www.brtchina.org>)

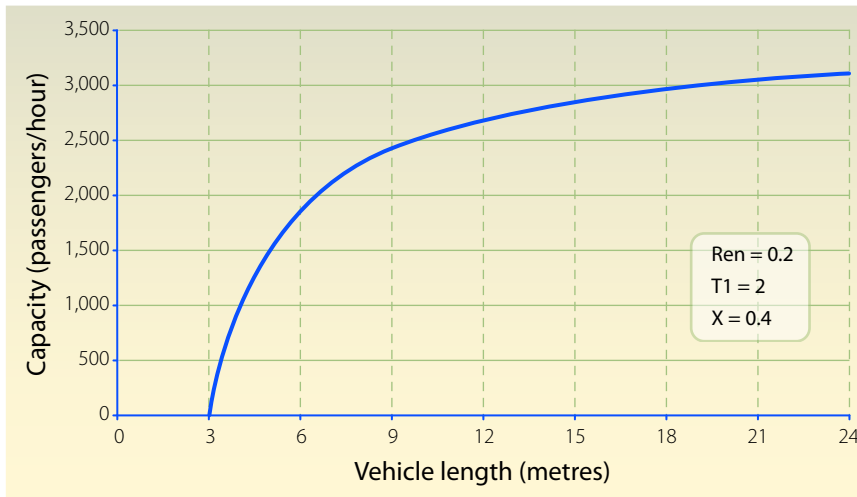


Fig. 8.13
Example curve for vehicle size versus capacity.

However, there may be instances, where the operational and physical characteristics of a corridor would make a bi-articulated vehicle an appropriate choice. Likewise, there are many lower-demand circumstances where a standard-sized vehicle (12 metres) would be the optimum choice. In general, mini-buses and van-sized vehicles would not be utilised in trunk corridor operations given their carrying-capacity limitations. Such vehicles, though, may be appropriate for feeder operations.

Chapter 12 (*Technology*) discusses most aspects of vehicle technology options.

As vehicle length increases, there can be a diminishing return in terms of delivered capacity. If stopping bay capacity and vehicle congestion occurs, then the additional capacity may not be fully realised. Figure 8.13 gives an example of this effect for a given set of parameters.

8.2.2 Vehicle size and corridor capacity

Higher vehicle capacity can in the right circumstances increase BRT system capacity. Normally, a vehicle can hold an additional 10 passengers for every additional metre of length, less the space for the driver and engine, which is usually estimated to be 3 metres. The actual number of passengers per metre of length is actually fairly culturally dependent. In some cultures, a fairly packed spatial arrangement is acceptable. In these instances, customers may not be offended by some contact between persons. In other cultures, there may be a greater need for each person's own personal space. The value of 10 passengers per metre of length is an average value across existing systems. System planners

will need to make some assumptions about acceptable levels of crowdedness within the vehicle to accurately set this value.

For conventional vehicles, Equation 8.4 summarises the relationship between vehicle size and vehicle capacity.

Equation 8.4 Calculating vehicle capacity from vehicle length

$$\text{Vehicle capacity (Cb)} = \frac{10}{\text{(Persons/metre)}} \times \left[\frac{\text{Length of vehicle (L)}}{\text{(Metres)}} - \frac{3 \text{ (Metres of space for driver)}}{\text{(Metres)}} \right]$$

$$C_b = 10 \times (L - 3)$$

The calculation will be somewhat different for double-decker vehicles, which do not lose space to the driver and engine on the second deck, although such vehicles do lose space to the stairway. Vehicle size also affects the dwell time. Most vehicles require about 10 seconds to open and close their doors and pull in and out of a station. However, if the vehicle is larger, an additional 1/6 of a second per metre of vehicle is generally required for pulling in and out of the station. Therefore, dwell time can be calculated as indicated in the following equation.

Equation 8.5 Impact of vehicle length on dwell time

$$\text{Dwell time (Td)} = \frac{10 \text{ (Average time for pulling in and out of bay)}}{\text{(Seconds)}} + \frac{1/6 \text{ additional second for each additional metre of vehicle length (L/6)}}{\text{(Seconds)}}$$

$$T_d = 10 + (L / 6)$$

If these calculations for vehicle capacity (Cb) and dwell time (Td) are inserted into the calculation for corridor capacity, then the result is equation 8.6.

Equation 8.6 Corridor capacity calculation

$$C_o = \frac{N_{sp} * 1,440}{\left[\frac{(10 + L/6) * (1 - Dir)}{10 * (L-3)} + (Ren * T1) \right]}$$

8.2.3 Optimising vehicle size

Determining the optimal vehicle size is usually one of the last decisions that should be made when designing a BRT system. It should be done only after the number of stopping bays and other considerations have already been decided. The relative costs of vehicle operations relative to waiting times must also be considered first.

Using the equation from before as a basis for vehicle sizing, the required vehicle size could be calculated as in Equation 8.7.

Equation 8.7 Determining required vehicle capacity

$$\begin{aligned}
 \text{Vehicle capacity (Cb)} &= \frac{\text{Corridor capacity (Co) (pphd)}}{\left[\text{Load factor (Lf)} \times \text{Service frequency (F) (vehicles/hr)} \times \text{Number of stopping bays (Nsb)} \right]} \\
 \text{Cb} &= \frac{\text{Co}}{\left[\text{Lf} \times \text{F} \times \text{Nsb} \right]}
 \end{aligned}$$

This approximate calculation can be used when the saturation level of the stopping bay is not critical (*i.e.*, the bus stop is occupied less than 40 percent of the time). In such a case, the vehicle size decision should be based on the size of the maximum passenger load on the critical link that yields a reasonable frequency and a reasonable load factor. For example, a potential vehicle frequency could be one minute, and a reasonable load factor would be .85 or below. If the demand analysis indicates a corridor

capacity of 15,000 pphpd and two stopping bays per station are assumed to be needed, then the optimal vehicle size would be calculated as:

$$\begin{aligned}
 \text{Cb} &= \frac{15,000 \text{ pphpd}}{\left[0.85 \times 60 \text{ vehicles / hr} \times 2 \right]} \\
 &= 147 \text{ passengers per vehicle}
 \end{aligned}$$

Thus, in this example, 160-passenger articulated vehicles would be sufficient for this corridor.

8.2.4 Size of vehicle fleet

The chosen vehicle capacity will directly determine the number of vehicles required for a corridor. Procurement of larger vehicles will reduce the total number of vehicles required (Figure 8.14). Smaller vehicles will require more vehicles to be purchased, but as noted earlier, smaller vehicles will also contribute higher-frequency services and thus shorter customer waiting times. Also, the cost of a vehicle is fairly proportional to its size, so there is not necessarily a cost penalty for purchasing smaller vehicles. However, each additional vehicle does add to total operational costs due to the need for an additional driver.

The factors involved in determining the operational size of the vehicle fleet include:

- Peak passenger demand at the critical point along a corridor
- Total travel time to complete a full travel cycle along the corridor
- Capacity of vehicle.



Fig. 8.14
The size of the required vehicle fleet demands on corridor demand, travel time to complete a corridor cycle, and each vehicle’s passenger capacity.
 Photo by Lloyd Wright

A larger fleet size will be required as the length of the corridor and the total travel time increases. Equation 8.8 provides the calculation for determining the operational fleet size for a particular corridor.

Equation 8.8 Calculating operational fleet size for a corridor

$$\begin{aligned}
 \text{Operational fleet size for corridor (Fo)} &= \frac{\text{Demand on critical link (D) (pphpd)}}{\text{Vehicle capacity (Cb) (passengers/vehicle)}} \times \frac{\text{Travel time for a complete cycle (Tc) (hours)}}{1} \\
 \text{Fo} &= \frac{D \times Tc}{Cb}
 \end{aligned}$$

As an example, if the demand along a corridor is 10,000 pphpd using a vehicle with an operational capacity of 140 passengers and requiring one hour to traverse a complete cycle of the corridor, then the required operational fleet size will be:

$$\text{Fo} = \frac{10,000 \text{ pphpd} \times 1 \text{ hour}}{140 \text{ passengers / vehicle}} = 72 \text{ vehicles}$$

Fig. 8.15
Curitiba's innovations with station design and the station-to-vehicle interface did much to make BRT a high-capacity option.
 Photo courtesy of Volvo



In this case, the corridor operations will require a fleet size of 72 vehicles.

In addition to the operational fleet, system planners will also have to factor in a contingency value. A certain percentage of vehicles should be withheld from service in case of problems

with the operating fleet. Some vehicles may have mechanical problems while others may be undergoing routine inspection and maintenance procedures. These contingency vehicles will thus fill the operational void whenever some vehicles are out of service. A contingency factor of 10 percent is commonly utilised. Equation 8.9 gives the calculation for the total required fleet for a particular corridor, including both operational and contingency vehicles.

Equation 8.9 Calculating the total fleet size for a corridor

$$\begin{aligned}
 \text{Total fleet size (Ft)} &= \\
 &\text{Operational fleet size for corridor (Fo)} + \left[\text{Operational fleet size for corridor (Fo)} \times \text{Contingency value (Cv)} \right]
 \end{aligned}$$

$$\text{Ft} = \text{Fo} + (\text{Fo} \times \text{Cv})$$

Based on the previous example for calculating the operational fleet size and an assumed contingency value of 10 percent, the total fleet required for the corridor will be:

$$\text{Ft} = 72 + (72 \times 0.1) = 79 \text{ vehicles}$$

In reality, there should not be any dedicated contingency vehicles that are always withheld from service. Instead, all vehicles should be rotated between operational service, maintenance, and contingency status. This practice ensures a relatively equal number of kilometres for each vehicle in the fleet.

8.3 Vehicle-station interface

“Let every man praise the bridge that carries him over.”

—English proverb

The innovations introduced by the Curitiba system, beginning in 1974, profoundly shaped the course of BRT (Figure 8.15). In particular, four of the most important innovations from Curitiba involved the vehicle-station interface:

1. Pre-board fare collection and fare verification;
2. At-level, platform boarding;
3. Efficient vehicle alignment to station;
4. Wide, multiple doorways;
5. Sufficient customer space on station platform.



Fig. 8.16
On-board fare collection and fare verification dramatically slows customer throughputs, as evidenced here in Goiânia (Brazil).
 Photo by Lloyd Wright

These features heralded the advent of rubber-tyred based systems that could begin to emulate the performance of rail transit. Curitiba’s innovations to the vehicle-station interface have enabled BRT systems to achieve quick boarding and alighting times (and therefore low dwell times). In turn, the low dwell times have been a cornerstone of alleviating vehicle congestion at stations and ultimately higher-capacity service.

From the main corridor capacity equation, measures improving the vehicle-station interface all help to reduce T1, which is the average boarding and alighting time per passenger.

$$C_o = \frac{N_{sp} * 1,440}{\left[\frac{T_d * (1 - Dir)}{C_b} + (Ren * T1) \right]}$$

This section discusses the particular techniques for improving boarding and alighting times.

8.3.1 Off-board fare collection and fare verification

Most BRT systems since Curitiba have instituted *external* or *off-board fare collection and fare verification*. Passengers pay their fare prior to entering the station, and then have their fare verified as they pass the entry turnstile.

8.3.1.1 Time savings

With most conventional bus services, the driver is responsible for the collection of fares as well

as driving the vehicle, and passengers are only allowed to enter through the front door. Thus, on-board fare collection means that boarding time is largely determined by the fare collection activity. If the fare collection process is slow, the whole public transport service is slow. Typically, passengers take from 2 to 4 seconds just to pay the driver. If drivers also have to give passengers change manually, even longer delays are seen. Once passenger flows reach a certain point, the delays and time loss associated with on-board fare collection become a significant system liability (Figure 8.16).

By contrast, in a BRT system with pre-board fare collection, boarding and alighting is conducted from all doors at once. When fares are collected off the vehicle, there is no delay in boarding and alighting related to the fare collection and fare verification processes. A pre-board fare collection and verification process will reduce boarding times from 3 seconds per passenger to 0.3 seconds per passenger. In turn, the reduction in station dwell time greatly reduces vehicle congestion at the stopping bay.

The introduction of contactless smart cards and other modern payment systems can reduce on-board payment to below 2 seconds per passenger. Systems such as the Seoul busway make use of on-board fare collection using smart card technology (Figure 8.17). However, any time the driver is responsible for verifying fares, the speed of the service will be highly compromised, particularly if there is a large volume of passengers.

Fig. 8.17 and 8.18
The Seoul busway system uses smart card technology for fare collection (left photo). However, the on-board nature of the fare verification means that dwell times are negatively affected. A single passenger searching through personal effects for their smart card can create a significant delay (right photo).

Photos by Lloyd Wright



In the case of the Seoul busway system, passengers must remember to swipe their smart card both upon entering the vehicle and when existing as well. Delays can occur simply if a person enters the vehicle and must search through their belongings to find the fare card (Figure 8.18). On-board payment and verification psychologically also creates a lower-market image for the service. Off-board payment and verification gives the sense of a more metro-like system.

With on-board fare collection and verification, alighting is usually faster than boarding. Typically, alighting times are approximately 70 percent of boarding times. In the case of off-board fare collection and verification, there usually is no significant difference between boarding and alighting times. Thus, an average time for both boarding and alighting can be used for the variable T1.

8.3.1.2 On-board and off-board options

Off-board payment collection is not necessarily the only way to reduce boarding and alighting times, but there are institutional reasons why this approach is generally more successful in the developing-country context. Passengers can also enter through all doors at once if there are sufficient conductors to check tickets once on board. Alternatively, many European light rail systems utilise and honour system, where it is the responsibility of passengers to punch their own tickets which they purchase at shops and kiosks. Enforcement is then the responsibility of the police or contracted security personnel. However, in developing countries such enforcement is usually ineffective.

Another reason for off-board fare collection and verification is that it enhances the transparency

of the process of collecting the fare revenues. When passengers pay on board, and do not have to pass through a turnstile, there is no clear count of how many passengers boarded the vehicle. Off-board fare sales to a third party make it easier to separate the fare collection process from the bus operators. By having an open and transparent fare collection system, there is less opportunity for circumstances in which individuals withhold funds. This separation of responsibilities has regulatory and operational advantages that will be discussed later. Further, by removing the handling of cash by drivers, incidents of on-board robbery are reduced.

Off-board payment also facilitates free transfers within the system. The enclosed, controlled stations also give the system another level of security, as the stations can be better protected by security personnel, and thus discouraging theft and other undesirable activities. Payment off board also is more comfortable than juggling change within a moving vehicle.

The main disadvantage to off-board fare collection is the need to construct and operate off-board fare facilities. Fare vending machines, fare sales booths, fare verification devices, and turnstiles all require both investment and physical space. In a BRT system with limited physical space for stations in a centre median, accommodating the fare collection and verification infrastructure can be a challenge. Depending on how the fare system is configured, there may be some time loss while paying off board, whereas paying on board theoretically means that the payment time occurs while the bus is moving. Of course, this type of activity can create safety issues if the driver is both handling fares and driving at the same time. Customers can also be

uncomfortably jostled about when trying to pay at the same time the vehicle is accelerating.

Some systems employ a reservoir area within the vehicle to hold passengers while they go through the fare payment and verification process (Figure 8.19). This system is utilised in Brazil to allow the passenger queue to quickly file into the vehicle, which can then accelerate to the next station without waiting for passengers to complete the fare verification process. However, this technique often requires on-board fare collection staff, which in turn raises operational labour costs.

8.3.1.3 Decision-making criteria

There is no one precise point at which a system’s capacity will determine if on-board or off-board fare collection is more cost effective. Much depends on demand figures from individual stations, station physical configurations, and average labour costs. However, the advantage of off-board payment clearly increases as the level of boardings and alightings at the station increases. In Goiânia (Brazil) the local public transport agency estimates that an off-board fare system is cost justified when the system capacity reaches 2,500 passengers per hour per direction. The development of a cost-benefit analysis may help determine this capacity point, provided the costing data is available. Figure 8.20 provides an example of this type of analysis.

8.3.2 Platform level boarding

To further reduce boarding and alighting times, most state-of-the-art BRT systems have introduced **platform level boarding**. With platform level boarding, the stopping bay platform is designed to be the same height as the vehicle floor. This allows for fast boarding and alighting, and also allows easier access for the persons in wheelchairs, parents with strollers, young children, and the elderly.

There are currently two different types of platform level boarding techniques. In one case, a gap exists between the platform and the vehicle. The gap may range from approximately 4 centimetres to over 10 centimetres, depending in the accuracy of the vehicle alignment process. Alternatively, a vehicle can employ a boarding bridge which physically connects the vehicle to the platform. The boarding bridge consists of a



Fig. 8.19
In Brazil, a “reservoir” space is provided within the vehicle where passengers queue to verify their fare. With the use of this reservoir, the vehicle is able to proceed even before all passengers have verified their fare.

Photo courtesy of the Municipality of Goiânia.

flip-down ramp that is attached to the vehicle’s doors. As the doors open, the boarding bridge is released and covers the enter gap area between the vehicle and platform (Figures 8.21 and 8.22).

Both techniques, gap entry and boarding bridge entry, have their advantages and disadvantages. Cities such as Curitiba and Quito have experienced much success with boarding bridges. A typical boarding bridge is 40 to 50 centimetres in width, meaning that the vehicle only needs to align within about 35 to 45 centimetres of the platform (Figure 8.23). Thus, there is much more room for error using the boarding bridge.

The boarding bridge also provides boarding and alighting passengers with greater confidence in placing their steps. The confidence means that customers will not have to look down at a gap to judge safe foot placement. Instead, customers confidently march forward. The small act

Fig. 8.20
Cost-benefit analysis of external fare collection.

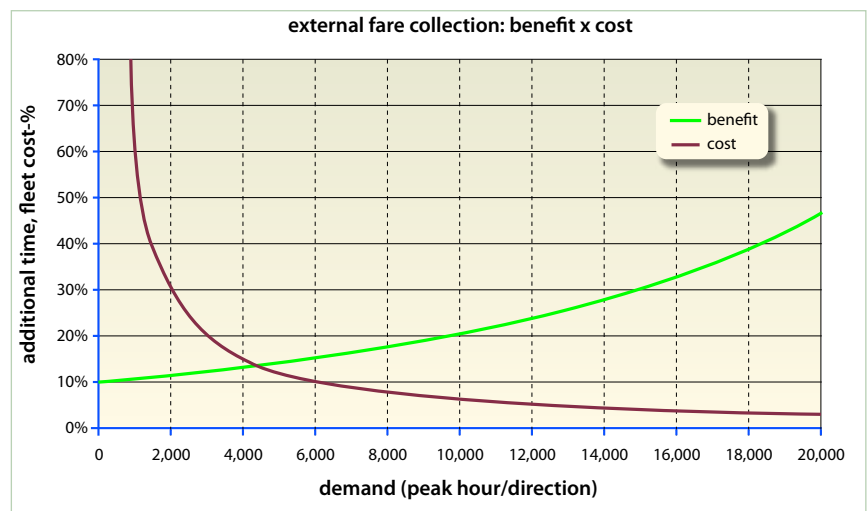




Fig. 8.21 and 8.22
Systems in cities such as Curitiba (left photo) and Guayaquil (right photo) utilise a boarding bridge between the vehicle and platform to facilitate easy boarding and alighting.

Left photo courtesy of Volvo
Right photo by Lloyd Wright

of looking down slows each person's boarding and alighting time. While this lost time seems small on a per passenger basis, the cumulative effect across all passengers can be quite significant. The added customer confidence with the boarding bridge also means that two persons can board or alight side-by-side. When a gap is present, passengers are less likely to board simultaneously. The uncertainty imposed by a gap means customers are less likely to handle both the placement of the foot and the distance beside another passenger at the interface point. A boarding bridge also is significantly more user-friendly to passengers with physical disabilities, wheelchairs, and strollers.

Despite these benefits, the boarding bridge does bring with it a few disadvantages. The added cost of the boarding plate and the pneumatic system to operate it does imply a modest increase to vehicle costs. As a moving part, the boarding bridge also introduces additional maintenance issues and the potential for malfunction. There is also one aspect of the boarding bridge that does not hold a time advantage. The deployment of the bridge itself takes about 1.5 seconds. Likewise, the retrieval of the boarding bridge at departure also requires about 1.5 seconds. While this deployment and retrieval roughly coincides with the opening and closing of the doors, it may introduce a slight delay to the boarding and alighting process. However, overall, the other efficiency advantages of the boarding bridge tend to more than compensate for the deployment and retrieval time.

In contrast to Curitiba and Quito, cities such as Bogotá, Goiânia, and Jakarta elected to forgo use of a boarding bridge. These systems instead permit the existence of a physical gap between the vehicle and the platform (Figures 8.24 and 8.25). Bogotá's TransMilenio system opted not to utilise a boarding bridge principally in order to save the seconds needed to deploy and retrieve the flip-down device. Likewise, the lack of a boarding bridge slightly reduces vehicle costs and maintenance costs.

Fig. 8.23

The presence of the boarding bridge means that the driver does not need to be as precise docking at the platform. In turn, this can significantly reduce the time lost at stops.

Photo by Lloyd Wright





Fig. 8.24
A gap entry system is employed in Goiânia (Brazil).

Photo by Lloyd Wright

While cities such as Bogotá do gain time lost to ramp deployment, time can be lost elsewhere. Depending upon the width of the gap, passengers will tend to look down and hesitate slightly. Further, passengers have a greater tendency to depart the vehicle one-by-one when a gap exists between the vehicle and the platform. A wide gap can also introduce a significant safety and liability risk. If a passenger missteps and falls through the gap, a serious injury can occur. Those passengers with disabilities, wheelchairs, and strollers will not only take longer to cross a gap but may have physical difficulty in doing so. The extremely wide gap occurring with the TransJakarta system is detrimental both to system performance and customer safety (Figure 8.26).

Since a gap entry requires the vehicle to get as close to the platform as possible, there may also be delays in the vehicle acceleration and deceleration process. The driver will need to be more careful in approaching and departing the platform. Clearly, it is simpler to dock the vehicle at a maximum distance of 45 centimetres rather than a distance of 5 or 10 centimetres.

8.3.3 Vehicle acceleration and deceleration

The time required for a vehicle to approach and then accelerate away from a stopping bay is also part of the equation for calculating the efficiency of stops. If conditions require a slow, careful approach to the stations, overall speeds and travel times will suffer. The time consumed

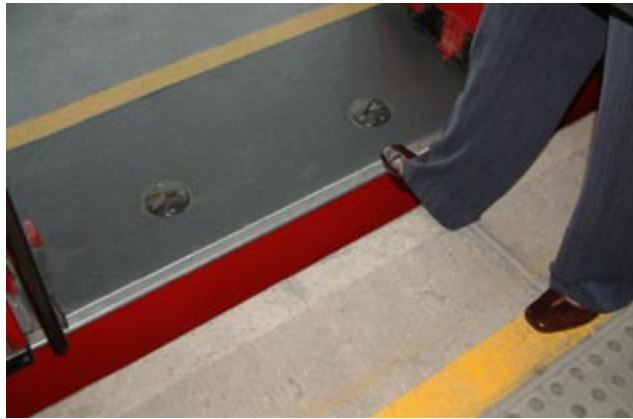


Fig. 8.25
If the vehicle can be aligned to the platform within 10 cm, then customers can safely board and alight with a gap entry.

Photo by Lloyd Wright

in the deceleration and acceleration process is affected by the following factors:

- Type of vehicle-platform interface;
- Use of docking technology;
- Vehicle weight and engine capacity;
- Type of road surface;
- Presence of nearby at-grade pedestrian crossings.

As noted above, the vehicle acceleration and deceleration time is greatly influenced by the closeness in docking required. Use of a boarding bridge requires drivers to only dock within 45 centimetres of the platform. By contrast, the close precision required to achieve a gap of only 5 or 10 centimetres will slow this alignment process. Manual alignment contributes to both slower docking time as well as greater variability



Fig. 8.26
The substantial gap between the vehicle and platform in Jakarta can be a significant safety risk to customers.

Photo courtesy of ITDP

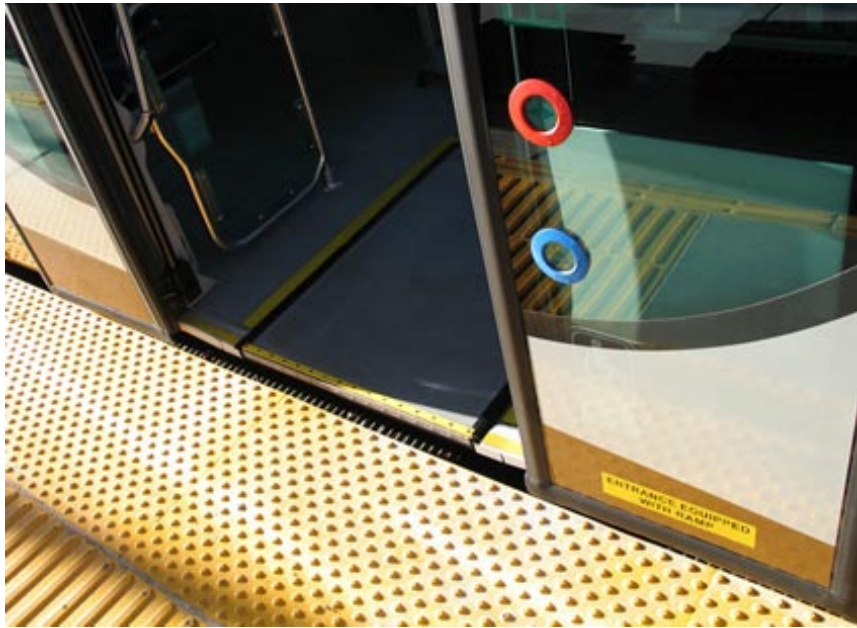


Fig. 8.27
When operating properly, the optical guidance system employed in Las Vegas can align the vehicle within a few centimetres of the platform.

Photo courtesy of NBRTI

in docking distances. Manual alignment can be improved somewhat through use of optical targets for drivers along the face of the station. Mirrors can also be utilised to improve the accuracy of manual targeting.

Alternatively, there are automatic docking technologies that can increase the speed and accuracy of vehicle to platform alignment. Mechanical, optical, and magnetic docking technologies can all be applied for this purpose. In each of these cases, the vehicle is automatically guided into platform position without any intervention from the driver.

Mechanical guideway systems, such as those utilised in Adelaide, Essen, Leeds, and Nagoya,

physically align the vehicle to the station through a fixed roller attached to the vehicle. In these cities, the fixed guideway is utilised both at stations and along the busway. However, a city could elect to only utilise the mechanical guidance at the station. Bangkok is currently considering use of mechanical guidance only at stations. A mechanical guidance system is likely to deliver a rapid alignment within a vehicle to platform distance of seven centimetres.

Optical docking systems operate through the interaction between an on-board camera and a visual indicator embedded in the busway. Software within the on-board guidance system then facilitates the automated steering of the vehicle. The Las Vegas MAX system has attempted to make use of this type of technology (Figure 8.27). Problems have occurred, though, due to the inability of the optical reader to function properly when the roadway is wet. Undoubtedly the early difficulties with this technology will be improved upon as more cities continue with experimentation.

A magnetic guidance system works on a similar principle to that of an optical system, but with magnetic materials placed in the roadway as the location indicator. The Philaeus bus, as utilised in the Eindhoven BRT system, is capable of magnetic guidance.

Optical and magnetic guidance systems produce a highly precise degree of docking. However, due to current limitations with these technologies and their software, required deceleration

Table 8.4: Observed boarding and alighting times for different configurations

Configuration characteristics				Boarding and alighting times	
Fare collection method	Doorway width (metres)	Stairway boarding or level boarding	Vehicle floor height	Observed boarding time	Observed alighting time
On-board, manually by driver	0.6	Stairway	High	3.0 ¹	NA
On-board, contactless smart card (no turnstile)	0.6	Stairway	High	2.0 ²	NA
Off-board	0.6	Stairway	High	2.0 ³	1.5 ³
Off-board	0.6	Stairway	Low	1.5	1.2
Off-board	1.1	Stairway	High	1.5	1.0
Off-board	1.1	Stairway	Low	1.1	0.9
Off-board	1.1	Level	High	0.75 ¹	0.5 ¹

1. Colombia, Mexico, 2. China, 3. Brazil, NA – Not available

and acceleration speeds can actually be slightly less than manual techniques. Further, the added hardware and software costs of an optically automated system can push vehicle costs well over US\$ 1 million each.

8.3.4 Doorways

All the efforts applied to vehicle size, station design, and docking systems can be lost if the vehicle’s doorways inhibit smooth passenger flows. The size, number, and the location of the doorways all play a role in facilitating efficient boarding and alighting. The most successful BRT systems have employed wide, multiple doorways to ensure platform bottlenecks are avoided. The combination of at-level boarding and wide, multiple doorways can reduce boarding and alighting times per passenger by between 0.25 seconds (down to 0.75 seconds) and 0.50 seconds in ideal conditions

For the 160-passenger articulated vehicle, four sets of double doors is becoming the standard configuration. Each double door is typically 1.1 metres in width. Each door thus allows two persons to simultaneously enter and/or exit the vehicle. Table 8.4 compares actual observed boarding and alighting times for different combinations of doorway and platform configurations.

From Table 8.4, it can be seen that a wide doorway (1.1 metres) with level platform boarding generates the most efficient boarding and alighting times. Bogotá’s TransMilenio system with its four sets of 1.1 meter wide doors has recorded boarding times in the area of 0.3 seconds per passenger.

Providing several doorways dispersed along the length of the vehicle multiples the capacity of the boarding and alighting process. Multiple doorways improve boarding and alighting

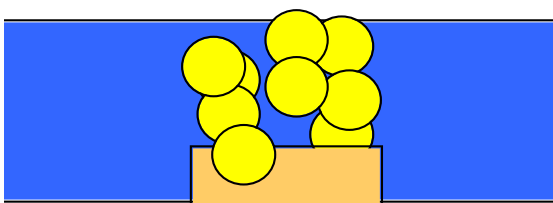


Fig. 8.28
Vehicles employing a single doorway almost invariably encounter customer congestion in attempting to board and alight.

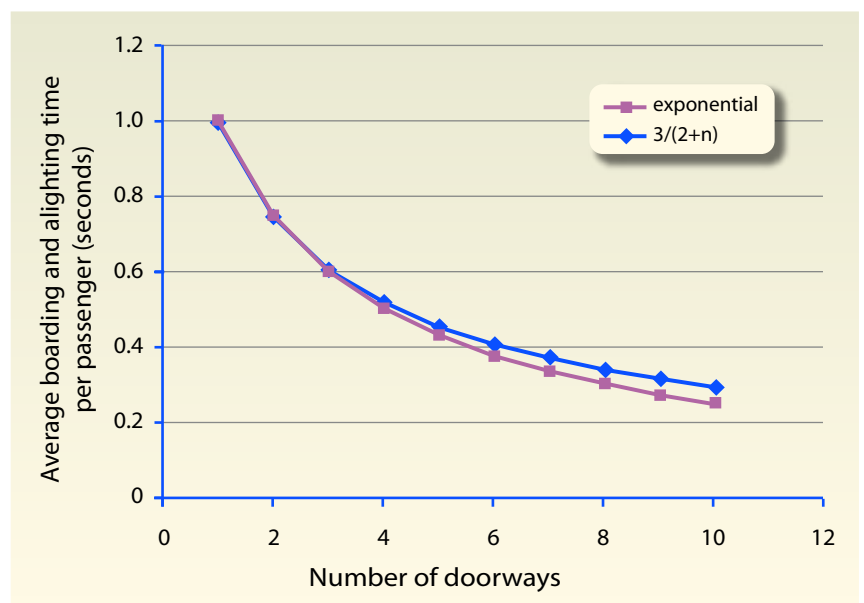
Image courtesy of Pedro Szasz

efficiency for two reasons: 1. Increased capacity; 2. Reduced passenger congestion. When there is only one doorway, passengers will tend to cluster in a congested manner (Figure 8.28). The subsequent jostling for position and conflicts between entering and exiting passengers will swell total boarding and alighting time. The presence of multiple doorways diminishes the occurrence of these types of bottlenecks.

The maximum theoretical reduction in boarding and alighting time for door width would be a vehicle with its side entirely open. In such a situation, passengers could enter and exit at all points at once. Such a vehicle could be filled to capacity in only 10 seconds. A vehicle of this type would be very useful at high-demand stations during peak hours.

However, in reality there are relatively sharp diminishing returns for each additional door after four. This finding probably accounts for why today four sets of 1.1 metre doorways has become the standard for articulated vehicles. In this configuration, 27 percent of the vehicle’s length is dedicated to doorways. This arrangement also occurs for practical, physical reasons. Doorways cannot be located in the driver’s space, above wheel wells, or along the articulation structure. Further, additional increases in doorway area may lead to a structural weakening of the vehicle. Figure 8.29 illustrates the relationship between the number of doorways and the average boarding and alighting time per passenger for the case of Brazilian cities.

Fig. 8.29
Impact of the number of doorways on boarding and alighting times.



Doorway efficiency can also be closely tied to the vehicle load factor and interior design. Once load factors exceed 85 percent, the area around the doorway will become exceedingly congested. Standing passengers will have little choice but to stand in this area, and thus reducing the effective door width (Figure 8.30). Passengers standing in this area may have to temporarily step off the vehicle to allow some passengers to alight. The fact that these persons must endure multiple boardings and alightings will diminish both customer satisfaction as well as operational efficiency. Likewise, the interior design and the amount of open space around the doorway area will determine the efficiency of customer movements. In extreme conditions, customers may miss their intended stations due to the inability to manoeuvre towards the doorway.

The directional conflict between boarding and alighting passengers will lead to delays, especially in peak periods. Alighting passengers are typically given priority over boarding passengers. However, the effectiveness of such a policy depends greatly upon cultural norms. Educating passengers to queue properly and show courtesy to alighting passengers can be difficult in some situations.

One solution to this conflict is designating some doorways as entry only and others as exit

only. Curitiba utilises this technique in some of its stations. This directional designation can improve boarding and alighting efficiency, but it can also cause customer confusion. Unless doorways are clearly denoted as exit or entry areas, customers may unwittingly use the wrong doorway. Further, if only two out of four doorways are available for alighting, customers will have more distance to cover in order to access an exit. In turn, this situation creates more jostling within the vehicle from customers seeking to make their way towards a doorway designated for alighting.

Consideration of doorway location and distribution should also be part of the design process. In general, it is most efficient to distribute doorways as widely as possible. The distribution of doorways permits customers to readily access an exit as a vehicle stops. If doorways are poorly distributed, customers may be forced to jockey for an exit position well before the vehicle nears the station. This sort of forced positioning by customers can make the public transport journey considerably less pleasant. As noted earlier, though, doorway location is constrained by the location of the driver's area, the wheel wells, and the articulation structure. Doorways at the extreme front or rear of the vehicle tend to reduce efficiency since alighting can only occur from a single direction.



Fig. 8.30
The overcrowding of vehicles results in delayed boarding and alighting due to customer congestion around the doorway.

Photo by Carlos F. Pardo



Fig. 8.31 and 8.32
The use of a single doorway in Jakarta has greatly limited the viable capacity of the system.

Left photo by Lloyd Wright
 Right photo by Shreya Gadepalli (ITDP)

The capacity of the Jakarta BRT system is largely inhibited due to the decision to utilise only a single doorway (Figures 8.31 and 8.32). The system’s current peak capacity is only approximately 2,700 passengers per hour per direction. TransJakarta’s capacity limitations are actually due to several design and operational problems, including:

- Single doorway;
- Standard-sized vehicle;
- Large open gap between vehicle and platform;
- Presence of conductor partially blocking doorway entrance.

As a solution to its capacity constraints, TransJakarta elected to increase its vehicle fleet by adding 36 buses to its existing fleet of 54 buses. However, only about 8 of these buses actually helped increase capacity before bus queuing at the stations dropped the level of service down to unacceptable levels.

Table 8.5 presents TransJakarta’s present situation along with potential solutions to its capacity problems. Shifting towards an articulated vehicle with wide, multiple doorways would add the most capacity to the existing system.

8.3.5 Station platform

The size and layout of the station platform will have a discernible impact on system capacity and efficiency. In some systems, platform size can even be the principal constraint on overall capacity. For many of the London tube lines, it is the relatively small platform width that ultimately determines the total possible passenger volumes.

The determination of the optimum platform size is based on the number of boarding and alighting passengers at peak periods. If the

platform hosts two service directions along one another, then the sum capacity requirements of both directions must be factored into platform sizing. Chapter 11 (*Infrastructure*) details the calculation of platform sizing.

Additionally, the layout of the platform will affect overall efficiency. To the extent possible, clear sight lines and walking paths should be maintained on the platform, especially near boarding and alighting doorways. Thus, any interior infrastructure such as public telephones and plants should be kept away from the doorways. Clear signage can likewise help ensure that optimum passenger movements are achieved.

8.3.6 Summary of vehicle-platform interface

As this section has indicated, improving the efficiency of the vehicle-platform interface can deliver significant dividends in terms of saved boarding and alighting times. Table 8.6 summarises the potential gains that can be achieved by improving the vehicle-platform interface as well as by properly sizing the vehicle. The noted capacity improvements can be achieved

Table 8.5: Scenarios for improving TransJakarta’s capacity

Scenario	Average boarding time (seconds)	Capacity (pphpd)	Dwell time (seconds)	Average speed (kph)	Required fleet size (vehicles)
Present situation	2.5	2,700	45	17	60
Improving boarding	1.7	3,700	35	19	56
Vehicle with two doors	0.5	6,000	22	21	51
Articulated vehicle (4-doors)	0.3	9,600	18	23	26

Table 8.6: Impacts of vehicle–platform interface and vehicle size on capacity²⁾

Vehicle and operation type	Maximum vehicle capacity	Average dwell time (Td)	Average boarding & alighting time (T1)	Corridor capacity (pphpd)	Vehicle capacity (vehicles/hour)
Mini-bus	15	10	3.0	1,137	76
Midi-bus	35	11	3.0	1,575	45
Standard bus	70	12	3.0	1,867	27
Articulated vehicle with conductor	160	13	1.5	3,777	24
Bi-articulated with conductor	240	14	1.5	4,019	17
Articulated, level platform, conductor	160	13	1.0	5,120	32
Bi-articulated, level platform, conductor	240	14	1.0	5,574	23
Articulated, level platform, off-board	160	13	0.3	9,779	61
Bi-articulated, platform, off-board	240	14	0.3	12,169	51

Source: Steer Davies Gleave

without compromising average vehicles speeds of around 25 kph.

Table 8.6 presents the optimised capacity values for a BRT system operating on a single lane and using a single stopping bay. For this type of scenario, the maximum capacity is approximately 12,000 passengers per hour per direction, assuming off-board fare collection and boarding and alighting with a level platform. Achieving even higher capacities at an acceptable level of service, will require other measures such as multiple stopping bays.

8.4 Multiple stopping bays and express services

“There can be no economy where there is no efficiency.”

—Benjamin Disraeli, former British Prime Minister, 1804–1881

8.4.1 Multiple stopping bays

8.4.1.1 Impact on capacity

Measures such as vehicle size, vehicle–station interface, and doorway widths all make a contribution to higher-capacity and higher-speed systems. However, even together, these measures will likely only produce capacities in the range of 12,000 pphpd. Thus, while systems such as

²⁾The capacity calculation takes into account the expected saturation levels of the stopping bay.

those in Curitiba and Quito are high-quality BRT systems, their maximum corridor capacities are limited to this value.

It was not until the year 2000, when Bogotá’s TransMilenio was introduced, that an entire new level of capacity was possible. Today, Bogotá achieves a peak capacity of 45,000 pphpd and there are good indications that values as high as 50,000 pphpd or even higher are now possible with BRT.

The main difference between TransMilenio and those systems that preceded it is the number of stopping bays utilised. By increasing the value of the “Nsp” (number of stopping bays) in the capacity equation, Bogotá has allowed BRT to enter a capacity region once thought to only be feasible through rail metro systems.

$$C_o = \frac{N_{sp} * 1,440}{\left[\frac{T_d * (1 - Dir)}{C_b} + (Ren * T1) \right]}$$

In some cases, a single TransMilenio station will host up to five stopping bays (Figure 8.33). As is evident from the corridor capacity equation above, the five stopping bays hold the potential to increase capacity by five times. Each stopping bay represents a different set of services or routes

(e.g., local services versus limited-stop services or routes with a different final destination).

The presence of multiple stopping bays serves two distinct purposes. First, the multiple stopping bays permit many different types of services from the same station, such as local services or limited-stop services. Each stopping bay represents a different set of services or routes.

Second, the multiple stopping bays can dramatically reduce the saturation level (the “X” variable in the capacity equation) at the stations. Since station saturation is typically the principal barrier to higher-capacity services, adding stopping bays is perhaps the cornerstone of any proposed system requiring higher capacity levels.

8.4.1.2 Multiple stopping bays and saturation levels

As noted earlier, to maintain a high level of service, saturation levels should be 40 percent or below. If saturation is over 0.40, a second lane and a second stopping bay are likely to be required. As saturation increases, more stopping bays will likely be needed.

In order to maintain a saturation factor of less than 0.40, services at each stopping bay must be properly scheduled and spaced to limit congestion. A saturation factor of 0.40 corresponds to approximately 60 vehicles per hour, but the specific stopping bay demand can reduce or increase this value. If 18-metre articulated vehicles are utilised, then 60 vehicles per hour corresponds to an approximate capacity of 9,000 pphpd, and this figure is a general limit for one lane simple operation. Since a lane will begin to congest once 70 vehicles per hour per direction is reached, a second stopping bay is recommended whenever volumes exceed this level.

The saturation level for an individual stopping bay can be calculated as in Equation 8.10.

Equation 8.10 Calculating the saturation level of a stopping bay

$$X = Td * F + [(Pb * Tb) + (Pa * Ta)]$$

Where:

X = Saturation level at a stopping bay

Td = Dwell time (seconds)

F = Frequency (vehicles per hour)



Fig. 8.33

The use of multiple stopping bays has been one of the principal reasons Bogotá is able to achieve very high passenger capacities.

Photo courtesy of Akiris

Pb = Total number of passengers boarding (passengers)

Tb = Average boarding time per passenger (seconds)

Pa = Total number of passengers alighting (passengers)

Ta = Average alighting time per passengers (seconds)

This equation simply shows that the saturation level “X” is a function of the total dwell time per hour plus total of the passenger boarding and alighting times. Box 8.1 provides a comparison of stopping bay saturation levels for two different situations.

8.4.1.3 Route distribution along multiple stopping bays

Multiple stopping bays imply the existence of multiple routes emanating from a single station. A question arises as to the distribution of the routes within the physical structure of the station. In other words, which routes should be grouped near one another and which routes can be separated by a longer walk for the customer?

The guiding principle should be based upon customer convenience. Ideally, the right distribution of routes along the stopping bays should minimise the walking distance covered by the largest majority of customers. Thus, the most common transfers should be grouped together.

Box 8.1: Examples of saturation levels for individual stopping bays

Saturation levels at a given stopping bay will vary considerably depending on the passenger demand and vehicle frequency. In the case of most developed-nation bus services, saturation levels are typically quite low. For example, for London bus service along the city's Oxford Street, the total dwell time per bus is 11 seconds, and the frequency is 24 buses per hour. An average total of 16 persons board or alight in a given hour, with each boarding and alighting requiring roughly three seconds each.

The saturation level is therefore calculated as follows:

$$X = (11 \text{ seconds} * 24 \text{ buses per hour}) + (3 \text{ seconds} * 16 \text{ passengers}) \\ = 312$$

Because frequencies are given in hours and dwell times, boarding times, and alighting times are given in seconds, 312 must be divided by 3600. Thus,

$$X = 312 / 3,600 = 0.09$$

This value is a very low saturation rate. At this level of bus flow, there is no problem with congestion at the stopping bay.

By contrast, BRT systems operated along high-capacity corridors will typically experience considerably higher saturation levels. Table 8.7 records values for a hypothetical BRT corridor served by a single stopping bay.

Table 8.7: Components to saturation level at a stopping bay

Flow components		Time components			Saturation level
Factor	Value (units / hour)	Factor	Value (seconds)	Value (hours)	Flow + Time
Frequency (F)	90	Dwell time (Td)	12	0.00333	0.3000
No. of boarding passengers (Pb)	400	Boarding time (Tb)	3	0.00083	0.3333
No. of alighting passengers (Pa)	300	Alighting time (Ta)	2	0.00056	0.1667
Total					0.8000

Table 8.7 highlights the individual contribution that each component makes to the overall saturation level. In this case, the sum of the components totals a saturation level of 0.8, which is exceedingly high. A saturation level of this magnitude will almost certainly produce busway congestion and thus reduce average vehicle speeds. At this level of saturation, it is clear that a second stopping bay should be added.

This philosophy will not only improve customer convenience but it will also improve overall station capacity. If large numbers of passengers are forced to criss-cross the length of the platform area, then passenger congestion will ensue. This congestion can subsequently have a negative impact on station capacity, dwell times, and the overall performance of the corridor.

Often, the greatest efficiency in stopping bay distribution can be gained by placing together routes which have destinations in relative

geographical proximity to one another. This geographical clustering of routes may take two different forms:

1. Routes with adjacent geographic coverage (Figure 8.34);
2. Routes shared by two different types of services (such as local and limited-stop services) covering a similar corridor (Figure 8.35).

If frequencies are sufficiently spaced, some routes can even share the same stopping bay area. For example, a local service and a limited-

stop service could share the same stopping bay if the frequency levels made a simultaneous arrival unlikely. However, in such instances, sufficient space should be reserved for a vehicle to wait behind the stopping bay, in case both routes arrive consecutively. The advantage of a shared stopping bay is that passengers changing from a local service to a limited-stop service (or vice versa) are not forced to walk to a different platform area. However, if different routes share a stopping bay, the risk of customer confusion increases. While vehicle route numbering, vehicle colour-coding, platform display messages, and platform audio announcements can all help to minimise such confusion, some passengers may unwittingly board the wrong vehicle.

8.4.1.4 Passing lanes

In order for multiple stopping bays to function properly, and for services to be split between various local and limited-stop routes, vehicles must be able to pass one another at the stations. Therefore, multiple stopping bays should be accompanied by a passing lane at the station (Figure 8.36). The second busway lane at the station stop allows vehicles to pass one another in accessing and exiting the correct bay.

The passing lane may exist as just a second lane in the station area, or the additional lane may be extended all along the corridor (Figures 8.37). Whether the second lane is needed beyond the station area depends upon the saturation levels along the corridor, and especially depends upon the level of congestion at intersections.

The principal difficulty in including a passing lane is the impact on road space. The additional lane in each direction would seem to require a road width few developing cities can reasonably provide. However, a staggered station design can help to permit passing lanes, even in relatively tight corridors. In this case, the sub-stops for each direction of travel are offset. The preferred median station design is retained, but its shape is elongated to help accommodate the passing lane. Passengers can still change directions within

Fig. 8.34
Platform order based on geographic proximity of routes.

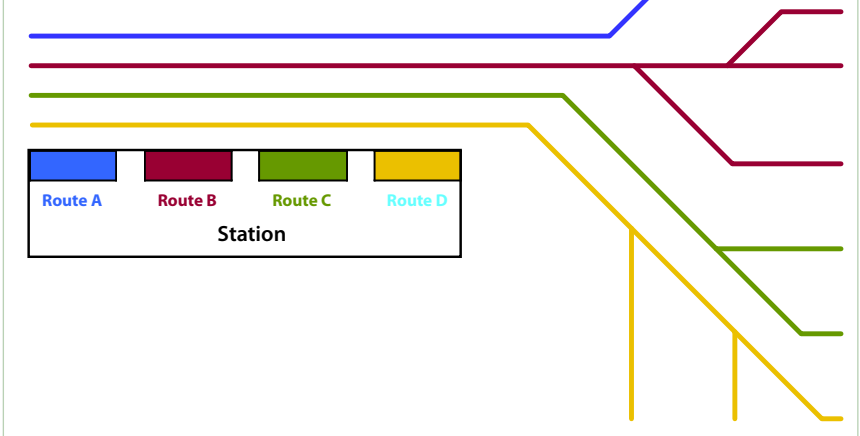


Fig. 8.35
Platform order based on service clustering.

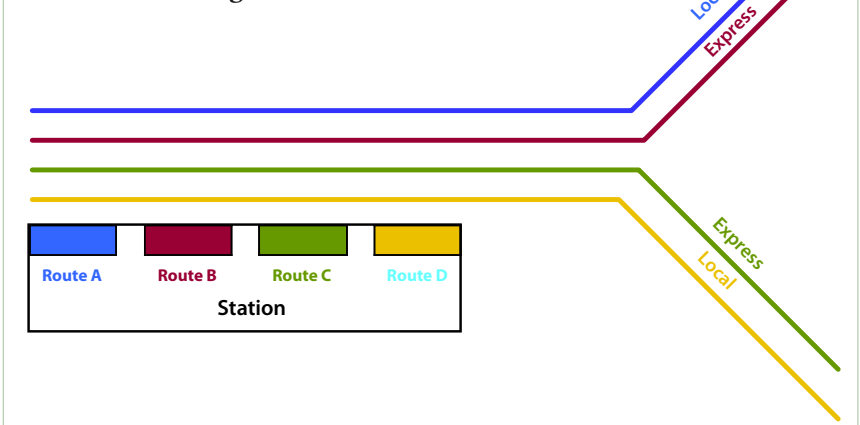


Fig. 8.36

The existence of a passing lane makes the high passenger capacities achieved in the Bogotá system possible.

Photo by Carlos F. Pardo



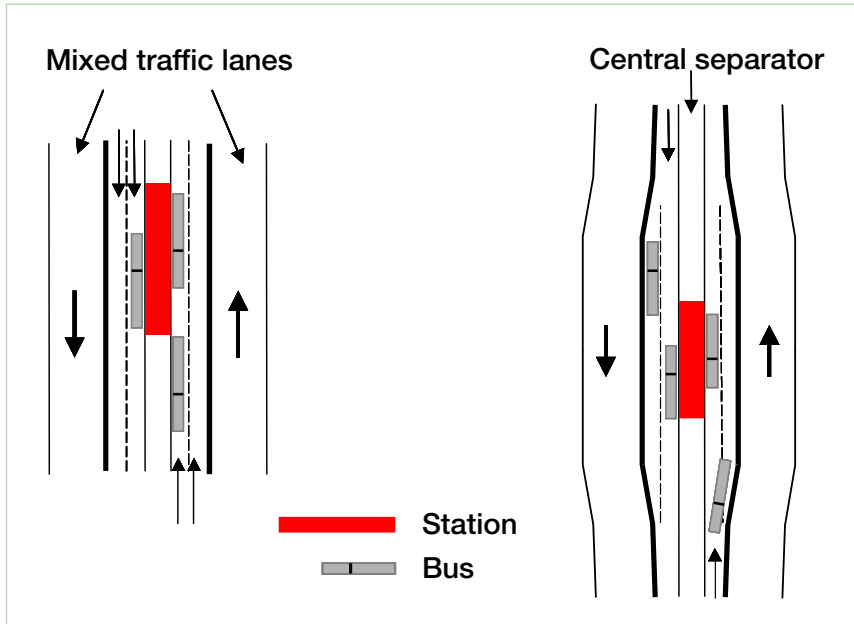


Fig. 37
Options for provision of a passing lane

the closed station area by crossing a connecting platform. In this case, the higher passenger flows within the stations are achieved by lengthening the stations instead of widening them.

Other options for accommodating passing lanes in relatively narrow roadways include reducing mixed traffic lanes as well as making property purchases for widening. In some BRT cities, such as Barranquilla (Colombia), plans call for the purchase of properties near station areas. The road infrastructure is widened in these areas in order to accommodate the passing lane. This same strategy is being proposed for some stations of the Dar es Salaam

system (Figure 8.38). The viability of property purchases for this purpose depends upon local property costs as well as the existence of a well-designed compensation programme for property owners.

8.4.2 Capacity impacts of limited-stop and express services

8.4.2.1 Impact on corridor capacity

Related to the availability of multiple stopping bays, limited-stop and express services can also help to significantly expand corridor capacity. The provision of express and limited-stop services can do much to prevent vehicle congestion at stations. Since these services avoid the need for vehicles to stop at each station, the overall congestion level is reduced.

Within the corridor capacity calculation, the provision of limited-stop and express services affects the term “1 – Dir”:

$$C_o = \frac{N_{sp} * 1,440}{\left[\frac{T_d * (1 - Dir)}{C_b} + (Ren * T1) \right]}$$

Box 8.2 provides an example of the potential impact of limited-stop services on corridor capacity.

8.4.2.2 Determining the number of routes

Optimising the number and location of local, limited-stop, and express routes within a traffic

Fig. 8.38
In order to accommodate passing lanes at stations of the proposed Dar es Salaam system, road widening is envisioned.

Image courtesy of the Dar es Salaam Rapid Transit system (DART)



Box 8.2: Increasing capacity with limited-stop services

In the corridor capacity calculation, the term “Dir” represents the percentage of vehicles that operate either limited-stop or express services. In the case of TransMilenio, approximately 50 percent of the vehicles serve these type of routes.

Using the following inputs, the capacity benefit of limited-stop services can be calculated:

Number of stopping bays (Nsp) = 3

Vehicle length (L) = 18 metres

Dwell time (Td) = 10 + L/6 = 13 seconds

1 – Dir (percent of limited-stop services) = 1 – 0.5 = 0.5

Average dwell time for limited-stop services = 13 * 0.5 = 7.5

Vehicle capacity = 160 passengers

Renovation rate = 0.25

Average boarding and alighting time per passenger = 0.3 seconds

$$\text{Corridor capacity (Co)} = \frac{3 * 1,440}{\left[\frac{(10 + 18/6) * (1 - 0.5)}{(10 * (18 - 3))} + (0.25 * 0.3) \right]}$$

$$= 35,446 \text{ pphpd}$$

If the value for “Dir” was zero (i.e. no limited-stop services), then the capacity for this corridor would be reduced to 26,721 pphpd, a 25 percent drop from the scenario with limited-stop services.

The calculated capacity of 35,466 pphpd is close to the actual capacity of TransMilenio today. With this formula, most of the secrets to TransMilenio’s capacity and speed performance become clear.

model is not a simple matter. The following list presents some general rules for this optimisation process:

1. Saturation at the station should not surpass its operational capacity, specifically calculated as: Saturation = 0.4 x number of sub-stops.
2. Stations with less demand should have fewer routes stopping.
3. Transfers between limited-stop and local services will significantly affect station congestion and vehicle dwell times. The selection of the appropriate stations to facilitate such transfers will help to control the station congestion levels.
4. Both directions of a route should produce roughly the same demand. To obtain this equilibrium, the opposite pairs need to be adequately chosen.
5. The set of stations served by a particular route may be geographically based (connecting a group of continuous stations) or demand base (connecting the highest demand stations). Connecting many high-demand stations seems attractive, particularly from a customer standpoint. However, one must be careful to avoid an excessive concentration of transfer demand at the highest-demand stations.
6. The stations with more demand for boarding and alighting should have more routes stopping in order to minimise transfers for the majority of passengers.
7. Routes with more demand should stop less, and thus be provided with more limited-stop and express options. If a local route has more demand than a limited-stop route along the same corridor, then the limited-

stop route should stop at more stations in order to increase its demand.

8. Routes should have peak frequencies ranging from 10 to 30 vehicles per hour (*i.e.*, headways ranging from 2 to 6 minutes), although systems such as TransMilenio are capable of having as many as 60 vehicles per hour on a single route. If the required frequency is higher than 30 vehicles per hour, the route can be divided into two. If the frequency is lower than 10 vehicles per hour, then the route should be joined with another.
9. In order to avoid large concentrations of transfers at high-demand stations, it may be useful to stop many routes at a nearby small station, so users can transfer there.
10. The size of the required vehicle fleet, travel times, waiting times, and transfer locations are the key variables in the simulation process for optimising the routing of local, limited-stop, and express services.

The best mechanism for optimising the number of routes and the split between local, limited-stop, and express services is through a public transport simulation model. Software packages such as EMME2, Transcad, Visum, and others are well suited for this purpose. The chosen software package must contain the origin-destination (OD) matrix for public transport trips, and must include a compartmental model in which each passenger has multiple corridor and route choices based on the generalised cost of the total trip, including waiting times.

However, a rapid calculation technique can provide a first approximation for the total number of routes. The base equation for this calculation is as follows:

Equation 8.11 Calculating the optimum number of routes

$$NR = 0.06 * (30 * 150)^{0.5}$$

$$= 4.0 \text{ routes}$$

Where:

NR= Optimum number of routes

NS = Number of stations along corridor (in one direction)

F = Frequency (vehicles per hour)

Thus, for a corridor with a total of 30 stations (NS = 30) and a frequency of 150 vehicles per hour (F = 150), the approximate optimum number of routes is calculated as:

In this case, planners may elect to develop two different local services and two different limited-stop services. Alternatively, the corridor could host a single local service along its entire length, two limited-stop services, and an express service.

8.5 Convoying

“Even if you are on the right track, you will get run over if you just stand there.”

—Will Rogers, social commentator and humorist, 1879–1935

In general, multiple stopping bays are coupled with passing lanes in order to allow vehicles to overtake one another and thus readily access the appropriate stopping bay. As Chapter 5 (*Corridor selection*) has noted, there are also design options that permit passing lanes even when right-of-way space is limited.

However, there may be circumstances when either political conditions or roadway space simply will not permit the development of a passing lane. If the capacity requirements along the corridor require multiple stopping bays, there is still an option to do so without a passing lane. In this case, some of the benefits of separate stopping bays can be achieved through the “convoying” or “platooning” of the vehicles. A convoy system permits multiple stopping bays but without a passing lane.

8.5.1 Overview of convoying systems

Convoys involve two or more vehicles operating along the busway in a closely bunched pack. In some respects, a convoy system is similar to an extended set of rail cars. The order of the vehicles is typically set so that the first vehicle stops at the far stopping bay and the next vehicle stops at the subsequent stopping bay (Figure 8.39). In this case, each stopping bay represents a different service or a different route. In other cases, multiple vehicles within the convoy may actually be serving the same route. For this situation, the convoy is simply adding vehicle capacity to a single route.

A single lane operating with a single stopping bay per station can achieve a corridor capacity of

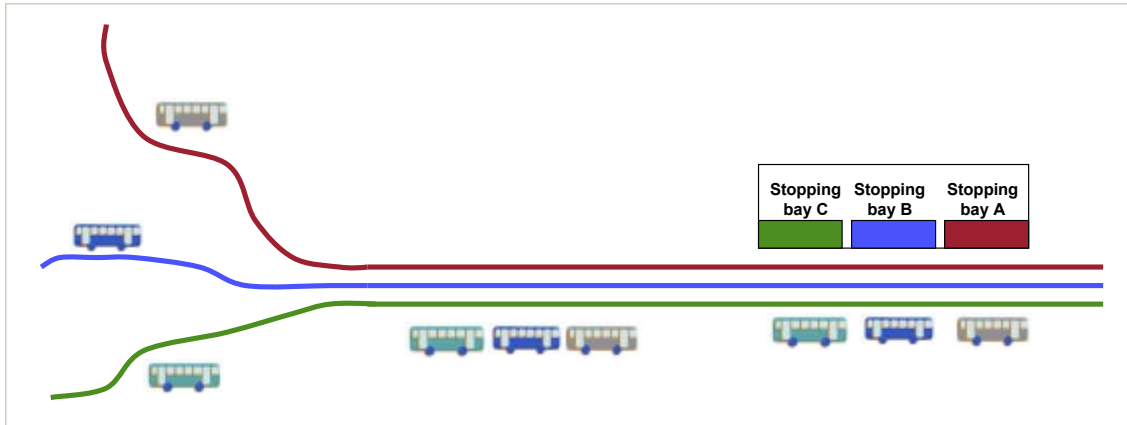


Fig. 8.39
Convoying systems work by permitting multiple routes to come together as a “train” of vehicles along a trunk corridor.

approximately 9,000 pphpd. Convoys can increase capacity by around 50 percent to a maximum of 13,000 pphpd without any reduction in the level of service. For demand volumes over this level, multiple stopping bays and passing lanes are necessary. However, some systems utilising convoying systems have achieved corridor capacities over 20,000 pphpd. Both the “Far-rapos” and the “Assis Brasil” corridors in Porto Alegre reach peak capacities of over 20,000 pphpd through convoying techniques (Figures 8.40 and 8.41). Nevertheless, the penalty for extending convoying to this level is a reduced level of service in terms of average speed.

A convoy system could also be possible on systems which have passing lanes at some but not all stations. In such a case, lower-demand stations with a single stopping bay would utilise a passing lane. At higher-demand stations, where all routes would be stopping, then the vehicles would stop as a convoy in a set order.

Systems may operate as ordered convoys or non-ordered convoys. In an ordered convoy, the vehicles must approach the station in a set order so that the vehicles stop in the designated stopping bay. Signage at the station instructs passengers which stopping bay corresponds with their intended route. To manage and control

the order of the vehicles entering the busway, a control centre in conjunction with automatic vehicle locating (AVL) technology may be essential. Communications between the control centre and the drivers allows each vehicle to adjust its position in order to enter the busway at the right moment.

In a non-ordered convoy, the vehicles approach the station in any order, depending on the timing of each vehicle’s entry into the main busway. In this case, customers will not know at which stopping bay their intended route will stop. However, visual displays or audio announcements may indicate the stopping bay number shortly before a vehicle’s arrival.

8.5.2 Disadvantages of convoys

Unfortunately, the convoying or platooning of vehicles is quite difficult to manage and control. The vehicles must enter the busway in the appropriate order or there will be considerable delays and backing up of vehicles. Further, since passenger boardings will vary for different vehicles, the dwell times will also vary. Some vehicles may needlessly wait behind others while a longer boarding takes place. Thus, in a convoy system the slowest vehicle will likely set the speed for the entire fleet. For these reasons,



Fig. 8.40 and 8.41
Convoying allows the Porto Alegre system to achieve peak capacities of over 20,000 pphpd, but at the same time this technique can result in busway and station congestion and therefore slowing average vehicle speeds.
 Photos by Lloyd Wright



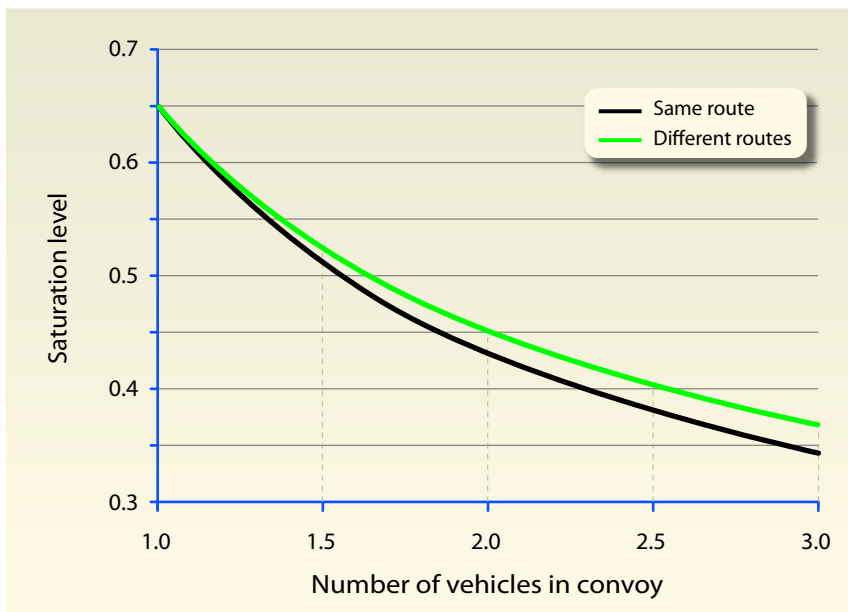
Fig. 8.42
Despite Porto Alegre’s system being a premium public transport service along a dedicated busway, customers are sometimes forced to flag down their desired vehicle.

Photo by Lloyd Wright

multiple stopping bays are probably best implemented through the provision of passing lanes at stations.

Non-ordered convoys will typically add further stress and confusion to a customer’s journey. In non-ordered systems, the customers may not know at which stopping bay their route will be arriving. Even if announcements give customers a brief warning, there is still likely to be some confusion. This situation implies that customers may be running from one end of the station to the other in search of their intended vehicle. Rather than spending one’s waiting time doing another value-added activity, such as reading or relaxing, a non-ordered convoy forces customers to stand at ready alert in search of their vehicle. In some cases, passengers may be forced to flag

Fig. 8.43
Impact of convoy length on saturation levels



down the desired vehicle in order for the vehicle to actually stop (Figure 8.42).

8.5.3 Convoys and saturation levels

The number of stopping bays necessary at each station is a function of the number of boarding and alighting passengers. For a low-demand station on an otherwise high-demand corridor, only a single stopping bay may be necessary. However, in this instance, a passing lane would be recommended. In circumstances with high levels of boarding and alighting passengers, systems have used as many as five stopping bays to accommodate the demand.

Convoys can be partially defined through two factors: 1. Average number of vehicles per convoy (m); and 2. A constant that defines the degree of similarity between the routes of the different convoy vehicles (K_c). The constant “ K_c ” must take on a value between one and two. If all vehicles in the convoy serve the same route, as if the convoy was a train, then K_c is equal to one. If all vehicles in the convoy serve different routes, then K_c is equal to two. The dwell time within a convoy system is defined by the following equation:

Equation 8.12 Dwell time within a convoy system

$$T_d = (10 / m) + (L / 4)$$

Properly managed and controlled convoys should theoretically produce reductions in saturation levels. Box 8.3 compares saturation levels for a system with and without convoying. However, the difficulty in managing and controlling a convoy quite often implies that saturation levels can actually increase.

In general, as the number of vehicles in the convoy increase, the theoretical saturation level will tend to decrease. Figure 8.43 illustrates this relationship.

As Figure 8.43 indicates, saturation levels for convoys with all vehicles serving the same route are slightly better than the saturation levels for convoys with vehicles serving different routes. However, this difference is marginal. As noted, though, the experience of convoys to date has not met its theoretical promise. The difficulty in

controlling vehicle entry to the convoy means that convoys can frequently suffer from congestion at stations. Additionally, the confusion created amongst customers can damage the image and efficiency of the system.

8.6 Station spacing

“Good design begins with honesty, asks tough questions, comes from collaboration and from trusting your intuition.”

—Freeman Thomas, designer

Station spacing will also affect the speed and capacity of a BRT system. If stations are spaced very far apart in the manner of a metro system, reaching very high-speeds and high-capacities is quite possible. Metro systems may space stations as far apart as one kilometre or more in order to reap speed and capacity advantages.

However, the disadvantage of such an approach is the additional distance customers must traverse in order to reach the station.

Therefore, BRT station spacing should try to

Box 8.3: The impacts of convoys on saturation levels

In the following example, two scenarios are developed in order to compare saturation levels for similar systems with and without the use of convoys. As noted earlier, the saturation level is calculated by the following equation:

$$X = T_d * F + [(P_b * T_b) + (P_a * T_a)]$$

Where:

- X = Saturation level
- T_d = Dwell time
- F = Vehicle frequency
- P_b = Number of boarding passengers
- T_b = Average boarding time
- P_a = Number of alighting passengers
- T_a = Average alighting time

The following characteristics will be common to both the scenarios (scenario with convoy and scenario without convoy):

- Articulated vehicles with four, 1.1 metre-wide doors
- P_b = 2,000 passengers
- P_a = 1,500 passengers
- F = 100 vehicles per hour

1. No convoy scenario

- T_a = 0.75 * 2 / (1 + 4) = 0.3 seconds/passenger
- T_b = 0.5 * 2 / (1 + 4) = 0.2 seconds/passenger
- T_d = 10 + (18 / 4) = 14.5 seconds/vehicle
- X = [14.5 * 100 + (0.3*2,000 + 0.2*1,500)] / 3,600 seconds/hour = 0.653

2. Convoy scenario

- Two vehicles in non-ordered convoy
- m = 1.33
- T_a = 0.3 * 3 / (2+1.33) = 0.27 seconds/passenger
- T_b = 0.2 * 3 / (2+1.33) = 0.18 seconds/passenger
- T_d = (10 / 1.33) + (18 / 4) = 12.2 seconds/vehicle
- X = [12.2 * 100 + (0.27 * 2,000 + 0.18 * 1,500)] / 3,600 seconds/hour = 0.566

Thus, from this theoretical example, conveying holds the potential to reduce saturation from 0.653 to 0.566, which represents a reduction of 13 percent.

strike an optimal balance between convenience for walking trips to popular destinations, and convenience for passengers in the form of higher speed and capacity. This balance can also be better achieved if the system allows for local and limited stop services.

Locating BRT stations close to popular destinations is the best way to minimise walking times. Thus, BRT stations are typically located near major destinations such as commercial centres, large office or residential buildings, educational institutions, major junctions, or any concentration of trip origins and destinations. Usually this siting is done based on intuitive local knowledge, because traffic modelling is rarely detailed enough to provide much insight.

The spatial and right-of-way characteristics of an area will also play a role in station location. The station area will typically consume more right of way than other sectors of the BRT system.

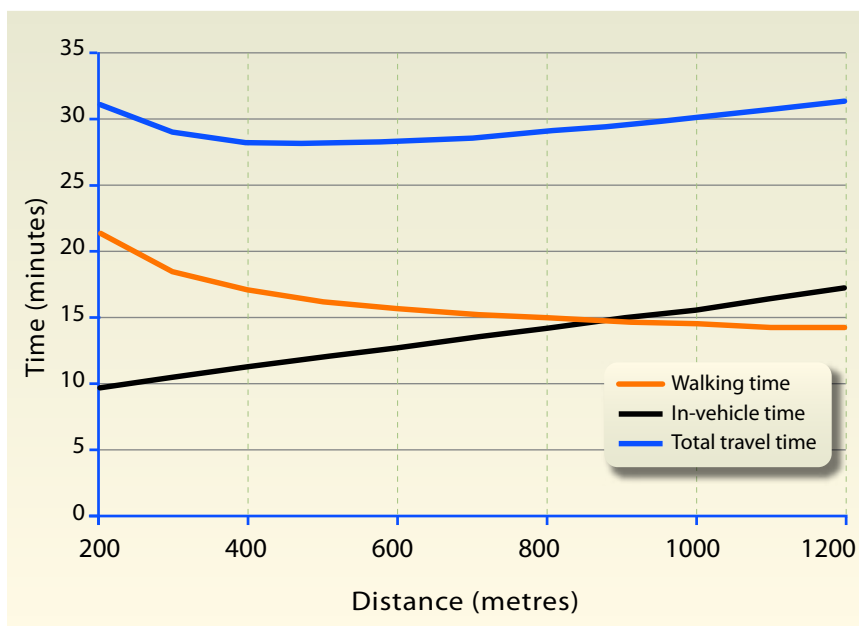
Because BRT systems are in essence trying to provide a high-speed service that competes with metro services, designers will tend to space stations farther apart than normal bus stops. However, the distances should also represent the noted balance between walking times and vehicle speeds. In general, distances of approximately 500 meters between stations tend to be the current standard for BRT corridors.

However, the actual spacing can range from 300 and 1,000 metres, depending on the local circumstances.

The optimal distance is not a constant but will vary depending on the number of boarding and alighting passengers, and the quality of the walking environment. Where there are large volumes of boarding and alighting passengers, more frequent stops will be optimal, because more people will be affected by the long walking times than will benefit from the faster vehicle speeds. In areas with very few boarding and alighting passengers, greater distances between stops will be optimal, because fewer people will benefit from the shorter walking distances, and more will benefit from the faster vehicle speeds. Figure 8.44 visually summarises the trade-off between walking times and BRT travel times in relation to the distance between stations.

In the case of Figure 8.44, the optimum point is where the total travel time (blue line) is minimised. From the figure, this point appears to occur in the range of a station separation of 400 metres to 500 metres. Box 8.4 provides a methodology for mathematically determining the optimum distance between stations.

Fig. 8.44
Optimising total travel time as function as station separation



Box 8.4: Calculating the optimum distance between stations

Optimising the distances between stops is done by minimising the generalised cost of travel for the walking distances to the stations and the travel speed of the passengers passing along the corridor.

For purposes of this example, it will be assumed that passengers walk a maximum of one-half of the distance between stations (D), and on average each passenger will walk one-quarter of this distance. Thus, walking time for boarding and alighting passengers is proportional to station distance. On the other hand, passengers in vehicles incur an additional delay for each stop, so the delay is inversely proportional to D. The calculation for determining the optimum distance between stations is as follows:

$$Dopt_x = [g1 * (C_x + g2 * Cmax) / Pk_x]^{0.5}$$

Where:

- Dopt_x = Optimum distance between stops in a particular area x
- C_x = Peak hour bi-directional demand (crossing volume/hour) on point x
- Cmax = Peak hour uni-directional maximum demand of lines that stop on stations x
- Pk_x = Bi-directional density of passengers boarding and alighting near point x
- g2 = A constant that reflects travel cost constants divided by walking cost constants
- g1 = 4 * (Cst / Csw) * Vw * Tob
- Cst = the value of walking time (US\$ / walking time)
- Csw = the value of time for transit passengers (US\$ / transit system time)
- Vw = walking speed (km hour)
- Tob = Dwell time lost at each station (excluding boarding and alighting time)

For this example, the following assumptions are made:

- Cst / Csw = 0.5 (i.e., people value transit time twice as much as walking time)
- Vw = 4 kph
- Tob = 30 seconds = 1/120 hours
- G2 = 0.4
- C_x = 7,000 passengers per hour
- Cmax = 9,000 passengers per hour
- Pk_x = 2,500 passengers / kph

Based on these assumptions:

$$g1 = 4 * 0.5 * 4 / 120 = 0.067 \text{ km}$$

$$Dopt_x = [0.067 * (7,000 + 0.4 * 9,000) / 2,500]^{0.5}$$

$$= 0.533 \text{ km} = 533 \text{ metres}$$

Thus, the optimum distance between the stations in area x is 533 metres. This example assumed that passengers will value time on the transit vehicle more than walking time. This preference is not always the case, especially in areas with a high-quality walking environment.

9. Intersections and signal control

“Every doorway, every intersection has a story.”
 —Katherine Dunn, novelist, 1945—

Intersections represent a critical point along any BRT corridor (Figure 9.1). A poorly designed intersection or a poorly timed signal phase can substantially reduce system capacity. Finding

solutions to optimising intersection performance can do much to improve system efficiency. Generally, the aim of intersection design for a BRT system is to:

- Minimise delay for the BRT system;
- Improve safe and convenient access to the bus station by pedestrians;
- Minimise delay for mixed traffic.



Fig. 9.1

Intersection design affects the public transport system's efficiency, pedestrian safety and access, and flows of mixed traffic vehicles.

Photo by Lloyd Wright

There are normally design solutions which optimise the total time savings for all modes, and achieve a reasonable balance between each of these aims. However, planners and political decision-makers will often give the highest priority to public transport vehicles and pedestrians for reasons of speed, safety and convenience.

The optimal solution depends on relative numbers of boarding and alighting public transport passengers, turning vehicles, and the bus operations. Since these factors will vary along any given corridor, it is generally not advisable to use a standard intersection configuration throughout a BRT corridor. Rather, it is best to design the intersection for the specific conditions at the given location. Intersection design is an iterative process, and the impact of a planned BRT system on overall intersection performance is often a significant consideration when deciding on the route structure of the BRT system, the location of the stations, and the design of the stations.

In BRT systems with very low vehicle volumes, relatively few passengers, and a large number of intersections, as is fairly typical in developed countries, the traffic signal may be the most significant cause of system delay. In developed countries, BRT system designers frequently focus considerable attention on reducing signal delay, and rely on a variety of traffic signal priority measures.

In developing countries, where typically the number of passengers and the number of buses per hour is much higher, where intersections tend to be fewer, and where traffic signal maintenance is less reliable, BRT system designers tend to rely more heavily on turning restrictions to improve intersection performance. In either case, improving the efficiency of the intersections is important.

BRT systems with physically segregated lanes create new turning conflicts. Whereas buses in mixed traffic can move to a mixed traffic

left turn lane when turning left, and to a right turn lane when turning right, in a physically separated busway the buses are physically constrained from moving to the other side of the road. If designed poorly, the introduction of BRT can lead to a multiplication of signal phases at the intersection, and/or a multiplication of turning lanes, delaying both the busway and the mixed traffic and consuming right of way at the intersection that might be better used for pedestrian facilities or other alternative uses, or requiring costly land acquisition. To avoid these problems, BRT system planners have tended to approach intersections in the following manner:

1. Identify existing bottlenecks and resolve using standard engineering practice;
2. Simplify the BRT system’s routing structure;

3. Calculate the projected traffic signal delay on the new BRT system;
4. Restrict as many mixed traffic turning movements on the BRT corridors as possible;
5. Decide on an approach to turning movements within the BRT system;
6. Optimise the location of the station;
7. Optimise the intersection design and the signal phasing;
8. In low volume systems, consider signal priority for public transport vehicles;
9. In high-volume systems, consider grade separation of busway at intersections (e.g., an underpass).

The following sections provide some general rules for making reasonable design decisions in these cases. The topics discussed in this chapter are:

- 9.1 Evaluating the intersection
- 9.2 Restricting turning movements
- 9.3 Designing for BRT turning movements
- 9.4 Station location relative to the intersection
- 9.5 Roundabouts
- 9.6 Traffic signal priority

9.1 Evaluating the intersection

“True genius resides in the capacity for evaluation of uncertain, hazardous, and conflicting information.”

—Winston Churchill, former British Prime Minister, 1874–1965

9.1.1 Intersection audits

BRT systems are generally built on corridors where mixed traffic congestion is already a problem, or where congestion is likely to occur in the near future, otherwise there would be no benefit of building a segregated busway. The worse the congestion appears, the greater the benefit of the exclusive busway (Figure 9.2). If a BRT system makes public transport services better but mixed traffic worse, it will be less politically successful than if it makes public transport better and also improves mixed traffic flow. BRT system planners therefore generally try to minimise adverse impacts on mixed traffic.

In developed countries, traffic departments have frequently spent large sums of investment in optimising intersections. In developing countries, by contrast, existing intersection design is frequently sub-optimal from the point of view of vehicular throughput and speed. This situation increases the chances that a new BRT system can be designed in a way that actually improves both public transport performance and mixed traffic flow. In short, general intersection improvement measures along the BRT corridor can usually be identified that will offset any new intersection inefficiency resulting from the implementation of the new BRT system.

As a first step, therefore, BRT system planners should carefully review the existing mixed traffic bottlenecks in the corridor. It is frequently the case that a small number of bottlenecks are responsible for the vast majority of mixed traffic delay. These bottlenecks are usually due to one or more of the following conditions:



Fig. 9.2
The introduction of BRT and design changes to poorly controlled and congested intersections often leads to efficiency improvements for both public transport vehicles and mixed traffic.

Photo by Lloyd Wright

- Badly placed bus stops or unregulated stopping of public transport vehicles;
- Narrow bridges and tunnels;
- Lack of grade separated railway crossings;
- Traffic convergence points;
- Poorly regulated parking;
- Sub-optimal timing at traffic signals;
- Improperly designed and channelised intersections.

For example, on the TransJakarta Corridor I, the vast majority of congestion was caused by only four problem locations, three of which were intersections, and the other was at a commercial centre with problems of parking, double

parking, and exiting and entering vehicles. Figure 9.3 illustrates the vehicular saturation along a planned BRT corridor. In this case, vehicle saturation (the variable “x”) is measured as vehicle volume divided road capacity.

From the example given in Figure 9.3, the most serious bottlenecks (*i.e.*, points A, B, and E) are signalised intersections. The capacity of the intersection is generally a function of the amount of green time per lane. The amount of green time per lane is generally a function of the number of signal phases. Saturation can increase up to 300 percent by increasing an intersection from two or three phases to four phases. Point C might be a bridge or tunnel where, for example, lanes are reduced from 3 to 2, increasing saturation by 50 percent. Point D might be a popular destination like a shopping mall where an extra volume of vehicles enters the road, increasing saturation. It might also be a popular bus interchange, a street market, or an area with regulated on-street parking area.

Quite often a new BRT system can lead to a reduction of the number of lanes available to mixed traffic. While ideally the removal of a large number of buses from the mixed traffic lanes will avoid worsening congestion in the mixed traffic lanes, this is not always possible, and mixed traffic saturation may increase (from the blue to the red line in Figure 9.3). Congestion, before restricted to point B, now occurs at A, B, C and E. Due to the implementation of

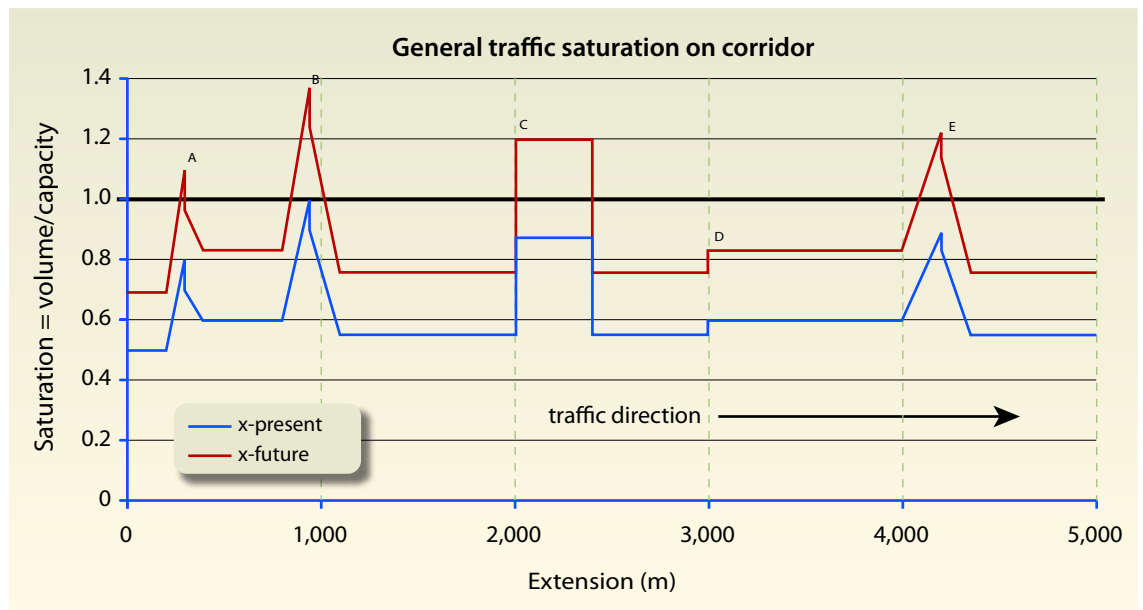


Fig. 9.3
Mixed traffic saturation along a BRT corridor.

the BRT project, these points now require more careful attention than before.

The non-intersection bottlenecks should be addressed first. These problem points can generally be resolved through a combination of tightening parking regulation and enforcement, tightening vendor regulation and enforcement, narrowing medians, improving parallel roads, or widening roads if all else fails.

Generally, the easiest and least expensive solution is to improve the efficiency of the intersections. While simply redesigning these intersections without the BRT system would have significantly improved traffic flow, packaging these intersection improvements with the introduction of the new BRT system will not only help to improve the public acceptance of the new BRT system. The implementation of the new BRT system requires changing the intersection design anyway, so the opportunity should be taken to improve the overall efficiency of the intersection. The less efficient the intersection was before the BRT system, the easier it will be to design the new system in a way that improves conditions for both public transport passengers and mixed traffic.

9.1.2 Calculating the impacts of signal delay

“All change is not growth, as all movement is not forward.”

—Ellen Glasgow, novelist, 1874–1945

Once the basic routing structure of the new BRT system has been determined, system designers should have a reasonable idea about likely vehicle frequencies within the BRT system. The first analysis should then be to determine if the busway will congest given the current intersection signal phasing and lane allocation along the BRT corridor. Each intersection in the corridor should be analysed.

To optimise any given traffic signal in the BRT corridor, priority should be given to reducing saturation for the public transport vehicles. This optimisation is much less complex than avoiding saturation at the stations, and will largely be a function of the cycle time and the vehicle frequency.

The total traffic signal delay in a busway is a function of two separate phenomena. First, the traffic signal delay is a function of simple delay,

which is caused by too many vehicles using the busway relative to the intersection’s capacity. Second, delays may be caused by the random occurrence of buses queuing. Equation 9.1 outlines the calculation of total traffic signal delay based on these two factors.

If the system planners have already given priority to buses along a particular corridor, and the signal phases have been simplified to as few as possible by restricting turns, then the BRT vehicles should benefit from much green phase time. Once this optimisation is done, the capacity of the intersection in terms of buses per hour will be very high, probably more than 200 buses per hour, which is more capacity than most busways will actually need.

Equation 9.1 Calculation of total signal delay

$$TS = TF + TQs$$

Where:

TF = Average signal delay per bus (the average amount of time it takes a bus to pass through the intersection)

TQs = Queuing delay (The random queue that forms at signals resulting from the fact that buses do not generally all arrive evenly dispersed, but rather in bunches.

The average delay (TF) is a function of the red time and the level of congestion within the busway (Equation 9.2).

Equation 9.2 Calculation of average delay

$$TF = TR^2 / (2*TC*(1-F/S))$$

Where:

TF = Average delay

TR = Time the traffic signal is red

TC = Total cycle time

F = Bus frequency per hour

S = Saturation flow, in bus units per lane, on the approach to the intersection.

The term “S” is a constant that is defined based on the type of bus. Assuming that there are no station stops, the intersection for a bus lane will be able to handle just a few less buses than it would be able to handle private cars, based on the passenger car units attributed to the specific bus.

In the example below, the intersection has been designed to heavily prioritise the BRT corridor, approximately 40 seconds of red time and 40

seconds of green time have been attributed to the BRT system (the actual red and green time will be reduced by the amount of yellow time). With this signal phasing, for articulated 18.5-metre buses, “S” will be roughly equal to 720, and for 12-metre buses, “S” will be approximately 900, or slightly less than what the intersection could handle if they were private cars.

Example:

TC = 80 (80 seconds in the signal cycle)

TR = 40 (40 seconds of red time)

F = 200 (200 articulated buses/hour)

S = 720 (intersection capacity for articulated buses for one lane/hour)

In this case, the intersection would be able to handle 200 articulated buses per hour per lane, which is far more than a typical BRT system would require. A standard BRT busway lane would move nearly 10,000 passengers per hour

per direction with just 60 articulated buses per hour per lane.

In the example given, the average intersection delay would be:

$$TF = 40^2 / (2 * 80 * (1 - 200/720)) = 13.8 \text{ sec}$$

Thus, if there are 200 articulated buses per hour in a single lane and there is an 80 second traffic signal cycle with up to a red phase of 35 seconds, there is no difference between total signal delay and average signal delay. In this case there is no additional delay resulting from bus queues at the stop light. However, if there is more than 35 seconds of red time, the random queuing of buses at the traffic light begins to add additional delay.

The random queuing delay (TQs) is a function of the saturation of the signal in the bus lane (Xs), vehicle saturation (x), and the intersection capacity (S).

Equation 9.3 Calculating the random queuing delay

$$TQs = [(Xs - x) / (1 - Xs)] / S$$

Where:

Xs = Saturation of the signal in the bus lane

x = Vehicle saturation

S = Saturation flow, in bus units per lane, on the approach to the intersection.

Equation 9.4 provides the calculation of the term “Xs”.

Equation 9.4 Calculating the saturation of the signal in the bus lane

$$Xs = (F / S) / (1 - TR/TC)$$

Based upon the previous example:

$$Xs = (200/720) / (1 - 40/80) = 0.5555$$

The value of the vehicle saturation level will be quite determinant on the extent of any possible queuing delay. There are essentially three distinct possibilities:

- a. If $x < 0.5$, then TQS equals 0, and there is no queuing delay
- b. If $0.5 < x < 1$, then the degree of queuing delay is determined as: $TQs = [(x - 0.5) / (1 - x)] / F$
- c. If $x > 1$, then there will be severe busway congestion.

Based upon the previous example and a saturation value of 0.5 ($x = 0.5$), TQs is

Table 9.1: Total signal delay and saturation as a function of red light cycle duration

Red light cycle duration (seconds)	Average signal delay (TF) (seconds)	Random queuing delay (TQs) (seconds)	Total signal delay (TS) (seconds)	Saturation level (x)
0	0.00	0.00	0.00	0.28
10	0.87	0.00	0.87	0.32
20	3.46	0.00	3.46	0.37
30	7.79	0.00	7.79	0.44
36	11.22	0.18	11.40	0.51
40	13.85	2.25	16.10	0.56
42	15.27	3.68	18.94	0.58
43	16.00	4.53	20.53	0.60
44	16.75	5.52	22.27	0.62
45	17.52	6.65	24.18	0.63
46	18.31	7.98	26.29	0.65
47	19.12	9.56	28.67	0.67
48	19.94	11.45	31.39	0.69
49	20.78	13.78	34.56	0.72
50	21.63	16.71	38.35	0.74
51	22.51	20.51	43.02	0.77
52	23.40	25.62	49.02	0.79
53	24.31	32.86	57.17	0.82
54	25.23	43.94	69.18	0.85
55	26.18	63.00	89.18	0.89
56	27.14	103.50	130.64	0.93
57	28.12	248.14	276.26	0.97

$$\begin{aligned}
 TQ_s &= [(0.5555-0.5) / (1-0.5555)] / 200 \\
 &= 0.0006244 \text{ hours} \\
 &= 0.0006244 \text{ hours} * 3600 \text{ seconds/hour} \\
 &= 2.25 \text{ seconds}
 \end{aligned}$$

Thus, based on these values of average signal delay and queuing delay, the total delay experienced for each bus is:

$$\begin{aligned}
 TS &= TF + TQ_s \\
 &= 13.8 \text{ seconds} + 2.2 \text{ seconds} \\
 &= 16 \text{ seconds}
 \end{aligned}$$

Table 9.1 provides sample values of signal delay for different red light durations. The values are based on the sample conditions of a single busway lane per direction, a total signal phase cycle of 80 seconds, and a busway flow of 200 articulated vehicles per hour.

In summary, intersection delay is largely a function of red time as a share of total signal time. If saturation is greater than 0.65, random delay becomes significant, and the project design should be changed to give a higher proportion of green time, and/or a second BRT lane on the approach to the intersection should be considered.

9.2 Restricting turning movements

“Change means movement. Movement means friction. Only in the frictionless vacuum of a nonexistent abstract world can movement or change occur without that abrasive friction of conflict.”

—Saul Alinsky, activist, 1909–1972

Optimising a BRT system to handle the highest number of passengers is often at odds with optimising the system to move at the fastest operating speeds. From the point of view of passenger demand, it is best to have a lot of routes feeding into the BRT system, and for the BRT system to have a dense network of interconnected routes. Turning movements can be quite positive in terms of allowing different routes to intersect. These types of interconnections will also tend allow customers to transfer between routes at platforms rather than walking long distances across intersections.

However, each time a turning movement is introduced into the BRT system, it introduces some additional delay either by complicating the intersection or by forcing buses to leave the busway. For this reason, it is generally a good



Fig. 9.4

Prior to Quito’s Ecovía line, mixed traffic vehicles were allowed to cross through this intersection as well as negotiate right and left turns. To give priority to public transport, straight and left turn movements have been blocked.

Photo by Lloyd Wright

idea to take another look at the routing structure of the planned new BRT operations from the perspective of whether or not the routing structure can be simplified. A balance should be struck between the density of the BRT network and the impact that turning movements have on average speeds.

In many projects to date, a standard technique for increasing BRT travel speeds and reducing signal delay is to restrict as many mixed traffic turning movements across the corridor as possible (Figure 9.4). If the busway is reaching saturation, or the introduction of the BRT system increases mixed traffic saturation to critical levels, it becomes imperative to consider some form of turning restrictions.

9.2.1 Techniques for reducing the number of signal phases

“On a traffic light green means go and yellow means yield, but on a banana it’s just the opposite. Green means hold on, yellow means go ahead, and red means where the hell did you get that banana.”

—Mitch Hedberg, comedian, 1968–2005

In ideal circumstances, the movements of BRT vehicles are unencumbered when passing an intersection. However, unless a system can be fully grade separated at an intersection (*i.e.*, through an underpass or overpass), some conflicts are likely to occur with mixed traffic movements.

Table 8.9 shows how different methods of simplifying the signal phase will impact the

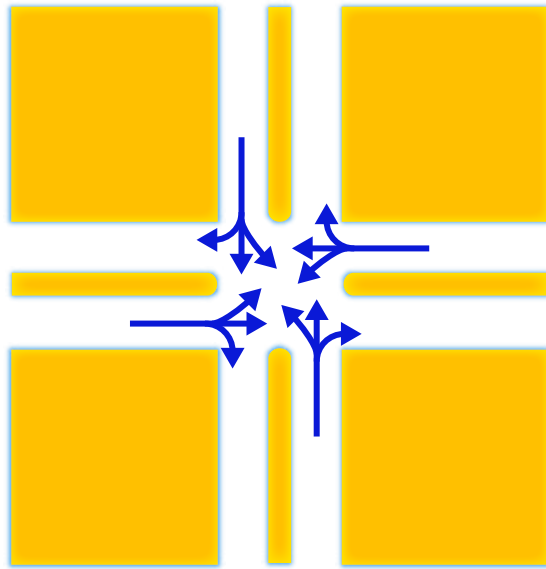


Fig. 9.5
Representation of possible turning movements at a typical intersection.

overall capacity of an intersection, assuming all other aspects are equal. The values given in Table 8.9 are just reference values for a unique set of conditions. The actual values in any given intersection will vary according to volume distribution and local geometry.

Figure 9.5 represents the starting point of evaluating a standard intersection, as projected by the calculations in Table 9.2. This figure outlines each of the possible turning movements. A standard assumption may be to project that left and right turns each represent 25 percent of the mixed traffic movements, and continuing straight represents 50 percent of the mixed traffic movements. For simplicity purposes, all approaches are identical in terms of vehicle volumes. In evaluating an actual intersection, the planning team would conduct peak and non-peak counts of all vehicle movements.

Table 9.2: Intersection capacity for different turning configurations

Option	Phases	Location of cross turning movement (left turn)	Location of side turning movement (right turn)	Capacity at intersection (passenger car units per lane per hour)
At-grade options				
A	4	Allowed at intersection	Allowed at intersection	450
B	4	Allowed at intersection	Allowed at intersection	600
C	2	U-turn after intersection and then a right turn	Allowed at intersection	760
D	2	Three right turns after intersection	A combination of right-left-right prior to intersection	950
E	2	A combination of right-left-left prior to intersection	A combination of right-left-right prior to intersection	1,267
F	2	A combination of left-right-left prior to intersection	Allowed at intersection	1,267
G	2	A combination of left-right-left prior to intersection	A combination of right-left-right prior to intersection	1,900
Grade-separated options (i.e., use of flyover or underpass)				
H	4 + underpass	Allowed at intersection	Allowed at intersection	700
I	3 + underpass	Allowed at intersection	Allowed at intersection	800
J	Underpass	Three right turns after intersection	Allowed at intersection	1,600
K	Underpass	Three right turns after intersection or a combination of right-left-left prior to intersection	A combination of right-left-right prior to intersection	2,000

9.2.1.1 At-grade options

From table 9.2, scenarios “A” and “B” are standard four-phase intersections, and the capacity of the intersection per lane is very low. In scenario “A”, left turn movements are given their own signal phase, with two directions being able to left simultaneously (Figure 9.6).

As an alternative, the configuration for option “B” is four phases with just a single directional approach on each phase (Figure 9.7).

For both options “A” and “B”, each approach faces a green signal less than one-quarter of the time since there is also some time devoted to yellow signal phases. Usually the average vehicle capacity per lane per hour is just 450 passenger car units (pcu) per lane per hour. By comparison vehicle capacity for expressway conditions is 2000 pcu/lane/hour.

If a one-way BRT system with no turns is introduced into the median of an intersection with standard four-phase signal phasing, option “A” is likely to be preferred. Option “B” will lead to conflicts between buses going straight and vehicles turning left. This conflict could be potentially overcome with an additional signal phase, but this additional phase would reduce BRT green phase length even further. In using option “A”, BRT buses are provided with at most one-quarter of the total time as a green phase (Figures 9.8 and 9.9).

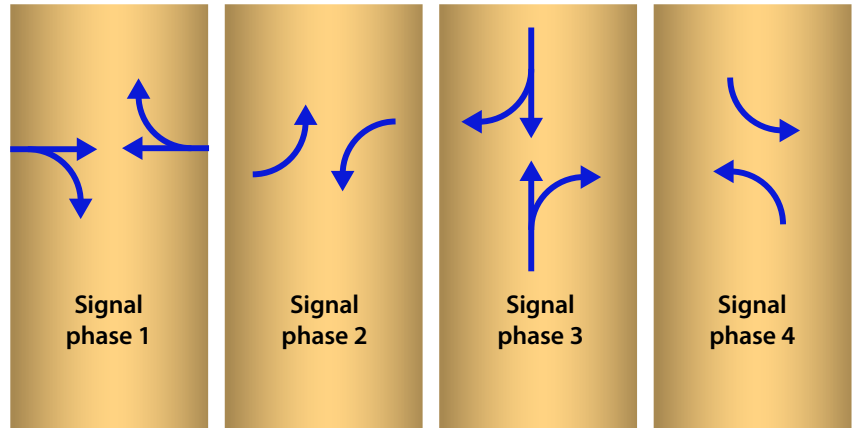


Fig. 9.6
Option “A”

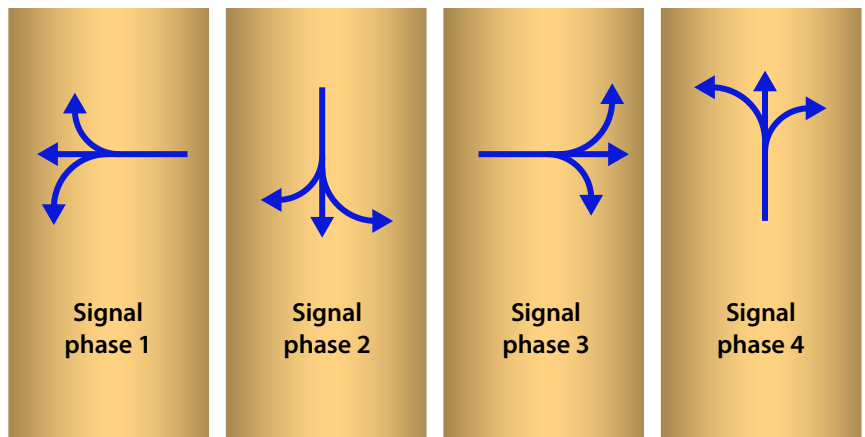


Fig. 9.7
Option “B”



Fig. 9.8
Along Quito’s Central Norte corridor, mixed traffic vehicles are given a phase to perform left turns.
Photo by Lloyd Wright



Fig. 9.9
The green phase for a BRT vehicle entering the Val de Marne busway in Paris.

Photo courtesy of the National Bus Rapid Transit Institute (NBRTI)

each direction. This additional lane gives mixed traffic vehicles a dedicated lane for left turns (or right turns for British-style road systems). By creating left turning lanes in both directions, the delays caused by waiting left turning vehicles can be reduced, and the capacity of the intersection per lane can increase up to 600 pcu/lane/hour.

To make this modification, space must be available at the intersection to provide a left turn lane for mixed traffic. This is generally more easily done if the BRT station is not located immediately adjacent to the intersection. However, locating the station farther from the intersection may cause inconvenience for passengers that need to transfer to perpendicular roads. Thus, some analysis of the time savings benefit of pedestrians relative to turning motorists may be required.

For options “C” through “G”, left turns are eliminated. The traffic signal is reduced to only two phases, and left turning traffic has to find some other place to make a left turn. This phase configuration thus removes the need for the mixed traffic turning lane at the intersection, which allows the BRT station to be moved to the intersection if desired.

Figure 9.10 illustrates the standard two phase traffic signal phase when left turns are disallowed.

By doubling the green time given to the BRT vehicles, the capacity and speed of the busway and mixed traffic is increased significantly for a very limited cost. For each alternative, the average lane capacity will vary depending on how the left turning traffic was accommodated.

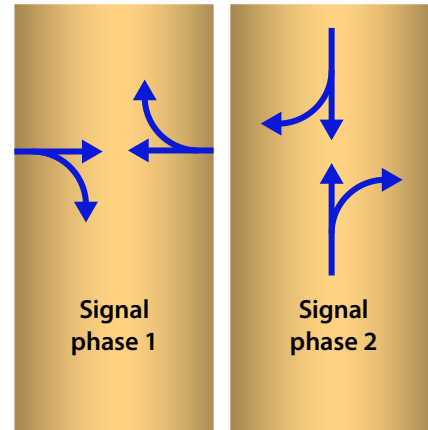


Fig. 9.10
Signal phases for options “C” through “G” (i.e., scenarios in which left turns are disallowed).

In option “C”, there are no alternative routes for left turning vehicles, so the elimination of left turns on one road requires the creation of two opposite u-turns on the BRT corridor itself (Figure 9.11).

In option “C”, as all left turn movements have to pass through intersection twice, the capacity of the intersection increases just to 760 pcu/lane/hour. Further, the act of making a u-turn along the busway can create conflicts for the BRT system.

In option “D”, the vehicle turns left by either making three right turns, or by making a right

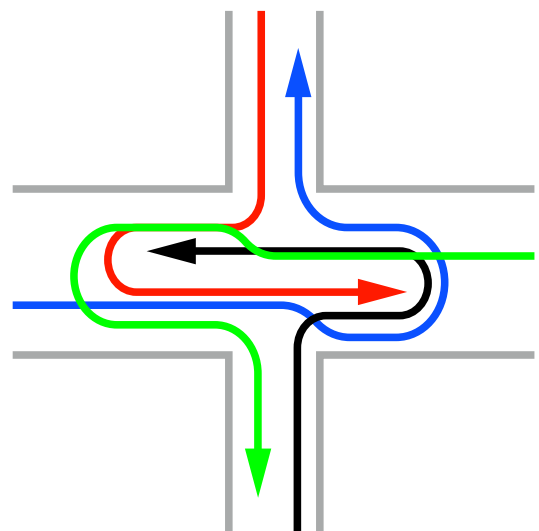


Fig. 9.11
In option “C”, a left turn for mixed traffic vehicles is accomplished through a u-turn along the busway.

turn and two subsequent left turns (Figure 9.12). Right turning traffic is forced to turn at a previous intersection, and make a turning combination of right – left – right. This measure still requires left turning vehicles to pass through the intersection twice, but removes right turning vehicles from the intersection all together. This measure can increase capacity to 950 pcu/lane/hour.

Unfortunately, the lack of a dense secondary street network can render option “D” through “G” ineffective. Without a set of nearby adjacent streets for turning, mixed traffic vehicles could be forced into extremely long detours.

Option “E” is similar to option “D”, but instead for the left turning movement, a right turn is initiated prior to the intersection (Figure 9.13). This configuration thus entails a turning combination of right-left-left in order to complete the full left turn. In this case, left movements pass through the main intersection only once. An additional signal may be needed to cross the main corridor, but the capacity increases to 1,267 pcu/lane/hour.

Like option “E”, option “F” also involves a turn prior to the intersection. However, in this case, the sequence is begun with a left turn. The full combination for scenario “F” is thus left-right-left (Figure 9.14). This scenario implies the need for two additional traffic signals. If the right turn in this case is made at the intersection, the intersection capacity will be 1,267 pcu/lane/hour.

Option “G” is the same as option “F”, but in this case, the right turn is also made before the intersection (Figure 9.15). The capacity under option “G” increases significantly to 1,967 pcu/lane/hour. To implement this option eight or more additional traffic signals (two for each approach) could be required.

Options “F” and “G” require an even greater density of auxiliary roads which is often simply not available.

Real-world scenarios cases usually use a combination of all these possible options. Optimising the selection of which measures are appropriate in each case can be a matter of both calculus and art. However, capacity increases with these types of solutions generally compare highly

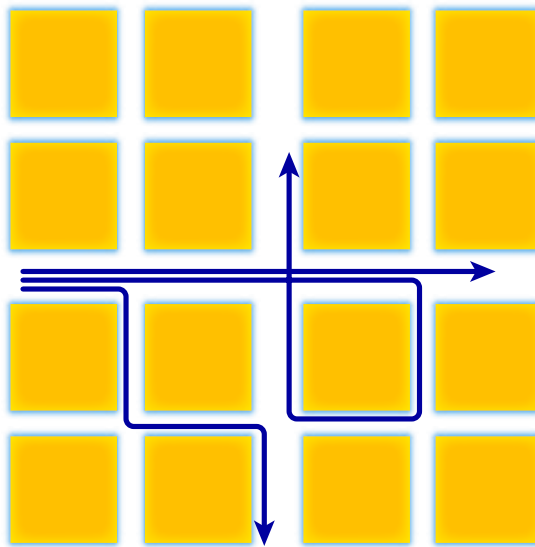


Fig. 9.12
Option “D”

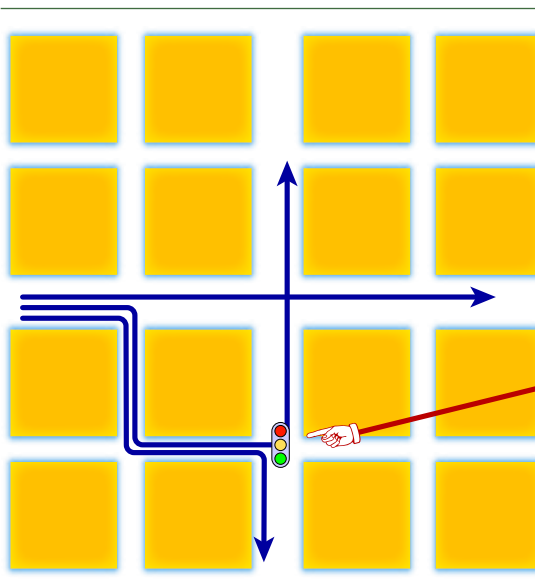


Fig. 9.13
Option “E”

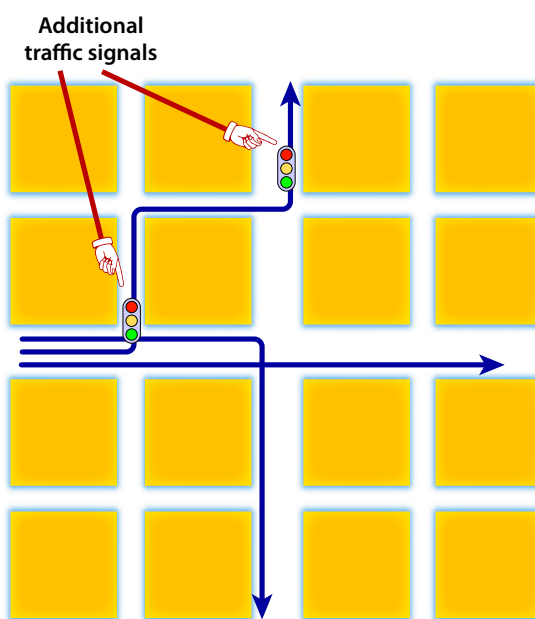
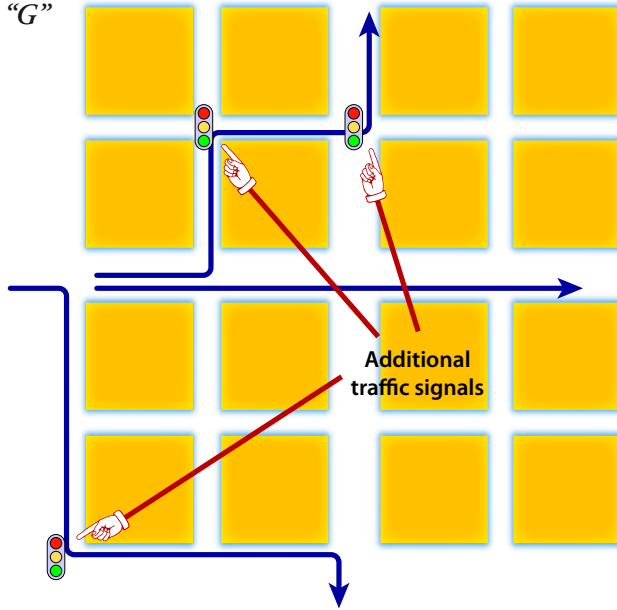


Fig. 9.14
Option “F”

Fig. 9.15 Option "G"



favourably with relatively inefficient results achieved from using four-phase traffic signals.

9.2.1.2 Grade-separated options

Typically, when the capacity of a 4-phase intersection is reaching saturation (more than 600 vehicles/lane/hour), it is fairly typical for engineers to suggest the construction a flyover or an underpass that allows straight movement for one main road (2 of the 12 movements), while all other movements remain at the same

level. The introduction of flyovers or underpasses can cause specific difficulties for BRT systems. At the same time, the flyover or underpass represents an opportunity to dramatically improve BRT vehicle movements through the intersection. Exclusive busway use of a flyover or underpass is a highly successful technique used in several existing BRT systems. Thus, a first option is to consider grade separation infrastructure that is dedicated to BRT usage.

A second possibility is when the flyover is built on the road perpendicular to the BRT corridor. In this case, the flyover does not introduce any special difficulty and can help to decongest a BRT intersection and increase green phase time.

If a single flyover in the median is built for mixed traffic while BRT buses are forced to use surface streets, the buses in the median must cross the mixed traffic going over the flyover. This problem is being confronted in Delhi. This scenario creates either the need for a new signalled intersection prior to the flyover, or it requires a merge lane where the BRT buses and mixed traffic can cross, introducing possible delay and confusion for both the BRT system and the mixed traffic. Figure 9.16 shows the conflict in a planned BRT system in Delhi where it must cross a mixed-traffic only flyover. Clearly, in this scenario, it would be far better to dedicate the flyover (or at least the middle lanes of the flyover) to the BRT system.

A third possibility is to construct two separate flyovers, one for traffic in each direction, leaving a space between the flyover for the BRT system that allows BRT buses to continue along the surface. A fourth possibility is to allow the BRT vehicles to also pass over the flyover, either in a segregated lane, or if there is no space for a segregated lane, then in mixed traffic. This last option sometimes results in stations being far from intersections, which may produce inconvenience for passengers seeking to reach destinations near the intersection. Additionally, this configuration can be particularly problematic if there is a connecting BRT corridor running on the perpendicular street below the flyover or above the underpass.

Option "H" shows the limited benefit of using a flyover or underpass if the BRT lanes remain at the surface level and four-phase signal timing is

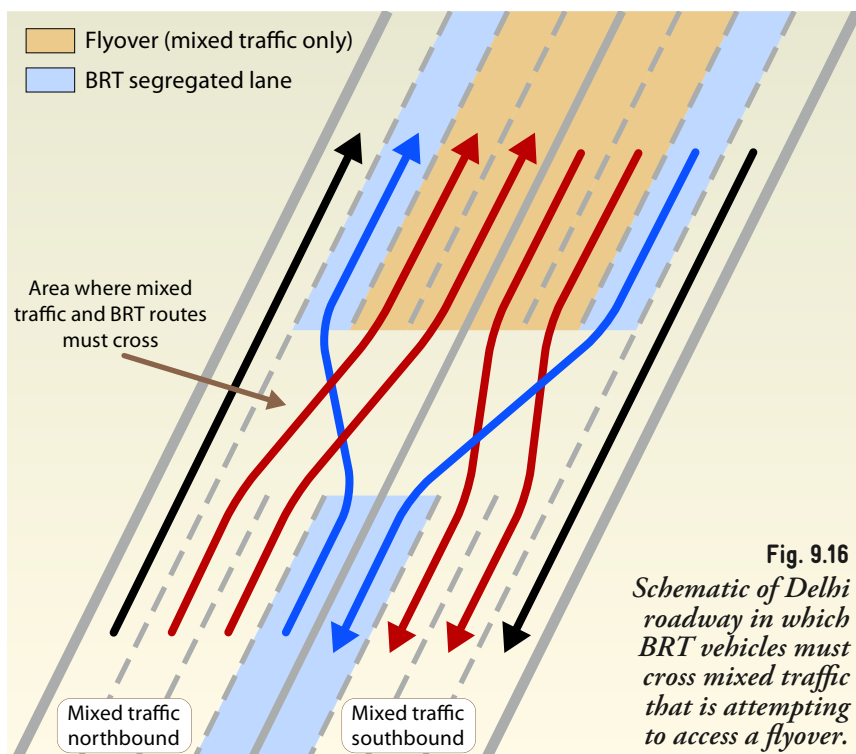
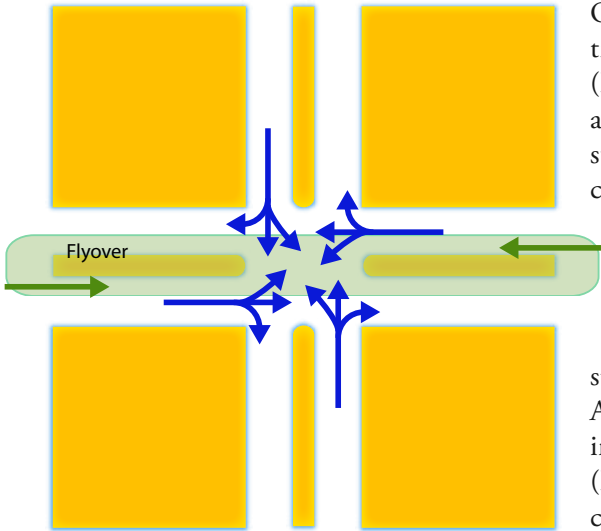


Fig. 9.16 Schematic of Delhi roadway in which BRT vehicles must cross mixed traffic that is attempting to access a flyover.



Option “H” is fairly common with conventional bus services in cities such as Bangkok (Figure 9.18). Mixed traffic vehicles have access to the flyover and thus are given a substantial priority at the intersection. By contrast, public transport vehicles servicing the intersection area are often mired in heavy congestion.

Option “I” is typical along a proposed BRT corridor in Guangzhou. In this case, all straight movement is relocated to the flyover. As a result, the number of signal phases for intersection on the surface is reduced to three (Figure 9.19). For this option, capacity increases marginally to 800 pcu/lane/hour.

Fig. 9.17
Option “H”

maintained (Figure 9.17). In this scenario, the overall increase in intersection capacity is quite small with the capacity only rising from 600 pcu/lane/hour to 700 pcu/lane/hour.



Fig. 9.18
While mixed traffic vehicles can bypass a congested intersection in Bangkok, public transport vehicles are often consigned to serving stations near the intersection. The result can be slow average speeds for public transport.

Photo by Lloyd Wright

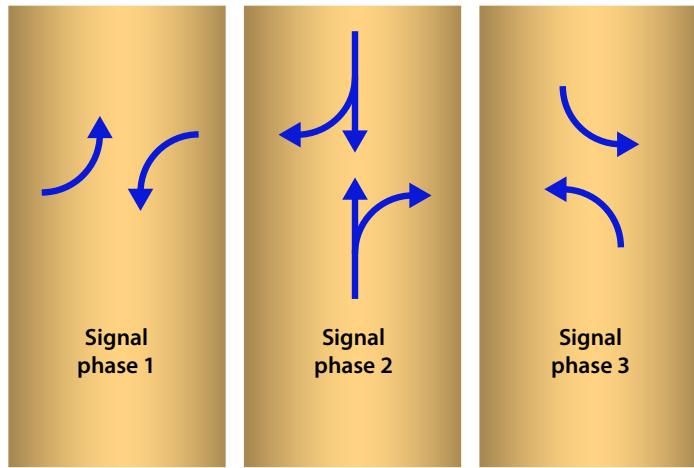


Fig. 9.19
In option “I”, the presence of a flyover handling all the straight vehicle movement in one direction (both mixed traffic vehicles and BRT vehicles), reduces the number of surface level phases to three.

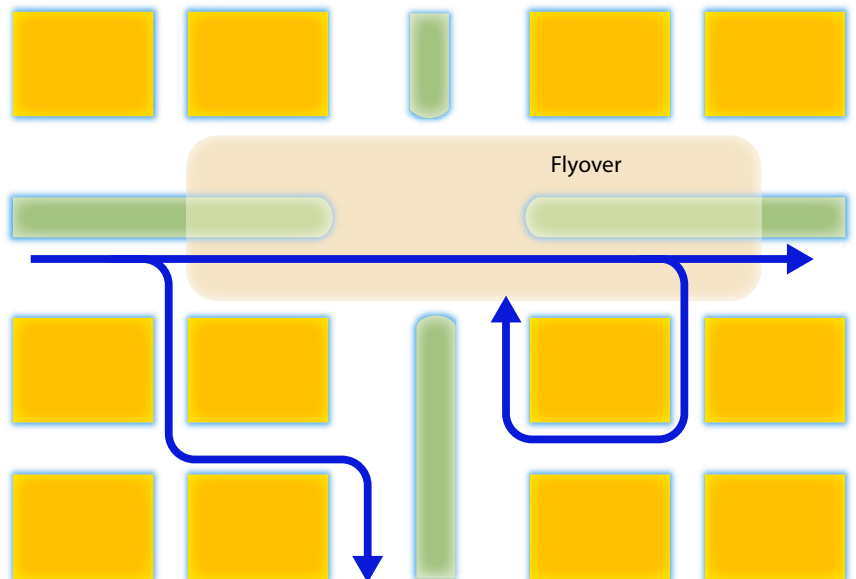


Fig. 9.20
Combining grade separation with limitations on turning movements can produce intersection capacities as high as 2,000 pcu/lane/hour.

Options “J” and “K” combine grade-separation infrastructure with limitations on turning movements. Thus, options “J” and “K” essentially replicate many of the turning movements from option “D” but with the added benefit of grade separation in some directions. In some cases, this combination may necessitate off-ramps from the flyover in order to facilitate certain turning movements (Figure 9.20). The combination of these configurations dramatically increases the intersection’s potential capacity. Option “J” is capable of delivering a capacity of 1,600 pcu/lane/hour while option “K” produces a capacity of 2000 pcu/lane/hour.

While both flyover and underpass options are presented here, underpasses are frequently a preferred option from a standpoint of aesthetics. The proliferation of flyovers within a city environment can do much to scar an area’s visual image. However, in cases where the road base is hard bedrock, underpass construction may be prohibitively expensive. Likewise, if an area possesses a high water table, then an underpass may not be technically viable or desirable.

This section has highlighted the idea that on any BRT corridor there are generally critical intersections where the addition of the new BRT system will create conditions nearing saturation. If full four-phase signalisation is maintained in such conditions (options “A”, “B”, “H”, or “I”), then congestion is a likely result. The best solutions tend to involve restrictions on turning movements plus, in some cases, grade separation. Typically, turning restrictions and grade separation are far more effective in maximising intersection capacity than signal prioritisation or green-wave signal phasing.

Any intersection, though, cannot be analysed in isolation. Optimum results are usually obtained when vehicle movements are not only analysed at the particular intersection but also along the corridor and the entire extended area close to the intersection.

9.2.2 Integrating pedestrian and cyclist movements

“The way I see it, I can either cross the street, or I can keep waiting for another few years of green lights to go by.”

—Camryn Manheim, actress, 1961–

A highly efficient intersection for mixed traffic and BRT vehicles may not be user-friendly to other street users, especially vulnerable users such as pedestrians and cyclists. Further, the entire viability of the BRT system can be undermined if the surrounding pedestrian environment is not amenable to attracting customers to the BRT station. This section examines design options that not only are conducive to effective vehicle movements at intersections but also options that successfully accommodate pedestrian and cyclist movements.

A standard two-phase traffic signal configuration does not offer any exclusive movements for pedestrians (Figure 9.21). The pedestrian is blocked by crossing or turning traffic in either phase. In such circumstances, the pedestrian must seek a discernible break in the traffic and make a quick crossing. Obviously, such conditions put pedestrians at considerable risk.

The lack of safe pedestrian options can also be the case for three and four phase intersections, depending on the configuration. If intersections are designed to slow turning vehicles and if turning vehicle volumes are not that high, the problem may not be serious. However, if turning volumes are high or intersections allow high speed right turns, bicyclists and pedestrians going straight will have problems crossing the road.

The normal solution to this problem is the creation of a pedestrian refuge island between the right turn slip lane and the intersection and not allowing right turns (or left turns in British-style systems) during the red signal phase (Figure 9.22). Pedestrians can generally cross to this pedestrian refuge island during the red phase, and then cross when the light turns

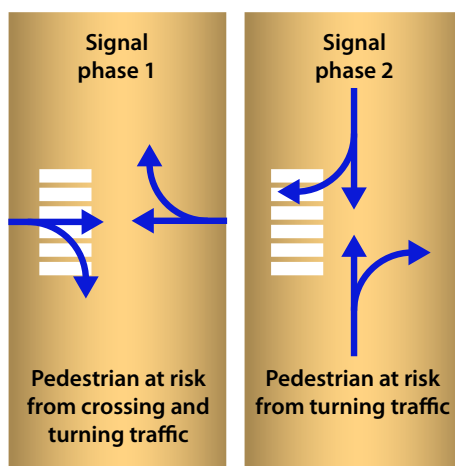


Fig. 9.21
In a standard two-phase traffic signal, pedestrians are potentially at risk during both phases.

Fig. 9.22

The introduction of a pedestrian island between the right-turn lane and the crossing can significantly help pedestrians safely cross within the standard two-phase traffic signal.

green. Another possible solution for this is a short “leading pedestrian interval” that allows pedestrians to cross in front of right turning vehicles prior to the change of the signal to green. This option still requires disallowing right turns on the red signal but mitigates the need for the pedestrian refuge island. More discussion on safe pedestrian access is included in Chapter 13 (*Modal integration*).

For cyclists, intersection risks often emanate from turning vehicles that threaten straight movements by the cyclists. Since the motorised vehicles are often travelling much faster than the bicycles, there is a great potential for conflict and risk at turning locations. Cyclists may feel particularly vulnerable when wanting to turn left (or right in a British-style configuration).

There are at least two mechanisms for permitting cyclists to safely navigate intersections:

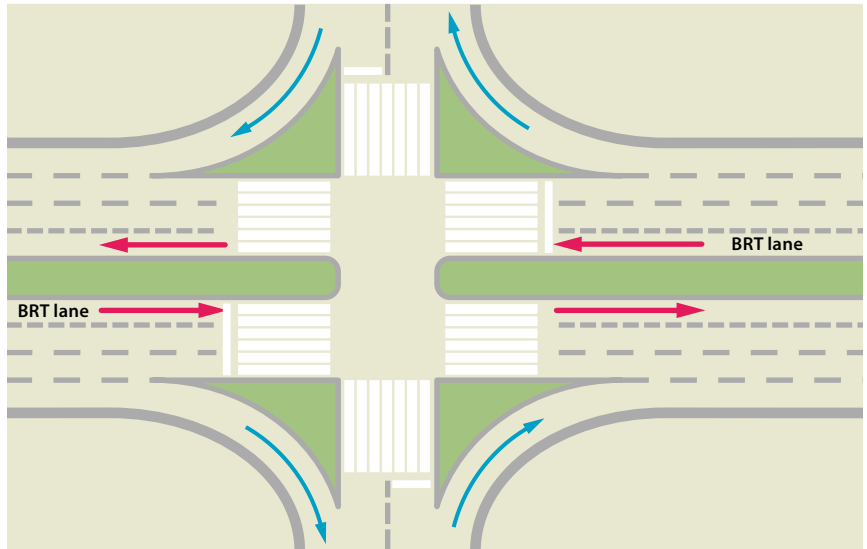
- Infrastructure giving physical priority to cyclists and allowing them to cross prior to private vehicles; and/or,
- Dedicated signalisation for cyclists.

In several countries, dedicated areas located in front of the stopping line for motorised vehicles have been an effective option (Figures 9.23 and 9.24). The idea is to give cyclists a head start over motorised vehicles in crossing the intersection. The cyclists are given a designated box to wait for the green signal phase. In some cases, this physical priority can be combined with a dedicated signal phase as well.

A schematic of the bicycle priority measures utilised in Xi’an is given in Figures 9.25 for each of the two signal phases.

Dedicated signal phasing for bicycles is increasingly common, especially in the presence of a median cycleway. Cycleways in Bogotá and Rio de Janeiro make use of such signalisation (Figure 9.26). A dedicated green phase for bicycles gives cyclists an added sense of security.

The addition of a median busway does make for an added complication, but it is still quite possible to adequately accommodate safe cyclist movements and maintain a high-volume public



transport system. One option is to place both a dedicated busway and a dedicated cycleway in the median area. Figure 9.27 shows how a standard two-phase signal could be combined with dedicated wait areas for turning bicycles in order to make both BRT and bicycle movements safe and efficient.

Other possible roadway configurations are also possible. Cycleways along the curbside are common in many cities.



Fig. 9.23 and 9.24

In Chinese cities such as Xi’an (upper left photo) cyclists are given designated waiting areas from which they have priority access to crossing the street. Likewise, in the UK (lower photo), a priority bicycle stopping area is placed ahead of the stopping line for motorised vehicles.

Left photo by Karl Fjellstrom
Right photo by Lloyd Wright

Fig. 9.25
Schematic of the dedicated waiting area utilised for bicycles wishing to make left turns in Xi'an.

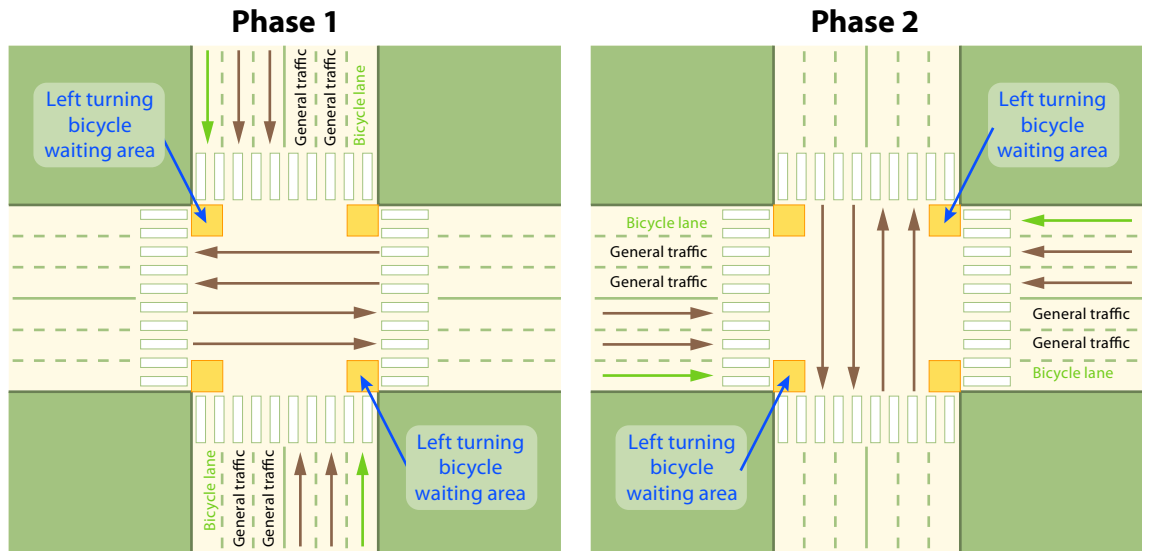
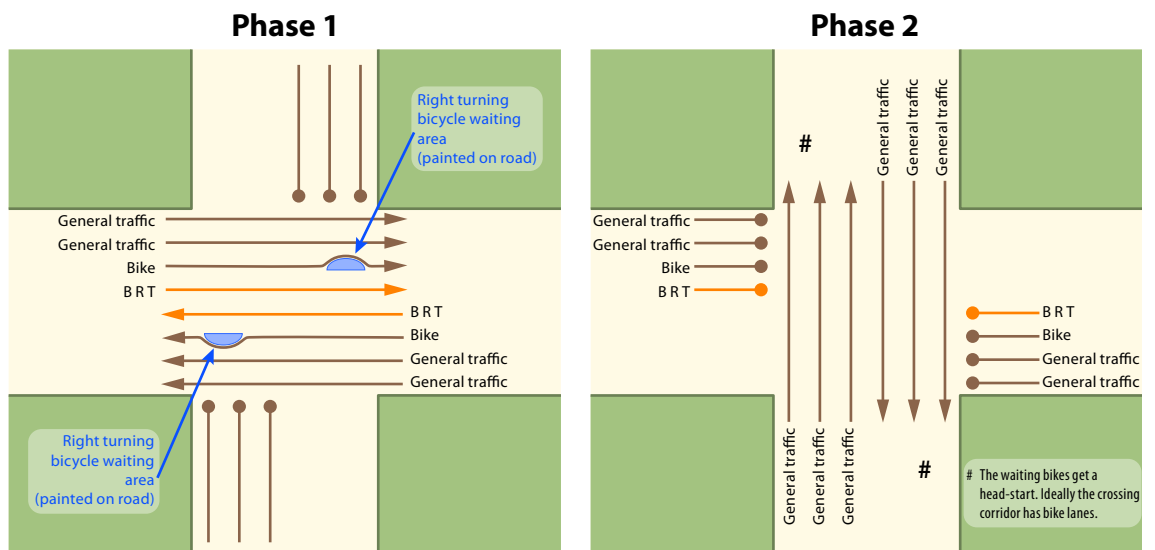


Fig. 9.26
A dedicated green phase for crossing cyclists is another effective solution as shown in this example from Rio de Janeiro.

Photo by Lloyd Wright

Fig. 9.27
A median cycleway and median busway can an effective solution to provide safe and efficient movements for both modes. In this case, a priority wait area for bicycles helps cyclists to get a head start over motorised vehicles in terms of negotiating a turn.



9.3 Designing for BRT turning movements

*“To everything—turn, turn, turn
There is a season—turn, turn, turn
And a time for every purpose under heaven.”*
—The Byrds, 1965

While route simplification and organisation may to an extent minimise turning movements for BRT vehicles, some turning is necessary. By developing BRT routes with turns, easy platform transfers for the customers are made possible. Thus, turning movements by BRT vehicles can be an integral part of designing an effective overall route structure. As the BRT system expands and provides an increasingly dense network of lines, the connections between these lines become more complex. As BRT systems grow, there will be a growing number of BRT trunk corridors that cross one another.

The costs of not allowing turning movements by BRT vehicles are quite evident, especially in terms of customer convenience. Quito’s three BRT corridors (Trolé, Ecovía, Metrobus-Q) all operate as independent corridors, despite each intersecting one another at several points in the city. At one of the critical intersections between two intersecting BRT corridors in Bogotá, customers must transfer by negotiating through stairs and an underground tunnel (Figures 9.28 and 9.29). In both these examples, allowing turning movements by the BRT vehicles could have permitted simpler and more convenient platform transfers for the customer. Further, the cost of constructing connecting pedestrian tunnels can add much to the overall infrastructure costs of the system.

The main problem with allowing all turning movements from within the BRT corridor is the increase in system complexity and the possible need for several additional signal phases. If the BRT corridor is built without any turns, the standard four phase intersection signal phasing shown functions well (Figure 9.30). In this case, customers will need to use an underground



Fig. 9.28 and 9.29
A tunnel is used to connect two intersecting corridors in Bogotá. However, for many, making a transfer of this type imposes physical hardship.
Photos by Lloyd Wright

tunnel or a pedestrian overpass to transfer from one corridor to the other.

However, in order to facilitate transfer-free travel or even platform transfers, BRT turning movements from one corridor to another are desirable. When BRT vehicles turn, though, several problems emerge. First, BRT vehicles

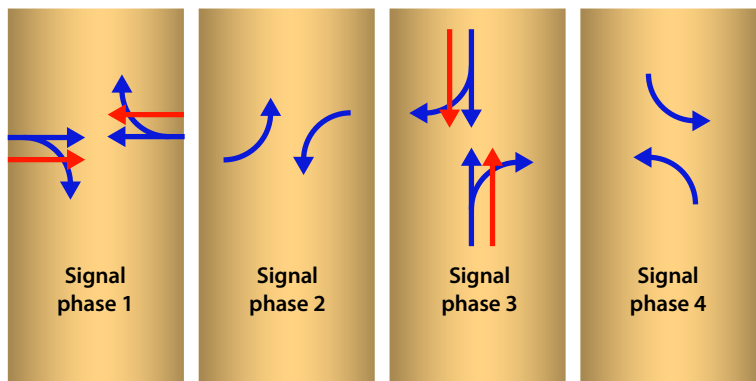


Fig. 9.30

In the case of two intersecting BRT corridors, a standard four-phase signal configuration can work if the BRT vehicles do not require any turning movements. In this example, BRT vehicle movements are represented by the red arrows.

turning right will conflict with mixed traffic wishing to go straight. One can add an additional signal phase to accommodate right turning buses and right turning mixed traffic only, but it adds a signal phase in both directions, increasing the signal phases to six.

The second problem is that if there is only one lane for the BRT at the intersection and more than one bus tends to be at the traffic light during any given signal phase, then congestion may occur. If the first bus in the queue is wishing to go straight, it will have to stop during the right turn and left turn signal phase, so all buses behind that one in the queue are forced to wait an entire signal phase to clear the intersection.

However, as will be discussed below there are solutions to each of these problems. For example, by restricting private vehicle left turns (or right turns in a British-style system), then all BRT turning movements can be handled in a simpler three-phase signal system. Alternatively, limiting the number of turning permutations for BRT vehicles can help to eliminate any conflicts with turning private vehicles. By adding a dedicated turning lane for BRT vehicles, the problem of turning congestion can also be resolved.

There are several solutions to this basic problem, and the appropriate solutions will depend on

the budget available, right of way available, the number of vehicles in the BRT system and their turning volumes, and the level of mixed traffic and its turning volumes. The optimal solution will be quite location specific and it is recommended that each intersection be evaluated and optimised separately. Five different options are presented in the following sections:

1. Dedicated turning lane and additional signal phase for BRT vehicles;
2. BRT vehicles operating in mixed traffic turning lane;
3. BRT turning movement prior to the intersection;
4. Conversion of intersection into roundabout
5. Queue jumping signalisation for BRT vehicles.

9.3.1 Dedicated turning lane for BRT vehicles

A dedicated turning lane for BRT vehicles has the advantage of keeping the BRT vehicles in controlled space at all times. This arrangement may require an additional signal phase if there was no previous left-turn phase (or right-turn phase in a British-style system). Otherwise the dedicated turn would take place at the same time that the mixed traffic is allowed to turn left.

Possibly the greatest challenge to this configuration is finding the physical space to place the additional turning lane. The roadway would likely have to accommodate at least 5 lanes (Figure 9.31). If two lanes of mixed traffic is to be maintained for straight car movements in each direction, then 7 lanes of space would be required. Additional lanes would also be

Fig. 9.31
Configuration for a system with a fully dedicated BRT turning lane.

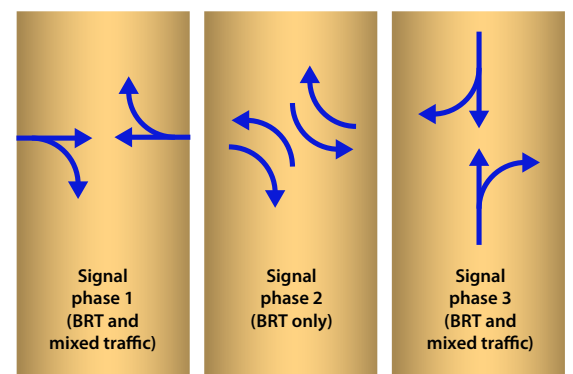
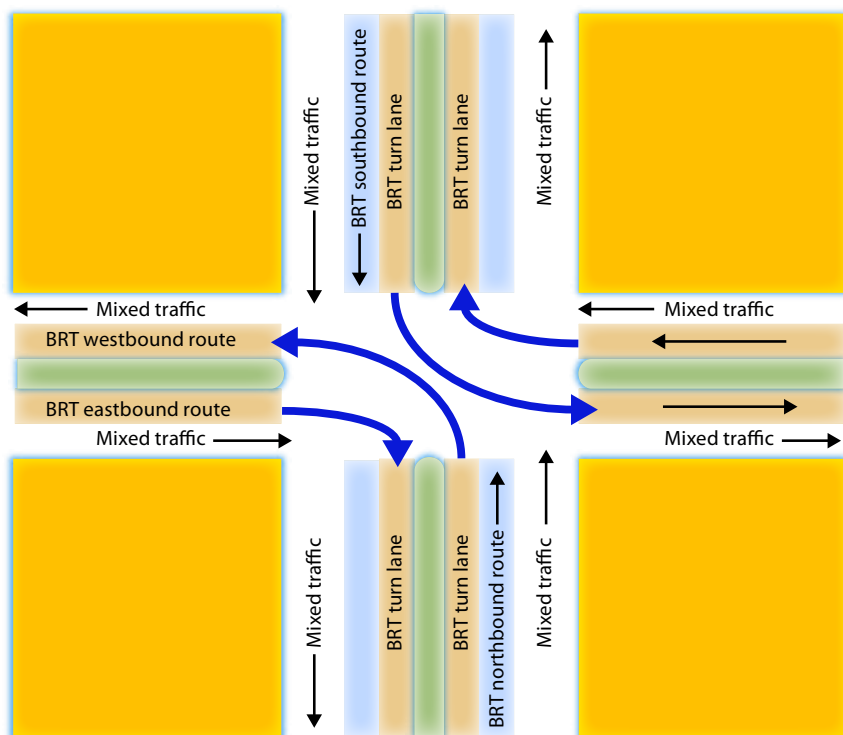


Fig. 9.32
In order to permit the BRT turning movements suggested in Figure 9.31, a three-phase traffic signal would be required.

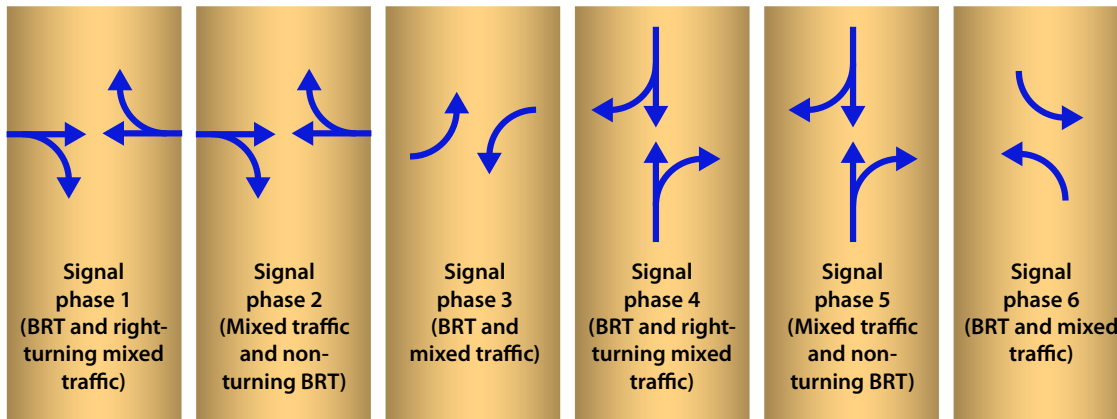


Fig. 9.33
To permit a full range of both BRT and mixed-traffic turning movements, a total of six signal phases would be required.

required if left turn movements were permitted for mixed traffic vehicles.

The configuration suggested in Figure 9.31 would require a three-phase traffic signal as indicated in Figure 9.32. This option is used in some BRT systems, and a variation of this solution is being discussed for Delhi but is meeting resistance from the traffic police.

In this case, it is important to note that not all turning permutations need to be provided for the BRT system. Instead, only one turn from each corridor to the other is required to give full access to all route permutations. This flexibility occurs due to the existence of a single median station. A southbound vehicle turning left will give passengers access to both the eastbound and westbound routes. Eastbound passengers will simply remain on board and continue along the corridor. Westbound passengers will undergo a platform transfer at the first station and reverse direction with a westbound vehicle. In designing this option, one would choose the highest demand routes to receive the transfer-free routing. In this scenario, one could technically also allow left turn movements for mixed traffic vehicles for traffic initiating the turn from north-south axis.

The complexity of dedicated turning lanes obviously increases as turning options for both BRT vehicles and mixed traffic vehicles increase. In the extreme of permitting all BRT turning options and all mixed traffic turning options, then a total of six traffic signal phases would be required (Figure 9.33). This number of phases clearly holds disadvantages in terms of waiting times for both BRT and mixed traffic movements.

Another alternative is to provide the dedicated turns through grade separated infrastructure. Bogotá utilises both underpasses and overpasses to provide dedicated turning infrastructure to BRT operations at its 80th Street-NQS interchange (Figure 9.34). While grade separation can be a highly efficient mechanism for facilitating free-flow turning, it can also be costly. The time saved to BRT customers and mixed traffic vehicles must be weighed against the cost of the underpass or flyover.

9.3.2 Mixed traffic operation

In this scenario, all turning BRT vehicles must leave the dedicated busway and enter mixed-traffic lanes. Thus, a left-turning BRT vehicle will leave the busway and directly enter the left-turn lane for cars. A right-turning BRT vehicle must leave the busway and merge to the right of the street. Once the turning BRT vehicles have left the intersection area they re-enter a busway.

Fig. 9.34
At the major intersection of TransMilenio's Calle 80 (80th Street) corridor and NQS corridor, a set of underpasses, a roundabout, and an overpass helps facilitate exclusive turning movements for BRT vehicles.

Photo courtesy of Eduardo Plata and Por el País que Queremos (PPQ)





Fig. 9.35
In Kunming, turning BRT vehicles leave the busway and enter a mixed-traffic lane to finalise the turning movement.

Photo courtesy of ITDP

This technique is the most common solution that has been used in many of the “open” BRT systems like in Kunming, China, and is being planned on several “direct services” BRT systems (Figure 9.35). If there is no physical separation of the busway, the merge with the mixed traffic can happen anywhere in the proceeding block. If there is physical separation, it must occur at the previous intersection, or a slip lane must be provided.

From a signal phase standpoint, this option is the easiest to implement, as it does not require changing the signal phase, and does not require any major new infrastructure. However, this option does present a serious disadvantage in terms

of congestion delay for the turning BRT vehicles. Further, if the mixed-traffic congestion is heavy, the BRT vehicles attempting to turn may not be able to readily leave the busway, and thus can cause delays to all BRT vehicles, even those vehicles continuing in a straight routing. The BRT vehicle turning right has particular challenges since it must essentially cross all mixed-traffic lanes both before and after the intersection. Attempting these lane changes is particularly difficult if the system is using 18.5-metre articulated vehicles or 24-metre bi-articulated vehicles.

Any time BRT vehicles must leave exclusive busway operation and enter mixed-traffic lanes the system loses a certain amount of psychological status with the customer. Mixed-traffic operation makes the system much more akin to a conventional bus system rather than a highly-efficient mass transit system. Once vehicles start operating in mixed traffic, the customer’s “mental map” of the system becomes more uncertain. Such confusion does much to discourage system use by occasional and discretionary system users.

9.3.3 BRT vehicle turning onto secondary street

Sometimes it is desirable to allow a special bus-only left turn at a smaller intersection just before a major intersection (Figure 9.36). In this case, no special BRT turning phase is required at the more congested intersection. The BRT vehicle will operate on secondary mixed traffic streets or on a dedicated lane on the secondary streets until it rejoins the busway. This option requires the availability of usable secondary streets, which is not always the case.

9.3.4 Convert intersection into roundabout

One approach that is being tested for BRT systems being developed in Ahmedabad and Jinan is to convert a standard four phase intersection into a two-phase signalized roundabout. The exclusive BRT busway terminates approximately 50 metres prior to the intersection with the BRT vehicles entering mixed traffic at that point.

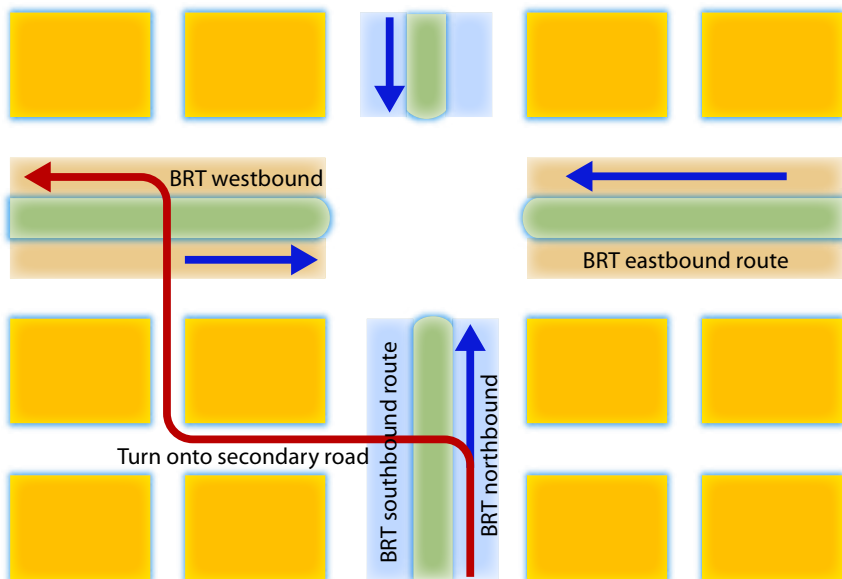


Fig. 9.36
In this scenario, the BRT turning movement is made prior to the main intersection. The BRT vehicle temporarily operates on the secondary road network.

This approach essentially turns the junction into a grid of one-way streets. It requires a fairly large amount of right-of-way at the junction. However, in many developing-nation cities, such right-of-way is available but underutilised.

Figure 9.37 indicates how the junction between two major boulevards can be turned into a two-phase traffic circle by creating a kind of mini-grid of one-way streets. At low traffic volumes, the BRT buses enter mixed traffic prior to the intersection. A series of queuing areas (marked as “A”, “B”, “C”, and “D” in Figure 9.37) help stage vehicle flows through the roundabout.

Figure 9.38 outlines the vehicle movements for first signal phase for this roundabout conversion. This example is given from the perspective of a British-style road configuration. All east-bound BRT vehicles and mixed traffic vehicles that are making right-hand turns would pass through the intersection and queue in area “C” at a traffic light. All east- and west-bound traffic can proceed straight. All vehicles making left-hand turns can proceed. All west-bound traffic would pass through the intersection and queue in area “B”.

In the second signal phase, all northbound and southbound traffic can proceed straight, all left hand turns can proceed, and all right turning traffic would queue in areas “A” and “D” (Figure 9.39).

This solution will work up to the point where the amount of space in areas “A”, “B”, “C”, and “D” is sufficient to accommodate all the turning traffic. Equations 9.5 and 9.6 define the calculations for the required and available queuing space.

Equations 9.5 and 9.6 Available and required space for queuing area

$$\text{Available static area capacity (pcu)} = \frac{\text{Length} * \text{Width}}{\text{Unitary pcu practical space}}$$

$$\text{Required capacity (pcu)} = \frac{\text{Turning volume (pcu)} * \text{Cycle time}}{\text{Cycle time}}$$

In equations 9.5 and 9.6, the calculated units are in passenger-car units (pcu). In order for the configuration to function, the available space must be equal or greater than the require space.

The following scenario provides an example of calculating the required and available capacity of the proposed roundabout queuing space.

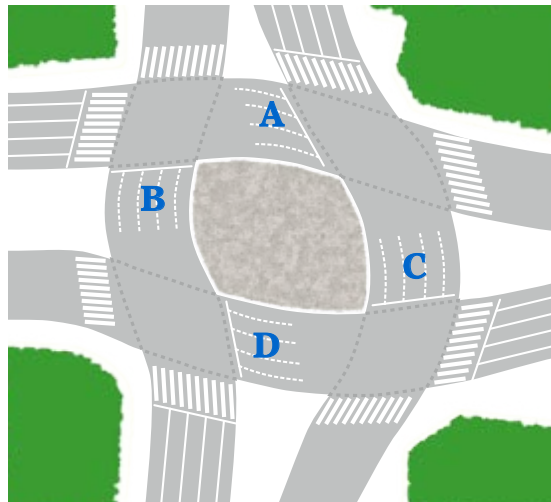


Fig. 9.37
In this scenario, the intersection is converted to a roundabout with vehicle queuing areas at points “A”, “B”, “C”, and “D”. The BRT vehicles enter mixed traffic just before the intersection and move through the intersection with a two-phase signal.

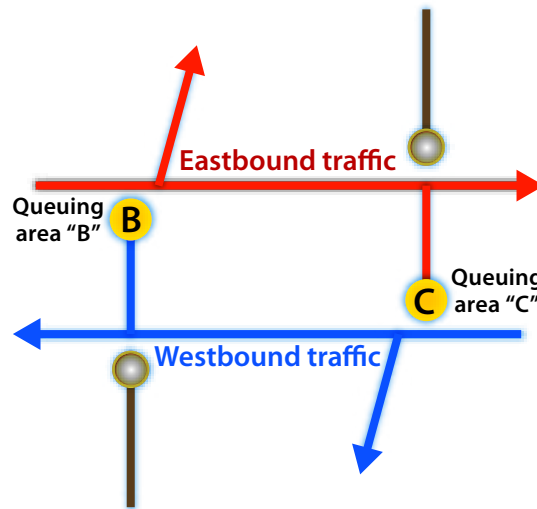


Fig. 9.38
Vehicle movements for signal phase 1.

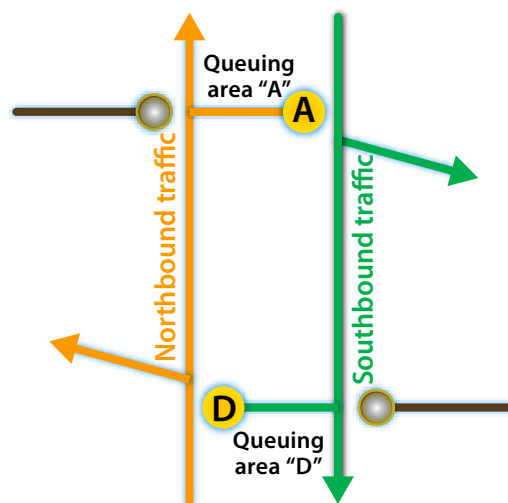


Fig. 9.39
Vehicle movements for signal phase 2.

Turning movement = 540 pcu/hour = 0.15 pcu/sec

Cycle time = 90 sec

Required capacity = 0.15 * 90 = 13.5 pcu

Unitary pcu space = 3 m * 5 m = 15 m²

Length = 30 m

Width = 12 m

Available capacity = (30 m * 12 m) / (15 m²/pcu) = 24 pcu

In this case, the available capacity is greater than the required capacity (24 pcu ≥ 13.5 pcu), so the proposed roundabout conversion could function.

When the number of mixed traffic vehicles and BRT vehicles rises to the point that areas "A", "B", "C", and "D" are too small to accommodate the number of turning vehicles, turns should be restricted for mixed traffic but not for BRT vehicles. Effectively, the queuing areas "A", "B", "C", and "D" would be reserved for BRT vehicles.

Cycle times on a signalised roundabout of this type should not be very high and never manually operated otherwise it would collapse by the inevitable universal tendency of manual operators to employ long cycles.

9.3.5 Queue jumping

"An Englishman, even if he is alone, forms an orderly queue of one."

—George Mikes, writer, 1912–1987

The signal system can be utilised to give BRT vehicles a head start on turning movements prior to private vehicle turning movements. In this case, a dual traffic signal is utilised for each direction of travel: 1. One traffic signal is located at the intersection; 2. Another traffic signal is located approximately 30 to 50 metres prior to the intersection. At the traffic signal prior to the intersection, the BRT vehicles on the busway would receive a green signal approximately 10 seconds prior to the green signal for the mixed traffic (Figure 9.40). During this head start, the BRT vehicle would be able to exit the busway and cross to the other side of the street.

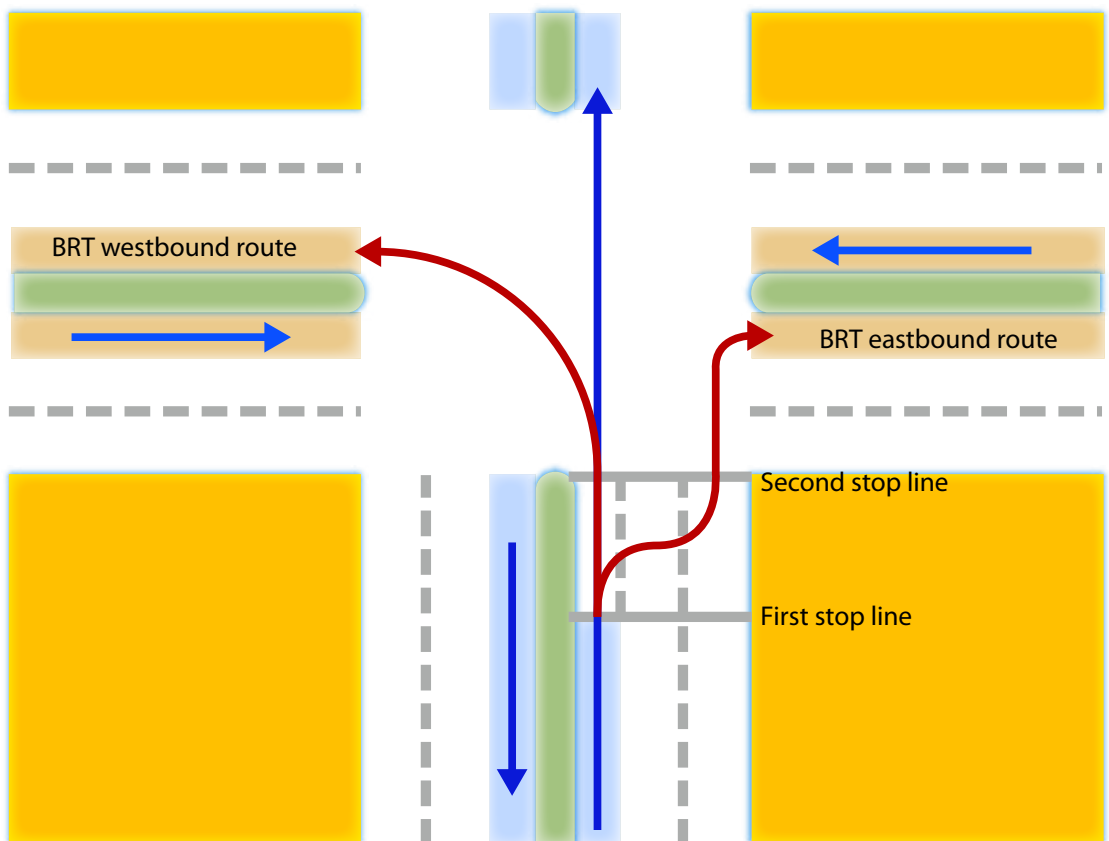


Fig. 9.40
While mixed traffic vehicles are held for an extra 10 seconds at the first traffic signal stop, BRT vehicles are given a queue-jumping head start.

Image adapted from TCRP Report Number 90 (Levinson et al., 2003b, p. 4-13)

9.4 Station location relative to the intersection

“The engineer’s first problem in any design situation is to discover what the problem really is.”

—Anonymous

One of the more contentious issues among BRT planners is the optimal location of the station relative to the intersection. Intersection and station design should generally be optimised to minimise the travel time of the majority of the customers. The station location in relation to the intersection will affect mixed traffic flow and speed, BRT system flow and speed, pedestrian travel times, and the right-of-way needed for the BRT system. Because conditions vary from intersection to intersection, it is generally advisable to find an optimal solution for each intersection rather than to presume a single solution will always be optimal. The greater amount of information the planning team has available regarding movements and demand, the easier it will be to optimise this decision for all modes of transport.

The following station locations are possible:

- At the intersection before or after the traffic signal;
- At the intersection but before the traffic signal in one direction and after it in the other direction (if using a split station configuration);
- Near the intersection but not at the intersection;
- Mid-block;
- Under (or over) the intersection.

9.4.1 Stations on each side of intersection

The normal justification for putting the bus stop at the intersection is that it reduces walking times for transferring passengers and passengers with destinations on perpendicular streets. The importance of this option will vary with pedestrian transfer volumes and the distribution of pedestrian destinations. As noted elsewhere, if using platform transfers, then customer transfers between nearby stations will be eliminated. In general, designing for platform transfers is far superior to forcing customers to walk across an intersection to another station. The practice of intersection transfers is typical in European tram systems where linear routing structures frequently cause heavy transfers at major intersections.



Fig. 9.41

In Taipei, the location of the stations prior to the intersection avoids the problem of BRT vehicles blocking the intersection. However, this configuration may mean that some vehicles will miss the green phase.

Photo courtesy of Jason Chang

For BRT systems with curb-side boarding, a separate station platform is needed in each direction. In order to maintain a more constant right of way, the standard practice is to put the stations for one direction on one side of the intersection, and the bus stop for the other direction on the other side of the intersection. System designers therefore usually put the stations before the intersection in both directions or after the intersection in both directions. However, this practice does have a substantial disadvantage for passengers wishing to change directions. These customers must make a difficult walk across the intersection.

There is an emerging consensus that in most cases placing the stations before the intersection, as in Taipei (Figure 9.41) increases the chances that boarding and alighting time can overlap with the traffic signal red phase, but the benefit may vary with local circumstances. However, in this configuration a single boarding and alighting delay can prevent the other BRT vehicles behind the first vehicle from clearing the intersection, forcing them to miss the green signal phase.

Alternatively, placing the stations after the intersection presents a different set of issues. This configuration does allow the station platform to be used as a physical barrier to help to ensure that mixed traffic does not enter the busway. The location of the stations after the intersection also sends a clearer visual clue to boarding passengers which direction the vehicle is likely to go.

However, if the system operates as an “open” system and there is a tendency for congestion on

the busway, a station after the intersection runs the risk that the buses could back-up into the intersection and block other traffic. This configuration could also mean that BRT vehicles will be forced to wait on the opposite side of the intersection and therefore miss an entire green phase. This situation occurs in the relatively congested busways of Kunming (Figure 9.42). For this reason, there is a tendency for some designers to prefer the placement of the station before the intersection.

If the station is before the signal, there is a chance that the BRT vehicle will arrive at the station just at the optimal moment, when the signal is turning red. If the BRT vehicle arrives when the signal turns red, all the boarding time will occur on red time. If this particular timing was always the case, then there are obvious travel time savings since station dwell time coincides with the period of the red signal phase.

However, there is as good a chance that the bus will pull into the bus stop just as the signal is turning green. In this case, all the boarding and alighting will take place during the green phase of the signal. Since the buses arrive at random times, there will be occasions when this occurs.



Fig. 9.42

In Kunming, the busway operates with high volumes and stations located after the intersection. These conditions may cause negative impacts: 1.) Buses may end up blocking the intersection if station area is occupied; or 2.) Buses may not be able to cross the intersection during the green signal phase.

Photo courtesy of the Municipality of Kunming

9.4.2 Single median station near intersection

In high-quality “full” BRT systems a single median station is the optimum solution. Such configurations allow customers to make comfortable platform transfers and this configuration also greatly simplifies routing options. Further, the construction of a single median station is generally less costly than constructing two side-aligned stations per direction.

If the median station is placed near an intersection, then the question of before or after the intersection is irrelevant. By definition, the platform(s) of one direction will be before the intersection and the platform(s) of the other direction will be after the intersection. If congestion for either the BRT system or mixed traffic is not a concern, then locating the BRT station at the intersection is not problematic.

9.4.3 Locating the station away from the intersection

In situations whether either mixed traffic volumes or bus volumes are nearing saturation, it is generally recommended to separate the BRT station and the intersection. If, for the sake of pedestrian convenience, the design team is considering placing the BRT station directly at the intersection anyway, the degree of saturation of the busway should be tested on an intersection by intersection basis. In the case of using the preferred single median station configuration, there is not likely to be any significant pedestrian advantage to an intersection location. In the central areas of a city, mid-block destinations may well be as important as intersection destinations.

Separating the station location and the intersection minimises the risk that BRT vehicles will be backed up at the station, which will inhibit the functioning of the intersection and the functioning of the station. If these two potential bottlenecks are co-located, the risk of mutual interference between the station and the intersection increases (Figures 9.43 and 9.44).

If the BRT system has physically defined stopping bays like in TransMilenio or Curitiba, there is a risk that buses queuing to pass through the intersection will also obstruct the station, and passengers will be unable to board

and alight until the buses in front clear the intersection. This problem is not as serious in “open” BRT systems without clearly designated stopping bays, but such systems force customers to find their appropriate bus rather than the bus finding the customers. In such systems, customers will have to run up and down the platform to locate and then board their bus. This chaotic boarding process not only creates stress for the customer but it also increases boarding times.

9.4.3.1 Station to intersection interference levels

Estimating the level of station to traffic signal interference

For an accurate assessment of the potential conflict between the intersection and a nearby station, micro-simulation modelling of the intersection would be ideal. However, proper micro-simulation modelling requires data generated by a fully calibrated traffic demand model, which is sometimes not readily available. As such, it is worth doing some basic calculations in order to approximate the likelihood of possible station-intersection bottlenecks.

It is generally advisable to investigate the degree to which the location at the intersection increases the time that BRT vehicles are blocking the station, or the level of saturation of the station.

As noted in Equation 9.7, the amount of interference between the station and the intersection depends first of all on the relationship (KR) between the time of the red signal phase (TR) and the average stop time per bus at the bus stop (TB).

Equation 9.7 Ratio of stopping time to red signal time

$$KR = TR / TB$$

Where:

KR = the ratio between the average stopping time for buses at the station and the time of the red signal phase

TR = amount of time of red signal phase

TB = average stopping time at the station

As a general rule, the higher the KR value, or the more the red signal time exceeds the average boarding time per bus, the greater the risk that traffic signal interference will saturate the station.

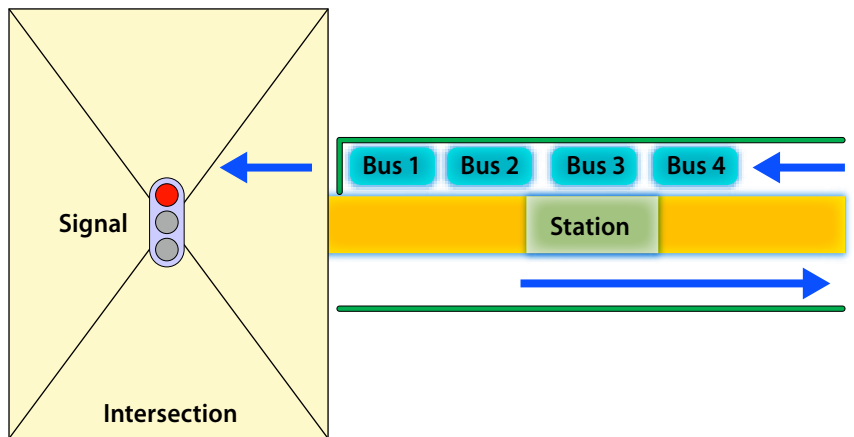


Fig. 9.43

For the direction of the BRT system that stops at the station before the intersection, there is a risk that vehicles will be delayed due to the signal phase.

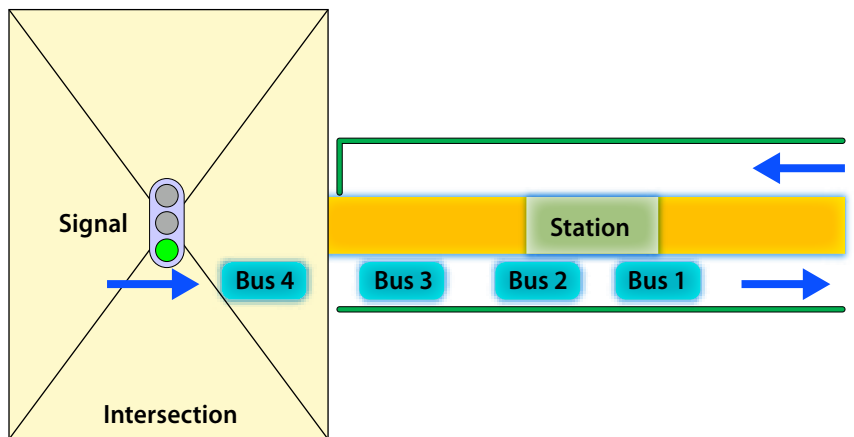


Fig. 9.44

For the direction of the BRT system that stops after the intersection, there is a risk that vehicles make back up into the intersection and block traffic.

Roughly, the combination of the station’s normal saturation and the additional saturation caused by traffic signal interference will tell one the degree of busway saturation. As a general rule, it is best to design the busway with a saturation level of under 0.4 at the station, meaning that the station is only occupied 40 percent of the time. Equation 9.8 shows how the level of saturation varies with different ratios (KR) of red signal time to vehicle boarding times.

Equation 9.8 Busway saturation

$$Xsb0 = x * TC / (TC - TB * KR)$$

Where:

Xsb0 = Saturation at the station resulting from both normal busway saturation and the signal

interference when there is “0” distance between the bus stop and the intersection

x = Normal saturation of the station without signal interference

The factor “ x ” involves a complex calculation, the derivation of which was illustrated earlier in this chapter. For this section, it will always be assumed that the normal busway saturation has been optimised, and station saturation without signal interference has been kept constant at 0.35, which will rarely congest.

TC = Total cycle time

TB = Average stopping time at the station

In equation 9.8, the variables of “ $TC/(TC-TB)$ ” shows the ratio of the total signal phase to the average bus stopping time. For example, if the signal phase is 60 seconds, and the average stopping time is 30 seconds, then $60/(60-30)$ is 2. In this case, the total signal phase is twice as long as the average stopping time per bus at the station.

The average bus stopping time TB is derived as indicated in Equation 9.9.

Equation 9.9 Average bus stopping time

$$TB = X / F * 3600$$

Where:

F = Frequency in buses per hour

3600 = seconds in an hour.

Since X has been assumed to be a constant of 0.35, this example produces the following result:

$$TB = 0.35 / F * 3600$$

Finally, the factor “ KR ” shows that the total saturation of the busway depends not only on the relationship between the total signal phase and the bus stopping time, but also on the relationship between the time of the red signal phase (TR) and the average stopping time per bus at the station (TB). The precise relationship between the bus stopping time, the total signal phase, and the total red time, will vary depending on whether the average bus stopping time (TB) is shorter or longer than the red signal phase (TR), which is reflected in the factor “ KR ” above.

Interference level when bus stopping time is shorter than red signal phase

The concern about interference is most acute when the bus stopping time (TB) is short and

the red phase (TR) is longer, or of similar magnitude. Interference is only of limited concern if the red phase is very short.

Looked at another way, the saturation of the station when the station and the intersection are co-located, will increase in relation to the average time that the boarding and alighting (TB) process overlaps with the green signal phase (Tv).

If the bus stopping time is shorter than the red signal time, then in the most extreme case the station can mostly only function during the green signal phase. For example, in a system with pre-paid platform level boarding, and designated stops for the bus doors, and an intersection with very few passengers boarding and alighting, it is quite possible that the average stopping time per bus could be quite low, as low as 10 seconds. In this case, the risk of interference between the bus stop and the intersection is extremely high.

During the red phase, the bus pulls up, and after only ten seconds, boarding and alighting is completed. After a few seconds, the next bus pulls up behind the first bus, but it cannot board and alight because the station is still occupied by the first bus waiting at the traffic light. A third and a fourth bus may pull up, during which time none of them can board or alight because the first bus is still facing a red signal. In this case, the level of interference between the signal and the bus stop is at a maximum.

Therefore, if

$$TB < TR$$

Then:

$$X_{sb0} = x * TC / (TC - TR + T_o)$$

Where:

X_{sb0} = Saturation at the station resulting from both normal busway saturation and the signal interference when there is “0” distance between the station and the intersection

x = Normal saturation of bus stop without signal interference

TC = Total cycle time

TR = Total red time

T_o = The average time that the boarding and alighting process overlaps with the red signal phase

$x = 0.35$

If the bus stopping time is less than the red time at the traffic light, the impact of the conflict between the signal and the station on the system's saturation can be estimated by assuming that half of the boarding time will take place during the red time and half will take place during the green time. This assumption will not be exact, but it will give a good indication of the risk of saturation.

Mathematically, therefore,

$$T_o = 0.5 * TB$$

Where:

0.5 = the probability that boarding and alighting will take place during the red phase.

$$TB = x / F * 3600$$

In this case, calculating the saturation of the station when faced with interference from the traffic signal, the following formula can be used:

$$X_{sb} = x * TC / (TC - TR + (0.5*TB))$$

Since the equation varies depending on the ratio of red time to stopping time (KR), the equation below shows how KR enters into the equation:

Since $KR = TR/TB$, then $TR = TB*KR$, so the above formula can also be written as follows:

$$X_{sb} = x * TC / [TC - (TB * KR) + (0.5*TB)]$$

Therefore, for the conditions in which the boarding and alighting occurs half during the red signal phase and half during the green signal phase, Equation 8.19 becomes:

$$X_{sb} = x * TC / (TC - TB * (KR - 0.5))$$

Box 9.1 provides an example of applying this equation for conditions in which there is a short boarding and alighting time relative to the read signal phase.

Box 9.1: Calculating station to intersection interference with a long red phase cycle

This example assumes that the vehicle stopping time occurs equally between the red and green signal phase.

$$X_{sb0} = x * TC / (TC - TR + (0.5 * TB))$$

$$x = 0.35$$

$$TC = 700 \text{ seconds of total cycle time}$$

$$TR = 500 \text{ seconds of total red time}$$

$$TB = 10 \text{ seconds (average bus stopping time)}$$

$$X_{sb0} = 0.35 * 700 \text{ seconds} / (700 \text{ seconds} - 500 \text{ seconds} + 0.5 * 10 \text{ seconds}) = 1.195$$

In this hypothetical example the station would operate on just the 200 seconds of green, but not on the 500 seconds of red, because just some seconds after the red phase begins the bus will finish boarding, but it will obstruct access to the bus stop during the entire 500 seconds of red.

Thus, at a value of 1.195 the high saturation leads to considerable congestion of the busway.

Interference levels with a short red phase

If the red signal phase is very short relative to the boarding and alighting time, then even if the signal changes to red just as boarding and alighting has been completed, it will be a short time before the light is green again. Thus, there is less concern about interference between the station and the intersection.

Based on empirical observation, while not exact, it is reasonable to assume that if the bus stopping time is greater than or equal to red signal phase, the formula for calculating the level of total saturation should be changed to reflect the lower chance of interference. Empirically, the following formula is generally a reasonable predictor of interference.

If $TB \geq TR$,

Then:

$$X_{sb0} = x * TC / (TC - TB * (KR^2 / 2))$$

Since $KR = TR / TB$,

$$X_{sb0} = x * TC / (TC - TR^2 / 2TB)$$

Box 9.2 provides an example of relative interference levels when the red phase time is short.

Box 9.2: Calculating station to intersection interference with a short red phase cycle

In this example, the red phase cycle time is relatively short when compared to the vehicle stopping time.

- TR = 15 seconds of red phase
- TB = 40 seconds of vehicle stopping time
- TC = 30 seconds full signal phase
- x = 0.35

$$X_{sb0} = 0.35 * 30 / (30 - 15^2 / (2 * 40))$$

$$= 0.386$$

In this case, because the red phase is quite short, there is fairly minimal risk that the traffic signal will disrupt the functioning of the bus stop, so saturation increases only marginally, from 0.35 to 0.386.



Fig. 9.45

A mid-block station location in Seoul allows greater right-of-way width for the station area.

Photo courtesy of the City of Seoul

9.4.3.2 Maximising right-of-way with mid-block stations

Another principal advantage of placing the BRT stop at some distance from major intersections is that it is generally a more optimal way of using a limited right of way. BRT systems consume the greatest amount of right-of-way at the station area. This is not only to provide as wide a station platform as possible, it is also sometimes necessary to provide an additional passing lane.

For a BRT system, the main congestion point is typically the station area. For mixed traffic, the main congestion point is typically the intersection. For this reason, it is generally advisable to provide the maximum right-of-way to the BRT system at the station, and the maximum right-of-way for mixed traffic at the intersection. If these two functions are separated, then a fixed amount of right-of-way can be used. The same right-of-way used for dedicated mixed traffic turning lanes at the intersections can be used for passing lanes at the BRT station (Figure 9.45).

For example, at the bus stop, if bus frequencies are high and an overtaking lane is needed at each station, the extra width required will be around 12 metres. If the station is located at the intersection, these 12 metres will be difficult to supply while also providing 6 metres for left and

right turn lanes for mixed traffic. Separating these functions will allow the same right of way to be used for the bus station at mid-block, and for left and right turn signals at the intersection. Figure 9.46 shows an application of this concept within a proposal for the Delhi BRT system.

9.4.3.3 Optimisation of station location when walking time is included

When pedestrian walking times are also considered, the optimisation calculation becomes somewhat more complicated. Optimising station location in terms of pedestrian walking times is location-specific, as it depends on the location of popular pedestrian destinations, the boarding and alighting passenger volumes, the passenger transfer volumes, the location of allowed pedestrian crossings, and the structure of the signal phasing.

The main bottleneck for pedestrians is the delay they face crossing the street, and the distance of the actual route between the station and their destination. The crossing time will be a function of the signal phase if the pedestrians are crossing at a signal and of the gaps in the traffic if they are crossing at non-signalised locations. The distance of the actual route will be affected both by the inherent location of the station in relation to popular destinations, and the places

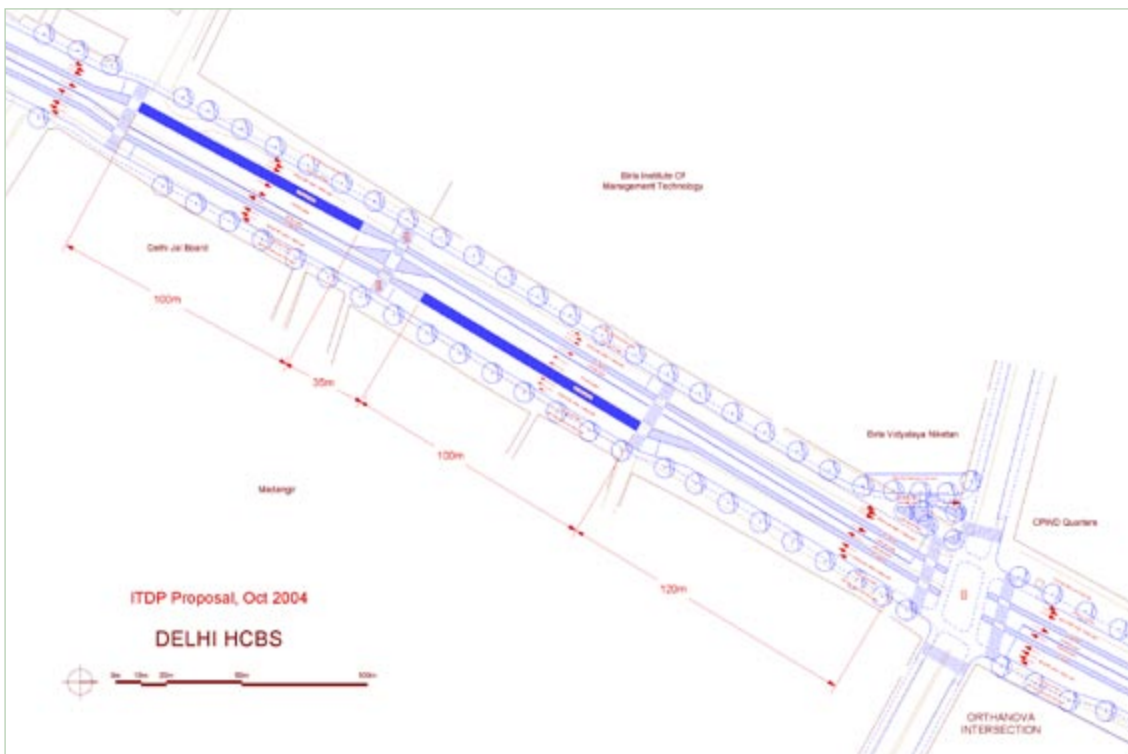


Fig. 9.46
In this proposed road layout for Delhi, the mid-block BRT stations are given additional right-of-way. However, at the intersections, right-of-way for mixed traffic vehicles is maximised.

Image courtesy of ITDP

where the pedestrian is able and allowed to cross the street safely.

Further, relevant pedestrian movements are not just confined to the area around the BRT station. Rather, consideration of a pedestrian's entire path must be considered, which may encompass an area of 1,000 metres or more from the station as well as several different street crossings.

To optimise station location for pedestrians with high precision would require labour intensive, site-specific analysis of the origin and destination patterns of boarding and alighting BRT passengers. These patterns would then have to be weighed against the impact that this decision has on the BRT system and on mixed traffic. If a highly complex case-specific analysis is not possible, some general rules can be applied to obtain a solid estimation of preferred station location:

- If mixed traffic turns are allowed, and turning volumes are high, and the number of boarding and alighting and transferring passengers is low, the BRT station should be situated far enough away from the intersection to avoid interference and to provide sufficient turning lane capacity.
- If a popular high volume pedestrian destination exists along the corridor, such as a commercial centre, school, or major office centre,

proximity to this location may be more important than proximity to the intersection.

- If the system operates with the less preferred design of side-aligned stations, then stations may need to be located near intersections in order to facilitate transfers to perpendicular roads; this situation is not relevant to the preferred option of median stations since transfers are accommodated at the platform through turning movements of the BRT vehicles.
- If both turning vehicle volumes and BRT vehicle volumes are high and a key destination is located at the intersection, then a more detailed study should be carried out.

If the BRT system does not require a passing lane to avoid congesting, there are no right-of-way constraints, and there are not high volumes of turning mixed traffic vehicles, then placing the station at the intersection can be an option to consider. If the BRT system has an "open" routing structure, where buses pass from the BRT system to mixed traffic streets, as a general rule, passenger transfer volumes will tend to be low. Proximity to the intersection is then less important.

Initial plans for the Delhi BRT system include four full bus lanes (two in each direction) and two full loading platforms at the intersection, consuming a total of six lanes (9.47). This configuration also includes two lanes of mixed traffic in each direction. As the existing right-of-way is extremely wide, and some turns will be restricted, it is possible to use this design. Analysis showed that placing the stations at the intersection was optimal from the perspective of pedestrian walking times. As this design has not yet been built, it has not yet been tested empirically. The designers in Delhi argued that location of the pedestrian crossing at the intersection was also likely to be safer and easier than if pedestrians have to cross mid block, though others argue that the complexity of vehicular movements at the intersection may make pedestrian crossing mid-block safer. The relative scarcity of research in this area makes the issue one for further study.

Detailed analysis requires a separate analysis of the different travel time impacts of different locations on each of the different types of trips: Pedestrian, BRT, and mixed traffic. To date, widely available micro-simulation models

- Space for BRT system (stations and runways)
- Space for mixed traffic (roadway)

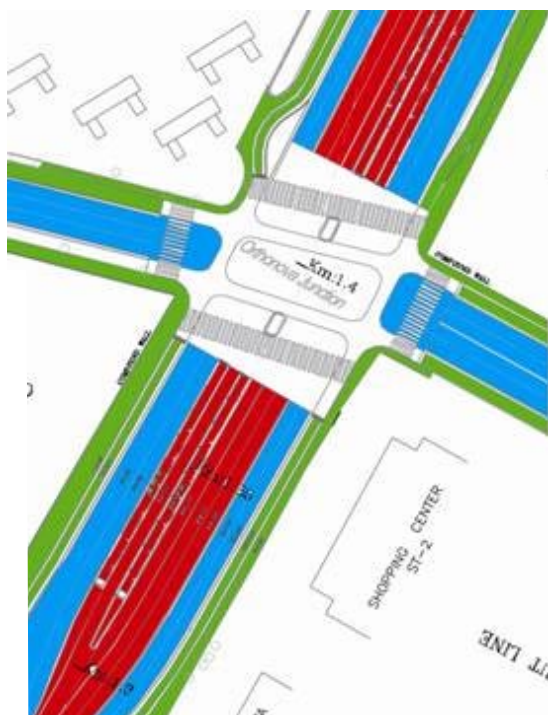


Fig. 9.47
Given the wide amount of right-of-way in this section of the Delhi BRT system, intersection section stations have been proposed in order to maximise pedestrian convenience.

Image courtesy of ITDP

for the analysis of intersections have not been developed to handle the complexity of pedestrian and BRT movements that would need to be analysed. Thus, for the time being, simple spreadsheet analysis may be an appropriate evaluation tool.

If the situation is optimised including walking times, it is quite probable that along a BRT corridor, some stations would be located at mid-block, others at the intersection, and still others adjacent to major trip destinations. Furthermore, some compromise between pedestrian travel times and the vehicular travel times can generally be found. Stations do not need to be in the middle of the block to avoid interference with the intersection, they just need to be far enough away to avoid the conflict.

9.4.3.4 Calculating the minimum distance to avoid station—intersection conflicts

To avoid conflicts between station areas and intersections, a mid-block station location is not the only option. Of course, a mid-block location could be optimum, depending on the local destinations and pedestrian patterns.

In any event, it is useful to calculate the minimum distance that will avoid any likely conflict between BRT vehicle movements at stations and mixed traffic movements at intersections. The minimum distance can be simply determined by the amount of space required by queuing BRT vehicles. In the case of lower-volume BRT systems, queuing vehicles may not be an issue at all. In the case of higher-volume systems, then consideration of the possible bus queue at intersections and stations should be taken into account (Equation 9.10).

Equation 9.10 Calculating the minimum distance between stations and intersections

$$D_{bs} > N_{br} * L_b$$

Where:

D_{bs} = Distance from the BRT station to the stop line of the nearest traffic signal

N_{br} = Likely number of BRT vehicles to queue during the red phase of the traffic light

L_b = Average length of lane space consumed by the queuing BRT vehicles

The factor “ L_b ” consists of two factors: 1.

Length of the BRT vehicle (L); and 2. Length

Box 9.3: Calculating the minimum recommended distance between the BRT station and the intersection

This example utilises data typical of an average city in India.

$$N_{br} = Tr_1 * F_b / (1 - (F_b / S_b)) / 3600$$

Tr_1 = 50 seconds of red time at intersection

F_b = 200 buses per hour passing a particular intersection

S_b = 720 articulated buses per hour per lane could pass intersection if the signal were green all the time

$$N_{br} = 50 * 200 / (1 - (200 / 720)) / 3600$$

$$= 3.8 \text{ buses}$$

Because one cannot actually operate 3.8 buses, “ N_{br} ” must be rounded to the nearest integer, so “ N_{br} ” is equal to 4.

L_b = Length of BRT vehicle + Length of space between vehicles when stopped
 = 18.5 metres + 1 metre
 = 19.5 metres

$$D_{bs} > N_{br} * L_b$$

$$> 4 * 19.5$$

$$> 78 \text{ metres}$$

Thus, based on the values presented in this example, the minimum recommended distance between the BRT station and the intersection would be 78 metres.

of space between BRT vehicles when stopped (usually assumed to be 1 metre).

Equation 9.11 is then used to derive the number of BRT vehicles that will queue at the signal.

Equation 9.11 Number of BRT vehicles that will queue at the signal

$$Nbr = Tr1 * Fb / (1 - (Fb / Sb)) / 3600$$

Where:

Tr1 = Amount of red time placed on the BRT vehicles at intersection

Fb = BRT vehicle frequency per hour at the intersection

Sb = Bus lane capacity (usually 720 articulated buses/lane/hour or 950 standard buses/lane/hour)

3600 = seconds in an hour

Box 9.3 provides an example of calculating the minimum recommended distance between the BRT station and the intersection.

9.4.3.5 Optimising station location when intersections are close together

Sometimes, intersections are too close together in order to optimise the station location relative to the intersection. In such instances, an assessment has to be made in terms of how important the station location is for boarding and alighting passengers. If it is an important location, the

time savings benefits for pedestrians of locating a station close to this destination must be weighed against the likelihood time lost within the BRT system due to interference between the station and the intersection. If there are no important destinations in that location, it is better not to locate a station there.

Mixed traffic vehicles will most likely be able to pass through the two intersections using a synchronised signalisation system. However, the same may not be true for BRT vehicles. Instead, the BRT vehicle will pass through the green phase at the first intersection and then stop at the station for passenger boarding and alighting. By the time the vehicle resumes movement towards the second intersection the signal phase may well have changed to red (Figure 9.48). Thus, this configuration may lead to considerable delay for public transport passengers.

Even for normal mixed traffic, having two intersections too close together will sometimes lead to problems. Vehicles queued at one intersection will back up to the point where vehicles are unable to clear the previous intersection during a green phase. Equation 9.12 defines the calculation for the distance at which this type of conflict may occur.

Equation 9.12 Calculating the distance at which intersection conflicts occur

$$D12 < 3 * Max (Tg1, Tg2)$$

Where:

D12 = Distance between intersection 1 and intersection 2

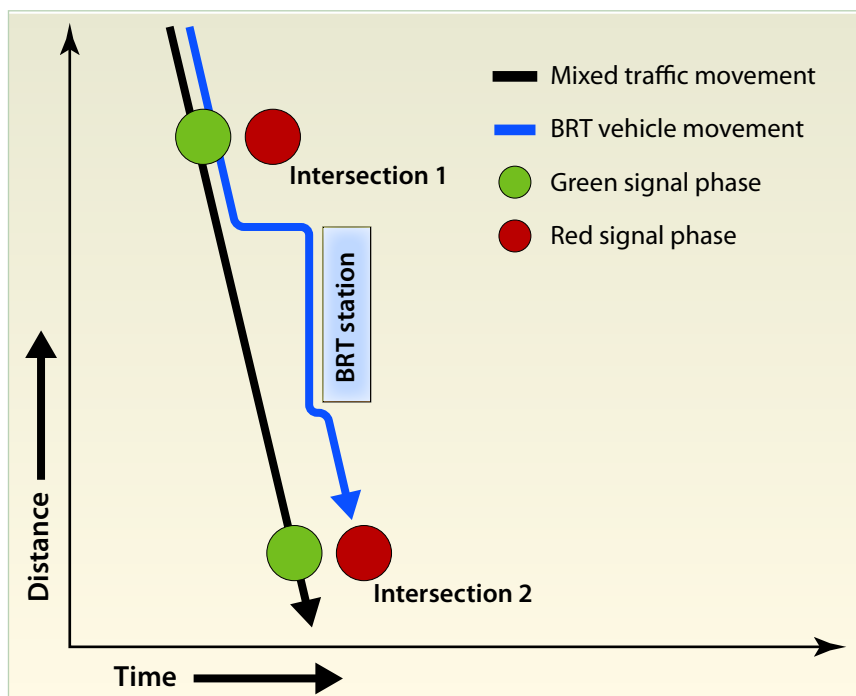
Tg1 = Green signal time per phase cycle at intersection 1

Tg2 = Green signal time per phase cycle at intersection 2

A mixed traffic lane can generally handle 1,800 vehicles per hour. This quantity translates to two vehicles per second (3,600 seconds in an hour). When vehicles are stopped at a stop light, the average amount of space they take up is 6 metres; this space includes the vehicle and some space between vehicles. This average vehicle distance means that for each second of time, 3 metres of vehicle-equivalents can be moved through the intersection.

Box 9.4 provides a sample calculation of the required spacing between two intersections.

Fig. 9.48
While mixed traffic vehicles may benefit from a synchronised green phase between two intersections, BRT passengers may encounter the red phase at the second intersection.



Box 9.4: Calculating vehicle queues between intersections

The following scenario is outlined in order to determine whether two intersections will result in free-flow operation or in congestion:

D12 = Distance between intersection 1 and intersection 2
= 100 metres

Tg 1 = Green phase time at intersection
= 40 seconds per phase

Tg 2 = Green phase time at intersection 2
= 30 seconds per phase

To determine if the distance between these intersections is sufficient, Equation 9.12 can be applied:

$$D12 < 3 * \text{Max} (Tg1, Tg2)$$

$$100 \text{ metres} < 3 * 40 = 120 \text{ metres}$$

Since 100 metres is less than the required 120 metres, there is not enough space between the intersections. It is therefore possible that vehicles queuing at the second light will back-up onto the first intersection. Since intersection 1 has a green phase of 40 seconds, some 20 vehicles will clear the intersection. As each vehicle on average consumes 6 metres of longitudinal space, 120 metres of vehicles will form a queue at the second intersection. If the intersection is only 100 metres away, then the queue will spill over into the first intersection and disrupt the functioning of the first traffic light.

9.4.4 Grade-separated stations

As has been noted earlier, grade-separating the busway at intersection locations brings with it many benefits from the perspective of travel time savings. A BRT tunnel or overpass will dramatically improve intersection capacity for both BRT vehicles and mixed traffic vehicles. A BRT tunnel will free-up surface space that can be utilised for mixed-traffic turning lanes.

However, grade-separation brings with it two complications. First, the infrastructure can be costly, depending on local circumstances. In many instances, the time savings to BRT passengers and to private vehicles will fully justify the added infrastructure costs, but limited capital resources will typically constrain infrastructure expenditures.

Second, grade-separation can limit the location of the stations. In most instances, grade-separation will imply placing the stations at a mid-block location, away from the tunnel or overpass. If a key destination is located at the intersection, this siting restriction will add walking time for customers travelling between the station and the key destination. The Quito

Central Norte line uses grade separation quite effectively with tunnels whisking BRT vehicles through congested intersection locations. However, the tunnels also imply that at important destinations, such as the Plaza de las Américas (Plaza of the Americas), the closest station is a considerable distance away (Figure 9.49). Thus, from a customer perspective, the time savings from the grade-separation can be essentially lost due to the longer walk in accessing the intended destination.

As an alternative to this conflict between intersection efficiency and convenient station location, it is possible to place the station beneath the intersection. In this case, both the time savings of grade separation is gained as well as a convenient station location to key destinations. Many underground metro stations utilise station siting in this manner. The Metro Center station of the Washington Metro exits directly into the basement floors of commercial shops. In such cases, though, accessing ground-level shops and offices will require a grade transfer for customers, implying either stairs, escalators, and/or elevators. Likewise, both the

Fig. 9.49

In the case of Quito's Central Norte line, the presence of an BRT underpass has meant that the closest station to a key destination, the Plaza of Américas commercial centre, is several hundred metres away.

Photo by Lloyd Wright



Brisbane and Ottawa BRT systems site stations at the tunnel level. In Brisbane, the station is just before the tunnel and thus provides good customer access to local destinations (Figure 9.50). In Ottawa, the station connects directly to a commercial shopping centre (Figure 9.51). Further, in the case of Ottawa, the tunnel station nicely protects customers from the harsh winter temperatures.

Again, while grade separate on at intersection does increase initial construction costs, the time savings can justify the investment.

9.5 Roundabouts

“So many roads. So many detours. So many choices. So many mistakes.”

—Sarah Jessica Parker, actress, 1965—

Fig. 9.50 and 9.51
Placing stations just before a BRT tunnel (left photo, Brisbane) or even within the tunnel (right photo, Ottawa) helps customers with comfortable access to local destinations.

Left photo courtesy of Queensland Transport
Right photo by Lloyd Wright



Intersections with roundabouts can create considerable uncertainty for the busway system. If the BRT vehicle must cross several lanes of mixed traffic within a heavily congested roundabout, the BRT vehicle may be hindered from proceeding. In turn, such unpredictability with congestion delays can create havoc for system controllers who are attempting to maintain frequent services and evenly-spaced distances between public transport vehicles.

However, there are some solutions to the difficulties posed by roundabouts. There are at least five distinct possibilities for accommodating BRT systems through a roundabout:

1. Mixed traffic operation;
2. Mixed traffic operation with signalled waiting areas;



Fig. 9.52
Quito's Ecovía line cuts directly through a roundabout.

Photo by Lloyd Wright

3. Exclusive lane along inside of roundabout;
4. Exclusive busway through the middle of the roundabout;
5. Grade separation.

If mixed traffic and BRT system volumes are not particularly heavy, then simply allowing the BRT vehicles to enter mixed traffic may be an effective and simple solution. In such cases, the BRT vehicle will leave the dedicated busway upon entering the roundabout, which may be either controlled through a traffic signal or left to operate on a yield priority basis.

Section 9.3.4 above has already discussed the possibility of converting a standard intersection to a roundabout with signalised control and BRT waiting areas. This option can be appropriate when a standard intersection has reached its saturation point and a variety of turning options for private vehicles must be accommodated.

In cases where BRT and mixed traffic volumes dictate that some priority must be retained for the BRT vehicles, then making the inside lanes of the roundabout exclusive to BRT can be an effective option. In this case, the BRT vehicles can access the exclusive roundabout lanes either by crossing mixed traffic lanes or by being given priority signalisation. Likewise, to exit the roundabout and re-enter the principal busway the BRT vehicle must cross mixed traffic lanes. As with the entry to the roundabout, the BRT vehicle can either manoeuvre across mixed

traffic to exit the roundabout or another set of traffic signals can be used to facilitate the exit.

Depending on the physical contents of the roundabout, a dedicated lane could be constructed through the centre of the roundabout. In this case, the busway is built straight through the roundabout while mixed traffic continues to circulate around it. Quito's Ecovía line provides an example of this technique (Figure 9.52). Likewise, the Cali (Colombia) system makes use of this approach (Figure 9.53). The ability to construct a dedicated lane through the centre of the roundabout will only be feasible when the centre area of the roundabout does not host a fountain, sculpture, or other permanent piece

Fig. 9.53
In Cali (Colombia), the busway also passes through the centre of the roundabout area.

Photo courtesy of Metrocali



of urban infrastructure. The construction of the BRT system should not involve the loss of any items of cultural identity. In this design, a traffic signal controls enter to and from the roundabout.

Finally, the most elaborate solution is to construct a busway underpass that goes below the roundabout, and thus avoids all conflicts with mixed traffic. Quito has achieved great success with its “Villa Flor” station that goes beneath the heavily-trafficked roundabout on Maldonado Avenue. Likewise, a series of underpasses near Plaza America en Quito avoids much potential congestion for the city’s Central Norte line (Figure 9.54). As noted previously, while grade separation is potentially the most effective solution in terms of intersection efficiency, its applicability depends on cost and locational

Fig. 9.54
Quito’s Central Norte line uses a series of underpasses to avoid a roundabout near Plaza Américas.

Photo by Lloyd Wright



factors. In some circumstances, underpasses can be quite expensive to construct, although the expected time savings for both BRT and mixed traffic vehicles can justify such costs. Also, an underpass can complicate station location, especially if there are key destinations near the intersection. Of course, as in the case of Quito’s Villa Flor roundabout, it is possible to locate the station within the underpass itself, which gives customers good access to destinations near the roundabout.

9.6 Traffic signal priority

“A common mistake that people make when trying to design something completely foolproof is to underestimate the ingenuity of complete fools.”

—Douglas Adams, novelist, 1952–2001

Traffic signal priority for BRT vehicles can take one of two forms:

1. Passive signal priority;
2. Active signal priority.

Passive signal priority is the adjustment of normal traffic signals to give priority to a corridor with a BRT system over a corridor without one, and to give priority to the BRT system over mixed traffic within that corridor. Active signal priority tends to be activated by electronic equipment that detects the arrival of a BRT vehicle at an intersection and adjusts the traffic signal accordingly.

9.6.1 Passive signal priority

Passive signal priority should always be a basic first step in giving a BRT system traffic signal priority in a given corridor. Signal priority is quite complementary to the signal phase simplification discussed earlier, and thus the two techniques can be considered jointly for implementation.

One of the most basic measures within passive signal priority is to give BRT corridors preference over cross streets that do not have public transport services. This prioritisation can be achieved by extending the green time for the BRT corridor over the cross street. This action will improve the travel speeds of all the traffic (both bus and mixed traffic) on the BRT corridor at the expense of all the traffic on the non-BRT corridor.

The next step is generally to see if the signal phases on the BRT corridor can be shortened. Because BRT vehicles are less frequent than mixed traffic vehicles, they are more adversely impacted than mixed traffic by long signal phases. The actual optimal signal phase will depend on both the flow of BRT vehicles and the flow of mixed traffic.

It is not unusual for total cycle time on a BRT corridor to be as low as 60 to 90 seconds, rising to as high as 120 seconds or longer only at major intersections or during peak hours and mainly to extend the green time within the BRT corridor. On a BRT corridor, the red time faced by the BRT system should be as close as possible to 50 percent of the total signal cycle. It is typical for the BRT green time to be 30 seconds in a 60 second cycle, or 40 to 60 seconds on a 120 second cycle.

In systems like Kunming where the station is adjacent to the intersection and the signal phase is 180 seconds, bus queuing problems are typical even at fairly low capacity. Likewise, delays occur in Kunming due pedestrians crossing against the light, which leads to serious safety problems.

Synchronisation of green signal phases between intersections is not common with BRT systems. Since BRT boarding and alighting times can be somewhat irregular, determining the signal timing between intersections is quite difficult. If BRT vehicle speeds are reasonably predictable, and intersections are less than 1.6 kilometres apart, it may be possible to coordinate traffic lights in a BRT corridor. This practice is used in Ottawa (Levinson et al., 2003b).

9.6.2 Active signal priority

Active, or real time priority techniques, change the actual traffic signal phasing when a BRT vehicle is observed to be approaching the intersection (Figure 9.55). At an even higher level of sophistication, the priority phasing can be based on observed traffic levels for both the BRT vehicles and the general traffic. The importance of traffic signal priority on BRT vehicle speeds tends to be greatest in systems with fairly low bus volumes, particularly with bus headways longer than five minutes. When BRT vehicle headways are less than 2.5 minutes, it is gener-

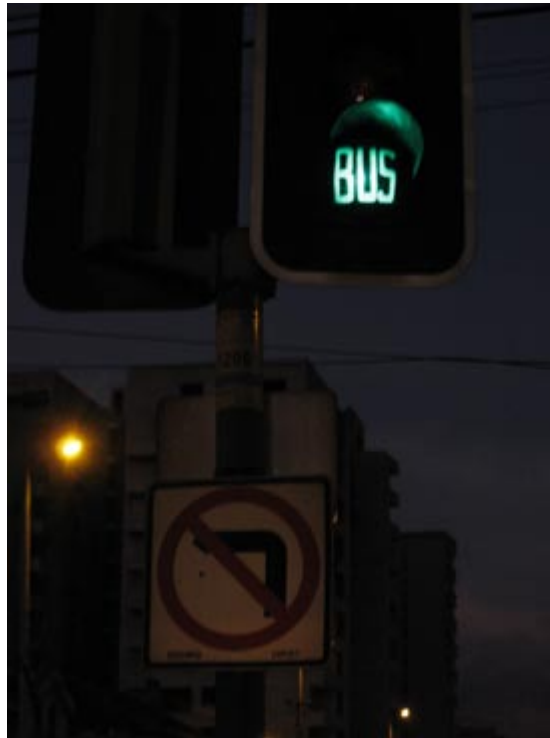


Fig. 9.55

Active signal priority for BRT and restricted turning movements for mixed traffic vehicles can do much to improve public transport travel times.

Photo by Lloyd Wright

ally difficult to implement active signal priority at all. If signal phasing was attempted in such high frequency circumstances, the non-BRT traffic direction would essentially be in a state of a permanent red phase, although applying the signal priority to alternating phases would still be possible.

In developing countries, where volumes on BRT corridors tend to be high, intersections relatively few and far between, and traffic light systems weak and badly maintained, traffic signal priority measures for BRT systems have been less used than in developed countries with frequent intersections and longer headways. However, even with high bus frequencies, measures such as green phase extension and red phase shortening can be used, particularly at less important cross streets, yielding benefits on the order of a 4 percent to 10 percent reduction in traffic signal delay. While this savings is not as significant as some other priority measures, it can be an important contributing factor to efficiency gains.

In the US and Europe, where intersections are frequent and lead times between buses often five minutes or longer, signal priority measures may be a more important measure for increasing bus or tram speeds. In such instances, signal priority may reduce signal delay by between 10 percent

and 20 percent. In this context, it is often easier to give buses signal priority at intersections without major disruption of mixed traffic flows.

Because most BRT systems to date have been developed in developing countries with high bus frequencies and relatively few intersections, most of the famous BRT systems have relied primarily on turning restrictions to increase intersection efficiency and have not relied heavily on sophisticated real time signalling systems. With an exclusive bus lane and an optimised station design, the additional benefits for BRT vehicles resulting from high technology signalling systems may be small relative to the cost of the signalling equipment. However, as vehicle detection, signalling equipment, and priority software have become increasingly common, the costs are becoming increasingly affordable.

For traffic systems where flows are quite irregular, real time control systems which weight signal times to observed traffic levels can yield benefits. In such real time systems, phase changing is usually based on a trade-off between the benefits and costs faced by the green and red approaches. A special weighting can be given to BRT vehicles or to the BRT corridor. For the general principle of shortening red times, a fully actuated system based on total vehicle movements which also includes BRT vehicles is probably more important than BRT-specific detection.

The normal vehicle identification mechanism is to have a transponder detect the BRT vehicle prior to its arrival at the stop line. If the BRT vehicle is detected during the green phase, and the green phase is nearing the yellow phase, the green phase is extended. If the detection occurs during the red or the yellow interval, the green time is recalled in advance of normal time. Some general guidelines for applying phase extension or phase shortening include:

- The minimum side street green time is set based on the amount of time pedestrians need to cross the road;
- The amount of green signal extension or advance should be up to a specific set maximum;
- The BRT corridor green is not generally both advanced and extended in the same cycle.

The green times are likely to be most easily extended at intersections with light cross traffic.

A possible important use for vehicle actuated signals is for special turning movements onto or off of the BRT corridor. If an intersection has a small number of BRT routes that need to turn left (or right in a British-style configuration), a special left turn phase can be added to the cycle upon the detection of the BRT vehicle. When the turning movement does not have a special lane, a TAG, GPS or similar individual bus detection technique may be needed. Benefits on these kinds of actuated systems for special turning movements can save up to 30 percent of signal delay not only for the BRT system but also for general traffic.

Real time activation of signals can also be used on specific critical bottlenecks along a BRT corridor. For example, sometimes a BRT system must pass through a narrow stretch of road that is impossible to widen. Such areas may include bridges, tunnels, city gates, or flyovers. Usually the heaviest congestion occurs not on the critical link but just before it, forming a large queue just to enter onto the bottleneck point.

When the facility itself is not congested, only the approach to the facility, a traffic signal is generally not needed, and it may be better to end the exclusive busway just a short distance before the bottleneck. The distance should be sufficient only to allow a convenient distance for merging (40 to 80 metres). This curtailment of the busway will allow BRT buses to pass through most of the congestion point without provoking any reduction of mixed traffic capacity at the critical section (Figure 9.56).

If the critical link is an approach to signalised intersection, the BRT lane should finish at a given distance. Equation 9.13 provides the calculation for determining the optimum distance for terminating the exclusivity of the busway.

Equation 9.13 Calculating the optimum distance for terminating the busway

$$L \text{ (metres)} = \sim 3 * T_v \text{ (seconds)}$$

Where:

T_v = Green phase time for the BRT approach

This calculation, however, no longer works if the facility itself also becomes congested. If there is a risk that the bottleneck facility itself may become congested, a special signal should

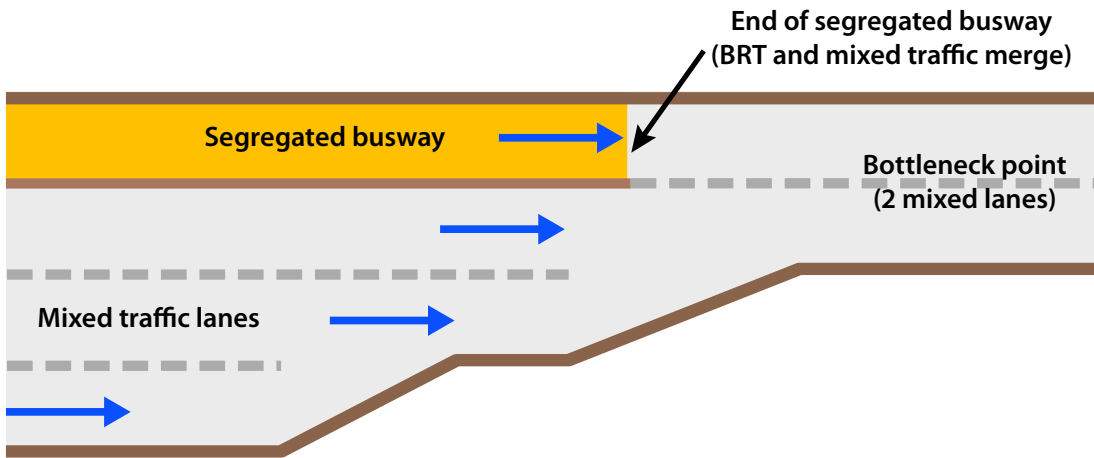


Fig. 9.56
In the case of a severe bottleneck point, it may be best to terminate the exclusivity of the busway prior to reaching the bottleneck.

be used. This signal would generally flash yellow until the point where traffic detectors note that the critical link has itself become congested. At that point, the signal would be activated, and a red signal would be given to mixed traffic until the bottleneck clears (Figure 9.57). The selective use of such a traffic signal will help to avoid congestion inside the busway. Instead the delay is transferred to the mixed

traffic in the previous link, resulting in improved velocity for BRT vehicles at the critical link. For tunnels, this approach has the extra advantage of avoiding idling vehicles within heavily polluted conditions.

The example given in Figure 9.57 essentially acts as a queue-jumping mechanism in which the BRT vehicles are given an advantage through a bottleneck point.

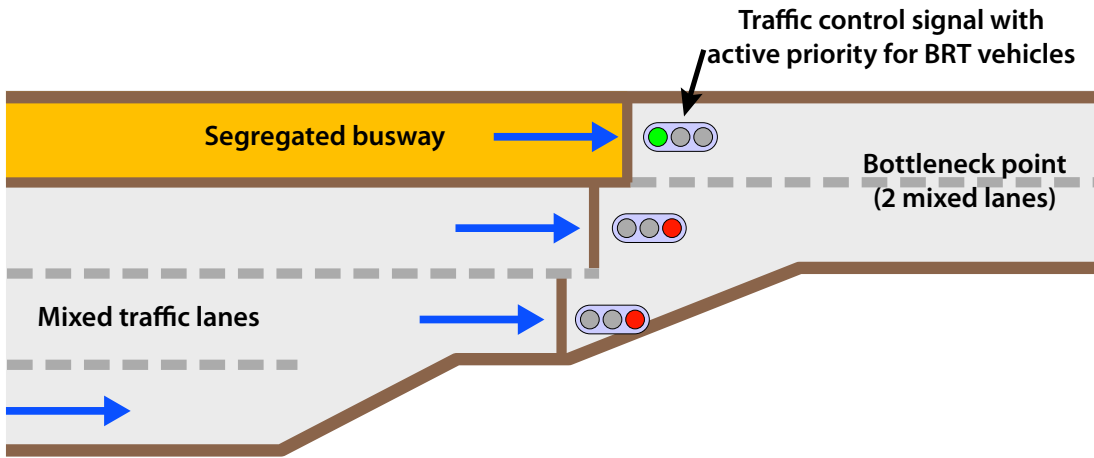


Fig. 9.57
If the bottleneck area itself is congested, then traffic signal control, with active priority for BRT vehicles, may be an appropriate solution.

10. Customer service

“Consumers are statistics. Customers are people.”

—Stanley Marcus, retail entrepreneur, 1905–2002

Unlike many existing bus services in developing cities, BRT places the needs of the customer at the centre of the system’s design and implementation criteria. The quality of customer service is directly related to customer satisfaction, which will ultimately determine customer usage and long-term financial sustainability.

Unfortunately, unclear maps and schedules, unclean and ill-maintained vehicles, and uncomfortable rides have all too frequently been the norm for those who utilise public transport in developing cities. Public transport and para-transit operators sometimes pay scant attention to customer service, assuming instead that their market is comprised of captive customers, who have no other option but to use their services. Such a predilection, though, can lead to a downward spiral, in which poor service pushes more commuters towards two-, three-, and four-wheeled motorised alternatives. In turn, the reduced ridership limits public transport revenues and further diminishes the quality of service, which in turn leads to a further erosion of the passenger base. The impacts of poor customer service may not be immediately evident when the majority of users are “captive” riders who indeed have few other transport options. However, in the medium and long term, as income increases, these captive riders will become discretionary riders. The discretionary

riders are quite likely switch to individual motorised transport as soon as it becomes financially feasible to do so.

Customer service is fundamental at each level of operation. Are drivers courteous, professional and well presented? Are the stations and the vehicles clean, safe and secure? Is the morning commute a pleasant and relaxing experience or is it a hazardous and unfortunate trauma that must be endured? Are there opportunities for people to complain, receive information, and be heard? Individually, factors such as driver behaviour, signage, and seat comfort may appear to be trivial measures, but their combined effect can be a significant determinant in a public transport service’s long-term viability.

While these design and service features can make dramatic improvements in system effectiveness and customer satisfaction, each is relatively low-cost to implement and relatively low-tech in nature. Thus, another lesson from BRT is that simple, ingenious, low-technology solutions are often of much greater value than more complex and costly alternatives. Customers probably do not care about the type of engine propulsion technology, but they do care greatly about the simple customer service features that directly affect journey comfort, convenience and safety. Despite this rather obvious observation, too many public transport developers devote their entire attention to the vehicle and engineering aspects of system design and forget about the customer service aspects.

The contents of this chapter include:

- 10.1 Customer information
- 10.2 System professionalism
- 10.3 Safety and security
- 10.4 Amenity features
- 10.5 Segmentation of services

10.1 Customer information

“Well done is better than well said.”

—Benjamin Franklin, author, politician, and scientist, 1706–1790

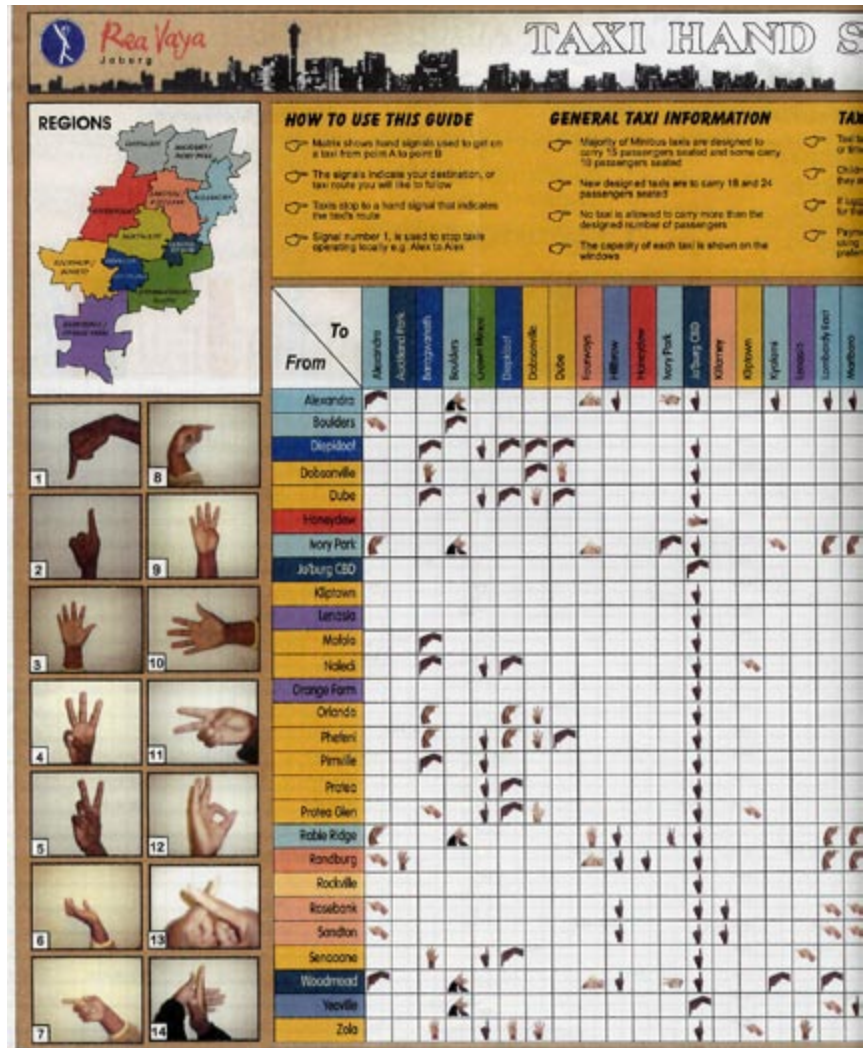
10.1.1 System maps

Historically, the ad hoc nature of para-transit systems in much of the developing world has followed informal and uncontrolled routings that require a seasoned system insider to fully understand and utilise. Many such systems are relatively incomprehensible to the customer. The lack of system clarity is especially a formidable barrier to potential new users (e.g., visitors) and those residents with only occasional transport needs.

In South Africa, customers must become familiar with a range of hand signals that indicate to the driver the destination of the customer. If the customer's hand signal matches the intended route of the driver, then the vehicle may stop and pick-up the customer. Subtle differences in the hand signal can mean a very different destination. Further, the hand signals vary by each city, so a person must learn a new set of hand signals for each different city and/or sector of a city. Clearly, this type of system creates a tremendous barrier to use. In order to help customers, the City of Johannesburg actually created a directory of hand signals (Figure 10.1). However, it would take a very dedicated user to learn all the signals.

In reality, better maps and signage is not a terribly difficult task. With just a bit of effort and imagination, cities can create visual cues that are highly customer friendly. For example, the Metrovía system in Guayaquil emulates the better metro systems of the world by providing clear and colourful system maps (Figures 10.2).

A good test of a system's user-friendliness is to determine whether a visitor who does not speak the local language can understand the system within two minutes of looking at a map and information display. It is possible to achieve this level of simplicity



y in conveying the system's operation, but, unfortunately, most public transport systems today do not even make the attempt to do so. By contrast, systems such as the Beijing BRT system, actually provide system information in multiple languages.

Unlike the well-designed and colour-coded maps accompanying many rail-based systems, maps for conventional bus systems are often quite confusing. While metros tend to use colourful “spider” maps to designate routes, most conventional bus systems use a complex web of mono-coloured lines and numbers (Figures 10.3). However, higher-quality bus

Fig. 10.1
A portion of a Johannesburg directory that instructs how customers can signal their intended destinations to minibus taxi drivers.

Image courtesy of the City of Johannesburg

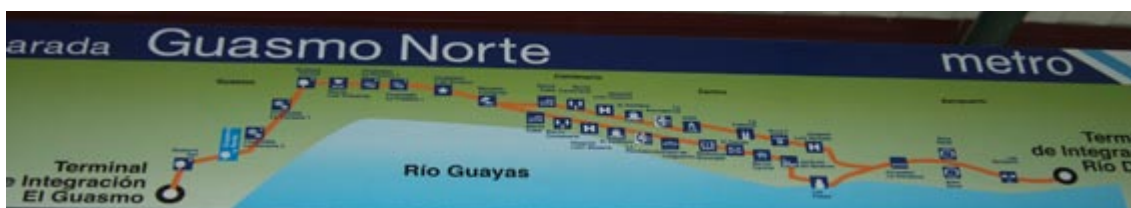


Fig. 10.2
System map for the Metrovía system in Guayaquil.

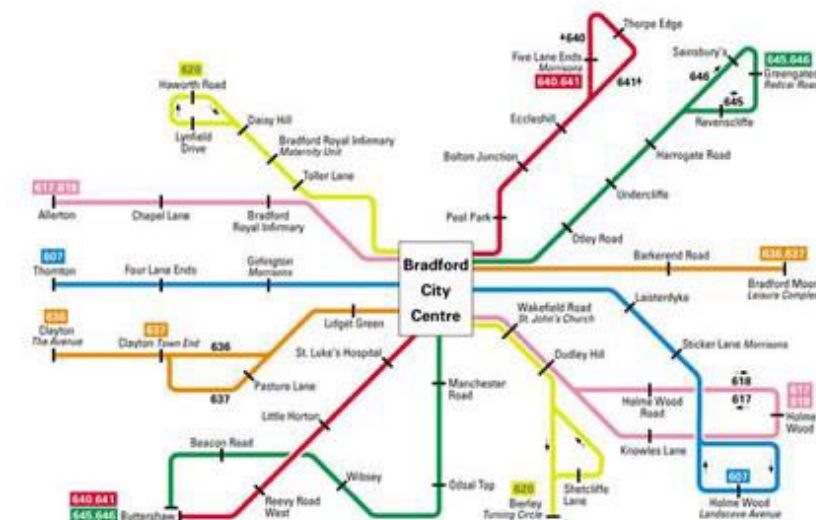
Photo by Lloyd Wright



Fig. 10.3
This conventional map of bus routes in central London is quite difficult to read and understand.
 Image courtesy of Transport for London (TfL)

Fig. 10.4
This "spider map" as used in Bradford (UK) provides a user-friendly view that allows customers to quickly understand how the system functions.

systems are increasingly making use of spider maps to better convey information to customers (Figure 10.4). The idea behind a spider map is to give each route its own colour-coded identity. The entire route is evident along with all major stations. The spider map from Bradford (UK) is part of a marketing strategy to re-brand the bus network as an "Overground" system. The word "Overground" is borrowed from the name of the London metro system which is known as the "Underground". Thus, the spider map in Bradford helps impart the idea that the bus network is a quality mass transit system. The differentiation of routes can be communicated through a variety of mechanisms including colours, numbers, and destination names. Colour-coding schemes are effective in allowing customers to readily differentiate between



multiple routes. Also, colour-coding can be reflected both in the system route maps and on the vehicle itself. For instance, a coloured sign-board on the front of the vehicle can designate the routing direction. The sign-board is easily removable in order to allow maximum flexibility in using the same vehicle on multiple corridors, depending on changes in customer demand patterns. Generally, customers can discern colours faster they can identify route numbers or worded destinations. However, in reality, route numbers, colour-coding, and destination labels can actually be used together to maximise customer recognition. Of course, care must be exercised so that too much visual complexity does not result. The best design is one that clearly communicates routes and destinations without undue complexity.

Quito's "Trolé" line operates a somewhat complex routing system in which five different sub-routes are utilised along a single corridor. Through this system, Quito is able to provide the most frequent services to the central routes with the highest customer demand. The provision of such sub-routes does much to improve the technical efficiency of the system. However, customers are largely on their own in terms of attempting to distinguish the route associated with the approaching vehicle. Since all vehicle routes stop at the same single platform sub-stop, customers must identify the appropriate routes based on a number card on the front of the vehicle. There are no platform announcements and there are no visual displays to indicate which sub-route is associated with the arriving vehicle. Unfortunately, the station infrastructure prohibits a clean view of the number card on the vehicle front (Figure 10.5). Thus, customers have just a blurred view for a split second of the sub-route number. Further, since the audio announcement within the vehicle is often not functioning or the sound is such poor quality that it is unintelligible, customers on-board may have no idea what sub-route they are using. This sort of poor communication ultimately affects system efficiency regarding customer transfers and bunching at transfer stations. In turn, customer satisfaction with the system is jeopardised through such difficulties.

Time-based route maps are a simple and yet highly useful customer service feature. With a



Fig. 10.5
With no announcements or electronic display, customers on the Quito Trolé only have a brief, sight-line impaired view of the route number for the vehicle approaching the station.

Photo by Lloyd Wright

time-based route map, the average amount of time required to travel between points is incorporated into the map (Figure 10.6). Customers can thus quickly gauge their expected journey time.

The completeness of a particular map can also affect system usability. In some systems, such as Curitiba, only the map for one particular corridor is displayed at stations and within the vehicles. This limitation implies that persons only have a good working knowledge of their most frequently utilised corridors. Therefore, people may not be able to use the system as adeptly for occasional trips. Moreover, the lack of an overall map means that customers cannot easily plot the most efficient routing for linked journeys with multiple destinations (e.g., work to shopping to school to doctor, etc.). The absence of a complete system map is also quite disadvantageous for visitors and occasional public transport users. Thus, it is recommended that a complete system map be present at stations and inside vehicles. Of course, there are cost issues associated with providing quality maps, but in comparison to other aspects of system development (vehicles, bus ways, stations, etc.) the cost is relatively small.

Effective placement of maps in vehicles and stations is also a determining factor in the system's user-friendliness. In Bogotá, updated maps are only available inside the station and within vehi-



Fig. 10.6

This time-based route map in Nagoya (Japan) allows customers to gauge the amount of time required to travel to their destination.

Photo by Lloyd Wright

cles. However, some customers would like to visualise the system and route before paying and entering the system. Thus, it would be best to also have a system map outside the station entry point. The idea is to make the system as simple and as inviting as possible to the customer. A major deterrent to public transport usage is the fact that many potential customers simply do not understand how the system works. A route map outside the station may also be an opportunity to visually engage persons who normally do not utilise the system. Thus, a visually-stimulating route map can actually be part of a marketing strategy to inform non-users, such as passing motorists, of the system's potential relevance to their daily travel patterns.

The provision of neighbourhood maps of the local area can be quite useful to customers. In many case, a person may be proceeding to an address near a particular station. A local area map can then direct the person to their destination from the station (Figure 10.7).

As the system grows, the updating of maps can become a costly exercise. Thus, careful consideration of how future map additions will be handled should be done at the outset. This planning exercise may include a cost comparison between printing and distributing new maps with each new corridor or merely adding an overlay to the existing map.



Fig. 10.7
A local area map at this station of the Bangkok MRTA system helps customers find their way to their final destination.

Photo by Lloyd Wright

10.1.2 Signage

In addition to system maps, the various signage in and around stations as well as within the vehicles are key in helping customers readily understand the system. Examples of the types of signage likely to be needed include:

- Instructions for using fare collection machines or vending booths;
- Identification of station entry and exit points (Figure 10.8);
- Standing location within the station for particular routes (if multiple stopping bays);
- Directions for making transfers at terminals and intermediate transfer stations;
- Actions required in the event of emergencies (instructions for call boxes, fire suppressing equipment, etc.) (Figure 10.9);
- Identification of locations within the vehicle for persons with special needs (physically disabled, elderly, parents with child, passengers with bicycles, etc.);
- Directions to amenity facilities (e.g., bicycle parking facilities, restrooms, etc.).



Fig. 10.8 and 10.9
Signage in stations in Quito (left photo) and Ottawa (right photo) provide clear guidance to customers.

Photos by Lloyd Wright



Fig. 10.10

As this example from Bangkok shows, instructions on the platform floor can be useful in facilitating efficient customer movements.

Photo by Lloyd Wright

The fare collection process is another area of potential customer confusion that may hinder the system's usability. While regular users and captive users will make efforts to understand pricing and purchase options, other customer groups can view the fare system as another complication, inhibiting usage. Clear and simple instructions are essential. Ideally, the design should be clear enough that a person who does not speak the local language can readily understand fare amounts and payment methods.

Transfer points and vehicle stopping locations are also potentially confusing for the customer. Confusion can be particularly acute during peak periods when crowds, noise, and distractions are at an intense level. Such signage should be sufficiently sized and eye-catching in order to effectively lead customers to the right location. System designers should walk through the likely steps of a prospective customer in order to place the signage at the correct point. For example, signage directing customers to transfer points may be best placed directly across from the exit points of alighting customers.

Certain vehicle areas are typically designated for customers with special needs, such as those with physical disabilities, the elderly, pregnant women and young children. These areas can be readily identified with the use of appropriate signage as well as colour-coding. The colour-coding may entail using distinctly coloured seating in such areas.

10.1.3 Advertising

Signage and visual displays may not just be present to inform customers on the public transport system. Advertising displays may be part of a strategy to secure needed income for the system.

However, while advertising in many cases performs an important revenue role, there may be instances when it becomes a detriment to the effective transmission of other forms of information. An overabundance of visual displays can hamper effective communication. If too much signage and/or advertising is present, a point of diminishing returns can be crossed. Too much signage can be visually distracting and may prevent customers from absorbing vital information. “Visual clutter” is particularly problematic when systems post extensive advertisements. In some cases, as practised with Japanese metro systems, the advertising actually protrudes into customer space and diminishes overall comfort as well as creating claustrophobic environment (Figure 10.11).

Advertising on the sides of vehicles can be an eye-catching opportunity for firms (Figures 10.12 and 10.13). However, the painting of the vehicles can restrict visibility for those inside the vehicle, which can create customer stress for those trying to identify the station name. Additionally, substituting a recognisable system name and colours with an advertising message can reduce the branding potential associated with a quickly identifiable vehicle.

Some cities have recognised that the space on the outside of the vehicle can represent a valuable property for advertising messages. Both the size of the vehicle sides and the eye-catching nature of a large message moving through a city centre make such advertising a potentially lucra-



Fig. 10.11
Visual clutter from hanging advertisements in Japanese rail systems can hamper the customer’s ability to see other information, such as system maps, as well as reduce inside and outside visibility.

Photo by Lloyd Wright

tive revenue source. However, the decision to replace the system’s brand and logo with a commercial message is not one to be taken lightly. By forfeiting this space to commercial uses, an opportunity to create a highly-recognisable marketing identity for the system can be lost. Even if the system’s logo appears in conjunction with the commercial message, its impact is substantially reduced due to the sharing of this visual space.

Further, the painted image can diminish visibility for passengers inside the vehicle. Generally, the commercial message is painted onto the vehicle in a pixelated manner in which an overall image is formed from many tiny spots of paint. The translucent nature of the paints and the pixelated nature of the image does allow passengers to see outside. However, the quality of the view is reduced. The ability to recognise outside landmarks can be important for passengers seeking to identify the correct stop for getting off the vehicle. Additionally, viewing the outside landscape is one of the factors that affect passenger enjoyment.

Fig. 10.12 and 10.13
Advertising painted onto the outside of the vehicle can be a useful in generating system income. However, the advertising will tend to reduce the system’s own marketing and branding efforts as well as diminish visibility for passengers inside the vehicle.

Left photo (Bangkok Skytrain) by Lloyd Wright
Right photo by Eric Strauss of Orlando LYNX



Fig. 10.14 and 10.15
Public service announcements such as air-quality information posted in the Montreal subway and a foster-care message in the UK do much to serve public awareness.

Left photo by Lloyd Wright
 Right photo courtesy of Adbus



Advertisements should thus be used discretely in order to not become too obtrusive towards other information. Quite often, reducing the quantity of advertisements can actually increase revenues. This result occurs due to the relative scarcity of the supply. As the space allowed for advertising becomes restricted, the bid price for the space becomes more valuable.

10.1.4 Public service messages

In addition to commercial messages, a public transport system may also wish to permit “public service announcements” (PSAs) within the system. While PSAs do not bring in any advertising revenue, their presence does serve an important public service. PSAs provide information on a variety of causes, including:

- Access to public services (health, education, employment, etc.);
- Awareness campaigns on key topics such as HIV/AIDs, child services (Figure 10.14), security and safety, the environment (Figure 10.15), voting, etc.

- Behaviour change in terms of smoking, litter disposal, abuse, etc.

Thus, a public transport system can be seen as a tool to achieve a variety of public outreach objectives and add even further value to the life of its customers. A public transport system may be one of the few places that a person might be exposed to such messages. PSAs demonstrate that a system recognises its role and responsibilities in serving the greater needs of the community. A public transport system should be viewed not only as a transit service moving persons from point A to point B, but also as a trusted member of the community.

10.1.5 Visual and voice information systems

Traditional signage is just one way of conveying information to customers. Visual displays with real-time information are increasingly being used to relay a variety of messages. Such devices can display the following types of information:

- Next station stop (display inside bus);



Fig. 10.16
An information display in the interior of a TransMilenio vehicle in Bogotá.

Photo by Dario Hidalgo



Fig. 10.17
Real-time information display along a platform of the Brisbane busway system.

Photo courtesy of Queensland Transport

- Estimated arrival time of next vehicle (display on station platform);
- Special advisories, such as delays, construction work, new corridors, etc.
- Customer service announcements such as information on fare discounts.

Real-time information displays that inform passengers when the next bus is due can be particularly effective at reducing “waiting anxiety”, which often affects passengers who are not sure when, or if, a public transport vehicle is coming (Figures 10.16 and 10.17). This feature allows customers to undertake other value adding activities to make best use of the time, rather than waiting nervously and paying close attention to the horizon. Such displays can reduce the customer’s perceived waiting time substantially.

Voice communications can also be a useful mechanism to transmit essential information. For instance, announcing the next station allows customers to focus on other activities (such as reading, talking with friends, etc.). Otherwise, customers usually tend to look up at displays or station names frequently. Forcing the customer to be familiar with the local environment can add stress to the journey, especially for visitors and occasional public transport users. Further, during crowded peak-hour conditions, obtaining a clear view of outside signage can be difficult.

Voice messages can be transmitted by way of the vehicle driver or by using recordings. Typically, recordings are recommended as they can be clearer and more consistent. Also, recorded messages can employ digital technology rather than analogue technology. Digital voice messages are more readily understood than local analogue messages. Furthermore, each driver will have his or her own accent and it may not be understood by all. Employing pre-recorded digital messages with automatic activation at certain points in the journey will assure a uniform and reliable information source. Additionally, digital messages will allow the driver to better concentrate on safety and other aspects of customer service. In some circumstances, it may be practical to deliver brief destination messages in more than one language.

Even with a digital recording that provides vehicle location, there will be instances when a message from the driver will be appropriate. If

there is an incident or system delay, the driver can relay that information to the passengers. It is always best to keep customers fully informed of any situation to the extent possible. Understanding the reason for a delay (*e.g.*, traffic accident, weather conditions, etc.) will tend to calm passenger anxiety. Driver messages are also obviously quite important during any emergency situation.

10.1.6 Customer interaction

Effective customer relations should not be a one-way flow of information. The best source of system evaluation and feedback is likely to emanate from actual users. In many cases, customers will identify problems and potential solutions long before system managers and designers. Unfortunately, this knowledge resource is often ignored.

Encouraging customer input is not an easy process. The dispersed and decentralised nature of customers can make a meaningful dialogue difficult. While virtually every customer will have a defined opinion on the public transport service, few will make the effort to provide feedback, especially if the system managers do not provide an easy opportunity to do so.

Some of the most common mechanisms to obtain customer inputs include:

- Call centre;
- Email contacts and web site information;
- Direct mail;
- Physical suggestion box;
- Customer service desk;
- User surveys;
- Ombudsperson and/or user representation in the board of directors.

Effective customer interaction should involve both “passive” and “active” mechanisms. Sole reliance upon passive measures, such as a call centre and an email address, means that only customers with a strongly-felt issue will provide inputs. Such self-selecting inputs may not be wholly representative of overall customer opinion. By contrast, a user survey, while more costly, is perhaps the most thorough mechanism to gather customer opinions and suggestions.

10.1.6.1 Call centres

Providing a telephone service for customer enquiries is one of the most basic features of

customer interactions. Call centres will likely handle a range of requests, including basic system information, complaints, and recommendations. These different types of requests can be handled through a single number or through individual numbers for different request types. However, as the number of telephone numbers increase, there can be increased confusion amongst users. A single telephone number for multiple customer enquiries can be easier to gain marketing awareness of the telephone number. However, a single enquiry line necessitates that all call centre operators are sufficiently knowledgeable to handle a wide range of requests. The number of available operators must be carefully selected to avoid customer waits. Ideally, an operator will pick-up immediately or within a few minutes of the customer's call.

Call centres can either be operated directly by the public transport operators, or the centres can be contracted to a specialised firm. In the case of a contracted firm, quality control oversight will likely be required to ensure that a useful service is being delivered. All the information collected by the call centre should be documented and analysed by the public transport agency. A

regular report on customer enquiries can be a useful evaluation tool to be shared with staff, board members, and the public.

The rapidly increasing use of mobile telephones also offers another avenue of customer inputs through SMS (Short Message Service) texting. A number should thus also be provided to permit comments and suggestions through texting.

10.1.6.2 Email contacts and web site information

Provisions for web-based inputs should also be made available. A "contact-us" icon along with basic contact details (telephone and email contact information) should be prominently noted on the home page of the system's web site.

Information on the web site can help to provide customers with basic questions about system operating hours, route structure, tariffs and payment methods, and system facts and figures. Thus, the contents of the web site can do much to answer enquiries without the need of a customer directly contacting the public transport agency. Common enquiries handled in this manner can save staff resources.

Fig. 10.18
The feedback form provided on the TransMilenio web site.

The screenshot shows the 'SISTEMA DISTRITAL DE QUEJAS Y SOLUCIONES' web interface. At the top left is the logo of the 'ALCALDIA MAYOR DE BOGOTA D.C. Secretaría General'. The main header features a group of people in a meeting. Below the header is a navigation bar with 'Ingreso al Sistema', 'Entidad del Distrito', 'Contáctenos', and 'Ayuda'. The main content area is titled 'Registro Requerimiento' and includes a sidebar with options like 'Ingresar', 'Usuario Nuevo', 'Regístrese aquí', 'Recordar Contraseña', and 'Consulta de Anónimos'. The main form is for 'Información del Ciudadano: ANONIMO' and contains fields for '*Asunto:', 'Observación:', and 'Documentos: Adicionar Documento.'. There are 'Registrar' and 'Cancelar' buttons at the bottom, and a note '* Campos Requeridos'.

The web site can also be used to encourage and structure feedback. An on-line form to handle complaints, suggestions, and comments can ease the feedback process. However, the nature of the form should not be too restrictive in terms of acquiring a broad range of customer inputs. Figure 10.18 provides an example of the feedback form utilised by TransMilenio in Bogotá.

Even with such automated data collection, agency response should be as personalised as possible. Each input should be carefully read and responded to in a timely fashion. System administrators may even wish to give gifts or special recognition to customers who provide highly useful suggestions for improving the system. A public transport pass (for a day or a week) or system merchandise can be effective incentives for rewarding useful inputs.

As with telephone inputs, it is advisable to organize all data received in order to provide a historical series of comments and concerns. In this way, managers can follow up on trends, and identify the main concerns over time. It is likely that the number of communications received will be small compared to the large number of passengers, but the fact that someone takes time to make a phone call, write an e-message, or fill out a complaint means that the message is of interest to system developers and managers.

10.1.6.3 Customer service desks

Web services, emails, telephone, and texting are fine options for some customers. However, in many developing-nation cities, not all customers will have access to such options. Thus, more direct and conventional options should also exist to encourage customer interactions.

The provision of a customer service desk or booth is quite important in terms of giving all customers access to a system representative (Figures 10.19). Further, such centres can help put a more human face onto customer interactions. Many customers simply prefer speaking face-to-face with a real person in order to answers to their most pressing questions.

Customer service centres are frequently located at terminal sites, especially given the relative availability of space over smaller stations. Terminals and large station locations also frequently provide a maximum throughput of customers



in order to ensure that the customer desk is adequately utilised. However, off system sites are also a possibility. Customer service centres in commercial centres, public buildings, and public plazas can also be quite appropriate.

Like call centres, staff working at the customer centres must be fully trained to handle a wide variety of requests and inputs. Staff should make note of all enquiries given, so that these comments and trends are properly categorised and passed along for managerial analysis. Service centres may also provide suggestion boxes and forms for customers who wish to provide written comments.

10.1.6.4 Survey forms

As noted, customer interactions should not just be passive in nature. Instead, system operators should actively seek out customer opinions and inputs on a regular basis. Customer surveys provide a structured mechanism to regularly evaluate customer satisfaction and customer concerns.

The structure of the survey should be professionally designed. Great care must be taken to ensure that biases are not introduced into the survey questions. Thought should be given to the long-term applicability of questions so that the same survey structure can record a time-series comparison of customer inputs. The length of a survey must be carefully determined. Customers within the system are likely to be

Fig. 10.19
A customer information service centre for the Ottawa BRT system. This office is located within a major commercial centre near a downtown station.

Photo by Lloyd Wright

unwilling to give anything more than a few minutes to a questionnaire.

Surveys for public transport are typically administered to customers within the system. Surveys can be applied to either customers waiting at the platform or within the moving vehicle. In many cases, in-vehicle interviews will give the surveyor more time to obtain answers. Telephone surveys are also possible but can be less focussed in terms of targeting actual customers. However, telephone surveys can be a highly useful means to understand the impressions of persons who do not regularly use the system. Understanding the concerns of those utilising other modes can be quite useful in terms of gaining future passengers.

Surveys are quite useful in providing a balanced picture of what is important for system users, with standardised measurements of different service features. User surveys can be part of the feedback mechanisms used to award bonuses to system operators, as service quality is the ultimate goal.

10.1.6.5 Public representation

In addition to all the mechanisms used to solicit information from the users, formally electing users' representatives to the system oversight agency can be quite useful. Such representation may be in the form of a public ombudsperson or members of the system's board of directors. By permitting such official representation, the system is providing more transparency and openness to its decision-making processes.

Further, as noted earlier, in many cases public inputs are more insightful than those of the so-called experts. By allowing citizens to feel more ownership over their public transport system, there is both greater acceptance of the system and greater patronage.

Choosing the appropriate representative can be potentially awkward. In many instances, the position may not warrant the cost and effort of fully democratic elections within the metropolitan area. However, for some cities, the position of ombudsperson can in fact be democratically elected. Alternatively, leading civic and non-governmental organisations can be approached in order to garner suggested names. Likewise, organisations such as the Chamber of Commerce and chapters of engineering, architectural, planning or other professional associations may also be appropriate for consultation and inclusion.

10.2 System professionalism

“A professional is someone who can do his best work when he doesn't feel like it.”

—Alistair Cooke, journalist and commentator, 1908–

10.2.1 Public transport staff

In public transport, as in life, sometimes a simple smile or kind word can make all the difference. The role of public transport staff in making customers feel respected and welcome is one of the most powerful promotional tools available (Figure 10.20). While staff behaviour is probably one of the lowest cost ways of practicing good customer service, it is also sometimes one of the most neglected.

Public transport staff training in social interaction skills should be undertaken on a regular basis. Establishing a positive environment between staff and customers is not only healthy when attracting ridership but it can also improve employee morale. For fare collection agents, conductors, and drivers who handle thousands of passengers per day, each customer may become just another face in the crowd. However, a customer's brief interaction with staff can significantly affect their opinion of the service. Thus, it is important that public transport staff view each interaction with care. A customer service training programme should emphasise these points (Figure 10.21).

Fig. 10.20
Staff of Bogotá's TransMilenio applaud international visitors viewing the system.

Photo by Lloyd Wright



Additionally, performance evaluations of public transport staff should reflect the importance of excellence in customer interactions. Staff members who excel in customer relations can be rewarded through salary incentives.

In many instances, the staff will not be public employees. The growing trend towards the use of private sector concessions means that these employees will be responding to the demands of their private employers. However, this situation does not imply that the public agency cannot influence positive interactions between transport staff and customers. Financial incentives in concession contracts can encourage appropriate behaviour. Staff training on customer interaction can be imposed as a mandatory requirement for the concessioned firm. Maximising profits can be a strong incentive for private firms to encourage a positive customer environment and a growing customer base.

Key customer interactions may occur at several points throughout the public transport experience:

- Fare collection and fare verification process;
- Customer information;
- Interactions with on-board staff;
- Security personnel.

Fare collection is typically the first point of interaction between customers and staff. A combination of professionalism and friendliness can bolster a person’s first impression of the system. A welcoming “hello” and a smile can

Fig. 10.22

Each person entering the Osaka monorail is greeted with a polite bow from a company employee.

Photo by Hiroto Inoi



Fig. 10.21

Employee training in Bogotá.

Photo by Lloyd Wright

be an effective personal touch that does little to slow down the overall process. As one enters and leaves the Osaka Monorail system, a staff person bows in thanks for using their system (Figure 10.22). Likewise, in the Keihan railway system in Osaka, customers are created by friendly and helpful staff at the system entrance (Figure 10.23). Obviously, such practice is in part due to the cultural context, but similar acts of appreciation are likely to be possible in a variety of situations.

Responses to basic customer needs such as fare options, questions on routing, and the availability of change should be well prepared and rehearsed. Fare collection services should be well staffed in order to avoid long queues, which may actually discourage persons from approaching a station.

Having available staff, dedicated exclusively to customer information, is a worthwhile investment. The presence of such staff in and

Fig. 10.23

Customers entering the Keihan railways system in Osaka are greeted by helpful staff.

Photo courtesy of Keihan Railways



Fig. 10.24
“Concierge” staff in the Osaka Keihan system make customers feel important.

Photo courtesy of Keihan Railways



around the station can act as a significant public relations boost for a system (Figures 10.24 and 10.25). Staff members can approach customers who look confused or appear unsure of how the system works.

In Bogotá, the “Mission Bogotá” programme is an example of a customer assistance programme that also works as a highly successful social upliftment initiative. Many of the participants in Mission Bogotá were individuals who were previously disenfranchised from society. Those who were formerly homeless, suffering from substance abuse, or otherwise working on the streets are given an opportunity to contribute to society through social service. Through training and confidence building, the participants are dispatched to the streets with their blue and orange uniforms, responding to public needs with a smile and in a professional manner (Figures 10.26). The programme provides the participants with a salary and many new skills.

Fig. 10.26
Mission Bogotá staff provide customer information assistance at TransMilenio stations.

Photo by Lloyd Wright



Fig. 10.25
A TransMilenio staff person provides assistance to customers.

Photo courtesy of Libros al Viento

As part of their duties, the Mission Bogotá team provides customer service duties at TransMilenio stations.

Security personnel can also serve public relations functions in addition to keeping public order. However, in some instances, public transport security staff report to the local police department or other entity. Thus, it is imperative that the public transport organisation works with these other departments to ensure that the security staff is appropriately trained. Training should include knowledge on the functioning of the system and inter-personal skills for interacting with the public. A customer is not likely to make a distinction between public transport staff and security staff and thus will form an opinion on the system based on their interactions with all system personnel.

Having smartly-styled uniforms for all personnel also helps in raising the public's perception of system quality and professionalism. Uniforms that are comfortable and project a stylish image can help change how the customers view public transportation.

10.2.2 Cleanliness

System cleanliness and hygiene is another seemingly trivial issue that has a major impact on customer perception and satisfaction. A public transport system strewn with litter and covered in graffiti tells the customer that the service is of poor quality. Such a scenario reinforces the general notion that public transport customers are somehow inferior to private vehicle owners. Conversely, an attractive and clean environment

sends the message that the system is of the highest quality (Figure 10.27). Such a level of aesthetic excellence can help convince members of all income groups that the public transport system is an acceptable means of travel. Ideally, the public transport system will come to be viewed as an oasis of calm and tranquillity in an otherwise chaotic world. Reaching this state of aesthetic quality merely requires good planning and design.

A combination of vigilance and maintenance is an effective strategy to avoid littering and graffiti. Strict policies with financial penalties for disobedience should be prominently employed. Additionally, any incidence of litter or graffiti should be cleaned up as soon as it is identified (Figure 10.28). This sort of immediate response helps to overcome the so-called “broken window” theory of policing. The broken window theory says that if one window in a building is broken and goes unfixed, then in a short time all the windows will be broken. However, if the window is promptly repaired, then further incidences are greatly reduced. The idea is that small-scale problems can grow into large-scale lawlessness when the problems are left to fester. Litter left untouched sends a psychological message to customers that it is acceptable to leave rubbish about.



Fig. 10.27
The cleanliness of this terminal in São Paulo sends a positive message to customers.
Photo by Dario Hidalgo

Strict cleaning schedules are a low-cost way of maintaining a positive public transport environment and customer confidence in the system. On Quito’s “Ecovía” line, vehicles are cleaned after every pass along a corridor. Once a vehicle reaches the final terminal, a cleaning team goes through the vehicle leaving it spotless in about four minutes (Figure 10.29). This practice reduces the time night-time cleaning teams need to spend on vehicles. Maintaining spotless operations also sends a message to the general public that littering is not tolerated, which tends to reduce the generation of trash. Likewise, a systematic cleaning schedule for stations and



Fig. 10.28
After just a few weeks of operation, every station along the Parajitos busway in Santiago is covered in graffiti.
Photo by Lloyd Wright



Fig. 10.29
BRT vehicles in Quito are cleaned after each pass along the corridor.
Photo by Lloyd Wright

terminals can also serve to keep a system in near pristine form. While one option is cleaning only after system closing times, in highly frequented systems, it is quite likely that cleaning will also be needed during the day. Thus, scheduling cleaning activities in stations just after peak periods can be a way of addressing litter accumulation without interfering in the free flow of customers.

Providing trash receptacles is another helpful option when combating litter, but in some instances security concerns limit their availability or feasibility. Since public transport has unfortunately become a target of acts of terrorism, hidden compartments, such as trash bins, are often too dangerous in places with large numbers of people. Alternatively, the provision of trash bins just outside of the stations is generally a safe and viable option. If the bins are placed in a consistent and well-demarcated space outside of the station, then customers will be able to have an option for disposing of trash.

Public transport facilities also offer the opportunity to effectively market and implement broad recycling programmes. Since public transport systems are likely to be one of the most frequented places in the city, synergies with other public campaigns, such as recycling, are a natural fit. The provision of multiple bins that allow for the separate disposal of glass, paper, metals, plastics, organic materials, and other items can be readily accomplished in conjunction with the public transport system. For example, Singapore's metro system maintains this sort of recycling programme near system entrances (Figure 10.30).

10.2.3 Food and drink

The consumption of food and refreshments within a public transport system would appear to be a relatively innocuous issue. However, the decision on whether to permit such consumption within the system is a source of debate amongst public transport professionals. On the one hand, permitting food and beverages would seem to be a simple act of customer service that essentially allows another value-added activity during travel. The convenience of a snack between destinations can help a customer's time efficiency and make for a happier patron.



Fig. 10.30

Public transport systems offer a great opportunity to coordinate with other public programmes such as recycling initiatives. Photo shows recycling bins outside a Singapore metro station.

Photo by Lloyd Wright

Despite these advantages, there is a substantial negative to food and beverages within the system. The price for allowing food and drinks on board can often be a deterioration in system cleanliness and in the long-term quality of the infrastructure. Stains resulting from spills can become a permanent addition to vehicle and station surfaces. Further, BRT may particularly be susceptible to spills due to the ride conditions being more uneven than rail systems. Beyond the damage to vehicles and station infrastructure, food items can also make conditions unpleasant for other customers due to odours. For these reasons, many systems have banned open food and beverage items. The Washington Metro has maintained its high-quality vehicle interiors since the system's 1976 opening. Washington's success in this area is in large part due to its zero-tolerance policy regarding food and drink. Security personnel once famously arrested a person for peeling a banana on board.

The decision to permit food and/or drink can also be somewhat dependent on the cultural context. In parts of South Asia, there may be a significant custom of permitting food and drink in public transport. In such circumstances, a public transport operator may not be able to realistically deny permitting such items. Such systems, though, must make particular effort

in terms of highly-frequent system cleaning. Spilled items that remain unattended do much to harm a system’s image.

This section has discussed many activities that a public transport system may want to prohibit such as eating, drinking, making a mobile telephone call, etc. (Figure 10.31). Clearly, there may be good reasons to impose such restrictions. However, system developers must maintain a balance between preserving the quality of the system and giving maximum freedom to the customer. If the staff-customer interface is principally a list of things not to be done, then the system may appear in somewhat heavy-handed terms to the public. Thus, it is quite important to focus on the most important restrictions (such as eating and drinking) and to do so in a clear and friendly manner.

10.3 Safety and security

“I don’t worry about crime in the streets; it’s the sidewalks that I stay off of.”

—Johnson Letellier, comedian

10.3.1 Safety

Of the 1.2 million annual deaths that arise from vehicle accidents in the world, the vast majority involve privately owned vehicles. Nevertheless, a single accident involving a public transport vehicle will make considerable news in comparison to the daily occurrence of car-related accidents. An accident involving public transport evokes emotions about governmental responsibility and public safety. The negative stigma that comes from an accident can greatly diminish the public’s trust and positive perception of the public transport system. Thus, maintaining high safety standards is fundamental.

Regular vehicle inspections, strict maintenance procedures, and required driver training are all basic elements of a safety programme. Driver behaviour can also be positively reinforced through financial incentives or reprimanded via speeding and other driving violations. Making clear evacuation instructions and fire protection equipment available sends a visible reminder to customers of safety preparedness and professionalism.

10.3.2 Security

Like any public place with large quantities of persons, buses can attract the wrong elements.



Fig. 10.31

Signage in a station of the Quito “Trolé” line indicating the prohibition of certain activities, such as eating and drinking.

Photo by Lloyd Wright

The close confines of crowded conditions provide the ideal environment for pick-pocketing and other assaults on person and property. Fear of crime and assault is a highly motivating factor in the movement towards more private modes of transport, especially for women, the elderly, and other vulnerable groups.

However, crime and insecurity can be overcome with the strategic use of policing and information technology. The presence of uniformed security personnel at stations and on buses can dramatically limit criminal activity and instil customer confidence. Further, security cameras and emergency call boxes (Figures 10.32 and 10.33) can both allow for more rapid responses to potential threats and can also deter crimes from happening in the first place.

An even more worrying issue is the rise of large-scale attacks on buses, such as the hijacking and murder that took place in front of television cameras in Rio de Janeiro, Brazil in 2000. This event has been made into a film called *Bus 174*. Crime and terrorism in cities such as Rio de Janeiro and Tel Aviv has had a chilling effect on system ridership. Israel has lost approximately one-third of its public transport ridership in just a two-year period (Garb, 2003). While not every



Fig. 10.32

The emergency call boxes in Ottawa BRT stations help to reassure passengers about security arrangements.

Photo by Lloyd Wright



Fig. 10.33
Security cameras, as shown here in Osaka, can do much to prevent crime as well as facilitate a rapid response in case an incident does occur.

Photo by Lloyd Wright

act of violence can be easily deterred, there are design features that can be helpful. Furthermore, a highly visible presence of security staff and the watchfulness of passengers can reduce the probability of attacks (Figures 10.34 and 10.35).

In addition to the presence of security personnel and cameras, good-quality lighting can do much to prevent and discourage criminal activity (Figures 10.36). If hidden areas in around stations are obscured by darkness, then customers may be vulnerable to attack and/or robbery. Well-lit stations are particularly vital in attracting certain user groups to the system. Women may avoid using the system at night if the area gives the impression of insecurity. Attractive lighting can also be another element in creating a public transport system that helps to enhance public space.

Security also affects the type of items customers may bring on board the vehicle. Systems may elect to ban certain types of bags and luggage



Fig. 10.34 and 10.35

The presence of security staff in cities such as Bogotá (left photo) and Quito (right photo) sends an important message to customers about the security of the public transport environment.

Photos by Lloyd Wright

Fig. 10.36
High-quality lighting in Pereira (Colombia) creates a secure environment as well as acts to enhance public space.

Photo courtesy of the Municipality of Pereira



due to security concerns over their contents. The Delhi Metro bans large carry-on items for both security and space reasons (Figure 10.37).

However, clearly this type of ban will limit the system’s usefulness to customers who have an occasion to transport large carry-on items. In many cultures, the ability to board with personal and commercial goods is fundamental to making public transport relevant to low-income users (Figure 10.38). In cases where local practices necessitate the ability board with goods but security threats are present, pre-board security inspections are an alternative. The Manila LRT and MRT systems allow employ security staff to inspect every purse and bag being brought into the system (Figure 10.39). While this type of 100 percent inspection does improve certain security threats, it can be costly to the system operators and time-consuming to customers. Random inspections are another option in which purses and bags are screened but only for a random number of customers.

10.4 Amenity features

“A market is never saturated with a good product, but it is very quickly saturated with a bad one.”

—Henry Ford, founder of Ford Motor Company, 1863–1947

Transport is not just about transport. The time available during travel can be used effectively by the customer. A major advantage of public

Fig. 10.38

The ability to bring large goods onto the vehicle can be important for low-income users who must access employment with public transport, as shown in this image from Quito.

Photo by Lloyd Wright



Fig. 10.37

The Delhi Metro bans large carry-on items, which improves system security but can be inconvenient for some customers.

Photo by Lloyd Wright

transport over private vehicles is that the time in-transit can be used for other value-added activities such as reading, talking with friends, and relaxing. Amenity features can help to make the most efficient use of this value-added time.

10.4.1 Comfort and convenience

Comfort and convenience issues can greatly affect ridership levels, especially amongst discretionary riders. Comfort is affected by the quality of the waiting space at stations, the interior of the public transport vehicles, and the overall environment of the system. Convenience refers to the proximity of stations to useful destinations as well as to how easily customers can reach stations from points of origin. Convenience is closely related to the transport concept of “accessibility”.



Fig. 10.39

The 100 percent screening of passenger belongings prior to entering the Manila MRT system reduces security threats, but can create significant passenger delays.

Photo by Lloyd Wright

Comfort, in the general public transport environment, can depend on the amount of personal space available for each customer. If peak hour services result in closely packed stations and vehicles, then the customer is subjected to discomfort and reduced security. Thus, the appropriate sizing of stations and vehicles and the provision of sufficiently frequent services are part of achieving a comfortable system.

Inside the vehicle, the amount of seating available and the type of seating plays a role in comfort. The trade-off between seated space and standing space depends on system capacity requirements. However, even if standing space is predominant due to capacity demands, the quality of the standing space can also be enhanced. Adequate holding straps and sufficiently wide corridors in the vehicle interior can improve standing conditions. Padded seating materials, such as cloth, can add cost to vehicle purchases, but should at least be considered, especially if travel distances are relatively long.

The provision of station seating partly depends on the nature of the service. In high capacity, high frequency services, it is unlikely that seating will be required at stations and terminals, since wait times are relatively short. The developers of the Bogotá system elected to forgo station seating in order to encourage passenger turnover. Seating can also consume valuable space in stations. In some instances, the presence of seating can obstruct boarding and alighting movements, and thus reduce throughputs in stations. However, in cases when wait times are relatively long, some form of seating or support device can be warranted to avoid “standing fatigue”. One space saving solution is a leaning bar that permits waiting passengers to partially sit while leaning against a slanted bar. The bar can be padded to increase comfort. While a leaning bar is not as comfortable as a formal seat, it can be an effective alternative. The leaning bars can also avoid problems with individuals who choose to sleep on rows of seats.

Waiting time can also be a factor in designing fare collection and fare verification areas. The best solution is to provide adequate capacity in the fare collection system in order to avoid significant queuing. However, in some instances, such as fans departing from a sporting

event, entry queues are unavoidable. Queue guideways may be useful mechanisms to ensure orderliness, fairness, and clarity for waiting passengers. Video displays showing information or entertainment can be another option to reduce waiting stress for queuing passengers.

In many developing cities, the local climatic conditions can warrant climate control devices in the stations and vehicles. Air conditioning can make a significant difference for travel in tropical conditions. Likewise, heating can be important for colder climates. In order to compete for discretionary commuters who may have climate control devices in their private vehicles, such devices in public transport systems can be quite influential. However, there are both capital and operational cost considerations. For instance, air conditioning adds marginally to station and vehicle construction costs and can reduce fuel efficiency by 15 to 25 percent in operation. Further, adapting stations to climate control devices inherently implies design restrictions. Stations must be closed and relatively sealed, and thus will likely require a sliding door interface at bus boarding zones. Again, this feature creates additional costs and also requires additional maintenance and complexity issues within the system. There are also less costly climate interventions, such as passive solar design and spray misting that can be helpful. Chapter 11 (*Infrastructure*) provides more discussion of such design options.

10.4.2 Hours of operation

The system’s opening and closing time affects both customer utility and cost effectiveness. Ridership levels during early morning and late evening operations may be somewhat limited. However, the lack of service during non-peak hours undercuts the system’s overall usability, which will negatively affect ridership during other times. The need for comprehensive utility does not imply systems must operate for 24 hours. In fact, many public transport systems with 24 hour service experience significant security problems (*e.g.*, robberies, assaults, graffiti, etc.) during late night and early morning hours.

The appropriate hours of operation are likely to be based around the schedules of the major employment, educational, and leisure activities

of the local citizenry. Thus, operating hours will depend on key local indicators, including:

- Working hours of major employers;
- Start and closing hours of educational institutions (including night classes);
- Closing times for restaurants, bars, cinemas, and theatres.

The appropriate operating hours will depend upon local cultural and social practices. In Bogotá, the TransMilenio system operates from 05:30 until 23:00, reflecting the relatively early start to the work day that is customary there.

The hours of operation may also be determined by labour laws and expected contractual arrangements with public transport staff. If local labour laws are flexible towards part-time employment, then the public transport operators may have greater flexibility in matching the demand and supply of services.

Scheduling late evening and early morning services may also necessitate arranging for different levels of non-peak service. For example, the frequency of non-peak services in the early evening (e.g., 19:00 to 21:00) may be greater than the frequency of non-peak services at later times (e.g., 21:00 to 24:00). The frequency of service may also increase briefly during late periods, such as the period immediately following

the closing of restaurants and bars. The principal aim is to maximise customer utility while simultaneously ensuring the cost-effectiveness of the system.

10.4.3 System aesthetics

Beauty is something rarely associated with public transport. And yet, public transport is in many respects a significant part of public space. Utilising this space in an aesthetically-pleasing manner can do much to improve a city's image and the well-being of its citizens.

The design and appearance of infrastructure components can do much to create a pleasing environment. Design factors such as the use of light, materials, art, and interior design can all project an ambiance of calm, clarity, and comfort (Figures 10.40 and 10.41).

Art exhibits within systems can do much to change how the public views the system (Figures 10.42, 10.43, and 10.44). Such efforts can help to attract different types of customers who may not ordinarily consider public transport as a desirable option. Artwork can also help to create a calming and stimulating environment for customers. Exhibitions also provide numerous opportunities for interaction between the public transport system and local schools.



Fig. 10.40
The use of light at the Villa Flor station in Quito creates a beautiful atmosphere for public transport users.

Photo courtesy of El Comercio

Fig. 10.41

Public transport infrastructure can be designed to enhance and not detract from the quality of public space.

Photo by Lloyd Wright



Fig. 10.42, 10.43, and 10.44

Artwork within the public transport system can be an inspiring choice for improving the customer's travel experience.

Clockwise from top left:

1. Art gallery within the Osaka monorail system

Photo by Lloyd Wright

2. Wall art in the Tokyo subway

Photo by Lloyd Wright and

3. Sculptures in the Lisbon subway

Photo courtesy of UITP



10.4.4 On-board news and entertainment

It has been noted that entertainment systems such as video can be effective in stemming passenger impatience and anxiety during waiting periods. Video presentations at station areas may include news, weather, music videos, and customer information announcements. Audio systems are also an option. Music can be played within stations and buses.

In 2005, the Atlanta rail systems, MARTA, added video screens to all of its rail cars. The service provides news and entertainment to customers. In return, the MARTA system is receiving US\$ 20 million over a ten-year period from the associated advertising revenues (McLaughlin, 2005).

Likewise, the Üstra system in Hanover (Germany) has equipped its vehicles with monitors. In this case, two screens are provided in each vehicle. One screen is devoted to providing customer service information, such as information about the next stop, possible transfer options, journey times, and updates related to any travel incidents (Figure 10.45). The other screen provides entertainment and news programming (UITP, 2005). Likewise, the Orlando Lymmo system has teamed up with a firm called Transit TV to provide on-board news and information (Figure 10.46).

While some customers will find video and audio entertaining and useful, this reaction is not always shared by all. For some, visual and aural displays contribute to an increased level of distraction and chaos in the public transport experience. One person’s symphony is another’s needless noise. In Quito, music on BRT vehicles was suspended after students complained that it was difficult to study with the noise. Customer groups in Hong Kong formed in protest to the playing of music



Fig. 10.45
Information displays on the Hanover Üstra system provide system information, news, and entertainment.

Photo courtesy of UITP

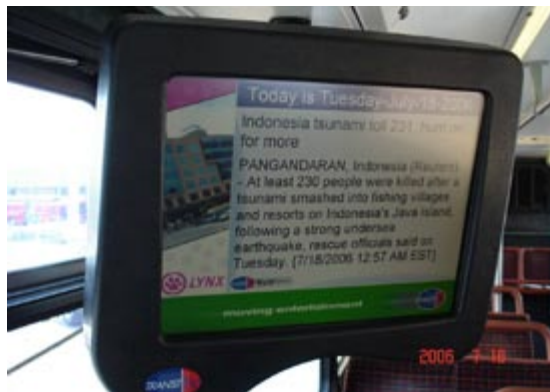


Fig. 10.46
“Transit TV” keeps Orlando system users up-to-date with the latest news.

Photo courtesy of Doug Jamison, Orland LYNX

in vehicles (Figure 10.47). Thus, care must be exercised when using certain entertainment features such as video and audio. The decision can be quite dependent on local customs and preferences. Moreover, like all such devices, video and audio systems involve costs, both in terms of the initial investment as well as in the long-term maintenance.

10.4.5 Wired stations and vehicles

The advent of communications technologies such as the internet, email, and mobile telephones have revolutionised how people do business and how people interact with others at a distance.

Public transport can offer services that take advantage of these communication technologies. Some public transport systems are already beginning to offer free wireless internet services to their customers. The wireless feature can be supplied into vehicles and stations via transmitter technologies. The Osaka Monorail provides free wireless access within some of its stations (Figure 10.48).



Fig. 10.47
Campaign material from the “Hush the Bus” programme in Hong Kong. Ensuring a quiet environment inside the bus helps customers who want a pleasant public transport experience.

Image courtesy of Hush the Bus programme, Hong Kong



Fig. 10.48 and 10.49
The Osaka monorail provides both free wireless internet connections as well as for-pay PC workstations.

Photos by Lloyd Wright



For patrons without their own notebook computer, personal digital assistant (PDA), or other handheld device, the Osaka system also provides PC workstations with for-pay internet access (Figure 10.49).

While internet and email access may seem a needless extravagance in a developing-city public transport system, cities wishing to attract current private vehicle users may find the technology of great value. Further, as information technologies continue to fall in cost, the concept is not entirely out-of-reach for developing cities.

Making effective use of digital technology within a vehicle, though, does imply the ride conditions are sufficiently smooth to permit

suitable work conditions. Likewise, a smooth ride is also a preferred state for any variety of on-board activities including reading, studying, writing, and relaxing. Both the vehicle technology and road conditions are principal determinants in the suitability of the environment for these activities. Thus, well-suspended vehicles in conjunction with level and well-maintained road conditions provide the best conditions. Nevertheless, in general, rail technologies provide smoother ride conditions than bus-based technologies such as BRT.

10.4.6 Telephone services

The availability of telephones within a public transport system can also be a much-valued service. A person waiting within a station or on-board a vehicle can take advantage of a telephone service to call home or to conduct business. Systems such as Quito provide a public telephone within each station (Figure 10.50).

The use of mobile telephones within the public transport system can also be of great utility to customers. Mobile technology is another easy means to stay in touch with the office or with friends while using public transport. In some circumstances, system developers may wish to provide special receivers to allow mobile connections in otherwise blocked areas such as tunnels.

However, telephone usage may also raise the same concerns, over quiet, as video and audio systems. The ringing of telephones and ensuing loud conversations can be a serious distraction to those passengers looking to study, work, or simply relax. Thus, some discretion over the use of mobile technology is advised. Again, any sort of restrictions would be highly dependent on local preferences and customs.



Fig. 10.50
Public telephone in a Quito Trolé station.

Photo by Lloyd Wright

10.4.7 Reading materials

As noted earlier, public transport systems frequently perform services beyond moving persons between two points in a city. Systems in cities such as Bogotá and São Paulo have initiated impressive literacy projects through the provision of free reading materials. By making books freely available to customers the systems are promoting reading as a pastime and also allowing customers to undertake another value-added activity during their journey.

The Bogotá programme is known as “Libros al Viento” (Books in the Wind). In this case, books are available to customers at TransMilenio stations and terminals (Figures 10.51 and 10.52). Customers may freely take the books and even make use of them at home or any other location outside the system. However, customers are encouraged to return the books to the system after being read. Remarkably, after two years of existence, the programme has reported that only one book has failed to be returned. This success factor perhaps speaks much to the respect the citizens give to the BRT system.

The provision of free newspapers is an increasingly popular service provided in several public transport systems worldwide. The “Metro”



Fig. 10.51 and 10.52
The “Libro al Viento” programme in Bogotá provides free books and literature to TransMilenio customers.

Images courtesy of “Libro al Viento”

newspaper in London and other cities is one of the best known examples (Figure 10.53). In some instances, the newspaper is circulated as a private sector initiative, with the private company receiving revenues from advertising. In other instances, the public transport company itself initiates



Fig. 10.53
The “Metro Hoy” newspaper provides patrons of the Quito Trolé line with news and information.

Photo by Lloyd Wright

the newspaper publication and distribution as a service to their customers (UITP, 2005).

10.4.8 Public services

Finally, there are some services that system developers may wish to provide customers as a courtesy. The provision of restrooms, baby changing facilities, lost and found offices, and emergency aid offices are examples. Opinions on whether to provide restrooms in a system can vary. If a system includes several hundred kilometres of runways and possible long commute times, then the provision of restrooms should be considered for patrons. Baby changing areas can also be quite appropriate in such circumstances. System developers in Bogotá elected to forgo restrooms based on a philosophy of wanting to keep passengers moving through the system without stopping.

Restrooms and other facilities also involve capital and operating costs. Public restrooms are particularly susceptible to vandalism and physical deterioration which undermines the image of the overall system, as well as the facility's functional utility. Nevertheless, a well maintained facility at major terminals may be a modest cost to provide adequate customer

service, such the ones available in the new Passa Rápido Terminals in São Paulo or in the central bus terminal of Nagoya (Figure 10.54).

Lost and found facilities are also an important service that people can reasonably expect to be provided in major public transport systems. The location of a lost and found office should be well noted in system literature and at certain signage points.

The provision of lockers can also be a convenient service to customers. Rather than carrying items for long periods during the day, a customer may prefer to store an item for a later retrieval. Lockers also represent a potential revenue source that can ultimately fund other aspects of a system. However, lockers also present difficulties that may not warrant their usage. Given security concerns in many of today's cities, the unknown nature of a locker's contents can pose a threat. Further, there are costs associated with the management of the locker system and the maintenance of the lockers. Policies and procedures must be developed regarding items left over-night or for long periods. Thus, the value of any customer service programme must be weighed against its potential costs. Nevertheless,



Fig. 10.54

The provision of high-quality restrooms at the central bus terminal in Nagoya greatly serves customer needs.

Photo by Lloyd Wright

there should always be an inherent bias towards maximising service to the customer.

10.5 Segmentation of services

“I’ll go through life either in first class or third, but never in second.”

—Noel Coward, actor, composer, and playwright, 1899–1973

No two customers are exactly alike. Each person has their own transportation patterns and habits as well personal preferences for comfort, convenience, and affordability. In some cities of the world, services are segmented to offer different public transport characteristics to more closely match specific customer preferences. Thus, in Hong Kong and Bangkok, premium air conditioned bus services are offered to persons who are willing to pay more. In the Kolkata metro and the Manila LRT 1 system, women are afforded the option of entering carriages that are women only (Figure 10.55). In Buenos Aires, Rio de Janeiro, and Sao Paulo, executive mini-buses provide express services from the city centres to affluent communities. These executive vehicles also tend to offer air conditioning, increased leg space, and more comfortable seating. The opportunity also exists for BRT systems to offer various types of services to cater to particular groups. The advantage of such segmentation is that it is possible to target groups who may not otherwise travel by public transportation. However, there are also disadvantages. Each layer of segmentation increases system management complexity. Ensuring the correct spacing of vehicles becomes all the more difficult when one is not only managing different routes but also routes plus special features, such as air conditioning. Further, purchasing vehicles with different characteristics can increase overall costs due to the loss of bulk purchasing possibilities. Each permutation of different features



Fig. 10.55

Women are provided their own platform waiting area and own carriages in the Manila LRT 1 system.

Photo by Lloyd Wright

(air-conditioning, seat types, interior spacing, vehicle size, etc.) reduces standardisation.

Perhaps more importantly, though, specialised services perpetuate some of the very social divisions that well-designed public transport systems try to overcome. As Enrique Peñalosa, the former Mayor of Bogotá, has noted, “the TransMilenio system is one of the few places in Bogotá where the wealthy and poor meet on an equal basis.” This sort of social familiarity helps achieve an important goal of community cohesion and unity in a city. Public transport is a place where all the citizenry (the young, the elderly, and the physically disabled) can experience the city’s complete diversity. Instead of providing a high-quality service to the wealthy and a different type of service to the poor, systems like TransMilenio have proven that it is possible to provide affordable excellence in public transport for everyone.

Part III – Physical Design

CHAPTER 11



Infrastructure

CHAPTER 12



Technology

11. Infrastructure

“A person should design the way he makes a living around how he wishes to make a life.”

—Charlie Byrd, jazz musician, 1925–1999

The physical design of the BRT system begins to give the project a tangible substance that better allows all stakeholders to properly envision the final product. This process also allows the planning team to better estimate the actual capital costs expected for the project.

Infrastructure consists of not only the roadwork that forms the busway but also a range of other components. The infrastructure components include:

- Busway infrastructure;
- Feeder infrastructure;
- Stations;
- Intermediate transfer stations;
- Terminals;
- Depots;
- Control centre;
- Traffic control signals;
- Integration infrastructure;
- Commercial space;
- Public utilities (electricity, gas, water, sewage, telephone, etc.);
- Landscape.

The design and engineering of these components is dependent upon several key factors that will dictate the eventual form of the infrastructure. These factors include: cost, functional attributes, and aesthetic design. Like so many topics in BRT, there is no one correct solution

to infrastructure design. Much depends upon local circumstances such as climatic and topological conditions, cost structures, and cultural preferences. For instance, what is aesthetically pleasing in one culture will not be considered as such in another.

The physical design and engineering of the system directly follows from the operational and customer service characteristics chosen in chapters 7, 8, and 9. The corridor selected, expected capacities, and service options all influence the physical design. However, the physical design may also exert influence on the operational characteristics as well. Given the varying cost ramifications of different physical designs, several iterations between operational design and physical infrastructure design may be required. Thus, physical or financial limitations that are placed upon infrastructure design can necessitate a revision of the previous work on operational characteristics.

The initial stage in the infrastructure design process is to develop a conceptual design framework for the system. Based upon the inputs from the previous demand modelling and the operational study, the physical location and initial designs are completed for the various infrastructure elements. An initial cost analysis can then be performed to determine the feasibility of the proposed design. Finally, once the conceptual design has been thoroughly evaluated and approved, detailed engineering designs can proceed.

The topics presented in this chapter are:

- 11.1 Conceptual design and detailed engineering design**
- 11.2 Runways**
- 11.3 Stations**
- 11.4 Transfer stations, terminals, and depots**
- 11.5 Control centre**
- 11.6 Feeder infrastructure**
- 11.7 Infrastructure costing**

11.1 Conceptual design and detailed engineering design

“The designer has an obligation to provide an appropriate conceptual model for the way that the device works. It doesn’t have to be completely accurate but it has to be sufficiently accurate that it will help in both the learning of the operation and also dealing with novel situations.”

—Don Norman, scientist and psychologist

The design of the infrastructure takes place in two basic stages, though in practice it is often more of an evolutionary process. In the first stage, conceptual designs will be developed based on the emerging operational plan. The second stage, the detailed engineering design, follows once the conceptual study and the initial cost estimates warrant a commitment towards a particular design. Thus, for each infrastructure component discussed in this section (*e.g.*, busways, stations, terminals, etc.), the planning team will first complete a conceptual study prior to moving towards more detailed engineering plans and specifications. Most of the conceptual design issues are addressed in the operations chapters. This chapter provides additional detail to the physical design process necessary to

complete the conceptual design. Detailed engineering will follow general engineering practice.

11.1.1 Conceptual design

The infrastructure conceptual design should provide a reasonable level of detail so that decision-makers may properly evaluate the cost, functionality, and aesthetics of the proposed system. Thus, the conceptual design will already include overall dimensions of the infrastructure components, basic drawings, and sufficient description to develop an initial cost estimate.

Even for a basic conceptual design, a considerable knowledge of the corridors will be required. A full audit and inspection of each corridor segment will allow the design team to understand the nuances of the corridor as well as identify the most problematic areas. Particular attention should be given to intersections and proposed station locations. It is at these points that the most complicated interactions with private vehicles and pedestrians will take place. Photography and video of the different segments can be an indispensable tool for design and engineering professionals. Recording each segment in a visual format helps to put together the options



Fig. 11.1
Early rendering of the proposed Guangzhou BRT system.

Image courtesy of ITDP

in the office. Likewise, aerial views of each segment can also provide a unique perspective that will aid in the process.

At the conceptual stage, a full range of options should be considered, even if some options appear to not be feasible in financial or technical terms. The conceptual stage is the time for creativity and out-of-the-box thinking. Thus, options such as grade-separation at problematic intersections should at least be given an initial consideration.

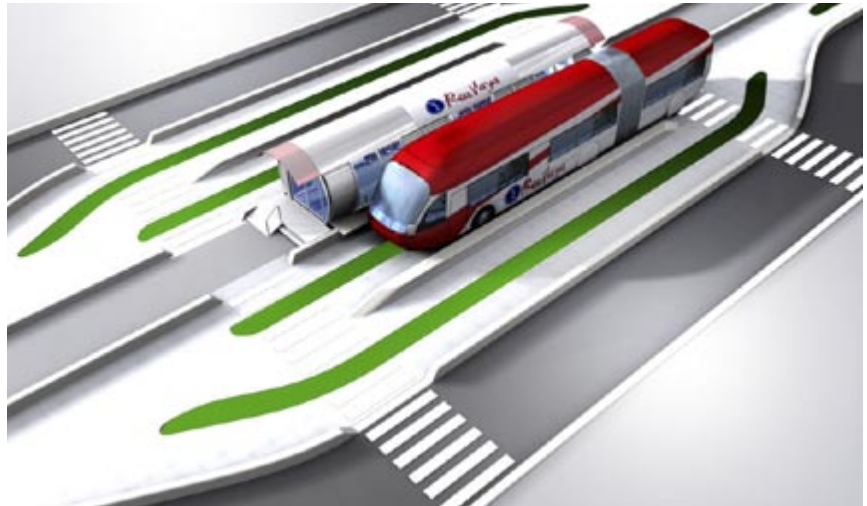
The conceptual design stage tends to be both evolutionary and iterative in nature. As each segment of the corridor is analysed in more detail, the physical design will often evolve from one form to another. Further, as decisions taken on one corridor segment will affect other segments and as cost estimates influence the technical options, the design will likely go back and forth through much iteration.

Once this stage is completed, it will be possible to develop fairly accurate artistic impressions and drawings of the system infrastructure. These initial renderings will help decision-makers and interested parties to begin to visualise the system. Figure 11.1 shows an artistic impression for the Guangzhou BRT system.

Likewise, renderings can also form an important input into simulation videos that give decision-makers a fairly realistic idea of the proposed system. Renderings for the proposed Johannesburg Rea Vaya system helped to secure the necessary political support.

Likewise, early renderings in Bogotá helped to communicate the project to a range of stakeholders, including the general public. Figure 11.3 shows an early image that closely approximates the final form eventually taken by the Bogotá TransMilenio system.

The contracting of the design consultants can take on several different forms. In some cases, the design is carried out by one firm while the ultimate construction is to be done by another firm. This option avoids any problems with conflicts of interest between the design and construction work. For example, if the design and construction firm are one in the same, then there could be a tendency to choose designs that minimise construction costs. However, such



a design may not be optimum from an operational perspective.

Combining the design and construction work into a single contract, though, does hold some advantages. With a single firm undertaking both these tasks, there is a greater degree of continuity between the design and construction. The single contract also can ensure a greater degree of responsibility in delivering the project. With two contracts, the construction firm may blame the design firm and vice versa if problems arise. In this sense, a single contract can be simpler to enforce from a legal perspective. Phase I of Bogotá's TransMilenio incurred legal disagreements over a failed surface material. The separation of the initial design from the detailed engineering and the construction resulted in various parties accusing others of the fault.

Fig. 11.2
Rendering for the proposed Johannesburg Rea Vaya system.
Image courtesy of the City of Johannesburg

Fig. 11.3
This early rendering of the Bogotá system closely matches the ultimate shape and form of the actual system.

Images courtesy of TransMilenio SA



Fig. 11.4

An Autocad drawing of a proposed station for the Barranquilla BRT system.

Image courtesy of the Municipality of Barranquilla



Fig. 11.5
An Autocad drawing of the North Terminal of the Barranquilla system.

Image courtesy of the Municipality of Barranquilla

11.1.2 Detailed engineering design

Once a conceptual design is completed and initial cost estimations are within an acceptable range, then more detailed engineering work can be undertaken. The detailed engineering design and specifications will be the basis for the actual construction work. The detailed design will also permit construction firms to make more accurate cost estimates within the construction bid process.

Given the topographical changes throughout any corridor, each section of roadway will have its own unique design. Detailed drawings generated from software such as AutoCAD will be required along each segment. Other drawings will begin to provide some of the more precise dimensional and structural details that will later be transformed into highly detailed engineering drawings. Figures 11.4 and 11.5 are examples of these types of drawings.

11.2 Runways

“You know more of a road by having travelled it than by all the conjectures and descriptions in the world.”

—William Hazlitt, Literary critic, 1778–1830

The construction of the busway will typically represent approximately 50 percent of the total infrastructure costs. Thus, savings through efficient design and material choice can produce significant dividends. Cost savings, though, must be viewed both from the perspective of initial construction costs and long-term maintenance costs. Lower-quality road materials may reduce capital costs but will dramatically increase maintenance costs if roadways need re-paving or reconstruction after just a few years.

11.2.1 Surface materials

The principal determinant in choice of runway materials is the axle weight of the BRT vehicles selected for operation and the number of projected BRT vehicles likely to use the infrastructure over the projected service life of the road. The roads must be built to a standard able to withstand the projected usage by vehicles with the specified axle weight. The appropriate choice of specific paving methods and materials that are both affordable and able to sustain vehicles of the specified BRT vehicle axle weight may vary from country to country. Also, one pavement treatment that works well in temperate climates may subside in tropical climates. Local pavement engineers should thus be a part of the decision-making team.

If the BRT vehicles are standard 18.5-metre articulated vehicles, these vehicles are very heavy

and unless the vehicle volumes are quite low may require reconstruction of the entire road bed with materials able to withstand these heavier axle loads. The total vehicle weight of the articulated vehicle utilised by the Bogotá Trans-Milenio system is approximately 30,000 kg and the maximum axle load is approximately 12,500 kg. The vehicle volumes were also extremely high, so busways must thus be constructed to withstand this axle load on a frequent basis.

The weight of the vehicle is most acutely experienced at the station areas, where the vehicle's acceleration and deceleration increases the amount of force on the road bed. The subsiding of the road bed from the weight and force of the vehicles is also a more serious problem at the station stops. Such subsiding can effectively render a station boarding area inoperative. As the road-bed level lowers, the station to vehicle interface will no longer align evenly and a step will form between the vehicle floor and the platform.

In terms of longevity, concrete is typically a better choice than asphalt. Concrete of a constant and reasonable quality is more resistant to the forces of heavy vehicles passing on a frequent basis (Figure 11.6). While concrete is generally more costly than asphalt, the longer life of the surface will likely justify the higher initial cost. Concrete paving if done properly can last 10



or even more with only minor maintenance. By contrast, asphalt often requires resurfacing as often as every two years in tropical climates with heavy use. Because of the additional force at the stations, one cost-cutting option is to consider concrete only at stations. In such instances, the runways between the stations are constructed with lower-cost asphalt.

Other building materials can also be used, though they tend to be more expensive.

Fig. 11.6
Reinforced concrete, as in this example from the construction of the Quito Central Norte line, has much greater longevity than asphalt.

Photo by Lloyd Wright



Fig. 11.7
For aesthetic reasons, Bogotá utilises brick and paving stones in the city centre area.

Photo by Carlos F. Pardo

Fig. 11.8

Due to the weight of the new BRT vehicles, the Jakarta asphalt runway quickly deteriorated.

Photo courtesy of ITDP



Particularly in the city centre, brick and other paving stones are frequently chosen for aesthetic reasons (Figure 11.7). These surface materials also send a useful visual signal to bus drivers that they are in a public space and must operate at safe speeds. Such materials are often quite able to withstand very heavy axle loads with regular maintenance.

Bogotá’s TransMilenio resurfaced the entire corridor in concrete and used brick in the city centre. TransJakarta initially used only asphalt and suffered from major problems of the roadway sinking and deteriorating at the stations, so the roadbed at the stations was repaved using concrete (Figure 11.8). For its first two corridors, Quito utilised asphalt on the runways but with concrete at the station areas. The latest corridor to be constructed in Quito, the Central Norte corridor, was built with concrete throughout the system. However, the higher investment in the



Fig. 11.9

Quito’s high-quality use of concrete on the runways of the Central Norte line contrasts with the relatively lower-quality of the station infrastructure.

Photo by Lloyd Wright

surface material for the Central Norte line may be one reason that the station infrastructure is of somewhat lower quality than the other two corridors in Quito (Figure 11.9). Thus, one must always weigh the alternative use of the investment when making decisions about any one item, such as surface material.

The surface material will only endure as long as the base materials are in tact. If water drainage is insufficient or if the base structure is inherently weak, then the surface material will quickly fail. A poor base design in Bogotá led to the premature failure of the concrete surface on the system’s Avenue Caracas corridor. Bogotá has largely relied upon a technique known as “white topping” for its concrete busways. The

Fig. 11.10

In parts of the Hangzhou BRT system, the separator is a fully landscaped median.

Photo by Karl Fjellstrom



Fig. 11.11

In Beijing, metal fencing is utilised at the separator.

Photo by Karl Fjellstrom



white topping method utilises the existing asphalt lane as the base material for the concrete surface material. White topping is thus a fairly economic option since it does not rely upon reconstruction of the busway base. However, the successful application of white topping depends on the strength of the base core, the integrity of the asphalt layer, and the level of cohesiveness between the asphalt and concrete layers.

11.2.2 Lane separation

While some busways are not physically separated from mixed traffic, most are separated by a physical barrier. This barrier can range from a fully landscaped median to simple blocks, bollards, curbing, permanent traffic cones, walls, metal fencing, or other types of barrier devices. The design of the separator should be sufficient to physically prohibit mixed traffic vehicles to enter the busway.

A wall or large landscaped median will provide the most complete protection for the busway, but will make it difficult for vehicles to escape the busway in case of an obstruction (Figure 11.10). Likewise, the metal fencing, as utilised in Beijing, makes it impossible for the BRT vehicles to leave the corridor in case of emergency (Figure 11.11). However, the Beijing fencing does have an advantage as a movable barrier. If the system developers later widen the Beijing busway, then the fencing is relatively easy to relocate.

It may be useful to design the separator to permit buses to leave the busway in case of an

Fig. 11.13

In Quito, the separator blocks have been susceptible to damage and deterioration.

Photo by Lloyd Wright



Fig. 11.12

In Bogotá, the separator blocks are high enough to discourage intrusions by private vehicles but low enough to allow a BRT vehicle to leave the busway in case of emergency.

Photo by Carlos F. Pardo

obstruction. For example, if a bus breaks down on the busway, it can be useful to allow other buses to leave the lane to avoid being blocked. Thus, a curbing separator that is high enough to dissuade private vehicles from entering but low enough to allow buses to safely leave the busway can be appropriate (Figure 11.12). One option is to employ a curbing material that is rounded on the busway side but forms a sharp edge on the private vehicle side.

If it is likely that at times buses will need to cross the separator, the divider should be built strong enough so as not to break under the wheels of the bus, and also low enough as not to damage the bottom of the bus. In Quito, for example, the stone blocks used as separators are frequently damaged and dislocated, creating hazardous obstacles in the roadway and undermining the barrier function (Figure 11.13). The breakdown of the barrier can then subsequently lead to private vehicles infringing upon the busway, creating safety hazards to both the private vehicles and the BRT customers (Figure 11.14).



Fig. 11.14

As more separator blocks erode, an increasing number of private vehicles intrude upon the busway, which can lead to serious accidents.

Photo by Lloyd Wright



Fig. 11.15
Curitiba's low curb medians with Portuguese-styled designs in the stones has enhanced the local urban environment.

Photo courtesy of ITDP



Fig. 11.16
Prior to its removal, the wall barriers on the São Paulo Novo de Julio corridor undermined the urbanistic qualities of the corridor.

Photo courtesy of ITDP

Pedestrian safety and aesthetics are other considerations. There are several advantages of using a metre-wide median to separate the busway from mixed traffic if the right of way allows. A metre-wide median allows the median to also serve as a pedestrian refuge for pedestrians crossing the road. A larger median tends to also provide the most aesthetically pleasing and complete demarcation of the busway. Curitiba's BRT system is separated by a low curb filled with decorative Portuguese stone to give an aesthetically pleasing median that provides some

pedestrian refuge (Figure 11.15). It was designed to facilitate crossing of the road anywhere along the corridor. In some places, motor vehicle parking in Curitiba is also adjacent to this median divider rather than adjacent to the curb, so the parking lane becomes part of the barrier protecting the integrity of the busway.



Fig. 11.17
Along Bogotá's Alameda Jimenez bollards are used to separate the busway from the pedestrian walkway.

Photo by Diego Velazquez

Walls were originally used in the Santa Amaru/Novo de Julio corridor in Sao Paulo. The walls provided complete protection from encroachments. They were intended to make it impossible for pedestrians to cross the busway except at designated locations. However, the walls were aesthetically unpleasing, and were impossible to escape if a vehicle broke down (Figure 11.16). They also created visibility problems for crossing pedestrians. The walls were eventually completely removed. This significantly improved the aesthetics of the corridor but the busway now suffers from encroachments from motor vehicles.

In pedestrian areas, the use of a separator medium will depend on the volume of BRT vehicles and pedestrians. In some instances, successful pedestrian malls have been created with no discernible separation between the busway and the pedestrian walkway. Instead, vehicle speeds are reduced to allow drivers to react to any pedestrians straying into the busway. However, in high-volume operations partial or even full separation may be appropriate. Along the Bogotá Alameda Jimenez route (also known as the “Environmental Axis”) nicely designed bollards act to separate the busways from the pedestrian zone (Figure 11.17).

Table 11.1: Recommended minimum lane widths per direction

Lane type	Minimum recommended width per direction
Footpath	3.0
Cycle way	2.5
Busway lane at station area	3.0
Busway lane along corridor	3.5
Median divider along corridor	0.5
Curb lane for mixed traffic	3.5
Other lanes for mixed traffic	3.0
Station width ¹⁾	3.0

¹⁾ Station width depends greatly on capacity; the minimum presented here is an actual figure from the Quito BRT system.

11.2.3 Typical BRT corridor cross sections

“The excellence of a road consists chiefly in its being protected from the reigning winds, and the swell of the sea; in having a good anchoring-ground, and being at a competent distance from the shore.”

—William Falconer, poet, 1732–1769

11.2.3.1 Standard runway configurations

Standard BRT runway widths have already been discussed in Chapter 5 (*Corridor selection*). This

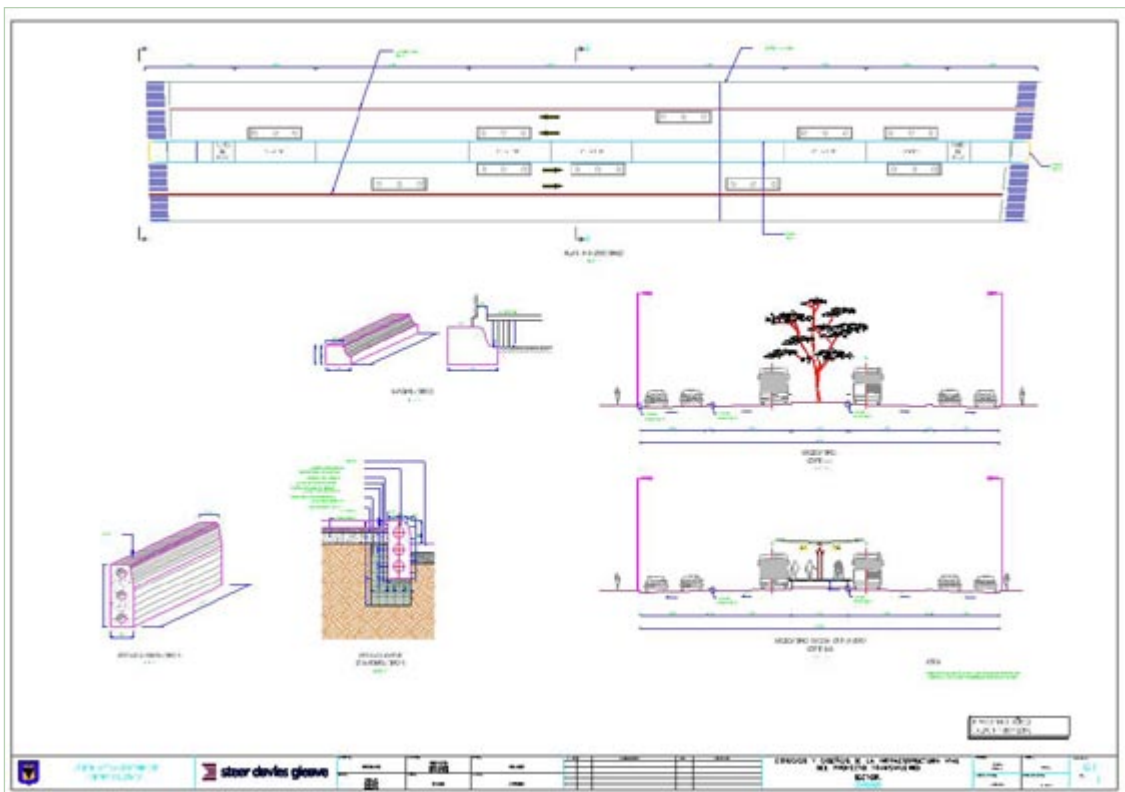


Fig. 11.18
In ideal conditions with wide right-of-ways, such as in Bogotá, the road design can accommodate busways, wide station platforms, and at least two lanes of mixed traffic. This figure shows a conceptual design for a segment of the TransMilenio system.

Image courtesy of Steer Davies Gleave

section summarises some of the common run-way configurations utilised in systems to date. Table 11.1 provides general recommendations for minimum lane widths.

The exact configuration of any particular corridor will depend on the level of mixed traffic, the level of pedestrian and bicycle traffic, and the frequency of buses within and outside the BRT system. The methodology for determining how many lanes are needed for each mode is explained in Chapter 8 (*System capacity and speed*). Below are shown some theoretical minimum right of way configurations, as well as a few actual configurations from different systems.

In ideal conditions, the width of the right-of-way will be sufficient for a busway, two mixed traffic lanes, adequate footpaths, and possibly even cycle ways (Figure 11.18). However, as has been noted, BRT systems in cities such as Rouen and Guayaquil have been successfully implemented with just a single mixed traffic lane.

Normally, at least the curb lane tends to be 3.5 metres wide in order to accommodate trucks and any buses not operating within the BRT system. The busway lanes themselves are normally 3.5 metres wide. At the stations, the busway lane can be narrowed to 3 metres because the BRT vehicle is operating at a slower speed and must pull up adjacent to the boarding platform. If a passing lane is provided, however,

the total lane width for the two lanes together should be 7 metres.

Footpaths less than 3 metres in width are very uncomfortable for pedestrians, especially if adjacent to a busy street of mixed traffic. While there are places in the Quito BRT system where the footpath is as narrow as one metre, it is not a comfortable walking space. Bicycle lane widths depend on the volume of bicycle traffic, but as a general rule, cycle ways should not be narrower than 2.5 metres per direction (Figure 11.19). If the cycle way is less than this width, cyclists will generally prefer to operate in the mixed traffic lanes.

11.2.3.2 Station areas and intersections

Space is generally at a premium at intersections and at the station areas. Space is a premium at intersections because of turning movements and the potential need for dedicated turn lanes. For this reason, as noted in Chapter 9 (*Intersections and signal control*), it is fairly typical to separate the location of the station from the location of the intersection.

Constraints on space at the stations areas are due to the presence of the station platform in addition to the busway lanes. On some systems with passing lanes, such as on 80th Street (Calle 80) in Bogotá two full BRT lanes are maintained throughout the system. The wide road widths found along this corridor permits the develop-

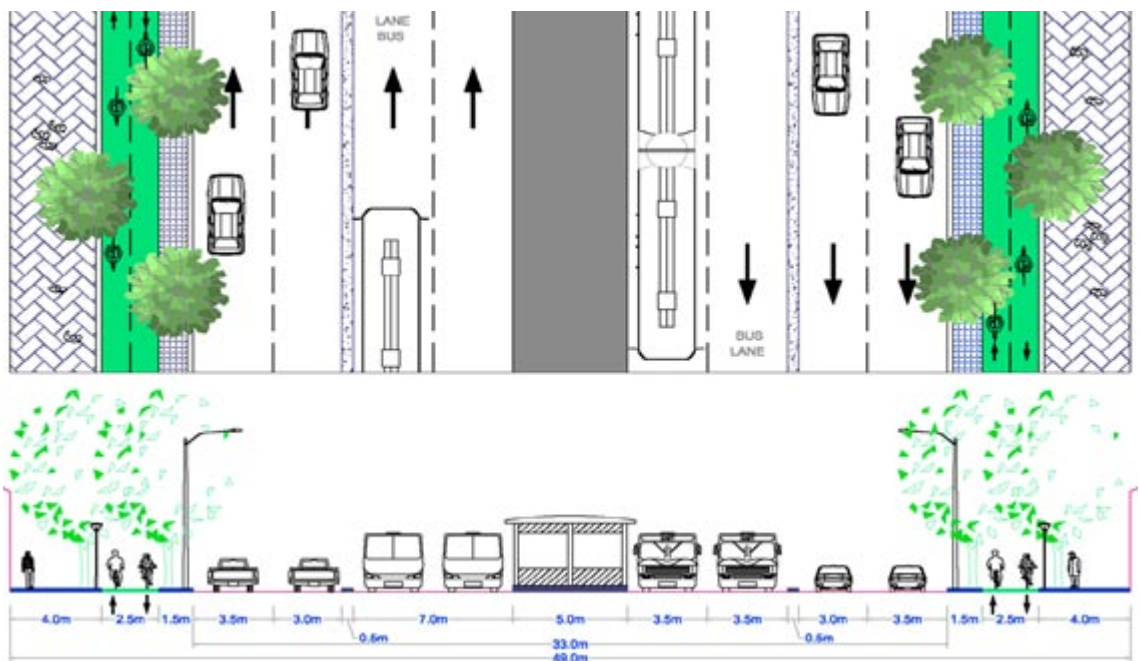


Fig. 11.19
This conceptual design of the Dar es Salaam BRT system (DART), shows the inclusion of 2.5-metre wide cycle ways on each side of the road.

Image courtesy of the City of Dar es Salaam

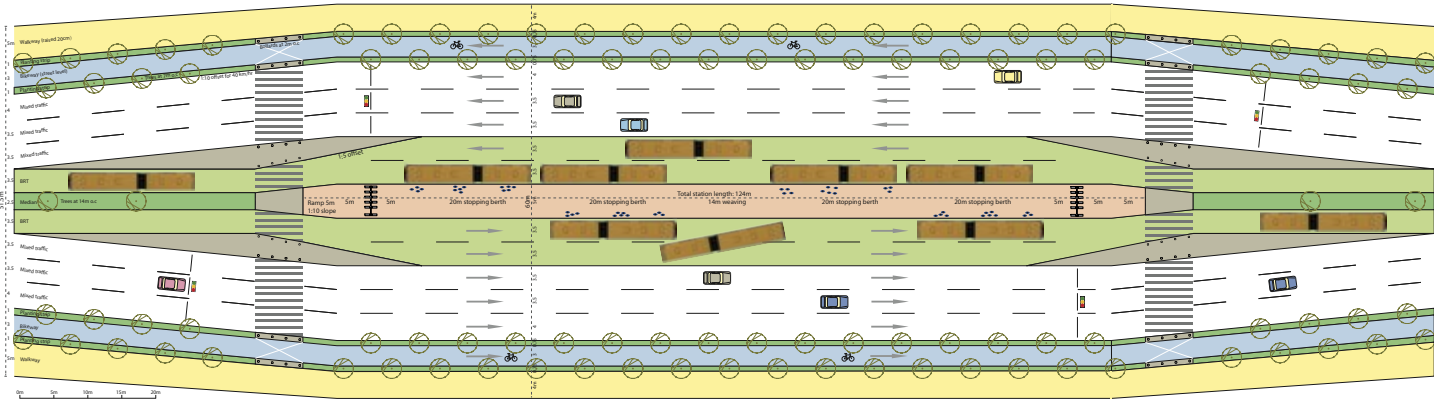


Fig. 11.20
In Guangzhou, the passing lane is provided through a widening of the roadway at the station areas.
 Image courtesy of ITDP

ment of two full BRT lanes. This configuration avoids the need to widen and narrow the right-of-way at station locations. In this case, two 3.5-metre wide BRT lanes are provided in each direction throughout the corridor.

In some areas where right-of-way space is limited, such as Avenida Caracas in Bogotá and along the phase one corridors of Dar es Salaam and Guangzhou (Figure 11.20), a passing lane is provided only at station areas. Outside the station areas, only a single lane of busway is provided for each direction of travel. This configuration helps to minimise the cost of possible land acquisition along the corridor. If there is plenty of right-of-way, this configuration allows for additional

turning lanes for mixed traffic at intersections. The configuration also allows for a median between the busway and the mixed traffic lanes that can serve as a pedestrian refuge, and for wider footpaths and bike lanes at non-station locations.

The required width can be mitigated somewhat by offsetting the location of the sub-stops for each direction of travel (Figure 11.21). This configuration reduces the required road width by one lane and still delivers full passing capabilities at the station. Of course, this configuration does elongate the station and also introduces a slight turn at the station area. Nevertheless, in cities with restricted road widths, this design can be effective in permitting passing lanes at stations.

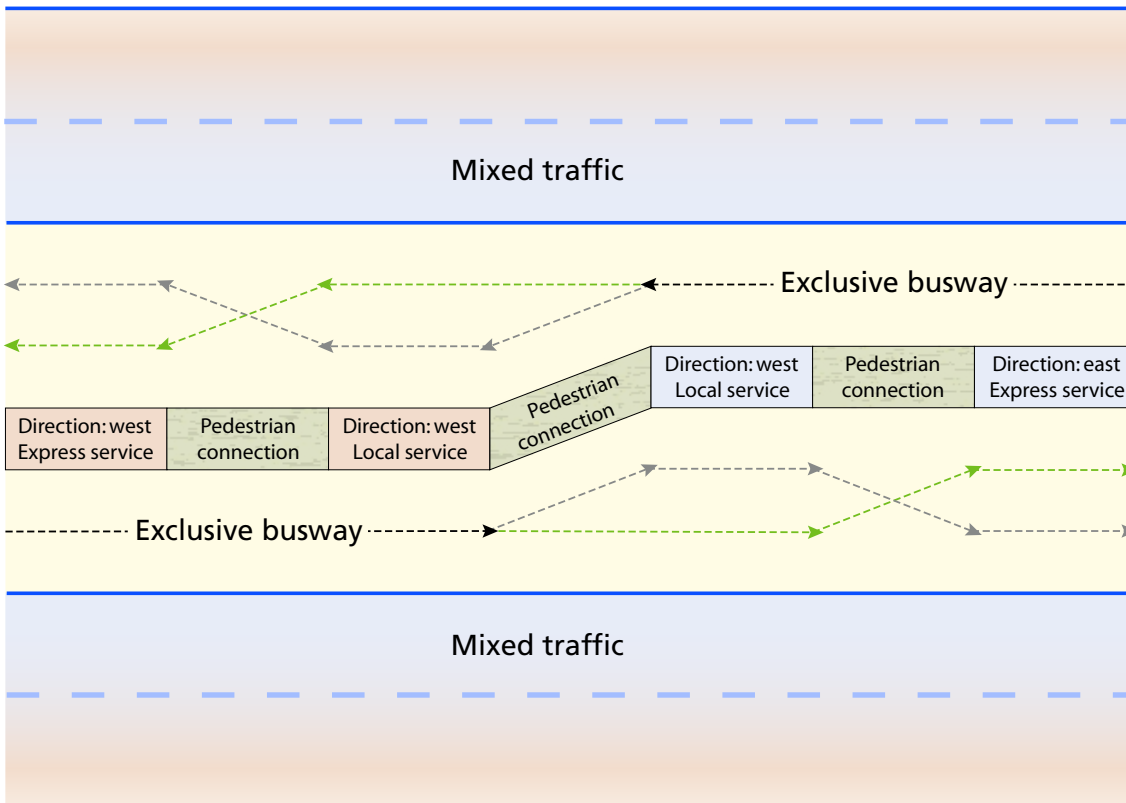


Fig. 11.21
By offsetting the sub-stops and elongating the platform, passing lanes can be fit into relatively narrow road widths.
 Design by Lloyd Wright

Fig. 11.22 and 11.23
The colouration of busways in cities such as Nagoya (left photo) and Seoul (right photo) does much to enhance the image and permanence of a BRT system.

Left photo courtesy of the City of Nagoya
 Right photo courtesy of the Municipality of Seoul



11.2.4 Colouration of surface

The aesthetic appearance of the lanes will have an impact on the public's image of the system. The colouration of the busway is one option for creating a special and attractive BRT environment (Figures 11.22 and 11.23). A smartly coloured busway not only raises the image of the system but also creates a greater sense of permanence to the existence of the system. Coloured lanes also create a psychological advantage over motorists who may potentially block the busway when the lane must cross mixed traffic. Motorists are more likely to recognise that they are committing a traffic infraction by blocking a highly visible busway, especially when compared to the crossing of a lane that is indistinguishable from a normal mixed-traffic lane.

Colouration of busway lanes can be accomplished by at least two techniques. First, a road surface paint can simply be applied to the

busway. The advantage of simply painting the lane is that colouration can be accomplished when just the existing street infrastructure is being converted to a busway. The disadvantage of paint-based techniques is the duration of the colour and the long-term maintenance costs. A second option is to utilise a coloured emulsion within the asphalt or concrete mix. In this case the colouration is a permanent part of the surface material. As the surface begins to wear down, the colour is retained. However, in general, the colour finish of an emulsified coloured surface is less bright than a painted surface. Thus, the aesthetic and marketing impact of an emulsified surface will tend to be inferior to that of a painted surface.

Pigments can be used that produce a luminescent effect. A busway that is luminescent in the evening can be another way of attracting positive attention to the system. In Jakarta the application of a red luminescent paint to the busway gives the system a majestic red carpet appearance in the evenings.

The choice of colour is highly specific to local preferences and local conditions. Local aesthetic values play a role in choosing a colour that will produce a readily identifiable and positive image for the BRT system. Further, a city-wide colour coding scheme should be considered as a mechanism to differentiate between various infrastructure purposes. For example, it might be useful to use a colour for the busway that is different than the colour utilised for the city's cycle ways. In this way, each set of sustainable transport infrastructure has its own unique visual identity. In general, darker colouring shades should be selected over lighter colours. With time tire marks will tend to stain busways

Fig. 11.24
Mechanically guided systems allow greater vehicle velocities and narrower busway width, but these systems to increase construction costs and reduce overall system flexibility.

Photo courtesy of the US Federal Transit Administration





using lighter colours while such wear marks will be less pronounced with darker colours.

11.2.5 Infrastructure for guided busways

A guided busway is a special type of BRT system in which the lateral movement of the bus is controlled by side roller wheels (Figures 11.24). A few guided systems have been developed in cities such as Essen (Germany), Adelaide (Australia), Leeds (UK), Bradford (UK), and Nagoya (Japan). The guidance systems consist of a physical bus track that steers the bus by way of a mounted side roller wheel.

These systems can have a positive effect on speed and safety since the guideway better controls the vehicle’s movements. Guided busways also permit a more narrow lane to be constructed, and thus is helpful when road space is limited. However, guided systems are still relatively rare due to their added costs, complexity, and lack

Fig. 11.27

The guideway allows for hands-free driving on the Nagoya Yurikamome Line.

Photo by Lloyd Wright



of flexibility in use of the vehicles. Table 11.2 summarises the advantages and disadvantages involved with guided systems.

Additionally, since busways do not require the need for vehicle lane changes, some system developers have elected to not pave the centre of the lane (Figures 11.25 and 11.26). The resulting savings in construction costs can be substantial. Further, the existence of earth or grass beneath the bus can help absorb engine

Fig. 11.25 and 11.26
Not paving the centre of the busway can produce infrastructure cost savings as well as reduce operational noise.

Left image (Eugene, USA) courtesy of Lane District Transit
Right photo (Leeds, UK) courtesy of the US Transit Cooperative Research Program

Table 11.2: Advantages and disadvantages of guided busway systems

Advantages	Disadvantages
Higher speeds (reduced travel times) are achievable within safety standards	Increases busway construction costs considerably
Permits construction of narrower busway lanes	Increases vehicle costs
Contributes to a more permanent image of the busway	Reduces flexibility with regard to the type of vehicles that may utilise the busway
Allows construction of lanes without paving the centre strip	Speed advantages of guided busways are only realised when the distances between stations are quite significant



Fig. 11.28

A stopping device at the end of the guideway ensures that the driver re-engages physical steering.

Photo by Lloyd Wright



Fig. 11.29
An elevated busway in Brisbane allows the system to manoeuvre through a sensitive greenway.

Photo courtesy of Queensland Transport

noise; noise reductions of up to 40 percent have been reported using this technique. Not paving the centre of the lane is also an option that other busway developers are considering, even when roller guides are not being utilised. The paved strips for non-guided buses will likely be wider than the strips for guided buses since non-guided buses will be subject to more variation in lateral movement. The feasibility of this approach and cost savings associated with not paving the centre lane area will depend on local construction costs and practices. In some instances, local contractors may not be well-versed in utilising this construction technique. However, given that the paving of the busway represents perhaps the single highest cost item in system infrastructure, any potential cost savings should be considered.

Fig. 11.31
A significant number of private vehicles entering the Nagoya busway.

Photo by Lloyd Wright

In operating a vehicle along a guided busway, the driver does not actually have to steer the vehicle. The guideways prevent any turning movements, and thus the vehicle can technically be operated “hands-free” (Figure 11.27). In some



Fig. 11.30
The Miami People Mover is an elevated system that covers destinations in the city's central district.

Photo by Lloyd Wright

systems, such as the Nagoya, there are safety concerns at the point the BRT vehicle leaves the guideway. If for some reason the driver does not re-engage physical steering, a mishap may occur. Thus, in the case of Nagoya, a forced stop is made at the exit from the guideway in order to remind the driver to use physical steering once again (Figure 11.28).

11.2.6 Infrastructure for grade separation

Grade separation has already been well discussed in this Guidebook as an option within narrow right-of-way configurations as well as an option at intersections and roundabouts. Grade

Fig. 11.32
Motorcycle illegally entering the busway in Pune (India).

Photo by Sujit Patwardhan and the Pune Traffic & Transportation Forum (PTTF)



separation can also be an option to consider to by-pass difficult terrain or water (Figure 11.29). Another common application could be loop lines that must manoeuvre through dense city centres (Figure 11.30).

In all cases, the physical terrain and base materials must be considered for their engineering appropriateness for tunnels or elevated structures. High water tables or hard bedrock can make underpasses and tunnels impractical from a cost and engineering standpoint. Likewise, soft soils can significantly increase the cost of securely siting pillars for elevated structures. Thus, an engineering and cost feasibility analysis should be conducted whenever grade separation is being considered as an option along certain BRT corridor segments.

11.2.7 Restricting access to the runways

The infringement of the busway by private vehicles can do much to harm BRT speeds and overall performance (Figures 11.31 and 11.32). Even just a few vehicles can cause delays to the BRT vehicles. Further, once a few vehicles enter the system, then a breakdown in the appearance of enforcement can lead to mass violations of the exclusive space.

Several mechanisms can be utilised to discourage private vehicle use of the busway:

- Clear signage noting busway use only (Figures 11.33 and 11.34);
- “Busway only” message imprinted upon the surface (Figure 11.35);
- Distinctive colouration of the lanes;
- Median differentiation between the mixed traffic lanes and the busway.

If the busway is separated from the mixed traffic lanes by vegetation or a constructed median, then there is a clearer distinction between the two areas.

Without such measures, there may be instances of inadvertent use of the busway. However, these measures may not be sufficient to deter intentional violations of busway usage. Thus, cooperation with the traffic police in monitoring and enforcing the exclusivity of the busway is also essential.



Fig. 11.33, 11.34, and 11.35
Signage is a basic mechanism to designate an exclusive busway, as seen in these examples from León (top photo) and Jakarta (left photo). Painted information on the busway surface is also an option, as show here form the example in Jakarta (right photo).

Photos by Lloyd Wright

11.2.8 Landscaping

“The smallest patch of green to arrest the monotony of asphalt and concrete is as important to the value of real estate as streets, sewers and convenient shopping.”

—James Felt, NYC Planning Commission

BRT systems should add to the aesthetic quality of a city’s public space rather than detract from it. All efforts should be made to retain existing green spaces. If the centre median is utilised as the location of the stations, the existing landscape can be left significantly in tact (Figure 11.36). Only the station footprint may require landscape alterations. The other areas can be enhanced with additional plantings (Figure 11.37). Greenery may also be an option as a divider between the BRT system and other traffic lanes.

Trees and plants can also provide climatic protection to pedestrian and bicycle corridors linking with the BRT system. In tropical climates, trees and vegetation can even help partially cover the station structure itself in order to reduce inside temperatures. Likewise, the retention of greenery along a BRT corridor will offset the overall urban heat-island effect which causes urban areas to exhibit heightened temperatures (Figure 11.38).

Some environmental groups in Jakarta expressed concern about the impact of the busway on the trees planted in the median. However, in many respects, the busway will serve as a protective buffer between the mixed traffic lanes and greenery in the median. Prior to the development of the busway, the lane nearest the trees was used for mixed traffic vehicles. Thus, previously the trees were subjected to a constant

bombardment from heavy traffic congestion and intense emissions. Now, cleaner public transport vehicles are operating along the corridor at frequencies of every three to five minutes. The busway has therefore calmed the environment around the greenery which should improve the health of the trees.

The development of the BRT system may actually provide an opportunity to create new green spaces in the city. At the same time the busway is constructed, a median can be converted from a dull concrete separator to something dominated by greenery. In the case of BRT tunnels, there can be the opportunity to create new public space. In some instances, the covering of the underpass presents the opportunity for plantings and green space (Figure 11.39).

There is a science to choosing the right plants and trees within the landscape plan. The height of the tree and its eventual branches will have to clear the height of the BRT vehicles. Also, the tree’s root structure should grow vertically rather than horizontally. Root structures that grow horizontally beneath the surface will likely cause buckling of the busway materials. Each type of tree has inherent growth characteristics, and thus some research is needed to determine which is most appropriate for the busway environment. The expected life of the tree is also a key factor since it can be quite disruptive to the system to require a new set of trees after only a few decades.

Fig. 11.37

Plantings along the busway and at stations can do much to improve the aesthetic nature of the area, as show here in an example from Vancouver.

Photo courtesy of the National Bus Rapid Transit Institute (NBRTI)

Fig. 11.36

In most cases, the median area along a BRT corridor can remain as green space.

Photo (Kunming) by Lloyd Wright





Fig. 11.38
Busway greenery, as shown in this example from Nagoya, can help to mitigate the urban heat island effect.

Photo by Lloyd Wright

Local weather conditions will also determine the desirability of whether “deciduous” trees or “coniferous” trees are appropriate. A deciduous tree will shed its leaves during the colder seasons, and thus more heat and sunlight will penetrate to the ground during this period. A deciduous tree is thus part of an effective passive solar strategy for cities which experience both



Fig. 11.39
The covering of a new BRT underpass creates new green space along the Central Norte corridor in Quito.

Photo by Lloyd Wright

warm and cold seasons. However, one disadvantage of deciduous trees is the possible need to clean fallen leaves from the BRT infrastructure. By contrast, cities without cold seasons may prefer trees that do not shed leaves. These types of trees will provide shade year-round in consistently tropical or warm climates.

Priority should be given to selecting indigenous trees rather than species that are not common to the area. Indigenous species create fewer problems regarding invading species and also typically are more suited to local soil and water conditions.



Fig. 11.40
Without adequate drainage, a heavy storm in Quito puts the operation of the Trolé line at risk.

Photo courtesy of El Comercio

11.2.9 Utilities

The street environment is often far more complicated than the surface would indicate. The street is the principal conduit of many critical city services, including water supply, drainage, sewer lines, and electricity lines. Since BRT systems typically operate on the principal corridors of a city, there is likely to be a concentration of city infrastructure alongside and beneath the busways.

Consultation of city infrastructure maps can determine the extent to which the new BRT system may affect these other services. The construction process must take care as to not disrupt or harm the water and drainage lines. If a new surface material is applied for the BRT lane, then water drainage should be explicitly considered in the design process. Concrete busways and painted busways may be less permeable than the previous surface materials. Worst case storm scenarios should be tested in terms of water build-up. Additionally, solutions for improving drainage on the busways should be such that conditions do not worsen for the mixed traffic lanes.

11.3 Stations

“All architecture is shelter, all great architecture is the design of space that contains, cuddles, exalts, or stimulates the persons in that space.”

—Philip Johnson, architect, 1906–2005

BRT stations generally are constituted by three principal elements: 1.) Sub-stops or platforms; 2.) Transition areas; and, 3.) Integration infrastructure such as necessary pedestrian walkways, space for vendors, bike parking, or other commercial activity.

Most sizing aspects of the station and sub-stop design are determined by the operational design. Station functional design and sizing will largely be a function of the projected number of passengers boarding and alighting at any particular station, and the frequency of buses that need to be accommodated at that station. Most of the critical issues of station design have thus already been determined in Part II of this Planning Guide (Operational Design). A few additional sizing issues are detailed in this section.

Beyond the size of a station area, though, there is a host of issues relating to station usability, comfort, and attractiveness. Thus, the aesthetic



Fig. 11.41
At many stations within the Bogotá TransMilenio system, a transition area exists between a single lane busway and two lane configuration for passing.

Photo by Lloyd Wright

form and architectural design of the station area plays a major role in determining the success of the system.

11.3.1 Transition area prior to stations

A busway corridor may change from a single runway lane between stations to two lanes at the station area. The addition of the second lane allows vehicles to pass one another and thus access different station sub-stops. As noted in Chapter 8 (*System capacity and speed*), the ability to operate multiple sub-stops has a highly positive impact on overall system passenger capacity.

In this type of design, a transition zone must exist where the lane configuration changes from a single lane to two lanes (Figure 11.41). This transition area exists both before and after the station area. The length of the transition area must be sufficiently gradual to avoid the necessity for sharp turning movements that will slow BRT travel speeds. The actual length will vary depending on speeds and local conditions. However, in general, approximately 70 metres will be required to expand from a single lane busway to two lanes.

11.3.2 Station platform sizing

The size of the station platform will have an impact on the efficiency with which the station and individual sub-stops operate. The size will also greatly affect passenger comfort. Sizing largely depends on the number of boarding and alighting passengers.

The height of the station is largely a function of aesthetics, although any passive solar extensions to enhance shading must obviously be above the height of the vehicle roof. From the standpoint of waiting passenger crowding, the critical factor is the width of the station.

For an individual sub-stop the length does not contribute greatly to platform capacity since boarding passengers will cluster around the doors waiting to board and exiting passengers disperse quickly. However, the length of the station may be quite relevant if sub-stops for each direction of travel are side-by-side. In cases where the platform width is constrained by the available road width, then staggering the sub-stops along the length of the road can be an effective solution. The staggering

of the sub-stops will lengthen the overall station, but it will effectively halve the pressure upon the station width (especially if two vehicles were to stop simultaneously).

The minimum length of the waiting area for passengers (L_p) must be greater than or equal to the length of the BRT bus (L_b). The total length of the platform must also be long enough to accommodate the ticket sales, turnstiles, and other amenities. Generally, adding length to a station is not problematic since the length does not encroach on the right-of-way.

The more sensitive issue is the width of the sub-stop. The platform must be wide enough to comfortably accommodate all projected waiting passengers, provide enough space for passengers to enter and exit the area, and enough space for the infrastructure itself. Equation 11.1 summarises the calculation of the required platform width.

Equation 11.1 Calculation of platform width

$$W_p = 1 + W_u + W_c + W_{opp}$$

Where:

W_p = Total platform width

1 metre = Width required for infrastructure

W_u = Width required for waiting passengers in one direction

W_c = Width required for circulating passengers

W_{opp} = Width required for passengers waiting for vehicles going in the other direction

Note that in the case of staggered or offset sub-stops, the value for W_{opp} will be zero. As indicated previously, staggering the sub-stops will likely double the capacity of a given platform width.

Normally, about 2,000 pedestrians can pass down a metre-wide sidewalk per hour, and still provide a reasonable level of service. Based on this standard, the width required for circulating passengers is given in Equation 11.2.

Equation 11.2 Width required for circulating passengers

$$W_c = P_{ph} / 2,000 \text{ passengers per hour}$$

Where:

P_{ph} = Number of circulating passengers expected per hour

The minimum area required for waiting passengers will be a function of the maximum number of passengers projected to queue divided by the capacity of a square meter to hold waiting passengers. Equation 11.3 thus provides the calculation for the minimum area required.

Equation 11.3 Minimum area required for waiting passengers

$$A_w = Q_p / D_wMax$$

Where:

A_w = Minimum area required for waiting passengers

Q_p = Maximum number of passengers projected to queue

D_wMax = Capacity of a square metre to hold waiting passengers

Box 11.1: Calculation of required platform width

The general equation for this calculation is:

$$W_p \text{ (platform width)} = 1 + W_u + W_c + W_{opp}$$

In this case, the waiting areas for the two directions are offset, so that “ W_{opp} ” is equal to zero. Also, it is assumed that the station infrastructure and curb consume 0.5 metres on each side for a total of 1 metre. Suppose also that the traffic model has determined that the average number of waiting passengers during the peak is 150 ($Q_p = 150$).

The articulated BRT vehicles are typically between 17.8 metres and 18.5 metres long. For simplicity, it will be assumed that $L_p \geq L_b = 18.5$ metres.

To first calculate the total area required, Equation 11.3 will be utilised:

$$A_w = Q_p / D_wMax = 150 \text{ waiting passengers} / 3 \text{ passengers per square metre} = 50 \text{ square metres}$$

Thus, 50 square meters of platform is required to accommodate the waiting passengers. If the BRT vehicle is 18 metres long:

$$W_u = 50 \text{ m}^2 / 18 \text{ m} = 2.8 \text{ metres}$$

The modelling also has projected that 6,000 passengers pass through this popular station every hour. Therefore,

$$P_{ph} = 6,000 \text{ passengers per hour}$$

Based on equation 10.2, the platform width for circulating passengers is:

$$W_c = 6,000 \text{ passengers per hour} / 2,000 \text{ passengers per hour per metre wide} = 3 \text{ metres}$$

Therefore, the total width required is:

$$W_p = 1 + W_u + W_c + W_{opp} = 1 \text{ m} + 2.8 \text{ m} + 3 \text{ m} + 0 \text{ m} = 6.8 \text{ metres}$$

Figure 11.42 provides an illustration of this platform.

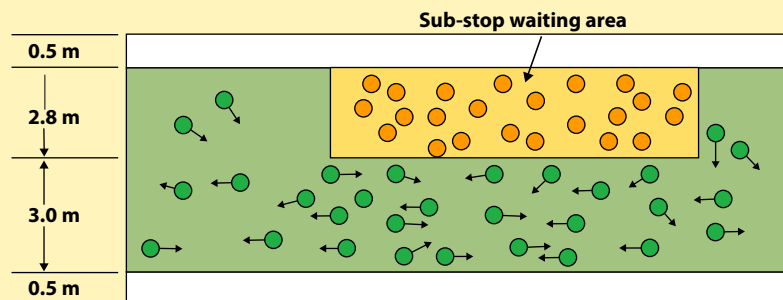


Fig. 11.42 Result of platform sizing analysis.

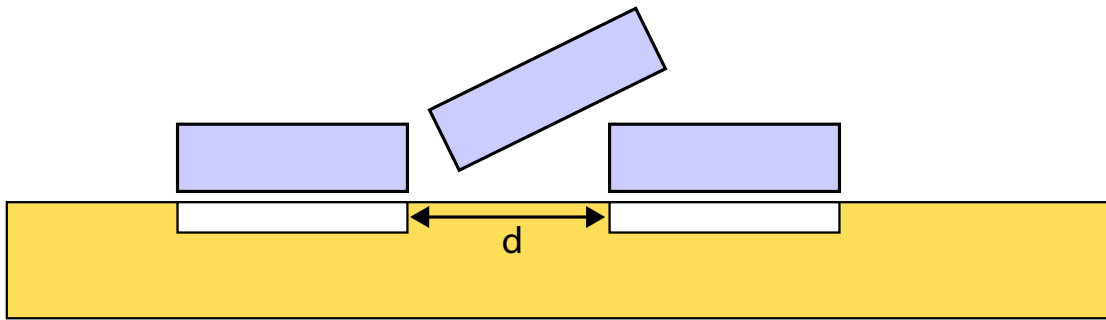


Fig. 11.43
If stopping bays are placed too closely together, then the station area can become congested.
 Image courtesy of Pedro Szasz

Normally, waiting passengers are not comfortable if they are constrained to less than a third of a square meter. Therefore, capacity for waiting passengers (Dw_{Max}) will be defined as three passengers per square meter, or:

$$Dw_{Max} = 3 \text{ passengers per m}^2$$

Some traffic demand models can generate a projected number of waiting passengers at each station based on the origin-destination (OD) matrix. The current number of boarding passengers on bus routes to be incorporated into the BRT system will also be a good guide. If available, this information should be used for the calculation. In the absence of this information, Equation 11.4 provides an estimation of the number of total boarding passengers. Equation 11.4 is used as a safe overestimate of this value.

Equation 11.4 Estimation of total boarding passengers at a sub-stop

$$Q_p = \sum (P_{Bi}/F_i) = \sum P_{bbi}$$

Q_p = Maximum passenger queue expected

P_{Bi} = Passengers boarding per hour on BRT route i

F_i = Frequency (BRT vehicles / hour) of line i

P_{bbi} = Average number of passengers boarding per BRT vehicle on line i

Box 11.1 provides a sample calculation for required platform area in conditions with a high-volume of boarding and alighting passengers.

11.3.3 Platform length

For systems with a single stopping bay, the above station sizing determination should be sufficient. For systems with multiple stopping bays, however, additional space has to be included between the sub-stops to accommodate BRT vehicles pulling around one another.

In order for multiple stopping bays to function properly, vehicles must be able to freely enter and exit. If the stopping bays are too closely spaced, then some vehicles may block access to an adjacent stopping bay (Figure 11.43).

In general, the absolute minimum distance required for one vehicle to pass another is one-half the bus length. For example, an 18-metre articulated vehicle requires at least 9 metres of separation between stopping bays. This minimum distance should only be used at stations with fairly low frequency, or where right of way constraint is a significant issue. Normally, BRT systems require more space because:

- Entering and exiting stopping bays with such limited space increases the time it takes to pull into the stopping bay, which reduces speeds and adds to saturation levels.
- If a vehicle using the same stopping bay is directly behind another, the waiting vehicle should be able to wait behind the first vehicle without blocking the stopping bay behind it.

Based upon this criteria, the minimum spacing should be approximately 1.7 times the length of the vehicle. In the case of an 18-metre articulated vehicle, this distance would be approximately 30 metres.

If the vehicle to platform interface does not utilise a boarding bridge, then greater precision is required to align the vehicle to the platform. While a boarding bridge only requires a vehicle to be within 40 centimetres of the platform, the lack of a boarding bridge requires that the vehicle be aligned within 10 centimetres or less. This degree of precision will possibly require a longer approach in order to maintain an effective speed.

Where space permits, room should be left for a second vehicle to wait behind each stopping bay, in order to avoid mutual interference between stopping bays. However, at a certain point, it

Table 11.3: Amount of queuing space required at stopping bays

Saturation level (X)		No. of stopping bays	No. of lanes	Amount of queuing space (vehicle lengths)	Total station length (metres)
From	To				
0.0	0.4	1	1	0	19
0.4	0.7	2	2	1	104
0.7	0.8	2	2	2	142
0.8	1.0	3	2	1	156
1.0	1.4	4	2	1	208
1.4	1.8	5	2	1	260
1.8	2.0	5	2	2	355

Notes:
 Total length = (19 m * number of stopping bays) + 33 m
 19 m = space for extra vehicle in queue
 33 m = 19 m + 14 m (space for stopping bay + overtaking distance)

is more efficient to simply add an additional stopping bay rather than leaving extra queuing space behind each stopping bay. Generally, it is optimal to provide just one queuing space, though in a few exceptional circumstances two queuing spaces are optimal. Table 11.3 outlines the conditions favouring one or two queuing spaces.

As evidenced from the results of Table 11.3, multiple stopping bays do tend to add considerable overall length to a station. This length requirement is particularly acute when additional queuing space is also required. The total length can cause difficulties on corridors with limited longitudinal right of way. Short city blocks may

thus constrain the ability to develop stations with multiple stopping bays.

Different stations will have different space requirements. If a particular station hosts a wide number of routes and services, then several additional bays will be needed. Conversely, if the station is just serving a few routes, then possibly only a single bay will be required. Figure 11.44 provides an overview of the different types of stations utilised in phase I of Bogotá’s TransMilenio system.

11.3.4 Aesthetic design

“Design in art, is a recognition of the relation between various things, various elements in the creative flux. You can’t invent a design. You recognize it, in the fourth dimension. That is, with your blood and your bones, as well as with your eyes.”

—D. H. Lawrence, writer, 1885–1930

Architectural considerations are critical to system success from aesthetic, cultural and customer-friendliness perspectives. At the same time, there is no one formula for determining a successful aesthetic design. What is architecturally attractive in one culture may not be attractive in another.

In many cases, the architectural design is a matter of “form following function” in which the required physical attributes determined by

Source: TransMilenio, SA

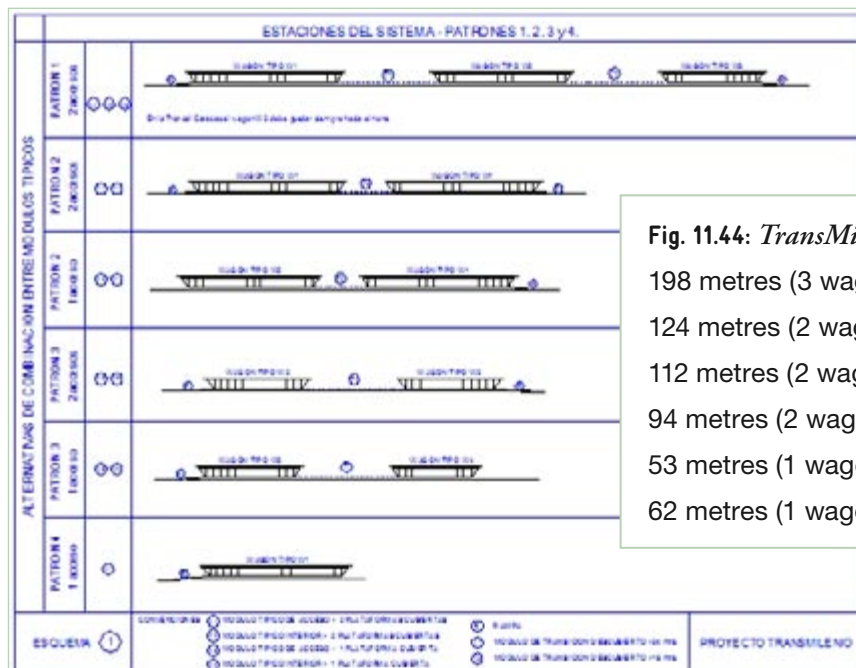


Fig. 11.44: TransMilenio stations
 198 metres (3 wagons, 5 platforms)
 124 metres (2 wagons, 4 platforms)
 112 metres (2 wagons, 4 platforms)
 94 metres (2 wagons, 2 platforms)
 53 metres (1 wagon, 2 platforms)
 62 metres (1 wagon, 2 platforms)

the operational plan will greatly influence the design. However, the station aesthetics should be given high consideration since the form and shape of the stations will partly determine customer acceptability. Thus, system planners should request that a range of architectural designs be developed in order to provide a full set of options. Aesthetic design is also not just about the shape of the station but also about other factors such as the colours utilised and the textures of the materials.

It is often desirable to choose an architectural design that reflects the local environment. An indigenous architectural style will ensure that the system is not merely a copy of a form created in another city. Utilising a local architectural style may also influence the extent citizens exude local pride over the system. The stations within the Guayaquil Metrovía system have been designed based upon an architectural style utilised in the city from the 1920s (Figure 11.45). Thus, the Metrovía system provides a connection to the city’s history and its surroundings.

Many systems opt for a highly modernised appearance, which helps to position BRT as a new class of public transport. Modern designs can conjure up customer impressions of sophistication, style, and speed. The tube structures in Curitiba have become an international symbol of BRT as well as provide customers with an image representing speed and modernity (Figure 11.46). The genesis of the tube design was in many ways to replicate the positive image of metro systems and their underground image of tubes whisking customers from one part of the city to another.



While the Curitiba tubes have been quite successful in creating an iconic image for the city, there are a few limitations to this type of design which could restrict its use elsewhere. First, the rounded design can be a limitation of system

Fig. 11.45
Guayaquil utilises an architectural style relating to the city’s history.

Photo by Carlos González



▲ Fig. 11.46
The modern tubed stations in Curitiba have created an iconic identity for the city.

Photo courtesy of URBS and the Municipality of Curitiba



◀ ◀ Fig. 11.47 and 11.48
Clean and simple design in Brisbane gives the system a look of modernity and sophistication.

Photos courtesy of Queensland Transport

Fig. 11.49
In the city's historical centre, Quito made its stations less obtrusive in order to be more congruent with the architectural surroundings.

Photo by Lloyd Wright



capacity. The circumference of the tube is limited by the required proximity between the station and the vehicle. A larger circumference will tend to push the nearness of the vehicle too far from the station floor. Second, the tubes can also act to create a mini-greenhouse effect in which heat is entrapped and thus making interior conditions uncomfortable for customers. However, louvered openings could be employed on tube stations which would allow for better airflow.

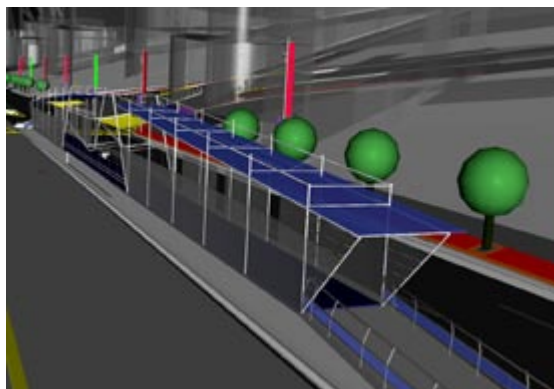
Modern architectural styles often deliver relatively “clean” look within a sort of minimalistic framework (Figures 11.47 and 11.48). The station designs in Brisbane epitomise this type of approach. The excellence of the Brisbane design has in fact resulted in the designers receiving various architectural awards. Likewise, stations in cities such as Las Vegas and Rouen have likewise utilised simple, clean designs to evoke a modern appearance.

Roof lines based on a “wave” design can also produce a highly modern perspective. The initial designs in Dar es Salaam and Johannesburg have made use of such a design appearance.

However, the modern look may not always be appropriate. If the system runs through or along corridors of great historical value, designers may wish to seek congruence with the adjoining architecture. Congruence with the surroundings was the reason that Quito re-designed some of its Trolé line stations in the city's historical centre (Figure 11.49). It was felt that the enclosed stations were visually too forceful within the historical centre, which is listed as a UNESCO World Heritage Site. Thus, the city opted for a more open design for the station at the Santo Domingo plaza. However, one negative aspect of such open-sided designs is that it makes passengers more exposed to wind and rain.

Fig. 11.50 and 11.51
An architect's vision may not be reflected in the implemented product due to the choice of materials and construction options, as demonstrated by this pre-project rendering and the resulting product along the Quito Central Norte line.

Left image courtesy of the Municipality of Quito
 Right photo by Lloyd Wright





The design's form, of course, is only part of the process in delivering a station of a particular style. The right combination of colours and textures can also affect the customer's perception of a station's aesthetics. The congruence of the chosen materials with local conditions, such as durability in local weather conditions, also plays a role. The premature rusting of stations in Quito may be due to both a lack of appropriate maintenance as well as the rainy conditions that exist for much of the year. Implementation choices also determine if the architect's vision is represented in the final product. The pre-project renderings of the stations for Quito's Central Norte line gave the impression of a high-quality and modern system (Figure 11.50). The reality of implementation and the chosen materials produced a somewhat less impressive result (Figure 11.51).

Station aesthetics can be negatively affected by over-use of advertisement displays. While advertising may be a needed source of revenue, too much advertising will detract from the visual clarity of the system and can lead to customer confusion, especially when system maps and other key information displays are difficult to find due to visual clutter. Thus, any decision to permit moderate amounts of advertising must be taken in conjunction with aesthetic and functional considerations.

The ultimate test of any architectural design is the public's opinion and usage of the infrastructure. A well-designed station is not only an entry point into a public transport system but also an intimate part of the urban fabric and a potential focus of community pride. The Villa

Flor station along the Quito Trolé line boasts an assortment of design interests apart from its functioning as a public transport station (Figure 11.52). The array of greenery and waterfalls actually draws crowds of persons who come just to observe the station area (Figure 11.53). In such cases, system designers may even wish to construct observatory points to allow residents to enjoy the system environs in the same way observation decks are utilised at airports.

11.3.5 Climate Control

"Climate is what we expect, weather is what we get."

—Mark Twain, author, 1835–1910

Protection from weather is a major consideration in station design. The image of the station as a refuge from the outside world can help attract customers. In many developing-nation cities, high temperatures and humidity are a concern. Open designs can also be an option, especially in warm locations. More open designs, though, do increase the need for protection against fare evasion. However, the example in Figure 11.54 shows that it is possible to achieve both an open design and relatively good natural deterrents to fare evasion.

The viability of an open design will depend on the variability of seasonal weather patterns. An open design may provide refreshing comfort during summer months, but such a design may also expose customers to wind, rain, and cold during winter periods. In cities with highly variable climatic conditions, a flexible design may be possible where louvers and foldable sides

Fig. 11.52 and 11.53

With an array of aesthetic attractions, the Villa Flor station in Quito actually draws persons who just come to observe the system.

Photos by Lloyd Wright

Fig. 11.54

A station design can provide both openness to encourage good air flow as well as protection against fare evasion.

Image courtesy of the Municipality of Pereira



allow station managers to adjust the station configuration according to the conditions.

Air conditioning systems and ventilator fans are options to consider, especially in hot and humid conditions. The use of air conditioning in both stations and vehicles can contribute greatly to the desirability of the system, especially with respect to capturing customers who were previously private vehicle users. Air conditioning in tropical climates can contribute to the image of the public transport system as a city oasis. However, the use of air conditioning units brings with it cost and technical considerations. With air conditioning, sliding doors must be utilised both at the entrance to the station as well as at the interface between the platform and the vehicle doorways.

The amount of time these doorways must be open will determine the viability of controlling the interior temperature with air conditioning. At high-volume stations, the amount of time the doorways must be open can make the sizing of the air conditioning system unrealistically costly. Further, a high use of electricity at the station can undermine the overall environmental performance of the system.

As an alternative to fully air conditioning (or heating) the entire station area, an enclosed refuge area can be built inside the station. Customers wishing to access a climate-controlled environment can open the door and enter the refuge area. Rail stations in Japan make particular use of refuge areas that provide air conditioning during the summer months and heating during the winter months (Figure 11.55).

Another lower cost alternative to full air conditioning can be fans and mist generators. These systems provide customers with a refreshing mist of cool water to reduce the discomfort of high temperatures (Figures 11.56 and 11.57). These systems also offer the advantage of allowing customers to choose their own comfort level by opting to stand near the device or not.

Passive solar design and natural design techniques offer the advantage of mitigating temperature extremes without the need for costly external energy inputs. Passive designs use shading and natural air flows to provide

Fig. 11.55

A refuge area within a station can provide an air conditioned and/or heated waiting environment at a fraction of the cost of controlling conditions along the entire station, as shown in this example from the Osaka Monorail.

Photo by Hiroto Inoi





relief to customers (Figure 11.58). For example, an overhang from the roof line can do much to shield the station platform from direct sun. In some cases, the same overhang can fold down to help close the station during non-operating hours. Also, as noted above, louvers in the station wall can encourage refreshing air flow across the platform area.

Vegetation above the station, either from planted trees or a green lattice, can also be an effective and attractive climate control option. Such vegetation can do much to mitigate the “heat-island effect” in which structural materials (such as concrete, asphalt, and metal) radiates and intensifies heat in the local area. Instead, trees and plants act to absorb heat and reduce the impact on waiting customers.

Fig. 11.58
Passive solar design provides shading and encourages natural air flows without the need for costly air conditioning systems.

Image courtesy of the Municipality of Barranquilla (Colombia)

While quite positive in terms of temperature moderation, passive design options should not detract from the aesthetic quality of the system. The curved overhangs on the Leon (Mexico) system are helpful in terms of climate control but have been criticised for aesthetic reasons (Figure 11.59). Thus, the functional design of a station area should be complementary and not detract from the aesthetic design.

Systems in cities with cold climates may also wish to consider climate control options. Heated station areas and heated vehicles will likewise create an image of the public transport system as a refuge from a hostile environment.

11.3.6 Platform doorways

The station to vehicle interface is the point at which a closed station is sometimes vulnerable to fare evasion. If left open, the platform doorways can be , even with high-floor stations (Figure 11.60). The station portals opening to the vehicle and the road are also points where

Fig. 11.56 and 11.57
Mist generators and ventilator fans are a cost-effective alternative to air conditioning as shown in these examples from the Pattaya (Thailand) bus terminal (left photo) and along a street in Kuala Lumpur (right photo).

Left photo by Carlos F. Pardo
 Right photo by Lloyd Wright

Fig. 11.59
While this roof overhang in León provides shading to passengers along the platform, many consider it to be aesthetically unappealing.

Photo by Lloyd Wright





Fig. 11.60
Without sliding doorways, customers may evade fare payment and endanger their safety by entering and exiting through the platform doorway.

Photo by Lloyd Wright

inclement weather can enter and affect passenger comfort. Further, this interface can also represent a safety hazard since passengers falling to the roadway can be seriously injured.

For all these reasons, a doorway that only opens upon the arrival of a vehicle can provide benefits to both the system and the customer. Sliding doors are used on various mass transit systems, including the BRT system in Bogotá and Quito. In addition to protecting the customer and preventing the entry of fare evaders, the sliding doors also create a higher sense of system professionalism (Figures 11.61 and 11.62).

The disadvantages to the sliding stations doors relate to cost issues. The initial infrastructure cost addition is relatively small to the overall cost of the station. Likewise, the on-going electricity costs for operating the doorway are

also relatively small. However, sliding doors do carry with it concerns affecting maintenance costs and system reliability. From experiences in cities such as Bogotá, the sliding doors are one of the most common system components to fail, albeit on a temporary basis. In the case of a breakdown, the doorways can be placed in the open position so as to not interfere with system operation. However, an open station doorway can create significant opportunity for fare evasion. Thus, the robustness of the sliding door technology as well as the availability of rapid-response repair teams are factors to consider in developing both the operational and infrastructure plans.

11.3.7 Station identification signage

The identification of a station's location from a distance can be useful in attracting patronage. Iconic signage that allows the customer to immediately identify the system can be an important element of the wider marketing effort. To extent, maps and signposts along footpaths can be helpful (Figure 11.63), but the immediacy of a station signage post provides a quick visual image to focus customer attention. The station signage posts can be quite useful to customers located between two stations. The posts allow such customers to quickly determine which station is the closest to them.

The height of the signage post will be a principal factor in creating a sight line that is visible from a great distance. However, the height of the signage post will be limited due to cost and local zoning restrictions. The colour and letter

Fig. 11.61 and 11.62
Sliding station doors serve several functions including customer safety, climate control, and fare evasion.

Top photo by Carlos F. Pardo
Bottom photo by Lloyd Wright





Fig. 11.63
System signage near station areas can be useful in pointing customers in the right direction as this example from Orlando shows.

Photo by Lloyd Wright

size on the post will also determine recognition levels (Figure 11.64). Typically, the name and logo of the system will be prominently displayed on the sign post along with the name of the particular station.

An image related to the particular station may also be displayed on the sign post. Such visual



imagery helps passengers to quickly recognise their destination. The name of a hospital, university, or zoo may not mean anything to some passengers (especially occasional visitors), and thus a representative drawing may provide more immediate recognition (Figures 11.65 and 11.66).

The sign post may also include other pertinent information. For example, in Bogotá each sign post also includes a clock (Figure 11.67). However, at the same time, designers must avoid placing too much information on the posts. Visual clutter will reduce the overall objective of allowing customers to quickly recognise a station's location.

Fig. 11.64
The colour, shape, and form of this station sign post in Brisbane allows customers to quickly recognise the presence of a station.

Photo courtesy of Queensland Transport



Fig. 11.65 and 11.66
In Quito, station sign posts reflect the local character of the station area. The image of children on the sign post (left photo) indicates that the Baca Ortiz children's hospital is located near this station. The stadium station sign post (right photo) is represented by a stadium image.

Photos by Lloyd Wright

Fig. 11.67
Station sign posts in Bogotá include the system name and logo, the name of the particular station, and a clock.

Photo by Lloyd Wright



11.3.8 Electrical supply

Stations, terminals, and depots require electrical energy in order to power a range of supporting infrastructure, including lighting, fare collection and fare verification equipment, automatic station doors, and climate control. The normal method is to supply the bus stop with power directly from the power grid. However, in some countries power from the grid is unreliable. In systems where the fare collection and verification system relies on a supply of electric power, a power failure can cause major problems in terms of the security and integrity of the fare collection system. In such cases, reliance on electric power at the station should be minimised to the greatest extent possible, or back up power generation systems should be included in the physical design from the beginning.

The median location of many BRT stations may make connections with electric power lines unsightly, and ideally they should be buried. Additionally, systems seeking to further boost their environmental credentials may wish to procure electricity from sustainable sources.

Against this backdrop, in higher income countries, solar energy systems are increasingly being viewed as a viable electricity supplier for bus shelters and stations. Solar photovoltaic panels (PV panels) generate electricity as photons from the sun strike the substrate material on the panel. As the market for PV panels has grown over the past decade, generation costs have dropped to reasonably competitive levels, especially in circumstances where the construction of costly transmission lines can be avoided. Electricity generated from PV panels produces no air emissions of any kind.

In 2005, Transport for London (TfL) completed a successful three-year evaluation of solar energy systems at 200 London bus shelters (Figure 11.68). As a result of this trial, London is now in the process of converting all 7,000 shelters in the city to solar PV panels. In Naples (Italy), three terminals currently make use of PV panels (Figure 11.69). The Naples system will produce approximately 5 million kWh during its expected 30-year lifespan (Allen, 2005).

11.3.9 Amenities

System designers also face decisions regarding the types of additional services that may be offered within a station. Amenity options for customer service have been discussed in Chapter 10 (*Customer service*). The provision of video, audio, seating, restrooms, security cameras, etc. involves decisions about costs and local preferences. Once the decision has been made

Fig. 11.68 and 11.69
Photovoltaic (PV) panels are an environmentally sustainable manner to service station and terminal electricity needs.

Left photo courtesy of Transport for London (TfL)
 Right photo courtesy of UITP





Fig. 11.70
Comfortable seating in a park-like setting enhances the customer experience at a Bogotá TransMilenio station.

Photo by Lloyd Wright

to include such amenity items, infrastructure design issues over colours, textures, materials, and location will arise. The addition of such amenity infrastructure should be done in a manner that is consistent with the other elements of the station.

The provision of seating at stations and terminals can help relieve tired bodies during the waiting period. The options for customer resting include formal benches as well as customer leaning posts (Figures 11.70, 11.71, and 11.72). Formal benches can sometimes be problematic if certain customers choose to lie down upon it, and subsequently pass long periods there without the intent to actually travel on the system. Thus, some systems, such as the Bogotá TransMilenio system, have purposely chosen not to provide seating for customers within many of its stations. TransMilenio also believes that its short wait times (usually less than three minutes) void the need for station seating (Figure 11.73). For systems with longer headways and thus longer wait times, some form of resting infrastructure may be considered. However, the placement of resting infrastructure should be such that it does not conflict with doorway locations or cause congested customer movements during the boarding and alighting process.



Fig. 11.71
Seating post as provided at a station in the Kunming BRT system.

Photo by Lloyd Wright

11.3.10 Commercial space

Public transport stations are more than boarding-alighting platforms for travel. They are urban public spaces, which have an architecturally defined space and aesthetics, where people meet and socialise or sit alone and wait to board the public transport vehicle. And like all in public spaces in the city, when people meet or wait, a variety of activities are undertaken, including shopping, eating, relaxing, and socialising. The availability of shops and vendors provides convenience to commuters who can combine travel with other value-added activities and chores. Some of the most common types of requested services include:

- Water, food and snacks;

Fig. 11.72
A leaning post can be an economical way of providing comfort to waiting passengers.

Photo by Lloyd Wright





Fig. 11.73
With high passenger flows and short headways between vehicles, TransMilenio has elected not to utilise seating in most of its stations.

Photo by Carlos F. Pardo

- General grocery products;
- Bakery goods;
- Pharmaceutical products;
- Clothing;
- Telecommunications services (telephone, internet, etc.);
- Shoe repair, key making;
- Bicycle repair.

In many cultures, it may be quite common to have tea, snacks, or juice prior to departing on a journey, or it may be common to enjoy such treats upon arrival at a destination.

Public transport stations also represent great value from the perspective of vendors and shop owners. The high volume of public transport customers through stations and terminals provides vendors with a concentration of potential clientele. The value of commercial property near stations often is representative of the high value merchants place upon potential customer volumes.

The needs of the commuters are met both by the services provided by the street vendors and the formal establishments like kiosks, shops, and large commercial centres. Given the variety of customer needs, each type of commercial establishment meets a certain market demand. Services provided by vendors are often less expensive because of low overhead costs and are also less time consuming to access. Therefore, commuters who are sensitive to out-of-pocket expenses, and are in a hurry, patronise these vendors. On the other hand, some commuters may have product needs that can only be met at larger retail facilities. It is important then to understand the roles of both types of commercial spaces in the public transport system, their

utility, their economics, their constraints and how they can be integrated in the design of the public transport stations.

Commercial spaces at public transport stations, whether planned or unplanned, answer the needs of the commuters. They work on the market model of demand and supply and are guided by the number of passengers, average wait time, average bus-trip distance etc. Therefore it is necessary to understand the exact nature of the demand for commercial spaces before planning for them. The integration of commercial exchange with public transport operations is another form of providing convenience and service to the customer. This section refers to the importance and planning process of integrating commercial spaces with BRT stations.

11.3.10.1 Street vendors

Benefits of vendor activity

In many cultures, street vendors are an indispensable part of daily life. Such merchants provide an array of services at minimal cost. A detailed study (Tinker, 1997) of vendors selling food on the streets of seven cities in Asia and Africa documents the important role these vendors play in a city. It found that street foods are frequently less expensive than home-prepared foods, especially when time spent shopping and cooking is factored in. Lower-income groups may spend 50 percent to 80 percent of the household budget on food, and thus money saved in this regard can be significant.

At the same time, the street vendors come from the lowest socio-economic strata of the city, finding livelihood in informal service provision. And hence, the employment in the street-vending sector is the means of survival for a large section of the urban poor. According to Tiwari (2000), the availability of work options on the street provides a positive outlet for employment and earning an honest livelihood to a large section of the population that is poor but with high entrepreneurial skills.

Apart from the economic contributions of the street vendors at public transport stations, they also contribute socially to the public transport system. Jacobs (1961) first coined the metaphor of “eyes on the street” while referring safety on the streets due to the presence of vendors. There



Fig. 11.74
Small-scale vendors in Dar es Salaam take over a lay-by area originally intended for mini-bus taxis.
 Photo by Lloyd Wright

is now a variety of literature that supports the theory that the presence of street vendors in Asian cities is a prime reason for the low street crime witnessed there.

Problems of unplanned vendor activity

However, the provision of infrastructure for commercial activities within or near public transport stations can also be a source of controversy. Some public transport agencies may not view commercial activities as being consistent with the objective of encouraging rapid customer movements. If left uncontrolled or unplanned, vendors may tend to block walkways, and thus inhibit access to stations (Figure 11.74). Aggressive sales techniques may also make some public transport customers uncomfortable with using the system. Further, waste and debris left behind by vendors can lead to an aesthetic deterioration of the station environment.

Some systems, such as TransMilenio in Bogotá, have largely prohibited vendor activity near stations in order to avoid these types of problems. Most public transport agencies also prohibit open food and drink containers inside the BRT system. The cost of cleaning spilled items and the impacts on the longevity of infrastructure components frequently justify this type of restriction.

Designing for vendor integration

However, in many cultures, the employment and social justice impacts of vendor displacement is a highly sensitive matter. Simply evicting these individuals will have traumatic impacts on the individual, their families, and



Fig. 11.75
In cities such as Delhi, vendor activity near public transport stops provide important employment opportunities.
 Photo courtesy of iStockphoto

society at large. Further, in cultures of South and Southeast Asia, the services provided by the vendors are intricately woven into daily life (Figure 11.75).

In Delhi (India), the BRT development team are implementing a novel approach of formal vendor integration into the infrastructure design process. By providing vendors with a formal space near the station, all sides can win. The higher quality space provided to the vendors can in fact improve their work conditions and their care of the public transport environment. Further, the formal inclusion of vendor space in the design process can ensure these sites do not conflict with passenger movements.

Prior to the commencement of design activities on the Delhi BRT system, the development team conducted a customer needs assessment (Figure 11.76). This assessment included a survey of the hawkers and the vendors associated with the existing bus-stops on the corridors. The survey showed that “the intensity and nature of commercial activity generated at a bus-stop is directly proportional to the rate of flow of passengers which is represented by the arrival rate of buses. The study concludes

that if the bus arrival rate is less than 2 every 30 seconds, no separate infrastructure needs to be provided for the vendors. At locations where the bus arrival rate is 2 or more, space between 2 adjacent bus-shelters can be developed for vendors” (Gandhi, 2002).

The survey also showed the great customer demand for vendor activity in conjunction with public transport services. Approximately 96 percent of the commuters surveyed had used the services provided by the street vendors. A majority of the vendors (77 percent) occupy spaces between 1 and 2 square metres near the bus stops. Approximately 70 percent of the hawkers earn less than US\$2 per day, and thus again indicating the significant socio-economic benefits of integrating vendors with system design.

A few bus shelters in Delhi have been designed with spaces for vendors as an integral part of their bus shelter design. The amount of area given to the vendors is decided on the basis of passenger volume counts and frequency of buses and integrating them in design ensures that while the vendors provide the requisite conveniences to the public transport commuters, they do not interfere with passenger and vehicle flow.

In some instances, there may be insufficient space in the median to accommodate vendor activity. However, the Delhi development team has resolved this problem by providing vendor spaces along the curb-side. In these cases, great care is taken to ensure that adequate space also remains for comfortable pedestrian movement alongside the vendor stalls (Figures 11.77 and 11.78).

In many cultures, the presence of vendors at public transport stations is an inevitable necessity, especially in locations where passenger volumes are high. The importance of vendors is especially the case in South and Southeast Asia. In such instances, the banning of vendors may in turn encourage undesirable side-effects, such as the bribing of security personnel and the invasion of vendors into unanticipated areas. Instead, the appropriate consideration of vendor space within station design and layout can produce a winning situation for the public transport agency, the vendor, and the public transport customer.

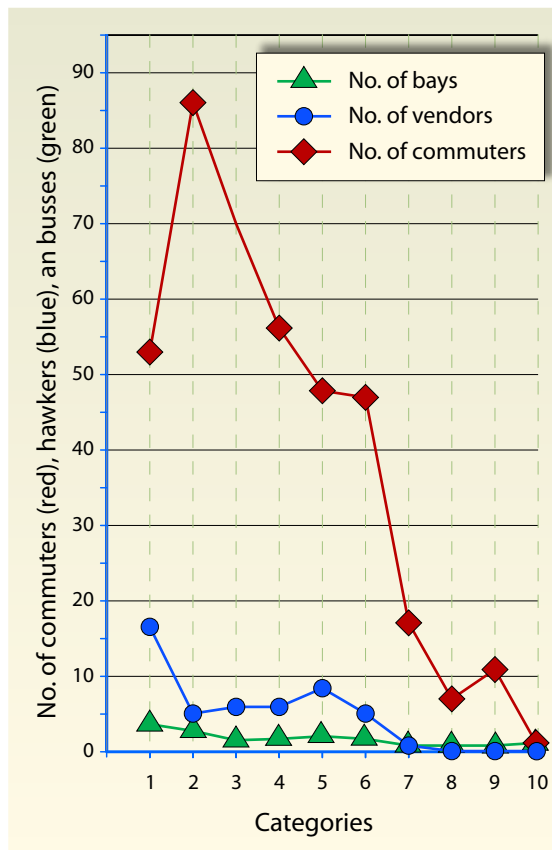


Fig. 11.76
Relationship between, vendor demand, bus bay requirements and commuter volumes.
 (Source: Gandhi, 2002)

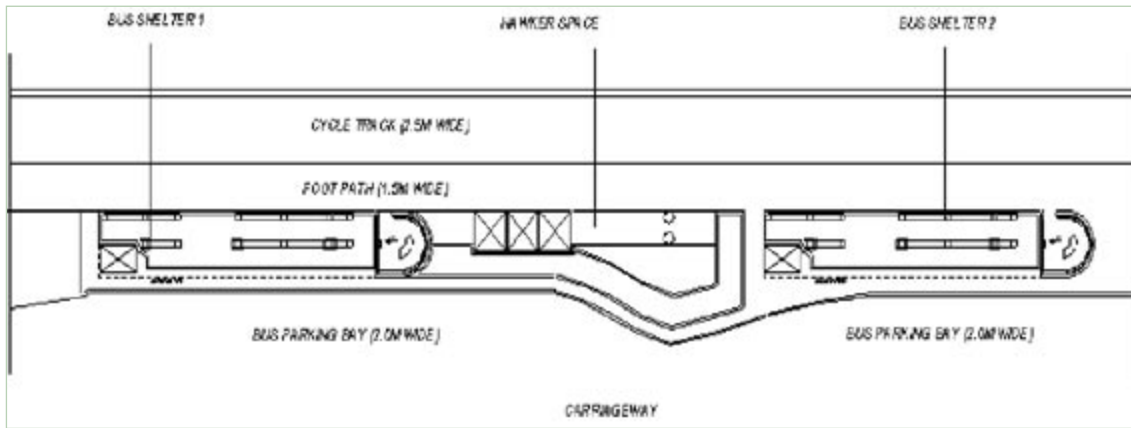


Fig. 11.77
Schematic of bus shelter with integrated space for vendor activity.

Image courtesy of the Indian Institute of Technology–Delhi

11.3.10.2 Larger commercial sites

Public transport stations may also attract the attention of large commercial retailers seeking to reap the benefits of passenger flows. Likewise, the ability to conduct grocery shopping and other tasks near the public transport corridor is a benefit to customers. The presence of these commercial entities also offers some opportunities for financing the station and terminal construction costs. Chapter 17 (*Financing*) provides more detail on this topic.

From an infrastructure standpoint, it is possible to integrate commercial enterprises into the station and/or terminal sites. The availability of space is the prime determinant along with the ability to design the shop to avoid conflicts with passenger movements. The Bangkok SkyTrain system hosts small shops within its elevated concourse. If a BRT system has an underground tunnel connecting interchange stations, then an underground shop location could be feasible. Terminals perhaps offer the greatest potential since space is typically more readily available. Terminal sites often also reduce the distance goods must be carried home.

Commercial enterprises can also benefit by locating near the station and terminal locations without actually being within the public transport property. In Bogotá, large commercial centres have opened near the TransMilenio corridor (Figure 11.79). Capturing the value added to these property developments and applying the added value to system financing is a subject of much interest. More information on land



Fig. 11.78 ▲
Complete bus shelter with integrated vendor space.

Photo by Lloyd Wright



Fig. 11.79

In Bogotá, many large commercial centres have opened alongside the TransMilenio corridors.

Photo by Lloyd Wright

benefit levies (LBL) can be found in Chapter 17 (*Financing*).

However, as noted previously, retail integration with the public transport system brings with it unintended complications. The presence of shops within the system adds a layer of complexity to passenger flows and can slow customer throughput. Some of the issues to be considered in retail integration include:

- The retail activity not being related to commuter movement and encouraging inflow of non-users to the station, thus inconveniencing the users and reducing efficiency of the station;
- Induced traffic and parking demand from non-users of the public transport station can put unanticipated load on parking areas and access roads leading to congestion around the stations and making the system unattractive to commuters;
- Retailing employees are typically given free access to the shops, but such exemptions can spiral into abuse of system entry;
- Finally, deliveries to shops can also create congestion if not carefully controlled or relegated to non-operating hours.

11.4 Transfer stations, terminals, and depots

“Design is directed toward human beings. To design is to solve human problems by identifying them and executing the best solution.”

—Ivan Chermayeff, architect, 1900–1996

Facilitating easy and efficient customer movements directly affects travel times, convenience, and ultimately customer satisfaction. In many BRT systems, transfer facilities provide the means to cost-effectively combine different types of services, such as feeder services and multiple trunk-line services. Thus, “intermediate transfer stations”, “interchange stations”, and “terminals” all serve to facilitate ease in customer movements between different routing services.

“Depots” and other BRT vehicle parking facilities do not directly affect customer transfer convenience, but the location, layout, and management of these facilities will affect overall system efficiency.

Each of the infrastructure elements that will be described in more detail in this section are defined as follows:

1. *Intermediate transfer stations*

Facility that permits transfers between feeder services and trunk-line services.

2. *Interchange stations*

Facility that permits transfers between different trunk-line routes.

3. *Terminals*

Large facility typically located at the end of a trunk-line corridor that allows transfers between multiple feeder services.

4. *Depots*

Facility that serves multiple system tasks including fleet parking, vehicle refuelling, vehicle washing, vehicle service and repair, employee services, and administrative support for operators.

5. *Intermediate parking facilities*

Facility that allows BRT vehicle parking at intermediate locations along the corridors.

Figure 11.80 illustrates how each of these infrastructure elements can come together within an actual system.

Not all of the facilities discussed in this section may be necessary in a given BRT system. The

usefulness of these infrastructure elements depend much upon the local circumstances. Systems employing “direct services” will likely not utilise either intermediate transfer stations or terminals. Instead, vehicles operating in a direct services system will proceed directly from trunk corridors into lower-density areas. Systems with direct services, though, may still utilise interchange stations where transfers between different trunk routes are facilitated.

One key difference between BRT systems and conventional bus systems is the nature of the transfer between different routes and services. Within a BRT system, all trip service and routing options are integrated both in terms of fare structure and physical proximity. It is the ease of transfers and the multiple travel options that sets BRT apart from conventional services.

The number and type of transfer facilities will depend largely on the operational plan that was articulated in Part II of this Planning Guide. The operational plan will have determined several key factors, including the number of BRT vehicles, the number of corridors, and the number of trunk and feeder routes converging upon a site. Likewise, local physical factors, such as available right-of-way, will in part determine the location of transfer facilities.

11.4.1 Intermediate transfer stations

Feeder connections to the trunk lines do not necessarily occur only at major terminal facilities. Feeders can also intersect the trunk corridors at what are known as intermediate transfer stations. These stations are somewhat a hybrid facility between ordinary local stations and terminal facilities. Figure 11.81 provides an overview of the relationship between standard stations, intermediate stations, and terminal facilities. As noted above, systems with direct services generally avoid the need for intermediate transfer stations.

Unlike terminal sites, intermediate transfer stations may not have the luxury of space to easily accommodate both feeder platforms and trunk-line platforms. Thus, a bit of creativity is required to design and control the transfer process.

The options for facilitating transfers can be divided into “open transfers” and “closed transfers”. As the name implies, an open transfer

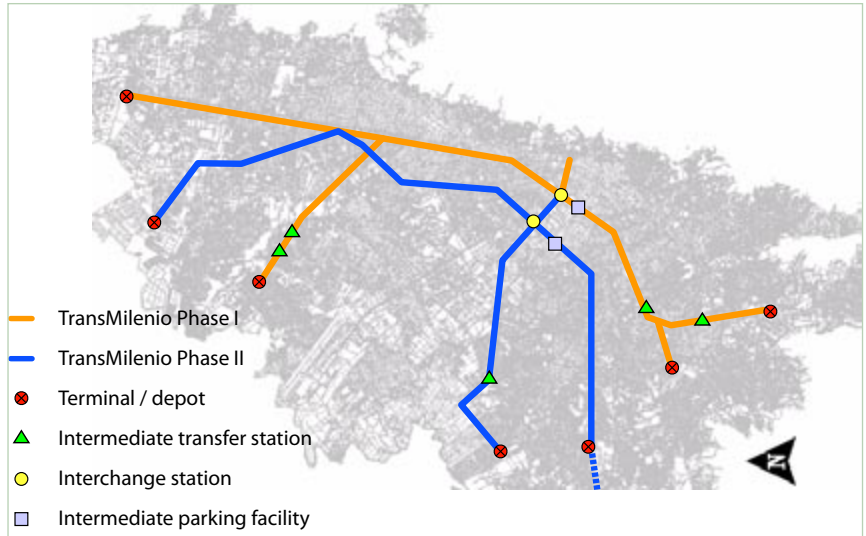


Fig. 11.80
Transfer stations, terminals, depots, and vehicle parking facilities for Bogotá's TransMilenio.

takes place in an open environment in which it is not necessary to physically combine the feeder and trunk sub-stops into an enclosed environment. By contrast, a closed transfer takes place in a fare-controlled environment in which one is either inside the system or outside the system.

11.4.1.1 Open transfers

For open transfers, there are several different options available. The simplest is perhaps the free fare option in which no fare is required to enter the system. Customers are able to transfer from one service to another without worrying about whether they are in a paid or unpaid zone. Systems such as the Orlando LYNX Lymmo and the Eugene EmX do not charge a fare, and thus, such systems have considerable flexibility with infrastructure and transfers. Of course, free fare options invoke other issues such as operational subsidies, which are discussed in Chapter 16 (*Operational costs and fares*).

Fig. 11.81
Schematic illustrating the difference between a terminal facility and intermediate transfer stations.

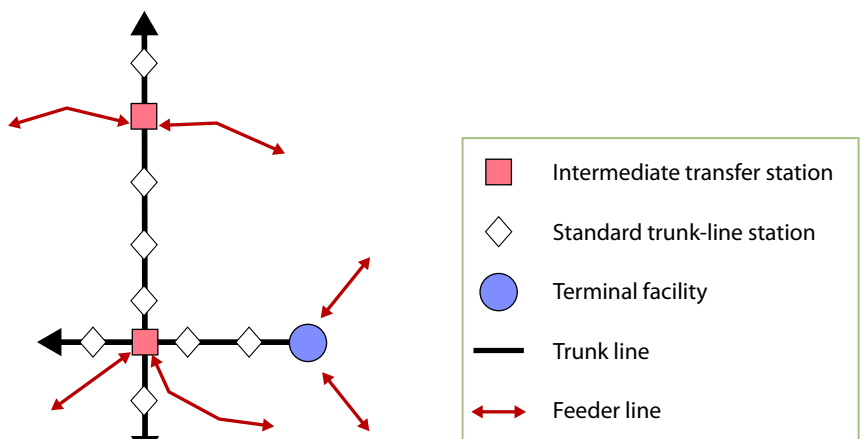


Fig. 11.82 and 11.83

Customers arriving by the green feeder vehicles in Bogotá transfer over a pedestrian bridge to enter the trunk service.

Photos courtesy of TransMilenio SA



Bogotá has utilised a form of the free fare approach by restricting fares only to the trunk service. Thus, customers utilising the feeder services do not pay a fare upon entering the feeder vehicle. Instead, customers only paid a fare once arriving at a terminal or at an intermediate transfer station. In the terminals there are clearly defined paid and unpaid zones which are separated by physical barriers. Likewise, at the intermediate transfer stations, customers must verify fare payment when entering the trunk line portion of the station area. In most cases, the feeder service has a stop nearby the trunk station and customers access the trunk station by way of pedestrian bridge (Figures 11.82 and 11.83). To date the TransMilenio system includes five intermediate transfer stations of this type.

At some intermediate transfer stations in Bogotá, such as the Banderas station, the interconnection between trunk and feeder services is quite elaborate (Figure 11.84). Customers cross between the two areas in a completely weather-protected environment (Figure 11.85).

The feeder area involves multiple stopping bays offering a variety of feeder route destinations.

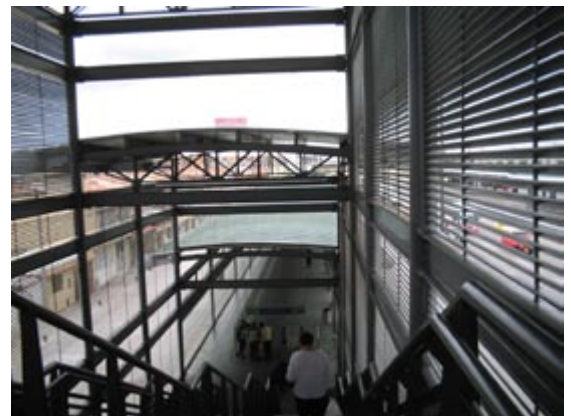
The provision of free feeder services in Bogotá has created its own problems due to some customers not utilising the trunk services upon arrival. A percentage of the customers are only using the feeder services and are thus not providing any income to the system. Since the operators have a financial interest in preventing this type of “free rider”, some policing of feeder customers does take place. However, to combat this issue, the TransMilenio system is looking at alternatives to the free feeder services.

Another option is to utilise a sophisticated fare technology to fare integrate feeder and trunk services without close physical integration. In this case, the feeder stop may be on a side street near the trunk corridor. Using smart card technology, the customer will validate his or her fare card upon both exiting the feeder system and upon entering the trunk system. The physical transfer between the feeder and trunk route may imply walking across a standard intersection with no special segregation for public transport customers. To make this type of transfer

Fig. 11.84 and 11.85

At the Banderas intermediate transfer station in Bogotá, customers cross a weather-protected sky bridge to go from the green feeder vehicles to the red trunk vehicles.

Left photo by Lloyd Wright
Right photo courtesy of ITDP



possible, a fairly sophisticated fare technology system must be in place. The smart card must record not only the location of the transfer but the time between the transfers. The customer will likely be given a time limit to reasonably make the transfer; otherwise, the transfer will be considered two separate trips requiring a separate fare payment. This type of fare-based transfer makes full use of the flexibility afforded by the advent of smart cards but at the same time can introduce complexity into the fare system and can cause some customer confusion.

Alternatively, a simple solution is to charge a separate fare for both the feeder service and the trunk service. One fare would be paid on-board the feeder vehicle and another fare would be paid upon entering the trunk station. The two fares imply that an open transfer could be achieved since no physical enclosure is required between trunk and feeder payment areas. However, the two fares suggest there is less integration between two services; there is no recognition of the overall distance travelled by the customer in the fare calculation. Some customers may be paying disproportionately higher fares due to this imprecision of distance in the fare equation. Further, this approach also implies that customers will have to potentially wait in more queues since fares must be purchased and verified with both services.

11.4.1.2 Closed transfers

Ideally, the feeder vehicles can enter a “closed” space in which a fare-free transfer can take place without concerns over fare evasion. However, this ideal is typically difficult to achieve due to space limitations at intermediate transfer points.

One solution is to simply allow feeder buses to enter the BRT trunk line system briefly and share the BRT station. This approach is being attempted on the Central Norte in Quito. At some wider stations areas along the Central Norte corridor, the combination of trunk and feeder stopping bays functions (Figure 11.86). At other locations, the complementary feeder services originally foreseen in the operational plan have never materialised.

The option of bringing together trunk and feeder vehicles within the same set of stopping bays is rarely used in other systems. Difficulties tend

to arise due to space and the different technical specifications between trunk and feeder vehicles. Typically, to make this option work, both the trunk and feeder vehicles must have doorways on the same side of the vehicles in order to share the same platform. This requirement likely means that the trunk vehicles will be forced to have curbside doorways, which creates many other disadvantages as noted in Chapter 7 (*Network and service design*). This configuration will also increase the level of saturation of the station area. If the station is far from saturation this will not cause a major problem, but if it is near to saturation, the combining of trunk and feeder vehicles could lead to a significant deterioration in trunk operating speeds.

Alternatively, a closed environment could be created through the use of segregated pedestrian tunnels or bridges connecting the feeder service to the trunk service. In this case, the feeder stop near the trunk service will be an enclosed environment where only paid customers may be present. The dedicated infrastructure connecting to the trunk station could only be utilised by paid public transport customers. This approach resolves many of the other problems noted in this section, but the infrastructure costs related to the segregated tunnel or bridge may make this option expensive to develop. The cost issue may be particularly acute if there is a considerable distance between the feeder station and the trunk station.

Fig. 11.86
At the Seminario Mayor station of the Quito Central Norte line, customers walk down a ramp from the yellow articulated vehicles to the smaller blue feeder vehicles.

Photo by Lloyd Wright





Fig. 11.87
Bogotá utilises stations with multiple stopping bays in order to permit platform transfers for customers wishing to change from one route to another.

Photo by Lloyd Wright

11.4.2 Interchange stations

As a system expands across a wider network, intersecting stations will require mechanisms to transfer from one trunk corridor to another. An “interchange station” is a facility that permits such transfers, and thus has additional design considerations than a standard station. Interchange stations are relevant to both systems utilising trunk-feeder services as well as systems utilising direct services.

There are several options for facilitating transfers between corridors. These options include:

- Platform transfers (Figure 11.87);
- Underground tunnels / overhead pedestrian bridges (Figure 11.88);
- Interchange facility (multi-bay or multi-storey facility).

A system may use a combination of these interchange options, depending on the local circumstances at the interchange point.

Platform transfers are the most desirable means to permit a customer to change from one route to another. The customer must merely walk a few metres in a protected environment to change services. This type of “closed” transfer is also simpler from a fare verification standpoint as



Fig. 11.88
In some instances, Bogotá also utilises pedestrian tunnels to allow customers move from one corridor to another.

Photo by Lloyd Wright

well since no special fare technology is required to discern from those persons “inside” the system and those persons “outside” the system.

However, allowing multiple routes and multiple turning movements within the BRT system can complicate route and intersection design. This complexity is multiplied if there are also various limited-stop and express services. At the crossing of two perpendicular corridors, vehicle turning actions from one corridor to another are required to provide a platform transfer for the customer.

In most cases it is preferable to bring the route to the customer rather than forcing a difficult



Fig. 11.89 and 11.90
A schematic and external view of the Ricaurte interchange station in Bogotá.

Image and photo courtesy of ITDP



Fig. 11.91 and 11.92
A gradual ramp and enclosed walkway allow customers to comfortably transfer between corridors at Bogotá's Ricaurte station.

Photos courtesy of Carlos F. Pardo

walk across an intersection (and effectively forcing the customer to go to the route). However, there may be instances, where BRT turning movements cannot be realistically accommodated within a complex intersection. The number of required signal phases may create an array of traffic movement problems. Thus, in such instances, it may be necessary to for transfers to take place by customers walking from one corridor to another, typically a diagonal walk across an intersection. To maintain a “closed” environment with paid customers only, a segregated tunnel or pedestrian bridge is required. Further, by providing segregated infrastructure, customers are not subjected to the difficulty of negotiating their way across busy traffic. However, the negative of such a transfer is the usual requirement for a grade change, meaning customers must walk up and down stairs and/or mechanical devices (escalators/elevators) must be provided.

The Ricaurte interchange station in Bogotá provides a quality example of how this type of walking transfer can be accomplished (Figures 11.89 and 11.90).

At the Ricaurte interchange, two perpendicular corridors are connected via a closed pedestrian tunnel. In this case, a gradual slope is used to avoid stairways which would otherwise create difficulties for the physically disabled and elderly (Figures 11.91 and 11.92). This option closely approximates transfer points within a rail underground system. The main advantage of this approach is that it simplifies the intersection design, and that it uses standard station stops in standard locations. The Ricaurte station also includes customer amenities such as restrooms, an information centre, and quality public space.

Another option is to construct an interchange station in which two (or more) trunk lines are physically joined by the same station infrastructure. This infrastructure can take the form of a single-level, multi-bay facility or of a multi-level facility in which one line is physically above the other. This option closely approximates transfer points within a rail underground system. Within this closed environment, passengers then transfer from one route to another. Disadvantages of this approach are the cost of the infrastructure and the space required to construct the facility. However, in comparison to requiring passengers walk from one corridor to another, there is less distance to walk between vehicles.

11.4.3 Terminals

Typically, in BRT systems, terminals are the most important transfer points. They are normally located at the end of each trunk corridor, and provide important transfers between trunk lines and feeder bus lines serving surrounding areas. The design of the interchange facility should minimise both customer and vehicle movements to the extent possible. Thus, the most likely transfer points between complementary routes should be located closely together. As both feeder vehicles and trunk-line vehicles will be staging at the terminal, the movement of vehicles should be devised to avoid congestion. Most typically, feeder vehicles arrive on one side of a platform area with trunk-line vehicles wait on the opposite side (Figure 11.93).

Likewise, the Bogotá system utilises a simple platform configuration to facilitate easy transfers from trunk services to feeder services. Figure 11.94 shows a schematic of the Bogotá terminal platform.



Fig. 11.93
At the El Recreo terminal of the Quito Trolé, customers easily transfer from trunk services to feeder services by crossing a platform.
 Photo by Lloyd Wright

Other configurations are also possible. Feeder platforms may be placed in an area somewhat separate from the trunk platforms. This configuration will likely imply that customers must walk farther to access the trunk services. However, such a configuration may be necessary if the number of feeder routes greatly exceed the number of trunk routes (and thus creating a mismatch in terms of platform space). Also, such alternative configurations may also be necessary due to the physical nature and layout of the intended site for the terminal facility. Figure 11.95 is a schematic of a proposed terminal facility in Dar es Salaam in feeder platforms are placed aside the trunk platform area.

Terminals are usually the largest transfer facilities in the system, but the terminals also serve other purposes. Space is typically made available for BRT vehicles to park in order to allow service adjustments. Obvious adjustments are required between operating during busy peak

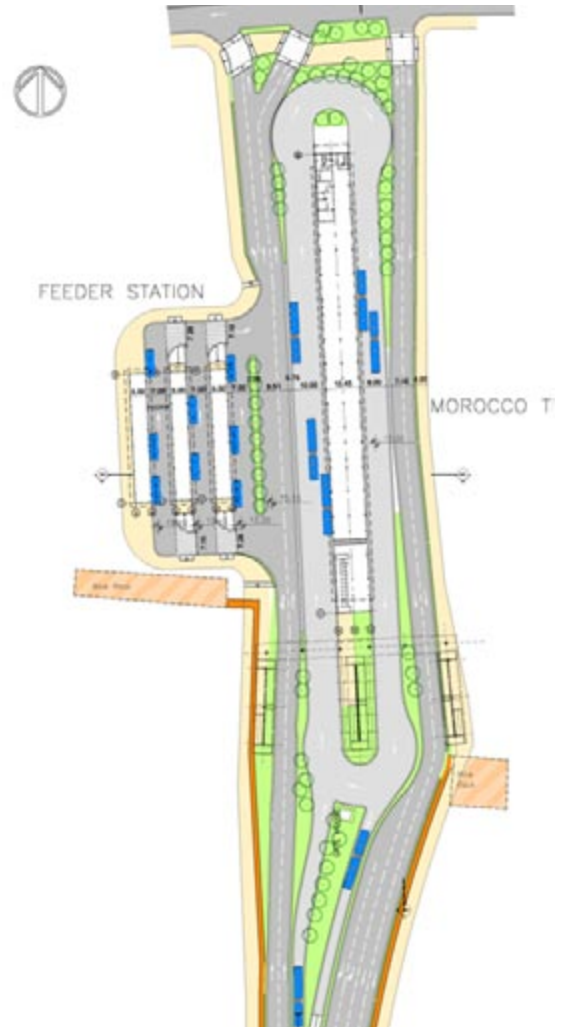


Fig. 11.95
In this proposed terminal in Dar es Salaam, the feeder platforms are slightly separated from the trunk platform.
 Image courtesy of the Dar es Salaam City Council

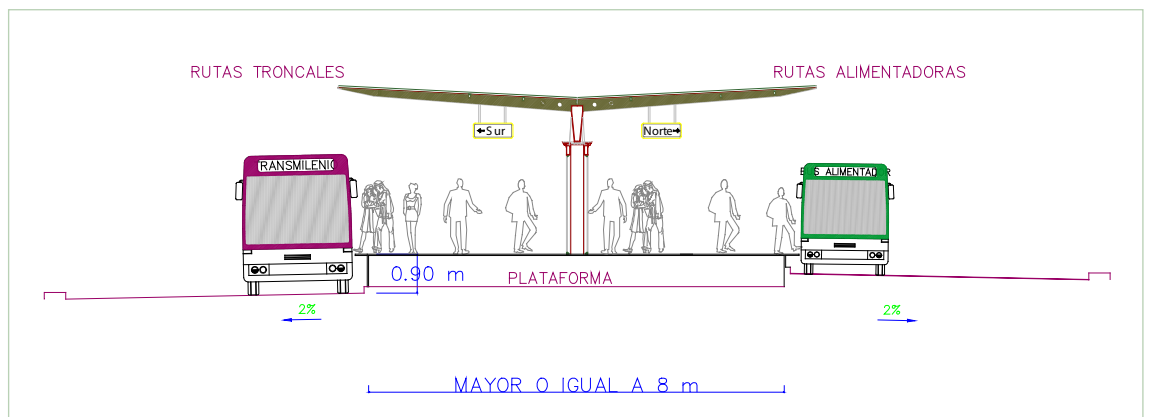


Fig. 11.94
Schematic showing the simple transfer from a trunk vehicle (on the left) to a feeder vehicle (on the right).
 Image courtesy of Steer Davies Gleave

periods and non-peak periods. In other cases, the departure times for vehicles are carefully adjusted in order to assure consistent headways.

The overall design of the terminal facility should seek to optimise fluid movements for both vehicles and customers. Appropriate spacing should be created to allow vehicles to comfortably move in and out of position at the stopping bays. Figure 11.96 provides a schematic of an entire terminal facility in Bogotá.

The terminal design must also take into account required turning movements of BRT vehicles. In the case of articulated and bi-articulated vehicles additional space is required for the vehicles to safely and easily complete a 180 degree turn. Figure 11.97 shows the turning

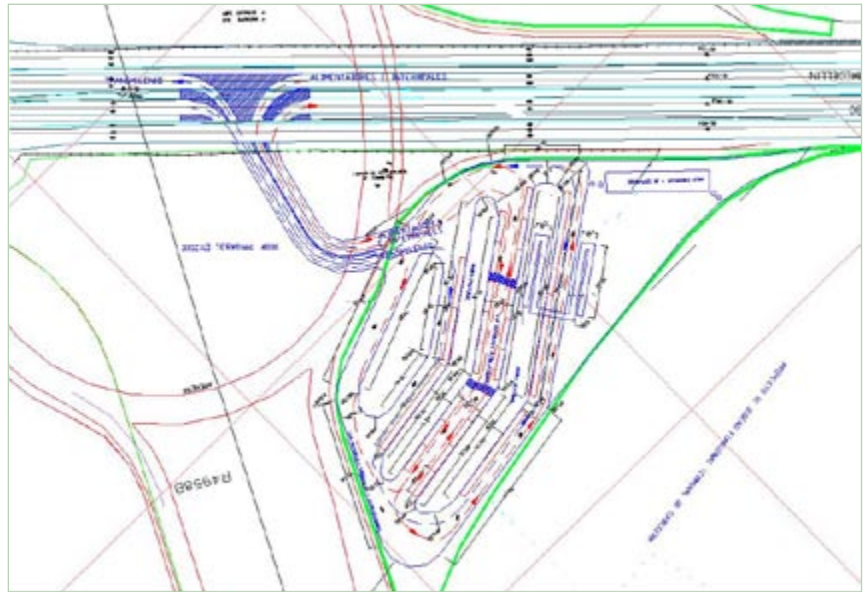


Fig. 11.96

Schematic of all platform and customer facilities at the Calle 80 terminal in Bogotá.

Image courtesy of Steer Davies Gleave

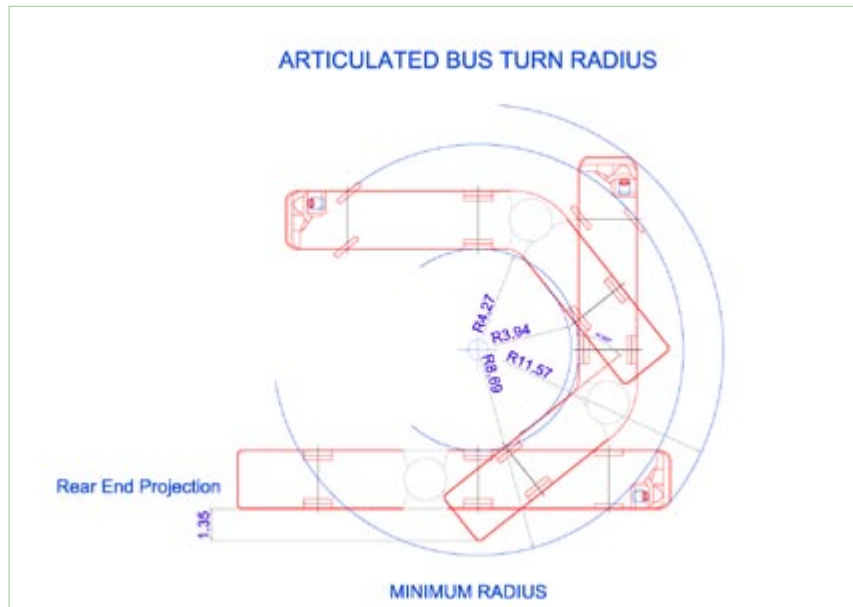


Fig. 11.97

Required turning radius to permit an articulated vehicle to safely change directions.

Image courtesy of ITDP

Fig. 11.98

To pass from the feeder side of the platform to the trunk side of the platform, customers in Bogotá must pass through fare payment and fare verification infrastructure.

Photo by Lloyd Wright

space required for an articulated vehicle (18-metre vehicle) to safely turn around.

Whether or not the facility is designed for fare-free transfers will have a significant impact on the facility's design. Fare-free transfers mean that passengers can move from feeder services to trunk-line services without an additional fare. If an additional fare payment is required, then space must be given to fare collection and fare verification activities (Figure 11.98). The physical division between the different fare areas must also be sufficient to avoid problems with fare evasion.

Given the large numbers of passengers passing through terminal areas, design against crimes such as pick-pocketing should also be





Fig. 11.99 ▼, 11.100 ◀, and 11.101 ▲

The architectural design of terminal facilities in Quito (top left photo), Bogotá (left photo), and Guayaquil (photo above) serve the functional purposes of efficient customer and vehicle movements as well as serve the aesthetic image of the systems.

Photos by Lloyd Wright

considered. Thus, measures such as security cameras may be appropriate.

Terminals may also serve a range of customer service functions. Some of the provided facilities may include information kiosks, lost and found offices, restrooms, and commercial establishments. Within the Bogotá TransMilenio system, many of the terminals also include “Super-CADE” centres where customers can access a range of municipal services. Allowing shops within transfer facilities is possible but can create an array of complications, including litter and security issues. It is also recognised that some systems intentionally elect not to provide additional services. These system designers feel that the most important task is to keep passengers moving through the system, and that additional services are an impediment to that over-arching goal.

The architectural design of terminals can either mimic the style of the system’s stations or take on a different look. Terminal platforms are typically not enclosed with walls since entrance to the terminal site is controlled from a distance (Figure 11.99). Terminal facilities in cities such as Bogotá and Quito have high ceiling designs

with modern roof structures (Figure 11.100). Guayaquil has created a great sense of space through its terminal design that features an ornate lattice structure (Figure 11.101). The scale and style of these facilities imparts an impression of importance to the customer and helps to instil the system’s professional image.

11.4.4 Depots

Depot areas serve an array of purposes including bus parking areas, re-fuelling facilities, vehicle washing and cleaning, maintenance and repair areas, administrative offices for operators, and employee facilities.

11.4.4.1 Depot location

Depots are generally, but not always, adjacent to terminals. Normally, the BRT vehicle will enter the terminal several times a day, but it will generally enter the depot only if it is being taken out of service, either because it is a non-peak period, because it is the end of the day, or because it is in need of repairs.

Ideally, depots will be located at or adjacent to terminal facilities, so that depot parking can also be used for BRT vehicles coming out

of service for off-peak periods without having to travel a long distance to return to a depot (Figure 11.102). Travel between the depot and terminal areas create “dead kilometres” since fuel and other expenses are consumed without generating any passenger revenues. These dead kilometres can considerably increase overall operating costs. Such separation can also create service irregularities, especially if the BRT vehicles are delayed in mixed traffic congestion while travelling from the depot.

However, since depots can consume considerable space, the location is often dependent upon the economical acquisition of sufficient property. In some cases, sufficient land is not available near a terminal site and any site acquisition can be quite costly. Thus, for example in Transjakarta, the depot area is located a considerable distance from the system’s two terminals. BRT vehicles must not only travel a long distance from the depot in the morning and to the depot in the evening, but must travel to depot parking during the non-peak periods. As an alternative to locating the depot nearby the terminal, it is possible to increase the amount of temporary vehicle parking at the terminal area or through

intermediate parking facilities. However, again, there is often a limitation on sufficient terminal parking to accommodate all the vehicles.

Terminals and depots for BRT may also be integrated with other transport facilities. In Dar es Salaam, a terminal and depot is being planned in the site of the long-distance bus services (Figure 11.103). This co-location of urban and long-distance services holds benefits both to the customer as well as the private operators. Customers are able to easily transfer from the long-distance services into the BRT system. The private operators may also gain benefit in terms of any shared facilities with long-distance operators.

11.4.4.2 Number of depot facilities and ownership

In many cases, it is desirable to provide enough depots so that each operator controls its own maintenance and parking facilities. Most private operators, if they own the buses, like to have control over their own depot so that they can take responsibility for the security, maintenance, and repair of their buses. The buses represent the biggest corporate asset, and private protection of the long term survival of this asset



Fig. 11.102
In Bogotá, most depots are located next to the terminal areas in order to improve operational efficiency.

Photo courtesy of Oscar Diaz and Por el País que Queremos (PPQ)

Fig. 11.103

The BRT terminal and depot in Dar es Salaam is being integrated with the long-distance bus terminal.

Image courtesy of the Dar es Salaam City Council



is one of the critical benefits of having private operators. The number of depots in a BRT system will therefore be partly a function of the number of private operators.

In the case of TransMilenio, for instance, in Phase I there were three terminals, each one under the control of a different operator. The trunk-line vehicles were stored at these depots. The feeder buses may be stored at smaller depots under the control of the private feeder companies. These facilities are generally in fairly remote locations near the feeder routes where low-cost land is available. However, there may also be circumstances where the feeder-line operators share depot facilities with the trunk-line operators. If some firms

operate both feeder and trunk services, then it can be more cost effective for such firms to utilise the same depot area (Figure 11.104). Also, depot services may be a profit centre for some trunk operators who have the depot space and capacity to also provide re-fuelling, repair, and maintenance services to feeder operators.

However, the number of operators should be determined in a manner that maximises system competition while also permitting administrative and management efficiency. For this reason, the number of operators can often exceed the realistic number of depot sites. In the extreme of a system with only one terminal and one depot, then all operators will have to share a single terminal and depot. In these cases, clear contractual language will be required to denote responsibilities at the site.

Regardless of whether there is one or multiple operators at a depot facility, site ownership should be maintained by the public authority. The operators may possess ownership-like responsibilities during the time of their concession, but at the termination of the concession, the public authority will wish to retain a high degree of flexibility. The next firm to gain the operating concession may or may be the same as the existing company.

If a depot location is already owned by a private operator, then it may not be possible for the public authority to assume ownership right away. Expropriation costs may be exorbitantly high and the legal process can be quite difficult. It may be necessary to move through the first concession period with the existing operator in full control of the site.

11.4.4.3 Depot sizing

The size of the terminals and depots depends greatly on the amount of vehicle parking needed, and the number of vehicles likely to need repairs. The configuration of the parking area can be a trade-off between parking efficiency and ease of entry. Some configurations may require some vehicles to be backed out which can be difficult with articulated and bi-articulated vehicles. Further, a densely packed parking area may be relatively space efficient, but it can also lead to occasional damage to vehicles bumping into one another.

Fig. 11.104

At the Usme depot in Bogotá, the green feeder vehicles are maintained at the same facility as the red trunk vehicles.

Photo by Lloyd Wright



Local land prices will likely determine the flexibility available with the depot design. High land prices and a restricted depot area will necessitate some creativity in the layout of the area.

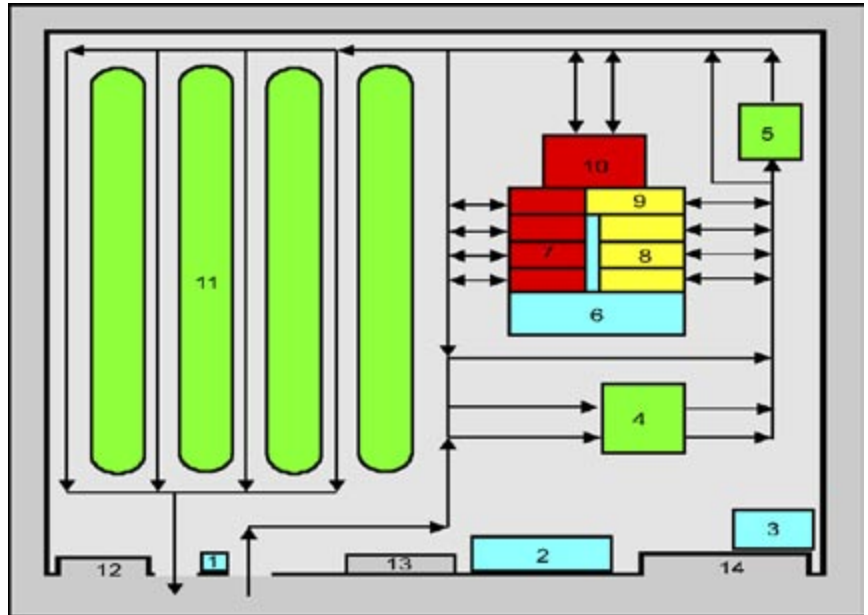
11.4.4.4 Depot layout

The internal design of the depot area should allow for a logical movement of vehicles based on their typical requirements. Figure 11.105 shows a typical layout for a depot area.

Vehicles will enter the depot area as they are instructed by the control centre to temporarily come out of service. As BRT vehicles enter the depot, they are visually inspected at point 1 in Figure 11.105. The vehicle is classified as “green” (operational), “yellow” (in need of minor repairs), or “red” (in need of major repairs).

If the bus is classified as “green”, it will typically first move to refuelling. Here fuel levels and vehicle kilometres are checked as a way of monitoring usage and operating costs. In Bogotá, a digital monitoring device records the pertinent vehicle information upon entering the re-fuelling area (Figure 11.106). If required, the vehicle will be re-fuelled at this time (Figure 11.107).

From the re-fuelling area, the vehicle will likely be either washed or placed in a parking bay. The exterior of the vehicle will typically be washed once per day. Most often, the washing occurs after the vehicle’s final run of the day. The vehicle’s interior may be cleaned upon each entry into the depot area, even if the vehicle is to return for the afternoon peak period. Maintaining a pristine interior area does much to



send a positive message to the customer as well as psychologically discourages any littering. In some systems, such as the Quito Ecovía corridor, the vehicle interior is cleaned after each pass through the corridor. The cleaning in this case is actually done at the terminal platform (as opposed to within the depot area).

The washing area should be designed to facilitate easy access to all parts of the vehicle. A channelised groove with drainage permits the washing of the vehicle’s underside (Figure 11.108). Special scaffolding equipment permits washing of the vehicle’s roof (Figure 11.109). In some depots in Bogotá, water recycling facilities have been established in order to permit re-use of the water from washing (Figure 11.110). Such recycling not only

Fig. 11.105
Standard layout for a depot area

1. Gate and visual inspection area;
 - 2, 3, and 6. Administrative offices for the concessioned operators;
 4. Refuelling area;
 5. Vehicle washing and cleaning area;
 - 7, 10. Major repairs;
 - 8, 9. Minor repairs and maintenance;
 11. BRT vehicle parking;
 12. Private vehicle parking.
- Green: Operational vehicles
Yellow: Vehicles requiring minor or routine maintenance
Red: Vehicles requiring major repairs



Fig. 11.106 and 11.107
Upon entering the re-fuelling area, a digital monitoring device (left photo) records the pertinent vehicle details (e.g., fuel level, odometre). If fuel is required, an attendant will then re-fuel the vehicle (right photo).

Photos by Lloyd Wright

Fig. 11.108, 11.109, and 11.110

A channel allows the underside of the vehicles to be washed (left photo) while scaffolding permits the top of the vehicles to be washed (right photo). A waste water pond helps to facilitate water recycling in Bogotá.

Photos by Lloyd Wright



improves the environmental aspects of the system but can also reduce operating costs.

If the BRT vehicle is classified as “yellow”, it is moved to the minor maintenance area (Figure 11.111). From the minor maintenance area a vehicle may return to service the same day or by the next morning. This area may also perform routine checks on the vehicle based on the total kilometres travelled.

Fig. 11.111
Vehicles are periodically removed from service for routine evaluation and maintenance.

Photo by Lloyd Wright



If the vehicle is classified as “red”, it goes to the major maintenance yard, and is replaced by a stand-by vehicle. A channelled work space below each vehicle permits repair staff to easily access the vehicle chassis for inspection and repair (Figure 11.112). Typically, a certain percentage of vehicles (5 to 10 percent) of the fleet are held in reserve to replace vehicles undergoing maintenance. However, in other systems, a just-in-time (JIT) philosophy prevails where all vehicles are fully utilised.

Sufficient parking space must be provided to hold the vehicle fleet during off-hour periods. The parking area design should also maximise easy entry and departure movements of vehicles. The numbering and assignment of the parking bays can provide efficient control over the fleet (Figure 11.113).

Fig. 11.112

A channel beneath the work area allows technical staff to service the underside of the vehicle.

Photo by Lloyd Wright





Fig. 11.113
Efficient organisation of the fleet parking improves management control over the depot area.

Photo by Lloyd Wright

Some private vehicle parking may also be required at the depot area. Certainly, access for emergency vehicles should be included in the design. In some cases, not all employees may be able to utilise the BRT system to arrive at work. Since the drivers, mechanics, and other employees will likely need to arrive prior to the start-up of the system in the morning, alternative arrangements should be considered. At the Bogotá Américas depot, bicycle parking is provided for the staff (Figure 11.114). Providing good pedestrian and bicycle access to the depot area helps to encourage staff to utilise sustainable forms of transport (Figure 11.115).

Spare parts storage is typically located near the maintenance and repair areas. The extent to which parts storage is required depends in part on the procurement practices of the particular operating company. Some firms may prefer to purchase in bulk and thus retain a fairly substantial spare parts inventory. In other cases, a just-in-time (JIT) philosophy may prevail and the operating company may hold just a minimum of spare parts (Figure 11.116). The operating company “Sí 99” in Bogotá maintains a very

Fig. 11.114

In Bogotá, system staff are provided with bicycle parking at the depot site.

Photo by Lloyd Wright



Fig. 11.115
A cycle way provides direct access to the nearby Américas depot in Bogotá.

Photo by Lloyd Wright

Fig. 11.116

Store rooms for spare parts should be planned into depot design.

Photo by Lloyd Wright



lean inventory in order to minimise costs. In fact, the spare parts are part of the contractual arrangements with the BRT vehicle supplier who must provide on-site service. Since this type of close manufacturer-operator relationship was not foreseen at the outset of the depot construction, facilities were not provided for the manufacturer offices. Instead, provisional trailers have been set-up to accommodate manufacturer offices and supplies (Figure 11.117).

Offices for operating companies are likely to be best provided at the depot areas. By being located at the depots, operating company officials can better monitor activities and oversee staff (Figure 11.118). The administrative offices may also include conference and training facilities.

Finally, the depot area should also provide facilities catering to the needs of staff such as drivers, mechanics, and administrative workers. These facilities may include showers and



Fig. 11.117

Makeshift trailers provide office and storage space for suppliers to the TransMilenio operators.

Photo by Lloyd Wright

lockers, luncheon areas, and recreational areas (Figure 11.119). The workplace environment should be designed to allow drivers and other employees an opportunity to relax after or in-between shifts as well as prepare prior to the start of a shift.

11.4.4.5 Aesthetic design

Although depot areas are not generally accessible to the public, there still may be many reasons to give attention to the aesthetic qualities of the space. First, depots consume large amounts of urban space and thus are typically quite visible to the general population as well as local residents. Thus, the visual aesthetics of the depot will affect the local population's image of

Fig. 11.118

Administrative office facilities for operating companies are provided at TransMilenio depots.

Photo by Lloyd Wright



Fig. 11.119

Cafeteria for drivers and other staff at the TransMilenio Américas terminal.

Photo by Lloyd Wright



Fig. 11.120 and 11.121
The architecture for the maintenance areas in both Bogotá (left photo) and Guayaquil (right photo) is both aesthetically pleasing and highly functional.

Photos by Lloyd Wright

the system. It is always important to be a good neighbour with populations living near the system. Second, a well-designed work environment can have a positive impact on employee satisfaction and work effectiveness. The maintenance depots of systems such as Bogotá and Guayaquil provide a highly-pleasing appearance to both local residents and employees (Figures 11.120 and 11.121)

The design should protect maintenance workers from adverse weather conditions, such as wind, rain, or strong sun. The maintenance area ceiling height should be sufficient to allow employees to comfortably perform maintenance on the topside of the BRT vehicles.

11.4.5 Intermediate parking facilities

Intermediate parking facilities provide parking for BRT vehicles during off-peak periods, so that the vehicles do not have to return all the way to the depot or the terminal to return to service in the afternoon peak. Bogotá’s Trans-Milenio has two intermediate parking locations.

Some systems will have specific turnabouts midway along a corridor, so that operations can be more closely adjusted to passenger volume. On a very long corridor, significant operational costs can sometimes be saved if for example half of the vehicles do not go all the way to the terminal, but instead turn around at some mid-point, so that more service can be provided on the part of the corridor with the highest demand. Sometimes an important depot and interchange facility is not located at the end of a corridor, but at some mid point, in which case the terminal may be an important turnabout location.

11.5 Control centre

“Everyone in a complex system has a slightly different interpretation. The more interpretations we gather, the easier it becomes to gain a sense of the whole.”

—Margaret J. Wheatley, writer and management consultant

A centralised control centre will help ensure smooth and efficient BRT operations. Controlling a high-volume BRT system spread across a major developing city is a complex and highly-involved activity. A centralised control and management system brings with it the following benefits:

- Immediate response to changes in customer demand;
- Immediate response to equipment failures and security problems;
- Efficient spacing between vehicles and avoidance of vehicle “bunching”;
- Automated system performance evaluation;
- Automated linkages between operations and revenue distribution.

This section reviews the various infrastructure aspects of developing an effective control centre. Chapter 12 (*Technology*) provides an overview of the various technologies that can be utilised to track and control vehicles.

11.5.1 Location of control centre

The control centre does not need to be located in any one special location. The control centre functions remotely from the corridor through its information and communications system. However, locating the control centre near one of the trunk corridors can be desirable since such a location allows a cost-effective, direct linkage to the system through a fibre optic line at the

Fig. 11.122
A distributed control centre at the Perituba Terminal in São Paulo.
 Photo by Dario Hidalgo



time of construction. The control centre must be situated in a place that has highly reliable communications connections and electrical power connections. Since the centre may also be receiving information by way of satellite or infra-red communications, the centre should not be located anywhere signals could be potentially blocked.

There could be some benefits to locating control centre staff in management facilities or in terminal facilities (Figure 11.122). These locations would allow greater interactions between control centre staff and management staff or vehicle operators. This sort of interaction could lead to certain synergies in gaining further insights on system operations.

11.5.2 Control room infrastructure

11.5.2.1 Work space

The control room itself will require particular spatial features. The size of the control room will depend upon the number of workstations required. Since a BRT system is likely to be developed in phases, the control room will

probably be only partly utilised during the initial years. However, planning for future space requirements at the outset is probably the best strategy (Figure 11.123). Otherwise, a disruptive move to larger facilities will be required later.

Each control centre operator will require space for a computer terminal, voice communications equipment, and additional work space (Figure 11.124). The number of operator workstations required for the total system is a factor of the size of the system and the number of vehicles each operator can safely control. The quality of the controller software package will play a role as well in determining the number of vehicles a control centre staff person can effectively oversee, but an average of 80 to 100 buses can be reasonably managed by each operator under normal conditions. Additionally, since the operators must be able to clearly communicate

Fig. 11.123
The control centre should be designed with sufficient space for future expansion.
 Photo by Lloyd Wright



Fig. 11.124
The work station should provide a comfortable environment with easy reach to all telecommunications equipment.
 Photo by Lloyd Wright





Fig. 11.125

Providing office space to the police agency at the control centre helps to ensure good co-ordination between the transport system and security services.

Photo by Lloyd Wright

with drivers, the acoustical arrangement of the workstations should be considered. If noise from one workstation interferes with the communications in another workstation, then the potential for lost or misinterpreted communications will be a problem.

Other municipal staff, such as police representatives, may also require their own workstations



Fig. 11.126

A large-screen display and vehicle tracking board can help staff and supervisors quickly assess the situation.

Photo courtesy of the Los Angeles County Metropolitan Transportation Authority

and offices in the control centre (Figure 11.125). Supervisory personnel will likely require work space that allows them to easily oversee the entire control centre operation.

Control centre operators can become fatigued by long hours of looking at monitors and tracking vehicles. Holding focussed concentration for long periods of time can be quite mentally exhausting. Typically, operators will have frequent scheduled breaks in order to maintain their alertness. Thus, the control centre should also have a relaxation area or break area that allows operators to refresh themselves.



Fig. 11.127

Multiple small-screen displays of each critical juncture in the system gives the control team a visual understanding of the system's operation.

Photo courtesy of Queensland Transport

11.5.2.2 Equipment requirements

The ergonomics of the workstation furniture should also be an important consideration. Comfortable seating and correctly adjusted placement of monitor screens can help prevent undue stress and discomfort.

In some instances, it is useful to permit visual tracking of vehicles not only by individual monitors but also by way of a large-screen display for the entire centre (Figure 11.126). The large screen can provide control centre supervisors with a macro-perspective on the system. The large screen would also help in circumstances when multiple staff members are resolving a complex issue together. Alternatively, multiple small screens of critical corridor points can help staff rapidly assess potential problems (Figure 11.127).

Fig. 11.128
In North America, queue-jumping lanes are used to give preferential treatment to buses at intersections.

Photo by Richard Drdul



Fig. 11.129
Providing standard feeder vehicles with dedicated right-of-way at key junctures can do much to improve average travel speeds.

Photo by Lloyd Wright

The entire control centre facility should have not only high-quality primary systems, but reliable back-up systems as well. Spare workstations should be available in case of a technical problem. Further, back-up electricity generators and telecommunications options should also be part of the infrastructure.

11.6 Feeder infrastructure

“O public road, I say back I am not afraid to leave you, yet I love you, you express me better than I can express myself.”

—Walt Whitman, poet, 1819–1892

Feeder services will likely provide a substantial percentage of a system’s ridership since the feeder corridors are the key link into residential areas. Quality infrastructure should not just be given only to trunk lines. Feeder lines should also receive a high level of quality service; otherwise, a large part of the customer base will never engage the system.

This section discusses several components of feeder infrastructure and service, including road infrastructure, stations, and the fare collection and fare verification process for feeder services. A discussion of feeder vehicle types is found in Chapter 12 (*Technology*).

11.6.1 Road infrastructure

Feeder services typically are not provided with dedicated busways but instead utilise mixed-traffic lanes. Since many feeder routes extend into fairly narrow residential streets, exclusive vehicle lanes is not always a practical option. However, there may be instances where road spacing permits exclusive feeder bus passing lanes or feeder “queue jumping” lanes.

A queue jumping lane is an exclusive bus lane at a signalled intersection (Figure 11.128). By entering this exclusive lane the vehicle is able to jump ahead of other waiting vehicles. A separate traffic light for the bus lane can in fact give the feeder vehicle a few seconds of a head start against the other traffic.

Passing lanes may also be feasible in sections of the roadway that

have sufficient width. Even a relatively short passing lane can be beneficial if it permits the feeder vehicle to avoid an area prone to congestion. London has successfully utilised short passing lanes with its conventional bus services (Figure 11.129). The London passing lanes have been effective in reducing the unpredictability of bus schedules due to traffic congestion.

Unlike busways, feeder vehicles typically use the lanes adjacent to the street curb rather than in the median. Thus, any bus lanes for feeder services may not be protected by a barrier from the mixed traffic. In many cases, the mixed traffic will need to access the curb lane in order to negotiate turns or to access parking. Under such conditions, infringement of the bus lane by private vehicles can undermine its usefulness. To combat private vehicles from illegally entering the passing lane, London utilises enforcement cameras that will record the license plate number of vehicles using the bus only lane. The key to maintaining the usefulness of a bus lane resides in the enforcements mechanisms utilised. Since feeder vehicles are typically smaller than trunk-line vehicles, the need for special surface materials (such as concrete) is not necessary. The lower vehicle weights do not damage streets to the same degree. Nevertheless, the proper maintenance of asphalt streets is important in maintaining the quality of the feeder fleet and in reducing maintenance costs. Thus, feeder streets should receive priority treatment for repairs and maintenance. Also, feeder vehicles will likely have less suspension support than trunk-line vehicles, so the smoothness of the ride and the comfort of the customers will be more dependent upon road conditions.

11.6.2 Feeder stations / shelters

Feeder services should not merely replicate the previous informal services that preceded the introduction of the BRT system. While previous services likely boarded and alighted passengers at random locations, depending on customer preferences, a formal feeder service should establish formal station areas. Just as travel times along the trunk lines benefit from well-spaced station, the same holds true for feeder corridors. However, it may be justifiable to place feeder stations somewhat closer together than the range recommended for trunk-line



Fig. 11.130

While feeder shelters will be more modest in scope than trunk stations, some basic customer comforts, such as rain protection and seating should be considered.

Photo by Lloyd Wright

services, which is approximately 300 metres to 1,000 metres. Since pedestrian conditions along feeder routes may be less developed than trunk-line routes, it can be difficult for some residents to access the system in such circumstances. The actual distance spacing between feeder stations will depend upon several factors, including the population density of the area as well as the location of major trip destinations and origins.

Feeder stations or shelters will likely not be as architecturally sophisticated as trunk-line stations, but nevertheless, the feeder stations should provide a quality wait environment. A shelter should be provided to protect customers from rain and heat. Given cost considerations and the nature of feeder services, the shelter does

Fig. 11.131

Vegetation is cleverly used as a bus shelter in Bangkok.

Photo by Lloyd Wright



not need to be closed as is the case for the trunk line. However, a roof cover along with back and side panels can be appropriate (Figure 11.130). Use of natural vegetation can also make for an intriguing structure (Figure 11.131).

In many instances, feeder shelter construction and maintenance can be funded in part by panel advertising. However, in such instances, the advertising should not detract from the functionality of the shelter. For example, advertising panels should not block the vision of passengers towards the arriving feeder vehicle. Panels should also include a full system map. Further, third party construction of a shelter should follow strict design guidelines developed by the public agency. Since wait times for feeder services tend to be somewhat longer than trunk-line services, some shelter amenities may be appropriate. For example, seating or a leaning post can be a low-cost way of significantly improving the comfort of those waiting.

11.7 Infrastructure costing

“You and I come by road or rail, but economists travel on infrastructure.”

—Margaret Thatcher, former UK Primer Minister, 1925–

Capital costs consist of both infrastructure costs and any related land or property acquisition costs. An initial analysis of these costs can help focus the possible design work on financially realistic options. Based on the preferred design characteristics in conjunction with the size of the initial phase of the project, a city can determine if the capital cost estimates are in line with realistic financial resources. Cities should be encouraged to experiment with a range of possibilities with respect to both design options and the amount of financial resources likely to be available. If the design team is overly pessimistic about the likely financial resources available, then the quality of the system may be needlessly compromised by an inadequate design. Several iterations of physical designs and operational designs are likely before finding a balance between system cost and system performance.

11.7.1 Range of infrastructure costs

Infrastructure costs for BRT systems can vary considerably depending on the complexity and

sophistication of the system as well as the local economic and topographical characteristics. Successful systems have been developed for as little as US\$500,000 per kilometre (Taipei).

Bogotá’s TransMilenio by many measures is a state of the art system, and this sophistication is reflected in its relatively high-cost infrastructure. Phase I of Bogotá’s TransMilenio cost US\$5.4 million per kilometre. The three corridors in Phase II cost from US\$9 million per kilometre to US\$15.9 million per kilometre. The higher costs in Phase II were due to the need to build some new bridges, a new highway interchange with the BRT system, and tunnels. Also, Phase II required a significantly higher amount of land acquisition. These items can dramatically escalate the total costs.

One of the major considerations is the volume of passengers the busway has to accommodate. Bogotá’s TransMilenio required a capacity of over 45,000 passengers per direction at the peak hour, which required two full lanes in each direction, and multiple station platforms at each stop, which increased the construction cost. Another major consideration is whether or not to reconstruct the entire roadway. BRT systems do impose heavy wear and tear on roads, and because repairs often require shutting down the system for a time, it is advisable to use materials able to withstand a maximum axle load with minimal repairs. Concrete is sometimes used for the entire roadbed. At a minimum, the roadway along the stations should be in concrete.

In some cases, BRT systems are developed when a major road is due for a scheduled rehabilitation. In this way, the major of the cost could be covered from the ongoing capital budget. Another factor is the quality of footpaths, bike paths, public space, street furniture and other amenities in the corridor. Bogotá dramatically improved the TransMilenio corridors, not only for the BRT vehicles but also for cyclists, pedestrians, and persons enjoying public space. All of these costs are folded into the overall cost per kilometre. These measures make a big difference in terms of the attractiveness of the system.

However, in general, developing-city BRT systems will cost in the range of US\$1 million to US\$7 million per kilometre. Some of the principal factors in determining the actual infrastructure costs will include:

- Number of exclusive lanes;
- Materials utilised in the construction of the lanes (asphalt or concrete);
- Expected system capacity, and thus the capacity and size of stations, terminals, and depots;
- Local construction costs;
- Amount of property expropriation required.

Table 11.4 lists the actual infrastructure costs for Phase I of TransMilenio.

11.7.2 Estimation techniques

The limited number of BRT systems to date combined with the lack of a shared costing database makes local estimations of infrastructure costs somewhat difficult. However, there are a few options for developing an initial estimate of infrastructure costs. These options include developing estimates based on:

- Costs from BRT systems in other cities with adjustments based on local design and macroeconomic factors;
- Similar past projects in similar areas of the municipality; such projects could include road expansion efforts and previous bus improvement measures;
- Informal discussions with local contractors and engineering trade associations; and,

Table 11.4: BRT construction cost breakdown, Bogotá’s TransMilenio

Component	Total Cost (US\$)	Cost per Kilometre (US\$)
Trunk line busways	94.7	2.5
Stations	29.2	0.8
Terminals	14.9	0.4
Pedestrian overpasses	16.1	0.4
Depots	15.2	0.4
Control centre	4.3	0.1
Other	25.7	0.7
Total	198.8	5.3

- Survey work by consultants, which may incorporate all of the above estimation techniques.

More accurate cost estimates will be generated at a later time when the project approaches the implementation stage. In the early development phase, the estimation techniques presented above should help narrow the design and performance characteristics into a relatively focused area of values.

Based on cost data from existing developing-nation BRT systems and inputs from BRT experts, a BRT cost calculator has been developed to

Table 11.5: Runway costs (Phase I project of 50 kilometres)

Item	Cost (US\$) per unit	Units	Reference info	Quantity requested	Cost (US\$)
Busway construction / roadway reconfiguration			No. of km	Enter no. of km of each type	
Use existing asphalt on busway / new concrete at stations	150'000	US\$ per kilometre	50		0
New asphalt on single lane busway / concrete at stations	700'000	US\$ per kilometre	50	50	35'000'000
New concrete on single lane busway / concrete at stations	1'250'000	US\$ per kilometre	50		0
New asphalt on double lane busway / concrete at stations	1'400'000	US\$ per kilometre	50		0
New concrete on double lane busway / concrete at stations	2'500'000	US\$ per kilometre	50		0
Lane separators			No. of km	Enter no. of km of each type	
Basic separator cones	1'000	US\$ per kilometre	50		0
7 cm separator blocks	5'000	US\$ per kilometre	50	50	250'000
50 cm separator wall	25'000	US\$ per kilometre	50		0
Busway colouration			No. of km	Enter no. of km of each type	
No colourisation	0				0
Colourised at intersections only	5'000	US\$ per kilometre	50		0
Busway with fully colourised lanes	50'000	US\$ per kilometre	50	50	2'500'000
Landscaping			No. of km	Enter no. of km of each type	
None	0	US\$ per kilometre	50		0
Basic (1 tree per 50 metres + plantings)	10'000	US\$ per kilometre	50		0
High-quality (1 tree per 10 metres + sculptures)	50'000	US\$ per kilometre	50	50	2'500'000
Intersection underpass				Enter no. of underpasses	
No underpasses	0	US\$ per underpass			0
Busway underpass	3'500'000	US\$ per underpass		2	7'000'000
Passing lanes at stations (i.e. express services)			No. of stations	Enter no. of stations w/ passing	
No express services	0	US\$ per station	100	0	0
Express services	50'000	US\$ per station	100		0
Runway sub-total					47'250'000

Table 11.6: Station costs (Phase I project of 50 kilometres)

Item	Cost (US\$) per unit	Units	Reference info.	Quantity requested	Cost (US\$)
Station construction			No. of stations	Enter no. of stations of each type	
3 metre wide stations	200'000	US\$ per station	100	100	20'000'000
5 metre wide stations	350'000	US\$ per station	100		0
Station air conditioning / heating			No. of stations	Enter no. of stations with each type	
No air conditioning	0	US\$ per station	100		0
Full air conditioning / heating	100'000	US\$ per station	100		0
Air conditioned / heated shelter inside station	30'000	US\$ per station	100		
Mist generators / fans	5'000	US\$ per station	100	100	500'000
Automatic sliding doors at boarding interface			No. of stations	Enter no. of stations w/ each type	
No sliding doors	0	US\$ per station	100		0
Sliding doors (8 doors per station)	40'000	US\$ per station	100	100	4'000'000
Sliding doors (16 doors per station)	80'000	US\$ per station	100		
Station identification - sign post			No. of stations	Enter no. of stations with post	
No station identification post	0	US\$ per station	100		0
Station identification post	800	US\$ per station	100	100	80'000
Maps and information			No. of stations	Enter no. of stations or kiosks	
No maps or information	0	US\$ per station	100		0
Maps at stations	3'000	US\$ per station	100		0
Maps at stations and in vehicles	6'000	US\$ per station	100	100	600'000
Information kiosks	30'000	US\$ per kiosk		5	150'000
Recycling receptacles at stations			No. of stations	Enter no. of stations w/ each type	
None	0	US\$ per station	100		0
Receptacles at station	1'000	US\$ per station	100	100	100'000
Station security			No. of stations	Enter no. of stations w/ each type	
No security measures	0	US\$ per station	100		0
Emergency callbox	1'500	US\$ per station	100		0
Security cameras	8'000	US\$ per station	100	100	800'000
Station sub-total					26'230'000

Table 11.7: Fare and ITS costs (Phase I project of 50 kilometres)

Item	Cost (US\$) per unit	Units	Reference info.	Quantity requested	Cost (US\$)
Fare collection readers			No. of stations	Enter no. of stations w/ each type	
Smart card system (4 readers per station)	10'000	US\$ per station	100	100	1'000'000
Magnetic strip system (4 readers per station)	7'000	US\$ per station	100		0
Coin-based system (2 readers per station)	1'500	US\$ per station	100		0
Fare collection turnstiles			No. of stations	Enter no. of stations with turnstiles	
Rotating turnstile (4 turnstiles per station)	7'000	US\$ per turnstile	100		0
Gate-arm turnstile (4 turnstiles per station)	2'800	US\$ per turnstile	100	100	280'000
Fare registering unit / vending machine			No. of stations	Enter no. of stations with machines	
Smart card system	15'000	US\$ per machine	100	100	1'500'000
Magnetic strip system	10'000	US\$ per machine	100		0
Coin-based system	0	US\$ per machine	100		0
Fare media			No. of cards	Enter no. of cards	
Smart card system with microprocessing ability	3.50	US\$ per card		500'000	1'750'000
Smart cards w/o microprocessing ability	1.20	US\$ per card			0
Magnetic strip cards	0.05	US\$ per card			0
Coin-based system	0.00	US\$ per card			0
Fare system software			No. of software	Enter no. of software	
Smart card system	500'000	US\$ per software	1	1	500'000
Magnetic strip system	300'000	US\$ per software	1		0
Coin-based system	100'000	US\$ per software	1		0
Intelligent Transportation Systems (ITS)			No. of stations/inters.	Enter no. of stations/inters.	
No ITS options	0	US\$ per station	100		0
Green light phase extension for BRT	20'000	US\$ per intersection	100	20	400'000
Real-time information displays	7'500	US\$ per station	100	100	750'000
Broad-band service at stations/terminals	750	US\$ per station	100	100	75'000
Fare system and ITS sub-total					6'255'000

Table 11.8: Integration infrastructure costs (Phase I system of 50 kilometres)

Item	Cost (US\$) per unit	Units	Reference info	Quantity requested	Cost (US\$)
Pedestrian crossings					
			No. of stations	Enter no. of stations with crossings	
No pedestrian crossing improvements	0	US\$ per station	100		0
Pedestrian crosswalk with signal	20'000	US\$ per station	100	75	1'500'000
Pedestrian bridge	300'000	US\$ per station	100	25	7'500'000
Pedestrian access to station areas					
			No. of busway km	Enter km of improved footpaths	
No improvements	0	US\$ per km	50		0
Improvements to pedestrian access ways	35'000	US\$ per km	50	100	3'500'000
Bicycle integration					
			No. of stations	Enter no. of stations w/ parking	
No bicycle integration	0	US\$ per station	100		0
Bicycle parking at stations	8'000	US\$ per station	100	50	400'000
Taxi integration					
			No. of stations	Enter no. of taxi stands	
No taxi integration	0	US\$ per station	100		0
Formal taxi stands at stations	60'000	US\$ per station	100	20	1'200'000
Park-and-ride facilities					
				Enter no. of facilities	
No park-and-ride facilities	0	US\$ per facility			0
Kiss-and-ride facilities only	40'000	US\$ per facility		2	80'000
Park-and-ride facility (open lot parking)	1'500'000	US\$ per facility		2	3'000'000
Park-and-ride facility (multi-level parking)	10'000'000	US\$ per facility			0
Integration infrastructure sub-total					17'180'000

give cities an initial estimation of infrastructure costs. Actual costing will depend much on local conditions and circumstances. However, the BRT cost calculator is useful in alerting project developers to the costing items that should be considered in planning a system. The actual cost calculator can be accessed at the following web site: www.itdp.org/programs/BRT.

An example use of the cost calculator is provided below. In this case, costing is estimated for a hypothetical Phase I project of 50 kilometres of trunk busways.

Table 11.5 summarises the runway construction costs for this hypothetical project. In this case, asphalt busways with concrete at the station areas have been selected. Budget is also provided to colourise the entire trunk busway.

Table 11.6 summarises the station costs for the hypothetical system. In this case, the stations are assumed to be 3 metres in width with sliding doors, customer service maps, and security cameras. There is also assumed to be a station at every 500 metres of trunk busway.

Table 11.7 summarises the technology costs associated with the system. These cost items include the fare collection and fare verification equipment as well as any applications of Intelligent Transportation Systems (ITS). In the case of this example, smart card technology will be utilised as well as some priority signalisation at intersections, real-time information displays at stations, and broad-band internet services at stations.

Table 11.8 summarises the cost of integration infrastructure associated with this hypothetical system. In this instance, it is assumed there will be either a new pedestrian crossing or a grade-separated pedestrian bridge at each station. Also, it is assumed that this system will include 100 kilometres of upgraded footpaths in the areas near the stations. Additionally, this system includes bicycle parking at stations, metred taxi integration facilities, and some park-and-ride facilities.

Table 11.9 summarises the remaining infrastructure cost items, which include feeder infrastructure, terminals, depots, intermediate transfer stations, and any land acquisition requirements. For this hypothetical system, it is assumed there will be 75 kilometres of feeder services, one control centre, two terminals and two depots, four intermediate transfer stations, and substantial land acquisition for the terminals, depots, and park-and-ride facilities.

In addition to the line items outlined in tables 11.6 through 11.9, the project team should also include contingency costs within any preliminary budget. The contingency item helps to predict any unforeseen infrastructure costs. Ideally, the preliminary budget will be appropriately conservative in nature so that decision-makers will not be faced with expenditure over-runs at a later date.

Table 11.10 summarises the sub-totals from each of the preceding costing categories. The total

Table 11.9: Other infrastructure cost items (Phase I project of 50 kilometres)

Item	Cost (US\$) per unit	Units	Reference info	Quantity requested	Cost (US\$)
Feeder system			Km of feeder roads	Enter no. of km of each type	
No feeder improvements	0	US\$ per kilometre			0
Feeder busway/station improvements	75'000	US\$ per kilometre		75	5'625'000
Control centre (including software)			No. of control centres	Enter "1" with the selected type	
No control centre	0	US\$	0		0
Control centre physical construction	1'500'000	US\$	1	1	1'500'000
Radio-based control only (equipment)	100'000	US\$	1		0
GPS system (equipment)	1'000'000	US\$	1	1	1'000'000
Software	3'000'000	US\$	1	1	3'000'000
Terminals and depots				Enter no. of terminals or depots	
Terminal facilities	3'000'000	US\$ per terminal		2	12'000'000
Depot facilities	5'000'000	US\$ per depot		2	20'000'000
Restrooms at terminals	15'000	US\$ per terminal		2	60'000
Intermediate transfer stations				Enter no. of corridors	
No intermediate transfer stations	0	US\$ per corridor			0
Standard intermediate transfer station	400'000	US\$ per corridor		4	3'200'000
Large intermediate transfer station for multiple feeder services	1'500'000	US\$ per corridor			0
Property acquisition				Enter no. of sites or km	
No property acquisition required	0	US\$ per site			0
Terminal site in peripheral area ¹	3'000'000	US\$ per site		2	6'000'000
Depot site in peripheral area ²	5'000'000	US\$ per site		2	10'000'000
Park-and-ride site in peripheral area ³	2'000'000	US\$ per site		2	4'000'000
Terminal site in central area ¹	60'000'000	US\$ per site			0
Street widening in central district (2 lanes eqv.)	40'000'000	US\$ per kilometre			0
Other infrastructure sub-total					66'385'000

1. Assumes 30,000 square metres required for terminal site
 2. Assumes 50,000 square metres required for depot area
 3. Assumes 20,000 square metres required for park-and-ride site

infrastructure budget projected for this hypothetical project comes to approximately US\$180 million, which equates to approximately US\$3.6 million per kilometre of trunk services.

11.7.3 Capital cost and operating cost options

In most BRT systems, the classification of capital costs versus operating costs is important from the standpoint of public versus private investment. The public sector generally provides the capital investment just as it typically funds roadways for private automobiles. Many BRT systems utilise private operators to cover operating costs, and thus such operators obtain access to revenues from fare collection. Some costs, such as vehicles and fare collection equipment, do not automatically fall into either category, and thus the assignment of these costs can depend upon local circumstances.

There are instances when some elements of the BRT system may be strategically moved between capital and operational cost categories. Typically, this situation arises when fare affordability in lower-income countries becomes a significant issue. For example, some African nations have per capita incomes of US\$200 or less. Since the cost of vehicles and fare collection equipment will likely not be appreciably

Table 11.10: Summary of system infrastructure costs (Phase I project of 50 kilometres)

Cost category	Total projected budget (US\$ million)	Cost per kilometre (US\$ million / km)
Runways	47.250	0.945
Stations	26.230	0.525
Fare system and ITS	6.255	0.125
Integration infrastructure	17.180	0.344
Other (terminals, depots, land costs, etc.)	66.385	1.328
Subtotal	163.300	3.266
Contingency (10%)	16.330	0.327
Total	179.630	3.593

different between a low-income and middle-income nation, the costs of such equipment can put significant pressure on total operating costs in low-income nations. Thus, moving some of these costs to the capital cost category can help permit reasonable fare levels without the need for operating subsidies.

Further, it is quite desirable to avoid operating subsidies since the subsidy process adds much administrative complexity to the system, as well as creates opportunities for the misappropriation of funds. A one-off subsidy for capital expenditures is typically a much more elegant manner for applying public funding support.

Moving equipment purchases to the capital cost category can bring with it some unintended consequences. In general, it is best to have the companies utilising the equipment to pay for it and to maintain it. Companies operating buses that they do not purchase or do not own the vehicles will tend to not maintain the vehicles properly. These companies may also not pursue the most cost-effective models at the time of purchase. Thus, public procurement of equipment can result in many misplaced incentives. A compromise to such circumstances is for the public sector to share costs with the private sector. For example, the public sector may provide 50 percent of the vehicle cost while the private firm must pay off the other 50 percent through fare revenues. In this way, the private firm still has an incentive to properly maintain for the vehicle, but the reduced cost means that pressure on cost recovery is lessened.

In general, it is always best for the private sector to purchase their own vehicles, based upon the well-defined specifications developed by the public sector. However, in some instances with low-income nations, it may be necessary to transfer some of the vehicle purchase costs to the capital cost category in order to achieve an affordable customer tariff. It is quite feasible to transfer the burden of the initial investment from private to public hands and to maintain the efficiency of the private sector is achievable. As an alternative to direct public investment in equipment such as vehicles and fare equipment, the public sector could also provide special condition loans or tax incentives that will reduce the impact of the investment on the cash flow



Fig. 11.132

Some cost items, such as vehicles and fare equipment, could be listed as either capital or operating costs. Shifting all or part of these expenses to one category or another will impact the affordability of fares and the amount of infrastructure investment required.

Photo by Lloyd Wright

and will not get involved the public sector in the actual purchasing process. The key element is to select financial options that will allow the city to achieve affordable fares, maximising the respective resources and capabilities of both the public and private actors.

There are also circumstances that may permit the shifting of costs in the other direction, from capital costs towards operating costs (Figure 11.132). Some systems have room for higher fare levels and may prefer to reduce their capital borrowing for the initial system infrastructure. In such instances, putting some elements of equipment into the operating cost category can make sense. For example, Bogotá required the private firm with the fare collection concession to include the electronic turnstiles and smart cards as part of the operational bid. The private fare collection firm thus amortises the cost of this infrastructure through their share of the fare revenue. In effect, the concessioned firm is acting as a financing agent for the particular piece of infrastructure.

11.7.4 Land and property acquisition

One of the most variable cost items when comparing different BRT systems is the level of land and property acquisition required. In many instances, the municipality will need to impose eminent domain upon private properties, which is a legal action to take ownership of land and/or property even when the owner is unwilling to sell.

Since the exclusive busways are most typically in the centre median, the private properties along the corridor remain relatively untouched. However, cities wishing to maintain the existing

number of mixed traffic lanes may purchase land and properties along the sides of the roadway. Space for terminals and depots can be problematic due to the larger land requirement. However, these sites are often located farther from the centre, and thus more open space and lower cost land are generally available at such peripheral locations.

In instances that property purchases are necessary, infrastructure costs can quickly skyrocket. Infrastructure costs on Bogotá's TransMilenio system jumped from approximately US\$5.3 million per kilometre in Phase I to as high as US\$15.9 million per kilometre in Phase II. Much of this increase was due to the much greater need for land purchases in the second phase. In Phase I of TransMilenio, approximately 600 plots were purchased. In Phase II, the municipality purchased approximately 4,000 plots (Figure 11.133).

The use of eminent domain law is a highly sensitive political and social issue. Emotions can run quite deep when businesses and families must give up workplaces and homes, especially when such sites have been owned for generations. Further, since low-income groups often live closest

to the busiest corridors, social justice issues will also come into play. International lending agencies, such as the World Bank, are quite sensitive to the appropriateness of eminent domain procedures. Failure to handle the property purchases in a fair manner can result in the loss of international financing. For all these reasons, property expropriation must be handled carefully and with the highest degree of transparency.

Some characteristics of a well-designed property purchase programme include:

- Clarity in the procedures;
- Transparency and openness of the process;
- Timeliness in processing and timeliness in resolving conflicts;
- An over-riding sense of fairness in the process.

The World Bank has developed a set of recommended procedures for compulsory purchase programmes in infrastructure projects. Likewise, Bogotá has developed a similar process to fairly deal with property purchases required by the expanding TransMilenio system. The following steps outline the Bogotá process:

1. Map the area plots in relation to the planned BRT system. Design adjustments should be undertaken to minimise land acquisition,



Fig. 11.133
Land and property expropriation in Phase II of TransMilenio greatly increased the overall capital investment.

Photo by Carlos F. Pardo

even if this implies reducing the number of mixed traffic lanes.

2. Determine the property ownership history of any required properties. This process includes investigating land titles, mortgages, and current occupants.
3. Survey the actual activities and socio-economic conditions of existing occupants, in order to define a baseline for potential financial compensation.
4. Assess the property value through independent appraisers to compensate the commercial value of the plots. If only the property tax registrar is used, properties may be significantly undervalued, which may prompt litigation and delays in the purchase process.
5. Estimate the required compensation based on the current property conditions. Also include a value for potential impacts on sales during the relocation process.
6. Offer assistance in searching for relocation options. Provide information on potential alternatives. This assistance should be particularly directed towards any low-income families and other vulnerable groups that are being displaced.
7. Provide a complete and well-documented compensation offer for the displaced inhabitants. It is recommended to include a down payment at this stage to help move the transaction towards completion.
8. If the offer is accepted, provide a fast-track process to complete the transaction docu-

ments and issue the down payment. Failure to promptly deliver promised documentation and payments will undermine public confidence in the process and lead to less cooperation in future acquisitions.

9. If the offer is declined due to the amount of the proposed compensation, then both parties can agree to an arbitration process to determine the correct value. This arbitration process should be well-defined at the outset of the purchase programme, and thus be set-up to provide a timely answer.
10. If the offer is declined and the parties do not agree to arbitration, then eminent domain law will be applied. A subsequent legal proceeding will take place in which the property owner(s) can present the case against expropriation or argue for a different compensation value. Given the lengthy duration of potential legal proceedings, the city may request that the court award the handover of the property immediately for system development. The awarded value of the compensation will then be determined at the termination of the legal process.

The key to any land expropriation process is the quality of the property appraisal and the clarity of the procedures to be undertaken. The entire process should be designed to account for all eventualities and to provide timely actions at each step. Even small delays due to legal proceedings can increase construction costs dramatically.

12. Technology

“Any sufficiently advanced technology is indistinguishable from magic.”

—Arthur C. Clarke, author and inventor, 1917–

Technological advances with vehicles, fare systems, and communications systems have played a key role in advancing the state-of-art of public transport. Intelligent Transportation Systems (ITS), such as automatic vehicle location (AVL) and real-time information displays, have done much to dramatically improve operational efficiency and customer service. Technology also conjures up images of modernity and sophistication which helps to sell project concepts to both political officials and the public.

At the same time, technology should not supplant the operational design. Instead, technological choices should simply follow from the customer requirements that have been prescribed by the demand analysis and desired

operational characteristics. Designing a system around a particular vehicle is bound to lead to compromise. The system should obviously be shaped around the customer and not a piece of technology. For this reason, the technological choices regarding vehicles, fare systems, and ITS are really the last activity in the BRT design process. Once the Operational Plan and much of the Business Plan are completed, then the relevant parameters for the technological options can be defined.

This Chapter outlines the various technological options for vehicles, fares systems, and ITS. As with other aspects of system planning, there is no one right or wrong answer to technology selection. Instead, each option carries with it different sets of benefits that must be weighed against the priorities set by the project developers. As always, the local context is the basis for determining the most appropriate solution for any given situation.

The topics discussed in this chapter are:

12.1 Vehicle technology

12.2 Fare collection systems

12.3 Intelligent transportation systems

12.4 Technology procurement process

12.1 Vehicle technology

“Don’t worry, sweetie, don’t worry! Nobody in New York notices a bus until it’s about to hit them!” (Samantha in “Sex and the City”)

—Kim Cattrall, actress, 1956–

Few decisions in the development of a BRT system invoke more debate than the choice of bus propulsion technology and bus manufacturer. However, it should always be remembered that BRT is far more than just a bus. The choice of bus technology is important, as it will strongly influence the system’s performance, but vehicle selection is not necessarily more so than the myriad of other system choices.

Regardless of whether the vehicle procurement is public or private, the technical specifications of the vehicle selected will largely have to be set by the system’s designers so that they interface properly with the infrastructure.

The current common practice is for the public agency to set vehicle standards while the private sector actually purchases and operates the vehicles. Thus, while a standard set of basic requirements must be met, many decisions, such as vehicle manufacturer, are actually left to the bus operating companies. The public agency will likely develop a detailed set of vehicle specifications that each operator will be required to fulfil. However, it is up to the bus operator, who is paying for the buses, to determine how to best meet the specifications. Thus, within Bogotá’s TransMilenio system, different operating companies have selected different vehicle manufacturers. However, thanks to the detailed specifications, from the perspective of the customer, all of the vehicles look and operate identically. This commonality is important to creating and preserving a clear system identity.



Fig. 12.1
The sophistication and attractiveness of a technology are factors to consider, but so are basic issues such as maintenance and operational cost efficiency.
 Photo courtesy of Advanced Public Transport Systems (APTS)

Operators purchasing BRT vehicles must weigh many factors in choosing a fuel and propulsion system technology. Beyond basic vehicle prices, there are a host of issues that must be considered. Will the vehicle technology meet required emission standards? Will the size and design of the vehicle fulfil capacity requirements? Does the technology have a history of operating consistently in developing city conditions? Does the technology require maintenance personnel with highly-specialised skills? Are spare parts for the technology expensive and difficult to obtain in a developing city? Are special re-fueling stations required for the technology? Is the technology selected financially viable? An attractive, sophisticated vehicle technology may entice decision-makers to make an instinctive choice, but nevertheless basic questions about maintenance, spare parts, and operational costs

should be an integral part of the decision-making process (Figure 12.1).

12.1.1 Decision-making matrix

Vehicle fleet technology selection, provision, and operation is complex and depends on legal, operational, institutional, and strategic factors particular to each individual case. Figure 12.2 displays a recommended methodology for vehicle selection and provision mechanisms.

Following through the four main activities described in Figure 12.2 can guarantee that the characteristics of the chosen vehicle will meet all the operational requirements necessary to ensure the system’s financial viability.

The first and most important activity involves identifying the project’s specific needs and requirements for its fleet. Most of this analysis

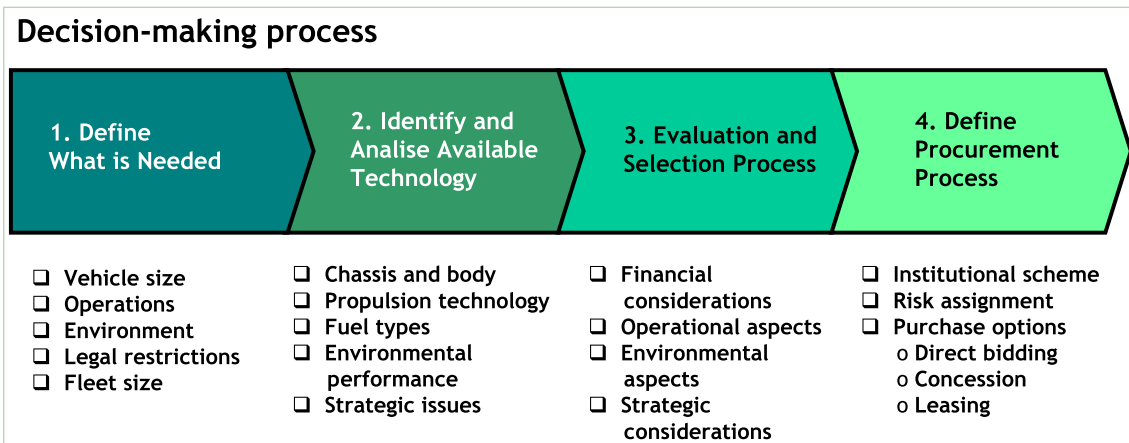


Fig. 12.2
Decision making process for vehicle selection.

Table 12.1: Decision factors for choosing a vehicle technology

Category	Factor
Cost	Purchase cost Maintenance costs Re-sale value in local market
Vehicle features	Passenger capacity Interior design options Aesthetics
Manufacturer support	Manufacturer support office in country Capabilities of manufacturing technical assistance staff Warranty coverage and conditions
Robustness	Track record of technology in a developing city Degree to which specialised skills are required for maintenance and operation Feasibility of making repairs on the road Expected percentage of up-time in operation Reliability Vehicle longevity
Re-fuelling	Re-fuelling time Type and cost of required re-fuelling station
Safety	Strength of body structure Chassis design Brake system effectiveness Anti-fire protection Emergency devices
Environment	Local emissions (NO _x , SO _x , CO, PM, toxics) Global emissions (CO ₂ , N ₂ O ₄ , CH ₄) Noise levels Other waste products (e.g., solid waste, waste oil, etc.)
Compliance with local regulations	Maximum weight per axle Height, width, and length restrictions

should already have been done in the operational design process. Vehicle characteristics should not be defined based only on aesthetic or political interests but must be defined based on optimising the system’s operations.

It would be a serious mistake to select the vehicle prior to performing the operational analysis. Selecting the vehicle type prior to defining the system’s operational design can result in either purchasing far more expensive vehicles than is necessary or vehicles too small to provide the required capacity without serious overcrowding or busway congestion.

Table 12.1 summarises many of the factors that an operator will consider in deciding upon a technology and a manufacturer.

Once the principal system requirements and needs have been identified, there remain many additional technical considerations that need to

be decided before finalising the technical specification. In general, the basic decision areas for the vehicle include:

1. Vehicle size;
2. Chassis and body configuration;
3. Interior design options;
4. Fuel and propulsion technology;
5. Aesthetic options;
6. Vehicle docking options.

12.1.2 Vehicle size

The size and required passenger capacity of the vehicle are largely determined by the modelling analysis conducted at the outset of the project. The analysis process will have determined a projected passenger volume for a particular corridor. Vehicle capacities in conjunction with service frequency are the primary factors that will help achieve a required volume of customers.

Table 12.2 summarises the various vehicle length options along with the associated passenger capacity. The actual passenger capacity depends upon a range of factors including interior layout, the number of seated versus standing passengers, and cultural norms regarding the space required per passenger.

12.1.2.1 Calculating the optimum vehicle size

The methodology for calculating the appropriate vehicle type in any given situation has already been put forward in Section 8.2 of this Planning Guide. Equation 12.1 summarises the principal calculation required to determine the optimum vehicle size.

Table 12.2: Vehicle options and passenger capacities

Vehicle type	Vehicle length (metres)	Capacity (passengers per vehicle)
Bi-articulated	24.0	240–270
Articulated	18.5	120–170
Tandem	15.0	80–100
Double decker	12–15	80–130
Standard	12.0	60–80
Midi-bus	6.0	25–35
Mini-bus (vans)	3.0	10–16

$$\begin{aligned}
 \text{Vehicle capacity (Cb)} &= \frac{\text{Corridor capacity (Co) (pphd)}}{\left[\text{Load factor (Lf)} \times \text{Service frequency (F) (vehicles / hr)} \times \text{Number of stopping bays (Nsb)} \right]} \\
 \text{Cb} &= \frac{\text{Co}}{[\text{Lf} \times \text{F} \times \text{Nsb}]}
 \end{aligned}$$

Equation 12.1 Determining required vehicle capacity

The so-called “optimum” vehicle size, though, may vary from corridor to corridor. One option is to operate different sized vehicles in different corridors of the city. However, this lack of commonality can be disadvantageous for several reasons. First, purchasing different vehicle types will tend to reduce economies of scale in procurement and lead to higher overall vehicle costs. Second, different vehicle types may require different maintenance needs and different sets of spare parts, and thus again undermining overall economies of scale. Third, managing a fleet of different vehicle types reduces operational flexibility in using vehicles in different corridors, especially when breakdowns and other maintenance requirements may take some vehicles offline for a period of time. Fourth, different sized vehicles means that station sizes will also need to vary, resulting in the possible inability of operating vehicles across multiple corridors in a single customer routing.

For all these reasons, it is typically preferred to choose a single vehicle type that can serve the spectrum of trunk line routes. Likewise, one or two smaller vehicle types can be chosen for the feeder services.

A common mistake involves assuming that larger vehicles are somehow “better”. In truth, the best vehicle size is one that allows for a cost-effective operation and for the given volumes and service frequency. If a large bus requires ten minute headways between vehicles so that the optimum load levels can be achieved, then choosing a lower capacity vehicle might be more convenient. Passengers prefer headways in the range of one to four minutes. Long wait times will ultimately lead passengers to choose alternative modes of transport, such as private vehicles. It is important that the operational design include a preference analysis that studies time valuation by customers in such a way that the optimum vehicle type and fleet numbers can

be chosen and that an appropriate quality level can be achieved with the allocated budget.

12.1.2.2 Bi-articulated, articulated, and standard-sized vehicles

High-volume systems (over 7,000 passengers per hour per direction) will likely require both



Fig. 12.3
In Curitiba, 24-metre bi-articulated vehicles are utilised on trunk corridors.
 Photo courtesy of Volvo Bus Corporation



Fig. 12.4
In Bogota, 18-metre articulated vehicles are utilised.
 Photo courtesy of TransMilenio SA



Fig. 12.5
In Brisbane, trunk corridors are served by standard 12-metre vehicles.
 Photo courtesy of Queensland Transport

large sized (articulate or bi-articulated) vehicles and high-frequency service (Figures 12.3 and 12.4). Lower-volume systems should also strive for high-frequency service, but obviously with smaller vehicle types. Systems in Brisbane and Jakarta operate trunk corridors with 12-metre standard-sized vehicles (Figure 12.5). The smaller size does not mean these systems are inferior to cities operating with larger vehicles. Instead, the size may just be a reflection of the appropriate configuration for the particular demand characteristics.

While the numerous vehicle manufacturers offer a wide-range of options, consideration of market availability is also a key factor. Engaging in informal discussions with vehicle manufacturers at the outset can help highlight the availability of different product features. Clearly, the vehicle specifications should not be designed around any one manufacturer, but a broad understanding of the existing options from manufacturers can help shape the analysis.

Along the same lines, the number of manufacturers providing a particular vehicle type is a legitimate consideration. A single-sourced vehicle will tend to increase costs due to the lack of a competitive manufacturing environment. As an example, currently only one major manufacturer produces a bi-articulated vehicle. Thus, if this type of vehicle is chosen the bidding process is more likely to be less competitive. The lack of competition ultimately results in higher prices for operators, which will then translate into higher customer fares.

Fig. 12.6
In Hong Kong, the double-decker represents an iconic image for the city.

Photo courtesy of Volvo Bus Corporation



12.1.2.3 Double-decker vehicles

Increasing the length of the vehicle is just one way of increasing passenger capacity. Adding another passenger level with a double-decker configuration is another option that is occasionally utilised. Despite being less popular at a global level, double-deckers have successfully created a niche market in such cities as Singapore, London, and Hong Kong (Figure 12.6).

To date, double-decker vehicles have not been utilised in a full BRT system. However, in the right circumstances, the double-decker vehicle can be an option to consider. Specifically, the double-decker has been successful in creating an iconic image for cities. Double deckers can generate an intriguing image to a public transport system and can be quite popular when applied to tourist routes, as the vehicle's upper deck offers a great vantage point for sightseeing.

Other arguments that support double-decker vehicles involves the fact that higher passenger density can be achieved while maintaining a low footprint density on the in-use road space. Thus, while an articulated vehicle gains passenger numbers by the length of the vehicle, a double-decker gains passenger numbers by its height. A double-decker vehicle will also consume less road space at stations.

However, double-deckers can bring many complications and additional costs. The costs of adding a second floor to the vehicle is not entirely devoted to customer space. A significant amount of space is consumed by the stairway on both decks of the vehicle. The stairway also creates potentially troublesome difficulties for passengers, particularly during boarding and alighting. Moving up and down the stairway as the vehicle moves can be dangerous. The width of the stairway also makes two-way passenger movement difficult. The net effect is dramatically lengthened passenger boarding and alighting times. London has phased out its iconic "Routemaster" in part due to the severe injuries and even deaths resulting from passengers falling from either the interior stairway or the back alighting step.

Double-deckers are also not particularly suitable for high-volume operations where passengers are frequently boarding and alighting. Double-deckers are best used on conventional commuter routes where most of the boarding and alighting takes

Fig. 12.7

Despite various operational limitations, double-decker models are still being sold in some markets, such as in Dhaka.

Photo by Lloyd Wright



place at a few station points in the centre of the city and then again at a distant suburban location.

Despite these disadvantages, some cities are still committing resources to double-decker vehicles. Due to enticements from a vehicle manufacturer, Dhaka (Bangladesh) has purchased double-decker models as part of its fleet (Figure 12.7).

Table 12.3 summarises the advantages and disadvantages of utilising double-decker vehicles within the context of BRT.

12.1.2.4 Floor height

After the physical length, the floor height tends to be one of the most crucial physical characteristics of the vehicle. The floor height will affect decisions on boarding and alighting strategies, customer convenience, vehicle costs, and maintenance costs.

In general, there are a full range of options including low floor, semi-low floor, and high-floor vehicles. With any of these options a level (step-free) boarding is possible. In fact, most of the well-known Latin American systems, such as Bogotá, Curitiba, Goiânia, Guayaquil, Pereira, and Quito, operate high-flow vehicles with platform level boarding.

Vehicle chassis tend to be produced in certain standard floor heights. Two of the most common interior floor heights are 20 cm (low-floor) and 90 cm (high-floor). There are also low-floor models with an interior floor height of less than 20 cm.

12.1.2.5 Manufacturing history

Bus manufacturing in most developing countries is still heavily reliant on high floor buses. High floor buses are a hold over from the days when buses were built by manufacturing bodies designed for passenger transportation and attaching them onto a chassis that was designed for hauling freight (Figure 12.8).

Fig. 12.8

Early buses were simply adaptations of freight vehicles, resulting in little customer convenience or comfort.

Photo courtesy of the Hank Suderman Collection



Table 12.3: Advantages and disadvantages of double-decker vehicles

Advantages	Disadvantages
Increases passenger carrying capacity without increasing road space footprint	Adds cost to vehicle; cost per passenger carried is much higher than articulated vehicles
Creates intriguing public transport image and is attractive for tourism	Stairway consumes passenger space on both floors and thus reduces overall passenger density in vehicle
	Can be dangerous for passengers using stairway while vehicle in motion
	Boarding and alighting can be delayed due to congestion on stairway
	Height of vehicle can be a problem on some routes with low-clearance infrastructure and trees
	Height of roof and the structural integrity of the roof creates difficulties in placing cylinders for natural gas or other alternative fuels



Fig. 12.9
A new CNG modelled low-floor vehicle developed by Tata Motors for the Dehli BRT system.

Photo courtesy of Tata Motors

At the end of the 1990's, a third generation of buses was developed: namely, low-floor vehicles whose principal objective was reducing the passenger platform's height in order to optimise access to the vehicle (Figure 12.9). Presently, the majority of these vehicles have integral structures, rather than an independent chassis and body, which has allowed for the development of hydraulic suspension systems and engine options which allow for interior space optimisation.

The first buses had major drawbacks in terms of user comfort and safety, as suspensions and braking systems were designed to transport loads of cargo, not people. The engine's frontal location created loud noise levels inside the vehicle and did not allow for interior space optimization. Most of the vehicles also rode very high on the chassis, requiring passengers to climb up a steep set of stairs to enter the bus. All these reasons led to the development of chassis, suspensions, and engines designed specifically for passenger services, which in turn improved comfort and safety conditions. The new generation of vehicles utilised metallic spring suspension systems, and engines were mounted in the rear. However, its passenger platform remained at 90 cm, so inconvenience and delay for passenger boarding continued.

12.1.2.6 Low-floor versus high-floor vehicles

From the perspective of BRT systems, the debate over low-floor versus high-floor is somewhat secondary to the preference for platform-level boarding and alighting. Steps of any type will slow dwell times as well as make a system off-limits to the many of the physically disabled. Even low-floor vehicles will slow boarding times as well as create a usage barrier to persons in wheelchairs.

Either low-floor vehicles or high-floor vehicles can be adapted for usage with platform-level boarding. Attempting to operate stepped boarding and alighting in high-volume operations can be detrimental to system performance, regardless of floor height. The Transantiago (Santiago, Chile) system elected to operate low-floor

Fig. 12.10 and 12.11
Low-floor vehicles without platform level entry and pre-board fare verification can result in longer dwell times and not actually provide access to the physically disabled, as shown in these images from Santiago (left photo) and Brisbane (right photo).

Left photo by Lloyd Wright
 Right photo courtesy of Queensland Transport





Fig. 12.12
In European cities, such as London, low-floor vehicles provide an improved image for conventional bus systems.

Photo by Lloyd Wright

(20 cm) vehicles without platform level boarding. In conjunction with the decision to have on-board fare verification, the result has been serious station delays (Figure 12.10). Likewise, the Brisbane system also combines low-floor vehicles and on-board fare verification (Figure 12.11). While these types of systems may provide an adequate service, they cannot match the operational performance levels of cities utilising platform-level boarding.

Low-floor vehicles have predominantly been deployed in conventional bus systems in developed nations in Europe and North America (Figure 12.12). These systems generally operate without closed stations, platform level boarding, or pre-board fare verification. In such cases, low-floor vehicles provide a somewhat better physical image and make boarding easier in comparison to high-step entry.

As low floor bus technology becomes more affordable and widely available in developing countries, it has become a matter of debate whether new BRT systems should be designed for use with high- or low-floor vehicles, and whether the high BRT platform is necessary or desirable.

The principal advantages of low-floor vehicles relate to the physical image of the vehicles as well as some aspects of operational flexibility. The principal advantages of high-floor vehicles relates to the procurement and maintenance costs of the vehicles (Figure 12.13). Further, high-floor vehicles in conjunction with platform-level boarding actually offer faster dwell times and greater access for the physically disabled than low-floor vehicles without platform-level boarding.

Low-floor vehicles offer greater operational flexibility since the vehicles can operate with and without boarding platforms. For BRT systems where the vehicles are likely to operate both on trunk corridors and in mixed traffic conditions where no boarding platforms will be available, the low floor height helps increase passenger boarding and alighting speeds during the curbside boarding sections of the route. System planners in India pushed strongly for low-floor vehicles in the hope that the BRT project would force the Indian bus industry to innovate and provide low-floor vehicles for conventional (non-BRT) services as well.

Fig. 12.13
High-floor vehicles in conjunction with platform-level boarding has been the cost-effective solution for most high-quality systems in Latin America, such as the system in León.
 Photo courtesy of Volvo



In instances where the trunk vehicle operates with two-sided doorways, the low-floor design can ease internal vehicle movements for customers. If a vehicle operates with high-floor on one-side (median station) and low-floor on the other (curbside), then there will be steps inside the vehicle. This configuration is utilised in Porto Alegre. By contrast, if a low-floor design is utilised, then there will be no internal steps since both the median and curbside doorways

would be at the same level. Also, by avoiding the need for any steps inside the vehicle, space for seating is saved.

Low-floor vehicles can also be preferred for aesthetic and urban design reasons. The 70 cm difference in floor height means that the station height is reduced by 70 cm. This height reduction can help to mitigate concerns over roadway severance. The lower height will also marginally reduce the construction cost of the stations since

Table 12.4: Comparison between high-floor and low-floor vehicles

Factor	High-floor vehicle	Low-floor vehicle
Purchase cost	Lower purchase costs	More complex chassis results in a purchase cost approximately 20% to 30% higher than high-floor vehicles
Maintenance cost	Distance from roadway impacts reduces maintenance costs	Higher maintenance costs (10% to 20%) due to proximity to roadway imperfections
Station costs	Somewhat higher (5%) station costs due to the higher base	Somewhat lower station costs
Urban design aesthetics	Station profile will be 70 cm higher	Station profile will be 70 cm lower and thus will somewhat reduce visual severance
Customer convenience	High-floor vehicles with platform-level boarding eases boarding and alighting for everyone	Same as high-floor if platform-level boarding is used; otherwise, the step will make wheelchair entry difficult
Vehicle towing	In case of breakdown high-floor vehicles can be towed by a conventional tow truck	Many low-floor vehicles require a special type of towing vehicle
Fare evasion	Provides a better natural defense against fare evasion	More susceptible to fare evasion
Vibrations	Higher suspension somewhat reduces roadway bumps and vibrations	Somewhat more susceptible to roadway vibrations and thus making reading potentially more difficult
Seating	Less impact on seating arrangement from the wheel-wells	Some impact on the height and number of seats due to the wheel-well

the concrete base of the station will be reduced by 70 cm.

However, low-floor buses have their drawbacks. Being closer to the ground, the buses typically incur more structural stress and thus have higher maintenance costs. Road surfaces must be maintained at a very high level for low-floor bus routes in order to avoid and minimise any potential vehicle damage. This is a particularly serious issue in developing countries. These problems will be made worse if flooding is a risk along the BRT corridor. Small imperfections in the road surface will also tend to make the ride less smooth and comfortable for the users.

Low-floor vehicles have somewhat lower passenger capacity in comparison with high floor vehicles because the wheel-wells encroach on the passenger seating area. Standard tow trucks are not always able to move low-floor vehicles when there are mechanical problems, so specialised towing vehicles are required.

Low-floor vehicles also somewhat complicate preventing fare evasion. With a ramped-entry high-floor vehicle, the height of the platform acts as a natural barrier against individuals trying to enter from outside the station. With low-floor vehicles, fare evaders can sneak between the station and the bus, and then enter the vehicle with relatively little difficulty.

Low-floor vehicles also typically cost 20 to 30 percent more than standard models. Manufacturing low-floor vehicles requires the use of modern manufacturing technology, which is not always available in developing countries. In some cases, this means that the use of a low-floor vehicle will affect whether the vehicles can be assembled locally or will need to be

imported, and thus have a significant impact on the cost of both procurement and maintenance.

Table 12.4 summarises the various trade-offs between high-floor and low-floor vehicles.

12.1.3 Interior design

“Art has to move you and design does not, unless it’s a good design for a bus.”

—David Hockney, painter and designer, 1937–

From a customer perspective, the interior of the bus is far more important than the mechanical components propelling the bus. The interior design will directly affect comfort, passenger capacity, security and safety.

A basic starting point for developing the interior design is to determine the amount of seated and standing space in the vehicle. The amount of space dedicated to standing areas and to seated areas will be based upon expected passenger flows, especially accounting for peak capacities. In general, customers will have a preference for as much seating as possible. However, the operational economics of the system may require a certain number of standing passengers, especially during peak periods, in order to deliver an affordable fare.

A sharp peak period will tend to force a greater number of standing customers. However, there are also other considerations. If travel distances are relatively long in the city (e.g., an average trip distance over 15 kilometres), then it will be quite tiring for customers to be standing. By contrast, if average trip distances are relatively short (e.g., under 5 kilometres), then standing is less of an issue (Figure 12.14 and Figure 12.15).

However, even in cases of relatively short trip distances, the value of a seat to a customer



Fig. 12.14 and 12.15

In cities, such as Quito and Bogotá, with relatively short average trip distances, there can be more tolerance for having many standing passengers. In cities with long travel distances, it can be quite tiring to customers.

Left photo by Lloyd Wright
Right photo by Carlos F. Pardo



Fig. 12.16

Customers in Bogotá make their own seating on the floor of the vehicle. Every effort should be made to maximise seating to the extent possible.

Photo by Carlos F. Pardo

single seats can also be preferred by customers who wish to maintain a degree of privacy. Double seats can create difficulties when customers prefer the aisle seat in order to be more accessible to the exit. In such circumstances, other customers must step over the aisle-seated customer to access the window seat. In other cases, customers may place belongings on one of the double seats in order to prevent others from sitting alongside. These circumstances can create conflicts between customers. Instead, good design practices should be employed to avoid potentially awkward customer situations.

The vehicle's internal layout must comply with legal restrictions and must also consider the number and location of doors in the vehicle, in such a way that internal circulation, handicap access, and access at stops is readily available in the least amount of time possible.

An 18-metre articulated vehicle will typically have either three or four sets of double doorways. There is a trade-off with each configuration. With only three doorways, there will be more space for seating. However, four doorways are considerably more efficient in allowing rapid boarding and alighting (Figure 12.18). As always, much depends on the local context to determine which trade-off is the most important.

Special arrangements should also be made to cater to the needs of physically disabled and elderly passengers. The station entry ramps are an important feature, but likewise adequate interior space for wheelchairs is key. Additionally, the safe attachment of wheelchairs to a fixed interior structure may be required. Space for wheelchairs can also double as standing capacity during peak periods (Figure 12.19).

Bicycles can also be safely and effectively secured inside the bus. Unfortunately, the bicycle is needlessly banned from many bus systems. With the ramped entryways of BRT vehicles, bicycles can be easily boarded, especially during non-peak periods. The space permitted for bicycles can also be an effective open space for standing passengers during peak times. BRT

should not be underestimated. After a day of work or school, many patrons are not pleased to stand for even a few kilometres (Figure 12.16). Every effort should thus be made to provide sufficient seating and/or manage operations to minimise standing.

A standard 18-metre articulated vehicle may have anywhere from 40 to 55 seated passengers, depending upon the seating and doorway configuration. With more doorways, there will be less space for seating. The width of aisle ways will also be part of this equation. To lessen the discomfort of standing, quality holding devices (poles, straps, etc.) should be provided.

Seating facing to the sides rather than to the front can be effective in opening up space for standing passengers (Figure 12.17). Front-facing

Fig. 12.17
Side facing seating, as shown in this example from Jakarta, will tend to maximise space for standing passengers and thus such a configuration will maximise overall passenger capacity per vehicle.

Photo by Karl Otta, courtesy of the GTZ SUTP Photo CD-ROM





Fig. 12.18
Bogotá utilises a four door configuration that helps to reduce boarding and alighting times.
 Photo courtesy of TransMilenio TM

Fig. 12.19
Space allocated for special needs passengers, such as those with wheelchairs, can also be useful in meeting standing capacity during peak periods.
 Photo by Lloyd Wright

vehicles in Rouen (France) provide this type of open area for easy bicycle entry (Figure 12.20).

In typical conditions, a seated passenger consumes as much as twice the space as that required by a standing passenger. However, the amount of personal space each passenger requires can vary between different cultures. In Latin America, it is somewhat acceptable to tolerate relatively packed conditions. Knowledge of local preferences in conjunction with stated preference surveys can help evaluate the best spatial arrangement. The interior of the Bogotá TransMilenio vehicles is designed to a standard of as many as 7 passengers per square metre. In other cultures this level of crowding would be completely unacceptable.

The type of seating can greatly affect customer comfort. Cloth and padded seating offers additional comfort to passengers (Figure 12.21). However, there are cost and maintenance issues to consider with these types of seats. While plastic seating is not as comfortable, such seating is less costly and is easier to clean and maintain.

Special panoramic windows allow better views of the external environment. Panoramic windows offer a larger visible area for customer views (Figure 12.22). Being able to see upcoming stations and station name plates is especially important for customers unfamiliar with a particular



Fig. 12.20
In cities such as Rouen (France), space is provided to allow bicycles to be taken directly onto the vehicle.

Photo by Graham Carey

Fig. 12.21

Cloth seating can greatly enhance the customer experience.

Photo courtesy of Advanced Public Transport Systems



corridor. Clean and highly visible windows also make the journey more enjoyable for passengers who wish to view of the outside environment.

The aesthetic design of the interior can also affect the customer's opinion of the system. As shown in Figures 12.21 and 12.22, the right choice of shapes, colours, and textures can all do much to create a professional and friendly environment.

12.1.4 Environmental performance

"The system of nature, of which man is a part, tends to be self-balancing, self-adjusting, self-cleansing. Not so with technology." (*Small is Beautiful*)

—E.F. Schumacher, economist, 1911–1977

In addition to complying with the governing legislation, the project must define its minimum environmental standards. Because of the profitability of BRT, it is usually possible to set a higher environmental standard on BRT vehicles than is required under the law without compromising the profitability of operations. As BRT projects play an important role in improving environmental conditions, raising environmental standards as high as can be financially sustained is generally recommended.



Fig. 12.22

Panoramic windows, as in this bus in Aichi (Japan), can dramatically improve the customer's ability to see the outside environment.

Photo by Lloyd Wright

Generally, the following must be considered in assessing the environmental quality of a system:

- Emission levels;
- Ambient air quality standards;
- Fuel quality;
- Fuel type and propulsion system;
- Levels on interior and exterior noise;
- Ventilation and temperature standards (air renewal/time unit).

In the needs assessment of the project, it is important to set the environmental goal. From an emissions standpoint, there is no one clear technical solution that is necessarily superior to another. Each fuel carries with it different trade-offs of costs, emissions, infrastructure, and potential operating constraints. In some instances, a fuel may emit less of one type of pollutant but more of another type of pollutant. Much will also depend on the availability of a particular fuel. For example, CNG may do well in terms of reducing particulate emissions, but its life-cycle greenhouse gas emissions may not offer a significant advantage over diesel technology.

Some fuels may produce less local emissions but may produce significant emissions at the point of electricity generation. Some fuels may produce few emissions from the standpoint of fuel tank to wheels but can produce significant emissions when the full fuel cycle is considered (e.g., well to wheels). For example, electric vehicles and hydrogen-fuelled vehicles may produce zero emissions at the tailpipe, but the emissions generated at the power-plant or through the hydrogen generation process can be quite substantial. Some fuels may work well in ideal conditions but are more polluting in circumstances when maintenance and road conditions are poor, or at high altitudes.

12.1.4.1 Emission standards, fuel quality, and ambient air standards

Emission standards

Emission standards are the most typical mechanism for differentiating between the emissions levels of different options. The standards set forward by the US Environmental Protection Agency (US EPA) and the European Commission are most typically used to classify emission performance of different technologies. Figure 12.23 gives an indication of how European and US EPA standards are related in terms of NO_x and PM emissions. For the most part, the two

systems follow similar long-term objectives, although there are a few differences.

In many developing nations, the “Euro” (i.e., European) standards are being applied. Table 12.5 provides more detail on the Euro emissions standards along with the likely fuel and technology requirements.

In order to achieve desired emissions standards or reductions from existing buses, several different components of the emissions control program must be taken into account including:

- Fuel quality;
- Engine technologies;
- Emission-control technologies;
- Inspection and maintenance program; and
- Driver training.

A strategy incorporating each of these components will be most effective (Figure 12.24). In order to ensure the greatest possible emissions reductions from both the new vehicles and the existing fleet a comprehensive emissions-control programme will be required.

In determining the appropriate emissions standards and technologies within a specific city or fleet perspective, many considerations must be taken into account, including the reliability of the fuel supply to meet quality standards, the mechanisms and incentives are in place to

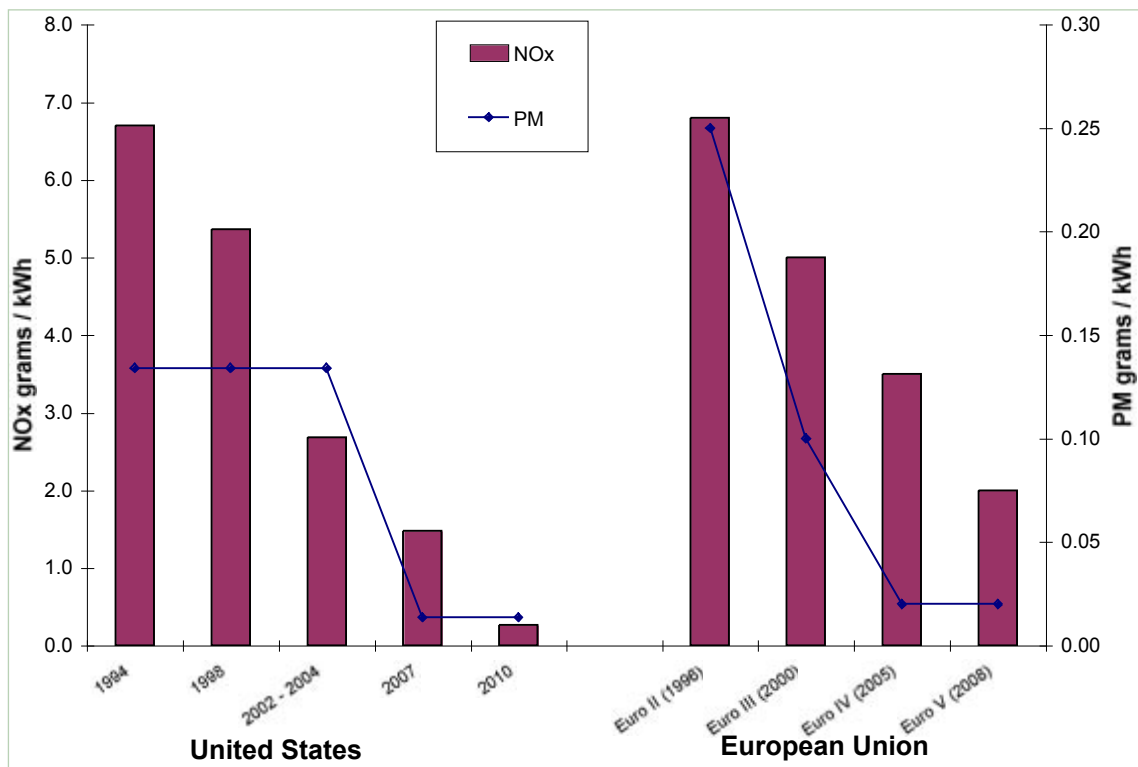


Fig. 12.23
NO_x and PM standards for heavy-duty trucks and buses in the US and Europe.

Table 12.5: Euro emission standards for heavy vehicles

Level	CO (g/kWh)	HC (g/kWh)	NO _x (g/kWh)	PM (g/kWh)	Certification fuel sulfur content (ppm)	Likely technological requirements
Euro I	4.5	1.1	8.0	0.612	2,000	Higher pressure fuel injection for PM control, timing retard for NO _x control.
Euro II (1996)	4.0	1.1	6.8	0.25	500	All engines are turbocharged, improved high pressure fuel injection and timing optimisation.
Euro III (2000)	2.1	0.66	5.0	0.1	350	In addition to above, electronic control for fuel injection, timing retard for NO _x , common rail (CR) fuel injection, some exhaust gas recirculation (EGR).
Euro IV (2005)	1.5	0.46	3.5	0.02	50	In addition to the above, further NO _x reduction using EGR or selective catalytic reduction (SCR). Some systems will use diesel particulate filters (DPFs) and most will incorporate oxidation catalysts.
Euro V (2008)	1.5	0.46	2.0	0.02	10	Similar to above, with more reliance on SCR.

Source: CITEPA, 2005

ensure follow-up and compliance with driver training and maintenance procedures, and the applicability of the technology in context to the operating conditions of the fleet. Each component has a different ramification in the developing-nation context. Can the quality of the incoming fuel be assured and how will

adulteration of fuels be avoided? If advanced engine and emission-control technologies are utilised, how robust are these technologies in developing city conditions? If an improved driver and maintenance programme is established, what mechanisms and incentives are in place to ensure follow-up and compliance?

Fig. 12.24
Technology is not the only solution to ensuring low emissions, as maintenance, fuel quality, and driving habits all contribute to the actual emission levels.

Photo by Lloyd Wright



In addition to emission standards, system planners may also specify the maximum allowable age of buses operating on the system. The age specification will help to maintain long-term system quality as well as ensure all private operators are competing on an equal basis. The maximum age will also play a fundamental role in calculating the operator's amortisation rate for the vehicle.

Fuel quality

In a BRT project, it is fairly typical that the BRT authority has control over the vehicle standard but only limited influence on the fuel standard and fuel availability. However, in several cases a BRT project has been used to pressure the energy companies to provide cleaner fuels. The additional operational controls within a BRT system may make it possible to ensure a higher-quality fuel supply than is available within the rest of the city and should make it possible to reduce the problems of fuel adulteration. In any case, the technical specification has to be set with awareness of available fuel quality. In Ecuador, the city of Quito maintains higher-fuel quality standards than other cities in the country. This higher level is in part due to the city's unique climatic and geographical conditions (2,800 metres of elevation) as well as the presence of a BRT system.

It is generally best to set the minimum allowable vehicle emission standard without specifying a specific technology, as this gives the operator greater flexibility to consider a range of factors such as fuel costs, fuel availability, maintenance, reliability, refuelling times, and performance when complying with the standard. These factors will vary by location and situation, and the private sector may be in the best position to weigh the relative economic value of each factor. For instance, in Bogotá, the BRT authority specifies that buses must meet a minimum Euro II emission standard and have set forward a schedule to move towards Euro IV standards. TransMilenio does not specify a particular fuel or propulsion technology. These decisions are left to the private operators. There are also incentives in place for operators to propose vehicles exceeding the minimum standard. Such operators receive more points during the bidding process.



For BRT, the cleanest new vehicles that are compatible with available fuel quality are generally advisable. In some cases, BRT systems have been operated with a mismatch between the vehicle technology and the available fuel (Figure 12.25). Somewhat cleaner vehicles may be able to cope with dirtier fuels but may face increased maintenance issues. While Euro II and III vehicles are generally more forgiving than Euro IV or V vehicles, higher sulphur levels than are found in certification fuels may still increase maintenance costs for sensitive electronic engine equipment, such as high pressure or common rail fuel injection. Lower sulphur fuels will reduce maintenance costs and improve vehicle durability for all vehicles, regardless of emissions standard.

Fig. 12.25
On the Quito Central Norte corridor, the Euro III compliant vehicles are not producing the desired results due to the use of 500 ppm diesel fuel.

Photo by Lloyd Wright

Fig. 12.26
All public transport vehicles in Delhi, including the oldest vehicles, faced a mandatory conversion to CNG fuel in order to overcome difficulties with adulterated fuels.

Photo by Lloyd Wright



However, in some instances, there may be reason to specify a particular fuel type. In Delhi (India) all public transport vehicles have been mandated to utilise compressed natural gas (CNG) as fuel (Figure 12.26). In order to improve profits, some fuel suppliers in India mix kerosene, which is subject to much lower taxation rates, into the diesel. The result is poor performing vehicles, higher emissions, and more costly maintenance requirements. Thus, requiring Euro II or Euro III technology can be meaningless in such a scenario since there is little control on the input fuel. By contrast, it is quite difficult to adulterate CNG and thus its quality is more assured. Despite the rationale of this course and the relative availability of CNG in India, Delhi's conversion from diesel fuels to CNG has been fraught with conflicts and political recriminations. Ultimately, it required the intervention of the national Supreme Court to intercede and ensure that the conversion process was finally undertaken.

Ambient air quality standards

Some cities also have ambient air quality standards, which can be used as a tool in driving improved environmental performance for vehicles. Though rarely enforced in developing countries and generally not linked directly to the transportation system, air quality standards could provide justification for cleaner fuels and more stringent emissions standards for a new bus fleet. If the air in a particular location is unhealthy and hence in violation of an ambient air standard, then there can be stronger justification for subsidising a cleaner bus technology.

Normally, if ambient air standards are in place and there are on-going violations of the standard, the responsible government agency will have an obligation to develop an air quality mitigation plan that will outline a step-by-step for resolving the problem. A clean vehicle standard can be an important part of such a mitigation plan.

12.1.4.2 Fuel types and propulsion systems

Many governments and promoters of clean technology rightly see BRT as a possibility for introducing cleaner vehicle technology. Because of BRT's profitability, it creates the potential of having a much cleaner vehicle without under-

mining the profitability of the service. However, this profitability is case specific, and clean technologies should not be forced on BRT systems without first assessing the impact the technology will have on the quality of service, the profitability of the system, the transparency of the vehicle procurement process, and other factors.

The choice of fuel and propulsion technology will have a profound impact on operating costs, maintenance costs, supporting infrastructure, as well as emission levels. Local circumstances play a central role in fuel choice as the availability of a fuel and experience in maintaining a particular vehicle technology are key factors. Further, as attention focuses more and more on the human and environmental costs of both local pollutants and global climate change, system developers are under increasing pressure to deliver cleaner vehicles options.

The following is a list of some of the most common fuel options currently being considered for public transport vehicles (Figure 12.27):

- Standard diesel;
- Clean diesel;
- Compressed natural gas (CNG);
- Liquid petroleum gas (LPG);
- Electric trolley-bus;
- Bio-diesel;
- Ethanol;
- Hybrid-electric (diesel-electric and CNG-electric);
- Hydrogen (fuel cell technology).

A range of other possibilities also exist such as fly-wheel technology, di-methyl ether (DME), and blended fuels (*e.g.*, water-in-oil emulsions).

Choosing the type of engines that will be purchased and the fuel that will be used requires that consideration be given to several important issues. The following factors are the most important when considering a fuel and propulsion technology:

- Fuel availability and price volatility;
- Vehicle cost;
- Reliability;
- Government policy;
- Environmental Impact.

Clean diesel

Clean diesel is a technology that both produces relatively low emissions and also is within the technology experience of most developing

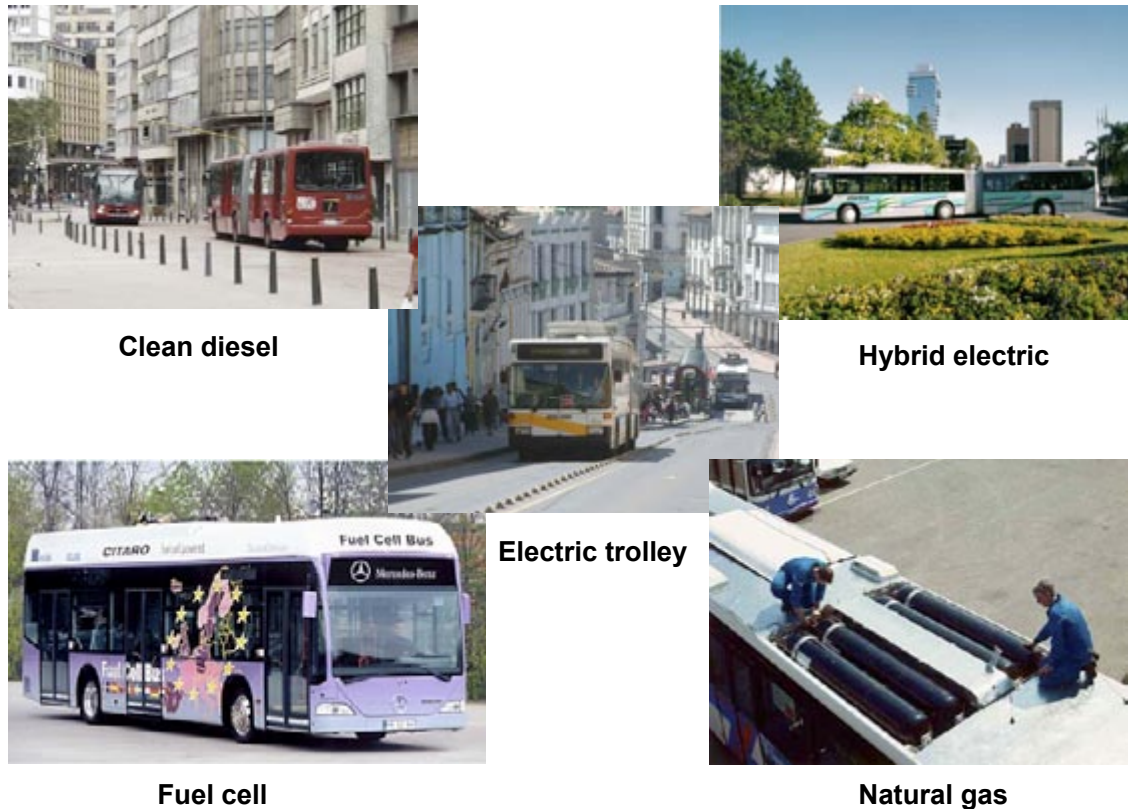


Fig. 12.27
Fuel and propulsion system options

cities. A “clean diesel” system implies that the propulsion system technology and the fuel quality are such that the end result is much lower emissions than a standard diesel vehicle. The International Energy Agency notes that (IEA, 2002b, p. 61):

“Diesel engines are recognised and favoured worldwide for their fuel efficiency, excellent durability and low maintenance requirements. They offer the convenience of using a liquid fuel that is easily dispensed through an established fuelling infrastructure. The technology is mature, widely produced and competitively priced. Although diesel engines have historically produced high levels of pollutant emissions, especially oxides of nitrogen (NO_x) and particulate matter (PM), recent improvements in engines, fuel and emissions-control technology have resulted in new diesel systems for buses that are substantially cleaner than they were only a few years ago.”

For diesel, sulphur content is the most critical factor to consider, as many of the pollution control devices used in the cleaner buses require lower sulphur fuels. In some developing cities, diesel fuels may contain over 2,000 parts

per million (ppm) of sulphur. To achieve Euro II standards, a sulphur level of less 500 ppm is likely to be required. To achieve “ultra-low-sulphur diesel” (ULSD), the fuel must contain less than 50 ppm. Many emission-control technologies will only function properly if the fuel sulphur levels are below acceptable levels.

Reducing sulphur from diesel fuel also carries with it other emissions benefits, such as simultaneously also reducing particulate matter (PM), which is a key pollutant from a public health perspective. As shown in Figure 12.28, sulphur contributes to the production of particulate matter in all diesel engines. At higher sulphur levels, sulphate can account for up to 5 to 15 percent of PM emissions from diesel. At lower sulphur levels, after-treatment emissions controls can reduce PM emissions much more substantially, either as retrofit devices or as standard equipment on new vehicles meeting more stringent standards. Diesel oxidation catalysts, which can reduce PM emissions by 20 percent to 30 percent, can generally be used with sulphur levels up to 500 ppm. Diesel particulate filters, which can reduce more than 90 percent of PM emissions, generally require sulphur levels to be under 50 ppm.

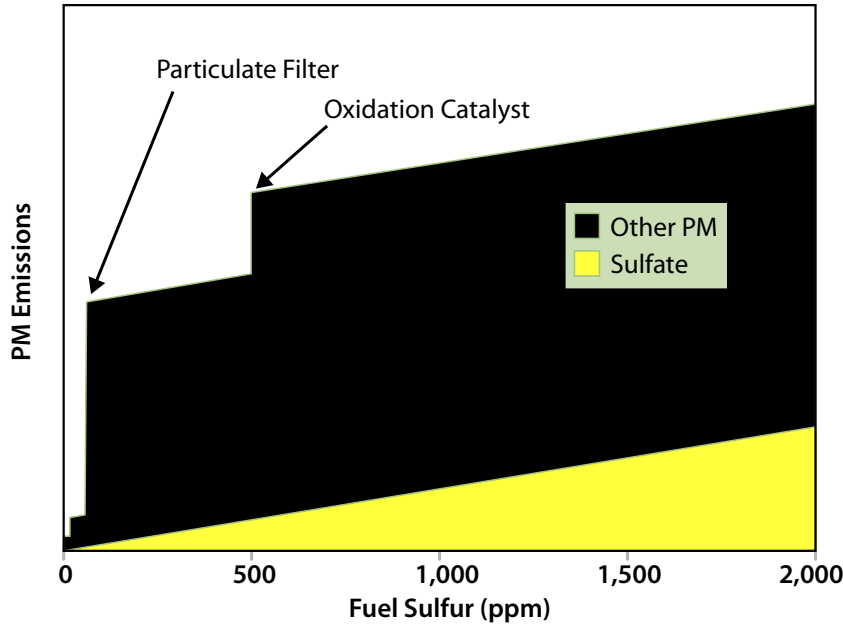
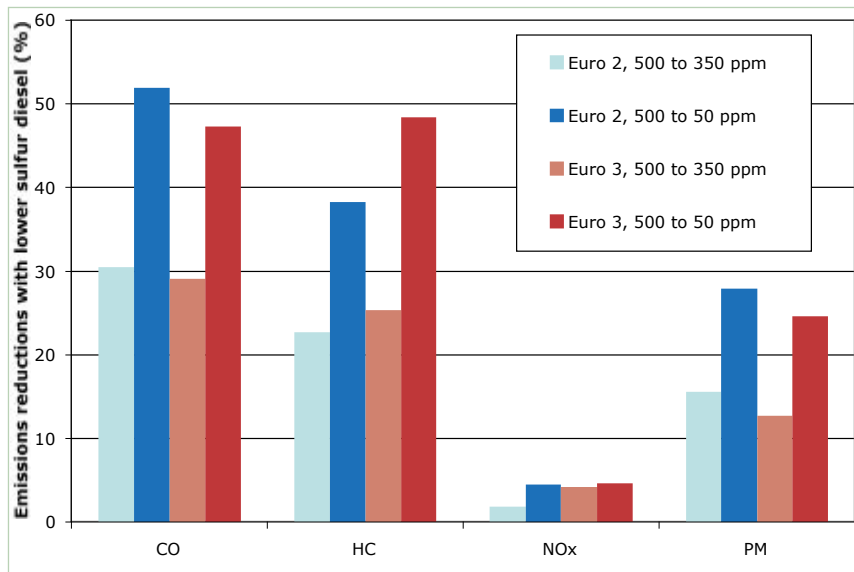


Fig. 12.28
There is a close relationship between the emissions of sulphur and emissions of particulate matter (PM).

Hydrocarbons (HC), carbon monoxide (CO), and even nitrogen oxides (NO_x) are also impacted by emissions standards and contingent on fuel quality. As can be seen in Table 12.5, the Euro standards are scheduled to reduce emissions of all major pollutants. Euro II and III each represent a 60 percent reduction in PM emissions from the previous standards (Figure 12.29). Euro IV standards have 80 percent lower PM emissions than Euro III, and thus representing a 97 percent reduction from Euro I standards. The cleaner the vehicle, however, the more sensitive it is to fuel quality.

Fig. 12.29
Size of possible emissions reductions with lower sulphur fuel (Wangwongwatana, 2003).

Emissions from diesel vehicles will vary depending on local conditions such as altitude,



atmospheric pressure, humidity, and climate. The quality of ongoing vehicle maintenance and the integrity of the fuel supply chain will also affect specific system emissions. Nevertheless, with the right fuel quality, diesel vehicles can produce emissions reductions in line with many of the more costly alternative fuels. In general, it can do so with a lower vehicle cost and with a more robust maintenance regime.

Compressed natural gas (CNG)

CNG is highly touted as a reliable fuel option that “inherently” achieves lower emissions. CNG contains virtually no sulphur and naturally burns quite cleanly. However, CNG is not a perfect solution. For some emission types, the performance of CNG may not be that much better than clean diesel vehicles.

In the case of greenhouse gas emissions, the entire well-to-wheels analysis of CNG production, distribution, and use may imply that there is little, if any, advantage over diesel. Upstream methane losses along pipelines can significantly increase total life-cycle greenhouse emissions for CNG. Some studies estimate that with the inclusion of methane leakage, CNG will actually produce significantly more total greenhouse gas emissions (CVTF, 2000).

There are also other issues to consider with CNG. The low energy density of the fuel means that the gas must be compressed for on-board storage in large, bulky cylinders. CNG vehicles also require different maintenance skills that may not be common in developing cities. In some cases, CNG vehicles may face power issues on steep hills, at high altitudes, and in some temperatures. The refuelling infrastructure for CNG can also be costly to develop. Refueling time is also a consideration. The amount of time required for refuelling is also an issue for CNG vehicles. Typically, refuelling time per vehicle will range from 20 minutes to 40 minutes.

Nevertheless, CNG holds much potential for emission reductions of PM and SO_x, and thus, if the fuel is available locally, then the technology should be given serious consideration. Further, as experience grows with CNG, the technology is becoming increasingly robust from a maintenance standpoint.



Fig. 12.30
Los Angeles has developed the infrastructure to utilise CNG technology for the entire fleet on its Orange Line.

Photo courtesy of the Los Angeles County Metropolitan Transport Authority

Electric-trolley vehicles

Electric-trolley vehicles are a well-established technology that produces zero emissions at the point of use. The total fuel-cycle emissions of electric-operated vehicles will depend upon the fuel used in the electricity generation. Fossil-fuel based electricity generation, such as electricity from coal or petroleum, will produce high levels of total emissions, while renewable sources, such as hydro-electric and wind sources, will be relatively emission free. Thus, in countries with clean electricity generation, electric trolleys can be a low-emitting option to consider. Electric-trolley vehicles are also extremely quiet in operation. Table 12.6 summarises the different issues to consider in choosing electric-trolley technology.

Biofuels (ethanol and bio-diesel)

Ethanol is a fuel produced from the fermentation of sugars in carbohydrates, derived from agricultural crops like corn and grains, wood, or animal wastes. Currently, ethanol is derived predominantly from corn and sugar cane (Figure 12.31). Brazil possesses an extensive ethanol programme using sugar cane. In the future, cellulosic ethanol may become viable, in which

the fuel can be derived from a broader range of plant and agricultural species. However, commercial production of cellulosic ethanol is yet to be fully realised.

Bio-diesel is a fuel derived from biological sources that can be used in diesel engines



Fig. 12.31
Sugar cane production in Mauritius.

Photo by Lloyd Wright

Table 12.6: Advantages and disadvantages of electric-trolley technology

Advantages	Disadvantages
Zero emissions at point of use (total emissions will depend on fuel type for electricity generation)	Vehicles can cost up to three times the amount of a comparable diesel vehicle
Quiet operation	Operating costs highly dependent on electricity prices; subsequent electricity deregulation can destabilise financial model
Smooth ride characteristics	Route modifications are very expensive
Longer vehicle life (up to twice the vehicle life of diesel vehicles)	Longer implementation time required to build the electric conduit network
	Risk of service disruption during power failure unless vehicles have backup diesel motor
	Infrastructure costs can be over twice that of a non-trolley BRT system
	Presence of wiring, posts, and transformers can create aesthetic concerns, particularly in historical centres

instead of petroleum-derived diesel. Through the process of trans-esterification, the triglycerides in the biologically derived oils are separated from the glycerin, creating a combustible fuel. Bio-diesel fuel is currently derived predominantly from soya.

Biofuels hold the potential to deliver a product with net zero greenhouse gas emissions. The CO₂ emitted by biofuels can be balanced by the CO₂ absorbed during plant growth, potentially resulting in a fixed carbon cycle. However, the reality is more complicated. Total greenhouse emissions from biofuel production are still quite poorly understood including certain factors that could increase net greenhouse gas emissions considerably. These factors include: 1. Energy inputs into the cultivation of crops; 2. Secondary emissions that have climate change impacts (e.g., black soot); 3. Amount of fertilizer use and resultant emissions of nitrous oxide (N₂O); 3. Amount of pesticide use; and, 4. Type of biomass being displaced by energy crops. In some instances, such as soy-based fuels, the resulting greenhouse gas emissions from nitrogen releases may overwhelm other benefits (Deluchi, 2003). Additionally, it is unclear if the amount of agricultural land is sufficient to produce biofuels in a quantity sufficient to dramatically offset petroleum fuels (IEA, 2004b).

Biofuel production may have an array of other unintended side effects. As the market for biofuel builds, there will be growing pressure on sensitive eco-systems to be converted into crop production. This phenomenon is already clearly evident in the Amazon region of Brazil,

where increased demand for soya is leading to further illegal destruction of the Amazon eco-system. Each year, approximately 20,000 square kilometres of the Amazon rainforest are cleared for agricultural use (Economist, 2006b). More intensive biofuel production can also imply greater depletion of input resources such as soil quality and water (Figure 12.32).

There is also increasing concern over the impact biofuel production will have upon food prices. It is reported that the grain required to fill the typical 95-litre petrol tank of a sport utility vehicle with ethanol will feed one person for a year. The grain to fill the tank every two weeks over a year will feed 26 people (Brown, 2006). In the US, the amount of the corn (maize) crop dedicated to ethanol production increased 34 percent from 2006 to 2005. In 2006, some 54 million tons of maize went to ethanol production, even though ethanol only represents a small percentage of the fuel used in US vehicles (Planet Ark, 2006). In late 2006, an increase in maize prices due to biofuel demand caused tortilla prices to triple in Mexico. Since tortillas represent the staple of the local diet, many low-income families were severely affected by these increases. With strong protests from the population, the government was eventually forced to adapt price controls. These types of conflicts may become more common as the market for biofuels expands.

Fig. 12.32
The growing demand for soya has fuelled further destruction of the Amazon rainforest.

Photo courtesy of iStockphotos



Fig. 12.33
As the demand for biofuel increases, production inputs, such as water, will also come under increasing demand.

Photo by Lloyd Wright



Hybrid-electric vehicles

Hybrid-electric vehicles will likely be the one of the first of the advanced technologies to gain large-scale acceptance in the market. Hybrids utilise both conventional fuels (*e.g.*, diesel, CNG) and electrical motors to propel the drive-train. Electric power can be generated during vehicle deceleration and then utilised to operate motors attached to each wheel. Since electric motors are used for part of the vehicle's operation, hybrids offer superior fuel economy, reduced emissions, and lower noise levels (Figure 12.34).

However, even with this technology, the emission reduction benefits can vary depending on the driving duty cycle. The city of Seattle (USA) has made one of the largest investments in hybrid-electric technology within its bus system. However, despite manufacturer claims of fuel efficiency gains of 25 percent or more, the initial results in Seattle were significantly less due to the route choice (Hadley, 2004). If the bus duty cycle does not involve sufficient stop and go travel, then the efficiency gains from regenerative braking are not realised. The additional weight of the hybrid-electric vehicle offsets the gains from the on-board electricity generation (Wright and Fulton, 2005).

Like all new technologies, a certain period of adjustments and experimentation are required prior to optimum results being achieved. However, the complexity of propulsion system and cost of the hybrid components means that hybrids may not be well-suited for all developing city applications.

Currently, efforts are being made to produce hybrid-electric vehicles in Brazil. Because of various local conditions, such as lack of driver familiarity with the technology, the environmental benefits have been less than anticipated, but the problems are likely to be resolvable.

Fuel-cell technology

National research and development budgets have heavily invested in fuel-cell technologies. In 2003, the United States launched its five-year Hydrogen Fuel Cell Initiative with a commitment of US\$1.7 billion in research funding. Likewise, the European Union is supporting a €2.8 billion (US\$3.7 billion) public-private partnership in a ten-year fuel cell development programme. In 2003, Japan dedicated US\$268



Fig. 12.34

The potential of hybrid-electric vehicles to cost-effectively reduce tailpipe emissions has drawn the attention of most manufacturers.

Photo courtesy of Volvo

million of its government research budget to fuel cells. Likewise, other governments such as Canada and China also have their own fuel cell programmes (Science, 2004).

Fuel-cell vehicles are under going testing in both developed and developing cities. Through a grant from the Global Environment Facility (GEF), several developing cities, such as Beijing and Cairo, have had an opportunity to evaluate the technology. However, none of these cities are actually operating full fleets with these technologies. The costs, environmental benefits, and performance of these vehicles are not entirely proven. Since most hydrogen is currently produced from electrolysis, the emissions benefits are directly tied to the type of technology utilised for the generation of the electricity.

The IEA notes that there are no certainties when hydrogen fuel cells will become commercially viable (IEA, 2004b). Hydrogen storage capabilities, the dependence on expensive rare-metal catalysts (*e.g.*, platinum), and the development of appropriate infrastructure all represent formidable uncertainties in the timely delivery of a commercial product. By depending solely on a technology without a known delivery date, action on transport-sector emissions can be significantly delayed:

“...by skewing research toward costly large-scale demonstrations of technology well before it's ready for market, governments risk

repeating a pattern that has sunk previous technologies such as synfuels in the 1980s. By focusing research on technologies that aren't likely to have a measurable impact until the second half of the century, the current hydrogen push fails to address the growing threat from greenhouse gas emissions from fossil fuels" (Science, 2004).

12.1.4.3 Fuel availability and price volatility

Not all fuels are widely available, particularly in developing countries. Many alternative fuels may simply not be available at the time that the BRT system is going into operation, and thus fuel availability will constrain the selection of propulsion technology.

Diesel and electricity are by far the most widely available fuels. Low-sulphur diesel is available in a growing number of countries, but its availability is still fairly limited in developing countries. Current price levels in different countries are well documented through the GTZ International Fuel Prices publication (Metschies *et al.*,

2007). As evidenced in Figure 12.35, subsidy and tax levels can make a significant difference in actual fuel costs.

Natural gas as a bus fuel requires a supply network in close proximity to fleet maintenance and parking areas. Some cities in developing countries have natural gas and others do not. Some cities have the gas but have not yet invested in the specialised equipment such as the pipeline, compressors, dehumidifiers, and other equipment necessary to make the fuel usable as a bus fuel. When Delhi was forced to switch to natural gas, the lack of sufficient sources of supply led to severe disruption of bus services. These problems can be mitigated with proper planning.

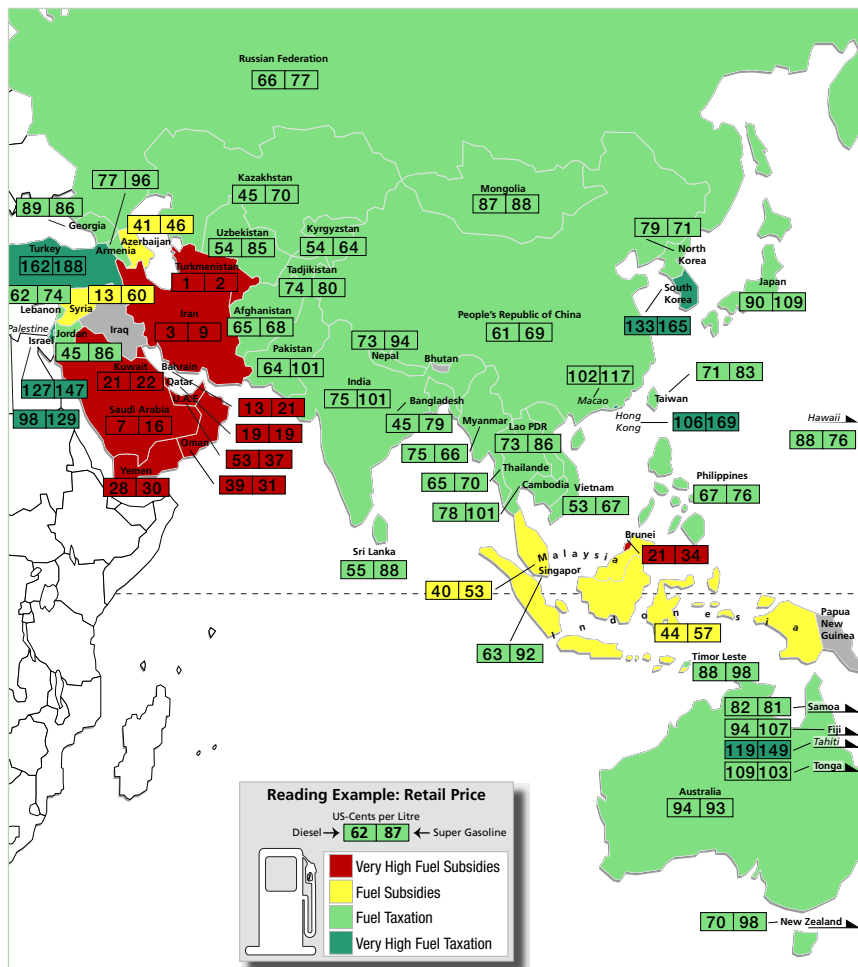
Hydrogen fuel cells are currently not commercially viable in developing countries without massive subsidies, but an additional problem is the availability of hydrogen. Hydrogen is not found in any substantial quantities in the natural environment. For this reason, hydrogen is not really a fuel type but rather an energy carrier, in a similar manner that an electric battery is an energy carrier. Most of the hydrogen fuel cell projects developed to date have relied upon electrolysis, which generates the hydrogen from passing an electrical current through water. This requires special equipment and electricity. The other likely source of hydrogen is natural gas, which then requires a natural gas supply. Both approaches require expensive specialised equipment. Further, depending on how the electricity is generated to produce the hydrogen, the life cycle emissions from a fuel cell vehicle can actually be considerably higher than a standard diesel vehicle.

The electricity for electric trolleybuses is less of a problem than the cost and maintenance of the electric conduit and the electricity stations that feed them. Electric-diesel hybrids which do not require electric conduits mitigate the need for expensive conduits.

In every case, a vulnerability and risk analysis associated with fuel supply systems is necessary, as public services like transportation cannot risk interruptions in operation due to problems within gas pipes tubes or power outages.

The risk of future fuel price volatility is a related issue. System operators will want to insulate themselves against the risk of sudden future

Fig. 12.35
The yellow and red coloured areas represent countries with significant fuel subsidies.
Image courtesy of GTZ SUTP



increases in fuel prices. A vehicle technology should be selected which reduces the risk of future fuel price increases.



Fig. 12.36
Sudden changes in fuel costs can put the entire economic viability of a system into jeopardy.

Photo by Lloyd Wright

While predicting future fuel supplies is difficult, this risk can be mitigated by having the vehicle operator negotiate long-term fixed rate contracts with the relevant fuel suppliers, or by buying futures options in the fuel. The risk can also be mitigated by the use of vehicle technologies that can run on multiple fuel types.

If a city has a nearby natural gas supply, it may be worth the investment in the necessary infrastructure and equipment to provide natural gas at the depot if a reasonably-priced long-term supply contract can be negotiated with the gas supplier. A local supply of natural gas is important because it is relatively easy to pipe but expensive to ship. Similarly, if oil is produced in the country, particularly if it is produced by a state run oil company, it may be possible to negotiate a long-term fixed rate supply contract.

Conversely, if a country has hydroelectric power, or large supplies of coal, or declining electricity demand (as in the case of the former socialist countries of Central and Eastern Europe and

the former Soviet Union) it may be that future electricity supplies are more predictable than prices for diesel or natural gas. Again, the issue may be more whether or not a long-term supply contract can be negotiated. It is not enough to assume that a government company will mean stable future fuel prices. System operators should still protect themselves with long-term supply contracts or futures contracts. Long-term supply contracts also may be possible from commercial providers though they will cost more.

In the case of Quito, for example, the decision to go with electric trolley buses was initially related to low electricity costs. While the initially low electricity rates made the operational costs competitive with diesel-based systems, a subsequent deregulation of the Ecuadorian electricity sector has seen electricity costs increase. Based on this experience, the future expansion of the trolley system in Quito may be limited.

12.1.4.4 Reliability

Reliability of the propulsion technology is a major concern for a BRT system. Vehicle breakdowns in a BRT system are more serious than in a normal bus operation because a broken down bus will congest the BRT lane and lead to a significant disruption of service.

One of the main advantages of diesel fuel is that the vehicle technology is more mature, and with proper maintenance vehicle breakdowns are more predictable and easier to repair (Figure 12.37).



Fig. 12.37
Diesel technology has a long operational track record, and thus the technology's robustness and maintenance requirements are well know.

Photo by Lloyd Wright

Fig. 12.38

Many of the operating companies in Bogotá directly contract the vehicle manufacturers to provide maintenance services for the vehicles.

Photo by Lloyd Wright



Electric trolleybuses themselves have excellent maintenance records, but there can be problems with power failures and maintenance failures in the electric conduits. Electric trolleybus technology is still used in BRT systems São Paulo but it is being phased out not because of electricity prices but because of failures in the overhead conduit due to poor maintenance. This problem is partially controllable by turning over control of conduit maintenance to the bus operator who has a bigger stake in a breakdown than the power company.

In any case, most important is a maintenance contract with the supplier. In the case of Trans-Milenio manufacturers have staff at the depot for major repairs (Figure 12.38). It is therefore critical that the degree of technical support offered by the vehicle supplier be a major consideration in the procurement contract. In Quito, for example, Spanish electric trolley bus suppliers were selected over lower-cost Russian suppliers largely because of the quality of maintenance support offered.

If the risks of vehicle breakdown are extremely high, local maintenance capacity low, and the ability of the local operators to mobilise capital weak, it may be worth exploring the option of leasing the vehicles from the manufacturer. This

option is being considered for the Dar es Salaam BRT system.

For any vehicle, it is also advisable to run fuel and general performance tests locally that simulate the anticipated conditions of operation before reaching a decision. Vehicles that work great in developed countries in temperate climates may work poorly in tropical climates on poor roads with major drainage problems.

12.1.4.5 Noise

Acceptable noise levels should also be specified within the bus procurement specifications. Excessively loud vehicles are both a health hazard as well as a detriment to the marketing image of the public transport service.

Noise levels are determined by several variables including:

- Fuel and propulsion system technology;
- Design of propulsion system;
- Size of vehicle relative to engine size;
- Dampening technologies and exhaust system employed;
- Quality of road surface; and
- Maintenance practices.

Some fuel and propulsion systems, such as electric vehicles, are naturally quiet. In other instances, the design of the propulsion system can encourage smooth operation as well as the dampening of sounds. Ensuring incentives for well-maintained vehicles and roads will also help achieve lower noise levels. In Bogotá, the vehicle specifications mandate that internal noise levels of the vehicles are specified to not exceed 90 decibels (dB).

A very quiet vehicle does introduce other issues. Electric trolley technology operates with little noise. However, in turn, the lack of noise can create a hazard for pedestrians who may not be aware of the presence of an on-coming vehicle. This type of hazard is particularly a concern for the sight-impaired who are often quite dependent on noise to guide their movements.

12.1.4.6 Ventilation and temperature standards

The presence or absence of climate control inside the vehicles can have an enormous impact not only on the quality of service but also on the costs of operations. In some climate

conditions, air conditioning is not that critical to customer comfort, but in other cases, the lack air conditioning alone may be enough to induce middle and upper income passengers to stay in cars. Requiring air conditioning is critical to a high status image for the system, but it will also put upward pressure on the fare. As a general rule, climate control inside the vehicles is preferred if it is at all possible given the profitability of the system.

Whether air conditioning is used or not, attention should be given to the amount of air turnover inside the vehicle. In highly crowded vehicles, the air quality can quickly deteriorate without adequate ventilation.

12.1.5 Other physical characteristics

Besides the vehicle length and propulsion system type, there are a range of other characteristics that will define the vehicle. The specifications set forth during the operational design will determine many other additional factors regarding the technical specification required for the bus, including the following:

- Body type (segregated from chassis, unified);
- Number of doorways and size of doorways;
- Type of system for opening and closing the doorways;
- Doorway location;
- Transmission type (automatic, manual, retarder);
- Type of propulsion system
- Engine location (front, centre, rear);
- Engine power rating;
- Acceleration capacity;
- Braking technology;
- Braking capacity;
- Suspension type (springs, hydraulic);
- Road turning radius (internal and external);
- Axle load capacity.

If decisions on these parameters are made without reference to the operational design, serious design mistakes can occur. For example, in Jakarta, a vehicle with plenty of capacity was procured but the vehicle had only one door. This single door decision causes such a serious deterioration in passenger boarding and alighting speed that the entire capacity of the corridor was severely compromised. Similarly, vehicles with axle loads above the weight bearing capacity of the road surface treatment on the corridor led to rapid deterioration of the road bed.

In most countries there are regulations and conditions that public transportation vehicles must meet pertaining to bus import, assembly, and manufacturing. Identifying all conditions and restrictions thus becomes necessary, along with any required certification and standardization processes. Norms, standards and regulations that cover the following fields are present in most countries:

- Environmental performance;
- Security standards;
- Physical conditions;
- Country of origin;
- Local manufacturing ratios;
- Import procedures and requirements;
- Tariffs and other import duties;
- Handicap accessibility.

In the absence of laws and regulations governing these issues, setting the vehicle technical specification should take these issues into consideration in any case, following international norms.

As a reference, Table 12.7 is a summary of the vehicle specifications put forward by the public company overseeing the Bogotá TransMilenio system. The actual specifications for any given city will vary depending on local preferences and circumstances.

Table 12.7: Bogotá vehicle specifications (trunk-line vehicles)

Vehicle attribute	Specification
Load weights	
GAWR front axle load	7,500 kg
GAWR middle axle load	12,500 kg
GAWR rear axle load	12,500 kg
GVWR total weight	30,000 kg

Vehicle attribute	Specification
Load weights	
GAWR front axle load	7,500 kg
GAWR middle axle load	12,500 kg
GAWR rear axle load	12,500 kg
GVWR total weight	30,000 kg
External dimensions	
Maximum width	2.60 metres
Maximum height	4.10 metres
Overall minimum length	17.50 metres
Overall maximum length	18.50 metres
Maximum front overhang	3,000 mm
Maximum rear overhang	3,500 mm
Load weights	
GAWR front axle load	7,500 kg
GAWR middle axle load	12,500 kg
GAWR rear axle load	12,500 kg
GVWR total weight	30,000 kg
External dimensions	
Maximum width	2.60 metres
Maximum height	4.10 metres
Overall minimum length	17.50 metres
Overall maximum length	18.50 metres
Maximum front overhang	3,000 mm
Maximum rear overhang	3,500 mm
Floor height from ground	
Minimum height	870 mm
Maximum height	930 mm
Turning radius	
Minimum between sidewalks	7,400 mm
Maximum between sidewalks	12,100 mm
Minimum between walls	7,400 mm
Maximum between walls	13,400 mm
Chassis and body	
Body type	Integral body or self-supporting body
Modification	Every modification of the chassis must be formally approved by the manufacturer
Certification of static load proof	Can be obtained by physical proof or computational model Minimum certified roof resistance in 5 minutes: 50% of GMV Maximum deformation in every point: 70 mm

Vehicle attribute	Specification
Passenger space	
Total passenger capacity	160 passengers
Seating capacity	48 passengers
Colour of seats	Red
Number of preferential seats	6
Colour of preferential seats	Blue
Standing passenger area	16 m ²
Standing design capacity	7 passengers per square metre
Wheelchair capacity	1 space for wheelchair (90 cm x 140 cm); Located in the first body of the bus in front of the second door
Layout of seats	2-2, 2-1, 1-1, 1-0; Perimeter or front-to-front
Internal dimensions	
Free internal height	2,100 mm minimum
Superior visibility height	1,850 mm minimum
Inferior visibility height	600 mm minimum; 850 mm maximum
Corridor width	600 mm minimum
Seating characteristics	
Characteristics	Individual seats Closed in back Direct anchorage to the vehicle floor Without upholstery or cushioned Without sharp edges or rivets
Materials	Plastic Washable Self-extinguishing and flame retardant No release of toxic gases during combustion
Seat dimensions	
Distance between seats	700 mm
Distance between seats front to front	1,300 mm
Seat depth	350 mm minimum; 430 mm maximum
Seat height (measured from floor)	350 mm minimum; 450 mm maximum
Back height	500 mm minimum; 600 mm maximum
Seat width	400 mm
Handles and handrails	
Characteristics	Surfaces without sharp edges End finished in a curve Continuous Non-slip surface
Dimensions	Diameter: Between 30 and 45 mm Horizontal handrail height: 1,750 mm minimum and 1,800 mm maximum Distance between vertical balusters: 1,500 mm or very two seats

Vehicle attribute	Specification
Windows	
Front window type	Laminated
Type, all other windows	Tempered
Colour of window	Green
Transparency level	70%
Advertising	Windows without advertisement
Inferior module	Fixed to the body with adhesive
Superior module height	Minimum: 30% of total height of the window Maximum: 50% of total height of the window
Doorways	
Number of passenger doorways	4
Position	Left side of bus
Minimum free width	1100 mm
Free height	1900 mm
Door opening time	2 seconds
Emergency doors	Type: single door Number of emergency doorways: 2 Minimum free width: 650 mm Free height: 1,800 mm With stairs covered and with a pneumatic opening system
Control and instrumentation	
Logic unit	Communication display in view of driver GPS and communications antennas Tachnograph (with register and storage of instant velocity, distance travelled, times of operation and non-operation over 24-hour period)
Control centre communications	Voice communication equipment
Instrumentation	Odometer with pulse output connected to the logic unit Complete instrumentation with alarms for low pressure of the air brake system and motor oil system
Ventilation	
Air renewal requirement	Minimum 20 times per hour
Noise	
Maximum internal sound level	90 dB(A)
Destination signs	
Number and size of signs	1 in front: 1950 mm x 300 mm 2 on left side: 450 mm x 250 mm
Visibility	Visible from a distance of 100 metres
Technical standards	
Bus	NTC 4901-1 Mass Transport Passenger Vehicles
Test methods	NTC 4901-2 Mass Transport Passenger Vehicles
Local standards	ICONTEC (Colombian Technical and Standardisation Institute)

Source: TransMilenio SA

12.1.6 Vehicle aesthetics

The aesthetic nature of the vehicle technology should also be an explicit component of the design and specification process. Vehicle styling, colour and aesthetic features figure greatly in the public’s perception of the system. Some manufacturers are now emulating many of the design features from light rail systems (Figure 12.39). Simply by covering the wheels and rounding the bus body, these manufacturers have greatly increased the aesthetic appeal of their product. These initial vehicle designs are relatively expensive, in part because other features such as optical guidance systems often accompany them. However, the idea of creating a customer pleasing form is not necessarily a costly endeavour.

It is important that the external and internal aesthetic design includes modern elements which differentiate the system from informal public transportation. Design elements that typically illicit a positive customer reaction include:

- Aerodynamic curvature of body, especially a rounded front;
- Covered wheels (Figure 12.40);
- Panoramic windows;
- Window colour and tint;
- Paint colour combination;
- Interior lighting of vehicle;
- High-quality floor and interior materials;
- Interior layout and design (Figure 12.41);
- Information systems for passengers (electronic information boards and sound systems).

12.1.7 Strategic considerations

There are a series of considerations that have to be taken into account besides technical, environmental or legal factors. These considerations are important from a political point of view and a strategic point of view and although they are not directly related to the system’s performance they are directly associated with its impact and positive contribution to the local transportation service and to users.

12.1.7.1 Government policies

Fuel type selection can also be affected by political considerations which may influence the systems stability, permanency, and economic viability. In particular, development policies

Fig. 12.39
Despite giving a distinctly light rail appearance, the Cavis vehicle is actually a bus.

Photo courtesy of US TCRP media library



Fig. 12.40 and 12.41
Covered wheels and well-designed interiors are seemingly small details that can have a big impact on the public’s perception of the vehicle.

Left photo courtesy of NBRTI
Right photo courtesy of Advanced Public Transport Systems (APTS)

established by administrations must be considered, including factors such as:

- Tariff structure for transportation equipment depending on their respective technology (it might be possible to obtain preferential tariffs for low emission fuels);
- Policies regarding subsidies;
- Tax incentives for clean vehicles;
- Future plans and investments in clean fuel production initiatives;
- Future fuel supply infrastructure expansion and maintenance plans.

12.1.7.2 Local assembly and production

Renovating bus fleet technology and public transportation creates provides a great opportunity for developing new industries and implementing technologies that can be groundbreaking in the country in question.

It is desirable that when selecting vehicle technology, one can take into account the real possibility of incorporating local businesses into whatever part of the process is possible. For instance, it may be possible to encourage local fabrication, chassis assembly, body fabrication and mounting (Figure 12.42).

Choosing more modern and state of the art technology might make it more difficult to try and obtain parts and equipment locally, as this equipment might not be available might no be offered. Further, such technology may prove difficult for local manufacturers to deliver. However, this should not mean that the technology chosen for the project has to be obsolete. On the contrary, even if the chosen technologies are advanced an effort should be made to could foment and encourage local industries to develop local capacity. Not being able to incorporate local business into the process might generate an unfavourable public opinion towards the project in some sectors and could also generate political opposition.

12.1.7.3 Ensuring competition among vehicle suppliers

The vehicle specifications should be developed in part to ensure that the widest number of manufacturers will be able to compete in the market. By maximising the number of eligible manufacturers, the operating companies will be able to undertake a competing tendering process that will minimise the vehicle costs. Limiting



Fig. 12.42

Cities such as Bogotá have put in the right incentives to encourage major vehicle manufacturers to set-up local manufacturing facilities.

Photo by Lloyd Wright

the vehicle type to just one or two manufacturers will quite likely increase the purchase costs.

12.1.8 Docking systems

The process of aligning the vehicle to the station will affect the speed of passenger boarding and alighting, customer safety, and vehicle quality. Vehicle alignment to the station can be critical for both the lateral and longitudinal distances. The lateral distance between the vehicle and the station is important in terms of customers easily and safely crossing. The longitudinal placement of the vehicle can be critical if the station has precise doorways that must match up with the doorways on the vehicle. If the station has an open platform without doorways, then the longitudinal placement is less critical.

Docking precision is also required to avoid damage to the vehicle. If a driver comes too close to the station platform, a collision between the vehicle and the station can easily occur. Rubber padding on the platform sides can mitigate some of the damage, but ultimately, small collisions will damage the vehicle.

Section 8.3.3 of this Planning Guide has already touched upon the issue of vehicle to platform guidance systems. To an extent, the need for exact vehicle to platform alignment is avoided through the use of a boarding bridge. In this case, a flip-down ramp is extended from the vehicle to the platform. The driver only needs to align the vehicle to within 45 cm of the platform to make a boarding bridge function properly.

Optical, mechanical, and magnetic docking systems are all possible technologies to assist the driver in the docking process. Of course, as the

technology becomes increasingly sophisticated, the vehicle and station costs can rise dramatically.

Mechanical guidance systems for station alignment are similar to the mechanical systems used on busways in Adelaide (Australia), Essen (Germany), and Nagoya (Japan). Such systems can also be used only at station to bus interfaces.

Optical systems can either be manually or electronically activated. A manual optical system is simply a visual target for the driver to focus upon while nearing the station platform. The driver's focus on the visual target can be improved through the use of a magnified video screen fed by a small camera under the vehicle or integrated into the wheel. Electronically-operated optical systems function in a similar manner but rely upon a micro-processor to actually steer the vehicle. Thus, as the vehicle nears the station, the micro-processor assumes control of the vehicle from the driver. This type of system is utilised on BRT systems in Las Vegas and Rouen (Figures 12.43 and 12.44).

Finally, the Phileas vehicle of Advanced Public Transport Systems (APTS) offers a magnetically controlled guidance system. Magnetic materials are inserted into precise locations of the roadway. A micro-processor interface with an on-board magnetic sensor then steers the vehicle along a precise path. Like the Cavis, the Phileas bus can be operated without driver intervention at both stations and along the busway.

For the developing city application, a simple optical system that is manually operated by the driver is quite sufficient. In conjunction with boarding bridges, these systems offer a cost-

Fig. 12.43 and 12.44
The dotted white line along the lanes of the Rouen system permit an optical guidance system to manoeuvre the vehicles to a high degree of accuracy.

Left photo courtesy of NBRTI
 Right photo by François Rambaud



effective way of achieving a sufficiently precise docking position in order to permit rapid boarding and alighting.

12.1.9 Fleet size

The fleet size will be determined entirely by the operational system. A method for calculating the fleet size needed based on projected passenger demand was outlined in Chapter 8 (*System capacity and speed*). The calculation formula is repeated here for convenience:

$$\begin{aligned}
 &\text{Operational fleet size for corridor (Fo)} = \frac{\text{Demand on critical link (D) (pphd)} \times \text{Travel time for a complete cycle (Tc) (hours)}}{\text{Vehicle capacity (Cb) (passengers/vehicle)}} \\
 &\mathbf{Fo = \frac{D \times Tc}{Cb}}
 \end{aligned}$$

The total fleet size will affect the likely purchase cost of the vehicles. As the economies-of-scale increase, manufacturers will provide operators with a better offer. In some cases, the pooling of a purchase order can help minimise purchase costs.

12.1.10 Vehicle costs

The one variable that often has an over-riding impact on vehicle selection is cost. The amortisation of the vehicle is one of the principal operating costs that affects both operator profit-

ability as well as the fare level. An exorbitantly high vehicle will reduce system profits and make fares unaffordable. For this reason, attention to vehicle costing must be undertaken jointly with the operational costing model.

Some of the principal determinants of a vehicle's cost are vehicle size (*i.e.*, length) and the type of propulsion system. Other factors, such as interior design, engine size, type of chassis, and number of doorways, will also play a role. For example, a low-floor vehicle will cost approximately 25 percent more than a higher-floor model.

Economies-of-scale in production is a major factor that affects pricing. For this reason, two 12-metre vehicles often cost less than a single 18-metre vehicle. This result occurs to the significantly greater number of 12-metre vehicles produced in the world.

Because vehicle cost is not fixed but a function of the scale of production, some cleaner new technologies face initial high costs which create a barrier to entry. However, cleaner vehicles also yield social benefits beyond just public transport passengers. These factors may in some cases constitute a justification for short term subsidisation of cleaner bus technologies.

Standard diesel vehicles are by far the least expensive bus technology. Most BRT systems are now using Euro II or Euro III diesel technology. Clean diesel technology in combination with good-quality fuel can often meet or even exceed the emission standards of supposedly more sophisticated propulsion systems.

After diesel, CNG is perhaps the next most common type of fuel used in road-based public transport today. In India, a CNG compatible standard bus increases the vehicle cost from about US\$30,000 to about US\$40,000 (Figure 12.45). Elsewhere, a CNG vehicle will increase the procurement price by between US\$25,000 and US\$50,000. The cost difference varies widely depending on how powerful the engine needs to be, which will be a function of vehicle size.

The electric trolleybus is also a fairly common propulsion type. Electric-trolleys can be three times the cost of a comparable Euro II diesel vehicle. Further, the added infrastructure costs of the electric conduit and transformers can be significant. These extra costs are somewhat

Fig. 12.45
In India, fairly cost-effective CNG vehicles are currently be supplied in substantial volumes.

Photo by Lloyd Wright





Fig. 12.46
The cost of the electric-trolley vehicles in Quito along with the cost of the associated infrastructure resulted in a comparatively expensive system.

Photo by Lloyd Wright

mitigated by the longer life of electric-trolley vehicles. Due to the lower mechanical demands on the electric-trolley technology, the life of the vehicles can be twice that of diesel vehicles. Usually electric trolley buses also have a backup diesel motor in case of a power failure, which accounts for part of the difference in cost.

Quito utilised electric-trolley technology on its first BRT corridor in 1996 (Figure 12.46). The technology was chosen primarily for its environmental benefits. Quito's historical core is a World Heritage Site and the municipality wished to reduce the impacts of diesel emissions on the integrity of the built environment. Further, Ecuador's electricity generation is primarily from hydro-electric sources. The price of each vehicle was approximately US\$700,000. In total, the added infrastructure for the electric-trolley corridor pushed capital costs to over US\$5 million per kilometre. By comparison, a subsequent BRT corridor in Quito using Euro II diesel technology resulted in capital costs of approximately US\$585,000 per kilometre.

Electric-diesel and electric-CNG hybrids are likely to be the next generation of clean vehicle technology. Currently electric-CNG and electric-diesel hybrids are available at US\$75,000–US\$100,000 more than a standard diesel bus. To date, no BRT system has utilised these technologies.

The BRT business plan outlined in Chapters 15 and 16 will determine how much money can reasonably be spent on the vehicle procurement without compromising the financial viability of the entire BRT system. The business plan will indicate the maximum cost of the vehicle procurement (depreciation) and the maximum ongoing operating cost (including maintenance) that can be sustained, and how much the system will have to charge per vehicle-kilometre in order to cover these costs. The technical specification can require high levels of environmental protection, high noise standards, high aesthetic standards, and high levels of passenger comfort, but only within the parameters that the business plan has determined to be financially viable. In some cases, the system being designed will be highly profitable, as in the case of TransMilenio, giving the system designers considerable freedom to set a high technical standard. In other cases, such as in very poor countries, passenger demand may be highly sensitive to even modest increases in fare prices, placing tight constraints on the options for the technical specification.

Many local conditions will influence the cost of the vehicle. Vehicles technologies with a longer history and large manufacturing volumes will hold a cost advantage in terms of manufacturing economies of scale. Many traditional Indian

Fig. 12.47
Specialised manufacturing of low-volume vehicles can dramatically increase overall costs.

Image courtesy of the TCRP
 BRT image library



buses, for example, are mass produced using a truck body, and are some of the lowest cost buses in the world, but they leave much to be desired from the point of view of customer comfort. New vehicle technologies will generally have lower manufacturing volumes and may incur additional research and tooling costs (Figure 12.47).

The location of the manufactured vehicle will also be a factor. Production sites in developing countries will often hold an advantage in terms of labour and site costs. Further, locally manufactured vehicles will have lower shipping costs to arrive at the destination city. However, in some instances, locally manufactured vehicles may raise quality issues in comparison to developed-nation production sites.

In some cases, the vehicle manufacturers themselves have determined that certain branches of their own company are responsible for specific regions, even though they may not be the lowest cost producers. For example, the cost of good quality name brand buses in Africa is sometimes more expensive only because the manufacturers have determined that the African market is to be supplied by the European branch rather than the Latin American or Asian branch of the company. The following factors are likely to strongly influence local vehicles procurement costs:

- Chassis cost;
- Body Cost;
- Sales tax;
- Licensing and paperwork fees and costs;

- Circulation permit costs;;
- Operational insurance costs
- Financing cost;
- Projected vehicle life;
- Projected resale value;
- Projected repair requirements.

For imported vehicles, there will be the following additional cost considerations:

- CIF costs;
- Shipping costs;
- Shipping insurance costs;
- Local port storage fees;
- Tariffs;
- Value added tax;
- Local customizing costs;
- Domestic transportation costs from ports to cities.

Table 12.8 provides a summary of vehicle cost estimation based on technology types and location of manufacture. However, these costs could be significantly underestimated particularly in the case of Africa which has limited proximate vehicle manufacturing capability, high financing costs, and high duties and value added taxes.

Determining an aggregate cost might be difficult considering there are several determining factors involved. However, it is advisable for BRT project managers to communicate with local vehicle manufacturers throughout the process, as this will allow for a comparison of all price options pertinent to vehicle choice.

In practical terms, a joint work effort will be required between system operational design and

Table 12.8: Bus vehicle costs

Vehicle type	Purchase cost (US\$)
Small, new or second-hand bus seating 20-40 passengers, often with truck chassis	\$10,000–\$40,000
Diesel technology, produced by indigenous companies or low-cost import (12-metre)	\$40,000–\$75,000
Diesel bus meeting Euro II standard, produced for (or in) developing countries by international bus companies (12-metre)	\$80,000–\$130,000
Standard OECD Euro II diesel bus sold in Europe or United States (18-metre articulated)	\$200,000–\$350,000
Diesel with advanced emissions controls meeting Euro III or better	\$5,000 to \$10,000 more than a comparable standard diesel bus
CNG, LPG buses	\$25,000 to \$50,000 more than a comparable standard diesel bus (less in developing countries)
Hybrid-electric buses	\$75,000 to \$150,000 more than a comparable standard diesel bus
Fuel-cell buses	\$850,000 to \$1,200,000 more than a comparable standard diesel bus

Source: Adapted from IEA, 2002b, p. 120

the business plan. An iterative process will help to find an optimal vehicle technology solution that both meets a high-level of customer comfort as well as achieves cost-effectiveness.

12.2 Fare systems

“Buy the ticket, take the ride.”

—Hunter S. Thompson, journalist and author, 1937–2005

12.2.1 Decision factors in choosing a fare system

The first step in selecting an appropriate fare collection and verification technology is deciding what sort of operational plan, what sort of fare policy, and what sort of institutional structure is needed for the specific BRT system.

The method of fare collection and fare verification has a significant impact on the operational efficiency of the BRT system, the ability of the system to integrate routes with each other and with other public transport systems, and the fiscal transparency of the system. Before making a final decision on a fare collection system technology, critical decisions regarding the operation of the fare collection system and the fare policy need to have already been made. Decisions that should already have been made include:

- Operational plan for the fare collection system;
- Fare policy and fare structure;

- Institutional structure of the fare collection system.

12.2.1.1 Operational plan for the fare collection system

As was discussed in Chapter 8 (*System capacity and speed*), an efficient fare collection system technology can significantly reduce boarding and alighting time, but also times queuing to purchase tickets and clearing turnstiles.

The process and physical location of the fare collection and fare verification activities can be determinant in the functioning of the overall system. “Fare collection” is the process of customer payment for the trip. “Fare verification” is the process of checking whether a person has actually paid for their intended (or completed) journey. In many BRT systems, fare collection and fare verification occur relatively simultaneously. However, it is also possible to collect fares in one manner and verify fares in another. For example, in many European public transport systems, fare collection is frequently conducted off-board while fare verification is conducted on-board.

Off-board payment system

The decision to collect and verify fares on or off-board will have a significant impact on the potential passenger capacity of the system. Off-board fare collection and fare verification

reduces the long delays that generally accompany on-board payment, particularly if the driver is also responsible for fare collection and fare verification.

Pre-board fare collection and fare verification also carries another benefit. By removing the handling of cash by drivers, incidents of on-board robbery are reduced. Further, by having an open and transparent fare collection system, there is less opportunity for circumstances in which individuals withhold funds.

On many systems, the amount of time it takes the driver to process the fare collection can be a substantial contributor to delay in the buses operations. These impacts are quantified in Chapter 8. Because the level of delay increases with the number of passengers boarding and alighting at any given stop, the importance of off-board fare collection systems is not uniform across a BRT system. It is very important at high volume stations, and may be of marginal importance at other stops.

While off-board fare collection and fare verification can considerably improve system efficiency by reducing dwell times, it does require the construction of closed station environments. There must be a physical separation between those customers who have paid and those who have not. The closed stations bring with them issues of cost, road space, aesthetics, and potentially severance. The average station cost in the TransMilenio system was approximately US\$500,000 each (Figure 12.48). Of course, it is also possible to construct simpler closed stations for less; the stations on the Ecovía line in Quito cost in the area of US\$35,000 each.

Fig. 12.48
Off-board fare collection and fare verification increases system efficiency by reducing station dwell times. However, it does require construction of stations that form a closed environment between paid (inside the station) and unpaid (outside the station) customers.

Photo by Carlos F. Pardo



Closed stations, though, also bring other benefits besides increased system efficiency. Such stations provide more protection from inclement weather, such as rain, wind, cold, and strong sun. Also, closed stations hold advantages in terms of providing security from crime as well as discouraging loitering.

On-board fare verification

Systems in Europe often employ “proof of payment” techniques, also known as “honour” systems. In such systems, very little actual fare verification is conducted. Occasional checks by public transport staff are done to control fare evasion. The actual payment of the fare is largely reliant on the public’s goodwill and overall willingness to comply. For those caught without a valid fare during the random inspection process, a penalty is applied. Honour systems do entail pre-board fare collection, usually through a vending machine or kiosk (Figure 12.49). From the fare payment point onwards, the customers proceed directly to the public transport vehicle without inspection.

One of the main advantages of proof of payment fare systems is that it allows one to avoid the construction of a closed entry station. No physical



Fig. 12.49
A pre-board fare vending machine in Berlin.

Photo by Lloyd Wright

separation between the station and the outside area is necessary. There is no separation of those who have paid from those who have not paid. This design advantage can help reduce station construction costs as well as permit better station design in areas with limited physical space.

The main disadvantage of such a system is that they usually result in some revenue loss. In principal, such systems do not have to have negative consequences for total system revenue if enforcement is sufficiently rigorous and fine levels are set high enough to create a significant deterrent for non-compliance. However, rigorous enforcement of fare evasion is something of an unpleasant business. Enforcement authorities have to be quasi police, either armed or physically large. Sometimes people are unable to figure out how to pay the fare, either because the cash point was not working, or closed, or it failed to punch the fare card properly. People need to retain the fare card, and sometimes it gets lost. When one of these things happens, it is highly unsettling for the passenger, for they face a stiff penalty, and a humiliating encounter with enforcement agents.

Such systems have not been widely used in developing countries. They tend to be prevalent in subsidised public systems where there is less direct institutional concern about collecting the fare revenue. This kind of system also requires a legal framework that allows verification staff (that usually are not police staff) to have de-facto police powers in the collection of penalties from violators, and a procedure for collecting when the passenger does not have the money to pay the fine. This legal framework is absent in many developing countries. Fare verification by personnel walking through the buses also is difficult on very crowded systems. Even with stringent verification requirements, cities such as Quito face non-negligible amounts of fare evasion. As such, the viability of operating an effective honour system in a low-income city is yet to be proven.

In any case, the operational plan needs to decide if fare collection will be only off-board, only on-board, or both on board and off board.

Fare integration

Most BRT systems offer free transfers within the BRT system, both between trunk lines and

between trunk and feeder lines. Some BRT systems may also offer free or discounted transfers between vehicles inside the BRT system and other modes of transport like metros, commuter rail lines, and standard buses. “Fare integration” means that the passenger pays no premium for moving from one mode to another and can do so without any physical difficulty. “Fare compatibility” is a lower form of integration in which the customer may pay twice but simply can use the same fare technology (*e.g.*, smart card) between the two systems.

If the system designers have built physically enclosed stations where passengers can transfer between lines without having to again pass through a turnstile, then cash and token-based ticketing systems can still be used. If the system requires such transfers to be made in an open environment, then more costly fare technologies (such as magnetic strip or smart card technology) will be required.

12.2.1.2 Fare policy and fare structure

It is critical that the fare policy and the fare structure for the BRT system be selected before the fare technology is selected. The options for the fare policy are discussed at length in Chapter 16 (*Operational costs and fares*). In general, there are five types of fare structures:

1. Free fare;
2. Flat fare;
3. Zonal fare;
4. Distance-based fare;
5. Time-based fare.

As the name suggests, a “free fare” structure requires no fare payment whatsoever. In this case, public transport is truly “public” with no requirement for payment by the user. Instead, the system’s costs are typically covered by another funding stream, such as parking fees for cars. Systems or routes in cities such as Hasselt (Belgium), Denver (US), Miami (US), and Orlando (US) utilise a free fare structure. This type of fare structure is obviously the simplest to implement as well as creates considerable cost savings in terms of not requiring fare equipment or enforcement.

A “flat fare” structure means that a single tariff will allow a customer to travel anywhere within the system. Whether the trip is for 500 metres

of 20 kilometres, the price is the same. Many Latin American cities, such as Bogotá and Quito, make use of a flat fare structure. In these cities, a flat fare structure brings with it social equity advantages. Since the poorest families tend to live at the periphery of the city, a sort of cross-subsidy is introduced where wealthier, centrally located customers are effectively supporting a lower fare for those that live some distance from the CBD.

A “zonal fare” structure is essentially a simplified distance-based structure. For each “zone” that the trip crosses, there is an additional cost to the customer. If a customer travels within just a single zone, there is a flat fare for the entire zone. The advent of magnetic strip and smart card technology has made zonal fares somewhat unnecessary since these technologies can handle more precise distance calculations. However, the zonal system does have the advantage of being relatively easily understood by customers.

“Distance-based fare” structures charge a tariff in relation to the number of kilometres travelled. Customers travelling a farther distance will pay more than someone travelling just a short distance. A distance-based structure most closely matches the actual costs being incurred to the system. At the same time, distance-based tariffs require an order of magnitude more technological sophistication in order to successfully implement and manage.

A “time-based fare” structure allows a customer to travel for a given amount of time for a flat fare. A higher fare is charged for going beyond a certain time limit. Like distance-based fares,

a time-based structure requires a higher degree of technical sophistication. Both time-based and distance-based structures are more costly to develop and implement.

A system may actually utilise a combination of different fare structures. For example, the feeder services may utilise a free fare or flat fare system while the trunk services could be a zonal fare or distance-based system. In fairly sophisticated fare systems, such as that utilised in Seoul, time- and distance-based fare elements are combined into a single package.

12.2.1.3 Institutional structure of the fare system

Institutional arrangements for the fare collection and verification system vary widely from system to system, with different benefits and risks. Most systems have the following components:

- The manager of the money (usually a bank or money manager);
- The equipment provider;
- The fare provider;
- The fare system operator;
- The public transport authority or its parent agency.

How these functions are related institutionally depends upon the technical competence of the public transport authority or its parent agency, the level of concern about corruption, the type of system desired, and the need for financing it with private money.

It is fairly standard for the manager of the money, the equipment provider, and the fare provider

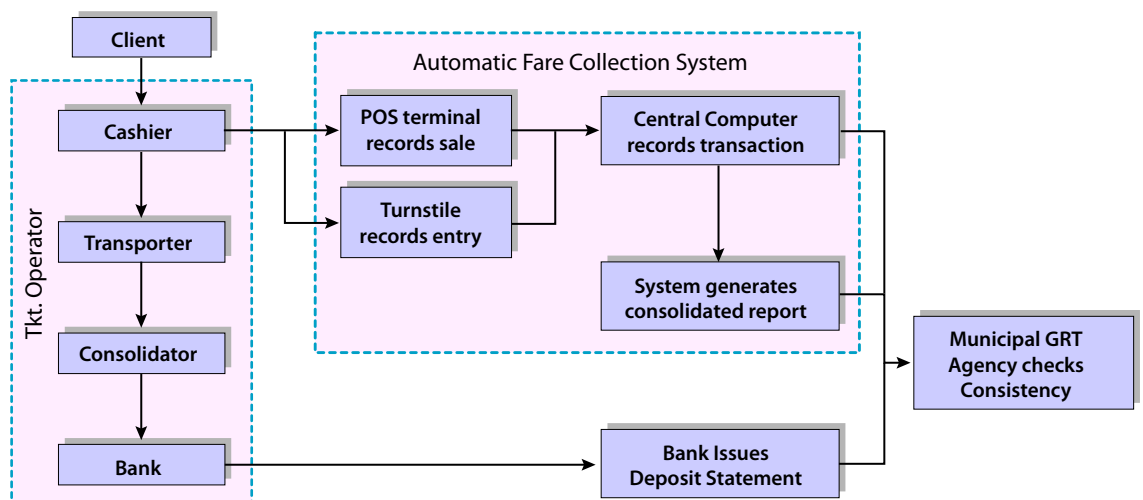


Fig. 12.50 Institutional relationships in a typical fare system.

Graphic courtesy of Fabio Gordillo

to be closely associated, while the fare system operator is separate. This allows the equipment provider/financial manager to monitor the fare system operator in order to avoid corruption. Figure 12.50 outlines a typical system structure.

In the case of TransJakarta, splitting the responsibility for operating the fare system and procuring the fare system equipment led to major problems. When problems with the equipment technology emerged, the fare system operator was unable to fix them, and claimed to have no legal responsibility for fixing the problem. The fare system equipment supplier should have been liable but the contract signed with TransJakarta did not provide for this eventuality. There was nothing inherently wrong with the structure, but any structure not backed by solid legal contracts outlining financial liability for service failures can lead to disaster.

In the case of TransMilenio in Bogotá, the fare system was implemented through a unique Build-Operate Transfer (BOT) model. In this case, there was a competitive tender for a single company to both procure the fare system equipment and operate the fare system. The company that won this tender, Angelcom SA, both selected and paid for the fare equipment and operates the system (Figure 12.51). The contract signed was between the public operating company (*i.e.*, TransMilenio SA) and the private firm, not between the Department of Transport or the Department of Public Works and the private firm. The private concession company in turn receives a fixed percentage of the revenues from TransMilenio. A third company was contracted by TransMilenio to be responsible for managing the revenue once collected. All fare revenue in TransMilenio is placed by the operator into a Trust Fund, and this company manages the TransMilenio Trust Fund on behalf of all the parties with a vested interest in the fair and accurate division of this revenue: TransMilenio SA, the trunk line operators, the feeder bus operators, and the fare collection company. This Build-Operate-Transfer institutional model for the fare system had some advantages and disadvantages. The system was eventually able to attract private investment for the fare system equipment in a country where private investment was difficult to secure due to political



risk. This private financing reduced the initial capital cost of the TransMilenio BRT system. However, the fare system operator receives 10 percent of TransMilenio's total revenue, whereas their operating costs are probably much lower. As such, it puts an unnecessary financial burden onto system operations. It would have been less costly if the fare system were simply purchased outright by TransMilenio.

This structure did assure that the fare system functioned on a basic level. Because the concession company's profits are determined based on the success of the system, they have a vested interest in making sure the system operates properly. Because they were also responsible for operating the system, they had a vested interest in getting equipment that functioned properly. Because they were a fare system operating company, they also knew more about the appropriate technology than the government, and were able to negotiate better equipment contracts with subcontractors and receive lower prices. By privatising the procurement contract, they also removed the risk of corruption in the procurement process.

On the other hand, the concession company bought relatively cheap equipment in an attempt to save money. They complied with their contractual obligations but the quality standards were reasonably poor, the design was inflexible and of poor quality, implementation was slow, and there were a host of technical problems in the first month of operation. These

Fig. 12.51
In Bogotá, the contract for purchasing and operating the fare collection equipment was awarded to a single private firm.

Photo by Lloyd Wright

problems could have been solved within the current structure by having harsher penalties for poor performance, and by having TransMilenio specify in the tender a higher technical standard for the fare equipment. TransMilenio could even have handled the procurement independently and then “novated¹⁾” the contract to the winning fare system operator. In this way, the operating system bidder becomes the owner of the new equipment, and can be required to pay for the investment, but the government would retain tighter control over the equipment selection process.

It is fairly common in the public transport industry to separate initial equipment procurement from operations. This practice is usually done when there is a public transport authority that directly collects the farebox revenue, and where there is no expectation that the operating company will provide the investment into the system. Technology providers such as Ascom Monetel, ERG, INDRA or Scheidt and Bachmann, have focused their attention on the technology development and integration tasks, leaving the fare system operation to the public transport agencies. This structure can reduce the ongoing financial burden that a BOT would impose. However, if equipment procurement and operations are separated, contracts will have to be structured carefully to ensure that the equipment providers are responsible to the operating company for system maintenance.

12.2.2 Choosing a technology

Once the critical decisions about the operational system, the fare policy and structure, and the administrative structure are determined, an appropriate fare collection system technology can be chosen.

Since the first BRT systems were opened back in the 1970s, fare system technology has evolved rapidly and prices are falling. Today there is a great diversity of technology options for ticketing systems. This section outlines some of the technological options for collecting and verifying fares.

¹⁾ “Novated” is a legal term meaning the replacement of one obligation by another by mutual consent of both parties.

12.2.2.1 Technological elements of a fare system

Normally, the physical equipment of the fare system consists of the following:

1. Payment medium
The payment medium is usually cash, tokens, paper tickets, magnetic strip cards, or smart cards.
2. Point-of-Sales (POS) terminals
These terminals are cash points where a ticket, token, magnetic card, or smart card can be purchased, or value can be added onto an existing card.
3. Value-deduction terminals
These terminals are usually turnstiles and/or card readers.
4. Central computer
The central computer is the repository of the various information streams; the central computer is typically connected to the Point-of-Sales terminals and the value-deduction terminals via a telecommunications and/or GPRS link.

12.2.2.2 Single or multiple payment medium

A system may employ a single fare medium or use two different ones for the different types of fare being offered. For example, many systems offer one type of payment medium for single trips and another type of payment medium for multiple trips.

The reason for this differentiation has to do with the cost of the payment medium itself. Issuing a smart card can be a somewhat costly investment for the public transport system. The efficiency gains of a smart card can make it a worthwhile investment when used by a loyal customer over weeks and months of trips. By contrast, making that same investment for a one-time user of the system may not be cost-effective. If a one-time user of the system was to somehow keep the smart card after his or her trip, then the public transport company would have lost revenue on the trip.

Thus, public transport systems, such as Delhi and Bangkok metro systems and the Quito BRT system, utilise two different payment mediums (Figures 12.52 and 12.53).

However, there is also much advantage in having a common payment medium for all



Fig. 12.52 and 12.53
The Delhi Metro utilises both smart card technology and electronic token technology. The smart cards allow multiple trips while the token is for single trips.
 Photos by Lloyd Wright

journeys. The multiple payment mediums can be confusing to customers and act as a barrier to entry for many. Handling multiple fare mediums can also result in process and administrative inefficiencies.

12.2.2.3 Payment mediums

The following payment mediums are in common use in BRT systems around the world:

- Coins;
- Tokens;
- Paper tickets;
- Magnetic strip cards;
- Smart cards.

No one solution is inherently correct. The choice of fare collection system often involves a trade-offs between costs, simplicity, cultural conditions and service features.

Coin / token systems

Coin and token systems are amongst the simplest technologies available to handle fare collection and fare verification. These systems can be quite robust and economical to operate. New York City’s mass transit system worked on a token based system for over one hundred years.

The number of sales personnel and can be reduced and ticketing machines are not necessary with coin-based systems because the customer does not need to go through the cumbersome process of programming the electronic card. Instead, the currency acts directly as the fare payment and verification mechanism. There is no need to issue any paper tickets to customers. Also, there is typically no queue at the exit side of the trip either. Thus, while other systems may involve at least three separate customer queues (purchase fare, verify fare at entrance, and verify fare at exit), coin-based systems require the

customer to only enter one queue (verify fare at entrance). However, once a ticket is purchased, contactless cards tend to have higher throughput at the turnstile; coin-based systems will likely move only 8 to 12 passengers per minute versus 15 to 20 passengers per minute with contactless cards.

In Quito, Ecuador, a simple coin-based system has worked successfully for both the city’s “Trolé” line and “Ecovía” line (Figure 12.54). The system thus avoids the need to purchase any payment medium whatsoever. In Quito, an attendant window does exist, but it is only to give change to those who require it. Upon exiting a system, passengers simply file through one-way exit doors without the need for further



Fig. 12.54
This fare verification machine in Quito handles both coins and a magnetic strip fare card.
 Photo by Lloyd Wright

fare verification. Quito's system also allows the flexibility to utilise discount fare cards as well; these fare cards are based on magnetic strip technology. However, the entire turnstile device can fit into a limited space, and thus permits two turnstiles within a relatively narrow station. Naturally, coin-based systems depend upon the availability of coins in the local currency. Further, the coins must be available in a combination that matches the desired fare level. If coins are not part of the local currency, then tokens are an option. However, the inclusion of tokens in the fare collection system defeats many of the benefits of coins. While still providing a relatively simple fare system, tokens require all customers to purchase from a machine or sales point. This activity increases the amount of customer queuing required to use the system. Another alternative is to utilise fare collection turnstiles that handle paper currency. However, this technology is not nearly as robust as coin readers. The extra moments required for authenticating the currency note will slow down the entry process and thus reduce system capacity. This problem is exacerbated by the poor quality of older currency notes often found in developing nations.

However, with this simplicity there are some limitations. Coin-based systems are only usable with flat-fare structures, and cannot offer multi-trip discounts, time of day discounts, or free transfers to other modes without physical integration facilities. Of course, there are many conditions where a flat fare is desirable, as discussed in Chapter 16 (*Operating costs and fares*). Also, by combining a coin-based system with another technology (such as magnetic strip cards or smart cards), then multiple-trip fares are also possible.

Coin and token systems are subject to the illegal use of slugs and counterfeit coins. The handling and administrative requirements related to coin collection and transaction accounting are also more labour intensive.

Paper systems

Simple paper tickets are issued for bus and rail systems throughout the world (Figure 12.55). In such instances, ticket purchases typically take place at vending booths, machines, kiosks, and

other shops. The ticket will often have enough recognisable detail to prevent counterfeiting.

In some instances, paper ticket systems will require a validation step to the process. The validation will involve inserting the paper ticket into a stamping machine. This machine will mark the time and sometimes the location of the validation. The validation process becomes important when paper systems are distance-based and/or have time limits on usage.

Verification of paper tickets can also take place manually upon entrance into the system or may only be verified on the occasion of a random inspection. In some instances, the verification may be done by the bus driver or a conductor. Such manual verification is quite problematic in high volume systems. The queuing points are likely to be quite lengthy and the detrimental impact on customer travel times would be significant.

Normally, verification for paper ticket systems is conducted on an honour system. However, the viability of an honour system in most developing cities has yet to be substantiated.

Paper systems can permit distance-based fares, but verification of distance travelled can only be verified manually. The feasibility of verifying distances travelled within in a high-volume system is somewhat suspect.

Magnetic strip technology

Magnetic strip technology has had a relatively long history of application and success in the field. Magnetic strip technology has been used successfully in metro systems around the world (Figures 12.56 and 12.57). There are two different standards for magnetic strip cards:

- 1.) The standard-sized ISO 7810 card;
- 2.) The smaller Edmonson card.

The technology requires the pre-purchase of the magnetic card for system entry and verification. Capital costs can be significant for both the fare vending machines and the magnetic strip readers at the fare gate. The systems require fare vending personnel and/or card vending machines (Figure 12.58). The advantage of magnetic strip technology is the relatively low-cost of the fare cards themselves, US\$0.02–US\$0.05 per card. However, unlike smart cards, magnetic strip cards have a limited lifetime. The cards are made of coated paper and can be



Fig. 12.55
A simple paper ticket as utilised on the Rome metro.

relatively easily damaged. However, systems such as the Bangkok Skytrain are reporting several years of usage per card.

The cards may be programmed to allow multiple trips and can also permit different fares to be charged for different distances travelled. Some system providers utilising magnetic strip cards also elect to permit discounted fares for individuals purchasing multiple trips.

The cards typically are verified both at entry into the system and at the exit. Data from the verification turnstile can provide system operators with information on customer movements.

Smart cards

Smart card technology is the latest advent in the fare collection field. Smart cards contain an electronic chip that can read and process a variety of information regarding cash inputs, travel and system usage with the highest possible security level. Smart cards also permit a wide range of information to be collected on customer movements, which ultimately can assist in system development and revenue distribution. BRT systems in Bogotá, Goiânia, and Guayaquil have successfully employed smart card technologies (Figure 12.59). Smart cards permit the widest range of fare collection options such as distance-based fares, discounted fares, and multiple trip fares. Such cards also

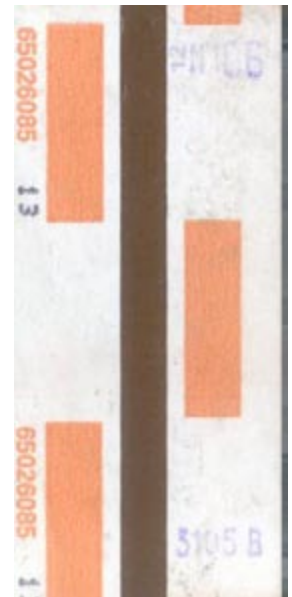


Fig. 12.56 and 12.57
 There are two types of magnetic strip cards: 1. The standard sized card, as shown in this example from the New York subway (left image); and, 2. The smaller Edmonson card, as shown in this example from the Paris Metro (right image).

bring a complete set of system statistics that can be helpful to system managers.

The main drawbacks of smart card technology are the relative cost of the card and complexity. The systems require fare vending personnel and/or card vending machines. The system also typically requires verification machines at the system exits, if distance-based fares are utilised. In each instance, the risk of long customer queues, especially during peak periods is increased at the point of sale but reduced at the turnstile. In addition to the costs of the vending and verification machines, each smart card is a relatively costly expense. Current prices are in the range of US\$1.00–US\$3.00 per card. The card cost depends on the card complexity.

Virtually all smart cards conform to the ISO 7816 size standard. The card material can vary with such options as PVC, PET, and even paper. The activation mechanism can either be realised by way of “contact” cards or “contactless cards”. As the name implies, contact cards



Fig. 12.58
 Magnetic strip vending machine in Bangkok.
 Photo by Lloyd Wright



Fig. 12.59
 The smart card utilised on the Bogotá TransMilenio system.

Fig. 12.60
The Mexico City smart card.

Photo courtesy of Volvo



require insertion in the card reader slot in order to establish an electrical contact between the reader and the card in order to be verified. Contactless cards permit the user to pass in the vicinity of the turnstile reader to activate verification (Figure 12.60). For this reason, contactless cards offer greater customer ease and convenience. Traditionally they have been more expensive than cards using a magnetic strip, but costs are coming down.

There are various types or standards of smart cards available in the market. Nevertheless there are some basic standards that define the features of the cards. Different manufacturers have developed their proprietary protocols and operating systems that define the security and compatibility between cards and reading devices (Mifare, Sony, Infineon, etc.). The basic characteristics that define most smart cards are:

- Mechanical (external dimensions, materials, longevity);
- Electrical source;
- Communications protocol;
- Commands interoperability.

The most common standard is defined in the “ISO 14443 A or B Standard”, which details the card characteristics.

The microchip on the card can either be “memory only” or “memory with micro-process-

ing” capabilities. Cards with a memory chip can only store data, and have pre-defined dedicated processing capabilities. The addition of micro-processing allows the smart card to actually execute applications as well. For example, a micro-processor chip can allow the stored value of the smart card to be used for purchases outside the public transport system. .

In Hong Kong, the Octopus card permits users to make purchases at shops as well as pay for public transport (Figure 12.61). The Octopus card allows up to HK\$1,000 (US\$125) of stored value to be placed on the card. While this feature can be quite convenient, smart cards with micro-processing capabilities tend to be more expensive than other types of cards. However, for systems such as Hong Kong, the flexibility and utility of the cards make them a worthwhile investment. There are currently an estimated 14 million Octopus cards in circulation in Hong Kong. Approximately 9.4 million transactions take place in Hong Kong each day using the Octopus card.

Once a card brand such as the Octopus is established, its ability to penetrate into a wide variety of related markets is significant. Octopus started with a core network of transport services in 1997 and soon expanded into almost all forms of transport payment services (Figure 12.62).

Likewise, the Octopus card is finding utility in several applications outside the transport sector. Some of these outside payment applications include supermarkets, convenience stores, fast food franchises, vending machines, photocopiers, cinemas, and sports venues (Figure 12.63). As of September 2006, 24 percent of Octopus



Fig. 12.61
Hong Kong’s “Octopus” card allows customers to use the card for purchases in shops outside of the public transport system.

transactions took place in the retail sector (Chambers, 2006). The flexibility of such cards means that the system’s marketplace and potential for profit can extend well beyond the transport sector. Such market diversity can help to strengthen overall company performance.

The Seoul T-Money system is in many ways quite similar in performance to the Octopus card. T-Money can be used both on the city’s metro system as well as other transport services such as the BRT system. Likewise, T-Money is crossing over into many non-transport applications, such as retail purchases. The fare card systems in Hong Kong and Seoul are also showing much creativity in the form of

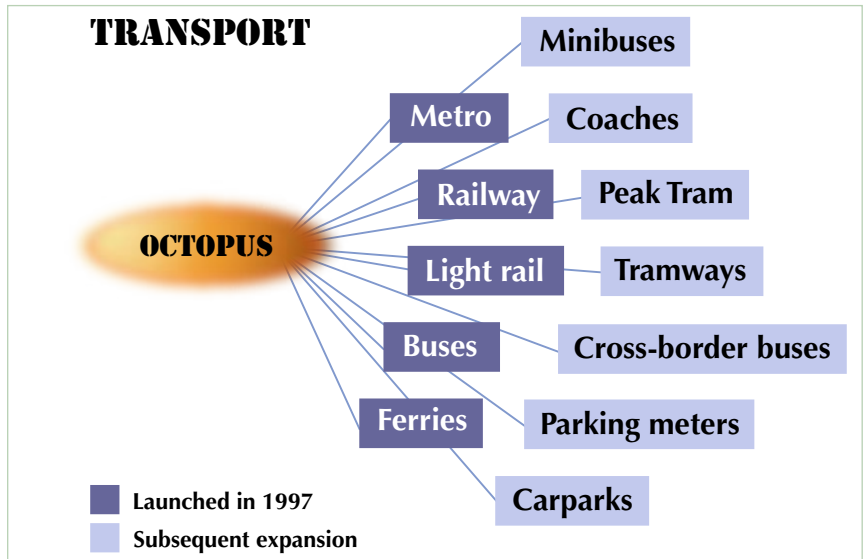


Fig. 12.62 ▲
Hong Kong’s Octopus card has expanded from a core network of public transport services into a broader array of services including parking meters and carparks.
 Graphic courtesy of Octopus Holdings Limited

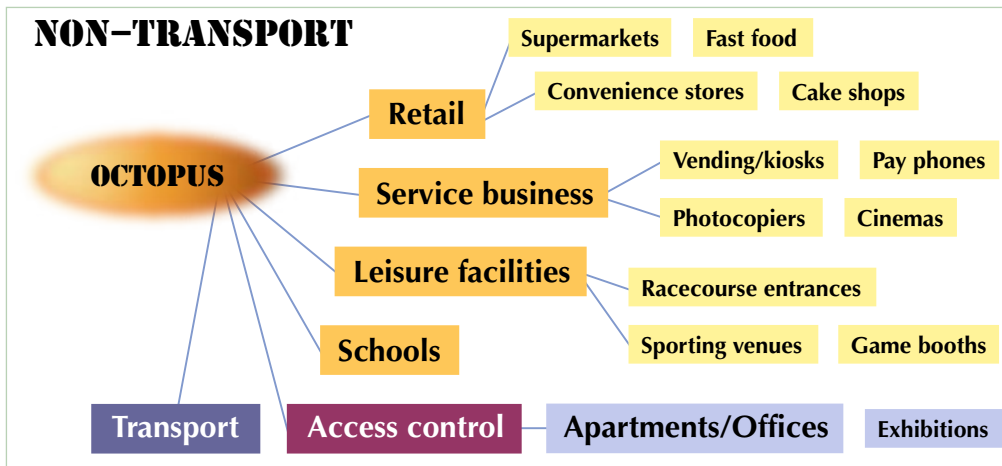


Fig. 12.63 ▲
The reach of the Octopus card extends well beyond the transport sector.
 Graphic courtesy of Octopus Holdings Limited

the cards themselves. Both cities are allowing customers accessorise themselves with fare chips that are inserted in a range of products such as watches and key chains (Figure 12.64). Also, in the future it will be likely that customers will be able to swipe their mobile telephones in order to make a payment.

There are several kinds of cards at the market, and prices vary depending on card capacity and the standard used. Typically smart cards for transport applications have from 1k to 4 k of memory. A 4k card will be able to support multiples applications like e-money transactions. Unlike magnetic strip cards, though, smart cards have a long life and can be re-used for periods in the range of 5 to 10 years. As smart

Fig. 12.64
The smart card chip can actually be placed in a range of products besides fare cards. In Seoul, customers can pay for their travel by swiping their watch or key chain across the card reader.
 Photos courtesy of the City of Seoul



cards become more common, the cost of the cards will undoubtedly continue to fall.

From the operational point of view, smart cards, have the widest range of capabilities for developing multiple applications and to solve very complex functionality needs, this include the possibility of managing multiple fares (time, distance based, flat fares, among others) and also the possibility of using the smart card for virtual integration without the necessity of integration stations.

Perhaps one of the most valuable characteristic of smart cards is the throughput performance, which is the highest available on the market.

From the financial point of view, although smart cards have a relative high initial cost, (US\$1.00–3.00 per card) the cost per transaction is significant less than that of magnetic stripe tickets. Some systems designers estimate that maintenance costs for contactless smart cards equipment are between 7 to 10 percent of the initial investment, compared with 15 to 20 percent for magnetic stripe systems.

Besides the cost of the cards, the chief disadvantage of smart cards is the relative complexity of the implementation. Jakarta went over one-year before the smart card system could actually function. Implementing a smart card system is an order of magnitude more difficult than many other payment mediums. Smart card systems are not yet in the category of a “plug-and-play”

technology, as much software programming and specialised skills must accompany the implementation.

Summary of payment mediums

This section has provided an overview of each of the major payment mediums. Table 12.9 summarises the major decision factors for each technology.

12.2.2.4 Turnstile options

Beyond the payment medium, there are also a range of technological options related to fare reading equipment and turnstiles. As with other equipment, the different product options offer trade-offs regarding cost and performance.

Turnstiles are generally available in two different sizes: 1.) Full-body height; and 2.) Half-body height. Most public transport systems utilise half-body height turnstiles, although in some cases, full-body height devices are applied in situations where there is little oversight. For example, Quito employs a half-body height turnstile at the entrances which also include the presence of a fare agent. However, a full-body height turnstile is used at the exits since there is less surveillance of the exits by station staff.

In general, there are three turnstile types: 1.) Wing barrier turnstile; 2.) Rotating-arm turnstile; and 2.) Gate-arm turnstile. Many high-quality metro rail systems make use of a wing barrier turnstile. Systems such as the London

Table 12.9: Summary of fare collection technologies

Factors	Coin system	Paper system	Magnetic strip system	Smart card system
Set-up / equipment costs	Medium	Low-Medium	High	High
Operating costs	Low-Medium	Low	Medium	Medium
Level of complexity	Medium	Low	High	Medium
Number of customer queues per trip	1	2-4	2-4	2-4
Can provide customer tracking information	No	No	Yes	Yes
Allows automated fare verification	Yes	No	Yes	Yes
Allows distance-based fare schemes	No	With difficulty	Yes	Yes
Passenger capacity through turnstile	Medium	Low to high*	Medium	High
Supports high-tech image of system	Medium	Low	Medium-High	High
Space requirements for fare equipment	Medium	Low	High	High
Susceptibility to counterfeiting	Medium	High	Low to medium	Low

* Paper ticketing can support high customer flows if an “honour” system is utilised for the fare verification.

Underground, Washington Metro, Delhi Metro, and the Bangkok Skytrain make use of this technology. Once the card reader deducts the payment, the “wings” of the turnstile automatically open to allow the customer to enter. The wing barriers provide a professional appearance and are effective against fare evasion. Some of these devices will detect whether the customer has passed, in order to ensure the device does not strike the person when closing. In other cases, such as in Bangkok, the wing is set to a timer; if the customer does not clear in time, the turnstile will strike them.

A rotating-arm turnstile also offers good protection against fare evasion. In this case, once the reader recognises the fare payment, the rotating-arm is released from its fixed position (Figure 12.65). The arm will then be free to rotate a single turn in order to ensure only one person can pass through. Systems such as the Bogotá TransMilenio system make use of a rotating-arm turnstile. Unlike the wing barrier and the gate-arm turnstile, the rotating arm turnstile is not friendly to those in wheelchairs or customers with baby strollers. If a system only utilises rotating-arm turnstiles, then persons with wheelchairs or strollers may effectively be locked out of the system.

The gate-arm turnstile is a simpler, less costly device that swings open like a gate (Figure 12.66). When payment is made, the turnstile is released. However, if the gate is held open, many persons could conceivably make their way



Fig. 12.65
Rotating-arm turnstiles, as utilised in Bogotá.
Photo by Lloyd Wright

through the opening. The gate-arm turnstile does not lock again until it returns to a closed position. The advantage, though, of the gate-arm turnstile is its user friendliness towards wheelchairs and strollers. Likewise, persons pulling luggage can easily enter as well. Further, unlike the wing barrier, there is no threat of the device closing upon a person halfway through the entry. Quito utilises the gate-arm turnstile for all entries into its Trolé and Ecovía lines.

A system may actually make use of several different turnstile types. For example, in many TransMilenio stations, a single gate-arm turnstile is offered to patrons requiring greater ease



Fig. 12.66
The gate-arm turnstile as used in Quito can be quite user-friendly, but does tend to increase the risk of fare evasion.
Photo by Lloyd Wright



Fig. 12.67
A drop-arm turnstile option is provided for customers with special needs in many TransMilenio stations.
Photo by Carlos F. Pardo

of entry, such as those in wheelchairs or a parent with a stroller (Figure 12.67). In rail systems there is generally ample space at entries to permit multiple technologies. By contrast, BRT systems operating in a narrow roadway median may have less space to offer multiple turnstile options. For example, in Quito, the narrow station widths imply that only two turnstiles can be fitted. Thus, when only a narrow space is provided, it is less likely that multiple technologies will be an option.

12.2.3 Bogotá and Jakarta case studies

Fare collection and fare validation are critical for quality of service and financial stability of the BRT system. Nevertheless, less effort is often assigned for its preparation, procurement and supervision than the effort given for trunk vehicle operations. Both Bogotá and Jakarta had troubles in the fare collection system at the beginning of their operation, which were gradually solved throughout the first years of operation.

In both cities there were initial operational difficulties with the fare collection systems, such as long queues for card acquisition, low throughput of the turnstiles and loss of trips stored in the cards. There were also problems with the quality and integrity of the data (sales, validation). These problems resulted in some loss of confidence amongst customers in the

system. These problems could have been avoided if better planning, procurement design and supervision were applied.

Bogotá and Jakarta wanted their systems to have up-to-date electronic fare collection systems using contact-less cards. In both cases they allocated relatively little time for system design, testing and implementation. Both systems also had contractors without previous experience in public transport operations.

The main differences between Bogotá and Jakarta were the institutional set-up and the contracting procedures. Bogotá procured and supervised the concessioned firm through a single organisation, the public company known as TransMilenio SA.

By contrast, Jakarta split equipment and operation between two different agencies. The equipment was procured the Transportation Department (Dinas Perhubungan or DisHub). The system supervision and operation was managed by the newly created operational entity known as TransJakarta. There was an apparent lack of coordination between these agencies. Furthermore, equipment and software procurement was separated from day-to-day operations, contracted afterwards directly by TransJakarta.

In terms of contracting procedures, TransMilenio SA conducted an open bidding process, while the Transportation Department in Jakarta apparently selected the provider directly. Later in the process TransJakarta selected the operator among a short list using an accelerated contracting process. Both companies operating the systems in Bogotá and Jakarta were visionary, entrepreneurial, but lacked the capacity to timely comply with the contract requirements. They were able to sort out the difficulties, but solutions only came after many months of problems (Figure 12.68).

Initial operations in both cases were not smooth. Bogotá initiated with paper tickets that were replaced in the first four months of operations by contact-less smart cards. Despite the requirement in the contract of using Edmonson ticket for 1 or 2 passenger trips, and contact-less cards for multiple trips only (3 or more), the local contractor asked for contact-less cards only, which was accepted by TransMilenio SA under the operators' own risk. Cards were not charged to

Fig. 12.68
Jakarta's smart card system could not be utilised through the first periods of operation due to several technical and managerial problems.

Photo by Lloyd Wright



the users, and hence the required card stock was, and still is, very large. Initial operation of the validation (check-in and check-out) was not reliable, and users lost confidence on multiple fares, which in turn increased queues at fare booths.

Problems with Bogotá's validation process resulted in an important change in the operational scheme: exit validation was eliminated due to numerous complaints by the users. Additionally, part of the stock of cards was unreliable and needed to be retired. Finally, a group of turnstiles using local integration were below the required standards and were replaced by more reliable equipment at the operator's expense.

In the case of Jakarta, most of the problems were the result of implementing a fare collection system without careful adaptation to the local conditions by a contractor without enough expertise to comply with the system requirements. Reliability of the power supply also caused problems, as did wireless communication scheme. There were even disputes on the property of the software rights. TransJakarta was reluctant to receive the system procured by the Department of Transport, and the contracted fare collection operator was also concerned.

Both cities found ways to improve the operations and quality of service of the fare collection component through their contractors. Current operations do not exhibit the problems reported in the first year. Nevertheless their experience shows lessons on some recommended practices:

- There are not “off-the-shelf” systems ready for “plug-and-play”. Time is required for system adaptation to local conditions and requirements (*e.g.*, reduced fares for certain populations such as students, zone and time based rather than flat fare, level of integration with the feeders). It is unlikely that a system could be adapted, developed, deployed and tested in less than 6 months. Hence, fare collection often becomes the critical path in system implementation.
- Open and competitive bidding is preferred to direct contracting, even if it takes more time and introduces relatively high transaction costs. In an open bidding process competition forces prices down (for the benefit of the users) while keeping the quality and service standards at a high level.
- It is advised that selection criteria include financial capability and experience in the implementation and operation of fare collection systems. Bogotá tried with the concept of technical assistants to comply with this experience, but this figure did not work well. Technical assistants did not share the risks of the main contractor and were not involved in the level it was expected for the project benefit. It is important that experience is checked and those members of the contractor (in case of consortiums) have an important share in responsibility of contract compliance (*e.g.*, more than 20 percent).
- Integration of installation and operation is recommended, as the operator is part of the decisions on system design and equipment and software acquisition. If contracts are separated is likely that the operator may claim that problems are the result of design and installation, not its own ability to perform according to standards set forth.
- Performance based contracts are preferred over standard procurement contracts. The concept behind this is that the BRT System is acquiring is a service; rather than the hardware and software of the fare collection system, what is important is the throughput and reliability of the solution provided. Which solution is finally provided is a decision of the operator.
- Testing each component and their integration is needed, hopefully well in advance to system commissioning.
- Supervision of fare collection is as important, if not more, than bus operations. This should be taken into account when organising the agency in charge of planning, developing and supervising BRT system operations.
- Having one agency running the entire system is better than trying to coordinate efforts by several agencies.
- Provide for contracting arrangements that promote system growth (additional sales). It is advised that remuneration for the fare collection provision and operation grows with passenger ridership. Current formulas in Bogotá contracts do not promote increased sales, at least from the perspective of the operator.
- Charging the reusable fare cards (*e.g.*, contact-less cards), for example through a

returnable deposit, can be better than providing them for free. Users may take responsibility of the cards and this reduces damages and required stock. However, charging for cards adds considerable administrative complexity and it can discourage use of the system.

12.3 Intelligent Transportation Systems (ITS)

“We live in a society exquisitely dependent on science and technology, in which hardly anyone knows anything about science and technology.”

—Carl Sagan, scientist and writer, 1934–1996

12.3.1 Control Centres

As noted in Chapter 11 (*Infrastructure*), a centralised control centre will help ensure smooth and efficient BRT operations. While not all systems utilise an automated control centre, it is increasingly becoming a standard practice in higher-quality systems.

A cornerstone of a modern control system is automated vehicle location (AVL) technology which allows the tracking of the vehicles along the corridor. With AVL the control centre can direct vehicle movements so as to avoid vehicle bunching, react swiftly to problems and emergencies, and allocate capacity resources in swift reply to changes in demand.

Chapter 11 (*Infrastructure*) has already discussed some of the logistical and organisational issues around the development of a control centre. This section provides a brief review of the technological options.

While the benefits seem clear, the costs of a real-time control system would seem prohibitive for a developing city. However, the cost of central control technologies has steadily decreased during the past few years. Thus, even cities in developing nations may now wish to consider the advantages of a central control system.

Several options exist to link buses and stations with a central control office. In some instances, a simple radio or mobile telephone system may suffice. However, increasingly Geographical Positioning Satellite (GPS) technology is providing an effective communications link (Figure 12.69). GPS technology permits real-time information on vehicle location and status. Modern GPS systems can track vehicle movements with an accuracy of 2 to 20 metres, depending on the type of system and local conditions. GPS location technology combined with a wireless communication system (GPRS) is utilised within the control system of Bogotá’s TransMilenio system. By using the GPS technology in conjunction with vehicle managing and tracking software and a voice communications system, Bogotá is able to closely control vehicle headways (Figure 12.70). A control

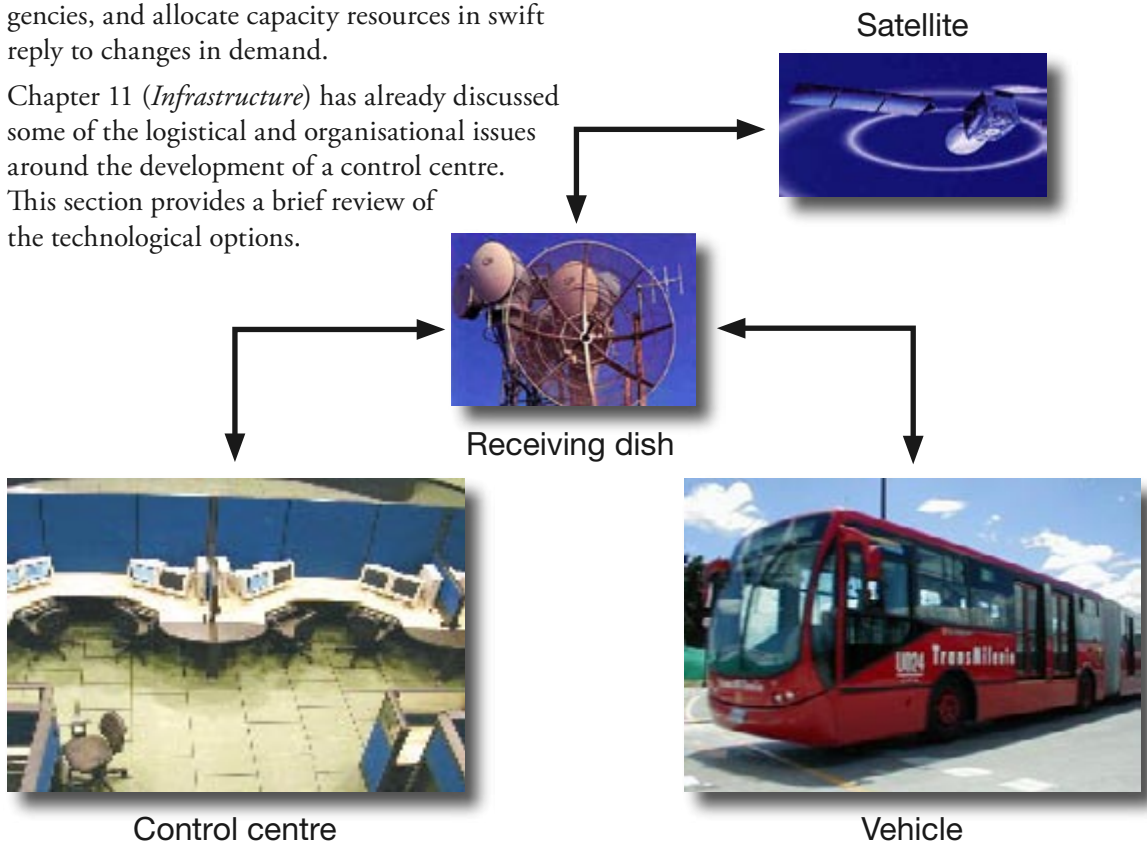


Fig. 12.69

GPS technology can be cost-effectively utilised for vehicle tracking capabilities.

Images courtesy of TransMilenio SA

centre operator will direct a driver to slow down or speed up depending on the location of other vehicles and the demand requested. Further, if a surge in demand occurs at a particular station, a new vehicle can be sent in to alleviate crowding.

In addition to GPS technologies, non-satellite based options can also be effective. For example, infra-red technology can track vehicle movements in a similar fashion utilising local beacons distributed through the public transport area. This type of technology can be an effective alternative when topography and tall buildings act to block satellite-based communications.

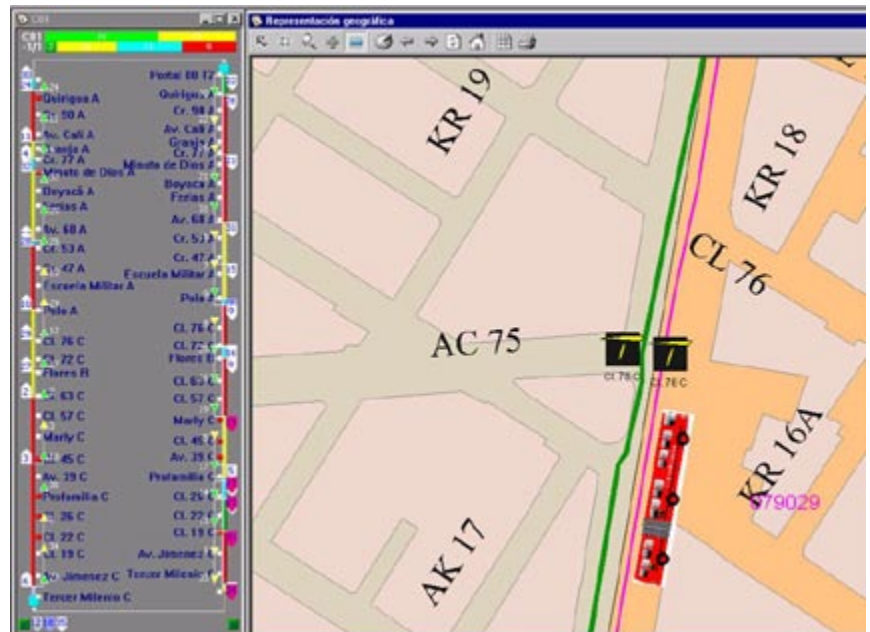
GPS became the preferred option for automatic vehicle location in the past years. Nevertheless there are other options such as loop inductors (e.g., Los Angeles Metro Rapid System) and signposts (e.g., London and Seattle). These technologies are based on non-continuous detection coupled with odometer readings (dead reckoning) and complex prediction algorithms. Costs of these systems are in the order of US\$5,000 per vehicle (London signpost system) to US\$14,000 per vehicle (Los Angeles Loop detector system). GPS systems cost, as reported in some applications around the world is in the order of US\$750 per vehicle (Kaohsiung and Taichung) up to US\$11,600 (San Francisco).

However, few of these technologies are “plug-and-play” applications providing easy, off-the-shelf solutions. Quite often a great deal of software programming must accompany the system set-up. Further, as a system expands and becomes more complicated, the underlying operating software will again require updating. The control centre for Bogotá worked adequately through the project’s first phase. However, as the system expanded to double its first-phase size, the existing control system no longer functioned and required substantial re-engineering.

12.3.2 Traffic signal control

The development of a BRT system can also present a unique opportunity to upgrade the traffic signal technology along the same corridor. A new BRT system will imply several changes that will affect traffic signal technology. These changes include:

- New priority treatment for public transport vehicles;



- New exclusive lanes;
- New turning movements for public transport vehicles;
- New restrictions on private vehicle turns.

These options have already been presented in detail in Chapter 9 (*Intersections and signal control*).

With new electronic signalling technologies and software programmes now available, an upgrade of the traffic signal system should be integrated into the BRT planning process.

The appropriate synchronisation of traffic lights often does not currently exist in developing cities. A readjustment of phase lengths and synchronisation should be undertaken with a special focus on smooth public transport vehicle flow. Some type of priority for buses can be introduced, such as “green extension” or “red shortening”. In these options vehicle detection, either using the GPS or fixed detectors (e.g., transducer), is required at the intersection. Information on arriving buses is given to the signal controller which can increase the green time or shorten the red time not to stop the buses. Green extension or red shortening is limited to by certain limitations so as to not affect signal synchronisation and the overall performance of the signal network. An extreme priority measure is signal pre-emption, where the signal turns green or remains green if a public transport vehicle is approaching. Pre-emption is quite commonly used in conjunction with priority for emergency vehicles.

Fig. 12.70
Vehicle location software helps maintain efficient operations for TransMilenio.

Image courtesy of TransMilenio SA

Priority signal technology is an option, but is not always feasible in high-frequency systems. In cities such as Los Angeles, signal priority is given to public transport vehicles by way of a message relayed from a vehicle transponder to the signal control box (Figure 12.71). As a public transport vehicle approaches, the traffic light will extend the green phase to allow the bus to pass. However, even with relatively long peak headways of five minutes or more in Los Angeles, the signal prioritisation will only function every other phase cycle. If the phase priority is given more frequently, it will essentially give a permanent green to the direction of the public transport corridor. Thus, other vehicle directions will become unavailable.

In developing cities with high population densities, peak public transport headways may be in the range of one to two minutes. In such a scenario, signal prioritisation becomes less viable. Nevertheless, other improvements such as adjusting phase lengths are still quite possible in the developing city context. Chapter 9 of this Planning Guide elaborates on this topic.

Integrating traffic signal control into the centralised control system is also an option to consider. In cities such as London, traffic cameras at key intersections permit control centre staff to directly observe potential congestion points. This technology can be used to provide priority to public transport vehicles entering a bottleneck point.

12.3.3 Real-time information displays

“All of the biggest technological inventions created by man—the airplane, the automobile, the computer—says little about his intelligence, but speaks volumes about his laziness.”

—Mark Kennedy, politician, 1957–

Information technology is changing all aspects of daily life. Public transport has likewise benefited from the reach of information technologies as well as the continuing reduction in technology costs. “Intelligent transportation systems” (ITS) refer to a range of information technologies that provide more choices and better quality for the customer.

Real-time information displays are one application of ITS that can alleviate concerns over the reliability of a service. Information on the public transport vehicle’s location can be relayed via several technologies to displays at stations informing waiting passengers of the next available vehicle (Figure 12.72). Real-time information helps to reduce customer “waiting stress”, which affects passengers who do not know when or if a particular route is going to arrive. By knowing the expected arrival time of a bus, the customer can mentally relax as well as potentially under-

Fig. 12.71
In Los Angeles, a transponder beneath the vehicle communicates with a control box at the intersection in order to give public transport vehicles signal priority.

Photo courtesy of the Los Angeles County Metropolitan Transport Authority



Fig. 12.72
A real-time information display in Berlin.

Photo by Lloyd Wright



Fig. 12.73
In Singapore, customers can view arrival times prior to entering the platform area.
 Photo by Lloyd Wright

take another value added activity to make best use of the time.

Some systems, such as the Singapore MRT system, even place a real-time information display at the outside of the station (Figure 12.73). This allows customers to make best use of their time as well as helps reduce stress and rushing. A customer may see that they have several extra minutes prior to entering the closed station boundaries. In such a case, the customer may elect to run an errand or enter a shop to make a purchase before going to the station platform. Indicating the arrival times outside the station areas can also be an effective marketing tool. Exposing motorists and other non-users to the frequency of the system can help to attract new users.

In high-frequency systems where headways are three minutes or less, real-time information displays may be of less value. However, even in these circumstances, customers can be aided in making travel route decisions. For example, passengers may be in a position to decide between taking a local or express route. With the expected arrival times of both options posted, the passenger can determine which route is optimum from a travel time perspective. Also, in cases of a vehicle being quite full, a passenger may decide to wait for the next vehicle if it is only a few minutes away. In this sense, real-time information can help balance passenger loads naturally, and thus mitigate the system delays when vehicles are overly loaded.

Variable message signs also post information when incidents occur, providing passengers with instructions and expected delays (Figure 12.74).

This type of information can also be useful inside the vehicle as well. A video or digital display inside the vehicle can list the next station (or even the next three stations) as well as

the final destination of the route. In conjunction with a recorded audio announcement of the next station, customers can enjoy a more relaxed ride without having to repeatedly check their position. Passengers can undertake other value-added activities, such as reading, without worrying about missing their destination. Further, in crowded vehicles, consulting the posted system or route map can be difficult. The video and audio information helps persons easily gain information without jostling about the vehicle.

Similar types of technology can also be integrated with public transport security efforts. Security cameras both inside stations and vehicles are increasingly cost-effective approach to system policing. The mere presence of the cameras themselves is often associated with a reduction in criminal activity. The cameras are also a visible sign to the customer of system security and can help reduce anxieties, particularly amongst vulnerable groups.

Once the information of vehicle location and schedule compliance is gathered, there are many alternatives to convey the arrival information for passengers. As telecommunication technologies

Fig. 12.74
Electronic kiosks inside the stations of the Taipei BRT system keeps passengers informed.
 Photo courtesy of Jason Chang



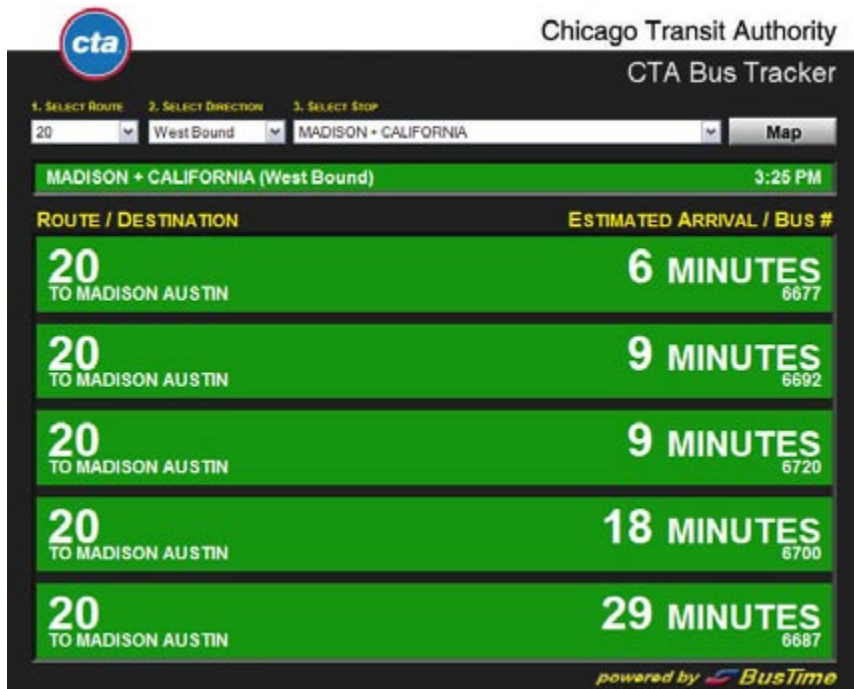


Fig. 12.75
In Chicago, public transport scheduling information can be downloaded from the internet or through text messaging.

Image courtesy of Chicago Transit Authority

advance there are opportunities to provide passengers with data via kiosk, Internet, SMS, Wireless PDAs and so on. Passengers can plan trips from home with scheduling and real time information, or just ask via cellular phone or wireless PDAs, when a public transport vehicle is arriving to a given location (Figure 12.75).

Overall, though, ITS can deliver substantive improvements to system efficiencies. With the cost

of such systems falling each day, even developing nation cities should conduct a full review of the options and potential implications. For further information on this topic, TCRP Synthesis Report 48 is a useful resource (TCRP, 2003).

12.4 Equipment procurement process

The appropriate structuring of the procurement process can create a competitive environment that will drive cost reduction and efficiency. Additionally, a well-designed procurement plan will promote an open and transparent process that will help to eliminate corruption and graft. System developers should seek a wide range of bidders for each piece of equipment needed. To achieve this environment of competitiveness, the procurement specifications should be sufficiently rigorous to meet system requirements while also permitting bidding firms the ability to innovate. Prior to issuing tenders, an explicit set of criteria should be created that sets forth the determining parameters for selecting a bid and the relative weight given to each factor (cost, experience, quality, etc.). The determination of winning bids ultimately should be decided by an objective, independent body whose members have no commercial interest with the overall project and have no relationship in any form to the bidding firms.

Part IV – Integration

CHAPTER 13



Modal integration

CHAPTER 14



TDM and land-use integration

13. Modal integration

“At first it may appear that pedestrian space is a frivolous issue in a developing country; but the privations of low income people are not really felt during working hours—it is during leisure hours that the differences are felt. While higher income people have cars, clubs, country houses, theatres, restaurants and vacations, for the poor, public space is the only alternative to television. Parks, plazas, pedestrian streets and sidewalks are essential for social justice. High quality sidewalks are the most basic element of respect for human dignity, and of consideration for society’s vulnerable members such as the poor, the elderly and children.”

—Enrique Peñalosa, former Mayor of Bogotá

BRT systems should not be designed and implemented in isolation. BRT systems work best when they are part of an integrated network of transport options that allow safe and convenient access to all parts of the city. Even private motorists have to walk to their cars, and therefore are pedestrians for part of their trip. The best BRT systems provide a seamless set of linkages from the doorstep of the home to the door of the office or shop, using many other transport modes for parts of the trip. By maximising the BRT system’s interface with other options, system designers are helping to optimise the potential customer base. The BRT system does not end at the entry or exit door of the station, but rather encompasses the entire client capture area. If customers cannot reach a station comfortably and safely, then they will cease to be customers.

The contents of this chapter include:

- 13.1 Corridor integration
- 13.2 Pedestrians
- 13.3 Bicycles
- 13.4 Other public transport systems
- 13.5 Taxis
- 13.6 Park and ride

13.1 Corridor integration

“The one thing we need to do to solve our transportation problems is to stop thinking that there is one thing we can do to solve our transportation problems.”

—Robert Liberty, 1000 Friends of Oregon

Before a public transport system can consider integration with other transport modes, a basic first step is to ensure that the system is integrated with itself. System integration of this type refers to ensuring that physical and fare integration exists between the different corridors, routes, and feeder services. Unfortunately, many busway systems fail this simple test of integration. In many lesser BRT systems such as Kunming, Porto Alegre, Recife, and Taipei, there is no free transfer between the different bus lines sharing a BRT corridor. In Quito, the three major BRT corridors share corridor

space at several different junctions (Figure 13.1). However, the three corridors do not even share common stations. A customer wishing to transfer from one corridor to another must physically endure a difficult walk between different stations and then must pay again for entering the new corridor.

Systems operating as individual corridors are forgoing the many synergies from forming a full integrated network. Since customer mobility needs are likely to include destinations on several corridors, the system is sacrificing a portion of its potential customer base. Rather than endure several different transfers each involving an additional payment, customers will likely seek alternative means of transport.

As noted previously in Chapter 7 (*Network and service design*), cities often choose open, non-integrated systems for political expediency.



Fig. 13.1
In Quito, the "Trolé" line shares the same roadway as the "Ecovía" line, but the passengers can not transfer between the two without walking to separate stations and paying another fare.
 Photo by Lloyd Wright

Rather than potentially upset the existing transport cartels, political figures will choose a system structure that does not entail any great operational changes for the fleet owners. In such instances, the city is essentially serving the desires of a few private operators over the needs of the customers. As has been stressed throughout this guidebook, basing public transport design around the customer almost always guarantees success. Basing public transport design around a few special interests almost always results in a

compromised system. Integration begins with a focus on a system’s internal routes and corridors. An internally integrated system can then expand its reach and customer base considerably by permitting other modes to form a seamless interconnection with the BRT system.

13.2 Pedestrians

“Traveler, there is no path. Paths are made by walking.”

—Antonio Machado, Spanish poet, 1875–1939

A key component of BRT station planning and design is the provision of safe, convenient and secure access for pedestrians. If it is not convenient or easy to walk to a BRT station, then customers will be discouraged from using the system. Providing a Safe Route To Transit is therefore a basic step to providing an effective BRT service.

While station locations vary by the origin-destination patterns to be served and local context, fundamental pedestrian factors remain constant. To evaluate the quality of pedestrian access to public transport, an evaluation framework has been devised (Table 13.1). Specifically, effective public transport access is achieved with infrastructure that is affordable, attractive, comfortable, direct, legible, safe, and secure. If any one of these elements is not adequately

Table 13.1: Evaluation framework for public transport access

Category	Description
Accessibility	“Accessibility” refers to the viability of individuals with physical disabilities in using the system and reaching destinations.
Affordability	The “affordability” of providing public transport access is greatly affected by the need for pedestrian bridges, underpasses, and other significant infrastructure.
Aesthetics	The “aesthetics” of the pedestrian access area encompasses the attractiveness of the walkway, the street furniture, and the congruence between street design and local architecture.
Directness and connectivity	“Directness” involves a pedestrian path that minimises the distance travelled to access the public transport station. “Connectivity” refers to the ability of pedestrians to readily access a broader network of destinations.
Ease of access	“Ease of access” refers to the pedestrian’s comfort level in walking along a corridor; this issue encompasses steepness of inclines, weather protection, condition of the walking surface, and protection from noise and air pollution.
Legibility	The “legibility” of an area refers to the ease in understanding the street environment. The availability of maps and signage can help legibility.
Safety	A “safe” pedestrian pathway implies that pedestrians are well protected from road hazards such as vehicles.
Security	“Security” refers to providing an environment where pedestrians are not susceptible to robberies or other crimes.



Fig. 13.2
The quality of access around and within stations greatly determines whether the system is used by the public.

Photo by Lloyd Wright

addressed, then the entire viability of public transport access can be undermined.

These qualities are not necessarily always mutually compatible. For example, the most direct path may involve conflicts with vehicles, or the safest route may imply using a difficult set of stairs. The design challenge is to prioritise competing interests while balancing the outcome.

Pedestrian access to public transport stations involves considering ease of movement at three critical points: 1. From the neighbourhood area to the corridor; 2. Crossing the corridor to access the station; and, 3. Movement within the station area (Figure 13.2). An effective pedestrian access plan will address each one of these trip segments in accessing the system. Ignoring just one of these pedestrian trip components can mean that the system is effectively non-accessible for a percentage of the customer base.

A well-designed pedestrian access plan will provide a natural flow of walking customers from the surrounding area. System planners should ask a few basic questions regarding the quality of pedestrian access. Are the pedestrian walkways leading to the station well maintained? Are they sufficiently broad to comfortably handle

the expected pedestrian traffic? Are they safe and well lit? Is there adequate signage to lead individuals easily to the stations? Are there logical pedestrian connections between major origins and destinations such as shops, schools and work places?

13.2.1 Pre-existing pedestrian conditions in developing-nation cities

“Any town that doesn't have sidewalks doesn't love its children.”

—Margaret Mead, anthropologist, 1901–1978

Public transport ridership in developing nations is frequently compromised by a general lack of acceptable pedestrian facilities. Pedestrians typically run a gauntlet of challenges that directly contribute to the high injury and fatality rates witnessed in these countries. These challenges include the following:

- Complete lack of pedestrian pavements;
- Poor quality of pavements, often dirt or mud;
- No physical separation from high levels of traffic and from high-speed traffic;
- Extreme levels of noise and air pollution;
- Intersection designs aimed at facilitating high vehicular turning speeds at the expense of safe pedestrian crossing;

Fig. 13.3
Communities like Alexandra in Johannesburg (South Africa) often lack proper pedestrian infrastructure.

Photo by Lloyd Wright



- Obstructed pavements due to parked cars (illegal or legal), poor design, utility poles and signs, uncollected rubbish, vendors, etc.
- No protection from harsh climatic conditions;
- Lack of sufficient lighting;
- Pedestrian overcrowding due to narrow or below-capacity pavements;
- High levels of robbery, assault and other crime befalling pedestrians.

Adapted from Vasconcellos (2001, p. 113) and Hass-Klau *et al.*, (1999, p. 105)

The complete lack of formal pedestrian pavements in developing nations is relatively common. Hook (2003) notes that: "Over 60 percent of the roads in Jakarta, for example, have no sidewalks, and those that exist are heavily obstructed by telephone poles, trees, construction materials, trash, and open sewer and drainage ditches." Likewise, in African cities, poor districts will rarely be provided with pedestrian infrastructure, even though virtually all of the population of such areas do not own a motorised vehicle (Figure 13.3). Vasconcellos (2001) also notes that even when crossings are provided, they rarely give priority to the pedestrian:

"Crossing facilities are also inadequate; zebra crossings are rare, and signals rarely consider pedestrian needs; in such cases, pedestrians are seen as something that might be 'stacked' until some gap is available in the traffic stream: 'second class citizens' have to wait until first class ones exert their rights to use roads."

Crossing a street can be particularly difficult in developing-nation cities due to a lack of formal crossings and restrictions on informal crossings, with the latter typically based on driving and not walking patterns (Figure 13.4).



Fig. 13.4

The lack of formal pedestrian crossings in Dhaka (Bangladesh) create significant risks.

Photo by Karl Fjellstrom

Lack of direct routes for cyclists and pedestrians between their homes and public transport stations can also encourage people to drive cars and motorcycles. Because walking speeds are so slow, even modest detours in the directness of a walking access route can have a dramatic negative impact on total travel time. Hook (2000) documents how sidewalk barriers and other detours in Surabaya result in substantially longer journeys for pedestrians:

"...pedestrian barricades and one way streets have been used to facilitate long distance motorised trips but which simultaneously impose huge detours for short distance cycling and pedestrian trips. People wishing to cross a main shopping street often find it easier to take a taxi two kilometres than to walk across the street. In Surabaya, the World Bank estimated that these measures generate an additional daily 7,000 kilometres of needless vehicle traffic."

For this reason, many cities developing BRT systems simultaneously develop pilot pedestrian improvement schemes along and adjacent to the new BRT corridor.

One of the first questions typically raised by engineers designing a new BRT system is "how are the passengers going to get to the BRT stations if they are in the centre of the carriageway?" While carefully designing safe station access is one of the most important elements of a BRT system, and it is discussed

at length in the following section under ‘safety,’ it should be kept in mind that safe pedestrian access is just as much of an issue for standard bus systems. Even without a BRT system, bus passengers need to cross streets, often at very dangerous intersections, in order to take buses going in the opposite direction. Competition for passengers along a curb lane bus stop is also frequently an important cause of death for pedestrians; a problem that BRT can solve. Therefore, BRT brings with it no special difficulties with regard to pedestrian access, but it does provide a strategic opportunity to significantly improve pedestrian safety and access for bus passengers.

The second most frequently asked question is whether pedestrian crossings should be at grade, elevated, or below ground. As a general rule, at grade pedestrian crossings are more convenient for pedestrians and disabled people, and can generally be made safe by various traffic calming measures. Where possible, at grade facilities are preferable. In most instances, pedestrian overpasses or underpasses are designed primarily with the aim of getting pedestrians out of

the way of vehicular traffic and not with the safety and convenience of pedestrians in mind. Such facilities frequently fail to protect pedestrians, who often eschew such infrastructure because it is poorly located, overly steep, badly maintained, filled with informal merchants, inherently dangerous from a crime and safety standpoint, or otherwise generally inconvenient. The safety benefits of an overpass will not be realised if most people (in all parts of the world) choose to take their chances crossing through the chaotic and dangerous maze of traffic. Nevertheless, there are conditions where full grade separation between pedestrians and motorised modes is preferable, and the following section provides some guidelines for making better informed decisions on this matter.

A new BRT system offers the opportunity to re-evaluate pedestrian conditions and develop a vastly improved pedestrian environment. However, if no attention is paid to the pedestrian environment, pedestrian conditions could actually be made worse. Initially, the Jakarta BRT system failed to properly address pedestrians (Figure 13.5), and pedestrian access bridges fully obstructed the existing footpath. However, Jakarta has now learned from this experience, and is now modernising the footpaths in all of the new TransJakarta BRT corridors.

13.2.2 Street audits

“The pedestrian remains the largest single obstacle to free traffic movement.”

—Los Angeles planning report (Engwicht, 1993)

As most pedestrians will be approaching a BRT station from within one kilometre, and as stations tend to be roughly 500 metres apart, the catchment area for BRT walking access trips is generally between 500 metres and 1,000 metres. Surveys from TransJakarta indicated that 58 percent of the passengers walked less than 500 metres to the station, and an additional 31 percent came from locations within 500 metres and 1000 metres. Longer distance walking trips are rare, unless there is a distinct corridor such as a path along a river.

Usually, in developing countries, the street grid is not very dense. Small local streets tend to have fairly slow operating speeds, so these smaller streets may already possess effective



Fig. 13.5
Pedestrian Infrastructure of the new BRT System in Jakarta.

Photo courtesy of ITDP

Fig. 13.6 and 13.7
Pedestrian conditions connecting Mexico City's metro system to nearby municipal offices.

Photos by Michael King



pedestrian facilities. The locations where major pedestrian improvements are likely to be needed are on arterials and intersections where vehicle speeds are likely to exceed 40 kph, so identifying these roads and intersections within the service area and assessing the quality of the pedestrian environment is the next step. To analyse facilities at this level of detail, precise maps, ideally at a minimum of 1:2000 scale, should be utilised.

The ease of walking from one's home or office to the BRT station depends on the street design and the overall urban form. Some of the design factors that will affect the decision to undertake this walk include:

- Quality of pavement materials;
- Amount of trees, vegetation, verandas, etc. providing climate protection;
- Quality of street lighting;
- Pedestrian priority at intersections;
- Absence of major barriers / severance issues.

Additionally, the aesthetic value of the walking environment will play a role in the potential customer's disposition towards the walk. If the walk is pleasant and intriguing, then more customers will be attracted to the BRT system. If the walk is an unpleasant experience punctuated by excessive noise, pollution, and risk to personal safety, then a significant portion of the system's customer base

can be lost (Figures 13.6 and 13.7). System developers thus should assess the quality of pedestrian corridors connecting the BRT stations with major origins and destinations.

At this stage, the project developers have identified the major pedestrian corridors linking the stations to origins and destinations. An audit to evaluate the quality of the existing pedestrian infrastructure along and serving these corridors will be useful in highlighting potential problem areas. With this data in hand, priority areas for improving pedestrian conditions can be identified and included in the BRT development budget.

Several auditing protocols have been developed for evaluating the condition of pavements, curbs, and other roadway features. These protocols are available for download from several organisations¹⁾.

The principal tools for conducting a pedestrian infrastructure audit are a map, a camera, and a distance measuring wheel (Figure 13.8). As the audit team walks along the pedestrian corridor, photographic images are collected approximately

¹⁾ http://www.bikewalk.org/vision/community_assessment.htm
<http://www.walkinginfo.org/walkingchecklist.htm>
<http://www.falls-chutes.com/guide/english/resources/pdf/WalkChecklistJuly29ForWeb.pdf>

every 30 metres and/or whenever a major feature or problem is noted. Once this information is collected, the street environment can be ranked based upon its suitability for providing public transport access. An example of this type of ranking scheme can be found in Figure 13.9. In this illustrative view of the quality of streets in Surabaya (Indonesia), the pedestrian environment has been colour-coded according to the footpath’s usability: 1. Usable (green); 2. Partially usable (yellow); and 3. Unusable (red).

13.2.3 Directness and connectivity

“All truly great thoughts are conceived by walking.”

—Friedrich Nietzsche, philosopher, 1844–1901

The directness of the route between the customer’s starting point and the public transport station plays a central role in the amount of walking time required. The connectivity afforded by the street infrastructure determines the ease of movement between two points. Connectivity also discusses the placement of the station within the larger context of the urban fabric.

13.2.3.1 Analysing connectivity

Improving the accessibility of the public transport station for pedestrians is not complicated, and a quick visual scan of the area around the station can usually determine whether good quality footpaths exist, whether good quality crossing facilities have been provided, whether proper lighting for night time crossing exists, or whether certain popular access points are obstructed by barriers, unsafe conditions or temporary obstructions that could cause significant inconvenience to pedestrians. While a site visit by a trained non-motorised transport (NMT) planning team is generally sufficient, a more detailed analysis is called for if engineers have no specific background in planning for pedestrians, or if intersections or stations have complex pedestrian movements.

Mapping pedestrian movements in the area of the proposed BRT station provides the baseline data that will help shape the optimum design of the supporting pedestrian infrastructure. Just as traffic counts were an important input element to the BRT modelling process, pedestrian counts and pedestrian movements are important parts of understanding issues around station

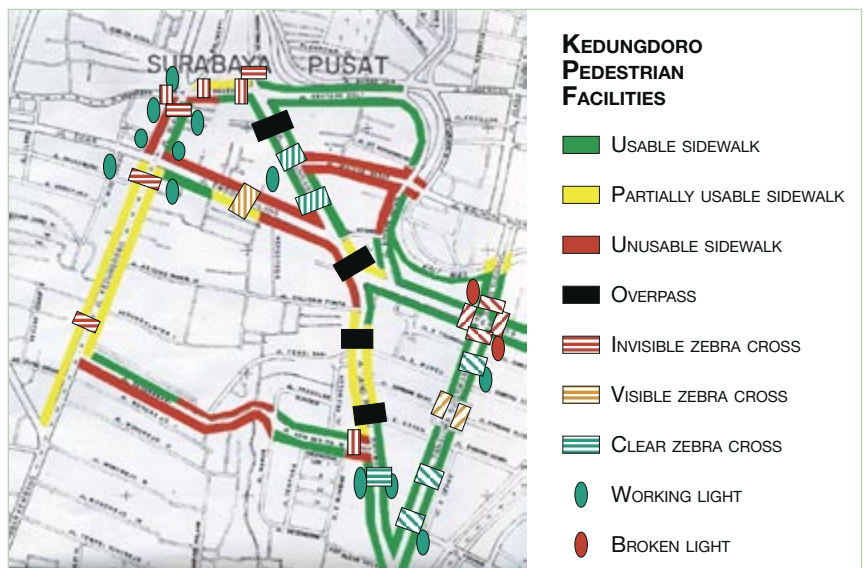


Fig. 13.8
A pedestrian infrastructure audit in Zurich.
Photo by Lloyd Wright

access. Tools such as walking origin-destination (O-D) studies, walking time maps, and tracking surveys allow planners to understand pedestrian movements at the local level. By identifying the likely origins and destinations of pedestrians and the most travelled walking routes, planners and designers can prioritise infrastructure improvements in the most effective locations.

If the most common walking routes are not inherently clear, it is sometimes helpful to do a small localised OD survey of passengers disembarking at a BRT station and their local destinations. The impact zone might be divided up into small 250 metre square zones around the BRT station with popular destinations such

Fig. 13.9
Results of street audit for Surabaya.
Image courtesy of GTZ and ITDP



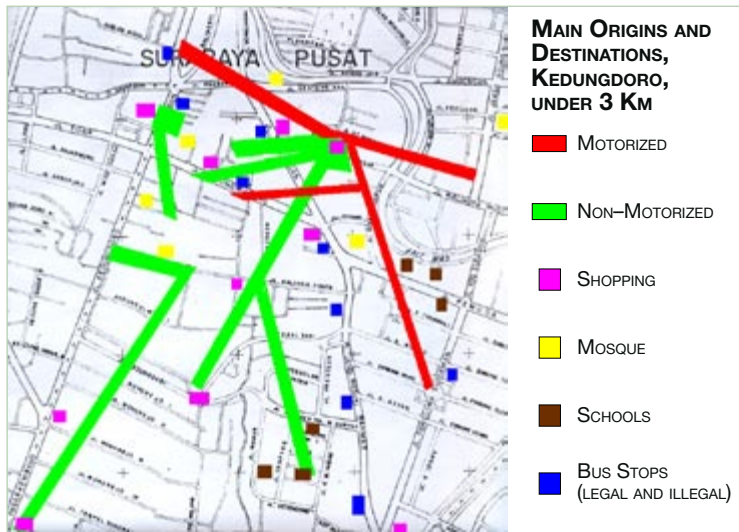


Fig. 13.10
Origin-destination map from Surabaya (Indonesia).

Image courtesy of ITDP

as schools, shopping areas, and office buildings identified. If there is a major trip attractor in the destination zone (e.g., a shopping centre, school or hospital), this location can serve as the destination point. If a clear major attractor is not present, the destination can be represented by a central point in each zone.

On this map it would be useful to highlight any roads or streets where bicycles or other modes are forbidden (i.e., pedestrian-only streets and other traffic restrictions). Particular focus should be given to all trips up to 1,000 metres from the station, regardless of the mode currently being utilised. If certain OD pairs show a very high proportion of short motorised trips, it may be because the pedestrian facilities are of very poor quality. Often, popular short OD pairs currently dominated by motorised modes can indicate locations where pedestrian improvements might be prioritised.

In Figure 13.10, popular short OD pairs between a major commercial centre, bus stops, and other high demand destinations are shown in red if the majority of trips are by motorised modes and in green if by non-motorised modes. Bus stops are shown in blue, schools in brown, mosques in yellow, and shopping areas in purple. The red lines indicate trips that are so difficult to make safely by walking that most people are taking motorised modes. This mode preference indicates there may be a severance problem. The green lines indicate trips that are already being made by walking. While this map indicates nothing in terms of the quality of the walking trip, the map does indicate that these trips are possible.



Fig. 13.11
Mapping of actual walking routes for school trips in Copenhagen (Denmark).

It is also generally possible to conduct a survey of public transport passengers alighting at a particular station and ask the passengers to map the specific route that they normally use. If a random sample is taken, each trip can be placed on a map and simply added up. The second image (Figure 13.11) shows a compilation of the actual routes that a sample of students takes from their homes to school. The same methodology would be used for a public transport station. If specific route data has not been collected, it is usually possible to assign the OD pairs to specific streets using the shortest route possible if the routes are observed to be safe for pedestrians.

Another type of mapping that can provide useful insights into severance problems is to record travel times from the station. Maps showing areas covered in such intervals as one minute, five minutes, ten minutes, twenty minutes, and thirty minutes not only indicate the potential catchment area for the station, but may also highlight potential barriers to pedestrian access. For example, a busy roadway near the station may create severance issues for approaching pedestrians. Other impediments such as blocked or non-existent pavements will become evident in a time-based mapping. Also, long signal cycles for pedestrian crossings will increase walking travel times. This type of analysis can often show areas where distances are relatively short but pedestrian travel times are lengthy.

Figure 13.12 shows a 1/3-mile (roughly 500 metres) circle around the main train station in Trenton, New Jersey (USA). In yellow is the distance that a person walking at 1.5 metres per second walked in five minutes. The person followed all traffic laws. This type of analysis is useful in planning station environs. Note that the person was able to walk further where the street network is denser, so it would be useful to create passages within blocks. Note also that crossing larger streets took longer, so the person was not able to walk as far. Here it would be useful to minimise delay at signals.

13.2.3.2 Detour factors

Once these actual trips are mapped, one can generally tell whether there are a lot of people walking a long way out of their way to reach a popular destination. This actual route mapping can be used to calculate detour factors. Detour factors are the most systematic way of identifying major severance problems. Severance problems can be created by unsafe, high-speed roads, by restrictions on non-motorised vehicles on specific streets, by barriers to crossing streets, by a one-way street system, and by large canals, railroad tracks, and other impassable infrastructure.

Detour factors are the distance that the average pedestrian, cyclist, or pedicab operator needs to travel out of their way in order to reach their destination, relative to the straight line distance. In a typical European or American traffic grid with no restrictions on non-motorised vehicle travel, the detour factors are generally very low. A detour factor of 1.2, as observed in Delft, Holland, is extremely low. This level means that the average cyclist only needs to travel 20 percent farther than a straight-line distance in order to reach the destination. Mapping of some detour factors in Surabaya indicates that Asian cities with many one-way streets, few intersections, a weak secondary and tertiary street system, and unsafe high-speed roads can have fantastically high detour factors.

It is fairly typical in developing countries for distances between intersections to be one kilometre or greater. Normally pedestrians are able to cross reasonably safely at-grade at intersections, but sometimes traffic planners even

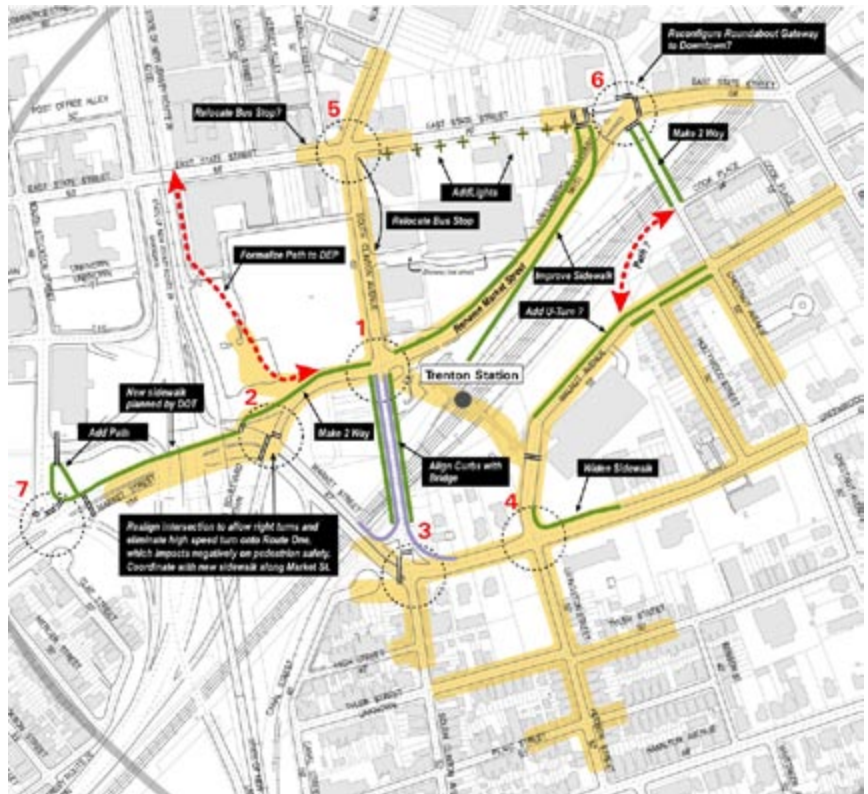


Fig. 13.12
The yellow lines represent areas that are accessible within a five minute walk of the transit station.
 Image courtesy of Nelson/Nygaard

discourage at-grade crossings at intersections in order to allow free left or right hand turns without any pedestrian conflicts. Traffic planners also like to erect barricades that try to force pedestrians to cross major roads only at designated pedestrian overpasses, and frequently, these overpasses as far as one kilometre apart. In these typical conditions, if a pedestrian simply wants to cross a 50 metre wide street, and the nearest overpass is 250 metres away, the pedestrian will have to walk 500 metres to go a straight line distance of 50 metres. This distance represents a detour factor of 1:10. This situation is fairly typical in developing countries, and is a frequent reason why pedestrians refuse to use pedestrian overpasses.

In these cases, adding safe at-grade or even elevated pedestrian crossing facilities at BRT stations either at mid-block or at the intersection will not only help to improve safe access to the public transport system, it can also help to improve pedestrian safety and convenience for pedestrians not using the BRT system. When the new pedestrian facilities along the TransJakarta system were opened, taxi drivers in the corridors complained of losing a considerable number of short fares.

Pedestrian connectivity to a BRT station is also a function of the layout of area roads and paths. It is fairly typical in developing countries for the secondary street system to be extremely weak. Residential areas frequently connect to major arterials only at a very limited number of access points, and these local streets rarely connect to other residential areas except via the major arterials. Street networks which rely on a high number of minor roads which do not connect with each other severely limit the pedestrian's ability to reach the BRT station. This pattern reduces the functionality of the BRT station, since it requires longer trips to reach destinations. Conversely, networks developed on an interconnected grid system provide greater accessibility because streets are more connected, which allows pedestrians to travel directly to BRT stations. A grid street system also tends to be more resilient, because the system will not fail if one link is blocked. It is sometimes possible to find locations for small pedestrian shortcuts to reduce high detour factors caused by the lack of a secondary street system.

13.2.3.3 Station location

On the macro level, stations should be located so that they best serve the general population and maximise ridership potential. While there are many, non-pedestrian issues in the location of stations, there are a few particulars which directly relate to pedestrian access and safety. Normally, locating stations near to popular trip origins and destinations like shopping malls, large office complexes, or popular intersections, will minimise pedestrian walking times.

However, there are many important reasons from overall traffic flow point of view that a slight offset of stations from these popular destinations is generally desirable, as is described in detail in Chapter 8 (*System capacity and speed*), where a methodology for determining station spacing and location is outlined. Clearly, customer safety and ease of access are additional considerations that should help define the exact location of a station.

13.2.4 Tracking pedestrian movements

“The place where you lose the trail is not necessarily the place where it ends.”

—Tom Brown, Jr., naturalist, 1950—

On the micro scale, pedestrian tracking surveys are a useful way to document exactly how people use a street, intersection, or plaza. These surveys have been used to redesign complex intersections, to show how the space is used throughout the day, in order to prioritise the locations where improved pedestrian facilities are needed. As the role of the pedestrian facilities designer is to facilitate pedestrian travel, it is normally advisable to keenly observe existing pedestrian behaviour and then determine what infrastructure interventions can be designed to ensure these trips are made safely, rather than designing pedestrian facilities that try to force pedestrians to behave in ways that are highly inconvenient to them.

13.2.4.1 Tracking surveys

Tracking surveys are usually conducted at complex intersections and public transport facilities,

Fig. 13.13 and 13.14
Despite efforts to force pedestrians to take alternative routes at Jakarta's Blok M, most customers still prefer to enter by the direct, at-grade approach.

Left photo by Lloyd Wright
 Right photo by Michael King





Fig. 13.15
A design was developed with multiple pedestrian islands in order to improve conditions.
 Image courtesy of Michael King

particularly if these facilities or intersections have been identified as having a high number of pedestrian injuries and fatalities, in order to show where pedestrian improvements are needed.

When TransJakarta was built, the Phase I corridor terminated at the Blok M bus station. At the time that the system opened, the expectation was that pedestrians accessing Blok M from the

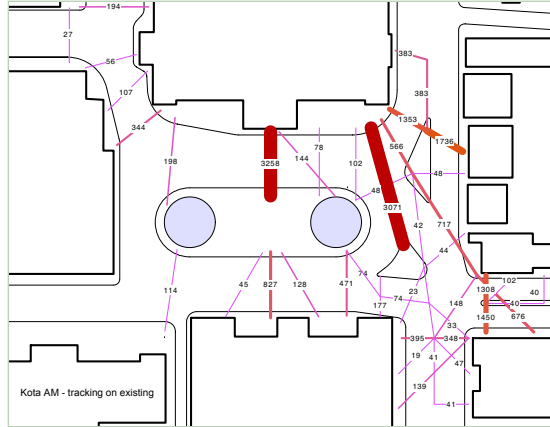


Fig. 13.16
Walking routes at a Jakarta public transport station in the morning.
 Figure courtesy of ITDP

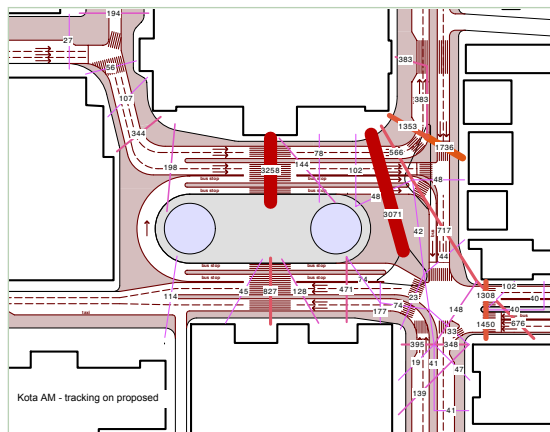


Fig. 13.17
Proposed solution based on the observed audit of walking routes.
 Figure courtesy of ITDP

North and East would all use the provided pedestrian bridge and underpass. In fact, only 210 passengers were using the pedestrian overpass at the morning peak, and none of the passengers

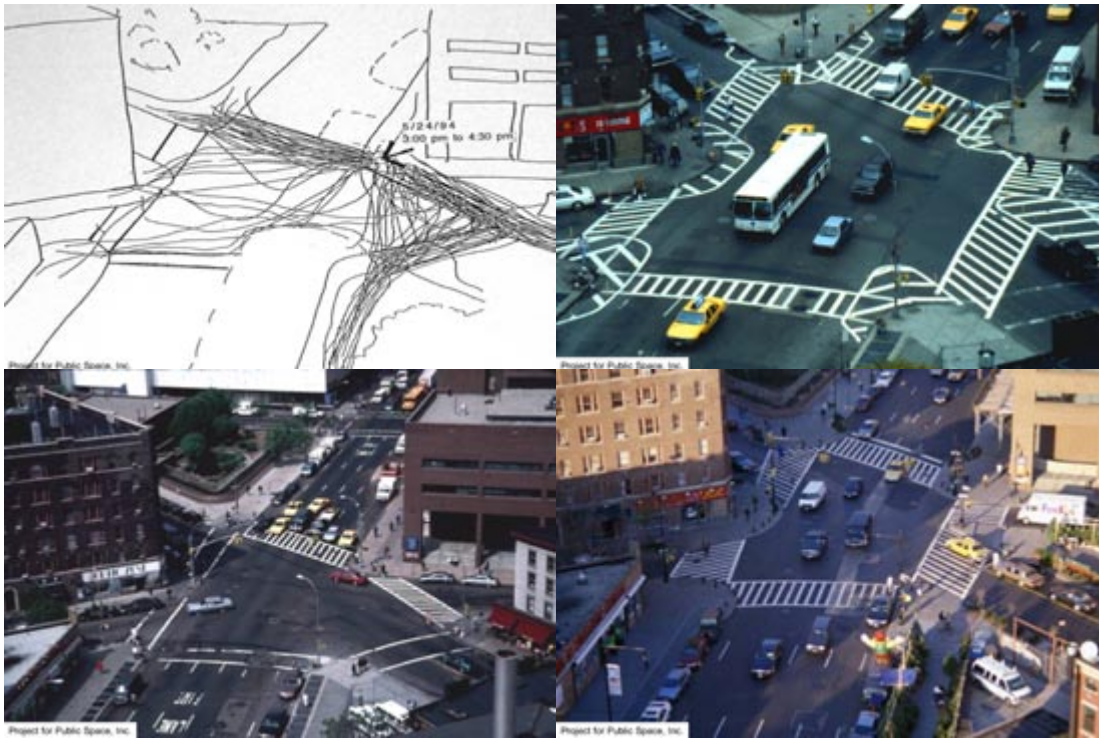


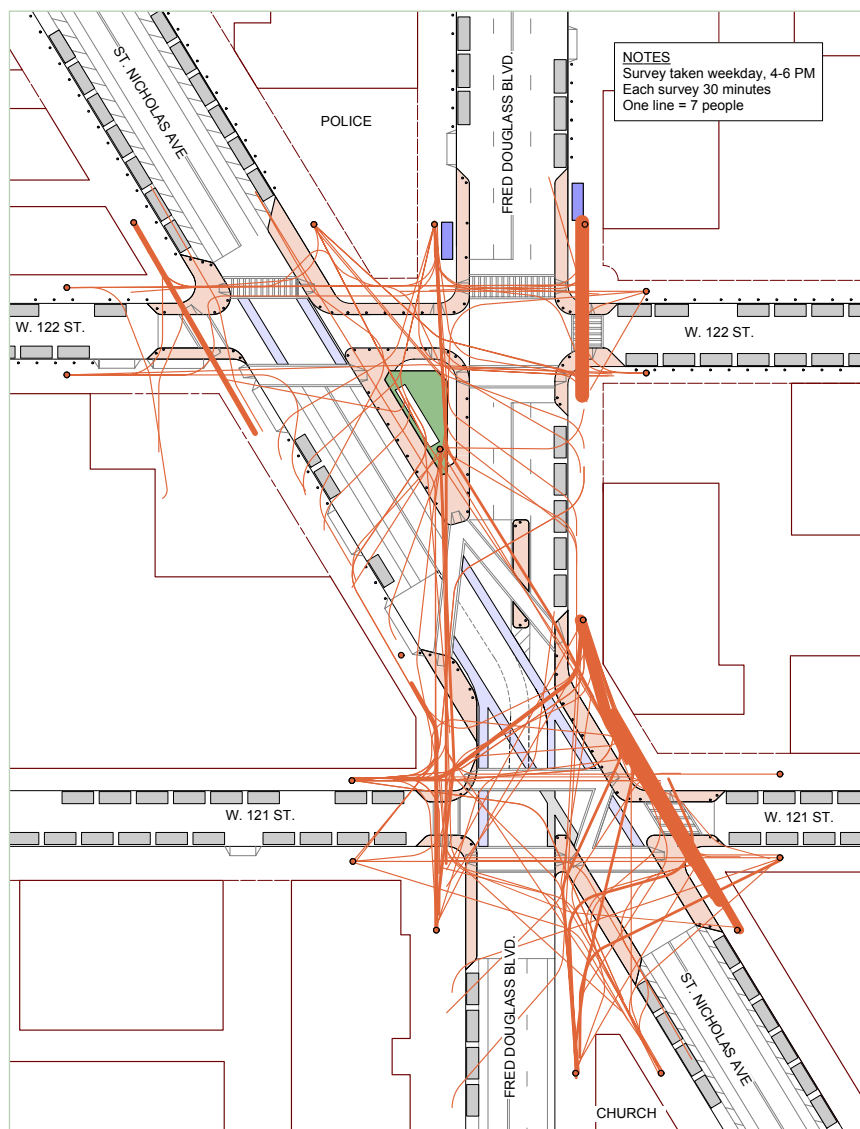
Fig. 13.18
Tracking survey as intersection redesign tool for Mulry Square in New York City.
 Photo courtesy of Project for Public Spaces

from the North and East were using the pedestrian underpass to the south. The remaining several thousand passengers were all entering or exiting the Blok M terminal at-grade, despite the efforts to station designers to make such access impossible, as shown in Figures 13.13 and 13.14.

An initial design concept of the Blok M intersection was attempted (Figure 13.15). However, designing an intersection of this complexity in order to optimise pedestrian safety and convenience without compromising mixed traffic throughput and BRT operating speeds is a highly complex matter. In developed countries, where traffic flows are far less complex, it would not be unusual to spend over US\$10 million to redesign an intersection of this complexity, using highly specialised micro-simulation modelling tools.

Fig. 13.19
Composite of tracking surveys conducted in Tubman Triangle, New York City.

Drawing courtesy of Michael King



The basic technique for tracking pedestrians is to position surveyors at the entries of the location. At a typical four-leg intersection, there are eight sidewalks that lead to the intersection, and hence there are eight entry points. As people walk past, the surveyors record on a plan of the area exactly where they walked, where they crossed the street, where they turned around, etc. The surveyors do not actually follow anyone. The survey can last from 30 minutes to two hours, depending on how long it takes to establish the walking patterns. However, the survey should be conducted across different periods since use patterns will likely vary by the time of day. For example, morning flows and evening flows are likely to be reversed. The optimum design accommodates the peak flows in both directions. Evaluation of rush hour volumes may be the key to maximising pedestrian convenience at transfer points (Figures 13.16 and 13.17). Whether alignments run east/west, north/south or any combination, most locations will have dominant flows.

Figure 13.18 of Mulry Square in New York shows how a tracking survey can be used to redesign an area. The lower left of Figure 13.18 shows the previous condition. In the upper left of the figure is the tracking survey. The upper right shows temporary curb extensions (in paint). The lower right of the figure shows the final built condition.

In complex environments, several individual tracking surveys can be drawn together to form a composite few of the area. This composite view is particularly useful in understanding how multiple intersections, plazas, and footpaths can interact to serve the customer. Figure 13.19 provides a composite tracking study from 19 different points in Tubman Triangle in New York City.

While it is possible to predict walking patterns, humans are highly adaptable. After the public transport station is opened it is good to re-analyse the area and see if the design works.

13.2.4.2 Aerial photos and video

Tracking surveys are highly specific and require a certain amount of personnel to perform. Another way to obtain similar information, although not as exact, is through aerial photographs. It is often easy to see from aerial photos



Fig. 13.20
Aerial image showing where people cross the street in a neighbourhood of Cape Town (South Africa).
 Photo courtesy of ITDP

where most pedestrians want to go based on the tracks left in the grass of median strips. Aerial images can show actual pedestrians, say at a market or along a sidewalk, or the paths in unpaved ground. Figures 13.20, 13.21, and 13.22 present examples of aerial photos being

Fig. 13.21
Aerial image recording how people access a bus stop in Brasilia (Brasil).

Photo by Michael King



used to assist in tracking pedestrian routes and movements.

The rise of video technology offers much promise to improve the accuracy of pedestrian tracking. Rather than rely upon a team of surveyors to catch pedestrian movements as they occur, a video of an area can capture the scene for a more studied analysis. Movements can be replayed in slow motion to catch nuances not seen in a single moment.

Fig. 13.22
Aerial image showing where people cross the street in Kuala Lumpur (Malaysia).

Photo by Michael King



13.2.5 Safety

“The car is a luxury that is apt to degenerate into a nuisance.” (1907)

—Herbert Asquith, former UK Prime Minister, 1852–1928

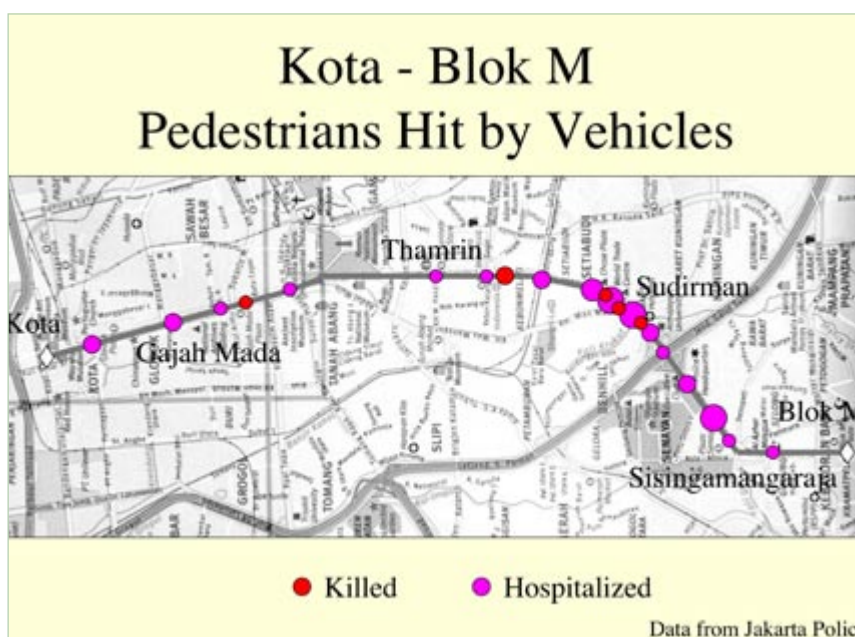
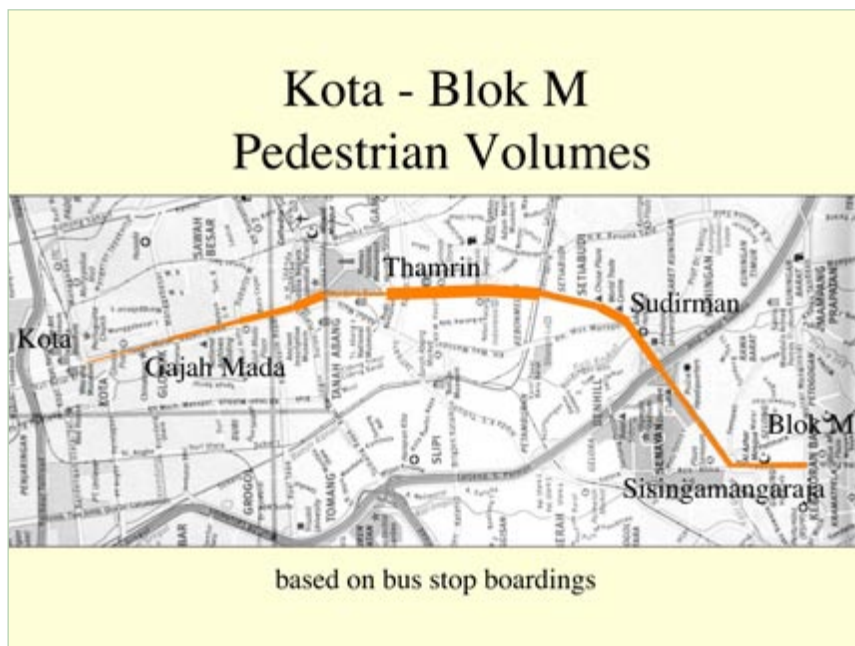
Improving pedestrian access for the BRT system most importantly requires designing facilities for pedestrian safety. While most of the pedestrian safety measures that will be recommended for a BRT corridor could be implemented with or without a BRT system, the introduction of a BRT system is often a strategic opportunity to implement these much needed measures anyway.

While analytical tools and measures suggested below are generic to safe pedestrian facilities design more generally, they are necessary for the specific application of safe station access, which is critical to the success of a BRT system.

Most of the road design measures used to increase pedestrian safety follows fairly standard rules that do not require in-depth analysis. However, analysis of existing safety conditions can greatly help prioritise interventions, and sometimes can dispel a lot of misunderstanding about road safety, much of which is quite counter-intuitive.

Fig. 13.23 and 13.24
Pedestrian volumes, injuries and deaths along a BRT Corridor in Jakarta.

Images courtesy of ITDP



13.2.5.1 Accident mapping

Determining where pedestrians and other vulnerable road users are hit by vehicles is a fundamental step in safety analysis in general, and for planning a transit station in particular. Planners should first collect traffic accident (crash) data for incidents involving non-motorised road users from the police and map the locations as precisely as possible. Differentiating between intersection and non-intersection accidents can be quite useful. Even though the numbers are likely to be significantly underreported (Box 13.1), this simple mapping exercise should make it possible to identify particularly dangerous locations.

Box 13.1: The limits of crash statistics

Vehicle-vehicle incidents and incidents involving fatalities are typically reported with reasonable accuracy and need not be adjusted. However, research indicates that only 35 to 85 percent of vehicle-bicycle and vehicle-pedestrian incidents involving injury are included in typical crash statistics. A study of California children estimated that police reports only cover 80 percent of hospital admissions (Agran *et al.*, 1990). A British study found that only 67 percent of slight injuries to pedestrians were reported while 85 percent of serious injuries were (James, 1991). In Germany the figures are 50 percent for major injuries and 35 percent for minor ones. Based on this research, it is appropriate to adjust vehicle-bicycle and vehicle-pedestrian injury statistics upwards by at least 50 percent (Hautzinger, 1993).

Once a particularly dangerous location or a future station area has been identified, more detailed analysis of the location should be conducted. Researchers at Lund University in Sweden have developed a “conflict-analysis” technique where a location is observed and conflicts between various roadway users are recorded. These “conflicts” could be near misses, evasive manoeuvres or simply a reduction in speed. The idea is that this type of information paints a more complete picture of the safety at a particular location than do accident statistics. The technique is especially useful in contexts where most traffic incidents go unreported.

Figures 13.23 shows pedestrian volumes along the first BRT corridor in Jakarta and figure 13.24 compares these volumes with injury locations.

Careful analysis of these locations showed that by far the largest number of serious pedestrian accidents and fatalities occurred in the slow lane of the higher-speed section of the BRT corridor, and determined that the primary cause was competition for passengers among bus drivers and other commercial vehicles in the curb lane (Table 13.2). The next most dangerous location was high-speed access and egress ramps onto highways. The next most dangerous location was at poorly lit underpasses where many people were crossing to catch buses and motorcycle taxis going in the opposite direction. Next were accidents in the fast lane, caused by pedestrians illegally crossing the roadway due to the inconvenience of walking to the nearest pedestrian overpass. As is consistent with research from India, but inconsistent from developed-nation



Fig. 13.25
The addition of higher-quality pedestrian crossings in Jakarta has done much to reduce pedestrian accidents.

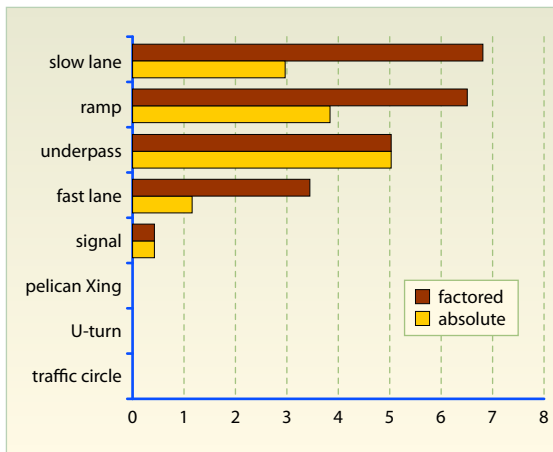
Photo courtesy of ITDP

research, very few accidents were taking place at intersections or roundabouts.

This comparison showed that higher pedestrian volumes are not necessarily accompanied by more deaths and severe injuries. In fact, vehicle speed was the most representative indicator of injury severity. Pedestrian volumes usually mean more absolute numbers getting hit, but generally with less severe outcomes. This “safety in numbers” argument is gaining currency within the pedestrian safety community.

Based upon these results, if pedestrian safety is to be improved along a BRT corridor, the first step is to end the competition for passengers amongst bus operators. This change can be accomplished through the business and operational structure of the system. Specifically, operator revenues should be based upon vehicle-kilometres travelled rather than the number of passengers. Secondly, the provision of high-quality pedestrian crossings at a wide variety of points along the corridor will do much to avoid pedestrians entering unmarked crossings. In Jakarta, the construction of higher quality, gradual gradient, pedestrian overpasses to largely mid-block BRT stations helped significantly in this respect (Figure 13.25).

Table 13.2: Location of serious pedestrian accidents in Jakarta



13.2.5.2 Key factors contributing to accidents

Table 13.3 lists weight factors which can be used to determine the relative safety of a location or area. This list includes direct costs

Table 13.3: Factors to determine the relative safety of a location

Factor	Severity
1,300	Fatality
90	Incapacitating injury
18	Evident injury
10	Possible injury
1	Property damage only

Source: Homberger et al., (1996)

(property damage, emergency medical services, medical treatment, lost productivity, insurance payouts) and indirect costs (insurance premiums, automobile safety features). These multipliers can be applied to existing crash data to show the approximate annual cost of the existing roadway configuration. This list can also be used to estimate potential cost savings of a proposal relative to the cost of construction.

Dangerous conditions can be mitigated by addressing the root causes of the danger, which can be grouped into three basic categories:

1. Vehicle speed and volume
 Vehicle speed is a significant determinant of crash severity but not their frequency. Vehicle volumes tend to correlate with frequency of accidents but not their severity. Both vehicle volume and vehicle speed are controllable, and ultimately determined by the decisions of road designers and policy makers who should be held accountable for these decisions, as people's lives are at stake. While mechanisms to reduce vehicle volumes will be discussed in Chapter 14 (*TDM and land-use integration*), many design options for reducing vehicle speeds, most of which do not compromise vehicle throughput, are discussed below.
2. Pedestrian "exposure" risk
 The time that pedestrians are exposed to traffic varies based on the distance between secure pedestrian facilities, the way traffic signals are phased, and the type of facility segregation. It has both a temporal and spatial component. To reduce exposure risk is to increase safety.
3. Driver and pedestrian predictability
 Drivers are constantly making decisions, and if other street users—walkers, cyclists and other drivers—can better predict those decisions, then the street will be safer. Reducing

the number of options for drivers at key junctions is the simplest way to improve driver predictability.

13.2.5.3 Reducing vehicle speeds

Speed and risk

The relationship between vehicle speeds and the risk of death or injury has been well documented in a range of settings (Figure 13.26). At speeds of less than 32 kph there are almost no pedestrian deaths; at 80 kph almost all vehicle-pedestrian incidents result in death. There is good reason why residential speed limits in countries with good traffic safety records are set at 30 kph or less.

Similarly, research from Australia suggests that a drop in speed of only 5 kph will result in:

- 10 percent fewer pedestrian fatalities; and
- 20 percent less severe pedestrian injuries (Anderson, 1997).

There are many techniques to lower traffic speeds, from lowering and better enforcing speed limits to changing road design. Camera enforcement of speeding vehicles and changing police incentives to crack down on speeding motorists can be effective. The focus here, however, will be on road design issues, as they are self enforcing and easy to implement as part of a BRT project.

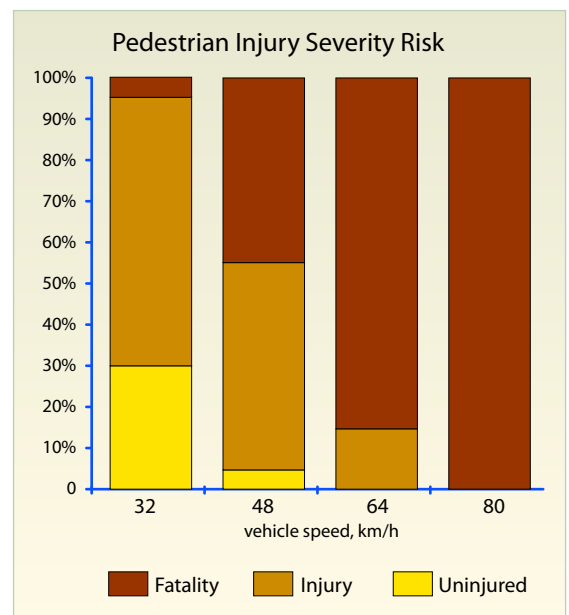


Fig. 13.26
Relationship between vehicle speed and pedestrian safety (UK DOT, 1993)

There are two basic approaches to slowing vehicle speeds through road design: “traffic calming” and what has been called “shared space” or “post traffic calming”. While in some cases slowing vehicle speeds through these methods will also compromise mixed traffic throughput, recent Dutch research has shown that it can frequently increase mixed traffic capacity through a process known as “traffic smoothening”, which ends the accordion-action that can lead to traffic bottlenecks.

Traffic calming

The most familiar family of interventions to slow down motor vehicle speeds for pedestrian safety are called “traffic calming”. At any locations critical to pedestrian access to the BRT system, or at any location where numerous accidents have been recorded, traffic calming measures should be considered. Box 13.2 summarises many of the most common forms of traffic calming.

Several other measures that both reduce motor vehicle speeds and increase pedestrian refuge space are discussed in the following section. Figures 13.27 through 13.30 illustrate some of these traffic calming techniques.

Shared space

Where a BRT system goes through a city centre or on smaller access roads, there may be opportunities to implement one of the most innovative concepts in recent years: the idea of “shared space”, also known by several other names including “post-traffic calming”,

Fig. 13.27

Before curb extension is installed (Salem, Oregon, USA).

Photo courtesy of Michael Ronkin



Box 13.2: Traffic calming measures

Speed humps – Rounded raised area across the vehicle lane with typical dimensions of 3-4 metres in length and 50–100 mm in height.

Speed table – Flat topped speed humps that are often constructed with brick or textured materials and are usually long enough for the wheel-base of a standard car to rest entirely on the flat surface

Raised sidewalks – These are speed tables outfitted with crosswalk markings and signage to channelise pedestrian crossings, providing pedestrians with a level crossing. Additionally, by raising the level of the crossing, pedestrians are more visible to approaching motorists.

Raised intersections – Flat raised areas that cover the entire area of the intersection, with ramps on all approaches and typically constructed of brick or other textured materials.

Realigned intersections – Changes in intersection alignment which converts a “T” shaped intersection with straight approaches into curving streets.

Textured and/or coloured pavements – Pavement materials are used to create a coloured or uneven surface for vehicles to traverse across an intersection, crossing, or even an entire city block.

Traffic circle – Raised islands in the centre of intersections, around which traffic circulates.

Chicanes – Curb extensions that alternate from one side of the street to the other, forming S-shaped curves.

Neckdowns – Curb extensions at intersections that reduce the distance required for a pedestrian to cross a street.

Chokers – Curb extensions at mid-block locations that narrow the street and widen the footpath area.

Pedestrian islands – A raised island located in the centre median area; also known as pedestrian refuges.

Traffic cells – A street enclosure that permits a direct link for a pedestrian or cyclist but force a longer trip by car.

Source: Adapted from Institute of Transportation Engineers, 2005



Fig. 13.28

After curb extension installed.

Photo courtesy of Michael Ronkin



Fig. 13.29
Raised intersection in Quito.

Photo by Lloyd Wright

“second-generation traffic calming”, “psychological traffic calming”, “context sensitive design” and even “naked streets”. In some respects “shared space” represents the antithesis to traffic calming, and yet, both share the ultimate goals of slower vehicle speeds and reduced accidents. With shared space, all physical differentiation between car space and pedestrian space is removed (Figure 13.31).

In shared space, the roadway is designed to look not like a road but like a public plaza where motor vehicles do not belong, sending a visual signal to motorists that they are in a space not intended for high speeds. Often, simply redesigning a street to look like a pedestrian zone alone, with no restrictions on motorist access,

Fig. 13.31
Shared space concept as applied in Guangzhou.

Photo by Karl Fjellstrom



Fig. 13.30
A fence in the centre of the road keeps drivers from swinging wide during a turn in Shenzhen (China).

Photo by Michael King

will fundamentally change driver behaviour in this environment. In such an environment, neither pedestrians nor motorists have explicit signage to dictate who has priority. People must resort to eye contact and other forms of subtle communication to navigate the roadway.

Whereas traffic calming might put traffic lights at every intersection and remove all green-waving to force vehicles to stop at every intersection, shared space removes all the traffic signals. When the driver does not have a clear right-of-way at an intersection, in most cases they will instinctively slow down. The end result is that motorists naturally reduce speeds in order to engage in a subtle communication process with pedestrians and other motorists. In other words, there are no lane markings, crosswalks, signals, or curbs. For many, the idea of shared space seems counter-intuitive: “Build roads that seem dangerous, and they’ll be safer” (McNichol, 2004). The idea is that the lack of signage and road markings increases the uncertainty for motorists, who will then be more cautious within an undefined road environment. Through intrigue and uncertainty motorists become more engaged in their surroundings (Engwicht, 1999).

By eliminating specific designations for motorised road users the total amount of usable public space for non-motorised transport increases.



Fig. 13.32
Alameda Jimenez in Bogotá only allows BRT and non-motorised access.

Photo courtesy of Diego Velazquez

Vehicles still use the street, albeit at a slower speed. Moreover, since driver speed is entirely self-enforced, shared space can be seen as the ultimate form of context sensitive design. Drivers' speed is determined not by arbitrary speed limits, but rather the presence of pedestrians, cyclists and public furniture in the "roadway".

The origins of shared space are attributed to Hans Monderman of the Netherlands who has taken his designs to roadway intersections of such Dutch cities as Drachten and Oosterwolde. In a short amount of time, these concepts have made their way to a variety of other locations including Christianfield in Denmark, Wiltshire and Suffolk in the UK, and West Palm Beach and Cambridge in the US. In each case, improvements in safety have been recorded.

Shared space along a BRT corridor is closely related to the transit mall concept introduced in Chapter 5 (*Corridor selection*). The BRT vehicle intermingles in an undefined space with pedestrians and other non-motorised users. The sharing of space will likely affect public transport vehicle speeds. However, this concept is successfully utilised along the corridors such as "Alameda Jimenez" in Bogotá (Figure 13.32). Shared space is also found along the central bus routes of Biel (Switzerland) (Figure 13.33).

Shared space is also relevant to BRT in the context of safe routes to accessing stations.



Pedestrian corridors connecting to the station can benefit from an application of shared space, which will reduce speeds of private motorised vehicles and thus encourage more persons to utilise the public transport system (Figure 13.34).

13.2.5.4 Reducing exposure risk

Expanding protected pedestrian space to reduce exposed walking time

Minimising the amount of time a pedestrian is exposed to traffic greatly reduces the risk of accidents. There are a few fundamental ways to reduce exposure risk when crossing the street.

The time it takes a pedestrian to cross a street is a function of the width of the road and the

Fig. 13.33
Public transport, pedestrians, and cyclists amicably share space in Biel (Switzerland).

Photo by Lloyd Wright

Fig. 13.34
As this image from Copenhagen illustrates, a shared space environment can make for a safe corridor for accessing public transport.

Photo courtesy of Cara Seiderman





Fig. 13.35
Authors successfully testing an abandoned toll plaza on a high speed road in Guangzhou as a possible safe pedestrian crossing for a very wide high speed road.

Photo courtesy of ITDP

distance between pedestrian refuge points. The greater the distance between pedestrian refuge islands, the longer the pedestrian is exposed to risk from oncoming vehicles. The more lanes a pedestrian must cross, and the wider the lanes, the greater the time of exposure. Many measures to increase pedestrian safety focus on expanding the amount of road space that can be used as pedestrian refuge islands in order to reduce pedestrian exposure time.

In an extreme example to illustrate the point, if a one-metre wide pedestrian refuge island is built between every lane, and at that point the lanes are narrowed from say 3.5 to 3 metres, pedestrians can cross even extremely wide extremely high speed roads in reasonable safety.



Most intersections and road links have a lot of space that is not actually used by through traffic. This lack of use is generally visible from dust collecting on the road, or by the occupation of the space by vendors, illegally parked vehicles, refuse, etc. Building pedestrian refuge islands in all locations where space is available within an intersection that is not absolutely needed for traffic throughput will not only regulate vehicle behaviour to make it more predictable but also significantly expand the amount of space where pedestrians can take refuge.

The roadway can be narrowed, either entirely or at specific points via curb extensions. Pedestrian refuge islands can be added or extended, permitting pedestrians to wait in the middle of the street (Figure 13.36).

While removing free right (or left) turns and slip lanes all together is ideal for pedestrians, sometimes traffic volumes do not permit this. As an alternative, building a pedestrian island and tightening the turning radius can slow turning vehicles at slip lanes and access ramps while reducing the distance pedestrians must cross to reach the other side of the road safely. In such cases, a “pork chop” slip lane design will force vehicles to slow down where they enter the oncoming traffic, just at the point where pedestrians need to cross (Figure 13.37). Coupled with an elevated crosswalk, this slip lane can significantly improve an intersection’s pedestrian safety.

Figure 13.38 shows an intersection on the Transjakarta BRT Corridor I before the busway was built. Existing crossing facilities for pedestrians were of poor quality. A pedestrian overpass some 50 metres from the intersection was available, but it was steep, narrow, poorly maintained, and virtually unused. Field observations showed that much of the roadway was not actually utilised for through traffic but rather for idling paratransit, illegally parked vehicles, and street vendors. Project consultants recommended at-grade

Fig. 13.36
A redesigned intersection in Mexico City for safe BRT access. The medians have been extended into the intersection to reduce turning speeds and provide more pedestrian refuge, and crosswalks brought into line with actual observed pedestrian movement.

Image courtesy of ITDP

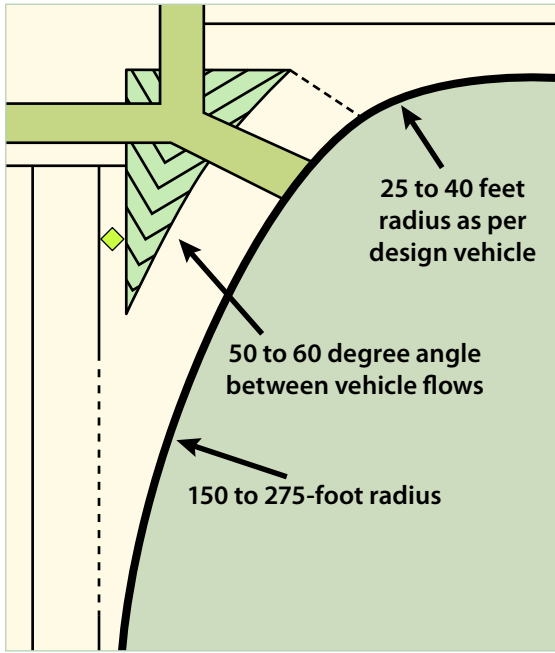


Fig. 13.37
A pedestrian island in conjunction with a tightened turning radius can do much to benefit pedestrian safety.
 Image courtesy of ITDP

access to the TransJakarta station with a significantly redesigned intersection that dramatically increased the amount of space dedicated to pedestrian refuge islands (Figure 13.39) without impeding traffic throughput.

On arterials with great distances between intersections, it is common for pedestrians to cross at random points along the corridor. The median

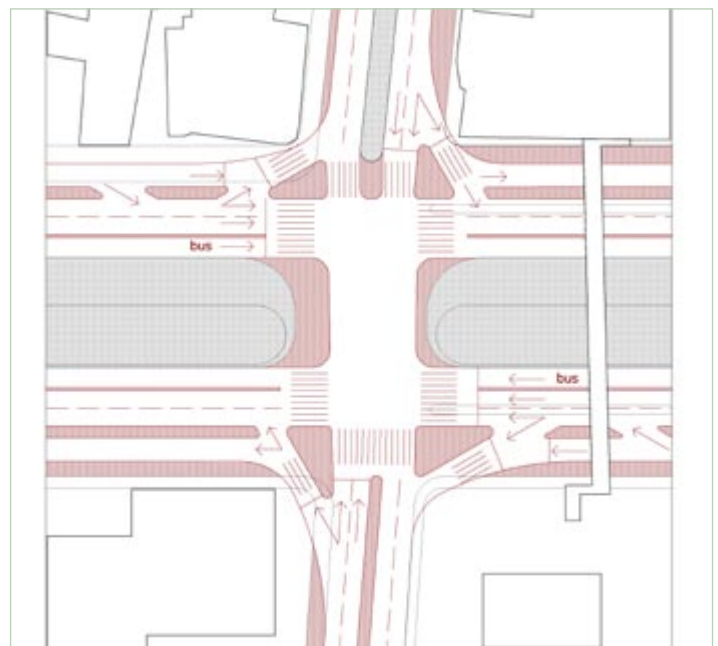
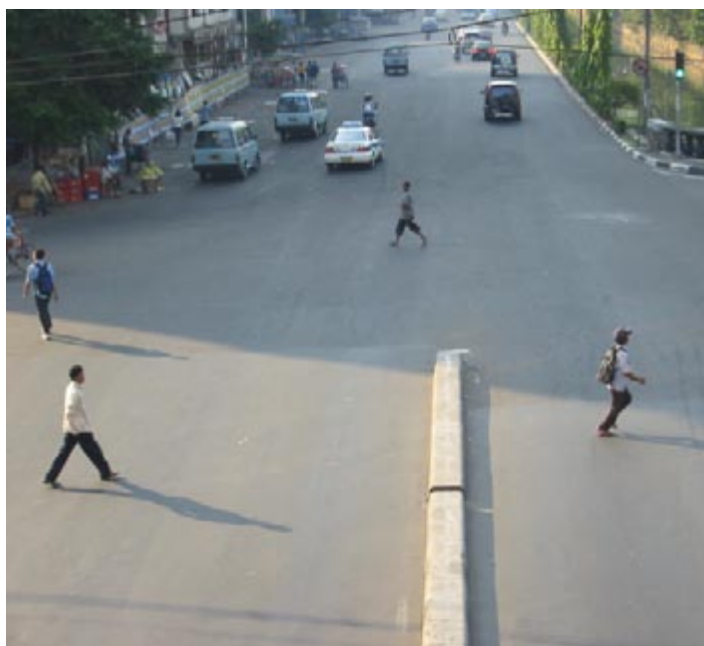
used to separate the BRT bus lanes from the mixed traffic lanes can also be used as an additional pedestrian refuge island. In the new BRT system being designed for Dar es Salaam, the entire corridor will use the separator median as a pedestrian refuge (Figure 13.40). As a result, pedestrians along the BRT corridor will only have to cross a maximum of two lanes at any given point.

Separating pedestrians and motorists through turning restrictions and signal timing

Pedestrian exposure can also be reduced by separating the use of the road in time through turning restrictions and signal phasing. Free right and left turns improve vehicular travel times but they are very dangerous for pedestrians, and induce additional delay for pedestrians. To optimise the intersection, the vehicular turning volumes should be weighted against the pedestrian volumes and the level of accidents at the intersection. If turning volumes are relatively low and pedestrian volumes and accidents are high, free right and left turns should be restricted. Simplifying the intersection from three or four phases to two phases will also help simplify turning movements and allow pedestrians to face fewer turning conflicts during the green phase of a traffic light.

A novel technique to reduce pedestrian exposure at intersections is the leading pedestrian interval (LPI). An LPI re-times the signal phasing so that a pedestrian-only phase begins

Fig. 13.38 and 13.39
A poor-quality intersection prior to the development of the TransJakarta BRT system (left photo). A potential solution to this intersection includes the introduction of pedestrian islands (right image).
 Photo and image courtesy of ITDP



a few seconds before the vehicular phase. Typically, this permits a pedestrian to get halfway across the street and establish presence in the crosswalk before vehicles start turning, thus increasing the chance that drivers will yield as required. Figure 13.41 shows the pedestrian phase of an LPI. Figure 13.42 shows the pedestrian plus vehicle phase, at which time all of the pedestrians have cleared the intersection.

An analysis of 10 years of crash data from New York City shows that intersections with LPIs have 26 percent fewer pedestrian injuries and those injuries are 36 percent less severe (King, 1998). Data from San Francisco (USA) show that 89 to 98 percent more drivers yielded to pedestrians after LPIs were installed (Fleck, 2000). Data from St. Petersburg (USA) show that 95 percent more drivers yielded to pedestrians after LPIs were installed (Van Houten, 2000). LPIs are relevant to BRT in situations where customers are accessing the median public transport station from an at-grade crosswalk located at an intersection.

Separating pedestrians and motorists through grade-separation

One of the most controversial aspects of BRT planning is how to get pedestrians to a BRT station in the middle of the road safely without significantly compromising mixed traffic flow. Though accessing a BRT station in the road median can be a challenge, it is no more challenging than getting pedestrians across the street safely. The most significant BRT access decision is typically whether to utilise at-grade crossings (street level crosswalks) or grade-separated infrastructure (overpasses or tunnels). Crossing at-grade over multiple traffic lanes with no pedestrian refuge islands is often unsafe and may be a psychological disincentive to using the BRT facility. By contrast, with grade separation, the exposure risk to pedestrians is effectively minimised. Grade-separated crossings also incur fewer delays to the BRT system itself due to customer entry. Grade separation can be done by forcing pedestrians to use overpasses or underpasses, or it can

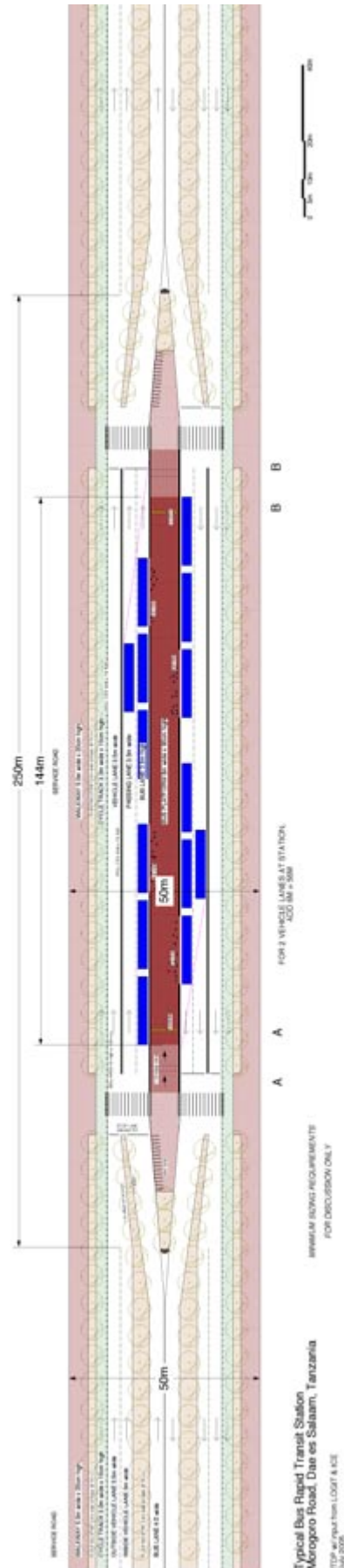


Fig. 13.40
The Dar es Salaam BRT system will include a median strip that will double as a pedestrian island, facilitating safer crossings for all pedestrians.

Image courtesy of the Dar es Salaam City Council



Fig. 13.41 and 13.42
Pedestrian and vehicle phases of a leading pedestrian interval (LPI) in New York City.

Photos by Michael King

be done by forcing the road to pass under or over an at-grade pedestrian crossing.

In general, pedestrians prefer at-grade crossings due to the directness of the access and the inconvenience of climbing up stairs or ramps (Figure 13.43). Elevators, escalators, and ramps with a low gradient partially mitigate the problems with grade separation. Further, there can be safety and security issues related to overpasses and tunnels. Pedestrians, and especially women, often feel vulnerable walking along overpasses and tunnels. The narrow confines of these spaces and infrequent usage mean that criminals have greater opportunities

for theft and assault. Overpass and underpass walkways which are more heavily utilised are also frequently infringed upon by informal vendors, which further narrows the space and slows walking speeds (Figure 13.44). Poorly maintained infrastructure with graffiti and litter will discourage potential customers from utilising the public transport system. If the overpass or underpass requires walking up and down stairs, then many individuals will simply not be able to make use of the infrastructure (Figure 13.45). The physically disabled, elderly, and parents with strollers will essentially lose access to the public transport system.



Fig. 13.43
Due to their ease of use and directness, at-grade crossings are almost always the preference of customers.

Photo by Lloyd Wright

Fig. 13.44
A pedestrian bridge in Dhaka (Bangladesh) is crowded with vendors, and thus limits and discourages passenger use.

Photo by Lloyd Wright

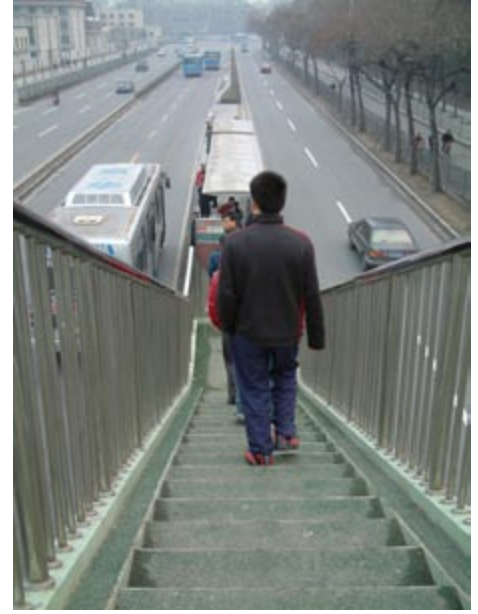


Fig. 13.45
A steep, narrow stairway in Beijing makes for poor accessibility to the busway.

Photo by Lloyd Wright

Pedestrian overpasses in the absence of a BRT system are frequently underutilised because it is frequently much faster to cross at grade and because users feel vulnerable to criminal activity. Studies indicate that as the additional time required by an overpass approaches 50 percent longer, almost no one will utilise it. Usage of underpasses (tunnels) was even less (Moore and Older, 1965). While grade-separated infrastructure is often built under the pretence of pedestrian “safety”, in reality, roadway engineers

Fig. 13.47
With traffic stopped at a signal crossing in Jakarta, pedestrians find it easy to cross without use of the overpass.

Photo by Walter Hook



Fig. 13.46
This overpass in Mexico City is virtually ignored as most pedestrians choose to cross directly.

Photo by Michael King



may simply want to give priority to motorised vehicles over persons (Figure 13.46 and 13.47).

However, there are conditions where vehicle topography, vehicle speeds and traffic levels make grade separation a reasonable option. If a closed BRT system can only be accessed from a pedestrian overpass, at least the BRT passengers will use the overpass. This usage alone will guarantee a certain minimum amount of traffic, which will reduce the feeling of insecurity to criminal activity. If the median station is flanked by high-volume, high speed multiple lane expressways far from any intersections, then the constant flow of high speed vehicles will be almost impossible to cross. Adding a signalised pedestrian crossing phase mid-block on such a facility may not be respected by motorists, creating unsafe conditions. In such circumstances, an overpass or underpass can be a reasonable option. Further, with high quality design standards and reasonable gradients, many of the problems of grade separation can be overcome. The conditions that may imply the need for grade-separated access to a median BRT station include:

- Three lanes or more of traffic to cross per direction without pedestrian refuge islands along a high-volume and high-speed arterial or expressway (Figure 13.48) ;

- Connecting an underground subway station to a median BRT station (a tunnel will be most effective in this situation);
- Overpass or underpass leads directly to a high-demand destination such as a sports facility, school, or shopping complex (Figure 13.49);
- Distance to nearest major intersection is far, so traffic flow is nearly constant;
- A culture of driving behaviour which does not respect traffic signals;
- If the street network funnels people to a bridge or tunnel, then they will be more inclined to use it.

While even in some of these situations there are frequently design solutions that could make at-grade crossing reasonably safe and feasible, pedestrian overpasses in these conditions are a reasonable option, and may even be preferred by pedestrians since it may reduce overall crossing time and improve the walking environment.

By contrast, the type of conditions that will favour an at-grade solution include:

- If the street has two lanes of less per direction, then an at-grade solution is almost always preferred;
- If traffic volumes are light and speeds are relatively slow (less than 40 kph);
- If there is a traffic signal within 200 metres of the crossing location, then gaps will be



Fig. 13.48
In conditions where the BRT station is in the median of a multi-lane expressway, Bogotá utilises a pedestrian overpass.

Photo by Lloyd Wright



Fig. 13.49
This elevated pedestrian passage directly links the Nagoya BRT system to the Nagoya Dome sports stadium.

Photo by Lloyd Wright

Fig. 13.50, 13.51, and 13.52

Bogotá utilises a variety of pedestrian access techniques, depending on the local circumstances.

Clockwise from top left:

1. At-grade crossing

Photo by Carlos F. Pardo

2. Pedestrian overpass

Photo courtesy of TransMilenio SA

3. Underground tunnel

Photo by Carlos F. Pardo



created in the traffic flow, and pedestrians will subsequently tend to eschew an overpass;

- If the network is more of a grid system with multiple paths, then people will want to cross the street as soon as they get to it.

A BRT system may use both at-grade and grade-separated solutions, depending on the local design and street features. Bogotá, in fact, uses multiple mechanisms to facilitate pedestrian access (Figures 13.50, 13.51, and 13.52).

Designing effective grade-separated infrastructure

The design of Bogotá's overpasses demonstrates how an effective grade-separated solution can be achieved. To enter the overpass, Bogotá provides a ramped entry with a sufficiently gradual slope to ease the climb. Passengers typically also have the option of a stairway if they wish to access the overpass more quickly. Utilising a 2.5 metre-wide pedestrian space and an open design, Bogotá's pedestrian bridges alleviate many of the security concerns normally associated with overpasses. The design is also quite aesthetically pleasing, which further enhances the overall image of the system. When designing grade-separated pedestrian access,

the following design considerations should be considered:

- **Illumination** – overpasses and tunnels should be well lit; otherwise, evening usage will fall dramatically;
- **Visibility** – There should be clear lines of sight between the bridge or tunnel, station and street; without clear sight lines, pedestrians will fear that criminals are lurking in hidden spaces;
- **Width** – Overpasses and tunnels should be wide enough to accommodate the peak hour number of people;
- **Ramps, escalators, or elevators** – The overpass or tunnel should be accessible to a person in a wheelchair, a parent pushing a baby carriage, someone with a bicycle or packages, or one who has trouble climbing stairs; if elevators are used, stairs must also be provided for circumstances when the lifts are not functioning;
- **Flood protection** – Tunnels must be supported by an effective drainage plan;
- **Vendors, graffiti, homeless, etc.** – If the bridge or tunnel is perceived as unsafe or unclean it will not be used, regardless of the design.

The aesthetic design of the pedestrian infrastructure will affect a system's overall image and therefore part of the system's ability to attract customers. If the access infrastructure looks pleasant and inviting, then more people will place confidence in the system. Figures 13.53 and 13.54 illustrate visually-appealing examples of overpass design.

Designing effective at-grade BRT access

Pedestrians need time to cross a road safely that is directly proportional to the width of the road.



Fig. 13.53
A park-like environment makes this pedestrian overpass in Guangzhou (China) more inviting.

Photo by Michael King

When the BRT station is at or near an intersection, pedestrians can cross with the rest of the traffic during the green signal phase. Measures suggested above for safe intersection design are generally applicable: elevating crosswalks across slip lanes to slow speeds, providing additional pedestrian refuge space, tightening vehicular turning ratios through “pork chop” slip lanes, extending medians, reducing the distance between curbs, etc.

Frequently, however, there are advantages of locating the station away from the intersection. This arrangement is generally done to avoid interference between public transport vehicles queuing to cross the intersection and public transport vehicles queuing to pick up and discharge passengers. Pedestrian facility designs for a mid-block BRT station have a few particular characteristics.

When the BRT station is mid-block, a few additional points need to be made. Pedestrian crossings mid-block are somewhat unexpected, so features which signal to the driver that they are approaching a pedestrian crossing are more important. A slow bump before the crosswalk will force motorists to slow down before they reach the crosswalk, rather than once they are already about to collide with the pedestrian. An elevated crosswalk will also help to slow the traffic down. Additional pedestrian refuge islands between lanes will further slow traffic



Fig. 13.54
The modernistic design of this pedestrian overpass in Seoul makes for a captivating sight.

Photo by Lloyd Wright

by narrowing lane widths while also reducing the pedestrian exposure time. Using different surface colours and textures will draw further attention to the motorists. Lighting at the crosswalk is important at night.

Several different types of signalling options may be employed at mid-block crossings. In some countries, where pedestrians only have to cross two lanes, and where speeds and vehicle volumes are not that high, no signals at all are necessary. With higher volumes and higher speeds, and more lanes, a simple flashing yellow signal is sometimes used to indicate that pedestrians have priority at all times (Figure 13.55). In this case, if a pedestrian appears on the sidewalk near a crossing, then motorists have the obligation of stopping, even if the pedestrian has not yet entered the crossing area. This approach has the benefit of not impeding traffic except when pedestrians need to cross. If pedestrian volumes are very high, this could have adverse effects on mixed traffic. The effectiveness of this approach will also depend on the local culture and the level of enforcement.

The signal can also be controlled by a request button on the sidewalk. In these instances, the cycle for vehicles will be shortened when a pedestrian activates the button. In developing countries, such signals have a high frequency of failure and sometimes are not respected by motorists.

As traffic speeds, volumes, and lanes increase, the need for standard red-yellow-green signals mid-block also tends to increase. Pedestrian

Fig. 13.55
In London, a pedestrian crossing with a flashing yellow light means that pedestrians have complete right of way.

Photo by Lloyd Wright



minimum green times for crossing roads are nearly proportional to the total width to be crossed. Traffic delay is roughly proportional to the amount of red signal time given to the mixed traffic. For mid-block signals, it is generally possible to only signalise the crossing for the mixed traffic lanes, allowing public transport vehicles to continue without a light. Pedestrians then cross the busway whenever a gap appears. At higher bus volumes, though, the public transport vehicles should also be controlled by a traffic signal. The mixed traffic signal will be a two phase signal and it should be timed to correspond to

the red and green time at the nearest intersection. In this way, most motorists will only have to stop once at either the pedestrian crossing or the intersection, but not twice.

Some cities have split the signal phasing for the pedestrian movements into two separate movements, one for each half of the road. In other words, instead of mixed traffic in both directions facing a red time of 40 seconds (green for pedestrians) to allow a full pedestrian crossing, two separate signals with 20 seconds of red time are utilised. Splitting the pedestrian crossing into two separate independent signals allows the lights to be adjusted to maintain a green wave on each direction, lessening the impact for general traffic. Figure 13.56 provides an illustration of this configuration.

However, by splitting the crossing, the planner is effectively giving priority to mixed traffic vehicles at the expense of pedestrian convenience. Forcing the pedestrian to wait through two separate signal phases can lead to higher levels of non-compliance and accidents amongst pedestrians, especially for pedestrians not entering the BRT system and simply wanting to cross the full intersection. The fences that attempt to force pedestrian behaviour are frequently disparaged as “cattle pens” due to the implicit priority the design gives motorists

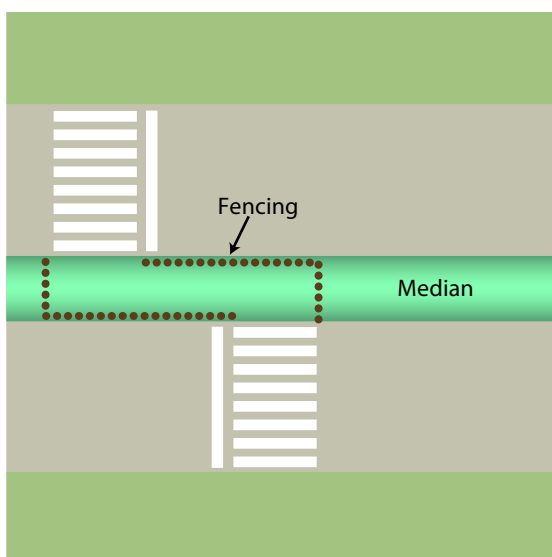


Fig. 13.56
Separating the pedestrian crossing into two separate phases may improve intersection efficiency for mixed traffic, but it may delay and frustrate pedestrians.

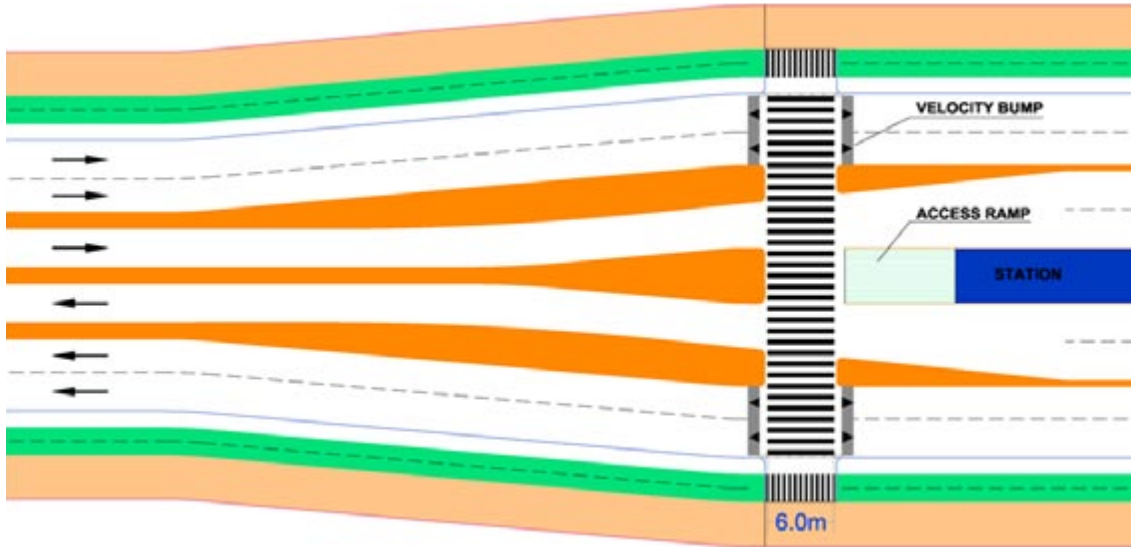


Fig. 13.57
 When passing lanes are required at stations, it is recommended to include pedestrian islands between the busway and mixed traffic lanes.

Image courtesy of ITDP

over the pedestrian. In many cultures and situations, pedestrians will attempt to run across the intersection rather than be forced to wait through two signal phases.

On BRT systems with very high demand (over 10,000 pphpd), an overtaking lane is required at each station in order to allow multiple stopping bays. The BRT system therefore will occupy more right-of-way throughout the length of the station, which may be as long as 200 metres. By simply extending this additional right of way by a few additional metres, (shown in orange in Figure 13.57) an additional pedestrian refuge island can be created between the BRT lanes

Fig. 13.58

This pedestrian crossing in León (Mexico) is 100 metres away from the BRT station, and thus will tend to encourage some persons to cross nearer to the station without a crossing.

Photo by Michael King



and the general traffic. This refuge allows pedestrians to cross only two lanes at any given time, instead of three. This island can be dimensioned to a convenient size for the projected passenger demand.

Finally, at-grade crossings should be placed as close to the station entrance as possible. Otherwise, customers may simply cross at an uncontrolled point closer to their intended destination. Figures 13.58 illustrates poorly placed crossings, in which the crossing is 100 metres away from the station. Passengers must walk 100 metres down the roadway and then 100 metres back to access a point that is actually less than 12 metres from their starting point. Figure 13.59 indicates the likely result of expecting the pedestrian to make a substantial detour. Quito's "Blue Heart" (Corazones Azules) programme places a blue heart in the street wherever a pedestrian has been killed. In the case of Figure

Fig. 13.59

These two "Blue Hearts" in Quito mark the spot where two pedestrians lost their lives while taking the most direct route to the BRT station.

Photo by Lloyd Wright



13.59, two different pedestrians were struck down while taking the most direct route to the Quito BRT station. Planners should strive to fully account for likely human behaviour whenever designing a pedestrian crossing.

13.2.5.5 Driver and pedestrian predictability

Promoting predictable pedestrian and motorist behaviour at stations

Station areas are prone to unpredictable pedestrian behaviour as customers have a tendency to run to catch an approaching bus or train without paying close attention to signals (Figure 13.60). Motorists may not be expecting this type of pedestrian movement, particularly in mid-block locations. Motorists may also not be expecting traffic lights at mid-block. At intersections, complex and badly timed turning movements sometimes give pedestrians the false security of a crossing light precisely when left turning vehicles are dashing across the crosswalk with their attention focused on the oncoming traffic. Counter-flow bus lanes may also confuse pedestrians and motorists. Thus, unpredictable movements often carry with them lethal consequences.

Pedestrian violations of crossing at red signals can best be avoided by timing the traffic signal to provide more frequent, shorter cycles. The likelihood of compliance with pedestrian signalisation falls greatly if wait times exceed 30 seconds (Table 13.3). In a similar fashion, elevators are generally designed so that people do not have to wait more than 30 seconds. The concept of pedestrian delay applies primarily to traffic signals, but also to gaps in traffic and to crosswalk location. Where there are no signals,

pedestrians generally must wait for a “gap” in traffic to cross the street. If the flow of traffic is so great that sufficient gaps are not available, then the person afoot will attempt to cross the street dangerously.

Table 13.3: Pedestrians Patterns per Delay (TRB, 2000)

Pedestrian Delay (seconds)	Likelihood of Non-compliance
<10	Low
10–20	
21–30	Moderate
31–40	High
41–60	
>60	Very High

Some physical barriers to inhibit this movement can also be used. Driver unawareness of mid-block pedestrian crossings can best be avoided by combining the mid-block crossing with clear signals, traffic calming measures like speed bumps, as well as vivid visual clues. Pedestrian conflicts at intersections can best be mitigated



Fig. 13.60
In Quito, customers rushing to catch a bus are at risk from passing motorists.

Photo by Lloyd Wright



Fig. 13.61
This BRT identification post in Quito is placed in a pedestrian island, and acts to block the pedestrian’s view of both oncoming mixed traffic as well as oncoming BRT vehicles.

Photo by Lloyd Wright



by simplifying the turning movements to two or three phases, restricting free right or left turns where possible, including slip lanes where possible, and using the physical measures described above.

Sight lines and visibility

The areas to the side of the roadway should allow for clear visibility, so that the sight lines of both pedestrians and vehicle users are unimpeded by signage or vegetation. Often, street landscaping is the focus of landscape architects who pay little attention to the median or the side of the road as a place for pedestrians, and place plants along the roadway that fully obstruct pedestrian sight lines. Likewise, signage from the BRT system should be carefully placed to avoid obstructing pedestrian sight lines (Figure 13.61).

The crossing’s painted surface should be highly visible and well maintained. Luminescent paints or reflectors can provide additional visibility for evening hours. Additionally, high illumination street lighting should be placed over the crossing area. In contrast, signage and advertisements can create an area of visual clutter that will distract motorists from seeing traffic signals and pedestrians properly, and should be avoided to the extent possible.

Figures 13.62 and 13.63 illustrate the value of good illumination. In the case without illumination, drivers cannot tell if there are people waiting on the pedestrian island, which makes it nearly impossible to predict what is going to happen.

13.2.6 Pedestrian level of service

”All walking is discovery. On foot we take the time to see things whole.”

—Hal Borland, author, 1900–1978

Walking in the right environment can be more than a means of going from one place to another; it can also be a desirable activity for its own sake. Much can be done to improve the quality of the walking environment that will simultaneously encourage people to use public transportation.

13.2.6.1 Effective width of footpath

Starting with the basic pedestrian facilities audit described previously, a more detailed audit will note each obstruction found along the footpath as well as record the remaining width. Figure 13.64 shows an audit sketch of a footpath in Bangkok. While the footpath itself is 5 metres in width, many obstructions line the route. These obstructions include signage, utility boxes, bus stands, telephone booths, stairways, and poles. Due to the presence of these obstructions, the “effective width” of the footpath is just 1.4 metres.

The notion of effective width is central to footpath usability. The effective width affects issues

Fig. 13.62 and 13.63
Pedestrian refuge island, with and without lighting, Guangzhou.

Photos by Michael King

Fig. 13.64
An audit of this footpath in Siam Square, Bangkok, indicates that obstructions have reduced the effective width from 5 metres to less than 1.5 metres.

Image courtesy of the Bangkok Metropolitan Administration

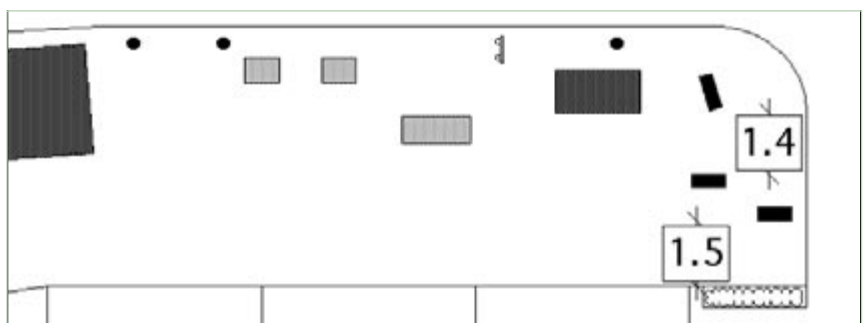




Fig. 13.65
This footpath in Rio de Janeiro provides ample space for high pedestrian volumes.
 Photo by Michael King



Fig. 13.66
These steps in Brasilia (Brazil) reduce the effective width of the footpath to less than 0.5 metres.
 Photo by Michael King

such as footpath capacity, pedestrian comfort, and personal security. Figures 13.65 and 13.66 give two different examples of effective width.

13.2.6.2 Walkway level of service

Just as a public transport corridor is designed to handle a particular passenger volume, a pedestrian corridor also possesses an inherent capacity. During peak periods, pedestrian path volumes can easily be reached. If pedestrian conditions become too closely packed, then the desirability of walking is compromised. Such conditions will delay overall travel times as well as create the opportunity for crime such as pick-pocketing.

Walkway level of service (LOS) is a scaled measurement which quantifies the flow of pedestrians in a given walkway width. It is most applicable to footpaths, corridors and bridges with high pedestrian volumes where the essential concern is the provision of sufficient space. Calculating LOS requires two inputs: effective width and number of pedestrians per hour. A

pedestrian facility provides a high LOS if few pedestrians are present.

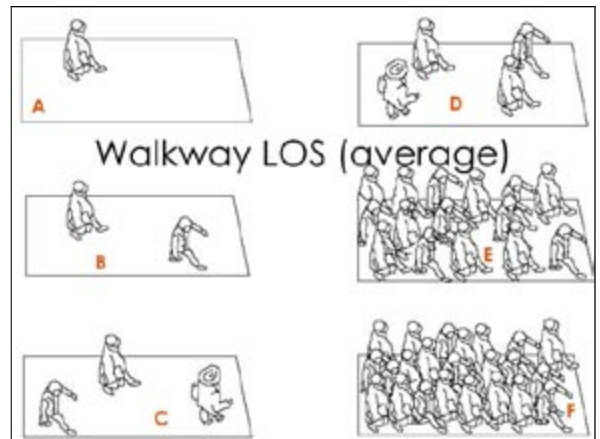
Figure 13.67 visually shows the range of area needed per person under average and platoon conditions. Platoons are created when a group of pedestrians is released en masse by crosswalk signals, public transport doorways, or other temporal displacements. A platoon of walkers requires more space than if the same number of people were spaced evenly throughout a footpath. When two platoons meet each other, as in a crosswalk, the spatial requirements are even greater.

Box 13.3 outlines a methodology for determining a broader “pedestrian level of service”. These types of methodologies can be useful as checklists for ensuring all relevant design factors are considered.

Fig. 13.67
Walkway area as a function of pedestrian volume.
 Source: TRB (2000)

Walkway LOS		
	Average	Platoon
A	> 5.6	> 49.2
B	> 3.7 - 5.6	> 8.4 - 49.2
C	> 2.2 - 3.7	> 3.7 - 8.4
D	> 1.4 - 2.2	> 2.1 - 3.7
E	> 0.7 - 1.4	> 1.0 - 2.1
F	≤ 0.7	≤ 1.0

square meters per person



Box 13.3: Pedestrian level-of-service model

The city of Kansas City (USA) has developed a pedestrian LOS model based on five specific measures: Directness, continuity, street crossings, visual interest and amenity, and security. The five measures essentially ask five questions:

1. Does the pedestrian network provide the shortest possible route to the transit facility?
2. Is the pedestrian network free from gaps and barriers?
3. Can the pedestrian safely cross streets?
4. Is the environment attractive and comfortable, offering protection from harsh conditions?
5. Is the environment secure, well lit with good line of sight to see the pedestrian, and far away enough from vehicular traffic to provide a feeling of safety?

While Kansas City developed these measures for citywide use, the points below are tailored for use in station access planning.

- **Directness:** The measure of directness is simply how well key destinations (e.g., schools, parks, commercial centers, or activity areas) are connected to the transit facility via the pedestrian network. The directness LOS is based on a ratio of the actual distance and minimum distance between two points. To determine the Directness Ratio, measure the actual distance between a representative key destination and the transit facility and divide it by the minimum distance between those two points.
- **Continuity:** Continuity is the measurement of the completeness of the pedestrian network with avoidance of gaps and barriers. The measure considers not only accessibility for the physically disabled, but also the condition of

the pedestrian pathways and whether there are barriers in the pathway (i.e., light poles in sidewalk, newspaper vending machines, etc.). This measure requires a field survey of the most logical routes to the transit facility from key destinations.

- **Street crossings:** This is the measurement that predicts how easy and safe it will be for a pedestrian to cross various types of streets with various street crossing and intersection designs to reach a transit facility based on Pedestrian Level of Service (LOS). The Pedestrian LOS is dependent on the type of crossing, the number of lanes to cross, lane widths, parking lanes, travel speed and the presence or lack of attributes listed above. As design elements and features are reduced, parking lanes exists, higher speeds are estimated, and/or additional lanes to cross are increased, the LOS is reduced. Some of the key measures of a crossing's effectiveness include:
 - How many lanes must the pedestrian cross to reach the transit facility?
 - Are the signals easily visible to the pedestrian and the motorist?
 - Is the intersection and crosswalk well lit so that the pedestrian is visible (to motorists) at night?
 - What are the walk-times (if any) for each phase?
 - Are median refuge areas available?
 - Are there any amenities, including signing and design features, that strongly suggest the presence of a pedestrian crossing?
 - What are the intersection's sight distances? Sight distance measures the unobstructed view between the motorist and the pedestrian.

13.2.7 Designing for ease of access

“The sum of the whole is this: walk and be happy; walk and be healthy. The best way to lengthen out our days is to walk steadily and with a purpose.”

—Charles Dickens, novelist, 1812–1870

A well-designed network for public transport access will encompass both a routing strategy and attention to design detail. As stressed in this chapter, the public transport corridors should extend from the stations well into the communities themselves. A few metres of quality

infrastructure around the public transport station do little to attract customers from their homes and offices.

Simple design features such as vegetation, water, pavement tiles, and covered pedestrian walkways can add much amenity value to the customer. Addressing these details is a relatively small investment in comparison to the total investment for the BRT system. However, providing a safe, attractive, and convenient pedestrian environment can deliver significant benefits in terms of customer satisfaction and total ridership.

13.2.7.1 Pedestrianised zones

Pedestrianising pathways leading to the public transport system can be part of a mutually beneficial strategy for both public transport and public space. A pedestrian zone, especially in city centre locations, can do much to concentrate large numbers of customers towards the BRT system. In Curitiba, the central pedestrianised areas lead directly to BRT stations (Figure 13.68).

The public transport system likewise supports the feasibility of pedestrian areas by reducing the demand for city centre parking. Without a high-quality public transport system, it is much more difficult to cater the both space for full pedestrianisation and car access to parking facilities.

13.2.7.2 Covered pedestrian walkways

Some cities now are providing low-cost, covered pedestrian walkways in order to eliminate the disincentive that the weather can bring to walking and cycling. In cities with extreme heat, covered walkways can reduce temperatures by 5 to 8 degrees Celsius, and thus make the difference to the viability of comfortably reaching a BRT station.

13.2.7.3 Urban context

Beyond the technical assessments described above, planning a BRT station requires an understanding of how it fits within the urban context. Key factors which influence the viability of

a station include flow, conflicting movements, and detours. An additional element of context is the pattern of land uses surrounding a BRT station, to which the traveller may want to access (the goal of the trip). Historically, segregated land uses were favoured in order to minimise conflicts. Such land-use patterns reduce the opportunities for access, forcing residents to drive to many individual destinations to run errands, attend school or find work. Instead, more mixed land use provides more concentrated origins and destinations, which can be served by a BRT station within walking distance.

Context should also include acknowledgment that many of these factors may be perceived and not actual. Even if a factor is only perceived, the resulting impact will limit the effectiveness of the BRT station.

The documentation of context will be necessarily qualitative. For example, if system users can see the BRT station across a plaza or large street, they will want to find the shortest route there. However, if the paths are organised such that the station is not visible until it is directly accessible, then they will be less likely to take a detour. However, placing the station in a prominent, more visible location will increase its presence, security and use. Ultimately one needs to have a good understanding of human travel characteristics when discussing pedestrian routes to a BRT station (Gehl, 1971).



Fig. 13.68

The pedestrian mall in Curitiba leads directly to the BRT stations.

Photo by Lloyd Wright



Fig. 13.69

As this example from Panama City illustrates, covered pedestrian walkways help to dramatically reduce pavement temperatures and thus make walking more comfortable.

Photo by Lloyd Wright.

13.2.8 Accessibility

“Some do not walk at all; others walk in the highways; a few walk across lots.” (from “Walking”)

—Henry David Thoreau, author and naturalist, 1817–1862

Accessibility refers to the user friendliness of the system from the perspective of the most physically challenged customers. Designing from the perspective of a parent with a stroller, a child, a senior, or a physically-disabled person can result in good design for everyone. The dominant considerations in accessibility design are overcoming physical barriers, avoiding excessive volumes which may impede timely access, providing a safe route, and minimising conflicts and detours. Accessible design does not end at the station door. There is little value in making station platforms and public transport vehicles friendly to the physically disabled if it is impossible for those individuals to reach the stations in the first place.

Universal design especially helps those with physical, sensory, and cognitive disabilities. Tourists, visitors, and first-time users in effect have cognitive disabilities as have difficulty understanding signs, layout, etc.

13.2.8.1 Customers with limited mobility

The key to providing accessibility to physically challenged customers revolves around providing

a level, consistent, and reliable access way. Designing appropriate infrastructure is increasingly being inscribed into law, even for developing-nation cities. While the field of accessibility is still growing, there are some key documents that can help cities with correct design (Rickert, 2006; Venter *et al.*, 2004; Rickert, 2003; Alvarez and Camisão, 2005). This section summarises some of the best practice recommendations developed to date.

For customers using a wheelchair, the Americans with Disabilities Act (ADA) prescribes an effective Paved Accessible Route (PAR). The PAR refers not just to a footpath or an individual walkway, but the entire system providing accessibility to all destinations. Table 13.4 summarises PAR recommendations for walkways and street crossings (Access Board, 2005). The recommendations can also be applied to interior space design issues, such as the width of turnstiles and other access points.

Figure 13.70 shows a good, accessible route to transit. Systems designed to these standards are not only useful to the physically disabled but also to the elderly and parents with strollers (Figure 13.71).

Curb ramps are a basic and yet essential infrastructure component for making public space and public transport more accessible to the physically disabled. The ramps should provide a reasonably gentle gradient to ease usage. Table

Table 13.4: Recommendations to accommodate customers with limited mobility

Factor	Recommendation
Walkways	
Access width	Minimum of 1.2 metre, although it is best to double this width to provide enough clearance for two wheelchairs to pass each other.
Surface	Surface should be stable and firm, and consist of slip resistant material.
Surface transitions	Transitions from ramps to planes should be flush; “Lippage”, or changes in elevation that are vertical, may not exceed 6.5 mm.
Vibrations	Materials should be smooth to minimise vibration
Grades	At existing planes with grades of more than 11 percent, a level strip should be provided to serve as a site-specific leveller.
Cross slopes	Cross slopes should be consistent (i.e., planar) and should not exceed 2 percent.
Obstacles	Obstacles, including grates, access covers, poles, parking metres, and bike racks, should be kept out.
Cracks	Maximum width of cracks: <ul style="list-style-type: none"> • 6.5 mm if vertical, 13 mm if bevelled; • Openings may not exceed 13 mm horizontally; • Must be at least 0.75 m between two horizontal planes; • Over 13 mm must be 1:12, like a ramp.
Crossings	
Curbs	Curbs along the pedestrian route to the transit station should all be ramped.
Corners	Corners should include small curb radii, to maximise visibility of pedestrians to turning drivers.
Ramp slope	The maximum slope of a ramp should be 1:12 and ramp runs should be straight.
Ramp direction	Ramps should be located directly adjacent to crosswalks to avoid the need for turns once a wheelchair is in the street.
Ramp location	Curb ramps should be located within crosswalks, i.e., within the marked pedestrian crossing.
Ramp foot	Include a level area at the foot of the ramp to avoid water from pooling.

Fig. 13.70
Level surfaces can greatly increase the accessibility of transit stations for those with physical disabilities.

Photo courtesy of Queensland Transport (Brisbane, Australia)



Fig. 13.71
Designing for the physically disabled also helps families with strollers and others carrying bicycles or large packages.

Photo by Carlos F. Pardo

13.5 summarises recommended ramp gradients and their associated appropriate uses. In general, a curb ramp should be the same width as the given pedestrian crossing (Rickert, 2006). A narrow ramp could force a disabled user to be unable to complete the crossing. A steep ramp can effectively make it unusable to a person in a wheelchair. Curb ramps should also include protective warning strips that advises users of the ramp's presence and the transition to the roadway.

All physical infrastructure should be designed with the physically disabled in mind. Station and vehicle entry points are critical as well as use of any fare collection equipment. Fare purchasing counters, fare vending machines, fare readers, and turnstiles should consider the usability for persons in a wheelchair. Rickert (2006) recommends the following structural dimensions for counters in order to be wheelchair friendly:

- 800 mm in height;
- 500 mm deep;
- 900 mm wide;
- 1,200 mm of clear space in front.

This Guidebook has stressed the preference for simple platform transfers rather than requiring customers cross intersections, overpasses,

Table 13.5: Ramp gradients and recommended uses

Ramp gradient	Recommended use	Maximum horizontal length
10% (1 in 10)	Very short distances only	1 metre
8% (1 in 12)	Most curb ramps	2 metres
5% (1 in 20)	Ideal gradient	10 metres

Adapted from Venter *et al.*, (2004) in Rickert (2006)

or tunnels in order to go from one route to another. This preference carries obvious advantages for the physically disabled who would otherwise require special infrastructure to make any grade-separated transfer happen (Figure 13.72). If grade separated transfers are required, then appropriate mechanisms must be put in place to make such transfers feasible and comfortable for the physically disabled. Elevators are perhaps the most convenient option, although breakdowns and initial costs do not make elevators the perfect solution (Figure 13.73). Often it is best to have another alternative. Ramps with gentle gradients are a solid secondary option in such instances. In some systems a movable platform can facilitate the movement of the disabled up a conventional set of stairs (Figure 13.74). Ideally, such a device can be operated independently by the customer since otherwise long waits for assistance from station personnel can be frustrating for users.



Fig. 13.72
The level station floors and platform transfers in Bogotá make it easy for anyone to move from one route to another.

Photo by Carlos F. Pardo

Fig. 13.73 and 13.74
If grade separated transfers across an intersection are necessary, then infrastructure must be available to make such transfers possible. Elevators as in Bogotá (left photo) and movable platforms as in Seoul (right photo) are two of the options.

Photos by Lloyd Wright



However, such devices are susceptible to mechanical breakdown and must be carefully monitored and tested.

Vehicle design is also an area that requires special focus on accessibility issues. The vehicle's entry points and interior design are particularly crucial in user-friendliness for the disabled.

As noted earlier, gaps between the vehicle and station platform can dissuade usage for those with wheelchairs and others. A boarding bridge as utilised in cities such as Guayaquil and Quito

can be quite beneficial in ensuring easy and safe entry for all.

Most high-quality BRT systems utilise at-level boarding for their trunk corridors (Figure 13.75). Other systems, such as the Kunming system, ply standard stepped vehicles on their principal busways (Figure 13.76). The result is

Fig. 13.75
In cities, such as Bogotá, platform level boarding on trunk corridors makes boarding and alighting easy for those in wheel chairs.

Photo courtesy of TransMilenio SA



Fig. 13.76
Stepped entry into the Kunming BRT system limits who can make use of public transport.

Photo by Lloyd Wright





Fig. 13.77
A manually operated ramp extended from the bus provides access for wheelchair users.

Photo courtesy of City of Seoul

that the system is largely unusable to sectors of the community who cannot rapidly manage the series of steps for boarding and alighting.

While BRT trunk corridors typically ensure easy vehicle entry with platform level boarding, feeder vehicles almost always utilise standard stepped-entry vehicles. Thus, despite the good design for accessibility in principal corridors, many parts of BRT systems remain off-limits to those who cannot easily access a standard bus. However, there are some solutions that can make feeder vehicles more amenable to the physically disabled. One option is to utilise low-floor vehicles for feeder services. Low-floor vehicles ease entry for a great number of persons as well as can be combined with a manual ramp to even permit wheelchair entry (Figure 13.77). Special suspension systems, known as “kneeling” vehicles, lower the vehicle close to the curb to further reduce the size of the step.

Another alternative is a higher-floor vehicle with a flip-out boarding bridge (Figure 13.78). While this device does not facilitate wheelchair entry, it does make boarding somewhat easier for the elderly and others who find steps difficult.

However, whenever external interventions are required, such as the driver manually pulling out a ramp, the disabled individual is dependent upon others. Likewise hydraulic lifts are a solution for feeder vehicles that do not have low-floor access, but the operation of the device



Fig. 13.78

In Nagoya, a feeder vehicle equipped with a flip-out boarding bridge does make boarding easier for many customers.

Photo by Lloyd Wright

requires a disruption of the entire service (Figure 13.79). The action of the driver walking to the doorway and manually operating the ramp will create delays for all passengers. This situation can make physically disabled persons feel quite different from others as well as creates feelings of being a burden to the other waiting passengers. For these reasons, entry systems, such as platform level boarding, that give the physically disabled complete independence are much preferred. Creating an environment in which the physically disabled can access the system in the same manner as anyone else is the best solution for everyone.



Fig. 13.79
A special lift allows access for a wheelchair patron to a high-floor feeder vehicle in Bogotá.

Photo courtesy of TransMilenio SA



Fig. 13.80
The blue seats within the Bogotá TransMilenio vehicles are set aside for the elderly, children, and pregnant women.

Photo by Lloyd Wright

Low-floor vehicles, especially on the secondary feeder routes of developing-nation cities, also have other limitations. The surface road conditions may make low-floor operations quite difficult and prone to expensive maintenance.

The interior design and space available will also be determinant in the vehicle's usability for the physically disabled. An open area near the doorway ensures there is sufficient space and manoeuvrability for a wheelchair patron. The wheelchair area may also include a tie-down

device that will reduce jarring movements during the journey. A tie-down device can be particularly important on hills and curves where the wheelchair may be susceptible to dangerous movement. The space provided to wheelchair patrons also serves a double purpose when not being used by a physically disabled patron. These open areas are quite useful during peak periods for handling large numbers of standing passengers.

Interior seating may also be reserved for special customers through the colour-coding of the seats. For example, blue seats within in the Bogotá TransMilenio system are reserved for certain patrons, such as the elderly, children, and pregnant women (Figure 13.80). Other customers may use the blue seats if there is no one from the designated groups using them. However, passengers are requested to surrender their seats in the event a needier person requires it. The effectiveness of such schemes clearly depends on local customs and culture.

Finally, creating an environment that is accessible to all must be based in the management philosophies of the public transport company and must extend to all staff levels. Thus, driver and staff training regarding sensitivity towards



Fig. 13.81
The peak period on Bogotá's TransMilenio is not entirely favourable to customers with special needs.

Photo by Carlos F. Pardo



Fig. 13.82
Raised pavement markings can be a cost-effective way of providing safe access to the sight impaired.

Photo by Lloyd Wright

the needs of the physically disabled must be a fundamental part of employee development. Drivers should be highly aware of the boarding and alighting requirements of the disabled and should conduct themselves accordingly, especially in terms of possibly extending stationary time until a wheelchair customer is securely on-board and other passengers have reach hand grasps.

Catering to the needs of these special customers also provides another reason to avoid overcrowding in the system. A wheelchair user or a parent with a stroller needs additional space within the station and the vehicle. If a system is operating at maximum capacities, these individuals may be stranded at the station platform for a considerable wait (Figure 13.81). Persons should not have to avoid peak periods simply because they have a disability.

13.2.8.2 Customers with limited vision

Like those with limited mobility, customers with limited vision can easily be catered for within a BRT system. Simple design features

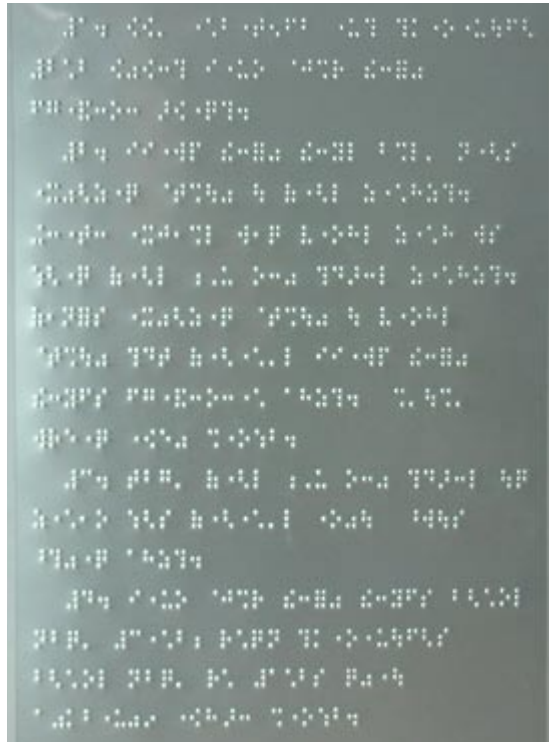


Fig. 13.83
Travel information in Braille helps the sight impaired to plan and undertake their journeys (Nagoya, Japan).
Photo by Lloyd Wright

and new technology can do much to improve accessibility for these individuals. The critical areas for design attention are intersections and the borders between pedestrian accessways and vehicular roadways. Further, design features, such as tactile guideways (*i.e.*, raise pavement markings) can be instrumental in leading those with limited vision to the public transport system (Figure 13.82). Likewise, the ability to access basic travel information through well-placed Braille readers can make a substantial difference in terms of the viability of the system for a sight-impaired person (Figure 13.83).

At intersection crossings with a pushbutton crossing request, several technologies are available to allow a person with limited vision to activate the walk phase. Additionally, these systems also permit the person to sense when the walk phase is active. These options include:

- Accessible Pedestrian Signals (APS);
- Pushbutton locator tones to alert the pedestrian to the audible WALK indication (Figure 13.84);
- Vibro-tactile WALK indication (Figure 13.85);
- Tactile arrow;
- Tactile map or pushbutton information message;
- Automatic sound adjustment.



Fig. 13.84
Audible signal at a crossing leading to a BRT station in León (Mexico).

Photo by Michael King

Detectable warnings are raised bulges at key locations which alert the pedestrian to a changing condition. These warnings are appropriate to denote station edges and curbs. Geometry and landscape modifications at intersections can also improve accessibility. Design recommendations include providing two ramps per corner, so that each ramp is aligned with the curb ramp on the opposite curb at the intersection. This usually



Fig. 13.85
A vibro-tactile pushbutton for requesting a crossing phase.

Photo courtesy of Janet Barlow

means curb ramps should cross perpendicular to the curb and gutter. However, there are times when the curb ramp should not be perpendicular to the curb and gutter if that tends to send a blind person across the roadway on a path which will not lead to the curb ramp on the other side.

13.2.9 Legibility

Legibility refers to how visually understandable a system is against the backdrop of the urban area. The selective use of appropriate signage and maps contributes to a system's legibility. Likewise, design options such as infrastructure colouring determine how quickly customers understand system information.

With regard to pedestrian access, good legibility can play a role in directing customers to the system. Local route signs along the pedestrian path serves both help the customer find the BRT station as well as direct customers to their destination (Figure 13.86). Thus, the development of a BRT system can be an effective mechanism to upgrade the street legibility along the main corridors of the city.



Fig. 13.86
In Kobe (Japan), distances to public transport stations and other key destinations are provided at the human scale.

Photo by Lloyd Wright

13.3 Bicycles

“When man invented the bicycle he reached the peak of his attainments. Here was a machine of precision and balance for the convenience of man. And (unlike subsequent inventions for man's convenience) the more he used it, the fitter his body became. Here, for once, was a product of man's brain that was entirely beneficial to those who used it, and of no harm or irritation to others. Progress should have stopped when man invented the bicycle.”
(From *“Hovel in the Hills”*)

—Elizabeth West, author

In a growing number of cities, BRT projects are being used to simultaneously improve the cycling environment. Integrating the design of cycling facilities into the BRT system is as important as integrating the design of facilities for motorised modes of travel. Since cycling generally improves human health through exercise, generates no pollution, reduces a nation's dependence on imported oil, and uses road space extremely efficiently, most cities these days are actively promoting cycling as a viable, sustainable, and low-cost commuting mode.

Feeder bus access to the BRT system is one of the most costly elements of the system, and if a large share of feeder trips can be made by bicycle it will significantly reduce system

Fig. 13.87

A cycle way integrated with a BRT corridor in Eindhoven (Netherlands) helps to maximise the mobility options for residents.

Image courtesy of Advanced Public Transport Systems



costs. Most customers will consider the public transport system a viable option if it is within a certain time budget of their home. For instance, individuals may consider a time travel budget of 20 minutes acceptable in reaching a BRT station. Bicycles are capable of covering a distance around five times greater than walking in the same time period. Thus, bicycles present the opportunity to increase one's effective customer catchment area by about 25 times (since area is related to the square of the distance travelled). Unfortunately, the lack of safe cycling streets and bicycle parking at stations sometimes means that many systems forgo this profitable opportunity.

13.3.1 Bicycle parking facilities

“Every time I see an adult on a bicycle, I no longer despair for the future of the human race.”

—H.G. Wells, novelist, 1866–1946

From the cyclist's viewpoint, the best option is to allow bicycles on-board the BRT vehicles, so that the person may use the bicycle to access his or her destination on the other end of the trip (Figures 13.88 and 13.89). The viability of permitting bicycles to be brought on board the transit vehicle depends on the level of crowding on the system and is discussed in more detail in Chapter 12 (*Technology*). Some systems, especially during non-peak hours, permit bicycles to be brought on board the BRT vehicles. This section will review options for bicycle parking at the station area.

Fig. 13.88

The Copenhagen metro system permits cyclists to enter the system with their bicycles. The use of one's bicycle on both sides of the journey is a significant benefit to the customer.

Photo by Lloyd Wright





Fig. 13.89
The Las Vegas MAX BRT system offers special entry points for customers with bicycles.

Photo courtesy of NBRTI



Fig. 13.90
An attractive and visible bicycle parking facility can do much to promote the use of bicycles.

Photo courtesy of TransMilenio SA

The provision of secure bicycle parking infrastructure is essential for cyclists to feel comfortable in leaving their bicycles prior to boarding the system. The challenge with bicycle parking facilities for BRT systems usually relates to the space available. To an extent, the location of the bicycle parking facility can act as a marketing tool to encourage

bicycle use. The more visible and attractive the cycling the facility, the more likely it is to gain the attention of potential users (Figure 13.90).



Fig. 13.91
Bicycle parking in front of the Oyumino rail station (Chiba, Japan).

Photo by Lloyd Wright



Fig. 13.92
Upon entering the TransMilenio terminal, the customer is provided with a secure bicycle parking areas.
Photo by Carlos F. Pardo



Fig. 13.93
The upright bicycle parking used in TransMilenio, does save space, but it can be difficult for many to use.
Photo by Carlos F. Pardo



Fig. 13.94
Bicycle lockers provide a highly secure environment for the bicycle, but the lockers can be somewhat costly relative to other options.
Photo courtesy of Cycle-Safe

Fig. 13.95
A self-locking U shaped post is a low-cost and relatively secure option.
Photo by Lloyd Wright



Fig. 13.96
Provision of bicycle parking with only the front wheel locked can be less secure.
Photo by Lloyd Wright

While rail stations in Denmark, the Netherlands, and Japan are often able to devote considerable space to bicycle parking (Figure 13.91), BRT facilities are typically more spatially constrained. For BRT stations located in the median of the roadway, space may be available in front of or behind the station structure in the median. Underneath the entry ramp of a pedestrian bridge may also be a possibility. Alternatively, bicycle parking could be provided on the curb side of the street. In all cases, the security of the bicycle becomes an over-riding consideration. At terminal sites in particular, BRT systems typically have sufficient space to provide a higher-quality parking area for bicycles.

An area being in view of security staff or public transport staff is preferred since a watchful presence can be a significant deterrent to theft. Security camera coverage of the bicycle parking area is also quite helpful. At the TransMilenio Americas Terminal, bicycle parking is provided inside the terminal, at a point after a person has paid to enter the system and in clear view of the fare collection agent (Figure 13.92).

The type of bicycle parking can also affect security and usability. The upright storage facility shown in Figure 13.93 provides secure parking, but it is quite difficult for children, women, and the elderly to lift their bicycle into position. TransMilenio selected this design to minimise the space required per bicycle, but the end result clearly has disadvantages in terms of usability

for some individuals. Another option is known as the bicycle locker (Figure 13.94). The locker is easy to use and provides a highly secure space which controls entry by a key. However, the disadvantage of the locker is its relatively high cost (approximately US\$300). Likewise, covered bicycle sheds provide both protection from rain and from theft, but can be costly to construct.

One of the best options for a simple, self-locking device is a "U" shaped tube cemented to the base layer (Figure 13.95). The "U" shape permits secure locking of both the front and rear wheels. Other self-locking devices that only permit the locking of a single wheel are less secure (Figure 13.96). If only one of the wheels can be locked, then the risk of theft will increase.

If a sufficient number of cyclists are utilising the station, it may be economically viable to offer a formal cycling storage area with a permanent attendant. The attendant ensures a secure environment through personal surveillance. Also, a system can be established in which the bicycle can only be taken by providing the appropriate "claim ticket". Financing the operating costs of the storage area (principally the salary of the attendant) can be accomplished in several ways. Preferably the cost is seen as part of the overall service provided to customers and thus included as part of the system's overall operating cost. Alternatively, it would also be possible for the attendant to charge a standard fee to each cyclist to cover the labour cost.

Fig. 13.97
Due to the lack of formal cycleways in Quito, cyclists frequently make use of the busway infrastructure. However, this practice can lead to serious accidents.

Photo by Lloyd Wright



13.3.2 Cycleway infrastructure

"The bicycle is the most civilized conveyance known to man. Other forms of transport grow daily more nightmarish. Only the bicycle remains pure in heart."

—Iris Murdoch, author and philosopher, 1919–1999

13.3.2.1 Basic principles of cycleway infrastructure

The best BRT systems reconstruct corridors not only to put in exclusive busways, but also to significantly increase amenities for cyclists, pedestrians, and mixed traffic. Reaching the station by bicycle can be a challenge if quality cycleways are not provided, and even for passengers wanting to transfer to the BRT system, cyclists are likely to use the BRT corridor for part of this trip (Figure 13.97). It is no coincidence that



Fig. 13.98 and 13.99
It is no coincidence that Bogotá possesses both a world-class BRT system and world-class bicycle infrastructure. The two systems are mutually complementary.

Photos by Lloyd Wright

cities with world-class BRT systems also possess exceptional bicycle networks. Bogotá is home to Latin America's largest bicycle network with some 320 kilometres of dedicated cycleways (Figures 13.98 and 13.99). The new Orange Line BRT system in Los Angeles, the BRT system in Eindhoven, and many other new BRT systems under development also have parallel bicycle facilities along the entire corridor.

Furthermore, just as separating the motorists and the buses can often increase the speed, capacity, and safety of both modes, so too separating facilities for cyclists and motorists can also increase the speed and safety of both in certain conditions. If no cycling facilities are provided, the likelihood of bicyclists using the busway as a bikeway is fairly high, and very difficult to control. Currently, the frequency of bicyclists in the Curitiba BRT system is higher than the frequency of buses, leading to some unfortunate accidents.

For all these reasons, a city planning to build segregated busways should also consider adding cycling facilities when the corridor is reconstructed. Cycling facilities on higher volume, higher speed access roads serving the corridor will also help bring cyclists to the BRT system, and should also be incorporated into the overall system design when possible. The combination of a BRT system with a cycleway network can do much to provide city-wide mobility on a sustainable basis.

The BRT system and the cycleway network should ideally be planned jointly. The planning process should aim to connect major cycleways with BRT stations at strategic locations. The idea is not to force cyclists to transfer to the BRT system but rather to offer the option of a combined public transport-bicycle commute.

Using concentric circles of two kilometres or more from the public transport station, important corridors should be analysed for the quality of the cycling environment. Most of the safety and traffic calming measures discussed in the previous section on pedestrians will not only slow down vehicle speeds but also simultaneously improve the cycling environment. A few simple rules should be considered when planning cycling facilities:

- Cyclists are even more sensitive to road surface than motorists, and prefer smooth surfaces. Cobblestones and rough brick may be aesthetically pleasing but such surfaces can discourage cycling.
- Cyclists want to go straight. Nicely meandering cycle paths often appeal to landscape architects but utilitarian cyclists want to get where they are going as fast as anybody else and do not want to have to meander around trees and park benches.
- Cyclists will not use sub-standard, poorly maintained, obstructed, narrow bikeways. Build high quality level of service A or B bike lanes, or else redesign the road for safe mixed bicycle and motorised vehicle traffic operation.



Fig. 13.100
Cyclists are often quite exposed to delays, safety risks, and high-levels of contamination when confined to using the curb lane.

Photo by Lloyd Wright

Developing an effective cycle way network involves an array of institutional, design, and infrastructure issues. The GTZ Training Course on “Non-Motorised Transport” provides a thorough overview of these issues (Hook, 2005) and should provide sufficient basic guidance for cycling facilities on non-BRT corridors. However, some specific issues with regard to the location of cycleways on a BRT corridor are presented in the next section.

13.3.2.2 Physical design

The physical design of bicycling facilities is an emerging art rather than a science, and much remains unknown about optimal facility design. Relocating buses into the central median already helps to resolve one of the most pressing conflicts faced daily by cyclists. On normal mixed traffic lanes, bicycles are typically required by law to use the curb lane. In the curb lane, cyclists frequently find themselves stopped behind boarding and alighting buses, taxis, parked vehicles, and loading and unloading freight and delivery vehicles. The curb location thus exposes the cyclists to safe risks and high levels of contamination. Further, having a large vehicle bearing down upon a cyclist can also be quite stressful (Figure 13.100). Relocating public

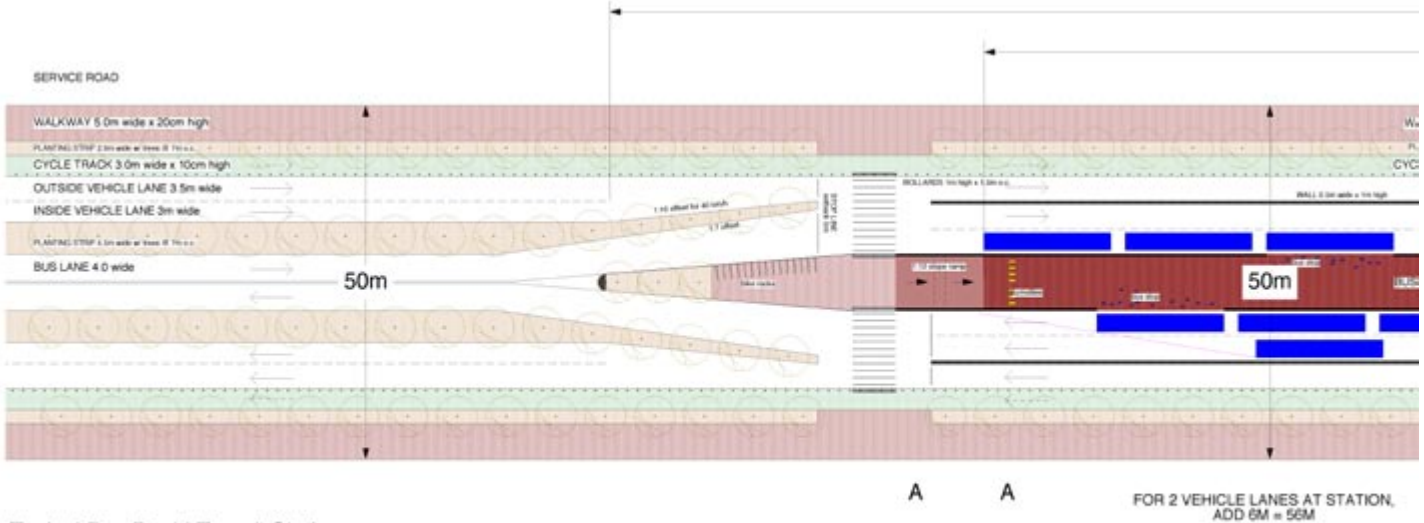
transport vehicles out of the curb lane by itself helps increase cycling speeds in a BRT corridor and reduces dangerous conflicts with stations.

Collecting information about existing cycling activity and cyclist behaviour is a useful first step before designing cycling facilities. Methodologies for doing this are roughly equivalent to methodologies for designing pedestrian facilities, starting with a review of existing cycling facilities, the identification of locations dangerous or illegal for cyclists to operate, mapping of popular cyclist OD pairs, identifying major severance problems, reviewing data about locations of high levels of cycling accidents, and targeting interventions to these locations. The methodologies are similar to those described for pedestrians above, and a more complete account is available in Hook (2004). Nevertheless, some specific guidance for BRT corridors is provided here.

BRT corridors tend to be located on reasonably wide primary or secondary urban arterials. In developing countries, which frequently lack a strong secondary road network, these arterials tend to serve a great diversity of trip types, from intercity bus and truck trips to medium and long distance intercity transit trips, to short distance cycling and walking trips. This complex, multi-functionality of a BRT corridor makes road design reasonably difficult. As the right-of-way widens, vehicle speeds tend to increase, and hence the desirability of segregating modes of significantly different operating speeds increases.

Just like motorists on such an arterial, some cyclists are going longer distances and value uninterrupted higher speed travel, while others are only going a short distance and value access to adjacent properties. For motorists on such arterials, this conflict is frequently resolved by providing separate through lanes for long distance vehicular travel and service lanes for property access. Introducing BRT on such an arterial into the central road verge introduces no particular problems for motorists. Excluding cycle tracks, the standard cross section would have bus lanes in the median, then two mixed traffic lanes, and then a median, and then a service lane for local access trips, and then a sidewalk.

The question which has led to considerable debate among the experts is where to put the bicycle lane.



Typical Bus Rapid Transit Station
Morogoro Road, Dae es Salaam, Tanzania

ITDP w/ input from LOGIT & ICE
July 2005

MINIMUM SIZING REQUIREMENTS
FOR DISCUSSION ONLY

FOR 2 VEHICLE LANES AT STATION,
ADD 6M = 56M

Whether or not there is a service lane, the standard location of the bicycle lane has been between the mixed traffic lanes and the walkway. Figure 13.101 shows this configuration for one proposed cross section in Dar es Salaam. This location of the bicycle lane serves well those cyclists making short access trips along the corridor. Normally, curb-side bicycle lanes are built adjacent to the roadway, and sidewalks are built between the bikeway and the building

wall. This arrangement occurs because bicycle speed and behaviour is closer to that of motor vehicles than pedestrians. If a cycle lane is obstructed, the cyclist needs to have easy opportunity to enter the roadway, and this access is more difficult if they must also pass through pedestrian flows. For this reason, frequently designers will design the bike lane adjacent to the roadway. The Hangzhou BRT system makes use of this configuration with wide cycleways

Fig. 13.101
Road layout for Dar es Salaam showing a median busway and a cycleway located between the walkway and the mixed traffic lanes.

Image courtesy of ITDP



Fig. 13.102
The cycleway along the Hangzhou BRT system is sited between the BRT lane and the pedestrian footpath.

Photo by Karl Fjellstrom



Fig. 13.103
Wide cycleways and footpaths allow the two modes to be successfully integrated in Bogotá.

Photo courtesy of Oscar Diaz and Por el País que Queremos (PPQ)

located between the pedestrian footpath and the BRT lane (Figures 13.102).

Some designers advocate putting a line of shrubbery and trees between the bicycle lane and the roadway, and placing the bicycle lane on a high curb on the same level as the footpath. With proper curb cuts at intersections, this design will insulate cyclists from speeding traffic, improve the cycling environment, and prevent motorists and delivery trucks from parking their vehicles on the bike lane. However, this line of shrubbery and trees between the bikeway and the roadway, and the high curb, makes it difficult for cyclists to pass between the bikeway and the roadway in case of an obstruction. In the developing world, obstructions are sadly the rule rather than the exception. If this configuration is used, as in some parts of Bogotá, it should be accompanied by very high grade, wide bicycle ways at minimal risk of obstruction (Figure 13.103).

In Dar es Salaam, where the risk of encroachments by vendors, high pedestrian volumes,

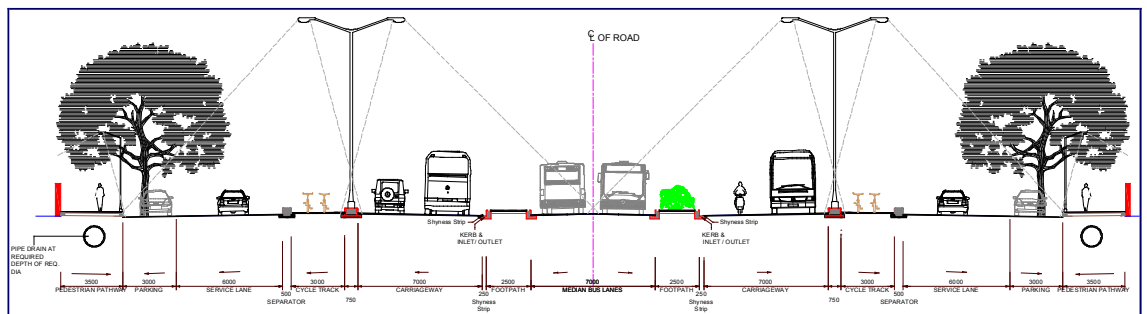
utility poles, and building materials from adjacent properties is high, it was decided to put the bike lane on a specially designated raised shoulder of the roadway, and to separate the bikeway from the pedestrian walkway with trees and shrubbery, but not the bikeway and the mixed traffic lanes. Putting the bikeway on a raised shoulder of the roadway makes motorists more aware of the cyclists' presence on the road, which becomes important at the intersections. It also allows the raised shoulder to be used by broken down vehicles if necessary. Placing trees and shrubbery between the bicycle lane and the walkway will help to inhibit encroachments onto the bikeway by pedestrians and street vendors, and allows the cyclists to more easily escape the bikeway in case of an obstruction. This configuration, however, still creates conflicts between cyclists and right turning vehicles, stopping taxis, illegally parked vehicles, and other curb-lane obstructions.

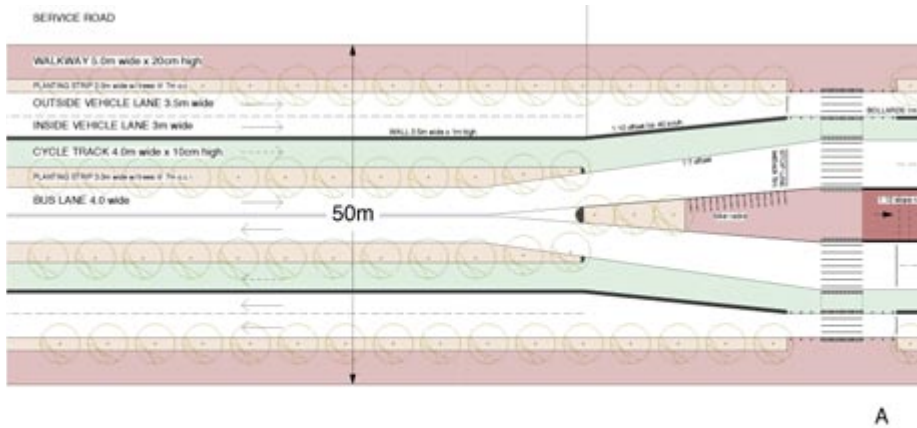
On wider arterials with existing service roads, it is being considered in the Ahmedabad BRT project and the Delhi BRT project to put the cycle tracks on the median between the service road and the mixed traffic lanes, as illustrated in Figure 13.104.

This configuration is generally accompanied by the termination of the service road before each intersection. In this way, the conflicts between many of the stopping and parking vehicles can be avoided as most of these activities will happen in the service lane. Access to the adjacent properties by bicycles can easily be accommodated in the slow moving service lanes. Such a configuration, however, requires a very wide right-of-way. It also fails to resolve the conflicts between cyclists going straight and right turning vehicles at intersections. These conflicts, though, can be resolved through standard intersection treatments.

Fig. 13.104
For wide roadways with service lanes, the cycleway can be located between the service lanes and the mixed traffic lanes.

Image courtesy of ITDP





Typical Bus Rapid Transit Station
Morogoro Road, Dae es Salaam, Tanzania

ITDP w/ input from LOGIT & ICE
June 2005

MINIMUM SIZING REQUIREMENTS
FOR DISCUSSION ONLY



Fig. 13.105.

A configuration placing the cycleway adjacent to the median busway potentially carries with it multiple benefits.

Image courtesy of ITDP

Another configuration that has been discussed is to give cyclists the same sort of advantages that buses enjoy from central lane operation: freedom for vehicles going straight at intersections from turning conflicts. Many cycleways in Bogotá are located in the street median, in a manner similar to BRT. Thus, another alternative would be to place the cycleways adjacent to the busway (Figure 13.105).

This configuration would remove many of the turning conflicts between bicycles going straight and turning and stopping vehicles. It would significantly reduce the risk of encroachments onto the bikeway by street vendors. It could provide a very high speed cycling corridor. Bicyclists wanting to make local access trips would simply exit the cycle way at the nearest intersection or pedestrian crosswalk to their destination, and use the service lane or sidewalk for the remaining distance.

13.3.3 Bicycle rental facilities

Increasing the availability of bicycles helps to fulfil the modes usefulness as an integrated component of a public transport trip. In developing-nation cities, bicycles may not be widely available or widely affordable. Further, casual users may not be willing to purchase a bicycle, but could consider short-term rentals. BRT system planners may thus wish to consider providing bicycle rental facilities within station areas. The Osaka Monorail system provides such a service at most of its stations (Figure 13.106). Rental bicycles can also be useful to even existing bicycle owners. If a person is travelling to a destination via

the public transport and the ultimate destination is beyond walking distance from the station, the rental bicycle may be the perfect solution as a highly-flexible feeder service. As in the case of the Osaka bicycle model, the availability of a carrying basket helps patrons with briefcases, shopping bags, and other personal items.

On a broader scale, the city of Copenhagen provides “free” city bicycles throughout the urban area, including public transport stations (Figure 13.107). A person only needs to insert a 20 DKr coin (US\$3.30) to gain access to a bicycle. Upon returning the bicycle at any station, the coin is fully returned to the user. If the bicycle is parked away from a bicycle station, then anyone can return it and collect the 20

Fig. 13.106

Bicycle rental facilities within stations of the Osaka Monorail provide a cost-effective option for casual users.

Photo by Lloyd Wright



Fig. 13.107

The City-Bike programme in Copenhagen makes bicycles available for “free” at public transport stations and elsewhere in the city.

Photo by Lloyd Wright



DKr coin. The brightly painted advertisements on the bicycles help to pay for maintenance. While bicycle theft had plagued many of the initial attempts at city-bike programmes, modern technology in combination with simple design changes has largely eliminated this concern. The Copenhagen bicycles are fitted with a chip to permit GPS-based tracking. Further, the shape and size of the bicycle components are unique to the City-Bike and thus rendering theft of components to be ineffective (Poulsen and Mozer, 2005). Many other European cities, such as Berlin and Zürich, have similar types of bicycle rental programmes.

In the developing-nation context, bicycle availability and affordability can be substantial barrier to usage. The Institute for Transportation & Development Policy (ITDP) has initiated a programme in conjunction with major bicycle manufacturers to improve bicycle distribution in developing nations. The basis of programme is a low-cost and high-quality bicycle, marketed as the “California Bike”, which is designed to meet the requirements of developing city conditions. ITDP and its local partners help small retailers access the “California Bike” and then distribute on an affordable basis to low-income customers.

13.4 Other public transport systems

“I waited and waited on the platform, but the train never came and it seemed odd that no one else was waiting with me... Finally, I went and asked a porter and he indicated to me that I had to take a bus and, when pressed as to where I might find this bus, motioned vaguely with the back of his hand in the direction of the rest of the world.” (From “African Diary”)

—Bill Bryson, author, 1951–

BRT can also be complementary with other urban and long-distance public transport options. Cities with existing metros and urban rail services should ideally integrate these options with BRT. Cities with water transport systems should also seek to closely integrate these systems with the BRT network.

São Paulo, for instance, uses BRT to connect the end of its metro line with other communities. Some cities with existing metro systems are unable to finance the completion of the metro. In such instances, BRT has been an economical option that will help bring a public transport connection to the entire city.

The key to a successful integration lies in the physical connection between the two systems,



Fig. 13.108
The Brisbane Busway (top centre) is closely integrated with the city’s commuter rail service (right).

Photo courtesy of Queensland Transport

the complementary marketing and promotion of the two systems, and the unification of fare structures. In São Paulo, the physical connection is made simple by ramps departing the metro system leading directly to the BRT system. In Brisbane, the co-location of a BRT station facility with the city’s commuter rail service makes for a good deal of customer convenience in moving from one system to another (Figure 13.108). Likewise, in Nagoya (Japan), the Yurikamome BRT Line is closely integrated with both the subway system as well as the suburban rail system (Figure 13.109).

Clear signage also helps make this integration relatively seamless. Further, the two systems can be marketed jointing under one name and logo, so that the systems are clearly unified in the eyes of the customer. Finally, an integrated fare structure permits customers to leave one mass transit mode to another without the need of purchasing an additional fare.

BRT should also be integrated with long-distance public transport infrastructure such as long-distance bus stations and train stations. Again, the physical planning of the interface is key to making this option viable. Passengers from such modes often are carrying luggage or goods, and thus particularly need a convenient transfer mechanism.



Fig. 13.109
The Ozone Station of the Nagoya public transport system represents a nexus of the elevated BRT system, the suburban rail system, the subway system as well as ample provisions for bicycle parking.

Photo by Lloyd Wright

13.5 Taxis

“Too bad all the people who know how to run the country are busy driving taxi cabs and cutting hair.”

—George Burns, comedian, 1896–1996

13.5.1 Car taxis

Car taxis are too frequently seen as competitors to public transport rather than as complementary services that can effectively extend the coverage of a transit system’s service area. By developing integrated car taxi facilities in conjunction with BRT stations and terminals, multiple benefits can be achieved.

In many cities of the world, and especially in developing-nation cities, taxis represent a large proportion of the vehicles on the road at any given time. However, taxis spend much of their time in search of passengers rather than providing actual passenger trips. Prior to the introduction of improved taxi ranks and dispatch systems, taxis in Shanghai were estimated to spend 80 percent of their travel time without passengers. Thus, these non-customer trips can add greatly to congestion levels without serving any real purpose.

Developing taxi ranks at public transport stations reduces the need for taxi drivers to operate without passengers. Instead, the passengers come to the taxis rather than the other way around. The strategic location of taxi stands in close integration with BRT stations can thus prove to be a win for system designers, taxi drivers, city officials, and the public (Figures

Fig. 13.110 and 13.111
In cities such as Quito (top photo) and Kuala Lumpur (bottom photo) the provision of formal taxi facilities integrated with the public transport system provides benefits to the customer, the transit system, and the taxi driver.

Photos by Lloyd Wright



13.110 and 13.111). System designers win by adding another important feeder service to their route structure. The taxi owners and drivers win by dramatically reducing their operating costs. The BRT stations provide a concentration of customers for the taxis without the need to circulate the city expending large quantities of petrol. City officials win by helping to reduce a major factor in urban traffic congestion. And finally, the public wins by having a more flexible and convenient public transport system that also reduces urban emissions and promotes greater overall efficiency.

Any policy affecting taxi operations will require planning and participation from the affected taxi owners. In developing-nation cities, taxi associations can be politically powerful and are often left relatively uncontrolled. Since taxi facilities at public transport stations will likely be perceived as quite favourable to the taxi owners, this infrastructure can be the basis for improved quality control with the industry.

13.5.2 Pedicabs (bicycle taxis)

Modern vehicle designs, escalating fuel prices, and growing environmental concerns have led to a resurgence in pedicabs in many parts of the world, especially in the Western European cities of Berlin, Copenhagen, and London. Pedicabs can make for an almost ideal feeder service to BRT stations, especially trips of 4 kilometres or less (Figures 13.112 and 13.113). Pedicabs are low-cost vehicles that provide high levels of employment while producing zero emissions.

In parts of the developing world, pedicabs have been actively banned in order to make room for more motorised vehicles. Pedicabs were banned in Bangkok beginning in the early 1960s. Subsequent bans have been employed in cities such as Jakarta and New Delhi. However, public attitudes are changing, and the Delhi BRT system has integrated designated pedicab parking into the corridor design. Through a collaboration between the Institute for Transportation & Development Policy (ITDP) and

Fig. 13.112 and 13.113
As evidenced by these images from Bogotá, the pedicab can help form part of a seamless package of integration options for BRT customers.

Photos courtesy of INSSA



several local partners a modernised “cycle rickshaw” (pedicab) was developed for the Indian market. Beginning in the Indian city of Agra in 1998, this initiative, sponsored by funding from the US Agency for International Development (US AID), has quickly spread to many other cities, including the capital of Delhi. The project produced a modern, light weight vehicle at a modest cost (Figure 13.114). Today, over 100,000 modernised pedicabs are plying the streets of Indian cities.

Manila has a long history of pedicab use in conjunction with other public transport options. Additionally, cities such as Yogyakarta in Indonesia are following the lead of the Indian cities and bringing back a modernised version of the cycle rickshaw (known as a “becak” in Indonesia).

A successful pedicab project will likely encompass a range of operational and design components. Some of the features of a modern pedicab initiative will include:

- Modernised, re-engineered or high-technology vehicles (Figure 13.115);
- Dedicated non-motorised vehicle lanes in some areas;
- Formal pedicab stations (Figure 13.116);
- Pedicab system maps;
- Posted fare information;
- Professionalised driver training;
- Driver uniforms.

Fig. 13.115

Modern pedicab designs help attract both customers as well as advertising revenues.

Photo by Lloyd Wright



Fig. 13.114

The modernised cycle rickshaw in India has revitalised the pedicab marketplace.

Photo courtesy of ITDP

Implementing a BRT system at the same time as introducing pedicab services can help both modes. Pedicabs can form a critical part of the feeder service, especially for communities with streets too narrow for buses. It may also be quite possible to integrate the fare of the BRT system with the pedicab fares.

13.6 Park-and-ride

Private vehicle owners can also be successfully integrated with the system through the development of “park-and-ride” or “kiss-and-ride” facilities. These facilities allow private vehicle

Fig. 13.116

Formal pedicab stations, posted fare information, and driver uniforms all help to boost the image of the system.

Photo by Lloyd Wright



users to access the transit system, and therefore complete their total commute by way of public transport. A park-and-ride facility provides a parking garage or parking lot for vehicles to be kept securely during the day. A kiss-and-ride facility does not provide parking but rather includes a passenger drop-off area for private vehicles. A park-and-ride facility should also include space for the kiss-and-ride option.

The benefits of park-and-ride facilities immediately adjacent to a popular public transport station must be weighted against the benefits of alternative uses for this land, such as for commercial development or public amenities. Commercial services and safe and comfortable access for feeder buses, cyclists, and pedestrians should have priority in public transport station design.

Park-and-ride and kiss-and-ride facilities are most appropriate in suburban locations where population densities may be insufficient to justify costly feeder services, and distances are too far to make direct walking and cycling access to the station viable for most people. In developing cities, these conditions will primarily be found in neighbourhoods dominated by affluent households that have sufficient disposable income to own a private vehicle. Attracting this income group to the public transport system can deliver several benefits. First, offsetting private vehicle use pays significant dividends in terms of emission reductions and congestion relief. Second, a public transport system that is

of sufficient quality to attract even the highest income groups is a worthy objective. Third, a healthy mix of all a city's income groups in the system means that all political interests will have an incentive to ensure the system's future. Finally, systems which serve all income groups also serve an important social function since the public transport system may be the one location where all segments of society come together.

The park-and-ride and kiss-and-ride facilities are best situated in suburban locations where land is less at a premium, and where the target customers are encouraged to travel as much of their total trip by public transport as possible. Park-and-ride is less desirable in downtown locations where the parking facility is likely to be used to drive into the downtown. The park-and-ride provided at the Mo Chit station of the Bangkok SkyTrain is quite popular due to its proximity to major residential areas (Figure 13.117). Private vehicle owners are less likely to use a park-and-ride facility if they are driving a substantial distance into the city and then using the public transport only for a small final portion (Figure 13.118). The time and cost of switching to public transport only for the final few kilometres means that few customers will utilise the system under such circumstances. The principal incentive to these customers will be the time savings achieved by the exclusive busways over the main portion of the commute.

The location of the parking facility should be convenient to the station area (Figure 13.119). A long walk may discourage usage from discretionary customers. In cities with frequently unseasonable weather (wind, rain, strong sun), covered walkways in the parking area may be a worthwhile investment. In some areas, it will be necessary to include security measures at the parking facilities. Security measures such as an attendant or security cameras can be effective. If security is insufficient, motorists will choose to use their private vehicle for the entire commute.

Whether motorists should be charged for parking at a park-and-ride facility depends on the location of the facility and the set of incentives in place. Subsidising parking for higher income motorists far from the city centre can be justified because it will encourage motorists to make a long public transport trip, reducing significantly

Fig. 13.117
The park-and-ride facility at the Mo Chit station of the Bangkok Skytrain helps to boost ridership, especially from customers who would normally drive in private vehicles.

Photo by Thirayoot Limanond





Fig. 13.118
Proposed park-and-ride facility in Nantes (France).

Image courtesy of François Rambaud

the congestion and air pollution that would otherwise have resulted from the trip. The closer the park-and-ride facility is to the city centre, the less the social benefit, and hence the weaker the justification for a public subsidy.

Parking facilities can be quite costly to develop and construct. Each at-grade parking bay may cost US\$3,000 to US\$15,000 when land purchase costs are included. Each parking bay

within a multi-level parking facility will likely cost in the range of US\$20,000 to US\$35,000. Costs can be even greater in areas with significant land costs. Thus, it can be quite appropriate to establish a fee for use of parking facilities at public transport stations. The challenge is to develop a fee structure that still provides a strong incentive for using the public transport system.



Fig. 13.119
The parking facility at the Eight Mile Plains station of the Brisbane BRT system provides convenient access for customers.

Photo courtesy of Queensland Transport

14. TDM and land-use integration

“I personally...do not understand why the Czech, European and global ideal is manufacturing an ever-increasing number of automobiles, which presumes the construction of more roads and motorways, and thereby again the irreversible destruction of our country. Are we perhaps happier, merrier, more satisfied? Not at all. We are restless, beaten, weary, incessantly hurrying from one place to another.”

—Vaclav Havel, former president of the Czech Republic, 1936–

BRT systems are often implemented simultaneously with restriction measures on private

vehicles, as bus speeds can be increased by simply reducing vehicular congestion. For example, Bogotá restricted private vehicle use during peak hours as well as eliminated on-street parking from parts of the city. London too has been a prominent leader in car restriction measures through its application of congestion charging. Transportation Demand Management (TDM) represents a collection of measures and techniques that encourage shifts from private vehicles to public transport options such as BRT. Likewise, land-use policies to encourage development and densification around public transport nodes can do much to incentivise shifts to public transport.

The contents of this chapter include:

14.1 Disincentives to automobile use

14.2 Integration with land-use policies

14.1 Disincentives to automobile use

“The right to have access to every building in the city by private motorcar, in an age when everyone possesses such a vehicle, is actually the right to destroy the city.”

—Lewis Mumford, historian, 1895–1990

BRT inherently changes the regulation of private vehicle use on certain roads. The implementation of a BRT system sometimes requires difficult-to-negotiate changes in how road space is designed and regulated on some streets, particularly on roads through the city centre. Often, traffic planners will advocate underground or elevated systems on the grounds that they do not “disrupt” the conditions on the road surface. However, conditions on the surface roads of most developing-nation cities are far from optimal. BRT, while more socially complex to implement as a result, also offers the opportunity to fundamentally change how surface street space is regulated and organised, with the potential of profoundly improving economic and social conditions in the city.

In order to deliver sustainable high speed bus service, BRT systems need to be protected from the problem of growing private motor vehicle-induced congestion. Because the best BRT systems provide improved services for the largest

number of passengers, they tend to be built on urban arterials serving the city centre, where congestion and competition for scarce road space is the highest; precisely where dedicating a lane will be the most difficult.

In ideal circumstances, BRT will be built on roads that pass through the city centre where bus volumes are high and the right of way is wide enough to allow for at least two traffic lanes open to trucks, private cars, and other forms of mixed traffic. Under these conditions, implementing BRT can increase both bus and mixed traffic speeds and throughput. In this case, the use of cars has been regulated but not restricted.

Sometimes, however, this sort of solution is not possible, and in other cases it may not be desirable. Decision-makers may decide that the benefits to public transport passengers outweigh the disbenefits to motorists. Building a BRT system may make congestion worse for mixed traffic on certain sections, and certainly during the construction phase, this problem is likely to be acute. Some parts of the BRT network may need to pass through very narrow streets with multiple access needs. On such streets, building physically segregated busways while allowing truck and car access may not be feasible or desirable. Inevitably, some parts of the BRT

network, as a minimum the feeder buses, will operate in congested mixed traffic conditions. One option to maintain bus speeds on those streets is to restrict car access by other means, through a variety of measures. Some of these measures will tend to decrease trips by private motorised vehicles, and are known as transportation demand management, or TDM. Other measures may not decrease car use, but regulate the time and location of private vehicles.

Restricting vehicle access and throughput on certain streets in order to improve bus system performance can generally be balanced by improvements for private vehicles on parallel streets, so that the net effect on mixed traffic is neutral or even positive.

However, a growing number of politicians are also deciding that BRT projects, by improving the quality of public transport service, create a unique opportunity to reduce car use in the city more generally, in order to reduce air pollution, increase public space, and to increase public transport ridership and profitability. This section discusses the mechanisms for implementing measures which increase the ability of the municipality to better regulate private motor vehicle access to different parts of a city according to specific local needs.

These measures include the following:

- Reduction in available parking units;
- Increased parking fees;
- Increased parking enforcement;
- Parking cash-out programmes;

- Day restrictions by license tag number;
- Congestion charging and road pricing;
- Travel Blending or TravelSmart™;
- Green travel plans;
- Traffic calming measures.

A more complete description of TDM options can be found in the on-line TDM Encyclopedia of the Victoria Transport Policy Institute (VTPI, 2006).

14.1.1 Parking regulation

“What if we fail to stop the erosion of cities by automobiles?... In that case, we Americans will hardly need to ponder a mystery that has troubled men for millennia: What is the purpose of life? For us, the answer will be clear, established and for all practical purposes indisputable: The purpose of life is to produce and consume automobiles.”

—Jane Jacobs, writer and activist, 1916–2006

Few policies are as emotionally charged for citizens as parking policy. Threatening to remove even a few parking spaces to put in a BRT system may seem a daunting challenge to a politician, even if it improves hundreds of thousands of public transport passenger trips daily. First world mayors have the legal powers to regulate on-street parking, but most fear to use this power. In the developing world, political control over parking is generally not fully in the hands of mayors, but in the hands of the police, sub-municipal governments, or even local mafias.

A lot of parking is in private hands. Often government employees and the police themselves

Fig. 14.1 and 14.2
Before and after images of Avenue 15 (“Carrera 15”) in Bogotá. Mayor Enrique Peñalosa was nearly impeached for enforcing parking laws and upgrading public space. In the end, he became one of most Bogotá’s most popular Mayors ever with his ambitious vision.

Photos courtesy of the Mayor’s Office of Bogotá



are recipients of privileged access to choice parking locations and parking revenues. Bogotá Mayor Peñalosa was nearly impeached when, in preparation for implementing TransMilenio, eliminated on-street parking from much of the central portion of the city (Figures 14.1 and 14.2). Curitiba Mayor Jaime Lerner faced similar upheaval from shopkeepers when removing parking and pedestrianising streets adjacent to the new BRT system. However, both mayors reaped large political rewards once citizens saw the benefits and shopkeepers saw their business increase rather than decrease.

Existing parking conditions in most developing countries are generally far from optimal from almost anyone’s perspective. This situation creates the opportunity to use a BRT project to actually improve the overall parking situation for motorists, even if the project itself needs to remove thousands of units of on-street parking. While a mayor may choose to use the BRT project to actually reduce total city centre parking in order to encourage public transport use and discourage driving, there are technical tools available even for a mayor that does not want to reduce parking availability. In either case, a technically sound parking plan is critical, and the mayor’s office should prepare a good public awareness and outreach campaign.

Table 14.1 summarises the various parking management strategies that better allow municipalities to control public space and the growth of private vehicle use.

14.1.1.1 Surveying parking conditions

Securing political support for any change in the existing parking regime is critical. The first step is to understand fully the existing parking situation and then publicise those elements of the status quo that are unfair and inequitable. The BRT system can then be presented as an opportunity to optimise parking regulation in the impacted area, and if time permits in the city more generally. To make this case to the public, policymakers should prepare themselves with as much information as possible. A good place to start is to conduct a parking occupancy study reviewing the existing parking situation.

The parking study usually first involves collecting data on the following:

- Total existing officially designated on-street parking units and their specific locations;
- Total locations where people regularly park, whether or not officially designated;
- Total off-street parking units available;
- Existing parking regulatory regime, including time period restrictions if any, and charging structure for each type of parking unit;
- Total actual occupancy of these parking units throughout the day.

The evaluation of the existing parking situation and its ramifications for parking availability in the area impacted by the BRT system should then be discussed at a public dialogue. In such a dialogue, it will generally become clear that some people benefit much more from the existing parking regime than others.

14.1.1.2 Parking fees

Even if the political will to reduce the existing number of parking spaces does not exist, there are measures that can be taken to improve parking efficiency. Increasing parking fees can do much to discourage vehicle usage even without removing any parking spaces.

Implementing progressive parking policies do frequently require certain legislative changes. In most cases, local council approval and even national legislative approval may be required to implement a fee of this type. Turning over the enforcement of parking infringements to a municipality or a private company from national or provincial level police can be a difficult process. As with many of these issues, political will is critical, and devising a successful political strategy is the key to success. As with any tax or fee, many interest groups will be vehemently opposed to it. Influential groups, such as motorists and business interests, could form a powerful opposition, but increasing parking fees can also increase the rotation of parking spaces which will help shopkeepers. Regaining political control from politically powerful mafias is always a challenge. Certainly, a direct link between increased parking fee revenues and a politically popular high profile public transport improvement like BRT can often be a successful political strategy.

Of course, not all vehicles that enter an urban area are destined to utilise a parking space.

Table 14.1: Parking management strategies

Management strategy	Description
Strategies that result in more efficient use of parking facilities	
Shared parking	Parking spaces are shared by more than one user, allowing facilities to be used more efficiently.
Regulate parking facility use	More convenient and visible parking spaces are managed and regulated to give priority to higher-value trips, increase efficiency and user convenience.
More accurate and flexible standards	Reduce or adjust standards to more accurately reflect demand at a particular location, taking into account geographic, demographic and economic factors.
Parking maximums	Establish maximum in addition or instead of minimum parking standards to avoid excessive parking supply.
Remote parking	Encouraging longer-term parkers to use off-site or fringe parking facilities, so more convenient spaces are available for priority users.
Improving user information and marketing	Provide convenient and accurate information on parking availability and price, using maps, signs, brochures and electronic communication.
Smart growth and location efficient development	Encourage more clustered, mixed, multi-modal, infill development, which allows more shared parking and use of alternative modes.
Improved walkability	Improve pedestrian conditions to allow parkers to conveniently access more parking facilities, increasing the functional supply in an area.
Transportation Management Associations	Transportation Management Associations are private, non-profit, member-controlled organizations that can provide variety of services that encourage more efficient use of transport and parking resources in an area.
Strategies that reduce parking demand	
Transportation Demand Management programmes	Various strategies and programmes can encourage more efficient travel patterns, which reduces automobile trips and parking demand.
Parking pricing	Charge motorists directly for using parking facilities, and set fees to encourage efficient use of parking facilities.
Improve parking pricing methods	Use of more convenient and effective parking pricing techniques to make parking pricing more acceptable and cost effective.
Commuter financial incentives	Parking cash out and transit benefits give commuters financial incentives to shift modes and reduce parking demand.
Unbundle parking	Rent or sell parking spaces separately from building space, so occupants pay for just the number of parking spaces that they use.
Tax parking facilities	Impose special taxes on parking facilities and commercial parking transactions.
Improve enforcement and control	Enforcement should be consistent, fair and friendly. Parking passes should have clear limitations regarding where, when and by whom they may be used, and these limitations should be enforced.
Bicycle facilities	Supply bicycle parking, storage and changing facilities instead of some automobile parking spaces.
Strategies that reduce negative impacts	
Develop overflow parking plans	Encourage use of remote parking facilities and promote use of alternative modes during peak periods, such as busy shopping times and major events.
Address spill-over problems	Address spill-over parking problems directly with management, pricing and enforcement strategies.
Parking facility design and management	Improved parking facility design to address safety, storm water management, user comfort, security and aesthetic objectives.

Source: Litman, 2004a

Traffic that is only passing through the city will not be affected by the parking fee. The imposition of a parking fee may also encourage additional chauffeured trips in which another family member, friend, or hired driver takes the person to their destination. In this case, the person is merely dropped-off at the destination and no parking is involved. These types of chauffeured trips actually double the number of trips taken and the distance covered since each journey involves a two-way trip (one trip into the city and another trip back to the home). Thus, in order for a parking fee programme to work, it will likely have to be combined with other TDM measures that will discourage such “gaming” of the system. For example, combining a parking fee with a license tag programme restricting travel to certain days based on one’s number plate can work well to avoid such problems.

Variable parking fees

Most parking experts agree that parking policy should aim to ensure that available parking is occupied roughly 85 percent of the time. If parking units are occupied less than 85 percent of the time, the space is being underutilised. If parking units are occupied more than 85 percent of the time, potential parking customers will have to spend a lot of time driving around looking for a parking space and contributing to traffic congestion.

Achieving an 85 percent parking unit occupancy rate is generally done through two mechanisms: time limits on free parking or parking charges (Figure 14.3), or a combination of both (meters combined with a time limit). Variable parking charges are the preferred method, for reasons that will be described below.

When planning a BRT system, the level of parking occupancy in different parts of the impact area will tell you a lot about whether there is an absolute shortage of supply or a misallocation of the existing supply. Very rarely is the status quo anywhere remotely close to the optimal. Most of the time, the existing parking supply has been badly misallocated, and optimising existing parking supply at the same time that parking units are removed by a BRT project will mitigate the need for building additional parking units.

Typically, even if parking is in short supply in some locations, there is plenty of parking available in nearby locations which require somewhat longer walking trips. Allocating the most convenient parking spaces on a first come first serve basis at a very low parking cost does not lead to the optimal allocation of a scarce parking resource. A good parking policy will rationally allocate the scarce parking units to those who need it the most. The convenience of a parking space should be proportional to the number of people who need to make the trip in a given day. The consumers of parking can be divided into different market segments with different parking needs:

- Local residents, who tend to park at night and make only a few trips per day between their apartment and their car;
- Employees, who will tend to park all day and pass between their car and their office only once a day;
- Trucking and delivery services who need to be adjacent to the curb only for short pickups and deliveries, but at many different locations throughout the day;
- Shoppers, who need to park at a shop for only a short time, or at a shopping area for a somewhat longer time, but a shop needs many of them to survive;
- Leisure users including recreational users, people going out to dinner, to movies, etc.



Fig. 14.3

A variable parking charge can be a simple yet effective means to control private vehicle usage, as seen here in Brasov (Romania).

Photo by Manfred Breithaupt

A good parking regime will discourage commuters and employees from parking in front of shops, where the space should be available for customers and delivery vehicles. If a hundred people would like to visit a downtown shop or museum, but only one person is working in the shop or museum, it is obviously better to allow the shoppers to park directly in front of the shop, and to encourage the person working at the shop or museum, or living in an apartment nearby, to park farther away. This approach increases efficiency since the worker or the apartment dweller only make the walking trip once a day, whereas inconveniencing the customers inconveniences hundreds of customers a day. Free and undervalued parking in front of shops creates the likelihood that one resident or one shop employee will consume the scarce parking space for an entire day, forcing perhaps hundreds of shoppers to walk a long distance, to the detriment of the businesses in the area (Figure 14.4). Increasing hourly parking charges will increase the availability of parking in popular locations for parking customers with the greatest economic incentive to use the parking: Short term shoppers and delivery trucks.

A parking analysis conducted under the Dar es Salaam BRT project helped to identify the potential for an increase in parking efficiency through a new parking fee structure. Box 14.1 summarises the process that led to parking management improvements in Dar es Salaam.

The next step is to investigate the hot spots, and the turnover rate of parking at these locations. If average parking time per vehicle is very long, it generally indicates that parking charges are too low. A study in the commercial district of Westwood, California (US), indicated that the parking occupancy rate was 100 percent, meaning that it was virtually impossible for shoppers to find a parking place. At a 100 percent parking occupancy rate, the hourly number of people who could park in 829 units was 829 vehicles. When curbside parking charges were increased to the same levels as off-street parking in garages, the number of vehicles able to park increased to 1,410, due to an increase in the turnover rate. It also induced people to share vehicles, so the vehicle occupancy went up as well. The total number of people arriving at the



shops therefore increased from 1,078 per hour to 2,397 per hour (Shoup, 2005, p. 366). As each one of these visitors is a potentially high-income customer, increasing prices was able to significantly increase the availability of parking downtown and the total number of shoppers. Therefore, increasing parking charges did not function as a traffic demand management measure; it in fact induced new demand. It did not reduce the supply of parking, it increased it. Therefore, if a BRT project has to cut parking units, this loss of parking availability can be mitigated by increasing the parking charges and hence the turnover rate of the available parking units.

Parking space levy

In developed countries, commercial parking taxes are perhaps the most common form of parking fee. This technique is a simple sales tax applied to private parking companies. The amount of the tax varies by city; examples include a 50 percent parking tax in Pittsburgh (US) and a 25 percent parking tax in San Francisco (US) (Litman, 2006a). While such taxes are quite popular, the commercial parking tax can create unwanted consequences. First, without a highly defined record-keeping and enforcement system, tax evasion can occur. Second, the tax burden will generally be fairly geographically restricted to commercial centres since commercial parking facilities are generally

Fig. 14.4

Uncontrolled parking in the historical centre of Quito means that pedestrians lose footpath access, the visual ambience of the historical architecture is compromised, and motorists have no incentives to use alternative means of transport.

Photo by Lloyd Wright

Box 14.1: BRT and parking management in Dar es Salaam

Dar es Salaam represents one of the better regulated parking systems for a developing country. The Dar City Council currently charges a single hourly rate for all on-street parking in the CBD, and a slightly lower hourly rate for parking in a popular market area nearby. No other areas within the city charge for on-street parking.

The project team for the Dar es Salaam BRT (DART) system determined that 1,004 parking units will require removal from central Dar es Salaam in order to accommodate the exclusive lanes of the BRT system. To assess whether these parking units needed to be replaced with new units somewhere else, or simply removed, a parking occupancy survey of the area was conducted.

The study found that there were 13,803 on- and off-street parking units available on average during peak business periods, and that only 10,594 of these were generally occupied. Some of the on-street parking supply had been sold in blocks to small businesses at a very low price, and other blocks of on-street parking were controlled by government and international agencies. These findings showed an occupancy rate of some 77 percent. As normally, 85 percent is generally considered the optimum balance between efficiency and ease of finding a space, the study

determined that there was no overall shortage of parking availability in the city centre, and that the removal of the parking units for the DART system could proceed without the need for constructing or designating new units.

It did find, however, that the occupancy rate was far from uniform. In the southern part of the CBD, the occupancy rate was 104 percent, due to a large number of illegally parked cars, whereas in other areas, the occupancy rate was as low as 62 percent. It also found that some 20 percent of the vacant parking spaces were in parking units reserved for specific businesses. From this it was concluded that parking in the Southern part of the CBD was underpriced, in other locations the prices were okay, and that the sale of blocks of parking to specific businesses was significantly limiting the overall supply of parking. These two changes would more than compensate for the loss of units resulting from the BRT project (Millard-Ball 2006).

These findings were presented in a public meeting and were successful in mitigating the concerns of most shopkeepers and property owners. The exercise demonstrated to the public that the issue of parking availability is not absolute but relative to location and price. Flat parking rates undercharge for parking in certain locations, and overcharge in others; it is not inherently more equitable and by no means economically optimal.

only found in such areas. Third, while the tax may provide an incentive for operators to reduce commercial parking spaces, it can at the same time encourage an increased number of free parking spaces.

By contrast, a “parking space levy” works by charging a set fee to all non-residential parking spaces, regardless of whether the space is used or not (Figure 14.5). A parking space levy can be collected on a periodic basis in a similar manner to common forms of land taxes. A parking space levy provides multiple benefits that can not only encourage public transport usage but also lead to improved usage of public space. Several cities in Australia, including Sydney and Perth, have pioneered the parking space levy concept.

Based on these experiences, a parking fee can be quite effective at multiple complementary

objectives: 1.) Reducing private vehicle usage; 2.) Encouraging journeys by public transport; and, 3.) Raising revenues for public transport infrastructure. Parking fees may also be a particularly relevant option for developing-nation cities, especially as a short- to medium-term revenue raising mechanism.

Since the parking space levy is assessed whether or not a space is being utilised regularly, property owners have an incentive to scrutinise the usefulness of maintaining each parking space. Without a parking space levy, an urban parking lot may be financially viable even if only a fraction of the spaces are actually used (Figure 14.6). With a parking space levy, property owners will tend to convert the space to more productive uses.



Fig. 14.5
With a parking space levy, shops have an inherent incentive to only provide the number of parking spaces that are truly required.
 Photo by Lloyd Wright

14.1.1.3 Parking enforcement

“A thousand policemen directing traffic cannot tell you why you come or where you go.”
 —T.S. Elliott, poet and dramatist, 1888–1965

The site of a vehicle parked on the pedestrian pavement is not uncommon in many developing cities (Figure 14.7). Police are often unable or unwilling to deter such practices. The result is a culture that permits private vehicles to consume public space, which further weakens the social position of walking and other sustainable forms of mobility. However, enforcement of traffic and parking laws can immediately produce the opposite effect. Applying fines and penalties to illegally parked vehicles will discourage the practice as well as curb the overall parking supply. Work has been done to suggest various mechanisms for improving parking enforcement (Cracknell, 2000). Improvements in parking enforcement hold many benefits beyond encouraging public transport usage. Parking enforcement also helps instil a citizen culture, improves pedestrian and traffic safety, and creates a more pleasant urban environment.

14.1.1.4 Reducing parking supply

Because BRT provides passengers with a new high quality mass transit service to a downtown area, a mayor may choose to reduce the total private motor vehicle parking supply in order to try and induce a modal shift between cars and the new BRT system, to reduce congestion, air pollution, and to free up city centre



Fig. 14.6
A parking levy can also lead to the re-development of parking lots that may be currently viable with a few parked vehicles.
 Photo by Lloyd Wright

land formerly used for parking for other public purposes. Bogotá has been the most aggressive about cutting back on available parking, cutting approximately one-third of the total on-street parking units in central areas prior to the implementation of TransMilenio. Off-street, private parking facilities took up some of this demand. However, unlike on-street parking, the private parking facilities charged a fee for the service. The end result was the termination of free city parking and the reclamation of public space. In many instances, the previous parking spaces have been converted to an attractive new environment for pedestrians (Figure 14.8).

Removing on-street parking, for all its political complexity, is extremely simple from a technical point of view. The designated parking area can simply be removed. It can be replaced either with a mixed traffic lane, a bicycle lane, a foot-

Fig. 14.7
Illegal parking on pedestrian sidewalks discourages walking and sends a message that private vehicles are more important than persons.
 Photo by Lloyd Wright





Fig. 14.8
Bogotá has eliminated much of its previous on-street parking in order to deter private vehicle use. The former parking spaces are being converted into more attractive public space.

Photo by Lloyd Wright

path, or landscaping. In many cases, planners may decide to replace the parking space with additional footpath space. Since enforcement is an issue in developing countries, the use of physical structures like very high curbs and bollards can be necessary to keep motorists off the footpaths. In general, though, use of trees or other landscaping are a more aesthetically-pleasing form of protective barrier. Some countries use bicycle parking as a bollard which provides a useful additional service (Figure 14.9).



Fig. 14.9
Bicycle parking facilities can double as bollards and useful infrastructure for cyclists.

Photo by Lloyd Wright

Off-street parking can also be regulated through taxation, the removal of subsidies, and changing building codes. In some countries building owners are given a property tax break if they provide off-street parking. Such tax breaks tend to encourage the use of private motor vehicle use. To discourage driving, these tax breaks should be removed or subsidies of equal value should be given to employees willing to bicycle or use public transport. Parking garages can also be taxed.

Building codes also often frequently create sub-optimal parking supply incentives, and should be reviewed and, if necessary, changed. A BRT project might be a good opportunity to review these standards. Table 14.2 notes the minimum parking standards required in Dar es Salaam.

Figure 14.2: Dar es Salaam minimum parking requirements

Use	Parking requirement
CBD	
Offices	1 space per 100 m ²
Commercial	1 space per 200 m ²
Hotel	1 space per 10 beds
Hospital	1 space per 10 beds
Flats	1 space per unit
Kariakoo district	
Low-rise buildings	One space per floor
High-rise buildings	Minimum of four spaces

These standards are roughly 25 percent to 50 percent of the same standards in the US, which are high by international standards. Dar es Salaam, however, has a modal split for private cars entering the city centre of under 5 percent, compared to a typical modal split for private cars in the US of greater than 70 percent. The Dar es Salaam figures are fairly typical for a developing nation. Developers would frequently be happy to build fewer parking units but are forced to overbuild parking facilities by government regulation. In Dar es Salaam, the result is that many of the parking facilities are actually used for storage and other purposes. A BRT project should be used to revise downward minimum parking requirements for buildings in the impact area.

14.1.2 Day restrictions by license plate number or vehicle occupancy

“If the automobile had followed the same development cycle as the computer, a Rolls-Royce would today cost \$100, get a million miles per gallon, and explode once a year, killing everyone inside.”

—Robert X. Cringely, InfoWorld

14.1.2.1 License plate-based restrictions

Deteriorating bus speeds, severe traffic congestion and air contamination in some developing cities has prompted officials to enforce vehicle bans based on license plate numbers. The last digit in a vehicle’s license plate number determines the day(s) during which the vehicle is permitted to operate in a particular zone of the city. Travelling with a license plate that is not valid for a particular day will result in a penalty or fine. Such measures could be implemented simultaneously with a BRT project in order to increase bus speeds in situations where the buses are still operating in mixed traffic.

License plate restrictions, to be effective, must be enforceable. This generally requires designating the area within which the restriction is to be enforced, such as within a ring road or some other natural perimeter like a river, where the number of access points that need to be monitored can be minimised. Smaller zones relating specifically to BRT impact areas could also be tested.

The success of license plate restriction programmes has been mixed. The benefit of the license plate restriction dissipates as the number of vehicles increases. In cities such as Mexico City and São Paulo, the programmes had initial success that faded over time, and the crudeness of the approach had some unintended consequences. Many residents in these cities avoided the restrictions by simply purchasing a second vehicle with a licence plate that ends with a different number. Thus, by possessing two vehicles with different numbers, the person is still able to travel each day by private vehicle. Further, since the second car was typically a lower-quality used vehicle, the end result meant that even more emissions were put into the air.

A well-designed programme, though, can avoid the problems experienced in Mexico City and São Paulo (Figure 14.10). Some of the



Fig. 14.10
A well-designed license plate scheme can easily avoid the problem of second-car purchases.

Photo courtesy of Fundación Ciudad Humana (Human City Foundation)

techniques used to prevent the gaming of tag numbers with multiple vehicles include:

- Restrict four or more numbers per day;
- Change the days corresponding to a particular day on a regular basis (*i.e.*, every 6 or 12 months);
- Only apply the restriction during peak hours
- Require the re-registration of any used vehicle changing ownership and give the same final number to any additional vehicle being registered at the same address;
- Apply vehicle ownership fees as a restraint to motor vehicle growth.

Bogotá has developed a license plate restriction programme that has succeeded in removing 40 percent of the city’s private vehicles from the streets each workday during peak periods. The Bogotá approach has succeeded by carefully designing a system to discourage the purchase of second (or third) vehicles. First, Bogotá has chosen to prohibit four license plate numbers each day from use instead of just two or three. Table 14.3 lists by the day of the week the licence plate numbers that are restricted. The restriction of four license plate numbers each day implies that a person would have to purchase three vehicles instead of two in order to cover every day of the week. Second, Bogotá’s vehicle prohibition only applies during peak hours. These hours are from 06:00 to 09:00 in the morning and from 16:30 to 17:30 in the afternoon. Thus, vehicles with the prohibited numbers for a given day may still travel at non-peak hours.

The net effect is to encourage a shift either to using public transport or to use a private vehicle at a non-peak time. This flexibility in conjunction with the restriction applying to four plate numbers has meant that Bogotá has not experienced a problem with persons purchasing multiple vehicles to overcome the restriction.

The measure has contributed to an estimated 10 percent of former car users to shift to public transport as their daily commuting mode.

Table 14.3: License plate restrictions in Bogotá

Day of week	License plates ending with these numbers are restricted from use
Monday	1, 2, 3, 4
Tuesday	5, 6, 7, 8
Wednesday	9, 0, 1, 2
Thursday	3, 4, 5, 6
Friday	7, 8, 9, 0

14.1.2.2 Restrictions based on vehicle occupancy

Cities can also restrict access to specific lanes, streets, or zones based on vehicle occupancy, and some have done so in a manner related to BRT. High occupancy vehicle lanes are popular in US cities. On highways where there are few stops, and in conditions like in the US and parts of Africa where bus volumes are very low but bus speeds are also low, combining a bus priority lane with other high occupancy vehicles may make bus priority lanes more acceptable to the public without significantly compromising their effect on bus speeds. A bus, HOV, and taxi lane exists in New York City on the Staten Island Expressway, the Brooklyn Queens Expressway, and over the Verazanno Bridge. Proposals for combined bus-HOV lanes are moving forward in Cape Town and several US cities. To be effective, vehicle occupancy restrictions require a fair amount of enforcement effort. The lack of enforcement in many developing-nation cities can

mean that such schemes are blatantly ignored by most motorists.

Jakarta has a three-in-one restriction during the morning peak on the same north-south corridor where the TransJakarta BRT system was constructed. This vehicle restriction system has some effect on traffic but also some perverse effects. It has led to an industry of people who will ride with the driver for a small fee to increase the vehicle occupancy. In some cases, children are abandoning their studies in order to become three-in-one jockeys for car owners. It has also led to a peculiar dual peak, one at the normal morning peak and one just after the three-in-one restriction. As a result of the BRT system, there are active discussions to extend the three-in-one system to the entire day, and to eventually replace it with a congestion charging scheme.

14.1.3 Congestion charging and road pricing

14.1.3.1 Defining congestion charging

A city's road infrastructure has a finite ability to accommodate ever increasing amounts of private vehicles. The resulting congestion places innumerable costs upon a city in the form of air contaminants, noise, personal stress, unreliable delivery services, and the inability of persons to travel efficiently.

Most economists agree that traffic congestion is the result of a failure to properly charge for the value of road access, and see congestion charging as the optimal solution. The last motorist to enter a road slows down his or her own trip only marginally, but he or she also slows down everyone else on the road. As a result, the social cost of the motorist's decision to use that road during a congested period is much higher than the cost to the individual who has to make the decision. A congestion charge, by making the motorist pay the full social cost of the decision to use a congested road, can do much to reduce congestion (Figure 14.11).

In practice, implementation of a perfect pricing regime for road access has proven elusive, but a growing number of cities are getting much closer. By providing much improved public transport service, a BRT project also creates a possible political opportunity to begin to introduce congestion charging. New electronic road



Fig. 14.11
Charging motorists for access to road space provides a financial incentive to consider alternative modes such as BRT.

Photo by Lloyd Wright



Fig. 14.12
Singapore's Electronic Road Pricing (ERP) system has been effective in curbing vehicle use, especially during peak periods.

Photo by Manfred Breithaupt

charging methods are creating new possibilities for regulating vehicle access in more location-specific ways which can increasingly be coupled with BRT projects to optimise road use and bus speeds in specific locations.

Different approaches to better internalise the full social costs of driving are known by different names, including congestion charging, road pricing, and cordon pricing.

Congestion charging places a monetary value on using the road space during peak travel times. Motorists who wish to enter a congestion zone must pay a fee to gain legal access to the use of the road. By charging for the use of the road resource, only those who value road access more than the congestion charge will travel during the peak times.

London, Singapore, Stockholm, and three cities in Norway have implemented pricing schemes. The results have shown a marked reduction in congestion as well as the generation of revenues for supporting sustainable transport options.

14.1.3.2 Electronic road pricing in Singapore

From 1975 until 1998, Singapore operated a manually-controlled road pricing scheme. The

scheme requires motorists to pay for entry into a central Restricted Zone. Technological advances enabled the city to implement an Electronic Road Pricing (ERP) scheme in 1998. The system utilises short-range radio signals between in-vehicle electronic units and overhead gantries (Figures 14.12). The gantries are both on major avenues entering the CBD and along certain highways. As such, charges are applied not only to the CBD but also to congested highways. A smart card is inserted into the in-vehicle unit to validate entrance into the Restricted Zone. Topping up the value on the smart card can be done at petrol stations or automatic teller machines (ATMs).

There are actually three functions to the gantries. First, one set of technology on the gantry sends a signal to the in-vehicle unit and deducts a charge. A second set of technology is an enforcement system. If the communication between the in-vehicle unit and the gantry radio antennae indicates that the road charge is not being paid, a camera on the gantry will photograph violating vehicles and identify their license plate. Third, the gantries collect traffic information and send it to a control centre to manage and coordinate the system.

The system software allows a different fee to apply during different half-hour periods. The

highest peak rate is currently US\$1.71 per half-hour spent in the Restricted Zone. The infrastructure cost of the Singapore ERP system was approximately US\$114 million. Each year the system generates US\$46 million in revenues with operating costs of US\$9 million. The ERP scheme is credited with reducing traffic levels by 50 percent and increasing average traffic speeds from around 18 kph to 30 kph.

The Singapore system gives traffic managers great power to adjust the congestion charge to very specific points where congestion is at its worst. As such, it has the potential to come much closer to optimising the charging structure to locations where congestion is at its worst.

The Singapore system, however, requires anyone entering the CBD to have an electronic unit in their car. Because Singapore is a city-state, there is not a high volume of traffic entering Singapore from other jurisdictions, and that level of traffic can easily be handled by roadside facilities where the transponder can be rented or purchased. While the price of the in-vehicle electronic units is falling, for other systems to use the same scheme, a mechanism for facilitating access to the in-vehicle units for motorists from other jurisdictions must be developed. Enforcement is also easier when virtually all traffic is from the same municipal jurisdiction.

14.1.3.3 Congestion pricing in London

The introduction of the congestion charging scheme in London has now helped to broaden the appeal of congestion charging to transport planners worldwide. Over the past decades,

London's traffic congestion had worsened to the point that average traffic speeds were similar to speeds of the horse carts utilised in London during the nineteenth century. In response, London's Mayor Ken Livingstone decided to implement a congestion charging scheme in the centre core of the city.

Currently, a £8 (US\$14) fee is imposed upon vehicles entering the central zone from 07:00 to 18:30 (Monday through Friday). Motorists can pay through a variety of mechanisms including the internet, telephone, mobile text messages, self-service machines, post, and retail outlets (Figure 14.13). Motorists have until midnight on the day of entry to pay the charge, although payments after 22:00 increase to £10 (US\$18). Subsequently, an £80 (US\$144) fine is applied to motorists who fail to pay by midnight.

The London system differs from the Singapore system in several ways. First, the London system does not require an in-vehicle electronic unit, and requires no system of cash cards. It is an enforcement only system. London does not utilise gantries but instead relies upon camera technology to identify the license plates of all vehicles passing the point, and sends this information to a central computer (Figure 14.14). At the end of each day, the list of vehicles identified entering the zone is compared to the list of vehicles that have made payments to the scheme operators. Any unpaid owners are referred for enforcement actions.

Fig. 14.13
Motorists have a range of options for paying the London congestion charge, including local shops.

Photo by Lloyd Wright



Fig. 14.14
Camera technology is utilised in London to enforce the congestion charge.

Photo by Lloyd Wright



London adopted a camera-based system rather than an electronic gantry system for several reasons. First, it was hoped that the elimination of the in-vehicle electronic system and the cash card would reduce administration costs. Second, London also had aesthetic concerns over the large overhead gantries employed in Singapore. Third, officials were concerned over the limitations of GPS-based systems to operate without interference in narrow urban roads lined by tall buildings.

London's system has some disadvantages. Unlike the Singapore system, London's system has to charge a flat fee for a carefully defined area. To win political support, residents with motor vehicles inside the charging zone were given a 90 percent discount. This exemption has made expanding the zone difficult, as expanding the zone also expanded the number of people eligible for the discount. Congestion is also not uniform around a zone, particularly a larger zone. For a larger zone, it may be that there is minimal congestion on access roads serving lower-income areas and higher congestion on access roads serving higher-income populations. A point-specific charging system like Singapore has much greater potential to optimise charges to specific points of congestion.

The license plate detection is not required to ensure payment, but rather it is only required to enforce non-payment. For this reason, the system does not have to be 100 percent accurate; the system is only accurate enough to induce people to pay the fee voluntarily. The London system also has some trouble charging motorcycles, which are therefore exempt. The cameras incurred a failure rate of between 20 percent and 30 percent in reading motorcycle license plates due to the smaller size of the plates and the fact that motorcycles do not always operate in the centre of the lane. Some license plates can be difficult to read due to glare or obstructions from trucks, or other sight restrictions, and motorcycles are more prone to these problems. In London they decided to exempt motorcycles to ensure a high level of consumer confidence in the system, but in other cities with a large number of motorcycles they would need to be included.

In addition to exempting motorcycles, the London congestion charge is also not applied



Fig. 14.15
The Stockholm charge zone and the 19 points of entry.

Image courtesy of the City of Stockholm

to taxis, public transport, police and military vehicles, physically disabled persons, certain alternative-fuel vehicles, certain health care workers, and tow trucks. The exempted vehicles represent 23 percent (25,000 vehicles) of the total traffic in the zone.

After one year of operation, London's congestion charge has produced some impressive results. Congestion levels have been reduced by 30 percent, and the total number of vehicles entering the zone has dropped by 18 percent. Average speeds have increased from 13 kph to 18 kph. Perhaps the most unexpected benefit was the impact on the London bus system. With less congestion bus journey speeds increased by 7 percent, prompting a dramatic 37 percent increase in bus patronage. The revenues from London's programme are applied to supporting bus priority schemes and cycleway projects. London is currently planning an extension of the congestion charging zone.

14.1.3.4 Congestion charging in Stockholm

On 3 January 2006, Stockholm joined London and Singapore as large cities employing a congestion charge. Stockholm has borrowed concepts from its two predecessors while also invoking several more recent technological innovations. The Stockholm charge was been implemented as a trial mechanism for a period

of six months, after which time the public would voted on whether to keep it. In fact, in September 2006, a majority of the citizens of Stockholm did vote to keep the congestion charge.

Stockholm’s charge zone includes the entire central area of the city with a total of 19 different gantry points permitting entry into the zone (Figure 14.15). Like Singapore, Stockholm has a fortuitous location with bodies of water restricting the number of actual access points to the city centre. Such naturally-restricted entry eases the technical tasks of controlling a large number of entry points.

The amount of the Stockholm charge depends on both the number of times a vehicle enters the central zone as well as the time of day (Table 14.4). For vehicles entering and exiting the charge zone multiple times per day, the maximum amount to be paid is 60 SEK (US\$7.80). Like London and Singapore, several types of exemptions are permitted, including emergency vehicles, public transport vehicles and school buses, taxis, vehicles with disability permits, environmentally-friendly vehicles (*e.g.*, electric, ethanol, and biogas), and motorcycles. The capital cost for the six-month trial period of the charge was SEK 3.8 billion (US\$494 million) (Pollard, 2006).

Table 14.4: Fee schedule for the Stockholm congestion charge

Time of crossing zone boundary	Cost (SEK)	Cost (US\$) ¹⁾
06:30 – 07:00	10	US\$1.30
07:00 – 07:30	15	US\$1.95
07:30 – 08:00	20	US\$2.60
08:30 – 09:00	15	US\$1.95
09:00 – 15:30	10	US\$1.30
15:30 – 16:00	15	US\$1.95
16:00 – 17:30	20	US\$2.60
17:30 – 18:00	15	US\$1.95
18:00 – 18:30	10	US\$1.30
18:30 – 06:30	0	US\$0

Source: City of Stockholm (2004)

Stockholm uses two different types of vehicle detection technologies, which are similar to both the technologies used in London and Singapore.

¹⁾ Exchange rate of US\$1 to SEK 7.7 (Swedish Kronor)

For regular travellers to the central area, motorists can obtain an electronic tag that automatically reads the vehicle’s entry into the area. With this electronic tag, the appropriate fee is automatically deducted from the person’s bank account. Approximately 60 percent of the people entering the zone utilise the electronic tag.

Alternatively, for vehicles not employing the electronic tag, a camera technology similar to that of London is utilised. The camera detects the plate number on the vehicle, and the motorist has five days to pay the charge by post or at a shop. If the charge is not paid within five days, then a fine of SEK 70 (US\$9) is assessed. After four weeks, the unpaid charge results in a fine of SEK 525 (US\$68) (Webster, 2006).

In the first month of operation, Stockholm’s congestion charge reduced congestion levels by 25 percent, which is equivalent to reducing private vehicle travel by approximately 100,000 cars each day. The percentage reduction is relatively similar to that of London, but it was achieved with a significantly lower charge. The congestion charge has both influenced the time that people travel as well as their mode of choice. Approximately 2,000 drivers now travel to work earlier in order to enter the zone prior to the 06:30 start of the charge. Another 40,000 private motorists have now switched to public transport (Public CIO, 2006).

Perhaps the most instructive lesson from Stockholm has been the manner of implementation. The congestion charge has been applied as a six-month trial ending in July 2006. In September 2006, the public voted on whether to continue with the charge. At the outset of the congestion charge experiment, approximately two-thirds (67 percent) of the public was opposed to it. On 17 September 2006, 52 percent of the public approved the referendum to make the congestion charge permanent.

The referendum approach can thus be an effective mechanism to gain public support permitting an initial trial. Otherwise, protests at the outset may prevent a project from happening at all. This approach, though, is not without its risks. As people experience the benefits of reduced congestion, support for the measure may dramatically increase, as was the case in Stockholm. Nevertheless, any city employing

a referendum approach to project approval and project continuance must be prepared for a negative vote. However, giving people a democratic voice in applying TDM measures can be an approach warranting serious consideration.

14.1.3.5 Developing city applications for congestion charging

The success of the London and Singapore pricing schemes has attracted interest for similar projects in developing cities. The high-tech nature of congestion charging amongst Mayors and other officials can increase its attractiveness to officials seeking modern technologies for their cities. However, the complexity of such schemes in conjunction with the relatively high initial costs may limit the extent to which congestion charging can be applied in the developing-nation context.

Several developing-nation cities, such as Jakarta and São Paulo, have given serious consideration of the congestion charging option. São Paulo under Mayor Martya Suplicy contracted a congestion charging feasibility study, but it was not implemented by the subsequent Mayor. The study nonetheless raised some issues of relevance to developing country applications.

The legal structures required for proper enforcement are one of the major concerns. It is important to determine legally whether it matters if the congestion charge is designated a “tax” or a “user fee”. The law needs to give the municipality the right to directly enforce the collection of the charge. In São Paulo, approximately one-third of the motorists are operating their vehicles without a valid vehicle registration, making enforcement very difficult. An additional large number of vehicles are registered outside the State of São Paulo in states where there are no mutual enforcement rules between states for traffic violations.

The simplest thing would be to convert the existing rodizio license plate restriction scheme to congestion charging, since motorists already face a type of vehicle restriction that is sub-optimal. The zone for the rodizio scheme, however, includes roughly half of the city’s population. Exemptions for residents inside the zone would render the charge meaningless in this situation, and the number of gantries or cameras needed is quite high.

Motorists in developed countries also value their time more than in developing countries. The technology used in the London and the new Singapore systems is quite expensive, and reaching full cost recovery for such high-tech systems would take much longer for lower-income motorists. Low-cost solutions such as the manually-operated Area Licensing Schemes (ALS) may be a more appropriate starting point for developing-nation cities. As was the case in Singapore, a manual ALS can eventually evolve into a more sophisticated Electronic Road Pricing (ERP).

Combining multiple, simpler TDM measures could be more appropriate for developing-nation cities. For example, the combination of day restrictions by license plate numbers and parking restrictions in Bogotá have been highly successful in reducing private vehicle use without the difficulty of implementing a road pricing scheme. Likewise, parking fee schemes can produce as many or more revenues (due to lower operating costs) than road pricing schemes. Thus, auto-restriction measures are not mutually exclusive. Road pricing schemes can be implemented in conjunction with parking reform and other TDM measures.

14.1.4 Reducing road supply

Priority public transport infrastructure on roadways serves an important purpose beyond providing a high-quality service to public transport customers. The simultaneous reduction in road space for cars creates a powerful incentive for motorists to shift to public transport use. While some may see the use of road space by public transport systems as a sacrifice, this consumption of car space may be one of the greatest overall benefits.

The notion of “induced traffic” is well supported in the mainstream of transport planning. Induced traffic implies a rather counter-intuitive conclusion: *Additional road construction results in more traffic congestion*. Induced traffic essentially says that a city cannot “build” its way out of the problem. While additional road construction may lead to a temporary reduction in traffic levels, this free road space eventually attracts additional traffic, especially when there is latent demand for private vehicle usage.

Fig. 14.16 and 14.17
Before and after images of the Cheonggyecheon corridor project in Seoul. Despite tearing down one of the principal expressways to the city, the resulting congestion impacts were minimal, especially since the new BRT corridors helped to gain ridership from former car users.

Images courtesy of the Seoul Development Institute



Interestingly, the research suggests the process works in reverse as well. Evidence from bridge and street closings in the UK and the US indicates that a reduction in road capacity actually reduces overall traffic levels, even accounting for potential traffic transfers to other areas (Goodwin *et al.*, 1998). This disappearance of traffic, known as “traffic degeneration” or “traffic evaporation”, gives one of the strongest indications to the viability of developing BRT infrastructure. Further, the reduction in private vehicle lanes can have an overall beneficial impact on the city’s urban environment.

Perhaps one of the most spectacular examples of this concept in practice is the Cheonggyecheon

corridor project in Seoul. The Cheonggyecheon stream was historically a defining part of Seoul’s environment, and in fact was the reason why Seoul was selected as the capital of the Joseon Dynasty in 1394. Unfortunately, in the face of modernisation, the waterway was covered in 1961 to provide better access for private cars. By 1968 an elevated expressway provided another layer of concrete erasing the memory of the waterway.

Upon his election in 2002, Seoul Mayor Myung Bak Lee decided it was time to bring back the Cheonggyecheon stream from its years of hiding under concrete. The Cheonggyecheon project has meant the restoration of 5.8 kilometres of waterway and historical pedestrian bridges,



Fig. 14.18
The new Seoul BRT system has helped make it possible to reduce road space dedicated exclusively to cars.

Photo courtesy of the City of Seoul

the creation of extensive green space, and the promotion public art installations (Figures 14.16 and 14.17). Based upon a study by the Seoul Development Institute (2003), the Cheonggyecheon restoration project will produce economic benefits of between 8 trillion and 23 trillion won (US\$8 billion to US\$23 billion) and create 113,000 new jobs. Over 40 million visitors experienced the Cheonggyecheon stream during the first year after restoration.

Further, despite the elevated expressway being the principal access way for cars into the city centre, there were no significant congestion impacts. In part, the new Seoul BRT system helped to defray some of the traffic impacts (Figure 14.18). Other cities as well, such as Portland, San Francisco, and Milwaukee in the US, have demolished roadways to reduce automobile dependence and return a more human environment. The development of a new BRT system can be an opportune time to investigate opportunities for the reduction of road space.

14.1.5 Travel blending

Several cities in Australia and Europe have developed a new technique for achieving dramatic changes in mode shares at very low costs.

Fig. 14.19

The high density of cities such as Bogotá makes public transport more financially viable and reduces overall trip distances.

Photo by Carlos Pardo



The technique, known as “travel blending”, is a form of social marketing. The idea is to simply give people more information on their commuting options through a completely personalised process, and then facilitating changes in travel behaviour. While the focus to date has been in developed countries, a recent success in Santiago (Chile) indicates that it may be applicable to developing cities as well.

More information on this technique is provided in Chapter 18 (*Marketing*).

14.2 Integrating BRT with land-use policy

“The suburb is a place where a developer cuts down all the trees to build houses, and then names the streets after the trees.”

—Bill Vaughn, columnist and author

A BRT project may be an opportune time to introduce long-sought land-use changes within the urban landscape. Land use refers to the manner in which urban form is shaped through policy actions and consumer preferences. Land use is often best characterised by what is known as the “3Ds”: Density, diversity, and design. If developed through a mutually-supporting package of measures, the 3Ds can be the basis of creating an effective ridership base for public transport systems such as BRT.

Areas with medium- and high-density populations provide a critical mass of inhabitants

Fig. 14.20
Low-density communities, such as those in Houston, tend to make cost-effective public transport services impractical.

Photo by Lloyd Wright



to support shops and public services without requiring access by motorised vehicles (Figure 14.19). In low-density areas, customers must be drawn from a wider area in order for commercial centres to reach financial viability (Figure 14.20). The car becomes a necessity to cross such distances. Higher-density communities can provide a sufficient customer base within a walking distance. For this reason, a fortuitous circle of relationships exist between urban density, vehicle ownership, energy use, and vehicle emissions.

Diversity refers to creating a mix of uses within a local area. By combining residential and commercial uses into a single area, the number of trips and the length of travel are both reduced. People are able to meet most of their daily needs by walking, cycling, or public transport.

Design refers to the planning of housing, shops, and public transport in a manner that supports a reduced dependence on cars. Transit-oriented development (TOD) has emerged as one of the principal mechanisms to make this happen. This section reviews how land-use policy can be shaped to support a successful BRT system.

14.2.1 Introduction to transit-oriented development (TOD)

“In spite of its diverse and often conflicting meanings, all parties superficially endorse ‘smart growth’ because it is clearly superior to the alternative: ‘dumb growth’.”

—Anthony Downs, writer and public administration scholar

Local land-use patterns significantly affect the usage of public transport systems. Travellers will generally only use public transport if it requires walking less than a kilometre. Increasing the

portion of destinations (homes, worksites, shops, schools, public services, etc.) located near public transport stations, and improving walking conditions in areas served by public transport, makes the system more effective to users and profitable for operators. This type of land use is called *transit-oriented development (TOD) or smart growth*.

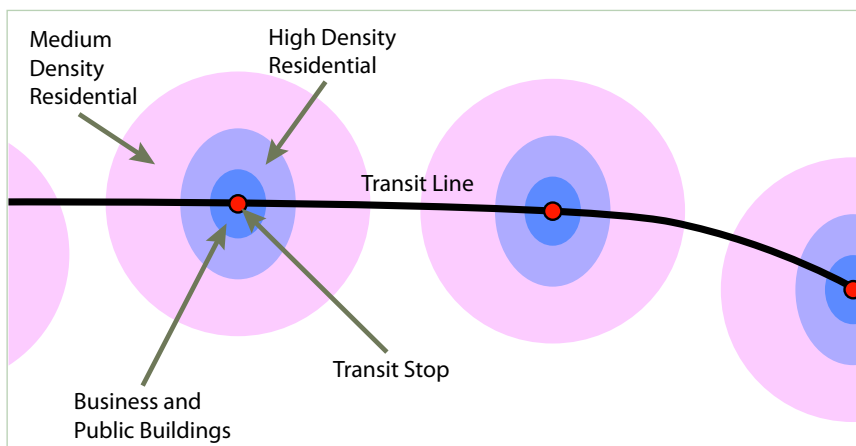
BRT projects can provide a catalyst for transit-oriented development. A public transport station can be the nucleus of a transit centre, also called an urban village (Figure 14.21). A typical village contains an appropriate mix of housing, schools, shops and public offices, employment centres, and religious (church, mosque, synagogue), recreation and entertainment facilities. As much as possible major destinations should be located within view of the public transport station so they are easy for visitors to find. Each urban village should have its own name and identity, which can be encouraged with appropriate signs and public art, and special events, such as a neighbourhood festival.

Higher density housing, such as multi-story apartment buildings and condominiums, should be located near public transport stations. Medium-density housing, such as low-rise apartments, townhouses, and small-lot single-family homes, can be located further away, but still within convenient walking distance of the transit centre.

A typical urban village has a diameter of 1 to 1.5 kilometres, a size that allows most destinations to be located within half a kilometre walking distance of the public transport station. This diameter contains an area of 80 to 160 hectares, enough to house 2,000 to 4,000 residents with medium-density housing (25 residents per hectare), or more with higher-density housing. Of course, not every urban village will follow this exact design, some may be primarily commercial, industrial or recreational centres, and others are limited in size due to geographic features such as parks and waterways. Some may be smaller or larger, depending on demographic and land use factors. Each urban village should be carefully planned to take advantage of its unique features.

Transit-oriented development provides many benefits compared with more dispersed land-use

Fig. 14.21
Transit-oriented development (TOD) creates urban villages along transit lines, with a transit stop with major commercial and public facilities in the centre, surrounded by high- and medium-density residential development.



patterns. TOD increases the number of destinations within walking range of public transport stations. This, in turn, increases public transport system ridership and revenues, and reduces local traffic problems. More compact development with well-planned urban villages tends to reduce the cost of providing public services such as utilities, roads, policing, and schools. Improved walking conditions, reduced motor vehicle traffic, and better public services tends to increase neighbourhood liveability. It also provides economic efficiency benefits, including increased lower business costs for parking and goods distribution, and an expanded labour pool. These efficiencies tend to increase overall economic productivity, business activity and tax revenues. Even people who do not use public transport, benefit from having BRT service and transit-oriented development in their communities (Table 14.5).

Because of these benefits, property values tend to increase in areas with high-quality public transport services (Smith and Gihring, 2004). A recent study of residential property values along BRT lines in Bogotá, found that, after controlling for other building and neighbourhood attributes, residential rental costs increased between 6.8 percent and 9.3 percent for each 5 minutes reduction in walking time to a BRT station. This indicates that residents significantly value public transport access (Rodríguez and Targa, 2004). The upsurge in commercial and residential development along TransMilenio corridors clearly indicates the link between a quality public transport system and land-value appreciation (Figure 14.22). Likewise, Curitiba's BRT stations and corridors have become renowned for the large influx of accompanying development.



14.2.2 Transit-oriented development design features

“Let’s have a moment of silence for every American stuck in traffic on their way to a health club to ride a stationary bicycle.”

—Representative Earl Blumenauer, US Congress, 1948–

Transit-oriented development reflects several specific land use features. Density refers to the number of people or jobs in a given area. Increased density tends to reduce per capita automobile travel and increase public transport ridership. This result occurs because density increases the number of people and destinations served by public transport, which leads to improved public transport service (more frequent service with greater coverage) and better pedestrian conditions. As a general rule, densities of at least 25 employees or residents per hectare are needed within walking distance of a public transport line (*i.e.*, within 0.5 kilometres of each station) to create the demand needed for quality service. The exact density

Table 14.5: Benefits of transit-oriented development (TOD)

Transit Users Benefits	Transit Operators Benefits	Benefits to Society
<ul style="list-style-type: none"> ■ More destinations near transit stations ■ Better walking conditions ■ Increased security near transit stations 	<ul style="list-style-type: none"> ■ Increased ridership ■ Lower costs per rider ■ Better image 	<ul style="list-style-type: none"> ■ Reduced traffic problems ■ Reduced public infrastructure and service costs ■ Community liveability ■ Increased property values, business activity and tax revenues

Fig. 14.22
Bogotá’s TransMilenio system has led to significant commercial and residential development at stations and along the corridors.

Photo by Carlos Pardo

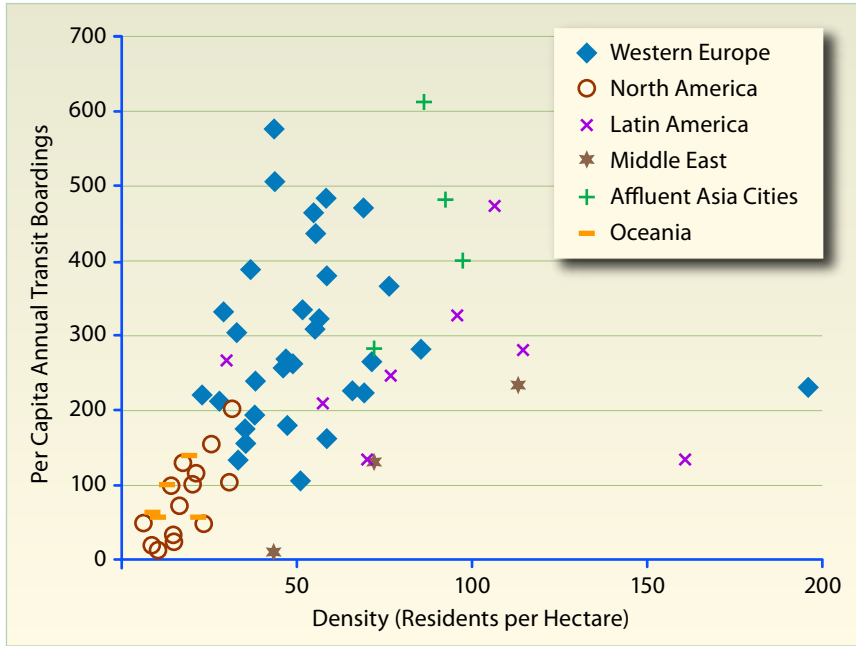


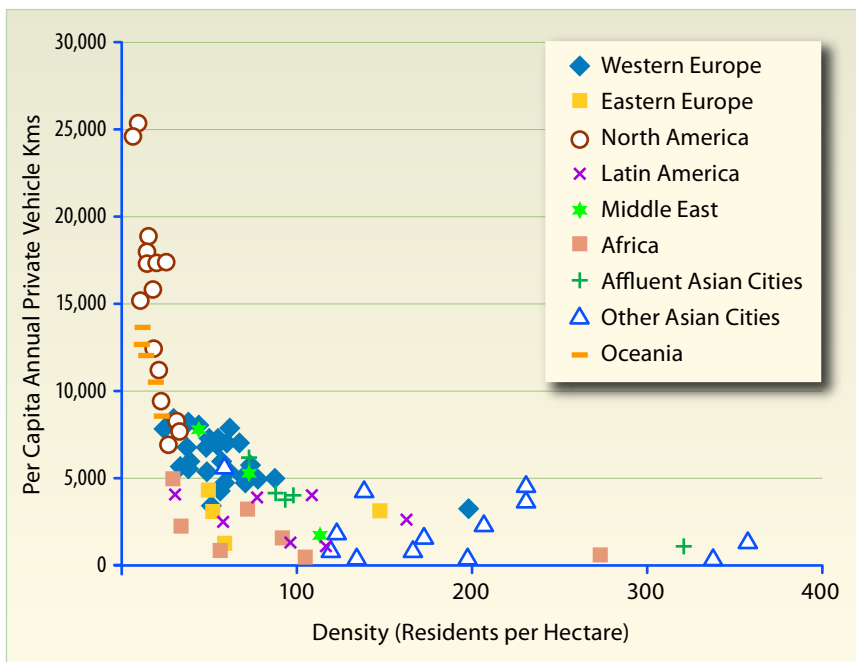
Fig. 14.23
City density vs. number of public transport trips.
Source: (Kenworthy and Laube, 2000)

requirements are affected by various factors, including the portion of residents who commute by public transport, and the distance that residents are accustomed to walk, and so may vary from one area to another.

Figures 14.23 and 14.24 illustrate the effects of density on public transport and automobile travel. As density increases, per capita public transport travel tends to increase and per capita automobile travel declines.

Fig. 14.24
City density versus private vehicle usage.
Source: (Kenworthy and Laube, 2000)

Clustering means that commonly-used businesses and public services are located together



in an urban village, mall or district, as opposed to these services being dispersed throughout a community or scattered along a roadway. Clustering makes these businesses and services more convenient for pedestrians and public transport access. Clustering allows several errands to be accomplished during a single trip, helps create the critical mass of public transport riders needed for quality service, and encourages public transport commuting by locating more services (cafes, banks, and stores) near worksites for employees to use during breaks.

Curitiba has sought to exploit the advantages of clustering in conjunction with its BRT stations by developing "Citizenship Streets". These streets are a mix of shops as well as key public services such as health care, counselling, employment services, gymnasiums, and libraries (Figure 14.25). The Citizenship Streets are fully pedestrianised with one side typically bordering a BRT station. A person can often meet most of their daily journey requirements through visiting a single Citizenship Street. Likewise, Bogotá has located its "SUPERCARDE" service centres at BRT terminals; these centres allow citizens



Fig. 14.25
Curitiba's "Citizenship Streets" are located near BRT stations and permit residents to fulfill multiple tasks within a single journey.
Photo by Vera deVera

Fig. 14.26

Bogotá locates public service centres at its BRT terminals in order to more efficiently bring such services to the population.

Photo by Lloyd Wright



to pay bills and access public services in a single location (Figure 14.26).

Land-use mix refers to locating different but related activities close together, such as homes, schools and stores. Land-use mix reduces the need for automobile travel by allowing residents and businesses to walk rather than drive to more activities.

Connectivity refers to the degree that road and path networks allow direct travel from one location to another. Smaller city blocks, connected streets and shortcuts for non-motorised travel tend to minimise travel distances and support walking and cycling, and therefore public transport travel. Large blocks, dead-end streets and inadequate walking facilities reduce connectivity, increasing the distance that people must travel to reach their destinations. Figure 14.27 illustrates the difference between low and high connectivity street patterns.

Walkability refers to the quality of the walking environment, including the condition of footpaths, road crossings, cleanliness and security. At a minimum, transit villages need wide, well-maintained footpaths, crosswalks that allow pedestrians to safely cross busy streets, and adequate cleanliness and security. In addition, it is desirable to have public parks, shade trees and other landscaping, attractive buildings, pedestrian refuges (so pedestrians need only cross half the street at a time) and traffic calming (to control vehicle traffic speeds), bicycle lanes, washrooms, drinking fountains, and other amenities to enhance pedestrian convenience, comfort and delight.

Site design refers to how buildings are designed and positioned with respect to roads, footpaths, and parking facilities. Buildings with entrances that connect directly to the footpath, rather than being set back behind a large parking lot, tend to encourage walking.

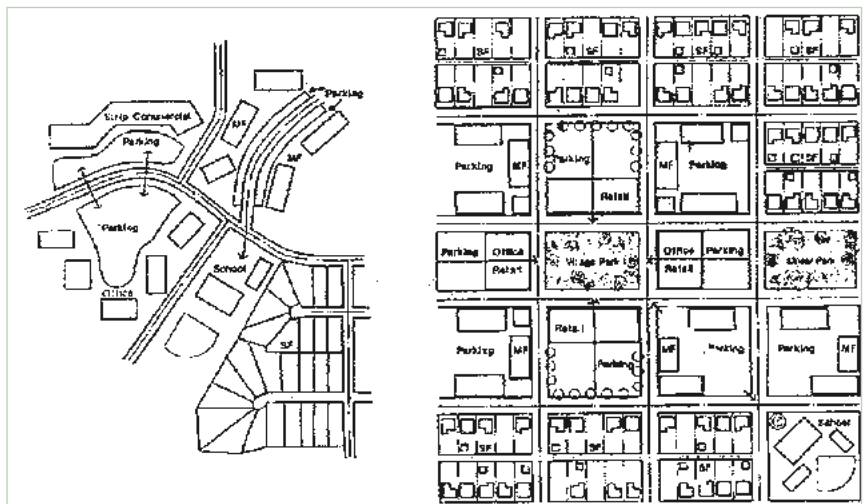
Parking management refers to how parking is supplied, regulated and priced. Generous parking supply creates more dispersed land-use patterns that are less suitable for walking and

public transit access. Free parking represents a subsidy of driving which increases vehicle ownership and use. Ineffective enforcement of parking regulations can lead to motorists parking on footpaths, creating barriers to pedestrian travel.

Together these land-use factors can have a major effect on travel behaviour. Research in both developed and developing countries indicates that a combination of increased density, land-use mix, street connectivity and walkability increase public transport and non-motorised travel, and reduce per capita automobile travel (Kenworthy and Laube, 1999; Ewing, Pendall and Chen, 2002; Mindali, Raveh and Salomon, 2004; and Litman, 2004b). Figure 14.28 shows results from one study indicating that residents of the most urbanised neighbourhoods in Portland (US) use public transport about eight times as much, walk six times as much, and drive about half as much as residents of the least urban areas.

Fig. 14.27

The conventional hierarchical road system, illustrated on the left, has many dead-end streets and requires travel on arterials for most trips. A connected road system, illustrated on the right, allows more direct travel between destinations and offers more routes to choose from, making non-motorised travel more feasible (Kulash, Anglin and Marks, 1990).



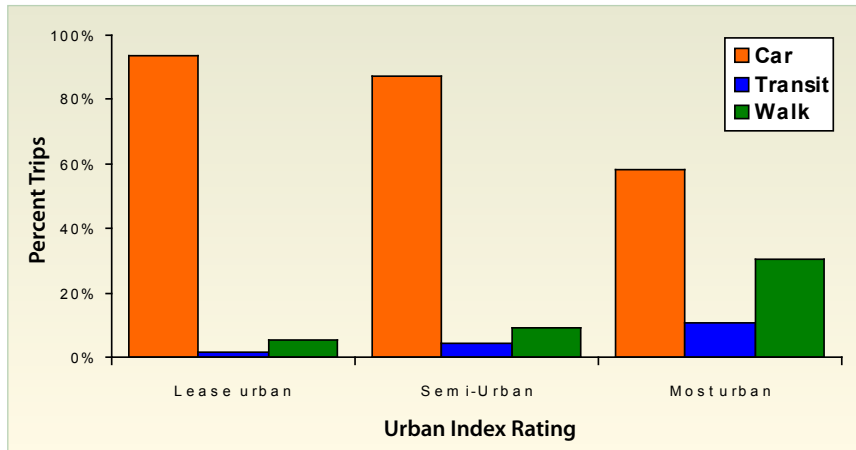


Fig. 14.28
The impact of urbanisation on mode choice.
 Source: Lawton, 2001

14.2.3 Transit-oriented development policies

“Development has become something to be opposed instead of welcomed; people move out to the suburbs to make their lives, only to find they are playing leapfrog with bulldozers. They long for amenities that are not eyesores, just as they long to give their kids the experience of a meadow, that child’s paradise, left standing at the end of a street. Many communities have no sidewalks, and nowhere to walk to, which is bad for public safety as well as for our nation’s physical health. It has become impossible in such settings for neighbors to greet one another on the street, or for kids to walk to their own nearby schools. A gallon of gas can be used up just driving to get a gallon of milk. All of these add up to more stress for already overstressed family lives.”

—Al Gore, former US Vice President, 1948–

In developing countries, where land use is frequently difficult to regulate, transport sector interventions like BRT are one of the best ways to affect changes in land use that are largely dominated by private market based decisions. However, there are some public policies that have been successfully used to encourage higher-density development in the area served by a new BRT system. This section describes specific public policies that can help implement transit-oriented development.

14.2.3.1 Public facility location and infrastructure investments

One of the easiest ways for a government to ensure transit-oriented development is to locate public facilities, such as government offices,

schools and colleges, sports and recreation centres, and cultural facilities along public transport corridors. Bogotá built several new schools along the TransMilenio BRT corridor.

Transit centres and urban villages can be given priority when public investments are made to improve footpaths, roads, parks, public utilities and services such as water and sewage, garbage collection, and electricity. For example, the Rhode Island Transportation Improvement Plan (TIP) gives priority to projects that encourage compact development. As a result, the majority of transportation funds are spent on system management and preservation projects, and less is devoted to expanding roadway capacity in areas with unplanned, dispersed development.

14.2.3.2 Zoning codes

In cities where zoning codes exist and are enforced, up-zoning along a BRT corridor and down-zoning areas off the BRT corridors can be one of the most powerful ways of maintaining and increasing BRT system ridership over the long term. Perhaps the most well-known application of zoning codes in conjunction with public transport is the Curitiba BRT system. High-rise development in Curitiba is restricted only to those areas along the BRT corridors (Figures 14.29 and 14.30). The effect is quite striking in terms of city efficiency and public transport ridership. Areas with rows of skyscrapers in Curitiba make identification of the busways quite easy.

Density bonuses (higher density than would otherwise be allowed) can also be used to encourage major developments in areas well served by public transport, and to incorporate transit-oriented development design features. Many cities have Alternative Development Standards (ADS) that apply in transit-oriented centres, allowing higher densities, mixed land use and lower parking requirements. For example, the city of Portland, Oregon (US) reduces its minimum parking requirements by 10 percent for locations near bus lines, and by 20 percent if located near a rail transit station. Parking is reduced further for developments that are located in walkable neighbourhoods or near bikeways.

To discourage dispersed, automobile-oriented development at the urban fringe, some



Fig. 14.29 and 14.30
Restricting high-rise development to only the mass transit corridors produces multiple benefits for Curitiba.

Photos courtesy of the Municipality of Curitiba

jurisdictions limit the amount of development that may occur outside urban areas with urban growth boundaries and agricultural land reserves. Others limit the extension of water and sewage lines to prevent higher-density development in undeveloped areas.

14.2.3.3 Housing and BRT

In the developing world, where zoning codes are often difficult to enforce, housing policies can be one of the more powerful tools to affect land-use changes. The degree and form of government intervention into the housing sector varies greatly from country to country.

Though rarely done, the ideal would be to coordinate low-income housing programmes and BRT project development so that the beneficiaries of the housing programme could also benefit from the improvement of basic mobility. If such programmes were co-ordinated at the outset, low-income families could also be insulated from the risk of rent increases resulting from the new BRT system.

Governments have varying degrees of influence over the housing sector. At one extreme are countries with very powerful states with a

lot of municipally-controlled land, like China. In China, all levels of government build some housing, publicly-owned enterprises own housing, and various branches of the government including the military are directly involved in real estate development. In such countries, the Mayor has enormous discretionary power to influence what land is developed and at what density. Densification of mass transit corridors in China happens almost automatically, however. At the other extreme, many very poor African countries can afford to do little to intervene in the housing sector short of providing some basic infrastructure.

Bogotá's Metrovivienda programme provides a good example of how low-income housing programmes can be linked to a BRT system. Metrovivienda is a municipal authority that bought land not immediately adjacent to the TransMilenio BRT trunk corridor, but in areas to be served by TransMilenio feeder services, where land was cheap but likely to increase due to the TransMilenio project (Figure 14.31). The municipality subsidised the land procurement, but then contracted private developers to develop affordable but profitable housing

Fig. 14.31

Bogotá's Metrovivienda programme has provided low-cost housing within close proximity to TransMilenio feeder services.

Photo courtesy of Por el País que Queremos (PPQ)



on the land. The developers were chosen by competitive bid. They were able to sell the houses at a profit because the developers did not have to pay for the land. This process was able to provide home ownership at prices roughly 25 percent less than could have been supplied

by the private market. Furthermore, after TransMilenio was built, land prices in the area increased by more than 6 percent above the increase of land prices generally. By having the government procure the land but having private developers develop the land, Metrovivienda was able to provide low-income housing in an area served by TransMilenio while insulating the residents from land price increases.

Curitiba did not incorporate low-income housing programmes into its BRT system, and the densification along the BRT corridor led to very high density middle and upper income real estate development that did dislocate lower-income families to less desirable locations. Likewise, Quito did not intervene directly to encourage housing projects along its BRT corridors. Instead, the private sector has recognised the opportunity and has constructed several new developments near the corridors and stations (Figure 14.32). However, Quito has altered zoning regulations to help facilitate this process.

An innovating example from the US, a co-operative effort by US local and federal agencies, and private banks, is known as the Location

Fig. 14.32

Quito's Ecovía has boosted the development of high-rise apartment buildings and shops along the corridor.

Photo by Lloyd Wright



Efficient Mortgage Initiative. This initiative allows homebuyers to qualify for larger homes loans if the proposed housing is located within a quarter mile (400 metres) of a bus line or half a mile (800 metres) from a train or light rail system. The initiative also offers discounted annual bus passes for one member of the household.

14.2.3.4 Tax and fees

Taxes and utility fees can be structured to favour development of urban villages, reflecting the greater efficiencies and lower unit costs of providing public services in such areas. For example, taxes can be deferred or discounted for buildings that reflect transit-oriented development features. Households that do not own an automobile can be offered a property tax discount, reflecting the lower costs they impose on city road networks and traffic services.

For example, the city of Austin (US) imposes a special “Transportation User Fee” (TUF) to finance roadways, which averages US\$30 to US\$40 annually for a typical household. This charge is based on the average number of daily motor vehicle trips made per property, reflecting its size and use. For example, single-family development is estimated to generate 40 motor vehicle trips per acre per day, condominiums and townhouses are estimated to generate 60 motor vehicle trips per acre per day, and offices generate approximately 180 motor vehicle trips per acre per day. The city provides exemptions to residential properties with occupants that do not own an automobile, and for businesses that encourage employees to use alternative modes, such as public transport.

14.2.3.5 Street design and management

Streets in transit villages should be designed and managed to favour public transport and non-motorised modes, including special lanes for buses and bicycles where warranted, adequate space for footpaths, particularly around public transport stations; amenities such as benches, shade trees, garbage cans and public washrooms along footpaths and parks; traffic calming and enforcement to control traffic speeds; and effective enforcement of traffic and parking laws, and personal security protection of pedestrians. Some cities have implemented “road diets,” which involves reducing the number of vehicle



Fig. 14.33

In central district of Curitiba, the design of the BRT system is carefully blended with the surrounding urban environment.

Photo courtesy of Volvo Bus Corporation

traffic lanes to allow more space for turning lanes, bike lanes, and footpaths.

For example, the city of Seattle (US) has implemented more than 1,000 traffic circles on residential streets and will be adding dozens more each year. The city has a standard process for residents to request the implementation of traffic calming on their streets, and various funding sources. The response has been positive: there are hundreds of requests each year for more traffic circles, and although devices can be removed if residents are unhappy with the final result, this has only happened once.

Part V – Business Plan

CHAPTER 15



Business and institutional structure

CHAPTER 16



Operating costs and fares

CHAPTER 17



Financing

CHAPTER 18



Marketing

15. Business and institutional structure

“Whenever you see a successful business, someone once made a courageous decision.”

—Peter Drucker, educator and writer, 1909–2005

The ultimate sustainability of the proposed BRT system is likely to depend as much on the system’s “software” (the business and regulatory structure) as it is on the “hardware” (buses, stations, busways, and other infrastructure).

Ideally, the institutional structure of a BRT system should (roughly in order of priority):

- Maximise the quality of the service over the long term;
- Minimise the cost of the service over the long term;
- Maximise the level of private sector investment over the long term;
- Maximise the public benefit from the public investment.

In examples around the world, the clever application of well-placed incentives has persuaded operators to concentrate more on customer service and less on battles between competing vehicles. From the BRT projects undertaken to date, there is a growing consensus over the core principles that lead to an effective business model. The principal components of this business model are:

1. Institutional regulatory environment in which privately concessioned firms operate the system with strong public oversight;
2. Achievement of cost sharing within a framework of Public-Private Partnerships (*e.g.*, private sector finances the vehicles);
3. Operator bidding process that encourages competition for the market but limits competition within the market;

4. Operator compensation based upon vehicle-kilometres travelled rather than number of passengers;
5. Independently concessioned fare collection system that distributes revenues in a wholly transparent manner.

Monopoly public bus operators and unregulated private operators both result in well known problems that end up compromising the quality of the public transport service. While circumstances will vary from case to case, there is an emerging consensus that some institutional and business structures work better than others.

Well-designed business structures for BRT systems have tended to seek considerable *competition for the market but limited competition in the market*. This strategic use of competitive motivations means that firms will have to compete aggressively to be allowed to operate. However, once the winning firms have been selected, there will not be competition on the streets to wrestle passengers away from other companies. Thus, firms will have an incentive to provide a high-level of service while simultaneously not generating the negative attributes of reckless driving, speeding, low profit margins, and cutting off other public transport vehicles to gain an advantage known as the “war of the cent”.

This mixed system of public regulation and private operation is increasingly seen as the optimal approach to achieving a competitive and transparent system responsive to user needs. This approach also generally makes it possible to attract private investment into modern vehicles, which is a critical factor in developing countries where public money is scarce.

The topics discussed in this chapter include:

- 15.1 Transforming existing systems
- 15.2 Business structure
- 15.3 Institutional structure
- 15.4 Operator tendering

15.1 Transforming existing systems

“To open a shop is easy, to keep it open is an art.”
— Chinese proverb

Establishing a good institutional structure for a BRT system is an intensely political process. Ultimately, success or failure depends largely on the political skill of the project sponsor. Management consultants and BRT experts can advise decision makers about their institutional options, but ultimately the decision must be confirmed by the political process.

The first step in developing a viable institutional structure and business plan for a BRT project is to review the existing transit regulatory structure and decision-making process. This may vary considerably from city to city. Which national, provincial and municipal institutions to involve in the establishment of the BRT institutional structure, and which civil society organizations to involve or not involve, is also highly political.

Nevertheless, there are some fairly common issues that all BRT systems face. How this process is handled varies, but there are common approaches for dealing with similar existing institutional structures.

The challenge becomes how to transform an existing market structure into one delivering a cost-effective and high-quality service. Figure 15.1 shows a pictorial view of the challenge within the transformation process.

Most developing cities begin with one of the three basic conditions:

1. Regulated – Public systems;
2. Non Regulated – Private sector systems;
3. Partially Regulated – Mixed systems (public and private roles).

The actual number of business structures is actually far greater than the simple categorisation of public, private, and mixed systems. Different types of contractual arrangements are possible within the framework of mixed systems. Table 15.1 outlines some of the options. Table 15.1 also distinguishes between situations where there is competition *for* the market and situations where there is competition *in* the market. Competition for the

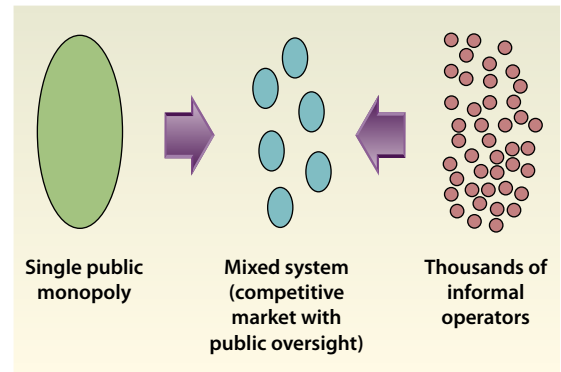


Fig. 15.1
The market transformation process

Source: Adapted from Meakin (2003)

market implies that operators must compete to win the right to operate in a corridor or an area. By contrast, competition in the market implies that a firm will operate simultaneously with other operators in the same corridor or area and will be directly competing for market share.

Some cities are caught in a vicious circle, moving between public and private systems along with intermediary steps of a highly-regulated private oligopoly and a mix of a publicly-operated entity competing with scores of unregulated operators (Figure 15.2). Cities such as Colombo (Sri Lanka) and Santiago (Chile) have moved around the entire spectrum of possibilities without ever finding a workable solution.

The cycle’s characteristics, along with the reasons for inevitable collapse of each stage are given in Table 15.2. As the spread of unregulated informal operators creates chaos on the street and poor quality services to the population, officials step in to regulate the industry.

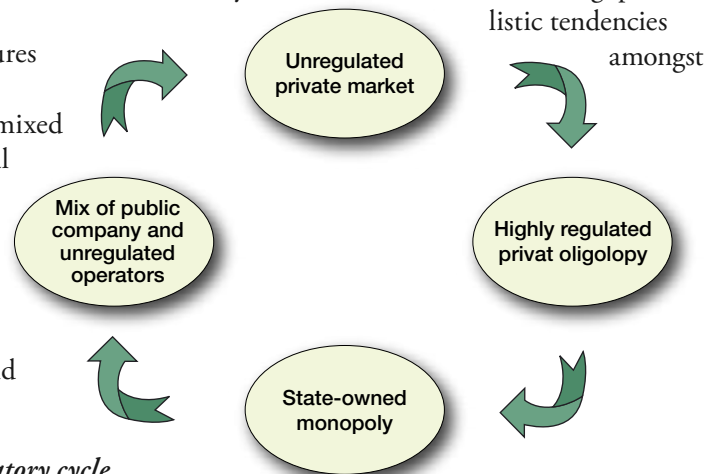


Fig. 15.2
The regulatory cycle

Source: Meakin (2003)

Table 15.1: Contractual options for different market structures

Type	Description	Competition for market	Competition in market
Public monopoly	All system assets and operations are under the control of a public agency.		
Management contracting	System assets remain in control of the public sector but certain operational and management functions are contracted to private firms.	X	
Gross cost service contracting	Private firms compete to operate routes but are paid on the basis of performance and not on the basis of passenger fare revenues.	X	
Net cost service contracting	Private firms compete to operate routes and are paid on the basis of passenger fare revenues.	X	
Franchising (exclusive)	Operator wins contract for exclusive operation of route, and has the ability to innovate; public agency still sets fares and service parameters.	X	
Concessions (exclusive)	Operator wins contract for exclusive operation of route, and full financial, planning, and operational responsibility within parameters set by the public agency.	X	
Franchising (non-exclusive)	Franchising with multiple operators in the same market.	Possible	X
Concessions (non-exclusive)	Concessions with multiple operators in the same market.	Possible	X
Open market	Operators provide services without any restraints or control; routes, schedules, fares, number of operators and vehicles, and levels of quality are left to the private sector.	X	X

Source: Adapted from Meakin (2002a)

Table 15.2: The regulatory cycle

Industry composition	Characteristics	“Solution”
1. Unregulated private operators	Chaotic, aggressive competition, dangerous driving, unstable services, no integration, variable fares.	Comprehensive regulation by Government.
2. Highly regulated private oligopoly	Industry consolidates into large companies producing low levels of competition followed by fare increases; political pressures from increased fares result in lower-quality services or company bankruptcies.	Government nationalisation of firms (because ‘only the state can assure adequate services’).
3. State-owned monopoly	Low cost-effectiveness due to confused corporate objectives (service or profit?); low, sporadic or inappropriate investment; poor services.	Government tolerates ‘illegal’ private operators to meet unfulfilled market demands.
4. Mix of public company and un-regulated operators	Deficits from public company become politically unacceptable resulting in reduced services and increasing paratransit in the market.	Government gets out of business by privatisation or by withdrawal.

Source: Meakin (2003)

the private firms mean that fare increases can be expected. Public pressure to reduce fares forces the firms to either curtail services or face bankruptcy. At this stage, the government decides to intercede in order to restore acceptable services. A public transport company is formed with monopolistic control over the entire market. Unfortunately, without the market incentives of profit and loss, the public company becomes quite inefficient. As public deficits mount, services and quality tend to diminish. Sensing an opportunity, illegal paratransit operators begin to fill the gaps in the public company's service. As the public company spirals into heavier and heavier losses, officials decide to turn the system entirely over to the private sector. Thus, the regulatory cycle comes full circle with a return to the chaos of uncontrolled private operators. One of the principal reasons for BRT's recent success has been its ability for ending this vicious circle.

15.1.1 Creating a BRT system from a public monopoly

"In health care, education, and transportation, government monopolies have proved to be a disaster."

—William Weld, former US governor, 1945–

Publicly-operated transit systems are quite common in developed nations. In many cities of North America and Europe, the public transport agency acts as both the regulator and operator. These public systems usually came into existence upon the collapse of private systems which faced stiff competition from private motor vehicles. In recent years, the trend has been towards contracting out the service through

public service contracts, while the fare revenue is retained by the public authority. Even with public contracting, the inherent lack of profitability of bus operations in many developed cities limits the number of viable options for privatisation. Most of these systems do not cover even their operating costs from farebox revenues, so the services remain subsidised.

Publicly-operated bus systems in the developing world were popular into the 1970s. Public systems still persist in South and East Asia, but are increasingly rare in Africa and Latin America. The historical development of public systems in developing nations stems from a diverse set of reasons. Since passenger demand has traditionally quite high in developing nations, system operations have always been seen as a potentially lucrative business. Thus, in contrast to the subsidised operations in the developed world, public operations in lower-income countries evolved for different reasons.

In some instances, the public sector took over routes and areas that were not sufficiently profitable for the private sector. The public sector thus can provide a role of social equity in under-served areas. Public operations also frequently grew out of dissatisfaction with the poor quality of privately provided service. In Africa for example, it was typical for bus manufacturers from the colonial power to own the municipal bus companies, often providing fairly poor quality service. In turn, public takeover was part of the process of decolonisation. Also, in lower-income countries, indigenous businesses sometimes did not possess the capital to procure buses, so only the state was able to assemble the levels of investment required for vehicle procurement (Figure 15.4).



Fig. 15.3
In many North American and European bus systems, the public sector still acts as both the regulator and operator.

Photo by Lloyd Wright.

In most cases, publicly-operated systems are not very efficient. These systems are quite often heavily subsidised, over-staffed, and offering a service that is not highly responsive to customer demands. They also generate private illegal services that respond to the quickly growth of the urban areas.

Nevertheless, some important public bus companies continue to exist in some countries, and in many countries some vestiges of the old public system continue to exist. In China and India, for example, some of the public bus authorities are reasonably well managed and do not require many subsidies, while others are badly managed. For example, the city of Bangalore (India) operates a reasonable public transport service without requiring operating subsidies. However, even in these countries a process of transition to private sector contracting is clearly evident. The rate of progress towards privatisation varies greatly between the different cities.

Introducing a BRT system into a city with a remaining powerful public operator in some ways makes BRT a lot easier, but in other ways it may undermine the possibility of more substantive reform. In practice, it has taken several forms. In Mexico City, where a BRT system opened in 2005, some 80 percent of the routes have been given to the single private monopoly operator that dominated the corridor, and the remaining 20 percent went to the public operator that also

Fig. 15.5
Non-BRT public transport services in Mexico City.

Photo by Lloyd Wright.



Fig. 15.4
The operations of a publicly-owned transit service in Dar es Salaam.

Photo by Lloyd Wright.

had routes in the corridor. The continuation of both a private consortium and a public authority creates some level of competition, but is not ideal (Figure 15.5).

In Delhi, there is also a large public operator (Delhi Transport Corporation) and a separate state regulator (STA) of many independent private operators (Figure 15.6). The system has not yet gone into operation, but it is likely that the new facilities will be open to both the private operators and to DTC, perhaps on condition that they upgrade their buses.

In the case of the Kunming BRT system, and the new Beijing BRT system, the public bus operator is simply running the new BRT lines. This situation is similar to the practice of BRT systems in the US and most of Europe, where the public authority simply implements and operates the BRT system also. This arrangement is also not ideal, as the public sector has

Fig. 15.6
Existing bus operations in Delhi.

Photo by Lloyd Wright.



to pay for the vehicle procurement, and all the problems that are typical of public procurement (overpayment, risk of graft, poor maintenance, etc.) are present.

In Johannesburg, the transformation of existing public bus company into the proposed BRT system is being seen as an opportunity to correct certain existing inequities in the market. Currently, the Metrobus company (publicly owned) operates alongside a private bus company and thousands of private minibus taxis (15-seater vans). Both Metrobus and the private operator (a company called Putco) receive state subsidies for providing operations. By contrast, the minibus taxis receive no subsidies. This inequitable treatment is particularly disappointing for the minibus industry since these companies and individuals provided badly needed services during the past Apartheid system. Further, the minibus industry represents a strong source of Black Economic Empowerment (BEE) in the country. Thus, the transformation to a BRT system is seen as a mechanism to put all three operating groups, Metrobus, Putco, and the minibus taxi, onto a level playing field. Figure 15.7 shows a graphical representation of the possible transformation process.

Several other possibilities are being considered in other countries at present but have not yet been implemented. Some other good options are:

- The existing public transport company is given the right to contract out private services on the routes with new BRT lines, and on these lines

becomes the regulatory authority for private operators. This arrangement could be implemented in a phased that will eventually see the system move fully to private entities.

- The public transit company is allowed to compete along with other private operators for the BRT operations under a different regulatory body. This arrangement is not exactly what happened in Mexico City, because there was no competitive bidding for operating the corridor. Instead, the operations were just given over to existing two operators, one of which was a public company.
- The public transit company is privatised through a transparent selling process, and the new firm subsequently competes for market access on equal terms with other private firms.
- The public authority relinquishes operations in the areas with the new BRT system and instead concentrates on other parts of the city.
- Assets of the public company are liquidated and used to capitalize a new BRT authority to help underwrite some of the costs of the new system, such as land costs. This option was considered in Dar es Salaam, largely because the former bus operator had some land that could have been used for depots and terminals, but it is unlikely to proceed because the former operator is encumbered with debt.

Clearly, to undertake any of these options will necessitate a certain degree of political will on the part of political leaders. Public employees and union leaders will likely oppose such drastic changes. Since public companies frequently operate with inefficient levels of employees, the transformed organisation will likely need to reduce staffing numbers. To an extent, staff reductions can be mitigated by transfers to other agencies and by retraining programmes, but the process of change can be difficult for those involved.

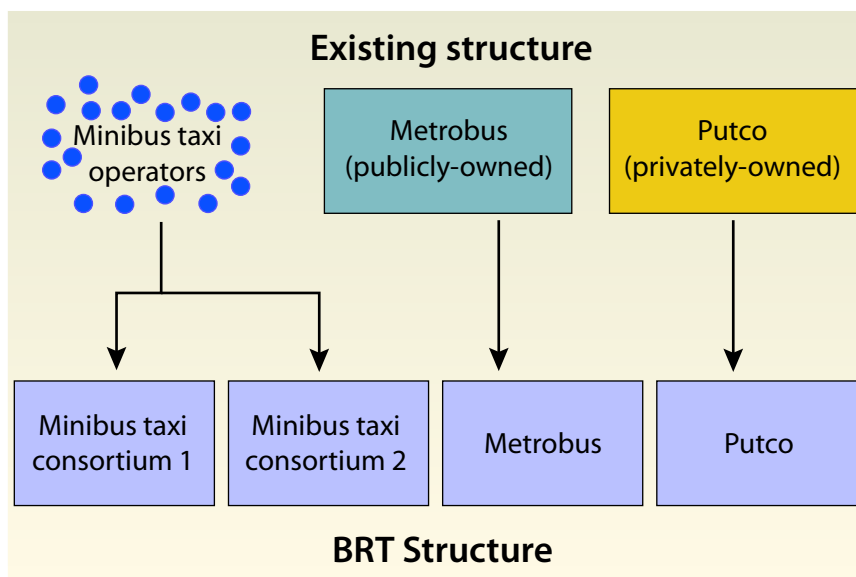
15.1.2 Transforming a weakly regulated, informal private bus industry

“If you don’t create change, change will create you.”

—Anonymous

Historically, the best known BRT systems, including Bogotá, Quito, and Curitiba, were developed from weakly regulated, informal sector-dominated private bus industries. As such,

Fig. 15.7
Illustration of possible industry transformation for the Johannesburg BRT project.



the transition from this type of system is the most well-known and well documented.

In many developing cities, a lack of financial resources and weak technical capacity within government institutions has meant that developing city public transport has been left largely to weakly regulated private operators. The level of government regulation varies widely. Some are completely unregulated. Most at least require a commercial operators license and a commercial vehicle license. Some of these systems require a license to operate within a particular route, and some, such as Dar es Salaam, operate on colour-coded routes. Inevitably, when there is little formal regulation, there is some form of informal regulation which allocates the best routes, best spaces in bus terminals etc. Sometimes these informal regulators are sometimes called “bus enterprises”, sometimes they are “unions” of collectives, sometimes they are “cooperatives”, and quite often they are basically like a mafia. Finding out exactly how these systems are regulated is often not easy, as many times well-placed politicians or military personnel will own several of these vehicles, and owning a few vehicles is a frequent form of a retirement plan for many middle-class families. As such, disrupting the value of these assets can have profound social consequences.

With fierce competition between many struggling small firms and little governmental control, the frequent result has been poor quality services that do little to meet the broader needs of the customer. Private operators will tend not to provide service to smaller neighbourhoods and will operate only at particular hours. Small operators also tend to be run in a relatively inefficient manner. Small vehicles are utilised in places where high-capacity vehicles could be operated at a more efficient level. This inefficiency can lead to higher fare levels than would otherwise be required (Figure 15.8).

An uncontrolled public transport environment can also lead to a serious over-supply of small vehicles. In Lagos (Nigeria) there are currently an estimated 70,000 mini-buses plying the streets. Until recently, over 50,000 mini-buses operated on the streets of Lima (Peru), and prior to TransMilenio, approximately 35,000 buses of various shapes and sizes ran along the streets of



Fig. 15.8
The plethora of many small vehicles providing public transport services in cities such as Manila translates into significant system inefficiencies.

Photo by Lloyd Wright.

Bogotá (Figure 15.9). The large number of small public transport vehicles contributes significantly to congestion and poor air quality. The unwieldy number of operators also represents a regulatory challenge to municipal agencies that lack sufficient resources.

The oversupply of public transport services on trunk corridors undermines their profitability, which makes it difficult for individual operators to invest in more modern vehicles. Most of these buses operate on very narrow profit margins. In addition, the fact that these businesses operate

Fig. 15.9
Prior to the development of the TransMilenio BRT system, Bogotá’s public transport services were of a chaotic and low-quality nature.

Photo by Lloyd Wright.





Fig. 15.10
Control of routes within the South Africa minibus taxi industry has at times meant armed violence between different operators.
 Photo by Lloyd Wright.

in the informal sector makes it very difficult for them to get credit from financial institutions for fleet modernisation.

In some instances, each vehicle is owned separately, often by the person who does the driving. In other instances, the public transport vehicle is operated by a driver who leases the vehicle from a separate owner. Since the driver pays a flat fee for access to the vehicle, he or she then has an incentive to drive the vehicle as much as possible during the day in order to maximise fare revenues. Usually these drivers have to pay some sort of mafia for the right to operate a particular route, and sometimes they have to pay off one or more sets of traffic police. Drivers will thus work as much as 16-hour days. Often these vehicles are not insured, and if the passengers are injured they have little recourse to the courts.

When the income of bus drivers is directly related to the number of passengers they pick up, several problematic behaviours emerge as a result of the “battle for the cent.” The drivers have an incentive to drive as rapidly as possible to make as many roundtrips as they can. Further, drivers will cut off other bus operators in order to prevent competitors from capturing customers. Bus drivers will also sometimes stop at random places along the road rather than just at bus stops, in order to capture more passengers. Often they will wait at the beginning of a route until the vehicle fills completely, making the scheduling of trips very unpredictable. In South Africa, sometimes rival gangs of operators have actually used firearms against

each other to establish their control over certain routes, leading to passenger injuries and even death (Figure 15.10).

Not surprisingly, the long hours, high speeds, and aggressive driving lead to extremely hazardous road safety conditions. At the same time, the captive riders have few options other than wait for the day that they can purchase their own private vehicle.

The process of consolidating the thousands of registered and unregistered small operators into a modern BRT system was a process that took several decades in Curitiba, and the result was not entirely satisfactory. In Bogotá, the transition was made all at once with the construction of the BRT system. For a history of the transformation processes in Bogotá and Curitiba, see *Transit Planning in Curitiba and Bogotá: Roles in Interaction, Risk, and Change* by Arturo Ardila-Gomez (Ardila-Gomez, 2004).

Normally, for political purposes, it is advisable to involve at least some of the existing bus and paratransit operators with routes in the corridor into the new system. How they are included, however, matters critically. On the one hand, if they are not included at all, they will resist the system politically. On the other hand, they should not be given veto power over design decisions or contracting decisions.

In Bogotá, prior to the BRT system, there were approximately 22,000 private bus operators providing licensed services. There were perhaps another 13,000 buses that were operating without a commercial operating license. Some of these operators owned their own buses, and some owned a few buses and leased them to other people to operate. These private operators were also given the right to operate on a particular route by several “bus enterprises.” These bus enterprises did not own buses. Their only economic function was to allocate the bus routes. There were only a small number of these bus enterprises, and one of these enterprises was much more powerful than the others. The regulatory role of these private bus enterprises was officially recognised by the Department of Transportation, which was the official regulatory agency. In other words, the drivers leased the bus from the owner, the owner paid for the right to operate the bus from the bus enterprise,

and the bus enterprise paid the Department of Transportation for the right to allocate bus routes. These payments were all essentially legally recognised. Nevertheless, the existence of this tiered payment scheme meant that the system was financially inefficient.

When Bogotá was planning TransMilenio, they first created TransMilenio SA as a public corporation (Figure 15.11). The Board of Directors included all of the important branches of the municipal government with responsibilities for urban public transit *except the Department of Transportation*. In the beginning, the Department of Transportation was intentionally excluded from the process because it earned significant revenues from the allocation of bus routes to the bus enterprises, and they thus had an institutional conflict of interest with the new system. Only later, after the system had been designed and established, was the Department of Transportation brought onto the Board of TransMilenio.

By contrast, in Jakarta, when TransJakarta was created, it was put under the control of the Department of Transportation, whose function is the same as that of the Department of Transportation in Bogotá. As a result, there was great reluctance on the part of the Department of Transportation to cut parallel bus routes in the TransJakarta corridor, as the Department lost revenue from each new line allocated. As a result, it is important that the Mayor make a decision about how best to wrest control over route regulation in the BRT corridor from the existing regulatory authority. The best approach depends on political realities.



Fig. 15.11
The city of Bogotá created a new entity, TransMilenio SA, to oversee BRT development in order to avoid the conflicts of interest associated with the existing transport department.
Photo by Lloyd Wright.

TransMilenio SA and their consultants first learned everything about the structure of the existing bus business. This knowledge was critical to handling smooth negotiations while winning the best deal possible for the public.

The Mayor himself met first with the heads of the bus enterprises and told them that the BRT system was going forward with them or without them, and they could either participate in a productive way or they would lose their rights to operate on TransMilenio routes. After this, nobody from the Mayors office met with the private operators until the plans for the institutional structure and the physical designs were already completed.

At the beginning of the project, the planning team must know whether or not it has the power to revoke or change existing route licenses. If private bus operators already have a 15-year concession to operate exclusive bus



Fig. 15.12
Institutional conflicts of interest in Jakarta made assignment of BRT routes somewhat difficult.
Photo courtesy of ITDP.

services along a particular corridor, the private bus operator could tie up the BRT project in the courts for years. In this situation, the government will need to buy out the operator. Normally, however, bus operators are guilty of hundreds of small regulatory violations, and these violations can be used as a “stick” to force the operators to the negotiating table.

When the designs were finished, TransMilenio knew exactly how profitable each route would be, because they knew the costs of bus operations, and they had done detailed traffic modeling of the specific operational design that they were planning. Having this information was critical to negotiating a reasonable price for the bus services.

At that point, a public competitive bid was offered, the details of which are discussed later in this chapter. The bidding rules gave additional points to firms that had experience operating bus services in the corridor. This gave an extra advantage to the bus companies already operating in the corridor. They also required, however, that the companies be formal sector businesses that owned a large number of buses (say 50 as a minimum.) This figure was derived at through negotiation based on how much capital it was thought the various bus enterprises could realistically assemble.

The bidding rules also required that the winning bidder destroy six old buses for every new bus they needed to buy. The requirement to

destroy old buses was partly to take them out of circulation, but it was also partly to force the bus enterprises to pay some money to the bus owners, many of whom were lower middle class people, so that they did not lose an important asset. This requirement meant that the big bus enterprises had to give some ownership of the new companies to the small bus owners (Figure 15.13). In this way, the bidding process itself forced the process of transition from informal sector to modern, formal sector bus operators.

Ultimately, some but not all of the original bus enterprises became operating companies on TransMilenio’s trunk corridors. Some of them did this with international partners, others without them. Most importantly, the biggest and most powerful bus enterprise became also the biggest bus operator.

The senior member of the family that controlled this business was an older man who did not understand what was being proposed, and he was completely against the BRT project, and wanted to fight it. The Mayor, however, sent the younger men, men in their 40s who were looking to become more legitimate business men, to Curitiba to understand the system. From the private bus operators in Curitiba they learned that BRT could be a much more profitable business than normal bus operations, and they were persuaded to participate in the project. Once the most powerful bus enterprise decided to bid to become one of the trunk line operators, the others were virtually forced to participate in the negotiations rather than fight the system.

Making sure that some companies are actually able to bid on the operating contracts is an important job of the management consultant. In some countries, it will be quite easy to find modern private bus operators ready to bid on the operating contracts. In other countries, it may be quite difficult to find any indigenous bus operators that have the sophistication to form themselves into modern corporate entities. In this case, it may be advisable to intervene more in the process.

As was the case with TransMilenio, it may be advisable to encourage local bus companies to partner with international bus operators with experience operating modern bus companies. The municipality may also wish to give

Fig. 15.13
On a wall outside the administrative headquarters, the names of all the operators that came together to form the “Si 99” company in Bogotá. This consortium consists of many local firms as well as an international operator.

Photo by Lloyd Wright.



additional technical support to ensure that all existing operators are able to participate fairly in the concession competition.

By building the business skills of the operators, the municipality will help to bolster individual competitiveness as well as improve the quality of the bidding process. In many instances, the operators may not even fully understand their own cost structure. Since the BRT system will represent a major professionalisation of their business, the operators will need new skills in accounting, negotiations, technological knowledge, and customer service (Figure 15.14).

Assistance can also be given in terms of helping individual operators form consortium groupings. An individual operator is unlikely to have the necessary resources and skills to bid as a single entity. Instead several small operators will likely form a consortium arrangement and bid jointly. Alternatively, a large company or an individual with sufficient financial resources will seek out smaller companies to join as partners. In either case, the smaller operators can be given stockholder status in the new venture. The operator's stake in the new enterprise will depend on the resources that are being contributed to the group. Small operators will likely be able to contribute the following types of assets:

- Points to the bid team as an existing operator;
- Vehicles for use in the system;
- Vehicles for scrapping (if required in bid conditions);
- Drivers and other staff;
- Business knowledge.

The value of the small operator's assets will determine their shareholder status. Operators will be able to “shop” their assets to many different consortiums in order to realise the best deal. Despite the inherently different business environment between BRT and informal operations, the existing operators may possess many valuable attributes. While their older vehicles will not likely be of use on trunk corridors, it is quite possible that good quality standard vehicles can be of use on feeder lines. The older vehicles also offer value in terms of meeting any requirements for scrapping vehicles. Drivers will likely need some re-training in order to achieve new levels of safety and customer service, but their basic skill levels and knowledge of the city streets will assist in the transformation process.



Fig. 15.14
An industry capacitation workshop taking place during the development of the Johannesburg BRT project.

Photo by Lloyd Wright.

At the end of the bidding process, it is possible that some existing operators will be left out of the new system. The losing bid teams and individuals who did not join a bid team may well take actions to thwart the new BRT system, but they should be encouraged to bid on the next corridors, or on feeder bus service contracts. Inevitably, and change involves some losers and some winners, and political pressure, legal challenges, and protest are fairly typical. Thus, the municipality may also wish to conduct a post-bid outreach effort with unsuccessful entities. The promise of future bidding opportunities and further skill training can help mitigate a negative backlash.

15.1.3 *Partial versus whole-system re-regulation*

In many developing-nation cities that are considering BRT, there exists a massive regulatory vacuum, and improving the regulation of the existing public transport system is as important a priority as building and operating a new BRT system. There is therefore often a desire on the part of Mayors to do both at once.

However, most historical evidence indicates that this is too much to tackle at once. In Curitiba, in the early 1960s, they first changed the entire regulatory structure throughout the city, forcing small private operators to form themselves into consortiums that had control over different parts of the city. Only later did they build the BRT system and institute the trunk and feeder system.

In Bogotá, the Mayor made a critical decision not to reform the entire public transport

regulatory structure at the same time, and instead decided to only regulate it step by step, one BRT corridor at a time. In other words, the corridors not yet slated for BRT were left under the regulatory control of the Department of Transportation, while the new corridors were put entirely under the regulatory control of TransMilenio. TransMilenio banned the old buses from operating directly on the BRT corridors, and this ban was enforced with police powers.

Because both transitions require a dramatic increase in the capacity of governmental bodies, tough negotiations, skilled staff, and political capital, it is generally too much for a single Mayor and his staff to do both at once. In fact, one of the key purposes of BRT is to gradually break down a regulatory log jam.

However, there are advantages to a complete city-wide transformation. The painful process of system conversion happens at once rather than through several difficult transitions. If a progressive Mayor is in place, then it may be a unique opportunity to make such a transition. It may be a policy that will not be later endorsed by subsequent Mayors.

In the case of a whole-system transition, there is still the need to develop the infrastructure over a series of phases. Thus, initially some parts of the system will operate as before while other corridors will be within a physical framework of BRT. However, both types of operation can be successfully brought under the control of a

single business plan. Both types of operation can share a single branding identity and share a common fare collection system. The Transantiago system of Santiago (Chile) has undertaken a whole system transformation in which some parts operate on busways and other parts operate as conventional services. As a mega-city of 6 million, transforming its entire public transport system at one time is not an insignificant task. The result has been a fair amount of confusion and operational problems, with decidedly negative reviews in both the national and international press (Economist, 2007). Thus, while a whole system transformation can ultimately represent a sound strategy, the implementation issues are quite challenging (Figure 15.15).

15.2 Business structure

“Perfection is achieved, not when there is nothing more to add, but when there is nothing left to take away.”

—Antoine de Saint Exupery, writer and aviator, 1900–1944

15.2.1 A model structure

With the success of several Latin American systems, such as Bogotá, Curitiba, Guayaquil, and Pereira, there is a growing consensus over the form a best practice business structure. While each city will likely have its own unique conditions that will ultimately determine the actual form of the business structure, based on the experiences to date, there are many common features that can lead to an effective structure.

In each of these successful cases, there has been the basic formula of *private sector competition within a publicly-controlled system* (Figure 15.16), following a partially regulated model. In the case of Bogotá, the public company, TransMilenio SA, holds overall responsibility for system management and quality control. However, TransMilenio SA itself is only an organization of less than 100 persons, with oversight for a system in a city of seven million inhabitants.

Private sector concessions are used to deliver all other aspects of the system including fare collection and bus operations. The vehicles and even fare collection equipment are purchased by the private sectors firms. TransMilenio and the municipal government are able to leverage private sector investment and defer a large portion of

Fig. 15.15
The city-wide transformation of the Santiago public transport system has created a great deal of chaos and customer confusion during its initial periods.

Photo by Lloyd Wright.





Fig. 15.16
The TransMilenio business structure features a public company overseeing quality control and contract management with an array of privately concessioned firms.
Image courtesy of TransMilenio SA

the financial risks while retaining overall control on the shape of the system.

The *independent concession for fare collection* helps ensure the system's revenues are properly controlled and administered. If anyone with a vested interest were to be handling the revenues, then there will always be suspicions amongst the different stakeholders. An independent fare collection process means that none of the vehicle operators have any relationship to handling the fares. Further, through the use of real-time sharing of fare information, all parties have an open and transparent view on revenues. In TransMilenio, fare data is streamed simultaneously to all relevant parties, creating an environment of confidence in the system.

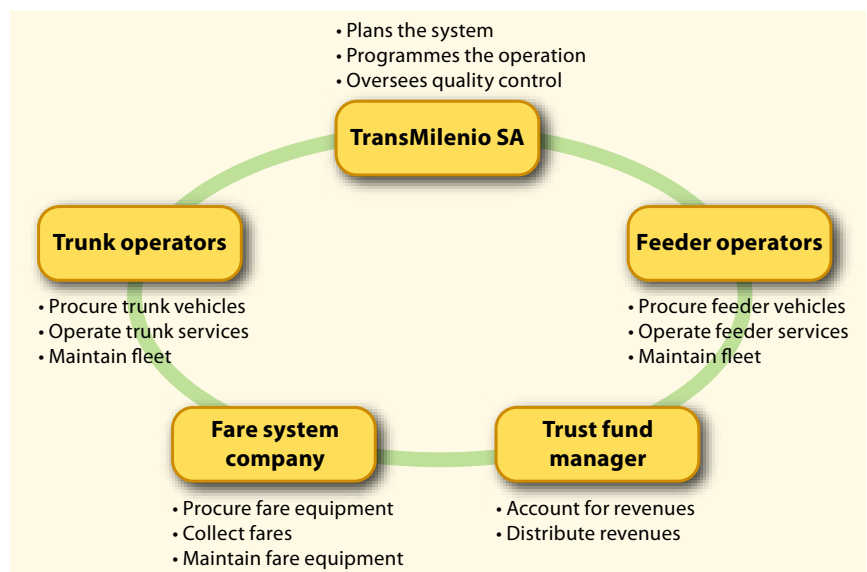
Generally, each trunk corridor will host 2 to 4 different operators. To the customer, the services all look the same. The tight product delivery specifications ensure that the look and feel of each vehicle is quite similar, regardless of which operating company is managing the vehicle. Even though there are several operators, none have an incentive to operate in an overly-competitive manner on the street. Each operator is making its revenues from the vehicle-kilometres travelled rather than from the number of passengers collected.

The feeder services can be particularly important in terms of finding a place for many existing operators in the new system. These contracts are tendered separately from the trunk operations.

Figure 15.17 provides more detail on the roles and responsibilities of different actors within the TransMilenio system of Bogotá.

The differentiation and clarity of the roles and the proper check and balances allow the various

Fig. 15.17
The roles and responsibilities of different organisations within the TransMilenio business model.
Image courtesy of Jariko Vlasak



pieces of the system to function well together. Only the roles requiring a public role, such as contract management and quality control, are left to the public sector. The business model maximises the financial leverage and entrepreneurial nature of the private sector in order to provide a customer-oriented product.

15.2.2 Financing responsibilities

Implied within the proposed business structure is a combination of investment responsibilities between the private and public sectors. In general, the infrastructure for these systems is publicly financed, in the same manner that all other municipal road infrastructure is developed. A separate public works agency issues the tender documents to competitive bidding for the infrastructure components (busways, stations, terminals, depots, etc.). The construction work is conducted entirely by the private sector. Thus, almost all possible aspects of systems such as Bogotá’s TransMilenio are contracted or concessioned to private sector entities with public agency oversight.

In most developing-nation applications to date, a BRT system should be able to cover its ongoing operating costs and the cost of maintaining the rolling stock from fare revenues. The tendency for BRT systems to cover operational costs through fare incomes is one of the fundamental benefits of BRT over alternative public transport systems. In many instances fare revenues will also fully or partially cover vehicle procurement. Thus, these systems represent a form of a Public-Private Partnership (PPP) structure based upon the private sector’s investment in the vehicles. To date, however, no BRT system has been able to also cover the cost of building and maintaining the new infrastructure. Chapter 17 (*Financing*) provides greater detail on financing infrastructure development.

As a result, decision makers should decide from the beginning to design the BRT system to be financially self-sustaining within an effective regulatory framework. This decision should drive the technical design process, rather than the other way around. The administrative and organisational structure of the system will have profound implications for the system’s efficiency, the quality of service, and the system’s cost over the long term.

Investing public money in improving the bus system, by creating dedicated lanes, special stations, and other amenities that define a BRT system, creates the unique opportunity to achieve profitable operations over the long term. As a result, it creates a unique opportunity to renegotiate the relationship between the private operators and the public. By taking public transport vehicles out of congestion and improving their capacity and speed, BRT systems can dramatically increase the profitability of the public transport system and end a downward spiral of declining public transport use and declining quality of service.

While most experts agree that this regulatory structure is generally optimal even for non-BRT bus services, historically, a BRT project creates a unique political opportunity to implement a regulatory reform agenda that otherwise has tended to prove difficult to implement. Effective regulatory and business structures are often quite difficult to achieve. Public operators may be unwilling to surrender their market and their administrative “turf”. Private operators may be resistant of any changes, especially when they are unaccustomed to any governmental oversight or taxation. The capacity and political power of public institutions may be too limited to effectively regulate.

15.3 Institutional structure

“In the infancy of societies, the chiefs of state shape its institutions; later the institutions shape the chiefs of state.”

— Charles de Montesquieu, politician and philosopher, 1689–1755

A new public transport system represents a fresh opportunity to establish an effective institutional structure for the entire transport sector. The new BRT system should probably not be turned over to the same institutional actors that have been providing sub-standard public transport services for decades. For this reason, many cities, such as Bogotá, have opted to create an entirely new institutional structure with new staffing.

Nevertheless, there exists a broad range of options to place from relatively focused specialised agencies to large transport departments that oversee all forms of public and private transport (Table 15.3). Further, these institutions can be either highly autonomous from the local

government or closely controlled by elected officials and civil servants. The responsible level of government for a transit system is often local in nature, but the system can also be controlled in some instances by provincial governments or even national ministries. Finally, the institutional oversight of a BRT system can be implemented through an existing agency or through a newly created organisation.

In general, transport institutions can have a range of responsibilities, including:

- Policy-making and setting standards;
- Regulation;
- Planning and design;
- Project implementation;
- Operational management;
- Financial management;
- Contracting and concessions;
- Regulation;
- Administration;
- Marketing.

At some level, each of these activities will need to be addressed by the organisation with responsibilities over the system. However, whether the entity is organised as a single institution or several different institutions depends greatly upon local political circumstances.

A single transport institution avoids many of the inter-organisational conflicts that can otherwise occur. Rather than risking battles over each organisation’s turf, a single institution removes much of this conflict. An organisation such as Transport for London (TfL) has a wide range of coordinating activities across the entire London metropolitan area. Prior to TfL’s creation in 2002, transport was largely the responsibility of London’s many local boroughs. Unfortunately, such an arrangement did little to foster coherent plans for systems that crossed borough boundaries. Although TfL contracts private firms for infrastructure development and operations, the public organisation maintains a wide range of responsibilities, including the following areas:

- London bus system (Figure 15.18);
- Underground system (Figure 15.19);
- Light rail lines;
- Walking and cycling (Figure 15.20);
- Congestion charging;
- Taxi regulation;
- Traffic management;

Table 15.3: Institutional options

Type of institution	Description
Transport department	Large entity with a wide range of regulatory and management responsibilities; typically reports directly to city political officials
Transport authority	Organisation with wide oversight on all public transport activities; frequently given autonomous status through a board of directors
Public company	A specially created company that is owned and managed by the local government
Specialised transport agency	Smaller organisation with a focused mandate; typically reports directly to city political officials
Non-governmental organisation	Independent outside organisation that is given the responsibility of managing the public transport system

- Maintaining major roadways;
- River services (Figure 15.21).

Internally, TfL organises around different divisions such as “street management” and “London buses”, but overall, TfL is a single entity. In a similar fashion, the Land Transport Authority of Singapore holds a wide array of transport responsibilities all within a single organisation (Meakin, 2002b). London and Singapore also provide examples of the advantages of transport planning across an entire metropolitan area. In other urban conglomerations that consist of multiple municipalities it is often difficult to achieve a coordinated public transport plan if each municipal government has its own planning processes. The single entity approach also enables London and Singapore to address car restraint measures, public transport, and traffic management activities in an integrated planning process and in a unified bureaucracy. However, a single transport institution does bring its own challenges. Large organisations can be more complex and more difficult to manage. With a range of priorities, a large institution may not have the same focus on BRT as a more specialised agency. In some instances, large organisations are also less responsive to market demands.

By contrast, in cities such as Bogotá and Curitiba, the BRT systems are overseen by smaller, fairly specialised organisations. In such instances, different aspects of BRT development and operation can reside in different organisations. In Curitiba, the planning and development of the transport master plan resides with the Institute of Urban Research and Planning

Fig. 15.18, 15.19, 15.20, and 15.21

In London, Transport for London (TfL) has a full range of responsibilities across multiple modes, which allows for whole system planning and integration.

Top right photo courtesy of iStockphoto
Other photos by Lloyd Wright



of Curitiba (IPPUC). Another organisation, Urbanisation of Curitiba (URBS), is responsible for the actual implementation and management of the BRT system.

Bogotá created a new entity, TransMilenio SA, to oversee the development and operation of its BRT system. TransMilenio SA was formed as a “public company” which reports to the city’s mayor through a board of directors. Other more traditional governmental departments also play a significant role in Bogotá’s BRT system, but the new public company has taken a lead in terms of ensuring efficiency and an entrepreneurial approach. TransMilenio’s board consists of ten directors who are derived from a cross-sectional representation of interested parties. The city’s Mayor or a representative of the Mayor acts as the board’s chairperson. Included in the board are non-governmental organisations and citizens groups who are able to better provide a customer perspective. The current TransMilenio board even includes an opera singer (she is the head of a Bogotá City Office). Many of the related agencies, such as the transport regulator and the public works

agency, also are represented on the board in order to assure coordination between all governmental organisations. In summary, the groups and individuals included in the TransMilenio board of directors are:

- Mayor of Bogotá;
- Secretariat of Transit and Transport (transport regulator);
- Institute for Urban Development (IDU);
- Civil society representative (from academia or elsewhere);
- Civil society representative (from transport or environmental NGO);
- Municipal Department of Planning;
- National Department of Planning;
- Municipal Secretariat of Finance.

Board meetings are also attended by the General Manager and Assistant General Manager of TransMilenio SA. The staff do not have a vote but are there to answer questions that may arise. The Board of Directors is also served by financial and accounting specialists who can evaluate financial audits of the system.

TransMilenio SA focuses upon mostly on the operational and contracting aspects of

managing the BRT system. The organisation is also involved in planning and financial aspects of the system but in coordination with other agencies. Specifically, the city’s Institute for Urban Development (IDU) holds responsibility on delivering the system’s infrastructure. In many cities, this responsibility is given to a “public works” department. Bogotá also has a Secretariat of Transit and Transport (STT), which plays a regulatory role in the overall bus transit system. STT continues to regulate and license the conventional bus services that still operate in many parts of the city. Figure 15.22 provides a schematic of the different institutional entities with a role in the Bogotá transport sector.

Smaller, specialised agencies can be more efficient and more customer responsive than larger organisations. TransMilenio SA is able to manage a BRT system that currently serves nearly one million passenger trips per day with a staff of less than 100 persons.

Despite the relative efficiency of a small public company like TransMilenio, such specialised entities do bring with them other challenges. TransMilenio SA has interfaced well with the city’s transport regulator and public works department, but in other cities, conflicts between such organisations can stifle progress on transit initiatives. Disagreements and “turf” conflicts can over-ride other shared values between agencies. Further, when problems arise, each organisation can blame the other without anyone taking responsibility. A problem with material failures on the concrete busways in Bogotá demonstrated the ease in which responsibility can be denied amongst a complex group of actors (Figure 15.23).

However, Bogotá’s introduction of a new organisation, TransMilenio SA, provided a crucial catalyst to innovation. Trying to implement a radically different public transport product through an existing entity can be difficult. Entrenched mindsets and vested interests can stifle the creativity required to develop a bold new approach such as BRT. Further, the blame for the current chaotic public transport services in many cities is not just due to the existing private operators. The existing institutions and agencies share some of the responsibility for the poor quality of services.

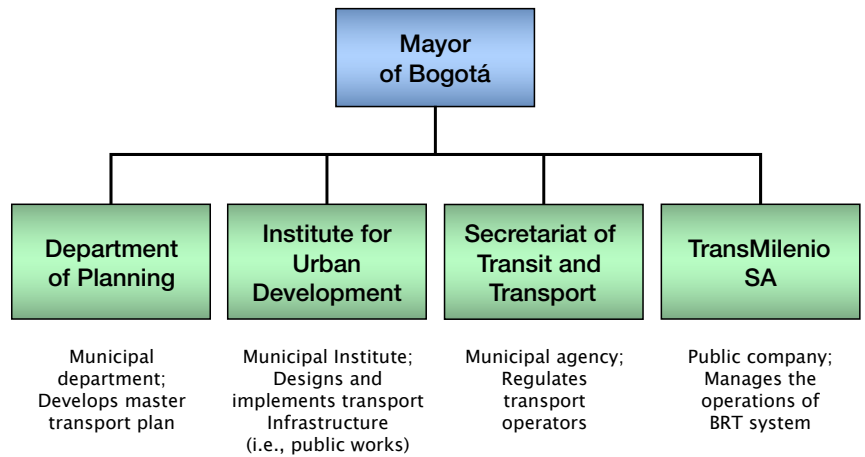


Fig. 15.22
Transport institutions in Bogotá

Thus, by bringing together an entirely new team with a fresh perspective, Bogotá created something quite special. Bogotá specifically sought personnel who had no previous contact with the existing public transport agencies. The average age of the initial TransMilenio staff team was under 30 years, and over 95 percent of the staff had never worked for an urban public transport authority or a private transit operator. For much of the team, TransMilenio represented the person’s first professional position after graduating from university. And yet, this “inexperienced” team developed the world’s premiere BRT system. It is perhaps because the team was not ingrained to established practices that TransMilenio demonstrated such refreshing innovation. Experience was provided to TransMilenio, but mostly through the relationship with outside consultants.

Guayaquil also created a new entity to oversee its new Metrovía system. However, due to the local legal system, it was decided that a non-profit structure would be a better fit than a

Fig. 15.23
When a design flaw resulted in material failures on the Bogotá busways, several of the involved stakeholder agencies and individuals resorted to blaming one another.

Photo by Carlos Pardo.



public company. In practical terms, the Guayaquil and Bogotá model are not that different. Guayaquil's non-governmental organisation includes a range of representatives on its board, including the Mayor of the city. Like Bogotá, the constitution of the organisation gives it quality-control and oversight responsibilities on the system. At the same time, the NGO status gives the organisation some independence which makes it somewhat removed from outright political considerations.

For other cities, the development of a new institutional entity may also be necessary in order to avoid established agencies that have a reputation for inefficiency and corruption. It would be unlikely to be able to create a major new initiative in such an environment. Further, given the legal and political difficulties in re-shaping existing agencies and replacing civil service staff, changing the existing agency structure and mindset may not be realistic within the confines of a relatively short political term.

London, Bogotá, and Guayaquil possess widely different institutional arrangements to oversee their public transport services. While TfL is a broad-based organisation with multiple roles and TransMilenio is a smaller, more focused public company, both organisations have achieved considerable success. The lessons from

London, Bogotá, and Guayaquil show that while the form of the institutional structure is highly dependent on local circumstances, bus priority measures can succeed in a variety of institutional forms when innovation and competitiveness are introduced.

15.4 Operator tendering

"The essence of competitiveness is liberated when we make people believe that what they think and do is important – and then get out of their way while they do it."

—Jack Welch, former CEO of General Electric, 1935–

Having made the basic decisions regarding which government agency will be responsible for regulating and managing the BRT system, and which elements of operations are to be managed by private firms, planners can begin to prepare the structure of the operating contracts.

The business structure of the new BRT system will ultimately be defined by operating contracts. These can either create an environment of efficiency and transparency or lead to misplaced incentives and even corruption. The "public" side of an effective public-private partnership will play a pivotal role in developing and maintaining a competitive transit environment. However, there is no one answer to an effective business structure since the existing agencies, historical precedents, geographical coverage of the system, and the local political dynamics will all shape the likely outcome

The nature of the operating contracts will have a powerful influence on many factors that are critical to the system's impact on public welfare. Three elements of best practice operating contracts will be discussed in this section:

- Developing a fair and transparent process;
- Ensuring sufficient competition for the market;
- Quality incentive contracting;
- Time-limited contracting.

15.4.1 Elements of successful contracting

"A verbal contract isn't worth the paper it's written on."

—Samuel Goldwyn, movie producer, 1882–1974

The right set of financial incentives can encourage contractors and concessioned firms to



Fig. 15.24
Guayaquil's Metrovía system is overseen by a non-governmental organisation (NGO).

Photo by Lloyd Wright.

operate a BRT system at the highest levels of quality and performance. The wrong set of incentives will cause operators to compete against each other in a manner that risks financial sustainability and customer safety. The success of BRT systems such as Bogotá, Curitiba, and Guayaquil owe much to achieving an incentive structure that is a win for the operators, a win for the municipality, and most importantly, a win for the customer.

Bogotá gained much from the Curitiba experience and extracted many of the positive incentives. These well-designed business structures systems have tended to seek considerable *competition for the market but limited competition in the market*. This strategic use of competitive motivations means that firms will have to compete aggressively to be allowed to operate. However, once the winning firms have been selected, there will not be competition on the streets to wrestle passengers away from other companies.

The principal mechanism for controlling competition in the market is to pay operators by the vehicle-kilometres of service and not by the number of passengers picked up. Thus, firms will have an incentive to provide a high-level of service while simultaneously not generating the negative attributes of reckless driving, speeding, low profit margins, and cutting off other transit vehicles to gain an advantage.

Some competition in the market can also be achieved by permitting multiple concession contracts along the same corridor, as will be discussed. Having multiple operators in each corridor is important not only because it allows for competition but also because it makes it possible for the system regulator to shift operations in response to changes in demand without changing the operating contracts.

One of the most important innovations of TransMilenio was the shift from route concessions to operating contracts based on a minimum number of vehicle kilometres over the life of the contract. In Curitiba, each operator controls a particular part of the city, like a slice of a pie. In TransMilenio operators have contracts that are not fixed to a particular corridor. Operators are guaranteed a certain minimum number of vehicle kilometres over the life of their operating contracts, but the contracts do

not specifically in which corridor these kilometres will be allocated. This flexibility gives TransMilenio the possibility of re-allocating buses from one corridor to another corridor without changing the operating contracts. As it is very hard to know in advance how many passengers a new BRT corridor is going to have, and how this demand may change over time with the addition of new corridors, this system flexibility becomes increasingly important to overall operational efficiency as the systems expand. Annex 5 provides an outline of a Phase II contract for TransMilenio trunk operators.

The importance of optimising the efficiency of operations is making some system planners consider contracting out control of the operations to private firms with an incentive to maximise the overall efficiency of the system's operations. Even TransMilenio it is said could improve the profitability of its operations by roughly 8 percent optimising the operational programming.

Allowing for multiple operators in a BRT corridor generally requires a transparent revenue distribution process along with an incentive system based on kilometres travelled rather than passenger numbers.

Bogotá also made other adjustments to the Curitiba model, such as not limiting the kilometres paid to the revenues collected. New systems will have to review both experiences in order to adopt a set of incentives that better fit the specific needs and challenges. As with any business, the market forces will always try to find ways to take advantages of potential holes on the business scheme.

For a “closed” type BRT system, incentive mechanisms can be erected in at least two distinct areas. First, an incentive bidding scheme can be established to determine which operators should be allowed to gain access to the system. Second, once the operators are in place, “quality incentive contracting” can be utilised to ensure that the firms are properly motivated to achieve high levels of service.

A successful incentives process will likely evoke the following qualities:

- Transparency;
- Clarity;
- Simplicity;
- Efficiency;

and has served a key historical role in providing transport services to marginalised communities. Immediately exposing this industry to the fierceness of new competitive realities would create much hardship for those who have long worked in the industry.

Thus, even the most competitively designed concession systems, such as Bogotá, introduce some degree of support to the existing operators. Guayaquil has found a bit of middle ground by providing for both a degree of certainty to existing operators while also bringing in elements of competition. Guayaquil’s Metrovía system has been developed around a tiered approach to operator contracting. The Metrovía oversight organisation set certain standards that any concession agreement must reach. Existing operators in the city were given first right to participate in the concession. If the operators did not accept this opportunity, then the second tier of opportunity would be extended to firms operating within the Province. If the system was still not fully subscribed after the second tier, then the operating contracts would be opened up to all national and international firms in the final tier. Given the impending presence of other firms entering their market, the existing operators agreed to terms with the city and thus filled the operating quota for the project’s first phase.

In other cases, though, when the political resolve behind a system is relatively weak, then the process can be designed to be overly generous to existing operators. This situation in turn erodes the cost efficiency and quality of the service. Cities such as Jakarta, Quito, and León have largely either made arbitrary contractual awards to a few selected firms or simply have given full grandfathering rights to existing companies.

On Quito’s Ecovía corridor, the existing operators formed a joint consortium (called TRANASOC) and were given exclusive rights to provide services for a ten-year period. The operators were also essentially given free financing on the new articulated vehicles since the municipality purchased the vehicles with public funds.

In Quito, the operators were to repay the municipality for the vehicles using revenues collected from the system. Unfortunately, fare collection was done directly by the operators so the municipality actually has little knowledge on actual passenger counts and revenues. Quite worryingly, the operators’ repayment of the articulated vehicles was tied to profit guarantees related to the number of passengers. Clearly, the operators had a strong incentive to underestimate passenger and revenue numbers in order to minimise any repayment of the vehicles. In the end, the city simply sold the vehicles to the operator at a greatly reduced price.

León’s BRT structure is likewise skewed towards rewarding existing operators rather than overall efficiency. Like Quito, existing operators formed a monopoly consortium, in this case called the “Coordinadora de Transporte.” The municipality acquiesced to the consortium’s demands for full monopolistic rights of operation. The consortium’s operating rights to the system also does not have a termination date, implying a monopoly in perpetuity. However, on the positive side, the consortium did invest directly in new vehicles.

In León, the consortium operates both the trunk corridors and the feeder services. However, the distribution of revenues is handled differently for each route type. Fares are not independently collected but rather handled



Fig. 15.26 and 15.27
In both the case of the Quito Ecovía line (left photo) and the León system (right photo), the ceding of system control to the operators meant sacrificing a certain quality standard.

Left photo by Lloyd Wright
 Right photo by Eric Ferreira

directly by the consortium. Even though the system has an integrated ticketing system and a single fare, fares collected by the feeder buses are kept by the feeder bus operators. The income of the feeder operators is thus based on the number of passengers. The fares collected on the trunk corridors are deposited into a fund established by the consortium. Funds are reportedly distributed to trunk operators on a basis of number of kilometres travelled. However, since the payment system is not transparent, the exact nature of the revenue distribution scheme is unclear to the municipality and the public.

Besides the non-transparency and lack of competitiveness within the system, the market design also has negative consequences for quality of service. Since the feeder operators only keep the fares that they collect, they only have an incentive to serve customers during the morning commute. On the return trip in the afternoon, the trunk line operators are collecting the revenues. Not surprisingly, then, the feeder companies provide very little service, and thus make the trip home a relatively unpleasant and difficult experience for the customer. The City is trying to fix the problem by creating a compensating fund. However, the only influence that the City and the State have over the regulation of the system is through a Technical Committee of the “Coordinadora de Transporte.”

Given the predictable results of manipulation and inefficiency, why do municipalities choose uncompetitive structures such as those in Quito, Leon, and Jakarta? Principally, the reason is a lack of political will. Municipal officials are not willing to entertain the possibility that some existing operators could lose their operational rights along a particular corridor. The resulting upheaval from disgruntled operators could have political consequences.

However, the choice between appeasing existing operators and creating a competitive environment is a false one. It is possible to design a system that gives an adequate opportunity to the existing operators without compromising the overall competitive structure.

15.4.3 Elements of a competitive bidding process

A competitive bidding process ensures that firms offering the best quality and most cost-

effective services are invited to participate in the new BRT system. A bidding process can also do much to shape the long-term sustainability of the system. Competition is not just reserved for trunk line operators as other aspects of a BRT system can also benefit, including feeder services, fare collection systems, control centre management, and infrastructure maintenance.

A bidding process sets the expectations for the private entities interested to be part of the system and establishes the terms and conditions that will define the relationship among the different actors. This section outlines the competitive bidding processes undertaken in Bogotá, both during the system’s Phase I and the subsequent lessons learned and adapted for the Phase II bidding. This section focuses on four areas of competitive tendering:

1. Trunk corridor bidding;
2. Feeder services bidding;
3. Quality incentive contract;
4. Duration of the concession.

15.4.3.1 Trunk corridor bidding

The bidding process developed by Bogotá’s TransMilenio stands out as one of the best examples of providing a competitive structure directed at both quality and low cost. In reality, Bogotá used its incentive structure to achieve a variety of objectives:

- Cost-effectiveness;
- Investment soundness;
- Risk allocation;
- Environmental quality;
- Opportunities for existing operators;
- Local manufacturing of vehicles;
- International experience and partnerships.

Bogotá’s competitive bidding process provided the incentives to completely modernise its public transport system by encouraging modern vehicles, wider company ownership, and sector reforms. The principle mechanism in Bogotá was the use of a points system to quantify the strength of bidding firms. By carefully selecting the categories and weightings within the points system, TransMilenio shaped the nature of the ultimate product. Table 15.4 provides a summary of the bidding categories and weightings.

The points system was used in a way that rewarded inclusion of the existing operators, but the design also provided an impetus to

consolidate small operators into more manageable groupings. TransMilenio established eligibility criteria that mandated a certain minimum working capital and firms to be legally incorporated as formal businesses. These requirements prompted small operators to seek out partners and to professionalise their business. Bid categories such as the equity contribution of previous operators and the experience level on a particular corridor gave value to the inclusion of the existing operators. However, the participation of the existing operators was not assured, as was the case in Quito and León. This uncertainty provided the necessary risk to drive a more competitive offering.

In the Phase I bidding of TransMilenio, 96% of all the local transport companies (62 out of 66 companies) acquired stock in the four consortiums that were awarded trunk line concessions

(Hidalgo, 2003). Thus, even within a competitive bidding process, the existing operators were able to compete extremely well. The bidding process favoured firms with experience in public transport provision, but it did not exclude any interested party.

The “economic capacity” category refers to the ability of the company to provide a minimum equity level as an initial investment. The minimum equity level is equal to 14 percent of the total value of the buses being offered to the system. The minimum owner’s equity is defined in equation 15.1.

Equation 15.1 Calculation of minimum owner’s equity

$$\text{Minimum Owner’s Equity} = \text{NMV} \times \text{US\$}200,000 \times 14\%$$

Table 15.4: Points system for bidding on TransMilenio trunk line operations

Factor†	Description	Eligibility	Points	
			Minimum*	Maximum**
Legal capacity	Bidding firm holds the appropriate credentials to submit a proposal	X	-	-
Economic capacity	Bidding firm holds the minimum amount of net owner’s equity to submit a proposal	X	-	-
Experience in operation	Passenger public transport fleet in operation		30	140
	Specific experience providing passenger services in Colombia		50	250
	International experience on mass transit projects		0	50
Economic proposal	Offer price per kilometre to operate the service		0	350
Proposal to the city	Right of exploitation of the concession			
	Valuation of the share given to TransMilenio SA from the revenue of the concessionaire ⁽¹⁾		21	50
	Valuation of the number of buses to be scrapped by the concessionaire ⁽²⁾		14	50
Composition of equity structure	Share of company’s stock held by former small bus operators		32	200
Environmental performance	Level of air emissions and noise; disposal plan for liquid and solid wastes ⁽¹⁾		0	200
Fleet offered	Size of fleet	X		
	Manufacture origin of the fleet		0	50

Total (1350 points possible)

† If the proposal meets all the requirements, then the proposal will be categorised as ELIGIBLE.
 * If the proposal is below any given minimal value, then the proposal will be categorised as NOT ELIGIBLE.
 ** If the proposal does not meet the established range, then the proposal will be categorised as NOT ELIGIBLE.
 (1) Not present on first phase
 (2) Fixed number on first phase

Where,

NMV = Maximum number of buses offered to the system

The value of US\$200,000 was the approximate cost of an articulated bus in Phase I of TransMilenio, based on the specifications required by TransMilenio SA.

“Experience in operation” refers to the bidding firm’s direct experience in providing public transport services. The experience can be in Bogotá, the greater metropolitan area, or in another Colombian city where vehicles of more than ten passengers are utilised. Companies are also awarded for partnering with international transport providers. For example, the principal transport operator in Paris, RATP (Régie Autonome des Transports Parisiens), is a partner with one of the TransMilenio operating firms. The idea is to encourage a sharing of knowledge that will improve the performance of the local operators.

The “economic proposal” is perhaps the most important bid category in terms of creating incentives for system that is cost-effective in operation and affordable to the majority of the population. The bid process ensures that firms closely analyse their cost structures to be as competitive as possible.

The salaries, office space, and other costs of the public company, TransMilenio SA, are not funded through municipal payments. Instead, the public company receives a portion of the system revenues. Thus, in the bidding process, the

interested private firms must state what percentage of operating revenues will be given to TransMilenio SA. On the initial phase, this amount was initially fixed and then was later increased after several negotiations with the operators.

In order to help eliminate the more polluting vehicles from the city, the private firms also bid on the number of old vehicles that they are willing to destroy. The older vehicles are to be physically scrapped so that these vehicles do not simply move to another municipality. In some instances, the private operators will be able to scrap their own vehicles. In other cases, it will be more economical to “buy” older vehicles from others. The idea is to find the lowest cost vehicles to destroy. Since the lowest-cost vehicles also tend to be the oldest and most polluting, the incentive works well in achieving its goal of reducing the over-supply of outdated vehicles. The vehicle scrapping process is quite formal. The older vehicles must be taken to a designated scrapping facility where a legal certification is awarded once the vehicle is destroyed. The process is designed to avoid any corruption or any “leakage” of vehicles to other cities.

The bidding firm’s “equity share” held by small operators is a key incentive to encourage the participation of existing operators. This bid category essentially gives value to these small operators and their existing resources. The bidding firm receives more points for the higher number of shares owned by small bus operators. During the negotiations between the bidding firms and the small operators, the existing assets of buses, drivers, and capital held by the small companies will likely determine their equity stake.

The “environmental performance” of the bid refers to the rated air emissions and noise levels expected from the provided vehicle technologies as well as the expected handling of any solid and liquid waste products. In the case of Bogotá, the initial minimum standard for tailpipe emissions is Euro II standards. With time, this requirement will increase to Euro IV. However, firms offering Euro III technology or higher can gain additional bid points for doing so. The bidding process thus offers an in-built incentive to not only meet minimal standards, but encourages firms to go much higher. In turn, this incentive creates a dynamic environment to push vehicle

Fig. 15.28
As part of the competitive tendering process, companies compete to destroy the greatest number of older vehicles.

Photo courtesy of TransMilenio SA



manufacturers to provide improved products. Prior to TransMilenio, Euro II technology was difficult to obtain in Latin America since the manufacturers produced such vehicles predominantly for the European, North American, and Japanese markets. Now, with the incentives from TransMilenio, some manufacturers in Latin America are even producing Euro III vehicles.

The bidding process also encourages the vehicle manufacturers to develop fabrication plants in Colombia. Local fabrication of vehicles is awarded additional points. This item is not a requirement, but does bring benefit to bidding firms that can secure local fabrication. Thus, the bidding process does not require local manufacturing in a draconian manner. Instead, the positive reinforcement of bidding points helps to instil a market-based outcome. To date, much to the credit of TransMilenio’s existence, two major international bus manufacturers have established production sites in Colombia. Marco Polo in conjunction with two local firms has built a fabrication plant in Bogotá (Figure 15.29) while Mercedes has built a plant in the Colombian city of Pereira.



Bogotá’s competitive bidding process has been successful in selecting operators who are most capable of delivering a high-quality product. Table 15.5 summarises some of the characteristics from the successful bids for Phase II trunk lines of TransMilenio.

The successful bids in Table 15.5 indicate different strategies by each firm. Interestingly, all firms entered the same price level and the same sharing of revenues to TransMilenio. The selection of these values is not due to collusion or coincidence. Instead, these values are the median of the allowed range. The column “vehicles to scrap” indicates the number of older vehicles that each

company is willing to destroy for each new articulated vehicle introduced. Thus, for example, the company “Connexion Mobil” will destroy 8.9 older vehicles for every new articulated vehicle that the firm purchases. With a total of 100 new vehicles being introduced, Connexion Mobil will thus destroy 890 older buses. The final columns set out the amount of participation each firm has given to existing small operators.

The second phase incorporated many additional requirements for the operators, but these additions did not discourage interest or reduce the value of the bids. The initial bidding process had many uncertainties and risks that did not hold with the second.

15.4.3.2 Feeder service bidding

Bogotá manages a similar bidding process for feeder services. Table 15.6 is a summary of results from TransMilenio Phase II bids for the feeder routes. Due to reasons of practicality, a single feeder company operates in a given zone of the city. A total of eight zones are demarcated

Fig. 15.29
Due to the incentive structure in the TransMilenio bidding process, bus manufacturers have been encouraged to develop local manufacturing sites.

Photo by Lloyd Wright

Table 15.5: Successful bids for Phase II trunk lines of TransMilenio

Company name	Fleet size	Emissions	Price / km (Colombian pesos)	Revenues* to TransMilenio (%)	Vehicles to scrap	Participation of existing operators	
						Owners	% of equity
TransMasivo SA	130	Euro III	3,774	3.53%	7.0	452	20.22
Sí – 02 SA	105	Euro II	3,774	3.53%	7.5	658	21.62
Connexión Mobil	100	Euro II	3,774	3.53%	8.9	740	29.39

Source: TransMilenio SA

* The “Revenues to TransMilenio” column represents the amount of revenues that the bidding firms are willing to give to the public company (TransMilenio SA) in order to manage the system.

for the feeder services in Bogotá (Figure 15.30). Six of these zones were open to bidding during the tendering process presented in Table 15.6.

The results of the Phase II bidding for feeder services in Bogotá indicate the great capacity of competitive bidding to achieve particular results. Specifically, the number of existing operators forming partnerships is quite impressive. As many as 1,333 small owners are participating in a single firm within the Phase II bids for feeder services. It is unlikely any sort of mandatory grouping could have derived such a large consortium. The power of the market in conjunction with a well-designed bid process can provide significant motivation to achieve desired results.

The duration of the concession contract has also played a pivotal role in influencing the results of Bogotá's bid process. A long concession period increases the value of the contract and thus increases the quality and quantity of the bids. However, if the concession period is too long, then the municipality's flexibility with future changes becomes limited. Further, a long concession period can have a negative effect on com-

petition since it creates a long-term oligopoly for the successful firms. In the case of Bogotá, the duration of the concessions match the estimated useful life of the new vehicles. Each successful firm thus receives a concession for ten years.

The ten-year concession period (based on Kilometres) also applies to the feeder services. During Phase I of TransMilenio, the feeder operators only received a concession for a period of four years. The trunk operators still had a ten-year concession during Phase I. The longer concession in Phase II for the feeder companies reflects increased expectations for these firms in terms of vehicle technology and service quality. By giving a longer concession period, the operators are able to purchase new vehicles and amortise the vehicles over the course of the contract.

15.4.3.3 Quality incentive contracts (QICs)

“The whole duty of government is to prevent crime and to preserve contracts.”

—Lord Melbourne, former UK Prime Minister, 1779–1848

The competitive bidding process ensures that the most able and most cost-effective companies will participate in the BRT system. Likewise, though, it is important to develop the right incentives to ensure continued high-quality service in the system's operation. A “quality incentive contract” is an effective mechanism to encourage operators to deliver excellence in service. In essence, a quality incentive contract stipulates how an operator's performance is tied to its financial compensation. If an operator fails to perform properly in certain aspects of its service, then the firm will incur penalties or deductions in its payments. Likewise, a firm that exceeds service expectations can actually be rewarded with additional payments.



Fig. 15.30
Distribution of feeder zones in Bogotá
Source: TransMilenio SA

Table 15.6: Successful bids for Phase II feeder services of TransMilenio

Zone	Company	Price / km (Col. pesos)	Price / passenger	Emissions Technology	Vehicles to scrap	Number of owners
Norte	Alnorte Fase 2	0.0	263.0	Euro III	3	240
Suba	Alcapital Fase 2	0.0	260.0	Euro III	3	457
Calle 80	TAO	0.0	295.3	Euro III	3	1141
Americas	ETMA	279.6	292.0	Euro III	3	807
Sur	Si - 03	0.0	332.2	Euro III	3	1,333
Usme	Citimovil	0.0	347.1	Euro III (35%)	3	997

Source: TransMilenio SA

Once again, Bogotá provides an excellent example of how quality incentive contracting can be used to motivate operator performance. However, many cities other cities, such as London and Hong Kong, also make use of quality incentive contracts in their bus operations. In the case of Bogotá’s TransMilenio system, poor

performing operators can experience revenue reductions of up to 10 percent of the operator’s monthly income. Further, in extreme cases, an operator can even lose the concession for consistently unacceptable services.

Since TransMilenio operators are paid based upon the number of kilometres travelled,

Table 15.7: Penalty system within TransMilenio’s quality incentive contracting

Area	Type of infraction	Penalty
Maintenance / vehicle deficiencies	Alteration of / damage to the vehicle interior or exterior: Unauthorized advertisements, non-functional signal lights, unclean bus, or damaged seating.	50 kilometres
	Failure to follow pre-determined schedules for maintenance, repair, or inspection.	50 kilometres
	Non-functional doors or worn tires.	100 kilometres
	Alteration of or damage to the GPS system or the radio communication system.	250 kilometres
Customer service / operations	Stopping at a different station than the assigned station or not stopping at an assigned station	25 kilometres
	Stopping for a longer period than requested	25 kilometres
	Blocking an intersection	25 kilometres
	Use of stereos, driver’s cellular or walkman devices.	50 kilometres
	Parking bus in an unauthorised location	60 kilometres
	Changing route without authorisation	60 kilometres
	Delaying system operation without a valid reason	60 kilometres
	Over-passing another bus with the same route without authorisation	60 kilometres
	Operating during unauthorised hours	175 kilometres
	Permitting the boarding or alighting of passengers in places other than stations.	250 kilometres
Consistency of driver performance	Operating bus on streets different than the formal trunk lines without authorisation	250 kilometres
	Abandoning a bus without a valid reason	250 kilometres
	Performance difference between best operator and other operators, < 20%	0 kilometres
	Performance difference between best operator and other operators, 20% - 25%	30 kilometres
Administrative / institutional	Performance difference between best operator and other operators, 25% - 30%	75 kilometres
	Performance difference between best operator and other operators, > 30%	120 kilometres
	Failure to send reports required by TransMilenio	50 kilometres
	Impeding the work of inspectors from TransMilenio SA	50 kilometres
	Hiding information or providing incorrect information	50 kilometres
Environmental	Inappropriate administrative or accounting procedures	100 kilometres
	Abuse of power in relations with staff	100 kilometres
	Fuel / oil leaks and spillages	25 kilometres
Security	Noise and air pollutant levels above the levels stipulated in the bid contract.	50 kilometres
	Mishandling of hazardous materials	50 kilometres
	Any security violations not in compliance with contractual obligations	100 kilometres for each day in violation

Source: TransMilenio SA

penalties for poor performance are imposed by reducing the number of kilometres assigned to the operator. The basis for fines and penalties are explicitly set out in the initial contract. Areas covered in the quality incentive contract include maintenance practices, customer service, driver safety, administrative practices, and environmental performance. Table 15.7 summarises the types of infractions and their associated penalties.

In some instances where public safety is compromised, TransMilenio SA will also directly impose penalties upon the drivers in addition to fining the operating company. Thus, violations such as driving at excessive speeds or disobeying traffic signals can result in driver suspensions or termination of employment (Table 15.8).

The public company, TransMilenio SA, is responsible for monitoring and evaluating compliance with contractual norms. Inspections occur both randomly and within periodic schedules. Some violations can also be detected through the GPS system. Control centre staff can record average speeds and vehicle movements, and thus staff can determine when speeding or other vehicle violations occur.

Ninety percent of the fines and penalties are collected into the “Fines and Benefits Fund” while the remainder is retained by TransMilenio SA. The “Fines and Benefits Fund” is then periodically distributed to the highest-performing operator. Thus, the scheme provides a double incentive to avoid poor performance by first penalising poor quality service and then rewarding excellence. In addition, since the penalised operators also forfeit a certain number of kilometres serviced, the well-performing operators also gain by receiving increased service allocations.

Penalised operators do have some recourse to contest unwarranted fines. If the operators feel that the penalties have been imposed unfairly, an appeal can be presented during the weekly meetings that take place between the operators and TransMilenio SA. If the other operators and TransMilenio SA concur that the fines were unwarranted, then the amount of the fine is returned.

When applied fairly, a system of quality incentive contracts provides a powerful tool in motivating high-quality service from operators. By selecting the appropriate measures and

Table 15.8: Penalties for driver infractions

Action	Penalty to driver	Penalty to operating company
Lack of driver’s license or bus registration document	Suspension (next day)	100 kilometres
Failure to provide first aid	One day suspension	100 kilometres
Refusal to provide customer with information	One day suspension	100 kilometres
Accident between two TransMilenio buses	Penalty depends upon investigation	100 kilometres
Running red light	Immediate suspension	100 kilometres
Backing up while on a trunk line	One day suspension	50 kilometres
Possession of a firearm	Immediate suspension	100 kilometres
Disobeying police instructions	One day suspension	200 kilometres
Driving while under the influence of alcohol or other prohibited substances	Immediate suspension	200 kilometres
Accident resulting from an irresponsible action	One day suspension	200 kilometres
Improper approach to station platform	Three times in a single day results in a one day suspension	50 kilometres
Excess velocity	One day suspension	100 kilometres
Encroachment onto pedestrian crossing		100 kilometres
Mechanical problems that are not resolved in less than one hour		50 kilometres
Verbal or physical aggression to passengers	Immediate suspension	100 kilometres
Conducting fare collection on board vehicle	Immediate suspension	200 kilometres
Disobeying instructions from Control Centre or traffic authorities	Immediate suspension	100 kilometres

Source: TransMilenio SA

following-up with a rigorous inspection regime, operators will be given the right level of incentives to remain focused on providing a quality product.

15.4.3.4 Duration of concession contracts

The duration of the concession contract affects the potential profitability of the service for the operating company and also the financial risk exposure of the government vis a vis the operator. Normally, the life of the contract needs to be sufficient to allow the private investors to recapture their investment. If the vehicles being procured can only be used on the BRT corridors, and the private operators are being expected to pay the full cost of the vehicles, then it is likely that the length of the contract will need to be roughly as long as the productive life of the vehicle. If the government is buying the vehicles or subsidising the vehicles, or the vehicles can easily be reused on other corridors, the government can probably attract the needed investment with shorter contracts.

Obviously it is in the interest of the government to keep the contracts as short as possible, and it is in the interest of the investor to get a contract as long as possible. Longer concession periods will thus tend to increase both profitability and investment levels. However, longer-term concessions have the negative effect of reducing the public sector's flexibility and control over the future direction of the system. Very long-term concessions can result in monopolistic behaviour that ultimately reduces system quality. Thus, the optimum duration for a concession contract will be such that it provides sufficient time for a profitable operation but does not impair future flexibility and competitiveness.

In Bogotá, in Phase I, the concession period was ten years or 850,000 vehicle kilometres, whichever came first. In Phase II, there was no fixed concession period. Instead, the terms were stated as 850,000 vehicles kilometres within a maximum period of 15 years. Generally the life of the contract is set at roughly the same length as the expected life of the new transit vehicles. By allowing the operators to fully amortise the vehicles over the life of the period of the concession contract, the lowest cost structure is achieved. A shorter period would place

additional risk on the operators who may not have use for the under-utilised vehicles if they were not successful with a future concession. A longer period would either mean that new vehicles would need to be purchased within the concession, or that pressure would be placed on the city to permit operation of older vehicles.

Since operators are paid by the vehicle kilometre, there is also going to be an issue over who regulates the total number of vehicle kilometres that the operators will serve in a given day.

Operating contracts also generally provide some sort of minimum guaranteed number of vehicle kilometres. If the BRT authority (TransMilenio) can reduce the operator's vehicle kilometres per day to zero, then the operators are fully exposed to demand risk. It is unlikely that an investor will be willing to invest if they are completely exposed to demand risk. If they are guaranteed a high number of vehicle kilometres per day that ensures they will make a profit, then they are not exposed to any demand risk. TransMilenio contracts guarantee a minimum number of vehicle kilometres over the life of the contract or else allow for the contract to be extended in time. In this way, the vehicle operators are exposed to short term demand risk but are guaranteed that eventually they will be able to recoup the cost of their investment.

In the newly contracted operations of Ahmedabad (India), by contrast, the private operators are guaranteed a daily minimum number of vehicle kilometres. This minimum number of vehicle kilometres turns out to be more than is actually needed, and the public transport authority is thus bearing most of the demand risk and losing money. In each case, it is up to the public transport authority to negotiate the best deal possible for the public while still attracting the needed private investment.

The optimum concession length will vary by local circumstances and the project's specific cost analysis. Acceptable vehicle ages and amortisation rates will vary. However, the over-riding principal is to select a contract duration that maximises competitiveness and cost effectiveness.

16. Operating costs and fares

“Everything should be made as simple as possible, but not simpler.”

—Robert Olson, writer, 1920–

The business structure of the BRT system should do what it can to ensure long term high-quality service to its passengers. BRT systems are vulnerable to being used for political purposes other than providing high-quality service to its passengers. A profitable system might see its resources reallocated to other purposes. Procurement decisions can be made for political rather than technical reasons. Even the exclusive use of the road right-of-way is vulnerable to being revoked by new political administrations. A good business structure backed by enforceable contracts can play a critical role in protecting good quality BRT service over the long term.

Because BRT usually aims to create a “market”, the business model for the BRT system as a whole must be developed, and this business case has to be built up from the business case of the separate components of the system: the trunk operations, feeder bus operations, fare systems, and possibly security services as well. The development of the system’s business model will require some initial analysis of projected operating costs and projected revenues. This analysis will help identify the conditions in which operating companies can reach profitable (and thus sustainable) revenue levels. The calculation of operating costs and projected revenues will also allow initial estimates of the fare levels that will allow the system to cover its operating costs.

The more profitable the new BRT system is, the more independent it can be financially from political influence, and the easier it will be to ensure long term high quality service for the passengers. The more elements of the system that can be paid for out of fare revenues, the less of a financial burden the system will be on the general taxpayers, and the less the riders will find their public transport service compromised by political objectives other than good quality public service.

One of the key purposes of the business plan for the system as a whole will be to estimate the overall profitability of the system. Knowing how profitable the planned BRT system will be in

advance is a critical first step in defining which elements of the system can be financed in a sustainable manner from the fare box revenue, and which elements of the system need to be paid for by government investment.

This analysis should be done prior to the final determination of the business structure, and before finalising the bus technology selection. To put it simply, a more profitable system can afford better vehicles. The first section of this chapter provides guidance for estimating the system’s operational costs. Operational costs include both operating costs and operations-related investments, such as the vehicle procurement. The second section provides guidance on estimating the system’s projected revenues.

With this information, it is a good idea to re-appraise the proposed operational model and vehicle procurement, to see if the system cannot be made more profitable. Once this is done, it will be possible to make a determination which elements of the system can be financed by the fare revenues, and which will need to be paid for by the government to make the system sustainable.

Once this basic structure is outlined, the chapter reviews how the fare revenue can best be collected and distributed.

Once the basic business structure has been optimised, the way in which the operating contracts with the private sector are negotiated and written will have long term implications for the quality of service. The second part of this chapter therefore provides guidance on the negotiation of operating contracts and the contents of these contracts.

This chapter is therefore structured as follows:

- 16.1 Operating costs
- 16.2 Fare levels
- 16.3 Revenue distribution
- 16.4 Fare policy
- 16.5 Fare system options
- 16.6 Reappraisal of operating costs

16.1 Operating costs

“The sovereign has the duty of erecting and maintaining certain public works and certain public institutions, which it can never be for the interest of any individual, or small number of individuals, to erect and maintain because the profit could never repay the expense to any individual or small number of individuals through it may frequently do much more than repay it to a great society.” (Wealth of Nations)

—Adam Smith, economist, 1723–1790

This Planning Guide recommends that infrastructure remain the financial responsibility of the government, while private investors take responsibility for the vehicle investment and other operational investments.

However, even if this broad definition of the respective public and private roles for the BRT system’s business structure are generally accepted, there are many tasks involved in managing and operating a BRT system. It is not always inherently clear which of these roles should be paid for by public funds and which should be paid for from fare revenue. Furthermore, it is not always clear what elements of the system should be treated as part of the initial capital investment paid for by the taxpayers, and what elements of the system should be depreciated and treated as ongoing operating expenses paid for by the fare box revenue. Finally, it is not inherently clear what part of the ongoing administrative costs of the public regulatory authority should be paid for by government revenues, and what part of administrative costs should be paid for by fare revenues.

This determination will largely depend on how profitable the system is. Since some systems are going to be more profitable than others,

financial responsibility for some elements of the BRT system will have to be strategically moved between the private investors and the government until the system can be made financially sustainable.

BRT operations involve two types of costs: operational investments and ongoing operational costs (Figure 16.1).

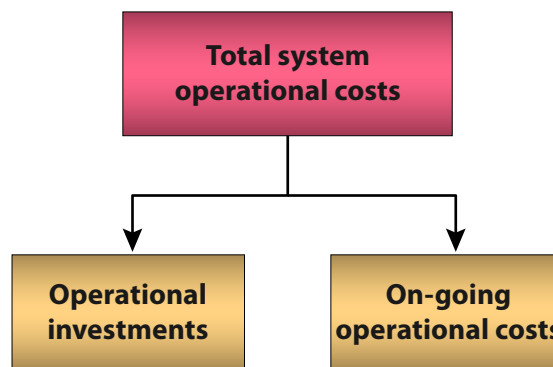


Fig. 16.1
Schematic of the types of operational costs.

16.1.1 Operational investments

Operational investments include the cost of investment into the trunk vehicles, the feeder vehicles, and fare collection and verification equipment. The fare equipment can include fare vending machines, fare readers, fare verifiers, turnstiles, software, and the payment medium (e.g., smart cards). Operational investments can also be taken to include some or all of the depot-related costs, and in some cases the costs of the control centre equipment as well. There may be other office supply costs, training costs, and personnel costs, such as uniforms for staff (security staff, customer service staff, etc.). The more profitable the system, the more of these costs that can be covered from the fare revenue. The principal objective, though, should always be to design a system with no operational

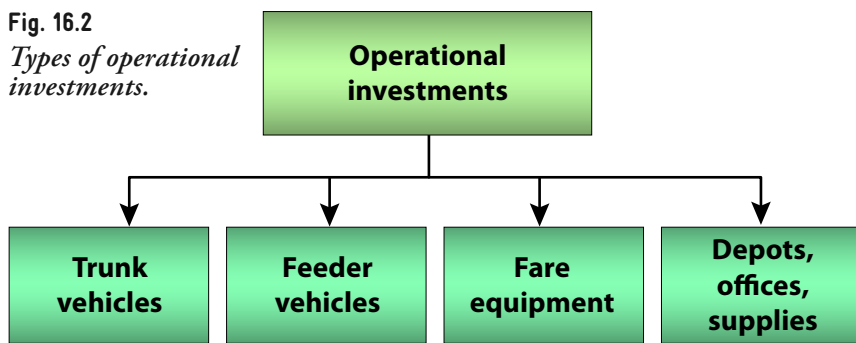
subsidies. If costs need to be shifted to the capital cost ledger, then there is a better solution than incurring an operational subsidy. A one-time subsidy infusion for infrastructure and other equipment is typically far preferable than an on-going subsidy for the life of the system. Operational subsidies require long-term administrative costs and close oversight. They are more difficult to control and thus are also more prone to improper and corruptive misuse. Operational subsidies can also be damaging to the image of public transport since it provides detractors with a focal point to say the system does not pay its own way and is a burden on public finances.

fare income, then it is highly recommended that the vehicles are fully purchased by the private operators. These operators can then incorporate the amortisation costs of the vehicles in their bids to the system management company.

In some cases, keeping customer fares low may be a political objective to foster social equity. Thus, a partial contribution by the public sector may be required to reach a targeted fare level. In such an instance, the vehicles should be fully owned by the private sector and not in any way held in the name of the public sector. If the vehicle is owned by the public sector and operated by the private sector, then maintenance and upkeep will likely be quite poor. The private operators would have no incentive to care for a vehicle they do not own. Additionally, public procurement of the vehicles also raises the potential for corruption through illegal payments from manufacturers to officials.

The fare collection and verification system includes both hardware and software. The fare system is overall considerably less expensive than the vehicles and will likely have a longer life (Figure 16.3). In many circumstances, it will be less costly for the government to simply directly procure the system. Further, publicly-owned fare equipment will give more flexibility with regards to the concession of the fare operations. If the fare concession company was to own the equipment as well, then the question arises as to what happens at the end of the concession period. It would be highly disruptive

Fig. 16.2
Types of operational investments.



The vehicle costs are typically a major portion of operational costs and thus can have a significant impact on fare levels. The temptation may be to simply pay for the vehicles fully from public funds. However, it is critical that at least a portion of the vehicle costs are financed by the fare revenue. If system profitability permits the full costs of the vehicles to be paid through the

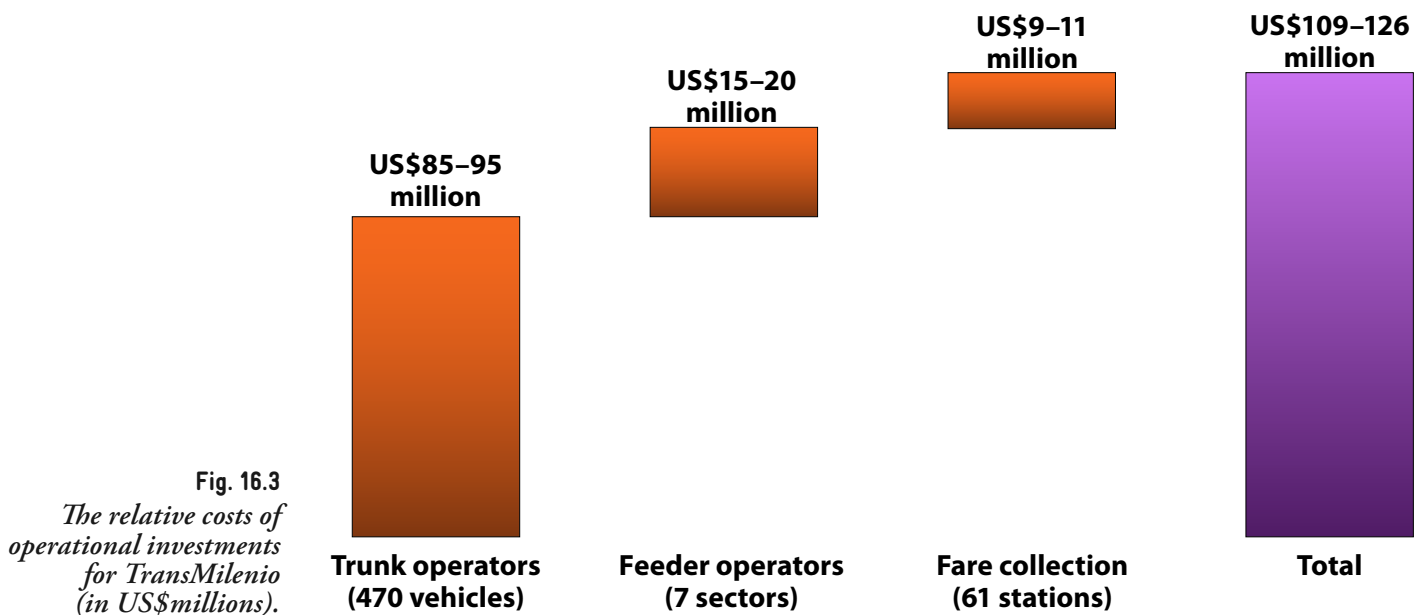


Fig. 16.3
The relative costs of operational investments for TransMilenio (in US\$ millions).

to have all the equipment removed due to a change in concession holders. Alternatively, a very long-term concession could be arranged, but this approach would limit the government’s control over the system and diminish incentives for operator performance.

The depot is another area where there is some flexibility. For example, the vehicle operators might be expected to pay for the buildings which house their administrative offices. They might also procure the equipment used to clean, refuel, and maintain the vehicles. However, again, any private ownership of these assets will limit system flexibility at a later date. If another company was to take over the concession at a later date, then it becomes quite disruptive if all or part of the depot area is owned by someone else. Such a situation could even force the entire relocation of the depot. Certainly with some moveable equipment, there would not be a problem in permitting private ownership. In general, though, the depot fixtures should probably remain in public hands.

If the system turns out to be extremely profitable, the control centre technology and station maintenance costs would be the next items to be covered out of fare revenue. After this, road maintenance too might be covered by fare revenues.

16.1.2 Ongoing operating costs

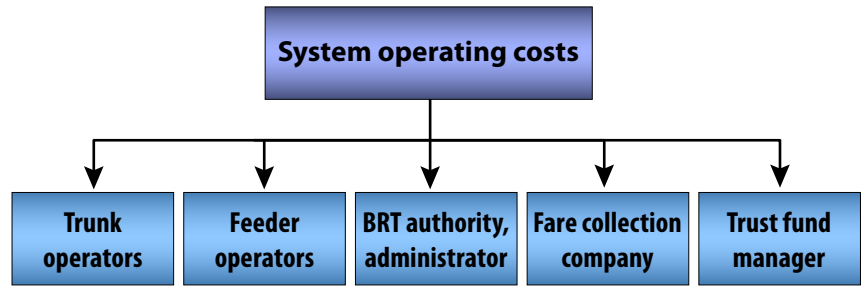
From the point of view of the system as a whole, the cost of vehicle operations on the trunk lines depends on the contractually determined rate that the BRT authority has agreed to pay the vehicle operator per kilometre, times the projected total annual kilometres of operations that are programmed. This relationship is outlined in Equation 16.1.

Equation 16.1 Calculation of payment to trunk operations

$$\text{Total payments to trunk operators} = \text{projected needed daily bus kilometres} * \text{projected total buses} * (\text{the estimated operating cost per kilometre} + \text{return on investment})$$

The operational costs of the BRT system as a whole are potentially composed of the following components:

- Payments to trunk operators;
- Payments to feeder operators;



- Payment to administration of BRT public authority;
- Payments to fare collection operator;
- Payments to trust fund manager.

Fig. 16.4
Distribution of operating costs amongst the principal cost centres.

These components are illustrated in Figure 16.4.

Similarly, from the point of view of the feeder operators, the operational cost will simply be the amount that the BRT authority has contractually agreed to pay the feeder operators per kilometre (or per passenger, whatever the contract stipulates), times the total projected passengers or kilometres provided by the planning consultants.

The administrative expenses of the BRT authority largely are principally the cost of salaries for the staff. Whether the operating costs of the BRT authority is paid from the fare revenues depends on how the business plan is initially organised. In some cases, the system administration may be simply part of the transport authority’s general budget. As with vehicles and other components, the viability of including administrative costs as part of the revenue distribution depends on the expected system profitability and the targeted customer fare level.

Payment to the fare collection company will similarly be determined by whatever payment was negotiated at the outset.

The trust fund manager is an independent entity that receives the revenues collected from the fare collection company. The trust fund manager is then responsible for distributing

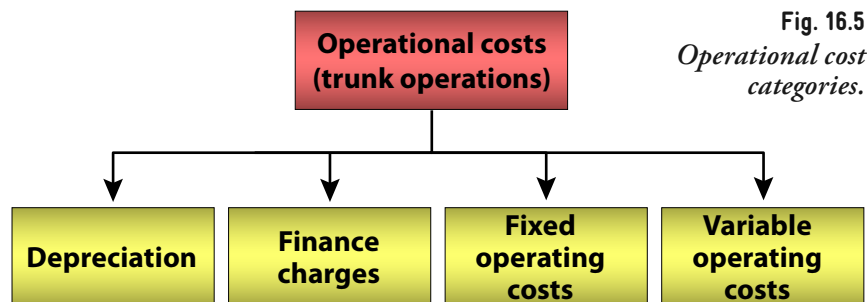


Fig. 16.5
Operational cost categories.

Table 16.1: Operational Cost Components of BRT

Item	Measurement units	Value per vehicle
Depreciation		
Vehicle depreciation	% of value of vehicle / year	10%
Finance charges		
Cost of capital	Effective annual interest rate on invested capital	14%
Fixed Operating Costs		
Driver salaries	Employees / vehicle	1.62
Salaries of mechanics	Employees / vehicle	0.38
Salaries of administrative personnel and supervisors	Employees / vehicle	0.32
Other administrative expenses	% of variable costs + maintenance + personnel	4.0%
Fleet insurance	% of value of vehicle / year	1.8%
Variable Operating Costs		
Fuel	Gallons of diesel / 100 km	18.6
	m ³ of natural gas / 100 km	74.0
Tires	– New tires	10.0
	– Retreading	27.6
Lubricants	– Motor	78.9
	– Transmission	4.5
	– Differential	5.8
	– Grease	3.0
Maintenance	% of value of vehicle / year	6.0%

Source: TransMilenio SA, Bogotá, Colombia, June 2002

the revenues to each party based on the prior contractual agreements. In many cases, the trust fund manager is a bank or other trusted financial institution. The trust fund manager receives a fee for providing these services.

All parties involved in the system will want to conduct a thorough analysis of the costs prior to

entering any negotiations. The operational cost analysis is pivotal to being secure with concession terms that will likely be the basis for payments over a period of ten years. The BRT authority responsible for negotiating the operating contracts with the private operators will want

to know ahead of time roughly what the cost of providing this operation should cost in order to strengthen their hand in the negotiations. Likewise, from the point of view of the private operator, they must ensure that the quoted payment per kilometre served is sufficient to cover their total operational costs, plus a reasonable rate of return on their investment.

The major operational cost categories are: 1. Depreciation of assets; 2. Finance charges; 3. Fixed operating costs; and, 4. Variable operating costs. Figure 16.5 outlines these costs.

Table 16.1 provides a summary of operational cost categories along with sample values from Bogotá's TransMilenio system. The values shown in Table 16.1 will vary greatly, depending on local circumstances. For example, labour costs in developing cities are often in the range of 10 percent to 25 percent of total costs. By comparison, labour costs in developed cities can range from 35 percent to 75 percent of total costs.

Table 16.2: Operating cost comparisons for TransMilenio

Cost item	Trunk services	Feeder services
Fuel	24.6%	17.3%
Tires	4.7%	5.2%
Lubricants	1.5%	1.7%
Maintenance	9.0%	10.8%
Wages	14.7%	29.2%
Station services	0.0%	2.6%
Other fixed costs	45.5%	33.2%
Total	100.0%	100.0%

Source: TransMilenio SA

The values presented in Table 16.1 are used to calculate an overall operating cost per kilometre for the system operators. This value is the basis for negotiating the remuneration given to the firms given operating contracts for the public transport services.

The above operating cost figures assume companies with a fleet size in the range of 90 to 160 vehicles. When the fleet size falls below a certain level, the fixed administrative costs per vehicle will tend to increase.

If it is decided that the above operational investments should be paid for from the fare revenue, then the operational cost model will need to take into account the depreciation of the capital asset, the finance charges related to the procurement of the capital asset, the fixed costs related to operations, and the variable costs related to operations.

Table 16.2 compares the relative size of the individual fixed costs and the variable costs for the TransMilenio system. This table compares these costs for both the trunk and feeder services.

16.2 Fare levels

“The price is what you pay; the value is what you receive.”

—Anonymous

The total revenues distributed to the various contracted parties are based on the amounts collected from system’s “technical fare”. The technical fare is equivalent to a flat fare that the system would be required to charge in order to break even. By contrast, the “customer fare” refers to the fare paid by the users of the system. As will be discussed in this section, the technical fare and customer fare are likely to be slightly different values.

16.2.1 Calculating the technical fare

The technical fare represents the actual cost per customer of providing the service. It is the basis for the subsequent distribution of revenues to the operators. It is calculated by simply adding up the full estimated operational costs calculated for the trunk operators, the feeder bus operators, the fare collection company, the trust fund manager, and the administration costs of the BRT authority (if the BRT authority costs are to be included). These operational costs

include both the on-going operational costs and any operational investments that will be the financial responsibility of the private investors, including the depreciation of the vehicle value and financing charges. Equation 16.2 summarises this basic relationship.

Equation 16.2 Basic form of technical fare calculation

$$\text{Technical fare} = \frac{\text{Total BRT system daily operational costs}}{\text{total projected daily passengers}}$$

Equation 16.3 provides a more detailed and expanded calculation of the technical fare.

Equation 16.3 Calculation of technical fare

$$F_T = \frac{\sum \frac{C_{MLI} \times Km_i}{Q_{ST}} + \frac{C_F \times Pas_F}{Q_{ST}} + C_C}{(1 - \%Tr - \%M)}$$

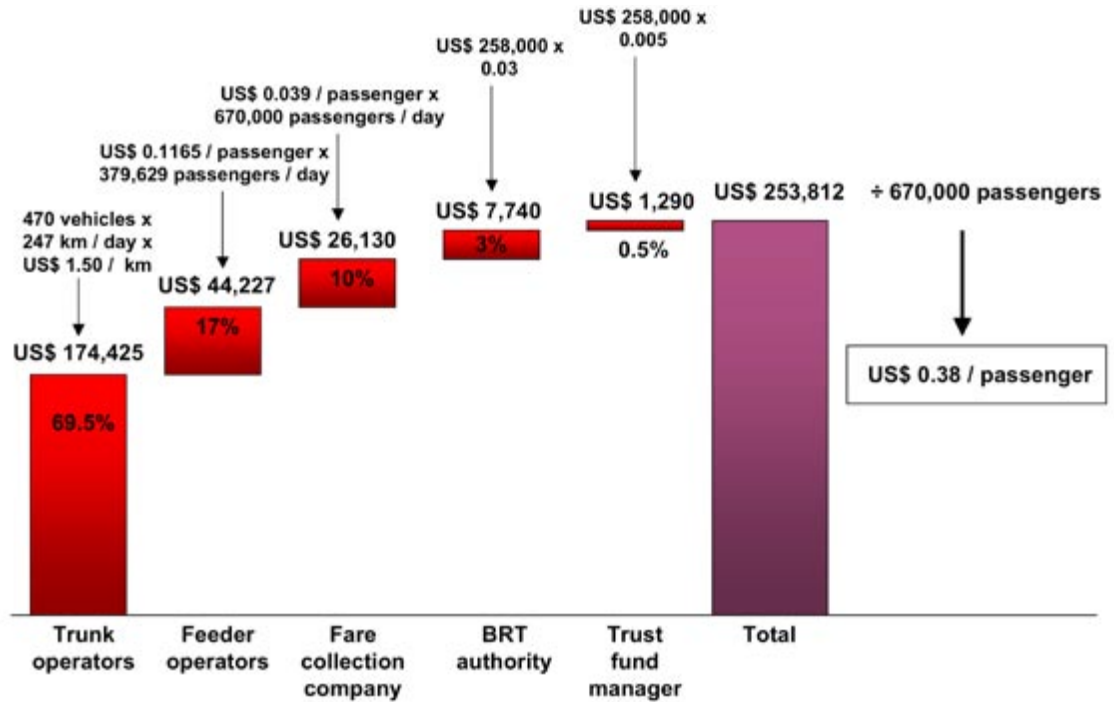
1/PKI %F

F_T = Technical Fare
 C_{MLI} = Main lane per kilometer of operator I (Trunk Cost)
 Km_i = Kilometers covered by the operator I
 Q_{ST} = Quantity of Sold tickets
 C_F = Feeding cost (per fed passenger)
 Pas_F = Quantity of fed passengers
 C_C = Collection cost per sold ticket
 $\%Tr$ = Trust Company Remuneration
 $\%M$ = Manager Remuneration
 $1/PKI$ = Passengers per Kilometer Index
 $\%F$ = Percentage of fed passengers

Source: TransMilenio SA

The contracts for the private operating companies are likely to be non-uniform. Some companies will invest only in 90 vehicles, while others will invest in more. In the case of TransMilenio, it was decided that there would be four trunk operating companies in the first phase. The number of vehicles purchased by the four different companies was: 1. 160 vehicles; 2. 120 vehicles; 3. 100 vehicles; and, 4. 90 vehicles. System planners estimated, based on projected demand, that each vehicle would operate roughly 247 kilometres per day, and used this estimate as the basis of the calculation of the technical fare. Contractually, however, the operators were not guaranteed any minimum number of vehicle kilometres per day, or they would not have been exposed to any demand risk. Rather, they were guaranteed 850,000 vehicle kilometres within a 15 year period.

Fig. 16.6
Calculation of technical fare for Phase I of TransMilenio
 Source: TransMilenio SA



Original calculations were conducted in Colombian pesos. Assumed exchange rate for this graphic is US\$ 1 = 2,000 pesos

Because the operator is paid per vehicle kilometre, this meant that the cost of trunk operations to TransMilenio was the total number of vehicles times the total number of vehicle kilometres. The actual formula to calculate the technical fare is depicted in Figure 16.6.

The example given in Figure 16.6 is particular to the first phase of the Bogotá TransMilenio system. Each system will have its own cost structure based on the amount of the service that is provided by the trunk line vehicles vis-à-vis the feeder vehicles, the fare collection costs, the negotiated service rates of each component, and the cost of administration. In the case of TransMilenio’s Phase I, 69 percent of the cost of operating the entire system resulted from payments to the trunk line operators, but this will be different for each system. This value also changed with the addition of the Phase II corridors in Bogotá.

The technical fare, calculated on a cost plus basis from the overall operating costs of the system, is basis for the distribution of fare revenues. In other words, each component of the TransMilenio system was promised a fixed percentage of the total fare revenues based on the calculation of the technical fare. In this way, these companies became shareholders with a collective stake in maintaining ridership.

16.2.2 Adjustments to the technical fare

A operator concession agreement will typically be in the range of 10 years, the estimated life of a vehicle, though it could be shorter if the vehicles can easily be resold. During that period, many of the input costs can change (e.g., fuel costs, labour costs, etc.). Since the concession agreements stipulate that revenues are paid based on the vehicle-kilometres travelled, both the BRT authority and the operators must be protected against dramatic changes in input cost levels.

The technical fare goes through a process of modification depending on cost swings in both system inputs and operational factors (Table 16.3). Fuel price volatility is one of the most

Table 16.3: Factors affecting changes in the technical fare

Category	Cost item
System inputs	Diesel price; Consumer price index; Minimum wage standard; Producer price indexes (lubricants, tires, maintenance).
Operational factors	Passenger per kilometre index (PKI); Percentage of passengers using feeder services.

significant risks. Spare parts that need to be imported will be subject to currency risk, a major factor in some countries. Base labour costs will vary in step with the local economy. Accurately predicting these cost levels over a long period is a nearly impossible task due to the great number of external influences. Thus, as base cost conditions change for the operators, the technical fare will go through adjustments.

On a periodic basis, such as every two weeks, the technical fare is updated based on the changes in the base factors outlines in Table 16.2. The calculation for the changes in the technical fare is given in Equation 16.4.

Equation 16.4 Calculating changes in the technical fare

$$\Delta F_T = \%C_{ML} \frac{\Delta C_{ML}}{\Delta PKI} + \%C_F(\Delta C_F + \Delta\%F) + \%C_C \Delta C_C - 1$$

where:

- ΔF_T = Change in the technical fare
- $\%C_{ML}$ = Proportion of the main lane cost (%)
- ΔC_{ML} = Change in the cost per kilometer (main lane)
- ΔPKI = Change in the Passengers per Kilometer Index (Main lane)
- $\%C_F$ = Proportion of the feeder cost
- ΔC_F = Change in the feeder remuneration, by passenger that use feeding services
- $\Delta\%F$ = Change in the percentage of passengers that use feeding services
- $\%C_C$ = Proportion of the collection cost
- ΔC_C = Change in the collection cost

16.2.3 Customer fare and contingency fund

As noted above, the “customer fare” is the payment required by the customer for a single trip on the system. Unfortunately, costs tend to rise over time, implying that fares must also rise. For reasons of customer clarity as well as political considerations, the fare paid by the customer should not be changed frequently, perhaps no more than once or twice per year. Customers would be quite confused and angry if the fare changed every time world fuel prices changed. Further, raising customer fares can have a range of social equity impacts that must always be considered. If a public transport company needs to obtain political approval for each fare increase, then the adjustments may never happen. In turn, the entire system will eventually become financially untenable.

To overcome such an inherent stalemate, the system for fare adjustments should be relatively

automatic in nature based upon contractual obligations linked to key trigger points. TransMilenio has worked out a mechanism for adjusting the fare automatically to such changes. In the case of Bogotá, all operating costs are calculated on a bi-weekly basis. If a particular trigger point is reached (such as the technical fare exceeding the customer fare), then a fare adjustment is authorised by the municipality. The Mayor and other political officials are still involved in the authorisation through the public company’s board of directors, but the stipulation of a fare adjustment is reached through the operating cost calculation.

However, at the same time, some political discretion is required. As noted, fare level changes should not be frequent events.

Also, it is probably sensible to establish fare levels that are round numbers in order to coincide with denominations of the local currency. For example, a fare of US\$0.375 is not a possibility. Further, a fare level that requires handling many small coins means that both fare collection and fiduciary handling of the revenues will be slowed down. This inefficiency will in effect increase costs even more. Thus, fare levels should only increase at prescribed trigger points,

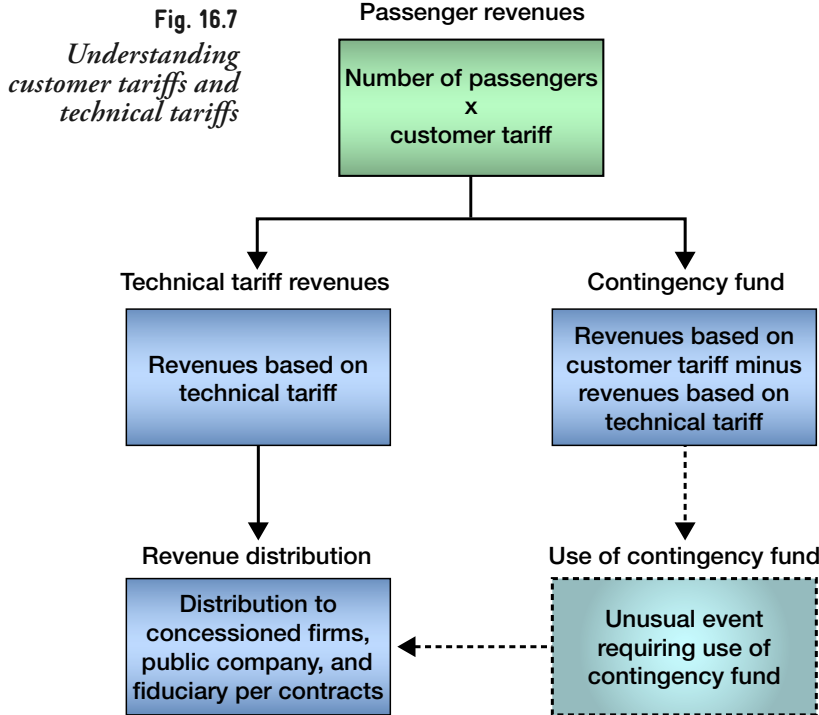
and the increase should be significant enough so that no further increases will be likely over the short term. A fare adjustment system should be ideally designed so that increases do not occur more than once or twice per year.

If unusual events occur (*e.g.*, hyper-inflation) that require frequent adjustments, a contingency fund should be in place to bridge revenue short-falls. The contingency fund thus provides a buffer that allows the system management company to stabilise fare levels even in turbulent times. It is this need for some buffer against unexpected contingencies that led to the development of a contingency fund in the case of TransMilenio. The difference between the technical fare in Bogotá and the customer fare is simply that an additional charge has been created to pay into a contingency fund (Equation 16.5).

Equation 16.5 Relationship between customer fare, technical fare and contingency fund

$$\text{Customer fare} = \text{Technical fare} + \text{Contingency fund payment}$$

Figure 16.7 graphically shows the relationship between the customer fare and the technical fare. In general, the customer fare should be slightly greater than the technical fare, and this difference is deposited into the contingency fund.



The contingency fund is designed to handle unexpected events such as unusual low levels of service demand, extended hours of operation, terrorism and vandalism, and problems associated with hyperinflation. In general, the

customer fare will be greater than the technical fare, and thus the contingency fund will build up a positive balance. When unforeseen circumstances occur and the technical fare exceeds the customer fare, then proceeds from the contingency fund will be drawn upon for a temporary period. The contingency fund effectively acts as a safety net in times of unusual cost fluctuations. As the contingency fund becomes exhausted, the board of directors of the system will have to act in order to avoid a financial crisis.

The standard remedy would be to raise the customer fare to a point securely above the technical fare. The operation of the contingency fund provides a level of security and confidence to the operators as well as any outside funding entities to the system.

Figure 16.8 tracks the technical fare and the customer fare in the TransMilenio system. As expected, the customer fare is generally greater than the technical fare. As the technical fare has increased with time, the customer fare has also increased in order to maintain a comfortable margin. The graphic also demonstrates the difference in fluctuations between each fare type. The customer fare only increases in discrete amounts since these represent points of actual fare increases to the customer. By contrast, the technical fare will likely vary to some degree each month, as the constituent cost categories will change with economic conditions and input prices.

16.3 Revenue distribution

"In the end it's a revenue stream. And all revenue streams eventually reach the sea."

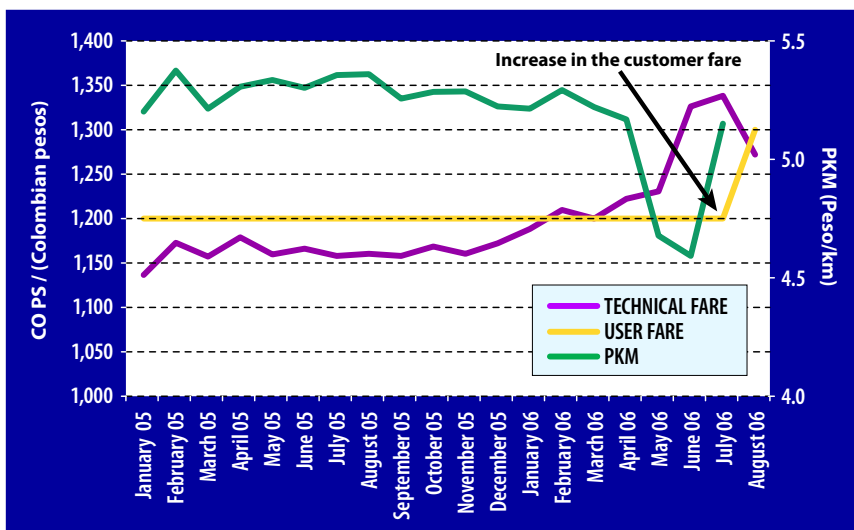
—Paul Schrader, screenwriter and film director, 1946–

The distribution of revenues is another process which will greatly influence the behaviour of the system operators. Distributing revenues on a basis of the number of passengers or on a basis of kilometres travelled will affect behaviour in different ways.

Fig. 16.8

Changes in the technical and customer fares for the TransMilenio system. When the technical fare exceeds the customer fare for any substantial length of time, an increase in the customer fare is likely to be required.

Graphic courtesy of TransMilenio SA



Traditionally, the handling of fare revenues in a developing-city public transport system is a rather opaque process. Portions of the fares may be kept by conductors or drivers with understood amounts being handed over to owners. There also may be payments to police or other official entities. As such, this process does not lend itself to a transparent business model in which the public interest is carefully weighed. This process also inherently rewards drivers to maximise the number of passengers they collect during the day. With the incentive of maximising passengers, drivers then work in a manner that can conflict with public safety and rider comfort.

The transparent and fair distribution of revenues is fundamental to operating a network of integrated transit providers. If operators do not have confidence in the distribution of revenues, then their behaviour will revert to self-interested actions that undermine customer satisfaction. The most important elements in a transparent system for revenue distribution are:

1. A business and institutional structure that provides for an independent fare collection system;
2. Checks and balances in place to verify revenues at different stages of process;
3. Revenues distributed based upon a clear set of rules and procedures;
4. An independent auditing system.

16.3.1 Revenue flows

Determining how the fare revenue is handled, and according to what guidelines the revenues are split, can determine the success or failure in a BRT system. There are many options, but generally, it is best to have an entity independent from the bus operating companies running the fare collection and distribution process.

The independent entity that collects the fare revenue could be the BRT authority itself, or it could be a private firm contracted out by the regulatory agency. An independent entity, acting as a custodian of the revenues, is preferable to having the bus companies collect fare revenues directly.

The reasons for taking revenue collection away from the bus companies is to facilitate the free integration of bus routes and lines among different BRT corridors without leading to conflicts between bus companies, and in order for the public sector to retain control over the information about the profitability of the system. Alleviating bus operators of the responsibility to collect fares also reduces system delays due to on-board fare collection, and reduces the likelihood of misappropriation of the revenues. The distribution of revenues should follow a clear set of rules based on contracts.

Figure 16.9 outlines the general process of revenue flows in Bogotá. The fare collection and

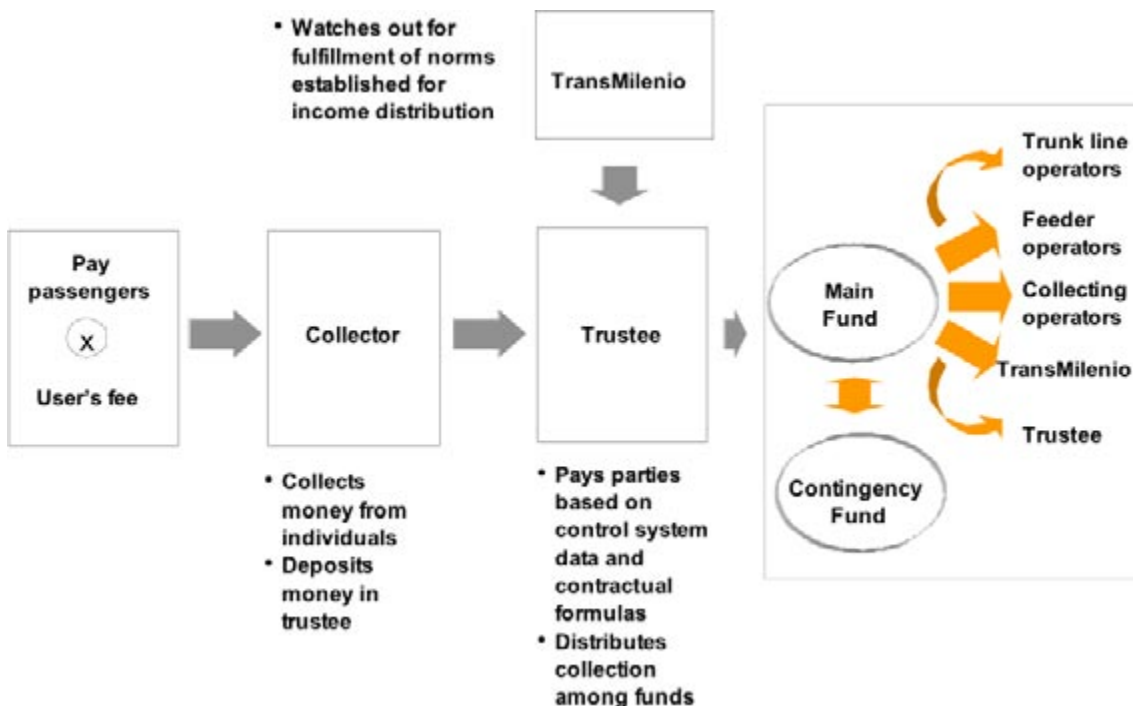


Fig. 16.9
Flow of fare revenues through distribution process

fare verification system is managed by a separate private company that successfully bid for the fare collection concession. The fare collection company has no involvement with any of the bus operating companies on the BRT system. In the case of Bogotá, this company agreed to procure the fare system equipment and operate it for a flat percentage of the fare revenue, approximately 9 percent. This amount was based on the calculation of the cost of this operation plus a reasonable rate of return. Most experts believe that this calculation was wrong and that the share for the fare collection system should have been lower, around 5 percent. Further, many systems may find it advantageous to capitalise the fare equipment rather than recoup these costs through the fare revenues. By capitalising fare equipment, there is less pressure on the required fare level.

In Bogotá, the fare system operator does not actually distribute the revenues to the operating companies. Since the fare collection company itself is due part of the proceeds, it would be a source of potential suspicion if the fare collection company was to fulfil this function. Instead, an independent fiduciary company (normally a bank) who manages the trust fund is the depository of the actual fares. Thus, the fare system operator collects the fare revenue and deposits it into the account of the trust fund manager. The trust fund manager first keeps their contractually determined 0.4 percent of the total revenues. At this stage, the BRT authority (TransMilenio) then tells the trust fund manager to pay the various operators based on their contractual agreements.

16.3.2 Revenue verification

In systems such as Bogotá where smart card fare systems are utilised, the data from the electronic system can act as a verification of the revenues collected. The revenues from a particular station or terminal should match the electronic records of the passengers entering the system. In the case of TransMilenio, the electronic records are actually independently verified in two locations. The electronic data is downloaded to mainframe computers at both the fare collection company and the public management company (Figure 16.10). This sort of electronic verification is an effective mechanism in building the confidence level of all parties in the fare collection system.

The electronic verification process requires a robust technological architectural design and the security levels that offer the require trust by the operators. Figure 16.11 describes the TransMilenio Technological Design Architecture. Under this architecture, a customer's entrance and payment into the system is recorded by the fare reader at the station. This information is downloaded to both the main computer of the oversight agency of the public transport company as well as the fare collection company. This information is also transparently available for review by the operating companies. Secure transmission lines help to ensure the integrity of the system. Additionally, a back office maintenance computer will oversee the data flows to guard against any problems.

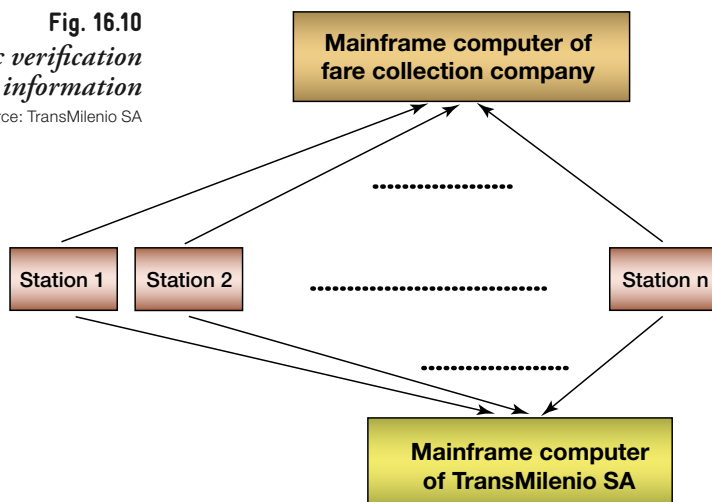
This type of information recording on fare transactions is most easily captured when systems are utilising smart card or magnetic strip type payment mediums. However, revenue verification can also be accomplished when non-electronic payment mediums (*e.g.*, paper, coins, tokens) are being utilised.

16.3.3 Revenue distribution process

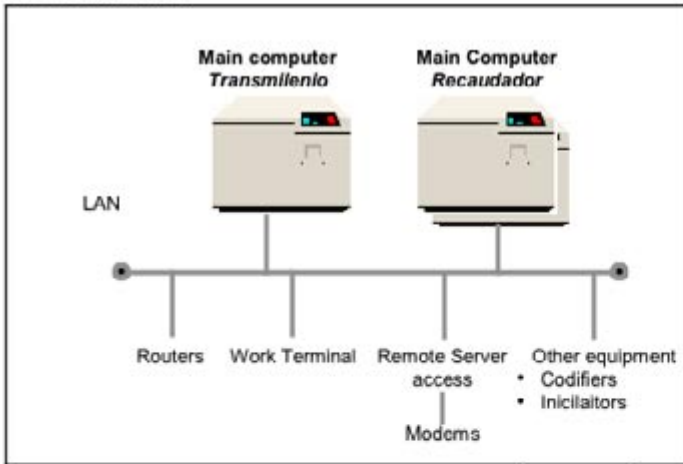
As revenues are collected into the system, a defined set of procedures then distributes these revenues based on the pre-arranged contracts. The distribution of revenues is based upon the technical fare and not the customer fare. As noted above, any surplus from the customer fare is allocated to the contingency fund.

Currently for TransMilenio, most of the revenues are distributed to the private bus operators

Fig. 16.10
Electronic verification of fare information
Source: TransMilenio SA



Processing center



Maintenance



Bus stations

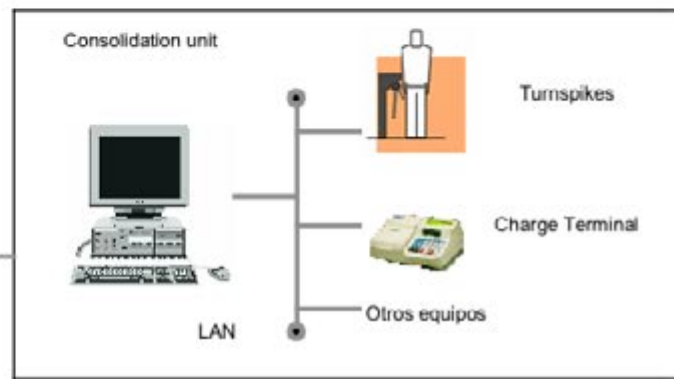


Fig. 16.11
Technological architecture

Source: Transmilenio

who are providing either trunk line services (71.9 percent of revenues) or feeder services (13.9 percent of revenues). The percentage going to TransMilenio, the fare collection company and the trust fund manager are all a fixed percentage of the total fare revenue. The company with the concession for the fare collection currently receives 9.1 percent of the technical tariff revenues. TransMilenio SA, the public company with overall management responsibility for the system, received initially a flat 3 percent, but with the high profitability, this was increased to 5 percent. Finally, the fiduciary company, called the Trust Fund Manager, retains 0.04 percent of the technical fare revenues. Figure 16.12 illustrates this distribution.

The trunk and feeder bus operators only receive a fixed percentage of the total revenue collectively. As individual firms, their percentage of the take is adjusted based on how many kilometres of service they actually provided, and this is adjusted as a form of reward and penalty for good or bad service, as has been discussed previously.

The categories of “trunk-line operators” and “feeder operators” actually consist of many different private firms. Thus, there is a further distribution process to divide these shares to each of the participating operating companies.

As noted earlier, the trunk-line operators are compensated strictly upon the number of kilometres travelled and any adjustments based upon performance. The number of kilometres each operating company is assigned is negotiated beforehand amongst all the interested

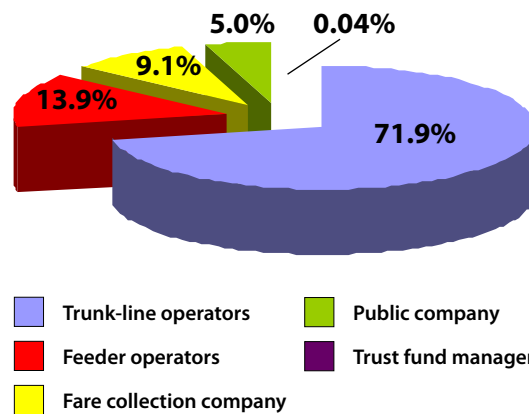


Fig. 16.12
Distribution of system revenues from TransMilenio

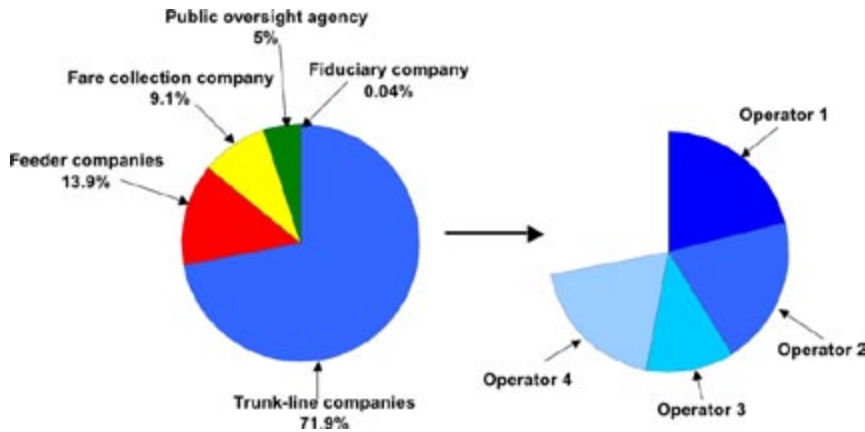


Fig. 16.13
Distribution of revenues to trunk-line operators

parties. The revenue distribution process to the trunk-line operators looks something like the process shown in Figure 16.13.

The basis for revenue distribution to feeder services is somewhat different than the trunk-line operators. On the trunk-line corridors, the activities of the operators are relatively controlled, due to the fixed nature of busways and the control centre oversight. Driver infractions such as not stopping at a station are readily observable as they are on the trunk lines. However, feeder services are less easily monitored and controlled. Thus, the revenue distribution system must account for any misplaced incentives.

For example, if the feeder services are compensated exclusively based on kilometres travelled, then the feeder operators have an incentive to drive as quickly as possible without picking up any passengers. Conversely, if the feeder operators are compensated exclusively on the number of passengers, then the operators will not operate during non-peak periods. Also, when the compensation is exclusively based on passenger numbers, the feeder operators are exposed to considerable demand risk. Thus, in some cases, the right incentive package for feeder operators may be compensation based upon both the number of kilometres travelled and the number of passengers carried. In this scenario, the operators have an incentive to both provide services across the daily schedule and to cater to passenger needs. In both Bogotá and Quito, feeder services were originally compensated only by the number of passengers served. However, both of these cities have now switched to a combined incentive scheme (distance travelled and passengers served) in order to improve feeder performance.

In reality, there is no reason why feeder movements cannot be controlled to the same degree as trunk line operations, using automatic vehicle location (AVL) technology to track movements. Regular auditing of feeder operations could be utilised to ensure that station stops are being respected. GPS-monitoring of feeder vehicles is also useful in terms of ensuring efficient spacing between the vehicles. Ultimately, the objective should be to create the same levels of customer service with feeder operations as there is on the trunk lines. Placing all efforts on the trunk lines and leaving feeder operations to their own devices will diminish the overall image of the system.

16.3.4 Auditing the process

The entire revenue collection and distribution process should be independently audited by a professional auditing firm. The selected firm should have no relation whatsoever with any of the other companies in the system (e.g., trunk operating companies, feeder operating companies, fare collection company, trust fund manager). This auditing process will especially check upon the handling of revenues by the fare collection company and the trust fund manager.

The auditing process in conjunction with the electronic verification of fares collected, as well as the presence of the trust fund manager, all help contribute to an environment of confidence in the system. Without such a rigorous and transparent process, operators would be less trustful of the system and less willing to act in a manner supporting the common good.

16.4 Fare policy

“The mere formulation of a problem is far more often essential than its solution, which may be merely a matter of mathematical or experimental skill. To raise new questions, new possibilities, to regard old problems from a new angle requires creative imagination and marks real advances.”

—Albert Einstein, physicist, 1879–1955

The fare policy will be as important to the long term sustainability of the system as the operating contracts and the business structure. If the BRT system is set up with a great business structure, but the government fixes the fare so low that the system does not generate enough

revenue to maintain its operating costs, the system is likely to collapse over time. If the fare is not allowed to rise with a sudden increase in fuel prices, then the profitability of the entire system can be jeopardized.

On the other hand, the fare is highly political, and if the fare price rises suddenly and sharply, it could have very serious consequences for low-income users and their employment. Because of these potential ramifications, fares are politically very sensitive. A bad policy can either undermine the long-term viability of the system on the one hand, or lead to social turmoil on the other. Fortunately, the efficiency of a good BRT system generally makes it possible to maintain low fares while still keeping the system profitable.

Now that the system’s costs have been estimated, system planners have a rough idea of the technical fare. The technical fare as explained above will tell the system planners how much they need to charge for the system to break even. This initial measurement of the technical fare, however, was based on the assumption of a flat fare per passenger.

While the technical fare will be the starting point for deciding on the ultimate fare structure, the optimal customer fare level and structure now needs to be evaluated. A technical fare based entirely on costs could be higher than passengers are willing to pay. Actual system profits might increase rather than decrease if the customer fare is lowered below the technical fare, if passengers are highly sensitive to price changes.

The optimal fare structure will therefore depend on how sensitive public transport passengers are to changes in fare prices, or the *elasticity of demand*. Making a BRT system self-financing requires not only that the customer fare be high enough to cover operating costs, but it also requires that the customer fare be low enough to attract large numbers of passengers and therefore maximise revenues.

The next step, therefore, is to determine the optimal customer fare level and the optimal fare structure from the point of view of profit, customer convenience, and ridership.

Once the optimal fare level and structure is determined, it must be compared to the technical fare. If the optimal customer fare is much lower

than the technical fare, then the system design will have to be modified to the point where the technical fare and the optimal fare are the same. Only then should the fare system technology be selected and the business plan finalized.

As has been suggested, setting the fare level requires analysing two different values:

- The technical fare, or the fare needed for full cost recovery;
- The optimal customer fare, or the fare that maximises the system’s profits.

Ideally, the business and operational model of the BRT system should bring the technical fare as close to the optimal customer fare as possible.

16.4.1 Cost recovery

The first decision that needs to be made regarding the basic fare level is how the fare revenues should relate to the system’s operating costs. While normal bus systems operate in mixed traffic congestion, and hence face escalating operating costs beyond their control, BRT systems have been specifically designed to prevent congestion from cutting into the profitability of the system. In fact, a new BRT system can increase system cost efficiency through several factors (Table 16.4).

For this reason, BRT systems can generally avoid the need for government subsidised services, and all the management problems that result from subsidised systems. It is generally recommended that in developing countries the BRT fare be set at a level high enough to cover

Table 16.4: Efficiency gains through BRT

Category	Cost-saving component
Operations	Exclusive busway operation instead of mixed traffic lanes; Centralised control to optimise performance; Priority measures at intersections; Defined station locations that are often farther spaced than informal stops; Coordinated and integrated system permitting free transfers between routes and corridors (network effect).
Economies of scale in procurement	Vehicle purchasing; Fare equipment purchasing; Fuel purchasing; Maintenance.
Additional ridership	Higher-quality service attracting former car users

the system's operational costs, including if possible the cost of depreciation of the vehicles.

Thus, the starting point for considering customer fare levels is an analysis of operational costs (see previous section). In other words, *the customer fare should be set above the technical fare.*

With so many competing needs for public financing in developing-nation cities, from education to clean water to health care and sanitation, there is rarely a good justification for subsidising a transportation system that has already been given privileged access to the road infrastructure. By avoiding subsidies, the city is also avoiding the complexity and added costs of managing a subsidy scheme. The appearance of subsidies also tends to undermine political support for the system and resentment among non-users, making the sustainability of the system highly vulnerable.

Of course, affordability is also a primary consideration. Not all BRT systems are as well designed as TransMilenio, and not all of them can reach cost recovery no matter how high the customer fare is set. If a customer fare based on the technical fare is too high, it will alienate passengers, and this situation will not help increase system profits. The elasticity of demand for low-income public transport users can be quite high.

Furthermore, a very high customer fare would consume a large percentage of the daily income of low-income citizens, undermining the social development objectives of the BRT system that were its original impetus. If the fare is too high, unemployment can result.

It is therefore imperative that the system be redesigned to the point where it is inherently profitable from the beginning.

It should be noted that in most societies, governments reserve the right to provide discounts to certain categories of users, like school children and the elderly, and the very poor. These discounts need not constitute a threat to the sustainability of the BRT system so long as the BRT authority is protected from such political decisions by a contractual obligation. If the government decides to mandate a lower fare or categorical discounts, then it should compensate the BRT authority for the losses incurred.

Even in the case of TransMilenio, which is one of the most profitable systems in the world, the municipality reserved the option to subsidise the fare. The government has the right to require a lower fare than the technical fare, so long as it compensates TransMilenio for the losses incurred. To date, this option has never been exercised.

Thus, the initial basis of the fare should be the cost of providing the service, or the technical fare. Even if government subsidies cannot be avoided, they should be treated as fee for service contracts with other government agencies that have no impact on the general fare, and no adverse impact on the financial stability of the BRT system as a whole.

Prior to determining if the system requires an operational subsidy, however, additional options should first be considered.

16.4.2 Optimal customer fare

As a first step to determining an optimal fare structure, the projected impact of different flat

Table 16.5: Flat fare demand and profit analysis for TransJakarta

Fare level (Rp)	Demand (paying passengers)	Collected revenue (US\$)	Vehicle-km travelled	Operating cost (US\$)	Profit (US\$)	Peak frequency (buses/h)
Rp 2,000	11,523	\$3,201	2,732 km	\$1,973	\$1,228	40
Rp 2,200	14,634	\$3,577	3,248 km	\$2,346	\$1,231	52
Rp 2,100	16,511	\$3,853	3,618 km	\$2,613	\$1,239	56
Rp 2,000	18,191	\$4,042	3,955 km	\$2,857	\$1,186	63
Rp 1,800	21,640	\$4,328	4,516 km	\$3,262	\$1,066	69
Rp 1,600	25,172	\$4,475	5,153 km	\$3,722	\$753	77
Rp 1,400	28,759	\$4,474	5,671 km	\$4,096	\$378	86
Rp 1,300	30,445	\$4,398	5,842 km	\$4,219	\$178	89

Source: ITDP

fares on total system profitability should be analysed. Even if the system may eventually utilise a distance-based fare, a flat fare analysis should be the initial basis of the calculations. This choice greatly simplifies the analysis.

If a traffic demand model was used to generate the original demand estimate, it should be possible to derive the elasticity of demand from the model. If not, the impact of the projected technical fare on demand can be estimated by simply assuming that elasticity is 1, or that a 10 percent increase in the fare price will lead to a 10 percent decrease in ridership. Local experience with the impact that fare price increases had on ridership in the past would be a better guide to base an elasticity estimate. In the case of the modelling done for TransMilenio, it was initially assumed that elasticity was 1.

By way of example, when advising the DKI Jakarta government on an appropriate fare for TransJakarta, it was determined that the optimal customer fare from the point of view of maximising operating profit was Rp 2,100 (US\$0.25), which is the yellow highlighted figure in Table 16.5. The optimal customer fare from the point of view of maximising operating revenue was around Rp 1,500 (US\$0.20), which is the green highlighted area of Table 16.5.

However, when the other operating costs (vehicle depreciation and fare system operation and equipment) were added (*i.e.*, when calculating the “technical fare”), the system was found to require a fare of Rp 2,700 to break even. At that fare, the system cannot make a profit because it would lose too much ridership. In other words, there was no way to make the system financially self sufficient in Phase I without changing the operational plan. In this case, the lack of feeder services and failure to cut parallel bus routes was needlessly depressing demand, and poorly negotiated operating contracts with private operators were artificially inflating the bus operating costs. Ultimately the system opened with a Rp 2,500 fare, and in Phase I operations had to be subsidized. Rather than immediately deciding the system needs to be subsidised, the system designers should first try to correct these operational problems.

In the case of Bogotá, the technical fare for the BRT system was approximately US\$0.40, and

the fare for the previous bus services was in the range of US\$0.30 to US\$0.35. Demand analysis showed, however, that the technical fare was close to the optimal customer fare from a profit perspective. This was in large measure because the government had previously regulated the fare at a very low level. This low level was both cause and effect of a lower quality of service, and very low profit margins for the bus operators did not allow them to invest in new vehicles.

Therefore, one year prior to opening TransMilenio, the city permitted the existing operators to increase their fares to above the technical fare of the BRT system. While the population was not entirely pleased with the increases, in general, any displeasure was directed at the private operators and not the municipality. Thus, when TransMilenio was finally introduced into operation, the cost was approximately the same as the existing services.

In other cases, such as Quito, the BRT service was introduced at a slight premium to the existing services. However, the vast difference in quality between the new system and the previous older buses meant that the public was supportive of the new system.

16.5 Fare system options

“Technology presumes there's just one right way to do things and there never is.”

—Robert M. Pirsig, philosopher, 1928

In developing an effective fare system, there are many structural options that must be considered. These different options will affect overall system profitability as well as the social equity of the fares. The topics covered in this section include:

- Fare structure (free fares, flat fares, zonal fares, distance-based fares, time-based fares);
- Fare discounts (multi-trip discounts, inter-system transfers, categorical discounts);
- Fare options for feeder services.

Once these basic structural decisions are made, then a recalculation of the system's profitability should be undertaken. An iterative process may follow in which various structural options are tested for their impacts on overall system profitability. As with many aspects of BRT planning, there are inherent trade-offs that must be considered when weighing system profitability

against design. These trade-offs will likely affect issues such as customer convenience and social equity.

16.5.1 Fare structure

As noted in Chapter 12 (*Technology*), system planners have a range of fare structure options. There are at least five different options for structuring the fare system:

1. Free fares;
2. Flat fares;
3. Zonal fares;
4. Distance-based fares;
5. Time-based fares.

These fare structures are not always mutually exclusive. For example, a time-based fare is usually combined with one of the other fare structures. Also, a different fare structure may be used for the trunk services than for the feeder services. For example, some systems utilise a free fare structure for the feeder vehicles while a flat fare or distance-based fare may be used for the trunk services.

16.5.1.1 Free fares

A relatively new approach to public transport fares is to eliminate the fares altogether. As the name implies, free fare systems involve charging nothing for public transport use. Some public transport systems in Belgium have realised that their fare collection process is actually so costly that it makes sense just to provide a free service. By eliminating the fare charges for public

transport, there is no need for fare collection and fare verification equipment, no staffing requirements for fare operations, no smart cards or other payment mediums, and no customer wait times for fare purchases.

Further, the design of vehicle interiors and stations is void of the requirements from the fare system. For the vehicle interiors, there is much more space for seating. The implications for station design means that an open rather than closed design can be utilised. An open design means that there is less visual and physical severance from the station (Figure 16.14). These types of stations are also less costly to construct.

Of course, the main benefit from fare-free systems is the impact on passenger numbers. In Hasselt (Belgium), bus patronage jumped from 23,000 passengers per month to 300,000 passengers per month with the introduction of fare-free service. About 25 percent of private vehicle users have switched to public transport since the implementation of this scheme. Likewise, urban rail fares have also been eliminated in certain areas of Belgium.

The basis of the decision in Belgium was the fact that approximately 60 percent of the system's revenues were being used to print, distribute, and inspect fares. If other externality costs, such as impacts on station design and customer wait times, are considered, then the case for fare-free travel will be even stronger.

Fare free systems have become increasingly common in both Europe and North America. In the US, cities such as Denver, Miami, and Orlando have some services that operate fare free (Figures 16.15).

The development of a fare-free system does not mean that the overall business structure must radically change. Private operators can still bid competitively for providing the services. Payment to the operators can still be based on the number of kilometres travelled. The only change is the origin of the revenue stream, which instead of being from the customers will be from other sources such as road pricing, petrol taxes, and parking fees. For example, Orlando pays entirely for its Lymmo service through a parking fee.

In the case of developing-nation cities, there is likely to be less of a case for a free fare system,

Fig. 16.14
The Orlando Lymmo system charges no fare, and thus the station designers had considerably more freedom to create an intriguing and open design.

Photo by Lloyd Wright



principally because the cost of fare collection will likely be less. With lower labour rates, there will be fewer instances in developing-nation cities where the costs of fare collection begin to approach the revenues gained, and thus justifying the elimination of fares.

However, there are examples of cities such as Bogotá utilising free fare structures for feeder services. Since feeder services will typically operate with open rather than closed station environments, any fare collection will likely have to occur on-board the vehicles. This arrangement implies that fare readers are required at the doorways. An exit reader may also be required if the transition from the feeder service to the trunk service passes through an open area. All this on-board fare equipment means that the vehicle costs are considerably higher. Additionally, on-board fare collection and verification may also imply a required intervention from the driver (such as providing change) that will slow dwell times and overall travel times. For all these reasons, free fare systems have a fairly wide applicability to feeder services in both developed and developing nations.

The main arguments against free fare systems relate to financial viability, security, and economic principle. First, for many developing-nation cities, the spectre of attempting to secure system financing from other sources besides fares may be limited. In most cases, though, the growth in private motorised vehicles does provide significant scope for using some form of vehicle fees as a revenue source.

Second, some cities fear that their public transport systems will become over-run with homeless persons and others seeking to commit crime. It is true that, in general, open station designs can tend to encourage loitering (Figure 16.16). However, this situation can be true of any public space, such as sidewalks and public parks, and no one would suggest eliminating these aspects of the city environment. Further, there are a number of enforcement techniques that can be utilised to discourage sleeping or loitering within the system.

Third, some argue against free fares on the economic principle that free goods always lead to market inefficiencies. If a product is not priced, it simply will not be valued by the public and



Fig. 16.15

The Miami People Mover is a free city centre circulator.

Photo by Lloyd Wright

thus the public transport system will be seen as an inferior good. Again, though, one could extend this argument to many other aspects of public space such as footpaths, public parks, and even city streets. Few persons would suggest charging pedestrians for using a footpath or families for using a park. In the same way, public transport could also be viewed as an essential public good that should not be burdened with a fee.

In some countries such as South Africa, though, the government has worked hard to overcome a culture of non-payment for services. During the Apartheid years, the non-payment of public services, such as water and electricity, was equated as a protest against the ruling bodies. Since the end of Apartheid, though, the culture has unfortunately continued, creating hardship for municipalities attempting to reach financial sustainability. In such cases, there may be resistance

Fig. 16.16

A man uses the city centre terminal platform of the Porto Alegre system as a place to sleep.

Photo by Toni Lindau



to introducing another free public good that may only further the culture of non-payment.

16.5.1.2 Flat fares versus distance-based fares

Many cities often debate whether to apply a flat fare or a distance-based fare. A flat fare means that a single price applies to any trip within the system. By contrast, a distance-based fare means that the fare level varies by the number of kilometres travelled.

Each of these options involves a different set of trade-offs. Flat fares can be equitable if low income groups tend to take long trips and reside at the urban fringe. These peri-urban areas offer property at substantially lower costs than central areas. The long distances between the peri-urban communities and employment opportunities in the city can inhibit access to jobs, health care, and education. If a distance-based fare was implemented in such a situation, the poor at the urban fringe would end up paying the highest transport costs. In order to achieve greater social equity, a flat fare helps to give such low-income groups access to city centre services and opportunities. In such instances, a flat fare acts as a cross-subsidy from higher-income residents in the central parts of the city to lower-income residents located in peri-urban areas. One of the principal reasons that Bogotá instituted a flat fare was to promote a greater

sense of social equity within its public transport system (Figure 16.17).

As TransMilenio's system has expanded, however, the average trip distance within the system is increasing, as is the cost of providing each trip. This trend is putting upward pressure on the base fare.

A flat fare also permits the use of simpler fare collection technologies. Ticket-less options, such as coin-based machines, are possible with a flat fare. Further, a flat fare implies that no distance verification step is required upon exiting the system. The lack of this verification step reduces queues and thus improves overall system efficiency. In general, a flat fare scheme reduces the level of complexity in fare collection by an order of magnitude.

Distance-based fare systems are utilised quite frequently in developed nations as well as some rail systems in developing cities, such as the SkyTrain in Bangkok (Thailand) and the Metro in Delhi (India). Distance-based fare structures most closely mirror actual operating costs and thus provide a truer measure of expenses for system operators. A longer journey implies that more fuel and labour is required. Thus, distance-based systems do not involve the implied cross-subsidy that exists in flat fare systems.

While the fare should be high enough to cover the cost of providing the service, it may be the case that a distance-based fare will get the planned system closer to full cost recovery than a flat fare. So long as the fare revenue is higher than the cost of operating the system, the fare can also vary based on trip distance. More complex fare structures offer the possibility of optimising the profitability and equity of the system, and hence should be investigated before finalising the business plan.

The principal disadvantage of complex fare systems, such as distance-based fares, is the added cost of collecting and verifying the fares. Unless an honour system is utilised, more sophisticated readers and payment mediums are required, which will be more costly. Also, such fare systems naturally involve more customer queuing, especially since the payment medium must also be swiped upon exiting the system. Customer confusion can occur over the actual cost of a given trip. In order to indicate

Fig. 16.17
Bogotá chose a flat fare structure in part to achieve greater social equity for low-income communities located at the periphery of the city.

Photo courtesy of Oscar Diaz and Por el País que Queremos (PPQ)



the system fare structure, typically a complex matrix of fares must be posted at the stations. Customers may enter the system without knowing exactly how much their trip will cost. In turn, the result may be that a customer arrives at a destination without sufficient funds in their fare card. This situation at least implies the need for a fare adjustment machine at the exit area (Figure 16.18). It may also imply that customers may be liable for penalties and fines, which will stir customer anger and/or embarrassment. Such incidents can be quite effective in discouraging future use of the system.

The complexity also means that more things can go wrong with the system, adding to maintenance costs and potential system shut-downs. In the case of cities such as Jakarta, the complexity of the fare system meant that it did not work properly for the first year of operation.

It is also possible to have a mix of both flat fares and distance-based fares. The base fare can be set quite high and the additional distance-based fee can be set quite low relative to the overall fare price. Alternatively, a flat fare may be utilised within a well-defined urban area while journeys extending to regional locations, such as other municipalities, can require an additional charge. A mixed fare system can be appropriate when a metropolitan area includes satellite commuter cities. If such cities are predominantly middle- or higher-income in nature, then the justification for cross-subsidies are less. For example, the busways in São Paulo (Brazil) charge a flat fare in central areas but revert to a distance-based scheme for continuing onto satellite destinations. The fare collection system in such instances may require greater sophistication, such as smart cards. Alternatively, the point between flat fare and distance-based fares may be realised at terminal sites where it is necessary to transfer between vehicles. At this stage, the transfer between vehicles can require an additional payment.

Before deciding on a flat fare, it is worth testing the impact of different fare structures on total system profits. Different fare structures can have widely different impacts on ridership under different conditions.

For example, on the first corridor of the TransJakarta system there are a lot of passengers



going very short distances, as it is a major shopping area, and people are going from shop to shop. TransJakarta, which adopted a flat fare system, loses a lot of passengers because there are minibuses that offer a competing service at a price below the fare for TransJakarta. For short distance trips, customers tend to use the minibuses, but for longer trips, where the time savings becomes a major issue, passengers tend to use TransJakarta. These short trips on the corridor, however, are generally a highly profitable sort of trip to serve.

On the other hand, on corridors 2 and 3, most passengers were making a very long trip from the periphery to the city centre. On these corridors, the flat fare structure gives TransJakarta a competitive advantage over other commercial operators who charged a zone-based fare. This flat fare also attracted a lot of ridership from low-income residents who live at the city's periphery and who are highly price sensitive.

Therefore, TransJakarta wished to test the impact of a distance-based fare on profit. Table 16.6 shows the results of this analysis. These results clearly show that shifting to a fare structure with a reasonably high minimum fare combined with a distance based fare would yield substantially more profit than a flat fare system. Figure 16.19 highlights the amount of ridership that each of the different fare strategies would generate.

Fig. 16.18
A fare adjustment machine at the exit of the urban rail system in Tokyo.

Photo by Lloyd Wright

Table 16.6: Comparing different fare structures on TransJakarta

Option	Base fare (Rp)	Variable portion of fare (Rp/km)	Demand (paying passen.)	Collected fare (US\$)	Average distance (km)	Operating cost (US\$)	Profit (US\$)	Max. peak frequency (buses/h)
Flat fare	Rp 2,500	0 Rp/km	11,523	\$3,201	13.47 km	\$1,973	\$1,228	40
Variable fare 1	Rp 1,500	70 Rp/km	13,653	\$3,283	9.87 km	\$1,927	\$1,356	46
Variable fare 2	Rp 1,000	110 Rp/km	16,374	\$3,719	7.94 km	\$2,054	\$1,666	53
Variable fare 3	Rp 1,500	50 Rp/km	18,270	\$4,129	10.68 km	\$2,521	\$1,607	62

Doing this analysis requires a public transport model with an OD matrix of public transport trips. If average public transport trip distances along the planned BRT corridor can be closely estimated, then the technical fare can be recalculated using a distance-based fare. This analysis should also take into account the higher fare collection costs associated with distance-based structures, including the value of time for longer customer queues.

16.5.1.3 Zonal fares

Zonal fares are sometimes touted as a simplified version of a distance-based fare. In the case of a zonal fare, customers are charged by the number of zones that are crossed. Thus, if a customer travels from one city district to another, he or she is charged more than someone who only travels within a single district.

The principal advantage of a zonal system is its simplicity, both in turns of reducing customer confusion over fares as well as in terms of the fare technology required. It is easier to understand the cost implications of travelling in a city with a few zones as opposed to a significant

number of permutations related to distance-base combinations.

The principal disadvantage of a zonal system relates to peculiarities in the fare structure where very short trips between zones can cost double a long trip inside a zone. This type of situation leads to a fairly inequitable application of fare policy and can lead to anger amongst customers. This very scenario has occurred in Santiago and has resulted in some dissatisfaction with the system (Figure 16.20).

To function properly, a zonal system thus requires a city with clear and logical physical separation between districts. Cities with rivers, hills, and other physical barriers can be amenable to a zonal system. However, zonal systems may also ultimately create artificial barriers within a city. Such barriers are clearly counter to the objective of most public transport systems, which is to act as a catalyst for corridor development and continuity. In many respects, zonal system rely upon a city demographic and development pattern that is at odds with the nature and expectation of good public transport.

To a certain extent, the advent of the smart card has made the zonal system unnecessary.

Fig. 16.19
Analysis of the impact of different fare structures on TransJakarta's Phase II ridership.

Graphic courtesy of ITDPV

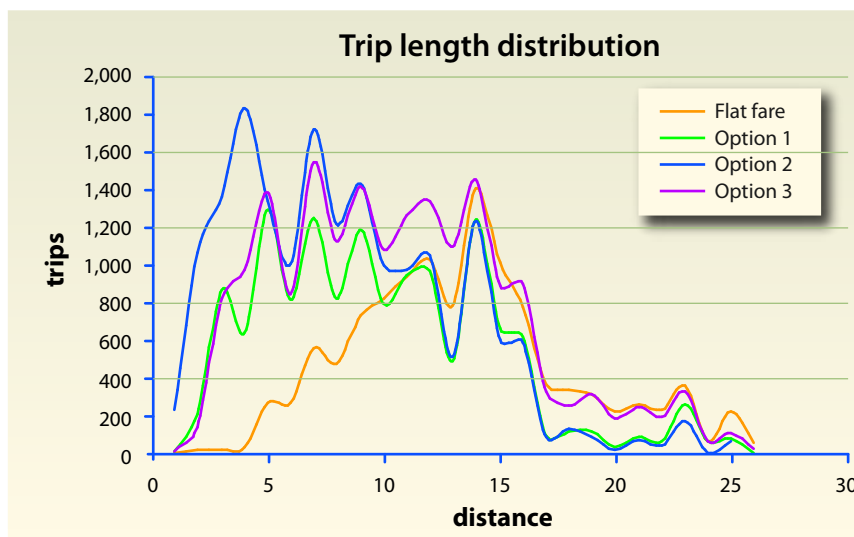


Fig. 16.21
London's Oyster smart card improves the cost-effectiveness of the fare system as well as creates new opportunities for more customer options.



Fig. 16.20
In this example from Santiago, the short passenger trip (Trip A) will cost double the long passenger trip (Trip B). Zonal fare systems can thus provide simplicity at the expense of fare equity.

Previously, technology limitations meant that zonal systems were a necessity in many situations. For smart cards, it is as easy to handle a pure distance-based system as it is a zonal system. The evolution on the London tube system from magnetic strip cards to the Oyster card (smart card) may allow it to move from a zonal system to a purely distance-based system (Figure 16.21).

16.5.1.4 Time-based fares

While fares can vary by distance, they can also vary by time. The most typical form of time-based pricing is to have a peak-period fare and an off-peak fare. Charging more for peak periods tends to be more profitable in part because roads are the most congested during peak hours, creating the strongest incentive to use a BRT system then. Peak-hour passengers are also mostly commuters, who have the least flexibility in their travel schedule. Being less flexible means they are less price sensitive, and will pay more to make the trip.

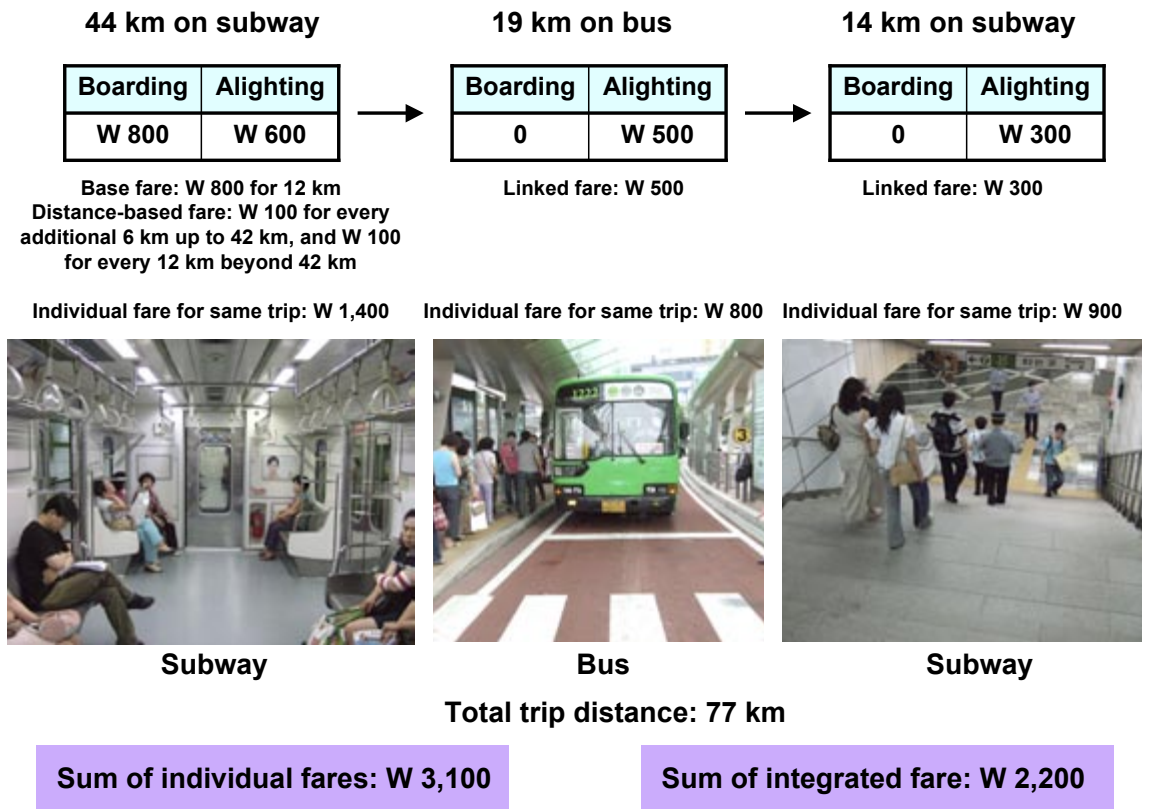
Heavily-peaked public transport services also have higher operating costs than demand that is more smoothly distributed throughout the day. The higher costs occur mainly because more vehicles are needed to service the peak period, and also because of the impact on labour. Bus drivers and other system operators tend to want

to work an 8 hour day, whereas the morning and evening peaks will require extra labour. The less peaked the demand, the fewer the number of additional workers that are required to cover the peak periods. A fare system which encourages people to travel during non-peak periods will help to better distribute demand in a way that is more operationally efficient.

Santiago (Chile) has defined a 20 percent discount during non-peak hours so transport users prefer to ride during non-peak hours reducing system congestion, and improving the efficiency of the fleet. TransJakarta also offered a discount for early morning passengers; before 07:30 am in the morning the fare was reduced from Rp 2,500 to Rp 1,500. This type of pricing acts to help spread the peak. Additionally, the lower price served social equity purposes since early morning riders tend to be from the lowest income groups.

Other systems use a time-based fare where the fare card buys the right to use the system for a maximum amount of time. This type of fare has much application when it is desirable to provide free transfers in systems without physical integration between stations. Thus, transfers between rail services, trunk BRT services, and feeder BRT services can take place without the need for physically closed transfer environments.

Fig. 16.22
Example of integrated fare structure for multi-modal travel in Seoul
 Photos by Lloyd Wright



The City of Seoul operates a combined time-based and distance-based fare system. Customers can transfer freely between the road and rail public transport systems within a certain time period. Each transfer must take place within a 30 minute window. Figure 16.22 provides an example of the integrated fare structure for a multi-modal trip (subway and bus) in Seoul. If the customer was to pay for each journey segment individually, the total fare would be W 3,100 (US\$3.25). Through the integrated fare structure, the total is only W 2,200 (US\$2.30), a savings of nearly 30 percent.

To make the Seoul system work, though, a customer must remember to swipe their fare

card upon exiting. Otherwise, the passenger will be hit with a penalty the next time they enter the system. This requirement of exit verification can lead to longer dwell times at stations as well as customer anger if the swiped card does not properly register or if the person simply forgets to swipe the card (Figure 16.23). Additionally, the complexity of combining both time-based and distance-based elements into the system means that a fairly sophisticated control and

Fig. 16.24
The complexity of a multi-modal fare system that is both time-based and distance-based requires a significant investment in control technology.

Photo by Lloyd Wright



Fig. 16.23
Forgetting to swipe one's card upon leaving the Seoul bus system will result in a penalty payment upon entering the system again.
 Photo courtesy of the City of Seoul



management centre must be in place, along with high-quality communications equipment and system software (Figure 16.24).

SPTrans, which serves the City of São Paulo, introduced a route system called Interligado comprising 1,200 km of high-capacity corridors and 3,300 km of local services (similar to feeder services), as presented in Figure 16.25. The routes can be used with a single payment of about US\$0.70 for two hours (boarding check-in), allowing customers to make as many transfers as needed to reach the desired destination. Most (95 percent) trips can be completed within this time frame, and nearly 100 percent of the trips can be accomplished with boarding onto the last trip segment within the two hours.

The São Paulo Interligado system is made possible through the use of electronic contact-less cards known as Billete Único (Figure 16.26). There are issues of distribution and evasion control, with this implementation, but it is a good example of innovative practices in the developing world.

The advantages to a time-based system is the savings provided to certain customers, especially those travelling at non-peak periods or those making linked trips using various modes. A time-based restriction also sometimes is useful to prevent some customers from loitering in the system.

However, there are also some disadvantages to time-based fare systems. These systems require more sophisticated and more costly fare equipment, payment medium, control system, and software. The system will also likely require fare adjustment equipment at the exits so that customers who stay too long in the system can pay a penalty. The technology also has to adjust for incidents when it is not the customer's fault that the time has been exceeded. For example, if a serious delay occurs in the system due to a breakdown, customers will become irate if they also have to pay more.

Time-based systems can also lead to fare inequities. For example, a person who is able to do three errands within 30 minutes each will only pay a single fare for three trips. A customer who takes 32 minutes each for three errands will pay triple the fare of the other person who is marginally faster. In a non-subsidised system,

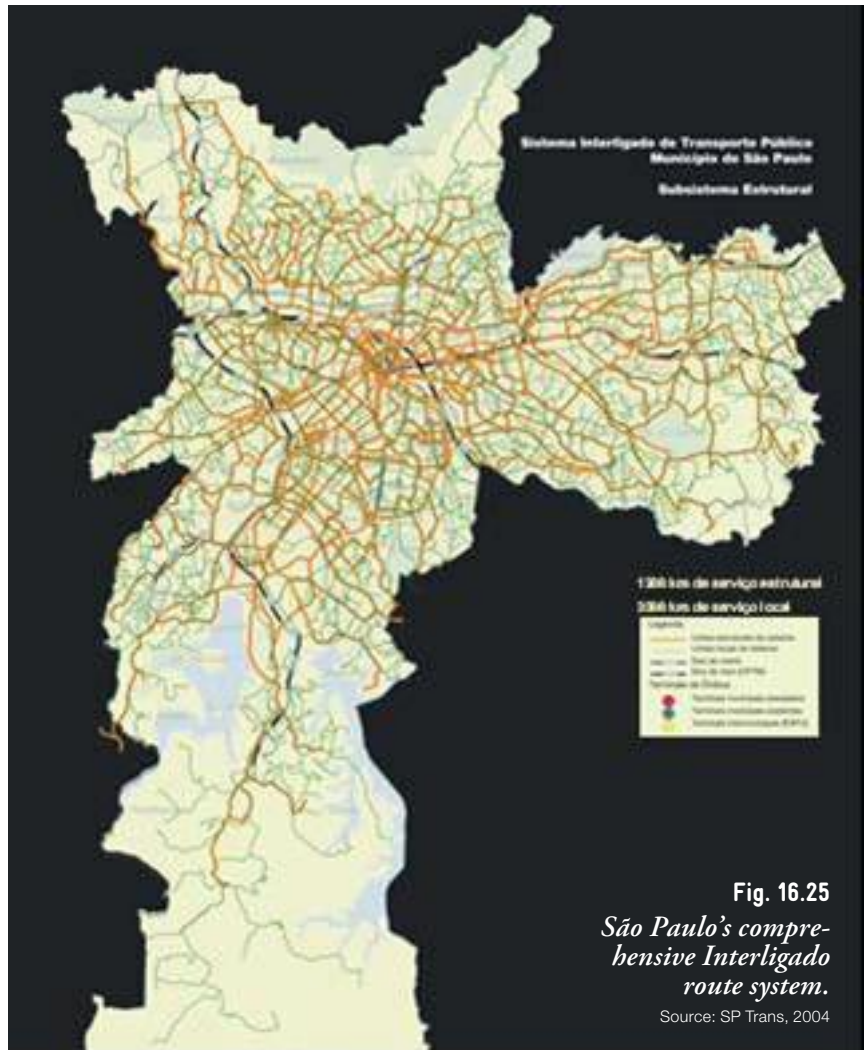


Fig. 16.25
São Paulo's comprehensive Interligado route system.
 Source: SP Trans, 2004

the total income must equal expenses. Thus, the person who happens to make quick errands rather arbitrarily receives a cross-subsidy from the person who makes slightly slower errands.

Further, the time-based nature of the fare can add considerable stress to the customer, who must dash quickly from one place to another to meet the time requirement. This type of rushed and stressful activity can lead to serious consequences. Individuals may rush across intersections to make the time deadline, and in doing so, may risk an accident (Figure 16.27).

There also may be instances when customers want to make a trip requiring much time. For example, tourists will sometimes use the public transport system as a way of viewing the city. A family may spend much time on the system just enjoying the sights of the city. Harassing tourists with fines and penalties for travelling too long is a very effective way of discouraging tourism.



Fig. 16.26
The contact-less smart card utilised in São Paulo makes it possible to operate a time-based fare system.



Fig. 16.27
In cities such as Seoul with time-based fares, customers may cross the street in a hurried manner to meet the time requirements. This situation can lead to an increased number of pedestrian accidents.

Photo by Lloyd Wright

16.5.2 Fare discounts

16.5.2.1 Multi-trip discounts

One of the main cost advantages that private motor vehicle travel has over public transit is that once the passenger has sunk the investment into the procurement of the vehicle, the marginal cost of using the car goes down the more the vehicle is used. This situation creates an incentive to drive more. Public transport fares that force people to pay per trip create the opposite incentive, to use the system as little as possible.

Daily, weekly, and monthly passes, and multi-trip discounts are a good way to create incentives among public transport passengers to use the system more. Studies show that such incentives will have a particularly large impact on discretionary travel during non-peak periods. Multi-trip passes can also have significant benefits in terms of reducing queues at the fare booths, and reducing the amount of labour needed to staff ticketing sales.

16.5.2.2 Discounting transfers from other transport systems

In many cities today, fare structures between different modes, such as between rail and bus services, are not well integrated. However, the increasing sophistication of cash cards and modern fare systems is creating many possibilities for giving special discounts for passengers transferring from other public transport systems. Such forms of integration can even take place without necessarily having to integrate these public

transport systems from a management perspective. This issue is particularly important in the growing number of cities that are building metro systems on some high demand corridors but are considering BRT on other corridors.

In the past, providing a discount for metro or commuter rail system users on the BRT system required a high level of inter-agency coordination, and discussions frequently broke down on these grounds. For example, in São Paulo, there were bus services operated by the State of São Paulo, the commuter rail service operated by the State of São Paulo, and the metro system operated by the State of São Paulo, but another, bigger bus system operated by the Municipality of São Paulo. Fare system integration between these systems remains elusive even today despite the fact that these systems are all currently governed by the same political party.

True fare “integration” between different modes is sometimes confused with fare “compatibility”. Fare integration implies that a customer pays for a multi-modal fare that does not incur any penalty for changing from one mode to another. Seoul’s fare system comes quite close to achieving this level of integration. Fare compatibility instead just means the various modes share the same payment medium. With fare compatibility, the customer will pay multiple fares, according to the number of systems utilised in the journey. Thus, with fare compatibility the customer gains some convenience with a single fare card but incurs another full fare cost whenever transferring between systems.



Fig. 16.28
Unified fare cards in Tokyo provide fare compatibility but not necessarily fare integration.

Photo courtesy of PASMO



Fig. 16.29 and 16.30
Integrating fares can be challenging when one service, such as the metro underground, requires significant operating subsidies, and another service, such as bus services, does not require a subsidy.
 Photos by Lloyd Wright

In Tokyo there are several different public transport systems, each with its own fare structure. For example, there is both the Tokyo Metro and the Toei Subway. There are several smart card systems that allow a customer to use the same card for the various modes. The most recent card to be introduced is called “PASMO” (Figure 16.28). However, these fare cards simply deduct a new fare amount for each mode utilised, and thus does not recognise linked journeys from the perspective of providing a discounted, single-journey trip.

Perhaps the greatest challenge to fare integration between different public transport modes is not the payment technology but the significant differences in operating costs. Attempting to combine systems with dramatically different per kilometre operational costs raises many equity issues. This incompatibility is especially true when one system requires a significant operating subsidy and another system does not. For example, in Seoul the underground rail system requires a massive operational subsidy while the bus system operates with no subsidy (Figures 16.29 and 16.30). In order to equilibrate an integrated fare and business structure, the underground metro operator receives a much higher payment per passenger-kilometre served than the bus operators. Such inequities may be acceptable in some cases, but it does raise questions about fairness, especially if two services are of comparable quality but of radically different cost structures.

16.5.2.3 Categorical discounts and vouchers

Providing fare discounts to special groups is a relatively common practice in mass transit systems around the world. In some countries,

legal regulations oblige transport systems to offer special discount fares to a range of special groups (Figure 16.31), including:

- Children;
- Students;
- Elderly;
- Physically disabled;
- Low-income households;
- Military and police personnel;
- Staff of the public transport authority;
- Other government workers.

These legal obligations have to be taken into account when designing the fare system.



Fig. 16.31
Providing fare discounts to special groups may be required by law.

While sometimes socially desirable, the requirement that a BRT authority accept special discount fares creates a difficult challenge for any public transport agency. Controlling fraud in the use of discount passes poses a difficult technical challenge.

The determination of discount eligibility for children and the elderly is typically based upon age limits. For example, system managers and operators may decide that children under five years of age and adults over 60 years of age qualify for special discounts. The determination of student eligibility is often predicated upon either age limits and/or the possession of a valid student identification. Student discounts may be limited to only certain student segments, such as primary, middle, secondary, and university levels of education.

Discounts to children, students, and the elderly are typically given for reasons of social equity (Figure 16.32). Economically, a discount strategy can make sense provided that the discounted fare covers at least the marginal cost of each passenger. If fare levels are to be reduced below marginal cost levels, then some sort of subsidy system will need to be put in place. Subsidies can take the form of cross-subsidies between customer user groups or direct subsidies from the government to the operators. In either case, the introduction of subsidies significantly increases financial complexity within the operation of the system, and subsidies also create complications with respect to operator incentives. Thus, if a discounted fare structure is to be utilised, it is usually best for the discounted fares to at least cover marginal costs. Otherwise, the resulting cross-subsidy can effectively render the discount meaningless while simultaneous

increasing the management costs of the system. For example, providing a below marginal cost subsidy to a child may simply mean that the parent must pay more to cover the subsidy. In effect, no social equity is being achieved.

Chile and Brazil, for example, both place a legal obligation on the public transport operators to accept special discounts for students and the elderly. In Brazil, private bus operators are not compensated for the provision of this service, and the cost burden related to this service and its fraudulent abuse is a continuing cause of operator claims that they need fare increases. In many instances, operators will simply not stop if they see many students at a stop.

If the BRT system does not have a reliable mechanism to track the number of trips made using such discount passes, it has no way to place a valid claim to the government for compensation. This situation has created an ongoing justification for requiring government subsidies, but no clear basis on which to determine an appropriate level. The subsidies are thus a source of ongoing tension between the government and the operators.

On the other hand, Brazil has another subsidised fare that goes to employed workers called "Valetransport". Valetransport is a public transport voucher that is as good as cash to any bus operator. Recently the Valetransport voucher system has been extended and can even be used with some formerly informal sector minivan services. As this increases demand for public transport services, and does not adversely affect bus system profits, it is generally supported in the public transport community. Critics of the programme are unhappy about the fact that it targets middle income people with jobs rather than the very poor, and it costs the government a lot of money to administer, but these are not problems from the point of view of the public transport operations. Voucher systems are therefore the preferred route for subsidising categorical discounts.

Discounted fare systems are also highly susceptible to fraud. As noted above, the qualifications for a child, student, or elderly discount is based upon age or a special identification. However, once the discount passes are issued, it is extremely difficult to ascertain exactly who is using the pass. The discount passes can be

TARIFAS	
TARIFA INTEGRAL	\$ 0.25 cts.
TARIFA REDUCIDA	\$ 0.12 cts.
Tercera edad, estudiantes, menores de edad	

Fig. 16.32

As noted from this fare pricing signage in Quito, the elderly, students, and children must only pay US\$0.12 per trip while others must pay the full fare of US\$0.25 per trip.

Photo by Lloyd Wright

“lent” to family or friends who otherwise do not qualify for the discount. More worryingly is the development of a grey market for discount passes in which persons obtain passes and sell them to others. Likewise, certain types of monthly passes for frequent users can be abused. If the monthly pass allows unlimited travel on the system, then the pass may end up being shared amongst several persons.

There are mechanisms to combat fare fraud to an extent. First, the avoidance of discount passes that allow unlimited travel is one option. Instead, discount fare passes that deduct credits for each trip undertaken can somewhat help avoid shared passes. Or, a discount pass could limit its use to no more than two trips per day (*i.e.*, the number of trips in a typical commute).

Second, formal registration and photo identification on the discount card can be the basis for a verification process. The verification could be conducted randomly when customers on inside the system. Also, when a discount card is read at the turnstile area, an indicator light could alert the platform staff. A random verification of such persons could help to stem fraud.

Third, advances in biometric technologies can quite effectively eliminate unauthorised usages. Biometric systems use inherent biological information, such as fingerprints or iris pattern, to assure that the person using the transit pass is the same as the person who was issued the pass. At the point of entry a scan verifies the identity of the user. The current cost of biometric technology, its complexity, and its impact on the speed of fare verification mean that it is not expected to be in widespread use for the short to medium term. However, the city of Goiânia (Brazil) is already testing such systems. Thus as the technology improves and the costs decrease, biometric systems may have a future role in fare verification processes.

An exception to these recommendations is travel for very young children as designated by a certain age. Requiring a travel pass for a very young child is problematic since it can create a burden on parents (Figure 16.33). Further, small children who sit in the lap of a parent are not necessarily adding significantly to the operational cost of the system, although certainly space for any strollers can more than compensate. Also, given



that the appearance of young children changes considerably in the earliest years, photo passes are not particularly useful. Undoubtedly, some parents will insist that their six or seven year old is only five, but the scope of this sort of deception is usually not significant enough to warrant a stringent approach.

An effective fare discount system also implies the need for more costly fare collection and fare verification technologies, such as magnetic strip or smart card technologies. The software to incorporate a fare discount system within these technologies will increase fare collection and verification costs to a degree. Further, the added complexity is another factor that can lead to system failure.

In summary, fare discounts are well-meaning attempts to increase affordability and social equity within a public transport system. In some cases, though, the added costs and complexity of implementing a fare discount strategy can negate these intended benefits. Before committing to a fare discount system, cities should carefully consider the full ramifications.

16.5.3 Fare options for feeder services

The fare handling system for feeder services will often follow a different operational process than the fare system for trunk lines. As noted earlier, cities such as Bogotá and Quito now compensate feeder operators by a combination of the vehicle-kilometres travelled and the number of

Fig. 16.33
Discounts for small children can benefit parents, provided there are no cross-subsidisation effects.

Photo by Lloyd Wright

passengers carried. This compensation package attempts to balance incentives in order to motivate operators to provide a high-quality service.

Within this model, feeder operations have a range of options for fare collection and fare verification. In Bogotá, feeder operators do not collect the fares from passengers boarding at feeder shelters. Instead passengers only pay once they reach the terminal stations or intermediate transfer stations. For the return trip home, passengers pay upon entering the trunk-line corridor, and then transfer fare free to the feeder services. However, for the return trip, entry into the feeder service is restricted to those persons collecting a transfer slip upon exiting the trunk service (Figure 16.34). This system holds the advantage of not making the feeder operators handle any revenues from passengers. By avoiding fare collection and fare verification at the feeder level, there is considerable time savings as well as the avoidance of any corruption.

However, the system has the disadvantage of allowing passengers to travel from one feeder stop to another feeder stop without paying anything. This situation occurs due to the fact that payment is only made once passengers reach a terminal. In some ways the “free ride” between feeder stops could be viewed as a positive marketing point for TransMilenio since

people will enjoy having a free neighbourhood service. However, the number of persons taking advantage of this free service is now reaching 15 percent of total feeder ridership. TransMilenio has changed feeder operator contracts from being based exclusively on kilometres travelled to being a combination of kilometres travelled and passengers carried. It is possible that the addition of passengers carried to the contract will provide an incentive for operators to curb the free use of the feeder services.

There are other options for feeder fare control that can avoid some of the issues faced by TransMilenio. Another option is for feeder services to collect fares when passengers board the feeder vehicle. While it would likely not be practical to make the driver handle fare collection and/or fare verification, the addition of fare collection staff to the vehicle could be a solution. Boarding the vehicle could take place at a single doorway (e.g., the rear door). Likewise, alighting the vehicle would then only be allowed at the other doorway (e.g., the front door).

The fare collection staff (i.e., conductor) could be from the fare collection company and not from the feeder operating company. This separation of interests would help to avoid any mishandling of fare revenues. Passengers boarding the feeder vehicle would enter a closed reservoir area in the bus, and then proceed through a turnstile once payment to the fare collection staff is made. The reservoir concept allows the bus to continue to the next stop while passengers are being processed through fare collection. The reservoir concept is already utilised extensively in countries like Brazil for conventional bus services. The disadvantage of this option is the cost of adding another staff person to the vehicle and the cost of the fare collection infrastructure within the vehicle. However, in many developing cities, the lower labour costs in conjunction with political needs to maximise employment make this option a viable possibility. Further, if the free ridership problem experienced in Bogotá was of such a magnitude, then the additional fare collection staff could be fully cost justified.

If the feeder passenger volumes are sufficiently high, then other options utilising more sophisticated fare technologies may be possible. These options include:



Fig. 16.34

In Bogotá, a customer takes a transfer pass upon leaving the trunk station.

Photo by Lloyd Wright

- Fare collection vending machines at feeder shelters (either open or closed shelters);
- Smart card readers upon entering a closed feeder station;
- Smart card readers upon entering the feeder vehicle.

Cities such as London are utilising coin-fed fare collection machines at conventional open bus stations (Figure 16.35). This type of technology could be adaptable to feeder services in some developing cities. If the shelter was closed (*i.e.*, no entrance without fare payment), then a coin-based or even smart-card based system could permit entrance to the shelter. Alternatively, a fare card purchased at a vending machine in an “open” shelter could then be verified inside the vehicle. The verification could either be done in a closed reservoir environment on the bus or by way of an honour system where passengers self-validate their fare tickets. If smart cards are utilised, then again the fare verification could take place through a self-validating machine inside the vehicle.

All of these technological solutions, though, do have limitations in the developing city context. First, the cost of the technologies for feeder services may be prohibitive from both a capital and operating cost standpoint. Second, creating “closed” stations at feeder stops may not be practicable from either a spatial or a cost perspective. Third, the effectiveness of “honour” payment and verification systems in developing cities is still not proven. Fourth, costly fare collection machines left unprotected at feeder shelters could be subject to maintenance issues and even theft.

16.5.4 Estimating system revenues

Once the analysis concludes that a particular fare structure will optimise the profitability of the system, the system’s basic revenues can be estimated. The system’s revenues can be calculated based on Equation 16.6.

Equation 16.6 Calculation of total system revenues

$$\text{Total system revenues} = (\text{Daily passengers per price category} * \text{Fare for that category}) + \text{Other revenues}$$

At this point, all that can be done to improve system profitability by changing the fare price



Fig. 16.35
Pre-board fare vending machine in London.
Photo by Lloyd Wright

has been done. If the total cost of operating the system, as reflected in the technical fare, is still higher than the optimal fare, then the system designers should still consider making some changes in the operational plan before resorting to subsidies. The areas to be considered first are discussed in the next section.

16.6 Reappraisal of operating costs

"We achieve everything by our efforts alone. We decide our own fate by our actions. You have to gain mastery over yourself... It is not a matter of sitting back and accepting."

—Aung San Suu Kyi, pro-democracy activist, 1945–

The calculation of the system’s profitability plays a critical role in the planning process. If the system is not going to be profitable given the initial proposed operational structure, before suggesting increased government subsidies or changes in vehicle technology, it is the responsibility of the team doing the business plan to request modifications in the proposed operational system to try and bring the system closer to profitability without subsidies.

There are at least four operational and costing areas to review first prior to any consideration of subsidies:

- Restrictions on competing transit and paratransit services;
- Restructuring of operations;
- Levels of compensation to operators;
- Shifting of costs from operations.

16.6.1 Restrictions on competing transit and paratransit services

When the operational plan was developed, some decision had to be made regarding what to do with existing public transport and paratransit operators already serving the BRT corridor, and how these will relate to the new service. If the initial business model is not profitable, one of the first things to investigate is whether or not more competing public transport services in the BRT corridor should be cut.

Normally, the original operational plan will cut some existing bus and paratransit routes that closely correlate to the route of the new BRT system, while allowing those routes that only use the BRT corridor for short stretches to continue to operate.

If too few of the old bus and paratransit routes are cut, the old bus routes will drain passengers away from the new BRT system, undermining profitability. The continuation of old buses in the mixed traffic lanes will also contribute to mixed traffic congestion, undermining political support.

On the other hand, many of these old buses may only use a portion of the busway corridor for their routes. At different points along the corridor, the operators will enter and exit from various other routes and neighbourhoods. Curtailing their operations will imply that some areas may be cut-off from public transport services altogether. Additionally, residents who

will be accustomed to a certain type of routing service may be displeased with the removal of these services.

Thus, to avoid difficulties both to the public transport operators and the serviced communities, the transit agency as part of its operational plan should have performed a complete review of transit routes and licensing along the BRT corridors. After the analysis of profitability of the system, this restructuring decision needs to be re-evaluated. If the system is not profitable, then the following should be considered:

- Banning more existing operators from servicing the same areas as the BRT system;
- Rerouting more of the existing operators to serve areas farther from the BRT corridor;
- Tighten restrictions on informal modes of public transport, like minibuses, shared taxi, combis, etc.

TransJakarta and TransMilenio took roughly opposite approaches to this problem. TransJakarta allowed all but 10 minor bus routes to continue in the new BRT corridor in the mixed traffic lanes. This decision led to good service for public transport passengers, very bad mixed traffic congestion, and low demand on the BRT system. TransMilenio, by contrast, removed all bus routes from the BRT corridor, forcing them to use parallel roads. As a result, TransMilenio is profitable, and TransJakarta is not (Figures 16.37 and 16.38).

While banning the operators from certain areas of the city may seem difficult to achieve in political terms, incentives can be used to encourage acceptance. The withdrawal of existing services can be a pre-requisite for participation in the BRT bidding process. Intransigent operators can lose the opportunity to participate in the new system. Additionally, technical assistance and identification of alternative markets can help ease the process of consolidating existing services.

Another strategy sometimes employed is to simply permit the existing operators to continue operating in the BRT corridors. If the BRT service is of superior quality at a similar price, then it is likely that the BRT service will dominate the market. The reduced travel times in busways along with a more secure and comfortable ride will likely attract the major share of the

Fig. 16.36
In Quito, the large number of conventional buses running alongside the Central Norte BRT corridor initially undermined the new system's profitability as well as caused significant traffic congestion.

Photo by Lloyd Wright





Fig. 16.37 and 16.38
Jakarta (left photo) did not initially cut competing bus lines from the BRT corridor. By contrast, Bogotá (right photo) did restrict competing services. Partly for this reason, the Jakarta was not profitable and Bogotá system was profitable.

Left photo courtesy of ITDP
 Right photo courtesy of TransMilenio SA

ridership. In this scenario, the existing operators will likely withdraw voluntarily due to the unprofitable market conditions. This strategy potentially avoids the conflicts that can arise from eliminating operators by mandate.

However, permitting the continued operation of the existing operators can also be a risk to the BRT system. Since many developing city residents are quite price sensitive, even small differences in fare levels may permit the existing operators to retain significant market share. In instances where existing operators provide direct services and the BRT system requires a transfer, the existing operators may retain an advantage. Thus, a strategy of permitting existing operators to continue along the BRT corridor should only be undertaken in situations where the BRT system will likely dominate the market due to its inherent advantages. Otherwise, the financial viability of the system will be undermined.

The disposition of existing operators is a sensitive point in the development of any new transport service. Since drivers, conductors, and other staff of existing services tend to come from lower-income groups, concerns over fairness and social justice should be at the forefront of addressing this issue. If the process is managed properly, the market opportunities within the new BRT system can be a win for everyone, including the existing operators. Solutions are available that can address the needs of the operators. However, at the same time, a strong sense of political will is required to ensure that the goal of a high-quality public transport system is the over-riding objective.

16.6.2 Restructuring of operations within the BRT system

There are many elements of the operational plan that will have significant impacts on the system

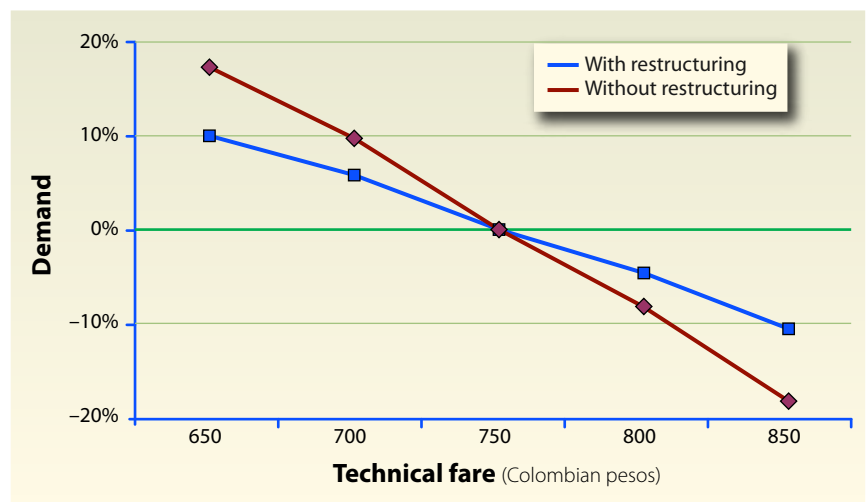
cost. System designers may wish to provide a good frequency of service and less crowded buses. However, if it is necessary to make the business work, the business planners may wish to consider cutting back on the frequency of service and increasing the load factors so that each vehicle is carrying more passengers per trip.

The load factor (passengers per vehicle) can also be increased by having some routes not make the entire trip from one end of the BRT corridor to the other, but rather to turn around and only cover the more congested parts of the route. Introducing such services, as discussed in the operations section, will increase system profitability.

Any shift from direct services to trunk and feeder services should also be reappraised. Initial system planners may have tried to maintain as many direct services as possible, or may have decided to retain direct services by having buses that operate both on and off the BRT corridor. This would increase the needed vehicle procurement, and hence the operational cost. At this point, it may be time to consider forcing more passengers to use feeder buses even if this

Fig. 16.38b
Analysis of the impact of route restructuring on the technical fare.

Source: Steer Davies Gleave.



decision implies that more customers will have to undertake a transfer.

When designing TransMilenio, the consulting team conducted an analysis of the overall impact of both cutting parallel bus routes and restructuring of the bus routes into trunk and feeder routes, and found that *the technical fare would be 15 percent higher without route restructuring.*

16.6.3 Compensation for existing bus owners and vehicle scrapping

Another issue to be reappraised is the amount of compensation paid to existing bus owners, and/or the number of vehicles that the bus operators will need to scrap in order to win the bid to operate the system. These two issues are related in many cases, because one way of ensuring that the former bus owners do not completely lose the value of their vehicle asset is to force the principal investors into the new BRT operations to scrap a minimum number of old buses. This vehicle scrapping requirement forces the new investors to buy the old buses from the former owners, either offering them stock in the new company or at least allowing them to cash out their old investment. Without this requirement, the main asset the former bus owners held is likely to drop significantly in value, creating a large group of very angry people.

However, this bus scrapping requirement will increase the costs of the BRT operations, and these costs can be fairly significant.

If the system is not very profitable, one option is to drop the bus scrapping requirement, and suffer the political consequences, or have this element of the project financed by a separate government programme. Several BRT projects in Latin America developed by the World Bank have considered using World Bank loans to finance the bus scrapping component of the BRT project, and having the government pick up these costs.

16.6.4 Shifting costs away from operations

Once all of the operational modifications suggested above have been made, and the system has been made as profitable as possible from an operations point of view, a final decision can be made regarding which parts of the new BRT system are to be financed out of the fare box and which will have to be financed by the government. Some operating costs can be shifted to capital/infrastructure costs and some can possibly be shifted to other budgets (*e.g.*, police department for security).

If the technical fare is now much lower than the optimal fare, then the system is highly profitable, and more capital, operating, and



Fig. 16.39
The business model for Transantiago is attempting to have private operators cover all operating costs as well as part of the infrastructure costs.

Photo by Lloyd Wright

infrastructure costs can be shifted from the responsibility of the government to the responsibility of the private operators. Ideally, the system as designed will be highly profitable, and many elements of the system can be paid for out of fare revenue. If the system is being designed on a high-demand corridor in a high-income country, the system could be highly profitable.

It is conceivable that for a very profitable system, not only could the fare revenues pay for the operations, system administration, and vehicle procurement, but also some elements of infrastructure, such as road and station maintenance. Transantiago (Santiago, Chile) is being designed so that operators contribute to portions of the road infrastructure.

In highly profitable circumstances, putting some elements of equipment into the operating cost category can make sense. For example, Bogotá required the private firm with the fare collection concession to include the electronic turnstiles and smart cards as part of the operational bid. The private fare collection firm thus amortises the cost of this infrastructure through their share of the fare revenue. In effect, the concessioned firm is acting as a financing agent for the particular piece of infrastructure.

On the other hand, it is quite likely that the technical fare will still be much higher than the optimal fare. In this case, the business model needs to be modified until the optimal fare is at least as high as the technical fare. Ultimately this can only be done by shifting more of the financial burden onto the government.

Where the BRT system has been designed in a corridor without much demand, and/or where riders are of low income, system designers will be hard pressed to find investors willing to pay for the vehicles, let alone other elements of the system. Typically, this situation arises when the BRT corridor has been chosen for political rather than demand reasons. It can also occur in lower-income countries. For example, many African nations have both relatively low- to medium-density urban environments as well as low per capita incomes. Since the cost of vehicles and fare collection equipment will probably be even higher in low income countries, as there is likely to be limited domestic manufacturing, it may prove

challenging to design the system to be financially sustainable without operating subsidies.

In the case when the system is not very profitable, system planners will need to consider the following modifications to the business plan:

- Explore value added tax and tariff exemptions on the vehicle procurement;
- Explore lower interest financing on the vehicle procurement;
- Change the technical specification on the vehicle and other equipment to make them more affordable;
- Pay for the public administration costs of the system from government revenues rather than fare revenues;
- Treat certain elements of operations such as station security and cleaning as part of ongoing public administration costs;
- Move some operating costs (*e.g.*, vehicle depreciation) to the capital cost category (government pays some part of the vehicle procurement or fare system procurement).

16.6.4.1 VAT and import duty relief

The taxes and import duties on the vehicles will be one of the most significant costs incurred by the private operators. Since these vehicles will be providing a public good, it is worth attempting to get an exemption so that import duties or VAT taxes do not have to be paid on the vehicle procurement. These taxes and fees are likely to be particularly onerous in the case of imported vehicles. In the case of Dar es Salaam, the VAT and import duties are significantly driving up the vehicle cost, making VAT and tariff exemptions critical to project success.

16.6.4.2 Alternative financing of vehicles

Financing will likely be a significant cost item within vehicle procurement. Because of the social benefits of BRT, many lending institutions like the International Finance Corporation (the private sector lending arm of the World Bank) and the bi-lateral lending agencies of developed countries might be willing to finance the vehicle procurement at a concessionary interest rate.

The local government itself might also play a role in vehicle financing through a lease-own arrangement with the private operators. For the Quito Ecovía corridor, the local government

purchased the vehicles and then attempted to obtain part of the fare revenue as a way of paying back the vehicles on a gradual basis. In Quito, this arrangement largely failed because of a lack of transparency in the fare system. However, in other circumstances a lease-own option could help reduce overall vehicle costs for operations. Such financing options are discussed in Chapter 17 (*Financing*).

16.6.4.3 Modifying the technical specifications of equipment

Modifying the technical specification on the vehicle and other technology items can be considered. For example, reducing the engine size can be an option to consider, although this size reduction will limit the maximum passenger capacity of the vehicle. The size of the vehicle is also a factor to consider. Because of peculiarities in local vehicle supply markets, different bus options are cheaper or more expensive than one would think. For example, in Dar es Salaam, the price difference between a standard-sized bus (12-metre vehicle) and an articulated bus (18-metre vehicle) is much higher than it is in Latin America. With only minimal system design changes, it is often possible to use normal buses without compromising the quality or comfort of service. Different types of interiors and customer amenities can also be considered. If these modifications are still not enough, changes in the technical specification that compromise the level of emissions, or the comfort and the quality of service could be considered.

At a certain point, however, if the technical specification is set too low, it will begin to compromise the quality and status of the system, and the loss of system quality will undermine the rationale for the entire project. The public must see the new system as a significant leap in terms of improved public transport service, and the vehicle itself will play a big role in giving that impression.

16.6.4.3 Moving system administrative costs off-budget

In Bogotá, the administrative oversight agency for the new public transport system requires 5 percent of the operating revenues in order to cover its costs. If this agency was instead funded

through general agency budgets, it would be a savings to the system.

The idea of public transport customers paying for their own administrative oversight can be controversial. Customers of other transport modes may not have to cover their own administrative costs and forcing public transport passengers to do so can be regarded as a regressive policy. It is likely that a city will have an existing Public Works Department, Transport Department, and/or Transport Authority. These agencies may oversee vehicle regulation, licensing, planning, emissions testing, and infrastructure development. In most cases, private vehicle licensing fees do not cover the costs of these activities. Thus, in such a case, private car owners are receiving their administration from the general tax base, which includes both car users and public transport users. It can therefore be quite inequitable to require public transport users to fully pay for their administrative costs when car users do not. This inequity can be particularly true when public transport users are primarily lower-income citizens.

For all these reasons, placing administrative costs of the public transport authority under the general municipal budget may be quite appropriate. However, it may also subject the BRT authority to increased levels of political interference and cumbersome civil service rules.

16.6.4.4 Moving security and maintenance costs to other budgets

Likewise, other system costs may be best moved to other budgets rather than burdening the operating budget of the new public transport system. System security, cleaning, and infrastructure maintenance are examples of such budget areas.

Security for the system can be either provided by the public security forces, such as the municipal or national police departments, or by private security staff. There are multiple reasons why it may be appropriate to place this responsibility with the public police forces. First, like the case of system administration, there is a question of budget equity. In most cities, car users receive much protection, support, regulation, and enforcement from the local police department. Typically, the policing of private vehicles is the

largest line item in a local police department’s budget (Figure 16.40). The income from fines and fees do not usually fully cover these costs. Thus, the policing for private vehicles essentially receives a public subsidy from the general tax income. To require public transport passengers to fully pay for their security is again a highly regressive policy, especially if wealthier car users receive their security from the general tax base.

Second, public policing may be more effective in terms of its scope of responsibility. In Bogotá, the national police are deployed to maintain a presence both at stations and at times inside vehicles (Figure 16.41). These police can respond to incidents and emergencies anywhere in and around the system. If a person is being mugged in the vicinity of the station, these police can take immediate action. The public police can also make a direct arrest of any perpetrator.

By contrast, the Ecovía line in Quito employs a private security force (Figure 16.42). They also patrol the stations and the vehicles. However, their jurisdiction ends at the station exit. The private security staff will not intercede if a crime is in place along the footpaths leading to the station. Instead, station staff may (or may not) call for help from the metropolitan or national police if they see a crime being committed in the area. Of course, if criminal activities outside the station are not their responsibility, the staff

Fig. 16.41
In Bogotá, public police officials provide security to the public transport system as well as the surrounding area.

Photo by Lloyd Wright



may not even consciously make an effort to be attentive to it. Further, during the time delay in calling in an incident, a robbery or beating could be fully consummated. Also, the private security team does not have the authority to actually make an arrest, although in most circumstances, they do have the authority to detain suspects.

Conversely, in some cities, private security staff are regarded as more reliable than the public forces. With private security, the public transport authority will have direct control over their schedule and performance. If the public police report to the national or local police departments, there can sometimes be coordination problems with the transport authority. Many

Fig. 16.40
Police departments expend significant resources in managing, protecting, assisting, and enforcing traffic laws for cars and motorcycles, as shown in this image from Port Louis (Mauritius).

Photo by Lloyd Wright

Fig. 16.42
On the Quito Ecovía line, a private security company is used to watch over the stations.

Photo by Lloyd Wright



of these issues can be overcome, though, if the transport authority is given some operational control over the scheduling, deployment, and priority-setting of the police personnel.

Cleaning and maintenance activities of vehicles and/or infrastructure are another area where philosophical issues are raised regarding the onus of responsibility for financing. Again, infrastructure for private cars is often paid for through the general tax base. It could be construed as inequitable to require public transport passengers to fully pay for their infrastructure maintenance if car users do not.

16.6.4.5 Capitalising some operating costs

Shifting a portion of equipment costs to the capital rather than operational cost category can significantly relieve pressure on the fare levels. However, moving equipment purchases to the capital cost category can bring with it some unintended consequences. In general, it is best to have the companies utilising the equipment to pay for it and to maintain it. Companies that operate buses that they do not purchase or do not own will tend to not maintain the vehicles properly. These companies may also not pursue the most cost-effective models at the time of purchase. Thus, public procurement of equipment can result in many misplaced incentives.

A compromise to such circumstances is for the public sector to share costs with the private sector. For example, the public sector may provide 50 percent of the vehicle cost while the private firm must pay off the other 50 percent through fare revenues. The vehicle would be entirely owned by the private operator but with an initial subsidy from the government. In this way, the private firm still has an incentive to properly maintain for the vehicle, but the reduced cost means that pressure on cost recovery is lessened.

As noted earlier turning an operational subsidy into a capital subsidy can be beneficial for many reasons. Operational subsidies are quite complex and costly to manage administratively and such subsidies can be prone to misuse. The preferred circumstance is obviously no subsidy at all.

However, to the extent any subsidy is required, a one-off infusion of capital at the project's outset is often preferable to long-term governmental commitments to on-going operational subsidies.

17. Financing

“Money never starts an idea; it is the idea that starts the money.”

—W. J. Cameron, author

Financing is rarely an obstacle to implementing a successful BRT project. In comparison to other mass transit options, BRT’s relatively low capital and operational costs puts the systems within the reach of most cities, even relatively low-income developing-nation cities. Many municipalities have actually found that loans and outside financing are unnecessary. Internal municipal and national funding may be sufficient to fully finance all construction costs. Further, since BRT systems should be designed to not require operational subsidies, at least in the medium term, minimal public financing should be necessary beyond the provision of infrastructure.

The first step in arranging the financing for a new BRT system is to design the system from its inception to be financially self-sufficient. Even with a financially viable system design, however, developing a complete financing package will require effort and persistence. Ideally, an effort on financing should begin at the earliest stages of the planning process. The financing plan should be developed on an iterative basis with the operational and infrastructure design process since the available financing will be a determining factor in the final design. For example, in Dar es Salaam, the architects and urban designers initially designed very beautiful stations requiring a lot of imported materials that drove the total system cost above the capacity of the government to finance, and some cost reductions

were required. Another typical example, the cost of an initially specified ultra-clean, high quality transit vehicle may exceed the projected revenues of the private operators. In this case, the technical specification for the vehicle may require modification in order to ensure medium-term financial sustainability.

The way in which different elements of the BRT system are financed may have a profound impact on the quality of the BRT system that is designed, the quality of the operations, the fare level, and the long-term sustainability of the system. The financing plan therefore needs to first define the basic principles upon which to make a financing decision. Some reasonable goals are listed below:

- maximise the quality of the service over the long term;
- minimise the cost of the service over the long term;
- maximise the level of private sector investment over the long term;
- minimise the public cost of financing.

Investment in a new public transport system must be compared to other possible uses of limited capital. Investment in transport can mean less capital availability for other high priority areas, such as education, health, nutrition, water, and sanitation. Some very low-income municipalities have legitimate financial constraints, and many cities may be near lending limitations with international development banks. However, in some cases, claims of financial constraints are often simply masking a lack of political will to develop a new system.

This chapter examines the principal BRT elements requiring a financial plan. The topics covered in this chapter thus include:

- 17.1 Financing overview
- 17.2 Financing planning and operations
- 17.3 Financing infrastructure
- 17.4 Financing equipment (vehicles, fare system, etc.)
- 17.5 Financing system maintenance

17.1 Financing overview

“Usually with things, you go where you can find the financing to do it.”

—Don Bluth, animator, 1937–

17.1.1 List of financing options

Financing for BRT can be divided into five groups of activities: planning, operations, infrastructure, equipment (such as vehicles and fare equipment), and system maintenance. Each of

these activity areas typically involves different sorts of financing or funding options. Table 17.1 summarises the potential financing and funding sources for these activity areas.

17.1.2 Financing strategy

At the outset, the planning team should develop an overall strategy and approach to system financing. Some common characteristics of a successful financing strategy are:

- Diversity;
- Competition;
- Sustainability;
- Clarity and transparency;
- Realism;
- Cost-effectiveness;
- Timeliness.

A diverse portfolio of financing options can be a healthy strategy to hedge against difficulties with a single financing organisation. All relevant local, regional, and international financing sources should be investigated as options. Ideally, the planning team will create such a strong financial case for the new system that a degree of competition will occur between potential financing groups. When multiple lenders are competing to participate in a project, the city will likely be able to negotiate more favourable terms.

Sustainability refers to whether the proposed financing package places an undue amount of pressure on future administrations. If the financing stream is based on tenuous assumptions about certain future revenues, then the long-term viability of the system will be placed in doubt. In such cases, the quality of all public services can be compromised if future administrations and future generations are burdened with an unrealistic debt level. For this reason, as far as is practicable, the financing process and the financing obligations should be discussed in a wholly transparent manner to allow all parties (including civil society) to provide input. The total financing package must also be cost-effective. The package should strive to achieve an optimum interest rate and a reasonable debt level. Finally, the financing needs to be timely. Generally, the political leadership of a BRT project will require implementation to be within a particular time frame, and sometimes higher interest rates may be required to

Table 17.1: Potential financing / funding sources for BRT

Activity Area	Financing Source
System Planning	Local government Provincial government National government Bi-Lateral assistance agencies (e.g., GTZ, USAID, JICA, Sida, etc.) United Nations agencies (e.g., UNDP, UNEP, UNCRD) Global Environment Facility (GEF) Loans or grants from the World Bank Loans or grants from regional development banks (e.g., IADB, ADB, etc.) Loans or grants from bi-lateral export banks Private sector (e.g., bus operators, property developers, vehicle manufacturers, fuel suppliers, etc.) Private Foundations
Operations	Fare revenues Leasing of commercial space near stations Advertising Merchandising Emissions trading
Infrastructure	Local, provincial, and national general tax revenues Petrol taxes Road pricing / congestion charging Parking fees Improved enforcement of traffic regulations Land value taxation Sales or leasing of commercial space near stations Advertising Merchandising Commercial banks Municipal bonds Loans from the World Bank Loans from regional development banks National and sub-national development banks Emissions trading Emerging private investment options (e.g., PPPs)
Equipment (e.g., vehicles)	Private sector operators / fare revenues Bus manufacturers Bi-lateral export banks International Finance Corporation Commercial banks
Maintenance	Local, provincial, and national general tax revenues Petrol taxes Road pricing / congestion charging Parking fees Private sector operators / fare revenues

bring a project on line in time to meet a specific political timetable.

The long-term vision of the financing strategy will likely vary from the financing applied to the system's initial corridors. Bogotá relied upon local funding sources in its first phase since the concept was relatively unknown at the outset. However, with the great success of TransMilenio's first phase, commercial banks and international entities now compete to participate in financing subsequent phases. If an initial project phase is successful, then subsequent cost of financing will likely decrease. This tendency is largely due to financial organisations gaining confidence in a project once the city successfully delivers initial phases.

17.1.3 Strategic recommendations

While there are exceptions, the general strategy for financing a BRT system will often focus on the following principles:

- BRT planning should be financed by the government and donor agencies with a combination of municipal funding and international funding when possible;
- Construction of BRT infrastructure and its maintenance should be paid for by the government;
- Revenue from fares will often be sufficient to cover the cost of the system's operations, vehicle procurement, and ongoing vehicle maintenance and replacement;
- In cases where the system can only achieve borderline profitability, the public sector may cover the cost of ancillary services such as security and station cleaning; in some cases, public sector contributions to vehicle procurement may also be required.

Most BRT systems in the developing-nation cities have been designed to be self-financing from an operational standpoint (*i.e.*, fare incomes cover all operational costs). The high density of many developing-nation cities in conjunction with lower labour costs makes operational profitability a viable objective. The advantage of designing a system without operational subsidies cannot be underestimated. Operational subsidies can cause significant complications in terms of requiring on-going governmental budgetary support, propagating a negative image of public transport being unable to finance itself, and

creating opportunities for misappropriation of public funds.

However, it is also recognised that there are inherent trade-offs between designing a system that is profitable and a system that is affordable to all. In some cases, the social objective of providing a highly affordable fare may take precedent over profitability objectives. This situation may be particularly true of smaller, lower-density cities in the developing world.

Nevertheless, an initial financial analysis should at least explore the opportunity of developing a system with profitable operations. While this point may seem self-evident, in practice, some BRT systems are built in ways that are inherently unprofitable. Because most BRT systems are designed by governments rather than private investors, the primary concerns of public officials may be political rather than purely economic. However, inherently unprofitable systems significantly constrain the conditions under which private investment can participate.

Finally, project developers must be careful not to be overly pessimistic on the finance possibilities and subsequently under-design the system. BRT's success in cities such as Bogotá and Curitiba has raised the profile of this mass transit option with many public, private, and international financing organisations. Political acceptance of BRT should not be the default result of officials turning to a low-quality, utilitarian BRT system against the alternative of an exorbitantly expensive metro system. Finance should not become an obstacle to delivering a high-quality system that not only meets a city's mobility needs but also restores pride of place to the citizens of the city.

17.2 Financing BRT planning and operations

“Thought, not money, is the real business capital.”

—Harvey Firestone, industrialist, 1868–1938

The financing of BRT planning and BRT operations has already been discussed in earlier chapters of this guidebook. In general, neither the financing of planning nor the financing of operations typically represent major obstacles to BRT development.

As noted earlier, a BRT plan for a Phase I BRT project will typically cost in the range of US\$1 million to US\$3 million per kilometre, although municipalities utilising principally in-house staff may be able to develop a plan at a lower cost. In comparison to other forms of mass transit, BRT’s planning requirements are relatively low-cost. For this reason, outside financing assistance to BRT planning may be unnecessary for many cities.

However, at the same time, abundant international sources exist to provide funding assistance for planning activities. BRT has found favour with many international funding entities, including the Global Environment Facility (GEF), United Nations Development Programme (UNDP), and bi-lateral agencies. Grant-based support from these types of international organisations is frequently focussed upon planning activities. Grants are obviously preferable to loan arrangements which require repayment. Chapter 3 (*Project set-up*) of this guidebook provides more detail on options for funding BRT planning.

Most successful BRT systems to date function without operational subsidies. If the cost of depreciation of the vehicle fleet is excluded from the operational cost, no BRT system in the developing world should be designed that cannot at least cover its ongoing operating costs from fare revenues virtually from its inception. The lack of such subsidies eliminates the need for operational financing. Instead, the revenues from fare collection cover all aspects of operational activities, including drivers, fare collection staff, fuel, and vehicle maintenance. In most cases, fare revenues are also utilised to finance the vehicles, as will be discussed later in this chapter. Chapters 15 and 16 of this guidebook provide more detail on creating a business structure that avoids the need for operational subsidies.

17.3 Financing BRT Infrastructure

“Money often costs too much.”

—Ralph Waldo Emerson; author, poet, and philosopher, 1803–1882

Building a BRT system is a major investment. As noted in Chapter 12 (*Infrastructure*), BRT systems will generally cost in the range of US\$1 million per kilometre to US\$7 million per

kilometre. The actual cost will depend upon a range of factors including the complexity of the infrastructure, the capacity level required, the desired quality of the stations and terminals, the necessity for property acquisition, the need for flyovers or tunnels at rivers, railway crossings or problematic intersections, the amount of general infrastructure improvements included in the corridor reconstruction (sewage, drainage, and electrical improvements), and the level and quality of corresponding public space improvements in the corridor (landscaping, cycling and pedestrian facilities, street furniture, etc). Since a Phase I project will generally involve from 20 to 80 kilometres of infrastructure, anywhere from US\$20 to US\$560 million may be required for a project’s initial phase. This total is a large infrastructure investment, and financing this investment will be similar to financial mechanisms for other public works of similar size in any given country.

To date, most international BRT projects have financed the infrastructure entirely from public sources. Only Santiago is in the process of leveraging large amounts of private sector capital for system infrastructure, though there are early discussions in other cities as well. In general, public financing of BRT infrastructure is recommended. As such, the bulk of this chapter reviews public sector financing options. It is theoretically possible to use private financing for BRT infrastructure development using Build-Operate-Transfer (BOT) methods and other forms of Public-Private Partnership (PPP) being increasingly used for highways and metros in developing countries. While this approach is generally not recommended, under some specific conditions it may be worth exploring.

17.3.1 Local government funding

Ultimately, it will generally be the taxpayers of the municipality who will pay for the bulk of the BRT infrastructure. Since local residents will be the principal beneficiaries of the new public transport system, it is appropriate that these citizens contribute the largest share of the funding. Cities may also exert more control over their own resources, and thus in many instances, can ascertain the long-term reliability of the revenue flow. Local officials may also have more incentive to make a project work

than national agencies. Many Mayors would like to have full control over the project since it can have a significant impact on their political career. Further, many potential local sources for BRT also carry the benefit of discouraging private vehicle use, which will only further strengthen the soundness of the BRT system.

While local tax revenues are often a principal local funding mechanism, local governments actually have access to a wide range of financing options. Dedicated funding streams from fuel taxes, parking fees, and road charges all hold much potential to assist BRT financing. Of course, financing public transport through charges on private vehicles can take a good deal of political will. Additionally, new local funding sources exist in the form of commercial development around station areas and Land Benefit Levies (LBL).

17.3.1.1 Existing transport budgets

The logical starting point for any financing plan is to examine existing budgets for public transport and roadway development. Often the price of a single flyover project is equivalent to launching much of the BRT system. Re-directing local and national roadway projects to public transport priority projects can be justified on both cost and equity grounds. In many instances, the BRT investments will serve the dual purpose of improving both public transport and private vehicle infrastructure. The construction of the TransMilenio corridors in Bogotá also included upgrades to the nearby mixed traffic lanes.

17.3.1.2 Congestion charging / cordon tolls

Congestion charging

As discussed in Chapter 14 (*TDM and land-use integration*), congestion charging and electronic road pricing has served as an effective mechanism to reduce traffic congestion in cities such as London, Singapore, and Stockholm (Figure 17.1). In the medium term to long term, congestion pricing can also provide revenues to system infrastructure, maintenance, and operations. In the very short term, the costs required to implement such a scheme will likely reduce immediate financial returns. The camera technology utilised in London and the electronic gantries now used in Singapore both require a

fair amount of initial investment and technical sophistication. However, the initial Singapore approach of special licensing zones enforced at police-monitored physical gantries, can be implemented more quickly and at lower cost. In addition to the equipment costs, substantial investments in consulting services are also likely to be required in order to deliver a successful scheme. For this reason, congestion charging is often cited as a highly-effective mechanism to reduce congestion, but its effectiveness in raising revenues will vary on a case by case basis:

“London has shown that congestion charging is a good way of reducing congestion, and for providing all the benefits such as reduced pollution, reduced traffic, more reliable bus services, fewer road crashes, and more efficient deliveries, but as we spend half the revenues on collection (staff, cameras, signage, advertising, computers, a call centre, links to the DVLA, chasing non-payers, payments to congestion charge sellers in shops and petrol stations, etc.), it is not about making money” (Wetzel, 2005a).

The rate of the congestion charge, and hence the amount of revenue that can be expected, is based on the price sensitivity of private motor vehicle trip demand. In developing countries,



Fig. 17.1
The London congestion charge generates about £ 122 million pounds of net revenue each year.

Photo by Lloyd Wright

motorists tend to be fewer, and price sensitivity of demand is much higher. Thus, the desired traffic impact can be achieved at a lower charge than in developed countries. These developing-nation circumstances also mean, unfortunately, that the potential revenue from congestion charging is also going to be considerably less.

The equipment cost of the system depends on the area being charged, the density of the road network, and the type of system chosen. Developing countries often have a fairly limited number of arterials providing access to a central business district (CBD), and thus the likely equipment costs may be reduced.

Before Singapore modernised its congestion charging system to Electronic Road Pricing (ERP), it had a simpler area licensing scheme (ALS). Entering the five-square kilometres of the central business district required a special colour-coded license that cost roughly US\$1.25 or US\$25 per month. Access to the CBD was controlled by police at gantries on all major roads entering the CBD. Violators were charged US\$22, so there were very few violations. The cost of the gantries was approximately US\$2.8 million and the police enforcement was about US\$400,000 per year. In 1975, the scheme's first year of operation, it generated an operating profit of US\$2.57 million, so the full investment cost was recovered in a little over a year. This revenue would, however, only have built about approximately 3 to 4 kilometres of BRT a year based on prices in the 1970s (Hau, 1992).

In London, the system cost £ 180 million (US\$324 million) to set-up and approximately £ 88 million (US\$158 million) annually to operate. These costs only apply to the relatively small central London zone that has been implemented in the project's initial phase. A city that includes an entire metropolitan area may cost considerably more. Thus, the London congestion charging system can cost more than the entire phase I of a BRT system in a developing-nation city.

However, the London system does return healthy annual gross revenues of £ 210 million (US\$378 million), and nets about £ 122 million (US\$220 million) (TfL, 2006). Based on these results, the London system returns its original investment after the third year of operation, and at this point the congestion charging scheme is

actually generating sufficient revenues to finance an initial BRT system. Furthermore, as congestion charging matures and economies-of-scale are achieved with the technologies, then implementation costs will likely fall.

In the case of a developing-nation city, the returns achieved in London are not likely to be equalled. The £ 8 (US\$14.40) per day charge utilised in London would not be achievable in a developing city, nor would such a charge bring in anywhere near the same amount of revenue. If a London-type system was adopted in a developing-nation city, the equipment costs would be not be appreciably less. As such, lower cost technologies, such as area licensing schemes, should be explored first.

Cordon tolls

A cordon toll is another option to consider, especially in circumstances requiring a lower initial investment. Rather than requiring electronic or visual technology to record vehicle movements within a confined zone, cordon tolling schemes only exact a toll at the entrance to a zone or across a cordon, often a river. A relatively low-technology and low-cost toll booth can potentially return greater net income to the city. The main problem with these systems is the traffic delay caused in paying the toll, and the space occupied by the tolling stations. Also, tolling stations generally do not afford the flexibility of an electronic system, which can more easily distinguish different user groups and permit charging based on time in the zone. The city's physical form and road structure will have to be amenable to road charging in order for it to be viable. Cities with naturally restricted entry points (*e.g.*, bridges) will have a better chance of making road charging work. Cities with many difficult to control entry points may be more suited to an electronic surveillance system, such as those used in congestion charging schemes, to properly monitor and enforce the charge.

Political support

Implementing a congestion or road pricing scheme is likely to require a high level of political leadership and will power. Objections from powerful lobby groups, such as motorists, can make political officials wary of this type of approach. For this reason, there are no congestion charging

projects to date in the developing world. Some cities, such as São Paulo and Jakarta, have considered the option, but political difficulties have pushed implementation off into the future.

Dedicating revenue streams from congestion charging or road charging to projects like BRT can help to improve public acceptance. If the funds are seen as directly benefiting public transport, non-motorised options, or public space, then some of the objections raised by lobbying groups can be overcome. London was particularly successful in marketing how the use of congestion charging revenues would benefit users of public transport and cycle ways. In practice, though, the direct linkage of revenues from one source to a particular expenditure is not always easy to arrange. In many cities, all public revenues are put into a single account and disbursed according to budget negotiations. In other cases, there may be some latitude for hypothecating funds to a specific purpose. In still other cases, governments have created a Road Fund with a somewhat independent governing board. However, whether it is advisable to give the Road Fund control over a congestion fee earmarked for public transport improvements will depend on many local factors.

17.3.1.3 Parking fees

Parking fees can be another effective mechanism for raising revenues for a BRT system, while also discouraging private vehicle use, and often at a lower implementation cost. Like with congestion charging, however, the cost of a parking scheme will depend on the technology used, and can vary widely. Similarly, as with congestion charging, in the cities of lower-income countries, motorists are more likely to be highly price sensitive to parking charges. This price sensitivity will increase the effectiveness of the measures from a traffic perspective, but limit somewhat the revenue-raising capability.

Politically, raising parking fees and enforcing them has proven to be as demanding as implementing congestion charging. Voters are as likely to resist an increase in parking fees as the imposition of a road user charge. Parking revenues are also frequently controlled by sub-municipal level governments that have no responsibility for public transport systems, and which are loathe to give up the revenue. Enforcement

is frequently controlled by police that are not under the control of the municipal government but under the control of provincial or national governments. Most importantly, in developing countries parking revenues are generally not fully under the control of the government, and are controlled by informal sector mafias with powerful political connections inside decision-making bodies.

Nonetheless, reclaiming public control of parking is a critical part of the process of regaining public political control over urban space. Once this political battle is won, parking fees are relatively easy to implement, and can generate significant revenues for BRT, while also reducing congestion. Since a parking space is a highly visible part of land use, it is a difficult type of fee to avoid or hide. Parking fees are discussed as a TDM measure in Chapter 14. This section discusses the revenue raising aspects of parking.

Parking fees can take several forms, including commercial parking taxes and per space fees (Litman, 2006). Parking areas can be either publicly or privately owned. The access to a particular parking area may be either open to the general public or reserved for specific individuals or groups. Table 17.2 notes the range of typologies for parking areas. To maximise the effectiveness of a parking strategy, such a strategy should address most of the typologies noted in table 17.2. A parking fee applied to all non-residential parking spaces has the potential to both raise considerable revenue as well as discourage the use of private vehicles. Further, relatively little physical set-up is required and the administrative structure may already be in place through existing parking regulations. Thus, a parking fee programme can begin providing BRT revenues relatively quickly, though in practice the amounts of money raised in a developing country context may not be that high.

Table 17.2: Typology of parking spaces

Ownership of parking space	Users of space	On-street or off-street
Local authority controlled	General public General public	On-street Off-street
Privately owned	General public Private non-residential parking Residential	Off-street Off-street Off-street

Source: Enoch and Ison, 2006, p. 6

Parking case studies

In the cities of developing countries, an important first step is therefore to wrest control of current on-street parking away from unregulated private mafias to legitimate corporate entities. The cases of Bogotá, Dar es Salaam, and Yogyakarta (Indonesia) are instructive.

During the period of TransMilenio's development, Bogotá eliminated on-street parking from many parts of the city. At the same time, Bogotá encouraged the development of off-street parking facilities, which could be subjected to special user fees (Figure 17.2). In many developing-nation cities, parking on city streets is a large hidden subsidy to relatively wealthy motorists, and charging for the use of this valuable real estate can both generate revenue as well as create more equity in how public space is utilised.

The city of Cuenca has utilised a parking control initiative to both regain control of urban space as well as to generate revenues for bus priority measures (Figure 17.3). Through the privatisation of parking services, Cuenca has formalised a sector that was previously relatively uncontrolled. Further, by contractually tying the public sector's share of parking revenues to bus improvement initiatives, the city has established a steady and reliable revenue base to move towards BRT-like infrastructure for its bus services. Likewise, Orlando utilises parking fees to support its Lynx LYMMO BRT system. In fact, due to the income of parking revenues, the

Fig. 17.2
By moving parking to off-street sites, Bogotá regained control of public space as well as concentrated parking revenue collection.

Photo by Lloyd Wright



Fig. 17.3
Cities such as Cuenca (Ecuador) have formalised city centre parking in order to generate revenues for public transport development.

Photo courtesy of the Municipality of Cuenca

Orlando system is able to offer its service with no fares to the customer. The parking of private vehicles is thus enabling the city to offer a free public transport service.

In Dar es Salaam, until the late 1990s, all on-street parking was controlled by street touts (Figure 17.4). In 1998, a contract was signed with a private company which allowed the company to collect parking fees set by the City Council on the Council's behalf. A fixed percentage of each fee collected was transferred back to the city, and the rest was retained by the company to cover the cost of its operations. In 2002, a study was completed which indicated that the company was only reporting about one-third of the actually parked vehicles. As a result of this study, the company was replaced and a new company hired.

Today, the new company generates roughly US\$475,000 a year for the City Council. This figure represents only 25 percent of the total revenue collected. Since this income is a more than three-fold increase in the total revenue going to the City Council, the project is universally viewed as a success. However, the contract



Fig. 17.4
In Dar es Salaam, parking is slowly being controlled in a more formalised manner.

Photo by Adam Millard-Ball

stipulates that the City Council should collect 75 percent of the total revenue (US\$1.43 million), but only after the capital costs of the new electronic ticketing machines has been fully repaid. These electronic ticketing machines are supposed to make the revenue collection process transparent, but in fact they are currently not used in a way that would achieve this result. As such, they are functionally useless.

As an alternative, it would be much better for a traffic expert to estimate the total projected parking revenue for the city centre and then have the City Council negotiate a lump sum contract for the operator. Then, the ticketing machines would not be necessary, and the company would have a stronger incentive to collect the fee. The City Council would still need to regulate the total amount of officially designated parking locations, as otherwise the private parking operator has an incentive to let as many motorists park on the streets as is physically possible. Enforcement is also a major problem, as the police remain under the control of the national government and do little on parking enforcement. The potential revenue being earned for parking is potentially large enough to pay for elements of a BRT system, but it is currently dedicated to the construction of designated parking places and for road maintenance (Millard-Ball, 2005).

In Yogyakarta (Indonesia) the city currently collects no legal revenue from on-street parking in



Fig. 17.5
A complex web of street bosses and informal parking attendants has made parking reform in Yogyakarta quite difficult.

Photo by Michael King

the central business district. As part of an effort to pedestrianise the central Malioboro Road market area, a parking analysis was done by Instran, an Indonesian NGO, which concluded that at least US\$860,000 per annum and probably closer to US\$2 million, is currently being appropriated by the informal sector in the Malioboro area alone.

At the bottom of the hierarchy are 118 on-street parking touts earning US\$2 a day. They in turn report to 14 street bosses, who have 8 parking attendants each under their control (Figure 17.5). The street boss is usually in a political party, and uses political connections to maintain market control. Above the street boss are land owners or “white-collar parking attendants.” These persons are generally in control of some form of thugs who can protect the interests of the land owners at the street level as necessary. Each land owner has three or four street bosses under their control, and these street bosses earn about US\$8 dollars a day. Above them are area leaders, who are usually active members of the police or military service. They receive up to US\$2 per day per location that they control.

There are about 2,650 parking units in the Malioboro area. When all this is added up, it indicates that approximately US\$2 million in annual parking fees are being appropriated by mafias just in the Malioboro Road area alone. Efforts to relocate this parking into off-street parking garages have continued for more than a decade, with talks breaking down largely over the issue of who is going to pay for the off-street garages (Aunurrohman, 2005).

Once a municipality has managed to bring parking under its control, parking revenues can be either collected directly by the municipality, or indirectly in the form of revenue sharing arrangements, concession agreements, or commercial parking taxes.

Parking space levies

As discussed in Chapter 14, parking fees can be effective at both discouraging private vehicle usage as well as achieving other municipal objectives, such as improved public space. While the most common application of a parking charge is perhaps the commercial parking tax, a “parking space levy” is a new technique that holds many advantages to the city. A parking space levy sets a fee to all non-residential parking spaces, regardless of whether the space is utilised or not.

In comparison to a commercial parking tax, a parking space levy provides the following benefits:

- Provides a steady and known revenue stream to the municipality;
- Encourages an overall reduction in the provision of parking spaces;
- Discourages private vehicle use and encourages public transport use;
- Reduces the incidence of problems of record-keeping, enforcement, and non-compliance.

Experiences to date with parking space levies indicate that overall numbers of parking spaces are reduced, and thus making public transport more competitive with private vehicle usage.

From a revenue standpoint, parking space levies have shown to be effective mechanisms for financing public transport infrastructure. The revenues generated from parking space levies can be directly tied to BRT financing.

In 1992, Sydney (Australia) initiated a parking space levy for non-residential parking spaces in the central and northern parts of the city. An annual fee of A\$200 (US\$150) was applied to each parking space (Enoch and Ison, 2006). The Sydney fee has now risen to A\$800 (US\$615) in the central business district and A\$400 (US\$308) in other business districts. The parking levy is currently returning approximately A\$40 million (US\$31 million) per year to the city (Litman, 2006a).

Land owners must pay the fee on all parking spaces, whether or not the spaces are actually being utilised. If an unmarked lot is utilised for parking, the Sydney municipality determines the number of space by “dividing the total area by 25.2 square metres, which takes into account parking spaces and access lanes” (Litman, 2006a, p. 6).

Some exemptions are permitted in Sydney, especially to parking spaces for the disabled and for areas of loading and unloading goods. Revenues from the Sydney programme are applied exclusively to public transport infrastructure and maintenance. In the case of Sydney, the revenues cannot be applied to subsidising public transport operations; any such subsidisation would give the appearance that the parking levy is simply replacing general revenue inputs to the public transport system. Also, such an arrangement may force the city to actually encourage parking in order to properly finance public transport operations.

Perth (Australia) adopted a “parking license fee” in 1999, which was applied to all on- and off-street non-residential parking spaces. The modest fee raised A\$3.35 million (US\$2.5 million) during its first year and most recently has produced A\$8.2 million (US\$6.3 million) in revenues (Litman, 2006a). Non-payment of the fee has been less than 2 percent of the total raised. The fee also helped to persuade land owners to convert over 6,000 parking spaces to other uses. All revenues from the Perth programme goes to supporting the local bus system (Enoch and Ison, 2006).

Fig. 17.6
Parking fees on all non-residential parking spaces are a steady and potentially lucrative revenue stream that can help finance BRT infrastructure.

Photo by Lloyd Wright



Beginning in 1975, Singapore assessed a S\$60 (US\$35) monthly fee on non-residential parking spaces. This fee provided approximately S\$40 million (US\$25 million) in annual revenues. The cost to administer the programme was relatively low at approximately S\$30,000 (US\$18,000) per month (Enoch and Ison, 2006). When the Electronic Road Pricing (ERP) was introduced in 1998, the authorities decided to phase out the parking fee. In this sense, a parking fee can be seen as transition stage towards congestion pricing or road pricing. This incremental approach may be particularly appropriate for developing-nation cities where establishing a congestion charging system may be both technically difficult and cost prohibitive.

17.3.1.4 Enforcement of traffic regulations

Enforcement of laws on speeding, stopping, and obeying lane markings will help ensure smoother traffic patterns as the new street configurations are introduced. Improved traffic enforcement can also generate revenues from fines and penalties. While enforcement of previously ignored traffic laws requires a tremendous change of street culture, the promise of the new public transport system can help mitigate some of the criticism. If the fines and penalties are dedicated towards the new public transport

Fig. 17.7

Simply enforcing existing traffic regulations can be a moderate revenue opportunity. However, in cases such as Quito where even the police may not obey such regulations, enforcement is difficult.

Photo by Lloyd Wright



system, then there may be greater public acceptance of tighter enforcement of traffic regulations. Clearly, though, coordination with the local and national police agencies will be required to implement a new enforcement ethic (Figures 17.7 and 17.8). Further, tying traffic fines to public transport development may require legislative action.

17.3.1.5 Municipal bonds

Municipal bonds, a popular mechanism for financing infrastructure in the US and Europe, have not yet been used extensively in most developing countries. Issuing municipal bonds requires that the municipal finances be audited by an internationally recognised accounting firm. The city’s financial conditions must be found sufficiently transparent and legally sound by an international bond rating company in order to provide sufficient security to bond holders. This process is not that expensive, generally costing around US\$1 million to US\$2 million, but municipal finance in many developing countries is insufficiently transparent and legally sound to secure the necessary approvals from the bond rating companies. Nonetheless, this is a process that cities should go through as they develop. Many central and eastern European cities have recently gone through this process and their bonds have sold well, offering reasonably priced financing for municipal infrastructure projects.

Fig. 17.8

The non-enforcement of parking regulations is particularly prevalent on the footpaths in front of police stations in Quito, which sets a bad example for parking enforcement elsewhere in the city.

Photo by Lloyd Wright



17.3.1.6 Land taxes and development rights

“The trouble with land is that they're not making it anymore.”

—Will Rogers, humorist and social commentator,
1879–1935

Introduction to land and property taxes

Unlike most things that are bought and sold, the value of a piece of real estate has more to do with investments near the land that affect its accessibility and the quality of the surrounding neighbourhood, as it has to do with improvements specific to the land. Land itself is a finite resource. Land as a tradable good is created by legal instruments which define the meaning of the ownership right in a specific context. Because any major urban investment that directly or indirectly affects the desirability of land will tend to have a significant impact on site value, most economists believe that land taxation is a good and equitable way for municipalities to recapture the value of their investments into infrastructure.

A property tax is generally based on the total value of the land inclusive of the value of what is built on it. A land tax is generally based on the value of the land exclusive of the value of the property built on the land. Followers of the late Henry George strongly feel that land should be taxed exclusive of the value of whatever has built upon it. This form of taxation, Georgists feel, is one of the most equitable forms of taxation as it only taxes pure land rents which arise from community activities and not from the activity of individual landowners. Land taxation also tends to encourage owners to build rather than to engage in real estate speculation and leave the land idle. Unfortunately, land taxes are still relatively rare, while property taxes are widely used in developed countries, and are increasingly used in developing countries. One of the problems with a property tax is that if a building is improved and thus made more valuable, more property tax has to be paid, but if the building is allowed to fall into disrepair the owner is rewarded with a lower property tax bill.

Some cities have developed more carefully targeted Betterment Taxes, which are imposed specifically on sites that benefit from specific public investments. In some countries, particularly in China, the municipal authorities have

the power to impose project-specific levies on specific land owners. This levy was implemented as a means of financing several metro projects. The somewhat arbitrary nature of this form of taxation makes it highly subject to abuse.

Because BRT projects can significantly increase land and property values along the BRT corridor, using land taxes to finance the infrastructure is a sound municipal finance decision. The stations and terminals in particular can increase commercial land values nearby due to the high volume of persons passing through the system. The proximity to the higher-speed public transport network can mean greater convenience for residents and greater customer flows for commercial enterprises. However, much depends on the impact the system on local noise and air quality, and this will vary on a case by case basis. Busways have had negative as well as positive impacts on land adjacent to the system when systems were badly designed, especially in areas that are a considerable distance from interchange access.

Also important is whether or not there are simultaneous changes in the zoning system. Most experts believe that zoning should be changed along a BRT corridor to allow increased population density along the corridor, though it is rarely done. Up-zoning properties along a corridor will tend to increase land values in that corridor irrespective of any public transport improvements.

Curitiba up-zoned properties along its BRT corridors at the same time it built its BRT system. It witnessed dramatic increases in land and property values along the corridor. Curitiba had a standard property tax that taxed the total value of the property, not just the land. While Curitiba benefited from the general increase in property taxes that resulted from the increase in property values along the corridor, no specific betterment tax was imposed. The increase in property values led to the construction of many high-rise buildings, but it also led to a proliferation of vacant lots owned by land speculators that would have been avoided by a general or corridor specific Location Benefit Levy (LBL). It also led to a displacement of the poor to the periphery. This example underscores the importance of simultaneously planning for affordable

housing in the corridors served by the new BRT system to insulate the poor from displacement.

Recent research from Bogotá, indicates that site values within a ten minute walk of the new TransMilenio trunk corridor increased on average by some 1.8 percent per annum relative to average property value increases, and by more than 5 percent per annum in areas served by feeder buses (Muñoz-Raskin, 2006). Bogotá did not change the zoning along the corridor. It did situate its “Metrovivienda” low-income housing programme in locations served by feeder buses to the TransMilenio system. Metrovivienda functioned as a kind of land banking, where the municipality bought the land and then had private developers develop the housing on a commercial basis exclusive of the land cost. In this way, Metrovivienda insulated its beneficiaries from the increases in land prices in the TransMilenio corridors.

By contrast, land and property values along São Paulo’s Novo de Julio/Santa Amaru busway and Bogotá’s pre-TransMilenio busway on Avenida Caracas suffered adverse impacts, as the busway concentrated polluting and noisy buses along a single corridor. Thus, any positive land value impact is directly tied to the quality of the new system.

The ability of the government to capture any positive land value impacts of a BRT system first requires that the municipality has the means to collect property or land taxes. In many developing countries, site ownership rights, particularly in poor neighbourhoods, are not that clearly defined (Figure 17.9). Land rights often exist along a continuum between outright illegal occupation and full ownership. Land title deeds are also frequently ambiguous even in higher income neighbourhoods. Accurate cadastral surveys are generally a pre-requisite for using municipal property taxation in developing countries, and for political reasons these surveys have often been difficult to implement. Nevertheless, most municipal governments are moving in the direction of implementing land or property taxes.

Location Benefit Levy (LBL)

A Location Benefit Levy (LBL) is a new financing opportunity that holds much promise to revolutionise the manner in which mass transit projects are financed. The concept has also been known as Land-Value Taxation (LVT). LBL is essentially a land tax applied annually based on a site’s “optimum permitted use” (Wetzel, 2006). A tax rate is applied to the estimated



Fig. 17.9
Developing-nation governments often do not have a formal land or property taxation system in place for informal settlements.

Photo by Lloyd Wright



Fig. 17.10
The Jubilee Line extension through Canary Wharf in London led to an explosion of high-rise development.

Photo by Lloyd Wright

value of the land and thus producing a public income. If land value increases due to a new public transport project, then the amount collected also rises. LBL is quite different from a standard property tax, which typically includes the value of added infrastructure such as buildings. LBL is only based on the value of the land itself, and thus a similarly placed property would pay the same LBL whether it hosts a skyscraper or an empty lot.

In most cases to date, public transport systems have not greatly benefited from the land value changes induced by the new systems. Instead, private individuals and companies have reaped significant financial windfalls based on public investment in the new public transport system. Site values within one kilometre of stations on the Jubilee Line extension (London Underground system) increased by approximately £ 13 billion (US\$23.4 billion) as the project developed (Riley, 2001). The extensive development around stations such as Canary Wharf reshaped London's urban landscape (Figure 17.10). The public transport management agency, Transport for London (TfL), estimates that land value appreciated by £ 2 billion (US\$3.6 billion) at Canary Wharf and by £ 800 million (US\$1,440 million) at the Southwark station (TfL, 2003). The land value appreciation in conjunction with other recorded benefits, including employment and time savings, will produce a gross GDP benefit of £ 21.2 billion over a 60-year appraisal period (TfL,

2003). The cost of the entire extension was only £ 3.5 billion (US\$6.3 billion).

Unfortunately, none of the windfall increases in site values were captured by the government. A tax on the land value increases could have paid for the Jubilee Line extension. Thus, many groups are devising land valuation mechanisms to help capture revenues to pay for the public transport infrastructure. LBL is increasingly recognised as the appropriate mechanism to do this.

LBL has already been applied in a few locales with highly positive results. Each year in Denmark, the value of all land is appraised and charged a percentage tax (Wetzel, 2005b). Harrisburg, Pennsylvania in the US has successfully utilised LBL to help revitalise the local economy and the urban environment. Some form of LBL is also practised in Estonia, Hong Kong, Singapore, and Taiwan as well as the cities of Sydney and Canberra (Australia).

LBL has not only been cited as the most effective mechanism to recoup investments to public transport improvements, but has also been recognised to provide the other following benefits:

1. Encourages urban revitalisation of brown-fields and abandoned properties

Since these underutilised sites will be taxed the same as other land in the same area, there is a significant incentive for the owner to make best use of the land or to sell the land to someone who will develop it (Figures 17.11 and 17.12).

2. Discourages sprawl and encourages smart growth

The LBL provides a strong incentive for land owners to maximise the use of sites within the central portions of a city. As the number of commercial and residential units increase, the overall market price for land should drop and thus allowing more affordable housing to individuals and families wishing to live closer to work and services. In turn, demand for land at the periphery of the city should be reduced.

3. Equitable and progressive

LBL essentially returns revenue to a community for value that the community itself has created. The public funds used to build a new public transport system will deliver a windfall

profit to property holders along the corridor. The LBL helps to return a portion of this windfall profit back to the public. Further, since city centre land holders tend to belong to the higher-income groups, the LBL is a highly progressive tax.

4. Fairness

The amount taxed by an LBL will vary depending on the land’s current market value. If for some reason land declines in value, then the amount taxed will decline as well. Thus, if proximity to new public infrastructure should somehow reduce a site’s value, the owner is compensated through a lower tax. Litigation for other forms of compensation can be avoided. Likewise, since a new public transport system will likely affect land values in relation to the distance from the station, the LBL automatically accounts for all distance-based value gradients. By contrast, a development tax that just targets new-build properties within a specific perimeter of the new infrastructure will invariably be somewhat arbitrary and unfair.

5. Administrative efficiency

LBL is generally a fairly low-cost and simple tax to implement. Since land ownership is fairly readily identifiable, LBL is quite difficult to evade. One cannot move land to another city or jurisdiction.

Another tax option for capturing private benefits from new public transport systems is known as the Development Land Tax (DLT). DLT applies a targeted tax only to new properties

around a public development project. Unfortunately, DLT essentially provides a disincentive to development and creates significant problems regarding administration and equity. In general, developers will likely strive to avoid the DLT by avoiding development. Further, since the positive impact of a new public transport system may extend well beyond the immediate area of the corridor and the public transport stations, there can be much inequity in terms of which properties are burdened with the tax. For these reasons, DLT is not regarded as an effective financing mechanism and is generally not recommended for any city or State.

The Bangkok Skytrain has utilised a form of a DLT by charging a fee to building owners who wish to link directly to a Skytrain station. The building owners must pay for the sky bridge infrastructure as well as an additional fee to obtain the linkage. Obviously, a commercial centre has a vested interest in allowing customers to enter directly and easily from the mass transit system (Figure 17.13). However, this approach does raise some concerns about the appropriateness of essentially selling station access. If a site owner cannot afford the connection fee, then customers may be needlessly forced to make a difficult transfer between the public transport station and their destination. For example, some key destinations, such as a school, may not be able to afford a direct link even though there is likely a good deal of public interest in permitting school children to easily access public transport.



Fig. 17.11 and 17.12
A Location Benefit Levy provides an inherent incentive for derelict and vacant land to be developed and rehabilitated.

Left photo by Carlos Pardo (Bogotá)
 Right photo by Lloyd Wright (Montevideo)



Fig. 17.13
The Bangkok BTS Skytrain charges a fee to building owners wishing to have a direct sky bridge link to the system. However, thi practice can raise questions over equity.

Photo by Lloyd Wright

Fig. 17.14
The Hong Kong subway system features underground commercial concourses that house a variety of shopping opportunities for customers.

Photo courtesy of the MTR Corporation

By contrast, LBL has been highly regarded for its ability to create a synergistic package of benefits which lead to a virtuous circle of economic development and improved public infrastructure. However, despite these accolades LBL is not being universally adopted at a rapid pace for several reasons. First, changing tax collection mechanisms is a process fraught with considerable public emotions and political challenges. Nobody likes any new tax, even if it provides multiple benefits and displaces less equitable revenue raising schemes. Second, LBL does require a regular appraisal and evaluation of all properties. For some cities and countries, a property appraisal system already exists and can be successfully converted to an LBL system. However, for many developing nations, the administrative and technical capacity to establish a competent appraisal regime may not be in place. The establishment of such a regime

could present a formidable challenge that would require several years of effort and investment. For those cities, though, that do make the effort to establish an LBL system, the rewards will not only be improved public transport but also a fairer and more effective tax system overall. There are agencies established that will assist cities that are interested in developing an LBL system (<http://www.labourland.org>).

17.3.1.7 Property development at public transport hubs

An attractive new public transport system can open up new commercial opportunities through property development at or near the stations and along the corridors. Land values often increase substantially upon the mere announcement of a new public transport project. Often the most attractive locations are stations with high volumes of passengers. For example, a new transfer station between a busway trunk line and its feeder buses in Belo Horizonte is being entirely financed by a private developer in exchange for the right to build a shopping mall adjacent to the station. Similar arrangements are being discussed in Porto Alegre. In other cases, the properties at popular stations and along corridors are managed directly by the public transport authority or concessionaires under contract to the authority. Mass transit systems in cities such as Bangkok and Hong Kong have used the leasing of commercial space to help fund infrastructure costs (Figures 17.14 and 17.15).

Fig. 17.15
The elevated platforms of the Bangkok Skytrain creates space for lucrative commercial opportunities.

Photo by Lloyd Wright



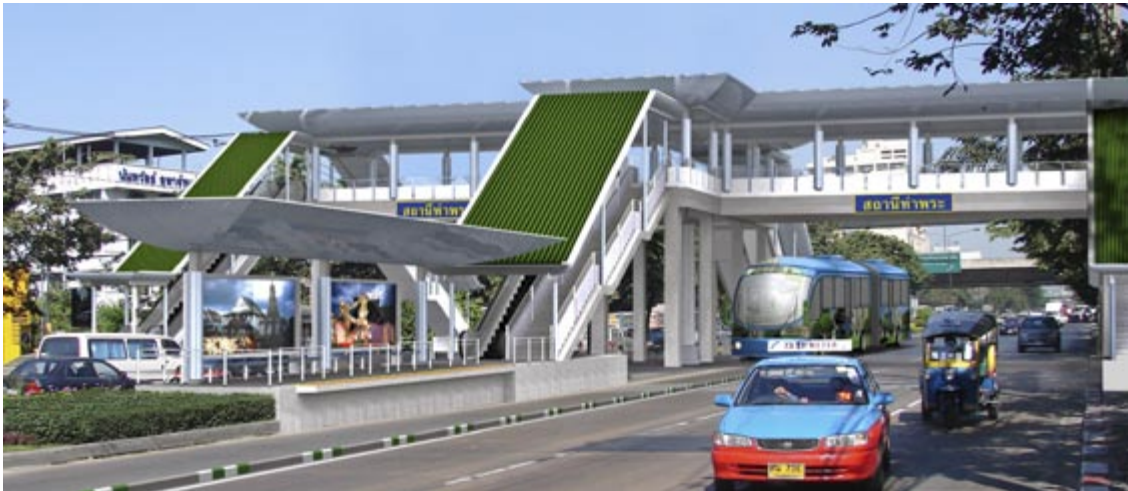


Fig. 17.16
The aerial platform envisioned for the Bangkok BRT system provides space for commercial leasing.

Image courtesy of Pacific Consultants International (PCI)

Land Banking

Municipalities planning to develop a new public transport system may find it profitable to purchase key properties prior to the announcement of the system. Since property values will tend to jump considerably at the time of system announcement, pre-empting this speculative surge with strategic land purchases can reap significant dividends for the municipality. Such purchasing was a common practice in Singapore and Hong Kong, though not related to BRT projects. Once the system is announced, the municipality may then elect to sell the properties to private developers or develop the property itself. However, one of the limitations of this approach is that it only provides a one-off financial assistance to the construction of the project and is incapable of utilising increases in land values that will arise with the operation of the system. By contrast, LBL provides an annual income to assist revenue funding forward into the future and increasing as the land values continue to rise.

This internalisation of property appreciation may not be possible in all local circumstances. Use of public funds for property transactions by local government is frequently restricted by law to those properties specifically needed for a public purpose, and some courts have defined “public purpose” quite narrowly. Further, keeping news of the impending new public transport system from the news media and general public may simply not be realistic in all circumstances. Further, land speculation by the municipality can open officials to charges of misappropriation and corruption. Thus, while municipal property development can be financially beneficial to

the public transport project, the management of this process must be carefully planned and administered. Otherwise, such dealings are perhaps best left to the private sector and an application of LBL in which the windfall gain can be captured for public use.

Aerial and underground rights

In general, land cannot be created. Municipalities, metropolitan areas, and even our planet have a finite size in which new land cannot be magically added. However, public transport systems can develop new property opportunities from previously unused forms of urban space. BRT stations can be designed to include new areas for commercial development above or below the road right of way. The construction of set aside areas for commercial development within the station area itself can return significant financial dividends. In some cases, this set-aside commercial space can pay for the entire station.

Fig. 17.17

The development of a hospital complex over the Mater Hill station in Brisbane generated important infrastructure revenues for the BRT system.

Photo courtesy of Queensland Transport





Fig. 17.18
An underground shopping concourse managed by the Hong Kong MTR.

Photo courtesy of the MTR Corporation

Some of Curitiba's transfer stations have leased a moderate amount of commercial space out to private shopkeepers. The currently planned Bangkok BRT system and the stalled Hyderabad BRT system had both planned to make extensive use of aerial commercial space. Since customers approach the stations by an overhead walkway and a large aerial platform, there is much opportunity for this form of commercial property development (Figure 17.16).

Perhaps the best known example of aerial property development is Brisbane's Mater Hill station. Shops and a hospital have been constructed over the exclusive lanes of the Brisbane busway (Figure 17.17). Proceeds from this property development have been utilised to build the BRT system's infrastructure.

Likewise, the pedestrian tunnels connecting nearby TransMilenio stations in Bogotá offer the potential to include commercial shops within the infrastructure, though Mayor Peñalosa was strongly opposed to this for fear of degrading the image of the system with litter and advertising. The Hong Kong subway system has turned its underground concourses into highly profitable shopping malls (Figure 17.18). Station shops can also add much convenience to the customer. Being able to conduct one's grocery shopping within the confines of a transfer station could do much to save customer time. Further, such amenities may also make the act of transferring less burdensome from the customer's perspective.

These in-station commercial spaces have much opportunity to generate significant revenues. Since the site is sometimes owned by the public transport system, though often managed by a

management company, there are a few different options for capturing value from the shop owners. The site can either be leased or sold to private developers. Typically, leasing is the preferred option since it gives the system future flexibility. If the system's alignment changes in the future or if platform space is required for other functions, then the system managers retain the right to make changes. Further, as the system expands, the ridership will increase and so will the likely value of the commercial space. Thus, a lease agreement allows the system managers to increase the future site income as the underlying economic conditions change. If the site is permanently sold to a commercial developer, then the initial income generated will be greater but future spatial flexibility will be lost.

Existing systems such as the Hong Kong subway and the Bangkok BTS Skytrain have whole divisions devoted to property management. The private Japanese commuter railway companies make most of their profits from real estate development and leasing both at stations and in areas served. Likewise, the British Airport Authority (BAA), which owns Heathrow Airport, makes nearly as much income from shop and site rentals as it does from landing fees. These companies are more than just transport providers, but also sophisticated property management companies. These activities have not yet become common practice in BRT systems but it is likely to be an emerging trend.

Development rights

In many cities, especially in developed nations, the right to develop a site in a particular manner must be formally approved by the local government. Zoning ordinances may also restrict a site to a particular type of development. The auctioning of the right to develop a site can be a significant revenue source to a new public transport system.

In order to gain access to development rights for a particular property, a developer will put forward a development plan. The local government will then determine whether this plan is in the public interest. Employment impacts, tax revenue impacts, and environmental impacts are some of the considerations that will typically determine whether a proposal is approved. Often there are competing development plans

for a site. In some cases, private developers will bid to gain the development rights. The private developers' contribution could include helping to finance the BRT infrastructure near the site.

The commercial opportunities around new public transport stations can make the auctioning of development rights a financing option to consider. The selling of development rights is not mutually exclusive with other property valuation sources such as a Location Benefit Levy (LBL). A city could reap benefits both from LBL and the auctioning of development rights.

17.3.2 Provincial and national funding

17.3.2.1 Roles of different government entities

While the bulk of the BRT funding should be contributed by local residents who will directly benefit from the new system, provincial and national funding can be a natural complement to local government investments. The exact role of provincial or national governmental entities in municipal transport depends much on local practices.

In some instances, national or provincial agencies may explicitly control all transport decision-making and investments within the cities. In other cases, national or provincial agencies may play a particular role in transport investments involving the largest cities or just the capital city. In Panama City, it is the national government that largely determines whether a public transport project will proceed. In Bangkok, public transport decision-making is largely a shared responsibility between the provincial and national governments. In Jakarta, the provincial government played the central role in developing the TransJakarta BRT system.

In Africa, municipalities more frequently lack the financing and institutional capacity to implement major infrastructure projects on their own without national government or at least provincial government (in a few countries) support. Even modest Phase I BRT infrastructure projects are major infrastructure projects, and municipalities without the finances or capacity to handle projects of this size are liable to rely on provincial or national government ministries for assistance both with the financing and with contracting and implementation.

In South Africa, the National Department of Transport has established a Public Transport Investment Fund (PTIF) that serves as a grant-making source for cities to prepare for hosting the 2010 World Cup event. BRT is currently being envisioned as a principal mechanism for many South African cities to meet the demand of World Cup visitors.

That being said, most countries in Africa and around the world are gradually increasing the power and financial independence of municipal governments, with generally positive impacts on the quality of urban management and local service delivery. Moderately sized BRT projects represent a unique opportunity to further develop the capacity of a municipal government.

A single city project can also inspire a national government to take a larger role in promoting and financing BRT. The success of Bogotá's TransMilenio system motivated the national government to launch an ambitious national BRT programme, encompassing the cities of Barranquilla, Bucaramanga, Cali, Cartagena, and Medellín, and the role of the national government increased significantly in TransMilenio Phase II and III.

The issue of who finances the project is largely a matter of control over the project. As different levels of government are frequently under the control of different political parties, forcing them all to agree on the financing is often a difficult barrier to overcome. In Bangkok, while the Bangkok Metropolitan Administration (BMA) wished to proceed with a BRT project, the national government, led by an opposing political party, did not give the BMA authority to utilise the roadways. The national government thus effectively blocked the project so as to prevent another political party from gaining the credit for improving the public transport situation in the city. In some cities, even parts of the same road might be controlled by different governmental agencies. In Delhi, for example, even two parts of a single major road might be controlled by the Delhi Municipal Corporation and the Delhi Development Authority.

17.3.2.2 Specialised taxes

Dedicated revenue streams from petrol taxes and sales taxes can help establish a long-term

sustainable basis for financing BRT development and expansion. Fuel taxation is both a lucrative revenue source as well as an effective mechanism to help discourage car usage. However, relatively few municipalities have the jurisdiction to control or impose their own locally collected fuel taxes. National legislation and national coordination is usually required to erect fuel taxes and to hypothecate the taxes to public transport projects.

For those municipalities that can gain access to fuel tax revenues, the possibility of funding much of the BRT system through such a tax is quite strong. Bogotá’s TransMilenio has benefited greatly from the proceeds of a petrol tax that is partly dedicated to public transport. 28 percent of Colombia’s petrol tax is hypothecated directly to eligible public transport projects. Approximately one-quarter of the first phase of TransMilenio was funded through petrol tax revenue.

General sales taxes also represent a significant revenue stream if national or provincial leaders approve its partial usage for public transport projects. The State of North Carolina in the US has developed an innovative scheme to ensure public transport projects receive the necessary funding. One-half of one percent of the State sales tax is set aside for municipal public transport projects. This revenue source generates approximately US\$50 million each year. The State then uses these funds to provide a 50 percent match for municipal public transport projects. New York State has a whole host of special taxes that finance public transport capital investments. These taxes include an indirect fuel tax imposed on oil companies called the “Petroleum Business Tax”, a dedicated portion (0.25 percent) of the sales tax, a tax on mortgages, and

also a fixed percentage of the toll revenue collected on several important bridges.

17.3.2.3 Ownership and licensing fees

While many of these revenue-raising mechanisms are based upon charging motorists for vehicle usage, the ownership and licensing of vehicles also represents a potential financing source. Vehicle ownership may not seem directly related to usage, but there is some evidence to suggest a relationship. Once a motorised vehicle is purchased, the convenience of use often induces additional trips (Gilbert, 2000). Further, once an individual makes a financial commitment to a vehicle, there is a psychological preference to maximise the vehicle’s use. Thus, discouraging vehicle ownership can help shift patronage to public transport. The financial disincentives to vehicle ownership also can produce revenues for public transport development.

Singapore has gained much fame not only from its Electronic Road Pricing (ERP) scheme but also from its vehicle fees that discourage ownership. Singapore uses an assortment of fees and charges to increase the total purchase price of a vehicle. These additional fees can work to increase the vehicle purchase cost by nearly three times its normal retail price (Table 17.3).

A vehicle arriving in Singapore is first subjected to a customs duty equalling 20 percent of the vehicle’s “Open Market Value” (OMV). The OMV consists of all the costs required to deliver the vehicle to Singapore, including vehicle purchase price, freight costs, handling fees, and any other cost associated with the vehicle arriving in the country. The new vehicle is also subject to two different registration fees. A basic registration fee (RF) is first assessed. Then, there is an Additional Registration Fee (ARF) which exacts a cost equal to 130 percent of the OMV. Another major cost is the “Certificate of Entitlement” (COE). The number of COEs are limited in order to keep vehicle numbers manageable within the city-state. Perspective vehicle owners must bid on the open market to obtain a COE. Finally, there is also a 5 percent Goods & Services Tax (GST) applied to the OMV. Thus, for the example given in table 17.3, a vehicle normally costing US\$40,000 will end up costing nearly three times this amount in Singapore (Figure 17.19).

Table 17.3: Vehicle ownership fees and charges in Singapore

Fee type	Cost (S\$)	Cost (US\$)
Open Market Value (OMV)	64,543	40,339
Customs Duty (CD), 20% of OMV	12,909	8,068
Goods & Services Tax (GST), 5% of OMV	3,227	2,017
Registration fee (RF)	140	88
Additional Registration Fee (ARF), 130% of OMV	83,906	52,441
Certificate of Entitlement (COE)	26,000	16,250
Total	190,725	119,203

¹⁾ Example given is for a BMW 325i; actual fee level will depend on the vehicle make and model.
Source: Ching Hoon Choor, 2004

Cities seeking to finance a BRT system could consider using a similar set of fees and charges to help pay for BRT infrastructure and system maintenance. Like all fees and taxes, though, implementation requires a good deal of political will. Further, cities will likely not be able to implement such a regime in isolation. National legislation would most often be required. Without nation-wide implementation prospective car-buyers could potentially avoid payment by purchasing and registering the vehicle outside of the city.

17.3.2.4 National development banks

National development banks are often the appropriate vehicle by which cities can leverage capital for major infrastructure projects. These banks lend funds to cities at interest rates below commercial rates. Projects that promote national developmental objectives are eligible for such loans. National development banks may hold several advantages over international development banks. First, these banks may be more receptive to national priorities, especially if a mayor or governor is particularly promoting a project. Second, these banks often have far less cumbersome application procedures and contracting rules than international development banks, and thus can deliver a loan more rapidly.

In both Asia and Latin America, financing from the national government is frequently made available indirectly through state development banks. India has several state development banks that have expressed interest in providing financing for BRT infrastructure, although actual loans have yet to occur, principally because BRT is a relatively new phenomenon there. China has banks both owned directly by municipalities as well as banks owned by the state and provincial governments. These banks are controlled by the Mayor or the Governor, and are frequently involved in major infrastructure projects, particularly if there is some sort of revenue stream associated with the project. The Brazilian Development Bank (BNDES) has provided considerable financing to BRT infrastructure projects in many Brazilian cities. For example, BNDES has played a key role in upgrading and modernising several of São Paulo's BRT corridors. Additionally, BNDES has played a role in supporting non-Brazilian



BRT projects in which Brazilian-built vehicles are utilised. Mexico's BanObras, a national development bank, is currently examining the viability of extending loans to BRT projects.

17.3.3 International funding sources

International financing may be an appropriate addition to a locally- and nationally-based financing plan. If outside financing proves to be necessary, bi-lateral and multi-lateral institutions are increasingly supportive of assisting BRT projects. The relative cost-effectiveness of BRT has gained the concept favour with a range of international financing sources.

When international financing is pursued as an option, it is generally in addition to locally- and nationally-based financing. International grants, for example, may help catalyse an initiative, but this type of funding typically only augments local sources. Funding organisations will want to see some risk and investment from local and national entities. Only with a substantive local component will it be clear that cities are taking ownership over the project.

The main disadvantage of international development bank financing has been that the procedures for loan approval tend to be time consuming. Given that one of the key benefits of BRT is the ability to implement the system within the administration of a single Mayor, international development bank financing may come on line more in the later phases of a BRT system. Most international development banks also require the approval of national financial ministries, and this requirement sometimes creates additional bureaucratic and political obstacles.

At this time there are no international donor agencies that have proven willing to provide grant funds for the development of BRT infrastructure. Grant funding is more typically applied during the planning stages. While

Fig. 17.19

Singapore's addition of various fees and charges to private vehicle costs helps to both discourage ownership as well as raise local revenues.

Photo courtesy of iStockPhoto

frequently discounted financing is available from international, national, bi-lateral, or regional development banks, ultimately these funds will come in the form of loans that have to be repaid primarily by municipal taxpayers.

17.3.3.1 World Bank

The World Bank is one of the premiere lenders to major infrastructure initiatives in the developing world. The World Bank is also increasingly interested in providing loans for BRT projects. The World Bank has active BRT-related loans in Lima, Santiago, six cities in Colombia, Dar es Salaam, and Accra, and countless others are under development. It is likely that BRT will become a growing part of the World Bank's urban transport portfolio in the coming years.

The World Bank Group actually consists of five different organisations, each with a different mandate in supporting development. Most loans for BRT would likely be managed through the International Bank for Reconstruction and Development (IBRD). However, for the lowest-income countries (Tanzania and Ghana, for instance), the International Development Association (IDA) is the appropriate lending organisation.

17.3.3.2 Regional development banks

Regional development banks operate in a similar manner as the World Bank but with a more

focused geographical mandate. In Latin America, the Inter-American Development Bank (IADB) was one of the earliest funders of BRT, providing financing to Phase II of the Curitiba BRT system back in the late 1970s. The IADB has been actively involved in financing many BRT projects particularly in Brazil, and are in discussions with Managua (Nicaragua) and several other cities.

In Asia, the Asian Development Bank (ADB) has yet to play a direct role in lending to BRT initiatives. However, this absence could soon change with ADB now taking active interest in financing BRT, particularly in India, China, and the Philippines (Figure 17.20).

Other development banks that finance infrastructure but have not to date loaned money specifically for BRT include:

- African Development Bank (AfDB);
- Andean Development Corporation (CAF);
- Central American Bank for Economic Integration (CABEI);
- Council of Europe Development Bank (CEDB);
- Development Bank of Southern Africa (DBSA);
- Eastern and Southern African Trade and Development Bank (PTA);
- European Bank for Reconstruction and Development (EBRD);
- European Investment Bank (EIB);
- Islamic Development Bank (ISDB);
- Nordic Development Bank (NDB);

In countries with access to World Bank, regional development bank, national, and sub-national development bank financing, there is frequently stiff competition for financing between these institutions. This competition generally does not influence significantly the cost of capital, but it does generally give the borrower a lot more independence from the influence of a single bank's policy agenda. However, in most cases the policy requirements of these banks represent good practice procedures; the requirement of a competitive and open tendering process is particularly beneficial to any project.

17.3.3.3 Bi-lateral export-import banks

For some developed nations, export-import banks are a mechanism to promote national technologies

Fig. 17.20
The ADB in conjunction with GTZ and UNCRD has supported BRT training in Manila.
Photo by Lloyd Wright



and firms. Loans are extended on a bi-lateral basis to developing nations if there appears to be a benefit to the developed nation's interests. Thus, if markets exist for construction companies, vehicle manufacturers, and fare equipment vendors from developed nations, then concessionary loans from bi-lateral export-import banks are a possibility for developing-nation cities.

While to date these bi-lateral lending institutions have not been involved in the infrastructure side of BRT projects, several of them are interested in lending money for BRT infrastructure if their own corporations are involved. Those export-import banks actively involved in lending money for infrastructure include (but are not limited to):

- German Kreditanstalt für Wiederaufbau (KfW);
- Japanese Bank for International Cooperation (JBIC);
- United States Export-Import Bank (EX-IM Bank);
- United States Overseas Private Investment Corporation (OPIC);
- US AID's Housing Guaranteed Loan program.

The German KfW has been a principal financier for the mass transit rail projects in Bangkok due to the use of technology from Siemens. KfW is potentially moving ahead with a grant and loan to the Johannesburg BRT project. Likewise, JBIC has helped to finance the Delhi Metro system and its use of technology from Hitachi.

This form of “tied” aid may act to ultimately compromise the intended direction and quality of the project as well as increase the overall capital cost. Further, promoting developed-nation companies at the expense of local suppliers will likely be counter to local development objectives. Nevertheless, financing from export-import banks can be an important part of the financing package for vehicle procurement in some circumstances.

17.3.3.4 Emissions trading

To date, the emerging global market for emissions trading has yet to be used for BRT projects. The more readily available sources of other financing will likely make emission trading less useful than other sources in the short to medium term. However, there is future potential



for financing mass transit initiatives through emission reduction credits. The most prominent opportunities are related to reductions in greenhouse gas emissions. In 1997, under the auspices of the United Nations, member nations drafted the Kyoto Protocol. The protocol calls for developed nations to reduce emissions by an average of 5.2 percent from a 1990 baseline. The Protocol went into force on 15 February 2005.

Several mechanisms under the Kyoto Protocol hold potential to generate revenues for projects in developing nations that reduce greenhouse gases such as carbon dioxide (CO₂) (Figure 17.21). The initiatives inspired by the Kyoto mechanisms are being developed under the framework of the “Clean Development Mechanism” (CDM) and “Joint Implementation” (JI). These mechanisms permit investors to gain Certified Emission Reductions (CERs) by investing in emission reducing projects in developing nations and economies-in-transition. There also exists an active emissions trading market within the European Union (EU). Companies with emission reduction requirements within the EU are able to offset their requirements by purchasing verified emission reductions from other nations, including nations in the developing world.

Several bi-lateral and international organisations are working to support the burgeoning market in carbon emission credits. Some of these programmes include:

- ERUPT Programme (Netherlands);
- Finnish CDM/JI Programme (Finland);
- Austrian CDM/JI Programme (Austria);
- Belgian CDM/JI Programme (Belgium);

Fig. 17.21
Efforts to fight global climate change has resulted in existing markets where Certified Emission Reductions (CERs) can be traded on the market.

Photo courtesy of iStockPhoto

- Japanese CDM Programme (Japan);
- Latin American Carbon Programme, Andean Development Corporation (CAF);
- Prototype Carbon Fund (World Bank).

In addition to these governmental programmes, there are many private trading firms seeking to arrange carbon credit deals between buyers and sellers.

TransMilenio SA of Bogotá and the Andean Development Corporation (CAF) have had a calculation methodology for BRT approved by the United Nations Framework Convention on Climate Change (UNFCCC). With approval of this methodology, Bogotá hopes to claim “Certified Emission Reduction” credits to help finance future extensions to the system. The methodological challenges to gaining approval can be daunting, especially for projects such as BRT which depends on emission reductions from mode shifts. Further, the administrative and transaction costs can greatly diminish the net proceeds earned from the sales of carbon credits. Nevertheless, emission credits should be explored by cities developing a new public transport system.

17.3.4 Private sector loans and investment

17.3.4.1 Commercial banks

While development banks will often offer interest rates below those of commercial lending institutions, this type of concessionary financing may not always be available. A country may not qualify for concessionary terms or a city may have reached its borrowing cap with a particular lender. Also, development banks may be wary of lending to a project if the loan will act to crowd out interested commercial banks. Further, in some circumstances, the commercial lending rate may also be quite competitive with a development bank, if project development costs are included. Cities may also wish to include a commercial lender in the project for several additional reasons: 1. Diversification of financing sources; and, 2. Development of a successful track record with a commercial lender could be useful in subsequent project phases.

Municipal, provincial, and national governments frequently approach commercial banks to participate in the financing major infrastructure projects like metros and BRT. In metro rail

projects it has been fairly common for private banks to participate as part of a consortium of public and private lending institutions. As the experience with BRT has grown, commercial lenders have increasingly viewed BRT infrastructure as a viable lending opportunity. While private banks did not participate in the infrastructure part of the first phase of Bogotá’s TransMilenio, the system’s success has spurred a competitive environment for banks vying for participation in later phases. However, as most of this type of lending goes to sovereign or sub-sovereign entities, a private bank loan to a municipality for BRT infrastructure is generally assessed based on the faith and credit in the overall municipal finances. In such cases, the viability of the BRT system itself would be only a secondary concern to a private bank.

17.3.4.2 Public-private partnerships (PPPs) for BRT Infrastructure

Private sector involvement in BRT infrastructure investment has been extremely limited to date. It is conceivable that under very specific circumstances it could be beneficial for the public. In some cases private equity investment into infrastructure could help to reduce the public sector’s overall financing costs and diversify a financing package from dependence on public sources only. However, in other cases private infrastructure investment simply represents an extremely expensive form of public sector financing used only to get around legal borrowing limits. The marketing and managerial skills of private sector actors can sometimes help deliver a higher-quality and more professional public service, or it can be used to take advantage of unsuspecting or corrupt public officials and compromise the public interest for private gain.

Private investment in public transport infrastructure can take an array of forms including Public-Private Partnerships (PPPs) and Build-Operate-Transfer (BOT) schemes. In general, the idea is that the private sector provides investment capital in exchange for a concession agreement that gives the investor the right to collect some revenue stream like the fare, and/or to develop real estate along the corridor on state land. Private sector investment in public transport infrastructure has a mixed history, with both successes and failures. This section will

attempt to highlight the conditions to make a PPP-type arrangement work both for the private investors and the public transport system.

A public-private partnership (PPP) generally refers to leveraging private sector investment to deliver a public good such as a new mass transit system. Most BRT projects to date have made at least some use of private sector investment, but in most cases, private investment is restricted to the vehicle procurement and sometimes the fare system. While these type of arrangements are a form of PPP, this section examines the extent to which PPPs can be utilised to help finance BRT infrastructure. Section 17.4 addresses private investment for vehicles and other system equipment.

To date, private investment has not been used extensively to finance BRT infrastructure, with only the Santiago project currently attempting this type of financing. However, this mode of financing is an increasingly popular method for metro rail projects and toll roads. As such, while not generally recommended, PPPs are likely to be pursued by an increasing number of governments facing constraints from traditional financing approaches. This section reviews the likely structure of a successful PPP and presents both the advantages and disadvantages of the PPP approach.

Conditions for a successful PPP

A successful PPP should deliver a higher quality, more sustainable project that better serves the long-term public interest at a price that is competitive with other financing mechanisms for achieving the same public good. In rare cases, the project itself will generate sufficient revenue that the private firm's infrastructure investment can be fully amortised over the life of the concession contract. In other cases, a PPP may still require large government subsidies, but because of legal borrowing limits, lack of government technical capacity, or other specific circumstances, may be the only way to get a reasonably well designed BRT project implemented.

It is exceptionally rare that a mass transit system can generate sufficient revenues from fare revenues and real estate development to cover not only the operations but also all or part of the infrastructure from private investment. While BRT systems are certainly likely to get closer

to full cost recovery than metro systems, the conditions remain rare. Having a clear grasp on the inherent profitability of the system being designed is the critical first step for the public administrator to negotiate a reasonable deal for the public from private investors. Certainly, a system with the following conditions will increase the chances of possible private investment into infrastructure:

- Public transport corridor(s) is capable of attracting very high levels of passenger demand;
- Other lucrative income opportunities are included in the agreement, such as property development rights, leasing of space for telecommunications cables, advertising rights, etc.
- Length of concession agreement is relatively long.

The limits to the viability of this form of PPP, where full-cost recovery for private infrastructure investment is expected, are due to the basic economics of most public transport corridors, and especially for corridors in developing nations. In order to deliver a realistic and equitable fare level, most corridors will simply not generate sufficient revenues to cover infrastructure, rolling stock, and operational costs.

There are a few cities and corridors where full cost recovery of private infrastructure investment proved to be possible. The Hong Kong subway system is perhaps the world's most successful PPP. In 2004, the Hong Kong MTR Corporation achieved net profits of nearly US\$500 million. Each day an average 2.4 million trips are realised on the Hong Kong subway. The extremely high population densities existing in much of Hong Kong means that the system can consistently rely upon high passenger demand. The peak demand of nearly 80,000 passengers per hour per direction (pphpd) also does not dramatically fall to extremely low levels at non-peak times. The average non-peak afternoon demand in Hong Kong is approximately 70,000 pphpd (Frommer, 2006). Thus, a successful PPP may not only require an extremely high peak demand but also a relatively high non-peak base as well.

Even in Hong Kong, though, the PPP structure has meant limitations to system development. While publicly-financed metro systems in New York, London, and Paris host networks

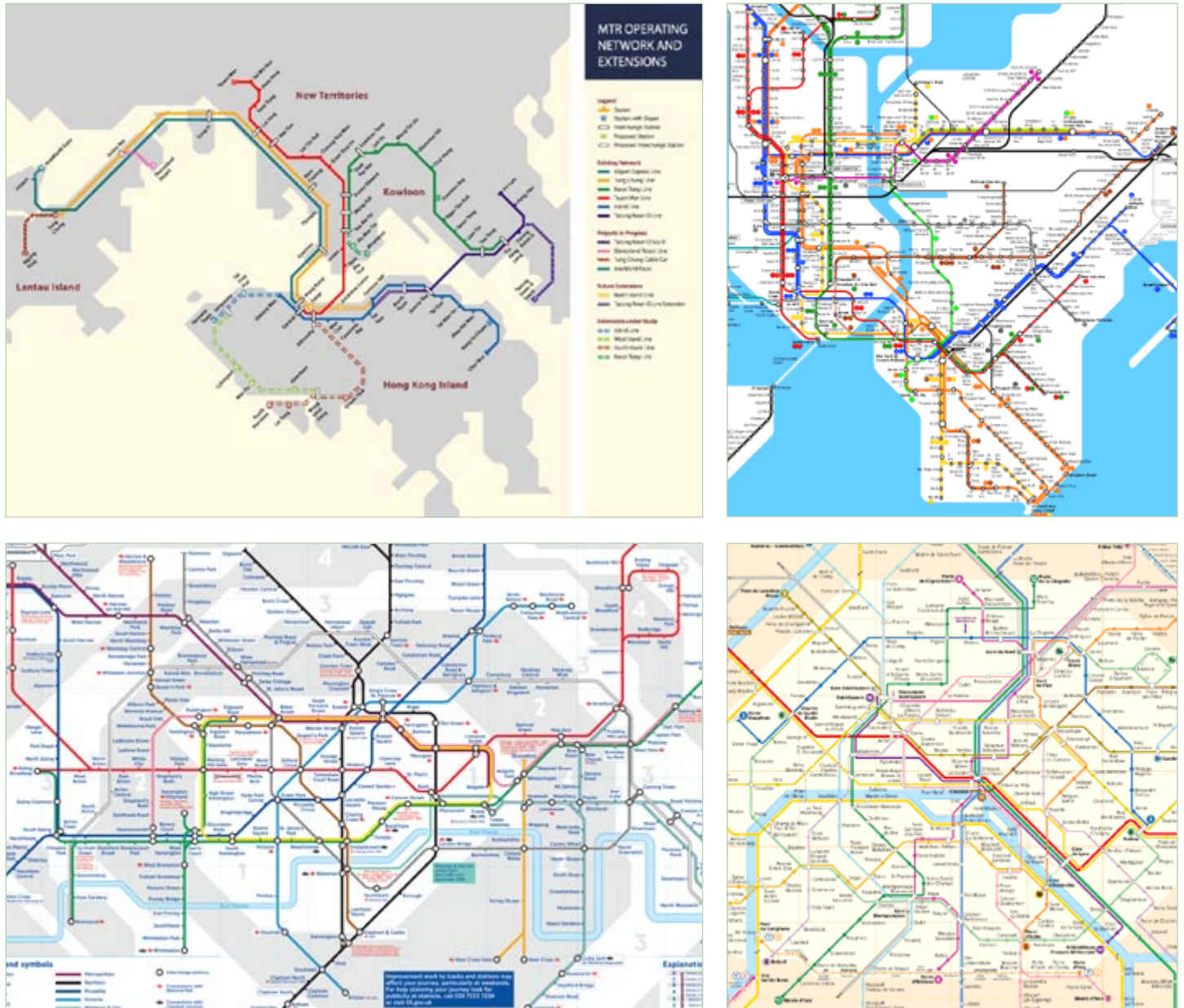


Fig. 17.22
Hong Kong's sole reliance on PPP financing for subway development limits the network size when compared to publicly-financed systems. Comparison of system networks (clockwise from upper left): 1. Hong Kong; 2. New York; 3. London; and 4. Paris.

spanning hundreds of kilometres of track, the Hong Kong system has been limited to just 88 kilometres (Figure 17.22). Since only the highest-demand corridors provide sufficient revenues for a PPP, Hong Kong's system effectively cannot expand beyond its smaller base (Frommer, 2005). For this reason, the Hong Kong PPP model is largely not being extended into the new metro systems of China. Instead, publicly-financed infrastructure is being combined with privately-managed operations. In many cases, the Hong Kong MTR Corporation is involved in managing the development and operations of these new systems. However, the Hong Kong MTR is largely not supplying the capital for

the infrastructure due to the limited number of cases where this approach meets investor requirements.

Beyond the example of Hong Kong, few other PPP arrangements have delivered the same degree of financial success. Both the STAR and PUTRA rail systems in Kuala Lumpur went through painful bankruptcies before eventually being nationalised by the government. The Bangkok BTS Skytrain system has likewise met with considerable financial difficulties in attempting to cover both the system's operations and the repayment of capital.

Advantages of PPP financing

From a government perspective, and particularly a developing-nation government perspective, the allure of PPP financing is quite clear. For a private company to promise a new mass transit system with no government cash contributions is an attractive proposition. A PPP can also bring with it managerial and technical expertise not normally accessible to many cities. Overall, the principal reasons a city may pursue a PPP are:

- The government may have a borrowing limit or other limitations in accessing long-term debt financing for large infrastructure projects;
- The government may not have the technical capacity to develop a good BRT system on its own, and may want to turn over the entire project development to a single private entity
- The government may want to share the risk of project failure with private sector entrepreneurs in order to better ensure project success.

While getting a low-interest loan from the World Bank or a regional development bank may ensure lower costs of capital, and better contracting procedures, it may be that the municipality cannot secure the political approval necessary from the national government to obtain an international loan. The municipality may also face legal limitations to turning directly to the capital markets or private banks for loans, or it may have already exceeded its legal borrowing limits. In such a case, the municipality might be willing to de facto give up a future revenue stream, such as toll revenue, land sale revenue, or land development rights along a BRT corridor, or might be willing to absorb a future debt obligation to a private company. If such circumstances exist, private financing should be considered as an alternative to project abandonment.

Designing a BRT system, preparing the contracts, negotiating with existing bus operators, and managing the entire project is not easy to do well, particularly in the reasonably short span of a single municipal administration. There are plenty of cases where public control over BRT projects have led to poorly designed and administered systems. Any problems with possible private infrastructure financing of BRT therefore must be weighed against the likely

outcome of public sector infrastructure financing in a specific context.

The most successful BRT projects benefited from an extremely enlightened Mayor and highly talented public administrators. This ideal condition rarely exists, however. Many developing country municipalities find it extremely daunting to handle a project of this magnitude and political and technical complexity. In reality, building the technical capacity within the municipality may be less costly than the concessions given to a PPP investor, and such in-house control may be more in the public's interest. However, if the capacity simply does not exist and cannot be readily attained, a PPP structure could be a reasonable alternative.

Proper management of any public sector initiative requires the careful balancing of private risks with private profits, and public risks with public profits. Because government incentives sometimes differ from those of public transport users, a case specific assessment will need to be made as to whether a commercial framework for project development will result in a better project than if largely political motives govern the project's design. If contracts are negotiated that protect the public interest with enforceable penalties for violation of contract, it is conceivable that a private concession for BRT infrastructure could be structured in a way that protected the public interest as well as a project with purely public investment, if the private financing creates an incentive for the BRT operations to be profitable and provide a good service.

Disadvantages of PPP financing

Applying PPP infrastructure financing to BRT projects faces some issues specific to BRT and some general issues that face most PPP infrastructure projects. The main issue with applying PPP to BRT infrastructure specifically is that BRT systems generally reconstruct an entire corridor in a way that affects not only the bus services but also mixed traffic, cyclists, and pedestrians and others not using the BRT system, and usually also involve improving water, drainage, and other infrastructure. For metro systems, the infrastructure being constructed is generally only used by the metro system. The total construction costs for BRT therefore tend to include very

important investments that are not absolutely necessary to the profitability of the BRT system but are critical for maximising the social benefit of the project. How to structure such a contract for a BRT project has yet to be resolved. There are some early discussions of BOT projects for the construction of “complete streets” but so far not in the context of a BRT system.

The remaining issues are generic to PPP infrastructure projects. The legitimate civic goals that could theoretically be accomplished through PPP should be balanced against the cautionary tale presented by the actual historical record of PPP in toll road and mass transit projects, where some problems have emerged. Such problems could also be encountered in a BRT project utilising PPP financing. Some of the difficulties encountered with PPPs have included:

- Inability of the government to protect the public interest in contracting;
- Only allows the most lucrative public transport corridors to be developed;
- Potentially results in reduced equity in terms of system coverage and fare levels;
- Potentially increased actual project cost to the taxpayers;
- Potentially less focus on quality of service;
- Political and regulatory risk to investors.

The main problem with PPP in infrastructure, and BRT would be no exception, is that to do it well requires a high level of sophistication in drafting and negotiating contracts, a highly

Box 17.1:
The Johannesburg Gautrain

In late 2005, the South African government approved the development of a heavy urban rail system for the Johannesburg area, as well as a link between Johannesburg and the capital of Tshwane (also called Pretoria). A “PPP” structure was highly touted by project developers as way to reduce public investment and public risk. However, in the case of Gautrain, the reality was a project with the vast bulk of the investment costs and the demand risk given to the taxpayer.

Since the project’s conception, the budget has increased by a factor of over three to R 25 billion (US\$ 3.3 billion) for a system that only provides a single corridor through Johannesburg. While the project’s success depends on high levels of mode switching from cars to rail, the risk of these projections fall almost entirely on the South African taxpayer. The private consortium thus enjoys the benefits of guaranteed government backing in case the ambitious passenger estimations are not realised. The Gautrain also is an example of using the “PPP” term to sell the project to the public. Private sector contributions from the Bombela consortium is expected to only total R 2.2 billion (US\$ 367 million), or less than 10 percent of the total. In return for this 10 percent investment, the consortium receives a 15-year operational concession along with demand guarantees from the government.

transparent decision-making process which reduces the risk of significant graft, and a legal system able to enforce contract violations. Of course, if these elements are in place, private investment into BRT infrastructure is probably not necessary. However, if a municipal government is sophisticated, transparent, and reasonably free of graft, many of the potential problems with PPP can be contained through careful contracting, sufficient public scrutiny and oversight, and transparent competitive bidding procedures.

PPP financing for infrastructure will quite often actually increase total financing costs. It is fairly typical for government officials to tell the public

Fig. 17.23
The Gautrain PPP gets underway in Johannesburg.
Photo by Lloyd Wright



that the private investor will pay for a public transport system with no financial burden to the taxpayers. However, the reality can be a series of hidden costs that actually amount to a higher interest rate than if the system was financed through other means. The municipality will likely be giving the private investor a long concession period in order to recover the investment. A long concession period reduces the municipality's control of the system and creates a loss of competitiveness over the operational concession. Systems like TransMilenio reap significant benefit from a structure that permits multiple operators competing within a single system. The proposed Gautrain system for the Johannesburg area of South Africa provides a striking example of how the "PPP" name has been used as a marketing tool to gain project approval but within a framework that puts the bulk of the costs and risks on the public sector (Box 17.1).

In a PPP, it will be likely that a single operator has complete control. Sole source contracts are likely to have more serious long-term consequences in terms of maintaining reasonable and equitable fare levels. Inflated construction costs are perhaps the least dangerous, for while they will increase the construction costs, these are a one time cost and need not necessarily be passed to passengers in the form of higher fares.

Usually, the parties willing to invest in a PPP or BOT structure are construction companies, vehicle manufacturers, public transport operating companies, real estate developers, and private banks. The primary motive for these private investors is frequently not the profits earned by the consortium itself, but rather from the lucrative no-bid financing, vehicle procurement, construction contracts, or side real estate developments. This loss of competitive tendering for financing, construction, and vehicle procurement will tend to increase project costs, and hence the real total financing costs. If a bus manufacturer was to lead a PPP, there could be considerable impact on long-term fare prices due to a non-competitive vehicle procurement process.

Being locked into a long-term concession contract with a single operator also carries with it the risk of being unable to replace an operator in the case of poor quality service. Since customer satisfaction may be a secondary objective to net

profit, service quality and customer care can suffer. An investing firm that is making most of its income from property development may in fact seek to minimise expenditures on public transport operations. However, to an extent these concerns can be mitigated by explicit penalties in the operating contracts. Further, in most cases, passenger volumes and therefore customer satisfaction will have an impact on the financial returns, even for non-transit revenues such as property development.

Hidden costs may also appear in the form of guarantees contained within the PPP contract. In some countries there are no laws requiring that the concession contract be a public document, and details of these guarantees may not surface until years later when the taxpayer may be called upon to absorb unfulfilled passenger revenues. Some PPP-type agreements contain language guaranteeing the investor a minimum passenger ridership, or government guarantees on loans, or operating subsidies, or a flat capital subsidy. The private investor thus has an incentive to present inflated passenger demand estimates relying on questionable modelling practices that are not certified by a credible technical authority. The level of financial risk that the taxpayers would be exposed to in the case of demand guarantees for a BRT project would likely be less than for a metro project, but the risk would nonetheless exist.

As has been noted by the successful example of Hong Kong, PPPs can imply an inherent limit to the network coverage provided by the public transport system, if a municipality insists on only financing projects where the full cost recovery form of a PPP is viable. Since in this case only the most lucrative corridors will provide an adequate return to the private investor, these corridors are the only ones constructed. Key origins and destinations from the customer's perspective may not be serviced if these areas lie outside the densest sectors of the cities. In turn, such origins and destinations may only be serviced by a lower-quality bus service, and thus implying a necessary transfer whenever a customer wants to access destinations along the main rail corridor. The "cherry-picking" of the most lucrative corridors by the PPP infrastructure also means that other public transport

options are at a distinct disadvantage in creating a full network with a sustainable customer base. However, if the services financed under the full cost recovery PPP financing system are fully integrated with other systems financed using different financing methods, this problem can be avoided.

The fare levels required for an adequate private sector return may also be at odds with public objectives of maximising public transport usage and overall social equity. The fare level that maximises revenues is rarely the fare level that maximises passenger use. As public transport use has positive externalities (less congestion, less pollution, etc), it is socially optimal to maximise ridership, but financially optimal to maximise profits. The Las Vegas Monorail was launched in July 2004 through a PPP-type financing arrangement with a private consortium. The system immediately ran into difficulties with both low ridership numbers and mechanical problems. The strain of capital repayment and operational losses has put the Las Vegas Monorail Company (the private sector firm) in possible jeopardy. In December 2005, the monorail company increased a one-way fare from US\$3 to US\$5. This move did lead to an increase in overall revenues, but conversely actually reduced the total number of passengers utilising the system.

By contrast, a publicly-developed system may place more emphasis on such issues as: 1.) Fare affordability; 2.) Benefits to low-income groups; and, 3.) Network coverage to all major sectors of the city and especially to low-income areas. It is possible that contractual agreements within a PPP could achieve some of these objectives, but the mixed objectives of private revenue maximisation and public policy maximisation can be difficult to reconcile within the constraints of a system only utilising private investment for infrastructure.

Finally, because such consortiums frequently make their money not from the operations itself but from the financing, construction, vehicle procurement contracts, or real estate developments, the consortium may allow the concession company to go bankrupt if problems arise. The firm will be essentially disposing of the non-performing public transport system. In this scenario, the debts of the bankrupt consortium are transferred to the government and ultimately to the taxpayer. However, the assets of the companies that won the lucrative construction and procurement contracts cannot be touched. The bankruptcy of both the STAR and PUTRA rail systems in Kuala Lumpur represents a classic example of this type of asset manipulation (Box 17.2).



Fig. 17.24
The PPP structure of the Las Vegas Monorail system has come under the strain of operational problems and poor passenger numbers.
 Photo courtesy of iStockPhoto

In some instances, capital costs can be reduced through concessionary financing or grants from developed-nation governments and private firms. The concessionary funds are provided as a means to promote the exportation of developed-nation products such as vehicles, information technology, and consultants. Concessionary terms can also be an effective technique to lock a city into a particular technology. The financial concessions may even be recouped later as the particular city extends the system. The Mexico City metro system, the Medellín (Colombia) urban rail system, and the Delhi metro system have also benefited from finance provided by,

respectively, France, Germany, and Japan at concessionary interest rates. Unfortunately, in the cases of Mexico City and Medellín the cost of extending the current rail system is prohibitively expensive since the concessionary terms are no longer available. Thus, some cities can become victim to a sort of “Trojan horse strategy” in which an initial corridor is provided at a reduced cost. However, once the city is locked into a particular technology, the price of future corridors returns to the higher standard rate.

It has also occurred that private investors have been hurt by governments unwilling to honour contractual obligations. In São Paulo, the Mayor

Box 17.2:
PPP bankruptcies in Kuala Lumpur

The PUTRA grade-separated LRT system went into operation in September 1998 with high expectations to help slow the city’s increasing dependence on private vehicle travel. With the PUTRA LRT Company (Projek Usahasama Transit Ringan Automatik Sdn Bhd) providing part of the investment in exchange for concession rights, the Malaysian government felt that the project represented a cost-effective option for the city.

However, after only three years of operation, the system had run up debts of over US\$ 1.4 billion. All the contractors and vehicle suppliers involved in PUTRA came away with large profits despite the system’s operational problems. Further, since the PUTRA LRT Company only contributed a 5 percent investment, the loss from the bankruptcy was minimal.

Unfortunately, Kuala Lumpur’s public transport problems were not exclusive to the PUTRA system. Another elevated rail system, known as the STAR Line, also had come under financial pressures. Like the PUTRA system, STAR was also based on PPP financing through a firm called Syarikat Transit Aliran Ringan Sdn Bhd. The STAR system was the first LRT to operate in Kuala Lumpur when it was launched in December 1996. After its first five years of operation, though, over US\$ 200 million in debt had been incurred.

With such losses becoming unsustainable, in December 2002, the Malaysian Ministry of Finance completed nationalisation of both the PUTRA and STAR systems. Thus, while the private developers slipped away with their profits in tact, the Malaysian taxpayer ended up bearing the debts left behind.



Fig. 17.25 and 17.26

The bankruptcies of the PUTRA and STAR rail systems in Kuala Lumpur meant that

the taxpayer and not the private operating firms absorbed the onerous debt levels.

Photos by Lloyd Wright

successfully convinced a private bus operator to invest in bus infrastructure in exchange for a monopoly concession in one corridor. The private operator agreed to build some new bus shelters and provide good-quality street furniture and other amenities. This arrangement did not include construction or maintenance of the roads, nor was it a full BRT system, but it could have laid the groundwork for such investments in the future. In the end, the municipality did not enforce the company's monopoly, and they could not win any compensation from the city for violation of the contract. This dispute led to rioting on the part of the bus company's employees. This experience has soured the idea of PPP in BRT infrastructure provision in Brazil, where it is perceived by some that the Brazilian courts find it difficult to enforce contracts with public entities.

Based on the issues identified in this section, *PPPs often prove to be a more costly financing option than traditional public financing.* A PPP can carry the risk of increasing operating costs, inflating fare levels, and delivering sub-optimal service provision. However, despite these problems, private sector investment in infrastructure is certainly an option to at least merit consideration during the development of a financing plan. Intelligently drafted contracts hold the potential to at least mitigate some of the worst problems associated with PPPs.

17.3.4.3 Advertising

Stations, terminals, and public transport vehicles will likely all come in contact with

thousands of customers each day. Since these customers are essentially a captive audience during much of their waiting and travel time, advertisers have not lost sight of the commercial potential within mass transit systems. The selling of advertising space to private firms can be a lucrative income opportunity for public transport systems (Figures 17.27 and 17.28). While advertising is unlikely to finance the majority of a new system, it may provide an income stream that can cover as much as 10 percent of a system's infrastructure costs.

The contracting of advertising rights can be accomplished through several different mechanisms. The public transport system can tender a concession to a private firm to manage system advertising for a set period of time. This private firm would have to abide by the advertising limits set forth in the contract. The private firm's payment to the municipality can either be in the form of a pre-determined amount or as a percentage of the advertising revenues. Alternatively, the private firm could fulfil its commitments through the direct provision of infrastructure. In this case, the firm takes the responsibility for constructing and maintaining a portion of the system's infrastructure in exchange for the advertising rights. In many bus systems, advertisers pay for bus shelters through which they obtain exclusive advertising access (Figure 17.29). Since the quality of the environment reflects how the advertising message is perceived, the advertising company has an incentive to maintain the shelter (or at

Fig. 17.27 and 17.28
Advertising such as utilised on the Kuala Lumpur PUTRA system (left photo) and the Bangkok Skytrain (right photo) can be effective revenue sources, but can also act to diminish the aesthetic nature and legibility of the transit system.

Photos by Lloyd Wright



least the part with the advertising message). For this type of arrangement to be successful, though, a carefully crafted contract is essential. Otherwise, the result can be a system that is quite effective at disseminating a marketing message but less effective at providing a public transport service.

In all cases, the commercialisation of the system must be done with a great deal of caution. Commercial signage should be discretely done, if at all, or it will risk degrading the visual and aesthetic quality of the system. When commercial signage overwhelms stations and vehicles, customers are then less able to distinguish signage relating to system use. The general despoiling of the aesthetic quality of the system can lower the image of the system, which is directly related to customer satisfaction and usage. Visual degradation can also lead to increased incidences of graffiti, vandalism and other criminal activities. Advertising messages delivered through audio and video messages may provide entertainment for some, but these messages can also be a significant distraction to customers wishing to read or study.

17.3.4.4 Merchandising

Merchandising the system brand can be a small, but steady revenue source that also brings with it other promotional advantages. The sale of system t-shirts, model stations and vehicles, and other souvenirs can in fact provide a reliable revenue stream. The marketability of the system relates back to the quality of the initial marketing impression (system name, logo, etc.) as well as the degree of social pride attained through the delivery of a high-quality product. Both the Bogotá and Curitiba systems make use of merchandising for both revenue and promotional reasons (Figures 17.30 through 17.33).

While the amount of revenue generated from merchandising activities is likely to only be a small percentage of total revenues, merchandising may help generate other forms of income. For example, merchandise with the system's brand name and image can do much to increase system awareness. In turn, this improved image and awareness can contribute to increased ridership.

Public transport agencies should move quickly to anticipate demand for products bearing their



Fig. 17.29

The advertising firm has an incentive to maintain the lighting at this bus shelter in Bogotá since the lighting directly affects the delivery of the message.

Photo by Lloyd Wright

brand and image. Otherwise, pirated products can quickly fill the market. The popularity of the Bogotá TransMilenio system was not lost upon street vendors who quickly delivered plastic toy articulated vehicles to the market. While such entrepreneurship can be a positive sign, it can also create issues over product quality and intellectual property rights. If the uncontrolled private sector merchandising leads to low-quality products bearing the system's name, then ultimately the value of the brand can be harmed. In response, TransMilenio eventually legally curtailed the sale of the street products and issued its own line of higher-quality goods.

17.3.4.5 Telecommunication rights

A new public transport system will likely traverse some of a city's most valuable properties. The reconstruction of the BRT right of way is generally a unique opportunity to improve all sorts of infrastructure, such as water, electricity, and telecommunications. Granting telecommunications companies the right to put telecommunications lines and services in the corridor potentially can help underwrite the infrastructure development costs.

Fig. 17.30, 17.31, 17.32, and 17.33
Clothing, umbrellas, office supplies, toys, and games are just a few of the merchandising products offered by TransMilenio.
 Photos courtesy of TransMilenio SA



As the information age of mobile telephones and internet communications has erupted onto the scene, companies providing these services sometimes lack the ability to cost-effectively deliver their product due through the existing street infrastructure. The array of water, sewer, electricity, and existing telecommunication infrastructure that consume limited above-ground and below-ground space makes adding new lines costly and difficult. Municipalities may be particularly reluctant to permit telecommunications firms to dig up the streets. The ensuing disruption to traffic can harm a city's economic functionality as well as erode public goodwill. The construction of the median busway presents a unique opportunity for telecommunications firms to deliver crucial infrastructure along a centrally-located corridor. For example, the construction of a new busway may make for the ideal opportunity to lay a fibre optic communications line. As the busway lanes and/or median

are being prepared, this construction period could be a low-cost time for other additions to communications services and public utilities. In many metro systems, air rights are being sold to mobile telephone companies wishing to make their service accessible while customers are in the underground system. Without special receivers and transmitters located in the subway tunnel, mobile telephone services are not possible inside the system. Since most BRT systems only operate above ground, there are no restrictions on mobile telephone access. However, in cases where BRT systems temporarily traverse underground or shielded areas, there may be some prospect for service agreements with mobile providers. Any addition of telecommunications infrastructure must be carefully planned in conjunction with the public transport infrastructure. Ease of access for repair work should be a prime consideration. A problem with the telecommunica-



Fig. 17.34

Selling rights to telecommunication lines, such as fibre optic systems, can be a business opportunity for some BRT systems.

tions line should not require disruption to the busway services. Thus, the telecommunications line should probably not be placed underneath a busway lane. Instead, the busway median or even the lane divider would be a more accessible location.

17.3.5 Infrastructure financing examples

Despite a relatively short history of implementation, BRT has been implemented through a wide variety of financing mechanisms. Local, national, international, and private sector sources have all played a role in system financing. This section briefly highlights the experiences to date.

17.3.5.1 Bogotá

As one of the world's most sophisticated BRT projects, Bogotá's TransMilenio is also amongst the most costly. With the project's first phase costing approximately US\$5.3 million per kilometre and the second phase requiring nearly US\$13.5 million per kilometre, the Bogotá system tested the viability of financing a world class system within a low-to-medium income nation.

Since the supporting Mayor, Enrique Peñalosa, had only three-years in office to implement the project's first phase, there was not a great deal of time to align extensive international financing. Thus, TransMilenio's Phase I relied principally upon the project team's ability to find local and national funding sources. Fortunately, the required local and national financing requirements did not represent an insurmountable obstacle.

The details of local financing for Bogotá Phase I are as follows:

- **Local fuel surcharge (46 percent):** Colombian national law allows City Councils to impose a surcharge on petrol. In 1997, the maximum a municipality could charge was 25 percent. However in Bogotá, the City Council had set this surcharge at only 10 percent. When Enrique Peñalosa was elected Mayor, he convinced the City Council to take the surcharge to its maximum, and earmarked the extra 15 percent to the construction of a new mass transit system. In 2003, President Uribe raised the maximum surcharge to 30 percent and Bogotá has already increased it to this new level, assuring resources for the future phases. Other Colombian cities are doing the same, especially those with BRT planning and implementation underway.
- **General local revenues and de-capitalisation of the municipal electricity company (28 percent):** In 1997, the Municipal Electricity Company was 51 percent owned by the municipality and the rest was privately held. At that time, the company had an excess of cash, and decided to de-capitalise itself. Some of these sources financed TransMilenio infrastructure.
- **World Bank credit (6 percent):** This was an initial credit given to the City of Bogotá (with the authorisation of the national government) to build a low-grade busway on "Calle 80" (80th Street). The World Bank allowed a change in the loan terms in order to use this credit for TransMilenio infrastructure.
- **National Government (20 percent):** Mayor Peñalosa signed an agreement with the national government to help finance the system. For Phase I, the national government contribution only accounts for 20 percent of the infrastructure costs, but for the upcoming

phases the national government is expected to finance 60 percent of the costs.

With the successful implementation of the project's Phase I, a wider diversity of financing sources have become available to subsequent phases. In fact, it has been the success of TransMilenio that has driven additional interest from sources such as the international development banks. The World Bank has become a major investor in Phase II of TransMilenio and has gone on to finance BRT projects elsewhere in the developing world, including other cities of Colombia.

17.3.5.2 Santiago

Santiago is the first city attempting to use PPP financing for BRT infrastructure. Most other private sector financing of BRT systems to date has been applied only to vehicles and fare collection equipment. The Santiago BRT system, called Transantiago, is hoped to overcome the city's infamous air quality and traffic congestion problems. Unfortunately, the launch of Transantiago has been beset with severe operational problems that resulted in four ministers being sacked.

In the case of Transantiago, the private sector operators are financing 69 percent of the Phase I infrastructure costs and 100 percent of the vehicles and the fare collection equipment. Construction of Phase I began in 2005. The system

opened with some of Phase I completed in February 2007. The public sector is contributing US\$103 million to Phase I infrastructure while the private sector is contributing US\$229 million. The Phase I infrastructure is being applied to a total of 81 kilometres of which only 22 kilometres will be segregated busways.

Transantiago is a bit different from a full BRT system. The system will extend to most parts of the city during Phase I through feeder services, which will be somewhat similar to the existing bus services. The trunk vehicles will operate both on and off the busways. All fare collection will be conducted on-board the vehicles. Thus, Transantiago is able to create a fairly broad city-wide network with a minimum of infrastructure investment. The trade-off is a lower-speed service than a full BRT system and a less-metro like performance overall.

If successful, Transantiago may do much to prove the viability of PPP financing for BRT applications. The challenge for Transantiago's private operators is to gain sufficient fare revenues to cover the system's operating costs while simultaneously repaying the initial investment. The current fare level for bus services in Santiago is a flat rate of 320 pesos (approximately US\$0.53). This fare level is somewhat higher than many developing-nation cities, and thus may help Transantiago's operators achieve a successful PPP.

17.3.5.3 Brazilian systems

Despite Brazil's fame in delivering some of the first BRT systems, there has been no national grant funding to support BRT development. By contrast, extensive national grant funding has been made available for the subway systems of Brasilia, Rio de Janeiro, and São Paulo. This discrepancy has been a source of ongoing political contention, and there are possibilities that the law may change. However, with the decentralisation of financing in Brazil, the national government has played a much less pronounced role in urban financing in general since 1988.

When BRT was first developed in Curitiba in the 1970s, Mayor Jaime Lerner was developing a system with few precedents, so the financing was difficult to secure, and the municipality had to rely on its own resources. With the success

Fig. 17.35
Transantiago is attempting to become the first BRT-type system to make use of PPP financing for infrastructure. The system's start-up has been plagued by severe operating problems.

Photo by Lloyd Wright



of the project, the Inter-American Development Bank (IADB) agreed to provide the financing for Phase II.

Brazil's national development bank (BNDES) is increasingly an option for cities developing BRT. In fact, the BNDES is also financing projects outside of Brazil when the vehicles utilised are manufactured in Brazil. The BNDES is currently supporting several of the new corridors within the São Paulo Interligado system. Historically, São Paulo has had BRT corridors under both the control of the municipality and of the state (*i.e.*, province), depending on which government body financed the project. To date, there has been no shared financing between local and state agencies, and thus coordination problems are a serious issue.

17.3.5.4 Mexico City

The BRT system in Mexico City opened in 2005, and the system currently carries approximately 250,000 passengers a day (Figure 17.37). Because of a financial crisis several years ago, the cost of obtaining international loans in Mexico can be quite high. For this reason, the Federal District of Mexico (*i.e.*, the city), when it paid for the BRT system's infrastructure, took out commercial loans from private banks. Such commercial loans are actually less expensive than World Bank loans, especially after the national bank BanObras adds all its national charges.

The State of Mexico (*i.e.*, provincial level) has also sought to develop BRT corridors. However, the State is currently so heavily indebted that commercial loans are not possible. A financial structure around three components was proposed to avoid the limitations due to the State's indebtedness. First, the municipalities in the State of Mexico through which the busway will pass still have viable credit. These municipalities may contribute roughly 30 percent of the infrastructure costs through either loans from commercial banks or from World Bank loans channelled through BanObras. Second, another 30 percent of the infrastructure costs may be financed through a special loan facility at BanObras. Third, the possibility is being explored of using the projected farebox revenues to back a bond issued by an investment bank. The



constituent municipalities and BanObras would be responsible for guaranteeing the bond issue. Thus, due to the State's debt status and a refusal to employ tolls on new motorways in the area, the interested parties are utilising a great deal of creativity to find a suitable financing structure.

17.3.5.5 African cities

As of April 2006, the new Dar es Salaam BRT system, the Dar Rapid Transit System (DART), is in the process of developing its financing package. The most likely scenario for financing the BRT infrastructure is a combination of World Bank loans and other development bank and bi-lateral loans to be repaid out of future revenues of the Road Fund (the national gasoline tax revenue), matched by current road funds and some modest municipal and sub-municipal (district) funds from parking fees and other general revenue. Currently the estimated cost of Phase I is around US\$60 million for a 23 km system, and the World Bank, using its low interest IDA window, is promising to fund around US\$40 million, leaving a US\$20 million financing gap.

Options for filling this gap are being explored while the final cost calculations are being completed. One such option is the Danish International Development Agency (DANIDA), which is already financing major road projects in Tanzania in conjunction with the European

Fig. 17.36
São Paulo's Interligado system is receiving financial support from the Brazilian national development bank (BNDES).

Photo by Gerhard Menckhoff

Fig. 17.37

Financing for the Mexico City “Metrobus” was largely obtained through loans with commercial banks.

Photo courtesy of Volvo Bus Corporation



Union. Additionally, the Japanese Bank for International Cooperation (JICA) and the German Bank for Reconstruction (KfW) are also possible sources of support.

For the proposed BRT projects in Dakar (Senegal) and Accra (Ghana), the most likely sources of financing are new World Bank loans, coupled with grant funding for project preparation from the Global Environmental Facility (GEF). In Dakar, the French Development Agency (AdF) has shown potential interest in financing the project.

17.3.5.6 Jakarta

Jakarta’s BRT system, called TransJakarta, has relied exclusively on local government funding. For the system’s initial phases, all infrastructure, vehicles, and fare collection equipment have been funded by the DKI Jakarta Government. DKI Jakarta is a special administrative district with the status of a province, although there is a minimal sub-municipal government structure within Jakarta. The Regional Parliament voted on and approved the financing. For TransJakarta’s first phase a total of only approximately US\$10 million was expended on the system’s infrastructure. The low initial investment level reflected lack of confidence in the project, and the deferral of other corridor improvements like improved footpaths until after the basic BRT

system was functioning. As political support has grown, annual investment into the system has increased.

Phase II, which was completed in 2006, cost roughly \$70 million, also included some improvements on the first corridor. Jakarta’s reliance on its own funds in part reflected its desire to not adhere to international competitive bidding rules, and in part based on tense relations between the Governor and the World Bank over unrelated issues.

17.3.5.7 India

Indian cities and the national government have shown much favour to PPP-type investments with regard to mass transit systems. For example, the Delhi metro system was financed with a 40 percent contribution from the national government, 40 percent from the Delhi local government, and 20 percent from private investors. Much of the governmental financing for the Delhi metro was actually provided by the Japanese Bank for International Development (JBIC) since Hitachi supplied the rolling stock and consulting contracts were awarded to Japanese firms.

The current policy of India’s national Ministry of Finance is to restrict government-subsidised contributions to 20 percent for any Build-Operate-Transfer mass transit or highway concession.

The remaining financing must come from either provincial and municipal governments or the private sector.

The new national policy towards PPP-financing has tried to bring some control to the ongoing free-for-all amongst specific transit technology promoters. Various competing plans for BRT, MRT, monorail, and a locally-developed “Skybus” are all being aggressively promoted by private interests across the country. Until recently, the lack of coherent planning guidelines and financing criteria has resulted in confusion. In Hyderabad, the government issued a competitive tender for a Build-Operate-Transfer project to provide mass transit services in three critical corridors. Expressions of interest were received from monorail companies, the Delhi Metro Rail Corporation, and other private investors, but no decision has been made on any of these proposals. Despite Hyderabad officials showing early interest in BRT, the lack of an existing consortium of BRT-related companies to promote the project has meant that the option may not have a chance there.

Currently, there are several BRT systems still moving forward in India: Ahmedabad, Bangalore, Delhi, Indore, Jaipur, and Pune. In Delhi, the Delhi Government has approved the financing of the first High Capacity Bus System (HCBS) corridor over an 18-kilometre stretch. The Delhi government has allocated roughly US\$30 million of general budget revenues to finance the construction. It has also given approval for numerous other additional corridors. Currently, disputes between the traffic police (which are under the control of the national government) and the Delhi Government continue to delay implementation.

Ahmedabad has in part given attention to the BRT option since national government support for a metro system is unlikely. As a relatively low-income city, Ahmedabad is investigating the potential of a PPP arrangement with private sector firms interested in BRT, but the most likely scenario is that for the 10-kilometre Phase I project the initial infrastructure financing will be paid by the Ahmedabad Municipal Corporation, using funds passed on to it from the State government of Gujarat. The profitability of the proposed system is insufficient to finance any



infrastructure from farebox revenues. In addition to any private sector sources, Ahmedabad is also investigating financing support from the World Bank, Asian Development Bank (ADB), and JBIC.

17.3.5.8 Chinese cities

To date, four existing bus systems in China might be broadly defined as BRT or busway systems: Kunming, Shejiazhuang, Beijing, and Hangzhou. Several others, including Jinan, Chengdu, and Guangzhou, are in the detailed planning stages.

Kunming

It was the lack of financing that made Kunming change its original plans to build a light-rail transit (LRT) system. Instead when the State Development Planning Commission did not approve the LRT funding in 1998, Kunming had to look at BRT as a more realistic option. Plans for the LRT system were already well advanced through the assistance of the Municipality of Zurich and the Swiss Development Corporation. Thus, the LRT plans simply served as the basis for the BRT system.

Kunming opened the first 5 kilometres of exclusive center lane busway in 1999 on Beijing Road, the major North-South arterial. In August of 2002 the city added 11 kilometres of exclusive busway down Dongfang Road, the main East-West corridor. The total existing

Fig. 17.38

The limited funding expended on Jakarta's Phase I infrastructure was provided by the Provincial government, DKI Jakarta.

Photo by Karl Otta, courtesy of the GTZ SUTP Photo CD-ROM

system cost approximately RMB 40 million (US\$5 million). Approximately half of the infrastructure investment paid for the bus shelters, and this entire cost has been covered by advertising revenues alone.

Prior to the construction of the BRT system, bus operations and bus procurement were subsidised by the government. However, with the completion of the BRT system, this subsidy has been removed as it is no longer necessary. However, the fares are regulated at 1 RMB (US\$0.13) per trip regardless of the distance or the type of vehicle, and all vehicles are owned by a public bus company. The revenue generated is not sufficient to significantly upgrade the quality of the vehicles, let alone to finance the expansion of the BRT infrastructure.

Shejiazhuang

The infrastructure in Shejiazhuang was paid for as part of a loan from the World Bank. The World Bank loan went to the national ministry of finance, which in turn loaned the money to a municipal corporation in Shejiazhuang. The building of the BRT was treated as a standard public works project.

Beijing

In Beijing, the cost of the initial phase was RMB 38 million (US\$4.75 million). The road infrastructure is being funded directly by the Beijing government. The vehicles, stations, and pedestrian infrastructure are financed by the BRT Company. Of the five shareholders in the BRT Company, two are private firms. For

future expansion, some of the financing options being considered for Beijing include pollution charges on private vehicles, congestion charging, and parking fees.

Hangzhou

In Hangzhou, the new BRT system has been financed by a municipal-owned company under the construction commission; the firm is called Hangzhou Urban Construction Assets Management Co. Ltd. Phase I of the BRT system required approximately RMB 150–RMB 200 million (US\$19 million–US\$25 million) for a system of 28 kilometres. This amount includes infrastructure construction and vehicles procurement. Some 40 percent of this cost, or approximately US\$9.6 million, is for the purchase of vehicles.

The first phase is regarded as a test, so the government will provide 80–90 percent of the financing. The other 10 to 20 percent will come from the General Bus Company, which is also owned by the Hangzhou Urban Construction Assets Management Co. Ltd. The system will be operated by the public bus company, General Bus Company, which will provide 10 percent to 20 percent of the vehicle procurement investments. There will be no bank loans for the first phase of the system.

17.3.5.9 US cities

The BRT systems developed to date in the US (Boston, Las Vegas, Los Angeles, Miami, Orlando, Pittsburgh) have been financed with a combination of national government subsidies and municipal and state bonds. Some 2 percent of the national gasoline tax revenues are earmarked for urban mass transit, and these revenues are administered by the US Federal Transit Administration (US FTA). US FTA has provided some capital grants for the BRT projects undertaken to date. Federal public transportation money for infrastructure in the US is largely controlled by congressional earmarks, leaving the US FTA minimal discretionary spending authority. The rest of the financing is generally the responsibility of state and municipal governments. State and municipal governments in the US finance most capital projects through bond issues. These financial instruments are less used in developing

Fig. 17.39
In Beijing, the local government financed the system's infrastructure while a consortium of shareholding firms purchased the vehicles.
 Photo courtesy of Kangming Xu





Fig. 17.40 and 17.41
Most US BRT systems, such as Orlando (left photo) and Miami (right photo), have been financed through a combination of municipal and state bonds as well as national government grants.

Photos by Lloyd Wright

countries, but they are gradually spreading to emerging markets. Prague (Czech Republic) and Krakow (Poland) have recently issued municipal bonds for urban mass transit projects.

17.4 Financing equipment (vehicles, fare system, etc.)

“When I was young I thought that money was the most important thing in life; now that I am old I know that it is.”

—Oscar Wilde, playwright and novelist, 1854–1900

The financing of BRT equipment such as vehicles and fare collection systems depends in part on the general operating economics of the system. If the system collects sufficient fare revenues, then these items can be amortised through the private operating companies. In general, successful BRT systems, such as Bogotá and Curitiba, have been able to finance vehicles through fare revenues. By contrast, if for some reason passenger numbers are not sufficient or if the city wished to maintain relatively low fares, then it is also possible to capitalise equipment. In this case, the financing would more likely resemble public infrastructure financing with a significant public sector contribution to the financing.

17.4.1 Financing vehicles

17.4.1.1 Vehicle costs

Vehicle costs are affected by a wide range of factors. The cost of the vehicles will first be related to vehicle size, the quality and power of the engine, the level of emissions controls, and the type of propulsion system. Features such

as the interior design and safety standards will also play a role. If vehicles have to be imported, which is frequently the case in the initial stages of a BRT system, shipping costs and the local tariff and tax treatment of the vehicles becomes extremely important. On top of this, the financing costs of vehicle procurement can be highly variable. Table 17.4 summarises approximate cost levels for different vehicle types, exclusive of shipping, tariffs and taxes.

Not all BRT systems invest in new vehicles. Some systems simply use the existing vehicles, or refurbished vehicles, especially in the case of feeder vehicles. The Transantiago system plans to make extensive use of existing vehicles for many of its corridors. However, in general, higher-end BRT systems will begin to modernise the vehicle fleets. New vehicles can be particularly important in attracting car owners into the new system.

The number of vehicles required will depend on the length of the corridors, the average speeds

Table 17.4: Approximate cost levels for vehicles

Vehicle type	Cost (US\$)
Diesel, standard sized (constructed in developing nation)	US\$30,000–US\$75,000
Diesel (Euro II or III), standard sized	US\$75,000–US\$130,000
Diesel (Euro III), articulated	US\$180,000–US\$250,000
Diesel (Euro III), bi-articulated	US\$325,000–US\$450,000
CNG or LPG, articulated	US\$250,000–US\$350,000
Hybrid-electric, articulated	US\$275,000–US\$400,000
Fuel cell, articulated	US\$800,000–US\$1,300,000

achieved, and the required frequency and capacity. Chapter 8 (*System capacity and speed*) of this guidebook provides the calculation methodology for determining the number of vehicles required for a BRT corridor.

17.4.1.2 Financing options

In cities generating sufficient fare revenue, the private concessioned operators will likely assume responsibility for purchasing the vehicles. Having the private operators own the vehicles also helps to set the right incentives with regard to vehicle care and maintenance. If the corporate entities responsible for operating the vehicles also own the vehicles, then it is likely that maintenance will be done in a more diligent manner.

Operator resources

While BRT systems can be highly lucrative in the medium and long term, the existing operators rarely have the upfront capital required to finance the vehicles. However, some upfront capital contribution should be required from the cash resources of the operators to ensure that the operator faces real financial risk in the venture. Existing operators often operate in difficult economic conditions constrained by set fare levels and poor network synergies. These firms may carry little capital and in some cases may be heavily indebted. Frequently bus operators are not really firms but simply individual owner-operators, which are in turn controlled by bus “enterprises” with few capital assets other than de facto regulatory control over lucrative routes. These enterprises and individual owners frequently have no or very limited credit history, and thus cannot not access standard bank loans. That does not mean, however, that they don’t have any investment capital. In Bogotá, the consortiums formed to bid on TransMilenio operations grew out of informal bus enterprises which did not have ready access to formal credit but did have access to investment capital.

It is critical for the government to thoroughly research the financial strength of the bus enterprises that are being invited to bid to become BRT operators so that a realistic assessment can be made about how much help they need in securing financing for the bus procurement. Thus, the starting place to analyse operator financing options is likely to be the operators’ own

resources. In some cases, the enterprises may possess quite a lot of cash revenues, and owner-operators have at least their existing vehicles as assets. Some operators may possess a bus depot area for vehicle parking, and this property may hold value to the new BRT system as a depot area, terminal area, or interchange station.

While the existing vehicles will likely not be of a quality standard for a new BRT trunk corridor, the older vehicles may hold value for feeder services. Even if the vehicles are not of use even for feeder services, vehicle scrappage may hold special value. In Bogotá, operators must destroy four to eight older buses for every new articulated vehicle introduced. The idea is to avoid these older, more polluting vehicles from simply being moved to another part of the city or to another city. Additionally, it is also a mechanism for ensuring that the owners of the old buses are compensated for the loss of value of their bus assets by the new bus enterprises. This practice is frequently important in lower-income countries where frequently many members of the middle class and even government officials have their private investments tied up in a few buses or minibuses. In order to obtain the required number of certified scrapped vehicles, operators may actually compete to find old buses to destroy. Thus, the older vehicles may actually hold a significant value to the companies wishing to operate in TransMilenio.

In most cases, though, the bus operators will have insufficient cash and collateral to pay cash for all the new vehicles required for the BRT system. Securing bank financing for newly created operating consortiums is frequently a challenge and should not be put off or the system will be built but have no vehicles to operate on it. Nevertheless, even with the lack of a credit history, credit can usually be secured under certain circumstances from the following:

- Vehicle manufacturers;
- Bi-lateral export-import banks;
- International Finance Corporation (IFC);
- Commercial banks.

Vehicle manufacturers

Vehicle manufacturers have an obvious vested interest in ensuring that the BRT system is successfully launched. In the case of the large, international manufacturers, such as Daimler-

FUNDING SUPPORT FROM GOVT. OF JAPAN FOR HIGH TECH ITEMS	
	(in million JPY)
GENERAL CONSULTANCY	5,742
FOUNDING AND TUNNELL'NG	3,719
ROLLING STOCK	37,960
AUTOMATIC FARE COLLECTION	2,291
SIGNAL & TELECOMMUNICATION	14,285
TRACTION	3,404
OTHERS	16,013
TOTAL	143,414



Fig. 17.42 and 17.43
The development of the Delhi Metro has been made possible due to the funding infusion from the government of Japan. In return, a Japanese technology supplier, Hitachi, has been awarded contracts for the system.

Photos by Lloyd Wright

Chrysler, Marco Polo, Scania, and Volvo, these companies sometimes provide the necessary financing. Companies like DaimlerChrysler have their own financial services branch to facilitate the procurement of buses. The financial services branch of vehicle manufacturers have much greater familiarity with the industry, the value of the product, access to resale markets for the vehicles in case of a default, and have other advantages as a credit provider for vehicle procurement. These companies may also have important relationships with bi-lateral lending agencies, and may be willing to provide credit guarantees that enables the operators to access other forms of commercial credit. The operators can and should use the competitiveness between the various vehicle manufacturers as leverage to shop for the best financing deal. This financing, however, ties the buyer to a specific manufacturer. Some of the new bus manufacturers emerging in China and India may eventually provide good vehicles at much lower costs, but they currently lack the financial servicing options.

Bi-lateral export-import banks

The home countries of the vehicle manufacturers may also hold a vested interest in ensuring their national products are used in the new system. In such cases, national export-import banks may step in to provide the required guarantees and financing. Rail system manufacturers such as Siemens and Hitachi have long benefited from national lending support to ensure developing nations select their products. Through lending of the German Bank of Reconstruction (KfW), Siemens has successfully been awarded large contracts for the urban rail systems in Bangkok. Through the assistance of

the Japanese Bank for International Cooperation (JBIC), Hitachi has successfully penetrated many Asian city markets including the Delhi metro system (Figures 17.42 and 17.43).

BRT systems are beginning to benefit from some of the same access to bi-lateral development banks. The Brazilian national development bank, BNDES, has financed Brazilian buses for Bogotá. Likewise, the Colombian national development bank has worked to enable financing for Colombian BRT vehicles to be utilised in Ecuador (Figure 17.44). In addition to requiring that the vehicles are manufactured in the home country, the export-import banks may place other stipulations on the loan. For example, the Brazilian development bank also required that the Bogotá operating companies secure vehicle insurance from Brazilian sources. This insurance requirement imposed additional costs on the operators, but ultimately the deal was arranged.

International Finance Corporation and regional development banks

The International Finance Corporation (IFC), the private sector lending arm of the World Bank, may be another option that private operator consortiums may consider for financing equipment like vehicles. An advantage of using the IFC is that it would provide the credit to the vehicle provider that won a competitive bidding process, rather than restricting the offer of credit to a specific vehicle manufacturer. The IFC’s mandate is to provide loans, equity, and structured finance in order to build the private sector in developing nations. While the IFC has yet to finance a BRT project, the organisation has given serious consideration to proposals, and its involvement is likely in Dar es Salaam.



Fig. 17.44
Through a loan from the Colombian national government, vehicles made at this plant in Bogotá have been exported to Quito (Ecuador).

Photo by Lloyd Wright

Perhaps the greatest difficulty from the perspective of the IFC is the relative size of a typical BRT project. Since the IFC normally prefers to manage loans of US\$20 million or greater (in order to reduce administrative costs), the bulk procurement of BRT vehicles for a typical developing-nation city may be below this amount. Thus, the very cost-effectiveness of BRT can in some instances work against its ability to interest certain types of investment. As part of the World Bank Group, the IFC may be able to offer credit terms that are better than those available through commercial lending institutions. However, whether or not the IFC actually offers an interest rate advantage will greatly depend on local conditions.

Many of the regional development banks, such as the ADB, the IADB, and the EBRD, are also allowed and even encouraged to make loans to the private sector, and also have private sector lending windows. These banks may provide smaller loans, and should also be explored regarding financing of the vehicle procurement.

Commercial banks

Commercial banks should be the first target for operators developing their financing strategy.

Securing commercial bank financing of BRT vehicles has been challenging though ultimately successful even without municipal or national credit guarantees. Unfortunately, since BRT is a relatively new concept, commercial lenders may be wary of participating in such a project. Alternatively, the commercial bank may attach an unusually high risk factor with such a new concept that will result in a very high interest rate, or require a full or partial guarantee from the municipality as a condition of the loan. Once the municipality provides a full credit guarantee, the municipality has absorbed the full financial risk of the project, something that should be avoided.

One mechanism to potentially gain a commercial bank's confidence in the project would be to invite the bank to participate in the consortium controlling fare collection. In such a scenario, the bank will have greater confidence in the revenue flows and thus will be more likely to extend the loan.

As noted above, the Phase I operators for Bogotá had little credit worthiness to access standard financing options. The Mayor did not want to offer a guarantee to the operators following the principal that the potential for profit should be balanced with the apportionment of financial risk. Their operating contracts with the city partially exposed the companies to demand risk. If the demand was below projections, the city was able to reduce the amount of vehicle kilometres, and as the operators were paid by the vehicle kilometre, this eventuality would adversely affect annual revenue. This possibility was partially mitigated by measures in the contract which allowed for the extension of the concession agreement in case demand was below projections. Despite the personal appeals of the Mayor, the Colombian commercial banks refused to finance vehicle procurement for these operators under these conditions. Thus, the Phase I vehicles were financed through the Brazilian national development bank, which had more familiarity with BRT and had the additional incentive to help the Brazilian vehicle manufacturing industry. However, with the success of Phase I, the concessioned operators in Phase II were able to gain greater access to loans from local commercial banks.



Fig. 17.45
In Phase I of TransMilenio, the Brazilian development bank (BNDES) was the principal financing entity for the procurement of vehicles by the private operators. However, with the success of the system, commercial lenders have now played a more active role.

Photo by Lloyd Wright

In Curitiba, by the time the BRT system was built, the private bus operators had already been formed into formal sector bus operators during an earlier round of bus sector reforms in the early 1960s. As such, these bus companies already had a relationship with private banks and had been operating profitable companies for many years. Curitiba's BRT system awarded the operating contracts for each trunk line to the same bus companies that had for more than a decade had a monopoly over bus operations in the same corridor. As such, the private bus companies had more investment capital of their own, and more ready access to bank loans. When Curitiba recently decided to upgrade to Euro III bi-articulated vehicles, for which there is only one supplier (Volvo), the cost was prohibitive even for these well-established operators. At this point, the private operators have turned to loans from BNDES, the national development bank, to finance the vehicle procurement.

Public financing of vehicles

Finally, public financing of BRT vehicles is also an option, although it should often be seen as the option of last resort. Public financing can create incentive problems regarding vehicle maintenance and long-term care. As noted earlier, the party that both owns and operates the vehicle has a clear incentive to maintain

the vehicles at a high level. A publicly-owned vehicle operated by a private company can be a recipe for poor maintenance and care. To an extent, these problems can be mitigated by a well-drafted contract that stipulates specific due diligence regarding maintenance and care. It can also be mitigated by having the private bus operator procure the vehicle but have the municipal public transport authority pay the operator at a rate per bus kilometre that is high enough to cover the cost of the vehicle procurement, even if the municipality is losing money on the service. In this way, the property right is transferred to the private operator and the maintenance incentive remains. The functionality of this approach depends much of the nature of the contract and the ability to enforce its contents.

Another disadvantage of public vehicle procurement is the risk of misappropriation or even corruption. The selection of a particular vehicle manufacturer or vendor may be accompanied by illegal payments to public officials. This situation obviously comprises the integrity of the entire project as well as undermines the quality of the final product.

Besides public ownership of vehicles, public sector involvement may also take the form of credit guarantees. In this case, the public sector is not directly providing the capital for the vehicles but rather is guaranteeing full or partial

repayment in case of an operator loan default. These guarantees should also be avoided, but may be necessary in order for a lending institution to do business with an operator that has little innate credit worthiness. From the government’s perspective, this arrangement can carry a fair amount of risk since a large liability could suddenly be forced upon the government. However, government-backed guarantees may be the only way some lenders may consider a project with actors of low credit worthiness. In some countries like China where the banks are directly controlled by the government, the requirement of a guarantee is less of an issue since the lenders are state banks and hence carry with them an implicit government guarantee.

Quito has largely provided public financing of vehicles for its three BRT corridors: 1. Trolé line; 2. Ecovía line; and 3. Central Norte line. In the case of Quito, public financing was a result of the operators’ limited capital resources and the uncompetitive nature of the system’s business structure. Quito did not competitively tender the two corridors that are operated by private companies (Ecovía line and Central Norte line). Instead, the existing operators on these corridors were given automatic concessions to the corridors. The lack of a competitive bidding process has limited the leverage of the local government over these operators.

Since the operators held out against contributing financing upfront for the vehicles, the municipality purchased the vehicles with the intent

to sell them over time to the operators through fare revenues (Figure 17.46). Unfortunately, since the operators control fare collection, there has been a lack of transparency in the remuneration of fare revenues. The operators claimed that due to insufficient demand, there were no remaining funds that could be applied to the vehicles. Only after five years of operation in September 2006, the operators of the Ecovía line finally purchased the vehicles at a greatly reduced price. As the Quito example demonstrates, public procurement of vehicles is wrought with a number of complications and incentives that can run counter to effective administration.

Government vehicle procurement is often quite common in the first phase of a project when other lenders may be uncomfortable with taking a risk on a new technology. In Jakarta, the Phase I of TransJakarta, the vehicles were procured by the DKI Jakarta government from general budget revenues, even though the service was turned over without a competitive bid to a consortium of the existing bus operators. In Phase II, the private operators invested in the vehicles, but again the contract was awarded without a competitive bid to a monopoly consortium comprised of the existing operators.

In Delhi, very few new buses (a total of six) have been included in the first phase of the High Capacity Bus Project, and these six new buses have been purchased by the Delhi Government. In Ahmedabad and Dar es Salaam no decision has yet been taken, but some form of subsidy for the vehicles may be required.

In China, the prevalence of public bus companies has prompted most existing projects to utilise public funds in vehicle procurement. In the case of Beijing, a BRT operating company was created at the project outset. This company is 46 percent owned by the Beijing Bus Corporation, a publicly owned monopoly bus provider. The Beijing vehicles cost approximately RMB 2.2 million (US\$275,000), including tax. In Hangzhou, Jinan, and other Chinese cities, the first phases of the BRT systems are all moving forward under the auspices of BRT companies owned by public bus companies, with the vehicle procurement being financed by the municipality and the bus company, with some

Fig. 17.46
On Quito’s Ecovía line, the municipality used public funds to purchase the vehicles for the private operators.

Photo by Lloyd Wright



marginal involvement of private investment being considered. In Guangzhou, where bus services were first deregulated in China, the BRT system is likely to be an open system with the new vehicles being procured by the existing assortment of public, private, and joint-venture public private bus operators.

Ideally, these systems will eventually shift vehicle procurement to private operators in future project phases. As governments and lenders become more experienced with BRT economics and profitability, then the scope for private sector involvement should increase.

17.4.2 Financing fare collection and ITS equipment

17.4.2.1 Financing fare collection equipment

The financing of fare collection and fare verification equipment depends much on how these costs are treated in the overall BRT business plan. If the equipment is considered part of the system's infrastructure, then it would likely be financed in a similar manner as other infrastructure components. If the equipment is expensed, though, then the financing burden would likely fall upon either the vehicle operating companies or an independently concessioned fare collection company.

The decision to capitalise or expense fare collection and fare verification equipment will likely rest with the potential fare levels and the cost of the fare collection technology. If the projected fare levels cannot accommodate amortisation of the fare equipment in addition to the other operating costs, then it is likely that the fare equipment will have to be included as an infrastructure item and financed accordingly. Most low-income nations will likely fall under this scenario since achieving a universally affordable fare level will be a major political objective.

Alternatively, in cities where higher fare levels are possible, then fare equipment might be accommodated within the operational cost structure. In this case, the financing options are largely the same as those of vehicle procurement: 1. Private operators; 2. Manufacturers; 3. Export-import banks; 4. Commercial banks; and, 5. Public sector. In the Seoul busway system, the concessioned fare company, called

the Korea Smart Card Company, financed the smart cards and much of the required fare equipment. This investment is recouped through a percentage charge on each fare transaction.

Likewise, the concessioned fare collection company on the Bogotá TransMilenio system financed the smart cards and fare equipment through its share of the fare revenues. The company receives approximately 9 percent of the fare revenues. In the cases of Seoul and Bogotá, the base fare levels of approximately US\$0.80 and US\$0.50 respectively, provides scope for this type of distribution to the fare companies. In lower-income cities, the ability to repay fare system costs through the fare revenues may be more limited.

17.4.2.2 Financing ITS equipment

Equipment related to applications of Intelligent Transportation Systems (ITS), such as real-time information displays, are most typically considered part of system infrastructure. ITS equipment is thus typically financed in the same manner as other infrastructure components. One exception to this rule is ITS equipment on-board vehicles. In this case, the ITS is just one part of the vehicle and would be financed as part of the vehicle procurement process.

Some systems have rather creatively financed ITS equipment through private sector means, usually through advertising revenues. The private firm will agree to provide, operate, and maintain the real-time information display in exchange for the right to also broadcast intermittent advertising messages on the displays. Thus, the display will switch between providing system operating information and marketing messages for private products. The obvious disadvantage of this arrangement is the reduction in value to customer who must wait through advertising messages before receiving the pertinent travel information. The LRT 2 system in Manila has employed this approach with its real-time displays on station platforms (Figure 17.47). The advertising messages will appear for 15 seconds while the next train information will only briefly appear. A customer may have to wait through several cycles before obtaining the desired information.

17.5 Financing for upkeep and maintenance

“Another flaw in the human character is that everybody wants to build and nobody wants to do maintenance.”

—Kurt Vonnegut, novelist, 1922–2007

Although maintaining the system’s infrastructure and component pieces may seem a far off concern at the outset of a BRT project, planning the financing of system maintenance should be well considered at the earliest stages. In many cases, the appropriate plan for financing system maintenance will involve embedding requirements within operator and manufacturer contracts. Thus, if maintenance stipulations are not considered early in the contracting process, the opportunity to optimise incentives for effective system maintenance can be lost.

A poorly maintained system will quickly undermine customer confidence and patronage as well as potentially affect system safety. Even after just a few years, weather and wear can act to cause infrastructure deterioration. Identifying a maintenance financing source at the earliest stages helps a city to proactively address an issue that has long-term ramifications on a system’s success.

17.5.1 Infrastructure upkeep and maintenance

The timing of BRT upkeep and maintenance will vary depending on the nature of the system component. In terms of basic upkeep, activities such as vehicle and station cleaning will commence from the first moments of operation. Landscaping along the routes will require

attention on a regular basis from the outset. The need for equipment and infrastructure repair and/or replacement will vary depending on usage conditions and the quality of the initial installation. Unforeseen material problems can occur early in the system operations. For example, deterioration of roadway or station infrastructure may occur due to local climatic conditions that were not considered in the original design.

17.5.1.1 System cleaning and upkeep

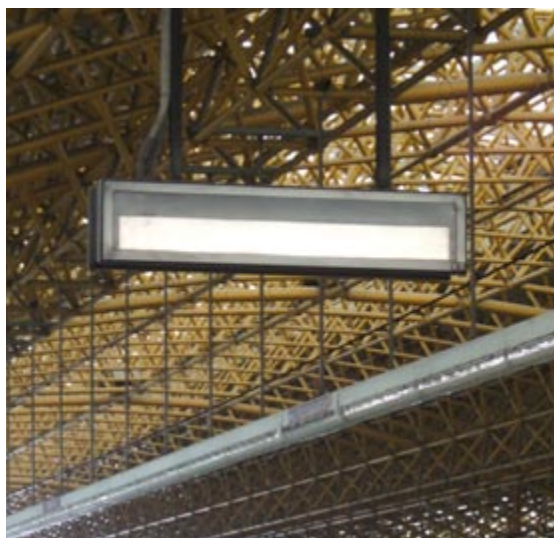
Most likely, a different financing strategy will be developed for basic cleaning and upkeep than for repair and replacement actions. Basic cleaning and upkeep are more closely related to on-going operational activities. Thus, one possible funding source for these activities is fare revenues. In this case, either the system’s public management company or the consortium of private system operators would finance and manage the cleaning activities from their share of fare revenues. Clearly, though, financing cleaning activities from fares will act to increase required fare levels. However, it is likely that cleaning activities are just one small part of overall operational costs and thus should not add appreciable pressure to fare levels.

Alternatively, infrastructure cleaning activities could be an activity entirely managed from the public sector side. This activity could then be funded by general tax revenues, just as street and footpath cleaning are currently funded and managed. In this case, the funding for cleaning and upkeep could be generated either from the general fund or from a dedicated stream tied to a transport-related revenue (*e.g.*, congestion charging, parking fees, licensing fees, etc.).

Additionally, some cities have turned over responsibility for station cleaning and upkeep to private firms through arrangements over advertising rights. Firms that are awarded advertising rights within the system essentially pay or partially pay for these rights through cleaning responsibilities. To an extent, these firms do have a vested interest in maintaining clean and attractive areas since the station environment will affect the value of their advertising product. In some cases, such as the functioning of lighting systems, there is a direct correlation to the effectiveness of the advertising and the quality of the infrastructure.

Fig. 17.47
The information displays on the platforms of the Manila LRT 2 system force customers to see advertising messages before providing pertinent travel information.

Photo by Lloyd Wright



17.5.1.2 Infrastructure repair and replacement

Infrastructure repair

Even for infrastructure components with a long lifetime, there will be routine maintenance activities requiring periodic attention. Stations will require painting or re-application of weatherisation coatings every few years, depending on the local climatic conditions, levels of exposure to exhaust emissions, etc. Runways may develop surface defects or “potholes” even prior to full repaving is required. Vehicle seating and interiors will become inadvertently damaged from wear and tear well before the vehicle’s ten-year lifespan is completed. Some levels of vandalism, such as graffiti, should be expected on an ongoing basis. For each of these scenarios, repair responsibility should be explicitly assigned to an entity well in advance of the project launch. Likewise, the financing of these routine repair activities should be pre-determined.

The Phase II contracts of TransMilenio represent a well-planned model for addressing on-going infrastructure maintenance needs. In

this case, maintenance is explicitly included as a responsibility within the original construction contract. Thus, the firm responsible for building the runways or the stations also has maintenance responsibilities over the expected lifetime of the infrastructure. This contractual arrangement holds several advantages over other forms of maintenance financing. First, the original contractors have a significant incentive to provide quality infrastructure at the time of construction. Since the same contractors will have maintenance responsibilities, they will want to make sure that long-term maintenance costs are minimised through quality construction. Second, the cost of maintenance is explicitly known at the project outset and is bundled within the total infrastructure cost. While this requirement may increase upfront capital expenditures, it does reduce the likelihood for maintenance to be ignored until it becomes a critical problem. The key to making this type of arrangement successful lies in the details of the construction contract. Penalties for poor-quality or untimely repair work should be clear in order to create the right set of performance incentives.

Alternatively, infrastructure repair activities could be managed by the public agency overseeing the BRT system or by the city’s public works department. In this case, infrastructure repairs would be funded in much the same way any other public infrastructure. The repairs could be enacted by public employees or by private contractors. Some of the standard financing mechanisms for this type of repair work include:

- Local tax revenues;
- Dedicated tax revenues (from road charging, congestion charging, parking fees, licensing fees, etc.).

Another option is to give infrastructure repair responsibilities to the private operating companies on the particular corridor. Originally, the public entity overseeing BRT corridors in São Paulo, charged operators 15 percent of fare revenues in order to finance system maintenance. However, since the public entity was doing a poor job of maintaining the busways, a new contract was established in which the operators took over direct responsibility for maintenance. In exchange for assuming the maintenance costs of the corridors, the operators were given a



Fig. 17.48

Ensuring a sustainable financing source for system upkeep and cleaning is essential to achieving good customer satisfaction, as shown in Bogotá.

Photo by Lloyd Wright



Fig. 17.49
Without a dedicated maintenance fund for dealing with problems such as graffiti, the quality of a system can quickly deteriorate.

Photo by Lloyd Wright

longer concession period. Since the state of the busway can directly affect the cost of maintaining the vehicles, the public entity decided it was the right incentive to give the operators control over system maintenance. However, there are several drawbacks to this approach. First, the maintenance costs are effectively increasing the required fare levels for customers. Second, the longer concession period given to the operators reduces the public entity's control and flexibility over managing the corridor.

Infrastructure replacement

Most BRT infrastructure should be designed to endure years if not decades of use. A well-designed station may be physically sound for 30 to 40 years. Runways will likely have a considerably lower lifespan, depending on local conditions and the materials utilised. An asphalt runway in a system using heavy vehicles and in a city with high rainfall may only last a few years. A concrete runway should last considerably longer, but as the Phase I experience of TransMilenio has demonstrated, failure can occur in a much shorter period of time.

Complete replacement of an infrastructure component (e.g., stations, terminals, and runways) should be given a projected timeframe at the outset. If a component will likely require replacement within a medium term period (less than seven years), then some early indications

of financing should be projected. Thus, the financing of runway replacement should be explicitly addressed at the time of its original construction. By contrast, for infrastructure components that will likely endure for 30 years or more (stations and terminals), there is no pressing reason to detail future financing requirements. By the time the replacement comes due, financial and system conditions will likely be significantly different so any projections would be quite speculative. Nevertheless, even for long-term replacement, some general financing strategies should be articulated and noted at the project's outset.

In general, the financing of component replacements should mirror financing options for the original infrastructure. These financing options include:

- Local, provincial, and national general tax revenues;
- Dedicated tax revenues (from road charging, congestion charging, parking fees, licensing fees, etc.);
- Commercial loans;
- Loans from development banks;
- Public-private partnerships.

Since the replacement period will follow a long operational track record, the financial community may be more interested in providing support. There will be less risk involved in financing an existing system with a known customer base than a new system with no certainties of success. Thus, the number of financing options for replacement infrastructure can well exceed the options available at the time of initial construction.

17.5.2 Equipment upkeep and maintenance

17.5.2.1 Vehicle maintenance

Mechanical maintenance

Ideally, the mechanical maintenance of a vehicle should be the responsibility of the same entity that owns and operates the vehicle. The owners have several strong incentives to maintain the vehicle at a high level. First, a well-maintained vehicle will operate more efficiently and thus minimise costs (e.g., fuel costs, spare part costs, repair costs, etc.). Second, a well-maintained vehicle will also retain a higher resale value once its BRT life is over.

Obviously, maintenance problems can inherently arise if the firm driving the vehicle is not the same as the firm owning the vehicle. In this case, the driver will likely take little care in maintaining the vehicle since the maintenance costs will fall upon someone else. For this reason, public vehicle ownership with private operating companies frequently results in poor vehicle life, although contractual conditions can mitigate these impacts to an extent.

Particularly in the beginning of a project when maintenance experience with a new bus type will be limited, it is generally a good idea for the bus owner to secure a service contract from the vehicle manufacturer, and to require representatives of the vehicle manufacturer to be on hand full time at the depot to ensure rapid vehicle repairs and ongoing maintenance. Vehicle failure at the initial stages of the project can be highly politically damaging and should be mitigated as much as possible. While the purchase price will likely be somewhat higher in order to accommodate the additional maintenance responsibilities by the manufacturer, it is generally well worth it in the initial stages until experience with the maintenance of the new bus type is developed. Some of the operators in the Bogotá system have entered this type of maintenance agreement with the vehicle supplier (Figure 17.50).

Cleaning and upkeep

Most often, the cleaning and upkeep of the vehicle is also the responsibility of the private company which owns and operates the vehicle. Contractual conditions within the company's concession agreement can make sure that the right incentives are in place to motivate a clean vehicle environment. Penalties for litter or lack of repairs can properly motivate the operators to maintain a clean vehicle. In the best performing BRT systems, operators will clean the interior of the vehicle after each corridor run and will wash the exterior at the end of the vehicle's shift.

In some systems, the responsibility for vehicle cleaning could fall upon the public company overseeing the system. This situation could especially be the case if the public company had some ownership role in the vehicles. However, as stressed earlier, this type of arrangement can be difficult to manage and can produce lower-quality results in terms of performance.



17.5.2.2 Fare and ITS equipment

The maintenance responsibility for fare equipment and Intelligent Transportation Systems (ITS) depends upon the contractual arrangement related to equipment ownership and management. In systems such as TransMilenio, where the concessioned fare company both procures and manages the equipment, then the responsibility will likely fall upon the private concessionaire. The reasoning is identical to that of vehicles; from an incentive standpoint, it is best for the equipment owner to take responsibility for maintenance issues.

However, if the fare equipment is owned by the municipality, then the fare operating company may not be in the best position to handle repairs and maintenance. The fare concessionaire may not feel comfortable taking responsibility for repairing equipment that it does not own. An improperly repaired machine may create warranty problems with the manufacturer and thus spark legal issues regarding responsibility. Thus, in some cases, or for some types of repairs, the actual owner of the equipment (*i.e.*, the municipality) may be best placed to take responsibility. For simple cleaning and upkeep, the concessioned fare operating company would likely be in the best position to take the lead.

As mentioned, the manufacturer of fare equipment and ITS equipment may also be involved in maintenance and repair work, especially

Fig. 17.50

The operating company Si 99 in Bogotá implemented a maintenance contract with Mercedes Benz, the manufacturer of the vehicles. Si 99 gains the maintenance experience of Mercedes while also minimising its own inventory of spare parts.

Photo by Lloyd Wright

when related to items under warranty. Since manufacturers may be unable to respond immediately to a failed system, contingency plans for back-up equipment should be firmly established. Fare collection or ITS equipment concessionaires may have responsibility over simple, quick repairs while the manufacturers will likely be responsible for more serious problems, provided the equipment is still under warranty at the time of the problem.

In all these cases, the actual responsibilities for maintenance and upkeep should be stated explicitly upfront through contractual arrangements. With clearly defined contracts, each party is able to appropriately assign cost estimates for their own responsibilities.

17.5.3 Security and policing

Security systems and personnel for mass transit systems can be financed in different ways, depending on the underlying philosophies and organisational structures involved. In some instances, security is financed just as any other operating cost. Alternatively, policing costs can be handled separately from the local or national police budget. Chapter 16 (*Operating costs and fares*) has already set out the merits of each approach.

18. Marketing

“We’re obviously going to spend a lot in marketing because we think the product sells itself.”

—James Allchin, former Microsoft executive, 1951–

Bus Rapid Transit is not just another bus service. However, communicating this effectively to the public is not an easy task. The negative stigma of existing bus systems is a formidable barrier to overcome in selling the BRT concept. In most parts of the world, the words “public transport” have the same connotation as some other public goods such as “public restrooms”. In other words, public transport is something that is not clean and not particularly nice, and should only be endured when truly necessary.

The right marketing campaign can help put BRT in a new light for the customer. Branding the system with an identifiable name, logo, and slogan can do much to place the new public transport system as a premium product choice for all. The marketing strategy should identify each of the appropriate mediums of communication, such as direct outreach, print, radio, and television, and devise a means to propagate the system’s message. Different marketing strategies should be tailored for each of the major target audiences, including existing public transport users, motorists, schools, and businesses.



Fig. 18.1

As the message in this bus shelter in Johannesburg indicates, the status and image of most bus services is poor in much of the world.

Photo by Lloyd Wright

All the best technical planning can be undone if the system is not presented appropriately to the general public. This chapter seeks to present the basic principles in outlining a marketing plan for the new public transport system. The topics discussed in this chapter are:

- 18.1 System name
- 18.2 System logo and slogan
- 18.3 Campaign strategy
- 18.4 Public education campaign

18.1 System name

“Make it simple. Make it memorable. Make it inviting to look at. Make it fun.”

—Leo Burnett, advertising executive, 1891–1971

The system’s name is one of the first decisions that will be taken on the new system since the project diffusion should be coupled with a specific name. Creating the right branding identity helps create the right image in the customer’s mind.

18.1.1 Naming options

There are a range of different strategies that can be taken in terms of creating an appropriate system name. Some of the different qualities that a new system name can exude include:

- Sophisticated
- Modern
- Serious
- Rapid
- Efficient
- Elegant
- Convenient

- Comfortable
- Social
- Fun and playful

The right identity will likely be the one that achieves to maximise ridership, especially with key constituent groups. Cities that have successfully implemented BRT have developed marketing identities that set their product apart and excite the public’s imagination.

Some systems, such as the Beijing BRT system, have elected not to create any marketing name at all. This decision means an opportunity has been lost in terms of creating a new identity for public transport in the city. Likewise, some cities choose fairly rudimentary names that merely provide a technical description of the system. Despite all the creativity that went into the Curitiba system, it is rather blandly called the Rede Integrada (the Integrated Network). While the name is accurate and descriptive, it perhaps lacks a flair that could better position the system in the minds of the public.

In many instances, avoiding the term “bus” can be part of a strategic plan to re-position the new public transport service in the market. The word “bus” can often carry a negative connotation, especially in cities where the existing bus service is of poor quality. Thus, the choice of “Metrobus” as the system name in both Mexico City and Quito may not maximise the opportunity for a new identity. Further, inclusion of the word “bus” can be restrictive in case the brand later expands to include other modes (*e.g.*, rail services, taxi services).

By contrast, terms such as “metro” or “rapid transit” can engender a very positive public image. For example, the developers of the proposed BRT system in Barranquilla (Colombia)

have chosen the name “TransMetro”, which helps to invoke an image of modernity, quality, and sophistication (Figure 18.2). Likewise, the new system in Guayaquil (Ecuador) is known as “Metrovía”.

Acronyms, such as BRT and MRT, should probably be avoided. An acronym will probably not have much meaning to a customer, and is thus in some ways a lost opportunity in terms of attaching an image around the system. Systems such as the MRTA in Bangkok and MRT in Hong Kong do not necessarily spark much meaning with the customer. Of course, in some cases, the acronym can double as a short word that holds relevant meaning. The Metropolitan Area Express or MAX in Las Vegas is an example of an acronym that works well in terms of holding a secondary meaning.

System names often work best when they carry a special local meaning, rather than just mimic some generic transport term. For example, system names such as TransJakarta (Jakarta) and Transantiago (Santiago) make use of the city’s identity within the name. Bogotá’s TransMilenio was developed at the beginning of the 21st Century and thus incorporated a word that notes the new millennium. Likewise, referring to the new century also brings about notions of modernity. Of course, names placed around a specific date or period must be careful not to be outdated in the future.

With the success of Bogotá TransMilenio system, many other cities have simply adopted a form of the word “Trans”. However, while there is value in associating a name with something successful, this also much merit to creating something fresh and new. Various cities have also taken a name from a variation of the word “rapid”, with Passo Rápido in São Paulo and Metro Rapid in Los Angeles.

The system name can be based upon a characteristic of the local environment. Thus, relating the name to a river, lake, or mountain can be appropriate, such as the proposed name for the Cartagena system, TransCaribe. Alternatively, the name of an indigenous animal can work quite well. The name of an animal that is fast or cute or both can be quite effective since it can serve both for the system name as well as a system mascot. Animals can be quite popular

Fig. 18.2

The proposed new system in Barranquilla (Colombia) uses the word “Metro” as part of its system name.



with young riders who can be important first movers in getting the entire family to use the public transport system. An animal or cartoon character can also be effective in personalising the system, and thus make it more than just a transport service (Figure 18.3). If the name evokes a sort of affectionate feeling, then there can be significant advantages in terms of creating public acceptance and ownership.



Fig. 18.3
In Aichi (Japan), a toy mascot is given the driver's seat in a driverless bus system with full optical guidance.

Photo by Lloyd Wright

A successful name in conjunction with a successful service can ultimately make the system a symbol for the city. The London Tube and the New York Subway are in many ways iconic symbols for their cities that in some ways are tourist attractions in their own right.

In tourist oriented cities or cities with a mix of cultures, a name that works in multiple languages should be considered. For this reason, shorter names tend to do well. The proposed Johannesburg system has developed the name of “Rea Vaya”, which translates to “We are Going”



Fig. 18.4
Johannesburg has created a name that works well across the variety of languages in South Africa.

Logo courtesy of the City of Johannesburg

in a local language (Figure 18.4). However, this name is also short enough and easily pronounceable that it works effectively with visitors as well.

Within Johannesburg’s system branding, the city has also incorporated the city’s shortened name of “Joburg”. Use of such nicknames can be effective in creating a personal affection for the system.

18.1.2 Process for name development

The creative inspiration for the system name and other marketing components (e.g., logo and slogan) can from any one of many sources. A municipality should make full use of the creative talents around it to develop its marketing approach.

Of course, assistance from a firm experienced in marketing and public relations can help to ensure all options and issues are considered. Public relations firms can help identify any potential problems with the marketing choices as well as lend advice on how to determine the appropriate name and logo. Marketing firms can also provide an array of different name options that may form the basis of the choice. The use of experienced marketing and branding firms in the process will ensure that the new public transport system receives as much professional advice as any consumer product going onto the market.

Fig. 18.5
Simulation of a focus group session during a training workshop in Montevideo (Uruguay).

Photo by Lloyd Wright



However, some of the best experts in terms of choosing the right branding are the future users of the system. Focus groups with perspective customers can be used to test name ideas as well as brainstorm on possible names. A focus group involves bringing together a random and representative sampling of the target audience to test out new concepts (Figure 18.5). In many cases, a public relations or marketing firm can help manage the focus group sessions.

Focus groups can also be conducted with other distinct groups, such as communications professionals, planners, and engineers. Each group can hold the potential to bring forward a different perspective. One technique for holding a focus group session is presented in Box 16.1.

Box 18.1:
Three-step focus group session

Step 1. Brainstorming

Open session in which as many suggested system names are generated as possible. Facilitator can help by suggesting names that address particular themes (fast, clean, etc.), concerns (security, comfort), and transport concepts (prefixes or suffixes such as trans-, metro-, express-, etc.). The key ideas behind the brainstorming session is developing a diverse set of options without criticising or evaluating the ideas presented. The brainstorming sessions can be held with public officials, marketing firms, as well as the general public.

Step 2. Focus group opinions

The system names generated in Step 1 are then placed before carefully selected focus groups. These groups will go through the names and give reactions and opinions. The focus groups will select a list of their five most favourite system names.

Step 3. Evaluating the final names

The initial group will meet again and decide on the final name, based on the report from the focus group and the name “finalists”. This group may also simply narrow the list to a few names to be given to political leaders for the final decision.

Source: Adapted from Pardo, 2006

Likewise, contests to develop a name and logo can be a creative and participatory way of bringing the public into the process. A contest with a substantive prize (such as a one-year public transport pass) can generate considerable excitement and interest in the new system.

Additionally, the system name and logo is certain topic area in which the political leaders, such as the Mayor, Councillors, and other public officials, can play an active role. In fact, the final decision on the system name should be made at the highest level of decision making for the system.

18.2 System logo and slogan

“You now have to decide what ‘image’ you want for your brand. Image means personality. Products, like people, have personalities, and they can make or break them in the market place.”

—David Ogilvy, advertising executive, 1911–1999

18.2.1 System logo

Beyond even the name of the system, perhaps the most recognisable and identifiable aspect of a system is its logo. The ideal logo will provide customers with instant recognition of the system’s purpose, quality, and location. The logo will appear on station signposts, system vehicles, as well as all outreach materials such as web sites and flyers.

The logo will likely consist of an image within a particular shape and colour scheme. The logo may also invoke wording, such as the system name and possibly, at times, the system slogan. In fact, great care should be taken to ensure that the system name and logo are complementary with one another.

The logo can take upon a variety of forms, including abstract shapes to defined images that directly relate to the system name. Brisbane’s simple red Busway logo is seen throughout the system (Figure 18.6). Signposts with this logo and colour scheme allow potential patrons to easily identify the location of a station.

The colours utilised within the logo and the physical system should also be carefully considered. Colours can both influence public receptiveness to the system as well as reinforce the system’s meaning to the city. For example,

Bogotá chose red as the colour for both the buses and the logo. The idea was to equate the TransMilenio system to the life-blood of the city with the BRT corridors representing the life-giving arteries. This concept was even extended to the system’s advertising campaign in which the circulatory system for the city was likened to that of the human body.

Other cities select colours that relate to a local flag or other identifiable attribute of the local environment. It must also be taken into account that colours generate different reactions in people. For example, psychological studies suggest that orange will make people walk faster, while a pale blue will make them feel calm. The Manila Metropolitan Development Authority (MMDA) chose to paint many of the sidewalk areas and other parts of its public space the colour pink. The Chairman of the MMDA, Bayani Fernando, felt that the pink colour would have a positive and calming influence on the population.

Figure 18.7 provides various examples of different system logos.



Fig. 18.6
The ubiquitous logo for the Brisbane system allows for rapid customer identification of station locations.

Photo courtesy of Queensland Transport



Fig. 18.7
Examples of system logos

Fig. 18.8

"Wherever life takes you!" is the tag line that accompanies promotional material for the Ottawa public transport system.



Unlike a system name or logo, the slogan or tag line can change with each new marketing campaign. The system name is intended as a permanent feature. The logo is likewise somewhat permanent, although it may be modernised and updated from time to time. However, the slogan will likely be tailored to the particular marketing emphasis of the moment. A campaign will likely run for a better of 6 months to 24 months, depending the budget available and the initial reception from the campaign's effectiveness.

18.2.3 Copyright protection

The new system's image, brand name, logo and slogan should be protected by trademarks and copyrights, as it will be an important asset for the system. The copyright should be held by the public authority and not by any of the related private sector firms, such as the operators or the marketing firms. If contractual conditions should later change, it is vital that rights to the system image remain in the public sphere.

A successful system will likely generate some imitation. For example, various businesses in Bogotá have adapted the name of TransMilenio in order to cash-in on the system's fame (Figures 18.10 and 18.11). Likewise, within a week of opening the Metrovía system in Guayaquil, other businesses were already expropriating the system name (Figure 18.12). As is often said, imitation is a form of flattery. Others will only try to expropriate the system's name if the name is perceived to have substantial value. The image would not be expropriated in this manner if it was not highly valued by the public.

To some extent, small-time borrowing of the system name should not be a significant concern, and in fact, can aid in marketing the system. However, if an outside firm is making a significant gain from the use of the name or image, or if the outside usage of the name or image could lead to a degradation of the system's perception amongst the public, then legal action should be taken. Thus, in general, the borrowing of the system's name and image should be avoided since their unauthorised use can ultimately damage the system's public esteem.

Illegal borrowing of the name or image can be a particular concern with merchandising. As noted in Chapter 17 (*Financing*), merchandising



Fig. 18.9

This marketing announcement for the Lo Angeles Orange Line highlights the time savings aspects of the service.

Image courtesy of the Los Angeles County Metropolitan Transportation Authority

18.2.2 System slogan

Creating a public recognition of the system can also be bolstered by a slogan or tag line that accompanies the name and logo. The message from such a slogan may highlight an aspect of the system that is of particular value to the targeted audience (Figures 18.8 and 18.9).

For example, the message may stress the time saving aspects, the level of convenience and comfort, or the modernity of the system. Above all, the slogan should be inspirational in motivating customer usage of the system. Some sample slogans include:

- Rapid transit for everyone;
- The fast way across the city;
- Relax and leave the driving to us;
- Not just another bus;
- Wherever life takes you;
- Connecting people to life;
- When you need to get there;
- The easy way to work;
- You'll never be late again.



Fig. 18.10
A toy TransMilenio roams the streets of Bogotá as an amusement ride for children.
 Photo courtesy of Oscar Diaz and Por el País que Queremos (PPQ)



Fig. 18.12
As the Guayaquil Metrovía system opens, so too does the "Metrovía Delicatessen". The expropriation of the system name for commercial purposes can be a concern of the system authorities who should seek copyright protection for the system name.
 Photo by Lloyd Wright

t-shirts, toy vehicles, and other items with the system name and logo can be a non-insignificant source of system revenue. If other private companies take the lead in doing this type of merchandising, then the system is forfeiting revenues. At first, street vendors sold many TransMilenio toy vehicles until TransMilenio itself took action to intercede and finally begin merchandising efforts itself.

Joint marketing efforts with corporate or other organisational partnerships can be an effective way to broad the reach of the system’s message. For example, the favourable response to the TransMilenio system and its positive image among the general public sparked a lot sponsorship and cross marketing interest within the business community. A prestigious bank for



Fig. 18.11
The TransMilenio name holds so much value that it is expropriated for other uses, such as TransMiperro ("Transport My Dog") which is a company that provides exercise for domestic pets.
 Photo courtesy of Activity Dog-TransMiperro

instance, offered a generous advertising budget to promote the system in exchange for permission to display its support for landmark ventures like TransMilenio in its official logo.

18.3 Marketing campaign strategy

"Business has only two functions—marketing and innovation."

—Milan Kundera, novelist, 1929—

The system name and image are just the outward representation of the overall branding and marketing effort. These tools should be supported by a comprehensive marketing campaign strategy that is directed towards achieving multiple objectives:

- Maximise interest and ridership in the system;
- Overcome doubts and concerns related to the system;
- Target different messages to specialised customer groups.

The marketing strategy will likely have initial educational elements as well as various long-term components. At the outset, the strategy will attempt to educate users about the new system and entice citizens to give it a try. At later stages, the strategy may play upon the initial successes as well as target groups that may lag behind in terms of usage (e.g., motorists).

18.3.1 Stakeholder analysis

As was done at the beginning of the planning process with the communications plan, a

stakeholder analysis is a logical starting point for developing a marketing strategy. Chapter 6 (Communications) provides a more detailed explanation of a stakeholder analysis.

In general terms, there are three stages to developing a stakeholder analysis:

1. Stakeholder identity;
2. Stakeholder positions;
3. Stakeholder strategy.

18.3.1.1 Stakeholder identity

Initially, the marketing team should attempt to understand the various segments that make up the potential public transport market. Some of the distinct customer groupings will include:

- Existing public transport users (bus users, rail users, etc.);
- Existing car users;
- Work-place commuters;
- Business professionals;
- Students (primary, secondary, tertiary) and parents;
- Persons with day-time errands;
- Women;
- Disabled persons.

In addition to these fairly broad consumer groupings, there may be specific organisations that are related to the particular market segment. For example, there may be a bus riders union that acts to protect the rights of public transport users. There are likely to be school and university officials, as well as parent

associations, who have an interest in the safe access to facilities for children and young adults. The Chamber of Commerce will have an interest in making sure employees have access to an efficient

18.3.1.2 Stakeholder positions

The segmentation process completed in the first stage of this exercise will help to recognise that different market groups will have different concerns and priorities. Each group will likely hold a different opinion on public transport. There are thus different types of “levers” that may either represent an obstacle to usage or represent an opportunity to sell.

For example, women may highly value the level of security within a system. This concern often means that women will not utilise a system, especially in the evenings. By understanding this concern, the marketing team may elect to highlight the various security elements of the new system (*e.g.*, security personnel, lighting, security cameras) when presenting the system to this audience.

As discussed in Chapter 6 (Communications), this segment of the process involves determining the concerns of each stakeholder group in relation to the use of public transport. Focus group sessions can be a useful technique to illicit the concerns and priorities of each stakeholder group. Bringing together a sampling of the potential stakeholder group and facilitating an honest and open exchange can be quite illuminating for the marketing team.

18.3.1.3 Stakeholder strategies

By understanding the needs and constraints of each market segment, tailored marketing strategies can then be designed and employed. This third part of the process is where the team begins to devise particular outreach strategies. The team will also begin to make decisions about which groups should be prioritised within the marketing budget.

The focus group sessions are a good place to begin testing individual strategies. For example, different types of messages may be tried in order to overcome concerns about system security, or sample messages regarding travel times and comfort may be attempted.

Fig. 18.13
By understanding the daily travel concerns of students and parents, it may be possible to position the new system as an affordable and safe option for a key constituency.

Photo by Lloyd Wright



Table 18.1 outlines some of the potential messages that may be appropriate for different market segments.

At some point, some decisions will be made regarding priorities within the marketing budget. Obviously, ensuring system acceptance from the core constituency of existing users, students, and commuters will be key to the financial sustainability of the system. However, it can also be worthwhile to put some efforts into influential market leaders, such as business professionals. These influential leaders can do much to enhance the system’s image through their participation. Further, attempting to attract existing car users will deliver multiple city-wide benefits in terms of environmental and congestion improvements as well as social integration. Catering to business professionals will also tend to force system developers to aim for a quality level that will be positive for all users.

Table 18.1: Potential marketing messages for market segments

Market segment	Potential messages
Students	Availability of special discounts Highlight technological aspects such as payment with mobile phone Social atmosphere of system Ability to study while using the system
Parents	Security aspects Safety aspects Cost-effectiveness of system
Business professionals	Work or relax while commuting Travel time savings Technological aspects of new system High-quality image of new system (status issue) Savings in the wear and tear on the personal vehicle Comfort and convenience Cost savings
Women	Safety and security issues Frequent off-peak services that cater to errands
Existing public transport users	Improvement in system quality Travel time savings
Disabled persons	Easy use features of systems

18.3.2 Campaign tactics

“Mix a little foolishness with your serious plans; it’s lovely to be silly at the right moment.”

—Quintus Horatius Flaccus, Roman poet, 65–8 BC

The market segmentation process and the development of particular strategies will next lead to the individual tactics required to carry out the strategies. These tactics will vary considerably depending upon the targeted audience, the concerns and priorities of that audience, and the resources available.

18.3.2.1 Approaches to stakeholder persuasion

Modern marketing techniques have increasingly looked upon the field of psychology as a basis for understanding personal decision-making processes. It is one thing to simply inform a person of a new public transport option, it is quite another to convince a person to change behaviour. An individual may undergo many stages of realisation before moving from contemplating a new transport option to actually trying out the new system. It may take further

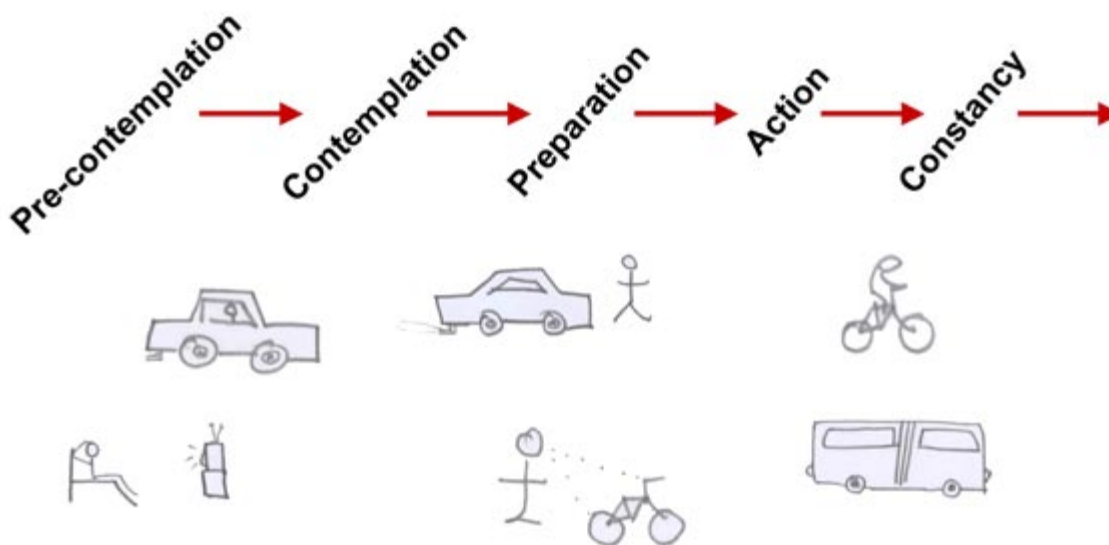


Fig. 18.14
Potential customers will likely move through many phases of understanding before actually making a commitment to a new transport option.

Illustration by Carlos Pardo

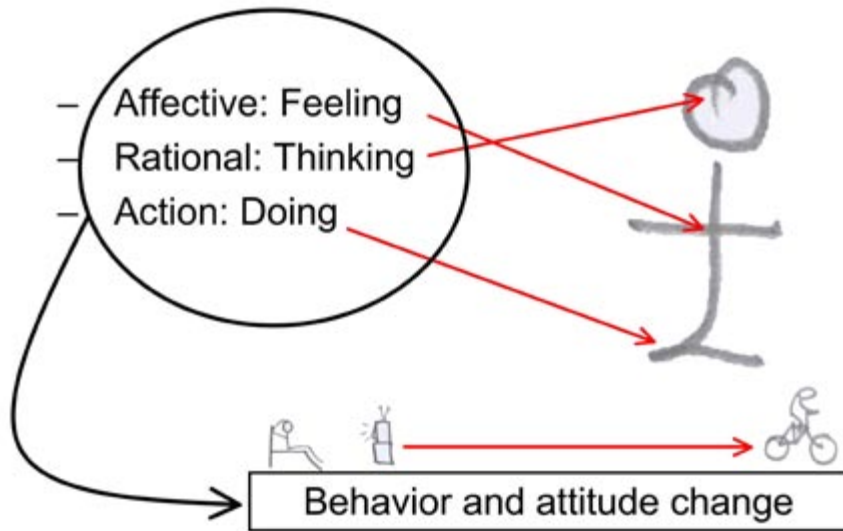


Fig. 18.15
By drawing upon a person's affective, rational, and active components, one can help stimulate behavioural change.
 Illustration by Carlos Pardo

conditioning and persuasion to move the person to a long-term commitment to a new form of mobility (Figure 18.14).

Many different techniques are available to help persuade individuals and targeted market segments to consider a new option. In general, there are three “channels” which are typically used to motivate personal change: Thinking, feeling and acting (Figure 18.15). These three degrees of personal involvement represent a stepped approach to realising behavioural change (Pardo, 2006).

Thinking: Logical arguments

The first (and the most common) approach towards changing someone’s view of a transportation mode’s effectiveness and sustainability is to explain the benefits of more sustainable mobility options through logical statements. Rational arguments over the cost and speed of a new travel option can help to capture a person’s attention and interest. A range of materials, including reports, presentations, photos, and videos, can help disseminate the logical arguments.

Feeling: Affective persuasion

Other than rational and logical arguments, emotional responses are also part of a human being’s attitude towards their physical environment. In this case, people feel good or bad in a certain place or with a certain mode of transport. In most instances, people feel better when riding a car, since it is more comfortable and they think it is the best option for all. There is also an emotional element to the status related to car ownership and usage (e.g., “you are what you drive”).

However, the attraction of the private car is not insurmountable. Customers may be persuaded towards public transport if they feel it is healthier, more socially friendly, and better for the natural environment. Additionally, a high-quality public transport system can begin to compete directly with the notion that a private car derives a higher status. Instead, if the car is associated with pollution, congestion, and alienation, then the entire concept of status related to transport can be reversed. If public transport is equated to better self-worth and a more beautiful city, then the person’s affective response could be quite strong.

Practice: Public transport usage

Finally, the third channel to change personal behaviour and attitude toward transportation is the development of practices that promote sustainable transport. A major obstacle is getting persons to try the public transport once. Thus, offering a free travel period, such as the first weeks of operations is one option. Holding car-free days is another. Finding creative ways to personally engage the public with their travel options can help to overcome the initial barrier that often prevents persons from even considering public transport. In a perfect scenario, thinking and feeling are setting the ground for sustainable transport practice, and people who have been exposed to all three channels should be convinced, persuaded and act accordingly.

18.3.2.2 Developing the outreach product

The creative process to produce a marketing message or advertisement varies with each marketing professional. The basis, though, should be the stakeholder analysis and an identification of the themes that will be important to key target audiences.

The copy (*i.e.*, text) of the message, the imagery, the voice, and the colours all should form a complementary package of ideas (Figures 18.16 and 18.17). Typically, a professional public relations or advertising firm should be employed to develop outreach products. Nevertheless, the in-house project team should also contribute to this process by providing ideas and feedback.



Fig. 18.16
Marketing outreach material for the São Paulo Interligado BRT system.

18.3.2.3 Events

Public transport is a concept intrinsically entwined with the quality of public space. The best mechanisms for promoting public transport are thus perhaps those that actively involve the citizen in the urban environment. Special events are opportunities to encourage the actual participation of the potential new public transport user.

Shows and entertainment

The civic pride exuded in the Bogotá TransMilenio system has meant that it has become a focal point for a range of public and private activities. These activities may actually not have any direct relation to public transport, but they can be effective in drawing new people to the system.

Special events such as fashion shows have been held inside the TransMilenio system. Television and radio shows have likewise been undertaken within TransMilenio. Interviews with celebrities are also known to take place against the now famous backdrop of the system. In one case, a couple even decided to hold their wedding reception inside the system (Figure 18.18).



Fig. 18.17
Material from the “TransMilenio: Capital Pride” campaign in Bogotá.

For the promoters of these events, TransMilenio offers a unique opportunity to relate the show or production with the city. For TransMilenio, the hosting of celebrity interviews and high-profile events represents priceless publicity and fame for the system.



Fig. 18.18
A couple decides to hold their wedding reception within the TransMilenio system.
Photo courtesy of TransMilenio SA

Fig. 18.19

Former Bogotá Mayor Enrique Peñalosa takes a TransMilenio vehicle for a test drive.

Photo courtesy of Por el País que Queremos (PPQ)



Public officials

The use of the system by public officials can also do much to draw attention to the system. If a Mayor, Governor, or other official makes regular use of the system, this practice sends an important message that the system is of high quality and that all members of society can be proud to use it (Figure 18.19). In some cases, cities have actively encouraged all public officials to use the system. Fare pass incentives and/or parking fee disincentives can do much to encourage usage.

Car-free days

Car-free days are increasingly high profile events that can be useful in awakening a city and its residents to the possibilities of a different urban environment. The principal premise behind such days is the idea of creating a “pattern break” in which awareness of transport alternatives is promoted.

“By creating a break in the normal pattern of behaviour, CFDs [Car-Free Days] can provide an opportunity for the citizens and the municipality to take a step back and reconsider the development path of the transport sector and whether it takes into account and meets the needs of all people... On an even broader scale, CFDs can serve to spark a dialogue about the future of the city and allow citizens to ask what exactly they envision their city to become in say, 20, 50, and 70 years” (UN-CFD, 2005).

Since 1998 several international campaigns have been initiated to promote car-free day activities. Western Europe has been a leader in the car-free day movement with France launching the first major nation-wide effort in 1998 with 34 cities participating. In the following year, over 90 Italian cities joined French cities in the event.



Fig. 18.20

The marketing identity of the International Car Free Day Campaign.

Image courtesy of the European Commission

In the year 2000, the European Commission’s Environmental Directorate became a member of the supporting consortium and now provides funding to promote the concept of a pan-European car-free day.

The day takes place on 22 September each year and varies in scope depending on the local circumstances. In some cases, the event may be just one street in one sector of a city. In other cases, there is a more expansive effort. The European car free day has also become known by the programme name of “In Town Without My Car!”. Since 2002, the day is held in conjunction with the European Commission’s “European Mobility Week”, which is a week of related activities aimed at raising public awareness on sustainable transport and acting as a focal point for new local initiatives (Figure 18.20).

The date of 22 September is now recognised as the International Car Free Day. While observed principally in Europe, other cities such as Bangkok (Thailand), Bogotá (Colombia), Jakarta (Indonesia), Taipei (Taiwan), and Toronto (Canada) have participated. Table 18.2 summarises the list of cities participating in the 2004 edition of the International Car Free Day (European Mobility Week, 2005).

There are at least two other significant dates in which some municipalities elect to promote car-free activities. “Earth Day” is held each year on 22 April. The first Earth Day was held in the US in 1970. An organisation known as the Earth Day Network uses the Earth Day event as an opportunity to promote awareness of a

range of ecological issues, including the impacts of motorised vehicles. The Earth Day Network encourages cities to mark the day with a pledge to supporting car-free experiments. In 2001, the Earth Day Network led efforts to hold the first car-free days in the US. In 2002, car-free events were held on Earth Day in not just US cities but also in Amman (Jordan), Dushanbe (Tajikistan), Kathmandu (Nepal), Lomé (Togo), and Seoul (South Korea).

Additionally, “World Environment Day” is held each year on 5 June. The activities of this day are coordinated through the United Nations Environment Programme (UNEP). The United Nations’ General Assembly established World Environment Day in 1972, which coincides with the establishment of UNEP. Car-free initiatives are sometimes one of the focus areas encouraged within the framework of World Environment Day.

Shenzhen (China) hosts its own “Green Action Day” in early June in conjunction with World Environment Day. Shenzhen’s inaugurated its event in 2004 and intends to continue into the future. The event in 2005 resulted in an estimated 100,000 residents giving up their cars for the weekday commute (Xinhuanet, 2005). Shenzhen is a special economic zone in China, meaning that the city is a target of significant economic development. Thus, Shenzhen’s experience represents a key example in one of the world’s most rapidly motorising nations.

Some cities have created their own day for car-free activities. The Peñalosa administration in Bogotá (1997-2000) chose the first Thursday of February as the target day. The Bogotá event has become the world’s largest car-free day by a single city since the private vehicle ban covers the entire expanse of the city, which has a population of approximately 7 million inhabitants. The Bogotá car-free day has been legally codified through a referendum. In addition, each Sunday some 120 kilometres of roadway is closed to car traffic (Figure 18.21).

A car-free day is an obvious opportunity to showcase public transport. It may be the only day that many persons will experience public transport since they may have few other mobility options for that day. Thus, every effort should be made to make a successful experience

Table 18.2:
Participating and supporting cities, International Car Free Day 2004

Country	Number of Participating Cities	Number of Supporting Cities
Albania	8	-
Argentina	-	1
Austria	197	-
Belgium	22	4
Brazil	59	8
Bulgaria	69	15
Canada	2	4
Colombia	3	-
Croatia	1	-
Cyprus	-	1
Czech Republic	25	7
Denmark	1	1
Estonia	1	1
Finland	15	2
France	33	3
Germany	27	21
Hungary	41	10
Iceland	7	-
Ireland	19	-
Italy	17	3
Japan	-	2
Latvia	1	4
Lithuania	18	-
Luxembourg	12	-
Malta	20	8
Moldova	1	-
Netherlands	-	20
Norway	1	3
Poland	109	-
Portugal	56	7
Romania	36	28
Serbia and Montenegro	6	-
Slovakia	1	1
Slovenia	18	3
Spain	211	1
Sweden	30	33
Switzerland	67	5
Taiwan	2	-
United Kingdom	10	42
Total	1,146	238

Source: European Mobility Week (2005)

Fig. 18.21

Bogotá's weekly closing of streets to cars on Sundays is an opportunity for many to enjoy the city with family members. It is also an opportunity to make use of public transport.

Photo by Lloyd Wright



for first timers to public transport. Unfortunately, because a car-free day encourages a large wave of new riders into the system, the vehicles can get over-crowded. For this reason, care must be taken to ensure that a person's first encounter with public transport is not a negative one with overwhelming numbers of persons. Assigning as many extra vehicles to the peak periods should be considered for any event of this type.

Commuter challenge

In many major cities today, traffic congestion has reached a point where public transport users, cyclists, and even pedestrians can often travel faster than the private car. Despite this reality, the perception of the car as the fastest way about the city remains. "Commuter Challenge" events were created to dramatically demonstrate the time advantage of alternative modes.

A Commuter Challenge event places teams of contestants about the city with the objective of reaching a final destination in the shortest amount of time. The event is partly a friendly race and partly a demonstration. The idea is basically to clock identical commute distances by as many different modes as possible. Thus, a jogger, a cyclist, a public transport user, and a car user all start off from the same origin and race the same distance to a defined final destination. Each tries to manage their commute in the shortest amount time that is legally possible.

Invariably, cyclists and public transport users end up "winning" by arriving ahead of the private vehicles (Figure 18.22). At times, even a jogger can get the best of a car commuter. The whole exercise is quite effective in raising awareness of actual door-to-door travel times. For example, it is often forgotten that a big part of any car commute is finding a parking space. Table 18.3 summarises the results from a Commuter Challenge event in Cambridge (US).

Table 18.3: Results of a 2003 Commuter Challenge in Cambridge (US)

Transport mode	Travel time (minutes)
Bicycle	13.6
Bus	20.2
Car	30.4

Fig. 18.22

In the London Borough of Merton, cyclists and public transport users get the better of car commuters during the 2004 Commuter Challenge event.

Photo courtesy of Paulo Câmara and the London Borough of Merton



18.3.2.4 Social marketing

To date, relatively little attention has been paid to one of the potentially transformative marketing techniques for the public sector. Social marketing, though, represents a package of outreach techniques that have shown much promise, especially in getting private vehicle users to shift to public transport and other sustainable options.

City officials and innovative social entrepreneurs in Australia and Europe have developed a new technique for achieving dramatic changes in mode shares at very low costs. The technique, a form of social marketing, is known as "TravelSmart" in some applications in Australia (Figure 18.23). The idea is to simply give people more information on their commuting options through a completely personalised process, and then facilitating changes in travel behaviour. While the focus to date has been in developed countries, recent successes in Santiago indicate that it may be applicable to higher-income developing economies as well.

The technique involves phone contact with all households in the area, identifying the proportion of respondents who would be interested in making some changes in travel behaviour, and supplying them with information, *e.g.*, public transport timetables, maps of cycling routes, information on local facilities. For a proportion of respondents there are follow-ups with household visits. In some cases the informational work is complemented by improvements suggested through the interviews, such as better access to public transport services, new bus stops, provision of new timetables, and the extension of service hours, but for the most part the technique relies upon people changing their behaviour.

Another concept called "travel blending" uses similar techniques but also has residents complete seven-day travel diaries, which teams later analyze to devise suggestions on alternatives for the participant.

The results to date have been remarkable. In the first trial of TravelSmart in Perth, approximately US\$ 61,500 was expended in consulting costs to conduct the surveys and information provision activities. Of the 380 households targeted, the program produced a 6 percent decrease in auto



use immediately and an additional 1 percent decrease after 12 months. Public transport trips rose from 6 percent of all trips to 7 percent, cycling trips doubled from 2 percent to 4 percent. The results have held even two years after the assistance was delivered. The technique is now being applied throughout Australia and in some cities in Europe. Similarly impressive results are being achieved at extremely low costs.

The consulting firm Steer Davies Gleave implemented a Travel Blending program in Santiago, Chile. The Santiago results suggest that Travel Blending could become part of an effective, low-cost emission reduction package for certain developing-nation cities (Figure 18.24). Steer Davies Gleave report an astonishing 17 percent reduction in car driver trips (as a proportion of participating and non-participating households combined), with a 23 percent reduction in car driver kilometres and a 17 percent reduction in time spent travelling.



Fig. 18.23

The TravelSmart programme uses personalised outreach to help people overcome any perceived obstacles to public transport use. The results from cities such as Perth (Australia) have shown dramatic increases in public transport usage.

Image courtesy of TravelSmart

Fig. 18.24

Travel Blending has proven successful even in high car growth cities such as Santiago (Chile).

Photo by Lloyd Wright

The early results from both TravelSmart and Travel Blending demonstrate a profound conclusion around public transport usage. Many people do not utilise public transport simply because they do not understand it. These social marketing programmes mostly just help people get over the communications and knowledge barriers that prevent them from making the most of their public transport systems.

Travel Blending techniques may be well suited to an active role by NGOs, particularly in the collection of survey data and the development and dissemination of transport alternatives. In many communities, NGOs maintain a close dialog with residents and thus would be well suited to this sort of activity.

18.3.3 Media tools

A range of media tools are available to extend the audience for the particular outreach message. Each medium of communication brings with it different costs and different levels of effectiveness. In general, more costly mediums, such as television, offer the greatest message exposure. Also, mechanisms for personal outreach, such as street interviews, can be effective but costly. However, there are also creative ways of putting across the message without expending significant financial resources.

The choice of communication medium depends upon the cost and expected number of persons to be reached. The types of communication mediums include:

- Television
- Radio
- Newspaper advertisements
- Magazine advertisements
- Web sites
- On-line video (Figure 18.25)
- Billboards
- Flyers
- Street kiosks
- Group seminars
- Personal interviews

The message of the particular advertisement will likely vary by the medium being utilised. Television and radio will reach the broadest audience in terms of numbers, which implies the message used with these mediums will also be fairly broad in nature. By contrast, a presentation to the local parent-teachers association will be much more focussed in the type of content.

Competing against the large sums of that the automobile industry dedicates to advertising can be quite daunting. In the US alone, the automobile industry spends US\$ 21 billion each year in advertising (eMarketer, 2007). This sum is greater than the entire gross domestic product of many nations. In special events alone, auto companies expend substantial resources, as shown in table 18.4.

Table 18.4: US special events spending by the automobile industry

Company name	Amount of spending on special events in US during 2005 (US\$)
General Motors	225 million
Daimler Chrysler	150 million
Ford	135 million
Toyota	35 million
Honda	25 million
Nissan	20 million

Source: IEG

Thus, there may appear to be little that an individual public transport system can do to compete directly in the world of television and special events spending. Nevertheless, as a public service, public transport does have several tools at its disposal not available to others. Public service announcements (PSAs) permit messages related to topics of public interest to be shown without cost on television and radio. In

Fig. 18.25
Video is increasing a powerful force for communicating ideas on public transport.
Image courtesy of Carlos Pardo





Fig. 18.26
Quito markets its future system expansion during a public exhibition.
 Photo by Lloyd Wright

many countries, public and private broadcasters are required by law to transmit a certain percentage of their air time with such messages.

Additionally, there are outreach resources that do not involve a significant cost, beyond the initial organisation. Outreach efforts with school children can be particularly effective. By developing materials for dissemination in schools, the public transport system cannot only lay the groundwork for future ridership but school children are one of the best resources for convincing parents. Giving public transport interactive materials to children often means that the children will be telling their parents about the new system.

Kiosks in public venues are a big advantage that public systems hold over the private sector. Cities such as Brisbane and Ottawa have quite effectively made use of information kiosks as a way of introducing the system to the public. Kiosks and displays afford a great opportunity for citizens to ask direct questions about the new system in an easy and comfortable environment (Figure 18.26).

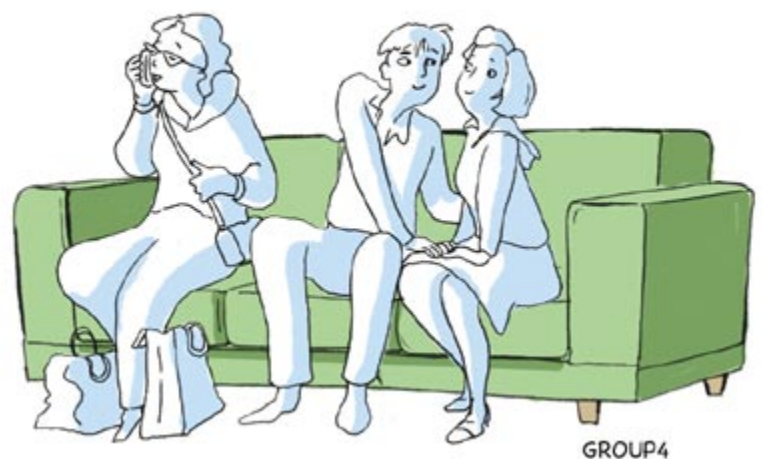
The United Nations Environment Programme (UNEP) in coordination with the International Association of Public Transport (UITP) produced a spot television advertisement in 2005 that highlights the benefits of public transport

use (Figure 18.27). The theme of the advertisement was “The World is Your Home, Look after It.” In addition to stressing the environmental credentials of public transport, the advertisement also utilised imagery of a home sofa to highlight themes of comfort and convenience.

The best advertisement for the system may well be the system itself. The sight of a public transport vehicle whizzing by motorists stranded in traffic is probably the most effective means of communicating the new system. Messages on the exterior of the vehicle can heighten the impact. A message such as “You would be home

Fig. 18.27
The UNEP-UITP advertisement mixes scenes of a home sofa inside a public transport carriage, a message that stresses the comfort advantages of public transport.

Image courtesy of UNEP and UITP.



now if you had taken the BRT” can really make motorists take note. Messages that particularly note the time gained with one’s family and loved ones are often utilised in systems such as TransMilenio to firmly highlight what is at stake with travel time savings.

The marketing messages should not end with just getting a person to try the system. Reassuring the new customer that they have made the right choice is a critical part of the process. Regardless of the product, there is always the spectre “buyer’s remorse” in which a person can regret their choice. Thus, advertisements inside the system can be effective in reassuring the customer that they have chosen wisely. The messages can remind customers about the time and money that they are saving, as well as other benefits such as environmental protection.

18.4 Public education plan

“No matter what your product is, you are ultimately in the education business. Your customers need to be constantly educated about the many advantages of doing business with you, trained to use your products more effectively, and taught how to make never-ending improvement in their lives.”

—Robert G Allen, investment advisor

The initial outreach efforts on the new public transport system will be crucial to setting the right perception with the general public. Further, in order to make the system financially viable from the outset, it will be important to draw sufficient patronage even in the initial weeks and months of the system. To seek with the initial outreach, developing a public

education plan on the system will be key. The public education plan is a component of the overall marketing plan in which the emphasis is on getting the public familiar with the system.

Prior to the new transportation system’s commissioning, the general public must be instructed on available routes, services, fare purchasing, pricing schemes, service attributes, boarding procedures, rules, restrictions, system advantages, etc. Instructions must be communicated using plain language so that users of even the lowest education and poverty levels can understand them. Similarly, instruction should always be available at the poorest localities. Even experienced public transport users in the city may be unaccustomed to the features brought by the new system.

18.4.1 Outreach techniques

The manner of disseminating this information must also be considered. Communicating how the system will function can be accomplished using similar techniques as developed for the overall marketing campaign. The news media, web sites, and direct outreach are all options to be utilised in this initial information blitz. Cities such as Honolulu and Bogotá have effectively utilised direct outreach on the street to get the message across (Figures 18.28 and 18.29). Face-to-face interactions of this type allow people to freely ask questions. Additionally, these encounters permit the promotion efforts to reach individuals and communities who may be inaccessible by conventional means.

The public education process actually starts well before the system goes into operation.

Fig. 18.28 and 18.29
By employing direct outreach teams in cities such as Honolulu (left photo) and Bogotá (right photo), the message of the new public transport system is taken directly to the communities.

Left photo courtesy of the Honolulu Department of Transportation;
Right photo courtesy of Fundación Ciudad Humana (Human City Foundation)



Information kiosks such as those shown in Figure 18.30 are an effective means of reaching out to potential customers at an early stage. The kiosk will likely contain route maps, information brochures on how to use the system, and possibly even models of the stations, vehicles, and other infrastructure. Kiosk staff should be well informed on the various aspects of the system. The development of a list of Frequently Asked Questions (FAQs) can be quite helpful to the outreach staff.

As has been stressed throughout this Planning Guide, there is now an array of outreach and presentation tools that can help officials and the general public better visualise the future system. Visual images are very powerful tools for conveying a message. As can be seen from many documents related to transport projects, there is much advantage in showing examples with photos and graphics, since visual information is better processed, stored and understood by human beings. Also, it has a greater power of evocation and it condenses a high amount of information into a small amount of space. Drawings and renderings permit the public to visualise a future system, which can often be difficult to imagine if only explained in words (Figure 18.31).



Fig. 18.30

This information kiosk in Brisbane helps answer basic customer questions as well as begins the awareness raising process.

Photo by Karl Fjellstrom

Another dramatic method for showing how the system will impact the city is to show before and after images. The comparison of the two situations can do much to motivate citizens to give support to the new vision. The use of before and after images helped the Seoul city government to push ahead with the Cheonggyecheon public space restoration project

Finally, videos, while perhaps the most expensive medium to produce, are also perhaps the most effective in showing a realistic view of the



Fig. 18.31

Visual renderings of the proposed system, as shown here with the Eugene (Lane Transit District) system, can do much to excite the public over the system's potential.

Image courtesy of the TCRP Media Library

Fig. 18.32 and 18.33

Lima built a demonstration station in a central park prior to system launch in order to introduce the system to the public.

Photo courtesy of Fundación Ciudad Humana (Human City Foundation)



future system. Three-dimensional images within a moving sequence allow citizens to actually gain a sense of how the system will operate.

18.4.2 Soft launch

A “soft launch” implies developing some small-scale infrastructure based on the system design and allowing the public to view it. For example, in some cases, a city will construct a demonstration station as well as have new vehicles on display (Figures 18.32 and 18.33).

The demonstration sites may be a public park, a shopping complex, or the public administrative offices. In Lima, a demonstration station and vehicle was placed in a central park of the city. The best site is usually the one that will maximize exposure of the system to the widest possible audience. In some cases, it may be best to place several demonstration sites around the city.

One of the principal purposes of the demonstration site relates to public education on how the system will function. While the demonstration site will likely not actually provide any transport services, it does give residents a tangible example of the proposed system. Allowing residents to practice using the fare collection system reduces future uncertainty that can act as a barrier to ridership. Further, the demonstration also is one of the best means for achieving public excitement over the possibilities of a new system. Citizens can actually see and feel how the new system will change their city and their lives.

Fig. 18.34

An invitation to a TransMilenio launch event.

Image courtesy of Vacastudio



Fig. 18.35

The launch ceremony for Phase II of TransMilenio.

Photo by Lloyd Wright



18.4.3 System launch

The launch of the new system will be the culmination of several years' worth of planning and implementation efforts. Over the course of the initial weeks of the system, an initial impression will likely be reached by the media and the general public.

18.4.3.1 Launch event

The launch event itself represents possibly the single largest media and marketing opportunity the system will ever encounter. Maximising positive coverage of the launch should be the principal priority. The development to press releases and press kits should be completed weeks ahead of the event. Presenting “invitations” to the launch to key individuals is often an effective way of building enthusiasm (Figure 18.34).

The launch event can include both public speaking opportunities as well as entertainment. The public officials who gave the vision and political support to the project should be given an opportunity to express their joy over the project's completion. Likewise, all the individuals who participated in the project development should be recognised for their efforts. Music or other forms of entertainment may also be part of this event in order to ensure a feeling of celebration is reached.

18.4.3.2 Initial service

A new system can first be somewhat intimidating to many people. City residents will be unsure of where the system goes and how to use it. While the barrier to learning about the system may seem to be non-threatening, it is nevertheless a barrier.

One option to make the transition to the new system easy for the public is to provide free public transport services during the initial weeks of operation. This gift of free public transport for a few weeks helps to give people a positive initial impression of the system. The no-cost nature also means that a greater number of persons are will give the system a try-out.

In both Bogotá and Jakarta, people were given free rides in the system during the first weeks of operation. Though it can seem a loss in terms the system's revenue, it has been seen as an investment to capture the largest possible ridership in



the medium term. If a system has been properly “branded”, users will have the curiosity to know how it will work, where it will go and, in the end, they will decide if they will become users.

However, some care must be taken to ensure that the free initial service does not become too popular to the point of causing crush loading. If severe over-crowding occurs due to the provision of free service, then persons may have a somewhat negative first impression (Figure 18.36). It would be unfortunate if the initial crowding led some persons to conclude that they would not become future customers. Thus, in some cases, it may be best to only offer the free initial trial during off-peak periods.

18.4.4 Start-up glitches

Unfortunately, initial problems with the system are inevitable. A new public transport system in a large city is no small feat, and there are countless small aspects may initially go awry. The flexibility of BRT does allow system developers to often counter problems in little time. Nevertheless, the media and marketing team supporting the launch should be prepared for the inevitable initial problems. In general, honest replies about the issues and how they will be resolved are the best strategy. Clearly stating the remedial actions as well as highlighting the positive aspects of the system is a good strategy for dealing with such situations.

Fig. 18.36

In Jakarta, the initial weeks of free service did draw large numbers of curious citizens. However, the initial over-crowding may have also dampened enthusiasm for future use.

Photo by Shreya Gadepalli ITDP

Part VI – Evaluation and Implementation

CHAPTER 19



Evaluation

CHAPTER 20



Implementation plan

19. Evaluation

“Never measure the height of a mountain, until you have reached the top. Then you will see how low it was.”

—Dag Hammarskjöld, former UN Secretary General, 1905–1961

The true impact of new public transport system is not simply the physical system but rather the improvements that it creates in people’s lives. There are several reasons why the promoters of a new public transport system will want to evaluate the expected impacts of the system on traffic levels, on economic development, on

environmental quality, on social interactions, and on urban form.

Quite often, these evaluations are in fact required by financial institutions or development agencies. Governments and development agencies alike have a need for prioritising among good and bad projects. Further, decision makers need to know in advance what problems they may need to mitigate, and what possible benefits the system will bring to help sell the project to the public. This chapter reviews the standard evaluation methodologies that can be utilised in projects such as BRT initiatives.

The topics discussed in this chapter include:

- 19.1 Traffic impacts**
- 19.2 Economic impacts**
- 19.3 Environmental impacts**
- 19.4 Social impacts**
- 19.5 Urban impacts**
- 19.6 Monitoring and evaluation**

19.1 Traffic impacts

“The new American finds his challenge and his love in the traffic-choked streets, skies nested in smog, choking with the acids of industry, the screech of rubber and houses leashed in against one another while the town lets with a time and die.”

—John Steinbeck, novelist, 1902–1968

Planning a BRT system is generally an iterative process, and having some preliminary sense of the likely impact of the new BRT system on mixed traffic will play an important role in the design process. However, before a city opens a new BRT system, it is a good idea to have a clear idea of the specific traffic impacts of the project, so that the public can be prepared, and any adverse traffic impacts mitigated ahead of time. For this reason, the traffic impact assessment is generally a short term assessment of what will happen to mixed traffic soon after the system opens.

The initial modelling work used to select the appropriate corridors and generate the projected

BRT ridership numbers will be helpful but insufficient to do a traffic impact assessment and mitigation plan. Usually, during the preliminary design process, the planners will try to engineer the system in a way which not only improves the speed and capacity of public transport services, but also improves conditions for mixed traffic, cyclists and pedestrians. Such “win-win” design solutions are generally the best way to ensure the acceptance of the BRT system by the general public. However, such “win-win” solutions are not always possible, and frequently some compromises have to be made. Knowing the likely impact of different design decisions on mixed traffic speeds and pedestrian and cycling conditions is critical to helping the political leadership make difficult choices in the final design phase.

Once these difficult decisions have been made, and the initial design and planning work has been completed, it is appropriate to examine with greater precision how the new system will affect the city’s transport system. Motorists, taxi operators, and others currently using the



Fig. 19.1
In cities such as Pereira (Colombia), documenting the chaotic road conditions prior to the implementation of the BRT system can help to justify the project.

Photo by Lloyd Wright

road network will want to be reassured that the development of the BRT system will not lead to deteriorating traffic conditions (Figure 19.1). Conversely, if a decision maker decides to go ahead and make mixed traffic conditions worse in order to increase public transport speeds, they should be prepared to justify this decision to the public rather than being taken by surprise by a negative public reaction. A traffic impact analysis can help provide the political reassurance that the system will deliver its promise.

Once the full operational plan of the system is completed, a traffic modelling exercise should be conducted to project how the designed system will affect all forms of traffic, not only public transport passengers. The design information from the operations and infrastructure plans are necessary as inputs into the model. However, the information required for the traffic model to design the BRT system is generally far more limited than what is required for modelling system-wide traffic impacts. Usually to design the system, planners can get away with fairly robust demand estimates for the BRT system itself, and not worry too much about what is happening outside the BRT system. Using this method, good designers use their judgement to

design a system that minimises adverse impacts on mixed traffic, but information about site-specific traffic impacts is probably not sufficiently detailed.

A detailed traffic impact assessment will be done differently depending on whether or not the city has a full traffic model for all travel modes, or just a more limited model of only the BRT system.

If the city has a fully calibrated traffic model, it should be possible to determine with reasonable precision the likely impacts on mixed traffic in the BRT corridor at site-specific locations. If the city does not have a fully calibrated traffic model, it should be possible for most engineers to use standard engineering parameters to estimate the impact on mixed traffic, based on the following:

- The amount of functional road space available to mixed traffic;
- The amount of road space available to cyclists and pedestrians;
- The capacity of the intersections for mixed traffic;
- The number of buses and paratransit vehicles that have been removed from the mixed traffic lanes.

Normally, if engineers know the current level of motorised passenger car equivalents (pcus) passing through the BRT corridor, the existing functional road space available to mixed traffic, and the signal phasing at the intersections, one can get a fairly good idea of how the new BRT system will affect mixed traffic speed and capacity.

It is also critical to know at this point what impact the new BRT system will have on existing bus and paratransit services. Because existing bus and paratransit services tend to stop frequently in one or more curb lanes, these vehicles tend to have a severe adverse impact on mixed traffic conditions (Figure 19.2). If all existing bus and paratransit services will be removed from the mixed traffic lanes and these trips relocated to the BRT system, then the number of PCUs in the mixed traffic lanes will also drop significantly. If, on the other hand, the chaotic stopping movements of paratransit vehicles in the BRT corridor are allowed to continue in the mixed traffic lanes after the BRT

system is opened, then the risk of adverse traffic impacts is much higher.

Finally, the above impacts of the new BRT system will have an influence on the level of modal shift that one can expect from the system. Estimating this modal shift is often important to justifying the project to funders concerned about greenhouse gas emission reduction benefits, such as the Global Environmental Facility (GEF).

If the speed and the capacity of mixed traffic lanes are severely compromised by the BRT system design, this will tend to increase the short-term modal shift that can be expected. Alternatively, if the system is well designed to minimise the adverse impacts on mixed traffic, it is highly likely that the short-term modal shift benefits will be minimal. In this case, the modal shift benefits will manifest themselves primarily in later years as the BRT system maintains its mode share, whereas normal bus services would be expected to lose mode share over time.

Most of the time, adverse mixed traffic impacts of new BRT systems are concentrated at either the station area, where more road space is needed for the BRT system, or at the intersections, where changes in signal phasing and the reduction of road space available to mixed traffic have the most significant adverse impact on mixed traffic speeds. In these locations, it is a good idea to suggest some additional mitigating measures.

Normally, in developing countries, there are a host of simple, standard traffic management measures that have not yet been implemented in the corridor that would dramatically increase the roadway capacity and speed for mixed traffic. Implementing these measures at the same time as the BRT system will make it quite easy to mitigate any adverse impacts on mixed traffic from the BRT system. These mitigation measures might include:

- Reducing the number of signal phases by restricting low-volume turning movements;
- Removing parking;

Fig. 19.3

In building a station lay-by for the Quito Central Norte line, the planners cut away virtually all remaining space for pedestrians.

Photo by Lloyd Wright



- Tightening enforcement of restrictions on vendor activity;
- Improving channelisation (i.e., separation of different modes);
- Adjusting the length and number of queuing lanes;
- Widening the road at intersections or at station area or both.

▲ Fig. 19.2

The random and often unpredictable stopping patterns of existing public transport services can imply that a segregated busway will greatly improve conditions for private cars.

Photo by Lloyd Wright



Unfortunately, traffic modellers rarely concern themselves with non-motorised transport (Figure 19.3). However, if a BRT system narrows sidewalks or increases mixed vehicle speeds, it can have a fairly adverse impact on non-motorised travel, and might contribute to blight in a corridor. When the Santa Amaru corridor was constructed in São Paulo, for example, the narrowing of sidewalks contributed to blight in the corridor. In some countries, notably India and China, simply segregating bicycle and bus traffic can lead to dramatic improvements in the safety, speed, and capacity of both bike and bus facilities.

Conversely, if a BRT system is implemented simultaneously with improved facilities for cycling and walking, the improved corridor may lead to significant modal shift from taxi to walking and cycling trips. This modal shift will help contribute to improved traffic speeds in the mixed traffic lanes. This phenomenon is observable in Jakarta and Bogotá, for example. As a general rule, as much pedestrian space and cycling infrastructure as possible should be provided in all BRT corridors, particularly where the corridor serves a large number of short trips, where there are heavy flows of cyclists and pedestrians, or where such heavy flows might be induced.

19.2 Economic impacts

“Economic advance is not the same things as human progress.”

—Sir John Harold Clapham, economic historian, 1873–1946

19.2.1 Economic evaluation of BRT projects

Development banks frequently require an economic analysis of any major infrastructure project. Economic analysis is usually performed to indicate that the economic benefit of the project is greater than its cost (including the opportunity cost of capital). As BRT projects generally fund the infrastructure investments from public sources, the public should be reassured that the project’s economic benefits will be greater than their economic cost. Currently, there are plenty of poorly conceived and planned BRT projects going forward that would never have passed a reasonable economic appraisal. As such, requiring any BRT project to demonstrate a reasonable economic rate of return should be a standard planning procedure for both governments and development institutions.

Because it will affect numerous decisions about financing, it is generally a good idea for the project promoter to decide early on which elements of the BRT project should be expected to be self-financing, and those elements which cannot be expected to be self-financing. As a general rule, BRT systems should be designed so that all operations including the cost of the vehicles are paid through farebox revenues (*i.e.*, self-financing). By contrast, the initial infrastructure investment and infrastructure maintenance is typically paid for by the public.

As such, the main cost that needs to be subjected to an economic appraisal is the cost of the infrastructure. Usually this includes the cost of the stations, the reconstruction of the right-of-way, the terminals and depots, signalling systems and any ITS applications, and the fare system. The engineering team in conjunction with the business plan team should generate these cost figures. Chapter 11 (Infrastructure) presented a infrastructure cost model that can assist in estimating infrastructure costs.

The benefits of the investment will then be calculated using standard cost benefit methodology. The primary benefits to be measured may include:

1. the decrease (or increase) in travel time of public transport passengers times total passengers,
2. the decrease (or increase) in travel cost faced by public transport passengers times total passengers,
3. the impact on travel time and travel cost of other forms of traffic, times the number of people affected,
4. the impact of the system on environmental quality (*e.g.*, air emissions, noise pollution) and any quantifiable benefits to health and/or productivity,
5. the impact of the system on accidents and the resulting reduction in injuries, loss of life, and economic productivity.

While some of this data can simply be taken from the traffic impact assessment, normally the traffic impact assessment is primarily concerned with what is going to happen to the traffic immediately after opening the system. By contrast, the economic evaluation will need to look at the projected system impacts for the

life of the capital asset, usually twenty years into the future.

The entire purpose of a BRT system is that it allows a single urban corridor to serve an ever growing number of passengers without diminishing travel speeds. This structure in turn makes possible the densification of the BRT corridor. For example, a new BRT system on a high-volume corridor will generally be designed in a location where the mixed traffic lanes are reaching capacity. Maybe these mixed traffic lanes currently handle some 2,000 to 4,000 passengers per hour per direction (pphd) at the peak hour (Figure 19.4). Normally, the capacity of the mixed traffic lanes would remain the same, whereas the new BRT lanes will now have the capacity to handle as many as 10,000 pphpd. If the system is using two lanes per direction, then capacities of 45,000 pphpd have been recorded (e.g., Bogotá’s TransMilenio). Not only does the BRT system make possible the densification of the corridor, it also virtually ensures that most new demand will be captured by the BRT system.

Defining and modelling scenarios for 20 years into the future with and without the new BRT system is a fairly typical traffic modelling exercise, with a few additional complexities. Normally, future trends are extrapolated from recent historical trends in population, employment, and vehicle ownership growth in the zones affected by the planned BRT corridor. Because the interactive nature of land use changes and public transport system improvements, one has to make certain reasonable assumptions about what will happen to population and employment growth in the corridor with and without the BRT project.

Without the BRT system, the 20 year projection should show a growth in motorised vehicular traffic and slowing speeds for both public transport and mixed traffic, until the lack of additional road capacity chokes off additional growth, at which point the assumption should be that new growth will go somewhere else. For



example, one might assume that population and employment growth in the corridor might relocate to some other location when traffic speeds drop below 10 kph.

With the BRT system, the 20-year projection would normally show a growth in motorised vehicular traffic and slowing speeds in the mixed traffic lanes until these lanes reach the design capacity. BRT vehicle speeds, by contrast, will be determined by the system design

Fig. 19.4
Mixed traffic lanes can generally only carry from 2,000 to 4,000 passengers per hour per direction at peak periods.

Photo by Lloyd Wright



Fig. 19.5
While a mixed-traffic lane will reach saturation in a given period, public transport systems have a large capacity to handle continued corridor growth.

Photo courtesy of ITDP

(ideally as high as 30 kph, at worst as low as 15 kph). These speeds should be assumed to be maintained throughout the 20-year life of the project, as the system should have been designed to comfortably handle 20 years of projected passenger growth (Figure 19.5). A safe general rule, therefore, would be to assume that the mixed traffic lanes will reach saturation, and that further growth in trips would be captured by the BRT system.

A primary difference between the BRT and non-BRT scenario in congested corridors would be that for the non-BRT scenario, after a certain number of years, population and employment growth in the corridor would stop, whereas in the BRT corridor it would continue at historical growth rates.

The economic appraisal of mass transit projects has been notoriously subject to manipulation by the project's promoters. One way to guard against abuse is to have the demand projections verified by an independent qualified evaluator. This entity should be a credible traffic demand modelling firm or agency whose results are trusted by banks.

Another way to minimise the risk of manipulation is to require that the demand estimate used in the economic benefits calculation be also used in the financial impact assessment, which in turn should be evaluated by private sector banking institutions.

To an extent, the business structure of BRT systems provides for a natural guard against overly-optimistic feasibility assumptions. In many toll road projects and metro rail projects, the system and its operations will ultimately remain in the public domain, and hence the losses incurred by wildly mistaken estimates must be absorbed by the hapless taxpayer. By contrast, with a BRT project, the private operator is typically responsible for vehicle procurement and must also absorb a significant share of the demand risk. Thus, when the private operator approaches a bank to lend money for the vehicles, the financial institution will likely insist upon some discipline with regard to the demand projections.

Once the 20-year scenarios (with and without the new system) have been developed, the difference in the net present value of the travel

time savings and cost savings of public transport passengers and the net present value of the travel time savings (or increases) and cost savings (or increases) for mixed traffic passengers can be compared.

Making this assessment requires giving a monetary value to time savings. This value can be calculated in several ways. The best way is to calculate the real value of time to existing public transport passengers. This value can sometimes be extrapolated from the traffic model based on observed behaviour. Otherwise, some reasonable value of time can be observed based on the observed demand on newly-introduced express bus services in the city, on new toll roads, etc. Alternatively, one can simply use a general rule, something between one-third and one-half of the average hourly wage rate.

If the net present value of the aggregate time and cost savings to public transport passengers and mixed traffic relative to the do nothing scenario is higher than the net present value of the cost of the infrastructure at a reasonable rate of return on capital, then the system is a good public investment.

As a general rule, if the BRT system serves a lot of existing bus passengers, and significantly increases travel speeds over existing conditions, the chances are good that it will perform extremely well in terms of the net present value calculation. On the other hand, if the BRT system is located on some elevated outer ring road with few bus passengers and no traffic congestion, the chances are that the economic rate of return will be extremely poor.

These measurements are fairly simple extrapolations from standard cost-benefit analysis techniques frequently employed in the transportation sector. However, cost-benefit analysis performs less well at estimating other important economic impacts, such as:

- Employment generation;
- Property values and land development; and,
- Technology transfer.

While these impacts are not generally included in a typical cost-benefit analysis, nor should they be, they are often important to decision makers and the impact of the BRT system on these issues needs to be considered.

19.2.2 Employment impacts

19.2.2.1 System construction

The new BRT system will likely represent a dramatic transformation of the proposed corridors. As with any project of this magnitude, the system will generate a considerable amount of employment through the construction process. Based upon similar projects from the past, it is possible to project the amount of employment and the duration of the employment from the construction phase (Figure 19.6). An additional measure of interest, particularly in the developing city context, can be the number of persons being supported by each construction job.

Due to the emphasis on high-quality infrastructure and services, BRT employment can range from artisan work on stations to the direct labour applied to road work (Figure 19.7). Construction jobs can sometimes be an important area of employment for unskilled labour groups. Employment generated for these individuals can be especially important since there may otherwise be limited opportunities.

Since BRT construction is not fundamentally different than other types of public works initiatives in the transport sector. Thus, standard methods of calculating construction job creation are adequate.

However, in some developing-nation applications, more labour intensive construction techniques may be preferred from an employment-creation standpoint. In such cases, standard employment multipliers will not be sufficient.

19.2.2.2 Operations

New BRT systems will often have dramatic impacts on the nature and level of employment among bus and competing paratransit operators. These impacts will vary greatly from system to system depending on:

- whether the BRT system incorporates former bus or paratransit operators into the new system,
- whether the new system simultaneously shifts the bus routing structure from direct services to trunk and feeder services or not,
- whether the new system offers new services previously not provided by the old public transport system,



Fig. 19.6

The construction of the BRT corridors can be a significant employment generator.

Photo by Lloyd Wright

- whether the new system encourages significant new ridership from former car users.
- In most cases, the new BRT system replaces a system of weakly regulated private bus or paratransit operators. These private bus operations are frequently not terribly profitable, as there is a lot of overlap in services particularly on the trunk corridors, leading to fairly few passengers per bus even during the peak periods. The most successful BRT systems generally shift existing public transport services on trunk corridors to trunk and feeder systems, which tend to increase the number of passengers per vehicle. This process can lead to the replacement of six

Fig. 19.7

Workers putting the final touches on the Transantiago stations.

Photo by Lloyd Wright



Fig. 19.8
Conditions for drivers can dramatically improve with a new BRT system.

Photo by Lloyd Wright



or more smaller buses, and their accompanying drivers and conductors, with one much larger bus on the trunk corridor. All other things being equal, this would lead to a reduction in total employment in the public transport sector.

However, employees in the bus sector typically find themselves confronted with a downward spiral of deteriorating numbers of jobs, and a deteriorating wage level, as more and more people switch to private vehicles. As such, BRT may be the only proven mechanism for maintaining long-term employment levels in the public transport sector. By increasing vehicle speeds and reducing operating costs relative to private motor vehicle travel, BRT can actually help maintain bus sector employment levels into the future.

Furthermore, the reduction in the number of small vehicles operating on the trunk corridors does not tell the whole employment story. The

standard mini-bus will generally operate with its single set of employees for as much as 16 hours in a day. The BRT vehicle will actually involve three to four different shifts of employees operating the same vehicle. Thus, the number of drivers will not appreciably change. When the feeder service drivers are included, BRT may actually increase the number of drivers (Figure 19.8). However, the big employment boost from operations stems from the myriad of positions created from fare collection, security, information services, cleaning, maintenance, and management and operations (Figure 19.9). Most of these functions did not exist in the previous informal sector.

A BRT system also generally brings with it significant improvements in the quality of the employment as well. The improved efficiency and lower operating costs in the new system will improve overall profitability. The allocation of these profits between better services for the public, better wages and working conditions for the workers, and higher profits for private investors, is determined by a negotiated political process. Union and civil society engagement in the process is therefore critical to equitable outcomes. Typically, workers in the informal transport sector may not receive any type of benefits package whatsoever. Within the new formalised system, employee training, medical and dental care, holidays and vacations, and sick leave would all be expected.

While it is entirely possible to design a BRT system with severe adverse impacts on employment, generally it has been possible and politically necessary to design BRT systems to have either neutral or overall positive impact on total employment. To date, few systematic analyses of the specific employment impacts of new BRT systems have been conducted, and the key decisions affecting overall employment levels have been determined through the political process rather than through any systematic technical analysis.

When setting the competitive bidding rules for private companies to operate the BRT system, it is possible to give additional points for firms which have greater capital participation from existing small bus operators as a way of encouraging the maximum level of participation in the

Fig. 19.9
A new formalised system can create many types of employment that never previously existed.

Photo by Lloyd Wright



new system from workers from the old system. The new BRT authority should also set labour standards on all operating companies in the system to ensure equitable and just treatment of the work force.

19.2.3 Economic development impacts

As with all transport projects, there are frequently significant secondary economic development impacts that are more difficult to predict. Improving any transportation system reduces the costs of production and consumption in particular locations. Because a new BRT system can increase the total capacity of a road corridor by as much as ten times, this corridor can accommodate high levels of growth without any deterioration in travel speeds. As more and more families and firms co-locate along the corridor, the transport costs related to connecting employees with their place of work, producers with their suppliers and final markets, all drop. This reduction in total transport costs resulting from co-location are known by economists as “agglomeration economies”.

These agglomeration economies tend to be captured by firms in the form of higher profits, by families in the form of lower costs of living and higher incomes, and finally, by landowners in the form of higher land rent. The concentration of new apartment buildings, offices, and shopping complexes adjacent to BRT stations and terminals are evidence of a well designed BRT system that has resulted in agglomeration economies.

As noted in Chapter 2 (Transit Technology Options), property values have been shown to have increased along the busways in Brisbane and Bogotá. This evidence is also supported by previous research on property value increases near urban rail stations. Bogotá has already seen considerable activity in the development of commercial centres along the BRT corridor (Figure 19.10). The increase in property values mirrors the expected increases in customer numbers at stations and terminals. For this reason, there is evidence to suggest that shop vacancies decrease in the area, leading to employment opportunities.

However, if the BRT system is poorly designed, it is quite possible that a new BRT system can have negative impacts. Some busway corridors, such as the Novo de Julio/Santa Amaru



corridor in São Paulo, and the former busway along Avenida Caracas in Bogotá, were widely perceived as having blighted these corridors. In both cases, “open” busway systems tended to concentrate very high volumes of old, polluting buses into a single corridor. The excess of old buses led to slow bus speeds but very high levels of ambient air pollution in the corridor. Both corridors also ignored the importance of good pedestrian facilities. Both corridors have since been improved, modernising the bus fleet with cleaner vehicles and changing the routing structure to increase the number of passengers per bus and decreasing the total number of buses. The urban environment and property values along these corridors are now recovering.

There is no denying that these economic impacts can result, and that they are important. However, because of the uncertainty of any system’s impact on property values, the impacts are generally not included in the formal economic evaluation. Currently, few BRT projects are being blocked due to weak economic appraisals. It may at some point in the future emerge that a BRT system is refused financing from a development bank because the economic rate of return is too low due to these potential benefits are being excluded.

However, for the time being, the greater danger is that far more expensive metro projects will continue to use heroic assumptions about projected economic development benefits to justify

Fig. 19.10
A commercial centre under construction near a TransMilenio terminal.

Photo by Lloyd Wright

Fig. 19.11

A new system offers the potential to introduce advanced technologies into a city and a country for the first time.

Photo courtesy of Advanced Public Transport Systems



projects of dubious economic benefit. As such, it is generally recommended that any economic development benefits for public transport projects be treated in a conservative manner.

19.2.4 Technology transfer

As noted in Chapter 12 (Technology), the new BRT system can bring with it the introduction of many new technologies to the city's transport sector. These technologies include advanced transit vehicles, fare collection and fare verification devices, and intelligent transportation systems (ITS). The introduction of new technologies presents several opportunities for overall economic benefits. First, as noted with vehicle manufacturing, there is the potential for new investment and job creation through local production. Second, technology transfer can lead to establishing a local advantage in a particular technology that can lead to export opportunities. Third, the new technology can lead to spin-off opportunities with other applications for new businesses.

When setting the technical specifications for vehicles and fare systems to be used in the BRT system, appropriate technical considerations should be the first and foremost concern. However, it is possible to include in competitive bidding criteria additional points for vehicles that are locally assembled or manufactured, and for the use of other inputs with higher local value added content.

19.3 Environmental impacts

“Because we don't think about future generations, they will never forget us.”

—Henrik Tikkanen, author and artist, 1924–1984

Public transport projects typically bring positive environmental impacts through the reduction of private vehicle use and subsequent associated emissions. Quantifying the expected environmental benefits of the BRT project can help to justify the project as well as strengthen the image of the initiative with the public. As a major project, an Environmental Impact Assessment (EIA) is likely to be required.

The expected reduction in vehicle emissions will likely be the principal benefit. However, the system will also likely reduce overall noise levels as well as the release of both liquid and solid waste products. The construction process itself can be disruptive and lead temporarily to some increases in emissions. However, by calculating emission reduction benefits across the life of the BRT project, the overwhelming evidence to date suggests that BRT can markedly improve the state of the urban environment.

LDVs – Gasoline		Blue cells = User-modifiable inputs White cells = calculations (better not to change)										
Variable	Region	Year										
		2000	2005	2010	2015	2020	2025	2030	2035	2040	2045	2050
Annual LDV Passenger travel (bil passenger km/yr) LDV load factor from master LDV sheet used here												
	OECD North America	6'596.4	6'734.8	6'991.0	7'417.0	7'820.6	8'100.2	8'343.6	8'563.4	8'766.3	8'955.7	9'135.8
	OECD Europe	2'956.8	2'853.6	2'710.9	2'550.8	2'438.1	2'368.3	2'343.1	2'315.9	2'287.9	2'260.3	2'232.9
	OECD Pacific	1'181.1	1'230.1	1'318.6	1'421.8	1'446.3	1'427.7	1'392.9	1'379.8	1'370.9	1'362.4	1'352.8
	FSU	572.9	663.2	780.5	934.4	1'136.3	1'270.3	1'435.3	1'583.3	1'701.0	1'809.7	1'898.6
	Eastern Europe	286.3	304.2	325.9	348.9	370.4	358.1	349.6	342.4	341.3	351.6	364.8
	China	296.8	405.3	575.6	822.5	1'164.2	1'506.1	1'955.9	2'488.6	3'099.5	3'833.0	4'678.4
	Other Asia	335.7	402.2	497.9	628.1	799.7	946.0	1'147.1	1'396.2	1'711.1	2'122.3	2'629.7
	India	107.4	154.9	220.8	309.4	425.8	524.9	654.4	818.6	1'037.3	1'340.9	1'744.6
	Middle East	151.4	171.1	203.5	249.8	310.9	362.1	421.9	480.9	538.0	598.9	659.3
	Latin America	646.2	795.0	980.3	1'204.5	1'470.6	1'624.4	1'852.4	2'121.6	2'442.9	2'835.5	3'272.2
	Africa	270.8	320.3	403.8	517.7	655.6	807.2	918.5	1'024.6	1'148.9	1'318.9	1'540.9
	World Total	13'401.8	14'034.7	15'008.8	16'404.9	18'038.5	19'295.3	20'814.7	22'515.3	24'445.1	26'789.2	29'510.0

19.3.1 Environmental Impact Assessments (EIAs)

“We must learn to provide affluence without effluence... by consuming less from the environment, not more. We can use less, and have more. Consume less, and be more. The interests of business, and the interests of environment, are not incompatible.”

—Tachi Kiuchi, former CEO of Mitsubishi

Impact analyses are often mandatory by law in terms of measuring the expected economic, environmental and social ramifications of the project. Completing an Environmental Impact Assessment (EIA) is also typically required by international lending agencies. The form of the EIA is generally well known but the practice of such assessments is still in its infancy in some nations. Currently, in developing countries and even in some developed countries, the environmental impacts that must be assessed according to law tend to focus mainly on the impacts of the construction process itself rather than on the longer-term traffic impacts. Similarly, to date, most BRT projects have completed EIAs following standard procedures established for any public works project. Since BRT should in most cases have quite positive environmental impacts and no more immediate adverse impacts from the construction process than any other civic work, from the standpoint of avoiding adverse impacts, this standard type of EIA is probably adequate.

Such a standard appraisal, however, will tend to ignore the significant environmental benefits of the system. Many funding agencies involved in financing BRT systems are doing so particularly because of environmental benefits. Thus, project developers should be motivated to measure the full actual and projected environmental benefits.

An EIA analysis of this type will typically involve comparing the baseline scenario (city without the public transport project) and the project scenario (city with project). Additionally, the EIA process may require the consideration of alternative options, such as road widening or other types of mass transit systems.

This sort of EIA, which is required in some countries when a new transport investment has to be demonstrated to be in conformity with prevailing ambient air quality standards, would normally use as an input the traffic impact analysis described above, and extrapolate the site specific emissions impacts from this traffic data. To do this properly generally requires inputting these traffic impacts into an emissions model, such as Mobile 5 created by the US EPA. Such models require additional information about likely tailpipe emissions under different operating conditions for the existing registered vehicle fleet. Most of these emissions models have not been calibrated for the diverse vehicle fleets frequently found in developing countries, so cruder methodologies for extrapolating the likely emissions impacts associated with the

Fig. 19.12
Excerpt from the IEA/SMP spreadsheet model.
Image courtesy of IEA/SMP

traffic impacts tend to be used. Typically, some values of emissions per vehicle-kilometre for different vehicle types will be available in studies, such as those studies produced through the World Bank's UrbAir programme.

Another useful source is the IEA/SMP spreadsheet model of the International Energy Agency and the Sustainable Mobility Programme (SMP) of the World Business Council for Sustainable Development (WBCSD) (IEA/SMP, 2004). The IEA/SMP spreadsheet is available on-line and provides reasonably good emissions data for most parts of the world (Figure 19.12).

Fig. 19.13
Vehicle emissions in Jakarta have a severe impact on health and quality of life.

Photo courtesy of Swisscontact and the GTZ SUTP Photo CD



Once values of emissions per vehicle-kilometre can be obtained, an estimate of the new system's impact on each vehicle type using the corridor can be assessed.

The Environmental Impact Assessment should be conducted by an independent organisation with no relationship to the project or other input services to the project. Specialist consultants are thus frequently utilised to give an objective and independent analysis as well as to lend experience to the effort. An effective Environmental Impact Assessment can greatly aid the BRT development process by highlighting possible areas of concern and by suggesting design alternatives that will mitigate environmental impacts.

19.3.2 Local air emissions

19.3.2.1 Emission impacts

Vehicle emissions are the predominant source of pollutants in many urban centres and are directly linked to severe health and environmental problems (Figure 19.13). In city centres, motorised vehicle emissions account for 95 percent of the ambient carbon monoxide (CO) and 70 percent of nitrogen oxides (NO_x) (WHO, 2000). The vehicle fleet is also frequently responsible for a majority of the particulate emissions and some of the sulphur dioxide (SO₂), which has particularly severe health impacts. The poor air quality in most developing cities limits economic growth and dramatically curtails quality of life.

The principal impacts from motorised vehicle emissions are:

- Health impacts, including respiratory illness, cardiovascular illness, and cancer;
- Economic impacts, including absenteeism and reduced productivity;
- Impacts on the built environment (*e.g.*, damage to buildings);
- Impacts on the natural environment (*e.g.*, harm to trees and vegetation);

Emission levels are set by national and international environmental agencies such as the US Environmental Protection Agency (US EPA), the European Commission, and the World Health Organisation (WHO). Emission

Fig. 19.14
Air quality in Shanghai on a normal day.

Photo courtesy of Manfred Breithaupt and the GTZ SUTP Photo CD

standards include both ambient emission levels and tailpipe emission levels.

19.3.2.2 Types of emissions

“Local” or “criteria” pollutants refer to the types of air emissions that are most directly linked to impacts on human health. These pollutants include nitrogen oxides (NO_x), sulphur oxides (SO_x), carbon monoxide (CO), and particulate matter (PM). Additionally, vehicles emit air toxics, including benzene, formaldehyde, acetaldehyde, 1,3-butadiene, and acrolein. While emitted in relatively small concentrations, air toxics are highly dangerous carcinogens. Also, the combination of NO_x and volatile organic compounds (VOCs) from vehicle emissions will combine in the atmosphere to form ground-level ozone (O₃). Ground level ozone is also commonly known as photochemical “smog” and is associated with a host of pulmonary illnesses and the brown haze that permeates cities with excessive automobile emissions (Figure 19.14). Further, many developing countries still permit leaded fuels. Lead emissions are closely associated with several diseases including cancer and inhibiting the mental development of children. Although international efforts are under way to eliminate the use of lead, the majority African nations still utilise leaded fuels.

While cleaner engine technologies have somewhat mitigated these emissions in developed nations, the age and maintenance of developing-nation vehicles means that even relatively

Fig. 19.15
Air quality analysing equipment for NO_x, CO, and PM.

Photo courtesy of UNCRD



Table 19.1: Air quality changes in Bogotá

Pollutant	Daily average concentration before system, year 2000 (ppb)	Daily average concentration after system, year 2001 (ppb)	Per cent reduction in pollutant (%)
Sulphur dioxide (SO ₂)	6.8	3.8	44%
Nitrogen dioxide (NO ₂)	24.0	22.4	7%
Particulate matter (PM ₁₀)	50.8	38.6	24%

Source: Hidalgo, 2003

low vehicle numbers can create health and air quality problems.

19.3.2.3 Air quality monitoring

Ideally, an air quality monitoring system will already be in place prior to the implementation of the new public transport system. An established network of monitoring stations will facilitate before and after comparisons of air quality. Such stations in Bogotá helped to prove that the new BRT system indeed contributed to better air quality. Table 19.1 summarises the improvements in ambient air quality in Bogotá after the first year of TransMilenio’s implementation.

However, in many developing-nation cities, there may be an insufficient number of air quality monitoring stations or such stations may not exist at all. The cost of air quality monitoring systems can make it difficult for some local environmental agencies to install and maintain the devices. Further, some specialise training is required to ensure the air monitoring data is properly collected and analysed (Figure 19.15).

Discussions with both the national environmental agency as well as international organisations, such as the Clean Air Initiative, the World



Fig. 19.16
Air intake opening for monitoring of ambient air quality.

Photo courtesy of UNCRD

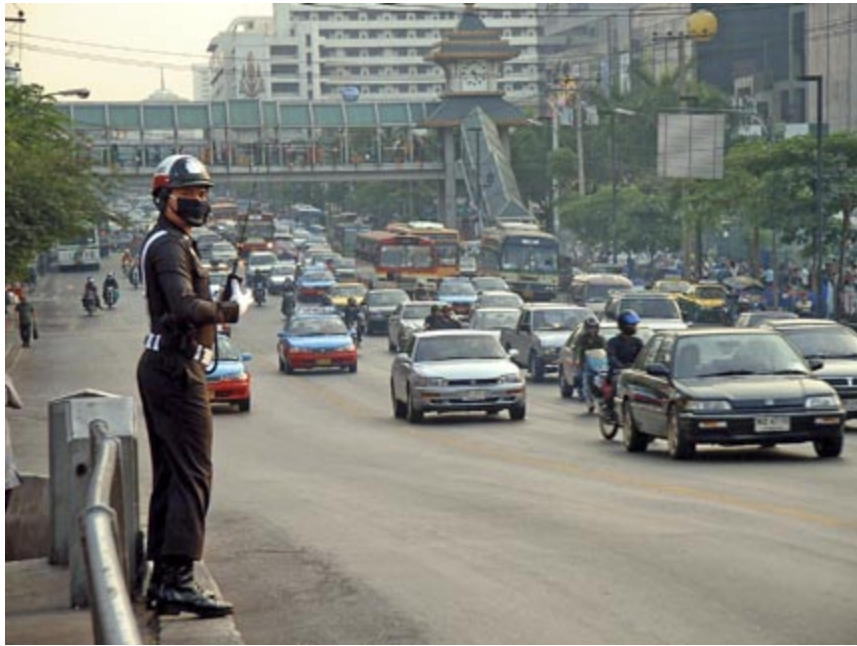


Fig. 19.17
Spot monitoring of localised contaminant levels can be especially important for some key groups, such as informal vendors and traffic police, as evidenced with this image from Bangkok.

Photo by Carlos Pardo

Bank, and regional development banks, should be undertaken to find a way of establishing an air quality monitoring network prior to the establishment of the new BRT system. In some cases, it may be necessary to add stations to strategic locations of the city in order to fully capture the mission impacts.

Air quality monitoring actually can encompass several different levels of measurement. Ambient monitors will capture the general background air quality levels of the city (Figure 19.16). These ambient measurements provide the basis for comparing to the established norms of the



World Health Organisation (WHO). However, there can also be reason to measure air quality levels at a much more localised level.

In many cases, the person walking along the street may experience contaminant levels well in excess of those experienced at the ambient level. Further, some susceptible members of society may be more exposed to contaminants than others. For example, the height of children means that they are actually more in the direct line of exhaust tailpipes. Low-income persons often work from informal stalls quite near the roadway, and may spend as much as 10 to 14 hours per day in an environment of intense emissions. Likewise, traffic police may spend long hours in direct contact with traffic and contaminants (Figure 19.17). For these special groups, spot monitoring of localised effects should be undertaken on a regular basis. In some cases, it may be possible to have individuals wear a personal monitor to record actual daily and weekly exposure levels.

Spot monitoring should also be conducted inside the BRT vehicles and stations as well. If ventilation is poor or if the station design creates a highly closed environment, air contaminants can build up to unsafe levels. With vehicles, there may be a difference in air quality between front-engine vehicles and rear-engine vehicles. For example, a front-engine vehicle may cause a higher concentration of emissions inside the vehicle. By monitoring the difference between such designs, the BRT authority can decide if they should alter their vehicle specifications.

Finally, vehicle emissions testing should be a formal part of the regulatory code, both for the new BRT vehicles as well as other existing public transport vehicles. Semi-annual or annual testing should be a base requirement to obtain an operating license for any vehicle. In addition, spot monitoring on the roadway can be a necessary measure. In some cases, operators may specially fix their vehicles to pass a known, one-off annual test. However, once the test is finished, the operators may remove filters and other emission reduction devices in order to improve fuel economy.

Fig. 19.18
Random, on-street spot monitoring of vehicles can be an effective way of ensuring regulatory norms are met in practice.

Photo courtesy of UNCRD

Random street tests thus serve the purpose of ensuring the actual vehicle performance meets the regulatory standards (Figure 19.18).

19.3.3 Greenhouse gas emissions

“Global warming is too serious for the world any longer to ignore its danger.”

—Tony Blair, British Prime Minister, 1953–

19.3.3.1 Global trends

Vehicle emissions are the fastest growing source of greenhouse gas emissions worldwide. Emissions from the transport sector are growing at an annual rate of 2.1 percent worldwide and 3.5 percent in developing nations (IEA, 2002a). Representing 24 percent of greenhouse gas emissions from fossil sources, vehicle emissions have emerged as one of the most significant challenges in mitigating the effects of global climate change. In terms of total emissions from fossil fuel sources, the transport sector is second only to the generation of electricity and heat (39 percent) (IEA/OECD, 2003). Greenhouse gas emissions from motorised vehicles are predominantly carbon dioxide (CO₂) but also include some emissions of methane (CH₄) and nitrous oxide (N₂O).

Much of the growth in transport sector emissions stems from the continued growth in the number of private motorised vehicles (*i.e.*, cars and motorcycles). The planet will soon reach a milestone of being resident to over one billion motorised vehicles. The International Energy Agency (IEA) and the World Business Council for Sustainable Development (WBCSD) has compiled a comprehensive set of spreadsheet analyses projecting transport trends between the year 2000 and 2050 (IEA/SMP, 2004).

Figure 19.19 shows the expected trends in vehicle ownership levels. There are two striking features of this graphic. First, despite the existing saturation of vehicle ownership in countries like the US, growth in ownership in these countries is expected to continue through 2050. Second, the rate of growth in developing countries is significant, resulting in the number of developing-nation vehicles surpassing the number of

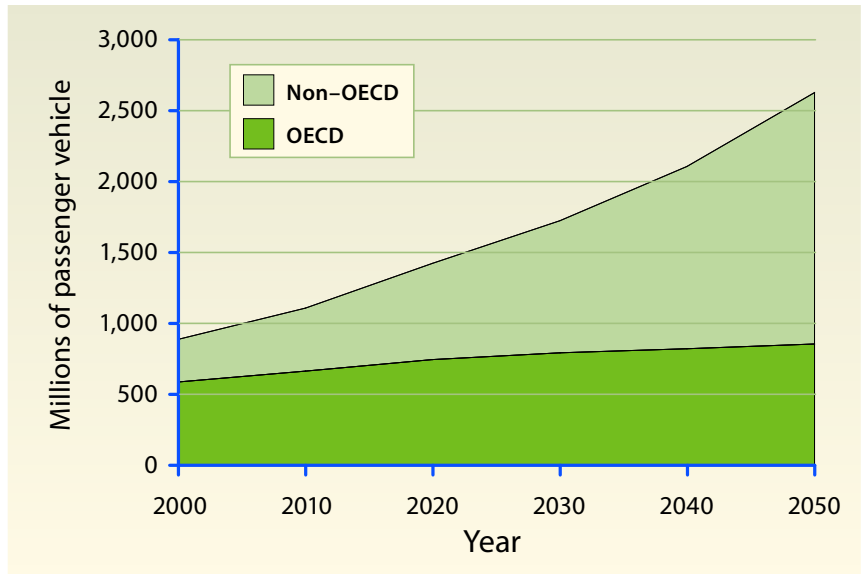
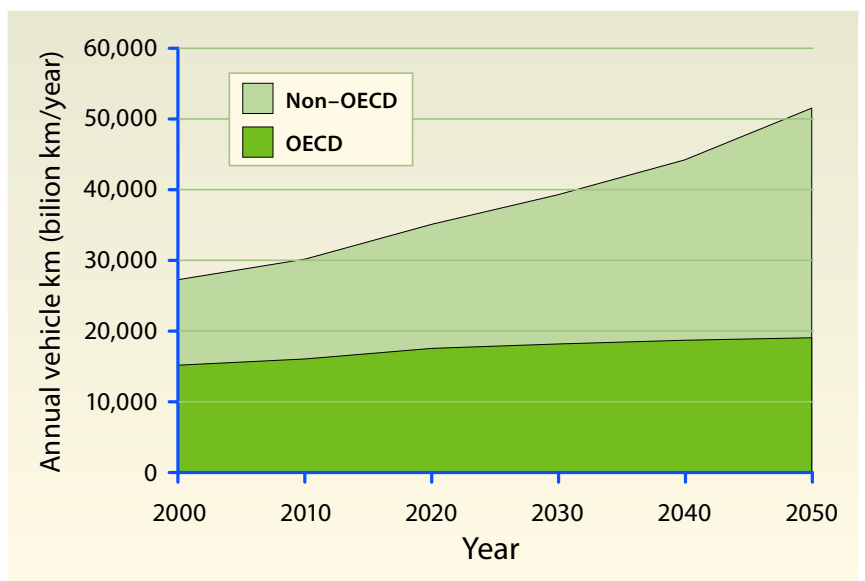


Fig. 19.19
Vehicle ownership by region
Source: IEA/SMP, 2004

vehicles in the OECD by 2030. Currently, there are approximately 982 million passenger vehicles worldwide; by 2050 this figure is projected to be 2.6 billion.¹⁾

The growth in motorised vehicle ownership has largely followed trends in per capita income. Dargay and Gately (1999) show that in the per capita income range of US\$2,000 to US\$5,000 vehicle purchases jump sharply. Other factors affecting vehicle ownership growth are population growth, urbanisation levels, importation regulations, and the quality of alternative transport services. The relative lower cost of suburban housing versus urban housing can also increase the demand for private vehicles. Several major developing nations are entering the income zone of rapid motorisation.

Fig. 19.20
Vehicle usage by region (vehicle-kilometres travelled)
Source: IEA/SMP, 2004



1) “Passenger vehicles” include cars, motorcycles, three-wheelers, mini-buses, and buses. This value does not include freight vehicles, train carriages, water transport, or air transport.

Fig. 19.21
A generalised emissions equation that also notes the constituent components of emission sources.
 Graphic courtesy of Wright and Fulton (2005).

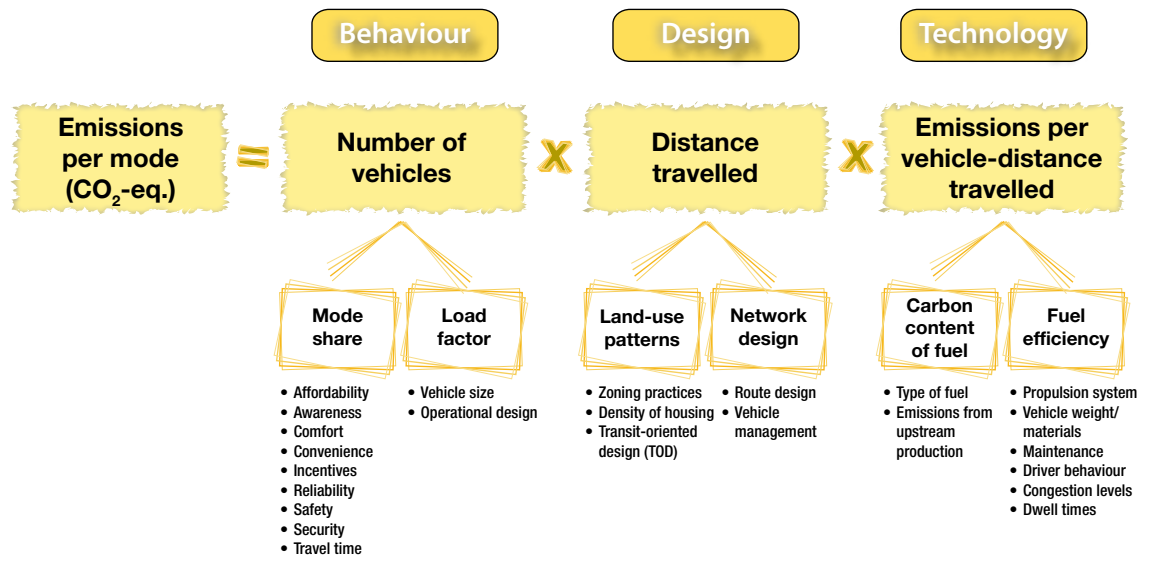


Figure 19.20 provides a projection of vehicle usage levels through 2050 for both OECD and non-OECD nations. Like vehicle ownership, vehicle usage is expected to grow for both OECD and non-OECD countries, with the highest growth rates in the developing world.

19.3.3.2 Emissions model

Figure 19.21 provides an overview of the general relationship between transport activity and emissions (Wright and Fulton, 2005). Figure 19.21 specifically provides the relationship between vehicle performance and carbon dioxide (CO₂) emissions, but the equation given can also be extended to other pollutants as well. Each of the three principal elements, behaviour, design, and technology, has a basic role to play in minimising emissions. In reality, the emission profile of each pollutant type is

fairly complex. The ambient emission levels will likely vary by time of day, day of the week, and the season of the year. Climate, topography, vehicle use patterns, maintenance practices, and driving behaviour will all play a role. Additionally, interactions between different pollutants will also change the composition and level of pollutants.

The broadly-defined variables defined in Figure 19.21 each relate to constituent components that can be influenced to reduce emissions. For example the mode share component of the behavioural variable is affected by all the factors related to customer satisfaction, including affordability, comfort, convenience, safety, security, and travel time. By improving the quality of these components, more car users are likely to switch to public transport. Likewise, the design of the network and the resulting land-use

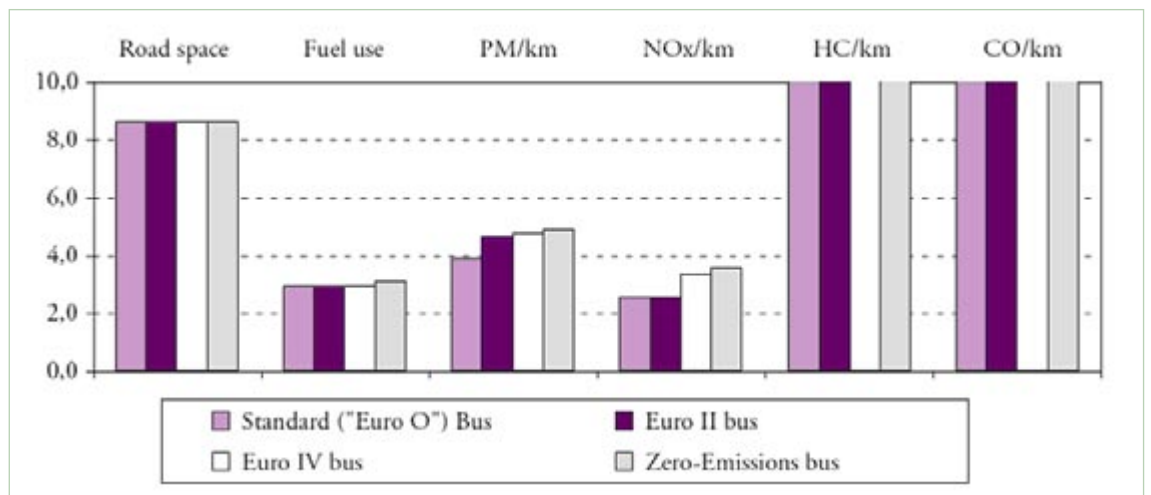


Fig. 19.22
Impacts of mode shifting to public transport

Table 19.2: Emission reduction costs for fuel technology scenarios

Scenario type	Fuel/tech. type	CO ₂ reduction	Incremental vehicle cost (\$US)	Incremental operating costs (US\$/km)	Refuelling infrastructure investment (US\$/vehicle)	Incremental fuel costs	Estimated cost (US\$/tonne of CO ₂)
Pessimistic	CNG	0%	30,000	0.02	20,000	Equal	NA
Optimistic	CNG	10%	20,000	0.02	10,000	Equal	442
Pessimistic	Hybrid-electric	5%	100,000	0.02	0	5% less	1,912
Optimistic	Hybrid-electric	20%	65,000	0.02	0	20% less	148
Pessimistic	Fuel cell	30%	1,000,000	0.05	50,000	100% higher	3,570
Optimistic	Fuel cell	75%	250,000	0.03	20,000	50% higher	463

Source: Wright and Fulton, 2005

patterns influence the number of trips and the average distance travelled. Transit oriented development (TOD) and good mixed-use design will influence both how people travel as well as their daily travel patterns. Finally, technology plays a role in terms of fuel quality and the fuel efficiency of the vehicle. A complete emissions reduction effort would likely address each one of these variables.

19.3.3.3 Emission reduction potential of mode shifting

The International Energy Agency (IEA) has conducted research to determine the relative impacts of mode share in comparison to different fuel and propulsion technology options. The IEA examined the emission impacts of shifting mode share by the capacity equivalent of one bus with a total capacity of 120 passengers. Even with the rather modest assumption of only a 50 percent load factor for the bus and only 8 percent of the passengers having switched from private vehicles, the resulting emission reductions were substantial. The projected reductions in hydrocarbon and carbon monoxide emissions per kilometre were over ten times the emissions of a single bus (IEA, 2002b). The reduction per kilometre of particulate matter, nitrogen oxides, and carbon dioxide (fuel use) ranged from two times to four times the emissions of a single bus (Figure 19.22).

Remarkably, the level of emissions reduced did not change significantly with buses of strikingly different emission standards. Buses with Euro 0, Euro II, Euro IV, and fuel-cell technology all produced roughly the same results. This result occurred because the relative impact of the tailpipe standard (and thus the fuel and propulsion

choice) was overwhelmed by the impact from mode switching. The IEA study notes that:

“Regardless of whether a bus is ‘clean’ or ‘dirty’, if it is reasonably full it can displace anywhere from 5 to 50 other motorised vehicles...” (IEA, 2002b, p. 12)

“Certainly, a cleaner bus will yield lower emissions, but in this scenario the emission reductions from technology choice are overshadowed by reductions from mode switching (and the resulting ‘subtraction’ of other vehicles)... Dramatic reductions in road space, fuel use, and most emissions can be achieved through displacing other vehicles with any bus, even the ‘Euro 0’ buses typically sold in the developing world.” (IEA, 2002b, p. 48)

The IEA results do not imply that fuel and propulsion technology should be ignored in achieving lower emissions. However, the results do suggest that these technologies alone only address a relatively small portion of the total emission reduction potential. Improving the efficiency of the transport sector and reducing emissions revolves around a full set of factors, including the many factors that are most important to customers such as cost, comfort, convenience, and security.

Further research has supported this analysis. In a comparison of the cost per ton to achieve carbon dioxide (CO₂) reductions, fuel technology options were found to be significantly more costly than mode shifting options (Wright and Fulton, 2005). Table 19.2 summarises projected emission reductions costs for different fuel technologies (CNG, diesel hybrid-electric, and fuel cell technology). Given the uncertainty of the future improvements in these technologies, both an optimistic and pessimistic case is presented.

Table 19.2: Impact of mode shifts on CO₂ emission reductions

Scenario name	Mode shares	Tonnes of CO ₂ over 20 years (thou.)	Tonnes of CO ₂ reduced from baseline (thou.)	Cost of infrastructure	Cost per tonne of CO ₂ (US\$ per ton)
BRT mode share increases from 0% to 5%	Automobile 19% Motorcycle 4% Taxi 4% Mini-bus 48% BRT 5% Walking 19% Bicycle 1%	47,409.7	1,905.5	US\$125 million (50 km of BRT at US\$2.5 million per km)	\$66
BRT mode share increases from 0% to 10%	Automobile 18% Motorcycle 4% Taxi 3% Mini-bus 45% BRT 10% Walking 19% Bicycle 1%	45,086.8	4,228.5	US\$250 million (100 km of BRT at US\$2.5 million per km)	\$59
Walking mode share increases from 20% to 25%	Automobile 19% Motorcycle 4% Taxi 4% Mini-bus 47% BRT 0% Walking 25% Bicycle 1%	45,888.7	3,426.6	US\$60 million (400 km of pedestrian upgrades at US\$150,000 per km)	\$17
Bicycle mode share increases from 1% to 5%	Automobile 19% Motorcycle 4% Taxi 5% Mini-bus 48% BRT 0% Walking 19% Bicycle 5%	47,393.3	1,922.0	US\$30 million (300 km of cycle ways at \$100,000 per km)	\$15
Bicycle mode share increases from 1% to 10%	Automobile 18% Motorcycle 3% Taxi 5% Mini-bus 46% BRT 0% Walking 18% Bicycle 10%	45,154.9	4,160.4	US\$60 million (500 km of cycle ways at \$100,000 per km, plus \$10 million promotional campaign)	\$14
Package: BRT, Pedestrian upgrades, Cycleways	Automobile 15% Motorcycle 3% Taxi 3% Mini-bus 34% BRT 10% Walking 25% Bicycle 10%	36,917.5	12,397.8	US\$370 million (BRT \$250 million; Footpaths \$60 million; Cycleways \$60 million)	\$30

Source: Wright and Fulton, 2005

The lowest cost emission reduction option under this analysis is the optimistic case for diesel hybrid-electric technology, which produced a value of US\$148 per metric ton of CO₂ reduced. The highest cost emission reduction option is the pessimistic case for fuel cell technology, which produced a value of US\$3,570 per metric ton of CO₂ reduced.

By comparison, a set of mode shifting scenarios produced far more cost competitive emission reductions (Wright and Fulton, 2005). Table 19.32 summarises the results of the mode shifting scenarios, based upon the conditions and emission factors from Bogotá. The specific modes focussed upon in the analysis are BRT, cycling, and walking.



Fig. 19.23
Promoting mode shifts to both public transport and non-motorised options, such as walking and cycling, will likely produce the most cost-effective emission reductions.

Photo by Karl Fjellstrom

Each of the mode shifting scenarios resulted in relatively cost-competitive emission reductions with no costs higher than US\$70 per ton of CO₂ reduced. By contrast the lowest cost fuel-based strategy was US\$148 per ton of CO₂ reduced.

Ideally, an emission reduction scenario would produce both large emission reductions as well as low-cost reductions. Each of the non-motorised options produced results under US\$20 per ton of CO₂ reduced. A US\$60 million investment in bicycle infrastructure produces a projected emission reduction of 4.1 million tons of CO₂ over 20 years at a cost of approximately US\$14 per ton.

However, the package of measures bundled together (BRT with pedestrian upgrades and cycleway investment) was the most effective combination of large and relatively low-cost reductions. The scenario with the package of measures produced over 12 million tonnes of CO₂ reductions at a cost of approximately US\$30 per ton. As an individual measure, BRT was more costly than the other scenarios at US\$66 per ton while the non-motorised options alone did not produce the largest reductions. This result is due to modal assignment between the different options. In the case of BRT or non-motorised options working individually, each will tend to suppress the mode share of the

other. For example, improved public transport (e.g., BRT) will tend to attract previously non-motorised users in addition to targeted trips by private vehicles. The net emission reductions will not be as great as compared to a scenario in which public transport and non-motorised transport increase together. In the bundled scenario, trips by BRT, walking, and cycling are all promoted and supported, and thus the loss of market share between these modes is minimised (Figure 19.23).

Finally, another interesting finding from this research has been the relative sensitivity of emission reductions from small changes in motorised mode share. A single percentage point reduction in motorised mode share and a subsequent gain by either non-motorised options or public transport is substantial in terms of greenhouse gas impacts. In the context of the stated reference case, a single percentage point reduction in mode share of private automobiles represents over one million tons of CO₂ through the 20-year project period. This finding implies that even shifting relatively small percentages of mode share to more sustainable options can be worthwhile.

It should be noted that the cost estimates generated in tables 19.3 and 19.3 are approximations based upon generic conditions and assumptions within project and baseline scenarios. The actual values will vary greatly depending on local

circumstances and a range of factors, including baseline mode shares, local infrastructure costs, and cultural preferences for particular modes. The scenarios presented here also did not account for any induced travel that may occur due to the availability of road space following a shift to lower-emitting options. Further, the final total cost of attempting to convert such reductions into tradable “Certified Emission Reductions” will also involve additional transaction costs as well as measurement and monitoring costs. Nevertheless, the results of these initial scenarios for mode shifting do appear promising from the standpoint of cost competitiveness.

19.3.3.4 Global emission reduction efforts

“In our every deliberation, we must consider the impact of our decisions on the next seven generations.”

—Iroquois Nation Maxim

To date, two major international agreements have been brought forward to curb greenhouse gas emissions. At the 1992 United Nations Conference on Environment and Development (UNCED), member nations developed the United Nations Framework Convention on Climate Change (UNFCCC). By 1994, a sufficient number of countries had ratified the convention to put the document into force. Although the convention was essentially a non-binding agreement, the UNFCCC did include a mechanism allowing participation by developing nations

in emission-reducing projects. The mechanism, known as “Activities Implemented Jointly” (AIJ), encouraged investment towards developing nation projects as a means to stimulate a future emissions trading market. Remarkably, though, of the 186 AIJ projects put forward, none addressed emissions in the transport sector (JIQ, 2002).

Subsequently, in 1997, the Kyoto Protocol was drafted. The protocol calls for developed nations to reduce emissions by an average of 5.2 percent from a 1990 baseline. Despite the absence of two major emitting nations, the US and Australia, the agreement came into force on 16 February 2005. Progress on the Kyoto Protocol is tracked by the UNFCCC Secretariat as well as through regular meetings of the members states (Figure 19.24).

The Kyoto Protocol offers a mechanism, known as the “Clean Development Mechanism” (CDM), that allows mitigation projects in developing nations to earn “Certified Emission Reductions” (CERs), which will have a monetary value. The Protocol also includes a mechanism known as “Joint Implementation” (JI) to promote emission reducing projects in “economies-in-transition” (*i.e.*, Eastern Europe). Thus, although developing nations and economies-in-transition do have not reduction requirements under the Kyoto Protocol, these nations can sell credits gained through CDM and JI to other nations that do have Kyoto emission reduction requirements.

However, early indications from project proposals indicate that transport will not be a major area of investment. CDM and JI projects are being supported by many institutions, including the governments of Finland, Japan, and The Netherlands, as well as the World Bank through its Prototype Carbon Fund. Through February 2007, a total of 1,743 CDM projects and 155 JI projects had been registered with the UNFCCC. Only three of these projects were related to the transport sector. Of these, only one project, Bogotá’s TransMilenio BRT project, was related to urban passenger transport (Fenhann, 2007).

The most frequently cited reasons behind the lack of greenhouse gas mitigation projects in the transport sector are the complexity of transport baselines and the cost-effectiveness of the

Fig. 19.24
Country officials and interested groups regularly meet through Conference of the Parties (COPs) to discuss progress with the Kyoto Protocol.

Photo by Lloyd Wright



projects. Projects encouraging shifts to lower-emitting modes depend upon modelling projections that are possibly not sufficiently rigorous to meet the standards of Certified Emission Reductions (Sandvik, 2005). Further, the duration and timing of transport emissions may also be at odds with the CDM process. Busways and infrastructure for bicycles and pedestrians will have a lifetime of 25 years or longer, and thus the initial capital costs are amortised through the emissions reduced over this period. CDM project periods only cover 7 or 10 years, and thus do not permit the full emission reduction in a single reporting period. Additionally, the nature of the CDM implies the presence of a motivated investor with a discrete product. Private sector opportunities largely reside in fuels and vehicles while upgrades such as improved customer service either do not have well-defined commercial opportunities or such opportunities are local in nature.

Apart from the UNFCCC mechanisms, the Global Environment Facility (GEF) is amongst the world's largest grant-making facilities to fund projects alleviating global environmental problems. The GEF's resources of over US\$2 billion are intended to catalyse demonstration initiatives that eventually lead to replication globally. However, the transport sector was one of the last sectors that the GEF climate change programme has addressed. Further, the GEF's operational strategy for transport was largely prepared by special interests from the fuel cell industry, and thus has focused much of the early investments towards fuel and propulsion system solutions (GEF, 2001).

Through February 2005, of the 566 registered GEF projects related to climate change, only 13 were in the transport sector. Six of these projects are focused on fuel cell technology. The fuel cell initiatives involve a US\$60 million investment by UNDP to finance 46 fuel-cell buses in developing cities such as Beijing, Cairo, Mexico City, São Paulo, and Shanghai. The actual project cost totals US\$120 million when matching funds from private sector fuel and vehicle firms are included. Thus, the end result is 46 buses at a cost of approximately US\$2.6 million per bus. However, given that in nations such as China the hydrogen for the fuel-cell buses will likely

be derived from largely coal-based electricity, the overall greenhouse gas emissions will actually be higher than if a standard diesel vehicle was utilised. If instead the US\$60 million GEF investment was applied towards BRT systems, then anywhere from 20 to 30 cities could have received funds to fully plan BRT systems. In response, the GEF is now moving towards a more systems-based approach to transport initiatives. The World Bank is currently leading GEF-financed BRT projects in Lima, Mexico City, Santiago, and Hanoi with additional projects being planned for cities in China, Colombia, Mexico, Brazil, and Argentina.

19.3.3.5 TransMilenio emission reductions

The Bogotá TransMilenio system is the first public transport initiative to be brought forward for consideration of international emission credits. Under the registration of the TransMilenio project with the UNFCCC, phase II through phase IV of TransMilenio is eligible for the emission credits. The first crediting period runs for seven years beginning on 1 January 2006. The TransMilenio system and its partners are projected to reduce approximately 247,000 tons of CO₂ per year under the application to the UNFCCC for emission credits. In turn, the revenues generated from the sale of the "Certified Emission Reductions" can then be applied to further expand the TransMilenio system.

As a system-based approach to public transport, the TransMilenio system is able to address virtually all the possible components in an emissions reduction effort, as outlined earlier in Figure 19.21. Specifically, TransMilenio is achieving emission reductions through the following mechanisms:

- Increasing the share of public transport ridership by dramatically improving the quality of service (in terms of travel time, comfort, security, cleanliness, etc.);
- Replacing 4 to 5 smaller buses with a larger articulated vehicle;
- Requiring the destruction of 4 to 8 older buses for every new articulated vehicle introduced into the system;
- GPS controlled management of the fleet allowing the optimisation of demand and supply during peak and non-peak periods;

- Encouraging transit-oriented development around stations and along corridors; and,
- Emission standards currently requiring a minimum of Euro II emission levels with a future schedule requiring eventual Euro III and Euro IV compliance.

Bogotá is one of the few cities in the world that is achieving a significant increase in public transport ridership. Approximately 20 percent of ridership on Bogotá’s BRT system comes from persons who previously drove a private vehicle to work. The quality of TransMilenio is such that even middle- and higher-income travellers are utilising the system. The older mini-buses that dominated Bogotá prior to TransMilenio were largely not an option that discretionary public transport users would frequent (Figures 19.25 and 19.26).

Prior to TransMilenio, as many as 35,000 public transport vehicles of various shapes and sizes plied the streets of Bogotá. In order to rationalise the system, companies bidding to participate in TransMilenio were required to scrap older transit vehicles. During the first phase of TransMilenio, the winning bids agreed to scrap approximately four older vehicles for each articulated vehicle introduced. In the second phase, the successful bids committed to scrapping between 7.0 and 8.9 older buses for each new articulated vehicle. The destruction of older vehicles prevents the “leakage” of these vehicles to other cities.

Other cities have since been influenced by Bogotá’s vehicle scrapping programme. For

example, the Guayaquil Metrovía also requires any private operator wishing to enter the system to scrap a certain number of vehicles (Figure 19.27).

Each articulated vehicle in TransMilenio has a capacity of 160 passengers. The vehicles are currently achieving a load factor of approximately 80 to 90 percent. The older public transport vehicles in Bogotá come in a variety of sizes, from micro-buses to full-sized conventional buses. Table 19.4 summarises data collected on characteristics of public transport vehicles in Bogotá.

The differences in “passengers per vehicle-kilometre travelled” are quite telling. The relative efficiency of operating a coordinated system in larger vehicles translates into economic advantages for the operators. By closely controlling the supply of vehicles during peak and non-peak periods, TransMilenio avoids wasteful trips.

19.3.4 Noise

The existing older vehicles in most developing cities not only produce high levels of contaminant emissions but also generate considerable noise pollution. The inefficient engine technologies in conjunction with poor noise dampening devices means that noise levels can exceed safe levels. Further, the large number of smaller

Fig. 19.25
The transformation of Bogotá’s public transport system from this...



Fig. 19.26
...to this, has resulted in significant emission reductions.

Top photo by Lloyd Wright
Bottom photo courtesy of Fundación Ciudad Humana (Human City Foundation)

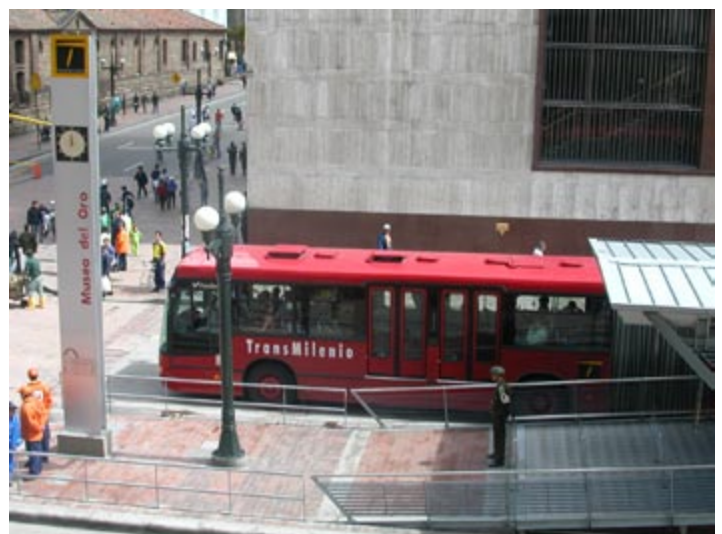




Fig. 19.27
Like Bogotá, Guayaquil has also implemented a vehicle scrapping requirement for private operators wishing to participate in the system.

Photo by Lloyd Wright

public transport vehicles means that existing systems have high numbers of noise generating mini-buses. BRT helps reduce vehicle noise by:

- Replacing 4 to 5 mini-buses with a larger public transport vehicle
- Using quieter engine technologies
- Managing the system to produce “smoother” vehicle operations
- Employing noise dampening devices
- Encouraging mode shifting from private vehicles to public transport.

Projecting the potential reduction in noise levels can be difficult since there may be no baseline noise levels collected for the city. Thus, baseline decibel measurements may be a recommended part of a pre-project evaluation of the existing environment. The projected external noise levels of new vehicles are typically specified by the vehicle manufacturers. This information in conjunction with the average noise level of an existing public transport vehicle can produce an initial estimation of the projected benefits.

Table 19.4: Characteristics of public transit vehicles in Bogotá

Vehicle type	Passenger capacity	Fuel consumption (km/litre)	Passengers per vehicle-kilometre travelled (IPK)
TransMilenio articulated bus, Euro II diesel	160	1.56	5.20
Conventional bus, diesel	70–80	2.14	1.00–2.27
Conventional bus, Gasoline	70–80	1.53	1.00–2.27
Medium-sized bus, diesel, models 1595-2004	27–45	5.02	0.90–2.24
Medium-sized bus, diesel, 1580 model	27–45	3.96	0.90–2.24
Medium-sized bus, gasoline, 1580 model	27–45	2.64	0.90–2.24
Micro-bus, diesel	13–15	5.54	0.60–1.44
Micro-bus, gasoline	13–15	3.43	0.60–1.44

Source: Martínez, 2004



Fig. 19.28
A waste recycling facility at the Usme depot of TransMilenio.
 Photo by Lloyd Wright

19.3.5 Liquid and solid wastes

Transit operations will also generate a variety of liquid and solid waste products. Waste oil, other lubricants, and industrial solvents should be recycled or disposed in an approved manner. Liquid wastes that are not properly treated can endanger water supplies. These wastes can be a particular danger to residents living near transit depots and other repair shops. Solid waste products such as worn tires and failed components should also be disposed in a safe manner.

A formal transit system, such as a BRT system, can help to reduce and control these emissions by providing standard procedures and a more controlled environment. While informal operators may dispose of waste products in an uncontrolled fashion, concessioned BRT operators must follow procedures stipulated in the contractual agreements. The TransMilenio depots in Bogotá include infrastructure to facilitate the recycling and proper disposal of wastes (Figure 19.28).

19.4 Social impacts

“Humans have always had a complex relationship with technology. Automobiles, for instance, changed the nature of life in America, where we live, how we work, what we can do with our leisure time. But they have also brought us traffic jams and contributed to global warming. The impact of information

technology may be equally profound, and these are things we need to think about and study.”

—Michael Quinn, historian, 1944—

As with other indicators, the social impacts of a BRT system will depend on how the system is designed, so project specific appraisal is generally necessary. Some development institutions require a social impact assessment for major projects like BRT, either as part of an EIA or as part of an assessment of the poverty alleviation impacts.

19.4.1 Types of social impacts

19.4.1.1 Property expropriation and resettlement

Usually, the greatest concern in social appraisal of infrastructure projects is with property expropriation and involuntary resettlement. Normally, BRT systems will be designed in such a way as to minimise involuntary resettlement, and in fact BRT systems frequently make it possible for municipalities to put off or stop all together new road projects which would have much higher levels of involuntary resettlement. Nevertheless, some BRT systems may require some involuntary resettlement, and in such circumstances the involuntary resettlement guidelines drafted by institutions such as the World Bank should be followed. Chapter 11 (Infrastructure) discusses good practice procedures for addressing property expropriation issues.

19.4.1.2 Displacement of paratransit workers

Of much greater concern with BRT projects is what will happen to the former paratransit operators and the families that rely on them for income. In most BRT systems, negotiations with existing bus operators have been tense. In the best cases, like in Bogotá, Guayaquil, and Jakarta, major social upheaval was avoided by negotiation and compromise which ensured that at least some existing operators enjoy the benefits of the new system, while at the same time not holding the public interest hostage to the demands of these private interests (Figure 19.29). In the worst case, like in Quito, a general strike by the former bus syndicates shut down the transit system for five days and the military had to be called in to avoid further violence (Figure 19.30).



Fig. 19.29

In Guayaquil, a negotiated concession process meant that existing owners and drivers embraced the new system.

Photo by Lloyd Wright

Certainly, if all the most lucrative public transport routes in a major city are taken away from local paratransit operators who own their own vehicles, and these routes are given to a foreign multinational corporation who brings in replacement workers from an even poorer country, and divests the profits, the social impact of a BRT system could be quite negative. The former paratransit drivers, who have put their life savings into their minibuses, now are holding a worthless asset. Such a decision would no doubt lead to significant social upheaval.

For this reason, most BRT systems do not completely turn private bus operations over to international competitive bidding, but rather structure the terms of the competitive bid to ensure that a significant number of the existing bus operators in the corridor affected are re-incorporated into the new system. How this is done specifically will vary depend on the structure of the existing paratransit industry.

In Bogotá, for example, the companies bidding on becoming the operators of the new BRT system got extra points for “experience operating buses in the corridor”. Also, each bidder had to destroy several of the old paratransit buses for each new vehicle that they procured. This

requirement forced the bus enterprises to buy from the small individual bus owners their old buses, so that they would be able to recoup the value of their only capital asset. Some of them accepted cash and some of them accepted shares in the new company.

19.4.1.3 Poverty alleviation

For certain sources of international financing, including ostensibly all World Bank financing, the project must demonstrate some sort of poverty alleviation impact, while others (US AID Housing Guarantee Loans, for example) require that the principal project beneficiaries are below median income levels. In the past, some members of the World Bank staff have questioned the viability of urban mass transit investments for lack of clear evidence that they benefit the poor.

Certainly, this is a valid criticism of many new metro systems in developing countries, where the cost of the new metro service tends to be several times higher than traditional bus services, while the wealthy tend to be disproportionately represented among the beneficiaries.

The same cannot be said of most BRT systems, however. Most BRT systems have managed to keep fares in line with normal bus services while dramatically improving service quality and speed.

Fig. 19.30

By contrast, in Quito private operators parked their vehicles and blocked the new Trolley system from initially operating.

Photo courtesy of El Comercio.

Fig. 19.31

In the planning of new BRT systems in South African cities such as Johannesburg and Tshwane, the emphasis is on bringing quality public transport to previously disadvantaged communities.

Photo by Lloyd Wright



Lower operating costs allow BRT systems to be self-financing at much lower fare levels, making it possible to keep the system in private hands while providing services affordable to the poor.

Further, many new systems have focussed initial corridors on the lowest-income neighbourhoods. This emphasis helps ensure that the new system will play a role in improving access to jobs and public services (Figure 19.31).

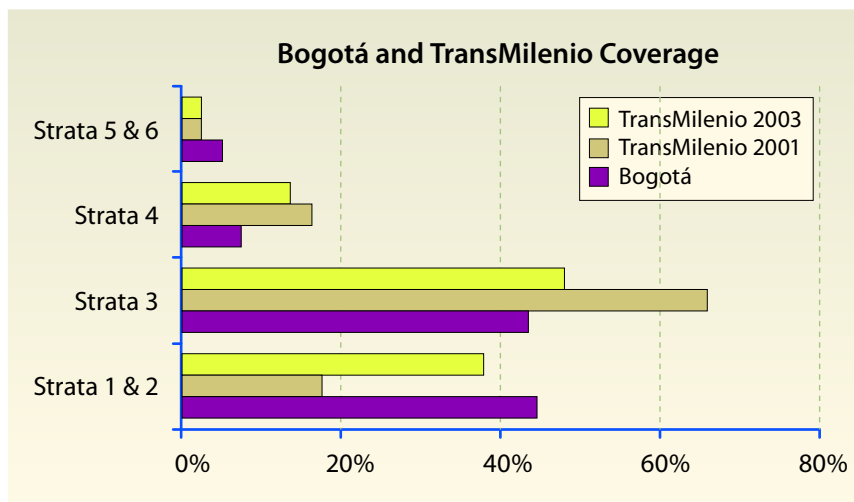
Colombia divides its population into six income groups. Category one and two are considered “poor” under Colombian law. Of all TransMilenio passengers, 37 percent are from these two lowest income categories, 47 percent are from category three (which represents 66 percent of the total population), 13 percent are from category four, and 3 percent are from categories five and six (Figure 19.32). On average,

TransMilenio passengers save roughly US\$134 per year in travel costs and 325 hours per year in time savings. In a separate survey, TransMilenio found that much of the time savings meant more time was spent with children and other family members.

Similar data has been collected for the TransJakarta system. From a sample of 350 system users, this study found that approximately 40 percent of passengers were defined as “low income” based on proxy indicators. Some 87 percent of respondents said their travel time was reduced while only 2 percent reported a longer travel time. In terms of travel cost, 47 percent said their travel cost was slightly lower, 29 percent said it was the same, and 21 percent said their travel cost was higher than before.

Fig. 19.32

Income levels and BRT usage in Bogotá.



19.4.1.4 System sociability

Public transport systems can also provide one of the few places in a city where all social groups are able to meet and interact. An affordable and high-quality system can attract customers from low-income, middle-income, and high-income sectors (Figure 19.33). This role as a common public good can be quite healthy in creating understanding and easing tensions between social groups.

The new system may also mean that persons who previously had no travel options now can visit the entire city. In Bogotá, approximately 9,000 trips per day are made in TransMilenio by persons who had some form of physical

disability preventing them from using the previous public transport service. In the new system, the platform level boarding and ramps to the stations means that a whole new world has opened up to these individuals.

19.4.1.5 Crime reduction

Some evidence suggests that public transport upgrades can also reduce crime. Improvements in station lighting and nearby footpaths as well as the presence of security cameras and security personnel can do much to create a different urban environment (Figure 19.34).

The development of the Bogotá BRT system contributed to an environment that experienced dramatic reductions in crime. In 1999, the year prior to the introduction of TransMilenio, 2,058 robberies were recorded in the city. By 2002, this figure had dropped to 1,370, a reduction of 33 percent. The city also experienced a 32 percent reduction in personal assaults and a 15 percent reduction in homicides over the same period. These impressive reductions were achieved through a combination of innovative measures, of which the BRT system and accompanying improvements in public space were just one component. Thus, the credit cannot be directly given to the BRT system, but it is likely that the system has contributed to creating a safer and more pleasant environment in the city.

19.4.1.6 Safety

The separation of public transport vehicles from mixed traffic and the improvements to pedestrian crossings and traffic signalisation are measures typically employed to make a new BRT operate efficiently. These same measures also tend to produce significant safety benefits. Thus, reductions in vehicle accidents and pedestrian accidents often accompany the implementation of a new system.

Figure 19.35 summarises the safety improvements emanating from the implementation of the Bogotá TransMilenio system.



19.4.1.7 Estimating social impacts

Predicting the likely beneficiaries of a BRT system is generally quite simple. As one can safely assume that the majority of BRT passengers will be drawn from existing bus and paratransit passengers using the same corridor, surveys of the income characteristics of existing bus and paratransit passengers in the corridor should provide a very close estimate to the population of beneficiaries for the final system. If the system primarily serves upper income neighbourhoods, the chances are that the beneficiaries will be similarly predominantly from among the upper income groups, and if it primarily serves

Fig. 19.33

A public transport system's ability to bring together people from all walks of life helps increase social understanding between different classes.

Photo by Lloyd Wright



Fig. 19.34

Lighting upgrades along the Guayaquil Metrovía corridors helps to create a more secure urban environment.

Photo by Lloyd Wright

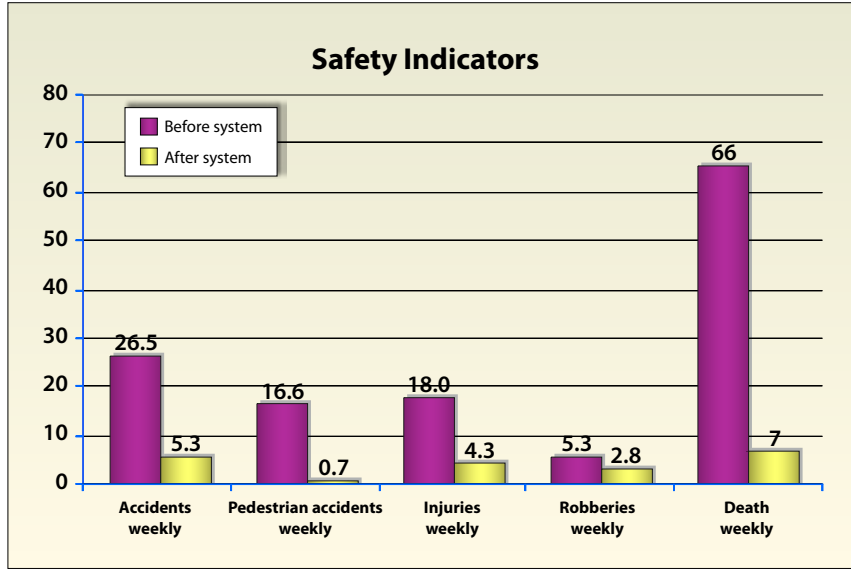


Fig. 19.35
Changes in key safety and security statistics before and after the implementation of the Bogotá TransMilenio system.

Graphic courtesy of TransMilenio SA

lower income neighbourhoods it will tend to serve lower income groups.

A rough estimate of the impact of the new BRT system on lower income groups can generally be calculated by assuming that the poor will have the same level of representation among the BRT system’s ridership as they have among the current bus and paratransit ridership in the same corridors. This result has been borne out by empirical research. The net benefits calculation would then be applied to this share of the population to calculate the benefits among the poor. A more detailed analysis can be done

with a traffic model by looking more closely at the impact of the new system on origin-destination pairs among the lowest income zones throughout the city.

The location of the poor in the urban area will tend to make different fare structures more or less equitable. In most developing-country mega-cities, the poor tend to live at the periphery of the city. In such circumstances, a flat fare structure such as that utilised in Bogotá, Guayaquil, and Quito will tend to cross subsidise long distance low-income trips. On the other hand, there are some exceptions, where the poor are more randomly distributed throughout the greater metropolitan area, or where the poor occupy the central city. In these rare instances, a distance-based fare structure may be more equitable.

With all the various social indicators, recording existing data on critical indicators prior to implementation will help to set an appropriate baseline by which the system can later be evaluated. Thus, ensuring that data on indicators such as safety and security are measured along the planned corridors will provide a point of future comparison.



Fig. 19.36
High-rise development in Curitiba takes place only along the BRT corridors.

Photo courtesy of the Municipality of Curitiba

19.5 Urban impacts

“Because I believe a lot of people share my feelings about the tragic landscape of highway strips, parking lots, housing tracts, mega-malls, junked cities, and ravaged countryside that makes up the everyday environment where most live and work. A land full of places that are not worth caring about will soon be a nation and a way of life that is not worth defending.”

—James Howard Kunstler, author and social critic, 1948–

19.5.1 Types of urban impacts

The relationship between BRT and land use can have long-lasting impacts on the form of the city. Busways can play an important role in concentrating new development in strategic locations which minimise the long term cost of providing transit and other urban services to these households and firms.

For example, the BRT stations in Curitiba are development nodes, which act to attract mixed commercial and residential development that reduces necessary vehicle kilometres travelled through co-location. Curitiba’s zoning system was closely linked with the BRT system’s development, and much higher density development was allowed along the BRT corridors than was allowed along the mixed traffic arterials. This policy ensured that as the city grew, it grew in a reasonably compact manner along the BRT corridors (Figure 19.36).

In Bogotá, while there was minimal link between TransMilenio and zoning changes, low-income housing sites were located near TransMilenio terminals, and connected to these terminals by pedestrian and walking-only facilities. In this way, the city is growing up around low-cost cycling and walking facilities closely linked to TransMilenio (Figure 19.37).

In fact, the busways and development nodes are mutually beneficial. The strategic siting of BRT stations improves customer access to shopping, employment, and services while the high-density centres ensure sufficient passenger traffic to maintain cost-effective busway operations. Curitiba has also coordinated new residential construction around bus arterials.

The end result is that the municipality can deliver basic infrastructure such as water, sewage, and electricity at a significant cost



Fig. 19.37
High-quality pedestrian and cycleway facilities connect low-income communities with the TransMilenio system in Bogotá.

Photo by Lloyd Wright

savings to areas with concentrated development. While mixed use, high-density planning does not always guarantee a sustainable urban environment, integrated planning efforts between land use and transport can provide a win-win situation for municipal officials, commercial developers, and residents.

19.5.2 Predicting changes in urban form

Estimating the projected changes in urban form induced by a new BRT system is difficult. Some transport-land use models have been developed, but such models are not very robust, and few have been calibrated for use in developing countries. It is probably easier to make fairly simple and plausible assumptions and embed these assumptions in the 20-year traffic projection. It is common among metro project promoters to make fairly heroic assumptions about possible land development in the corridor as a way of justifying the massive investment, but it is probably wiser to make fairly modest assumptions about future development in the corridor. After all, if the system is poorly designed, operated, or maintained (much of which will be difficult to determine in the early planning stages), it may be that there will be disinvestment rather than investment into the corridor.

19.6 Monitoring and evaluation plan

“Do not believe in anything simply because you have heard it. Do not believe simply because it has been handed down for many generations. Do not believe in anything simply because it is spoken and rumoured by many... Do not believe in anything merely on the authority of teachers, elders or wise men. Believe only after careful observations and analysis, and when you find that it agrees with reason and is conducive to the good and benefit of one and all, then accept it and live up to it.”

—Buddha, spiritual leader, 560 BC–480 BC

19.6.1 Fundamentals of monitoring and evaluation

In many respects, the success or failure of a system can be apparent from public reactions to the system. The customer’s opinion is perhaps the single most important measure. However, to obtain an objective and quantifiable indication of a system’s overall performance, a defined monitoring and evaluation plan is fundamental. The feedback from such a plan can help identify system strengths as well as weaknesses requiring corrective action.

The identification of a full set of system targets and indicators is a first basic step in the development of a monitoring and evaluation plan. A baseline value should be created for the relevant indicators. Thus, the evaluation work will begin prior to the development of the system. By noting such factors as average vehicle speeds,

travel times, and public transport usage prior to the system’s development, it will be possible to quantify the benefits gained by the new system. Most indicators will be quantitative in nature, but qualitative assessments can also be accommodated through survey work.

A strict monitoring and evaluation schedule should be established. Many of the system performance indicators, such as passenger numbers, will be collected automatically through the management control system and the fare collection data system. Other indicators will require direct periodic measurement. The initial period of system operation will likely be a period of more frequent measurement since there will be great interest to evaluate the original design and operational assumptions. Feedback from the initial monitoring may shape the design and operational adjustments that frequently occur in the first year of operation. After the initial months of operation, though, a regular pattern of data collection should be established.

Baseline data may also need to be collected across several different points of time. Some baseline factors will likely vary by time of day, day of the week, and months of the year. The original modelling process is another rich source of potential baseline data. Evaluating the projections from the demand modelling process will also be helpful in determining the accuracy of the model for future applications.

19.6.2 System performance indicators

The potential indicators for evaluating system performance include:

- Mode shares (public transport, private vehicles, walking, cycling, taxis, motorcycles, etc.);
- Average travel times;
- Average public transport vehicle speeds;
- Average private vehicle speeds;
- Passenger capacity of roadway;
- Peak capacity of public transport system;
- Average wait times;
- Total travel cost;
- Public transport subsidy levels;
- Number of positive media reports on system/ number of negative media reports on system;
- Customer satisfaction (Figure 19.38).

Fig. 19.38
Customer satisfaction is perhaps the most important indication of a system’s success or failure.

Photo courtesy of TransMilenio SA



19.6.3 Economic indicators

The potential indicators for evaluating economic impacts include:

- Employment created during the construction phase;
- Employment created in the operational phase;
- Economic value of travel time savings;
- Economic value from the reduction of congestion;
- Property values near stations and corridor;
- Shop sales near stations and corridor;
- Vacancy rates of properties near stations and corridor;
- Creation of private firms producing BRT technologies (*e.g.*, vehicles, fare collection technology);
- Employment generated from local production of BRT technologies.

19.6.4 Environmental indicators

“Not everything that counts can be counted, and not everything can be counted counts.”

—Albert Einstein, physicist, 1879–1955

The potential indicators for evaluating the environmental impact of the system include:

- Levels of local air pollutants (CO, NO_x, SO_x, PM, toxics, O₃);
- Emissions of greenhouse gases (CO₂, CH₄, N₂O);
- Noise levels;
- Hospital admissions for respiratory illnesses (Figure 19.39);
- Indices of asthma in city;
- Number of older buses retired from service.

19.6.5 Social indicators

The potential social indicators for evaluating the system include:

- Percentage of public transport passengers from each socio-economic grouping;



Fig. 19.39

Health indicators can say much about the actual effectiveness of any new public transport system.

Photo courtesy of Swisscontact and the GTZ SUTP Photo CD

- Percentage of household incomes required for transport;
- Crime levels along corridor;
- Crime levels within public transport vehicles;
- Vehicle accidents on corridor;
- Pedestrian accidents, injuries, and fatalities.

19.6.6 Urban indicators

The potential indicators for evaluating impacts on urban form include:

- Number of new property developments along corridor;
- Opinion surveys on quality of public space along corridor.

19.6.7 Political indicators

The potential indicators for evaluating political impacts include:

- Change in number of political officials supporting project over time;
- Re-election success rate of officials supporting system.

20. Implementation plan

“Plans are only good intentions unless they immediately degenerate into hard work.”

—Peter Drucker, management consultant and writer, 1909–2005

The production of a planning document is not the end objective of this process. Without implementation, the planning process is a rather meaningless exercise. And yet, too often significant municipal efforts and expenditures on plans end in idle reports lining office walls, with little more to show for the investment.

The planning process should instead provide a confidence boost to leaders and ensure that sufficient considerations have been taken to ensure a successful implementation. Thus, this final stage of the BRT planning process is the critical point to ensure that the spirit and form of the plans can be brought to completion in an efficient and economic manner.

During the planning process, the team of planners, engineers, and business professionals likely operated within an organisational structure that was tailored to delivering a high-quality plan. As the project turns to implementation, the new oversight organisation (e.g., a BRT authority) will take on different roles and responsibilities. Thus, an organisational framework must be

developed to maximise the efficiency of the long-term entity. Ultimately, the organisation’s success or failure will likely rest upon the type of persons recruited. Therefore, the hiring process must be conducted in a manner to attract the best professionals possible.

Once the body of the operational design, physical design, and business plan are complete, a political commitment will be required to move towards construction and full implementation. The designation of an agency to oversee implementation should be made well before the planning process ends. Also, many contractual agreements will be required in order to legally release the implementation work. These contracts will cover areas such as construction, maintenance, and operations.

If the construction process itself results severe traffic congestion and general city-wide chaos, the new system may acquire a negative public image even before it is opened. Thus, construction itself requires a fairly well-defined schedule and operational plan to minimise disruptions.

Finally, the system will require some maintenance and upkeep activities right from the start. A well-articulated preventative maintenance plan can help ensure the new systems appears “new” for as long as possible.

The topics discussed in this chapter include:

20.1 Implementing agency

20.2 Operating contracts

20.3 Construction

20.4 Maintenance

20.1 Implementing agency

“The implementation is what has to be done next, and sometimes a fresh eye is what is needed for that. I see this as a good time to retire.”

—Helen Krause, animal rights activist, 1904–1999

All the planning might be completed, and it still may not be clear who is responsible for implementing the project. Normally, the institution responsible for the planning of the system will become the agency responsible for the managing the operational contracts, though this progression

is not always the case. The planning might be done by private consultants under contract to a project management office inside a municipal government or national government agency.

20.1.1 Appointing the implementation agency

“Men often oppose a thing merely because they have had no agency in planning it, or because it may have been planned by those whom they dislike.”

—Alexander Hamilton, statesman, 1755–1804

The critical first step in implementation is therefore for the Mayor or the Governor to decide on which government agency or agencies are going to implement the project, and if there are multiple agencies, how they are going to relate to each other. If it is decided that a new agency is to be set up to implement the project, this agency needs to already have been established by the time implementation begins, because the agency will need to have the legal power to issue contracts. If a new agency is to be set up, work on this must begin early, as this process can be legally complex.

Responsibility for implementation is generally divided between the construction aspects of the project, and the operational aspects of the project. Responsibility for managing the construction is generally under the department of government normally responsible for large urban road works. This responsibility often lies with a municipal department of public works, but sometimes a municipal department of transportation, or even a provincial or national department of urban roads. Responsibility for the operational aspects of the BRT system is normally under a new BRT authority, a pre-existing public transport authority, or a department of transportation. Responsibility for coordination must rest with a person with direct access to the principal decision-maker, either the Mayor or the Governor, or the relevant national or provincial Minister (Figures 20.1 and 20.2).

The decision regarding which agency should be responsible for implementation needs to be chosen based on both technical and political

criteria. Most important is to choose the agency which has the most competence in implementing similar projects of this size and scope, and the regulatory power to implement the project without complex inter-governmental approvals. The larger contracts generally run in the tens of millions of dollars rather than the hundreds of millions, and the smaller contracts in the millions of dollars, so the agency selected should have experience managing contracts of this size.

However, sometimes the agency with the most experience has a conflict of interest. A typical issue, for example, is that the agency responsible for regulating the existing public transport service, often a department of transportation, may raise considerable revenue (both licit and illicit) from the existing regulatory structure, and may be highly resistant to change. In other cases, a poorly run public bus company may exist, and it may not be desirable to encumber the new system with the poor management of the old system. It may be politically more expedient in this situation to create a new BRT authority than to reform an entrenched agency. In other cases, a new BRT project may be the impetus for the creation of a public transport authority with broader powers. The important issue is that whichever agency is responsible focuses its primary attention on the successful implementation of the BRT project, or else the project will risk failure.

Fig. 20.1 and 20.2
Ultimately, the project's momentum will depend upon the drive of the top leadership, such as Mayor Myung-Bak Lee of Seoul (left photo) or Governor Sutiyoso of Jakarta.

Left photo by Erik Möller
 Right photo by Michael Replogle



20.1.2 Case studies

“Those who cannot remember the past are condemned to repeat it.”

—George Santayana, poet, 1863–1952

20.1.2.1 Bogotá

In the case of Bogotá, it was decided early in the project to create a special BRT authority called TransMilenio to manage the bus operations. It was decided that the project would not be put under the administration of the Secretary of Transport and Transit (STT), the existing public transport regulator. This division was made since they wanted the staff to be able to work full time on the BRT project, and not be encumbered with other duties. Also, it was perceived that the existing public transport regulator was an entrenched bureaucracy with a vested interest in revenues earned from the issuance of bus routing licenses (Figure 20.3).

TransMilenio started out in January of 1998 as just a project office in the Mayor’s office, with three young engineers. By August of 1998, a senior businessman was hired to head the new office, and the staff grew to five. They prepared a law for the Mayor to submit to the City Council which would authorise Mayor Peñalosa to establish the BRT agency, TransMilenio SA. This law was not actually approved by

the City Council until February of 1999, and TransMilenio SA was not actually created until October of 1999.

Prior to the establishment of TransMilenio SA, the project was run out of a “virtual” BRT agency under the senior businessman’s leadership, in an office directly under the Mayor. Once TransMilenio SA was created as a legal entity, a new Managing Director was hired. All the former staff members of the “virtual” agency became employees of TransMilenio SA. The previous director of the virtual agency became the Mayor Peñalosa’s representative for the project.

Since TransMilenio SA had not yet been created as a legal entity at the beginning of the planning, the contracts for the planning and conceptual design were not done under contract to TransMilenio SA. The system design consultants, the investment banks, and the lawyers were hired under contracts that were legally under the Transport and Transit Secretary (STT), but in practice the supervision of these contracts rested with temporary director of the virtual agency. The contract with the management consultants was a contract directly with the Mayor’s office, and it was also supervised by virtual agency.

By consolidating the control of the supervision of all of the relevant contracts under his authority, the Mayor essentially created a new government agency composed of new direct hires and all the relevant consultants. The Institute for Urban Development (IDU) was essentially the Department of Public Works for Bogotá. Even though the IDU would eventually take responsibility for the actual construction, it was not directly involved at this early stage. The consulting firms worked independently from the public works department (IDU) and the existing public transport regulator (STT), but both agencies were instructed that they had to cooperate with the consulting teams in full, and this clear instruction from the Mayor, and oversight by his direct representative, ensured full cooperation from both the public works department and the existing public transport regulator.

By the time Bogotá was ready to implement TransMilenio, however, TransMilenio SA had been created as an agency. TransMilenio SA became mainly responsible for the operational side of

Fig. 20.3
It was felt that the public transport regulator in Bogotá had too many entrenched interests with the existing bus operators, so a new agency was created for the new BRT system.

Photo by Karl Fjellstrom, courtesy of the GTZ SUTP Photo CD



TransMilenio as well as the development, completion, and tendering of the operating contracts.

The detailed conceptual design for the infrastructure was designed by the original planning consultants (Figure 20.4). At the implementation phase, these designs became the basis of contracts drawn up by the public works department so that a new set of firms could do the detailed engineering and actual construction. The public works department then handled the actual bidding process and signed the contracts with the winning bidders.

The structure of the various departments was such that coordination problems were successfully avoided. First, the director of TransMilenio SA, the Mayor’s project representative, and the Mayor himself were all members of the Board of Directors of the public works department, which met every two weeks to discuss the progress of the construction on the BRT project, and on other related urban development works. Second, there was a weekly meeting between TransMilenio SA and the public works department, to go over the detailed physical designs and ensure that the detailed designs stayed true to the conceptual design. This meeting was attended by the Mayor’s project representative and the Deputy Director of the public works department. Finally, there was a weekly meeting between Mayor Peñalosa, the Mayor’s project representative, and the director of TransMilenio SA to review progress and discuss any problems. At this meeting, Mayor Peñalosa would bring in the relevant persons from other agencies should coordination problems arise.

20.1.2.2 Jakarta case study

In the case of TransJakarta, the Provincial Governor put the responsibility for the physical infrastructure into the hands of the Department of Transportation, (DisHub), which had an infrastructure unit. Planning was nominally the responsibility of an inter-agency task force chaired by a senior advisor to the Governor.

In practice, as the budget for project implementation for both the infrastructure and the operators was passed entirely through the Department of Transportation, the project was tightly controlled by that department, and the influence of the inter-agency task force was nominal at best.

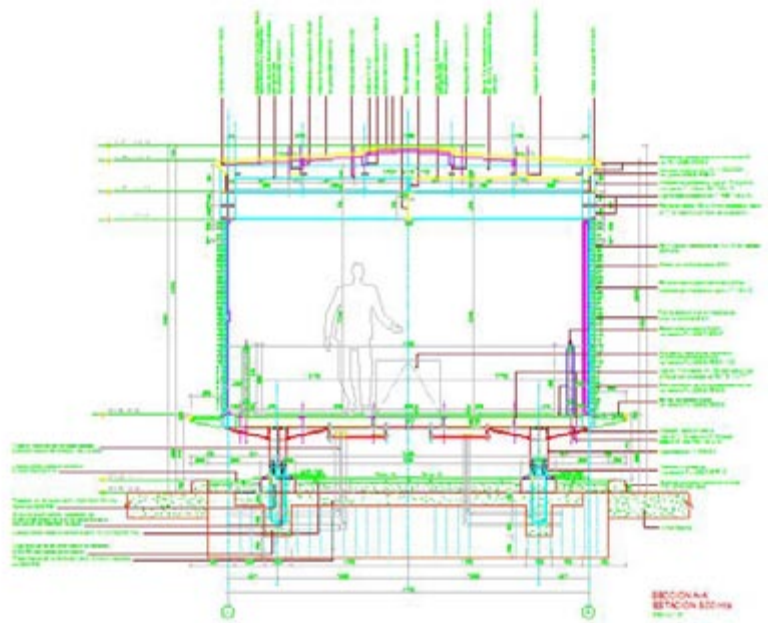


Fig. 20.4

The detailed design work performed by the consultants became the basis for the subsequent efforts of the public works department.

Image courtesy of TransMilenio SA.

The head of this task force later became the head of TransJakarta, the operating authority, but this operating authority had much weaker powers than TransMilenio, and most key decision making authority remained with the Department of Transportation. In this way, the project managed to achieve a certain level of coordination within the Department of Transportation.

20.1.2.3 Dar es Salaam

In the case of Dar es Salaam, the project is planned by a team of international consultants answering to a Project Management Unit under the Dar es Salaam City Council, answering to the Mayor. Unlike with TransMilenio, the planning taking place in Phase I will bring the

Fig. 20.5

In Jakarta, the Governor himself chaired the inter-agency task force.

Photo by Michael Replogle





Fig. 20.6
Small-scale model of the proposed Delhi system.

Image courtesy of the Indian Institute of Technology-Delhi (IIT-Delhi).

project to the point of having detailed engineering designs. Though not yet fully decided, the implementing agency for the operational contracts is likely to be a new government agency under the National Ministry of Local Government, probably incorporating many members of the current project management unit. Infrastructure will either be the responsibility of a national roads agency called TanRoads, or an upgraded provincial-level branch of TanRoads to be called DarRoads. The final decision will require a Cabinet Paper identifying the powers of the new agency.

20.1.2.4 Delhi

In the case of Delhi, the designs were done by a consortium under contract to the Transport Commissioner. There are no operational changes planned in the early stages, so operations will continue to be divided between the existing public bus authority, the Delhi Transport Corporation, and small private operators. Management of the construction work is likely to be split between agencies, depending on which agency has jurisdictional responsibility for the particular road. In the first phase, the Delhi Municipal Corporation will manage the construction work since this organisation controls the roads for that phase. However, later corridors will likely fall under the control of the Delhi Development Authority. Such split responsibilities over the construction work can lead to problems with project co-ordination and design compatibilities, if not carefully managed.

20.1.2.5 Ahmedabad

In the case of Ahmedabad, the operations are likely to be managed by the public transport corporation that already largely contracts out bus operations to private operators. The construction contracts are probably going to be issued by the Ahmedabad Municipal Corporation's engineering department, but a separate management contract for a private firm may later be issued. The detailed design is being done by the system's planners, CEPT, with some engineering details being done under contract to consulting firms. The construction contractor is responsible for the traffic re-routing during construction.

20.1.3 Co-ordinating operations and physical infrastructure

Care must always be taken to ensure that there are not coordination problems between the operational design and the construction design. Normally, it is best to have an overall project manager answering directly to the Mayor or Governor with direct responsibility to make sure that these two activities are done in a complimentary and coordinated manner.

The implementation of the operational plan and the implementation of the construction plan must be done simultaneously. It is a common problem that municipalities, more comfortable with construction projects than with difficult management decisions, move forward on construction greatly in advance of the implementation of the operations. This partial implementation has resulted in more than one case of the BRT infrastructure being completed long before there are any buses to operate in the system or any companies to operate them. In Cali (Colombia), for example, the new BRT system as of this writing continues to sit vacant of want of buses, after almost two years (Figure 20.7 and 20.8). Likewise, Ciudad Juarez in Mexico built a 3.5 kilometre corridor, but for various reasons it is not actually operating after over a year of possessing the infrastructure (Figure 20.9). Without a coordinating committee chaired directly by the Mayor or Governor to make sure that the construction contracts and operating contracts are carefully coordinated, projects can become badly stalled.



Fig. 20.7 and 20.8
The Cali (Colombia) system is an example of infrastructure development being far ahead of the business model. Without a business model in place, no vehicles can be purchased by the operators, and thus, the costly infrastructure is going unused.

Photos courtesy of Metrocali

Ensuring that construction is completed and that the vehicle operating systems and fare systems are all ready simultaneously is no easy task. In the case of TransMilenio, the Mayor’s representative had detailed information on the progress of the construction contracts. The construction contracts had very stiff penalties

Fig. 20.9

Despite possessing vehicles and the infrastructure, the Ciudad Juarez system is not actually operating.

Photo by Oscar Diaz



for late completion. The director of TransMilenio SA had very up to date information on the progress on the vehicles operations and fare system operations, and these contracts also required start of operations or penalties would be incurred. The contracted firms faced, as a worst case, the cancellation of the contract with the responsibility to pay more than US\$1 million in fines and being barred for signing any contract with the Colombian State for five years. In fact, deadlines were indeed pushed back, but

not until the very last minute and all parties were bullied and threatened with penalties and threats. The Mayor’s representative tightly controlled all this information, telling the construction companies that the bus operators were ready, and telling the bus operators that the construction companies were nearly finished.

20.1.4 Agency staffing

“In the end, all business operations can be reduced to three words: people, product and profits. Unless you’ve got a good team, you can’t do much with the other two.”

—Lee Iacocca, former CEO of Chrysler, 1924–

As the project moves closer to implementation, the full establishment and staffing of the BRT authority will be required. While a staff of three to ten persons may be sufficient at the planning stage, to develop the full management organisation a wider range of positions and skills will be

needed. The build-up of staff will likely occur in a phased manner with certain key positions being filled initially.

The formal establishment of the BRT authority should follow from the structures detailed in Chapter 15 (Business and Institutional Structure). This structure has the BRT authority to the mayor’s or governor’s office either directly or through a representative board of directors. As noted above, the legal process to form the management entity should be completed well before the system is launched.

The organisational structure of the management entity should promote clear lines of responsibility and should provide logical sub-units pertaining to the major functions of the organisation. Such units may include administration, financial control, legal affairs, operations, and planning. Figure 20.10 outlines the internal organisational structure utilised by TransMilenio SA.

The General Manager position has overall responsibility for developing and implementing the organisation’s strategy. The General Manager reports directly to the Board of Directors, and is the organisation’s principal interface with other governmental agencies and with private entities. The Assistant General Manager directly manages the day-to-day activities of TransMilenio’s four divisions: Administration, Planning, Operations, and Finance. The Internal Control Officer ensures that TransMilenio’s internal financial operations are conducted in a proper manner in accordance with the regulations established by the Board of Directors and the municipality. This position also oversees the fulfilment of the internal financial audit. The Legal Affairs Officer ensures that legal documents and contracts are in compliance with all local and national laws.

The Planning Division of TransMilenio is focused upon the planning activities required for the expansion of the system. The Planning Division thus takes the lead on new corridor projects. Figure 20.11 indicates the structure of the Planning Division.

The Operations Division of TransMilenio ensures that the system functions in an efficient manner. The Operations team monitors the performance of the private bus operators, the functioning of the control centre, and the

Fig. 20.10
Organisational structure of TransMilenio SA

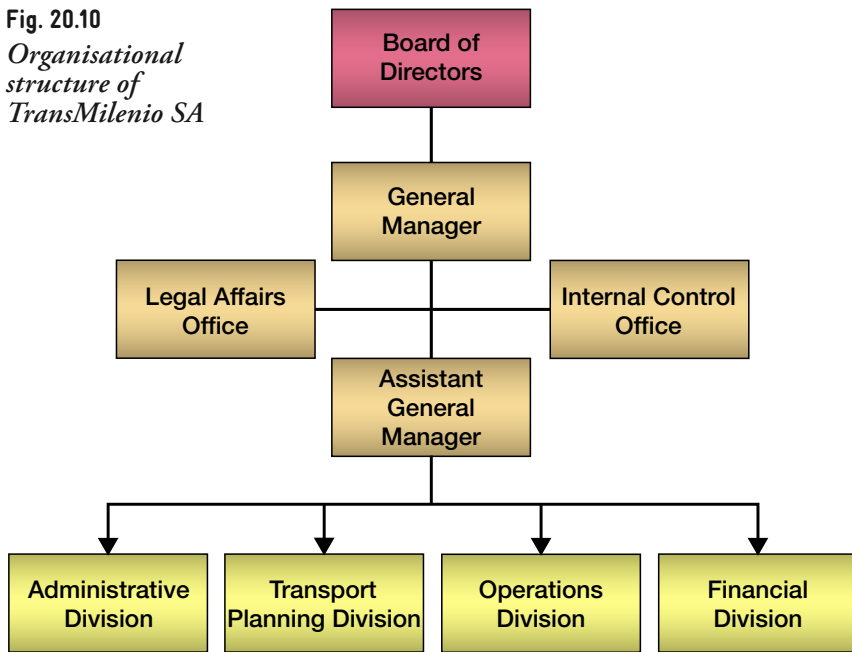


Fig. 20.11
Planning Division of TransMilenio SA

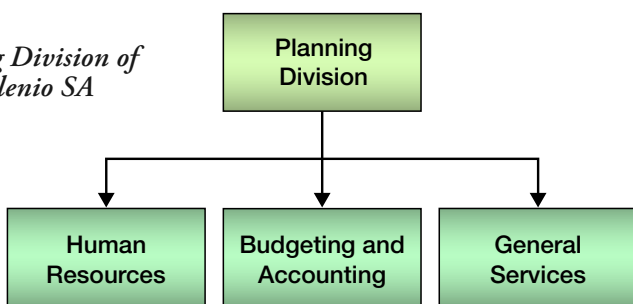
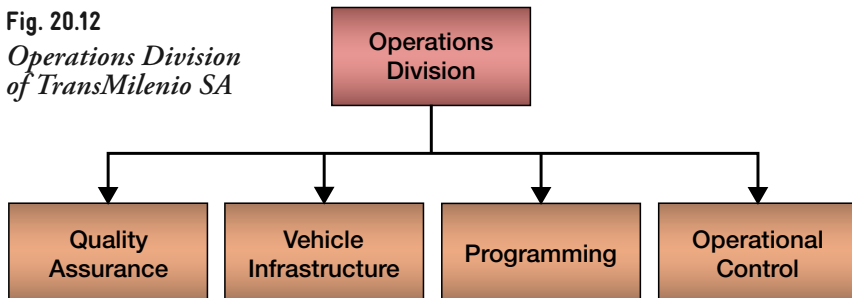


Fig. 20.12
Operations Division of TransMilenio SA



overall service quality of the system. Figure 20.12 provides an outline of the structure of the Operations Division.

The Financial Division of TransMilenio monitors the system’s cost structure to ensure the proper levels of technical fares and customer fares. This division also oversees the private operator with the fare collection concession. Figure 20.13 gives the structure for the Financial Division.

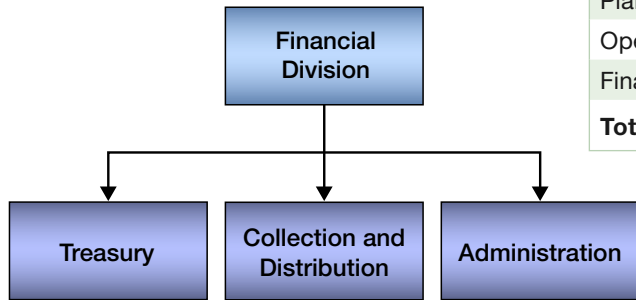


Fig. 20.13
Financial Division of TransMilenio SA.

The Administrative Division provides support services to TransMilenio SA in terms of human resources, budgeting, and general services. The structure of the Administrative Division is given in Figure 20.14.

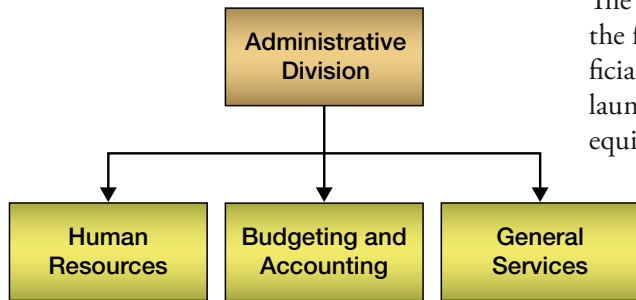


Fig. 20.14
Administrative Division of TransMilenio SA

During Phase I, TransMilenio managed to fulfil its mandate with a staff of approximately 80 persons. The simplicity of BRT systems along with the increasing prominence of information technology have permitted large public transport systems to be administered by relatively lean management agencies. Table 20.1 lists the number of staff by functional area during the first phase of the system’s operation.

Table 20.1: Employees by functional area during TransMilenio’s Phase I

Functional area	Number of employees
General Manager’s Office	5
Assistant Manager’s Office	5
Legal Affairs Office	5
Internal Control Office	3
Administrative Division	17
Planning Division	11
Operations Division	27
Financial Division	7
Total	80

Source: TransMilenio SA

Each position should be competitively advertised and processed through a formal interview process. The long-term success of the system will very much depend on the skills and creativity of the management agency’s staff.

20.2 Operating contracts

“We think in generalities, but we live in detail.”
—Alfred North Whitehead, mathematician and philosopher, 1861–1947

The contracts for the vehicle operators and the fare operators must be completed and officially registered well before the system is to be launched. Obviously, operators cannot purchase equipment (e.g., vehicles) until a signed contract is in hand. Since equipment delivery time may require as much as 12 months of lead time, the contracts must be finalised at least one year prior to the launch of the system. This timing is critical to a successful opening.



Fig. 20.15
Without providing effective contracts in a timely manner, the system’s implementation will be in jeopardy.

Photo courtesy of iStockphotos

20.2.1 Bogotá operational contracting

The drafting of the bidding documents and the negotiation of the operating contracts can require a good deal of effort and time. In the case of TransMilenio, it took eight months of discussion and research before the first public draft of the operating contracts for the trunk lines, the feeder lines, and the fare system, were produced and released for discussion. The posting of this official draft was the first time the private bus operators and fare system vendors had an idea of what to expect from the TransMilenio operational system. From that point, it took another six full months to draft these contracts. This drafting process was done in communication with bus operators and fare system vendors, but the decisions were made by TransMilenio.

The city of Bogotá did not have their own legal department, so they had to contract skilled outside legal experts to draft the actual bidding documents. These bidding documents required also strong leadership from TransMilenio SA because the lawyers needed to understand clearly the goals of the operating agency. In Phase II, this process took much less time, only one month, because they already had worked out the basic system structure, and had model contracts that they only needed to modify. An outline of a Phase II contract for trunk operators of TransMilenio is given in Annex 5.

Once the tender documents were released, companies were given three months to prepare their bids. The potentially bidding firms require an adequate amount of time in order to prepare themselves properly. Existing private bus corporations may not fit the bidding requirements laid

out in the contracting guidelines and in all probability will have to form new legal entities. The private bus operators may have limited experience operating a modern bus company, competing in a tendering process. These companies may be little more than a leasing operation with no experience in scheduling, vehicle maintenance, labour management, or driver training. Management consultants are generally required to help with this process. The BRT authority may wish to provide training assistance to small firms in order to prepare them for the tendering process.

Once the winners of the bid were announced it took another 38 days to award the contract. The tendering documents were almost identical to the contract, but not completely identical. The final contract had to be written but the contents were already locked in by the bidding process, and not subject to further negotiation, so it did not take long. However, it took some 38 days to go through the government internal procurement procedures, and to hold a formal award ceremony.

After they had the contracts, it took two months to put together the financing for the vehicles. This financing becomes easier in later phases, but in any first project phase this process can be very difficult and time consuming. In Bogotá, the operators could not secure financing until they had their operating contracts from the city in hand, as this is the basis of the revenue for the new company (Figure 20.16). This financing did not happen automatically, and was a matter of constant worry for the Mayor. The Mayor did not want to offer municipal guarantees since he wanted to keep the risk on the operators. The Mayor's office spent a lot of time and energy locating possible sources of financing for the vehicle procurement which did not require municipal government guarantee, and finally they succeeded. The procurement of the vehicles by the private operators was very important to making sure that the company making the profits also bears some of the risk of project failure.

Once the private operators secured the financing, it took another six months to produce and deliver the vehicles. This process could take longer if the vehicles are not standard, are coming from a smaller-scale manufacturer, or are being shipped to a more distant location.

Table 20.2: Timetable for operational contracting

Activity	Amount of time required
Hiring process for personnel to draft operating contracts	4 months
Preparation of draft operating contracts	8 Months
Completion of formal tender documents	6 months
Preparation of bids	3 months
Awarding of bids and signing of contracts	1.5 months
Identifying financing for bus procurement	2–3 months
Bus manufacturing and shipping	8–10 months
Total	32.5–35.5 months

In summary, from the time that TransMilenio began to prepare the operating contracts until the time vehicles were rolling on the street took a full twenty eight and a half months. In the case of TransMilenio this process was relatively fast-tracked, meaning no expenses were spared in terms of legal fees and management consultants.

While it can be done much faster, the shortcuts are likely to lead to significant operational problems or political problems. Many systems going forward today are moving rapidly on the physical infrastructure, while the operational contracting is being left to the last minute. A full 29 months should be considered the minimum amount of time required to set up a well managed system of private BRT operations. It can be done in less time if the structure of an existing system is more or less copied or if public procurement is used for the vehicles. The exact time will depend on the tendering rules of the particular country or city.

20.2.2 Jakarta operational contracting

In the case of Jakarta, the operational contracts were drawn up somewhat at the last minute. The Governor determined that it was politically necessary to have the system up and running by a certain date, January 2004. Without such a date, he feared the bureaucracy would continually delay the project. As is typically the case, the project was initially thought of largely in terms of the physical infrastructure, and the politically difficult and awkward negotiation of the operating contracts with the bus operators was left until the last minute.

With the system opening in January of 2004, TransJakarta had still not decided in July of 2003 whether the operators would be a single private entity, a public operator, or multiple entities. Around August it was finally decided that the operator would be a single private operator, a consortium to be formed largely of the bus operators currently controlling the bus routes along Corridor I. This decision, typical of Curitiba, Quito, and Mexico City (though a public operator shares some 20 percent of the routes in Mexico City) is usually taken not because it is in the interest of the system's users but because it is politically expedient to avoid conflict with bus operators. The legal entity that this consortium became was not actually



Fig. 20.16

Until the operators actually possessed the official contracts, they were not able to obtain financing for the vehicles.

Photo by Lloyd Wright

created until January of 2004, just days prior to the beginning of operations.

Because there was no legal entity able to procure the vehicles, there was no other option available than having the government procure the vehicles directly, in this case the Department of Transportation. This procurement meant that the municipal government had to incur the entire cost of the vehicles using public revenues (Figure 20.17). It also meant that the municipality remained the owner of the vehicles, and the incentive of the operators to maintain the vehicles was not strong. Nor did the municipality have the technical expertise to select the optimal vehicle, so the buses were over-powered, overly-heavy, causing needless fuel consumption and road damage.

There was not even enough time for the government to buy the buses using normal municipal competitive bidding rules. As a result, the Department of Transportation had to use a



Fig. 20.17
In Jakarta, the urgency of implementation forced government procurement of the vehicles.

Photo by Karl Otta, courtesy of the GTZ SUTP Photo CD-ROM

Fig. 20.18
Bogotá gave a lump-sum contract to the fare system company to both purchase the fare equipment and to operate the system.

Photo by Klaus Banse, courtesy of the GTZ SUTP Photo CD-ROM



clause in the law that allows the Governor to go around the normal competitive bidding rules in the case of “exceptional circumstances”, a clause normally intended to allow the city to cope with natural disasters. This action made the procurement subject to suspicions of government impropriety and subjected the municipal administration to an invasive investigative procedure and a near lawsuit. Though no impropriety was found, this investigation tarnished the reputation of the project politically.

The sole-source contract that was signed with a consortium of the existing bus operators created a monopoly that had a very strong bargaining position relative to the government.

TransJakarta, the operating agency, was also created at the last minute, and its powers were tightly restricted. It had to agree to pay the companies a very high fee per vehicle kilometre to convince the operators to cooperate. These firms had no experience in running a BRT system, or even experience running a formal sector corporation. Many of the drivers were initially operating the vehicles without any clear labour contract and some of the drivers hired turned out not to be competent or trustworthy. This situation led to labour disputes in the early months, with staff walking off the job and disrupting services. Neither the operators nor the operating authority had any experience with bus service scheduling, so the vehicles left at almost random times, leading to bunches of vehicles arriving at stations simultaneously during some periods, and then long periods where no vehicles would arrive.

20.2.3 Fare system contracting

Problems with the contracting of the fare system equipment and operations can also lead to operational difficulties. In the case of TransMilenio, there was a single lump sum contract with a single company to provide all of the fare system equipment and to operate the fare system equipment over a period of eight years. This lump sum contract approach to the fare system did ensure that there were no problems between the fare system operator and the owner of the fare system equipment (since they were one in the same). However, it turned out to be a very expensive way for TransMilenio to procure fare system equipment, and the system implemented was extremely simple and had operational problems at the beginning (Figure 20.18).

In Jakarta, the Department of Transportation procured the fare system equipment directly and then TransJakarta hired a separate operator who was responsible for running the system. In a rush to implement the system, Jakarta did not take good care in negotiating this contract, and the fare system equipment seller provided no guarantees to turn over the secret codes needed for programming the system to the company overseeing fare operations. It also did not include penalties for major system failure, and the system had every type of failure imaginable, from failure of the smart cards to failure of the fare readers to failure of the equipment to send

information to central computers. The weakness of the contracts and the division between the two companies made it very difficult to penalise either company when major problems arose.

Despite all the problems that can occur, and some negative publicity that can result, it is easier in some political systems to just start operating the system, and then fix the problems as they become readily apparent and a crisis exists. Nevertheless, proper planning can avoid many of these problems.

20.3 Construction

“The whole difference between construction and creation is exactly this: that a thing constructed can only be loved after it is constructed; but a thing created is loved before it exists.”

—Charles Dickens, novelist, 1812–1870

20.3.1 Construction contracts

“Society is indeed a contract. It is a partnership in all science; a partnership in all art; a partnership in every virtue, and in all perfection.”

—Edmund Burke, statesman and philosopher, 1729–1797

20.3.1.1 Overview

Construction actually involves four separate activities, and the way contracts for implementing these activities are packaged varies:

1. Detailed conceptual design;
2. Detailed engineering design;
3. Construction;
4. Maintenance.

Furthermore, BRT systems involve several different types of construction, not just roads. Unlike with a standard road project, a BRT system will involve fairly distinct types of construction, including:

1. Runways;
2. Stations;
3. Intermediate transfer stations, terminals, and depots;
4. Control centre and administrative buildings;
5. Pedestrian access infrastructure;
6. Integration infrastructure such as footpaths, bike lanes, and parking garages.

The contracting strategy may involve bundling different elements of the four construction phases, and almost all combinations are possible with different benefits and risks. Guidance on how best to group these activities together has



Fig. 20.19

A flawed tendering process with the Jakarta fare system meant many operational problems at the outset.

Photo by Karl Otta, courtesy of the GTZ SUTP Photo CD-ROM

not yet been fully systematised, but some experiences to date are given in this section.

The structure of the contracting should be done in a way that:

- Minimises the government’s cost of engineering and construction;
- Minimises the risk of unexpected increases in the construction cost;
- Minimises financing cost;
- Minimises construction delays and transaction costs;
- Minimises coordination problems;
- Minimises the risk of substandard construction;
- Achieves other social and political goals.

How these objectives can best be achieved will depend on local circumstances.

20.3.1.2 Bundled contracts vs. separated contracts

The implementation process can involve a single large contract with all activities bundled together. In such cases, a large construction consortium would likely oversee the entire process. At the other extreme, each aspect of the process can be divided into many different contracts. There are also many possible permutations in between these two options. This section discusses some of the different considerations in choosing the structure of the contracts. Figure 20.20 summarises the different issues with each option.

Minimising overall engineering and construction costs

If a government is not entirely sure it wants to go ahead with a BRT project, one way to minimise the cost of the project is to separate the conceptual design from the detailed engineering. Likewise, the city can separate detailed engineering from construction. A government might be ready to spend the money on design and detailed engineering but not yet on the construction. A government may also not need to borrow money to implement the project if the total cost of the work package is kept under a certain minimum cost. Separating these steps would allow the government to pay for the design and construction more incrementally.

In other circumstances, a government may be in a great hurry to implement the system during a single political term of office, and may wish to lump together the design, engineering and construction all into a single contract to speed up the contracting process, even if it increases costs and risks. A single contract may also ensure there is commitment to full implementation, even if subsequent political administrations are less enthused about the project.

The size of construction firms operating in any given country will also vary, and their capacity to handle large projects will be a factor. Any major construction job requires certain fixed costs, such as the hiring of project personnel,

and certain variable costs, such as the construction materials. The larger the job, the less these fixed costs will be as a share of total costs. If contracts are broken down into very small project pieces, the loss of scale economies could significantly increase project overheads. In Delhi, the initial decision to break up the construction of the first corridor into two phases dramatically increased the total project cost due to the need to retain certain fixed costs over a longer period of time. If the contracts are too small, the project may also not be able to attract the interest of the largest construction companies that may have lower total costs due to returns to scale.

If a project is sufficiently large, it can actually increase the cost of locally procured construction materials by bidding up the price of these materials in the local market. BRT projects can be large enough to have such impacts. For this reason, for very large construction projects, international competitive bidding for the construction may be desirable. International construction firms are often able to mobilise resources from all over the world for a single project very rapidly, without significantly adversely impacting the local construction industry.

On the other hand, competition is also a factor. Governments generally like to have a reasonably large group of contractors available that can

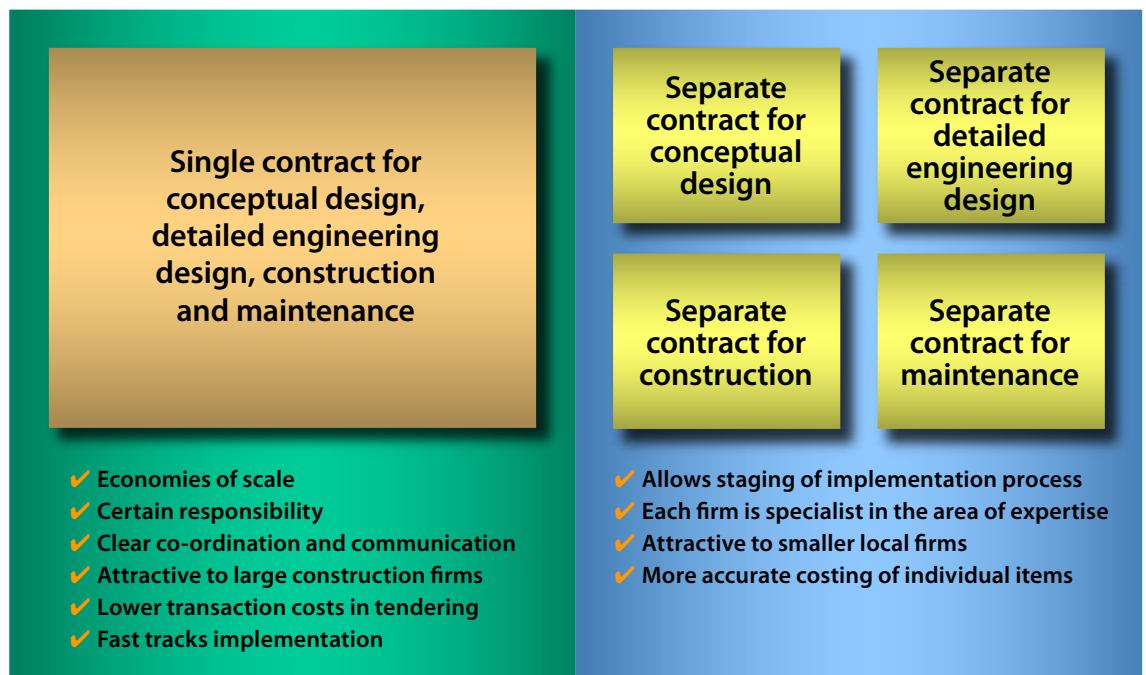


Fig. 20.20

The implementation contracting can be either bundled together or separated into individual pieces. Each approach carries specific advantages and disadvantages.

provide any given government service so as to ensure solid competition during a competitive bidding process. If the size of the BRT construction contract is too large, the number of firms that will be able to bid will be limited. If too many activities are bundled together, the number of firms able to provide all these services is likely to be limited, forcing firms to create consortiums, and these consortiums are sometimes unstable and unpredictable entities.

Breaking up different parts of the construction job to different companies will also create a sense of competition among government contractors. The municipality will be able to judge the performance of each company, and thus make decisions about the best performing firms for future contracts. This comparative analysis will likely spur a better performance from each of the participating firms.

Minimising the risk of unexpected construction cost increases

Like any major infrastructure project, one of the most difficult problems faced by governments is how to anticipate the actual cost of construction in the face of enormous uncertainties. Because no firm is actually sure what will be discovered once the ground is dug up, it is typical for all sorts of unexpected problems to be discovered once construction begins. Many construction companies take advantage of this uncertainty to systematically increase their billing on government contracts.

Predicting actual construction costs before the work begins is difficult even for normal road projects. BRT projects may be more difficult since many construction elements can be unique. Both governments and construction companies may have limited experience with such projects, and thus will not readily be able to estimate the cost based on previous projects. The station costing can vary widely depending on what sort of station has been designed by the architects, the sort of material used, etc. Street furniture, bike lanes, decorative lighting, landscaping and other amenities that usually accompany reconstruction in a BRT corridor

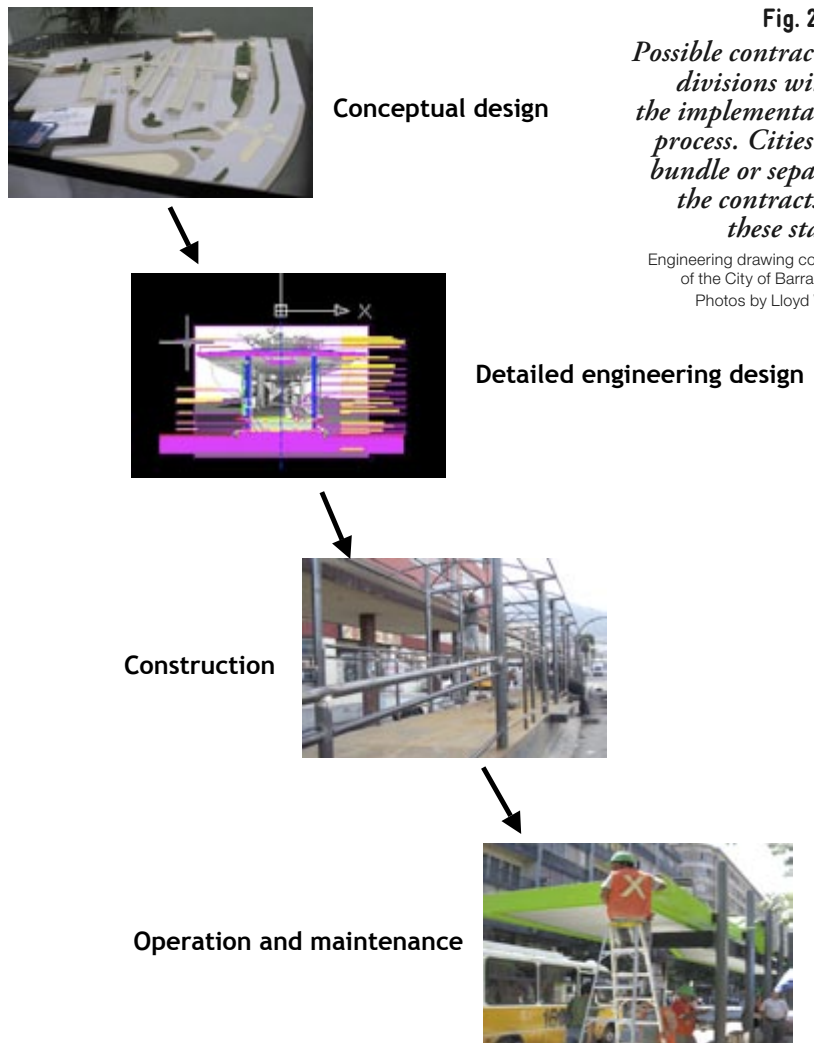


Fig. 20.21
Possible contractual divisions within the implementation process. Cities can bundle or separate the contracts for these stages.

Engineering drawing courtesy of the City of Barranquilla
Photos by Lloyd Wright



Fig. 20.22
The sub-surface of any street can be a complicated environment, creating uncertainty in full construction costs.

Photo by Lloyd Wright

may also vary widely in cost. A standard road construction firm may have no idea how to cost out stations, street furniture, and the like, but may also not want to bring in an outside firm once they have already received the contract in order to maximise their profits.

As a result of these problems, it is fairly typical for actual construction costs to be double original estimates. In the case of TransMilenio Phase I, the construction costs were on average 50 percent higher than original estimates. In the Delhi BRT project, for instance, the firms responsible for the detailed engineering had no experience with BRT infrastructure components. Ultimately, the actual bids by construction companies came in some 30 percent higher than the designers had estimated, and insufficient funds had been allocated in the budget. In turn, more funds had to be secured from the government, and the bidding process had to be repeated.

In lower-income developing countries, the cities may not have recent topographical surveys upon which to base the detailed engineering design, and the quality of local topographical surveying may not be high. In the case of the Dar es Salaam BRT project, the completion of

proper topographical surveys took six months longer than anticipated, creating great uncertainty about financing options. The detailed conceptual design was already completed in December of 2005, but as of a year later, the detailed engineering design was still not completed, so detailed cost estimates for the construction were also delayed.

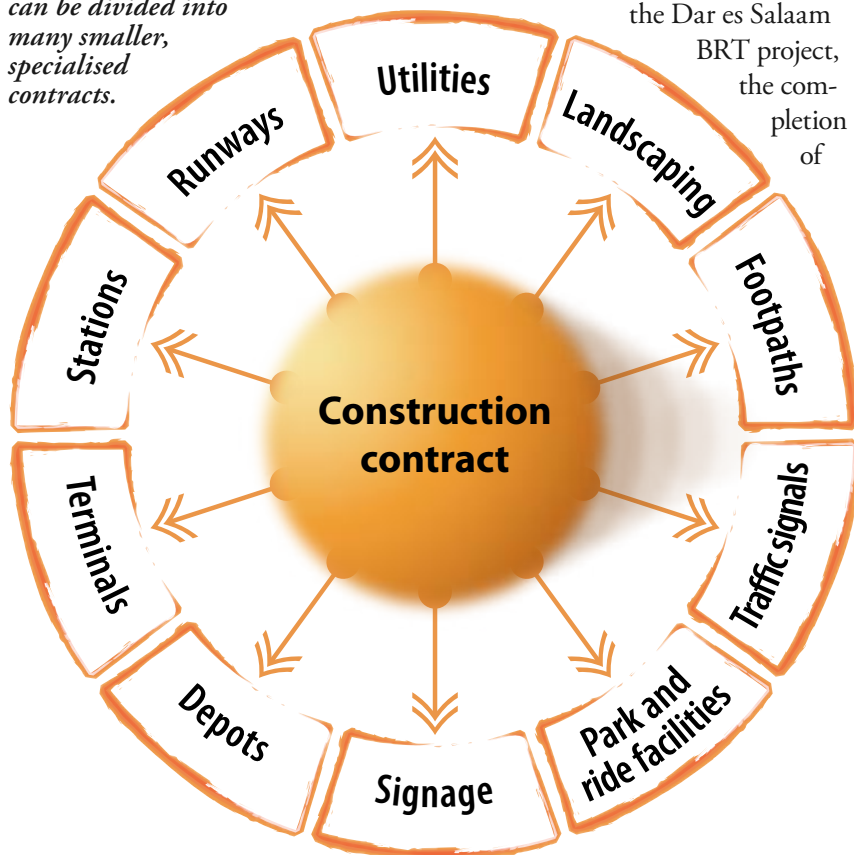
Government agencies managing a public works contract typically have to carefully monitor that both the technical specifications are met and also that any cost overruns are justified.

The first step in avoiding unanticipated construction cost overruns is to break out the contracts so that firms with experience with similar types of construction prepare the cost estimates. Firms with experience in building roads may have no idea how to estimate the cost of a BRT station, a depot, or a terminal. Government agencies with experience in managing road contracts and estimating their prices may similarly be unable to estimate likely reasonable costs. Thus, in some cases cities choose to split these different infrastructure components (runways, stations, landscaping, etc.) into separate contracts (Figure 20.23).

There are also some basic ways of using the construction contracts to place a limit on the total exposure of the government to unanticipated cost increases. One way to do this is to separate the detailed engineering contract from the construction contract. The firm that does the detailed engineering design has to produce a cost estimate, and is then not allowed to bid on the actual construction. This firm would be expected to establish a reasonable upper limit for the total cost of construction, or a "global price".

Once this global price is established, the actual construction contracts would be bounded within this upper price limit. If there are any allowances made for cost increases, they would be highly restricted to very specific circumstances. The construction contractor would then be paid a lump-sum contract. The monitoring role of the government on such a contract then becomes a matter of watching very carefully that the technical specifications are met, but there is far less concern about cost overruns. In this case, if the company's own risk assessment for cost overruns turn out to be too low, they bear

Fig. 20.23
The construction contract itself can be kept as a single concession with "wall-to-wall" responsibilities, or it can be divided into many smaller, specialised contracts.



the financial risk. If the company over-estimates the risk, they benefit.

If the detailed engineering design is separated from the construction, then if a problem arises, it is not clear whether the engineering or the construction firm is responsible. Separating the contracts in this way therefore requires a four-month pre-construction phase. In this process, the bidding construction firms know what the top limit on the price of the contract will be, and they also know the minimum technical specification. Once a firm wins the bid, however, they cannot start work immediately. The firm is allowed to further explore the costing and make some modifications in the engineering specifications to meet the minimum technical standard, but these changes must be approved by the authorities. Once these final changes are made, the construction company assumes full legal responsibility for the designs, and there can be no question about their full responsibility for the final engineering designs.

Minimising financing costs

The structure of contracts may also be influenced by financial considerations. Many development banks and bi-lateral lending agencies are willing to offer low-interest financing for BRT projects, but under the condition that the implementing government is willing to follow the contracting rules required by the financial institution. Bi-lateral donor agencies may offer very low-interest loans, but may restrict bidding to firms with partners from the donor country, and may require that the tender documents are structured in a way that favours firms from that nationality (Figure 20.24).

Multi-lateral development banks generally have very detailed bidding requirements, with most of them requiring international competitive bidding. The contracting rules of the multi-lateral development banks are carefully negotiated by governments on behalf of the interests of large contractors from the donor countries, so sometimes the bidding rules tend to favour large international companies over multiple smaller contracts. This tendency has frequently led in the past to lumping many of the various elements of BRT construction into a smaller number of larger contracts. On some World Bank financed BRT projects, for instance, major



construction works have been linked with BRT design and construction contracts into a single large competitive bid.

Minimising construction delays and transaction costs

Given the opportunity, contractors may under certain circumstances delay the implementation of contracts. A huge contract might require a firm to add a lot of additional staff that it does not believe it can retain over the medium term, for instance. For all kinds of reasons, firms may be late in finishing construction. Given the enormous political importance of having the infrastructure completed in a timely manner, both for political reasons and to minimise traffic disruption, BRT construction contracts generally should include very stiff penalties for implementing the project late. In the case of late completion of a TransMilenio contract, the construction firm faced a US\$1 million fine, the suspension of the contract, and being barred from bidding on government contracts for five years.

Accurate cost assessments are also as important to avoiding delays as they are to minimising government exposure to cost overruns. In Delhi, under-estimation of the construction costs required a new request for government funds, which delayed the implementation of the project by six months.

In some countries, the procedural rules for contracting out work packages are cumbersome and time consuming. Breaking out detailed conceptual planning, detailed engineering, construction, and maintenance to separate firms, and contracting out different elements of the construction to separate firms, can cause

Fig. 20.24
Bi-lateral donors, such as the Japanese International Co-operation Agency (JICA), will sometimes wish to favour construction firms and consultants from their own country.

Photo by Lloyd Wright

Fig. 20.25

The construction contracts may be organised in a way so that firms with specialist skills, such as station construction, are able to focus solely on one infrastructure component.

Photo by Lloyd Wright



considerable delays, especially if each stage must go through its own competitive bidding. Each new firm taken on for the next phase needs to re-learn the project from the beginning. Each separate tendering process also incurs transaction costs for lawyers and staff to prepare and manage the tender. If time is of the essence, and transaction costs are an issue, it may be easier to lump more of the contracts together into a smaller number of lump sum contracts.

Minimising coordination problems

The importance of coordination is also a factor. Breaking up the construction contracts into numerous small contracts may be desirable for spreading the benefits of the contracts among a wide range of constituents, but it may introduce problems of coordination between firms. If the government administration is weak, it may be that giving a single firm many of the project's construction projects to coordinate will yield a better result than if this is done by an agency of the government with no core competency in some areas of the project.

Minimising the risk of sub-standard construction

The quality of construction and long-term maintenance is as important as the cost of

construction. The quality of construction and long-term maintenance of a BRT system is more important than for normal roadways because fixing the road frequently requires shutting down the entire system, or diverting buses out of the exclusive busways temporarily. Such closures and diversions can result in significant revenue losses. If the busway uses electric trolleybuses with overhead electric conduits, the maintenance issues become even more important, as a single vehicle failure can obstruct the entire system.

Governments can do a lot to ensure good-quality construction. The first step in ensuring good-quality construction is to structure the contracts in such a way that the best firms can bid for the most appropriate elements of the BRT system. Lumping all the BRT design and construction contracts together may result in having firms with backgrounds primarily in road works managing construction projects for public space, terminals, stations, and other project elements about which they lack experience and expertise.

Governments may structure the contracts so that those elements of the contracts for which they need international help and are therefore willing to subject to international competitive

bidding will be lumped together, whereas contracts where local competence is sufficient may be kept separate.

Using construction contracting to achieve social objectives

Finally, political considerations will always play a role. Often these political considerations are largely about awarding patronage to political supporters, but sometimes these considerations attempt to address legitimate social concerns. In Cartagena, for example, current plans are to give the construction of the TransCaribe BRT system out to a separate construction company for each kilometre, in order to ensure that smaller scale local firms are able to bid, and to spread political patronage among a wider diversity of different groups. More numerous, smaller contracts may increase the chances that women-owned or minority owned firms have the chance to win the contract, or that the benefits of the project are more broadly spread among different interest groups. Given the enormous social ramifications of having a poorly designed and/or constructed BRT system, however, it is generally not a good idea to try to embed too many conflicting social objectives into a BRT construction contract. Rather, contracts should be given to firms offering the best quality construction at the lowest price.

20.3.2 Bogotá case study

20.3.2.1 TransMilenio Phase I

In the case of TransMilenio, the BRT Plan prepared by the principal consulting firm (Steer Davies Gleave) and its subcontractors was a detailed conceptual design. This plan provided overall technical specifications for the system. However, the detailed engineering design plan was left to be done as part of the construction contract. The public works department drew up the bidding documents for the detailed engineering and actual construction. Separate contracts were also drawn up for:

1. Stations;
2. Roads (by section);
3. Footpaths and pedestrian infrastructure;
4. Urban design and construction for the transit mall in the city centre;
5. Maintenance.

Many of these contracts were broken up into sections of the corridor. The entire roadway was rebuilt with concrete to handle the heavier axle



Fig. 20.26
The Calle 80 corridor in Bogotá.

Photo courtesy of TransMilenio SA

loads of the TransMilenio articulated vehicles. The use of concrete was also done in hopes to reduce long-term maintenance costs.

In Phase I, TransMilenio road construction contracts were packaged as follows. Phase I consisted of four sections: 1.) Calle 80 section (12 km); 2.) Autopista Norte section (10 km); 3.) Avenida Caracas section (23 km); and, 4.) Eje Ambiental section (2 km).

On the “Calle 80” section, there were two contracts for the trunk lines and improvements on the mixed traffic lanes adjacent to the busway. The contracts were for roughly two years, 1998 to 2000. There was a separate contract for the detailed design and construction of the Calle 80 depot, a separate one for the Calle 80 terminal, and four separate contracts for the footpaths and pedestrian overpasses.

Fig. 20.27
The Avenida Caracas/ Autopista Norte corridor in Bogotá.

Photo by Lloyd Wright



On the “Autopista Norte” section, there was only one contract for repaving the trunk roads and the adjacent mixed traffic lanes. There was one contract for the depot, and one contract for the terminal and for 1 kilometre of roadway leading to the terminal.

On the “Avenue Caracas”, there were four contracts for trunk lanes and the adjacent mixed traffic lanes, there were two contracts for two depots, two contracts for two terminals, and 12 contracts for footpaths and pedestrian facilities.

The “Eje Ambiental” section represented a short 2-kilometre segment that passed through the city centre. For this section, there was one special contract for a detailed urban design given to an architectural firm and a separate contract for construction. The urban design element on this particular stretch of road was critical, and thus was deemed worthwhile to bring in a separate architectural firm for a more detailed urban design.

The detailed design and construction of the stations was done by five separate firms. There were also three separate maintenance contracts for the roads for a period of five years after the completion of the system.

Separating the detailed conceptual design contract from the detailed engineering design and construction contracts, avoids any conflict between the design and the detailed engineering. However, separating these contracts did lead to confusion about who was responsible

when problems emerged. Separating responsibility for maintenance from responsibility for construction also created the risk that the construction company could cut corners on the construction, hoping that problems will not emerge until later, with earlier than anticipated “maintenance” needs.

In fact, when only three months after TransMilenio opened, there were already problems of cracking pavement, the construction company blamed the conceptual designers and the conceptual designers blamed the construction companies. The construction company also claimed that it did not have any responsibility for maintenance under the contract.

20.3.2.2 TransMilenio Phase II

The problems experienced in Phase I of TransMilenio convinced the city to alter the contracting structure. In Phase II in TM they changed the contracting structure to a type of “concession” agreement. This change was done to make sure that the same firm responsible for construction was also responsible for five years of maintenance. This structure also had the added benefit of using the construction companies to finance the infrastructure, rather than paying the companies in a single lump-sum payment.

In Phase II responsibility for the detailed design was separated from the responsibility for construction. As noted, responsibility for construction was given to the same firm as the responsibility for long-term maintenance (five years). Furthermore, the design of the footpaths and street amenities were no longer separated from the rest of the roadway design. The firm doing the detailed design of the corridor did the designs from wall to wall, not just either the road or the footpaths. Similarly, the firm doing the construction did the whole section of the road wall to wall, rather than having one firm for the roadways and another firm for the footpaths.

The packaging of the construction contracts and the maintenance contracts was linked in Phase II to a change in the financing. The government had less money to finance the public works. If the normal pay-as-you-go financing used in Phase I had been implemented in Phase II, the construction would have been spread out over five years instead of over two. Phase II

Fig. 20.28
The Eje Ambiental corridor in Bogotá.
Photo by Lloyd Wright



construction contracts were therefore written as concession contracts. The companies did not collect toll revenue. However, the construction company had to pay the construction costs up-front, and the roads had to be completed within 18 months. The construction companies secured loans from banks, and the government reimbursed the company over a period of five years as part of the maintenance contract. This contracting structure increased financing costs somewhat but it also ensured that capital would be available to build the entirety of Phase II in just two years, when using the budget alone would have taken five years due to restrictions on total borrowing. This contract structure also had the advantage that if maintenance problems arise, the government has the power to withhold payment.

Specifically, Phase II of TransMilenio had four different sections: 1.) Calle 13 (4 km); 2.) Americas and Avenida Cali (7km); 3.) Norte-Quito-Sur (21 kms); and 4.) Suba (12 km).

On the “Calle 13” section, there was one contract for detailed design and one contract to build from wall to wall and maintain the section for five years. On the “Americas and Avenida Cali” section, there was one contract for detailed design, and three contracts to build everything wall to wall and provide five years of maintenance, one contract to design the depot and the terminal, and one contract to build the depot and the terminal. On the “Norte-Quito-Sur” section, there was one contract to do the detailed design, and three contracts to build everything wall to wall and provide five years of maintenance, and one contract to build both the depot and the terminal. On the “Suba” section, there was one contract for detailed design, two contracts to build everything wall to wall and provide five years of maintenance, and one contract to build both the depot and the terminal.

20.3.3 Timeframe for construction

The timeframe for detailed engineering design and construction can vary widely depending on the size and complexity of the construction works that need to be undertaken, the size of the firms involved, and the governmental procedures required for any public works project. The only particular difficulty with a BRT project is that the relative complexity of the works being



Fig. 20.29
Construction on the Americas corridor in Bogotá.

Photo by Lloyd Wright

undertaken may make it difficult to estimate in advance the time it will take.

Table 20.3 gives the timetable for constructing the first phase of TransMilenio. This time line indicates that 28.5 months is the minimum realistic time frame for going from no background with BRT to the completion of the construction.

In the case of TransMilenio, construction in Phase I was actually broken into two separate components. Phase I was defined based on the minimum system size required to make the system financially viable. However, the first part of

Table 20.3: Timetable for construction of TransMilenio Phase I

Activity	Minimum amount of time required
Preparation of Conceptual Design–SDG	8 months
Completion of Formal Tender Documents–IDU	4 months
Preparation of Bids	3 months
Awarding of Bids and Signing of Contracts	1.5 months
Detailed Engineering and Construction	12–28 months
Total	28.5–44.5 months

Table 20.4: Timetable for constructing Phase II of TransMilenio

Activity	Amount of time
Preparation of Conceptual Design–TMSA	3 months
Detailed Engineering Designs-Consultants hired by IDU	6 months
Completion of Formal Tender Documents–IDU	4 months after the design had been finished (However, 6 months were spent preparing the legal and financial concept at the same time that the engineers performed design work)
Preparation of Bids	3 months
Awarding of Bids and Signing of Contracts	1 months
Pre-construction	4 months
Construction	12-18 months
Maintenance	5 years
Total	33–39 months (without maintenance)

Phase I was defined based on what could realistically be constructed during the Mayor’s term in office. The total Phase I was to be a 44 kilometre system. However, the first part of Phase I totalled just 18 kilometres. In the timetable above, 28.5 months was for the completion of the smaller first part of Phase I. The full completion of Phase I took an additional 16 months.

The timetable for Phase II of TransMilenio is given in Table 20.4. In Phase II, the conceptual design took less time, because Phase II did not significantly modify the conceptual design established in Phase I. Separating the detailed

engineering design from the construction took a bit more time, and required a four month “pre-construction” phase. Nevertheless, once construction began it went faster, and the problems with sub-standard construction were significantly reduced.

Normally, construction delays are related rather to contracting and budgeting issues. Most countries and most financial institutions require the works to be competitively tendered following specific tendering procedures. The time this process takes varies from country to country. Normally, the tender is published and bidders are allowed a fixed amount of time to give an expression of interest. Then a short list is drawn up, and detailed bids are solicited. This process can take anywhere from three to six months even if there are no problems.

20.3.4 Communications plan for construction

The construction process represents a great risk to the image and future of the new public transport system. The closing of roadways, the construction noise, and the blowing dust can all give the new system a negative first impression to the population (Figure 20.30).

A communications public education plan can also help to keep affected parties well informed in a timely manner. Before construction begins, a communications plan must be designed and it should feature meetings with local business associations and residential communities. The purpose of these meetings is to assess the potential negative impacts and their duration, so that affected stakeholders can work out the measures necessary to cope with the process.

Providing proper instructions during the system’s implementation stage facilitates the decision-making process for the parties involved. Instructions also help to minimise risks associated with construction, changes in operation schemes, and cultural acceptance of the new system. A detailed program containing alternate routes and traffic re-direction schemes must be released during the system’s construction phases. The program must include applicable date ranges, specific routes, signage formats, and a plan for its wide release to the general public. It is vital to define changes in public service routes, bus stops, and schedules.

Fig. 20.30
Road-widening work taking place on the Santa Rosa corridor in Santiago.

Photo by Lloyd Wright



Businesses and communities in close proximity to construction sites are usually affected by noise pollution, construction equipment, interruptions in the provision of utilities, and scarce road availability. In the narrow streets of the city centre, businesses may lose both customer access by cars as well as limited means to bring in deliveries (Figure 20.31).

A good communications plan must incorporate feedback mechanisms so that complaints, claims, and other comments can be acknowledged and addressed. Feedback mechanisms act as a complement to instructions by helping people evaluate and deal with the negative impacts related with the construction process. Nevertheless, continuously restating the future benefits the project will bring to the city and to the temporarily affected communities is essential. Also, feedback from users can be used to appropriately address their concerns and integrate them into the planning process.

20.3.5 Construction plan and mitigating impacts

“Vision without action is merely a dream. Action without vision just passes the time. Vision with action can change the world!”

—Joel Arthur Barker, author and management consultant

Organising the construction work in a city-friendly manner should be a top consideration. While planning the construction of the BRT infrastructure is not fundamentally different than planning any other public works project, there are a few differences:

- BRT construction involves many more different types of construction than simple road projects;
- The speed and quality of the construction are more important than for standard road projects;
- Long-term maintenance of the BRT infrastructure is also more important than for a standard road project.

Normally, responsibility for a good construction implementation plan rests with the construction companies, though some traffic impact mitigation measures may have been prepared by the firm doing the conceptual design. Proven experience with developing a successful construction



Fig. 20.31

Construction can be a major disruption to city centre businesses, as shown here during the construction of the Pereira Megabus system.

Photo by Edgar Enrique Sandoval

implementation plan should be a factor in selecting the construction firms.

A construction plan should be developed in conjunction with the contracted firms. Each step of the process should be mapped out to minimise the negative impacts. The manner of the construction process should also be noted in the construction contract. Structuring the road construction through a concession structure may give greater leverage to limit adverse social impacts. It is also possible to include financial incentives to construction firms that successfully minimise negative impacts of road closings and construction dust and noise.

In some cases, construction at nights, weekends, and holidays may be the best options for avoiding the prolonged closure of key connecting roads. It may also be best to work on a segment by segment basis rather than closing the entire length of a particular corridor. However, the particular strategy will depend much upon local circumstances.

The management of traffic re-routing and traffic control during the construction should be coordinated between the construction firm, the police, and the public transport agency. Particular care should be taken in handling intersection and underpass construction since significant congestion and inconvenience can occur when closing off entire intersections (Figure 20.32).



Fig. 20.32
Re-routing traffic around intersections that are under heavy construction can be particularly challenging.

Photo by Lloyd Wright

Phase I of TransMilenio was very popular, but received some criticism for adverse impacts resulting from chopping down trees, and disrupting businesses and residential life along the corridor during the construction (Figure 20.33). For that reason, Phase II had much more detailed programs to reduce adverse social impacts, and minimising these impacts were the responsibility of the construction company. There was a special set-aside for social impact mitigation within the lump sum contract, around 10 percent of the total contract value.

20.4 Maintenance

“A beautiful woman and a wooden boat are very expensive in maintenance.”

—Dutch proverb

Start-up problems aside, most systems operate well and project a highly-positive image through its initial years. As systems age, though, the question arises as to whether it will maintain its initial quality and performance. Bus systems are notoriously left with little investment and civic care over the long term. Thus, developing a maintenance plan and dedicated funding stream to upkeep the system is fundamental to its long-term performance.

20.4.1 Maintenance of vehicles

The maintenance of system equipment, such as vehicles, fare systems, and ITS equipment, will depend on the ownership structure. Since vehicles are almost always owned and managed by the private operators, responsibility for the maintenance of the vehicles will rest with these private operators (Figure 20.34).

However, there will still be a role for the BRT authority to ensure that the quality of the vehicles is maintained. Maintenance and quality standards should be explicitly stated in the original contractual agreements with the operators. Certain aspects of the vehicle are likely to require regular maintenance and upkeep. The



Fig. 20.33
The disruption to traffic and businesses during Phase I construction of TransMilenio did receive some criticism. More mitigation measures were subsequently applied in Phase II.

Photo courtesy of TransMilenio SA

pneumatic doorways are particularly prone to occasional failure. Likewise, the quality of the seating may deteriorate with use and any vandalism. Windows that are scratched or discoloured will appear functional but nevertheless will affect the image of the system.

Fare system and ITS equipment may be privately or publicly owned, depending on the nature of the system’s business structure. If privately owned, then the operating contracts should clearly delineate responsibility and timeliness over any maintenance issues. If publicly owned, then the city may elect to establish a private sector maintenance contract for these items.

Since BRT stations are relatively narrow due to median width restrictions, there is typically only space for a few fare readers and turnstiles. Thus, if one reader/turnstile should fail, the functionality of the entire station is greatly diminished. For this reason, there should always be stipulation that a certain number of units and/or spare parts are held in reserve. There should be contractual language requiring the maintenance firm to react within a certain time period to any breakdowns.

20.4.2 Maintenance of infrastructure

The maintenance of system infrastructure components (busways, stations, terminals, depots, and control centre) will depend on the nature of the original construction contracts. As noted in the previous section, maintenance may or may not be linked to the original construction contracts. There are trade-offs between separating and linking the contracts. Thus, responsibility for maintenance may be held by either the private construction firms or the municipality.

20.4.2.1 Basic principles of maintenance

Maintenance practices should ensure that any problems are addressed as they occur. A damaged roadbed will not only create discomfort for passengers but also increase maintenance costs for public transport vehicles. Maintenance teams should be constantly on the watch for graffiti and other types of system vandalism. If vandalism is not repaired immediately, it can create an impression that such actions are tolerated and will thus encourage even more acts of vandalism (Figures 20.35).



In some cases, the failure to act upon maintenance issues can result in significant legal and financial liability. If roadways are improperly maintained and thus damage the vehicles, the private operators may file a legal suit over the cost of vehicle repair. Likewise, if emergency equipment is not functioning properly, there could be serious ramifications (Figure 20.36).

Fig. 20.34
The maintenance of the vehicles is almost always the responsibility of the private sector operating companies, with some provisions for inspection and oversight from the BRT authority.

Photo by Lloyd Wright



Fig. 20.35
Graffiti, as shown in this example from Quito, can do much to tarnish the image of the system.

Photos by Lloyd Wright

Fig. 20.36

These emergency telephones in a Johannesburg terminal are ripped out, potentially leaving system users in peril. The system operators may have a substantial legal liability for failure to maintain the equipment.

Photo by Lloyd Wright



The external surfaces of station and terminal facilities are subjected to both environmental pollution as well as the variances of the climate. Rain, wind, heat, and contaminants can all lead to premature weathering of the station appearance. Often a treated coating is applied to the surfaces to slow the effects of corrosion and discolouration. The maintenance contracts should foresee the necessary reapplication of coating materials prior to any major deterioration in appearance (Figures 20.37 and 20.38).

Fig. 20.37 and 20.38

Untreated surfaces or neglected surfaces can rapidly decay due to the influences of corrosion, as these images from Quito indicate. Such problems should be prevented before the appearance and image of the system is compromised.

Photos by Lloyd Wright



Likewise, the original infrastructure design should accommodate easy cleaning and upkeep (Figure 20.39). Vaulted ceilings and artistic curves can be pleasing to the eye but challenging from a maintenance standpoint. The original infrastructure design plans should be evaluated for maintenance viability prior to the approval of the architectural plans.

If certain infrastructure components are requiring frequent maintenance actions, then this information should be incorporated into decisions on future extensions of the system. A maintenance logbook should thus be kept by all maintenance contractors with copies submitted to the public transport agency or the public works department. Analysing maintenance actions and the nature of the problems can possibly help in devising future solutions.

At a certain point, each infrastructure component will likely require a major overhaul. The expected lifetimes of roadways, stations and other infrastructure will depend upon such factors as use patterns, topography, and climate. Roadways may require reconstruction every five to ten years, depending on the materials utilised in the original construction. Stations, terminals, and depots should last for several decades before major reconstruction is required. Estimating the lifespan of the infrastructure components will also allow financial planners to determine later re-capitalisation needs of the system.

20.4.3 Maintenance contracts

The way the contracts are structured, and the type of incentives they include will strongly affect the effectiveness of the system's maintenance and upkeep. If construction firms have no responsibility for maintenance, then their



incentive may be to ignore future maintenance problems. Instead, the contractors will have an incentive to only worry about a rapid and low-cost delivery and not whether the product is still functional in a few years.

The best mechanism to ensure a higher-quality and more durable product is to make the same firm responsible for construction also responsible for maintenance over the first several years. The firm that builds the busway or station can be contractually required to maintain it to specific standards. If the firm has a five to ten year maintenance contract, then automatically the company will want to build the infrastructure to endure. If the construction is delivered in poor quality, then the firm will have higher costs maintaining the infrastructure over the entire period of the contract.

Giving a construction firm responsibility for maintenance, however, must be accompanied by a shift in the contract structure to a lump-sum contract. Otherwise, if the firm has the ability to continually return to the government and ask for additional funds for unanticipated maintenance costs, the purpose of linking the construction contract to the maintenance contract is effectively undermined. Linking construction and maintenance contracts, therefore, tends to be done as part of an overall concession-oriented approach to road construction contracting.

In Phase I of TransMilenio, the construction firms were not responsible for long-term maintenance. Thus, when severe road construction faults occurred after only three months of operation, the city had limited legal recourse to hold the private companies as the responsible party (Figure 20.40). The firms did have to carry insurance in case of a major construction problem, but this insurance partially insulated the company from the full risk of a construction problem. With this lesson in mind, TransMilenio restructured the Phase II contracts in order to link construction and maintenance together.

The EMTU busway in the State of Sao Paulo also faced maintenance issues. This busway had overhead conduit wires maintained by the electrical company, and the roads were maintained by the State roads agency. When maintenance was done poorly, the private bus operators faced significant losses in terms of lost passengers and



Fig. 20.39

The original station design should include an appropriate plan for dealing with routine upkeep requirements.

Photo by Lloyd Wright

vehicular damage, but they had limited recourse. Eventually, most buses stopped using the electrical conduits due to frequent maintenance issues. The problem was resolved in this case by shifting responsibility for the maintenance of the conduit and also the road bed to the bus operator. The bus operators do not have a core competency in road maintenance, but they had a powerful vested interest in avoiding damage to their vehicles, so they ensured that the contracting out to construction firms was done well. This approach was also reasonably successful. The costs of maintenance were still covered by the government, but in the form of a higher payment to the bus operators per bus kilometre.

“When you want something, all the universe conspires in helping you to achieve it.”

—Paulo Coelho, novelist, 1947–

Fig. 20.40

Severe cracking and subsiding of the TransMilenio busways in Phase I led to legal battles over responsibility.

Photo courtesy of Diego Velazquez



Resources

“You see things as they are and you ask why. But I dream of things that never were and I ask why not.”

—George Bernard Shaw, 1856–1950

Cities embarking upon improvements to their public transport system are not alone in this

endeavour. Many organisations and resources are available to cities seeking to upgrade the quality of public transport. This section notes some of the key organisations that provide either technical assistance or distribute technical information. Also, this section presents some of the key resource materials and websites on BRT. The full content of this section is:

1. Support organisations
2. Technical resources
3. BRT city websites

Support organisations

1. Access Exchange International

Access Exchange International (AEI) is a non-governmental organisation promoting accessible public transport for persons with disabilities and seniors in Latin America, Africa, Asia, and eastern Europe. The organisation’s web site provides resources on good design practices that improve quality access for those with physical disabilities.

<http://globalride-sf.org>

2. American Public Transportation Association (APTA)

APTA is a national trade association representing public transport agencies and operators in the United States. The APTA website includes useful background documentation on BRT concepts.

<http://www.apta.com>

3. Associação Nacional de Transportes Públicos (ANTP)

The Brazilian National Association for Public Transport provides information on a range of sustainable transport topics, including BRT. The Portuguese web site includes access to a range of publications.

<http://portal.antp.org.br/default.aspx>

4. Bus Rapid Transit China

BRT China is a Mandarin language web site devoted to providing BRT information and updates on projects in China.

<http://www.brtchina.org>

5. Bus Rapid Transit Central

This site holds articles on BRT and links to technical information on various BRT systems.

<http://www.busrapidtransit.net>

6. Bus Rapid Transit Policy Center

The Bus Rapid Transit Policy Center has been developed by the Breakthrough Technologies Institute is a US-based organisation that seeks to provide key background information on the BRT option. The web site provides news on BRT developments, links to key BRT reports, and information on different vehicle technologies. Also, the Breakthrough Technologies Institute publishes a journal called *Transport Innovator* that provides analysis of BRT issues as well as updates on projects around the world.

<http://www.gobrt.org>

7. Bus Rapid Transit UK (BRT-UK)

BRT-UK is an association dedicated to the sharing of information about evolving bus based rubber tyred rapid transit technology. BRT-UK is a particularly key resource for news and publications related to BRT in the United Kingdom.

<http://www.brtuk.org>

8. Clean Air Initiative

The Clean Air Initiative (CAI) advances innovative ways to improve air quality in cities by sharing knowledge and experiences through partnerships in selected regions of the world. The CAI website as well as its training initiatives provides knowledge and information on

mechanisms to improve public transport.

<http://www.cleanairnet.org>

9. The Commons

The Commons is an “Open Society Sustainability Initiative” developed by Eric Britton and EcoPlan International. The site provides information and offers the opportunity for cities and individuals to exchange experiences. The site also hosts a wide selection of BRT related videos (see the “World Outreach” and “Video Libraries” headings).

<http://www.ecoplan.org>

10. Energy Foundation

The China Sustainable Energy Program of the Energy Foundation has done much to spread awareness of BRT in the context of Chinese cities. Of particular note is the development of the China Sustainable Transportation Centre which provides training and resources on BRT.

<http://www.efchina.org/FProgram.do?act=list&type=Programs&subType=2>

11. GTZ Sustainable Urban Transport Programme (SUTP)

The German Overseas Technical Assistance Agency (GTZ) has developed an information source on a wide range of sustainable transport topics. The SUTP web site hosts this BRT module and other documents on sustainable transport. GTZ also supports sustainable transport projects in a variety of developing-nation cities.

<http://www.sutp.org>, <http://www.sutp.cn>

12. Institute for Transportation & Development Policy (ITDP)

ITDP is an international non-governmental organisation that provides supports to BRT initiatives and other sustainable transport projects in Africa, Asia, and Latin America. ITDP has assisted BRT projects in such countries as Brazil, China, Colombia, Ghana, Senegal, South Africa, Tanzania, Bangladesh, India, and Indonesia. ITDP also publishes a regular newsletter, *e-Sustainable Transport*, which features frequent articles on BRT projects worldwide.

<http://www.itdp.org>

13. International Association of Public Transport (UITP)

UITP is a worldwide network of public transport professionals that acts as a point of reference

for sharing information across the public transport sector. UITP publications and conferences provide a key international perspective on best practice in the field.

<http://www.uitp.com>

14. International Energy Agency (IEA)

The IEA has compared the environmental performance of different fuel and propulsion options for buses in its publication entitled *Bus Systems for the Future: Achieving Sustainable Transport Worldwide*. This research has also compared the emission impacts of tailpipe technologies to the benefits of mode-shifting strategies.

<http://www.iea.org>

15. Metro Magazine

Metro Magazine’s website hosts a BRT home page that provides a range of information including updates on recent BRT news stories.

http://www.metro-magazine.com/t_brt_home.cfm

16. National Bus Rapid Transit Institute

Based at the University of South Florida (US), the National BRT Institute is an information clearinghouse on BRT. The site includes BRT publications, presentations, video, and images from both US and international projects.

<http://www.nbrti.org>

17. Transit Cooperative Research Program (TCRP)

TCRP is a component of the US Transportation Research Board (TRB). TCRP has produced several key studies on topics related to BRT, including a compendium of BRT case studies and planning guidances.

<http://www4.trb.org/trb/crp.nsf>

18. Transportation Research Board (TRB)

TRB is a division of the US National Research Council which acts as an independent advisor to the US government. TRB seeks to promote innovation and progress in transport through research. Each year in January, TRB hosts its annual review conference which includes many useful sessions on BRT related themes.

<http://gulliver.trb.org>

19. *Transport Roundtable Australia*

This site provides useful information and articles both on general BRT issues as well as specific links to Australian systems in cities such as Brisbane and Adelaide. The site also provides information on the “Smart Urban Transport” conferences which cover a range of sustainable transport topics, including BRT.

<http://www.transportroundtable.com.au>

20. *US Federal Transit Administration (USFTA)*

This site provides an overview of the USFTA’s national BRT programme as well as information on the activities underway in each of the participating cities. The site also provides a number of useful links to technical documents.

http://www.fta.dot.gov/assistance/technology/research_4234.html

21. *Victoria Transport Policy Institute (VTPI)*

The Victoria Transport Policy Institute (VTPI) has produced the on-line TDM Encyclopaedia, which is one of the most complete and expansive works to date on sustainable transport topics. Amongst the topics covered by the On-line TDM Encyclopaedia are: BRT, Non-Motorised Planning, Park & Ride, Transit Improvements, Transit Examples, Transit-Oriented Development (TOD), and Evaluation.

<http://www.vtpi.org>

22. *Weststart-CALSTART*

WestStart-CALSTART is an advanced transportation technologies consortium, dedicated to creating and expanding a global advanced transportation technologies industry and its markets through technology development, analysis, and implementation. Weststart-CALSTART particularly provides much information on different BRT vehicle types. Weststart-CALSTART also regularly publishes the BRT Newslane which provides project updates and information on BRT vehicle options.

<http://www.calstart.org/programs/brt/new/newbrtinfo.php>

23. *Wikipedia*

Wikipedia, the free on-line encyclopedia, provides an overview article on the BRT concept.

http://en.wikipedia.org/wiki/Bus_rapid_transit

24. *World Bank*

The World Bank, along with the Global Environment Facility (GEF), has supported many BRT initiatives world wide. The World Bank also publishes a range of useful background topics, including reference guides on access for the physically disabled and data sets on existing systems.

<http://www.worldbank.com/transport>

25. *World Resources Institute - Embarq*

Established in 2002, *EMBARQ* - The World Resources Institute Center for Sustainable Transport - acts as a catalyst for socially, financially, and environmentally sound solutions to the problems of urban mobility. The Embarq website includes information on specific projects as well as information resources.

<http://embarq.wri.org>

Technical resources

This document has sought to provide an overview of the BRT concept as well as provide insights into the BRT planning process. However, there are several other publications that also provide additional perspectives and information on the topic of BRT. This section lists some of these documents.

Public transport technology options

Allsop, R. (2000), *Mass rapid transit in developing countries*. London: Halcrow Fox.

Flyvbjerg, B., Bruzelius, N., and Rothengatter, W. (2003), *Megaprojects and risk: An anatomy of ambition*. Cambridge: Cambridge University Press.

Fouracre, P., Dunkerley, C., and Gardner, G. (2003), Mass rapid transit systems for cities in the developing world. *Transport Reviews*, 23(3): 299-310.

Hass-Klau, C., Crampton, G., Weidauer, M., and Deutsch, V. (2003), *Bus or light rail: Making the right choice*. Brighton: Environmental & Transportation Planning.

Hidalgo, D. (2006), Comparing transit alternatives after recent developments in BRT in Latin America. Paper presented at the 85th Annual Meeting of the Transportation Research Board, Washington, US, January 2006.

US GAO (United States General Accounting Office) (2001), *Bus rapid transit shows promise*. Washington: US GAO.

Vuchic, V. (2007), *Urban transit systems and technology*. Hoboken: John Wiley & Sons.

Vuchic, V. (2005), *Urban transit operations, planning, and economics*. Hoboken: John Wiley & Sons.

Wright, L. and Fjellstrom, K. (2003), *Mass transit options*. Germany: GTZ.

General BRT guidance

CALTRANS (2007), *Bus rapid transit: A handbook for partners*. Sacramento: California Department of Transport (CALTRANS).

Diaz, R. (ed.) (2004), *Characteristics of bus rapid transit for decision-making*, Project number FTA-VA-26-7222. Washington: US FTA.

Diaz, R. and Schnek, D. (2000), Innovative service design among bus rapid transit systems in the America. Paper presented at the APTA 2000 *Bus and Paratransit Conference*, (http://www.apta.com/research/info/briefings/briefing_2.cfm).

Kang, A. and Diaz, R. (2000), Bus rapid transit: An integrated and flexible package of service. Paper presented at the *APTA 2000 Rail Transit Conference*, (http://www.apta.com/research/info/briefings/briefing_2.cfm).

Levinson, H., Zimmerman, S., Clinger, J., Rutherford, S., Smith, R., Cracknell, J., and Soberman, R. (2003a), *Bus rapid transit, Volume 1: Case studies in bus rapid transit*, TCRP Report 90. Washington: US TCRP.

Levinson, H., Zimmerman, S., Clinger, J., Gast, J., Rutherford, S., and Bruhn, E. (2003b), *Bus rapid transit, Volume 1: Implementation guidelines*, TCRP Report 90. Washington: US TCRP.

Shen, L. Elbadrawi, H., Zhao, F., and Ospina, D. (1998), *At-grade busway planning guide*. Florida: National Urban Transit Institute.

Transportation Research Laboratory (TRL) (1993), *Design guidelines for busway transit*, Overseas Road note 12. Workingham (UK): TRL.

US FTA (2004), *Bus rapid transit characteristics for decision-making*. Washington: USFTA.

Specific bus system issues

Gwilliam, K., Meakin, R. and Kumar, A. (2000), *Designing competition in urban bus passenger transport: Lessons from Uzbekistan*, World Bank Discussion Paper TWU-41. Washington: World Bank.

Hidalgo, D. and Yepes, T. (2005), Are bus rapid transit systems effective in poverty reduction? Experience of Bogotá's TransMilenio and lessons for other cities. Paper presented at the 2005 *Annual Meeting of the Transportation Research Board (TRB)*, Washington, DC, US, January 2005.

Kittelson & Associates, Inc. assisted by KFH Group, Inc., Parsons Brinckerhoff Quade & Douglas, Inc., and Hunter-Zaworski, K (2003), *Transit capacity and quality of service manual*, TCRP report number 100. Washington: Transportation Research Board.

Lusk, A. (2001), Bus and bus stop designs related to perceptions of crime. Report number FTA MI-26-7004-2001.8, Washington: US FTA.

Menckhoff, G. and Zegras, C. (1999), *Experiences and issues in urban transport infrastructure*. Presented at the International Road Federation Symposium, Hanoi, Vietnam, (<http://www.worldbank.org/transport/publicat/twu-38/twu-38.pdf>)

Pardo, C. (2006), *Raising public awareness about sustainable urban transport*. Eschborn: GTZ, (<http://www.sutp.org>).

TAS Partnership Ltd. (2000), *Quality bus infrastructure: A manual and guide*. London: Landor Publishing.

Transportation Research Laboratory (TRL) (2004), *The demand for public transit: A practical guide*, Report TRL 593. Wokingham (UK): TRL.

US TCRP (1999), *The role of transit amenities and vehicle characteristics in building transit ridership*, TCRP Report 46. Washington: National Academy Press.

Modelling

Abdelghany, K., Abdelghany, A., Mahmassani, H., and Abdelfatah, A. (2006), Modeling bus priority using intermodal dynamic network assignment-simulation methodology. *Journal of Public Transportation*, vol. 9, no. 5.

Ortúzar, J. and Willumsen, L. (2002), *Modeling transport*. Chichester (UK): John Wiley & Sons Ltd.

BRT vehicles

Arrillaga, B., Wnuk, L. and Silver, F. (2004), *Bus rapid transit vehicle demand analysis update*, Report number FTA-CA-26-7044-2003.2. Washington: US FTA.

Hardy, M., Stevens, W., and Roberts, D. (2001), *Bus rapid transit vehicle characteristics*, USFTA report number FTA-DC-26-7075-2001.1. Washington: US FTA.

King, R. (1998), *New designs and operating experiences with low-floor Buses*. TCRP Report 41, Columbus.

US FTA (2006), *Vehicle catalog: A compendium of vehicles and powertrain systems for bus rapid transit service, 2006 update*. Washington: US FTA.

US FTA (2001), *Proceedings of the bus rapid transit vehicle design meeting*. Washington: Federal Transit Administration.

Zimmerman, S. and Levinson, H. (2004), Vehicle selection for BRT: Issues and options. *Journal of Public Transportation*, vol. 7, no. 1.

BRT – Regional

Baltes, M. and Hinbaugh, D. (2003), *Lynx LYMMO bus rapid transit evaluation*, Report number NCTR-392-15, RPWO-BC 137-17. Washington: US FTA.

Baltes, M., Perk, V., Perone, J., and Thole, C. (2003), *South Miami Dade busway system summary*. Tampa: National Bus Rapid Transit Institute, (<http://www.nbrti.org>).

Cain, A., Darido, G., Baltes, M., Rodriguez, P., and Barrios, J. (2006), *Applicability of Bogotá's TransMilenio BRT system to the United States*. Tampa: National Bus Rapid Transit Institute (NBRTI), (<http://www.nbrti.org>).

Currie, G. (2006), Bus rapid transit in Australasia: Performance, lessons learned and futures. *Journal of Public Transportation*, vol. 9, no. 3.

Darido, G. (2006), *Bus rapid transit developments in China*, Report number FTA-FL-26-7104.02, Washington: US FTA.

Friberg, L. (2000), Innovative solutions for public transport: Curitiba. *Sustainable Development International*, 3: 153-157.

Gardner, G., Cornwell, P., and Cracknell, J. (1991), *The performance of busway transit in developing cities*, research report no. RR329. Crowthorne: TRL.

Golub, A. (2003), Brazil's buses: Simply successful. *Access*, Spring 2004, no. 24, pp. 2-9.

Hidalgo, D., Custodio, P., and Graftieaux, P. (2007), Planning, implementation and operation of BRT systems: The cases of Quito, Bogotá, León, México City, Jakarta, and Beijing. Paper presented at the 2007 *Annual Meeting of the Transportation Research Board (TRB)*, Washington, US, January 2007.

Hidalgo, D. and Hermann, G. (2004), *The Bogotá model for sustainable transportation: Inspiring developing cities throughout the world*. Trialog, Germany, August 2004.

Hidalgo, D. (2003), TransMilenio: A high capacity - low cost bus rapid transit system developed for Bogotá, Colombia. Presented at *55th UITP World Congress*, Madrid, 4-9 May 2003.

Hidalgo, D. (2002), Bogotá and Its transportation characteristics. Paper presented at the *Second International Conference on Urban Transportation Systems: Ensuring Sustainability through Mass Transit*, 14-18 April, 2002, Alexandria, VA, US.

Hidalgo, D. (2002), A high capacity – low cost bus rapid transit system developed for Bogotá, Colombia. Paper presented at the *CODATUX Conference*, 12-15 November, 2002, Rotterdam, The Netherlands.

ITDP (Institute for Transportation and Development Policy) (2005), *Making Transjakarta a world class BRT system: Final recommendations*. New York: ITDP.

- Kenworthy, J. and Laube, F. (2000), *Millennium cities database for sustainable transport*. Brussels: UITP.
- Kim, E., Darido, G., and Schneck, D. (2005), Las Vegas Metropolitan Area Express (MAX) BRT demonstration project evaluation, Report number FTA VA-26-7222-2005.1.
- Lobo, A. (2006), *BRT options and results after six months: Applicability anywhere else in Mexico*. Mexico City: Centro de Transporte Sustentable.
- Major, M. (1997), Brazil's busways. *Journal of Mass Transit*, Vol. 23, no. 3, pp. 26-34.
- Meirelles, A. (2000), *A review of bus priority systems in Brazil: From bus lanes to busway transit*. Presented at the Smart Urban Transport Conference, 17-20 October, 2000, Brisbane, Australia.
- Menckhoff, G. (2005), Latin American experience with bus rapid transit. Paper presented at the 2005 Annual Meeting of the Institute of Traffic Engineers, Melbourne, Victoria, Australia, 7-10 August, 2005.
- Robelo, J. (2003), *Basic busway data in Latin America*, Washington: World Bank. (<http://www.worldbank.org/transport/urbtrans/pubtrans.htm>).
- Schimek, P., Darido, G., and Schneck, D. (2005), *Boston silver line Washington Street BRT demonstration project evaluation*, project number FTA-VA-26-7222-2005.2. Washington: US FTA, (<http://www.nbrti.org>).
- Seoul Development Institute (SDI) (2005), *Toward better public transport: Experiences and achievements of Seoul*. Seoul: SDI.
- Smith, N. and Hensher, D. (1998), The future of exclusive busways: The Brazilian experience. *Transport Reviews*, 18: 131-152.
- Steer Davies Gleave (SDG) (2000), *Diseño operacional del sistema TransMilenio: Proyecto de transporte urbano para Santa Fe de Bogotá*, BIRF 4021-FONDATT-10. SDG: Bogotá.
- TransMilenio (2003), *TransMilenio: La joya de Bogotá*. Bogotá: Alcaldía Mayor de Bogotá.
- TransMilenio (2003), *Plan marco sistema: TransMilenio*. Bogotá: TransMilenio SA.
- Wright, L. (2001), Latin American busways: Moving people rather than cars. *Natural Resources Forum*, May 2001.
- BRT – Business and institutional model**
- Ardila-Gomez, A. (2004), *Transit planning in Bogota and Curitiba: Roles in interaction, risk, and change*. PhD thesis in Urban and Transportation Planning at the Massachusetts Institute of Technology (MIT). Boston: MIT.
- Meakin, R. (2002a), *Bus regulation and planning*. Eschborn: GTZ.
- Meakin, R. (2002b), *Urban transport institutions*. Eschborn: GTZ.
- Meakin, R. (2001), *Technical guidelines on bus route tendering*. Eschborn: GTZ.
- Fare systems and ITS**
- Lobron, R. (2003), *Developing a recommended standard for automated fare collection for transit*, TCRP Research Results Digest 57. Washington: US TCRP.
- Multisystems, Inc. in association with Mundle & Associates, Inc. and Simon & Simon Research and Associates, Inc. (2003), *Fare policies, structures, and technologies update*, TCRP Report 94. Washington: Transportation Research Board.
- Smith, H., Hemily, B., and Ivanovic, M. (2005), *Transit signal priority: A planning and implementation handbook*. Washington: ITS America.
- Stern, R. (1997), *Bus transit fare collection practices*, TCRP Synthesis of Transit Practice 26. Washington: Transportation Research Board.
- Robelo, J. (1999), *Automated ticketing systems: The state of the art and case studies*. Washington: World Bank. (<http://www.worldbank.org/transport/urbtrans/pubtrans.htm>)
- Schweiger, C. (2003), *Real time bus arrival information systems*, TCRP Synthesis 48. Washington: US TCRP.
- UITP (International Association of Public Transport) (2005), *Towards an integrated travel information system*. Brussels: UITP.
- US FTA (2001), *Proceedings of the FTA / PRHTA bus rapid transit fare collection workshop*. Washington: Federal Transit Administration.

US TCRP (2002), *A toolkit for self-service, barrier-free fare collection*, TCRP Report 80. Washington: National Academy Press.

Transit-Oriented Development

CALTRANS, *California transit-oriented development (TOD) searchable database* (2004), Sacramento: California Department of Transportation. (<http://transitorienteddevelopment.dot.ca.gov>).

Cervero, R., Murphy, S., Ferrell, C., Goguts, C., Tsai, Y., Arrington, G., Boroski, J., Smith-Heimer, J., Golem, R., Peninger, P., Nakajima, E., Chui, E., Dunphy, R., Myers, M., McKay, S., and Witeenstein, N. (2004), *Transit-oriented development in the United States: Experiences, challenges, and prospects*, TCRP report number 102. Washington: US TCRP.

Currie, G. (2006), Bus transit oriented development: Strengths and challenges relative to rail. *Journal of Public Transportation*, Vol. 9, No. 4.

Dittmar, H. and Ohland, G. (2004), *The new transit town: Best practices in transit-oriented development*. Washington: Island Press.

Marya Morris (ed) (1996), *Creating transit-supportive land-use regulations*, Planning Advisory Service Report No. 468, Washington: American Planning Association.

Munoz-Raskin, R. (2006), *Walking accessibility to Bus Rapid Transit: Does it affect property prices, The case of Bogotá, Colombia*. A Master's thesis presented to the Faculty of Architecture and Planning, Columbia University, New York.

Rodriguez, D. and Targa, F., 2004, The value of accessibility to Bogotá's bus rapid transit system. *Transport Reviews*, 24(5).

Smith, J. and Gihring, T. (2004), *Financing transit systems through value capture: An annotated bibliography*. Victoria: Victoria Transport Policy Institute.

US TCRP (1997), *The role of transit in creating livable metropolitan communities*, TCRP Report 22. Washington: National Academy Press.

Pedestrian and bicycle access

Gehl, J. and Gemzøe, L. (1996), *Public spaces—public life*. Copenhagen: The Danish Architectural Press.

Gehl, J. (1987), *Life between buildings: Using public space*. New York: Van Nostrand Reinhold.

Hook, W. (2005), *Non-motorised transport*. Eschborn: GTZ, (<http://www.sutp.org>).

Hook, W. (2004), *Preserving and expanding the role of NMT*. Eschborn: GTZ, <http://www.sutp.org>.

King, M. and Wright, L. (2005), Safe routes to transit in developing cities. Paper presented at the *Walk21 Conference*, Zurich, Switzerland, September 2005.

Rickert, T. (2006), *BRT accessibility guidelines*. Washington: World Bank, (<http://web.worldbank.org/WBSITE/EXTERNAL/TOPICS/EXTSOCIALPROTECTION/EXTDISABILITY/0,,contentMDK:20192134~menuPK:414202~pagePK:148956~piPK:216618~theSitePK:282699,00.html>).

Schneider, R. (2005), *Integration of bicycles and transit*, TCRP synthesis report number 62. Washington: US TCRP.

Environment and energy

EA/SMP (International Energy Agency / Sustainable Mobility Programme of the World Business Council for Sustainable Development) (2004), *The IEA/SMP transportation model*, (<http://www.wbcds.org/plugins/DocSearch/details.asp?type=DocDet&ObjectId=MTE0Njc>)

International Energy Agency (IEA) (2002), *Bus systems for the future: Achieving sustainable transport worldwide*. Paris: IEA.

Schipper, L. (2006), Transforming transportation: Cleaning up the buses in Mexico City. Paper presented in *2006 TRB Annual Meeting*, Washington DC, January 2006.

Shapiro, H. (2002), *Conserving Energy and Preserving the Environment: The Role of Public Transportation*. Washington: APTA.

Vasconcellos, E. (2001), *Urban transport, environment and equity: The case for developing countries*. London: Earthscan.

Whitelegg, J. (1997), *Critical mass: Transport, environment and society in the twenty-first century*. London: Pluto Press.

Wright, L. and Fulton, L. (2005), *Climate change mitigation and transport in developing nations*, Transport Reviews, vol. 25, no. 6, pp. 691-717.

Evaluation

Litman, T. (2004), *Evaluating public transit benefits and costs*. Victoria: Victoria Transport Policy Institute.

Ryus, P., Connor, M., Corbett, S., Rodenstein, A., Wargelin, L., Ferreira, L., Nakanishi, Y., and Blume, K. (2003), *A guidebook for developing a transit performance-measurement system*, TCRP Report 88. Washington: Transportation Research Board.

Schwenk, J (2002), *Evaluation guidelines for bus rapid transit demonstration projects*, report number DOT-VNTSC-FTA-02-02, DOT-MA-26-7033-02.1. Cambridge: Volpe National Transportation Systems Center.

US TCRP (2002), *Estimating the benefits and costs of public transit projects: A guidebook for practitioners*, TCRP Report 78. Washington: National Academy Press.

BRT city websites

Adelaide, Australia

<http://www.adelaidemetro.com.au/guides/obahn.htm>

Alameda and Contra Counties (AC Transit), US

http://www.actransit.org/planning_focus/planning_focus.wu?category_id=1
http://www.actransit.org/planning_focus/details.wu?item_id=30

Amsterdam, Netherlands

<http://www.roa.nl/live/index.jsp?nav=423&loc=7502&det=4055>

Auckland, New Zealand

<http://www.busway.co.nz>

Bogotá, Colombia

<http://www.transmilenio.gov.co>

Boston, US

http://www.mbta.com/about_the_mbta/t_projects/?id=1072

Bradford, UK

<http://www.firstgroup.com/ukbus/yorkhumber/bradford/guidedbusway/index.php>

Brisbane, Australia

http://www.translink.com.au/qt/translin.nsf/index/busway_main

Caen, France

<http://www.twisto.fr>

Calgary, Canada

<http://www.calgarytransit.com/BRT/brt.html>

Cali, Colombia

http://www.metrocali.gov.co/mio_index.htm

Cartagena, Colombia

http://www.transcaribe.gov.co/transcaribe_interfaz/menu.asp

Charlotte, US

<http://www.charmeck.org/Departments/CATS/Rapid+Transit+Planning/Home.htm>

Cleveland, US

<http://euclidtransit.org/home.asp>

Crawley, UK

<http://www.westsussex.gov.uk/ccm/navigation/roads-and-transport/public-transport/fastway/>

Curitiba, Brazil

<http://www.curitiba.pr.gov.br>

Douai, France

<http://www.transportsdudouais.fr>

Eugene, US

<http://www.ltd.org>

Evry, France

<http://www.bus-tice.com>

Guangzhou, China

<http://www.gzbrt.org>

Guatemala City, Guatemala

<http://transmetro.muniguate.com>

Guayaquil, Ecuador

<http://www.metrovia-gye.com/start.htm>

Hartford, US

<http://www.ctbusway.com>

Honolulu, US

<http://www.oahutrans2k.com/corridor/corridor.htm#>

Jakarta, Indonesia

<http://www.jakarta.go.id/transjakarta/home/index.php>

Kent, UK

<http://www.go-fastrack.co.uk>

Leeds, UK

http://www.leeds.gov.uk/Transport_and_streets/Public_transport/page.aspx?pageID=B87A58A52B06F5EE80256E1400521B09

León, Mexico

http://correo.leon.gob.mx/admon03_06/transporte/sitioweb/

Long Island, US (New York)

<http://www.litp2000.com>

Los Angeles, US

http://www.metro.net/projects_programs/orange-line/images/ol_interactive.htm

Mexico City, Mexico

<http://www.metrobus.df.gob.mx/>

Miami, US

<http://www.co.miami-dade.fl.us/transit/metrobus.asp>

Nancy, France

<http://www.reseau-stan.com>

Nantes, France

<http://www.tan.fr>

New York City, US

<http://www.mta.info/mta/planning/brt>

Nice, France

<http://www.lignedazur.com>

Orlando, US

<http://www.golynx.com>

Ottawa, Canada

http://www.octranspo.com/Main_MenuE.asp

Paris, France

<http://www.v2asp.paris.fr/v2/Deplacements/mobilien/default.asp>

Pereira

<http://www.megabus.gov.co/megabus.html>

Phoenix, US

<http://www.ci.phoenix.az.us/PUBLICTRANSIT/rapid.html>

Pittsburgh, US

<http://www.portauthority.org/PAAC/CustomerInfo/BuswaysandT/tabid/111/Default.aspx>

Quito, Ecuador

http://www.quito.gov.ec/DMT/dmt_inicio.htm

Rouen, France

http://www.tcar.fr/presentation/index.asp?rub_code=52

San Francisco, US

<http://www.sfcta.org/geary.htm>

<http://www.sfcta.org/vanness>

Santa Clara, US

<http://www.vta.org/projects/line22brt.html>

Santiago, Chile

<http://www.transantiagoinforma.cl>

São Paulo, Brazil

http://www.prefeitura.sp.gov.br/servicos/cidadaos/transito_e_transporte/onibus/index.php

Sydney, Australia

<http://www.t-way.nsw.gov.au>

Vancouver, Canada

<http://www.translink.bc.ca>

West Sussex, UK

<http://www.fastway.info/home.htm>

York, Canada

<http://www.vivayork.com>

Annex 1

BRT system comparisons

The information provided in this comparison matrix of different BRT systems has been collected from a variety of sources, including the transport authorities of the particular cities.

The authors of this Planning Guide thus cannot ascertain the veracity of the information provided. System characteristics also change with time as cities extend and improve services.

The data presented here is based on information received in early 2007. A copy of the most recently updated comparison matrix can be found at: <http://www.itdp.org/programs/BRT>.

Qualitative comparisons

Colombia

✓ – Yes x – No P – Partial I – Insufficient network to make a conclusion NA – Not applicable

BRT Feature	Bogotá (TransMilenio)	Pereira (Megabus)
Segregated busways or bus-only roadways	✓	✓
Existence of an integrated “network” of routes and corridors	✓	I
Enhanced station environment (<i>i.e.</i> , not just a bus shelter)	✓	✓
Special stations and terminals to facilitate transfers	✓	✓
Overtaking lanes at stations / Provision of express services	✓	x
Improvements to nearby public space	✓	✓
High average commercial speeds (> 20 km/h)	✓	✓
Actual peak ridership over 8,000 passengers per hour per direction	✓	x
Pre-board fare collection and fare verification	✓	✓
At-level boarding and alighting	✓	✓
Fare- and physical-integration between routes and feeder services	✓	✓
Entry to system restricted to prescribed operators under a reformed business and administrative structure (closed system)	✓	✓
Competitively-bid and transparent contracts and concessions	✓	✓
No need for operational subsidies	✓	✓
Independently operated and managed fare collection system	✓	✓
Quality control oversight from an independent entity / agency	✓	✓
Low-emission vehicle technology (Euro III or higher)	P	x
Automated fare collection and fare verification system	✓	✓
System management through centralised control centre, utilising automatic vehicle location system	✓	✓
Signal priority or grade separation at intersections	P	x
Distinctive marketing identity for system	✓	✓
High-quality customer information (<i>e.g.</i> , clear maps, signage, real-time information displays)	✓	✓
Modal integration at stations (<i>e.g.</i> , bicycle parking, taxi stations, easy transfers between public transport systems)	P	x
Supporting car-restriction measures (<i>e.g.</i> , road pricing)	✓	x

1. Bogotá data courtesy of TransMilenio SA

2. Pereira data from Monica Venegas, Megabus System Manger, 2nd TransMilenio International Conference, 8 Nov 2006

Qualitative comparisons

Brazil

✓ – Yes x – No P – Partial I – Insufficient network to make a conclusion NA – Not applicable

BRT Feature	Curitiba (Rede Integrada)	Goiânia (METROBUS)	Porto Alegre (EPTC)	São Paulo (Inteligado)
Segregated busways or bus-only roadways	✓	✓	P	P
Existence of an integrated “network” of routes and corridors	✓	✓	x	✓
Enhanced station environment (<i>i.e.</i> , not just a bus shelter)	✓	✓	P	P
Special stations and terminals to facilitate transfers	✓	✓	x	P
Overtaking lanes at stations / Provision of express services	x	x	x	P
Improvements to nearby public space	P	x	x	x
High average commercial speeds (> 20 km/h)	✓	x	x	P
Actual peak ridership over 8,000 passengers per hour per direction	✓	✓	✓	✓
Pre-board fare collection and fare verification	✓	✓	x	x
At-level boarding and alighting	✓	✓	P	x
Fare- and physical-integration between routes and feeder services	✓	✓	✓	✓
Entry to system restricted to prescribed operators under a reformed business and administrative structure (closed system)	✓	✓	✓	✓
Competitively-bid and transparent contracts and concessions	x	P	x	✓
No need for operational subsidies	✓	P	✓	x
Independently operated and managed fare collection system	✓	✓	✓	✓
Quality control oversight from an independent entity / agency	✓	P	✓	x
Low-emission vehicle technology (Euro III or higher)	x	x	P	P
Automated fare collection and fare verification system	P	✓	x	✓
System management through centralised control centre, utilising automatic vehicle location system	x	x	x	P
Signal priority or grade separation at intersections	x	x	x	x
Distinctive marketing identity for system	✓	✓	x	✓
High-quality customer information (<i>e.g.</i> , clear maps, signage, real-time information displays)	✓	✓	x	P
Modal integration at stations (<i>e.g.</i> , bicycle parking, taxi stations, easy transfers between public transport systems)	P	x	x	x
Supporting car-restriction measures (<i>e.g.</i> , road pricing)	x	x	x	✓

1. Brazil data courtesy of Eric Ferreira (ITDP) and Wagner Colombini (Logit)

Qualitative comparisons

Ecuador

✓ – Yes x – No P – Partial I – Insufficient network to make a conclusion NA – Not applicable

BRT Feature	Guayaquil (Metrovía)	Quito (Trolé)	Quito (Ecovía)	Quito (Central Norte)
Segregated busways or bus-only roadways	✓	✓	✓	P
Existence of an integrated “network” of routes and corridors	I	P	P	X
Enhanced station environment (<i>i.e.</i> , not just a bus shelter)	✓	✓	✓	✓
Special stations and terminals to facilitate transfers	✓	✓	✓	✓
Overtaking lanes at stations / Provision of express services	x	x	x	P
Improvements to nearby public space	✓	✓	x	X
High average commercial speeds (> 20 km/h)	✓	x	✓	✓
Actual peak ridership over 8,000 passengers per hour per direction	✓	✓	✓	✓
Pre-board fare collection and fare verification	✓	✓	✓	✓
At-level boarding and alighting	✓	✓	✓	✓
Fare- and physical-integration between routes and feeder services	✓	✓	✓	P
Entry to system restricted to prescribed operators under a reformed business and administrative structure (closed system)	✓	✓	✓	✓
Competitively-bid and transparent contracts and concessions	✓	x	x	P
No need for operational subsidies	✓	P	✓	✓
Independently operated and managed fare collection system	✓	x	x	X
Quality control oversight from an independent entity / agency	✓	P	P	P
Low-emission vehicle technology (Euro III or higher)	✓	✓	x	P
Automated fare collection and fare verification system	✓	✓	✓	X
System management through centralised control centre, utilising automatic vehicle location system	✓	x	x	X
Signal priority or grade separation at intersections	x	P	x	✓
Distinctive marketing identity for system	✓	✓	✓	P
High-quality customer information (<i>e.g.</i> , clear maps, signage, real-time information displays)	✓	✓	✓	P
Modal integration at stations (<i>e.g.</i> , bicycle parking, taxi stations, easy transfers between public transport systems)	x	x	x	X
Supporting car-restriction measures (<i>e.g.</i> , road pricing)	x	x	x	X

1. Guayaquil data courtesy of César Arias.

2. Quito data courtesy of the Metropolitan Municipality of Quito and Hidalgo et al., 2007

Qualitative comparisons

Chile and Mexico

✓ – Yes x – No P – Partial I – Insufficient network to make a conclusion NA – Not applicable

BRT Feature	Santiago (Transantiago)	León (Optibus SIT)	Mexico City (Metrobús)
Segregated busways or bus-only roadways	P	✓	✓
Existence of an integrated “network” of routes and corridors	✓	✓	x
Enhanced station environment (<i>i.e.</i> , not just a bus shelter)	P	✓	✓
Special stations and terminals to facilitate transfers	✓	✓	x
Overtaking lanes at stations / Provision of express services	P	x	x
Improvements to nearby public space	P	x	x
High average commercial speeds (> 20 km/h)	P	✓	x
Actual peak ridership over 8,000 passengers per hour per direction	P	✓	x
Pre-board fare collection and fare verification	x	✓	✓
At-level boarding and alighting	x	✓	✓
Fare- and physical-integration between routes and feeder services	✓	P	x
Entry to system restricted to prescribed operators under a reformed business and administrative structure (closed system)	✓	✓	✓
Competitively-bid and transparent contracts and concessions	✓	x	x
No need for operational subsidies	✓	✓	P
Independently operated and managed fare collection system	✓	✓	✓
Quality control oversight from an independent entity / agency	x	P	✓
Low-emission vehicle technology (Euro III or higher)	✓	✓	✓
Automated fare collection and fare verification system	✓	✓	✓
System management through centralised control centre, utilising automatic vehicle location system	x	P	✓
Signal priority or grade separation at intersections	x	x	x
Distinctive marketing identity for system	✓	✓	✓
High-quality customer information (<i>e.g.</i> , clear maps, signage, real-time information displays)	✓	✓	✓
Modal integration at stations (<i>e.g.</i> , bicycle parking, taxi stations, easy transfers between public transport systems)	x	x	x
Supporting car-restriction measures (<i>e.g.</i> , road pricing)	x	x	x

1. Santiago data courtesy of Eduardo Giesen.

2. León and Mexico City data courtesy of Bernardo Baranda (ITDP)

Qualitative comparisons

China

✓ – Yes	x – No	P – Partial	I – Insufficient network to make a conclusion	NA – Not applicable
---------	--------	-------------	---	---------------------

BRT Feature	Beijing	Hangzhou	Kunming
Segregated busways or bus-only roadways	P	P	✓
Existence of an integrated “network” of routes and corridors	I	I	✓
Enhanced station environment (<i>i.e.</i> , not just a bus shelter)	P	✓	P
Special stations and terminals to facilitate transfers	x	x	NA
Overtaking lanes at stations / Provision of express services	P	x	x
Improvements to nearby public space	✓	✓	x
High average commercial speeds (> 20 km/h)	✓	✓	x
Actual peak ridership over 8,000 passengers per hour per direction	x	x	✓
Pre-board fare collection and fare verification	✓	✓	x
At-level boarding and alighting	P	P	x
Fare- and physical-integration between routes and feeder services	x	P	NA
Entry to system restricted to prescribed operators under a reformed business and administrative structure (closed system)	P	x	x
Competitively-bid and transparent contracts and concessions	x	x	P
No need for operational subsidies	x	x	✓
Independently operated and managed fare collection system	✓	x	x
Quality control oversight from an independent entity / agency	P	P	P
Low-emission vehicle technology (Euro III or higher)	✓	✓	x
Automated fare collection and fare verification system	✓	✓	x
System management through centralised control centre, utilising automatic vehicle location system	✓	x	P
Signal priority or grade separation at intersections	x	x	P
Distinctive marketing identity for system	x	✓	x
High-quality customer information (<i>e.g.</i> , clear maps, signage, real-time information displays)	✓	✓	x
Modal integration at stations (<i>e.g.</i> , bicycle parking, taxi stations, easy transfers between public transport systems)	P	P	P
Supporting car-restriction measures (<i>e.g.</i> , road pricing)	x	x	P

1. Beijing data courtesy of Kangming Xu
2. Kunming data courtesy of Lin Wei (Municipality of Kunming)

Qualitative comparisons

Indonesia, Japan, South Korea, and Taiwan

✓ – Yes	x – No	P – Partial	I – Insufficient network to make a conclusion	NA – Not applicable
---------	--------	-------------	---	---------------------

BRT Feature	Jakarta (TransJakarta)	Nagoya (Yurikamome line)	Taipei	Seoul
Segregated busways or bus-only roadways	✓	✓	✓	P
Existence of an integrated “network” of routes and corridors	x	P	✓	✓
Enhanced station environment (<i>i.e.</i> , not just a bus shelter)	✓	✓	P	x
Special stations and terminals to facilitate transfers	x	P	x	x
Overtaking lanes at stations / Provision of express services	x	x	P	x
Improvements to nearby public space	x	x	x	✓
High average commercial speeds (> 20 km/h)	✓	✓	✓	x
Actual peak ridership over 8,000 passengers per hour per direction	✓	x	✓	✓
Pre-board fare collection and fare verification	✓	x	x	x
At-level boarding and alighting	✓	x	x	x
Fare- and physical-integration between routes and feeder services	I	x	✓	✓
Entry to system restricted to prescribed operators under a reformed business and administrative structure (closed system)	✓	✓	x	P
Competitively-bid and transparent contracts and concessions	x	x	x	
No need for operational subsidies	x	x	✓	x
Independently operated and managed fare collection system	✓	x	x	✓
Quality control oversight from an independent entity / agency	P	x	P	✓
Low-emission vehicle technology (Euro III or higher)	x	x	✓	✓
Automated fare collection and fare verification system	✓	x	✓	✓
System management through centralised control centre, utilising automatic vehicle location system	x	x	✓	✓
Signal priority or grade separation at intersections	x	✓	x	x
Distinctive marketing identity for system	✓	x	x	x
High-quality customer information (<i>e.g.</i> , clear maps, signage, real-time information displays)	✓	✓	P	P
Modal integration at stations (<i>e.g.</i> , bicycle parking, taxi stations, easy transfers between public transport systems)	x	✓	P	P
Supporting car-restriction measures (<i>e.g.</i> , road pricing)	P	x	x	x

1. Jakarta data courtesy of ITDP
2. Nagoya data courtesy of Hiroyuki Takeshita (Nagoya University)
3. Seoul data courtesy of the Municipality of Seoul
4. Taipei data courtesy of Dr. Jason Chang (Taiwan National University)

Qualitative comparisons

Australia

✓ – Yes x – No P – Partial I – Insufficient network to make a conclusion NA – Not applicable

BRT Feature	Adelaide (O-Bahn)	Brisbane (SE Busway)	Sydney (Liverpool - Parramatta)
Segregated busways or bus-only roadways	✓	✓	✓
Existence of an integrated “network” of routes and corridors	✓	✓	x
Enhanced station environment (<i>i.e.</i> , not just a bus shelter)	✓	✓	✓
Special stations and terminals to facilitate transfers	✓	✓	✓
Overtaking lanes at stations / Provision of express services	✓	P	✓
Improvements to nearby public space	✓	✓	P
High average commercial speeds (> 20 km/h)	✓	✓	✓
Actual peak ridership over 8,000 passengers per hour per direction	x	✓	x
Pre-board fare collection and fare verification	x	P	x
At-level boarding and alighting	x	x	x
Fare- and physical-integration between routes and feeder services	✓	✓	P
Entry to system restricted to prescribed operators under a reformed business and administrative structure (closed system)	✓	✓	✓
Competitively-bid and transparent contracts and concessions	P	P	P
No need for operational subsidies	x	x	x
Independently operated and managed fare collection system	x	x	x
Quality control oversight from an independent entity / agency	✓	✓	✓
Low-emission vehicle technology (Euro III or higher)	P	P	P
Automated fare collection and fare verification system	P	x	P
System management through centralised control centre, utilising automatic vehicle location system	P	P	✓
Signal priority or grade separation at intersections	✓	✓	✓
Distinctive marketing identity for system	✓	✓	✓
High-quality customer information (<i>e.g.</i> , clear maps, signage, real-time information displays)	✓	✓	✓
Modal integration at stations (<i>e.g.</i> , bicycle parking, taxi stations, easy transfers between public transport systems)	✓	✓	✓
Supporting car-restriction measures (<i>e.g.</i> , road pricing)	x	x	x

1. Australia data courtesy of Richard Filewood (McCormick Rankin Cagney)

Qualitative comparisons

France

✓ – Yes	x – No	P – Partial	I – Insufficient network to make a conclusion	NA – Not applicable
---------	--------	-------------	---	---------------------

BRT Feature	Caen (Twisto TVR)	Lyon (C-lines)	Nantes (Busway -Line 4)
Segregated busways or bus-only roadways	✓	P	✓
Existence of an integrated “network” of routes and corridors	x	x	x
Enhanced station environment (<i>i.e.</i> , not just a bus shelter)	✓	P	✓
Special stations and terminals to facilitate transfers	✓	✓	✓
Overtaking lanes at stations / Provision of express services	x	x	x
Improvements to nearby public space	✓	x	✓
High average commercial speeds (> 20 km/h)	x	x	x
Actual peak ridership over 8,000 passengers per hour per direction	x	x	x
Pre-board fare collection and fare verification	✓	x	✓
At-level boarding and alighting	✓	x	✓
Fare- and physical-integration between routes and feeder services	✓	✓	✓
Entry to system restricted to prescribed operators under a reformed business and administrative structure (closed system)	✓	✓	✓
Competitively-bid and transparent contracts and concessions	✓	✓	x
No need for operational subsidies	x	x	x
Independently operated and managed fare collection system	x	x	x
Quality control oversight from an independent entity / agency	✓	✓	✓
Low-emission vehicle technology (Euro III or higher)	✓	✓	✓
Automated fare collection and fare verification system	✓	✓	x
System management through centralised control centre, utilising automatic vehicle location system	✓	✓	✓
Signal priority or grade separation at intersections	✓	✓	✓
Distinctive marketing identity for system	✓	✓	✓
High-quality customer information (<i>e.g.</i> , clear maps, signage, real-time information displays)	✓	✓	✓
Modal integration at stations (<i>e.g.</i> , bicycle parking, taxi stations, easy transfers between public transport systems)	P	P	✓
Supporting car-restriction measures (<i>e.g.</i> , road pricing)	x	x	x

1. Caen, Lyon, and Nantes data courtesy of François Rambaud (CERTU)

Qualitative comparisons

France continued

✓ – Yes x – No P – Partial I – Insufficient network to make a conclusion NA – Not applicable

BRT Feature	Paris (RN305, Mobilien, Val de Marne)	Rouen (TEOR)	Toulouse
Segregated busways or bus-only roadways	✓	✓	P
Existence of an integrated “network” of routes and corridors	x	x	x
Enhanced station environment (<i>i.e.</i> , not just a bus shelter)	P	P	P
Special stations and terminals to facilitate transfers	P	✓	P
Overtaking lanes at stations / Provision of express services	x	x	x
Improvements to nearby public space	x	✓	P
High average commercial speeds (> 20 km/h)	✓	✓	x
Actual peak ridership over 8,000 passengers per hour per direction	x	x	x
Pre-board fare collection and fare verification	P	P	x
At-level boarding and alighting	x	✓	x
Fare- and physical-integration between routes and feeder services	✓	✓	✓
Entry to system restricted to prescribed operators under a reformed business and administrative structure (closed system)	✓	✓	✓
Competitively-bid and transparent contracts and concessions	x	✓	✓
No need for operational subsidies	x	x	x
Independently operated and managed fare collection system	x	x	x
Quality control oversight from an independent entity / agency	✓	✓	✓
Low-emission vehicle technology (Euro III or higher)	✓	P	✓
Automated fare collection and fare verification system	x	x	x
System management through centralised control centre, utilising automatic vehicle location system	✓	✓	✓
Signal priority or grade separation at intersections	✓	✓	✓
Distinctive marketing identity for system	P	✓	x
High-quality customer information (<i>e.g.</i> , clear maps, signage, real-time information displays)	P	✓	P
Modal integration at stations (<i>e.g.</i> , bicycle parking, taxi stations, easy transfers between public transport systems)	P	P	P
Supporting car-restriction measures (<i>e.g.</i> , road pricing)	x	x	x

1. Rouen data courtesy of Werner Kutil (Veolia Transport)

2. Paris and Toulouse data courtesy of François Rambaud (CERTU)

Qualitative comparisons

Netherlands

✓ – Yes x – No P – Partial I – Insufficient network to make a conclusion NA – Not applicable

BRT Feature	Amsterdam (Zuidtangent)	Eindhoven
Segregated busways or bus-only roadways	✓	✓
Existence of an integrated “network” of routes and corridors	x	P
Enhanced station environment (<i>i.e.</i> , not just a bus shelter)	✓	✓
Special stations and terminals to facilitate transfers	x	✓
Overtaking lanes at stations / Provision of express services	x	x
Improvements to nearby public space	x	✓
High average commercial speeds (> 20 km/h)	✓	✓
Actual peak ridership over 8,000 passengers per hour per direction	x	x
Pre-board fare collection and fare verification	x	P
At-level boarding and alighting	✓	✓
Fare- and physical-integration between routes and feeder services	✓	x
Entry to system restricted to prescribed operators under a reformed business and administrative structure (closed system)	✓	✓
Competitively-bid and transparent contracts and concessions	✓	x
No need for operational subsidies	x	x
Independently operated and managed fare collection system	x	✓
Quality control oversight from an independent entity / agency	✓	
Low-emission vehicle technology (Euro III or higher)	✓	✓
Automated fare collection and fare verification system	✓ (from 1-1-2008)	x
System management through centralised control centre, utilising automatic vehicle location system	✓	✓
Signal priority or grade separation at intersections	✓	✓
Distinctive marketing identity for system	✓	✓
High-quality customer information (<i>e.g.</i> , clear maps, signage, real-time information displays)	✓	✓
Modal integration at stations (<i>e.g.</i> , bicycle parking, taxi stations, easy transfers between public transport systems)	✓	✓
Supporting car-restriction measures (<i>e.g.</i> , road pricing)	x	x

1. Amsterdam data courtesy of Ruud van der Ploeg (Stadsregio Amsterdam)
2. Eindhoven data courtesy of Jacques Splint (Municipality of Eindhoven)

Qualitative comparisons

United Kingdom

✓ – Yes x – No P – Partial I – Insufficient network to make a conclusion NA – Not applicable

BRT Feature	Bradford (Quality Bus)	Crawley (Fastway)	Edinburgh (Fastlink)	Leeds (Superbus, Elite)
Segregated busways or bus-only roadways	P	✓	✓	P
Existence of an integrated “network” of routes and corridors	P	✓	P	P
Enhanced station environment (<i>i.e.</i> , not just a bus shelter)	P	✓	P	P
Special stations and terminals to facilitate transfers	I	P	P	I
Overtaking lanes at stations / Provision of express services	x	x	x	x
Improvements to nearby public space	x	P	P	x
High average commercial speeds (> 20 km/h)	x	P	P	x
Actual peak ridership over 8,000 passengers per hour per direction	x	x	x	x
Pre-board fare collection and fare verification	x	x	x	x
At-level boarding and alighting	P	P	P	P
Fare- and physical-integration between routes and feeder services	P	✓	P	P
Entry to system restricted to prescribed operators under a reformed business and administrative structure (closed system)	I	✓	I	I
Competitively-bid and transparent contracts and concessions	x	✓	I	x
No need for operational subsidies	P	✓	✓	P
Independently operated and managed fare collection system	x	x	x	x
Quality control oversight from an independent entity / agency	x	x	x	x
Low-emission vehicle technology (Euro III or higher)	I	✓	✓	I
Automated fare collection and fare verification system	x	x	x	x
System management through centralised control centre, utilising automatic vehicle location system	x	✓	P	x
Signal priority or grade separation at intersections	P	✓	P	P
Distinctive marketing identity for system	x	✓	P	x
High-quality customer information (<i>e.g.</i> , clear maps, signage, real-time information displays)	P	✓	P	P
Modal integration at stations (<i>e.g.</i> , bicycle parking, taxi stations, easy transfers between public transport systems)	I	✓	P	I
Supporting car-restriction measures (<i>e.g.</i> , road pricing)	x	x	x	x

1. UK data courtesy of Dr. Alan Brett (BRT-UK)

Qualitative comparisons

Canada and United States

✓ – Yes x – No P – Partial I – Insufficient network to make a conclusion NA – Not applicable

BRT Feature	Ottawa (Transitway)	Boston (Silver Line Waterfront)	Eugene (EmX)	Los Angeles (Orange line)
Segregated busways or bus-only roadways	✓	✓	✓	P
Existence of an integrated “network” of routes and corridors	✓	✓	✓	✓
Enhanced station environment (<i>i.e.</i> , not just a bus shelter)	x	P	✓	P
Special stations and terminals to facilitate transfers	x	✓	✓	P
Overtaking lanes at stations / Provision of express services	x	x	x	x
Improvements to nearby public space	x	✓	✓	✓
High average commercial speeds (> 20 km/h)	✓	✓	✓	✓
Actual peak ridership over 8,000 passengers per hour per direction	x	x	x	x
Pre-board fare collection and fare verification	x	x	NA (free fare)	x
At-level boarding and alighting	x	x	✓	x
Fare- and physical-integration between routes and feeder services	P	x	✓	✓
Entry to system restricted to prescribed operators under a reformed business and administrative structure (closed system)	✓	✓	✓	x
Competitively-bid and transparent contracts and concessions	✓	x	x	x
No need for operational subsidies	x	x	x	x
Independently operated and managed fare collection system	x	x	NA (free fare)	x
Quality control oversight from an independent entity / agency	✓	✓	x	x
Low-emission vehicle technology (Euro III or higher)	x	✓	✓	✓
Automated fare collection and fare verification system	P	P	NA (free fare)	✓
System management through centralised control centre, utilising automatic vehicle location system	x	✓	✓	✓
Signal priority or grade separation at intersections	x	✓	✓	✓
Distinctive marketing identity for system	✓	✓	✓	✓
High-quality customer information (<i>e.g.</i> , clear maps, signage, real-time information displays)	✓	✓	✓	✓
Modal integration at stations (<i>e.g.</i> , bicycle parking, taxi stations, easy transfers between public transport systems)	P	x	✓	x
Supporting car-restriction measures (<i>e.g.</i> , road pricing)	x	x	x	x

- Ottawa data based on Metro Magazine (2006) and OCTransit website
- Eugene data courtesy of Graham Carey, Lane Transit District
- Boston data based on Schimek et al. (2005) and MBTA website
- Los Angeles data courtesy of Gary Spivack, Los Angeles County Metropolitan Transportation Authority

Qualitative comparisons

Canada and United States

✓ – Yes x – No P – Partial I – Insufficient network to make a conclusion NA – Not applicable

BRT Feature	Miami (South Miami-Dade Busway)	Orlando (LYNX Lymmo)	Pittsburgh (South Busway)	Pittsburgh (MLK East Busway)	Pittsburgh (West Busway)
Segregated busways or bus-only roadways	✓	✓	✓	✓	✓
Existence of an integrated “network” of routes and corridors	x	x	✓	✓	✓
Enhanced station environment (<i>i.e.</i> , not just a bus shelter)	P	✓	P	✓	✓
Special stations and terminals to facilitate transfers	✓	x	P	✓	✓
Overtaking lanes at stations / Provision of express services	x	x	P	✓	✓
Improvements to nearby public space	x	✓	x	✓	P
High average commercial speeds (> 20 km/h)	✓	x	✓	✓	✓
Actual peak ridership over 8,000 passengers per hour per direction	x	x	x	x	x
Pre-board fare collection and fare verification	x	NA (free fare)	x	x	x
At-level boarding and alighting	x	x	x	P	P
Fare- and physical-integration between routes and feeder services	✓	x	P	P	P
Entry to system restricted to prescribed operators under a reformed business and administrative structure (closed system)	✓	P	✓	✓	✓
Competitively-bid and transparent contracts and concessions	✓	✓	P	P	P
No need for operational subsidies	x	x	x	x	x
Independently operated and managed fare collection system	x	NA (free fare)	x	x	x
Quality control oversight from an independent entity / agency	✓	✓	P	P	P
Low-emission vehicle technology (Euro III or higher)	x	✓	x	P	x
Automated fare collection and fare verification system	x	NA (free fare)	x	x	x
System management through centralised control centre, utilising automatic vehicle location system	x	x	x	x	x
Signal priority or grade separation at intersections	✓	✓	✓	✓	✓
Distinctive marketing identity for system	P	✓	x	P	P
High-quality customer information (<i>e.g.</i> , clear maps, signage, real-time information displays)	P	✓	P	P	P
Modal integration at stations (<i>e.g.</i> , bicycle parking, taxi stations, easy transfers between public transport systems)	P	x	P	✓	✓
Supporting car-restriction measures (<i>e.g.</i> , road pricing)	x	x	x	x	x

1. Miami data courtesy of the Miami Dade Bus Transit Services
2. Orlando data courtesy of Doug Jamison (Lynx Lymmo)
3. Pittsburgh data courtesy of David Wohlwill (Port Authority of Pittsburgh)

Quantitative comparisons

Colombia

BRT Feature	Bogotá (TransMilenio)	Pereira (Megabus)
Year system commenced	2000	2006
Number of existing trunk corridors	6	2
Total length of existing trunk corridors (km)	84 km	15 km
Number of trunk routes	84	3
Location of busway lanes	Centre lanes	Centre lanes
Location of doorways	Median side (left)	Median side (left)
Type of surface material on runways	Concrete	Concrete
Type of surface material on runways at stations	Concrete	Concrete
Total length of existing feeder routes (km)	212 km	Not available
Projected length of total future trunk corridors (km)	388 km	16.7 km
Number of stations	107	38
Average distance between stations (m)	500 m	395 m
Number of stations with passing lanes	Not available	0
Number of terminals	7	2
Number of depots	7	1
Number of total system passenger-trips per day	1,450,000	100,000
Actual peak ridership (passengers per hour per direction)	45,000	6,900
Actual non-peak ridership (passengers per hour per direction)	28,000	Not available
Average commercial speed (km/h)	27 km/h	20 km/h
Average peak headway (seconds or minutes)	3 min	3-5 min
Average non-peak headway (seconds or minutes)	5 min	5 min
Average dwell time at stations (seconds)	25 seconds	20 seconds
Number of trunk vehicles	1,013	51
Trunk vehicle type	Articulated	Articulated
Fuel type used in trunk vehicles	Diesel Euro II/III	Diesel Euro II
Trunk vehicle capacity	160	160
Trunk vehicle length (m)	18.5 m	18.5 m
Number of feeder vehicles	407	85
Type of guidance system, if applicable	None	None
Type of fare collection / verification technology	Smart card	Smart card
Number of intersections with priority signal control	0	0
Number of grade-separated intersections	3	0
Fare (US\$)	US\$0.58	US\$0.48
Total planning costs (US\$)	US\$5.3 million	Not available
Average trunk vehicle costs (US\$)	US\$200,000	US\$200,000
Total infrastructure costs (US\$/km)	\$5.3 mill/km (ph. I) \$13.3 mill/km (ph. II)	US\$1.7 million/km

1. Bogotá data courtesy of TransMilenio SA

2. Pereira data from Monica Venegas, Megabus System Manger, 2nd TransMilenio International Conference, 8 Nov 2006

Quantitative comparisons

Brazil

BRT Feature	Curitiba	Goiânia	São Paulo (Interligado)	Porto Alegre
Year system commenced	1972	1976	2003	1977
Number of existing trunk corridors	6	2	9	8
Total length of existing trunk corridors (km)	64.6 km	35 km	129.5 km	45.6 km
Number of trunk routes	12	1	> 40	> 40
Location of busway lanes	Curbside & centre	Centre lanes	Centre lanes	Centre lanes
Location of doorways	Curbside (right)	Median side (left)	Median & curbside	Curbside (right)
Type of surface material on runways	Asphalt	Asphalt	Asphalt	Asphalt
Type of surface material on runways at stations	Concrete	Concrete	Concrete	Asphalt
Total length of existing feeder routes (km)	Not available	Not available	Not applicable	Note applicable
Projected length of total future trunk corridors (km)	Not available	Not available	Not available	Not available
Number of stations	123	23	235	128
Average distance between stations (m)	540 m	560 m	500 m	550 m
Number of stations with passing lanes	0	0	43	0
Number of terminals	16	5	27	1
Number of depots	12	Not available	Not available	Not available
Number of total system passenger-trips per day	562,000	140,000	2,780,000	900,750
Actual peak ridership (passengers per hour per direction)	20,000	11,500	34,900	28,000
Actual non-peak ridership (passengers per hour per direction)	Not available	Not available	Not available	Not available
Average commercial speed (km/h)	19 km/h	18 km/h	22 km/h	15 km/h
Average peak headway (seconds or minutes)	2 minutes	40 seconds	30 seconds	30 seconds
Average non-peak headway (seconds or minutes)	6 minutes	2 minutes	45 seconds	2 minutes
Average dwell time at stations (seconds)	22 seconds	20 seconds	30 seconds	30 seconds
Number of trunk vehicles	232	87 articul./5 bi-articulat.	Not available	Not available
Trunk vehicle type	Bi-articulated	Articul./Bi-articulated	Articulated / Standard	Standard
Fuel type used in trunk vehicles	Euro III Diesel	Euro II/III Diesel	Diesel	Diesel
Trunk vehicle capacity	270	160 & 270	100	100
Trunk vehicle length (m)	24 m	18.5 m & 25 m	18.5 m	12 m
Number of feeder vehicles	Not available	Not available	Not applicable	Note applicable
Type of guidance system, if applicable	None	None	None	None
Type of fare collection / verification technology	Smart card	Smart C. & Magnetic Strip	Smart card	Smart card
Number of intersections with priority signal control	0	0	0	0
Number of grade-separated intersections	0	0	0	1
Fare (US\$)	US\$0.74	US\$0.59	US\$1.00	US\$0.68
Total planning costs (US\$)	US\$380,000	Not available	Not available	Not available
Average trunk vehicle costs (US\$)	US\$395,000	US\$220,000	Not available	Not available
Total infrastructure costs (US\$per km)	US\$1.1 – US\$6 mill/km	US\$1.3 mill/km	US\$2 – US\$22 mill/km	US\$1.2 mill/km

1. Curitiba data courtesy of URBS
 2. São Paulo data courtesy of SPTrans

Quantitative comparisons

Ecuador

BRT Feature	Guayaquil (Metrovía)	Quito (Trolé)	Quito (Ecovía)	Quito (Central Norte)
Year system commenced	2006	1995	2001	2004
Number of existing trunk corridors	1	2	1	1
Total length of existing trunk corridors (km)	15.5 km	16.2 km	9.4 km	12.8 km
Number of trunk routes	1	5	1	2
Location of busway lanes	Centre lanes	Centre lanes	Centre lanes	Centre lanes
Location of doorways	Median side (left)	Curbside (right)	Median side (left)	Curbside (right)
Type of surface material on runways	Concrete	Asphalt	Asphalt	Concrete
Type of surface material on runways at stations	Concrete	Concrete	Concrete	Concrete
Total length of existing feeder routes (km)	24 km	Not available	Not available	Not available
Projected length of total future trunk corridors (km)	44.1 km	Not available	Not available	Not available
Number of stations	34	34	19	16
Average distance between stations (m)	62 m	476 m	494 m	800 m
Number of stations with passing lanes	0	0	0	0
Number of terminals	2	2	2	1
Number of depots	2	1	1	1
Number of total system passenger-trips per day	100,000	246,000	81,000	120,000
Actual peak ridership (passengers per hour per direction)	5,400	9,600	6,400	6,400
Actual non-peak ridership (passengers per hour per direction)	3,700	2,900	1,680	1,680
Average commercial speed (km/h)	22 km/h	15 km/h	18 km/h	23 km/h
Average peak headway (seconds or minutes)	2.5 minutes	1 minute	2 min	2 min
Average non-peak headway (seconds or minutes)	5 minutes	3 minutes	5 min – 10 min	5 min
Average dwell time at stations (seconds)	20 seconds	20 seconds	20 seconds	30 seconds
Number of trunk vehicles	40 artic./10 stand.	113	42	74
Trunk vehicle type	Articulated/stand.	Electric trolley	Articulated	Articulated
Fuel type used in trunk vehicles	Diesel Euro III	Electricity	Diesel Euro II	Diesel Euro II / III
Trunk vehicle capacity	160	160	160	160
Trunk vehicle length (m)	18.5 m	18.5 m	18.5 m	18.5 m
Number of feeder vehicles	30	90	36	135
Type of guidance system, if applicable	None	None	None	None
Type of fare collection / verification technology	Smart cards	Coins / mag. Strip	Coins / mag. strip	Paper
Number of intersections with priority signal control	0	0	0	0
Number of grade-separated intersections	0	1	0	4
Fare (US\$)	US\$0.25	US\$0.25	US\$0.25	US\$0.25
Total planning costs (US\$)	US\$1,300,000	US\$400,000	US\$500,000	Not available
Average trunk vehicle costs (US\$)	US\$240,000	US\$650,000	US\$167,000	US\$180,000
Total infrastructure costs (US\$per km)	US\$1.4 million	US\$5.1 million	US\$585,000	US\$1.4 million

1. Guayaquil data courtesy of César Arias.
 2. Quito data courtesy of the Metropolitan Municipality of Quito and Hidalgo et al., 2007

Quantitative comparisons

Chile and Mexico

BRT Feature	Santiago (Transantiago)	León (Optibus)	Mexico City (Metrobús)
Year system commenced	2005-2007	2003	2005
Number of existing trunk corridors	2	3	1
Total length of existing trunk corridors (km)	Not available	26 (15 km exclusive)	20 km
Number of trunk routes	Various	3	3
Location of busway lanes	Centre lanes and curbside	Centre lanes	Centre lanes
Location of doorways	Curbside (right)	Median side (left)	Median side (left)
Type of surface material on runways	Asphalt	Concrete: 99% Asphalt: 1%	Asphalt
Type of surface material on runways at stations	Asphalt	Concrete: 92% Asphalt: 8%	Concrete
Total length of existing feeder routes (km)	Not applicable	140 km	0
Projected length of total future trunk corridors (km)	Not available	34 km	Not available
Number of stations	Not available	51	34
Average distance between stations (m)	Not available	400 m	450 m
Number of stations with passing lanes	Not available	0	0
Number of terminals	0	3	2
Number of depots	Not available	2	Not available
Number of total system passenger-trips per day	Not available	220,000	260,000
Actual peak ridership (passengers per hour per direction)	Not available	2,900	8,500
Actual non-peak ridership (passengers per hour per direction)	Not available	900	Not available
Average commercial speed (km/h)	20 km/h	18 km/h	19 km/h
Average peak headway (seconds or minutes)	3 minutes	T1: 2.5 min, T2/T3: 7 min	63 seconds
Average non-peak headway (seconds or minutes)	7 minutes	T1: 7 min, T2/T3: 12 min	Not available
Average dwell time at stations (seconds)	1 – 3 minutes	7 seconds	Not available
Number of trunk vehicles	Not available	55	97
Trunk vehicle type	Articulated & standard	Articulated	Articulated
Fuel type used in trunk vehicles	Diesel Euro II/III	Diesel	Diesel Euro III
Trunk vehicle capacity (passengers)	160	160	160
Trunk vehicle length (m)	18 m & 12 m	18.5 m	18.5 m
Number of feeder vehicles	Not applicable	Feeder serv: 350 Auxiliar serv: 150	0
Type of guidance system, if applicable	None	None	None
Type of fare collection / verification technology	Smart card	Smart card	Smart card
Number of intersections with priority signal control	0	0	0
Number of grade-separated intersections	0	0	0
Fare (US\$)	US\$0.70	US\$0.50	US\$0.35
Total planning costs (US\$)	Not available	US\$1.5 million	Not available
Average trunk vehicle costs (US\$)	US\$240,000	US\$260,000	US\$243,000
Total infrastructure costs (US\$million per km)	Not available	US\$1.0 mill. / km	US\$1.5 mill. / km

1. Santiago data courtesy of Eduardo Giesen, 2. León data courtesy of Dr. Dario Hidalgo, Booz Allen Hamilton, 3. Mexico City data courtesy of Bernardo Baranda (ITDP) and Gerhard Menckhoff (World Bank consultant)

Quantitative comparisons

China

BRT Feature	Beijing	Hangzhou	Kunming
Year system commenced	2004	2006	1999
Number of existing trunk corridors	1	1	4
Total length of existing trunk corridors (km)	16 km (14 exclusive)	27.2 km	32.2 km
Number of trunk routes	1	2	Not available
Location of busway lanes	Centre lanes	Curb lanes	Centre lanes
Location of doorways	Median side (left)	Curbside (right)	Curbside (right)
Type of surface material on runways	Asphalt	Asphalt	Asphalt
Type of surface material on runways at stations	Asphalt	Asphalt	Asphalt
Total length of existing feeder routes (km)	0	0	Not applicable
Projected length of total future trunk corridors (km)	100 km	180 km	179 km
Number of stations	18	16	53
Average distance between stations (m)	940 m	1,800 m	500 m
Number of stations with passing lanes	7	0	4
Number of terminals	1	3	8
Number of depots	1	1	5
Number of total system passenger-trips per day	120,000	40,000	156,000
Actual peak ridership (passengers per hour per direction)	8,000	1,500	6,300
Actual non-peak ridership (passengers per hour per direction)	1,500	500	1,000
Average commercial speed (km/h)	22 km/h	24 km/h	18 km/h
Average peak headway (seconds or minutes)	1 minute	2 minutes	40 seconds
Average non-peak headway (seconds or minutes)	4 - 8 minutes	5 minutes	3 minutes
Average dwell time at stations (seconds)	20 seconds	18 seconds	34 seconds
Number of trunk vehicles	87	48	Not available
Trunk vehicle type	Articulated	Articulated	Standard
Fuel type used in trunk vehicles	Diesel Euro III, CNG	Diesel Euro III	Diesel Euro II
Trunk vehicle capacity	160	160	80
Trunk vehicle length (m)	18 m	18 m	12 m
Number of feeder vehicles	0	0	Not applicable
Type of guidance system, if utilised	None	None	None
Type of fare collection / verification technology	Smart card	Smart card	Smart card & coin
Number of intersections with priority signal control	3	3	0
Number of grade-separated intersections	3	0	5
Fare (US\$)	US\$0.26	US\$0.40	US\$0.12 – US\$0.26
Total planning costs (US\$)	US\$765,000	US\$255,000	US\$60,000
Average trunk vehicle costs (US\$)	US\$250,000	US\$250,000	US\$250,000
Total infrastructure costs (US\$per km)	US\$4.68 million/km	US\$450,000 / km	US\$750,000 / km

1. Beijing data courtesy of Kangming Xu
2. Kunming data courtesy of Lin Wei (Municipality of Kunming)

Quantitative comparisons

Indonesia, Japan, South Korea, and Taiwan

BRT Feature	Jakarta (TransJakarta)	Nagoya	Seoul	Taipei
Year system commenced	2004	2001	2002	1998
Number of existing trunk corridors	3	1	6	11
Total length of existing trunk corridors (km)	46.9 km	6.8 km	86 km	60 km
Number of trunk routes	3	1	Various	Not available
Location of busway lanes	Centre lanes	Separated ROW	Centre & curbside	Centre lanes
Location of doorways	Median side (right)	Curbside (left)	Curbside (right)	Curbside (right)
Type of surface material on runways	Asphalt	Concrete	Asphalt	Asphalt
Type of surface material on runways at stations	Concrete	Concrete	Asphalt	Concrete
Total length of existing feeder routes (km)	0	None	9,000	0
Projected length of total future trunk corridors (km)	97 km (2008)	11.9 km	192 km	90 km
Number of stations	54	9	73	150
Average distance between stations (m)	860 m	720 m	750 m	380 m
Number of stations with passing lanes	1	0	0	4
Number of terminals	4	5	Not available	Not available
Number of depots	3	3	40	10
Number of total system passenger-trips per day	140,000	9,000		1,200,000
Actual peak ridership (passengers per hour per direction)	3,600	Not available	12,000	9,500
Actual non-peak ridership (passengers per hour per direction)	1,000	Not available	5,000	3,500
Average commercial speed (km/h)	17 km/h	30 km/h	17 km/h	17 km/h (peak hour), 22 km/h (non-peak)
Average peak headway (seconds or minutes)	1.5 minutes	3-4 minutes	4-5 buses / minute	15-30 seconds
Average non-peak headway (seconds or minutes)	Not Available	10 minutes	3-4 buses / minute	1-2 minutes
Average dwell time at stations (seconds)	Not Available	Not available	10 sec – 20 sec	7-25 seconds
Number of trunk vehicles	Not Available	25	Not available	Not available
Trunk vehicle type	Standard	Standard	Standard	Standard
Fuel type used in trunk vehicles	I: Euro I diesel II&III: Euro III CNG	Diesel	CNG	Diesel
Trunk vehicle capacity	75	75	75	69
Trunk vehicle length (m)	12 m	12 m	10 m & 12 m	10 m & 12 m
Number of feeder vehicles	0	0	Not applicable	Not applicable
Type of guidance system, if applicable	None	Mechanical	None	None
Type of fare collection / verification technology	Smart Card	Coins/magnetic card	Smart cards	Smart cards & coins
Number of intersections with priority signal control	None	Not applicable	0	0
Number of grade-separated intersections	None	All (elevated)	0	0
Fare (US\$)	US\$0.30	US\$2.00	US\$1.00	US\$0.45
Total planning costs (US\$)	US\$2 million	Not available	US\$1 million	Not available
Average trunk vehicle costs (US\$)	Not Available	Not available	US\$150,000	US\$125,000
Total infrastructure costs (US\$/km)	US\$1 million/km	US\$46.5 mill./km	US\$1.2 million/km	US\$350,000 / km

1. Jakarta data courtesy of ITDP, 2. Nagoya data courtesy of Hiroyuki Takeshita (Nagoya University), 3. Seoul data courtesy of the Seoul Development Institute, 4. Taipei data courtesy of Dr. Jason Chang (Taiwan National University)

Quantitative comparisons

Australia

BRT Feature	Adelaide (O-bahn)	Brisbane (SE Busway)	Sydney (Liverpool-Par.)
Year system commenced	1986	2001	2003
Number of existing trunk corridors	2	1	1
Total length of existing trunk corridors (km)	12 km	16.5 km	10 exclusive + 20
Number of trunk routes	18	117	1
Location of busway lanes	Centre lanes	Separated ROW	Curbside lanes
Location of doorways	Curbside (left)	Curbside (left)	Curbside (left)
Type of surface material on runways	Concrete	Concrete	Asphalt
Type of surface material on runways at stations	Concrete	Concrete	Asphalt
Total length of existing feeder routes (km)	Not applicable	Not applicable	None
Projected length of total future trunk corridors (km)	0	Not available	Not available
Number of stations	3 stations	10 stations	36 stations
Average distance between stations (m)	5,000 m	1,650 m	861 m
Number of stations with passing lanes	0	Not available	0
Number of terminals	Not available	0	Not available
Number of depots	Not available	Not available	Not available
Number of total system passenger-trips per day	25,000	93,000	6,800
Actual peak ridership (passengers per hour per direction)	4,500	10,000	Not available
Actual non-peak ridership (passengers per hour per direction)	Not available	Not available	Not available
Average commercial speed (km/h)	80 km/h	55 – 58 km/h	29 – 34 km/h
Average peak headway (seconds or minutes)	50 seconds	23 seconds	10 minutes
Average non-peak headway (seconds or minutes)	5 min – 15 min	27 seconds	20 minutes
Average dwell time at stations (seconds)	Not available	Not available	Not available
Number of trunk vehicles	118	475	15
Trunk vehicle type	Articulated / Standard	Standard	Standard
Fuel type used in trunk vehicles	Diesel	Diesel & CNG	Diesel
Trunk vehicle capacity	Not available	Not available	Not available
Trunk vehicle length (m)	18.5 m / 12 m	12 m	12 m
Number of feeder vehicles	Not applicable	Not applicable	0
Type of guidance system, if applicable	Mechanical	None	None
Type of fare collection / verification technology	Magnetic strip	Smart card and paper	Not available
Number of intersections with priority signal control	None	Not available	None
Number of grade-separated intersections	25	8	None
Fare (US\$)	US\$1.92 – US\$3.17	US\$1.83 – US\$14.50	US\$1.42 – US\$4.67
Total planning costs (US\$)	Not available	Not available	Not available
Average trunk vehicle costs (US\$)	Not available	Not available	Not available
Total infrastructure costs (US\$/km)	US\$7.2 / km	US\$20.2/km – US\$33.3/km	US\$23.9 / km

1. Source: Currie (2006)

Quantitative comparisons

France

BRT Feature	Caen	Lyon	Nantes
Year system commenced	2002	2006	2006
Number of existing trunk corridors	2	1	1
Total length of existing trunk corridors (km)	15.7 km	4 km	7 km
Number of trunk routes	2	1	1
Location of busway lanes	Centre lanes	Curbside lanes	Centre lanes
Location of doorways	Curbside (right)	Curbside (right)	Curbside (right)
Type of surface material on runways	Asphalt	Asphalt	Asphalt
Type of surface material on runways at stations	Asphalt / concrete	Asphalt	Asphalt "percolés"
Total length of existing feeder routes (km)	Not applicable	Not applicable	Not applicable
Projected length of total future trunk corridors (km)	Not available	26	Not available
Number of stations	34	10	15
Average distance between stations (m)	500 m	430 m	500 m
Number of stations with passing lanes	0	0	0
Number of terminals	4	2	2
Number of depots	1	1	1
Number of total system passenger-trips per day	45,000	Not available	25,000
Actual peak ridership (passengers per hour per direction)	Not available	Not available	Not available
Actual non-peak ridership (passengers per hour per direction)	Not available	Not available	Not available
Average commercial speed (km/h)	20	17	20
Average peak headway (seconds or minutes)	6min	10 min	4 to 5 min
Average non-peak headway (seconds or minutes)	10 to 15min	10 min	6 to 7 min
Average dwell time at stations (seconds)	Not available	Not available	Not available
Number of trunk vehicles	24	Not available	20
Trunk vehicle type	Bi-articulated	Articulated	Articulated
Fuel type used in trunk vehicles	trolley	trolleybus	CNG
Trunk vehicle capacity	150	110	110
Trunk vehicle length (m)	24.5	18	18
Number of feeder vehicles	Not applicable	Not applicable	Not applicable
Type of guidance system, if applicable	Central rail	None	None
Type of fare collection / verification technology	Not available	Not available	Not available
Number of intersections with priority signal control	49	All	All
Number of grade-separated intersections	0	0	0
Fare (US\$)	US\$1.5	US\$1.5	US\$1.5
Total planning costs (US\$)	US\$190 million	US\$29 million	US\$75 million
Average trunk vehicle costs (US\$)	US\$2 million	US\$800,000	US\$600,000
Total infrastructure costs (US\$per km)	Not available	Not available	Not available

1. Caen, Lyon, and Nantes data courtesy of François Rambaud (CERTU)

Quantitative comparisons

France (continued)

BRT Feature	Paris (Val de Marne)	Rouen
Year system commenced	1993	2001
Number of existing trunk corridors	1	3
Total length of existing trunk corridors (km)	12.5 km	26 km (12 exclusive)
Number of trunk routes	1	3
Location of busway lanes	Centre lanes	Centre & curbside
Location of doorways	Curbside (right)	Curbside (right)
Type of surface material on runways	Asphalt	Asphalt
Type of surface material on runways at stations	Asphalt	Asphalt
Total length of existing feeder routes (km)	Not available	Not available
Projected length of total future trunk corridors (km)	20.2 km	38 km
Number of stations	22	41
Average distance between stations (m)	600 m	535 m
Number of stations with passing lanes	0	0
Number of terminals	2	1
Number of depots	1	1
Number of total system passenger-trips per day	45 000	32,000
Actual peak ridership (passengers per hour per direction)	Not available	1,770
Actual non-peak ridership (passengers per hour per direction)	Not available	640
Average commercial speed (km/h)	23 km/h	16.6 km/h
Average peak headway (seconds or minutes)	4 minutes	3 minutes
Average non-peak headway (seconds or minutes)	8 minutes	4 minutes
Average dwell time at stations (seconds)	Not available	6.3
Number of trunk vehicles	19	38
Trunk vehicle type	Articulated	Articulated
Fuel type used in trunk vehicles	Diesel	Diesel Euro II & III
Trunk vehicle capacity (passengers)	110	110
Trunk vehicle length (m)	18 m	17.9 m
Number of feeder vehicles	Not available	Not available
Type of guidance system, if applicable	None	Optical
Type of fare collection / verification technology	Not available	Magnetic strip
Number of intersections with priority signal control	All	15 (out of 25)
Number of grade-separated intersections	2	1
Fare (US\$)	US\$1.5	US\$0.90
Total planning costs (US\$)	US\$9 million	Not available
Average trunk vehicle costs (US\$)	Not available	US\$390,000
Total infrastructure costs (US\$ per km)	Not available	US\$8.3 million/km

1. Rouen data courtesy of Werner Kutil (Veolia Transport)
 2. Paris data courtesy of François Rambaud (CERTU)

Quantitative comparisons

Netherlands and United Kingdom

BRT Feature	Amsterdam (Zuidtangent)	Eindhoven	Crawley (Fastway)
Year system commenced	2002	2003	2003
Number of existing trunk corridors	1 (2 nd opens , 1-1-2008)	2	2
Total length of existing trunk corridors (km)	30 km (2nd: 8 km)	12 km exclusive	24 km
Number of trunk routes	1	2	2
Location of busway lanes	Separated ROW and curbside	Centre lanes	Curbside lanes
Location of doorways	Curbside (right)	Curbside (right)	Curbside (left)
Type of surface material on runways	Concrete	Concrete	Concrete/asphalt
Type of surface material on runways at stations	Concrete	Concrete	Concrete/asphalt
Total length of existing feeder routes (km)	1 km	0	None
Projected length of total future trunk corridors (km)	50 km	50 km	Not available
Number of stations	22	32	62
Average distance between stations (m)	1500 m	550 m	400 m
Number of stations with passing lanes	0	0	0
Number of terminals	5	3	3
Number of depots	2	1	1
Number of total system passenger-trips per day	28,500	12,000	6,000
Actual peak ridership (passengers per hour per direction)	Not available	Not available	Not available
Actual non-peak ridership (passengers per hour per direction)	Not available	Not available	Not available
Average commercial speed (km/h)	38 km/h	21 km/h	20 km/h
Average peak headway (seconds or minutes)	7.5 minutes	7.5 minutes	10 minutes
Average non-peak headway (seconds or minutes)	10 minutes	10 minutes	10 minutes
Average dwell time at stations (seconds)	10-15 seconds	10 seconds	Not available
Number of trunk vehicles	33	11	Not available
Trunk vehicle type	Articulated	Articulated	Single deck rigid
Fuel type used in trunk vehicles	Diesel Euro III	LPG	Diesel Euro IV
Trunk vehicle capacity	130	120	60
Trunk vehicle length (m)	18 m	18 m	11 m
Number of feeder vehicles	0	0	0
Type of guidance system, if applicable	None	Magnetic	Mechanical
Type of fare collection / verification technology	Paper (strippenkaart)	Paper (strippenkaart)	Cash, smart card
Number of intersections with priority signal control	45 (all)	20 (all)	None
Number of grade-separated intersections	11	0	None
Fare (US\$)	US\$1.00- \$4.00	US\$2.27	Not available
Total planning costs (US\$)	US\$350 million	US\$143 million	Not available
Average trunk vehicle costs (US\$)	Not available	Not available	US\$250,000
Total infrastructure costs (US\$ per km)	US\$11 million / km	US\$10 million / km	US\$2 million

1. Amsterdam data courtesy of Ruud van der Ploeg (Stadsregio Amsterdam)
 2. Eindhoven data courtesy of Jacques Splint (Municipality of Eindhoven)

Quantitative comparisons

Canada and United States

BRT Feature	Ottawa (Transitway)	Boston (Silver Line Waterfront)	Eugene (ExM)	Los Angeles (Orange Line)
Year system commenced	1983	2004	2007	2005
Number of existing trunk corridors	3	1	1	1
Total length of existing trunk corridors (km)	30 km	11.3 km	6.44 km	22.7 km
Number of trunk routes	Various	4	1	1
Location of busway lanes	Curbside and separated ROW	Curbside and separated ROW	Centre lanes and curbside	Centre, curbside, separated ROW
Location of doorways	Curbside (right)	Curbside (right)	Double-sided (3 right / 2 left)	Curbside (right)
Type of surface material on runways	Asphalt	Asphalt	Concrete	Asphalt
Type of surface material on runways at stations	Asphalt	Asphalt	Concrete	Concrete
Total length of existing feeder routes (km)	Not applicable	Not available	Various	Various
Projected length of total future trunk corridors (km)	Not available	Not available	145 km	14.2 km
Number of current stations	37	11	8	14
Average distance between stations (m)	810 m	1,130 m	530 m	1,610 m
Number of stations with passing lanes	Not available	0	None	14
Number of terminals	4	1	2	2
Number of depots	Not available	Not available	1	1
Number of total system passenger-trips per day	200,000	9,300	3,500	22,000
Actual peak ridership (passengers per hour per direction)	10,000	Not available	500	Not available
Actual non-peak ridership (passengers per hour per direction)	Not available	Not available	Not available	Not available
Average commercial speed (km/h)	Not available	Not available	24 km/h	34 km/h
Average peak headway (seconds or minutes)	2 minutes	3 minutes	10 minutes	5 minutes
Average non-peak headway (seconds or minutes)	15 minutes	12 minutes	10 - 20 minutes	20 minutes
Average dwell time at stations (seconds)	10-20 seconds	24 seconds	10 seconds	10-20 seconds
Number of trunk vehicles	Not available	Not available	4	30
Trunk vehicle type	Standard	Articulated & standard	Articulated	Standard
Fuel type used in trunk vehicles	Diesel	Dual mode (electric-diesel)	Hybrid-electric	CNG
Trunk vehicle capacity (passengers)	50	104	120	120
Trunk vehicle length (m)	12 m	18 m & 12 m	18 m	18 m
Number of feeder vehicles	Not applicable	Not available	Various	Not available
Type of guidance system, if applicable	None	None	None	None
Type of fare collection / verification technology	Cash, paper, pass	Cash, paper, magnetic strip	Free (no fare)	Cash, paper
Number of intersections with priority signal control	0	None	24	35
Number of grade-separated intersections	0	Bay tunnel	0	0
Fare (US\$)	US\$0.85	US\$1.70 – US\$2.00	Free	US\$1.25
Total planning costs (US\$)	Not available	Not available	US\$1.5 million	US\$1.8 million
Average trunk vehicle costs (US\$)	Not available	US\$640,000	US\$966,000	US\$663,000
Total infrastructure costs (US\$/km)	US\$8.3 mill/km	US\$53.2 mill/km	US\$2.8 mill/km	US\$14.9 mill/km

1. Ottawa data based on Metro Magazine (2006) and OCTransit website, 2. Eugene data courtesy of Graham Carey, Lane Transit District, 3. Boston data based on Schimek et al. (2005) and MBTA website
4. Los Angeles data courtesy of Gary Spivack, Los Angeles County Metropolitan Transportation Authority

Quantitative comparisons

Canada and United States

BRT Feature	Miami (Busway)	Orlando (Lynx LYMMO)	Pittsburgh (South Busway)	Pittsburgh (MLK East Busway)	Pittsburgh (West Busway)
Year system commenced	1997	1997	1977	1983 & 2003	2000
Number of existing trunk corridors	1	1	1	1	1
Total length of existing trunk corridors (km)	21.9	4.8 km	6.9 km	14.7 km	8.1 km
Number of trunk routes	6	1	15	38	10
Location of busway lanes	Separated ROW	Curbside, septd. ROW	Separated ROW	Separated ROW	Separated ROW
Location of doorways	Curbside (right)	Right Side	Curbside (right)	Curbside (right)	Curbside (right)
Type of surface material on runways	Asphalt	Concrete	Concrete	Concrete	Concrete
Type of surface material on runways at stations	Asphalt	Concrete	Concrete	Concrete	Concrete
Total length of existing feeder routes (km)	Not applicable	0	Not applicable	Not applicable	Not applicable
Projected length of total future trunk corridors (km)	Not available	30.42 km	6.9 km	25.7 km	9.3 km
Number of stations	21	13 (plus 7 stops)	2 (plus 8 stops)	9	6
Average distance between stations (m)	920 m	300 m	627 m	1,633 m	1,350 m
Number of stations with passing lanes	0	10	2	9	6
Number of terminals	3	2	2	3	1
Number of depots	1	1	5	5	5
Number of total system passenger-trips per day	22,500	3,000	11,000	26,000	9,100
Actual peak ridership (passengers per hour per direction)	Not available	Not available	1,650	5,000	1,365
Actual non-peak ridership (passengers per hour per direction)	Not available	Not available	Not available	Not available	Not available
Average commercial speed (km/h)	45 km/h	Not available	34.5 km/h	40.1 km/h	40.5 km/h
Average peak headway (seconds or minutes)	10 minutes	4 minutes	2 minutes	4 minutes	5 minutes
Average non-peak headway (seconds or minutes)	20 minutes	10 minutes	8.6 minutes	8.6 minutes	20 minutes
Average dwell time at stations (seconds)	Not available	Not available	Not available	Not available	Not available
Number of trunk vehicles	62	9 (plus 1 spare)	68	162	50
Trunk vehicle type	Low Floor	Low Floor	Standard	Articulated	Standard
Fuel type used in trunk vehicles	Diesel	CNG	Diesel	Diesel + Hybrid-Electric	Diesel
Trunk vehicle capacity (passengers)	52	30	50	80	50 & 57
Trunk vehicle length (m)	12 m	10.7 m	12.2 m	18.3 m	12.2 m & 13.7 m
Number of feeder vehicles	Not applicable	None	Not applicable	Not applicable	Not applicable
Type of guidance system, if applicable	None	None	None	None	None
Type of fare collection / verification technology	Cash, paper, mag. strip	Free Fare	Cash, paper	Cash, paper	Cash, Paper
Number of intersections with priority signal control	All	10	None	1	1
Number of grade-separated intersections	0	None	None	None	None
Fare (US\$)	US\$1.50		US\$1.75	US\$1.75	US\$1.75
Total planning costs (US\$)	Not available	Not available	Not available	Not available	Not available
Average trunk vehicle costs (US\$)	Not available	Not available	US\$357,000	US\$477,000	US\$357,000 & US\$395,000
Total infrastructure costs (US\$per km)	US\$21 mill/km	US\$4.3 mill/km	US\$3.9 mill/km	US\$12.5 mill/km	US\$31.9 mill/km

1. Miami data courtesy of Miami Dade Transit Bus Services
 2. Orlando data courtesy of Doug Jamison (Lynx Lymmo)
 3. Pittsburgh data courtesy of David Wohlwill (Port Authority of Pittsburgh)

Annex 2

BRT consultant directory

The information provided in this BRT Consultant Directory has been provided by the consultants themselves. The authors of this Planning Guide thus cannot ascertain the veracity of the information provided in this directory. The appearance of a particular consultant in this directory is not indicative of any sort of endorsement by the authors of this Planning Guide. Likewise, if a particular consultant does not appear in this directory, it is not indicative of any sort of disapproval. A copy of the most recently updated BRT Consultant Directory can be found at: <http://www.itdp.org/programs/BRT>.

Consultant	Firm name or independent	Contact details	BRT project experience (list cities)	Specialities (indicated by an "X")								
				BRT Project management	Demand modelling	Operational planning	Infrastructure planning	Technology (fare systems, vehicles, ITS)	Strategic, legal, business plan	Marketing, communications	Evaluation	
Andrade, Luis Fernando	McKinsey & Company	Carrera 7 No. 71-21, Torre B, Of. 802 Bogota Colombia Tel. +57 1 313 7000 Fax +57 1 313 7079 luis_andrade@mckinsey.com	Bogotá							X		
Ardila, Arturo	Universidad de los Andes	Calle 78 No. 12 – 29 Int. 4, Apt. 901 Bogotá Colombia Tel. + 57 311 230 4553 aardila@alum.mit.edu	Bogotá, Medellín, Bucaramanga, Barranquilla, Panama, Guatemala, Managua, Tegucigalpa, San Salvador, San José				X			X		X
Arias, César	A & Y Consultores Cia. Ltda.	Calle El Comercio 402 y Shyris Quito Ecuador Tel. +593 2 2251 906 Fax +593 2 2251 907 Cel. +593 9 9781 494 fraarias@uio.satnet.net cesarh_arias@yahoo.com	Gold Coast, Guayaquil, Hanoi, Ho Chi Minh City, Quito, Cuenca Lima, Arequipa Querétaro, Tecamac	X		X				X		
Ayles, Chris	MVA Asia Limited	Bangkok Thailand chrisa@mva.co.th	Hanoi, Ho Chi Minh City, Bangkok	X	X		X					
Berczuk, Phil	Steer Davies Gleave	28-32 Upper Ground, London, SE1 9PD, UK Tel: +44 20 7919 8500 David.Bosers@sdgworld.net	Bogotá, Santiago, Concepción								X	
Bowers, David	Steer Davies Gleave	28-32 Upper Ground, London, SE1 9PD, UK Tel: +44 20 7919 8500 David.Bosers@sdgworld.net	Lagos	X	X	X	X	X			X	X
Burley, Chris	MVA Asia Limited	Hong Kong Tel. +852 2864 6417 cjb@mva.com.hk	Hanoi, Ho Chi Minh City	X	X		X					X

Consultant	Firm name or independent	Contact details	BRT project experience (list cities)	Specialities (indicated by an "X")								
				BRT Project management	Demand modelling	Operational planning	Infrastructure planning	Technology (fare systems, vehicles, ITS)	Strategic, legal, business plan	Marketing, communications	Evaluation	
Cagney, Neil	McCormick Rankin Cagney	50 Park Road Milton QLD 4064 Australia Tel. +61 7 3320 3600 Fax +61 7 3320 3636 ncagney@mrcagney.com	Brisbane, Auckland	X		X	X	X	X		X	
Cal y Mayor, Patricio	Cal y Mayor & Associates	Dr. Pallares y Portillo 174, 1er piso México DF 04040 México Tel. +52 55 44 37 18 Fax +52 55 44 64 63 pcalymayor@calymayor.com.mx	Lima, Mexico	X		X	X					
Carey, Graham	Independent and Lane Transit District	3500 East 17th Avenue Eugene, OR 97403 USA Tel. +1 541 682 6100 Fax +1 541 682 6111 graham.carey@ltd.org	Eugene, Houston, Monterey, Honolulu, Johannesburg	X		X	X	X		X		
Castro, Angélica	TransMilenio SA	Avenida Eldorado #66 – 63 Bogota, Colombia Tel. +57 1 275 7000 angelica.castro@transmilenio.gov.co mariav.miranda@transmilenio.gov.co	Bogotá	X		X	X	X	X			
Ceneviva, Carlos	Instituto Jaime Lerner	Rua Bom Jesus , 76 Curitiba - Paraná - Brasil CEP 80.035-010 Tel. 55 41 2141 0700 Fax 55 41 2141 0718 ceneviva@jaimelerner.com	Curitiba, State of Mexico, Mexico, Rio de Janeiro, State of Oaxaca	X		X	X			X	X	
Chang, Jason	Independent	National Taiwan University Department of Civil Engineering Taipei 10617, Taiwan Tel. +886 935178543 Fax +886 223639990 skchang@ntu.edu.tw	Taipei, Beijing	X	X	X		X	X		X	

Consultant	Firm name or independent	Contact details	BRT project experience (list cities)	Specialities (indicated by an "X")							
				BRT Project management	Demand modelling	Operational planning	Infrastructure planning	Technology (fare systems, vehicles, ITS)	Strategic, legal, business plan	Marketing, communications	Evaluation
Chiu, Michael	MVA Asia Limited	Hong Kong mkc@mva.com.hk	Hanoi, Beijing			X	X				
Colombini Martins, Wagner	Logit Consultoria	Avenida Eng.Luis Carlos Berrini,1700 São Paulo, SP CEP 04571-000 Brazil Tel. +55 11 5505 8800 wagner@logitconsultoria.com.br	Bogotá, Dar es Salaam	X	X	X	X	X	X		
Correa, Germán	Independent	Santiago Chile Tel. +56 2 285 2985 vgermancorrea@hotmail.com	Santiago						X		
Custodio, Paulo	Independent	São Paulo Brazil Tel. +55 11 8245 1478 custodiops@uol.com.br custodio.ps@gmail.com	Bogotá, Cartagena, Cali, Pereira, La Paz, Mexico City, State of Mexico, Dar Es Salaam, Jakarta, Jinan, Xian, Chengdu	X	X	X	X				X
de Bruyn, Johan	Arcus Gibb	Block A, 1st Floor, East Wing Lynwood Corporate Park 36 Alkantrant Road Lynwood Manor, Pretoria 0081 South Africa Tel. +27 12 348 5880 Fax +27 12 348 5878 jdebruyn@gibb.co.za	Johannesburg	X		X	X	X			
de Guzman, Ignacio	Akiris	Calle 86 Bogotá, Colombia Tel. +57 310 327 8343 Fax +57 1 317 3161 ignaciodeguzman@akiris.net	Bogotá, Mexico City	X					X		

Consultant	Firm name or independent	Contact details	BRT project experience (list cities)	Specialities (indicated by an "X")								
				BRT Project management	Demand modelling	Operational planning	Infrastructure planning	Technology (fare systems, vehicles, ITS)	Strategic, legal, business plan	Marketing, communications	Evaluation	
de la Barra, Tomas	Modelistica	Qta. Morichalito Calle San Antonio Bello Monte Caracas, Venezuela tomas@modelistica.com	Bogotá, Mexico City, Sao Paulo, Panamá, Maracaibo, Mérida (Ven), Barcelona (Ven)		X	X	X			X		X
de Pommerol, Alexis	SYSTRA	5, avenue du Coq Paris 9 Tel. +33 1 40166100 Fax +33 1 40166104 systra@systra.com	La Paz, Pereira	X		X	X	X				
Diaz, Juan Carlos	Akiris	Carrera 7 No. 71-21 Torre A, Oficina 601 Bogotá, Colombia Tel. +57 1 317 3337 Fax +57 1 317 3161 juandiaz@akiris.net	Bogotá, Lima	X		X		X				
Ernst, John	ITDP	127 W. 26th St., suite 1002 New York, NY 10001 johnernst@itdp.org	Jakarta, Hyderabad	X								X
Escallon Morales, Fernando	Escallon Morales & Asociados	Carrera 4A, No. 73-71 Bogotá Colombia escallonmorales@yahoo.com	Bogota, Dar es Salaam							X		
Ferreira, Eric Amaral	IMAE	Rua Harmonia 755 / 142 São Paulo Brazil Tel. +55 83814933 abcderic@gmail.com	Leon, México, Curitiba	X	X	X						
Fialho, Andre	AGKF Servicios de Ingeniería SS	Rua Nilo Peçanha 3.555 Curitiba/ Paraná / Brasil codigo postal CEP 82.120.440 telefonos; 00.55.41. 3252.9823 celular; 00.55.41. 9977.8704 agkf@uol.com.br	Curitiba, Arequipa, Posadas, Quito, Guayaquil	X		X						

Consultant	Firm name or independent	Contact details	BRT project experience (list cities)	Specialities (indicated by an "X")								
				BRT Project management	Demand modelling	Operational planning	Infrastructure planning	Technology (fare systems, vehicles, ITS)	Strategic, legal, business plan	Marketing, communications	Evaluation	
Filewood, Richard	McCormick Rankin Cagney	50 Park Road Milton QLD 4064 Australia Tel. +61 7 3320 3600 Fax +61 7 3320 3636 rfilewood@mrcagney.com	Brisbane, Auckland			X	X			X		X
Fjellstrom, Karl	ITDP	127 W. 26th St., Suite 1002 New York, NY 10001 kfjellstrom@itdp.org	Guangzhou, Ahmedabad, Dar es Salaam	X		X						X
Forshaw, Pauline	Namela Projects	PO Box 73267 Lynnwood Ridge South Africa, 0040 Tel: +27 12 349 1887 Fax: +27 12 349 1515 Mobile: +27 83 274 7886 pauline@namela.co.za	Johannesburg, Pretoria	X		X				X		
Frazier, Charles	ALG	Comte d'Urgell, 240 3 C 08036 Barcelona Spain Tel. +34 93 430 40 16 Fax +34 93 419 5524 cfrazier@alg-global.com	Guatemala City, Lima	X		X	X					
Frieslaar, André	HHO Africa	Cape Town South Africa Tel. +27 21 425 2870 Fax +27 21 419 4689 Email andre@hho.co.za	Cape Town	X		X	X					
Fuller, Charles	Axios Consulting	PO Box 7121 Roggebaai 8012 South Africa Tel. +27 21 419 2115 Fax +27 21 425 2544 crfuller@mweb.co.za	Cape Town	X		X						

Consultant	Firm name or independent	Contact details	BRT project experience (list cities)	Specialities (indicated by an "X")								
				BRT Project management	Demand modelling	Operational planning	Infrastructure planning	Technology (fare systems, vehicles, ITS)	Strategic, legal, business plan	Marketing, communications	Evaluation	
Gómez, Pedro	Getinsa	Calle Raimundo Fernandez Villaverde, 59 Madrid Spain Tel. +34 91 533 3551 pdgomez@getinsa.es	Lima	X								
Gordillo, Fabio	Independent	Calle 80 N 7 49 Ap. 202 Bogota, Colombia Tel. +57 1 321 0416 fgr@alum.mit.edu	Bogotá, Jakarta, Dar es Salaam, Mexico City, London					X				
Gosselin, Ken	McCormick Rankin International	2655 North Sheridan Way Mississauga, Ontario Canada L5K 2P8 Tel. +1 905 823 8500 Fax +1 905 823 8503 kgosselin@mrc.ca	Brisbane, Ottawa, Pittsburgh	X								
Hidalgo, Dario	Booz Allen Hamilton and independent	Carrera 12 79-43 P4 Bogotá, Colombia Tel. +57 1 628 5050 Fax +57 1 313 0093 hidalgo_dario@ne.bah.com	Bogotá, Lagos, São Paulo	X		X				X		X
Hoffman, Alan	The Mission Group	World Trade Center Building 1250 Sixth Avenue, Suite 214 San Diego, CA 92101 USA Tel. +1 619 232 1776 Fax +1 619 374 2785 alan@missiongrouponline.com	Brisbane, Las Vegas, Sarasota, San Diego, Atlanta			X	X			X	X	X
Jeanneret, Remi	Independent	Rio de Janeiro Brazil Tel. +55 21 3970 3188 remijeanneret@uol.com.br	Ahmedabad, Bogotá, Cali, Dar es Salaam, Jakarta, Jinan		X	X						

Consultant	Firm name or independent	Contact details	BRT project experience (list cities)	Specialities (indicated by an "X")								
				BRT Project management	Demand modelling	Operational planning	Infrastructure planning	Technology (fare systems, vehicles, ITS)	Strategic, legal, business plan	Marketing, communications	Evaluation	
Johnstone, Len	Pacific Consultants International (PCI)	518/3 Maneeya Centre North 4th Floor, Ploenchit Road, Lumpini, Pathumwan Bangkok 10330 Thailand Tel. +66 2 2556813 Fax +66 2 2537369 lenj@loxinfo.co.th	Bangkok	X	X							X
Joos, Ernst	Independent	Lahnstrasse 81 8200 Schaffhausen Switzerland Tel. +41 52 624 8870 ernst.joos@spectraweb.ch	Kunming	X					X			
Kijmanawat, Kerati	Pacific Consultants International (PCI)	518/3 Maneeya Centre North 4th Floor, Ploenchit Road, Lumpini, Pathumwan Bangkok 10330 Thailand Tel. +66 2 2556813 Fax +66 2 2537369 kijmanawatk@pcitokyo.co.jp	Bangkok, Chiang Mai	X		X	X	X				X
Kuranami, Chiaki	PADECO	Izumikan Sanbancho Building 3-8 Sanbancho, Chiyoda-Ku Tokyo 102-0075 kuranami@padeco.co.jp	Cuenca, Hanoi	X								X
Lerner, Jaime	Instituto Jaime Lerner	Rua Bom Jesus , 76 Curitiba - Paraná - Brasil CEP 80.035-010 Tel. 55 41 2141 0700 Fax 55 41 2141 0718 contato@jaimelerner.com	Curitiba, State of Mexico	X							X	X
Levinson, Herbert S.	Independent	40 Hemlock Road New Haven, Ct 06515 USA Tel. +1 203 389 2092 hslevinson@aol.com	Albany, New York	X		X	X					X

Consultant	Firm name or independent	Contact details	BRT project experience (list cities)	Specialities (indicated by an "X")								
				BRT Project management	Demand modelling	Operational planning	Infrastructure planning	Technology (fare systems, vehicles, ITS)	Strategic, legal, business plan	Marketing, communications	Evaluation	
Lillo, Enrique	diaDro Consulting España	Goya, 51-5º3, 28001 Madrid Spain Tel. +34 91 576 26 37 enrique.lillo@diadro.com www.diadro.com	Bogotá, Cape Town	X	X	X						
Lleras, Germán	Steer Davies Gleave	Carrera 7, No 21-71, Torre A Oficina 604 Edificio Avenida Chile, Bogotá, Colombia g.lleras@sdgworld.net	Bogotá, Pereira, Medellín	X		X	X	X				
Lobo, Adriana	Centro de Transporte Sustentable (CTS)	Colonia Villa Coyacán C.P. 04000 Mexico City Mexico Tel. +52 55 3096 5742 director@cts-ceiba.org	Mexico City	X								X
Marchezetti, Antonio	Logitrans	Rua México, 320 Bacacheri CEP 82510-060 Curitiba PR Brazil Tel/Fax +55 41 3357 2142 marchezetti@logitran.com.br	Curitiba, Bogotá	X	X	X	X	X				X
McCaul, Colleen	Colleen McCaul Associates	40 Avalanche Street Westdene Johannesburg 2092 South Africa Tel. +27 11 482 6038 Fax +27 11 482 7680 mccaul@pixie.co.za	Johannesburg		X	X				X		
Menckhoff, Gerhard	Independent	3110 Cathedral Avenue, NW Washington, DC 20008 USA Tel. +1 202 473 1868 gmenckhoff@worldbank.org	Bogotá, Lima, Hanoi	X						X		X

Consultant	Firm name or independent	Contact details	BRT project experience (list cities)	Specialities (indicated by an "X")								
				BRT Project management	Demand modelling	Operational planning	Infrastructure planning	Technology (fare systems, vehicles, ITS)	Strategic, legal, business plan	Marketing, communications	Evaluation	
Motta, Paulo	Independent	Porto Alegre Brazil Tel. +55 51 3332 8598 motta.paulo@gmail.com	Lima, Monterrey, León, Barquisimeto, Porto Alegre	X		X	X					
Navarro, Ulises	Modelistica	Qta. Morichalito Calle San Antonio Bello Monte Caracas, Venezuela ulises@modelistica.com	Mexico City Dar es Salaam, Jakarta	X	X	X	X					
Olyslagers, Frits	TransTech Engineering Pty Ltd	PO Box 795 Bulimba 4171, Queensland Australia Tel. +61 (0)418 875 740 olyslagers@optusnet.com.au	Adelaide, Bangkok, Chiang Mai, Johannesburg, Karachi	X		X				X		X
Perera, Fernando	Grupo BMCP Consultores C.A / Independent	Av. Terepaima. Multicentro Empresarial Cristal Plaza. Of 3-E. Urb el Piñal. Barquisimeto. Venezuela perera_fernando@yahoo.com	Barquisimeto, Lima, Santo Domingo	X		X	X	X	X	X	X	
Pérez, José Enrique	ALG	Comte d'Urgell, 240 3 C 08036 Barcelona Spain Tel. +34 93 430 40 16 Fax +34 93 419 5524 jeperez@alg-global.com	Guatemala City, Lima, Caracas, Santiago, Arequipa, Montevideo, Panamá City, Toluca	X	X	X	X	X	X	X		
Reck, Garrone	Logitrans	Rua México, 320 Bacacheri CEP 82510-060 Curitiba PR Brazil Tel/Fax +55 41 3357 2142 garrone@logitran.com.br	Bogotá, Curitiba, Pereira	X	X	X	X					X
Sandoval, Edgar Enrique	Independent	Transversal 18 No. 127-43 Torre 5, Apt. 702 Bogotá, Colombia eesandoval@cable.net.co	Bogotá, Dar es Salaam	X						X		

Consultant	Firm name or independent	Contact details	BRT project experience (list cities)	Specialities (indicated by an "X")								
				BRT Project management	Demand modelling	Operational planning	Infrastructure planning	Technology (fare systems, vehicles, ITS)	Strategic, legal, business plan	Marketing, communications	Evaluation	
Sayeg, Philip	Independent	Policy Appraisal Services Pty Ltd PO Box 139, Paddington, Brisbane Australia 4064 Tel. +61 7 3102 3007 Fax +61 7 3369 7185 p.sayeg@uq.net.au	Brisbane, Bangkok	X								X
Scatena, J. Carlos	Independent	Rua Dr. Paulo Vieira, 258 São Paulo – SP Cep: 01257-000 Tel. +5511 3872 4118 Fax +5511 9656-2152 jcscatena@gmail.com jcscatena@terra.com.br	Jakarta, Jinan, São Paulo, Ciudad Guayana, Xi'an Porto Alegre, Goiania	X	X	X						X
Shibata, Junji	Pacific Consultants International (PCI)	1-7-5, Sekido, Tamashi Tokyo 206-8550 Japan Tel. +81 42 372 6201 Fax +81 42 372 6353 shibataj@pcitokyo.co.jp	Bangkok, Chiang Mai, Doha	X	X	X	X					
Silva, Germán	Silva Carreño y Asociados SA	Carrera 7 No. 74-21, Of. 301 Bogotá Colombia Tel. +57 210 5510664 gsilva42@etb.net.co	Bogotá, Pereira, Lima				X					
Siriwarapitak, Somchai	PlanPro Corp., Ltd.	335 Moo 3 Bangkruiy-Sanoi Rd Bangrakpattana, Bangbuathong, Nonthaburi 11110 Thailand Tel. +66 2571 2741 somchai@planpro.co.th	Bangkok	X	X	X	X	X				
Stanbury, Jim	Arcus Gibb	Cape Town South Africa jstanbury@gibb.co.za	Cape Town	X	X	X	X					

Consultant	Firm name or independent	Contact details	BRT project experience (list cities)	Specialities (indicated by an "X")							
				BRT Project management	Demand modelling	Operational planning	Infrastructure planning	Technology (fare systems, vehicles, ITS)	Strategic, legal, business plan	Marketing, communications	Evaluation
Su, Allen Chih-Che	THI Shanghai Consultants Inc.	R 706, No. 65, Chifeng Road, Shanghai 200092, China Tel. +86-21-65975023 Fax +86-21-65975023 thi_shanghai@163.com www.thiconsultants.com	Shenzhen, Jinan, Shanghai, Huaian	X		X	X	X	X		
Sun, John	THI Consultants Inc.	THI Consultants Inc. 5F, No. 130, Sungshan Road Taipei, Taiwan 110 Tel. +886 2 2748 8822 Fax +886 2 2748 6600 jsun@ms1.thi.com.tw www.thi.com.tw	Taipei, Shenzhen, Jinan, Shanghai, Huaian, Taichung, Kaohsiung, Chiayi	X	X	X	X	X	X		X
Szasz, Pedro	Independent	São Paulo Brazil szasz@terra.com.br	Bogotá, Guangzhou, São Paulo, Jakarta, Ahmedabad	X	X	X	X				
Tapia, Juan	CIDATT	Av. Javier Prado Este 1104 – Oficina 402 San Isidro Lima Peru Telefono +51 1 2249800 Fax +51 1 2251677 jtapia@cidatt.com.pe	Lima, Monterrey, Chihuahua						X		X
Tewari, Geetam	IIT-Delhi	Indian Institute of Tech. – Delhi TRIPP Room MS 808 (Main Building Hauz Khas New Delhi - 110 016 India Tel. 91-11-26596361 Fax 91-11-26858703 geetamt@gmail.com	Delhi, Pune	X		X					
Thompson, John	Pacific Consultants International (PCI)	1-7-5, Sekido, Tamashi Tokyo 206-8550 Japan Tel. +81 42 372 6201 Fax +81 42 372 6353 johnjanete@aol.com	Bangkok, Chiang Mai, Doha	X		X	X				

Consultant	Firm name or independent	Contact details	BRT project experience (list cities)	Specialities (indicated by an "X")								
				BRT Project management	Demand modelling	Operational planning	Infrastructure planning	Technology (fare systems, vehicles, ITS)	Strategic, legal, business plan	Marketing, communications	Evaluation	
Tofie, Zaida	Pendulum Consulting	Cape Town South Africa Tel. +27 21 447 8904 Fax +27 21 448 6499 ztofie@pendulumsa.co.za	Cape Town	X		X					X	
Tsuzuki, Koichi	Yachiyo Engineering Co., Ltd.	2-18-12 Nischiochiai Shinjuku-ku Tokyo 161-8575 Japan Tel. +81 3 5906 0363 tsuzuki@yachiyo-eng.co.jp	Lima	X			X					
Utria, Antonio	Independent	Bogota Colombia Tel. +57 1 218 2600 autria@etb.net.co					X					
Vlasak, Jarko	Independent	Bogota Colombia Mf_jarko@hotmail.com	Bogotá, Lima, Cape Town	X						X		
Wartel, Alain	Veolia Transport (Connex)	15, rue de la Petite Chartreuse B.P. 99 76002 Rouen Cedex 1 France Tel. +33 (0)2 35 52 52 12 Fax +33 (0)2 35 52 52 38 alain.wartel@veolia-transport.fr werner.kutil@veolia-transport.fr www.veolia-transport.com	Bogotá, Las Vegas, Rouen, York	X	X	X		X		X	X	X
Williams, Paul	MVA Asia Limited	Bangkok Thailand paulw@mva.co.th	Hanoi, Ho Chi Minh City, Bangkok	X	X		X	X		X		X
Willumsen, Luis	Steer Davies Gleave	28-32 Upper Ground London SE1 9PD UK Tel. +44 71 919 8500 Fax +44 71 827 9850 l.willumsen@sdgworld.net	Bogotá, Cape Town	X	X	X	X					

Consultant	Firm name or independent	Contact details	BRT project experience (list cities)	Specialities (indicated by an "X")								
				BRT Project management	Demand modelling	Operational planning	Infrastructure planning	Technology (fare systems, vehicles, ITS)	Strategic, legal, business plan	Marketing, communications	Evaluation	
Xu, Kangming	3E Transportation System	1564 NW 183rd Avenue Pembroke Pines, Florida USA Tel: +1 954 663 1683 Tel. +86 139 1092 3155 Fax. +1 954 538 1492 kangmingxu@gmail.com	Beijing Kunming Hangzhou Shenzhen Changzhou Xian Shanghai Miami	X		X	X	X				X

Annex 3

Templates for consultant solicitation

A3.1 Template: “Expression of Interest” (EOI) document for planning consultant

Request for Expression of Interest

Project title:

Project number: (if applicable)

Date of EOI announcement:

Contracting agency:

Brief project description:

- Project goals and objectives
- History of project to date
- Type of system envisioned for city (size, level of quality, etc.)
- Estimated project timeline (estimated date of project commencement, estimated date of project completion)

Expected consultant outputs for project:

- Type of plan to be developed (pre-feasibility, feasibility, demand analysis, conceptual plan, detailed engineering design, communications and marketing, business and regulatory, financing, or impact evaluation)
- Output types (report, models, video, drawings, etc.)

Requested inputs in reply to Expression of Interest:

- Name of lead firm/individual
- Name of any associate firms/individuals
- Experience to date with similar types of projects (name of client, dates of execution, name of lead and associate firms, project results, financing sources)
- Available project staff (name, title, specialties, and years of experience)

Submission deadline:

Date and time (specify time zone)

Decision date:

Date and method of contact for decision on short-listed firms

Submission details:

- Formatting standards
- Maximum word length
- Submission delivery options (post, email, etc.)
- Signature of firm representative

Submission contact details:

- Contact details for any questions (telephone, email, etc.)
- Postal address for submission

A3.2 Template: “Terms of Reference” (TOR) document for planning consultant

Terms of Reference

Project title:

Project number: (if applicable)

Date of TOR announcement:

Contracting agency:

Project background:

- Summary of economic, environmental, and social conditions of city
- Transport sector background (mode shares, travel patterns, congestion levels, road network, etc.)
- Summary of existing plans (e.g., Master Transport Plan)

Project description:

- Project goals and objectives
- History of project to date
- Type of system envisioned for city (size, level of quality, etc.)
- Expected contents of plan
- Methodology for execution of plan
- Expected project outcomes

Expected consultant outputs for project:

- Intermediate plans and final plan
- Additional materials (models, videos, drawings, etc.)
- Estimated project timeline (estimated date of project commencement, estimated date of delivery of intermediate outputs, estimated date of project completion)

Requested inputs in reply to TOR:

- Name of lead firm/individual
- Name of any associate firms/individuals
- Bid price
- Proposed delivery dates of project outputs
- Experience to date with similar types of projects (name of client, dates of execution, name of lead and associate firms, project results, financing sources)
- Available project staff (curriculum vitae with name, title, specialties, and years of experience)

Legal requirements: (if applicable)

- Anticorruption agreement
- Equal opportunity employment agreement
- Local and national tax provisions





Decision process:

- Expected date of decision
- Evaluation committee
- Proposal evaluation criteria and weightings (*e.g.*, bid price, experience, staff qualifications, proposed delivery date, etc.)
- Method of contact for decision on short-listed firms
- Declaration of no chosen winner (if applicable)

Submission deadline:

Date and time (specify time zone)

Submission details:

- Formatting standards
- Maximum word length
- Submission delivery options (post, email, etc.)
- Signature of firm representative

Submission contact details:

- Contact details for any questions (telephone, email, etc.)
- Postal address for submission

Annex 4

List of financing organisations

A4.1 Foundations

Alternative Gifts International
<http://www.altgifts.org>

Blue Moon Foundation
<http://www.bluemoonfund.org>

Charles Stewart Mott Foundation
<http://www.mott.org>

Codespa Foundation
<http://www.codespa-asia.org>

David and Lucile Packard Foundation
<http://www.packard.org>

Earth Share
<http://www.earthshare.org>

Ford Foundation
<http://www.fordfound.org>

Global Greengrants Fund
<http://www.greengrants.org>

MacArthur Foundation
<http://www.macfound.org>

New Land Foundation
http://www.gm-uncd.org/FIELD/Foundations/NewLand/FR_Gr.htm

Rockefeller Foundation
<http://www.rockfound.org>

Rockefeller Brothers Foundation
<http://www.rfb.org>

Rockwood Foundation
<http://www.rockwoodfund.org>

Rose Foundation
<http://www.rosefdn.org>

Roy A. Hunt Foundation
<http://www.rahuntdn.org>

Shell Foundation
<http://www.shellfoundation.org>

Soros Foundation
<http://www.soros.org>

Surdna Foundation
<http://www.surdna.org>

Tides Foundation
<http://www.tides.org>

Toyota Foundation
<http://www.toyotafound.or.jp/etop.htm>

Wallace Global Fund
<http://www.wgf.org>

William and Flora Hewlett Foundation
<http://www.hewlett.org>

William J. Clinton Foundation
<http://www.clintonfoundation.org>

W.K. Kellogg Foundation
<http://www.wkkf.org>

Working Assets
<http://www.workingassets.com/recipients.cfm>

A4.2 International organisations

African Development Bank (AfDB)
<http://www.afdb.org>

Asian Development Bank (ADB)
<http://www.adb.org/Vehicle-Emissions/default.asp>

Clean Air Initiative – Asia (CAI-Asia)
<http://www.cleanairnet.org/caiasia>

Clean Air Initiative – Latin America (CAI-LAC)
<http://www.cleanairnet.org/cailac>

Clean Air Initiative – Sub-Saharan Africa (CAI-SSA)
<http://www.cleanairnet.org/caissa>

Development Bank of Southern Africa (DBSA)
<http://www.dbsa.org>

East African Development Bank (EADB)
<http://www.eadb.org>

European Bank for Reconstruction and Development (EBRD)
<http://www.ebrd.com>

European Union
Directorate General VIII, Development
http://europa.eu.int/comm/development/index_en.htm

European Union
Directorate General XI, Environment
http://europa.eu.int/comm/environment/funding/intro_en.htm

European Union
Directorate General XVII, Energy and Transport
http://europa.eu.int/comm/energy_transport/en/prog_cut_en.html

Global Environment Facility (GEF)
<http://www.gefweb.org>

Inter-American Development Bank (IDB)
<http://www.iadb.org>

International Finance Corporation (IFC)
<http://www.ifc.org>

Pan American Health Organisation (PAHO)
<http://www.paho.org>

United Nations Centre for Regional
 Development (UNCRD)
<http://www.uncrd.or.jp/env/est>

United Nations Development Programme
 (UNDP)
<http://www.undp.org>

United Nations Environment Programme
 (UNEP)
<http://www.unep.org>

United Nations Human Settlement
 Programme (UN-Habitat)
<http://www.unchs.org/programmes/sustainablecities>

World Bank
<http://www.worldbank.org/transport>

World Health Organization
<http://www.euro.who.int/healthy-cities>

A4.3 Bi-lateral agencies

Australian Agency for International
 Development (AusAID)
<http://www.ausaid.gov.au>

Austrian Development Agency (ADA)
http://www.ada.gv.at/view.php3?r_id=3042&LNG=de&version=

Belgium Development Cooperation (DGCD)
<http://www.dgcd.be/en/index.html>

Belgium Technical Cooperation (BTC)
<http://www.btctb.org/showpage.asp?iPageID=2&sLangCode=EN>

Canadian International Cooperation Agency
 (CIDA)
<http://www.acdi-cida.gc.ca>

Danish Cooperation for Environment and
 Development (DANCED)
<http://www.mst.dk/homepage>

Danish International Development Agency
 (DANIDA)
<http://www.danida.dk>

Danish Ministry of Foreign Affairs
<http://www.um.dk/en/menu/DevelopmentPolicy/DanishDevelopmentPolicy>

Development Cooperation Ireland (DCI)
<http://www.dci.gov.ie>

Dutch Ministry for Development Cooperation
 (DGIS)
http://www.minbuza.nl/default.asp?CMS_ITEM=MBZ257572

Finnish Ministry of Foreign Affairs,
 Development Cooperation (Global.Finland)
<http://global.finland.fi/index.php?kieli=3>

French Development Agency (Afd)
<http://www.afd.fr/jahia/Jahia/lang/en/pid/1>

French Ministry of Foreign Affairs
<http://www.diplomatie.gouv.fr/thema/dossier.gb.asp?DOS=SOLIDARITYDEVEL>

German Agency for Technical Cooperation
 (GTZ)
<http://www.gtz.de/en>

German Ministry of Foreign Affairs (BMZ)
<http://www.bmz.de/de/english.html>

Italian Ministry of Foreign Affairs
<http://www.esteri.it/eng/index.asp?>

Japanese International Cooperation Agency
 (JICA)
<http://www.jica.go.jp/english>

Japanese Bank for International Cooperation
 (JBIC)
<http://www.jbic.go.jp/english/index.php>

KfW Entwicklungsbank
 (German Development Bank)
<http://www.kfw.de/EN>

Lux Development (Luxembourg)
<http://www.lux-development.lu/e/home.htm>

New Zealand International Aid and
 Development Agency (NZAID)
<http://www.nzaid.govt.nz>

Norwegian Agency for Development
 Cooperation (NORAD)
http://www.norad.no/default.asp?V_ITEM_ID=1139&V_LANG_ID=0

Portuguese Institute for Development
Support (IPAD)
<http://www.ipad.mne.gov.pt>

Spanish Agency for International
Cooperation (AECI)
<http://www.aeci.es/Default.htm>

Swedish International Cooperation Agency
(Sida)
<http://www.sida.se/Sida/jsp/polopoly.jsp?d=107>

Swiss Agency for Development and
Cooperation (SDC)
<http://www.sdc.admin.ch>

UK Department for International
Development (DFID)
<http://www.dfid.gov.uk>

US Agency for International Development
(USAID)
http://www.usaid.gov/our_work/environment

Annex 5

Template for concession contract

Basis of template

This operational contract template is based upon the Phase II contract for trunk services in the Bogotá TransMilenio system. The original contract is 183 pages in length with significant technical detail. The template merely provides the outline of the original contract. For a reading of the complete contract, please visit the website of the Institute for Transportation & Development Policy (ITDP), <http://www.itdp.org/programs/BRT.html>.

Concession title

Provide official title of document. For example, in Bogotá the contract title was: “Concession Contract for Passenger Land Public Transport Service in the Urban Area”.

Initial context (2 pages)

The initial section provides the legal context of the project, describes the background to the project’s development, and outlines the basic objectives.

Definitions (10 pages)

Clear and precise definitions are provided for key terms that will be used in the document. These definitions include both technical and legal terms. For example, each physical component, such as stations, vehicles, terminals, etc., should be defined. Also, key operational terms such as technical and user tariffs, express services, etc. should be explained. Finally, legal terms, such as “penalty clauses”, “civil liability”, “risks”, and “proceedings”, should be defined as well.

Part I: Description of system (14 pages)

In order to properly bid on becoming a trunk operator, the various companies must gain a very detailed description of the proposed system.

1. Introduction

This section provides background on the project’s history.

2. Principles and objectives of the new system

This section details the overall principles and objectives the City wishes to achieve in implementing the new public transport system.

3. Regulation and control mechanisms

The appropriate regulatory bodies that oversee the project should be clearly noted along with their exact roles.

4. Components of the TransMilenio system

The physical and operational components of the proposed system must be clearly defined. These details will include the corridors and routes of operation and the number and location of stations, terminals, and depots.

5. Operation of vehicles

This section refers to the exclusivity of the use of the vehicles to the system.

6. Fare system

This section provides an overview of how the fare collection system will function.

7. Trunk service operators

This section gives a definition of the role of the trunk service operators.

8. Feeder service operators

This section gives a definition of the role of the feeder service operators.

9. Related services

This section refers to the other key services involved in the system, such as cleaning and maintenance services.

10. System operation

This section describes the operational characteristics of the trunk and feeder services, as well as the planning, management, and control of those services.

Part II:

Concessional contract (148 pages)

1. Object and nature of contract (1 page)

This section provides a basic framework of the contract.

2. Rights and duties of the concession holder (11 pages)

This section details the responsibilities of the concession holder (*e.g.*, performance of services) and also notes the rights or aspects provided to the concession holder (*e.g.*, access to use terminal facilities). This section also touches upon specific topics such as restrictions on advertising, payments to the public transport authority, etc.

3. Rights and duties of the public transport authority (4 pages)

This section details the rights of the public transport authority (*e.g.*, ownership of system, right to inspect operator performance) and the obligations of the authority (*e.g.*, availability of maintenance depot to operators).

4. Economic aspects of concession (28 pages)

This section details how revenues will be collected and distributed. Specifically, this section defines the “user” and “technical” tariffs that will be the basis for revenue distribution. It also discusses the circumstances and methodologies utilised to make adjustments in the tariffs. Operators must become familiar with the calculations presented in this section in order to assess their bid relative to the expected profitability. The public transport authority is essentially presenting their expectations of the operating costs to be incurred by the operators.

This section also outlines how the fare revenues will be handled and distributed from a procedural standpoint. This description includes an overview of how the “contingency” and “trust” funds will function.

5. Revenues of the concession holder (3 pages)

This section explains the share value of the particular concession holder relative to the other concession holders within the system. Formulas are presented on calculating the concession holder’s participation value.

6. Revenues to the public transport authority (1 page)

Likewise, the distribution and use of part of the revenues to the public transport authority is explained.

7. Infrastructure (3 pages)

This section denotes the infrastructure that will be provided to the concession holder and the related responsibilities between the different parties in terms of maintaining and operating the infrastructure.

8. Vehicles (31 pages)

The role of the operators in providing the vehicles is explained. Additionally, the exact details of the vehicle specification are given here. These detailed specifications include precise definitions on all internal, external, instrumentation, and mechanical aspects of the vehicles. This section also discusses the expected fleet size and any requirements for a reserve fleet. Maintenance and performance requirements (*e.g.*, environmental performance) are also noted.

9. Trunk route operation (14 pages)

This section discusses the operational regime, including start and termination times, scheduling, and performance indicators.

10. Supervision and control (3 pages)

This section outlines how the performance of the concession holder will be monitored and controlled. The application of both external and internal audits is discussed. These inspections include both operational performance as well as financial and accounting oversight.

11. Implementation (1 page)

This section discusses the steps that will take place upon execution of this contract. It stipulates the testing and operational periods that will govern the start-up responsibilities of the concession holder.

12. Allocation of contract risks (3 pages)

This section notes the contractual risks of each party.

13. Fines (11 pages)

BRT systems of the type operated in Bogotá make payments to concession holders based on the vehicle-kilometres served (instead of based on the number of passengers). Thus, any fines for poor performance result in a reduction in vehicle-kilometres. This section specifies the type of activities and performance errors that will result in fines as well as the number of vehicle-kilometres deducted.

14. Guarantees and insurance (11 pages)

The contract agreement stipulates that the operator must deposit a monetary guarantee once the contract is signed. The details of the guarantee requirement are noted in this section. The guarantee is held to assure that the operator is always able to comply with obligations, such as salaries and social benefits to employees. Likewise, the operators must hold certain types of insurance to operate within the system.

15. Takeover of concession (3 pages)

This section outlines the steps taken if the concession holder fails to abide by the stipulated agreements in the contract. In such

cases, the public transport authority will take the concession away from the contracted party.

16. Abuse of a dominant position and unfair competition (3 pages)

This section outlines prohibited practices in which a concession holder may attempt to restrict competition. The specific acts which constitute an abuse of a dominant position are discussed.

17. Duration of contract (1 page)

In the case of Bogotá, the length of the contract is determined by the earlier of 15 years or an average fleet operation of 850,000 vehicle-kilometres. This formula for the duration is explained in this section.

18. Termination of contract (5 pages)

This section notes the points at which the contract is terminated. The reasons for termination can conclusion of the stipulated contract duration or an early termination due to a list of reasons.

19. Reversion phase (2 pages)

This section discusses the manner in which certain assets (*e.g.*, property, equipment) are returned to the public transport authority at the conclusion of the contract.

20. Liquidation of assets (1 page)

In the event that actions by the concession holder results in a required liquidation of assets, this section sets out the process.

21. Unilateral decisions (1 page)

This section notes the conditions in which the public transport authority would take unilateral decisions in the disposition of assets or termination of activities.

22. Settlement of conflicts (4 pages)

In the event that the parties disagree over a particular issue, this section sets forth the procedures for resolving such disagreements. The options for resolving disputes include direct settlement, conciliation, and arbitration.

23. Final aspects (3 pages)

This final section covers an assortment of legal issues penalty clauses, subjection to national law, relationship of the parties, and the defined domicile of the contract.

Signature

Finally, both the public transport authority and the concession holder must sign and date the document.

References

- Access Board** (2005), *Guidelines*, (<http://www.access-board.gov>).
- Agran P., Castillo D., and Winn D.** (1990), Limitations of data compiled from police reports on pediatric pedestrian and bicycle motor vehicle events. *Accident Analysis and Prevention*, vol. 22, no. 4, pp. 361–370.
- Allen, H.** (2005), Successful examples of sustainable public transport. Presentation at the *Getting Around Cities Workshop*, Bangkok, Thailand, 25–26 October 2005.
- Allport, R.** (2000), *Urban mass transit in developing countries*. London: Halcrow Fox.
- Alvarez, E. And Camisã, V.** (2005), *Guía operativa de accesibilidad para proyectos de desarrollo urbano, con criterios de diseño universal*. Washington: Inter-American Development Bank (IADB), (http://www.iadb.org/sds/SOC/publication/gen_6191_4180_e.htm).
- Ardila-Gomez, A.** (2004), *Transit planning in Bogota and Curitiba: Roles in Interaction, Risk, and Change*. PhD thesis in Urban and Transportation Planning at the Massachusetts Institute of Technology (MIT). Boston: MIT.
- Aunurrohman, C.** (2005), *Problems in reforming transportation and parking: A case study in Yogyakarta*. New York: ITDP.
- Avendaño, C. (2003), Congress asked to probe LRT cost overrun. *Inquiry News Service*, (http://www.inq7.net/brk/2003/jun/06/brkoth_1-1.htm).
- Bautista, K.** (2005), MRT-7 project gets clearance from Transportation Department. *Business World*, 15 October 2005.
- Benjamin, J. and Sirmans, S.** (1996), Mass transportation, apartment rent and property values. *Journal of Real Estate Research*, vol. 12, no. 1, pp. 1–8.
- Brown, L.** (2006), Supermarkets and service stations now competing for grain. *Eco-Economy Update*, 2006 number 5.
- Bruton, M.** (1985), *Introduction to Transportation Planning*. London: Hutchinson.
- Cervero, R. and Duncan, M.** (2002a), *Land value impacts of rail transit services in San Diego County*. Report to the National Association of Realtors & Urban Land Institute.
- Cervero, R. and Duncan, M.** (2002b), *Land value impacts of rail transit services in Los Angeles County*. Report to the National Association of Realtors & Urban Land Institute.
- Chambers, B.** (2006), Octopus electronic fare management of the future. Presentation at the *Second International Mass Transport Fair 2006*, Bogotá, 9 November 2006.
- Chin Hoong, C.** (2004), Transportation planning: Singapore style. Presentation at *Cities and Changes in Mobility seminar*, GTZ, Berlin, 29 October 2004.
- CITEPA** (Centre Interprofessionnel Technique d'Etudes de la Pollution Atmosphérique) (2005), *Road transport-passenger cars, light duty vehicles, heavy duty vehicles*. Synopsis Sheet.
- City of Stockholm (2004), *City to introduce congestion charges on a trial basis*, (http://www.stockholm.se/files/63600-63699/file_63617.pdf).
- Como Vamos Bogotá** (2005), *Ficha técnica*. Bogotá: Como Vamos Bogotá.
- Como Vamos Bogotá** (2001), *Boletín números 6 y 7*, Bogotá: Como Vamos Bogotá.
- Cracknell, J.** (2000). *Experience in urban traffic management and demand management in developing countries*, Background paper for World Bank Urban Transport Strategy Review. London: UK Department for International Development (UK DFID).
- Custodio, P.** (2005), BRT planning and operation. Presentation at the *International Forum on Bus Rapid Transit Development and Implementation*, Beijing, China, 19 October 2005.
- CVTF** (Cleaner Vehicles Task Force) (2000), *The report of the alternative fuels group of the cleaner vehicles task force: An assessment of the emissions performance of alternative and conventional fuels*. London: UK Department of Trade and Industry.
- Dabinett, G.** (1998), Realising regeneration benefits from urban infrastructure investment: Lessons from Sheffield in the 1990s. *Town Planning Review*, vol. 69, no. 2, pp. 171–189.
- Dargay, J. and Gatley, D.** (1999), Income's effect on car and vehicle ownership, worldwide: 1960–2015. *Transportation Research Part A*, vol. 33, pp. 101–138.
- de Guzmán, I.** (2005), Personal communication with Ignacio de Guzmán, former Project Director for TransMilenio.
- Deluchi, M.** (2003), *A lifecycle emissions model (LEM): Lifecycle emissions from transportation fuels, motor vehicles, transportation modes, electricity use, heating and cooking fuels, and materials*, report number UCD-ITS-RR-03-17. Davis: University of California at Davis.

- Doganis, R.** (2001), *The airline business in the 21st century*. New York: Routledge.
- Dueker, K. and Bianco, M.** (1999), Light rail transit impacts in Portland: The first ten years. *Transportation Research Record*, vol. 1685, pp. 171–180.
- Economist** (2007), Transport heaven and hell: First commandeer your bus. *Economist*, 15 Febr. 2007.
- Economist** (2006a), Making the trains run on time. *Economist*, 16 February 2006, (http://www.economist.com/business/displaystory.cfm?story_id=5519214).
- Economist** (2006b), The Brazilian Amazon: How green was my valley. *Economist*, 27 April 2006, (http://www.economist.com/world/la/displaystory.cfm?story_id=6859779).
- eMarketer** (2007), Auto industry pouring money into digital. *eMarketer*, 15 March 2007, (<http://www.marketingvox.com/archives/2007/03/15/emarketer-auto-industry-pouring-money-into-digital>).
- Engwicht, D.** (1999), *Street reclaiming: Creating livable streets and vibrant communities*. Gabriola Island, BC, Canada: New Society Publishers.
- Engwicht, D.** (1993), *Reclaiming our cities & towns: Better living with less traffic*. Philadelphia: New Society Publishers.
- Enoch, M. and Ison, S.** (2006), Levying charges on private parking: Lessons from existing practices. *World Transport Policy & Practice*, vol. 12, no. 1, pp. 5–14.
- Enoch, M.** (2001), Workplace parking charges down under. *Traffic Engineering and Control*, November 2001, pp. 357–360, (<http://eetu.open.ac.uk/staff/marcus/Workplace%20parking.PDF>).
- European Mobility Week** (2005), *Participating and supporting cities and towns*, (<http://www.22september.org/part/en/day04.html>).
- Ewing, R., Pendall, R., and Chen, D.** (2002), *Measuring sprawl and its impacts*. Washington: Smart Growth America.
- Fenhann, J.** (2005), *UNEP Risoe pipeline*, Report of the UNEP Risoe Laboratory, 14 March 2007, (CDM pipeline: <http://www.cd4cdm.org/Publications/CDMpipeline.xls>), (Jl pipeline: <http://www.cd4cdm.org/Publications/Jlpipeline.xls>).
- Flyvbjerg, B., Bruzelius, N., and Rothengatter, W.** (2003), *Megaprojects and risk: An anatomy of ambition*. Cambridge: Cambridge University Press.
- Frommer, G.** (2006), Personal communication on 24 January 2006 with Glenn Frommer, Director of Sustainable Development, Hong Kong MRT Corporation.
- Frommer, G.** (2005), Hong Kong – transport and the MRT. Presentation at the *Getting Around Cities Workshop*, Bangkok, 25 October 2005.
- Gandhi, S.** (2002), Bus shelter as integral part of the urban transport system in low income countries. *CODATUX Conference Proceedings*, Lome, Togo.
- Garb, Y.** (2003), Transit terror: The view from Jerusalem. *Sustainable Transport*, Fall 2003, vol. 15, pp. 12–13, 17.
- Gehl, J.** (1971), *Life between buildings: Using public space*. Copenhagen: Danish Architectural Press.
- Gilbert, R.** (2000), Sustainable mobility in the city. Proceedings from *URBAN21, Global Conference on the Urban Future*, Berlin, Germany, 4–6 July, 2000.
- Goodwin, P., Hass-Klau, C., and Cairns, S.** (1998), Evidence on the effects of road capacity reduction on traffic levels. *Traffic Engineering and Control*, June, pp. 348–354.
- Hadley, J.** (2004) Hybrid buses' fuel economy promises don't materialize: Older models have gotten better mpg. *Seattle Post-Intelligencer*, 12 December 2004.
- Hass-Klau, C.** (1993), Impact of pedestrianization and traffic calming on retailing: A review of the evidence from Germany and the UK. *Transport Policy*, vol. 1, no. 1, pp. 21–31.
- Hau, T.** (1992), *Congestion charging mechanisms for roads: An evaluation of current practice*. Washington: World Bank.
- Hautzinger, H., Dürholt, H., Hörnstein, E., Tassaux-Becker, B.** (1993), *Dunkelziffer bei Unfällen mit Personenschaden* (Unreported Proportion of Personal-Injury Accidents), Report M13. Bergisch Gladbach (Germany): Bundesanstalt für Straßenwesen (Federal Highway Research Institute).
- Hazel, G. and Parry, R.** (2003), *Making cities work*. London: Academy Editions.
- Hidalgo, D.** (2003), The backbone of the mobility strategy of Bogotá: TransMilenio. *Public Transport International*, vol. 51, pp. 28–31.
- Hidalgo, D.** (2003), TransMilenio: A high capacity – low cost bus rapid transit system developed for Bogotá, Colombia. Presented at the *55th World Congress of the International Public Transport Union (UITP)*, May 2003, Madrid, Spain.

- Hindu Business Line** (2006), Volvo mulls launching BRT systems in India. *Hindu Business Line*, 16 January 2006, (<http://www.thehindubusinessline.com/bline/2006/01/17/stories/2006011702460300.htm>).
- Homburger, W., Hall, J., Loutzenheiser, R., and Reilly, W.** (1996), *Fundamentals of traffic engineering*, 14th edition. Berkeley: Institute of Transportation Studies.
- Hook, W.** (2005), *Non-motorised transport*. Eschborn: GTZ, (<http://www.sutp.org>).
- Hook, W.** (2004), *Preserving and expanding the role of NMT*. Eschborn: GTZ, (<http://www.sutp.org>).
- Hook, W.** (2000), *Improving conditions for non motorized transport in Surabaya, Indonesia: A pilot project in two neighbourhoods*. Eschborn: GTZ.
- Husler, W.** (2005), The Zürich tram system. Presentation at the *Walk 21 Conference*, Zürich, September 2005.
- Institute of Transportation Engineers** (2005), *Traffic calming for communities*, (web document accessed on 3 May 2005, <http://www.ite.org/traffic/tcdevices.htm>).
- IEA** (International Energy Agency) (2004), *Biofuels for transport – An international perspective*. Paris: IEA.
- IEA** (International Energy Agency) (2002a), *World energy outlook – 2002*. Paris: IEA.
- IEA** (International Energy Agency) (2002b), *Bus systems for the future: Achieving sustainable transport worldwide*. Paris: IEA.
- IEA/OECD** (International Energy Agency / Organisation for Economic Co-operation and Development) (2003), *CO₂ emissions from fuel combustion 1970–2001*. Paris: IEA.
- IEA/SMP** (International Energy Agency / Sustainable Mobility Programme of the World Business Council for Sustainable Development) (2004), *The IEA/SMP transportation model*. (<http://www.wbcsd.org/plugins/DocSearch/details.asp?type=DocDet&ObjectId=MTE0Njc>).
- IplanRio** (Prefeitura da Cidade do Rio de Janeiro) (1996), *Transportes urbanos: Perfil do usuário na área metropolitana, Rio de Janeiro*. Rio de Janeiro: IplanRio.
- Jacobs, J.** (1961), *The death and life of great American cities*. New York: Vintage.
- James, H.** (1991), Under-reporting of road traffic accidents. *Traffic Engineering and Control*, December 1991, pp. 574–583.
- JIQ** (2002), AIJ pilot projects. *Joint Implementation Quarterly*, vol. 8, no. 4, pp. 14.
- Kenworthy, J. and Laube, F.** (1999), *Millennium cities database for sustainable transport*. Brussels: International Union of Public Transport (UITP).
- Kim, G.** (2005), *Toward better public transport: Experiences and achievement of Seoul*. Seoul: Seoul Development Institute.
- Levinson, H., Zimmerman, S., Clinger, J., Rutherford, S., Smith, R., Cracknell, J., and Soberman, R.** (2003a), *Bus rapid transit, volume 1: Case studies in bus rapid transit*, TCRP Report 90. Washington: US TCRP (US Transit Cooperative Research Program).
- Levinson, H., Zimmerman, S., Clinger, J., Gast, J., Rutherford, S., and Bruhn, E.** (2003b), *Bus rapid transit, volume 1: Implementation guidelines*, TCRP Report 90. Washington: US TCRP (US Transit Cooperative Research Program).
- Lewis-Workman, S. and Brod, D.** (1997), Measuring the neighborhood benefits of rail transit accessibility. *Transportation Research Record*, vol. 1576, pp. 147–153.
- Litman, T.** (2006), *Parking management best practices*. Washington: Planners Press.
- Litman, T.** (2006a), *Parking taxes: Evaluating options and impacts*, (http://www.vtpi.org/parking_tax.pdf).
- Litman, T.** (2005a), *Transportation costs and benefits*, (<http://www.vtpi.org/tdm/tdm66.htm>).
- Litman, T.** (2005b), *Road space allocation*, (web document accessed on 7 February 2006, <http://www.vtpi.org/tdm/tdm56.htm>).
- Litman, T.** (2005c), *Transportation elasticities*, (web document accessed on 4 April 2006, <http://www.vtpi.org/tdm/tdm11.htm>).
- Litman, T.** (2004a), *Parking management*, (<http://www.vtpi.org/tdm/tdm28.htm>).
- Litman, T.** (2004b), *Land use impacts on transport*, (<http://www.vtpi.org/tdm/tdm20.htm>).
- McLaughlin, E.** (2005), Atlanta subways to get TV, radio feeds. *Environmental News Network*, (http://www.enn.com/biz_PF.html?id=309).
- Meakin, R.** (2003), Institutional framework for bus regulation and planning. Presentation at the *Sustainable Urban Transport Development Conference*, Bucharest, Romania, 19 Nov. 2003.
- Meakin, R.** (2002a), *Bus regulation and planning*, Eschborn: GTZ, (<http://www.sutp.org>).

- Meakin, R.** (2002b), *Urban transport institutions*, Eschborn: GTZ, (<http://www.sutp.org>).
- Meirelles, A.** (2000), A review of bus priority systems in Brazil: From bus lanes to busway transit. Presented at the *Smart Urban Transport Conference*, 17–20 October, 2000, Brisbane, Australia.
- Menckhoff, G.** (2002), Summary presentation of World Bank transport projects in Latin America. Presented at *World Bank Seminar*, 16 January 2002, Washington.
- Metschies, G., Friedrich, A., Heinen, F., Peters, J., and Thielmann, S.** (2007), *International fuel prices 2007*. Eschborn: GTZ, (<http://www.sutp.org>).
- Millard-Ball, A.** (2005), *Bus Rapid Transit for Dar es Salaam: Parking management report*. New York: ITDP.
- Mindali, O., Raveh, A., and Salomon, I.** (2004), Urban density and energy consumption: a new look at old statistics. *Transportation Research Part A: Policy and Practice*, vol. 38, no. 2, February 2004, pp. 143–162(20).
- Moore, R. and Older, S.** (1965), Pedestrians and motor vehicles are compatible in today's world. *Traffic Engineering*, vol. 35, no. 12.
- Munoz-Raskin, R.** (2006), *Walking accessibility to Bus Rapid Transit: Does it affect property prices, The case of Bogotá, Colombia*. A Master's thesis presented to the Faculty of Architecture and Planning, Columbia University, New York.
- Ortúzar, J. and Willumsen, L.** (2002), *Modelling transport*. Chichester (UK): John Wiley & Sons Ltd.
- Pardo, C.** (2006), *Raising public awareness about sustainable urban transport*. Eschborn: GTZ, (<http://www.sutp.org>).
- Planet Ark** (2006), Ethanol, biodiesel eats into US corn stockpiles, *Planet Ark*, (<http://www.planetark.com/dailynewsstory.cfm/newsid/36348/story.htm>).
- Pollard, N.** (2006), Stockholm residents choke on new congestion charge. *Reuters News Service*, (<http://www.planetark.com/dailynewsstory.cfm/newsid/34307/story.htm>).
- Poulsen, E. and Mozer, D.** (2005), *Rainbow of free bikes*. International Bicycle Fund (IBF), (web document accessed on 3 September 2005, <http://www.ibike.org/encouragement/freebike-details.htm>).
- Public CIO** (2006), Congestion pricing system trial reduces Stockholm traffic 25 percent in one month. *Public CIO*, (<http://www.public-cio.com/newsStory.php?id=2006.03.06-98651>).
- Rickert, T.** (2006), *BRT accessibility guidelines*. Washington: World Bank, (<http://web.worldbank.org/WBSITE/EXTERNAL/TOPICS/EXTSOCIALPROTECTION/EXTDISABILITY/0,,contentMDK:20192134~menuPK:414202~pagePK:148956~piPK:216618~theSitePK:282699,00.html>).
- Rickert, T.** (2003), *Making access happen: Promoting and planning transport for all*. San Francisco: Access Exchange International (AEI), (<http://www.independentliving.org>).
- Rodriguez, D. and Targa, F.** (2004), The value of accessibility to Bogotá's bus rapid transit system. *Transport Reviews*, vol. 24, no. 5.
- Sandvik, E.** (2005), Clean development mechanism as a vehicle for funding transport systems in developing countries. Proceedings from the *Annual Meeting of the Transportation Research Board*, Washington, January 2005.
- Schipper, L.** (2003). Personal communication with Dr. Lee Schipper of the World Resources Institute, Embarq Programme.
- Science** (2004), The hydrogen backlash. *Science*, vol. 305, 13 August 2004, pp. 958–961.
- Shoup, D.** (2005), *The high cost of free parking*. Washington: The American Planning Association.
- Smith, J. and Gihring, T.** (2004), *Financing transit systems through value capture: An annotated bibliography*. Victoria: Victoria Transport Policy Institute.
- Sofradzija, O.** (2005), Monorail to up visitor fare, locals to pay less. *Las Vegas Review-Journal*, 15 December 2005, (http://www.reviewjournal.com/lvrj_home/2005/Dec-15-Thu-2005/news/4800435.html).
- Steer Davies Gleave** (2003), *Estimation of private vehicle trips replaced by TransMilenio: Phase II report*. SDG: Bogotá.
- Thomas, E.** (2001), Bus rapid transit. Presentation at the *Institute of Transportation Engineers Annual Meeting*, Chicago, August 2001.
- Thomson, I.** (2001), The Impact of Social, Economic and Environmental Factors on Public Transport in Latin American Cities, *International Seminar on Urban Transport*, November 2001, Bogotá, Colombia.
- Tinker, I.** (1997), *Street foods: Urban food and employment in developing countries*. New York: Oxford University Press.

- Tiwari, G.** (2000), Encroachers or service providers? *Seminar*, vol. 491, pp. 26–31, (<http://www.india-seminar.com/2000/491/491%20geetam%20tiwari.htm>).
- TCRP** (2003), *TCRP synthesis report 48: Real-time bus arrival information systems*. Washington: US TCRP.
- TfL** (2006), *Impacts monitoring: Fourth annual report, June 2006*. London: Transport for London (TfL).
- TfL** (2003), *Summary of the main benefits of the Jubilee Line*. London: Transport for London (TfL).
- TRB** (Transportation Research Board) (2000), *Highway capacity manual*. Washington: TRB.
- UITP** (International Association of Public Transport) (2005), *Towards an integrated travel information system*. Brussels: UITP.
- UNCFD** (United Nations Car Free Days) (2005), *Why use car free days?*, (<http://www.uncfd.org/index2.php?menu=1&id=1&pid=0&tl=0&page=About.php>).
- US GAO** (United States General Accounting Office) (2001), *Bus rapid transit shows promise*. Washington: US GAO.
- Vasconcellos, E.** (2001), *Urban transport, environment and equity: The case for developing countries*. London: Earthscan.
- Venter, C., Sentinella, J., Rickert, T., Maunder, D. and Venkatesh, A.** (2004), *Enhancing the mobility of disabled people: Guidelines for practitioners*. TRL Overseas Road Note 21, Wokingham (UK): TRL.
- VTPI** (Victoria Transport Policy Institute) (2006), *On-line TDM encyclopaedia*, (<http://www.vtpi.org/tdm/index.php>).
- Wangwongwatana, S.** (2003), Use of appropriate technology for air quality solutions. Presentation at the *Air and Waste Management Association national conference*, San Diego, US.
- Webster, B.** (2006), Congestion charge chiefs may profit from a Swedish lesson. *The Times Online*, (<http://www.timesonline.co.uk/article/0,,2-2120871,00.html>).
- Wetzel, D.** (2006), Innovative ways of financing public transport. *World Transport Policy & Practice*, vol. 12, no. 1, pp. 40–46.
- Wetzel, D.** (2005a), Communication on the New Mobility Cafe group (<http://groups.yahoo.com/group/NewMobilityCafe>). Dave Wetzel, Vice Chair, Transport for London (TfL), 24 October 2005.
- Wetzel, D.** (2005b), A smart tax. *Estates Gazette*, 12 March, pp. 54–57.
- Whitelegg, J.** (1997), *Critical mass: Transport, environment and society in the twenty-first century*. London: Pluto Press.
- WBSCD** (World Business Council for Sustainable Development) (2001), *Mobility 2001*. Switzerland: Atar Roto Presse.
- Wright, L.** (2003), *Bus rapid transit*. First edition. Eschborn: GTZ.
- Wright, L. and Fulton, L.** (2005), Climate change mitigation and transport in developing nations. *Transport Reviews*, vol. 25, no. 6, pp. 691–717.
- Wright, L. and Fjellstrom, K.** (2003), *Mass transit options*. Eschborn: GTZ, (<http://www.sutp.org>).
- Xinhuanet** (2005), Shenzhen drivers walk to work on 'car-free day'. *Xinhuanet News Service*, (http://news.xinhuanet.com/english/2004-06/11/content_1521766.htm, 11 June 2005).



Institute for Transportation & Development Policy (ITDP)
127 West 26th Street
Suite 1002
New York, NY 10001
USA
mobility@itdp.org
<http://www.itdp.org>