

Interferencia

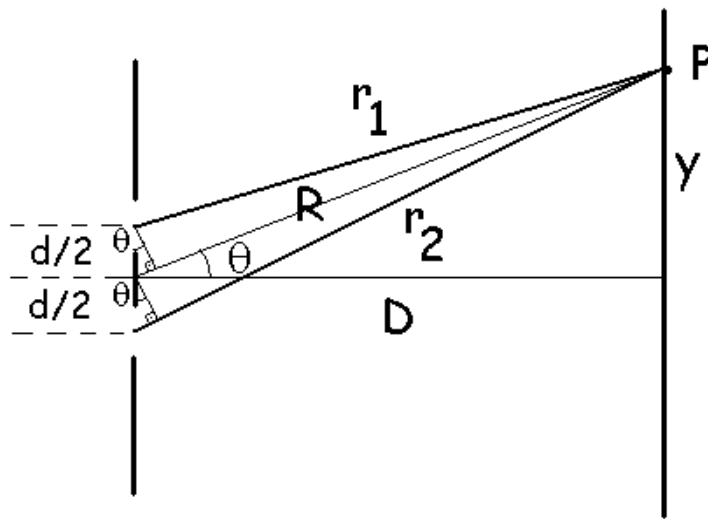

$$\tan \theta = \frac{y}{D}$$

$$r_1 \approx R - \frac{d}{2} \sin \theta$$

$$\vec{E}(P) = \frac{E_0}{r_1} \hat{e} \exp[i(kr_1 - \omega t)] + \frac{E_0}{r_2} \hat{e} \exp[i(kr_2 - \omega t)]$$

$$r_2 \approx R + \frac{d}{2} \sin \theta$$

$$\vec{E}(P) = \frac{E_0}{R} \hat{e} \exp[i(kR - \omega t)] \left\{ \exp\left[-i\left(k \frac{d}{2} \sin \theta\right)\right] + \exp\left[i\left(k \frac{d}{2} \sin \theta\right)\right] \right\}$$

diferença de fase entre as duas ondas:

$$\Delta = k \frac{d}{2} \sin \theta - \left(-k \frac{d}{2} \sin \theta\right) \quad \text{com: } k = \frac{2\pi}{\lambda}$$

$$\frac{2\pi}{\lambda} d \sin \theta = 2\pi m$$

$d \sin \theta = m\lambda, m = 1, 2, 3, 4, \dots$	Interferência construtiva
$d \sin \theta = \frac{m}{2} \lambda, m = 1, 3, 5, \dots$ ou, $d \sin \theta = \left(m + \frac{1}{2}\right) \lambda, m = 0, 1, 2, 3, 4,$...	Interferência destrutiva

Lâminas delgadas

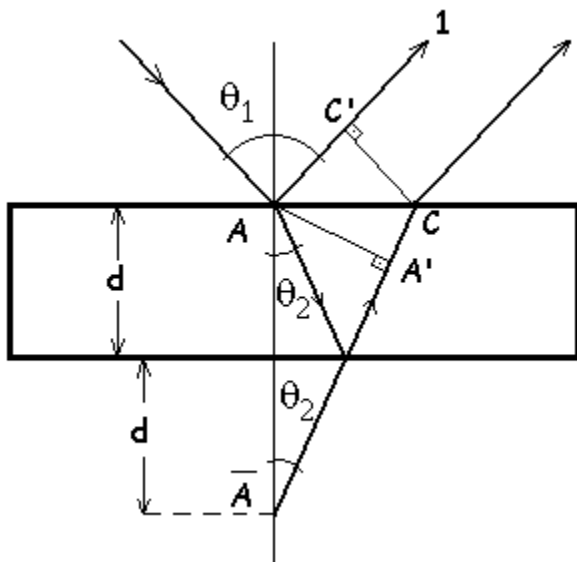

Fator de fase associado a um percurso l :

$$e^{ikl} = e^{ik_0nl} = e^{i\frac{2\pi}{\lambda_0}nl}$$

frente $\overline{AA'}$ = frente $\overline{C'C}$

mesmo caminho ótico
 $\overline{AC'} = \overline{A'C}$

ATENÇÃO: raio [1] apresenta defasagem de π ($\lambda/2$)

$$[2] - [1] = 2 n d \cos \theta_2$$

Portanto, se:

$2 n d \cos \theta_2 = m \lambda$ $m = 0, 1, 2, 3, \dots$	MÍNIMO de reflexão MÁXIMO de transmissão
$2 n d \cos \theta_2 = (m + 1/2) \lambda$ $m = 0, 1, 2, 3, \dots$	MÁXIMO de reflexão MÍNIMO de transmissão

No caso de observação normal ($\theta_1 \approx \theta_2 \approx 0$):

$$d \approx \frac{1}{4} \lambda_0 / n = \frac{1}{4} \lambda$$

Filmes anti-reflexo:

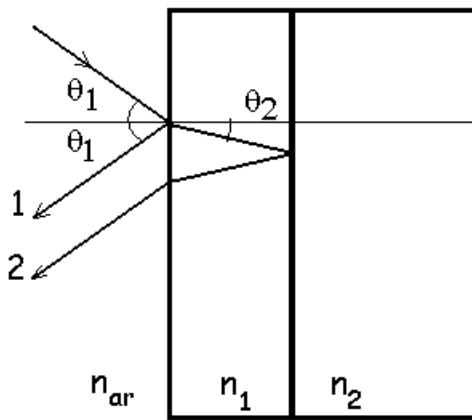

Com $n_{ar} < n_1 < n_2$

Raios [1] e [2]:
mudam de fase

ambos os raios refletidos
apresentam mesma fase

$2 n d \cos \theta_2 = m \lambda$ $m = 0, 1, 2, 3, \dots$	Interferência construtiva
$2 n d \cos \theta_2 = (m + 1/2) \lambda$ $m = 0, 1, 2, 3, \dots$	Interferência destrutiva

Para incidência normal ($\theta_1 \approx \theta_2 \approx 0$):

$$2 n d = \frac{1}{2} \lambda \quad d = \frac{1}{4} \lambda_0 / n = \frac{1}{4} \lambda$$

conhecidos como filmes $\lambda/4$

Reflexão de ondas

Superposição de 2 ondas progressivas:

$$Y(x, t) = f(x-vt) + g(x+vt)$$

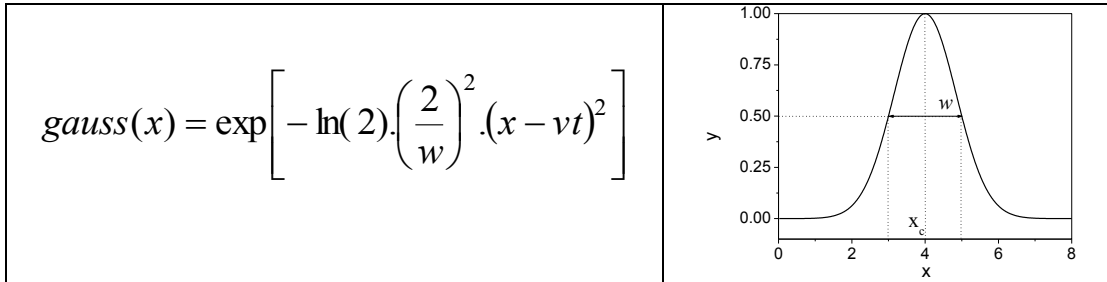

Pulso: $f(x-vt) = \exp\left[\left(\frac{2}{w}\right)^2 (x-vt)^2\right]$

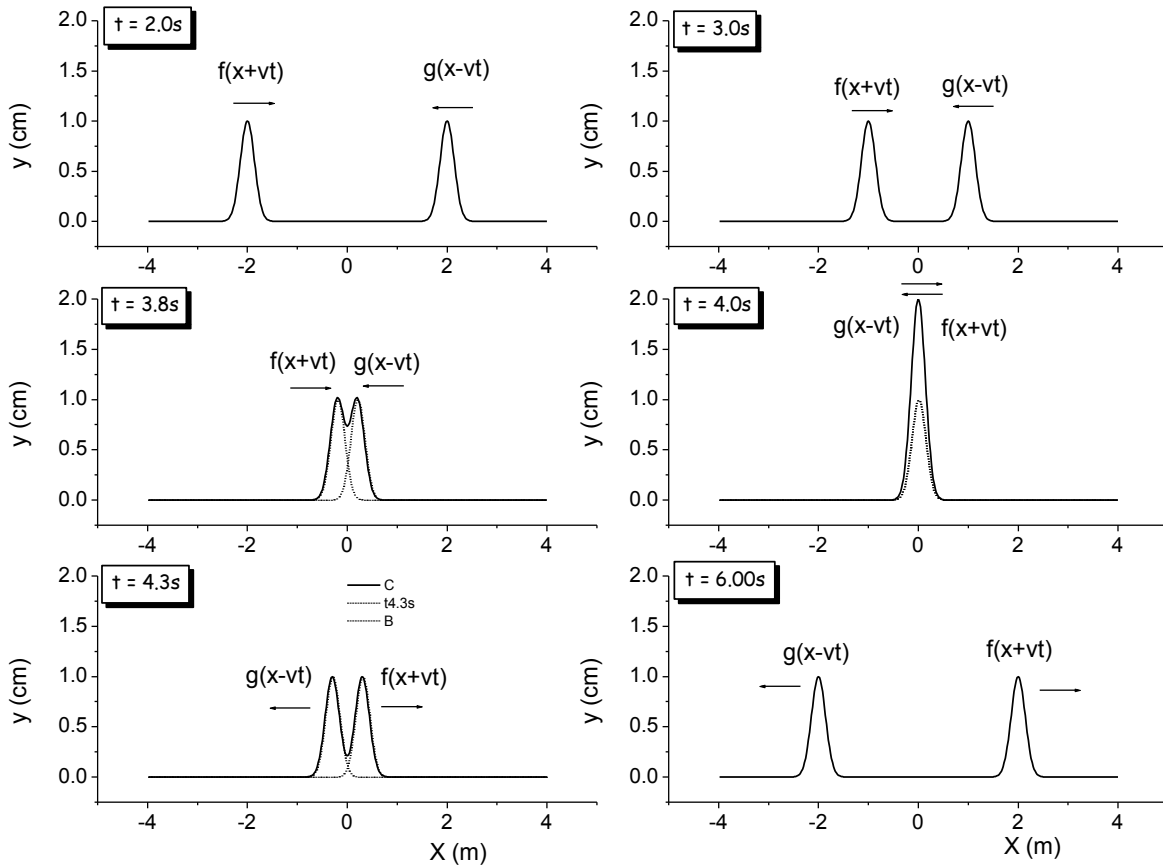

EXTREMIDADE FIXA

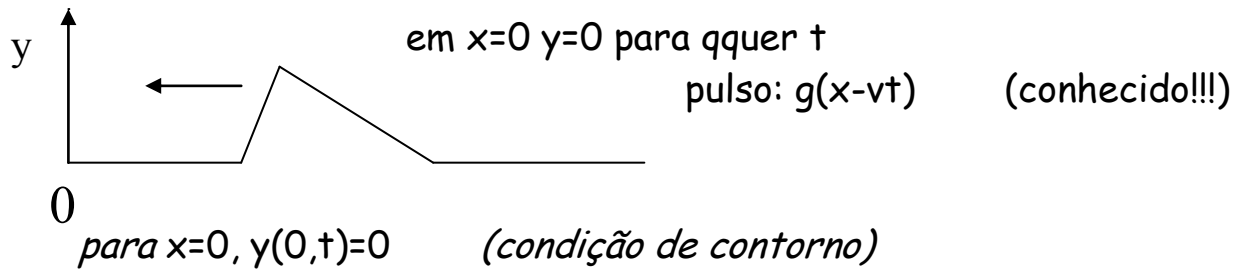

como, $Y(x,t) = f(x-vt) + g(x+vt)$, então:

$$y(0,t) = f(-vt) + g(vt) = 0 \quad , p/ qquer t$$

$f(x')$ função incógnita

$$f(x') = -g(-x')$$

substituindo x' por $x-vt$: $f(x-vt) = -g(vt-x)$

$$y(x,t) = g(x-vt) - g(vt-x)$$

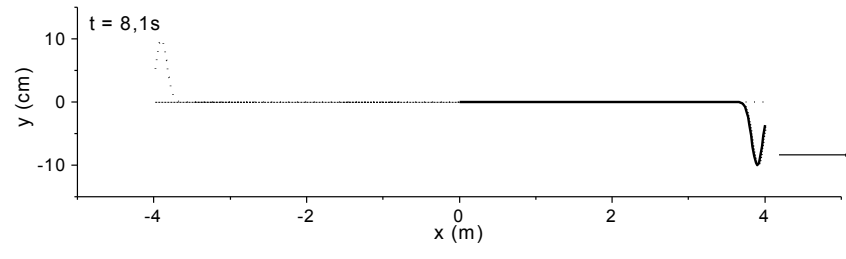
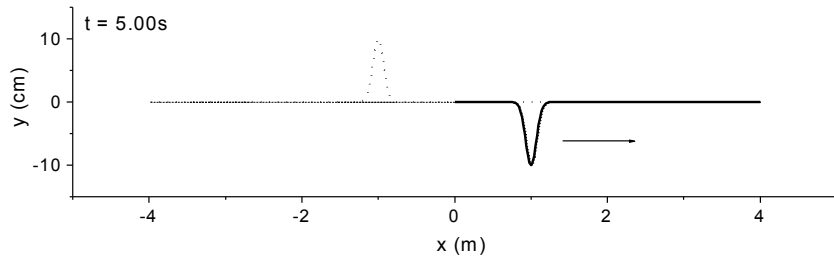
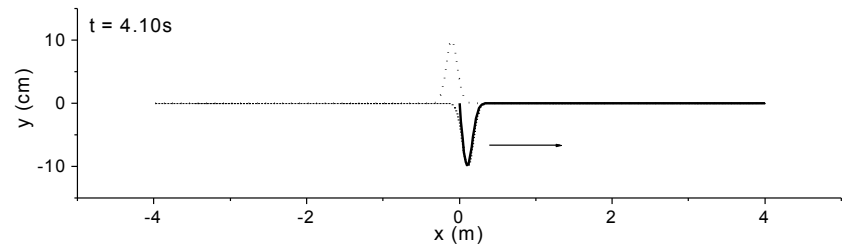
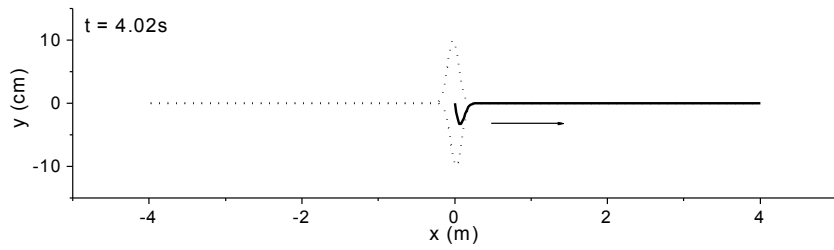
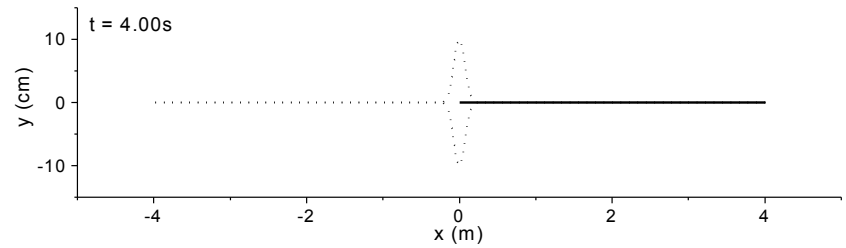
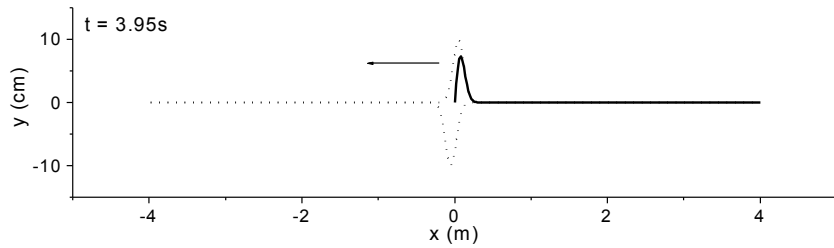
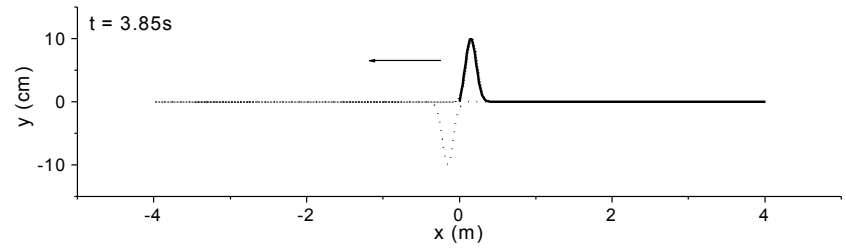
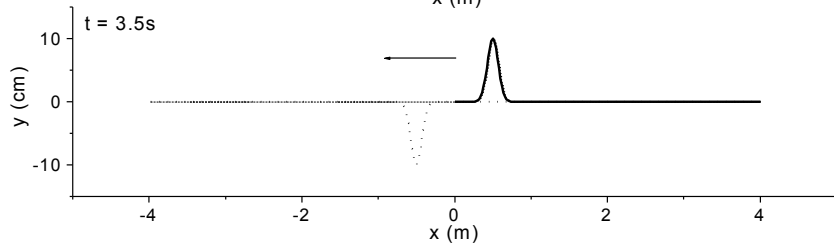
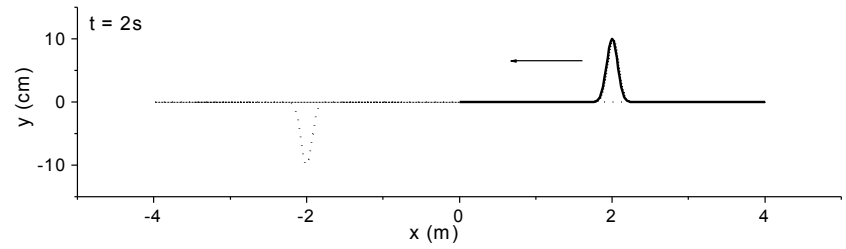
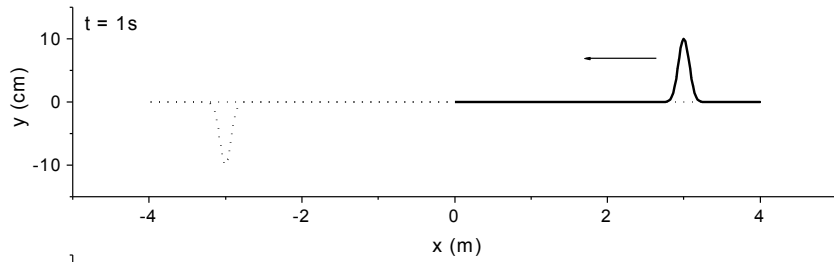

EXTREMIDADE LIVRE

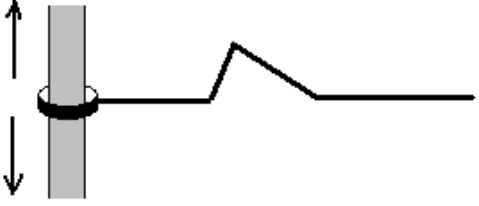
	<ul style="list-style-type: none"> - Movimenta-se livre em y - $T_y = 0$ - Apenas aparece T_x, <div style="border: 1px solid black; padding: 5px; width: fit-content; margin: 5px auto;"> $F_y(0,t) = -T \frac{\partial y(0,t)}{\partial x} = 0$ </div>
---	---

"Significa que a tangente à corda na extremidade permanece sempre na horizontal"

como $Y(x,t) = f(x-vt) + g(x+vt)$

$$\frac{\partial y(0,t)}{\partial x} = f'(-vt) + g'(vt) = 0$$

o que dá: $f'(-vt) = -g'(vt)$

$f(x')$ função incógnita

$f(x') = g(-x')$, derivando dy/dx' :

$$f'(x') = -g'(-x')$$

finalmente:

$$Y(x,t) = g(x+vt) + g(vt-x)$$

Quando uma onda EM que parte de um meio **menos refringente** e é **refletida** em uma interface **mais refringente**, a onda refletida apresentará defasagem de π .

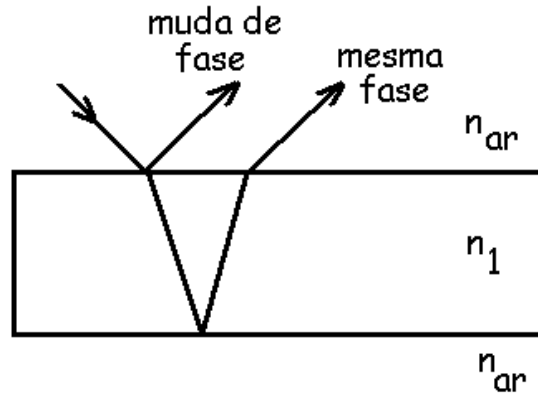

Quando uma onda EM que parte de um meio **mais refringente** e é **refletida** em uma interface **menos refringente**, a onda refletida apresentará a **mesma fase** da onda incidente.

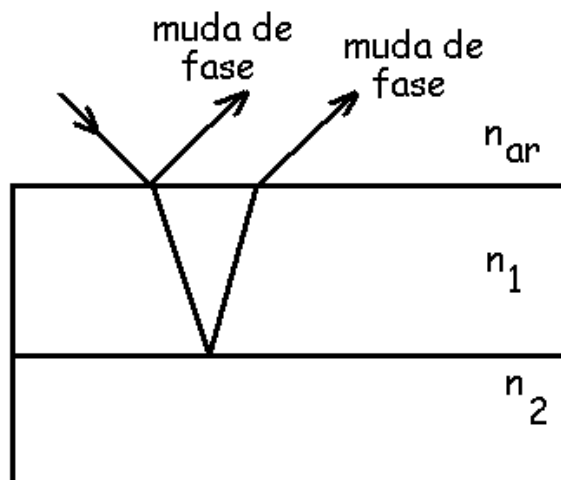

com:
 $n_2 > n_1 > n_{ar}$

Espelho de Lloyd

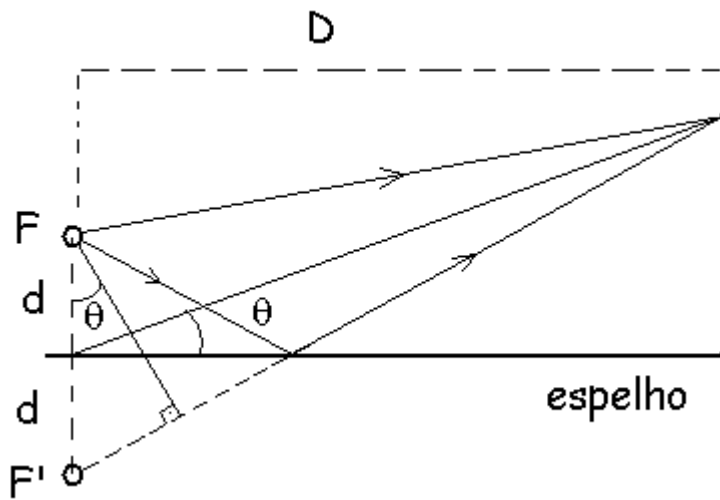
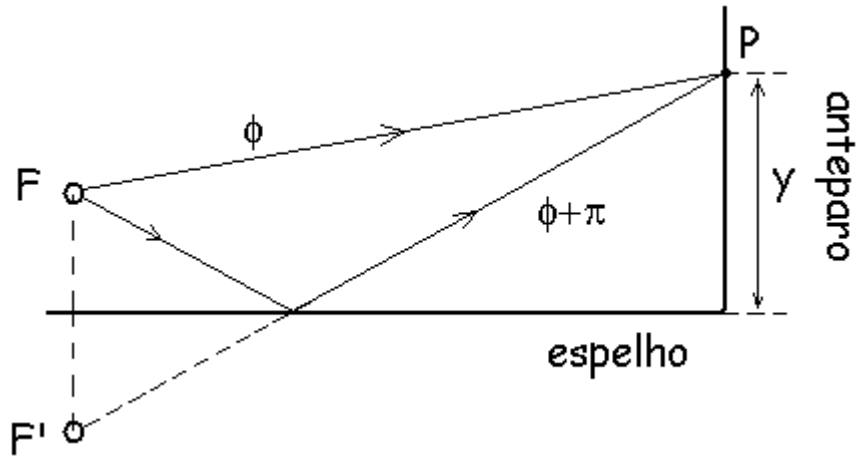

$$2 d \sin \theta = (m + \frac{1}{2})\lambda$$

$$\sin \theta \sim \tan \theta = y/D$$

$$\frac{y}{D} = \frac{\lambda}{4d} \Rightarrow y = \frac{\lambda D}{4d}$$

Anéis de Newton

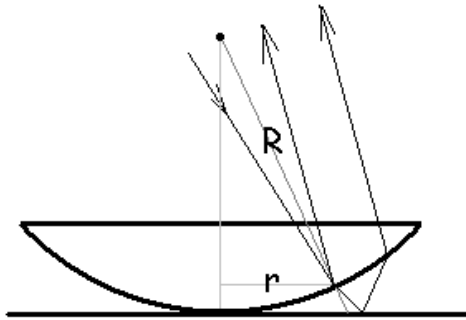

ângulo θ qquer

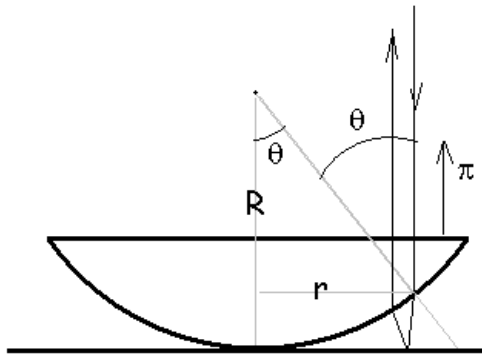

Incidência normal

$$\text{sen } \theta = r/R$$

$$d = R - R \cos \theta$$

$$d = R - R\sqrt{1 - \frac{r^2}{R^2}} = R\left[1 - \left(1 - \frac{r^2}{2R^2}\right)\right] = \frac{r^2}{2R}$$

$2d = m \lambda$ $r = \sqrt{Rm\lambda}$	Mínimo
$r = \sqrt{R\left(m + \frac{1}{2}\right)\lambda}$	Máximo

Franjas de igual espessura

