

Perda de carga singular em condutos



PMC 3230

Prof. Marcos Tadeu Pereira

2016

(Diversas figuras retiradas da internet sem identificação de origem)

Resumo

- 1) Equação da Continuidade fluido incompressível, regime permanente, em um duto:

A vazão mássica é dada por $\dot{m} = \rho_1 V_1 s_1 = \rho_2 V_2 s_2$

- 2) Equação da Energia Cinética, mesmas condições:

$$H_1 - H_2 = \left(\frac{\alpha_1 V_1^2}{2g} + \frac{P_1}{\gamma} + z_1 \right) - \left(\frac{\alpha_2 V_2^2}{2g} + \frac{P_2}{\gamma} + z_2 \right) = \frac{\dot{w}_a}{\gamma Q} - \frac{\dot{w}_m}{\gamma Q}$$

- 3) Equação da Quantidade de Movimento mesmas condições:

$$\sum F_{ext} = \sum \dot{m}_e V_e - \sum \dot{m}_s V_s$$

Resumo cont.

4) Equação de Darcy-Weisbach

$$h_f = f \frac{l V^2}{D 2g}$$

5) Equação de Colebrook

$$\frac{1}{\sqrt{f}} = 1.14 - 2 \log \left(\frac{\varepsilon}{D} + \frac{9.35}{\mathbf{Re} \sqrt{f}} \right)$$

6) Diagramas de Moody e de Rouse



CURVA CARACTERÍSTICA DA BOMBA E PERDAS DO SISTEMA

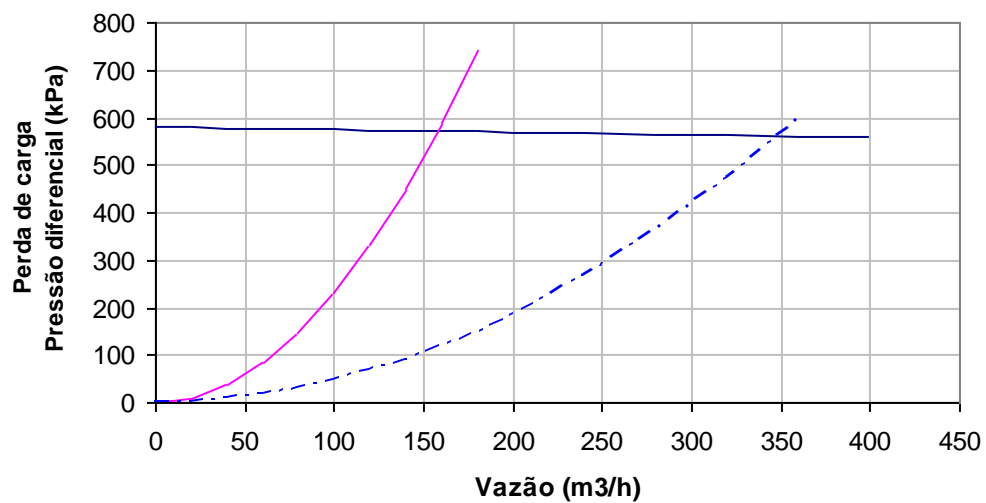

- Curva da Bomba
- Perda de carga - Situação atual - Rugosidade 15 mm
- - - Perda de carga - Situação sem curvas - Rugosidade 2,5 mm

Economic velocity

$$d = \sqrt{\frac{4V_s}{\pi u}}$$

$u \uparrow \rightarrow d \downarrow$

pipes' cost ↓

pumping cost ↑, due to frictional loss

Fluids	Economic velocities (m/s)	Fluids	Economic velocities (m/s)
Water and liquids of low viscosities	0.5~3	High-pressure gas	15~25
Oil and liquids of high viscosities	0.5~1	Saturated steam	
Low-pressure gas	8~20	<1MPa	15~20
		1~4MPa	20~40
		4~12MPa	40~60

Cálculo das perdas de carga singulares (*minor losses*)

Assim com as perdas de carga distribuídas ao longo de trechos retos de dutos, cada singularidade introduz uma perda de carga adicional nos sistemas fluidos.

Estas perdas ocorrem em:

- Entrada ou saída de dutos;
- Expansões ou contrações, bruscas ou suaves;
- “T”s, cotovelos, joelhos, curvas e outras conexões;
- Válvulas, abertas total ou parcialmente;
- Mudanças de seção devido à introdução de corpos no interior das tubulações (p.ex. medidores de vazão, de temperatura, filtros, grades, etc)

Perda de carga distribuída em duto reto:

$$h_f = f \frac{l}{D} \frac{V^2}{2g}$$

A perda singular é representada por h_s :

$$\frac{\gamma h_s}{\frac{1}{2} \rho V^2} = k_s \left(\frac{\rho V D}{\mu}, \text{coef. de forma da singularidade} \right)$$

$$h_s = k_s \frac{V^2}{2g} \quad \text{ou} \quad h_s = f \frac{l_{eq}}{D} \frac{V^2}{2g}$$

Onde k_s é o coeficiente de perda de carga singular, adimensional

e l_{eq} é o comprimento equivalente, em metros, da perda de carga causada pela singularidade

Observar que k_s é o equivalente a f , e depende geralmente do número de Reynolds e de um fator de forma da singularidade (no caso de f a singularidade depende de Reynolds e de ε/D)

A perda de carga total em uma instalação hidráulica é dada por:

$$h_{total} = \sum h_f + \sum h_s$$

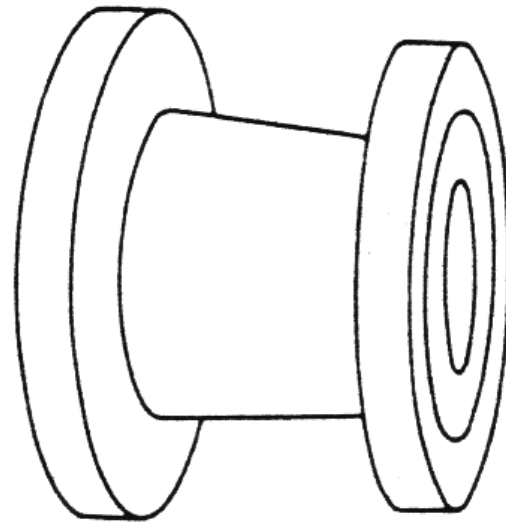
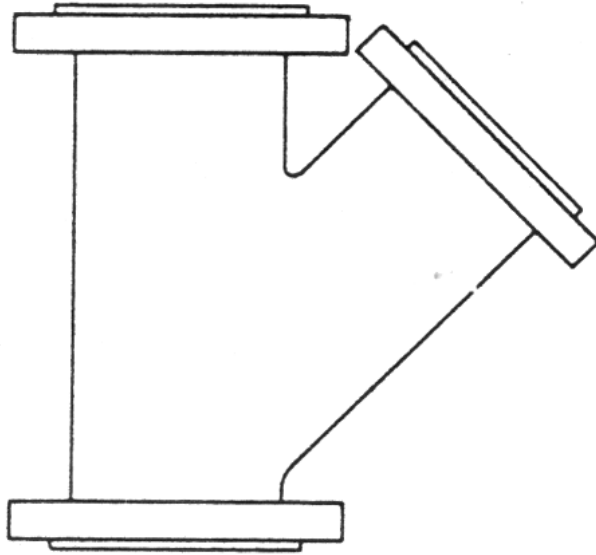
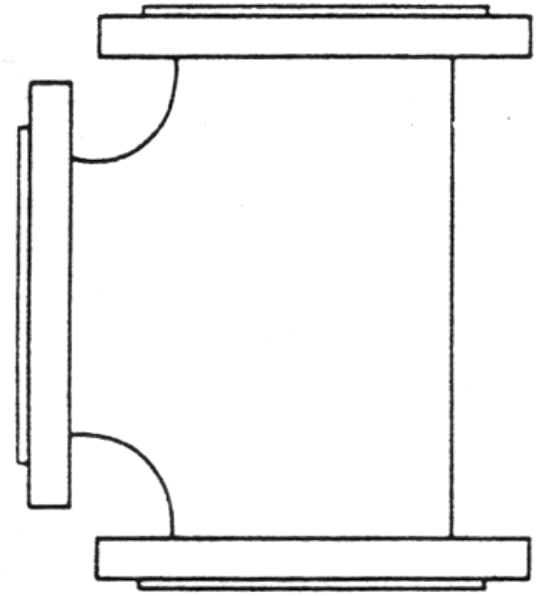
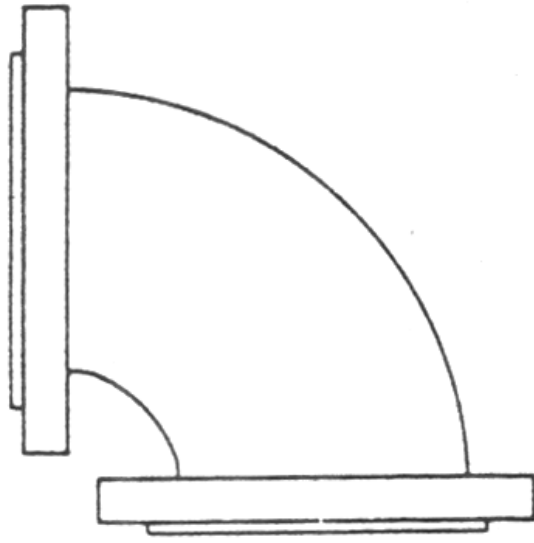

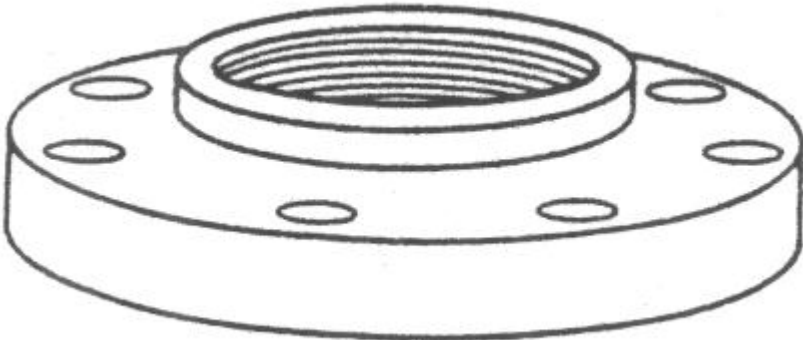
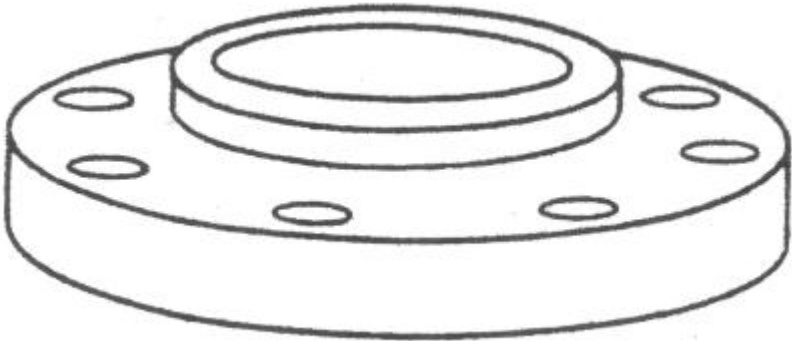
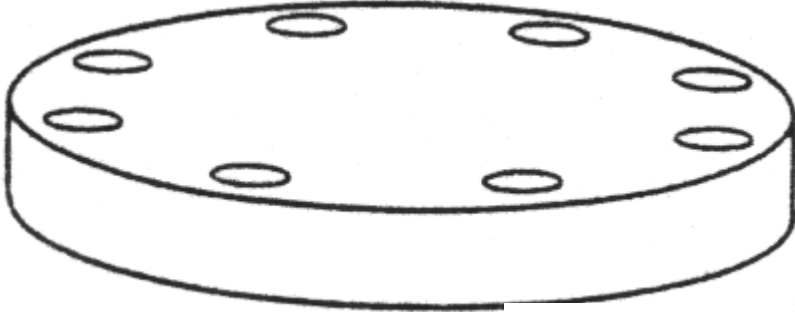

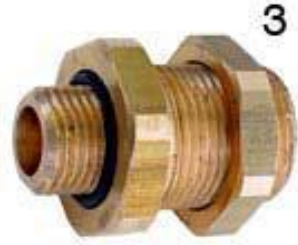

12

13

14

6





















9

8

7

Comprimentos equivalentes a perdas localizadas. (Expressos em metros de canalização retilínea)*

DIÂMETRO D mm pol	COTOVELO 90° RAIO LONGO		COTOVELO 90° RAIO MÉDIO		COTOVELO 90° RAIO CURTO		COTOVELO 45°		CURVA 90° R/D = 1½		CURVA 90° R/D = 1		CURVA 45°		ENTRADA NORMAL	ENTRADA DE BORDA	REGISTRO DE GAVETA ABERTO	REGISTRO DE GLOBO ABERTO	REGISTRO DE ÂNGULO ABERTO	TÊ PASSAGEM DIRETA	TÊ SAÍDA DE LADO	TÊ SAÍDA BILATERAL	VÁLVULA DE PE E CRIVO	SAÍDA DA CANALIZ.	VÁLVULA DE RETENÇÃO TIPO LEVE	VÁLVULA DE RETENÇÃO TIPO PENADO
																										
13	1/2	6,3	0,4	0,5	0,2	0,2	0,2	0,2	0,2	0,4	0,1	4,9	2,6	0,3	1,0	1,0	3,6	0,4	1,1	1,6						
19	3/4	0,4	0,6	0,7	0,3	0,3	0,4	0,2	0,2	0,5	0,1	6,7	3,6	0,4	1,4	1,4	5,6	0,5	1,6	2,4						
25	1	0,5	0,7	0,8	0,4	0,3	0,5	0,2	0,3	0,7	0,2	8,2	4,6	0,5	1,7	1,7	7,3	0,7	2,1	3,2						
32	1 1/4	0,7	0,9	1,1	0,5	0,4	0,6	0,3	0,4	0,9	0,2	11,3	5,6	0,7	2,3	2,3	10,0	0,9	2,7	4,0						
38	1 1/2	0,9	1,1	1,3	0,6	0,5	0,7	0,3	0,5	1,0	0,3	13,4	6,7	0,9	2,8	2,8	11,6	1,0	3,2	4,8						
50	2	1,1	1,4	1,7	0,8	0,6	0,9	0,4	0,7	1,5	0,4	17,4	8,5	1,1	3,5	3,5	14,0	1,5	4,2	6,4						
63	2 1/2	1,3	1,7	2,0	0,9	0,8	1,0	0,5	0,9	1,9	0,4	21,0	10,0	1,3	4,3	4,3	17,0	1,9	5,2	8,1						
75	3	1,6	2,1	2,5	1,2	1,0	1,3	0,6	1,1	2,2	0,5	26,0	13,0	1,6	5,2	5,2	20,0	2,2	6,3	9,7						
100	4	2,1	2,8	3,4	1,5	1,3	1,6	0,7	1,6	3,2	0,7	34,0	17,0	2,1	6,7	6,7	23,0	3,2	6,4	12,9						
125	5	2,7	3,7	4,2	1,9	1,6	2,1	0,9	2,0	4,0	0,9	43,0	21,0	2,7	8,4	8,4	30,0	4,0	10,4	16,1						
150	6	3,4	4,3	4,9	2,3	1,9	2,5	1,1	2,5	5,0	1,1	51,0	26,0	3,4	10,0	10,0	39,0	5,0	12,5	19,3						
200	8	4,3	5,5	6,4	3,0	2,4	3,3	1,5	3,5	6,0	1,4	67,0	34,0	4,3	13,0	13,0	52,0	6,0	16,0	25,0						
250	10	5,5	6,7	7,9	3,8	3,0	4,1	1,8	4,5	7,5	1,7	85,0	43,0	5,5	16,0	16,0	65,0	7,5	20,0	32,0						
300	12	6,1	7,9	9,5	4,6	3,6	4,8	2,2	5,5	9,0	2,1	102,0	51,0	6,1	19,0	19,0	78,0	9,0	24,0	38,0						
350	14	7,3	9,5	10,5	5,3	4,4	5,4	2,5	6,2	11,0	2,4	120,0	60,0	7,3	22,0	22,0	90,0	11,0	28,0	45,0						

*Os valores indicados para registros de globo aplicam-se também às torneiras, válvulas para chuveiros e válvulas de descarga

Type	Equivalent Length in Pipe Diameters L_e/D
Globe valve—fully open	340
Angle valve—fully open	150
Gate valve—fully open	8
— $3/4$ open	35
— $1/2$ open	160
— $1/4$ open	900
Check valve—swing type	100
Check valve—ball type	150
Butterfly valve—fully open, 2–8 in	45
—10–14 in	35
—16–24 in	25
Foot valve—poppet disc type	420
Foot valve—hinged disc type	75
90° standard elbow	30
90° long radius elbow	20
90° street elbow	50
45° standard elbow	16
45° street elbow	26
Close return bend	50
Standard tee—with flow through run	20
—with flow through branch	60

Source: Crane Valves, Signal Hill, CA.

Coefficientes de perda localizada $K = h_{p\ell}/[V^2/(2g)]$ para válvulas abertas, cotovelos e tês.

	Diâmetro nominal, pol (mm)									
	Parafusada					Flangeada				
	$\frac{1}{2}$ (13)	1 (25)	2 (50)	4 (100)	1 (25)	2 (50)	4 (100)	8 (200)	20 (500)	
Válvulas (totalmente abertas):										
Globo	14	8,2	6,9	5,7	13	8,5	6,0	5,8	5,5	
Gaveta	0,3	0,24	0,16	0,11	0,80	0,35	0,16	0,07	0,03	
Retenção basculante	5,1	2,9	2,1	2,0	2,0	2,0	2,0	2,0	2,0	
Em ângulo	9,0	4,7	2,0	1,0	4,5	2,4	2,0	2,0	2,0	
Cotovelos:										
45° normal	0,39	0,32	0,30	0,29						
45° raio longo					0,21	0,20	0,19	0,16	0,14	
90° normal	2,0	1,5	0,95	0,64	0,50	0,39	0,30	0,26	0,21	
90° raio longo	1,0	0,72	0,41	0,23	0,40	0,30	0,19	0,15	0,10	
180° normal	2,0	1,5	0,95	0,64	0,41	0,35	0,30	0,25	0,20	
180° raio longo					0,40	0,30	0,21	0,15	0,10	
Tês:										
Escoamento direto	0,90	0,90	0,90	0,90	0,24	0,19	0,14	0,10	0,07	
Escoamento no ramal	2,4	1,8	1,4	1,1	1,0	0,80	0,64	0,58	0,41	

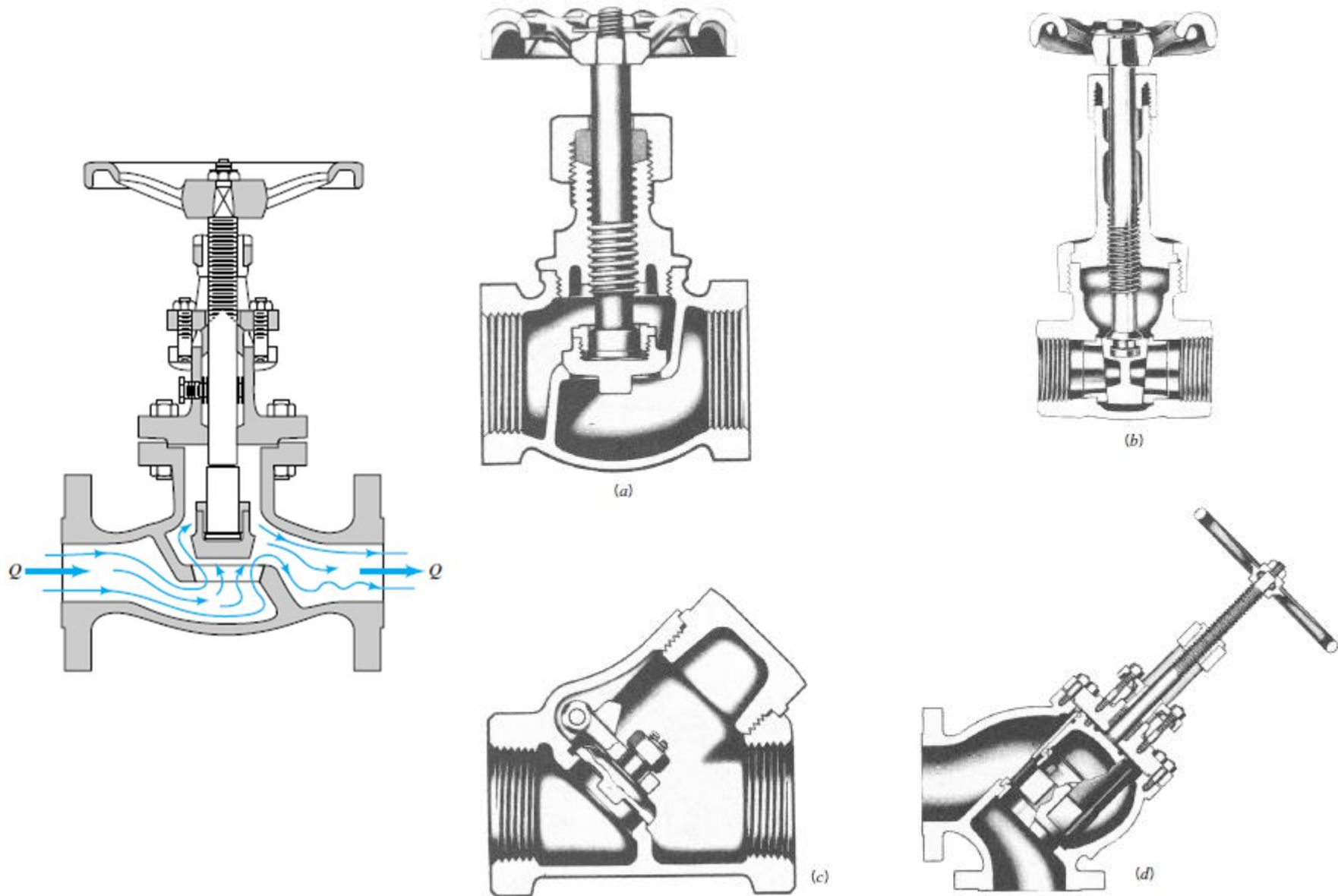

■ **FIGURE 8.32** Internal structure of various valves: (a) globe valve, (b) gate valve, (c) swing check valve, (d) stop check valve. (Courtesy of Crane Co., Valve Division.)



Válvula globo: grande perda de carga

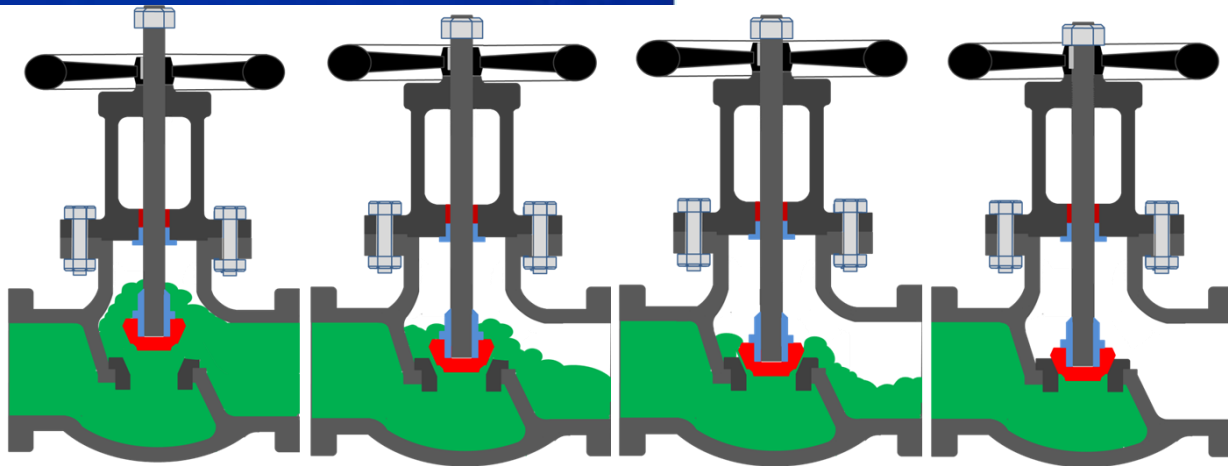

1. Fully Open

2. Throttling

3. Throttling

3. Fully Closed

Válvula de esfera:
menor perda de carga
quando aberta.

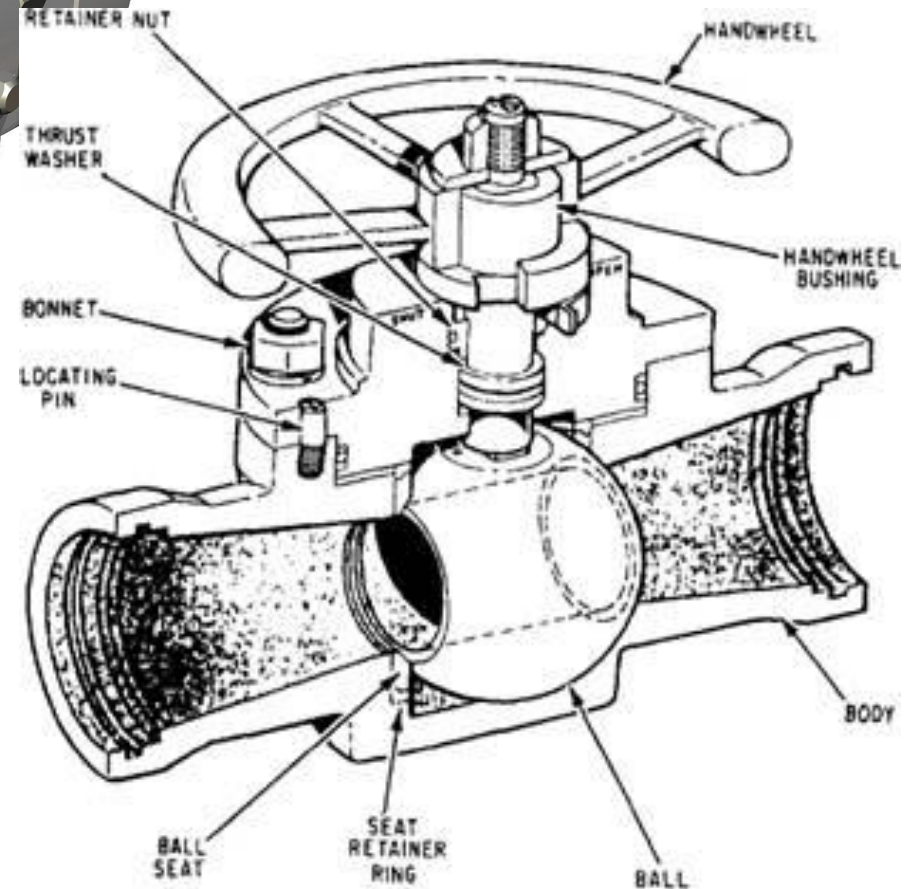
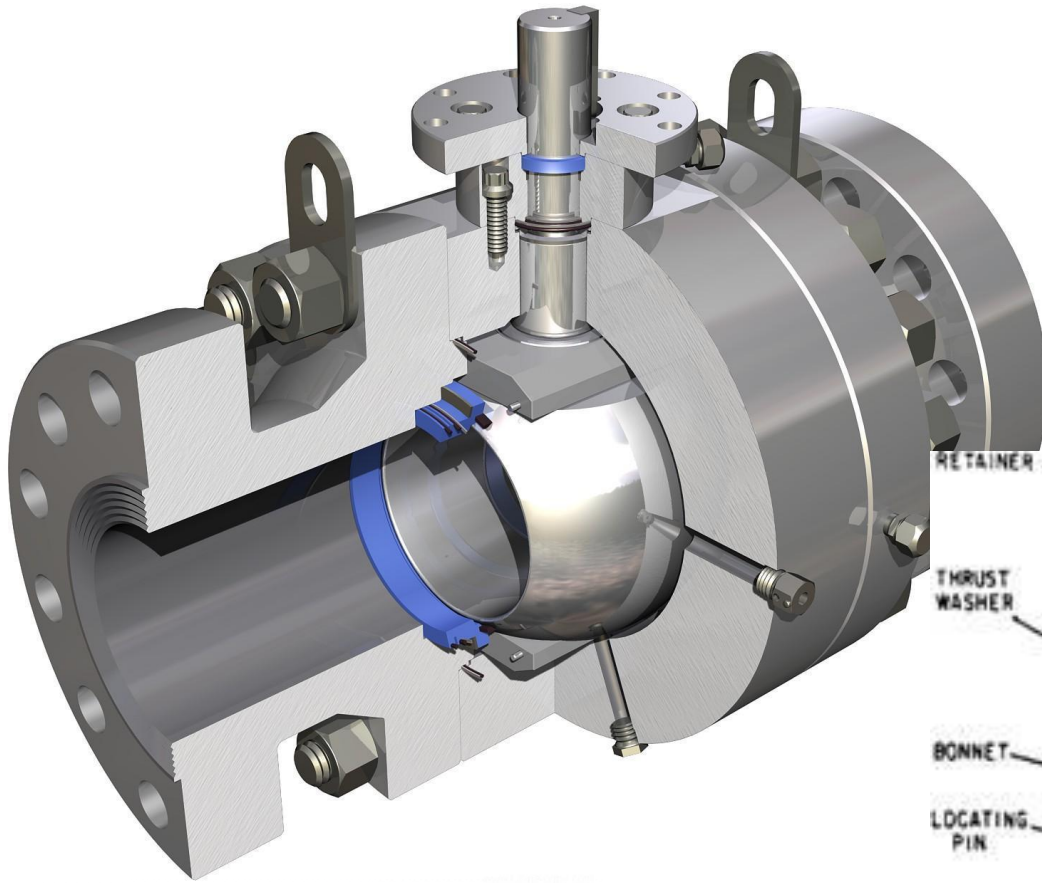

Válvula de Gaveta

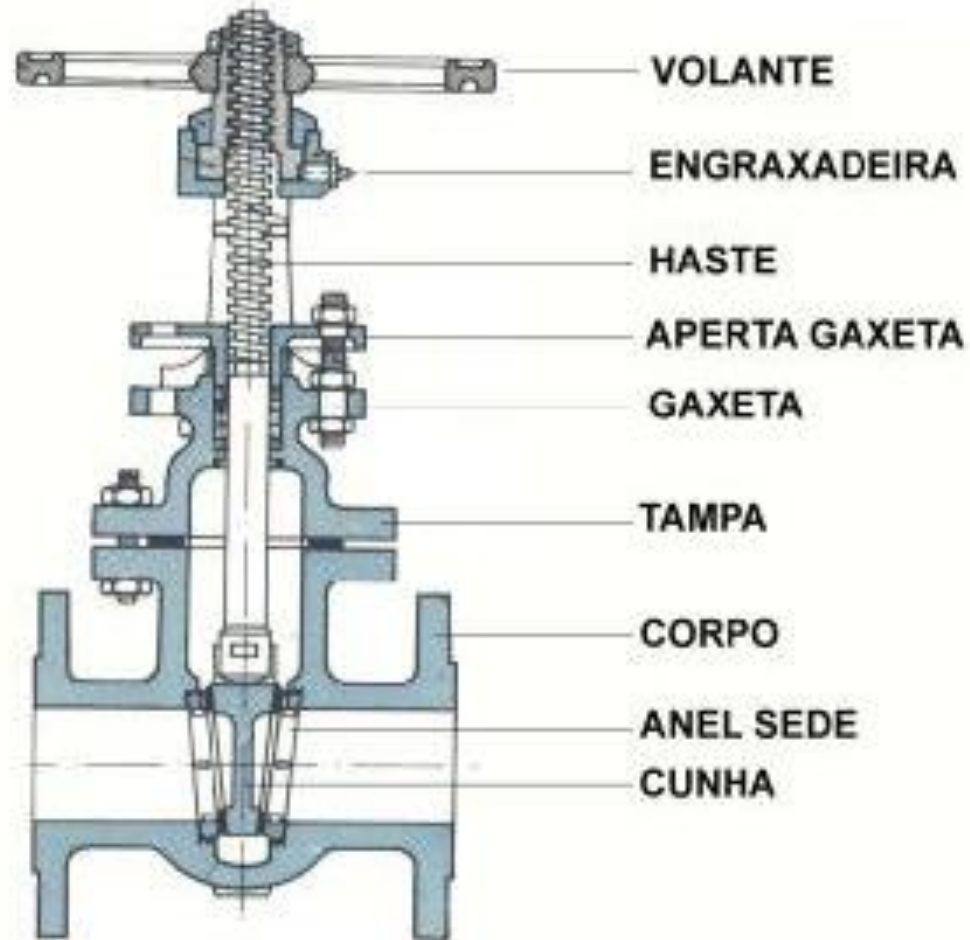

Registro de Gaveta

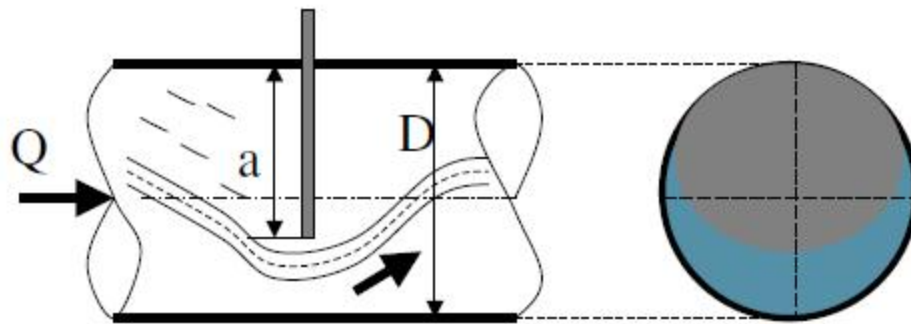

a/D	0	1/4	3/8	1/2	5/8	3/4	7/8
K	0,15	0,26	0,81	2,06	5,52	17,0	97,8



Válvula Borboleta

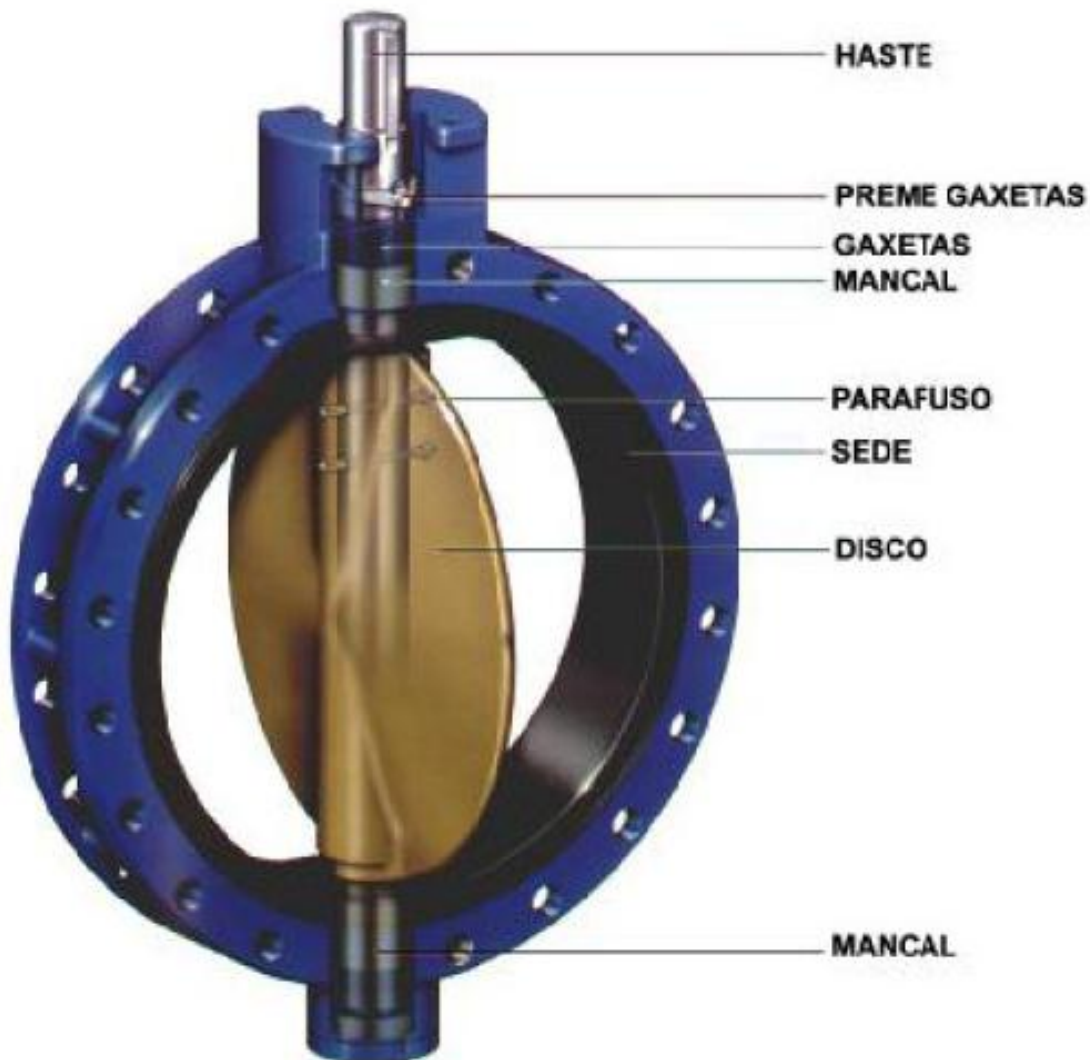

Válvula Borboleta

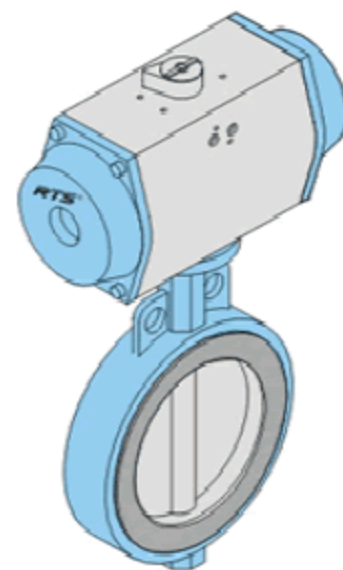
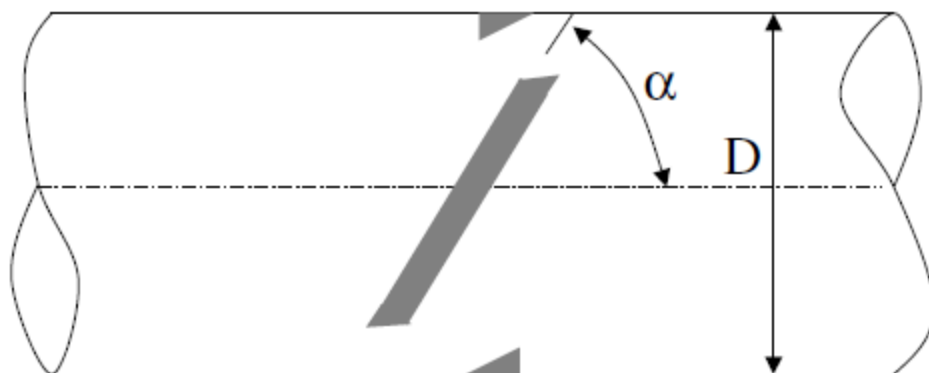
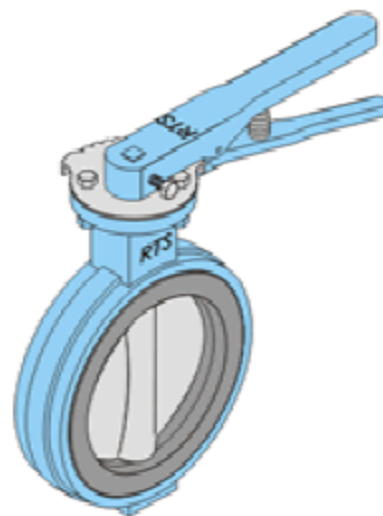

α°	0	5	10	15	20	25	30	35	40	45	50
K	0,15	0,24	0,52	0,90	1,54	2,51	3,91	6,22	10,8	18,7	32,6

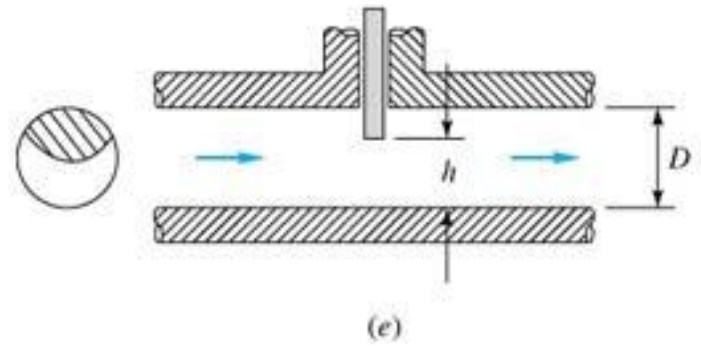
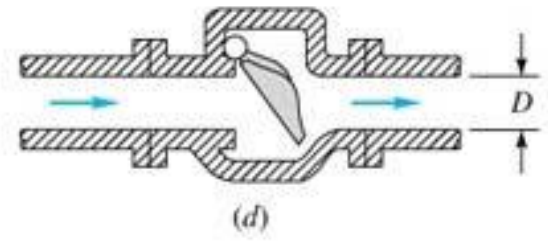
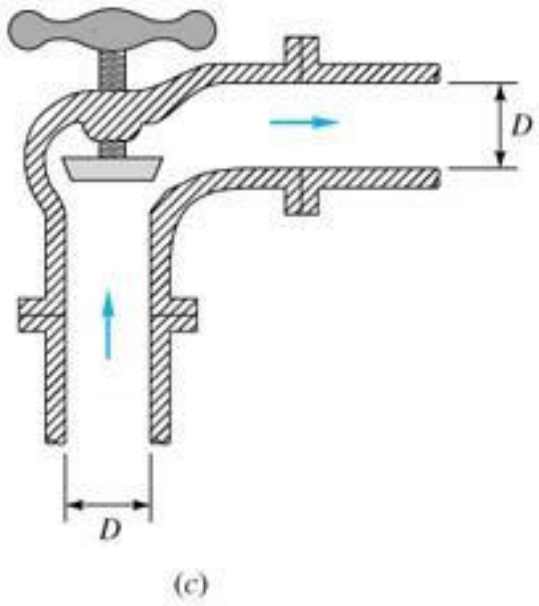
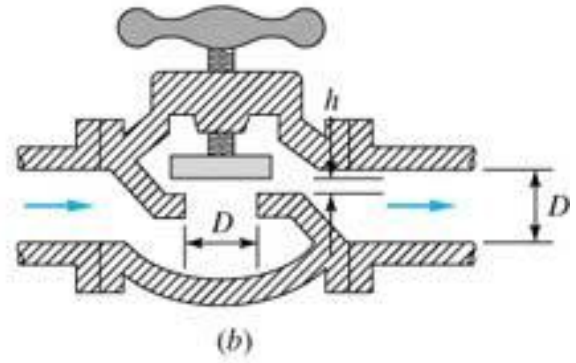
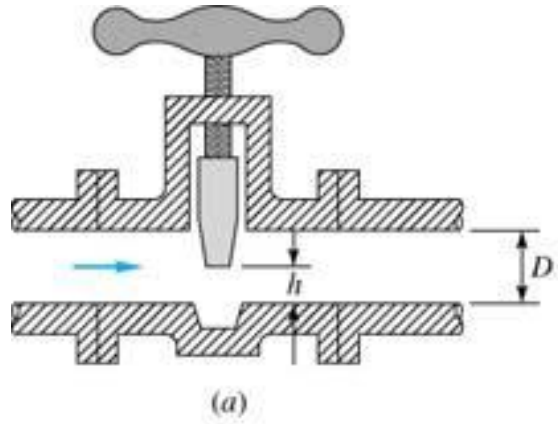



BASIC VALVE MECHANISMS

FLUID CONTROL ELEMENTS (DISCS)

CHART 3.1

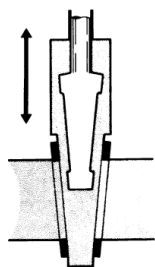
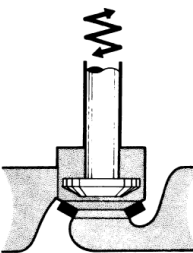
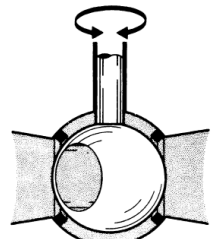
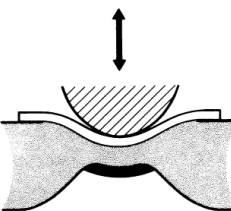
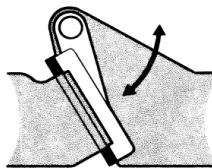
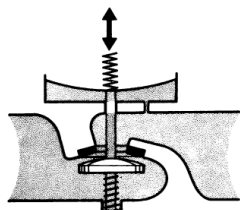
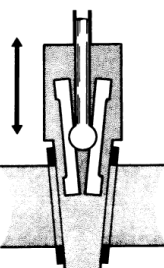
IN THESE SCHEMATIC DIAGRAMS, THE DISC IS SHOWN WHITE, THE SEAT IN SOLID COLOR, & THE CONVEYED FLUID SHADED.

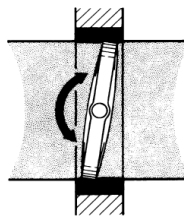
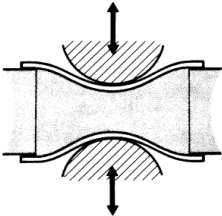
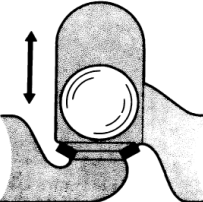
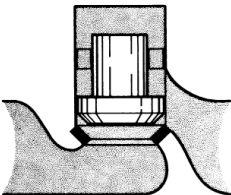
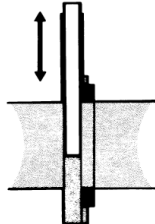
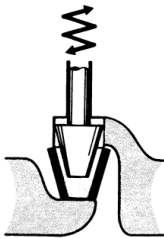
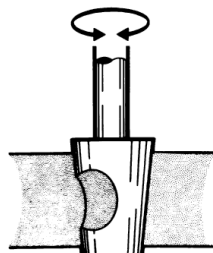
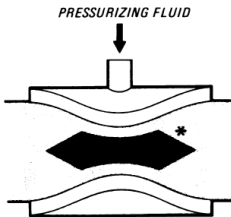
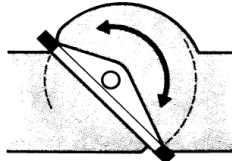
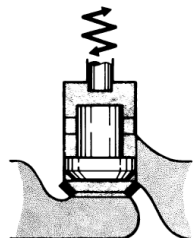
OPERATED VALVES				SELF-OPERATED VALVES	
GATE	GLOBE	ROTARY	DIAPHRAGM	CHECK	REGULATING
 <p>SOLID-WEDGE GATE</p>	 <p>GLOBE</p>	 <p>ROTARY-BALL</p>	 <p>DIAPHRAGM (SAUNDERS TYPE)</p>	 <p>SWING CHECK</p>	 <p>PRESSURE REGULATOR</p>
 <p>SPLIT-WEDGE GATE</p>	 <p>ANGLE GLOBE</p>	 <p>BUTTERFLY</p>	 <p>PINCH</p>	 <p>BALL CHECK</p>	 <p>PISTON CHECK</p>
 <p>SINGLE-DISC SINGLE-SEAT GATE</p>	 <p>NEEDLE</p>	 <p>PLUG or COCK</p>	 <p>PRESSURIZING FLUID</p> <p>*Central seat is optional</p> <p>SQUEEZE</p>	 <p>TILTING DISC CHECK</p>	 <p>STOP CHECK</p>

Acessório	K
Cotovelo de 90° raio curto	0,9
Cotovelo 90° raio longo	0,6
Cotovelo de 45°	0,4
Curva 90°, r/D=1	0,4
Curva de 45°	0,2
Tê, passagem direta	0,9
Tê, saída lateral	2,0



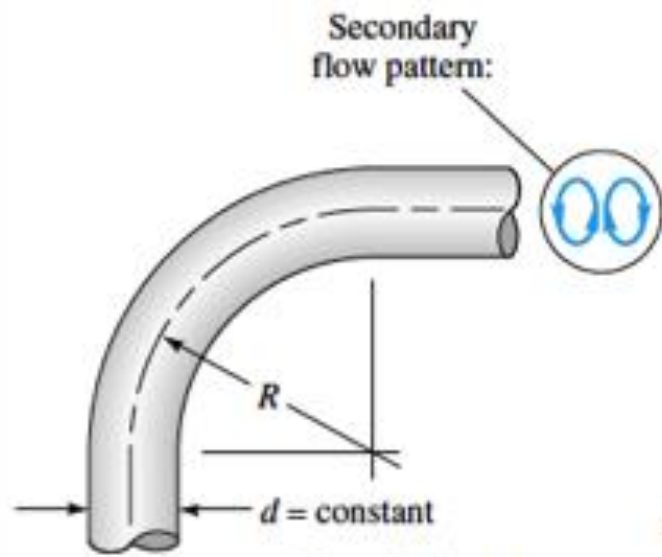

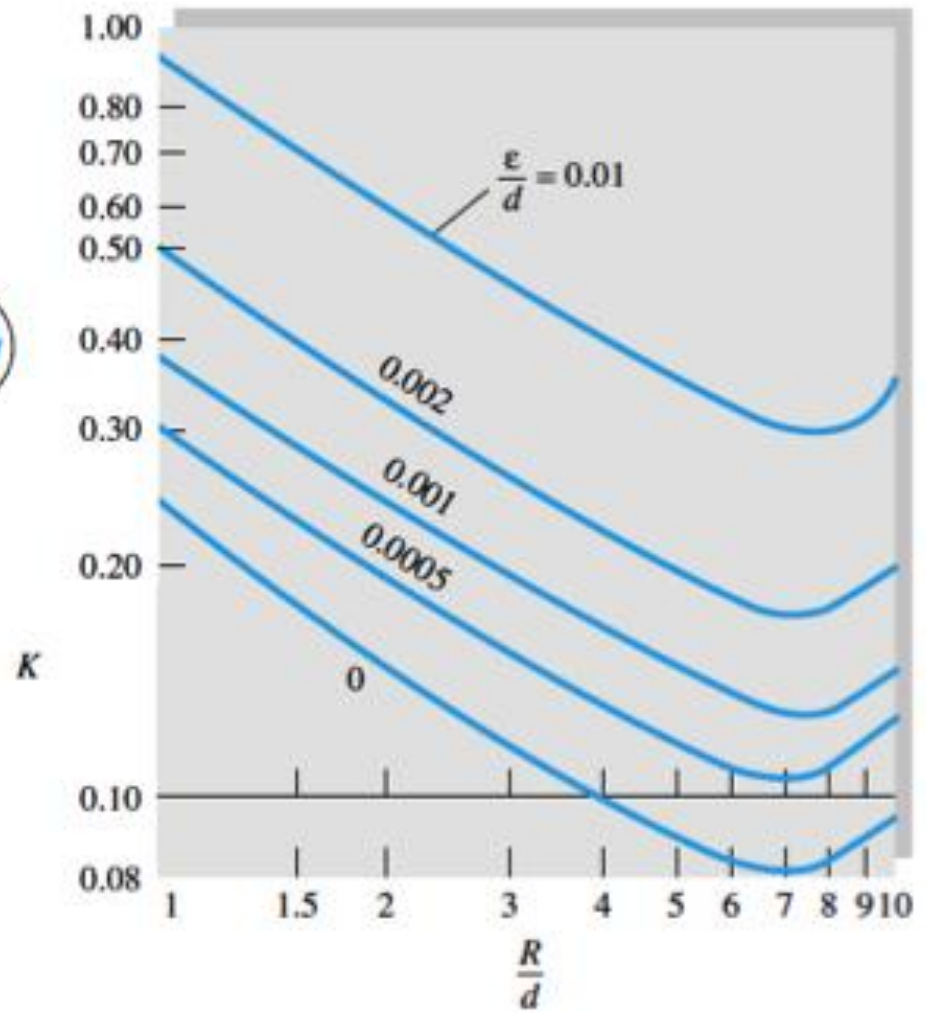

(Note: Resistance due to bend length must be added.)

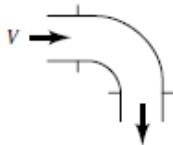

■ TABLE 8.2

Loss Coefficients for Pipe Components ($h_L = K_L \frac{V^2}{2g}$) (Data from Refs. 5, 10, 27)

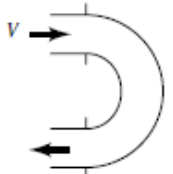
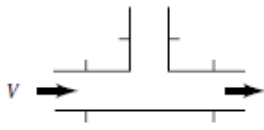
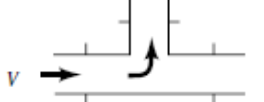
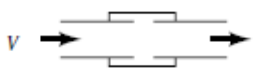
Component	K_L		
a. Elbows			
Regular 90°, flanged	0.3		
Regular 90°, threaded	1.5		
Long radius 90°, flanged	0.2		
Long radius 90°, threaded	0.7		
Long radius 45°, flanged	0.2		
Regular 45°, threaded	0.4		
b. 180° return bends			
180° return bend, flanged	0.2		
180° return bend, threaded	1.5		
c. Tees			
Line flow, flanged	0.2		
Line flow, threaded	0.9		
Branch flow, flanged	1.0		
Branch flow, threaded	2.0		
d. Union, threaded			
	0.08		
e. Valves			
Globe, fully open	10		
Angle, fully open	2		
Gate, fully open	0.15		
Gate, 1/4 closed	0.26		
Gate, 1/2 closed	2.1		
Gate, 3/4 closed	17		
Swing check, forward flow	2		
Swing check, backward flow	∞		
Ball valve, fully open	0.05		
Ball valve, 1/3 closed	5.5		
Ball valve, 2/3 closed	210		

Tipos de entrada em dutos

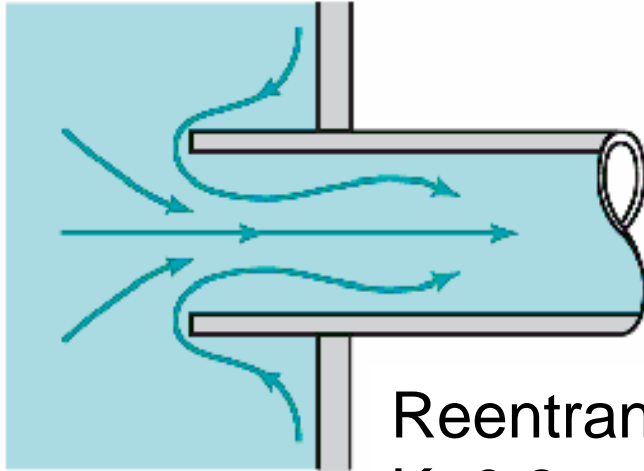

(a)

Reentrante
 $K=0,8$

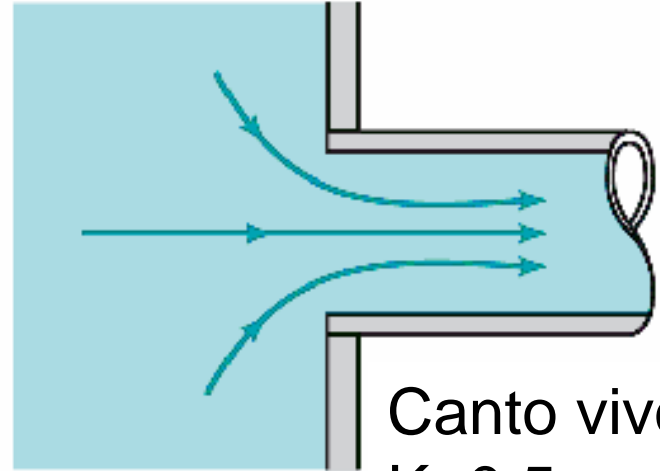

(b)

Canto vivo
 $K=0,5$

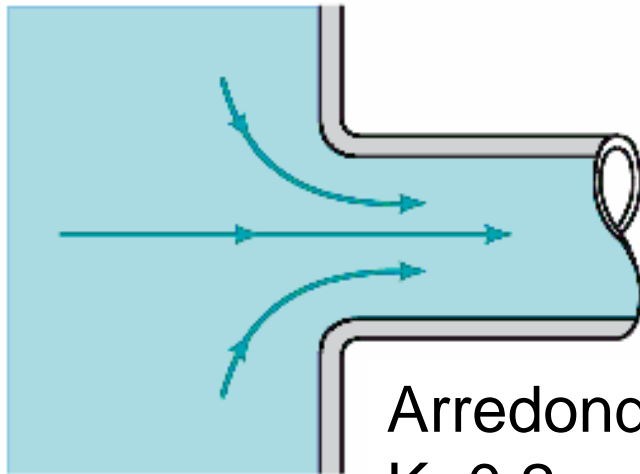

(c)

Arredondado
 $K=0,2$

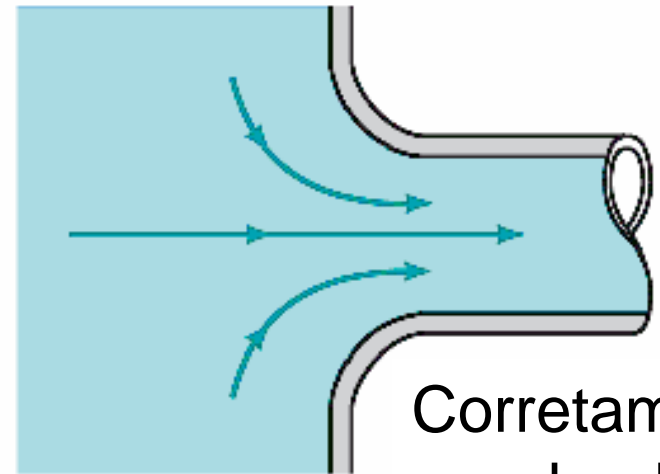

(d)

Corretamente
arredondado
 $K=0,04$

Tipos de saída de dutos

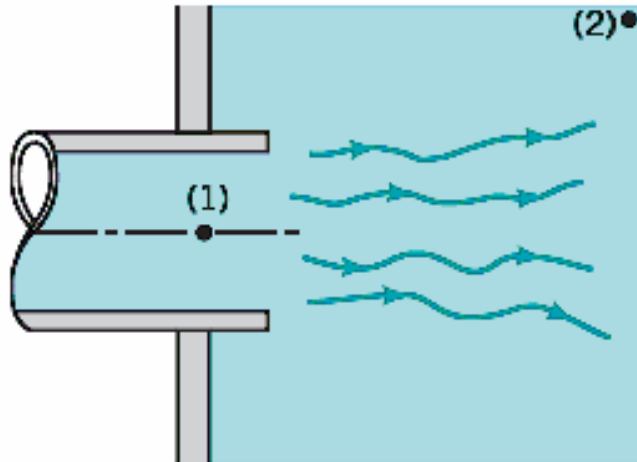

(a) Reentrante
 $K=1,0$

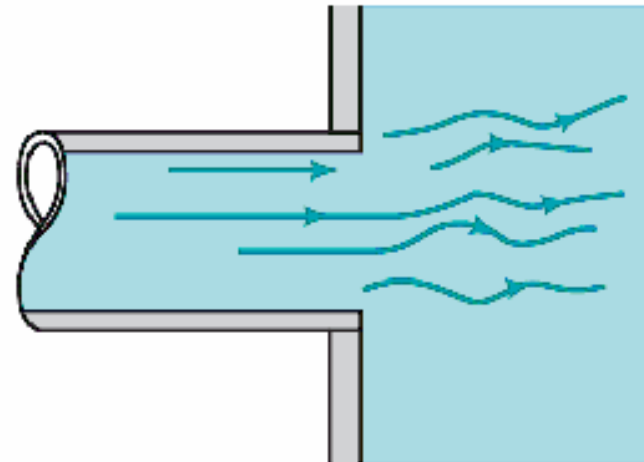

(b) Canto vivo
 $K=1,0$

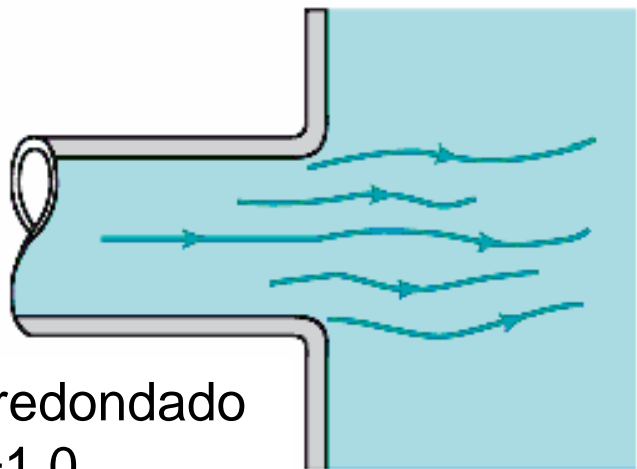

Arredondado
 $K=1,0$

(c)

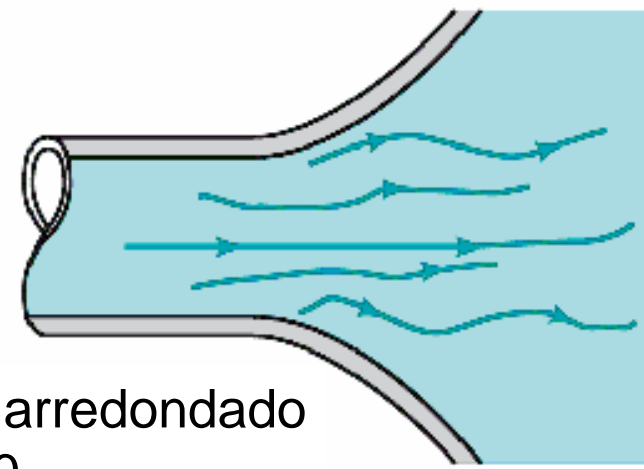

Bem arredondado
 $K=1,0$

(d)

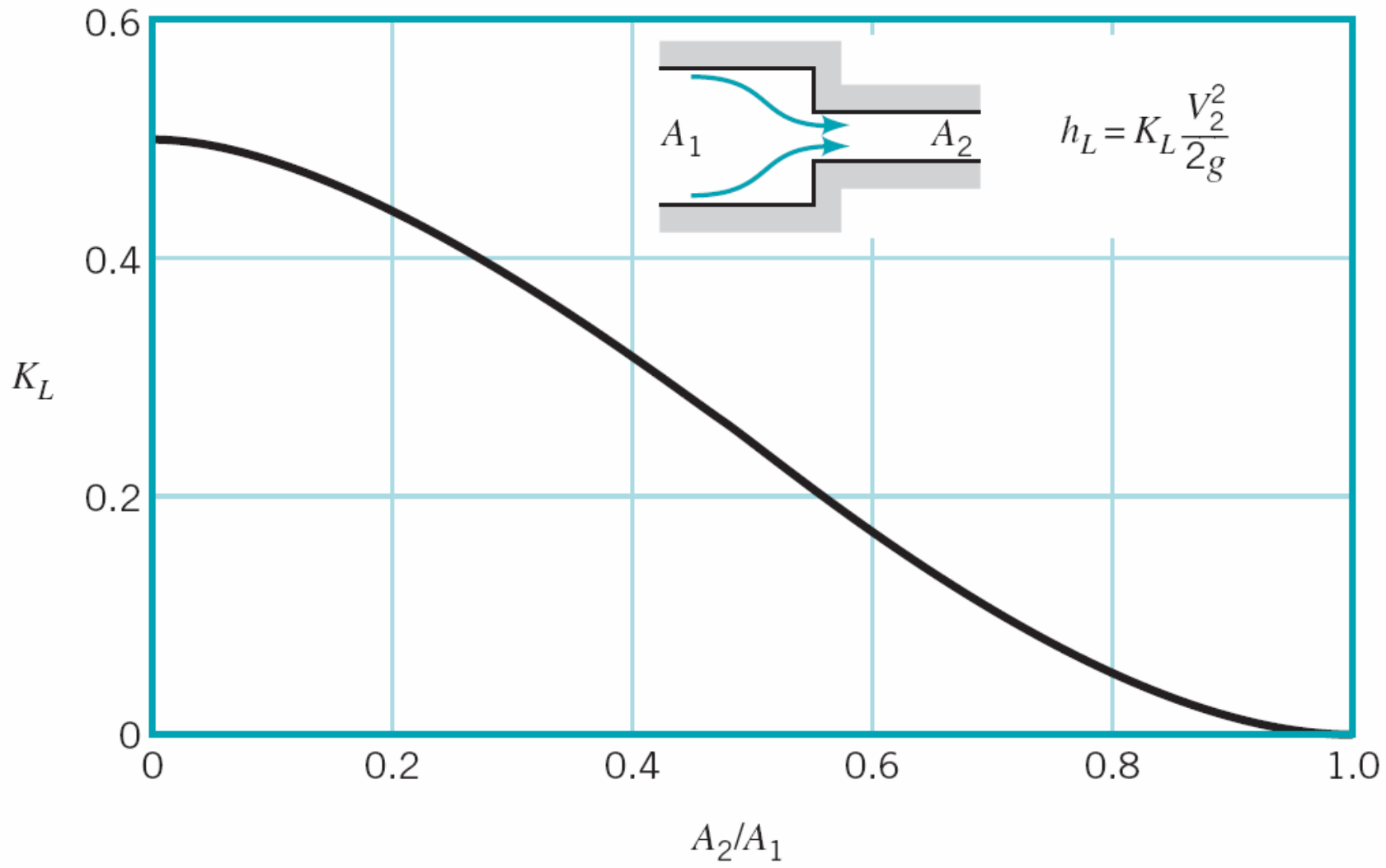

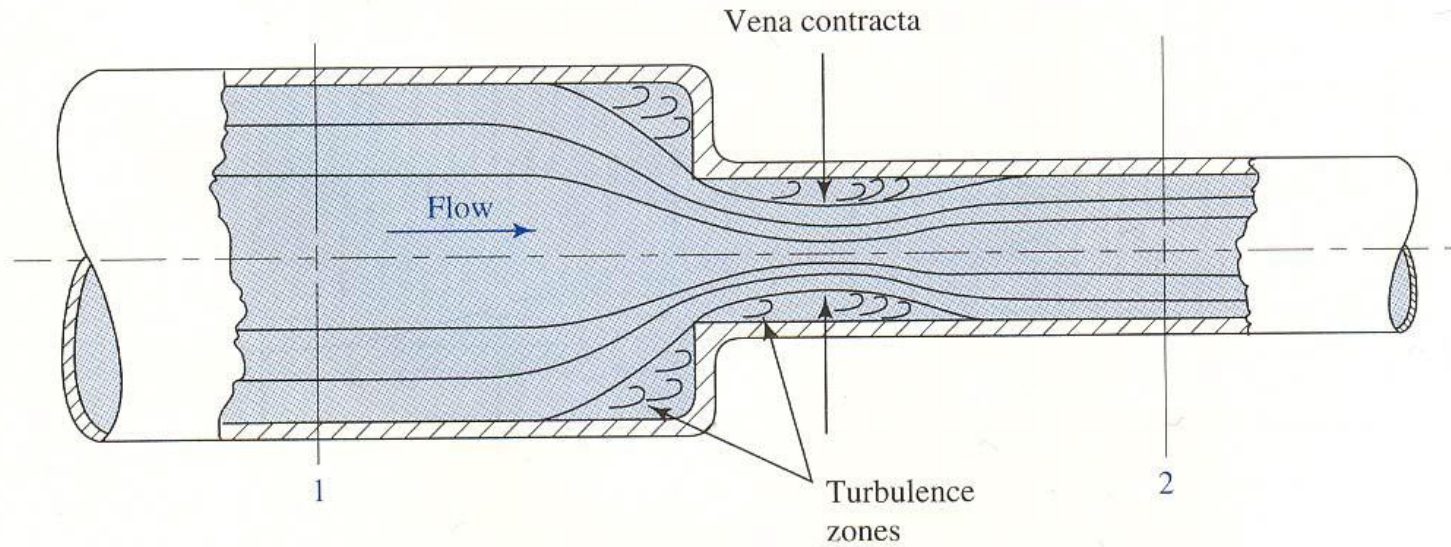
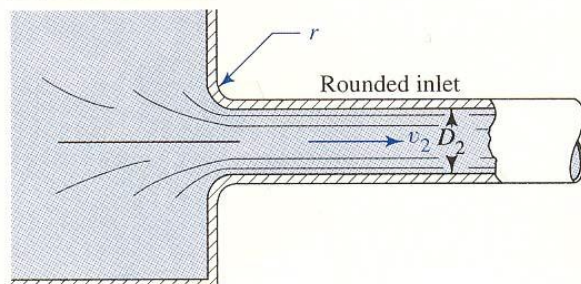
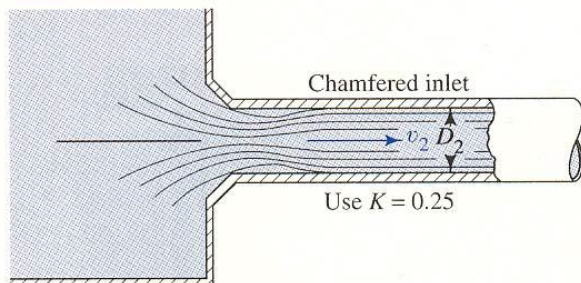
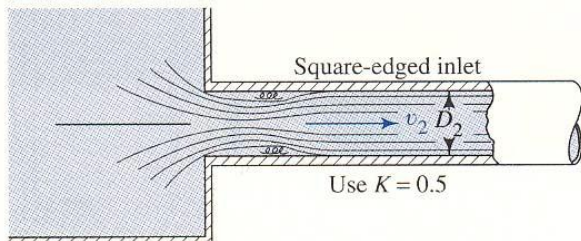
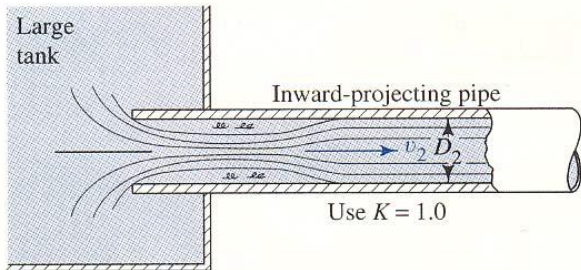
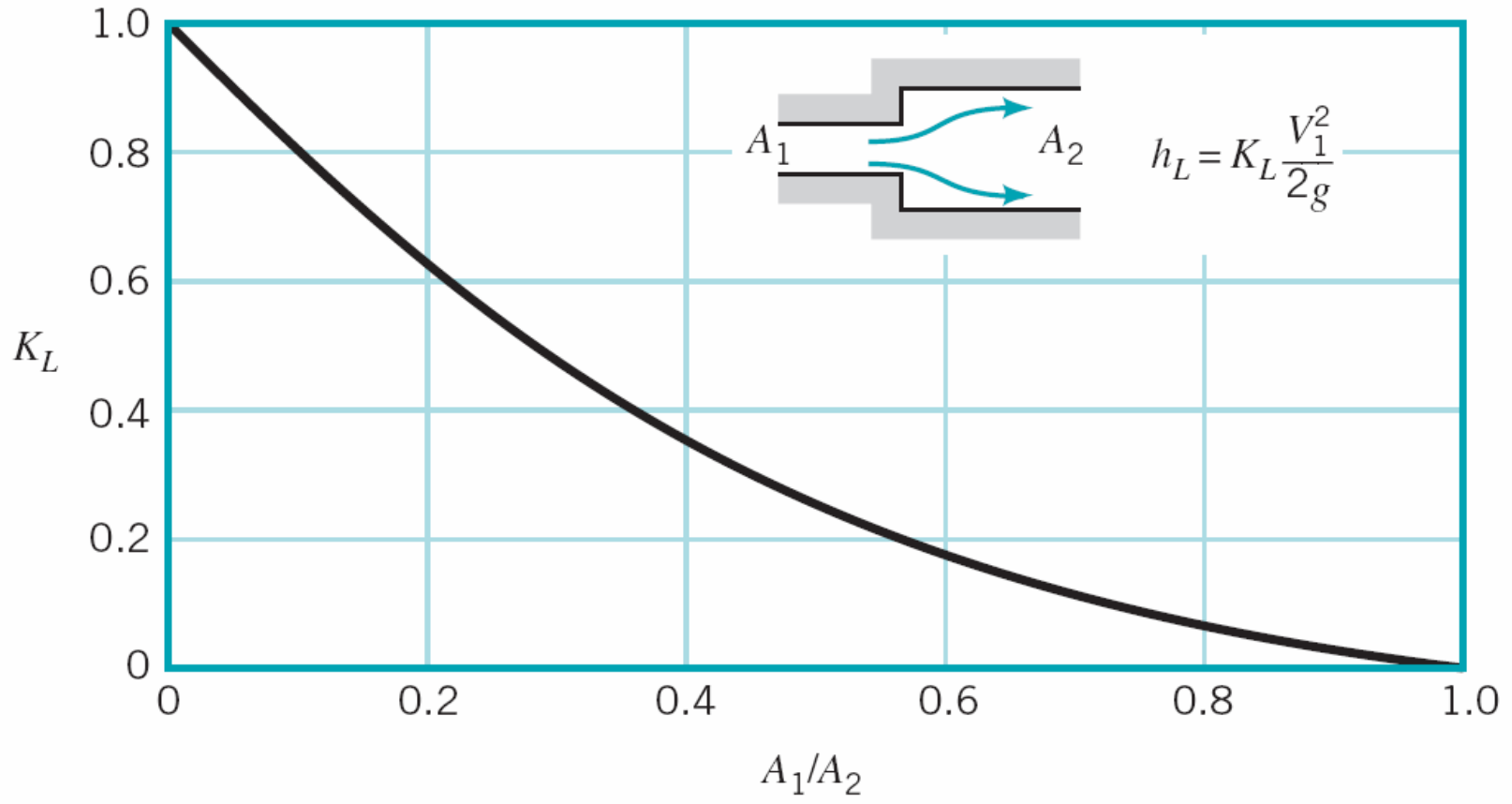

FIGURE 10.8 Vena contracta formed in a sudden contraction.



r/D_2	K
0	0.50
0.02	0.28
0.04	0.24
0.06	0.15
0.10	0.09
>0.15	0.04 (Well-rounded)



Region of turbulence

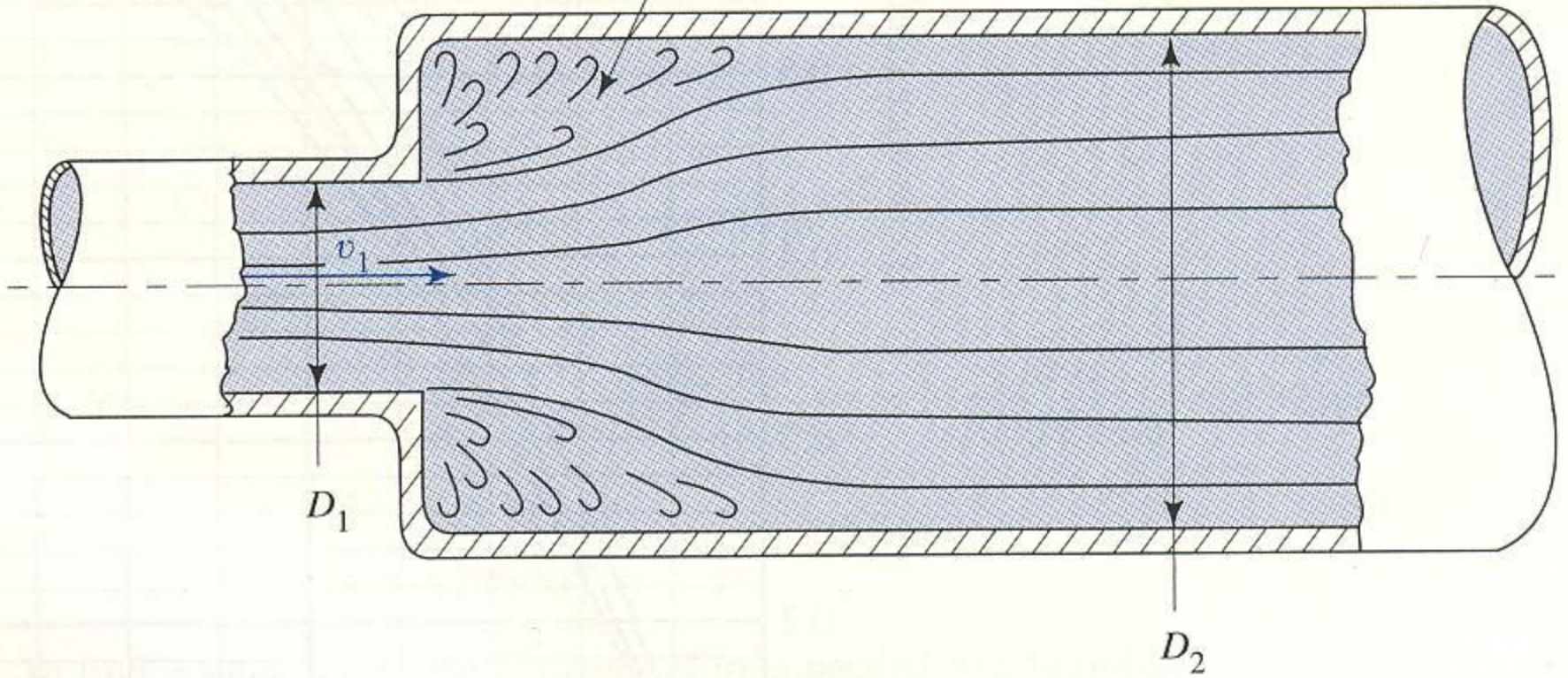

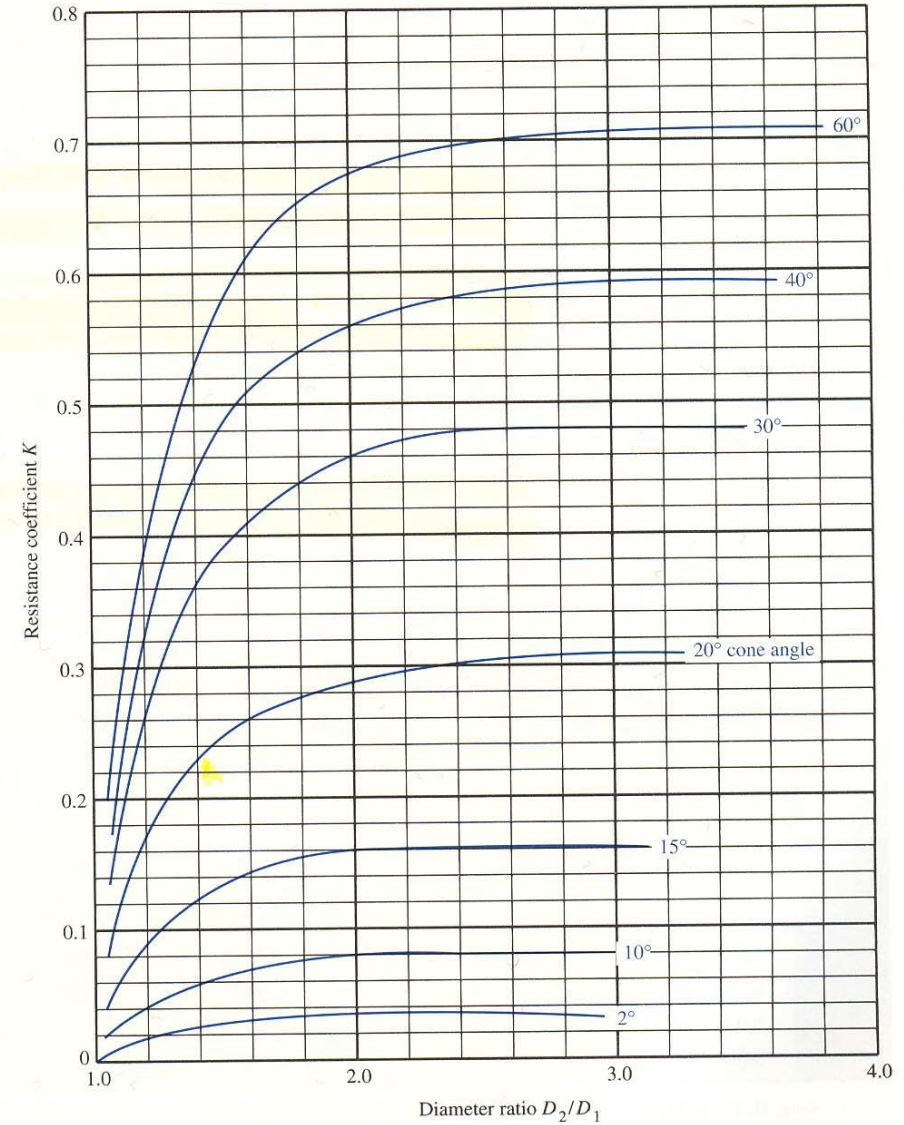
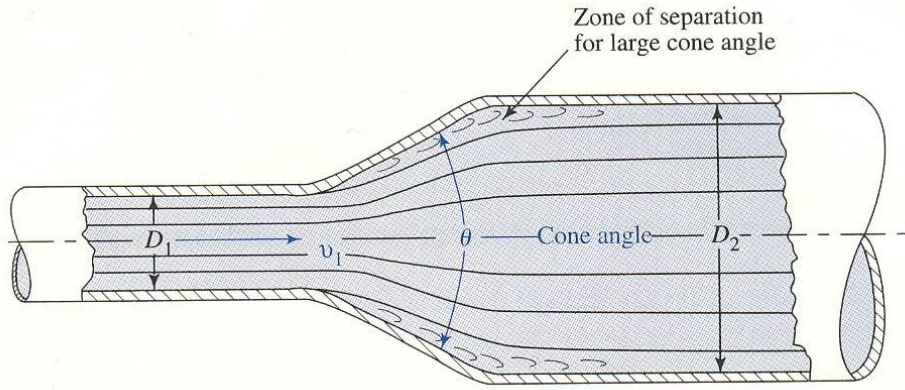

Alargamento gradual

— Gibson ($D_2/D_1=3$) — Huang ($D_2/D_1=2$)
— Peters ($D_2/D_1=1,53$) — Gibson ($D_2/D_1=1,5$)

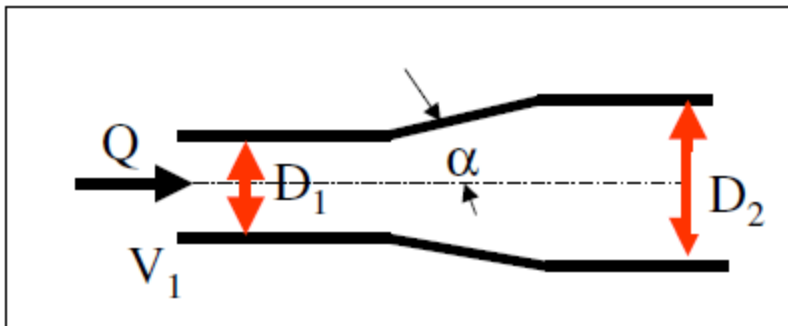
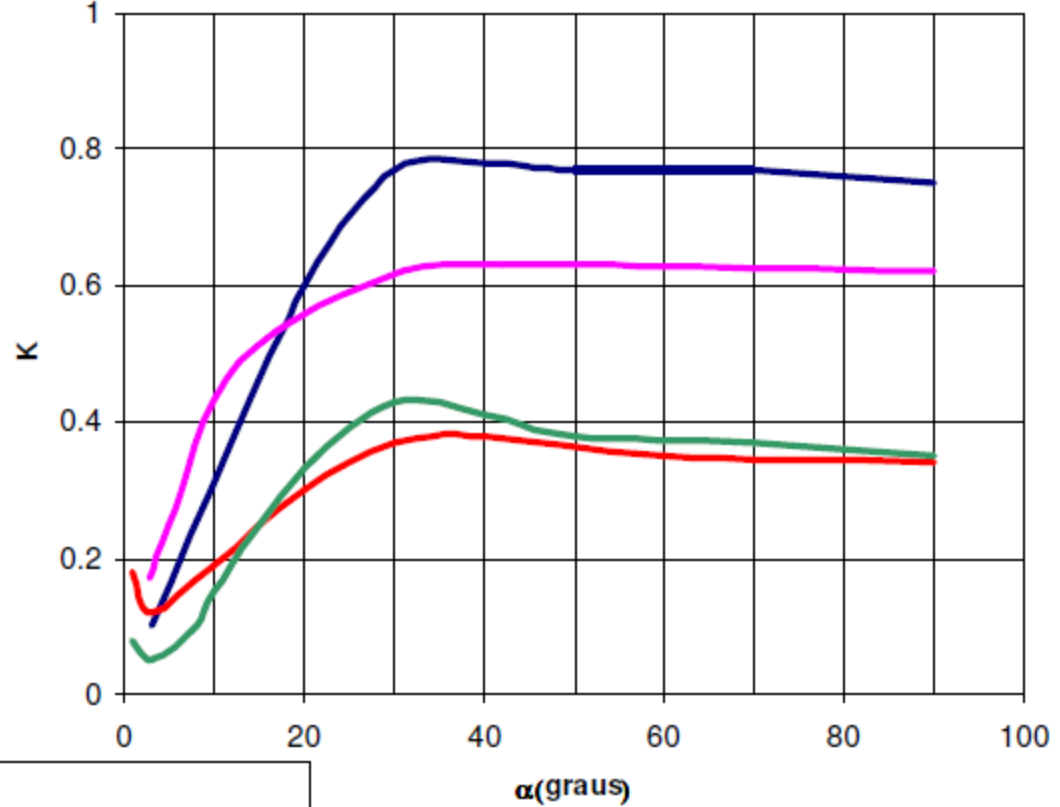

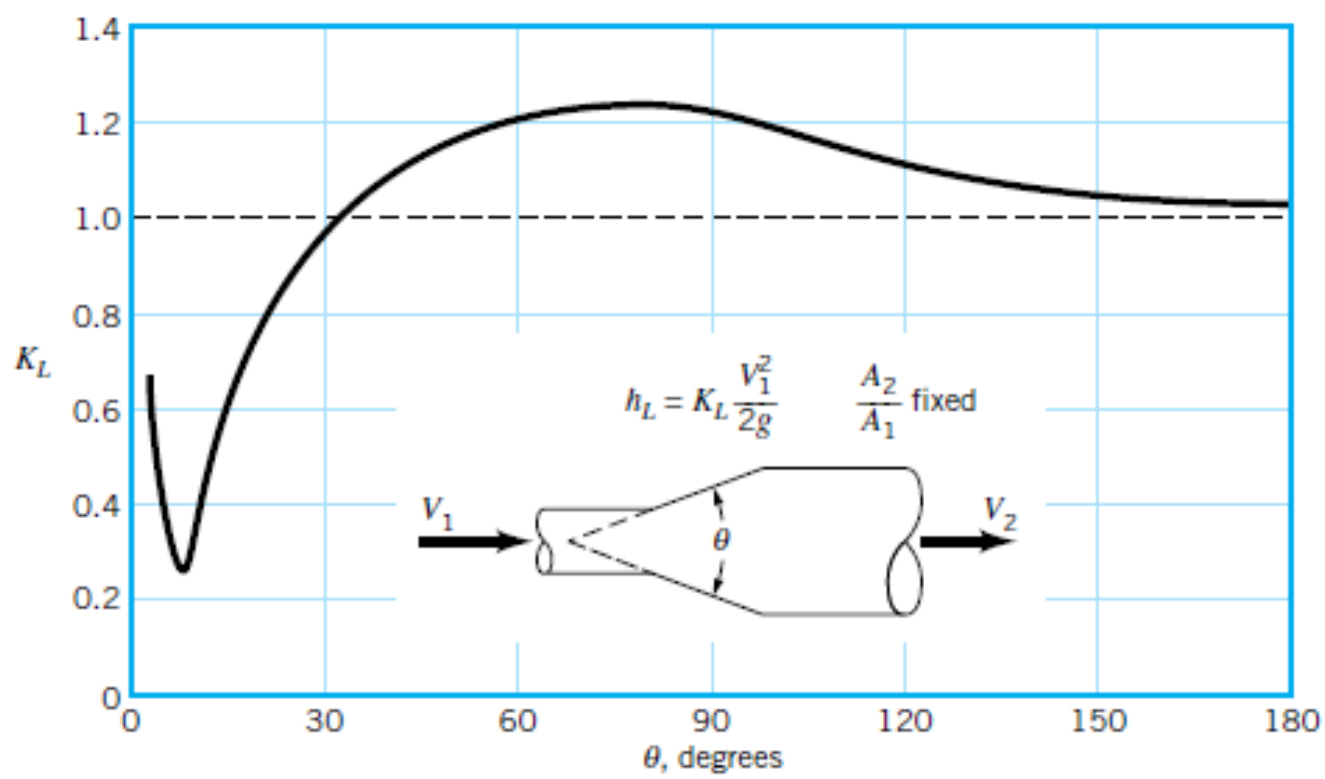

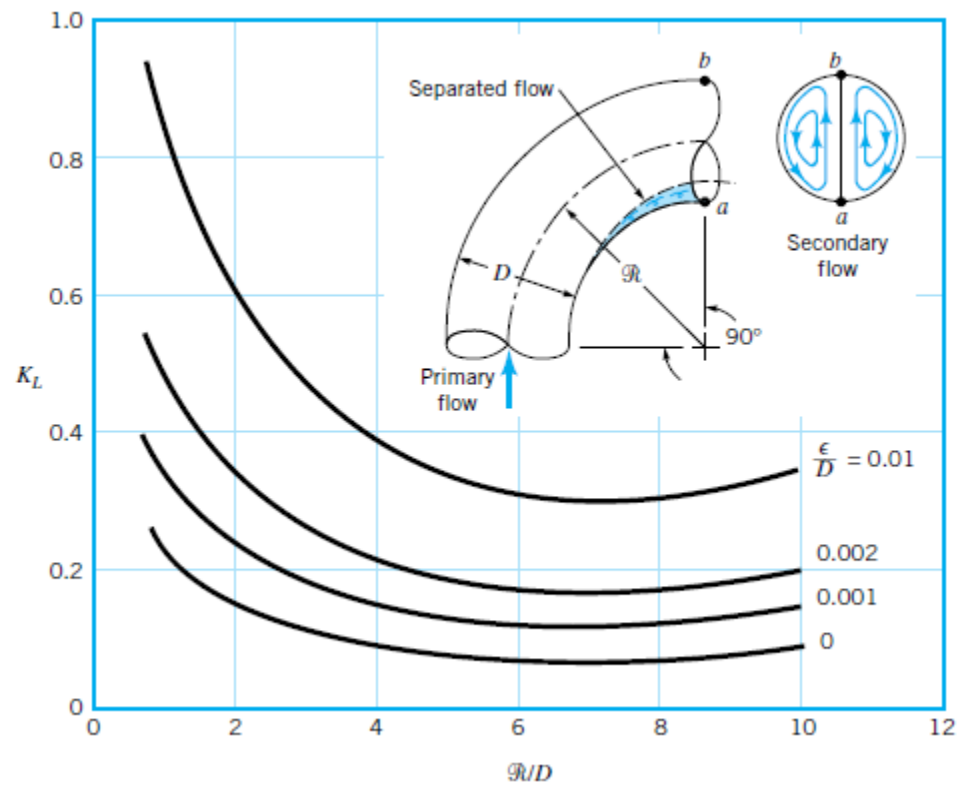

Minimizing Elbow Resistance

- The minimum resistance is achieved by an elbow when outer & inner radii is related as

$$\frac{r_1}{d_o} = \frac{r_o}{d_o} + 0.6$$

- The resistance of right angle elbows can greatly be reduced by installing a **fairing** on the inner corner
 - An optimum fairing with a ratio of $r_o/d_o = 0,45$ reduces the pressure losses by approx 50%
 - An additional fairing on the outer corner with a ratio of $r_1/d_o = 0,45$ reduces the losses by an additional 5%.
- Reduction in the elbow resistance can also be attained by beveling sharp corners of the bend especially the inner corner

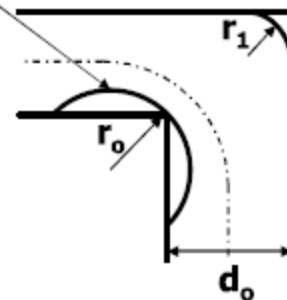
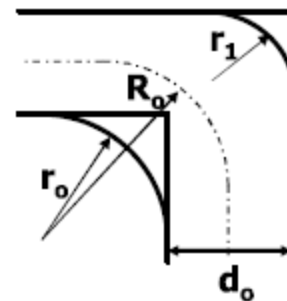

Minimizing Elbow Resistance

Example of a Coolant Return Elbow

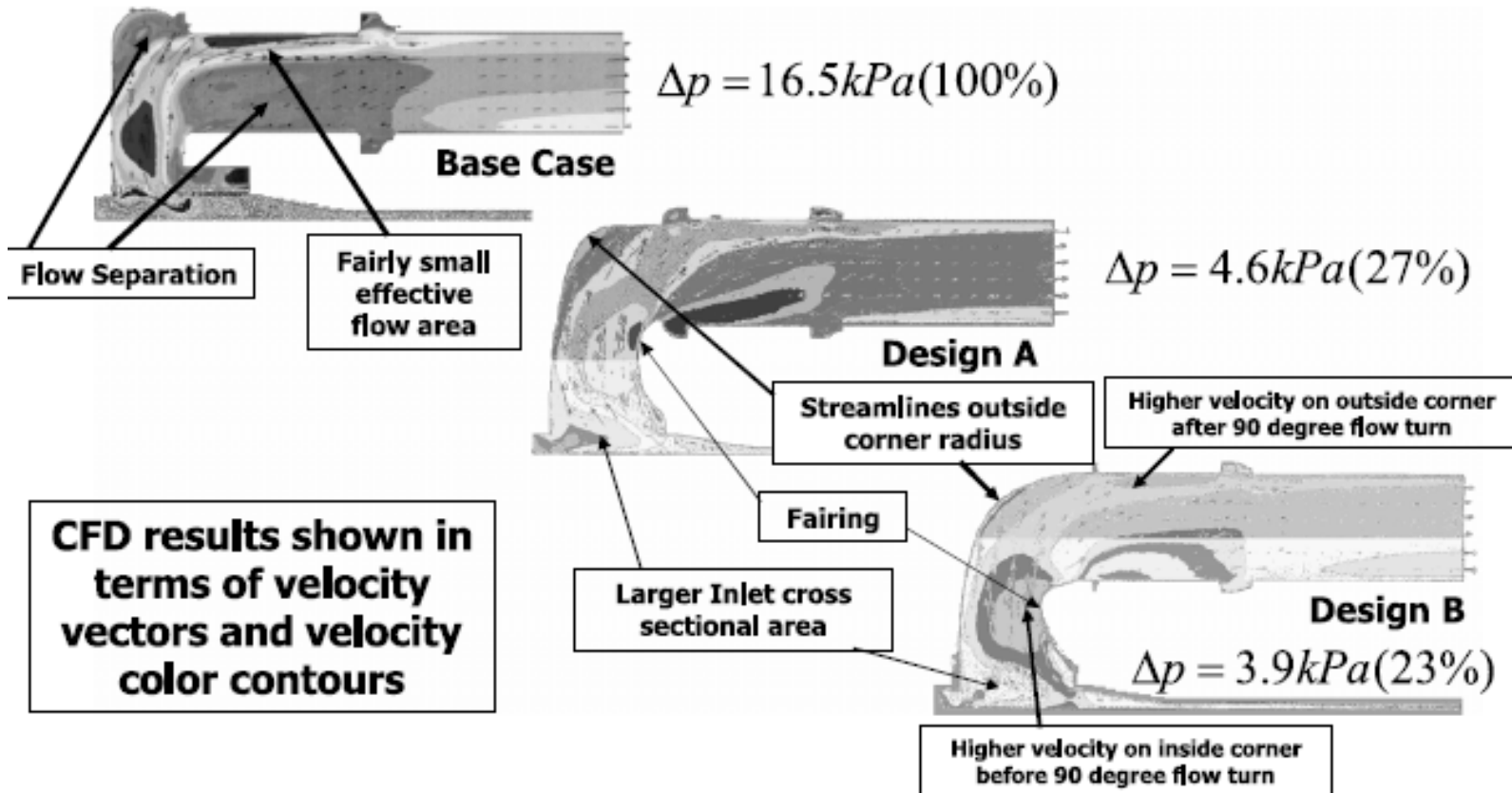

77% reduction in pressure losses is significant!

Circular Metal Wire Screens

Idelchik Diagram 8.6 Pg 522

$$\text{Re} = \frac{v_o \delta_m}{\mu} \geq 10^3$$

$$50 < \text{Re} < 10^3$$

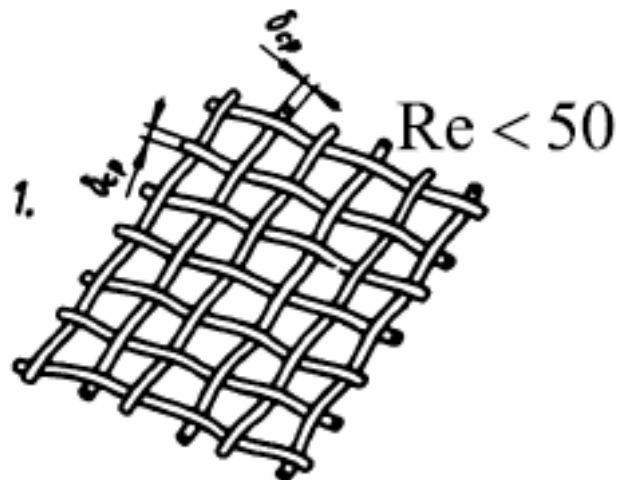

A_o is open area on screen

A_1 is pipe upstream flow area

$$K_{\text{Wire-Screen}} = 1.3 \left(1 - \frac{A_0}{A_1}\right) + \left(\frac{A_1}{A_0} - 1\right)^2$$

$$K_{\text{Wire-Screen}} = k_1 1.3 \left(1 - \frac{A_0}{A_1}\right) + \left(\frac{A_1}{A_0} - 1\right)^2$$

$$K_{\text{Wire-Screen}} = \frac{22}{\text{Re}} + 1.3 \left(1 - \frac{A_0}{A_1}\right) + \left(\frac{A_1}{A_0} - 1\right)^2$$

Base area is A_o

