



Metalurgia do Pó

Introdução

Peças automotivas e filtros





Metal Duro (Cermets)

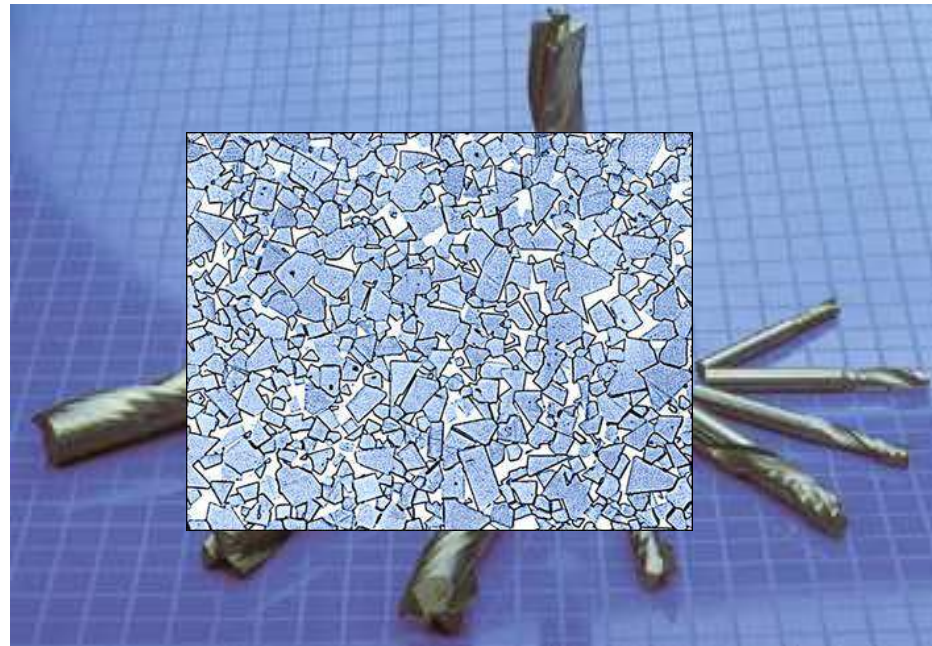



Aplicações

Application	Metals	Uses
Abrasives	Fe, Sn, Zn	Cleaning, abrasive wheels
Aerospace	Al, Be, Nb	Jet engines, heat shields
Automotive	Cu, Fe, W	Valve inserts, bushings, gears
Electrical/electronic	Ag, Au, Mo	Contacts, diode heat sinks
Heat treating	Mo, Pt, W	Furnace elements, thermocouples
Joining	Cu, Fe, Sn	Solders, electrodes
Lubrication	Cu, Fe, Zn	Greases, abradable seals
Magnetic	Co, Fe, Ni	Relays, magnets
Manufacturing	Cu, Mn, W	Dies, tools, bearings
Medical/dental	Ag, Au, W	Implants, amalgams
Metallurgical	Al, Ce, Si	Metal recovery, alloying
Nuclear	Be, Ni, W	Shielding, filters, reflectors
Office equipment	Al, Fe, Ti	Electrostatic copiers, cams

Source: R. M. German.

Esquema geral do processo

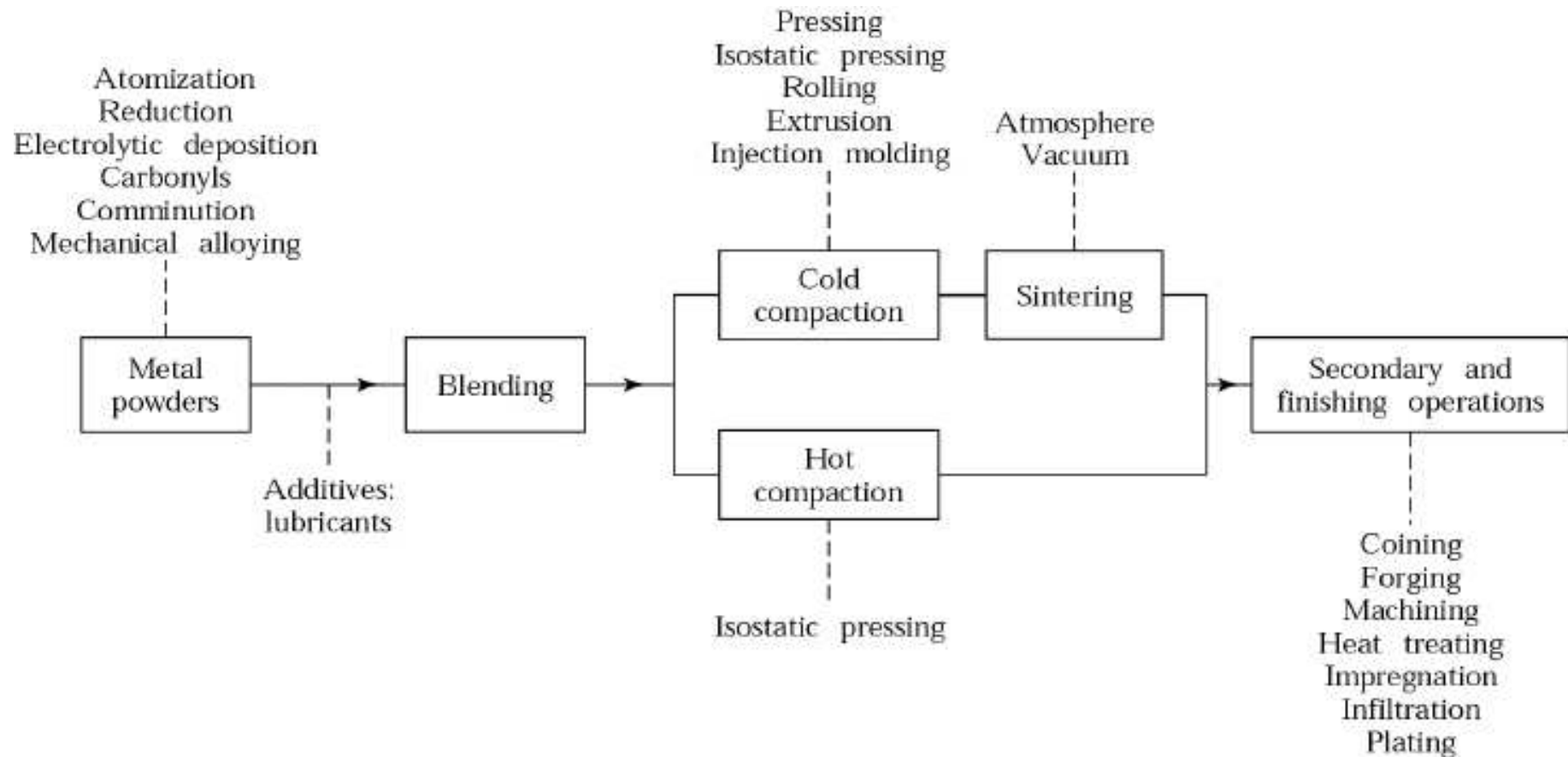



Métodos Químicos de produção de pós

- Redução de óxidos
 - Ex.: Fe₃O₄
- Precipitação a partir de soluções
 - Ex.: Ni
- Decomposição térmica
 - Carbonilas (Fe, Ni, etc.)

Obtenção de pós por moagem

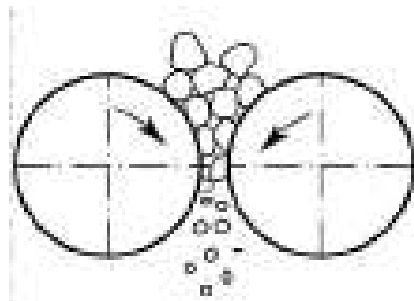

Moinho de rolos



Moinho de martelos

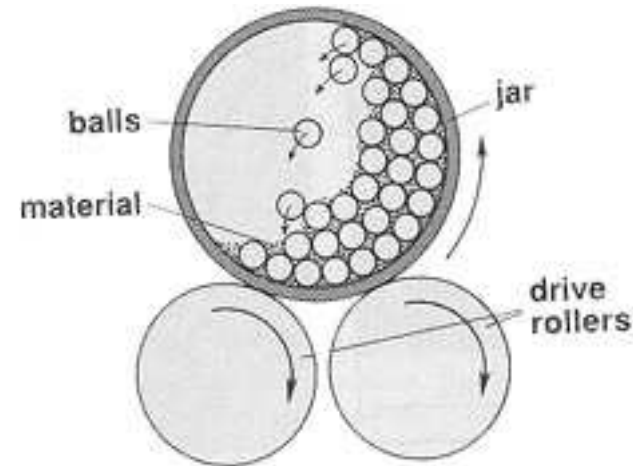
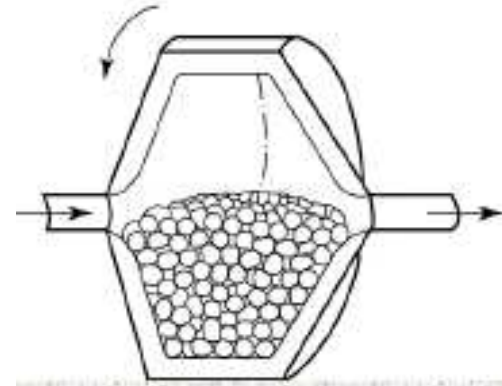

Moinho de bolas

Moagem de Alta Energia

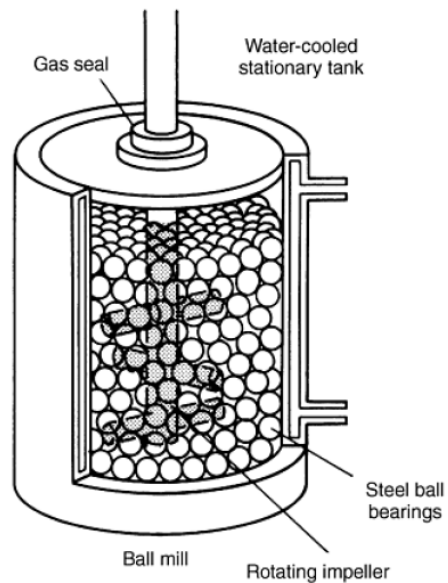

Atritor



Moinho Vibratório
(SPEX)



Moinho Planetário

Quebra e soldagem de partículas

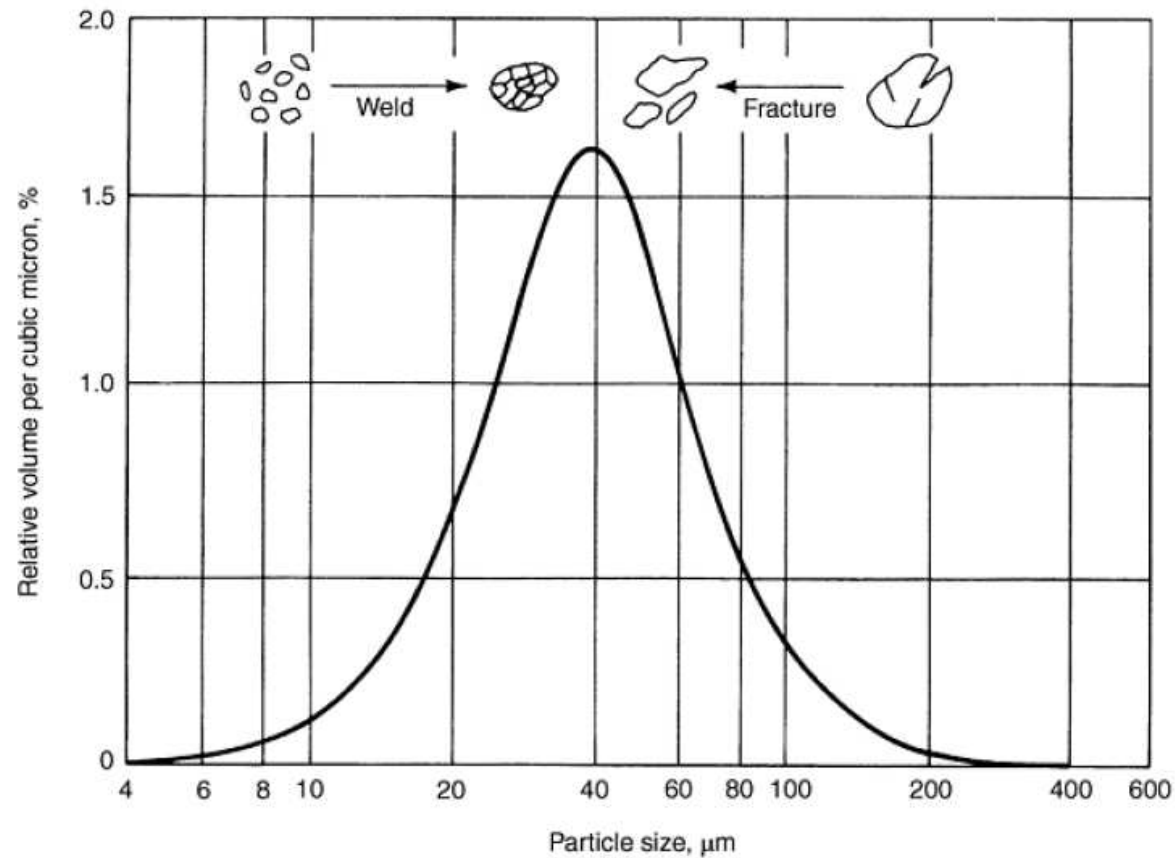
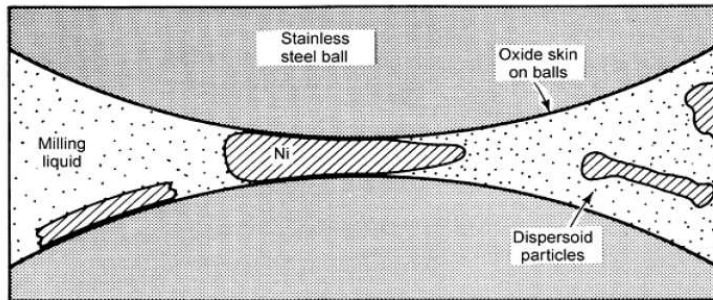
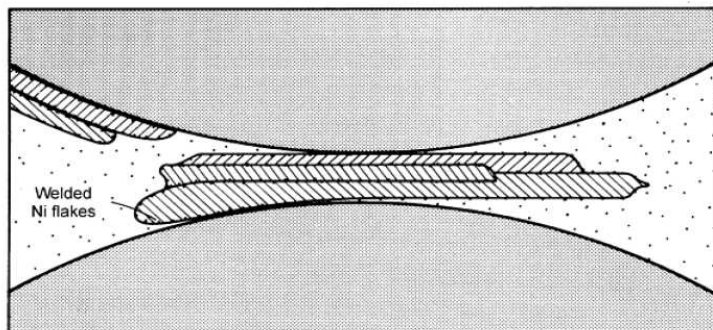

Fig. 16 Narrow particle size distribution caused by tendency of small particles to weld and large particles to fracture

Mechanical alloying



(a)



(b)

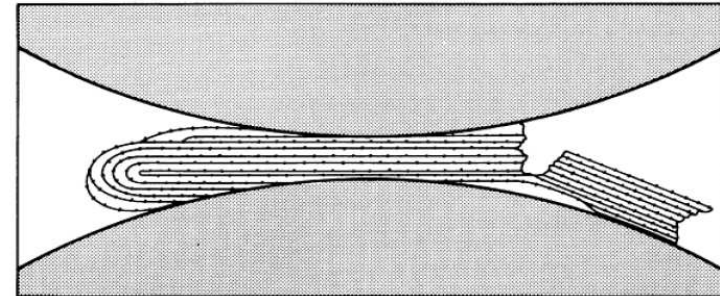

(c)

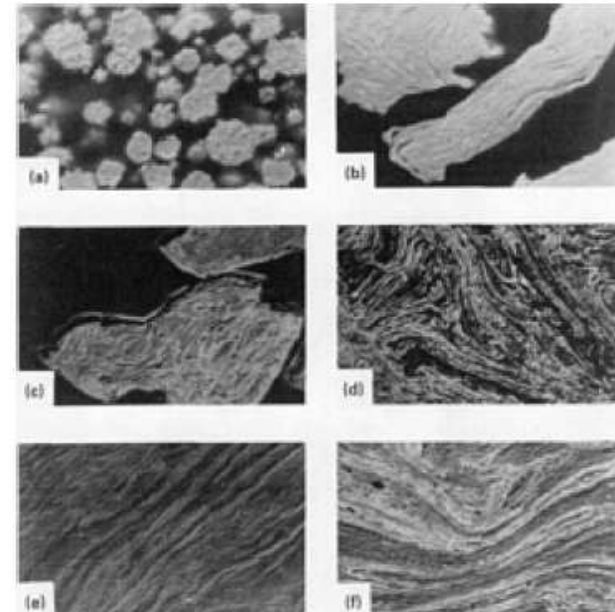

Obtenção de pós por Deposição Eletroquímica

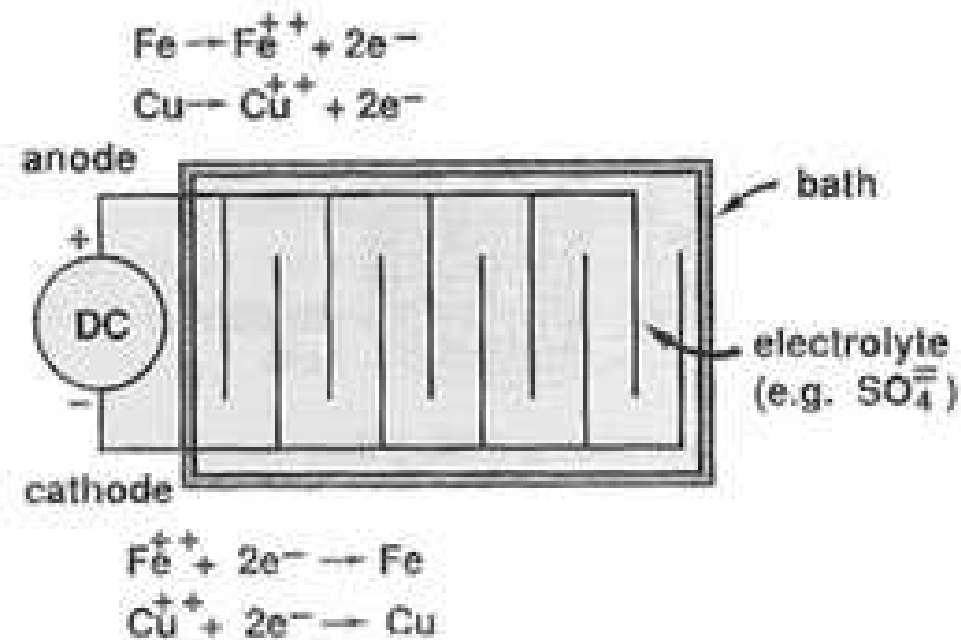

Métodos de Atomização

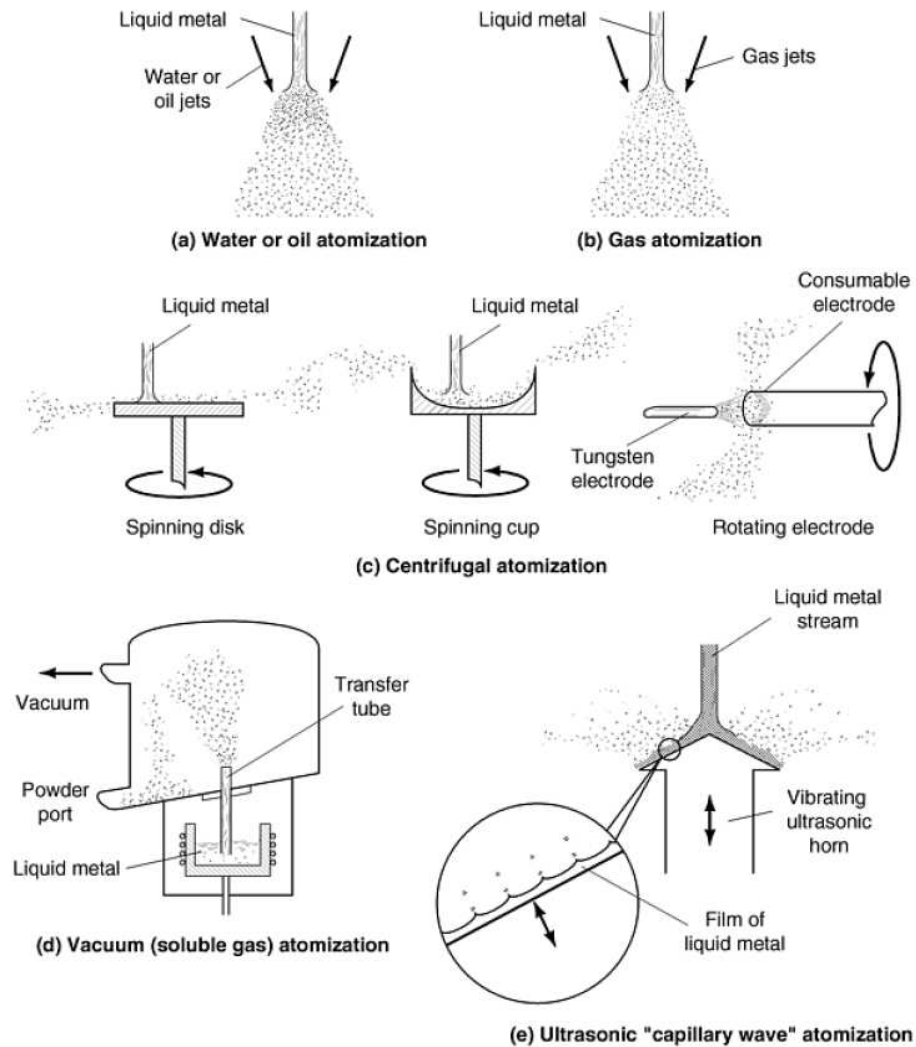

Atomização a água e a gás

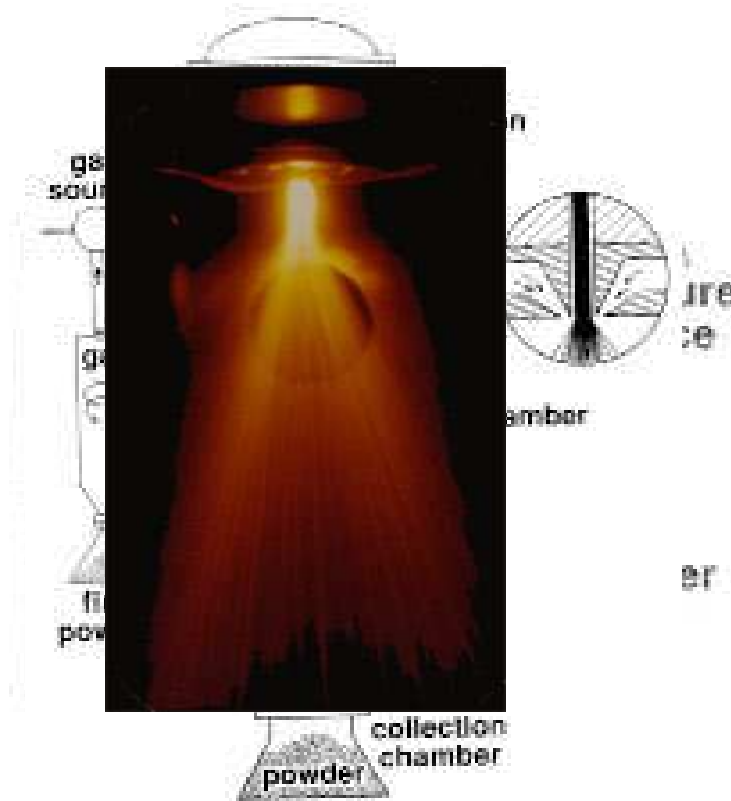

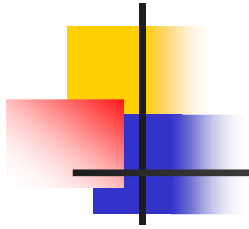

Configurações dos jatos de água

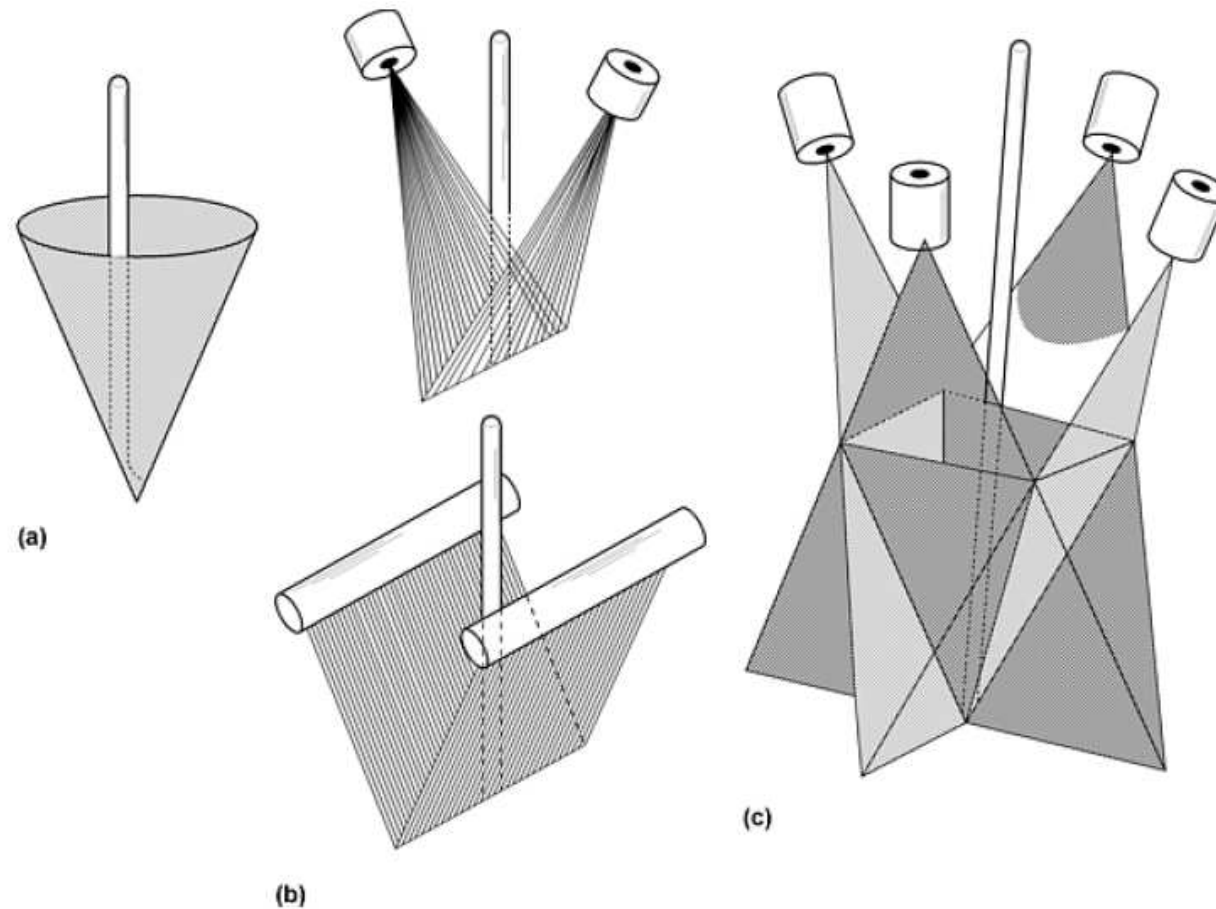

Fig. 5 Water-jet configuration. (a) Annular jet. (b) Open V-jets. (c) Closed V-jets

Configurações dos bocais

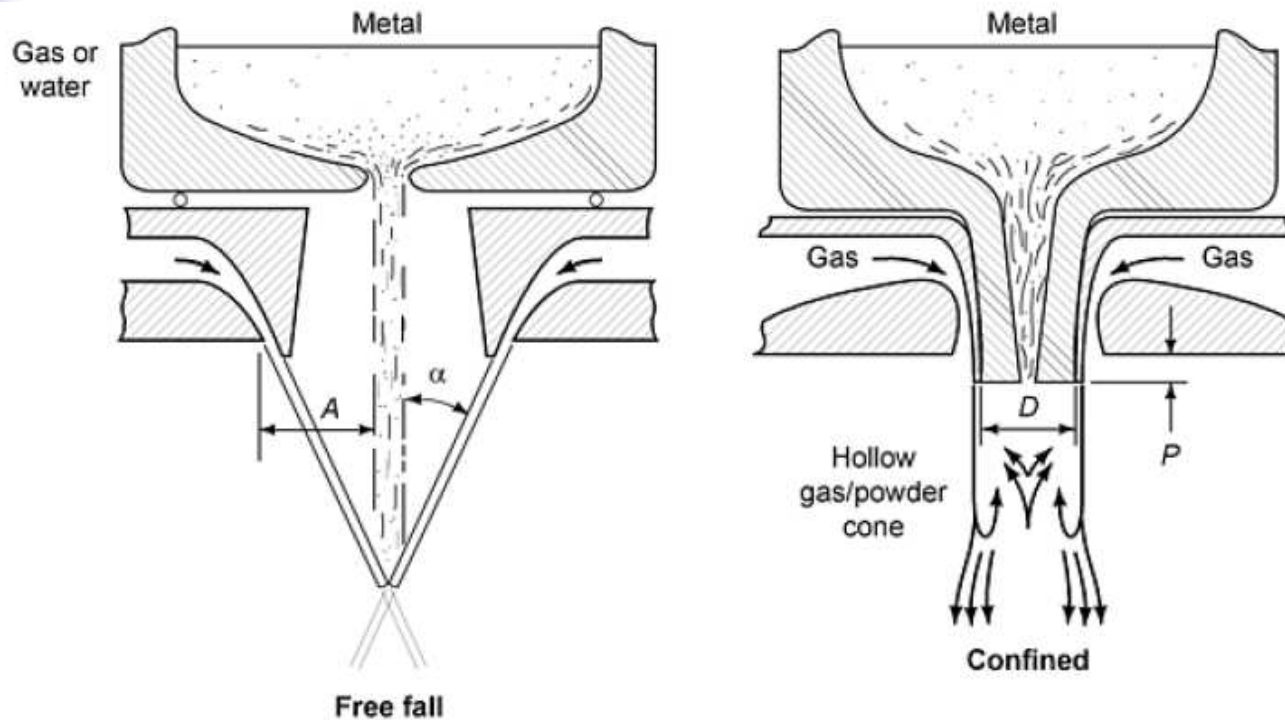
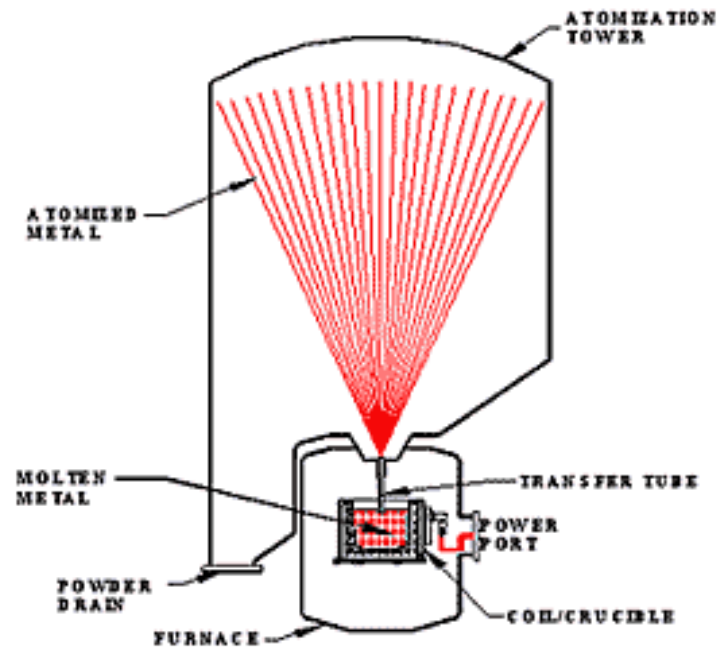

Fig. 18 Two-fluid atomization with (a) free-fall design (gas or water) and (b) continued nozzle design (gas only). Design characteristics: α , angle formed by free-falling molten metal and atomizing medium; A , distance between molten metal and nozzle; D , diameter of confined molten metal nozzle; P , protrusion length of metal nozzle

Atomização a vácuo

HMI ATOMIZATION PROCESS



Atomização por disco rotativo

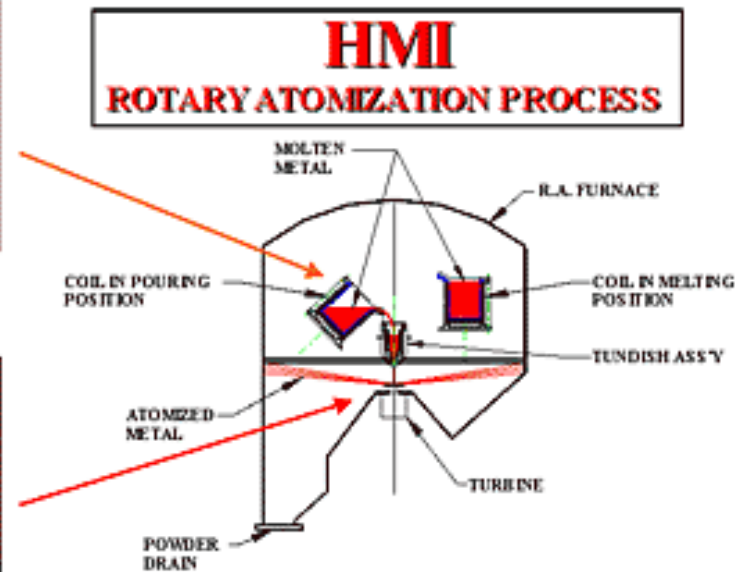

Atomização por eletrodo rotativo

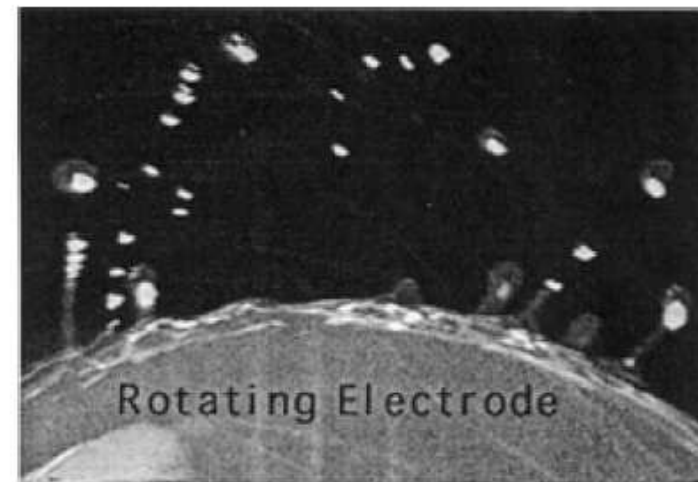
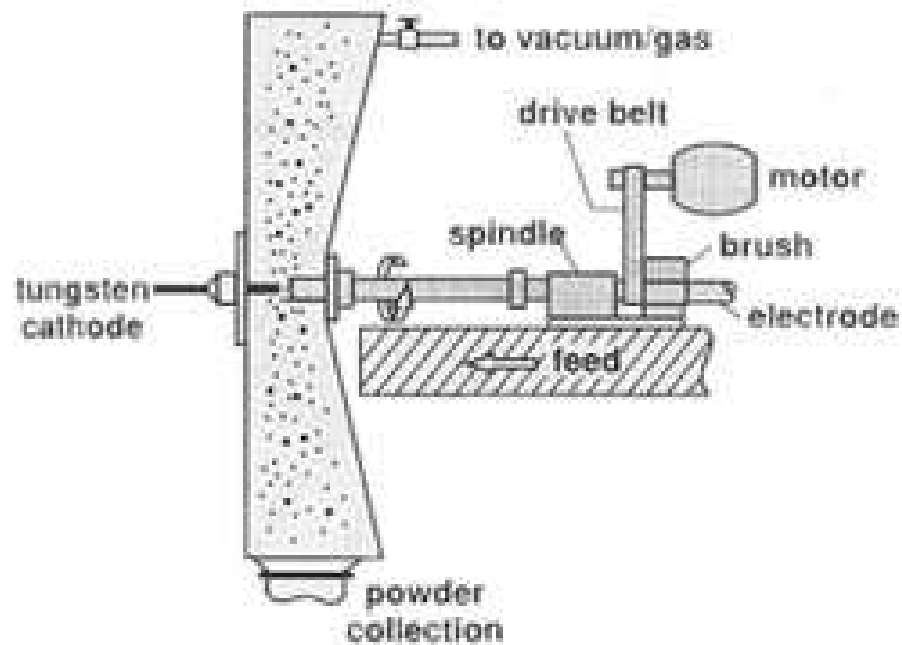

Morfologia dos pós

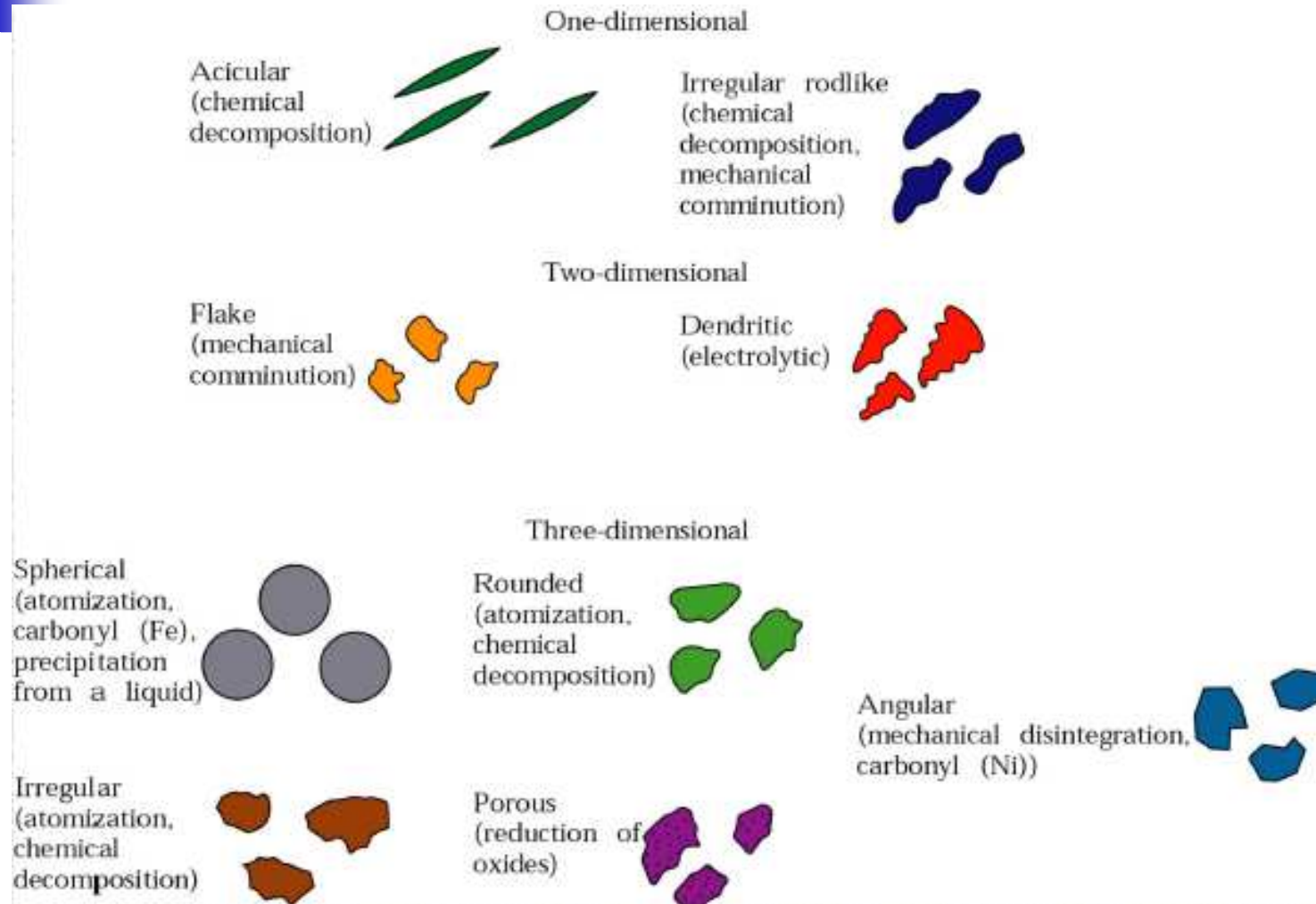

Morfologia dos pós

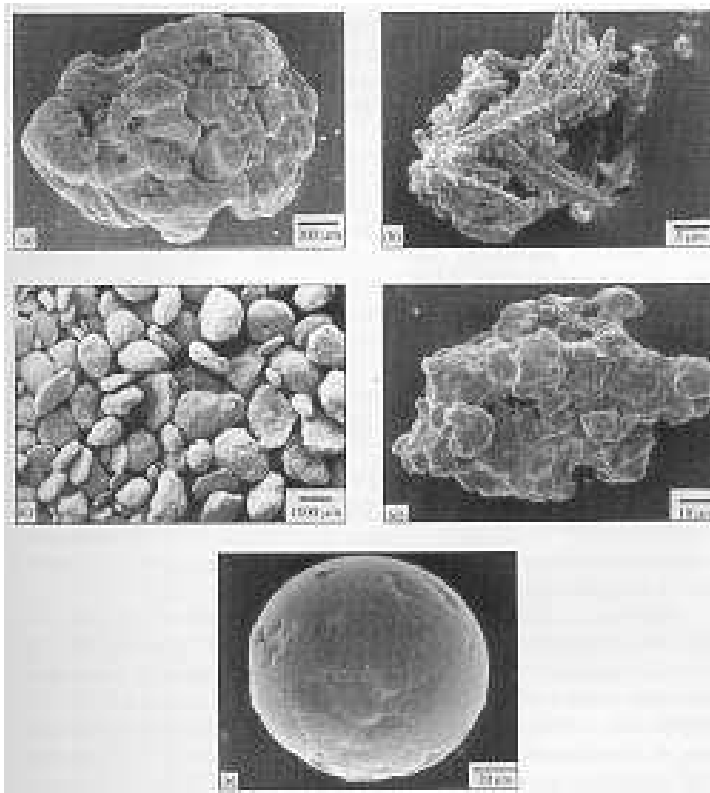

- a - redução do óxido
- b - deposição eletrolítica
- c - moagem
- d - atomização a água
- e - atomização a gás

Misturadores

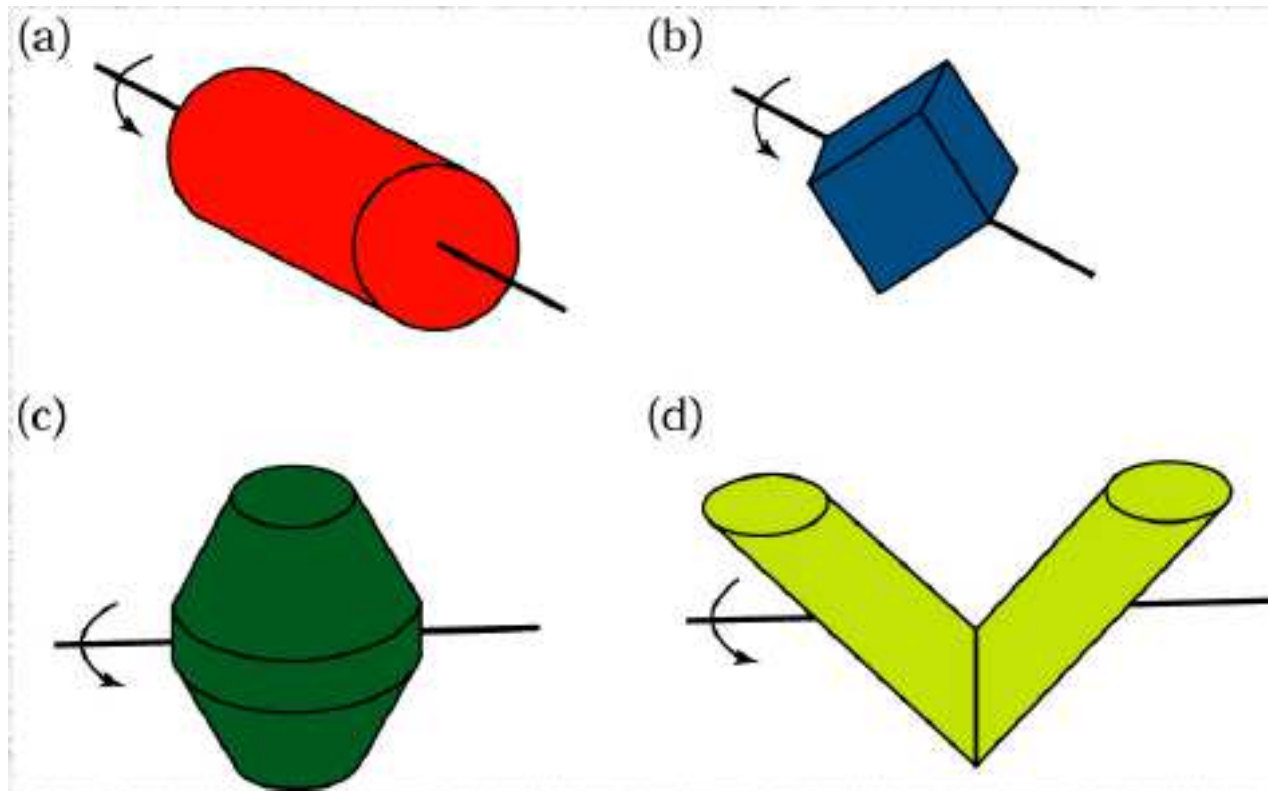

Prensagem uniaxial

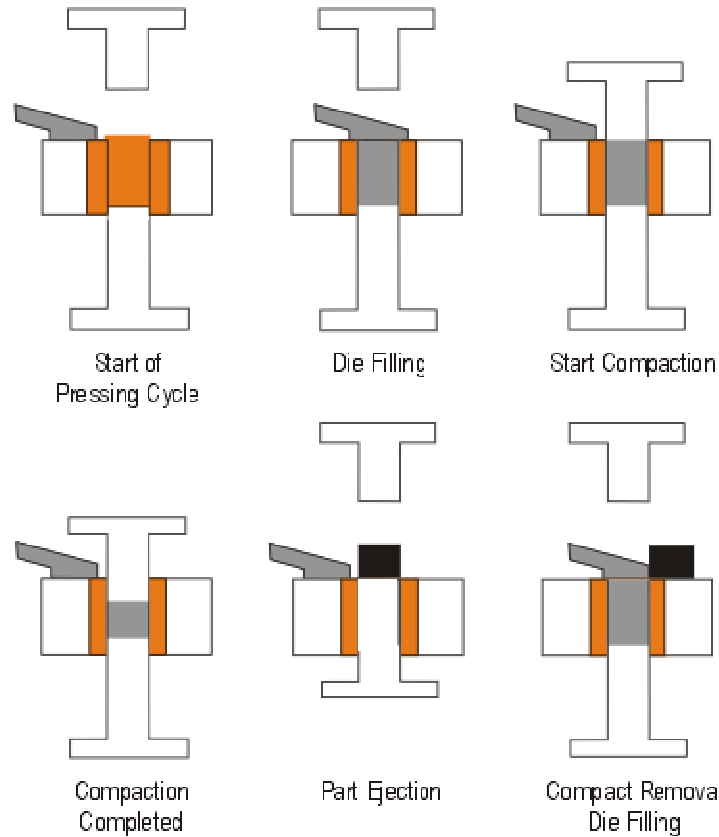

Prensagem uniaxial

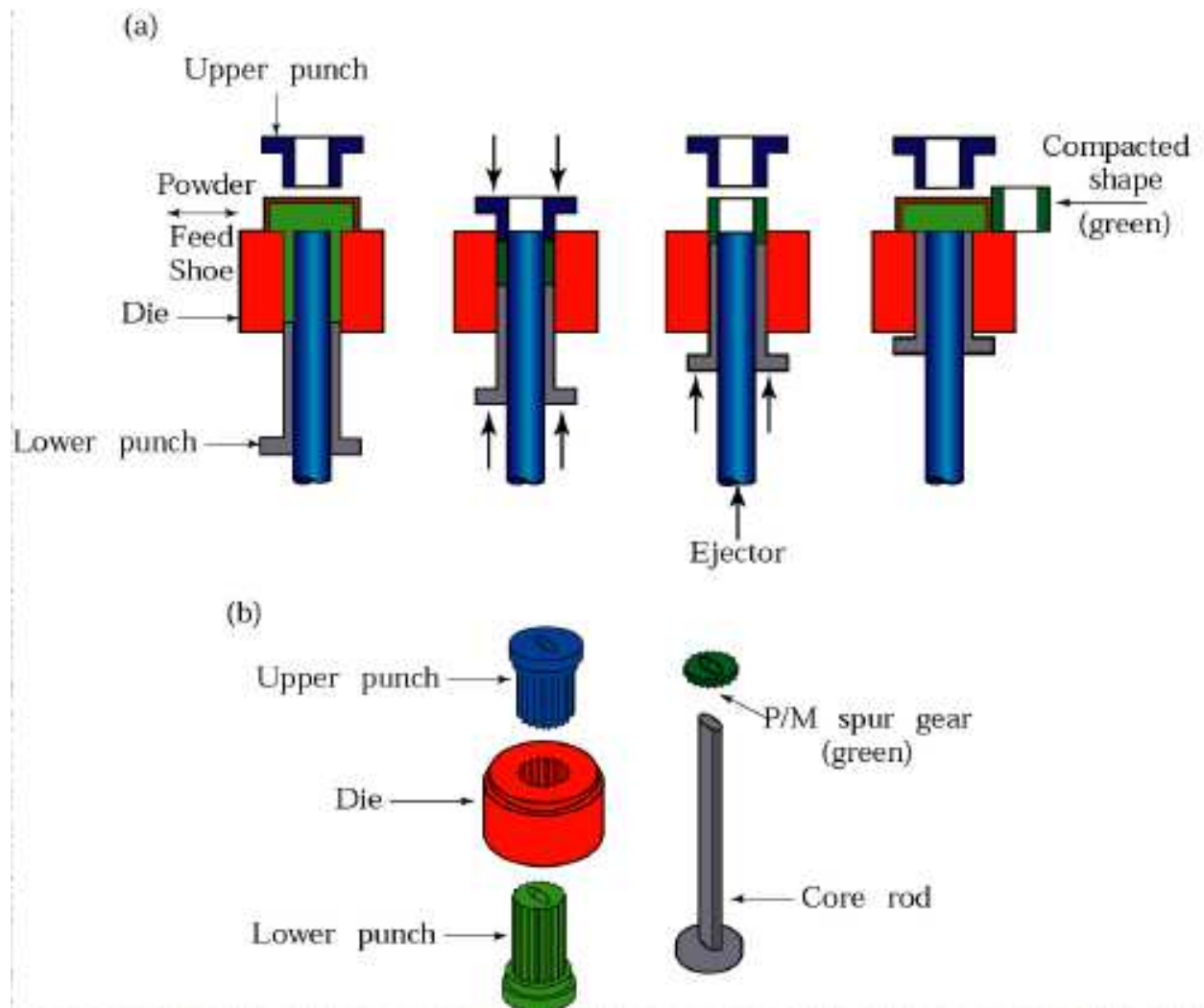

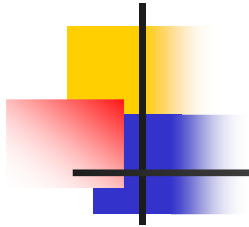

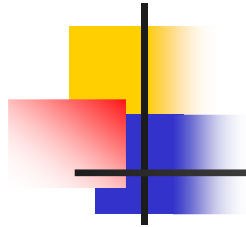



Pressões típicas

Metal	Pressure (MPa)
Aluminum	70–275
Brass	400–700
Bronze	200–275
Iron	350–800
Tantalum	70–140
Tungsten	70–140
Other materials	
Aluminum oxide	110–140
Carbon	140–165
Cemented carbides	140–400
Ferrites	110–165

Efeitos da densidade

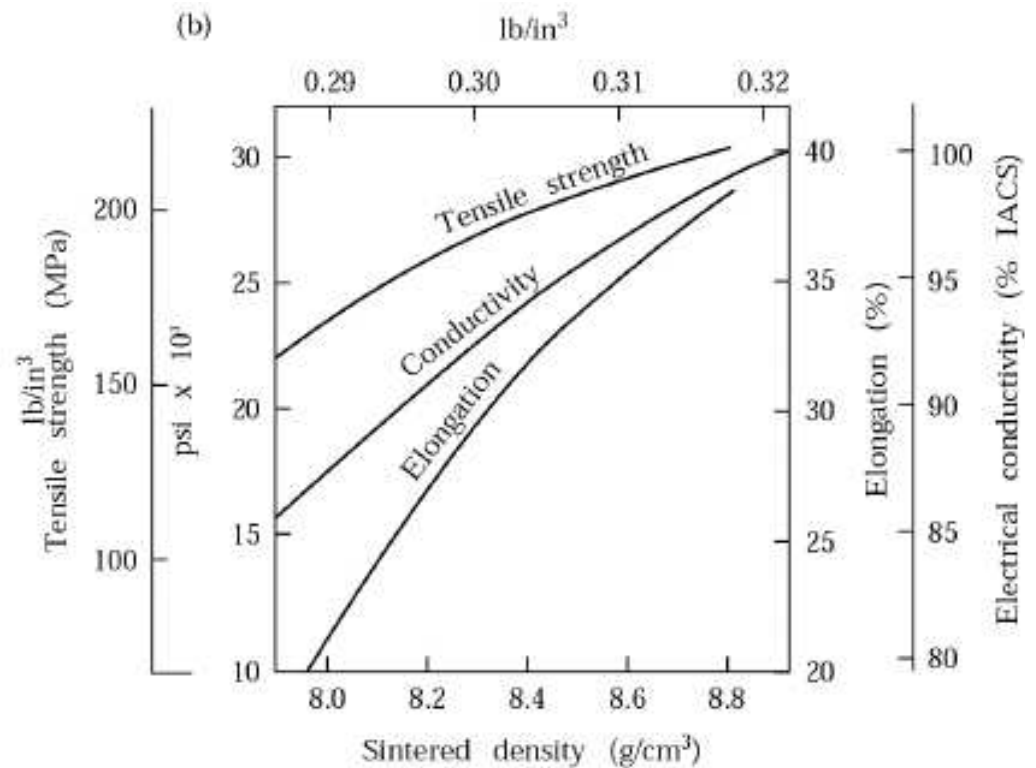
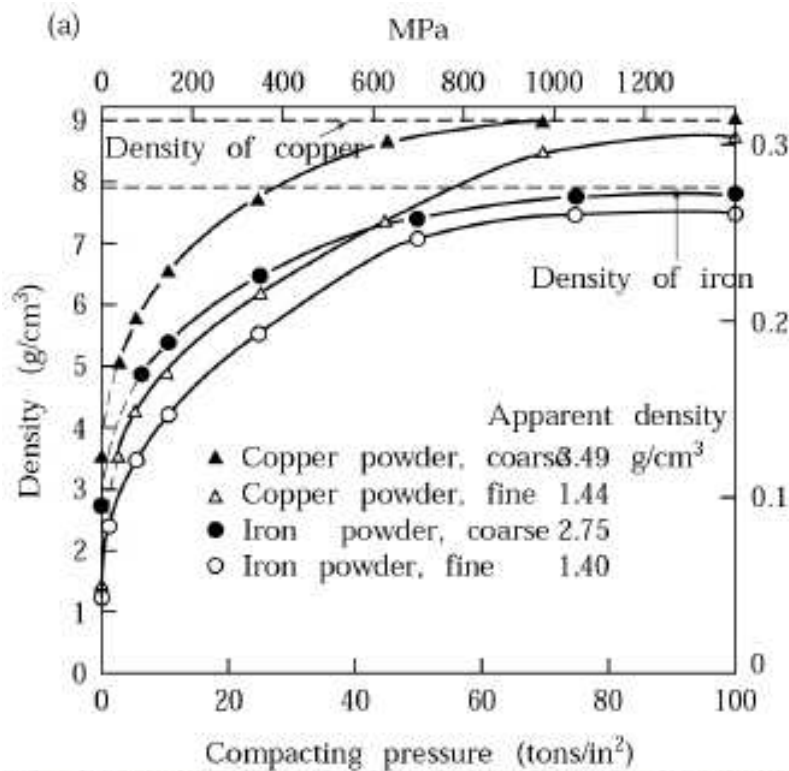

Distribuição de Densidades

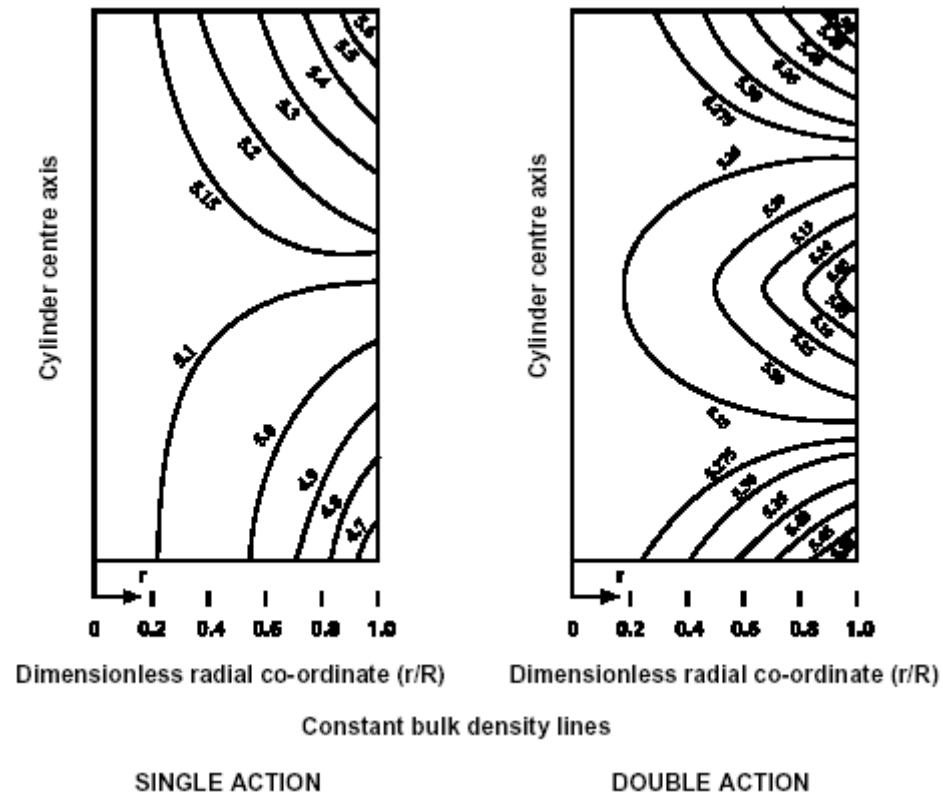

Matriz Flutuante

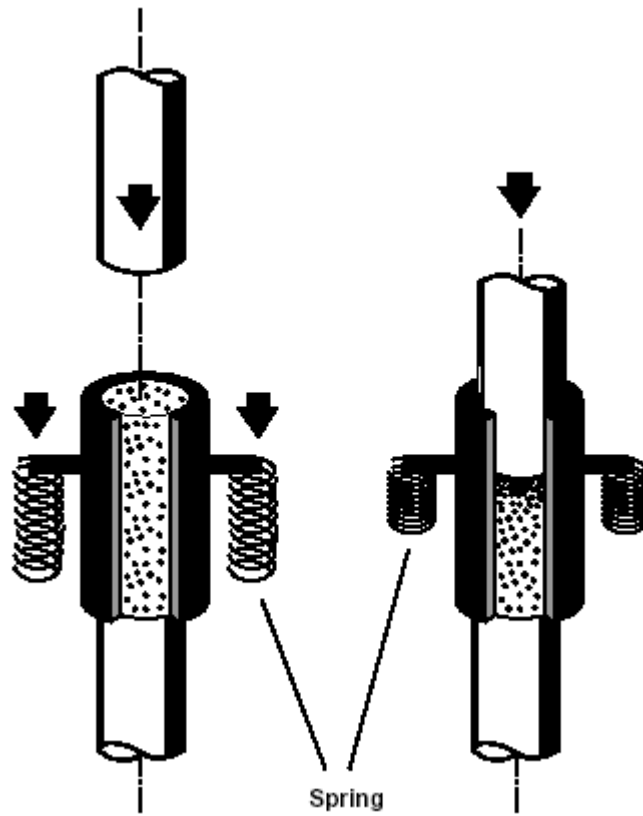

Múltiplos Estágios

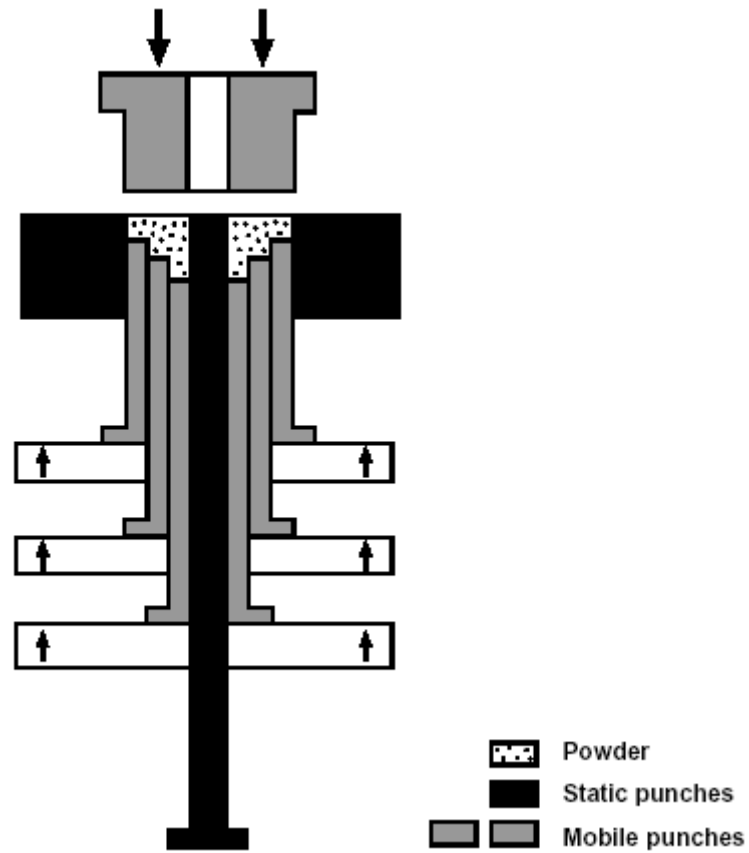

Prensagem Isostática

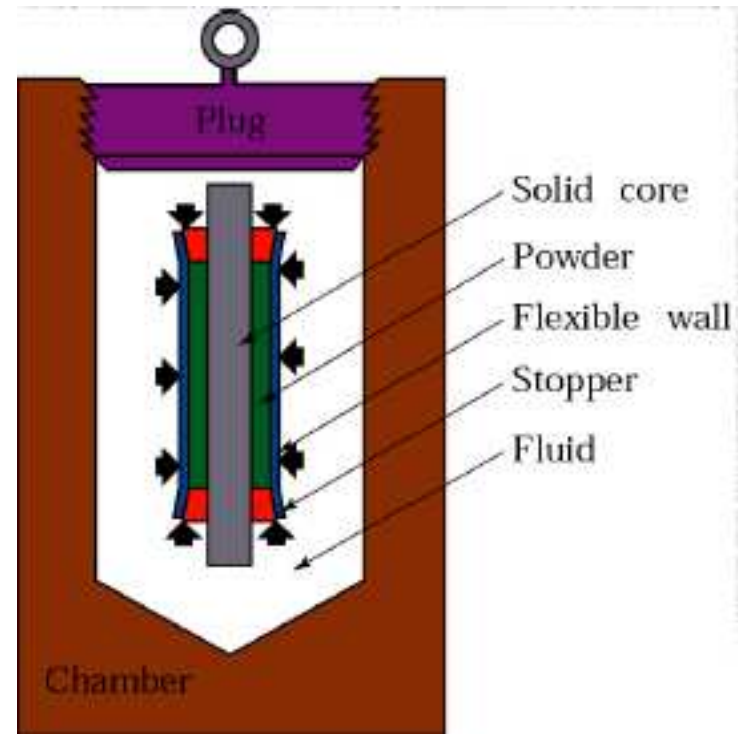
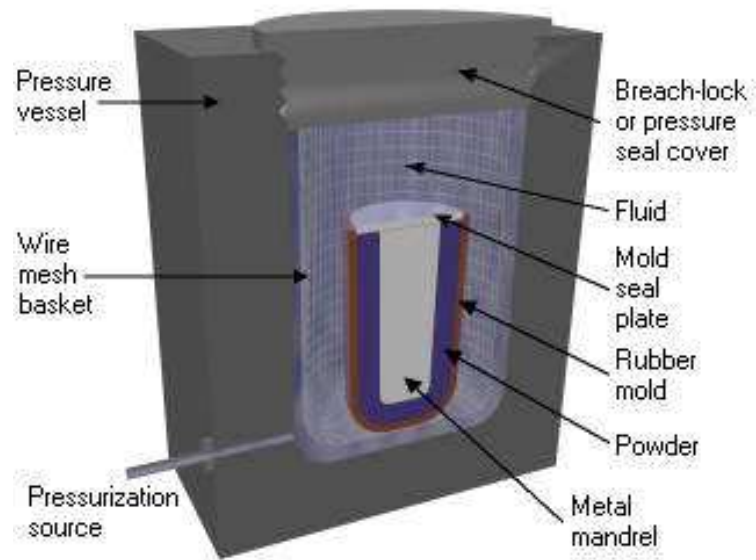

Prensagem Isostática a Quente

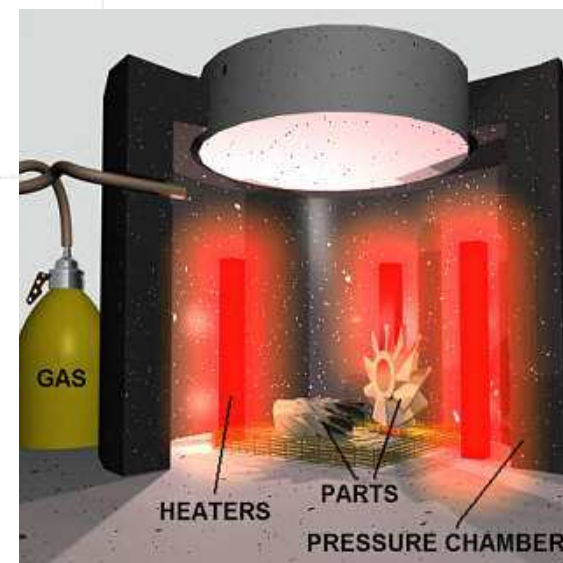
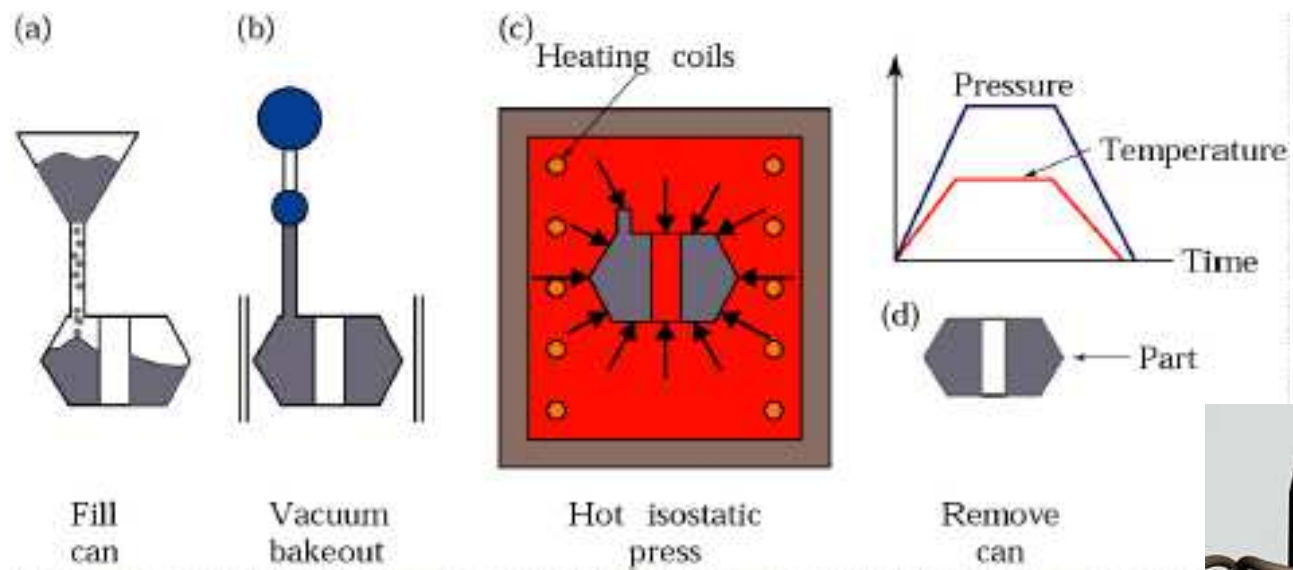



Injeção de pós





Comparação entre processos de compactação

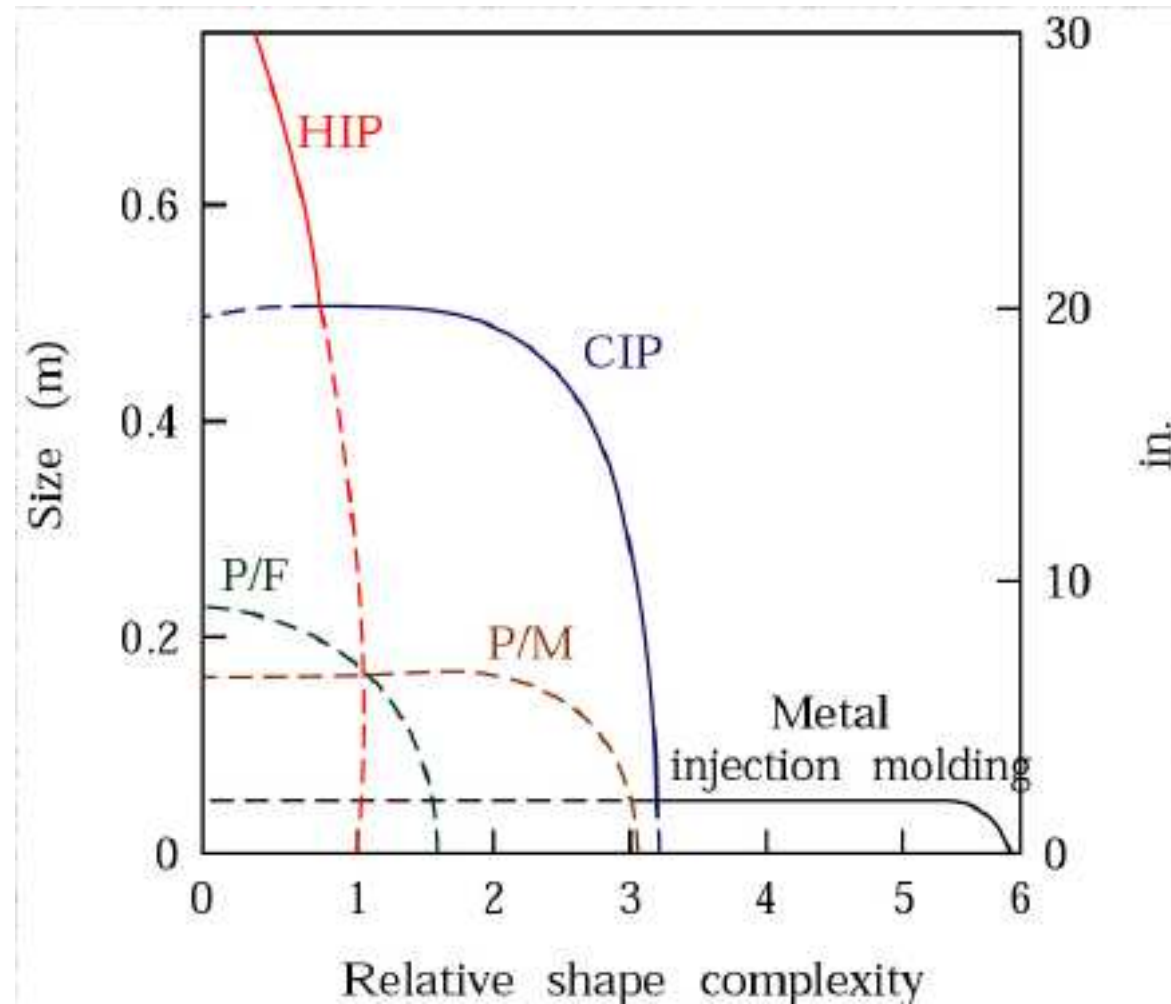



Sinterização

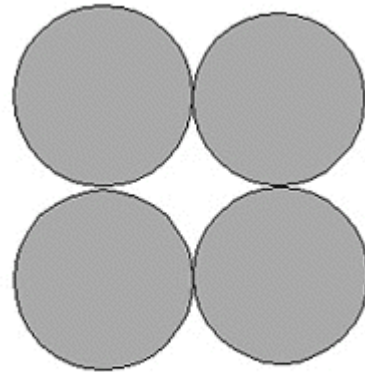

Representation of the initially unsintered powder particles.

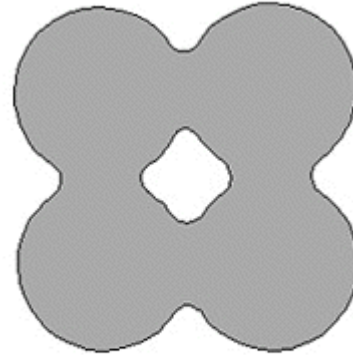

Representation of Sintered Powder Particles



Sinterização

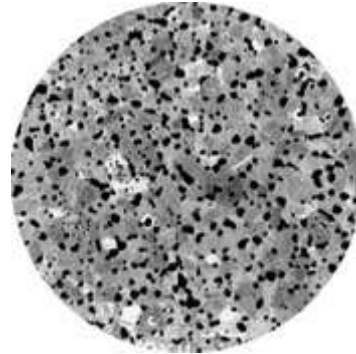
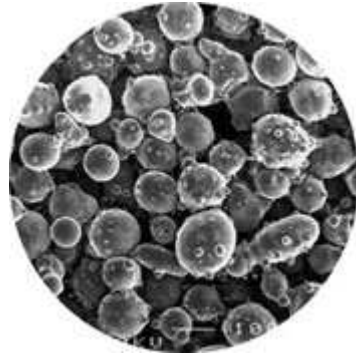



Sinterização



Mecanismos

(a) Difusão no sólido

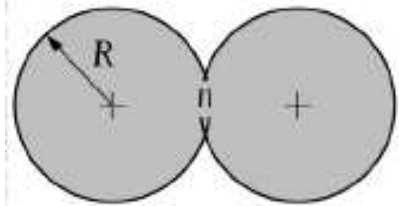
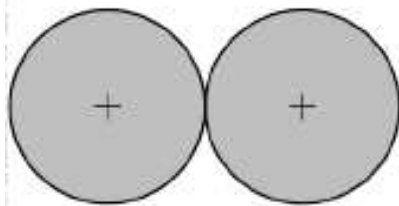

Neck formation
by diffusion

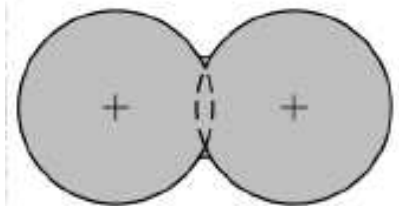

Distance between
particle centers
decreased, particles
bonded

(b) c/ presença de fase líquida

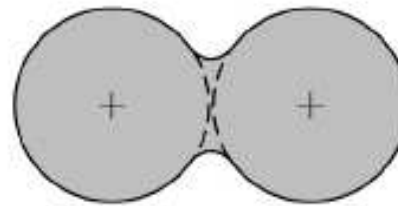
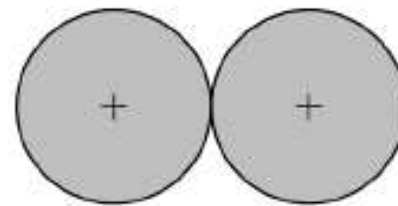

Neck formation
by vapor phase
material transport

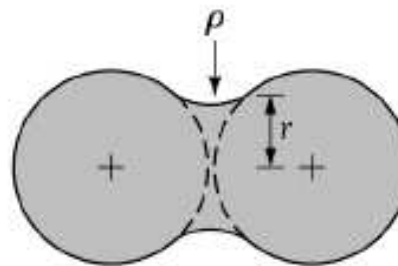

Particles bonded,
no shrinkage (center
distances constant)



Temperaturas típicas

Material	Temperature (° C)	Time (Min)
Copper, brass, and bronze	760–900	10–45
Iron and iron-graphite	1000–1150	8–45
Nickel	1000–1150	30–45
Stainless steels	1100–1290	30–60
Alnico alloys (for permanent magnets)	1200–1300	120–150
Ferrites	1200–1500	10–600
Tungsten carbide	1430–1500	20–30
Molybdenum	2050	120
Tungsten	2350	480
Tantalum	2400	480



Operações de acabamento

- Tratamentos térmicos
- Reprensagem (Calibragem)
- Infiltração
- Acabamentos superficiais

Métodos de Infiltração

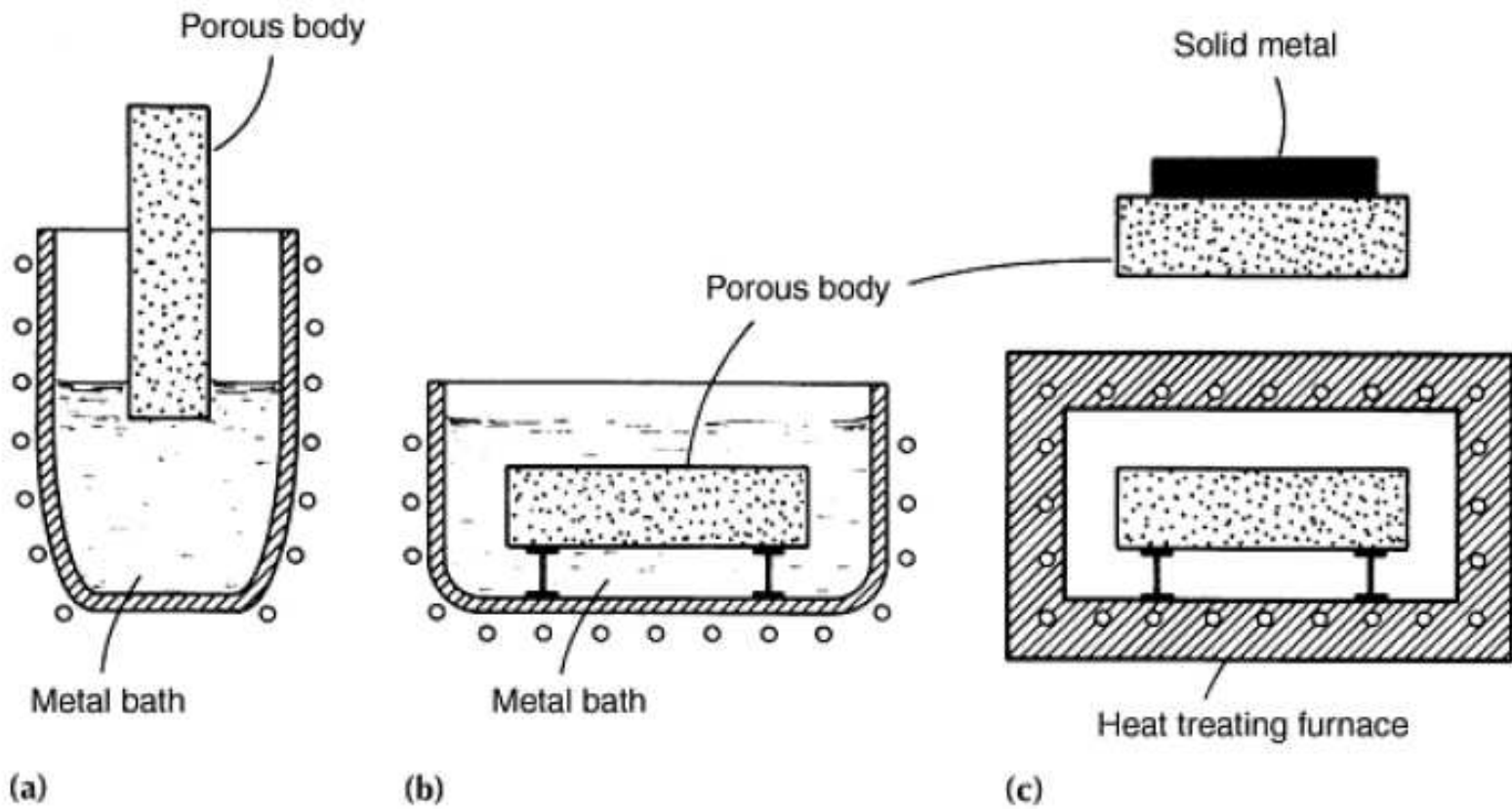

Aspectos do design de peças sinterizadas

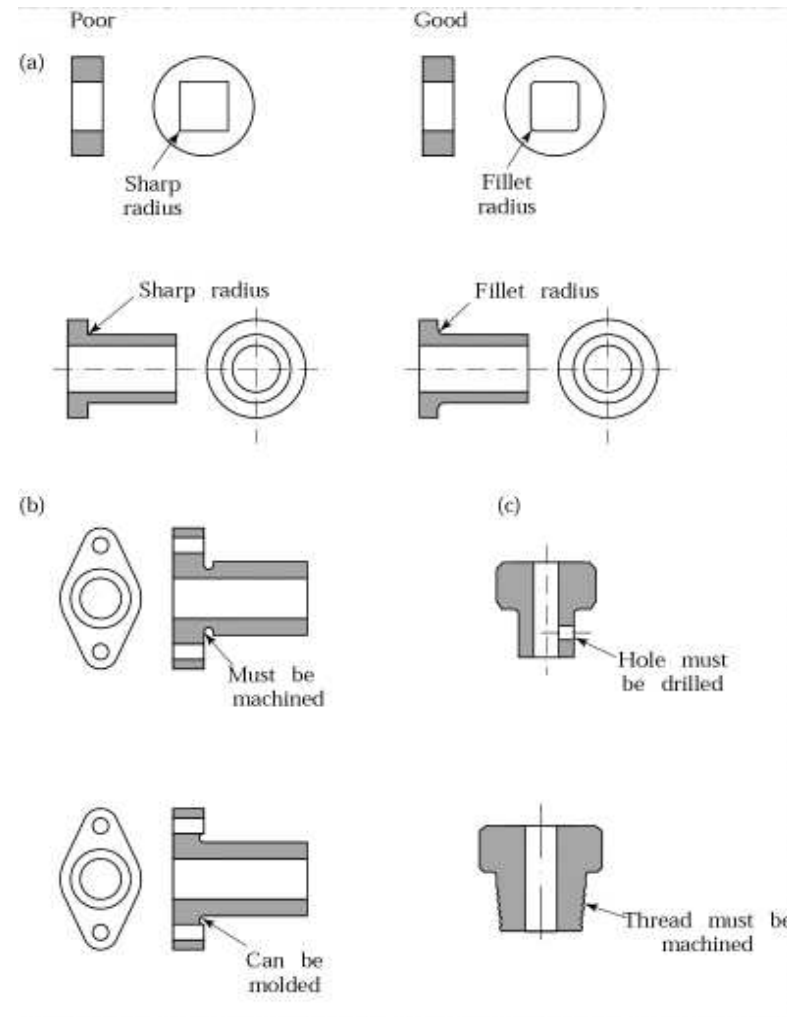

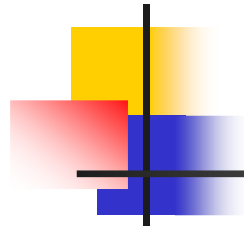

Outros Processos

Conformação por Spray

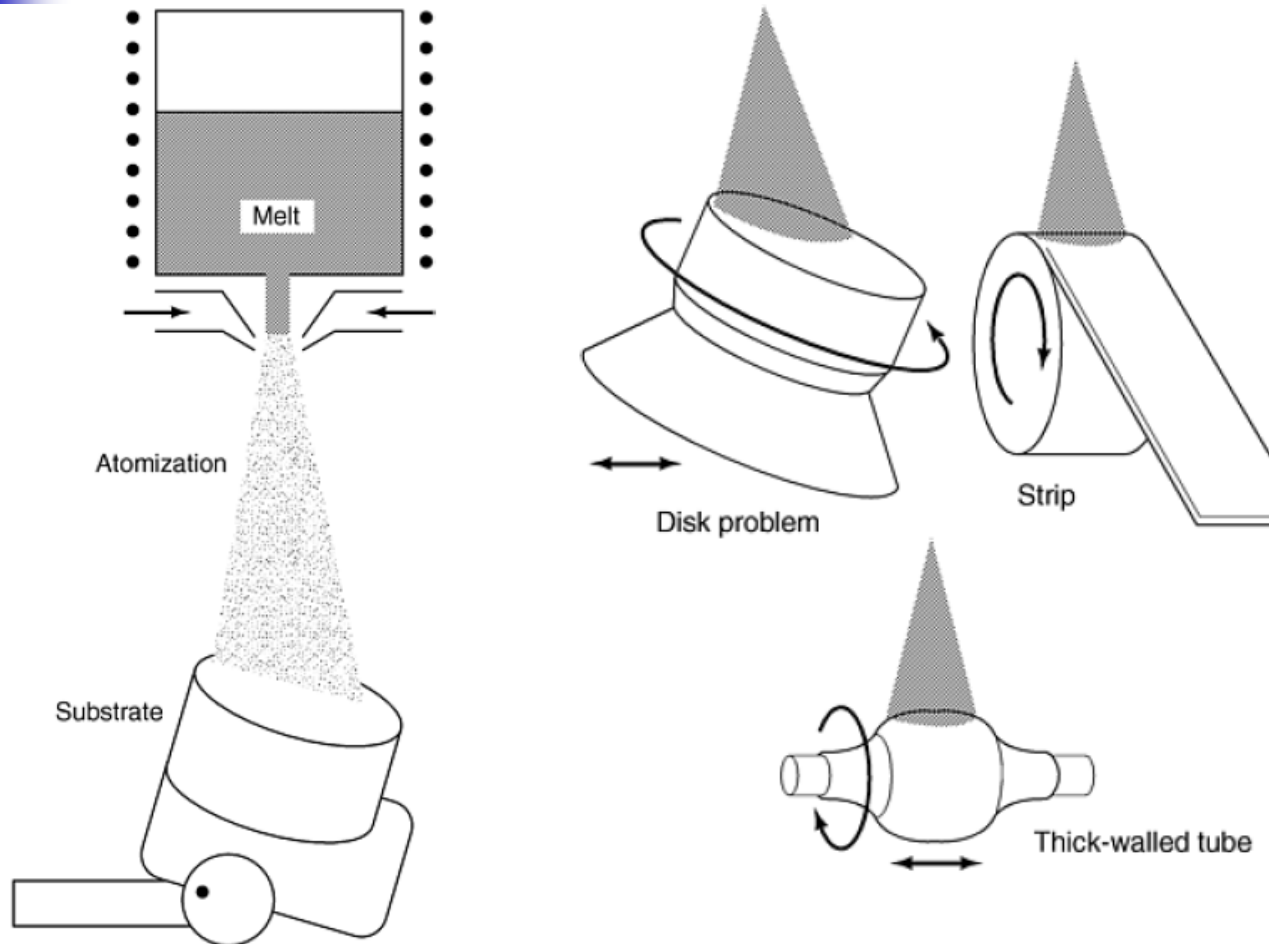

- Filme

Revestimento por Spray

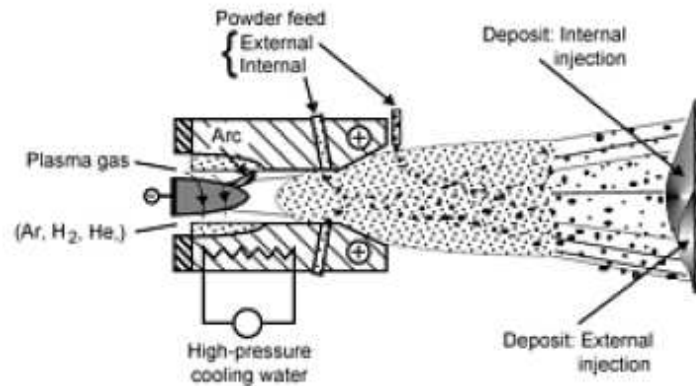
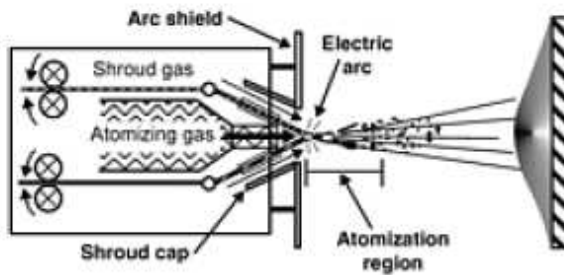
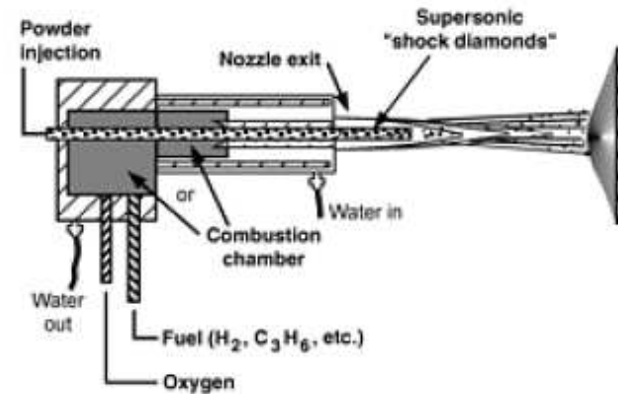
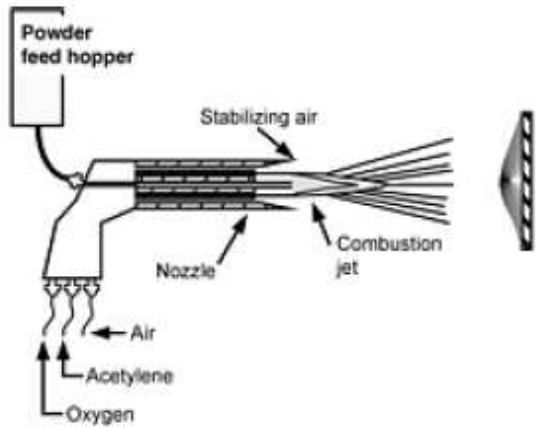

Formação do depósito por spray

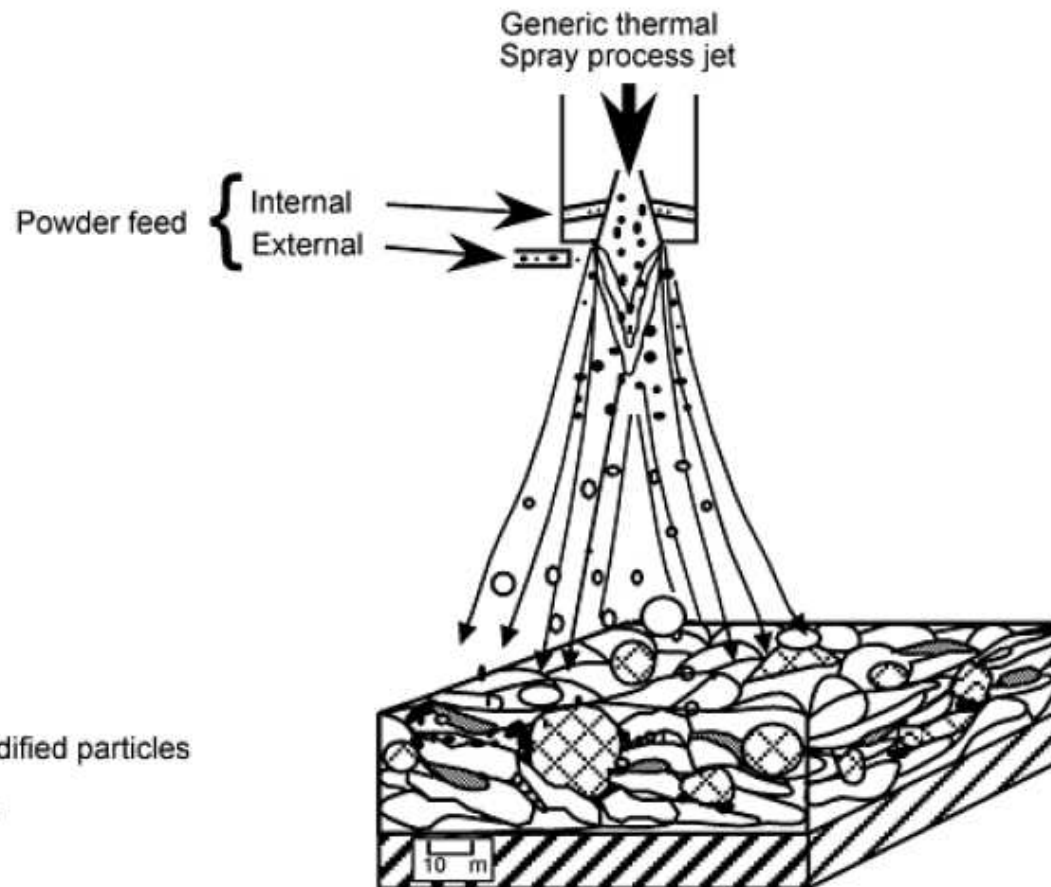

Sinterização a LASER

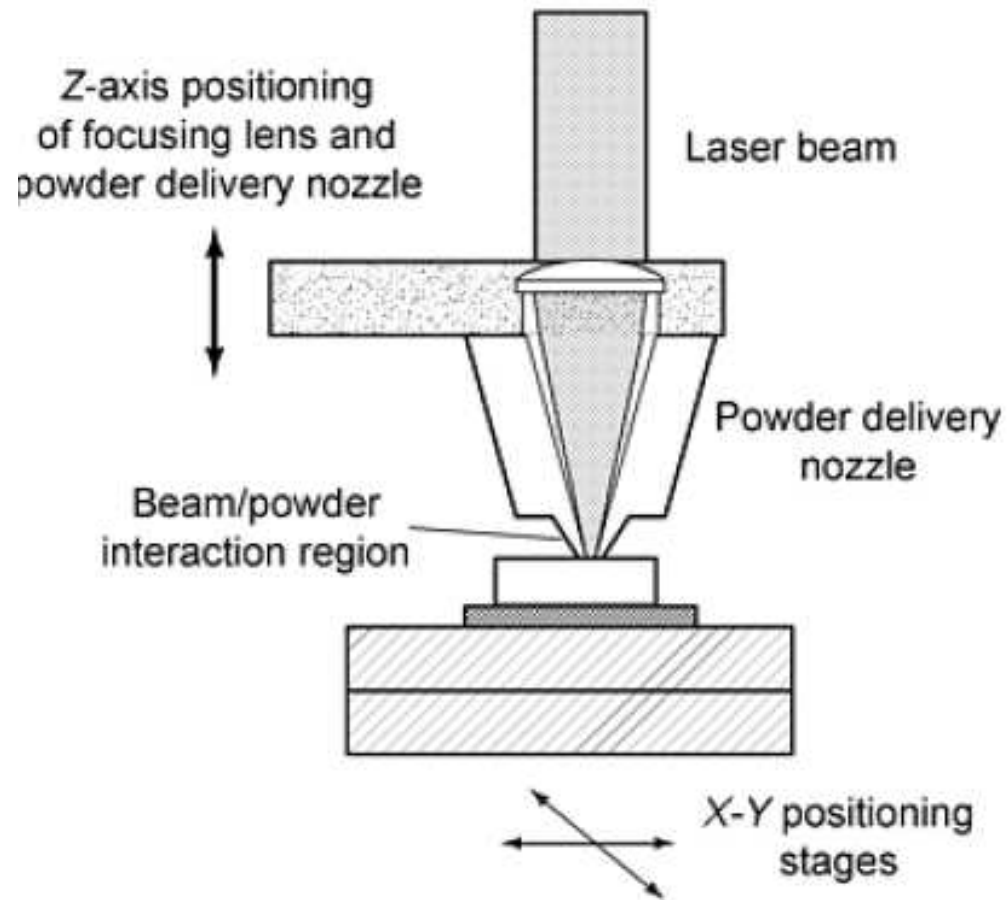

Caso: Bucha autolubrificante

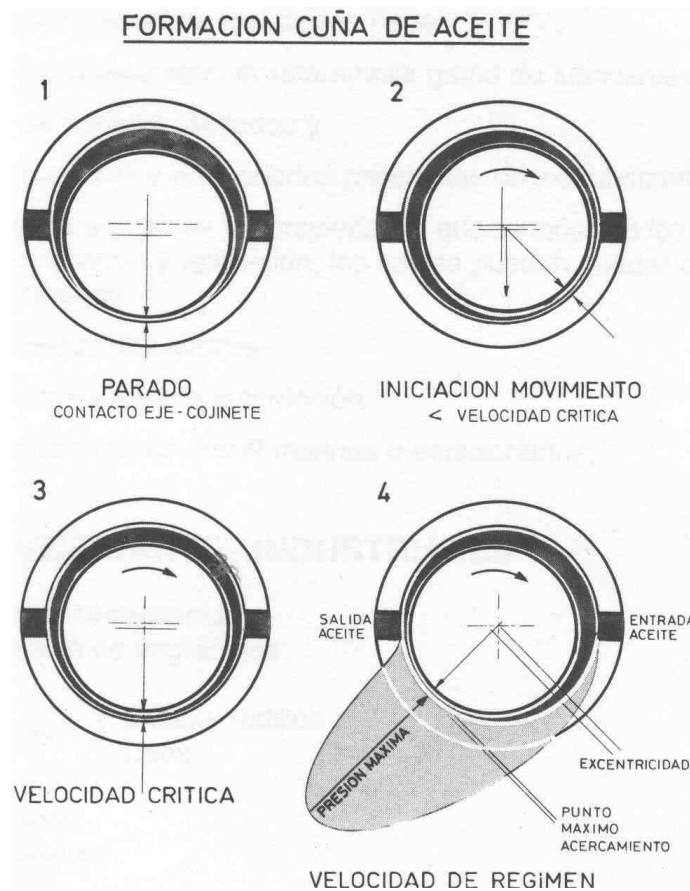

- Funcionamiento de una bucha comum

-Funcionamiento de uma bucha autolubrificante

Caso: Bucha autolubrificante

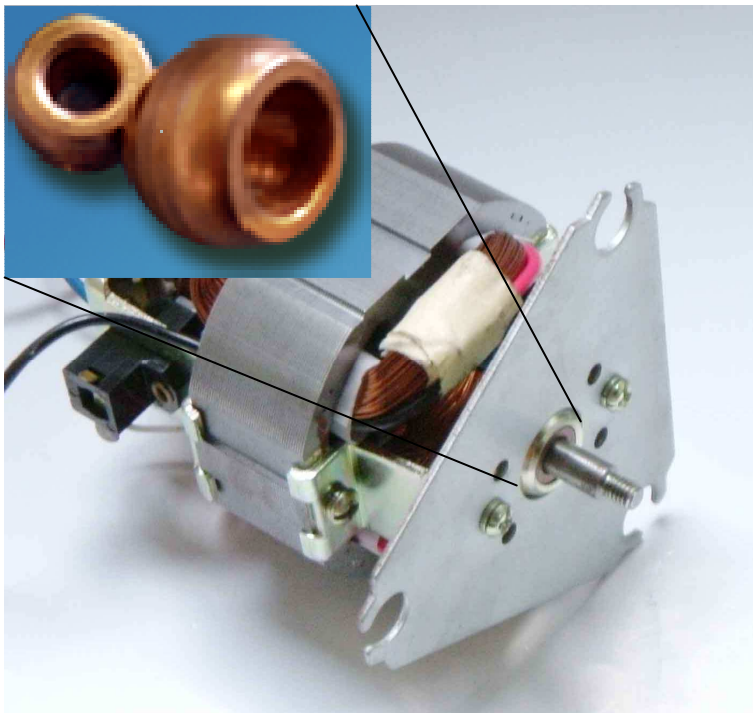

Exemplo de aplicação

Características exigidas:

Diâmetro interno: $7,952 - 7,961 \text{ mm}$

Diâmetro esférico: $15,95 - 16,05 \text{ mm}$

Altura total: $10,973 - 11,227 \text{ mm}$

Resistência Radial: $21,3 \text{ kgf}$

Densidade: $5,5 - 6,0 \text{ g/cm}^3$

Porosidade: 20%

Poros arredondados

Características adicionais?



Caso: Bucha autolubrificante

Composição química típica (% em peso)

C	Cu	Pb	Fe
1,2	3,0	1,5	94,3

C – aumenta RM do Fe por SS, grafita livre (lubrificante sólido e absorve vibrações)

Cu – endurecimento por precipitação

Pb – dificulta difusão do C em Fe (grafitizante)

Caso: Bucha autolubrificante

- Mistura

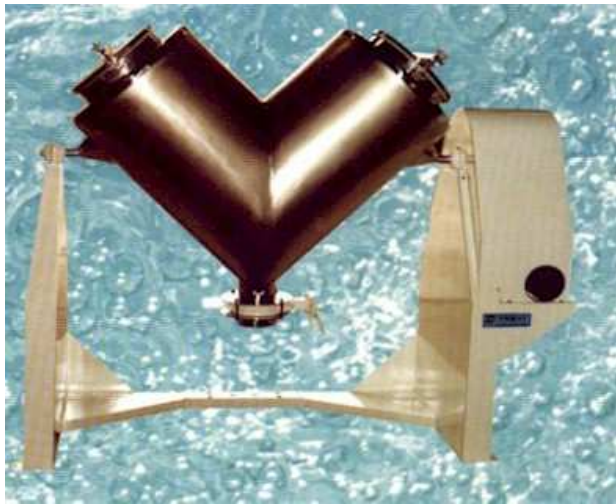

Pós elementares e cera
Lubrificante
Tempo ~ 25 minutos

QQ da mistura por medidas de
Densidade aparente



Caso: Bucha autolubrificante

- Prensagem uniaxial (dupla ação)
- Sinterização em atmosfera levemente redutora
- Forno com 3 zonas: pré-sinterização (780oC), sinterização (1020oC), resfriamento
- Recompressão: para garantir tolerância interna de 9 micrometros



Caso: Bucha autolubrificante

- Impregnação
 - Vácuo de $\sim 0,9$ atm
 - Peça mergulhada em óleo
 - SAE 30 – uso geral
 - SAE 10 – eixos rápidos e de baixa carga
 - SAE 5 – baixas T ou grandes variações climáticas

Caso: Filamento de lâmpada

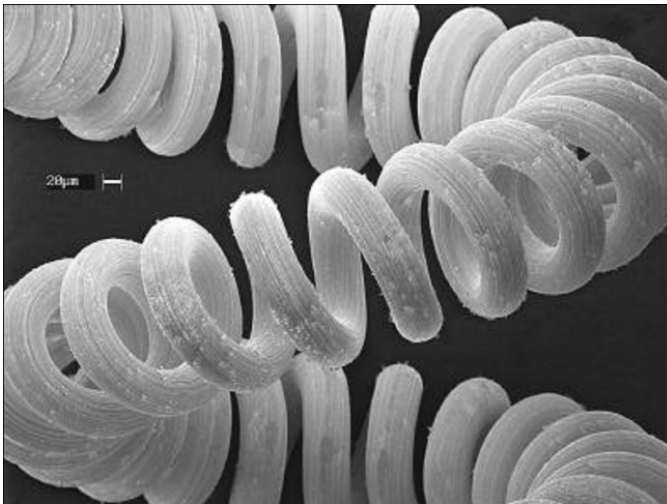

Filamento de uma lâmpada incandescente comum

$T \sim 3000\text{oC}$

1,5 a 300V

Apenas 5% da energia é convertida em luz

Lâmpada comum 60W:

580 mm

45 micrometros



- Características exigidas

- Alta T de fusão
- Baixo coeficiente de dilatação (fadiga térmica)
- Resistência à fluência

W: $T_f = 3410^\circ\text{C}$, $\alpha = 4,5 \times 10^{-6} \text{ }^\circ\text{C}^{-1}$

Adições (ppm) de óxidos de K, Si e Al

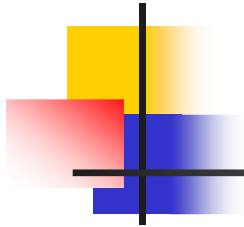

- Redução carbotérmica do óxido de W
- Moagem (partículas de $\sim 150 \mu\text{m}$)
- Mistura com lubrificante
- Prensagem isostática (300 MPa) em molde de borracha: barra 4-30 mm x 60-120 mm, densidade de $\sim 56\%$
- Pré-sinterização: 1200 a 1400°C, 10 a 15 minutos, atm. de H_2

Caso: Filamento de lâmpada

- Sinterização:
passagem direta
de corrente, 5000
a 6000 A, atm. de
hidrogênio, $T \sim$
2900°C, 45 min
densidade final \sim
85 a 95%

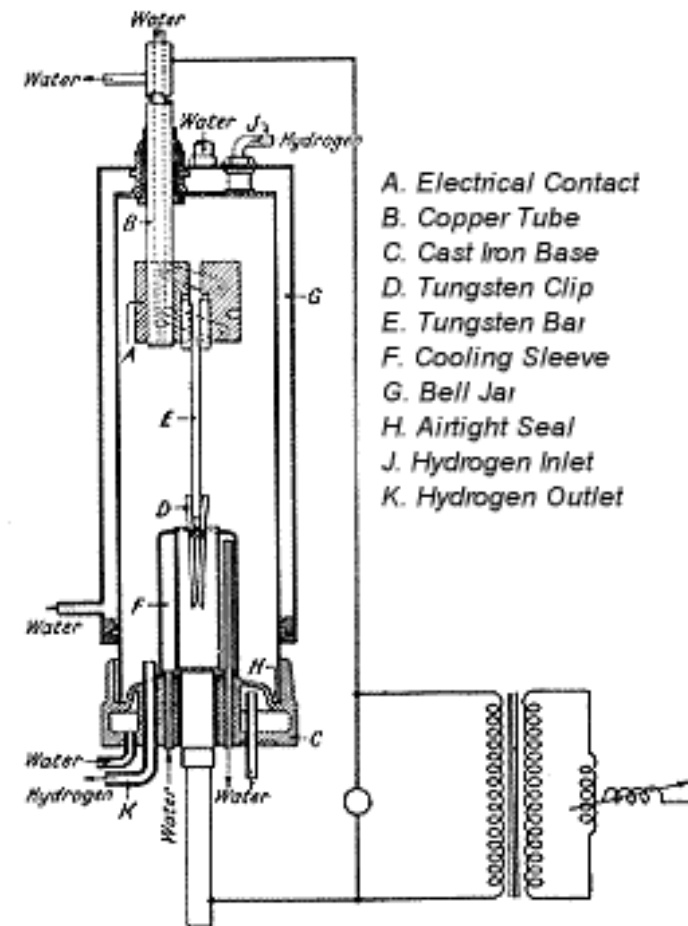

Caso: Filamento de lâmpada

■ Sinterização

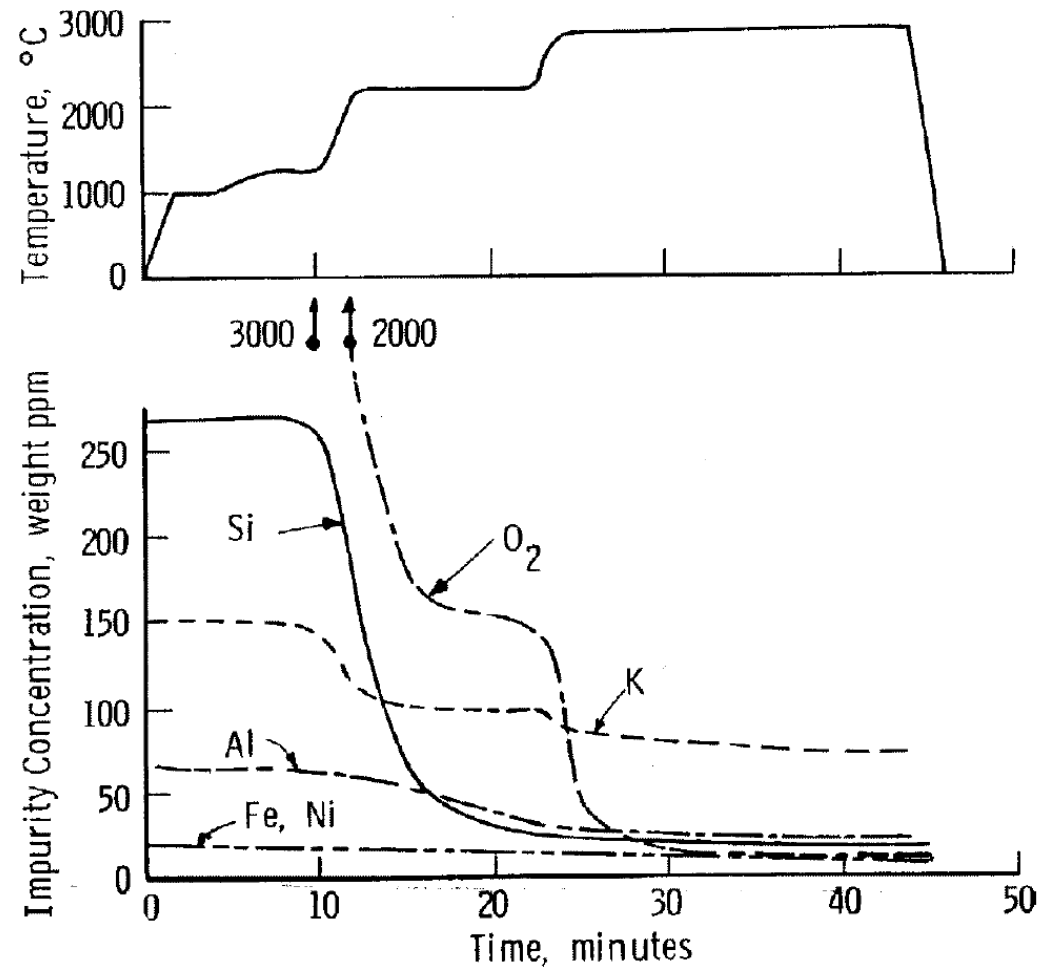

Caso: Filamento de lâmpada

- Conformação a quente
- Forjamento rotativo para barras de 4 a 7 mm (10000 rpm)

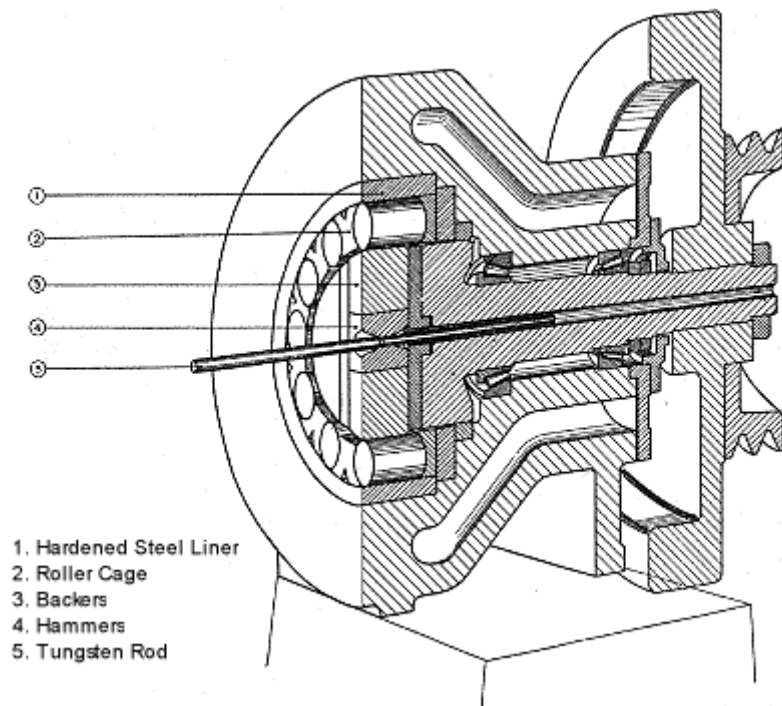



Caso: Filamento de lâmpada

- Barras mais espessas: trem de laminação (c/ recrist. e alívio de tensões)
- Espessura final: 2,5 mm
- Trefilação a quente: matrizes de metal duro (até 0,5 mm), diamante (até 5 μm), lubrificante: grafita



Referências

- KIMINAMI, Claudio S.; CASTRO, Walman B. e OLIVEIRA, Marcelo F. Introdução aos processos de fabricação de produtos metálicos, Blucher, São Paulo, 2013.
- KALPAKJIAN, Serope e SCHMID, Steven. Manufacturing processes for engineering materials, 5a ed., Pearson Education, New Jersey, 2007.
- A METALURGIA DO PÓ: alternativa econômica com menor impacto ambiental, Ed. Metallum Eventos Técnicos E Científicos, ISBN 978-85-62404-00-9, 1ª ed., 2009.
- CHIAVERINI, Vicente, Metalurgia do pó, São Paulo: ABM, 4a ed., 2001.
- ASM International. ASM Handbooks Online, <http://products.asminternational.org/hbk/index.jsp>