Feedback Systems

An Introduction for Scientists and Engineers
SECOND EDITION

Karl Johan Åström
Richard M. Murray

Version v3.0c (10 January 2014)

This is the electronic edition of *Feedback Systems* and is available from <http://www.cds.caltech.edu/~murray/amwiki>. Hardcover editions may be purchased from Princeton University Press, <http://press.princeton.edu/titles/8701.html>.

This manuscript is for personal use only and may not be reproduced, in whole or in part, without written consent from the publisher (see <http://press.princeton.edu/permissions.html>).

PRINCETON UNIVERSITY PRESS
PRINCETON AND OXFORD

Chapter Six

State Feedback

Intuitively, the state may be regarded as a kind of information storage or memory or accumulation of past causes. We must, of course, demand that the set of internal states Σ be sufficiently rich to carry all information about the past history of Σ to predict the effect of the past upon the future. We do not insist, however, that the state is the least such information although this is often a convenient assumption.

R. E. Kalman, P. L. Falb and M. A. Arbib, *Topics in Mathematical System Theory*, 1969 [KFA69].

This chapter describes how the feedback of a system's state can be used to shape the local behavior of a system. The concept of reachability is introduced and used to investigate how to design the dynamics of a system through assignment of its eigenvalues. In particular, it will be shown that under certain conditions it is possible to assign the system eigenvalues arbitrarily by appropriate feedback of the system state.

6.1 Reachability

One of the fundamental properties of a control system is what set of points in the state space can be reached through the choice of a control input. It turns out that the property of reachability is also fundamental in understanding the extent to which feedback can be used to design the dynamics of a system.

Definition of Reachability

We begin by disregarding the output measurements of the system and focusing on the evolution of the state, given by

$$\frac{dx}{dt} = Ax + Bu, \quad (6.1)$$

where $x \in \mathbb{R}^n$, $u \in \mathbb{R}$, A is an $n \times n$ matrix and B a column vector. A fundamental question is whether it is possible to find control signals so that any point in the state space can be reached through some choice of input. To study this, we define the *reachable set* $\mathcal{R}(x_0, \leq T)$ as the set of all points x_f such that there exists an input $u(t)$, $0 \leq t \leq T$ that steers the system from $x(0) = x_0$ to $x(T) = x_f$, as illustrated in Figure 6.1a.

Definition 6.1 (Reachability). A linear system is *reachable* if for any $x_0, x_f \in \mathbb{R}^n$ there exists a $T > 0$ and $u: [0, T] \rightarrow \mathbb{R}$ such that the corresponding solution satisfies $x(0) = x_0$ and $x(T) = x_f$.

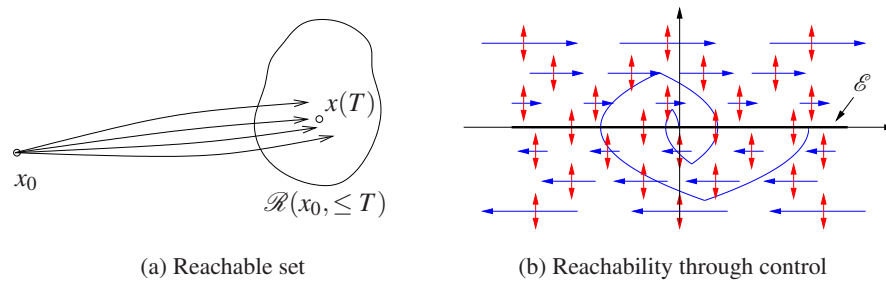

Figure 6.1: The reachable set for a control system. The set $\mathcal{R}(x_0, \leq T)$ shown in (a) is the set of points reachable from x_0 in time less than T . The phase portrait in (b) shows the dynamics for a double integrator, with the natural dynamics drawn as horizontal arrows and the control inputs drawn as vertical arrows. The set of achievable equilibrium points is the x axis. By setting the control inputs as a function of the state, it is possible to steer the system to the origin, as shown on the sample path.

The definition of reachability addresses whether it is possible to reach all points in the state space in a *transient* fashion. In many applications, the set of points that we are most interested in reaching is the set of equilibrium points of the system (since we can remain at those points once we get there). The set of all possible equilibria for constant controls is given by

$$\mathcal{E} = \{x_e : Ax_e + Bu_e = 0 \text{ for some } u_e \in \mathbb{R}\}.$$

This means that possible equilibria lie in a one- (or possibly higher) dimensional subspace. If the matrix A is invertible, this subspace is spanned by $A^{-1}B$.

The following example provides some insight into the possibilities.

Example 6.1 Double integrator

Consider a linear system consisting of a double integrator whose dynamics are given by

$$\frac{dx_1}{dt} = x_2, \quad \frac{dx_2}{dt} = u.$$

Figure 6.1b shows a phase portrait of the system. The open loop dynamics ($u = 0$) are shown as horizontal arrows pointed to the right for $x_2 > 0$ and to the left for $x_2 < 0$. The control input is represented by a double-headed arrow in the vertical direction, corresponding to our ability to set the value of \dot{x}_2 . The set of equilibrium points \mathcal{E} corresponds to the x_1 axis, with $u_e = 0$.

Suppose first that we wish to reach the origin from an initial condition $(a, 0)$. We can directly move the state up and down in the phase plane, but we must rely on the natural dynamics to control the motion to the left and right. If $a > 0$, we can move the origin by first setting $u < 0$, which will cause x_2 to become negative. Once $x_2 < 0$, the value of x_1 will begin to decrease and we will move to the left. After a while, we can set u_2 to be positive, moving x_2 back toward zero and slowing the motion in the x_1 direction. If we bring $x_2 > 0$, we can move the system state in the opposite direction.

Figure 6.1b shows a sample trajectory bringing the system to the origin. Note that if we steer the system to an equilibrium point, it is possible to remain there indefinitely (since $\dot{x}_1 = 0$ when $x_2 = 0$), but if we go to any other point in the state space, we can pass through the point only in a transient fashion. ∇

To find general conditions under which a linear system is reachable, we will first give a heuristic argument based on formal calculations with impulse functions. We note that if we can reach all points in the state space through some choice of input, then we can also reach all equilibrium points.

Testing for Reachability

When the initial state is zero, the response of the system to an input $u(t)$ is given by

$$x(t) = \int_0^t e^{A(t-\tau)} B u(\tau) d\tau. \quad (6.2)$$

If we choose the input to be a impulse function $\delta(t)$ as defined in Section 5.3, the state becomes

$$x_\delta = \int_0^t e^{A(t-\tau)} B \delta(\tau) d\tau = \frac{dx_\delta}{dt} = e^{At} B.$$

(Note that the state changes instantaneously in response to the impulse.) We can find the response to the derivative of an impulse function by taking the derivative of the impulse response (Exercise 5.1):

$$x_{\dot{\delta}} = \frac{dx_\delta}{dt} = A e^{At} B.$$

Continuing this process and using the linearity of the system, the input

$$u(t) = \alpha_1 \delta(t) + \alpha_2 \dot{\delta}(t) + \alpha_3 \ddot{\delta}(t) + \cdots + \alpha_n \delta^{(n-1)}(t)$$

gives the state

$$x(t) = \alpha_1 e^{At} B + \alpha_2 A e^{At} B + \alpha_3 A^2 e^{At} B + \cdots + \alpha_n A^{n-1} e^{At} B.$$

Taking the limit as t goes to zero through positive values, we get

$$\lim_{t \rightarrow 0^+} x(t) = \alpha_1 B + \alpha_2 AB + \alpha_3 A^2 B + \cdots + \alpha_n A^{n-1} B.$$

On the right is a linear combination of the columns of the matrix

$$W_r = \begin{bmatrix} B & AB & \cdots & A^{n-1}B \end{bmatrix}. \quad (6.3)$$

To reach an arbitrary point in the state space, we thus require that there are n linear independent columns of the matrix W_r . The matrix W_r is called the *reachability matrix*.

An input consisting of a sum of impulse functions and their derivatives is a very violent signal. To see that an arbitrary point can be reached with smoother signals

we can make use of the convolution equation. Assuming that the initial condition is zero, the state of a linear system is given by

$$x(t) = \int_0^t e^{A(t-\tau)} B u(\tau) d\tau = \int_0^t e^{A\tau} B u(t-\tau) d\tau.$$

It follows from the theory of matrix functions, specifically the Cayley–Hamilton theorem (see Exercise 6.10), that

$$e^{A\tau} = I\alpha_0(\tau) + A\alpha_1(\tau) + \cdots + A^{n-1}\alpha_{n-1}(\tau),$$

where $\alpha_i(\tau)$ are scalar functions, and we find that

$$\begin{aligned} x(t) &= B \int_0^t \alpha_0(\tau) u(t-\tau) d\tau + AB \int_0^t \alpha_1(\tau) u(t-\tau) d\tau \\ &\quad + \cdots + A^{n-1} B \int_0^t \alpha_{n-1}(\tau) u(t-\tau) d\tau. \end{aligned}$$

Again we observe that the right-hand side is a linear combination of the columns of the reachability matrix W_r given by equation (6.3). This basic approach leads to the following theorem.

Theorem 6.1 (Reachability rank condition). *A linear system is reachable if and only if the reachability matrix W_r is invertible.*

The formal proof of this theorem is beyond the scope of this text but follows along the lines of the sketch above and can be found in most books on linear control theory, such as Callier and Desoer [CD91] or Lewis [Lew03]. We illustrate the concept of reachability with the following example.

Example 6.2 Balance system

Consider the balance system introduced in Example 2.1 and shown in Figure 6.2. Recall that this system is a model for a class of examples in which the center of mass is balanced above a pivot point. One example is the Segway Personal Transporter shown in Figure 6.2a, about which a natural question to ask is whether we can move from one stationary point to another by appropriate application of forces through the wheels.

The nonlinear equations of motion for the system are given in equation (2.9) and repeated here:

$$\begin{aligned} (M+m)\ddot{p} - ml \cos \theta \ddot{\theta} &= -c\dot{p} - ml \sin \theta \dot{\theta}^2 + F, \\ (J + ml^2)\ddot{\theta} - ml \cos \theta \ddot{p} &= -\gamma\dot{\theta} + mgl \sin \theta. \end{aligned} \tag{6.4}$$

For simplicity, we take $c = \gamma = 0$. Linearizing around the equilibrium point $x_e = (p, 0, 0, 0)$, the dynamics matrix and the control matrix are

$$A = \begin{pmatrix} 0 & 0 & 1 & 0 \\ 0 & 0 & 0 & 1 \\ 0 & m^2 l^2 g / \mu & 0 & 0 \\ 0 & M_l m g l / \mu & 0 & 0 \end{pmatrix}, \quad B = \begin{pmatrix} 0 \\ 0 \\ J_l / \mu \\ l m / \mu \end{pmatrix},$$



(a) Segway

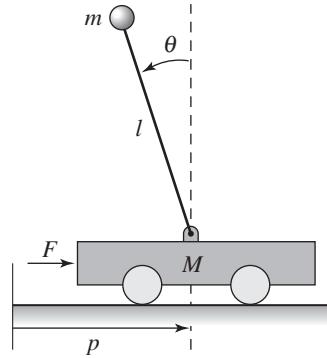

(b) Cart-pendulum system

Figure 6.2: Balance system. The Segway Personal Transporter shown in (a) is an example of a balance system that uses torque applied to the wheels to keep the rider upright. A simplified diagram for a balance system is shown in (b). The system consists of a mass m on a rod of length l connected by a pivot to a cart with mass M .

where $\mu = M_t J_t - m^2 l^2$, $M_t = M + m$ and $J_t = J + m l^2$. The reachability matrix is

$$W_r = \begin{pmatrix} 0 & J_t/\mu & 0 & g l^3 m^3 / \mu^2 \\ 0 & l m / \mu & 0 & g l^2 m^2 (m + M) / \mu^2 \\ J_t/\mu & 0 & g l^3 m^3 / \mu^2 & 0 \\ l m / \mu & 0 & g l^2 m^2 (m + M) / \mu^2 & 0 \end{pmatrix}. \quad (6.5)$$

The determinant of this matrix is

$$\det(W_r) = \frac{g^2 l^4 m^4}{(\mu)^4} \neq 0,$$

and we can conclude that the system is reachable. This implies that we can move the system from any initial state to any final state and, in particular, that we can always find an input to bring the system from an initial state to an equilibrium point. ∇

It is useful to have an intuitive understanding of the mechanisms that make a system unreachable. An example of such a system is given in Figure 6.3. The system consists of two identical systems with the same input. Clearly, we cannot separately cause the first and the second systems to do something different since they have the same input. Hence we cannot reach arbitrary states, and so the system is not reachable (Exercise 6.3).

More subtle mechanisms for nonreachability can also occur. For example, if there is a linear combination of states that always remains constant, then the system is not reachable. To see this, suppose that there exists a row vector H such that

$$0 = \frac{d}{dt} Hx = H(Ax + Bu), \quad \text{for all } u.$$

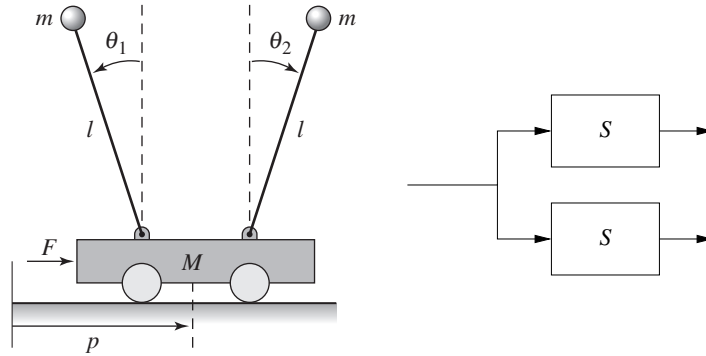

Figure 6.3: An unreachable system. The cart–pendulum system shown on the left has a single input that affects two pendula of equal length and mass. Since the forces affecting the two pendula are the same and their dynamics are identical, it is not possible to arbitrarily control the state of the system. The figure on the right is a block diagram representation of this situation.

Then H is in the left null space of both A and B and it follows that

$$HW_r = H \begin{pmatrix} B & AB & \cdots & A^{n-1}B \end{pmatrix} = 0.$$

Hence the reachability matrix is not full rank. In this case, if we have an initial condition x_0 and we wish to reach a state x_f for which $Hx_0 \neq Hx_f$, then since $Hx(t)$ is constant, no input u can move from x_0 to x_f .

Reachable Canonical Form

As we have already seen in previous chapters, it is often convenient to change coordinates and write the dynamics of the system in the transformed coordinates $z = Tx$. One application of a change of coordinates is to convert a system into a canonical form in which it is easy to perform certain types of analysis.

A linear state space system is in *reachable canonical form* if its dynamics are given by

$$\begin{aligned} \frac{dz}{dt} &= \begin{pmatrix} -a_1 & -a_2 & -a_3 & \cdots & -a_n \\ 1 & 0 & 0 & \cdots & 0 \\ 0 & 1 & 0 & \cdots & 0 \\ \vdots & & \ddots & \ddots & \vdots \\ 0 & & & 1 & 0 \end{pmatrix} z + \begin{pmatrix} 1 \\ 0 \\ 0 \\ \vdots \\ 0 \end{pmatrix} u, \\ y &= \begin{pmatrix} b_1 & b_2 & b_3 & \cdots & b_n \end{pmatrix} z + du. \end{aligned} \quad (6.6)$$

A block diagram for a system in reachable canonical form is shown in Figure 6.4. We see that the coefficients that appear in the A and B matrices show up directly in the block diagram. Furthermore, the output of the system is a simple linear combination of the outputs of the integration blocks.

The characteristic polynomial for a system in reachable canonical form is given

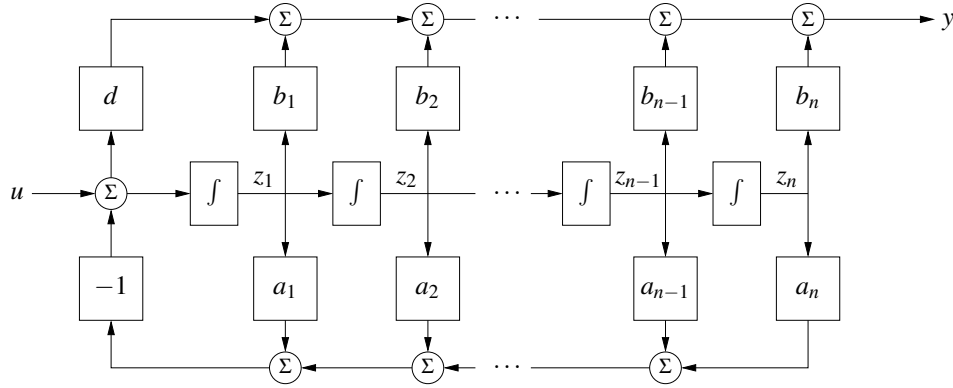

Figure 6.4: Block diagram for a system in reachable canonical form. The individual states of the system are represented by a chain of integrators whose input depends on the weighted values of the states. The output is given by an appropriate combination of the system input and other states.

by

$$\lambda(s) = s^n + a_1 s^{n-1} + \cdots + a_{n-1} s + a_n. \quad (6.7)$$

The reachability matrix also has a relatively simple structure:

$$W_r = \begin{pmatrix} B & AB & \cdots & A^{n-1}B \end{pmatrix} = \begin{pmatrix} 1 & -a_1 & a_1^2 - a_2 & \cdots & * \\ 0 & 1 & -a_1 & \cdots & * \\ \vdots & \vdots & \ddots & \ddots & \vdots \\ 0 & 0 & 0 & 1 & * \\ 0 & 0 & 0 & \cdots & 1 \end{pmatrix},$$

where * indicates a possibly nonzero term. This matrix is full rank since no column can be written as a linear combination of the others because of the triangular structure of the matrix.

We now consider the problem of changing coordinates such that the dynamics of a system can be written in reachable canonical form. Let A, B represent the dynamics of a given system and \tilde{A}, \tilde{B} be the dynamics in reachable canonical form. Suppose that we wish to transform the original system into reachable canonical form using a coordinate transformation $z = Tx$. As shown in the last chapter, the dynamics matrix and the control matrix for the transformed system are

$$\tilde{A} = TAT^{-1}, \quad \tilde{B} = TB.$$

The reachability matrix for the transformed system then becomes

$$\tilde{W}_r = \begin{pmatrix} \tilde{B} & \tilde{A}\tilde{B} & \cdots & \tilde{A}^{n-1}\tilde{B} \end{pmatrix}.$$

Transforming each element individually, we have

$$\begin{aligned}\tilde{A}\tilde{B} &= TAT^{-1}TB = TAB, \\ \tilde{A}^2\tilde{B} &= (TAT^{-1})^2TB = TAT^{-1}TAT^{-1}TB = TA^2B, \\ &\vdots \\ \tilde{A}^n\tilde{B} &= TA^nB,\end{aligned}$$

and hence the reachability matrix for the transformed system is

$$\tilde{W}_r = T \begin{pmatrix} B & AB & \cdots & A^{n-1}B \end{pmatrix} = TW_r. \quad (6.8)$$

Since W_r is invertible, we can thus solve for the transformation T that takes the system into reachable canonical form:

$$T = \tilde{W}_r W_r^{-1}.$$

The following example illustrates the approach.

Example 6.3 Transformation to reachable form

Consider a simple two-dimensional system of the form

$$\frac{dx}{dt} = \begin{pmatrix} \alpha & \omega \\ -\omega & \alpha \end{pmatrix} x + \begin{pmatrix} 0 \\ 1 \end{pmatrix} u.$$

We wish to find the transformation that converts the system into reachable canonical form:

$$\tilde{A} = \begin{pmatrix} -a_1 & -a_2 \\ 1 & 0 \end{pmatrix}, \quad \tilde{B} = \begin{pmatrix} 1 \\ 0 \end{pmatrix}.$$

The coefficients a_1 and a_2 can be determined from the characteristic polynomial for the original system:

$$\lambda(s) = \det(sI - A) = s^2 - 2\alpha s + (\alpha^2 + \omega^2) \implies \begin{aligned} a_1 &= -2\alpha, \\ a_2 &= \alpha^2 + \omega^2. \end{aligned}$$

The reachability matrix for each system is

$$W_r = \begin{pmatrix} 0 & \omega \\ 1 & \alpha \end{pmatrix}, \quad \tilde{W}_r = \begin{pmatrix} 1 & -a_1 \\ 0 & 1 \end{pmatrix}.$$

The transformation T becomes

$$T = \tilde{W}_r W_r^{-1} = \begin{pmatrix} -(a_1 + \alpha)/\omega & 1 \\ 1/\omega & 0 \end{pmatrix} = \begin{pmatrix} \alpha/\omega & 1 \\ 1/\omega & 0 \end{pmatrix},$$

and hence the coordinates

$$\begin{pmatrix} z_1 \\ z_2 \end{pmatrix} = Tx = \begin{pmatrix} \alpha x_1/\omega + x_2 \\ x_1/\omega \end{pmatrix}$$

put the system in reachable canonical form. ▽

We summarize the results of this section in the following theorem.

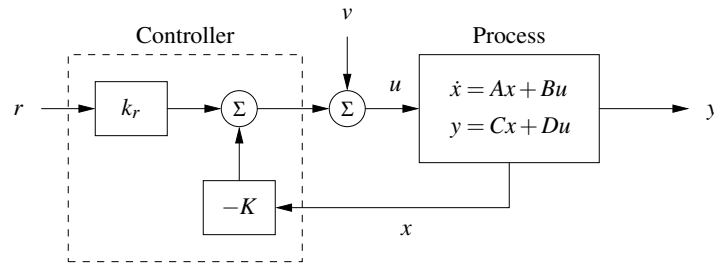

Figure 6.5: A feedback control system with state feedback. The controller uses the system state x and the reference input r to command the process through its input u . We model disturbances via the additive input v .

Theorem 6.2 (Reachable canonical form). *Let A and B be the dynamics and control matrices for a reachable system. Then there exists a transformation $z = Tx$ such that in the transformed coordinates the dynamics and control matrices are in reachable canonical form (6.6) and the characteristic polynomial for A is given by*

$$\det(sI - A) = s^n + a_1s^{n-1} + \cdots + a_{n-1}s + a_n.$$

One important implication of this theorem is that for any reachable system, we can assume without loss of generality that the coordinates are chosen such that the system is in reachable canonical form. This is particularly useful for proofs, as we shall see later in this chapter. However, for high-order systems, small changes in the coefficients a_i can give large changes in the eigenvalues. Hence, the reachable canonical form is not always well conditioned and must be used with some care.

6.2 Stabilization by State Feedback

The state of a dynamical system is a collection of variables that permits prediction of the future development of a system. We now explore the idea of designing the dynamics of a system through feedback of the state. We will assume that the system to be controlled is described by a linear state model and has a single input (for simplicity). The feedback control law will be developed step by step using a single idea: the positioning of closed loop eigenvalues in desired locations.

State Space Controller Structure

Figure 6.5 is a diagram of a typical control system using state feedback. The full system consists of the process dynamics, which we take to be linear, the controller elements K and k_r , the reference input (or command signal) r and process disturbances v . The goal of the feedback controller is to regulate the output of the system y such that it tracks the reference input in the presence of disturbances and also uncertainty in the process dynamics.

An important element of the control design is the performance specification. The simplest performance specification is that of stability: in the absence of any

disturbances, we would like the equilibrium point of the system to be asymptotically stable. More sophisticated performance specifications typically involve giving desired properties of the step or frequency response of the system, such as specifying the desired rise time, overshoot and settling time of the step response. Finally, we are often concerned with the disturbance attenuation properties of the system: to what extent can we experience disturbance inputs v and still hold the output y near the desired value?

Consider a system described by the linear differential equation

$$\frac{dx}{dt} = Ax + Bu, \quad y = Cx + Du, \quad (6.9)$$

where we have ignored the disturbance signal v for now. Our goal is to drive the output y to a given reference value r and hold it there. Notice that it may not be possible to maintain all equilibria; see Exercise 6.8.

We begin by assuming that all components of the state vector are measured. Since the state at time t contains all the information necessary to predict the future behavior of the system, the most general time-invariant control law is a function of the state and the reference input:

$$u = \alpha(x, r).$$

If the feedback is restricted to be linear, it can be written as

$$u = -Kx + k_r r, \quad (6.10)$$

where r is the reference value, assumed for now to be a constant.

This control law corresponds to the structure shown in Figure 6.5. The negative sign is a convention to indicate that negative feedback is the normal situation. The closed loop system obtained when the feedback (6.10) is applied to the system (6.9) is given by

$$\frac{dx}{dt} = (A - BK)x + Bk_r r. \quad (6.11)$$

We attempt to determine the feedback gain K so that the closed loop system has the characteristic polynomial

$$p(s) = s^n + p_1 s^{n-1} + \cdots + p_{n-1} s + p_n. \quad (6.12)$$

This control problem is called the *eigenvalue assignment problem* or *pole placement problem* (we will define poles more formally in Chapter 8).

Note that k_r does not affect the stability of the system (which is determined by the eigenvalues of $A - BK$) but does affect the steady-state solution. In particular, the equilibrium point and steady-state output for the closed loop system are given by

$$x_e = -(A - BK)^{-1} B k_r r, \quad y_e = C x_e + D u_e,$$

hence k_r should be chosen such that $y_e = r$ (the desired output value). Since k_r is a scalar, we can easily solve to show that if $D = 0$ (the most common case),

$$k_r = -1 / (C(A - BK)^{-1} B). \quad (6.13)$$

Notice that k_r is exactly the inverse of the zero frequency gain of the closed loop system. The solution for $D \neq 0$ is left as an exercise.

Using the gains K and k_r , we are thus able to design the dynamics of the closed loop system to satisfy our goal. To illustrate how to construct such a state feedback control law, we begin with a few examples that provide some basic intuition and insights.

Example 6.4 Vehicle steering

In Example 5.12 we derived a normalized linear model for vehicle steering. The dynamics describing the lateral deviation were given by

$$\begin{aligned} A &= \begin{pmatrix} 0 & 1 \\ 0 & 0 \end{pmatrix}, & B &= \begin{pmatrix} \gamma \\ 1 \end{pmatrix}, \\ C &= \begin{pmatrix} 1 & 0 \end{pmatrix}, & D &= 0. \end{aligned}$$

The reachability matrix for the system is thus

$$W_r = \begin{pmatrix} B & AB \end{pmatrix} = \begin{pmatrix} \gamma & 1 \\ 1 & 0 \end{pmatrix}.$$

The system is reachable since $\det W_r = -1 \neq 0$.

We now want to design a controller that stabilizes the dynamics and tracks a given reference value r of the lateral position of the vehicle. To do this we introduce the feedback

$$u = -Kx + k_r r = -k_1 x_1 - k_2 x_2 + k_r r,$$

and the closed loop system becomes

$$\begin{aligned} \frac{dx}{dt} &= (A - BK)x + Bk_r r = \begin{pmatrix} -\gamma k_1 & 1 - \gamma k_2 \\ -k_1 & -k_2 \end{pmatrix} x + \begin{pmatrix} \gamma k_r \\ k_r \end{pmatrix} r, \\ y &= Cx + Du = \begin{pmatrix} 1 & 0 \end{pmatrix} x. \end{aligned} \quad (6.14)$$

The closed loop system has the characteristic polynomial

$$\det(sI - A + BK) = \det \begin{pmatrix} s + \gamma k_1 & \gamma k_2 - 1 \\ k_1 & s + k_2 \end{pmatrix} = s^2 + (\gamma k_1 + k_2)s + k_1.$$

Suppose that we would like to use feedback to design the dynamics of the system to have the characteristic polynomial

$$p(s) = s^2 + 2\zeta_c \omega_c s + \omega_c^2.$$

Comparing this polynomial with the characteristic polynomial of the closed loop system, we see that the feedback gains should be chosen as

$$k_1 = \omega_c^2, \quad k_2 = 2\zeta_c \omega_c - \gamma \omega_c^2.$$

Equation (6.13) gives $k_r = k_1 = \omega_c^2$, and the control law can be written as

$$u = k_1(r - x_1) - k_2 x_2 = \omega_c^2(r - x_1) - (2\zeta_c \omega_c - \gamma \omega_c^2)x_2.$$

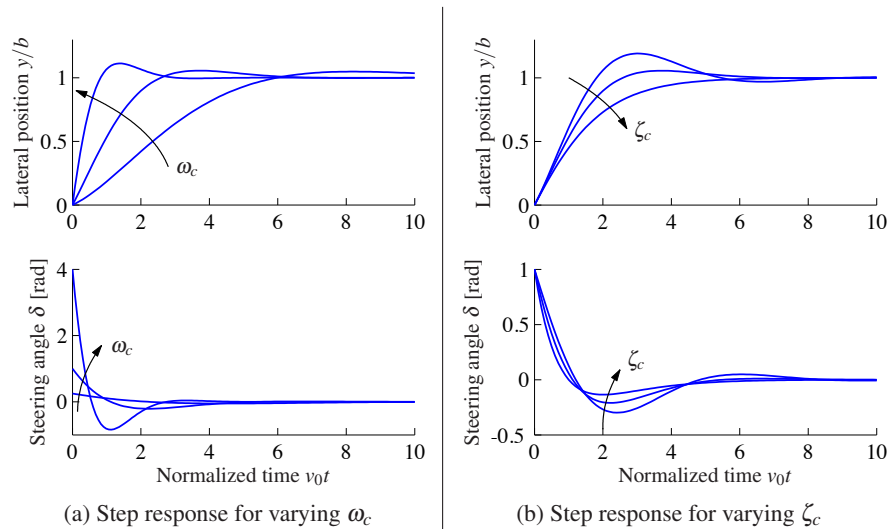

Figure 6.6: State feedback control of a steering system. Step responses obtained with controllers designed with $\zeta_c = 0.7$ and $\omega_c = 0.5, 1$ and 2 [rad/s] are shown in (a). Notice that response speed increases with increasing ω_c , but that large ω_c also give large initial control actions. Step responses obtained with a controller designed with $\omega_c = 1$ and $\zeta_c = 0.5, 0.7$ and 1 are shown in (b).

The step responses for the closed loop system for different values of the design parameters are shown in Figure 6.6. The effect of ω_c is shown in Figure 6.6a, which shows that the response speed increases with increasing ω_c . The responses for $\omega_c = 0.5$ and 1 have reasonable overshoot. The settling time is about 15 car lengths for $\omega_c = 0.5$ (beyond the end of the plot) and decreases to about 6 car lengths for $\omega_c = 1$. The control signal δ is large initially and goes to zero as time increases because the closed loop dynamics have an integrator. The initial value of the control signal is $u(0) = k_r = \omega_c^2 r$, and thus the achievable response time is limited by the available actuator signal. Notice in particular the dramatic increase in control signal when ω_c changes from 1 to 2. The effect of ζ_c is shown in Figure 6.6b. The response speed and the overshoot increase with decreasing damping. Using these plots, we conclude that reasonable values of the design parameters are to have ω_c in the range of 0.5 to 1 and $\zeta_c \approx 0.7$.

▽

The example of the vehicle steering system illustrates how state feedback can be used to set the eigenvalues of a closed loop system to arbitrary values.

State Feedback for Systems in Reachable Canonical Form

The reachable canonical form has the property that the parameters of the system are the coefficients of the characteristic polynomial. It is therefore natural to consider systems in this form when solving the eigenvalue assignment problem.

Consider a system in reachable canonical form, i.e.,

$$\frac{dz}{dt} = \tilde{A}z + \tilde{B}u = \begin{pmatrix} -a_1 & -a_2 & -a_3 & \cdots & -a_n \\ 1 & 0 & 0 & \cdots & 0 \\ 0 & 1 & 0 & \cdots & 0 \\ \vdots & & \ddots & \ddots & \vdots \\ 0 & & & 1 & 0 \end{pmatrix} z + \begin{pmatrix} 1 \\ 0 \\ \vdots \\ 0 \\ 0 \end{pmatrix} u \quad (6.15)$$

$$y = \tilde{C}z = \begin{pmatrix} b_1 & b_2 & \cdots & b_n \end{pmatrix} z.$$

It follows from (6.7) that the open loop system has the characteristic polynomial

$$\det(sI - A) = s^n + a_1s^{n-1} + \cdots + a_{n-1}s + a_n.$$

Before making a formal analysis we can gain some insight by investigating the block diagram of the system shown in Figure 6.4. The characteristic polynomial is given by the parameters a_k in the figure. Notice that the parameter a_k can be changed by feedback from state z_k to the input u . It is thus straightforward to change the coefficients of the characteristic polynomial by state feedback.

Returning to equations, introducing the control law

$$u = -\tilde{K}z + k_r r = -\tilde{k}_1 z_1 - \tilde{k}_2 z_2 - \cdots - \tilde{k}_n z_n + k_r r, \quad (6.16)$$

the closed loop system becomes

$$\frac{dz}{dt} = \begin{pmatrix} -a_1 - \tilde{k}_1 & -a_2 - \tilde{k}_2 & -a_3 - \tilde{k}_3 & \cdots & -a_n - \tilde{k}_n \\ 1 & 0 & 0 & \cdots & 0 \\ 0 & 1 & 0 & \cdots & 0 \\ \vdots & & \ddots & \ddots & \vdots \\ 0 & & & 1 & 0 \end{pmatrix} z + \begin{pmatrix} k_r \\ 0 \\ 0 \\ \vdots \\ 0 \end{pmatrix} r, \quad (6.17)$$

$$y = \begin{pmatrix} b_1 & b_2 & \cdots & b_n \end{pmatrix} z.$$

The feedback changes the elements of the first row of the A matrix, which corresponds to the parameters of the characteristic polynomial. The closed loop system thus has the characteristic polynomial

$$s^n + (a_1 + \tilde{k}_1)s^{n-1} + (a_2 + \tilde{k}_2)s^{n-2} + \cdots + (a_{n-1} + \tilde{k}_{n-1})s + a_n + \tilde{k}_n.$$

Requiring this polynomial to be equal to the desired closed loop polynomial

$$p(s) = s^n + p_1s^{n-1} + \cdots + p_{n-1}s + p_n,$$

we find that the controller gains should be chosen as

$$\tilde{k}_1 = p_1 - a_1, \quad \tilde{k}_2 = p_2 - a_2, \quad \dots \quad \tilde{k}_n = p_n - a_n.$$

This feedback simply replaces the parameters a_i in the system (6.15) by p_i . The feedback gain for a system in reachable canonical form is thus

$$\tilde{K} = \begin{pmatrix} p_1 - a_1 & p_2 - a_2 & \cdots & p_n - a_n \end{pmatrix}. \quad (6.18)$$

To have zero frequency gain equal to unity, the parameter k_r should be chosen as

$$k_r = \frac{a_n + \tilde{k}_n}{b_n} = \frac{p_n}{b_n}. \quad (6.19)$$

Notice that it is essential to know the precise values of parameters a_n and b_n in order to obtain the correct zero frequency gain. The zero frequency gain is thus obtained by precise calibration. This is very different from obtaining the correct steady-state value by integral action, which we shall see in later sections.

Eigenvalue Assignment

We have seen through the examples how feedback can be used to design the dynamics of a system through assignment of its eigenvalues. To solve the problem in the general case, we simply change coordinates so that the system is in reachable canonical form. Consider the system

$$\frac{dx}{dt} = Ax + Bu, \quad y = Cx + Du. \quad (6.20)$$

We can change the coordinates by a linear transformation $z = Tx$ so that the transformed system is in reachable canonical form (6.15). For such a system the feedback is given by equation (6.16), where the coefficients are given by equation (6.18). Transforming back to the original coordinates gives the feedback

$$u = -\tilde{K}z + k_r r = -\tilde{K}Tx + k_r r.$$

The results obtained can be summarized as follows.

Theorem 6.3 (Eigenvalue assignment by state feedback). *Consider the system given by equation (6.20), with one input and one output. Let $\lambda(s) = s^n + a_1s^{n-1} + \cdots + a_{n-1}s + a_n$ be the characteristic polynomial of A . If the system is reachable, then there exists a feedback*

$$u = -Kx + k_r r$$

that gives a closed loop system with the characteristic polynomial

$$p(s) = s^n + p_1s^{n-1} + \cdots + p_{n-1}s + p_n$$

and unity zero frequency gain between r and y . The feedback gain is given by

$$K = \tilde{K}T = \begin{pmatrix} p_1 - a_1 & p_2 - a_2 & \cdots & p_n - a_n \end{pmatrix} \tilde{W}_r W_r^{-1}, \quad (6.21)$$

where a_i are the coefficients of the characteristic polynomial of the matrix A and the matrices W_r and \tilde{W}_r are given by

$$W_r = \begin{pmatrix} B & AB & \cdots & A^{n-1}B \end{pmatrix}, \quad \tilde{W}_r = \begin{pmatrix} 1 & a_1 & a_2 & \cdots & a_{n-1} \\ 0 & 1 & a_1 & \cdots & a_{n-2} \\ \vdots & & \ddots & \ddots & \vdots \\ 0 & 0 & \cdots & 1 & a_1 \\ 0 & 0 & 0 & \cdots & 1 \end{pmatrix}^{-1}.$$

The reference gain is given by

$$k_r = -1/(C(A - BK)^{-1}B).$$

For simple problems, the eigenvalue assignment problem can be solved by introducing the elements k_i of K as unknown variables. We then compute the characteristic polynomial

$$\lambda(s) = \det(sI - A + BK)$$

and equate coefficients of equal powers of s to the coefficients of the desired characteristic polynomial

$$p(s) = s^n + p_1s^{n-1} + \cdots + p_{n-1}s + p_n.$$

This gives a system of linear equations to determine k_i . The equations can always be solved if the system is reachable, exactly as we did in Example 6.4.

Equation (6.21), which is called Ackermann's formula [Ack72, Ack85], can be used for numeric computations. It is implemented in the MATLAB function `acker`. The MATLAB function `place` is preferable for systems of high order because it is better conditioned numerically.

Example 6.5 Predator-prey

Consider the problem of regulating the population of an ecosystem by modulating the food supply. We use the predator-prey model introduced in Section A.7. The dynamics for the system are given by

$$\begin{aligned} \frac{dH}{dt} &= (r+u)H \left(1 - \frac{H}{k}\right) - \frac{aHL}{c+H}, & H \geq 0, \\ \frac{dL}{dt} &= b\frac{aHL}{c+H} - dL, & L \geq 0. \end{aligned}$$

We choose the following nominal parameters for the system, which correspond to the values used in previous simulations:

$$\begin{aligned} a &= 3.2, & b &= 0.6, & c &= 50, \\ d &= 0.56, & k &= 125, & r &= 1.6. \end{aligned}$$

We take the parameter r , corresponding to the growth rate for hares, as the input to the system, which we might modulate by controlling a food source for the hares. This is reflected in our model by the term $(r+u)$ in the first equation. We choose the number of lynxes as the output of our system.

To control this system, we first linearize the system around the equilibrium point of the system (H_e, L_e) , which can be determined numerically to be $x_e \approx$

(20.6, 29.5). This yields a linear dynamical system

$$\frac{d}{dt} \begin{pmatrix} z_1 \\ z_2 \end{pmatrix} = \begin{pmatrix} 0.13 & -0.93 \\ 0.57 & 0 \end{pmatrix} \begin{pmatrix} z_1 \\ z_2 \end{pmatrix} + \begin{pmatrix} 17.2 \\ 0 \end{pmatrix} v, \quad w = \begin{pmatrix} 0 & 1 \end{pmatrix} \begin{pmatrix} z_1 \\ z_2 \end{pmatrix},$$

where $z_1 = H - H_e$, $z_2 = L - L_e$ and $v = u$. It is easy to check that the system is reachable around the equilibrium $(z, v) = (0, 0)$, and hence we can assign the eigenvalues of the system using state feedback.

Determining the eigenvalues of the closed loop system requires balancing the ability to modulate the input against the natural dynamics of the system. This can be done by the process of trial and error or by using some of the more systematic techniques discussed in the remainder of the text. For now, we simply choose the desired closed loop eigenvalues to be at $\lambda = \{-0.1, -0.2\}$. We can then solve for the feedback gains using the techniques described earlier, which results in

$$K = \begin{pmatrix} 0.025 & -0.052 \end{pmatrix}.$$

Finally, we solve for the reference gain k_r , using equation (6.13) to obtain $k_r = 0.002$.

Putting these steps together, our control law becomes

$$v = -Kz + k_r L_d,$$

where L_d is the desired number of lynxes. In order to implement the control law, we must rewrite it using the original coordinates for the system, yielding

$$\begin{aligned} u &= u_e - K(x - x_e) + k_r(L_d - y_e) \\ &= - \begin{pmatrix} 0.025 & -0.052 \end{pmatrix} \begin{pmatrix} H - 20.6 \\ L - 29.5 \end{pmatrix} + 0.002(L_d - 29.5). \end{aligned}$$

This rule tells us how much we should modulate u as a function of the current number of lynxes and hares in the ecosystem. Figure 6.7a shows a simulation of the resulting closed loop system using the parameters defined above and starting with an initial population of 15 hares and 20 lynxes. Note that the system quickly stabilizes the population of lynxes at the reference value ($L_d = 30$). A phase portrait of the system is given in Figure 6.7b, showing how other initial conditions converge to the stabilized equilibrium population. Notice that the dynamics are very different from the natural dynamics (shown in Figure A.20). ∇

The results of this section show that we can use state feedback to design the dynamics of a system, under the strong assumption that we can measure all of the states. We shall address the availability of the states in the next chapter, when we consider output feedback and state estimation. In addition, Theorem 6.3, which states that the eigenvalues can be assigned to arbitrary locations, is also highly idealized and assumes that the dynamics of the process are known to high precision. The robustness of state feedback combined with state estimators is considered in Chapter 12 after we have developed the requisite tools.

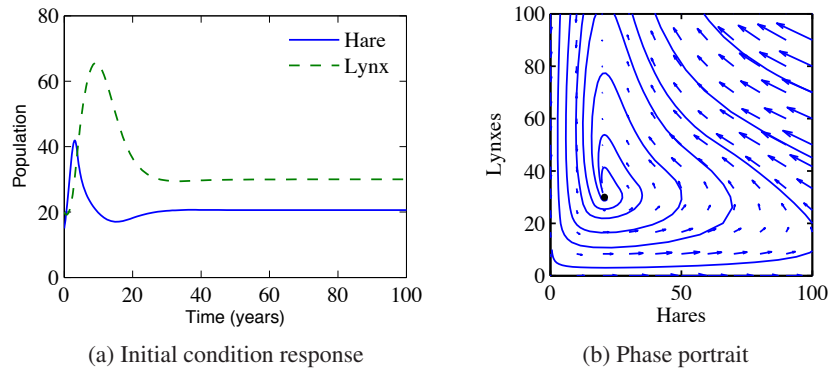

Figure 6.7: Simulation results for the controlled predator–prey system. The population of lynxes and hares as a function of time is shown in (a), and a phase portrait for the controlled system is shown in (b). Feedback is used to make the population stable at $H_e = 20.6$ and $L_e = 30$.

6.3 State Feedback Design

The location of the eigenvalues determines the behavior of the closed loop dynamics, and hence where we place the eigenvalues is the main design decision to be made. As with all other feedback design problems, there are trade-offs among the magnitude of the control inputs, the robustness of the system to perturbations and the closed loop performance of the system. In this section we examine some of these trade-offs starting with the special case of second-order systems.

Second-Order Systems

One class of systems that occurs frequently in the analysis and design of feedback systems is second-order linear differential equations. Because of their ubiquitous nature, it is useful to apply the concepts of this chapter to that specific class of systems and build more intuition about the relationship between stability and performance.

The canonical second-order system is a differential equation of the form

$$\ddot{q} + 2\zeta\omega_0\dot{q} + \omega_0^2q = k\omega_0^2u, \quad y = q. \quad (6.22)$$

In state space form, this system can be represented as

$$\frac{dx}{dt} = \begin{pmatrix} 0 & \omega_0 \\ -\omega_0 & -2\zeta\omega_0 \end{pmatrix} x + \begin{pmatrix} 0 \\ k\omega_0 \end{pmatrix} u, \quad y = \begin{pmatrix} 1 & 0 \end{pmatrix} x. \quad (6.23)$$

The eigenvalues of this system are given by

$$\lambda = -\zeta\omega_0 \pm \sqrt{\omega_0^2(\zeta^2 - 1)},$$

and we see that the origin is a stable equilibrium point if $\omega_0 > 0$ and $\zeta > 0$. Note that the eigenvalues are complex if $\zeta < 1$ and real otherwise. Equations (6.22)

and (6.23) can be used to describe many second-order systems, including damped oscillators, active filters and flexible structures, as shown in the examples below.

The form of the solution depends on the value of ζ , which is referred to as the *damping ratio* for the system. If $\zeta > 1$, we say that the system is *overdamped*, and the natural response ($u = 0$) of the system is given by

$$y(t) = \frac{\beta x_{10} + x_{20}}{\beta - \alpha} e^{-\alpha t} - \frac{\alpha x_{10} + x_{20}}{\beta - \alpha} e^{-\beta t},$$

where $\alpha = \omega_0(\zeta + \sqrt{\zeta^2 - 1})$ and $\beta = \omega_0(\zeta - \sqrt{\zeta^2 - 1})$. We see that the response consists of the sum of two exponentially decaying signals. If $\zeta = 1$, then the system is *critically damped* and solution becomes

$$y(t) = e^{-\zeta \omega_0 t} (x_{10} + (x_{20} + \zeta \omega_0 x_{10})t).$$

Note that this is still asymptotically stable as long as $\omega_0 > 0$, although the second term in the solution is increasing with time (but more slowly than the decaying exponential that is multiplying it).

Finally, if $0 < \zeta < 1$, then the solution is oscillatory and equation (6.22) is said to be *underdamped*. The parameter ω_0 is referred to as the *natural frequency* of the system, stemming from the fact that for small ζ , the eigenvalues of the system are $\lambda = -\zeta \omega_0 \pm i \omega_0 \sqrt{1 - \zeta^2}$. The natural response of the system is given by

$$y(t) = e^{-\zeta \omega_0 t} \left(x_{10} \cos \omega_d t + \left(\frac{\zeta \omega_0}{\omega_d} x_{10} + \frac{1}{\omega_d} x_{20} \right) \sin \omega_d t \right),$$

where $\omega_d = \omega_0 \sqrt{1 - \zeta^2}$ is called the *damped frequency*. For $\zeta \ll 1$, $\omega_d \approx \omega_0$ defines the oscillation frequency of the solution and ζ gives the damping rate relative to ω_0 .

Because of the simple form of a second-order system, it is possible to solve for the step and frequency responses in analytical form. The solution for the step response depends on the magnitude of ζ :

$$\begin{aligned} y(t) &= k \left(1 - e^{-\zeta \omega_0 t} \cos \omega_d t - \frac{\zeta}{\sqrt{1 - \zeta^2}} e^{-\zeta \omega_0 t} \sin \omega_d t \right), \quad \zeta < 1; \\ y(t) &= k (1 - e^{-\omega_0 t} (1 + \omega_0 t)), \quad \zeta = 1; \\ y(t) &= k \left(1 - \frac{1}{2} \left(\frac{\zeta}{\sqrt{\zeta^2 - 1}} + 1 \right) e^{-\omega_0 t (\zeta - \sqrt{\zeta^2 - 1})} \right. \\ &\quad \left. + \frac{1}{2} \left(\frac{\zeta}{\sqrt{\zeta^2 - 1}} - 1 \right) e^{-\omega_0 t (\zeta + \sqrt{\zeta^2 - 1})} \right), \quad \zeta > 1, \end{aligned} \tag{6.24}$$

where we have taken $x(0) = 0$. Note that for the lightly damped case ($\zeta < 1$) we have an oscillatory solution at frequency ω_d .

Step responses of systems with $k = 1$ and different values of ζ are shown in Figure 6.8. The shape of the response is determined by ζ , and the speed of the response is determined by ω_0 (included in the time axis scaling): the response is

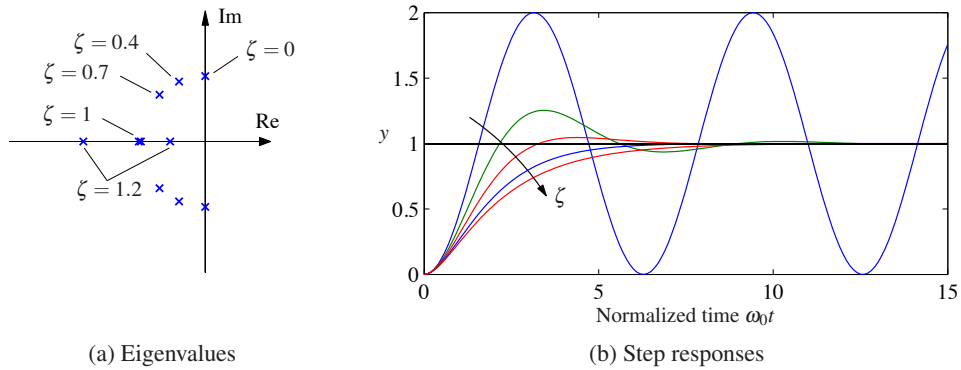

Figure 6.8: Step response for a second-order system. Normalized step responses h for the system (6.23) for $\zeta = 0, 0.4, 0.7, 1$ and 1.2 . As the damping ratio is increased, the rise time of the system gets longer, but there is less overshoot. The horizontal axis is in scaled units $\omega_0 t$; higher values of ω_0 result in a faster response (rise time and settling time).

faster if ω_0 is larger.

In addition to the explicit form of the solution, we can also compute the properties of the step response that were defined in Section 5.3. For example, to compute the maximum overshoot for an underdamped system, we rewrite the output as

$$y(t) = k \left(1 - \frac{1}{\sqrt{1-\zeta^2}} e^{-\zeta \omega_0 t} \sin(\omega_d t + \varphi) \right), \quad (6.25)$$

where $\varphi = \arccos \zeta$. The maximum overshoot will occur at the first time in which the derivative of y is zero, which can be shown to be

$$M_p = e^{-\pi \zeta / \sqrt{1-\zeta^2}}.$$

Similar computations can be done for the other characteristics of a step response. Table 6.1 summarizes the calculations.

The frequency response for a second-order system can also be computed ex-

Table 6.1: Properties of the step response for a second-order system with $0 < \zeta < 1$.

Property	Value	$\zeta = 0.5$	$\zeta = 1/\sqrt{2}$	$\zeta = 1$
Steady-state value	k	k	k	k
Rise time	$T_r \approx 1/\omega_0 \cdot e^{\varphi/\tan \varphi}$	$1.8/\omega_0$	$2.2/\omega_0$	$2.7/\omega_0$
Overshoot	$M_p = e^{-\pi \zeta / \sqrt{1-\zeta^2}}$	16%	4%	0%
Settling time (2%)	$T_s \approx 4/\zeta \omega_0$	$8.0/\omega_0$	$5.9/\omega_0$	$5.8/\omega_0$

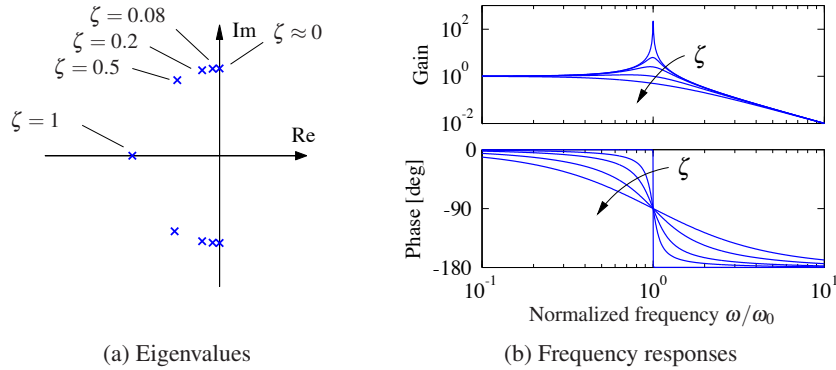

Figure 6.9: Frequency response of a second-order system (6.23). (a) Eigenvalues as a function of ζ . (b) Frequency response as a function of ζ . The upper curve shows the gain ratio M , and the lower curve shows the phase shift θ . For small ζ there is a large peak in the magnitude of the frequency response and a rapid change in phase centered at $\omega = \omega_0$. As ζ is increased, the magnitude of the peak drops and the phase changes more smoothly between 0° and -180° .

plicitly and is given by

$$Me^{j\theta} = \frac{k\omega_0^2}{(i\omega)^2 + 2\zeta\omega_0(i\omega) + \omega_0^2} = \frac{k\omega_0^2}{\omega_0^2 - \omega^2 + 2i\zeta\omega_0\omega}.$$

A graphical illustration of the frequency response is given in Figure 6.9. Notice the resonant peak that increases with decreasing ζ . The peak is often characterized by its *Q-value*, defined as $Q = 1/2\zeta$. The properties of the frequency response for a second-order system are summarized in Table 6.2.

Example 6.6 Drug administration

To illustrate the use of these formulas, consider the two-compartment model for drug administration, described in Section A.6. The dynamics of the system are

$$\frac{dc}{dt} = \begin{pmatrix} -k_0 - k_1 & k_1 \\ k_2 & -k_2 \end{pmatrix} c + \begin{pmatrix} b_0 \\ 0 \end{pmatrix} u, \quad y = \begin{pmatrix} 0 & 1 \end{pmatrix} c,$$

where c_1 and c_2 are the concentrations of the drug in each compartment, $k_i, i =$

Table 6.2: Properties of the frequency response for a second-order system with $0 < \zeta < 1$.

Property	Value	$\zeta = 0.1$	$\zeta = 0.5$	$\zeta = 1/\sqrt{2}$
Zero frequency gain	M_0	k	k	k
Bandwidth	ω_b	$1.54\omega_0$	$1.27\omega_0$	ω_0
Resonant peak gain	M_r	$1.54k$	$1.27k$	k
Resonant frequency	ω_{mr}	ω_0	$0.707\omega_0$	0

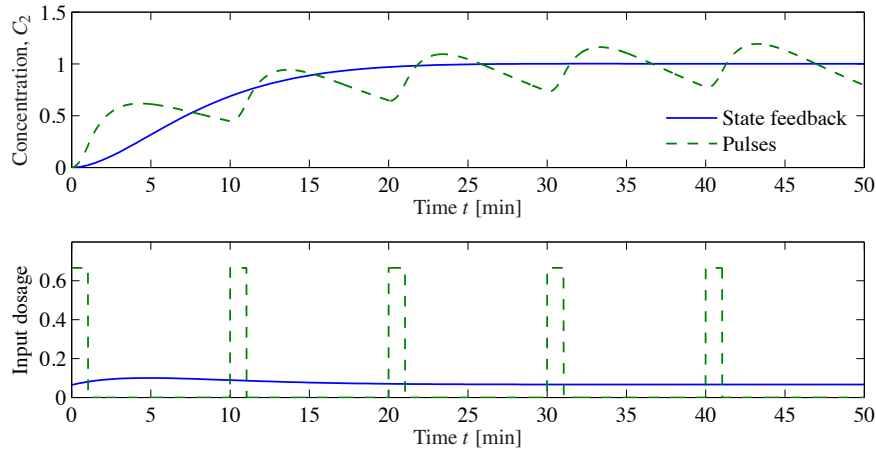

Figure 6.10: Open loop versus closed loop drug administration. Comparison between drug administration using a sequence of doses versus continuously monitoring the concentrations and adjusting the dosage continuously. In each case, the concentration is (approximately) maintained at the desired level, but the closed loop system has substantially less variability in drug concentration.

$0, \dots, 2$ and b_0 are parameters of the system, u is the flow rate of the drug into compartment 1 and y is the concentration of the drug in compartment 2. We assume that we can measure the concentrations of the drug in each compartment, and we would like to design a feedback law to maintain the output at a given reference value r .

We choose $\zeta = 0.9$ to minimize the overshoot and choose the rise time to be $T_r = 10$ min. Using the formulas in Table 6.1, this gives a value for $\omega_0 = 0.22$. We can now compute the gain to place the eigenvalues at this location. Setting $u = -Kx + k_r r$, the closed loop eigenvalues for the system satisfy

$$\lambda(s) = -0.198 \pm 0.0959i.$$

Choosing $k_1 = -0.2027$ and $k_2 = 0.2005$ gives the desired closed loop behavior. Equation (6.13) gives the reference gain $k_r = 0.0645$. The response of the controller is shown in Figure 6.10 and compared with an open loop strategy involving administering periodic doses of the drug. ∇

Higher-Order Systems

Our emphasis so far has considered only second-order systems. For higher-order systems, eigenvalue assignment is considerably more difficult, especially when trying to account for the many trade-offs that are present in a feedback design.

One of the other reasons why second-order systems play such an important role in feedback systems is that even for more complicated systems the response is often characterized by the *dominant eigenvalues*. To define these more precisely,

consider a system with eigenvalues λ_j , $j = 1, \dots, n$. We define the *damping ratio* for a complex eigenvalue λ to be

$$\zeta = \frac{-\operatorname{Re} \lambda}{|\lambda|}.$$

We say that a complex conjugate pair of eigenvalues λ, λ^* is a *dominant pair* if it has the lowest damping ratio compared with all other eigenvalues of the system.

Assuming that a system is stable, the dominant pair of eigenvalues tends to be the most important element of the response. To see this, assume that we have a system in Jordan form with a simple Jordan block corresponding to the dominant pair of eigenvalues:

$$\frac{dz}{dt} = \begin{pmatrix} \lambda & & & \\ & \lambda^* & & \\ & & J_2 & \\ & & & \ddots \\ & & & & J_k \end{pmatrix} z + Bu, \quad y = Cz.$$

(Note that the state z may be complex because of the Jordan transformation.) The response of the system will be a linear combination of the responses from each of the individual Jordan subsystems. As we see from Figure 6.8, for $\zeta < 1$ the subsystem with the slowest response is precisely the one with the smallest damping ratio. Hence, when we add the responses from each of the individual subsystems, it is the dominant pair of eigenvalues that will be the primary factor after the initial transients due to the other terms in the solution die out. While this simple analysis does not always hold (e.g., if some nondominant terms have larger coefficients because of the particular form of the system), it is often the case that the dominant eigenvalues determine the (step) response of the system.

The only formal requirement for eigenvalue assignment is that the system be reachable. In practice there are many other constraints because the selection of eigenvalues has a strong effect on the magnitude and rate of change of the control signal. Large eigenvalues will in general require large control signals as well as fast changes of the signals. The capability of the actuators will therefore impose constraints on the possible location of closed loop eigenvalues. These issues will be discussed in depth in Chapters 11 and 12.

We illustrate some of the main ideas using the balance system as an example.

Example 6.7 Balance system

Consider the problem of stabilizing a balance system, whose dynamics were given in Example 6.2. The dynamics are given by

$$A = \begin{pmatrix} 0 & 0 & 1 & 0 \\ 0 & 0 & 0 & 1 \\ 0 & m^2 l^2 g / \mu & -c J_t / \mu & -\gamma J_t l m / \mu \\ 0 & M_t m g l / \mu & -c l m / \mu & -\gamma M_t / \mu \end{pmatrix}, \quad B = \begin{pmatrix} 0 \\ 0 \\ J_t / \mu \\ l m / \mu \end{pmatrix},$$

where $M_t = M + m$, $J_t = J + ml^2$, $\mu = M_t J_t - m^2 l^2$ and we have left c and γ nonzero. We use the following parameters for the system (corresponding roughly to a human being balanced on a stabilizing cart):

$$\begin{aligned} M &= 10 \text{ kg}, & m &= 80 \text{ kg}, & c &= 0.1 \text{ N s/m}, & g &= 9.8 \text{ m/s}^2. \\ J &= 100 \text{ kg m}^2/\text{s}^2, & l &= 1 \text{ m}, & \gamma &= 0.01 \text{ N m s}, \end{aligned}$$

The eigenvalues of the open loop dynamics are given by $\lambda \approx 0, -0.0011, -2.68, 2.68$. We have verified already in Example 6.2 that the system is reachable, and hence we can use state feedback to stabilize the system and provide a desired level of performance.

To decide where to place the closed loop eigenvalues, we note that the closed loop dynamics will roughly consist of two components: a set of fast dynamics that stabilize the pendulum in the inverted position and a set of slower dynamics that control the position of the cart. For the fast dynamics, we look to the natural period of the pendulum (in the hanging-down position), which is given by $\omega_0 = \sqrt{mgl/(J + ml^2)} \approx 2.1$ rad/s. To provide a fast response we choose a damping ratio of $\zeta = 0.5$ and try to place the first pair of eigenvalues at $\lambda_{1,2} \approx -\zeta \omega_0 \pm i \omega_0 \approx -1 \pm 2i$, where we have used the approximation that $\sqrt{1 - \zeta^2} \approx 1$. For the slow dynamics, we choose the damping ratio to be 0.7 to provide a small overshoot and choose the natural frequency to be 0.5 to give a rise time of approximately 5 s. This gives eigenvalues $\lambda_{3,4} = -0.35 \pm 0.35i$.

The controller consists of a feedback on the state and a feedforward gain for the reference input. The feedback gain is given by

$$K = \begin{pmatrix} -15.6 & 1730 & -50.1 & 443 \end{pmatrix},$$

which can be computed using Theorem 6.3 or using the MATLAB `place` command. The feedforward gain is $k_r = -1/(C(A - BK)^{-1}B) = -15.6$. The step response for the resulting controller (applied to the linearized system) is given in Figure 6.11a. While the step response gives the desired characteristics, the input required (bottom left) is excessively large, almost three times the force of gravity at its peak.

To provide a more realistic response, we can redesign the controller to have slower dynamics. We see that the peak of the input force occurs on the fast time scale, and hence we choose to slow this down by a factor of 3, leaving the damping ratio unchanged. We also slow down the second set of eigenvalues, with the intuition that we should move the position of the cart more slowly than we stabilize the pendulum dynamics. Leaving the damping ratio for the slow dynamics unchanged at 0.7 and changing the frequency to 1 (corresponding to a rise time of approximately 10 s), the desired eigenvalues become

$$\lambda = \{-0.33 \pm 0.66i, -0.18 \pm 0.18i\}.$$

The performance of the resulting controller is shown in Figure 6.11b. ▽

As we see from this example, it can be difficult to determine where to place

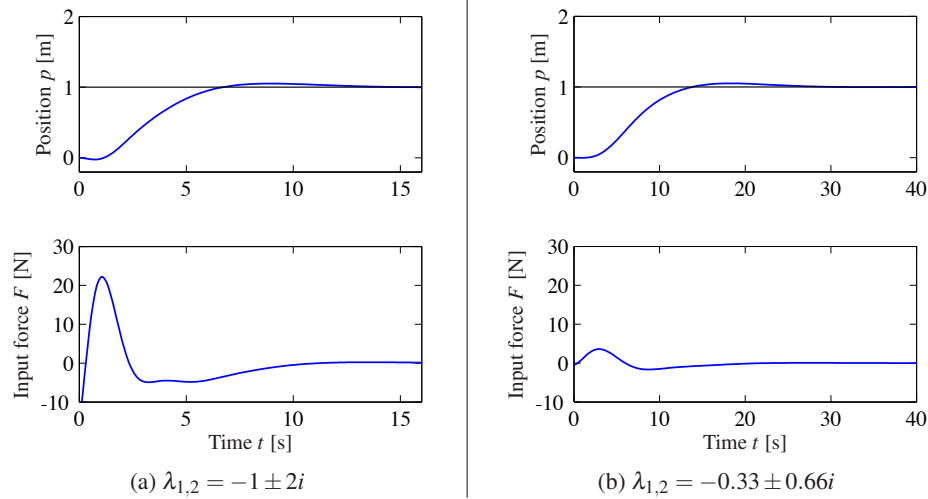

Figure 6.11: State feedback control of a balance system. The step response of a controller designed to give fast performance is shown in (a). Although the response characteristics (top left) look very good, the input magnitude (bottom left) is very large. A less aggressive controller is shown in (b). Here the response time is slowed down, but the input magnitude is much more reasonable. Both step responses are applied to the linearized dynamics.

the eigenvalues using state feedback. This is one of the principal limitations of this approach, especially for systems of higher dimension. Optimal control techniques, such as the linear quadratic regulator problem discussed next, are one approach that is available. One can also focus on the frequency response for performing the design, which is the subject of Chapters 8–12.



Linear Quadratic Regulators

As an alternative to selecting the closed loop eigenvalue locations to accomplish a certain objective, the gains for a state feedback controller can instead be chosen by attempting to optimize a cost function. This can be particularly useful in helping balance the performance of the system with the magnitude of the inputs required to achieve that level of performance.

The infinite horizon, linear quadratic regulator (LQR) problem is one of the most common optimal control problems. Given a multi-input linear system

$$\frac{dx}{dt} = Ax + Bu, \quad x \in \mathbb{R}^n, u \in \mathbb{R}^p,$$

we attempt to minimize the quadratic cost function

$$\tilde{J} = \int_0^{\infty} (x^T Q_x x + u^T Q_u u) dt, \quad (6.26)$$

where $Q_x \geq 0$ and $Q_u > 0$ are symmetric, positive (semi-) definite matrices of the appropriate dimensions. This cost function represents a trade-off between the distance of the state from the origin and the cost of the control input. By choosing

the matrices Q_x and Q_u , we can balance the rate of convergence of the solutions with the cost of the control.

The solution to the LQR problem is given by a linear control law of the form

$$u = -Q_u^{-1}B^T Px,$$

where $P \in \mathbb{R}^{n \times n}$ is a positive definite, symmetric matrix that satisfies the equation

$$PA + A^T P - PBQ_u^{-1}B^T P + Q_x = 0. \quad (6.27)$$

Equation (6.27) is called the *algebraic Riccati equation* and can be solved numerically (e.g., using the `lqr` command in MATLAB).

One of the key questions in LQR design is how to choose the weights Q_x and Q_u . To guarantee that a solution exists, we must have $Q_x \geq 0$ and $Q_u > 0$. In addition, there are certain “observability” conditions on Q_x that limit its choice. Here we assume $Q_x > 0$ to ensure that solutions to the algebraic Riccati equation always exist.

To choose specific values for the cost function weights Q_x and Q_u , we must use our knowledge of the system we are trying to control. A particularly simple choice is to use diagonal weights

$$Q_x = \begin{pmatrix} q_1 & & 0 \\ & \ddots & \\ 0 & & q_n \end{pmatrix}, \quad Q_u = \begin{pmatrix} \rho_1 & & 0 \\ & \ddots & \\ 0 & & \rho_n \end{pmatrix}.$$

For this choice of Q_x and Q_u , the individual diagonal elements describe how much each state and input (squared) should contribute to the overall cost. Hence, we can take states that should remain small and attach higher weight values to them. Similarly, we can penalize an input versus the states and other inputs through choice of the corresponding input weight ρ .

Example 6.8 Vectored thrust aircraft

Consider the original dynamics of the system (2.26), written in state space form as

$$\frac{dz}{dt} = \begin{pmatrix} z_4 \\ z_5 \\ z_6 \\ -\frac{c}{m}z_4 \\ -g - \frac{c}{m}z_5 \\ 0 \end{pmatrix} + \begin{pmatrix} 0 \\ 0 \\ 0 \\ \frac{1}{m}\cos\theta F_1 - \frac{1}{m}\sin\theta F_2 \\ \frac{1}{m}\sin\theta F_1 + \frac{1}{m}\cos\theta F_2 \\ \frac{r}{J}F_1 \end{pmatrix}$$

(see also Example 5.4). The system parameters are $m = 4$ kg, $J = 0.0475$ kg m², $r = 0.25$ m, $g = 9.8$ m/s², $c = 0.05$ N s/m, which corresponds to a scaled model of the system. The equilibrium point for the system is given by $F_1 = 0$, $F_2 = mg$ and $z_e = (x_e, y_e, 0, 0, 0, 0)$. To derive the linearized model near an equilibrium point, we

compute the linearization according to equation (5.34):

$$A = \begin{pmatrix} 0 & 0 & 0 & 1 & 0 & 0 \\ 0 & 0 & 0 & 0 & 1 & 0 \\ 0 & 0 & 0 & 0 & 0 & 1 \\ 0 & 0 & -g & -c/m & 0 & 0 \\ 0 & 0 & 0 & 0 & -c/m & 0 \\ 0 & 0 & 0 & 0 & 0 & 0 \end{pmatrix}, \quad B = \begin{pmatrix} 0 & 0 \\ 0 & 0 \\ 0 & 0 \\ 1/m & 0 \\ 0 & 1/m \\ r/J & 0 \end{pmatrix},$$

$$C = \begin{pmatrix} 1 & 0 & 0 & 0 & 0 & 0 \\ 0 & 1 & 0 & 0 & 0 & 0 \end{pmatrix}, \quad D = \begin{pmatrix} 0 & 0 \\ 0 & 0 \end{pmatrix}.$$

Letting $\xi = z - z_e$ and $v = F - F_e$, the linearized system is given by

$$\frac{d\xi}{dt} = A\xi + Bv, \quad y = C\xi.$$

It can be verified that the system is reachable.

To compute a linear quadratic regulator for the system, we write the cost function as

$$J = \int_0^{\infty} (\xi^T Q_{\xi} \xi + v^T Q_v v) dt,$$

where $\xi = z - z_e$ and $v = F - F_e$ again represent the local coordinates around the desired equilibrium point (z_e, F_e) . We begin with diagonal matrices for the state and input costs:

$$Q_{\xi} = \begin{pmatrix} 1 & 0 & 0 & 0 & 0 & 0 \\ 0 & 1 & 0 & 0 & 0 & 0 \\ 0 & 0 & 1 & 0 & 0 & 0 \\ 0 & 0 & 0 & 1 & 0 & 0 \\ 0 & 0 & 0 & 0 & 1 & 0 \\ 0 & 0 & 0 & 0 & 0 & 1 \end{pmatrix}, \quad Q_v = \begin{pmatrix} \rho & 0 \\ 0 & \rho \end{pmatrix}.$$

This gives a control law of the form $v = -K\xi$, which can then be used to derive the control law in terms of the original variables:

$$F = v + F_e = -K(z - z_e) + F_e.$$

As computed in Example 5.4, the equilibrium points have $F_e = (0, mg)$ and $z_e = (x_e, y_e, 0, 0, 0, 0)$. The response of the controller to a step change in the desired position is shown in Figure 6.12a for $\rho = 1$. The response can be tuned by adjusting the weights in the LQR cost. Figure 6.12b shows the response in the x direction for different choices of the weight ρ . ∇

Linear quadratic regulators can also be designed for discrete-time systems, as illustrated by the following example.

Example 6.9 Web server control

Consider the web server example given in Section A.4, where a discrete-time model for the system was given. We wish to design a control law that sets the

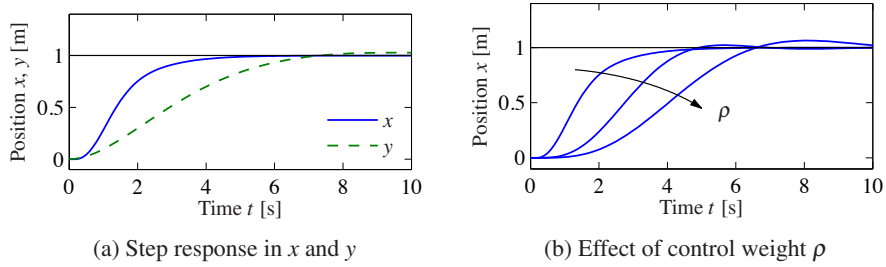

Figure 6.12: Step response for a vectored thrust aircraft. The plot in (a) shows the x and y positions of the aircraft when it is commanded to move 1 m in each direction. In (b) the x motion is shown for control weights $\rho = 1, 10^2, 10^4$. A higher weight of the input term in the cost function causes a more sluggish response.

server parameters so that the average server processor load is maintained at a desired level. Since other processes may be running on the server, the web server must adjust its parameters in response to changes in the load.

A block diagram for the control system is shown in Figure 6.13. We focus on the special case where we wish to control only the processor load using both the `KeepAlive` and `MaxClients` parameters. We also include a “disturbance” on the measured load that represents the use of the processing cycles by other processes running on the server. The system has the same basic structure as the generic control system in Figure 6.5, with the variation that the disturbance enters after the process dynamics.

The dynamics of the system are given by a set of difference equations of the form

$$x[k+1] = Ax[k] + Bu[k], \quad y_{\text{cpu}}[k] = C_{\text{cpu}}x[k] + d_{\text{cpu}}[k],$$

where $x = (x_{\text{cpu}}, x_{\text{mem}})$ is the state, $u = (u_{\text{ka}}, u_{\text{mc}})$ is the input, d_{cpu} is the processing load from other processes on the computer and y_{cpu} is the total processor load.

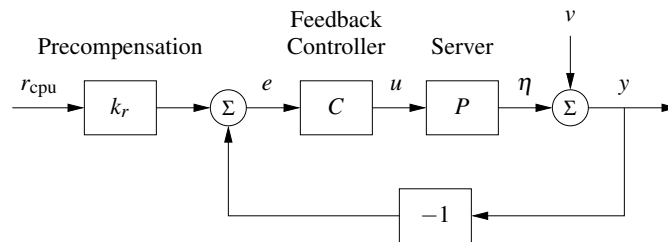

Figure 6.13: Feedback control of a web server. The controller sets the values of the web server parameters based on the difference between the nominal parameters (determined by $k_r r$) and the current load y_{cpu} . The disturbance v represents the load due to other processes running on the server. Note that the measurement is taken after the disturbance so that we measure the total load on the server.

We choose our controller to be a state feedback controller of the form

$$u = -K \begin{pmatrix} y_{\text{cpu}} \\ x_{\text{mem}} \end{pmatrix} + k_r r_{\text{cpu}},$$

where r_{cpu} is the desired processor load. Note that we have used the measured processor load y_{cpu} instead of the state to ensure that we adjust the system operation based on the actual load. (This modification is necessary because of the nonstandard way in which the disturbance enters the process dynamics.)

The feedback gain matrix K can be chosen by any of the methods described in this chapter. Here we use a linear quadratic regulator, with the cost function given by

$$Q_x = \begin{pmatrix} 5 & 0 \\ 0 & 1 \end{pmatrix}, \quad Q_u = \begin{pmatrix} 1/50^2 & 0 \\ 0 & 1/1000^2 \end{pmatrix}.$$

The cost function for the state Q_x is chosen so that we place more emphasis on the processor load versus the memory use. The cost function for the inputs Q_u is chosen so as to normalize the two inputs, with a `KeepAlive` timeout of 50 s having the same weight as a `MaxClients` value of 1000. These values are squared since the cost associated with the inputs is given by $u^T Q_u u$. Using the dynamics in Section A.4 and the `dlqr` command in MATLAB, the resulting gains become

$$K = \begin{pmatrix} -22.3 & 10.1 \\ 382.7 & 77.7 \end{pmatrix}.$$

As in the case of a continuous-time control system, the reference gain k_r is chosen to yield the desired equilibrium point for the system. Setting $x[k+1] = x[k] = x_e$, the steady-state equilibrium point and output for a given reference input r are given by

$$x_e = (A - BK)x_e + Bk_r r, \quad y_e = Cx_e.$$

This is a matrix differential equation in which k_r is a column vector that sets the two inputs values based on the desired reference. If we take the desired output to be of the form $y_e = (r, 0)$, then we must solve

$$\begin{pmatrix} 1 \\ 0 \end{pmatrix} = C(A - BK - I)^{-1} Bk_r.$$

Solving this equation for k_r , we obtain

$$k_r = \left((C(A - BK - I)^{-1} B) \right)^{-1} \begin{pmatrix} 1 \\ 0 \end{pmatrix} = \begin{pmatrix} 49.3 \\ 539.5 \end{pmatrix}.$$

The dynamics of the closed loop system are illustrated in Figure 6.14. We apply a change in load of $d_{\text{cpu}} = 0.3$ at time $t = 10$ s, forcing the controller to adjust the operation of the server to attempt to maintain the desired load at 0.57. Note that both the `KeepAlive` and `MaxClients` parameters are adjusted. Although the load is decreased, it remains approximately 0.2 above the desired steady state. (Better results can be obtained using the techniques of the next section.) ∇

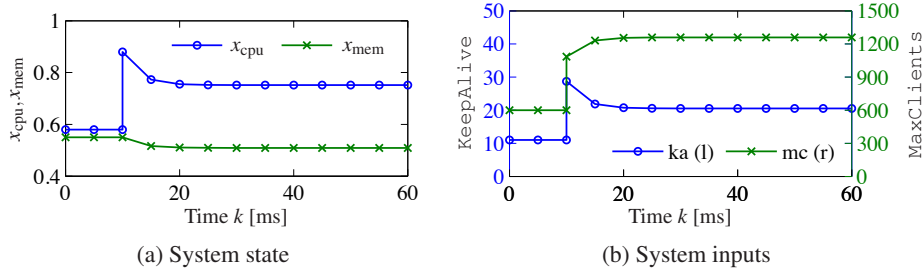

Figure 6.14: Web server with LQR control. The plot in (a) shows the state of the system under a change in external load applied at $k = 10$ ms. The corresponding web server parameters (system inputs) are shown in (b). The controller is able to reduce the effect of the disturbance by approximately 40%.

6.4 Integral Action

Controllers based on state feedback achieve the correct steady-state response to command signals by careful calibration of the gain k_r . However, one of the primary uses of feedback is to allow good performance in the presence of uncertainty, and hence requiring that we have an *exact* model of the process is undesirable. An alternative to calibration is to make use of integral feedback, in which the controller uses an integrator to provide zero steady-state error. The basic concept of integral feedback was given in Section 1.4 and in Section A.1; here we provide a more complete description and analysis.

The basic approach in integral feedback is to create a state within the controller that computes the integral of the error signal, which is then used as a feedback term. We do this by augmenting the description of the system with a new state z :

$$\frac{d}{dt} \begin{pmatrix} x \\ z \end{pmatrix} = \begin{pmatrix} Ax + Bu \\ y - r \end{pmatrix} = \begin{pmatrix} Ax + Bu \\ Cx - r \end{pmatrix}. \quad (6.28)$$

The state z is seen to be the integral of the difference between the the actual output y and desired output r . Note that if we find a compensator that stabilizes the system, then we will necessarily have $\dot{z} = 0$ in steady state and hence $y = r$ in steady state.

Given the augmented system, we design a state space controller in the usual fashion, with a control law of the form

$$u = -Kx - k_i z + k_r r, \quad (6.29)$$

where K is the usual state feedback term, k_i is the integral term and k_r is used to set the nominal input for the desired steady state. The resulting equilibrium point for the system is given as

$$x_e = -(A - BK)^{-1} B(k_r r - k_i z_e).$$

Note that the value of z_e is not specified but rather will automatically settle to the value that makes $\dot{z} = y - r = 0$, which implies that at equilibrium the output will equal the reference value. This holds independently of the specific values of A ,

B and K as long as the system is stable (which can be done through appropriate choice of K and k_i).

The final compensator is given by

$$u = -Kx - k_i z + k_r r, \quad \frac{dz}{dt} = y - r,$$

where we have now included the dynamics of the integrator as part of the specification of the controller. This type of compensator is known as a *dynamic compensator* since it has its own internal dynamics. The following example illustrates the basic approach.

Example 6.10 Cruise control

Consider the cruise control example introduced in Section A.1 and considered further in Example 5.11. The linearized dynamics of the process around an equilibrium point v_e , u_e are given by

$$\frac{dx}{dt} = ax - b_g \theta + bw, \quad y = v = x + v_e,$$

where $x = v - v_e$, $w = u - u_e$, m is the mass of the car and θ is the angle of the road. The constant a depends on the throttle characteristic and is given in Example 5.11.

If we augment the system with an integrator, the process dynamics become

$$\frac{dx}{dt} = ax - b_g \theta + bw, \quad \frac{dz}{dt} = y - v_r = v_e + x - v_r,$$

or, in state space form,

$$\frac{d}{dt} \begin{pmatrix} x \\ z \end{pmatrix} = \begin{pmatrix} a & 0 \\ 1 & 0 \end{pmatrix} \begin{pmatrix} x \\ z \end{pmatrix} + \begin{pmatrix} b \\ 0 \end{pmatrix} w + \begin{pmatrix} -b_g \\ 0 \end{pmatrix} \theta + \begin{pmatrix} 0 \\ v_e - v_r \end{pmatrix}.$$

Note that when the system is at equilibrium, we have that $\dot{z} = 0$, which implies that the vehicle speed $v = v_e + x$ should be equal to the desired reference speed v_r . Our controller will be of the form

$$\frac{dz}{dt} = y - v_r, \quad w = -k_p x - k_i z + k_r v_r,$$

and the gains k_p , k_i and k_r will be chosen to stabilize the system and provide the correct input for the reference speed.

Assume that we wish to design the closed loop system to have the characteristic polynomial

$$\lambda(s) = s^2 + a_1 s + a_2.$$

Setting the disturbance $\theta = 0$, the characteristic polynomial of the closed loop system is given by

$$\det(sI - (A - BK)) = s^2 + (bk_p - a)s + bk_i,$$

and hence we set

$$k_p = \frac{a_1 + a}{b}, \quad k_i = \frac{a_2}{b}, \quad k_r = -1 / (C(A - BK)^{-1}B) = \frac{a}{b}.$$

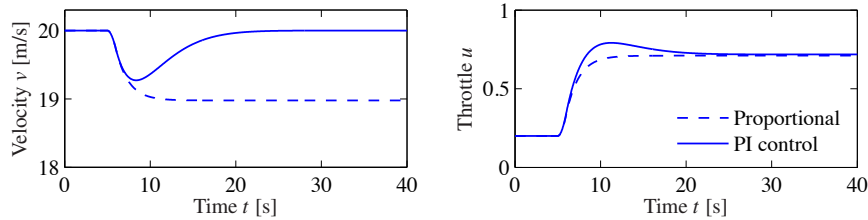

Figure 6.15: Velocity and throttle for a car with cruise control based on proportional (dashed) and PI control (solid). The PI controller is able to adjust the throttle to compensate for the effect of the hill and maintain the speed at the reference value of $v_r = 20$ m/s.

The resulting controller stabilizes the system and hence brings $\dot{z} = y - v_r$ to zero, resulting in perfect tracking. Notice that even if we have a small error in the values of the parameters defining the system, as long as the closed loop eigenvalues are still stable, then the tracking error will approach zero. Thus the exact calibration required in our previous approach (using k_r) is not needed here. Indeed, we can even choose $k_r = 0$ and let the feedback controller do all of the work.

Integral feedback can also be used to compensate for constant disturbances. Figure 6.15 shows the results of a simulation in which the car encounters a hill with angle $\theta = 4^\circ$ at $t = 8$ s. The stability of the system is not affected by this external disturbance, and so we once again see that the car’s velocity converges to the reference speed. This ability to handle constant disturbances is a general property of controllers with integral feedback (see Exercise 6.4). ∇

6.5 Further Reading

The importance of state models and state feedback was discussed in the seminal paper by Kalman [Kal60], where the state feedback gain was obtained by solving an optimization problem that minimized a quadratic loss function. The notions of reachability and observability (Chapter 7) are also due to Kalman [Kal61b] (see also [Gil63, KHN63]). Kalman defines controllability and reachability as the ability to reach the origin and an arbitrary state, respectively [KFA69]. We note that in most textbooks the term “controllability” is used instead of “reachability,” but we prefer the latter term because it is more descriptive of the fundamental property of being able to reach arbitrary states. Most undergraduate textbooks on control contain material on state space systems, including, for example, Franklin, Powell and Emami-Naeini [FPEN05] and Ogata [Oga01]. Friedland’s textbook [Fri04] covers the material in the previous, current and next chapter in considerable detail, including the topic of optimal control.

Exercises

6.1 (Double integrator) Consider the double integrator. Find a piecewise constant control strategy that drives the system from the origin to the state $x = (1, 1)$.

6.2 (Reachability from nonzero initial state) Extend the argument in Section 6.1 to show that if a system is reachable from an initial state of zero, it is reachable from a nonzero initial state.

6.3 (Unreachable systems) Consider the system shown in Figure 6.3. Write the dynamics of the two systems as

$$\frac{dx}{dt} = Ax + Bu, \quad \frac{dz}{dt} = Az + Bu.$$

If x and z have the same initial condition, they will always have the same state regardless of the input that is applied. Show that this violates the definition of reachability and further show that the reachability matrix W_r is not full rank.

6.4 (Integral feedback for rejecting constant disturbances) Consider a linear system of the form

$$\frac{dx}{dt} = Ax + Bu + Fd, \quad y = Cx$$

where u is a scalar and v is a disturbance that enters the system through a disturbance vector $F \in \mathbb{R}^n$. Assume that the matrix A is invertible and the zero frequency gain $CA^{-1}B$ is nonzero. Show that integral feedback can be used to compensate for a constant disturbance by giving zero steady-state output error even when $d \neq 0$.

6.5 (Rear-steered bicycle) A simple model for a bicycle was given by equation (A.5) in Section A.2. A model for a bicycle with rear-wheel steering is obtained by reversing the sign of the velocity in the model. Determine the conditions under which this systems is reachable and explain any situations in which the system is not reachable.

6.6 (Characteristic polynomial for reachable canonical form) Show that the characteristic polynomial for a system in reachable canonical form is given by equation (6.7) and that

$$\frac{d^n z_k}{dt^n} + a_1 \frac{d^{n-1} z_k}{dt^{n-1}} + \cdots + a_{n-1} \frac{dz_k}{dt} + a_n z_k = \frac{d^{n-k} u}{dt^{n-k}},$$

where z_k is the k th state.

6.7 (Reachability matrix for reachable canonical form) Consider a system in reachable canonical form. Show that the inverse of the reachability matrix is given by

$$\tilde{W}_r^{-1} = \begin{pmatrix} 1 & a_1 & a_2 & \cdots & a_n \\ 0 & 1 & a_1 & \cdots & a_{n-1} \\ 0 & 0 & 1 & \ddots & \vdots \\ \vdots & & & \ddots & a_1 \\ 0 & 0 & 0 & \cdots & 1 \end{pmatrix}.$$

6.8 (Non-maintainable equilibria) Consider the normalized model of a pendulum on a cart

$$\frac{d^2x}{dt^2} = u, \quad \frac{d^2\theta}{dt^2} = -\theta + u,$$

where x is cart position and θ is pendulum angle. Can the angle $\theta = \theta_0$ for $\theta_0 \neq 0$ be maintained?

6.9 (Eigenvalue assignment for unreachable system) Consider the system

$$\frac{dx}{dt} = \begin{pmatrix} 0 & 1 \\ 0 & 0 \end{pmatrix} x + \begin{pmatrix} 1 \\ 0 \end{pmatrix} u, \quad y = \begin{pmatrix} 1 & 0 \end{pmatrix} x,$$

with the control law

$$u = -k_1x_1 - k_2x_2 + k_r r.$$

Show that eigenvalues of the system cannot be assigned to arbitrary values.

6.10 (Cayley–Hamilton theorem) Let $A \in \mathbb{R}^{n \times n}$ be a matrix with characteristic polynomial $\lambda(s) = \det(sI - A) = s^n + a_1s^{n-1} + \cdots + a_{n-1}s + a_n$. Assume that the matrix A can be diagonalized and show that it satisfies

$$\lambda(A) = A^n + a_1A^{n-1} + \cdots + a_{n-1}A + a_nI = 0,$$

Use the result to show that A^k , $k \geq n$, can be rewritten in terms of powers of A of order less than n .

6.11 (Motor drive) Consider the normalized model of the motor drive in Exercise 2.10. Using the following normalized parameters,

$$J_1 = 10/9, \quad J_2 = 10, \quad c = 0.1, \quad k = 1, \quad k_I = 1,$$

verify that the eigenvalues of the open loop system are $0, 0, -0.05 \pm i$. Design a state feedback that gives a closed loop system with eigenvalues $-2, -1$ and $-1 \pm i$. This choice implies that the oscillatory eigenvalues will be well damped and that the eigenvalues at the origin are replaced by eigenvalues on the negative real axis. Simulate the responses of the closed loop system to step changes in the command signal for θ_2 and a step change in a disturbance torque on the second rotor.

6.12 (Whipple bicycle model) Consider the Whipple bicycle model given by equation (A.7) in Section A.2. Using the parameters from the companion web site, the model is unstable at the velocity $v = 5$ m/s and the open loop eigenvalues are $-1.84, -14.29$ and $1.30 \pm 4.60i$. Find the gains of a controller that stabilizes the bicycle and gives closed loop eigenvalues at $-2, -10$ and $-1 \pm i$. Simulate the response of the system to a step change in the steering reference of 0.002 rad.

6.13 (Atomic force microscope) Consider the model of an AFM in contact mode given in Example 5.9:

$$\frac{dx}{dt} = \begin{pmatrix} 0 & 1 & 0 & 0 \\ -k_2/(m_1+m_2) & -c_2/(m_1+m_2) & 1/m_2 & 0 \\ 0 & 0 & 0 & \omega_3 \\ 0 & 0 & -\omega_3 & -2\zeta_3\omega_3 \end{pmatrix} x + \begin{pmatrix} 0 \\ 0 \\ 0 \\ \omega_3 \end{pmatrix} u,$$

$$y = \frac{m_2}{m_1+m_2} \begin{pmatrix} m_1k_2 & m_1c_2 & 1 & 0 \end{pmatrix} x.$$

Use the MATLAB script `afm_data.m` from the companion web site to generate the system matrices.

- Compute the reachability matrix of the system and numerically determine its rank. Scale the model by using milliseconds instead of seconds as time units. Repeat the calculation of the reachability matrix and its rank.
- Find a state feedback controller that gives a closed loop system with complex poles having damping ratio 0.707. Use the scaled model for the computations.
- Compute state feedback gains using linear quadratic control. Experiment by using different weights. Compute the gains for $q_1 = q_2 = 0, q_3 = q_4 = 1$ and $\rho_1 = 0.1$ and explain the result. Choose $q_1 = q_2 = q_3 = q_4 = 1$ and explore what happens to the feedback gains and closed loop eigenvalues when you change ρ_1 . Use the scaled system for this computation.

6.14 Consider the second-order system

$$\frac{d^2y}{dt^2} + 0.5\frac{dy}{dt} + y = a\frac{du}{dt} + u.$$

Let the initial conditions be zero.

- Show that the initial slope of the unit step response is a . Discuss what it means when $a < 0$.
- Show that there are points on the unit step response that are invariant with a . Discuss qualitatively the effect of the parameter a on the solution.
- Simulate the system and explore the effect of a on the rise time and overshoot.

6.15 (Bryson's rule) Bryson and Ho [BH75] have suggested the following method for choosing the matrices Q_x and Q_u in equation (6.26). Start by choosing Q_x and Q_u as diagonal matrices whose elements are the inverses of the squares of the maxima of the corresponding variables. Then modify the elements to obtain a compromise among response time, damping and control effort. Apply this method to the motor drive in Exercise 6.11. Assume that the largest values of the ϕ_1 and ϕ_2 are 1, the largest values of $\dot{\phi}_1$ and $\dot{\phi}_2$ are 2 and the largest control signal is 10. Simulate the closed loop system for $\phi_2(0) = 1$ and all other states are initialized to 0. Explore the effects of different values of the diagonal elements for Q_x and Q_u .