



# Estruturas Cerâmicas

---

- Cristais
- Defeitos
- Vidros

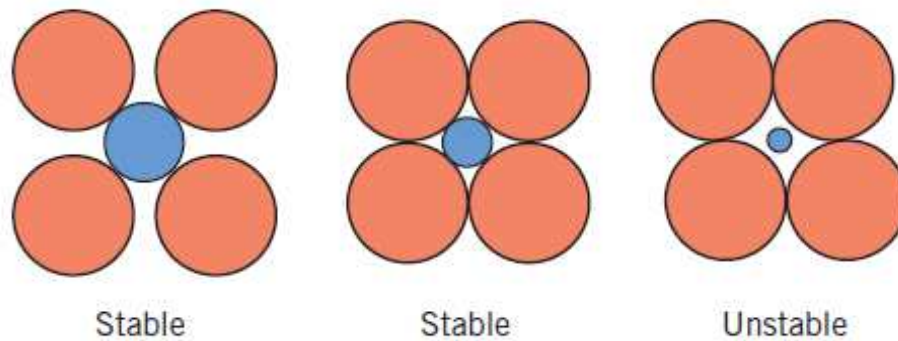


# Caráter da ligação química

**Table 12.1** For Several Ceramic Materials, Percent Ionic Character of the Interatomic Bonds

<i>Material</i>	<i>Percent Ionic Character</i>
CaF <sub>2</sub>	89
MgO	73
NaCl	67
Al <sub>2</sub> O <sub>3</sub>	63
SiO <sub>2</sub>	51
Si <sub>3</sub> N <sub>4</sub>	30
ZnS	18
SiC	12

# Cerâmicas iônicas - Nc

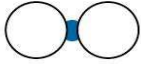
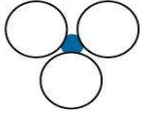
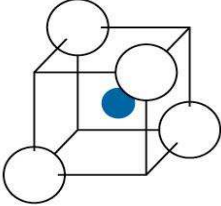
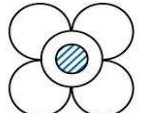
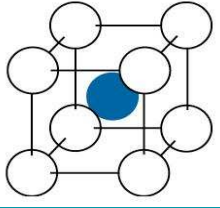


**Figure 12.1** Stable and unstable anion–cation coordination configurations. Red circles represent anions; blue circles denote cations.

Estabilidade do arranjo iônico

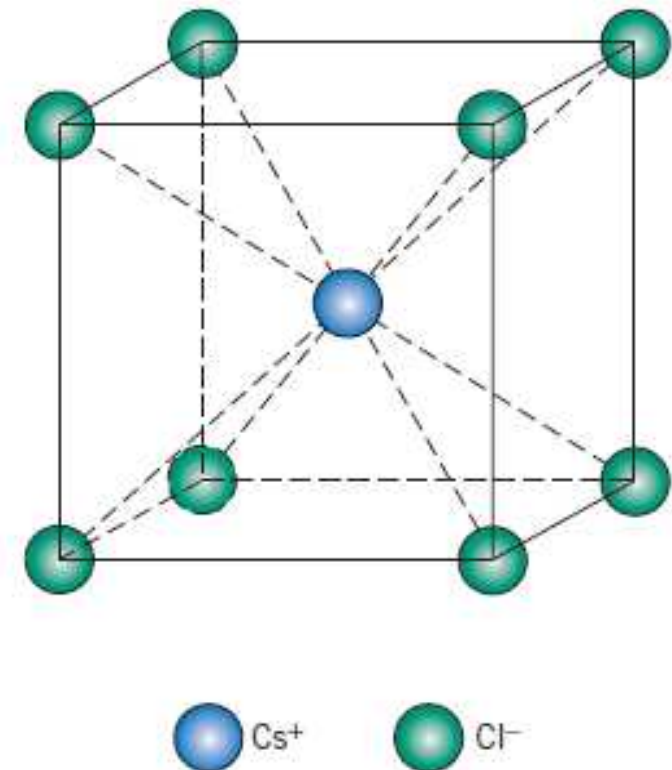
# Cerâmicas iônicas - Nc

**TABLE 3-6** ■ *The coordination number and the radius ratio*

Coordination Number	Interstitial Location of Number	Radius Ratio	Representation
2	Linear	0–0.155	
3	Center of triangle	0.155–0.225	
4	Center of tetrahedron	0.225–0.414	
6	Center of octahedron	0.414–0.732	
8	Center of cube	0.732–1.000	

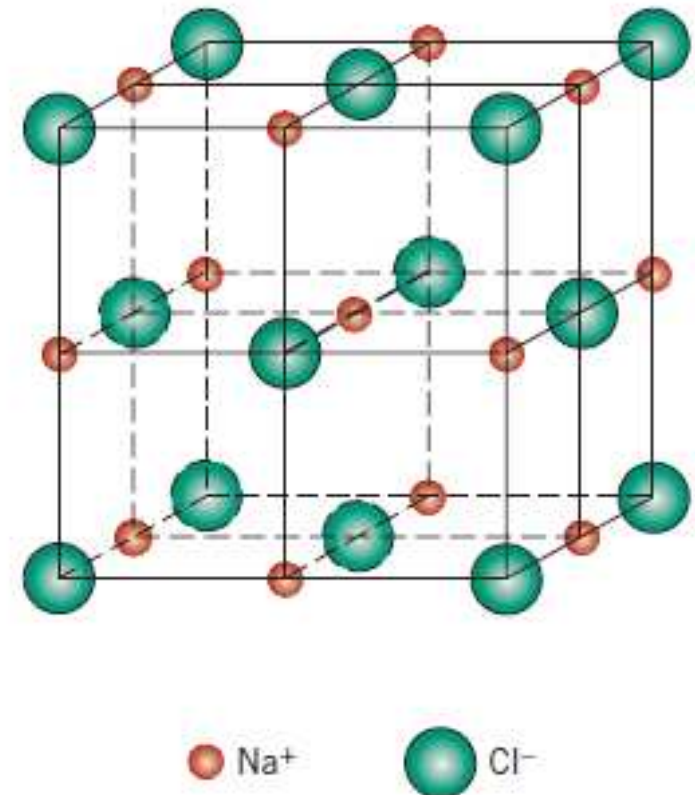
# Cloreto de Césio

- CsCl
  - NC = 8
  - Estrutura CS
  - Ânions nos pontos da rede
  - Cátions no interstício cúbico da rede



# Sal de cozinha

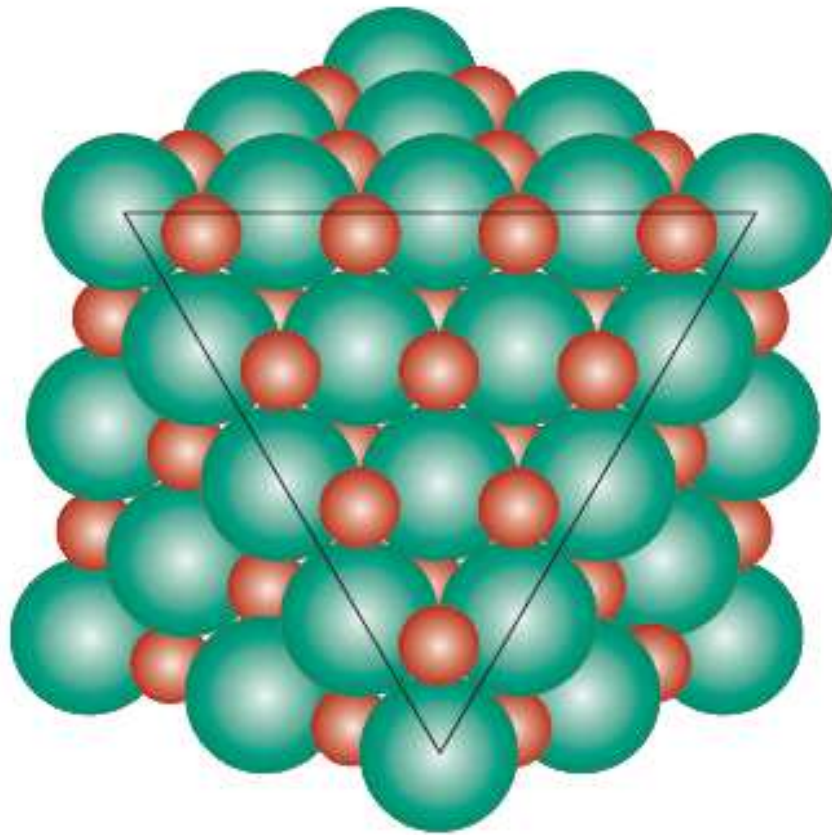
- NaCl
  - NC = 6
  - Estrutura CFC ([clique aqui](#))
  - Ânions nos pontos da rede
  - Cátions nos interstícios octaédricos da rede





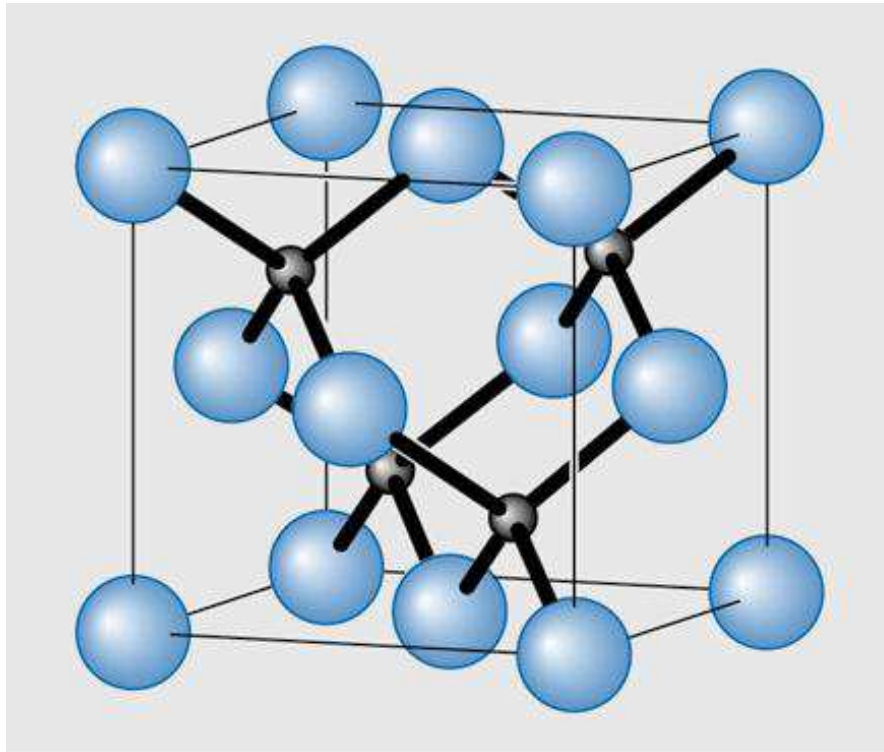
# NaCl

---

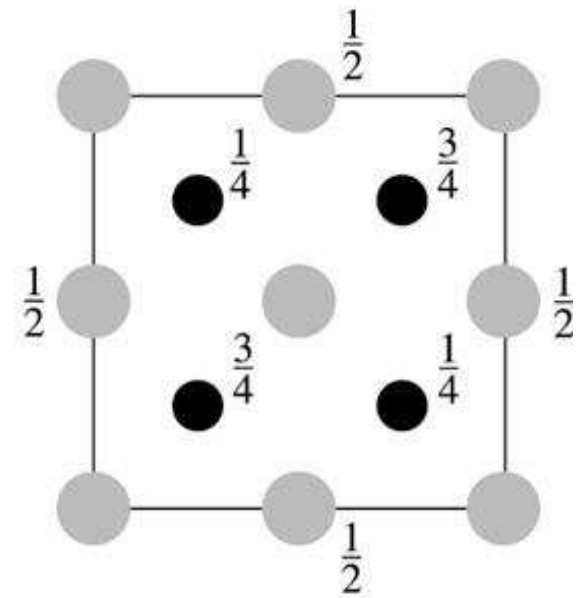


**Figure 12.8** A section of the rock salt crystal structure from which a corner has been removed. The exposed plane of anions (green spheres inside the triangle) is a  $\{111\}$ -type plane; the cations (red spheres) occupy the interstitial octahedral positions.

# GaAs, ZnS, SiC



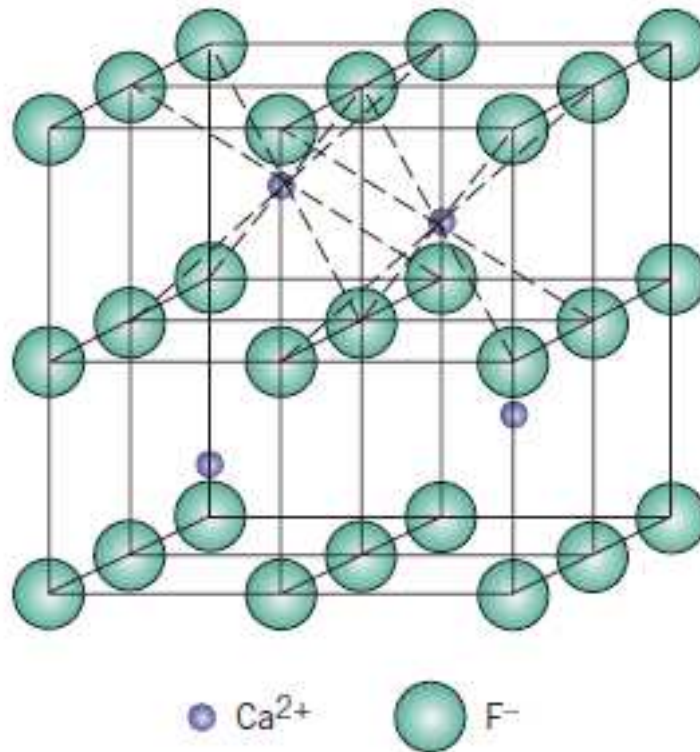
(a)



(b)

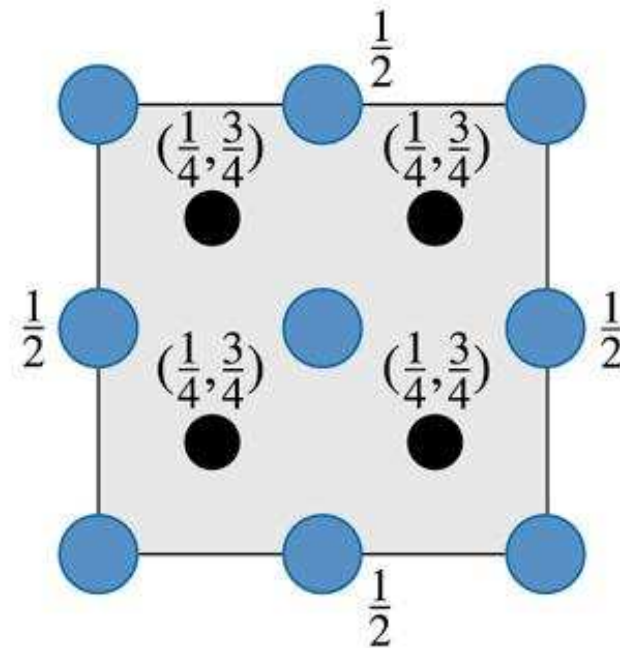


# Fluorita ( $\text{CaF}_2$ )



Fluorite cell

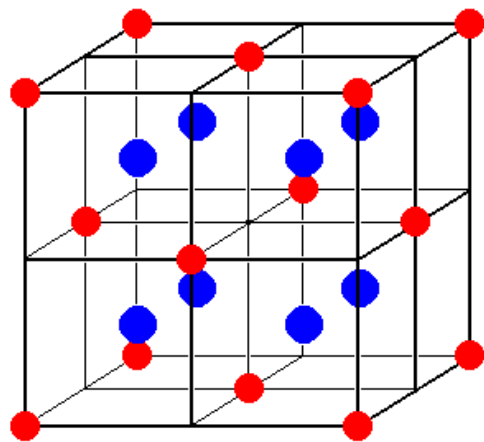
(a)



Plan view

(b)

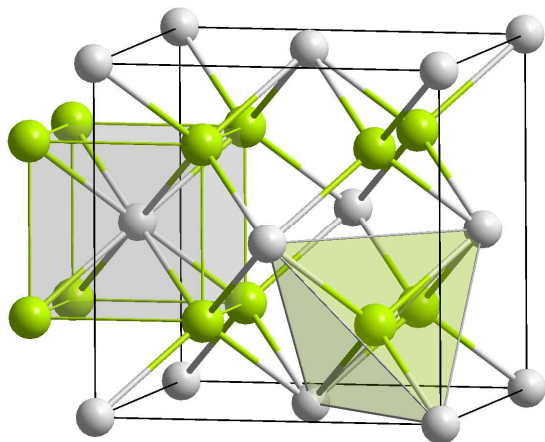
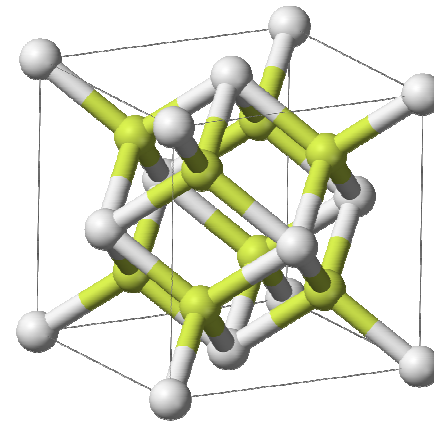
# Fluorita (CaF<sub>2</sub>)



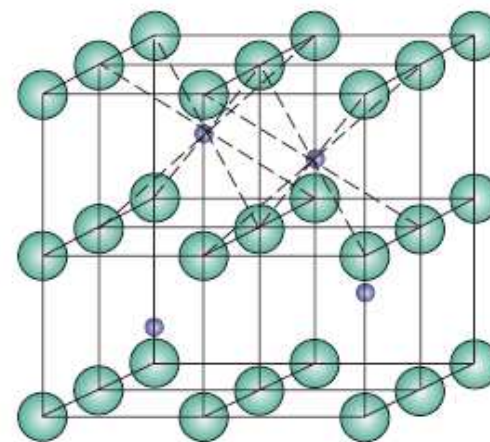
● Ca<sup>++</sup>

● F<sup>-</sup>

CaF<sub>2</sub>



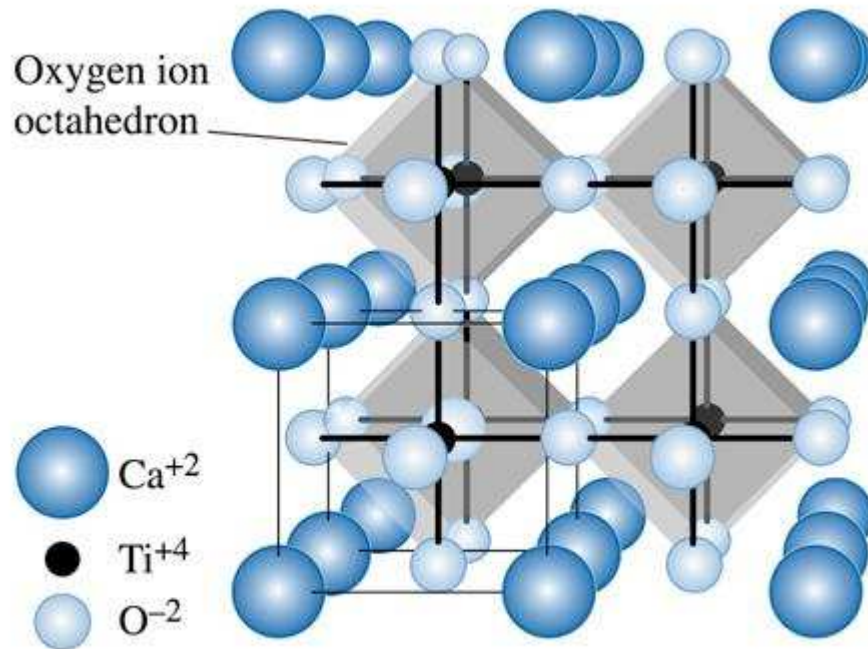
← equivalentes →



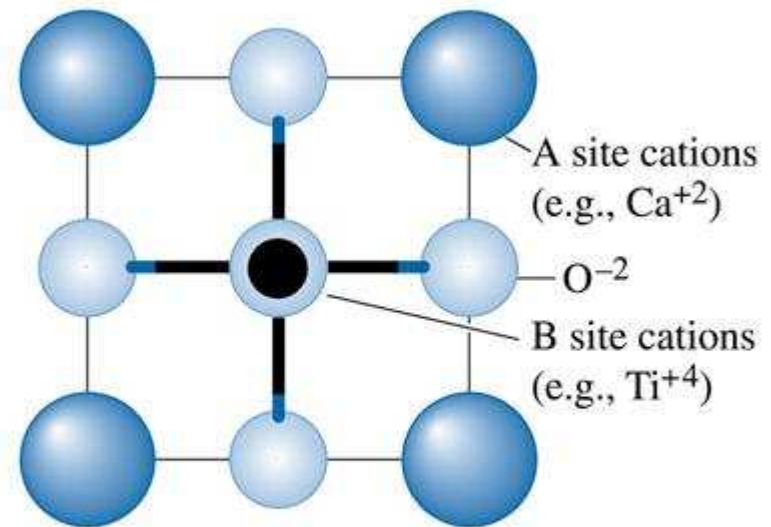
● Ca<sup>2+</sup>

● F<sup>-</sup>

# Perovskita, BaTiO<sub>3</sub>

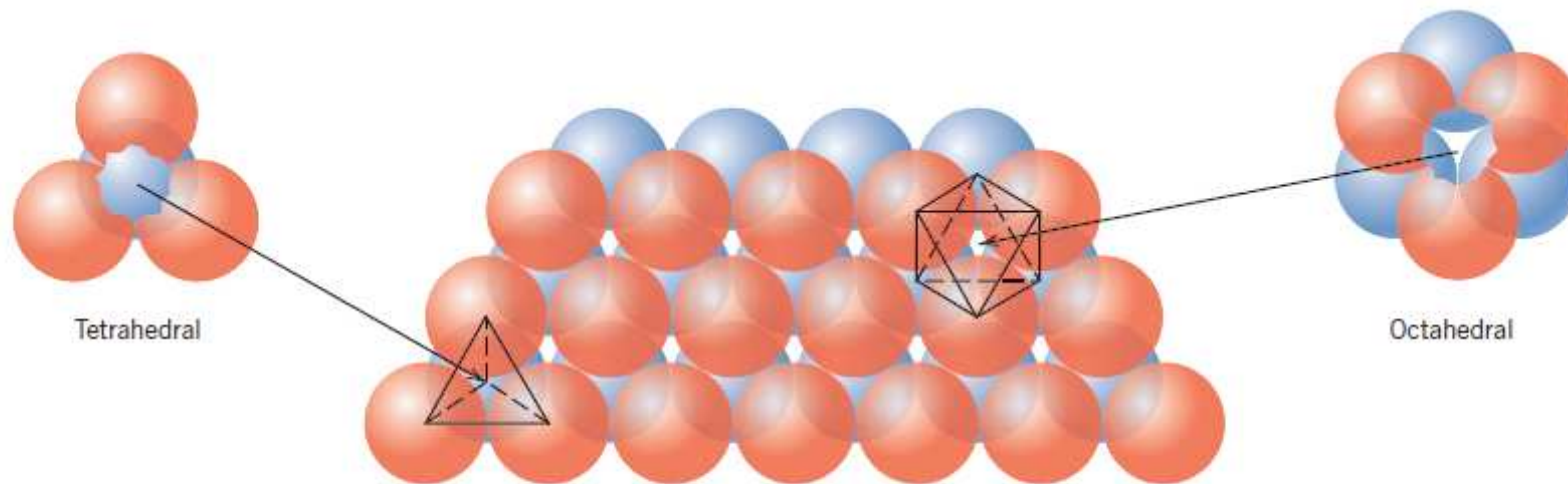


Perovskite



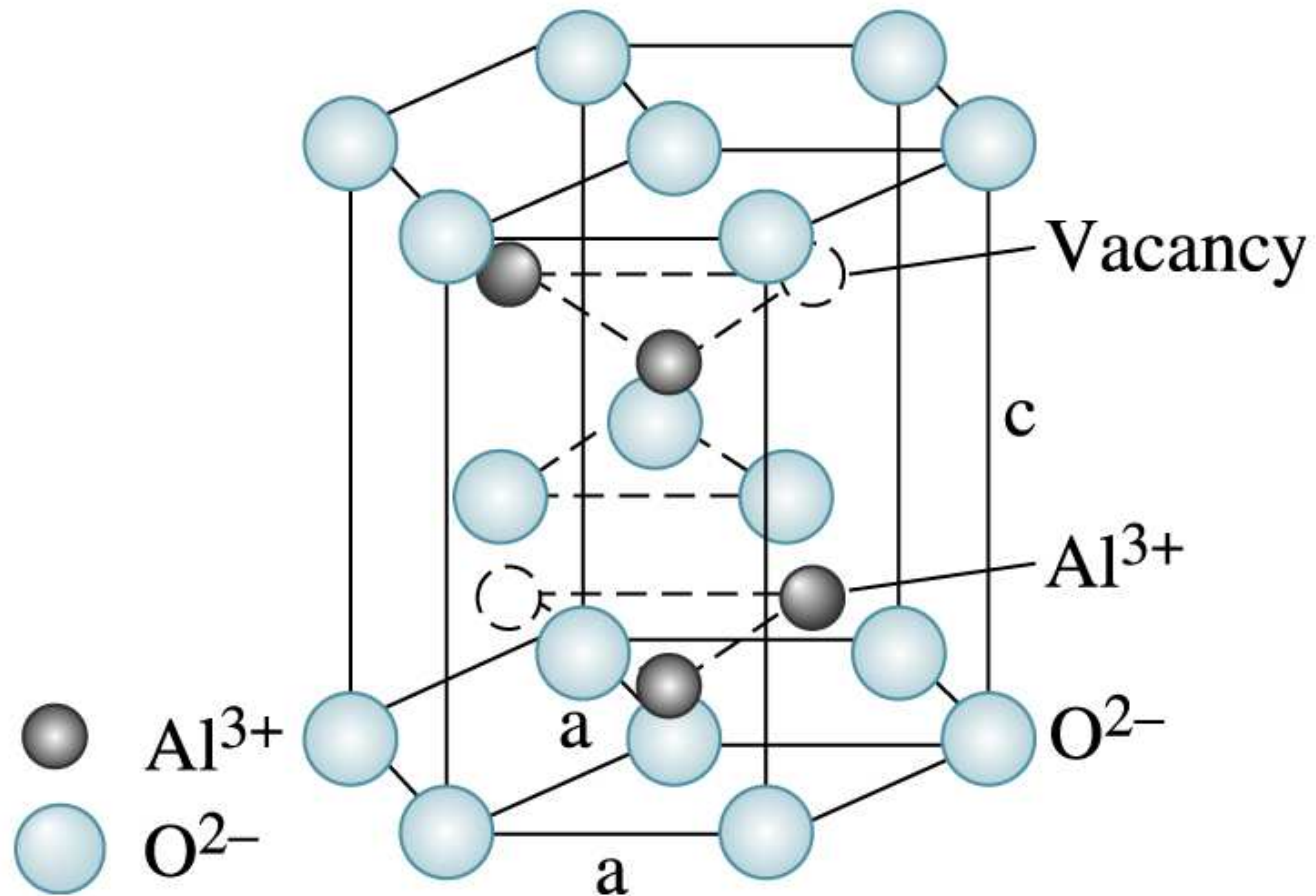
Perovskite, plan view

# Arranjos compactos de ânions (CFC e HCP)



**Figure 12.7** The stacking of one plane of close-packed (orange) spheres (anions) on top of another (blue spheres); the geometries of tetrahedral and octahedral positions between the planes are noted. (From W. G. Moffatt, G. W. Pearsall, and J. Wulff, *The Structure and Properties of Materials*, Vol. I, *Structure*. Copyright © 1964 by John Wiley & Sons, New York. Reprinted by permission of John Wiley & Sons, Inc.)

# Alumina



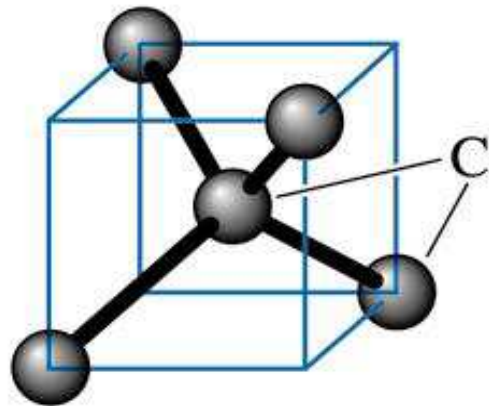
# Resumo das estruturas mais simples

**Table 12.4** Summary of Some Common Ceramic Crystal Structures

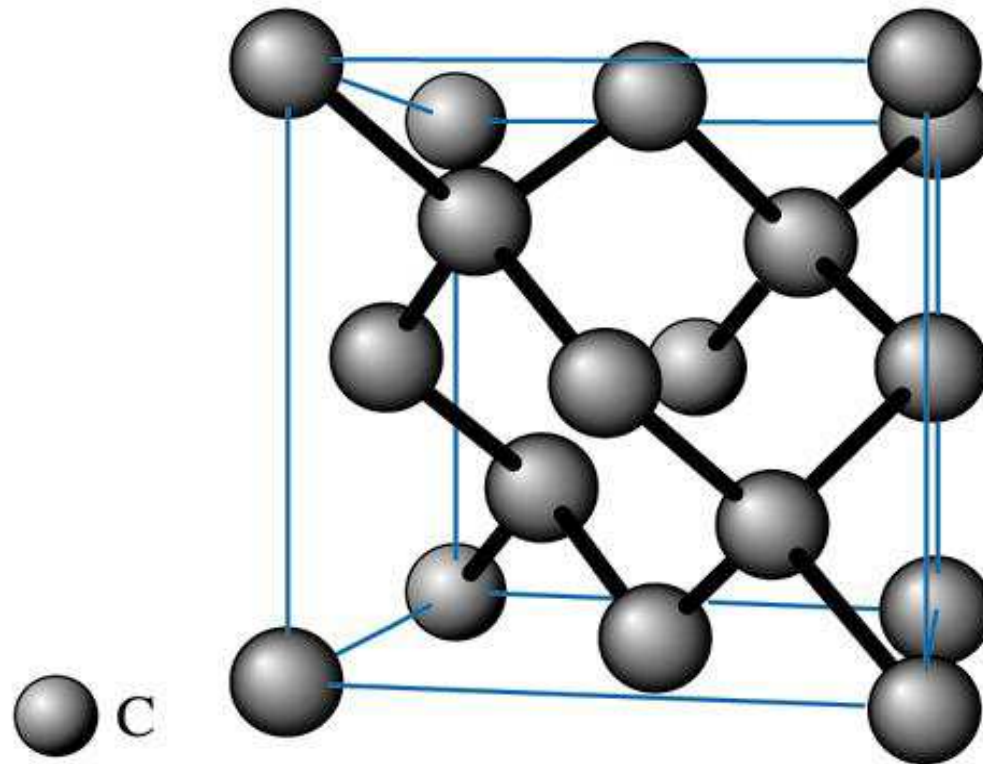
<i>Structure Name</i>	<i>Structure Type</i>	<i>Anion Packing</i>	<i>Coordination Numbers</i>		<i>Examples</i>
			<i>Cation</i>	<i>Anion</i>	
Rock salt (sodium chloride)	AX	FCC	6	6	NaCl, MgO, FeO
Cesium chloride	AX	Simple cubic	8	8	CsCl
Zinc blende (sphalerite)	AX	FCC	4	4	ZnS, SiC
Fluorite	AX <sub>2</sub>	Simple cubic	8	4	CaF <sub>2</sub> , UO <sub>2</sub> , ThO <sub>2</sub>
Perovskite	ABX <sub>3</sub>	FCC	12(A) 6(B)	6	BaTiO <sub>3</sub> , SrZrO <sub>3</sub> , SrSnO <sub>3</sub>
Spinel	AB <sub>2</sub> X <sub>4</sub>	FCC	4(A) 6(B)	4	MgAl <sub>2</sub> O <sub>4</sub> , FeAl <sub>2</sub> O <sub>4</sub>

**Source:** W. D. Kingery, H. K. Bowen, and D. R. Uhlmann, *Introduction to Ceramics*, 2nd edition. Copyright © 1976 by John Wiley & Sons, New York. Reprinted by permission of John Wiley & Sons, Inc.

# Diamante (covalente)

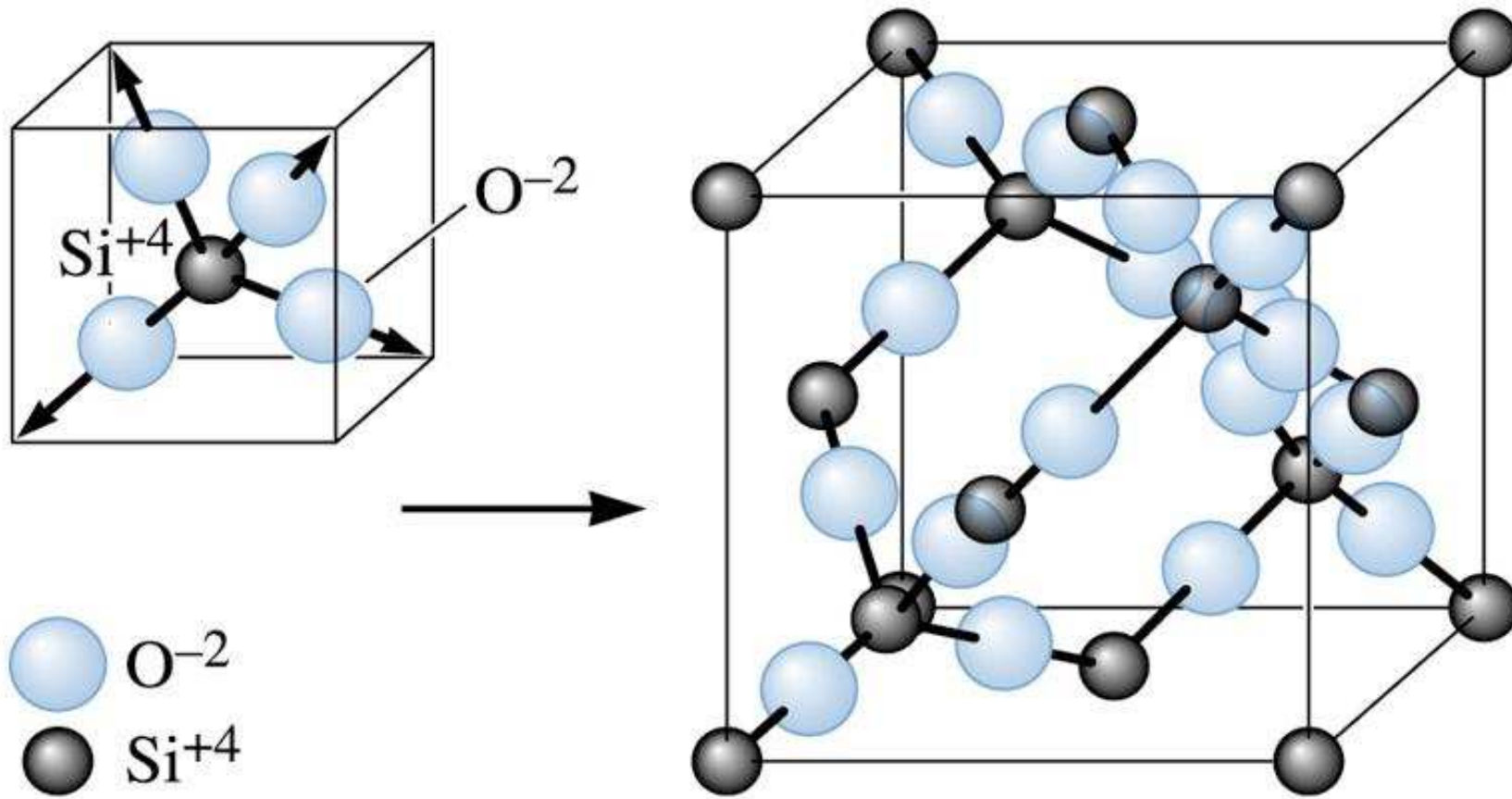


(a)



(b)

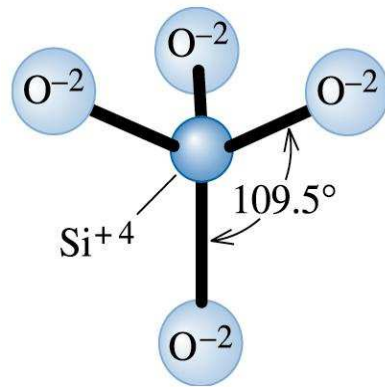
# Cristobalita (coval. + iônica)



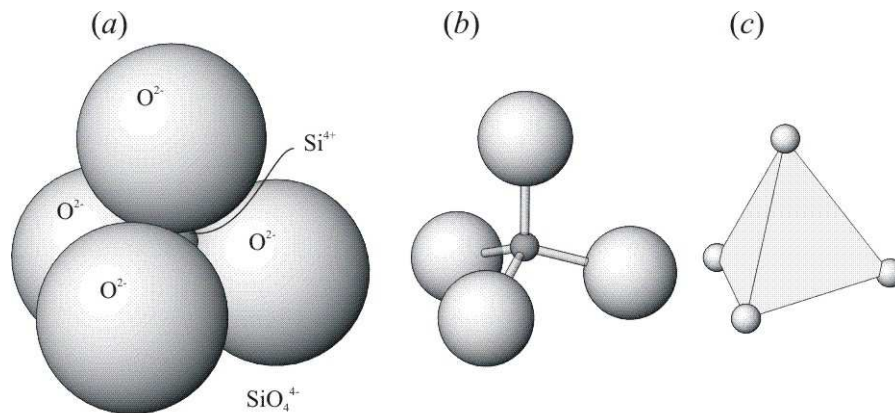
Tecto-silicato



# Silicatos



Unidade básica



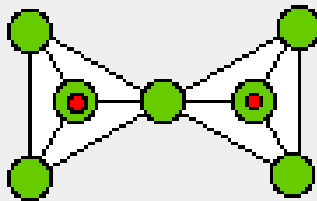
Ortossilicatos (1 tet.)  
Ex.:  $\text{Ca}_2\text{SiO}_4$

Figure 11.1



# Dissilicatos $(\text{Si}_2\text{O}_7)^{6-}$

Arrangement of  
silica tetrahedra



Formula of  
complex ion

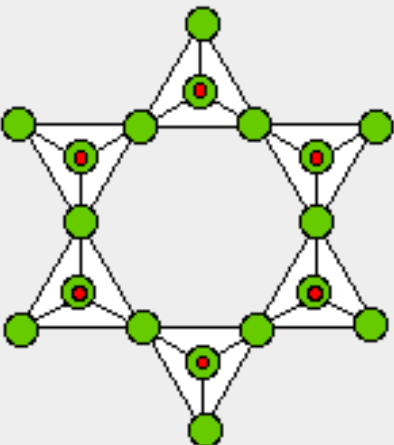


Common minerals

Epidote

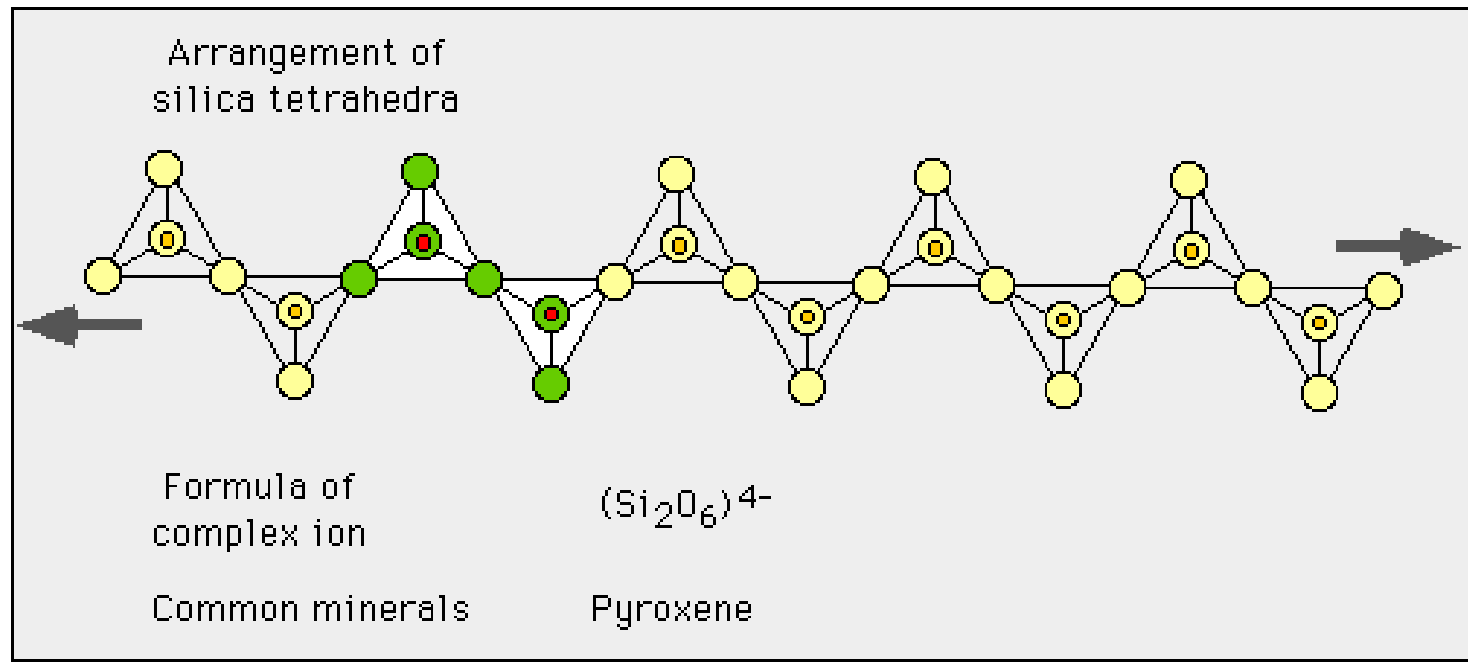
# Ciclo-silicatos

- Ex.:  $(\text{Si}_6\text{O}_{18})^{12-}$
- Berilo:  $\text{Be}_3\text{Al}_2(\text{Si}_6\text{O}_{18})$

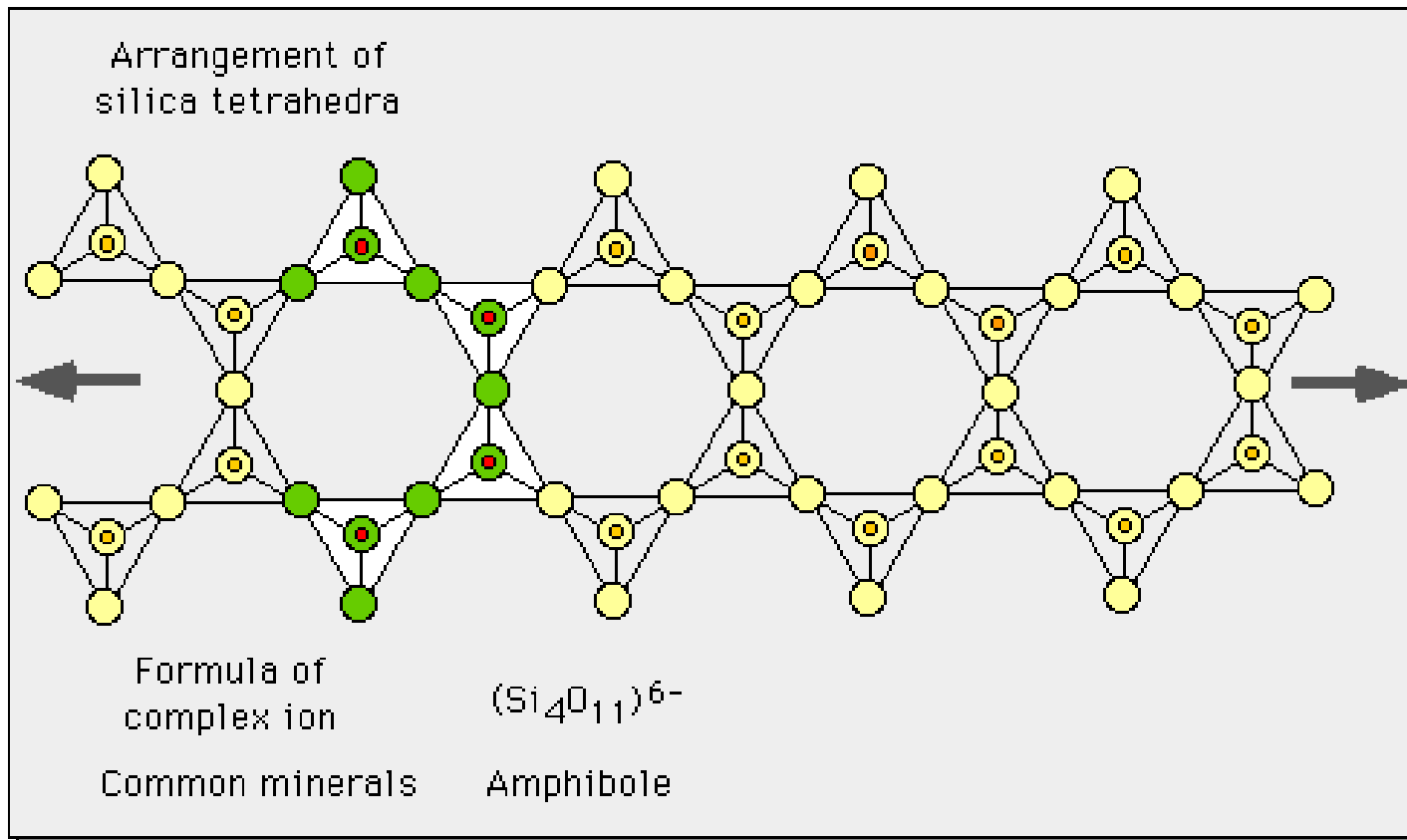
Arrangement of silica tetrahedra	Formula of complex ion	Common minerals
	$(\text{Si}_6\text{O}_{18})^{12-}$	Tourmaline Beryl

# Ino-silicatos $(\text{SiO}_3)^{2-}_n$

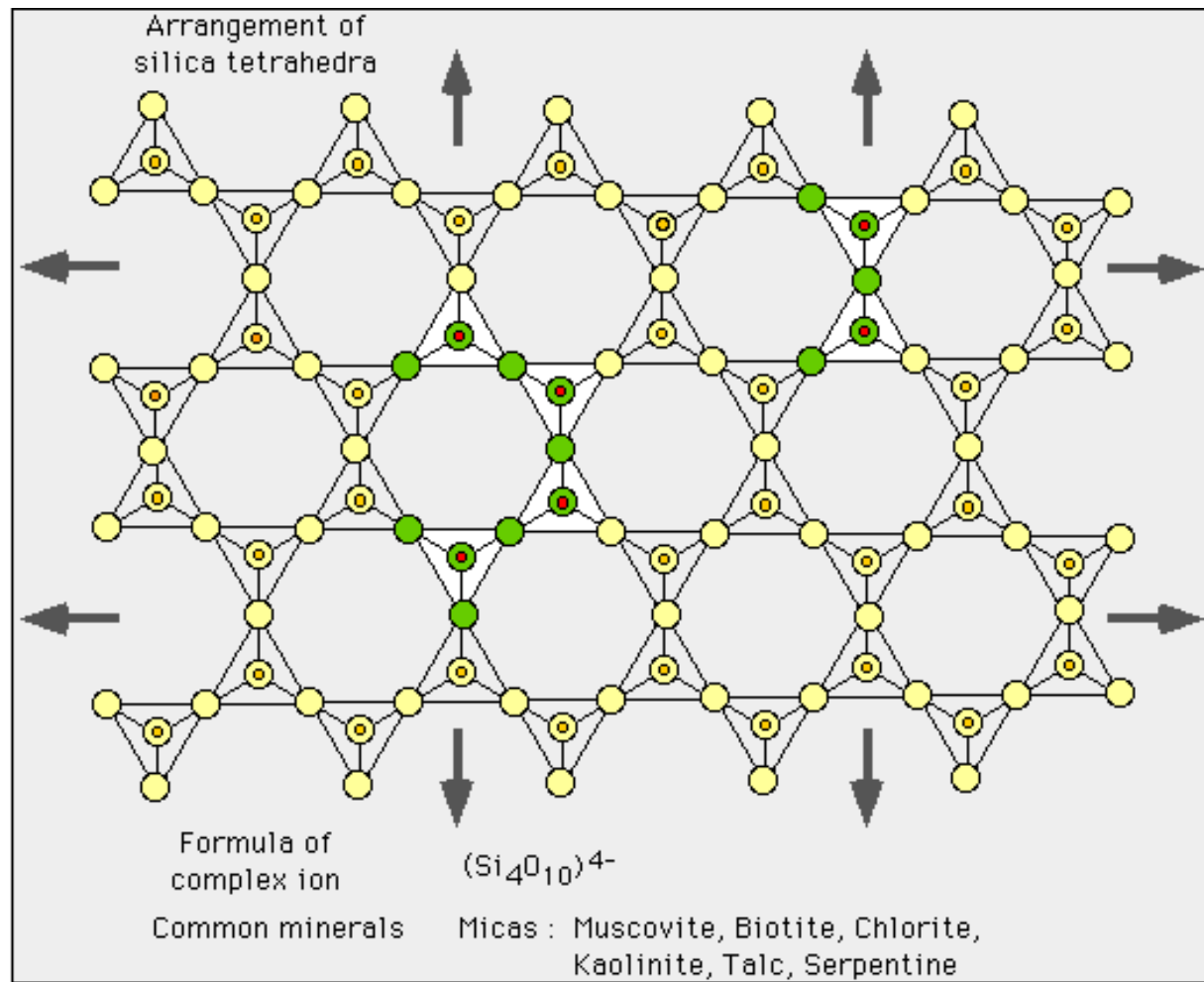
## Cadeias Simples



# Cadeias duplas $(\text{Si}_4\text{O}_{11})^{6-}_n$



# Filossilicatos $(\text{Si}_2\text{O}_5)^{2-}_n$





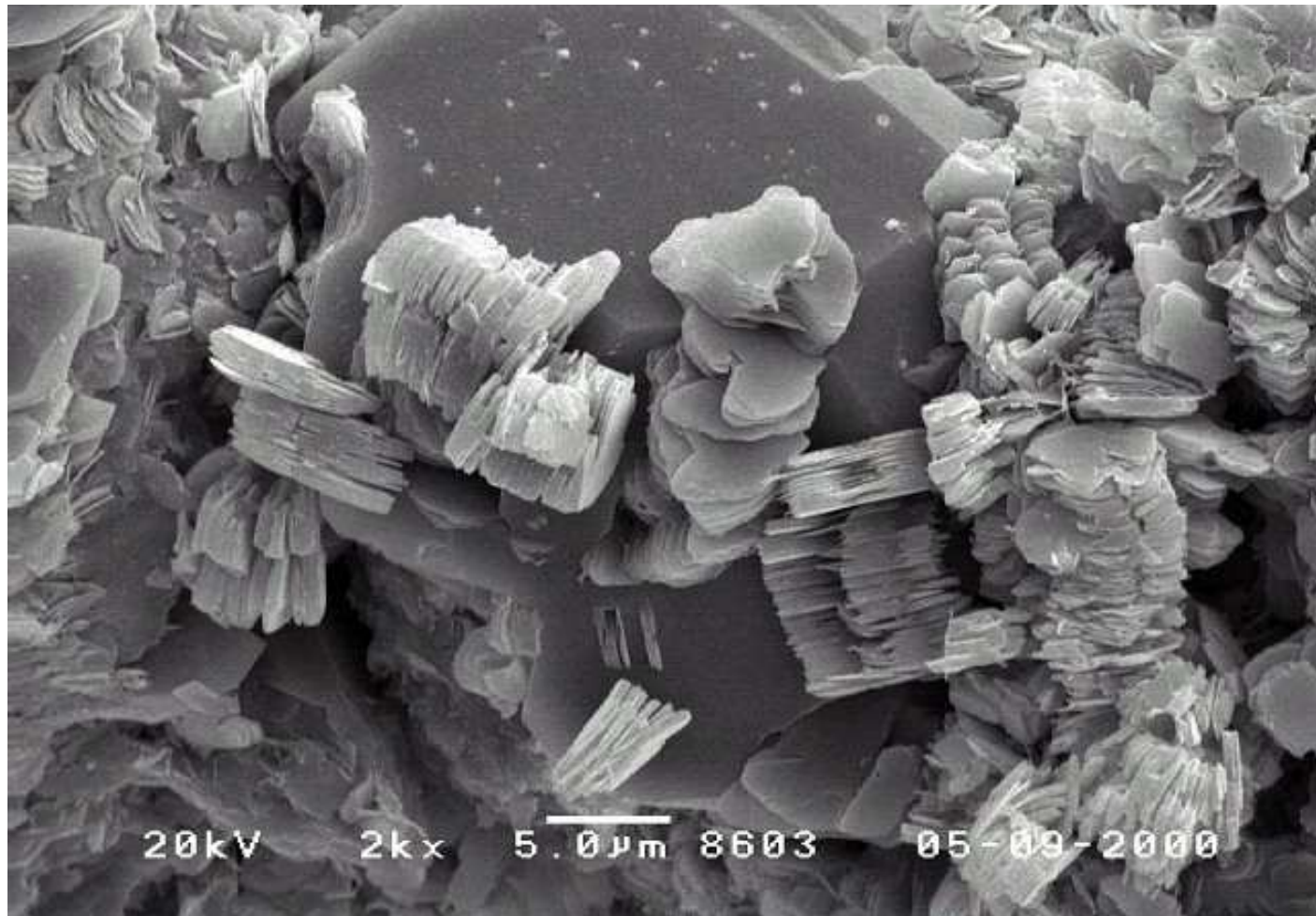
# Cristais em camadas

---

- [Caulinita](#) (filossilicato)  $\text{Al}_2(\text{OH})_4\text{Si}_2\text{O}_5$
- [Montmorilonita](#) (filossilicato)
- [Talco](#) (filossilicato)  $\text{Mg}_3(\text{OH})_2\text{Si}_4\text{O}_{10}$
- [Grafita](#)
- [MoS<sub>2</sub>](#)

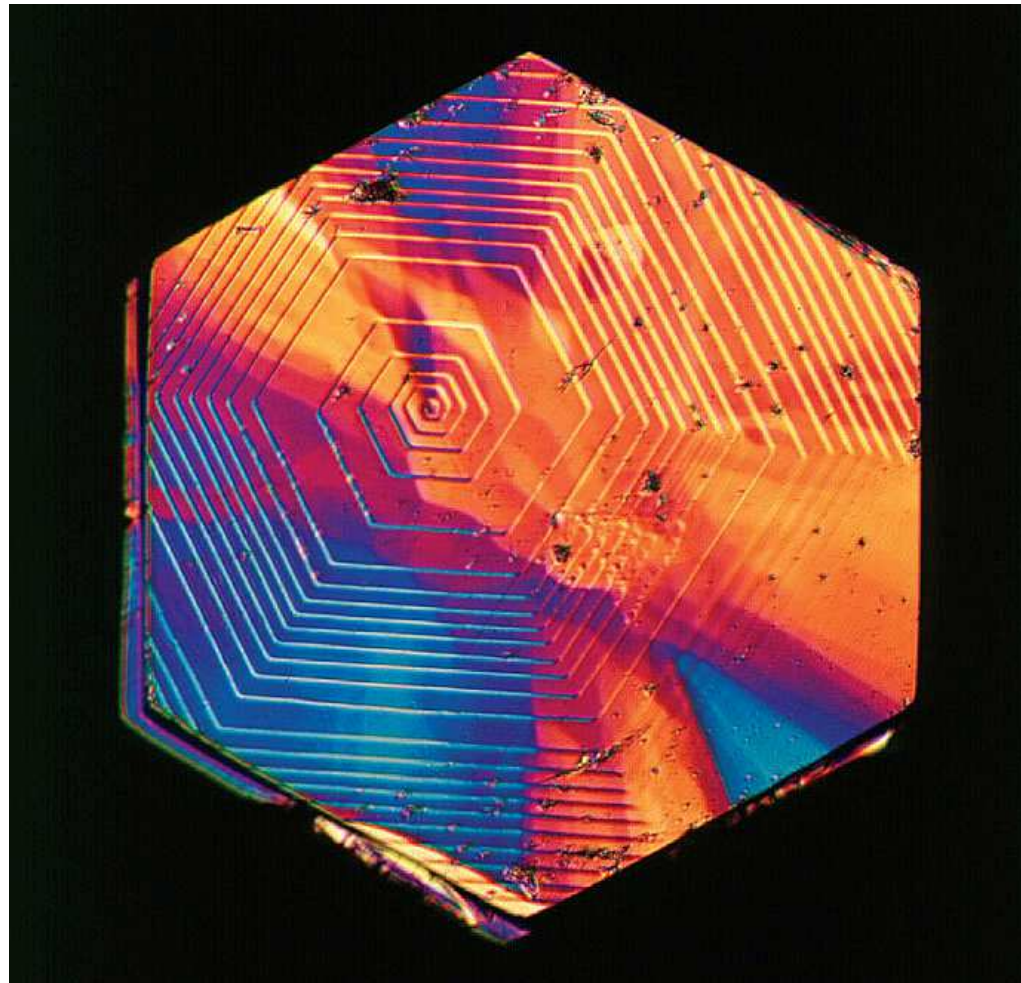
■ obs.: os nomes são links p/ as estruturas

# Cristais de Caulinita

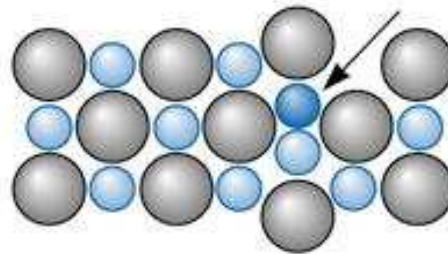




# Monocristal de Grafita



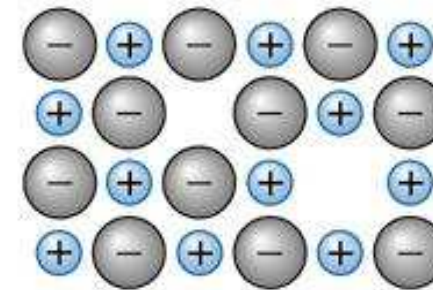
# Defeitos em cristais cerâmicos



(e)

**Figure 4.1 Point defects: (e) Frenkel defect.**  
**All of these defects disrupt the perfect arrangement of the surrounding atoms.**

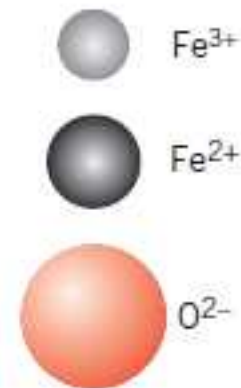
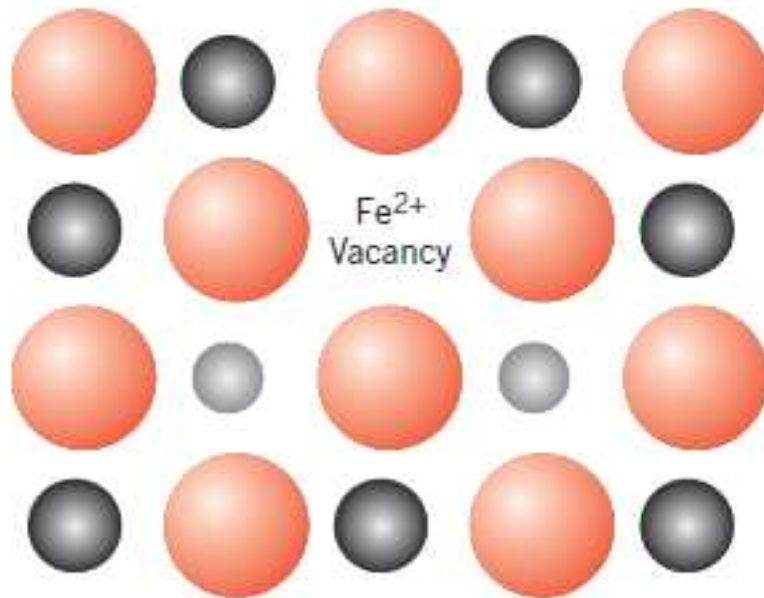
# Defeitos em cristais cerâmicos



(f)

**Figure 4.1 Point defects: (a) vacancy, (b) interstitial atom, (c) small substitutional atom, (d) large substitutional atom, (e) Frenkel defect, (f) Schottky defect. All of these defects disrupt the perfect arrangement of the surrounding atoms.**

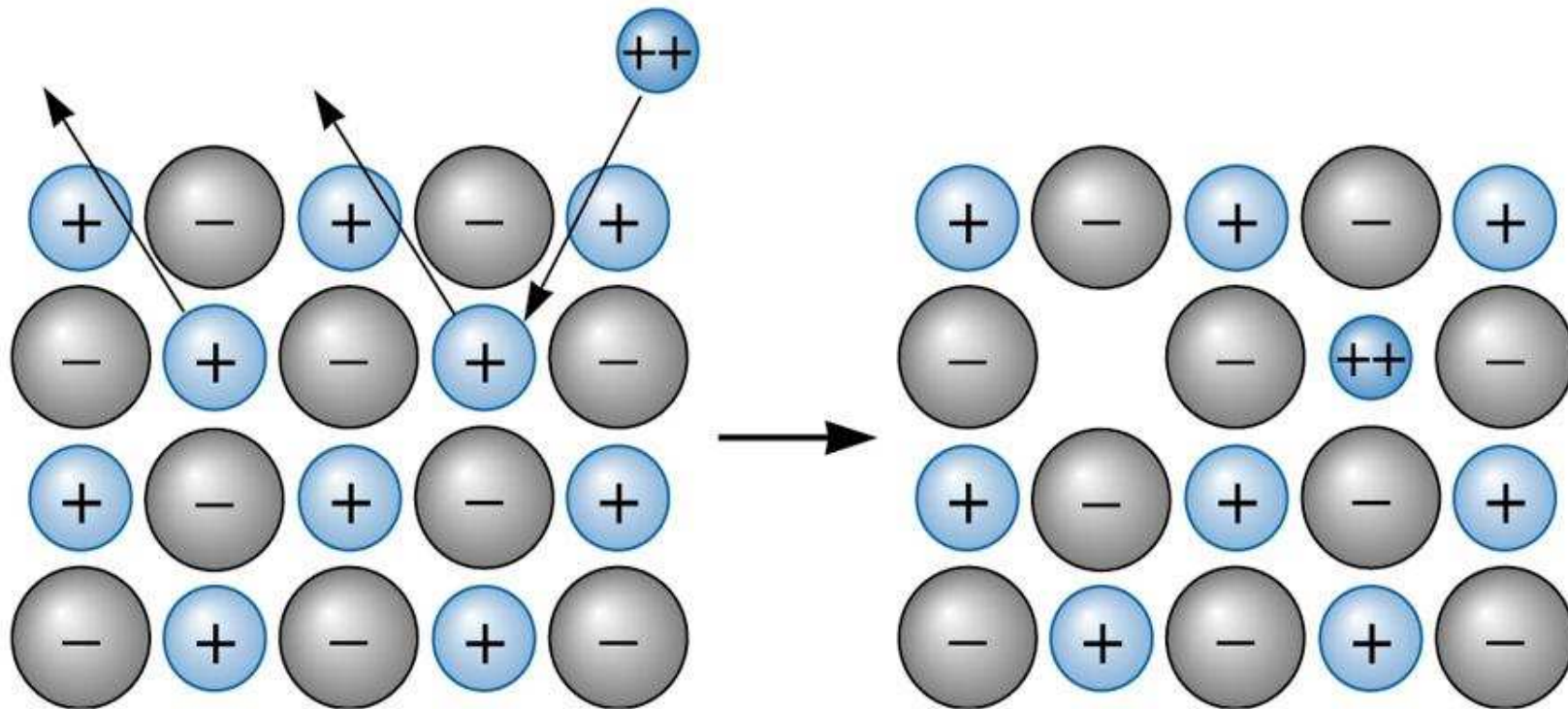
# Cristais não estequiométricos



**Figure 12.22** Schematic representation of an Fe<sup>2+</sup> vacancy in FeO that results from the formation of two Fe<sup>3+</sup> ions.

# Sol. Sol. Em Cerâmicas e a formação de vacâncias

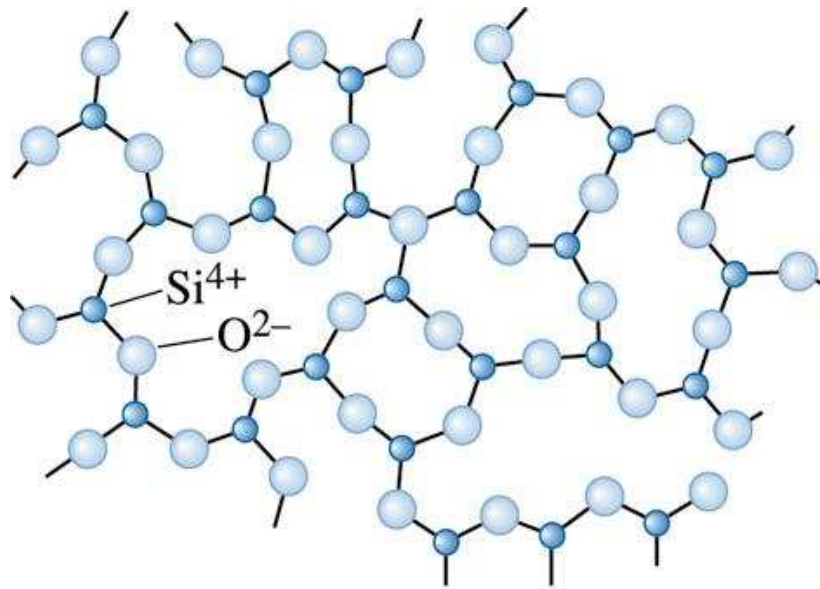
(c) 2005 Brooks/Cole Publishing / Thomson Learning



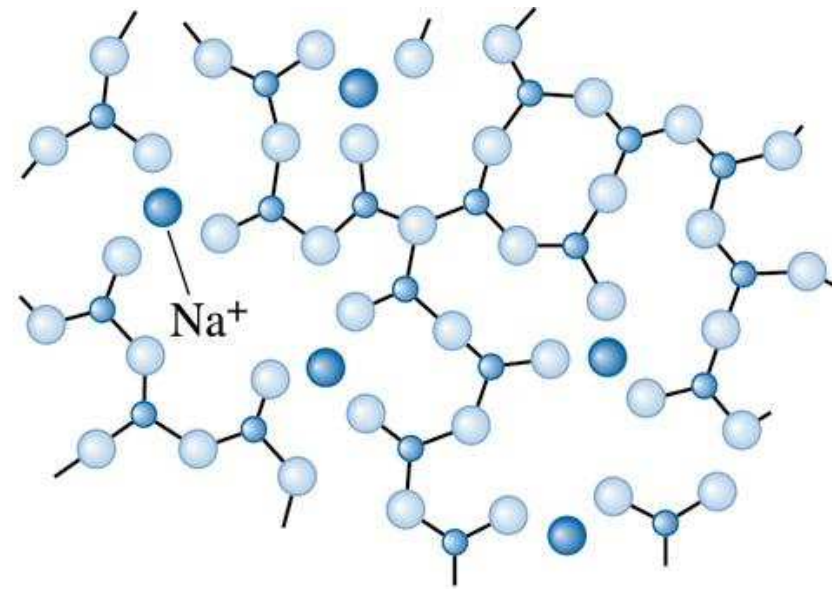
**Figure 4.3** When a divalent cation replaces a monovalent cation, a second monovalent cation must also be removed, creating a vacancy.

# Estruturas amofas

## Vidros de Silicatos



SiO<sub>2</sub> glass



Na<sub>2</sub>O modified glass



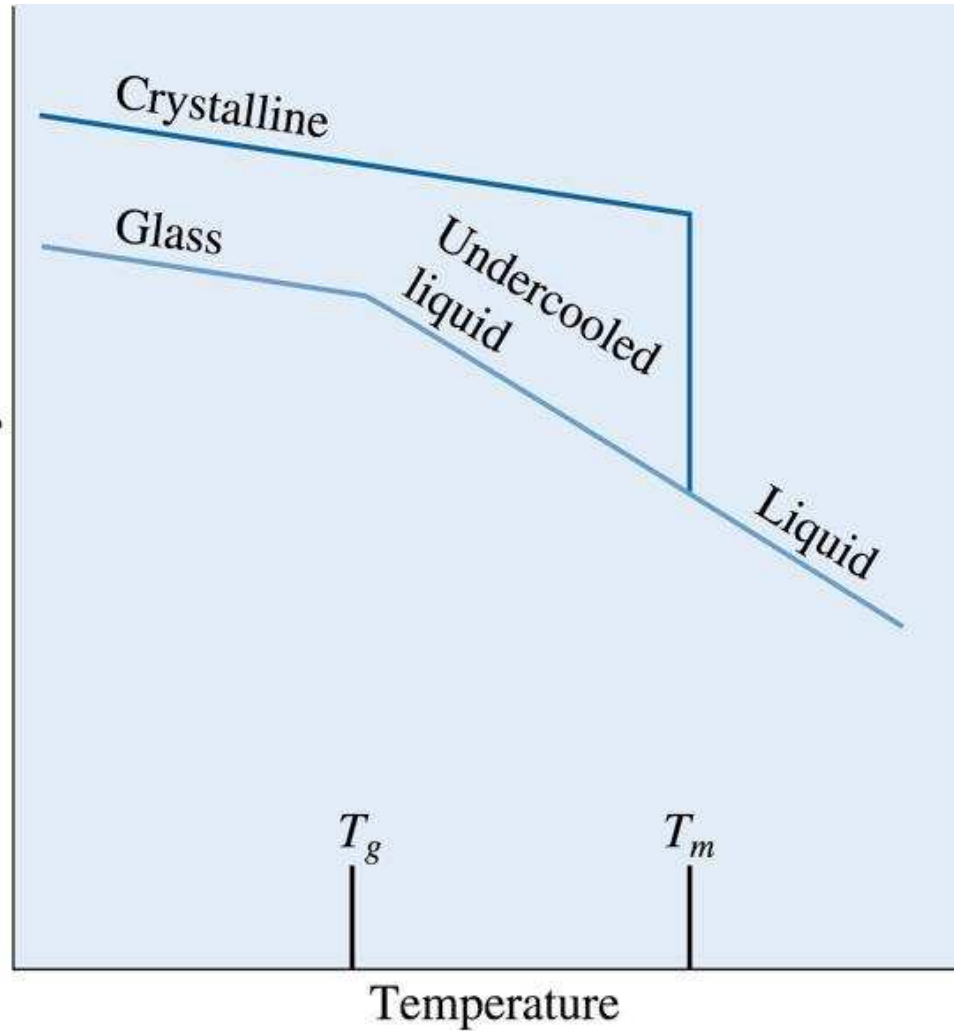
# Formadores e Modificadores

**TABLE 14-5** ■ *Division of the oxides into glass formers, intermediates, and modifiers*

<b>Glass Formers</b>	<b>Intermediates</b>	<b>Modifiers</b>
$B_2O_3$	$TiO_2$	$Y_2O_3$
$SiO_2$	$ZnO$	$MgO$
$GeO_2$	$PbO_2$	$CaO$
$P_2O_5$	$Al_2O_3$	$PbO$
$V_2O_3$	$BeO$	$Na_2O$

# Transição Vítre

©2003 Brooks/Cole, a division of Thomson Learning, Inc. Thomson Learning<sup>®</sup> is a trademark used herein under license.





# Expansão térmica

