

# Antenas

## Parte 1

## Teoria

SEL 413 Telecomunicações

Amílcar Careli César  
Departamento de Engenharia Elétrica da EESC-USP



# Atenção!

---

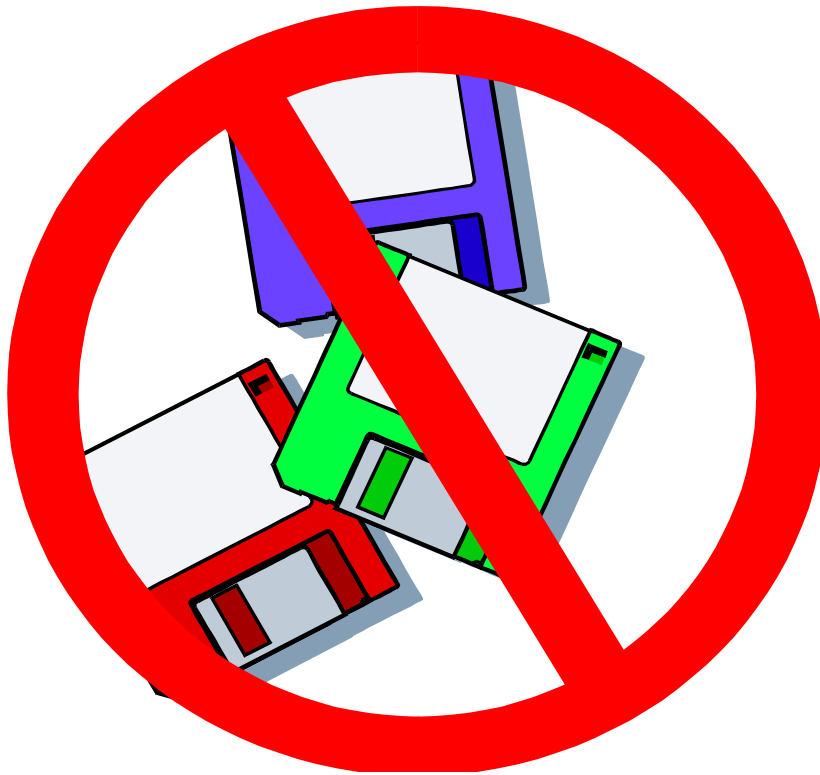

- ✓ Este material didático é planejado para servir de apoio às aulas de **SEL-413: Telecomunicações**, oferecida aos alunos regularmente matriculados no curso de engenharia aeronáutica.
- ✓ Não são permitidas a reprodução e/ou comercialização do material.
- ✓ solicitar autorização ao docente para qualquer tipo de uso distinto daquele para o qual foi planejado.

Rede de comunicação em aeronaves

Antenas em aeronaves

# MOTIVAÇÃO

# Antena para comunicação de voz e dados



**Esterline**  **CMC Electronics**

MONTREAL • OTTAWA • CHICAGO • [www.cmcelectronics.ca](http://www.cmcelectronics.ca)

- ✓ Serviço
  - ✓ Inmarsat
  - ✓ Voz e dados até 432 kbps
  - ✓ Compatibilidade ARINC 781
- ✓ Frequências
  - ✓ Recepção: 1525 a 1559 MHz
  - ✓ Transmissão: 1626,5 a 1660,5 MHz
- ✓ Cobertura
  - ✓ Entre 12 e 17 dBi sobre 90%
  - ✓ Mínimo de 9 dBi sobre 100%
- ✓ Polarização
  - ✓ Circular à direita
- ✓ Aerodinâmica
  - ✓ Penalidade combustível: 0,04%
- ✓ Certificação A330 e A340

# OnAir

- ✓ Inmarsat
- ✓ Global System for Mobile Communications (GSM) and General Packet Radio Service (GPRS)
- ✓ IP data até 432kbps
- ✓ IP data streaming sob demanda 32, 64 e 128kbps (largura de faixa dedicada)
- ✓ Telemedicina
- ✓ Conexão a partir de 4 km de altura
- ✓ Desconexão automática em decolagem e pouso
- ✓ Voos de longa distância: rede Wifi a bordo



- ✓ Picocélula a bordo
- ✓ Central de comutação a bordo
- ✓ Interconexão com serviços em terra
- ✓ No Brasil
  - Airbus A21
- ✓ [www.onair.aero](http://www.onair.aero)

# Inmarsat SwiftBroadband-cobertura

---

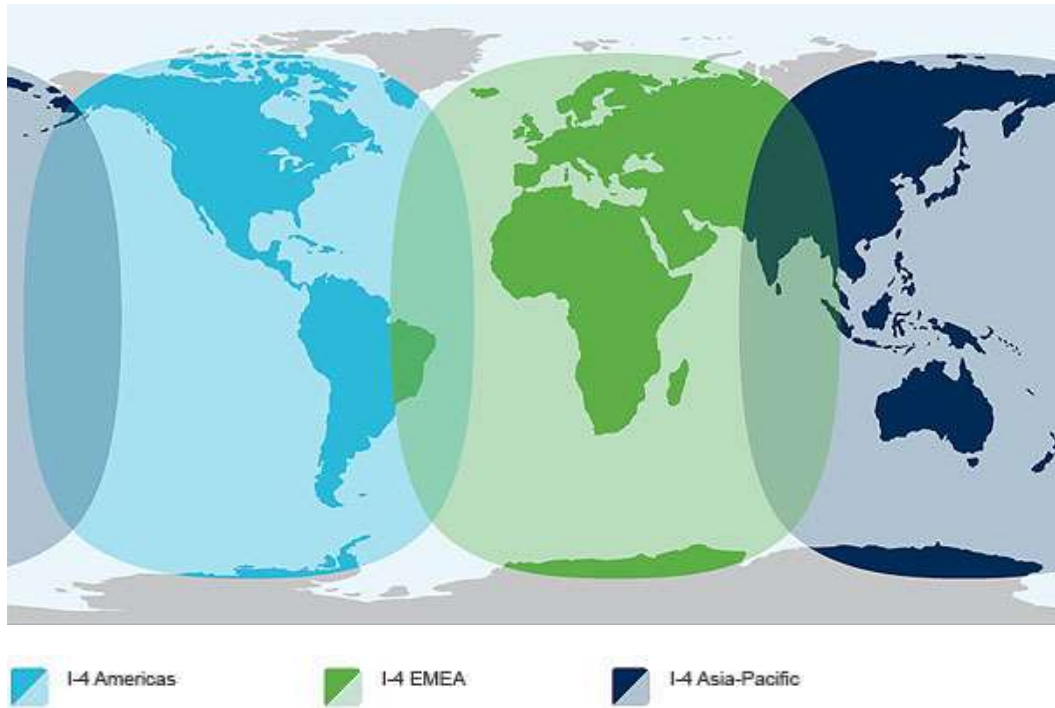

- ✓ 3 constelações
- ✓ 11 satélites
- ✓ Órbita geoestacionária (37,786 km)

The TopFlight satcom establishes a new level of performance for making and receiving voice calls, SMS text messaging, e-mails or surfing the web with personal electronic devices, passing data over Inmarsat SwiftBroadband. SwiftBroadband is being used as the backbone for the cell phone/GSM in aircraft solutions - these are being developed by AeroMobile and OnAir for both data and voice usage. These solutions will allow passengers to use their own devices to make phone calls, text messages and emails.

[www.inmarsat.com/services/swiftbroadband](http://www.inmarsat.com/services/swiftbroadband)

# EMC conectividade (1)

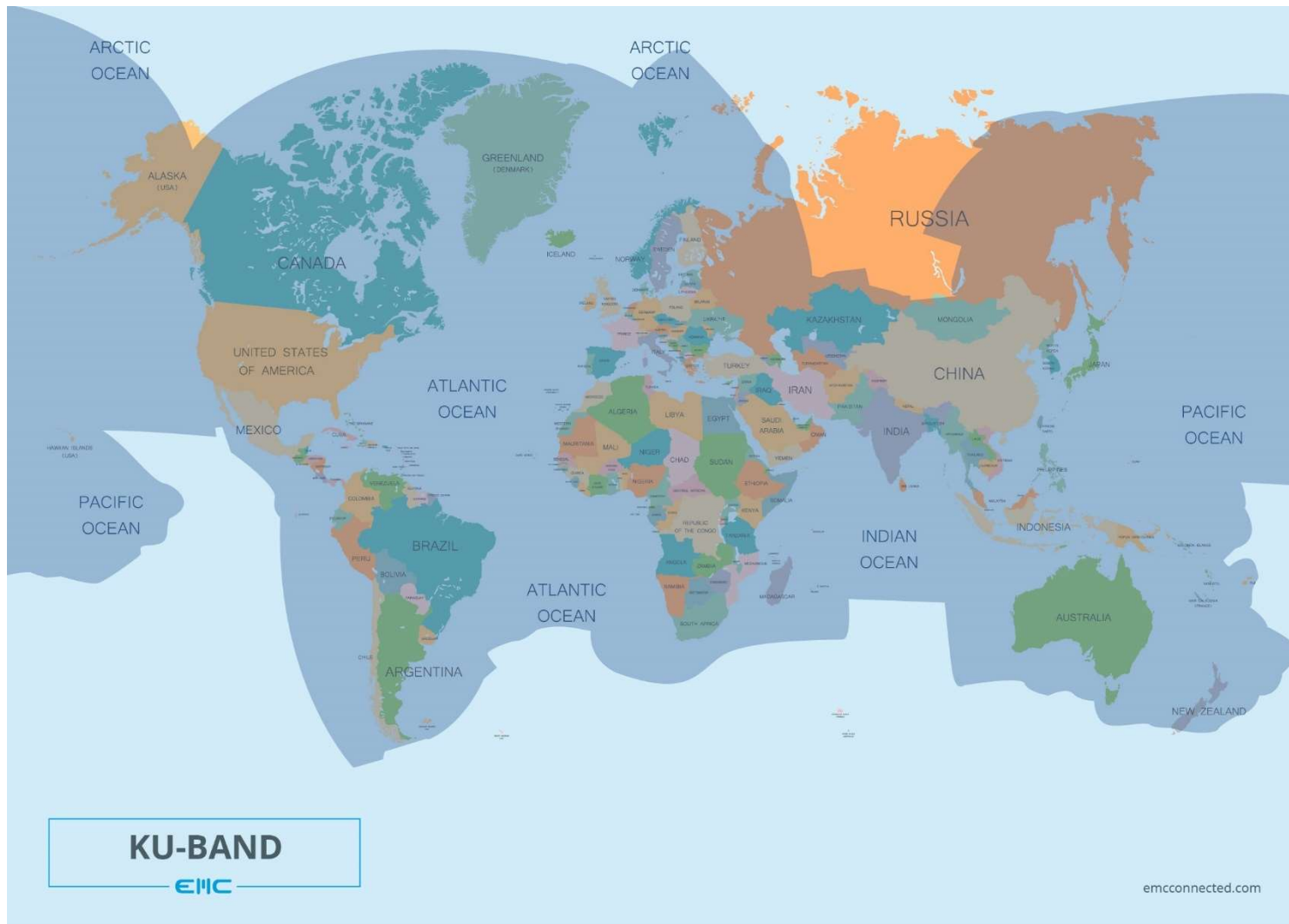

<http://emconnected.com/>

# EMC conectividade (2)

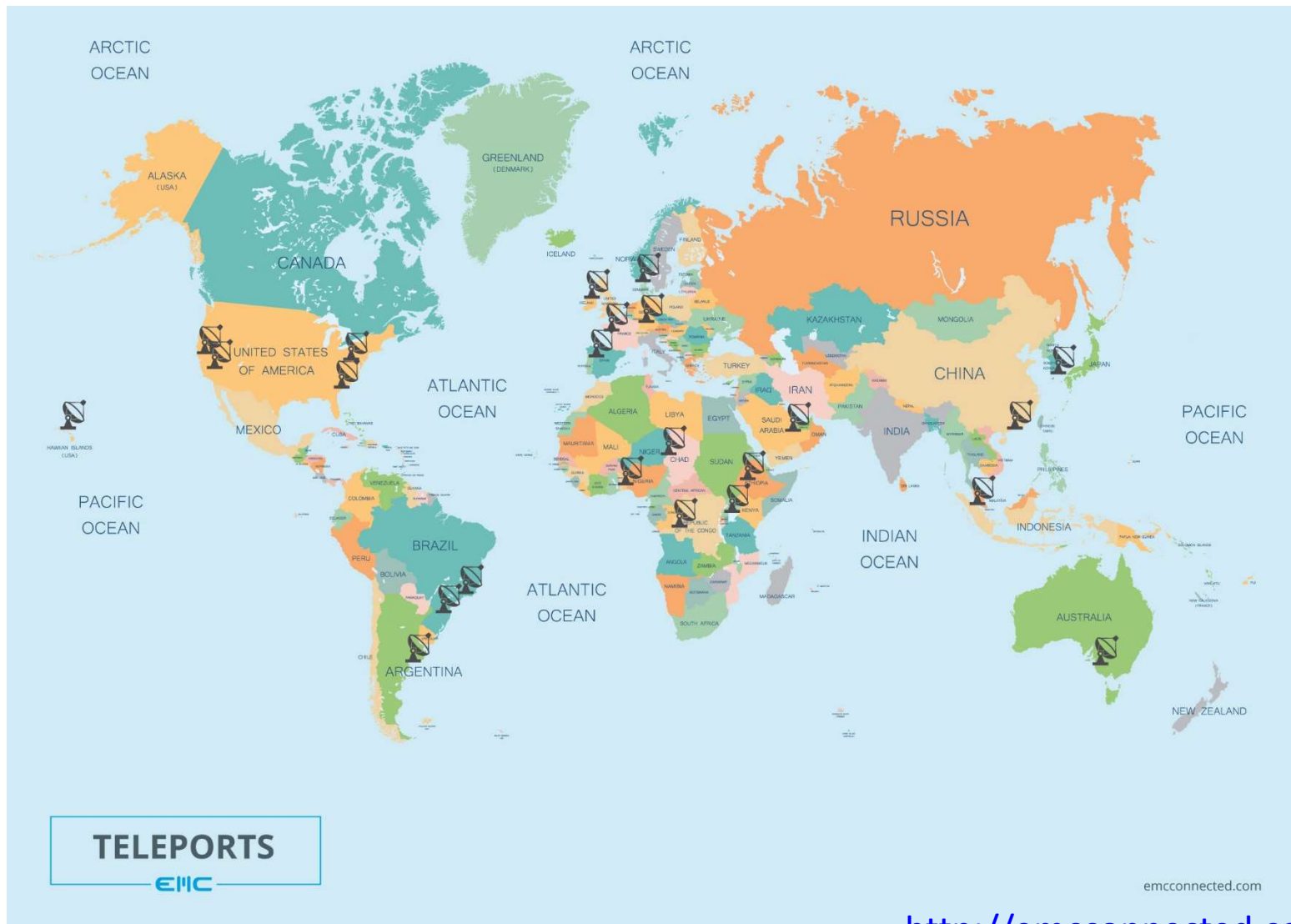

<http://emcconnected.com/>



# Antenas e localização

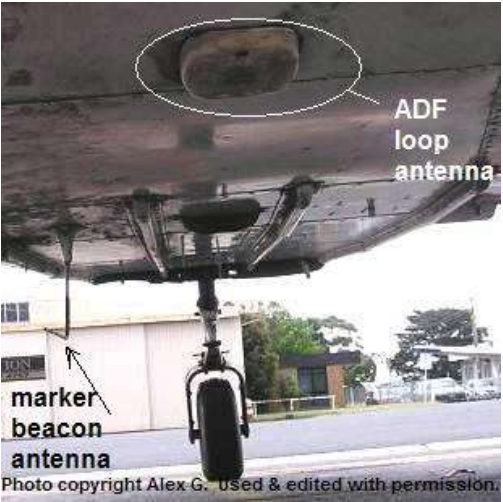
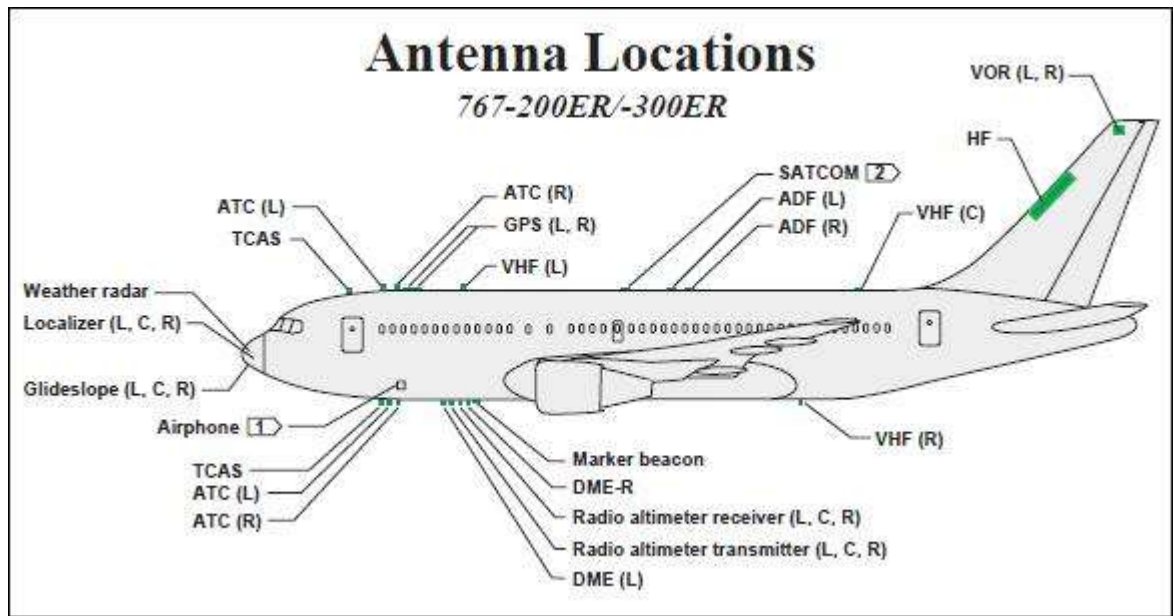

- DME: Distance measuring equipment
- VOR: VHF omnidirectional range
- ATC: Air traffic control
- ADF: Automatic direction finder
- TCAS: Traffic collision avoidance system

# Antena patch triangular em fuselagem

Frequência central: 4,3 GHz; Ganho: 9 dBi  
E-plane beam width: 88 °; H-plane beam width: 52°

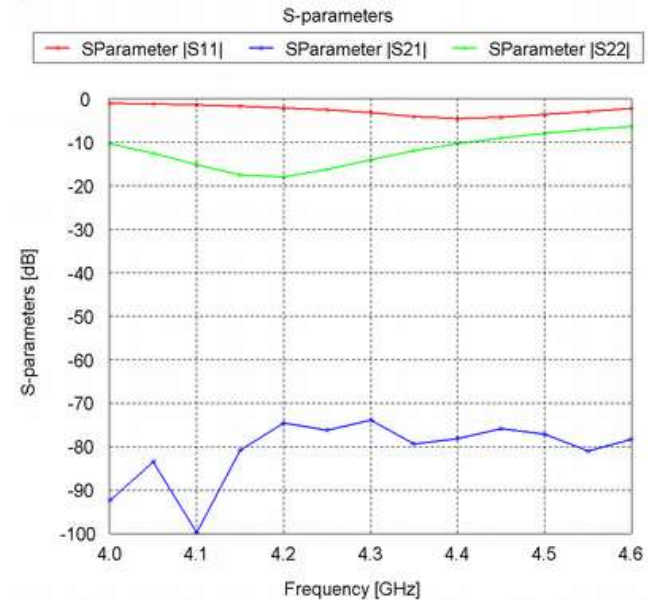
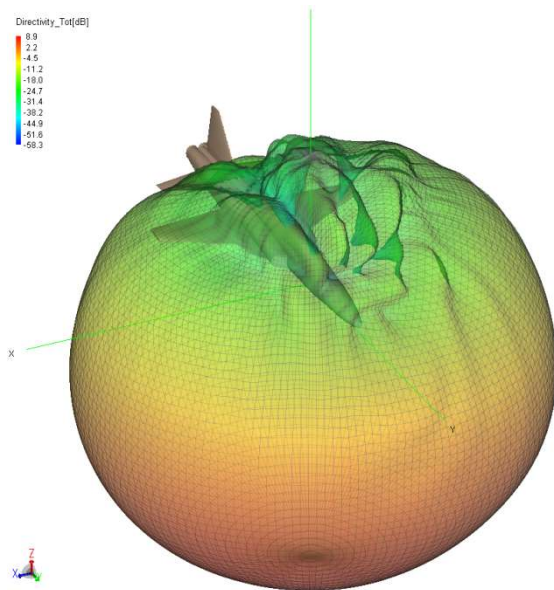
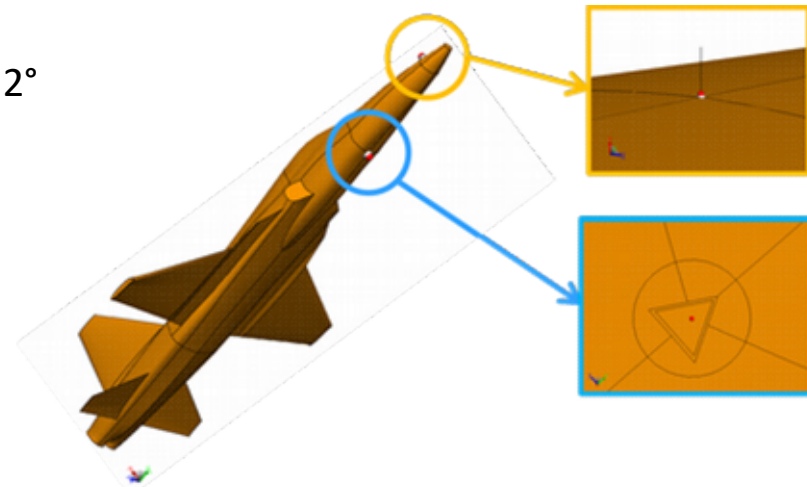
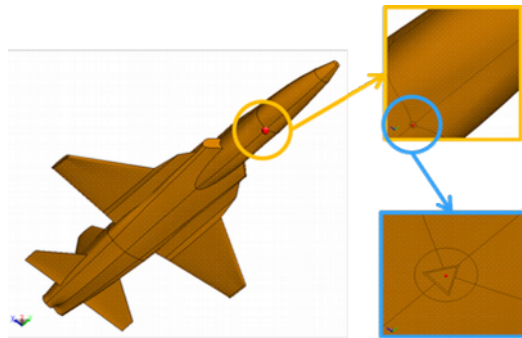

[www.feko.info/](http://www.feko.info/)

# Campo magnético e antena em aeronave

---

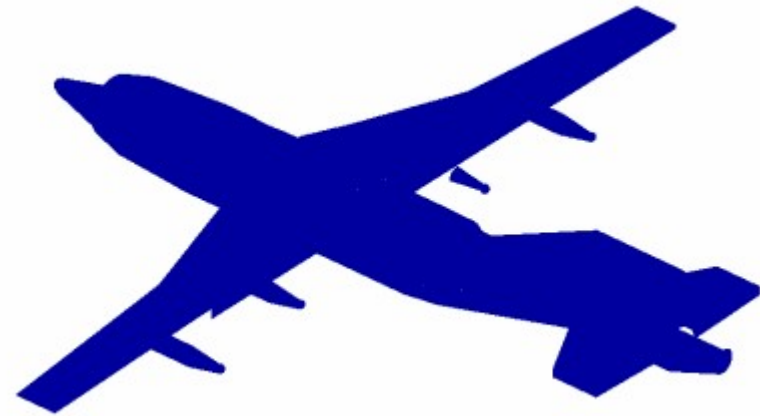
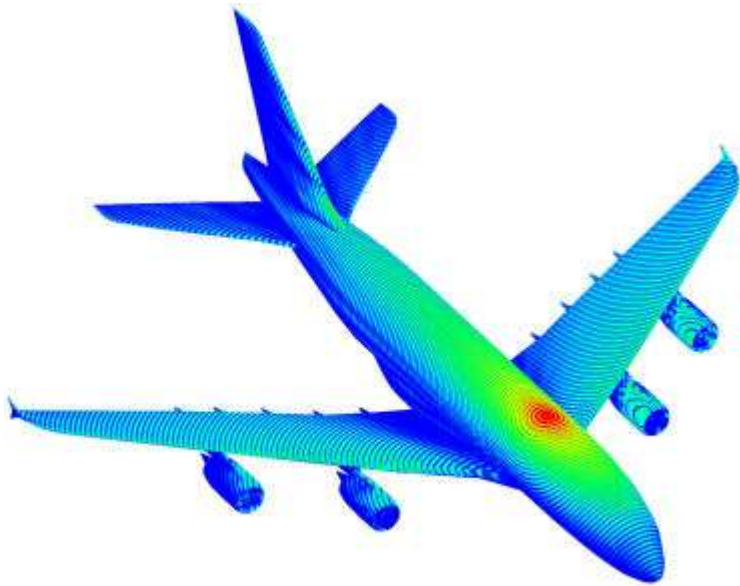

[www.feko.info/product-detail/numerical\\_methods/mlfmm](http://www.feko.info/product-detail/numerical_methods/mlfmm)

[www.integratedsoft.com/Products/Chronos](http://www.integratedsoft.com/Products/Chronos)

# EXEMPLOS DE ANTENAS

# Antenas

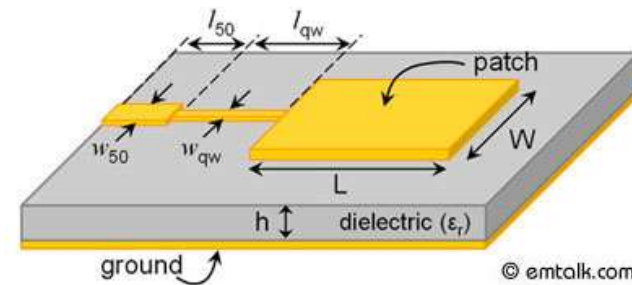

# Radioastronomia

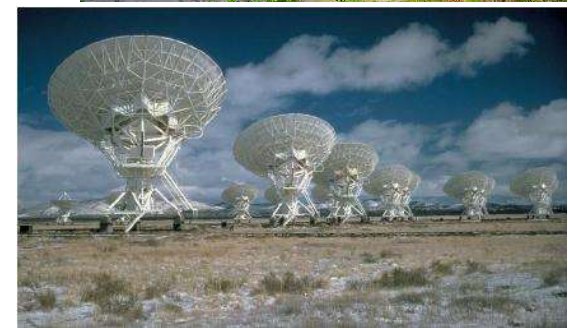
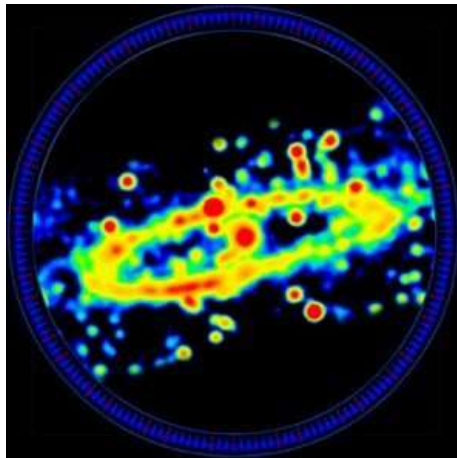

# NASA's Deep Space Network 70 metres

---



Goldstone, California; [www.nasa.gov/topics/technology/features/dsn20100714.html](http://www.nasa.gov/topics/technology/features/dsn20100714.html)

---

# RADIAÇÃO ELETROMAGNÉTICA E ANTENAS



# Antena: ondas guiada e radiada

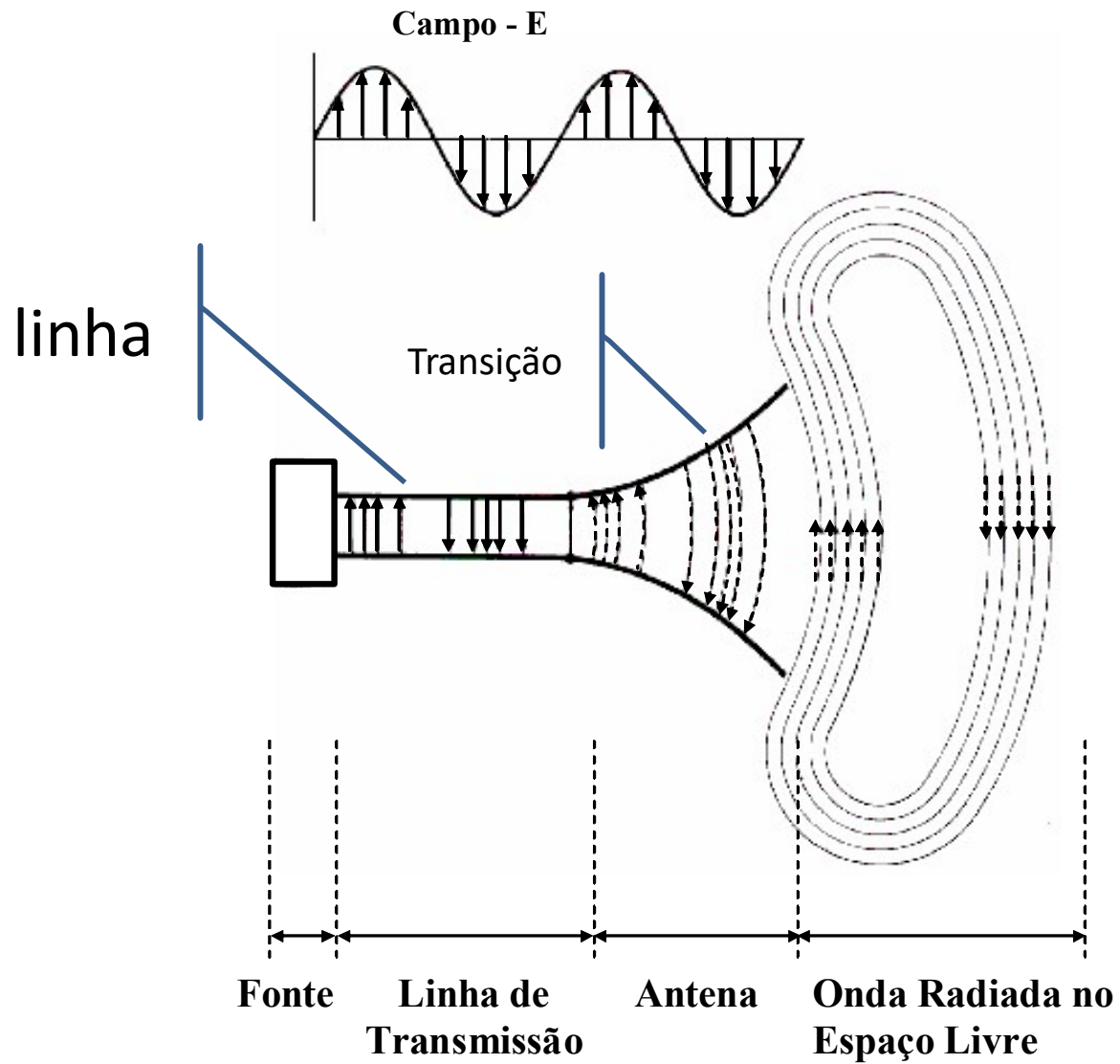

# Carga em movimento com velocidade uniforme

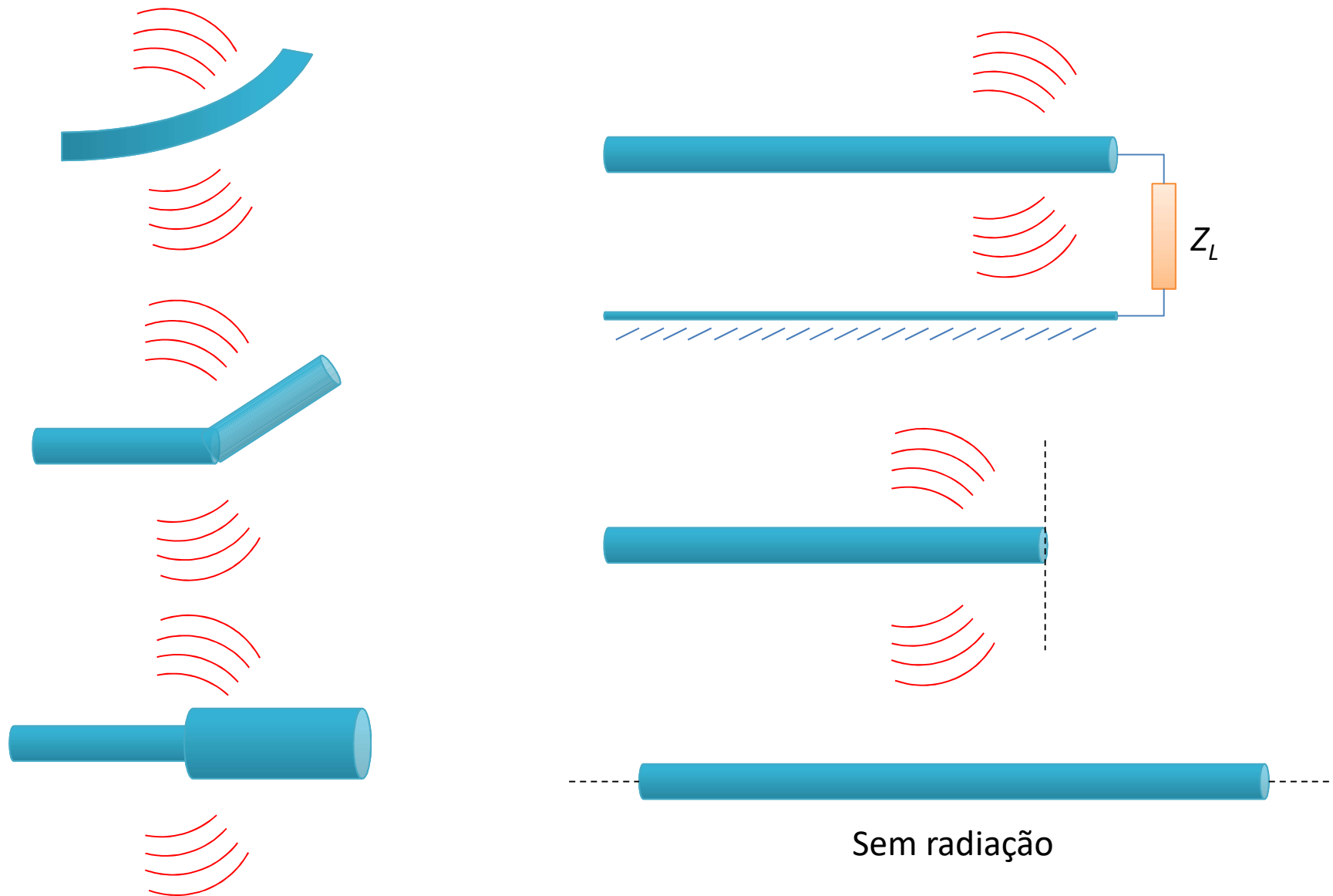

# Para haver radiação eletromagnética

---

- ✓ Carga não está em movimento
  - Não há corrente e não há radiação
- ✓ Carga em movimento com velocidade uniforme
  - Não há radiação se o fio for reto e infinito
  - Há radiação se o fio for curvo, vergado, descontínuo ou truncado
- ✓ Carga em movimento com variação temporal
  - Há radiação mesmo que o fio seja reto
- ✓ Corrente variante no tempo
- ✓ Aceleração ou desaceleração de carga

# Radiação eletromagnética: animações

---

[Carga elétrica em movimento](#) (Phet)

[Onda eletromagnética e campos](#) (Phet)

[Cargas e campo elétrico](#) (Phet)

Phet: <https://phet.colorado.edu>

# Campo distante de antena dipolo

---

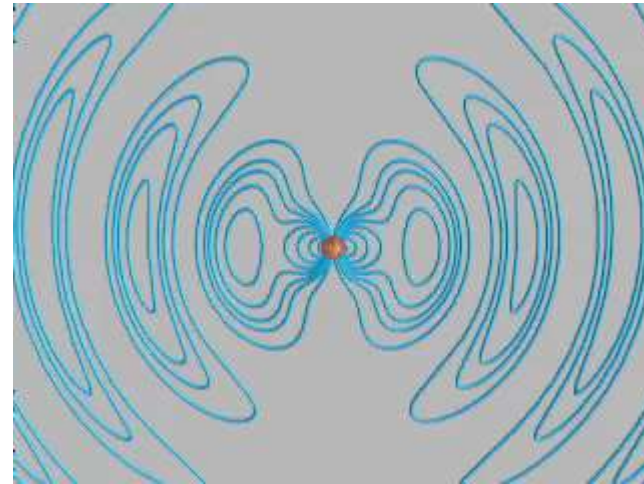
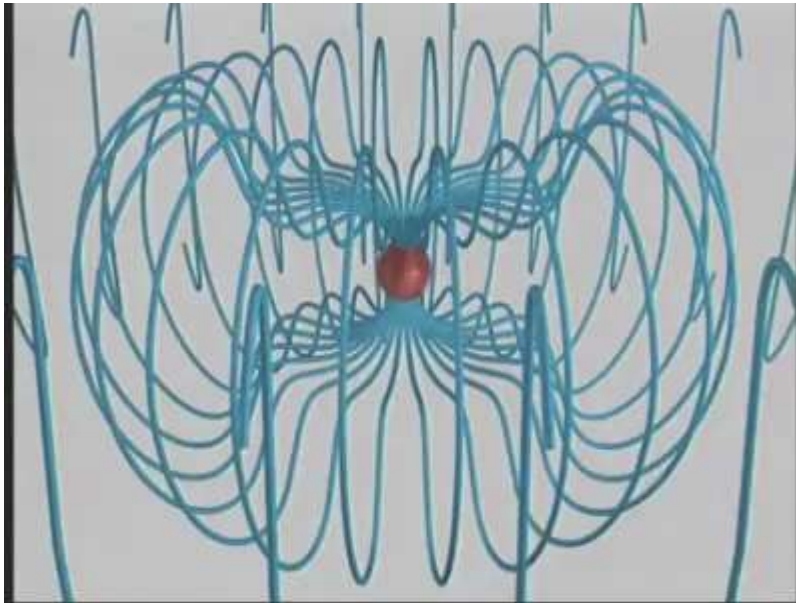

*Ref.:* Hon Tat Hui; EE4101 RF Communications, First Semester, 2010/11  
Department of Electrical and Computer Engineering, National University of Singapore  
[www.ece.nus.edu.sg/stfpage/elehht/Teaching/EE4101/](http://www.ece.nus.edu.sg/stfpage/elehht/Teaching/EE4101/)

# Faixas de frequências

Faixa	Abrev.	Frequência e comprimento de onda (vácuo)	Exemplos de utilização
High	HF	3–30 MHz 100 m – 10 m	Shortwave broadcasts, citizens' band radio, amateur radio and over-the-horizon aviation communications, RFID, Over-the-horizon radar, Automatic link establishment (ALE) / Near Vertical Incidence Skywave(NVIS) radio communications, Marine and mobile radio telephony
Very high	VHF	30–300 MHz 10 m – 1 m	FM, television broadcasts and line-of-sight ground-to-aircraft and aircraft-to-aircraft communications. Land Mobile and Maritime Mobile communications, amateur radio, weather radio
Ultra high	UHF	300–3000 MHz 1 m – 100 mm	Television broadcasts, microwave ovens, microwave devices/communications, radio astronomy, mobile phones, wireless LAN, Bluetooth, ZigBee, GPS and two-way radios such as Land Mobile,FRS and GMRS radios, amateur radio
Super high	SHF	3–30 GHz 100 mm – 10 mm	Radio astronomy, microwave devices/communications, wireless LAN, most modern radars, communications satellites, satellite television broadcasting, DBS, amateur radio
Extremely high	EHF	30–300 GHz 10 mm – 1 mm	Radio astronomy, high-frequency microwave radio relay, microwave remote sensing, amateur radio, directed-energy weapon, millimeter wave scanner
Terahertz ou Tremendously high	THz ou THF	300–3,000 GHz 1 mm – 100 µm	Terahertz imaging – a potential replacement for X-rays in some medical applications, ultrafast molecular dynamics, condensed-matter physics,terahertz time-domain spectroscopy, terahertz computing/communications, sub-mm remote sensing, amateur radio

[http://en.wikipedia.org/wiki/Radio\\_spectrum](http://en.wikipedia.org/wiki/Radio_spectrum) ; [www.radioreference.com/](http://www.radioreference.com/)

Diagrama de radiação

# SISTEMA DE COORDENADAS

# Antena e Sistema de Coordenadas

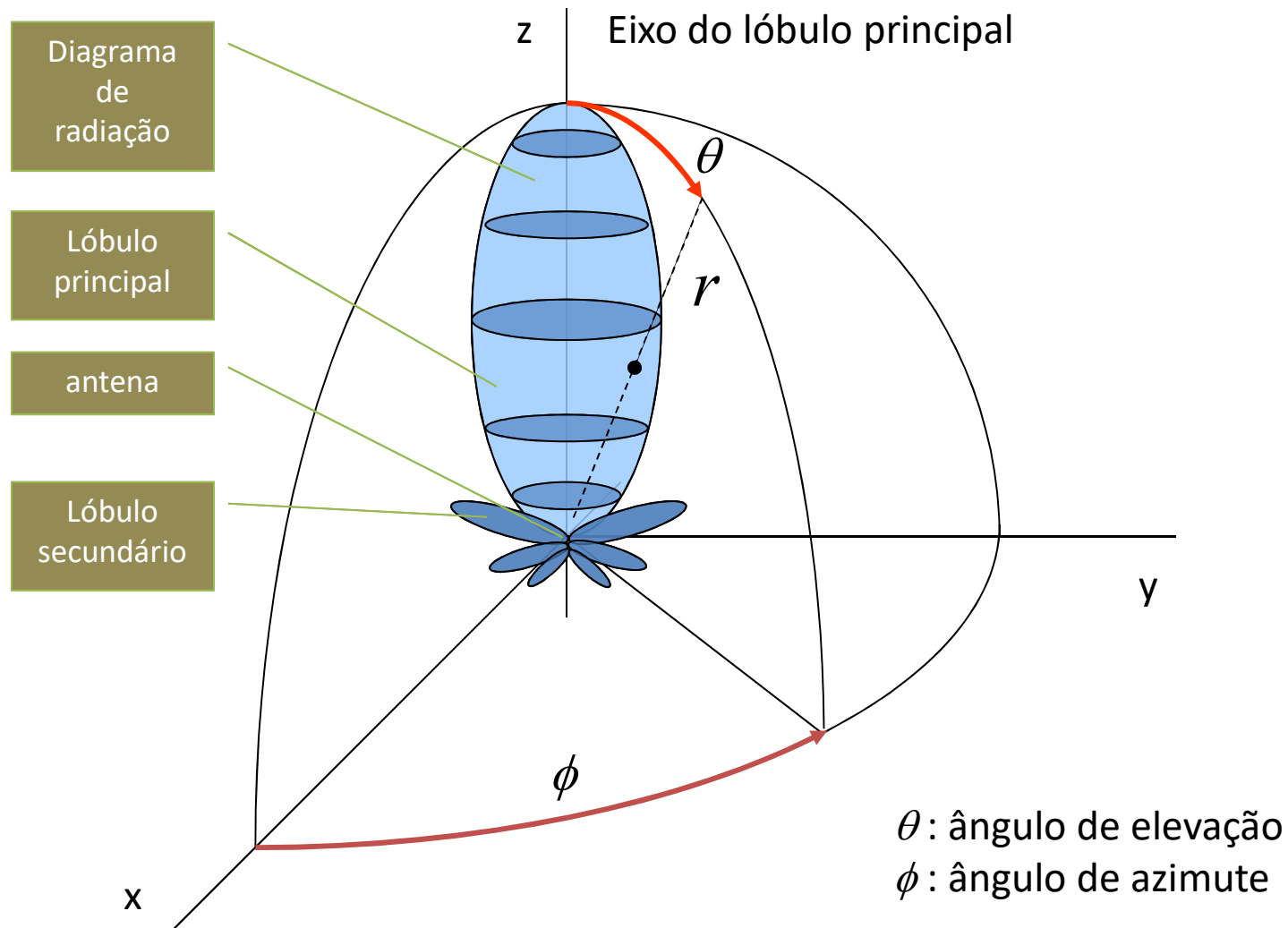



# Coordenadas esféricas (1)

---

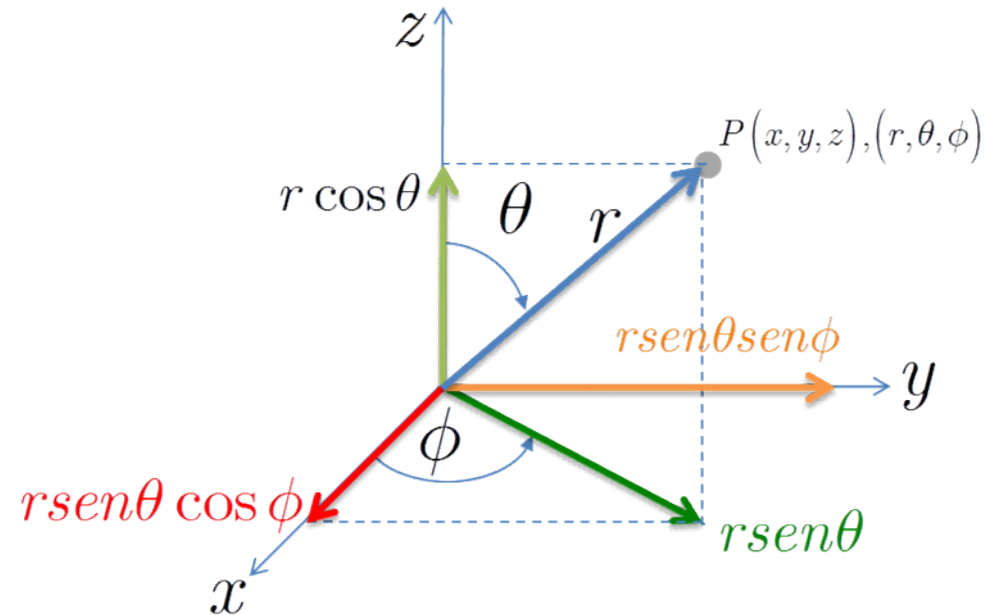

$$r \geq 0$$

$$0 \leq \theta \leq 180^\circ (\pi \text{ rad}); -\pi/2 \leq \theta \leq \pi/2$$

$$0 \leq \phi \leq 360^\circ (2\pi \text{ rad}); -\pi \leq \theta \leq \pi$$

$\theta$ : inclinação

$\phi$ : azimute

## Coordenadas esféricas (2)

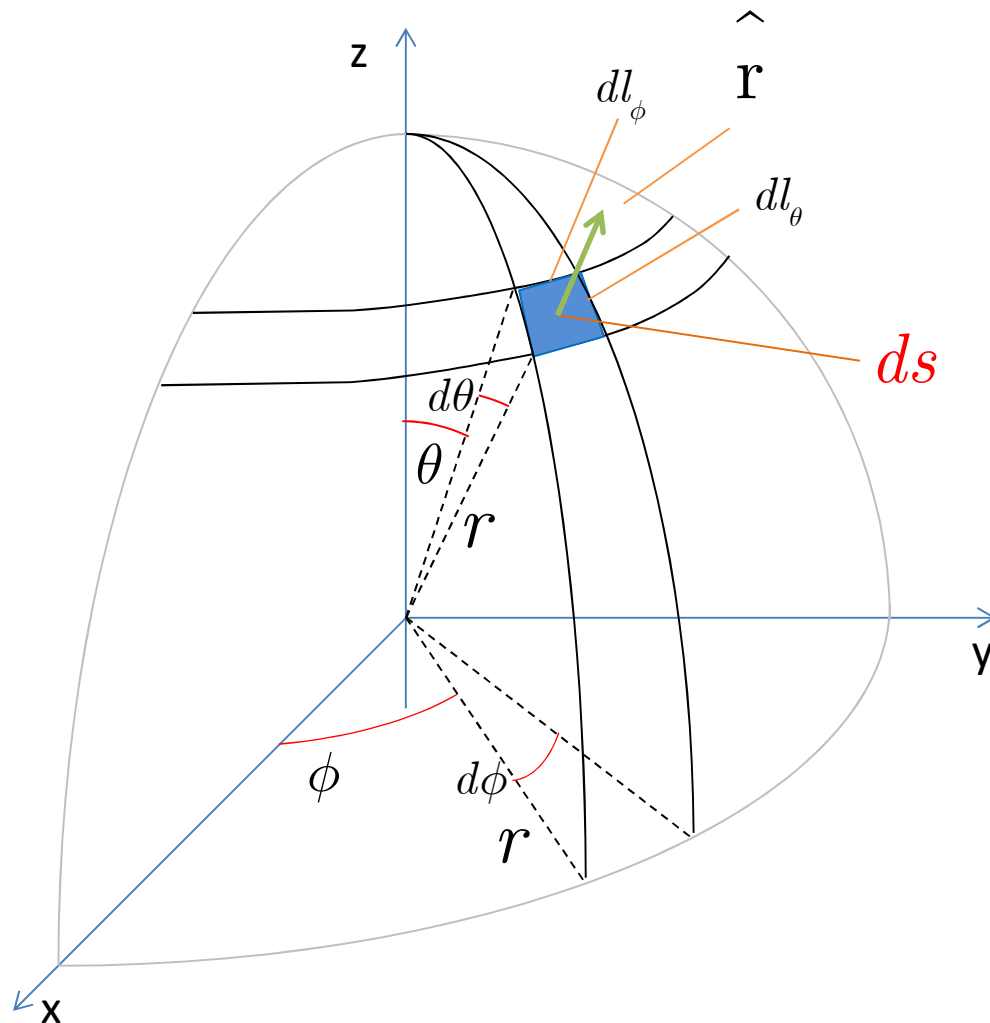

$$dl_{\phi} = r \sin \theta d\phi$$

$$dl_{\theta} = r d\theta$$

$$d\mathbf{s} = \hat{\mathbf{r}} dS$$

$$dS = dl_{\theta} dl_{\phi}$$

$$dS = r^2 \sin \theta d\theta d\phi, \text{ m}^2$$

elemento de ângulo sólido  
(ângulo sólido diferencial)

$$d\Omega = \frac{dS}{r^2} = \sin \theta d\theta d\phi, \text{ sr}$$

$$dS = r^2 d\Omega$$

$$0 \leq \theta \leq \pi ; 0 \leq \phi \leq 2\pi$$

# Radiano e esterradiano

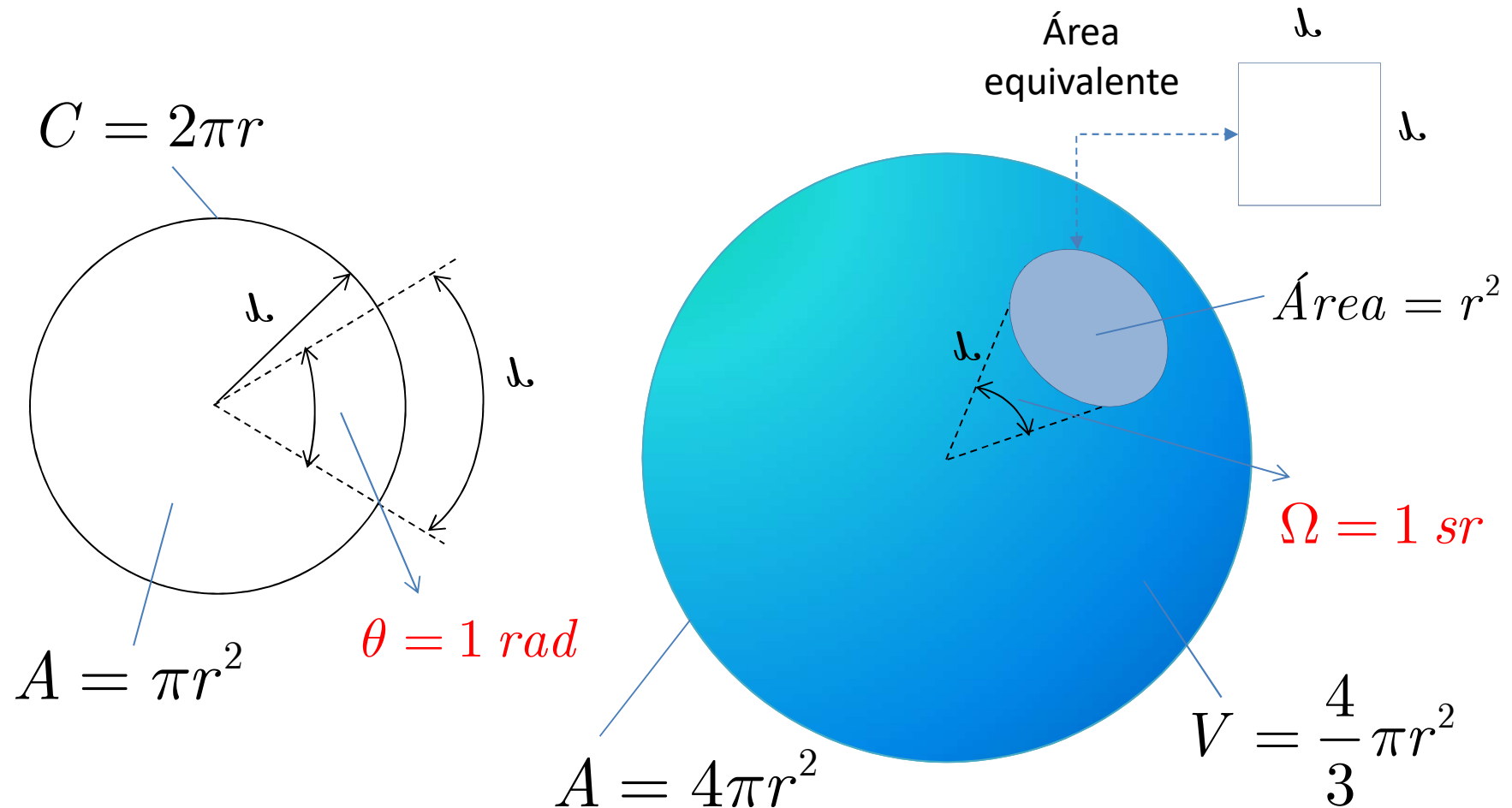

Unidade derivada no SI; dicionários (Brasil): esferorradiano, INMETRO: esterradiano (Portugal)

# Ângulo sólido

---

Seja um cone com vértice no centro da esfera.

O **esferorradiano** ou esterradiano (sr) é o ângulo sólido subentendido no centro da esfera de raio  $r$  por uma porção de superfície de área  $r^2$ .

Unidade de medida suplementar e padrão no Sistema Internacional de Unidades (SI)

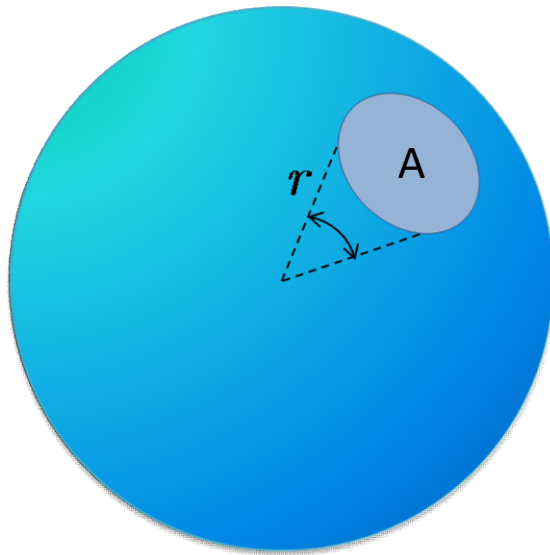

$$\Omega = \frac{A}{r^2} \left[ m^2 \cdot m^{-2} = sr \right]$$

$$\Omega_{esfera} = \int_0^\pi \text{sen}\theta d\theta \int_0^{2\pi} d\phi$$

$$\Omega_{esfera} = 4\pi \text{ sr}$$

# Coordenadas polares e esféricas

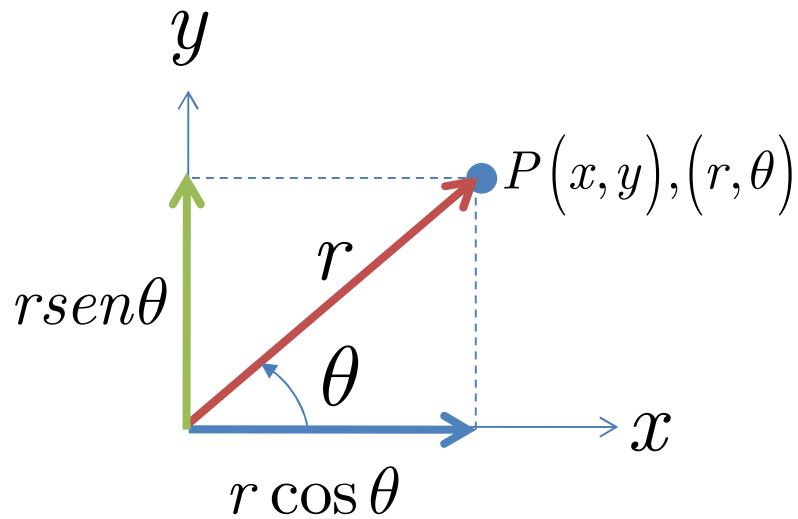

$$x = r \cos \theta$$

$$y = r \operatorname{sen} \theta$$

$$r = \sqrt{x^2 + y^2}$$

$$\theta = \operatorname{tg}^{-1} \left( \frac{y}{x} \right)$$

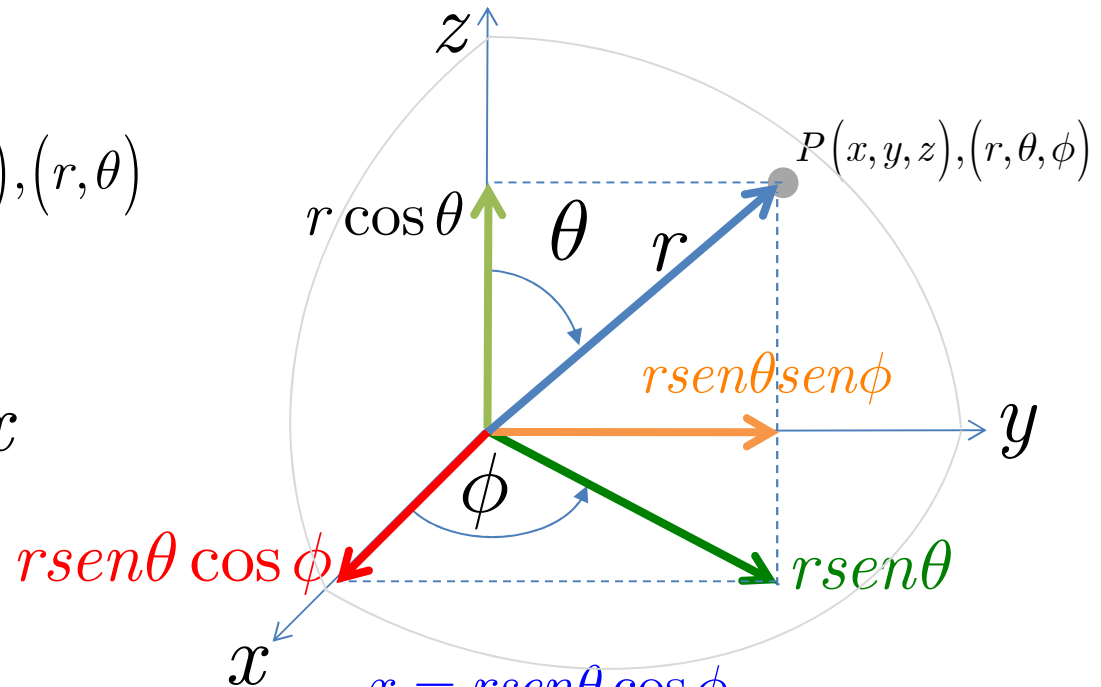

$$x = r \operatorname{sen} \theta \cos \phi$$

$$y = r \operatorname{sen} \theta \operatorname{sen} \phi$$

$$z = r \cos \theta$$

$$r = \sqrt{x^2 + y^2 + z^2}$$

$$\phi = \operatorname{tg}^{-1} (y/x); \theta = \cos^{-1} (z/r)$$

# Diagrama polar

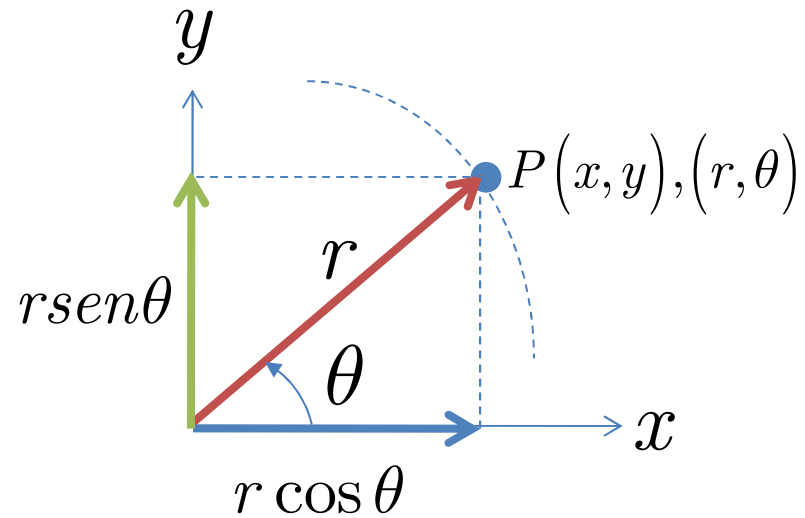

$$x = r \cos \theta$$

$$y = r \sin \theta$$

$$r = \sqrt{x^2 + y^2}$$

$$\theta = \operatorname{tg}^{-1} \left( \frac{y}{x} \right)$$

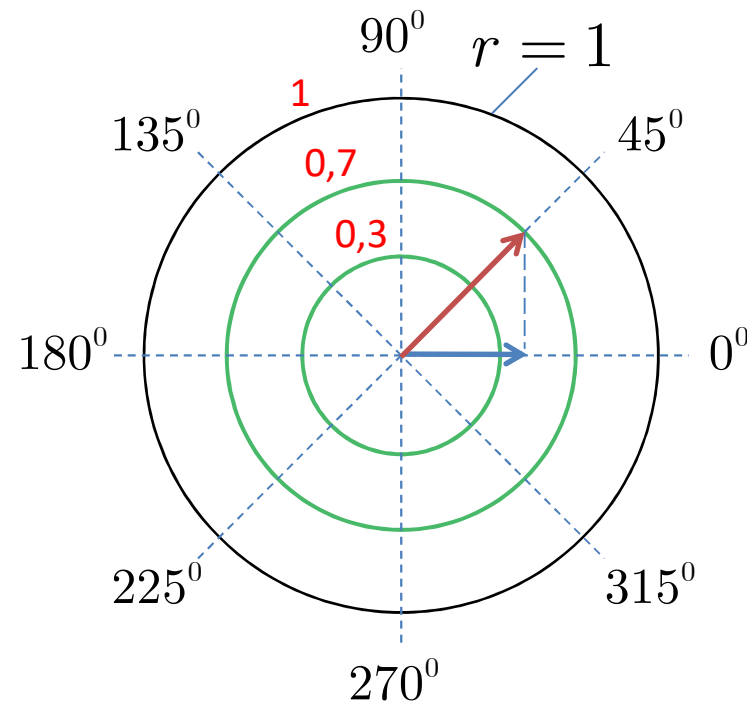

Fonte isotrópica

Potência radiada por fonte isotrópica

Antenas onidirecional e direcional

# DIAGRAMA DE RADIAÇÃO

# Analogia: Sombra e cobertura de farol

---

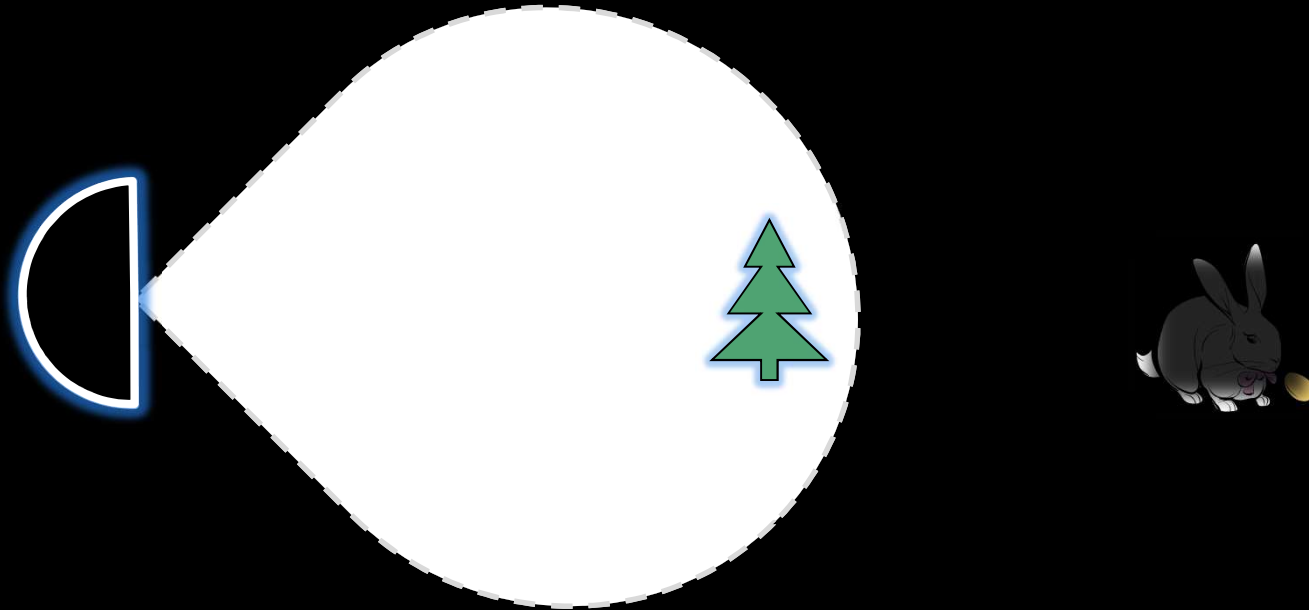



# Diagramas de radiação de antenas

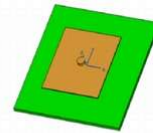
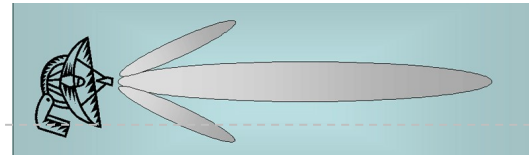
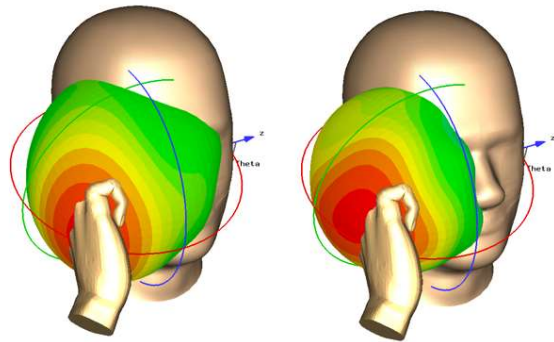

(a) Patch Antenna Model

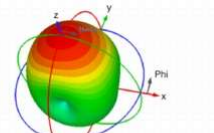

(b) Patch Antenna 3D Radiation Pattern

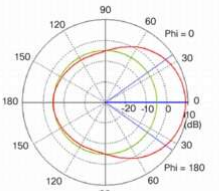

(c) Patch Antenna Azimuth Plane Pattern

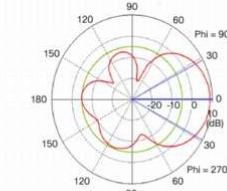

(d) Patch Antenna Elevation Plane Pattern

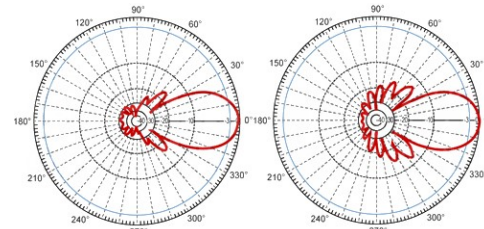

Vertical

Horizontal

900 MHz 14 dBi Yagi

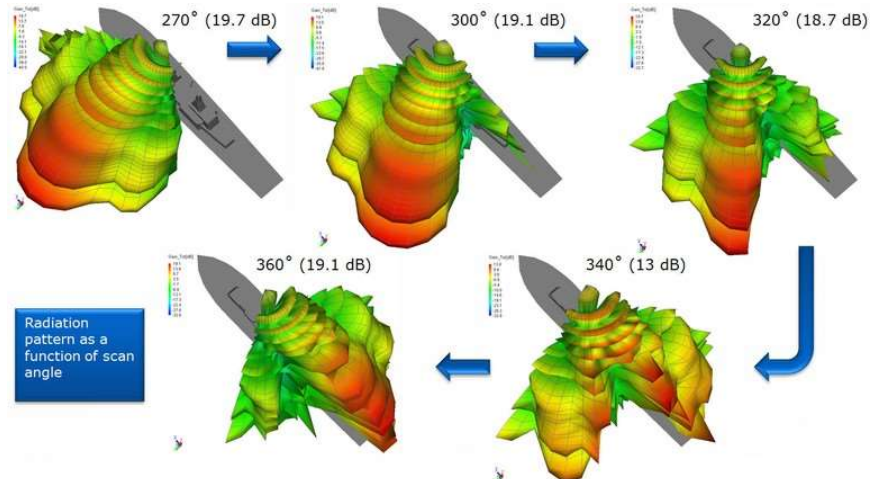
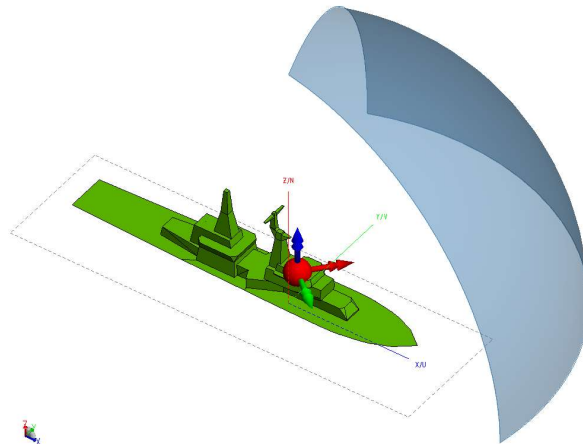

# Representação complexa

---

tensão instantânea real

$$\mathcal{V}(z, t) = V_0 \cos(\omega t - kz + \phi)$$

tensão complexa instantânea

$$V(z, t) = V_0 \exp(-jkz) \exp(j\omega t)$$

tensão fasorial

$$V(z) = V_0 \exp(-jkz)$$

# Campo eletromagnético

---

campo elétrico distante da antena

$$\mathbf{E}(r, \theta, \phi) = \left[ \hat{\theta} F_{\theta}(\theta, \phi) + \hat{\phi} F_{\phi}(\theta, \phi) \right] \frac{\exp(-jk_0 r)}{r} \text{ V} \cdot \text{m}^{-1}$$

campo magnético correspondente

$$H_{\phi} = \frac{E_{\theta}}{\eta_0} ; H_{\theta} = -\frac{E_{\phi}}{\eta_0} \text{ A} \cdot \text{m}^{-1}$$

$k_0 = 2\pi / \lambda_0 = 2\pi f / c$  : constante de propagação no vácuo

$c$ : velocidade da luz no vácuo,  $\text{m} \cdot \text{s}^{-1}$

$f$ : frequência, Hz

$\lambda_0$  : comprimento de onda no vácuo, m

$\eta_0 = \sqrt{\mu_0 / \epsilon_0} = 377 \text{ } \Omega$  : impedância intrínseca do meio

# Densidade de potência de radiação

---

$$\mathbf{W}(x, y, z; t) = \mathbf{E}(x, y, z; t) \times \mathbf{H}(x, y, z; t)$$

valor médio

$$\mathbf{W}_{med} = \frac{1}{2} \text{Re} \left\{ \mathbf{E}(x, y, z) \times \mathbf{H}^*(x, y, z) \right\}$$

$$\mathbf{W}(x, y, z; t)$$

vetor de Poynting instantâneo,  $\text{W} \cdot \text{m}^{-2}$

$$\mathbf{E}(x, y, z; t)$$

vetor intensidade de campo elétrico instantâneo,  $\text{V} \cdot \text{m}^{-1}$

$$\mathbf{H}(x, y, z; t)$$

vetor intensidade de campo magnético instantâneo,  $\text{A} \cdot \text{m}^{-1}$

# Intensidade de radiação

---

$$U(\theta, \phi) = \begin{cases} r^2 \mathbf{W}_{med} \\ \frac{r^2}{2} \operatorname{Re} \left\{ E_\theta \hat{\theta} \times H_\phi^* \hat{\phi} + E_\phi \hat{\phi} \times H_\theta^* \hat{\theta} \right\} \\ \frac{r^2}{2\eta_0} \left( |E_\theta|^2 + |E_\phi|^2 \right) \\ \frac{1}{2\eta_0} \left( |F_\theta|^2 + |F_\phi|^2 \right) \end{cases}$$

unidade:  $\text{W} \cdot \text{sr}^{-1}$

potência radiada por unidade de ângulo sólido

# Diagrama de radiação

---

$$F(\theta, \phi) = \text{sen}^2(\theta)$$

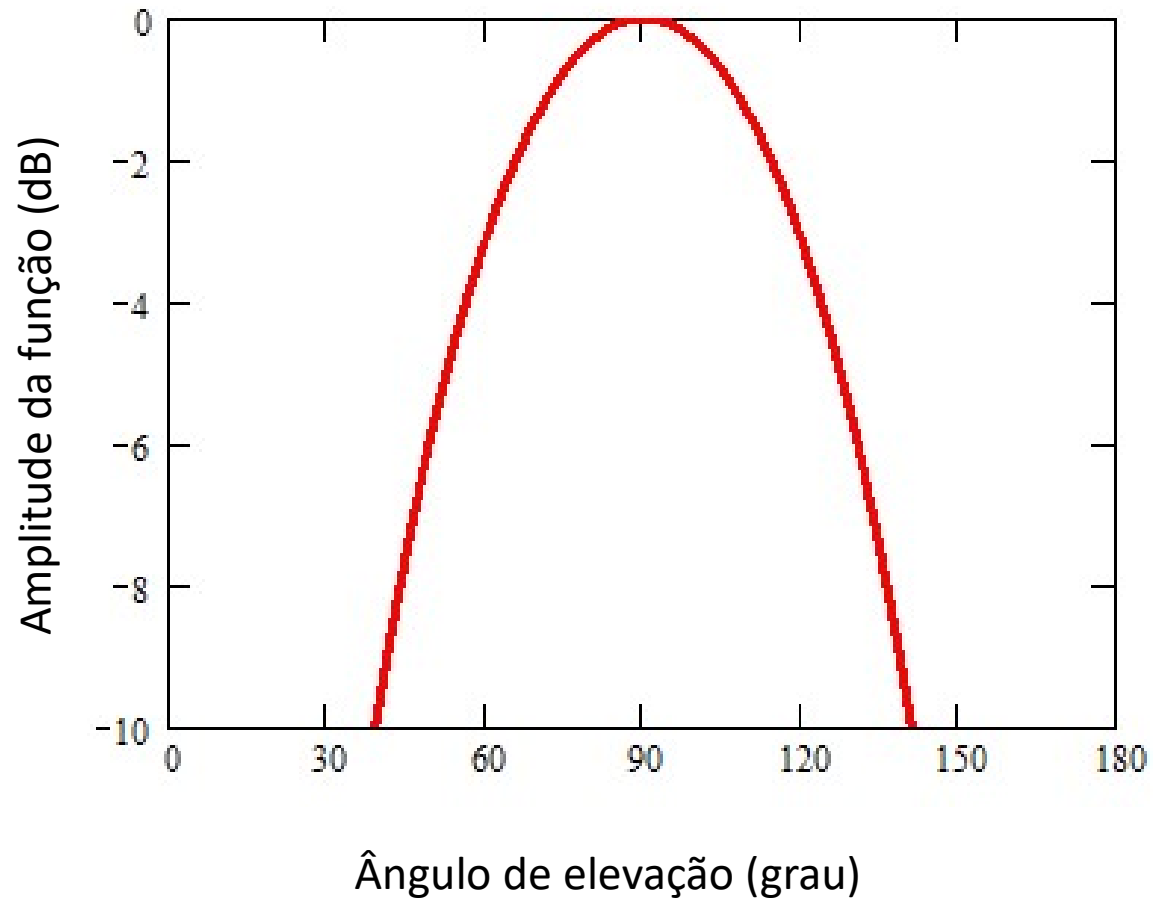

# Diagrama de radiação antena para celular

870-960 MHz, polarização vertical, ganho de 16 dBi, 50 ohms  
CTS09G-10514-0D

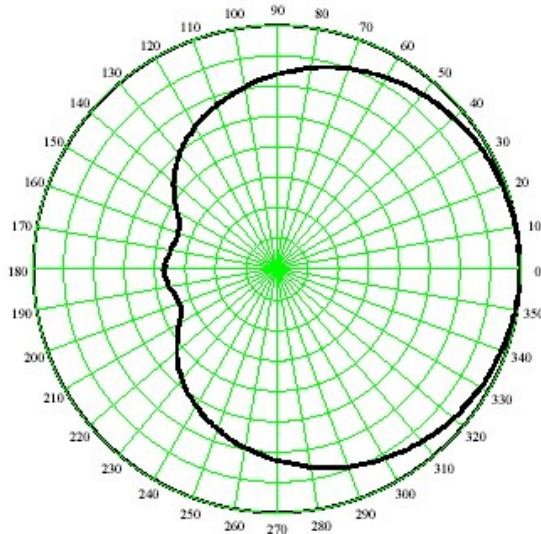

Padrão: azimute  
Centro: - 40dB  
5 dB/divisão radial  
10 graus/divisão angular  
Largura do feixe: 105<sup>o</sup>  
Medidas em 920 MHz

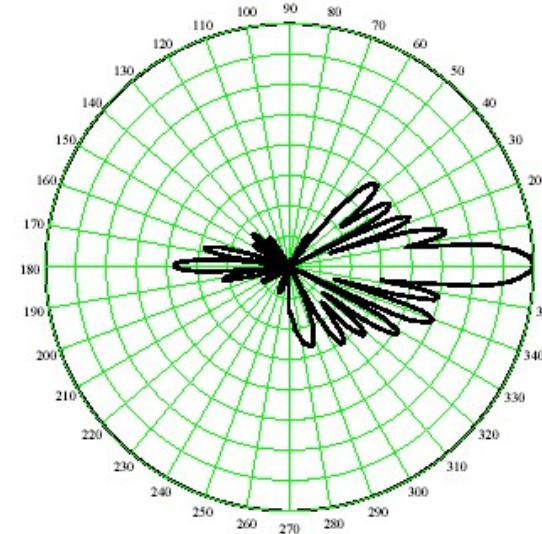

Padrão: elevação  
Centro = - 40dB  
5 dB/divisão radial  
10 graus/divisão angular  
Largura do feixe: 7<sup>o</sup>  
Medidas em 920 MHz

# Fonte isotrópica

---

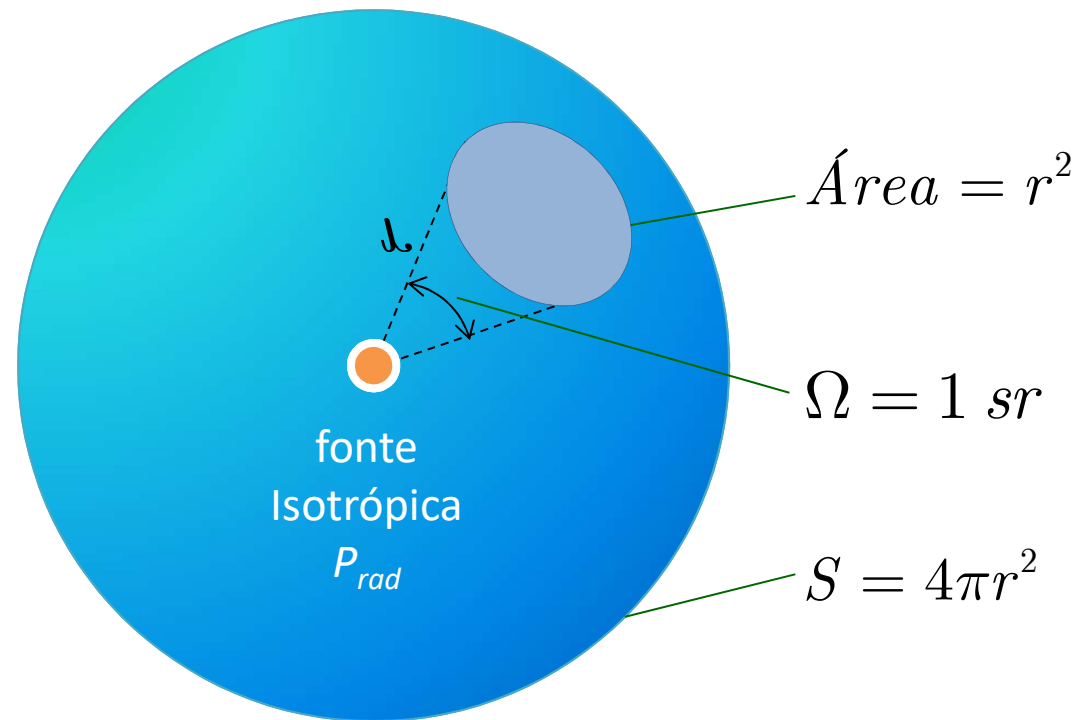



# Potência radiada por fonte isotrópica

$$P_{rad} = \oiint_S \mathbf{W}_0 \cdot d\mathbf{s}$$

$$P_{rad} = \int_0^{2\pi} \int_0^\pi \left[ W_0(r) \hat{\mathbf{r}} \right] \cdot \left[ r^2 \sin(\theta) d\theta d\phi \hat{\mathbf{r}} \right]$$

$$P_{rad} = 4\pi r^2 W_0, \text{ W}$$

A densidade de potência é

$$\mathbf{W}_0 = W_0 \hat{\mathbf{r}} = \hat{\mathbf{r}} \left( \frac{P_{rad}}{4\pi r^2} \right), \text{ W} \cdot \text{m}^{-2}$$

distribuição uniforme  
sobre esfera de raio  $r$

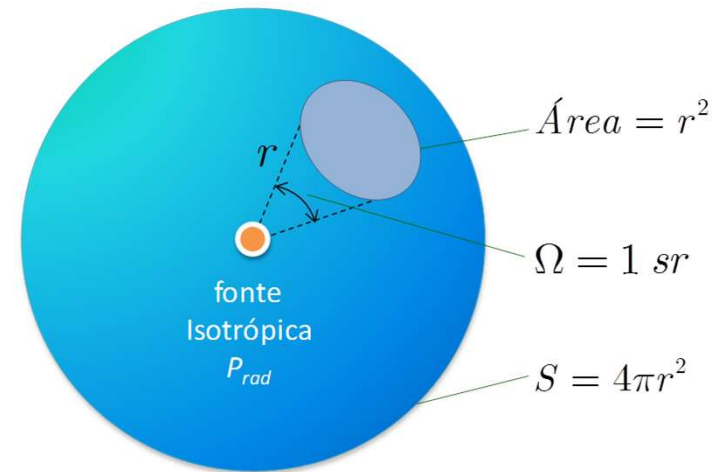

densidade de potência

$$\mathbf{W}_0 = W_0 \hat{\mathbf{r}} = \hat{\mathbf{r}} \left( \frac{P_{rad}}{4\pi r^2} \right), \text{ W} \cdot \text{m}^{-2}$$

intensidade de radiação

$$U_0 = \frac{P_{rad}}{4\pi}, \text{ W} \cdot \text{sr}^{-1}$$

## Antena isotrópica: Relação entre densidades de potência

Relação entre as densidades de potência em duas posições

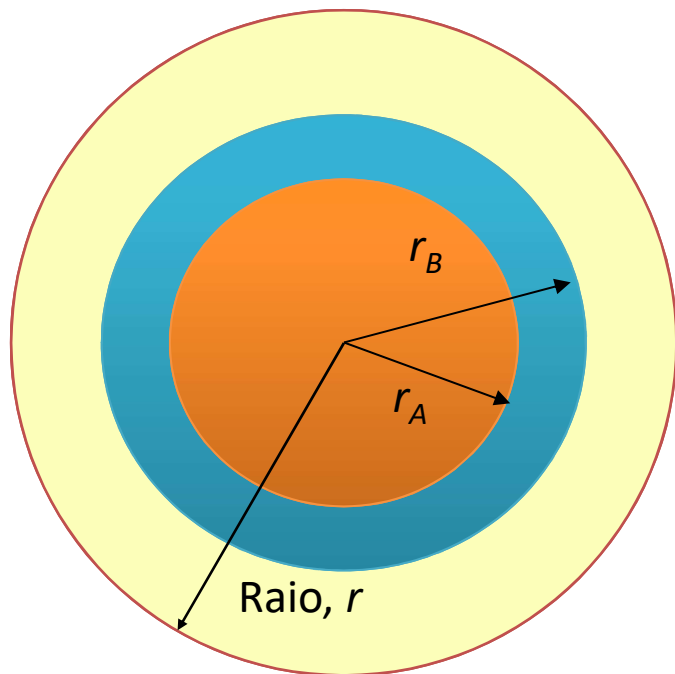

$$\frac{W_A}{W_B} = \frac{P_{rad} / 4\pi r_A^2}{P_{rad} / 4\pi r_B^2} = \left( \frac{r_B}{r_A} \right)^2$$

Exemplo:

$r_A = 250$  m e  $r_B = 500$  m

$$\frac{W_A}{W_B} = \left( \frac{500}{250} \right)^2 = 2^2 = 4$$

$$\frac{W_A}{W_B} = 10 \log(4) = 6 \text{ dB}$$

# Fonte isotrópica: densidade de potência radiada

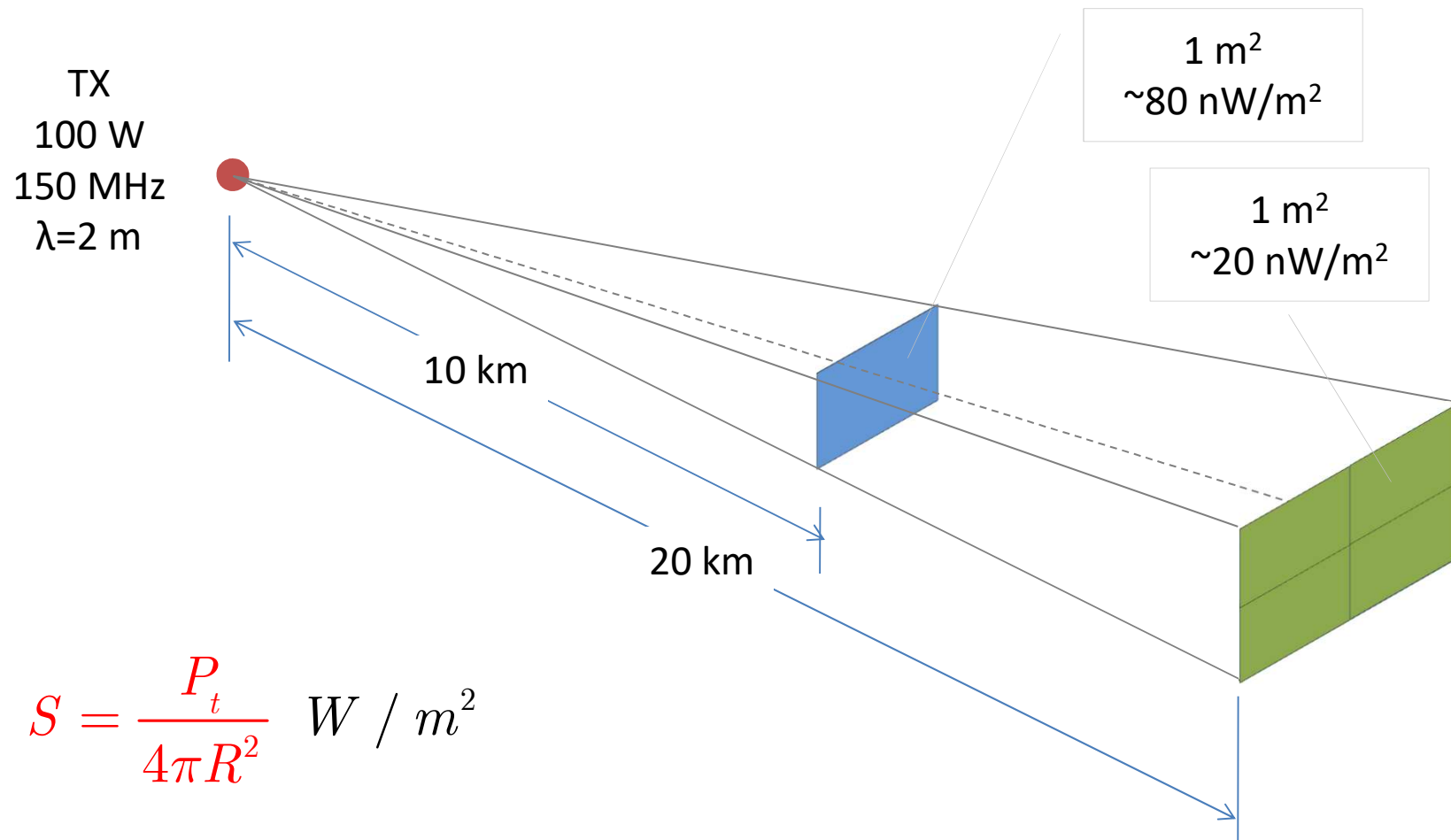

# Exemplo: Distância Terra-Marte

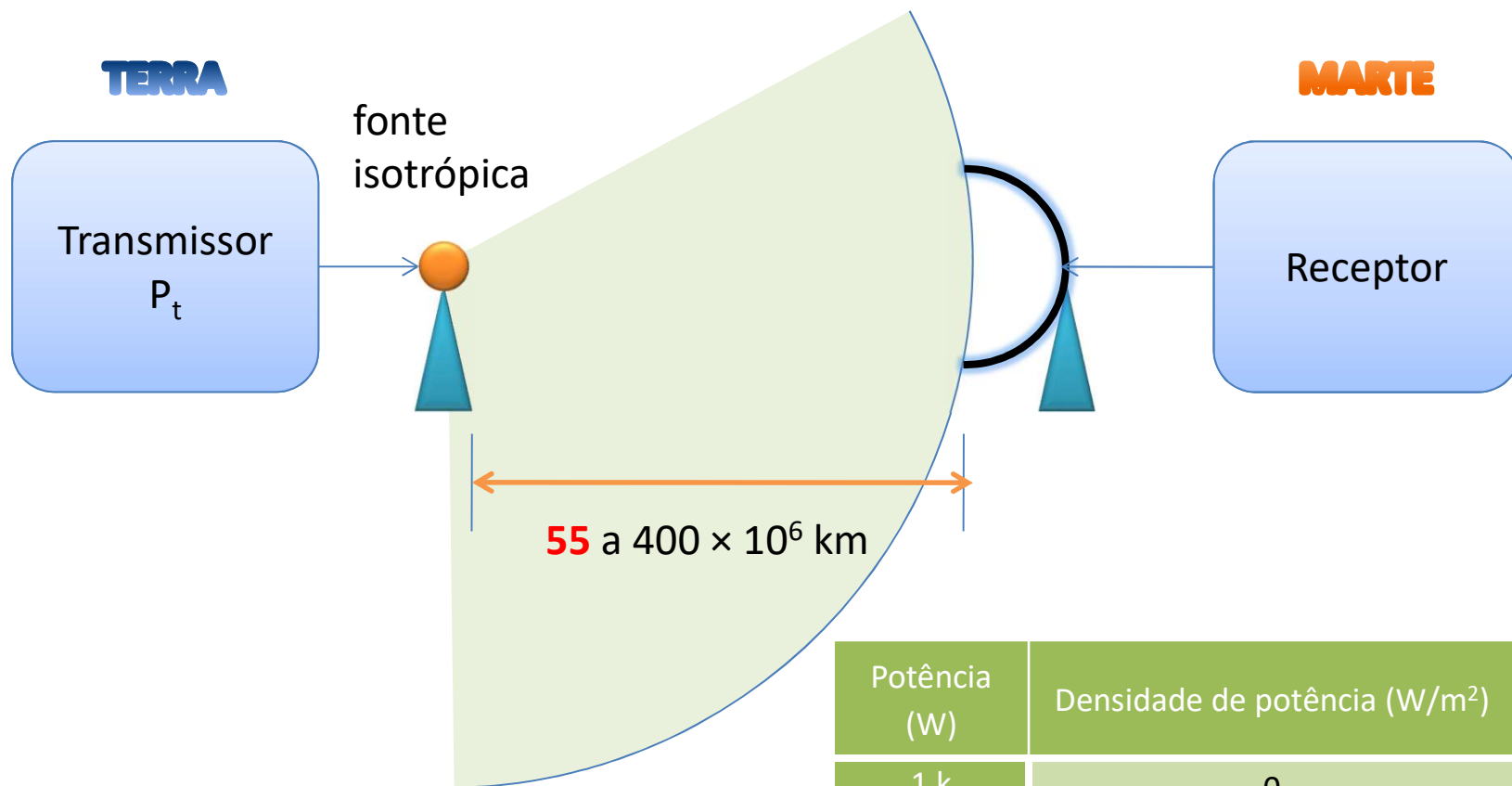

$$S = \frac{P_t}{4\pi R^2} \text{ W / m}^2$$

Potência (W)	Densidade de potência (W/m <sup>2</sup> )
1 k	0
1 M	0
100 M	$2,6 \times 10^{-15}$
1 G	$2,6 \times 10^{-14}$
100 G	$2,6 \times 10^{-12}$

# Diagrama de Radiação (DR): Coordenadas Polares

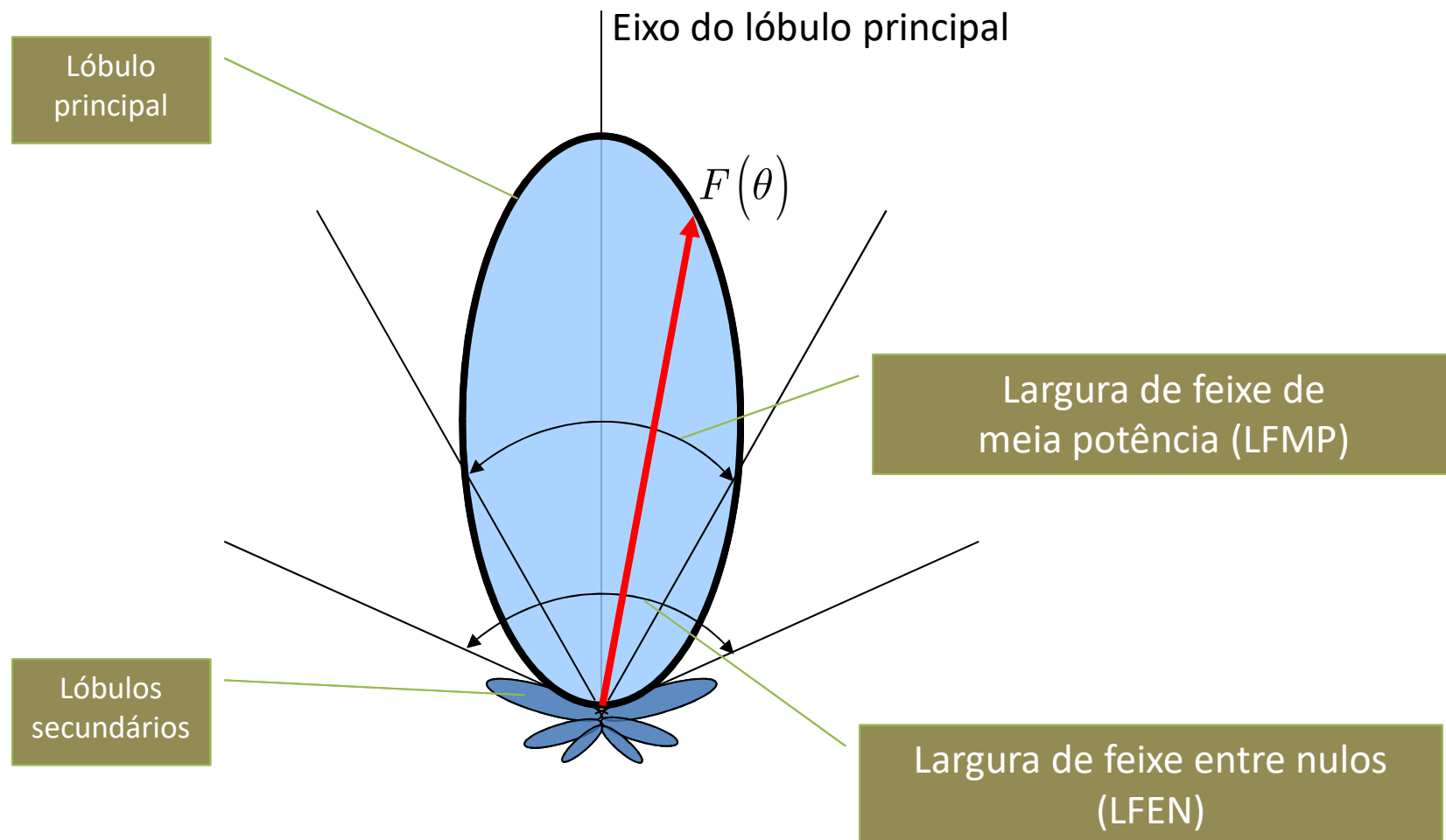

## Coordenadas polares

**HPBW**: half power beam width; **BWFN**: beam width first null; **P**: potência

# DR: Coordenadas Polares e Lineares

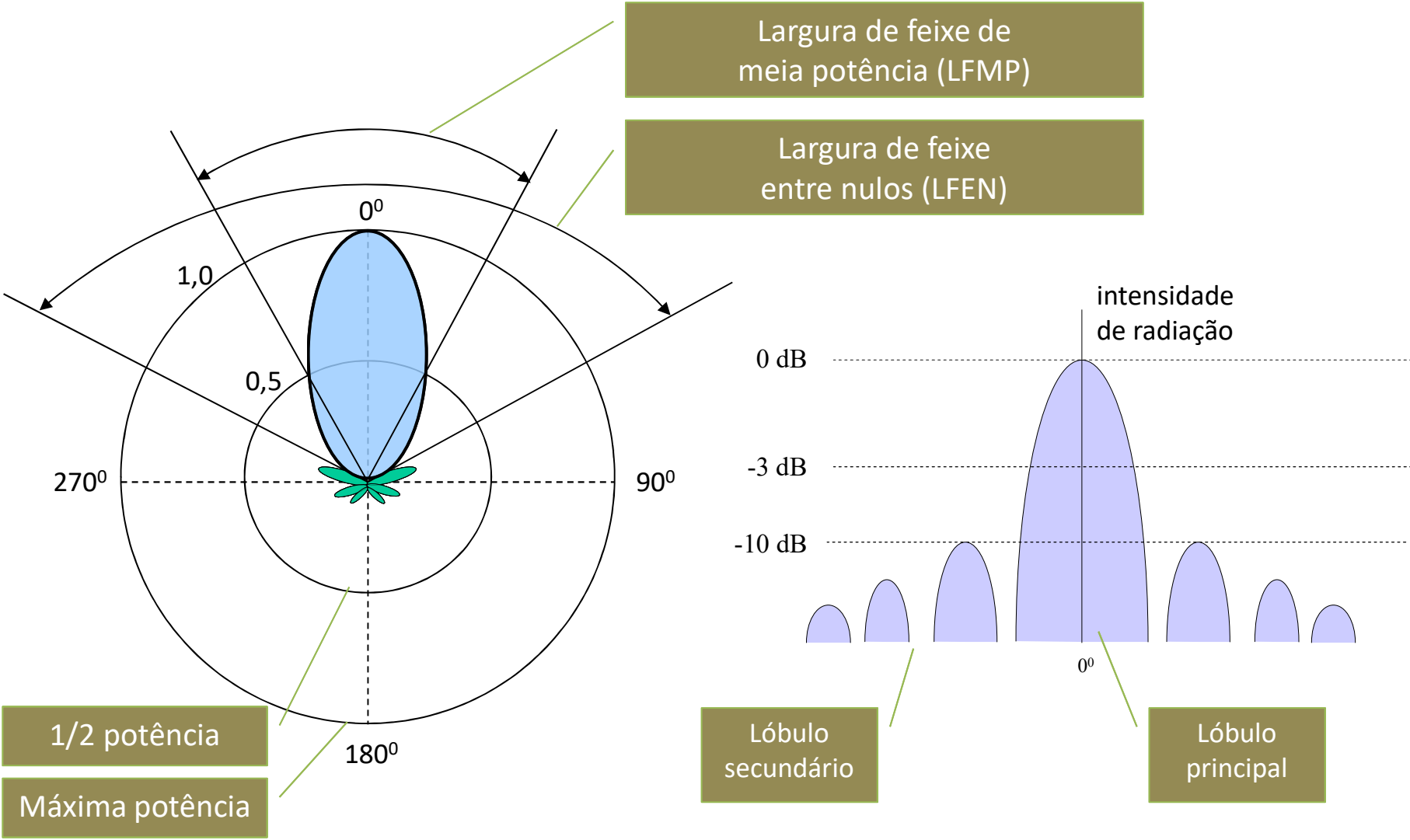

**HPBW:** half power beam width; **BWFN:** beam width first null

# Antenas onidirecional e direcional-1

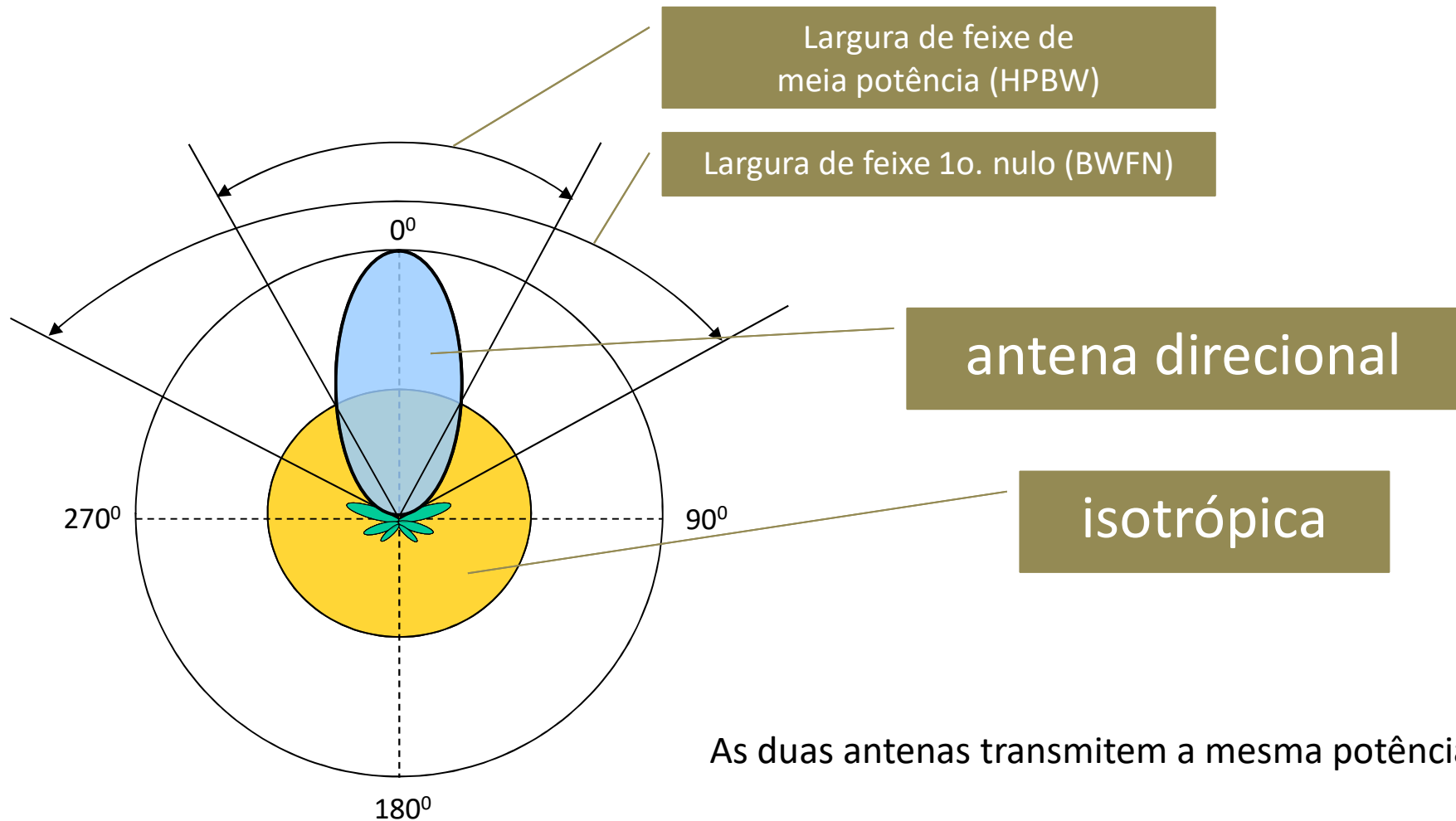

**HPBW:** half power beam width; **BWFN:** beam width first null



Definição

Exemplo

# REGIÕES DE CAMPOS PRÓXIMO E DISTANTE

# Regiões de campo (aproximação)

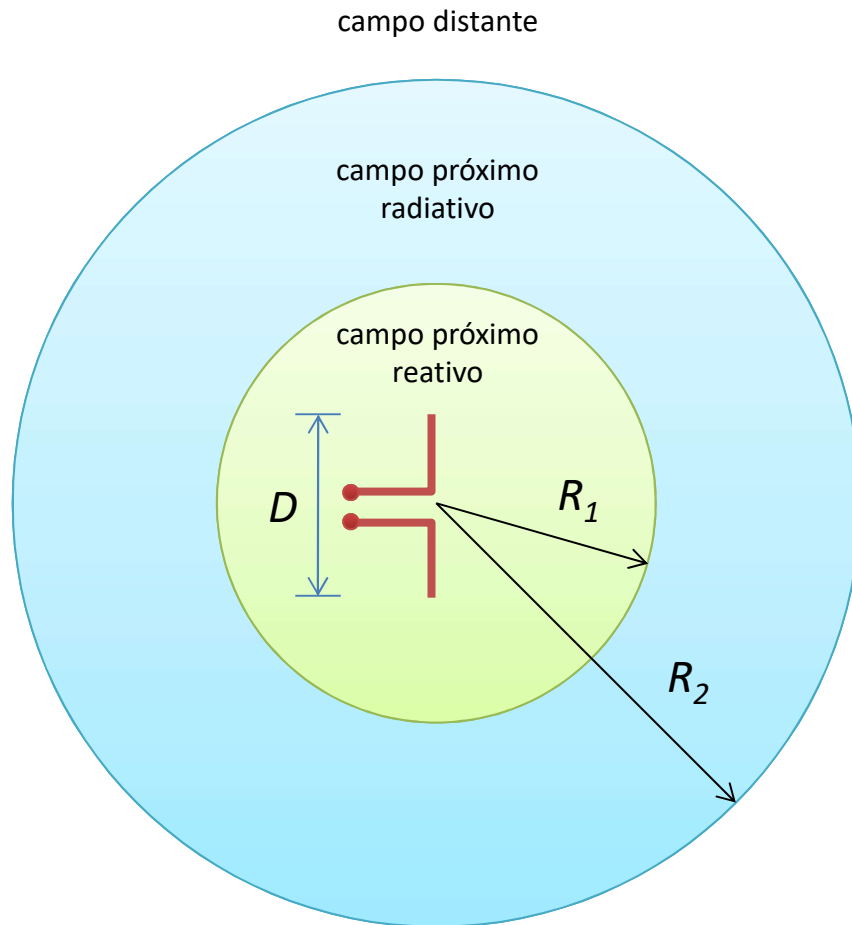

campo próximo

$$R_1 = 0,62\sqrt{\frac{D^3}{\lambda}}$$

campo distante

$$R_{ff} = 2\frac{D^2}{\lambda}$$

$\lambda$  : comprimento de onda

Constantine A. Balanis, Antenna Theory: Analysis Design, 3ª edição, John Wiley & Sons, Inc., 2005, p. 34, Fig. 2.7

# Região de Campo Distante-1

---

Nesta região, onda esférica pode ser aproximada por onda plana

$$R_{ff} = \frac{2D^2}{\lambda} \text{ m}$$

$D$ : abertura;  $\lambda$ : comprimento de onda  
 $ff$ : far field

Condição para qual a onda esférica difere de  $\pi/8=22,5^\circ$  de onda plana ao longo da maior dimensão da antena

Para antenas pequenas,  $R_{ff}$  é pequena e deve ser usado  $R_{ff}=2\lambda$

# Região de Campo Distante-2

---

*Exemplo:* antena parabólica de 18" de diâmetro e operando em 12,4 GHz

$$R_{ff} = \frac{2D^2}{\lambda} m$$

$$\lambda = \frac{c}{f} = \frac{3 \times 10^{10}}{12,4 \times 10^9} = 2,42 \text{ cm}$$

$$18'' \rightarrow 0,457 \text{ m}$$

$$R_{ff} = \frac{2 \times 0,457^2}{0,0242} = 17,3 \text{ m}$$

# Área efetiva (seção reta de absorção)

---

Potência recebida pela antena receptora

$$P_R = SA_e$$

Eficiência da antena

$$\eta = \frac{A_e}{A}$$

$$P_R = \frac{P_T}{4\pi R^2} A_e \quad W$$

$\eta$ : indica o quanto uma antena converte a radiação eletromagnética incidente em sinal elétrico

Parabólica: 45 a 75%; Outras antenas direcionais: 50 a 80%

$A_e$ : área efetiva;  $A$ : área física

# GANHO E DIRETIVIDADE DE ANTENA

# Ganho

---

Ganho de antena transmissora

$$G_T(\theta, \phi) = \frac{\text{densidade de potência na direção } (\theta, \phi)}{\text{densidade de potência da antena isotrópica}}$$

Ganho de antena receptora

$$G_R(\theta, \phi) = \frac{\text{área efetiva na direção } (\theta, \phi)}{\text{área efetiva da antena isotrópica}}$$

Ganho máximo de antena em qualquer direção

$$G_{\max} = \frac{A_e}{A_{iso}} = \frac{4\pi}{\lambda^2} A_e$$

# Diretividade e ganho

---

Se a antena não apresenta perdas, a eficiência é 100%  
Se há perdas, a eficiência é menor que 100% e

$G = \eta_{rad} D$  adimensional

fator de eficiência da antena

$$\eta_{rad} = \frac{P_{rad}}{P_{in}} = \frac{P_{in} - P_{perda}}{P_{in}} = 1 - \frac{P_{perda}}{P_{in}}$$

A diretividade de uma antena em dB é

$$D(dB) = 10 \log \left( \frac{D}{D_i} \right) = 10 \log (D)$$

$D_i = 1$ : diretividade da antena isotrópica

X dB acima da diretividade da antena isotrópica significa que é mais diretiva

Não há direção preferencial na antena isotrópica,  
que radia igualmente em todas as direções



# Diretividade: Exemplo de duas antenas

---

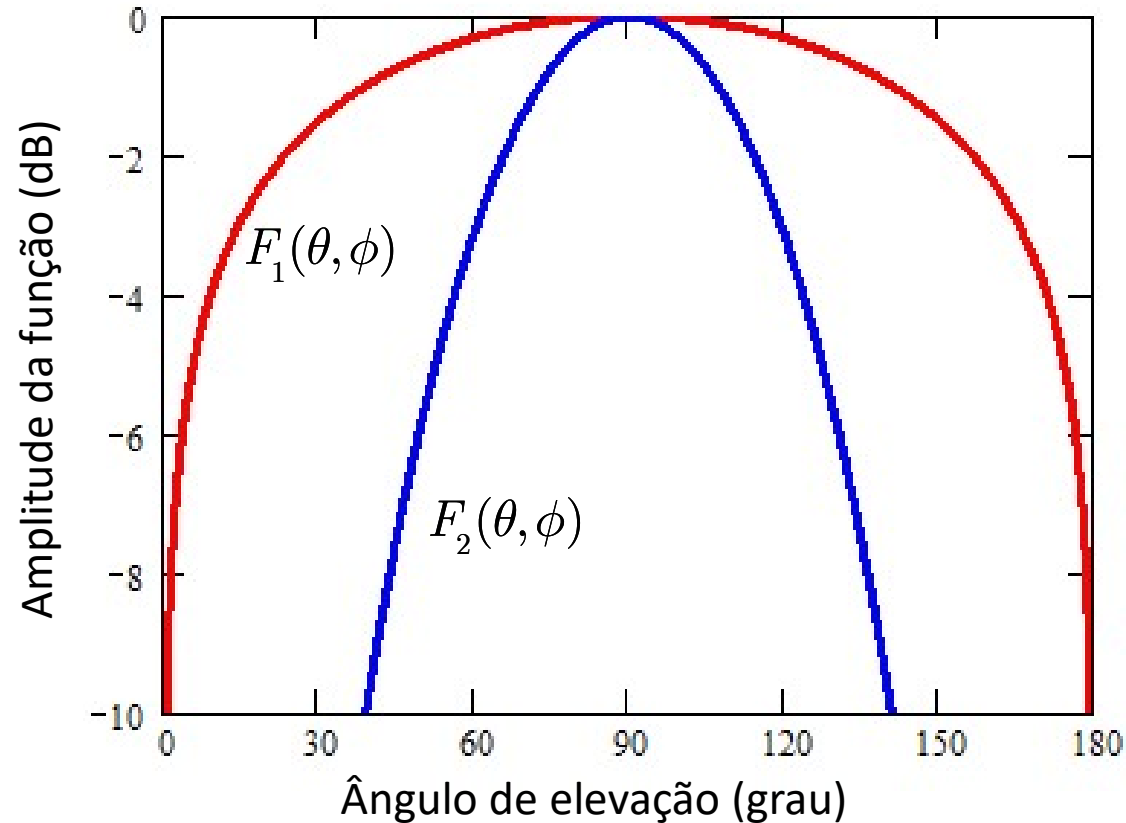

$$F_1(\theta, \phi) = \sqrt{\text{sen}(\theta)}, \quad D_1 = 1,273 \quad (1,05 \text{ dB})$$

$$F_2(\theta, \phi) = \text{sen}^2(\theta), \quad D_2 = 2,707 \quad (4,32 \text{ dB})$$

A antena 2 é mais diretiva que a antena 1

# ÁREA DE CAPTURA DE ANTENA

# Área de Captura (1)

---

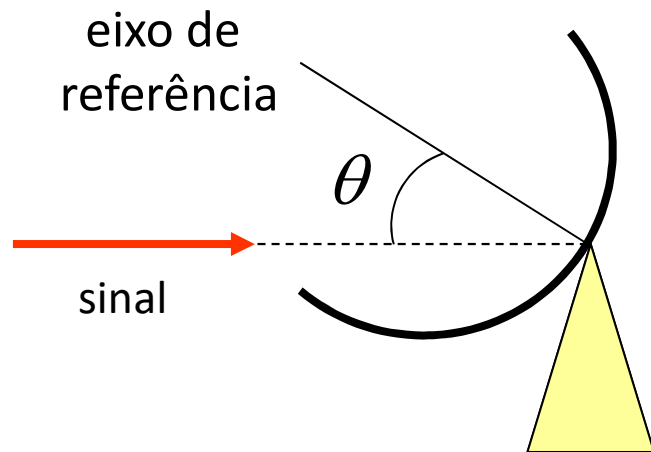
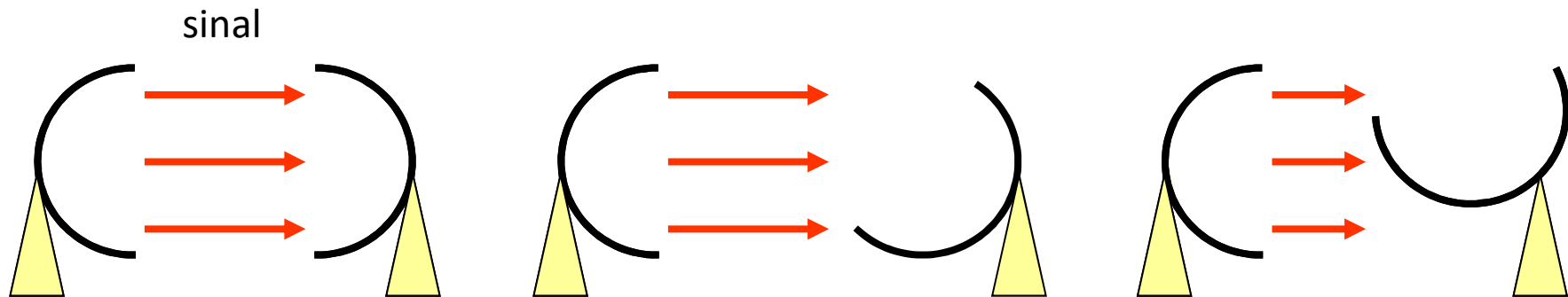

$$A_c = A_p \cos(\theta)$$

$A_c$ : área de captura

$A_p$ : área física

## Área de Captura (2)

---

*Exemplo:* Uma antena, cuja área física pode ser representada por uma circunferência de raio 5 m, forma ângulo de  $10^\circ$  com o sinal. Calcular a área de cobertura.

A área física é

$$A_p = \pi r^2 = \pi \times 5^2 = 78,54 \text{ m}^2$$

A área de cobertura é

$$A_c = A_p \cos(\theta) = 78,54 \times \cos(10^\circ) = 77,35 \text{ m}^2$$

$$A_p = 78,54 \text{ m}^2 \quad A_c = 77,35 \text{ m}^2$$

# Área de Captura (3)

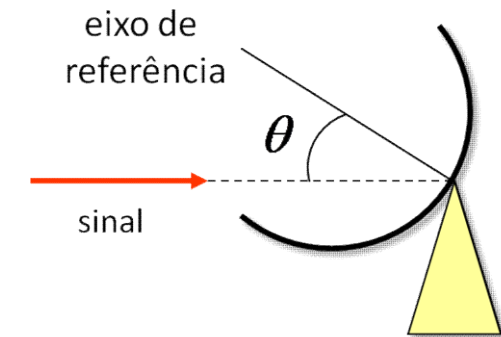
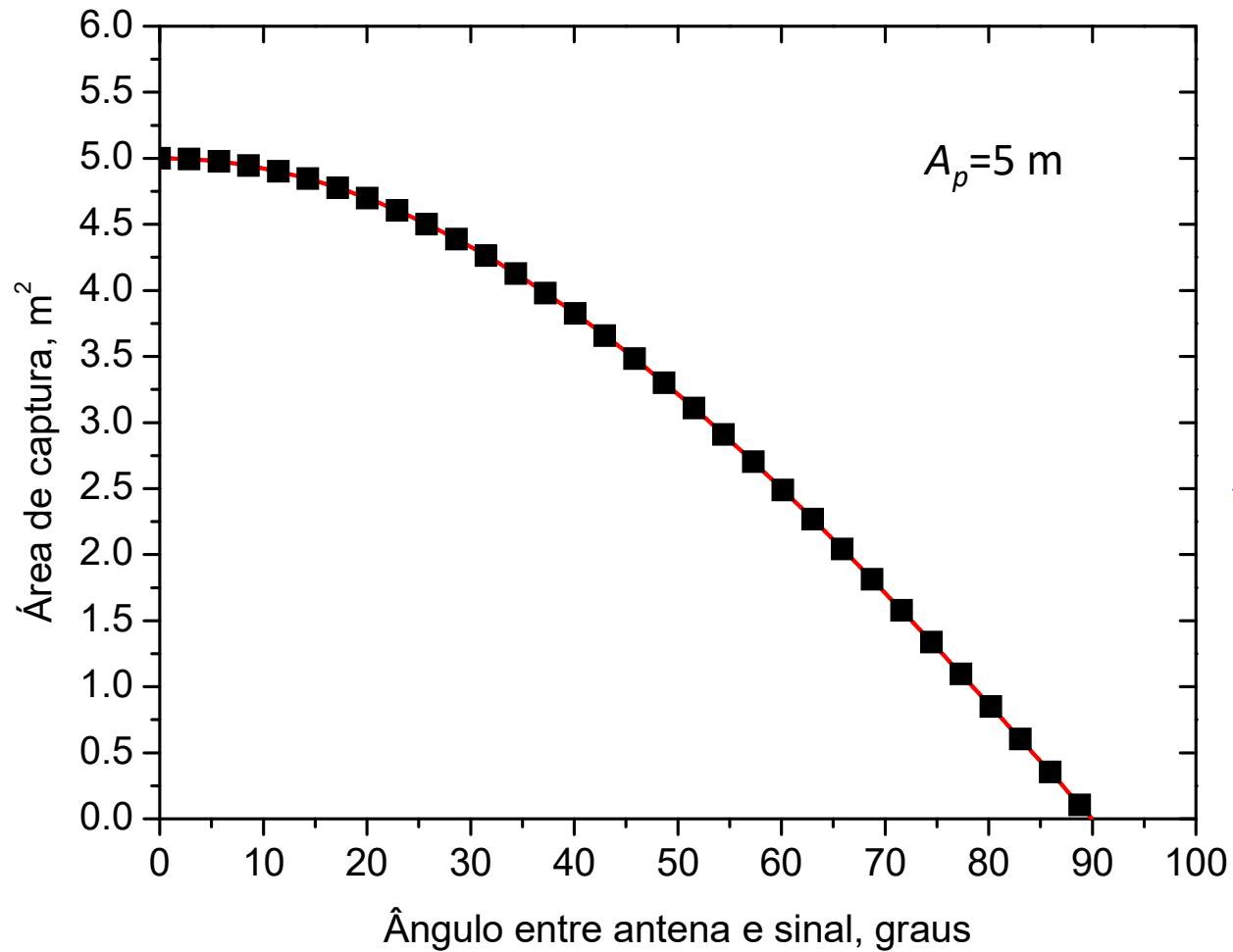

$$A_c = A_p \cos(\theta)$$

$A_c$ : área de captura  
 $A_p$ : área física

# Área de captura (4): Potência recebida

---

$$P_r = S \times A_c$$

S: densidade de potência do sinal recebido  
Ac: área de captura

*Exemplo:* Uma antena isotrópica transmite sinal de 10 W.

À distância de 1 km uma antena de área física 10 m<sup>2</sup> recebe o sinal, mas formando ângulo de 45<sup>0</sup> com o sinal.

Calcular a potência recebida.

$$S = \frac{10}{4\pi \times 1000^2} = 7,96 \times 10^{-7} \text{ W / m}^2$$

$$A_c = A_p \cos(\theta) = 10 \times \cos(45^0) = 7,07 \text{ m}^2$$

$$P_r = 7,96 \times 10^{-7} \times 7,07 = 5,63 \text{ mW}$$

# Referências sobre antena log-periódica

---

## ✓ Projeto online

- Detalhado; fornece dimensões para elementos e distâncias entre elementos; projetos de outros tipos de antenas
- <http://www.changpuak.ch/electronics/lpda.php>

## ✓ Dimensões

- <http://www.antenna-theory.com/antennas/wideband/log-periodic-dipole.php>

# Animações (1)

---

Carga elétrica em movimento

<http://www.cco.caltech.edu/~phys1/java.html>

[Phet](#)

Dish Antenna Animation (Parabolic antenna / reflector)

<http://www.youtube.com/watch?v=785kRIZ7ael>

Antena WiFi em aeronave

<http://www.youtube.com/watch?v=fd3dGtNhGis#t=92>

How To Identify Aircraft Antennas Through Understanding Aircraft...

<http://www.youtube.com/watch?v=dZqu5v5Eth0>

Antena, fabricação, Panasonic

[https://www.youtube.com/watch?v=IDStQBE\\_pnw&index=5&list=FLO4alMf38WFQWgUQIncZ\\_yg](https://www.youtube.com/watch?v=IDStQBE_pnw&index=5&list=FLO4alMf38WFQWgUQIncZ_yg)

Pouso noturno Congonhas

[https://www.youtube.com/watch?v=MI0M8JJcCso&index=2&list=FLO4alMf38WFQWgUQIncZ\\_yg](https://www.youtube.com/watch?v=MI0M8JJcCso&index=2&list=FLO4alMf38WFQWgUQIncZ_yg)



# Animações (2)

---

Antena WiFi em aeronave

<http://www.youtube.com/watch?v=fd3dGtNhGis#t=92>

<https://www.youtube.com/watch?v=8TIHUzsZ7V0>

<https://www.youtube.com/watch?v=eFvwtfxPwac>

<https://www.youtube.com/watch?v=PJrOw6sGznc>

<https://www.youtube.com/watch?v=dINHrpy0w40>

Antena, fabricação, Panasonic

[https://www.youtube.com/watch?v=IDStQBE\\_pnw&index=5&list=FLO4aIMf38WFQWgUQIncZ\\_yg](https://www.youtube.com/watch?v=IDStQBE_pnw&index=5&list=FLO4aIMf38WFQWgUQIncZ_yg)

Thales Air Traffic Management - Global Surveillance

[https://www.youtube.com/watch?v=O3b3VZurdNg&index=4&list=FLO4aIMf38WFQWgUQIncZ\\_yg](https://www.youtube.com/watch?v=O3b3VZurdNg&index=4&list=FLO4aIMf38WFQWgUQIncZ_yg)

Antenna Array

[https://www.youtube.com/watch?v=RqX9vLj3\\_7w](https://www.youtube.com/watch?v=RqX9vLj3_7w) (Beyond the Visible: The Story of the Very Large Array)

Arecibo Observatory

<https://www.youtube.com/watch?v=YX4PZ-fW2YA>

# Referências

---

- ✓ Antenna Patterns and Their Meaning
  - Texto da Cisco sobre diagramas de radiação de várias antenas
    - [http://www.cisco.com/en/US/prod/collateral/wireless/ps7183/ps469/prod\\_white\\_paper0900aecd806a1a3e.pdf](http://www.cisco.com/en/US/prod/collateral/wireless/ps7183/ps469/prod_white_paper0900aecd806a1a3e.pdf)
- ✓ Antenna Types
  - Texto resumo sobre antenas monopolo e dipolo
    - <https://www.ncjrs.gov/pdffiles1/nij/185030b.pdf>
- ✓ Site Antena Theory
  - Resumo sobre teoria, tipos de antenas e projetos
    - <http://www.antenna-theory.com/>
- ✓ Aulas, animações
  - [Antenna Fundamentals 2 Directivity](#)
  - Antenna properties and terminology
    - [Uma boa aula sobre antenas](#))Antenna basics
    - [Uma boa aula sobre fundamentos de antenas](#)