

Controle e Medida da Poluição do AR

Controle Industrial

- Procedimentos simples: umidificação
- Controle de particulado
- Controle de gases



Cubatão-2010

- * Umidificação do solo do parque industrial
- * vista da área
- * “eco-pátio”.



Filtro Manga (particulado)

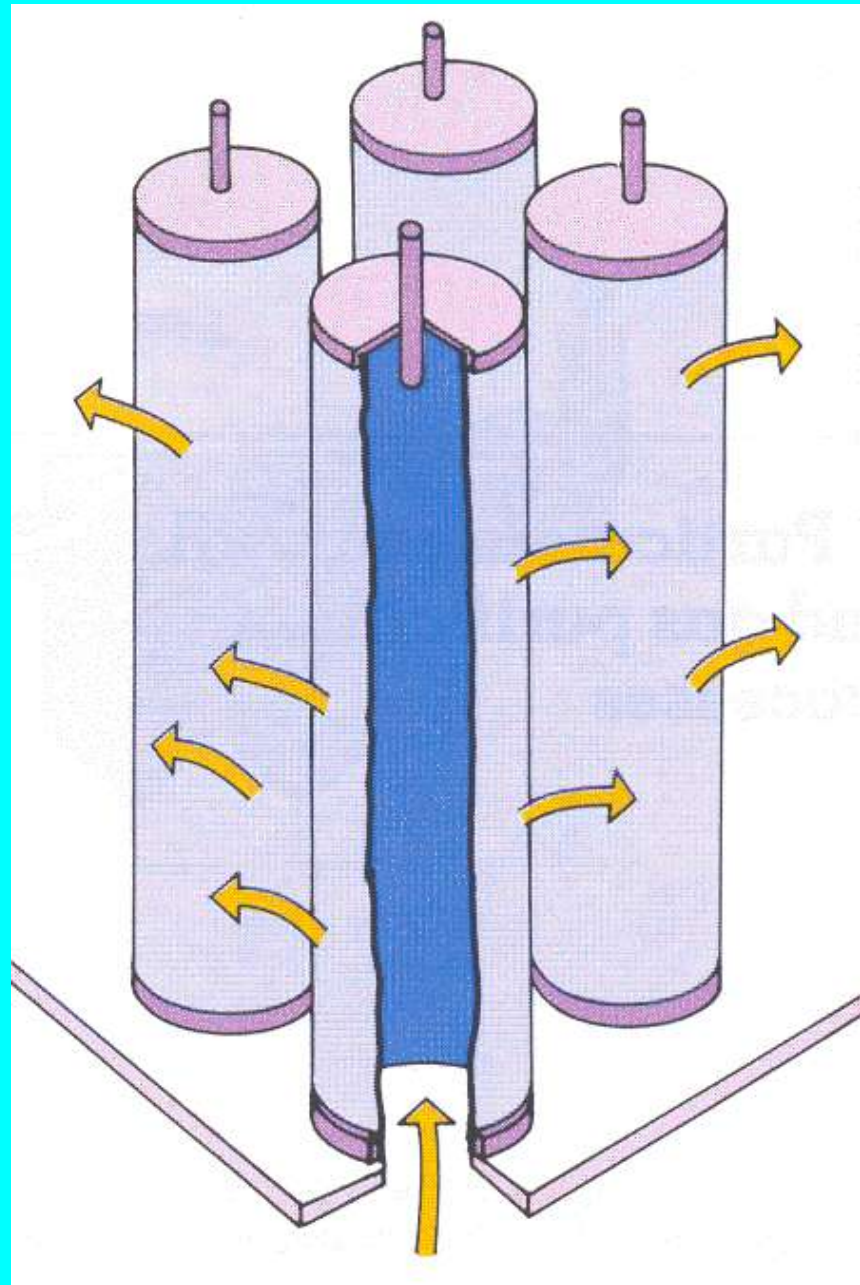

Ciclone

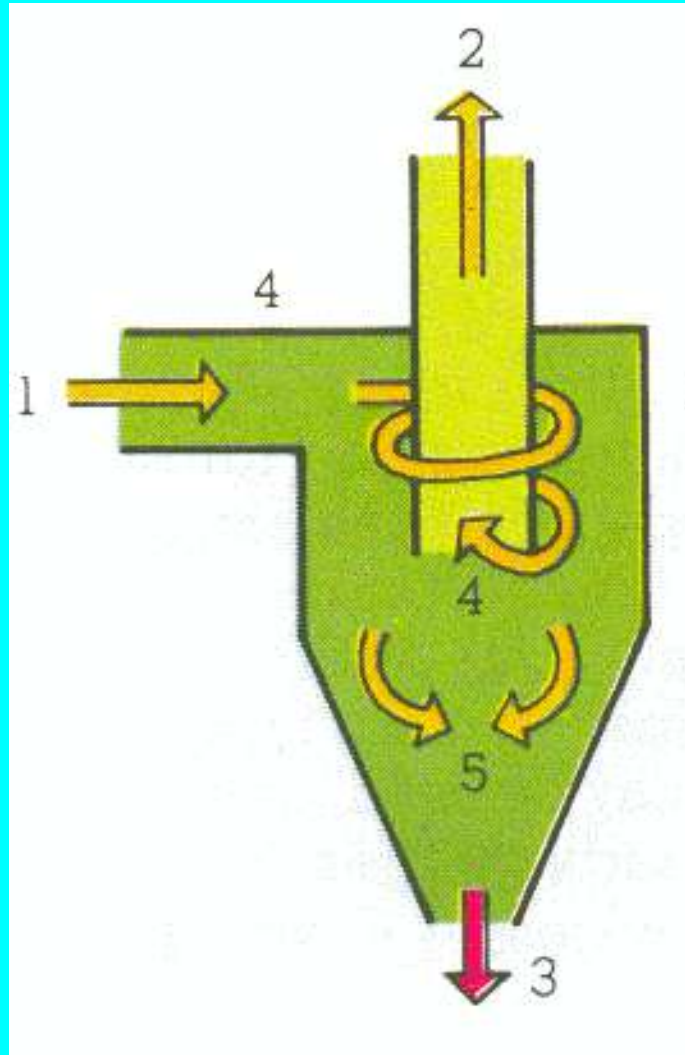

Precipitador Eletrostático

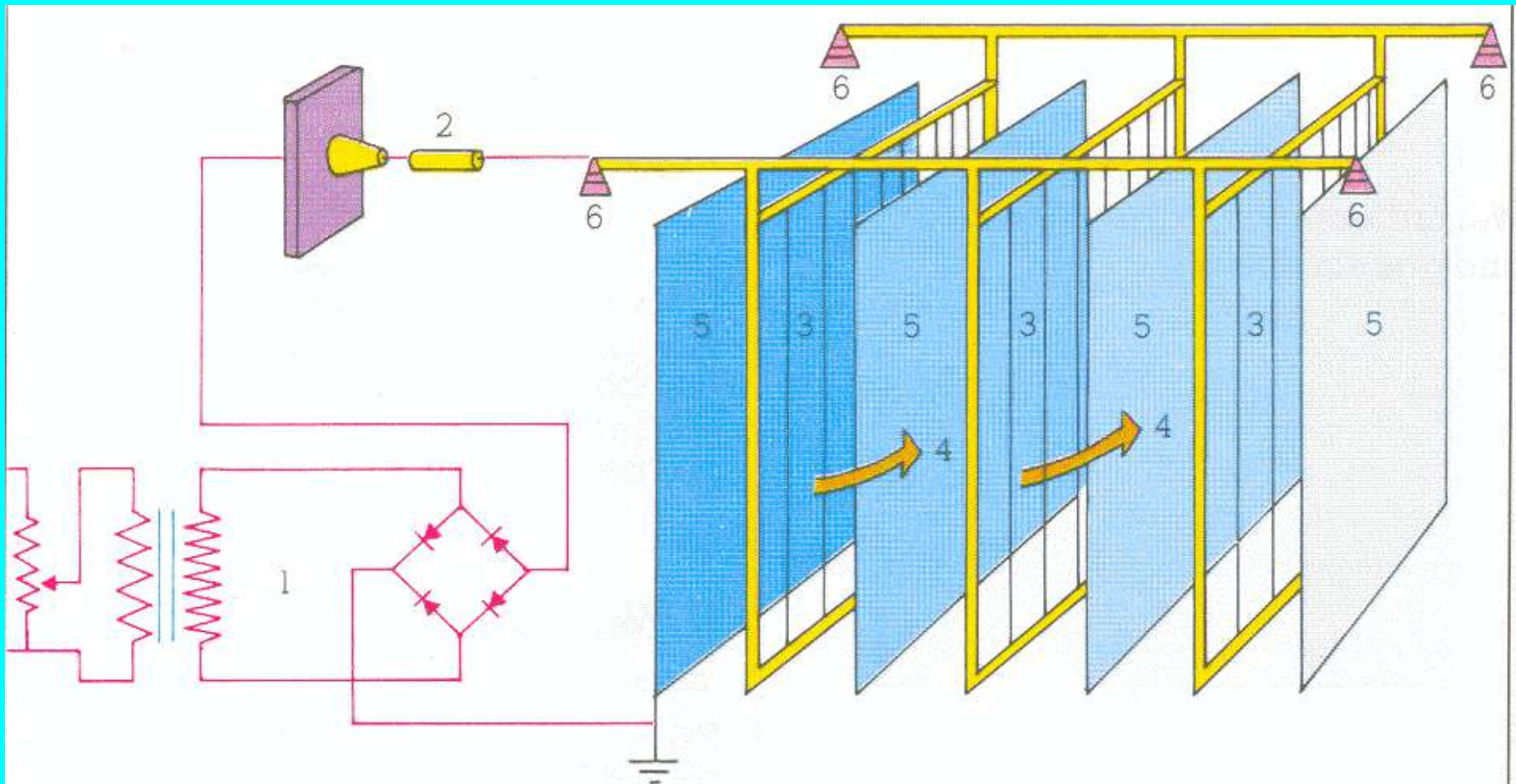

1. rectifier transformer - 2. damping resistance - 3. emitting electrodes - 4. gas flow direction - 5. collector electrodes - 6. post insulator

Desulfurizador

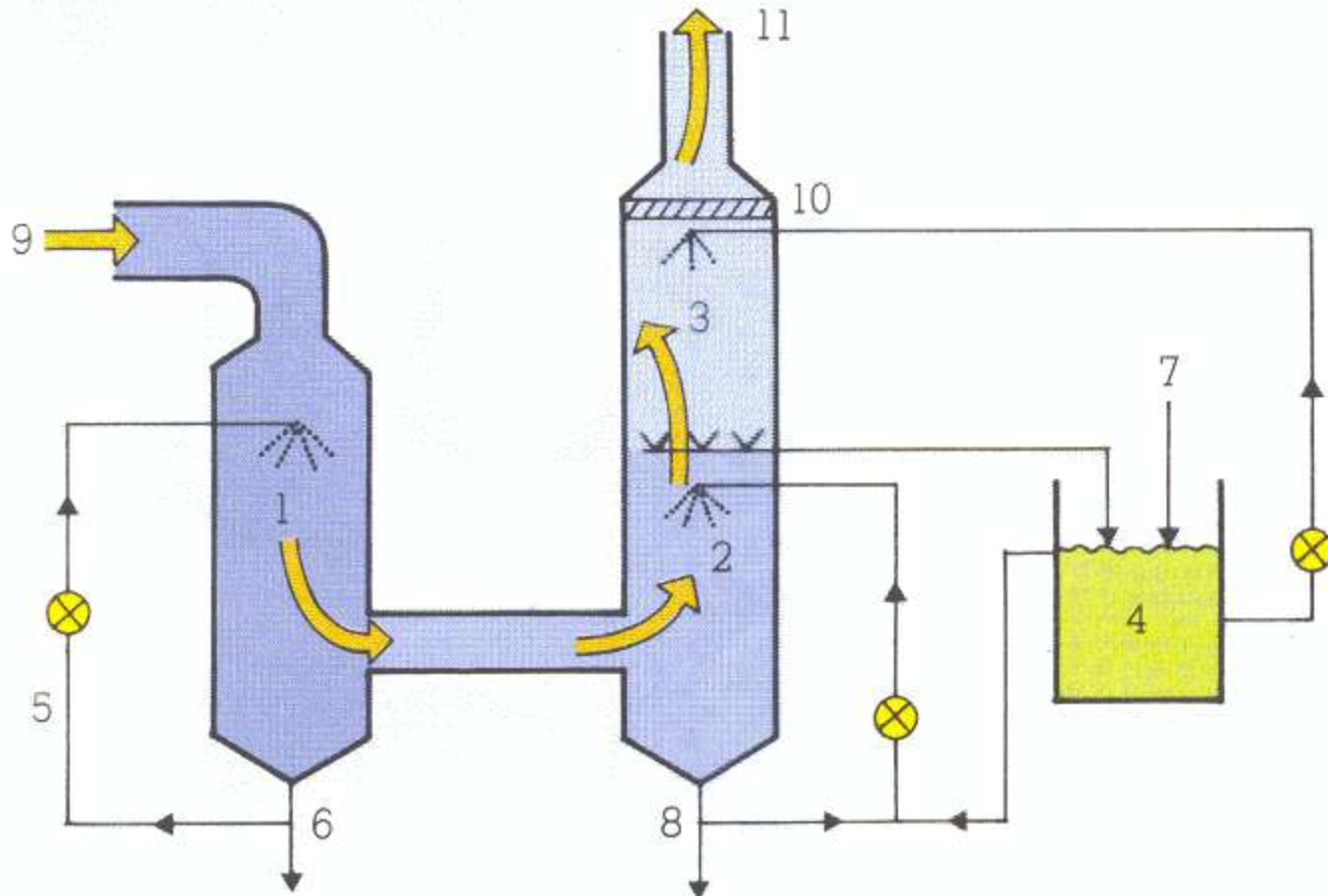

1. preliminary particulate removal - 2. stage 1 scrubbing tower - 3. stage 2 scrubbing tower - 4. solution storage tank - 5. saturated aqueous solution of SO_2 - 6. waste water to water treatment plant - 7. ammonia intake (NH_4OH) - 8. sulphite and bisulphite solution recirculated into production process - 9. SO_2 -laden gas from black liquor incineration - 10. vesicle remover - 11. treated gas

Redução de Emissão Veicular

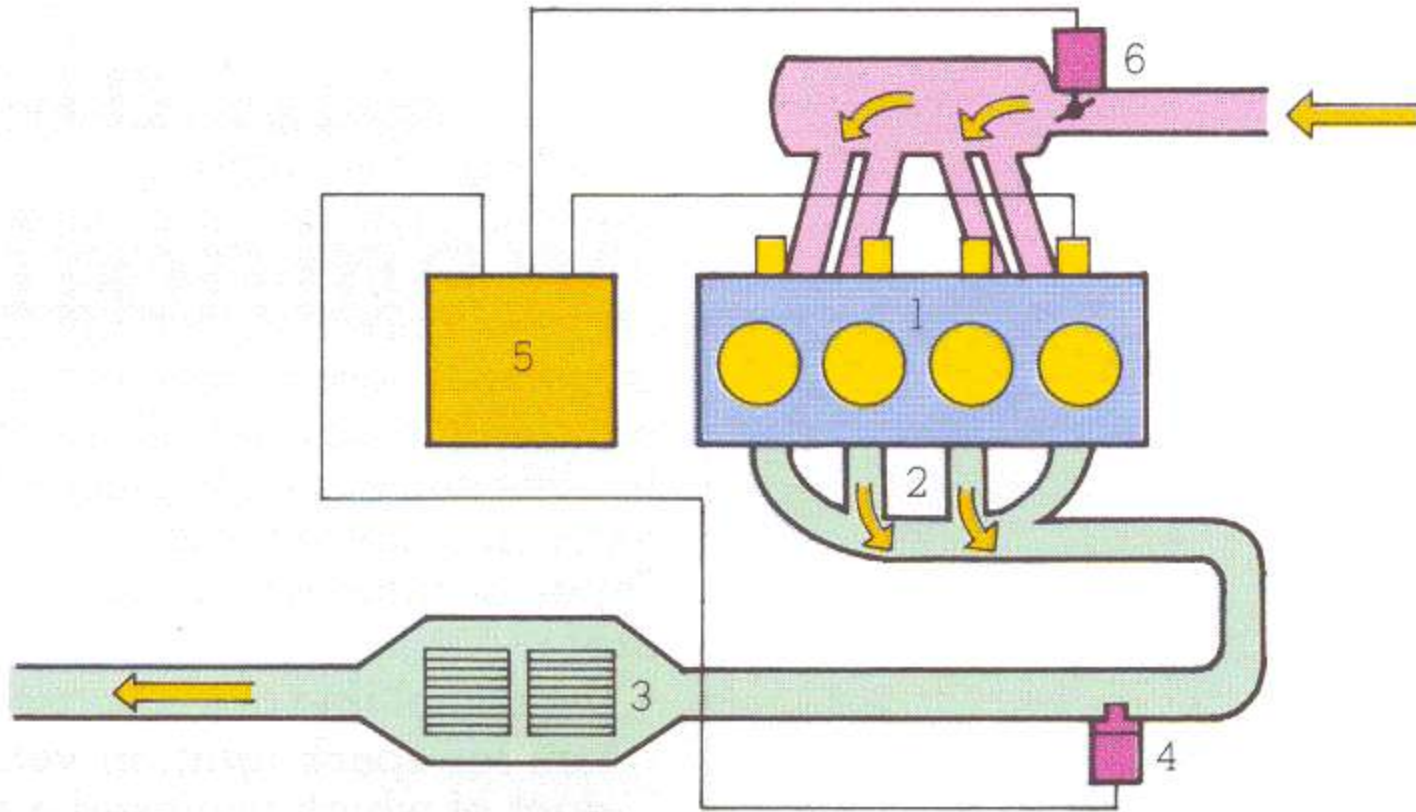

1. engine - 2. exhaust manifold - 3. catalytic convecter - 4. lambda sensor - 5. calculator - 6. butterfly valve housing

PM₁₀ - Beta

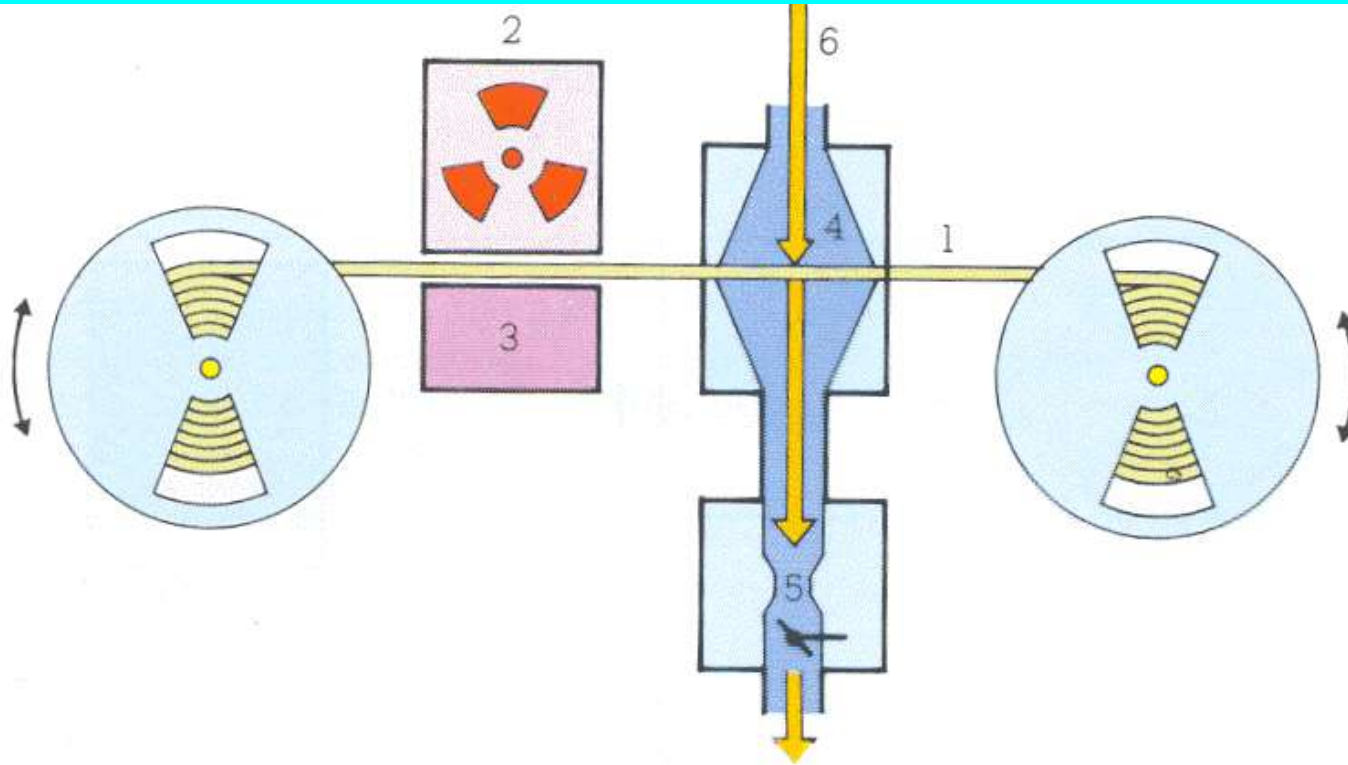

1. filtering strip - 2. beta radiation source - 3. Geiger-Müller counter - 4. filter support - 5. sample flow rate measurement and regulation device - 6. particulate-laden gas or air

CO - absorção de infravermelho

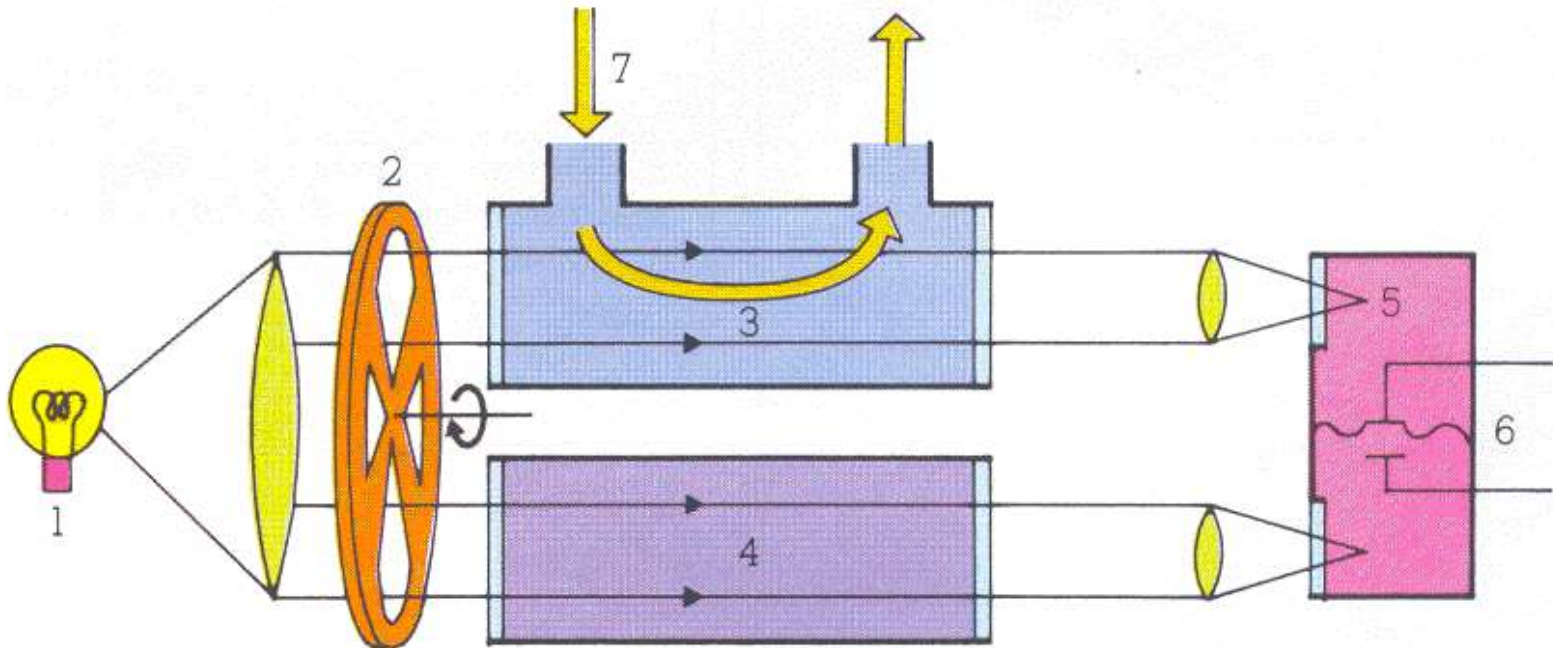

1. infrared lamp - 2. rotating seal - 3. analysis cell - 4. reference cell - 5. detector filled with carbon monoxide - 6. variable condenser - 7. gas to be analyzed

Fluorescência UV SO_2

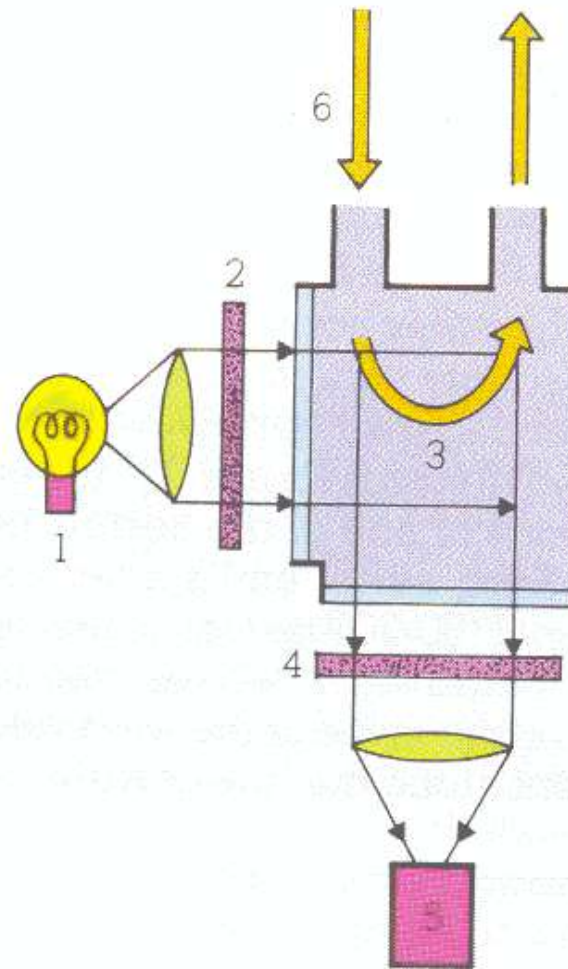

1. UV lamp - 2. filter - 3. measurement cell
4. filter - 5. photomultiplier cell - 6. gas
to be analyzed

Luminescência

O_3 , NO_2

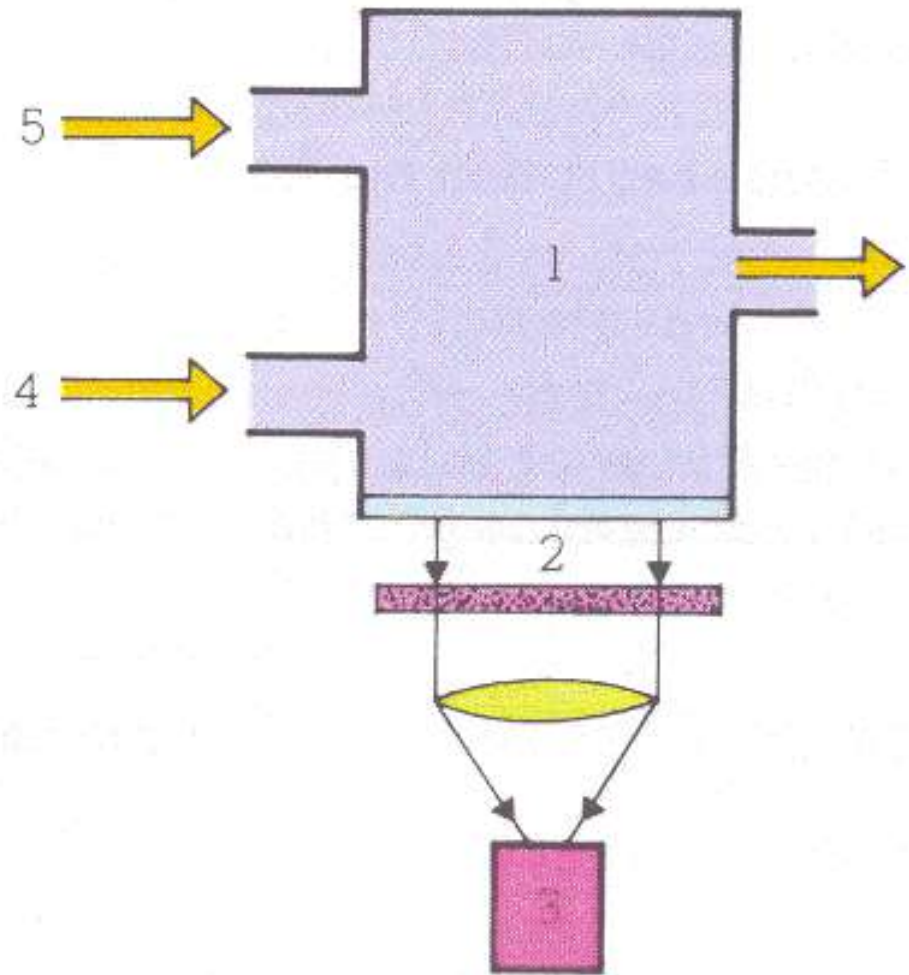

1. reaction chamber - 2. filter - 3. photo-multiplier cell - 4. ozone - 5. gas to be analyzed

Espectroscopia da Massa + Cromatografia Gasosa

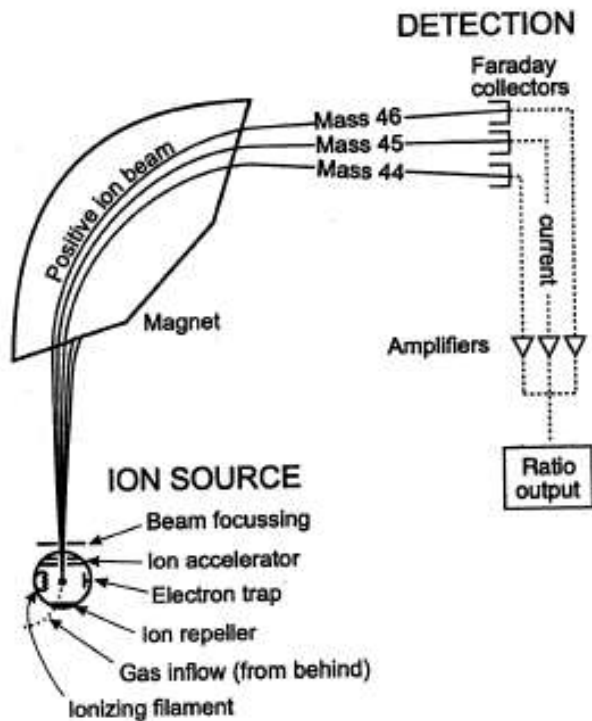

Cromatografia Gasosa

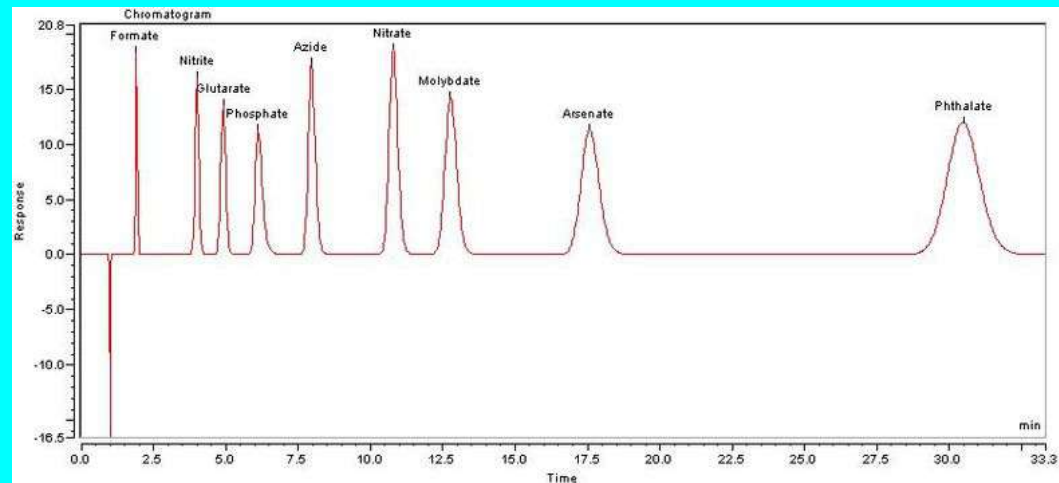

Esquema de Amostragem com AFG

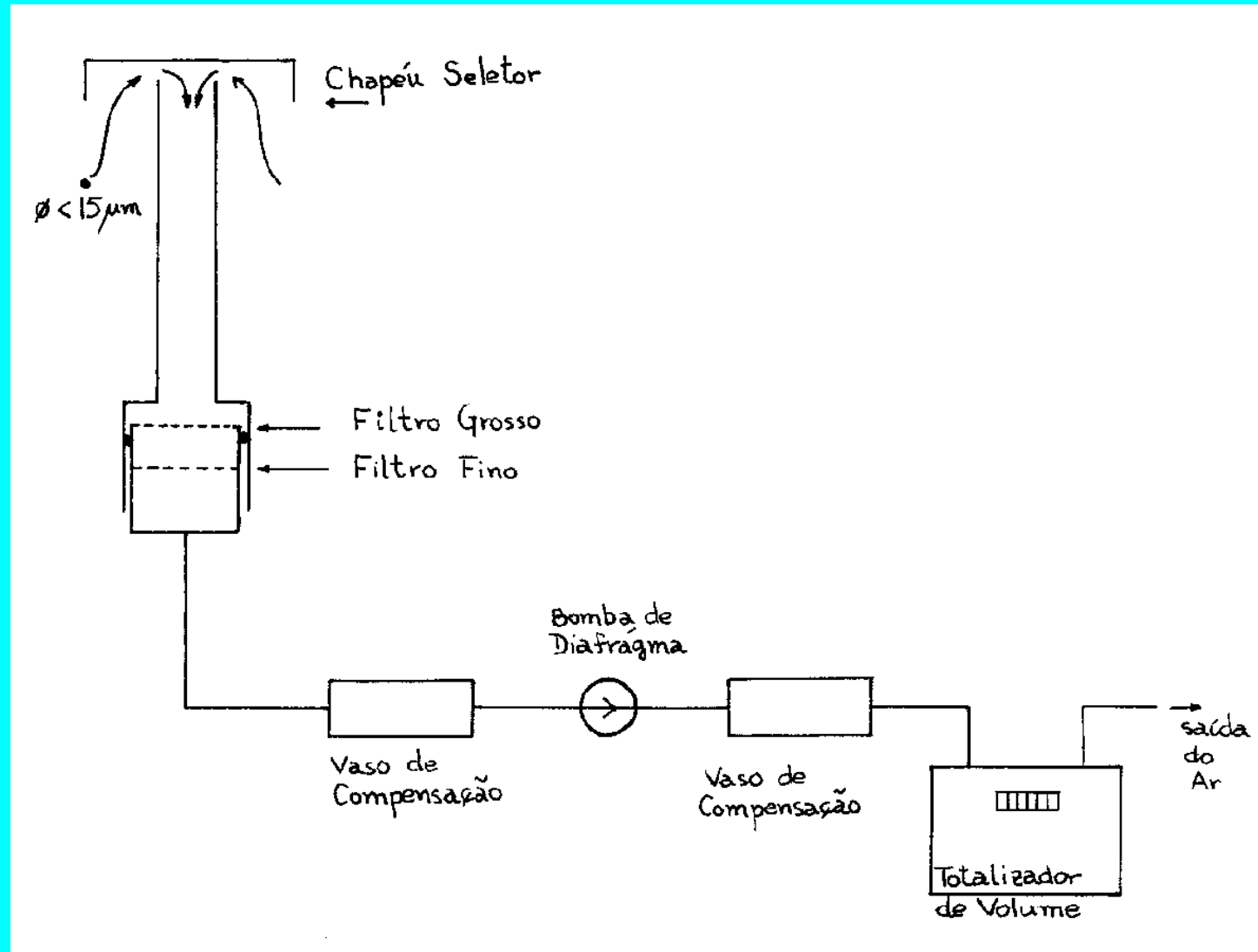

Suporte dos filtros no AFG

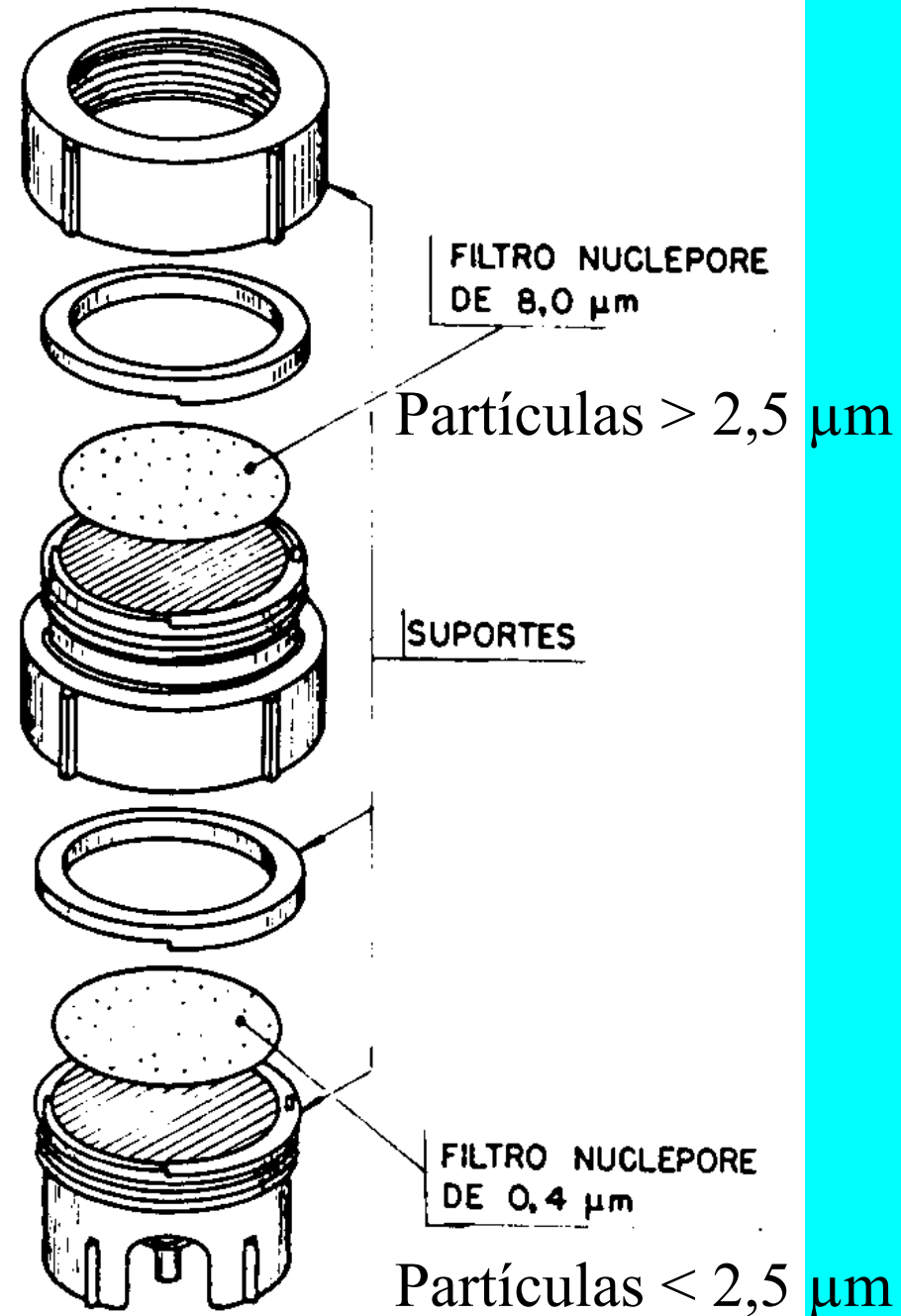

Impactação e Interceptação em filtro *Nuclepore*

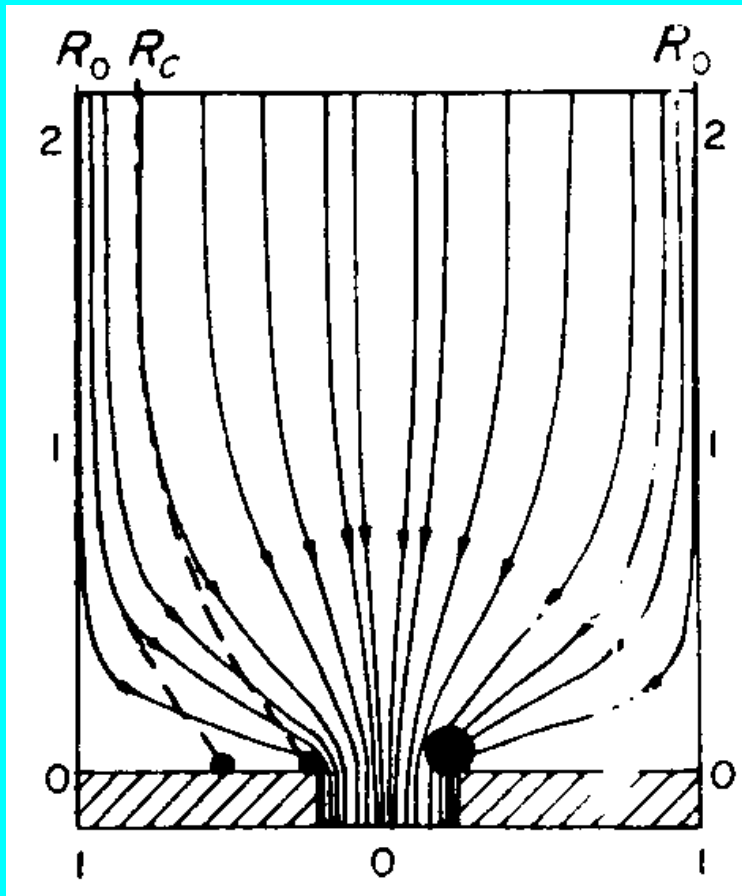

PRODUÇÃO:

Policarbonato irradiado com neutrons colimados perpendicularmente à superfície do filtro.

RETENÇÃO:

- Impactação
- Interceptação
- Difusão
- Obstrução
- Atração Eletrostática

Dicotômico

(Andersen, 1981)

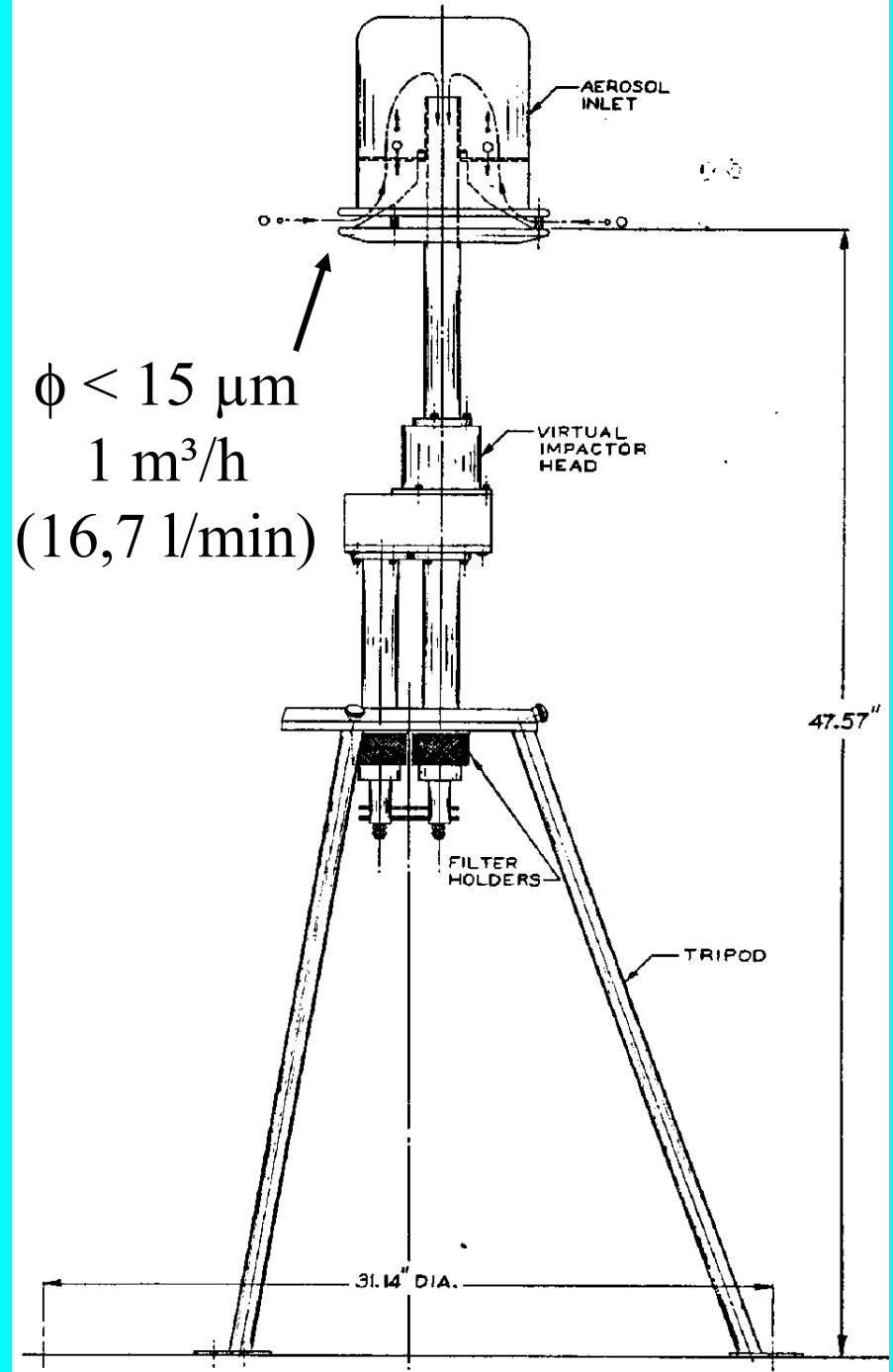

Separação Inercial

(Andersen, 1981)

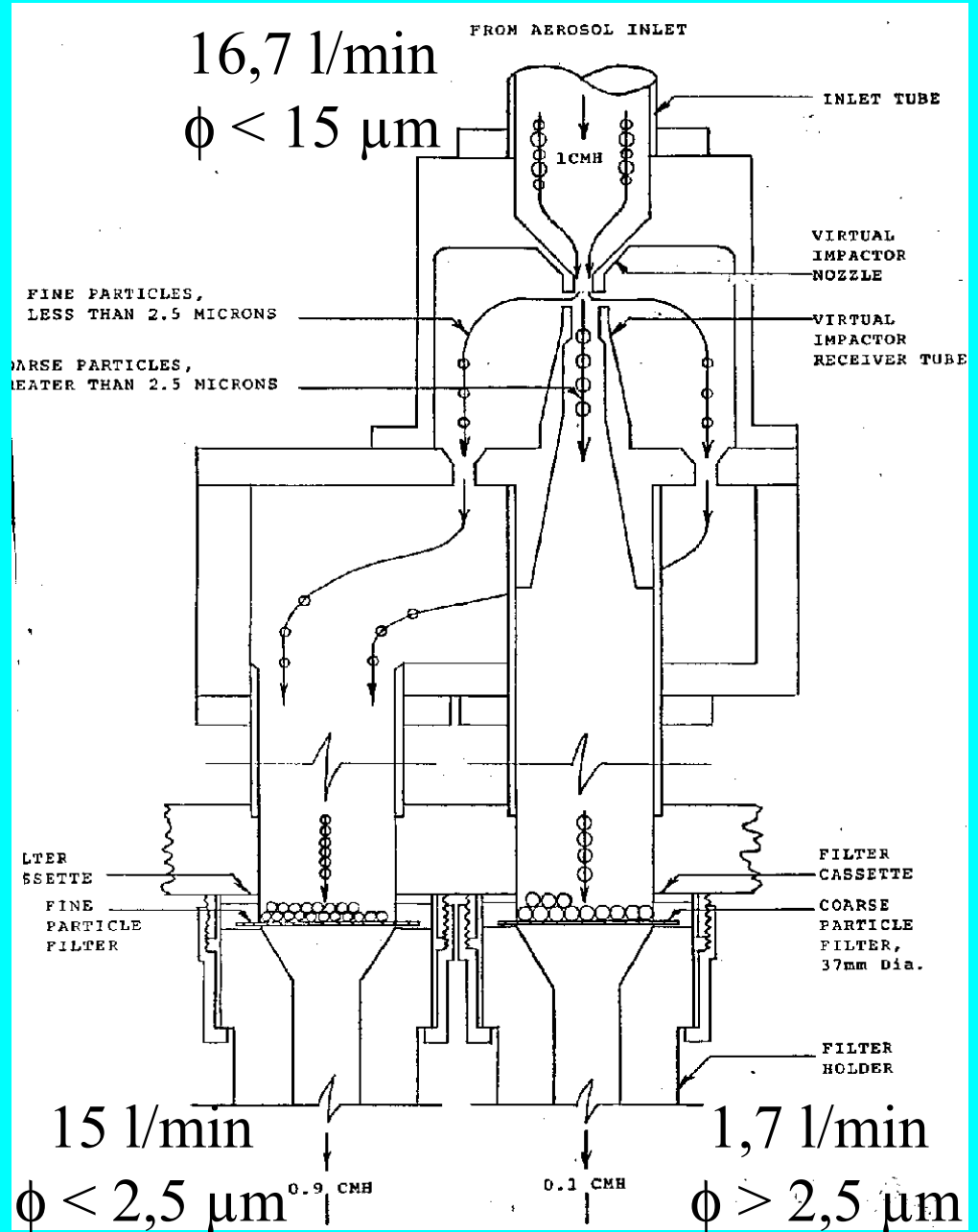

Sistema Respiratório

Se $P > f_v$, partícula sedimenta.

Isso tende a ocorrer quando:

$\phi > 10 \mu\text{m}$ (nariz)

$\phi > 15 \mu\text{m}$ (boca)

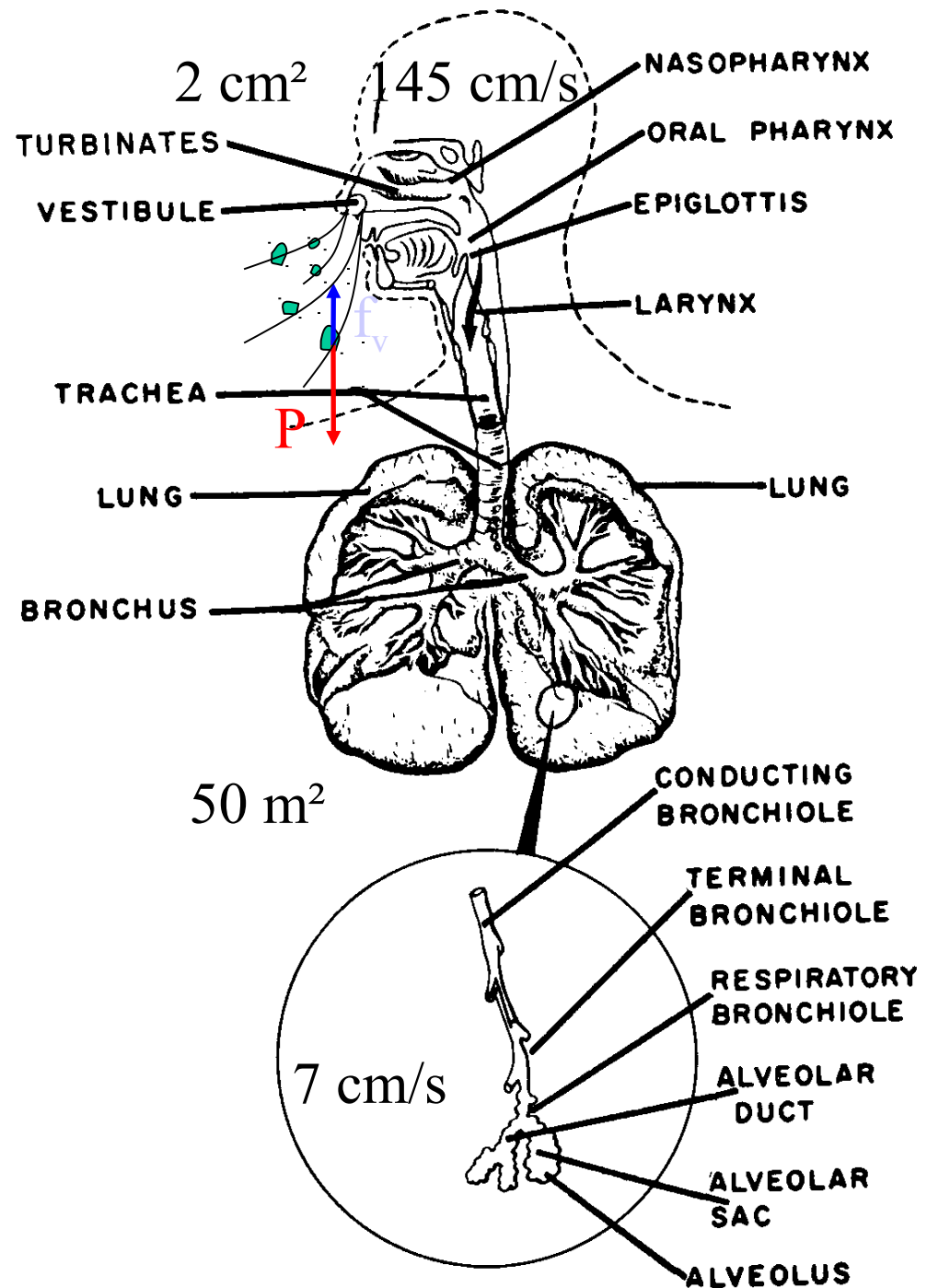

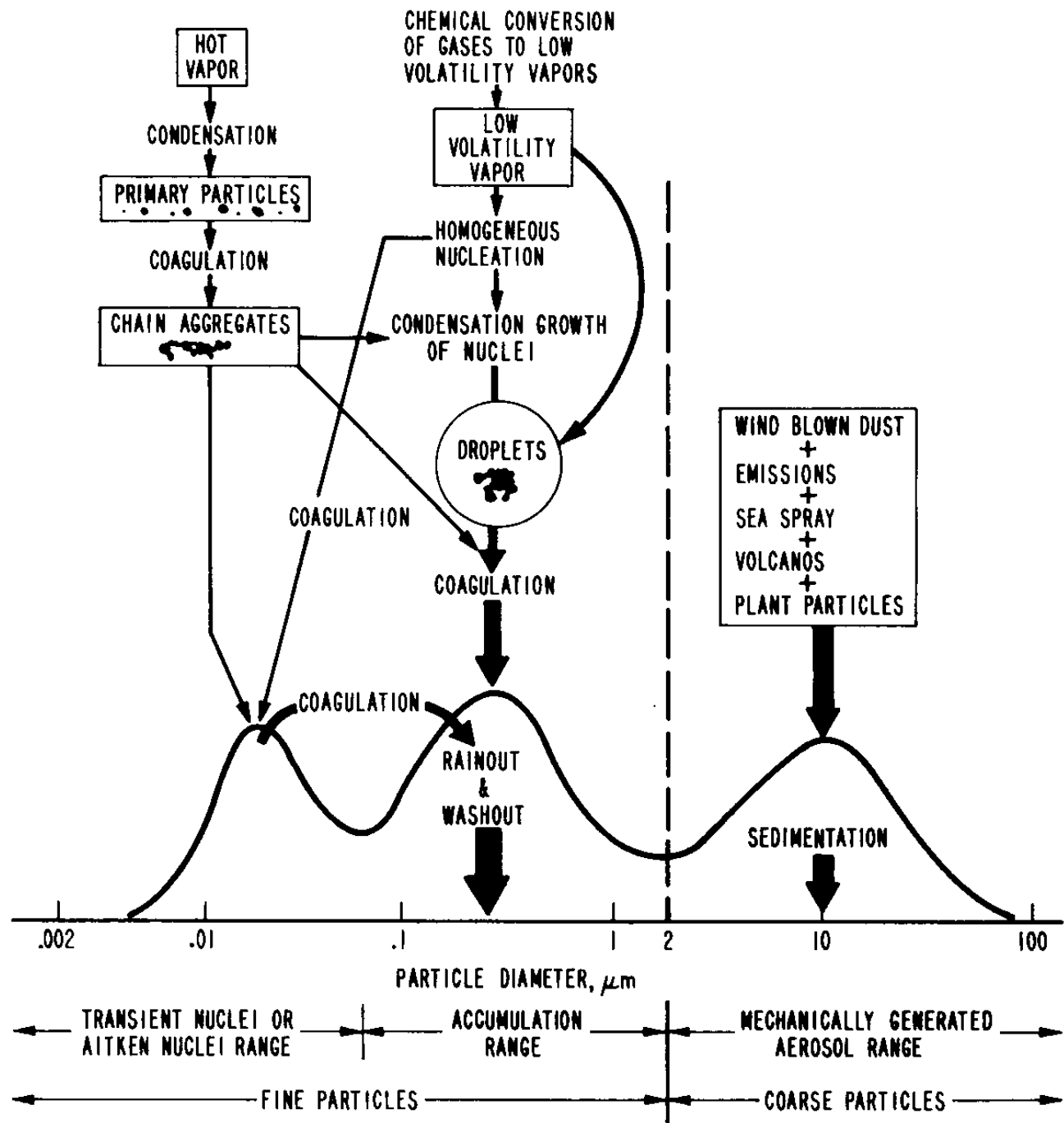

HIVOL

(OMS, 1976)

Filtro de fibra de vidro:
20 x 25 cm²

Coleta:

$0,1\mu\text{m} < \phi < 100\mu\text{m}$

ou

$0,1\mu\text{m} < \phi < 10\mu\text{m}$,
com chapéu seletor

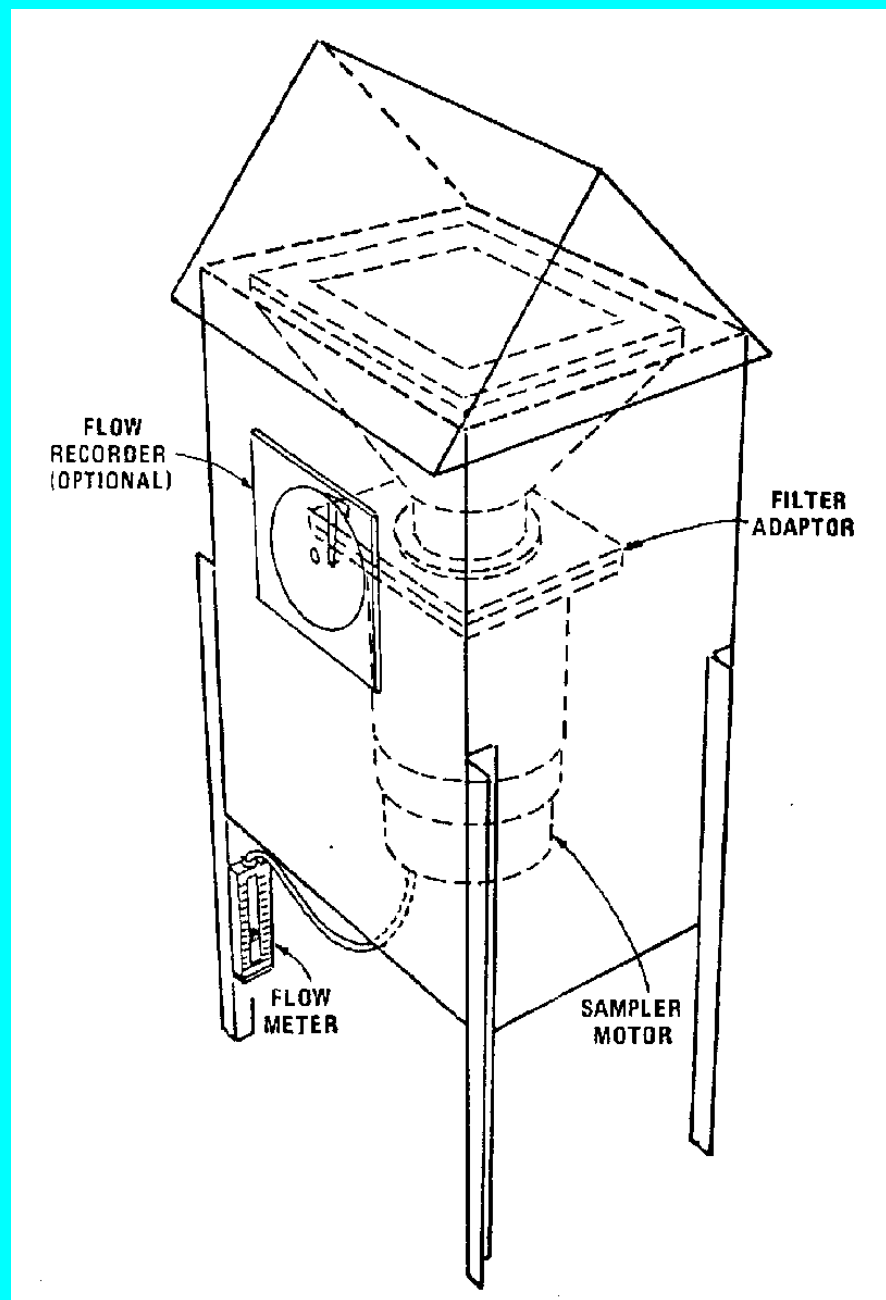

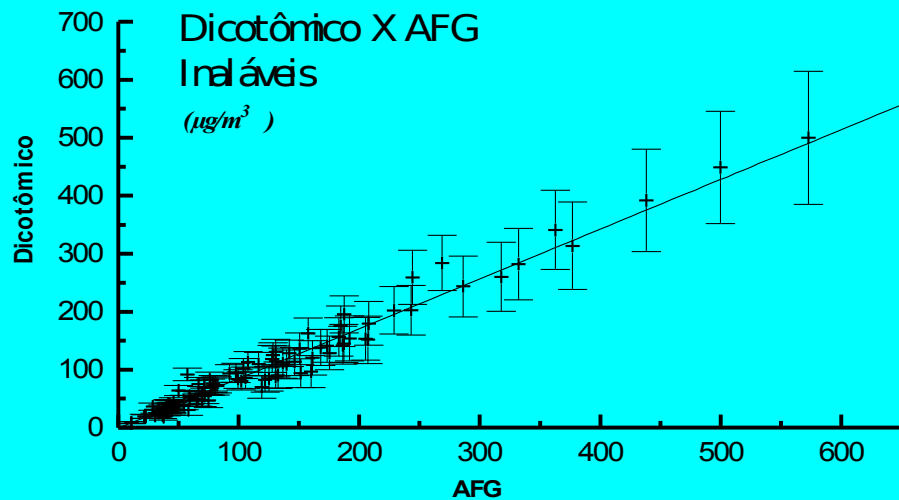
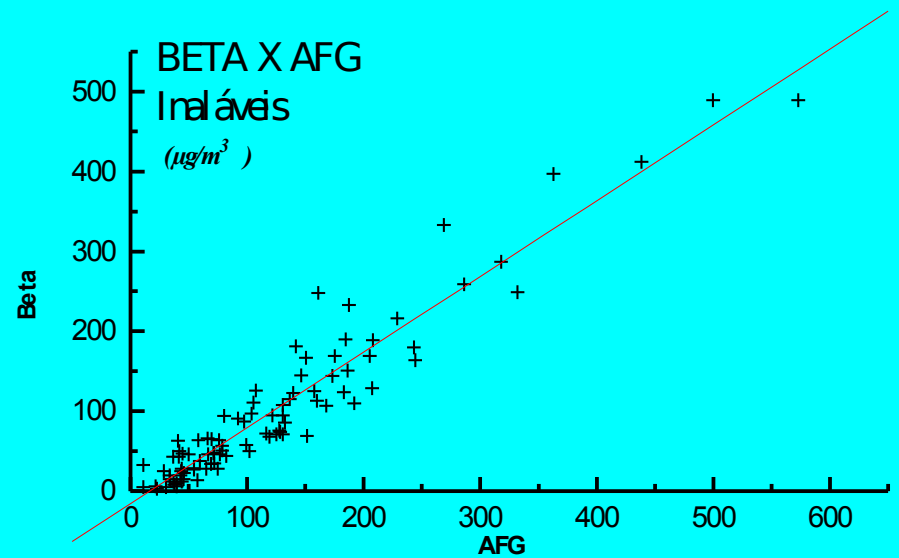
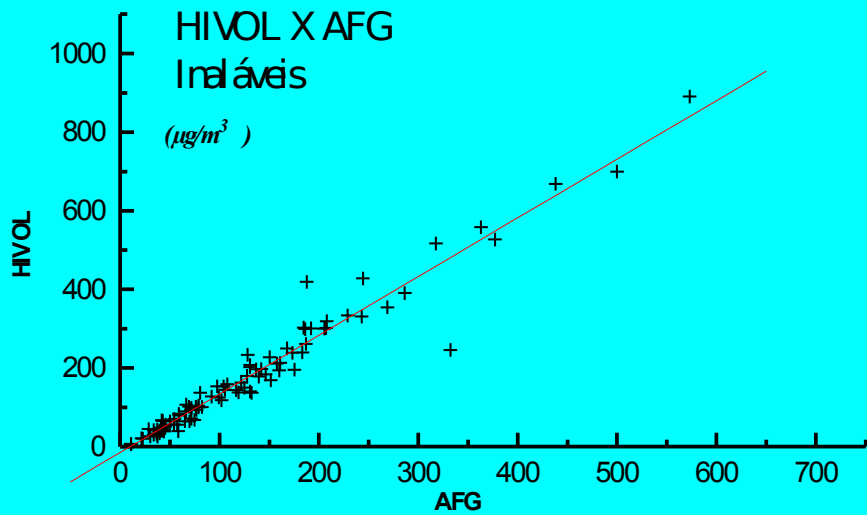

Correlação
entre
amostradores

Dicotômico x AFG

Fino e Grosso

