

SMM0224

Introdução à Fundição, Soldagem
e Metalurgia do pó

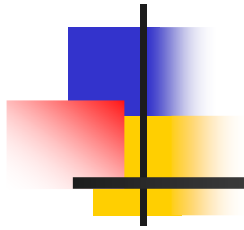

Rotas de Fabricação Metalúrgica

SMM0224

-  Fundição
-  Soldagem
-  Metalurgia do Pó

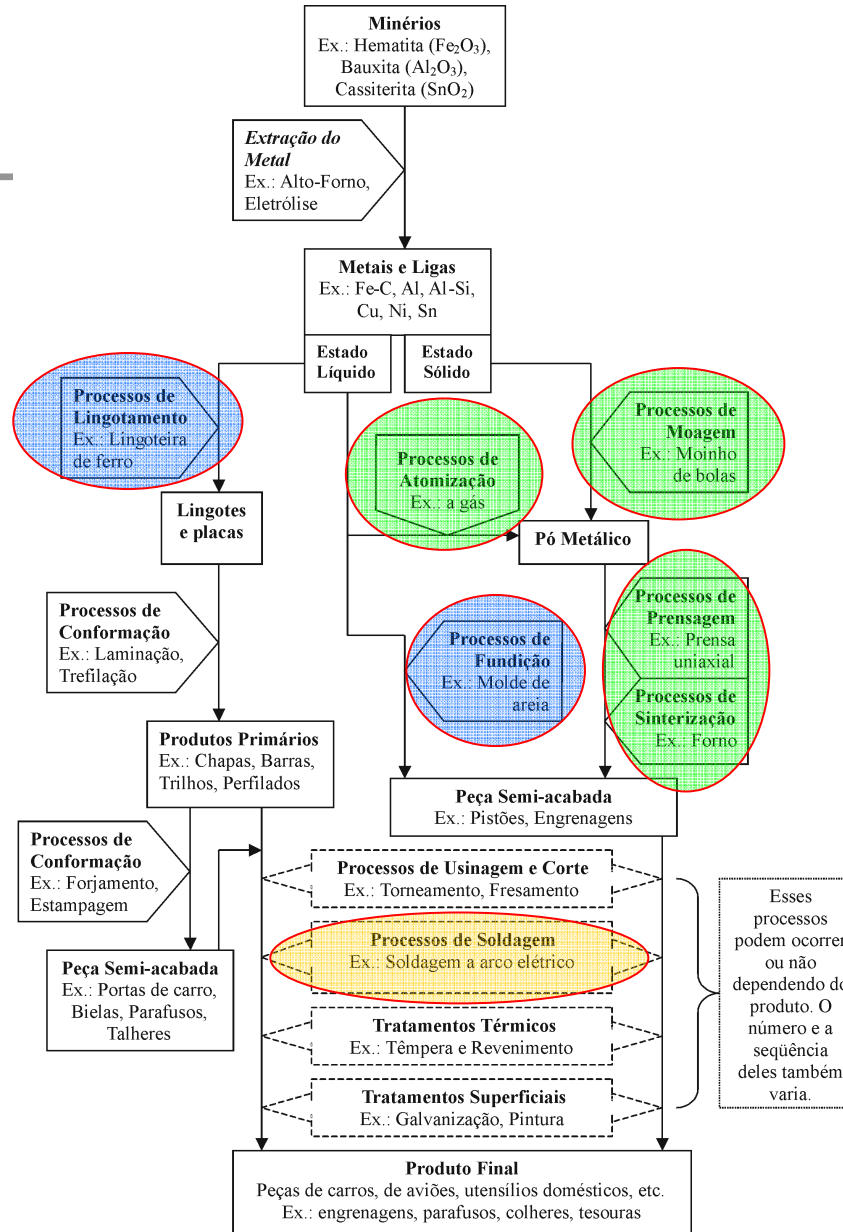



Fundição

- Produção de peças pela solidificação de metal líquido em moldes
- ***Além de "dar forma" às peças determina as suas propriedades***



Função

Exemplo

Exemplo de produto fundido



Exemplo de produto fundido



Bronze
9,6 m diam.
130 t

Mecklenburger Metallguss GmbH
(MMG) - 2006

Navio: Emma Maersk (397 x 56 m,
171 kt)

Exemplo de produto fundido



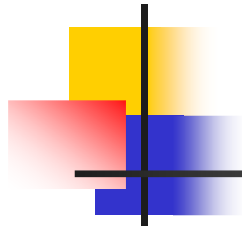

Produção Brasileira

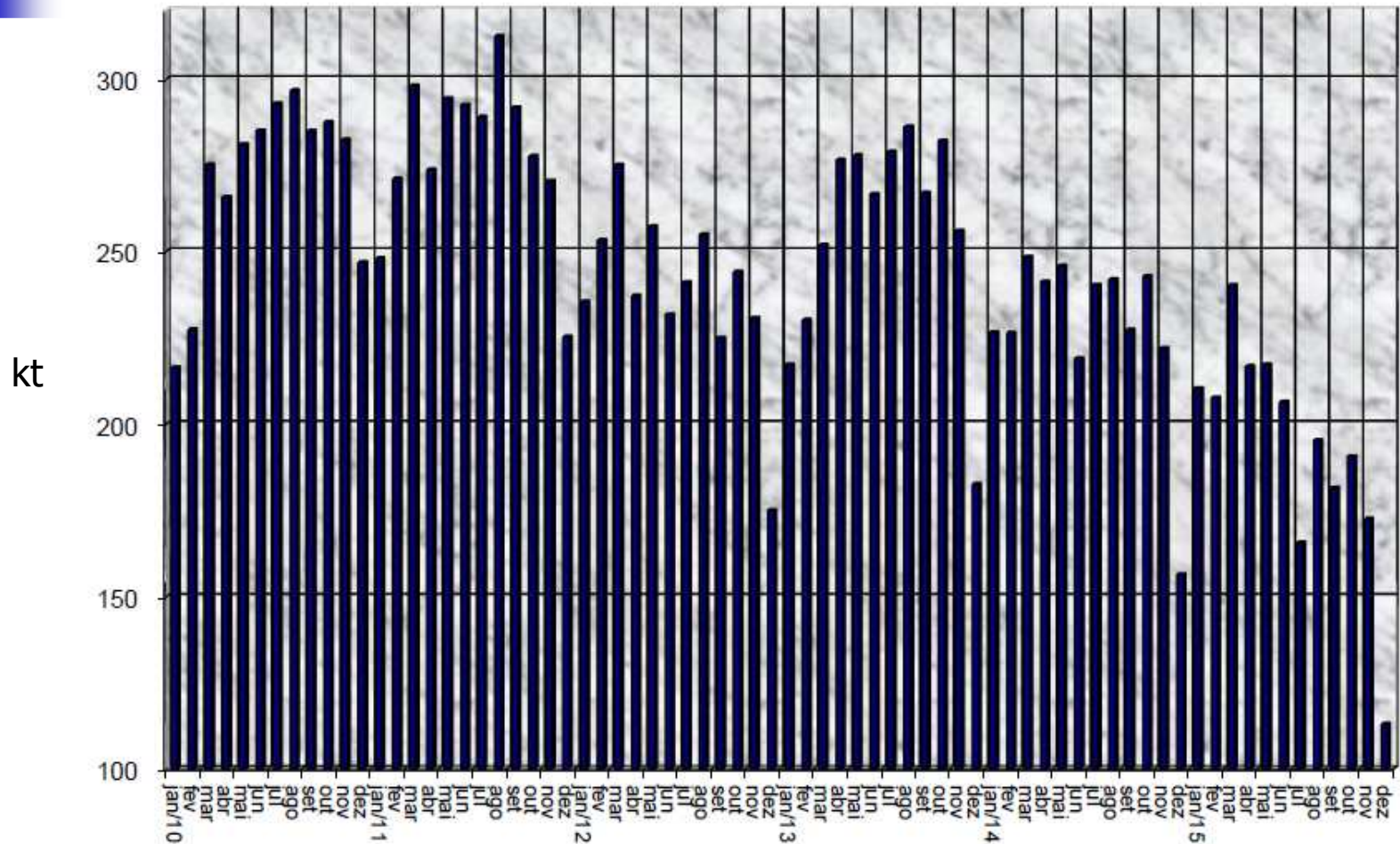

Fonte: ABIFA



Produção Brasileira

toneladas

Fonte: ABIFA

PERÍODO	DEZ/15	NOV/15	DEZ/14	A/B %	A/C %	JAN-DEZ/15	JAN-DEZ/14	D/E %
METAL	(A)	(B)	(C)			(D)	(E)	
79,4% 1- FERRO TOTAL	89.750	145.122	127.088	(38,2)	(29,4)	1.890.932	2.256.869	(16,2)
10,8% 2- AÇO TOTAL	12.151	14.241	16.168	(14,7)	(24,8)	243.085	262.815	(7,5)
9,8% 3- NÃO FERROSOS	11.083	13.062	13.142	(15,1)	(15,7)	181.880	217.557	(16,4)
3.1 - COBRE	1.413	1.440	1.792	(1,9)	(21,1)	21.749	22.226	(2,1)
3.2 - ZINCO	86	99	120	(13,1)	(28,3)	1.266	1.667	(24,1)
8,1% 3.3 - ALUMÍNIO	9.172	11.100	10.837	(17,4)	(15,4)	153.949	188.731	(18,4)
3.4 - MAGNÉSIO	412	423	393	(2,6)	4,8	4.916	4.933	(0,3)
4 - TOTAL GERAL	112.984	172.425	156.398	(34,5)	(27,8)	2.315.897	2.737.241	(15,4)

Aço bruto: ~2.400.000 t dez. 2015 (fonte:açobrasil)

Al primário: ~63.800 t dez. 2015 fonte:ABAL

Pessoal Empregado

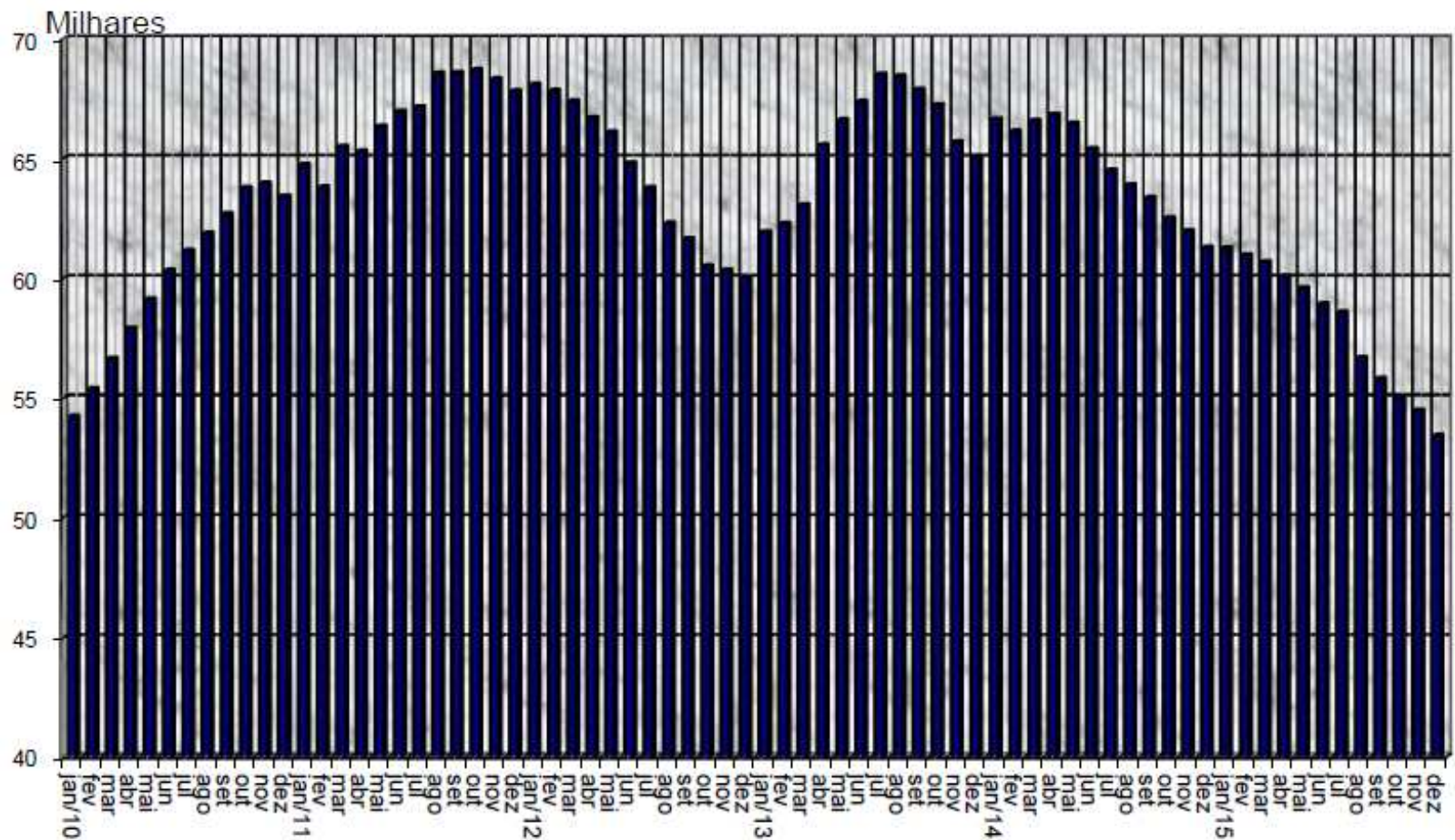

Fonte: ABIFA

Produtividade

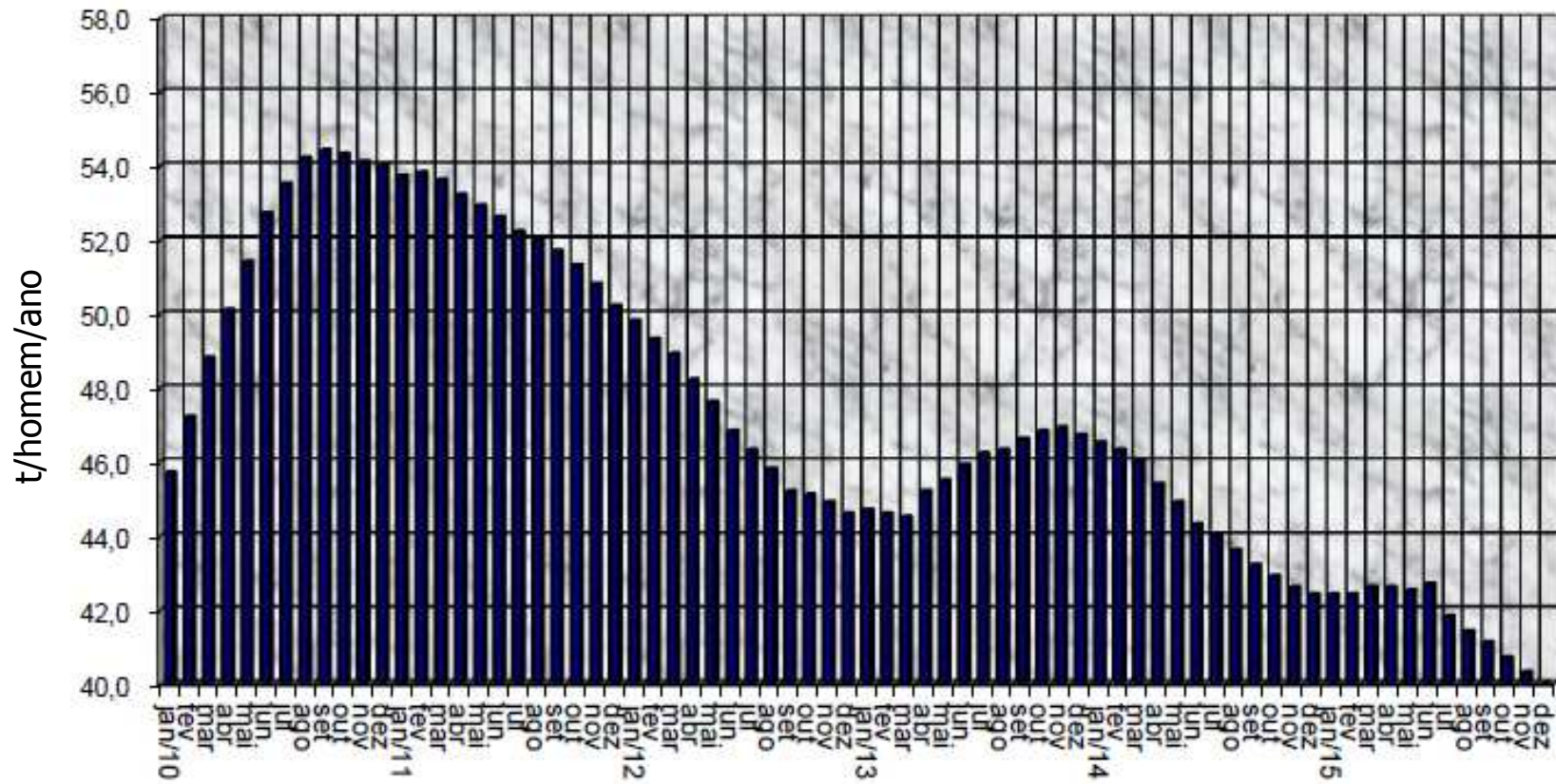

Fonte: ABIFA

Microestrutura do Fundido

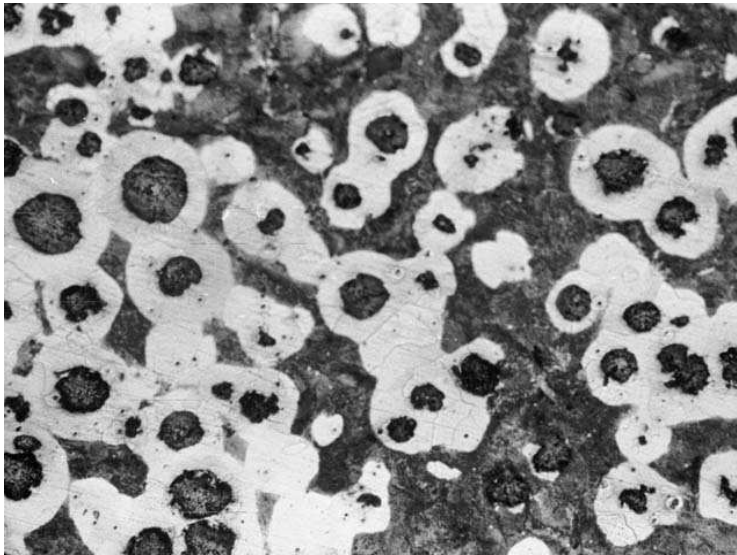

FoFo nodular

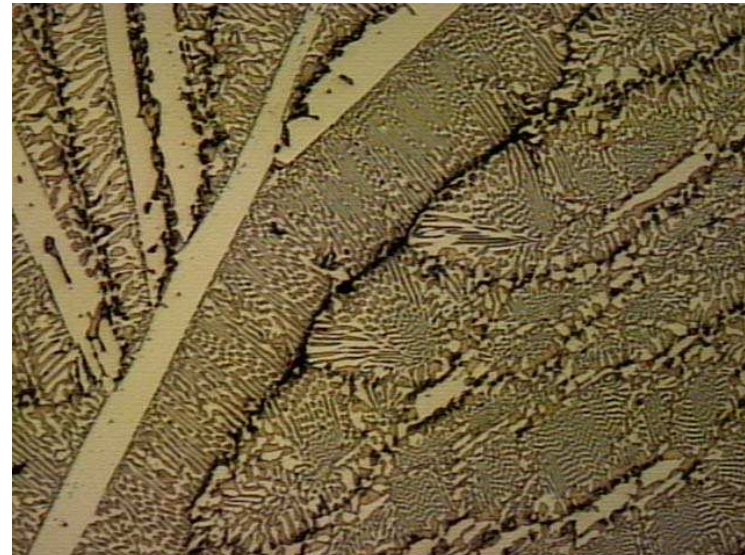

FoFo branco

**DEPENDE DAS CONDIÇÕES DE PROCESSAMENTO
(tipo de molde, T inicial, impurezas, etc.)**

Outro exemplo



(a)



(b)

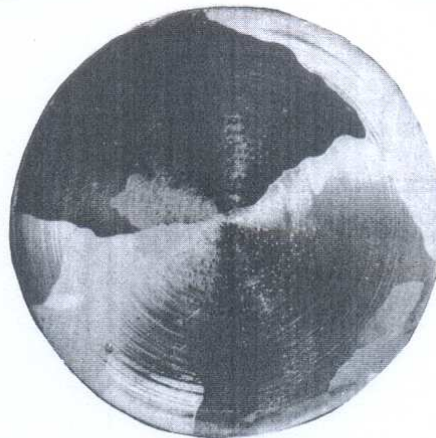

(c)

Fig. 5.18 Tamanho de grão da estrutura inicial resultante da solidificação do Alumínio com diferentes contatos térmicos na interface metal/molde: (a) molde polido; (b) molde com revestimento condutor; (c) molde com revestimento isolante.

Exemplo de aplicação do controle da solidificação

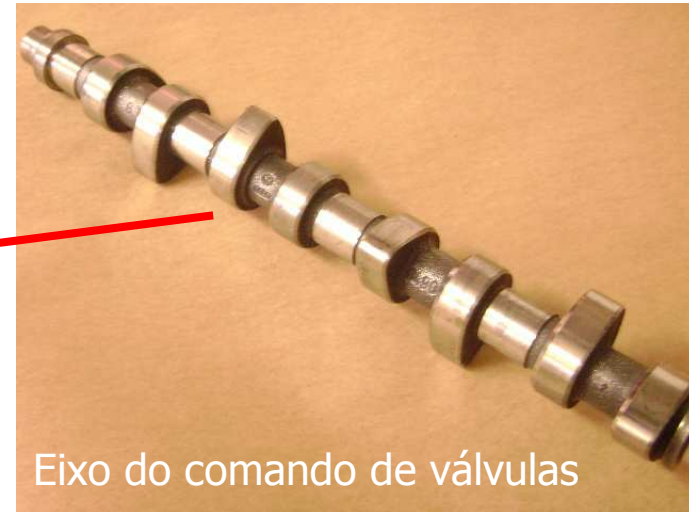
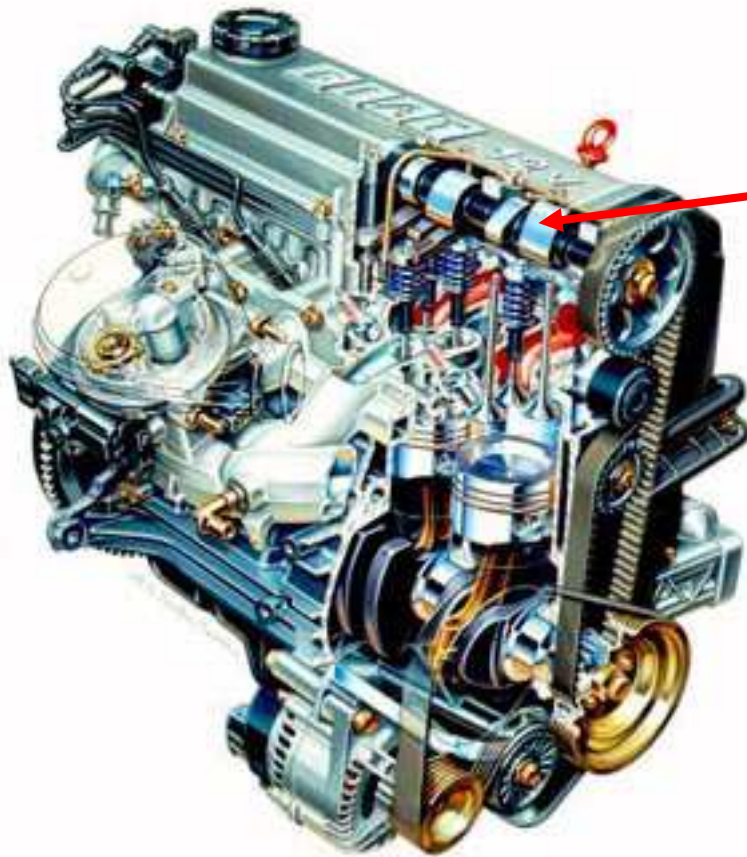

Eixo do comando de válvulas

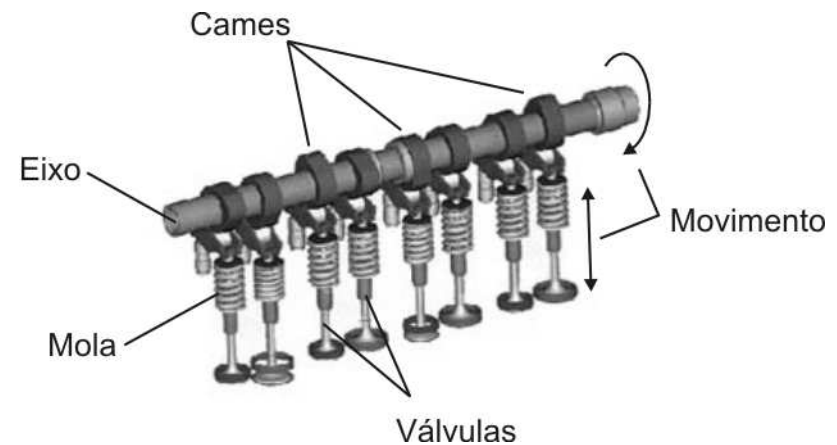

Exemplo de aplicação do controle da solidificação

Eixo do comando
em corte
(Macrografia)

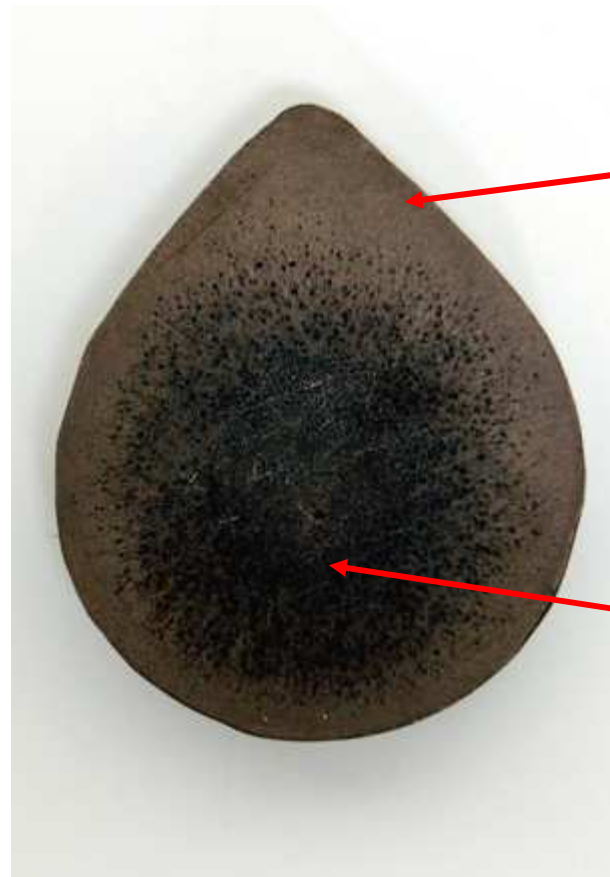

FoFo branco

FoFo cinzento

Solidificação

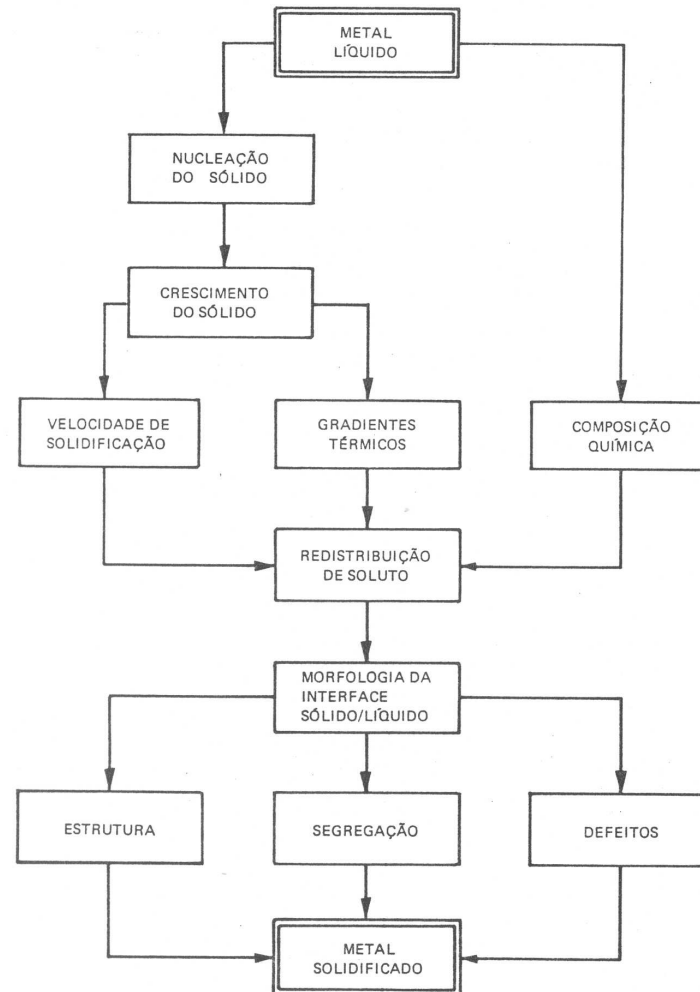

Nucleação Homogênea

Super-resfriamento 1

Super-resfriamento 2

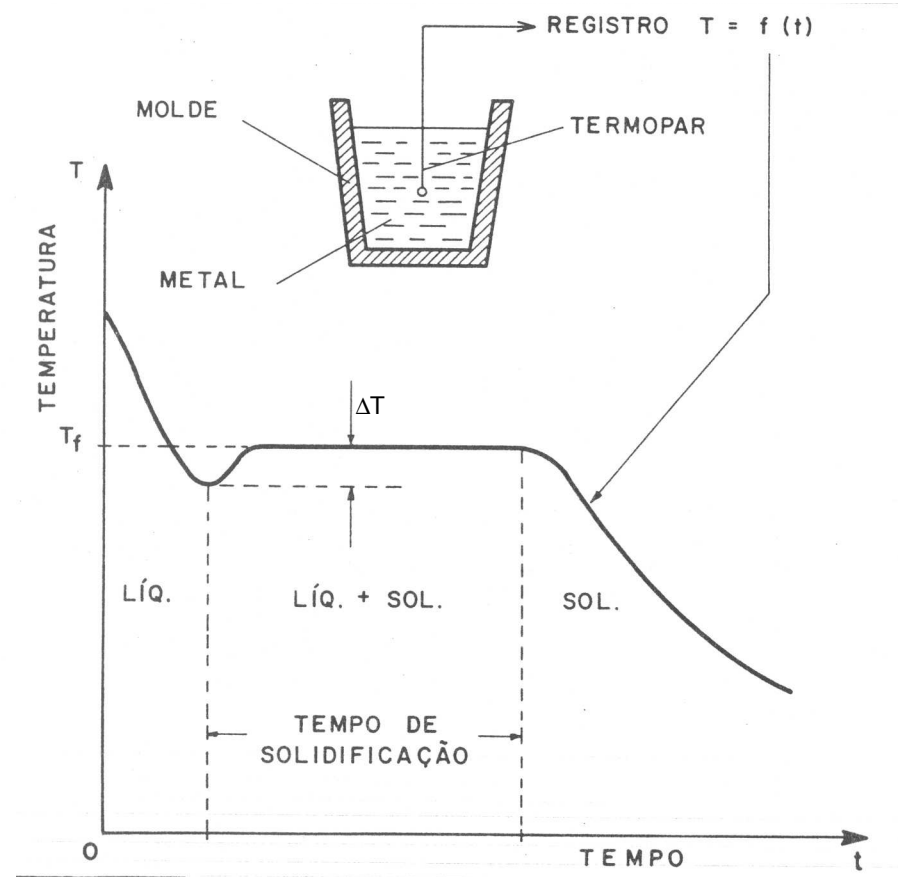
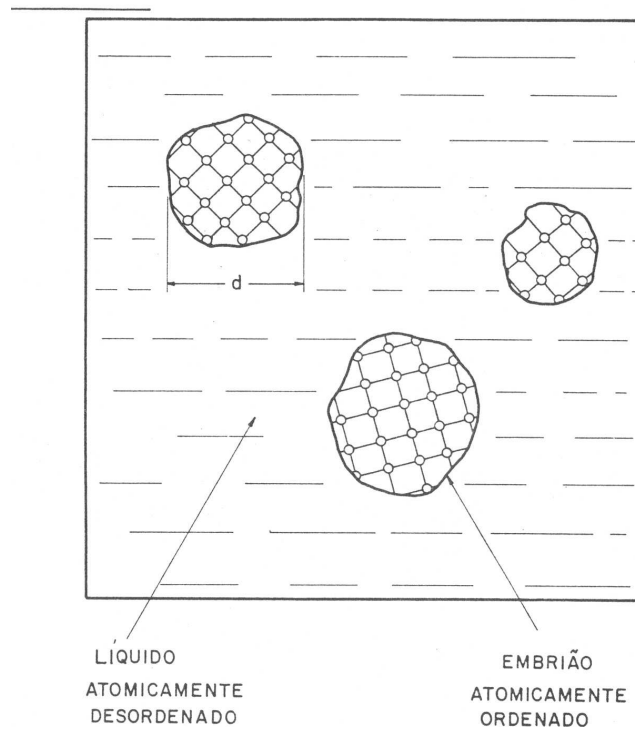

Raio Crítico

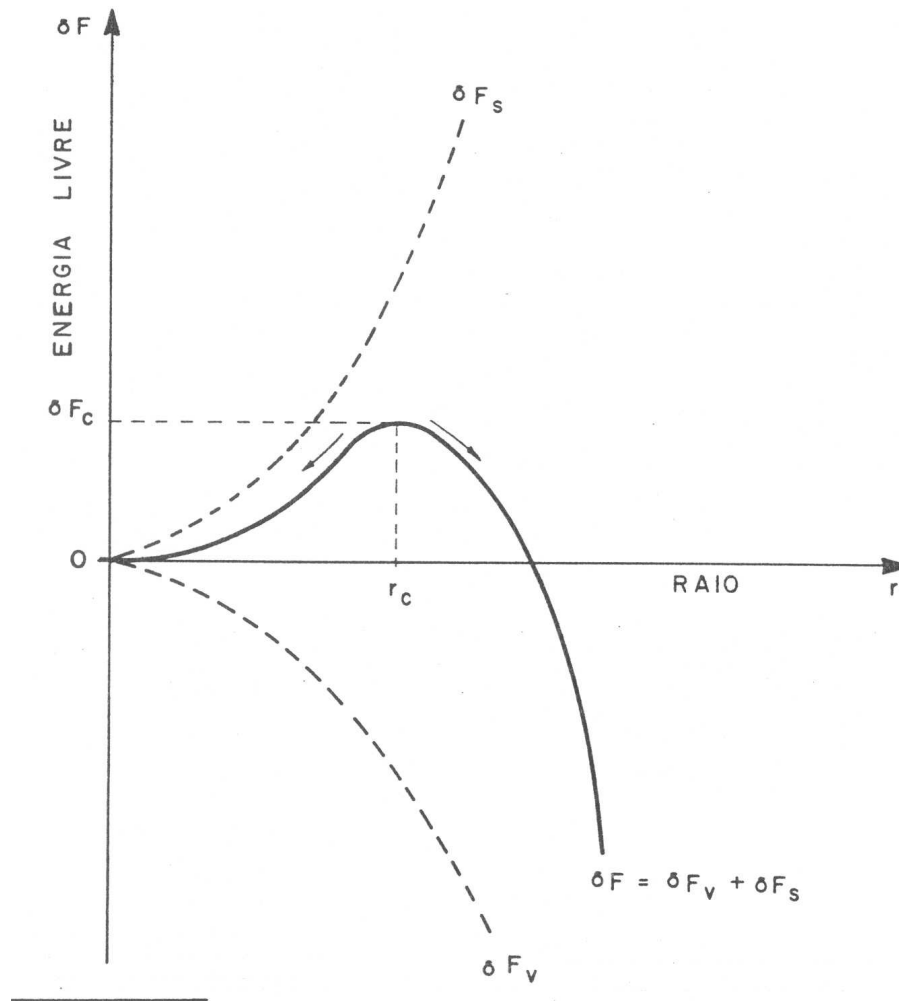



Raio crítico e Energia crítica

	Nucleação Homogênea	Nucleação Heterogênea
Raio Crítico r_c	$\frac{2\gamma_{SL}T_f}{\Delta H_f \Delta T}$	r_c^{Homo}
Energia de ativação δF_c	$\frac{16\pi\gamma_{SL}T_f^2}{3\Delta^2 H_f \Delta^2 T}$	$f(\theta) \cdot \delta F_c^{Homo}$

Nucleação Heterogênea

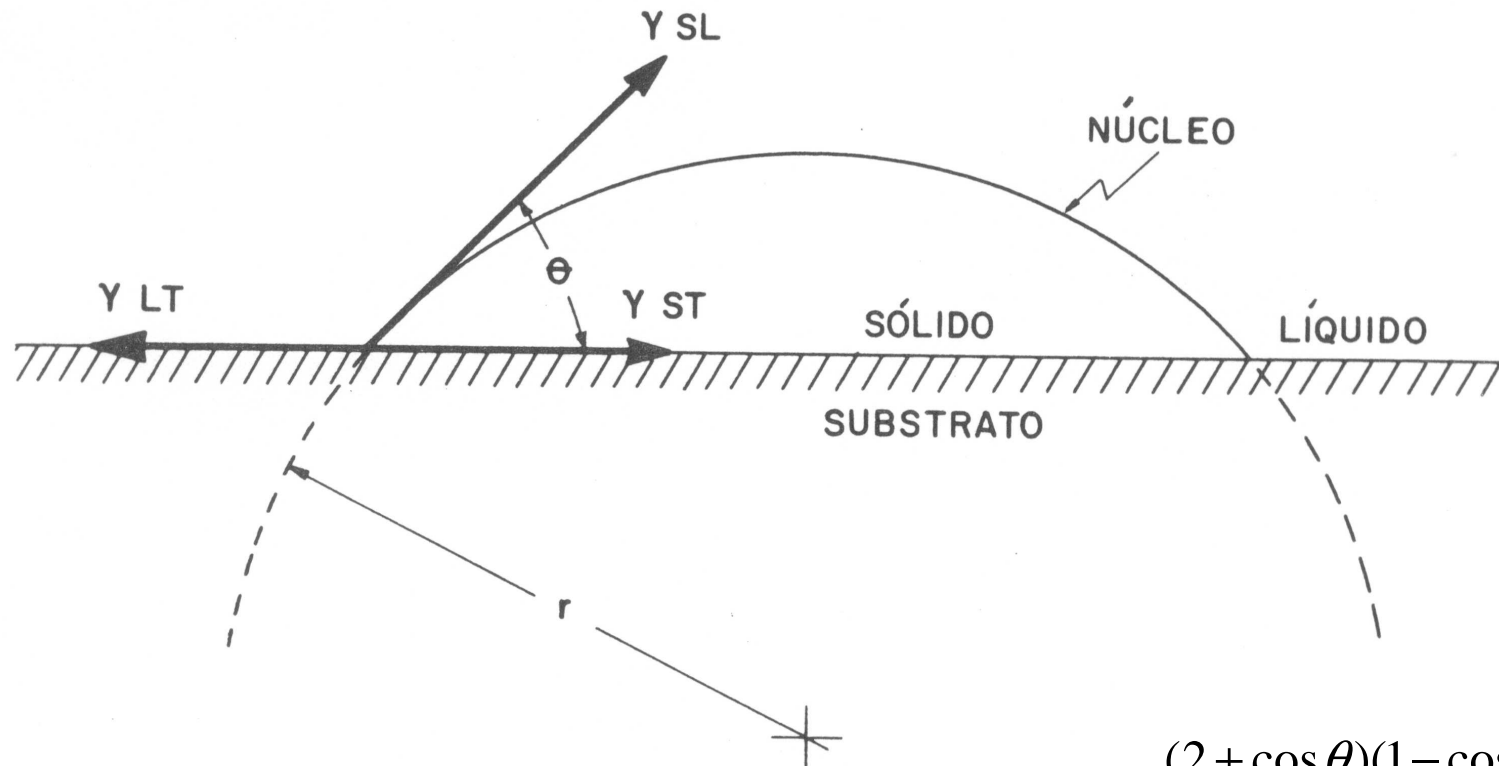

Filme tensão superficial

$$f(\theta) = \frac{(2 + \cos \theta)(1 - \cos \theta)^2}{4}$$

Nucleação Heterogênea

Fig. 2.9 Casos-limite de molhamento entre o em
brão e o substrato na nucleação heterogênea.



MOLHAMENTO
TOTAL

$$\theta = 0^\circ$$

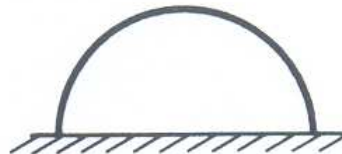

MOLHAMENTO
PARCIAL

$$0^\circ < \theta < 180^\circ$$

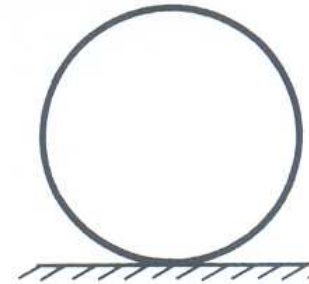

MOLHAMENTO
NULO

$$\theta = 180^\circ$$



Molhamento

$\theta(^{\circ})$	Type of Nucleation	$f(\theta)$
0 complete wetting	no nucleation barrier (§)	0
10	heterogeneous	0.00017
20		0.0027
30		0.013
40		0.038
50		0.084
70		0.25
90		0.5
110		0.75
130		0.92
150		0.99
170	0.9998	
180 no wetting	homogeneous	1

§ immediate growth can occur

Taxa de Nucleação x Taxa de resfriamento

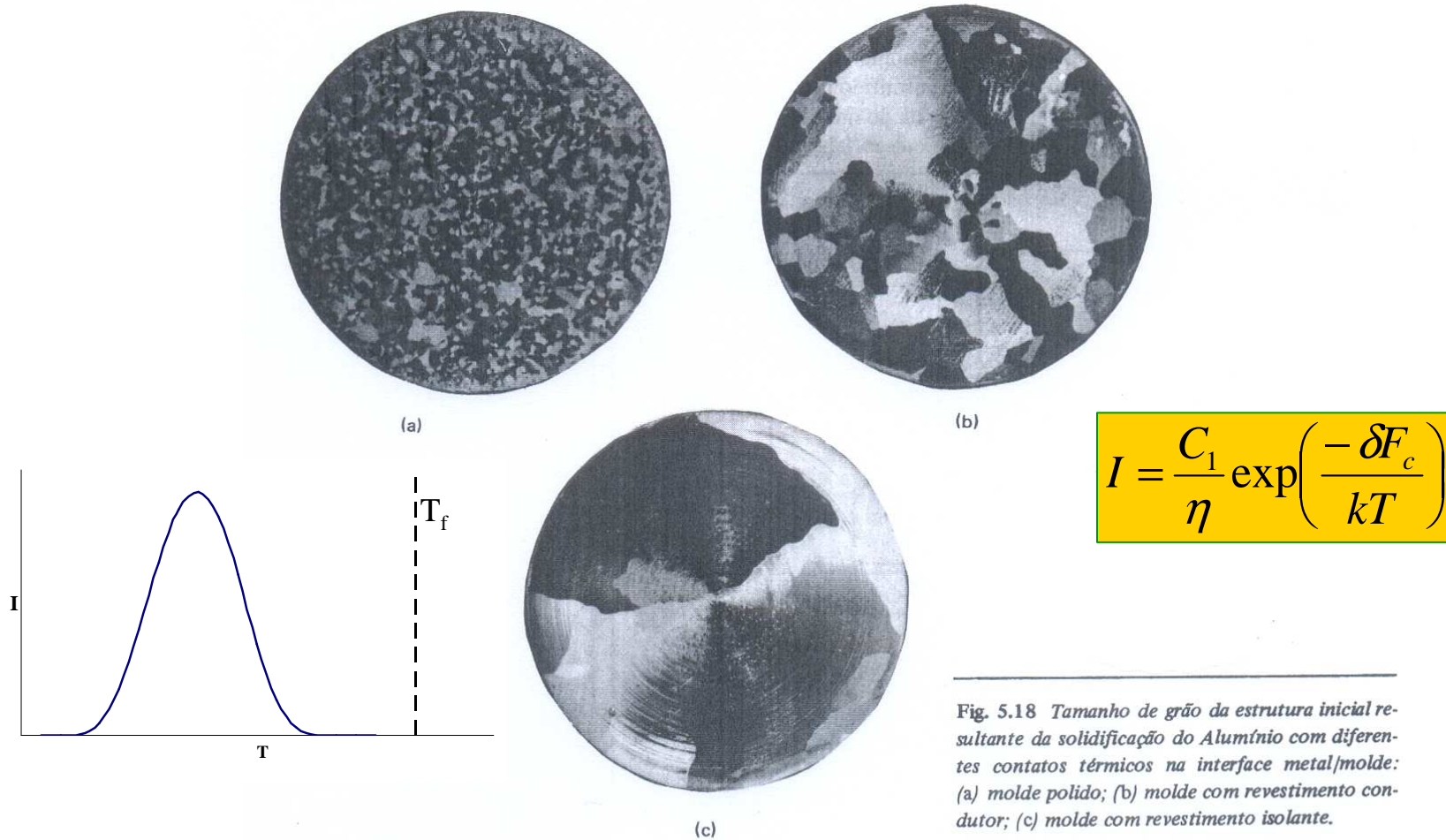

Nucleação heterogênea (inoculação)

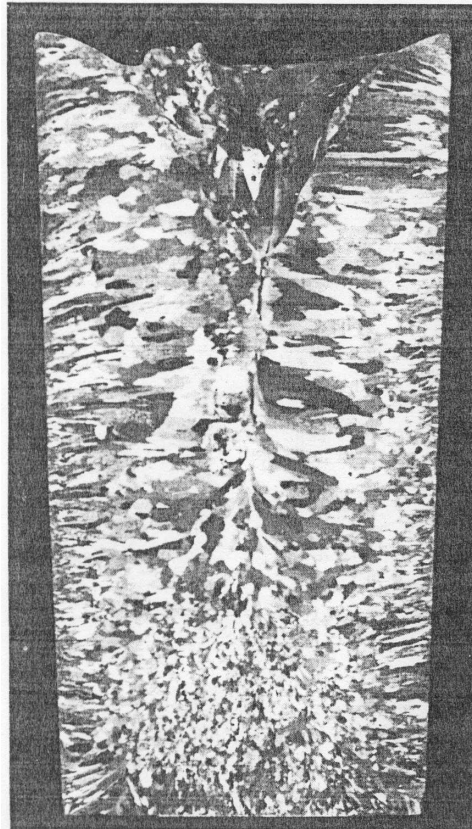

(a)

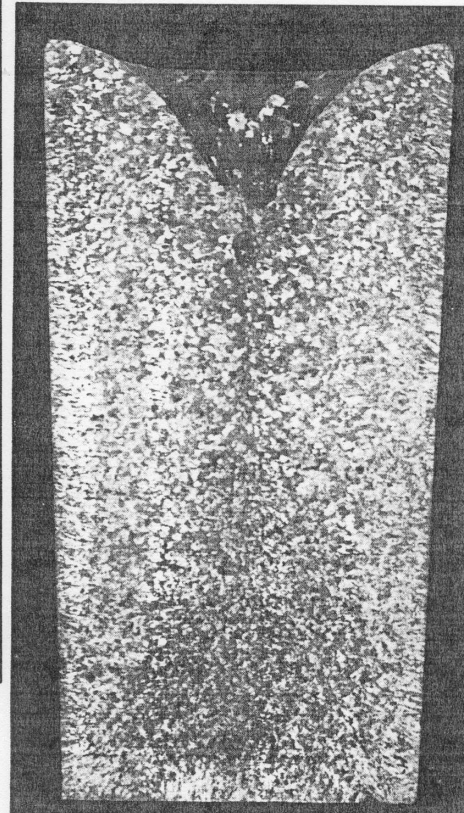

(b)

Fig. 2.11 Macroestrutura ($\times 1$) da seção longitudinal de lingotes de alumínio solidificados em molde-coquilha de aço: (a) estrutura de solidificação normal, sem nenhum tipo de inoculação; (b) com inoculação prévia de boro-titânio para refino de grão.

[Filme Exemplo](#)

Segregação de Soluto

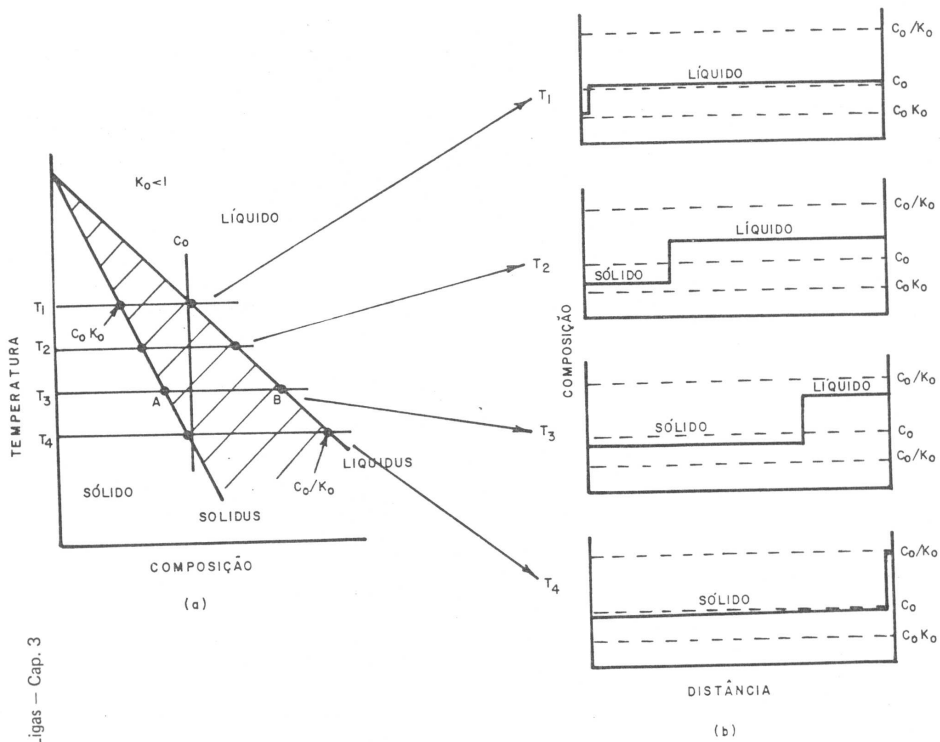

Ligas - Cap. 3

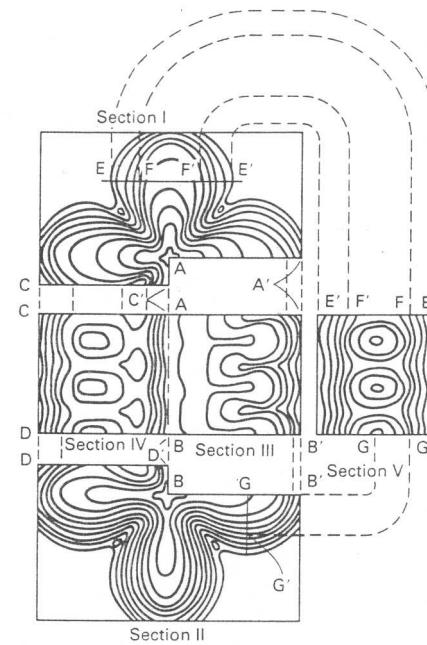
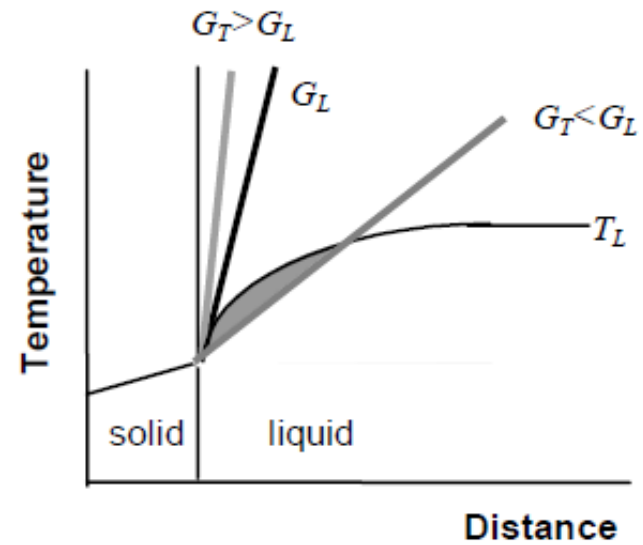
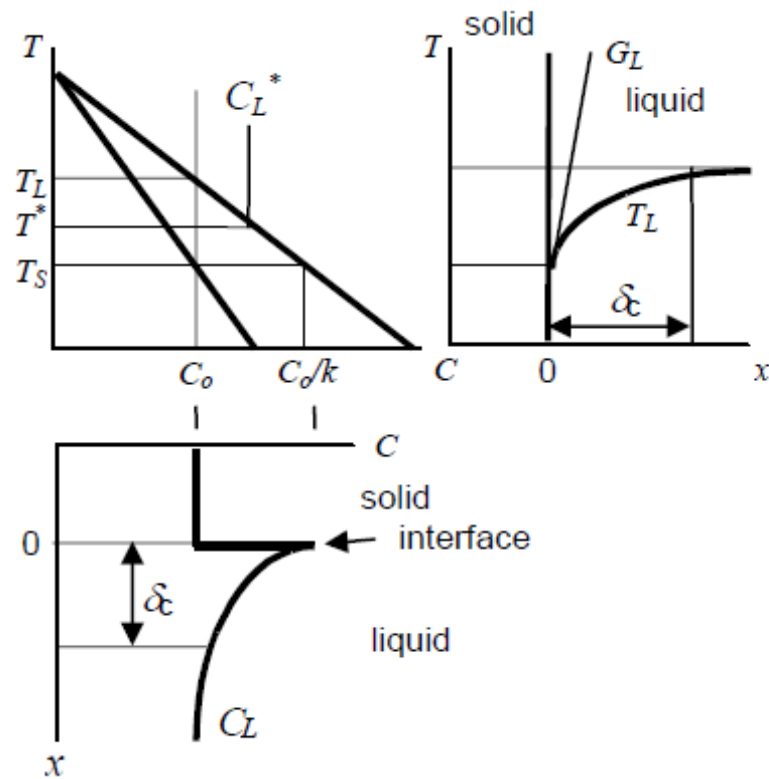
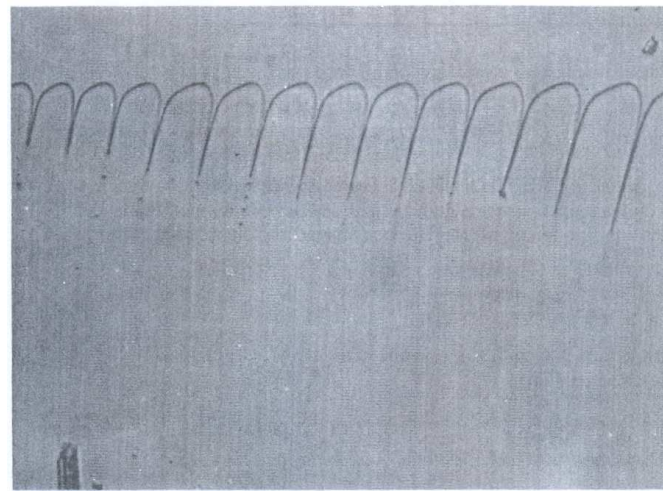
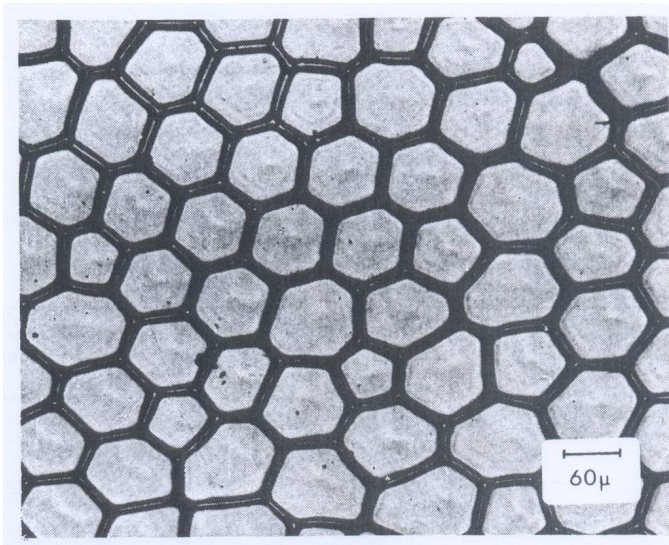

Fig. 3 Isoconcentration profile in an Fe-25Cr-20Ni columnar dendrite

Super-resfriamento constitucional



Crescimento Celular





Crescimento Celular

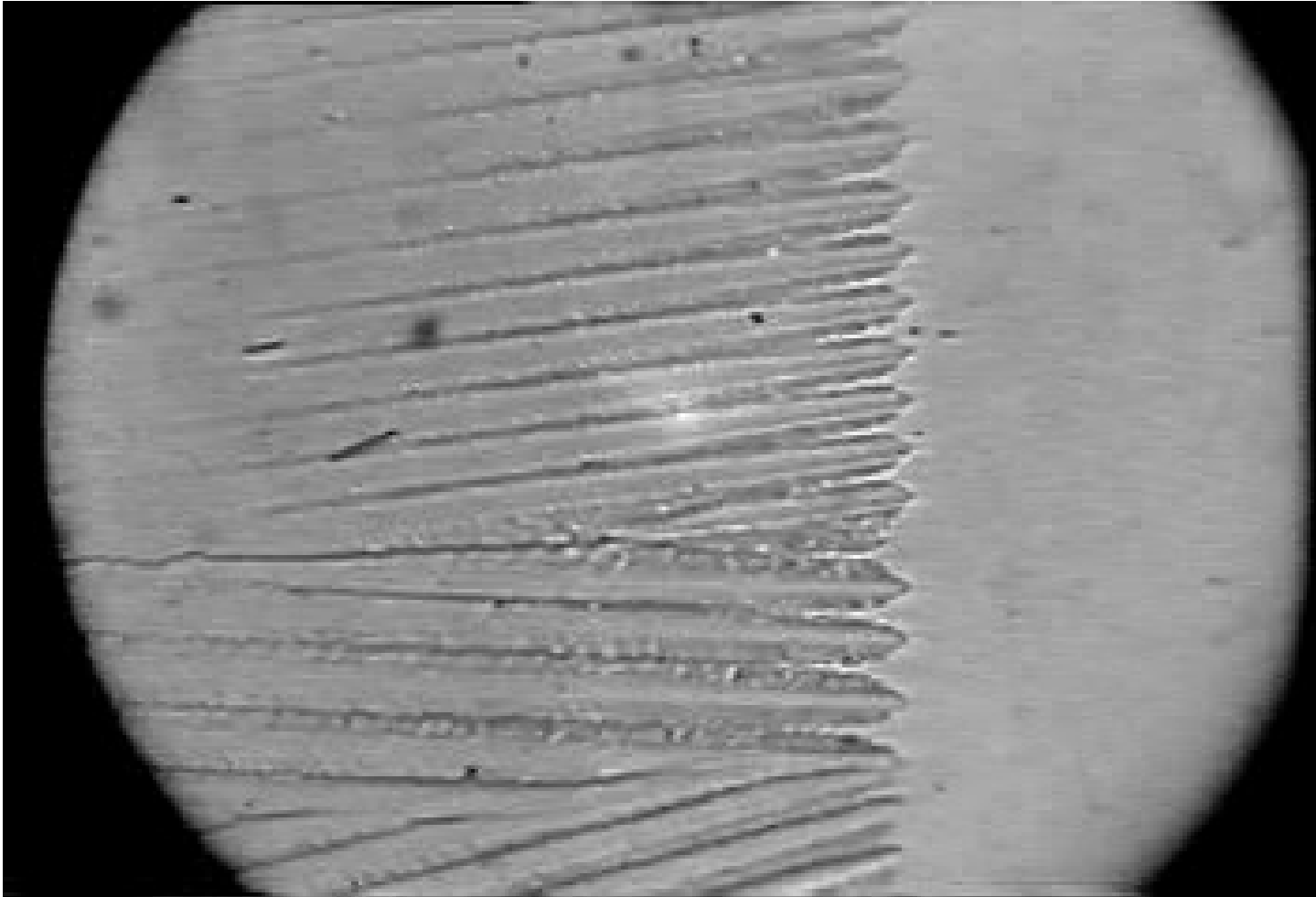

Crescimento Dendrítico

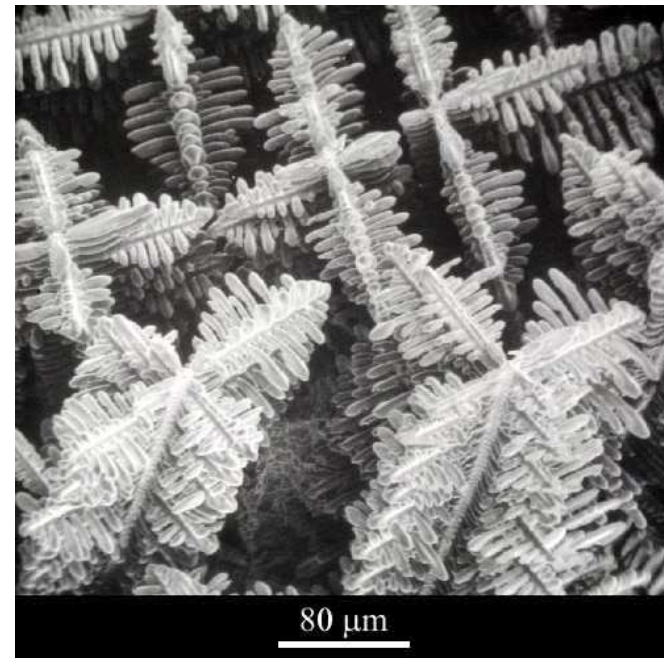
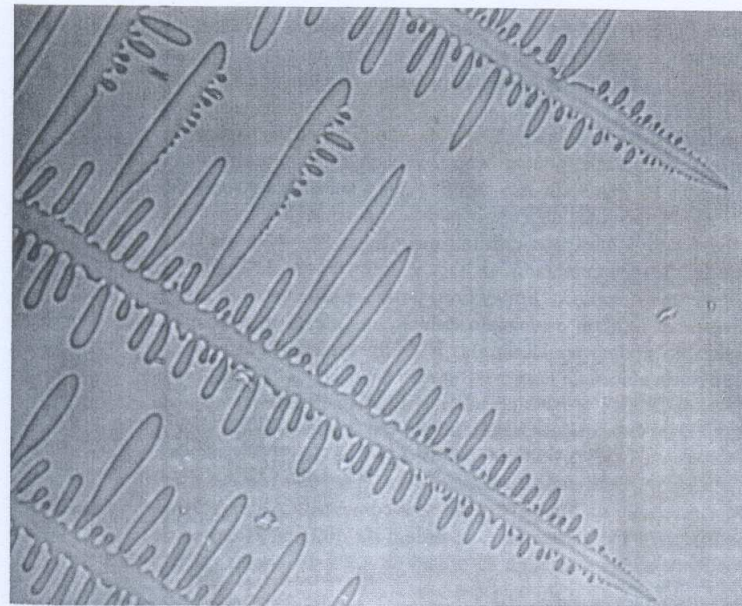

Crescimento Dendrítico

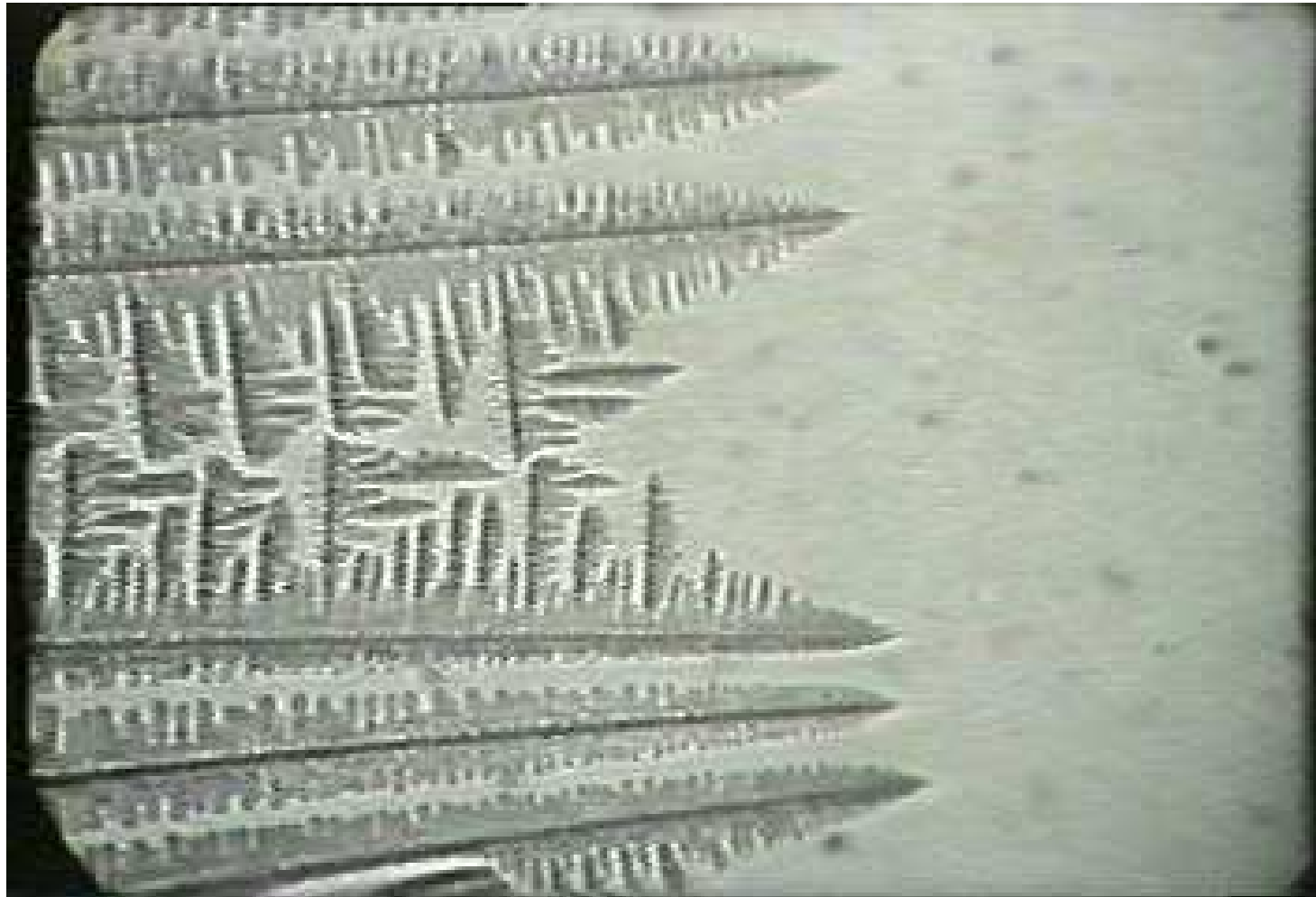

Formação dos grãos

- No caso de crescimento dendrítico

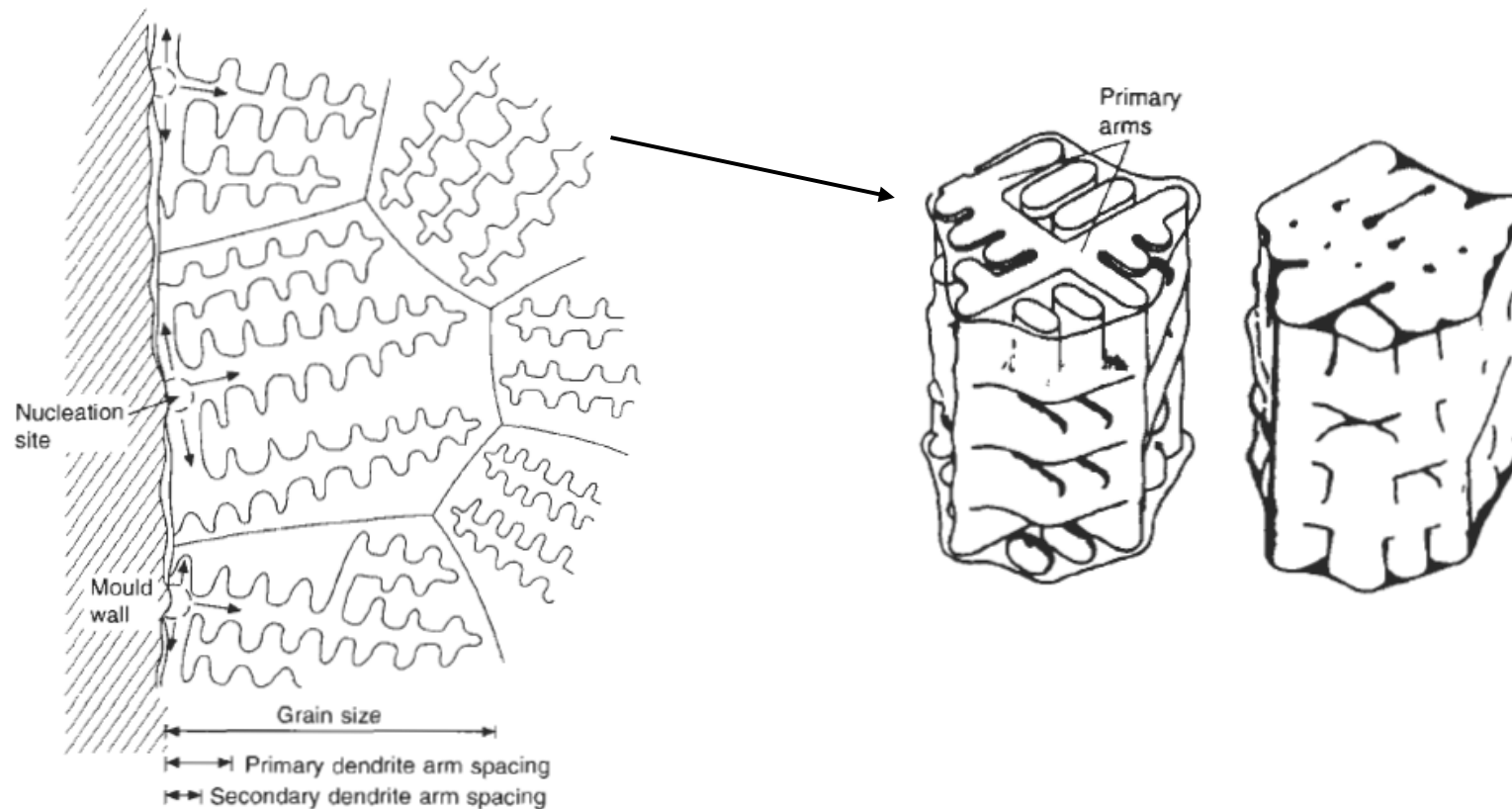

Microporosidades de solidificação interdendrítica (zona pastosa)

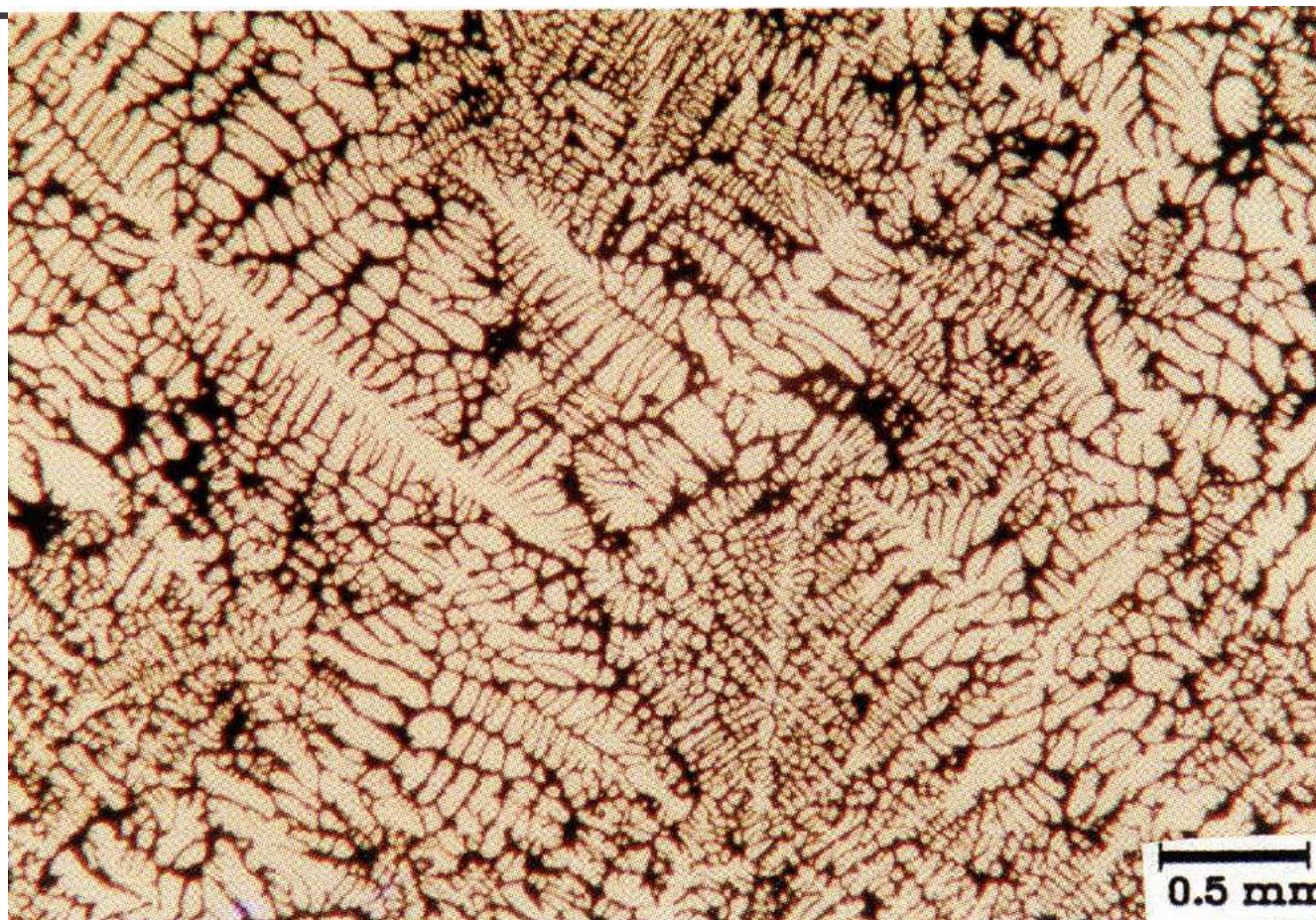

Microporosidade de solidificação interdendrítica

Aços ao carbono

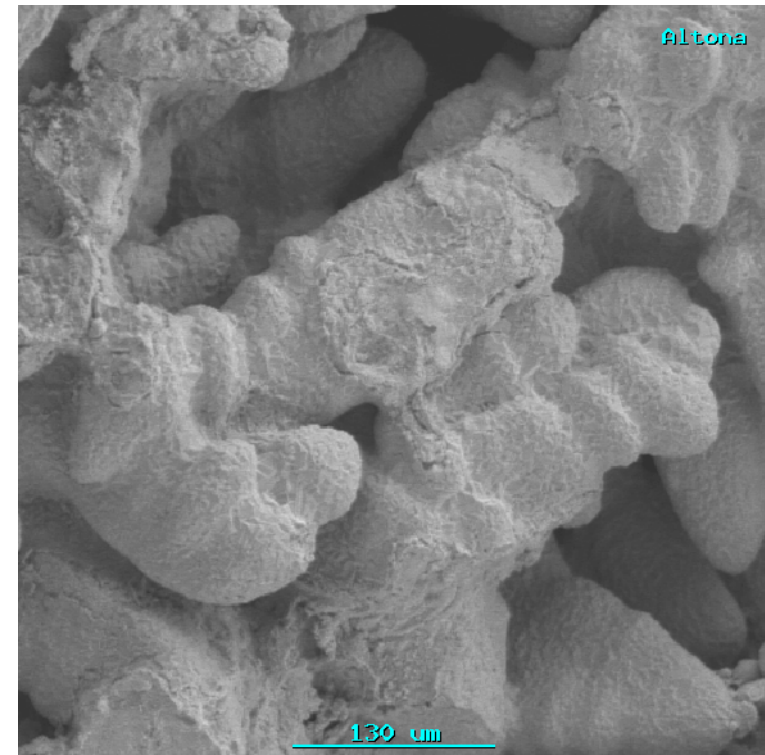
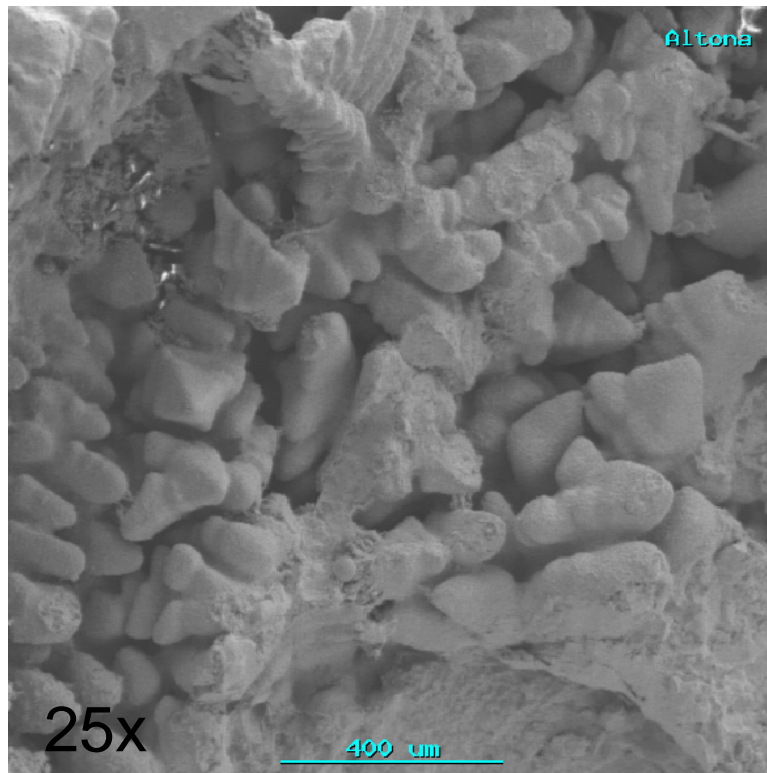

Microporosidades de solidificação interdendrítica

Aços ao carbono (WCB)

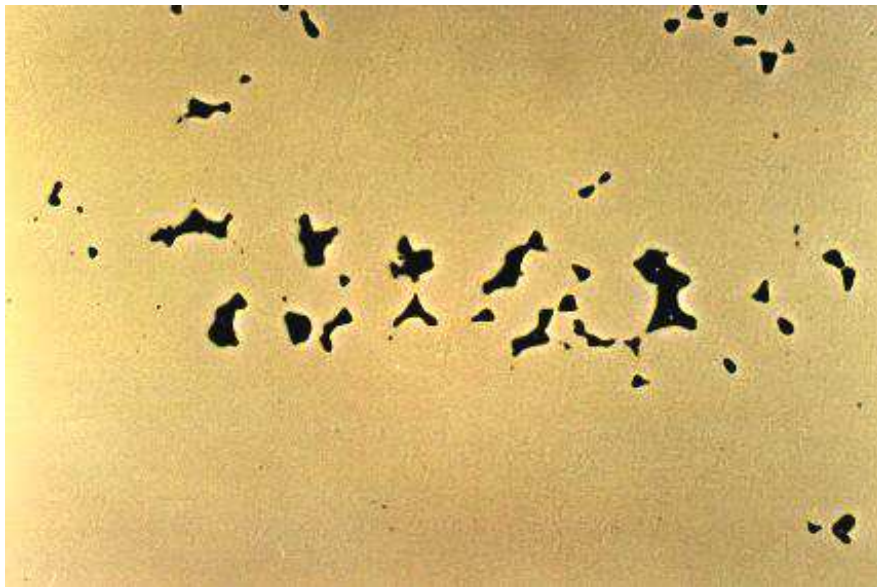

Microporosidades de solidificação interdendrítica

Bronze 85-5-5-5 fundido em coquilha

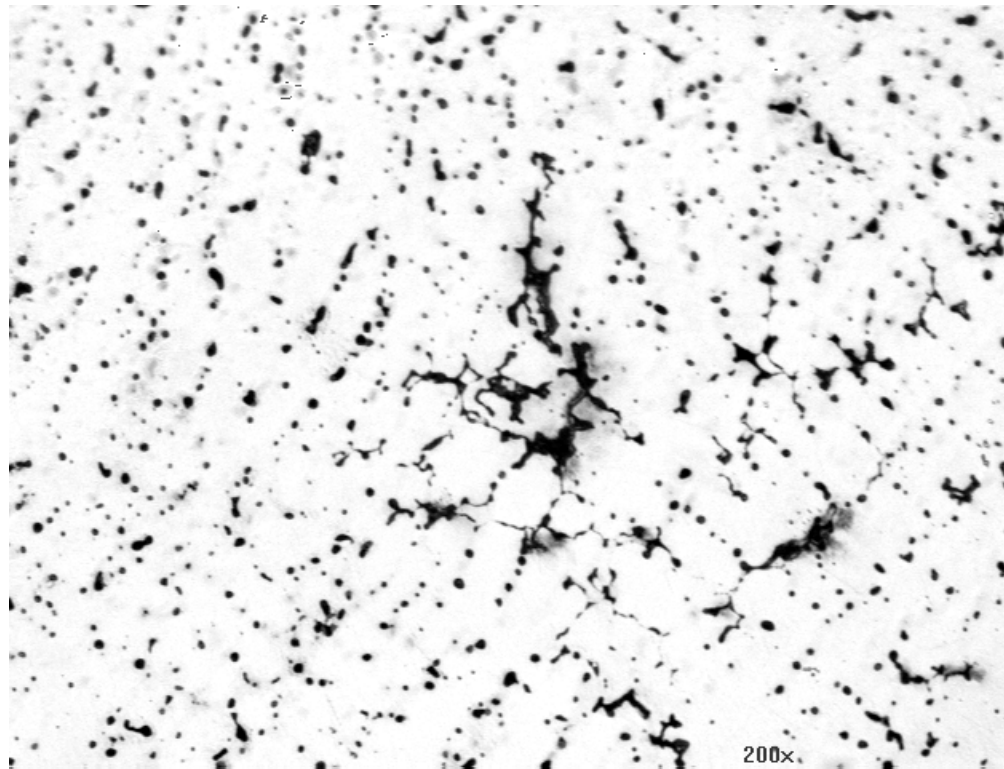

Microporosidades de solidificação interdendrítica

Liga Al- 8%Si + 3,5%Cu



Microsegregação de gases e inclusões

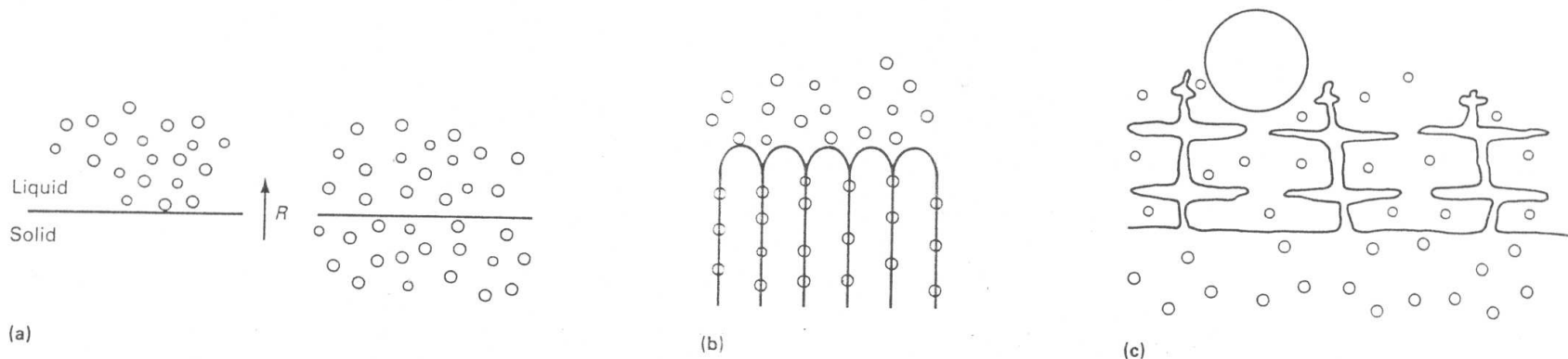

Fig. 3 Influence of interface shape on pushing or entrapment of particles. (a) Planar interface can result in pushing (left) or engulfment (right). (b) Cellular interface showing pushing at interface and entrapment between cells. (c) Dendritic interface; small particles are entrapped in interdendritic spaces while large particles are pushed

Source: Ref 9

Macrossegregação

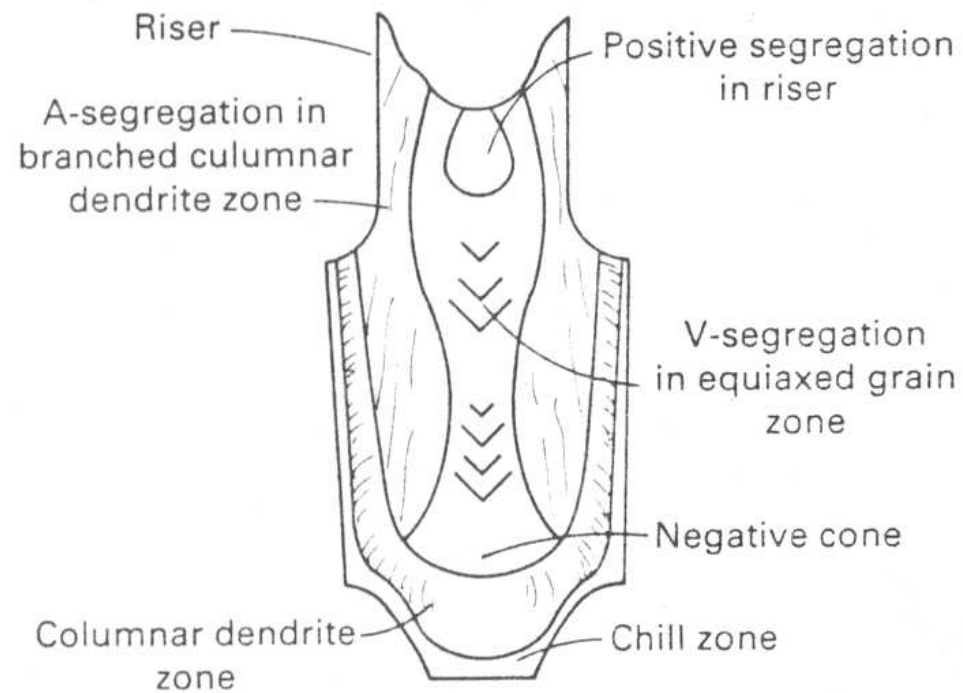
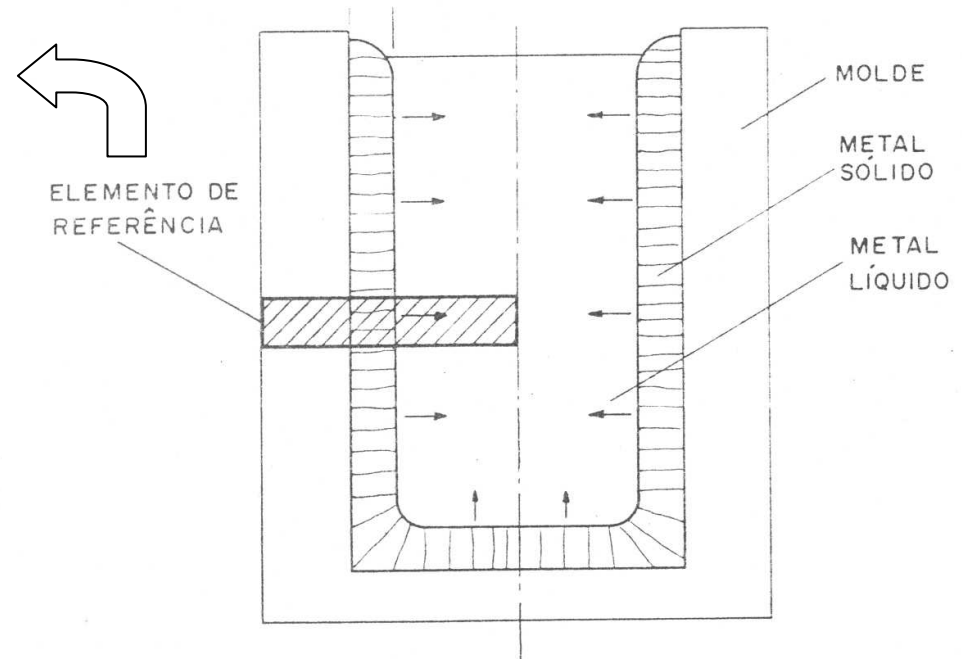
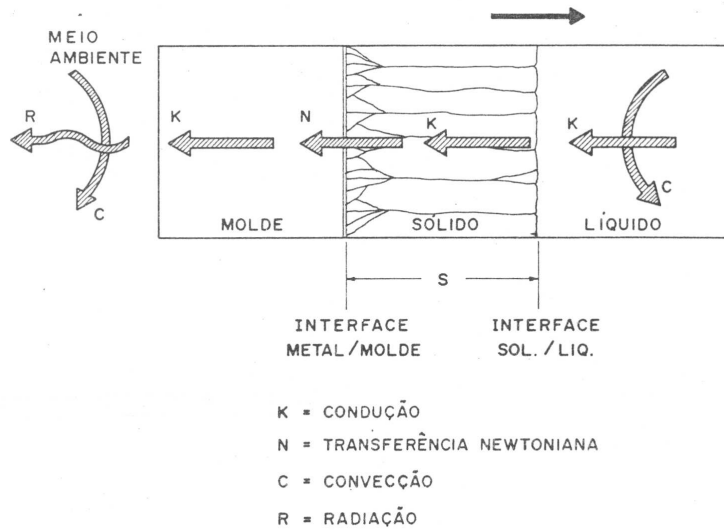
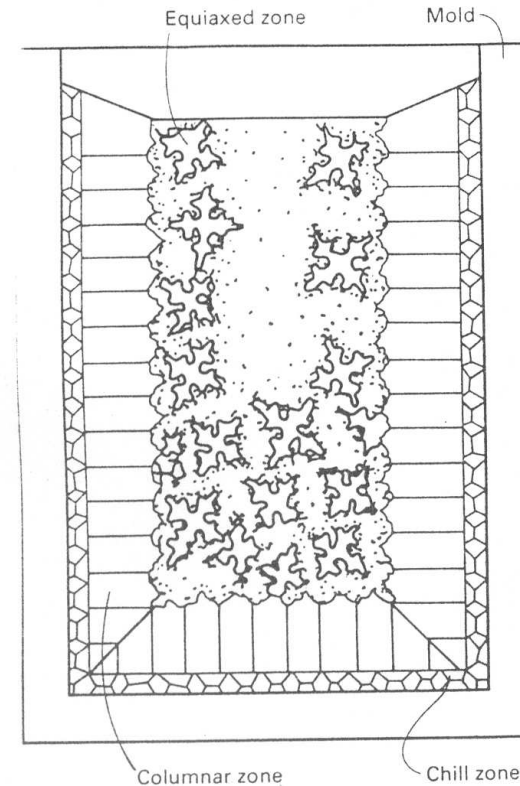
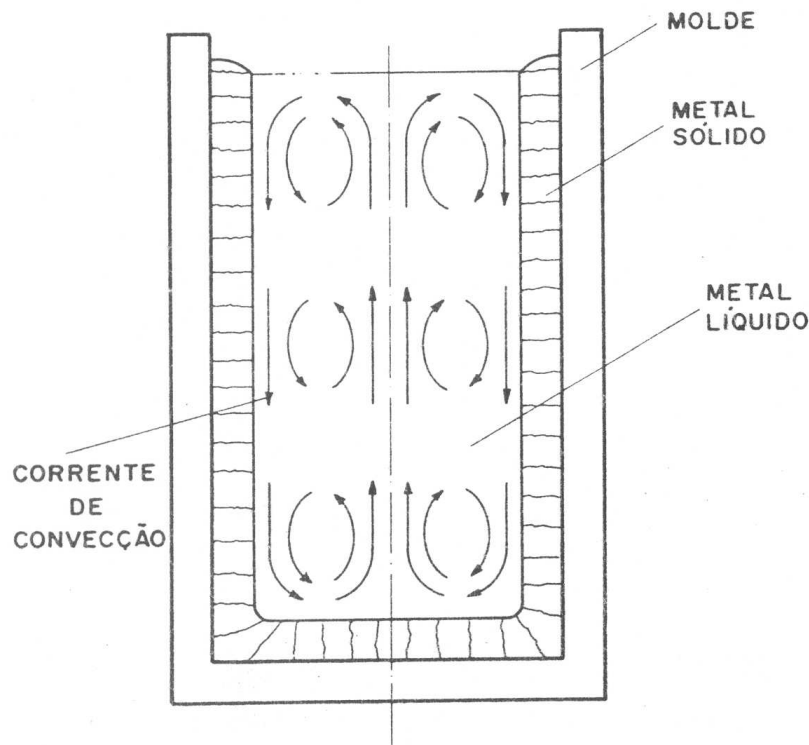

Fig. 7 Typical macrosegregation observed in steel ingots. A-segregation and V-segregation are discussed later in this article.

Fluxo de calor e direção de crescimento



Convecção e formação de novos núcleos



Filme

Fig. 11 Schematic of microstructure zone formation in castings. Directional solidification conditions give rise to a columnar zone, while an equiaxed zone is formed at the center where the liquid is undercooled.

O Molde (partes básicas)

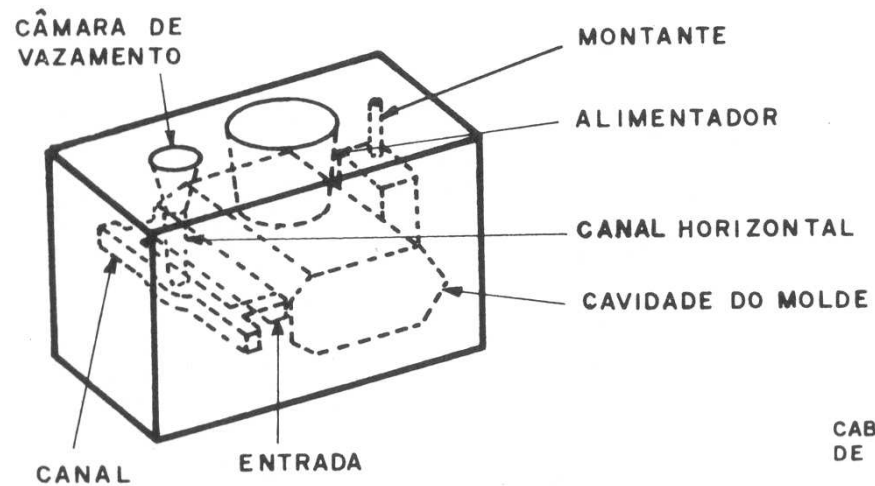

CAVIDADE DO MOLDE

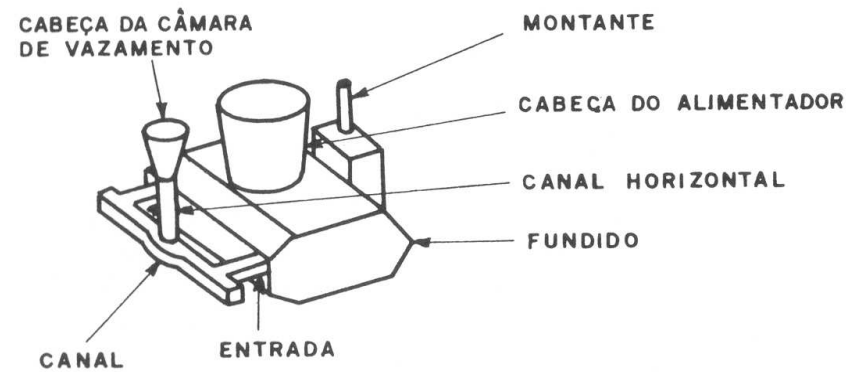

PEÇA FUNDIDA

Contração na Solidificação

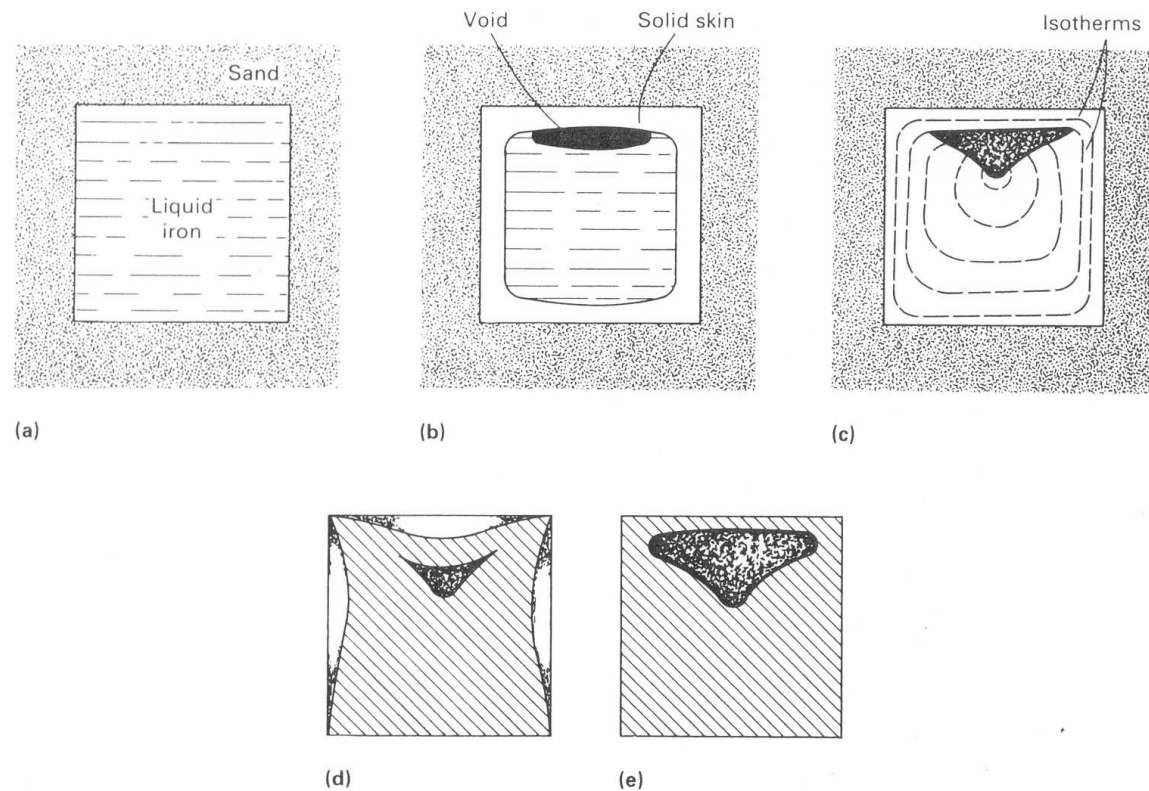

Fig. 2 Schematic of sequence of solidification shrinkage in an iron cube. (a) Initial liquid metal. (b) Solid skin and formation of shrinkage void. (c) Internal shrinkage. (d) Internal shrinkage plus dishing. (e) Surface puncture

Rechupe e Massalote

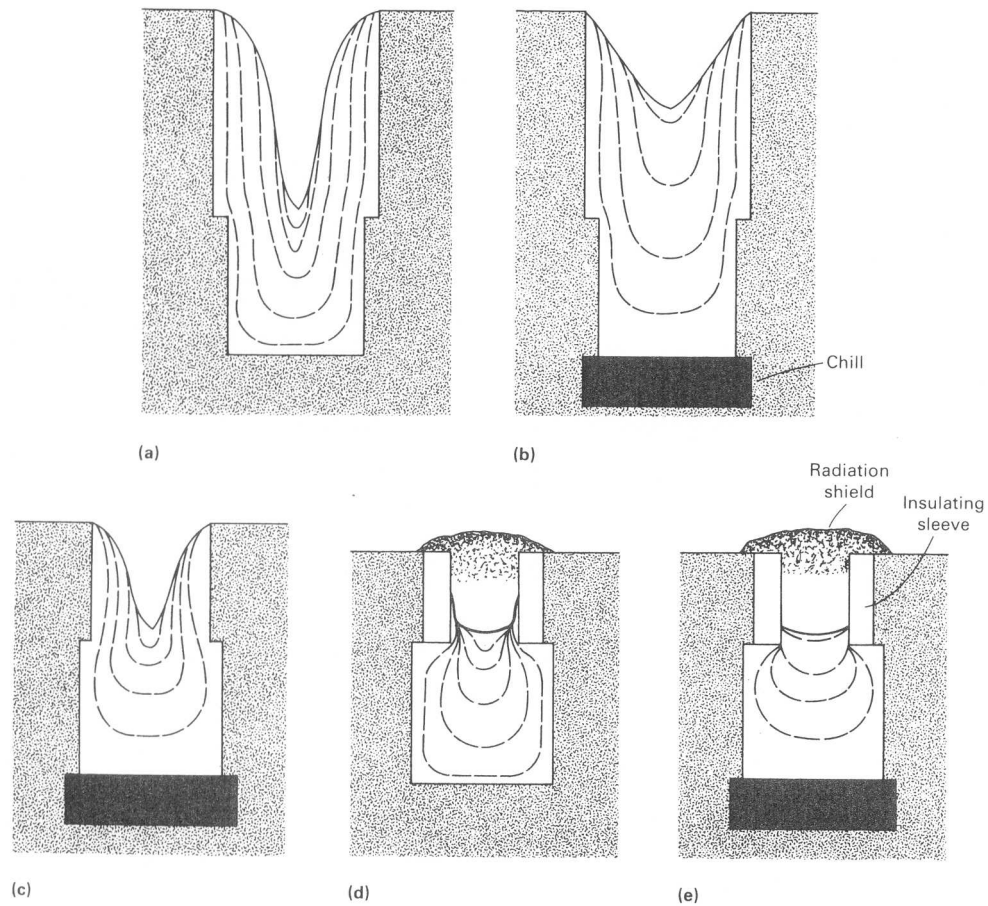

Fig. 3 Methods of controlling shrinkage in an iron cube to reduce riser size. (a) Open-top riser. (b) Open-top riser plus chill. (c) Small open-top riser plus chill. (d) Insulated riser. (e) Insulated riser plus chill



Projetando Moldes (massalote)

- Módulo de Resfriamento

$$MR = \frac{Volume}{Superfície}$$

- Tempo de Solidificação

$$TS = c.(MR)^n \quad \blacksquare \quad 1,5 < n < 2$$

- Exemplos:
 - Calcular p/ Esfera, Chapa, Cubo, Cilindro
 - Como maximizar MR p/ Cilindro?
 - Comparar

Projetando Moldes

(massalotes, coquilhas e isolantes)

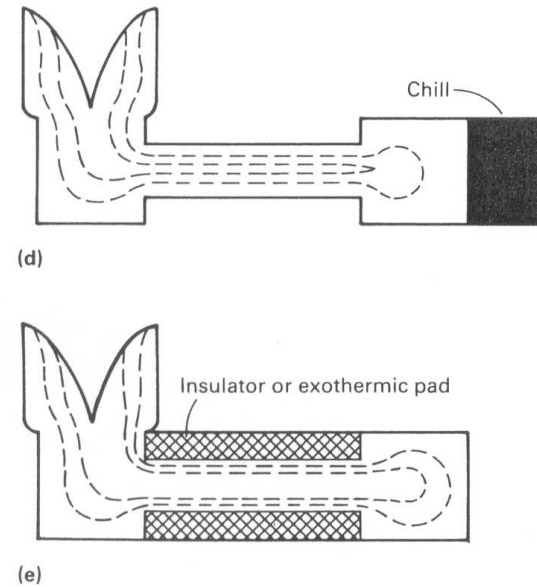
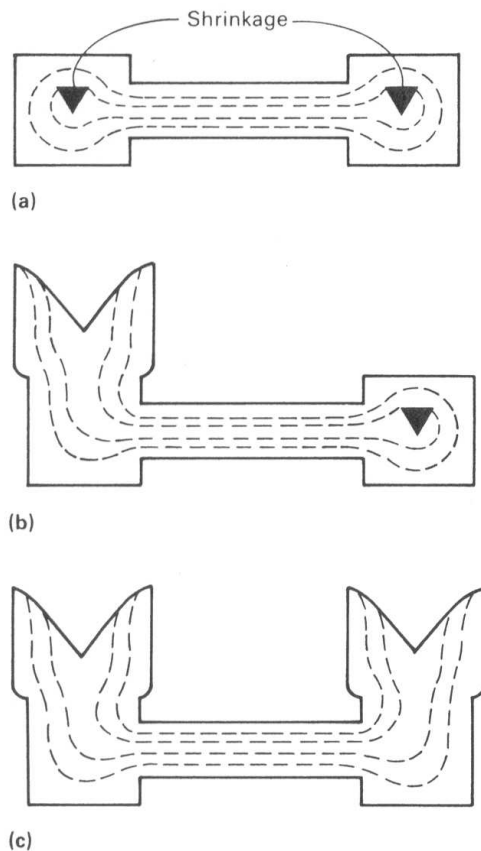

Fig. 16 Riser of isolated heavy sections joined by a thinner section to minimize shrinkage and number of risers. (a) Workpiece with no risers. (b) Riser added to one side. (c) Risers located on both ends. (d) Chill applied to one end and riser to other end. (e) Riser used on one end and insulator or exothermic pad on opposite end

Projetando Moldes (posições)

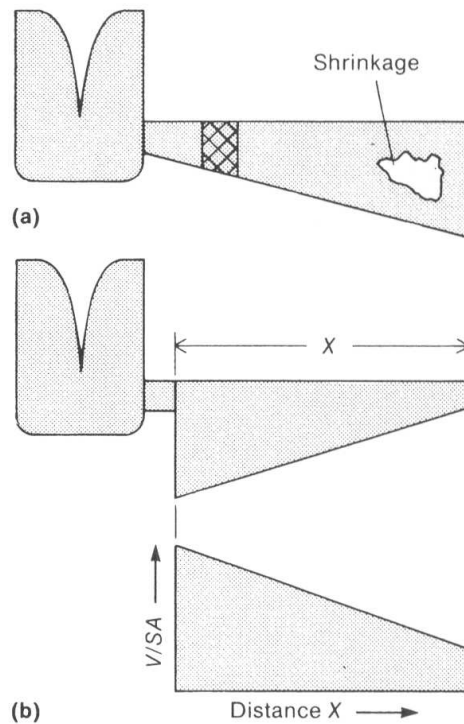

Fig. 3 Casting design and solidification of a simple wedge. (a) Riser placed at narrow end of wedge; shrinkage occurs at wide end. The crosshatched region represents the approximate area of the casting where solidification is first complete, thus cutting off the feeding path of the casting. (b) Correct riser placement. V/SA is the volume-to-surface-area ratio (casting modulus).

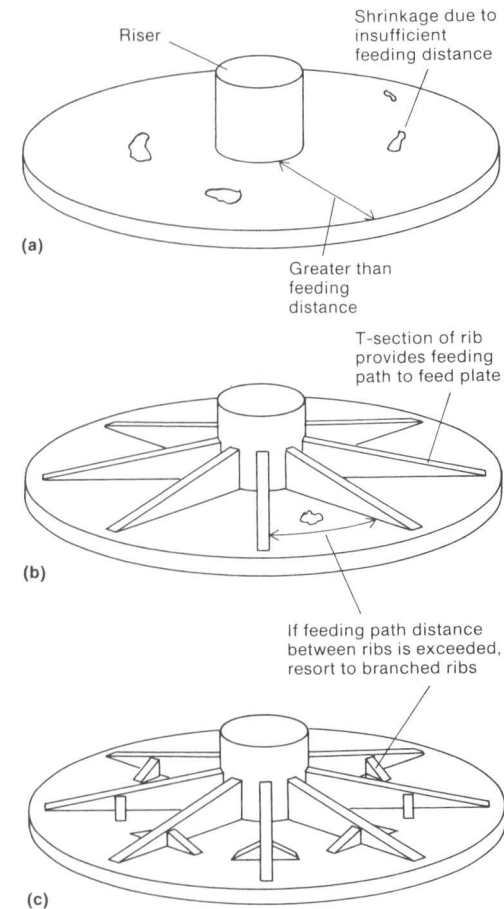
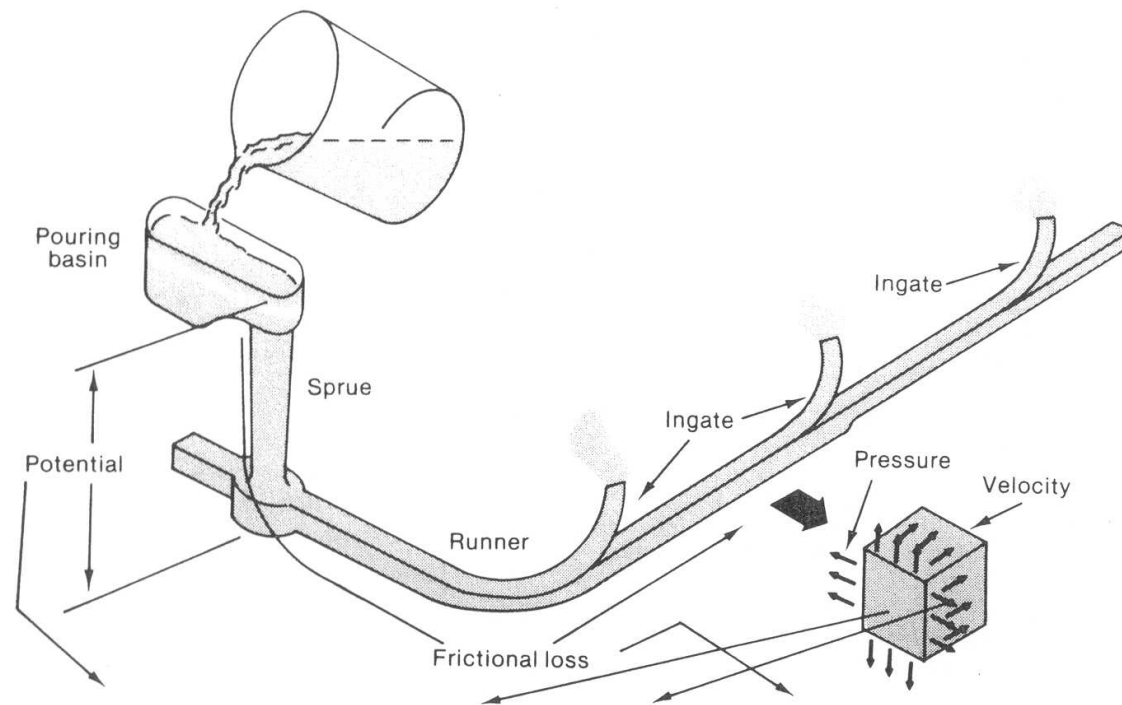

Fig. 16 Feeding path design considerations. (a) Circular flat plate with a single riser. (b) Addition of wedge-shaped ribs to ensure proper solidification. (c) Branched ribs to overcome feeding problems at the circumference of the plate

Projetando Moldes (canais)



Filme
turbulência

$$\text{Potential head } (wZ) + \text{Pressure head } (wPv) + \text{Velocity head } (wV^2/2g) + \text{Friction loss of head } (wF) = \text{Constant } (K)$$

Fig. 2 Schematic illustrating the application of Bernoulli's theorem to a gating system. Source: Ref 1

Projetando Moldes (canais)

$$\frac{A_S}{A_I} = \sqrt{\frac{h_I}{h_S}}$$

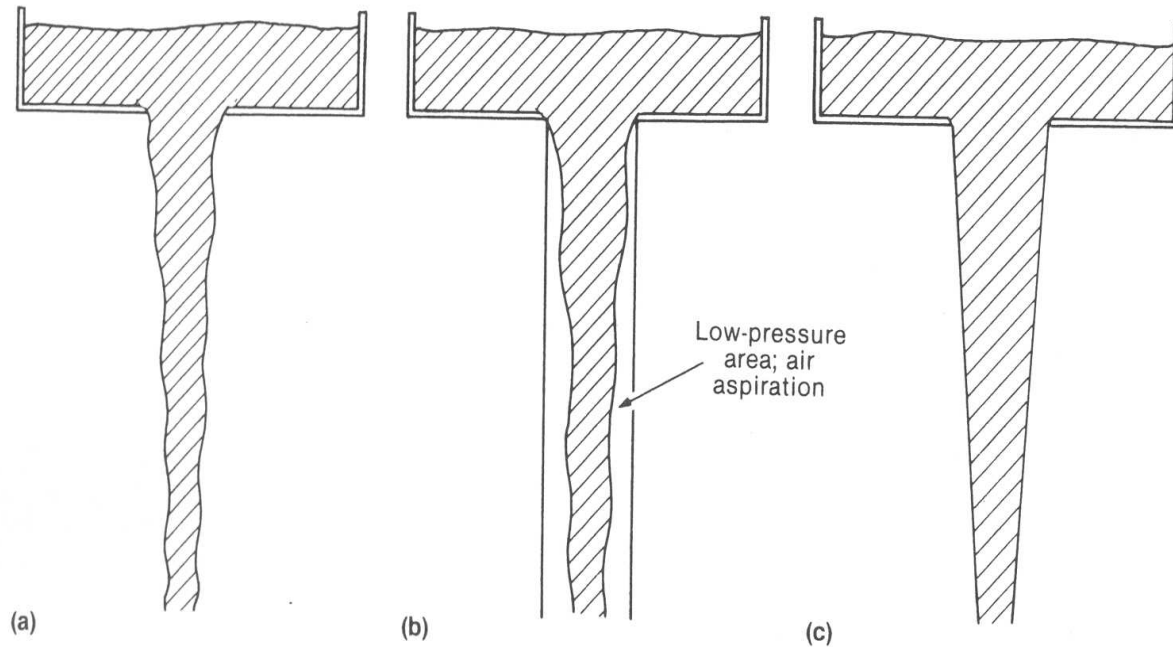

Fig. 3 Schematic showing the advantages of a tapered sprue over a straight-sided sprue. (a) Natural flow of a free-falling liquid. (b) Air aspiration induced by liquid flow in a straight-sided sprue. (c) Liquid flow in a tapered sprue

Projetando Moldes (canais)

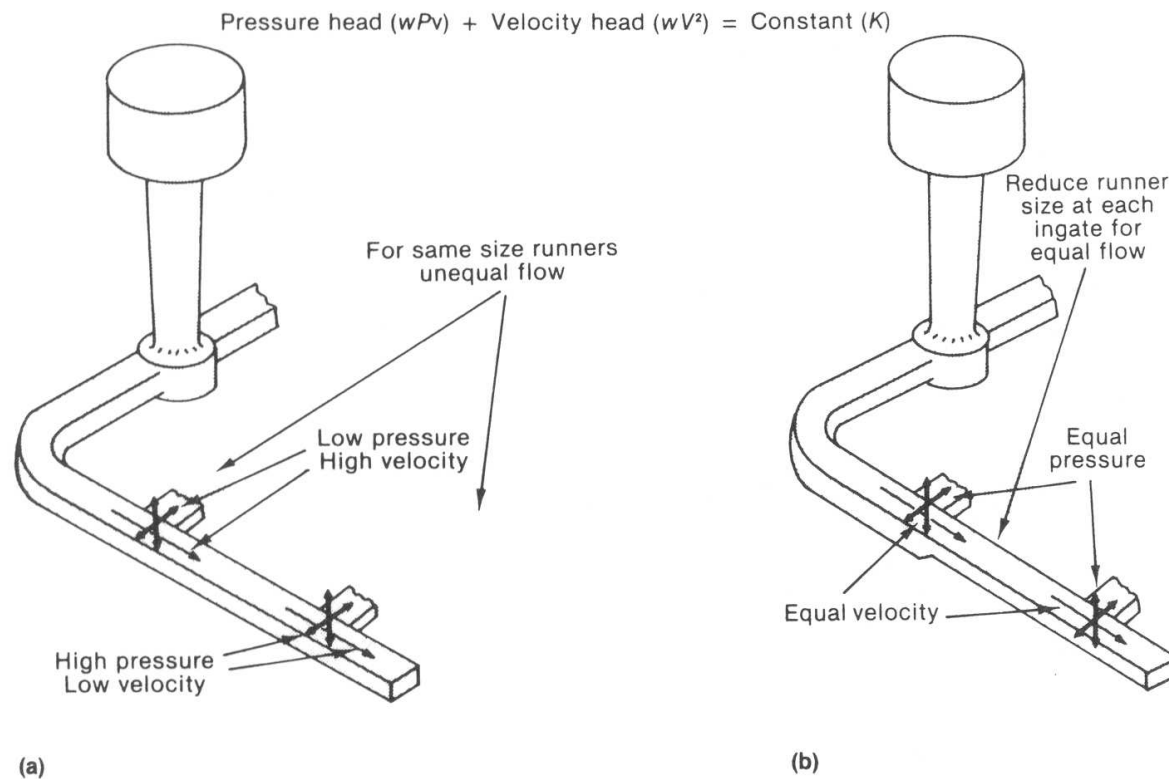

Fig. 9 Applying Bernoulli's theorem to flow from a runner at two ingates for a filled system and comparing velocity and pressure at the ingates for two runner configurations. (a) Same runner cross section at both ingates. (b) Stepped runner providing two different runner cross sections at each ingate. Source: Ref 1

Projetando Moldes (canais)

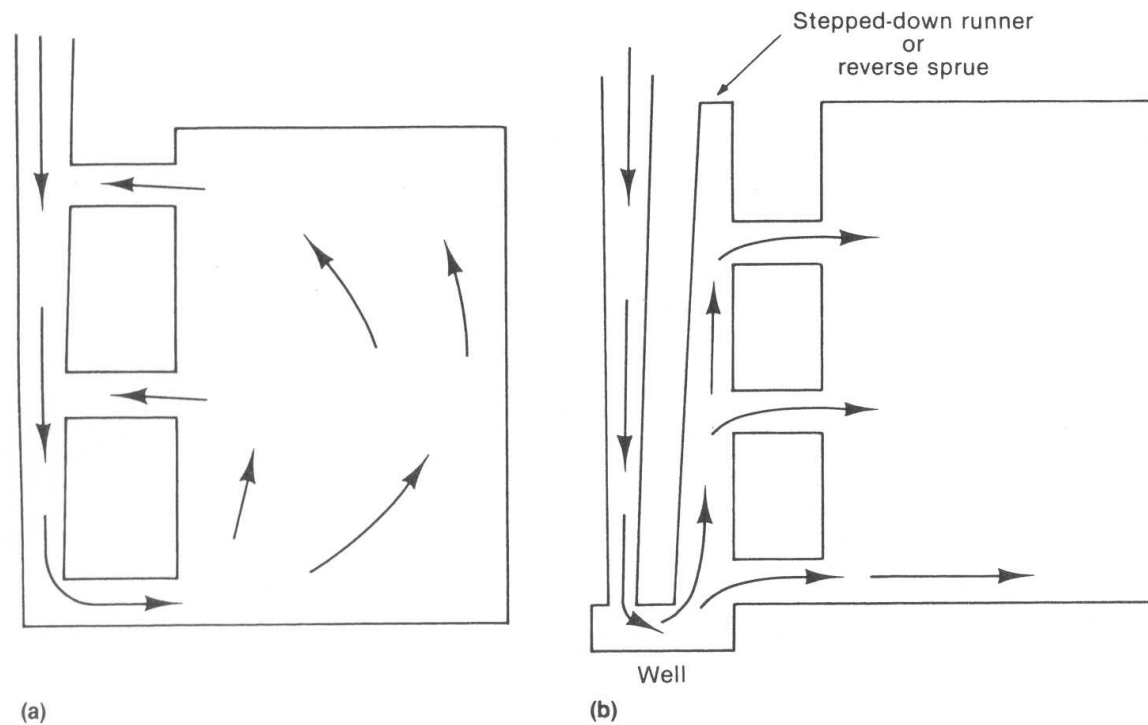

Fig. 10 Comparison of flow patterns in two vertical gating systems. (a) Poorly designed system. (b) Properly designed system utilizing a tapered runner that equalizes flow through the ingates

Projetando Moldes (canais)

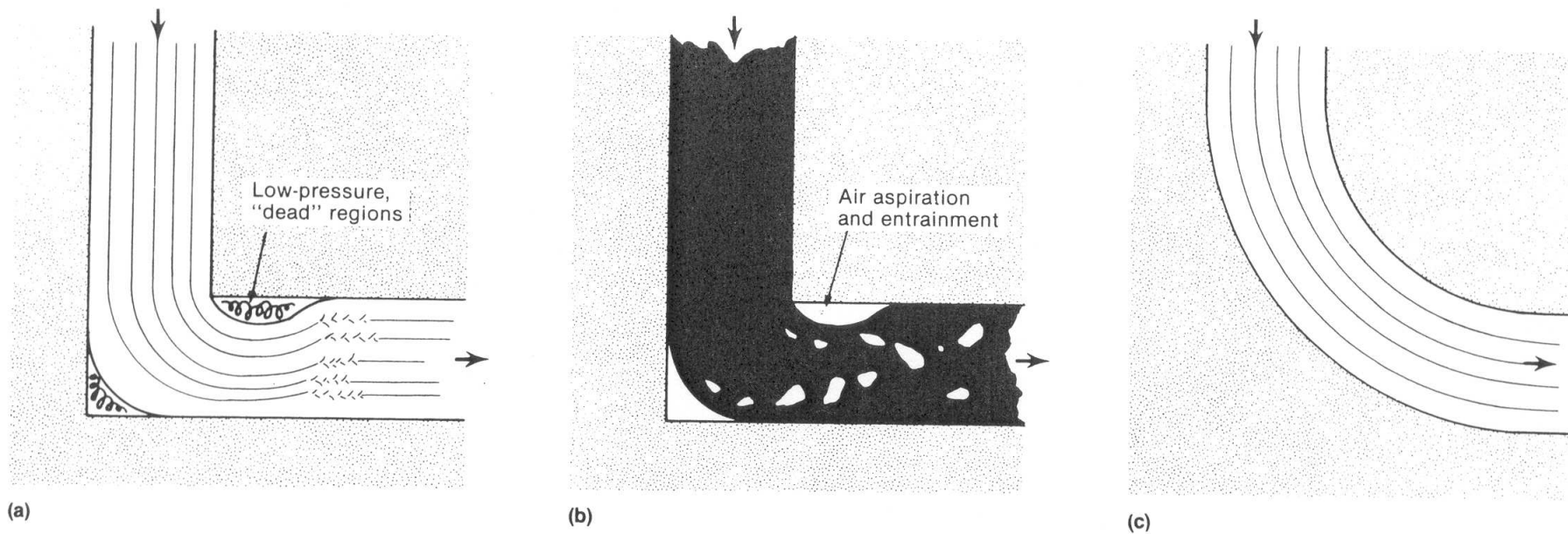

Fig. 7 Schematic illustrating fluid flow around right-angle and curved bends in a gating system. (a) Turbulence resulting from a sharp corner. (b) Metal damage resulting from a sharp corner. (c) Streamlined corner that minimizes turbulence and metal damage

Projetando Moldes (canais)

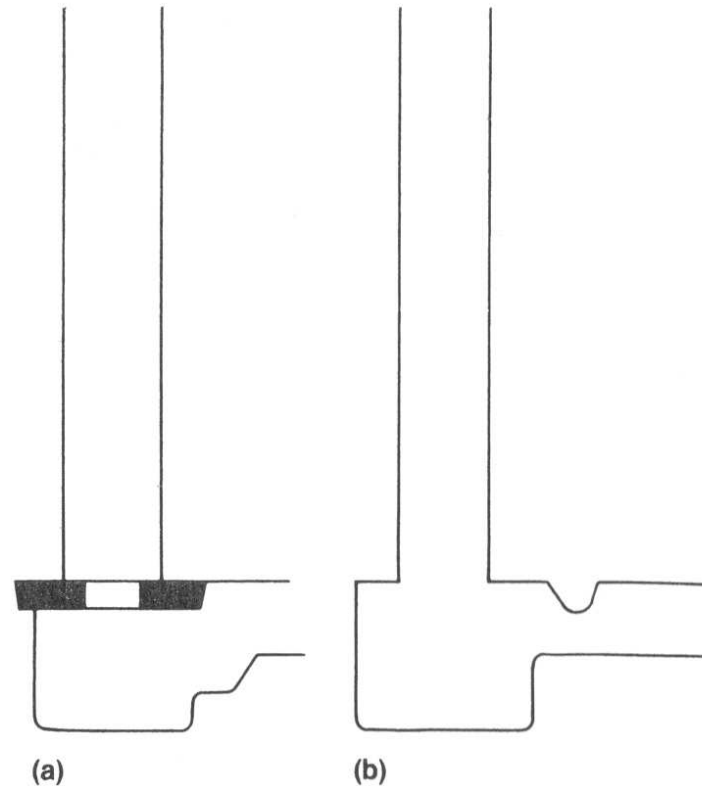

Fig. 4 Choke mechanisms incorporated into straight-sided sprues to approximate liquid flow in tapered sprues. (a) Choke core. (b) Runner choke

Projetando Moldes (filtros)

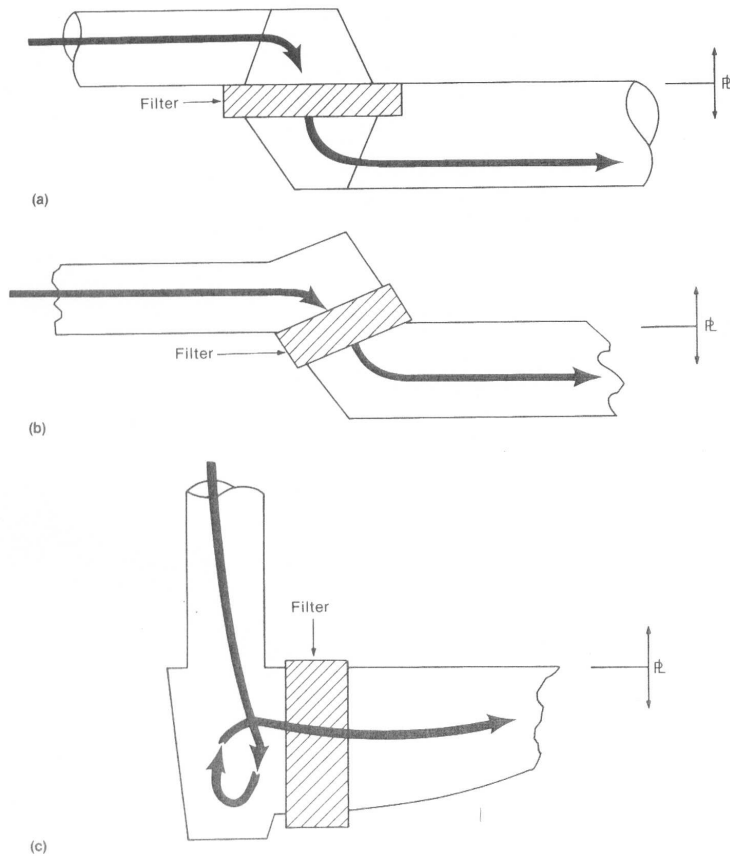

Fig. 16 Common methods of filter placement in horizontally parted molds. (a) Parallel to parting line. (b) Between 0 and 90° to parting line. (c) 90° to parting line. Arrows indicate the direction of metal flow.

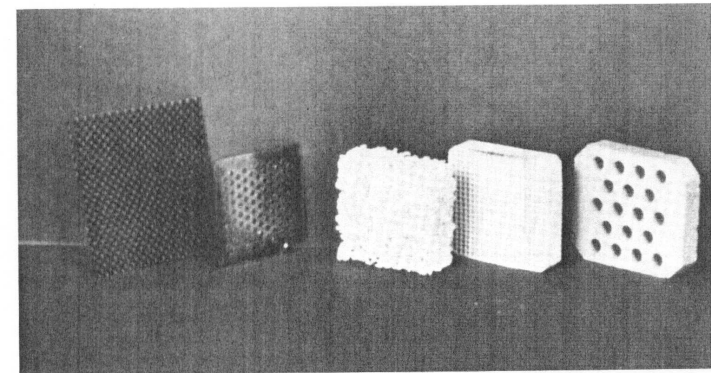

Fig. 14 Several common filtration and flow modification devices (from left to right): strainer core, extruded ceramic filter, ceramic foam filter, mica screen, and woven fabric screen. The two types of ceramic filters are by far the most widely used.



Comparação de processos

Processo	Limites de peso	Menor secção (mm)	Acabamento superficial (μm)	Tolerância dimensional Dimensão de x (mm)
Areia	30g a 200T	3 a 6	4 a 8	0,005x a 0,03x
Casca	30g a 120Kg	1,5 a 3,5	2,5 a 6	0,01x a 0,025x
Gesso	100g a 50Kg	1,5	1	0,005x
Cera Perdida	2g a 25Kg	0,8 a 1	1	0,003x a 0,005x
Molde Cheio	-	-	-	0,002x a 0,007x
Molde Permanente	100g a 50Kg	3 a 5	2	0,01x a 0,025x
Sob pressão	15g a 50Kg	0,8	1	0,0015x

Comparação de processos p/ ligas de Al

Processo	Capacidade Produção	Tolerâncias	Superfície	Custo de Maquinário
Molde cheio	De 0,05 à 150 Kg	$\pm 0,001$ à 0,25 m $\pm 0,0007$ /metro	63-250 RMS	\$8000 a \$120000
Cera Perdida	0,05 à 10 Kg	$\pm 0,001$ à 0,127m $\pm 0,0007$ /metro	63-250 RMS	\$4000 a \$40000
Fundição em Areia	0,03 à toneladas	$\pm 0,007$ à 1,5 m $\pm 0,0007$ /metro	200-550 RMS	\$1000 a \$10000
Injeção	0,05 à 10 Kg	$\pm 0,0005$ /metro	32-63 RMS	\$10000 a \$300000
Molde Permanente	0,5 à 50 Kg	$\pm 0,003$ to 0,25 m $\pm 0,0005$ /metro	150-300 RMS	\$12000 a \$100000

Moldagem em Areia

Caixa (areia verde ou cura a frio)

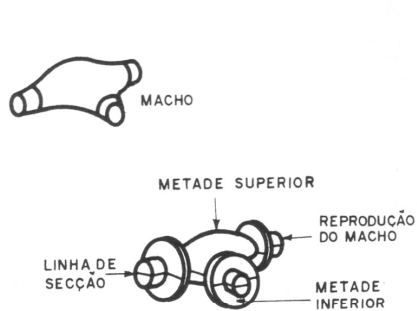

MODELO

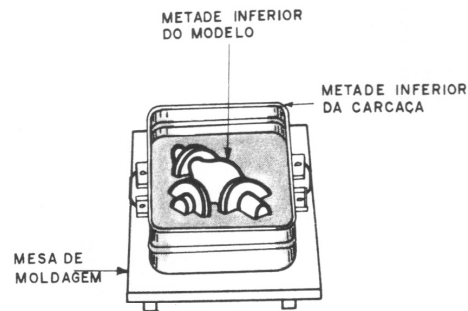

APLICAÇÃO DA SUPERFÍCIE DE SEPARAÇÃO

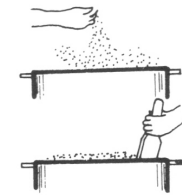

SOLAGEM

ENCHIMENTO COM AREIA

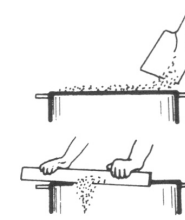

RASPAGEM DO EXCESSO DE AREIA

1. A PARTE INFERIOR DO MODELO É COLOCADA SOBRE A MESA DE MOLDAGEM, NA PARTE INFERIOR DA CARÇA

2. PREPARAÇÃO DA METADE INFERIOR DO MOLDE

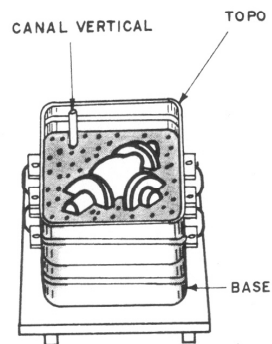

3. A METADE INFERIOR DO MOLDE É INVERTIDA, E A METADE SUPERIOR DO MODELO E DA CARÇA SÃO FIXADAS NA POSIÇÃO.

4. A METADE SUPERIOR DO MOLDE É PREPARADA DA MESMA FORMA QUE ANTERIORMENTE.

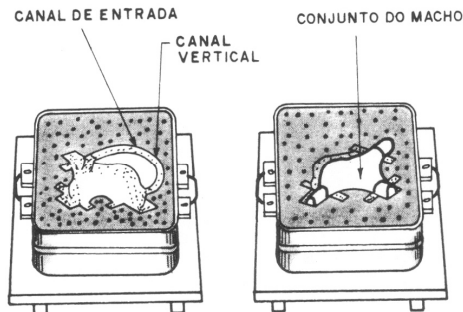

5. A CARÇA É SEPARADA, OS MODELOS SÃO REMOVIDOS, O MACHO É POSICIONADO E ENTÃO, AS CAIXAS SÃO FECHADAS.

BACIA DE VAZAMENTO

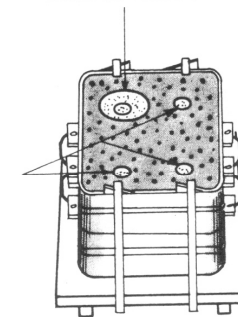

6. QUANDO AS CAIXAS SÃO FECHADAS E FIXADAS LATERALMENTE, O CONJUNTO ESTÁ PRONTO PARA O VAZAMENTO.

Filme

Moldagem em Areia

Caixa (areia verde ou cura a frio)

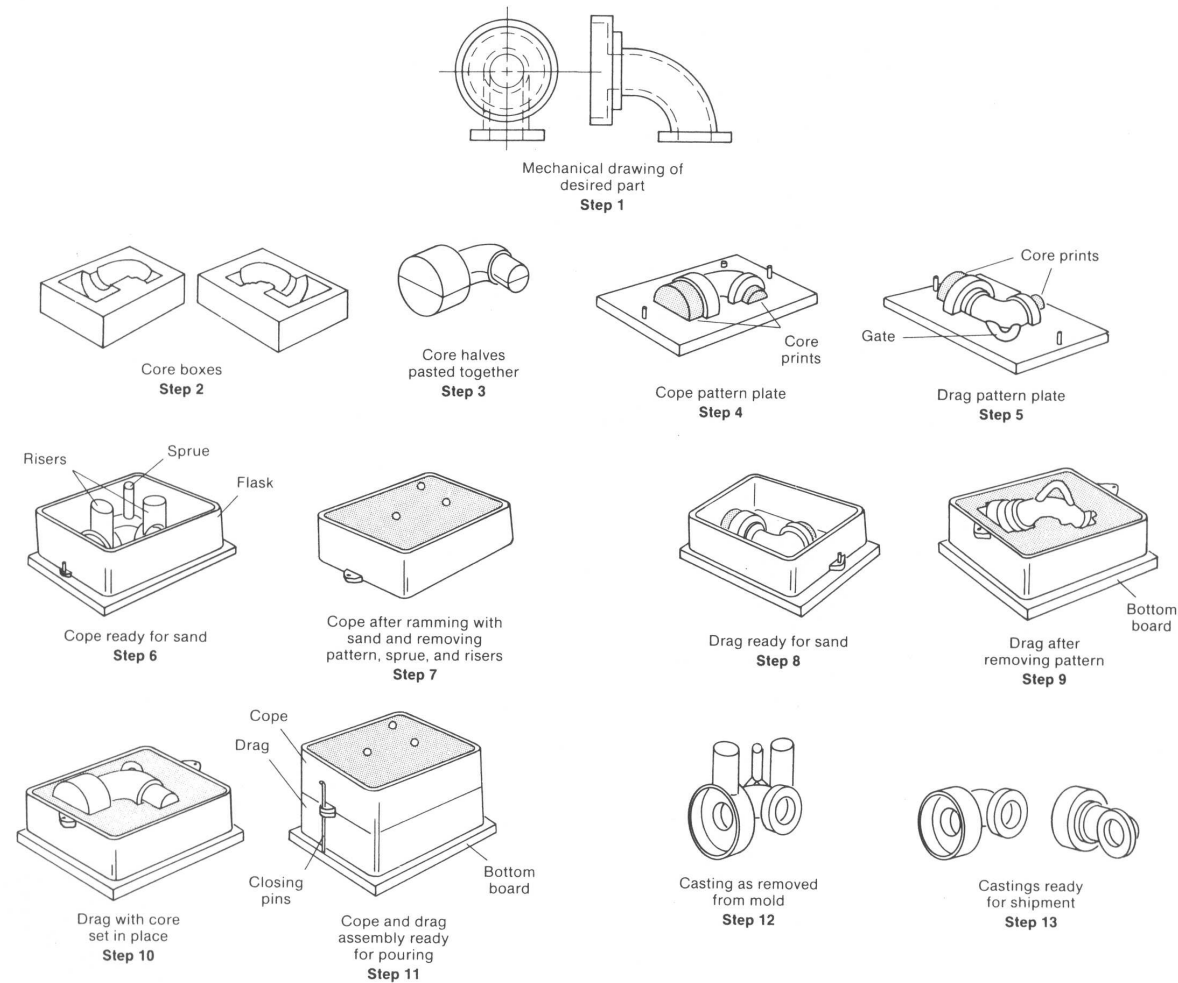

Fig. 2 Basic steps involved in making a casting from a green sand mold

Moldagem em areia

Compactação Automatizada (caixa)

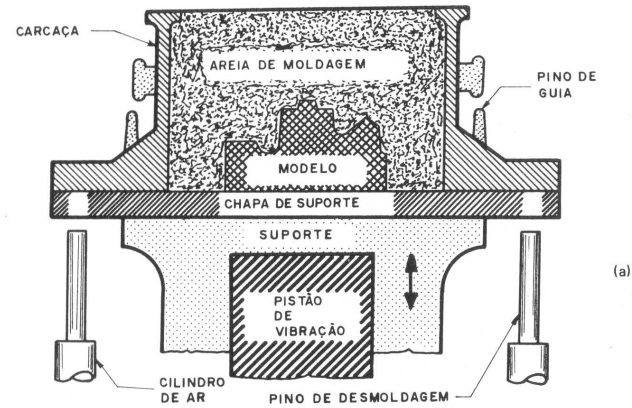
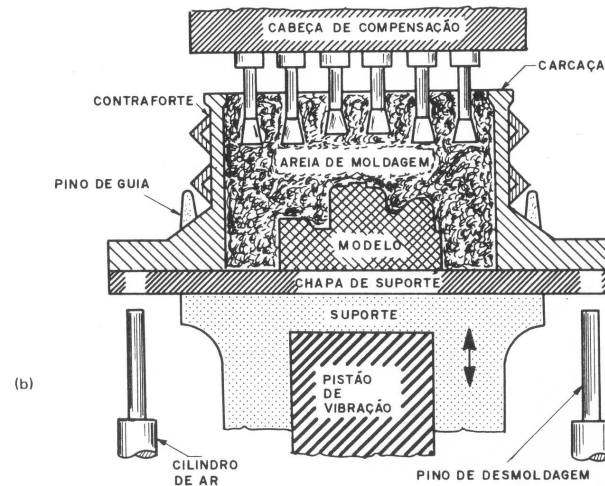
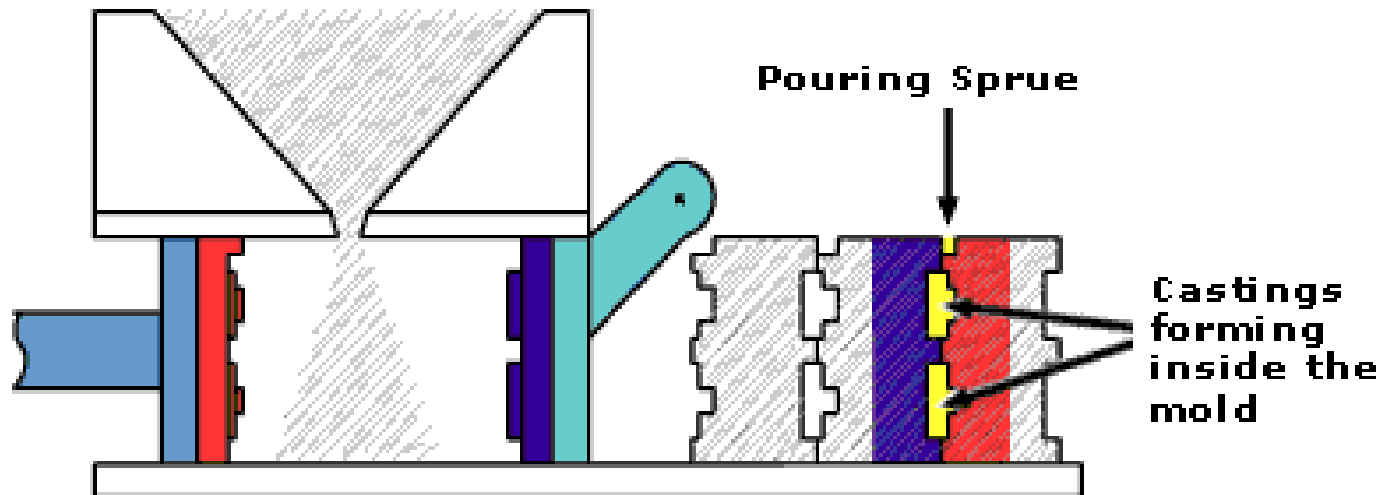

Fig. 6.6 Componentes essenciais de: (a) equipamento de moldagem com vibração. A vibração é produzida por levantamento e abaixamento do suporte; (b) equipamento de moldagem por vibração-compressão. Após a compactação pela vibração, é aplicada uma pressão de compressão.



Moldagem em Areia

Automação (processo Disamatic)



**Sand enters the Molding Chamber for the next mold.
Iron is poured into the pouring sprue on top of the
formed molds.**



Filmes

- Link 1

- Cura a frio mais comum:
 - Resina fenólica + trimetilamina

- Link 2

Moldagem em Casca

Shell Molding (cura a quente)

Fig. 6.9 Etapas da produção de molde em casca usando uma caixa basculante.

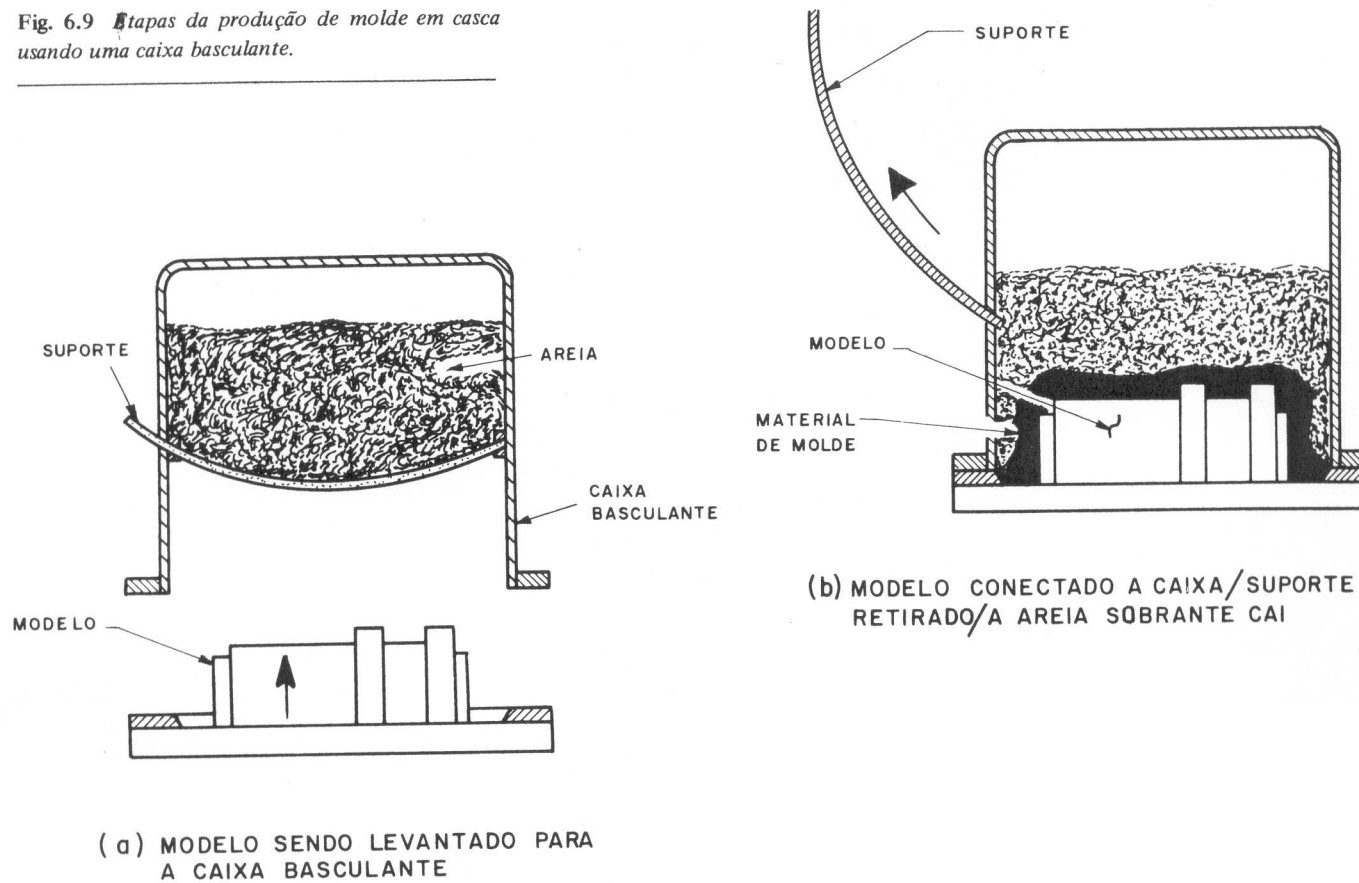

Moldagem em Casca

Shell Molding (cura a quente)

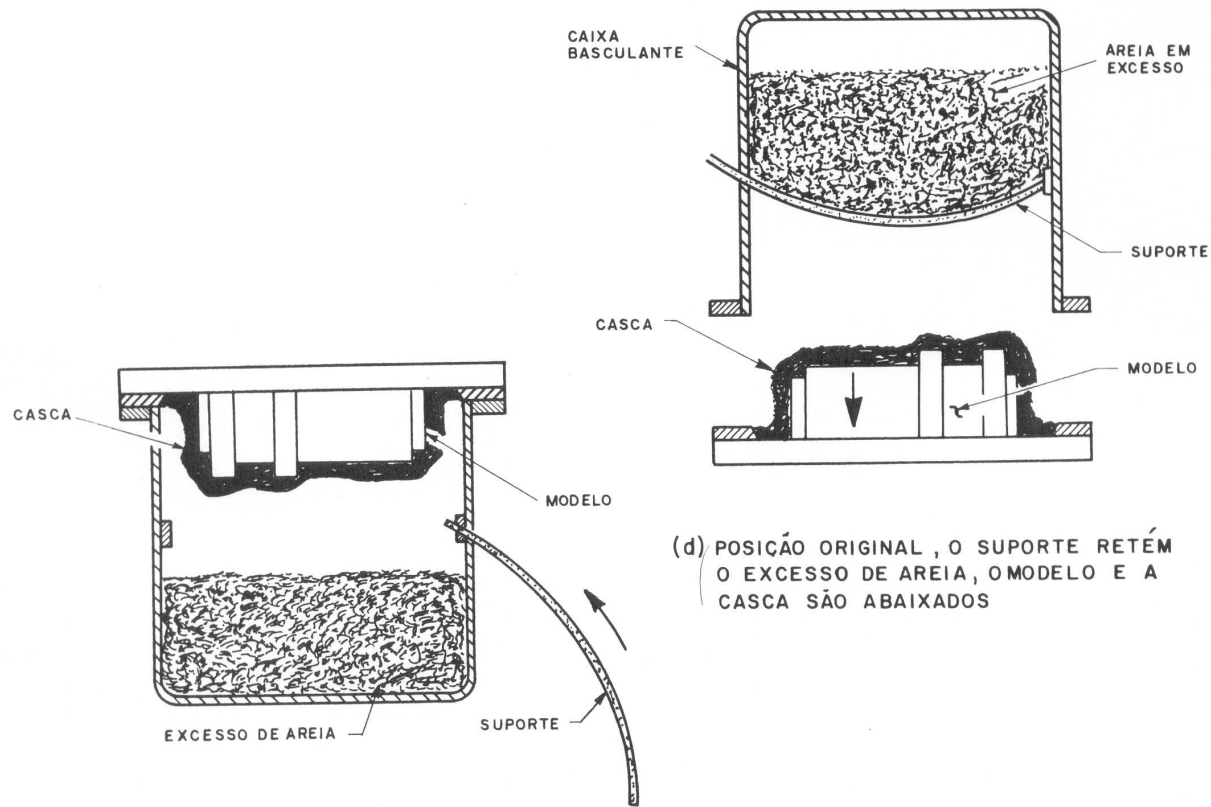

Molde para virabrequim fundido

Silicato de Sódio

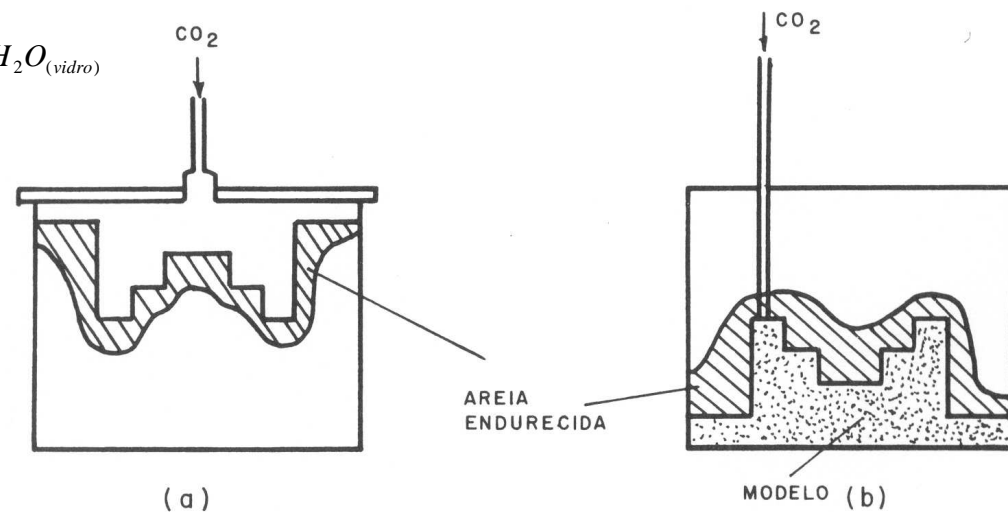
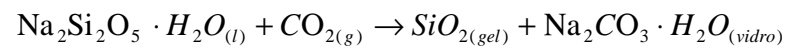

Quando não se usa silicato de sódio:

- ligante orgânico
 - Resina Fenoluretânica + vapor de amina (dimetilamina ou trimetilamina)
 - Resina Epoxiacrílica + dióxido de enxofre

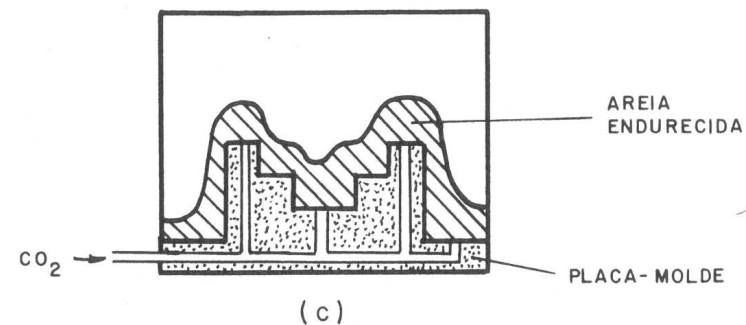

Molde cheio (lost-foam)

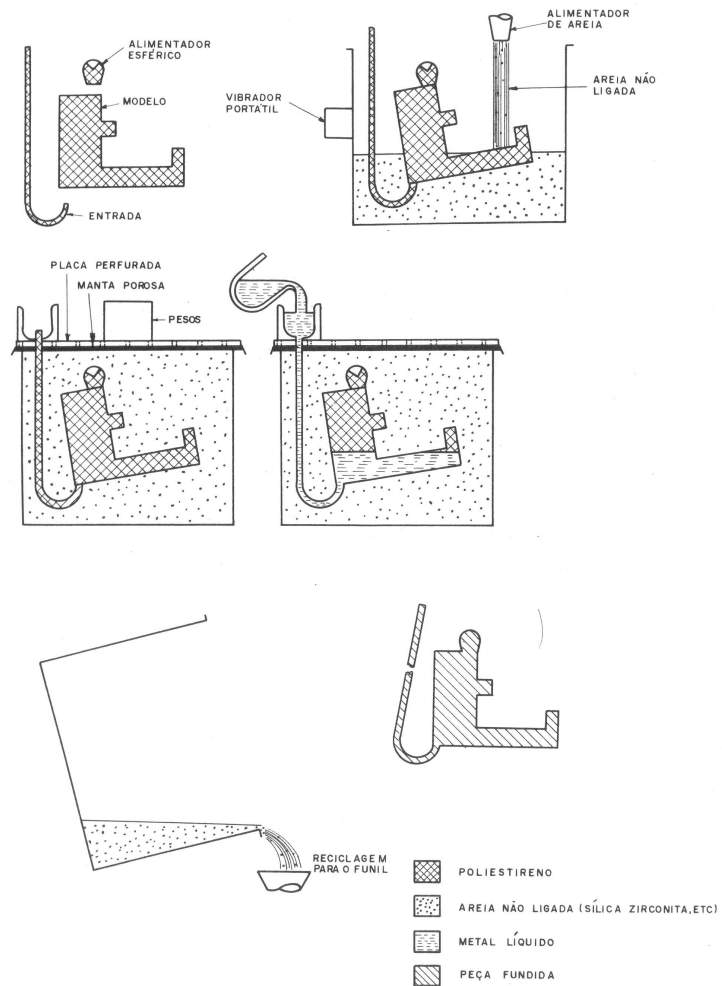

Molde cheio (lost-foam)

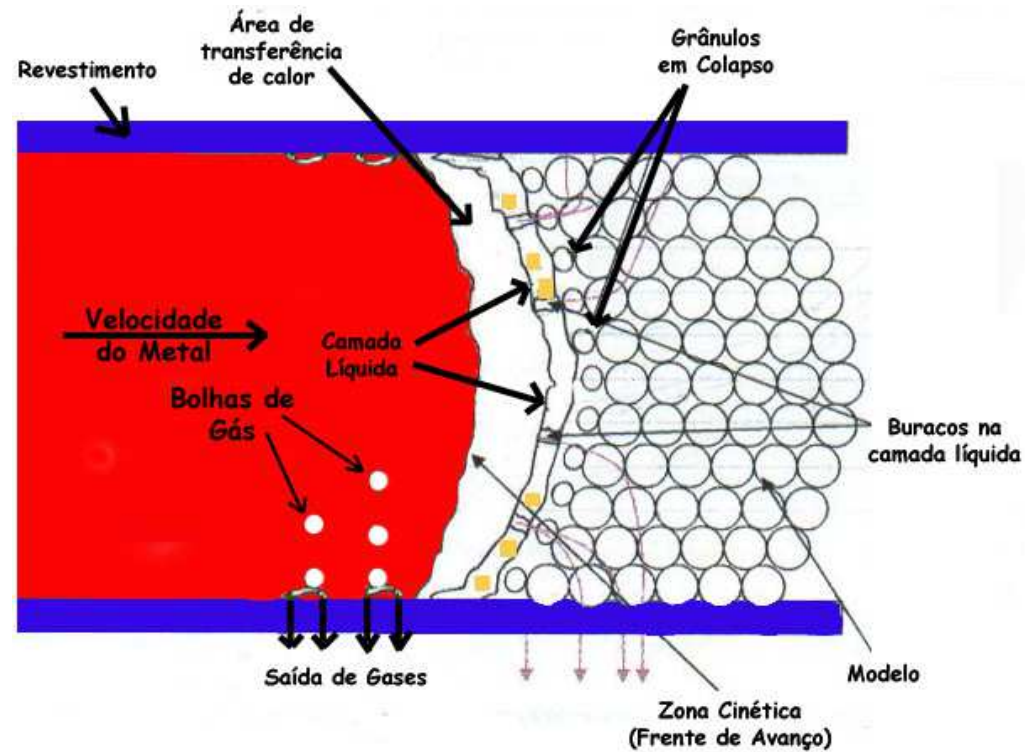

Molde cheio (lost-foam)

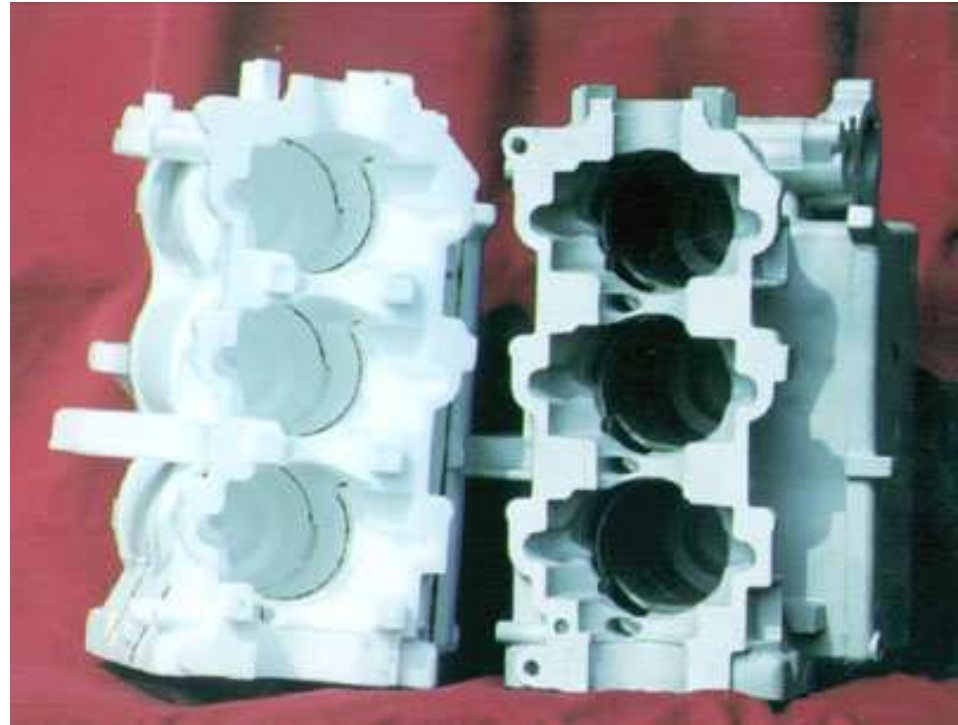
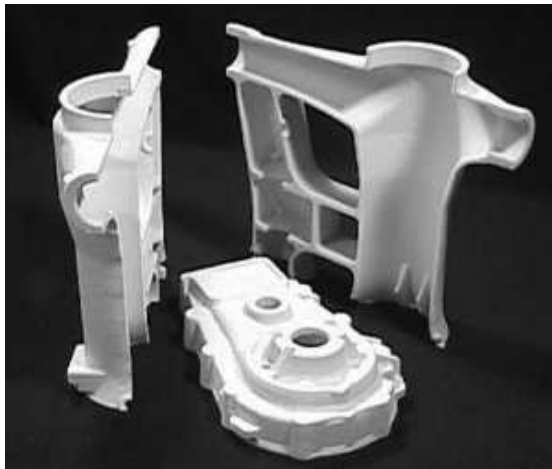

Molde Cerâmico



Refractory

Consists of a variety of specially blended groups of refractory powders.

Step 1

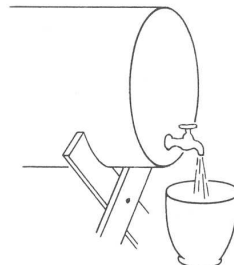

Binder

The liquid medium is usually based on ethyl silicate and is specifically produced to proprietary formulations.

Step 2

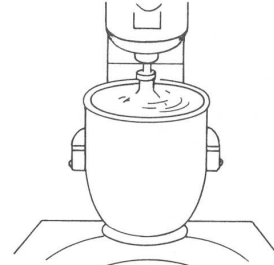

Mixing

A small percentage of gelling agent is added to the binder and mixed with the refractory powder to produce a creamy slurry.

Step 3

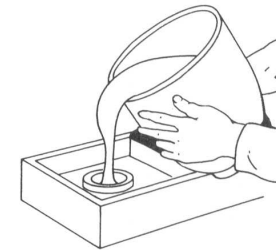

Pattern

The slurry is poured over a pattern made of wood, metal, plaster, plastic, and so on. It is then allowed to gel in about 2 to 3 min.

Step 4

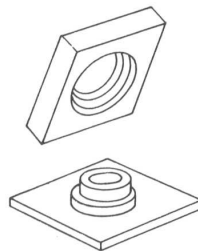

Stripping

The gelled refractory mass is stripped from the pattern by hand or with a mechanical stripping mechanism.

Step 5

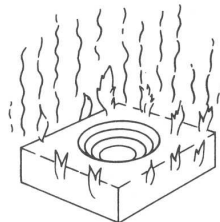

Burn-off

The mold is ignited. It burns until all volatiles are consumed; this sets up the microcrazed structure.

Step 6

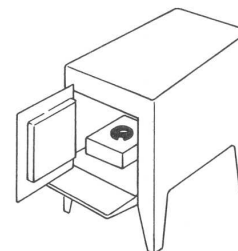

Baking

The Shaw mold, now immune to thermal shock, is placed in a high-temperature oven or skin heated with a torch until all traces of moisture are driven off.

Step 7

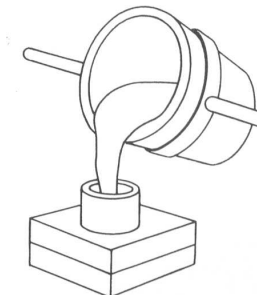

Pouring

Cope and drag mold pieces are assembled, along with any necessary cores, and the casting is poured.

Step 8

Fig. 1 Sequence of operations used in the Shaw all-ceramic mold process

Cera perdida (Fundição de Precisão)

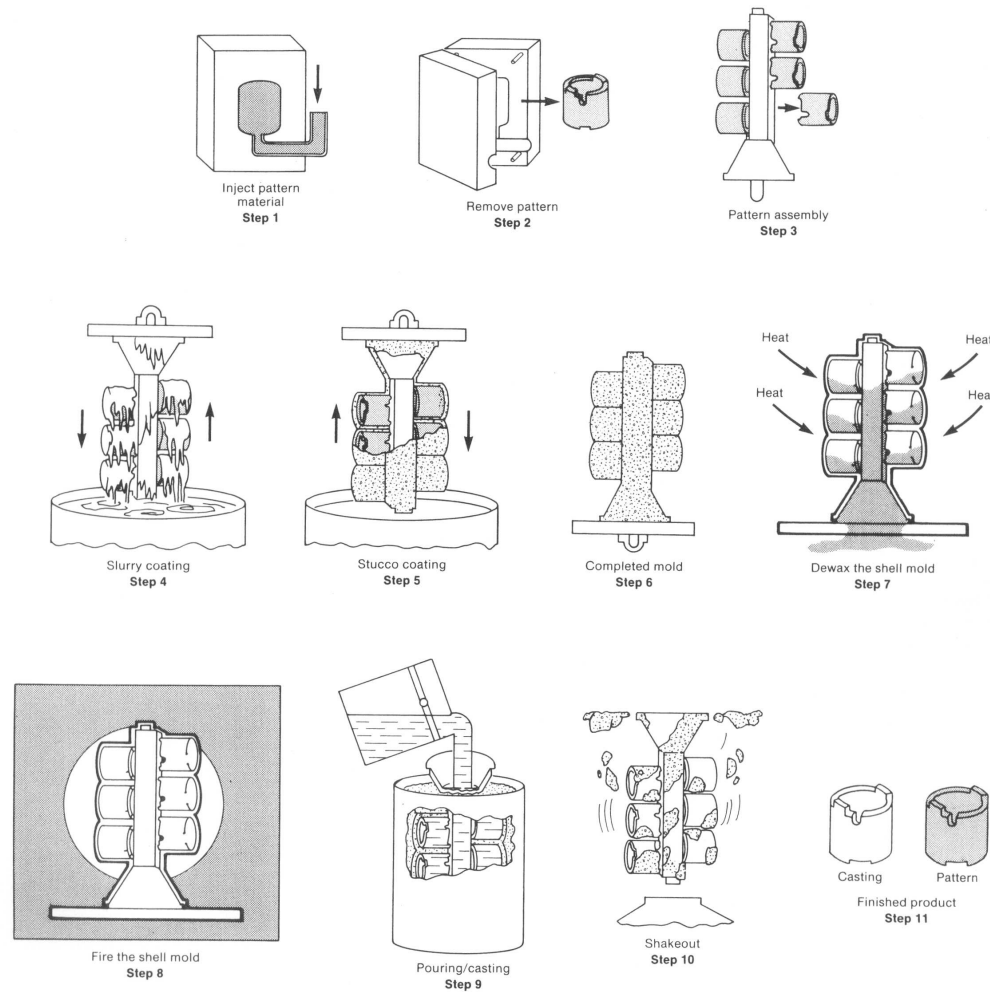

Fig. 3 Basic steps involved in investment casting



Cera Perdida (filme)

- Parte 1
- Parte 2
- Parte 3
- Parte 4
- Parte 5
- Parte 6

Exemplo: Cera perdida

Palheta de Turbina (Solid. Direcional)

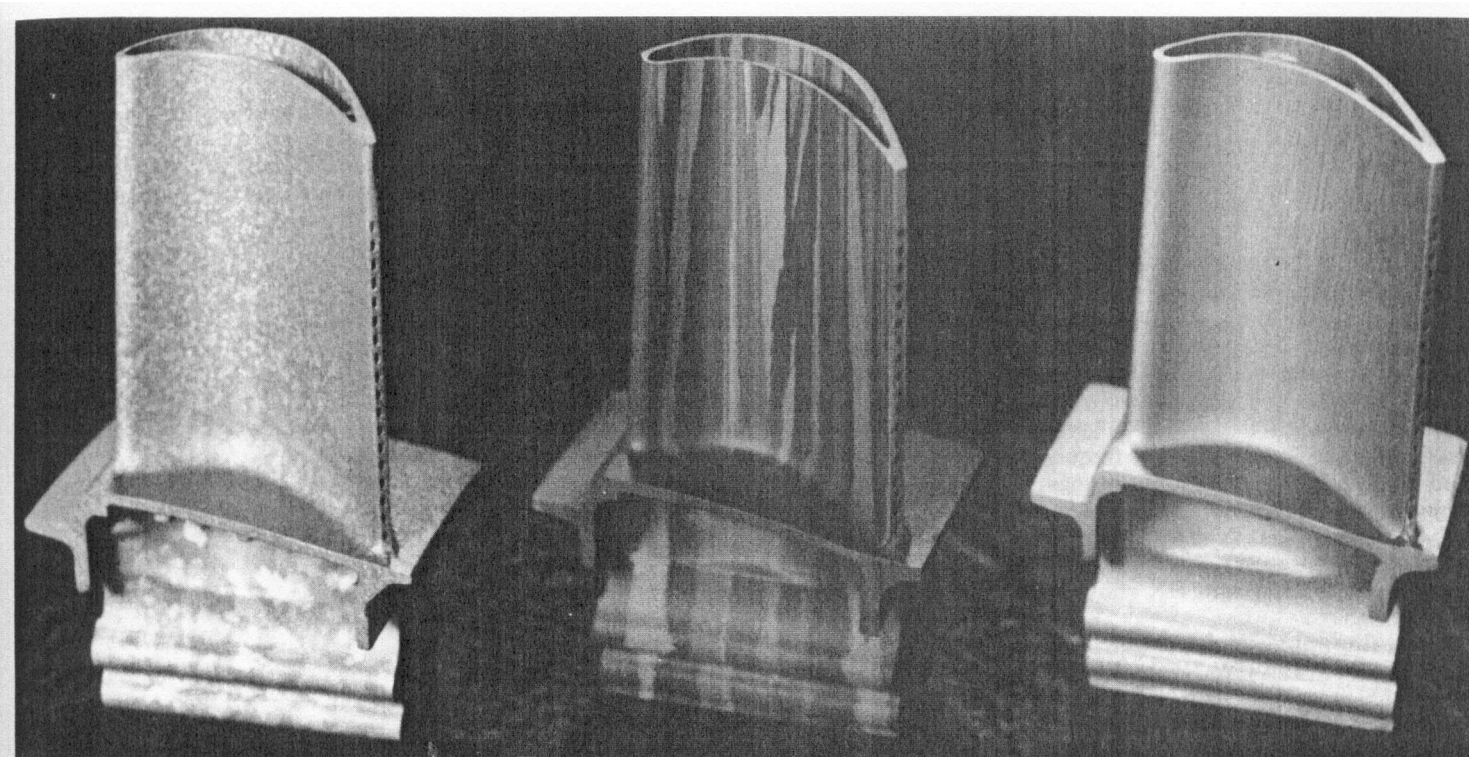
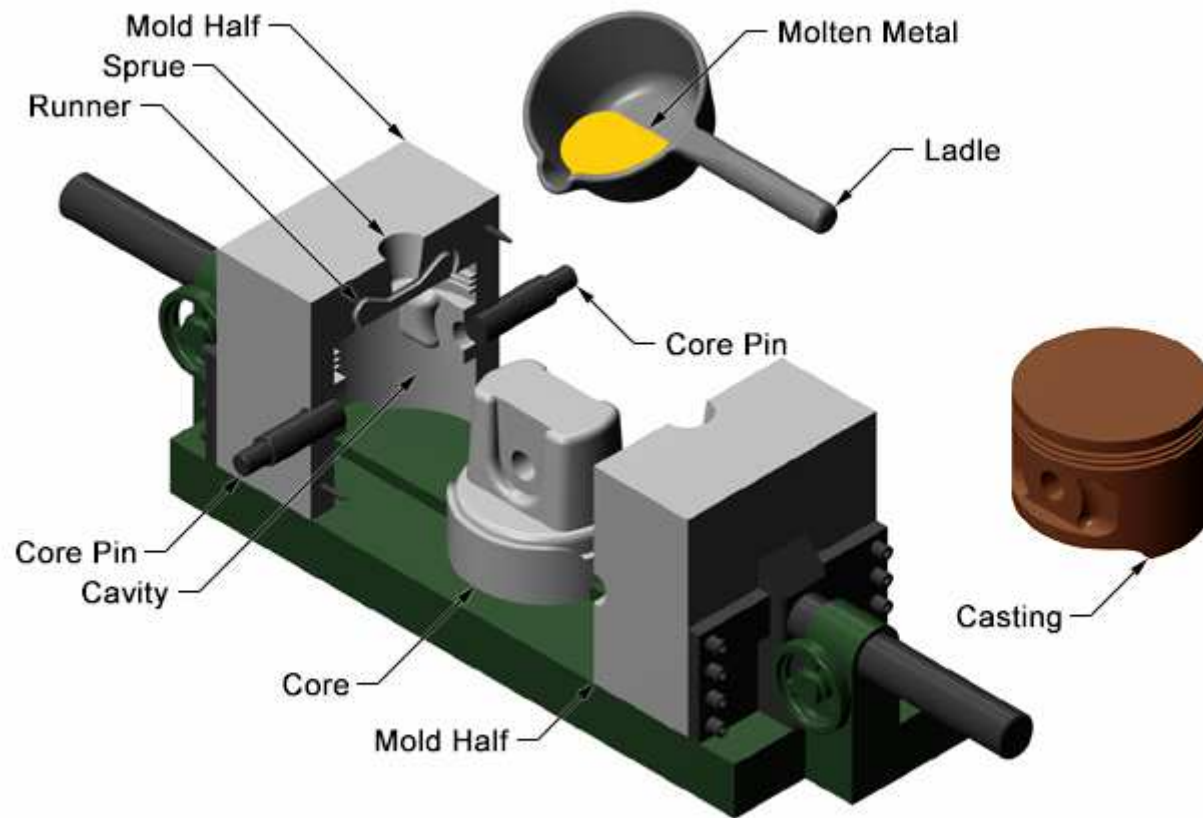

Fig. 1 Comparison of equiaxed (left), directionally solidified (center), and single-crystal (right) nickel-base alloy turbine blades for an aircraft engine. Courtesy of Howmet Corporation, Whitehall Casting Division

Fundição em coquilha por gravidade



Fundição sob pressão

Fig. 6.19 Ciclo de operação de um equipamento de fundição de câmara fria horizontal em matriz.

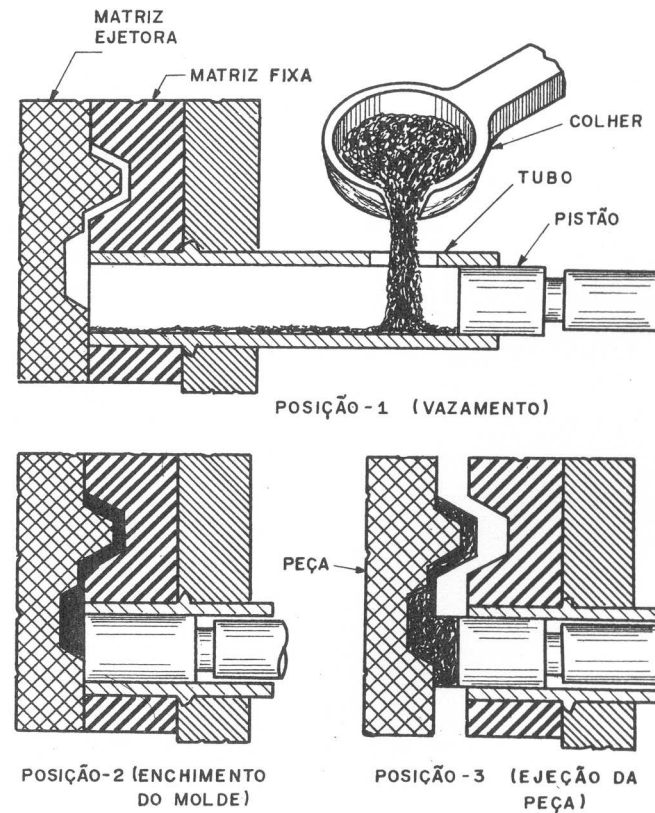

Fundição sob pressão

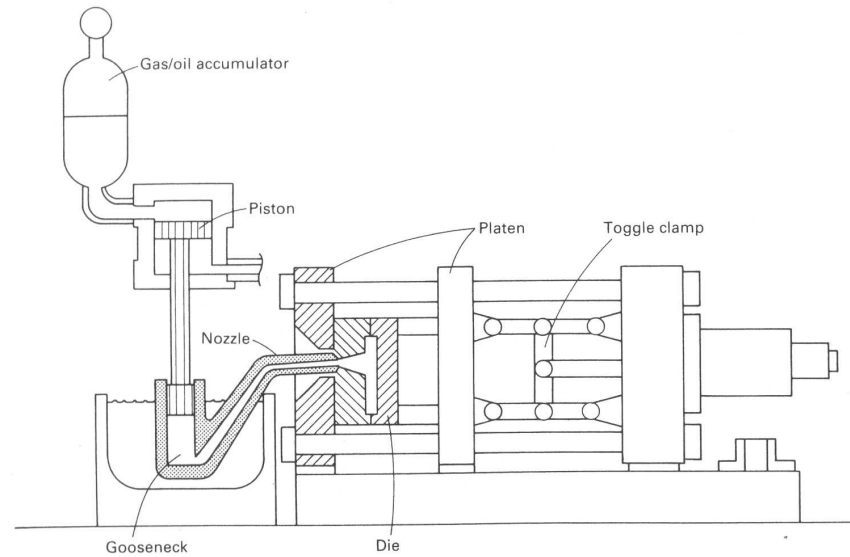

Fig. 1 Schematic showing the principal components of a hot chamber die casting machine

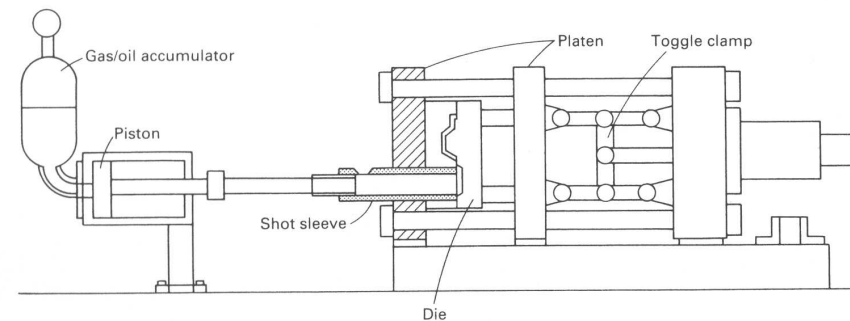

Fig. 2 Schematic showing the principal components of a cold chamber die casting machine



Fundição sob pressão (filmes)

Link Filme 1

Link Filme 2

Fundição Centrífuga horizontal

6.10 Fundição Centrífuga

A fundição centrífuga envolve a solidificação de metal num molde rotativo. Sua maior aplicação é em moldes horizontais, que giram ao redor do seu eixo de simetria. O

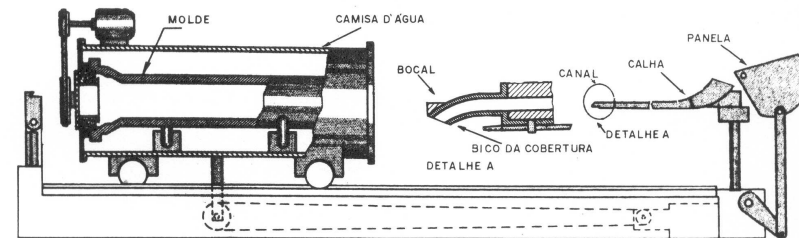

EQUIPAMENTO DE FUNDIÇÃO CENTRÍFUGA

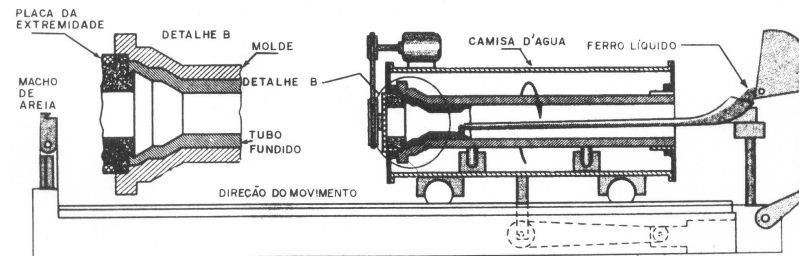

EQUIPAMENTO EM OPERAÇÃO

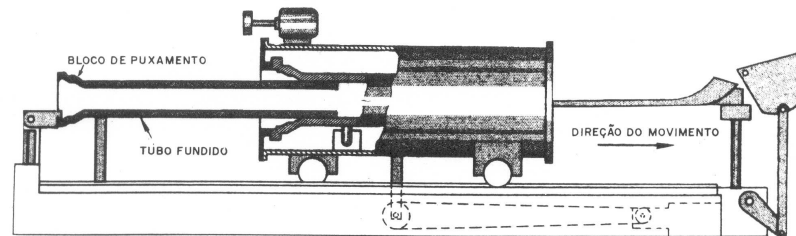

EQUIPAMENTO DURANTE A DESMOLDAGEM

Fig. 6.21 Fundição centrífuga de um tubo de ferro fundido.

Fundição centrífuga vertical

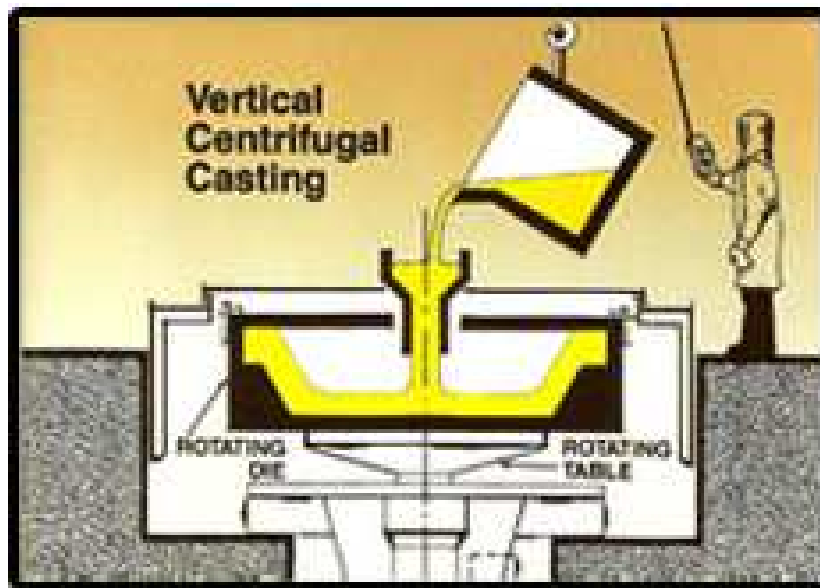

Um sólido de revolução

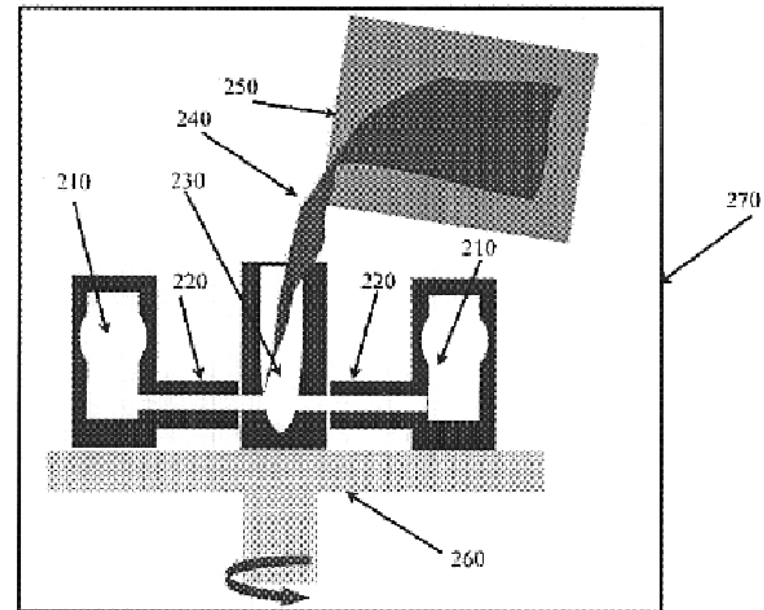

Várias peças

Lingotamento Contínuo

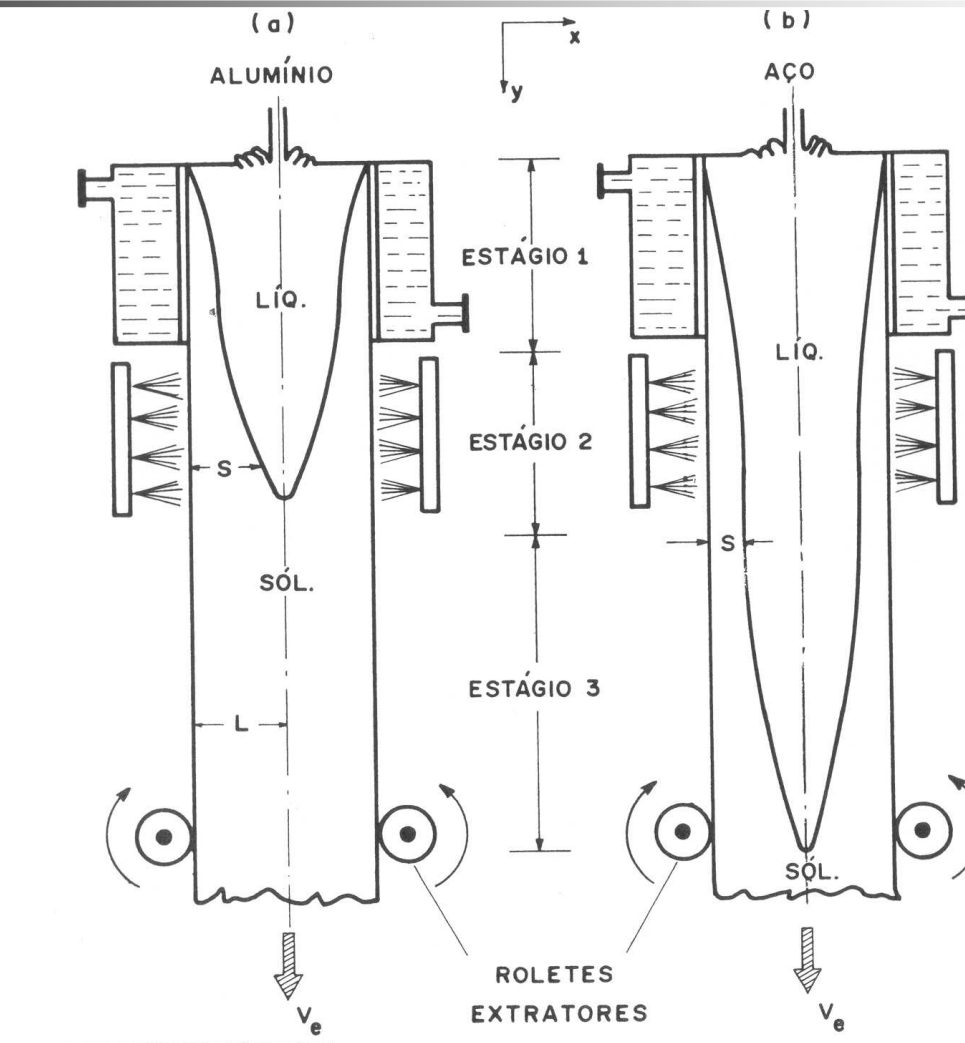



Lingotamento Contínuo (filme)

Link

Reofundição / Tixofundição



Reofundição / Tixofundição

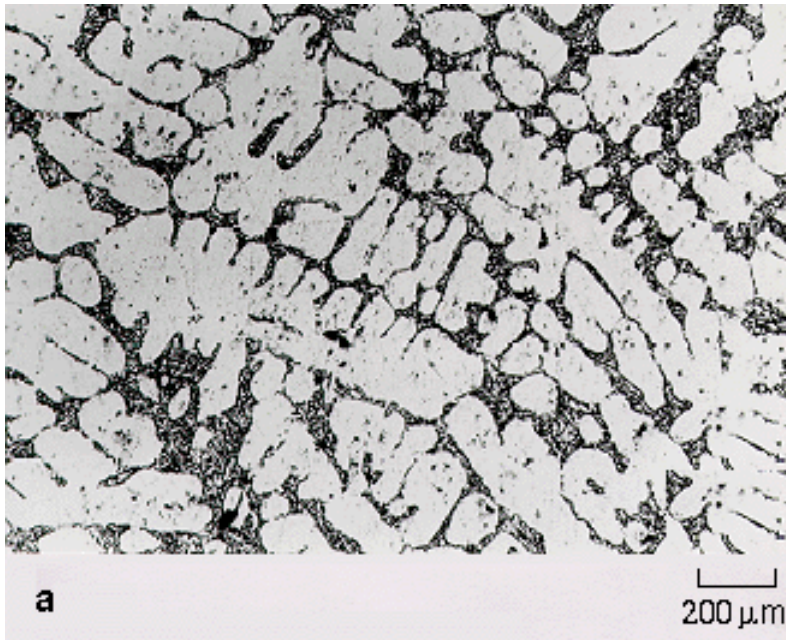

Solidificação Normal

Após agitação

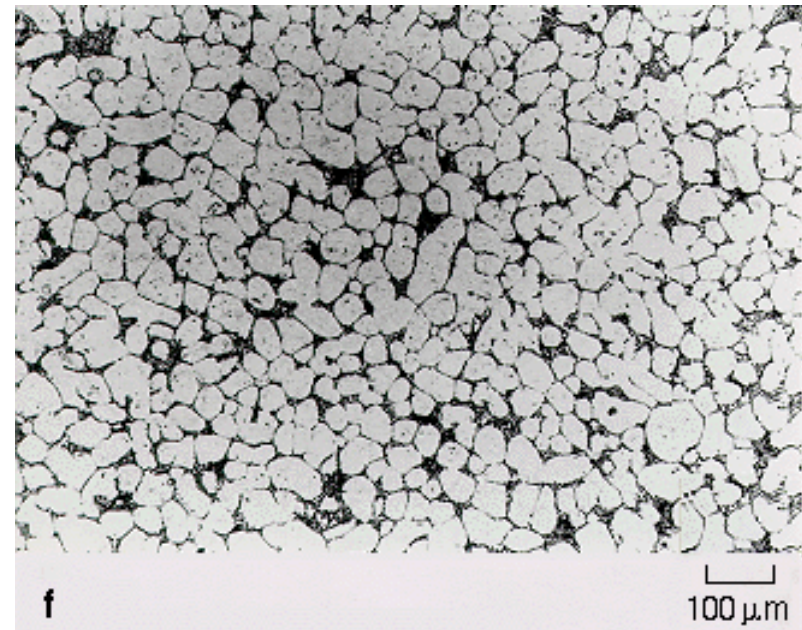

Reofundição / Tixofundição



Reofundição / Tixofundição

Usual



a

Reofundição

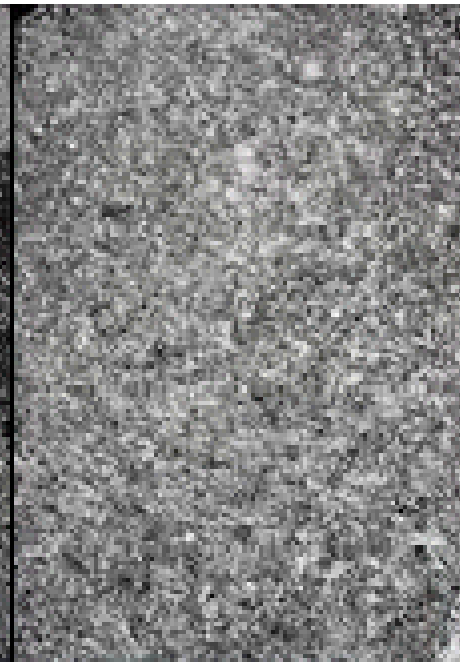

b



Reofundição / Tixofundição

Filme



Bibliografia

- KIMINAMI, Claudio S.; CASTRO, Walman B. e OLIVEIRA, Marcelo F. Introdução aos processos de fabricação de produtos metálicos, Blucher, São Paulo, 2013.
- KALPAKJIAN, Serope e SCHMID, Steven. Manufacturing processes for engineering materials, 5a ed., Pearson Education, New Jersey, 2007.
- CHIAVERINI, Vicente. Tecnologia Mecânica, 2ª ed., McGraw-Hill, São Paulo, 1986. GARCIA, Amauri, Solidificação – fundamentos e aplicações, UNICAMP, 2a ed., 2007
- CAMPOS FILHO, Mauricio Prates de e DAVIES, Graeme John. Solidificação e fundição de metais e suas ligas, Rio de Janeiro: Livros Técnicos e Científicos, 1978.
- CAMPBELL, John. Castings, 2ª ed., Elsevier Butterworth-Heinemann, 2003.
- American Society for Metals. ASM Handbook Committee. Metals Handbook (Casting), 9a ed., vol. 15, Ohio, 1988.
- ASM International. ASM Handbooks Online, <http://http://products.asminternational.org/hbk/index.jsp>