

Universidade de São Paulo – USP
Faculdade de Zootecnia e Engenharia de
Alimentos - FZEA

PROJEÇÕES

Prof. Celso Oliveira
Prof. Dr. Juliano Fiorelli

2022

projeções

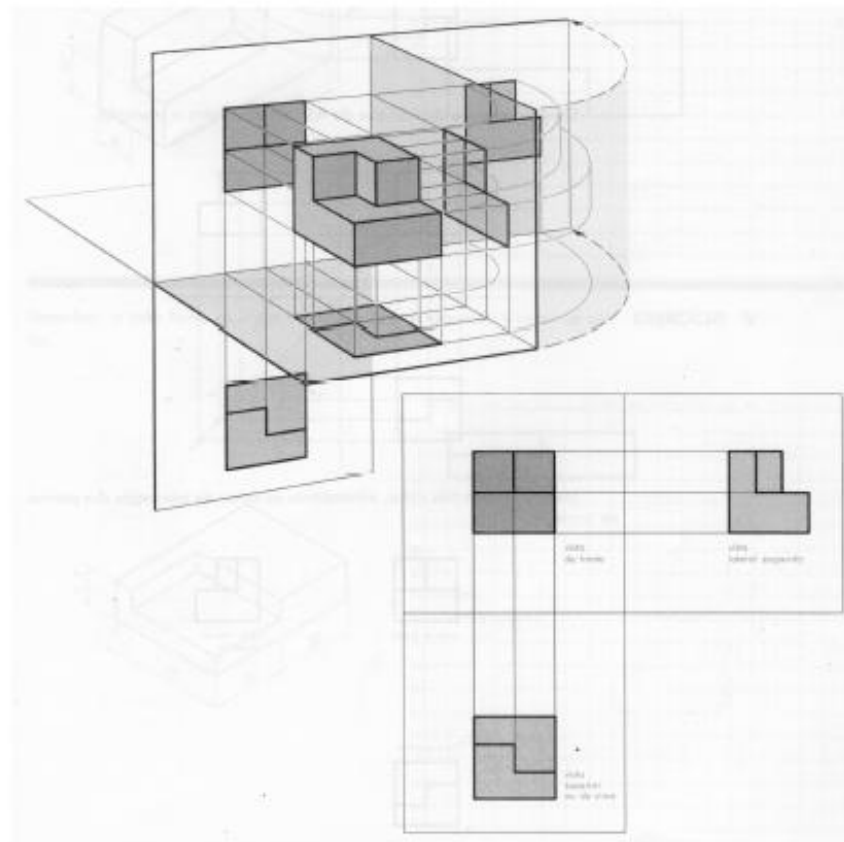
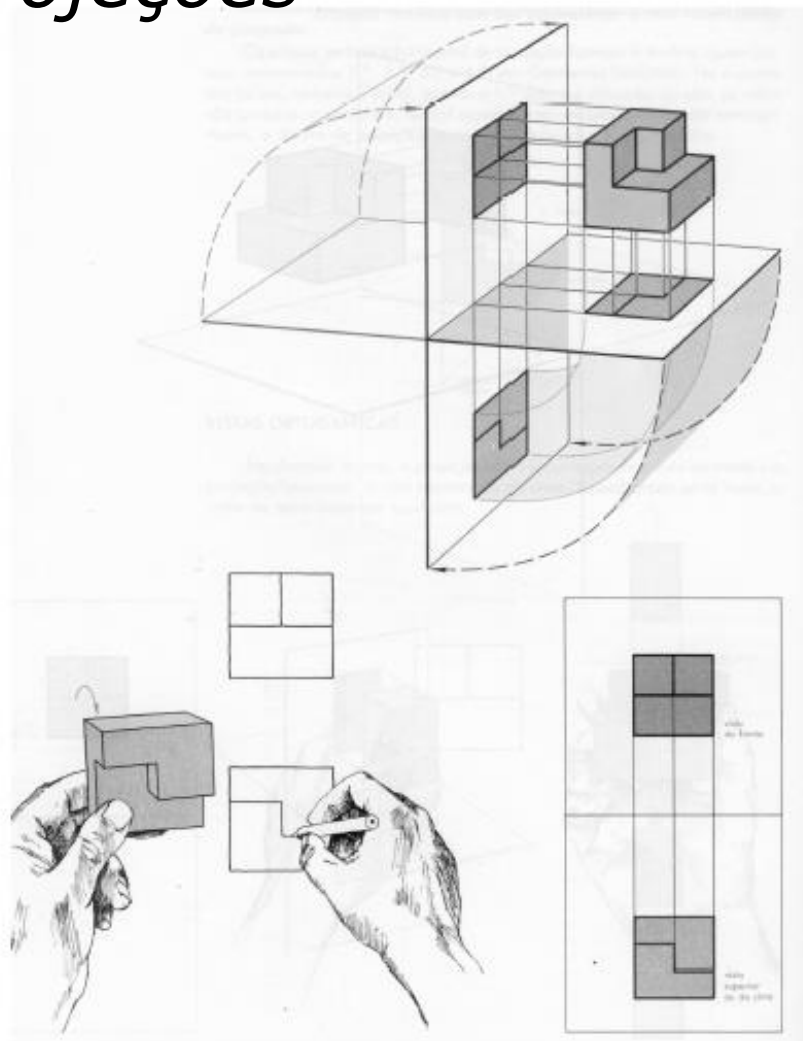

aldper70 ,71

Desenho Técnico
MEC Fename, p.70 e 71



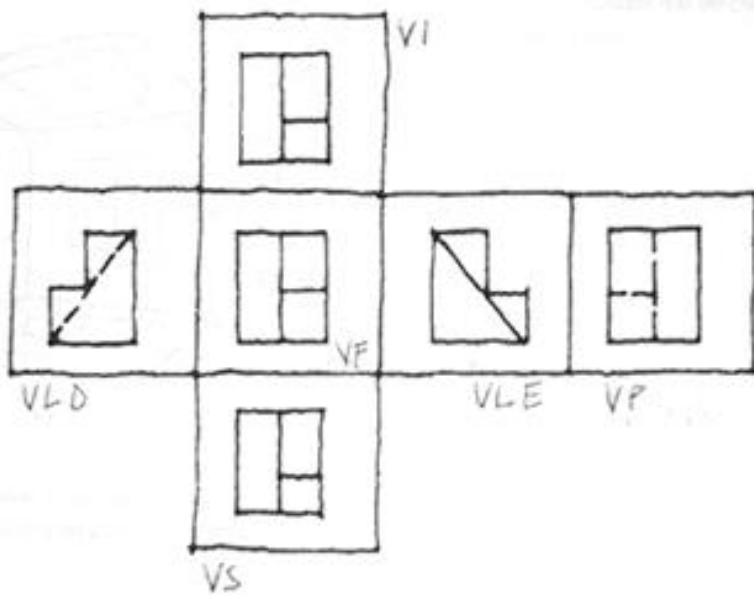
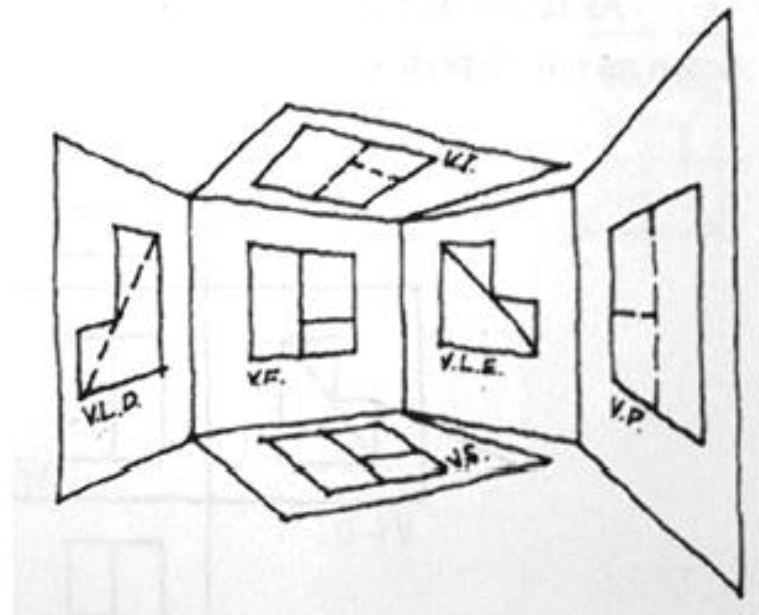
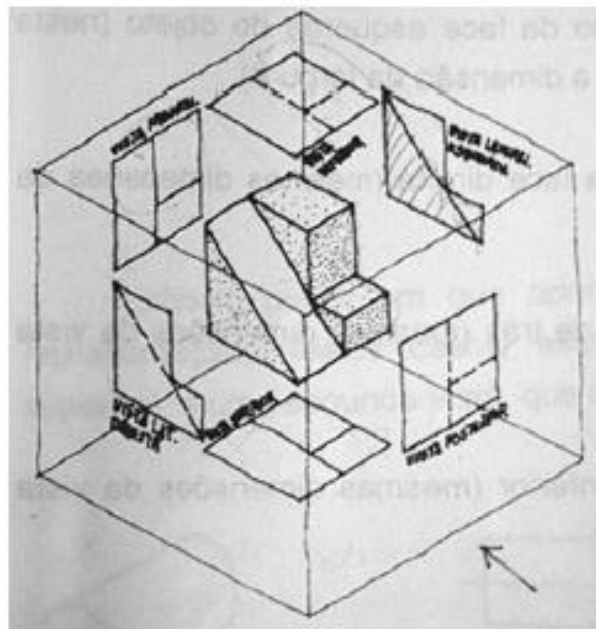

ang-1, -2, -3







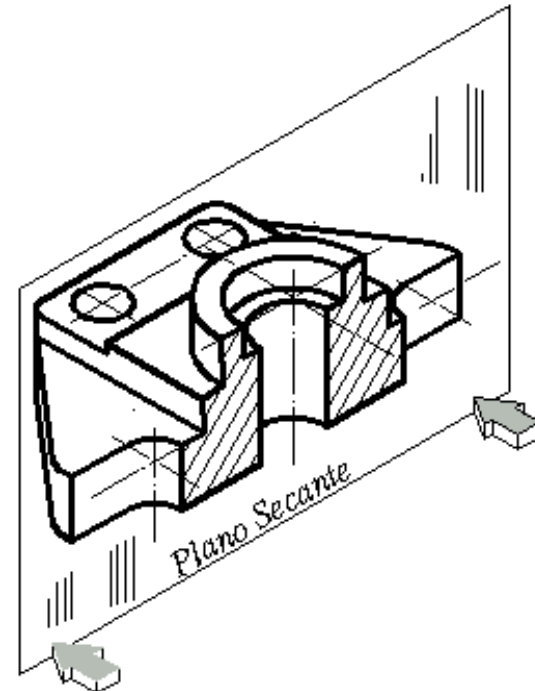
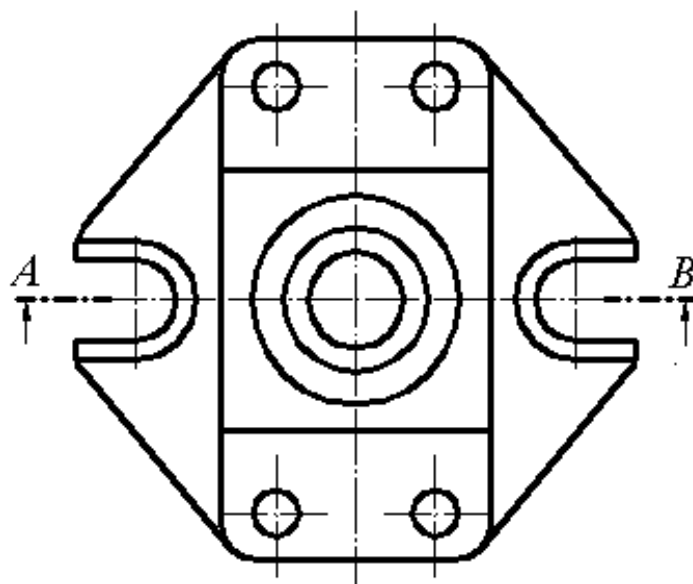
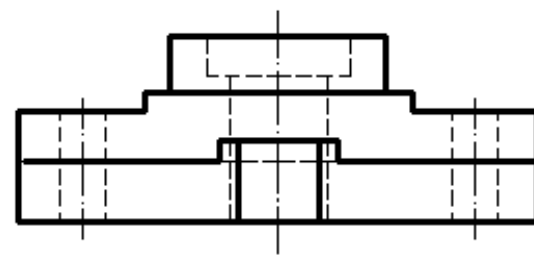
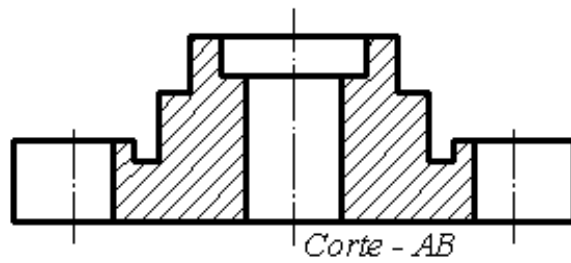



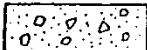
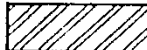
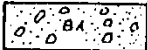
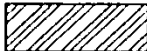

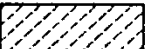

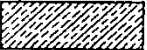

Desenho Técnico, apostila, EESC, 1996

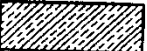
Maria Angela Bortolucci e Myrian V. P. Cortesi

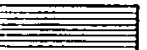
cortes

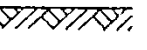
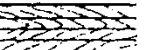
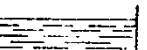

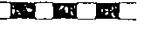
hachuras

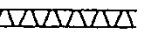
Metais em geral		Cinzentos	Betão		Cinzentos
Ferro fundido Ferro maleável		Azul	Betão armado		Cinzentos
Ferro forjado Aço		Lilás	Pedra natural		Cinzentos
Aço inoxidável		Lilás	Pedra artificial em blocos		Cinzentos
Cobre e suas ligas		Alaranjado	Elementos cerâmicos resistentes		Vermelho-de- -venera
Estanho, chumbo e zinco		Verde claro	Elementos cerâmicos de enchimento ou de revestimento		Vermelho-de- -venera
Alumínio, magnésio e suas ligas		Verde	Rebocos e argamassas		Branco sujo
Metal branco (Liga antifricção)		Lilás claro	Fibrocimento, gesso e outros materiais minerais em blocos ou placas		Cinzentos claros
Fibras, cortiça, couro, feltro e materiais similares		Sépia	Vidro		Verde claro
Madeira		Alaranjado	Terreno		Sépia
Contraplacado		Alaranjado	Líquido		Azul claro
Aglomerados de madeira		Alaranjado	Isolamento hidrófugo		—
Plásticos, borracha e betuminosos		Verde claro	Isolamentos acústico e térmico		—

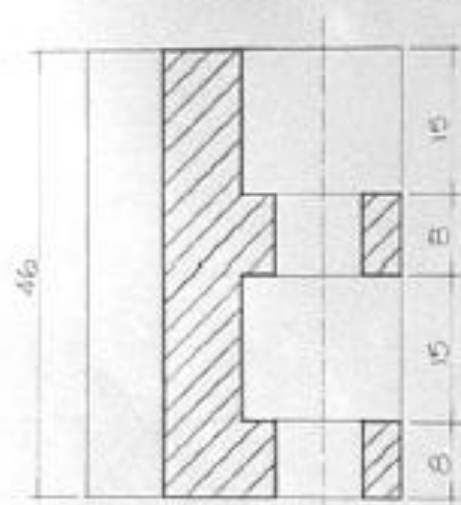

CORTE AA

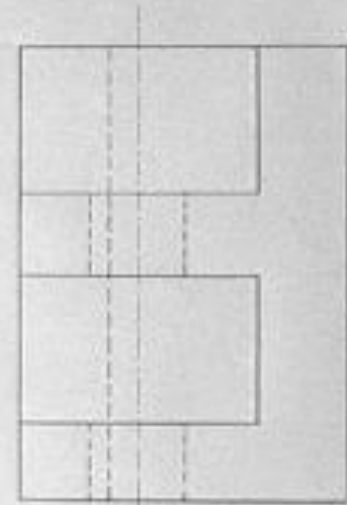

VISTA FRONTAL

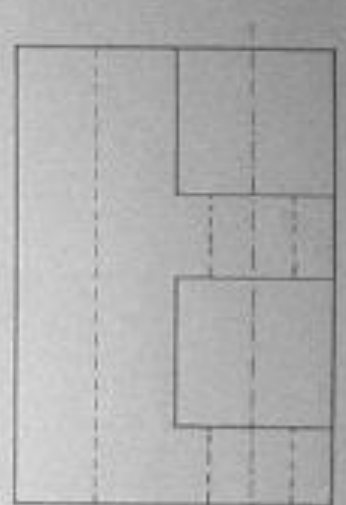

VISTA LATERAL ESQUERDA

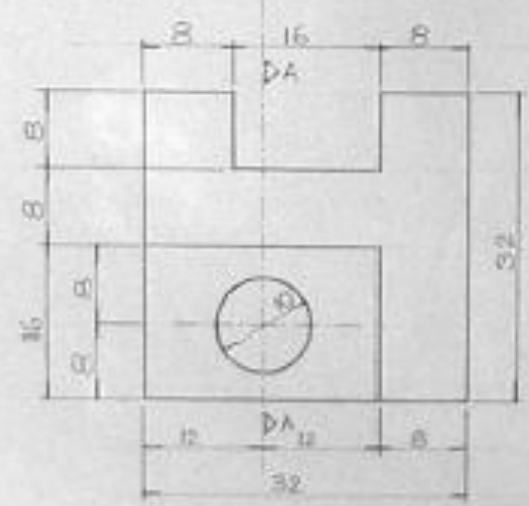

VISTA SUPERIOR

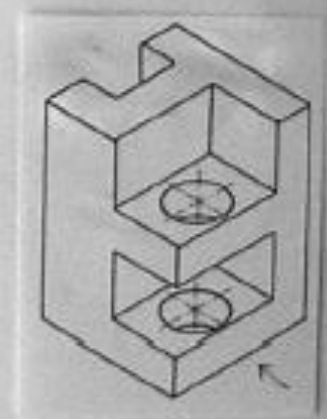

CORTES E COTAS	5	LAP 105
		1 50
ALECIA PIMENTA JUN/24	1052	01/2024

ESPECIFICAÇÕES TECNICAS
FABRICANTE: PETROBRAS INDUSTRIAL S.A.
TIPO DE PRODUTO: CELULAR M202
SERIE: S.F.V - 1245 W. LIND
PLANTA PRODUÇÃO: - DO BRASIL

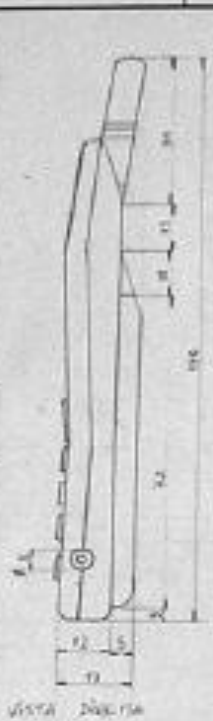

VISTA LATERAL



VISTA FRONTAL



VISTA LATERAL



VISTA TRASEIRA

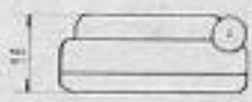

VISTA SUPERIOR



ISOMÉTRICA

PROJETO	15	SIN. P. 11
DESENHO		11
PROJ. VEIC. P. 11	11	11/11/11

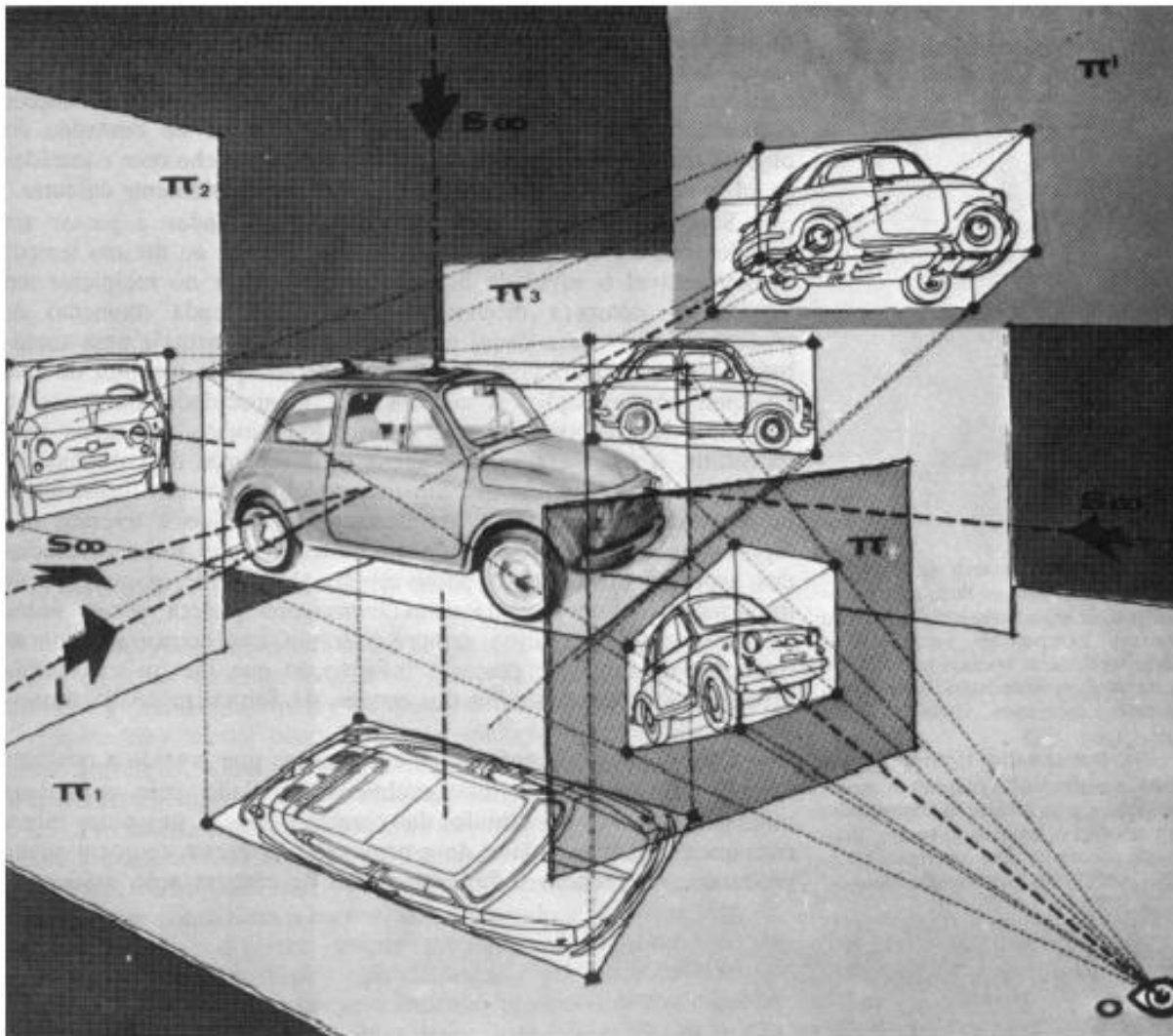

mass-087
Geometria Projetiva
Ver pelo Desenho, Massironi, p.87

Desenho de Arquitetura
SAP 620 / CAU EESC USP
Heverson Akira Tamashiro

