



Universidade de São Paulo
Instituto de Química



L4 - Determinação da concentração micelar crítica por **Tensiometria e Condutometria**

Prof. Vitor Leite Martins

martinsv@usp.br

QFL1444 - 2023



Interface entre duas fases

Interface entre duas fases

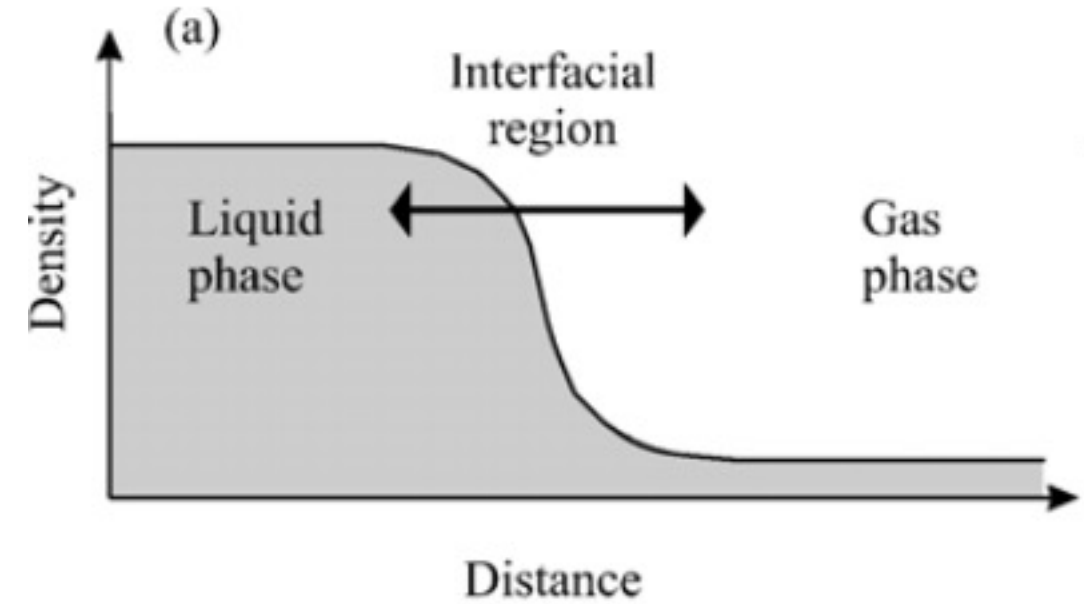

Butt, Graf, Kappl. Physics and Chemistry of Interfaces. 2003, Wiley-VCH

Interface entre duas fases

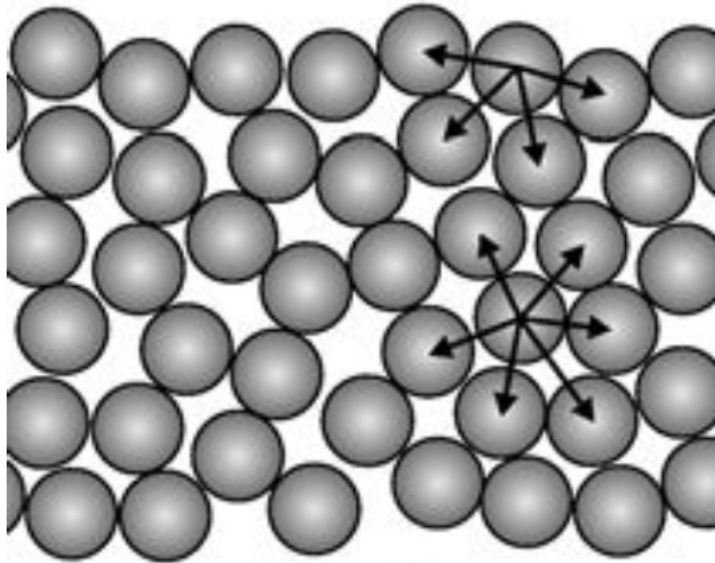
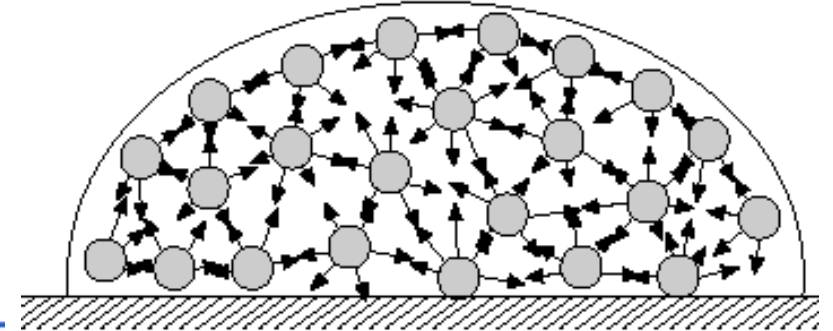
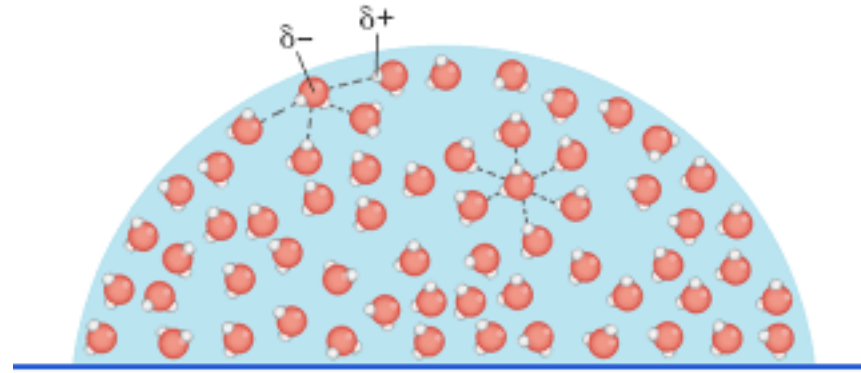
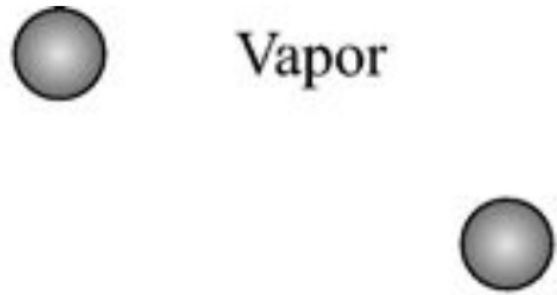

Liquid

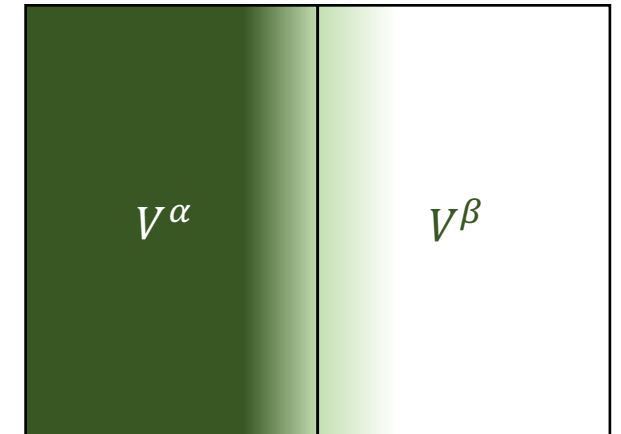
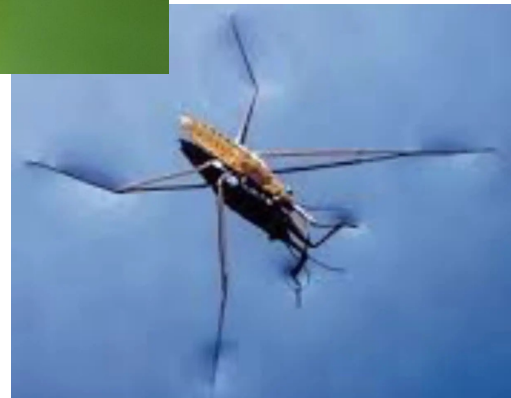

Interface de área σ

Definição de Tensão Superficial, γ

Energia livre de Gibbs $G = H - TS$

$$G(p, T) \quad dG = Vdp - SdT$$

$$\left(\frac{\partial G}{\partial p}\right)_T = V \quad \left(\frac{\partial G}{\partial T}\right)_p = -S$$

$$G(p, T, n_A) \quad dG = Vdp - SdT + \mu_a dn_a$$
$$\left(\frac{\partial G}{\partial n_A}\right)_{p,T}$$

$$G(p, T, n_A, \sigma) \quad dG = Vdp - SdT + \mu_a dn_a + \gamma d\sigma$$

$$\left(\frac{\partial G}{\partial \sigma}\right)_{p,T,n_A}$$

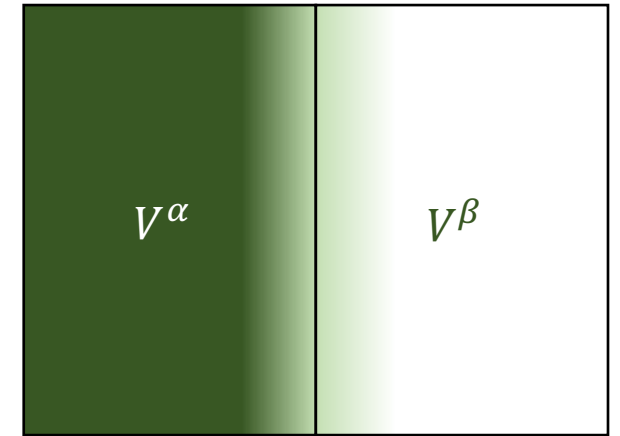

Interface de área σ

Definição de Tensão Superficial, γ

$$dG = Vdp - SdT + \mu_a dn_a + \gamma d\sigma$$

Trabalho máximo sem expansão: $dG = dw_{add,rev}$

$$dw = \gamma d\sigma$$

Trabalho para aumentar a área

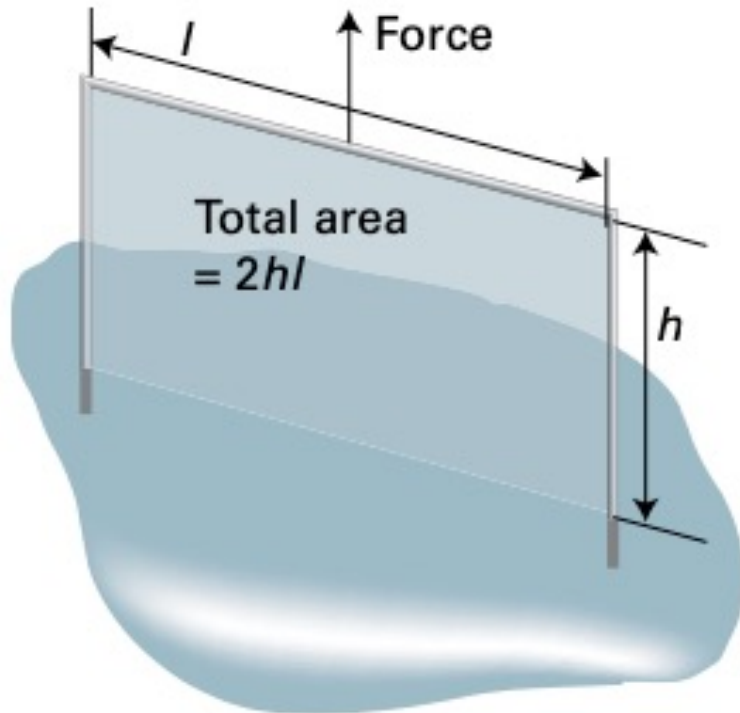

$$Nm = Nm^{-1} m^2$$

unidade SI

Também comum:

$$\frac{dyn}{cm} = \frac{10^{-3} N}{m} = \frac{mN}{m}$$

	$\gamma / (\text{mN m}^{-1})$
Benzene	28.88
Mercury	472
Methanol	22.6
Water	72.75

a 293 K

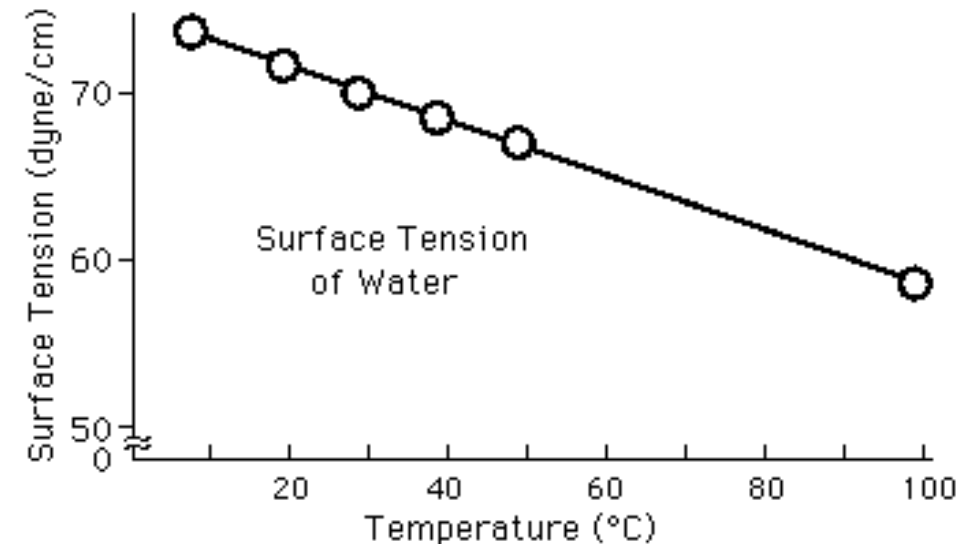

Medindo a tensão superficial

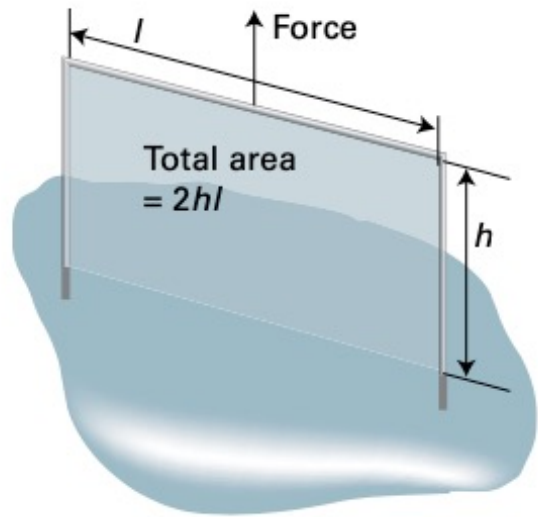

Atkins' Physical Chemistry 11th ed.

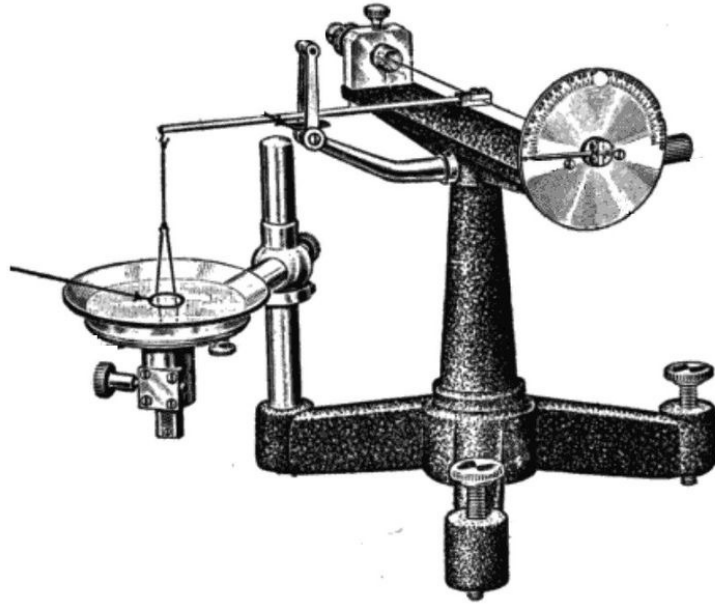

Tensiômetro de anel (du Noüy)

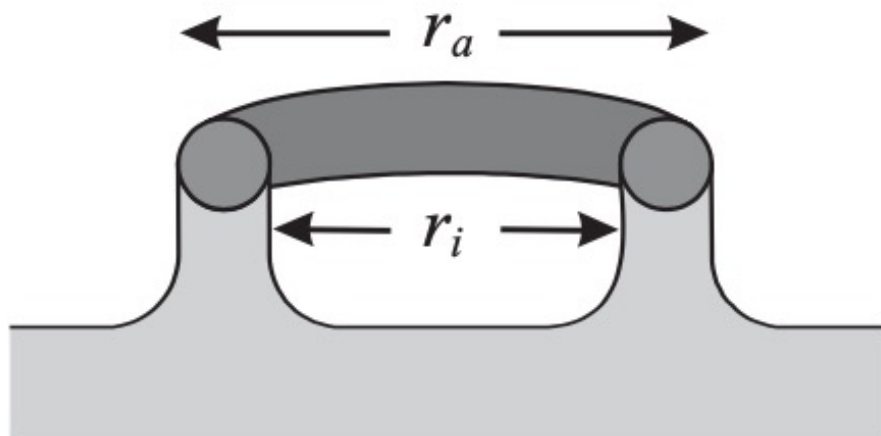

$$F = 2\pi(r_i + r_a)\gamma$$

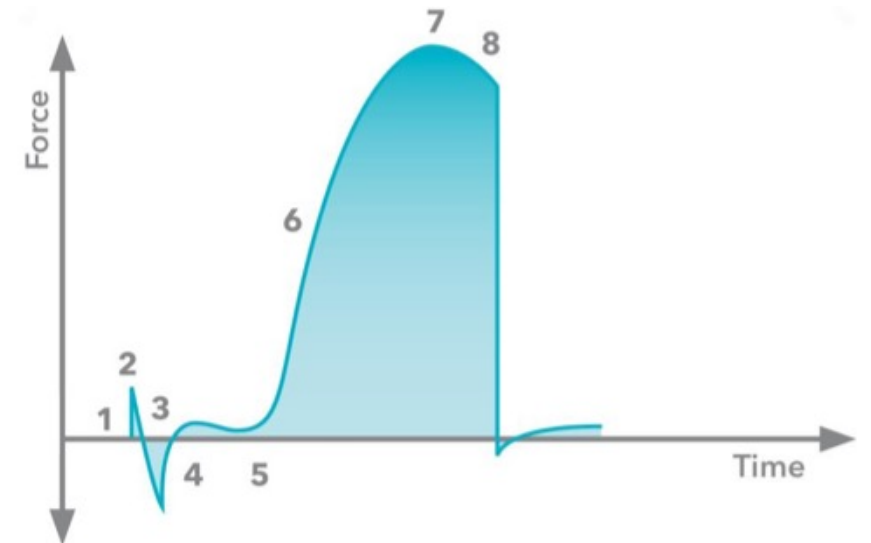
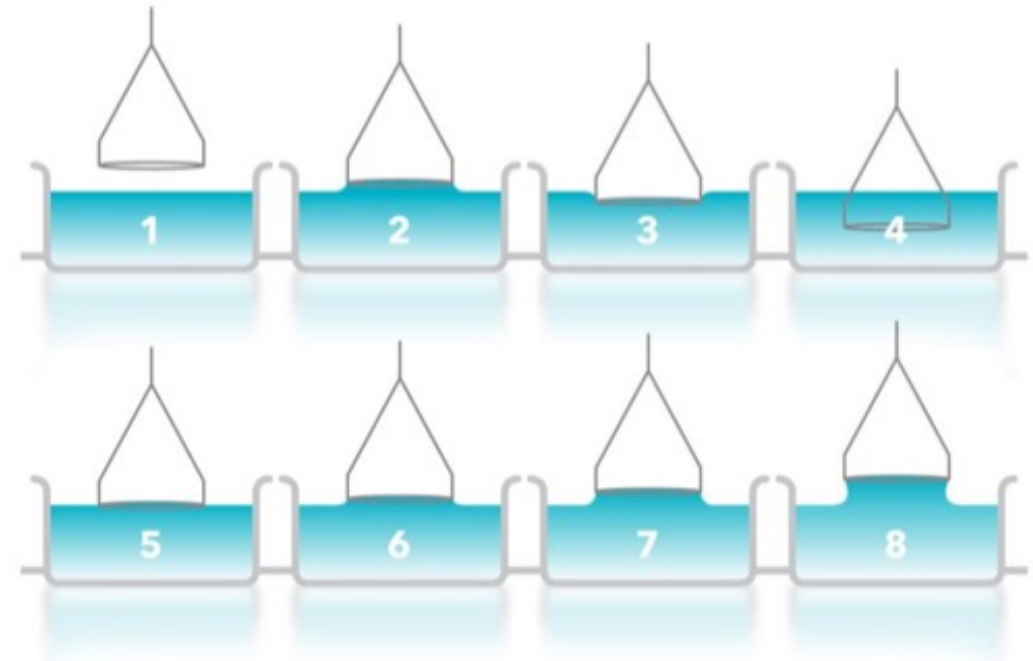

Medindo a tensão superficial

AN INTERFACIAL TENSIO METER FOR UNIVERSAL USE.

By P. LECOMTE DU NOÛY.

(From the Laboratories of The Rockefeller Institute for Medical Research.)

PLATE 5.

(Accepted for publication, April 6, 1925.)

J Gen Physiol (1925) 7 (5): 625–631.

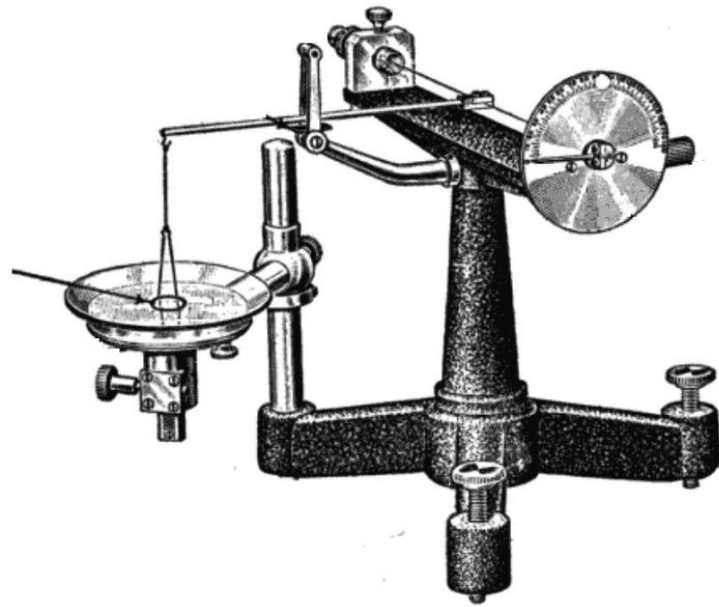

Tensiômetro de anel (du Noüy)

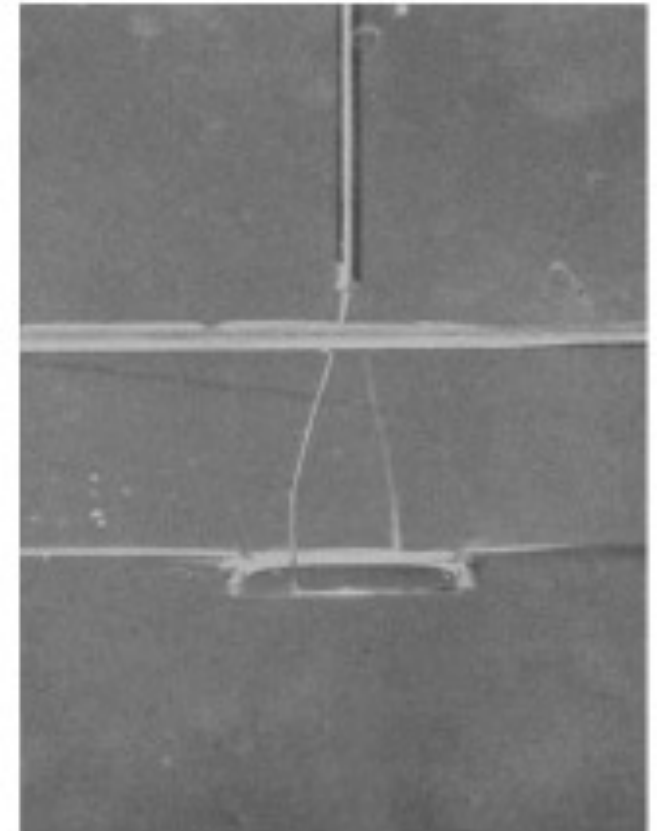
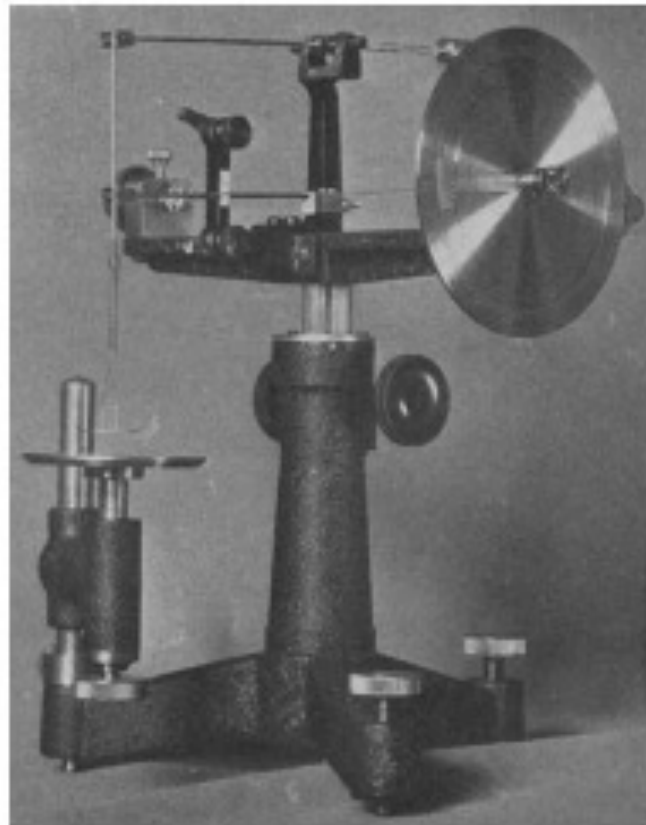

Medindo a tensão superficial

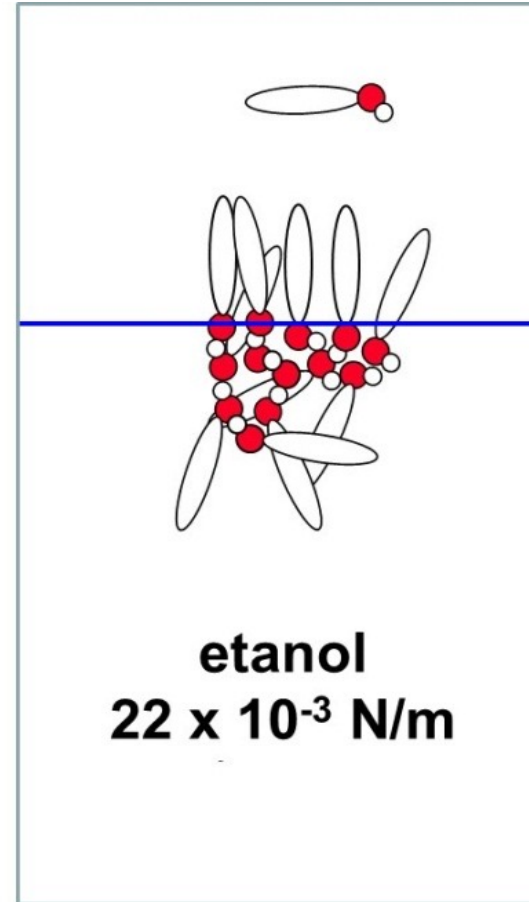
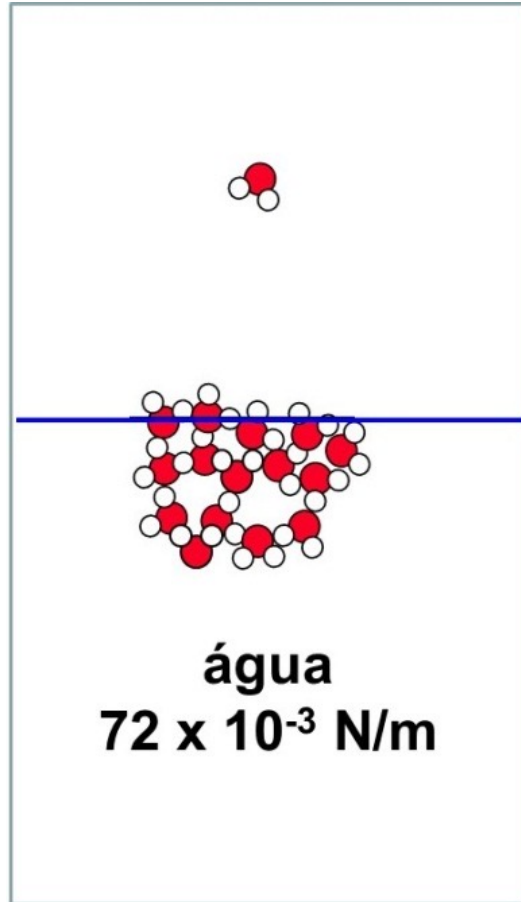

E soluções de surfactante!

Surfactantes

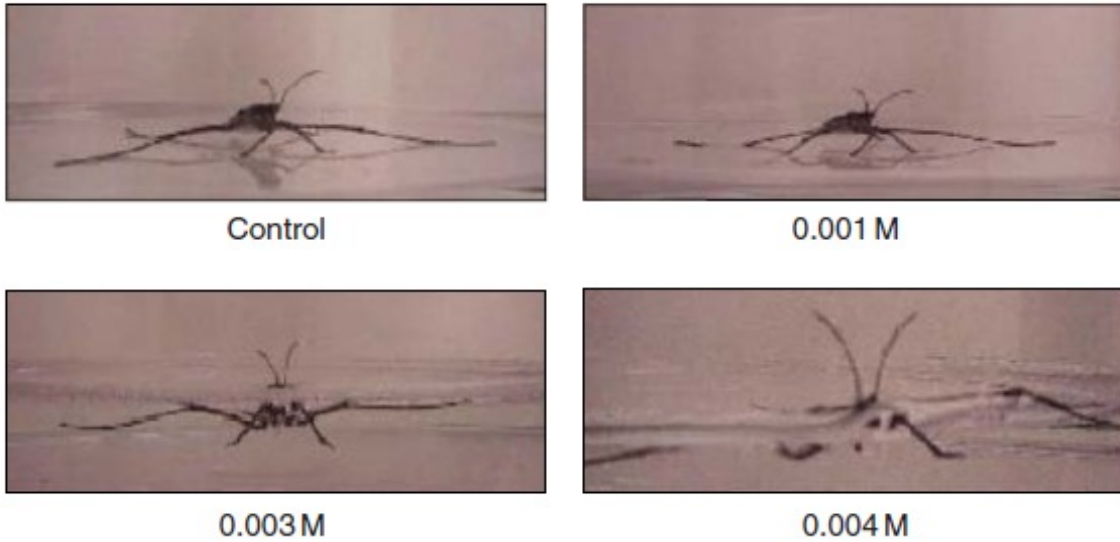

Inseto-jesus em soluções aquosas de SDS

Kontogeorgis & Kiil, *Introduction to Applied Colloid and Surface Chemistry*-
John Wiley & Sons (2016)

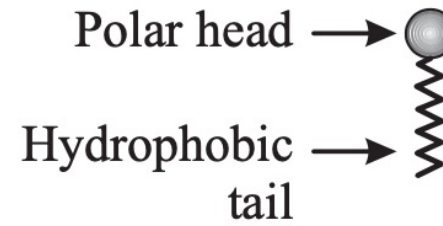
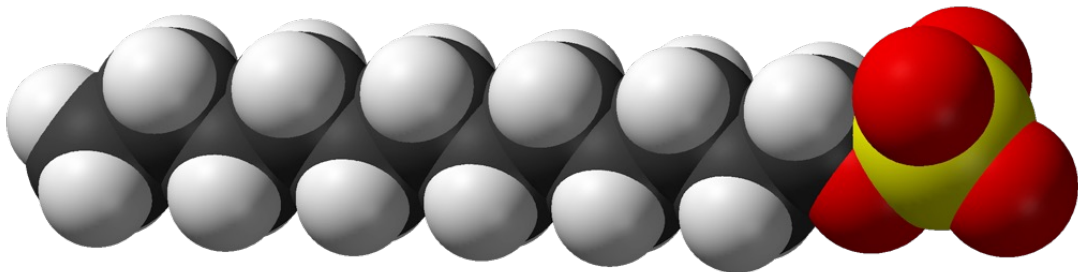
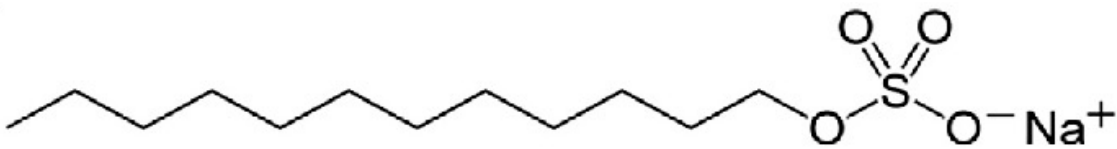

Interação com a água?
Depende da concentração!

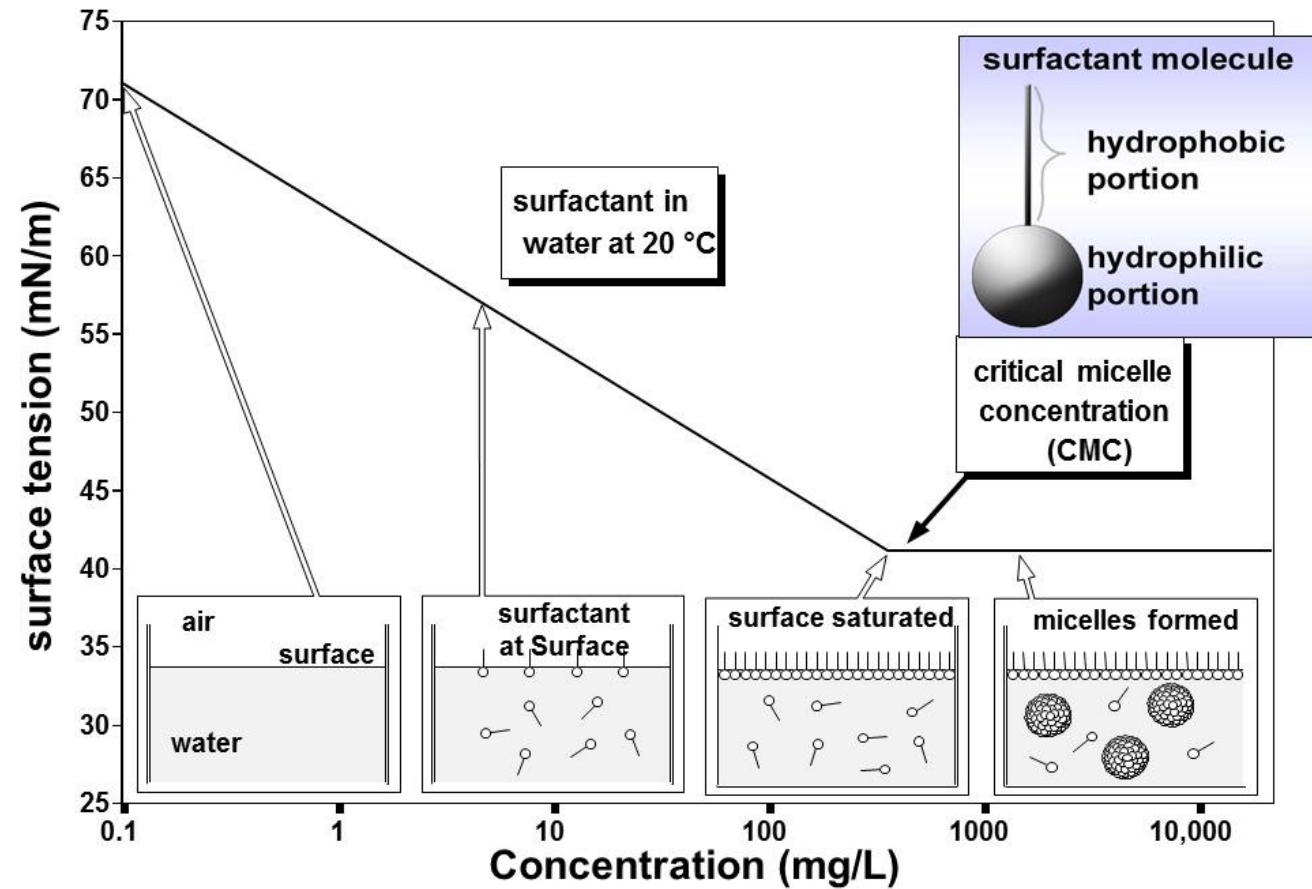

Micelas e CMC

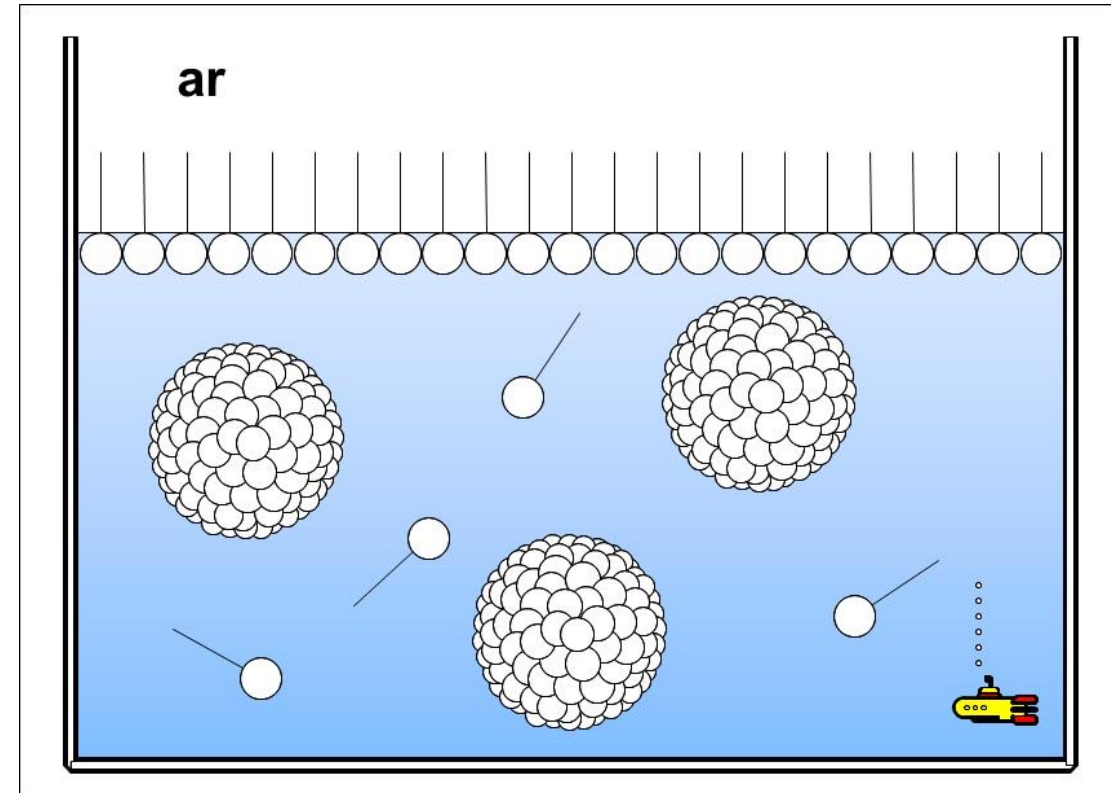
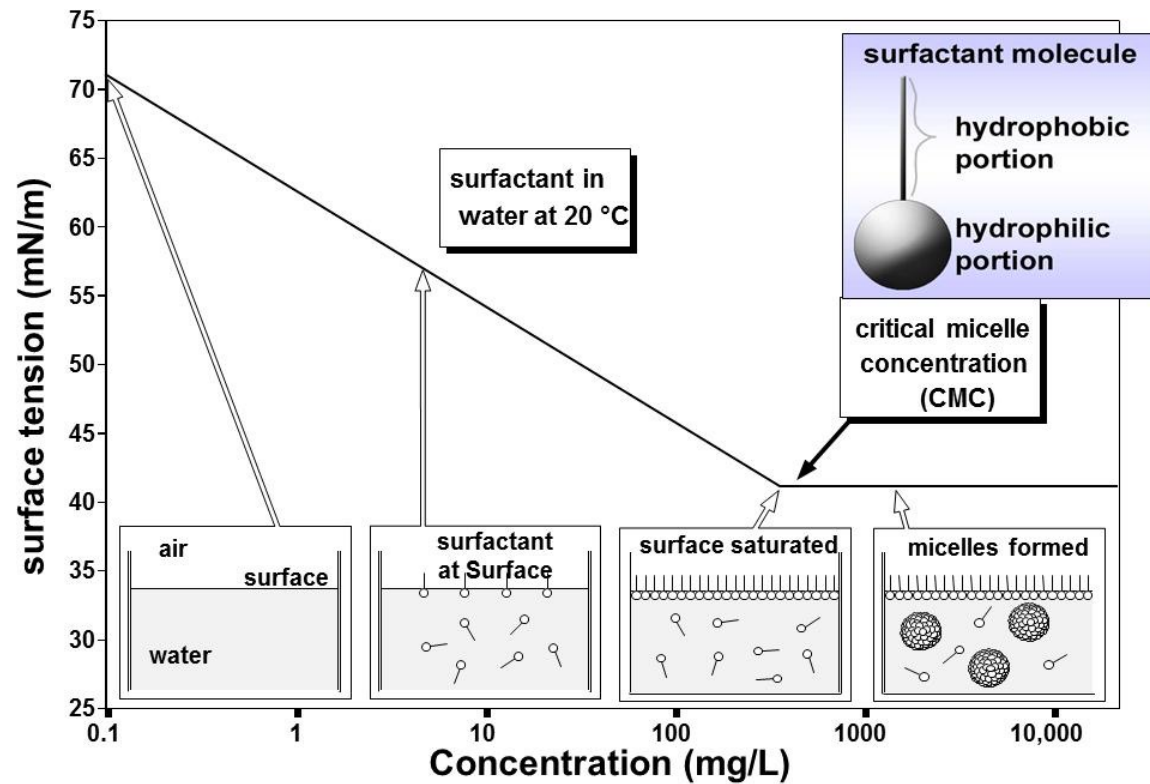

Tipos de Surfactantes

Aniônicos

Sodium alkylcarboxylate

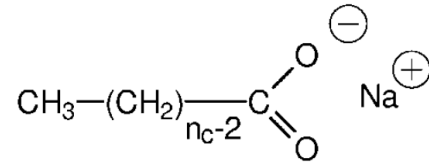

Sodium salt of

$n_C = 10$, decanoic acid	100
$n_C = 11$, undecanoic acid	50
$n_C = 12$, dodecanoic (lauric) acid	25
$n_C = 13$, tridecanoic acid	13
$n_C = 14$, tetradecanoic (myristic) acid	6.3
$n_C = 16$, hexadecanoic (palmitic) acid	1.8
$n_C = 18$, octadecanoic (stearic) acid	
$n_C = 20$, eicosanoic (arachidic) acid	
$n_C = 22$, docosanoic (behenic) acid	

CMC

Catiônico

Alkyltrimethylammonium bromide

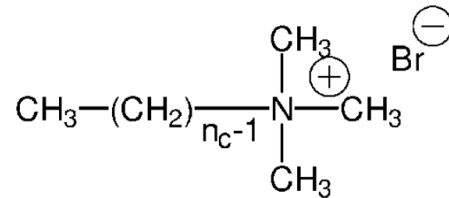

$n_C = 10$, decyl trimethylammonium bromide	66
$n_C = 12$, dodecyl trimethylammonium bromide	15
$n_C = 14$, tetradecyl trimethylammonium bromide (TTAB)	3.5
$n_C = 16$, hexadecyl trimethylammonium bromide (CTAB)	0.9

Não-iônico

Alkylethylene glycol

$\text{C}_{10}\text{H}_{21}(\text{OCH}_2\text{CH}_2)_4\text{OH}$	C_{10}E_4	0.79
$\text{C}_{10}\text{H}_{21}(\text{OCH}_2\text{CH}_2)_6\text{OH}$	C_{10}E_6	0.9
$\text{C}_{10}\text{H}_{21}(\text{OCH}_2\text{CH}_2)_8\text{OH}$	C_{10}E_8	1.0
$\text{C}_{12}\text{H}_{25}(\text{OCH}_2\text{CH}_2)_8\text{OH}$	C_{12}E_8	0.071
$\text{C}_{14}\text{H}_{29}(\text{OCH}_2\text{CH}_2)_8\text{OH}$	C_{14}E_8	0.009

Estrutura dos agregados

Parâmetro de empacotamento:

$$P = \frac{V}{l_c a}$$

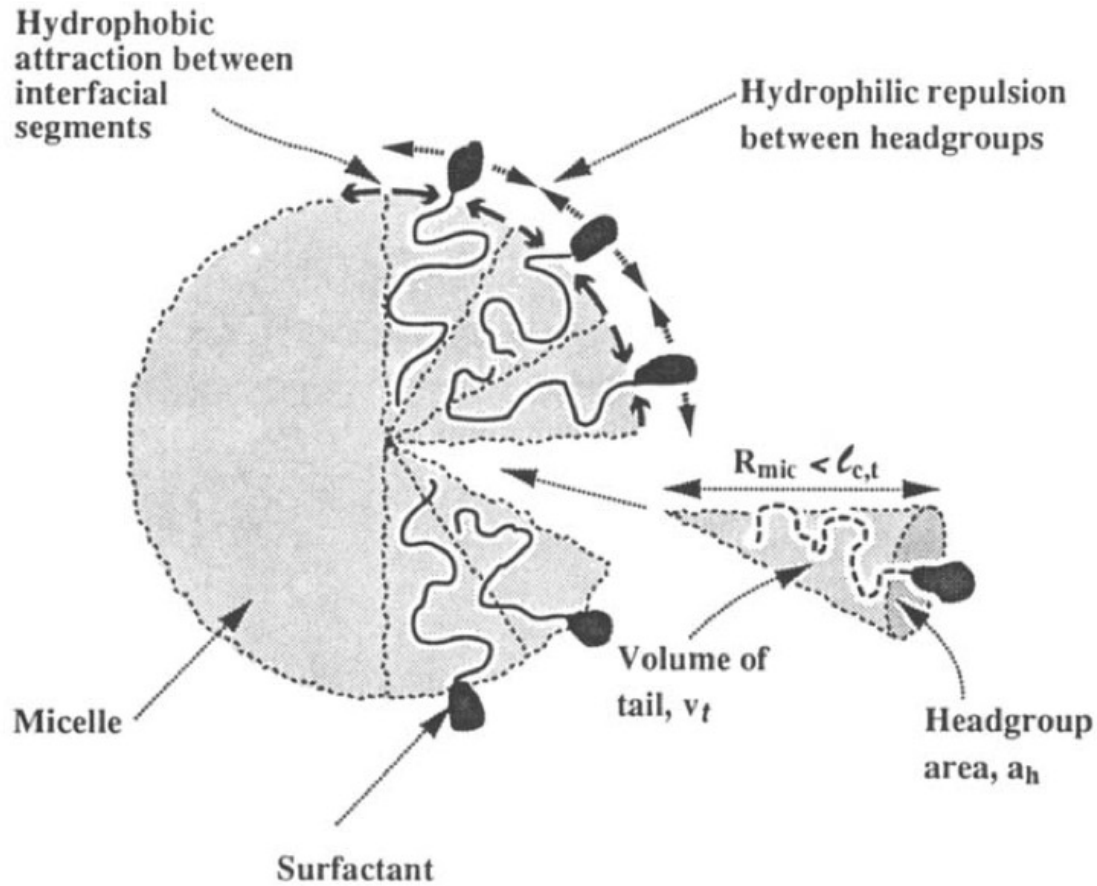

Critical packing parameter	Critical packing shape	Structures formed
$< 1/3$	Cone	Spherical micelles
$1/3 - 1/2$	Truncated cone	Cylindrical micelles
$1/2 - 1$	Truncated cone	Flexible bilayers, vesicles
~ 1	Cylinder	Planar bilayers
> 1	Inverted truncated cone or wedge	Inverted micelles

Termodinâmica da micelização

$$nS \rightleftharpoons S_n$$

Equilíbrio!

Podemos encontrar ΔG ?

$$\Delta G_{mic} = \mu_{surf,mic} - \mu_{surf}^0 = RT \ln(x_{cmc})$$

Podemos encontrar ΔS_{mic} ?

$$\left(\frac{\partial G}{\partial T}\right)_p = -S$$

Podemos encontrar ΔH_{mic} ?

$$\Delta G_{mic} = \Delta H_{mic} - T\Delta S_{mic}$$

Na CMC temos o eq. da micelização:

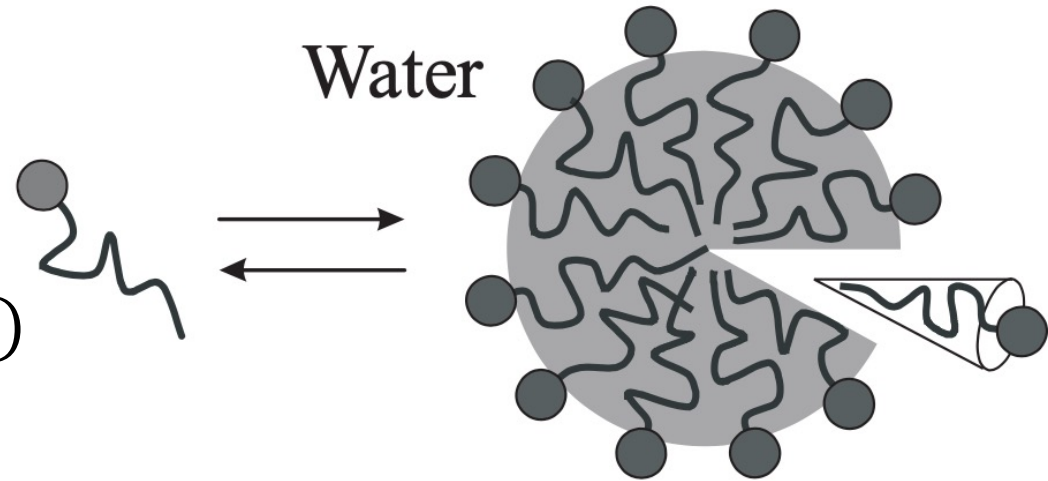

Exemplo:
SDS a 25 °C

$$\Delta G_{mic} = -21 \text{ kJ mol}^{-1}$$

$$\Delta H_{mic} = +2,54 \text{ kJ mol}^{-1}$$

$$\Delta S_{mic} = +81,9 \text{ kJ mol}^{-1}$$

Qual a força
motriz da
micelização?

Concentração superficial em excesso, Γ

$$\Gamma = \frac{n_{surf}}{\sigma}$$

n° de moléculas na superfície
área da superfície

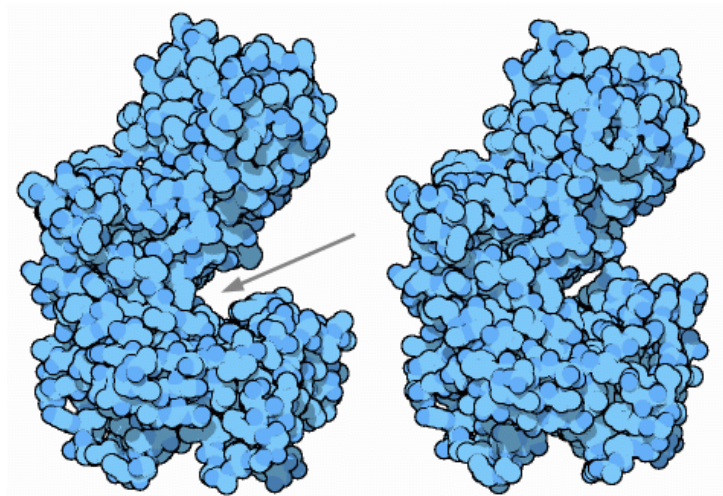

Hexokinase: catalisa a fosforilação da glicose

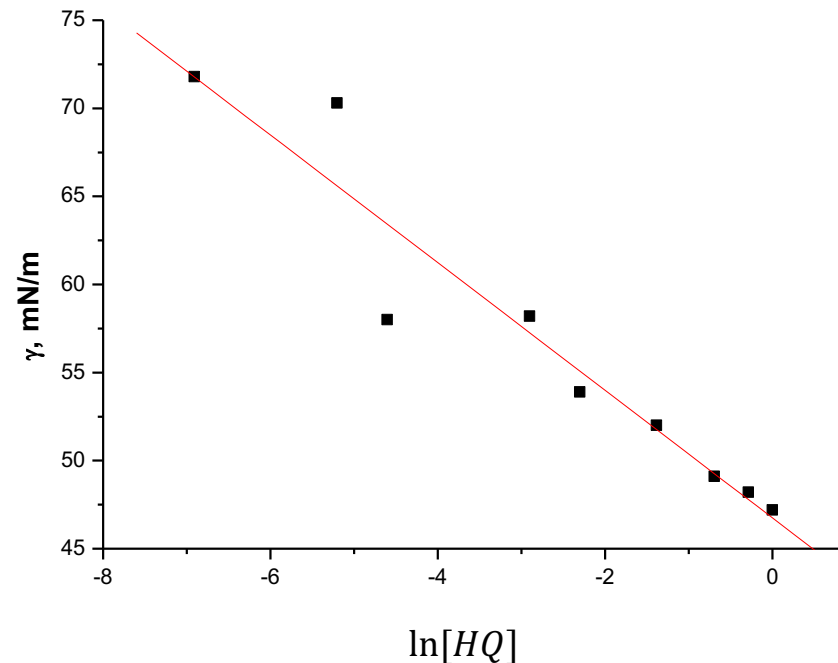
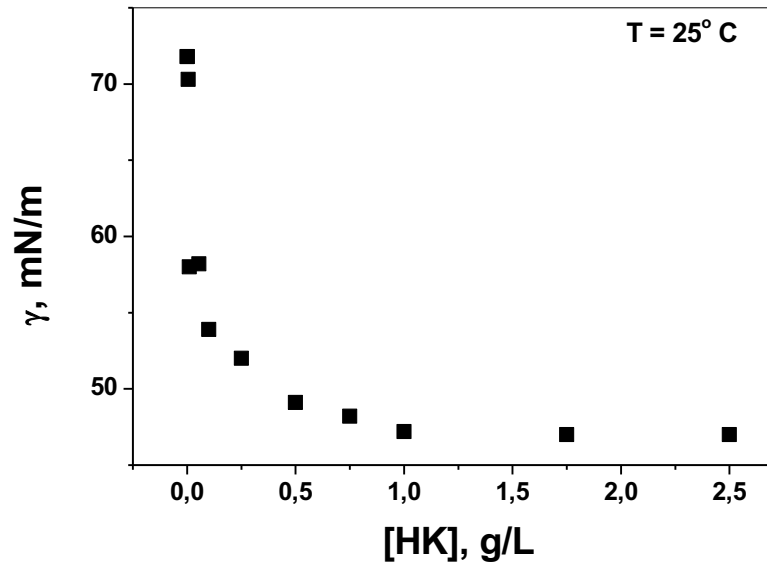

Isoterma de adsorção de Gibbs*

$$\Gamma = -\frac{1}{RT} \left(\frac{d\gamma}{d \ln(c)} \right)_{p,T}$$

$$\left(\frac{d\gamma}{d \ln(c)} \right)_{p,T} = -RT \Gamma$$

$$\gamma \times \ln(c)$$

$$\Gamma = 8,80 \cdot 10^{17} \text{ moléculas/m}^2$$

*ver pag. 610 Atkins' Physical Chemistry 11th ed.

Outras propriedades

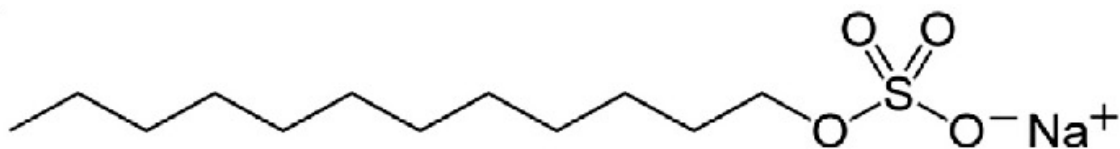
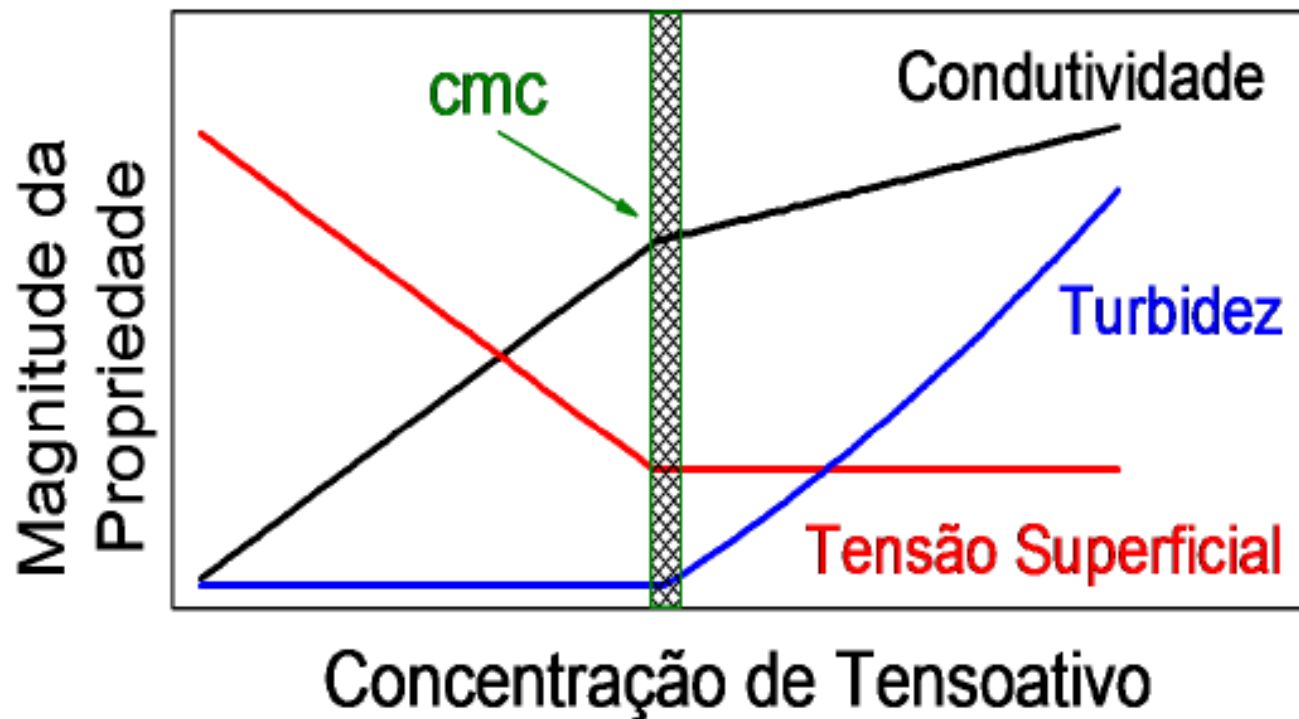

O que afeta a condutividade?

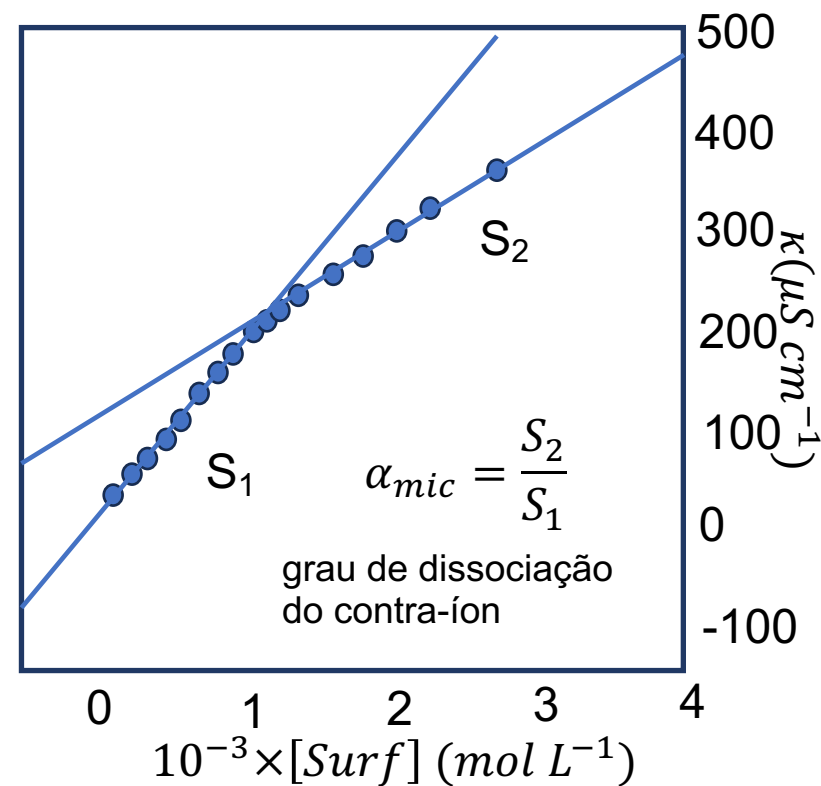
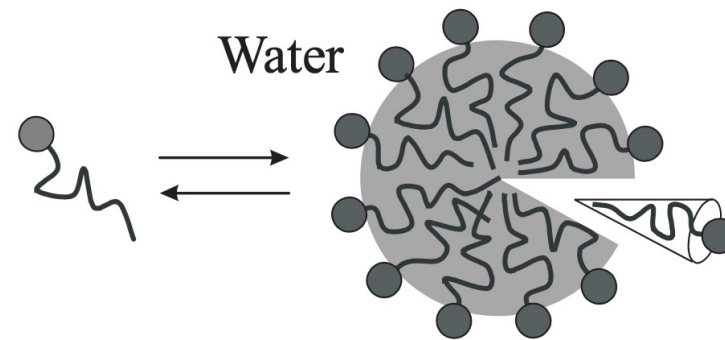

No lab.

Medidas de tensão superficial



Assista ao vídeo de operação disponibilizado no e-disciplinas antes da aula prática.

1. Limpeza do anel em Etanol antes do experimento e em água antes de todas as medidas
2. Colocar o anel no braço do aparelho. A cuba onde serão realizadas as medidas deverá ser preenchida aproximadamente com o mesmo volume em cada experimento (metade de sua capacidade). Coloque a cuba sobre a plataforma do aparelho e ajuste a altura da plataforma até que o anel entre no líquido. Verifique se o tensiômetro está no zero de sua escala e ajuste a altura da plataforma até que o braço esteja posicionado horizontalmente, dentro da marcação do aparelho

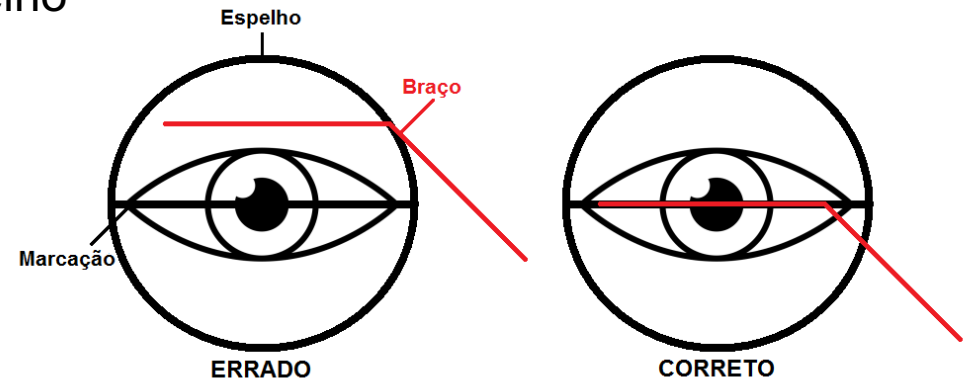

3. Fator de correção:
$$F = \frac{\gamma_{H_2O}^{literatura}}{\gamma_{H_2O}^{medido}}$$

No lab.

Medidas de tensão superficial

Amostras	M1	M2	Média \pm s	Temperatura
H ₂ O				
SDS 0,25 mmol L ⁻¹				
SDS 0,50 mmol L ⁻¹				
SDS 1,0 mmol L ⁻¹				
SDS 2,0 mmol L ⁻¹				
SDS 4,0 mmol L ⁻¹				
SDS 6,0 mmol L ⁻¹				
SDS 8,0 mmol L ⁻¹				
SDS 10 mmol L ⁻¹				
SDS 20 mmol L ⁻¹				
Álcool comercial				

Cada grupo irá medir 3-4 concentrações.
Todos devem realizar medidas.
Medir da mais diluída para a mais concentrada

- Estimar CMC do SDS
- Calcular Γ e área ocupada por cada molécula
- Comparar e explicar os valores de tensão superficial da água, etanol comercial e solução de SDS 8 mmol L⁻¹.

No lab.

Medidas de condutividade



Antes de cada medida, lavar o eletrodo com água deionizada e secar bem com papel absorvente.

Insira e retire o eletrodo da solução de 2-3 vezes, Aguarde estabilizar.

Meça da mais diluída para a mais concentrada.

Meça todas as soluções.

Amostras	M1	M2	Média ± s	Temperatura
H ₂ O				
SDS 0,50 mmol L ⁻¹				
SDS 1,0 mmol L ⁻¹				
SDS 2,0 mmol L ⁻¹				
SDS 4,0 mmol L ⁻¹				
SDS 6,0 mmol L ⁻¹				
SDS 8,0 mmol L ⁻¹				
SDS 10 mmol L ⁻¹				
SDS 12 mmol L ⁻¹				
SDS 16 mmol L ⁻¹				
SDS 20 mmol L ⁻¹				

Relatório

Seguir modelo pedido na apresentação do curso:

Objetivos

Resultados e Discussão

Tensiometria

Condutometria

Conclusões

Referências

Algarismos Significativos

Parâmetros que devem ser calculados e comparações que devem ser feitas estão no roteiro e na descrição da tarefa de entrega do relatório.

Referências



- Butt, Graf, Kappl. Physics and Chemistry of Interfaces. 2003, Wiley-VCH.
- Atkins' Physical Chemistry 11th ed.
- Hiemenz, Rajagopalan. Principles of Colloid and Surface Chemistry. 1998, Marcel Dekker Inc.
- Introdução da química dos colóides e de superfícies, D. J. Shaw, Ed. Edgard Blücher Ltda, 1975.