



**PME 3543**  
**Estruturas Mecânicas e de Veículos**  
**Notas de Aula**

**Prof. Leandro V. da S. Macedo**

**01**



## Disciplina: PME 3543 Estruturas Mecânicas e de Veículos

### Programa

### Critério de Aprovação:

$$Média = \frac{2P1 + 4P2 + 2S + L}{9} \geq 5,0$$

Onde P1 e P2 são provas, S é seminário e L são listas de exercícios.

### Bibliografia

- MORELLO et alli. "The Automotive Body" vols. I e II, Ed. Springer 1st ed., 2011, ISBN 978-94-007-0512-8.  
TIMOSHENKO & GODIER "Teoria da Elasticidade" Guanabara Dois, 3ª edição 1980  
ZIENKIEWICZ & TAYLOR "The finite element method", McGraw-Hill, 4th ed., 1989(vol.1) e 1991(vol.2)  
ALVES Fo. "Elementos Finitos - A base da tecnologia CAE", Érica, 2000.  
TIMOSHENKO & WOINOWSKI-KRIEGER, S. "Theory of plates and shells", McGraw-Hill, 2nd ed., 27th printing 1987  
CLOUGH & PENZIEN "Dynamics of Structures" McGraw-Hill, 7th printing 1986  
POPOV "Introdução à Mecânica dos Sólidos" Edgard Blücher, 1978.  
HIERMAIER, S.J. "Structures under Crash and Impact", Springer, 2008, ISBN 978-0-387-73862-8 e-ISBN 978-0-387-73863-5  
SIMMS, C. & WOOD, D. "Pedestrian and Cyclist Impact" Springer, 2009 ISBN 978-90-481-2742-9 e-ISBN 978-90-481-2743-6  
BAUER, H. (ed.) "Automotive handbook", Robert Bosch GmbH, Alemanha, 2000



## Carroceira: Função

Desempenha função de estrutura, esqueleto do veículo.

Dá suporte a todos os demais sistemas do veículo, que de alguma forma ou de outra são fixados, montados nesta estrutura, tais como:

- motor, sistema de arrefecimento, escapamento;
- transmissão;
- suspensão dianteira e traseira;
- sistemas de freio, direção, combustível;
- bancos;
- painel de instrumentos;
- revestimentos (teto, colunas, carpetes);
- ancoragem de cintos de segurança;
- componentes elétricos (bateria, chicotes...);
- ...

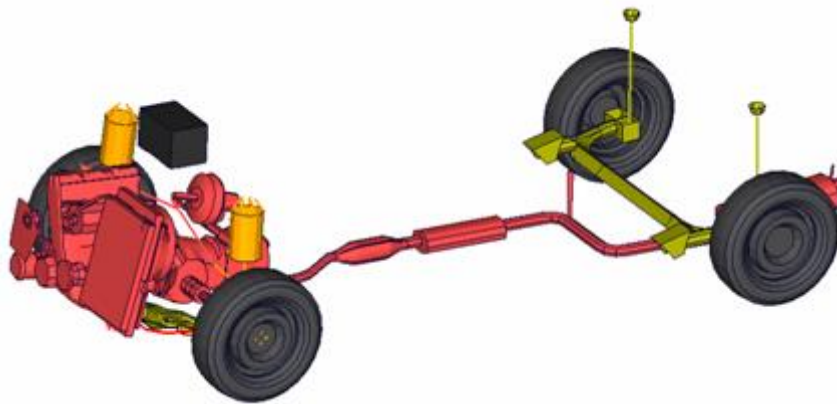
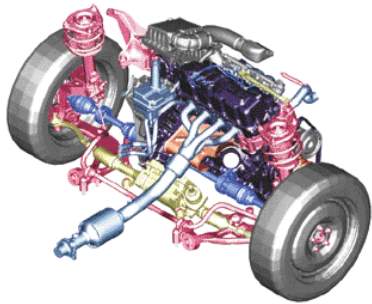
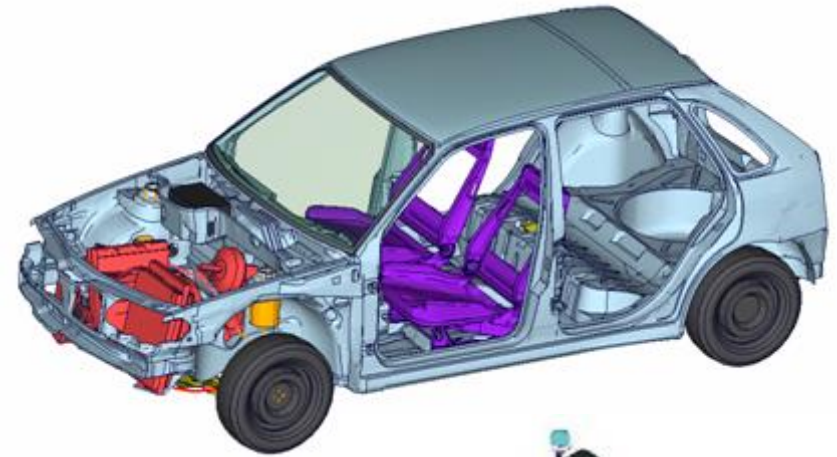



## Mono-bloco (carroceria) vs. Chassis (chassis + carroceria)

O status atual de projeto padrão para veículos de passeio utiliza o conceito de estrutura “mono-bloco” que consiste em utilizar os próprios painéis que dão a forma e aparência exterior como elementos estruturais, em oposição ao conceito chassis+carroceria usual em veículos comerciais, caminhões e pick-ups, onde o elemento estrutural principal é uma plataforma formada por vigas e travessas, sendo a carroceria (painéis que formam o habitáculo) e demais sistemas do veículo fixados, montados, nesta plataforma.

Pode haver confusão então com a definição mais ampla e atual dos sistemas de chassis, que englobam os sistemas de suspensão, direção, freios, rodas e pneus e combustível.





**Karl Benz 1885**  
**1º veículo automotor**



**Benz-Velo 1895**





# Ford T

## Produção em massa

### Modelos em chapa de aço

A Complete Line of Model T's to Choose From



1-Passenger Touring Car. Fully Equipped



1-Passenger Roadster. Fully Equipped



1-Passenger Cab Roadster. Fully Equipped

Ford Car Models Supply Every Demand



1-Passenger Coupe. Equipped with 1000 Lamps. Tires, Spare and Set of Tools



1-Passenger Touring Roadster. Fully Equipped



1-Passenger Runabout. Equipped with 1000 Lamps. Tires, Spare and Set of Tools



**Caminhão Ford 1924**

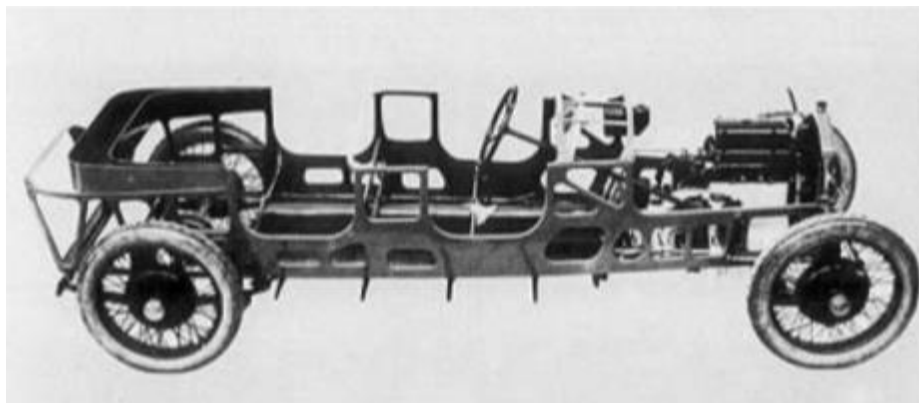

**Chassis Monobloco 1922**



**Chassis rodoviário**

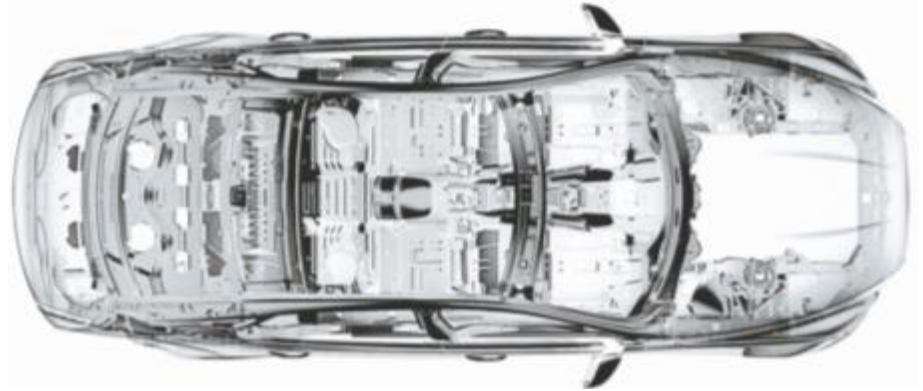

**Carroceria de Alumínio 2006**



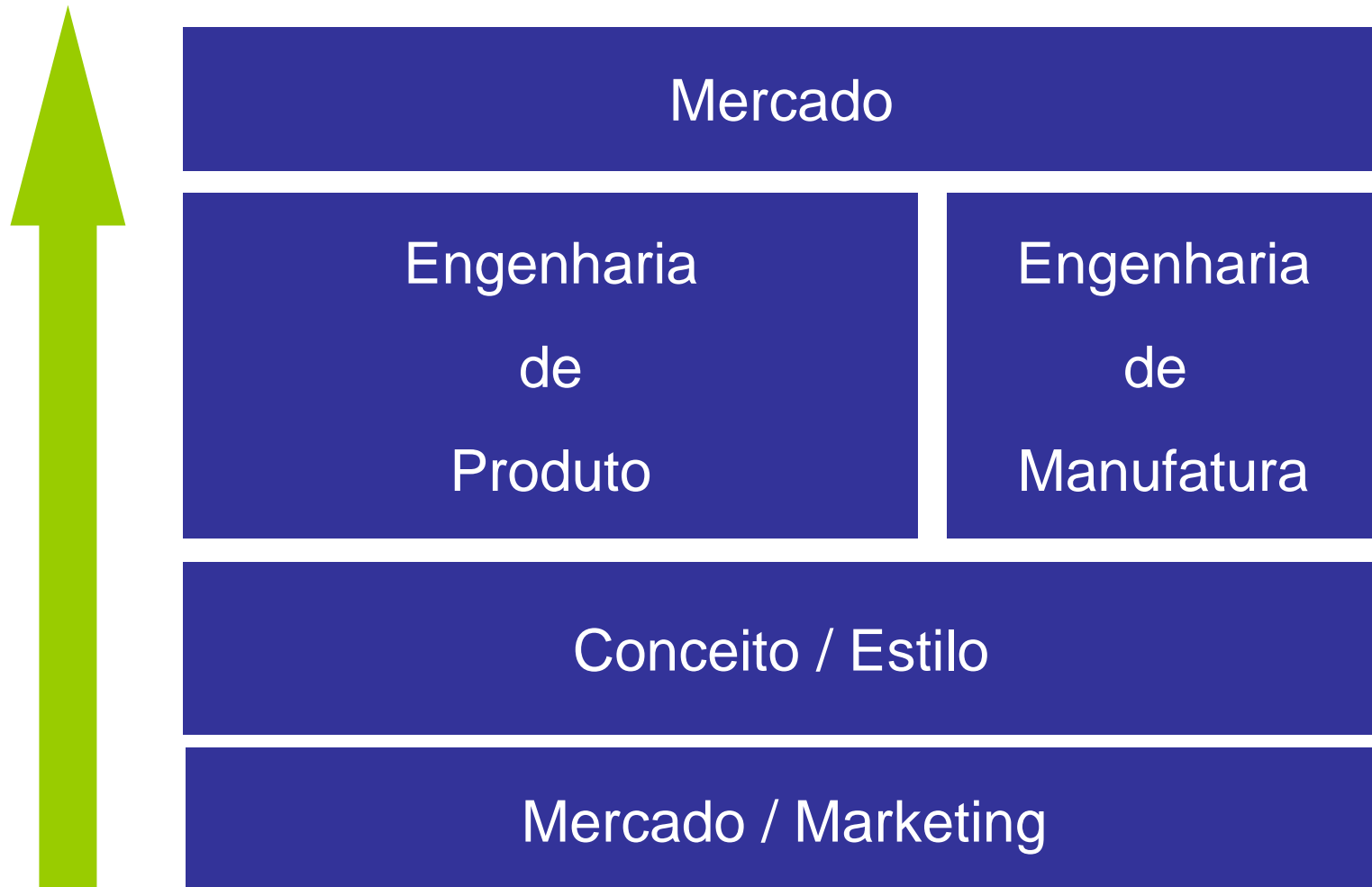

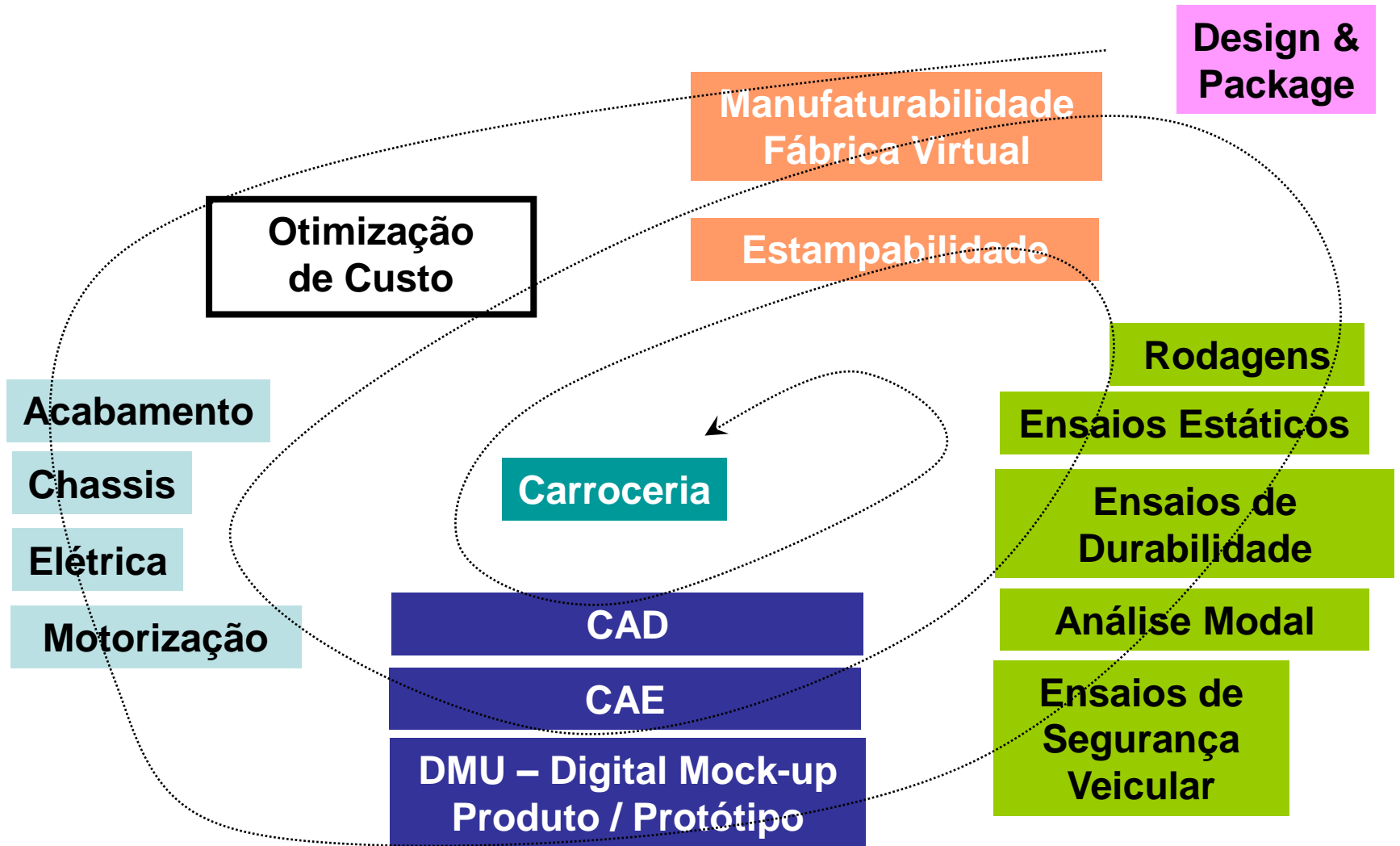



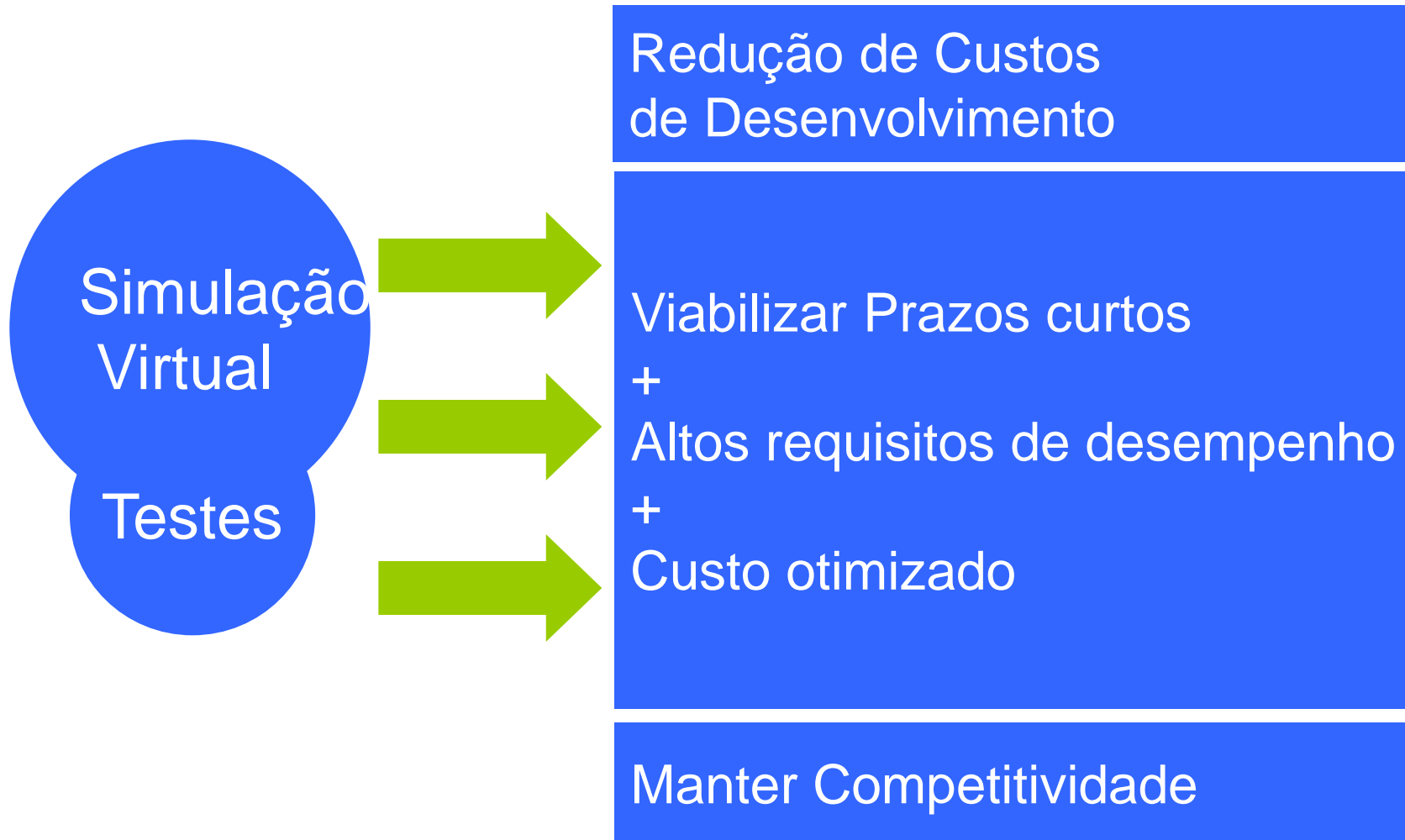



## Cronograma de Projeto

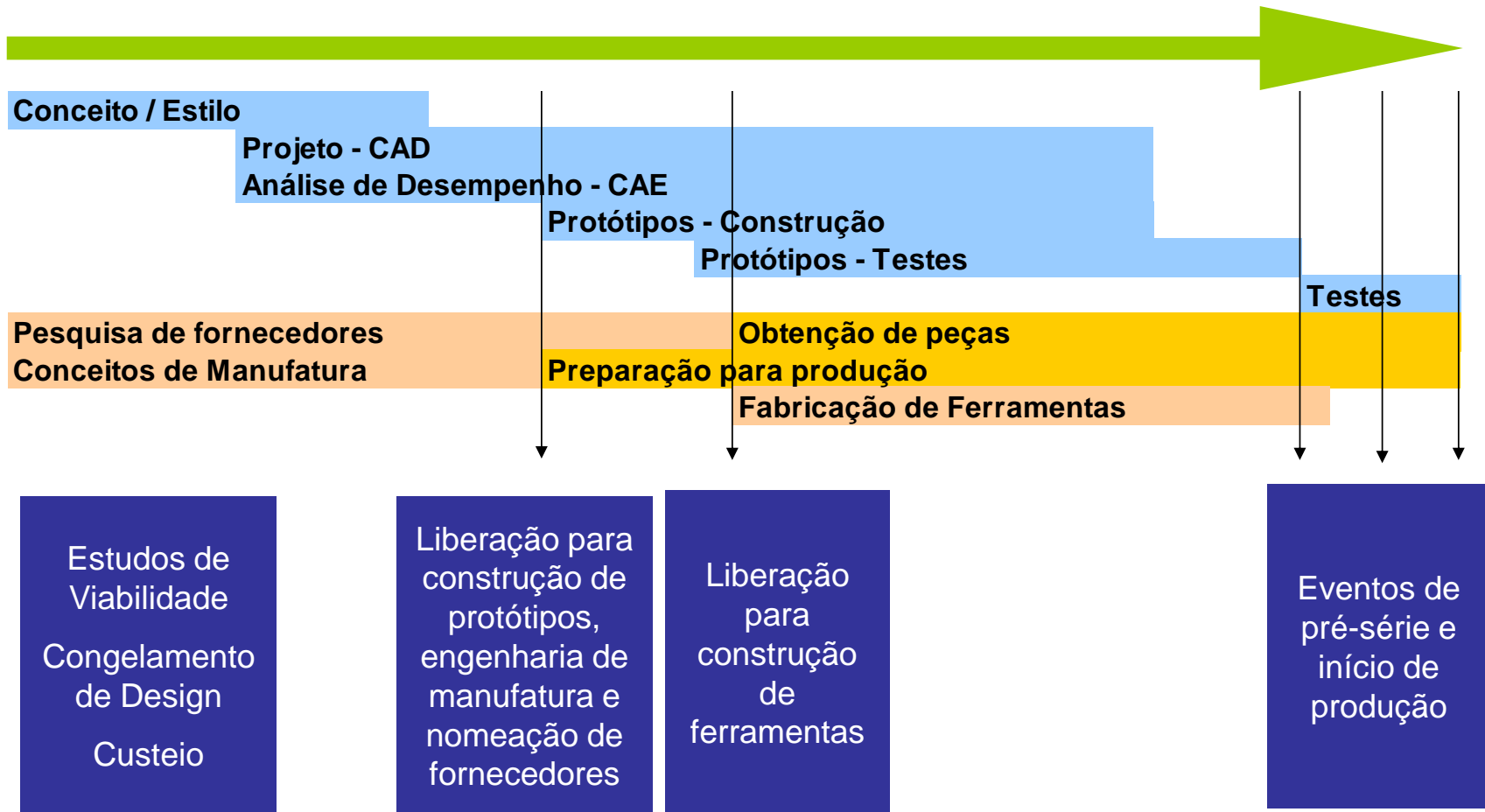



Estrategia de Produto

Vendas e Marketing

Gerenciamento de Produto

Finanças

Engenharia de Produto

Engenharia de Manufatura

Qualidade

Compras



## Do Estilo ao Produto

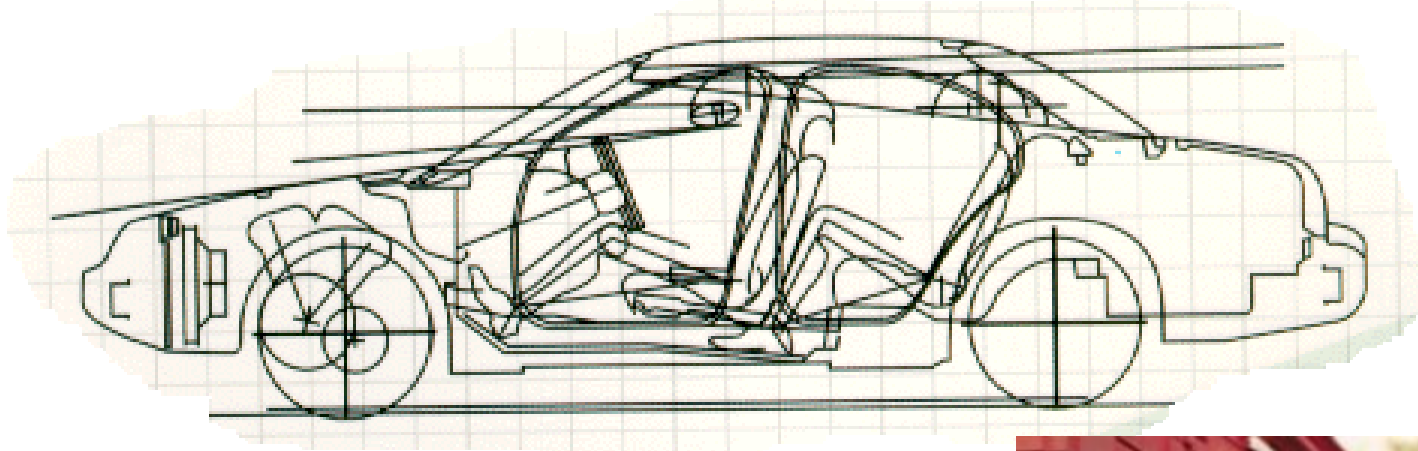



# Estilo

“Sketches” à mão e no computador

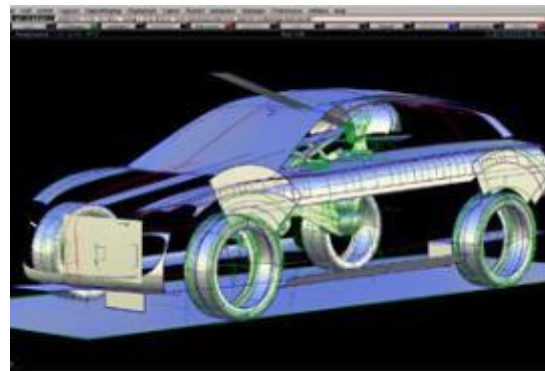
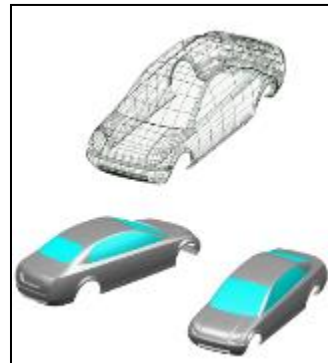

Visualização foto realística em 3D  
“Virtual Reality Center”







## Estilo

### Modelos em escala em Clay



O “scanning” digital 3D dos modelos Clay acelera a criação de modelos obtendo uma nuvem de pontos de alta densidade e precisão para a construção das superfícies digitais.



## Estilo

Usinagem de um modelo em Clay 1:1 a partir de modelos em CAD



Usinagem de um modelo em espuma de alta densidade partir de modelos em CAD



Modelos em Clay 1:1



<http://www.carsdesignonline.com/design/modelling/clay-modelling.php>



## Conceito Plataforma e Derivativos

Hatch  
Sedan  
Station Wagon  
Monovolume  
Pick-up

...





# Conceito de Plataforma e Modularização



Drive systems in MQB





## Requisitos Técnicos e Econômicos Gerais

**Design** (externo, interno, zonas cinzentas, folgas)

**Aerodinâmica** (consumo de combustível, estabilidade direcional, acúmulo de sujeira, ruído...)

**Requisitos Funcionais** (Abertura de portas e tampas, vidros, folgas, vão livre do solo, espaço de bagagem...)

**Ergonomia** (Espaço interno, Posicionamento de bancos, Visibilidade...)

**Custos de peças, ferramental, armação, logística**

**Manufaturabilidade** (estampabilidade, sequência de armação, disponibilidade de tecnologia,...)

**Capacidade de suprimento**

**Reciclagem**

**Estrutura para produção em massa**

**Rigidez - Ruído e Conforto - NVH**

**Durabilidade**

**Desempenho em Crash - Proteção de Ocupantes e Pedestres**

**Custo de Reparo**

**Resistência à corrosão**



# Largura de Gaps (“Fugen”)

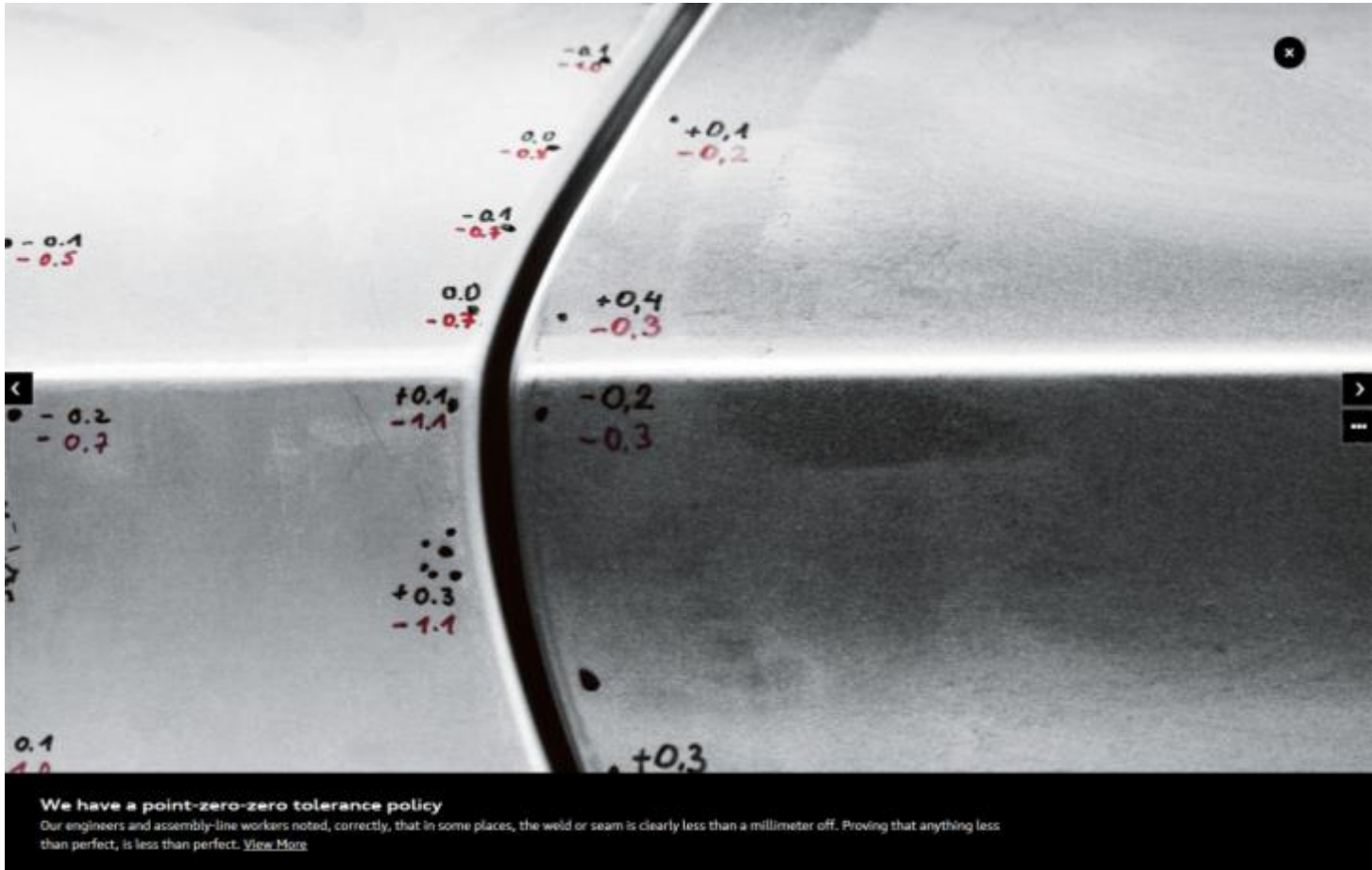



## **Manufaturabilidade**

**Estampabilidade**

**Unões entre peças (soldas, adesivos...)**

**Sequência de Armação**

**Pintura**



# Estampabilidade: Curva limite de conformação - CLC

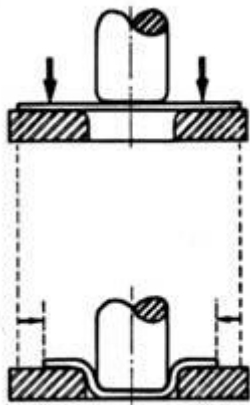

Estampagem

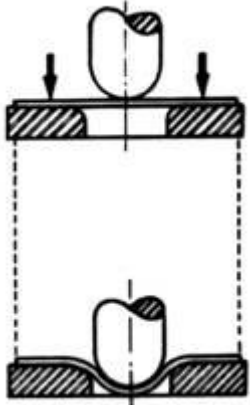

Estiramento

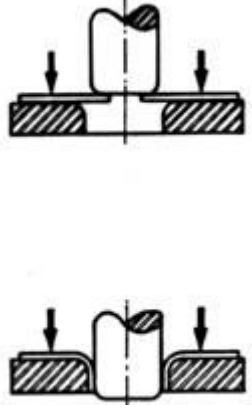

Flangeamento

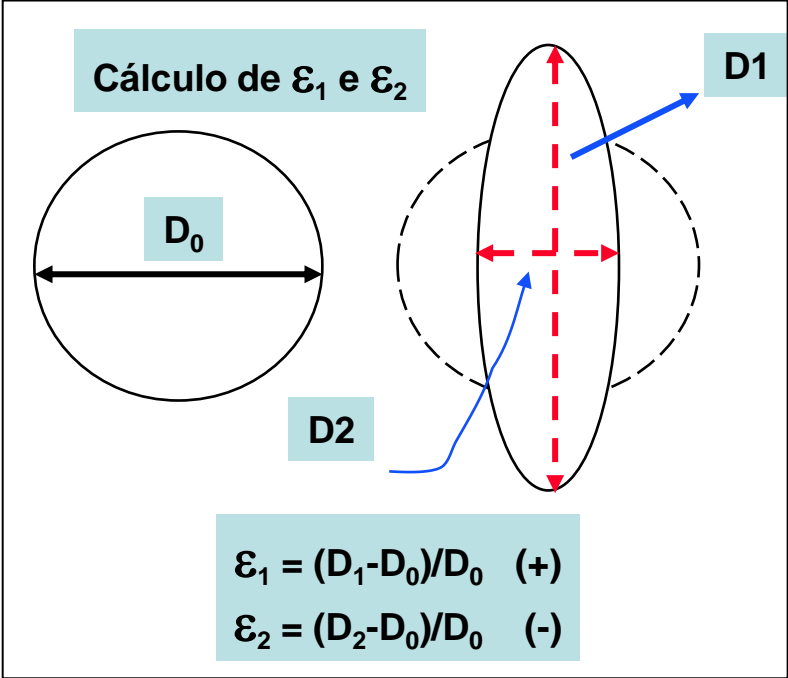
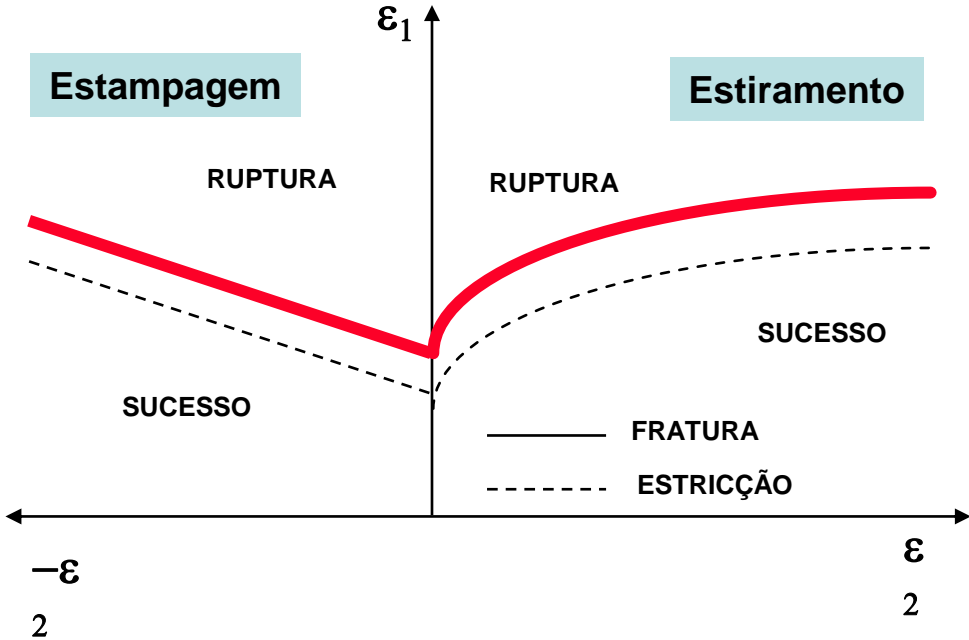
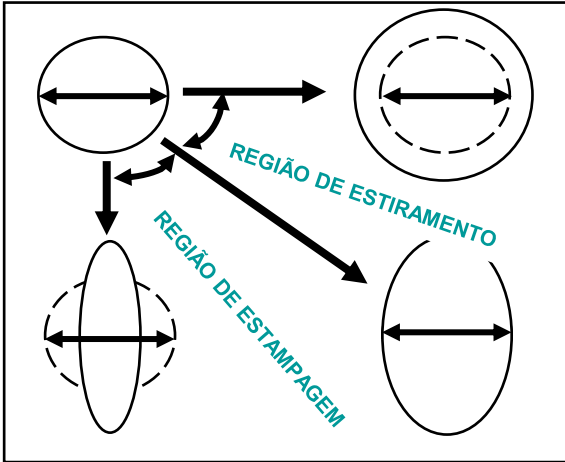





# Estampabilidade: Curva limite de conformação - CLC

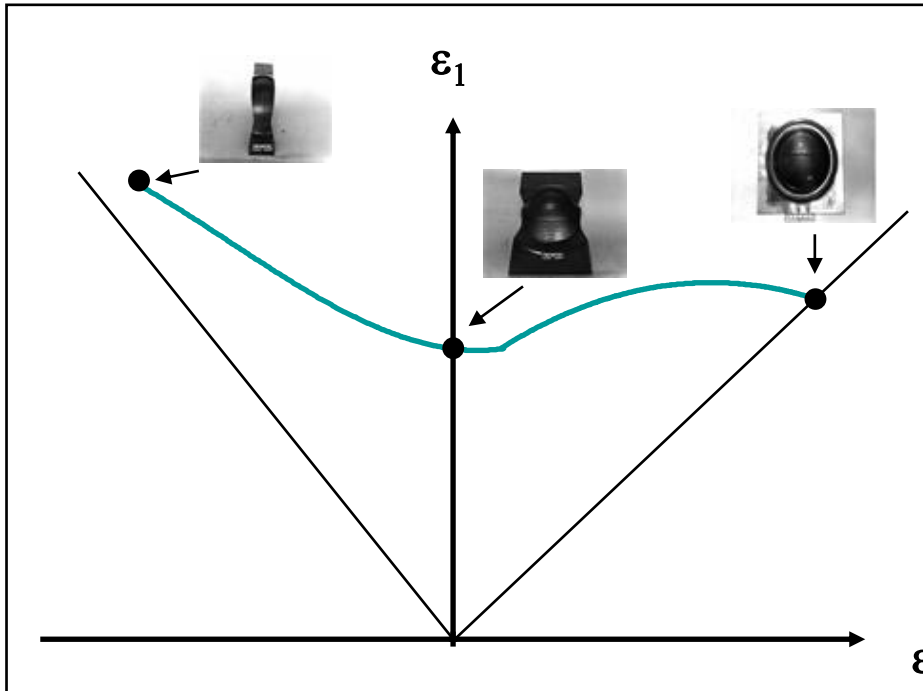
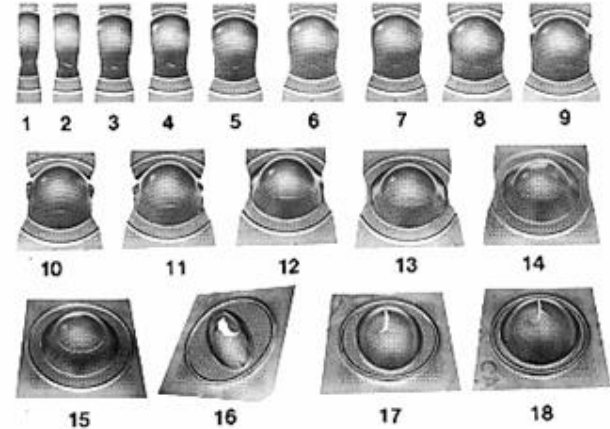
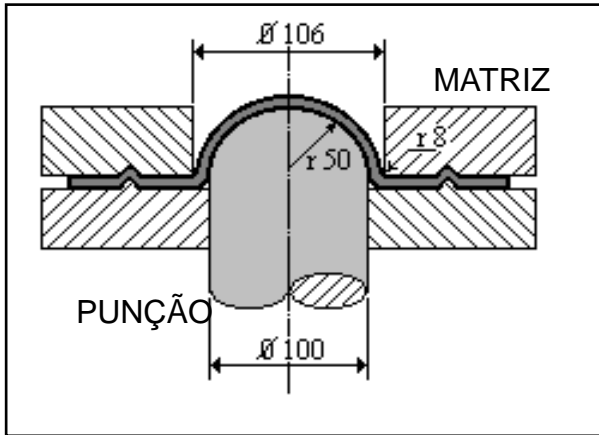

## Fatores que afetam a posição das CLC:

- Diâmetro dos círculos da rede
- Espessura da chapa (limite atingido primeiro em espessuras muito finas ou muito grossas)
- Trajetória da deformação (melhor primeiro estampar e depois esticar)

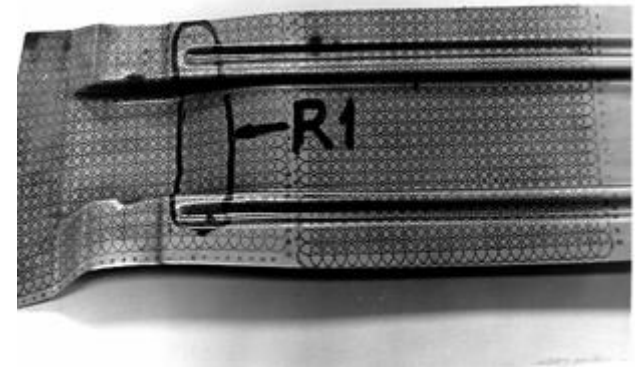



# Estampabilidade: Curva limite de conformação - CLC

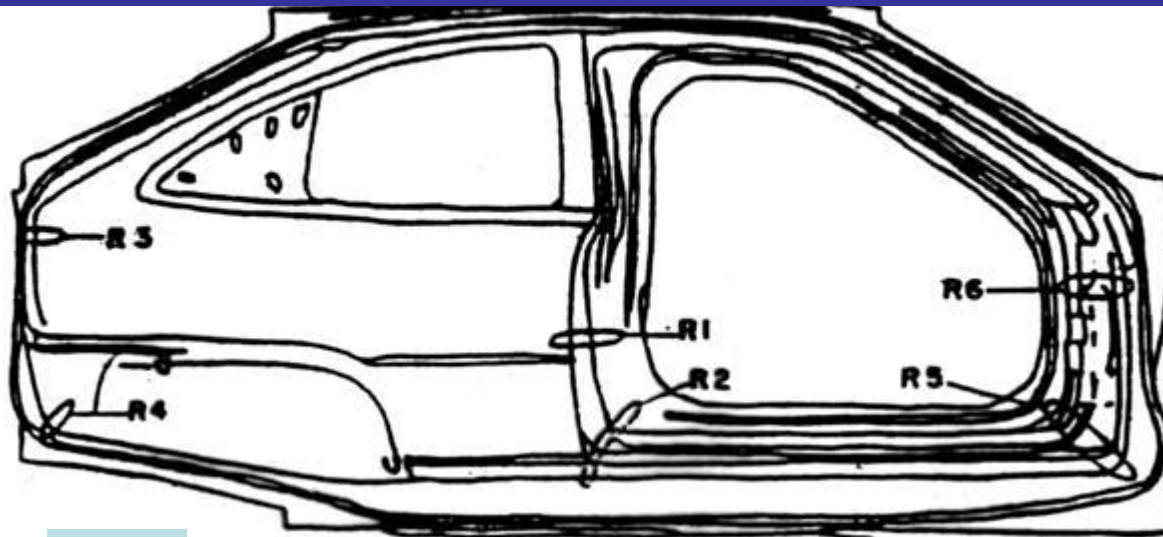

Aço 1

Aço 2

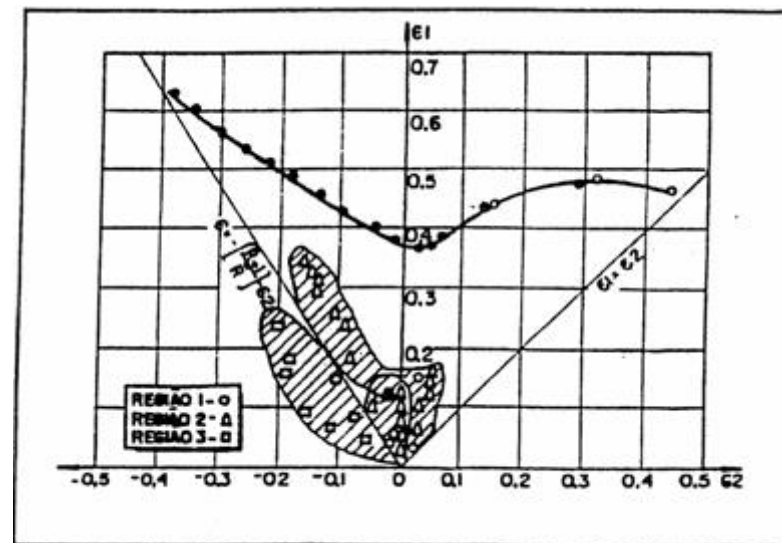
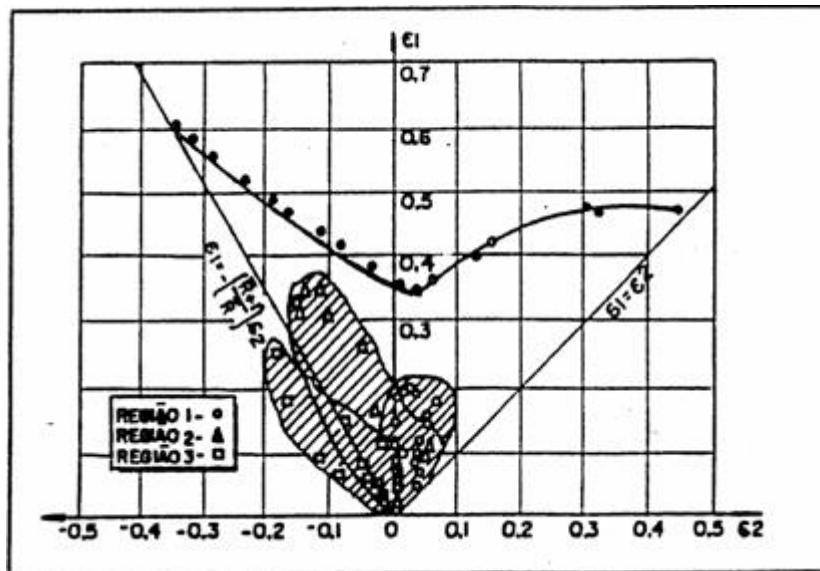



## Estampabilidade: Simulação de estampagem

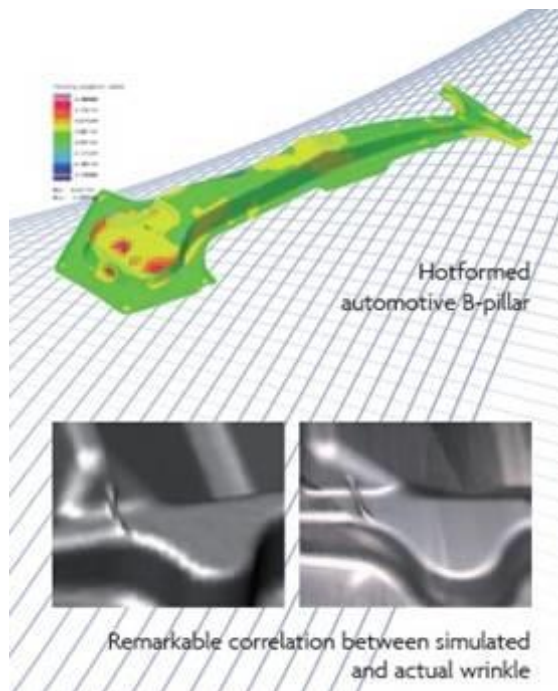

### Simulação de Estampagem

- Projeto de ferramental
- Formabilidade (trincas, nervuras, redução de espessura)
- Compensação de ferramenta (correção de “spring-back”)



## Estampabilidade: Simulação de estampagem

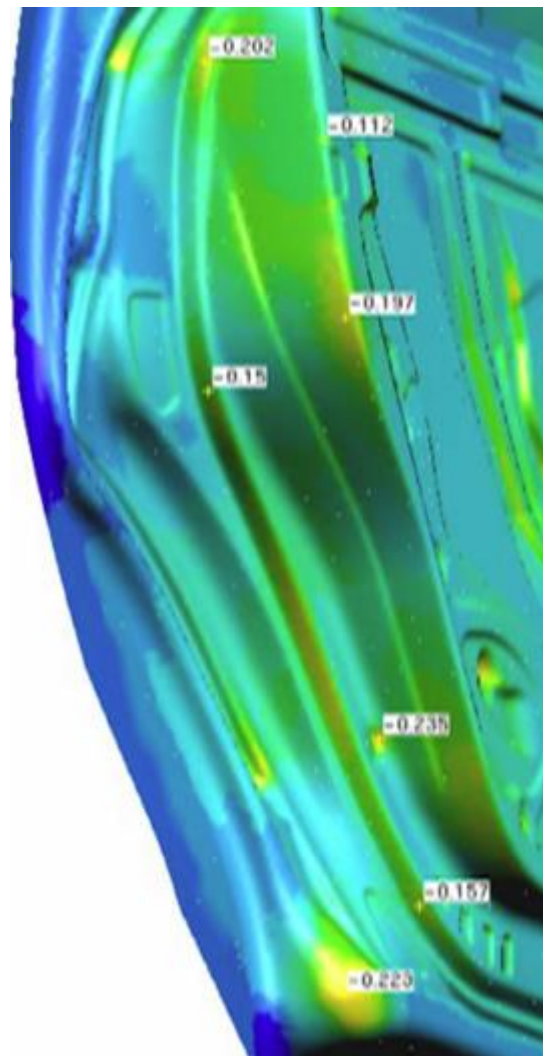
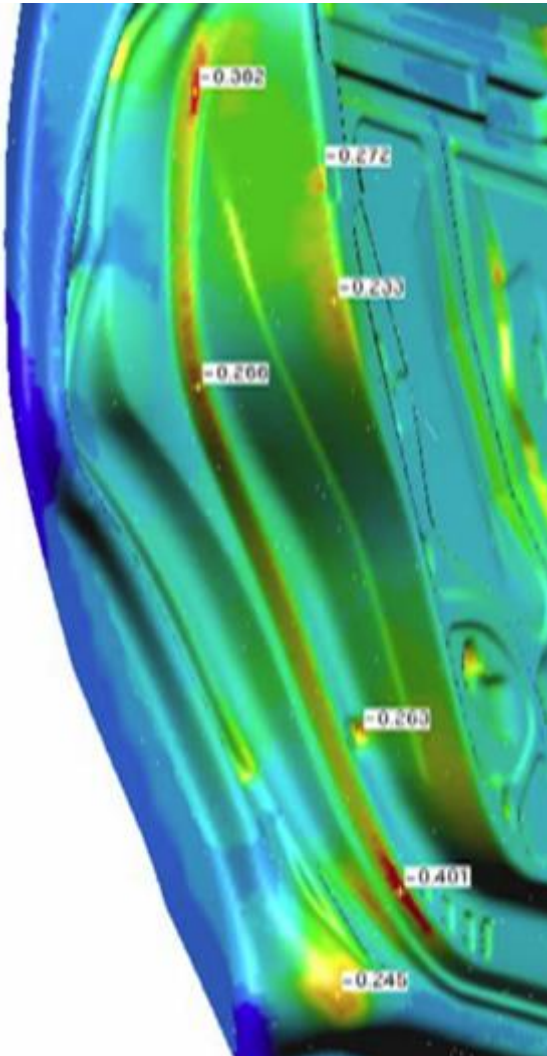

### Resultados de análise:

- atendimento à CLC
- afinamento (redução de espessura)
- acúmulo de material, formação de rugas

Subsídio adicional:  
Tensões residuais para simulações de crash



## Unões entre peças

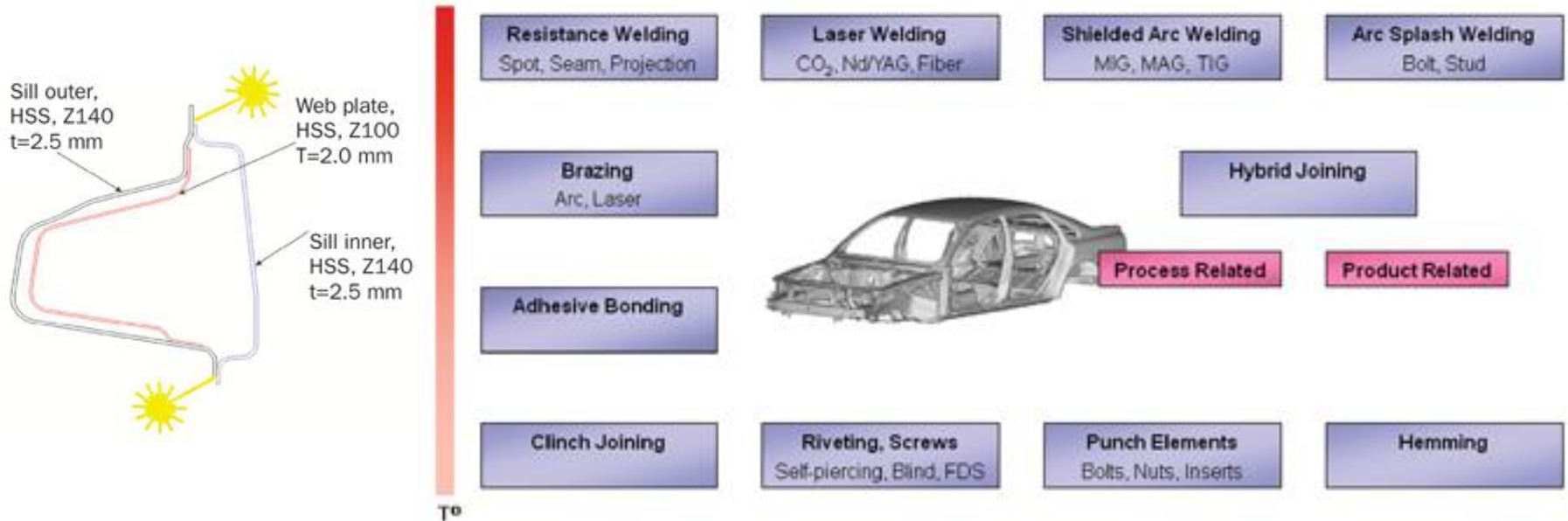

**Pontos de solda equivalentes:** somatório da quantidade de pontos de solda e comprimentos de cordões de solda e áreas coladas (estas transformadas por fatores de equivalência para ptos. de solda).

**Objetivo:** avaliar o custo do projeto sob o ponto de vista da quantidade de uniões entre peças necessária de ser manufaturada.

Disponibilidade de equipamento na posição da linha de montagem

Tempo de tacto

Acessibilidade

Sequência de armação



## Solda a ponto

Consiste na junção de duas ou mais peças de metal através da aplicação de calor e de pressão

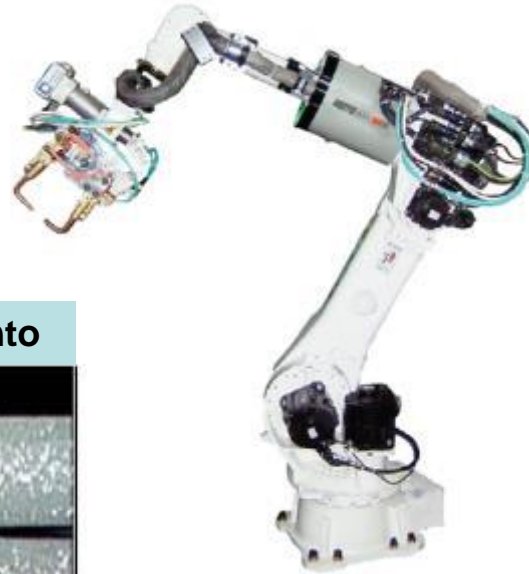

Corte transversal de uma solda a ponto

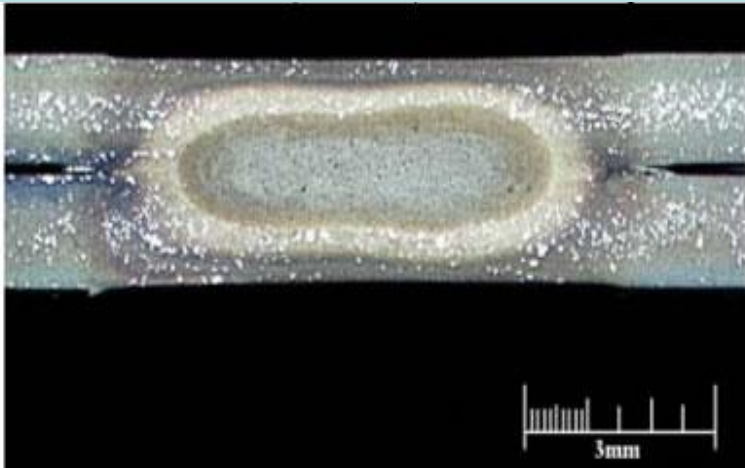



## Solda a ponto

- **Largura de flange necessária**
- **Distanciamento entre os pontos de solda**
- **Compatibilidade entre as espessuras das chapas**
- **Pacote máximo de espessura possível de ser soldado**
- **Acessibilidade para ponteadeira**
- **Tempo de tacto**



## Weld Bonding – Cola estrutural

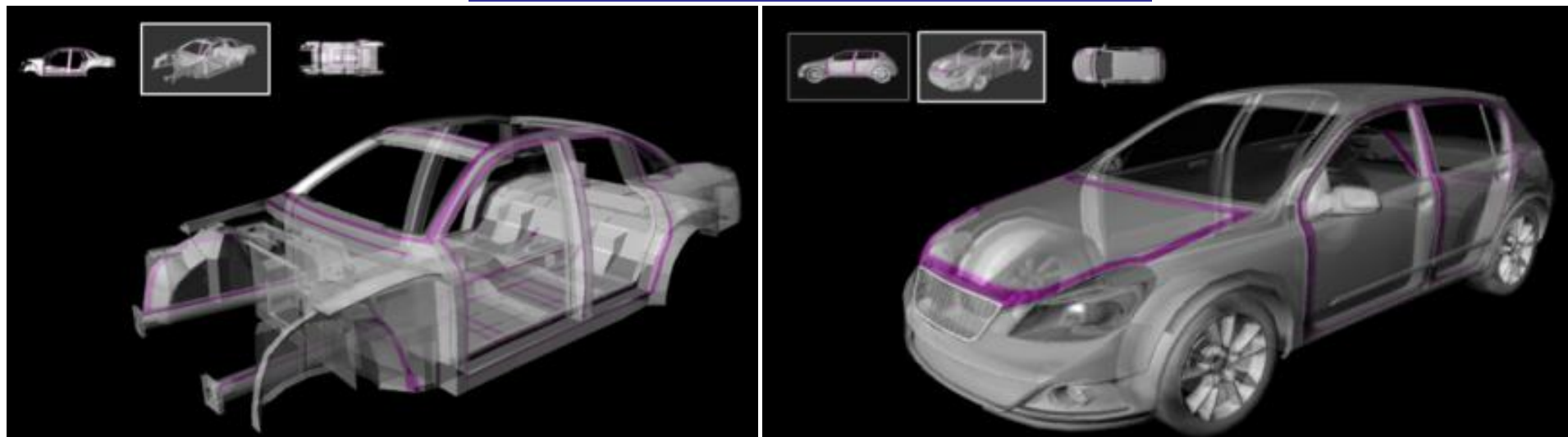

**Aplicação de adesivo (cola estrutural) para unir flanges**

**Aumento da durabilidade e rigidez**

**Melhora vedação**

**Aplicação onde não é possível acesso para soldar**





## Adesivos

### Vantagens

**Distribuição uniforme das tensões**

**Redução de peso**

**Permite união de diferentes materiais**

**Bom isolamento impedindo a corrosão**

**Evita necessidade de furos para solda**

**Melhor acabamento**

**Diminuição no custo de produção**

**Amortecimento/diminuição de vibrações**

**Maior segurança em acidentes**

### Desvantagens

**Critérios para dimensionamento ainda não bem estabelecidos**

**Necessidade de preparação prévia das superfícies**

**Podem não ser totalmente resistentes a determinadas condições extremas**

**Tempo para cura**

### Características desejáveis

Bom preenchimento de folgas

Cura rápida

Grande resistência mecânica

Alta resistência ao impacto



# Adesivos

## Preparação da Junta

### Limpeza e tratamento da Superfície

- Nenhum tratamento
- Lavagem por solventes
- Lavagem a vapor
- Abrasão mecânica
- Ataque químico
- Deposição química

### Aplicação de Primers

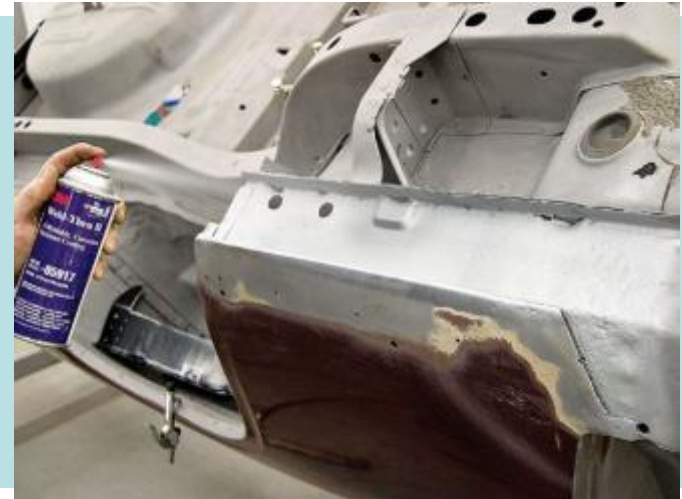

## Tipos de Falha

**Adesiva**  
**Coesiva**

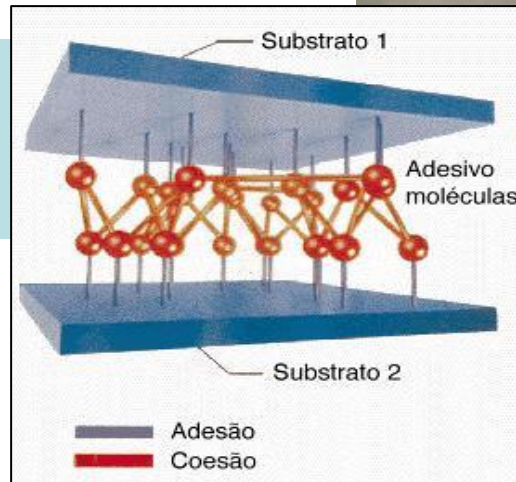



# Adesivos

## Esforços

- Cisalhamento
- Descascamento (Peeling) → EVITAR
- Tração
- Clivagem → EVITAR

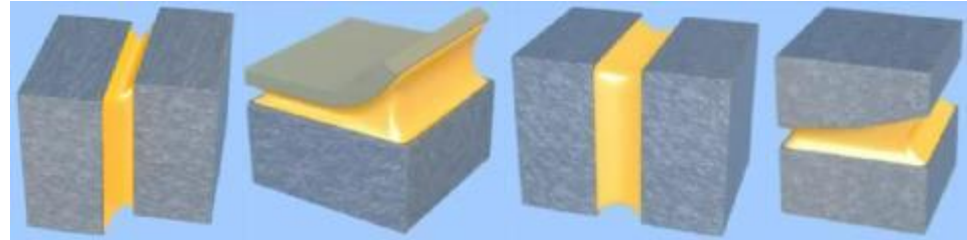

## Peeling

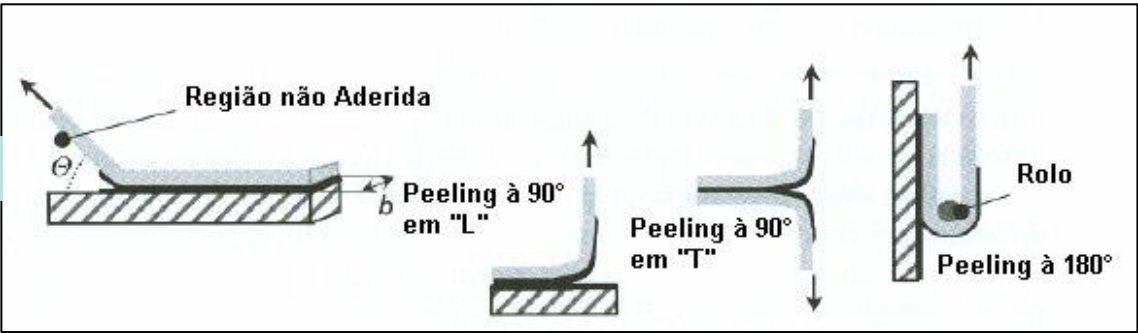

## Clivagem





# Grafagem (“Hemming”)

grafagem

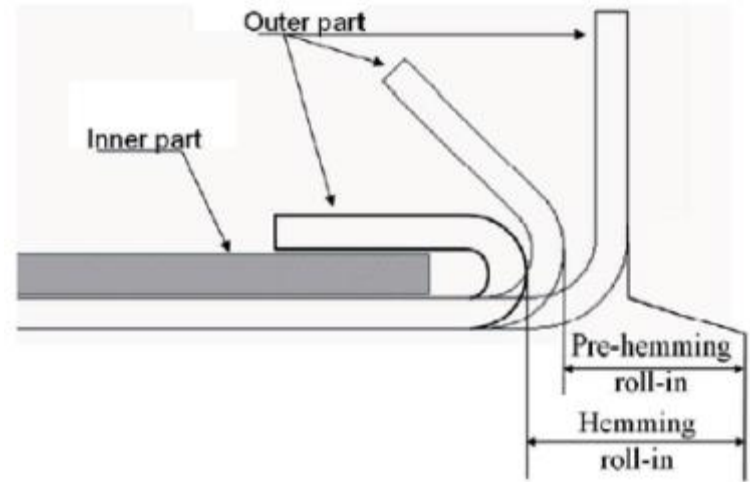
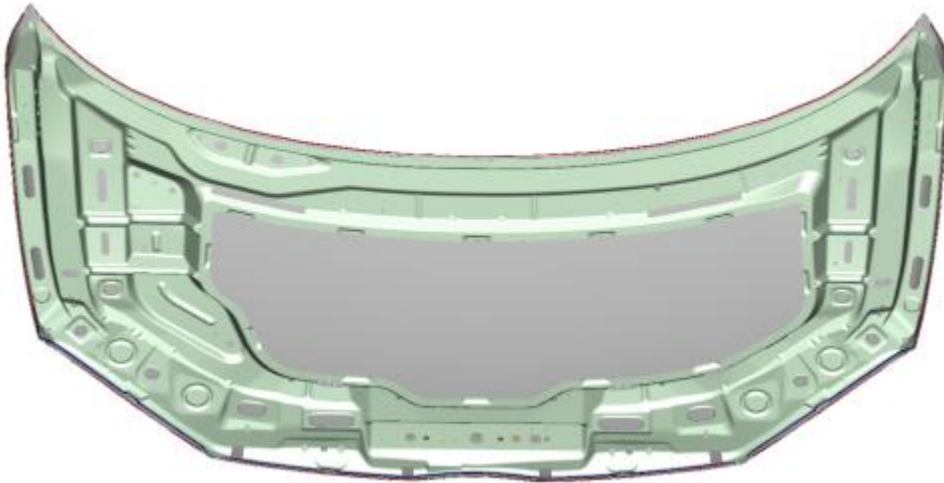



## Grafagem (“Hemming”)





# Grafagem (“Hemming”)

## Pré-grafagem

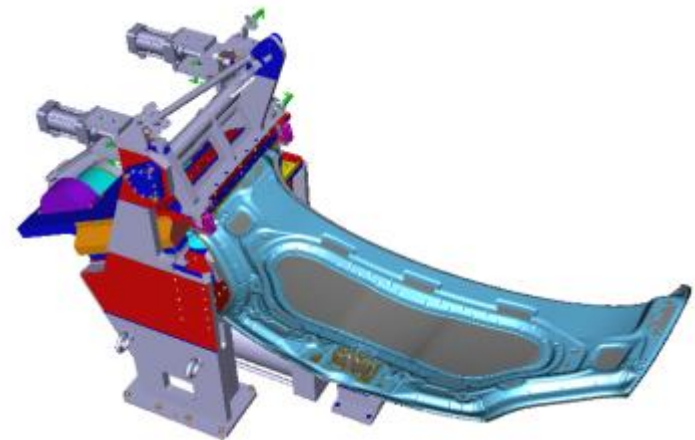
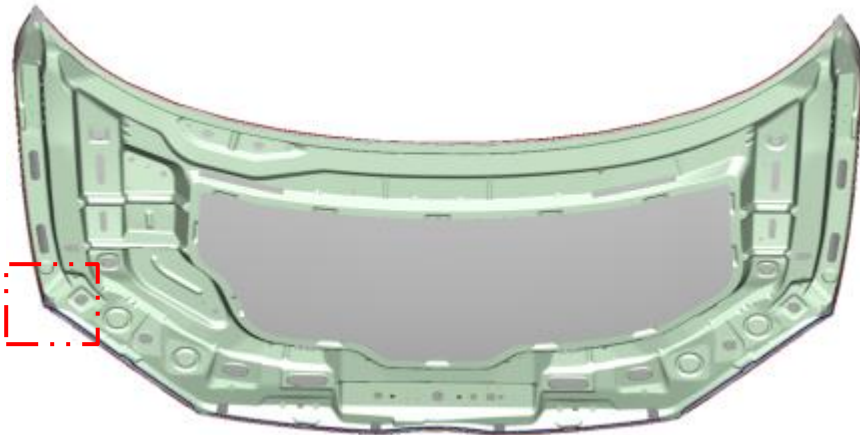
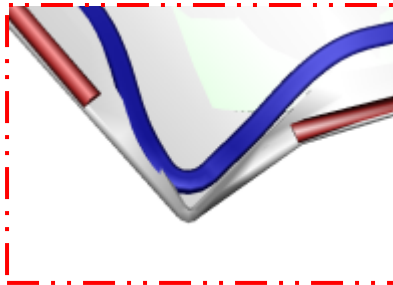



## Grafagem (“Hemming”)

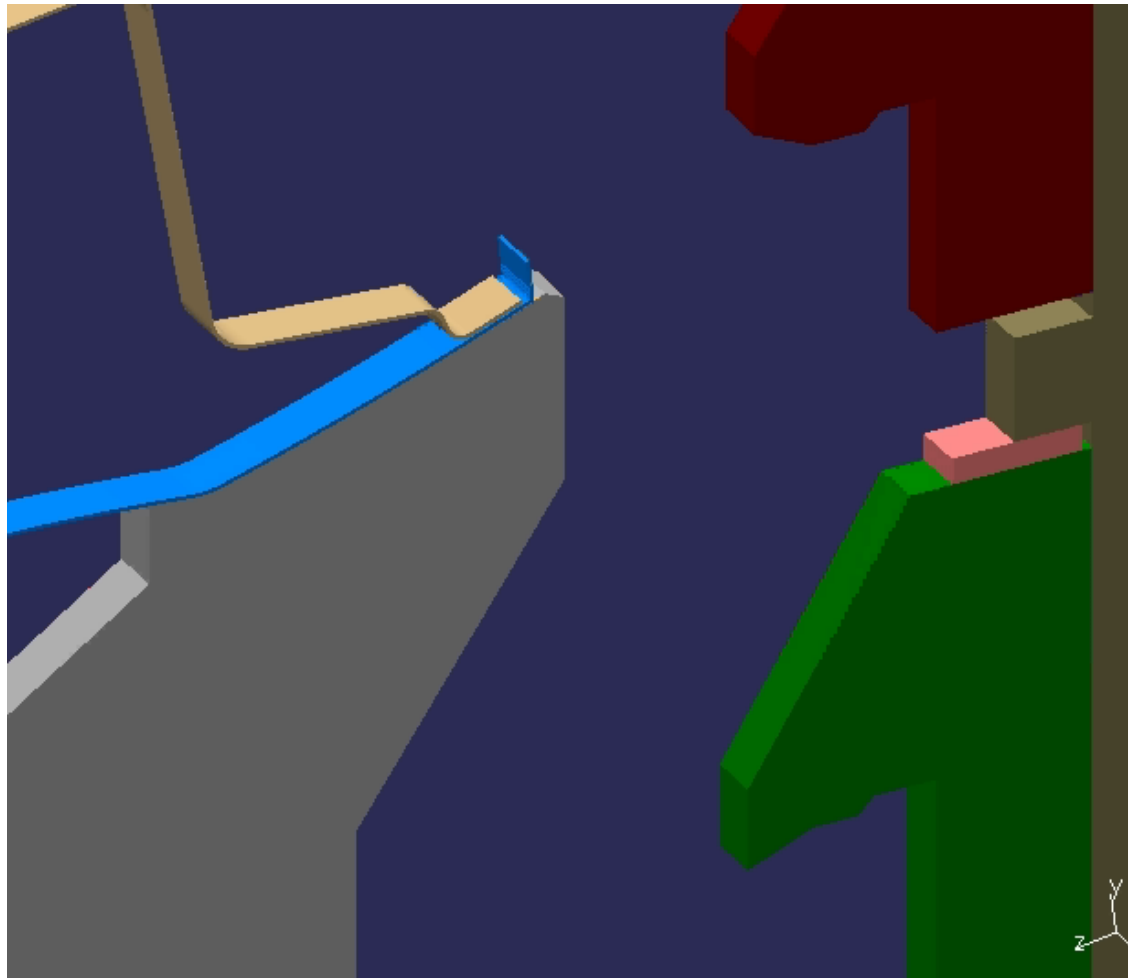



## Grafagem (“Hemming”)

Grafagem  
“Table Top”

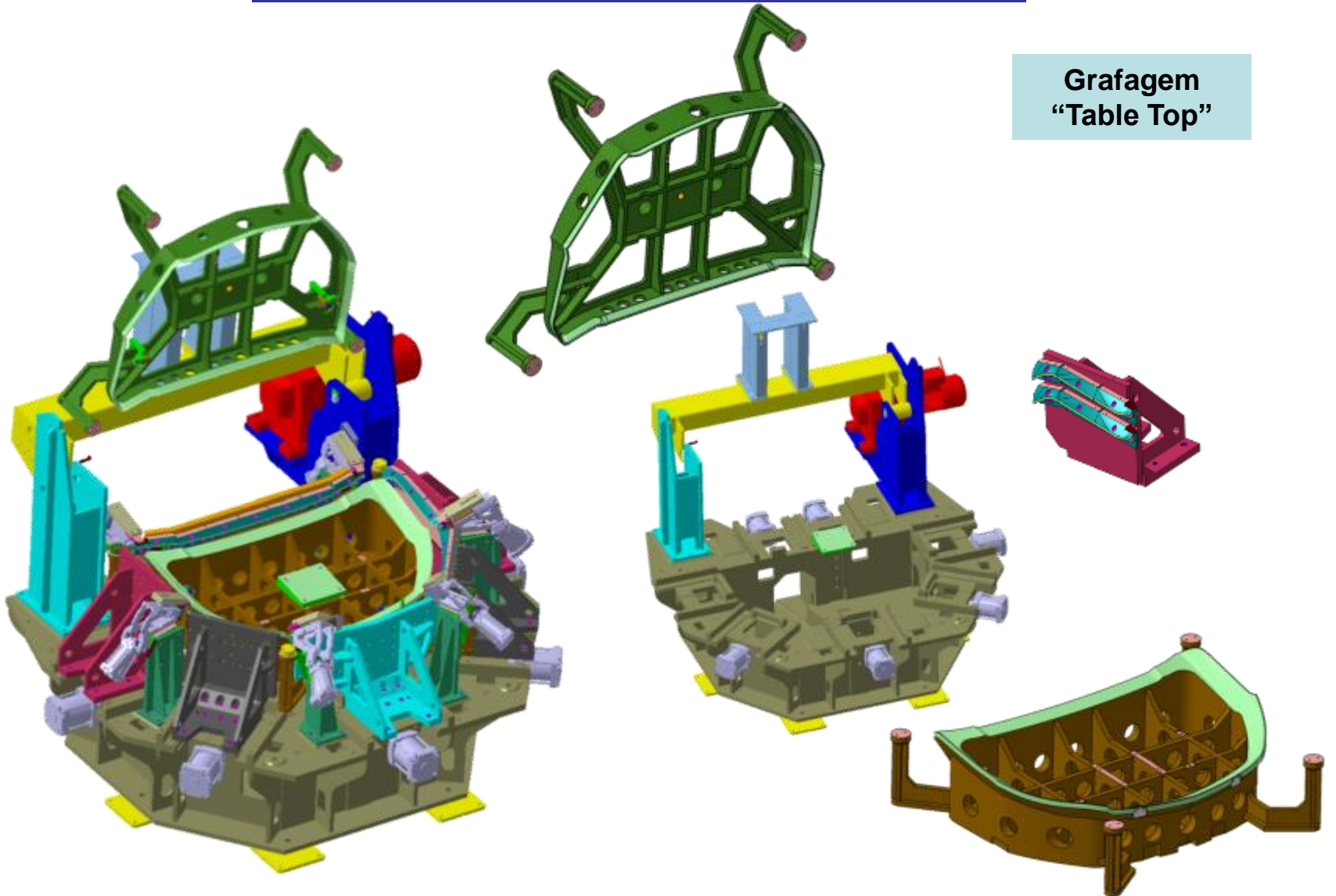





## Grafagem (“Hemming”)

Grafagem por roletes guiados por robô

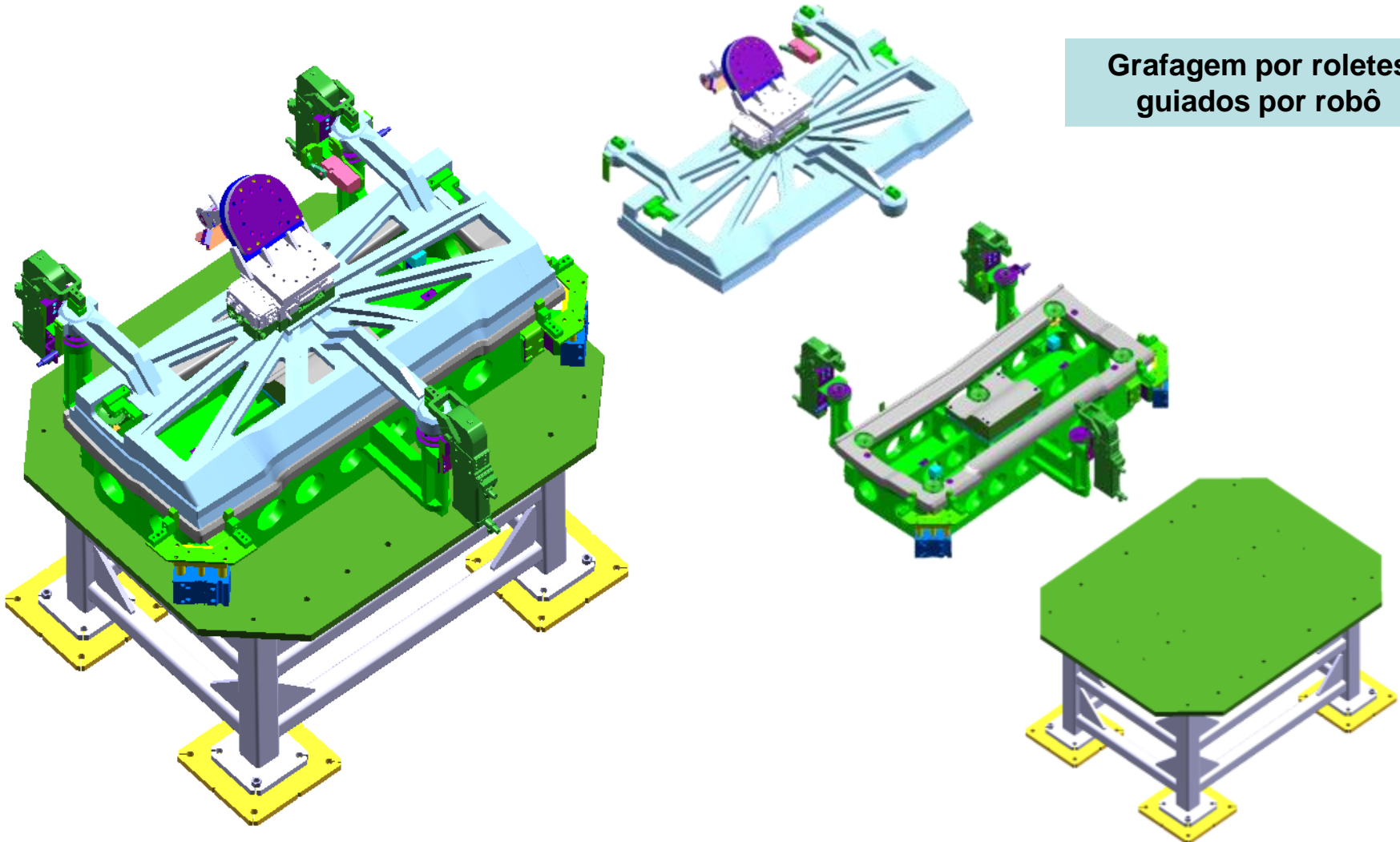



## Grafagem (“Hemming”)

Cura (endurecimento) do adesivo por indução  
Processo automatizado

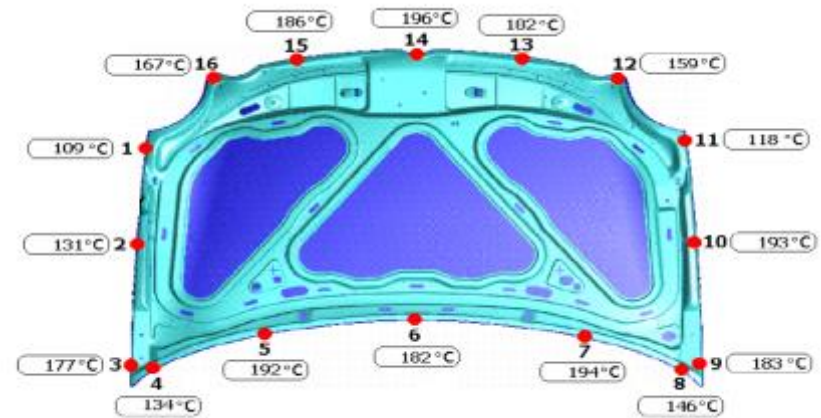
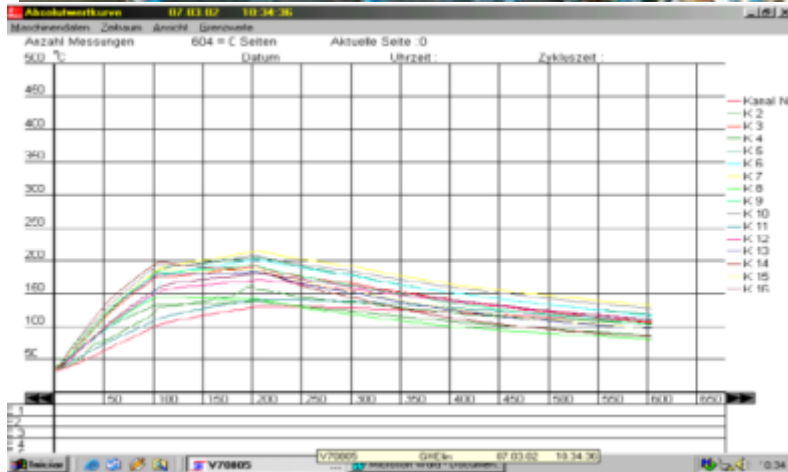

**OBS:** A Cura também pode se dar durante o processo de pintura



## Aparafusamento

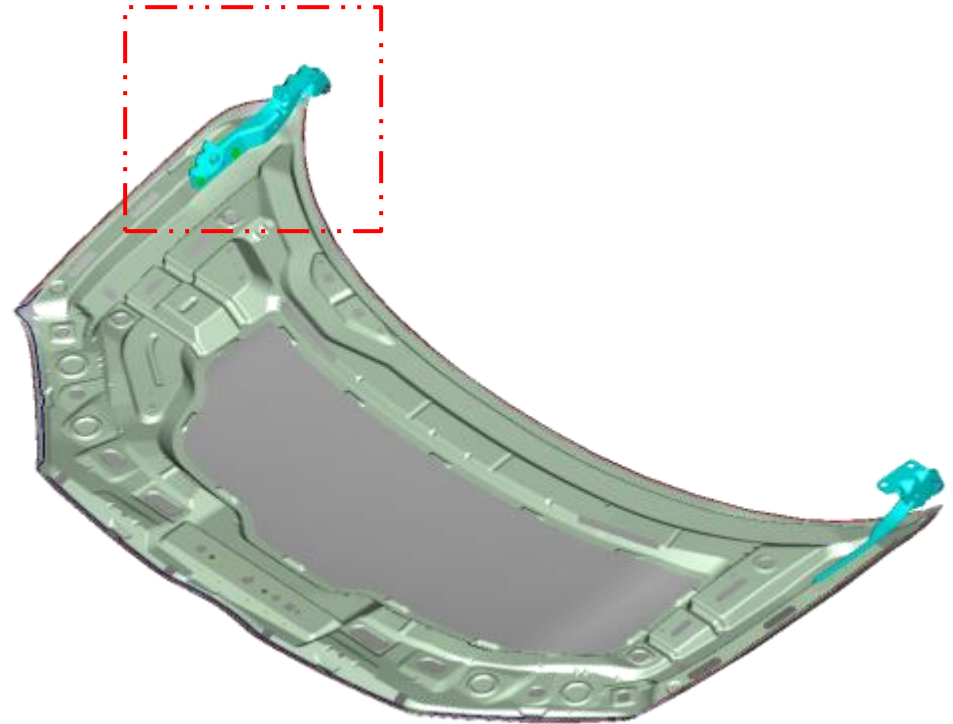
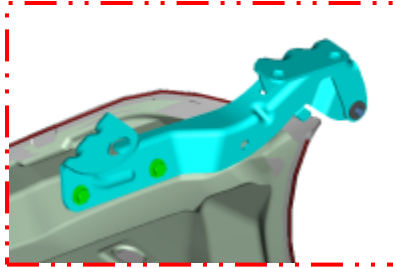

### Aplicações:

Dobradiças  
Cintos de segurança  
Trilhos de bancos  
Ancoragens da suspensão

### Solda projeção



## Pontos de fixação para clips plásticos e outros componentes Pinos Tucker™

Fixação sem necessidade de furação de chapas

Pino soldado à chapa por arco elétrico com alimentação automática de pinos

A forma cônica do flange de solda tem a função de estabilizar e centralizar o arco elétrico retirado, e conseqüentemente contribui para uma qualidade de solda livre de falhas

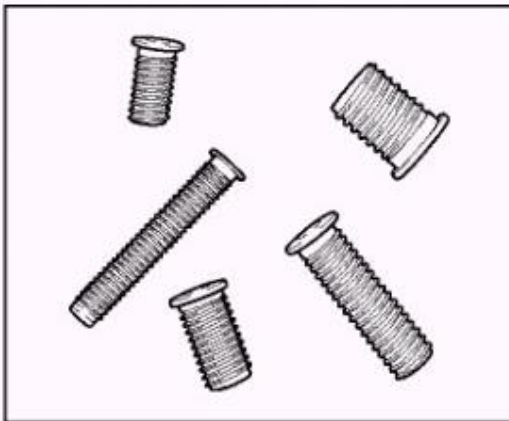

Diversos tipos de rosca, tamanhos, diâmetros, material (aço, aço, inox, bronze), proteção superficial

Aplicações:

- Fixação de módulos/componentes
- Substituição de parafusos / prisioneiros / porcas

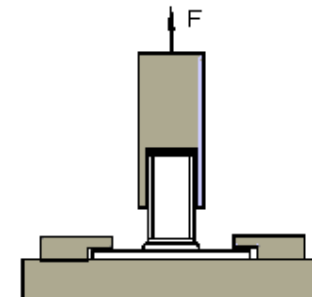
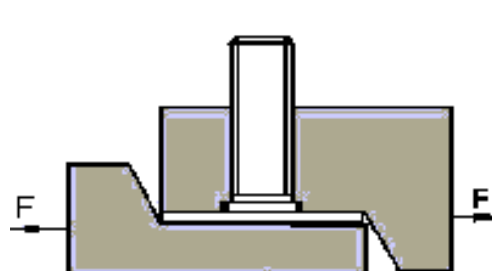
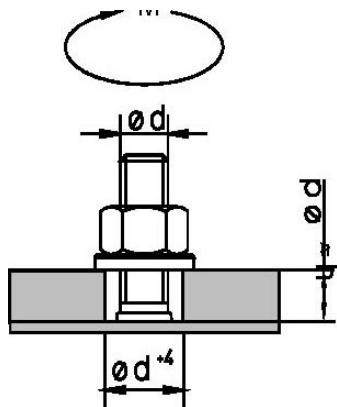



## Sequência de Armação Exemplo: Conjunto Tampa dianteira

Solda ponto

Cola

Grafagem

Aquecimento

Aparafusamento

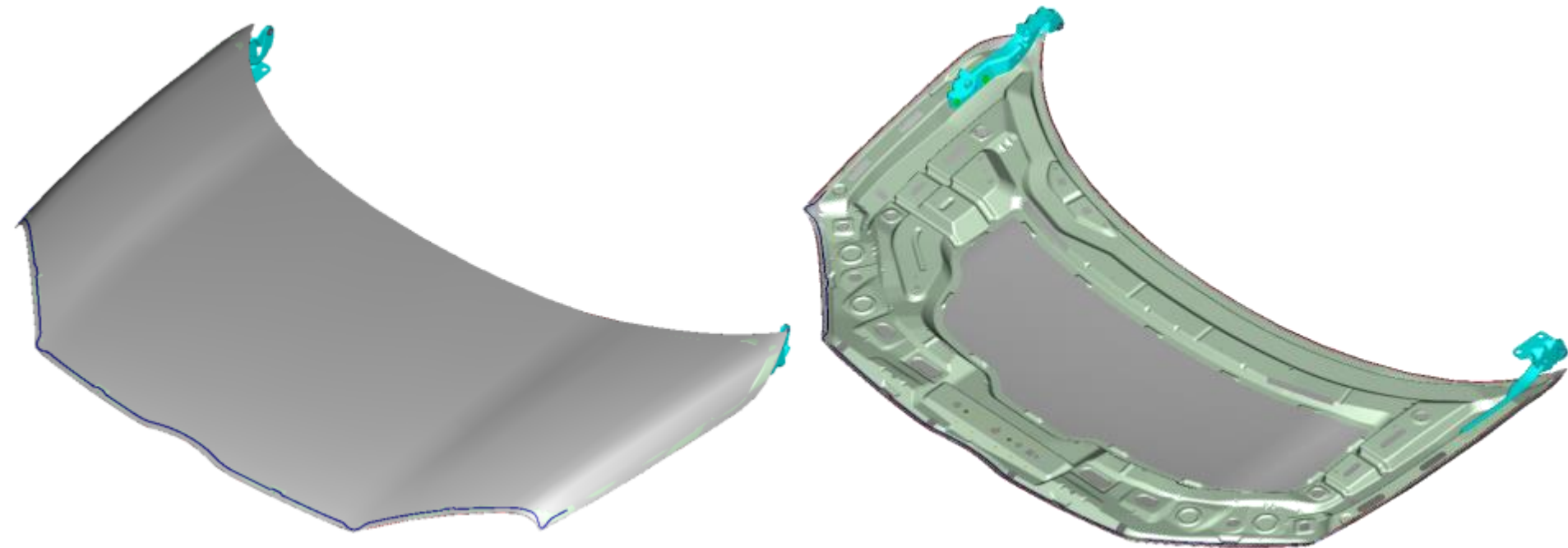



# Sequência de Armação

## Exemplo: Conjunto Tampa dianteira

### Fluxo do Processo

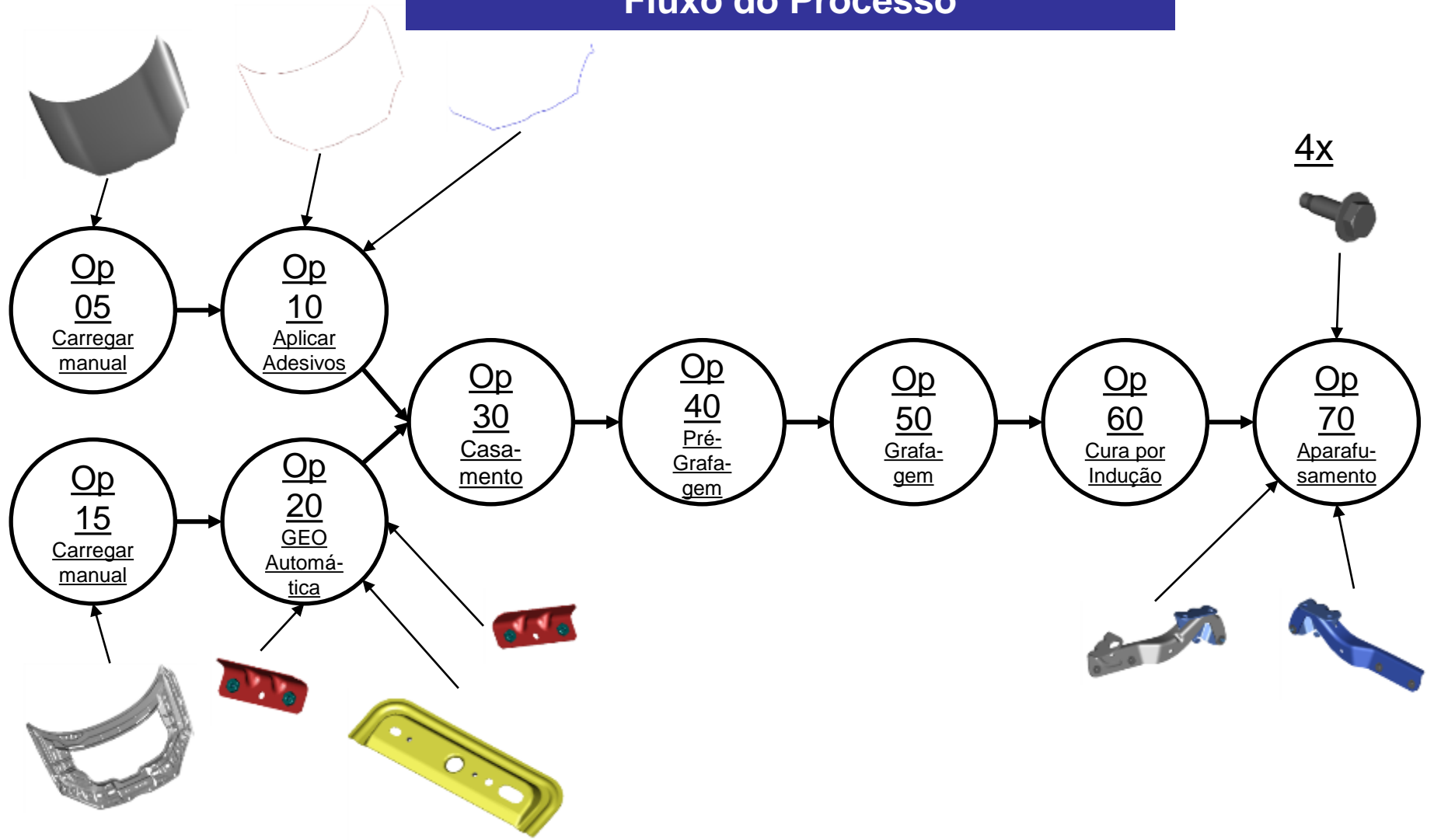



# Sequência de Armação

## Exemplo: Conjunto Tampa dianteira

### Leiaute da célula

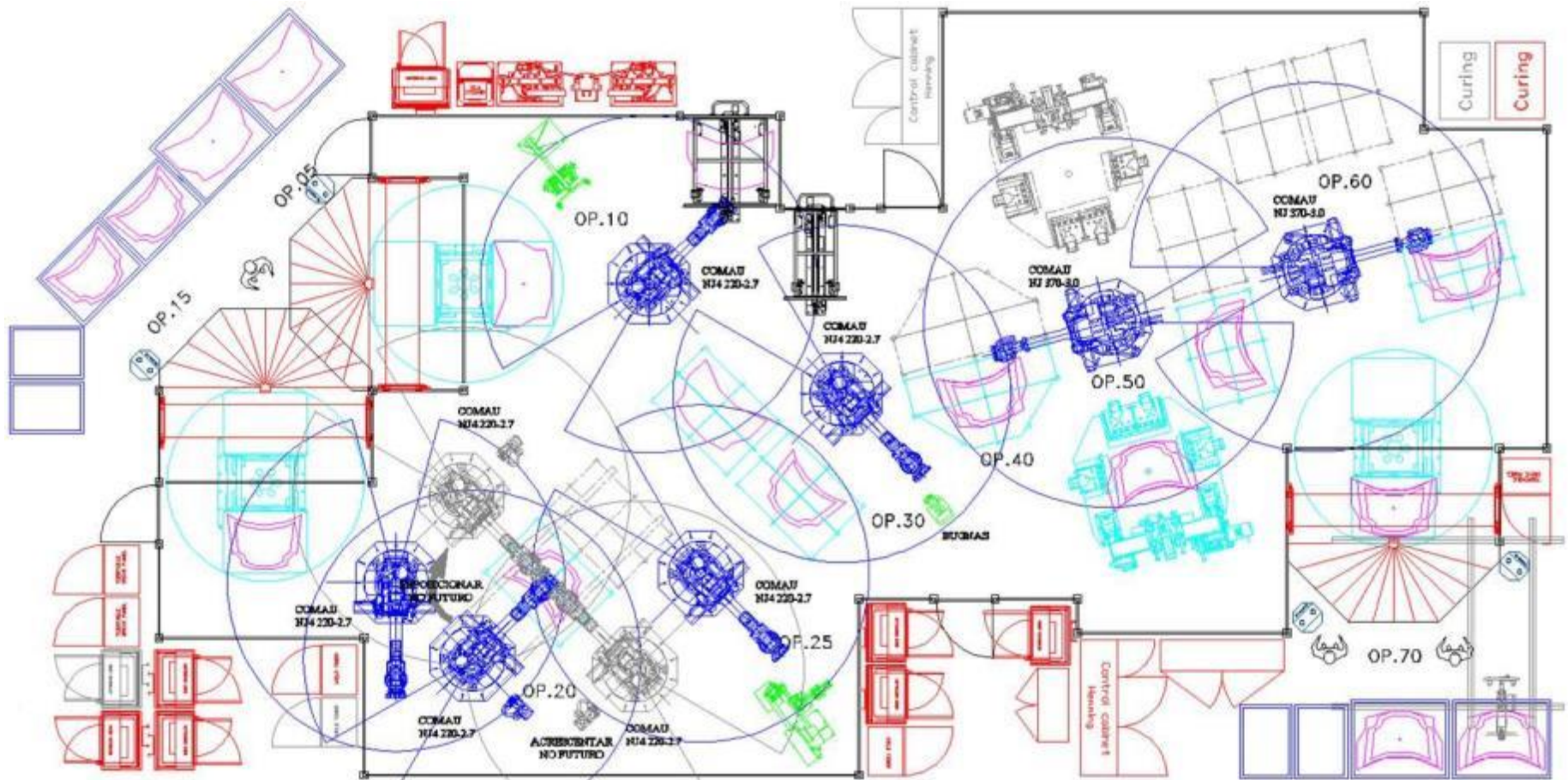



## Anti-ruídos

### Aplicações na Indústria Automotiva

Mantas Reforçantes  
Adesivos para Flanges  
Adesivos pré-formados

Adesivo de aplicação a quente

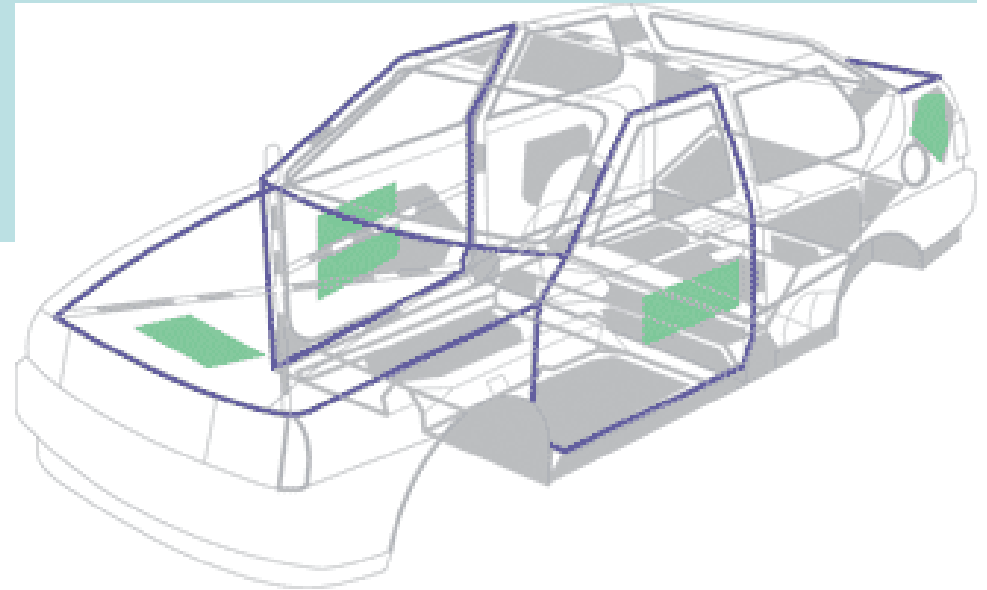





# Adesivos e Componentes Plásticos de vedação e reforço estrutural

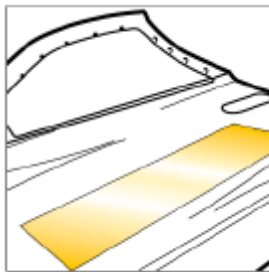
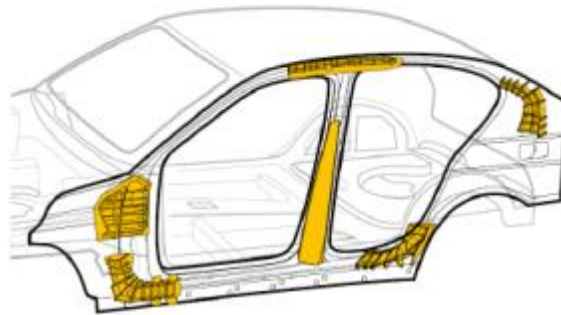
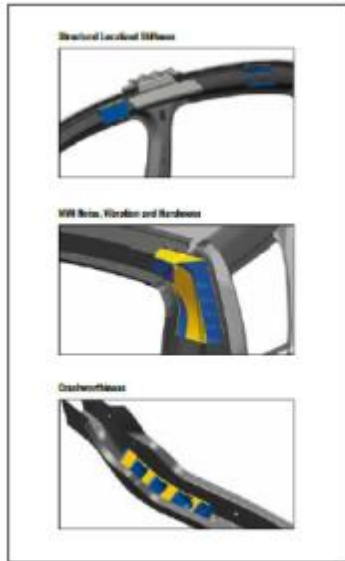

Vibration Damping of Body

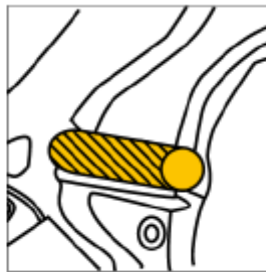

Sound Insulation of Body Cavities

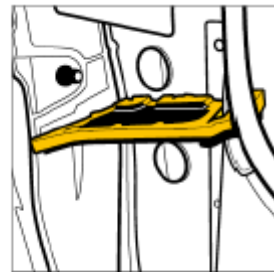

Patented design solutions



## Proteção contra corrosão, Vedação, Pintura

### Proteção contra corrosão:

Chapas de aço zincadas (à fogo; eletrolítico)

Âodos de sacrifício

Proteção contra corrosão na pintura:

- KTL

- Furos para escoamento de pintura (evitar bolhas; passagem nos tanques de pintura)

Vedação (entrada de água e poeira, ruído de vento):

Aplicação de PVC fino e grosso (também protege contra corrosão)

Selantes expansivos (bloqueio de cavidades)

Teste de água e teste de poeira



## Componentes →

Painéis metálicos estampados (painéis externos/externos – teto, laterais, assoalhos, portas, tampas)

Peças metálicas estampadas (reforços, suportes, travessas)

Elementos metálicos tubulares (longarinas)

Vidros, componentes plásticos,...

## Uniões →

soldadas (pontos de solda, cordões de solda, solda laser) rebites, cola estrutural, cola não estrutural)

parafusadas

## Materiais →

aços comum

aços de alta resistência

alumínio

plásticos



## Conjuntos que formam a carroceria

### Vistas explodidas - modalidades:

- Por sequência de armação de subconjuntos e conjuntos
- De peças unitárias (plataforma e chapéu)

### Planilha Árvore de de Armação:

- Conjuntos
  - Sub-conjuntos
    - Peça unitária
- Número e nome da peça
- Especificação de material
- Espessura
- Pesos da peças e conjuntos
- Elementos de união normalizados
- Ptos. de solda equivalente

### Vista explodida:

- Número e nome da peça
- Especificação de material
- Espessura
- Peso da peça
- Status da construção

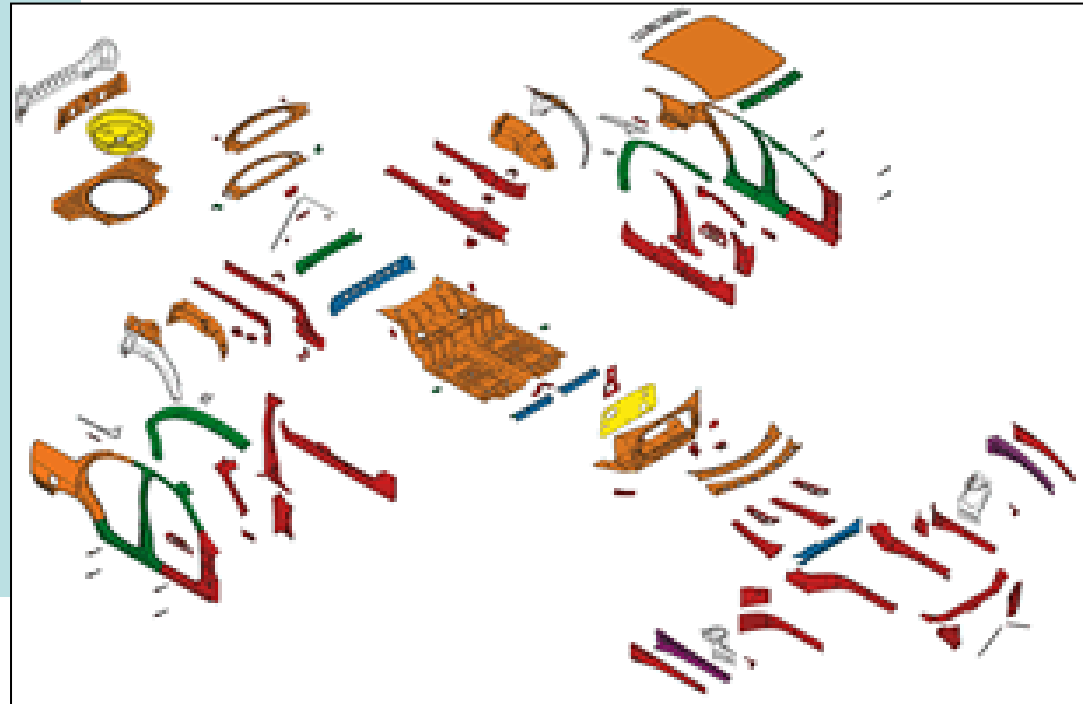



## **Conjuntos que formam a carroceria:**

### **Plataforma dianteira:**

Parachoques dianteiro

Front-end (Arrefecimento do motor, condensador AC, intercoller, reforço de fechadura tampa)

Longarinas dianteiras (coxinização de motor e câmbio, suporte de bateria)

Caixas de roda (suporte de perna de mola)

Longarinas superiores

Caixa d'água (limpadores de parabrisa)

Painel corta-fogo (pedaleira)

Assoalho dianteiro (bandejas, semilongarinas, reforços dianteiros, reforços de ancoragem da suspensão, suportes de trilho de banco, travessas)

Túnel (reforços longitudinais, reforço de freio de mão, reforço ponte sob o túnel)

Soleira (chapa de reforço, reforços locais anti-colapso)

Coluna A inferior (reforço de dobradiças e limitadores de porta, reforço de ancoragem da travessa do painel de instrumentos)



### **Plataforma traseira:**

Assoalho traseiro anterior (travessas, ancoragem de banco, ancoragem de cintos, ancoragem de tanque de combustível, ancoragem de escapamento)

Assoalho traseiro posterior (alojamento do estepe, ancoragem de escapamento)

Longarinas traseiras (ancoragem de suspensão traseira)

Caixas de roda (ancoragem de suspensão traseira – mola e amortecedor, ancoragem de cinto)

Painel traseiro

Parachoque traseiro

### **Chapéu (“Hut”):**

Coluna A superior (reforço de coluna)

Coluna B (ancoragem de cinto, ancoragem de desviador do cinto, reforços para colisão lateral, reforços de dobradiças e limitadores de porta traseira)

Coluna C (e/ou D) ancoragem de cinto, ancoragem de desviador de cinto

Travessa dianteira do teto (suporte do parabrisa)

Travessa intermediária do teto

Travessa traseira do teto (reforços de dobradiças de tampa traseira, ancoragem de cinto 3 pontos)

Teto

Porta-chapéu



## **Portas:**

Painel externo  
Painel interno  
Reforço de dobradiças  
Reforço de fechadura  
Reforço de vão da janela (externo e interno)  
Reforço contra impacto lateral  
Quadro superior e trilhos de vidro

## **Tampa dianteira:**

Painel externo  
Painel interno  
Reforço de dobradiças  
Reforço de fechadura  
Reforço de apoio de mãos

## **Tampa traseira:**

Painel externo  
Painel interno  
Reforço de dobradiças  
Reforço de fechadura  
Reforço de mola a gás



A construção da carroceria deve prover adequados níveis de rigidez, resistência e durabilidade para as diversas condições de carregamento a que o veículo possa ser submetido.

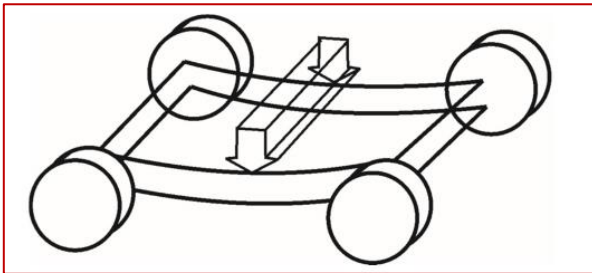
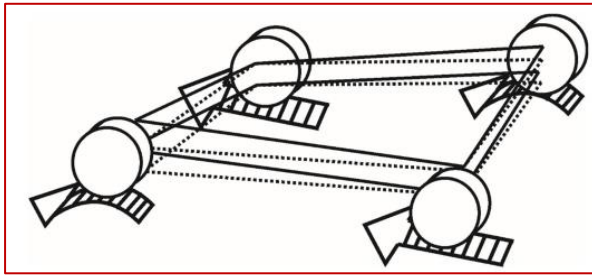









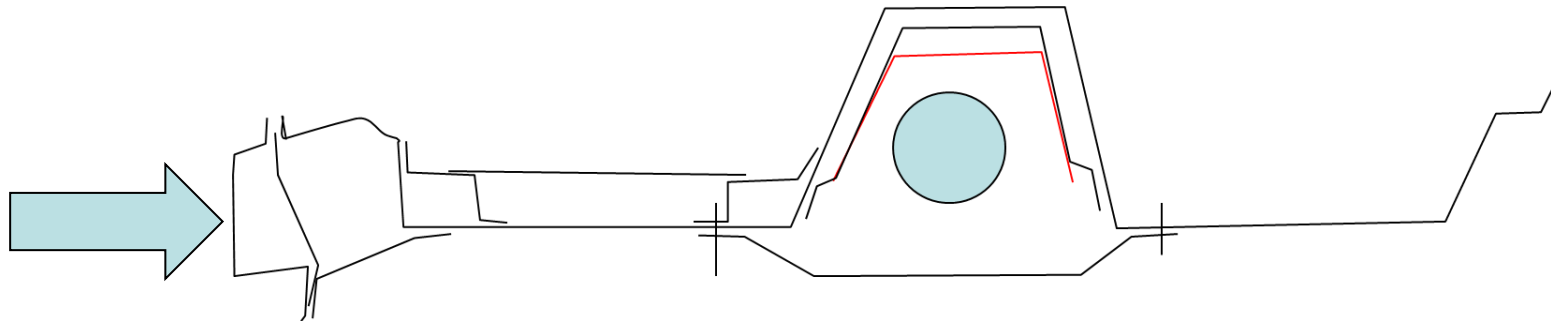







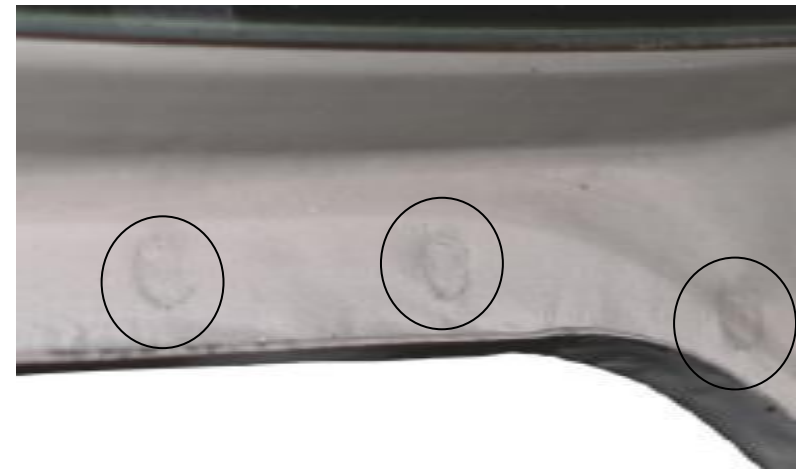
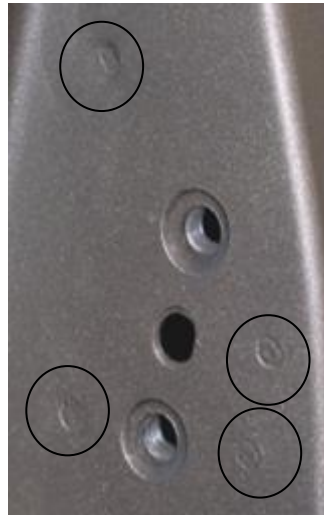



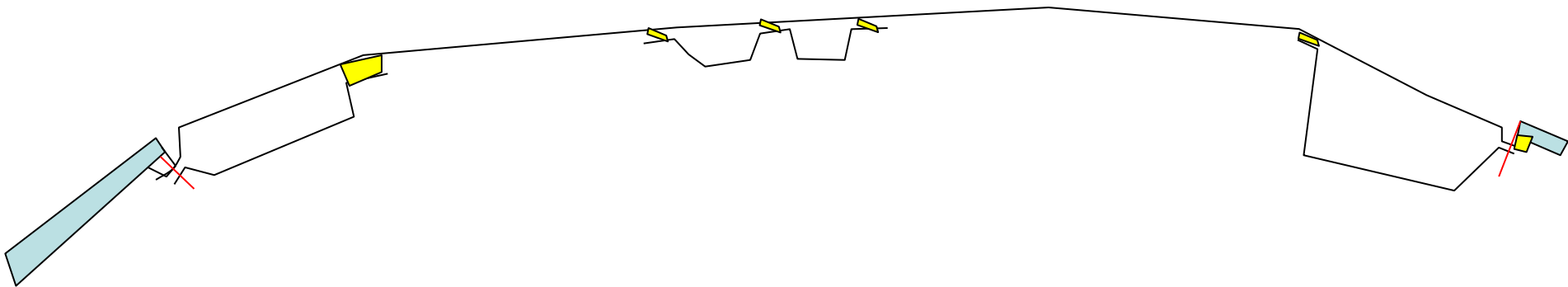



Vedação de cavidades → ruído

Expansível térmico durante secagem da pintura



Cavalete →  
função estrutural  
em “crash” lateral

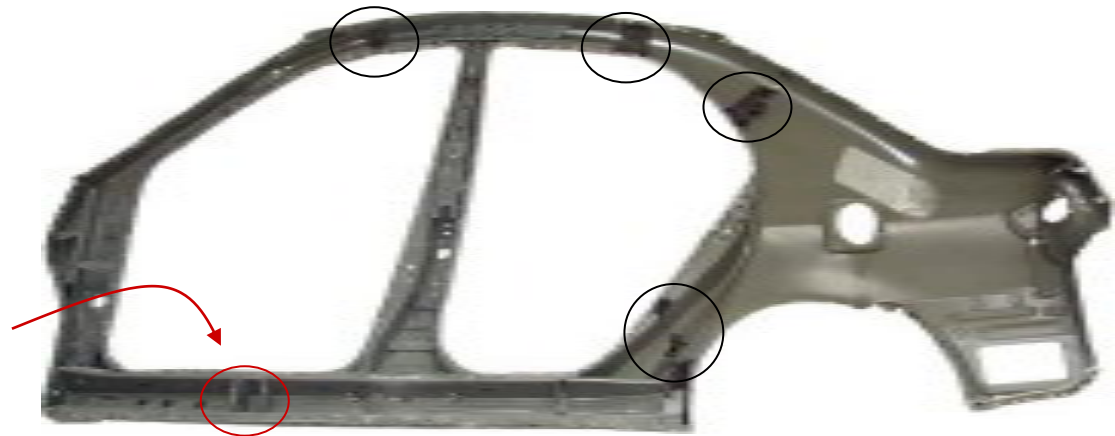

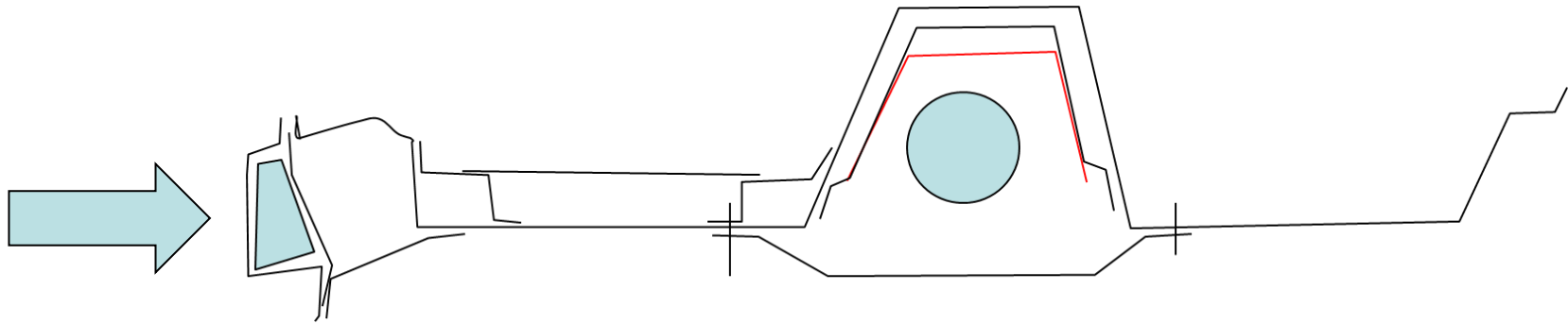

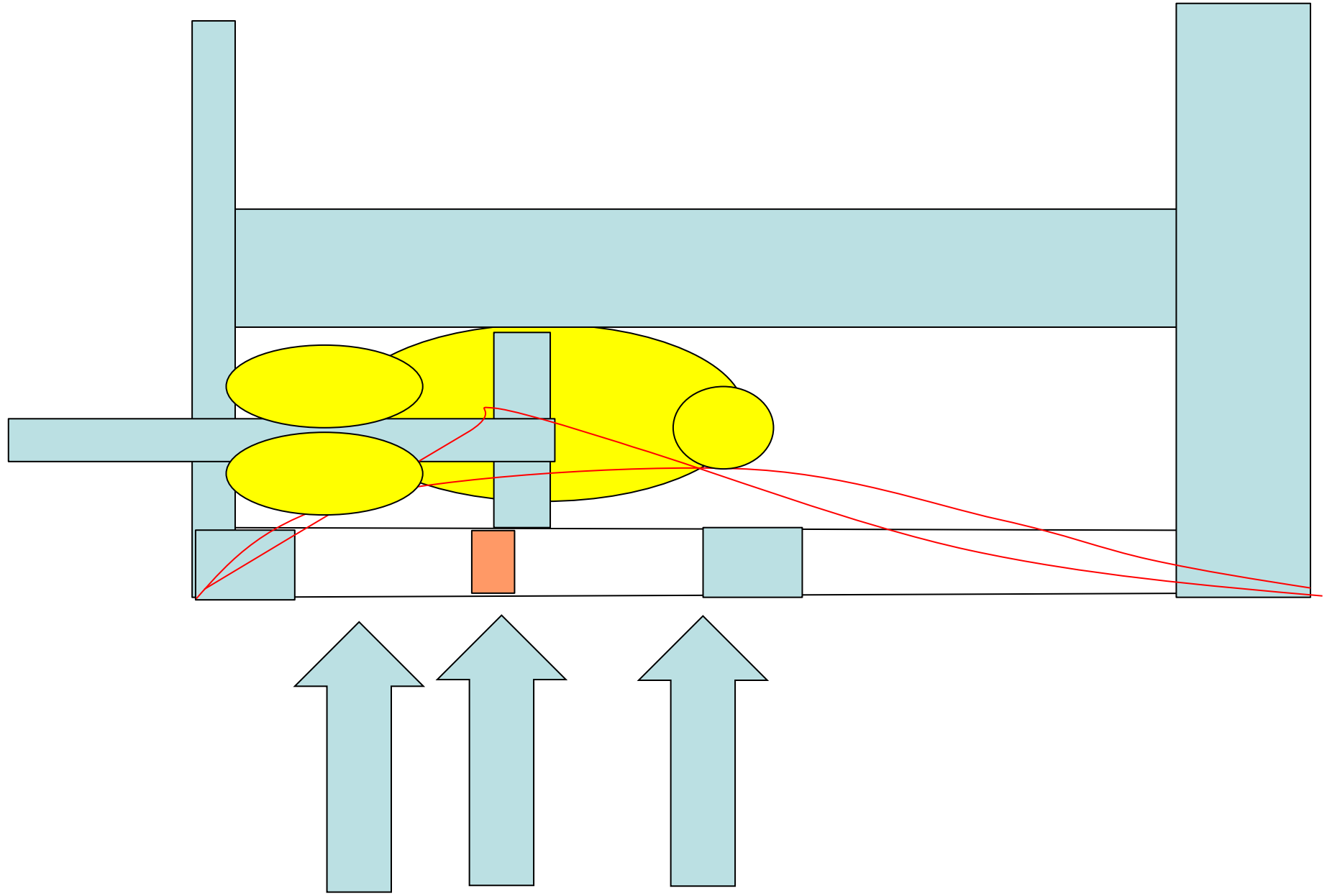







## Hatchback

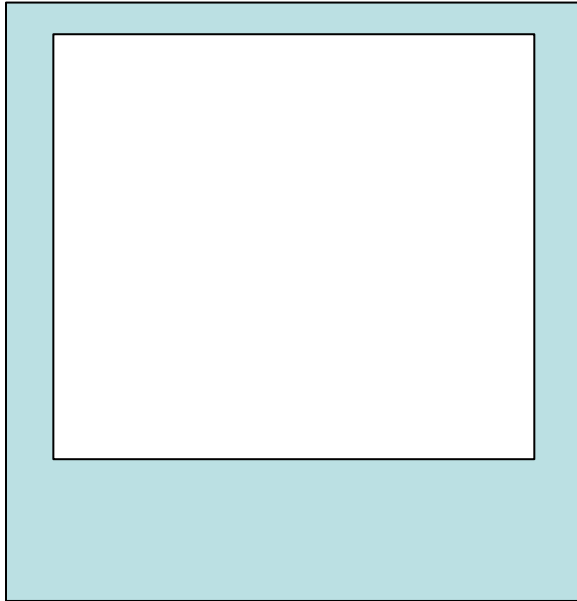

## Sedan

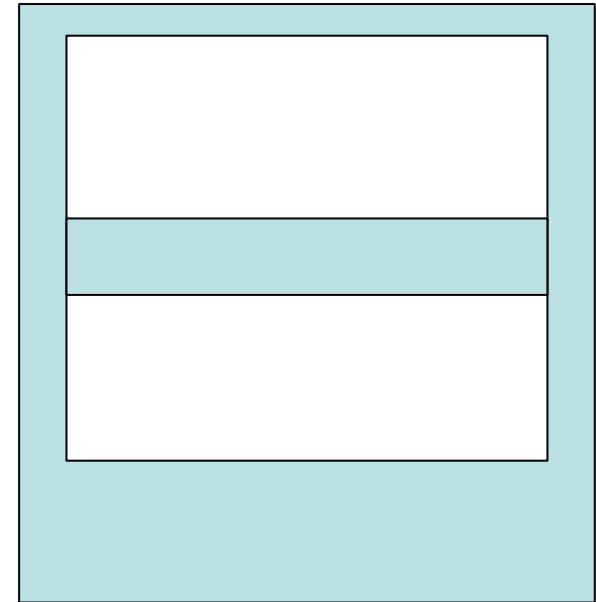



## Deformação no modo de torção

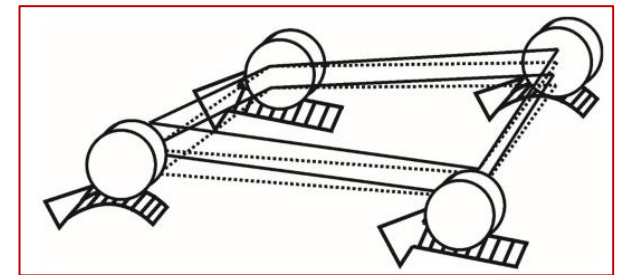
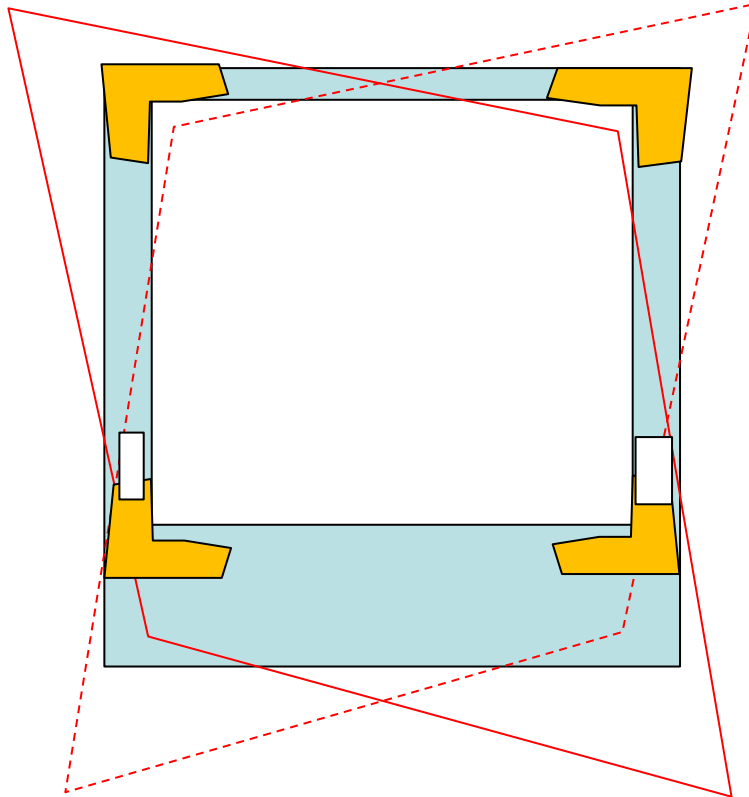





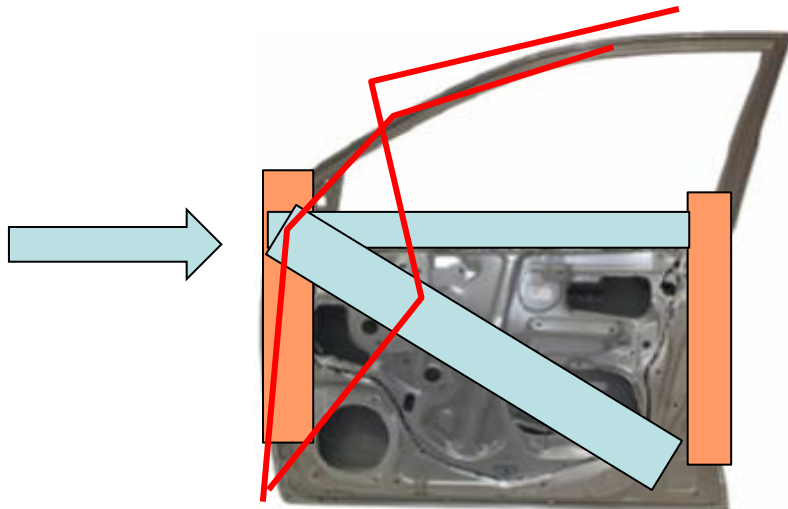
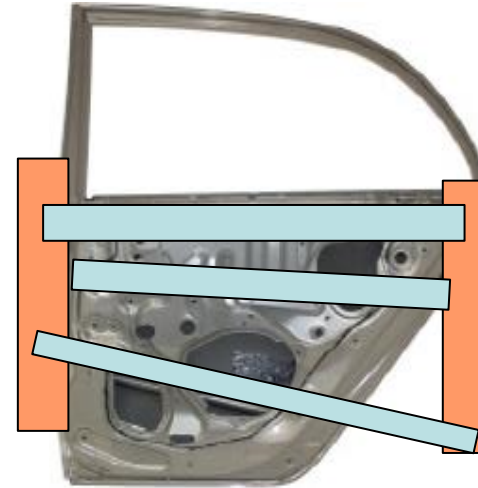



## Limitador de abertura de porta





**Compensação da carga de vedação na ferramenta do quadro superior da porta**

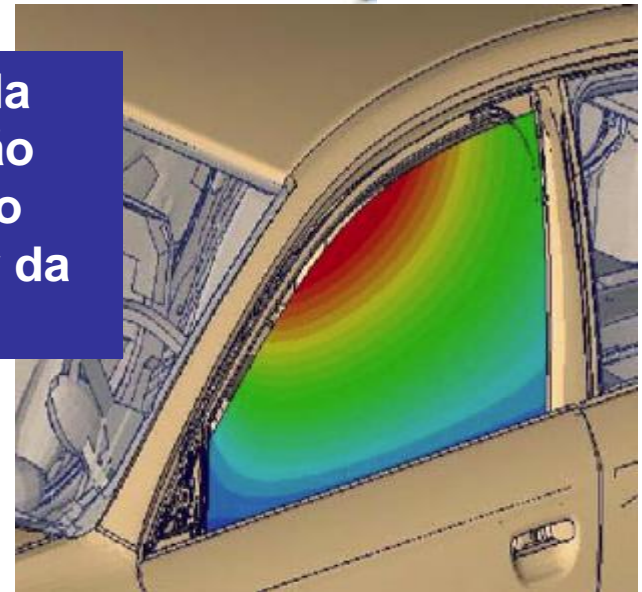





## Vedação do vidro das portas:

- Esforço de abertura e fechamento
- eficácia da vedação → ruído de vento, conforto

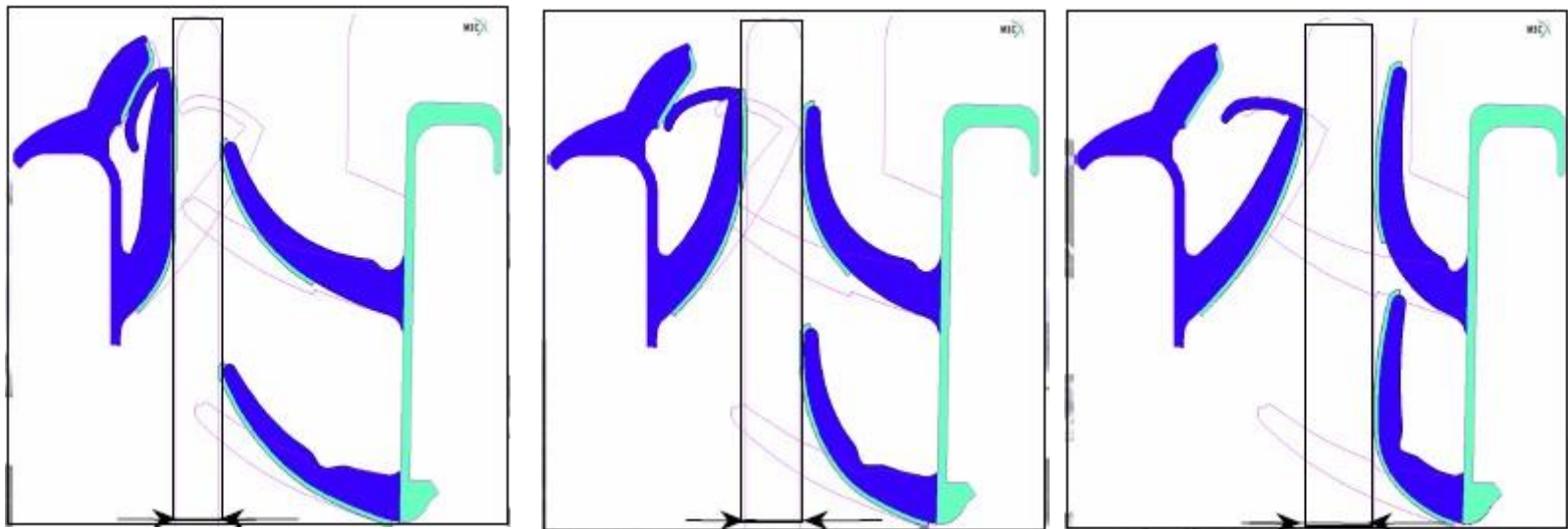











## Sistema ISOFIX para cadeirinhas de criança





## Sistema ISOFIX & Topheter para cadeirinhas de criança



- 1 garra de engate
- 2 capa guia encaixada entre encosto e assento
- 3 alça de ancoragem na carroceria

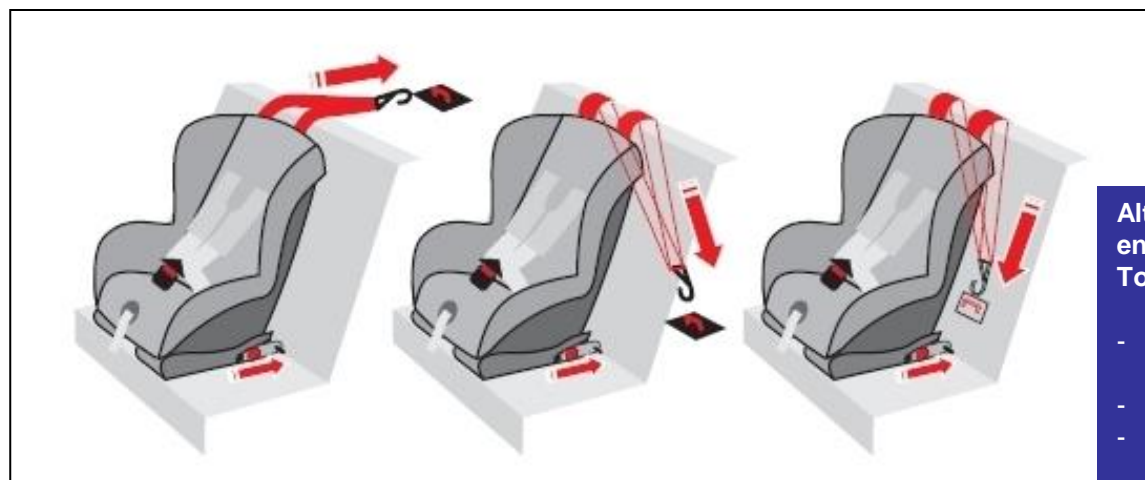

Alternativas para enganche do Topheter:

- no "porta-pacotes"
- no assoalho
- no encosto do banco



## Consórcio ULSAB Ultra Light Steel Auto Body

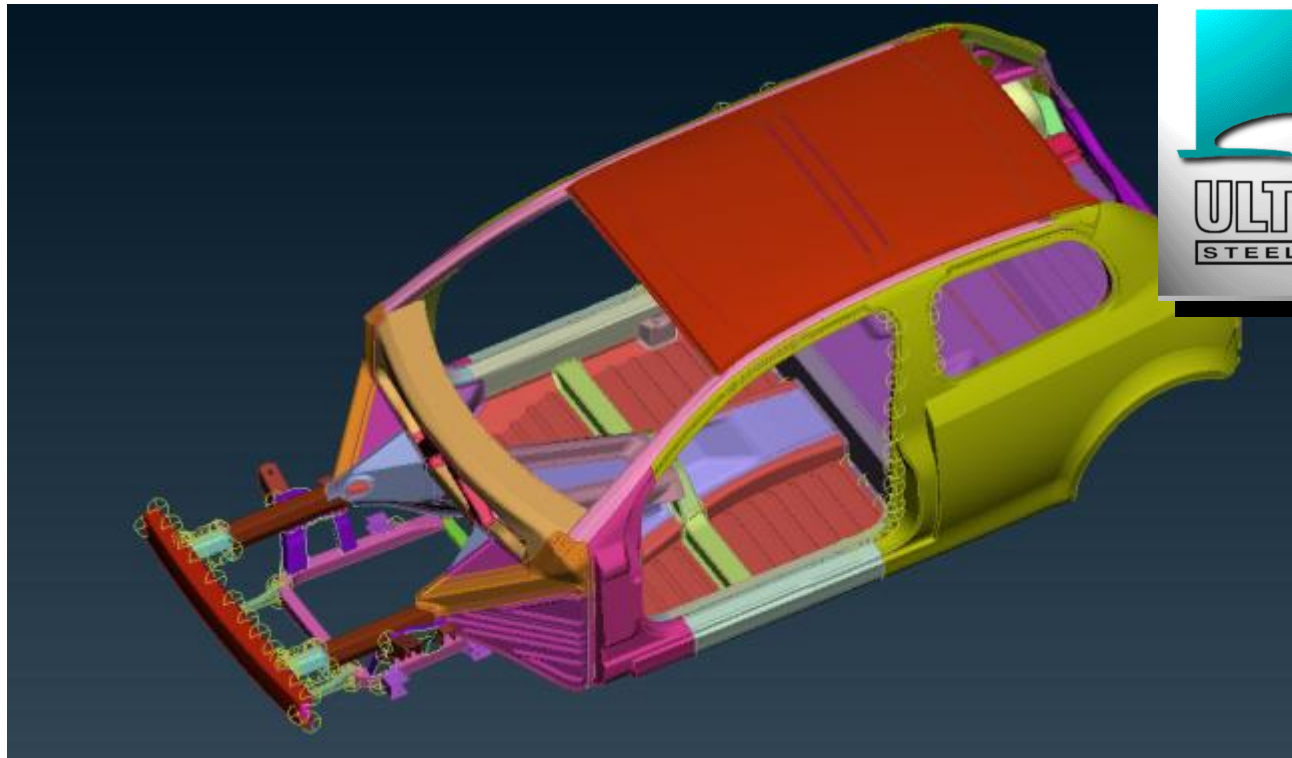



## Consórcio ULSAB

uso de aços de alta resistência  
uso de tailored blanks  
solda a laser  
processo hydroforming

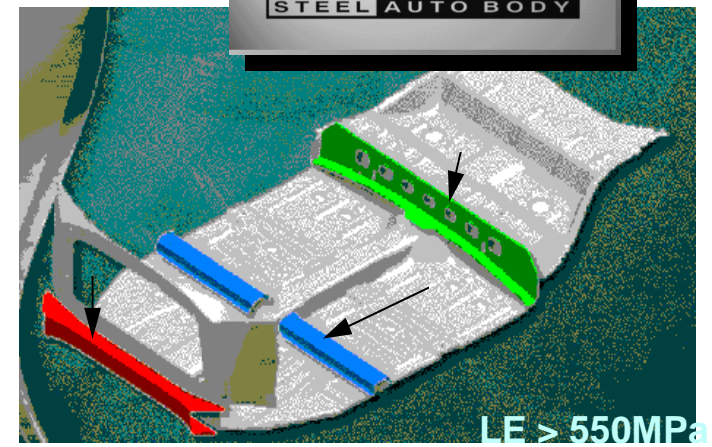
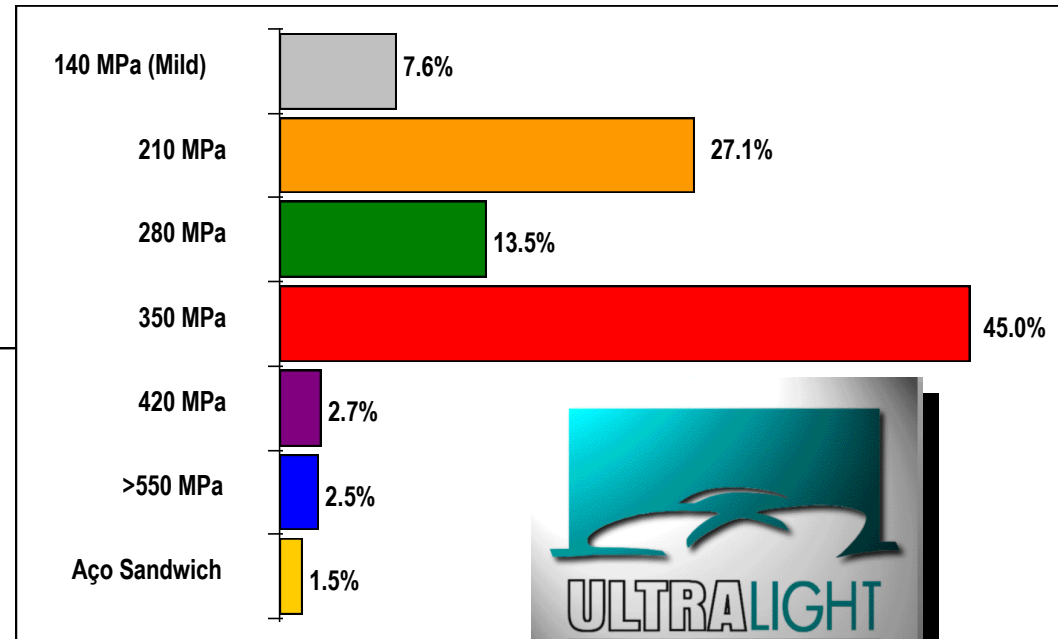
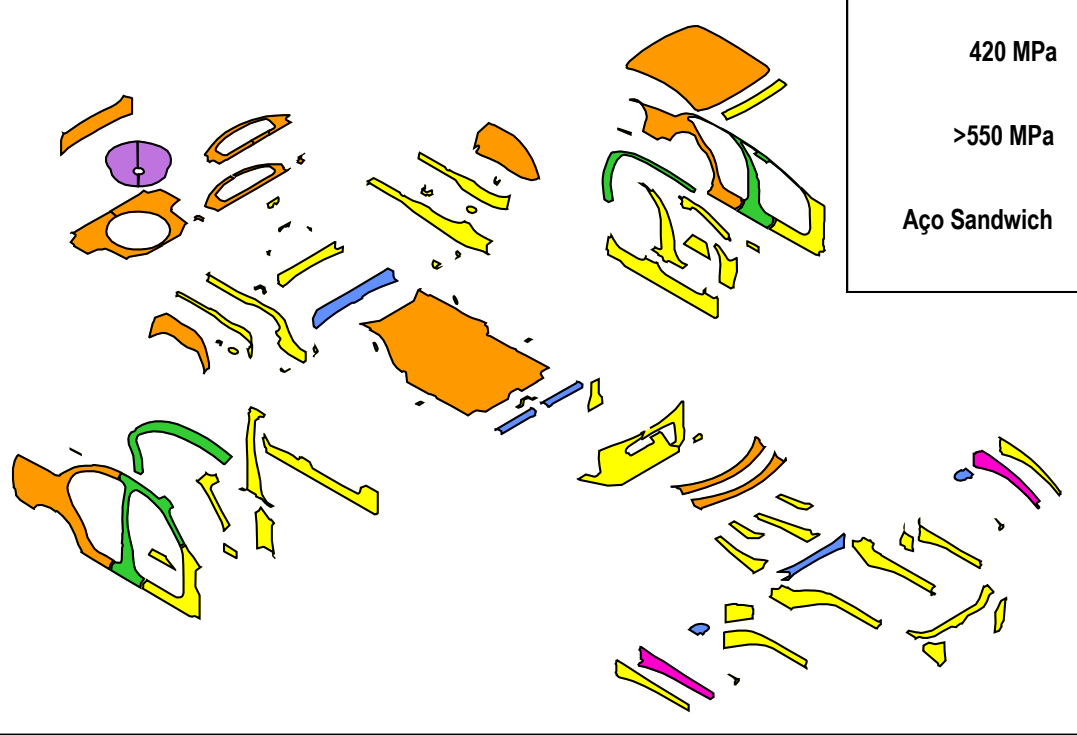



## Consórcio ULSAB

### uso de aços de alta resistência

**Melhor desempenho em situações de colisão**

**Mesmo nível de resistência com uma massa menor → diminuição da inércia → círculo virtuoso**

**10% redução no peso → 5% redução de consumo  
Redução de emissões (CO<sub>2</sub> e Nox)**

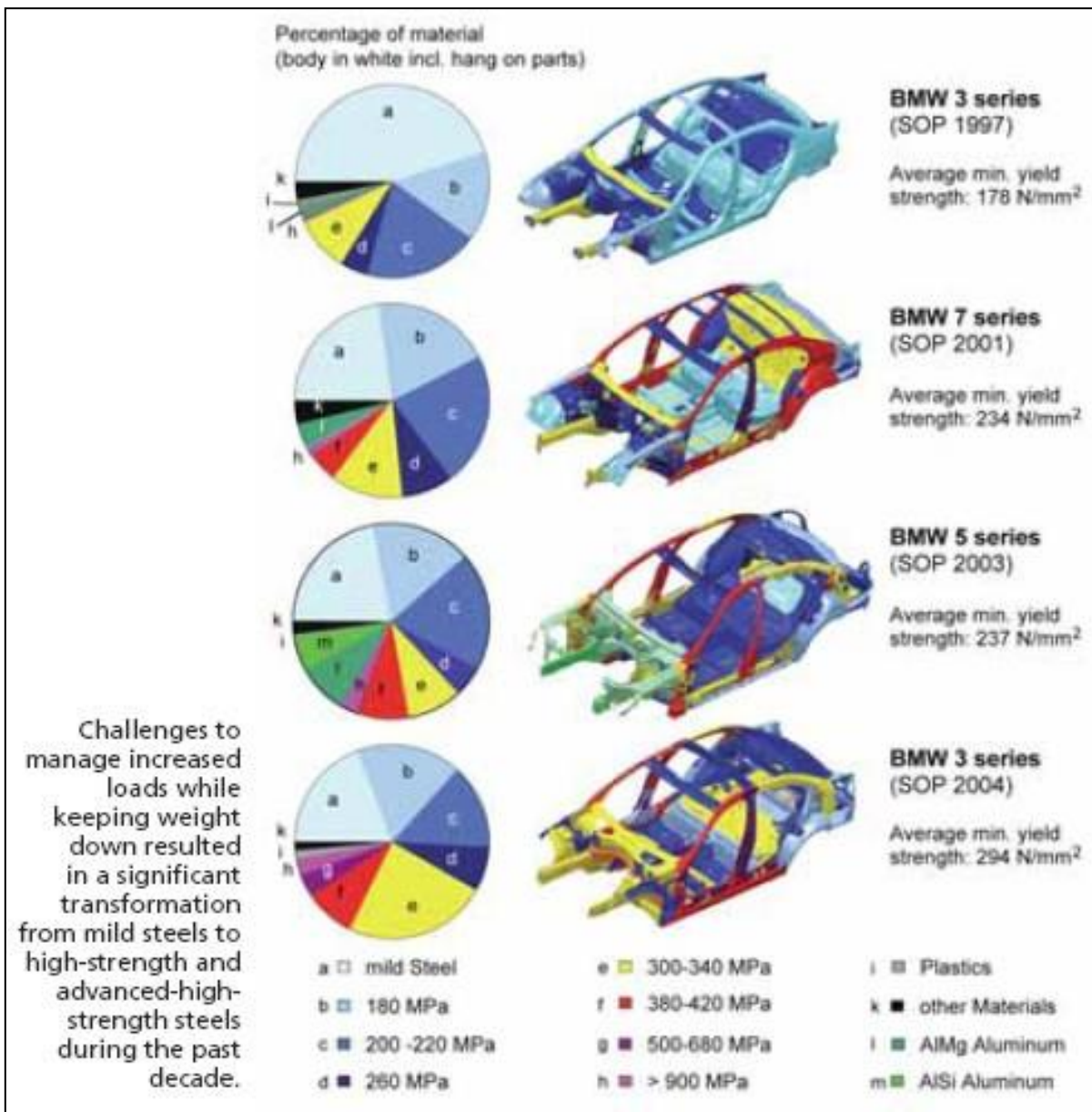

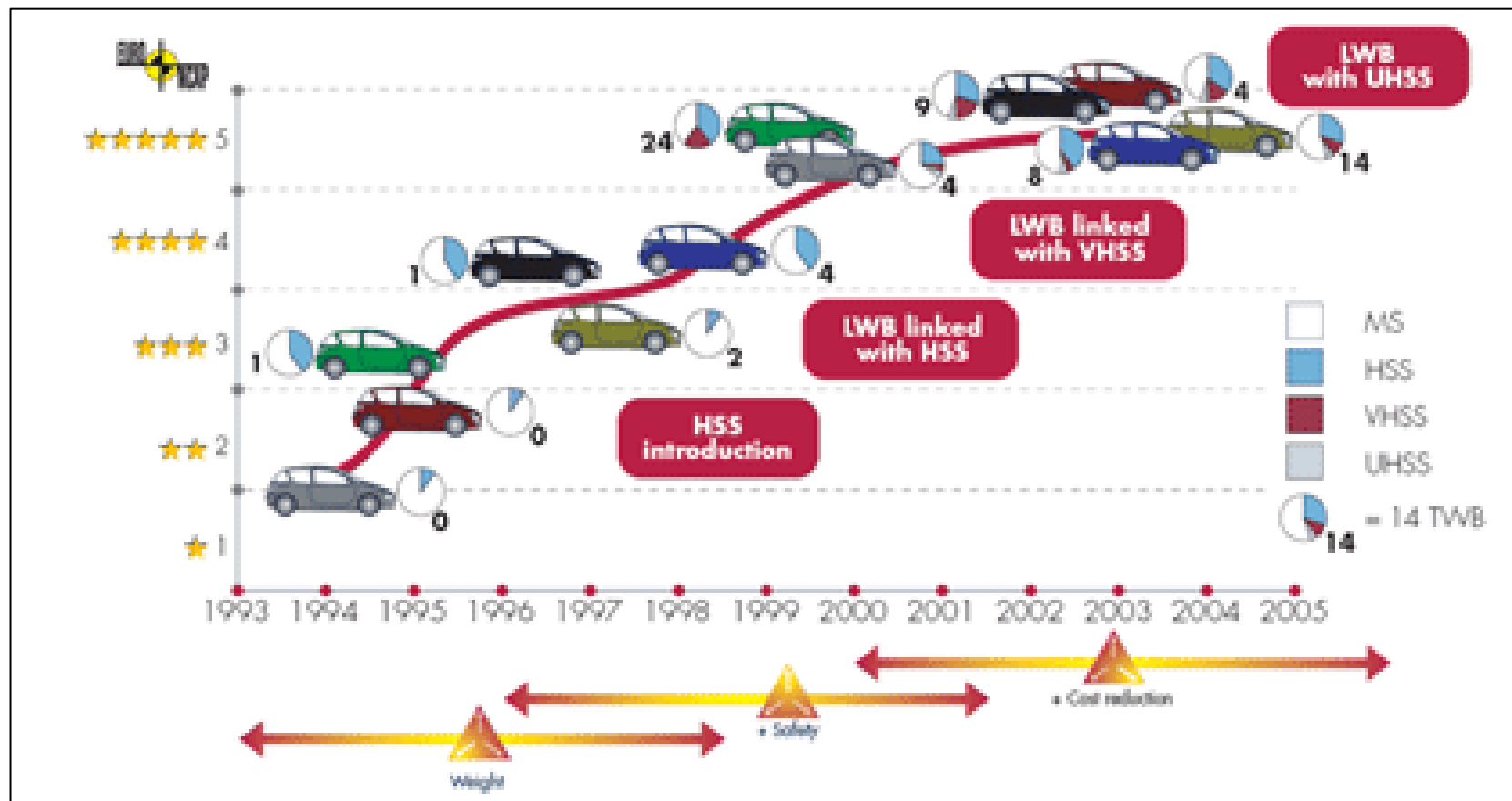





## “Tailor Welded Blanks” Blanks feitos sob medida

Diferentes espessuras de chapas soldadas a laser  
previamente à estampagem

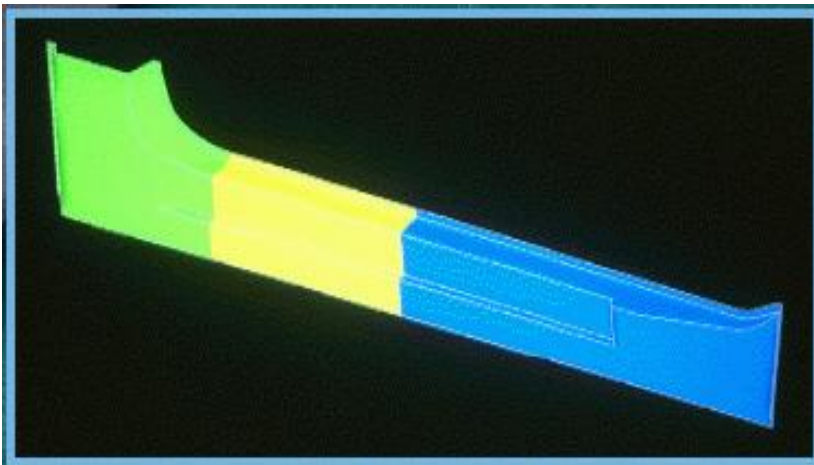

**Elimina reforços**  
**Reduz o número de partes, ferramentas, soldas**  
**Reduz a massa**  
**Melhora desempenho em crash**

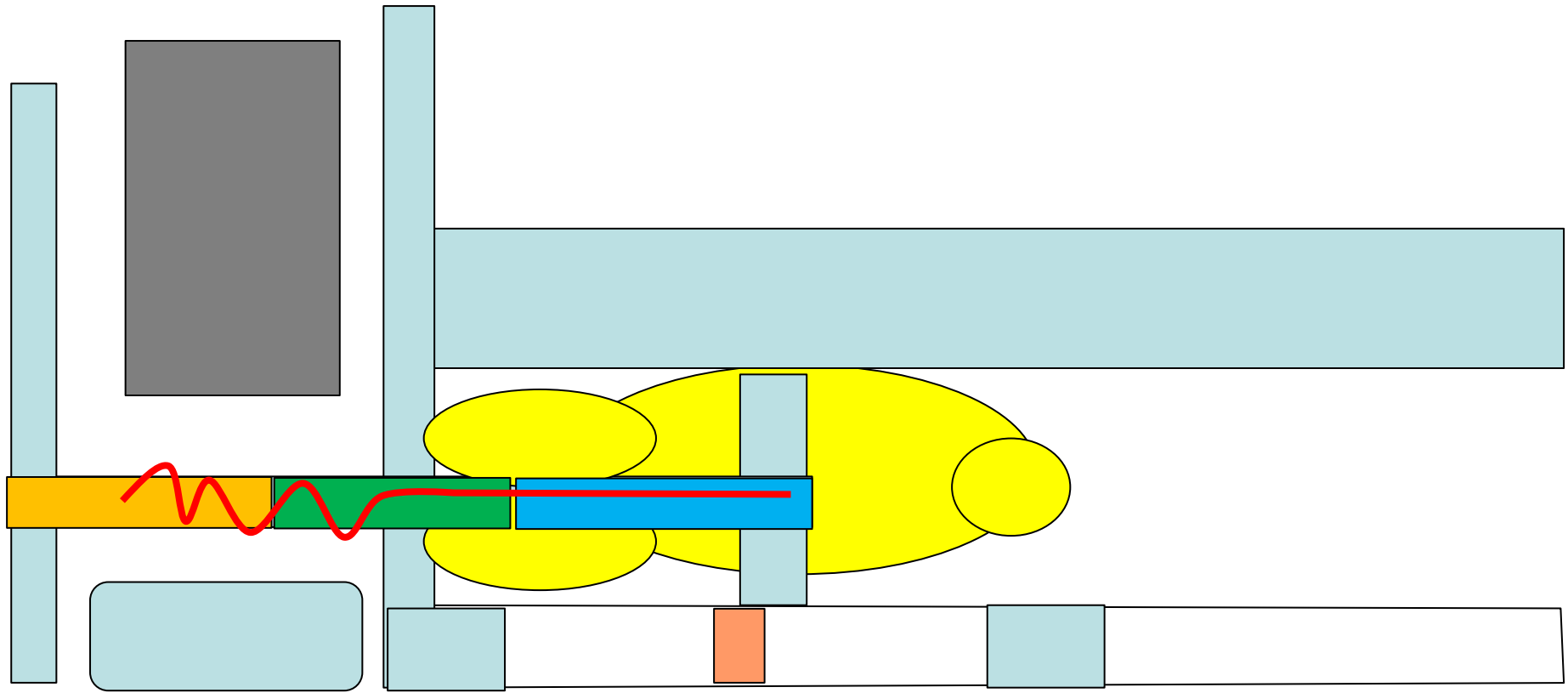

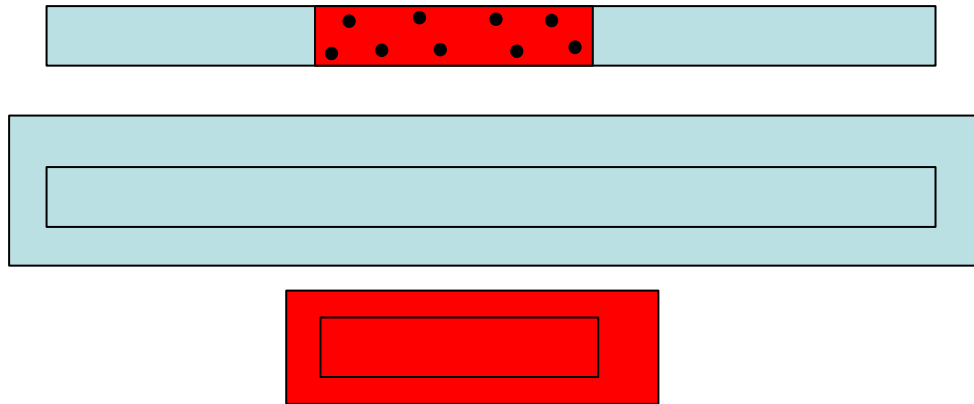

**Solução convencional:**  
**Longarina + reforço**  
2 ferramentais  
+ dispositivo de armação

União por pontos de solda  
(em pontos discretos)

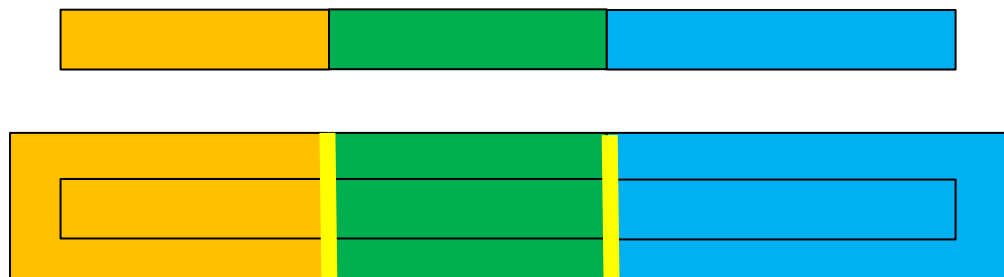

**Solução com Tailored Welded Blank:**

1 ferramental  
União por solda laser  
(contínua)  
3 espessuras de chapa  
3 especificações de materiais



## “Tailor Welded Blanks”

Proposta ULSAB p/ Lateral externo:  
Escoamento: 210 MPa até 350 MPa  
Usa 5 espessuras: 0.7 mm até 1.7 mm  
Peça estampada  
Usa “taylor blank” soldado a laser

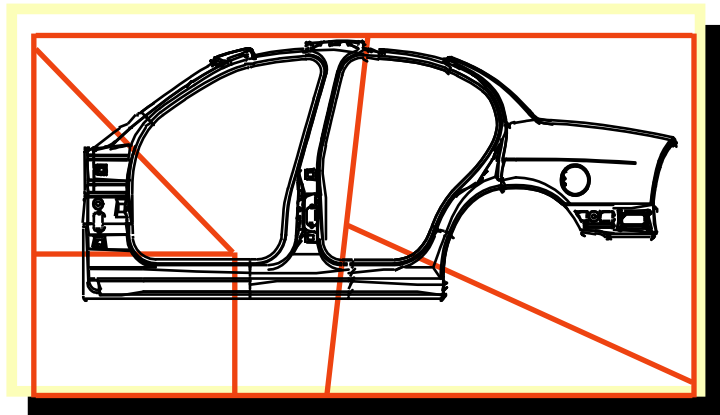



## “Tailor Welded Blanks”

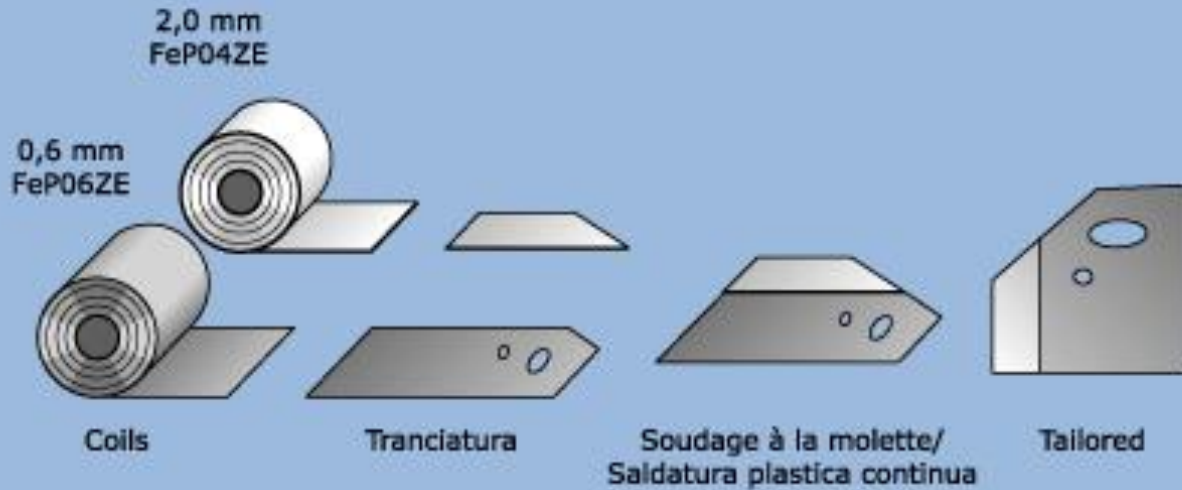

Representação esquemática do TWB: as chapas individuais podem ter diferentes especificação de material (tipo de aço), diferentes espessuras, diferentes revestimentos superficiais.

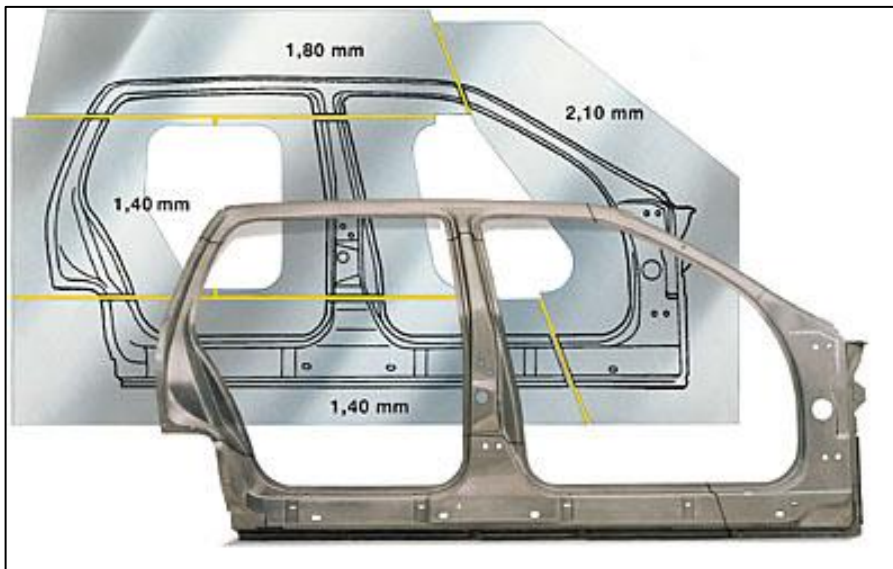



## “Tailor Welded Blanks”

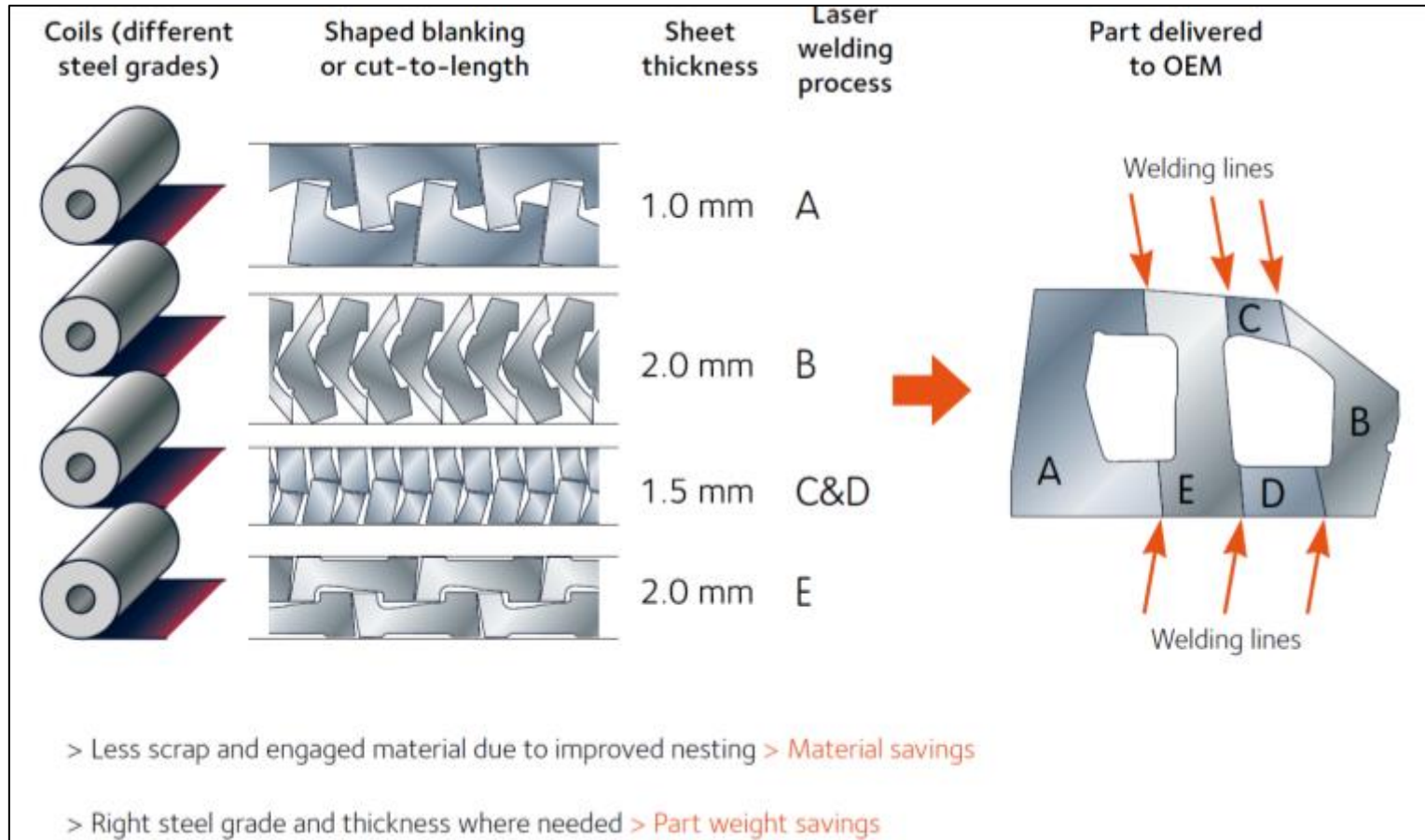



# “Tailor Welded Blanks” & Patchworks

## Butt welding

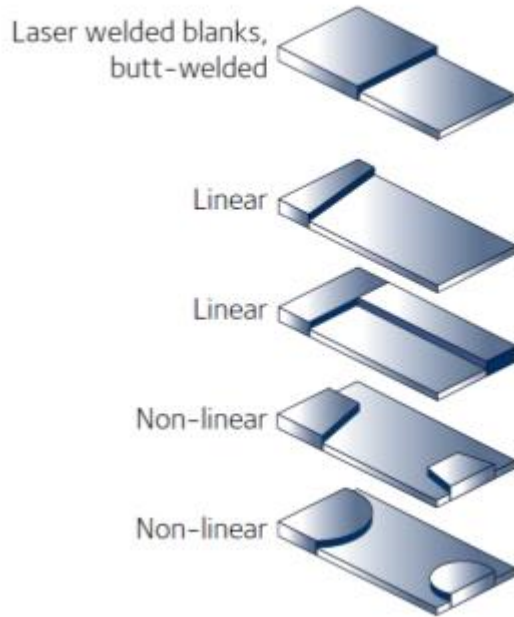

Body Side Inner

## Hybrid

Butt-welded blanks combined with patchwork



Lateral Door

## Patchwork

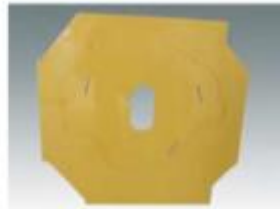
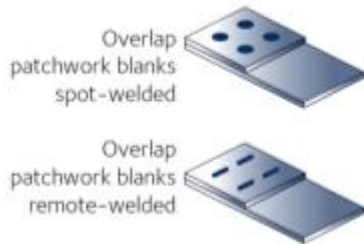

Shock Tower Patch Blank



Shock Tower Part





# “Tailor Welded Blanks” & Patchworks

**Blanks híbridos:  
TWB + Patchwork → mais uma proposta  
visando redução de peso ( e custo...?)**

Increase of function integration by a combination of butt laser welding and patches welded by laser remote stitches

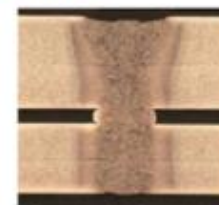
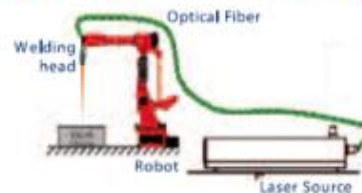

Macrograph of a weld



Lateral Door with:

1 laser butt weld and  
3 laser welded patches:

- > Lock reinforcement
- > 2 Hinge reinforcements

Closures inner panels

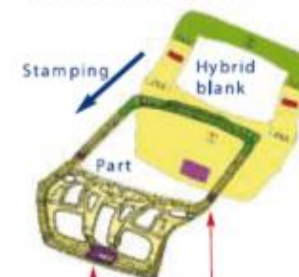

Tail Gate	Lock reinf.	Cylinder reinf.
Inner	6 stitches 50 mm each	3 stitches 20 mm each

Body In White parts

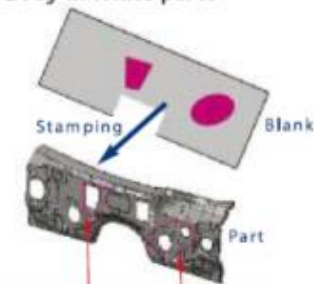

Dash-Panel	Air vent Stiffener	Mastervac & axle reinf.
	8 stitches 18 mm each	10 stitches 18 mm each

ArcelorMittal Tailored Blanks  
Innovatis  
5, rue Eug. Chervin  
F-93212 La Plaine St-Denis  
France  
www.arcelormittal.com





# “Tailor Welded Blanks” → Corte dos Blanks

## Arcelor Mittal Tailored Blanks

Nesting possibilities studies

Nesting is the process of maximising the number of blanks that can be cut from a steel coil. It is basically a geometrical exercise but some other aspects must be respected to optimise the nesting:

Rolling direction imposed by the formability requirements of the part or its in-service behavior

Tool constraints such as feasibility of the press geometry, evacuation of the blanks and the scrap, and the cutting quality of the edges to be welded

Coil width feasibility and economics

Tailored blanks production process (number of parts per weld cycle, edge preparation, linear/non-linear welding)

The blanks can be divided into two families depending on their shape:

### 1. Simple shaped blanks which are rectangular or trapezoidal

These blanks can be cut on a shear line and require no part specific investments.

This process is well suited for low and medium volume vehicles.

### 2. Complex blanks or shaped blanks

Blanking is made with tools on press line. The tools are dedicated to a specific part. For this reason, this process is efficient for high volume series where the investment is low per vehicle.

The ability to produce blanks by the most cost-effective process will always be determined before the blanking tools are ordered

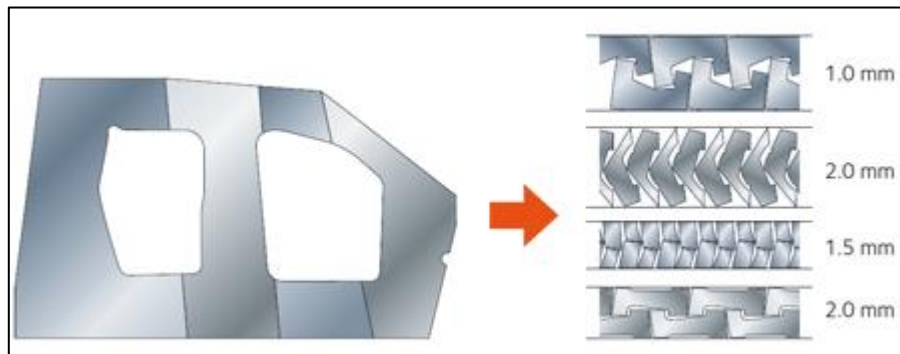

	Complex shaped blanks	Simple shaped blanks
High volume car > 400,000 vehicles/year	Tool blanking	Tool blanking for increased productivity
Low volume car < 50,000 vehicles/year	High tool cost per part, try to review the design of the tailor welded blanks	Shear blanking



## “Tailor Welded Blanks” → “Business Case” (análise econômica)

### Cost assessment & Mass comparison with post Assembly solution

- > We can realize complete business cases to compare Tailored Blanks solution with any other one.

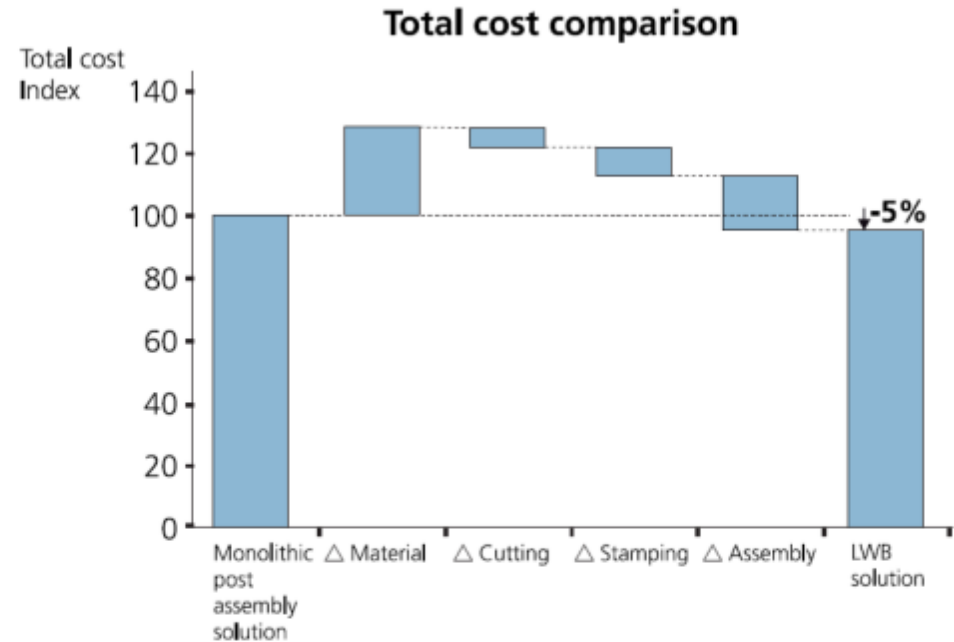

ArcelorMittal Tailored Blanks  
Innovatis  
5, rue Luigi Cherubini  
F-93212 La Plaine St-Denis  
France  
[www.arcelormittal.com](http://www.arcelormittal.com)



## Tailor Rolled Blank

Variação de espessura contínua ao longo da peça

→ Elimina a necessidade da solda a laser de blanks

→ Elimina descontinuidade brusca da espessura

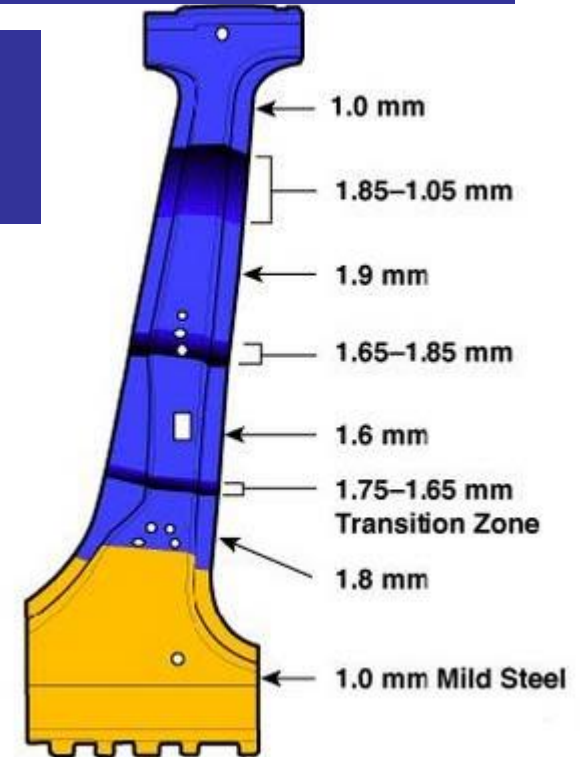
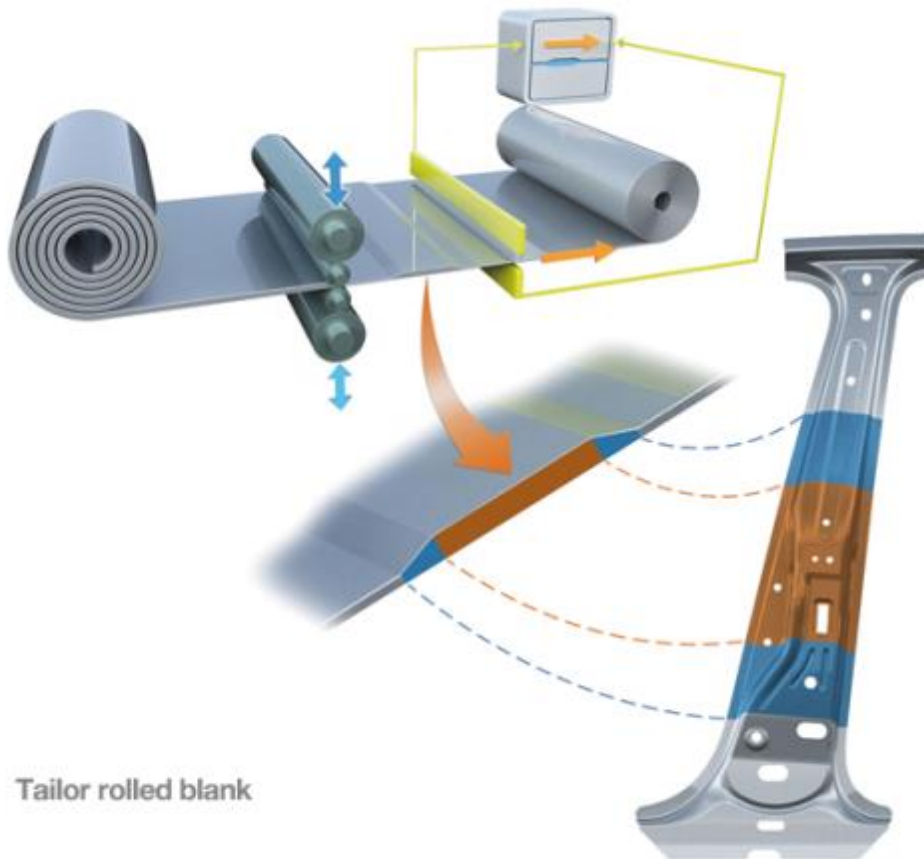

### Dodge Caliber

The 2007 and later Dodge Caliber has Ultra-High Strength Steel UHSS in the A-pillar, B-pillar, and roof-rail reinforcements. The B-pillar is made from a tailor-rolled, hot stamped steel which would tell you that the pillar will have different thicknesses. The two-piece pillar includes a lower section made from mild strength steel, and is combined with a tailor-rolled ultra high-strength steel upper se



## Tailor Rolled Blank apenas no flange de solda da peça!!

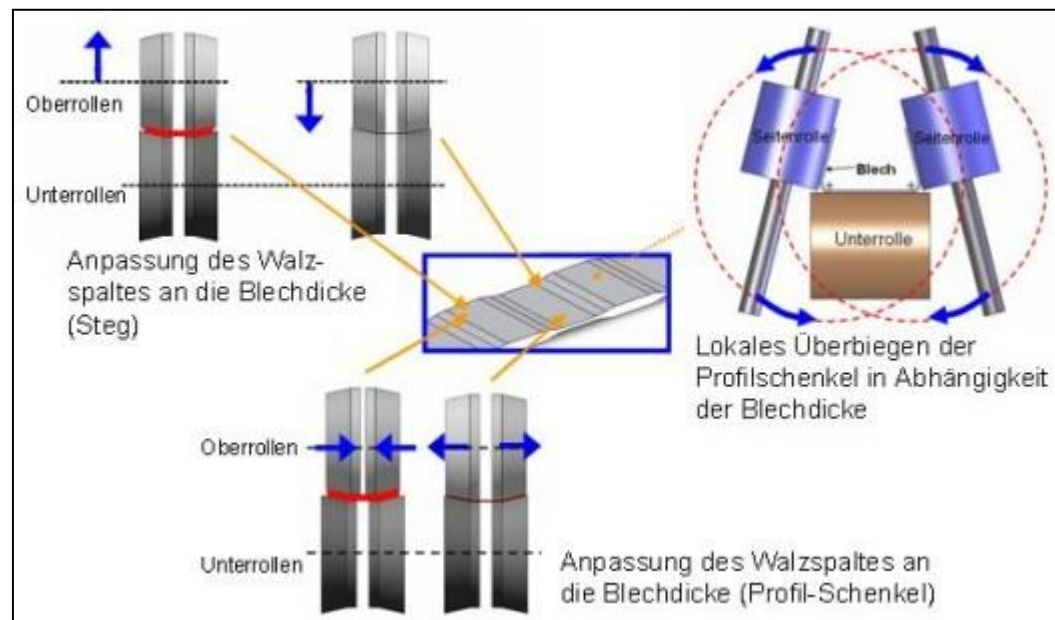
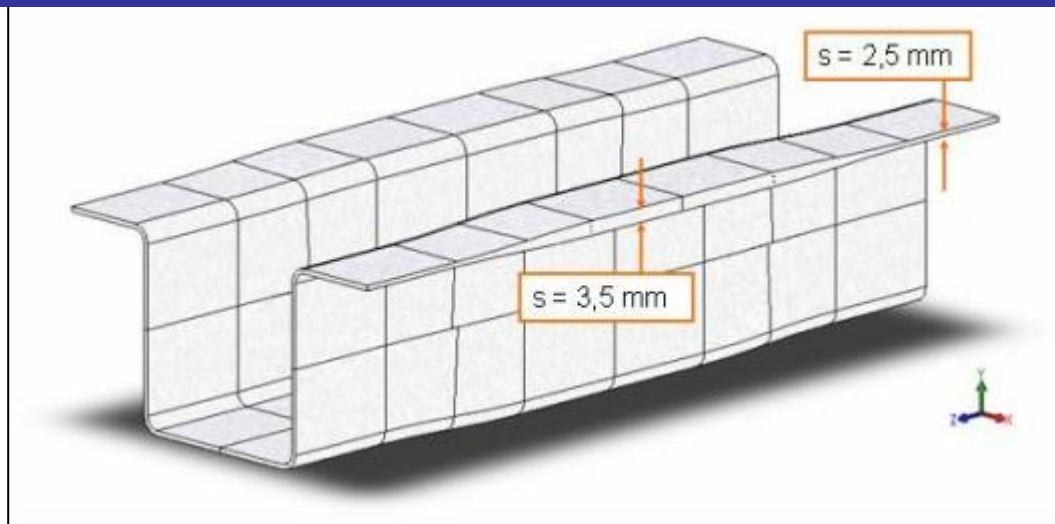



# uso de aços de alta resistência com estampagem a quente

Boa estampabilidade, pequeno “spring back” e com alta resistência mecânica ?? Como??

→ Estampagem a quente (“Hot Stamping”)  
aço baixo carbono → temperatura → estampagem → tratamento térmico

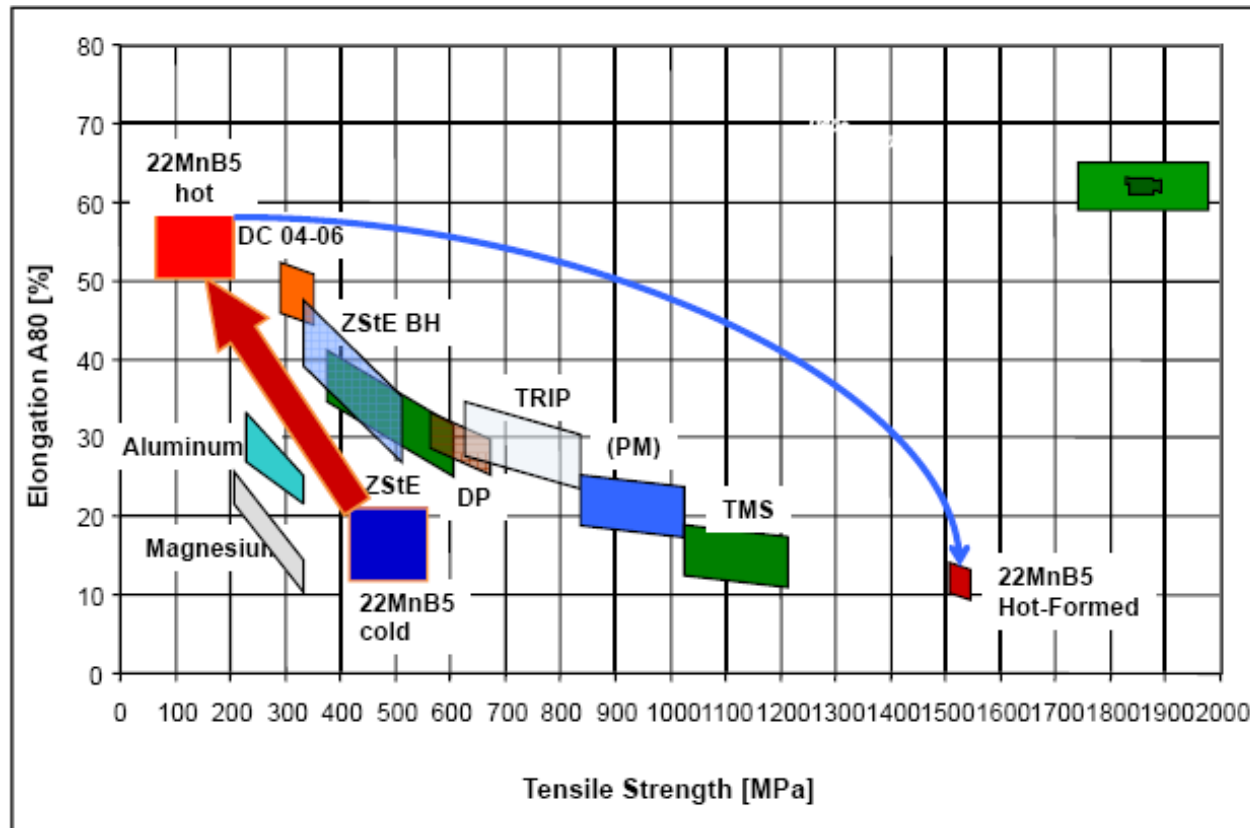



# uso de aços de alta resistência com estampagem a quente

Steel	Al	B	C	Cr	Mn	N	Ni	Si	Ti
20MnB5	0.04	0.001	0.16	0.23	1.05	-	0.01	0.40	0.034
22MnB5	0.03	0.002	0.23	0.16	1.18	0.005	0.12	0.22	0.040
8MnCrB3	0.05	0.002	0.07	0.37	0.75	0.006	0.01	0.21	0.048
27MnCrB5	0.03	0.002	0.25	0.34	1.24	0.004	0.01	0.21	0.042
37MnB4	0.03	0.001	0.33	0.19	0.81	0.006	0.02	0.31	0.046

Steel	Martensite start temperature in °C	Critical cooling rate in K/s	Yield stress in MPa		Tensile strength in MPa	
			As delivered	Hot stamped	As delivered	Hot stamped
20MnB5	450	30	505	967	637	1354
22MnB5	410	27	457	1010	608	1478
8MnCrB3	-*	-*	447	751	520	882
27MnCrB5	400	20	478	1097	638	1611
37MnB4	350	14	580	1378	810	2040

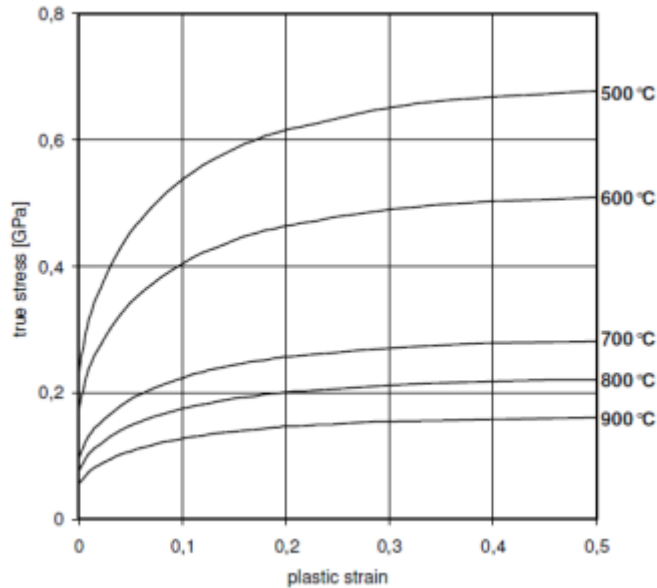

## Diagrama TTT (tempo, temperatura, transformação)



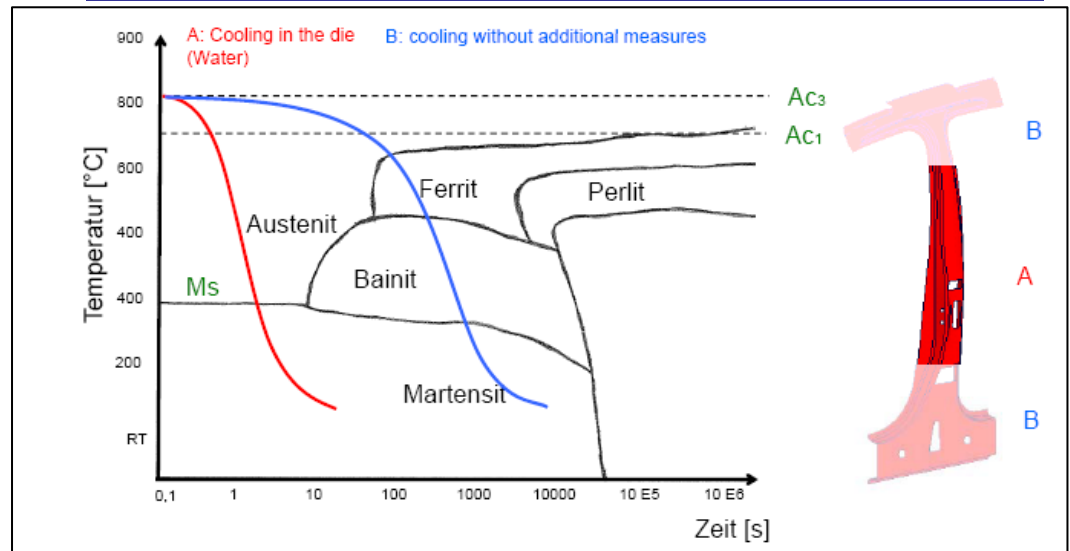

## uso de aços de alta resistência com estampagem a quente

### Início do processo

Configuração ferrita-perlita (600 MPa)

### 3 etapas principais

Aquecimento da chapa de aço

Conformação a quente

Têmpera no interior da ferramenta → Transformação completa da microestrutura em martensita (1500 MPa)

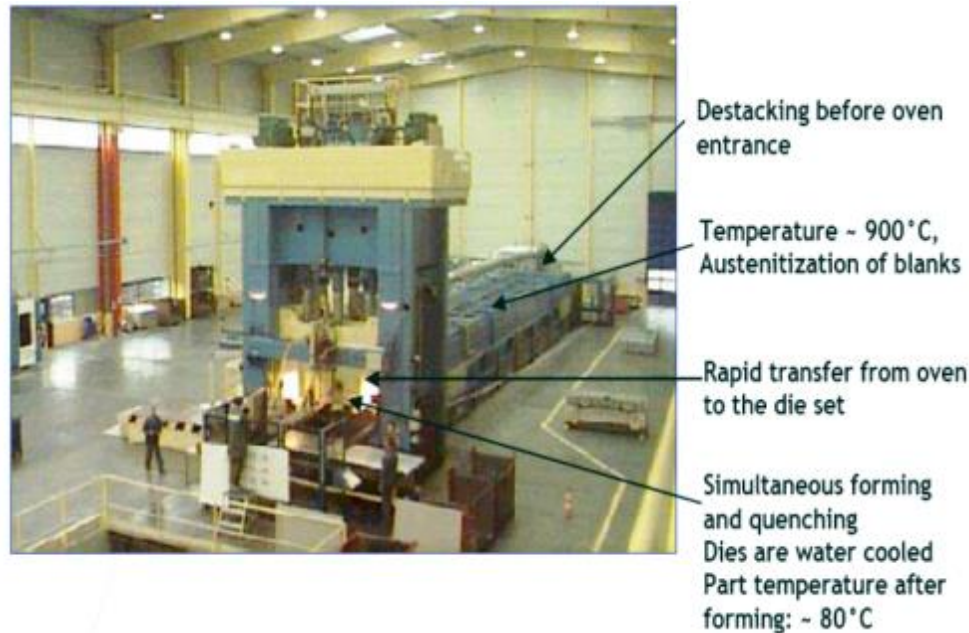



# uso de aços de alta resistência com estampagem a quente

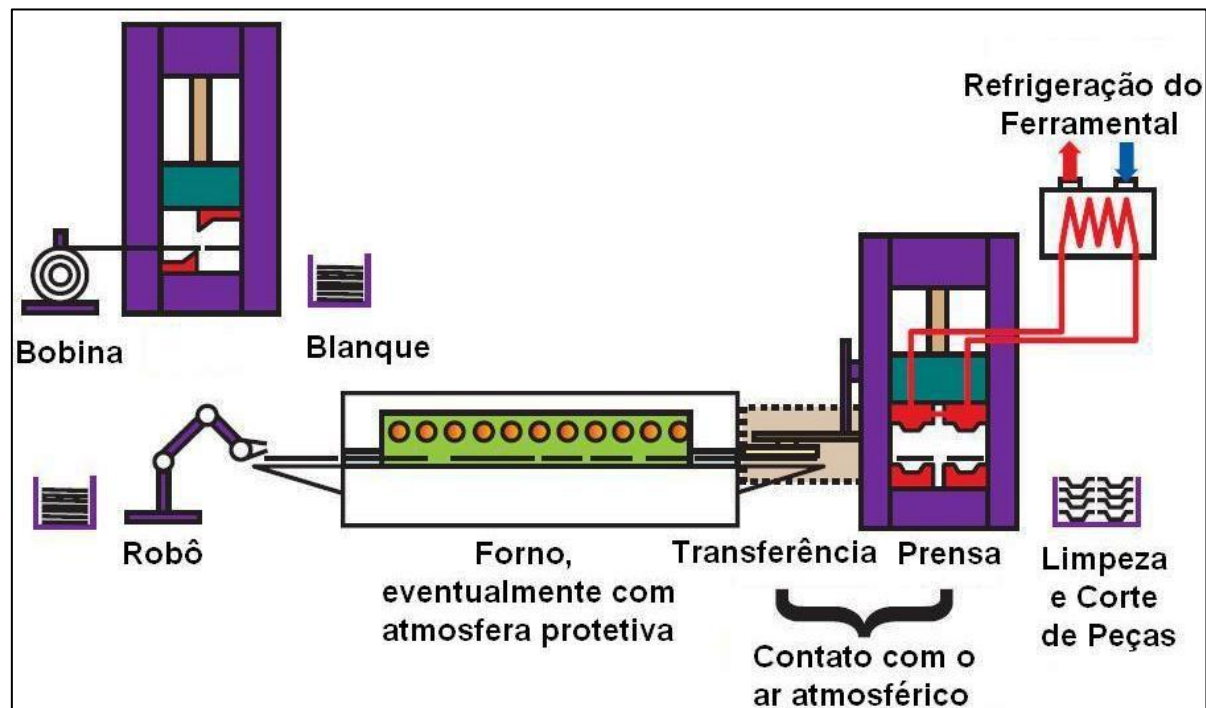

**Resfriamento no interior da ferramenta (dutos de água)**

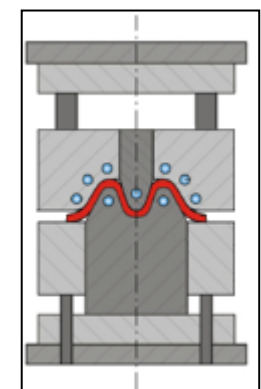





## Exemplos diversos de construções “modernas”

### ThyssenKrupp

Laser welded automotive floor panel with thicker sheet in the tunnel

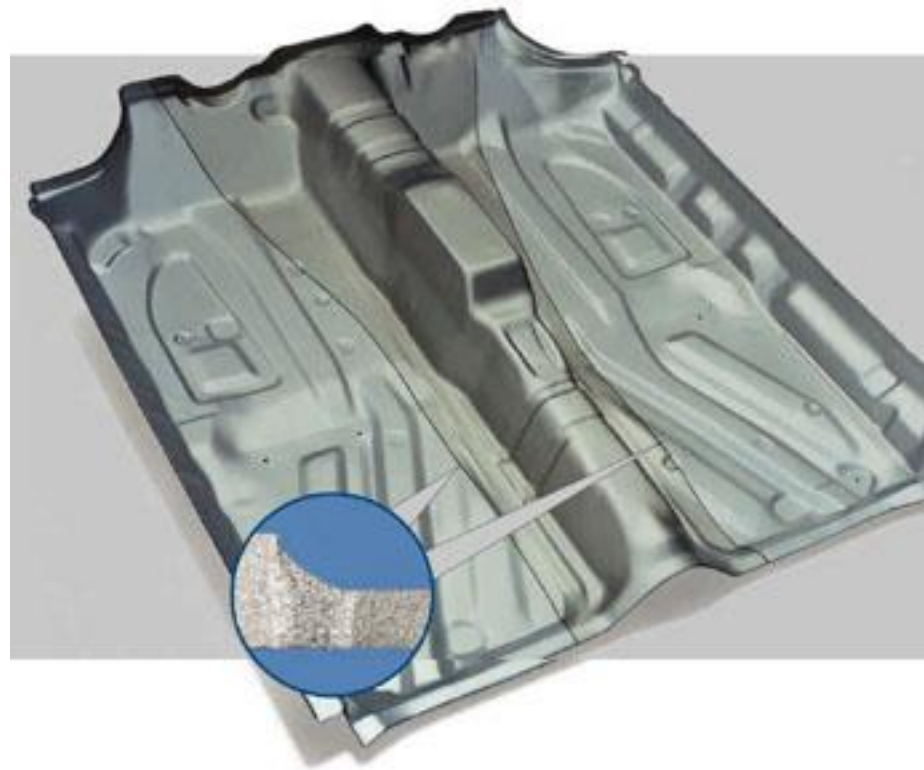

### ThyssenKrupp

Mash seam welding:  
Thyssen has produced several million weld seams using this process to date

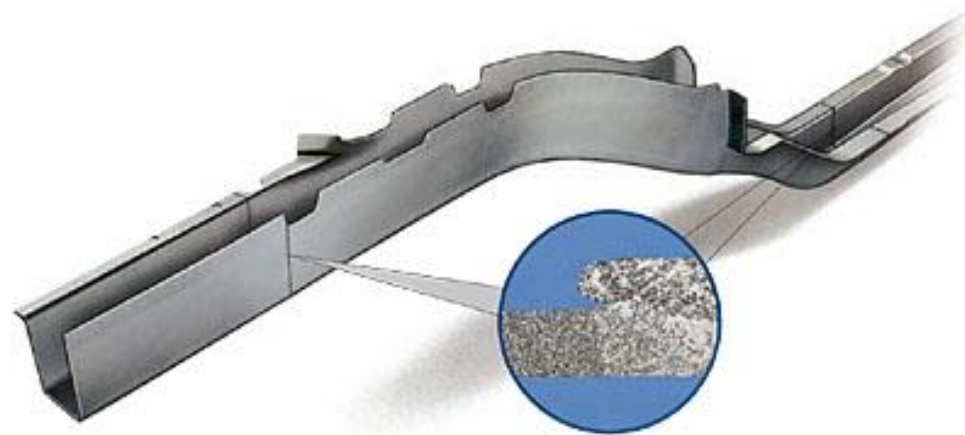



## Exemplos diversos de construções “modernas”

### Construção de Baixo Peso

#### SAE Online Poll: Lightweight materials to most benefit heavy vehicles for upcoming regs

20-Dez-2012 22:01 GMT

Lightweight materials will make the greatest impact in helping medium- and heavy-duty trucks achieve upcoming greenhouse gas/fuel efficiency regulations, according to respondents to an online poll posted on *SAE Off-Highway Engineering Online* and *Automotive Engineering International Online* for two weeks in late November and early December. Lightweight materials were chosen by about 42% of the 64 respondents, hailing from 15 nations.

Automatic engine shutdown (idle reduction) came in second with nearly 22% of the vote, followed by design optimization (17%), aerodynamics (11%), and intelligent electronics (e.g., predictive cruise control) at almost 8%. Low rolling resistance tires did not receive a vote.

Half (32) of the respondents were from the U.S., who likewise selected lightweight materials as the most beneficial technology area at 37.5%. Design optimization and automatic engine shutdown swapped places compared to the overall vote, with 22% and 19%, respectively. Aerodynamics received nearly 16% of the U.S. vote, and intelligent electronics received just over 6%.

India had the second most respondents with 8, and Canada was third with 5. Countries posting a single vote included Pakistan (for design optimization), Singapore (lightweight materials), Malaysia (intelligent electronics), and Sri Lanka (automatic engine shutdown).

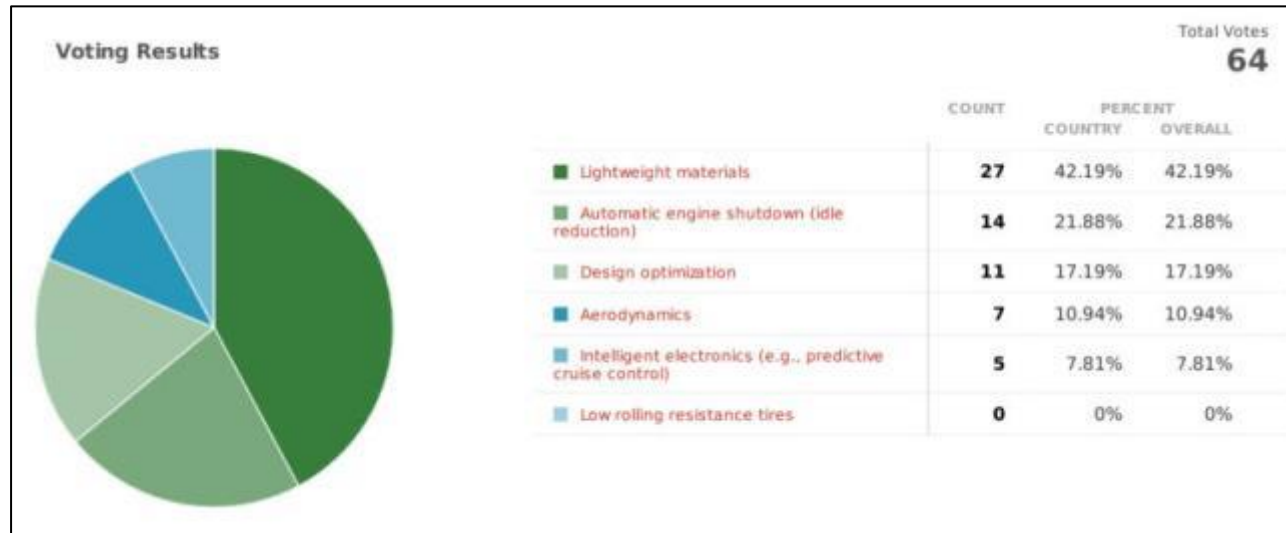

Voting results for the poll question: “Which technology area will make the greatest impact in achieving upcoming greenhouse gas/fuel efficiency regulations for medium- and heavy-duty vehicles?”



## Exemplos diversos de construções “modernas”

### Construção de Baixo Peso

#### **Detailed FEV study shows the way to major vehicle mass savings**

13-Dez-2012 21:36 GMT Patrick Ponticel

Significant vehicle mass reduction—up to 20%—is achievable if weight reduction is pursued as part of a "full-vehicle approach," according to a study by FEV Inc. released Dec. 13. The company used a 2010 Toyota Venza for its research because that model was used in an earlier, related study. The comprehensive phase-two study by FEV was conducted for the U.S. EPA. The previous study, by Lotus Engineering (go to [www.sae.org/mags/aei/8512](http://www.sae.org/mags/aei/8512) to read more), was conducted for the International Council on Clean Transportation. That study did not address mass savings from the powertrain to the extent the new one does, nor did it use advanced CAE tools to judge the impact of mass-savings measures on safety, according to FEV. In both cases, the mass savings were to be achieved with no degradation in safety or other parameters. The new study shows that the body-in-white and closures offered the most mass reduction at 68.32 kg (150.62 lb), followed closely by suspension. Total mass savings of 18.3% (312 kg/688 lb) was achieved, and at a cost savings of \$148 from manufacturing efficiencies.





## Exemplos diversos de construções “modernas”

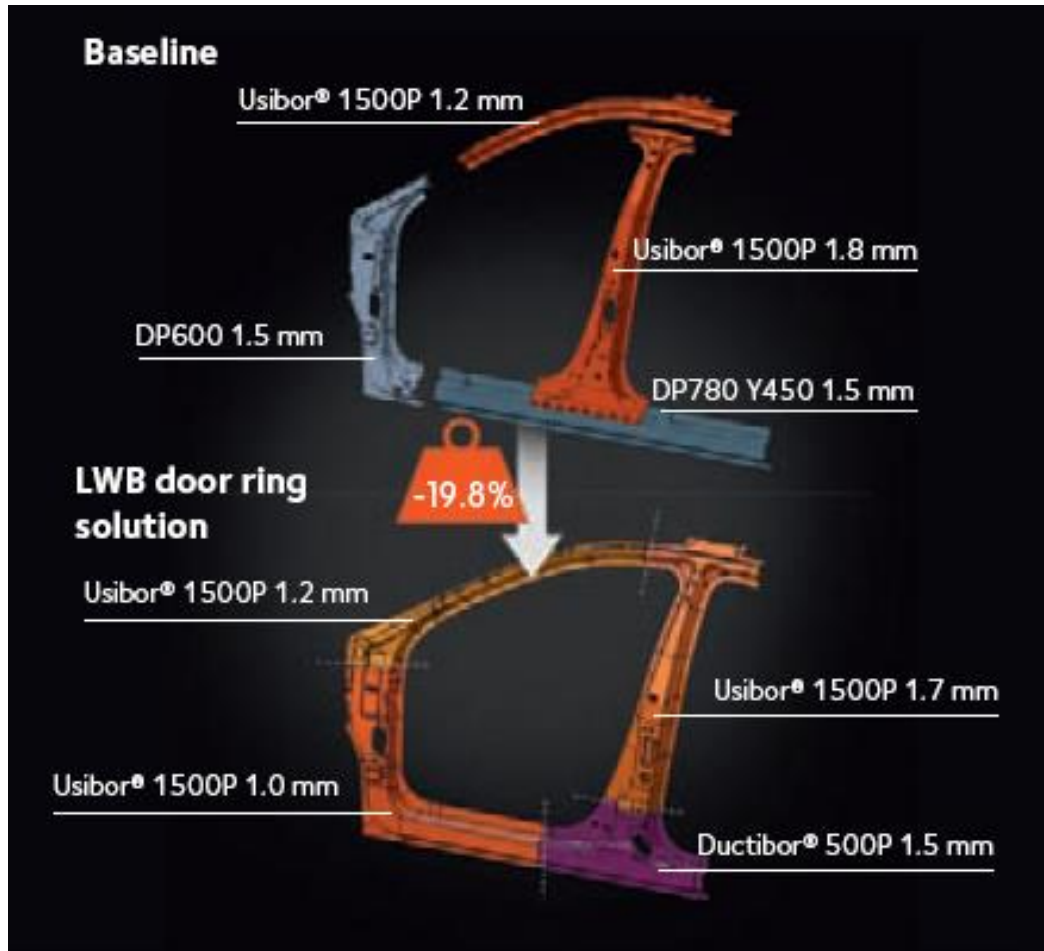

### Taking steel and technology to the limit: LWB hot stamped door ring

**ArcelorMittal Tailored Blanks** has developed a new hot stamped door ring concept which combines the benefits of laser welding technology with the high performance of hot stamped steel. The new door ring is stamped as one part instead of the four parts which are usually required. Forming the part requires just one stamping tool and one stamping operation. No post-assembly tasks are required. Reducing the number of parts and operations required also reduces the manufacturing cost of the door ring significantly. By using Usibor® 1500P and Ductibor® 500P, the weight of the optimised door ring was reduced to just 12.7 kg, a 19.8% weight saving compared to a baseline C-segment vehicle. Front, side and pole impact tests were performed on the door ring using Euro NCAP standards. In all cases the optimised door ring met the required standard and, in the case of the side and pole tests, outperformed the existing baseline solution.

The new door ring concept has already been adopted by a major car manufacturer and will go into serial production in a new vehicle. The vehicle is scheduled to be launched in North America during 2013.



## Exemplos diversos de construções “modernas”

### “Suporte” para estudos de viabilidade e desempenho

#### Arcelor Mittal Tailored Blanks

##### Laser welding feasibility analysis

Experts from ArcelorMittal R&D can study tailored blanks in order to provide data preparing the design study in an optimum design. These first studies are characterisations and risk removals.

##### Different objectives

Compare performance of tailored blanks with different steel grades

Obtain a first feasibility assessment of a part

Provide data for analysis of numerical stamping simulations of a tailored blanks part

Such data are usually completed by the Forming Limit Curve of the Laser welded area.

The objective is an experimental evaluation of the formability of the laser welded seam; the acceptable value depends on the part severity. Such analysis is composed of different steps:

##### Blanking quality analysis

Hardness measurement in the weld area

Weld geometry

180° Bending test

Erichsen test

Tensile test

U-forming test

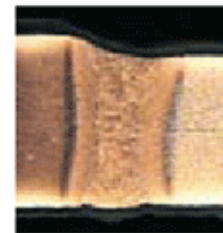

Microscopic  
analysis

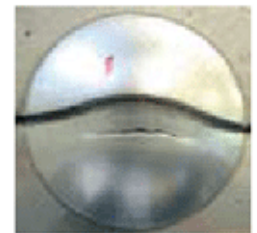

Erichsen sample



Crash tensile test carried out on real parts



## Exemplos diversos de construções “modernas”

### “Suporte” para estudos de viabilidade e desempenho

#### Arcelor Mittal Tailored Blanks

Specific tools for numerical analysis developed by ArcelorMittal allow to achieve an accurate analysis taking into account the desired safety margin in the final design of the part. Exclusive ArcelorMittal tools are based on:

- Specific forming limit curves for the welding areas of tailored blanks
- Specific methodologies to analyse forming operations by Finite Element Model (FEM)
- Specific numerical tool to predict and compensate springback after stamping named Outifo

Stamping feasibility studies rely on the Forming Limit Curves (FLC) of the welded area model developed by ArcelorMittal. The FLC of the weaker material is not sufficient to predict the behavior of the tailored blanks during stamping

#### A unique Forming Limit Curve model specific to Laser Welded Blanks

Fracture on real part

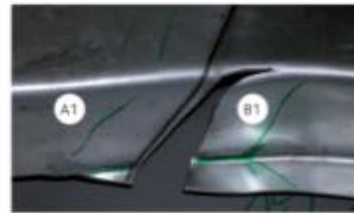

Simulation WITHOUT Tailored Blanks FLC for material A1 and B1

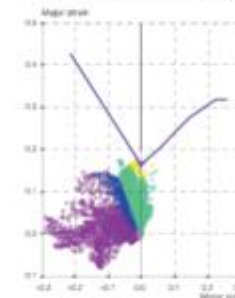

Part feasibility looks OK

Tailored Blanks FLC allows to predict rupture by stamping simulation



Simulation WITH Tailored Blanks FLC for material A1 and B1

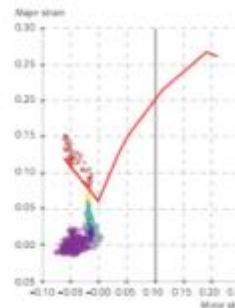

Rupture prediction



# Exemplos diversos de construções “modernas”

## Tailor Rolled Blank

### BMW X5 - UHSS

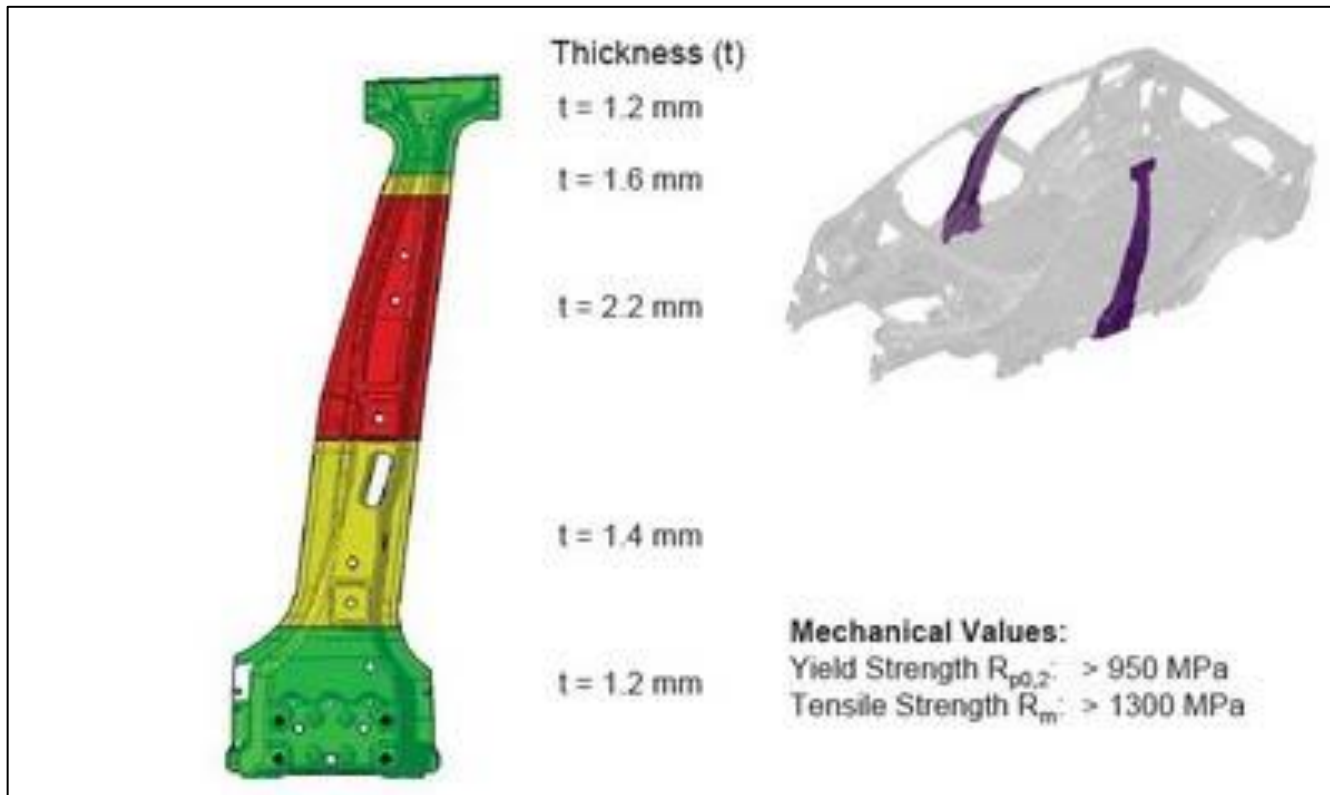





# Exemplos diversos de construções “modernas”

estampagem a quente

Exemplo de redução de peso obtida:

Reforço de coluna B



Laguna II

HE450M  
ép 1,8mm



HE400M  
ép 1,8mm

Laguna III

22MnB5  
ép 1,8 mm



XE360D  
ép 1,5 mm

saving = 3,5 Kg



## Exemplos diversos de construções “modernas”

**Agência Autodata de Notícias Fev/2014 - André Barros**

**Matérias-primas**

**ArcelorMittal localiza produção de aço de alta resistência**

Um dia depois do Seminário Eficiência Energética a ArcelorMittal anunciou investimento de US\$ 15 milhões para localizar produção do Usibor, sua marca de aço de alta resistência usado pela indústria automotiva, em sua unidade ArcelorMittal Vega, em São Francisco do Sul, no Estado de Santa Catarina, justamente de olho na demanda gerada pelo Inovar-Auto e substituindo importações da matéria-prima da Europa.

A unidade receberá equipamentos e adequações em sua linha de aços galvanizados para permitir a aplicação do revestimento de alumínio-silício, AlSi, na estampagem a quente. O Usibor faz parte do portfólio de aços de alta resistência da ArcelorMittal Brasil desde 2012, quando começou a ser importado da Europa. De acordo com André Munari, gerente geral de vendas automotivas da companhia, o produto ajuda a diminuir em até 20% o peso do veículo e, assim, a reduzir cerca de 15% as emissões de CO<sub>2</sub> durante sua produção e vida útil. Sua nacionalização foi motivada pela perspectiva de aumento na demanda por esse tipo de aço no mercado nacional. “É um caminho sem volta”, entende Munari. “As montadoras estão trazendo plataformas globais para o Brasil e mantendo as exigências usadas em outros mercados nos produtos daqui. A tendência de tropicalização está diminuindo.”

Segundo Munari o novo regime automotivo teve peso importante na decisão da companhia de trazer a produção do aço especial para o País, pois exige das montadoras aumento do conteúdo local e eficiência energética. “Praticamente todas as montadoras têm projetos de veículos que demandam uso de aços especiais. Quem ainda não usa, usará.”

A Arcelor Mittal projeta crescimento de 6% para 25% no uso de aços de alta resistência nos veículos nacionais até 2025, seguindo a tendência da indústria global. O Usibor é usado na produção de peças estruturais críticas em segurança, como as colunas A e B e elementos de reforço, como os para-choques frontais e traseiros, travessa do teto, longarinas e o túnel do assoalho. As linhas catarinenses deverão entrar em operação no segundo trimestre de 2015 e substituirão 100% as importações do Usibor. Munari espera demanda de 100 mil toneladas do material por ano – a Vega, em São Francisco do Sul, produz cerca de 950 mil toneladas de aço por ano, das quais um terço atende a indústria automotiva.

## Produção no Brasil





## Exemplos diversos de construções “modernas”

The 2011 Porsche Cayman Body Structure is shown below, not that there are a ton of these on the road. However, cutting up a car that cost more than the average house has got to be a rush! The metals shown in green are Ultra-High Strength Steel (UHSS) while the pink or magenta are parts formed from Tailored blanks. This means the thickness can vary throughout the entire part because Tailored blanks are made from several different blanks of varying thicknesses that are laser welded together.

Fonte: Automotive Engineering online

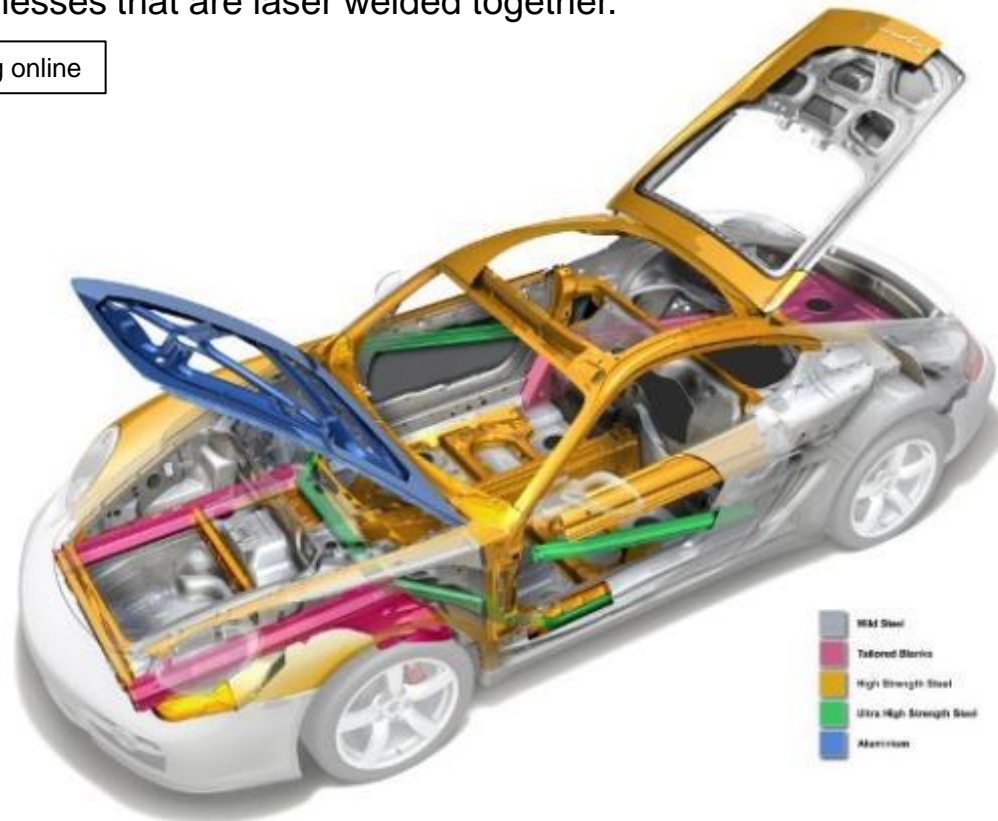



## Exemplos diversos de construções “modernas”

### S-Class Sedan (Model 221) – continued

#### Materials Mix

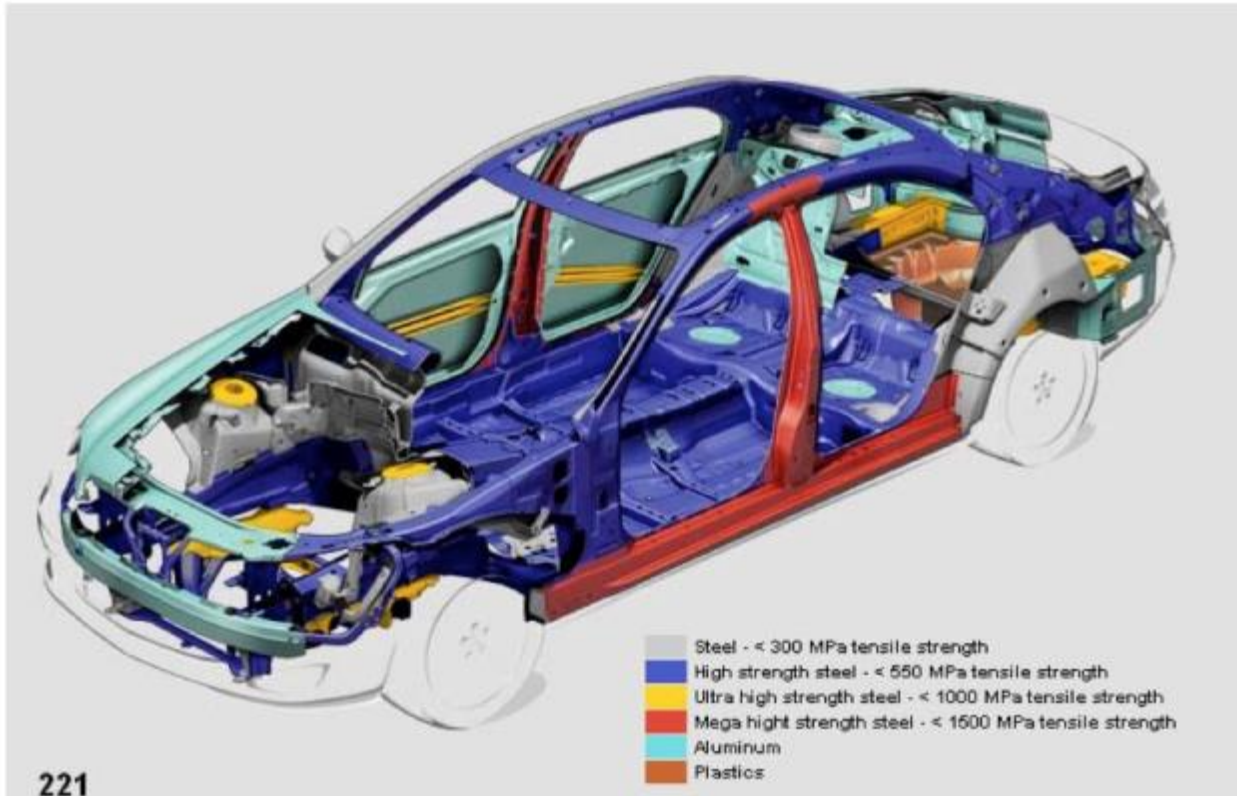

Fonte: Automotive Engineering online



## Exemplos diversos de construções “modernas”

Fonte: Automotive Engineering online

### Focus B-pillar 'tailor rolled' to 8 different thicknesses

24-Fev-2010 14:25 G Paul Weissler

Colors indicate eight different thicknesses in the B-pillar post of the forthcoming **Ford Focus**. The right-hand color strip starts with the thinnest sections at the bottom (four shades of blue), rising to two shades of green and then one each of yellow and orange (thickest at 2.7 mm).

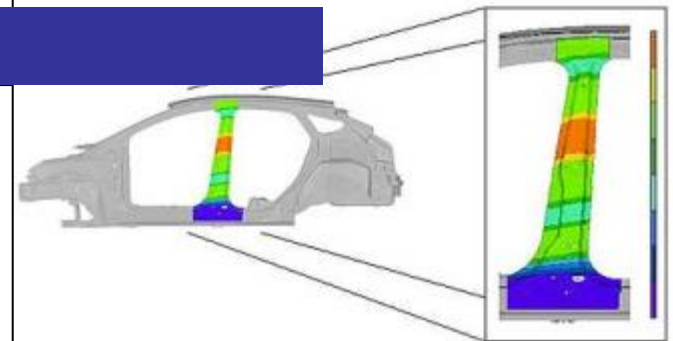

How important is the B-pillar in the new Ford Focus, which goes into U.S. production later this year? The answer is it's important enough to have Ford specify an ultrahigh-strength (boron) steel blank made at one German supplier with a highly developed cold-rolling process, where it is precision tailored to eight different thicknesses. Then it is shipped to another German supplier to be shaped and strengthened by a hot-stamping process and finally delivered to Ford for installation.

The new Focus is a world car, and its suppliers are worldwide, too, but the B-pillar certainly is not just an exercise in world sourcing. The design was intended to meet difficult Ford engineering objectives, specifically weight reduction while improving side-impact performance. The B-pillar has to contribute to passing federal procedures, of course, but particularly help with the very difficult dynamic side-impact tests run by Insurance Institute for Highway Safety (IIHS). The operating characteristics of the B-pillar are key factors in the results of those tests.

The new Focus B-pillar post starts as a "tailor rolled" blank from the process employed by German supplier Mubea, which produces strips that can be changed in thickness along their length by precision control of the gap between pairs of rollers. Mubea is able to execute smooth, quick transitions from one thickness to another along the blank, making a change of perhaps less than 0.2 mm (0.008 in), accurate to within 0.1 mm (0.004 in) overall— $\pm 0.05$  mm (0.002 in)—at each step and from one end to the other.

As used for the Focus B-pillar, the eight thicknesses produced by the Mubea process range from a maximum of 2.7 mm (0.1 in) to as thin as 1.35 mm (0.05 in). The engineering of the shape puts the greatest thicknesses where they are needed for maximum strength in side impacts, and in the case of the B-pillar it's just above the midpoint (orange area in illustration), explained Mark C. Kaufman, Ford C-Segment Marketing Manager.

The thinnest sections will be at the bottom (blue in the illustration), and there actually will be four thicknesses in that area alone. Total weight of the B-pillar post is just over 7 kg (15.4 lb), a weight savings over a conventional design of 1.3 kg (2.9 lb), Kaufman added.

Tailored blanks produced by the rolling process permitted Ford to do more precise tuning of the shape than with the more conventional method of laser welding strips of different thicknesses, as is done with many body sections. There are two inherent advantages in tailor rolling: It is possible to get many stepped changes in the thickness of the part. And there are no weld seams—just a smooth transition at each change in thickness, which results in more uniformity overall.

The Mubea blanks will go to Benteler Automotive, which will do the finish-shaping and the hot-stamping that increases the material strength while maintaining shape accuracy.

The finished B-pillar post will be welded into position on the Focus body assembly line. The facing body section is shaped to mate up to the stepped thicknesses of the post.

To date, Mubea process blanks have been used in Europe for body structural parts by several German manufacturers, including General Motors' Opel. The Focus reportedly will be Ford's first U.S. application.



## Exemplos diversos de construções “modernas”

Ford F-150 2004: Utiliza TWB na coluna B.





# Hydroforming

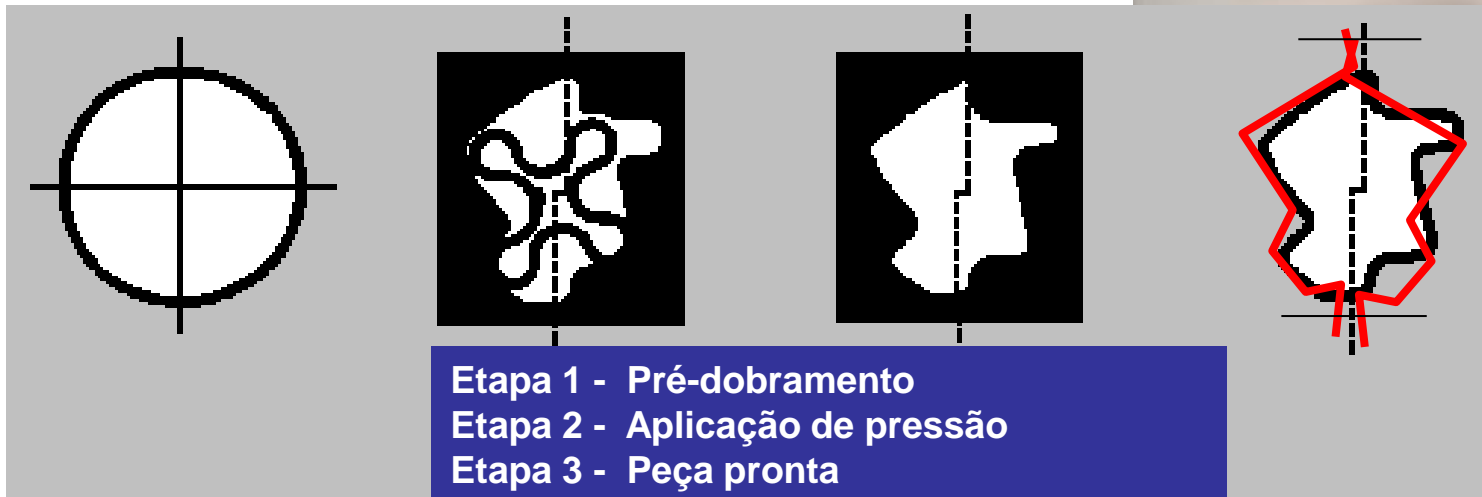
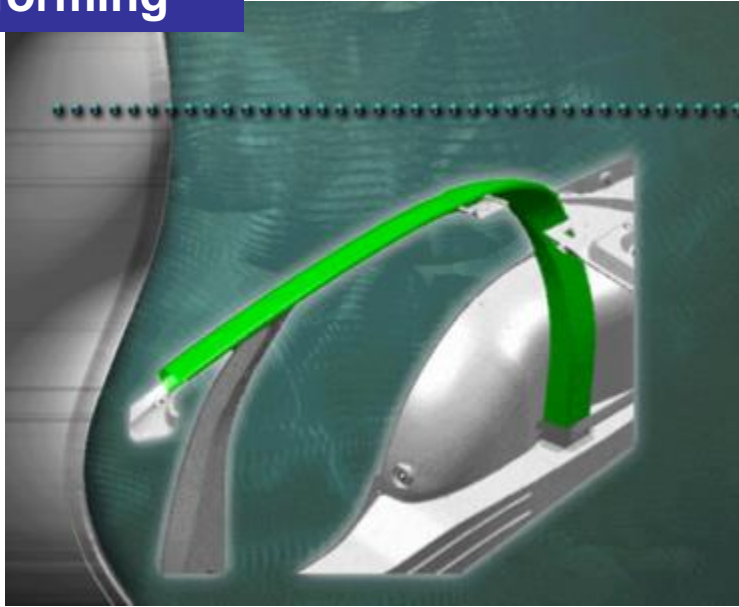

Etapa 1 - Pré-dobramento  
Etapa 2 - Aplicação de pressão  
Etapa 3 - Peça pronta



## Hydroformed pillars are world's first in 2013 Ford Fusion

24-Sep-2012 SAE International (Lindsay Brooke)

## Hydroforming

2013 Ford Fusion B-pillar and A-pillar roof rail (shown in blue) laid bare on a display buck. The orange stampings are DP780 coated advanced high-strength steel formed using a transfer die process. The green component behind the vertical tubes are in HSLA, CR300/340LA.

Ford's 2013 Fusion uses hydroformed steel tubes for its B-pillars, an application that Ford body engineers claim is a production world's first for hydroformed components. The car also features a hydroformed A-pillar roof rail.

Using hydroforming instead of hot-stamped welded sheet to create the car's roof-pillar structure reduced mass, saved cost, reduced the bill of material, and helped improve the new Fusion's crash performance, said Shawn Morgans, Ford's Technical Leader and Global Core Manager, Body Structure, Closures, and Body CAE.

"The benefits we're getting from using a closed continuous section, including giving us better structural continuity throughout the pillars, are driving big improvements to our body structures," Morgans told *AEI*. He said in developing the Fusion pillars, his team uncovered no other similar production applications featuring hydroformed tubes.

Ford is driving increased use of hydroformed components across its global body structures going forward, Morgans said. The new C/D-segment Fusion sedan is built on Ford's new CD4 architecture developed by Ford Europe. It replaces the seven-year-old Mazda G-derived CD3 platform used on the previous-generation Fusion. The CD4, which also underpins Lincoln's new MKZ, is a predominantly steel structure featuring a high level of high- and ultrahigh-strength alloy content. It is claimed to be stiffer in torsion and bending and more mass-efficient than the former platform.

### Proven on F-Series programs

Morgans said the genesis of the Fusion pillar designs came in 2003, during development of a new front end for the F-250 pickup.

"In that first go-around we took our front structure from 18 stampings down to 9 components, including the hydroforms," he recalled. "We also had a big reduction in spot welds, and we found that we could reduce the mass significantly—the first design was about 42 kg and by the third generation, which ended up on the F-150, we were down to about 26 kg.

"Based on that work, we realized there are huge benefits in using hydroform, so we started to push the envelope," he said. A hydroformed A-pillar roof rail for the P415 program (2009 F-150) followed, again bringing significant mass savings with lower variable cost.

At the time, Ford had separate Truck and Car engineering groups. Since the groups were combined under one vehicle-engineering organization, the hydroforming "book of knowledge" has been shared across the body-on-frame and unibody teams. Morgans' boss, Chief Engineer Bruno Bartholemew, has been pushing the teams to advance the technology.

"Bruno's a very thorough engineer who understands that closed sections and continuous structures are much better than what we were getting by welding a bunch of sheet-metal stampings together," Morgans explained. The next major hydroform application—the 2011 Explorer front rail—enabled a 5-kg (11-lb) weight-save on that vehicle.







## Hydroforming

On the Fusion program, the initial direction was to take the F-Series design for the A-pillar roof rail and get it into a unibody. Compared with the truck application, the sedan's design is slightly modified because the load requirements are different than what the truck sees due to its separate frame. Still, much effort went into it, and the team was able to pull 4 kg (8.8 lb) out per vehicle using hydroform, compared with a hot-stamped design.

"We replaced two hot stampings and some other high-strength stampings, with the two hydroformed tubes in DP1000. This enabled the mass reduction as well as a significant cost save," Morgans said. The concept was brought forward by a colleague who developed it working nights at home. "He brought it in and sold us all on the benefits," Morgans noted.

The hydroformed parts are supplied by Cosma International, an operating unit of Magna International, for North American production.

The hydroformed B-pillar enabled Ford to improve the Fusion's side-impact performance significantly over the hot-stamped design that was originally intended for the vehicle, Morgans said. The tubes give much less deformation and overall better control over the deformation—which helped improve the car's roof-strength numbers as well.

"If you meet the IIHS [Insurance Institute of Highway Safety] side-impact requirement, the 4X roof crush test is very, very close. It didn't take a whole lot more to get up to the 4X," Morgans said. In the test procedure, a metal plate is pushed against one side of the vehicle's roof panel at a constant speed. The roof must withstand a force of four times the vehicle's weight before reaching 5 in (127 mm) of crush.

"Tubular structures definitely help here," he asserted. "We maximized the sectional values within the package space we're given. When you eliminate the weld flanges you get more usable structure out of the components, as well as greater continuity—without the weld joints between the A-pillar and the roof rail. Typically that's four parts coming together so you get those joints staggered around. And depending on how the vehicle's built, you don't always get the ideal connection between those two."

He explained that because the hydroform tube runs all the way through, there is no discontinuity in the structure. It's a much better load path.

### **Laser welding = better joints**

The ability to combine parts and moving away from the hot stamping process brought "significant cost benefits," Morgans said. Hot stamping is time-consuming due to the time it takes to heat up the blanks as well as post-treatment of the parts including using a laser to trim edges. "We were able to get rid of that with the hydroforming," he said.

Ford has moved to some single-side joining operations in its assembly plant body shops. For the hydroforms, the company is using some stamped brackets to make the transition from the stampings to the hydroform tube.

"Typically on the F-Series we would MIG-weld those on to the tube and then use that stamping as the interface to the other stampings in the structure that allow us to use spot-welds within the plant," Morgans explained. "For the Fusion, we took a step forward—all the brackets have been laser-welded on, and the brackets we're using are primarily for tube-to-tube connections. They're all laser welded and they're giving us better joints. That's allowed us to eliminate a number of the holes that would have needed to be there.

"And the process allows more welds within a given cycle time than is typically possible with a spot welding or MIG-weld system."



# Alumínio





APX by Lotus Engineering  
(Aluminium Performance  
Crossover')

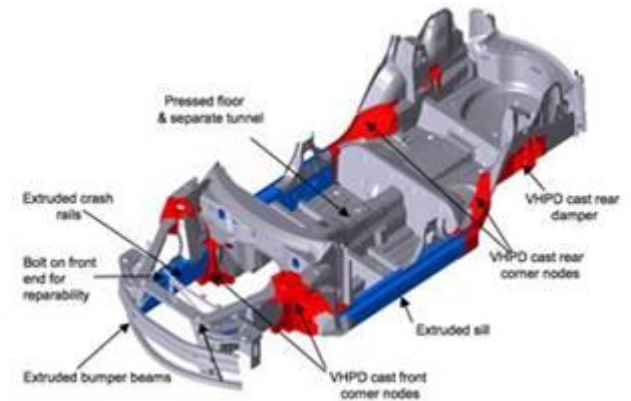

SPORTS  
CARS



MPV

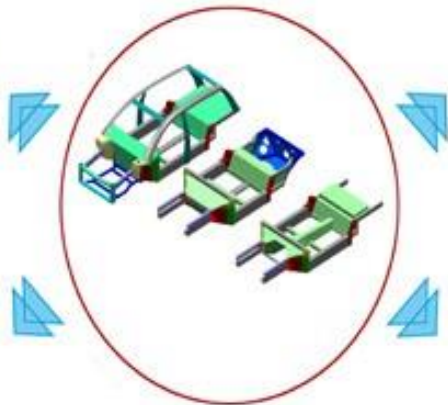

CROSSOVER  
VEHICLES



SPORTS SEDANS

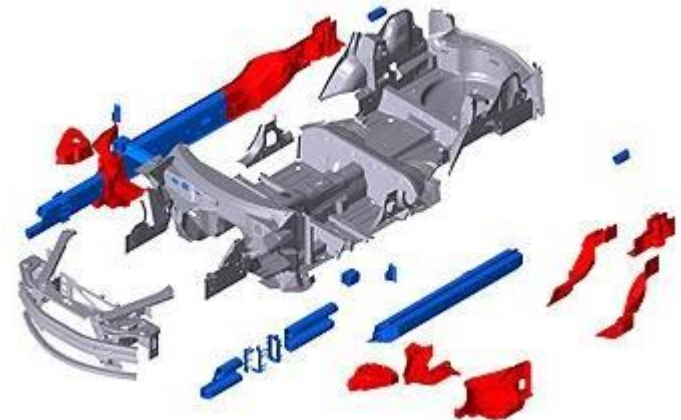



Jaguar all aluminum car

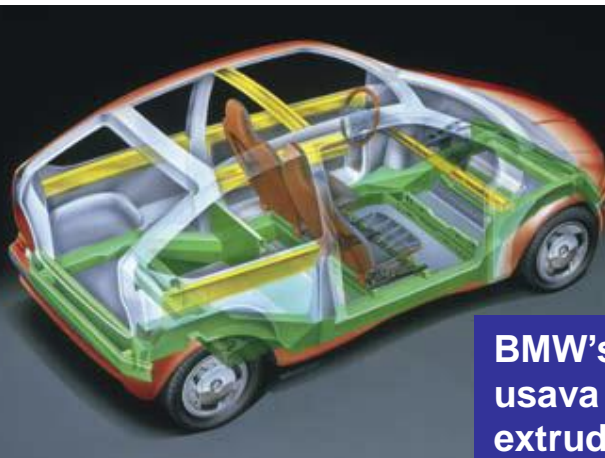

BMW's E1 (elétrico) de 1991 usava uma combinação de perfis extrudados de alumínio e painéis externos de alumínio e plástico para uma construção de carroceria de peso reduzido.

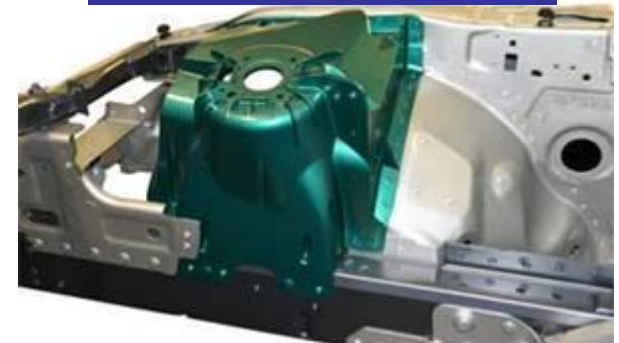

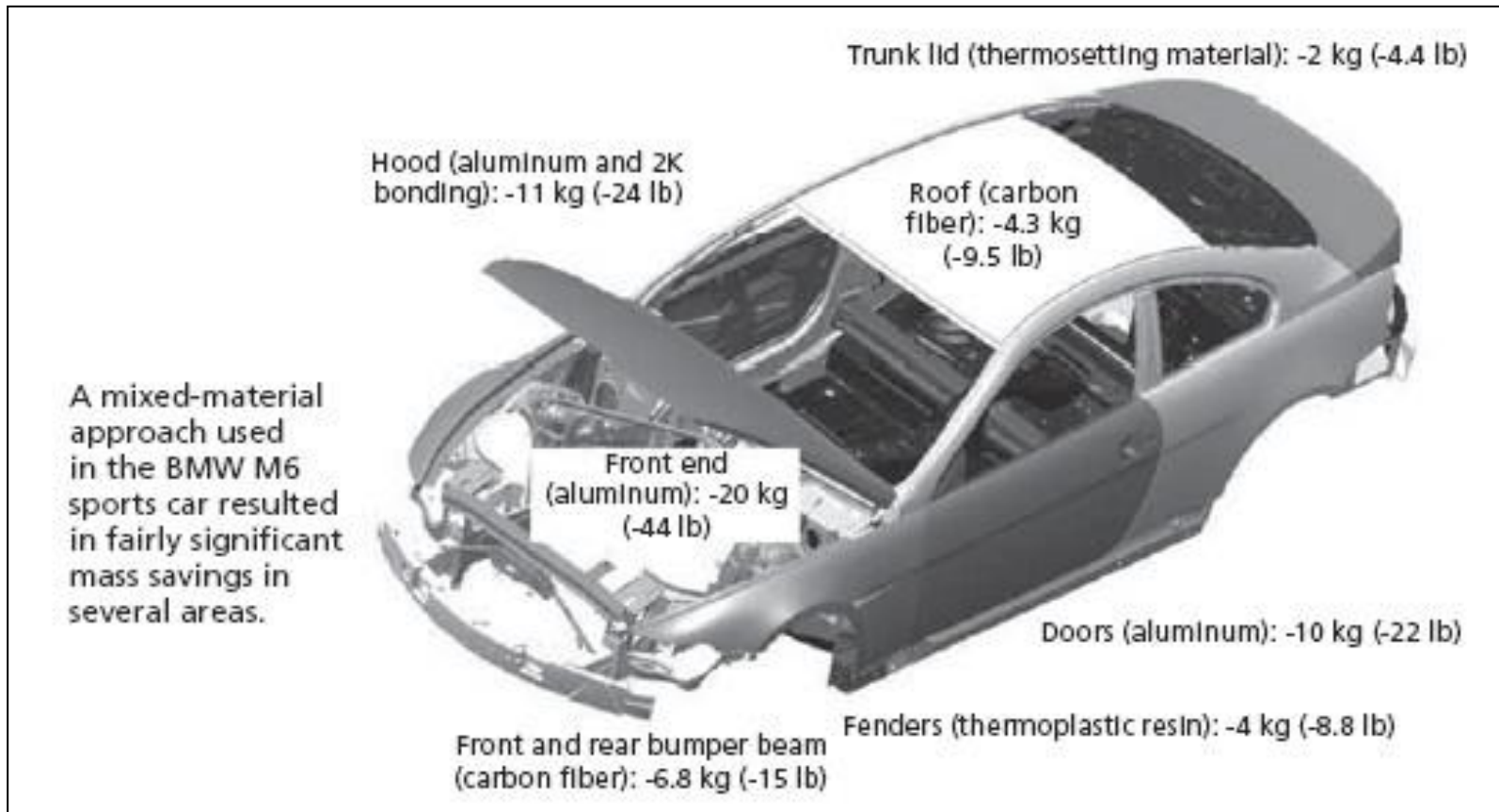



AHSS as well as aluminum are used in the body structure of the 2013 Cadillac ATS.



The 2013 Mercedes-Benz SL550 (body-in-white shown) marks the first time that Mercedes has done a full production vehicle with an all-aluminum structure.



ASF – AUDI SPACE FRAME - 100% alumínio  
A8, R8, TT  
Mais de 550.000 carros produzidos

Lamborghini: mais de 9000 carros produzidos

### Audi Space Frame®

Cast aluminium  
Aluminium profiles  
Aluminium sheets  
Steel sheets

Material	Percentage
Fundido (alumínio)	22%
Perfil (alumínio)	16%
Chapa (alumínio)	31%
Chapa (aço)	31%

In the TT various semi-finished products and materials such as aluminium plates, steel plates, cast aluminium and aluminium profiles are

### Audi Space Frame®

Cast aluminium  
Aluminium profiles  
Aluminium sheets

**Carroceria híbrida do Audi TT**  
**Tipos de Aplicação do alumínio no Audi TT**

This is achieved by the combination of various aluminium components such as sheets, cast parts and extruded profiles.

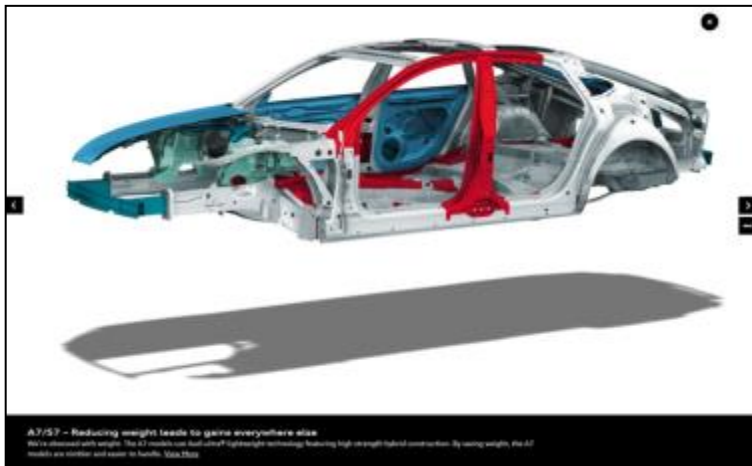

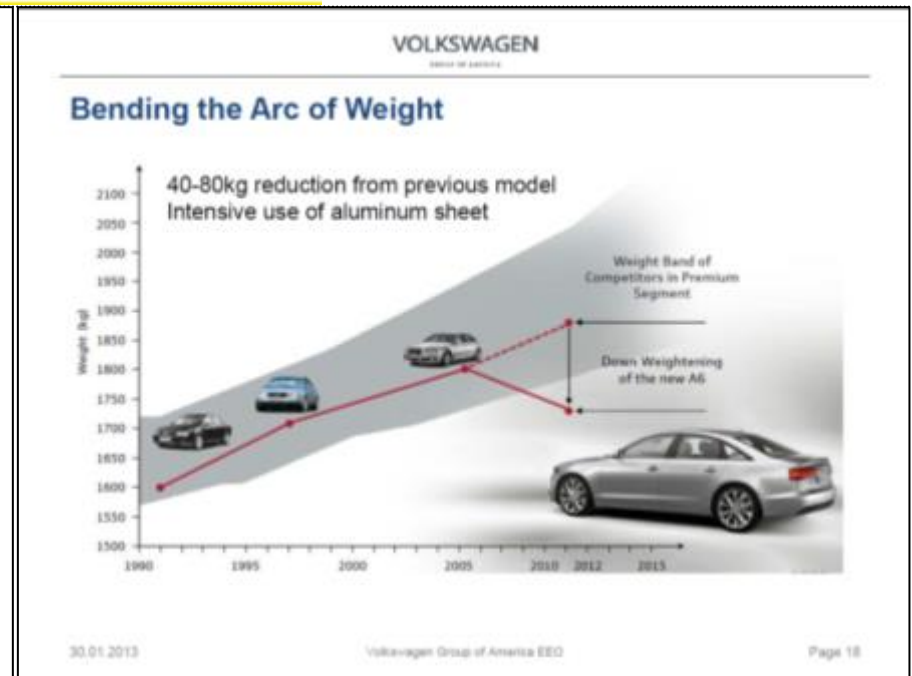
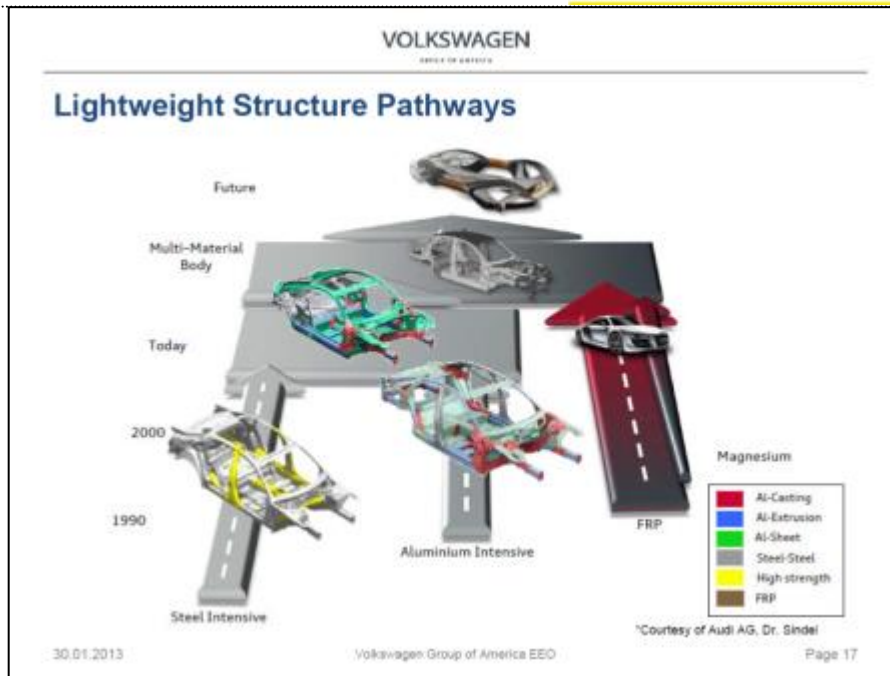

[http://www.sae.org/events/gim/presentations/2013/tamborra\\_nick.pdf](http://www.sae.org/events/gim/presentations/2013/tamborra_nick.pdf)





VOLKSWAGEN

### Audi Certified Aluminum Repair Facilities

33 shops in the US are certified to repair Audi aluminum vehicles

- TÜV certification required, must be renewed every 2 years.
- \$x00,000 investment in tooling, welders, training

30.01.2013 Volkswagen Group of America LLC Page 25

[http://www.sae.org/events/gim/presentations/2013/tamborra\\_nick.pdf](http://www.sae.org/events/gim/presentations/2013/tamborra_nick.pdf)



Técnica	Procedimento	Quantidade de procedimentos aplicados por veículo Audi TT
Técnica de União Mecânica	Rebites	1654 un.
	Recalque	164 un.
	Parafusos ( <i>Flow-Drill</i> )	96 un.
	Rebites maciço ( <i>Kerb-Konus</i> )	229 un.
Técnica de União Térmica	Solda-MIG	21462 mm
	Solda Laser	5309 mm
	Solda a ponto por resistência	1287 Pontos
	Solda-MAG	809 mm
	Solda de pinos	234 un.
Técnica de Colagem	Colagem	97156 mm
Técnica de trabalho	Fresagem	188 mm
	Perfuração	16 un.
	Abertura de Rosca	8 un.
	Escovagem	2300 mm
	Rebarbação	26737 mm
	Limpeza a Laser	4000 mm

VOLKSWAGEN  
GROUP OF AMERICA

### Multi-Material Joining Techniques Become More Complex

- Mixed material joining must account for dissimilar materials and their interactions
- Significant investment in tooling
- Process time can be impacted

30.01.2013 Volkswagen Group of America EEO Page 23

[http://www.sae.org/events/gim/presentations/2013/tamborra\\_nick.pdf](http://www.sae.org/events/gim/presentations/2013/tamborra_nick.pdf)





**Processo de colocação de rebites estampados na produção**



**Aplicação de cola para colagem da estrutura.**

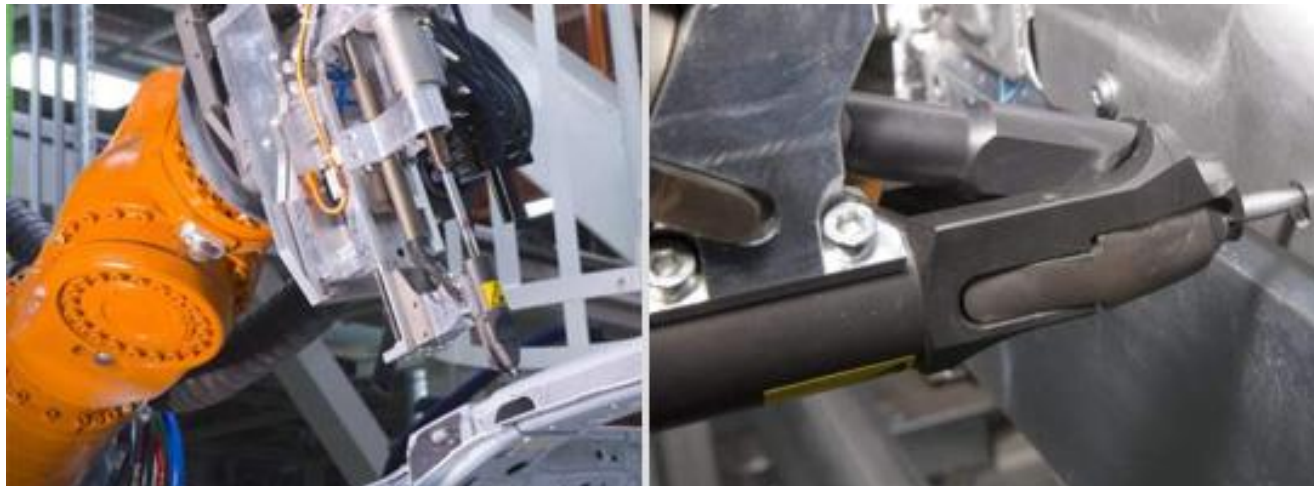

**Processo de rosqueamento do parafuso Flow-Drill na produção.**



**Solda MIG na linha de produção.**



**Processo de soldagem contínua a laser do teto na produção.**



## Aluminium futures

01 September 2010 | Dermot Healey

### **New joining techniques and recent advances in forming technology for aluminium, and how new aluminium products can match steel in crash safety performance**

In this energy-conscious age, automotive manufacturers want materials that can project them into that virtuous circle where lightweight construction allows part downsizing, reducing overall vehicle weight and returning improved vehicle fuel economy. Yet faced with a market that places a premium on successively larger models, it is a quest that has largely eluded most carmakers. As each generation of new vehicles increases in size, weight and complexity in order to win customer approval, aluminium has come to be regarded as the material to help reduce the increasing weight of modern vehicles. Studies done by Aluminium Transportation suggest that for every kilogram of weight removed from a vehicle structure, a further 680g can be saved as a result of component downsizing. Whilst this precise ratio of primary to secondary weight reduction can perhaps be questioned, the basic principle holds true. The study concludes: "As OEMs look for cost-effective solutions to reducing fuel consumption and emissions of their vehicles, lightweight, high-strength aluminum vehicles with appropriately-sized powertrains are very attractive." Yet in the process of weight reduction, simple material substitution is rarely the answer. Instead, component design and manufacturing processes must reflect the distinct characteristics of the new materials. Simple usage comparisons between aluminum and steel in vehicle composition can be misleading. Different body construction processes – and most crucial of all, increased production volumes – serve to alter the cost balance and labour content associated with the use of particular materials. Each generation of engineers and designers faces the task of reassessing this ever-shifting balance between time and production. Currently, the balance is in favour of aluminium, with the automotive sector representing the fastest-growing area of consumer-facing usage.

### **Adhesive bonding for high-volume production**

Increasing use of aluminium in bonded vehicle structures has been dependant upon advances in build processes and adhesive technologies. Bernard Sikkel, a senior technologist with 3M, says the process of generating and developing new adhesive systems for bonding aluminum and other disparate metals results from a close partnership with OEMs and their Tier One suppliers.

Well-established applications taken from the aerospace industry demonstrate that highly-efficient structural bonding is readily achievable, but the industry's comparatively low volumes are an ideal fit for the required surface preparation. Sikkel stresses that with considerably higher volumes, increased automation and a comparatively hostile environments, carmakers are looking for structural adhesives that can be applied with a minimum of surface preparation. 3M's latest SA9820 two-part adhesive is an attempt to meet some of these challenges. The product offers advantages in the assembly process, allowing off-site construction of substructures by suppliers up to sixty days before final vehicle assembly, which in turn allows greater flexibility in outsourcing and longer supply chains. Defects in application can be readily identified with colour-coded adhesive components, a tool to deliver quality assurance in the bonding process. It should be noted that crucial technology gains – which can mark the boundary between the adoption of one material or another – arise most commonly from the practicalities of the production process as much from the cost or sheer technical performance of the associated material.

Surface pretreatments are another area where important developments have appeared; developments that will impact the wider adoption of aluminium. Novelis has pioneered application-specific surface engineering to add value to flat-rolled aluminium carbody sheets. Thin anodic films are generated using an electrolysis process, which has several advantages over conventional surface cleaning and pretreatment methods. The thickness and morphology of the films can be closely controlled and as they consist only of aluminium oxides, they can offer an attractive alternative to competing surface pretreatments. The films can also be produced with great precision, incorporating continuous barrier layers or layers with controlled porosity and strength. Seen within the context of an increasing interest in adhesive bonding, the anodic films offer enhanced durability and excellent adhesion properties. Further, they prove compatible with press lubricants and all the standard assembly and finishing processes used in highvolume body construction.



### Formability issues

For some years, mass market cars have been made with aluminium panels. Key to this usage has been the enhanced formability resulting from developments in both the process and in the metal alloys. Quick plastic forming, where air pressure is used to shape preheated blanks against a heated dye, carries significant investment costs but offers the prospect of complex aluminium closures becoming ever-more common in mass-market vehicles. In fact, QPF aluminium can exceed the formability of steel. Barriers to adoption in very large volumes come in the longer cycle times required by the process, but Alcoa has developed alloys with fine grain structures which respond well to plastic forming technology. Superform Aluminium is another company that offers expertise in the forming of aluminium panels. The company has invested heavily in advanced forming processes linked to CAD/CAM systems. As a result, high-quality panel work with reduced tooling costs for low-volume production can be developed within a very short timeframe. Key to the process is the ability to generate tooling directly from native CAD data supplied by the customer using Catia V5 design software. Post forming fabrication can also be undertaken, offering the manufacturer the opportunity to have components supplied in kit form or in assembled units. The aluminium-bodied Morgan Aero 8 offers such an example, Superform Aluminium supplying the wings of the car in a ready-to-fit form.

Audi pioneered the use of aluminium extrusions in space frame structures but many other manufacturers have found that aluminium extrusion processes offer the solution for a variety of components. For closures such as doors and bonnets, aluminium is a natural choice, offering weight advantages and good energy absorption. AA6016-series alloys offer appropriate surface quality after forming and compatibility with the OEM paint/flash cycles. Formability remains an issue though, with manufacturers often previously utilizing 5-Series alloys for such nonvisible areas as inner door panels. Development work by Hydro Aluminium has resulted in the introduction of 6/30+ Series sheet which offers a 30% improved elongation-to fracture ratio. This enhanced formability simplifies panel construction and allows complex single-sheet specification alloy panel structures to be economically produced.





### **Stabilized aluminium foam and impact absorption**

Aluminium has considerable energy absorption properties, whether incorporated into body structures or when used as a specific energy absorbing material. In recent years, Stabilized Aluminium Foam (SAF), a material technology originally developed by Alcan and Norsk Hydro and now commercialized by Cymat Technologies, has attracted interest in the areas of structural reinforcement and crash management. SAF is a metal matrix composite composed of aluminium alloy with added ceramic particles, where the particles stabilize the foam bubbles, preventing their collapse.

The material is formed by injecting gas into a molten metal matrix composite, which promotes foaming on the surface of the material. The foam can then be drawn off, with the texture and composition of the cells controlled by the percentage mix. Crash-absorbing structures using aluminium deformable extrusions filled with SAF provide high levels of energy absorption with a minimum weight penalty. In addition, the added SAF modifies the way in which the outer crash box structure loads under impact, allowing it to fold more comprehensively and thus absorb more energy. Three-dimensional SAF castings can be used to provide lightweight reinforcement to side impact and rollover protection structures, whilst the replacement of sand cores with SAF cores in aluminium casting processes offer enhanced NVH properties.

Cymat Technologies continues to explore the potential of low-pressure casting systems for SAF, offering the ability to produce complex shapes with a thin wall aluminium surface skin. The intention is to provide a low-cost alternative to powder metallurgy in the production of complex-shape components.

### **End-of-life considerations**

The future potential of aluminium cannot be estimated based on its attractiveness as a material and any benefit its adoption could bring the end user. Instead, the material must be evaluated against rivals across its total lifespan. To this end, 3M recently hosted a low carbon technology conference where delegates studied end-of-life recycling of carbon composite materials. In contrast to aluminium, where recycling rates are very high and the infrastructure for the recovery of used material is well established, carbon composite materials present new and significant challenges. For real value in the recycling process, the product should be reusable without significant degradation of the material properties; preferred to the production of low-grade, low value products from recycled materials. It is in this respect that established materials like steel and aluminium have, so far, scored heavily.





## Evaluating future potential

Recent research undertaken by the University of Aachen compares the potential of different materials with regards to weight reduction in vehicle body structures, in order to address the complex interplay of stiffness requirements, shape, dimensioning and yield strengths as they apply to different materials. Interestingly, it found that car bodies featuring mostly steel components are constructed from steel grades with a yield strength that aluminium can readily match.

Assigning quantitative values for the strength and stiffness of hundreds of different car body components, the study attempted to highlight in a formal and rigorous way the complexity of the issues involved in material choice. With component shape, size and irreducible wall thickness serving to limit the benefits to be gained from using high-strength steels, the report argues that aluminium usage is set to grow disproportionately in comparison to alternatives as vehicle lightweighting advances. The study goes on to suggest that the environmental and safety advantages of aluminium have yet to be fully realized; maximum weight reductions could reach 40%, while still retaining – or improving – vehicle safety. The analysis, which may yet be challenged by those promoting the cause of steel, talks of the comparable figure for steel being approximately 11%. It concludes that the market penetration of aluminium closures, for example, in middle- and budget-range vehicles will continue to grow.

Lotus is famed for having pioneered many vehicle lightweighting techniques. That said, classic Lotus models employed imaginative design rather than advanced materials to improve vehicle performance, with aluminium usage not coming into play until the last decade. While retaining this traditional Lotus philosophy, the current model range employs a more adventurous range of materials, with bonded aluminium chassis structures being first used with the Elise and more recently with the Evora.

Lotus Engineering has been exploring the further potential of lightweight materials, undertaking a study to develop a commercially-viable mass-reduction strategy for mainstream passenger vehicles. The study, released by the International Council on Clean Transportation, says a 38% reduction in vehicle mass can be achieved for only a 3% cost increase using engineering techniques and technologies suitable for high-volume production programmes by 2020. Benchmarked against a current Toyota Venza CUV, Lotus says the 2020 vehicle architecture utilizes a mix of stronger and lighter materials, a high degree of component integration, and advanced joining and assembly techniques. The study showed 37% of BIW materials to be made from aluminium, with the material used for the main beam supporting the front bumper and a deformable crash structure, resulting in a 11% reduction in component mass. The Lotus Variable Vehicle Architecture (VVA) concept, which exploits the potential of aluminium in imaginative, yet commercially-focused ways, continues to be developed, most recently demonstrated in the Evora Hybrid. The vehicle structure progresses the Lotus 'bonded and riveted' technology with the inclusion of new and unique extrusions and folded panels, claimed to provide capacity-increasing build modularity and reduced-cost repairs. The strength and stiffness of the low-volume VVA chassis can be cost effectively modified by varying the wall thickness of the extrusions, without altering the exterior dimensions. Further, the scalable chassis, which can be extended in width, length and height, opens up options with regards to tailoring chassis stiffness, as well as vastly increasing the number of vehicles that can be developed from this single vehicle architecture.

Inevitably, future material choices will be influenced by the continuing environmental debate and various political initiatives. More than most, the motor industry has seen technologies moulded and shaped by legislative activity. It is no surprise that the European Aluminium Association have been actively encouraging the European Commission and European Parliament to create a regulatory framework that is technologically neutral, while fully recognizing the potential of lightweight materials to meet environmental challenges. The extent to which they, and their partners in other key markets, are successful in these endeavours will undoubtedly influence how bright the future is for aluminium.



## Joining aluminium

18 June 2014

### **As aluminium becomes increasingly used by carmakers, Mark Simms looks at the mechanical methods required to join this material**

Ever increasing pressures to reduce fuel consumption and vehicle emissions have seen a raft of technical innovations introduced to the automotive industry, but ultimately it is weight that has the single biggest impact. It is easy to understand, then, the interest in lightweight materials such as aluminium, plastics, composites and new aluminium alloys for body-in-white (BIW) applications.

Aluminium and its alloys in particular have great attractions for automotive body structures: aluminium is about one-third the weight of steel, and while steel is ultimately stronger, comparable or better body strength can be achieved in aluminium at a much lower weight. In addition, aluminium is inherently more corrosion resistant.

A switch to aluminium for automotive body applications is not an easy decision, however. For one thing, aluminium costs significantly more. Yet that is not an insurmountable challenge when consumers are prepared to pay higher prices for a vehicle that will return notably better fuel consumption. Perhaps more importantly, the welding processes that are used with steel cannot simply be transferred to aluminium.

Compared with steel, the melting point of aluminium is much lower and it has a higher thermal conductivity, meaning that traditional welding techniques are highly likely to damage the panels. In addition, the aluminium oxide layer at the surface of the panel leads to a weld that is weak and has a low fatigue resistance, potentially compromising safety.

Welding costs are also greater because the high electrical conductivity of aluminium increases the electrical current requirement. Also, the advantage of aluminium in forming a corrosion-resistant oxide at its surface becomes a disadvantage when it comes to welding, as the reaction of the oxide during the welding process quickly contaminates the spot welding tip, reducing its life and so again pushing up welding costs.





## Joining aluminium

18 June 2014

### Alternatives for aluminium

Spot welding technology is highly entrenched in the automotive industry, and a typical vehicle might have 3,000 to 5,000 spot welds across its structure, with material gauges ranging from 0.6-1.0mm for closures to 1.2-2.5mm for structural joints, and with cycle times ranging from 1.5-2.0 seconds per weld. But if traditional welding falls down when used with aluminium, what are the alternatives, and how do they fit into an industry where automation is needed more than ever to deliver the speed and flexibility that modern automotive production demands?

Increasingly the focus is on mechanical joining technologies, with four methods most often under consideration: adhesives, self-pierce rivets, clinching and flow drill screws. In 2013, Alcoa produced a presentation looking at the common methods and compared their properties with resistance spot welding. The study showed that, as might be expected, all methods produced a better mechanical performance and that all had a higher consumable cost.

But beyond that, performance was broadly comparable in terms of parameters such as the need for surface presentation (with the exception of adhesive bonding), potential for automation, process speed, compatibility with adhesives and alignment precision. As an important benefit over resistance spot welding, all of the mechanical alternatives allow for bonding of dissimilar materials, such as aluminium to steel or aluminium to composite.

### Self-pierce riveting leads the way

Of the most common mechanical joining methods, self-pierce riveting is by far the most widely adopted. Strong enough to be used for joining structural components, and with the ability to be highly automated, self-pierce riveting has been proven to meet the requirements of the automotive industry.

A single-step technique, the self-pierce riveting process punches a semi-tubular rivet into two sheets of material. The self-pierce rivet pierces the upper layer of material, and as it does so the die shape causes it to flare within the lower layer to form a clinched mechanical joint. As the name suggests, pre-drilled holes are not required, allowing a high-strength joint to be formed in a single operation. There is little or no damage to pre-coated materials.

Self-pierce riveting offers a number of advantages over alternative mechanical joining methods. It offers high-strength joints that are suitable for visual inspection. It is reproducible and requires no pre-drilling. Joints are watertight and airtight. It can join both metallic and non-metallic materials, and will fasten dissimilar metals. It is also suitable for use with different material strengths and thicknesses. Meeting requirements from manual assembly right up to the most automated processes, riveting machines are available in a variety of configurations, from hand-held guns to multi-head automated tools that are electrically, pneumatically or hydraulically actuated.

Suppliers also offer tips for the successful use of self-pierce rivet technology, in particular with reference to the direction of rivet insertion where different materials or thicknesses are involved. For best joint integrity, the self-pierce rivet should be inserted from the thin material into the thick, and from the hard into the soft.

Self-pierce riveting of aluminium bodies is already being used by some of the biggest names in the business, including Jaguar Land Rover (JLR) and Audi. Jaguar's XJ, XK and new F-Type are all constructed from aluminium and assembled using self-pierce riveting, as is the latest Range Rover. For its part, Audi uses self-pierce riveting on both the A8 and A2 models.



## Joining aluminium

18 June 2014

### HSPR & Rivaset self-pierce technology

One of the leading exponents of self-pierce rivet technology is Henrob, which has a client list that includes BMW, Audi, Jaguar, Volvo, Mercedes and Hyundai. In 1994 Audi used Henrob's pre-clamping self-pierce riveting system for the majority of the Audi A8's single point joints, and in 1999 the same system was used for various parts of the Audi A2. Henrob technology is also in evidence at Jaguar, which first implemented a self-pierce system in 2001 for the aluminium-bodied X350, developed by Henrob and using Kawasaki robots to apply the rivets. When the system was re-evaluated in 2005, Jaguar concluded that self-pierce riveting still presented the best solution for joining aluminium.

Henrob's self-pierce riveting technology, HSPR, promises fast cycle times, low energy demands and can be used after coating or painting with virtually no aesthetic or other damage. The process is highly repeatable, and can be readily used with automatic rivet feeds that allow continuous production.

Another leading name in self-pierce riveting technology is Bollhoff, which offers a Rivaset system that is suitable for use with aluminium (pressure-cast, extruded and sheet), as well as steel, and is also appropriate for use with different material combinations, including magnesium, copper, films, metal mesh, plastic and sandwich materials. Bollhoff says that as well as joining steel sheets each of 1.0mm thickness, or aluminium sheets each of up to 3.0mm thickness, Rivaset will also join combinations of materials. These include: 1.0mm steel sandwiched between 1.2mm aluminium; or 1.2mm aluminium to 1.5mm magnesium; or 2.0mm plastic to 2.0mm aluminium; or 3.0mm plastic to 3.0mm aluminium; or aluminium to aluminium with an adhesive middle layer.

Bollhoff's Rivaset system is now in its second generation, promising a halving of the process time during the joining of mixed materials and high-strength steels (HSS). It enables a process cycle time of better than 1.5 seconds, depending on the setting tool, and provides rivet length control to within  $\pm 0.25$ mm. Furthermore, Bollhoff says that optimised configuration management, with the possibility of customised configurations, means low investment costs.

Setting tool size and weight have been reduced, presenting a load to the robot of 80kg yet providing a maximum setting force of 78kN. The tool has a C-frame design with a throat depth of 500mm as standard or 750mm in the light frame design, providing a great deal of flexibility when positioning the tool in and around automotive body structures. The tool uses a hydraulic cylinder for its motive force, with a design that ensures the best possible lifetime for the cylinder with lower maintenance costs.

Bollhoff's tool can deliver 60 rivets per minute and has a storage capacity of around 15,000 rivets. The control system provides local hardware configuration with central control of machine components over a bus architecture, with an open interface that supports all of the standard protocols used by the typical automotive production robots. Options include a panel PC to give operators local control via a touch screen, while manual control is also available with complete visualisation of the process.

The control system also enables process data from multiple self-pierce riveting systems to be displayed on the central control system, analysed and archived, guaranteeing full documentation of process data over the production period and traceability over the lifetime of the vehicle.

Both Henrob and Bollhoff offer monitoring systems for their self-pierce rivet tools, tracking the force and punch movement throughout the riveting process. The results are compared with a pre-defined reference to give a pass or fail for the joint, providing a useful tool in the drive for continued improvement in quality control.



## Joining aluminium 18 June 2014

### Securing results with ClinchRivet

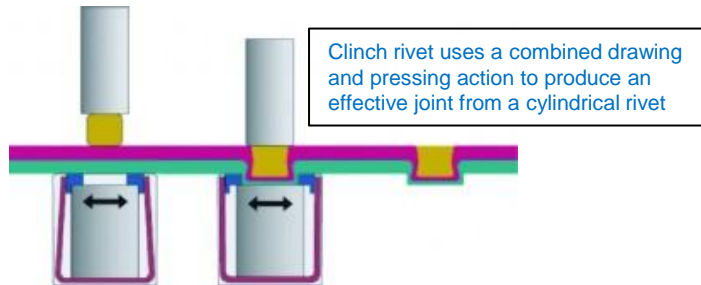

A derivation of the self-pierce rivet is what Tox Pressotechnik calls the ClinchRivet, which differs from conventional self-pierce riveting by not cutting through the top layer of material. Furthermore, because the ClinchRivet itself is simple and symmetrical, the result is trouble-free feed and compression. During the ClinchRivet joining process, the combined drawing and pressing action produces an effective joint from a very simple, cylindrical rivet. The complete joining represents an effective combination of round point forming and rivet joining. The simple geometrical shape provides the basic joining, with the cold-formed sheet metal materials having an additional holding function. Tox says the result is a clean and highly reproducible joint.

Particularly suitable for use with thinner sheet materials, the ClinchRivet gives a high-strength joint that the company says is superior to self-pierce riveting in terms of both tensile strength and shear strength. The ClinchRivet joint obtains its high-strength values from the formed full rivet firmly positioned in the joint, and the hardening of the sheet metal materials in the neck zone created during the deep-drawing process.

Tox claims that the closed rivet form compared to the semi-open, self-pierce rivet offers advantages in that there is no need for any adhesive and no possibility of the creation of air pockets which could cause corrosion. Tox also argues that the ClinchRivet is less sensitive to negative production influences such as clearance between the sheets, misalignments and the use of adhesives. Provided the punch side stripper force is sufficient, the existence of a small gap between the metal sheets will not impact the joining strength.

For automotive applications, Tox offers a robotic unit with a rivet supply module. The supply module holds approximately 600 rivets in a magazine tube, and the robotic unit docks with this magazine when required and is filled with some 200 rivets. A modular design allows the quick and simple exchange of components.

As with the self-pierce monitoring options, Tox offers full monitoring capabilities, with a force sensor continuously measuring the press force during the entire joining process, while a travel sensor monitors the total pressing travel. These parameters can be combined with the type of material, the sheet metal thickness, the number of layers and so on to provide full quality and traceability information.

Within its clinching technology, Tox also offers Round Joint, in which a simple round punch presses the materials to be joined into a die cavity. As the force continues to increase, the punch side material spreads outwards within the die side material. Round Joint enables 30-60% cost savings compared with spot welding, and achieves up to 70% of the static strength of a spot weld – without any screw or rivet.

Tox clinching technology is used in numerous applications throughout the automotive industry, perhaps most notably on the Audi TT. The Round Joint was considered during the development of the TT and selected as an efficient and economic solution for the production version. Through subsequent Coupé and Roadster iterations, Tox clinching technology was used in numerous areas, often combined with glueing in highly automated robot cells.



Ford's aluminum bodied F-150 could be a game-changer

## Joining aluminium

18 June 2014

### Challenges remain

A common thread through all the examples discussed so far, however, is that the vehicles in question are not mass-market models, so perhaps this is why doubts have lingered over the viability of aluminium. But that could be set to change with the news that Ford's 2015 model F-150 pickup truck will be made from this material. Compared with a luxury saloon which might see sales of 10,000-15,000 in a year, the F-Series pick-up trucks sold more than 760,000 units in 2013. This will surely represent a sea change in attitudes towards aluminium vehicle construction.

This is not to say that all challenges have evaporated. The big advantage of welding is its flexibility on the production line, enabling multiple platforms to be assembled on the same line. In its 2013 presentation, Alcoa pointed out that aluminium assembly lines tend to be single platform, and that it might be some time before there are self-pierce rivet or clinching assembly lines that can produce multiple platforms, or single-platform mixes of aluminium and steel vehicles, or production lines that can assemble mixed-material, multi-platform vehicles. With spot welding, multiple models can flow down a single line, and each gun dynamically changes its weld schedule to accommodate different vehicle requirements. OEMs can make gauge changes without downtime or capital costs to retool. Such flexibility is much more difficult to achieve with mechanical joining technologies.

At the same time, General Motors is pursuing a patented aluminium welding technology that it says results in a stronger weld than has traditionally been achievable. When it went public with the innovation at the end of 2012, GM reckoned its patented technology could eliminate almost 1kg of rivets from a vehicle. It might also simplify end-of-life recycling of aluminium parts. Furthermore, GM has previously stated that it would be prepared to license its new welding technology to other manufacturers.

A look under the paintwork of the Audi TT – which combines sheet steel parts with aluminium castings, aluminium extruded sections and aluminium sheet-metal parts in the body structure – reveals no fewer than eight joining methodologies, including punch riveting, clinching, MIG welding, resistance spot welding, adhesive bonding, solid punch riveting, flow drill screwing and aluminium laser welding. Then there is the Audi Crosslane concept, presented at the Paris Auto Show in 2012, which added carbon fibre composites and carbon fibre reinforced composites into the multi-material mix, so bringing further complexity to the joining methodology.

As noted earlier, the Ford F-150 looks set to be a game-changer, bringing aluminium body structures to a mass-market platform. But a challenge for the industry as a whole is to extend that ethos into a wider range of volume production vehicles, and on multi-platform assembly lines. As the Audi TT illustrates, that may well mean embracing a whole raft of different joining methodologies, and looking at how best to combine them in automated assembly processes.



## GM patents aluminium welding process

10 January 2014 | Automotive Manufacturing Solutions

The vehicle-maker has protected the industry-first technique it uses for the 2014 Corvette Stingray as one of 1,672 patents the company acquired in 2013. GM noted that, according to figures from The Patent Board, this was 176 more than second-placed Toyota and over twice as many as Ford.

The Corvette Stingray involves 354 spot-welds which eliminate nearly 2lbs of rivets. The welding process uses a multi-ring domed electrode head to conduct an electrical current that creates intense heat, disrupting the oxide on sheet, extruded and cast aluminium surfaces. The result is a strong weld.

Another new technology patented by GM is a lightweight shape memory alloy wire, which replaces a heavier motorised actuator that opens and closes the Stingray's hatch vent, releasing air from the trunk and enabling its lid to close more easily than on previous models. The Patent Board also named GM "No.1 in Technology Strength".

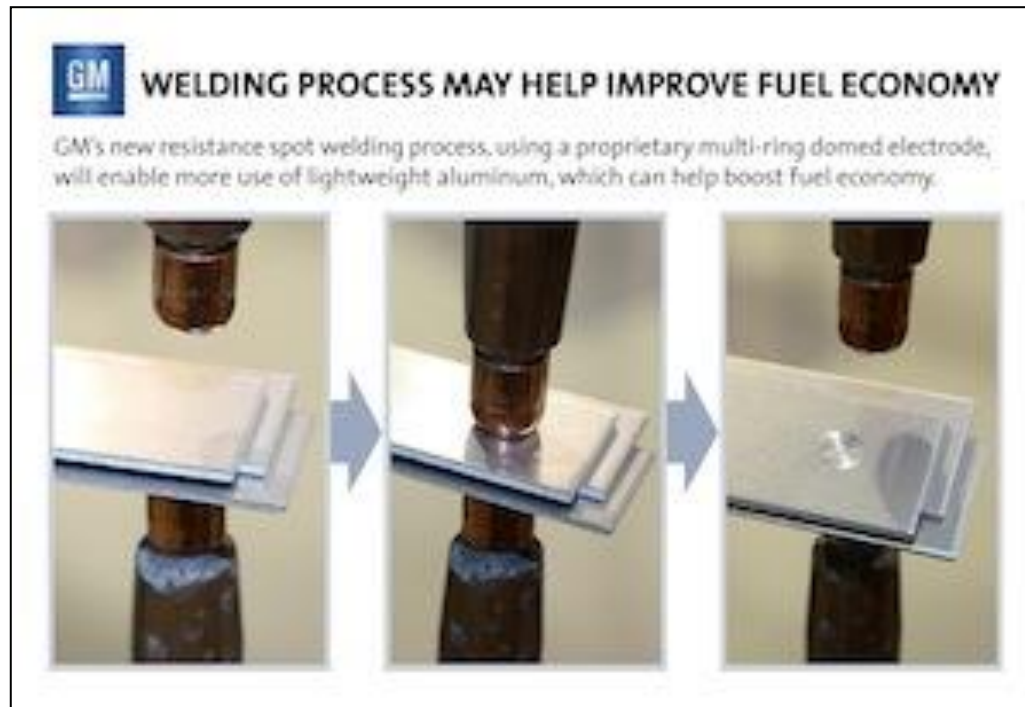



## Potential for aluminium in high volume

01 September 2013 | Ruari McCallion

When, at a demonstration of the new Range Rover Sport, the presenter talked about it being in excess of 25% stiffer than its predecessor, the point was made by forcing the vehicle's front right wheel off the ground, tilting the whole thing across its diagonal axis and banging it back down to earth. Certainly, there was no evidence of sag, or any suggestion of the creaks and squeaks that one would expect from most other vehicles, if they were to be put through that particular exercise.

[How to make the best joint](#)

[The Audi experience](#)

[A question of cost](#)

[No cure for this condition](#)

[GM solution](#)

Like the latest Range Rover on which it is based, the new car is made from aluminium and it has delivered improvements not just in stiffness, but in weight, recyclability, performance, NVH and fuel economy. This is just the latest iteration of Jaguar Land Rover's (JLR) march towards an all-aluminium vehicle line-up. Mark White, now the company's chief engineer for body, complete business unit, has been involved from the outset; he was team leader on the original long wheelbase XJ sedan in 2002. If anyone understands the company's aluminium strategy, he does, so why, for example, go for aluminium rather than, say, engineering plastics?

"Of course, we use some engineering plastics," says White. "The rear tailgate of the new Range Rover Sport, for example, is an SMC (sheet-moulding composite) part. We incorporated the interior trim with the moulding because, while aluminium is lighter than SMC, we would have ended up putting decorative trim on the inside and that would have added weight."

He adds that there are still some issues with engineering plastics that preclude its wider use, such as surface quality. "The quality has to be top notch and we still can't get the finish on horizontal surfaces – the tailgate is vertical, obviously – and there is a need for stiffening ribs in order for it to be self-supporting."

There are other advantages to using sheet metal, including its relative inert reaction to temperature differences – drying in the paint shop, for example.

"We also have to consider end-of-life and recycling requirements. Some plastics are recyclable, but not normally back to prime source material. Aluminium will recycle back to prime," he explains. Then there is a question of infrastructure. "We have factories that we did not want to throw away. We can use the same press shop with aluminium as with steel; we have developed different techniques for making aluminium. Our paint shop can cope with steel or aluminium – it's just a question of reformulating the electrocoating."

White dismisses some issues as being under the heading of 'urban myths', such as concerns about painting and joining. "It isn't too hard to adapt," said White. "You need special adhesives and seals that take account of aluminium's character as a heat sink but, in the main, the paint shop is the same – we paint steel alongside aluminium, which doesn't need as much electrocoat and base coat as steel as it has its own corrosion protection."





## Potential for aluminium in high volume

01 September 2013 | Ruari McCallion

### How to make the best joint

Dr Matt Savage, technical manager at ITW Polymers Europe, broadly agrees with White – but not totally.

“Realistically,” he says, “challenges [of joining and painting] tend to revolve around the surface condition of aluminium. If you have a thick oxide layer then it makes a weaker bond – it is only going to be as strong as what it is connected to.”

Pre-treatment, such as anodising or abrading, may be necessary in order to create a substantial bond, but Dr Savage maintains that ITW technology does not suffer from that problem. Aluminium oxide has what is described as a ‘reasonably open’ molecular structure, which allows adhesives to penetrate several microns into it; a clean and grease-free surface will facilitate a very good bond, depending on the application.

Joining aluminium to other materials presents particular challenges, as a composite’s surface layer is likely to be its weakest link. A lot of relevant work has been going on in the marine industry, and experiences there can be carried across to other sectors. However, while the auto sector often leads in R&D, the level of investment in change is so huge that it can take some time before results are seen on the road.

Aluminium is one such example, as are alternative power sources. Any company will take its time in getting to the level of deployment at JLR and Audi because of the cost of changing production lines.

“We are seeing more and more use of aluminium in structural applications,” Dr Savage continues. “At a conference on lightweight vehicles last year, a number of manufacturers said they were going down the aluminium route as far as possible. It is becoming the material of choice because of the challenges of, for example, carbon fibre. We seem to have gone as far as we can with steels and exotic materials are not reliable.” One problem with aluminium, however, is its commodity pricing; the price this week and next can be very different from each other.

### The Audi experience

Audi has been facing these challenges and dealing with them for nearly two decades. Its ASF (Audi Space Frame) concept premiered on the A8 in 1997; its current strategy is the MSF (Multimaterial space Frame), which combines aluminium, steel and fibre-reinforced plastics and is manifested in the A6, A7 Sportback and in elements of the A8, which has a frame comprising of extruded sections and pressure diecast parts of aluminium. The aluminium panels – such as the roof panels and the side panels – are joined by friction connections. While 8% of the weight of the body is extremely high-tensile steel in the area of the B-pillars, most of the rest is aluminium. This breaks down as 35% panels, 35% castings and 22% extruded sections. The wrought components and the 251 individual parts that make up its body are joined using a process that was intensively refined specifically for the A8.

The A6 also uses a composite steel-aluminium construction, which weighs in at approximately 15% less than a conventional all-steel makeup. It has strong stiffness, vibration and crash performance characteristics, in addition to its aerodynamics and aeroacoustics. Audi has used new construction methods and materials for the body, more than 20% of which is made of aluminium. The A4 has an aluminium crossmember behind the front bumper but is otherwise made of steel.

Audi says its MSF strategy enables its engineers to “design each body structure optimally for the requirements, whether the desired distribution of the axle loads, vehicle production volumes or body construction flexibility.”



## Potential for aluminium in high volume

01 September 2013 | Ruari McCallion

### A question of cost

It is almost inevitable that the higher-volume models will have lower proportions of aluminium, for reasons that JLR's Mark White makes clear. "The major challenge in making all-aluminium cars across the board is the cost of doing it," said White. It is quite a lot more expensive than steel, which we can buy for somewhere around £600-£800 (US\$900-\$1,200) a tonne. Aluminium is something of the order of \$1,150 per tonne. When we started our project at Jaguar, the cost of an all-aluminium body was twice that of steel. We have worked very hard to get it down to less than 50% higher but it is still more expensive. The volume segment cannot pass on that type of cost to its customers."

There has been progress in a number of areas and from an original time of twice that of steel to make a car, an aluminium car now takes around the same length of time or even less. The recognition and development of a virtuous circle of lower weight, leading to opportunities for downsizing – engines, fuel tanks, brakes and so on – while maintaining or even improving performance has been enthusiastically embraced. Painting has been important – it is conducted at a lower temperature than is required for steel, which also means a lower energy requirement as well as shorter curing period – but joining has been absolutely key.

"We made the decision early on that spot welding (and similar techniques) was not appropriate for the aluminium car. Cold joining, with adhesives and riveting, was the way to go," White explains. "Our view was that the challenge was to develop ways to put the adhesive on automatically. We also developed a self-piercing riveting technology for aluminium structures." By happy coincidence, it turns out that self-piercing rivets are also the ideal technology for joining steel to aluminium; welding the two materials together works great with steel but is very bad for the aluminium side; steel-to-aluminium hot joining is normally done by means of a bimetallic strip, where it is done at all. "The only hot joining process we have used is a brazing methodology, which does not fuse the two materials together; it uses a filler wire."

### No cure for this condition

"Our joining technology does not need heat to cure it," says ITW's Matt Savage. "The key advantage is the lack of need for preparation. As long as the surfaces are degreased and clear of mould, oil or other pollutants, they can be bonded immediately." The technology has been in existence for around 20 years but mostly been found in composites, and in the marine industry. "Over the last five to six years it has been extended to metal materials. For the very best results, a surface activator is needed, but that involves just wiping on a solution. We have spent a lot of time looking at how to make the processes simpler, cleaner and with fewer steps and processes – generally, making it easier to use."

Audi uses a range of techniques, including self-tapping screws on models including the TT, which are used to join aluminium and carbon fibre-reinforced parts. An adhesive layer eliminates the risk of corrosion posed by the carbon reinforced materials while simultaneously sealing the joint.

Friction stud welding is used to join steel and aluminium. A steel element, a kind of rivet, penetrates an aluminium panel while rotating at high speed and under great pressure, creating a friction-welded joint with the steel sheet below. Meanwhile, the result of JLR's decision to go the rivet-and adhesive route is manifested in the new Range Rover Sport's 25% increase in stiffness over its steel-built predecessor. The advantages are significant but the cost hurdles are multiple: the expense of the raw material is one and the higher price of building it is another. JLR has now got to the point that its assembly lines can cope with steel and aluminium without breaking step, but large volume manufacturers are going to be very cautious before throwing out their expensive infrastructure, which includes welding and time-consuming paint shops oriented towards steel. The price of building new facilities is too high for the perceived benefit – for the time being.

However, advances continue to be made.



## Potential for aluminium in high volume

01 September 2013 | Ruari McCallion

### GM solution

If the expense of changing joining technology is hindering a switch to aluminium for the larger volume manufacturers, interesting news emerged not long ago as David Mason, vice-president, global automotive, at Altair points out.

“General Motor’s R&D organisation announced what it claims is an industry-first in aluminium welding. If it is true, then it will start to change the scene for assembly in aluminium,” he says.

The technique GM announced, already in use, was described as a “new resistance spot welding process” and uses a patented multi-ring domed electrode that does what smooth electrodes are unreliable at doing – welding aluminium to aluminium. The electrode is claimed to disrupt the oxide on aluminium’s surface, enabling a stronger weld. GM expects the process to eliminate nearly two pounds of rivets from aluminium body parts such as hoods, liftgates and doors. It is currently in use on the bonnet/hood of the Cadillac CTS-V and the liftgate of the hybrid versions of the Chevrolet Tahoe and GMC Yukon.

GM plans to use this technology more extensively from 2013 on, asserting that the process is fast, inexpensive and reliable, with advantages of flexibility and weight-saving. It also says that recycling welded parts is easier.

If such techniques are practical and adopted more widely then it is very likely that aluminium will spread beyond its current restricted role in premium segments and limited high volume applications.



This article also appears in

**AUTOMOTIVE  
ENGINEERING**

Subscribe now »

*Built for speed and comfort: The C8 chassis is designed to deliver near-neutral handling characteristics on track, with slight understeer during normal street driving. (GM)*

## **Engineering the Chevrolet Corvette's first-ever mid-engine architecture**

2020-03-09 DON SHERMAN

How GM engineers for the all-new, eighth-generation Corvette tackled structural, vehicle-dynamics and other challenges in the move to a mid-engine layout.

Shifting 500 lb (227 kg) of engine mass rearward by 7.5 feet (2.3 m) and moving 300 lb (136 kg) of transmission components aft by almost three feet transformed the 2020 Chevrolet Corvette Stingray into a budding supercar. General Motors' motive behind adopting a mid-engine layout for the eighth-generation (C8) Corvette was to improve acceleration, braking and handling via substantially increased rear-tire loading.

While numerous test-drive reviews and 'Of the Year' trophies mark that mission accomplished, there are lessons behind the hoopla: how GM engineers solved problems they encountered reinventing America's sports car. "Porsche was our primary benchmark, especially in reference to their PDK dual-clutch automatic transmission's overall dynamics," revealed executive chief engineer Tadge Juechter, in an interview with SAE's *Automotive Engineering*. He said GM also purchased a Ferrari 458 for testing and tear-down analysis.

The first running Stingray prototypes exhibited a high-frequency whirring noise emanating from accessory drives for the alternator, AC compressor and water pump located at the front of the engine. This caused concern, as the noise was being generated only a foot from the occupants' ears. Insulation placed on the firewall wasn't as effective in muffling the noise as the engineers had hoped, Juechter noted. So, they analyzed Ferrari's solution: an unusually thick rear window. "For C8, we increased the thickness of that piece of acoustic glass to 8.6 mm (0.34 in), which is nearly three times as thick as the 3.2-mm (0.13-in) tempered glass shrouding the engine bay," he explained.

Jordan Lee, global chief engineer for GM's small-block V8, added: "It's a balancing act – hearing the satisfying sounds, such as the engine's throaty intake and exhaust rumble, over distractions such as belt whir, injector tick and valvetrain clicks." He noted that while most competitors hard-mount their fuel injectors between the engine's cylinder heads and fuel rails, GM has been using an isolated arrangement in the small block since 2014.



"For C8, GM's NVH engineers invested extra effort in developing effective insulation materials and assuring that the seal around the laminated acoustic glass at the rear of the cockpit is sufficiently robust to hush the belt whir," Lee said. Further dialing-in of build processes is aimed at eliminating audible fuel-injector noise in the production cars.

A related issue is that the driver's view rearward is through both the near-vertical glass panel in the rear cabin bulkhead and the long, nearly horizontal hatch over the engine compartment. In addition to providing rear visibility, the bottom edge of the glass hatch and surrounding surfaces must vent heat and moisture from the engine bay. What Juechter calls C8's "chimney" passes large volumes of hot, wet vapor during rainy driving and when the car is parked following a drive. A fan helps vent that heat from the engine bay. In addition, all the electrical connectors subjected to road splash have weathertight seals.

When the hatch glass is soiled, the driver's view to the rear is diminished. To address this concern, Corvettes with up-level 2LT and 3LT interior trim are equipped with a two-way center mirror. Mode one is a conventional view through the two glass panels. The second choice is an electronic display provided by a high-definition camera mounted to the trailing edge of the roof.

Assuming the lens is clean, the camera provides a broad rear view, unobstructed by the wide roof pillars and soiled hatch glass. As is not uncommon in other rearview camera-mirror applications, reviewers have reported that it takes a second or so for their eyes to focus when the camera view is in use. All Corvettes have a conventional backup camera as standard equipment.

#### **Stymied by the FEAD**

Given the C8's aggressive cornering capability, powertrain engineers knew that it was essential to improve the 6.2-L LT2 V8's lubrication system. Jordan explained that with the previous-generation Corvette, "dialing in the lube system was like threading a needle. We lost several C7 engines when the oil pickup in the tank was starved during high-g maneuvers." Another issue was oil blown out the optional dry sump's vent system.

To solve these problems, the C8 program opted for two additional scavenge pumps to assure that track performance would be uncompromised. "Thanks to the new engine-mounted dry-sump oil reservoir that's now standard equipment, we encountered virtually no [oil-starvation] drama during development," Lee reported. "We were astounded how well it works and throughout C8's comprehensive test program we experienced only one engine failure."

One challenge that has thus far stymied engineers is a straightforward procedure for replacing the front-of-engine accessory drive (FEAD) belts. Doing so requires dropping the entire engine-transaxle assembly from the car. Corvette owners can only hope that will be a rare occurrence necessary only every 100,000 miles or so.

While shuffling powertrain component locations, C8 engineers also switched from semi-elliptic composite suspension springs (pioneered on Corvette' rear axle in 1981) to steel coils. "We would have preferred to keep the composite springs because they are quite efficient from a mass standpoint," Juechter explained. "Unfortunately, with our low-mounted engine and transaxle, there's no room for the tall cross-car path that a rear composite spring requires. In a rear view of the chassis, the arc of the spring would occupy the exact same space as spinning transmission gears."

Once C8's rear suspension design changed to coil springs, the engineers had to follow suit in front. Juechter said this was because of the significant difference between composite- and coil-spring force-versus-deflection characteristics. "To match the ride and roll rates at both ends of the car—something we deem absolutely essential—we switched to a steel coil spring at each corner," he explained.



### Rear-tire mass loading

The other fundamental C8 design change is a new aluminum spaceframe consisting of six elaborately ribbed die castings—which the engineering team dubbed “the Bedford Six” because they’re manufactured at GM’s Bedford, Indiana, facility – plus 14 conventional castings, extrusions, stampings and hydroformed parts joined together with a variety of fasteners and structural adhesive.

Flow-drill screws used at dozens of locations pierce an attaching hole and form threads to secure frame components. As in C7, suspension control arms and knuckles are stiff aluminum forgings and castings. Thanks to the more robust spaceframe, C8’s torsional stiffness is 7% greater than C7 with its roof panel in place and 12% stiffer in the open configuration, according to GM engineers.

In its C8 review, *Car and Driver* reported an increase in the Corvette’s center-of-gravity height. Confirming that, Juechter shed light on the situation: “While C8’s engine and transaxle are both mounted as low as possible in the chassis, there are several parts that are higher than before,” he said. “The rear coil springs are not only heavier than the previous composites, they reside above the tops of the tires and are anchored at their upper ends by substantial pockets cast into our new spaceframe.”

In addition, C7’s low-mounted torque tube is gone and C8’s exhaust system sweeps upward as it flows rearward, raising the height of the catalytic converters, Juechter noted. The net result: the C8’s center-of-gravity height is 470 mm (18.5 in), 15-mm (0.59-in) higher than C7’s.

An oft-cited reason for choosing mid-engine over alternative powertrain layouts is to minimize the car’s polar moment of inertia for optimum agility. Asked to compare C8 and its predecessor, vehicle performance manager Alex MacDonald calls the polar-moment-of-inertia figures of both C7 and C8 “pretty comparable.” That said, two substantial components now reside some distance from the center of gravity.

“C8 has two large radiators full of coolant situated in the nose of the car,” MacDonald noted. “And our fairly heavy transaxle lives at the opposite end of the car, well behind the center of mass. So, positioning the engine near the middle doesn’t automatically yield a low polar moment of inertia. In the end, the added traction achieved with 60 percent of the Corvette’s mass loading its rear tires is a greater influence on overall performance.”

Another non-trivial challenge facing the C8 team was tightening EPA and global regulations for brake-dust emissions. Studies have shown that the dust created by vehicle brake-pad abrasion is the source of approximately 20% of total PM2.5 (fine particulate) traffic pollution. “We had to reinvent our brakes,” Juechter explained, “because our previous pads’ 25-percent copper content is no longer permissible. To avoid abrasion of the new pad material, we can no longer use the drilled and slotted rotor venting that flushes water from the friction surfaces during wet driving. While I personally prefer the look of slotted rotors, they’re gone in C8.”



### Balancing handling and ride quality

An unsung C8 achievement is a base curb weight increased by only 70 lb (32 kg) over its predecessor despite added features: roomier passenger accommodations, the new Tremec TR-9080 8-speed dual-clutch automated-manual transmission with one more gear than C7's manual transmission, dry-sump lubrication, increased cooling capacity and larger rear wheels and tires. Even with the more stringent 2020 EPA test procedures, highway fuel efficiency increases by 2 mpg (to 27 mpg).

To hold the line on weight, Juechter's team supplemented its sharp-pencil engineering with a few carbon-fiber composite components. One is an industry-first curved and hollow rear bumper beam. The supplier, Shape Corp., uses pultrusion technology developed by Germany's Thomas Technik and Innovation to draw carbon fiber material, wet with urethane-acrylate resin, through a die. The resulting beam, which is 4.9-lb (2.2-kg) lighter than an aluminum extrusion, bolts to the Corvette's spaceframe extensions.

Another ultralight part is the center tunnel close-out panel, supplied by the Molded Fiber Glass company. It is made using MFG's PRiME liquid composite molding process. Two carbon fiber and three fiberglass sheets wet with vinyl ester resin are molded under pressure, yielding a stiff 10.4- x 49.5- x 0.16-in (26.5 x 125.7 x 4.0-mm) panel weighing only 4.9 lb. It attaches to the bottom of the aluminum spaceframe with 30 fasteners.

The new Corvette's passenger compartment floor panels are SMC (sheet molding compound) moldings topped with stamped aluminum panels at the rear to support the car's bucket seats. Front and rear luggage compartment bins made by MFG use ultralight SMC with a specific gravity below 1.0 – indicating that each part would float in water. A die-cast magnesium cross-car beam bolts between the A-pillars to rigidly support the dash panel. For the first time, the Corvette's bottom surface is flat and smooth to minimize aerodynamic drag.

One enduring C7 owner gripe is front-tire chatter during cold-weather, full-steering-lock maneuvering. According to Juechter, considerable effort was invested in remedying that shortcoming. "In the past, we pushed our front-engine performance limits with near-racing tire compounds and steering geometry favoring handling," he said. "Unfortunately, below 40-degrees F, this results in stick-slip tire chatter that owners notice. To improve this in C8, we revised the steering geometry to improve the Ackermann correction and walked back a bit from our previous aggressive tire compounds because they're less essential with mid-engine to achieve our performance goals."

The net result, Juechter noted, "is nowhere near as much stick-slip chatter as we had in C7 even with the tighter turn circle provided in C8's equipped with our MR (magnetorheological) dampers." Now in their fourth design generation, the highly effective MR dampers supplied by BWI cost \$1,895 over the \$5,000 Z51 Performance Package.

The Corvette development team collaborated five years with Michelin to develop new run-flat tires for C8. The base rubber is a Pilot Sport ALS (all season) while Pilot Sport 4S (summer only) radials are included with the Z51 option. This is the first application of all-season tires on the Corvette, which should encourage owners to use this supercar more months of the year in northern climes.

Juechter is on record not wanting C8 to be a handful at the cornering limit – a preference dating to his youth under the wing of a fighter-pilot father who enjoyed owning and driving Porsche 911s. "We definitely didn't want our first mid-engine effort to earn a reputation as a car that's tricky at the limit," he asserted. "There are numerous variables that must be addressed to achieve benign, totally controllable handling. By that, I mean near-neutral characteristics on the track with a bit of understeer during normal street driving."

A key variable is lateral compliance, which begins at the tire sidewall and continues through the wheel's construction, wheel bearings, suspension knuckles, rubber bushings and control arms all the way to the suspension anchor points on the spaceframe. "We want the tire's stick-slip characteristics to be very progressive with gradual changes in the coefficient of friction," Juechter explained. Suspension geometry was tailored to provide a small amount of steering into the turn as the car rolls. The lateral compliance built into the suspension bushings also provides a few minutes of steer angle under high lateral loading, he said.

Engine-mounting strategies were also deliberated, with the team deciding to "softly" mount the LT-2 V8 for vibration isolation. "But you definitely don't want a two-stage step function when the engine reaches the limit of its roll," Juechter explained. "So, the compliance and damping built into the engine mounts are also important." Finally, spring, anti-roll bar and damper calibrations were selected to work with all the other variables to give the driver the perception of a totally integrated driving experience.



### **Dimensional factors**

In the plan view, the 2020 Corvette Stingray has a fighter-jet look with an aggressively curved nose tip and front corners drawn back tight – seemingly a triumph of styling over engineering. The car also is 2.2 in (5.6 cm) wider and 5.3 in (13.5 cm) longer than its C7 predecessor. The increase in length is attributable to ergonomic and storage improvements. Fore-aft seat travel was increased by an inch (25.4-mm) and the seat-backrest recline angle doubled, to 18 degrees, to better accommodate tall occupants. The C8's extra length also provides storage space in the rear trunk for the removable roof, a feature considered essential in Corvettes.

The increase in overall width is due to wider rear tires and wheels. "It's not practical to tuck them in closer to the centerline if you want outstanding ride and handling balance," Juechter said. "We prefer long suspension travel with lower spring rates than are common in competitors. Shortening the halfshafts isn't practical because that increases universal-joint angularity, greatly reducing the life of the rubber boots surrounding the U-joints."

Also contributing to the C8's added width is the substantial duct integrated into each rear quarter panel. These openings are responsible for ingesting an enormous volume of air for engine induction and engine-bay cooling (cars equipped with the Z51 performance package have a third radiator on the passenger side to assure that they're fully track capable at ambient temperatures of 100-degrees F).

Juechter acknowledges that the wider fenders and rear tires are responsible for a frontal area that's slightly greater in C8 (2.075 m<sup>2</sup>/22.3 ft<sup>2</sup>) than in C7 (2.023 m<sup>2</sup>/21.78 ft<sup>2</sup>). Because aerodynamic downforce is notably greater with the Z51 performance package, a C8 so configured has an 0.322 drag coefficient versus C7's 0.313 Cd.

The bottom line is a 2020 Corvette Stingray chassis and body engineered to fully exploit the performance strides delivered by the SAE-certified 495-hp LT2 V8 and the Tremec DCT. Considering the new Corvette's \$59,995 base price and the sold-out 2020 production run, Juechter's team has seemingly wrought the supercar value of the century.





Corvette's new aluminum-intensive space frame laid bare. (GM)

merous test drive reviews and 'Of the Year' trophies mark that mi

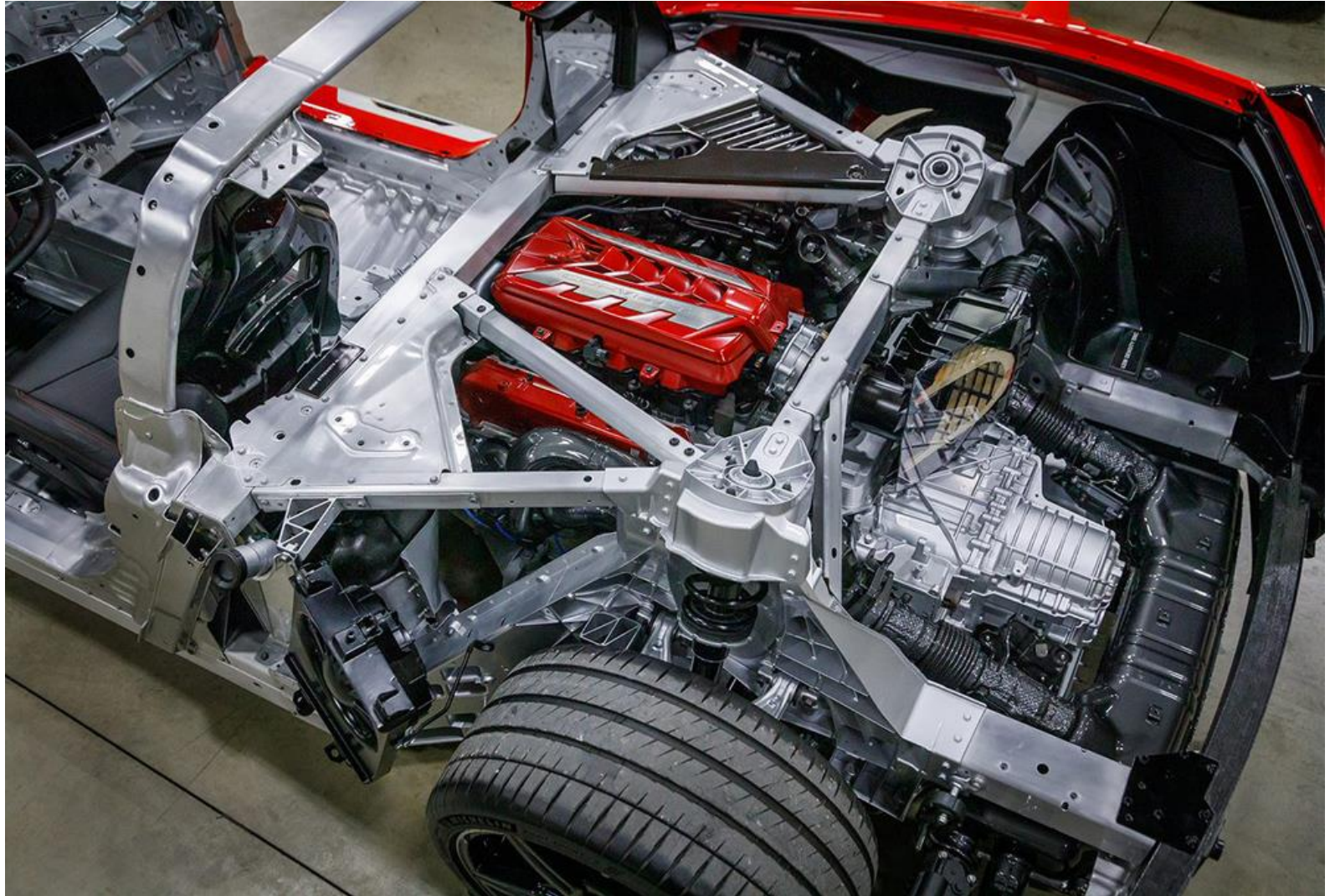

C8 rear structure is a feast of clever engineering solutions. Note near-vertical rear window aperture, side-mounted engine bay fan, exquisitely webbed castings, and carbon-composite rear bumper beam. (GM)

ELECTRIFICATION MOBIL



Details of C8's magnesium crosscar beam and instrument module. At left is deep-section center-tunnel structure. (SAE/Lindsay Brooke)



31/05/2014

<http://www.auto-types.com/autonews/jaguar-presents-new-teaser-image-of-xe-successor-to-x-type-11664.html>

Jaguar is preparing to launch a new sedan in its range, which will be the entry-level model in the British brand's portfolio. We are talking about the XE, the successor to the X-Type, whose prototype was presented in a camouflaged version on the brand's official Facebook account in the United Kingdom.

We can notice a scale version of the XF's silhouette with generously sized side mirrors, and thin optical blocks extended towards the wings, and a side window line, inspired by that of a coupe. The first information announced a new platform for this model. It is expected the new iQ(AI) platform will be used, with increased structural strength, a very low total mass, and its modulation capacity will allow its use for many body types. Also, the architecture allows the installation of a rear propulsion or four-wheel drive, as well as allowing usage for an electric propulsion system.

The engine range of Jaguar XE will have more four-cylinder units, but it is expected that a supercharged V6 engine, that will have a displacement of 3.0 liters and could deliver 350 hp, might appear. Jaguar could launch the new XE at the Auto Show in Paris, while the commercial debut of the model is likely to come next year.

The exhibit from the teaser image presented by the British has a number of lines drawn on the bodywork, which emphasizes the aluminum chassis of the model, as well as the integrated safety features.

Just like X-Type, Jaguar thought out the new XE to fight in the premium segment of the middle class, with models such as the Audi A4, BMW 3 Series, Mercedes-Benz C-Class and Lexus IS.

"It's a logical idea to use the momentum from Land Rover and expand the Jaguar range. Jaguar is less than half the size of Land Rover so they need to do something, plus investors will like a move downscale," said Christoph Stuermer, IHS Automotive research director, on the idea behind the new, more affordable vehicle approach.

Those from Jaguar have declared that the British Ingenium family offers the flexibility to introduce models that can reach a top speed of over 300 km / h, as well as others that emit less than 100 g / km of CO<sub>2</sub>.

Jaguar will also launch an SUV, a compact sedan and a wagon in 2015. According to sources, the British brand will launch these models using a new platform made of aluminum and the bodywork may likewise have aluminum elements. Commercial debut of the new models will take place in the second half of the year, says Reuters quoted by Automotive News.

The English will invest 4.23 billion dollars every year over the four years to develop new products and production facilities.

In 2012, Jaguar Land Rover signed a contract with a company in Saudi Arabia, specializing in recycling aluminum, to purchase large quantities of aluminum, and will thus provide new platforms at competitive prices, although they have a high level of quality and performance.



## **Revealed: The 'baby' Jaguar XE the car maker hopes will win over the world's middle classes from the BMW 3-Series New Jaguar XE will take on German rivals**

**Annual Jaguar sales are currently 60k - wants to increase this to 300k  
PM opened new £500m engine factory near Wolverhampton last month**

Read more: <http://www.thisismoney.co.uk/money/cars/article-2572895/First-official-picture-baby-Jaguar-XE-revealed.html>

By [Ray Massey, Transport Editor At The Geneva Motor Show](#)

**PUBLISHED:** 12:55 GMT, 4 March 2014 | **UPDATED:** 09:21 GMT, 7 March 2014

A sneak peek of a new 'baby' Jaguar on which the British car firm has 'bet the house' to win over the world's middle classes was given to visitors to the first day of the Geneva Motor show today.

The new medium-sized leaping cat sports saloon – which it was announced will be called the XE - is part of an audacious masterplan by Jaguar to take on its mighty German rivals and quadruple sales.

The British-made upstart will gun for the German car-makers in their own heartland territory in a bid to grow the size of the firm four-fold.

And Jaguar has already put in the foundations after Prime Minister David Cameron last month opened their new £500million state of the art engine factory near Wolverhampton which will build the super-green but super-fast new motors for the cars.

Jaguar bosses served notice on the best-selling BMW-3 series – the dominant mid-market premium small family and executive car, which even outsells the Ford Mondeo. Also in its sights is Mercedes-Benz with its C-Class and Audi with its A4 saloon.

Annual Jaguar sales are currently just above 60,000 a year – which experts say is 'paltry' and 'not viable'.

But the firm want to get closer to 250,000 or even 300,000 – which would mean at least quadrupling Jaguar sales.

The new XE car – until now codenamed X760 - will be Jaguar's big volume seller and will massively boost the firm's production.

The car was not, however, unveiled at the show. But as a teaser bosses a displayed brief image of it at the end of a short video presentation to the crowds, as Jaguar chief executive Dr Ralf Speth gave his show speech.

The real car is set to be officially revealed in the summer, with its formal launch at the Frankfurt Motor Show in September before going on sale in spring 2015.

The new range of Wolverhampton-built engines which will power the XE will be called 'Ingenium'.

Jaguar said the new XE mid-sized sporty family saloon will be 'the most advanced, efficient and refined sports saloon in its class.'

But unlike the stunning F-Type roadster and coupe – which is seen as a 'halo' car bringing excitement to the British marque, it is the more down to earth XE which will have to bring in the big bucks.

It will also be the first of a new generation of Jaguars to use an advanced aluminium chassis system in which Jaguar Land Rover has invested £1.5billion and which was pioneered in the prototype C-X17 concept car at the Frankfurt Auto Show in 2013.

Jaguar bosses will also be hoping to avoid the mistakes of their last volume challenge to the Germans with the lack-lustre mid-range X-Type Jaguar – with Ford Mondeo underpinnings – which nearly sent the firm to the wall.

X-Type production ended in 2009. This time the new car will be brand new from the ground up.



Jaguar's global brand director Adrian Hallmark said: 'Jaguar Land Rover's aspiration is to be the fourth premium car company in the world. To do that, Jaguar needs to pull its weight. We need to multiply volumes over the next few years.'

He stressed that Jaguar's growth would be in 'multiples not percentage increased.'

Jaguar's design director Ian Callum said: 'The new Jaguar XE is every bit a modern Jaguar; more compact in size but visually striking. Customers will expect a great deal from a mid-size Jaguar - it must be practical but premium.'

'We never forget we are designing a Jaguar and that means it must be as exciting to look at and drive as it is brilliant to run and practical to own. We believe we've done just that with the Jaguar XE.'

The Jaguar XE will also be the first car to use the powerful but still fuel-efficient Ingenium engines in four-cylinder two-litre petrol and diesel variants. They promise top speeds of more than 186mph but emissions lower than 100g of CO<sub>2</sub> per km travelled.

Speaking at the Geneva Motor Show, Jaguar Land Rover chief executive Dr Ralf Speth, said: 'We announced just a few weeks ago that our new Engine Manufacturing Centre would produce a new family of premium, lightweight, low-friction, low emission four-cylinder petrol and diesel units.'

'The first of our Ingenium engine range will be used in our all-new mid-sized Jaguar sports sedan. That car will be called the Jaguar XE, and it will be unveiled in production form later this year.'

But Phil McNamara, editor of the respected CAR magazine set out the scale of the task. He said: 'In the whole of last year Jaguar sold over 60,000 cars worldwide. That's still a paltry figure. By July, BMW had sold 73,000 cars in Britain alone.'

'But their masterplan could quadruple Jaguar's size to more than 250,000 annual sales by 2018.'

He added: 'Good times are ahead for Jaguar.'

The new £500million engine plant in Wolverhampton is located between the company's three other factories at Halewood, Castle Bromwich and Solihull and will create nearly 1,400 jobs by the time the plant reaches its full capacity.

It boasts almost 100,000 square metres of internal floor area, equivalent to the area of 14 football pitches. The first engines will come off the assembly line in early 2015.

The Prime Minister said on his recent visit: 'Everywhere I go in the world I support Jaguar Land Rover. This is a great British success story.'

Kevin Stride, Jaguar's vehicle line director for the new XE model said: 'The engineering development of the XE has focused on delivering customers with the most advanced, efficient and refined sports saloon in its class.'

'We are excited about our progress to date and are looking forward to soon being able to demonstrate what we have achieved.'

The XE will be positioned 'logically' alongside the sporty XF and stately XJ saloons in the range. As part of its ambitious and expanding model range, Jaguar is also planning a crossover off-roader and has already shown a prototype code-named C-X17.

Jaguar Land Rover is owned by Indian industrial giant TATA which bought it from Ford for £1.2billion and initially struggled, but in the 12 months to 31 March 2013, it generated profit before tax of £1.675billion with revenues of £15.8billion.

Then in January this year it announced it had smashed its annual sales records selling 425,006 vehicles in 2013 – a 19 per cent increase on 2012 – with new sales records set in 38 international markets. At home, Jaguar sales rose 15 per cent in 2013, with Land Rover up 13 per cent.

Tata has also invested billions in Britain including £1.5billion in a new hi-tech aluminium facility in Solihull creating 1,700 new jobs which bring the total number of UK manufacturing jobs announced by Jaguar Land Rover over the last three years to almost 11,000.

JLR will also invest around £2.75billion in its product creation and facilities in the financial year to March 2014.





<http://www.handelsblatt.com/auto/nachrichten/jaguar-xe-mit-alu-auf-konkurrenzkurs/10204496.html>

### **Mit Alu auf Konkurrenzkurs**

16.07.2014, 08:31 Uhr

*Mit ihrer neuen Mittelklasse wollen die Briten sportliche Fahrer begeistern. Deshalb erhält der Jaguar XE auch Komponenten aus dem Sportwagen F-Type.*

*Anfang September zeigt Jaguar das neue Mittelklasse-Modell XE, das Mitte 2015 zu den Kunden rollen soll und sich dann unterhalb des Oberklassemodells XJ sowie des eine Klasse kleineren XF einordnet. Im Vorfeld geben die Briten bereits einige Details bekannt, anhand derer klar wird, dass sie aus alten Fehlern gelernt haben.*

*Anders als der geflopte Vorgänger X-Type von 2001 basiert der XE zum einen nicht auf einem Allerwelts-Modell wie dem Ford Mondeo, sondern teilt sich die Architektur mit dem kommenden SUV C-X17. Zum anderen enthält die neue Mittelklasse, die gegen Konkurrenten wie Audi A4, BMW 3er, Lexus IS und Mercedes C-Klasse antritt, aktuelle Bausteine der Jaguar-DNA.*

*So setzen die Briten zum Beispiel auf den Leichtbau-Werkstoff Aluminium, aus dem das Monocoque bestehen soll. Für die Balance zwischen Komfort und Dynamik setzt Jaguar eine Integral-Mehrlenkerachse hinten ein, die Vorderachse ist dem Sportwagen F-Type entlehnt. Komponenten beider sind aus geschmiedetem oder hohl gebohrtem Aluminium gefertigt.*

*Erstmals im XE kommt die aktuellste Generation der elektrischen Servolenkung zum Einsatz. Durch eine neue Softwareabstimmung soll sich die Lenkung der Fahrsituation besser anpassen und zu einem optimierten Lenkgefühl beitragen. Zum Anfahren auf rutschigem Untergrund erhält das hinterradgetriebene Modell eine neue Traktionshilfe ASPC, durch die der XE ohne Zutun des Fahrers seine Kraft auf die Straße bringen kann.*

Jaguar will present its new mid-class XE model in early September. It is expected to start deliveries to customers in mid-2015 and the model will be positioned below the luxury XJ and the XF, which is one class smaller. The British brand has already revealed some details ahead of the launch which show that it has learned from past mistakes. Unlike the unsuccessful X-type from 2001, the XE is not based on an everyday model like the Ford Mondeo, but shares its architecture with the upcoming SUV C-X17. Moreover, the new mid-sized car, which will go up against competitors like the Audi A4, BMW 3 Series, Lexus IS and Mercedes C-Class, will receive some current elements of the Jaguar DNA. For example, the carmaker is banking on the use of aluminium. The lightweight material is to be used for the monocoque.



Fonte: Automotive Engineering online

## Fibra de Carbono

### **BMW and Boeing to collaborate on carbon-fiber materials**

12-Dez-2012 19:41 GMT Patrick Ponticel

Two heavyweights in the automotive and aerospace industries are joining minds on lighter materials. BMW and Boeing on Dec. 12 announced they would do joint research on carbon-fiber recycling and share knowledge about the material and its manufacture. As part of the collaboration agreement, the two companies will also share carbon-fiber manufacturing process simulations and ideas for manufacturing automation. BMW in 2013 plans to introduce two models from its new i brand (i3 battery-electric and i8 plug-in hybrid) featuring bodies made of carbon-fiber-reinforced plastic. Boeing's new 787 Dreamliner aircraft is made up of 50% carbon fiber. The collaboration is the first ever between the two companies.



The bodies of BMW's i brand models will use carbon-fiber-reinforced plastic.





Fonte: Automotive Engineering online



The all-new 2014 C7 Corvette is a lightweight materials-fest. The base model gains a carbon-fiber hood (inner and outer) and roof panel. Quarters, doors, and hatch are in lighter-density SMC than the previous fenders, and the fascias are in TPO.

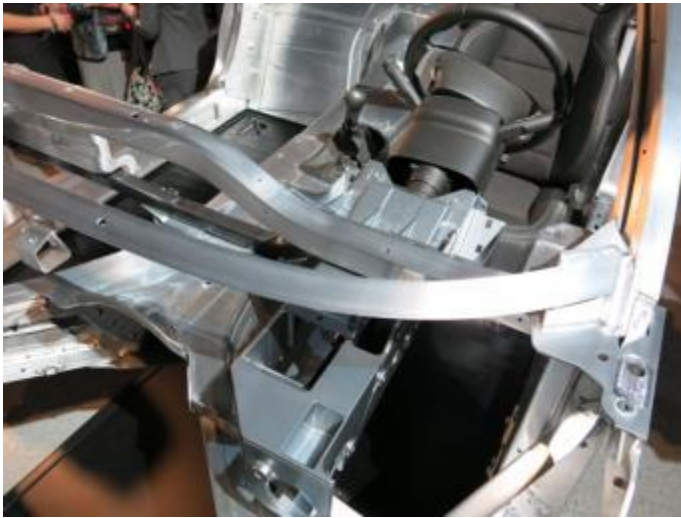

The C7 steering column support is a new thin-wall magnesium casting in AZ91 material said to be five times stiffer than the previous column structure. Note hydroformed Al cross-car beam. (Lindsay Brooke)



The Corvette's aluminum-intensive body structure was completely revised for the C7. Carbon nano-composite floor panels replace the C6's balsa-wood honeycomb floor. Note large hydroformed main rails under passenger cell, and five-piece front rails composed of hydroformed tube and large cast nodes.



The C7 rear control arms (right) are hollow aluminum castings. The C6 arms (left) are solid. (Lindsay Brooke)



Fonte: Automotive Engineering online



A-pillar support and front quarter junction details on the C7 structure.



Carbon-fiber roof panel and hood are molded by Plasan Carbon Composites in western Michigan.



**Carbon fiber, new aluminum structure lighten 2014 Corvette Stingray** Lindsay Brooke - Automotive Engineering online February 2013

14-Jan-2013 14:54 GMT

"We had very aggressive weight-reduction targets on this program," said Leonard Brohl, Lead Engineer for Closure Panels on the 2014 C7 Chevrolet Corvette, unveiled Jan. 13 at a media event preceding the Detroit Auto Show. General Motors has resurrected the Stingray name for the latest generation of its iconic sports car, which continues to be a lightweight-materials wellspring for the automaker.

The C7, which enters production in 3Q13, boasts an all-new aluminum chassis/passenger cell structure that is 57% stiffer in torsion and 99 lb (45 kg) lighter than the previous C6 steel-and-aluminum structure, said GM engineers. At the car's world debut, GM had not yet published a production curb weight for the car. It is expected to be slightly lighter overall than the base C6 coupe's 3208 lb (1455 kg).

Besides reducing mass while increasing strength, the development team aimed to retain the Corvette's ideal 50/50 front/rear weight distribution deemed essential for superior handling.

Compared to the C6, which uses continuous hydroformed main frame rails with a constant 2-mm (0.08-in) wall thickness, the C7's main rails each feature five aluminum segments, including extrusions at each end, a center main rail section, and hollow-cast nodes at the suspension interface points. Each segment is tuned by varying wall thickness from 2 to 11 mm (0.08 to 0.433 in). This tailors each section's gauge, shape, and strength properties to optimize the structural requirements for each frame section while keeping mass to a minimum.

The frame is assembled at an all-new welding shop at the Bowling Green, KY, assembly plant using a precision laser welding process that GM claims holds tolerances to about 0.001 in (0.025 mm).

Supporting the frame's greater strength and lower weight are complementing chassis elements, including hollow-cast aluminum front and rear cradles that are approximately 25% lighter and 20% stiffer than the solid cradles used on the C6 car's structure. The steering column support is stiffened by a factor of five compared with the outgoing car using a new thin-wall magnesium casting.

C7's use of materials includes a standard carbon-fiber hood and roof panel, supplied by Plasan Carbon Composites' new Walker, MI, plant. Plasan has innovative manufacturing processes that shatter previous autoclave-type processing times, getting per-part processing down to 17-min machine cycles. For more detail, [read this AEI article](#).

The unique balsa-wood-sandwich floor construction of the C6 Corvette has been superseded on C7 by a new carbon nano-composite floor pan that is lighter while maintaining strength and stiffness, said Chief Engineer Tadge Juechter.

C7's front fenders, doors, rear quarter panels, and the rear hatch panel are made with lighter-density sheet molding compound (SMC) than the previous generation. The door outer panel measures 1.2 mm (0.047 in) thick and the inner panel 0.8 mm (0.031 in). Combined, the body materials and their design/engineering save approximately 37 lb (17 kg) vs. the C6 body structure.

(The Corvette C7's composites program will be discussed in depth as part of a free *AEI* Webcast in March. Go to <http://www.sae.org/mags/aei/webcasts.htm> to register.)

C7 seat frames are a new magnesium structure on both the standard GT seat and the Competition Sport seat with more aggressive side bolstering. Juechter said that the Stingray's 50/50 weight balance combined with its estimated 450 hp (335 kW) output (final SAE ratings are not yet finalized) offers the new Corvette a power-to-weight ratio that is superior to those of the Porsche 911 Carrera and Audi R8.



This article also appears in

**AUTOMOTIVE  
ENGINEERING**

[Subscribe now »](#)

Exploded image shows the materials mix used in GM's new carbon fiber composite cargo bed on the 2019 GMC Sierra Denali (image: GM).

## **GM turns to carbon fiber for 2019 GMC Sierra pickup bed**

2018-03-20 KAMI BUCHOLZ

Steel truck beds. Aluminum truck beds. The battle to create the lightest, strongest pickup cargo bed intensifies yet again, as carbon fiber debuts as the bed material for the 2019 GMC Sierra Denali.

"This is a revolutionary application on the next-generation Sierra," said Mark Voss, General Motors' engineering group manager for pickup boxes. Voss and others involved with the industry-first carbon fiber truck box spoke with *Automotive Engineering* at the new Sierra Denali's recent global debut in Detroit.

The carbon-fiber composite material, developed by GM and Continental Structural Plastics, offers superior dent, scratch and corrosion resistance, according to Tim Herrick, the 2019 Sierra's chief engineer. Compared to the Sierra's standard steel truck bed, the carbon fiber bed is 62 lb (28 kg) lighter. Because of the material's formability, the sides of the carbon fiber box are pushed further outward--increasing the bed's total volume by a cubic foot. The carbon-fiber bed will be available for the GMC Sierra Denali in short-bed configuration. This 5-ft 9-in short box is 1 in (25 mm) longer and 2 in (50 mm) taller than that of the previous generation Sierra.

"We didn't start out saying, 'Let's create a carbon-fiber truck box'," Herrick said, pointing out that other carbon fiber applications, including some under the body, were considered before the cargo-bed program got the green light.

Making a carbon-fiber truck bed a production reality began with creating the material chemistry. "The decision to go with a carbon-fiber thermoplastic (nylon 6) allows for reusing and recycling the material," noted Voss. "There are actually two parts on this cargo bed that are made from 100% of the recycled material that's created during the production process," he said, referencing the right- and left-side front stake pocket reinforcements. Rather than opting for woven carbon fiber, the material is in a "chopped" form. "We really want to use every ounce of fiber—and with the chopped fiber we're able to do that," Voss explained.

The production process requires the joining of two layers, according to Herrick. "With sheetmetal, you'd spot-weld the layers together. But with this, we're using a structural adhesive and a mechanical fastener at the beginning of the bond to prevent the susceptibility of peeling," he said.

Akio Nakaishi, general manager of the composites business unit for the Teijin Group, parent company of Continental Structural Plastics, said the molding of parts has a one-minute takt time. "That is very innovative and it makes us able to produce this part on a large scale," Nakaishi noted.

To confirm the cargo bed's durability, the GM team loaded and unloaded objects that included snowmobiles with carbide-steel runners. They also flagrantly dumped in bricks, rocks, firewood and other material. Said Voss, "We tested many, many different scenarios of how the truck bed could be used and abused."

Production versions of the carbon fiber truck bed will differ in one significant fashion from the prototype version shown to media at the vehicle's debut. "A special production tool will be used that will make the top of the corrugations have a sandpaper-like grip," said Voss. "The lower portion of the corrugation is made from a smoother grain, making it easy to wash out sand, dirt and mud."

Workers at Continental Structural Plastics plant in Huntington, IN, will mold and form the carbon-fiber bed, which will then be trimmed out at GM's Fort Wayne, assembly plant.

The 2019 GMC Sierra Denali goes on sale this fall.



Standard Publicações News Artigos Learn Participações Links

# 2019 GMC SIERRA

## CARBONPRO BOX

- Glass fiber composite
- Plastic trim
- Steel
- Aluminum
- Carbon fiber

This article also appears in

**AUTOMOTIVE ENGINEERING** [Subscribe now >](#)

“ Compared to the Sierra's standard steel truck bed, the carbon fiber bed is 62 lb (28 kg) lighter.



Fonte: Automotive Engineering online

### GM intros first 'smart' materials app on 2014 Corvette Lindsay Brooke

The 2014 Chevrolet Corvette will feature General Motors' first production application of a shape-memory alloy (SMA)—a wire used to open and close the vent hatch that releases air from the car's trunk area. The SMA wire, developed in-house by GM materials experts, replaces a motorized actuator and reduces component mass by approximately 1.1 lb (0.5 kg). GM vehicle engineers said use of the wire enables the trunk lid to close more easily than on the previous Corvette, where trapped air could make the lid harder to close.

SMA's typically are made of copper-aluminum-nickel (CuAlNi) alloys, nickel-titanium (NiTi) alloys, and copper-zinc-aluminum (CuZnAl) alloys. They're considered "smart" materials because they can change their shape, strength, and/or stiffness when activated by heat (from electrical current, in the case of the Corvette), stress, a magnetic field, or electrical voltage. CuAlNi SMA's are much cheaper to make than NiTi alloys due to cheaper raw materials and less extensive processing. Their transformation temperatures—in the range of 80 to 200°C (176 to 392°F)—also are lower.

SMA's are being used increasingly in the medical and aerospace industries. They have "memory" and return to their original shape when deactivated. In the new Corvette, when activated the wire contracts and moves a lever arm to open the vent, allowing the trunk lid to close. Once the trunk lid is closed, the electrical current switches off, allowing the wire to cool and return to its normal shape, which shuts the vent to maintain cabin temperature.

Research for the SMA used on the Corvette began in late 2009, according to Paul Alexander, GM smart materials and structures researcher. He said GM has 247 patents in SMA technologies. GM Chief Technology Officer Jon Lauckner noted that SMA's enable new and improved features "at a lower cost than traditional motors and actuators."

Lauckner and Alexander indicated that SMA's and other "smart" materials potentially could replace about 200 motorized movable parts on the typical vehicle, adding up to significant mass reduction.

The 2014 Corvette's rear cabin vent actuator (shown in red) is GM's first production application of an SMA—in this case a thin wire likely made of copper-aluminum-nickel (CuAlNi) alloy





**MORE THAN A POWER SOURCE**

The battery is a rigid, high-performance structure in its own right. But when married to the state-of-the-art body structure, Model S achieves even higher torsional rigidity and a lower center of gravity. The battery itself is designed for safety. Liquid-cooled, the battery maintains consistent temperatures to prevent cells from overheating. In the event of a crash, the battery structure protects cells from impact and automatically disconnects the power nearby. The battery not only protects its contents, but its position augments the overall strength of the passenger cabin.



	60 kWh
EPA 5-Cycle Certified Range	208 miles
0 to 60 mph	5.9 seconds
Quarter Mile Time	14.2 seconds
Top Speed	120 mph
Peak Motor Power	302 hp (225 kW) 5,000-8,000 rpm
Peak Motor Torque	317 lb-ft (430 Nm) 0-5,000 rpm
Energy Storage	60 kWh
Battery Warranty	8 years, 125,000 miles
Supercharging	Optional

**ALUMINUM BODY STRUCTURE**

**STRONG, RIGID, AND LIGHT**

The Model S body is a state-of-the-art, aluminum-intensive design. Weight-saving benefits make aluminum a natural choice. Extrusions, stampings, and castings are expertly joined for rigidity and strength. A rigid and strong structure not only protects you and your passengers, but also contributes to overall control behind the wheel.

Unhindered by an internal combustion engine, the front of the car is optimized for occupant safety. Perfectly straight double-octagonal rails run along the bottom of the structure and are designed to absorb the energy of impact should one occur. High-strength steel is used in key areas to enhance occupant safety.

**AIRBAGS:** Model S is equipped with airbags throughout to keep the most precious cargo safe.

**RIGID OCCUPANT CELL:** High-strength steel is combined with aluminum to augment safety.

**NO ENGINE:** The front crumple zone is optimized for safety in ways not possible in conventional cars.

**ALL GLASS PANORAMIC ROOF**

With the All Glass Panoramic Roof, Model S is the only vehicle capable of delivering a convertible-like drive experience every day. It's more than a sunroof. The entire roof is constructed from lightweight safety glass. With a simple swipe of the Touchscreen, it opens wider than any other vehicle's panoramic roof. On even the hottest days, the executive glass keeps the cabin comfortable by blocking 100% of UV rays and 81% of heat.

**BLOCKS**  
100% | 81%  
ON LIGHT | HEAT

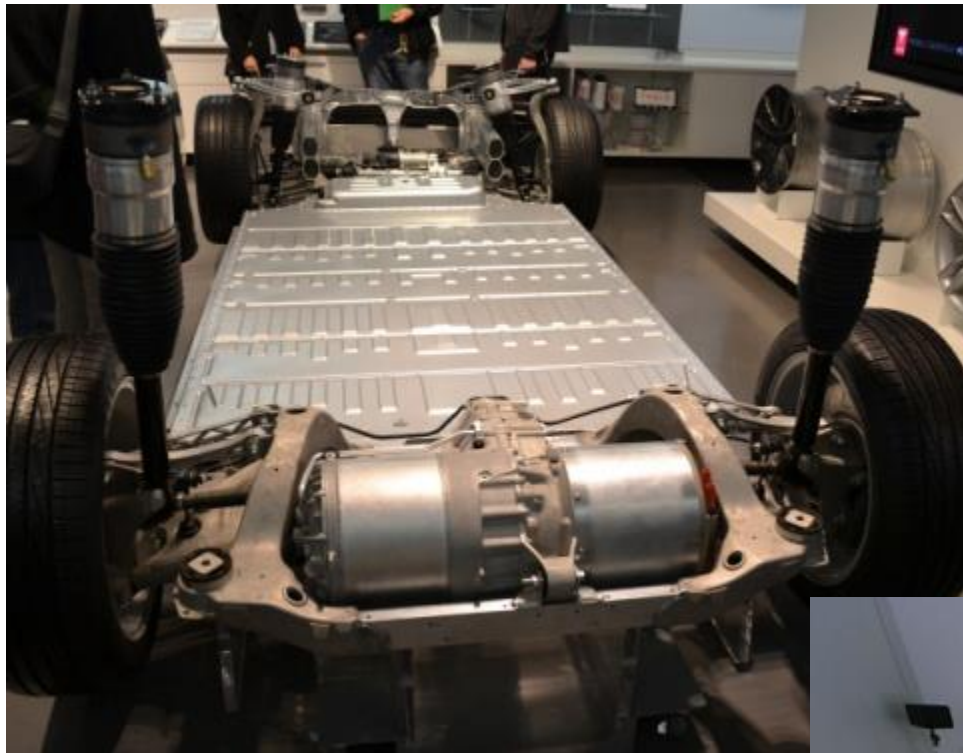





This article also appears in

**AUTOMOTIVE  
ENGINEERING**

[Subscribe now >](#)

*Area of the Tesla Model Y's body structure to be composed of a single cast component. (Tesla)*

## **Tesla casts a new strategy for lightweight structures**

2020-06-02 BILL VISNIC

The EV maker boldly invests in the world's largest aluminum die-casting machine to manufacture entire rear underbody structures.

Aluminum is synonymous with “weight-saving” in most contemporary automotive-engineering reference points. But apart from a few applications – most notably Ford’s F-Series pickups – aluminum largely is deployed where steel can be readily displaced without performance loss or for comparatively small components that deliver comparatively small weight or process savings. Electric-vehicle maker Tesla is readying the next step in aluminum use, however – one that effectively matches Ford’s “big gain” approach by specifying a massive piece of structural die-cast aluminum for the rear underbody of the recently launched Model Y crossover. According to Tesla CEO Elon Musk, this new aluminum application represents a radical step for its design and manufacturing advantages and its lightweighting potential.

Musk is renowned for outsized promises, but in the case of the Model Y’s die-cast rear underbody, his enthusiasm for this advanced use of aluminum – cast by a house-sized “giga press” – is supported by manufacturing experts who call it a game-changer. “It’s definitely an all-new look at how to do things,” asserted Laurie Harbour, president at Harbour Results Inc. manufacturing consultancy. “Elon Musk has always pressed his engineers to be creative.”



### **Reductions in – pretty much everything**

Musk spoke in detail about the new casting process in an episode of the “Third Row Tesla Podcast” in April and made more than a passing mention of it in Tesla’s 1Q2020 financial results call in early May. “The current version of Model Y has basically two big high-pressure diecast [HPDC] aluminum castings that are joined and there’s still a bunch of other bits that are attached. Later this year,” he said on the podcast, “we’ll transition to the rear underbody being a single-piece casting that also integrates the rear crash rails.

“It gets better,” he continued. “The current castings, because you’ve got to interface with so many different things, we have to CNC-machine the interfaces and there’s a bunch of things that have to be joined; they have datums on them and that kind of thing. The single-piece casting has no CNC machining – it doesn’t even have datums. It took us a lot of iterations, by the way, to get there.”

Sandy Munro, CEO at Munro & Associates, the benchmarking and competitive analysis firm renowned for its highly analytic “teardowns” of popular and innovative vehicles, recently completed a teardown of a Model Y. A series of internet videos covering Munro’s assessment garnered more than 36 million impressions in little more than a month. Munro was particularly impressed by the current two-piece aluminum underbody structure – and openly offered admiration in an interview with SAE’s *Automotive Engineering*.

He said the current Tesla Model Y has “two of the biggest castings we’ve ever seen in a car. We’ve never seen them used in an automobile before of that size. There’s lots [of innovative aluminum applications] at Cadillac, BMW, Audi – they’ve all used castings. But nothing quite the size of this thing.” Munro also participated in the podcast in which Musk spoke of the coming single-piece casting. Moving to the “megacasting,” as Munro dubbed it, “definitely wins the prize,” he asserted. “That’s going to be the biggest casting for quite a while. Nobody’s exploring that.”

The mammoth machine is being supplied by IDRA Group, an Italian leader in HPDC equipment founded in 1946. Tesla is the first customer for IDRA’s hulking OL6100 CS (with upgraded locking force to handle the special Tesla casting), destined for installation in the company’s Fremont, California and Shanghai, China, plants. IDRA’s “Giga Press” measures some 64 feet (19.5 m) long and 17 feet (5.3 m) tall. Along with the higher clamping force is a maximum aluminum-alloy “shot” weight of 104.6 kg (231 lb). The OL6100’s output may be lightweight castings, but the machine itself is anything but light, weighing in excess of 410 tons.

The single-piece casting for Model Y will replace around 70 stampings, extrusions and castings that currently make up the same fabricated assembly in the Model 3, on which much of the Model Y is based. Musk described the Model 3’s rear structure as “a patchwork quilt – it’s not great. The complexity in the body shop is insane,” he said.

Harbour agreed. With such a large and inclusive casting, “Even with a big cycle time, you eliminate all the labor to assemble pieces and subcomponents,” she observed. “You’re saving on automation cells, you’re saving on people. It would be tough to put dollars to it, but think of multiple suppliers doing stampings, you could save maybe 20% on labor cost. And reduction in footprint is major. My guess is that it’s a net-net efficiency gain.”

Musk claimed the new single-piece casting design, and the goliath machine that will produce it, will deliver a 30% reduction in the size of the body shop. He added that the process probably will transfer to Model 3 production as well. “That’s the thing we want to bring to bear on the Model 3 over time,” he said.

### **Potential caveats**

Munro said Tesla is pondering a similar strategy for the front of the Model Y. And a large casting probably makes changes to the affected structure a less-expensive proposition than “trying to change a bunch of stamping dies.” Alterations such as wheelbase changes also could easily be accommodated by such an architecture, he said. But it wouldn’t be the approach for low-volume production, Munro maintained. And “castings don’t repair very well,” he added. “If an impact was severe enough, the car’s a write-off,” he said. Of course, such is the case with many contemporary vehicle designs.

Munro said Tesla plans to assemble up to 1 million vehicles annually off the Model Y architecture, so the company’s Giga Press investment likely is a sound one. He and Harbour agree that the mega-casting approach is an example of Tesla being Tesla. “They do continuous improvement in design,” a practice most auto companies typically don’t embrace, Munro said.



IDRA Group's OL 5500 CS, part of the company's new Giga Press lineup designed to produce large aluminum die castings. (IDRA Group)



One side of the current Model Y's two-piece rear-underbody aluminum casting. (Tesla)



# FIM 01