

INCH-POUND

MIL-HDBK-5J
31 January 2003

SUPERSEDING
MIL-HDBK-5H
1 December 1998

**DEPARTMENT OF DEFENSE
HANDBOOK**

**METALLIC MATERIALS AND ELEMENTS FOR
AEROSPACE VEHICLE STRUCTURES**



This handbook is for guidance only.

Do not cite this document as a requirement.

AMSC N/A

FSC 1560

DISTRIBUTION STATEMENT A. Approved for public release; distribution is unlimited.

MIL-HDBK-5J
31 January 2003

FOREWORD

1. This handbook is approved for use by all Departments and Agencies of the Department of Defense and the Federal Aviation Administration. This is the last planned edition of MIL-HDBK-5. MIL-HDBK-5J is equivalent to MMPDS-01, the first edition of the Metallic Material Properties Development and Standardization Handbook, which is maintained by the Federal Aviation Administration. The FAA plans to publish annual updates and revisions to the MMPDS. As a result, MIL-HDBK-5J is scheduled to be reclassified as noncurrent in the Spring of 2004. It will be superseded at that time by the MMPDS Handbook.
2. This handbook is for guidance only. This handbook cannot be cited as a requirement. If it is, the contractor does not have to comply.
3. This document contains design information on the strength properties of metallic materials and elements for aerospace vehicle structures. All information and data contained in this handbook have been coordinated with the Air Force, Army, Navy, Federal Aviation Administration, and industry prior to publication, and are being maintained as a joint effort of the Federal Aviation Administration and the Department of Defense.
4. The electronic copy of the Handbook is technically consistent with the paper-copy Handbook; however, minor differences exist in format; e.g., table or figure position. Depending on monitor size and resolution setting, more data may be viewed without on-screen magnification. The figures were converted to electronic format using one of several methods. For example, digitization or recomputation methods were used on most of the engineering figures like typical stress-strain and effect of temperature, etc. Scanning was used to capture informational figures such as those found in Chapters 1 and 9. These electronic figures were also used to generate the paper-copy figures to maintain equivalency between the paper copy and electronic copy. In all cases, the electronic figures have been compared to the paper-copy figures to ensure the electronic figures are technically equivalent. Appendix E provides a detailed listing of all the figures in the Handbook, along with a description of each figure's format.
5. Beneficial comments (recommendations, additions, deletions) and any pertinent data which may be of use in improving this document should be addressed to: Chairman, MIL-HDBK-5 Coordination Activity (937-656-9133 voice, 937-255-4997 fax), AFRL/MLSC, 2179 Twelfth St., Room 122, Wright-Patterson AFB, OH 45433-7718, by using the Standardization Document Improvement Proposal (DD Form 1426) appearing at the end of this document or by letter. Alternatively, comments may be sent directly to: Chairman, MMPDS Coordination Activity (609-485-4784 voice, 609-485-4004 fax), AAR-431, Aging Aircraft Structural Integrity Research, FAA William J. Hughes Technical Center, Atlantic City International Airport, Atlantic City, NJ 08405.

EXPLANATION OF NUMERICAL CODE

For chapters containing materials properties, a deci-numeric system is used to identify sections of text, tables, and illustrations. This system is explained in the examples shown below. Variations of this deci-numerical system are also used in Chapters 1, 8, and 9.

Example A 2.4.2.1.1

General material category (in this case, steel)			
A logical breakdown of the base material by family characteristics (in this case, intermediate alloy steels); or for element properties			
Particular alloy to which all data are pertinent. If zero, section contains comments on the family characteristics			
If zero, section contains comments specific to the alloy; if it is an integer, the number identifies a specific temper or condition (heat treatment)			
Type of graphical data presented on a given figure (see following description)			

Example B 3.2.3.1.X

Aluminum			
2000 Series Wrought Alloy			
2024 Alloy			
T3, T351, T3510, T3511, T4, and T42 Tempers			
Specific Property as Follows			
Tensile properties (ultimate and yield strength)			1
Compressive yield and shear ultimate strengths			2
Bearing properties (ultimate and yield strength)			3
Modulus of elasticity, shear modulus			4
Elongation, total strain at failure, and reduction of area			5
Stress-strain curves, tangent-modulus curves			6
Creep			7
Fatigue			8
Fatigue-Crack Propagation			9
Fracture Toughness			10

THIS PAGE INTENTIONALLY BLANK

CONTENTS

<u>Section</u>	<u>Page</u>
Chapter 1	
1.0 General	1-1
1.1 Purpose and Use of Document	1-1
1.1.1 Introduction	1-1
1.1.2 Scope of Handbook	1-1
1.2 Nomenclature	1-3
1.2.1 Symbols and Definitions	1-3
1.2.2 International Systems of Units (SI)	1-3
1.3 Commonly Used Formulas	1-4
1.3.1 General	1-4
1.3.2 Simple Unit Stresses	1-4
1.3.3 Combined Stresses (see Section 1.5.3.5)	1-4
1.3.4 Deflections (Axial)	1-4
1.3.5 Deflections (Bending)	1-4
1.3.6 Deflections (Torsion)	1-5
1.3.7 Biaxial Elastic Deformation	1-5
1.3.8 Basic Column Formula	1-5
1.3.9 Inelastic Stress-Strain Response	1-6
1.4 Basic Principles	1-7
1.4.1 General	1-7
1.4.2 Stress	1-8
1.4.3 Strain	1-8
1.4.4 Tensile Properties	1-9
1.4.5 Compressive Properties	1-11
1.4.6 Shear Properties	1-11
1.4.7 Bearing Properties	1-12
1.4.8 Temperature Effects	1-13
1.4.9 Fatigue Properties	1-14
1.4.10 Metallurgical Instability	1-17
1.4.11 Biaxial Properties	1-17
1.4.12 Fracture Toughness	1-19
1.4.13 Fatigue-Crack-Propagation	1-24
1.5 Types of Failures	1-28
1.5.1 General	1-28
1.5.2 Material Failures	1-28
1.5.3 Instability Failures	1-29
1.6 Columns	1-30
1.6.1 General	1-30
1.6.2 Primary Instability Failures	1-30
1.6.3 Local Instability Failure	1-30
1.6.4 Correction of Column Test Results	1-31
1.7 Thin-Walled and Stiffened Thin-Walled Sections	1-40

NOTE: Information and data for alloys deleted from MIL-HDBK-5 may be obtained through the Chairman, MIL-HDBK-5 Coordination Activity.

CONTENTS (Continued)

<u>Section</u>	<u>Page</u>
References	1-41
Chapter 2	
2.0 Steel	2-1
2.1 General	2-1
2.1.1 Alloy Index	2-1
2.1.2 Material Properties	2-2
2.1.3 Environmental Considerations	2-5
2.2 Carbon Steels	2-6
2.2.0 Comments on Carbon Steels	2-6
2.2.1 AISI 1025	2-7
2.3 Low-Alloy Steels (AISI Grades and Proprietary Grades)	2-10
2.3.0 Comments on Low-Alloy Steels (AISI and Proprietary Grades)	2-10
2.3.1 Specific Alloys	2-15
2.4 Intermediate Alloy Steels	2-66
2.4.0 Comments on Intermediate Alloy Steels	2-66
2.4.1 5Cr-Mo-V	2-66
2.4.2 9Ni-4Co-0.20C	2-74
2.4.3 9Ni-4Co-0.30C	2-79
2.5 High-Alloy Steels	2-91
2.5.0 Comments on High-Alloy Steels	2-91
2.5.1 18 Ni Maraging Steels	2-93
2.5.2 AF1410	2-104
2.5.3 AerMet 100	2-107
2.6 Precipitation and Transformation-Hardening Steels (Stainless)	2-115
2.6.0 Comments on Precipitation and Transformation-Hardening Steels (Stainless)	2-115
2.6.1 AM-350	2-115
2.6.2 AM-355	2-122
2.6.3 Custom 450	2-128
2.6.4 Custom 455	2-140
2.6.5 Custom 465	2-151
2.6.6 PH13-8Mo	2-157
2.6.7 15-5PH	2-167
2.6.8 PH15-7Mo	2-183
2.6.9 17-4PH	2-195
2.6.10 17-7PH	2-213
2.7 Austenitic Stainless Steels	2-220
2.7.0 Comments on Austenitic Stainless Steel	2-220
2.7.1 AISI 301 and Related 300 Series Stainless Steels	2-222
2.8 Element Properties	2-237
2.8.1 Beams	2-237
2.8.2 Columns	2-237
2.8.3 Torsion	2-240
References	2-246

NOTE: Information and data for alloys deleted from MIL-HDBK-5 may be obtained through the Chairman, MIL-HDBK-5 Coordination Activity.

CONTENTS (Continued)

<u>Section</u>	<u>Page</u>
Chapter 3	
3.0 Aluminum	3-1
3.1 General	3-1
3.1.1 Aluminum Alloy Index	3-2
3.1.2 Material Properties	3-2
3.1.3 Manufacturing Considerations	3-18
3.2 2000 Series Wrought Alloys	3-26
3.2.1 2014 Alloy	3-26
3.2.2 2017 Alloy	3-65
3.2.3 2024 Alloy	3-68
3.2.4 2025 Alloy	3-150
3.2.5 2026 Alloy	3-152
3.2.6 2090 Alloy	3-154
3.2.7 2124 Alloy	3-157
3.2.8 2219 Alloy	3-166
3.2.9 2297 Alloy	3-195
3.2.10 2424 Alloy	3-199
3.2.11 2519 Alloy	3-202
3.2.12 2524 Alloy	3-205
3.2.13 2618 Alloy	3-209
3.3 3000 Series Wrought Alloys	3-218
3.4 4000 Series Wrought Alloys	3-218
3.5 5000 Series Wrought Alloys	3-218
3.5.1 5052 Alloy	3-218
3.5.2 5083 Alloy	3-231
3.5.3 5086 Alloy	3-237
3.5.4 5454 Alloy	3-247
3.5.5 5456 Alloy	3-252
3.6 6000 Series Wrought Alloys	3-258
3.6.1 6013 Alloy	3-258
3.6.2 6061 Alloy	3-262
3.6.3 6151 Alloy	3-290
3.7 7000 Series Wrought Alloys	3-293
3.7.1 7010 Alloy	3-293
3.7.2 7040 Alloy	3-302
3.7.3 7049/7149 Alloy	3-305
3.7.4 7050 Alloy	3-322
3.7.5 7055 Alloy	3-363
3.7.6 7075 Alloy	3-368
3.7.7 7150 Alloy	3-427
3.7.8 7175 Alloy	3-439
3.7.9 7249 Alloy	3-454
3.7.10 7475 Alloy	3-458
3.8 200.0 Series Cast Alloys	3-486
3.8.1 A201.0 Alloy	3-486

NOTE: Information and data for alloys deleted from MIL-HDBK-5 may be obtained through the Chairman, MIL-HDBK-5 Coordination Activity.

CONTENTS (Continued)

<u>Section</u>	<u>Page</u>
3.9 300.0 Series Cast Alloys	3-496
3.9.1 354.0 Alloy	3-496
3.9.2 355.0 Alloy	3-498
3.9.3 C355.0 Alloy	3-501
3.9.4 356.0 Alloy	3-503
3.9.5 A356.0 Alloy	3-506
3.9.6 A357.0 Alloy	3-510
3.9.7 D357.0 Alloy	3-513
3.9.8 359.0 Alloy	3-516
3.10 Element Properties	3-518
3.10.1 Beams	3-518
3.10.2 Columns	3-519
3.10.3 Torsion	3-521
References	3-525
 Chapter 4	
4.0 Magnesium Alloys	4-1
4.1 General	4-1
4.1.1 Alloy Index	4-1
4.1.2 Material Properties	4-1
4.1.3 Physical Properties	4-2
4.1.4 Environmental Considerations	4-2
4.1.5 Alloy and Temper Designations	4-3
4.1.6 Joining Methods	4-5
4.2 Magnesium-Wrought Alloys	4-6
4.2.1 AZ31B	4-6
4.2.2 AZ61A	4-17
4.2.3 ZK60A	4-19
4.3 Magnesium Cast Alloys	4-27
4.3.1 AM100A	4-27
4.3.2 AZ91C/AZ91E	4-29
4.3.3 AZ92A	4-33
4.3.4 EZ33A	4-39
4.3.5 QE22A	4-44
4.3.6 ZE41A	4-48
4.4 Element Properties	4-53
4.4.1 Beams	4-53
4.4.2 Columns	4-53
4.4.3 Torsion	4-56
References	4-57
 Chapter 5	
5.0 Titanium	5-1
5.1 General	5-1
5.1.1 Titanium Index	5-1

NOTE: Information and data for alloys deleted from MIL-HDBK-5 may be obtained through the Chairman, MIL-HDBK-5 Coordination Activity.

CONTENTS (Continued)

<u>Section</u>	<u>Page</u>
5.1.2 Material Properties	5-1
5.1.3 Manufacturing Considerations	5-2
5.1.4 Environmental Considerations	5-2
5.2 Unalloyed Titanium	5-5
5.2.1 Commercially Pure Titanium	5-5
5.3 Alpha and Near-Alpha Titanium Alloys	5-15
5.3.1 Ti-5Al-2.5Sn	5-15
5.3.2 Ti-8Al-1Mo-1V	5-27
5.3.3 Ti-6Al-2Sn-4Zr-2Mo	5-43
5.4 Alpha-Beta Titanium Alloys	5-51
5.4.1 Ti-6Al-4V	5-51
5.4.2 Ti-6Al-6V-2Sn	5-92
5.4.3 Ti-4.5Al-3V-2Fe-2Mo	5-110
5.5 Beta, Near-Beta, and Metastable-Beta Titanium Alloys	5-118
5.5.1 Ti-13V-11Cr-3Al	5-118
5.5.2 Ti-15V-3Cr-3Sn-3Al (Ti-15-3)	5-135
5.5.3 Ti-10V-2Fe-3Al (Ti-10-2-3)	5-139
5.6 Element Properties	5-144
5.6.1 Beams	5-144
References	5-145
 Chapter 6	
6.0 Heat-Resistant Alloys	6-1
6.1 General	6-1
6.1.1 Material Properties	6-3
6.2 Iron-Chromium-Nickel-Base Alloys	6-4
6.2.0 General Comments	6-4
6.2.1 A-286	6-4
6.2.2 N-155	6-15
6.3 Nickel-Base Alloys	6-19
6.3.0 General Comments	6-19
6.3.1 Hastelloy X	6-21
6.3.2 Inconel 600	6-27
6.3.3 Inconel 625	6-34
6.3.4 Inconel 706	6-45
6.3.5 Inconel 718	6-51
6.3.6 Inconel X-750	6-77
6.3.7 Rene 41	6-83
6.3.8 Waspaloy	6-90
6.3.9 HAYNES® 230®	6-96
6.4 Cobalt-Base Alloys	6-116
6.4.0 General Comments	6-116
6.4.1 L-605	6-117
6.4.2 HS 188	6-124
References	6-140

NOTE: Information and data for alloys deleted from MIL-HDBK-5 may be obtained through the Chairman, MIL-HDBK-5 Coordination Activity.

CONTENTS (Continued)

<u>Section</u>	<u>Page</u>
Chapter 7	
7.0 Miscellaneous Alloys and Hybrid Materials	7-1
7.1 General	7-1
7.2 Beryllium	7-1
7.2.1 Standard Grade Beryllium	7-1
7.3 Copper and Copper Alloys	7-8
7.3.0 General	7-8
7.3.1 Maganese Bronzes	7-9
7.3.2 Copper Beryllium	7-12
7.4 Multiphase Alloys	7-21
7.4.0 General	7-21
7.4.1 MP35N Alloy	7-21
7.4.2 MP159 Alloy	7-27
7.5 Aluminum Alloy Sheet Laminates	7-32
7.5.0 General	7-32
7.5.1 2024-T3 Aramid Fiber Reinforced Sheet Laminate	7-32
References	7-50
Chapter 8	
8.0 Structural Joints	8-1
8.1 Mechanically Fastened Joints	8-2
8.1.1 Introduction and Fastener Indexes	8-2
8.1.2 Solid Rivets	8-11
8.1.3 Blind Fasteners	8-37
8.1.4 Swaged Collar/Upset-Pin Fasteners	8-110
8.1.5 Threaded Fasteners	8-125
8.1.6 Special Fasteners	8-147
8.2 Metallurgical Joints	8-150
8.2.1 Introduction and Definitions	8-150
8.2.2 Welded Joints	8-150
8.2.3 Brazing	8-172
8.3 Bearings, Pulleys, and Wire Rope	8-172
References	8-173
Chapter 9	
9.0 Index	9-1
9.1 General	9-5
9.1.1 Introduction	9-5
9.1.2 Applicability	9-5
9.1.3 Approval Procedures	9-5
9.1.4 Documentation Requirements	9-5
9.1.5 Summary	9-6
9.1.6 Data Basis	9-8
9.1.7 Rounding Procedures	9-10
9.2 Material, Specification, Testing, and Data Requirements	9-11

NOTE: Information and data for alloys deleted from MIL-HDBK-5 may be obtained through the Chairman, MIL-HDBK-5 Coordination Activity.

CONTENTS (Continued)

<u>Section</u>	<u>Page</u>
9.2.1	Material Requirements 9-11
9.2.2	Specification Requirements 9-11
9.2.3	Required Test Methods/Procedures 9-11
9.2.4	Data Requirements 9-24
9.2.5	Experimental Design 9-40
9.3	Submission of Data 9-50
9.3.1	Recommended Procedures 9-50
9.3.2	Computer Software 9-50
9.3.3	General Data Formats 9-50
9.4	Substantiation of S-Basis Minimum Properties 9-59
9.5	Analysis Procedures for Statistically Computed Minimum Static Properties 9-60
9.5.1	Specifying the Population 9-60
9.5.2	Regression Analysis 9-64
9.5.3	Combinability of Data 9-77
9.5.4	Determining the Form of Distribution 9-82
9.5.5	Direct Computation Without Regression 9-94
9.5.6	Direct Computation by Regression Analysis 9-104
9.5.7	Indirect Computation without Regression (Reduced Ratios/Derived Properties) 9-106
9.5.8	Indirect Computation using Regression 9-109
9.6	Analysis Procedures for Dynamic and Time Dependent Properties 9-110
9.6.1	Load and Strain Control Fatigue Data 9-110
9.6.2	Fatigue Crack Growth Data 9-130
9.6.3	Fracture Toughness Data 9-133
9.6.4	Creep and Creep-Rupture Data 9-135
9.7	Analysis Procedures for Structural Joint Properties 9-142
9.7.1	Mechanically Fastened Joints 9-142
9.7.2	Fusion-Welded Joint Data 9-158
9.8	Examples of Data Analysis and Data Presentation for Static Properties 9-162
9.8.1	Direct Analyses of Mechanical Properties 9-162
9.8.2	Indirect Analyses of Mechanical Properties 9-175
9.8.3	Tabular Data Presentation 9-179
9.8.4	Room Temperature Graphical Mechanical Properties 9-184
9.8.5	Elevated Temperature Graphical Mechanical Properties 9-202
9.9	Examples of Data for Dynamic and Time Dependent Properties 9-212
9.9.1	Fatigue 9-212
9.9.2	Fatigue Crack Growth 9-228
9.9.3	Fracture Toughness 9-230
9.9.4	Creep and Creep Rupture 9-234
9.9.5	Mechanically Fastened Joints 9-240
9.9.6	Fusion-Welded Joints 9-244
9.10	Statistical Tables 9-247
9.10.1	One-Sided Tolerance Limit Factors, K, for the Normal Distribution, 0.95 Confidence, and n-1 Degrees of Freedom 9-248
9.10.2	0.950 Fractiles of the F Distribution Associated with n ₁ and n ₂ Degrees of Freedom 9-250

NOTE: Information and data for alloys deleted from MIL-HDBK-5 may be obtained through the Chairman, MIL-HDBK-5 Coordination Activity.

CONTENTS (Continued)

<u>Section</u>		<u>Page</u>
9.10.3	0.950 Fractiles of the F Distribution Associated with n_1 and n_2 Degrees of Freedom	9-251
9.10.4	0.95 and 0.975 Fractiles of the t Distribution Associated with df Degrees of Freedom	9-252
9.10.5	Area Under the Normal Curve from $-\infty$ to the Mean $+Z_p$ Standard Deviations.....	9-253
9.10.6	One-Sided Tolerance-Limit Factors for the Three-Parameter Weibull Acceptability Test with 95 Percent Confidence	9-254
9.10.7	One-Sided Tolerance Factors for the Three-Parameter Weibull Distribution with 95 Percent Confidence	9-255
9.10.8	γ -values for Computing Threshold of Three-Parameter Weibull Distribution.....	9-261
9.10.9	Ranks, r , of Observations, n , for an Unknown Distribution Having the Probability and Confidence of T99 and T90 Values	9-264
Standards and References.....		9-266
Chapter 10		
10.1	Intended Use.....	10-1
10.2	Subject Term (Key Word) Listing.....	10-1
10.3	Changes from Previous Issue	10-1
Appendices		
A.0	Glossary.....	A-1
A.1	Abbreviations.....	A-1
A.2	Symbols	A-5
A.3	Definitions	A-6
A.4	Conversion of U.S. Units of Measure Used in MIL-HDBK-5 to SI Units...	A-17
B.0	Alloy Index.....	B-1
C.0	Specification Index.....	C-1
D.0	Subject Index	D-1
E.0	Figure Index	E-1

NOTE: Information and data for alloys deleted from MIL-HDBK-5 may be obtained through the Chairman, MIL-HDBK-5 Coordination Activity.

CHAPTER 1

GENERAL

1.1 PURPOSE AND USE OF DOCUMENT

1.1.1 INTRODUCTION — Since many aerospace companies manufacture both commercial and military products, the standardization of metallic materials design data, which are acceptable to Government procuring or certification agencies is very beneficial to those manufacturers as well as governmental agencies. Although the design requirements for military and commercial products may differ greatly, the required design values for the strength of materials and elements and other needed material characteristics are often identical. Therefore, this publication provides standardized design values and related design information for metallic materials and structural elements used in aerospace structures. The data contained herein, or from approved items in the minutes of MIL-HDBK-5 coordination meetings, are acceptable to the Air Force, the Navy, the Army, and the Federal Aviation Administration. Approval by the procuring or certifying agency must be obtained for the use of design values for products not contained herein.

This printed document is distributed by the Document Automation and Production Service (DAPS). It is the only official form of MIL-HDBK-5. If computerized third-party MIL-HDBK-5 databases are used, caution should be exercised to ensure that the information in these databases is identical to that contained in this Handbook.

U.S. Government personnel may obtain free copies of the current version of the printed document from the Document Automation and Production Service (DAPS). Assistance with orders may be obtained by calling (215) 697-2179. The FAX number is (215) 697-1462.

U.S. Government personnel may also obtain a free electronic copy of the current document from DAPS through the ASSIST website at <http://assist.daps.mil>.

1.1.2 SCOPE OF HANDBOOK — This Handbook is primarily intended to provide a source of design mechanical and physical properties, and joint allowables. Material property and joint data obtained from tests by material and fastener producers, government agencies, and members of the airframe industry are submitted to MIL-HDBK-5 for review and analysis. Results of these analyses are submitted to the membership during semi-annual coordination meetings for approval and, when approved, published in this Handbook.

This Handbook also contains some useful basic formulas for structural element analysis. However, structural design and analysis are beyond the scope of this Handbook.

References for data and various test methods are listed at the end of each chapter. The reference number corresponds to the applicable paragraph of the chapter cited. Such references are intended to provide sources of additional information, but should not necessarily be considered as containing data suitable for design purposes.

MIL-HDBK-5J
31 January 2003

The content of this Handbook is arranged as follows:

Chapter(s)	Subjects
1	Nomenclature, Systems of Units, Formulas, Material Property Definitions, Failure Analysis, Column Analysis, Thin-Walled Sections
2-7	Material Properties
8	Joint Allowables
9	Data Requirements, Statistical Analysis Procedures

1.2 NOMENCLATURE

1.2.1 SYMBOLS AND DEFINITIONS — The various symbols used throughout the Handbook to describe properties of materials, grain directions, test conditions, dimensions, and statistical analysis terminology are included in Appendix A.

1.2.2 INTERNATIONAL SYSTEM OF UNITS (SI) — Design properties and joint allowables contained in this Handbook are given in customary units of U.S. measure to ensure compatibility with government and industry material specifications and current aerospace design practice. Appendix A.4 may be used to assist in the conversion of these units to Standard International (SI) units when desired.

1.3 COMMONLY USED FORMULAS

1.3.1 GENERAL — Formulas provided in the following sections are listed for reference purposes. Sign conventions generally accepted in their use are that quantities associated with tension action (loads, stresses, strains, etc.), are usually considered as positive and quantities associated with compressive action are considered as negative. When compressive action is of primary interest, it is sometimes convenient to identify associated properties with a positive sign. Formulas for all statistical computations relating to allowables development are presented in Chapter 9.

1.3.2 SIMPLE UNIT STRESSES —

$$\begin{aligned}
 f_t &= P / A \text{ (tension)} && [1.3.2(a)] \\
 f_c &= P / A \text{ (compression)} && [1.3.2(b)] \\
 f_b &= My / I = M / Z \text{ (bending)} && [1.3.2(c)] \\
 f_s &= S / A \text{ (average direct shear stress)} && [1.3.2(d)] \\
 f_x &= SQ / Ib \text{ (longitudinal or transverse shear stress)} && [1.3.2(e)] \\
 f_x &= Ty / I_p \text{ (shear stress in round tubes due to torsion)} && [1.3.2(f)] \\
 f_s &= (T/2At) \text{ (shear stress due to torsion in thin-walled structures of closed} && [1.3.2(g)] \\
 &\quad \text{section. Note that A is the area enclosed by the median line of the section.)} \\
 f_A &= Bf_H ; f_T = Bf_L \text{ (axial and tangential stresses, where B = biaxial ratio)} && [1.3.2(h)]
 \end{aligned}$$

1.3.3 COMBINED STRESSES (SEE SECTION 1.5.3.4) —

$$\begin{aligned}
 f_A &= f_c + f_b \text{ (compression and bending)} && [1.3.3(a)] \\
 f_{s\max} &= \left[f_s^2 + (f_n/2)^2 \right]^{1/2} \text{ (compression, bending, and torsion)} && [1.3.3(b)] \\
 f_{n\max} &= f_n/2 + f_{s\max} && [1.3.3(c)]
 \end{aligned}$$

1.3.4 DEFLECTIONS (AXIAL) —

$$\begin{aligned}
 e &= \delta / L \text{ (unit deformation or strain)} && [1.3.4(a)] \\
 E &= f/e \text{ (This equation applied when E is obtained from the same tests in which} && [1.3.4(b)] \\
 &\quad \text{f and e are measured.)} \\
 \delta &= eL = (f / E)L && [1.3.4(c)] \\
 &= PL / (AE) \text{ (This equation applies when the deflection is to be} && [1.3.4(d)] \\
 &\quad \text{calculated using a known value of E.)}
 \end{aligned}$$

1.3.5 DEFLECTIONS (BENDING) —

$$di/dx = M / (EI) \text{ (Change of slope per unit length of a beam; radians per unit length)} \quad [1.3.5(a)]$$

$$i_2 = i_1 + \int_{x_1}^{x_2} [M/(EI)] dx \quad \text{— Slope at Point 2. (This integral denotes the area under the curve of } M/EI \text{ plotted against } x, \text{ between the limits of } x_1 \text{ and } x_2.) \quad [1.3.5(b)]$$

$$y_2 = y_1 + i(x_2 - x_1) + \int_{x_1}^{x_2} (M/EI)(x_2 - x) dx \quad \text{— Deflection at Point 2.} \quad [1.3.5(c)]$$

(This integral denotes the area under the curve having an ordinate equal to M/EI multiplied by the corresponding distances to Point 2, plotted against x , between the limits of x_1 and x_2 .)

$$y_2 = y_1 + \int_{x_1}^{x_2} i dx \quad \text{— Deflection at Point 2. (This integral denotes the area under the curve of } x_1(i) \text{ plotted against } x, \text{ between the limits of } x_1 \text{ and } x_2.) \quad [1.3.5(d)]$$

1.3.6 DEFLECTIONS (TORSION) —

$$d\phi / dx = T / (GJ) \quad \text{(Change of angular deflection or twist per unit length of a member, radians per unit length.)} \quad [1.3.6(a)]$$

$$\Phi = \int_{x_1}^{x_2} [T / (GJ)] dx \quad \text{— Total twist over a length from } x_1 \text{ to } x_2. \text{ (This integral denotes the area under the curve of } T/GJ \text{ plotted against } x, \text{ between the limits of } x_1 \text{ and } x_2.) \quad [1.3.6(b)]$$

$$\Phi = TL/(GJ) \quad \text{(Used when torque } T/GJ \text{ is constant over length } L.) \quad [1.3.6(c)]$$

1.3.7 BIAXIAL ELASTIC DEFORMATION —

$$\mu = e_T/e_L \quad \text{(Unit lateral deformation/unit axial deformation.) This identifies Poisson's ratio in uniaxial loading.} \quad [1.3.7(a)]$$

$$Ee_x = f_x - \mu f_y \quad [1.3.7(b)]$$

$$Ee_y = f_y - \mu f_x \quad [1.3.7(c)]$$

$$E_{\text{biaxial}} = E(1 - \mu B) \quad \text{— } B = \text{biaxial elastic modulus.} \quad [1.3.7(d)]$$

1.3.8 BASIC COLUMN FORMULAS —

$$F_c = \pi^2 E_t (L' / \rho)^2 \quad \text{where } L' = L / \sqrt{c} \quad \text{— conservative using tangent modulus} \quad [1.3.8(a)]$$

$$F_c = \pi^2 E (L' / \rho)^2 \quad \text{— standard Euler formula} \quad [1.3.8(b)]$$

1.3.9 INELASTIC STRESS-STRAIN RESPONSE —

$$e_{\text{total}} = f / E + e_p \text{ (elastic strain response plus inelastic or plastic strain response)} \quad [1.3.9(a)]$$

where

$$e_p = 0.002 * (f/f_{0.2ys})^n, \quad [1.3.9(b)]$$

$f_{0.2ys}$ = the 0.2 percent yield stress and

n = Ramberg-Osgood parameter

Equation [1.3.9(b)] implies a log-linear relationship between inelastic strain and stress, which is observed with many metallic materials, at least for inelastic strains ranging from the material's proportional limit to its yield stress.

1.4 BASIC PRINCIPLES

1.4.1 GENERAL — It is assumed that users of this Handbook are familiar with the principles of strength of materials. A brief summary of that subject is presented in the following paragraphs to emphasize principles of importance regarding the use of allowables for various metallic materials.

Requirements for adequate test data have been established to ensure a high degree of reliability for allowables published in this Handbook. Statistical analysis methods, provided in Chapter 9, are standardized and approved by all government regulatory agencies as well as MIL-HDBK-5 members from industry.

1.4.1.1 Basis — Primary static design properties are provided for the following conditions:

Tension	F_{tu} and F_{ty}
Compression	F_{cy}
Shear	F_{su}
Bearing	F_{bru} and F_{bry}

These design properties are presented as A- and B- or S-basis room temperature values for each alloy. Design properties for other temperatures, when determined in accordance with Section 1.4.1.3, are regarded as having the same basis as the corresponding room temperature values.

Elongation and reduction of area design properties listed in room temperature property tables represent procurement specification minimum requirements, and are designated as S-values. Elongation and reduction of area at other temperatures, as well as moduli, physical properties, creep properties, fatigue properties and fracture toughness properties are all typical values unless another basis is specifically indicated.

Use of B-Values — The use of B-basis design properties is permitted in design by the Air Force, the Army, the Navy, and the Federal Aviation Administration, subject to certain limitations specified by each agency. Reference should be made to specific requirements of the applicable agency before using B-values in design.

1.4.1.2 Statistically Calculated Values — Statistically calculated values are S (since 1975), T_{99} and T_{90} . S, the minimum properties guaranteed in the material specification, are calculated using the same requirements and procedure as AMS and is explained in Chapter 9. T_{99} and T_{90} are the local tolerance bounds, and are defined and may be computed using the data requirements and statistical procedures explained in Chapter 9.

1.4.1.3 Ratioed Values — A ratioed design property is one that is determined through its relationship with an established design value. This may be a tensile stress in a different grain direction from the established design property grain direction, or it may be another stress property, e.g., compression, shear or bearing. It may also be the same stress property at a different temperature. Refer to Chapter 9 for specific data requirements and data analysis procedures.

Derived properties are presented in two manners. Room temperature derived properties are presented in tabular form with their baseline design properties. Other than room temperature derived properties are presented in graphical form as percentages of the room temperature value. Percentage

values apply to all forms and thicknesses shown in the room temperature design property table for the heat treatment condition indicated therein unless restrictions are otherwise indicated. Percentage curves usually represent short time exposures to temperature (thirty minutes) followed by testing at the same strain rate as used for the room temperature tests. When data are adequate, percentage curves are shown for other exposure times and are appropriately labeled.

1.4.2 STRESS — The term “stress” as used in this Handbook implies a force per unit area and is a measure of the intensity of the force acting on a definite plane passing through a given point (see Equations 1.3.2(a) and 1.3.2(b)). The stress distribution may or may not be uniform, depending on the nature of the loading condition. For example, tensile stresses identified by Equation 1.3.2(a) are considered to be uniform. The bending stress determined from Equation 1.3.2(c) refers to the stress at a specified distance perpendicular to the normal axis. The shear stress acting over the cross section of a member subjected to bending is not uniform. (Equation 1.3.2(d) gives the average shear stress.)

1.4.3 STRAIN — Strain is the change in length per unit length in a member or portion of a member. As in the case of stress, the strain distribution may or may not be uniform in a complex structural element, depending on the nature of the loading condition. Strains usually are present also in directions other than the directions of applied loads.

1.4.3.1 Poisson’s Ratio Effect — A normal strain is that which is associated with a normal stress; a normal strain occurs in the direction in which its associated normal stress acts. Normal strains that result from an increase in length are designated as positive (+) and those that result in a decrease in length are designated as negative (-).

Under the condition of uniaxial loading, strain varies directly with stress. The ratio of stress to strain has a constant value (E) within the elastic range of the material, but decreases when the proportional limit is exceeded (plastic range). Axial strain is always accompanied by lateral strains of opposite sign in the two directions mutually perpendicular to the axial strain. Under these conditions, the absolute value of a ratio of lateral strain to axial strain is defined as Poisson’s ratio. For stresses within the elastic range, this ratio is approximately constant. For stresses exceeding the proportional limit, this ratio is a function of the axial strain and is then referred to as the lateral contraction ratio. Information on the variation of Poisson’s ratio with strain and with testing direction is available in Reference 1.4.3.1.

Under multiaxial loading conditions, strains resulting from the application of each directional load are additive. Strains must be calculated for each of the principal directions taking into account each of the principal stresses and Poisson’s ratio (see Equation 1.3.7 for biaxial loading).

1.4.3.2 Shear Strain — When an element of uniform thickness is subjected to pure shear, each side of the element will be displaced in opposite directions. Shear strain is computed by dividing this total displacement by the right angle distance separating the two sides.

1.4.3.3 Strain Rate — Strain rate is a function of loading rate. Test results are dependent upon strain rate, and the ASTM testing procedures specify appropriate strain rates. Design properties in this Handbook were developed from test data obtained from coupons tested at the stated strain rate or up to a value of 0.01 in./in./min, the standard maximum static rate for tensile testing materials per specification ASTM E 8.

1.4.3.4 Elongation and Reduction of Area — Elongation and reduction of area are measured in accordance with specification ASTM E 8.

1.4.4 TENSILE PROPERTIES — When a metallic specimen is tested in tension using standard procedures of ASTM E 8, it is customary to plot results as a “stress-strain diagram.” Typical tensile stress-strain diagrams are characterized in Figure 1.4.4. Such diagrams, drawn to scale, are provided in appropriate chapters of this Handbook. The general format of such diagrams is to provide a strain scale nondimensionally (in./in.) and a stress scale in 1000 lb/in. (ksi). Properties required for design and structural analysis are discussed in Sections 1.4.4.1 to 1.4.4.6.

1.4.4.1 Modulus of Elasticity (E) — Referring to Figure 1.4.4, it is noted that the initial part of stress-strain curves are straight lines. This indicates a constant ratio between stress and strain. Numerical values of such ratios are defined as the modulus of elasticity, and denoted by the letter E . This value applies up to the proportional limit stress at which point the initial slope of the stress-strain curve then decreases. Modulus of elasticity has the same units as stress. See Equation 1.3.4 (b).

Other moduli of design importance are tangent modulus, E_t , and secant modulus, E_s . Both of these moduli are functions of strain. Tangent modulus is the instantaneous slope of the stress-strain curve at any selected value of strain. Secant modulus is defined as the ratio of total stress to total strain at any selected value of strain. Both of these moduli are used in structural element designs. Except for materials such as those described with discontinuous behaviors, such as the upper stress-strain curve in Figure 1.4.4, tangent modulus is the lowest value of modulus at any state of strain beyond the proportional limit. Similarly, secant modulus is the highest value of modulus beyond the proportional limit.

Clad aluminum alloys may have two separate modulus of elasticity values, as indicated in the typical stress-strain curve shown in Figure 1.4.4. The initial slope, or primary modulus, denotes a response of both the low-strength cladding and higher-strength core elastic behaviors. This value applies only up to the proportional limit of the cladding. For example, the primary modulus of 2024-T3 clad sheet applies only up to about 6 ksi. Similarly, the primary modulus of 7075-T6 clad sheet applies only up to approximately 12 ksi. A typical use of primary moduli is for low amplitude, high frequency fatigue. Primary moduli are not applicable at higher stress levels. Above the proportional limits of cladding materials, a short transition range occurs while the cladding is developing plastic behavior. The material then exhibits a secondary elastic modulus up to the proportional limit of the core material. This secondary modulus is the slope of the second straight line portion of the stress-strain curve. In some cases, the cladding is so little different from the core material that a single elastic modulus value is used.

1.4.4.2 Tensile Proportional Limit Stress (F_{p}) — The tensile proportional limit is the maximum stress for which strain remains proportional to stress. Since it is practically impossible to determine precisely this point on a stress-strain curve, it is customary to assign a small value of plastic strain to identify the corresponding stress as the proportional limit. In this Handbook, the tension and compression proportional limit stress corresponds to a plastic strain of 0.0001 in./in.

1.4.4.3 Tensile Yield Stress (TYS or F_{y}) — Stress-strain diagrams for some ferrous alloys exhibit a sharp break at a stress below the tensile ultimate strength. At this critical stress, the material elongates considerably with no apparent change in stress. See the upper stress-strain curve in Figure 1.4.4. The stress at which this occurs is referred to as the yield point. Most nonferrous metallic alloys and most high strength steels do not exhibit this sharp break, but yield in a monotonic manner. This condition is also illustrated in Figure 1.4.4. Permanent deformation may be detrimental, and the industry adopted 0.002 in./in. plastic strain as an arbitrary limit that is considered acceptable by all regulatory agencies. For tension and compression, the corresponding stress at this offset strain is defined as the yield stress (see Figure 1.4.4). This value of plastic axial strain is 0.002 in./in. and the corresponding stress is defined as the yield stress. For practical purposes, yield stress can be determined from a stress-strain diagram by extending a line parallel to the elastic modulus line and offset from the origin by an amount of 0.002 in./in.

strain. The yield stress is determined as the intersection of the offset line with the stress-strain curve.

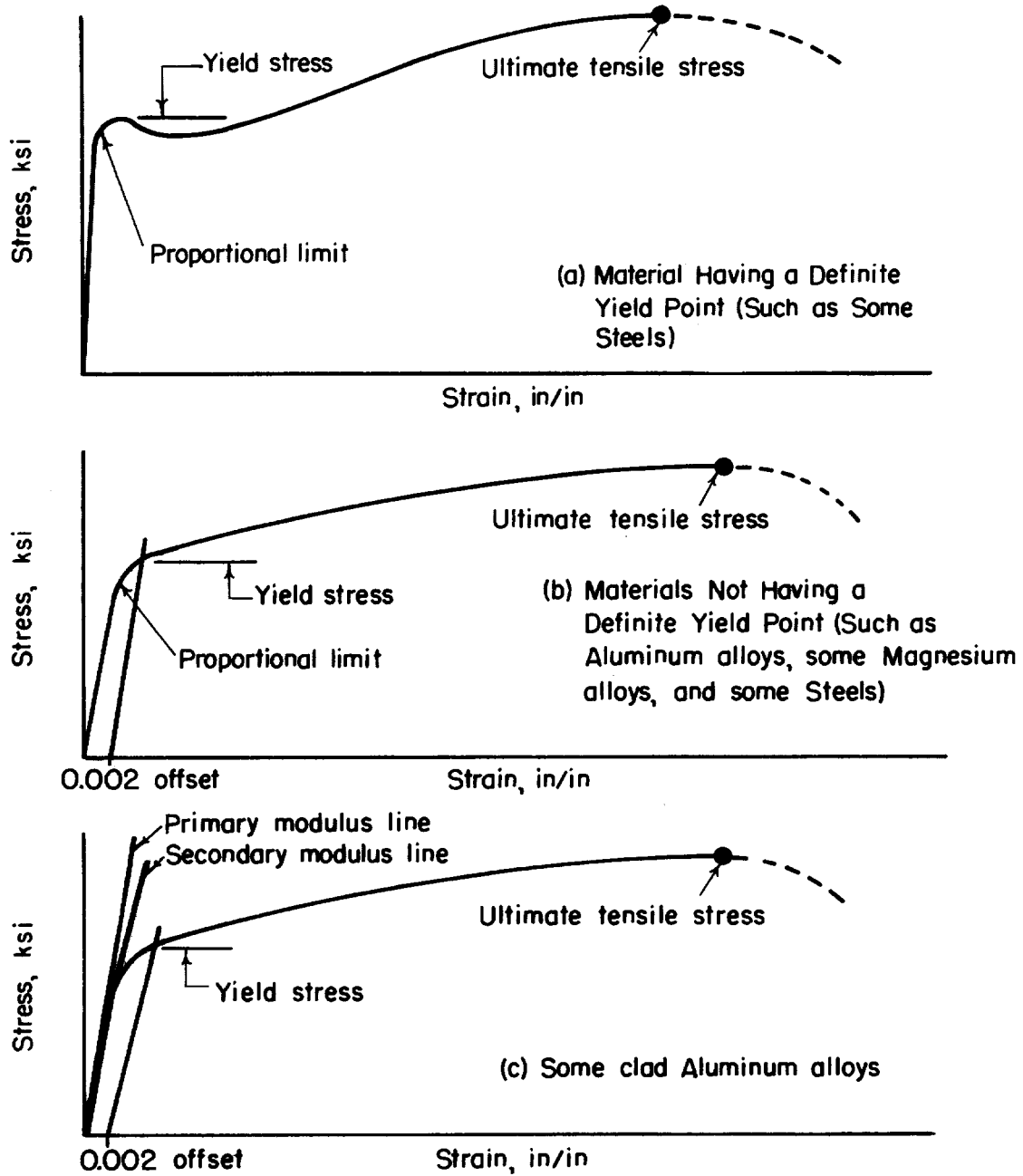

Figure 1.4.4. Typical tensile stress-strain diagrams.

1.4.4.4 Tensile Ultimate Stress (TUS or F_{ty}) — Figure 1.4.4 shows how the tensile ultimate stress is determined from a stress-strain diagram. It is simply the maximum stress attained. It should be noted that all stresses are based on the original cross-sectional dimensions of a test specimen, without regard to the lateral contraction due to Poisson's ratio effects. That is, all strains used herein are termed engineering strains as opposed to true strains which take into account actual cross sectional dimensions. Ultimate tensile stress is commonly used as a criterion of the strength of the material for structural design, but it should be recognized that other strength properties may often be more important.

1.4.4.5 Elongation (e) — An additional property that is determined from tensile tests is elongation. This is a measure of ductility. Elongation, also stated as total elongation, is defined as the permanent increase in gage length, measured after fracture of a tensile specimen. It is commonly expressed as a percentage of the original gage length. Elongation is usually measured over a gage length of 2 inches for rectangular tensile test specimens and in 4D (inches) for round test specimens. Welded test specimens are exceptions. Refer to the applicable material specification for applicable specified gage lengths. Although elongation is widely used as an indicator of ductility, this property can be significantly affected by testing variables, such as thickness, strain rate, and gage length of test specimens. See Section 1.4.1.1 for data basis.

1.4.4.6 Reduction of Area (RA) — Another property determined from tensile tests is reduction of area, which is also a measure of ductility. Reduction of area is the difference, expressed as a percentage of the original cross sectional area, between the original cross section and the minimum cross sectional area adjacent to the fracture zone of a tested specimen. This property is less affected by testing variables than elongation, but is more difficult to compute on thin section test specimens. See Section 1.4.1.1 for data basis.

1.4.5 COMPRESSIVE PROPERTIES — Results of compression tests completed in accordance with ASTM E 9 are plotted as stress-strain curves similar to those shown for tension in Figure 1.4.4. Preceding remarks concerning tensile properties of materials, except for ultimate stress and elongation, also apply to compressive properties. Moduli are slightly greater in compression for most of the commonly used structural metallic alloys. Special considerations concerning the ultimate compressive stress are described in the following section. An evaluation of techniques for obtaining compressive strength properties of thin sheet materials is outlined in Reference 1.4.5.

1.4.5.1 Compressive Ultimate Stress (F_{cu}) — Since the actual failure mode for the highest tension and compression stress is shear, the maximum compression stress is limited to F_{tu} . The driver for all the analysis of all structure loaded in compression is the slope of the compression stress strain curve, the tangent modulus.

1.4.5.2 Compressive Yield Stress (CYS or F_{cy}) — Compressive yield stress is measured in a manner identical to that done for tensile yield strength. It is defined as the stress corresponding to 0.002 in./in. plastic strain.

1.4.6 SHEAR PROPERTIES — Results of torsion tests on round tubes or round solid sections are plotted as torsion stress-strain diagrams. The shear modulus of elasticity is considered a basic shear property. Other properties, such as the proportional limit stress and shear ultimate stress, cannot be treated as basic shear properties because of "form factor" effects. The theoretical ratio between shear and tensile stress for homogeneous, isotropic materials is 0.577. Reference 1.4.6 contains additional information on this subject.

1.4.6.1 Modulus of Rigidity (G)— This property is the initial slope of the shear stress-strain curve. It is also referred to as the modulus of elasticity in shear. The relation between this property and the modulus of elasticity in tension is expressed for homogeneous isotropic materials by the following equation:

$$G = \frac{E}{2(1 + \mu)} \quad [1.4.6.1]$$

1.4.6.2 Proportional Limit Stress in Shear (F_{sp})— This property is of particular interest in connection with formulas which are based on considerations of linear elasticity, as it represents the limiting value of shear stress for which such formulas are applicable. This property cannot be determined directly from torsion tests.

1.4.6.3 Yield and Ultimate Stresses in Shear (F_{sy} or F_{su}) and (F_{sy} or F_{su})— These properties, as usually obtained from ASTM test procedures tests, are not strictly basic properties, as they will depend on the shape of the test specimen. In such cases, they should be treated as moduli and should not be combined with the same properties obtained from other specimen configuration tests.

Design values reported for shear ultimate stress (F_{su}) in room temperature property tables for aluminum and magnesium thin sheet alloys are based on “punch” shear type tests except when noted. Heavy section test data are based on “pin” tests. Thin aluminum products may be tested to ASTM B 831, which is a slotted shear test. Thicker aluminums use ASTM B 769, otherwise known as the Amsler shear test. These two tests only provide ultimate strength. Shear data for other alloys are obtained from pin tests, except where product thicknesses are insufficient. These tests are used for other alloys; however, the standards don’t specifically cover materials other than aluminum

1.4.7 BEARING PROPERTIES— Bearing stress limits are of value in the design of mechanically fastened joints and lugs. Only yield and ultimate stresses are obtained from bearing tests. Bearing stress is computed from test data by dividing the load applied to the pin, which bears against the edge of the hole, by the bearing area. Bearing area is the product of the pin diameter and the sheet or plate thickness.

A bearing test requires the use of special cleaning procedures as specified in ASTM E 238. Results are identified as “dry-pin” values. The same tests performed without application of ASTM E 238 cleaning procedures are referred to as “wet pin” tests. Results from such tests can show bearing stresses at least 10 percent lower than those obtained from “dry pin” tests. See Reference 1.4.7 for additional information. Additionally, ASTM E 238 requires the use of hardened pins that have diameters within 0.001 of the hole diameter. As the clearance increases to 0.001 and greater, the bearing yield and failure stress tends to decrease.

In the definition of bearing values, t is sheet or plate thickness, D is the pin diameter, and e is the edge distance measured from the center of the hole to the adjacent edge of the material being tested in the direction of applied load.

1.4.7.1 Bearing Yield and Ultimate Stresses (F_{bry} or F_{brv}) and (F_{brv} or F_{brv})— F_{brv} is the maximum stress withstood by a bearing specimen. F_{bry} is computed from a bearing stress-deformation curve by drawing a line parallel to the initial slope at an offset of 0.02 times the pin diameter.

Tabulated design properties for bearing yield stress (F_{bry}) and bearing ultimate stress (F_{brv}) are provided throughout the Handbook for edge margins of $e/D = 1.5$ and 2.0 . Bearing values for e/D of 1.5 are not intended for designs of $e/D < 1.5$. Bearing values for $e/D < 1.5$ must be substantiated by adequate

tests, subject to the approval of the procuring or certificating regulatory agency. For edge margins between 1.5 and 2.0, linear interpolation of properties may be used.

Bearing design properties are applicable to t/D ratios from 0.25 to 0.50. Bearing design values for conditions of $t/D < 0.25$ or $t/D > 0.50$ must be substantiated by tests. The percentage curves showing temperature effects on bearing stress may be used with both e/D properties of 1.5 and 2.0.

Due to differences in results obtained between dry-pin and wet-pin tests, designers are encouraged to consider the use of a reduction factor with published bearing stresses for use in design.

1.4.8 TEMPERATURE EFFECTS — Temperature effects require additional considerations for static, fatigue and fracture toughness properties. In addition, this subject introduces concerns for time-dependent creep properties.

1.4.8.1 Low Temperature — Temperatures below room temperature generally cause an increase in strength properties of metallic alloys. Ductility, fracture toughness, and elongation usually decrease. For specific information, see the applicable chapter and references noted therein.

1.4.8.2 Elevated Temperature — Temperatures above room temperature usually cause a decrease in the strength properties of metallic alloys. This decrease is dependent on many factors, such as temperature and the time of exposure which may degrade the heat treatment condition, or cause a metallurgical change. Ductility may increase or decrease with increasing temperature depending on the same variables. Because of this dependence of strength and ductility at elevated temperatures on many variables, it is emphasized that the elevated temperature properties obtained from this Handbook be applied for only those conditions of exposure stated herein.

The effect of temperature on static mechanical properties is shown by a series of graphs of property (as percentages of the room temperature allowable property) versus temperature. Data used to construct these graphs were obtained from tests conducted over a limited range of strain rates. Caution should be exercised in using these static property curves at very high temperatures, particularly if the strain rate intended in design is much less than that stated with the graphs. The reason for this concern is that at very low strain rates or under sustained loads, plastic deformation or creep deformation may occur to the detriment of the intended structural use.

1.4.8.2.1 Creep and Stress-Rupture Properties — Creep is defined as a time-dependent deformation of a material while under an applied load. It is usually regarded as an elevated temperature phenomenon, although some materials creep at room temperature. If permitted to continue indefinitely, creep terminates in rupture. Since creep in service is usually typified by complex conditions of loading and temperature, the number of possible stress-temperature-time profiles is infinite. For economic reasons, creep data for general design use are usually obtained under conditions of constant uniaxial loading and constant temperature in accordance with Reference 1.4.8.2.1(a). Creep data are sometimes obtained under conditions of cyclic uniaxial loading and constant temperature, or constant uniaxial loading and variable temperatures. Section 9.3.6 provides a limited amount of creep data analysis procedures. It is recognized that, when significant creep appears likely to occur, it may be necessary to test under simulated service conditions because of difficulties posed in attempting to extrapolate from simple to complex stress-temperature-time conditions.

Creep damage is cumulative similar to plastic strain resulting from multiple static loadings. This damage may involve significant effects on the temper of heat treated materials, including annealing, and

the initiation and growth of cracks or subsurface voids within a material. Such effects are often recognized as reductions in short time strength properties or ductility, or both.

1.4.8.2.2 Creep-Rupture Curve — Results of tests conducted under constant loading and constant temperature are usually plotted as strain versus time up to rupture. A typical plot of this nature is shown in Figure 1.4.8.2.2. Strain includes both the instantaneous deformation due to load application and the plastic strain due to creep. Other definitions and terminology are provided in Section 9.3.6.2.

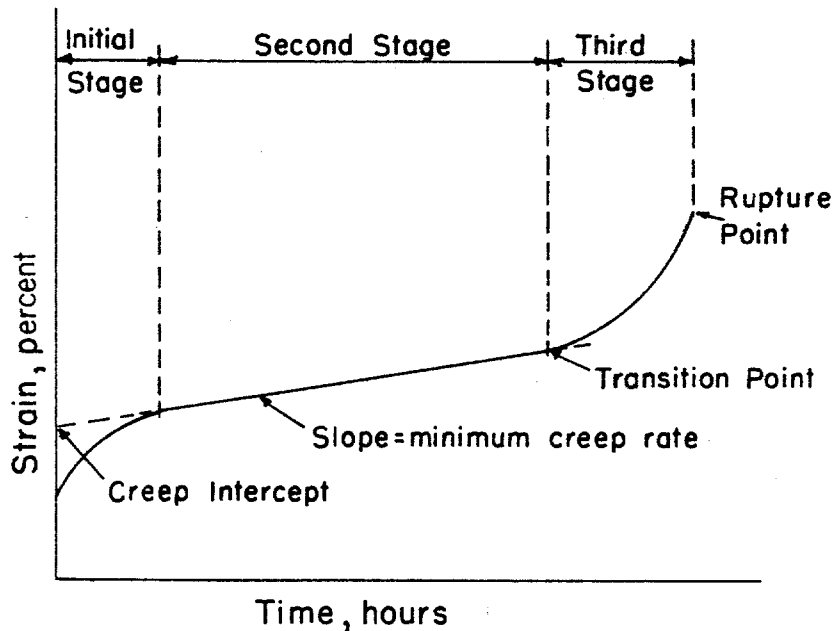

Figure 1.4.8.2.2. Typical creep-rupture curve.

1.4.8.2.3 Creep or Stress-Rupture Presentations — Results of creep or stress-rupture tests conducted over a range of stresses and temperatures are presented as curves of stress versus the logarithm of time to rupture. Each curve represents an average, best-fit description of measured behavior. Modification of such curves into design use are the responsibility of the design community since material applications and regulatory requirements may differ. Refer to Section 9.3.6 for data reduction and presentation methods and References 1.4.8.2.1(b) and (c).

1.4.9 FATIGUE PROPERTIES — Repeated loads are one of the major considerations for design of both commercial and military aircraft structures. Static loading, preceded by cyclic loads of lesser magnitudes, may result in mechanical behaviors (F_{tu} , F_{ty} , etc.) lower than those published in room temperature allowables tables. Such reductions are functions of the material and cyclic loading conditions. A fatigue allowables development philosophy is not presented in this Handbook. However, basic laboratory test data are useful for materials selection. Such data are therefore provided in the appropriate materials sections.

In the past, common methods of obtaining and reporting fatigue data included results obtained from axial loading tests, plate bending tests, rotating bending tests, and torsion tests. Rotating bending tests apply completely reversed (tension-compression) stresses to round cross section specimens. Tests of this type are now seldom conducted for aerospace use and have therefore been dropped from importance in this Handbook. For similar reasons, flexural fatigue data also have been dropped. No

significant amount of torsional fatigue data have ever been made available. Axial loading tests, the only type retained in this Handbook, consist of completely reversed loading conditions (mean stress equals zero) and those in which the mean stress was varied to create different stress (or strain) ratios ($R =$ minimum stress or strain divided by maximum stress or strain). Refer to Reference 1.4.9(a) for load control fatigue testing guidelines and Reference 1.4.9(b) for strain control fatigue testing guidelines.

1.4.9.1 Terminology— A number of symbols and definitions are commonly used to describe fatigue test conditions, test results and data analysis techniques. The most important of these are described in Section 9.3.4.2.

1.4.9.2 Graphical Display of Fatigue Data— Results of axial fatigue tests are reported on S-N and $\epsilon - N$ diagrams. Figure 1.4.9.2(a) shows a family of axial load S-N curves. Data for each curve represents a separate R-value.

S-N and $\epsilon - N$ diagrams are shown in this Handbook with the raw test data plotted for each stress or strain ratio or, in some cases, for a single value of mean stress. A best-fit curve is drawn through the data at each condition. Rationale used to develop best-fit curves and the characterization of all such curves in a single diagram is explained in Section 9.3.4. For load control test data, individual curves are usually based on an equivalent stress that consolidates data for all stress ratios into a single curve. Refer to Figure 1.4.9.2(b). For strain control test data, an equivalent strain consolidation method is used.

Elevated temperature fatigue test data are treated in the same manner as room temperature data, as long as creep is not a significant factor and room temperature analysis methods can be applied. In the limited number of cases where creep strain data have been recorded as a part of an elevated temperature fatigue test series, S-N (or $\epsilon - N$) plots are constructed for specific creep strain levels. This is provided in addition to the customary plot of maximum stress (or strain) versus cycles to failure.

The above information may not apply directly to the design of structures for several reasons. First, Handbook information may not take into account specific stress concentrations unique to any given structural design. Design considerations usually include stress concentrations caused by re-entrant corners, notches, holes, joints, rough surfaces, structural damage, and other conditions. Localized high stresses induced during the fabrication of some parts have a much greater influence on fatigue properties than on static properties. These factors significantly reduce fatigue life below that which is predictable by estimating smooth specimen fatigue performance with estimated stresses due to fabrication. Fabricated parts have been found to fail at less than 50,000 cycles of loading when the nominal stress was far below that which could be repeated many millions of times using a smooth-machined test specimen.

Notched fatigue specimen test data are shown in various Handbook figures to provide an understanding of deleterious effects relative to results for smooth specimens. All of the mean fatigue curves published in this Handbook, including both the notched fatigue and smooth specimen fatigue curves, require modification into allowables for design use. Such factors may impose a penalty on cyclic life or upon stress. This is a responsibility for the design community. Specific reductions vary between users of such information, and depending on the criticality of application, sources of uncertainty in the analysis, and requirements of the certifying activity. References 1.4.9.2(a) and (b) contain more specific information on fatigue testing procedures, organization of test results, influences of various factors, and design considerations.

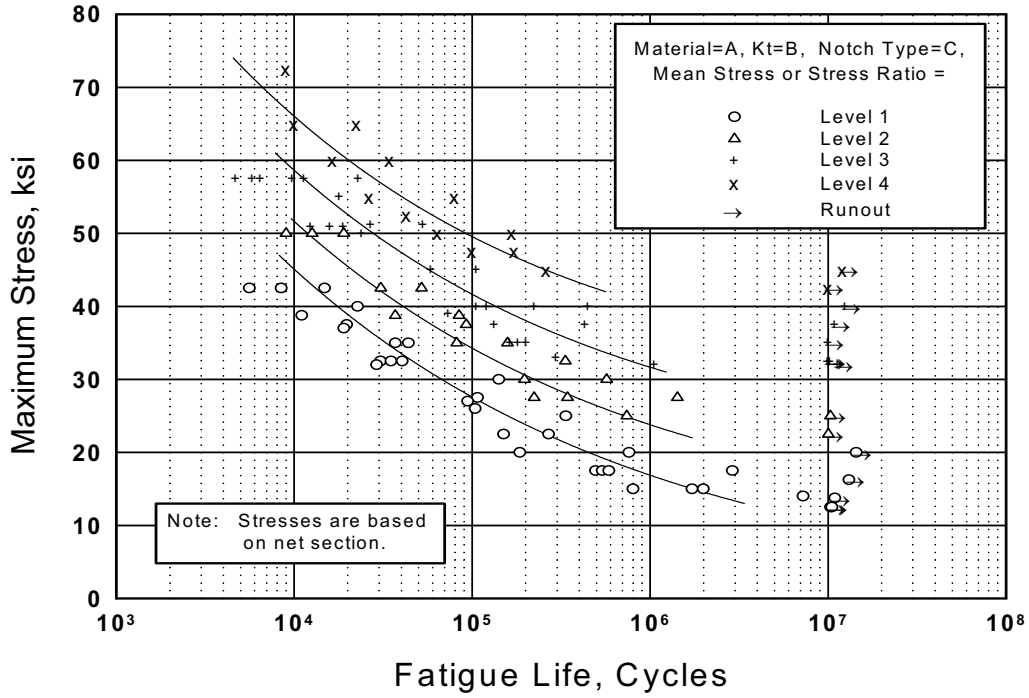

Figure 1.4.9.2(a). Best fit S/N curve diagram for a material at various stress ratios.

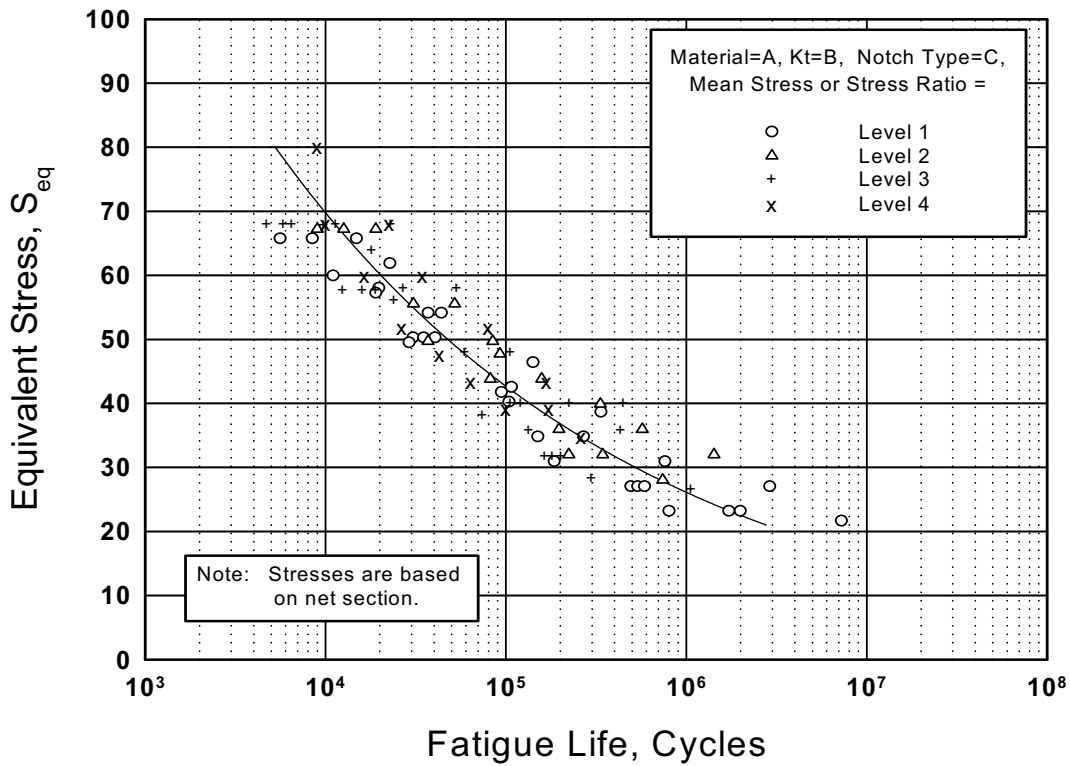

Figure 1.4.9.2(b). Consolidated fatigue data for a material using the equivalent stress parameter.

1.4.10 METALLURGICAL INSTABILITY — In addition to the retention of strength and ductility, a structural material must also retain surface and internal stability. Surface stability refers to the resistance of the material to oxidizing or corrosive environments. Lack of internal stability is generally manifested (in some ferrous and several other alloys) by carbide precipitation, spheroidization, sigma-phase formation, temper embrittlement, and internal or structural transformation, depending upon the specific conditions of exposure.

Environmental conditions, that influence metallurgical stability include heat, level of stress, oxidizing or corrosive media, and nuclear radiation. The effect of environment on the material can be observed as either improvement or deterioration of properties, depending upon the specific imposed conditions. For example, prolonged heating may progressively raise the strength of a metallic alloy as measured on smooth tensile or fatigue specimens. However, at the same time, ductility may be reduced to such an extent that notched tensile or fatigue behavior becomes erratic or unpredictable. The metallurgy of each alloy should be considered in making material selections.

Under normal temperatures, i.e., between -65°F and 160°F , the stability of most structural metallic alloys is relatively independent of exposure time. However, as temperature is increased, the metallurgical instability becomes increasingly time dependent. The factor of exposure time should be considered in design when applicable.

1.4.11 BIAXIAL PROPERTIES — Discussions up to this point pertained to uniaxial conditions of static, fatigue, and creep loading. Many structural applications involve both biaxial and triaxial loadings. Because of the difficulties of testing under triaxial loading conditions, few data exist. However, considerable biaxial testing has been conducted and the following paragraphs describe how these results are presented in this Handbook. This does not conflict with data analysis methods presented in Chapter 9. Therein, statistical analysis methodology is presented solely for use in analyzing test data to establish allowables.

If stress axes are defined as being mutually perpendicular along x-, y-, and z-directions in a rectangular coordinate system, a biaxial stress is then defined as a condition in which loads are applied in both the x- and y-directions. In some special cases, loading may be applied in the z-direction instead of the y-direction. Most of the following discussion will be limited to tensile loadings in the x- and y-directions. Stresses and strains in these directions are referred to as principal stresses and principal strains. See Reference 1.4.11.

When a specimen is tested under biaxial loading conditions, it is customary to plot the results as a biaxial stress-strain diagram. These diagrams are similar to uniaxial stress-strain diagrams shown in Figure 1.4.4. Usually, only the maximum (algebraically larger) principal stress and strain are shown for each test result. When tests of the same material are conducted at different biaxial stress ratios, the resulting curves may be plotted simultaneously, producing a family of biaxial stress-strain curves as shown in Figure 1.4.11 for an isotropic material. For anisotropic materials, biaxial stress-strain curves also require distinction by grain direction.

The reference direction for a biaxial stress ratio, i.e., the direction corresponding to $B=0$, should be clearly indicated with each result. The reference direction is always considered as the longitudinal (rolling) direction for flat products and the hoop (circumferential) direction for shells of revolution, e.g., tubes, cones, etc. The letter B denotes the ratio of applied stresses in the two loading directions. For example, biaxiality ratios of 2 and 0.5 shown in Figure 1.4.11 indicate results representing both biaxial stress ratios of 2 or 0.5, since this is a hypothetical example for an isotropic material, e.g., cross-rolled sheet. In a similar manner, the curve labeled $B=1$ indicates a biaxial stress-strain result for equally applied

stresses in both directions. The curve labeled $B = \infty, 0$ indicates the biaxial stress-strain behavior when loading is applied in only one direction, e.g., uniaxial behavior. Biaxial property data presented in the Handbook are to be considered as basic material properties obtained from carefully prepared specimens.

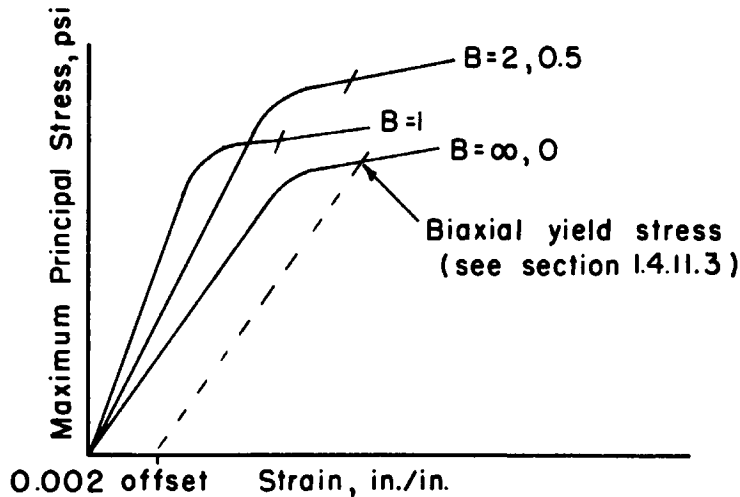

Figure 1.4.11. Typical biaxial stress-strain diagrams for isotropic materials.

1.4.11.1 Biaxial Modulus of Elasticity — Referring to Figure 1.4.11, it is noted that the original portion of each stress-strain curve is essentially a straight line. In uniaxial tension or compression, the slope of this line is defined as the modulus of elasticity. Under biaxial loading conditions, the initial slope of such curves is defined as the biaxial modulus. It is a function of biaxial stress ratio and Poisson's ratio. See Equation 1.3.7.4.

1.4.11.2 Biaxial Yield Stress — Biaxial yield stress is defined as the maximum principal stress corresponding to 0.002 in./in. plastic strain in the same direction, as determined from a test curve.

In the design of aerospace structures, biaxial stress ratios other than those normally used in biaxial testing are frequently encountered. Information can be combined into a single diagram to enable interpolations at intermediate biaxial stress ratios, as shown in Figure 1.4.11.2. An envelope is constructed through test results for each tested condition of biaxial stress ratios. In this case, a typical biaxial yield stress envelope is identified. In the preparation of such envelopes, data are first reduced to nondimensional form (percent of uniaxial tensile yield stress in the specified reference direction), then a best-fit curve is fitted through the nondimensionalized data. Biaxial yield strength allowables are then obtained by multiplying the uniaxial F_{ty} (or F_{cy}) allowable by the applicable coordinate of the biaxial stress ratio curve. To avoid possible confusion, the reference direction used for the uniaxial yield strength is indicated on each figure.

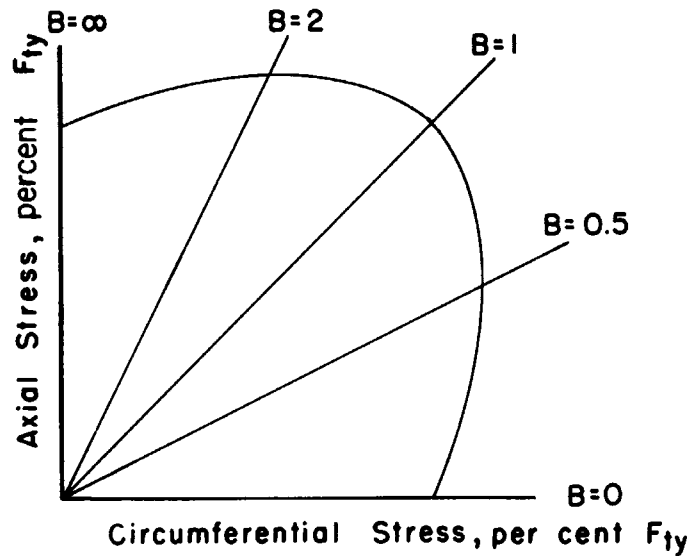

Figure 1.4.11.2. Typical biaxial yield stress envelope.

1.4.11.3 Biaxial Ultimate Stress — Biaxial ultimate stress is defined as the highest nominal principal stress attained in specimens of a given configuration, tested at a given biaxial stress ratio. This property is highly dependent upon geometric configuration of the test parts. Therefore, such data should be limited in use to the same design configurations.

The method of presenting biaxial ultimate strength data is similar to that described in the preceding section for biaxial yield strength. Both biaxial ultimate strength and corresponding uniform elongation data are reported, when available, as a function of biaxial stress ratio test conditions.

1.4.12 FRACTURE TOUGHNESS — The occurrence of flaws in a structural component is an unavoidable circumstance of material processing, fabrication, or service. Flaws may appear as cracks, voids, metallurgical inclusions, weld defects, design discontinuities, or some combination thereof. The fracture toughness of a part containing a flaw is dependent upon flaw size, component geometry, and a material property defined as fracture toughness. The fracture toughness of a material is literally a measure of its resistance to fracture. As with other mechanical properties, fracture toughness is dependent upon alloy type, processing variables, product form, geometry, temperature, loading rate, and other environmental factors.

This discussion is limited to brittle fracture, which is characteristic of high strength materials under conditions of loading resulting in plane-strain through the cross section. Very thin materials are described as being under the condition of plane-stress. The following descriptions of fracture toughness properties applies to the currently recognized practice of testing specimens under slowly increasing loads. Attendant and interacting conditions of cyclic loading, prolonged static loadings, environmental influences other than temperature, and high strain rate loading are not considered.

1.4.12.1 Brittle Fracture — For materials that have little capacity for plastic flow, or for flaw and structural configurations, which induce triaxial tension stress states adjacent to the flaw, component behavior is essentially elastic until the fracture stress is reached. Then, a crack propagates from the flaw suddenly and completely through the component. A convenient illustration of brittle fracture is a typical load-compliance record of a brittle structural component containing a flaw, as illustrated in Figure 1.4.12.1. Since little or no plastic effects are noted, this mode is termed brittle fracture.

This mode of fracture is characteristic of the very high-strength metallic materials under plane-strain conditions.

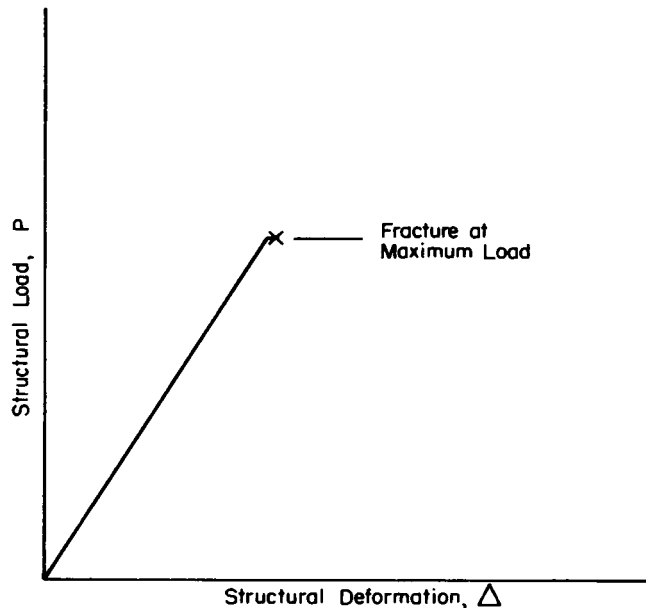

Figure 1.4.12.1. Typical load-deformation record of a structural component containing a flaw subject to brittle fracture.

1.4.12.2 Brittle Fracture Analysis — The application of linear elastic fracture mechanics has led to the stress intensity concept to relate flaw size, component geometry, and fracture toughness. In its very general form, the stress intensity factor, K , can be expressed as

$$K = f\sqrt{a}Y, \text{ ksi} \cdot \text{in.}^{1/2} \quad [1.4.12.2]$$

where

- f = stress applied to the gross section, ksi
- a = measure of flaw size, inches
- Y = factor relating component geometry and flaw size, nondimensional. See Reference 1.4.12.2(a) for values.

For every structural material, which exhibits brittle fracture (by nature of low ductility or plane-strain stress conditions), there is a lower limiting value of K termed the plane-strain fracture toughness, K_{Ic} .

The specific application of this relationship is dependent on flaw type, structural configuration and type of loading, and a variety of these parameters can interact in a real structure. Flaws may occur through the thickness, may be imbedded as voids or metallurgical inclusions, or may be partial-through (surface) cracks. Loadings of concern may be tension and/or flexure. Structural components may vary in section size and may be reinforced in some manner. The ASTM Committee E 8 on Fatigue and Fracture has developed testing and analytical techniques for many practical situations of flaw occurrence subject to brittle fracture. They are summarized in Reference 1.4.12.2(a).

1.4.12.3 Critical Plane-Strain Fracture Toughness — A tabulation of fracture toughness data is printed in the general discussion prefacing most alloy chapters in this Handbook. These critical plane-strain fracture toughness values have been determined in accordance with recommended ASTM testing practices. This information is provided for information purposes only due to limitations in available data quantities and product form coverages. The statistical reliability of these properties is not known. Listed properties generally represent the average value of a series of test results.

Fracture toughness of a material commonly varies with grain direction. When identifying either test results or a general critical plane strain fracture toughness average value, it is customary to specify specimen and crack orientations by an ordered pair of grain direction symbols per ASTM E399. [Reference 1.4.12.2(a).] The first digit denotes the grain direction normal to the crack plane. The second digit denotes the grain direction parallel to the fracture plane. For flat sections of various products, e.g., plate, extrusions, forgings, etc., in which the three grain directions are designated (L) longitudinal, (T) transverse, and (S) short transverse, the six principal fracture path directions are: L-T, L-S, T-L, T-S, S-L and S-T. Figure 1.4.12.3(a) identifies these orientations. For cylindrical sections where the direction of principle deformation is parallel to the longitudinal axis of the cylinder, the reference directions are identified as in Figure 1.4.12.3(b), which gives examples for a drawn bar. The same system would be useful for extrusions or forged parts having circular cross section.

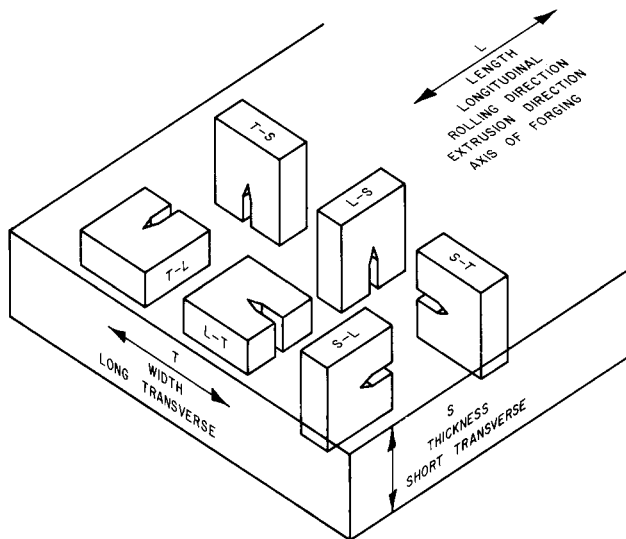

Figure 1.4.12.3(a). Typical principal fracture path directions.

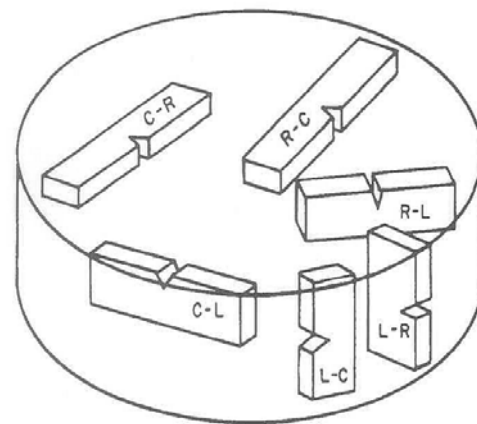

Figure 1.4.12.3(b). Typical principal fracture path directions for cylindrical shapes.

1.4.12.3.1 Environmental Effects — Cyclic loading, even well below the fracture threshold stress, may result in the propagation of flaws, leading to fracture. Strain rates in excess of standard static rates may cause variations in fracture toughness properties. There are significant influences of temperature

on fracture toughness properties. Temperature effects data are limited. These information are included in each alloy section, when available.

Under the condition of sustained loading, it has been observed that certain materials exhibit increased flaw propagation tendencies when situated in either aqueous or corrosive environments. When such is known to be the case, appropriate precautionary notes have been included with the standard fracture toughness information.

1.4.12.4 Fracture in Plane-Stress and Transitional-Stress States — Plane-strain conditions do not describe the condition of certain structural configurations which are either relatively thin or exhibit appreciable ductility. In these cases, the actual stress state may approach the opposite extreme, plane-stress, or, more generally, some intermediate- or transitional-stress state. The behavior of flaws and cracks under these conditions is different from those of plane-strain. Specifically, under these conditions, significant plastic zones can develop ahead of the crack or flaw tip, and stable extension of the discontinuity occurs as a slow tearing process. This behavior is illustrated in a compliance record by a significant nonlinearity prior to fracture as shown in Figure 1.4.12.4. This nonlinearity results from the alleviation of stress at the crack tip by causing plastic deformation.

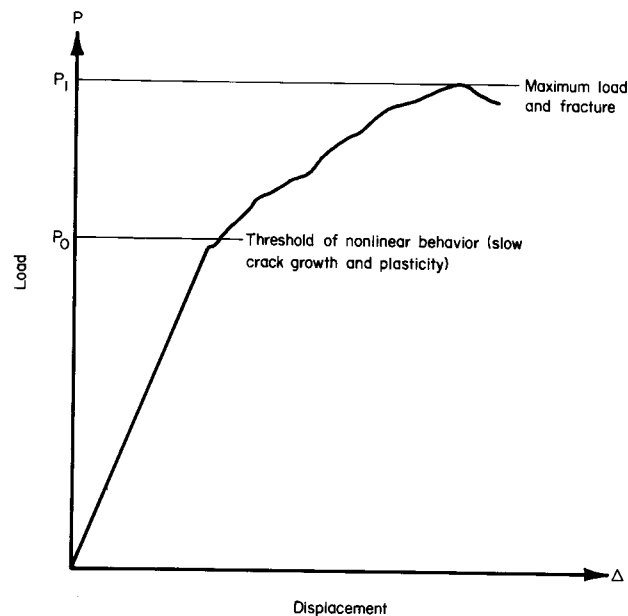

Figure 1.4.12.4. Typical load-deformation record for non-plane strain fracture.

1.4.12.4.1 Analysis of Plane-Stress and Transitional-Stress State Fracture — The basic concepts of linear elastic fracture mechanics as used in plane-strain fracture analysis also applies to these conditions. The stress intensity factor concept, as expressed in general form by Equation 1.4.12.2, is used to relate load or stress, flaw size, component geometry, and fracture toughness.

However, interpretation of the critical flaw dimension and corresponding stress has two possibilities. This is illustrated in Figure 1.4.12.4.1. One possibility is the onset of nonlinear displacement with increasing load. The other possibility identifies the fracture condition, usually very close to the

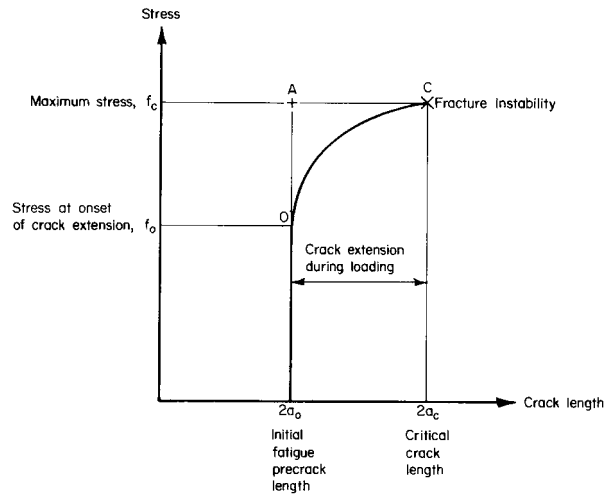

Figure 1.4.12.4.1. Crack growth curve.

maximum load. Generally, these two conditions are separated in applied stress and exhibit large differences in flaw dimensions due to stable tearing.

When a compliance record is transformed into a crack growth curve, the difference between the two possible K-factor designations becomes more apparent. In most practical cases, the definition of nonlinear crack length with increasing load is difficult to assess. As a result, an alternate characterization of this behavior is provided by defining an artificial or “apparent” stress intensity factor.

$$K_{app} = f \sqrt{a_o} Y \quad [1.4.12.4.1]$$

The apparent fracture toughness is computed as a function of the maximum stress and initial flaw size. This datum coordinate corresponds to point A in Figure 1.4.12.4.1. This conservative stress intensity factor is a first approximation to the actual property associated with the point of fracture.

1.4.12.5 Apparent Fracture Toughness Values for Plane-Stress and Transitional-Stress States — When available, each alloy chapter contains graphical formats of stress versus flaw size. This is provided for each temper, product form, grain direction, thickness, and specimen configuration. Data points shown in these graphs represent the initial flaw size and maximum stress achieved. These data have been screened to assure that an elastic instability existed at fracture, consistent with specimen type. The average K_{app} curve, as defined in the following subsections, is shown for each set of data.

1.4.12.5.1 Middle-Tension Panels — The calculation of apparent fracture toughness for middle-tension panels is given by the following equation.

$$K_{app} = f_c \left(\pi a_o \cdot \sec \pi a_o / W \right)^{1/2} \quad [1.4.12.5.1(a)]$$

Data used to compute K_{app} values have been screened to ensure that the net section stress at failure did not exceed 80 percent of the tensile yield strength; that is, they satisfied the criterion:

$$f_c \leq 0.8(TYS) / (1 - 2a / W) \quad [1.4.12.5.1(b)]$$

This criterion assures that the fracture was an elastic instability and that plastic effects are negligible.

The average K_{app} parametric curve is presented on each figure as a solid line with multiple extensions where width effects are displayed in the data. As added information, where data are available, the propensity for slow stable tearing prior to fracture is indicated by a crack extension ratio, $\Delta 2a/2a_0$. The coefficient (2) indicates the total crack length; the half-crack length is designated by the letter "a." In some cases, where data exist covering a wide range of thicknesses, graphs of K_{app} versus thickness are presented.

1.4.13 FATIGUE CRACK GROWTH — Crack growth deals with material behavior between crack initiation and crack instability. In small size specimens, crack initiation and specimen failure may be nearly synonymous. However, in larger structural components, the existence of a crack does not necessarily imply imminent failure. Significant structural life exists during cyclic loading and crack growth.

1.4.13.1 Fatigue Crack Growth — Fatigue crack growth is manifested as the growth or extension of a crack under cyclic loading. This process is primarily controlled by the maximum load or stress ratio. Additional factors include environment, loading frequency, temperature, and grain direction. Certain factors, such as environment and loading frequency, have interactive effects. Environment is important from a potential corrosion viewpoint. Time at stress is another important factor. Standard testing procedures are documented in Reference 1.4.13.1.

Fatigue crack growth data presented herein are based on constant amplitude tests. Crack growth behaviors based on spectrum loading cycles are beyond the scope of this Handbook. Constant amplitude data consist of crack length measurements at corresponding loading cycles. Such data are presented as crack growth curves as shown in Figure 1.4.13.1(a).

Since the crack growth curve is dependent on initial crack length and the loading conditions, the above format is not the most efficient form to present information. The instantaneous slope, $\Delta a/\Delta N$, corresponding to a prescribed number of loading cycles, provides a more fundamental characterization of this behavior. In general, fatigue crack growth rate behavior is evaluated as a function of the applied stress intensity factor range, ΔK , as shown in Figure 1.4.13.1(b).

1.4.13.2 Fatigue Crack Growth Analysis — It is known that fatigue-crack-growth behavior under constant-amplitude cyclic conditions is influenced by maximum cyclic stress, S_{max} , and some measure of cyclic stress range, ΔS (such as stress ratio, R , or minimum cyclic stress, S_{min}), the instantaneous crack size, a , and other factors such as environment, frequency, and temperature. Thus, fatigue-crack-growth rate behavior can be characterized, in general form, by the relation

$$da/dN \approx \Delta a/\Delta N = g(S_{max}, \Delta S \text{ or } R \text{ or } S_{min}, a, \dots). \quad [1.4.13.3(a)]$$

By applying concepts of linear elastic fracture mechanics, the stress and crack size parameters can be combined into the stress-intensity factor parameter, K , such that Equation 1.4.13.3(a) may be simplified to

$$da/dN \approx \Delta a/\Delta N = g(K_{max}, \Delta K, \dots) \quad [1.4.13.3(b)]$$

where

$$\begin{aligned} K_{max} &= \text{the maximum cyclic stress-intensity factor} \\ \Delta K &= (1-R)K_{max}, \text{ the range of the cyclic stress-intensity factor, for } R \geq 0 \\ \Delta K &= K_{max}, \text{ for } R \leq 0. \end{aligned}$$

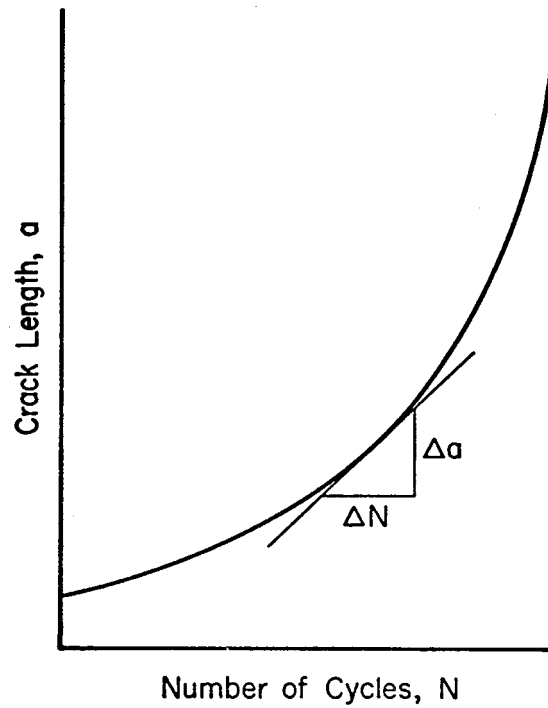

Figure 1.4.13.1(a). Fatigue crack-growth curve.

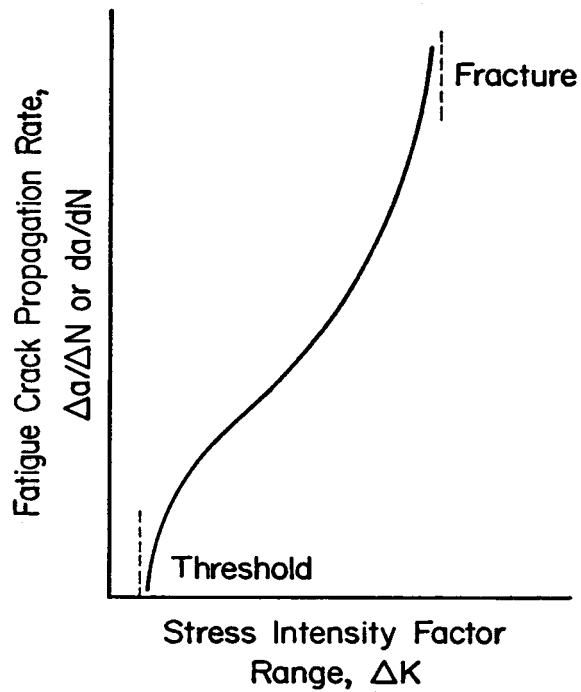

Figure 1.4.13.1(b). Fatigue crack-growth-rate curve.

At present, in the Handbook, the independent variable is considered to be simply ΔK and the data are considered to be parametric on the stress ratio, R , such that Equation 1.4.13.3(b) becomes

$$da/dN \approx \Delta a/\Delta N = g(\Delta K, R). \quad [1.4.13.3(c)]$$

1.4.13.3 Fatigue Crack Growth Data Presentation — Fatigue crack growth rate data for constant amplitude cyclic loading conditions are presented as logarithmic plots of da/dN versus ΔK . Such information, such as that illustrated in Figure 1.4.13.3, are arranged by material alloy and heat treatment condition. Each curve represents a specific stress ratio, R , environment, and cyclic loading frequency. Specific details regarding test procedures and data interpolations are presented in Chapter 9.

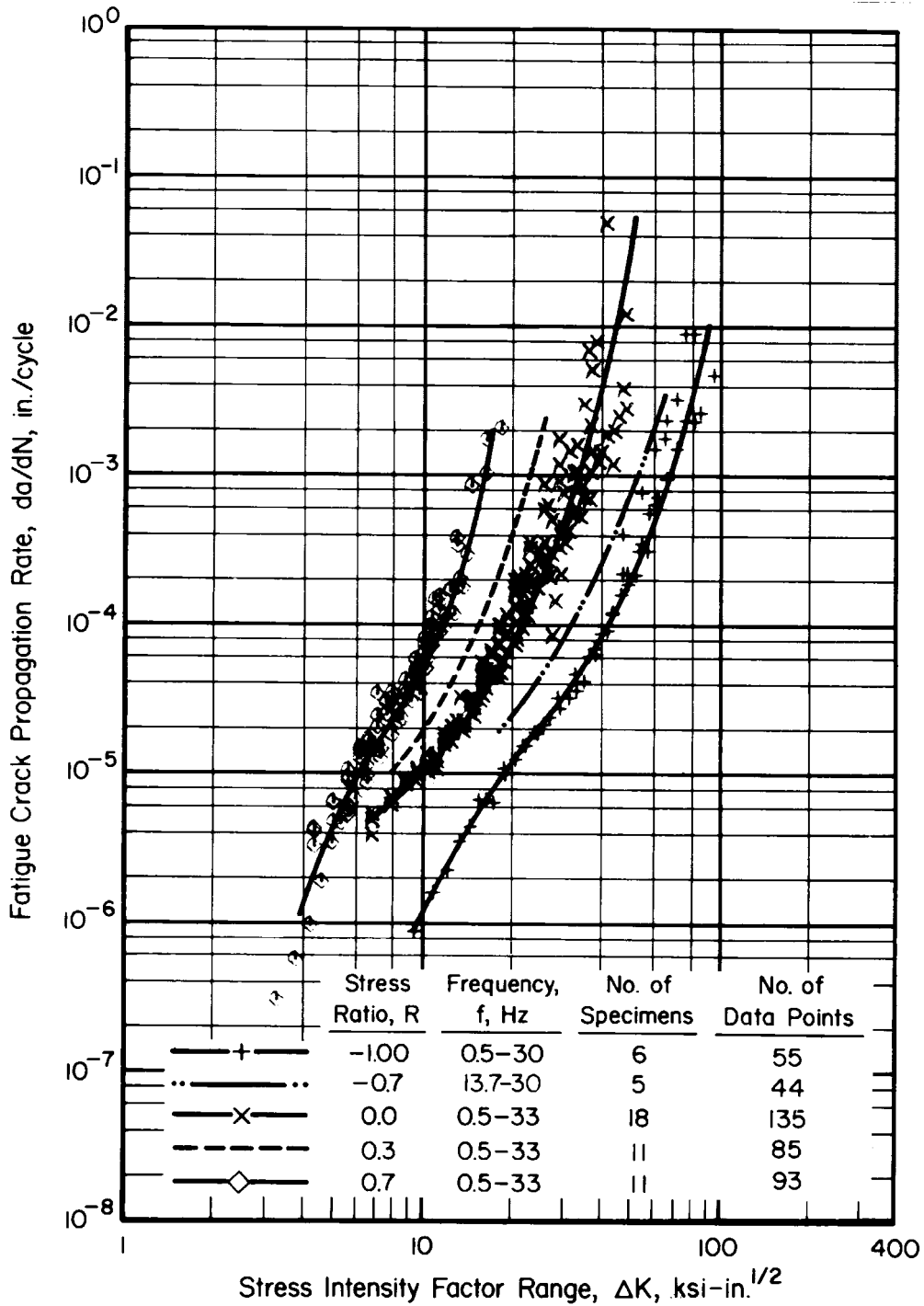

Figure 1.4.13.3. Sample display of fatigue crack growth rate data.

1.5 TYPES OF FAILURES

1.5.1 GENERAL — In the following discussion, failure will usually indicate fracture of a member or the condition of a member when it has attained maximum load.

1.5.2 MATERIAL FAILURES — Fracture can occur in either ductile or brittle fashions in the same material depending on the state of stress, rate of loading, and environment. The ductility of a material has a significant effect on the ability of a part to withstand loading and delay fracture. Although not a specific design property for ductile materials, some ductility data are provided in the Handbook to assist in material selections. The following paragraphs discuss the relationship between failure and the applied or induced stresses.

1.5.2.1 Direct Tension or Compression — This type of failure is associated with ultimate tensile or compressive stress of the material. For compression, it can only apply to members having large cross sectional dimensions relative to their lengths. See Section 1.4.5.1.

1.5.2.2 Shear — Pure shear failures are usually obtained when the shear load is transmitted over a very short length of a member. This condition is approached in the case of rivets and bolts. In cases where ultimate shear stress is relatively low, a pure shear failure can result. But, generally members subjected to shear loads fail under the action of the resulting normal stress, usually the compressive stress. See Equation 1.3.3.3. Failure of tubes in torsion are not caused by exceeding the shear ultimate stress, but by exceeding a normal compressive stress which causes the tube to buckle. It is customary to determine stresses for members subjected to shear in the form of shear stresses although they are actually indirect measures of the stresses actually causing failure.

1.5.2.3 Bearing — Failure of a material in bearing can consist of crushing, splitting, tearing, or progressive rapid yielding in the direction of load application. Failure of this type depends on the relative size and shape of the two connecting parts. The maximum bearing stress may not be applicable to cases in which one of the connecting members is relatively thin.

1.5.2.4 Bending — For sections not subject to geometric instability, a bending failure can be classed as either a tensile or compressive failure. Reference 1.5.2.4 provides methodology by which actual bending stresses above the material proportional limit can be used to establish maximum stress conditions. Actual bending stresses are related to the bending modulus of rupture. The bending modulus of rupture (f_b) is determined by Equation 1.3.2.3. When the computed bending modulus of rupture is found to be lower than the proportional limit strength, it represents an actual stress. Otherwise, it represents an apparent stress, and is not considered as an actual material strength. This is important when considering complex stress states, such as combined bending and compression or tension.

1.5.2.5 Failure Due to Stress Concentrations — Static stress properties represent pristine materials without notches, holes, or other stress concentrations. Such simplistic structural design is not always possible. Consideration should be given to the effect of stress concentrations. When available, references are cited for specific data in various chapters of the Handbook.

1.5.2.6 Failure from Combined Stresses — Under combined stress conditions, where failure is not due to buckling or instability, it is necessary to refer to some theory of failure. The “maximum shear” theory is widely accepted as a working basis in the case of isotropic ductile materials. It should be noted that this theory defines failure as the first yielding of a material. Any extension of this theory to cover conditions of final rupture must be based on evidence supported by the user. The failure

of brittle materials under combined stresses is generally treated by the “maximum stress” theory. Section 1.4.11 contains a more complete discussion of biaxial behavior. References 1.5.2.6(a) through (c) offer additional information.

1.5.3 INSTABILITY FAILURES — Practically all structural members, such as beams and columns, particularly those made from thin material, are subject to failure due to instability. In general, instability can be classed as (1) primary or (2) local. For example, the failure of a tube loaded in compression can occur either through lateral deflection of the tube acting as a column (primary instability) or by collapse of the tube walls at stresses lower than those required to produce a general column failure. Similarly, an I-beam or other formed shape can fail by a general sidewise deflection of the compression flange, by local wrinkling of thin outstanding flanges, or by torsional instability. It is necessary to consider all types of potential failures unless it is apparent that the critical load for one type is definitely the controlling condition.

Instability failures can occur in either the elastic range below the proportional limit or in the plastic range. These two conditions are distinguished by referring to either “elastic instability” or “plastic instability” failures. Neither type of failure is associated with a material’s ultimate strength, but largely depends upon geometry.

A method for determining the local stability of aluminum alloy column sections is provided in Reference 1.7.1(b). Documents cited therein are the same as those listed in References 3.20.2.2(a) through (e).

1.5.3.1 Instability Failures Under Compression — Failures of this type are discussed in Section 1.6 (Columns).

1.5.3.2 Instability Failures Under Bending — Round tubes when subjected to bending are subject to plastic instability failures. In such cases, the failure criterion is the modulus of rupture. Equation 1.3.2.3, which was derived from theory and confirmed empirically with test data, is applicable. Elastic instability failures of thin walled tubes having high D/t ratios are treated in later sections.

1.5.3.3 Instability Failures Under Torsion — The remarks given in the preceding section apply in a similar manner to round tubes under torsional loading. In such cases, the modulus of rupture in torsion is derived through the use of Equation 1.3.2.6. See Reference 1.5.3.3.

1.5.3.4 Failure Under Combined Loadings — For combined loading conditions in which failure is caused by buckling or instability, no theory exists for general application. Due to the various design philosophies and analytical techniques used throughout the aerospace industry, methods for computing margin of safety are not within the scope of this Handbook.

1.6 COLUMNS

1.6.1 GENERAL — A theoretical treatment of columns can be found in standard texts on the strength of materials. Some of the problems which are not well defined by theory are discussed in this section. Actual strengths of columns of various materials are provided in subsequent chapters.

1.6.2 PRIMARY INSTABILITY FAILURES — A column can fail through primary instability by bending laterally (stable sections) or by twisting about some axis parallel to its own axis. This latter type of primary failure is particularly common to columns having unsymmetrical open sections. The twisting failure of a closed section column is precluded by its inherently high torsional rigidity. Since the amount of available information is limited, it is advisable to conduct tests on all columns subject to this type of failure.

1.6.2.1 Columns with Stable Sections — The Euler formula for columns which fail by lateral bending is given by Equation 1.3.8.2. A conservative approach in using this equation is to replace the elastic modulus (E) by the tangent modulus (E_t) given by Equation 1.3.8.1. Values for the restraint coefficient (c) depend on degrees of ends and lateral fixities. End fixities tend to modify the effective column length as indicated in Equation 1.3.8.1. For a pin-ended column having no end restraint, $c = 1.0$ and $L' = L$. A fixity coefficient of $c = 2$ corresponds to an effective column length of $L' = 0.707$ times the total length.

The tangent modulus equation takes into account plasticity of a material and is valid when the following conditions are met:

- (a) The column adjusts itself to forcible shortening only by bending and not by twisting.
- (b) No buckling of any portion of the cross section occurs.
- (c) Loading is applied concentrically along the longitudinal axis of the column.
- (d) The cross section of the column is constant along its entire length.

MIL-HDBK-5 provides typical stress versus tangent modulus diagrams for many materials, forms, and grain directions. These information are not intended for design purposes. Methodology is contained in Chapter 9 for the development of allowable tangent modulus curves.

1.6.2.2 Column Stress (f_{co}) — The upper limit of column stress for primary failure is designated as f_{co} . By definition, this term should not exceed the compression ultimate strength, regardless of how the latter term is defined.

1.6.2.3 Other Considerations — Methods of analysis by which column failure stresses can be computed, accounting for fixities, torsional instability, load eccentricity, combined lateral loads, or varying column sections are contained in References 1.6.2.3(a) through (d).

1.6.3 LOCAL INSTABILITY FAILURES — Columns are subject to failure by local collapse of walls at stresses below the primary failure strength. The buckling analysis of a column subject to local instability requires consideration of the shape of the column cross section and can be quite complex. Local buckling, which can combine with primary buckling, leads to an instability failure commonly identified as crippling.

1.6.3.1 Crushing or Crippling Stress (f_{cc}) — The upper limit of column stress for local failure is defined by either its crushing or crippling stress. The strengths of round tubes have been

thoroughly investigated and considerable amounts of test results are available throughout literature. Fewer data are available for other cross sectional configurations and testing is suggested to establish specific information, e.g., the curve of transition from local to primary failure.

1.6.4 CORRECTION OF COLUMN TEST RESULTS — In the case of columns having unconventional cross sections which are subject to local instability, it is necessary to establish curves of transition from local to primary failure. In determining these column curves, sufficient tests should be made to cover the following points.

1.6.4.1 Nature of "Short Column Curve" — Test specimens should cover a range of L'/ρ values. When columns are to be attached eccentrically in structural application, tests should be designed to cover such conditions. This is important particularly in the case of open sections, as maximum load carrying capabilities are affected by locations of load and reaction points.

1.6.4.2 Local Failure — When local failure occurs, the crushing or crippling stress can be determined by extending the short column curve to a point corresponding to a zero value for L'/ρ . When a family of columns of the same general cross section is used, it is often possible to determine a relationship between crushing or crippling stress and some geometric factor. Examples are wall thickness, width, diameter, or some combination of these dimensions. Extrapolation of such data to conditions beyond test geometry extremes should be avoided.

1.6.4.3 Reduction of Column Test Results on Aluminum and Magnesium Alloys to Standard Material — The use of correction factors provided in Figures 1.6.4.3(a) through (i) is acceptable to the Air Force, the Navy, the Army, and the Federal Aviation Administration for use in reducing aluminum and magnesium alloys column test data into allowables. (Note that an alternate method is provided in Section 1.6.4.4). In using Figures 1.6.4.3(a) through (i), the correction of column test results to standard material is made by multiplying the stress obtained from testing a column specimen by the factor K. This factor may be considered applicable regardless of the type of failure involved, i.e., column crushing, crippling or twisting. Note that not all the information provided in these figures pertains to allowable stresses, as explained below.

The following terms are used in reducing column test results into allowable column stress:

F_{cy} is the design compression yield stress of the material in question, applicable to the gage, temper and grain direction along the longitudinal axis of a test column.

F_c' is the maximum test column stress achieved in test. Note that a letter (F) is used rather the customary lower case (f). This value can be an individual test result.

F_{cy}' is the compressive yield strength of the column material. Note that a letter (F) is used rather than the customary lower case (f). This value can be an individual test result using a standard compression test specimen.

Using the ratio of (F_c' / F_{cy}') , enter the appropriate diagram along the abscissa and extend a line upwards to the intersection of a curve with a value of (F_{cy}' / F_{cy}) . Linear interpolation between curves is permissible. At this location, extend a horizontal line to the ordinate and read the corresponding K-factor. This factor is then used as a multiplier on the measured column strength to obtain the allowable. The basis for this allowable is the same as that noted for the compression yield stress allowable obtained from the room temperature allowables table.

If the above method is not feasible, due to an inability of conducting a standard compression test of the column material, the compression yield stress of the column material may be estimated as follows: Conduct a standard tensile test of the column material and obtain its tensile yield stress. Multiply this value by the ratio of compression-to-tensile yield allowables for the standard material. This provides the estimated compression yield stress of the column material. Continue with the analysis as described above using the compression stress of a test column in the same manner.

If neither of the above methods are feasible, it may be assumed that the compressive yield stress allowable for the column is 15 percent greater than minimum established allowable longitudinal tensile yield stress for the material in question.

1.6.4.4 Reduction of Column Test Results to Standard Material-Alternate Method — For materials that are not covered by Figures 1.6.4.4(a) through (i), the following method is acceptable for all materials to the Air Force, the Navy, the Army, and the Federal Aviation Administration.

- (1) Obtain the column material compression properties: F_{cy} , E_c , n_c .
- (2) Determine the test material column stress (f_c') from one or more column tests.
- (3) Determine the test material compression yield stress (f_{cy}') from one or more tests.
- (4) Assume E_c and n_c from (1) apply directly to the column material. They should be the same material.
- (5) Assume that geometry of the test column is the same as that intended for design. This means that a critical slenderness ratio value of (L'/ρ) applies to both cases.
- (6) Using the conservative form of the basic column formula provided in Equation 1.3.8.1, this enables an equality to be written between column test properties and allowables. If

$$(L'/\rho) \text{ for design} = (L'/\rho) \text{ of the column test} \quad [1.6.4.4(a)]$$

Then

$$(F_c/E_t) \text{ for design} = (f_c'/E_t') \text{ from test} \quad [1.6.4.4(b)]$$

- (7) Tangent modulus is defined as:

$$E_t = df / de \quad [1.6.4.4(c)]$$

- (8) Total strain (e) is defined as the sum of elastic and plastic strains, and throughout the Handbook is used as:

$$e = e_e + e_p \quad [1.6.4.4(d)]$$

or,

$$e = \frac{f}{E} + 0.002 \left(\frac{f}{f_y} \right)^n \quad [1.6.4.4(e)]$$

MIL-HDBK-5J
31 January 2003

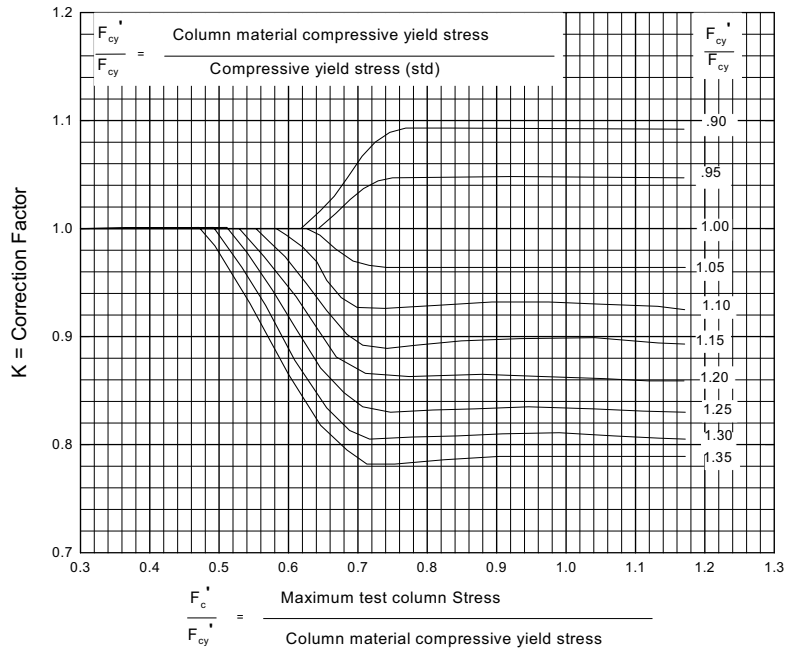

Figure 1.6.4.4(a). Nondimensional material correction chart for 2024-T3 sheet.

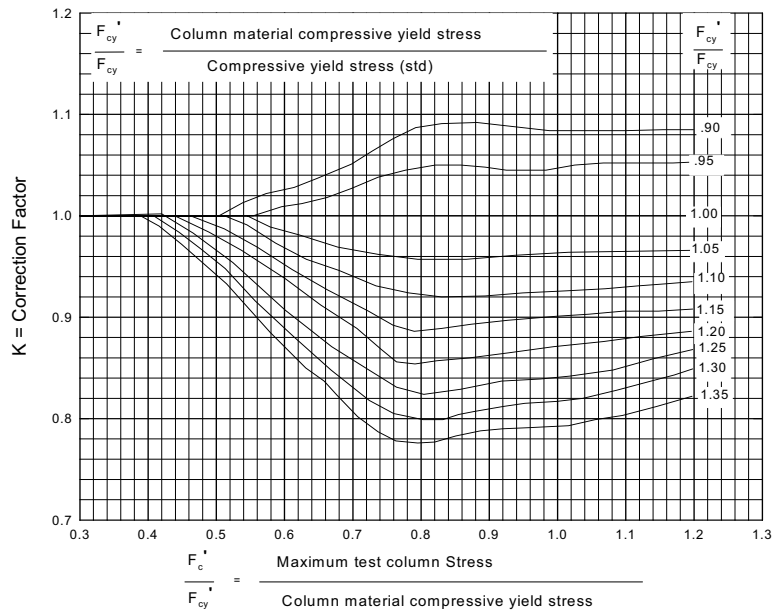

Figure 1.6.4.4(b). Nondimensional material correction chart for 2024-T3 clad sheet.

MIL-HDBK-5J
31 January 2003

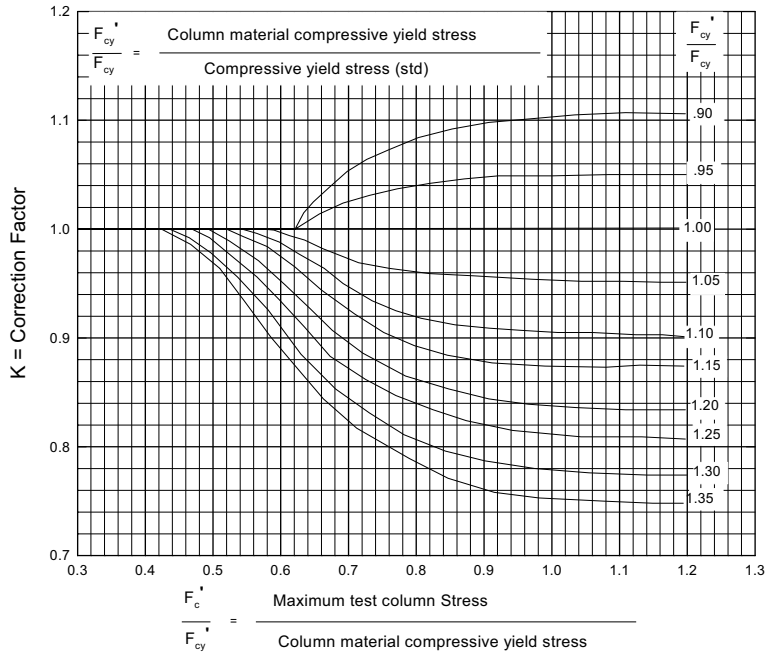

Figure 1.6.4.4(c). Nondimensional material correction chart for 2024-T4 extrusion less than 1/4 inch thick.

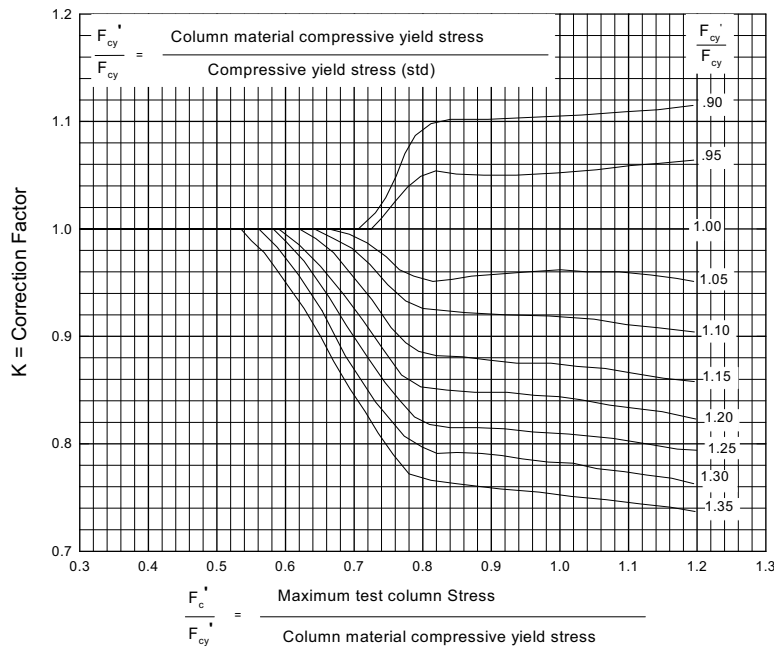

Figure 1.6.4.4(d). Nondimensional material correction chart for 2024-T4 extrusion 1/4 to 1-1/2 inches thick.

MIL-HDBK-5J
31 January 2003

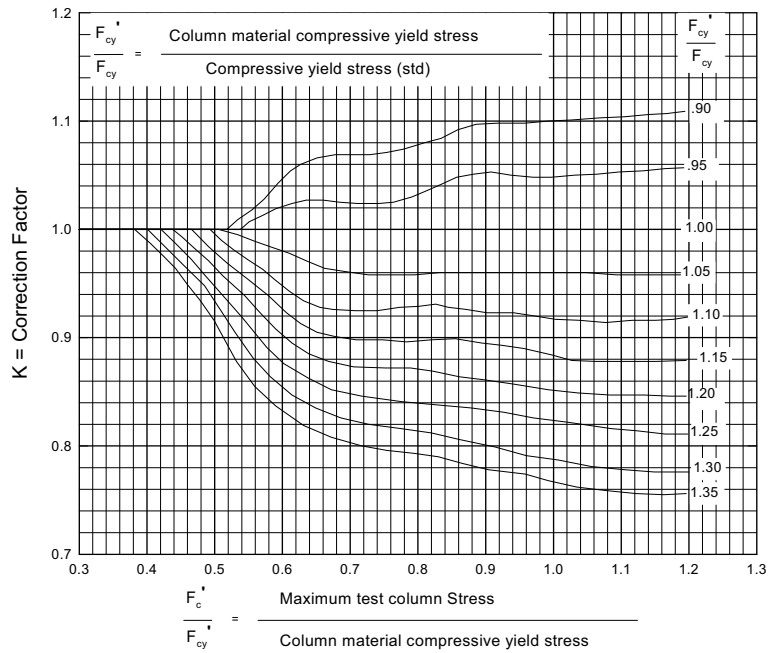

Figure 1.6.4.4(e). Nondimensional material correction chart for 2024-T3 tubing.

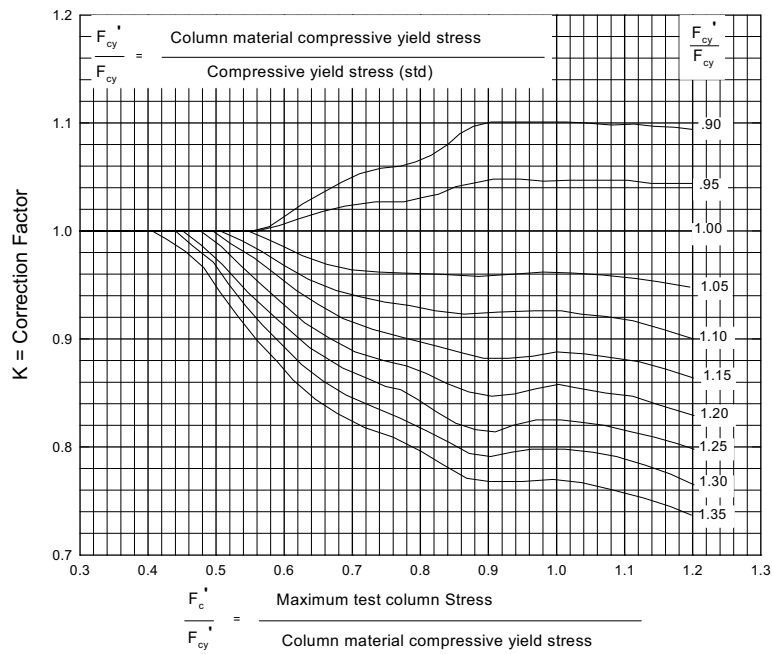

Figure 1.6.4.4(f). Nondimensional material correction chart for clad 2024-T3 sheet.

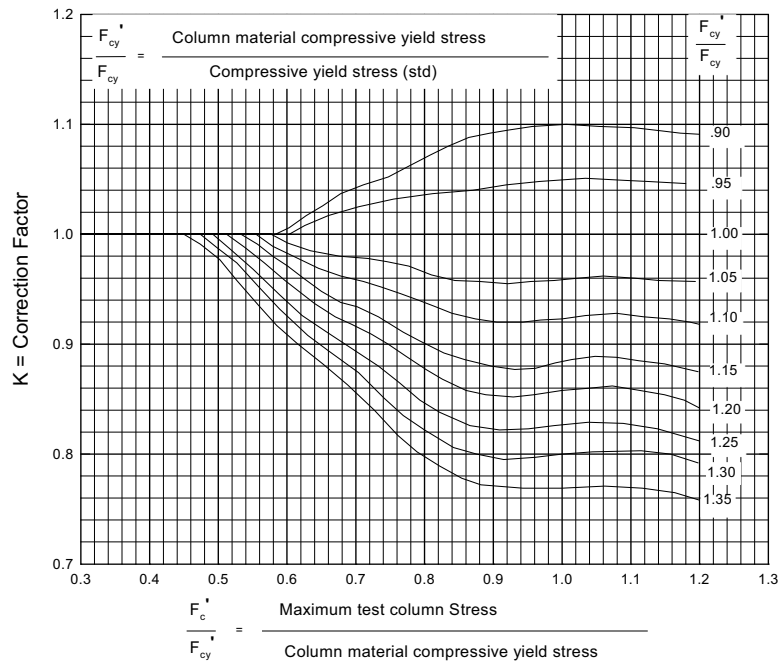

Figure 1.6.4.4(g). Nondimensional material correction chart for 7075-T6 sheet.

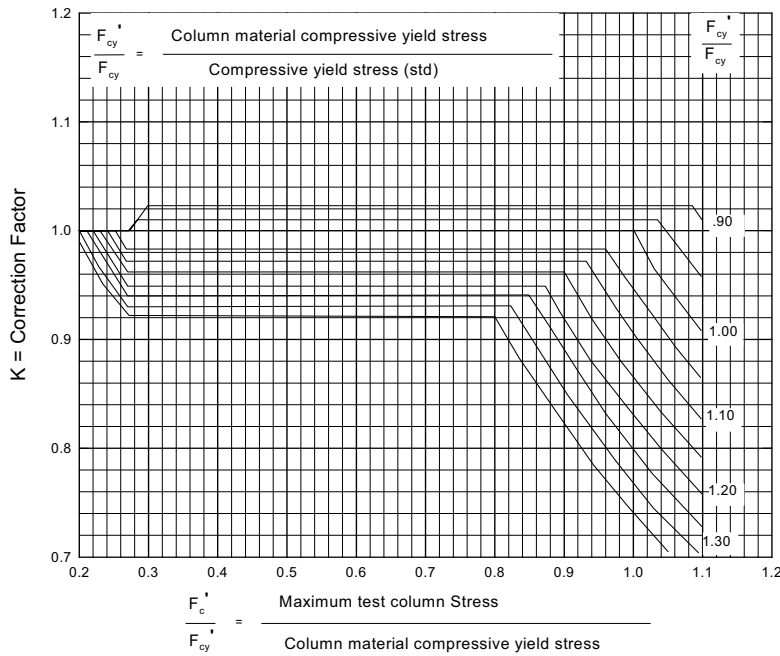

Figure 1.6.4.4(h). Nondimensional material correction chart for AZ31B-F and AZ61A-F extrusion.

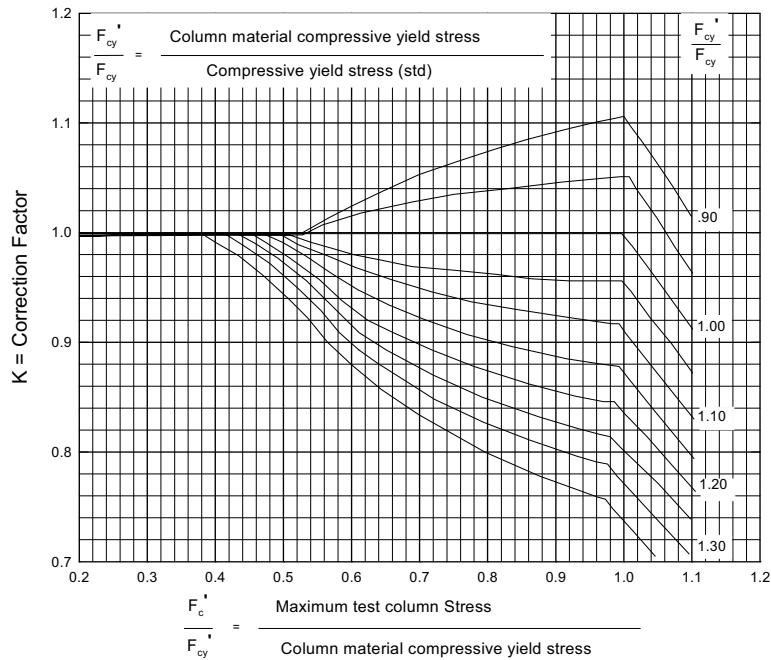

Figure 1.6.4.4(i). Nondimensional material correction chart for AZ31B-H24 sheet.

Equation 1.6.4.4(c) can be rewritten as follows:

$$E_t = \frac{f}{\frac{f}{E} + 0.002n \left(\frac{f}{f_y} \right)^n} \quad [1.6.4.4(f)]$$

Tangent modulus, for the material in question, using its compression allowables is:

$$E_t = \frac{F_c}{\frac{F_c}{E_c} + 0.002n_c \left(\frac{F_c}{F_{cy}} \right)^{n_c}} \quad [1.6.4.4(g)]$$

In like manner, tangent modulus for the same material with the desired column configuration is:

$$E_t' = \frac{f_c'}{\frac{f_c'}{E_c} + 0.002n_c \left(\frac{f_c'}{f_{cy}'} \right)^{n_c}} \quad [1.6.4.4(h)]$$

MIL-HDBK-5J
31 January 2003

Substitution of Equations 1.6.4.4(g) and 1.6.4.4(h) for their respective terms in Equation 1.6.4.4(b) and simplifying provides the following relationship:

$$\frac{F_c}{E_c} + 0.002n_c \left(\frac{F_c}{F_{cy}} \right)^{n_c} = \frac{f_c'}{E_c} + 0.002n_c \left(\frac{f_c'}{f_{cy}'} \right)^{n_c} \quad [1.6.4.4(i)]$$

The only unknown in the above equation is the term F_c , the allowable column compression stress. This property can be solved by an iterative process.

This method is also applicable at other than room temperature, having made adjustments for the effect of temperature on each of the properties. It is critical that the test material be the same in all respects as that for which allowables are selected from the Handbook. Otherwise, the assumption made in Equation 1.6.4.4(c) above is not valid. Equation 1.6.4.4(i) must account for such differences in moduli and shape factors when applicable.

1.7 THIN-WALLED AND STIFFENED THIN-WALLED SECTIONS

A bibliography of information on thin-walled and stiffened thin-walled sections is contained in References 1.7(a) and (b).

REFERENCES

- 1.4.3.1 Goodman, S. and Russell, S.B., U.S. Air Force, "Poisson's Ratio of Aircraft Sheet Materials for Large Strain," WADC-TR-53-7, 58 pp (June 1953).
- 1.4.4 "Test Methods of Tension Testing of Metallic Materials," ASTM E 8.
- 1.4.5(a) Hyler, W.S., "An Evaluation of Compression-Testing Techniques for Determining Elevated Temperature Properties of Titanium Sheet," Titanium Metallurgical Laboratory Report No. 43, Battelle Memorial Institute, 38 pp, Appendix 28 pp (June 8, 1956).
- 1.4.5(b) "Compression Testing of Metallic Materials at Room Temperature," ASTM E 9.
- 1.4.6 Stange, A.H., Ramberg, W. and Back, G., "Torsion Tests of Tubes," National Advisory Committee for Aeronautics, Report No. 601, pp 515-535 (Feb. 1937).
- 1.4.7(a) Stickley, G.W. and Moore, A.A., "Effects of Lubrication and Pin Surface on Bearing Strengths of Aluminum and Magnesium Alloys," Materials Research and Standards, **2**, (9), pp 747-751 (September 1962).
- 1.4.7(b) "Method of Pin-Type Bearing Test of Metallic Materials," ASTM E 238.
- 1.4.8.2.1(a) "Recommended Practice for Conducting Creep, Creep-Rupture, and Stress-Rupture Tests of Metallic Materials," ASTM E 139.
- 1.4.8.2.1(b) Rice, Richard, "Reference Document for the Analysis of Creep and Stress Rupture Data in MIL-HDBK-5," AFWAL-TR-81-4097 (September 1981).
- 1.4.8.2.1(c) Aarnes, M.N. and Tuttle, M.M., "Presentation of Creep Data for Design Purposes," ASD Technical Report 61-216 (June 1961) (MCIC 45114).
- 1.4.9(a) "Recommended Practice for Constant Amplitude Axial Fatigue Tests of Metallic Materials," ASTM E 466.
- 1.4.9(b) "Recommended Practice for Constant-Amplitude Low-Cycle Fatigue Testing," ASTM E 606.
- 1.4.9.2(a) Grover, H.J., "Fatigue of Aircraft Structures," Prepared for Naval Air Systems Command, Department of the Navy, 335 pp (1966).
- 1.4.9.2(b) Osgood, C.C., "Fatigue Design," Wiley-Interscience, A Division of John Wiley and Sons, Inc., 523 pp (1970).
- 1.4.11 Bert, C.W., Mills, E.J. and Hyler, W.S., "Mechanical Properties of Aerospace Structural Alloys Under Biaxial-Stress Conditions," AFML-TR-66-229, (August 1966).
- 1.4.12.2(a) "Standard Method of Test for Plane-Strain Fracture Toughness of Metallic Materials," ASTM E 399.
- 1.4.13.1 "Test Method for Measurements of Fatigue Crack Growth Rates," ASTM E 647.

MIL-HDBK-5J
31 January 2003

- 1.4.13.2 Paris, P.C., "The Fracture Mechanics Approach to Fatigue," Proc. 10th Sagamore Conference, p. 107, Syracuse University Press (1965).
- 1.5.2.4 Cozzone, F.P., "Bending Strength in the Plastic Range," Journal of the Aeronautical Sciences, 10, pp 137-151, (1943).
- 1.5.2.6(a) Dieter, G.E., Jr., "Mechanical Metallurgy," McGraw-Hill Book Company, Inc., 615 pp (1961).
- 1.5.2.6(b) Freudenthal, A.M., "The Inelastic Behavior of Engineering Materials and Structures," John Wiley and Sons, Inc., New York, 587 pp (1950).
- 1.5.2.6(c) Parker, E.R., "Brittle Behavior of Engineering Structures," John Wiley and Sons, Inc., New York, 323 pp (1957).
- 1.5.3.3 Lundquist, E.E., "Strength Tests of Thin-Walled Duralumin Cylinders in Pure Bending," U.S. National Advisory Committee for Aeronautics, Technical Note No. 479, 17 pp (December 1933).
- 1.6.2.3(a) Hill, H.N. and Clark, J.W., "Straight-Line Column Formulas for Aluminum Alloys," Aluminum Company of America, Aluminum Research Laboratories, Technical Paper No. 12, 8 pp (1955).
- 1.6.2.3(b) AFFDL-TR-69-42, "Stress Analysis Manual," Air Force Flight Dynamics Laboratory, Air Force Systems Command, Wright-Patterson Air Force Base (February 1970).
- 1.6.2.3(c) "Astronautic Structure Manual," George C. Marshall Space Flight Center (August 15, 1970).
- 1.6.2.3(d) Niles, A.S., and Newell, J.S., "Airplane Structure," 2, Third Edition, John Wiley and Sons (1943).
- 1.7(a) "Index of Aircraft Structures Research Reports," U.S. National Advisory Committee for Aeronautics, Index No. 7E29, 40 pp (June 1947).
- 1.7(b) Gerard, and Becker, H., "Handbook of Structural Stability," National Advisory Committee for Aeronautics Technical Note, Nos. 3781, 102 pp (July 1957); 3782, 72 pp (July 1957); 3783, 154 pp (August 1957); 3784, 93 pp (August 1957); and 3785, 89 pp (August 1957).

THIS PAGE INTENTIONALLY BLANK

CHAPTER 2

STEEL

This chapter contains the engineering properties and related characteristics of steels used in aircraft and missile structural applications. General comments on engineering properties and other considerations related to alloy selection are presented in Section 2.1. Mechanical and physical property data and characteristics pertinent to specific steel groups or individual steels are reported in Sections 2.2 through 2.7. Element properties are presented in Section 2.8.

2.1 GENERAL

The selection of the proper grade of steel for a specific application is based on material properties and on manufacturing, environmental, and economic considerations. Some of these considerations are outlined in the sections that follow.

2.1.1 ALLOY INDEX — The steel alloys listed in this chapter are arranged in major sections that identify broad classifications of steel partly associated with major alloying elements, partly associated with processing, and consistent generally with steel-making technology. Specific alloys are identified as shown in Table 2.1.1.

Table 2.1.1. Steel Alloy Index

Section	Alloy Designation
2.2	Carbon steels
2.2.1	AISI 1025
2.3	Low-alloy steels (AISI and proprietary grades)
2.3.1	Specific alloys
2.4	Intermediate alloy steels
2.4.1	5Cr-Mo-V
2.4.2	9Ni-4Co-0.20C
2.4.3	9Ni-4Co-0.30C
2.5	High alloy steels
2.5.1	18 Ni maraging steels
2.5.2	AF1410
2.5.3	AerMet 100
2.6	Precipitation and transformation hardening steel (stainless)
2.6.1	AM-350
2.6.2	AM-355
2.6.3	Custom 450
2.6.4	Custom 455
2.6.5	Custom 465
2.6.6	PH13-8Mo
2.6.7	15-5PH
2.6.8	PH15-7Mo
2.6.9	17-4PH
2.6.10	17-7PH

Table 2.1.1(Continued). Steel Alloy Index

Section	Alloy Designation
2.7	Austenitic stainless steels
2.7.1	AISI 301 and Related 300 Series Stainless Steels

2.1.2 MATERIAL PROPERTIES — One of the major factors contributing to the general utility of steels is the wide range of mechanical properties which can be obtained by heat treatment. For example, softness and good ductility may be required during fabrication of a part and very high strength during its service life. Both sets of properties are obtainable in the same material.

All steels can be softened to a greater or lesser degree by annealing, depending on the chemical composition of the specific steel. Annealing is achieved by heating the steel to an appropriate temperature, holding, then cooling it at the proper rate.

Likewise, steels can be hardened or strengthened by means of cold working, heat treating, or a combination of these.

Cold working is the method used to strengthen both the low-carbon unalloyed steels and the highly alloyed austenitic stainless steels. Only moderately high strength levels can be attained in the former, but the latter can be cold rolled to quite high strength levels, or “tempers”. These are commonly supplied to specified minimum strength levels.

Heat treating is the principal method for strengthening the remainder of the steels (the low-carbon steels and the austenitic steels cannot be strengthened by heat treatment). The heat treatment of steel may be of three types: martensitic hardening, age hardening, and austempering. Carbon and alloy steels are martensitic-hardened by heating to a high temperature, or “austenitizing”, and cooling at a recommended rate, often by quenching in oil or water. This is followed by “tempering”, which consists of reheating to an intermediate temperature to relieve internal stresses and to improve toughness.

The maximum hardness of carbon and alloy steels, quenched rapidly to avoid the nose of the isothermal transformation curve, is a function in general of the alloy content, particularly the carbon content. Both the maximum thickness for complete hardening or the depth to which an alloy will harden under specific cooling conditions, and the distribution of hardness can be used as a measure of a material’s hardenability.

A relatively new class of steels is strengthened by age hardening. This heat treatment is designed to dissolve certain constituents in the steel, then precipitate them in some preferred particle size and distribution. Since both the martensitic hardening and the age-hardening treatments are relatively complex, specific details are presented for individual steels elsewhere in this chapter.

Recently, special combinations of working and heat treating have been employed to further enhance the mechanical properties of certain steels. At the present time, the use of these specialized treatments is not widespread.

Another method of heat treatment for steels is austempering. In this process, ferrous steels are austenitized, quenched rapidly to avoid transformation of the austenite to a temperature below the pearlite

and above the martensite formation ranges, allowed to transform isothermally at that temperature to a completely bainitic structure, and finally cooled to room temperature. The purpose of austempering is to obtain increased ductility or notch toughness at high hardness levels, or to decrease the likelihood of cracking and distortion that might occur in conventional quenching and tempering.

2.1.2.1 Mechanical Properties —

2.1.2.1.1 Strength (Tension, Compression, Shear, Bearing) — The strength properties presented are those used in structural design. The room-temperature properties are shown in tables following the comments for individual steels. The variations in strength properties with temperature are presented graphically as percentages of the corresponding room-temperature strength property, also described in Section 9.3.1 and associated subsections. These strength properties may be reduced appreciably by prolonged exposure at elevated temperatures.

The strength of steels is temperature-dependent, decreasing with increasing temperature. In addition, steels are strain rate-sensitive above about 600 to 800°F, particularly at temperatures at which creep occurs. At lower strain rates, both yield and ultimate strengths decrease.

The modulus of elasticity is also temperature-dependent and, when measured by the slope of the stress-strain curve, it appears to be strain rate-sensitive at elevated temperatures because of creep during loading. However, on loading or unloading at high rates of strain, the modulus approaches the value measured by dynamic techniques.

Steel bars, billets, forgings, and thick plates, especially when heat treated to high strength levels, exhibit variations in mechanical properties with location and direction. In particular, elongation, reduction of area, toughness, and notched strength are likely to be lower in either of the transverse directions than in the longitudinal direction. This lower ductility and/or toughness results both from the fibering caused by the metal flow and from nonmetallic inclusions which tend to be aligned with the direction of primary flow. Such anisotropy is independent of the depth-of-hardening considerations discussed elsewhere. It can be minimized by careful control of melting practices (including degassing and vacuum-arc remelting) and of hot-working practices. In applications where transverse properties are critical, requirements should be discussed with the steel supplier and properties in critical locations should be substantiated by appropriate testing.

2.1.2.1.2 Elongation — The elongation values presented in this chapter apply in both the longitudinal and long transverse directions, unless otherwise noted. Elongation in the short transverse (thickness) direction may be lower than the values shown.

2.1.2.1.3 Fracture Toughness — Steels (as well as certain other metals), when processed to obtain high strength, or when tempered or aged within certain critical temperature ranges, may become more sensitive to the presence of small flaws. Thus, as discussed in Section 1.4.12, the usefulness of high-strength steels for certain applications is largely dependent on their toughness. It is generally noted that the fracture toughness of a given alloy product decreases relative to increase in the yield strength. The designer is cautioned that the propensity for brittle fracture must be considered in the application of high-strength alloys for the purpose of increased structural efficiency.

Minimum, average, and maximum values, as well as coefficient of variation of plane-strain fracture toughness for several steel alloys, are presented in Table 2.1.2.1.3. These values are presented as indicative information and do not have the statistical reliability of room-temperature mechanical properties. Data showing the effect of temperature are presented in the respective alloy sections where the information is available.

Table 2.1.2.1.3. Values of Room Temperature Plane-Strain Fracture Toughness of Steel Alloys^a

Alloy	Heat Treat Condition	Product Form	Orientation ^b	Yield Strength Range, ksi	Product Thickness Range, inches	Number of Sources	Sample Size	Specimen Thickness Range, inches	K _{IC} , ksi √in.			
									Max.	Avg.	Min.	Coefficient of Variation
AerMet 100	Anneal, HT to 280ksi	Bar	L-R	236-281	2.75-10	1	183	1	146	121	100	7.9
AerMet 100	Anneal, HT to 280ksi	Bar	C-R	223-273	2.75-10	1	156	1	137	112	90	8.5
AerMet 100	Anneal, HT to 290ksi	Bar	L-R	251-265	3-10	1	29	1	110	99	88	6.5
AerMet 100	Anneal, HT to 290ksi	Bar	C-R	250-268	3-10	1	24	1	101	88	73	9.7
Custom 465	H950	Bar	L-R ^c	229-249	3-12	1	40	1-1.5	104	89	76	7.4
Custom 465	H950	Bar	R-L ^c	231-246	3-12	1	40	1-1.5	94	82	73	6.4
Custom 465	H1000	Bar	L-R ^c	212-227	3-12	1	40	1-1.5	131	120	108	5.2
Custom 465	H1000	Bar	R-L ^c	212-225	3-12	1	40	1-1.5	118	109	100	3.7
D6AC	1650°F, Aus-Bay Quench 975°F, SQ 375°F, 1000°F 2 + 2	Plate	L-T	217	1.5	1	19	0.6	88	62	40	22.5
D6AC	1650°F, Aus-Bay Quench 975°F, SQ 400°F, 1000°F 2 + 2	Plate	L-T	217	0.8	1	103	0.6-0.8	92	64	44	18.9
D6AC	1650°F, Aus-Bay Quench 975°F, SQ 400°F, 1000°F 2 + 2	Forging	L-T	214	0.8-1.5	1	53	0.6-0.8	96	66	39	18.6
D6AC	1700°F, Aus-Bay Quench 975°F, OQ 140°F, 1000°F 2 + 2	Plate	L-T	217	0.8-1.5	1	30	0.6-0.8	101	92	64	8.9
D6AC	1700°F, Aus-Bay Quench 975°F, OQ 140°F, 1000°F 2 + 2	Forging	L-T	214	0.8-1.5	1	34	0.7	109	95	81	6.7
9Ni-4Co-20C	Quench and Temper	Hand Forging	L-T	185-192	3.0	2	27	1.0-2.0	147	129	107	8.3
9Ni-4Co-20C	1650°F, 1-2 Hr, AC, 1525°F, 1-2 Hr, OQ, -100°F, Temp	Forging	L-T	186-192	3.0-4.0	3	17	1.5-2.0	147	134	120	8.5
PH13-8Mo	H1000	Forging	L-T	205-212	4.0-8.0	3	12	0.7-2.0	104	90	49	21.5

^a These values are for information only.

^b Refer to Figures 1.4.12.3(a) and 1.4.12.3(b) for definition of symbols.

^c L-R also includes some L-T, R-L also includes some T-L.

2.1.2.1.4 Stress-Strain Relationships — The stress-strain relationships presented in this chapter are prepared as described in Section 9.3.2.

2.1.2.1.5 Fatigue — Axial-load fatigue data on unnotched and notched specimens of various steels at room temperature and at other temperatures are shown as S/N curves in the appropriate section. Surface finish, surface finishing procedures, metallurgical effects from heat treatment, environment and other factors influence fatigue behavior. Specific details on these conditions are presented as correlative information for the S/N curve.

2.1.2.2 Physical Properties — The physical properties (ω , C , K , and α) of steels may be considered to apply to all forms and heat treatments unless otherwise indicated.

2.1.3 ENVIRONMENTAL CONSIDERATIONS — The effects of exposure to environments such as stress, temperature, atmosphere, and corrosive media are reported for various steels. Fracture toughness of high-strength steels and the growth of cracks by fatigue may be detrimentally influenced by humid air and by the presence of water or saline solutions. Some alleviation may be achieved by heat treatment and all high-strength steels are not similarly affected.

In general, these comments apply to steels in their usual finished surface condition, without surface protection. It should be noted that there are available a number of heat-resistant paints, platings, and other surface coatings that are employed either to improve oxidation resistance at elevated temperature or to afford protection against corrosion by specific media. In employing electrolytic platings, special consideration should be given to the removal of hydrogen by suitable baking. Failure to do so may result in lowered fracture toughness or embrittlement.

2.2 CARBON STEELS

2.2.0 COMMENTS ON CARBON STEELS

2.2.0.1 Metallurgical Considerations — Carbon steels are those steels containing carbon up to about 1 percent and only residual quantities of other elements except those added for deoxidation.

The strength that carbon steels are capable of achieving is determined by carbon content and, to a much lesser extent, by the content of the residual elements. Through cold working or proper choice of heat treatments, these steels can be made to exhibit a wide range of strength properties.

The finish conditions most generally specified for carbon steels include hot-rolled, cold-rolled, cold-drawn, normalized, annealed, spheroidized, stress-relieved, and quenched-and-tempered. In addition, the low-carbon grades (up to 0.25 percent C) may be carburized to obtain high surface hardness and wear resistance with a tough core. Likewise, the higher carbon grades are amenable to selective flame hardening to obtain desired combinations of properties.

2.2.0.2 Manufacturing Considerations —

Forging — All of the carbon steels exhibit excellent forgeability in the austenitic state provided the proper forging temperatures are used. As the carbon content is increased, the maximum forging temperature is decreased. At high temperatures, these steels are soft and ductile and exhibit little or no tendency to work harden. The resulfurized grades (free-machining steels) exhibit a tendency to rupture when deformed in certain high-temperature ranges. Close control of forging temperatures is required.

Cold Forming — The very low-carbon grades have excellent cold-forming characteristics when in the annealed or normalized conditions. Medium-carbon grades show progressively poorer formability with higher carbon content, and more frequent annealing is required. The high-carbon grades require special softening treatments for cold forming. Many carbon steels are embrittled by warm working or prolonged exposure in the temperature range from 300 to 700°F.

Machining — The low-carbon grades (0.30 percent C and less) are soft and gummy in the annealed condition and are preferably machined in the cold-worked or the normalized condition. Medium-carbon (0.30 to 0.50 percent C) grades are best machined in the annealed condition, and high-carbon grades (0.50 to 0.90 percent C) in the spheroidized condition. Finish machining must often be done in the fully heat-treated condition for dimensional accuracy. The resulfurized grades are well known for their good machinability. Nearly all carbon steels are now available with 0.15 to 0.35 percent lead, added to improve machinability. However, resulfurized and leaded steels are not generally recommended for highly stressed aircraft and missile parts because of a drastic reduction in transverse properties.

Welding — The low-carbon grades are readily welded or brazed by all techniques. The medium-carbon grades are also readily weldable but may require preheating and postwelding heat treatment. The high-carbon grades are difficult to weld. Preheating and postwelding heat treatment are usually mandatory for the latter, and special care must be taken to avoid overheating. Furnace brazing has been used successfully with all grades.

Heat Treatment — Due to the poor oxidation resistance of carbon steels, protective atmospheres must be employed during heat treatment if scaling of the surface cannot be tolerated. Also, these steels are subject to decarburization at elevated temperatures and, where surface carbon content is critical, should be heated in reducing atmospheres.

2.2.0.3 Environmental Considerations— Carbon steels have poor oxidation resistance above about 900 to 1000°F. Strength and oxidation-resistance criteria generally preclude the use of carbon steels above 900°F.

Carbon steels may undergo an abrupt transition from ductile to brittle behavior. This transition temperature varies widely for different carbon steels depending on many factors. Cautions should be exercised in the application of carbon steels to assure that the transition temperature of the selected alloy is below the service temperature. Additional information is contained in References 2.2.0.3(a) and (b).

The corrosion resistance of carbon steels is relatively poor; clean surfaces rust rapidly in moist atmospheres. Simple oil film protection is adequate for normal handling. For aerospace applications, the carbon steels are usually plated to provide adequate corrosion protection.

2.2.1 AISI 1025

2.2.1.0 Comments and Properties— AISI 1025 is an excellent general purpose steel for the majority of shop requirements, including jigs, fixtures, prototype mockups, low torque shafting, and other applications. It is not generally classed as an airframe structural steel. However, it is available in aircraft quality as well as commercial quality.

Manufacturing Considerations— Cold-finished flat-rolled products are supplied principally where maximum strength, good surface finish, or close tolerance is desirable. Reasonably good forming properties are found in AISI 1025. The machinability of bar stock is rated next to these sulfurized types of free-machining steels, but the resulting surface finish is poorer.

Specifications and Properties— Material specifications for AISI 1025 steel are presented in Table 2.2.1.0(a). The room-temperature mechanical and physical properties are shown in Table 2.2.1.0(b). The effect of temperature on thermal expansion is shown in Figure 2.2.1.0.

Table 2.2.1.0(a). Material Specifications for AISI 1025 Carbon Steel

Specification	Form
ASTM A 108	Bar
AMS 5075	Seamless tubing
AMS-T-5066 ^a	Tubing
AMS 5077	Tubing
AMS 5046	Sheet, strip, and plate
AMS-S-7952	Sheet and strip

^a Noncurrent specification

Table 2.2.1.0(b). Design Mechanical and Physical Properties of AISI 1025 Carbon Steel

Specification	AMS 5046 and AMS-S-7952	AMS 5075, AMS 5077 and AMS-T-5066 ^a	ASTM A 108
Form	Sheet, strip, and plate	Tubing	Bar
Condition	Annealed	Normalized	All
Thickness, in.
Basis	S	S	S ^b
Mechanical Properties:			
<i>F_{tu}</i> , ksi:			
L	55	55	55
LT	55	55	55
ST	55
<i>F_{ty}</i> , ksi:			
L	36	36	36
LT	36	36	36
ST	36
<i>F_{cy}</i> , ksi:			
L	36	36	36
LT	36	36	36
ST	36
<i>F_{su}</i> , ksi	35	35	35
<i>F_{bru}</i> , ksi:			
(e/D = 1.5)
(e/D = 2.0)	90	90	90
<i>F_{bry}</i> , ksi:			
(e/D = 1.5)
(e/D = 2.0)
<i>e</i> , percent:			
L	c	c
LT	c
<i>E</i> , 10 ³ ksi	29.0		
<i>E_c</i> , 10 ³ ksi	29.0		
<i>G</i> , 10 ³ ksi	11.0		
<i>μ</i>	0.32		
Physical Properties:			
<i>ω</i> , lb/in. ³	0.284		
<i>C</i> , Btu/(lb)(°F)	0.116 (122 to 212 °F)		
<i>K</i> , Btu/[(hr)(ft ²)(°F)/ft] ..	30.0 (at 32 °F)		
<i>α</i> , 10 ⁻⁶ in./in./°F	See Figure 2.2.1.0		

a Noncurrent specification.

b Design values are applicable only to parts for which the indicated *F_{tu}* has been substantiated by adequate quality control testing.

c See applicable specification for variation in minimum elongation with ultimate strength.

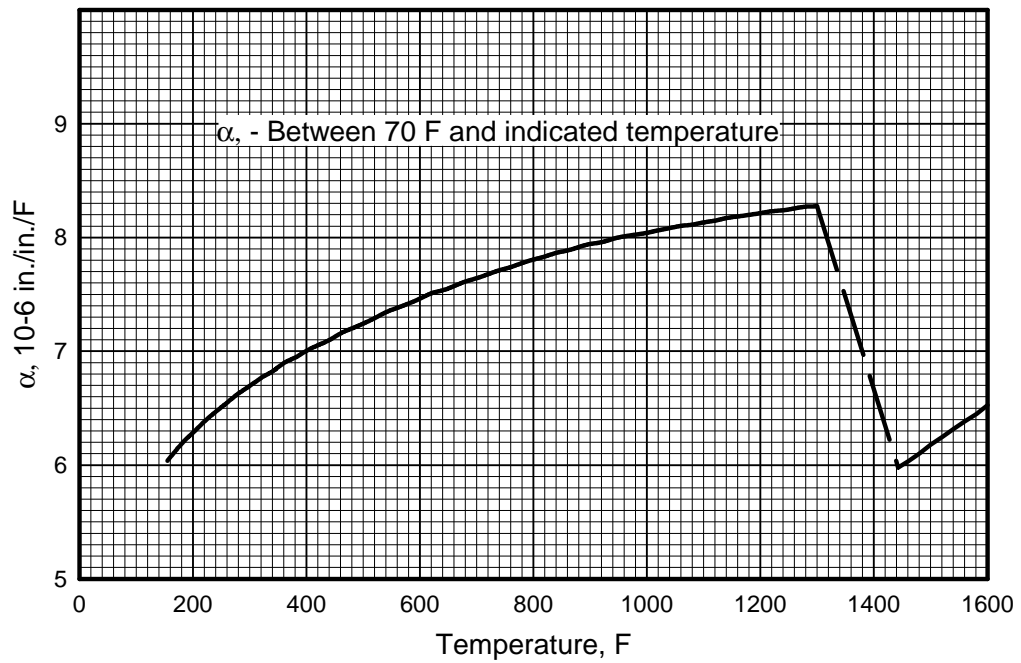

Figure 2.2.1.0. Effect of temperature on the thermal expansion of 1025 steel.

2.3 LOW-ALLOY STEELS (AISI GRADES AND PROPRIETARY GRADES)

2.3.0 COMMENTS ON LOW-ALLOY STEELS (AISI AND PROPRIETARY GRADES)

2.3.0.1 Metallurgical Considerations — The AISI or SAE alloy steels contain, in addition to carbon, up to about 1 percent (up to 0.5 percent for most airframe applications) additions of various alloying elements to improve their strength, depth of hardening, toughness, or other properties of interest. Generally, alloy steels have better strength-to-weight ratios than carbon steels and are somewhat higher in cost on a weight, but not necessarily strength, basis. Their applications in airframes include landing-gear components, shafts, gears, and other parts requiring high strength, through hardening, or toughness.

Some alloy steels are identified by the AISI four-digit system of numbers. The first two digits indicate the alloy group and the last two the approximate carbon content in hundredths of a percent. The alloying elements used in these steels include manganese, silicon, nickel, chromium, molybdenum, vanadium, and boron. Other steels in this section are proprietary steels which may be modifications of the AISI grades. The alloying additions in these steels may provide deeper hardening, higher strength and toughness.

These steels are available in a variety of finish conditions, ranging from hot- or cold-rolled to quenched-and-tempered. They are generally heat treated before use to develop the desired properties. Some steels in this group are carburized, then heat treated to produce a combination of high surface hardness and good core toughness.

2.3.0.2 Manufacturing Conditions —

Forging — The alloy steels are only slightly more difficult to forge than carbon steels. However, maximum recommended forging temperatures are generally about 50°F lower than for carbon steels of the same carbon content. Slower heating rates, shorter soaking period, and slower cooling rates are also required for alloy steels.

Cold Forming — The alloy steels are usually formed in the annealed condition. Their formability depends mainly on the carbon content and is generally slightly poorer than for unalloyed steels of the same carbon content. Little cold forming is done on these steels in the heat-treated condition because of their high strength and limited ductility.

Machining — The alloy steels are generally harder than unalloyed steels of the same carbon content. As a consequence, the low-carbon alloy steels are somewhat easier to finish machine than their counterparts in the carbon steels. It is usually desirable to finish machine the carburizing and through-hardening grades in the final heat-treated condition for better dimensional accuracy. This often leads to two steps in machining: rough machining in the annealed or hot-finished condition, then finish machining after heat treating. The latter operation, because of the relatively high hardness of the material, necessitates the use of sharp, well-designed, high-speed steel cutting tools, proper feeds, speeds, and a generous supply of coolant. Medium- and high-carbon grades are usually spheroidized for optimum machinability and, after heat treatment, may be finished by grinding. Many of the alloy steels are available with added sulfur or lead for improved machinability. However, resulfurized and leaded steels are not recommended for highly stressed aircraft and missile parts, because of drastic reductions in transverse properties.

Welding — The low-carbon grades are readily welded or brazed by all techniques. Alloy welding rods comparable in strength to the base metal are used, and moderate preheating (200 to 600°F) is usually necessary. At higher carbon levels, higher preheating temperatures, and often postwelding stress relieving, are required. Certain alloy steels can be welded without loss of strength in the heat-affected zone provided that the welding heat input is carefully controlled. If the composition and strength level are such that the strength of the welded joint is reduced, the strength of the joint may be restored by heat treatment after welding.

Heat Treatment — For the low alloy steels, there are various heat treatment procedures that can be applied to a particular alloy to achieve any one of a number of specific mechanical (for example tensile) properties. Within this chapter, there are mechanical properties for three thermal processing conditions: annealed, normalized, and quenched and tempered. The specific details of these three thermal processing conditions are reviewed in Reference 2.3.0.2.5. In general, the annealed condition is achieved by heating to a suitable temperature and holding for a specified period of time. Annealing generally softens the material, producing the lowest mechanical properties. The normalized condition is achieved by holding to a slightly higher temperature than annealing, but for a shorter period of time. The purpose of normalizing varies depending on the desired properties; it can be used to increase or decrease mechanical properties. The quenched and tempered condition, discussed in more detail below, is used to produce the highest mechanical properties while providing relatively high toughness. The mechanical properties for these three processing conditions for specific steels are as shown in Tables 2.3.1.0(c), (f), and (g).

Maximum hardness in these steels is obtained in the as-quenched condition, but toughness and ductility in this condition are comparatively low. By means of tempering, their toughness is improved, usually accompanied by a decrease in strength and hardness. In general, tempering temperatures to achieve very high strength should be avoided when toughness is an important consideration.

In addition, these steels may be embrittled by tempering or by prolonged exposure under stress within the “blue brittle” range (approximately 500 to 700°F). Strength levels that necessitate tempering within this range should be avoided.

The mechanical properties presented in this chapter represent steels heat treated to produce a quenched structure containing 90 percent martensite at the center and tempered to the desired F_{tu} level. This degree of through hardening is necessary (regardless of strength level) to insure the attainment of reasonably uniform mechanical properties throughout the cross section of the heat-treated part. The maximum diameter of round bars of various alloy steels capable of being through hardened consistently are given in Table 2.3.0.2. Limiting dimensions for common shapes other than round are determined by means of the “equivalent round” concept in Figure 2.3.0.2. This concept is essentially a correlation between the significant dimensions of a particular shape and the diameter of a round bar, assuming in each instance that the material, heat treatment, and the mechanical properties at the centers of both the respective shape and the equivalent round are substantially the same.

For the quenched and tempered condition, a large range of mechanical property values can be achieved as indicated in Table 2.3.0.2. Various quench media (rates), tempering temperatures, and times can be employed allowing any number of processing routes to achieve these values. As a result of these processing routes, there are a large range of mechanical properties that can be obtained for a specific alloy. Therefore, the properties of a steel can be tailored to meet the needs for a specific component/application.

Because of the potential for several different processing methods for these three conditions, the MIL, Federal, and AMS specifications do not always contain minimum mechanical property values (S-basis). They may contain minimum mechanical property values for one specific quenched and tempered condition. Those specifications cited in this Handbook that do not contain mechanical properties are identified with a footnote in Tables 2.3.1.0(a) and (b). The possible mechanical properties for these alloys covered in the specifications for the normalized, and quenched and tempered conditions in Table 2.3.0.2 are presented in Tables 2.3.1.0 (g₁) and (g₂). Users must rely on their own in-house specifications or appropriate industry specifications to validate that the required strength was achieved. Therefore, no statistical basis (A, B, S) for these values are indicated in Tables 2.3.1.0 (g₁) and (g₂).

Table 2.3.0.2. Maximum Round Diameters for Low-Alloy Steel Bars (Through Hardening to at Least 90 Percent Martensite at Center)

F_{mz} , ksi	Maximum Diameter of Round or Equivalent Round, in. ^a						
	0.5	0.8	1.0	1.7	2.5	3.5	5.0
270 & 280	300M ^c
260	AISI 4340 ^b	AISI 4340 ^c	AISI 4340 ^d	...
220	AMS Grades ^{b,e}	AMS Grades ^{c,e}	D6AC ^b	D6AC ^c
200	...	AISI 8740	AISI 4140	AISI 4340 ^b AMS Grades ^{b,e}	AISI 4340 ^c AMS Grades ^{c,e}	AISI 4340 ^d	D6AC ^c
≤180	AISI 4130 and 8630	AISI 8735 4135 and 8740	AISI 4140	AISI 4340 ^b AMS Grades ^{b,e}	AISI 4340 ^c AMS Grades ^{c,e}	AISI 4340 ^d D6AC ^b	D6AC ^c



a This table indicates the maximum diameters to which these steels may be through hardened consistently by quenching as indicated. Any steels in this table may be used at diameters less than those indicated. The use of steels at diameters greater than those indicated should be based on hardenability data for specific heats of steel.

b Quenched in molten salt at desired tempering temperature (“martempering”).

c Quenched in oil at a flow rate of 200 feet per minute.

d Quenched in water at a flow rate of 200 feet per minute.

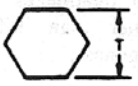
e 4330V, 4335V, and Hy-Tuf.

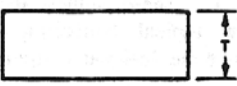
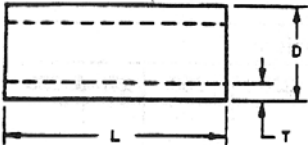
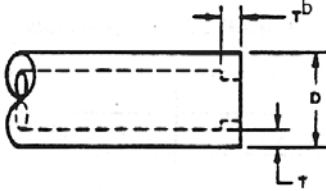
SOLIDS, LENGTH L			
ROUND	HEXAGON	SQUARE	RECTANGULAR OR PLATE
			
ER ^a = T	ER = 1.1 T	ER = 1.25 T	ER = 1.5 T
WHEN L IS LESS THAN T, CONSIDER SECTION AS A PLATE OF L THICKNESS			
TUBE (ANY SECTION)		RESTRICTED OR CLOSED AT ONE OR BOTH ENDS	
 ER = 2 T NOTE: WHEN L IS LESS THAN D, CONSIDER AS A PLATE OF T THICKNESS. WHEN L IS LESS THAN T, CONSIDER SECTION AS A PLATE OF L THICKNESS.		 ER = 2.5 T WHEN D IS LESS THAN 2.5 INCHES. ER = 3.5 T WHEN D IS GREATER THAN 2.5 INCHES.	

^aER = equivalent round. (Illustration after MIL-H-6875.)

^bUse maximum thickness for calculation.

Figure 2.3.0.2. Correlation between significant dimensions of common shapes other than round, and the diameters of round bars.

2.3.0.3 Environmental Considerations — Alloy steels containing chromium or high percentages of silicon have somewhat better oxidation resistance than the carbon or other alloy steels. Elevated-temperature strength for the alloy steels is also higher than that of corresponding carbon steels. The mechanical properties of all alloy steels in the heat-treated condition are affected by extended exposure to temperatures near or above the temperature at which they were tempered. The limiting temperatures to which each alloy may be exposed for no longer than approximately 1 hour per inch of thickness or approximately one-half hour for thicknesses under one-half inch without a reduction in strength occurring are listed in Table 2.3.0.3. These values are approximately 100°F below typical tempering temperatures used to achieve the designated strength levels.

Table 2.3.0.3. Temperature Exposure Limits for Low-Alloy Steels

F_{tu} , ksi	Exposure Limit, °F						
	125	150	180	200	220	260	270 & 280
Alloy:							
AISI 4130 and 8630	925	775	575
AISI 4140 and 8740	1025	875	725	625
AISI 4340	1100	950	800	700	...	350	...
AISI 4135 and 8735	975	825	675
D6AC	1150	1075	1000	950	900	500	...
Hy-Tuf	875	750	650	550	450
4330V	925	850	775	700	500
4335V	975	875	775	700	500
300M	475

a Quenched and tempered to F_{tu} indicated. If the material is exposed to temperatures exceeding those listed, a reduction in strength is likely to occur.

Low-alloy steels may undergo a transition from ductile to brittle behavior at low temperatures. This transition temperature varies widely for different alloys. Caution should be exercised in the application of low-alloy steels at temperatures below -100°F. For use at a temperature below -100°F, an alloy with a transition temperature below the service temperature should be selected. For low temperatures, the steel should be heat treated to a tempered martensitic condition for maximum toughness.

Heat-treated alloy steels have better notch toughness than carbon steels at equivalent strength levels. The decrease in notch toughness is less pronounced and occurs at lower temperatures. Heat-treated alloy steels may be useful for subzero applications, depending on their alloy content and heat treatment. Heat treating to strength levels higher than 150 ksi F_{ty} may decrease notch toughness.

The corrosion properties of the AISI alloy steels are comparable to the plain carbon steels.

2.3.1 SPECIFIC ALLOYS

2.3.1.0 Comments and Properties — AISI 4130 is a chromium-molybdenum steel that is in general use due to its well-established heat-treating practices and processing techniques. It is available in all sizes of sheet, plate, and tubing. Bar stock of this material is also used for small forgings under one-half inch in thickness. AISI 4135, a slightly higher carbon version of AISI 4130, is available in sheet, plate, and tubing.

AISI 4140 is a chromium-molybdenum steel that can be heat treated in thicker sections and to higher strength levels than AISI 4130. This steel is generally used for structural machined and forged parts one-half inch and over in thickness. It can be welded but it is more difficult to weld than the lower carbon grade AISI 4130.

AISI 4340 is a nickel-chromium-molybdenum steel that can be heat treated in thicker sections and to higher strength levels than AISI 4140.

AISI 8630, 8735, and 8740 are nickel-chromium-molybdenum steels that are considered alternates to AISI 4130, 4135, and 4140, respectively.

There are a number of steels available with compositions that represent modifications to the AISI grades described above. Four of the steels that have been used rather extensively at $F_{tu} = 220$ ksi are D6AC, Hy-Tuf, 4330V, and 4335V. It should be noted that this strength level is not used for AISI 4340 due to embrittlement encountered during tempering in the range of 500 to 700°F. In addition, AISI 4340 and 300M are utilized at strength levels of $F_{tu} = 260$ ksi or higher. The alloys, AISI 4340, D6AC, 4330V, 4335V, and 300M, are available in the consumable electrode melted grade. Material specifications for these steels are presented in Tables 2.3.1.0(a) and (b).

The room-temperature mechanical and physical properties for these steels are presented in Tables 2.3.1.0(c) through 2.3.1.0(g). Mechanical properties for heat-treated materials are valid only for steel heat treated to produce a quenched structure containing 90 percent or more martensite at the center. Figure 2.3.1.0 contains elevated temperature curves for the physical properties of AISI 4130 and AISI 4340 steels.

2.3.1.1 AISI Low-Alloy Steels — Elevated temperature curves for heat-treated AISI low-alloy steels are presented in Figures 2.3.1.1.1 through 2.3.1.1.4. These curves are considered valid for each of these steels in each heat-treated condition but only up to the maximum temperatures listed in Table 2.3.0.1(b).

2.3.1.2 AISI 4130 and 8630 Steels — Typical stress-strain and tangent-modulus curves for AISI 8630 are shown in Figures 2.3.1.2.6(a) through (c). Best-fit S/N curves for AISI 4130 steel are presented in Figures 2.3.1.2.8(a) through (h).

2.3.1.3 AISI 4340 Steel — Typical stress-strain and tangent-modulus curves for AISI 4340 are shown in Figures 2.3.1.3.6(a) through (c). Typical biaxial stress-strain curves and yield-stress envelopes for AISI 4340 alloy steel are presented in Figures 2.3.1.3.6(d) through (g). Best-fit S/N curves for AISI 4340 are presented in Figures 2.3.1.3.8(a) through (o).

2.3.1.4 300M Steel — Best-fit S/N curves for 300M steel are presented in Figures 2.3.1.4.8(a) through (d). Fatigue-crack-propagation data for 300M are shown in Figure 2.3.1.4.9.

2.3.1.5 D6AC Steel — Fatigue-crack-propagation data for D6AC steel are presented in Figure 2.3.1.5.9.

MIL-HDBK-5J
31 January 2003

Table 2.3.1.0(a). Material Specifications for Air Melted Low-Alloy Steels

Alloy	Form		
	Sheet, strip, and plate	Bars and forgings	Tubing
4130	AMS-S-18729, AMS 6350 ^a , AMS 6351 ^a	AMS-S-6758 ^a , AMS 6348 ^a , AMS 6370 ^a , AMS 6528 ^a	AMS-T-6736, AMS 6371 ^a , AMS 6360, AMS 6361, AMS 6362, AMS 6373, AMS 6374
8630	AMS-S-18728 ^b , AMS 6350 ^a	AMS-S-6050, AMS 6280 ^a	AMS 6281 ^a
4135	AMS 6352 ^a	...	AMS 6372 ^a , AMS 6365, AMS-T-6735 ^b
8735	AMS 6357 ^a	AMS 6320 ^a	AMS 6282 ^a
4140	AMS 6395 ^a	AMS-S-5626 ^a , AMS 6382 ^a , AMS 6349 ^a , AMS 6529 ^a	AMS 6381 ^a
4340	AMS 6359 ^a	AMS-S-5000 ^a , AMS 6415 ^a	AMS 6415 ^a
8740	AMS 6358 ^a	AMS-S-6049 ^b , AMS 6327, AMS 6322 ^a	AMS 6323 ^a
4330V	...	AMS 6427 ^a	AMS 6427 ^a
4335V	AMS 6433	AMS 6430	AMS 6430

a Specification does not contain minimum mechanical properties.

b Noncurrent specification.

Table 2.3.1.0(b). Material Specifications for Consumable Electrode Melted Low-Alloy Steels

Alloy	Form		
	Sheet, strip, and plate	Bar and forgings	Tubing
4340	AMS 6454 ^a	AMS 6414	AMS 6414
D6AC	AMS 6439	AMS 6431, AMS 6439	AMS 6431
4330V	...	AMS 6411	AMS 6411
Hy-Tuf	...	AMS 6425	AMS 6425
4335V	AMS 6435	AMS 6429	AMS 6429
300M (0.40C)	...	AMS 6417	AMS 6417
300M (0.42C)	...	AMS 6419, AMS 6257	AMS 6419, AMS 6257

a Specification does not contain minimum mechanical properties.

Table 2.3.1.0(c₁). Design Mechanical and Physical Properties of Air Melted Low-Alloy Steels

Alloy	AISI 4130		AISI 4135		AISI 8630	
Specification [see Tables 2.3.1.0(a) and (b)]	AMS 6360 AMS 6373 AMS 6374 AMS-T-6736 AMS-S-18729		AMS 6365 AMS-T-6735 ^a		AMS-S-18728 ^a	
Form	Sheet, strip, plate, and tubing		Tubing		Sheet, strip, and plate	
Condition	Normalized and tempered, stress relieved ^b					
Thickness or diameter, in. ...	≤0.188	>0.188	≤0.188	≤0.188	≤0.188	≤0.188
Basis	S	S	S	S	S	S
Mechanical Properties:						
F_{tu} , ksi	95	90	100	95	95	90
F_{ty} , ksi	75	70	85	80	75	70
F_{cy} , ksi	75	70	89	84	75	70
F_{su} , ksi	57	54	60	57	57	54
F_{bru} , ksi:						
(e/D = 1.5)
(e/D = 2.0)	200	190	190	180	200	190
F_{bry} , ksi:						
(e/D = 1.5)
(e/D = 2.0)	129	120	146	137	129	120
e , percent	See Table 2.3.1.0(d)					
E , 10 ³ ksi	29.0					
E_c , 10 ³ ksi	29.0					
G , 10 ³ ksi	11.0					
μ	0.32					
Physical Properties:						
ω , lb/in. ³	0.283					
C , K , and α	See Figure 2.3.1.0					

a Noncurrent specification.

b Design values are applicable only to parts for which the indicated F_{tu} has been substantiated by adequate quality control testing.

Table 2.3.1.0(c₂). Design Mechanical and Physical Properties of Air Melted Low-Alloy Steels

Alloy	AISI 4130		
Specification [see Tables 2.3.1.0(a) and (b)]	AMS 6361 AMS-T-6736	AMS 6362 AMS-T-6736	AMS-T-6736
Form	Tubing		
Condition	Quenched and tempered ^a		
Thickness or diameter, in.	≤0.188	≤0.188	All Walls
Basis	S	S	S
Mechanical Properties:			
F_{tu} , ksi	125	150	180
$F_{0.2}$, ksi	100	135	165
F_{cy} , ksi	109	141	173
F_{su} , ksi	75	90	108
F_{bru} , ksi:			
(e/D = 1.5)	194	231	277
(e/D = 2.0)	251	285	342
F_{brv} , ksi:			
(e/D = 1.5)	146	210	257
(e/D = 2.0)	175	232	284
e , percent	See Table 2.3.1.0(e)		
E , 10 ³ ksi	29.0		
E_c , 10 ³ ksi	29.0		
G , 10 ³ ksi	11.0		
μ	0.32		
Physical Properties:			
ω , lb/in. ³	0.283		
C , K , and α	See Figure 2.3.1.0		

^a Design values are applicable only to parts for which the indicated F_m has been substantiated by adequate quality control testing.

Table 2.3.1.0(c₃). Design Mechanical and Physical Properties of Air Melted Low-Alloy Steels

Alloy	AISI 8630		AISI 8740	
	AMS-S-6050	AMS-S-6049 ^a	AMS 6327	
Form	Bars and forgings			
Condition	Quenched and tempered ^b			
Thickness or diameter, in. ...	≤1.500	≤1.750		
Basis	S	S		
Mechanical Properties:				
F_{tu} , ksi	125	125	125	
F_{ty} , ksi	100	103	100	
F_{cy} , ksi	109	108	109	
F_{su} , ksi	75	75	75	
F_{bru} , ksi:				
(e/D = 1.5)	194	192	194	
(e/D = 2.0)	251	237	251	
F_{bry} , ksi:				
(e/D = 1.5)	146	160	146	
(e/D = 2.0)	175	177	175	
e , percent	See Table 2.3.1.0(e)			
E , 10 ³ ksi	29.0			
E_c , 10 ³ ksi	29.0			
G , 10 ³ ksi	11.0			
μ	0.32			
Physical Properties:				
ω , lb/in. ³	0.283			
C , K , and α	See Figure 2.3.1.0			

a Noncurrent specification

b Design values are applicable only to parts for which the indicated F_{tu} has been substantiated by adequate quality control testing.

Table 2.3.1.0(c₄). Design Mechanical and Physical Properties of Air Melted Low-Alloy Steels

Alloy	AISI 4135			
Specification [see Tables 2.3.1.0(a) and (b)]	AMS-T-6735			
Form	Tubing			
Condition	Quenched and tempered ^a			
Wall thickness, in.	≤0.8			< 0.5 ^b
Basis	S	S	S	S
Mechanical Properties:				
F_{tu} , ksi	125	150	180	200
F_{ty} , ksi	100	135	165	165
F_{cy} , ksi	109	141	173	181
F_{su} , ksi	75	90	108	120
F_{bru} , ksi:				
(e/D = 1.5)	194	231	277	308
(e/D = 2.0)	251	285	342	380
F_{bry} , ksi:				
(e/D = 1.5)	146	210	257	274
(e/D = 2.0)	175	232	284	302
e , percent	See Table 2.3.1.0(e)			
E , 10 ³ ksi	29.0			
E_c , 10 ³ ksi	29.0			
G , 10 ³ ksi	11.0			
μ	0.32			
Physical Properties:				
ω , lb/in. ³	0.283			
C , K , and α	See Figure 2.3.1.0			

a Design values are applicable only to parts for which the indicated F_{tu} and through hardening has been substantiated by adequate quality control testing.

b Wall thickness at which through hardening is achieved and verified through quality control testing.

b The S-basis value in MIL-T-6735 is 165 ksi.

Table 2.3.1.0(d). Minimum Elongation Values for Low-Alloy Steels in Condition N

Form	Thickness, in.	Elongation, percent	
		Full tube	Strip
Sheet, strip, and plate (T)	Less than 0.062	--	8
	Over 0.062 to 0.125 incl.	--	10
	Over 0.125 to 0.187 incl.	--	12
	Over 0.187 to 0.249 incl.	--	15
	Over 0.249 to 0.749 incl.	--	16
	Over 0.749 to 1.500 incl.	--	18
Tubing (L)	Up to 0.035 incl. (wall)	10	5
	Over 0.035 to 0.188 incl.	12	7
	Over 0.188	15	10

Table 2.3.1.0(e). Minimum Elongation Values for Heat-Treated Low-Alloy Steels

F _m , ksi	Round specimens (L)		Elongation in 2 in., percent				
			Sheet specimens			Tubing (L)	
	Elongation in 4D, percent	Reduction of area, percent	Less than 0.032 in. thick	0.032 to 0.060 in. thick	Over 0.060 in. thick	Full tube	Strip
125	17	55	5	7	10	12	7
140	15	53	4	6	9	10	6
150	14	52	4	6	9	10	6
160	13	50	3	5	8	9	6
180	12	47	3	5	7	8	5
200	10	43	3	4	6	6	5

MIL-HDBK-5J
31 January 2003

Table 2.3.1.0(f). Design Mechanical and Physical Properties of Low-Alloy Steels

Alloy	Hy-Tuf	4330V	4335V	4335V	D6AC	AISI 4340 ^a	0.40C 300M	0.42C 300M
Specification	AMS 6425	AMS 6411	AMS 6430	AMS 6429	AMS 6431	AMS 6414	AMS 6417	AMS 6257 AMS 6419
Form	Bar, forging, tubing							
Condition	Quenched and tempered ^b							
Thickness or diameter, in.	c				d	e	f	
Basis	S	S	S	S	S	S	S	S
Mechanical Properties:								
F_{tu} , ksi	220	220	205	240	220	260	270	280
F_{ty} , ksi	185	185	190	210	190	217	220	230
F_{cy} , ksi	193	193	199	220	198	235	236	247
F_{su} , ksi	132	132	123	144	132	156	162	168
F_{bru} , ksi:								
(e/D = 1.5)	297	297	315	369	297	347	414 ^g	430 ^g
(e/D = 2.0)	385	385	389	465	385	440	506 ^g	525 ^g
F_{bry} , ksi:								
(e/D = 1.5)	267	267	296	327	274	312	344 ^c	360 ^c
(e/D = 2.0)	294	294	327	361	302	346	379 ^c	396 ^c
e, percent:								
L	10	10	10	10	12	10	8	7
LT	5 ^a	5 ^a	7	7	9
E , 10 ³ ksi	29.0							
E_c , 10 ³ ksi	29.0							
G , 10 ³ ksi	11.0							
μ	0.32							
Physical Properties:								
ω , lb/in. ³	0.283							
C , K , and α	See Figure 2.3.1.0							

- a Applicable to consumable-electrode vacuum-melted material only.
- b Design values are applicable only to parts for which the indicated F_{tu} has been substantiated by adequate quality control testing.
- c Thickness \leq 1.70 in. for quenching in molten salt at desired tempering temperature (martempering); \leq 2.50 in. for quenching in oil at flow rate of 200 feet/min.
- d Thickness \leq 3.50 in. for quenching in molten salt at desired tempering temperature (martempering); \leq 5.00 in. for quenching in oil at flow rate of 200 feet/min.
- e Thickness \leq 1.70 in. for quenching in molten salt at desired tempering temperature (martempering); \leq 2.50 in. for quenching in oil at flow rate of 200 feet/min.; \leq 3.50 in. for quenching in water at a flow rate of 200 feet/min.
- f Thickness \leq 5.00 in. for quenching in oil at a flow rate of 200 feet/min.
- g Bearing values are "dry pin" values per Section 1.4.7.1.

Table 2.3.1.0(f). Design Mechanical and Physical Properties of Low-Alloy Steels

Alloy	4335V	D6AC	
Specification	AMS 6435	AMS 6439	
Form	Sheet, strip, and plate		
Condition	Quenched and tempered ^a		
Thickness or diameter, in.	b	≤0.250	≥0.251
Basis	S	S	S
Mechanical Properties:			
F_{tu} , ksi	220	215	224
F_{ty} , ksi	190	190	195
F_{cy} , ksi	198	198	203
F_{su} , ksi	132	129	134
F_{bru} , ksi: ^c			
(e/D = 1.5)	297	290	302
(e/D = 2.0)	385	376	392
F_{bry} , ksi: ^c			
(e/D = 1.5)	274	274	281
(e/D = 2.0)	302	302	310
<i>e</i> , percent:			
L	10
LT	7	7	7
E , 10 ³ ksi	29.0		
E_c , 10 ³ ksi	29.0		
G , 10 ³ ksi	11.0		
μ	0.32		
Physical Properties:			
ω , lb/in. ³	0.283		
C , K , and α	See Figure 2.3.1.0		

- a Design values are applicable only to parts for which the indicated F_{tu} has been substantiated by adequate quality control testing.
- b Thickness ≤1.70 in. for quenching in molten salt at desired tempering temperature (martempering); ≤2.50 in. for quenching in oil at a flow rate of 200 feet/min.
- c Bearing values are “dry pin” values per Section 1.4.7.1.

Table 2.3.1.0(g₁). Design Mechanical and Physical Properties of Low-Alloy Steels

Alloy	AISI 4130		AISI 4135		AISI 8630		AISI 8735	
Specification [see Tables 2.3.1.0(a) and (b)]	AMS 6350 AMS 6528 AMS-S-6758		AMS 6352 AMS 6372		AMS 6281		AMS 6357	
Form	Sheet, strip, plate, bars, and forgings		Sheet, strip, plate, and tubing		Tubing		Sheet, strip, and plate	
Condition	Normalized and tempered, stress relieved ^a							
Thickness or diameter, in. ...	≤0.188	>0.188	≤0.188	>0.188	≤0.188	>0.188	≤0.188	>0.188
Basis	b							
Mechanical Properties:								
F_{tu} , ksi	95	90	95	90	95	90	95	90
F_{ty} , ksi	75	70	75	70	75	70	75	70
F_{cy} , ksi	75	70	75	70	75	70	75	70
F_{su} , ksi	57	54	57	54	57	54	57	54
F_{bru} , ksi:								
(e/D = 1.5)
(e/D = 2.0)	200	190	200	190	200	190	200	190
F_{bry} , ksi:								
(e/D = 1.5)
(e/D = 2.0)	129	120	129	120	129	120	129	120
e , percent	See Table 2.3.1.0(d)							
E , 10 ³ ksi	29.0							
E_c , 10 ³ ksi	29.0							
G , 10 ³ ksi	11.0							
μ	0.32							
Physical Properties:								
ω , lb/in. ³	0.283							
C , K , and α	See Figure 2.3.1.0							

- a Design values are applicable only to parts for which the indicated F_{tu} has been substantiated by adequate quality control testing.
- b There is no statistical basis (T_{99} or T_{90}) or specification basis (S) to support the mechanical property values in this table. See Heat Treatment in Section 2.3.0.2.

Table 2.3.1.0(g₂). Design Mechanical and Physical Properties of Low-Alloy Steels

Alloy	4330V	See steels listed in Table 2.3.0.2 for the applicable strength levels					
Specification	AMS 6427	See Tables 2.3.1.0(a) and (b)					
Form	All wrought forms						
Condition	Quenched and tempered ^a						
Thickness or diameter, in.	≤ 2.5	b				c	
Basis	d						
Mechanical Properties:							
F_{tu} , ksi	220	125	140	150	160	180	200
F_{ty} , ksi	185	100	120	132	142	163	176
F_{cy} , ksi	193	109	131	145	154	173	181
F_{su} , ksi	132	75	84	90	96	108	120
F_{bru} , ksi:							
(e/D = 1.5)	297	209	209	219	230	250	272
(e/D = 2.0)	385	251	273	287	300	326	355
F_{bry} , ksi:							
(e/D = 1.5)	267	146	173	189	202	230	255
(e/D = 2.0)	294	175	203	218	231	256	280
e , percent:	10	See Table 2.3.1.0(e)					
L	5 ^a						
LT							
E , 10 ³ ksi				29.0			
E_c , 10 ³ ksi				29.0			
G , 10 ³ ksi				11.0			
μ				0.32			
Physical Properties:							
ω , lb/in. ³				0.283			
C , K , and α				See Figure 2.3.1.0			

- a Design values are applicable only to parts for which the indicated F_{tu} has been substantiated by adequate quality control testing.
- b For $F_{tu} \leq 180$ ksi, thickness ≤ 0.50 in. for AISI 4130 and 8630; ≤ 0.80 in. for AISI 8735, 4135, and 8740; ≤ 1.00 in. for AISI 4140; ≤ 1.70 in. for AISI 4340, 4330V, 4335V, and Hy-Tuf [Quenched in molten salt at desired tempering temperature (martempering)]; ≤ 2.50 in. for AISI 4340, 4330V, 4335V, and Hy-Tuf (Quenched in oil at a flow rate of 200 feet/min.); ≤ 3.50 in. for AISI 4340 (Quenched in water at a flow rate of 200 feet/min.); ≤ 5.00 in. for D6AC (Quenched in oil at a flow rate of 200 feet/min.)
- c For $F_{tu} = 200$ ksi AISI 4130, 8630, 4135, 8740 not available; thickness ≤ 0.80 in. for AISI 8740; ≤ 1.00 in. for AISI 4140; ≤ 1.70 in. for AISI 4340, 4330V, 4335V, and Hy-Tuf [Quenched in molten salt at desired tempering temperature (martempering)]; ≤ 2.50 in. for AISI 4340, 4330V, 4335V, and Hy-Tuf (Quenched in oil at a flow rate of 200 feet/min.); ≤ 3.50 in. for AISI 4340 (Quenched in water at a flow rate of 200 feet/min.); ≤ 5.00 in. for D6AC (Quenched in oil at a flow rate of 200 feet/min.)
- d There is no statistical basis (T_{99} or T_{90}) or specification basis (S) to support the mechanical property values in this table. See Heat Treatment in Section 2.3.0.2.

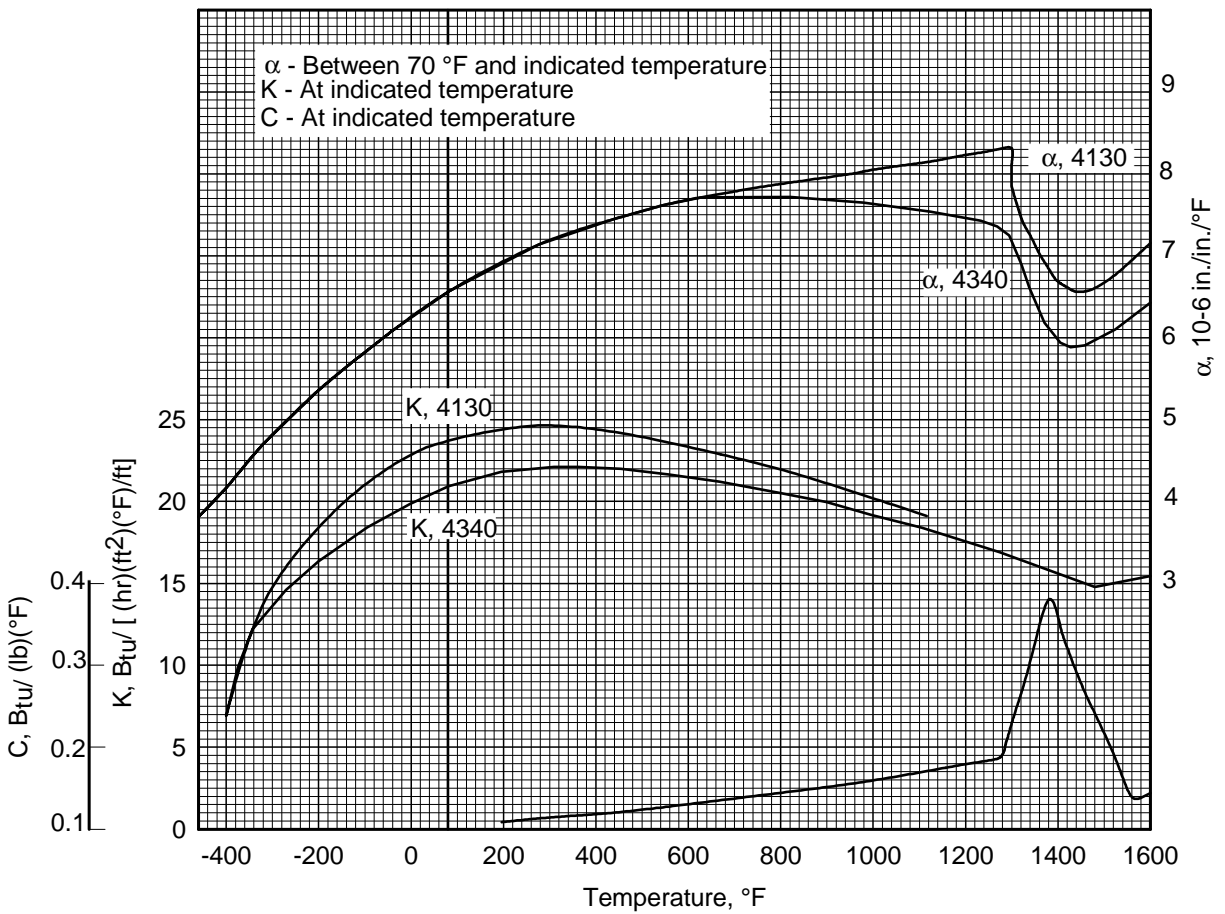

Figure 2.3.1.0. Effect of temperature on the physical properties of 4130 and 4340 alloy steels.

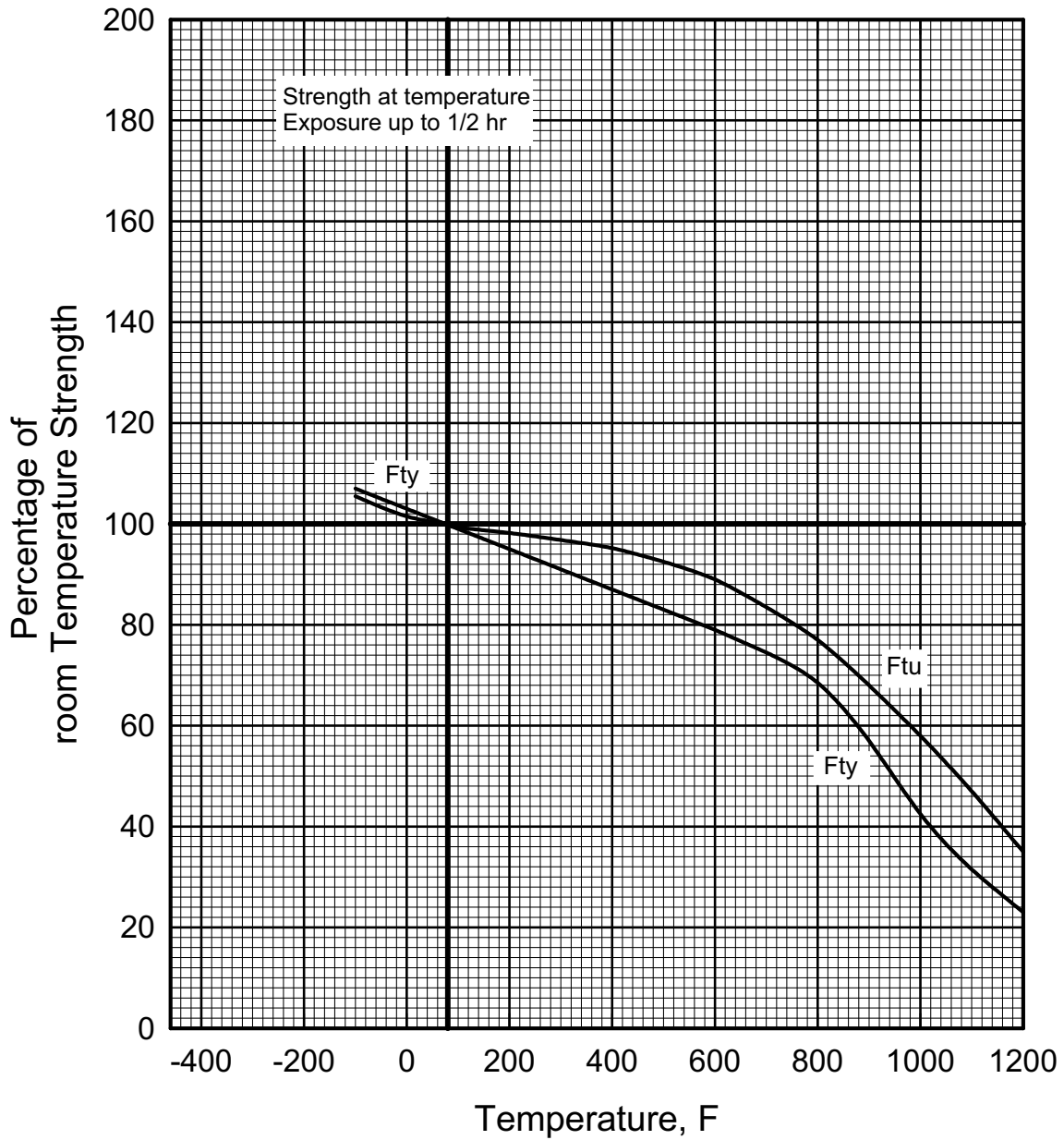

Figure 2.3.1.1.1. Effect of temperature on the tensile ultimate strength (F_{tu}) and tensile yield strength (F_{ty}) of AISI low-alloy steels (all products).

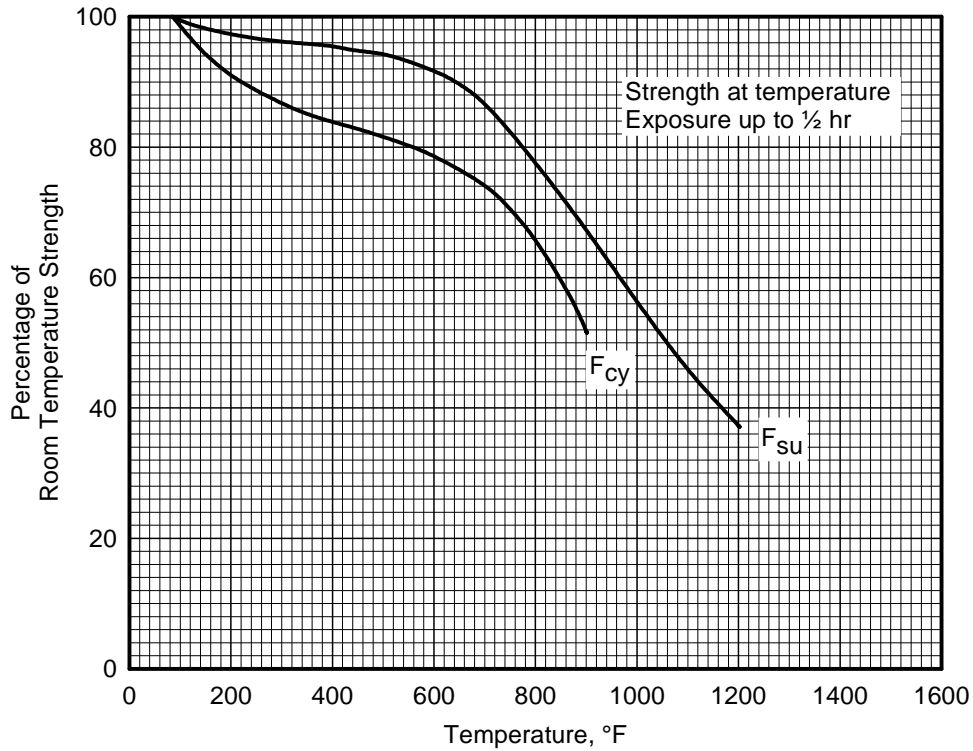

Figure 2.3.1.1.2. Effect of temperature on the compressive yield strength (F_{cy}) and the shear ultimate strength (F_{su}) of heat-treated AISI low-alloy steels (all products).

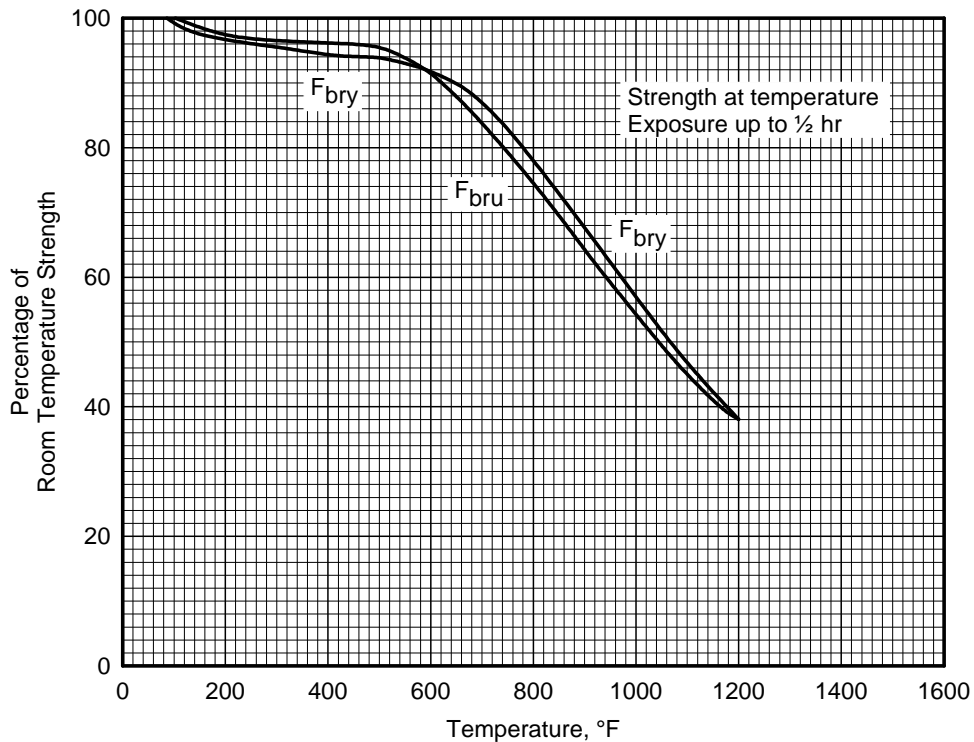

Figure 2.3.1.1.3. Effect of temperature on the bearing ultimate strength (F_{bru}) and the bearing yield strength (F_{bry}) of heat-treated AISI low-alloy steels (all products).

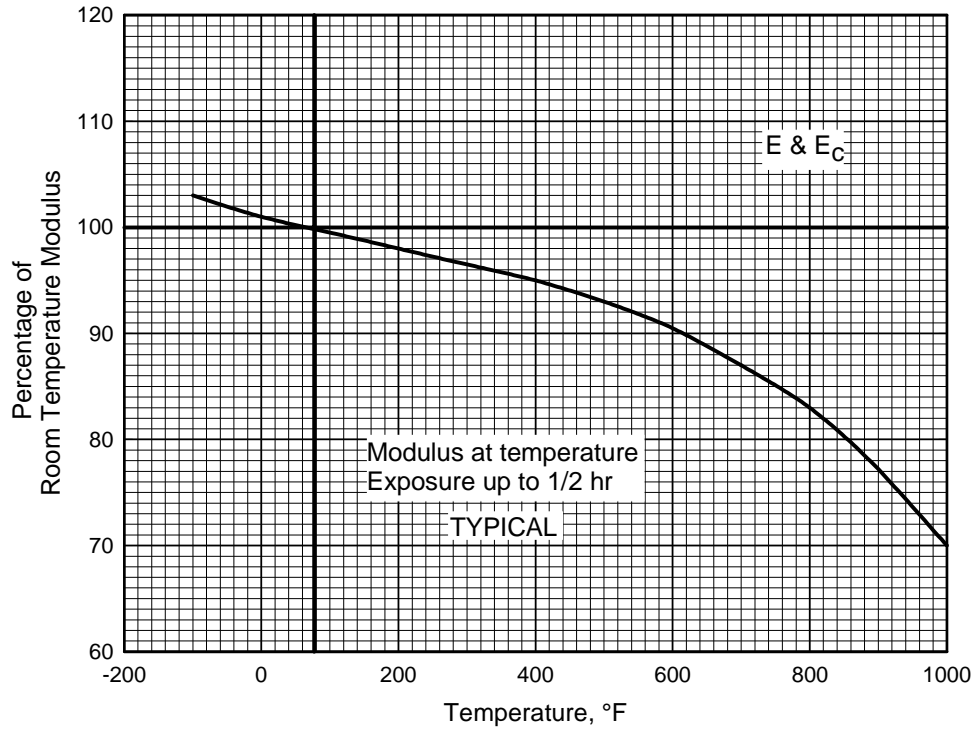

Figure 2.3.1.1.4. Effect of temperature on the tensile and compressive modulus (E and E_c) of AISI low-alloy steels.

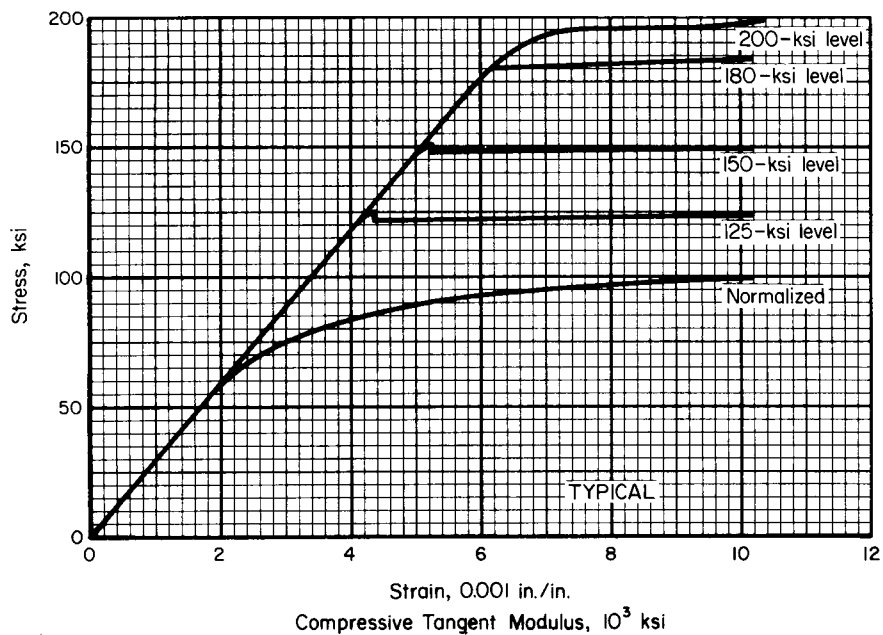

Figure 2.3.1.2.6(a). Typical tensile stress-strain curves at room temperature for heat-treated AISI 8630 alloy steel (all products).

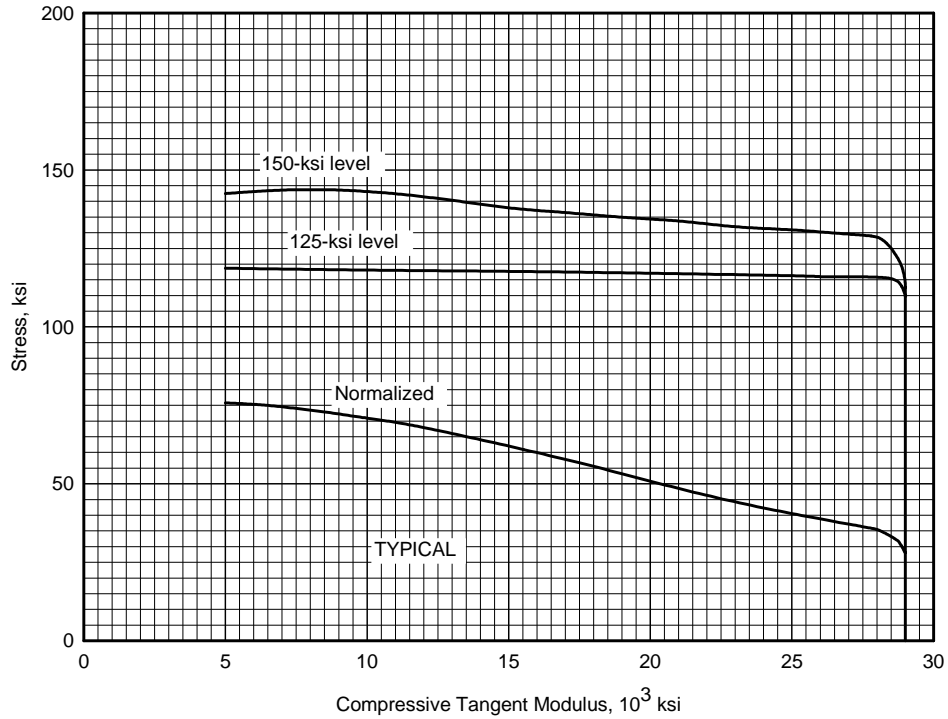

Figure 2.3.1.2.6(b). Typical compressive tangent-modulus curves at room temperature for heat-treated AISI 8630 alloy steel (all products).

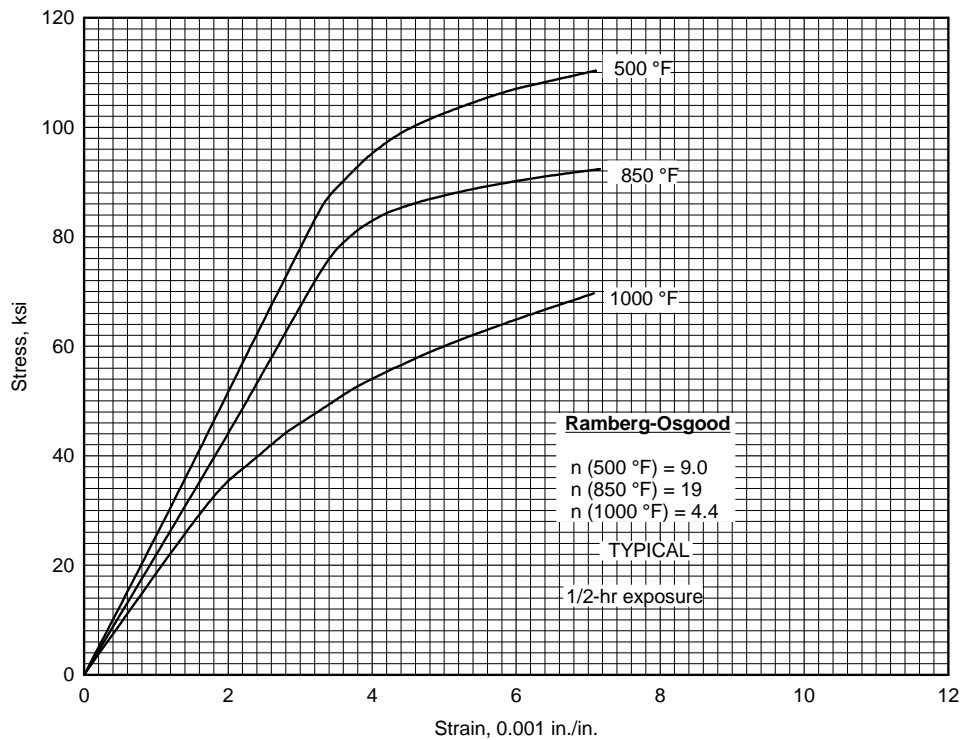

Figure 2.3.1.2.6(c). Typical tensile stress-strain curves at elevated temperatures for heat-treated AISI 8630 alloy steel, $F_u = 125$ ksi (all products).

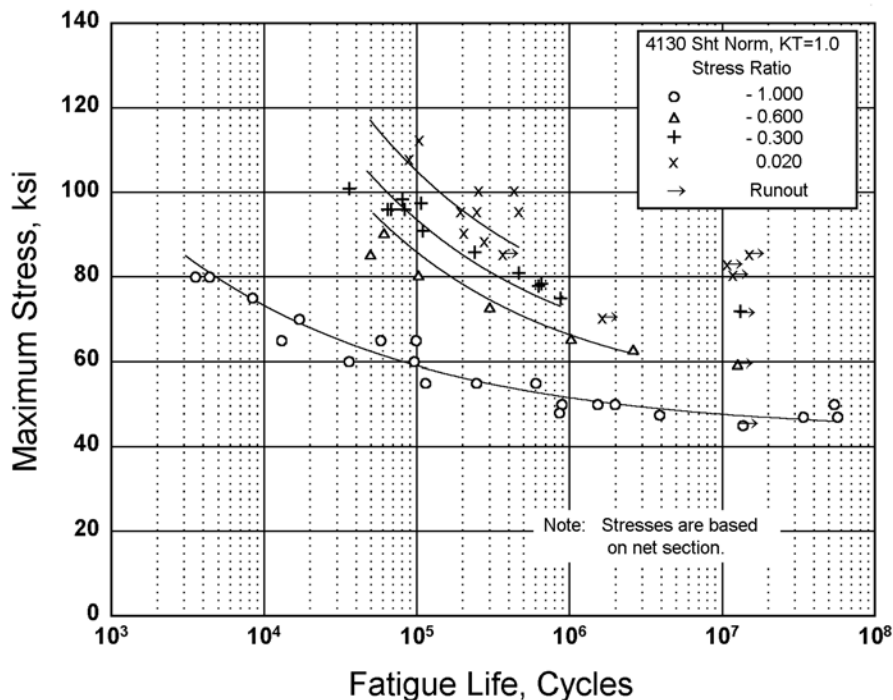

Figure 2.3.1.2.8(a). Best-fit S/N curves for unnotched 4130 alloy steel sheet, normalized, longitudinal direction.

Correlative Information for Figure 2.3.1.2.8(a)

Product Form: Sheet, 0.075 inch thick
Properties: TUS, ksi TYS, ksi Temp., °F
117 99 RT

Test Parameters:
Loading - Axial
Frequency - 1100-1800 cpm
Temperature - RT
Environment - Air

Specimen Details: Unnotched
2.88-3.00 inches gross width
0.80-1.00 inch net width
12.0 inch net section radius

No. of Heats/Lots: Not specified

Equivalent Stress Equations:

Surface Condition: Electropolished

For stress ratios of -0.60 to +0.02
 $\text{Log } N_f = 9.65 - 2.85 \log (S_{eq} - 61.3)$
 $S_{eq} = S_{max} (1-R)^{0.41}$
Std. Error of Estimate, $\text{Log (Life)} = 0.21$
Standard Deviation, $\text{Log (Life)} = 0.45$
 $R^2 = 78\%$

References: 3.2.3.1.8(a) and (f)

[Caution: The equivalent stress model may provide unrealistic life predictions for stress ratios beyond those represented above.]

Sample Size = 23

For a stress ratio of -1.0
 $\text{Log } N_f = 9.27 - 3.57 \log (S_{max} - 43.3)$

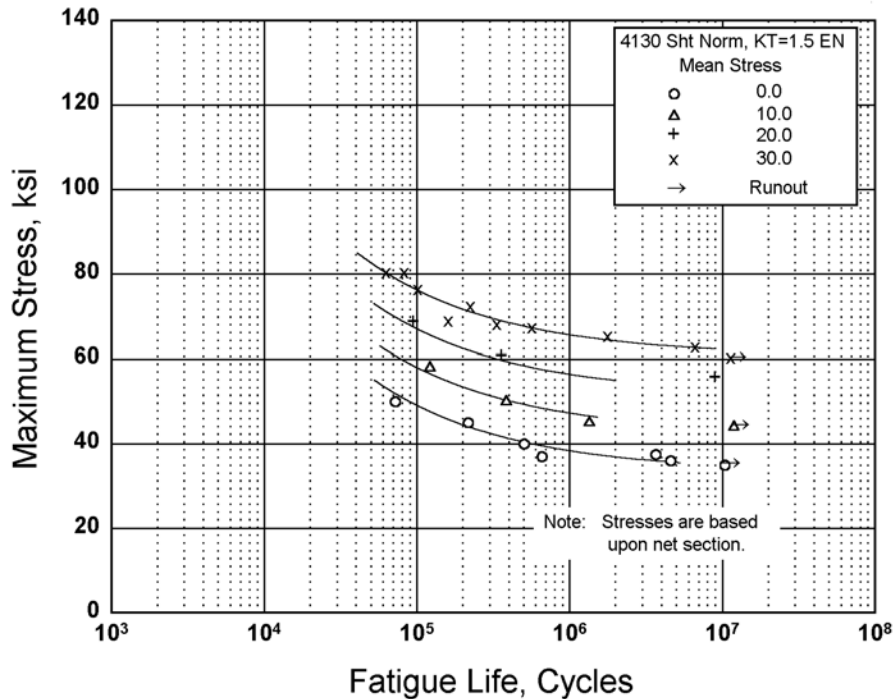

Figure 2.3.1.2.8(b). Best-fit S/N curves for notched, $K_t = 1.5$, 4130 alloy steel sheet, normalized, longitudinal direction.

Correlative Information for Figure 2.3.1.2.8(b)

Product Form: Sheet, 0.075 inch thick

Properties:

TUS, ksi	TYS, ksi	Temp., °F
117	99	RT (unnotched)
123	--	RT (notched) K_t 1.5

Test Parameters:
Loading - Axial
Frequency - 1100-1500 cpm
Temperature - RT
Environment - Air

No. of Heats/Lots: Not specified

Specimen Details: Edge Notched, $K_t = 1.5$
3.00 inches gross width
1.50 inches net width
0.76 inch notch radius

Equivalent Stress Equations:
 $\log N_f = 7.94 - 2.01 \log (S_{eq} - 61.3)$
 $S_{eq} = S_{max} (1-R)^{0.88}$
Std. Error of Estimate, $\log (\text{Life}) = 0.27$
Standard Deviation, $\log (\text{Life}) = 0.67$
 $R^2 = 84\%$

Surface Condition: Electropolished

Sample Size = 21

Reference: 3.2.3.1.8(d)

[Caution: The equivalent stress model may provide unrealistic life predictions for stress ratios beyond those represented above.]

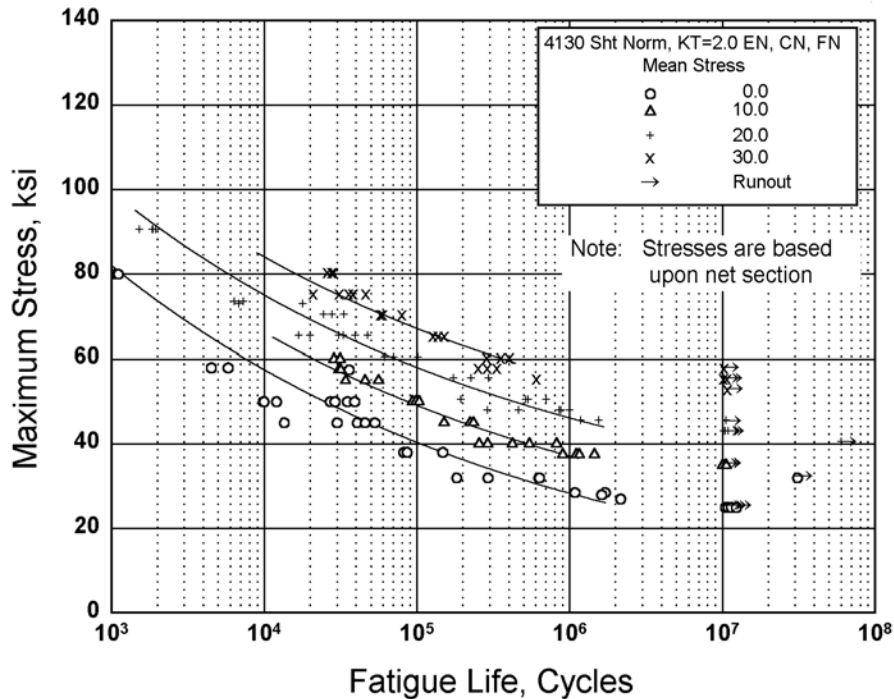

Figure 2.3.1.2.8(c). Best-fit S/N curves for notched, $K_t = 2.0$, 4130 alloy steel sheet, normalized, longitudinal direction.

Correlative Information for Figure 2.3.1.2.8(c)

Product Form: Sheet, 0.075 inch thick

Properties:

TUS, ksi	TYS, ksi	Temp., °F
117	99	RT (unnotched)
120	--	RT (notched) K_t 2.0

Test Parameters:
 Loading - Axial
 Frequency - 1100-1800 cpm
 Temperature - RT
 Environment - Air

No. of Heats/Lots: Not specified

Specimen Details: Notched, $K_t = 2.0$

Notch Type	Gross Width	Net Width	Notch Radius
Edge	2.25	1.500	0.3175
Center	4.50	1.500	1.500
Fillet	2.25	1.500	0.1736

Equivalent Stress Equation:
 $\log N_f = 17.1 - 6.49 \log (S_{eq})$
 $S_{eq} = S_{max} (1-R)^{0.86}$
 Std. Error of Estimate, $\log (\text{Life}) = 0.19$
 Standard Deviation, $\log (\text{Life}) = 0.78$
 $R^2 = 94\%$

Sample Size = 107

Surface Condition: Electropolished

References: 3.2.3.1.8(b) and (f)

[Caution: The equivalent stress model may provide unrealistic life predictions for stress ratios beyond those represented above.]

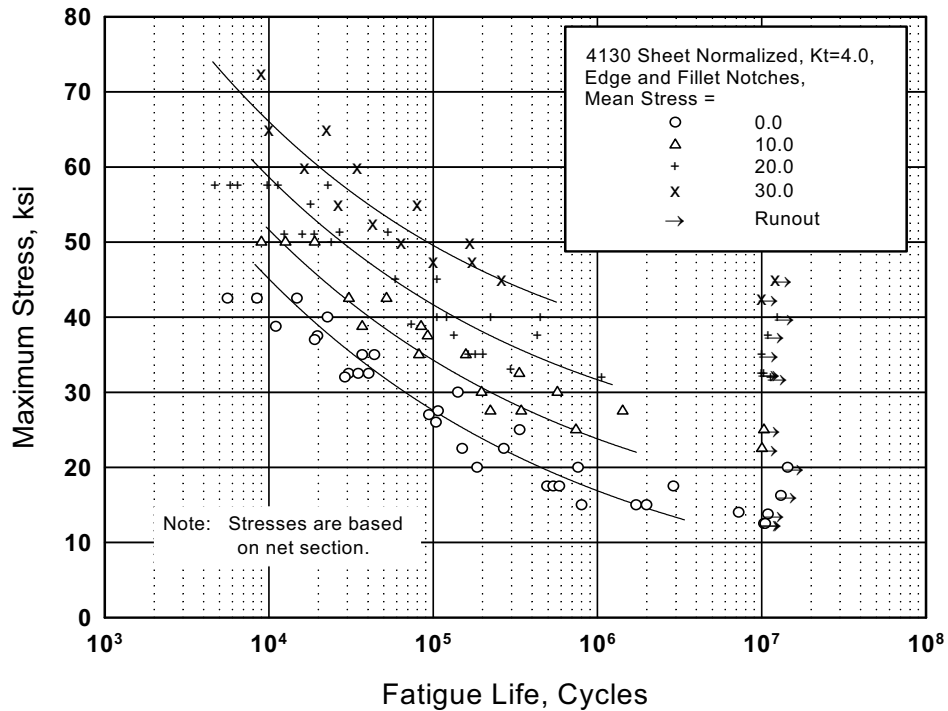

Figure 2.3.1.2.8(d). Best-fit S/N curves diagram for notched, $K_t = 4.0$, 4130 alloy steel sheet, normalized, longitudinal direction.

Correlative Information for Figure 2.3.1.2.8(d)

Product Form: Sheet, 0.075 inch thick

Properties:

TUS, ksi	TYS, ksi	Temp., °F
117	99	RT (unnotched)
120	—	RT (notched) $K_t = 4.0$

Test Parameters:
Loading - Axial
Frequency - 1100-1800 cpm
Temperature - RT
Environment - Air

No. of Heats/Lots: Not specified

Specimen Details: Notched, $K_t = 4.0$

Notch Type	Gross Width	Net Width	Notch Radius
Edge	2.25	1.500	0.057
Edge	4.10	1.496	0.070
Fillet	2.25	1.500	0.0195

Equivalent Stress Equation:
 $\log N_f = 12.6 - 4.69 \log(S_{eq})$
 $S_{eq} = S_{max} (1-R)^{0.63}$
Std. Error of Estimate, $\log(\text{Life}) = 0.24$
Standard Deviation, $\log(\text{Life}) = 0.70$
 $R^2 = 88\%$

Sample Size = 87

Surface Condition: Electropolished

[Caution: The equivalent stress model may provide unrealistic life predictions for stress ratios beyond those represented above.]

References: 3.2.3.1.8(b), (f), and (g)

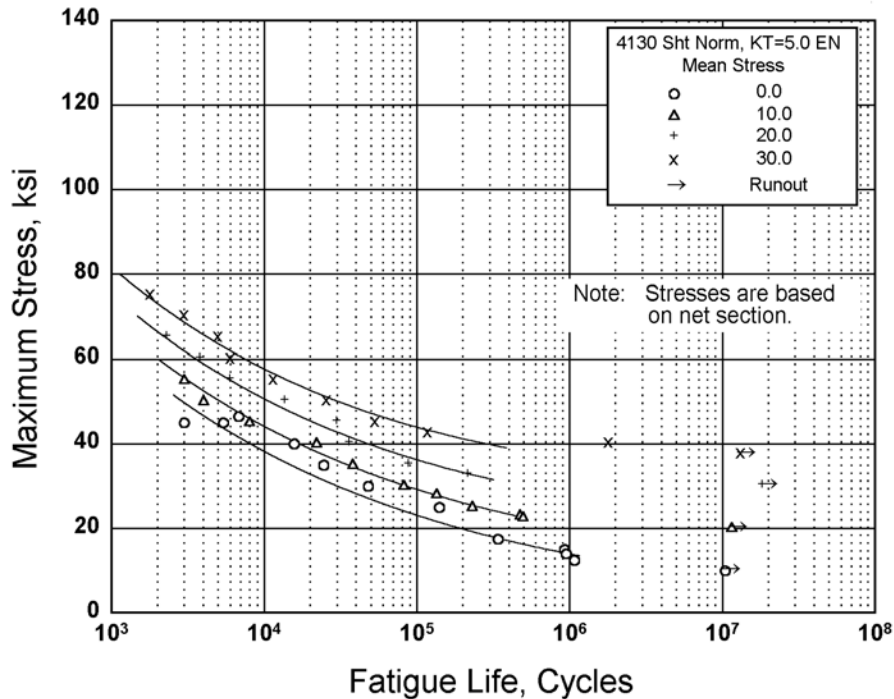

Figure 2.3.1.2.8(e). Best-fit S/N curves diagram for notched, $K_t = 5.0$, 4130 alloy steel sheet, normalized, longitudinal direction.

Correlative Information for Figure 2.3.1.2.8(e)

Product Form: Sheet, 0.075 inch thick

Properties:

TUS, ksi	TYS, ksi	Temp., °F
117	99	RT (unnotched)
120	—	RT (notched) $K_t = 5.0$

Test Parameters:
Loading - Axial
Frequency - 1100-1500 cpm
Temperature - RT
Environment - Air

No. of Heats/Lots: Not specified

Specimen Details: Edge Notched, $K_t = 5.0$
2.25 inches gross width
1.50 inches net width
0.075 inch notch radius

Equivalent Stress Equation:
 $\log N_f = 12.0 - 4.57 \log (S_{eq})$
 $S_{eq} = S_{max} (1-R)^{0.56}$
Std. Error of Estimate, $\log (\text{Life}) = 0.18$
Standard Deviation, $\log (\text{Life}) = 0.87$
 $R^2 = 96\%$

Surface Condition: Electropolished

Sample Size = 38

Reference: 3.2.3.1.8(c)

[Caution: The equivalent stress model may provide unrealistic life predictions for stress ratios beyond those represented above.]

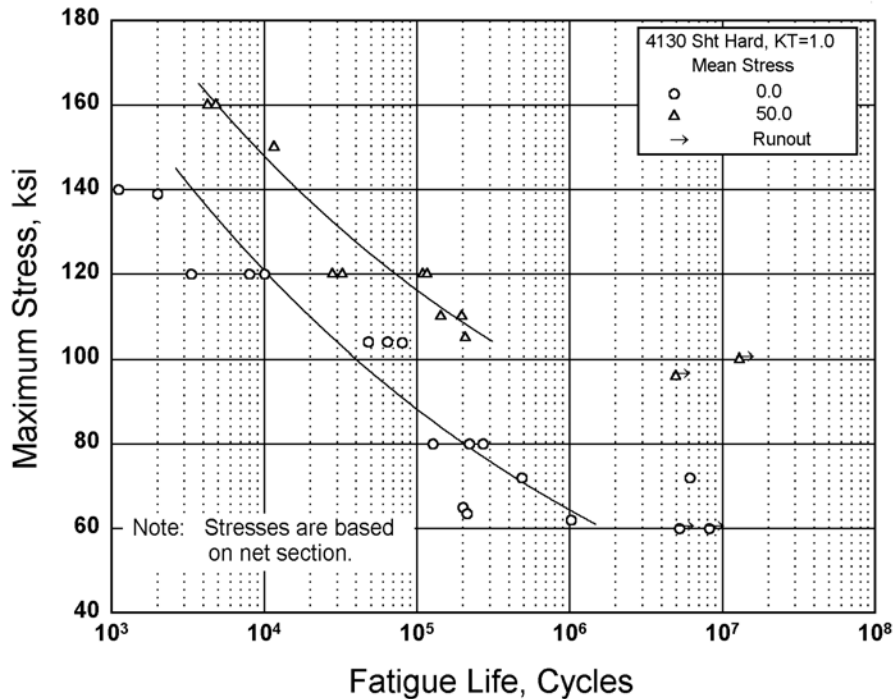

Figure 2.3.1.2.8(f). Best-fit S/N curves for unnotched 4130 alloy steel sheet, $F_{tu} = 180$ ksi, longitudinal direction.

Correlative Information for Figure 2.3.1.2.8(f)

Product Form: Sheet, 0.075 inch thick
Properties: TUS, ksi 180 TYS, ksi 174 Temp., °F RT

Test Parameters:
Loading - Axial
Frequency - 20-1800 cpm
Temperature - RT
Environment - Air

Specimen Details: Unnotched
2.88 inches gross width
1.00 inch net width
12.0 inch net section radius

No. of Heats/Lots: Not specified

Surface Condition: Electropolished

Equivalent Stress Equation:
 $\log N_f = 20.3 - 7.31 \log (S_{eq})$
 $S_{eq} = S_{max} (1-R)^{0.49}$
Std. Error of Estimate, $\log (\text{Life}) = 0.39$
Standard Deviation, $\log (\text{Life}) = 0.89$
 $R^2 = 81\%$

Reference: 3.2.3.1.8(f)

Sample Size = 27

[Caution: The equivalent stress model may provide unrealistic life predictions for stress ratios beyond those represented above.]

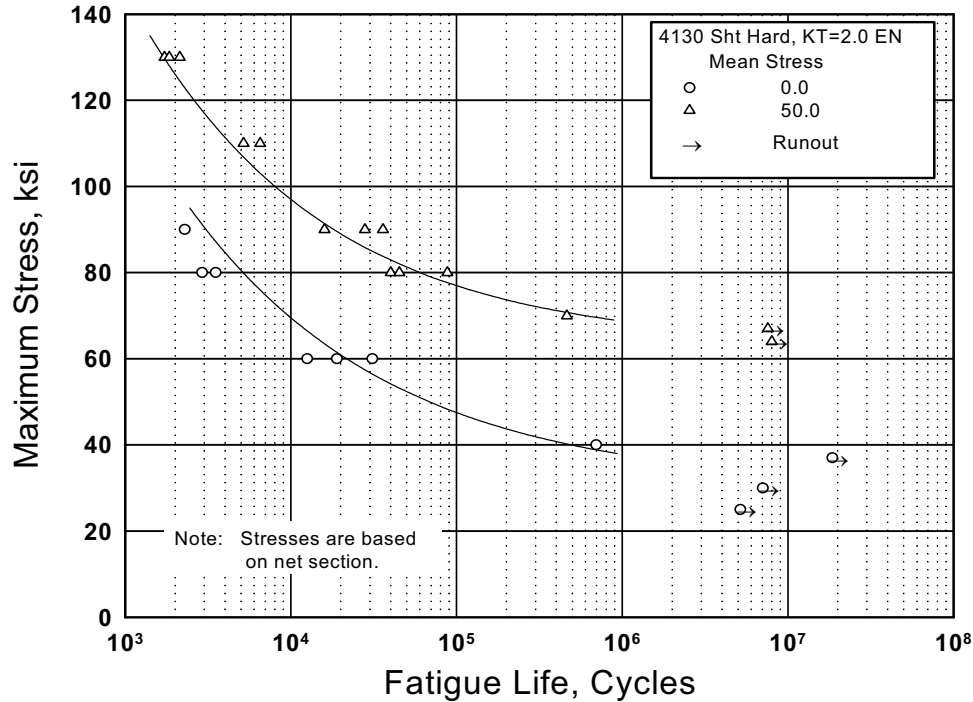

Figure 2.3.1.2.8(g). Best-fit S/N curves for notched, $K_t = 2.0$, 4130 alloy steel sheet, $F_u = 180$ ksi, longitudinal direction.

Correlative Information for Figure 2.3.1.2.8(g)

Product Form: Sheet, 0.075 inch thick

Properties: TUS, ksi 180 TYS, ksi 174 Temp., °F RT

Specimen Details: Edge Notched
2.25 inches gross width
1.50 inches net width
0.3175 inch notch radius

Surface Condition: Electropolished

Reference: 3.2.3.1.8(f)

Test Parameters:
Loading - Axial
Frequency - 21-1800 cpm
Temperature - RT
Environment - Air

No. of Heats/Lots: Not specified

Equivalent Stress Equation:
 $\log N_f = 8.87 - 2.81 \log (S_{eq} - 41.5)$
 $S_{eq} = S_{max} (1-R)^{0.46}$
Std. Error of Estimate, $\log (\text{Life}) = 0.18$
Standard Deviation, $\log (\text{Life}) = 0.77$
 $R^2 = 94\%$

Sample Size = 19

[Caution: The equivalent stress model may provide unrealistic life predictions for stress ratios beyond those represented above.]

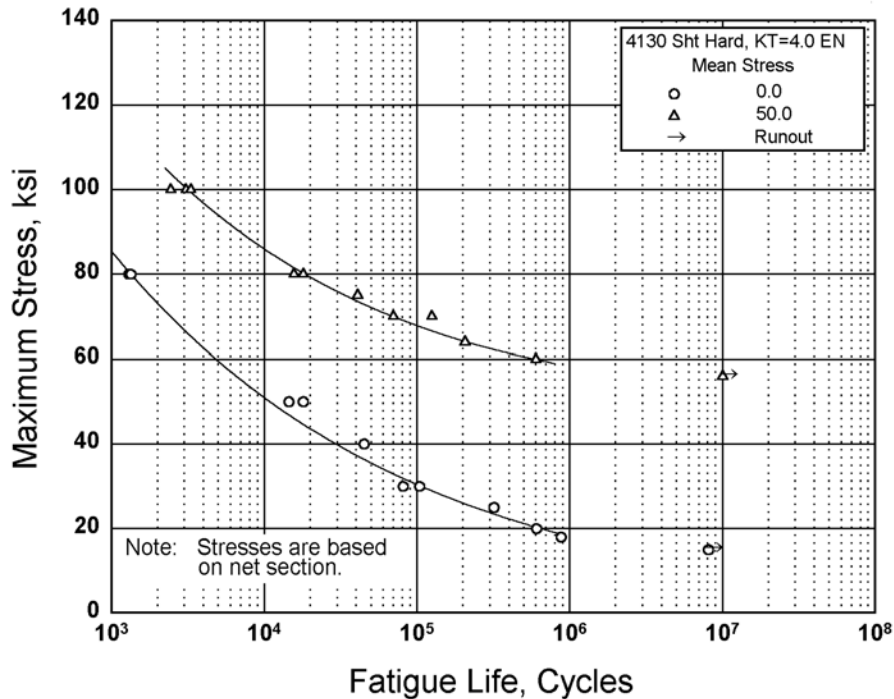

Figure 2.3.1.2.8(h). Best-fit S/N curves for notched, $K_t = 4.0$, 4130 alloy steel sheet, $F_{iu} = 180$ ksi, longitudinal direction.

Correlative Information for Figure 2.3.1.2.8(h)

Product Form: Sheet, 0.075 inch thick
Properties: T_{US} , ksi 180 T_{YS} , ksi 174 Temp., °F RT

Test Parameters:
Loading - Axial
Frequency - 23-1800 cpm
Temperature - RT
Environment - Air

Specimen Details: Edge Notched
2.25 inches gross width
1.50 inches net width
0.057 inch notch radius

No. of Heats/Lots: Not specified

Surface Condition: Electropolished

Equivalent Stress Equation:
 $\log N_f = 12.4 - 4.45 \log (S_{eq})$
 $S_{eq} = S_{max} (1-R)^{0.60}$
Std. Error of Estimate, $\log (\text{Life}) = 0.11$
Standard Deviation, $\log (\text{Life}) = 0.90$
 $R^2 = 98\%$

Reference: 3.2.3.1.8(f)

Sample Size = 20

[Caution: The equivalent stress model may provide unrealistic life predictions for stress ratios beyond those represented above.]

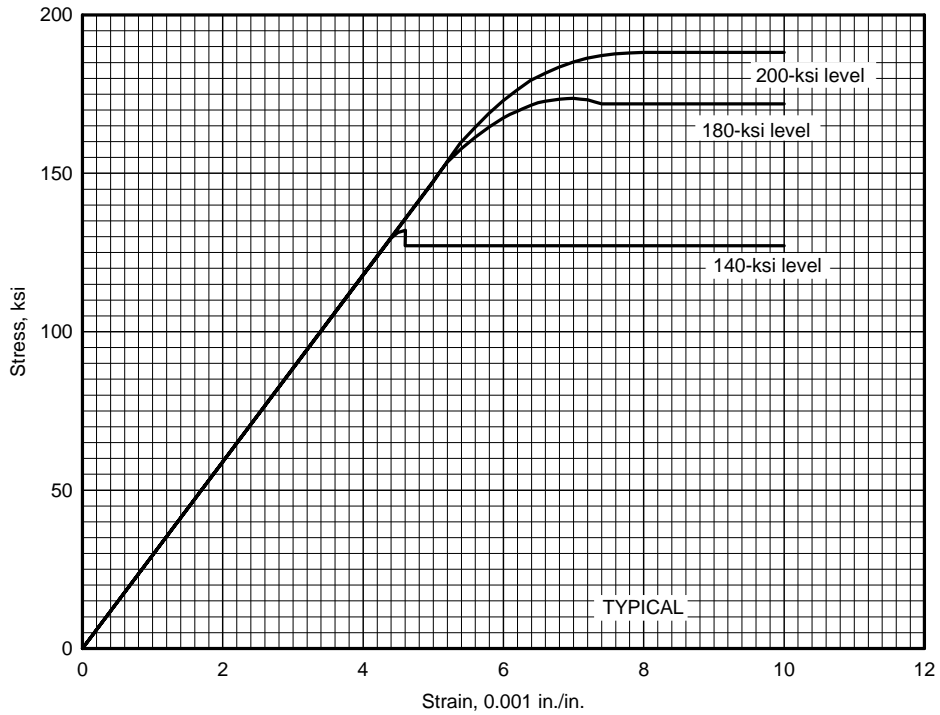

Figure 2.3.1.3.6(a). Typical tensile stress-strain curves at room temperature for heat-treated AISI 4340 alloy steel (all products).

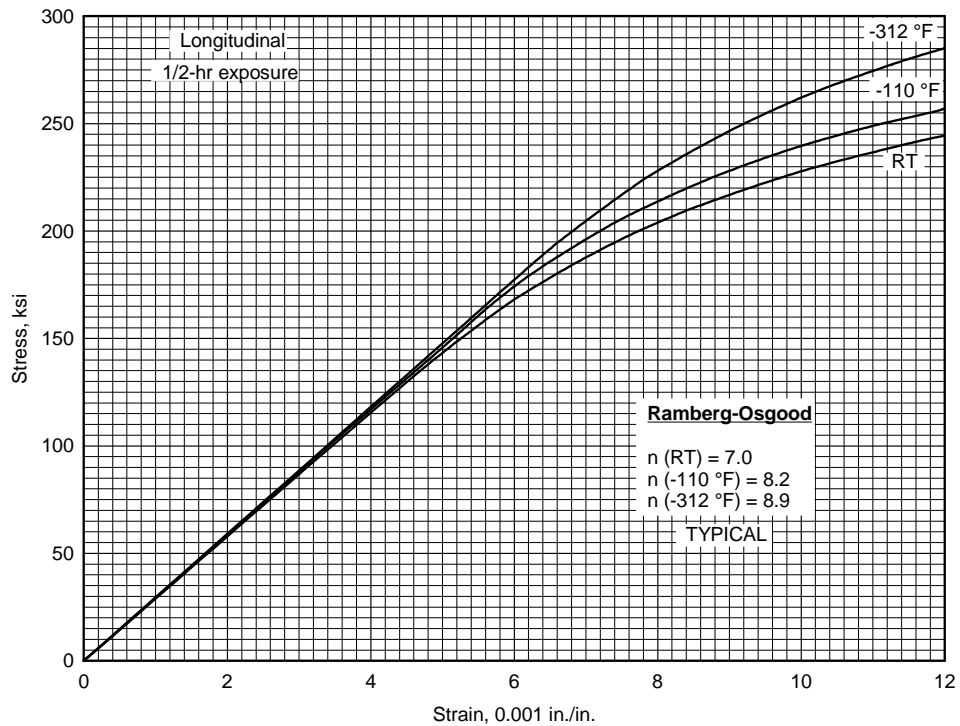

Figure 2.3.1.3.6(b). Typical tensile stress-strain curves at cryogenic and room temperature for AISI 4340 alloy steel bar, $F_{tu} = 260$ ksi.

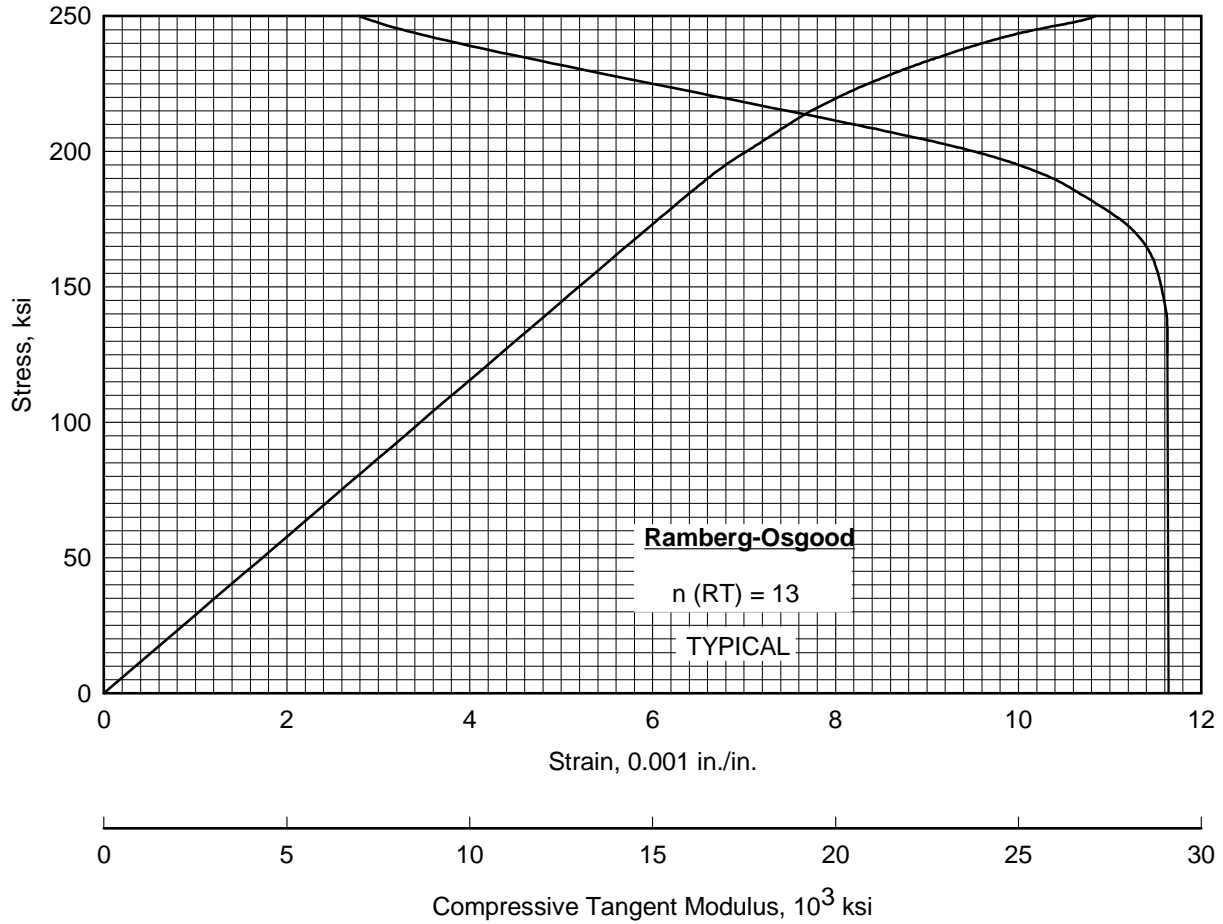

Figure 2.3.1.3.6(c). Typical compressive stress-strain and compressive tangent-modulus curves at room temperature for AISI 4340 alloy steel bar, $F_{tu} = 260$ ksi.

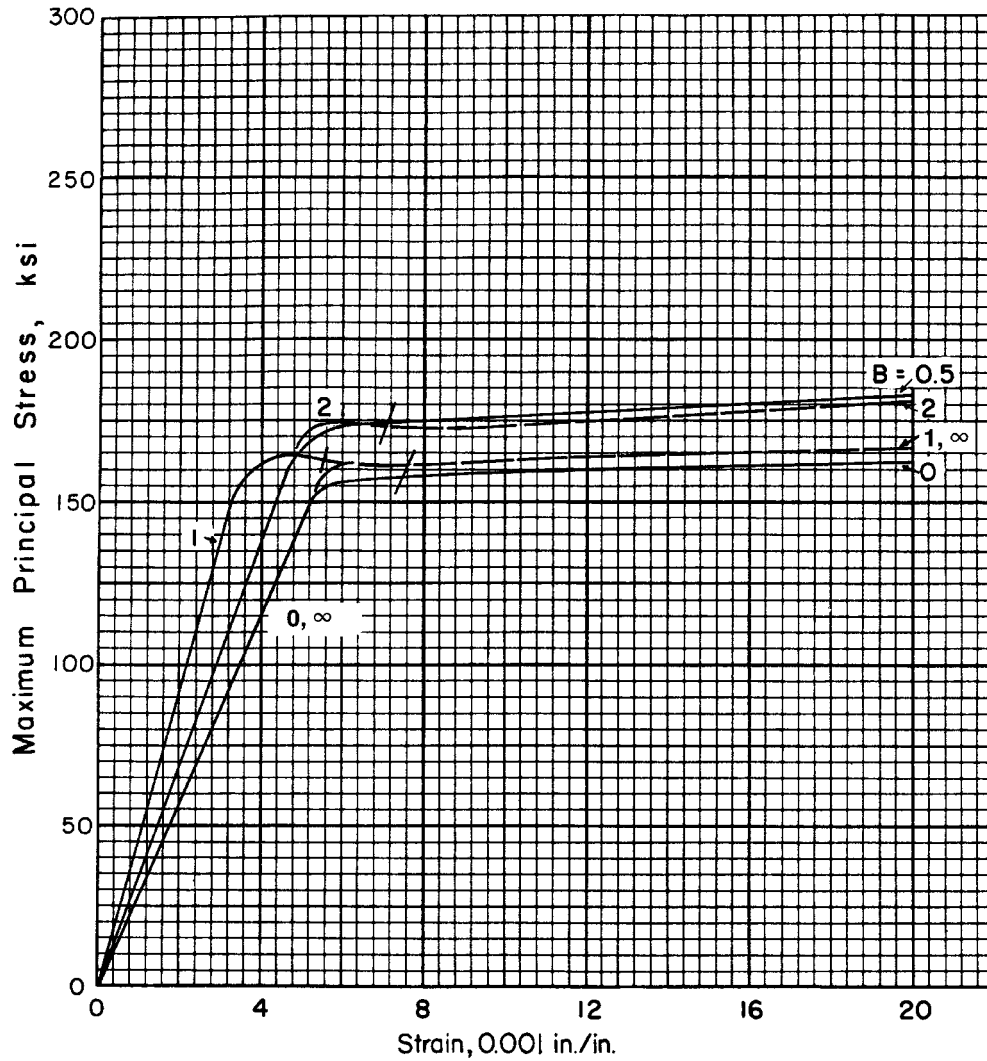

Figure 2.3.1.3.6(d). Typical biaxial stress-strain curves at room temperature for AISI 4340 alloy steel (machined thin-wall cylinders, axial direction = longitudinal direction of bar stock), $F_{tu} = 180$ ksi. A biaxial ratio, B , denotes the ratio of hoop stresses to axial stresses.

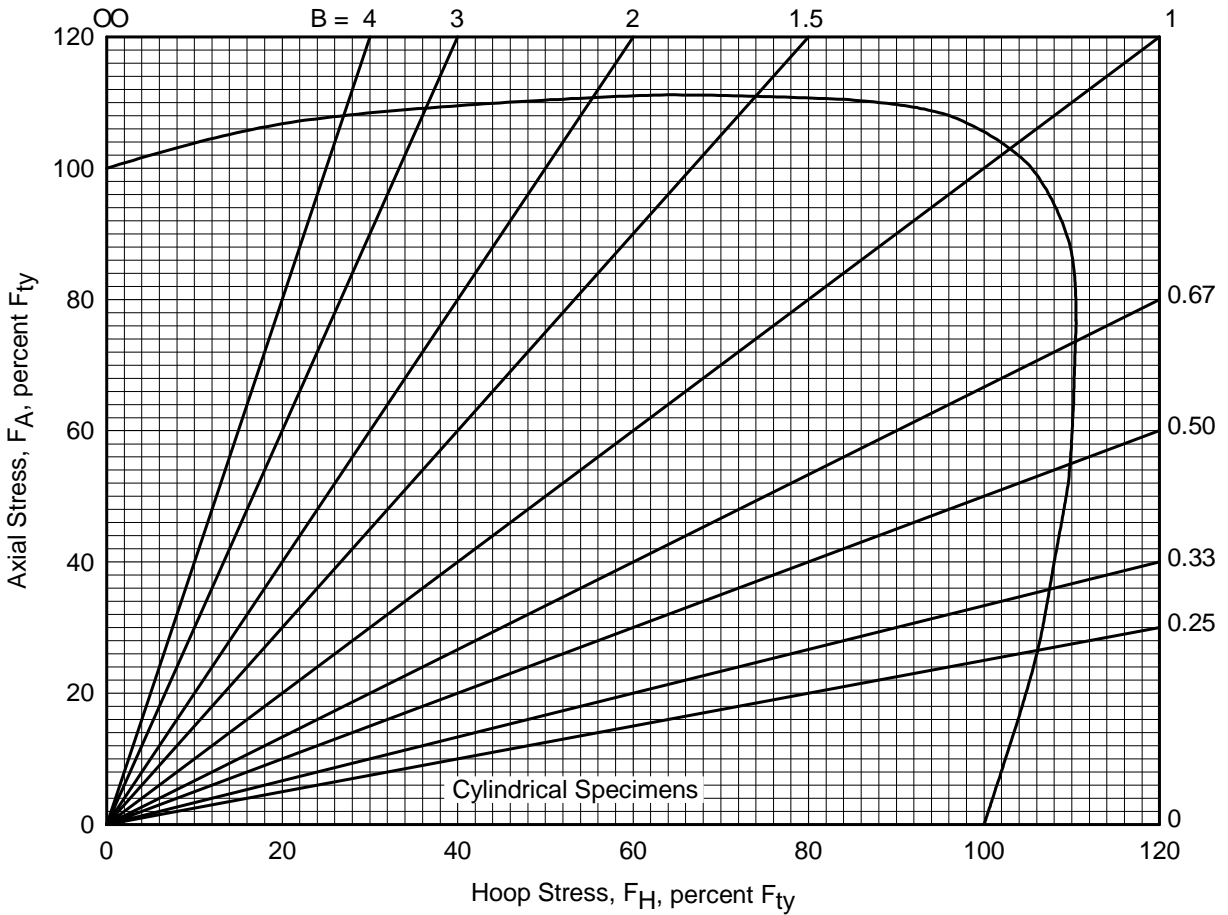

Figure 2.3.1.3.6(e). Biaxial yield-stress envelope at room temperature for AISI 4340 alloy steel (machined thin-wall cylinders, axial direction = longitudinal direction of bar stock), $F_{tu} = 180$ ksi, F_{ty} measured in the hoop direction.

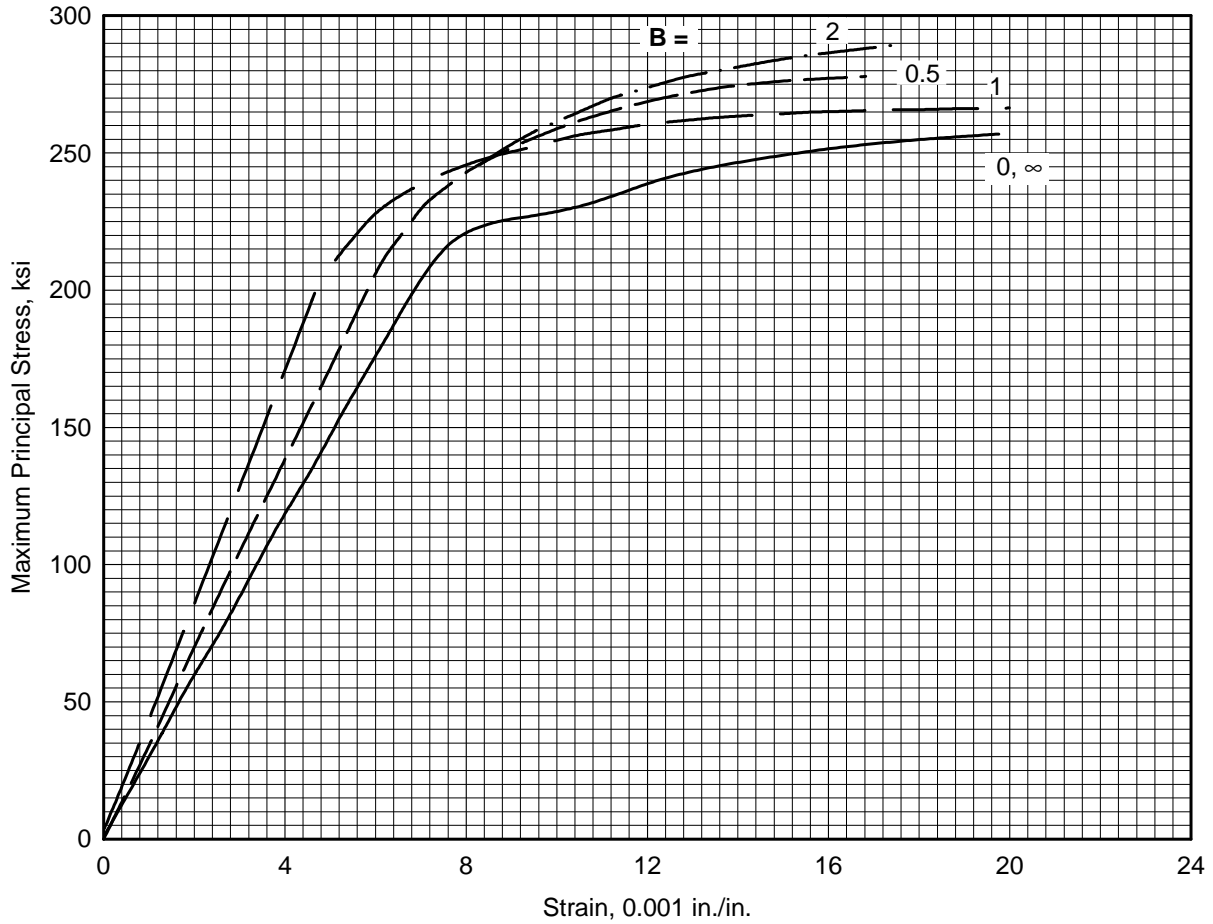

Figure 2.3.1.3.6(f). Typical biaxial stress-strain curves at room temperature for AISI 4340 alloy steel (machined thin-wall cylinders, axial direction = longitudinal direction of bar stock), $F_{tu} = 260$ ksi. A biaxial ratio B of zero corresponds to the hoop direction.

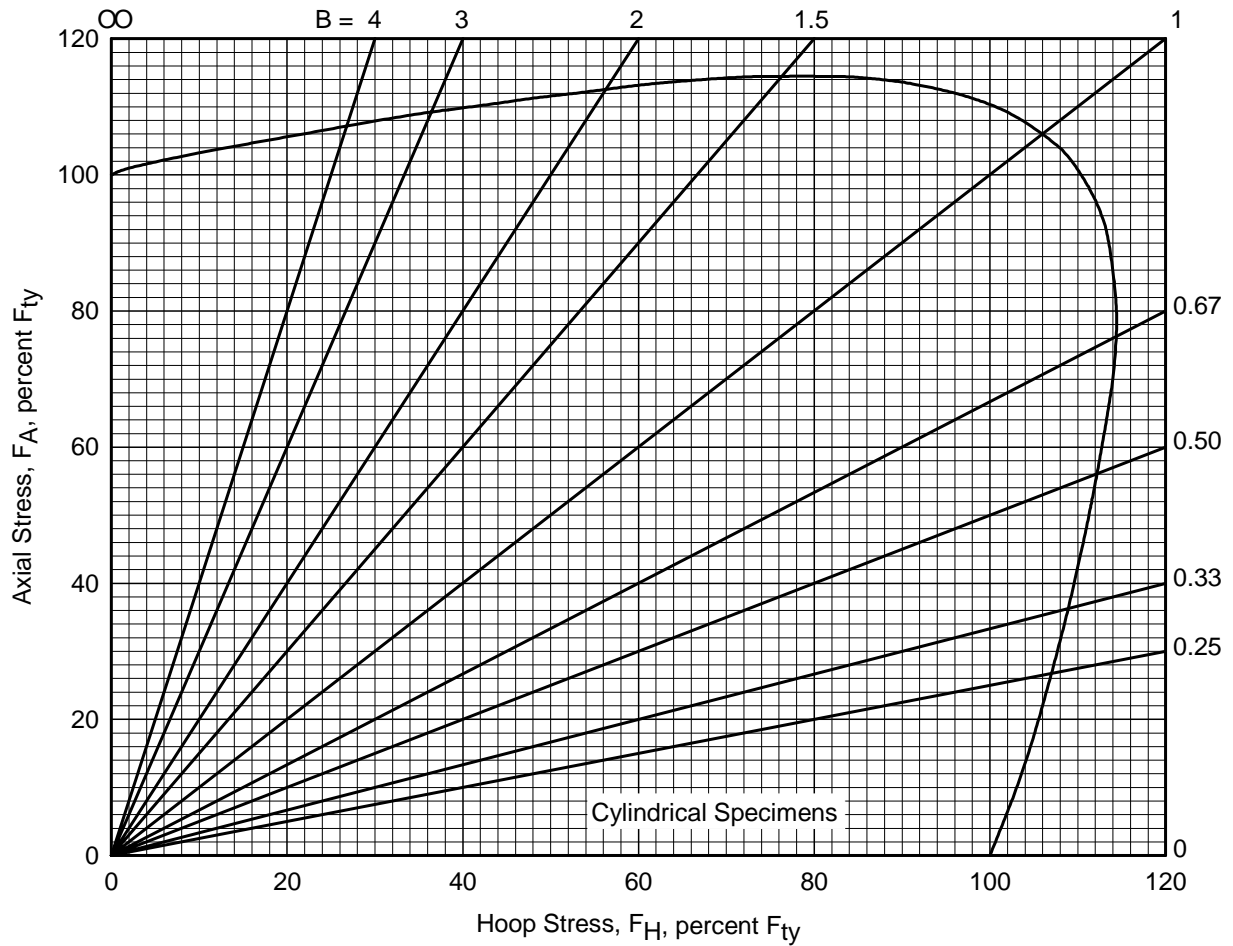

Figure 2.3.1.3.6(g). Biaxial yield-stress envelope at room temperature for AISI 4340 alloy steel (machined thin-wall cylinders, axial direction = longitudinal direction of bar stock), $F_{tu} = 260$ ksi, F_{ty} measured in the hoop direction.

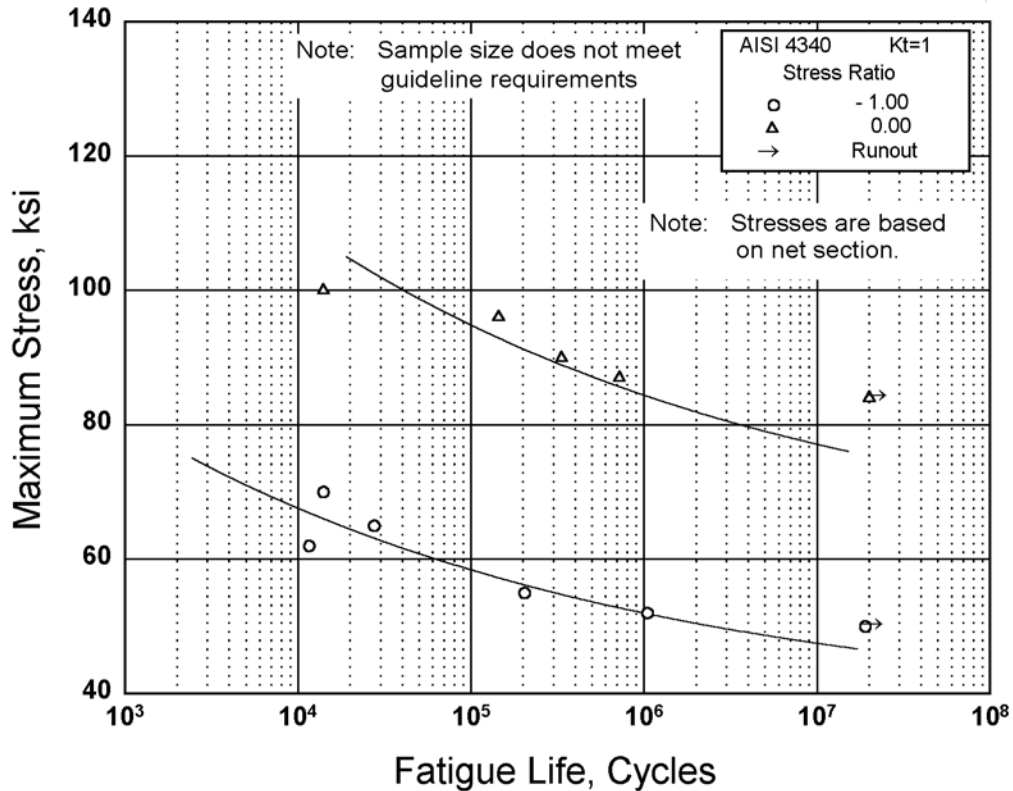

Figure 2.3.1.3.8(a). Best-fit S/N curves for unnotched AISI 4340 alloy steel bar, $F_{tu} = 125$ ksi, longitudinal direction.

Correlative Information for Figure 2.3.1.3.8(a)

Product Form: Rolled bar, 1.125 inch diameter, air melted

Properties:

TUS, ksi	TYS, ksi	Temp., °F
125	—	RT (unnotched)
150	—	RT (notched)

Specimen Details: Unnotched
0.400 inch diameter

Surface Condition: Hand polished to RMS 10

Reference: 2.3.1.3.8(a)

Test Parameters:

Loading - Axial
Frequency - 2000 to 2500 cpm
Temperature - RT
Atmosphere - Air

No. of Heat/Lots: 1

Equivalent Stress Equation:

$\log N_f = 14.96 - 6.46 \log (S_{eq} - 60)$
 $S_{eq} = S_{max} (1 - R)^{0.70}$
 Std. Error of Estimate, $\log (\text{Life}) = 0.35$
 Standard Deviation, $\log (\text{Life}) = 0.77$
 $R^2 = 75\%$

Sample Size = 9

[Caution: The equivalent stress model may provide unrealistic life predictions for stress ratios beyond those represented above.]

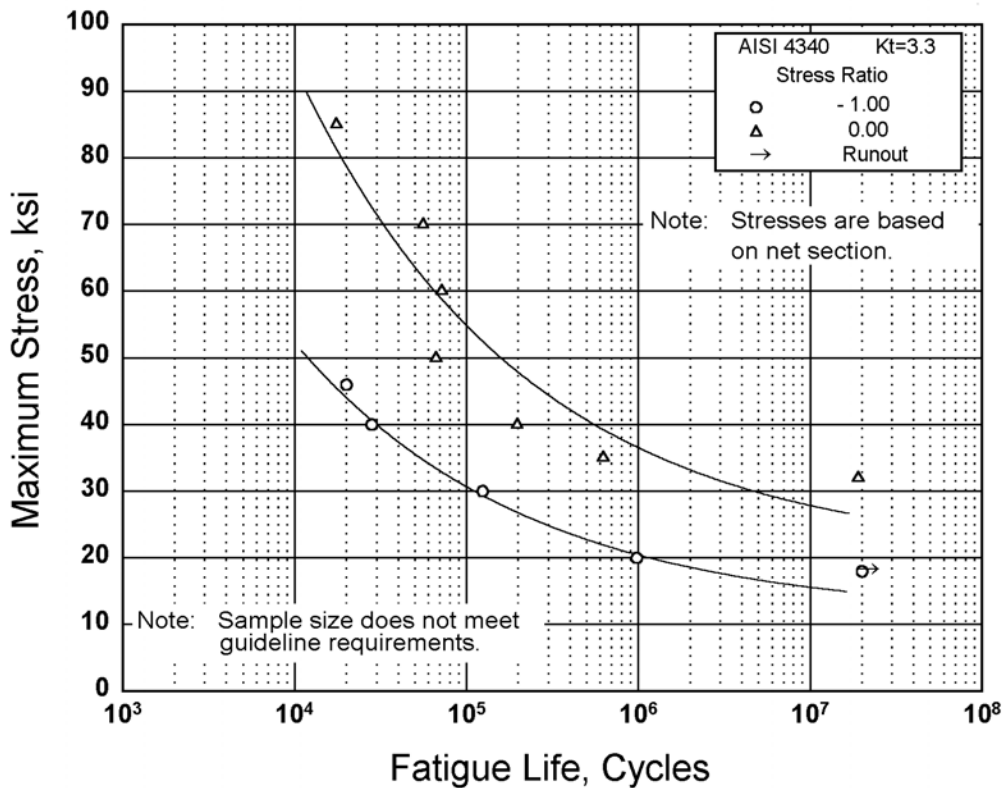

Figure 2.3.1.3.8(b). Best-fit S/N curves for notched, $K_t = 3.3$, AISI 4340 alloy steel bar, $F_{tu} = 125$ ksi, longitudinal direction.

Correlative Information for Figure 2.3.1.3.8(b)

Product Form: Rolled bar, 1.125 inch diameter, air melted

Test Parameters:

Loading - Axial
Frequency - 2000 to 2500 cpm
Temperature - RT
Atmosphere - Air

Properties:

TUS, ksi	TYS, ksi	Temp., °F
125	—	RT (unnotched)
150	—	RT (notched)

No. of Heat/Lots: 1

Specimen Details: Notched, V-Groove, $K_t=3.3$
0.450 inch gross diameter
0.400 inch net diameter
0.010 inch root radius, r
60° flank angle, ω

Equivalent Stress Equation:

$\log N_f = 9.75 - 3.08 \log (S_{eq} - 20.0)$
 $S_{eq} = S_{max} (1-R)^{0.84}$
Std. Error of Estimate, $\log (\text{Life}) = 0.40$
Standard Deviation, $\log (\text{Life}) = 0.90$
 $R^2 = 80\%$

Surface Condition: Lathe turned to RMS 10

Sample Size = 11

Reference: 2.3.1.3.8(a)

[Caution: The equivalent stress model may provide unrealistic life predictions for stress ratios beyond those represented above.]

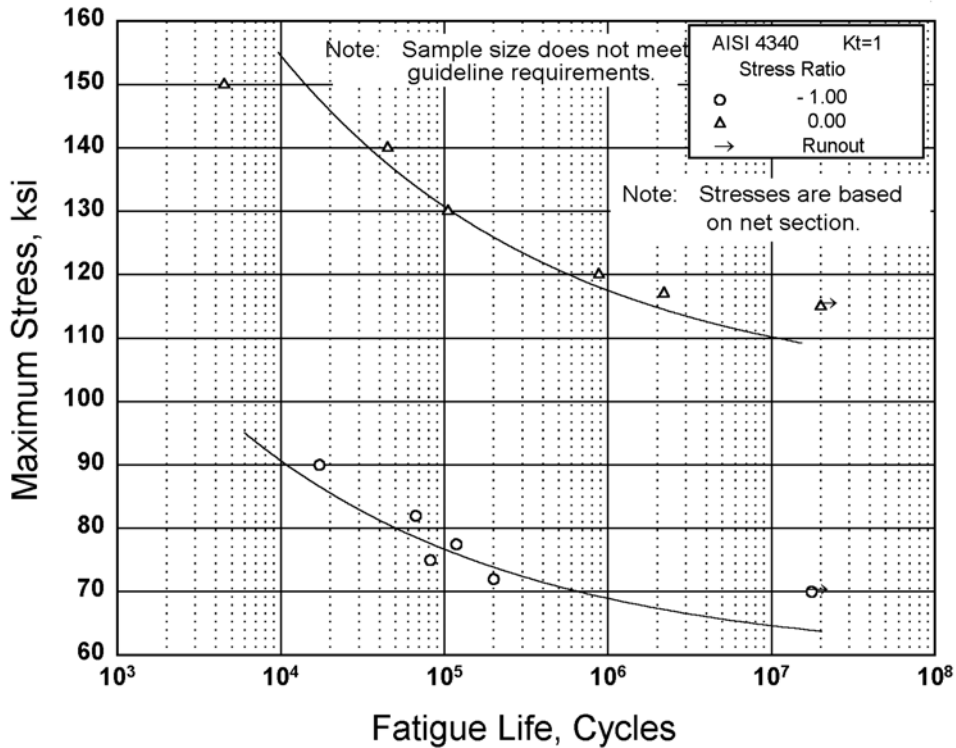

Figure 2.3.1.3.8(c). Best-fit S/N curves for unnotched AISI 4340 alloy steel bar, $F_{tu} = 150$ ksi, longitudinal direction.

Correlative Information for Figure 2.3.1.3.8(c)

Product Form: Rolled bar, 1.125 inch diameter, air melted

Properties:

TUS, ksi	TYS, ksi	Temp., °F
158	147	RT (unnotched)
190	—	RT (notched)

Specimen Details: Unnotched
0.400 inch diameter

Surface Condition: Hand polished to RMS 10

Reference: 2.3.1.3.8(b)

Test Parameters:

Loading - Axial
Frequency - 2000 to 2500 cpm
Temperature - RT
Atmosphere - Air

No. of Heat/Lots: 1

Equivalent Stress Equation:

$$\log N_f = 10.76 - 3.91 \log (S_{eq} - 101.0)$$

$$S_{eq} = S_{max} (1-R)^{0.77}$$

Std. Error of Estimate, Log (Life) = 0.17

Standard Deviation, Log (Life) = 0.33

Adjusted R² Statistic = 73%

Sample Size = 9

[Caution: The equivalent stress model may provide unrealistic life predictions for stress ratios beyond those represented above.]

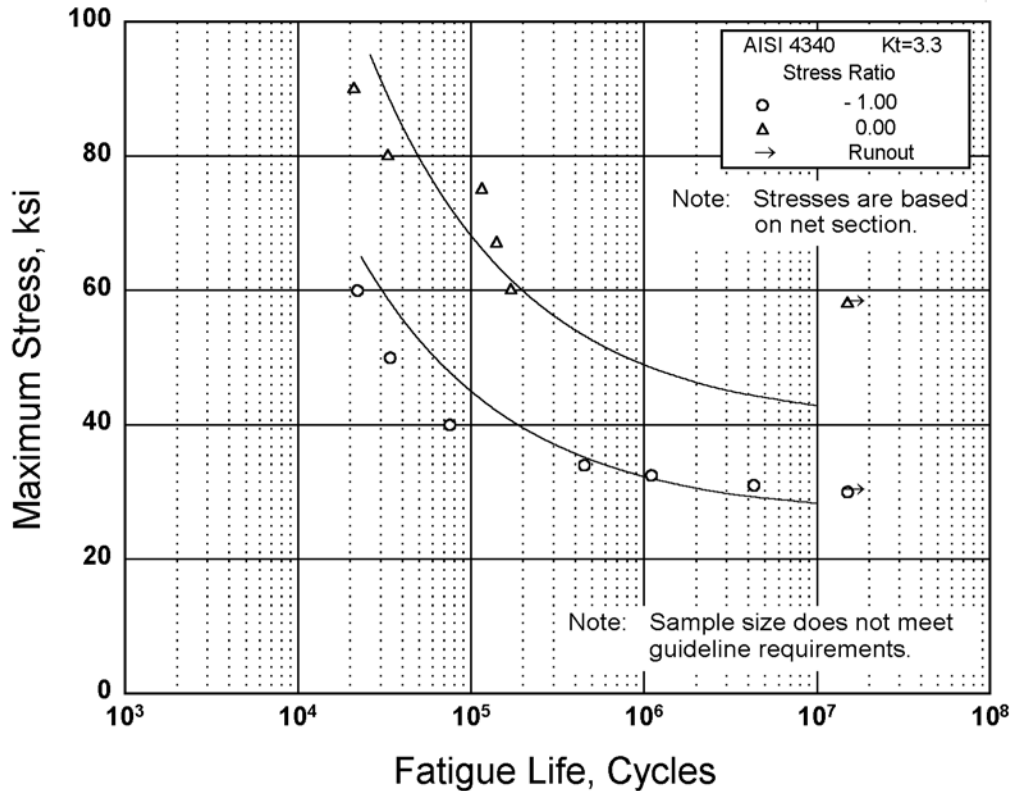

Figure 2.3.1.3.8(d). Best-fit S/N curves for notched AISI 4340 alloy steel bar, $F_{tu} = 150$ ksi, longitudinal direction.

Correlative Information for Figure 2.3.1.3.8(d)

Product Form: Rolled bar, 1.125 inch diameter, air melted

Test Parameters:

Loading - Axial
Frequency - 2000 to 2500 cpm
Temperature - RT
Atmosphere - Air

Properties:

TUS, ksi	TYS, ksi	Temp., °F
158	147	RT (unnotched)
190	—	RT (notched)

No. of Heat/Lots: 1

Specimen Details: Notched, V-Groove, $K_t = 3.3$
0.450 inch gross diameter
0.400 inch net diameter
0.010 inch root radius, r
60° flank angle, ω

Equivalent Stress Equation:

$\text{Log } N_f = 7.90 - 2.00 \text{ log } (S_{eq} - 40.0)$
 $S_{eq} = S_{max} (1-R)^{0.60}$
Std. Error of Estimate, $\text{Log } (\text{Life}) = 0.27$
Standard Deviation, $\text{Log } (\text{Life}) = 0.74$
 $R^2 = 86\%$

Surface Condition: Lathe turned to RMS 10

Sample Size = 11

Reference: 2.3.1.3.8(a)

[Caution: The equivalent stress model may provide unrealistic life predictions for stress ratios beyond those represented above.]

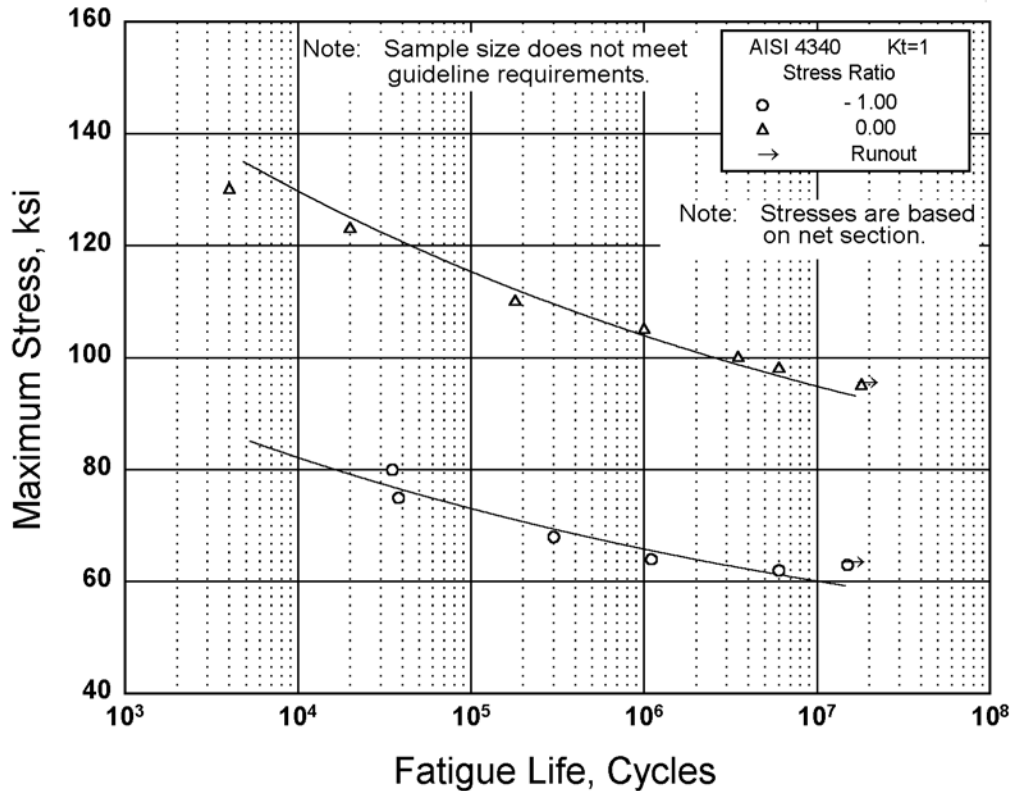

Figure 2.3.1.3.8(e). Best-fit S/N curves for unnotched AISI 4340 alloy steel bar at 600°F, $F_w = 150$ ksi, longitudinal direction.

Correlative Information for Figure 2.3.1.3.8(e)

Product Form: Rolled bar, 1.125 inch diameter, air melted

Test Parameters:

Loading - Axial
Frequency - 2000 to 2500 cpm
Temperature - 600°F
Atmosphere - Air

<u>Properties:</u>	<u>TUS, ksi</u>	<u>TYS, ksi</u>	<u>Temp., °F</u>
	158	147	RT (unnotched)
	153	121	600 (unnotched)
	190	—	RT (notched)
	176	—	600 (notched)

No. of Heat/Lots: 1

Equivalent Stress Equation:

$\text{Log } N_f = 22.36 - 9.98 \text{ log } (S_{eq} - 60.0)$
 $S_{eq} = S_{max} (1-R)^{0.66}$
 Std. Error of Estimate Log (Life) = 0.24
 Standard Deviation, Log (Life) = 1.08
 $R^2 = 95\%$

Specimen Details: Unnotched
0.400 inch diameter

Sample Size = 11

Surface Condition: Hand polished to RMS 10

Reference: 2.3.1.3.8(b)

[Caution: The equivalent stress model may provide unrealistic life predictions for stress ratios beyond those represented above.]

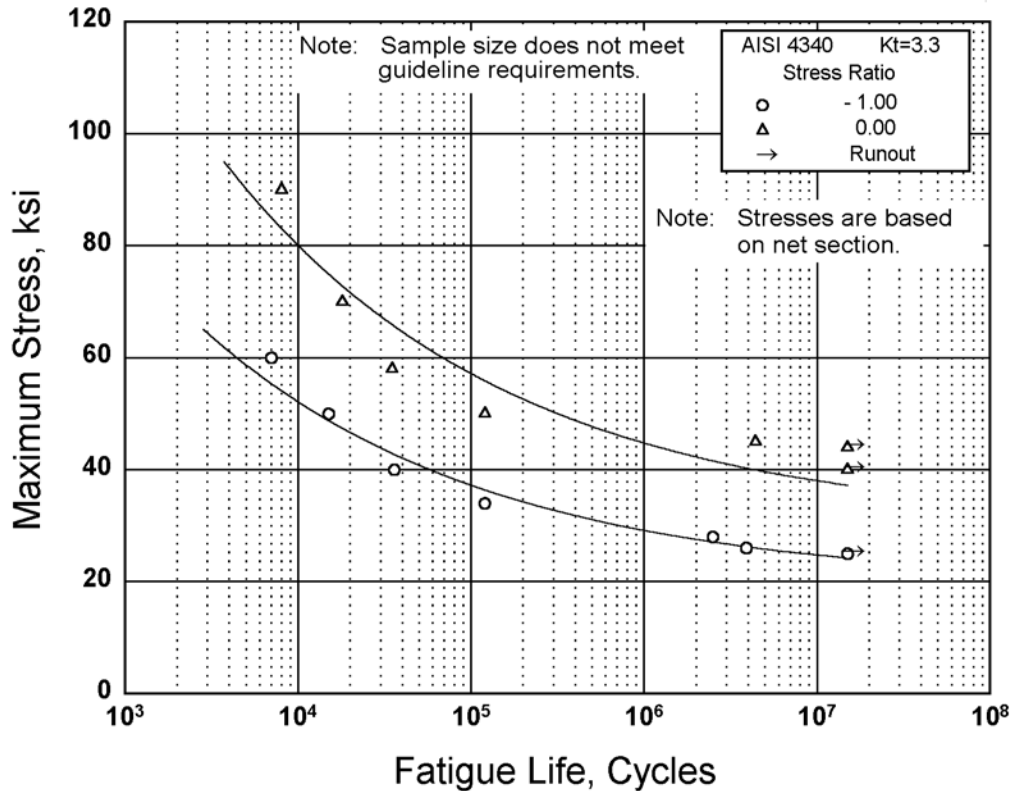

Figure 2.3.1.3.8(f). Best-fit S/N curves for notched, $K_t = 3.3$, AISI 4340 alloy steel bar at 600°F, $F_{iu} = 150$ ksi, longitudinal direction.

Correlative Information for Figure 2.3.1.3.8(f)

Product Form: Rolled bar, 1.125 inch diameter, air melted

Test Parameters:
Loading - Axial
Frequency - 2000 to 2500 cpm
Temperature - RT
Atmosphere - Air

<u>Properties:</u>	<u>TUS, ksi</u>	<u>TYS, ksi</u>	<u>Temp., °F</u>
	158	147	RT (unnotched)
	153	121	600 (unnotched)
	190	—	RT (notched)
	176	—	600 (notched)

No. of Heat/Lots: 1

Equivalent Stress Equation:
 $\log N_f = 10.39 - 3.76 \log (S_{eq} - 30.0)$
 $S_{eq} = S_{max} (1-R)^{0.62}$
 Std. Error of Estimate, $\log (\text{Life}) = 0.36$
 Standard Deviation, $\log (\text{Life}) = 1.06$
 $R^2 = 89\%$

Specimen Details: Notched, V-Groove, $K_t = 3.3$
0.450 inch gross diameter
0.400 inch net diameter
0.010 inch root radius, r
60° flank angle, ω

Sample Size = 11

[Caution: The equivalent stress model may provide unrealistic life predictions for stress ratios beyond those represented above.]

Surface Condition: Lathe turned to RMS 10

Reference: 2.3.1.3.8(b)

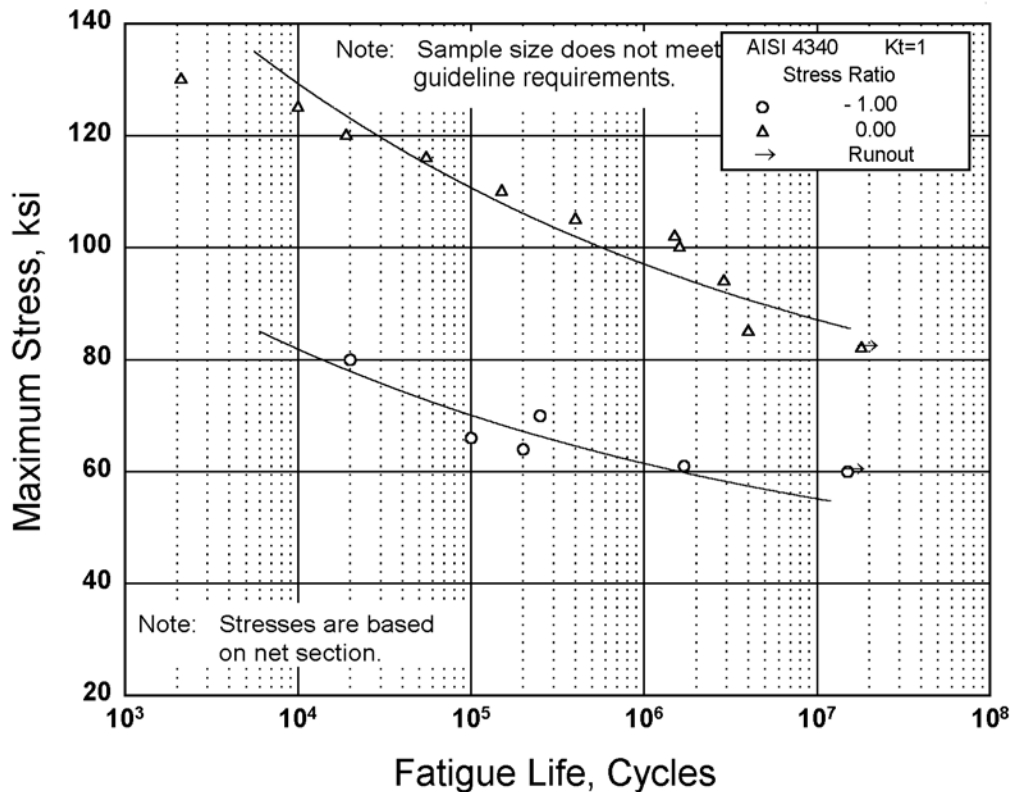

Figure 2.3.1.3.8(g). Best-fit S/N curves for unnotched AISI 4340 alloy steel bar at 800°F, $F_{iv} = 150$ ksi, longitudinal direction.

Correlative Information for Figure 2.3.1.3.8(g)

Product Form: Rolled bar, 1.125 inch diameter, air melted

Test Parameters:
Loading - Axial
Frequency - 2000 to 2500 cpm
Temperature - 800°F
Atmosphere - Air

<u>Properties:</u>	<u>TUS, ksi</u>	<u>TYS, ksi</u>	<u>Temp., °F</u>
	158	147	RT (unnotched)
	125	101	800 (unnotched)
	190	—	RT (notched)
	154	—	800 (notched)

No. of Heat/Lots: 1

Equivalent Stress Equation:
 $\log N_f = 17.53 - 7.35 \log (S_{eq} - 60.0)$
 $S_{eq} = S_{max} (1-R)^{0.66}$
 Std. Error of Estimate, $\log (\text{Life}) = 0.42$
 Standard Deviation, $\log (\text{Life}) = 0.99$
 $R^2 = 82\%$

Specimen Details: Unnotched
0.400 inch diameter

Sample Size = 15

Surface Condition: Hand polished to RMS 10

Reference: 2.3.1.3.8(b)

[Caution: The equivalent stress model may provide unrealistic life predictions for stress ratios beyond those represented above.]

MIL-HDBK-5J
31 January 2003

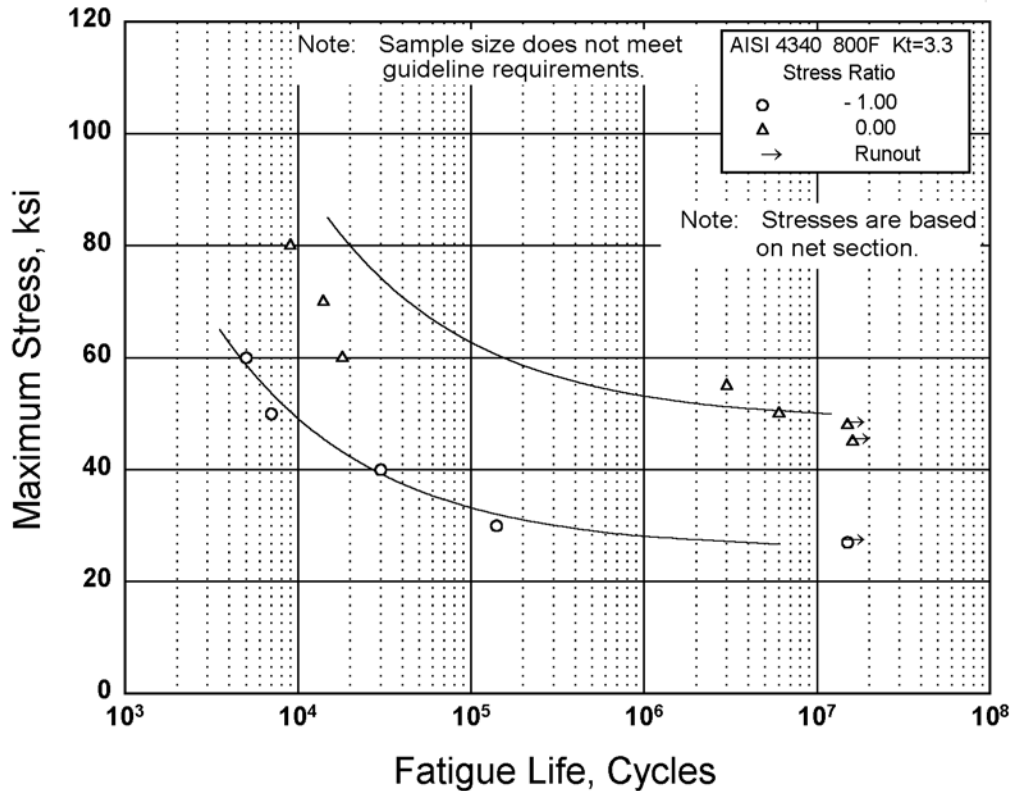

Figure 2.3.1.3.8(h). Best-fit S/N curves for notched, $K_t = 3.3$, AISI 4340 alloy steel bar at 800°F, $F_{tu} = 150$ ksi, longitudinal direction.

Correlative Information for Figure 2.3.1.3.8(h)

Product Form: Rolled bar, 1.125 inch diameter, air melted

Properties:

TUS, ksi	TYS, ksi	Temp., °F
158	147	RT (unnotched)
125	101	800 (unnotched)
190	—	RT (notched)
154	—	800 (notched)

Specimen Details: Notched, V-Groove, $K_t = 3.3$
0.450 inch gross diameter
0.400 inch net diameter
0.010 inch root radius, r
60° flank angle, ω

Surface Condition: Lathe turned to RMS 10

Reference: 2.3.1.3.8(b)

Test Parameters:

Loading - Axial
Frequency - 2000 to 2500 cpm
Temperature - 800°F
Atmosphere - Air

No. of Heat/Lots: 1

Equivalent Stress Equation:

$\log N_f = 7.31 - 2.01 \log (S_{eq} - 48.6)$
 $S_{eq} = S_{max} (1 - R)^{0.92}$
Std. Error of Estimate, Log (Life) = 0.60
Standard Deviation, Log (Life) = 1.14
 $R^2 = 72\%$

Sample Size = 9

[Caution: The equivalent stress model may provide unrealistic life predictions for stress ratios beyond those represented above.]

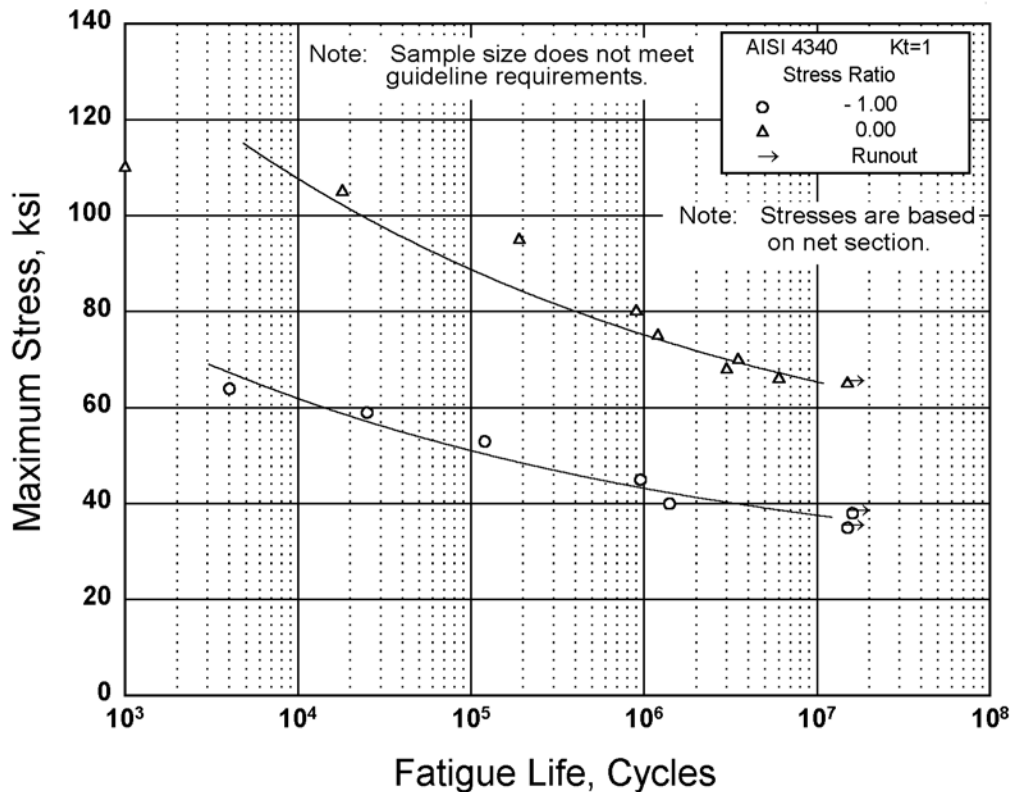

Figure 2.3.1.3.8(i). Best-fit S/N curves for unnotched AISI 4340 alloy steel bar at 1000°F, $F_{tu} = 150$ ksi, longitudinal direction.

Correlative Information for Figure 2.3.1.3.8(i)

Product Form: Rolled bar, 1.125 inch diameter, air melted

Test Parameters:
Loading - Axial
Frequency - 2000 to 2500 cpm
Temperature - 1000°F
Atmosphere - Air

<u>Properties:</u>	<u>TUS, ksi</u>	<u>TYS, ksi</u>	<u>Temp., °F</u>
	158	147	RT (unnotched)
	81	63	1000°F (unnotched)
	190	—	RT (notched)
	98	—	1000°F (notched)

No. of Heat/Lots: 1

Equivalent Stress Equation:
 $\log N_f = 16.85 - 7.02 \log (S_{eq} - 40.0)$
 $S_{eq} = S_{max} (1-R)^{0.80}$
 Std. Error of Estimate, $\log (\text{Life}) = 0.42$
 Standard Deviation, $\log (\text{Life}) = 1.20$
 $R^2 = 88\%$

Specimen Details: Unnotched
0.400 inch diameter

Sample Size = 13

Surface Condition: Hand polished to RMS 10

Reference: 2.3.1.3.8(b)

[Caution: The equivalent stress model may provide unrealistic life predictions for stress ratios beyond those represented above.]

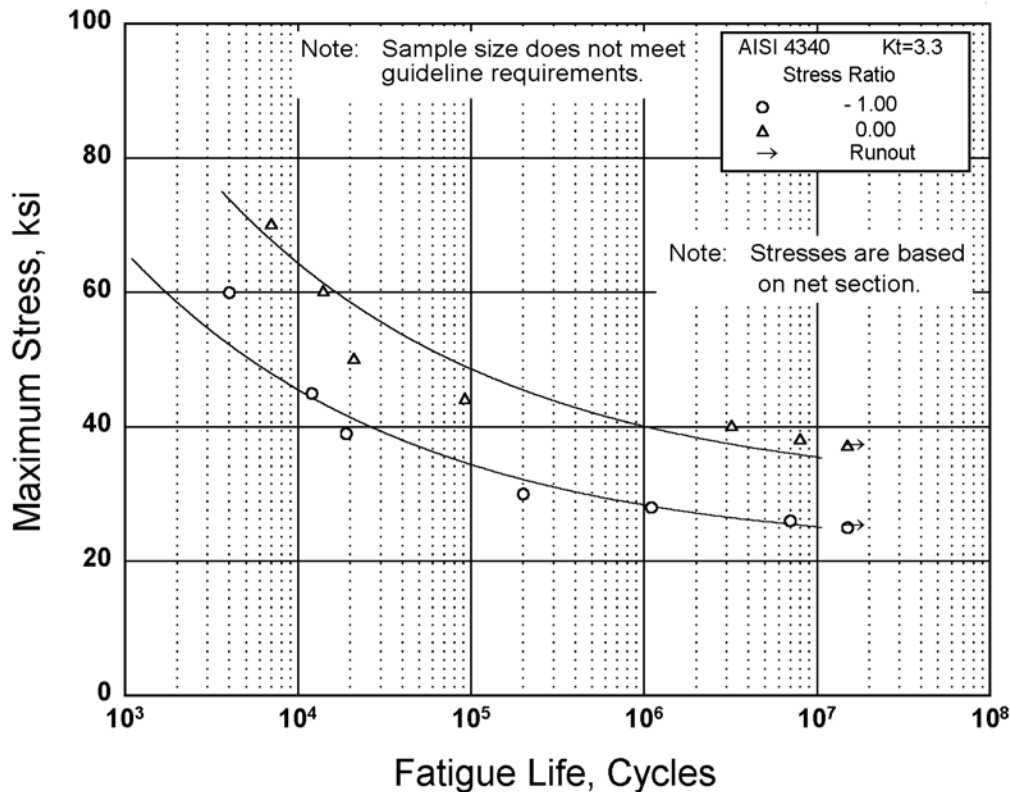

Figure 2.3.1.3.8(j). Best-fit S/N curves for notched, $K_t = 3.3$, AISI 4340 alloy steel bar at 1000°F, $F_{tu} = 150$ ksi, longitudinal direction.

Correlative Information for Figure 2.3.1.3.8(j)

Product Form: Rolled bar, 1.125 inch diameter, air melted

Properties:	TUS, ksi	TYS, ksi	Temp., °F
	158	147	RT (unnotched)
	81	63	1000°F (unnotched)
	190	—	RT (notched)
	98	—	1000°F (notched)

Specimen Details: Notched, V-Groove, $K_t = 3.3$
0.450 inch gross diameter
0.400 inch net diameter
0.010 inch root radius, r
60° flank angle, ω

Surface Condition: Lathe turned to RMS 10

Reference: 2.3.1.3.8(b)

Test Parameters:

Loading - Axial
Frequency - 2000 to 2500 cpm
Temperature - 1000°F
Atmosphere - Air

No. of Heat/Lots: 1

Equivalent Stress Equation:

$$\log N_f = 9.76 - 3.75 \log (S_{eq} - 30.0)$$

$$S_{eq} = S_{max} (1-R)^{0.50}$$

Std. Error of Estimate, Log (Life) = 0.40

Standard Deviation, Log (Life) = 1.22

$R^2 = 89\%$

Sample Size = 12

[Caution: The equivalent stress model may provide unrealistic life predictions for stress ratios beyond those represented above.]

MIL-HDBK-5J
31 January 2003

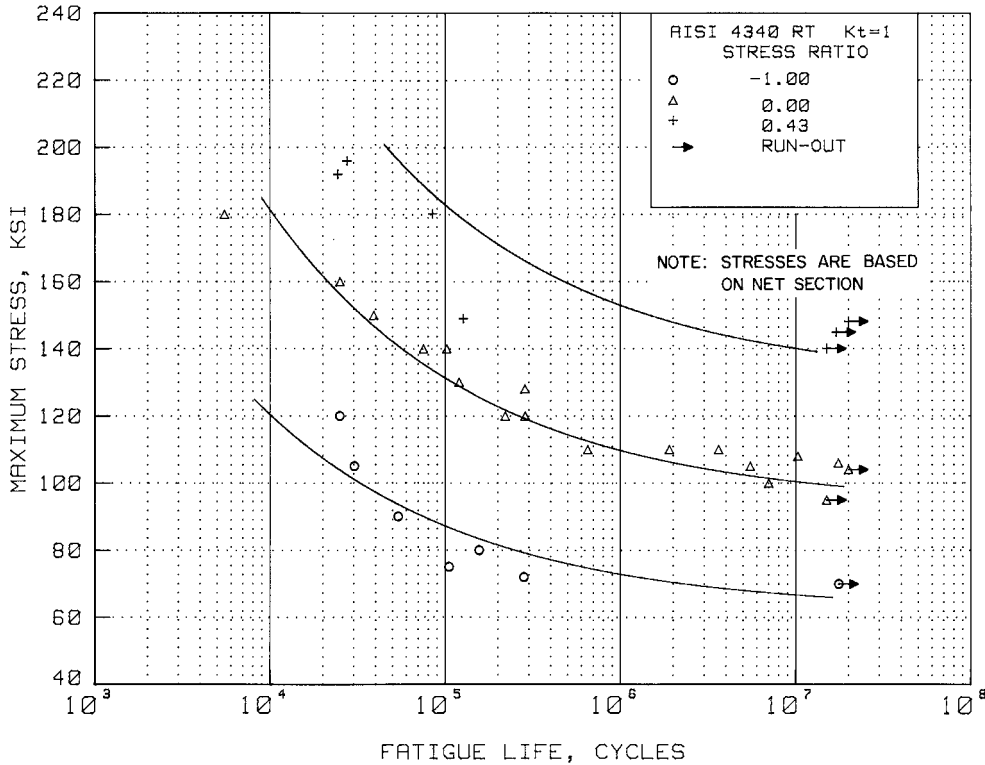

Figure 2.3.1.3.8(k). Best-fit S/N curves for unnotched AISI 4340 alloy steel bar and die forging, $F_{iu} = 200$ ksi, longitudinal direction.

Correlative Information for Figure 2.3.1.3.8(k)

Product Form: Rolled bar, 1.125 inch diameter,
air melted
Die forging (landing gear-B-36
aircraft), air melted

Test Parameters:
Loading - Axial
Frequency - 2000 to 2500 cpm
Temperature - RT
Atmosphere - Air

Properties:

<u>TUS, ksi</u>	<u>TYS, ksi</u>	<u>Temp., °F</u>
208, 221	189, 217	RT
		(unnotched)
251	—	RT
		(notched)

No. of Heat/Lots: 2

Specimen Details: Unnotched
0.300 and 0.400 inch diameter

Equivalent Stress Equation:
 $\log N_f = 9.31 - 2.73 \log (S_{eq} - 93.4)$
 $S_{eq} = S_{max} (1 - R)^{0.59}$
Std. Error of Estimate, $\log (\text{Life}) = 0.49$
Standard Deviation, $\log (\text{Life}) = 0.93$
 $R^2 = 72\%$

Surface Condition: Hand polished to RMS 5-10

Sample Size = 26

References: 2.3.1.3.8(a) and (c)

[Caution: The equivalent stress model may provide unrealistic life predictions for stress ratios beyond those represented above.]

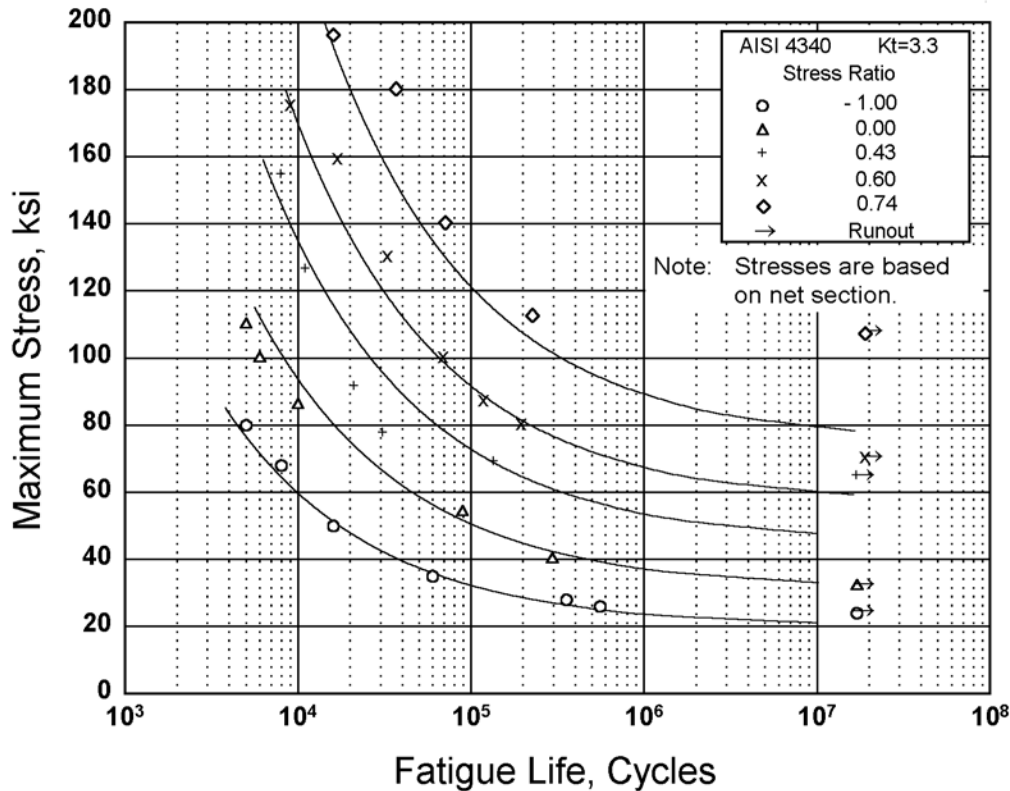

Figure 2.3.1.3.8(I). Best-fit S/N curves for notched, $K_t = 3.3$, AISI 4340 alloy steel bar, $F_{tu} = 200$ ksi, longitudinal direction.

Correlative Information for Figure 2.3.1.3.8(I)

Product Form: Rolled bar, 1.125 inch diameter, air melted

Test Parameters:
Loading - Axial
Frequency - 2000 to 2500 cpm
Temperature - RT
Atmosphere - Air

Properties:

TUS, ksi	TYS, ksi	Temp., °F
208	—	RT (unnotched)
251	—	RT (notched)

No. of Heat/Lots: 1

Specimen Details: Notched, V-Groove, $K_t = 3.3$
0.450 inch gross diameter
0.400 inch net diameter
0.010 inch root radius, r
60° flank angle, ω

Equivalent Stress Equation:
 $\log N_f = 7.52 - 1.96 \log (S_{eq} - 31.2)$
 $S_{eq} = S_{max} (1-R)^{0.65}$
Std. Error of Estimate, $\log (\text{Life}) = 0.16$
Standard Deviation, $\log (\text{Life}) = 0.62$
 $R^2 = 93\%$

Surface Condition: Lathe turned to RMS 10

Sample Size = 26

Reference: 2.3.1.3.8(a)

[Caution: The equivalent stress model may provide unrealistic life predictions for stress ratios beyond those represented above.]

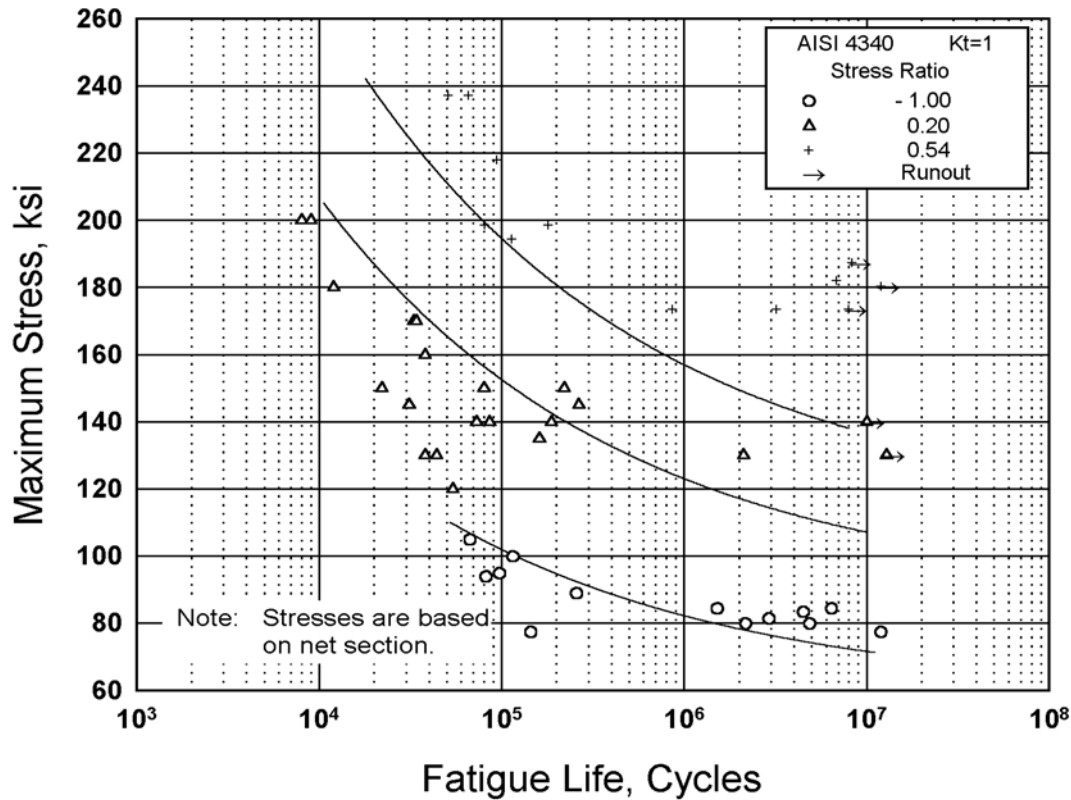

Figure 2.3.1.3.8(m). Best-fit S/N curves for unnotched AISI 4340 alloy steel bar and billet, $F_{tu} = 260$ ksi, longitudinal direction.

Correlative Information for Figure 2.3.1.3.8(m)

Product Form: Rolled bar, 1.125 inch diameter, air melted
Billet, 6 inches RCS air melted

Properties:

<u>TUS, ksi</u>	<u>TYS, ksi</u>	<u>Temp., °F</u>
266, 291	232	RT
		(unnotched)
352	—	RT
		(notched)

Specimen Details: Unnotched
0.200 and 0.400 inch diameter

Surface Condition: Hand polished to RMS 10

References: 2.3.1.3.8(a) and (b)

Test Parameters:
Loading - Axial
Frequency - 1800 to 2500 cpm
Temperature - RT
Atmosphere - Air

No. of Heat/Lots: 2

Equivalent Stress Equation:
 $\log N_f = 11.62 - 3.75 \log (S_{eq} - 80.0)$
 $S_{eq} = S_{max} (1-R)^{0.44}$
Std. Error of Estimate, $\log (\text{Life}) = 0.64$
Standard Deviation, $\log (\text{Life}) = 0.86$
 $R^2 = 45\%$

Sample Size = 41

[Caution: The equivalent stress model may provide unrealistic life predictions for stress ratios beyond those represented above.]

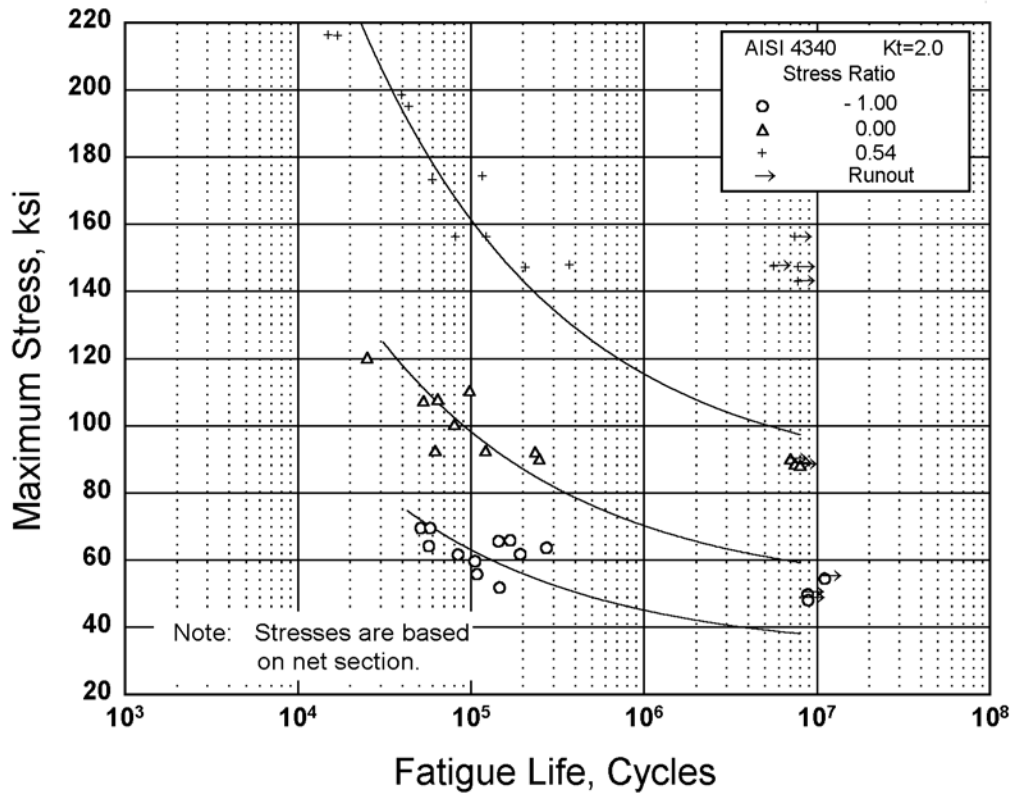

Figure 2.3.1.3.8(n). Best-fit S/N curves for notched, $K_t = 2.0$, AISI 4340 alloy steel bar, $F_u = 260$ ksi, longitudinal direction.

Correlative Information for Figure 2.3.1.3.8(n)

Product Form: Rolled bar, 1.125 inch diameter, air melted

Test Parameters:

Loading - Axial
Frequency - 2000 to 2500 cpm
Temperature - RT
Atmosphere - Air

Properties:

TUS, ksi	TYS, ksi	Temp., °F
266	232	RT (unnotched)
390	—	RT (notched)

No. of Heat/Lots: 1

Specimen Details: Notched, V-Groove, $K_t = 2.0$
0.300 inch gross diameter
0.220 inch net diameter
0.030 inch root radius, r
60° flank angle, ω

Equivalent Stress Equation:

$\log N_f = 9.46 - 2.65 \log (S_{eq} - 50.0)$
 $S_{eq} = S_{max} (1-R)^{0.64}$
Std. Error of Estimate, $\log (\text{Life}) = 0.22$
Standard Deviation, $\log (\text{Life}) = 0.34$
 $R^2 = 58\%$

Surface Condition: Lathe turned to RMS 10

Sample Size = 30

Reference: 2.3.1.3.8(a)

[Caution: The equivalent stress model may provide unrealistic life predictions for stress ratios beyond those represented above.]

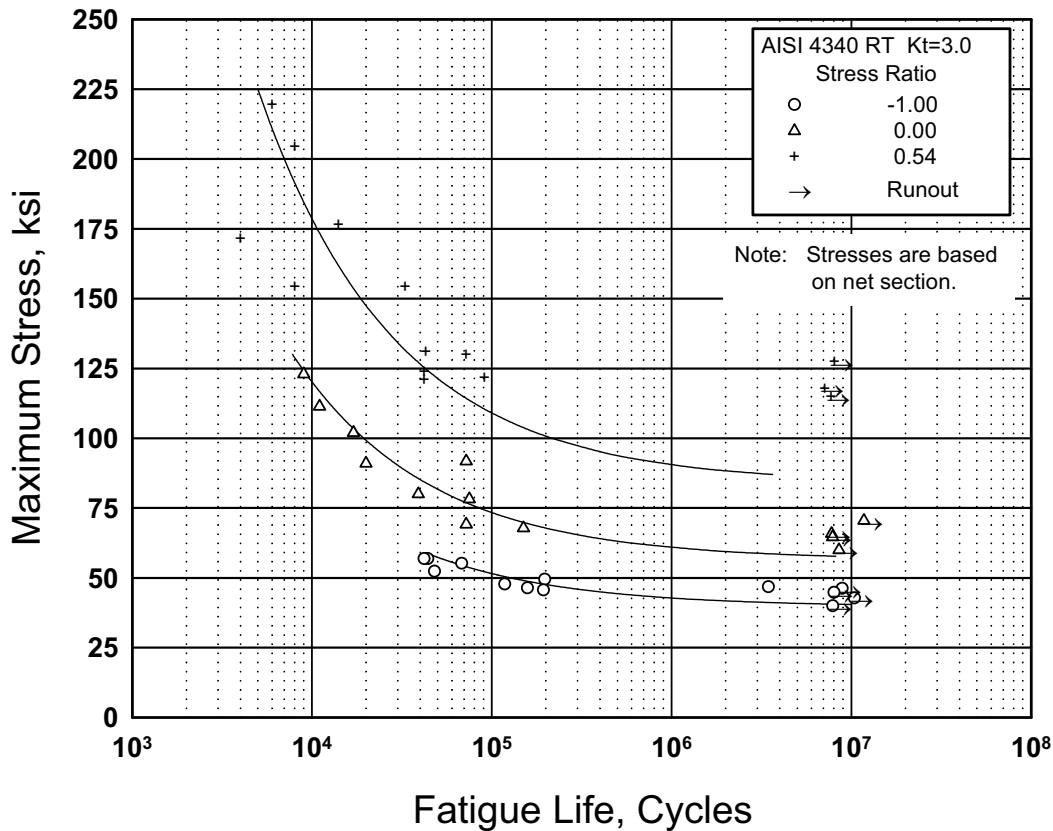

Figure 2.3.1.3.8(o). Best-fit S/N curves for notched, $K_t = 3.0$, AISI 4340 alloy steel bar, $F_{tu} = 260$ ksi, longitudinal direction.

Correlative Information for Figure 2.3.1.3.8(o)

Product Form: Rolled bar, 1.125 inch diameter, air melted

Properties: T_{US} , ksi T_{YS} , ksi $Temp.$, °F
266 232 RT
(unnotched)
352 — RT
(notched)

Specimen Details: Notched, V-Groove, $K_t = 3.0$
0.270 inch gross diameter
0.220 inch net diameter
0.010 inch root radius, r
60° flank angle, ω

Surface Condition: Lathe turned to RMS 10

Reference: 2.3.1.3.8(a)

Test Parameters:

Loading—Axial
Frequency—2000 to 2500 cpm
Temperature—RT
Atmosphere—Air

No. of Heats/Lots: 1

Equivalent Stress Equation:

$\log N_f = 7.14 - 1.74 \log (S_{eq} - 56.4)$
 $S_{eq} = S_{max} (1-R)^{0.51}$
Std. Error of Estimate, $\log (\text{Life}) = 0.32$
Standard Deviation, $\log (\text{Life}) = 0.59$
 $R^2 = 71\%$

Sample Size = 29

[Caution: The equivalent stress model may provide unrealistic life predictions for stress ratios beyond those represented above.]

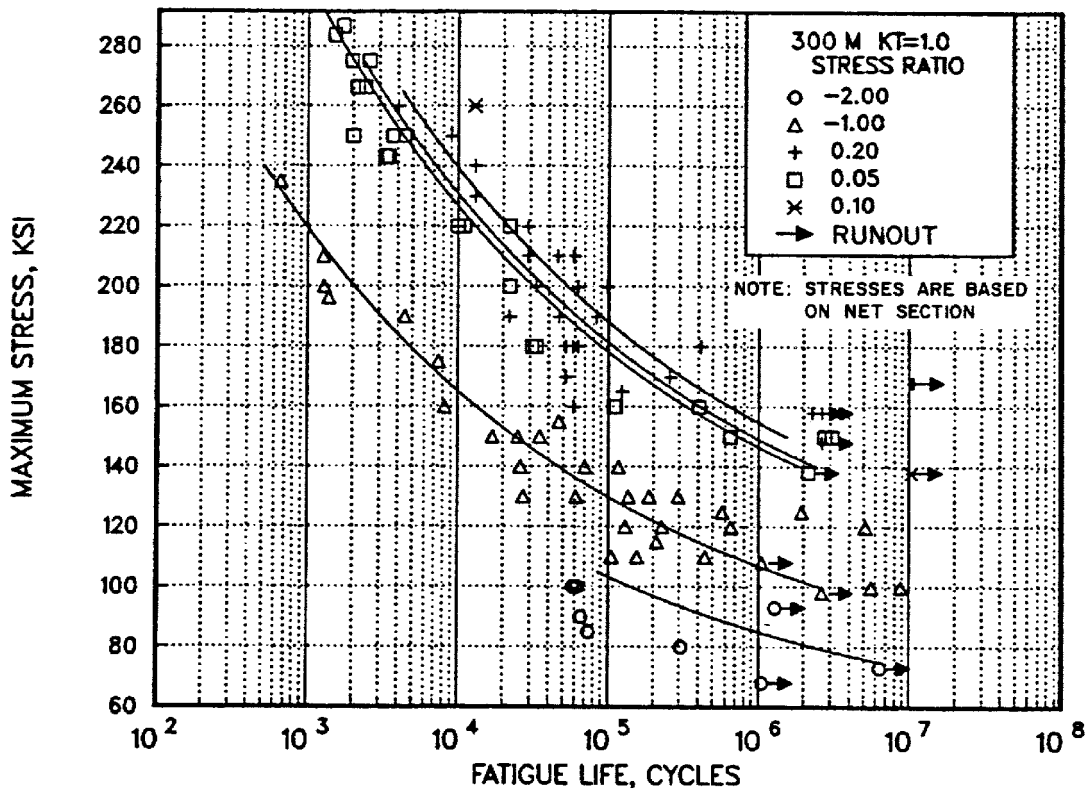

Figure 2.3.1.4.8(a). Best-fit S/N curves for unnotched 300M alloy forging, $F_{tu} = 280$ ksi, longitudinal and transverse directions.

Correlative Information for Figure 2.3.1.4.8(a)

Product Forms: Die forging, 10 x 20 inches
CEVM
Die forging, 6.5 x 20 inches
CEVM
RCS billet, 6 inches CEVM
Forged Bar, 1.25 x 8 inches
CEVM

Test Parameters:
Loading - Axial
Frequency - 1800 to 2000 cpm
Temperature - RT
Atmosphere - Air

No. of Heat/Lots: 6

Properties: TUS, ksi TYS, ksi Temp., °F
274-294 227-247 RT

Equivalent Stress Equation:
 $\text{Log } N_f = 14.8 - 5.38 \log (S_{eq} - 63.8)$
 $S_{eq} = S_a + 0.48 S_m$
Std. Error of Estimate, $\text{Log (Life)} = 55.7 (1/S_{eq})$
Standard Deviation, $\text{Log (Life)} = 1.037$
 $R^2 = 82.0$

Specimen Details: Unnotched
0.200 - 0.250 inch diameter

Sample Size = 104

Surface Condition: Heat treat and finish grind
to a surface finish of RMS
63 or better with light
grinding parallel to
specimen length, stress
relieve

[Caution: The equivalent stress model may
provide unrealistic life predictions for stress
ratios beyond those represented above.]

References: 2.3.1.4.8(a), (c), (d), (e)

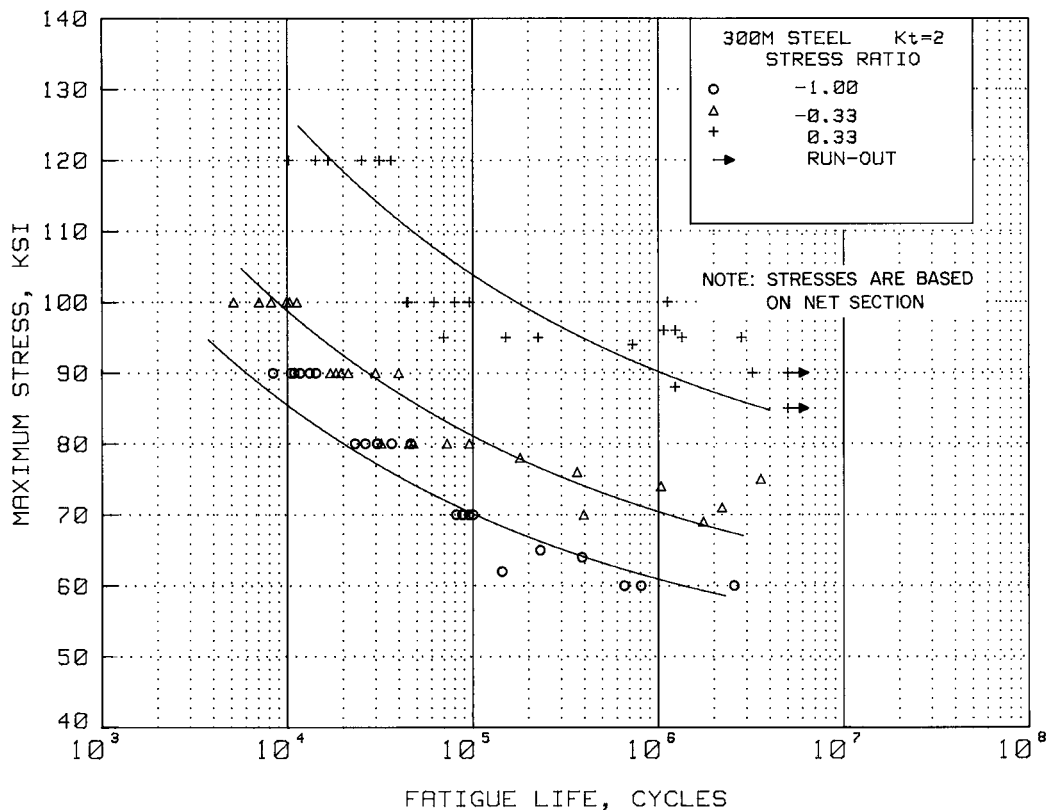

Figure 2.3.1.4.8(b). Best-fit S/N curves for unnotched, $K_t = 2.0$, 300M alloy forged billet, $F_{iu} = 280$ ksi, longitudinal direction.

Correlative Information for Figure 2.3.1.4.8(b)

Product Form: Forged billet, unspecified size, CEVM

Test Parameters:

Loading - Axial
Frequency -
Temperature - RT
Atmosphere - Air

Properties:

TUS, ksi	TYS, ksi	Temp., °F
290	242	RT (unnotched)
456	—	RT (notched)

No. of Heats/Lots: 3

Specimen Details: Notched, 60° V-Groove, $K_t=2.0$
0.500 inch gross diameter
0.250 inch net diameter
0.040 inch root radius, r
60° flank angle, ω

Equivalent Stress Equation:

$\log N_f = 12.87 - 5.08 \log (S_{eq} - 55.0)$
 $S_{eq} = S_{max} (1-R)^{0.36}$
 Std. Error of Estimate, $\log (\text{Life}) = 0.79$
 Standard Deviation, $\log (\text{Life}) = 1.72$
 $R^2 = 79\%$

Surface Condition: Heat treat and finish grind notch to RMS 63 ± 5 ; stress relieve

Sample Size = 70

Reference: 2.3.1.4.8(b)

[Caution: The equivalent stress model may provide unrealistic life predictions for stress ratios beyond those represented above.]

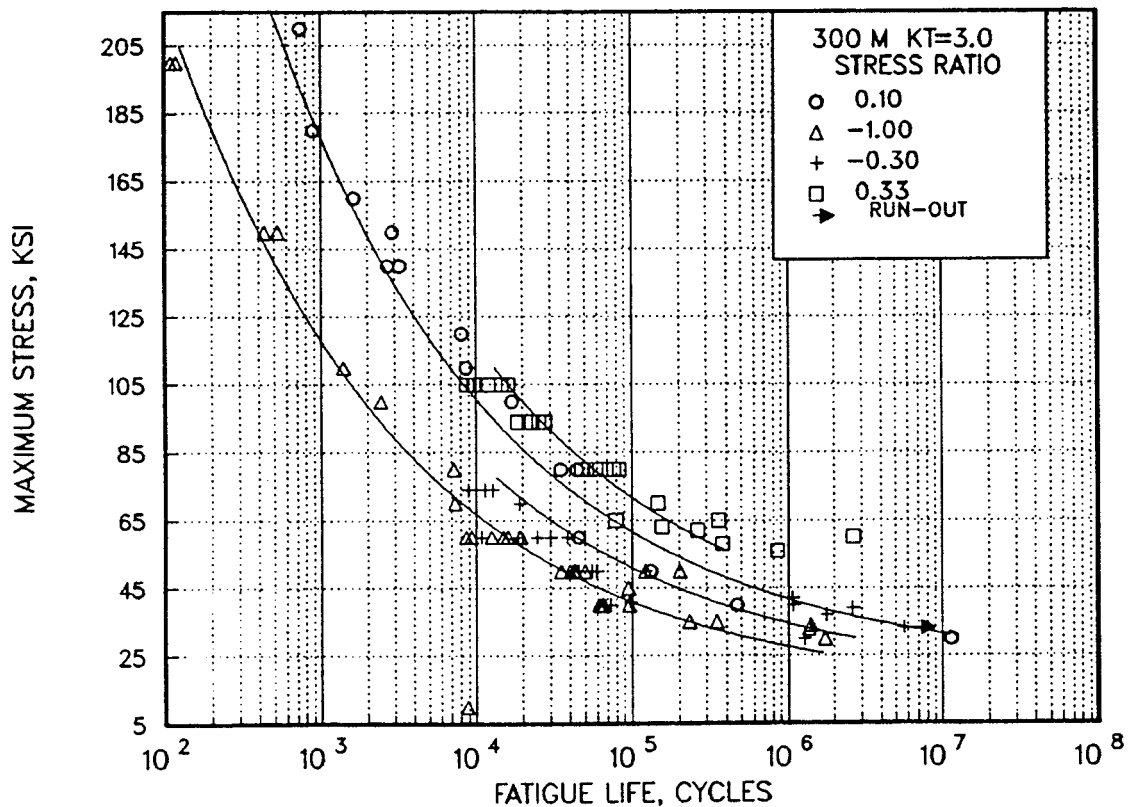

Figure 2.3.1.4.8(c). Best-fit S/N curves for notched, $K_t = 3.0$, 300M alloy forging, $F_{tu} = 280$ ksi, longitudinal and transverse directions.

Correlative Information for Figure 2.3.1.4.8(c)

Product Forms: Forged billet, unspecified size, CEVM
Die forging, 10 x 20 inches, CEVM
Die forging, 6.50 x 20 inches, CEVM

Test Parameters:
Loading - Axial
Frequency -
Temperature - RT
Atmosphere - Air

Properties:

TUS, ksi	TYS, ksi	Temp., °F
290-292	242-247	RT (unnotched)
435	—	RT (notched)

No. of Heats/Lots: 5

Equivalent Stress Equation:
 $\log N_f = 10.40 - 3.41 \log (S_{eq} - 20.0)$
 $S_{eq} = S_{max} (1 - R)^{0.51}$
 Std. Error of Estimate, $\log (\text{Life}) = 18.3 (1/S_{eq})$
 Standard Deviation, $\log (\text{Life}) = 2.100$
 $R^2 = 97.4$

Specimen Details: Notched 60° V-Groove, $K_t = 3.0$
0.500 inch gross diameter
0.250 inch net diameter
0.0145 inch root radius, r
60° flank angle, ω

Sample Size = 99

Surface Condition: Heat treat and finish grind notch to RMS 63 or better; stress relieve

[Caution: The equivalent stress model may provide unrealistic life predictions for stress ratios beyond those represented above.]

References: 2.3.1.4.8(a), (b), (c)

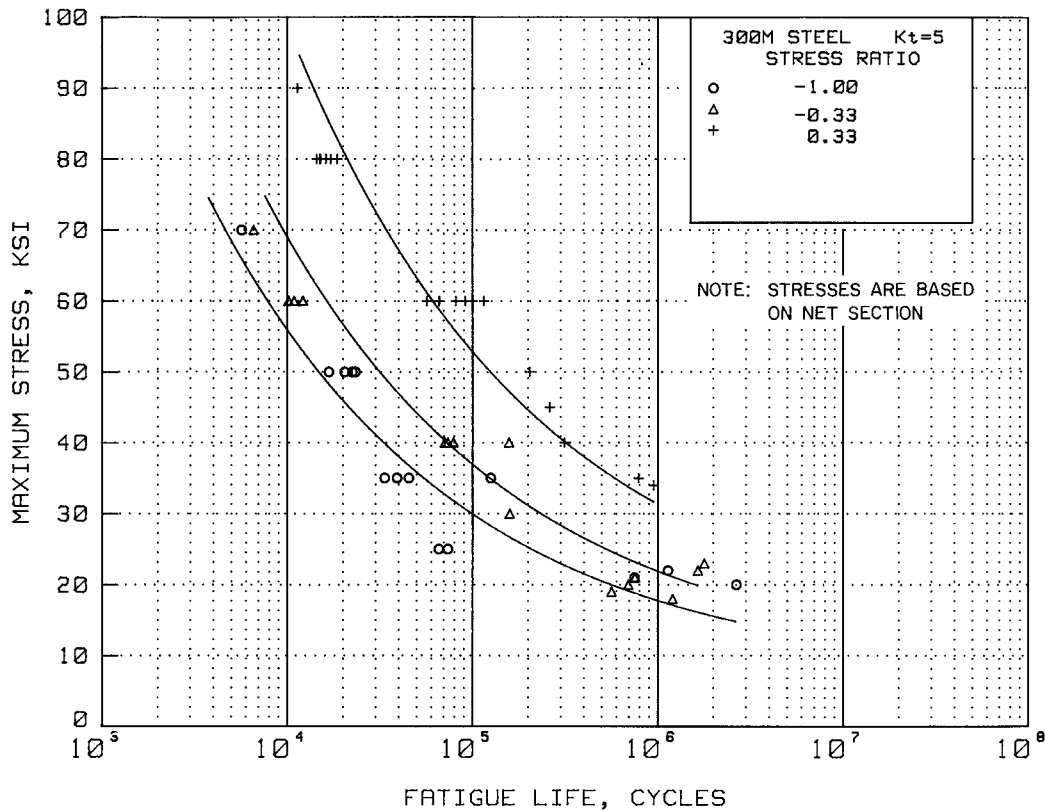

Figure 2.3.1.4.8(d). Best-fit S/N curves for notched, $K_t = 5.0$, 300M alloy forged billet, $F_{iu} = 280$ ksi, longitudinal direction.

Correlative Information for Figure 2.3.1.4.8(d)

Product Forms: Forged billet, unspecified size, CEVM

Test Parameters:

Loading - Axial

Frequency -

Temperature - RT

Atmosphere - Air

Properties:

TUS, ksi	TYS, ksi	Temp., °F
290	242	RT
		(unnotched)
379	—	RT
		(notched)

No. of Heat/Lots: 2

Specimen Details: Notched, 60° V-Groove, $K_t=5.0$
0.500 inch gross diameter
0.250 inch net diameter
0.0042 inch root radius, r
60° flank angle, ω

Equivalent Stress Equation:

$$\log N_f = 9.61 - 3.04 \log (S_{eq} - 10.0)$$

$$S_{eq} = S_{max} (1-R)^{0.52}$$

Std. Error of Estimate, Log (Life) = 0.28

Standard Deviation, Log (Life) = 0.81

$R^2 = 88\%$

Surface Condition: Heat treat and finish grind notch to RMS 63 maximum; stress relieve

Sample Size = 48

Reference: 2.3.1.4.8(b)

[Caution: The equivalent stress model may provide unrealistic life predictions for stress ratios beyond those represented above.]

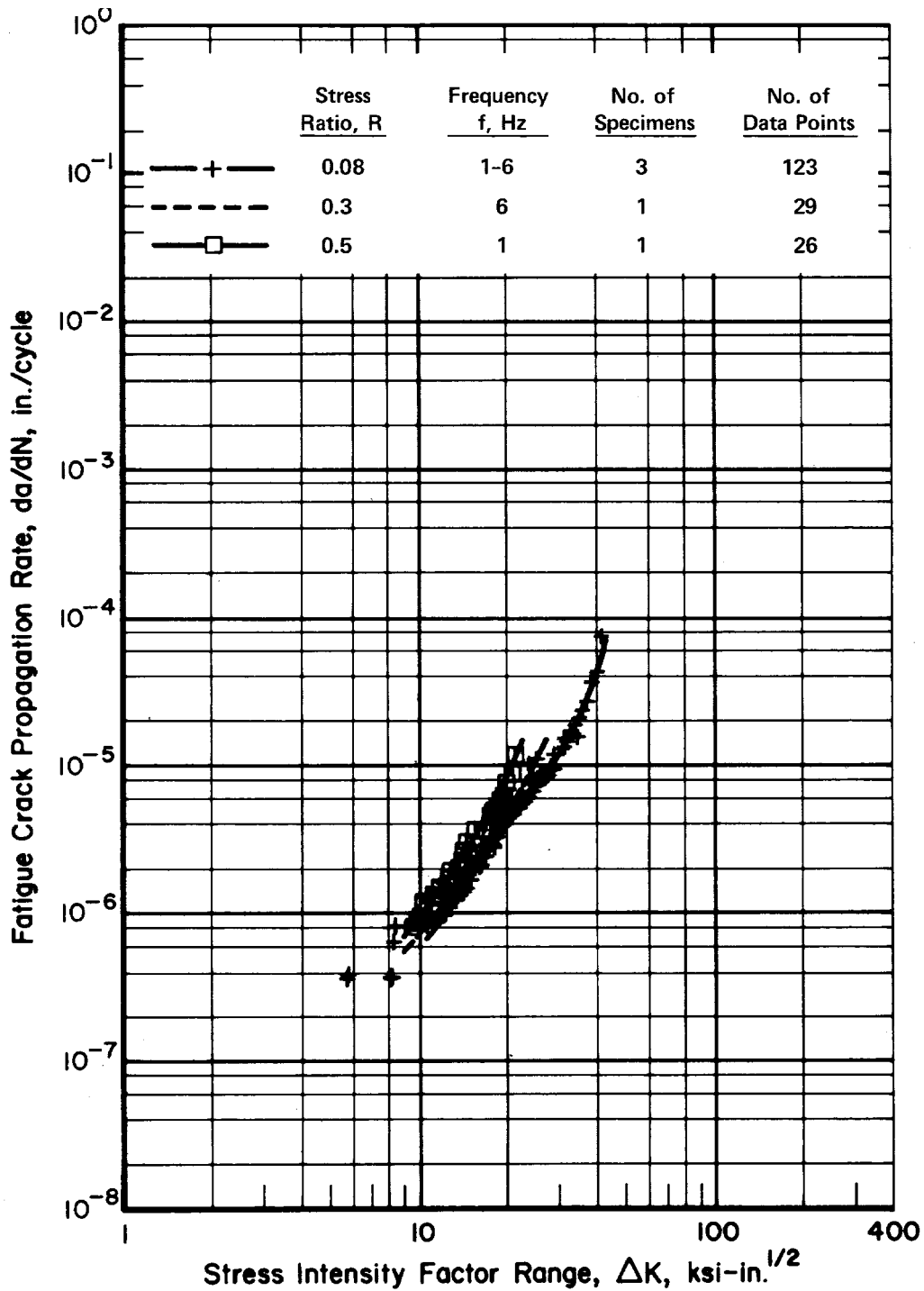

Figure 2.3.1.4.9. Fatigue-crack-propagation data for 3.00-inch hand forging and 1.80-inch thick, 300M steel alloy plate (TUS: 280-290 ksi). [References - 2.3.1.4.9(a) and (b).]

Specimen Thickness: 0.900-1.000 inches
 Specimen Width: 3.09-7.41 inches
 Specimen Type: CT

Environment: Low-humidity air
 Temperature: RT
 Orientation: L-T and T-L

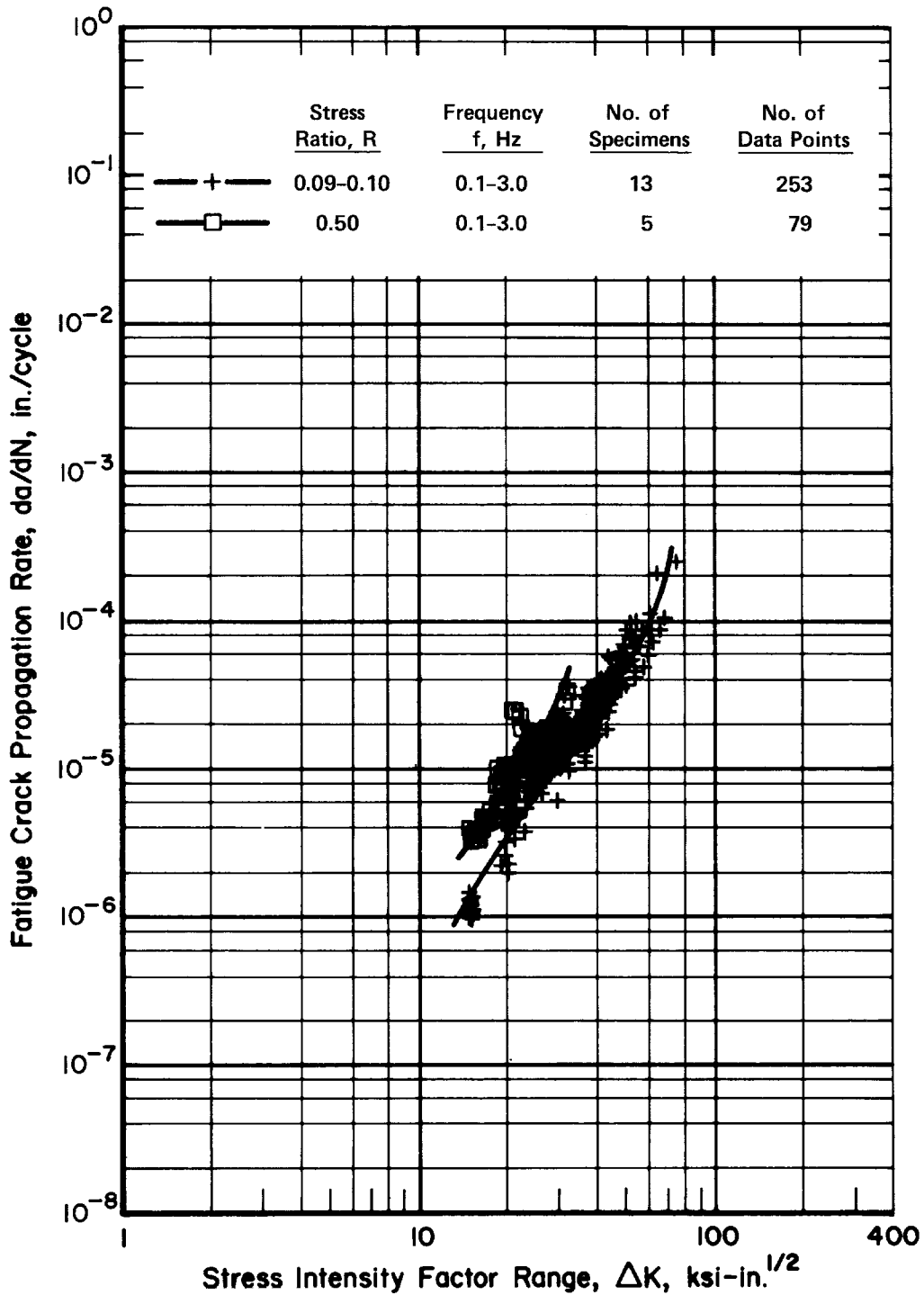

Figure 2.3.1.5.9. Fatigue-crack-propagation data for 0.80-inch D6AC steel alloy plate. Data include material both oil quenched and salt quenched (TUS: 230-240 ksi). [Reference - 2.3.1.5.9.]

Specimen Thickness: 0.70-0.75 inch
Specimen Width: 1.5-5.0 inches
Specimen Type: CT

Environment: Dry air and lab air
Temperature: RT
Orientation: L-T

2.4 INTERMEDIATE ALLOY STEELS

2.4.0 COMMENTS ON INTERMEDIATE ALLOY STEELS — The intermediate alloy steels in this section are those steels that are substantially higher in alloy content than the alloy steels described in Section 2.3, but lower in alloy content than the stainless steels. Typical of the intermediate alloy steels is the 5Cr-Mo-V aircraft steel and the 9Ni-4Co series of steels.

2.4.0.1 Metallurgical Considerations — The alloying elements added to these steels are similar to those used in the lower alloy steels and, in general, have the same effects. The difference lies in the quantity of alloying additions and the extent of these effects. Thus, higher chromium contents provide improved oxidation resistance. Additions of molybdenum, vanadium, and tungsten, together with the chromium, provide deep air-hardening properties and improve the elevated-temperature strength by retarding the rate of tempering at high temperatures. Additions of nickel to nonsecondary hardening steels lower the transition temperature and improve low-temperature toughness.

2.4.1 5Cr-Mo-V

2.4.1.0 Comments and Properties — Alloy 5Cr-Mo-V aircraft steel exhibits high strength in the temperature range up to 1000°F. Its characteristics also include air hardenability in thick sections; consequently, little distortion is encountered in heat treatment. This steel is available either as air-melted or consumable electrode vacuum-melted quality although only consumable electrode vacuum-melted quality is recommended for aerospace applications.

The heat treatment recommended for this steel consists of heating to 1850°F ± 50, holding 15 to 25 minutes for sheet or 30 to 60 minutes for bars depending on section size, cooling in air to room temperature, tempering three times by heating to the temperature specified in Table 2.4.1.0(a) for the strength level desired, holding at temperature for 2 to 3 hours, and cooling in air.

Table 2.4.1.0(a). Tempering Temperatures for 5Cr-Mo-V Aircraft Steel

F_{tu} , ksi	Temperature, °F	Hardness, R _c
280	1000 ± 10	54-56
260	1030 ± 10	52-54
240	1050 ± 10	49-52
220	1080 ± 10	46-49

Material specifications for 5Cr-Mo-V aircraft steel are presented in Table 2.4.1.0(b). The room-temperature mechanical and physical properties are shown in Tables 2.4.1.0(c) and (d). The mechanical properties are for 5Cr-Mo-V steel heat treated to produce a structure containing 90 percent or more martensite at the center prior to tempering.

Table 2.4.1.0(b). Material Specifications for 5Cr-Mo-V Aircraft Steel

Specification	Form
AMS 6437	Sheet, strip, and plate (air melted)
AMS 6488	Bar and forging (air melted, premium quality)
AMS 6487	Bar and forging (CEVM)

The room-temperature properties of 5Cr-Mo-V aircraft steel are affected by extended exposure to temperatures near or above the tempering temperature. The limiting temperature to which the alloy may be exposed for extended periods without significantly affecting its room-temperature properties may be estimated at 100°F below the tempering temperature for the desired strength level. The effect of temperature on the physical properties is shown in Figure 2.4.1.0.

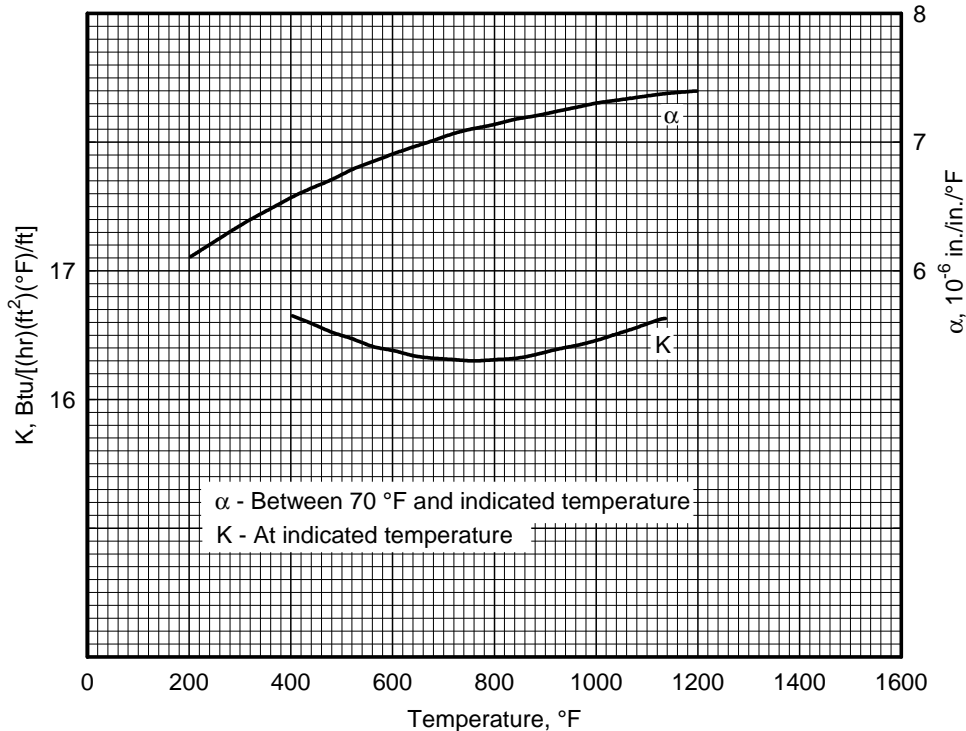

Figure 2.4.1.0. Effect of temperature on the physical properties of 5Cr-Mo-V aircraft steel.

2.4.1.1 Heat-Treated Condition— The effect of temperature on various mechanical properties for heat-treated 5Cr-Mo-V aircraft steel is presented in Figures 2.4.1.1.1(a) through 2.4.1.1.4.

Table 2.4.1.0(c). Design Mechanical and Physical Properties of 5Cr-Mo-V Aircraft Steel Bar and Forging

Specification	AMS 6487 and AMS 6488		
Form	Bars and forgings		
Condition	Quenched and tempered		
Cross-sectional area, in. ²	a,b		
Basis	S ^c	S ^c	S ^c
Mechanical Properties:			
F_{tu} , ksi:			
L	260 ^a	...
T	240	260 ^b	280
F_{ty} , ksi:			
L	215 ^a	...
T	200	215 ^b	240
F_{cy} , ksi:			
L
T	220	234	260
F_{su} , ksi	144	156	168
F_{bru} , ksi:			
(e/D = 1.5)
(e/D = 2.0)	400	435	465
F_{bry} , ksi:			
(e/D = 1.5)
(e/D = 2.0)	315	333	365
e , percent:			
L	9	8 ^a	7
T
RA , percent:			
L	30 ^a	...
T	6 ^b	...
E , 10 ³ ksi	30.0		
E_c , 10 ³ ksi	30.0		
G , 10 ³ ksi	11.0		
μ	0.36		
Physical Properties:			
ω , lb/in. ³	0.281		
C , Btu/(lb)(°F)	0.11 (32°F) ^d		
K and α	See Figure 2.4.1.0		

- a Longitudinal properties applicable to cross-sectional area ≤ 25 sq. in.
- b Transverse properties applicable only to product sufficiently large to yield tensile specimens not less than 4.50 inches in length.
- c Design values are applicable only to parts for which the indicated F_m has been substantiated by adequate quality control testing.
- d Calculated value.

Table 2.4.1.0(d). Design Mechanical and Physical Properties of 5Cr-Mo-V Aircraft Steel Sheet, Strip, and Plate

Specification	AMS 6437		
Form	Sheet, strip, and plate		
Condition	Quenched and tempered		
Thickness, in.		
Basis	S ^a	S ^a	S ^a
Mechanical Properties:			
F_{tu} , ksi:			
L
LT	240	260	280
F_{ly} , ksi:			
L
LT	200	220	240
F_{cy} , ksi:			
L
LT	220	240	260
F_{su} , ksi	144	156	168
F_{bru} , ksi:			
(e/D = 1.5)
(e/D = 2.0)	400	435	465
F_{brl} , ksi:			
(e/D = 1.5)
(e/D = 2.0)	315	340	365
e , percent:			
L
LT, in 2 inches ^b	6	5	4
LT, in 1 inch	8	7	6
E , 10 ³ ksi	30.0		
E_c , 10 ³ ksi	30.0		
G , 10 ³ ksi	11.0		
μ	0.36		
Physical Properties:			
ω , lb/in. ³	0.281		
C , Btu/(lb)(°F)	0.11 ^c (32°F)		
K and α	See Figure 2.4.1.0		

a Design values are applicable only to parts for which the indicated F_{tu} has been substantiated by adequate quality control testing.
b For sheet thickness greater than 0.050 inch.
c Calculated value.

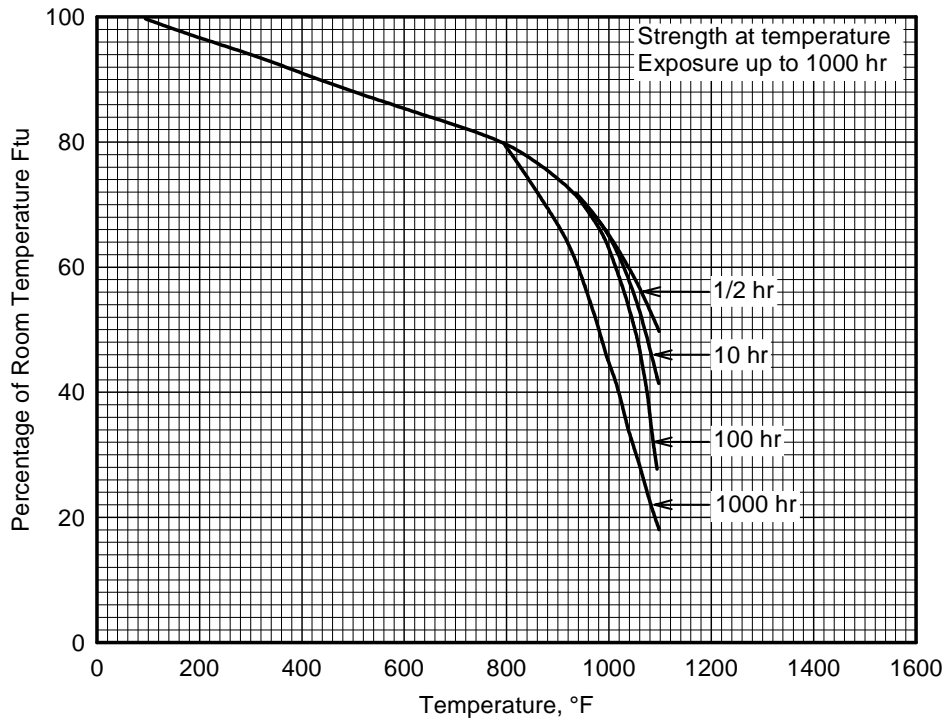

Figure 2.4.1.1.1(a). Effect of temperature on the ultimate tensile strength (F_{tu}) of 5Cr-Mo-V aircraft steel.

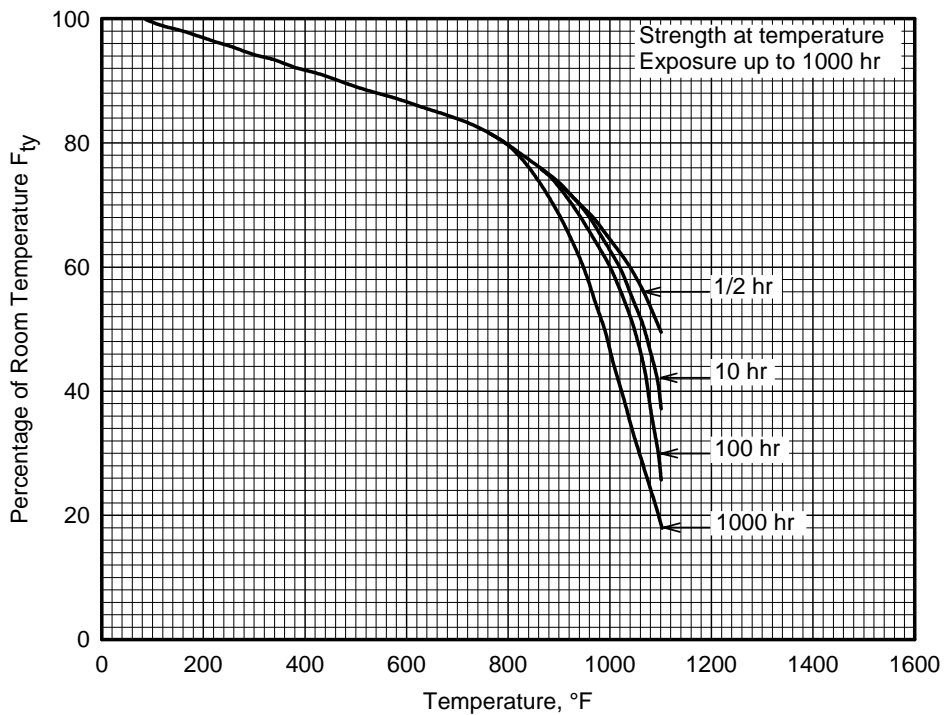

Figure 2.4.1.1.1(b). Effect of temperature on the tensile yield strength (F_{ty}) of 5Cr-Mo-V aircraft steel.

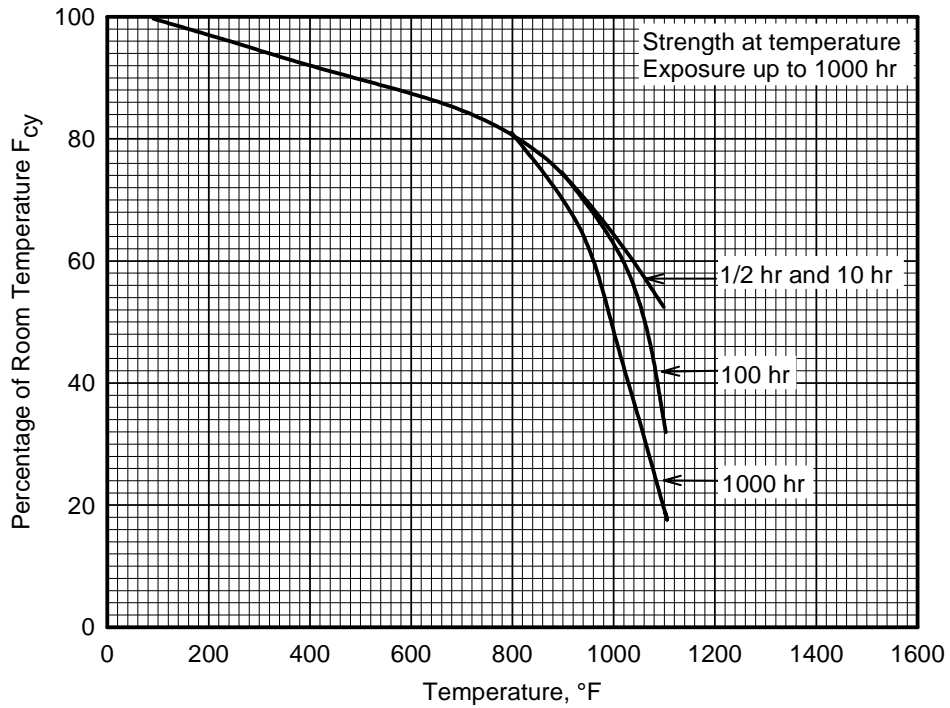

Figure 2.4.1.1.2(a). Effect of temperature on the compressive yield strength (F_{cy}) of 5Cr-Mo-V aircraft steel.

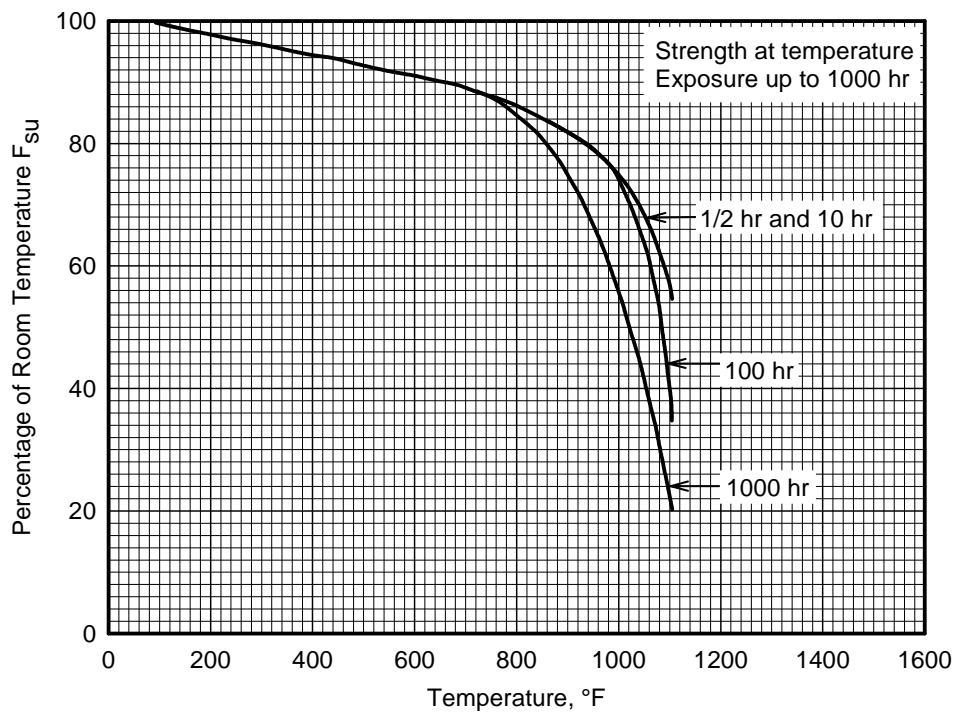

Figure 2.4.1.1.2(b). Effect of temperature on the ultimate shear strength (F_{su}) of 5Cr-Mo-V aircraft steel.

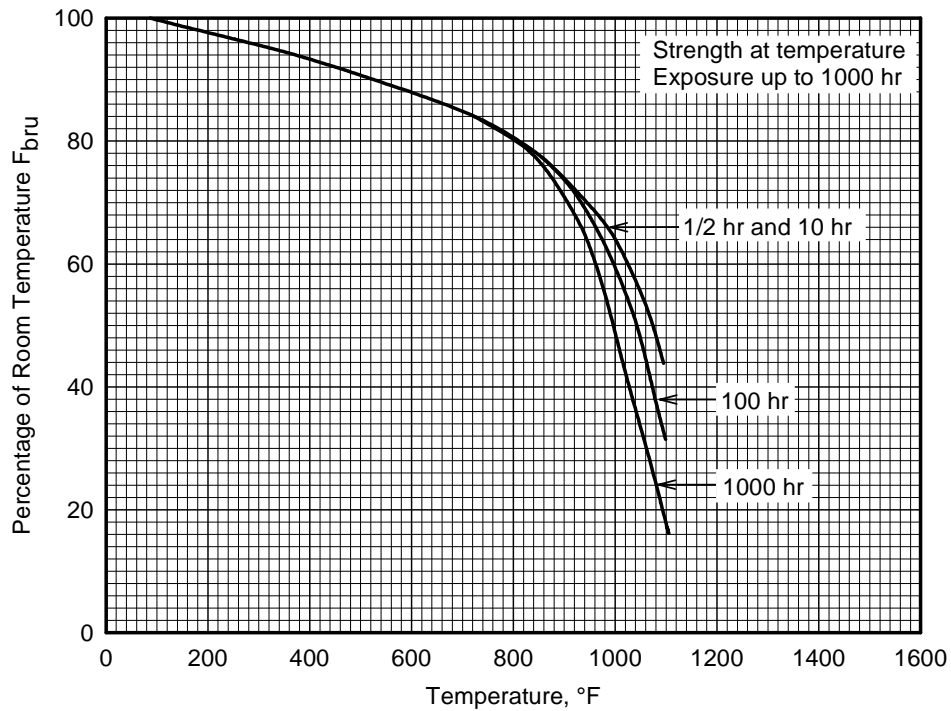

Figure 2.4.1.1.3(a). Effect of temperature on the ultimate bearing strength (F_{bru}) of 5 Cr-Mo-V aircraft steel.

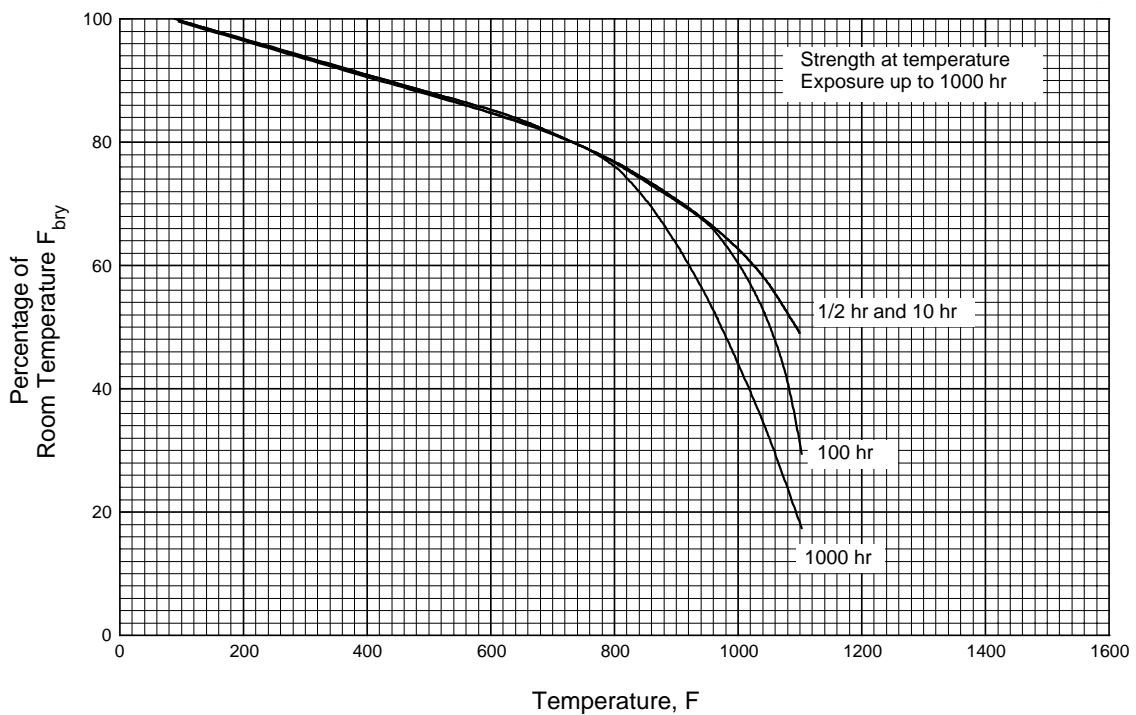

Figure 2.4.1.1.3(b). Effect of temperature on the bearing yield strength (F_{bry}) of 5Cr-Mo-V aircraft steel.

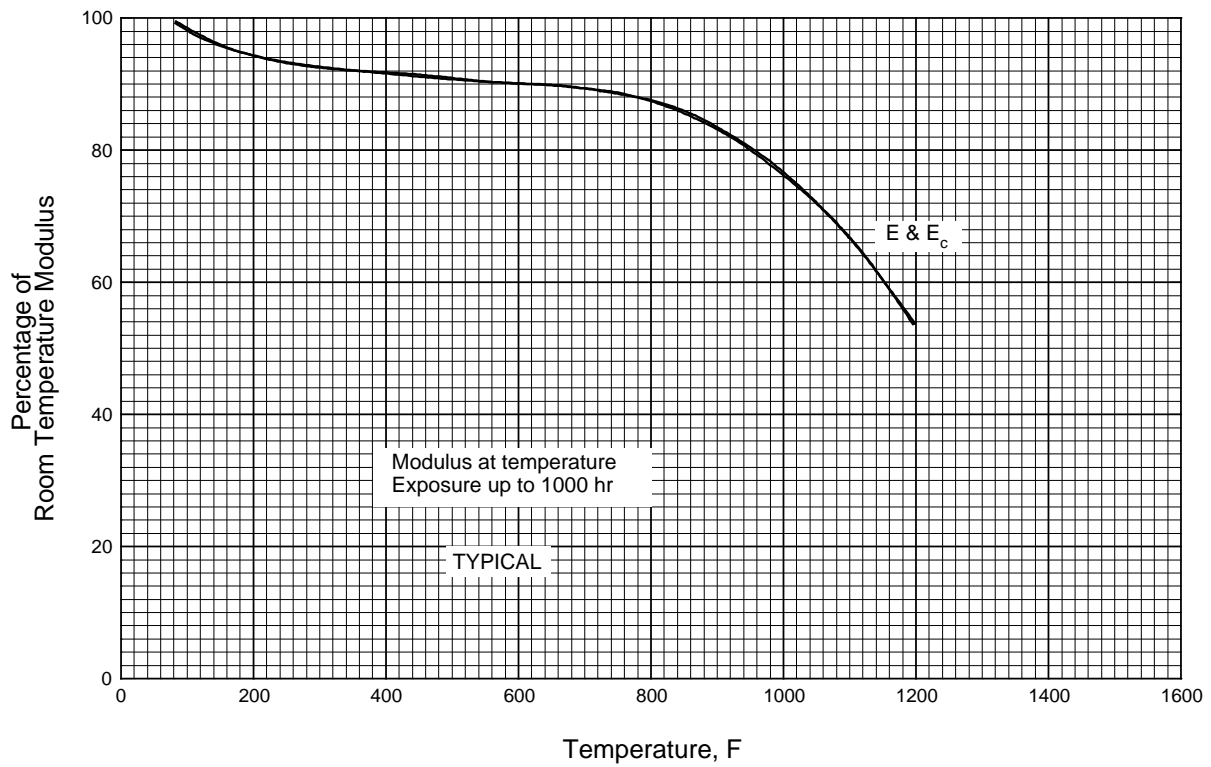

Figure 2.4.1.1.4. Effect of temperature on the tensile and compressive moduli (E and E_c) of 5Cr-Mo-V aircraft steel.

2.4.2 9Ni-4Co-0.20C

2.4.2.0 Comments and Properties — The 9Ni-4Co-0.20C alloy was developed specifically to have excellent fracture toughness, excellent weldability, and high hardenability when heat-treated to 190 to 210 ksi ultimate tensile strength. The alloy can be readily welded in the heat-treated condition with preheat and post-heat usually not required. The alloy is through hardening in section sizes up to at least 8 inches thick. The alloy may be exposed to temperatures up to 900°F (approximately 100°F below typical tempering temperature) without microstructural changes which degrade room temperature strength.

The heat treatment for this alloy consists of normalizing at $1650 \pm 25^\circ\text{F}$ for 1 hour per inch of cross section, cooling in air to room temperature, heating to $1525 \pm 25^\circ\text{F}$ for 1 hour per inch of cross section, quenching in oil or water, hold at $-100 \pm 20^\circ\text{F}$ for 2 hours within 2 hours after quenching, and double tempering at $1035 \pm 10^\circ\text{F}$ for 2 hours.

A material specification for 9Ni-4Co-0.20C steel is presented in Table 2.4.2.0(a). Room temperature mechanical and physical properties are shown in Table 2.4.2.0(b). The effect of temperature on thermal expansion is shown in Figure 2.4.2.0.

Table 2.4.2.0(a). Material Specification for 9Ni-4Co-0.20C Steel

Specification	Form
AMS 6523	Sheet, strip, and plate

2.4.2.1 Heat-Treated Condition — Effect of temperature on various mechanical properties is presented in Figures 2.4.2.1.1, 2.4.2.1.2, and 2.4.2.1.4. Typical tensile stress-strain curves at room and elevated temperatures are shown in Figure 2.4.2.1.6(a). Typical compression stress-strain and tangent-modulus curves are presented in Figure 2.4.2.1.6(b).

Table 2.4.2.0(b). Design Mechanical and Physical Properties of 9Ni-4Co-0.20C Steel Plate

Specification	AMS 6523	
Form	Plate	
Condition	Quenched and tempered	
Thickness, in.	<0.250	≥0.250
Basis	S ^a	S ^a
Mechanical Properties:		
<i>F_{tu}</i> , ksi:		
L	186	186
LT	190	190
<i>F_{ty}</i> , ksi:		
L	173	173
LT	175	175
<i>F_{cy}</i> , ksi:		
L	188	188
LT	187	187
<i>F_{su}</i> , ksi	114	114
<i>F_{bru}</i> , ksi:		
(e/D = 1.5)
(e/D = 2.0)
<i>F_{brt}</i> , ksi:		
(e/D = 1.5)
(e/D = 2.0)
<i>e</i> , percent:		
LT	5	10
<i>RA</i> , percent:		
LT	45	45
<i>E</i> , 10 ³ ksi	28.8	
<i>E_c</i> , 10 ³ ksi	28.8	
<i>G</i> , 10 ³ ksi	11.1	
<i>μ</i>	0.30	
Physical Properties:		
<i>ω</i> , lb/in. ³	0.283	
<i>C</i> , Btu/(lb)(°F)	
<i>K</i> , Btu/[(hr)(ft ²)(°F)/ft]	14.2 (75°F)	
<i>α</i> , 10 ⁻⁶ in./in./°F	See Figure 2.4.2.0	

a Design values are applicable only to parts for which the indicated *F_{tu}* has been substantiated by adequate quality control testing.

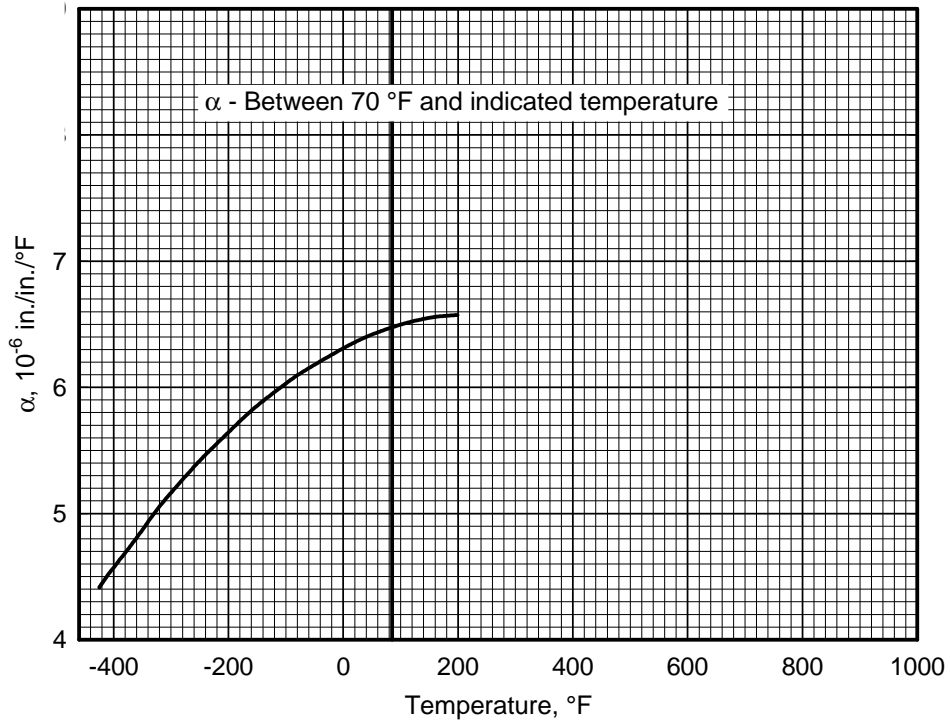

Figure 2.4.2.0. Effect of temperature on the thermal expansion of 9Ni-4Co-0.20C steel.

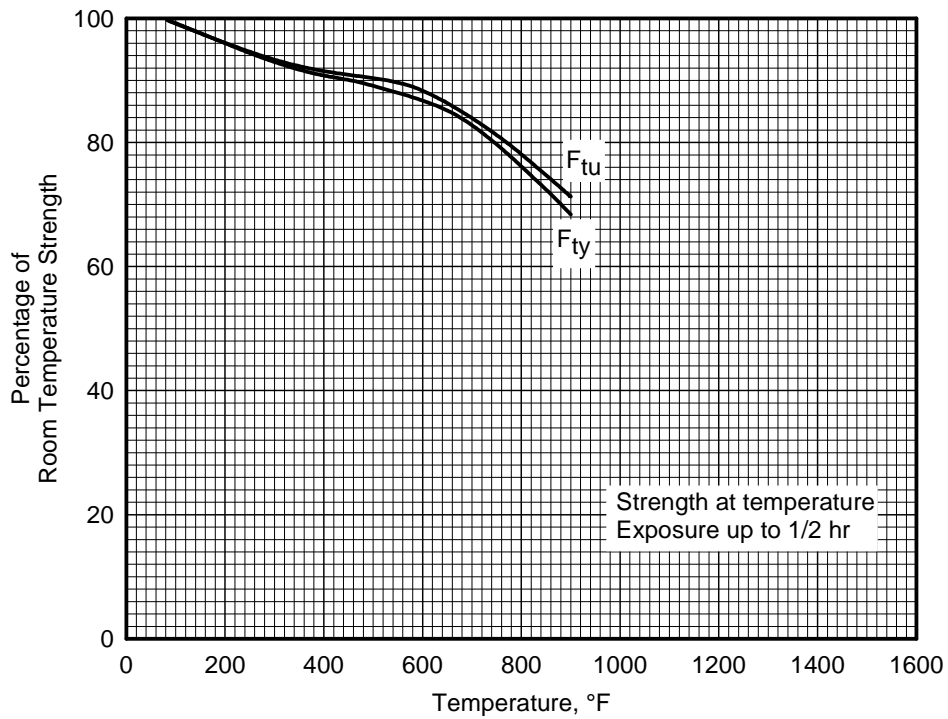

Figure 2.4.2.1.1. Effect of temperature on the tensile ultimate strength (F_{tu}) and tensile yield strength (F_{ty}) of 9Ni-4Co-0.20C steel plate.

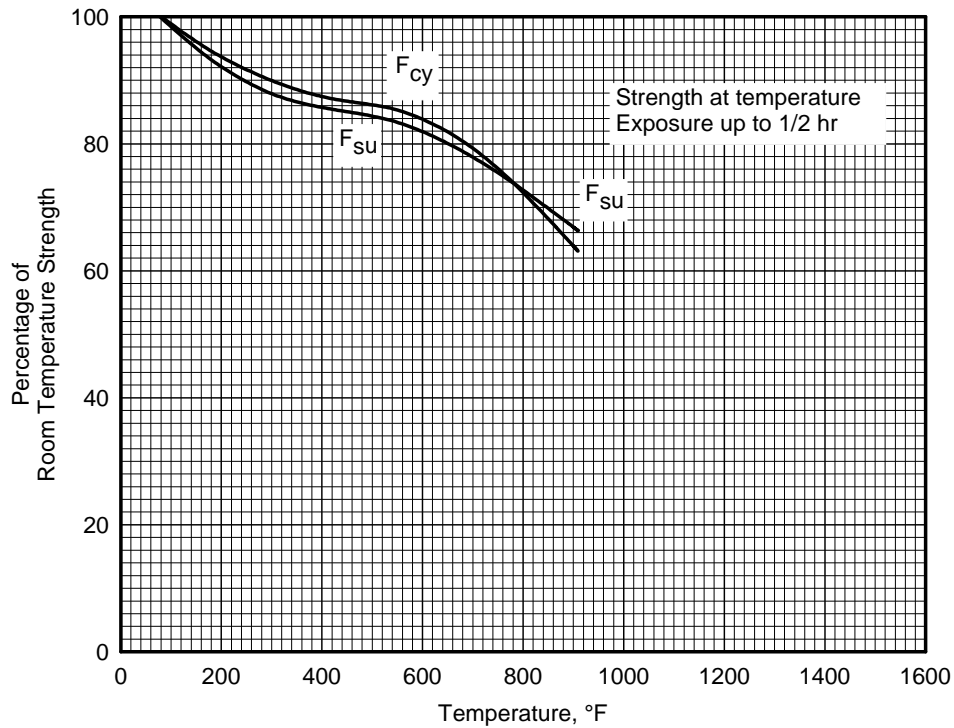

Figure 2.4.2.1.2. Effect of temperature on the compressive yield strength (F_{cy}) and the shear ultimate strength (F_{su}) of 9Ni-4Co-0.20C steel plate.

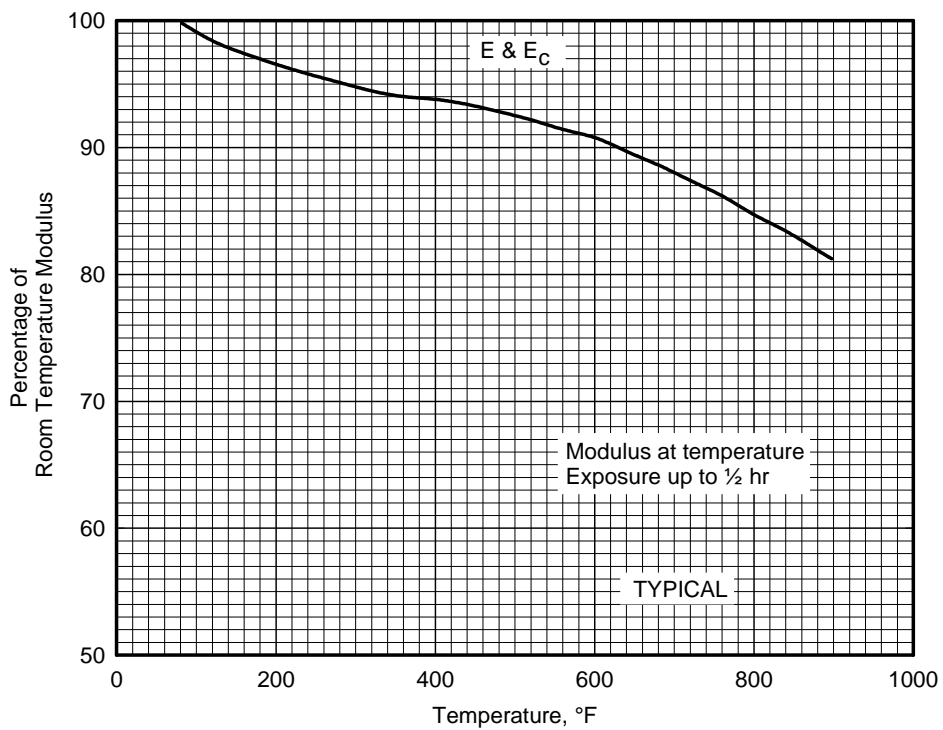

Figure 2.4.2.1.4. Effect of temperature on the tensile and compressive moduli (E and E_c) of 9Ni-4Co-0.20C steel plate.

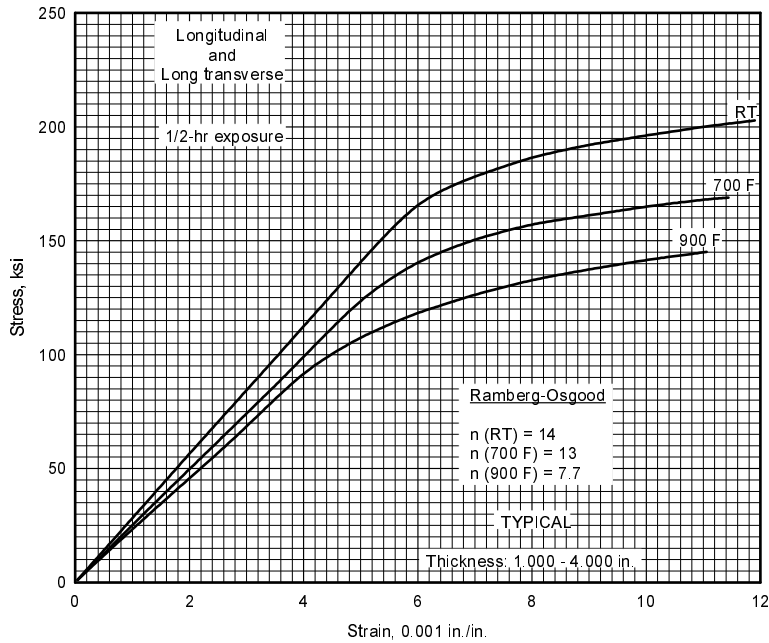

Figure 2.4.2.1.6(a). Typical tensile stress-strain curves for 9Ni-4Co-0.20C steel plate at various temperatures.

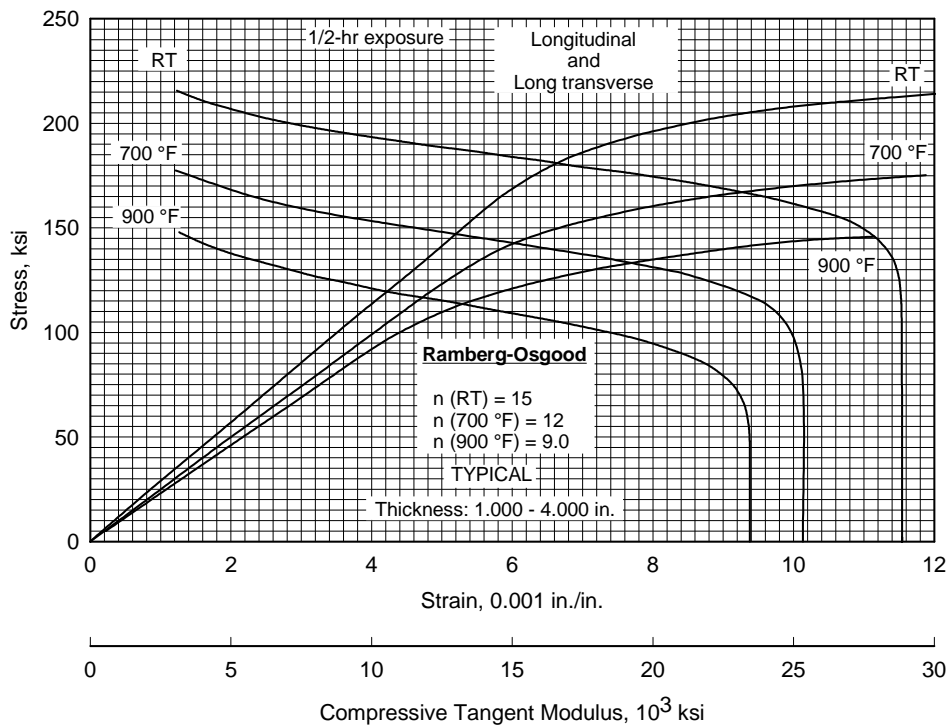

Figure 2.4.2.1.6(b). Typical compressive stress-strain and compressive tangent-modulus curves for 9Ni-4Co-0.20C steel plate at various temperatures.

2.4.3 9Ni-4Co-0.30C

2.4.3.0 Comments and Properties — The 9Ni-4Co-0.30C alloy was developed specifically to have high hardenability and good fracture toughness when heat treated to 220 to 240 ksi ultimate tensile strength. The alloy is through hardening in section sizes up to 4 inches thick. The alloy may be exposed to temperatures up to 900°F (approximately 100°F below typical tempering temperature) without microstructural changes which degrade room temperature strength. This grade must be formed and welded in the annealed condition. Preheat and post-heat of the weldment is required. The steel is produced by consumable electrode vacuum melting.

The heat treatment for this alloy consists of normalizing at $1650 \pm 25^\circ\text{F}$ for 1 hour per inch of cross section, cooling in air to room temperature, heating to $1550 \pm 25^\circ\text{F}$ for 1 hour per inch of cross section but not less than 1 hour, quenching in oil or water, subzero treating at -100°F for 1 to 2 hours, and double tempering at $975 \pm 10^\circ\text{F}$ (sheet, strip, and plate) or $1000 \pm 10^\circ\text{F}$ (bars, forgings, and tubings) for 2 hours.

Material specifications for 9Ni-4Co-0.30C steel are presented in Table 2.4.3.0(a). The room temperature mechanical and physical properties are shown in Table 2.3.4.0(b). The effect of temperature on thermal expansion is shown in Figure 2.4.3.0.

Table 2.4.3.0(a). Material Specifications for 9Ni-4Co-0.30C Steel

Specification	Form
AMS 6524 ^a	Sheet, strip, and plate
AMS 6526	Bar, forging, and tubing

^a Noncurrent specification.

2.4.3.1 Heat-Treated Condition — Effect of temperature on various mechanical properties is presented in Figures 2.4.3.1.1. through 2.4.3.1.4. Typical stress-strain and tangent-modulus curves are presented in Figures 2.4.3.1.6(a) through (d). Notched fatigue data at room temperature are illustrated in Figure 2.4.3.1.8.

Table 2.4.3.0(b). Design Mechanical and Physical Properties of 9Ni-4Co-0.30C Steel

Specification	AMS 6524 ^a		AMS 6526
	Sheet, strip, and plate		Bar, forging, and tubing
Form	Quenched and tempered		Quenched and tempered
Condition	≤0.249	≥0.250	≤4.000
Thickness, in.	S ^b	S ^b	S ^b
Basis			
Mechanical Properties:			
F_m , ksi:			
L	220
LT	220	220	...
F_{ty} , ksi:			
L	190
LT	185	190	...
F_{cy} , ksi:			
L	209
LT	209	...
F_{su} , ksi	137	137
F_{bru}^c , ksi:			
(e/D = 1.5)	346	346
(e/D = 2.0)	440	440
F_{bry}^c , ksi:			
(e/D = 1.5)	291	291
(e/D = 2.0)	322	322
e , percent:			
L	10
LT	6	10	...
RA , percent:			
L	40
LT	35	...
E , 10 ³ ksi	28.5		
E_c , 10 ³ ksi	29.8		
G , 10 ³ ksi		
μ		
Physical Properties:			
ω , lb/in. ³	0.28		
C , Btu/(lb)(°F)		
K , Btu/[(hr)(ft ²)(°F)/ft]	13.3 (75°F)		
α , 10 ⁻⁶ in./in./°F	See Figure 2.4.3.0		

a Noncurrent specification.

b Design values are applicable only to parts for which the indicated F_m has been substantiated by adequate quality control testing.

c Bearing values are “dry pin” values per Section 1.4.7.1.

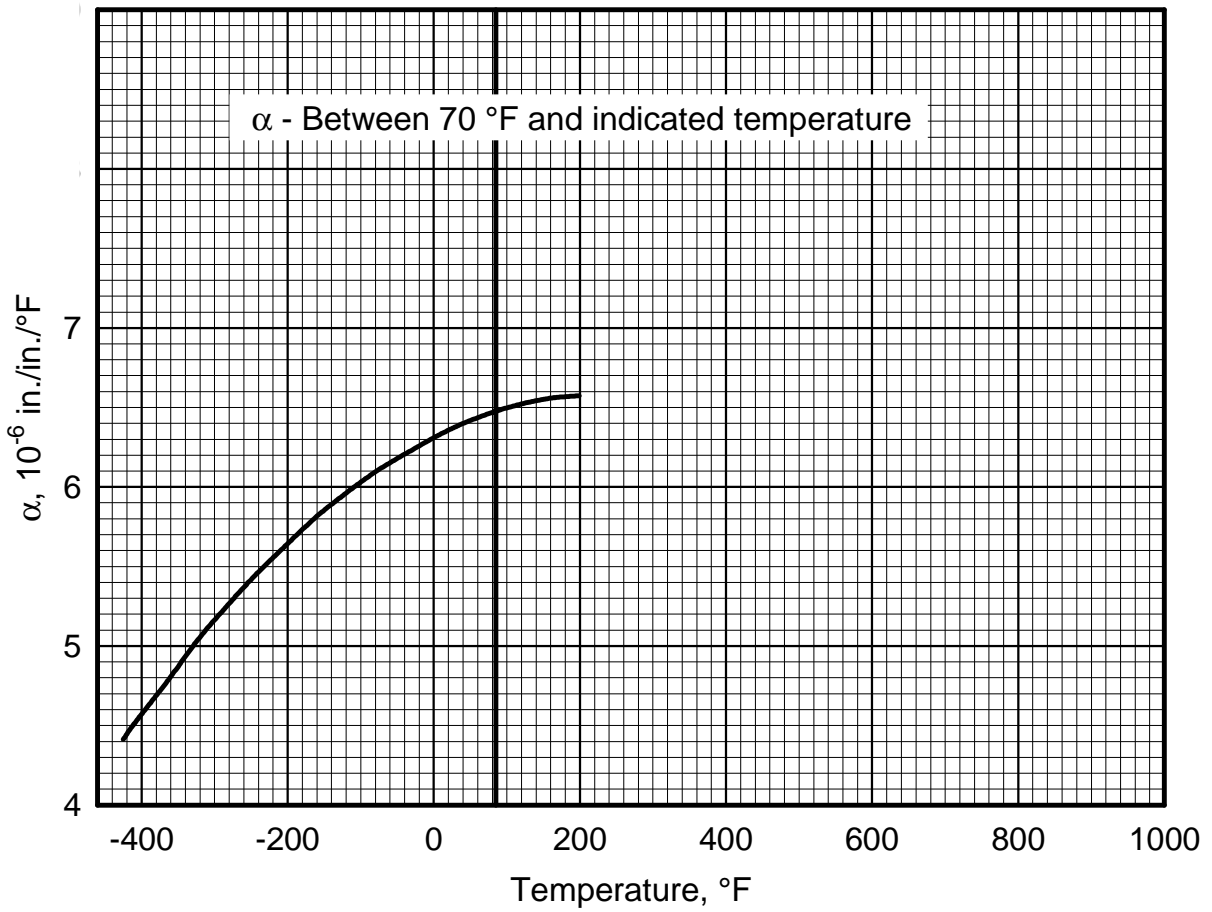

Figure 2.4.3.0. Effect of temperature on the thermal expansion of 9Ni-4Co-0.30C steel.

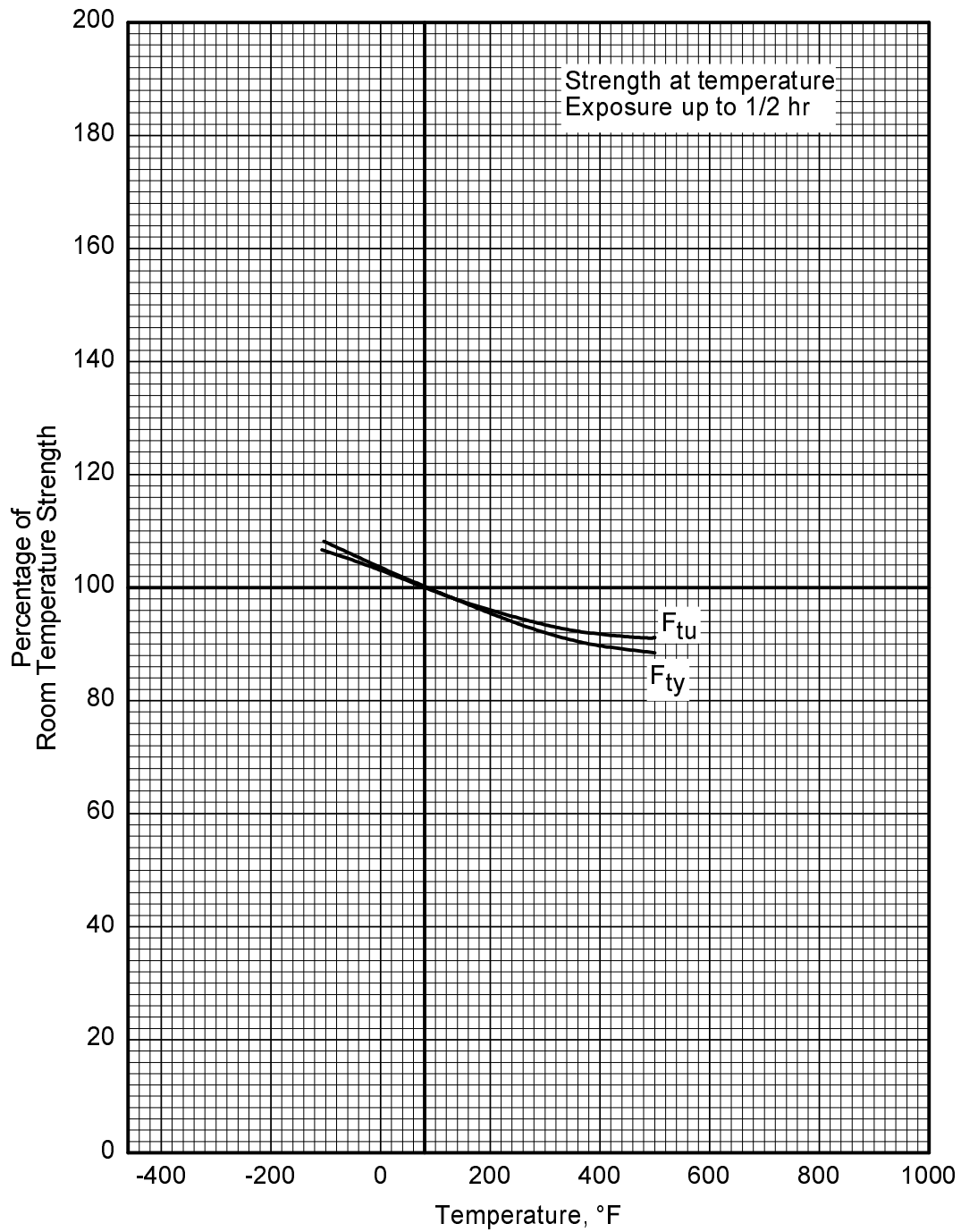

Figure 2.4.3.1.1. Effect of temperature on the tensile yield strength (F_{ty}) and the tensile ultimate strength of 9Ni-4Co-0.30C steel hand forging.

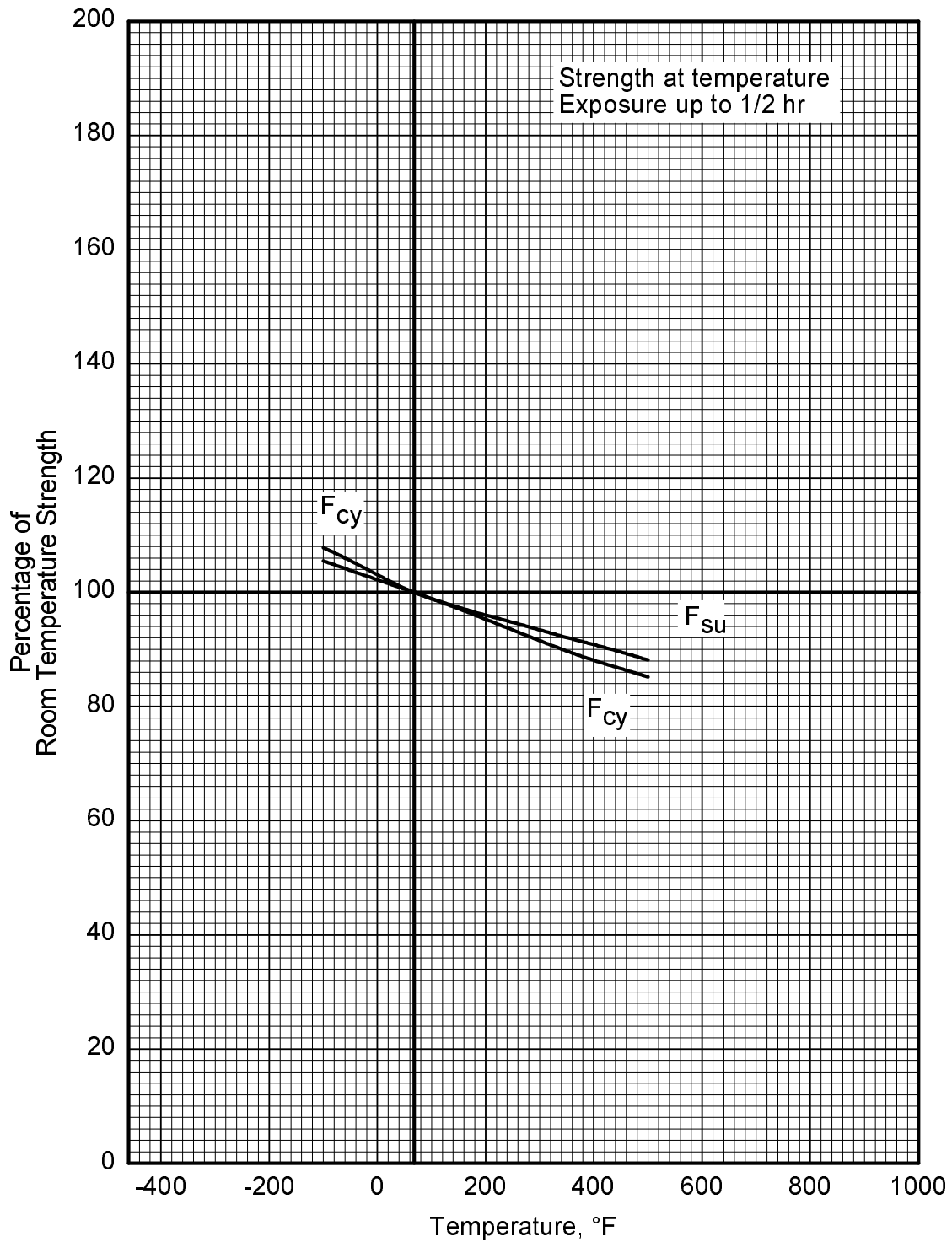

Figure 2.4.3.1.2. Effect of temperature on the compressive yield strength (F_{cy}) and the shear ultimate strength (F_{su}) of 9Ni-4Co-0.30C steel hand forging.

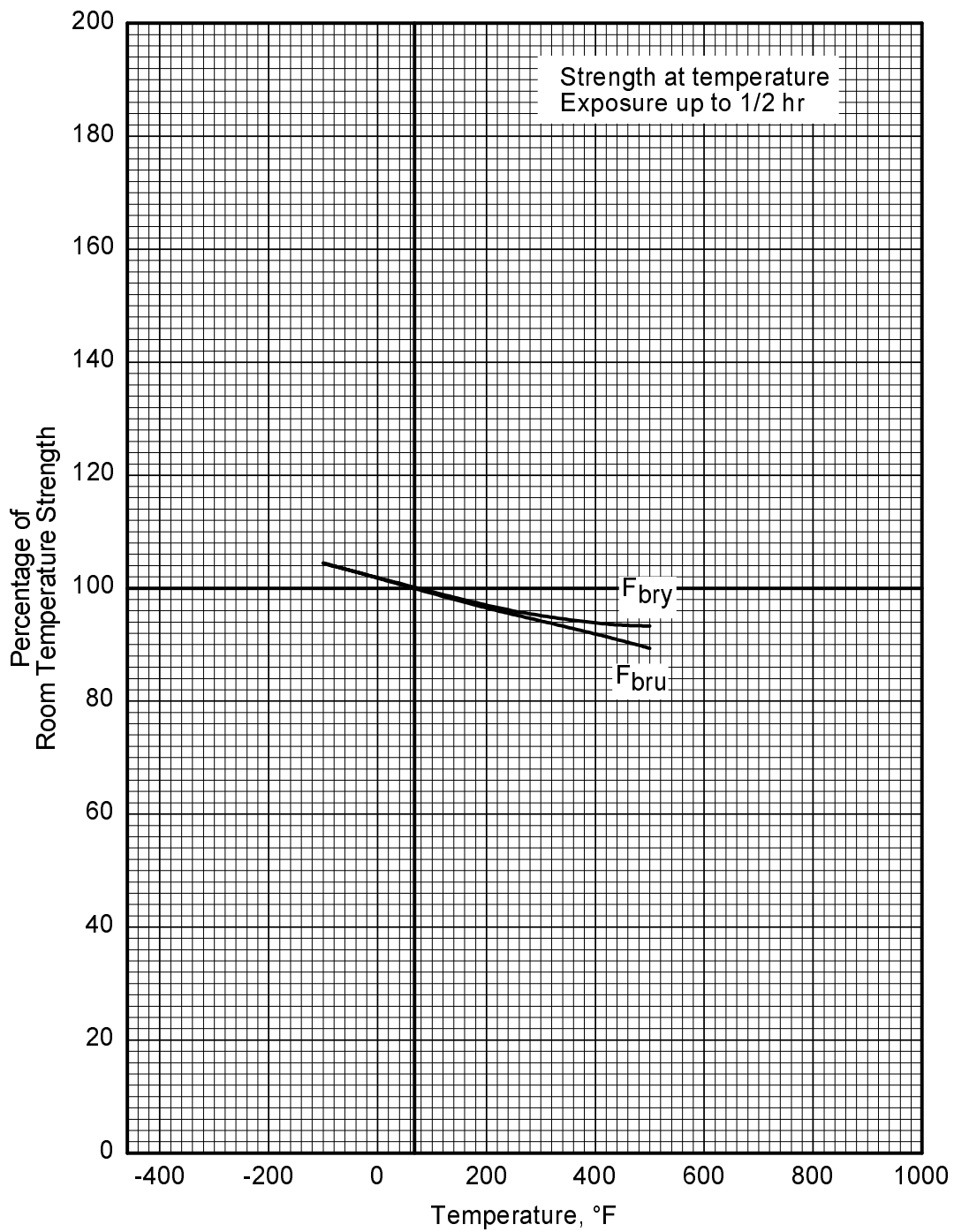

Figure 2.4.3.1.3. Effect of temperature on the bearing ultimate strength (F_{bru}) and the bearing yield strength (F_{bry}) of 9Ni-4Co-0.30C steel hand forging.

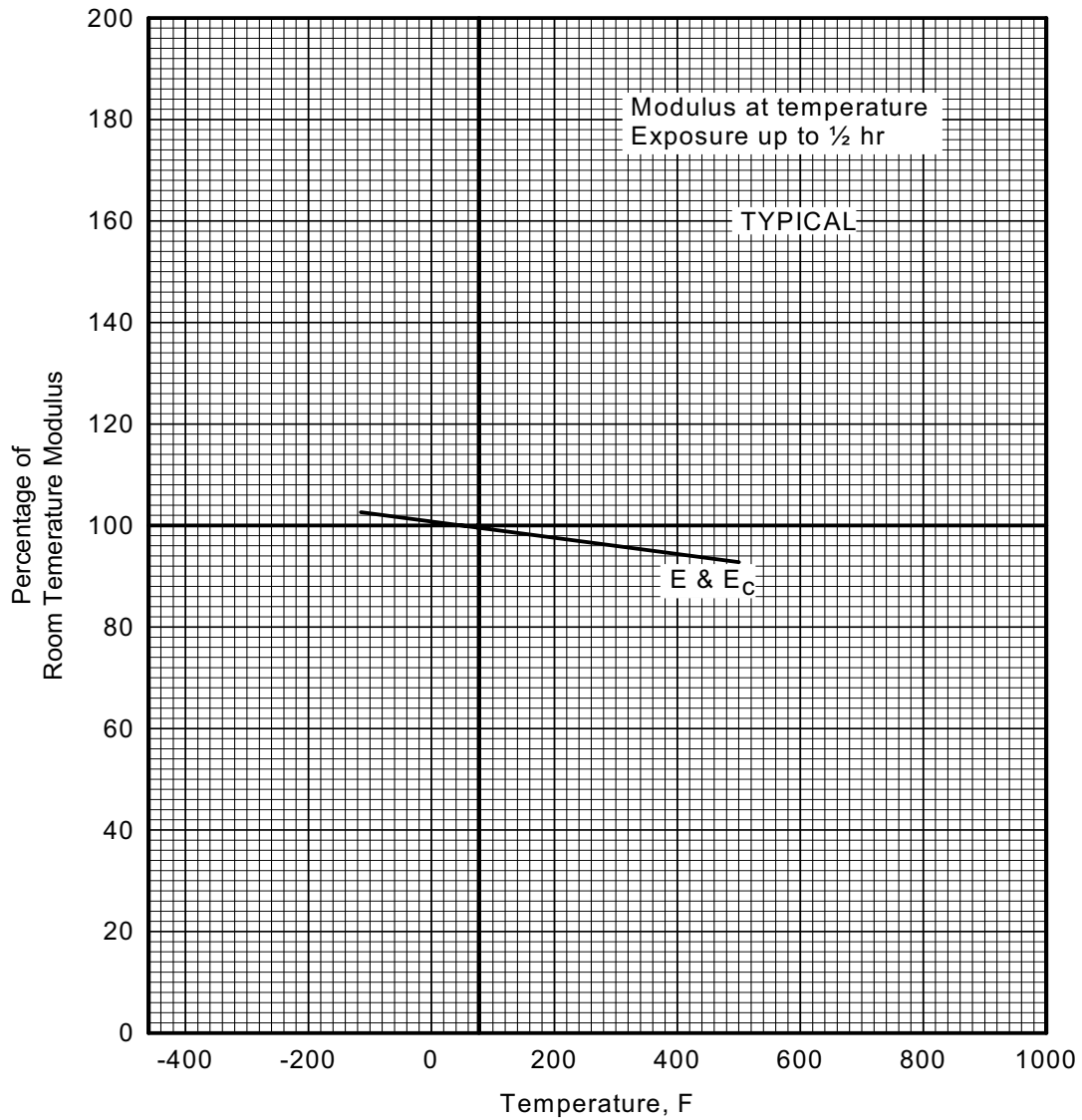

Figure 2.4.3.1.4 Effect of temperature on the tensile and compressive moduli (E and E_c) of 9Ni-4Co-0.30C steel.

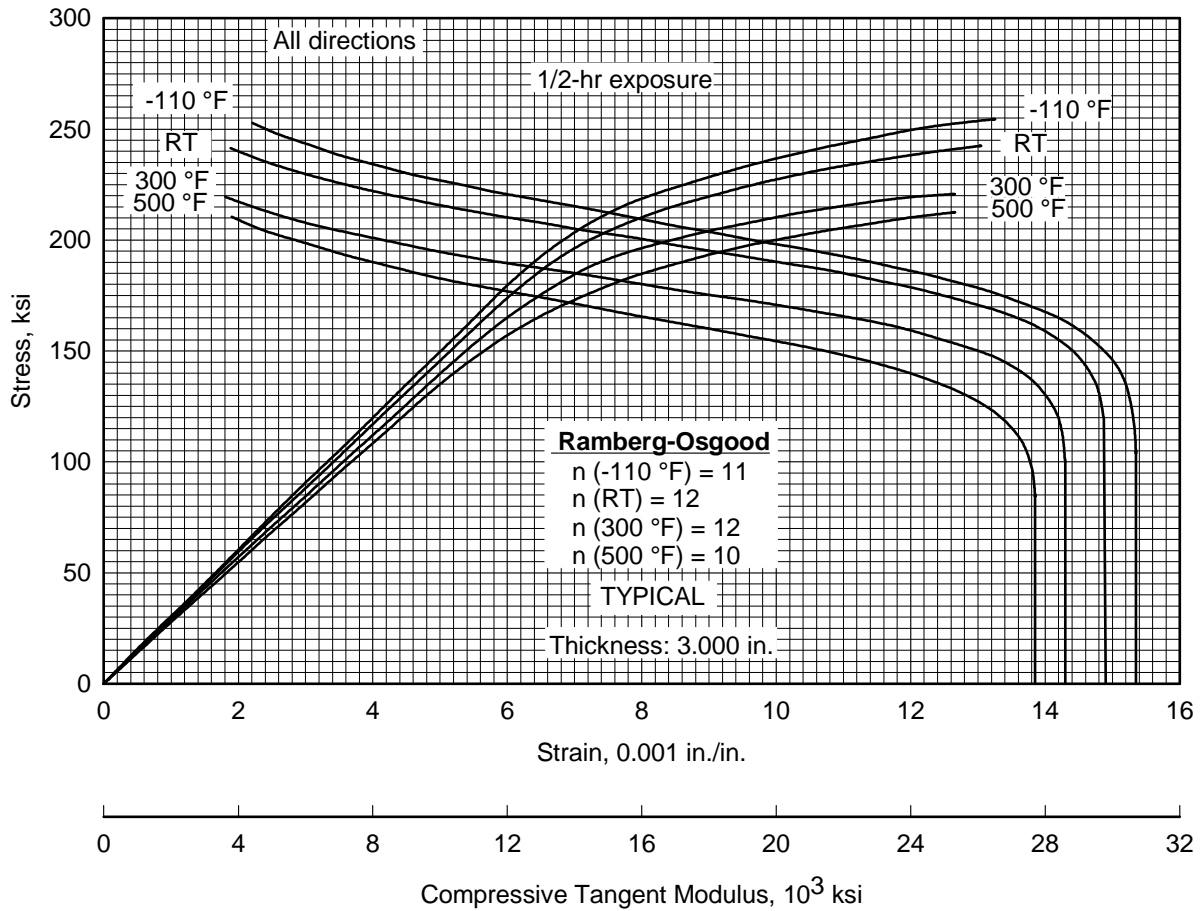

Figure 2.4.3.1.6(a). Typical compressive stress-strain and compressive tangent-modulus curves for 9Ni-4Co-0.30C steel hand forging at various temperatures.

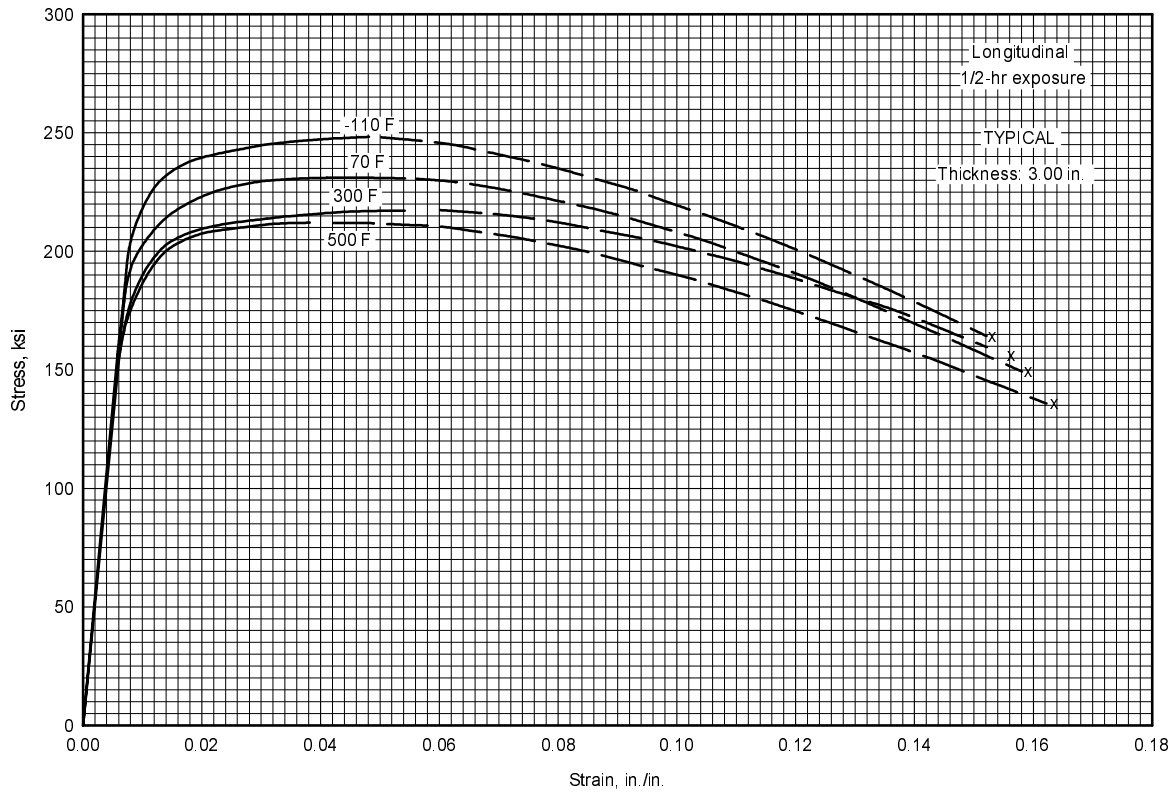

Figure 2.4.3.1.6(b). Typical tensile stress-strain curves (full range) for 9Ni-4Co-0.30C hand forging at various temperatures.

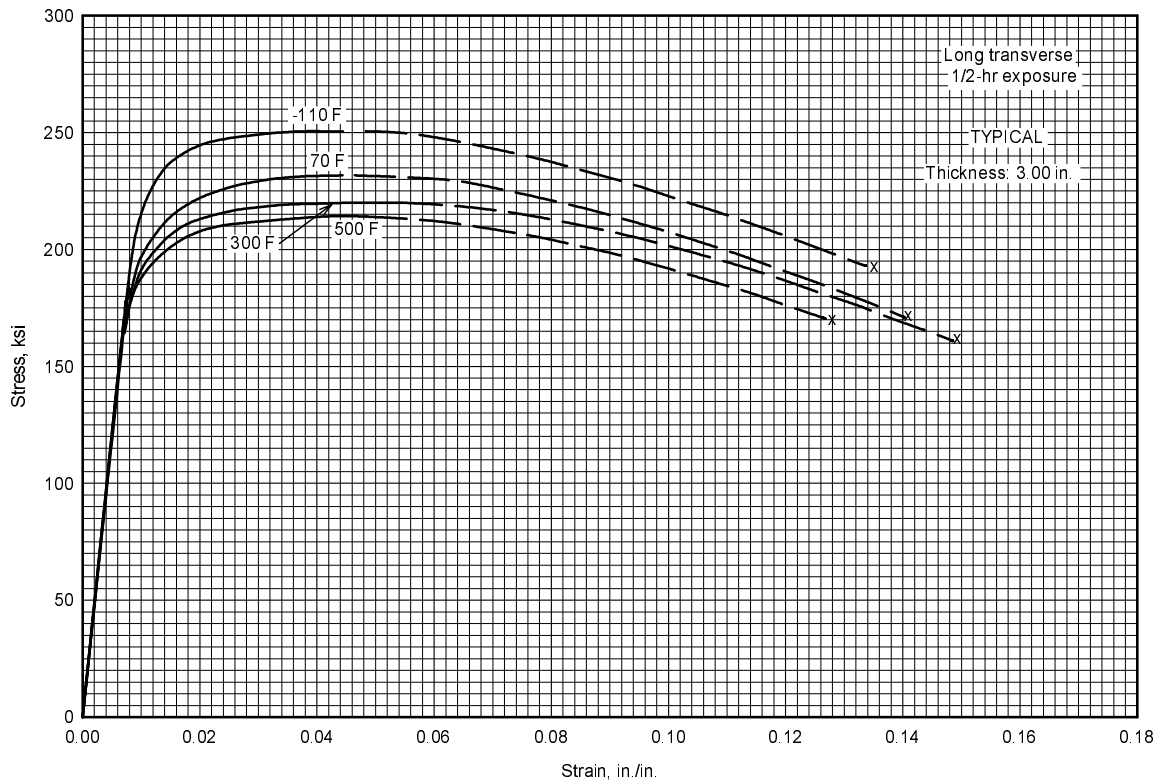

Figure 2.4.3.1.6(c). Typical tensile stress-strain curves (full range) for 9Ni-4Co-0.30C hand forging at various temperatures.

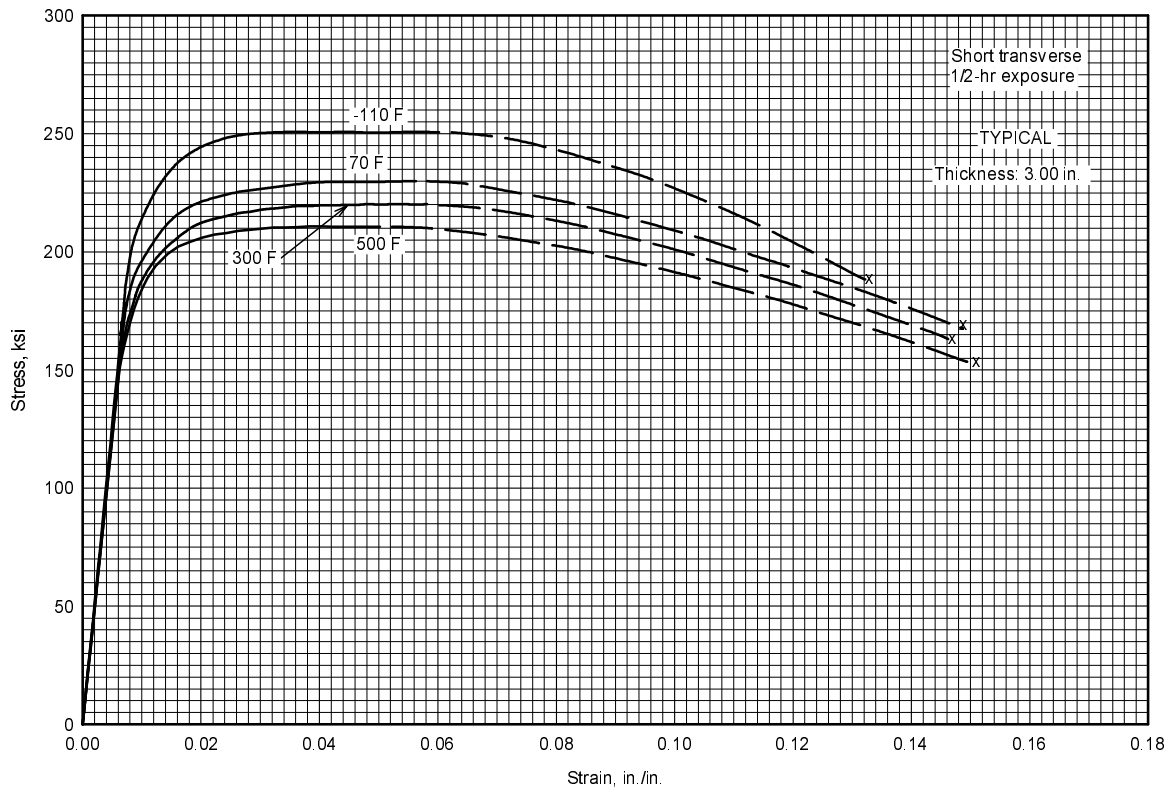

Figure 2.4.3.1.6(d). Typical tensile stress-strain curves (full range) for 9Ni-4Co-0.30C hand forging at various temperatures.

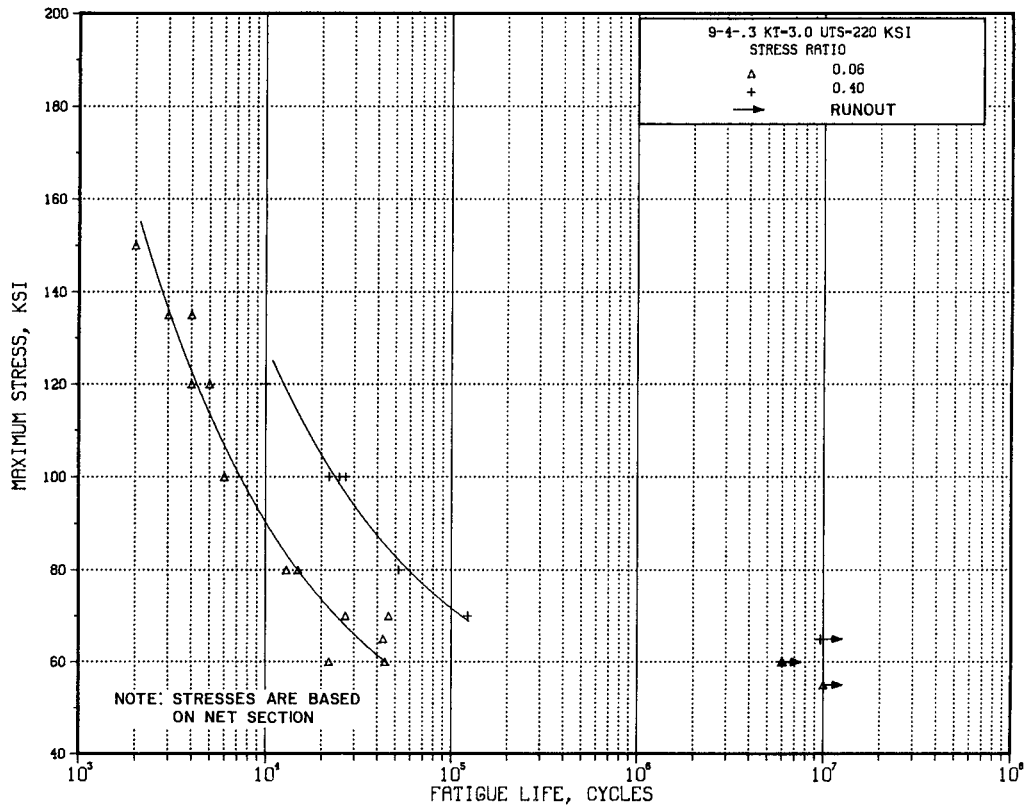

Figure 2.4.3.1.8. Best-fit S/N curves for notched, $K_t = 3.0$, 9Ni-4Co-0.30C steel hand forging, long and short transverse directions.

Correlative Information for Figure 2.4.3.1.8

Product Form: Hand forging, 3 x 9 inches

Test Parameters:

Properties: TUS, ksi TYS, ksi Temp., °F
 231 197 RT (LT)

Loading - Axial
Frequency - 1800 cpm
Temperature - RT
Environment - Air

Specimen Details: Notched, V-Groove $K_t=3.0$
 0.354 inch gross diameter
 0.250 inch net diameter
 0.01 inch root radius
 60° flank angle, ω

No. of Heats/Lots: 3

Surface Condition: Not specified

Equivalent Stress Equation:

$$\log N_f = 7.77 - 2.15 \log (S_{eq} - 28.32)$$

$$S_{eq} = S_{max} (1-R)^{0.79}$$

Std. Error of Estimate, $\log (\text{Life}) = 0.12$

Standard Deviation, $\log (\text{Life}) = 0.47$

$R^2 = 93\%$

Reference: 2.4.3.1.8

Sample Size = 22

[Caution: The equivalent stress model may provide unrealistic life predictions for stress ratios beyond those represented above.]

2.5 HIGH-ALLOY STEELS

2.5.0 COMMENTS ON HIGH-ALLOY STEELS — The high-alloy steels in this section are those steels that are substantially higher in alloy content than the intermediate alloy steels described in Section 2.4 but are not stainless steels. The 18 Ni maraging and AF1410 steels are in this category.

2.5.0.1 Metallurgical Considerations — The 18 Ni maraging steels are iron base alloys with nominally 18 percent nickel, 7 to 9 percent cobalt, 3 to 5 percent molybdenum, less than 1 percent titanium, and very low carbon content, below 0.03 percent. Upon cooling from the annealing or hot-working temperature, these steels transform to a soft martensite which can be easily machined or formed. The steels can be subsequently aged (maraged) to high strengths by heating to a lower temperature, 900°F.

AF1410 is an iron base alloy with nominally 14 percent cobalt, 10 percent nickel, 2 percent chromium, 1 percent molybdenum, and 0.15 percent carbon. When quenched from austenitizing temperatures, AF1410 forms a highly dislocated lath martensitic structure with very little twinning or retained austenite. At aging temperatures ranging from 900 to 1000°F, a precipitation of extremely fine alloy carbide containing chromium and molybdenum occurs, which simultaneously develops strength and toughness properties.

2.5.0.2 Environmental Considerations — The stress corrosion cracking resistance of high strength steels is of concern for highly loaded structural components such as landing gears and wing attach fittings that are subjected to corrosive environments such as sea spray or water. Figure 2.5.0.2(a) indicates the relative stress corrosion cracking resistance of several high-strength steel alloys. The data in this figure were obtained from Reference (2.5.0.2). The stress corrosion cracking threshold stress intensity ($K_{I_{SSC}}$) for each steel was defined as the value at which cracking did not occur. For most of these alloys, this value is about 20 ksi $\sqrt{\text{in}}$. As indicated, there is a definite difference in the stress corrosion resistance between the alloys.

In general, the high-strength steels do not reach a true threshold stress intensity until after 1000 hours of exposure. The highest stress corrosion cracking resistance in high-strength steels is associated with low carbon levels and lath martensite microstructure containing a fine distribution of M_2C type carbides; alloys AF1410 and AerMet 100. The effect of low carbon is indicated between the AF1410 and 0.20AF1410 where the carbon levels are 0.15 and 0.20%, respectively. The lower stress cracking corrosion resistance is associated with higher carbon and the martensite is of plate morphology that exhibits a twinned structure; alloys 4340 and 300M. A slight anisotropic effect was observed for Hy-Tuf (TL vs LT); however, the effect was not apparent for AF1410. The differences in anisotropic properties may be due to differences in the cleanliness of the steels since Hy-Tuf was an air melted product and the others were either vacuum induction melted (VIM) or electroslag remelted (ESR).

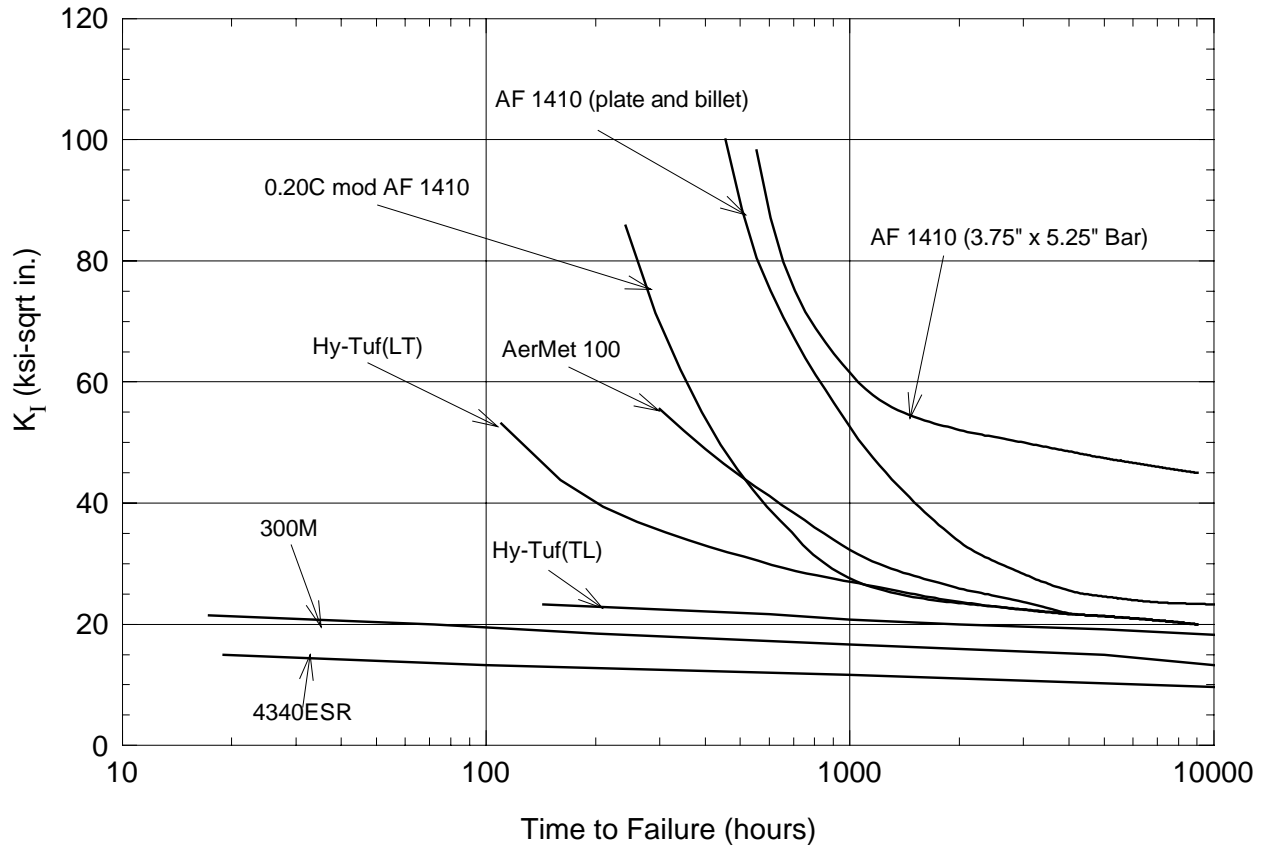

Figure 2.5.0.2(a). The relative stress corrosion cracking resistance of several high-strength steels tested in an environment of 3.5% NaCl (Reference 2.5.0.2).

2.5.1 18 Ni MARAGING STEELS

2.5.1.0 Comments and Properties — The 250 and 280 (300) maraging steels are normally supplied in the annealed condition and are heat treated to high strengths, without quenching, by aging at 900°F. The steels are characterized by high hardenability and high strength combined with good toughness. The 250 and 280 (300) designation refers to the nominal yield strengths of the two alloys. The two alloys are available in the form of sheet, plate, bar, and die forgings. Only the consumable electrode-vacuum-melted quality grades are considered in this section.

Manufacturing Considerations — The 250 and 280 grades are readily hot worked by conventional rolling and forging operations. These grades also have good cold forming characteristics in spite of the relatively high hardness in the annealed (martensitic) condition. The machinability of the 250 and 280 grades is not unlike 4330 steel at equivalent hardness. The 18 Ni maraging steels can be readily welded in either the annealed or aged conditions without preheating. Welding of aged material should be followed by aging at 900°F to strengthen the weld area.

Environmental Considerations — Although the 18 Ni maraging steels are high in alloy content, these grades are not corrosion resistant. Since the general corrosion resistance is similar to the low-alloy steels, these steels require protective coatings. The 250 grade reportedly has better resistance to stress corrosion cracking than the low-alloy steels at the same strength.

Specifications and Properties — Material specifications for these steels are shown in Table 2.5.1.0(a). The room temperature properties for material aged at 900°F are shown in Tables 2.5.1.0(b) and (c), and the effect of temperature on physical properties is shown in Figure 2.5.1.0.

Table 2.5.1.0(a). Material Specifications for 18 Ni Maraging Steels

Grade	Specification	Form
250	AMS 6520	Sheet and plate
250	AMS 6512	Bar
280 (300)	AMS 6521 ^a	Sheet and plate
280 (300)	AMS 6514	Bar

^a Noncurrent specification.

2.5.1.1 Maraged Condition (aged at 900 ° F) — Effect of temperature on 250 and 280 grade maraging steel is presented in Figures 2.5.1.1.1 through 2.5.1.1.4. Figures 2.5.1.1.6(a) and (b) are room and elevated temperature tensile stress-strain curves. Typical compressive stress-strain and tangent-modulus curves at room temperature are presented in Figures 2.5.1.1.6(c) and (d). Figure 2.5.1.1.6(e) is a full-range stress-strain curve at room temperature for 280 grade maraging steel.

Table 2.5.1.0(b). Design Mechanical and Physical Properties of 250 Maraging Steel

Specification	AMS 6520			AMS 6512	
	Sheet	Plate		Bar	
Condition	Maraged at 900°F			Maraged at 900°F	
Thickness or diameter, in. ...	≤0.187	0.187-0.250	>0.250	<4.000	4.000-10.000
Basis	S	S	S	S	S
Mechanical Properties:					
F_{tu} , ksi:					
L	247	252	...	255	245
T	255	255	255	255	245
F_{ty} , ksi:					
L	238	242	...	250	240
T	245	245	245	250	240
F_{cy} , ksi:					
L	221	260	...
T	225	255
F_{su} , ksi	148	155	...	148	...
F_{bru} , ksi:					
(e/D = 1.5)	327	352
(e/D = 2.0)	444	448
F_{bry} , ksi:					
(e/D = 1.5)	278	324
(e/D = 2.0)	353	354
e , percent:					
L	6	5
T	a	a	a	4	3
RA , percent:					
L	45	30
T	35	20
E , 10^3 ksi	26.5				
E_c , 10^3 ksi:					
L	28.2				
T	29.4				
G , 10^3 ksi				
μ	0.31				
Physical Properties:					
ω , lb/in. ³	0.286				
C , K , and α	See Figure 2.5.1.0				

a Elongation properties vary with thickness as follows:

≤0.090	2.5%
0.091-0.125	3.0%
0.126-0.250	4.0%
0.251-0.375	5.0%
≥0.376	6.0%

Table 2.5.1.0(c). Design Mechanical and Physical Properties of 280 Maraging Steel

Specification	AMS 6521 ^a			AMS 6514	
	Sheet	Plate		Bar	
Form	Maraged at 900°F			Maraged at 900°F	
Condition	≤0.187	0.188-0.250	>0.250	<4.000	4.000-10.000
Thickness or diameter, in.	S	S	S	S	S
Basis	S	S	S	S	S
Mechanical Properties:					
<i>F_{tu}</i> ksi:					
L	271	276	...	280	275
T	280	280	280	280	275
<i>F_{ty}</i> ksi:					
L	262	267	...	270	270
T	270	270	270	270	270
<i>F_{cy}</i> ksi:					
L	244	281	...
T	248	281
<i>F_{su}</i> ksi	163	170	...	162	...
<i>F_{bru}</i> ksi:					
(e/D = 1.5)	359	386
(e/D = 2.0)	487	492
<i>F_{bry}</i> ksi:					
(e/D = 1.5)	306	357
(e/D = 2.0)	389	390
<i>e</i> , percent:					
L	5	5	5	5	4
T	4	4	4	4	2
<i>RA</i> , percent:					
L	30	25
T	25	20
<i>E</i> , 10 ³ ksi	26.5				
<i>E_c</i> , 10 ³ ksi:					
L	28.6				
T	29.6				
<i>G</i> , 10 ³ ksi				
<i>μ</i>	0.31				
Physical Properties:					
<i>ω</i> , lb/in. ³	0.286				
<i>C</i> , <i>K</i> , and <i>α</i>	See Figure 2.5.1.0				

a Noncurrent specification.

b Elongation properties vary with thickness as follows:

≤0.090	2.5%
0.091-0.125	3.0%
0.126-0.250	4.0%
0.251-0.375	5.0%
≥0.376	6.0%

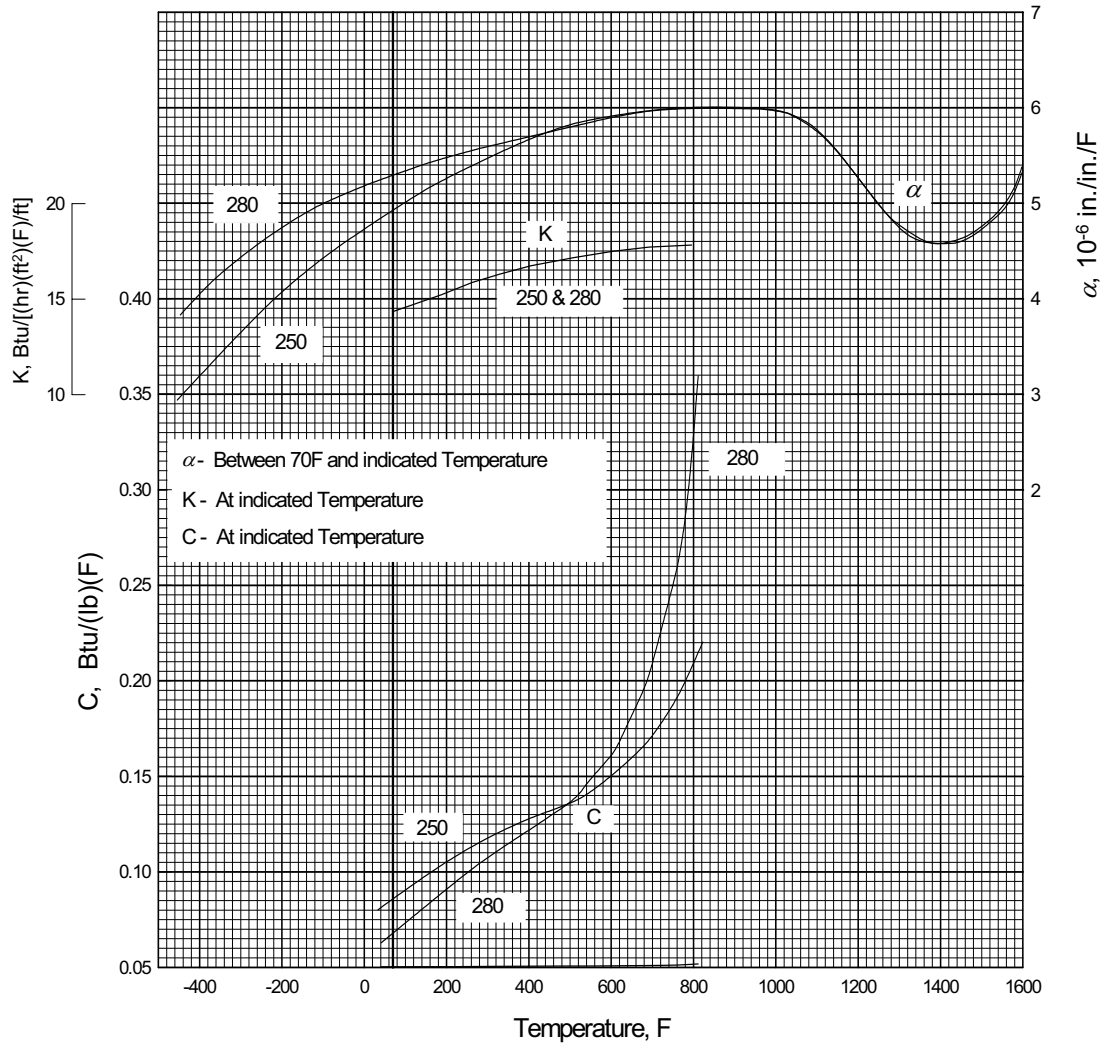

Figure 2.5.1.0. Effect of temperature on the physical properties of 250 and 280 maraging steels.

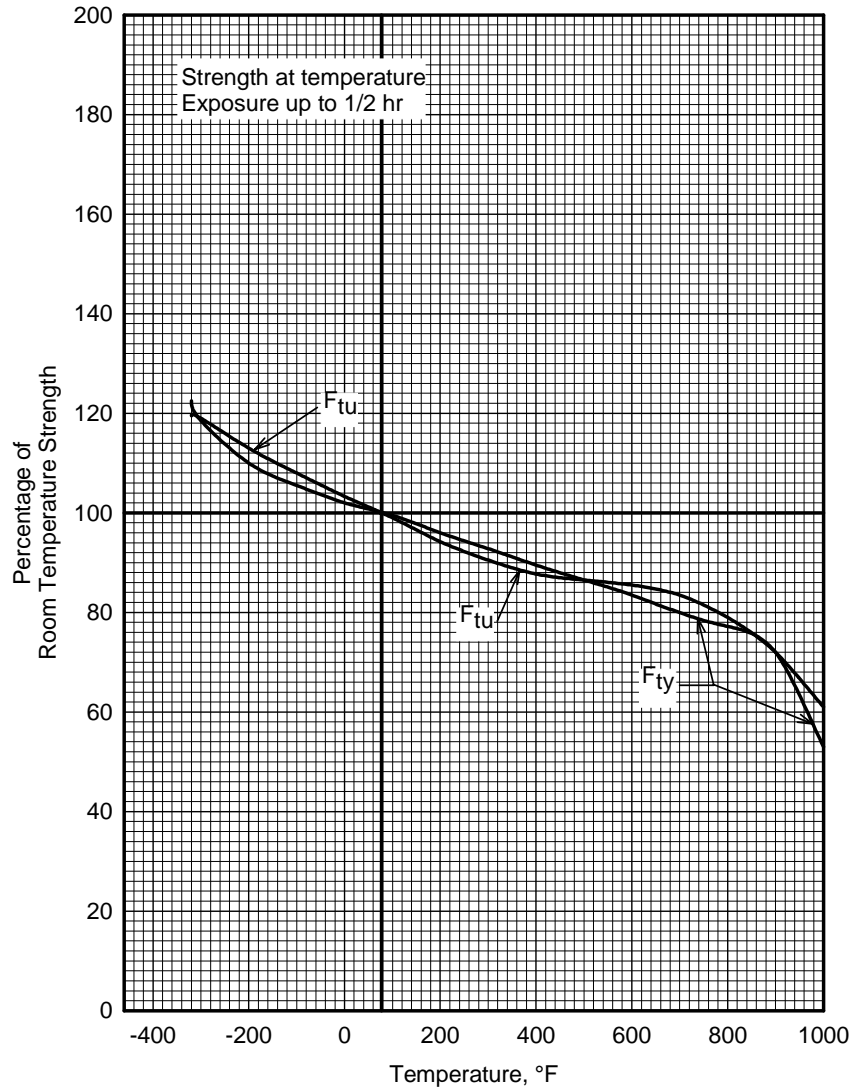

Figure 2.5.1.1.1. Effect of temperature on the tensile ultimate strength (F_{tu}) and the tensile yield strength (F_{ty}) of 250 and 280 maraging steel sheet and plate.

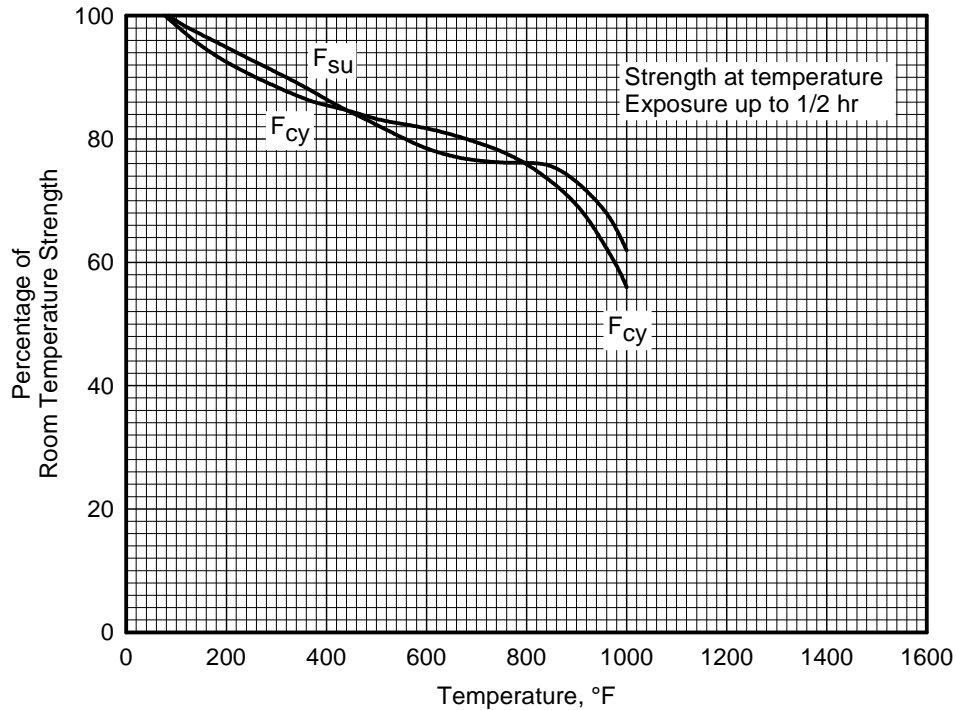

Figure 2.5.1.1.2. Effect of temperature on the compressive yield strength (F_{cy}) and the shear ultimate strength (F_{su}) of 250 and 280 maraging steel sheet and plate.

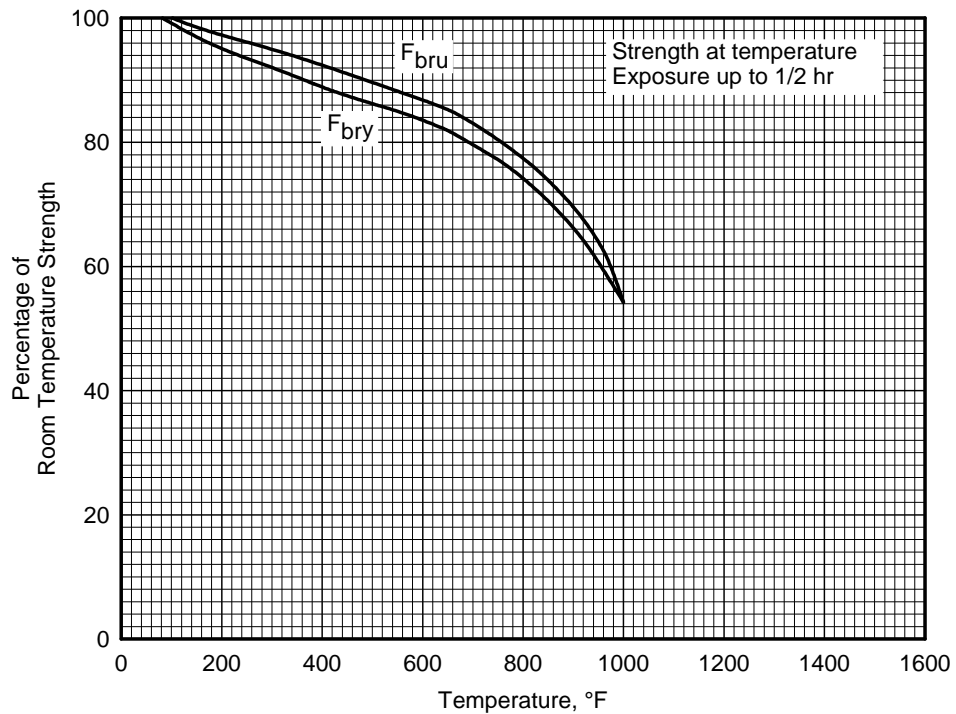

Figure 2.5.1.1.3. Effect of temperature on the bearing ultimate strength (F_{bru}) and the bearing yield strength (F_{bry}) of 250 and 280 maraging steel sheet and plate.

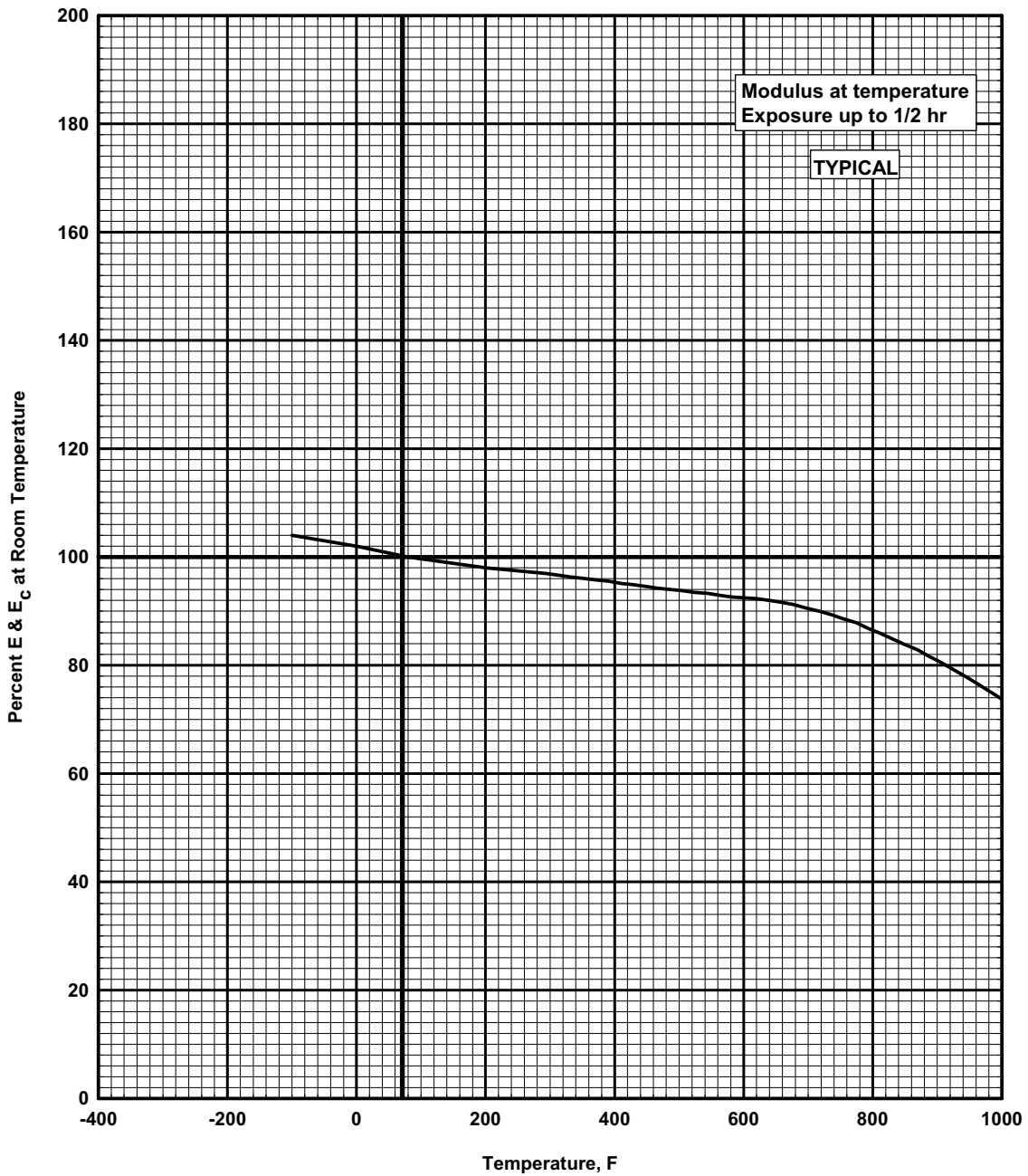

Figure 2.5.1.1.4. Effect of temperature on the tensile and compressive moduli (E and E_c) of 250 and 280 maraging steel.

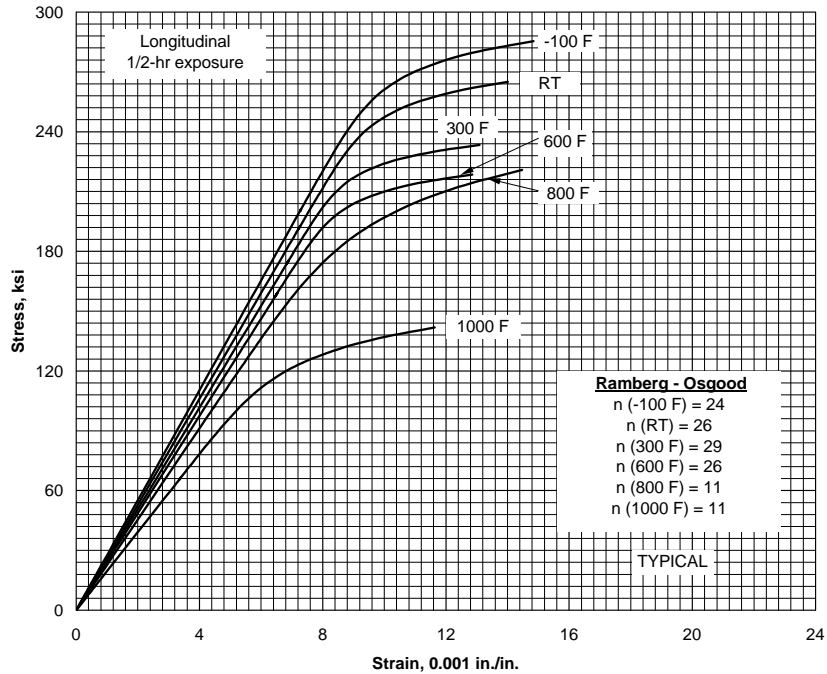

Figure 2.5.1.1.6(a). Typical tensile stress-strain curves at room and elevated temperatures for 250 maraging steel bar.

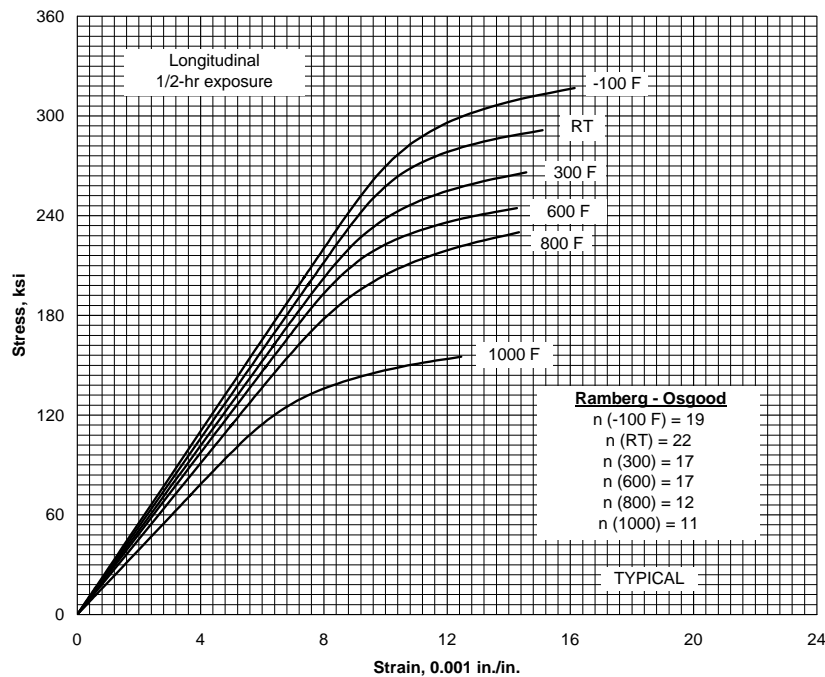

Figure 2.5.1.1.6(b). Typical tensile stress-strain curves at room and elevated temperatures for 280 maraging steel bar.

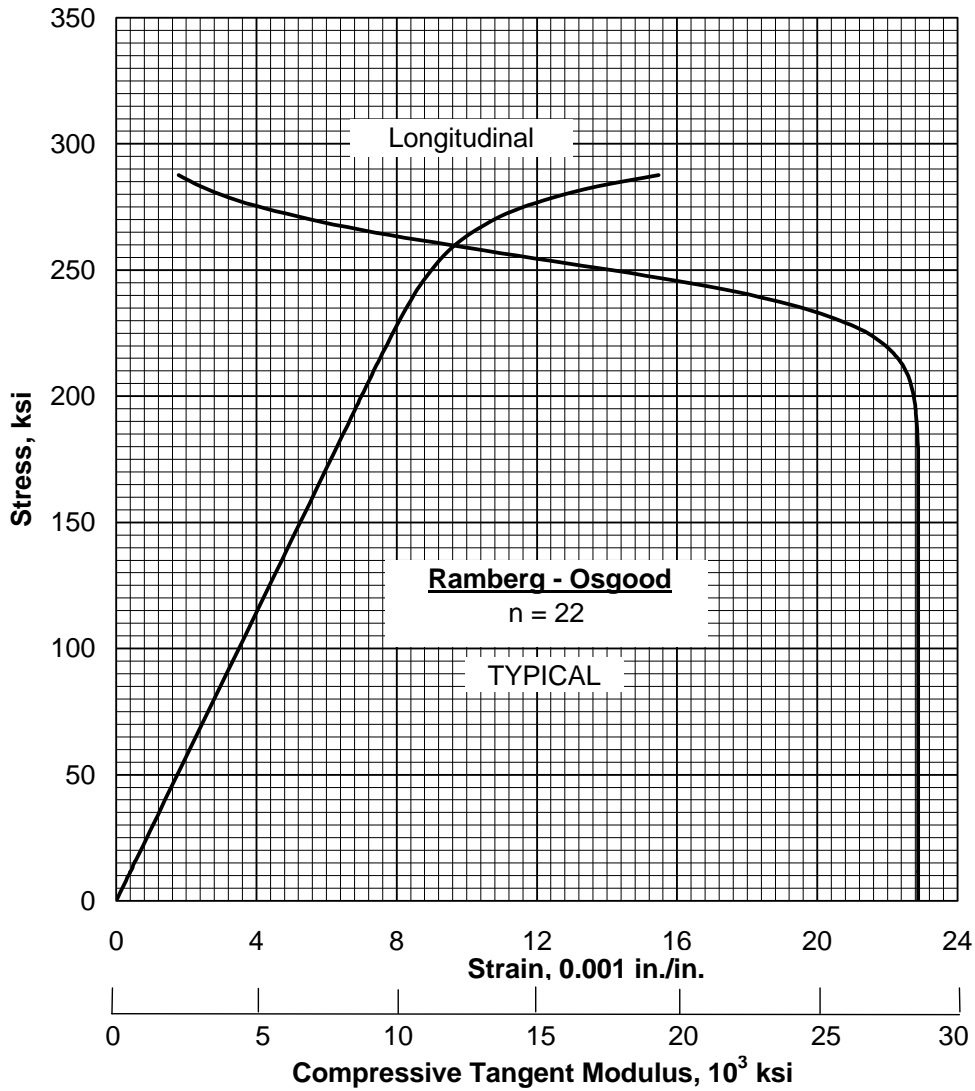

Figure 2.5.1.1.6(c). Typical compressive stress-strain and compressive tangent-modulus curves for 250 maraging steel bar at room temperature.

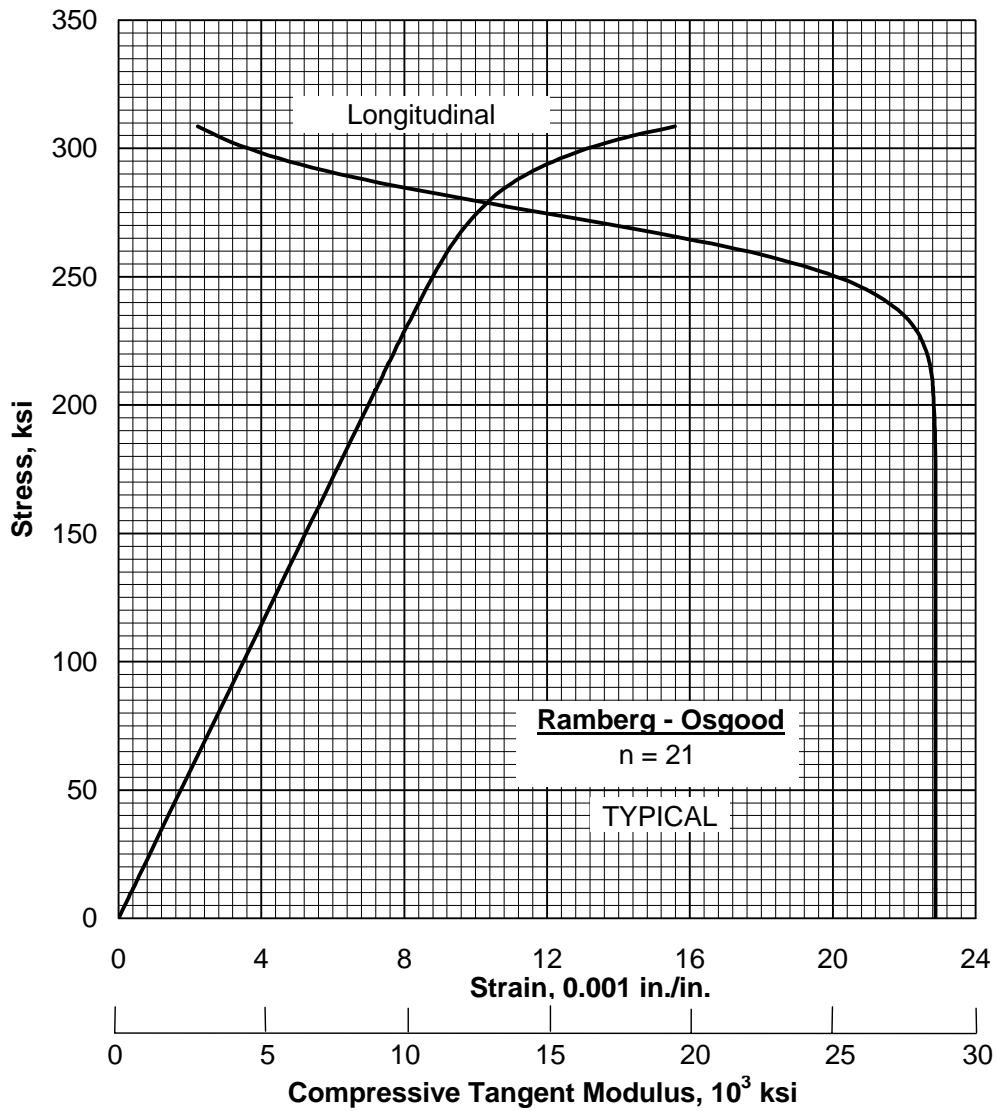

Figure 2.5.1.1.6(d). Typical compressive stress-strain and compressive tangent-modulus curves for 280 maraging steel bar at room temperature.

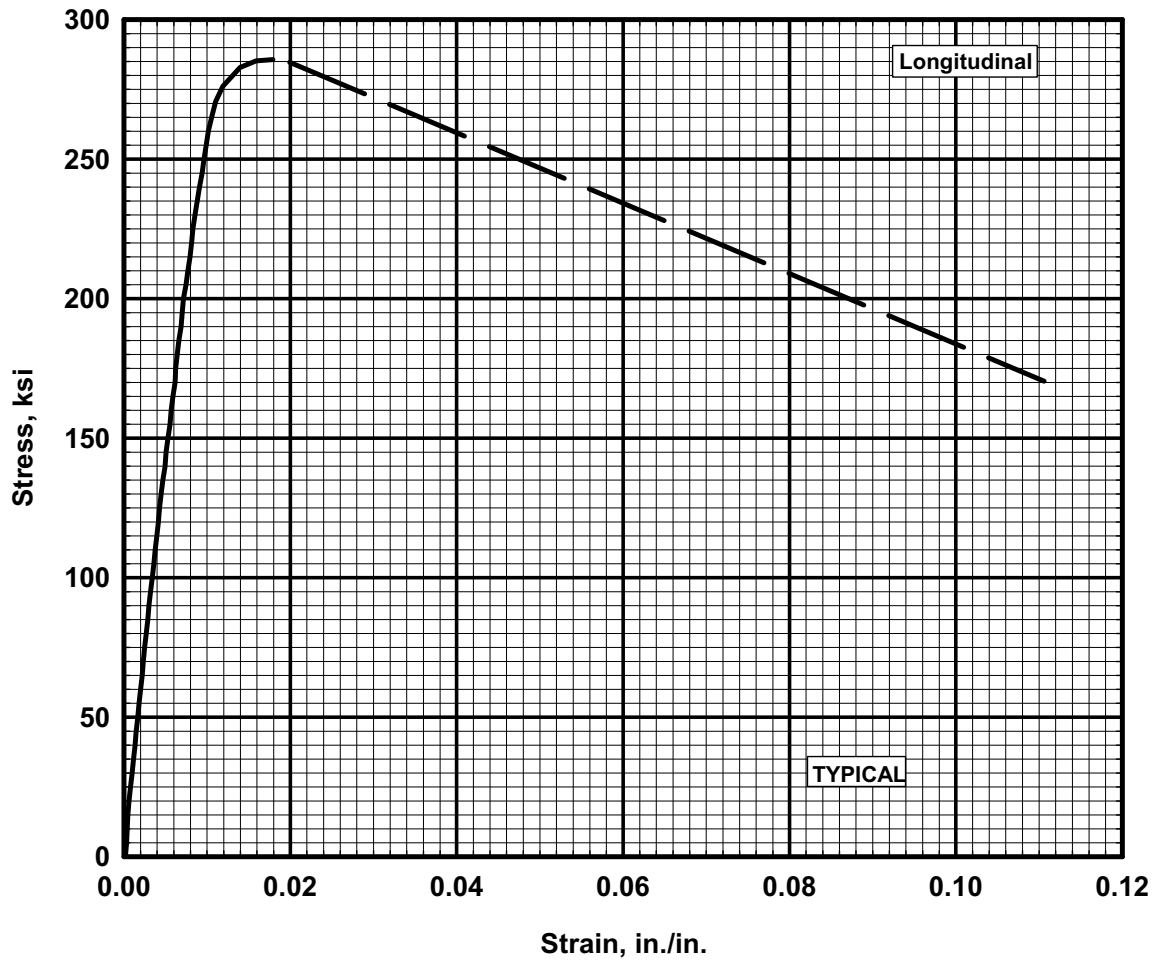

Figure 2.5.1.1.6(e). Typical tensile stress-strain curve (full range) for 280 maraging steel bar at room temperature.

2.5.2 AF1410

2.5.2.0 Comments and Properties — AF1410 alloy was developed specifically to have high strength, excellent fracture toughness, and excellent weldability when heat treated to 235 to 255 ksi ultimate tensile strength. AF1410 has good weldability and does not require preheating prior to welding. The alloy maintains good toughness at cryogenic temperatures, as well as high strength and stability at temperatures up to 800°F. The alloy is available in a wide variety of sizes and forms, including billet, bar, plate, and die forgings. The alloy is produced by vacuum induction melting followed by vacuum remelting.

Heat Treatment — The heat treatment for this alloy consists of heating to $1650 \pm 25^\circ\text{F}$ for 1 hour, forced-air cooling to room temperature, reheating to $1525 \pm 25^\circ\text{F}$ for 1 hour, forced-air cooling to room temperature, cooling to $-100 \pm 15^\circ\text{F}$, holding at temperature for 1 hour, warming to room temperature, and aging at $950 \pm 10^\circ\text{F}$ for 5 hours, and air cooling. A forced-air cool from austenitizing temperatures should be used for section thicknesses up to 2 inches. For sections of greater thickness, an oil quench should be utilized. A single austenitizing treatment ($1525 \pm 25^\circ\text{F}$) can be used to minimize heat treating distortion with a resulting slight decrease in fracture toughness.

Environmental Considerations — AF1410 has general corrosion resistance similar to the maraging steels. It should not be used in the unprotected condition. The alloy is highly resistant to stress-corrosion cracking compared to other high-strength steels.

Specification and Properties — A material specification for AF1410 is presented in Table 2.5.2.0(a). Room temperature mechanical properties are shown in Table 2.5.2.0(b).

Table 2.5.2.0(a). Material Specification for AF1410 Steel

Specification	Form
AMS 6527	Bar and forging

2.5.2.1 Heat-Treated Condition — Typical stress-strain curves at room temperature are shown in Figures 2.5.2.1.6(a) and (b).

Table 2.5.2.0(b). Design Mechanical and Physical Properties of AF1410 Steel Bar

Specification	AMS 6527
Form	Bar
Condition	a
Cross-sectional area, sq. in.	<100 ^b
Thickness or diameter, in.	<4.25 ^b
Basis	S
Mechanical Properties:	
<i>F_u</i> , ksi:	
L	235
LT ^c	235
ST ^c	235
<i>F_{0.2}</i> , ksi:	
L	215
LT ^c	215
ST ^c	215
<i>F_{cy}</i> , ksi:	
L	223
ST ^c	225
<i>F_{su}</i> , ksi	
141	
<i>F_{bru}</i> , ksi:	
(e/D = 1.5)	334
(e/D = 2.0)	435
<i>F_{brp}</i> , ksi:	
(e/D = 1.5)	269
(e/D = 2.0)	300
<i>e</i> , percent:	
L	12
LT ^c	12
ST ^c	12
<i>RA</i> , percent:	
L	60
LT ^c	55
ST ^c	55
<i>E</i> , 10 ³ ksi	29.4
<i>E_c</i> , 10 ³ ksi	30.9
<i>G</i> , 10 ³ ksi
<i>μ</i>
Physical Properties:	
<i>ω</i> , lb/in. ³	0.283
<i>C</i> , <i>K</i> , and <i>α</i>

- a Heat at 1650 ± 25°F for one hour, forced-air cool to room temperature, heat at 1525 ± 25°F for one hour, forced-air cool to room temperature, cool at -100 ± 15°F for one hour, age at 950 ± 10°F for 5 hours, and air cool.
- b Maximum size from which test specimens were rough machined prior to heat treatment.
- c Applicable providing LT or ST dimension is ≥ 2.500 inches.

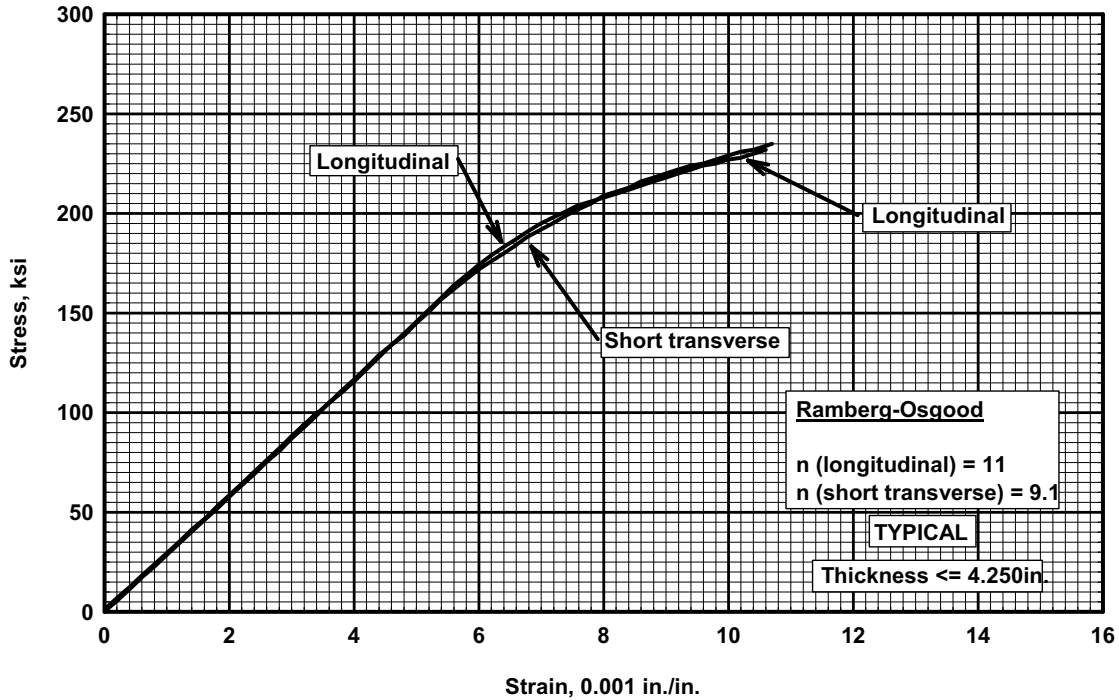

Figure 2.5.2.1.6(a). Typical tensile stress-strain curves at room temperature for heat-treated AF1410 steel bar.

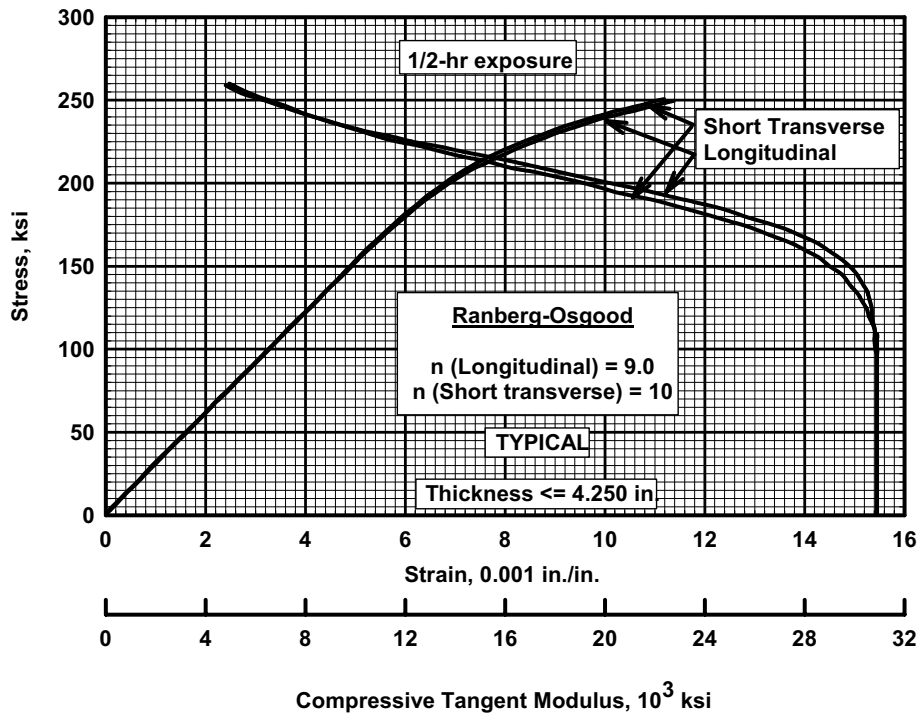

Figure 2.5.2.1.6(b). Typical compressive stress-strain and compressive tangent-modulus curves at room temperature for heat-treated AF1410 steel bar.

2.5.3 AERMET 100

2.5.3.0 Comments and Properties — AerMet 100 is a higher strength derivative of AF1410. The Ni-Co-Fe alloy can be heat treated to 280-300 ksi or to 290-310 ksi tensile strength while exhibiting excellent fracture toughness and high resistance to stress-corrosion cracking. AerMet 100 has good weldability and does not require preheating prior to welding. AerMet 100 is available in a wide variety of sizes and forms including billet, bar, sheet, strip, plate, wire, and die forgings. The alloy is produced by vacuum induction melting followed by vacuum-arc remelting.

Heat Treatment — This alloy can be heat treated to several strength levels. Consult the applicable materials specification for specific procedures.

Environmental Considerations — AerMet 100 is not considered corrosion resistant; consequently, parts should be protected with a corrosion resistant coating. The alloy is highly resistant to stress corrosion cracking compared to other high-strength steels of the same strength level.

This alloy displays good toughness at cryogenic temperatures as well as high strength and stability at temperatures up to 800°F.

Specification and Properties — A material specification for AerMet 100 is shown in Table 2.5.3.0(a). Room temperature mechanical properties are presented in Table 2.5.3.0(b) for both heat treated conditions.

Table 2.5.3.0(a). Material Specification for AerMet 100 Steel

Specification	Form
AMS 6532	Bar and forging
AMS 6478	Bar and forging

2.5.3.1 280-300 ksi Heat-Treated Condition — Typical stress-strain curves at room temperature are shown in Figures 2.5.3.1.6(a) and (b). A full-range tensile stress-strain curve is presented in Figure 2.5.3.1.6(c).

2.5.3.2 290-310 ksi Heat-Treated Condition — Typical tensile and compression stress-strain curves and compression tangent-modulus curves at room temperature are shown in Figures 2.5.3.2.6(a) and (b). A full-range tensile stress-strain curve is presented in Figure 2.5.3.2.6(c).

MIL-HDBK-5J
31 January 2003

Table 2.5.3.0(b). Design Mechanical and Physical Properties of AerMet 100 Steel Bar

Specification	AMS 6532		AMS 6478
Form	Bar and forging		
Condition	Solution treated and aged		
Cross-sectional area, in. ²	≤ 100		
Thickness or diameter, in.	≤ 10.000		
Basis	A	B	S
Mechanical Properties:			
<i>F_{tu}</i> , ksi:			
L	275	284	290
LT ^a	280	284	290
ST ^a	280 ^b	...	290
<i>F_{ty}</i> , ksi:			
L	235	247	245
LT ^a	235	246	245
ST ^a	235 ^b	...	245
<i>F_{cy}</i> , ksi:			
L	262	276	281
ST ^a	263	277	279
<i>F_{su}</i> , ksi			
L	174	177	182
<i>F_{bru}</i> ^c , ksi:			
(e/D = 1.5)	432	440	448
(e/D = 2.0)	569	579	581
<i>F_{bry}</i> ^c , ksi:			
(e/D = 1.5)	361	380	378
(e/D = 2.0)	411	432	442
<i>e</i> , percent: (S-basis)			
L	10	...	10
LT ^a	8	...	8
ST ^a	8	...	8
<i>RA</i> , percent: (S-basis)			
L	55	...	50
LT ^a	45 ^d	...	35
ST ^a	45	...	35
<i>E</i> , 10 ³ ksi			
		28.0	
<i>E_c</i> , 10 ³ ksi			
		28.1	
<i>G</i> , 10 ³ ksi			
		...	
<i>μ</i>			
		0.305	
Physical Properties:			
<i>ω</i> , lb/in. ³			
		0.285	
<i>C</i> , <i>K</i> , and <i>α</i>			
		...	

- a Applicable providing LT or ST dimension is ≤2.500 inches.
- b S-Basis value
- c Bearing values are “dry pin” values per Section 1.4.7.1.
- d Rounded T₉₉ value is 41%.

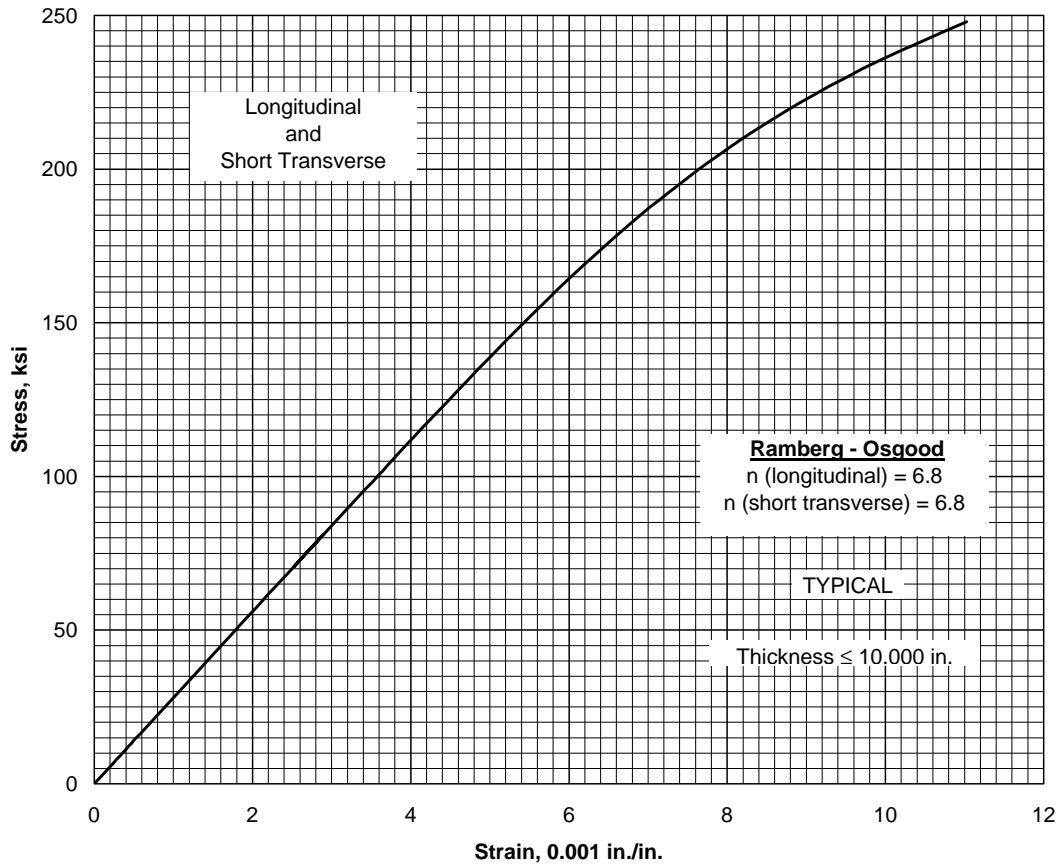

Figure 2.5.3.1.6(a). Typical tensile stress-strain curve at room temperature for AerMet 100 steel bar, heat treated to 280-300 ksi.

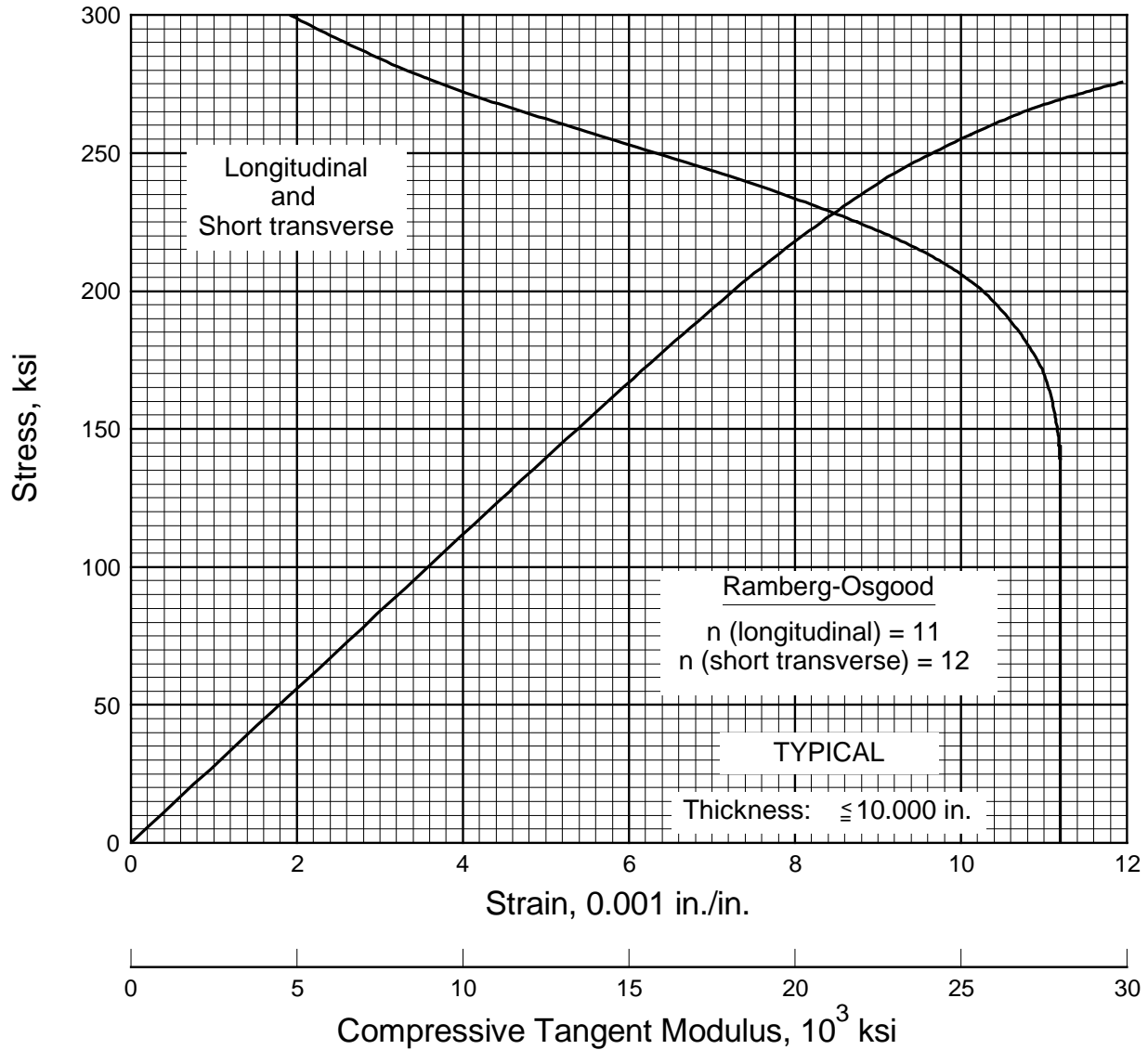

Figure 2.5.3.1.6(b). Typical compressive stress-strain and compressive tangent-modulus curves at room temperature for AerMet 100 steel bar, heat treated to 280-300 ksi.

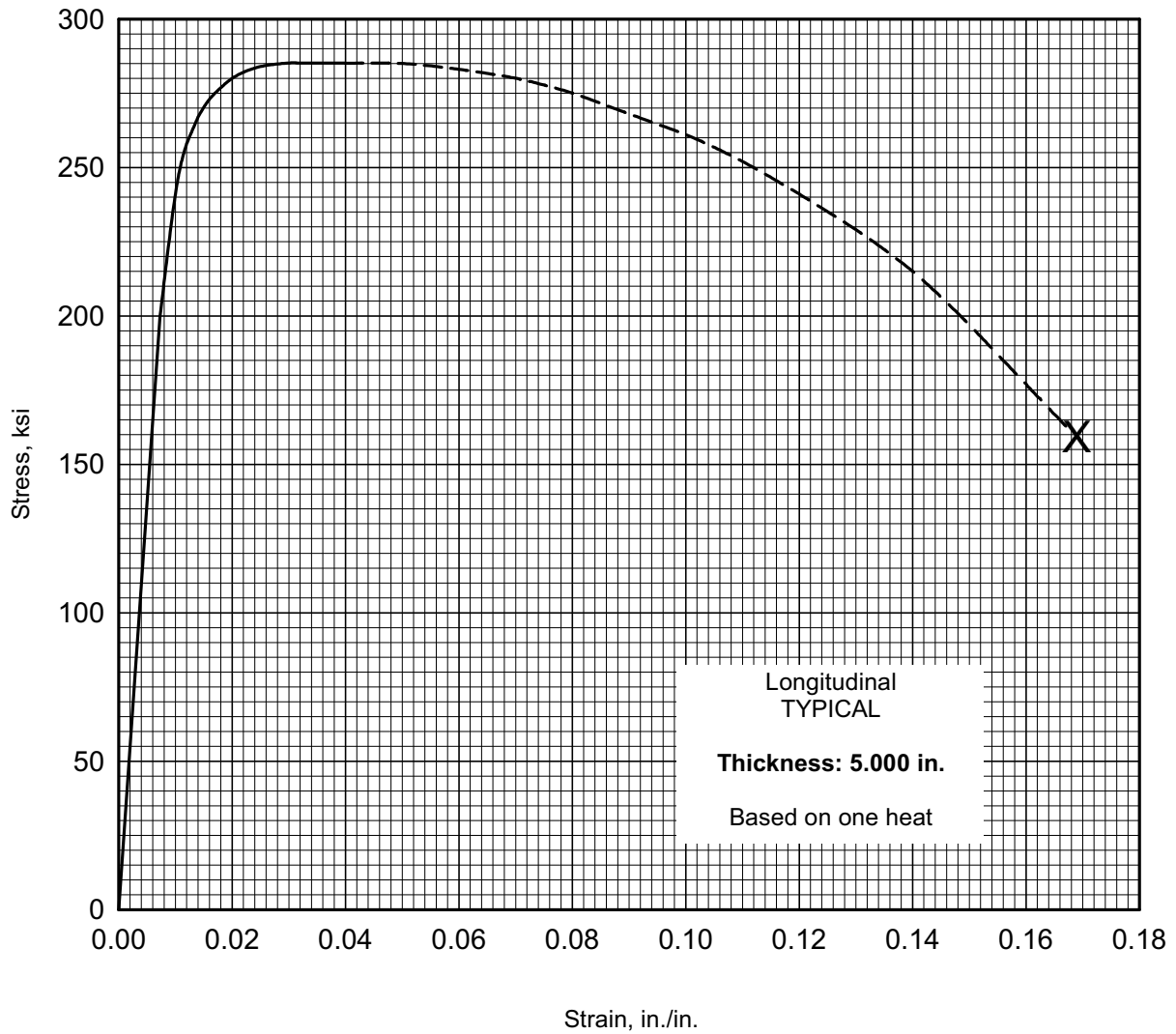

Figure 2.5.3.1.6(c). Typical tensile stress-strain curve (full range) at room temperature for AerMet 100 steel bar, heat treated to 280-300 ksi.

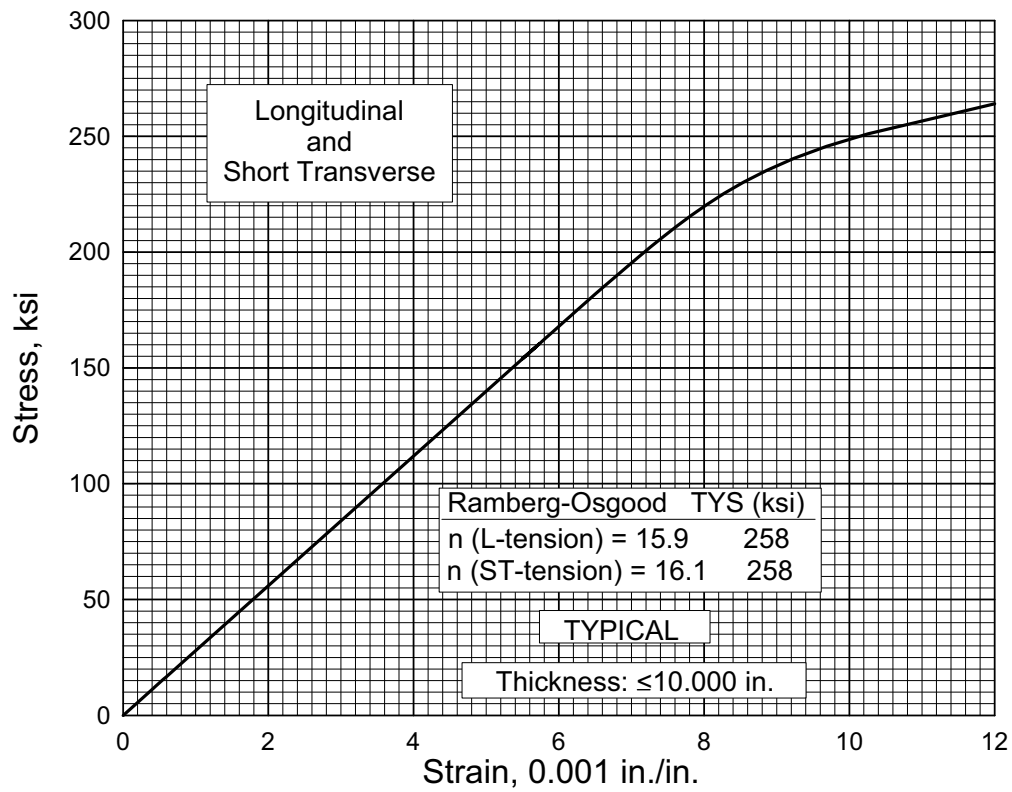

Figure 2.5.3.2.6(a). Typical tensile stress-strain curve at room temperature for AerMet 100 steel bar, heat treated to 290-310 ksi.

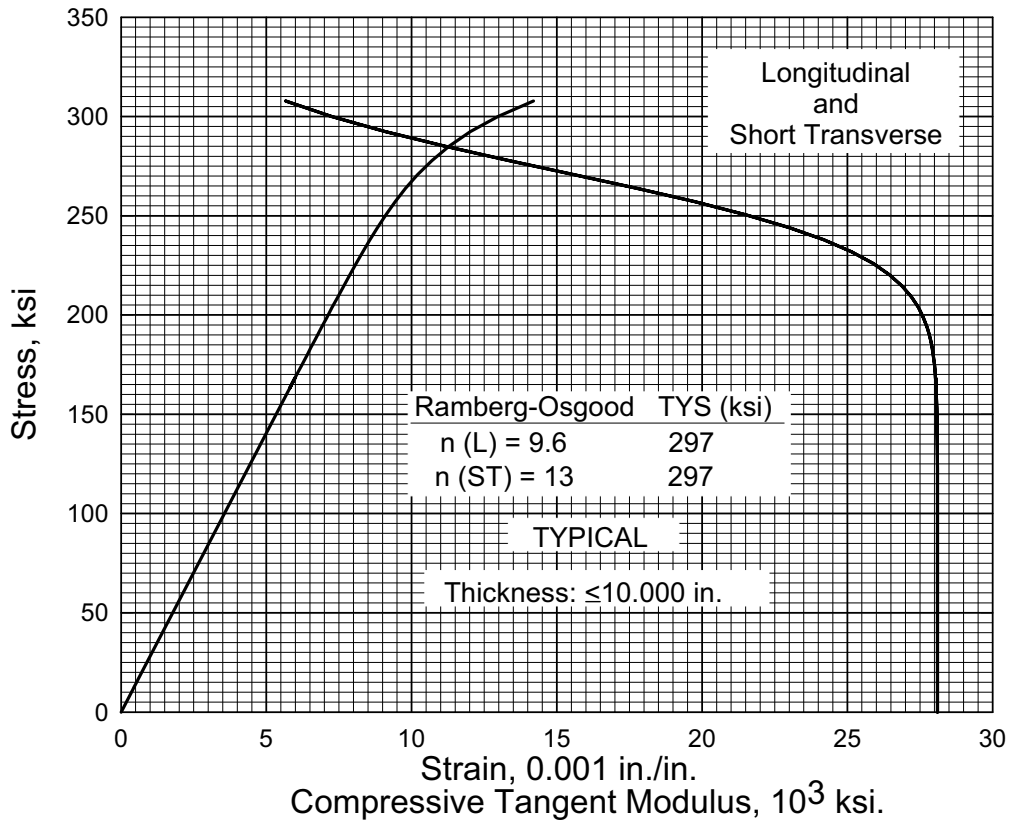

Figure 2.5.3.2.6(b). Typical compressive stress-strain and compressive tangent-modulus curves at room temperature for AerMet 100 steel bar, heat treated to 290-310 ksi.

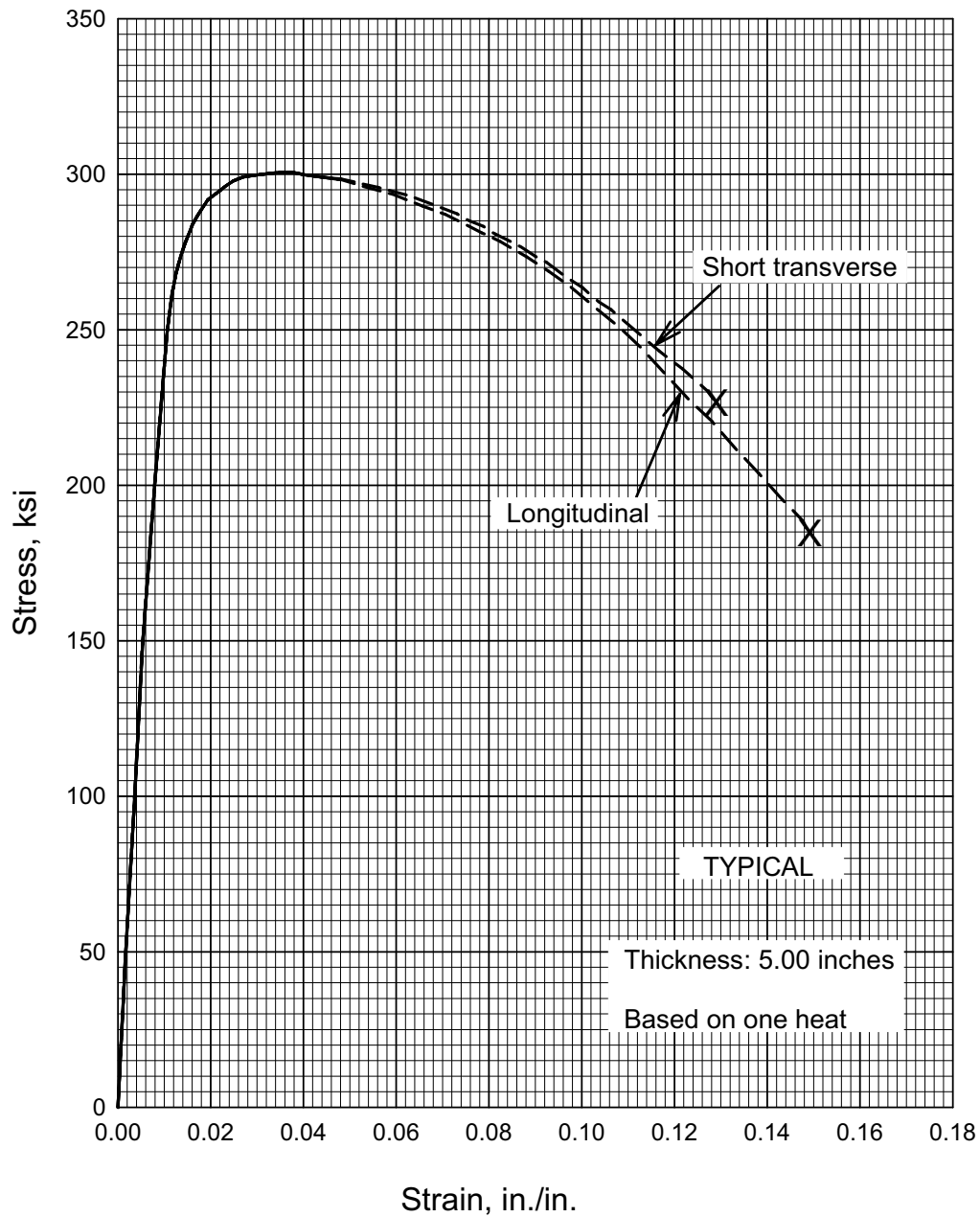

Figure 2.5.3.2.6(c). Typical tensile stress-strain curve (full range) at room temperature for AerMet 100 steel bar, heat treated to 290-310 ksi.

2.6 PRECIPITATION AND TRANSFORMATION-HARDENING STEELS (STAINLESS)

2.6.0 COMMENTS ON PRECIPITATION AND TRANSFORMATION-HARDENING STEELS (STAINLESS)

2.6.0.1 Metallurgical Considerations — The transformation and precipitation-hardening stainless steels are martensitic or semiaustenitic stainless steels that are hardenable by heat treatment.* The martensitic alloys require only a single step heat treatment to develop maximum strength. The others are austenitic in the fully annealed condition but become martensitic during subsequent heat treatment or as a result of extensive cold working. During a final heat treatment designed to temper the martensite, several of these steels are hardened further by the precipitation of copper, aluminum, or titanium.

Some dimensional change may be experienced during the heat treatment of the semiaustenitic steels. A dimensional expansion of approximately 0.0045-in./in. occurs during the transformation from the austenitic to the martensitic condition; during aging, a contraction of about 0.0005-in./in. takes place.

2.6.0.2. Manufacturing Considerations — The martensitic precipitation-hardening steels, before age hardening, are similar to the straight-chromium martensitic stainless steels (Type 410 or 431) in their general fabricating characteristics. The semiaustenitic grades, in the annealed condition, are similar to the austenitic stainless steels (Types 301, etc.) in this respect, and are readily cold formed. Forming of hardened steels after final heat treatment should be avoided.

These alloys can be welded by the conventional methods used for the austenitic stainless steels. Inert-gas-shielded welding is recommended to prevent the loss of titanium or aluminum in certain of these alloys. Postweld annealing is recommended for some grades.

The heat treatments for these steels are compatible with the cycles used for honeycomb panel brazing. Vapor blasting of scaled parts, after final heat treatment, is recommended because of the hazards of intergranular corrosion in inadequately controlled acids pickling operations.

2.6.0.3 Environmental Considerations — The precipitation-hardening stainless steels have good strength and oxidation and corrosion resistance in their service range. Prolonged exposures above 600°F and below the tempering range may cause further hardening, with possible decrease in ductility. Prolonged exposures in or above the temperature range result in loss of strength due to overtempering, overaging, or reaustenizing.

2.6.1 AM-350

2.6.1.0 Comments and Properties — AM-350 has high strength up to 800°F and good oxidation resistance up to about 1000°F. The alloy can be hardened by subzero cooling and tempering (Condition SCT).

Manufacturing Considerations — AM-350 is readily formed, welded, and brazed. Its forming characteristics are similar to the AISI 300 series stainless steels; however, it does have a higher rate of strain hardening. When fabricating AM-350 in the annealed condition, proper design allowance must be made for growth which occurs upon hardening. To obtain proper response to the SCT treatment after welding, the alloy must be reannealed.

Environmental Considerations — AM-350 shows good corrosion-resisting properties in ordinary atmospheres and also in a number of chemical environments. Exposure in the 600 to 800°F range for 1,000

* Heat treating procedures for these steels are specified in MIL-H-6875 and are further described in producers' literature.

hours at stress levels below the short-time yield strength tends to increase room-temperature yield strength and room-temperature tensile strength slightly. Exposure to 800°F results in a decrease in elongation. Typical data are presented in Table 2.6.1.0(a).

Table 2.6.1.0(a). Effect of Elevated Temperature Exposure on Typical Tensile Properties of AM-350 Alloy in the SCT 850 Condition

Exposure temperature, °F	Exposure stress, ksi	Exposure time, hr	Room-temperature properties		
			TUS, ksi	TYS, ksi	e, %
RT	201	158	12.0
600	60	1,000	198	162	14.0
700	60	1,000	204	169	11.0
800	60	1,000	220	190	7.0
600	90	1,000	202	177	13.0
700	90	1,000	206	180	11.0
800	90	1,000	214	192	7.0

Specifications and Properties — A material specification for AM-350 stainless steel is presented in Table 2.6.1.0(b). The room-temperature properties of AM-350 in the SCT 850 condition are shown in Table 2.6.1.0(c). Figure 2.6.1.0 presents elevated temperature physical property information.

Table 2.6.1.0(b). Material Specifications for AM-350 Stainless Steel

Specification	Form
AMS 5548	Sheet and strip

2.6.1.1 SCT 850 Condition — Effect of temperature on various mechanical properties of AM-350 is presented in Figures 2.6.1.1.1 through 2.6.1.1.4. Typical stress-strain and tangent-modulus curves at several temperatures are shown in Figures 2.6.1.1.6(a) and (b).

Table 2.6.1.0(c). Design Mechanical and Physical Properties of AM-350 Stainless Steel Sheet and Strip

Specification	AMS 5548
Form	Sheet and strip ^a
Condition	SCT 850
Thickness, in.	≤ 0.187
Basis	S
Mechanical Properties:	
F_{tu} , ksi:	
L	183
LT	185
F_{ly} , ksi:	
L	147
LT	150
F_{cy} , ksi:	
L	163
LT
F_{su} , ksi	121
F_{bru} , ksi:	
(e/D = 1.5)
(e/D = 2.0)	373
F_{bry} , ksi:	
(e/D = 1.5)
(e/D = 2.0)	252
e , percent:	
LT	10 ^b
E , 10 ³ ksi	29.0
E_c , 10 ³ ksi	30.0
G , 10 ³ ksi	11.0
μ	0.32
Physical Properties:	
ω , lb/in. ³	0.282
C , Btu/(lb)(°F)	0.12 (32 to 212°F)
K and α	See Figure 2.6.1.0

a Test direction longitudinal for widths less than 9 in.; transverse for widths 9 in. and over.

b Elongation is 8 percent for sheet thickness in the range 0.010 to 0.050 inch. Listed value is for thickness > 0.050 inch.

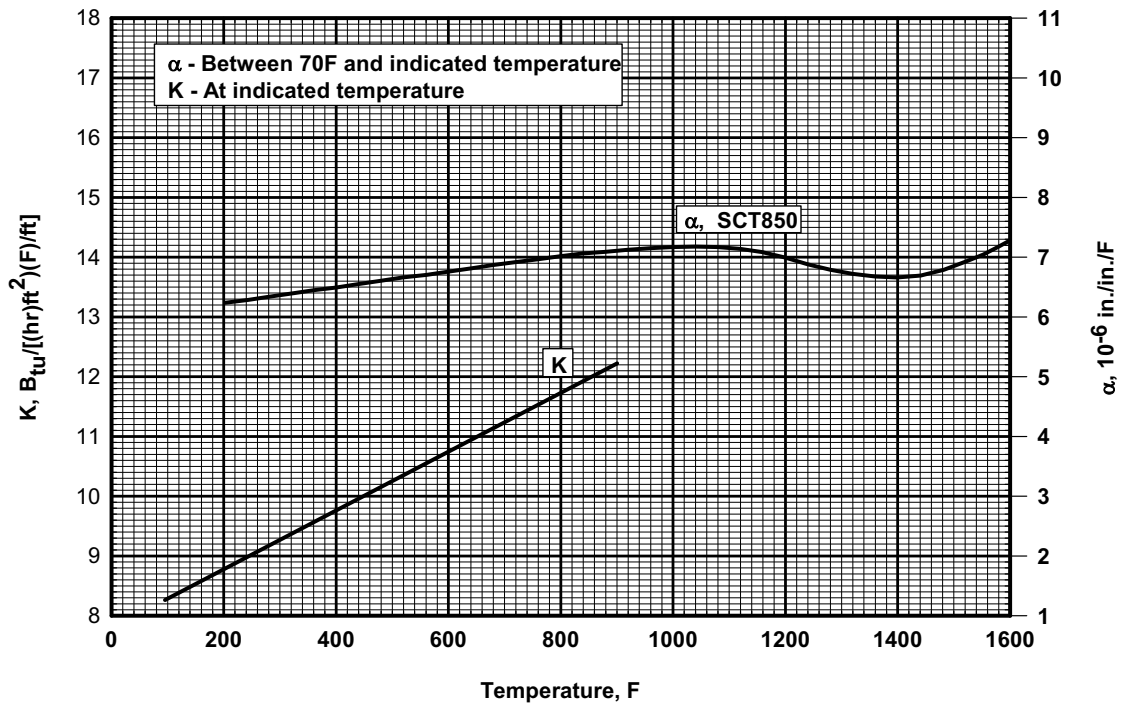

Figure 2.6.1.0. Effect of temperature on the physical properties of AM-350 stainless steel.

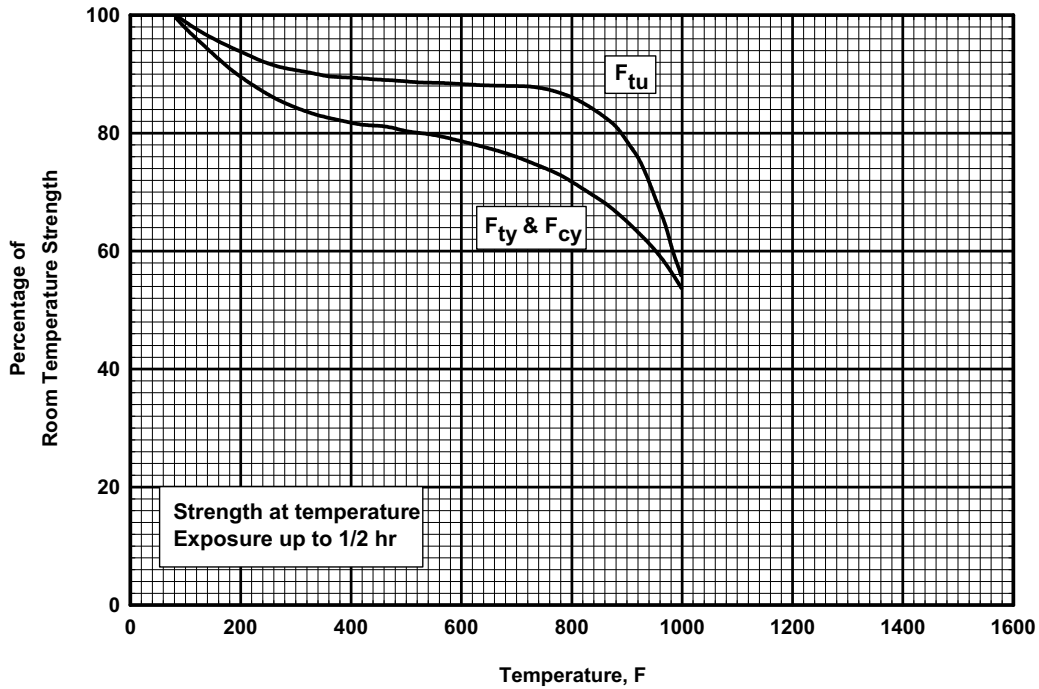

Figure 2.6.1.1.1. Effect of temperature on the tensile ultimate strength (F_{tu}), the tensile yield strength (F_{ty}), and the compressive yield strength (F_{cy}) of AM-350 (SCT 850) stainless steel sheet.

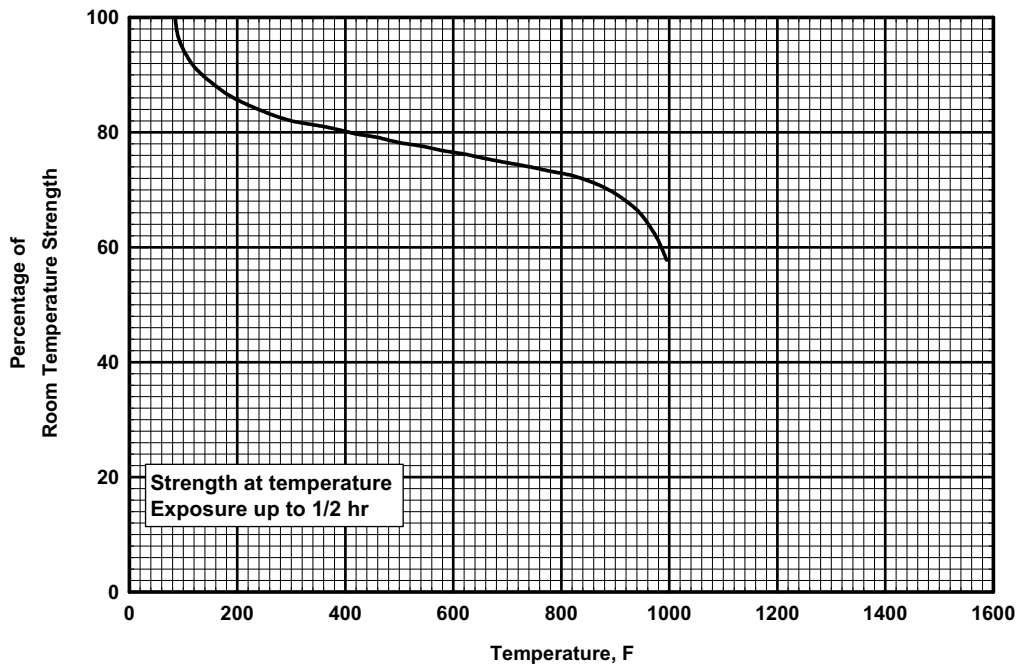

Figure 2.6.1.1.2. Effect of temperature on the shear ultimate strength (F_{su}) of AM-350 (SCT 850) stainless steel sheet.

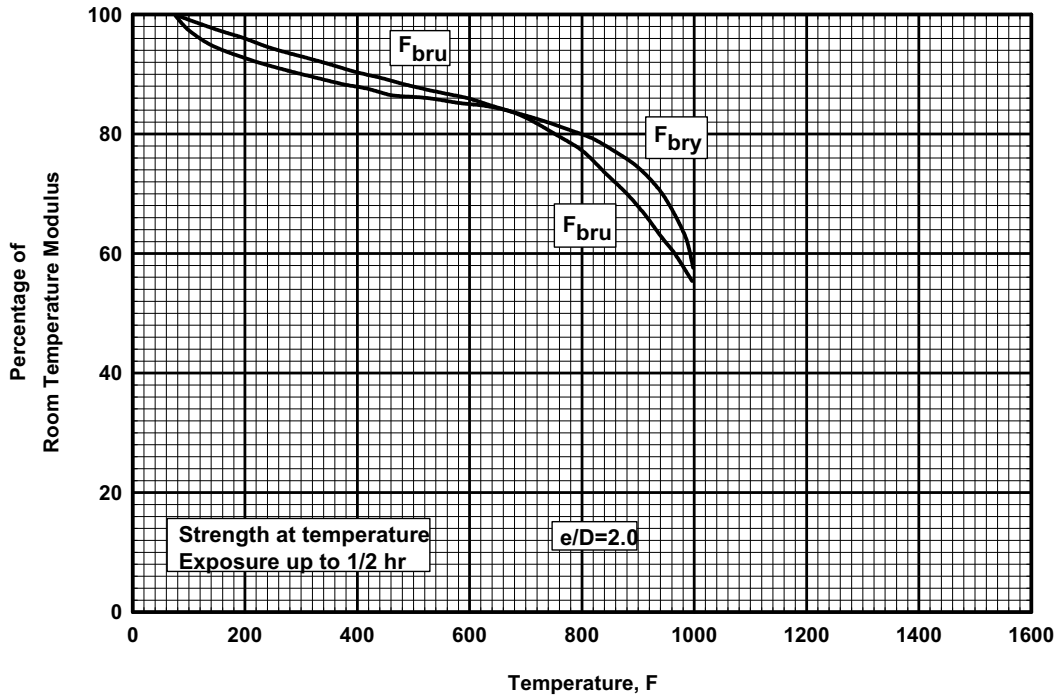

Figure 2.6.1.1.3. Effect of temperature on the bearing ultimate strength (F_{bru}) and the bearing yield strength (F_{bry}) of AM-350 (SCT 850) stainless steel sheet.

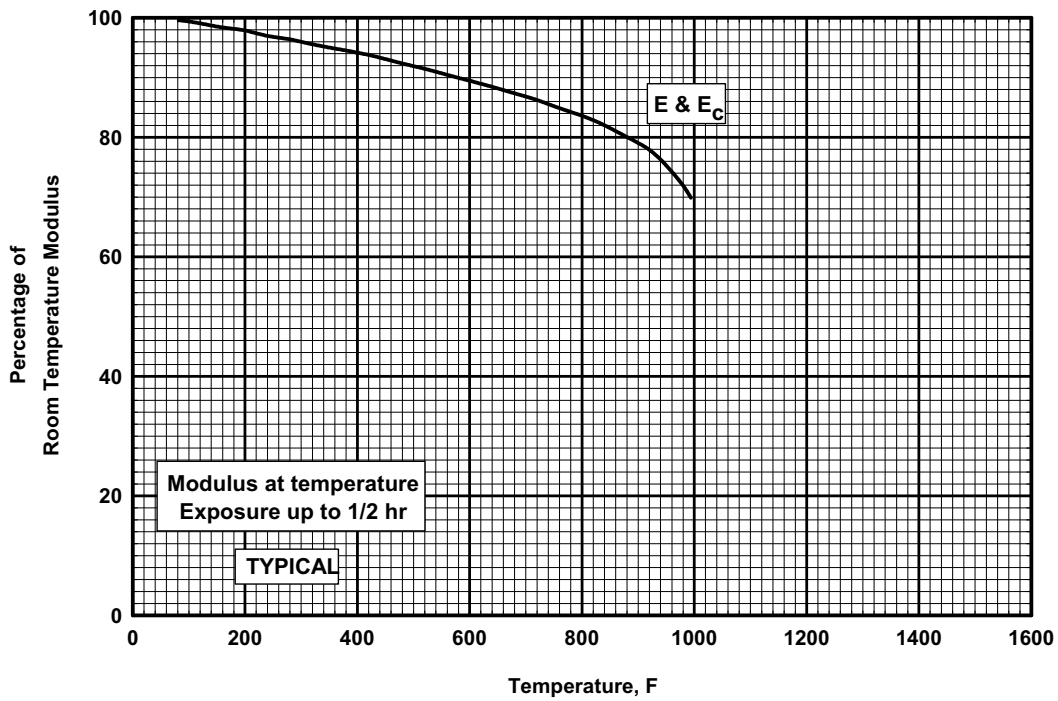

Figure 2.6.1.1.4. Effect of temperature on the tensile and compressive moduli (E and E_c) of AM-350 (SCT 850) stainless steel sheet.

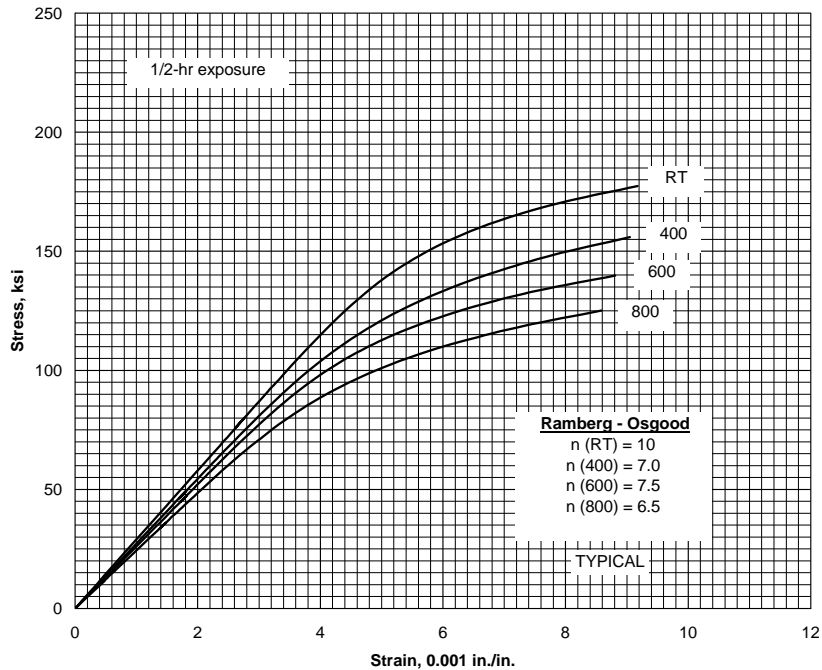

Figure 2.6.1.1.6(a). Typical tensile stress-strain curves at various temperature for AM-350 (SCT 850) stainless steel sheet.

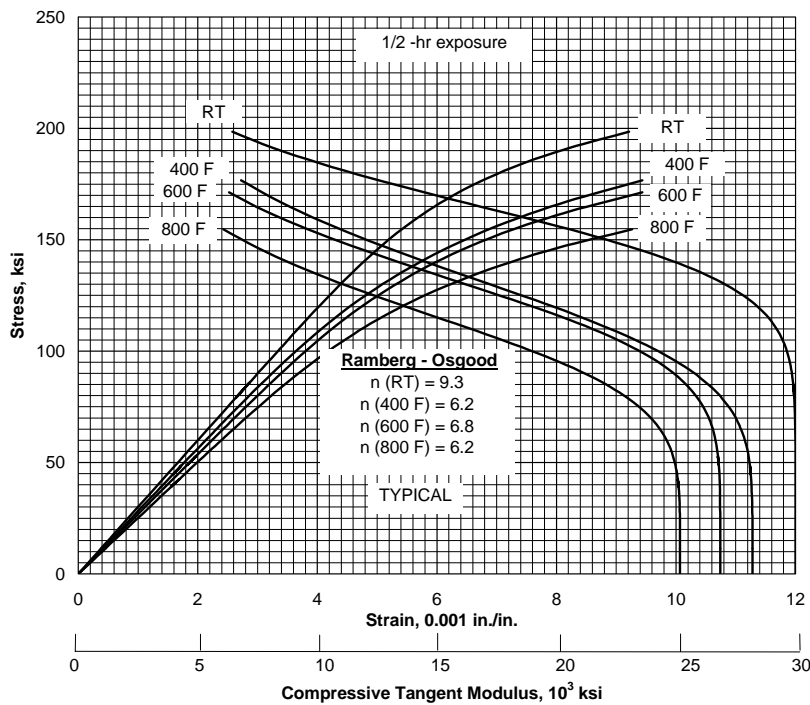

Figure 2.6.1.1.6(b). Typical compressive stress-strain compressive tangent-modulus curves at various temperatures for AM-350 (SCT 850) stainless steel sheet.

2.6.2 AM-355

2.6.2.0 Comments and Properties — AM-355, like AM-350, has high strength up to 800°F and good oxidation resistance up to 1000°F. The AM-355 alloy is generally hardened by subzero cooling and tempering (Condition SCT).

AM-355 is available in all mill products. The manufacturing considerations for AM-355 are similar to those for AM-350. Machining of AM-355 bars and forgings is best accomplished after overtempering at 1000°F to 1100°F.

The differences between AM-350 and AM-355 are a result of higher carbon, lower chromium, and reduced delta ferrite in AM-355. This difference in composition makes AM-355 slightly stronger but slightly less corrosion resistant than AM-350.

Environmental Considerations — Exposure in the 600°F to 800°F range for 100 hours at stress levels below the short time yield strength tends to increase room-temperature yield strength and room-temperature tensile strength slightly, with little change in elongation. Typical data are shown in Table 2.6.2.0(a).

Table 2.6.2.0(a). Effect of Elevated Temperature Exposure on Typical Tensile Properties of AM-355 Alloy in the SCT 850 Condition

Exposure temperature, °F	Exposure stress, ksi	Exposure time, hr	Room-temperature properties		
			TUS, ksi	TYS, ksi	e, %
RT	211	170	11.5
600	66	1,000	213	172	12.0
700	65	1,000	218	178	10.5
800	62	1,000	227	200	12.5
600	99	1,000	214	180	10.5
700	97	1,000	218	189	11.5
800	93	1,000	224	204	12.5

Specifications and Properties — Material specifications for AM-355 are presented in Table 2.6.2.0(b). The room temperature properties of AM-355 SCT are shown in Table 2.6.2.0(c) through (e). The physical properties of this alloy are presented in Figure 2.6.2.0.

Table 2.6.2.0(b). Material Specifications for AM-355 Stainless Steel

Specification	Form
AMS 5547	Sheet and strip
AMS 5549 ^a	Plate
AMS 5743	Bar, forging, and forging stock

^a Noncurrent specification.

2.6.2.1 SCT Condition — Elevated-temperature properties for AM-355 in the SCT (subzero cooled and tempered) condition are presented in Figures 2.6.2.1.1 through 2.6.2.1.4.

Table 2.6.2.0(c). Design Mechanical and Physical Properties of AM-355 Stainless Steel

Specification	AMS 5547		AMS 5743	
	Sheet and strip ^a		Bar and forging	
Condition	SCT850 ^b	SCT1000	SCT850 ^b	SCT1000
Thickness or diameter, in.	0.0005-0.187	0.010-0.187
Basis	S	S	S	S
Mechanical Properties:				
F_{tu} , ksi:				
L	188	...	200	170
LT	190	165
F_{ty} , ksi:				
L	162	...	165	155
LT	165	140
F_{cy} , ksi:				
L	180
LT
F_{su} , ksi	124
F_{bru} , ksi:				
(e/D = 1.5)
(e/D = 2.0)	383
F_{bry} , ksi:				
(e/D = 1.5)
(e/D = 2.0)	278
e , percent:				
L	10	12
LT	^c	10
RA , percent:				
L	20	25
E , 10 ³ ksi	29.0			
E_c , 10 ³ ksi	29.0			
G , 10 ³ ksi	11.0			
μ	0.32			
Physical Properties:				
ω , lb/in. ³	0.282			
C , K , and α	See Figure 2.6.2.0			

a Test direction longitudinal for widths less than 9 inches; transverse for widths 9 inches and over.
b Note: Condition SCT850 has been superseded by Condition SCT1000 in the applicable specifications. The tensile properties in these columns are the values previously specified for Condition SCT850.
c See Table 2.6.2.0(e).

Table 2.6.2.0(d). Design Mechanical and Physical Properties of AM-355 Stainless Steel Plate

Specification	AMS 5549 ^a			
Form	Plate ^b			
Condition	SCT850 ^c			SCT 1000
Thickness, in.	<0.375	0.375-1.000	>1.000	<0.187
Basis	S	S	S	S
Mechanical Properties:				
F_{tu} , ksi:				
L	188
LT	190	190	190	165
F_{ty} , ksi:				
L	162
LT	165	150	^d	140
F_{cy} , ksi:				
L	180
LT
F_{su} , ksi	124
F_{bru} , ksi:				
(e/D = 1.5)
(e/D = 2.0)	383
F_{bry} , ksi:				
(e/D = 1.5)
(e/D = 2.0)	278
e , percent:				
LT	10	10	10	12
E , 10 ³ ksi	29.0			
E_c , 10 ³ ksi	29.0			
G , 10 ³ ksi	11.0			
μ	0.32			
Physical Properties:				
ω , lb/in. ³	0.282			
C , K , and α	See Figure 2.6.2.0			

- a Noncurrent specification.
- b Test direction longitudinal for widths less than 9 inches; transverse for widths 9 inches and over.
- c Note: Condition SCT850 has been superseded by Condition SCT1000 in the applicable specifications. The tensile properties in these columns are the values previously specified for Condition SCT850.
- d As agreed upon by purchaser and vendor.

Table 2.6.2.0(e). Minimum Elongation Values for AM-355 (SCT 850) Stainless Steel Sheet and Strip

Thickness, inches	e (LT), percent in 2 inches
0.0005 to 0.0015	2
Over 0.0015 to 0.0020	3
Over 0.0020 to 0.0050	5
Over 0.0050 to 0.0100	7
Over 0.0100 to 0.1875	8

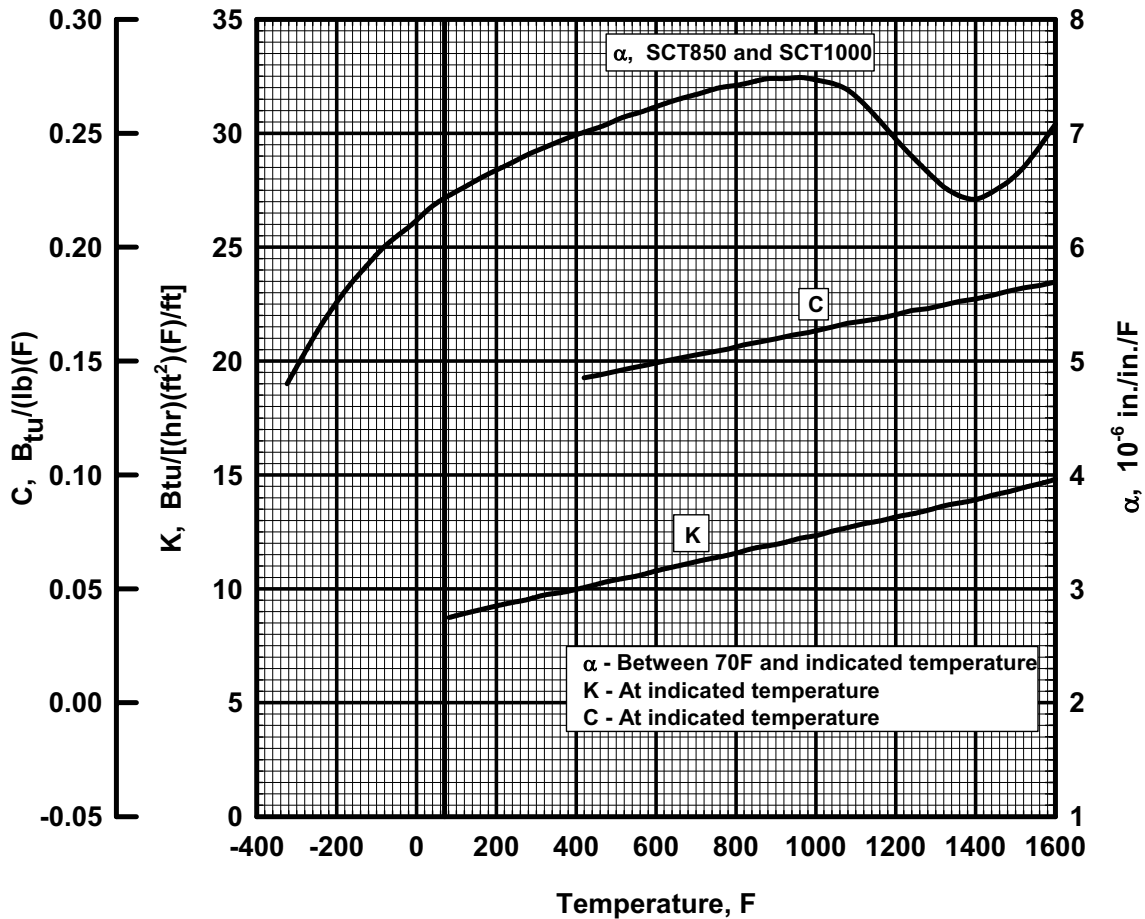

Figure 2.6.2.0. Effect of temperature on the physical properties of AM-355 stainless steel.

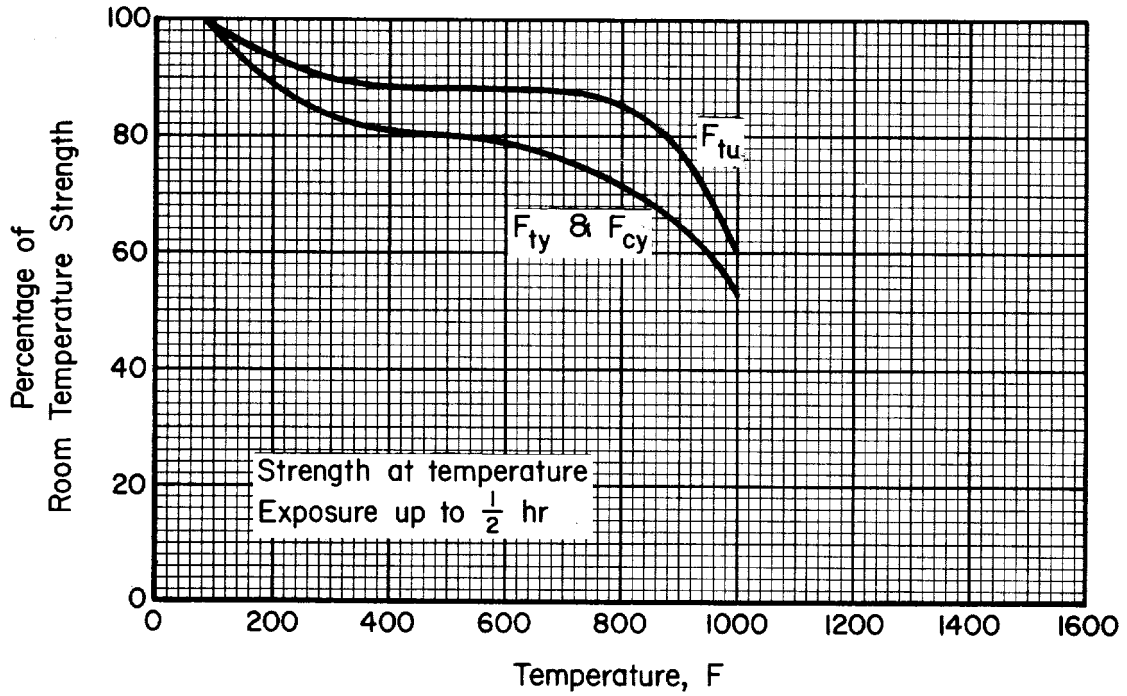

Figure 2.6.2.1.1. Effect of temperature on the tensile ultimate strength (F_{tu}), the tensile yield strength (F_{ty}), and the compressive yield strength (F_{cy}) of AM-355 (SCT 850) stainless steel (all products).

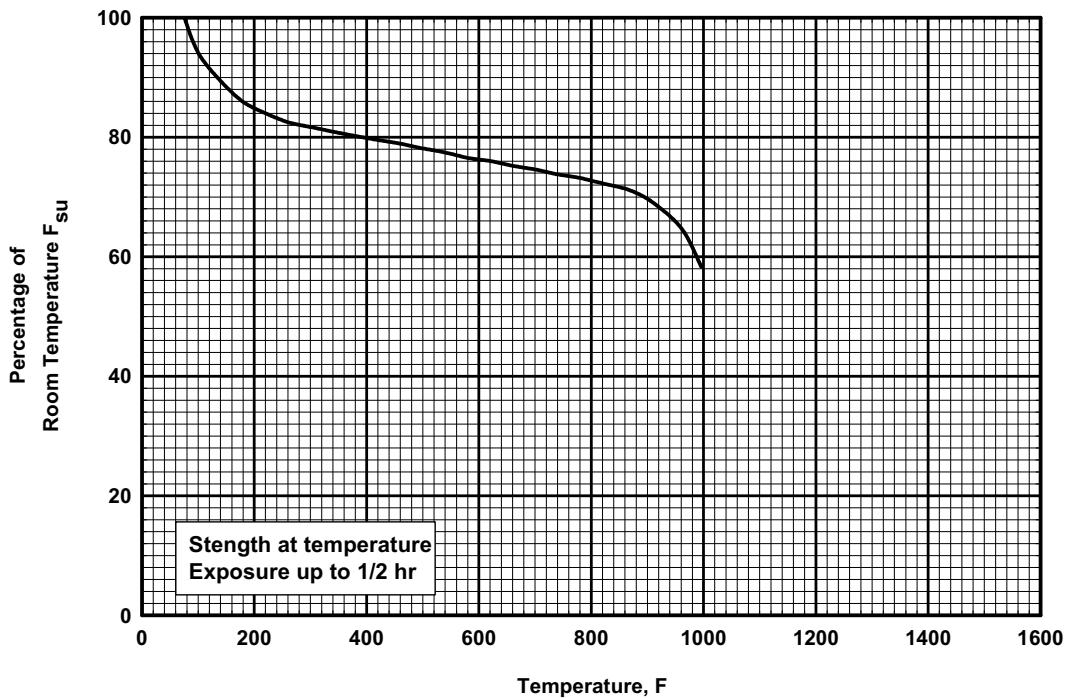

Figure 2.6.2.1.2. Effect of temperature on the shear ultimate strength (F_{su}) of AM-355 (SCT 850) stainless steel (all products).

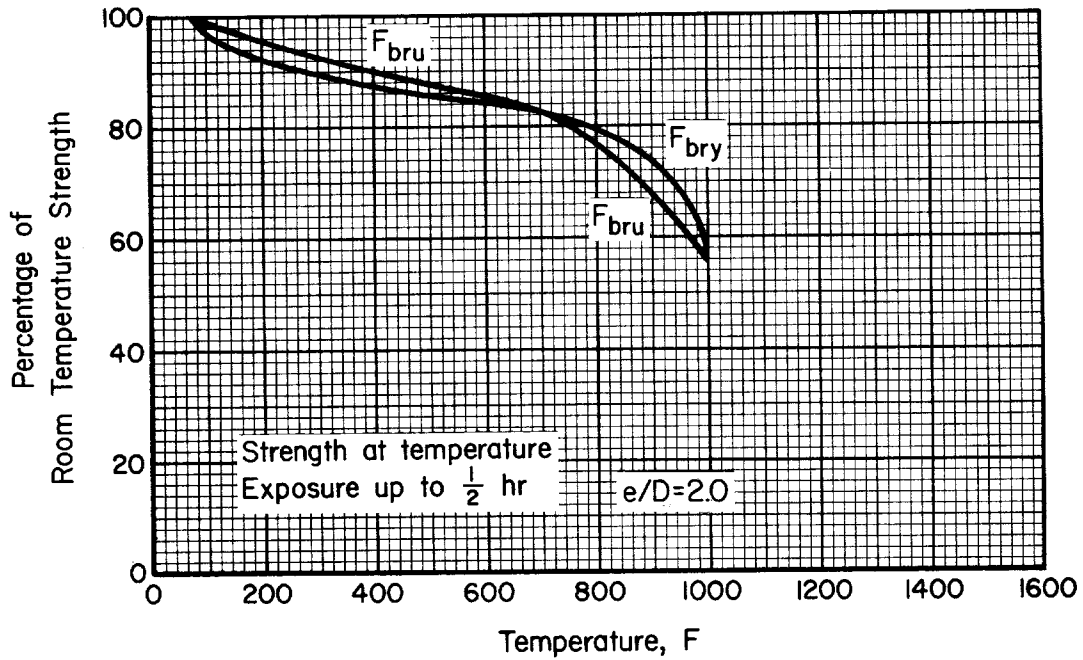

Figure 2.6.2.1.3. Effect of temperature on the bearing ultimate strength (F_{bru}) and the bearing yield strength (F_{bry}) of AM-355 (SCT 850) stainless steel sheet.

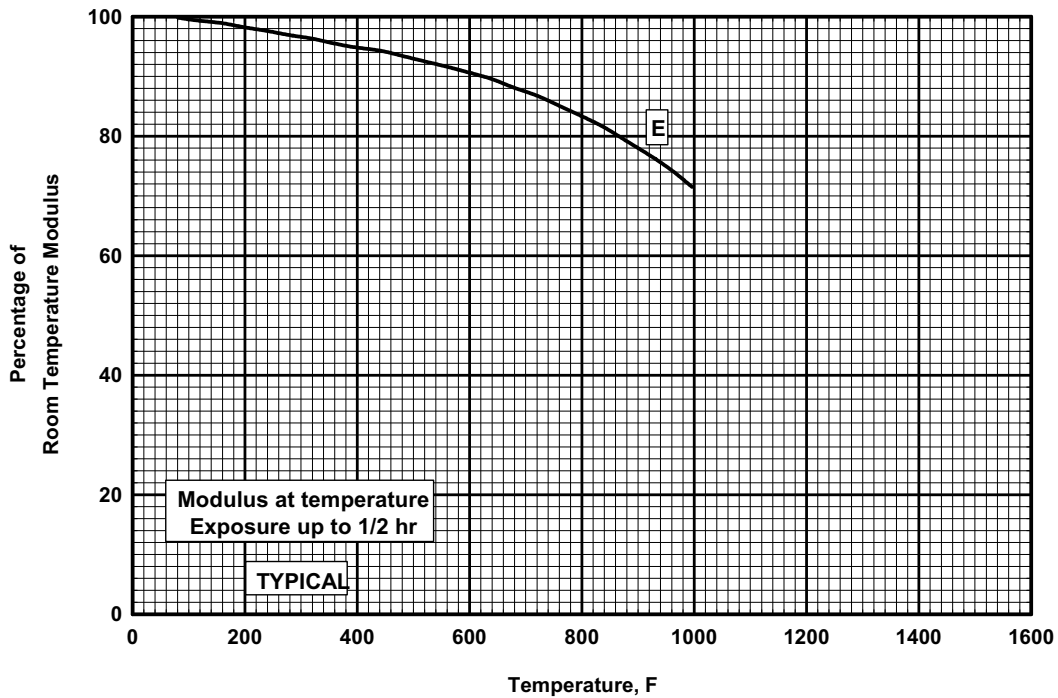

Figure 2.6.2.1.4. Effect of temperature on the tensile modulus (E) of AM-355 (SCT 850) stainless steel (all products).

2.6.3 CUSTOM 450

2.6.3.0 Comments and Properties — Custom 450 is a martensitic, precipitation-hardening stainless steel used for parts requiring corrosion resistance and high strength at temperatures up to 800°F for aged conditions. It is available in the form of forgings, billet, bar, wire, strip, and welded tubing.

Manufacturing Considerations — Custom 450 is normally supplied and fabricated in the solution-treated condition except wire for cold heading is supplied in the H1150M condition. Forming, machining, and joining operations are similar to those employed for other precipitation hardening stainless steels.

Heat Treatment — Among the alloys of its type, Custom 450 is the only one recommended for use in the solution-treated condition at temperatures up to 500°F. The alloy can also be heat treated to various strength levels having a wide range of properties. Consult the applicable material specification or MIL-H-6875 for specific heat treatment procedures.

In all heat treat conditions, Custom 450 has excellent ductility and toughness. Cryogenic properties are optimum in the H1150 condition. Maximum strength is achieved with the 900°F aging treatment while optimum fatigue life is exhibited with a 1050°F age.

When the as-supplied solution-treated condition is altered during processing by hot working, severe cold working, or welding, parts should be resolution annealed prior to aging. A dimensional contraction of about 0.0002 in./in. with the 900°F age and about 0.001 in./in. for the 1050°F aging treatment can be expected.

Environmental Considerations — The general corrosion resistance of Custom 450 is similar to AISI Type 304 stainless steel. Custom 450 shows excellent resistance to atmosphere corrosion and mild chemical environments. It has good resistance to stress corrosion cracking in the solution-treated condition. Like all martensitic precipitation hardening alloys, if stress corrosion is of concern, it should be aged at the highest temperature compatible with strength requirements. It offers the best resistance to stress corrosion cracking and hydrogen embrittlement when aged at 1150°F. The general corrosion resistance is very slightly decreased by the higher aging temperatures.

Material specifications for Custom 450 are shown in Table 2.6.3.0(a). The room-temperature mechanical properties are presented in Tables 2.6.3.0(b) and (c). The effect of temperature on thermal expansion is shown in Figure 2.6.3.0.

Table 2.6.3.0(a). Material Specifications for Custom 450 Stainless Steel

Specification	Form
AMS 5763	Bar, forging, tubing, wire, and ring (air melted)
AMS 5773	Bar, forging, tubing, wire, and ring (CEM)

2.6.3.1 H900 Condition — Elevated temperature curves are presented in Figures 2.6.3.1.1, 2.6.3.1.2, and 2.6.3.1.5. A tensile stress-strain curve at room temperature is shown in Figure 2.6.3.1.6. Fatigue data at room temperature are presented in Figure 2.6.3.1.8.

2.6.3.2 H1050 Condition — Elevated temperature curves are presented in Figures 2.6.3.2.1, 2.6.3.2.2, and 2.6.3.2.5. A tensile stress-strain curve at room temperature is shown in Figure 2.6.3.2.6. Fatigue data at room temperature are presented in Figure 2.6.3.2.8.

Table 2.6.3.0(b). Design Mechanical and Physical Properties of Custom 450 Stainless Steel Bar

Specification	AMS 5763		
	Bar		
	Solution Treated	H900	H1050
	≤8.000	≤8.000	≤8.000
Form			
Condition			
Thickness or diameter, in.			
Basis	S	S	S ^a
Mechanical Properties:			
F_{tu} , ksi:			
L	125	180	145
ST	179	144
F_{ty} , ksi:			
L	95	170	135
ST	168	133
F_{cy} , ksi:			
L	175	143
ST	173	141
F_{su} , ksi	114	93
F_{bru} , ksi:			
(e/D = 1.5)	298	239
(e/D = 2.0)	381	307
F_{bry} , ksi:			
(e/D = 1.5)	265	204
(e/D = 2.0)	326	257
e , percent:			
L	10	10	12
RA , percent:			
L	40	40	45
E , 10 ³ ksi	28.0	29.0	
E_c , 10 ³ ksi	31.0	
G , 10 ³ ksi	11.2	
μ	0.29	
Physical Properties:			
ω , lb/in. ³	0.28		
C , Btu/(lb)(°F)		
K , Btu/[(hr)(ft ²)(°F)/ft]		
α , 10 ⁻⁶ in./in./°F	See Figure 2.6.3.0		

a Suppliers guaranteed minimum properties.

Table 2.6.3.0(c). Design Mechanical and Physical Properties of Custom 450 Stainless Steel Bar

Specification	AMS 5773						
Form	Bar						
Condition	Solution treated	H900	H950	H1000	H1050	H1100	H1150
Thickness or diameter, in.	≤12.000						
Basis	S	S	S	S	S	S	S
Mechanical Properties:							
F_m , ksi:							
L	125	180	170	160	145	130	125
T	...	180	170	160	145	130	125
F_{ty} , ksi:							
L	95	170	160	150	135	105	75
T	...	170	160	150	135	105	75
F_{cy} , ksi:							
L	...	175	143
T	...	173	141
F_{su} , ksi	...	114	93
F_{bru} , ksi:							
(e/D = 1.5)	...	298	239
(e/D = 2.0)	...	381	307
F_{bry} , ksi:							
(e/D = 1.5)	...	265	204
(e/D = 2.0)	...	326	257
e , percent:							
L	10	10	10	12	12	16	18
T	...	6	7	8	9	11	12
R , percent:							
L	40	40	40	45	45	50	55
T	...	20	22	27	30	30	35
E , 10^3 ksi	28.0	29.0					
E_c , 10^3 ksi	...	31.0					
G , 10^3 ksi	...	11.2					
μ	...	0.29					
Physical Properties:							
ω , lb/in. ³	0.28						
C , Btu/(lb)(°F)	...						
K , Btu/[(hr)(ft ²)(°F)/ft]	...						
α , 10^{-6} in./in./°F	See Figure 2.6.3.0						

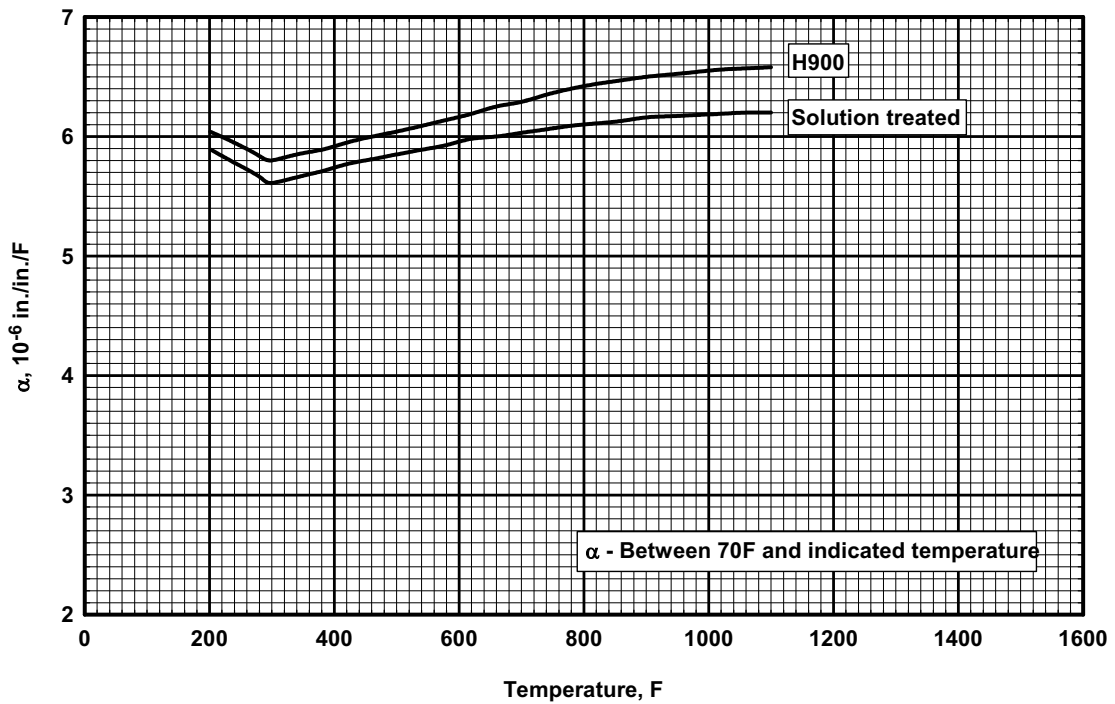

Figure 2.6.3.0. Effect of temperature on the physical properties of Custom 450 stainless steel.

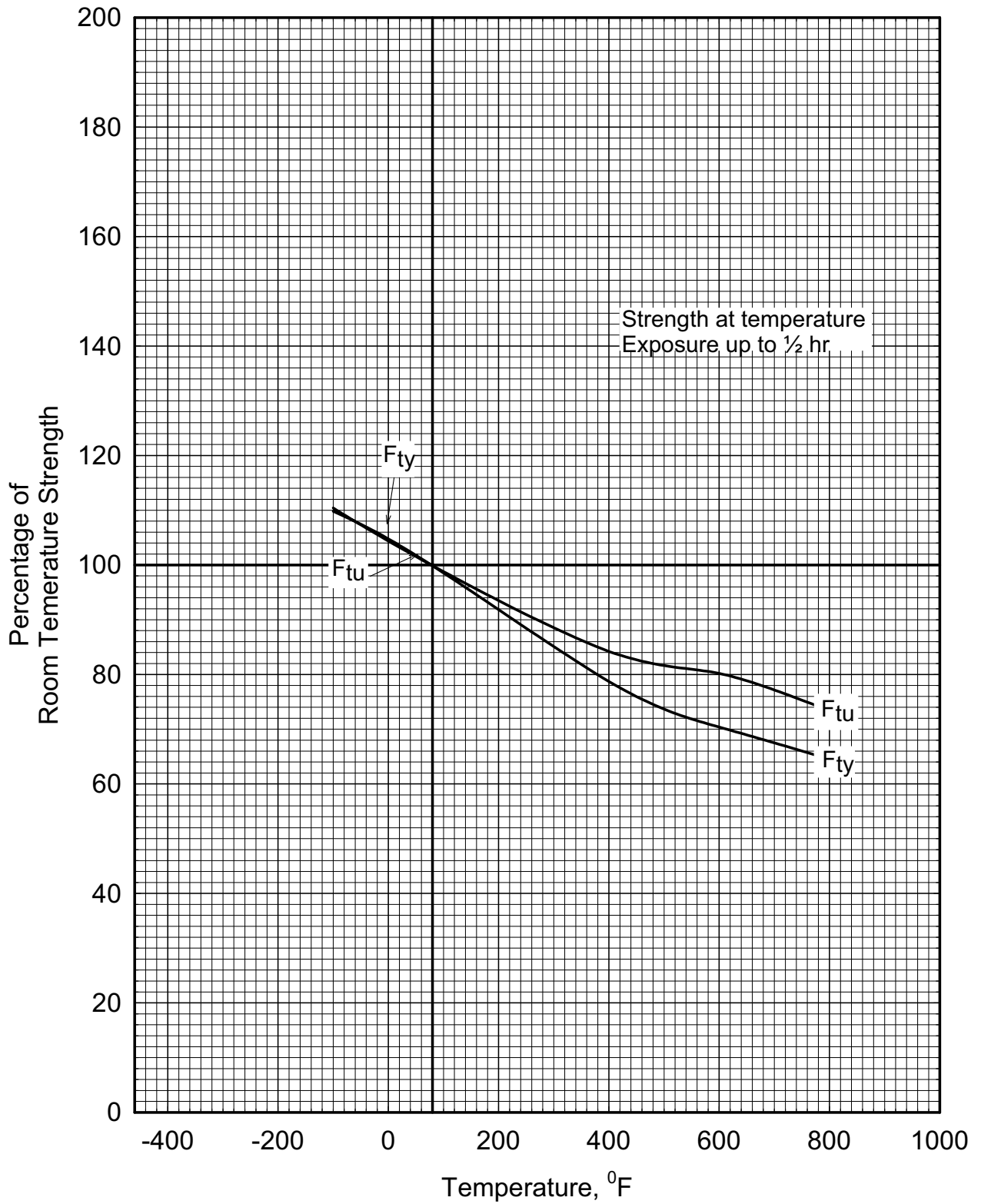

Figure 2.6.3.1.1. Effect of temperature on the tensile ultimate strength (F_{tu}) and the tensile yield strength (F_{ty}) of Custom 450 (H900) stainless steel bar.

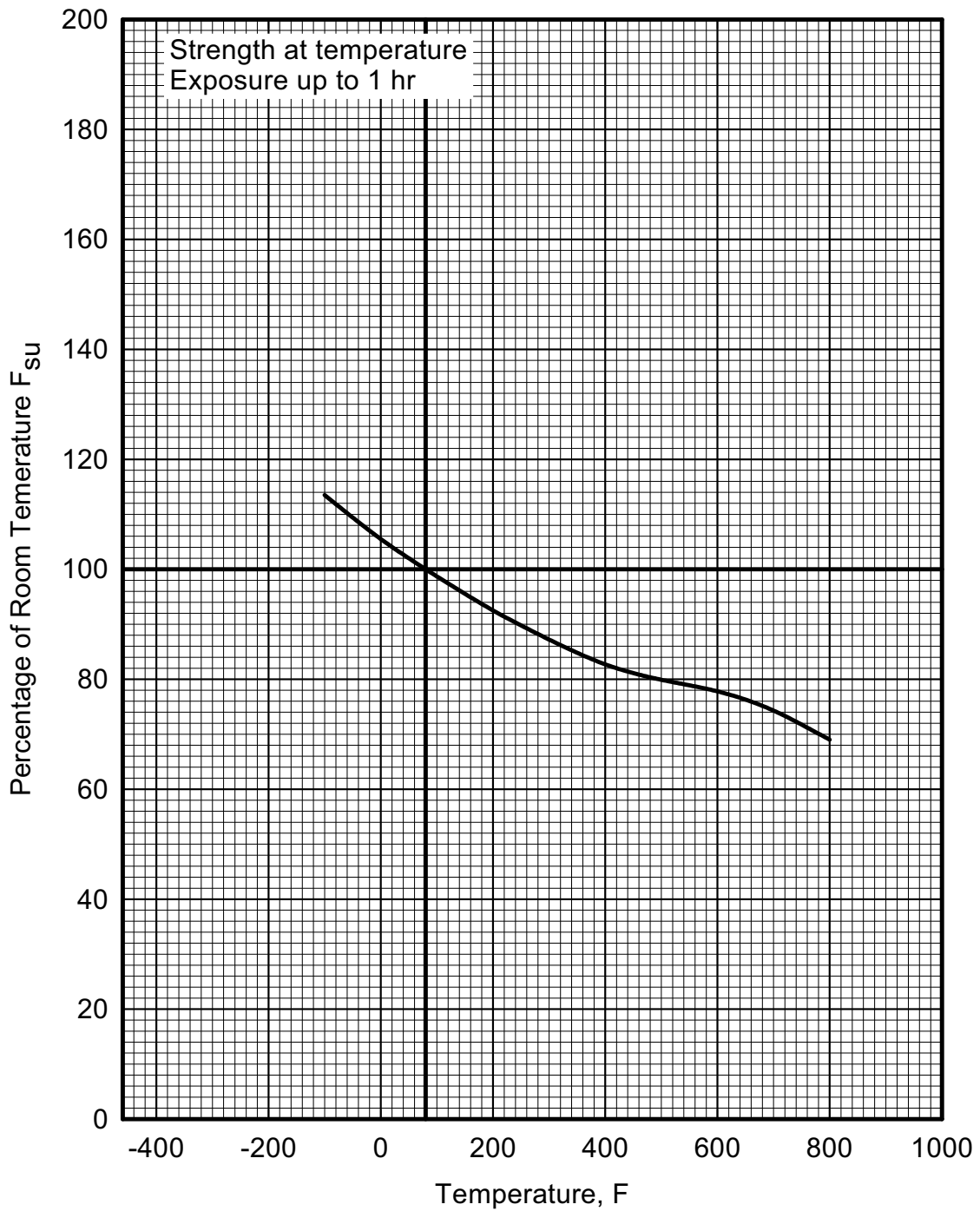

Figure 2.6.3.1.2. Effect of temperature on the ultimate shear strength (F_{su}) of Custom 450 (H900) stainless steel bar.

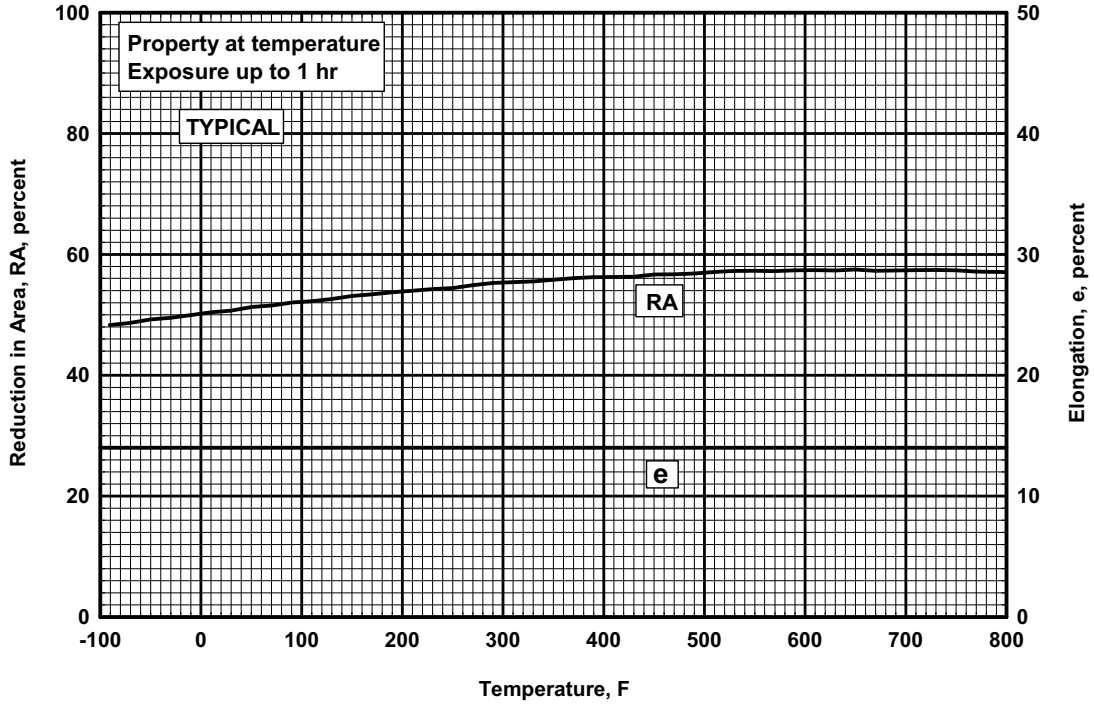

Figure 2.6.3.1.5. Effect of temperature on the elongation (e) and the reduction of area (RA) of Custom 450 (H900) stainless steel bar.

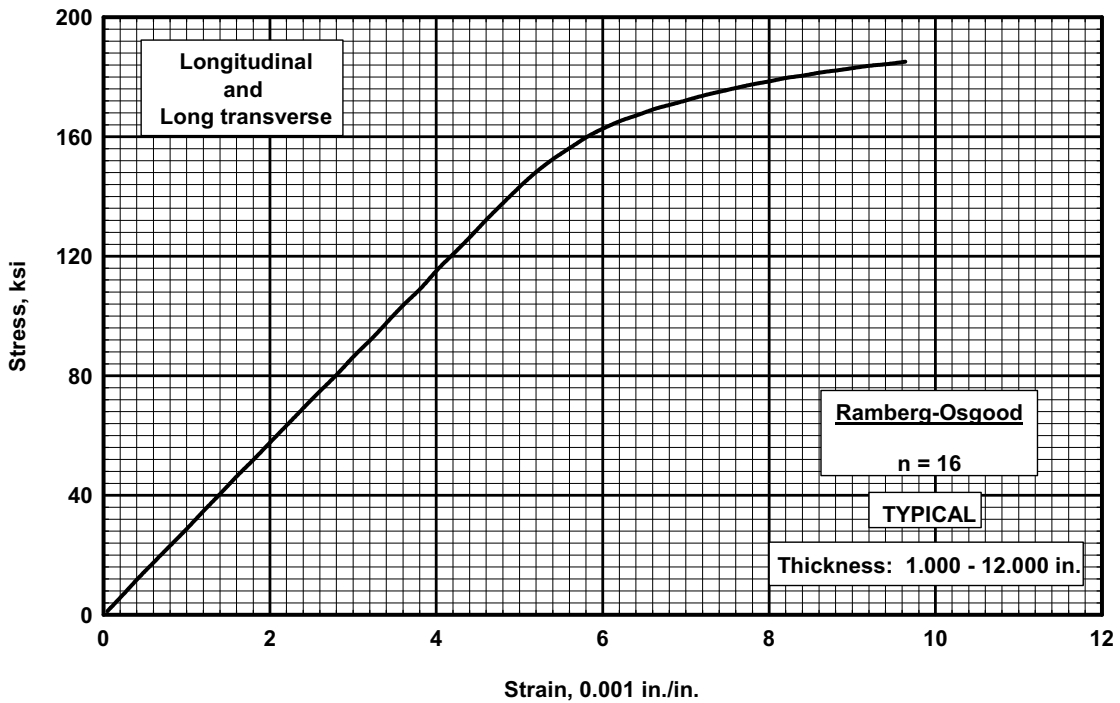

Figure 2.6.3.1.6. Typical tensile stress-strain curve for Custom 450 (H900) stainless steel bar at room temperature.

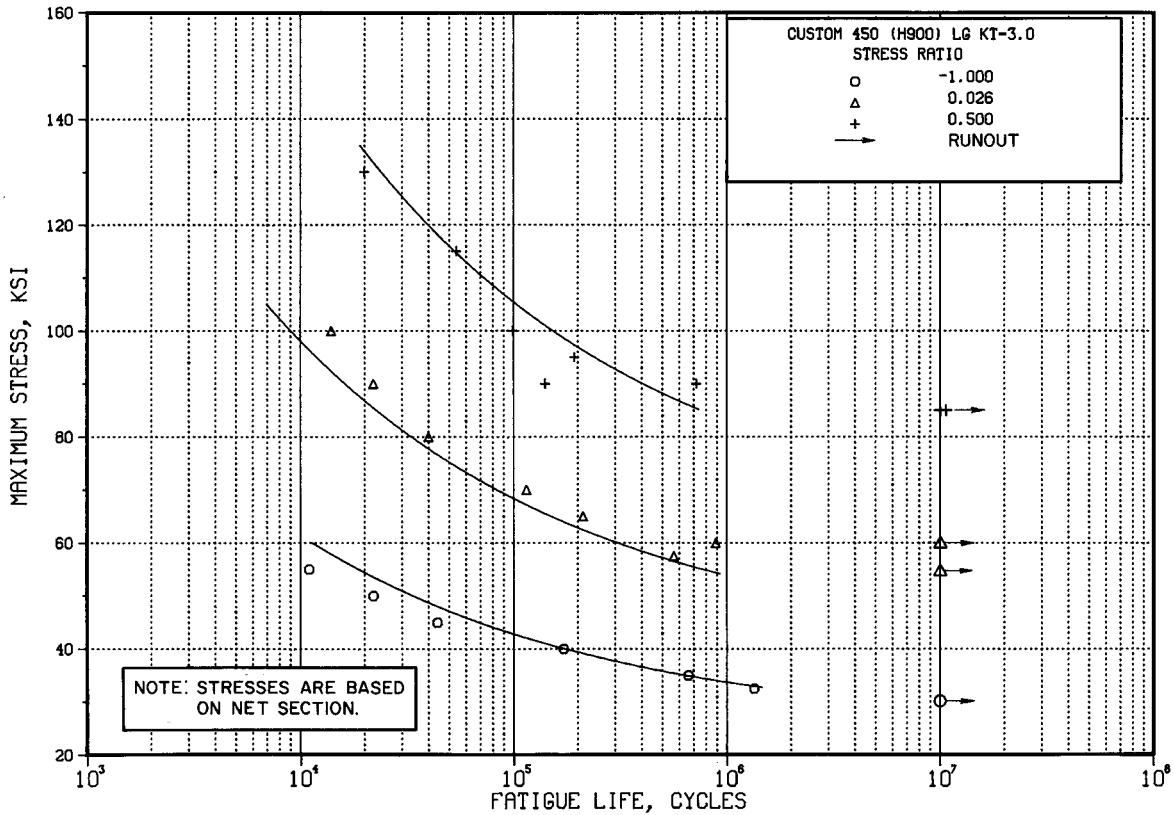

Figure 2.6.3.1.8. Best-fit S/N curves for notched, $K_t = 3.0$, Custom 450 (H900) stainless steel (ESR) bar, longitudinal direction.

Correlative Information for Figure 2.6.3.1.8

Product Form: Bar, 1.0625 inch diameter

Test Parameters:

Properties:

TUS, ksi	TYS, ksi	Temp., °F
192	188	RT (unnotched)
304	—	RT (notched)

Loading - Axial
Frequency - 1800 cpm
Temperature - RT
Environment - Air

No. of Heats/Lots: 1

Specimen Details: Notched, V-Groove, $K_t=3.0$
0.283 inch gross diameter
0.200 inch net diameter
0.010 inch root radius, r
60° flank angle, ω

Equivalent Stress Equation:

$\log N_f = 9.64 - 3.21 \log (S_{eq} - 39.28)$
 $S_{eq} = S_{max} (1-R)^{0.65}$
Std. Error of Estimate, $\log (\text{Life}) = 0.228$
Standard Deviation, $\log (\text{Life}) = 0.656$
 $R^2 = 88\%$

Surface Condition: Polished with abrasive nylon cord

Sample Size = 19

Reference: 2.6.3.1.8

[Caution: The equivalent stress model may provide unrealistic life predictions for stress ratios beyond those represented above.]

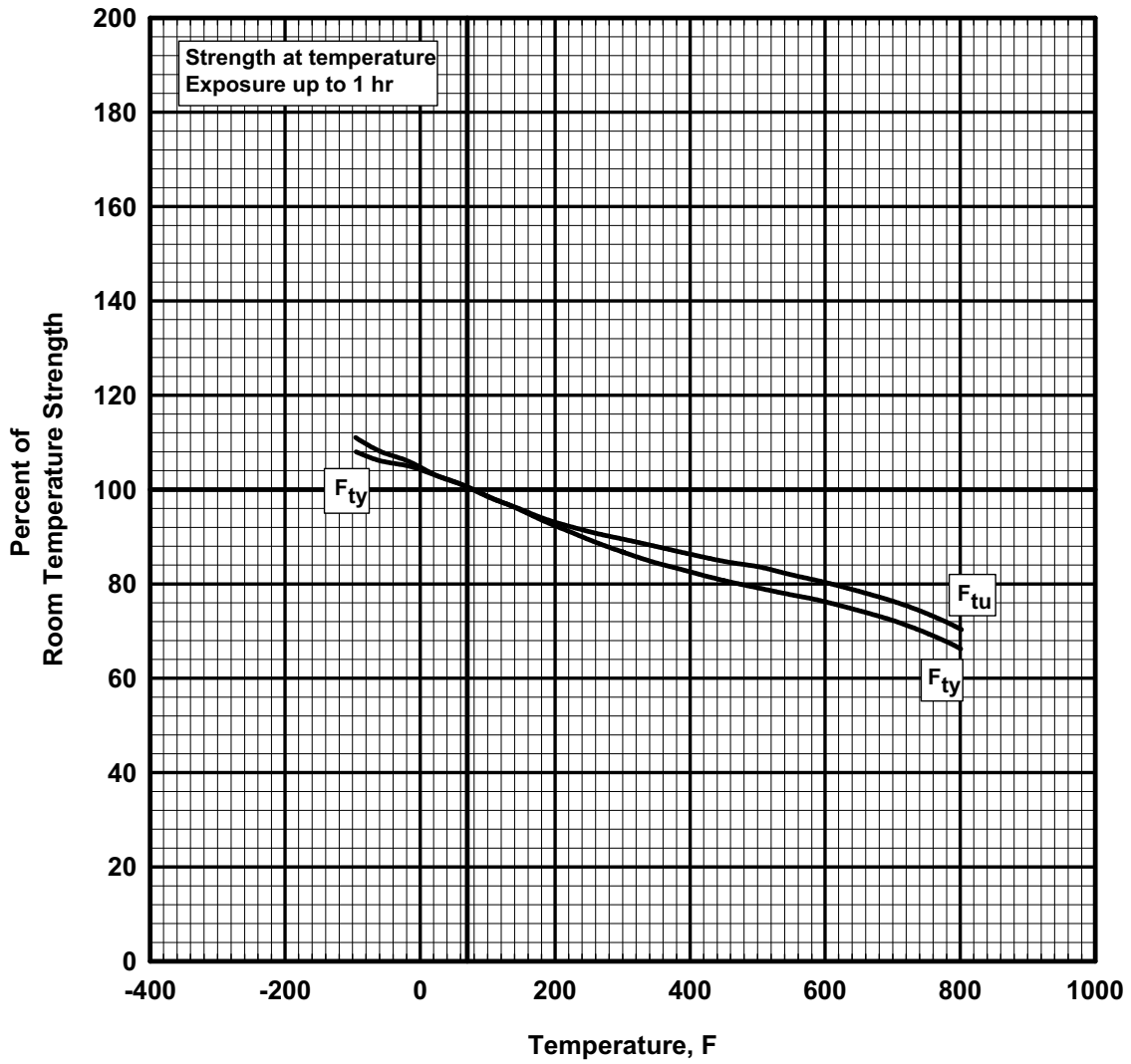

Figure 2.6.3.2.1. Effect of temperature on the tensile ultimate strength (F_{tu}) and the tensile yield strength (F_{ty}) of Custom 450 (H1050) stainless steel bar.

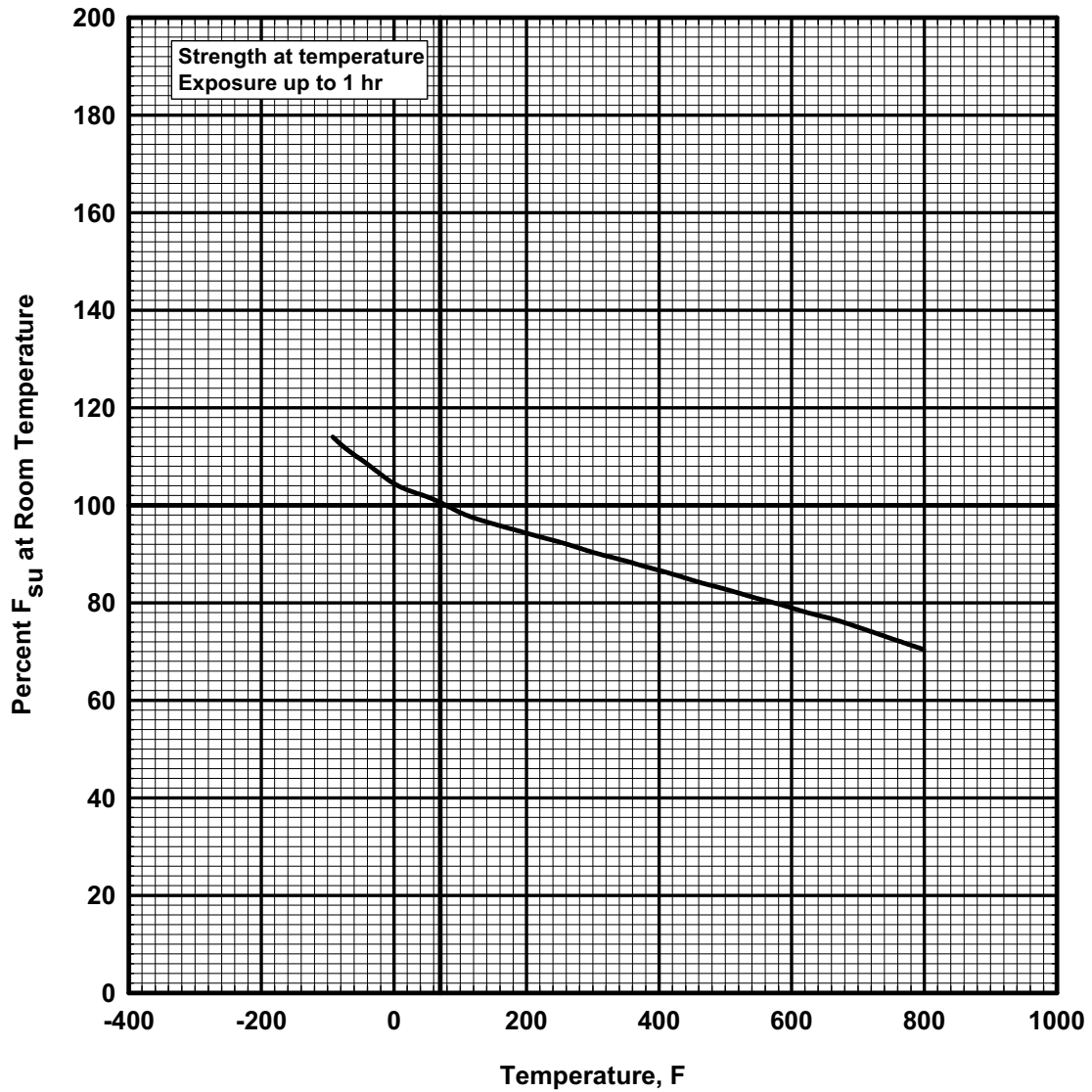

Figure 2.6.3.2.2. Effect of temperature on the ultimate shear strength (F_{su}) of Custom 450 (H1050) stainless steel bar.

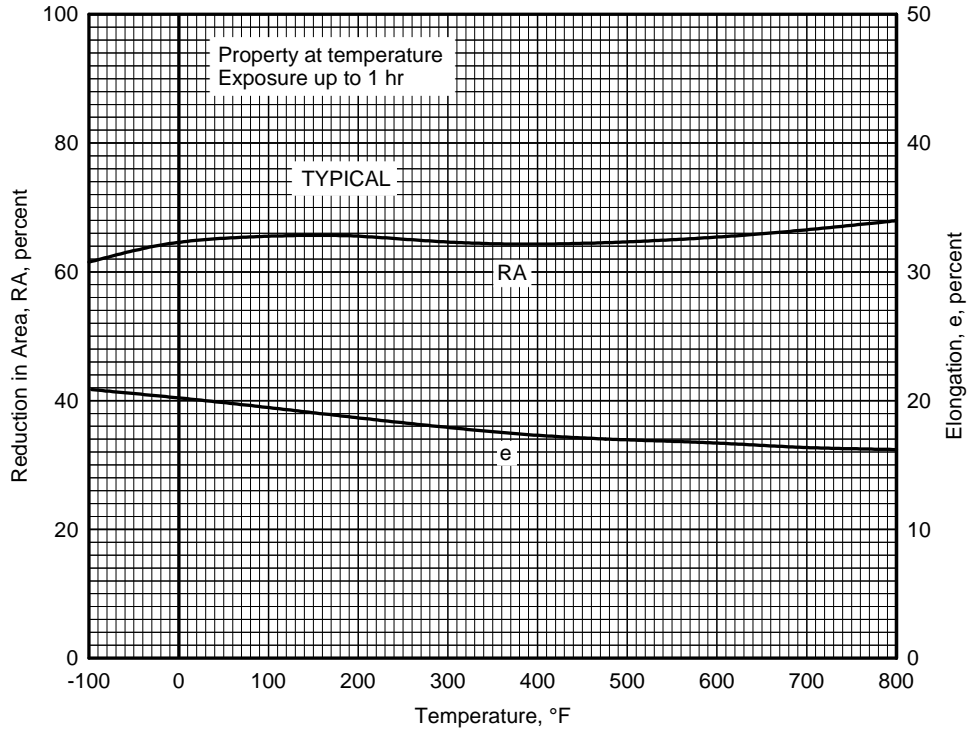

Figure 2.6.3.2.5. Effect of temperature on the elongation (e) and the reduction of area (RA) of Custom 450 (H1050) stainless steel bar.

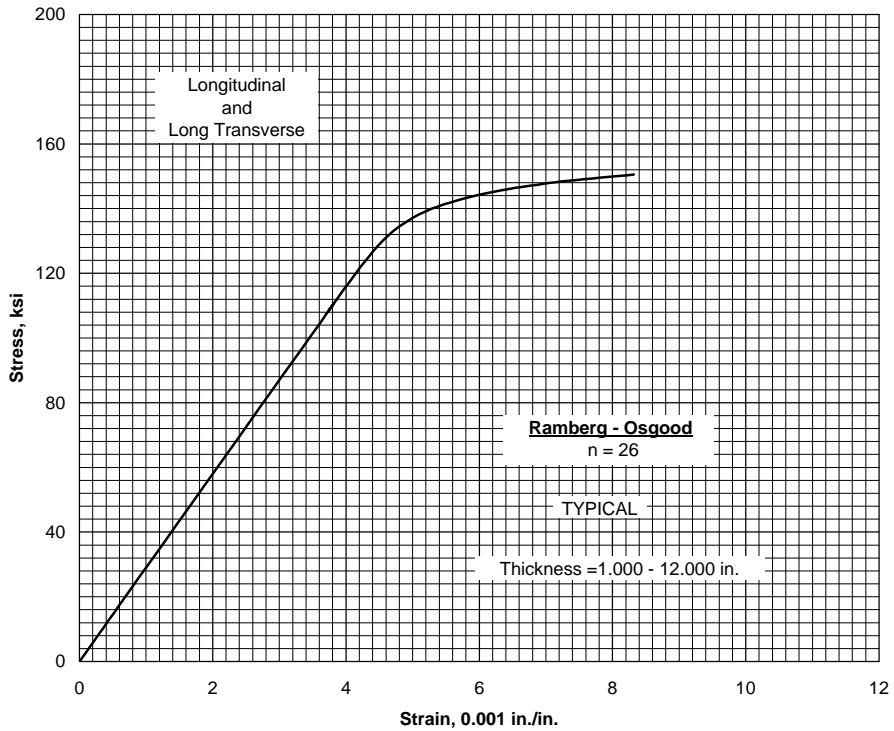

Figure 2.6.3.2.6. Typical tensile stress-strain curve for Custom 450 (H1050) stainless steel bar at room temperature.

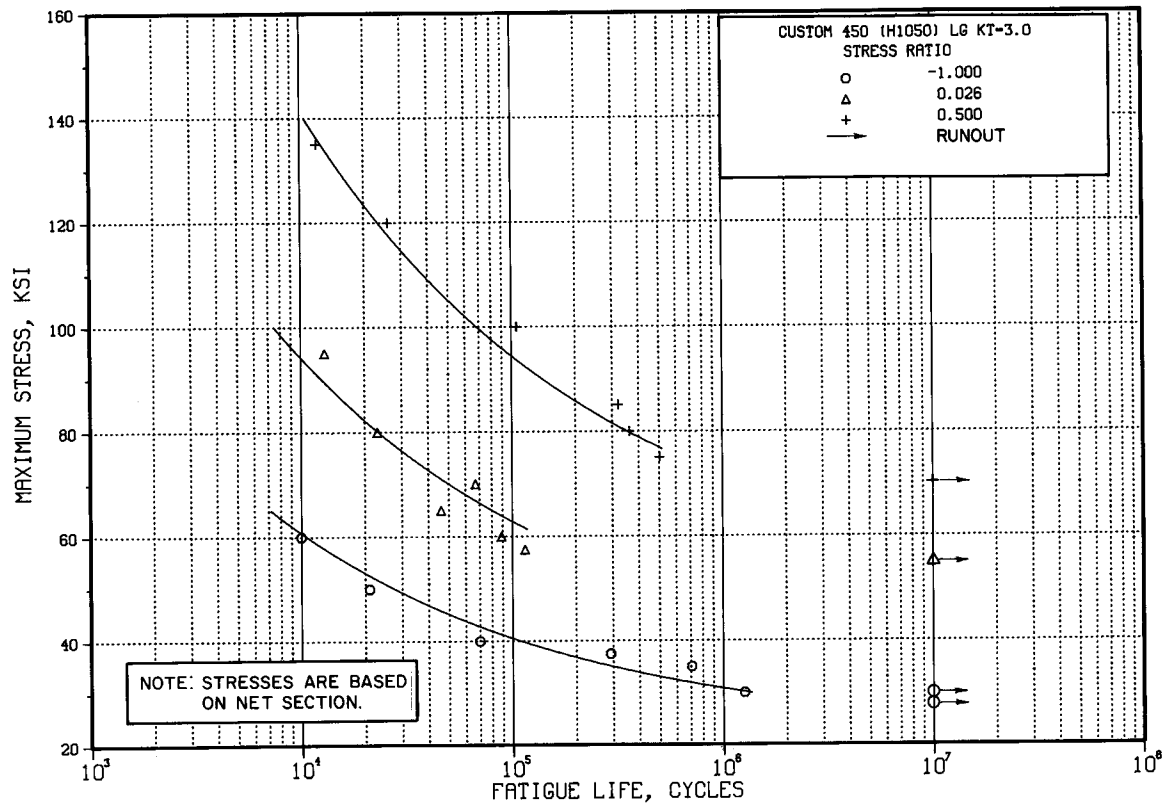

Figure 2.6.3.2.8. Best-fit S/N curves for notched, $K_t = 3.0$, Custom 450 (H1050) stainless steel (ESR) bar, longitudinal direction.

Correlative Information for Figure 2.6.3.2.8

Product Form: Bar, 1.0625 inch diameter

Test Parameters:

Properties:

TUS, ksi	TYS, ksi	Temp., °F
156	151	RT (unnotched)
244	—	RT (notched)

Loading - Axial
Frequency - 1800 cpm
Temperature - RT
Environment - Air

No. of Heats/Lots: 1

Specimen Details: Notched, V-Groove, $K_t=3.0$
0.283 inch gross diameter
0.200 inch net diameter
0.010 inch root radius, r
60° flank angle, ω

Equivalent Stress Equation:
 $\log N_f = 9.59 - 3.15 \log (S_{eq} - 33.23)$
 $S_{eq} = S_{max} (1-R)^{0.607}$
Std. Error of Estimate, $\log (\text{Life}) = 0.188$
Standard Deviation, $\log (\text{Life}) = 0.649$
 $R^2 = 92\%$

Surface Condition: Polished with abrasive nylon cord

Sample Size = 18

Reference: 2.6.3.1.8

[Caution: The equivalent stress model may provide unrealistic life predictions for stress ratios beyond those represented above.]

2.6.4 CUSTOM 455

2.6.4.0 Comments and Properties — Custom 455 is a precipitation hardenable stainless steel with a martensitic structure in both the solution annealed and hardened conditions. It is used for parts requiring corrosion resistance and high strength at temperatures up to 800°F. It is produced by consumable electrode remelting and is available in the form of forgings, billet, bar, wire, strip, and welded tubing.

Manufacturing Considerations — Custom 455 is normally supplied and fabricated in the solution annealed condition. Forming, machining, and joining operations are similar to those employed for other precipitation hardening stainless steels. Optimum weld ductility is obtained by postweld solution annealing prior to aging.

Heat Treatment — The alloy can be heat treated to several strength levels. Consult the applicable materials specification or MIL-H-6875 for specific procedures. The minimum recommended hardening temperature to produce the optimum combination of strength, fracture toughness, and stress corrosion cracking resistance is 950°F. Higher strength is attainable with the 900°F aging treatment but at a sacrifice of fracture toughness and stress corrosion cracking resistance. Like other precipitation hardening stainless steels, the fracture toughness and stress intensity below which stress corrosion cracking does not occur improve with increasing aging temperature within the range of 900°F to 1000°F.

Usually parts are aged directly from the as-supplied solution annealed condition. When this condition has been altered during processing by hot working, severe cold working, or welding, the parts should be resolution annealed prior to aging. A dimensional contraction of about 0.0009 in./in. should be expected with the 950°F aging treatment.

Environmental Considerations — The general corrosion resistance of Custom 455 is about equivalent to that of AISI Type 430 stainless steel.

Hydrogen embrittlement tests in 5 percent by weight acid saturated with H₂S at room temperature show the same degree of susceptibility as other high-strength martensitic stainless steels.

When stress-corrosion cracking is of concern, one should use the highest aging temperature consistent with the strength properties required. The 900°F aging treatment should not be employed when stress corrosion cracking is a consideration. Consult the material producers literature for available stress corrosion data.

Like other precipitation hardening stainless steels, Custom 455 increases slightly in tensile strength and loses some toughness when exposed for long periods of time at temperatures around 700°F. For most applications, the loss in toughness which occurs is not detrimental to performance.

Specifications and Properties — Material specifications for Custom 455 are presented in Table 2.6.4.0(a). The room-temperature mechanical properties of Custom 455 are presented in Table 2.6.4.0(b). Physical properties at elevated temperatures are presented in Figure 2.6.4.0.

Table 2.6.4.0(a). Material Specifications for Custom 455 Stainless Steel

Specification	Form
AMS 5578	Tubing (welded)
AMS 5617	Bar and forging

MIL-HDBK-5J
31 January 2003

Table 2.6.4.0(b). Design Mechanical and Physical Properties of Custom 455 Stainless Steel

Specification	AMS 5578		AMS 5617		
	Tubing (Welded)		Bar		
Condition	H950		H950		H1000
Thickness or diameter, in. ^a	0.020-0.062	>0.062	≤4.000	4.001-6.000	≤8.000
Basis	S	S	S	S	S
Mechanical Properties:					
<i>F_m</i> , ksi:					
L	220	220	225	220	200
LT	225 ^b	220 ^b	...
ST	225 ^b	220 ^b	...
<i>F_{ty}</i> , ksi:					
L	205	205	210	205	185
LT	210 ^b	205 ^b	...
ST	210 ^b	205 ^b	...
<i>F_{cy}</i> , ksi:					
L	219	214	193
LT	219	214	193
ST	219	214	193
<i>F_{su}</i> , ksi					
...	133	130	124
<i>F_{bru}</i> , ksi:					
(e/D = 1.5)	355	347	324
(e/D = 2.0)	450	440	409
<i>F_{brp}</i> , ksi:					
(e/D = 1.5)	311	303	285
(e/D = 2.0)	366	358	343
<i>e</i> , percent:					
L	3	4	10	10	10
LT	5 ^b	5 ^b	...
ST	5 ^b	5 ^b	...
<i>RA</i> , percent:					
L	40	40	40
LT	20 ^b	20 ^b	...
ST	20 ^b	20 ^b	...
<i>E</i> , 10 ³ ksi			28.5		28.9
<i>E_c</i> , 10 ³ ksi			30.0		30.0
<i>G</i> , 10 ³ ksi			11.3		11.5
<i>μ</i>			0.27		0.26
Physical Properties:					
<i>ω</i> , lb/in. ³			0.28		
<i>C</i> , Btu/(lb)(°F)		
<i>K</i> , Btu/[(hr)(ft ²)(°F)/ft]			See Figure 2.6.4.0		
<i>α</i> , 10 ⁻⁶ in./in./°F			See Figure 2.6.4.0		

a Wall thickness for tubing.
b For Grade 2 material only.

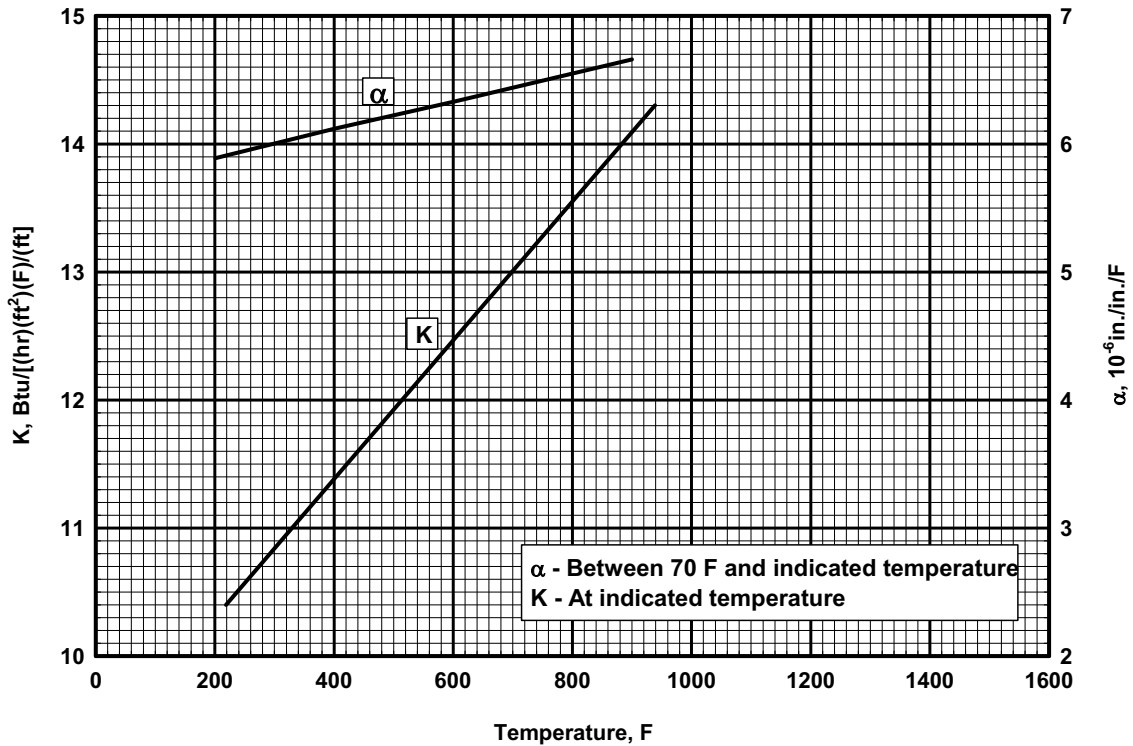

Figure 2.6.4.0. Effect of temperature on the physical properties of Custom 455 (H950) stainless steel.

2.6.4.1 H950 Condition — Elevated temperature curves are presented in Figure 2.6.4.1.1, 2.6.4.1.2, and 2.6.4.1.5. A tensile stress-strain curve at room temperature is shown in Figure 2.6.4.1.6. Fatigue data at room temperature are presented in Figure 2.6.4.1.8(a) and (b).

2.6.4.2 H1000 Condition — Elevated temperature curves are shown in Figures 2.6.4.2.1, 2.6.4.2.2, and 2.6.4.2.5. A tensile stress-strain curve at room temperature is presented in Figure 2.6.4.2.6. Fatigue data at room temperature are shown in Figure 2.6.4.2.8.

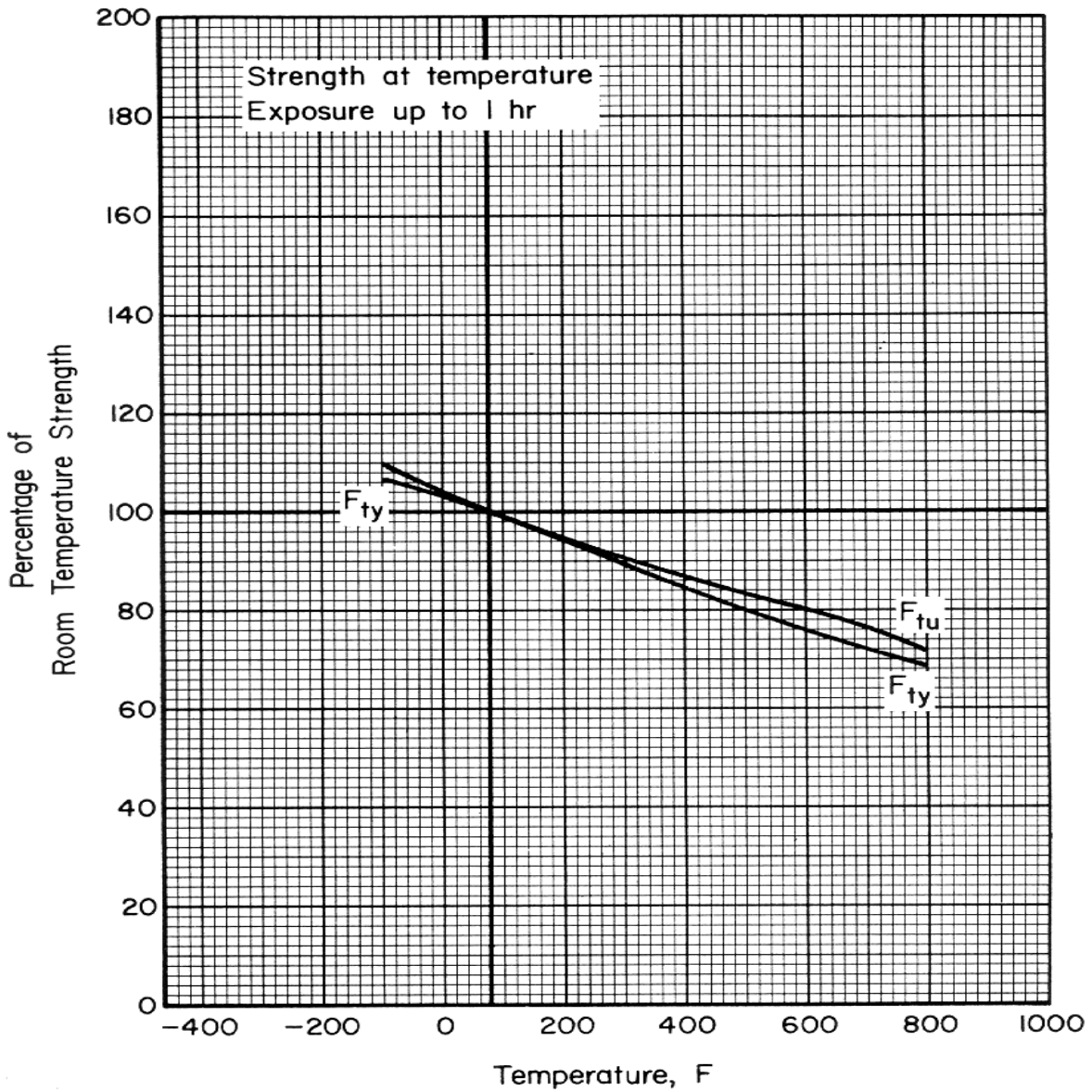

Figure 2.6.4.1.1. Effect of temperature on the tensile ultimate strength (F_{tu}) and the tensile yield strength (F_{ty}) of Custom 455 (H950) stainless steel bar.

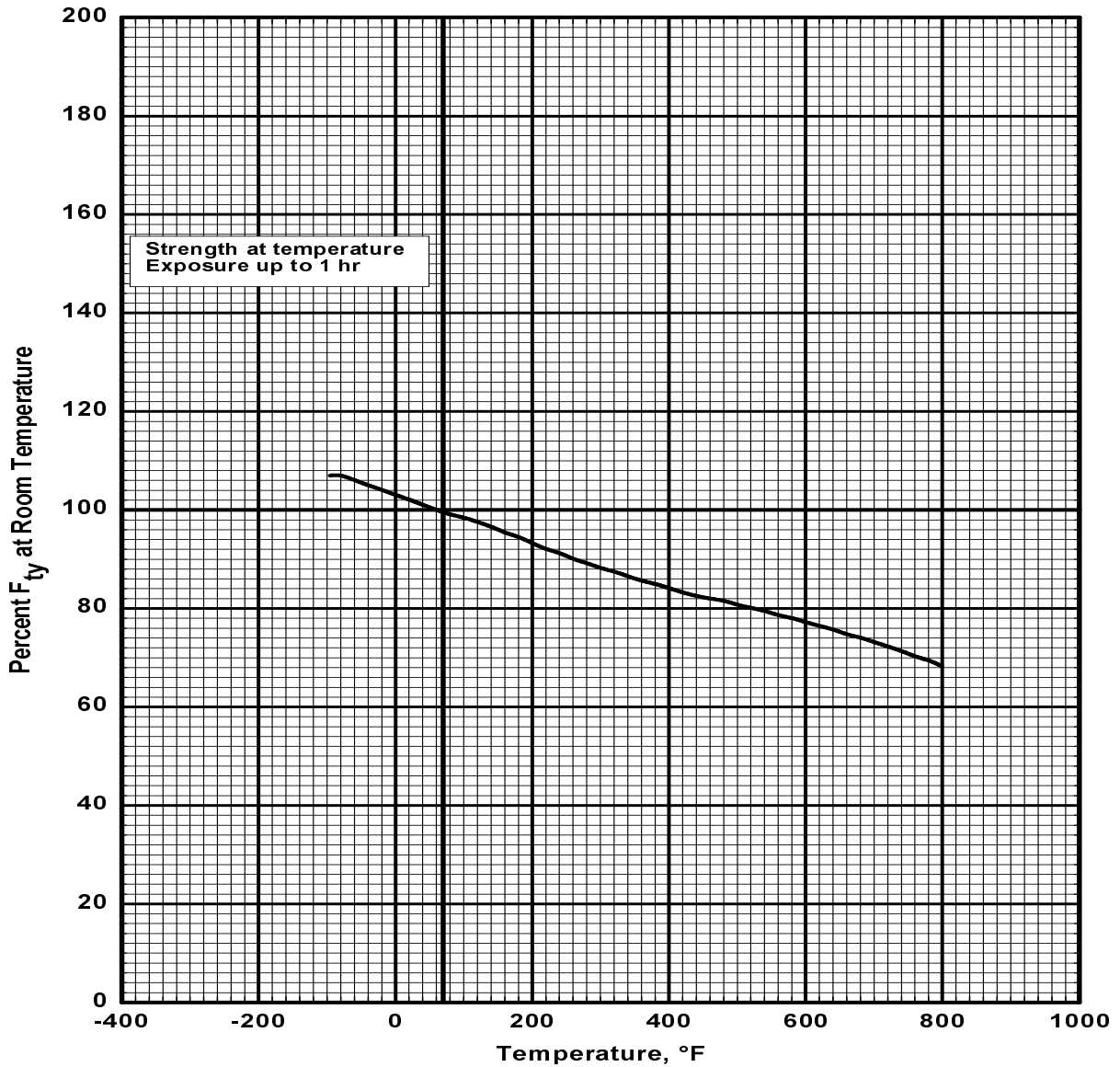

Figure 2.6.4.1.2. Effect of temperature on the ultimate shear strength (F_{su}) of Custom 455 (H950) stainless steel bar.

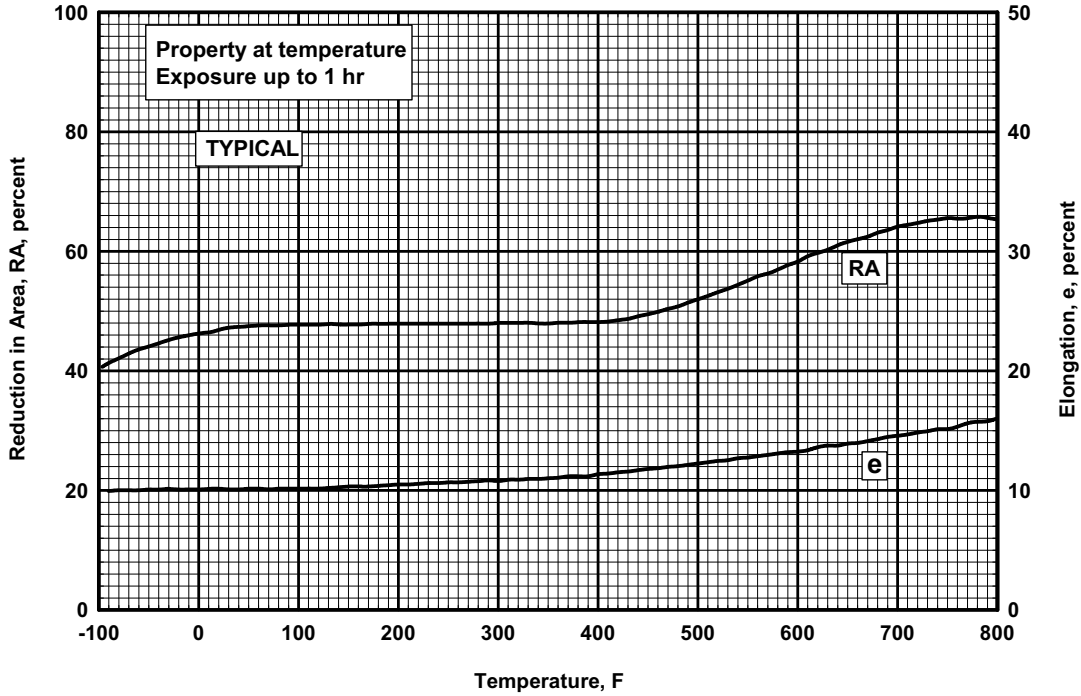

Figure 2.6.4.1.5. Effect of temperature on the elongation (e) and reduction of area (RA) of Custom 455 (H950) stainless steel bar.

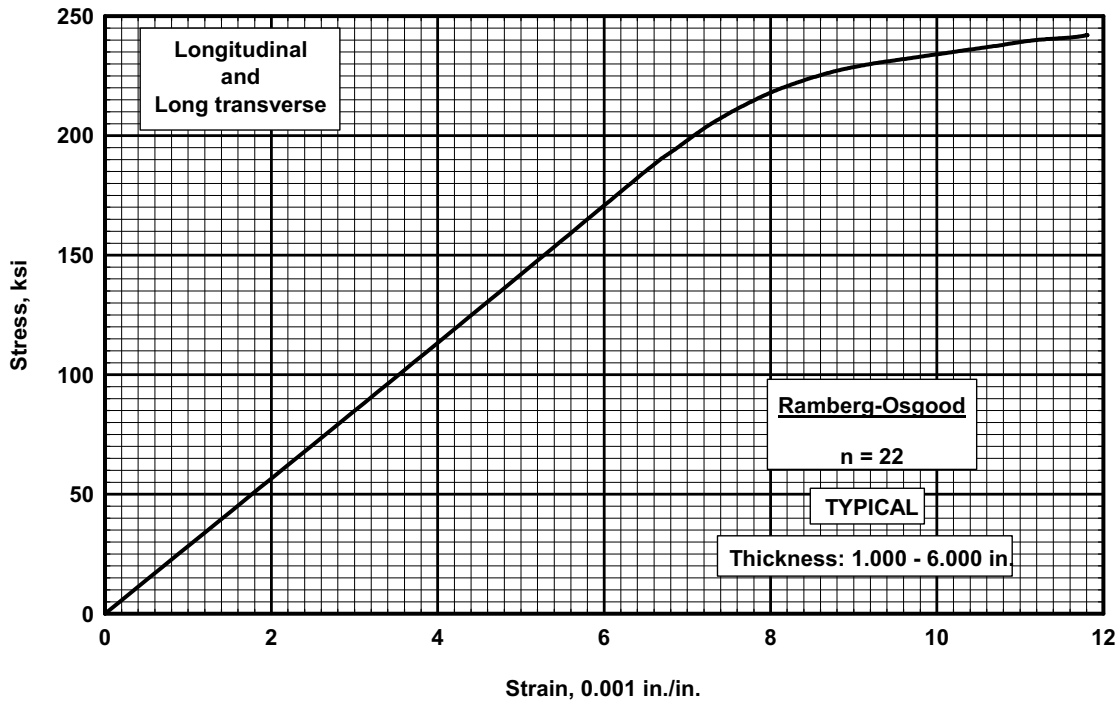

Figure 2.6.4.1.6. Typical tensile stress-strain curve for Custom 455 (H950) stainless steel bar at room temperature.

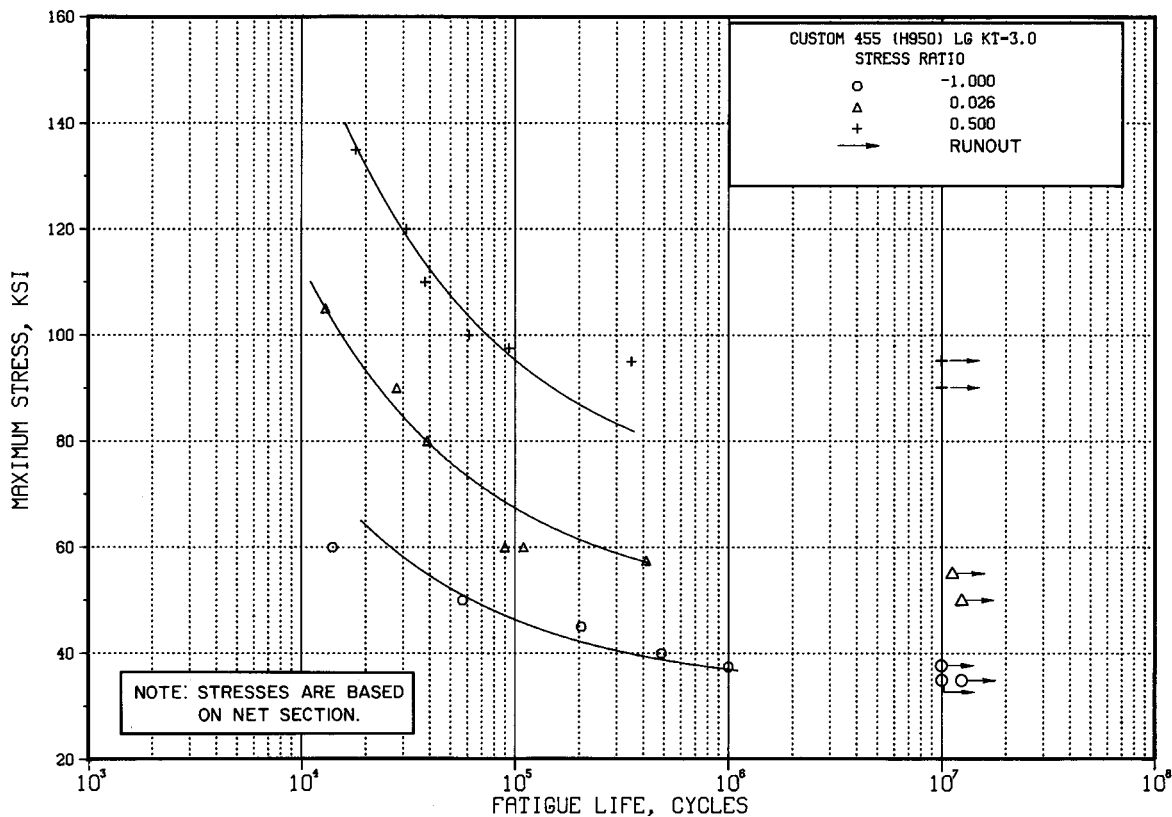

Figure 2.6.4.1.8(b). Best-fit S/N curves for notched, $K_t = 3.0$, Custom 455 (H950) stainless steel bar, longitudinal direction.

Correlative Information for Figure 2.6.4.1.8(b)

Product Form: Bar, 1.0625 inch diameter

Test Parameters:

Properties:

TUS, ksi	TYS, ksi	Temp., °F
245	242	RT
		(unnotched)
361	—	RT
		(notched)

Loading - Axial
Frequency - 1800 cpm
Temperature - RT
Environment - Air

No. of Heats/Lots: 1

Specimen Details: Notched, V-Groove, $K_t = 3.0$
0.283 inch gross diameter
0.200 inch net diameter
0.010 inch root radius, r
60° flank angle, ω

Equivalent Stress Equation:

$\log N_f = 7.42 - 1.90 \log (S_{eq} - 47.34)$
 $S_{eq} = S_{max} (1-R)^{0.515}$
Std. Error of Estimate, $\log (\text{Life}) = 0.246$
Standard Deviation, $\log (\text{Life}) = 0.568$
 $R^2 = 81\%$

Surface Condition: Polished with abrasive nylon cord

Sample Size = 17

Reference: 2.6.3.1.8

[Caution: The equivalent stress model may provide unrealistic life predictions for stress ratios beyond those represented above.]

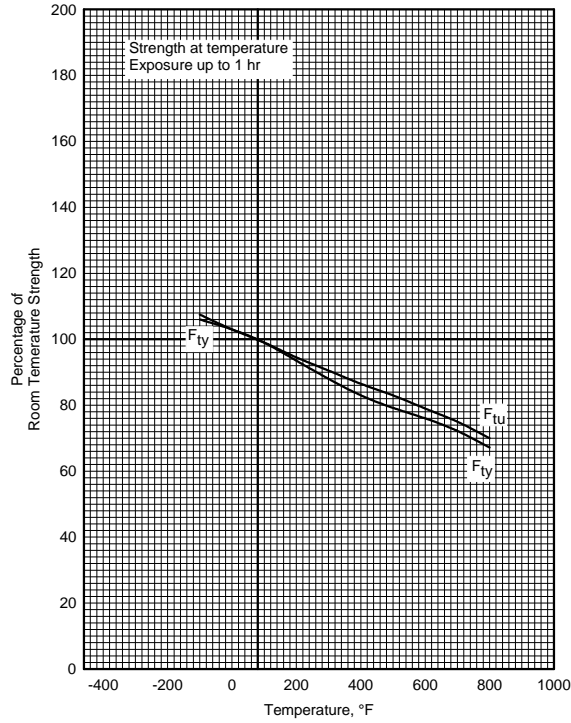

Figure 2.6.4.2.1. Effect of temperature on the tensile ultimate strength (F_{tu}) and the tensile yield strength (F_{ty}) of Custom 455 (H1000) stainless steel bar.

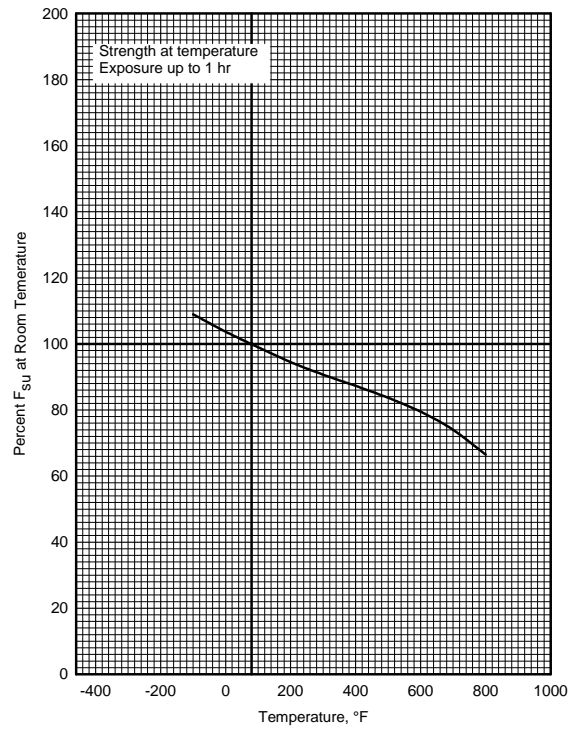

Figure 2.6.4.2.2. Effect of temperature on the ultimate shear strength (F_{su}) of Custom 455 (H1000) stainless steel bar.

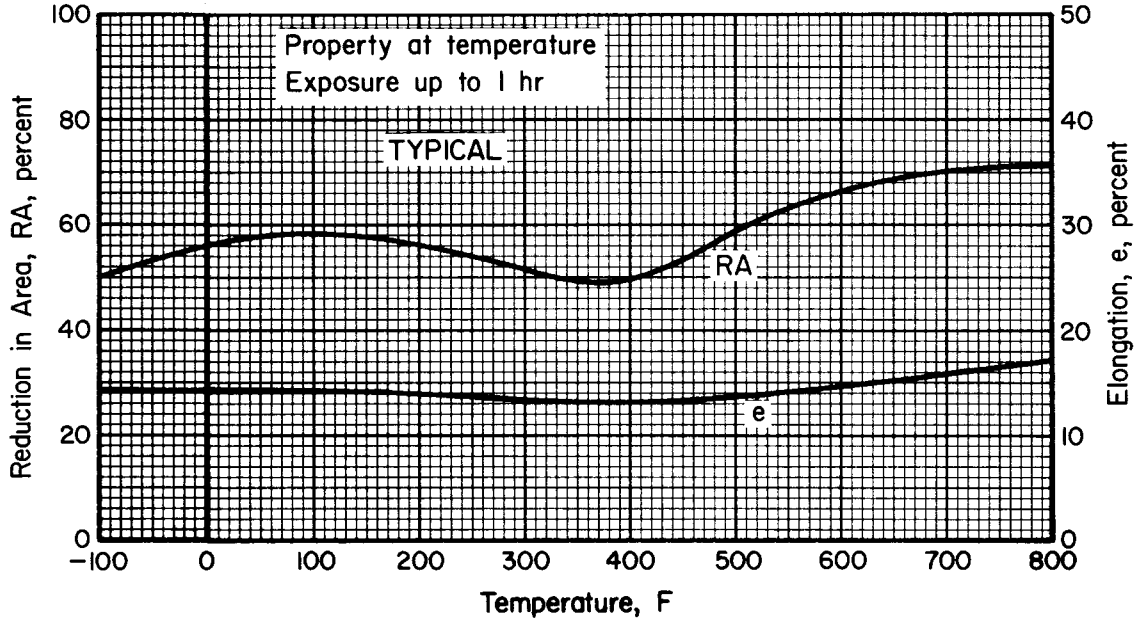

Figure 2.6.4.2.5. Effect of temperature on the elongation (e) and the reduction of area (RA) of Custom 455 (H1000) stainless steel bar.

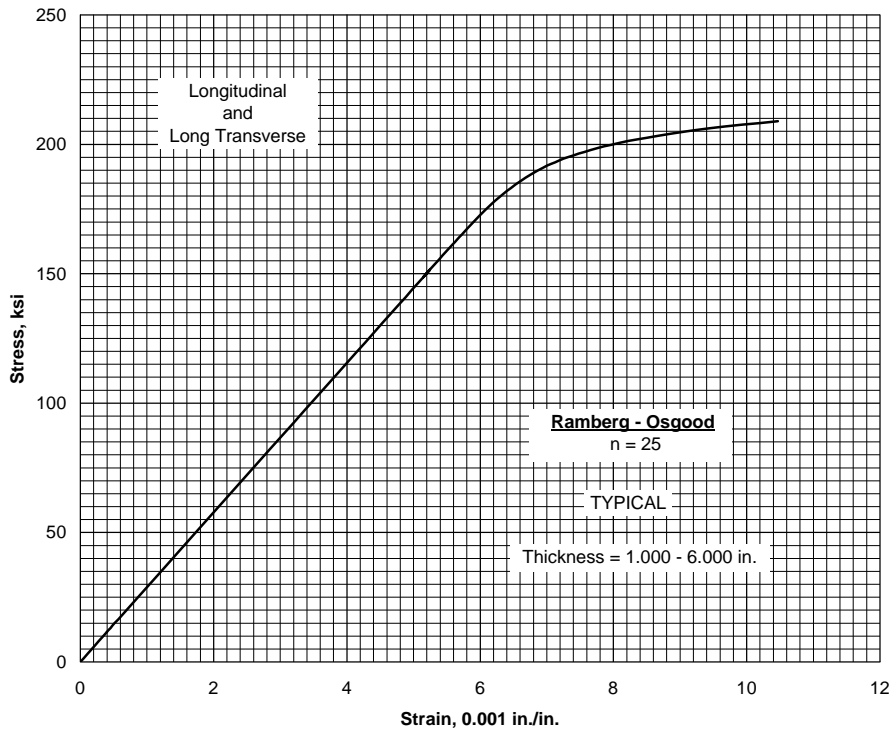

Figure 2.6.4.2.6. Typical tensile stress-strain curve for Custom 455 (H1000) stainless steel bar at room temperature.

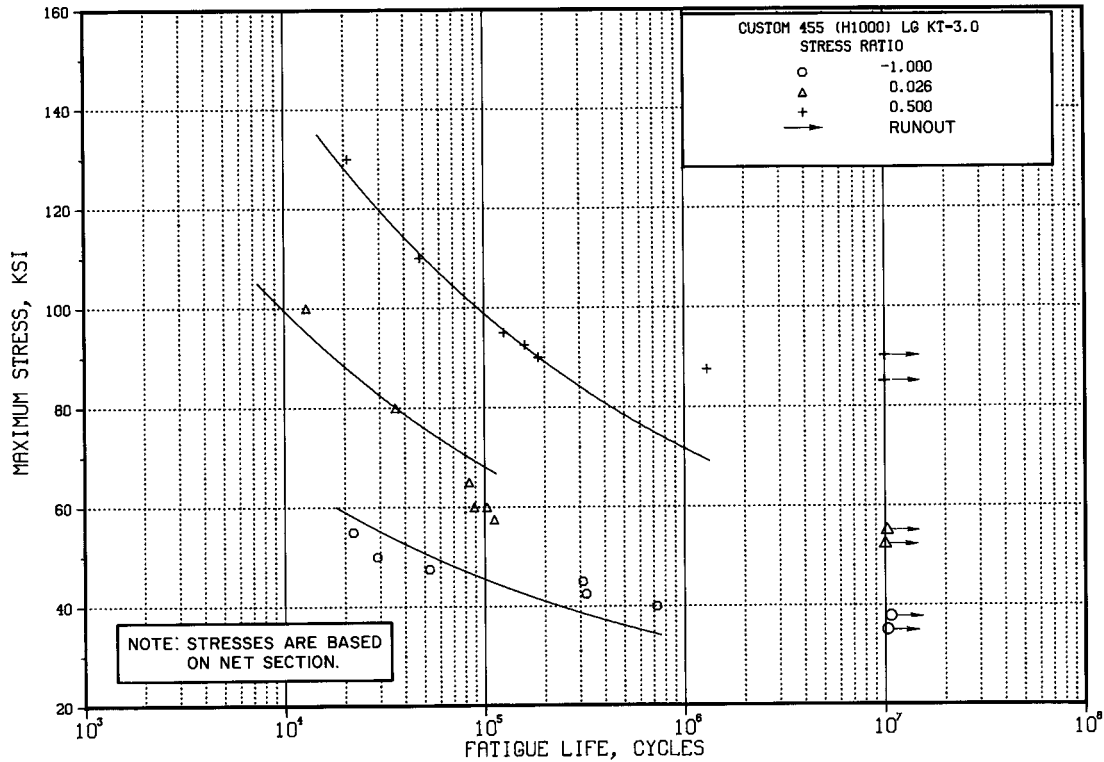

Figure 2.6.4.2.8. Best-fit S/N curves for notched, $K_t = 3.0$, Custom 455 (H1000) stainless steel bar, longitudinal direction.

Correlative Information for Figure 2.6.4.2.8

Product Form: Bar, 1.0625 inch diameter

Test Parameters:

Properties:

TUS, ksi	TYS, ksi	Temp., °F
214	209	RT
		(unnotched)
335	—	RT
		(notched)

Loading - Axial
Frequency - 1800 cpm
Temperature - RT
Environment - Air

No. of Heats/Lots: 1

Specimen Details: Notched, V-Groove, $K_t=3.0$
0.283 inch gross diameter
0.200 inch net diameter
0.010 inch root radius, r
60° flank angle, ω

Equivalent Stress Equation:
 $\log N_f = 12.37 - 4.44 \log (S_{eq} - 21.43)$
 $S_{eq} = S_{max} (1-R)^{0.561}$
Std. Error of Estimate, $\log (\text{Life}) = 0.359$
Standard Deviation, $\log (\text{Life}) = 0.540$
 $R^2 = 56\%$

Surface Condition: Polished with abrasive nylon cord

Sample Size = 18

Reference: 2.6.3.1.8

[Caution: The equivalent stress model may provide unrealistic life predictions for stress ratios beyond those represented above.]

2.6.5 CUSTOM 465

2.6.5.0 Comments and Properties — Custom 465® stainless is a double-vacuum melted, martensitic, age-hardenable alloy. This alloy was designed to have excellent notch tensile strength and fracture toughness over a wide range of section sizes. In the H950 condition, the alloy achieves a minimum ultimate tensile strength of 240 ksi while retaining good toughness and resistance to stress-corrosion cracking. Overaging to the H1000 condition provides a greater level of toughness at a minimum ultimate tensile strength of 220 ksi. Custom 465 stainless provides a superior combination of strength, toughness and stress corrosion cracking resistance compared with other high-strength PH stainless alloys such as Custom 455® stainless or PH13-8Mo® stainless. Other combinations of strength and toughness are possible employing age-hardening temperatures between 900°F and 1150°F. Custom 465 stainless is available in the form of forgings, billet, bar, wire and strip.

Manufacturing Considerations — Custom 465 stainless normally is supplied and fabricated in the solution-annealed condition. Billet products will be provided in the hot finished condition. Forming, machining, and joining operations are similar to those employed for other precipitation-hardening stainless steels. Optimum weld strength and ductility are obtained by postweld solution annealing and subzero cooling prior to aging. Pyromet®X23 stainless filler metal should be considered under multi-bead GMA welding conditions.

Heat Treatment — Among the corrosion-resistant alloys of its type, Custom 465 stainless provides the highest minimum combinations of strength and toughness in the H950 and H1000 conditions. Usually, parts are aged directly from the mill-supplied, solution-annealed condition. However, if material has been hot worked or welded, components should be reannealed (1800°F/982°C) and subzero cooled (-100°F/-73°C, 8-hour hold) prior to age hardening. Components should be cooled rapidly from the annealing temperature. Section sizes up to 12" (305 mm) can be cooled in a suitable liquid quench medium. The subsequent subzero treatment should be applied within 24-hours of solution annealing. The refrigeration treatment after annealing is important for achieving optimum aging response by eliminating small amounts of retained austenite from the microstructure. The mill-supplied solution anneal includes the subzero treatment.

Aging treatments are performed by heating components to the specified temperature, holding for four hours, followed by cooling in air, oil or other suitable liquid quench medium. The 4-hour aging cycle is important developing optimum toughness and ductility at the specified strength levels. Increased cooling rates from the aging temperature tend to improve toughness and ductility and may be beneficial for 3" (76mm) section sizes and greater.

Environmental Considerations — The general corrosion resistance of Custom 465 stainless approaches that of Type 304 stainless. Exposure to 5% neutral salt spray at 95°F (35°C) (per ASTM B117) caused little or no corrosion after 200 hours regardless of condition (i.e., annealed or H900-H1100 conditions).

Double cantilever beam tests conducted in 3.5% NaCl (pH 6) show Custom 465 stainless to possess inherently good resistance to stress corrosion cracking which improves with increasing aging temperature. Typical results for 1/2" thick double cantilever beam specimens (T-L orientation) from 4-1/2" x 2-3/4" forged bar exposed to 3.5 wt. % NaCl (pH 6) for 1270 hours by constant immersion per NACE Standard TM0177-96 (Reference 2.6.5.0), are shown in Table 2.6.5.0(a).

Table 2.6.5.0(a). Typical Stress Corrosion Cracking Resistance^a

Condition	TYS (T), ksi	K_{Isc} , ksi√in.	Remarks
H950	226	68	No cracking
H1000	213	98	No cracking

a Double-cantilever-beam, wedge loaded, constant immersion in 3.5% NaCl (pH 6) per NACE Standard TM0177-96. See Reference 2.6.5.0.

Typical tensile properties following exposure to elevated temperatures for 200 and 1000 hours are shown in Table 2.6.5.0(b).

Table 2.6.5.0(b). Effect of Elevated Temperature Exposure on Typical Tensile Properties of Custom 465 Alloy^a

Condition	Exposure Temp., °F	Exposure Time, Hours	Room-temperature properties			
			UTS, ksi	TYS, ksi	e, %	RA, %
H950	Room Temp.	Unexposed	255	238	14	62
	600	200	258	240	14	61
	700	200	266	249	13	59
	800	200	266	249	14	58
	900	200	236	223	15	64
	600	1000	259	242	16	59
	700	1000	268	250	14	56
	800	1000	272	253	13	54
	900	1000	223	211	19	67
	H1000	Room Temp.	Unexposed	231	218	16
600		200	234	220	14	66
700		200	241	226	15	64
800		200	240	226	14	66
900		200	230	218	16	66
600		1000	232	219	18	65
700		1000	240	226	16	64
800		1000	245	229	15	62
900		1000	222	210	20	66

a Data from 1 heat, 4.5" x1.5" forged bar, duplicate tests

Specifications and Properties — Material specifications for Custom 465 are shown in Table 2.6.5.0(c). The room-temperature mechanical properties are presented in Tables 2.6.5.0(b).

Table 2.6.5.0(c). Material Specifications for Custom 465 Stainless Steel

Specification	Form
AMS 5936	Bars, Wires, and Forgings

2.6.5.1 H950 and H1000 Condition — Figure 2.6.5.1(a) presents the typical tensile stress-strain curves at room temperature. Figures 2.6.5.1(b) and (c) present the full-range tensile stress-strain curves at room temperature for the H950 and H1000 conditions.

Table 2.6.5.0(d). Design Mechanical and Physical Properties of Custom 465 Stainless Steel Bar

Specification	AMS 5936			
	Bar			
	H950		H1000	
	≤12.000		≤12.000	
Basis	A	B	A	B
Mechanical Properties:				
F_{tu} , ksi:				
L	240 ^a	251	220 ^b	226
T	240 ^a	251	220 ^b	226
F_{ty} , ksi:				
L	220 ^a	236	200 ^b	212
T	220 ^a	236	200 ^b	213
F_{cy} , ksi:				
L	233	249	210	223
T	233	250	211	224
F_{su} , ksi	134	140	129	132
F_{bru}^c , ksi:				
(e/D = 1.5)	359	375	333	342
(e/D = 2.0)	462	484	428	440
F_{bry}^c , ksi:				
(e/D = 1.5)	321	344	294	312
(e/D = 2.0)	365	391	353	374
e , percent: (S-basis)				
L	10	...	10	...
T	8	...	10	...
RA , percent: (S-basis)				
L	45	...	50	...
T	35	...	40	...
E , 10 ³ ksi	28.7		28.4	
E_c , 10 ³ ksi	28.9		29.4	
G , 10 ³ ksi	11.2		11.3	
μ	0.28		0.28	
Physical Properties:				
ω , lb/in. ³	0.28		0.28	
C , Btu/(lb)(°F)		see Figure 2.6.5.0(a)	
K , Btu/[(hr)(ft ²)(°F)/ft]		see Figure 2.6.5.0(a)	
α , 10 ⁻⁶ in./in./°F		see Figure 2.6.5.0(a)	

a S-basis. The rounded T99 value for F_{tu} (L) = 246 ksi, F_{tu} (T) = 249, F_{ty} (L) = 230 ksi, and F_{ty} (T) = 231 ksi

b S-basis. The rounded T99 value for F_{tu} (L) = 221 ksi, F_{tu} (T) = 221, F_{ty} (L) = 206 ksi, and F_{ty} (T) = 208 ksi

c Bearing values are "dry pin" values per Section 1.4.7.1

MIL-HDBK-5J
31 January 2003

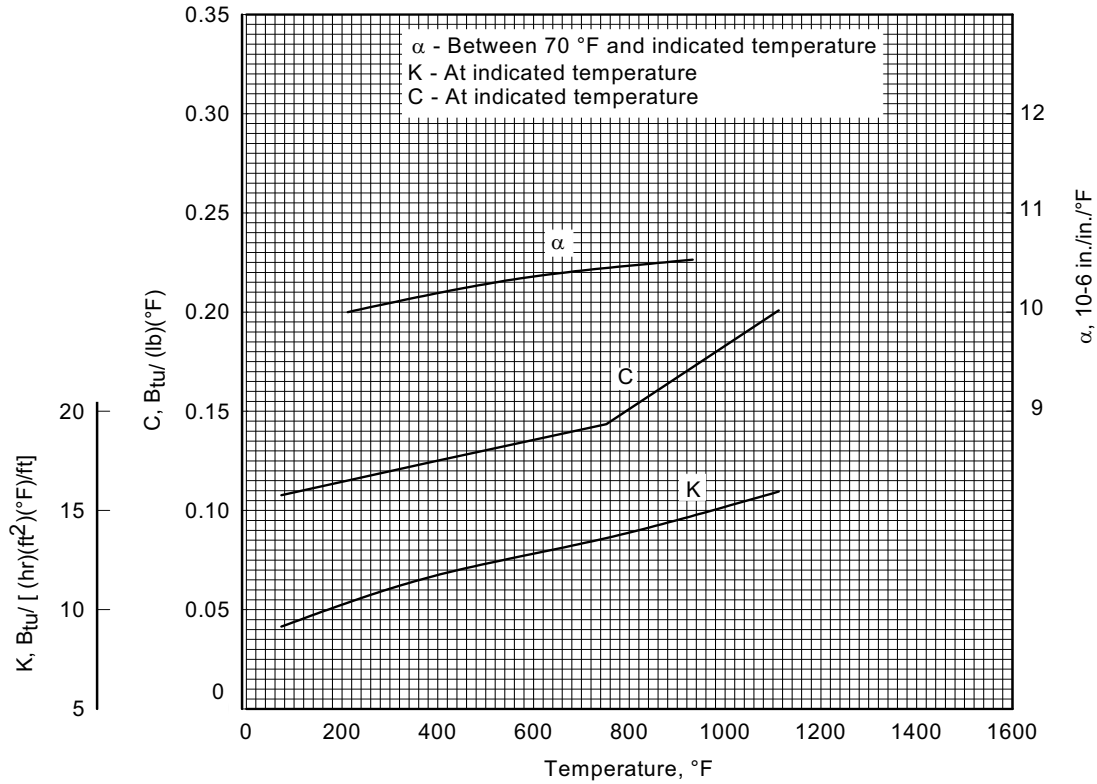

Figure 2.6.5.0(a). Effect of temperature on the physical properties of Custom 465 H1000 stainless steel bar.

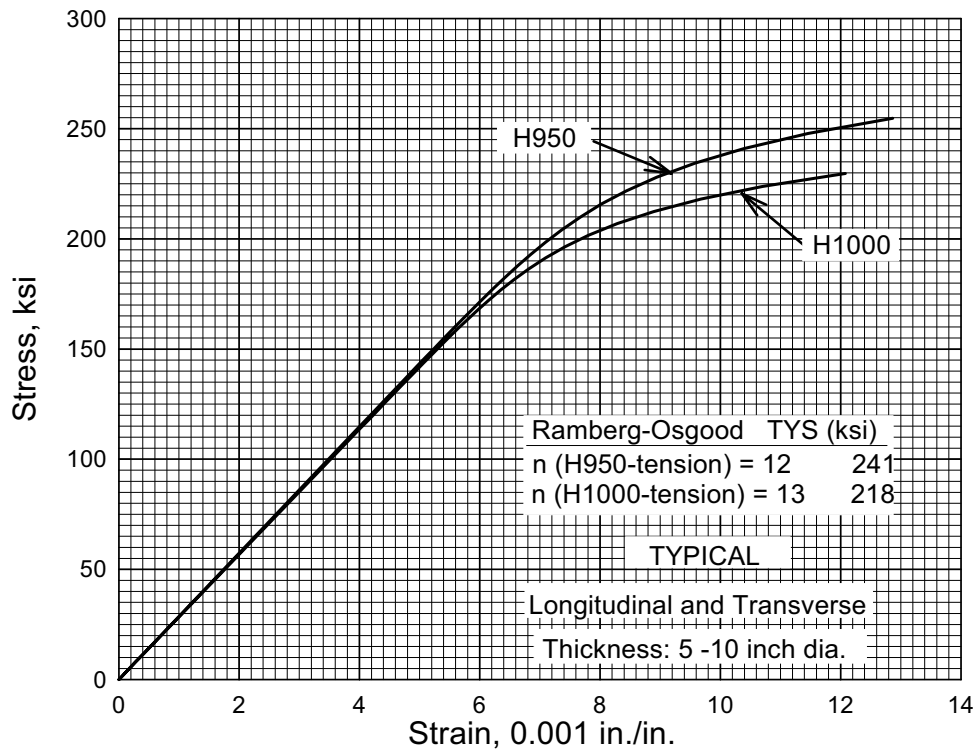

Figure 2.6.5.1(a). Typical tensile stress-strain curves for Custom 465, H950 and H1000 condition bar at room temperature.

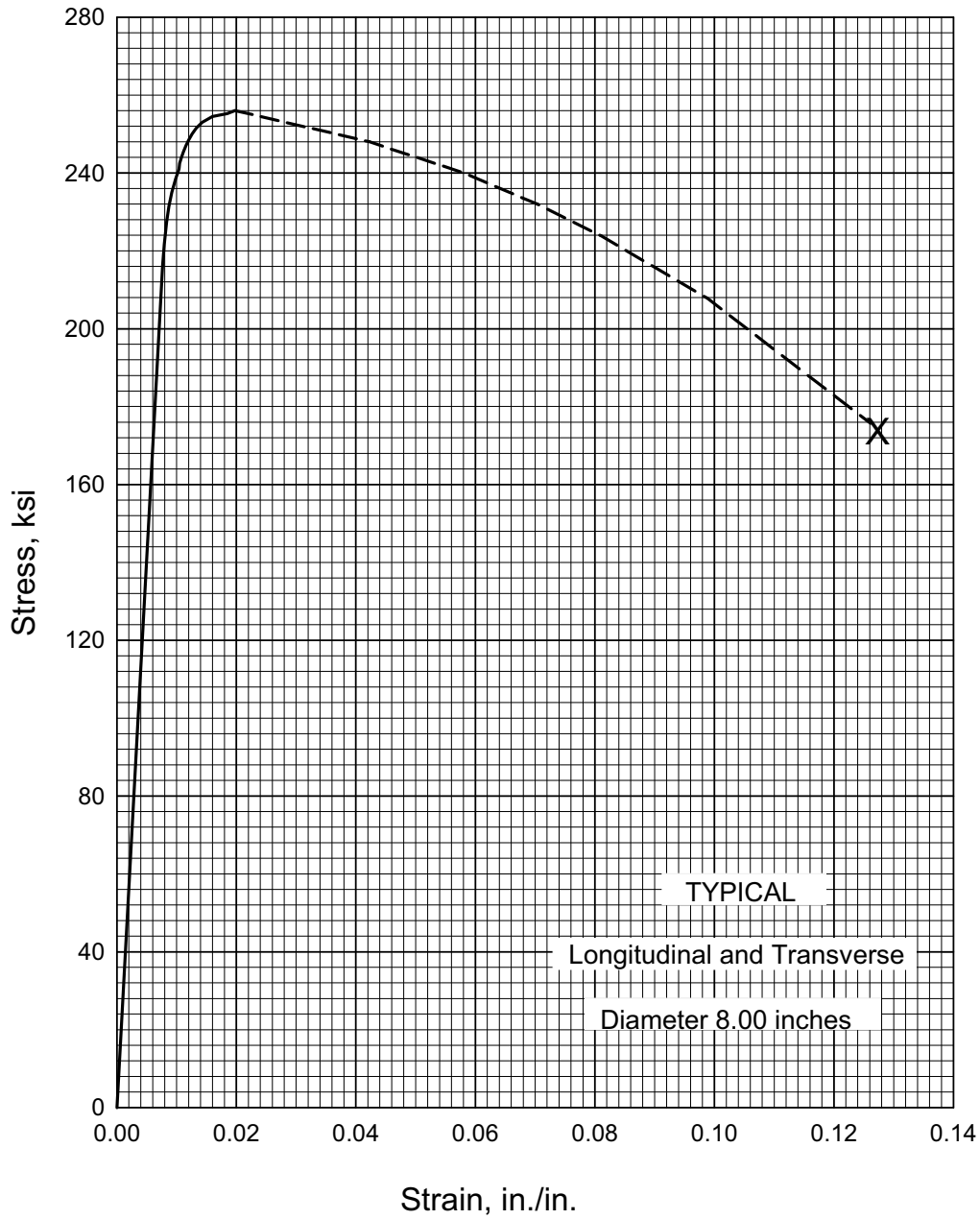

Figure 2.6.5.1(b). Typical tensile stress-strain curves (full range) for Custom 465 H950 bar at room temperature.

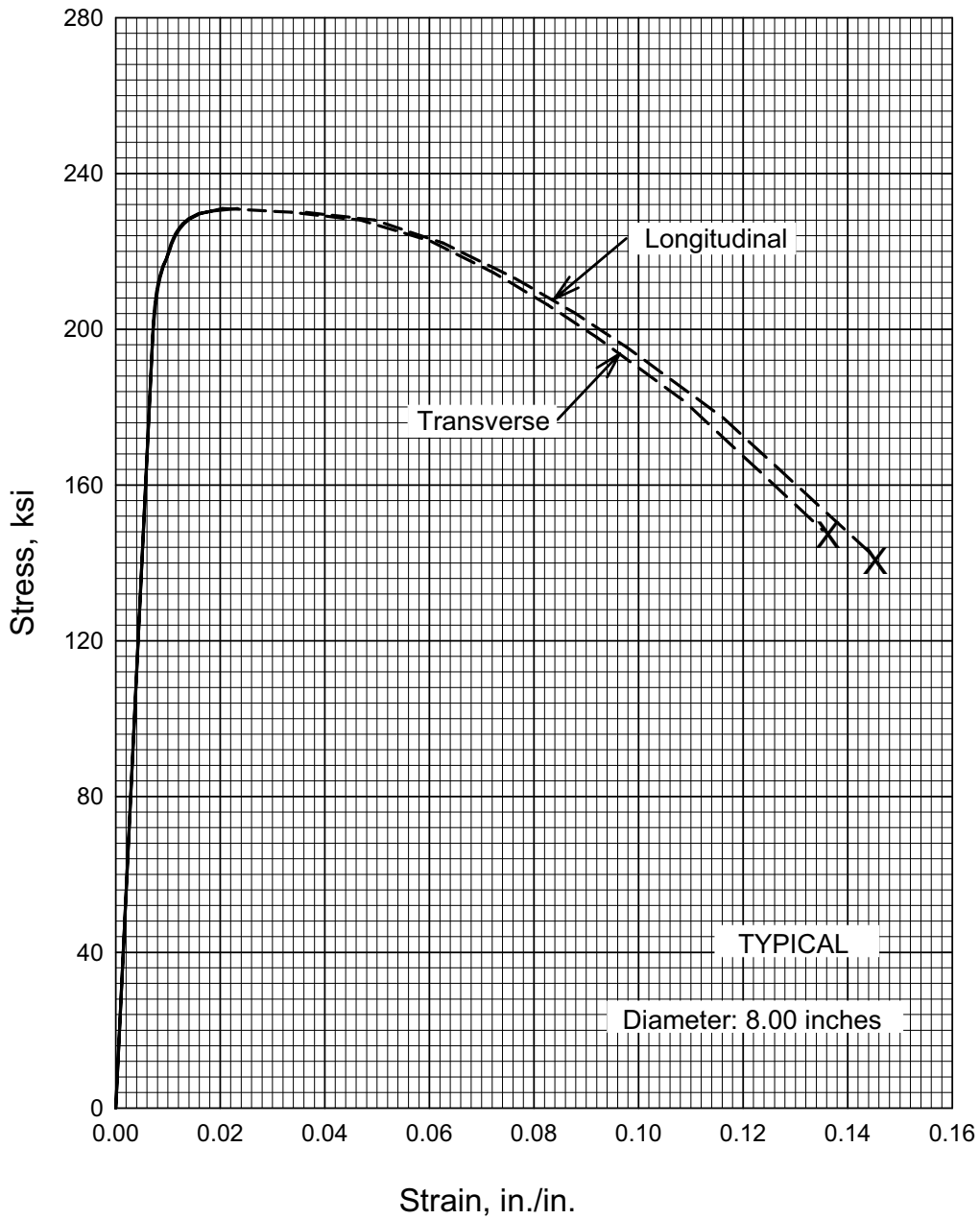

Figure 2.6.5.1(c). Typical tensile stress-strain curves (full range) for Custom 465, H1000 bar at room temperature.

2.6.6 PH13-8Mo

2.6.6.0 Comments and Properties — PH13-8Mo is a martensitic precipitation-hardening stainless steel used for parts requiring corrosion resistance, high strength, high fracture toughness, and oxidation resistance up to 800°F. When used at temperatures between 600°F and 800°F, some loss in notch toughness will occur. The loss is time-temperature dependent and will occur gradually over thousands of hours at 600°F and hundreds of hours at 800°F. Depending upon the application, this loss in notch toughness may not be important and useful engineering properties may still be available. Good transverse mechanical properties are one of the major advantages of PH13-8Mo. PH13-8Mo is produced by double vacuum melting and is available in the form of forgings, plate, bar, and wire, normally furnished in the solution-treated (A) condition.

Manufacturing Considerations — Forming, joining, and machining operations are usually performed on material in Condition A, using similar procedures and equipment to those employed for other precipitation-hardening stainless steels. Best machinability is exhibited by Conditions H1150 and H1150M. A dimensional contraction of 0.0004 to 0.0006 and 0.0008 to 0.0012 in./in. occurs upon hardening to the H1000 and H1100 conditions, respectively.

Heat Treatment — PH13-8Mo must be used in the heat-treated condition and should not be placed in service in Condition A. The alloy can be heat treated to various strength levels having a wide range of properties. Consult the applicable material specification or MIL-H-6875 for specific heat treatment procedures.

Environmental Considerations — PH13-8Mo is nearly equal to 17-4PH in general corrosion resistance and surpasses the other hardenable stainless steels in stress-corrosion resistance. However, for tensile application where stress corrosion is a possibility, PH13-8Mo should be aged at the highest temperature compatible with strength requirements and at a temperature not lower than 1000°F for 4 hours minimum aging time.

Specification and Properties — A material specification for PH13-8Mo is presented in Table 2.6.6.0(a). The room-temperature mechanical and physical properties for PH13-8Mo are presented in Table 2.6.6.0(b) and (c). The physical properties of this alloy at elevated temperatures are presented in Figure 2.6.6.0.

Table 2.6.6.0(a). Material Specification for PH13-8Mo Stainless Steel

Specification	Form
AMS 5629	Bar, forging, ring, and extrusion (VIM plus CEVM)

2.6.6.1 H950 and H1000 Conditions — Elevated temperature curves for tensile yield and ultimate strengths are presented in Figure 2.6.6.1.1. Typical tensile and compressive stress-strain and tangent-modulus curves for the H1000 condition at room temperature are depicted in Figures 2.6.6.1.6(a) and (b). Figure 2.6.6.1.6(c) contains typical full-range stress-strain curves at room temperature for various heat-treated conditions. Unnotched and notched fatigue information for H1000 condition at room temperature is presented in Figures 2.6.6.1.8(a) through (c).

Table 2.6.6.0(b). Design Mechanical and Physical Properties of PH13-8Mo Stainless Steel

Specification	AMS 5629							
	Round, hex, square and flat bar							
Form								
Condition	H950	H1000		H1025	H1050	H1100	H1150	
Thickness or diameter, in. ...	<9.0		<8.0		≤12.0			
Basis	A	B	A	B	S	S	S	S
Mechanical Properties:^a								
<i>F_{tu}</i> , ksi:								
L	217	221	201	208	185	175	150	135
T	217	221	201	208	185	175	150	135
<i>F_{ty}</i> , ksi:								
L	198	205	190 ^b	200	175	165	135	90
T	198	205	190 ^b	200	175	165	135	90
<i>F_{cy}</i> , ksi:								
L	200	211
T	200	211
<i>F_{su}</i> , ksi								
...	117	122
<i>F_{bru}</i> , ksi:								
(e/D = 1.5)	302	313
(e/D = 2.0)	402	416
<i>F_{bry}</i> , ksi:								
(e/D = 1.5)	263	277
(e/D = 2.0)	338	356
<i>e</i> , percent (S-basis):								
L	10	...	10	...	11	12	14	14
T	10	...	10	...	11	12	14	14
<i>RA</i> , percent (S-basis):								
L	45	...	50	...	50	50	50	50
T	35	...	40	...	45	45	50	50
<i>E</i> , 10 ³ ksi					28.3			
<i>E_c</i> , 10 ³ ksi					29.4			
<i>G</i> , 10 ³ ksi					11.0			
<i>μ</i>					0.28			
Physical Properties:								
<i>ω</i> , lb/in. ³					0.279			
<i>C</i> , Btu/(lb)(°F)					0.11 (32 to 212°F) (Est.)			
<i>K</i> and <i>α</i>					See Figure 2.6.6.0			

a Design allowables were based mainly upon data from samples of material, supplied in the solution treated condition, which were aged to demonstrate response to heat treatment by suppliers.
b S-basis. Rounded T₉₉ value = 193 ksi.

Table 2.6.6.0(c). Design Mechanical and Physical Properties of PH13-8Mo Stainless Steel

Specification	AMS 5629					
Form	Forging, flash welded ring, and extrusion					
Condition	H950	H1000	H1025	H1050	H1100	H1150
Thickness or diameter, in.	≤12					
Basis	S	S	S	S	S	S
Mechanical Properties:						
F_m , ksi:						
L	220	205	185	175	150	135
T	220	205	185	175	150	135
F_y , ksi:						
L	205	190	175	165	135	90
T	205	190	175	165	135	90
F_{cy} , ksi:						
L
T
F_{su} , ksi
F_{bru} , ksi:						
(e/D = 1.5)
(e/D = 2.0)
F_{bry} , ksi:						
(e/D = 1.5)
(e/D = 2.0)
e , percent:						
L	10	10	11	12	14	14
T	10	10	11	12	14	14
RA , percent:						
L	45	50	50	50	50	50
T	35	40	45	45	50	50
E , 10 ³ ksi	28.3					
E_c , 10 ³ ksi	29.4					
G , 10 ³ ksi	11.0					
μ	0.28					
Physical Properties:						
ω , lb/in. ³	0.279					
C , Btu/(lb)(°F)	0.11 (32 to 212°F) (Est.)					
K and α	See Figure 2.6.6.0					

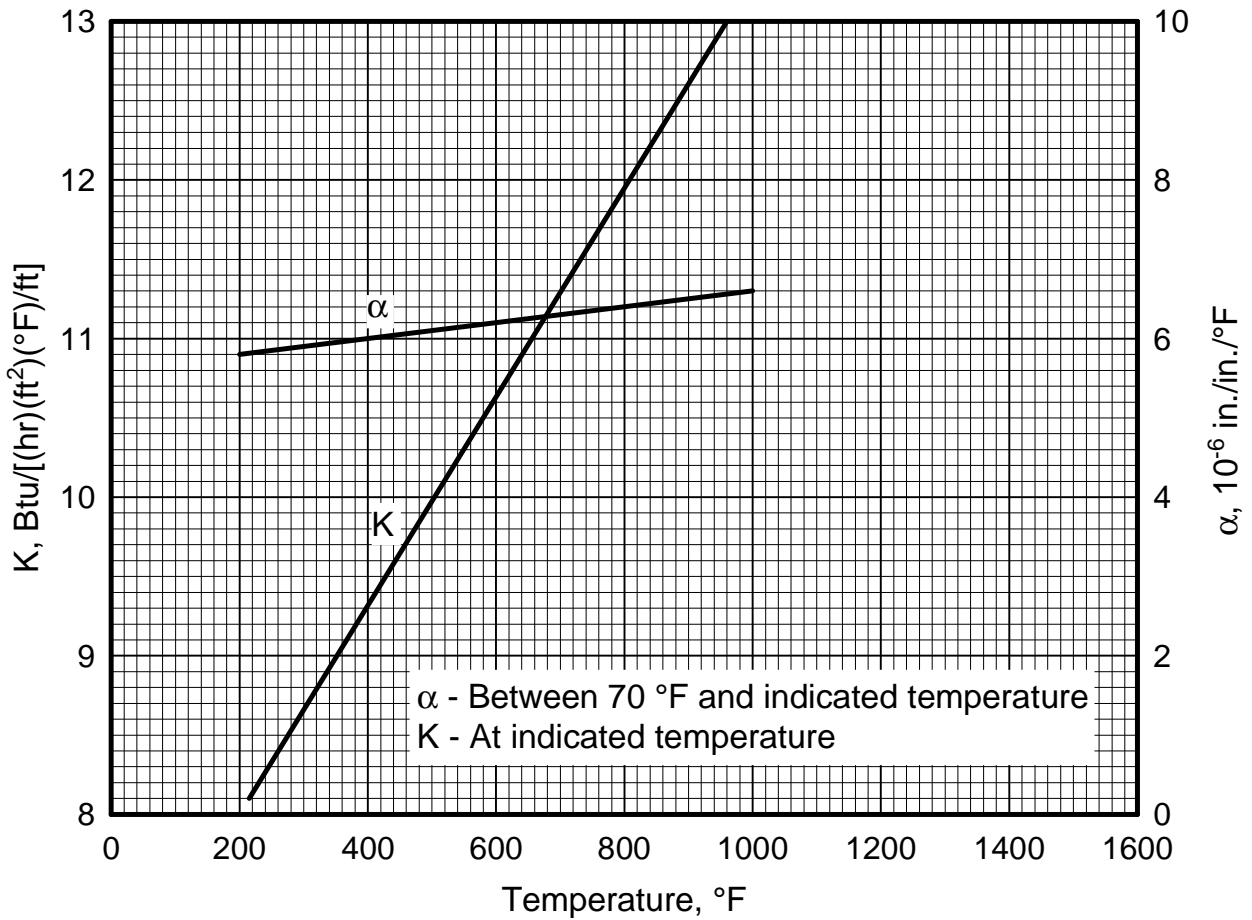

Figure 2.6.6.0. Effect of temperature on the physical properties of PH13-8Mo stainless steel.

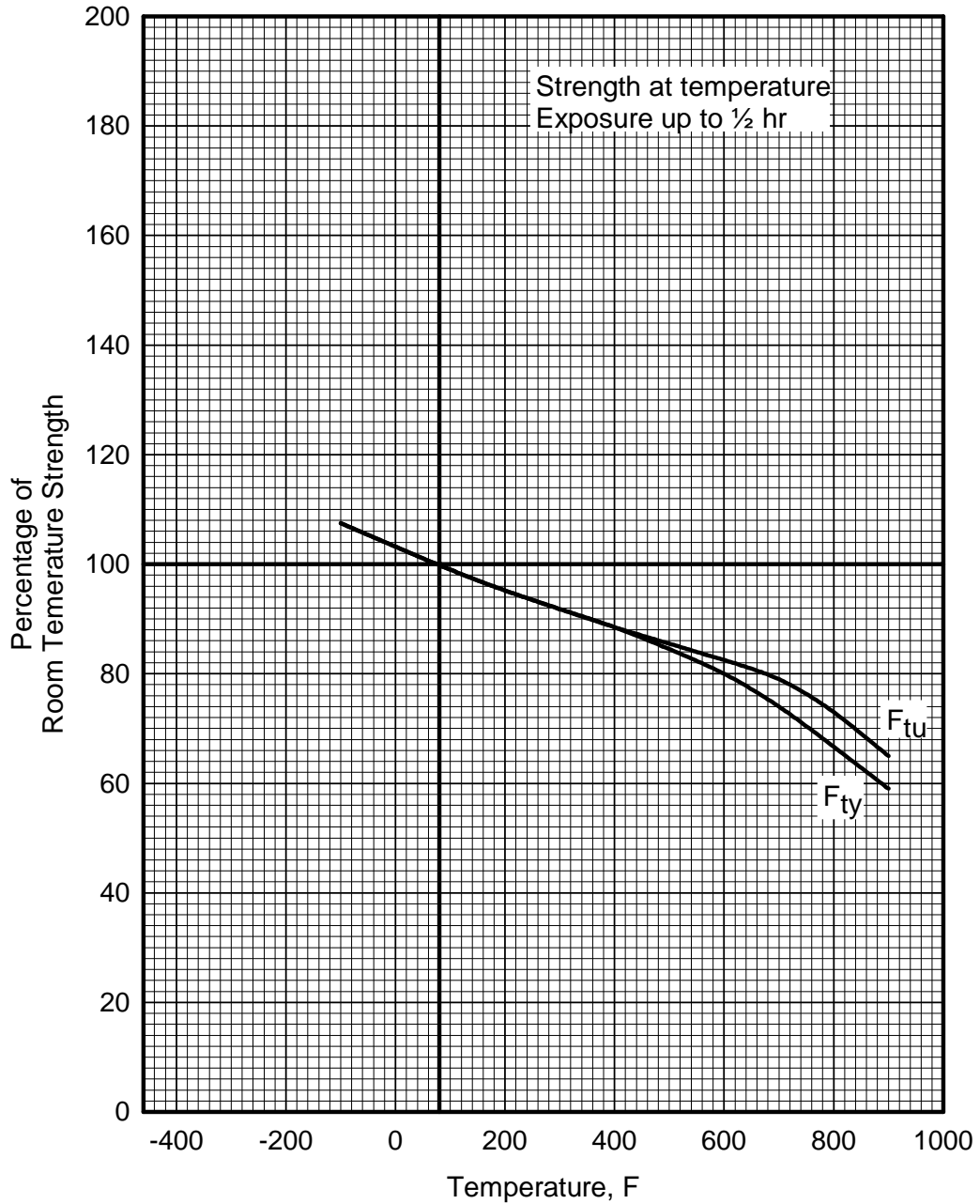

Figure 2.6.6.1.1. Effect of temperature on the tensile ultimate strength (F_{tu}) and the tensile yield strength (F_{ty}) of PH13-8Mo (H950 and H1000) stainless steel bar.

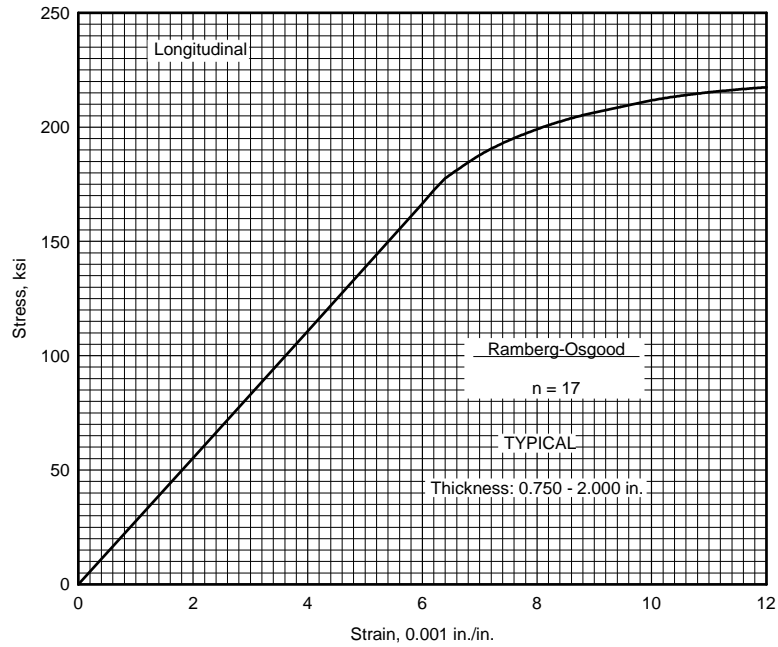

Figure 2.6.6.1.6(a). Typical tensile stress-strain curve at room temperature for PH13-8Mo (H1000) stainless steel bar.

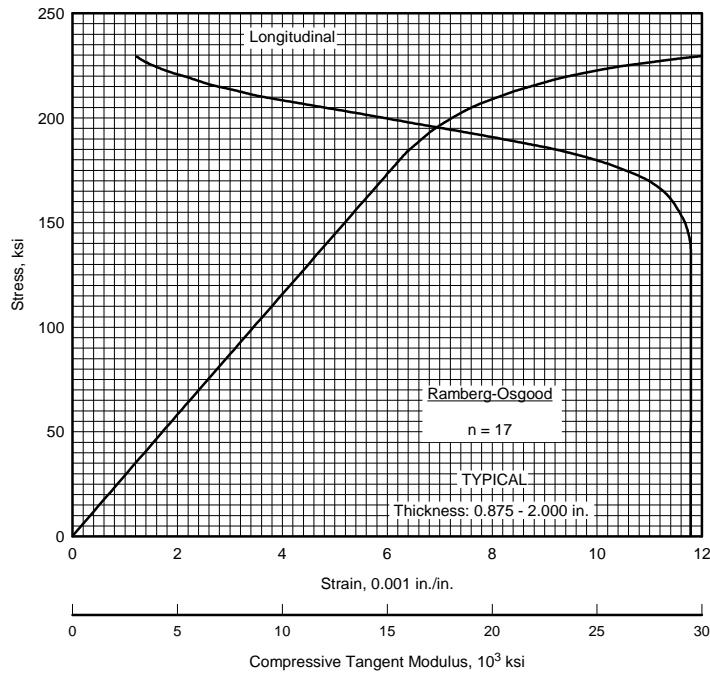

Figure 2.6.6.1.6(b). Typical compressive stress-strain and compressive tangent-modulus curves at room temperature for PH13-8Mo (H1000) stainless steel bar.

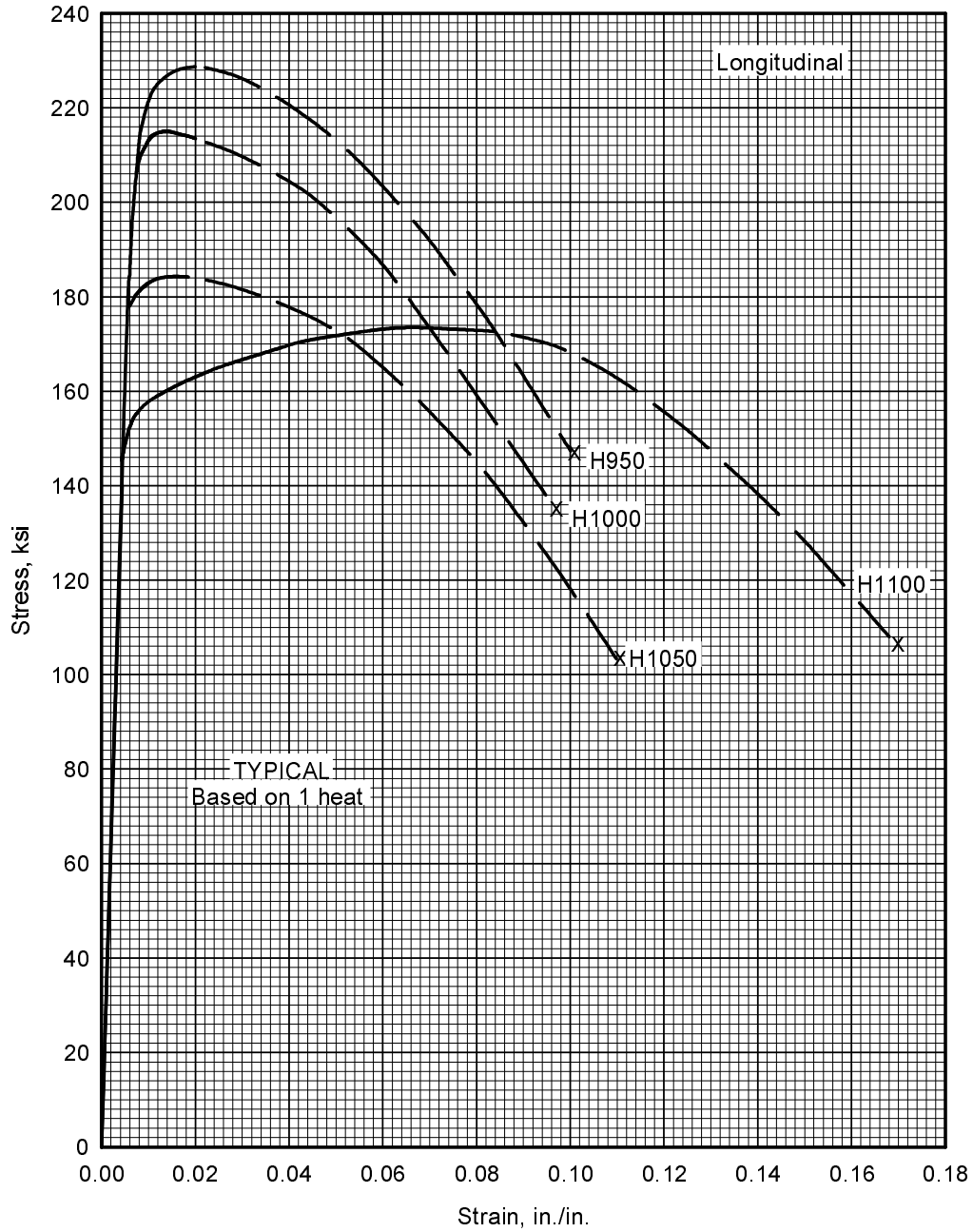

Figure 2.6.6.1.6(c). Typical tensile stress-strain curves (full range) at room temperature for various heat treated conditions of PH13-8Mo stainless steel bar.

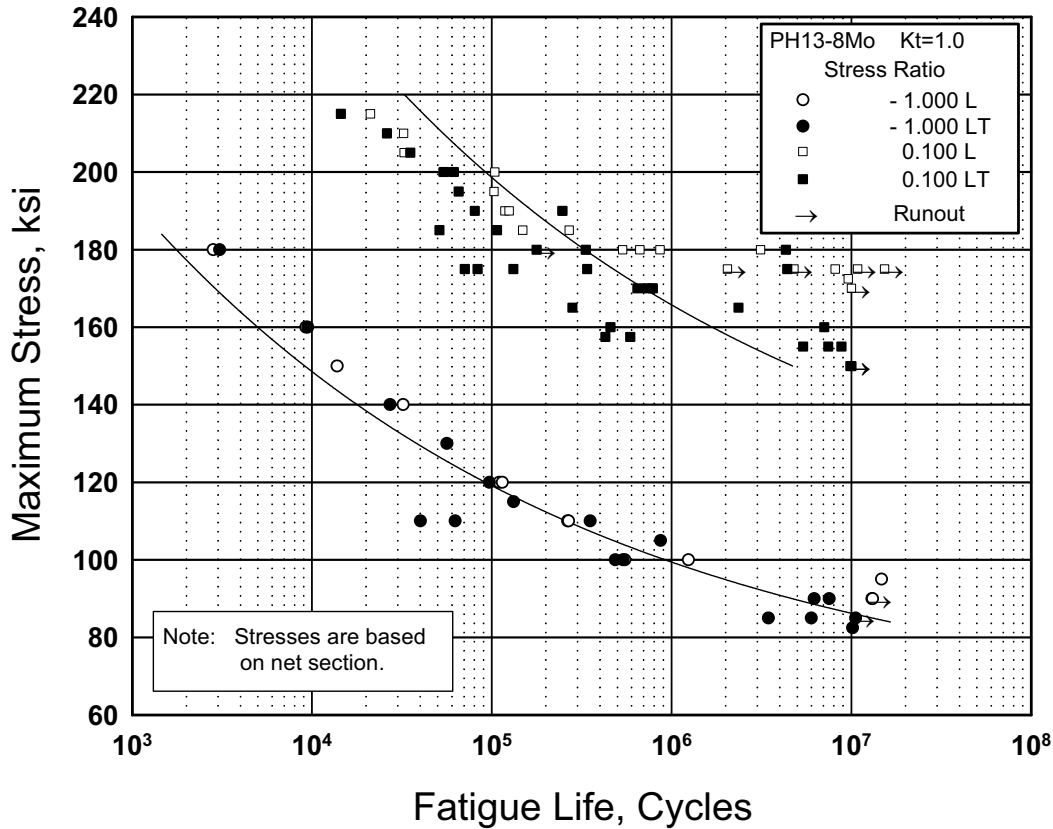

Figure 2.6.6.1.8(a). Best-fit S/N curves for unnotched PH13-8Mo (H1000) forged bar, longitudinal and transverse directions.

Correlative Information for Figure 2.6.6.1.8(a)

Product Form: Forged bar, 4 x 5 and 2 x 6 inches

Test Parameters:

Properties: TUS, ksi TYS, ksi Temp., °F
 205 197 RT

Loading - Axial
Frequency - Not Specified
Temperature - RT
Environment - Air

Specimen Details: Unnotched

No. of Heats/Lots: 4

	Gross	Net
	<u>Diameter</u>	<u>Diameter</u>
	0.50 - 0.75	0.25

Equivalent Stress Equation:

$$\log N_f = 16.32 - 5.75 \log (S_{eq} - 92.6)$$

$$S_{eq} = S_{max} (1 - R)^{0.64}$$

Std. Error of Estimate, Log (Life) = 0.461

Standard Deviation, Log (Life) = 0.919

$R^2 = 75\%$

Surface Condition: Polished to RMS 10

References: 2.6.6.1.8(a), (b), (d)

Sample Size: 86

[Caution: The equivalent stress model may provide unrealistic life predictions for stress ratios beyond those represented above.]

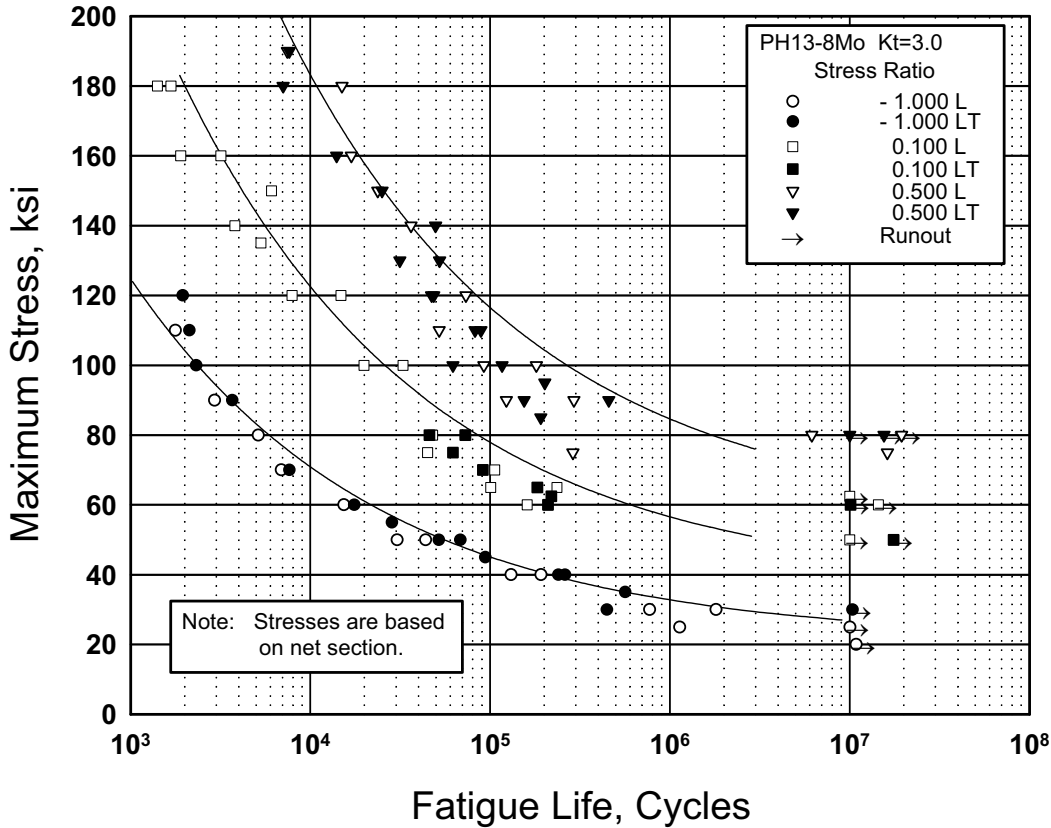

Figure 2.6.6.1.8(b). Best-fit S/N curves for notched, $K_t = 3.0$, PH13-8Mo (H1000) forged bar, longitudinal and long transverse directions.

Correlative Information for Figure 2.6.6.1.8(b)

Product Form: Forged bar, 4 x 5 and 2 x 6 inches

Loading - Axial

Frequency - Not Specified

Properties: TUS, ksi TYS, ksi Temp., °F
205 197 RT

Temperature - RT

Environment - Air

Specimen Details: Notched, $K_t = 3.0$

No. of Heats/Lots: 4

Gross Diameter	Net Diameter	Notch Root Radius
0.750	0.252	0.013
0.500	0.250	0.013

Equivalent Stress Equation:

$$\log N_f = 9.90 - 3.13 \log (S_{eq} - 34.4)$$

$$S_{eq} = S_{max} (1 - R)^{0.68}$$

Std. Error of Estimate, $\log (\text{Life}) = 23.1 (1/S_{eq})$

Standard Deviation, $\log (\text{Life}) = 1.15$

$$R^2 = 92\%$$

60° flank angle

Surface Condition: Notch was polished with abrasively charged wire and rotating wire with oil and aluminum grit

Sample Size: 104

[Caution: The equivalent stress model may provide unrealistic life predictions for stress ratios beyond those represented above.]

References: 2.6.6.1.8(a), (b), (d)

Test Parameters:

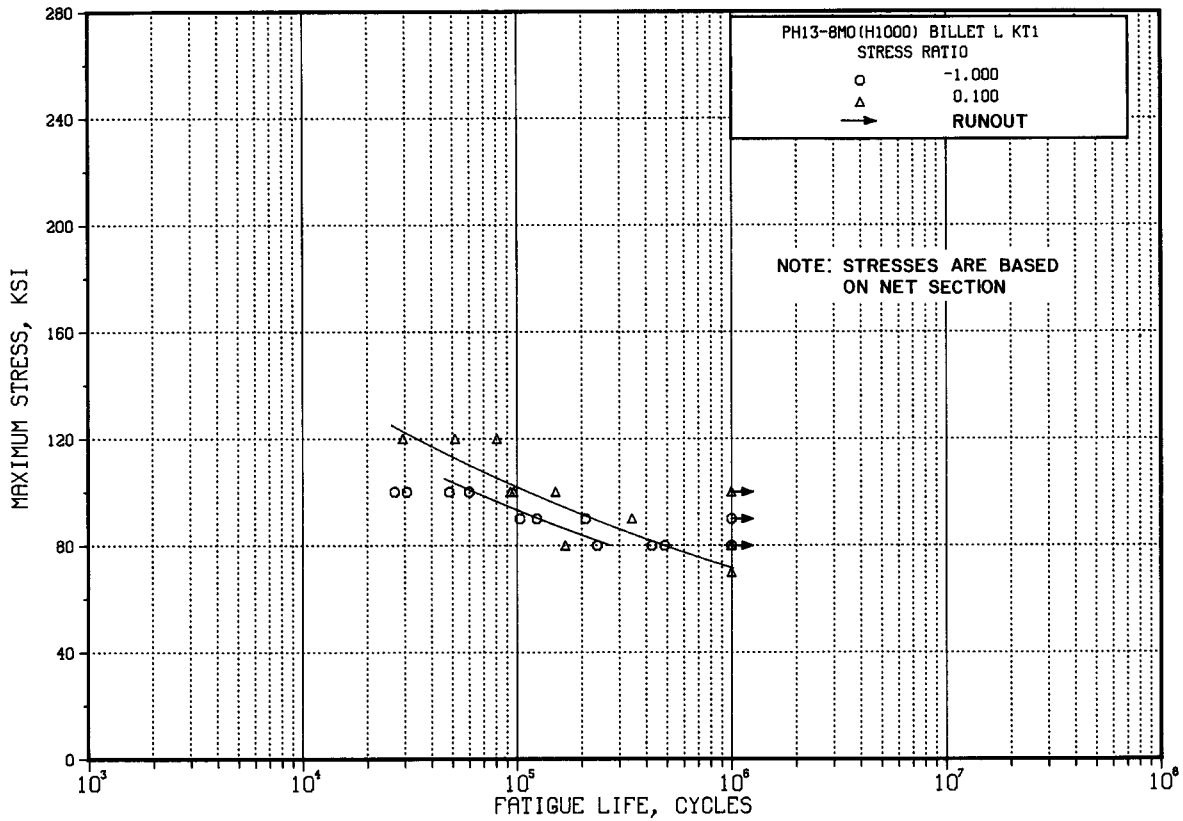

Figure 2.6.6.1.8(c). Best-fit S/N curves for unnotched PH13-8Mo (H1000) hand forging, longitudinal direction.

Correlative Information for Figure 2.6.6.1.8(c)

Product Form: Forged bar, 7 x 7 inches

Test Parameters:

Properties: TUS, ksi TYS, ksi Temp., °F
 210 204 RT

Loading - Axial
Frequency - Not Specified
Temperature - RT
Environment - Air

Specimen Details: Unnotched
 0.500 inch gross diameter
 0.250 inch net diameter

No. of Heats/Lots: 2

Surface Condition: Machined to RMS 63-270,
 solution treated and aged,
 grit blasted

Equivalent Stress Equation:
 $\log N_f = 18.12 - 6.54 \log (S_{eq})$
 $S_{eq} = S_{max} (1-R)^{0.11}$
Std. Error of Estimate, $\log (\text{Life}) = 0.263$
Standard Deviation, $\log (\text{Life}) = 0.475$
 $R^2 = 69\%$

Reference: 2.6.6.1.8(c)

Sample Size: 20

[Caution: The equivalent stress model may provide unrealistic life predictions for stress ratios beyond those represented above.]

2.6.7 15-5PH

2.6.7.0 Comments and Properties — 15-5PH is a precipitation-hardening, martensitic stainless steel used for parts requiring corrosion resistance and high strength at temperatures up to 600°F. Alloy 15-5PH has good transverse ductility and strength in large section sizes. This material is supplied in either the annealed or overaged condition and is heat treated after fabrication. Parts should never be used in Condition A. When good fracture toughness or impact properties are required, both at or below room temperature, conditions H900 and H925 should not be used. Conditions H1025, H1075, H1100, and H1150 provide lower transition temperatures and more useful levels of fracture toughness than the H900 and H925 conditions. The H1150M condition has the best notch toughness and is recommended for cryogenic applications.

Manufacturing Considerations — 15-5PH is readily forged and welded. Forging procedures are similar to those used for 17-4PH, the forgeability of 15-5PH being superior to that of 17-4PH in critical types of upset-forging and hot-flattening operations. Machining in the solution-treated condition is done at rates similar to Type 304 and 60 percent of these rates work well for Condition H900. Highest machining rates are possible with Conditions H1150 and H1150M. Material which is hot worked must be solution-treated before hardening. A dimensional contraction of 0.0004 to 0.0006 and 0.0008 to 0.0010 in./in. will occur on hardening to the H900 and H1150 conditions, respectively.

Heat Treatment — 15-5PH must be used in the heat-treated condition and should not be placed in service in Condition A. The alloy can be heat treated to various strength levels having a wide range of properties. Consult the applicable material specification or MIL-H-6875 for specific heat treatment procedures.

Environmental Considerations — The corrosion resistance of 15-5PH is comparable to that of 17-4PH. For tensile applications where stress corrosion is a possibility, 15-5PH should be aged at the highest temperature compatible with strength requirements and at a temperature not lower than 1025°F for 4 hours minimum aging time.

Specifications and Properties — Material specifications for 15-5PH are presented in Table 2.6.7.0(a). Room-temperature mechanical and physical properties of 15-5PH are shown in Tables 2.6.7.0(b) through (d). The effect of temperature on physical properties is depicted in Figure 2.6.7.0.

Table 2.6.7.0(a). Material Specifications for 15-5PH Stainless Steel

Specification	Form
AMS 5659	Bar, forging, ring, and extrusion (CEVM)
AMS 5862	Sheet, strip, and plate (CEVM)
AMS 5400	Investment casting

2.6.7.1 Various Heat-Treated Conditions — Elevated temperature curves for the various mechanical properties are shown in Figures 2.6.7.1.1 and 2.6.7.1.4. Typical stress-strain and tangent-modulus curves are shown in Figures 2.6.7.1.6(a) through (c).

2.6.7.2 H1025 Condition — An elevated temperature curve for compressive yield strength is presented in Figure 2.6.7.2.2. Stress-strain and tangent-modulus curves are shown in Figures 2.6.7.2.6(a) and (b). Fatigue data at room temperature are illustrated in Figures 2.6.7.2.8(a) through (c).

2.6.7.3 H1150 Condition — An elevated temperature curve for compressive yield strength is presented in Figure 2.6.7.3.2. Compressive stress-strain and tangent-modulus curves at various temperatures are shown in Figure 2.6.7.3.6.

MIL-HDBK-5J
31 January 2003

Table 2.6.7.0(b). Design Mechanical and Physical Properties of 15-5PH Stainless Steel Bar and Forging

Specification	AMS 5659					
	Bar ^a					
Form	H900	H925	H1025	H1075	H1100	H1150
Condition	≤12	≤12	≤12	≤12	≤12	≤12
Thickness or diam., in. .	S	S	S	S	S	S
Basis	S	S	S	S	S	S
Mechanical Properties:						
F_{tu} , ksi:						
L	190	170	155	145	140	135
T	190	170	155	145	140	135
F_{ty} , ksi:						
L	170	155	145	125	115	105
T	170	155	145	125	115	105
F_{cy} , ksi:						
L	143	99
T	143	99
F_{su} , ksi	97	85
F_{bru}^b , ksi:						
(e/D = 1.5)	263	230
(e/D = 2.0)	332	293
F_{bry}^b , ksi:						
(e/D = 1.5)	211	166
(e/D = 2.0)	250	201
e , percent:						
L	10	10	12	13	14	16
T	6	7	8	9	10	11
RA , percent:						
L	35	38	45	45	45	50
T	20	25	32	33	34	35
E , 10 ³ ksi	28.5					
E_c , 10 ³ ksi	29.2					
G , 10 ³ ksi	11.2					
μ	0.27					
Physical Properties:						
ω , lb/in. ³	0.283					
C , Btu/(lb)(°F)					
K and α	See Figure 2.6.7.0					

a Forging, ring, and extrusion product forms are also covered by AMS 5659.

b Bearing values are “dry pin” values per Section 1.4.7.1.

Table 2.6.7.0(c). Design Mechanical and Physical Properties of 15-5PH Stainless Steel Plate

Specification	AMS 5862			
Form	Plate			
Condition	H1025 ^a			
Thickness, in.	0.187-0.625	0.626-2.000	2.001-3.000	3.001-4.000
Basis	S	S	S	S
Mechanical Properties:				
F_{tu} , ksi:				
L	154	154	154	...
LT	155	155	155	155
F_{ty} , ksi:				
L	143	143	143	...
LT	145	145	145	145
F_{cy} , ksi:				
L	150	150	150	...
LT	152	149	146	...
F_{su} , ksi	97	97	96	...
F_{bru}^b , ksi:				
(e/D = 1.5)	257	257	257	...
(e/D = 2.0)	331	331	331	...
F_{bry}^b , ksi:				
(e/D = 1.5)	211	211	211	...
(e/D = 2.0)	246	246	246	...
e , percent:				
LT	8	12	12	12
RA , percent:				
LT	35	40	40	40
E , 10 ³ ksi	28.5			
E_c , 10 ³ ksi	29.2			
G , 10 ³ ksi	11.2			
μ	0.27			
Physical Properties:				
ω , lb/in. ³	0.283			
C , Btu/(lb)(°F)			
K and α	See Figure 2.6.7.0			

a The H900, H925, H1075, H1100, and H1150 conditions are included in AMS 5862.
b Bearing values are "dry pin" values per Section 1.4.7.1.

Table 2.6.7.0(d). Design Mechanical and Physical Properties of 15-5PH Stainless Steel Investment Casting

Specification	AMS 5400
Form	Investment casting
Condition	H935
Location within casting	Any area
Basis	S
Mechanical Properties:^a	
F_{tu} , ksi	170
F_{ty} , ksi	150
F_{cy} , ksi	155
F_{su} , ksi	107
F_{bru}^b , ksi:	
($e/D = 1.5$)	269
($e/D = 2.0$)	349
F_{bry}^b , ksi:	
($e/D = 1.5$)	209
($e/D = 2.0$)	240
e , percent	6
RA , percent	14
E , 10^3 ksi	28.5
E_c , 10^3 ksi	29.2
G , 10^3 ksi	11.2
μ	0.27
Physical Properties:	
ω , lb/in. ³	0.283
C , Btu/(lb)(°F)
K , and α	See Figure 2.6.7.0

- a Properties apply only when drawing specifies that conformance to tensile property requirements will be determined from specimens cut from castings or integrally cast specimens.
b Bearing values are “dry pin” values per Section 1.4.7.1.

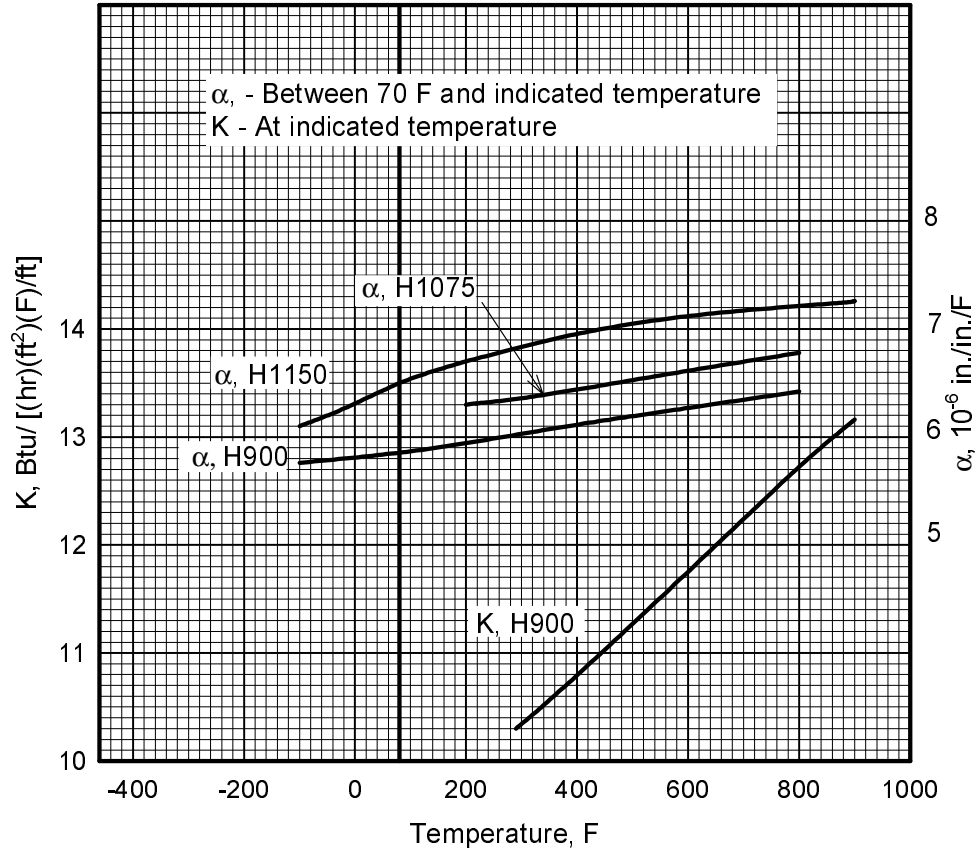

Figure 2.6.7.0. Effect of temperature on the physical properties of 15-5PH stainless steel.

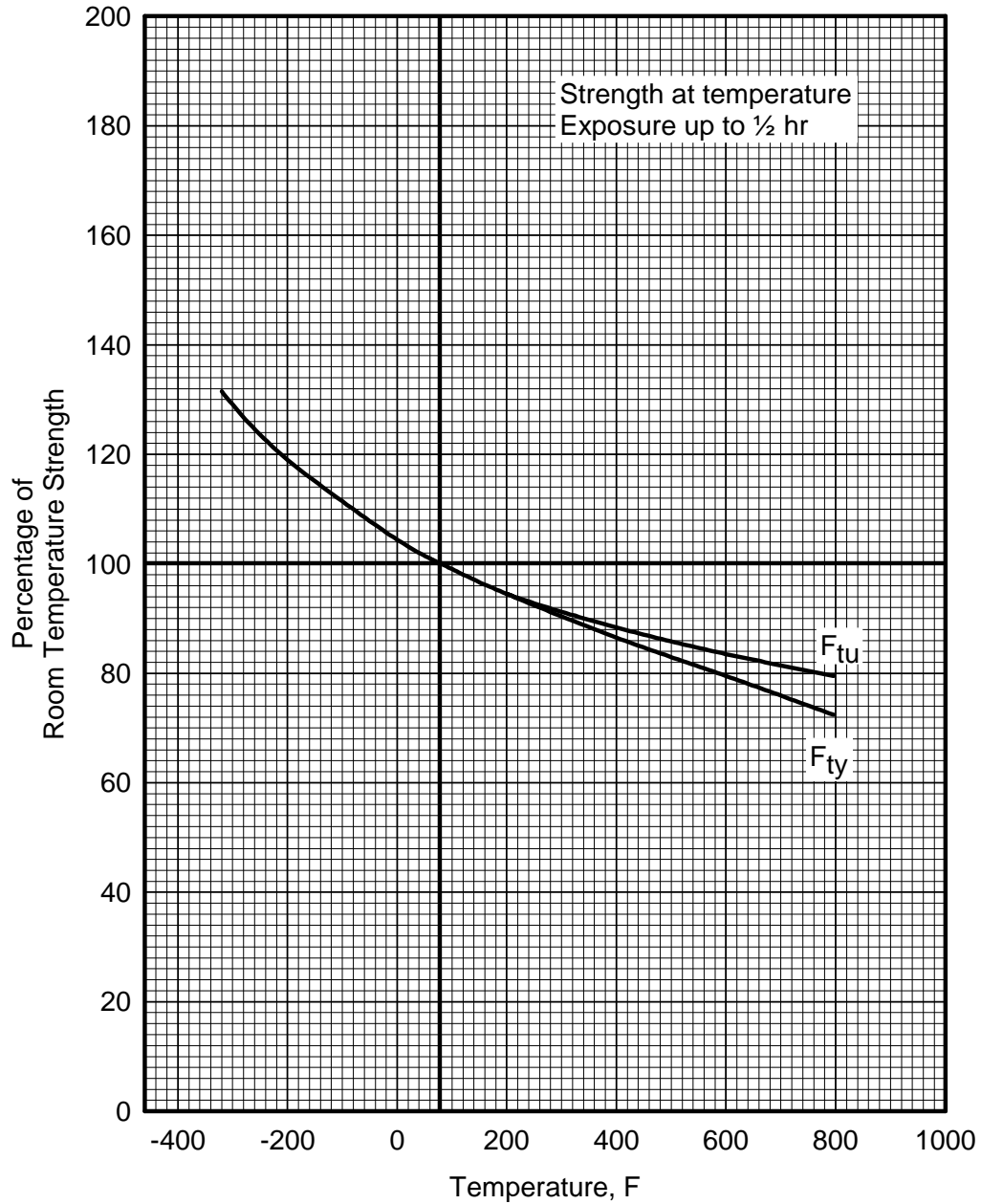

Figure 2.6.7.1.1. Effect of temperature on the tensile ultimate strength (F_{tu}) and the tensile yield strength (F_{ty}) of 15-5PH (H925, H1025, and H1100) stainless steel bar.

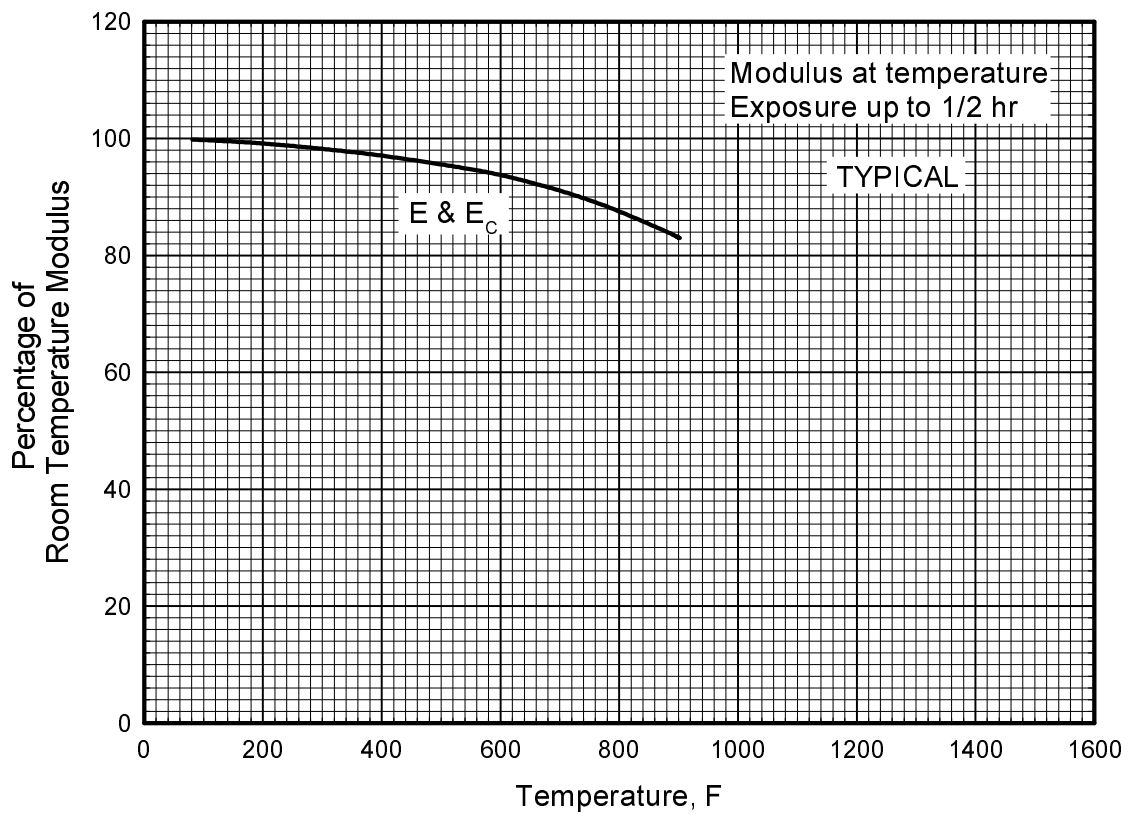

Figure 2.6.7.1.4. Effect of temperature on the tensile and compressive moduli (E and E_c) of 15-5PH stainless steel.

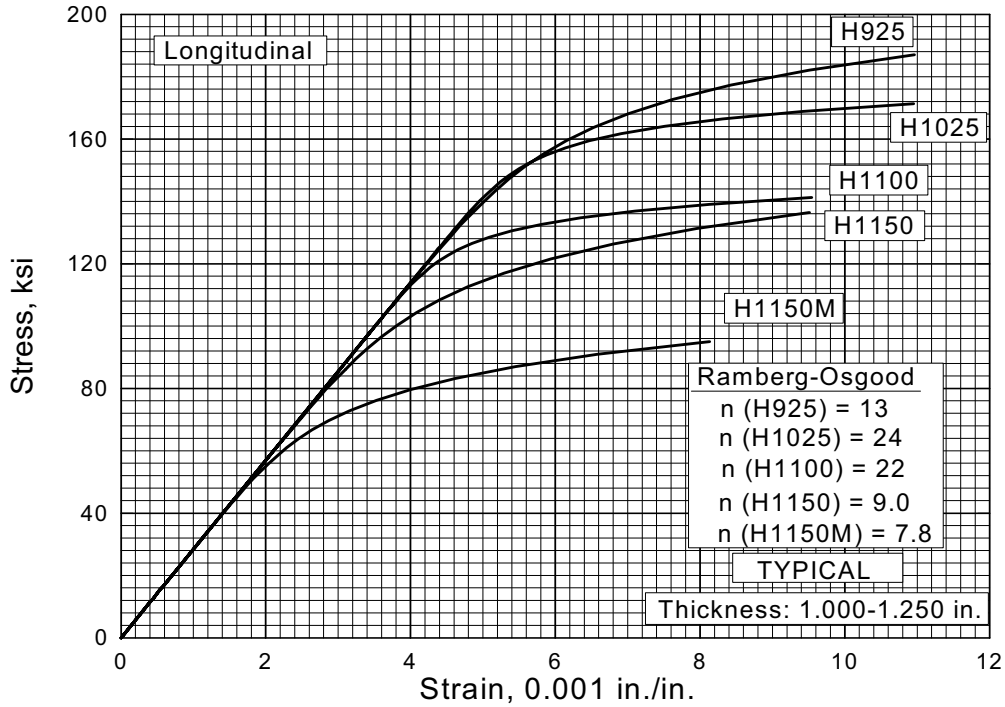

Figure 2.6.7.1.6(a). Typical tensile stress-strain curves at room temperature for various heat-treated conditions of 15-5PH stainless steel bar.

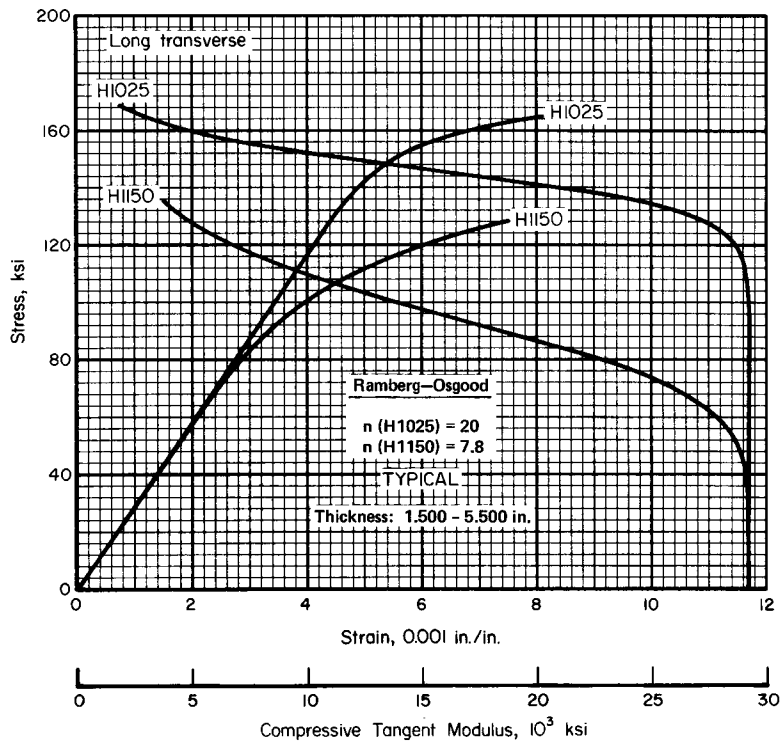

Figure 2.6.7.1.6(b). Typical compressive stress-strain and compressive tangent-modulus curves at room temperature for various heat-treated conditions of 15-5PH stainless steel bar.

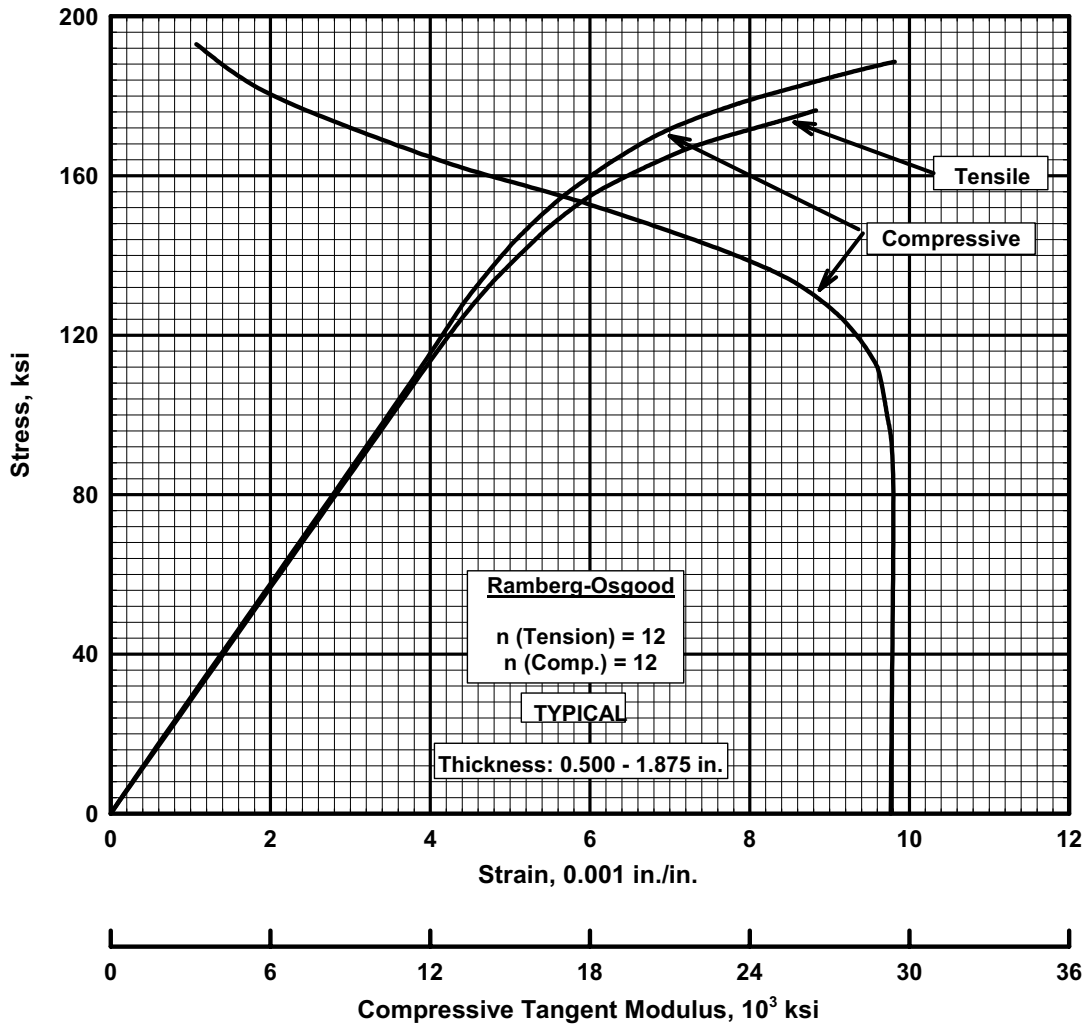

Figure 2.6.7.1.6(c). Typical tensile and compressive stress-strain and compressive tangent-modulus curves for 15-5PH (H935) stainless steel casting.

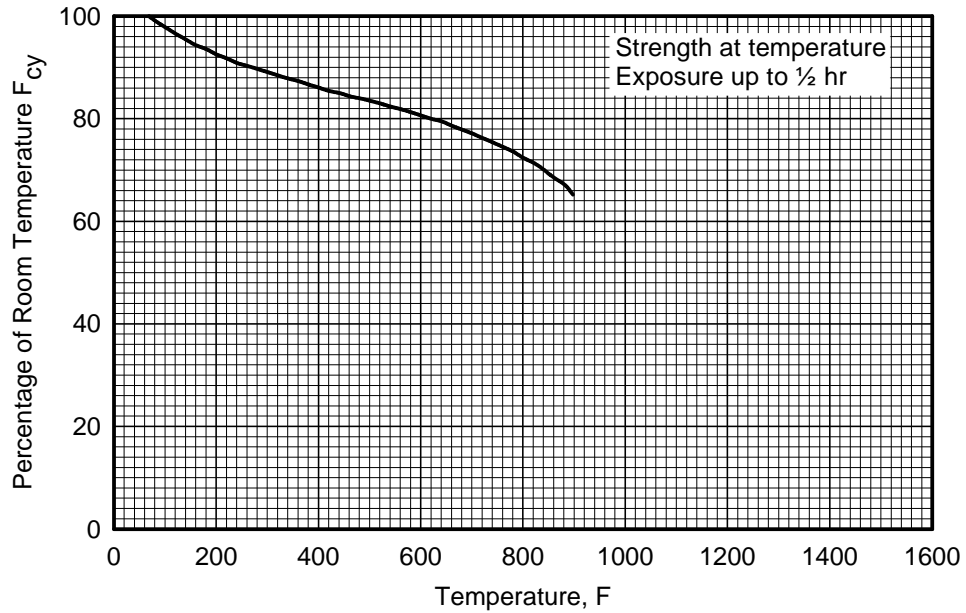

Figure 2.6.7.2.2. Effect of temperature on the compressive yield strength (F_{cy}) of 15-5PH (H1025) stainless steel bar.

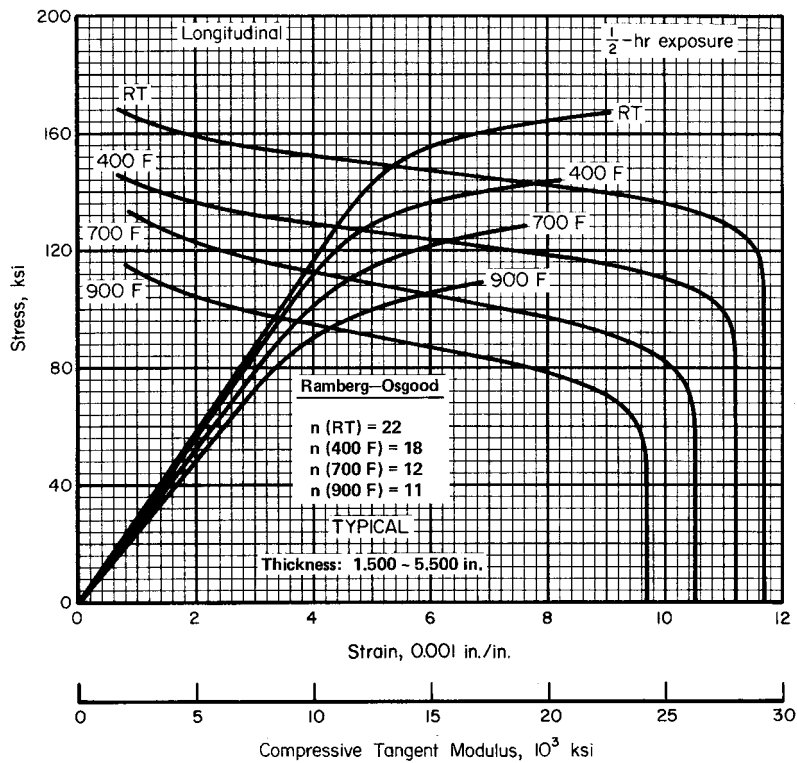

Figure 2.6.7.2.6(a). Typical compressive stress-strain and compressive tangent-modulus curves at various temperatures for 15-5PH (H1025) stainless steel bar.

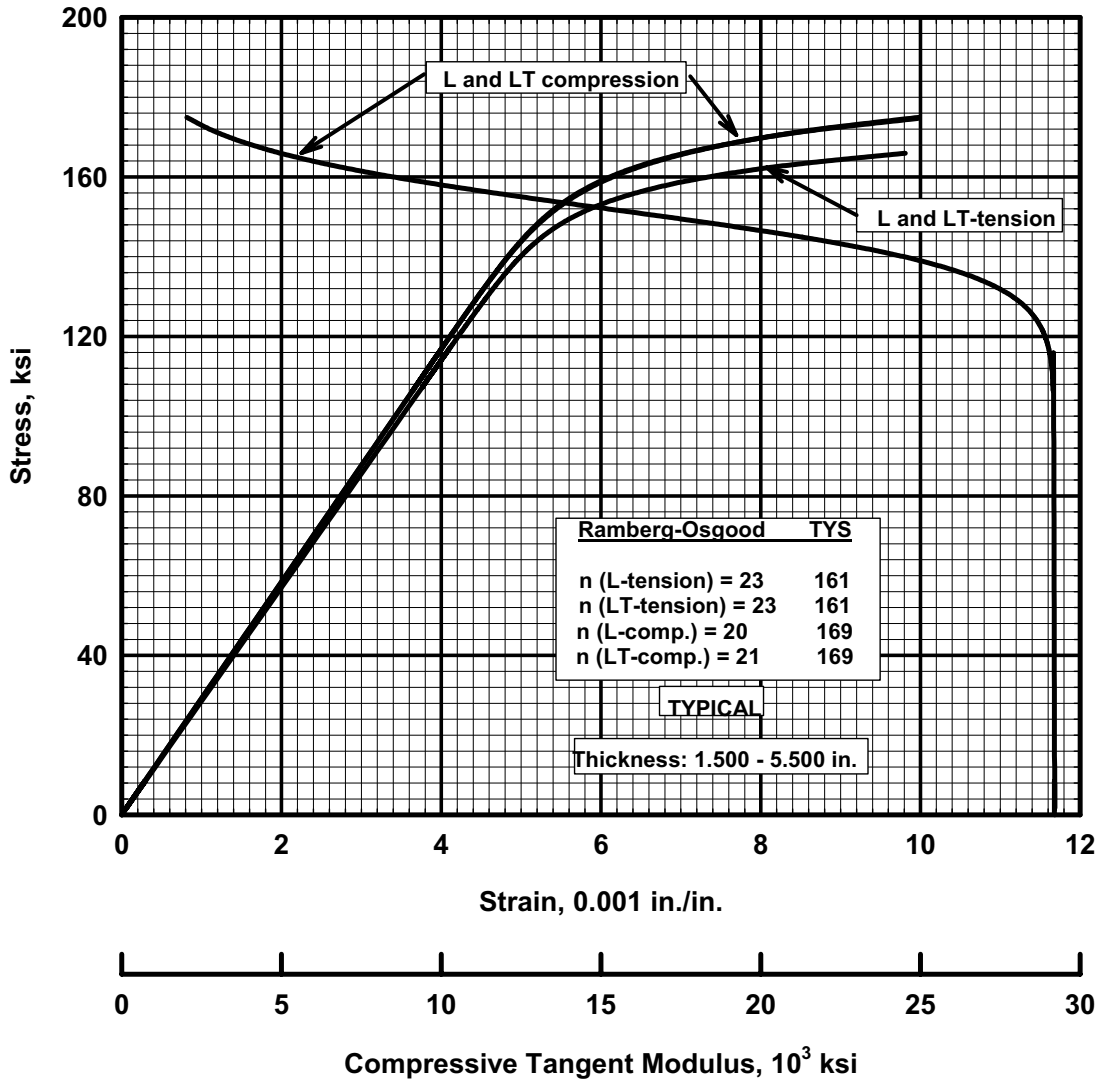

Figure 2.6.7.2.6(b). Tensile and compressive stress-strain and compressive tangent-modulus curves for 15-5PH (H1025) stainless steel plate.

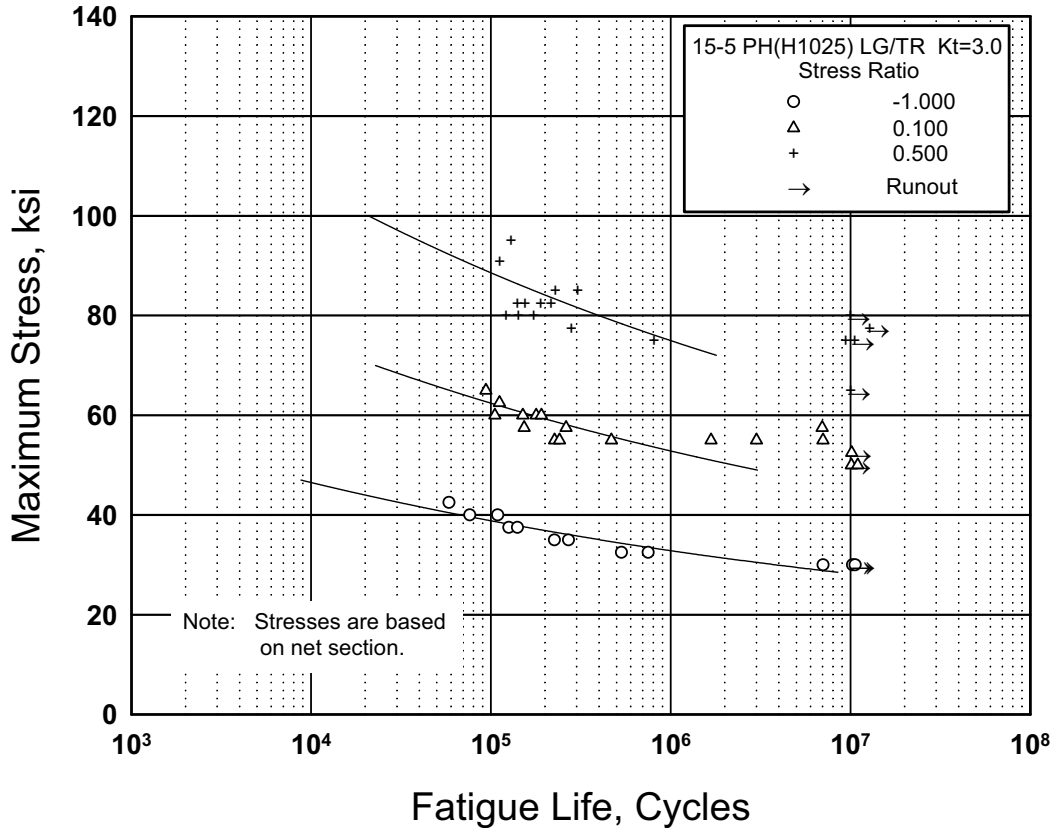

Figure 2.6.7.2.8(a). Best-fit S/N curve for notched, $K_t = 3.0$, 15-5PH (H1025) stainless steel bar, longitudinal and long transverse directions.

Correlative Information for Figure 2.6.7.2.8(a)

Product Form: Bar, 2 x 6 inches

Test Parameters:

Properties:	TUS, ksi	TYS, ksi	Temp, °F
Longitudinal	163	159	RT
Long Transverse	164	160	RT
Longitudinal	278	—	RT
			(notched)
Long Transverse	277	—	RT
			(notched)

Loading - Axial
Frequency - 1800 cpm
Temperature - RT
Environment - Air

No. of Heats/Lots: 3

Specimen Details: Notched, V-Groove, $K_t = 3.0$
0.375 inch gross diameter
0.250 inch net diameter
0.013 inch root radius, r
60° flank angle, ω

Equivalent Stress Equation:

$$\log N_f = 19.69 - 9.14 \log (S_{eq} - 18.16)$$

$$S_{eq} = S_{max} (1 - R)^{0.595}$$

Std. Error of Estimate, Log (Life) = 0.449
Standard Deviation, Log (Life) = 0.627
 $R^2 = 49\%$

Surface Condition: Ground notch

Sample Size: 40

Reference: 2.6.7.2.8(a)

[Caution: The equivalent stress model may provide unrealistic life predictions for stress ratios beyond those represented above.]

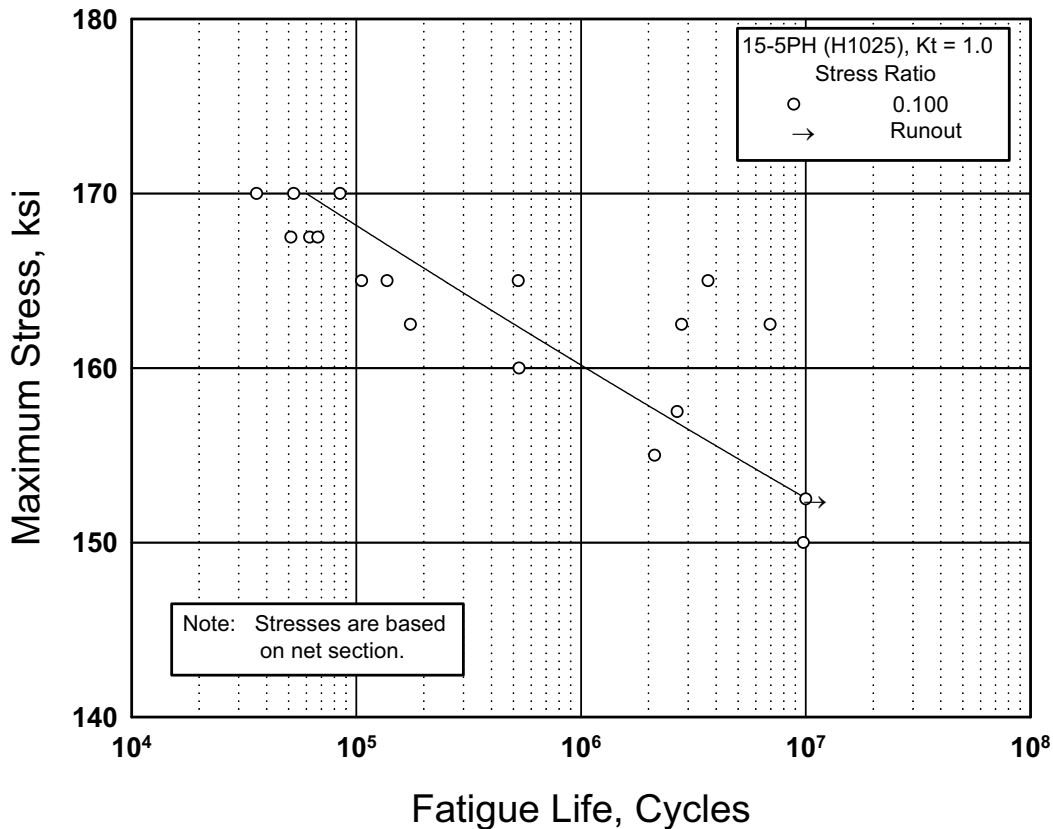

Figure 2.6.7.2.8(b). Best-fit S/N curve for unnotched, K_t = 1.0, 15-5PH (H1025) stainless steel plate, longitudinal and long transverse directions.

Correlative Information for Figure 2.6.7.2.8(b)

Product Form: Plate, 0.808 inch, 2.024 inch, and 2.579 inch thick

<u>Properties:</u>	<u>TUS, ksi</u>	<u>TYS, ksi</u>	<u>Temp, °F</u>
Longitudinal	169.9	165.7	RT
Long Transverse	170.2	166.1	RT

Specimen Details: Unnotched
0.250 inch diameter

Surface Condition: Axial, ground RMS 8

Reference: 2.6.7.2.8(b)

Test Parameters:
Loading - Axial
Frequency - 30 Hz
Temperature - RT
Atmosphere - Air

No. of Heats/Lots: 4

Fatigue Life Equation:
Log N_f = 110.1 - 47.22 log (S_{max})
Std. Error of Estimate, Log (Life) = 0.58
Standard Deviation, Log (Life) = 0.84
R² = 52.8%

Sample Size = 19

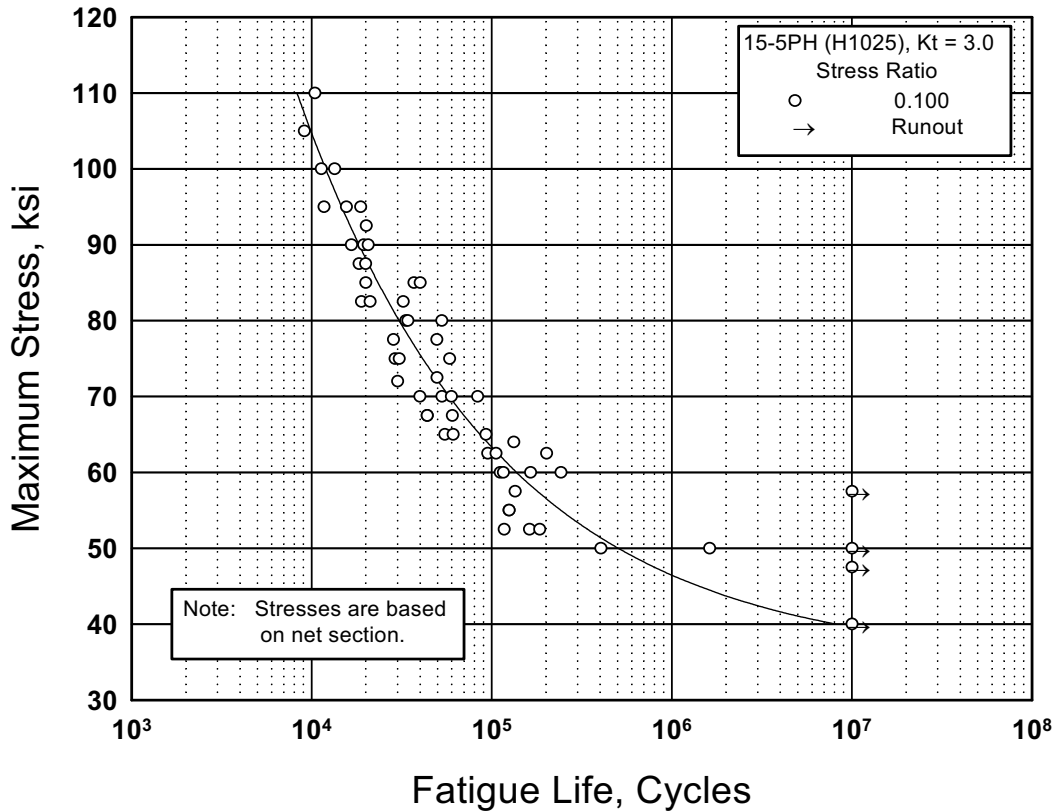

Figure 2.6.7.2.8(c). Best-fit S/N curve for notched, $K_t = 3.0$, 15-5PH (H1025) stainless steel plate, longitudinal and long transverse directions.

Correlative Information for Figure 2.6.7.2.8(c)

Product Form: Plate, 0.215 inch, 0.269 inch, 0.277 inch, 0.394 inch, 0.524 inch, 0.908 inch, 2.024 inch, and 2.579 inch

Test Parameters:
Loading - Axial
Frequency - 30 Hz
Temperature - RT
Atmosphere - Air

Properties: TUS, ksi TYS, ksi Temp, °F
Longitudinal 170.8 165.6 RT
Long Transverse 170.2 166.1 RT

No. of Heats/Lots: 10

Specimen Details: Notched, V-Groove, $K_t = 3.0$

Flat, 0.590-inch gross width
0.500-inch net width
0.025-inch root radius
60° flank angle, ω

Fatigue Life Equation:
 $\log N_f = 8.72 - 2.56 \log (S_{\max} - 34.9)$
Std. Error of Estimate, $\log (\text{Life}) = 10.9 (1/S_{\max})$

$R^2 = 88.2\%$

Round, 0.374-inch gross diameter
0.252-inch net diameter
0.013-inch root radius
60° flank angle, ω

Sample Size = 55

Surface Condition: RMS 32 notch

Reference: 2.6.7.2.8(b)

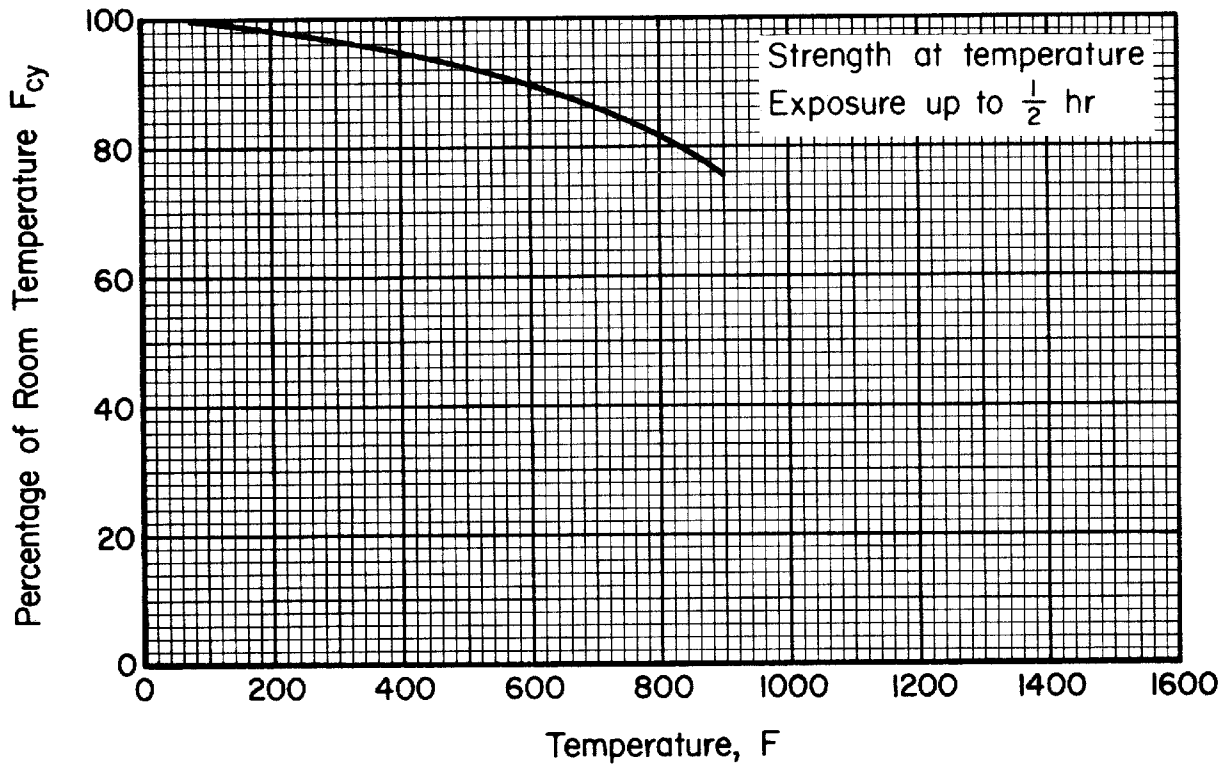

Figure 2.6.7.3.2. Effect of temperature on the compressive yield strength (F_{cy}) of 15-5PH (H1150) stainless steel bar.

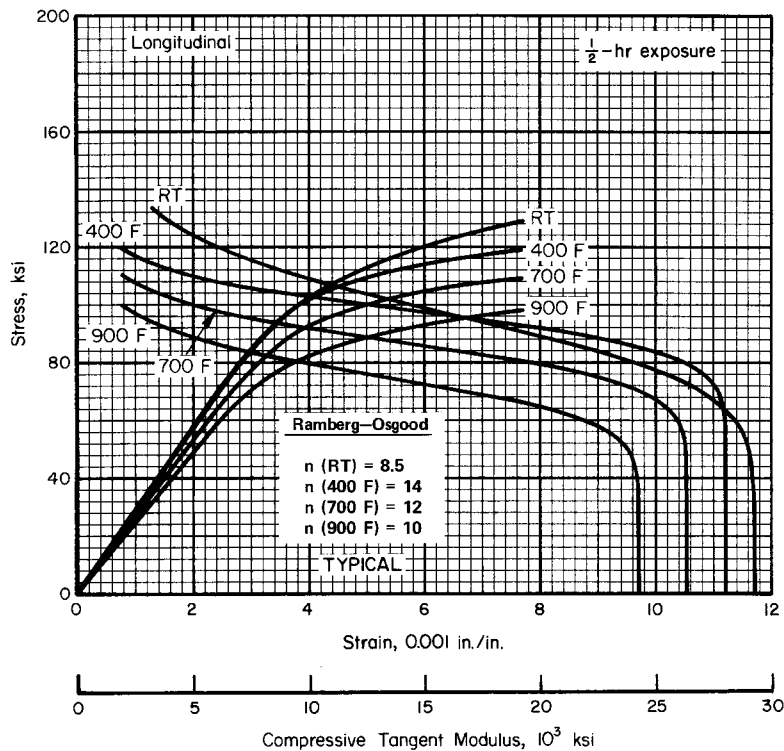

Figure 2.6.7.3.6. Typical compressive stress-strain and tangent-modulus curves at various temperatures for 15-5PH (H1150) stainless steel bar.

2.6.8 PH15-7Mo

2.6.8.0 Comments and Properties — PH15-7Mo is a semiaustenitic stainless steel used where high strength and good corrosion and oxidation resistance are needed up to 600°F. This steel is supplied in Condition A for ease of forming or in Condition C when highest strength is required.

Manufacturing Considerations — PH15-7Mo in Condition A is readily cold formed. Conventional inert-gas shielded arc and resistance techniques are generally used for welding. The heat treatments for this steel are compatible with the cycles used for honeycomb panel brazing. Vapor blasting of scaled Condition TH1050 parts is recommended because of the hazards of intergranular corrosion in adequately controlled pickling operations.

In hardening this steel from Condition A to Condition TH1050 a net dimensional growth of 0.004 in./in. should be anticipated. Use of this steel in Conditions T and T-100 is not recommended.

Environmental Considerations — The resistance of PH15-7Mo to stress-corrosion cracking in chloride environments has been evaluated and found to be superior to that of the alloy steels and the hardenable chromium steels. Conditions C and CH 900 provide maximum resistance to stress corrosion.

Specification and Properties — A material specification for PH15-7Mo stainless steel is presented in Table 2.6.8.0(a). The room-temperature properties of PH15-7Mo are shown in Tables 2.6.8.0(b) and (c). The physical properties of this alloy at room and elevated temperatures are presented in Figure 2.6.8.0.

Table 2.6.8.0(a). Material Specification for PH15-7Mo Stainless Steel

Specification	Form
AMS 5520	Plate, sheet, and strip

2.6.8.1 TH1050 Condition — Effect of temperature on various mechanical properties for this condition is presented in Figures 2.6.8.1.1 and 2.6.8.1.4. Typical stress-strain and tangent-modulus curves at room temperature and elevated temperature are presented in Figures 2.6.8.1.6(a) through (c). Unnotched and notched fatigue information at room and elevated temperatures are illustrated in Figures 2.6.8.1.8(a) through (f).

Table 2.6.8.0(b). Design Mechanical and Physical Properties of PH15-7Mo Stainless Steel Sheet, Strip, and Plate

Specification	AMS 5520
Form	Sheet, strip, and plate
Condition	TH1050
Thickness, in.	0.0015-0.500
Basis	S
Mechanical Properties:	
F_{tu} , ksi:	
L	185
LT	190
F_{ty} , ksi:	
L	165
LT	170
F_{cy} , ksi:	
L	182
LT	188
F_{su} , ksi	120
F_{bru} , ksi:	
($e/D = 1.5$)	327
($e/D = 2.0$)	377
F_{bry} , ksi:	
($e/D = 1.5$)	259
($e/D = 2.0$)	272
e , percent:	
LT	a
E , 10^3 ksi	29.0
E_c , 10^3 ksi	30.0
G , 10^3 ksi	11.4
μ	0.28
Physical Properties:	
ω , lb/in. ³	0.277
C , Btu/(lb)(°F)
K and α	See Figure 2.6.8.0

a See Table 2.6.8.0(c).

Table 2.6.8.0(c). Minimum Elongation Values for PH15-7Mo (TH1050) Stainless Steel Sheet

Thickness, inches	e (LT), percent
0.0015 to 0.0049	2
0.0050 to 0.0099	3
0.010 to 0.019	4
0.020 to 0.1874	5
0.1875 to 0.500	6

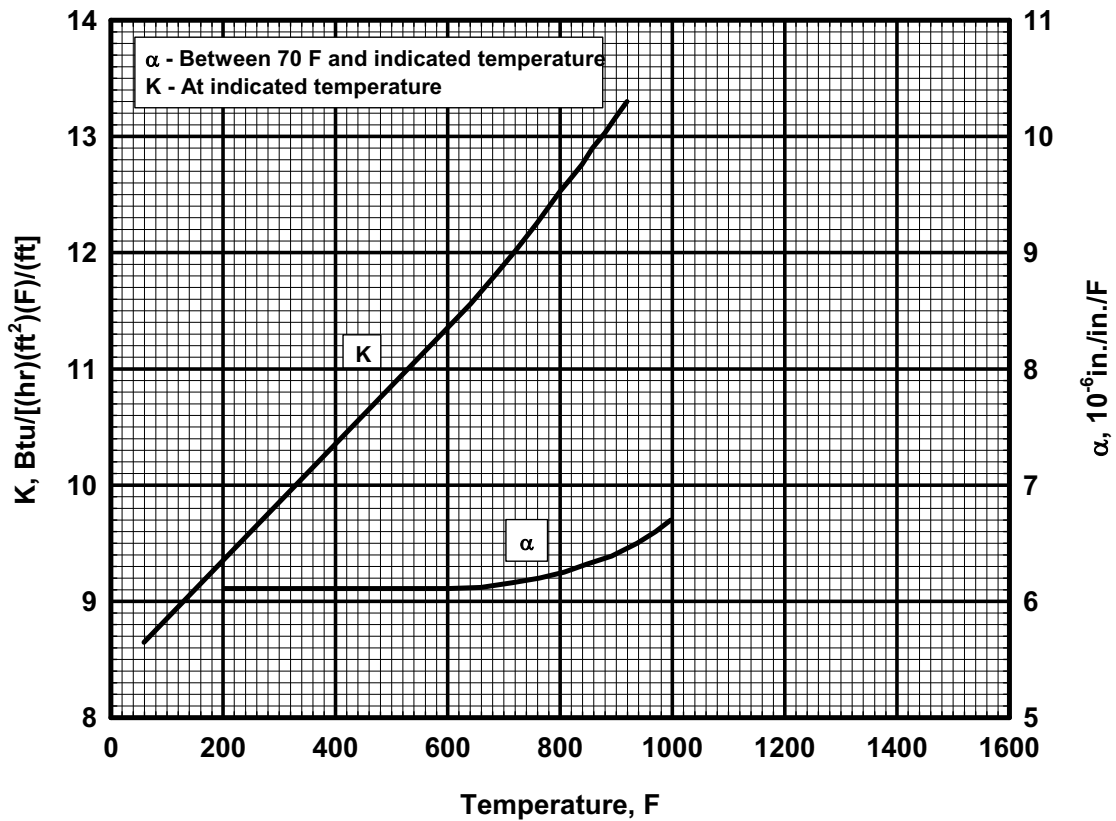

Figure 2.6.8.0. Effect of temperature on the physical properties of PH15-7Mo (TH1050) stainless steel.

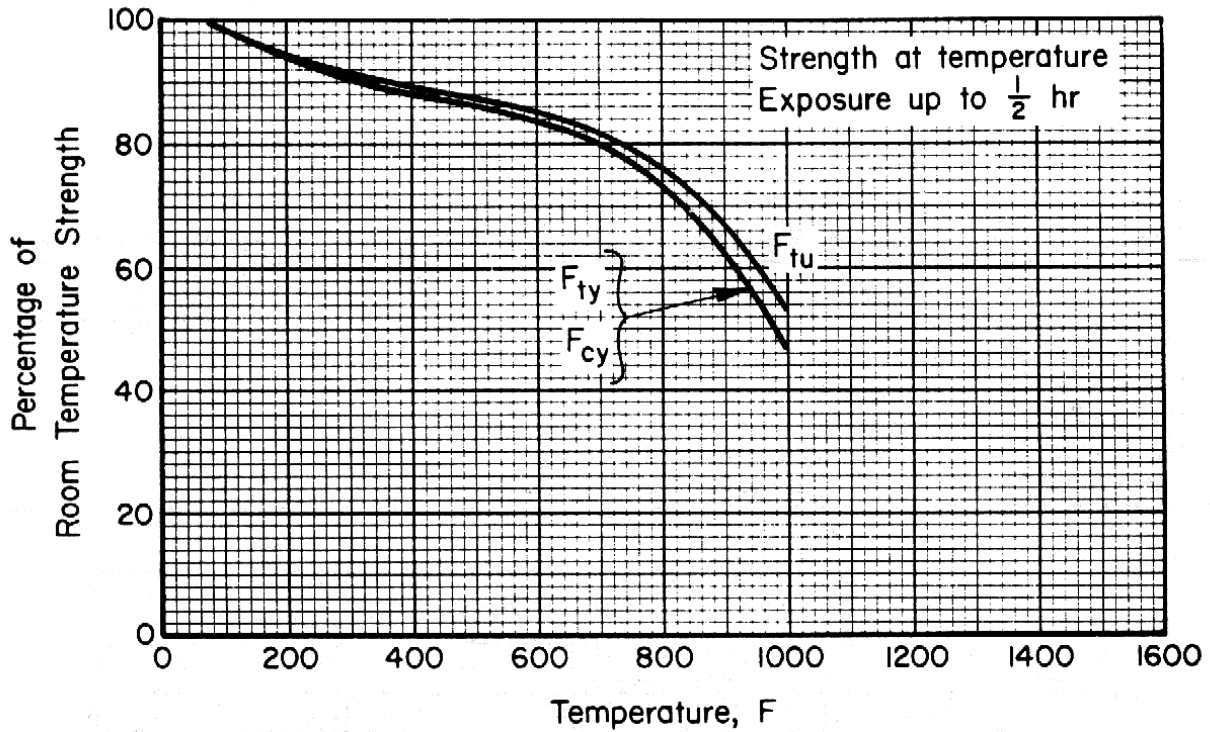

Figure 2.6.8.1.1. Effect of temperature on the tensile ultimate strength (F_{tu}), tensile yield strength (F_{ty}), and compressive yield strength (F_{cy}) of PH15-7Mo (TH1050) stainless steel sheet.

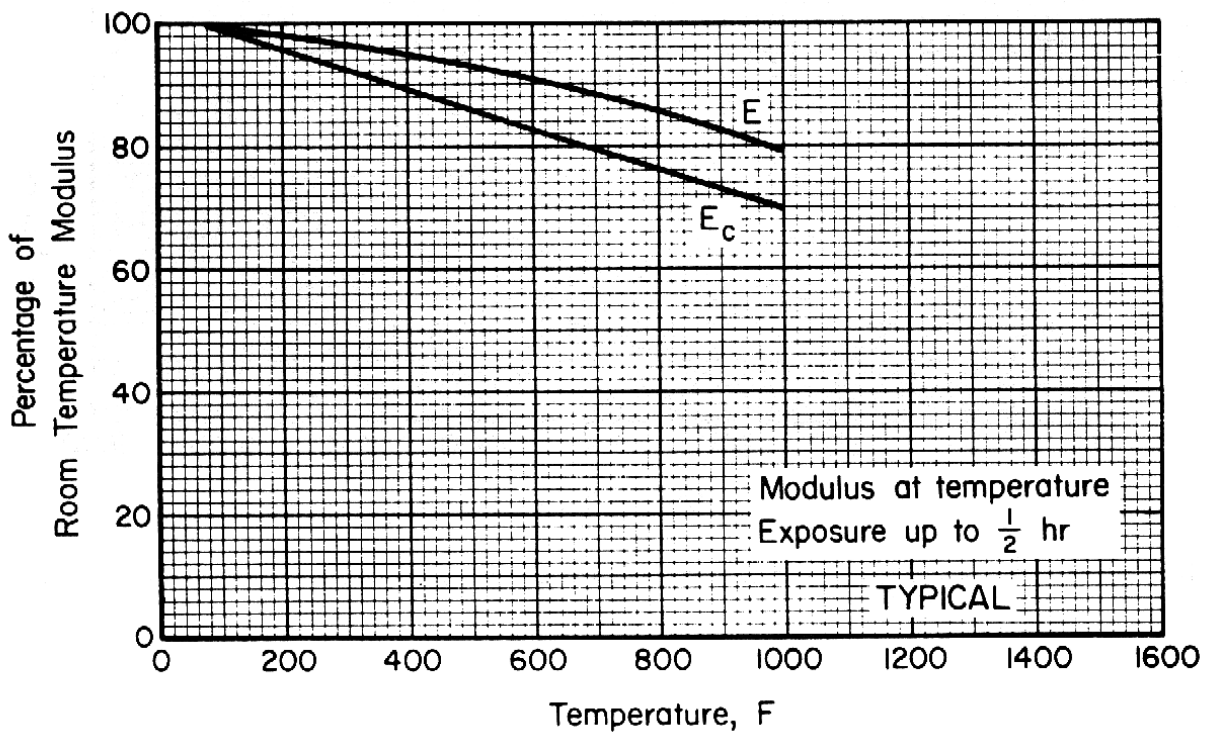

Figure 2.6.8.1.4. Effect of temperature on the tensile and compressive moduli (E and E_c) of PH15-7Mo (TH1050) stainless steel sheet.

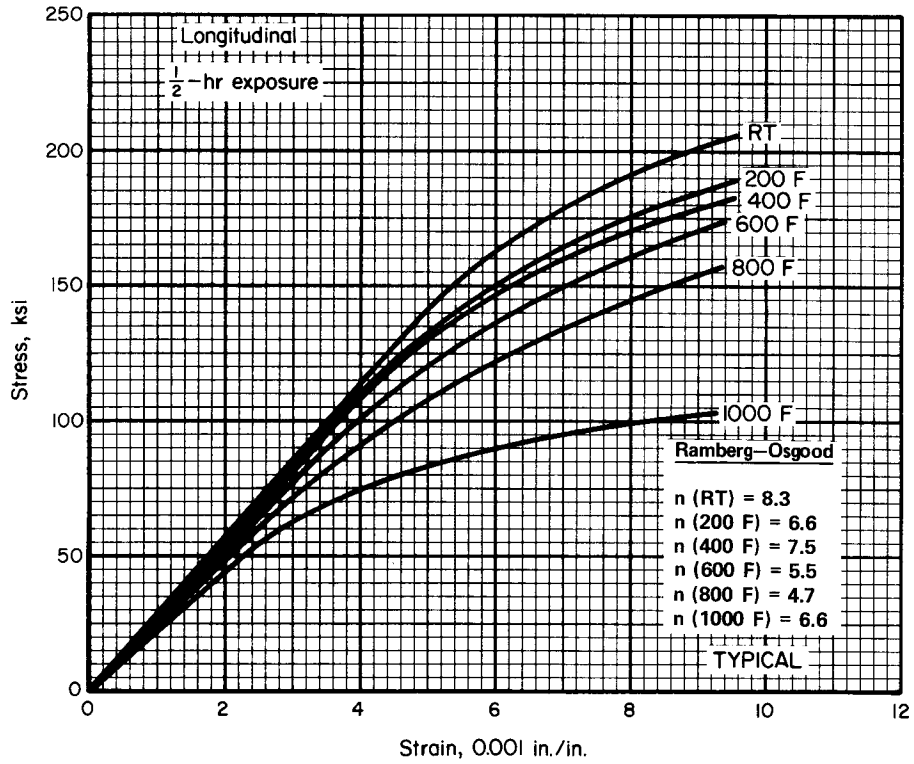

Figure 2.6.8.1.6(a). Typical tensile stress-strain curves at various temperatures for PH15-7Mo (TH1050) stainless steel sheet.

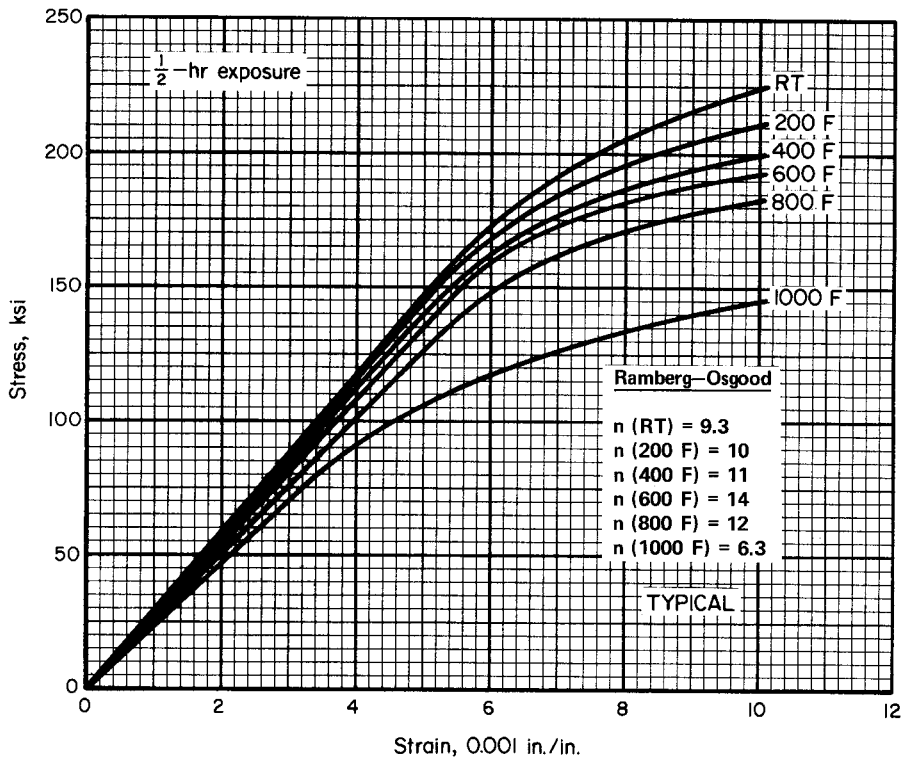

Figure 2.6.8.1.6(b). Typical compressive stress-strain curves at various temperatures for PH15-7Mo (TH1050) stainless steel sheet.

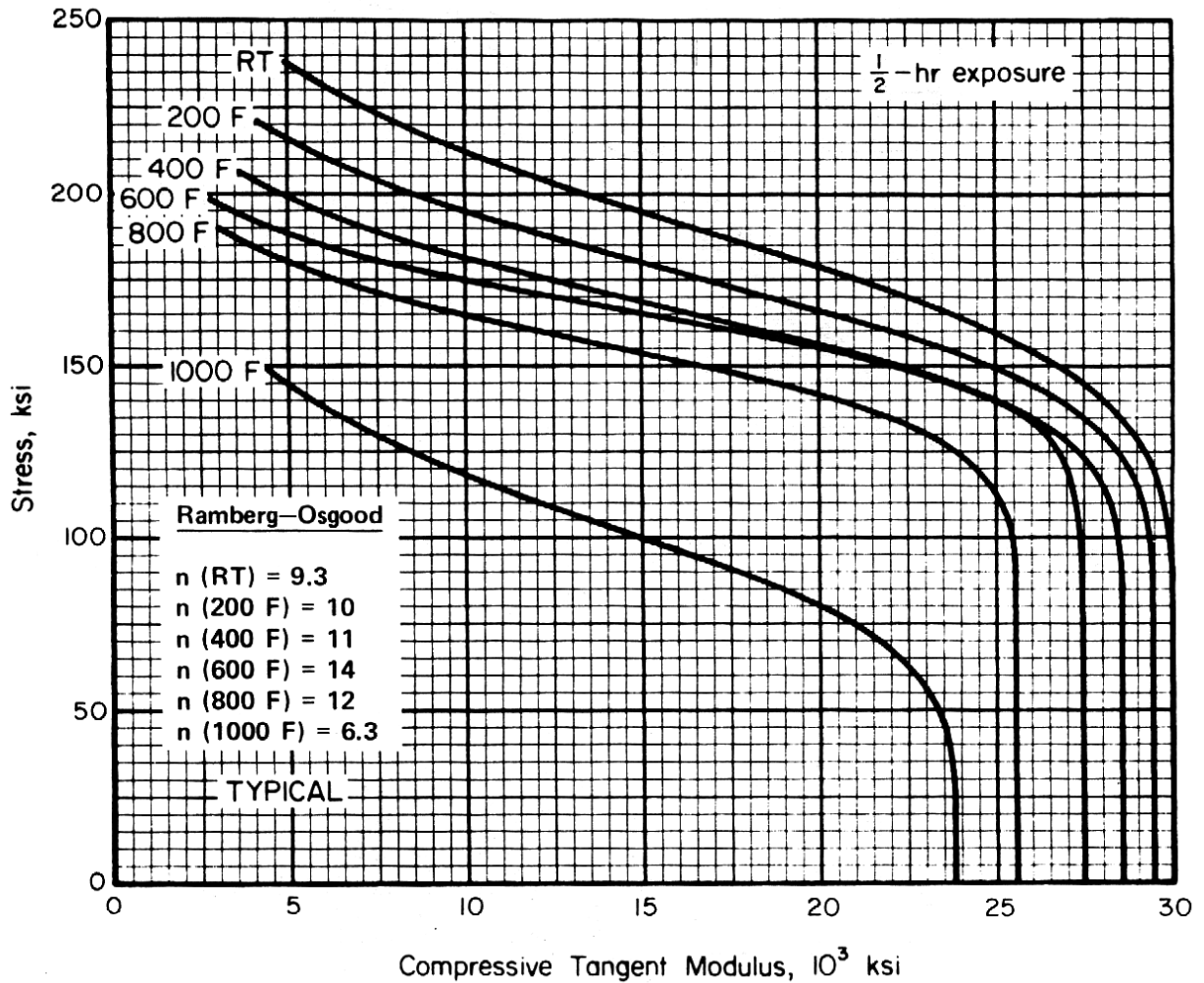

Figure 2.6.8.1.6(c). Typical compressive tangent-modulus curves at various temperatures for PH15-7Mo (TH1050) stainless steel sheet.

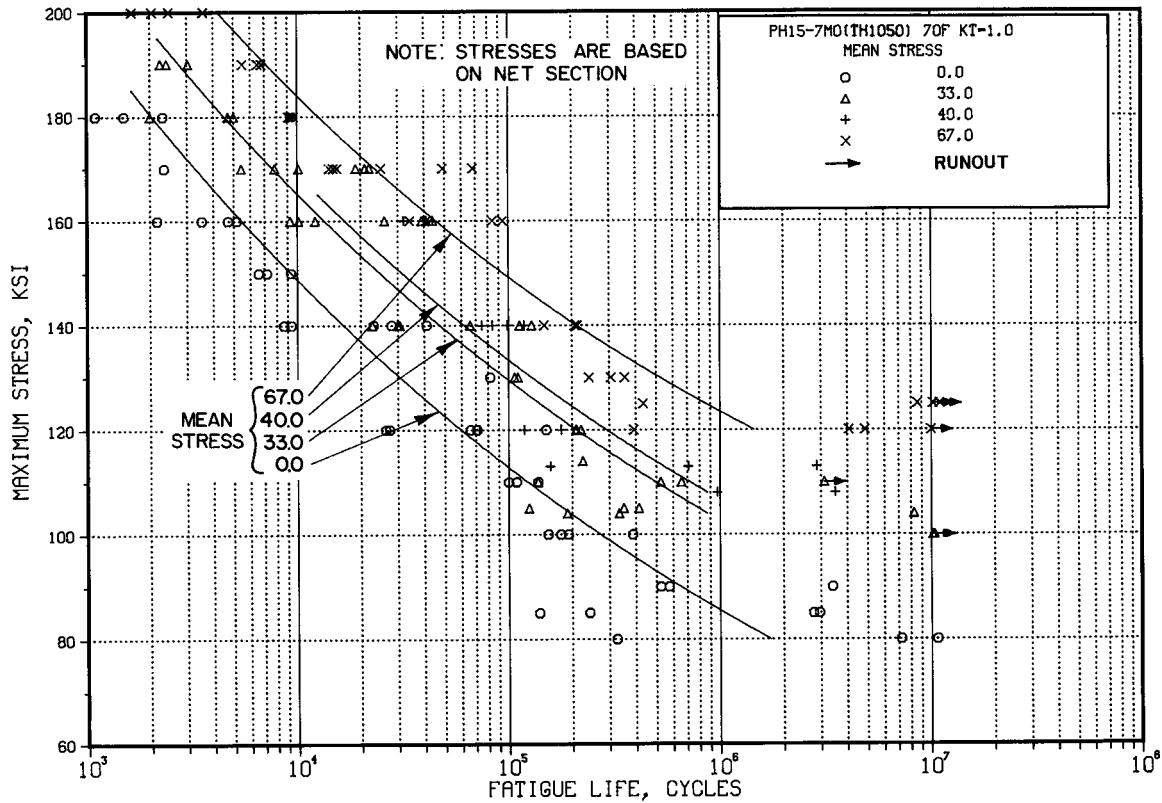

Figure 2.6.8.1.8(a). Best-fit S/N curves for unnotched PH15-7Mo (TH1050) sheet, longitudinal direction.

Correlative Information for Figure 2.6.8.1.8(a)

Product Form: Sheet, 0.025 inch

Test Parameters:

Properties: TUS, ksi TYS, ksi Temp., °F
201 196 RT

Loading - Axial
Frequency - 24 and 1800 cpm
Temperature - RT
Environment - Air

Specimen Details: Unnotched
2.0 inch gross width
0.75 inch net width

No. of Heats/Lots: Not specified

Surface Condition: Specimen edges machined in longitudinal direction, edges polished with 320 grit emery paper

Equivalent Stress Equation:
 $\log N_f = 23.24 - 8.32 \log S_{eq}$
 $S_{eq} = S_{max} (1-R)^{0.47}$
Std. Error of Estimate, $\log(\text{Life}) = 0.35$
Standard Deviation, $\log(\text{Life}) = 0.94$
 $R^2 = 86\%$

References: 2.6.8.1.8(a) and (b)

Sample Size: 124

[Caution: The equivalent stress model may provide unrealistic life predictions for stress ratios beyond those represented above.]

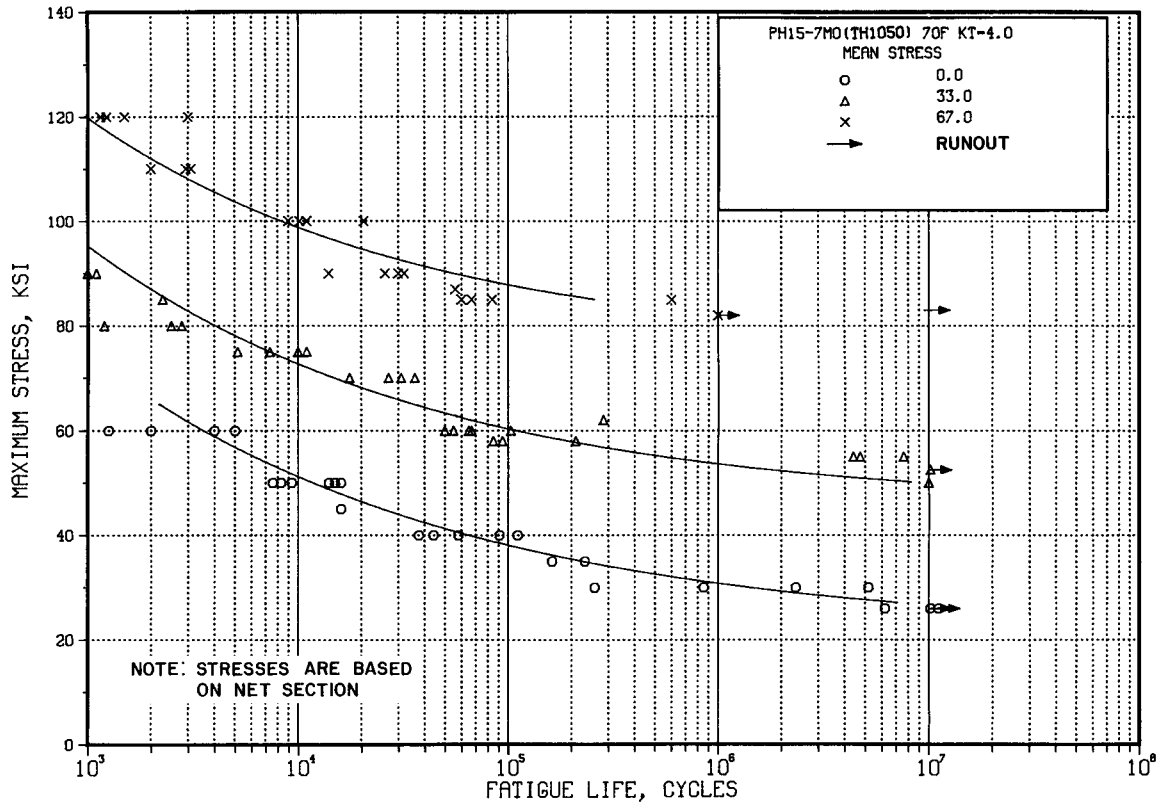

Figure 2.6.8.1.8(b). Best-fit S/N curves for notched, $K_t = 4.0$, PH15-7Mo (TH1050) sheet, longitudinal direction.

Correlative Information for Figure 2.6.8.1.8(b)

Product Form: Sheet, 0.025-inch

Test Parameters:

Properties: TUS, ksi TYS, ksi Temp., °F
 201 196 RT

Loading - Axial
Frequency - 24 and 1800 cpm
Temperature - RT
Environment - Air

Specimen Details: Edge Notched, $K_t = 4.0$
2.25 inch gross width
1.50 inch net width
0.058 inch notch radius
0° flank angle, ω

No. of Heats/Lots: Not specified

Surface Condition: Drilled holes near edges
and slots milled from
edge, corners of notch were
beveled with rubber abrasive

Equivalent Stress Equation:
 $\log N_f = 10.42 - 3.91 \log (S_{eq} - 32)$
 $S_{eq} = S_{max} (1 - R)^{0.58}$
Std. Error of Estimate, $\log (\text{Life}) = 0.36$
Standard Deviation, $\log (\text{Life}) = 1.07$
 $R^2 = 89\%$

Sample Size: 74

Reference: 2.6.8.1.8(b)

[Caution: The equivalent stress model may provide unrealistic life predictions for stress ratios beyond those represented above.]

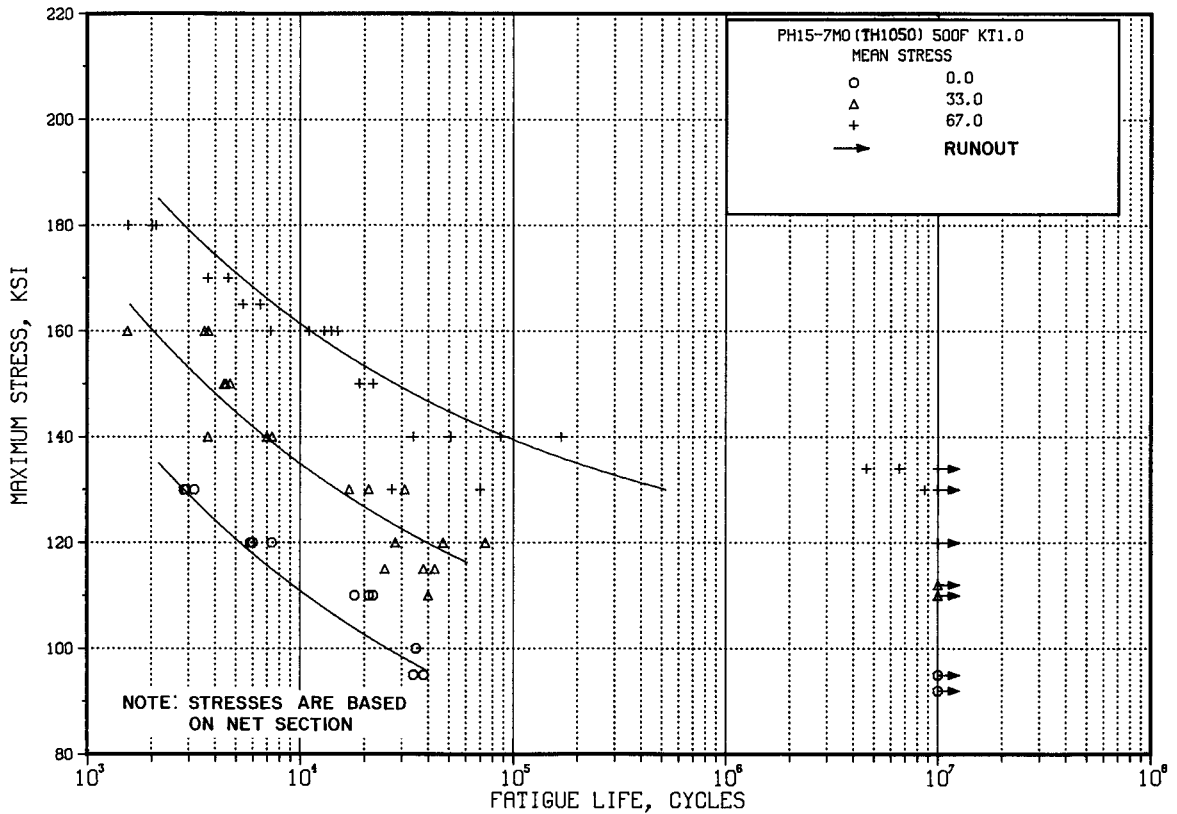

Figure 2.6.8.1.8(c). Best-fit S/N curves for unnotched PH15-7Mo (TH1050) sheet at 500°F, longitudinal direction.

Correlative Information for Figure 2.6.8.1.8(c)

Product Form: Sheet, 0.025 inch

Properties:

TUS, ksi	TYS, ksi	Temp., °F
201	196	RT
179	173	500

Specimen Details: Unnotched
2.0 inch gross width
0.75 inch net width

Surface Condition: Machined in longitudinal direction, edges polished with 320 grit emery paper

Reference: 2.6.8.1.8(b)

Test Parameters:

Loading - Axial
Frequency - 24 and 1800 cpm
Temperature - 500°F
Environment - Air

No. of Heats/Lots: Not specified

Equivalent Stress Equation:

$\log N_f = 11.71 - 4.00 \log (S_{eq} - 96)$
 $S_{eq} = S_{max} (1 - R)^{0.70}$
 Std. Error of Estimate, $\log (\text{Life}) = 0.44$
 Standard Deviation, $\log (\text{Life}) = 0.79$
 $R^2 = 69\%$

Sample Size: 55

[Caution: The equivalent stress model may provide unrealistic life predictions for stress ratios beyond those represented above.]

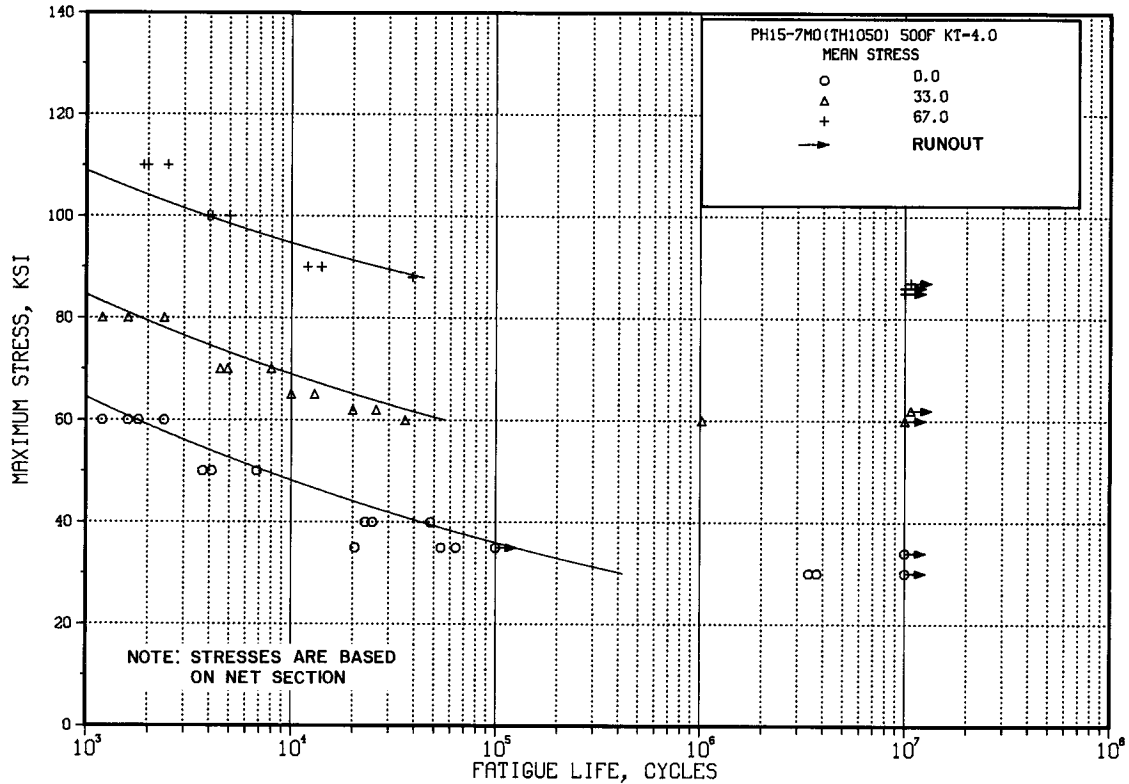

Figure 2.6.8.1.8(d). Best-fit S/N curves for notched, $K_t = 4.0$, PH15-7Mo (TH1050) sheet at 500°F, longitudinal direction.

Correlative Information for Figure 2.6.8.1.8(d)

Product Form: Sheet, 0.025 inch

Test Parameters:

Properties:

TUS, ksi	TYS, ksi	Temp., °F
201	196	RT
179	173	500

Loading - Axial
Frequency - 24 and 1800 cpm
Temperature - 500°F
Environment - Air

Specimen Details: Edge Notched, $K_t = 4.0$
2.25 inch gross width
1.50 inch net width
0.058 inch notch radius
0° flank angle, ω

No. of Heats/Lots: Not specified

Surface Condition: Drilled holes near edges and slots milled from edge, corners of notch were beveled with rubber abrasive

Equivalent Stress Equation:
 $\log N_f = 18.60 - 7.92 \log (S_{eq})$
 $S_{eq} = S_{max} (1-R)^{0.55}$
Std. Error of Estimate, $\log (\text{Life}) = 0.41$
Standard Deviation, $\log (\text{Life}) = 0.86$
 $R^2 = 77\%$

Sample Size: 37

Reference: 2.6.8.1.8(b)

[Caution: The equivalent stress model may provide unrealistic life predictions for stress ratios beyond those represented above.]

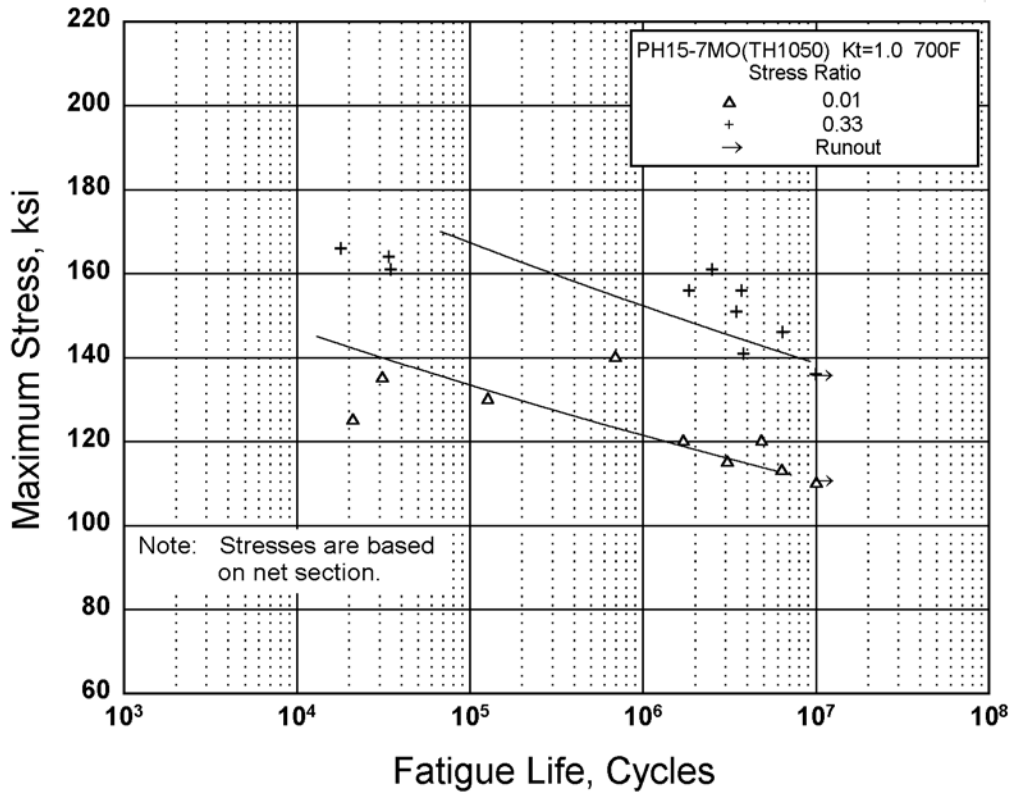

Figure 2.6.8.1.8(e). Best-fit S/N curves for PH15-7Mo (TH1050) sheet at 700°F, transverse direction.

Correlative Information for Figure 2.6.8.1.8(e)

Product Form: Sheet, 0.050 inch

Properties: TUS, ksi 175 TYS, ksi 161 Temp., °F 700 (LT)

Specimen Details: Unnotched
2.0 inch gross width
0.375 inch net width

Surface Condition: Polished in longitudinal direction with wet 600 grit silicon carbide paper

Reference: 2.6.8.1.8(c)

Test Parameters:

Loading - Axial
Frequency - 1200 cpm
Temperature - 700°F
Environment - Air

No. of Heats/Lots: Not specified

Equivalent Stress Equation:

$\log N_f = 56.92 - 24.46 \log (S_{eq})$
 $S_{eq} = S_{max} (1-R)^{0.58}$
 Std. Error of Estimate, Log (Life) = 0.77
 Standard Deviation, Log (Life) = 0.99
 $R^2 = 39\%$

Sample Size: 17

[Caution: The equivalent stress model may provide unrealistic life predictions for stress ratios beyond those represented above.]

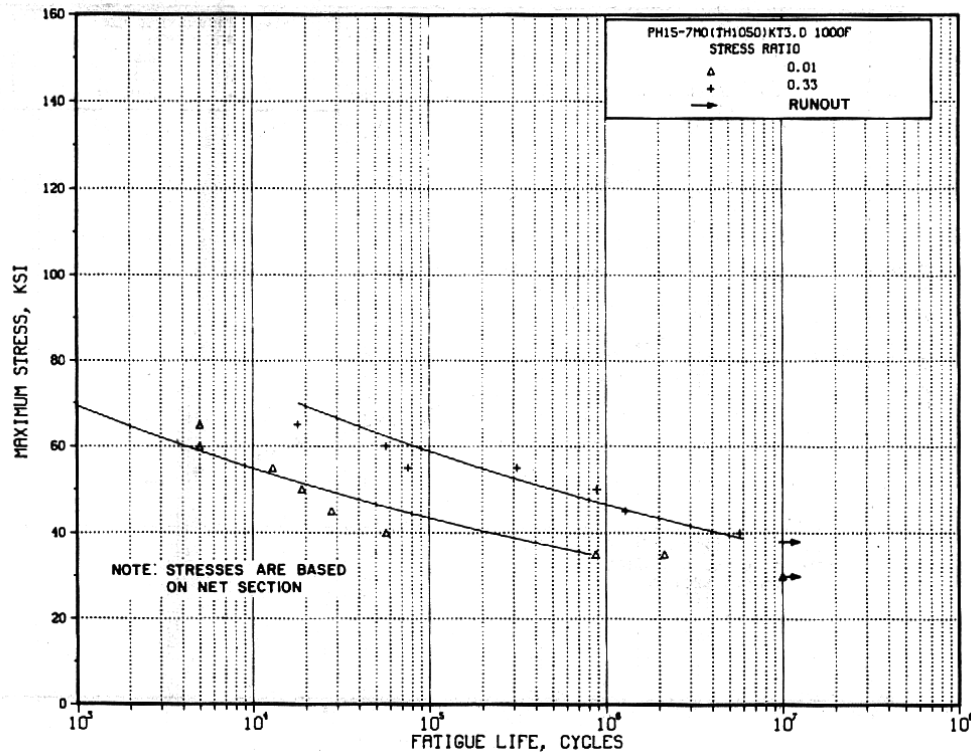

Figure 2.6.8.1.8(f). Best-fit S/N curves for notched, $K_t = 3.0$, PH15-7Mo (TH1050) sheet at 1000°F, transverse direction.

Correlative Information for Figure 2.6.8.1.8(f)

Product Form: Sheet, 0.050 inch

Test Parameters:

Properties: TUS, ksi 107
TYS, ksi 92
Temp., °F 1000 (LT)

Loading - Axial
Frequency - 1200 cpm
Temperature - 1000°F
Environment - Air

Specimen Details: Edge Notched, $K_t = 3.0$
0.535 inch gross width
0.375 inch net width
0.021 inch notch radius
60° flank angle, ω

No. of Heats/Lots: Not specified

Surface Condition: Polished longitudinally

Equivalent Stress Equation:

$$\log N_f = 21.00 - 9.80 \log (S_{eq})$$

$$S_{eq} = S_{max} (1-R)^{0.78}$$

Std. Error of Estimate, Log (Life) = 0.33

Standard Deviation, Log (Life) = 0.99

$R^2 = 89\%$

Reference: 2.6.8.1.8(c)

Sample Size: 16

[Caution: The equivalent stress model may provide unrealistic life predictions for stress ratios beyond those represented above.]

2.6.9 17-4PH

2.6.9.0 Comments and Properties — Alloy 17-4PH is a precipitation-hardening, martensitic stainless steel used for parts requiring high strength and good corrosion and oxidation resistance up to 600°F. The alloy is available in all product forms.

Manufacturing Considerations — 17-4PH is readily forged, machined, welded, and brazed. Machining requires the same precautions as the austenitic stainless steels except that work-hardening is not a problem. Best machinability is exhibited by Conditions H1150 and H1150M. A dimensional contraction of 0.0004 to 0.0006 and 0.0008 to 0.0010 in./in. occurs upon hardening to the H900 and H1150 conditions, respectively. This fact should be considered before finish machining prior to aging treatment.

When permanent deformation is performed, such as cold straightening of hardened parts, reaging is recommended to minimize internal stresses.

Alloy 17-4PH can be fusion welded with any of the normal processes using 17-4PH filler metal without preheat. For details up to ½-inch thickness, Condition A is satisfactory prior to welding, but for heavy sections, an overaged condition (H1150) is recommended to preclude cracking. After welding, weldments should be aged or solution treated and aged.

Alloy 17-4PH castings are produced in sand molds, investment molds, and by centrifugal casting. While 17-4PH has good castability, it is subject to hot-tearing, so heavy X or T sections, sharp corners, and abrupt changes in section size should be avoided. Alloy 17-4PH castings are susceptible to microshrinkage which will decrease the ductility but have no effect on the yield or ultimate strength. During heat treatment, care must be exercised to avoid carbon or nitrogen contamination from furnace atmospheres. Combusted hydrocarbon and dissociated ammonia atmospheres have been sources of contamination. Air is commonly used and both vacuum and dry argon are effective for minimizing scaling. Oxides formed during solution treating in air may be removed by grit blasting or abrasive tumbling.

Alloy 17-4PH can be heat treated to develop a wide range of properties. Heat treatment procedures are specified in applicable material specifications and MIL-H-6875.

Design and Environmental Considerations — For tensile applications where stress corrosion is a possibility, 17-4PH should be aged at the highest temperature compatible with strength requirements and at a temperature not lower than 1025°F for 4 hours minimum.

The impact strength of 17-4PH, especially large size bar in the H900 and H925 conditions, may be very low at subzero temperatures; consequently, the use of 17-4PH for critical applications at low temperatures should be avoided. For non-impact applications, such as valve seats, parts in the H925 condition have performed satisfactorily down to -320°F. The H1100 and H1150 conditions have improved impact strength so that parts made from small diameter bar can be used down to -100°F with low risk. For critical low temperature applications, a similar alloy, 15-5PH (consumable electrode vacuum melted), should be used instead of 17-4PH because of its superior impact strength at low temperature.

Specifications and Properties — Material specifications for 17-4PH are presented in Table 2.6.9.0(a). Room temperature mechanical and physical properties for various conditions of 17-4PH products are presented in Table 2.6.9.0(b) through (f). The physical properties of this alloy at room and elevated temperatures are presented in Figure 2.6.9.0.

Table 2.6.9.0(a). Material Specifications for 17-4PH Stainless Steel

Specification	Form
AMS 5604	Sheet, strip, and plate
AMS 5643	Bar, forging, and ring
AMS 5342	Investment casting (H1100)
AMS 5343	Investment casting (H1000)
AMS 5344	Investment casting (H900)

2.6.9.1 H900 Condition — Elevated temperature curves for various mechanical properties are presented in Figures 2.6.9.1.2 through 2.6.9.1.4. Unnotched and notched fatigue information at room temperature is presented in Figures 2.6.9.1.8(a) through (c).

2.6.9.2 Various Heat Treat Conditions — Elevated temperature curves for tensile yield and ultimate strengths are depicted in Figure 2.6.9.2.1. Room temperature stress-strain and tangent-modulus curves are shown in Figures 2.6.9.2.6(a) and (b).

2.6.9.3 H1000 Condition — Room temperature stress-strain and tangent-modulus curves for castings are shown in Figures 2.6.9.3.6(a) and (b).

2.6.9.4 H1025 Condition — Notched fatigue information is presented in Figure 2.6.9.4.8 for bar.

2.6.9.5 H1100 Condition — Notched fatigue information is presented in Figure 2.6.9.5.8 for bar.

2.6.9.6 H1150 Condition — Elevated temperature curves for tensile yield and ultimate strengths are shown in Figure 2.6.9.6.1.

Table 2.6.9.0(b). Design Mechanical and Physical Properties of 17-4PH Stainless Steel Sheet, Strip, and Plate

Specification	AMS 5604					
	Sheet, strip ^a , and plate					
Form	H900	H925	H1025	H1075	H1100	H1150
Condition	≤ 4.000					
Thickness, in.						
Basis	S	S	S	S	S	S
Mechanical Properties:						
F_{tu} , ksi:						
L
LT	190	170	155	145	140	135
F_{ty} , ksi:						
L
LT	170	155	145	125	115	105
F_{cy} , ksi:						
L
LT
F_{su} , ksi
F_{bru} , ksi:						
(e/D = 1.5)
(e/D = 2.0)
F_{bry} , ksi:						
(e/D = 1.5)
(e/D = 2.0)
e , percent:						
LT	b	b	b	b	b	b
E , 10 ³ ksi	28.5					
E_c , 10 ³ ksi	30.0					
G , 10 ³ ksi	11.2					
μ	0.27					
Physical Properties:						
ω , lb/in. ³	0.282 (H900), 0.283 (H1075), 0.284 (H1150)					
C , K , and α	See Figure 2.6.9.0					

- a Test direction longitudinal for widths less than 9 inches; long transverse for widths 9 inches and over.
b See Table 2.6.9.0(c).

Table 2.6.9.0(c). Minimum Elongation Values for 17-4PH Sheet, Strip, and Plate

Thickness	e, percent (LT)					
	H900	H925	H1025	H1075	H1100	H1150
0.015 through 0.186	5	5	5	5	5	8
0.187 through 0.625	8	8	8	9	10	10
0.626 through 4.000	10	10	12	13	14	16

Table 2.6.9.0(d). Design Mechanical and Physical Properties of 17-4PH Stainless Steel Forging, Tubing, and Rings

Specification	AMS 5643						
Form	Forging, tubing, and rings						
Condition	H900	H925	H1025	H1075	H1100	H1150	H1150M ^a
Thickness, in.	<8.000						
Basis	S	S	S	S	S	S	S
Mechanical Properties:							
F_{tu} , ksi:							
L	190	170	155	145	140	135	115
T
F_{ty} , ksi:							
L	170	155	145	125	115	105	75
T
F_{cy} , ksi:							
L
T
F_{su} , ksi
F_{bru} , ksi:							
(e/D = 1.5)
(e/D = 2.0)
F_{bry} , ksi:							
(e/D = 1.5)
(e/D = 2.0)
e , percent:							
L	10	10	12	13	14	16	18
E , 10 ³ ksi	28.5						
E_c , 10 ³ ksi	30.0						
G , 10 ³ ksi	11.2						
μ	0.27						
Physical Properties:							
ω , lb/in. ³	0.282 (H900), 0.283 (H1075), 0.284 (H1150)						
C , K , and α	See Figure 2.6.9.0						

a Not covered by AMS 5643. S values are producers' guaranteed minimum tensile properties.

Table 2.6.9.0(e). Design Mechanical and Physical Properties of 17-4PH Stainless Steel Bar

Specification	AMS 5643										
	Bar										
	H900	H925	H1025	H1075	H1100	H1150	H1150M ^a				
	<8.000										
Basis	A	B	A	B	S	A	B	S	A	B	S ^a
Mechanical Properties: ^b											
F_{tu} , ksi:											
L	190	195	170	178	155	143	150	140	125	134	115
T
F_{ty} , ksi:											
L	170	175	155 ^c	167	145	125 ^d	143	115	100	115	75
T
F_{cy} , ksi:											
L	170	175	139	90	104	...
T
F_{su} , ksi	123	126	95	79	85	...
F_{bru} , ksi:											
(e/D = 1.5)	313	322	263 ^e	213 ^e	228 ^e	...
(e/D = 2.0)	380	390	332 ^e	270 ^e	289 ^e	...
F_{bry} , ksi:											
(e/D = 1.5)	255	262	211 ^e	152 ^e	175 ^e	...
(e/D = 2.0)	280	288	250 ^e	181 ^e	208 ^e	...
e , percent (S-basis):											
L	10	...	10	...	12	13	...	14	16	...	18
E , 10 ³ ksi	28.5										
E_c , 10 ³ ksi	30.0										
G , 10 ³ ksi	11.2										
μ	0.27										
Physical Properties:											
ω , lb/in. ³	0.282 (H900), 0.283 (H1075), 0.284 (H1150)										
C , K , and α	See Figure 2.6.9.0										

- a Not covered by AMS 5643. S values are producer's guaranteed minimum tensile properties.
- b Design allowables were based upon data from samples of material, supplied in the solution treated condition, which were aged to demonstrate response to heat treatment by suppliers.
- c S-basis. Rounded T_{99} value = 157 ksi.
- d S-basis. Rounded T_{99} value = 136 ksi.
- e Bearing values are "dry pin" values per Section 1.4.7.1.

Table 2.6.9.0(f). Design Mechanical and Physical Properties of 17-4PH Stainless Steel Investment Casting

Specification	AMS 5344	AMS 5343	AMS 5342
Form	Investment Casting		
Condition	^a	H1000 ^b	H1100 ^c
Location within casting	Any area		
Basis	S	S	S
Mechanical Properties^d:			
F_{tu} , ksi	180	150	130
F_{ty} , ksi	160	130	120
F_{cy} , ksi	132	...
F_{su} , ksi	98	...
F_{bru}^e , ksi:			
($e/D = 1.5$)	254	...
($e/D = 2.0$)	329	...
F_{bry}^e , ksi:			
($e/D = 1.5$)	189	...
($e/D = 2.0$)	222	...
e , percent	4	4	6
RA , percent	12	12	15
E , 10^3 ksi	28.5		
E_c , 10^3 ksi	30.0		
G , 10^3 ksi	12.7		
μ	0.27		
Physical Properties:			
ω , lb/in. ³	0.282 (H900)		
C , K , and α	See Figure 2.6.9.0		

- a Aged at 900 to 925°F for 90 minutes.
- b Aged at 985 to 1015°F for 90 minutes.
- c Aged at 1085 to 1115°F for 90 minutes.
- d Properties apply only when drawing specifies that conformance to tensile property requirements will be determined from specimens cut from casting or integrally cast specimens.
- e Bearing values are “dry pin” values per Section 1.4.7.1.

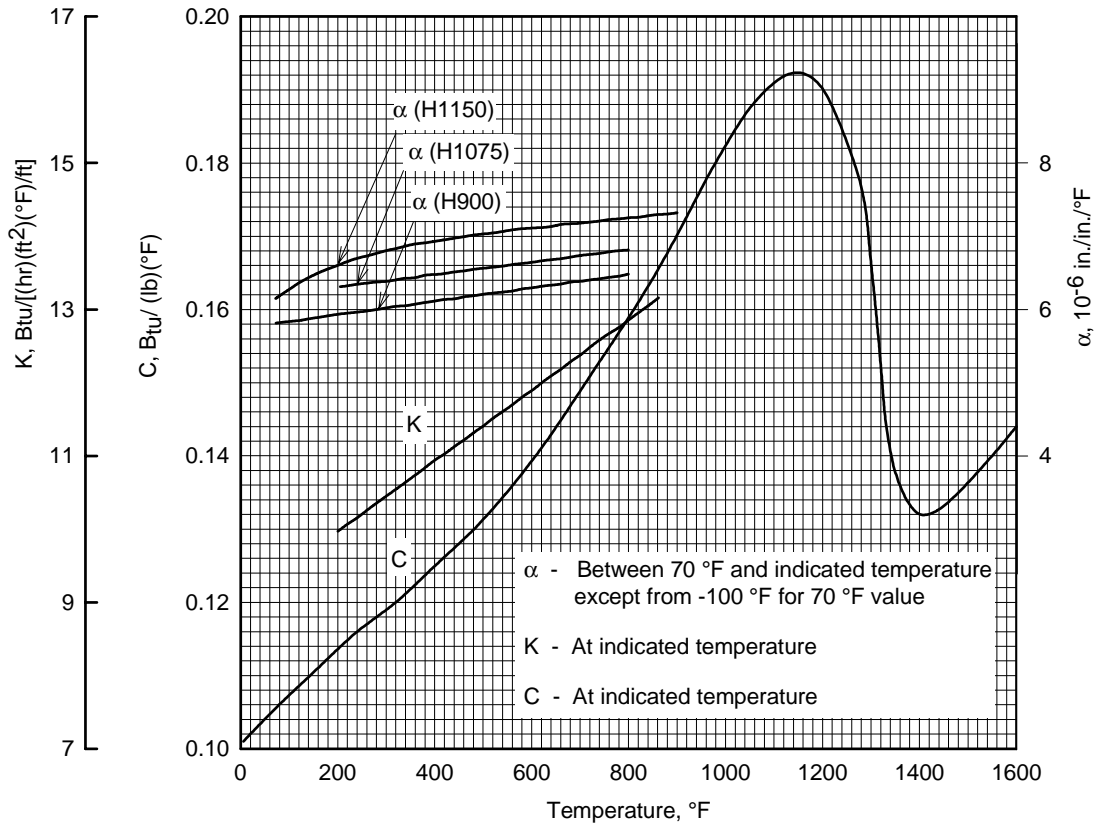

Figure 2.6.9.0. Effect of temperature on the physical properties of 17-4PH stainless steel.

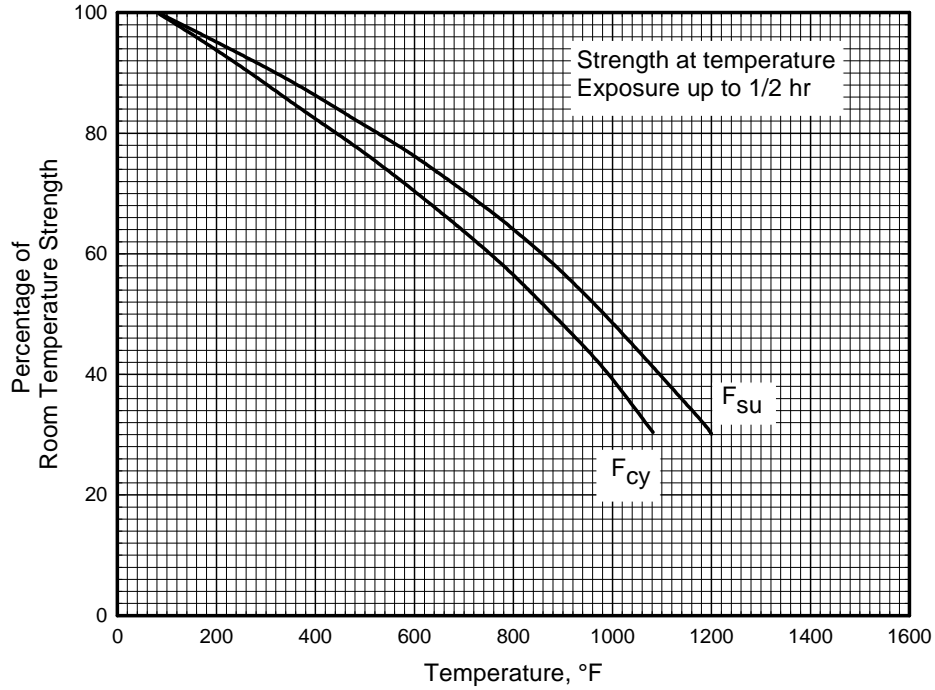

Figure 2.6.9.1.2. Effect of temperature on the compressive yield strength (F_{cy}) and the shear ultimate strength (F_{su}) of 17-4PH (H900) stainless steel bar and forging.

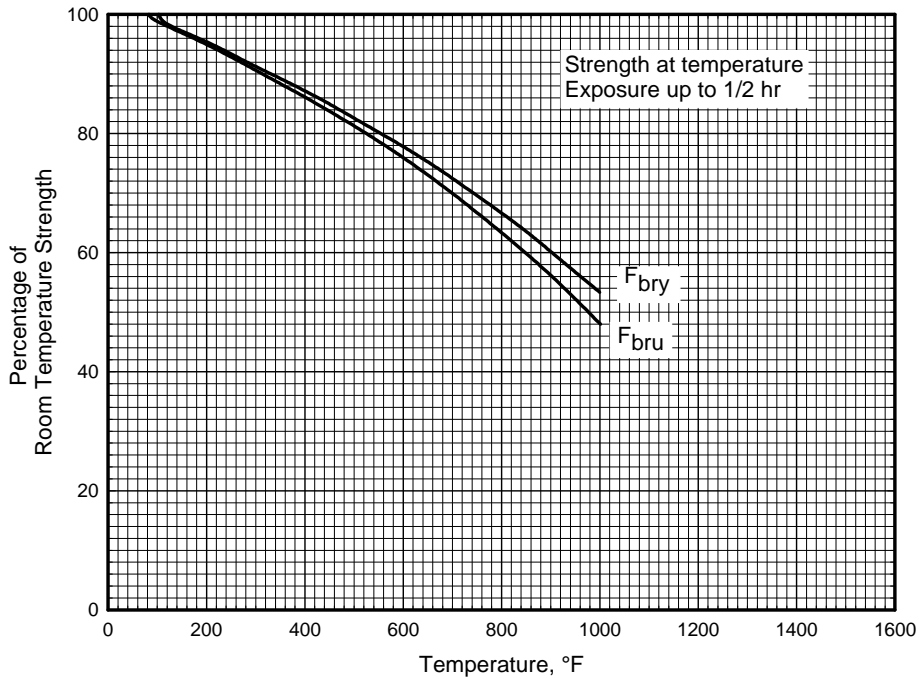

Figure 2.6.9.1.3. Effect of temperature on the bearing ultimate strength (F_{bru}) and the bearing yield strength (F_{bry}) of 17-4PH (H900) stainless steel bar and forging.

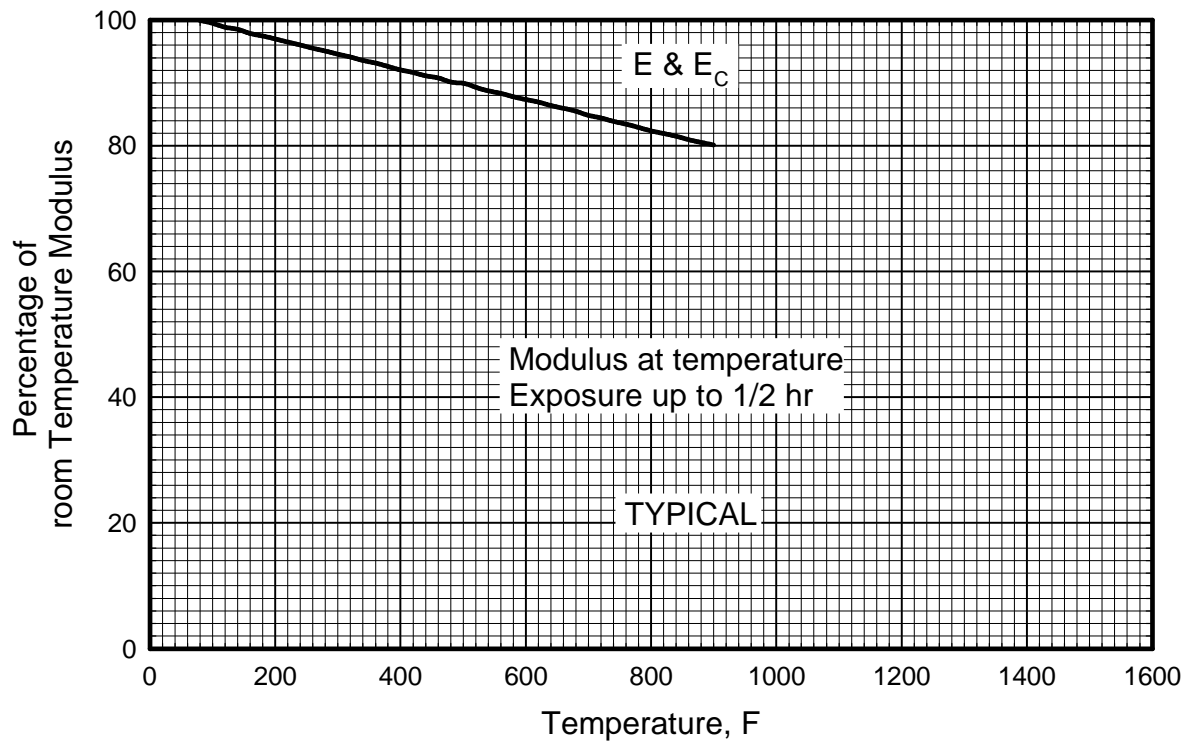

Figure 2.6.9.1.4. Effect of temperature on the tensile and compressive moduli (E and E_c) of 17-4PH (H900) stainless steel bar and forging.

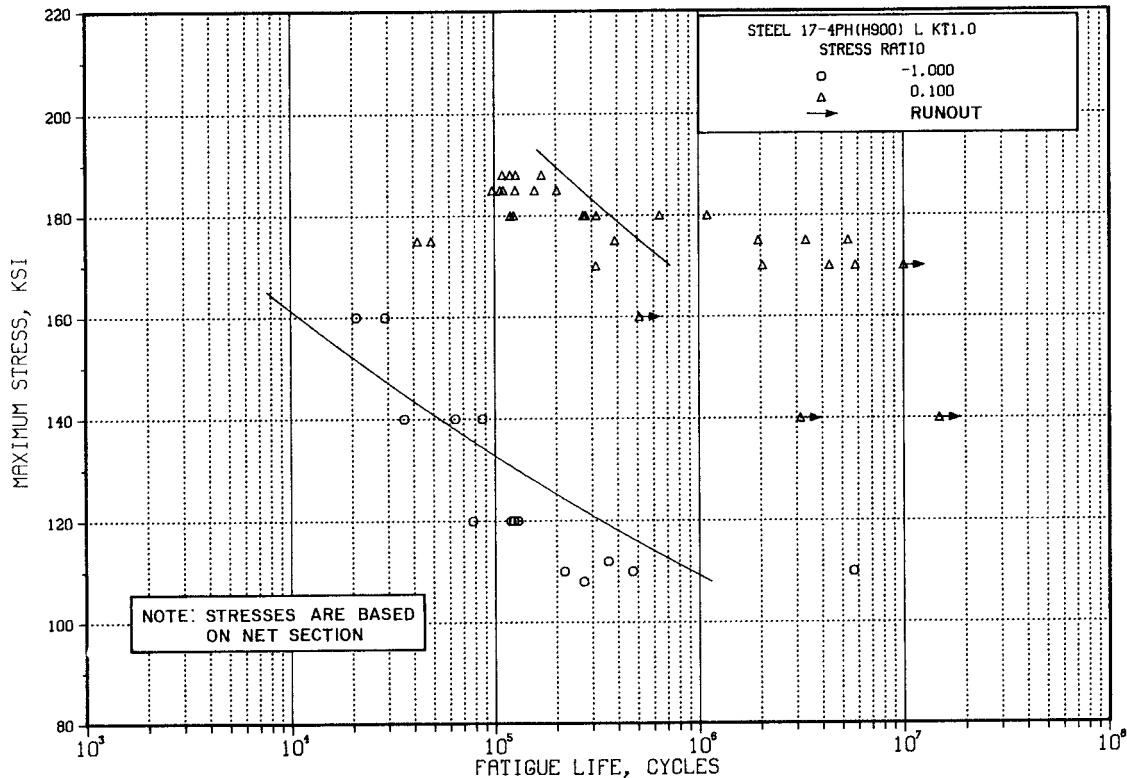

Figure 2.6.9.1.8(a). Best-fit S/N curves for unnotched 17-4PH (H900) bar, longitudinal direction.

Correlative Information for Figure 2.6.9.1.8(a)

Product Form: Bar, 1 inch and 1.125 inch diameter

Test Parameters:

Loading - Axial
Frequency - 1800 cpm
Temperature - RT
Environment - Air

Properties: TUS, ksi TYS, ksi Temp., °F
202 195 RT

Specimen Details: Unnotched
1.25 inch gross diameter
0.252 inch net diameter

No. of Heats/Lots: Not specified

Surface Condition: Polished

Equivalent Stress Equation:

$\log N_f = 30.6 - 11.2 \log (S_{eq})$
 $S_{eq} = S_{max} (1-R)^{0.52}$
Std. Error of Estimate, $\log (\text{Life}) = 0.531$
Standard Deviation, $\log (\text{Life}) = 0.672$
 $R^2 = 38\%$

References: 2.6.9.1.8(a)

Sample Size: = 42

[Caution: The equivalent stress model may provide unrealistic life predictions for stress ratios beyond those represented above.]

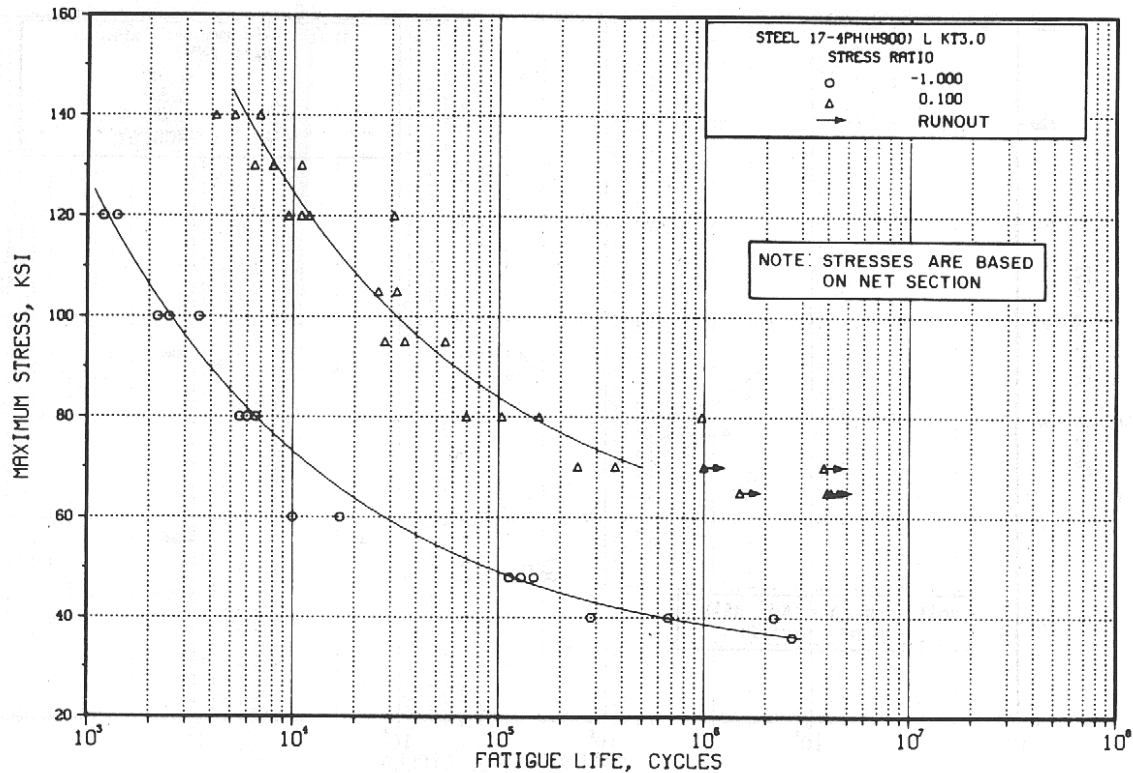

Figure 2.6.9.1.8(b). Best-fit S/N curves for notched, $K_t = 3.0$, 17-4PH (H900) bar, longitudinal direction.

Correlative Information for Figure 2.6.9.1.8(b)

Product Form: Bar, 1 inch and 1.125 inch diameter

Test Parameters:

Properties: TUS, ksi TYS, ksi Temp., °F
 202 195 RT

Loading - Axial
Frequency - Not specified
Temperature - RT
Environment - Air

Specimen Details: Circumferential V-Groove,
 $K_t = 3.0$

No. of Heats/Lots: Not specified

Gross diameter	Net diameter	Notch radius
<u>inches</u>	<u>inches</u>	<u>inches</u>
0.430	0.300	0.016
0.357	0.252	0.013

Equivalent Stress Equation:
 $\log N_f = 9.10 - 2.79 \log (S_{eq} - 48.4)$
 $S_{eq} = S_{max} (1-R)^{0.67}$
Std. Error of Estimate, $\log (\text{Life}) = 0.235$
Standard Deviation, $\log (\text{Life}) = 0.897$
 $R^2 = 93\%$

60° flank angle, ω

Sample Size: 39

Surface Condition: Polished

Reference: 2.6.9.1.8(a)

[Caution: The equivalent stress model may provide unrealistic life predictions for stress ratios beyond those represented above.]

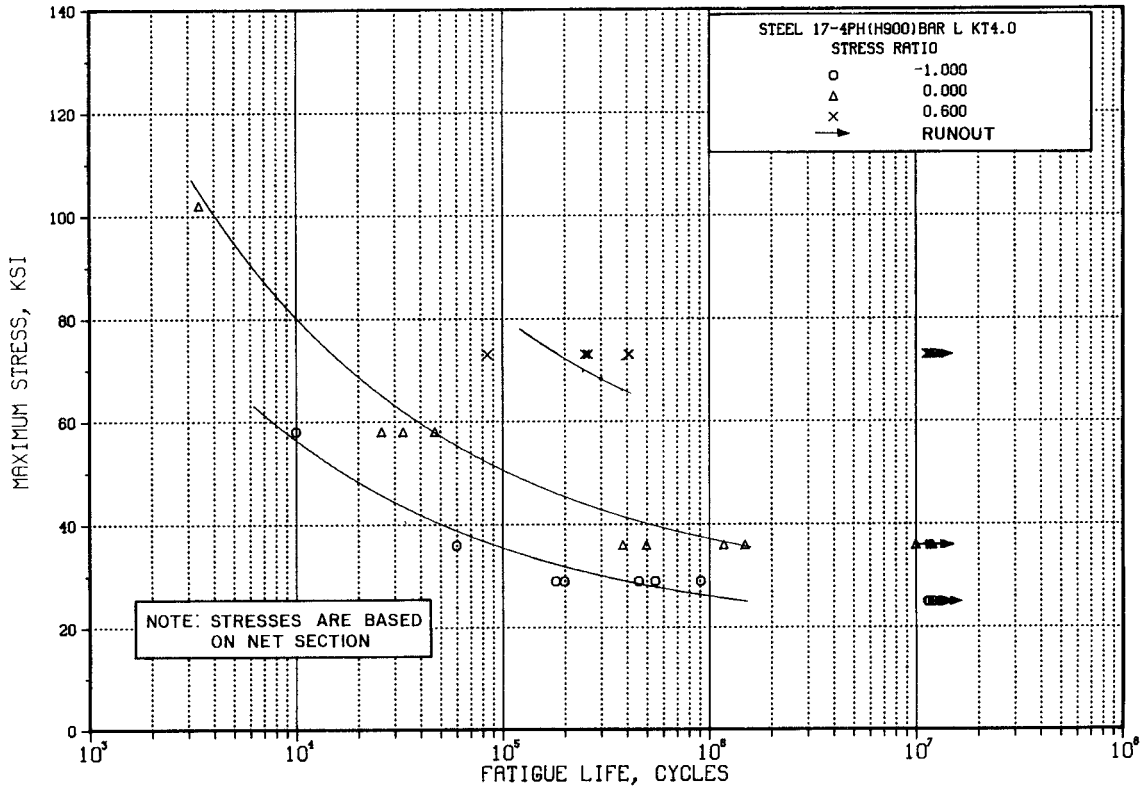

Figure 2.6.9.1.8(c). Best-fit S/N curves for notched, $K_t = 4.0$, 17-4PH (H900) bar, longitudinal direction.

Correlative Information for Figure 2.6.9.1.8(c)

Product Form: Bar, 0.787 inch diameter, vacuum melted

Test Parameters:
Loading - Axial
Frequency - 2000 cpm
Temperature - RT
Environment - Air

Properties: TUS, ksi 207 TYS, ksi — Temp., °F RT

Specimen Details: Circumferential
V-Groove, $K_t = 4.0$
0.492 inch gross diameter
0.256 inch net diameter
0.008 inch notch radius, n
60° flank angle, ω

No. of Heats/Lots: 1

Equivalent Stress Equation:
 $\log N_f = 9.03 - 2.91 \log (S_{eq} - 26.1)$
 $S_{eq} = S_{max} (1-R)^{0.51}$
Std. Error of Estimate, $\log (\text{Life}) = 0.345$
Standard Deviation, $\log (\text{Life}) = 0.812$
 $R^2 = 82\%$

Surface Condition: Machined and aged

Sample Size: = 22

Reference: 2.6.9.1.8(b)

[Caution: The equivalent stress model may provide unrealistic life predictions for stress ratios beyond those represented above.]

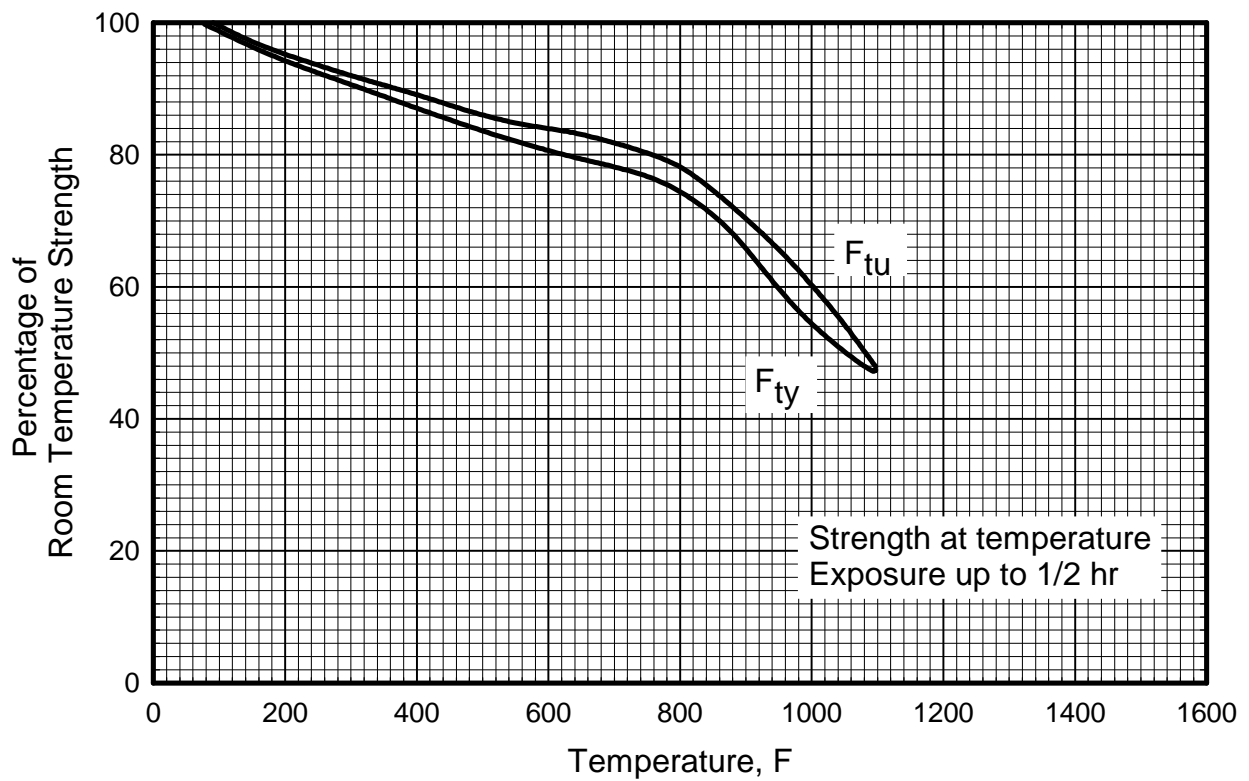

Figure 2.6.9.2.1. Effect of temperature on the tensile ultimate strength (F_{tu}) and the tensile yield strength (F_{ty}) of 17-4PH (H900, H925, H1025, and H1075) stainless steel bar.

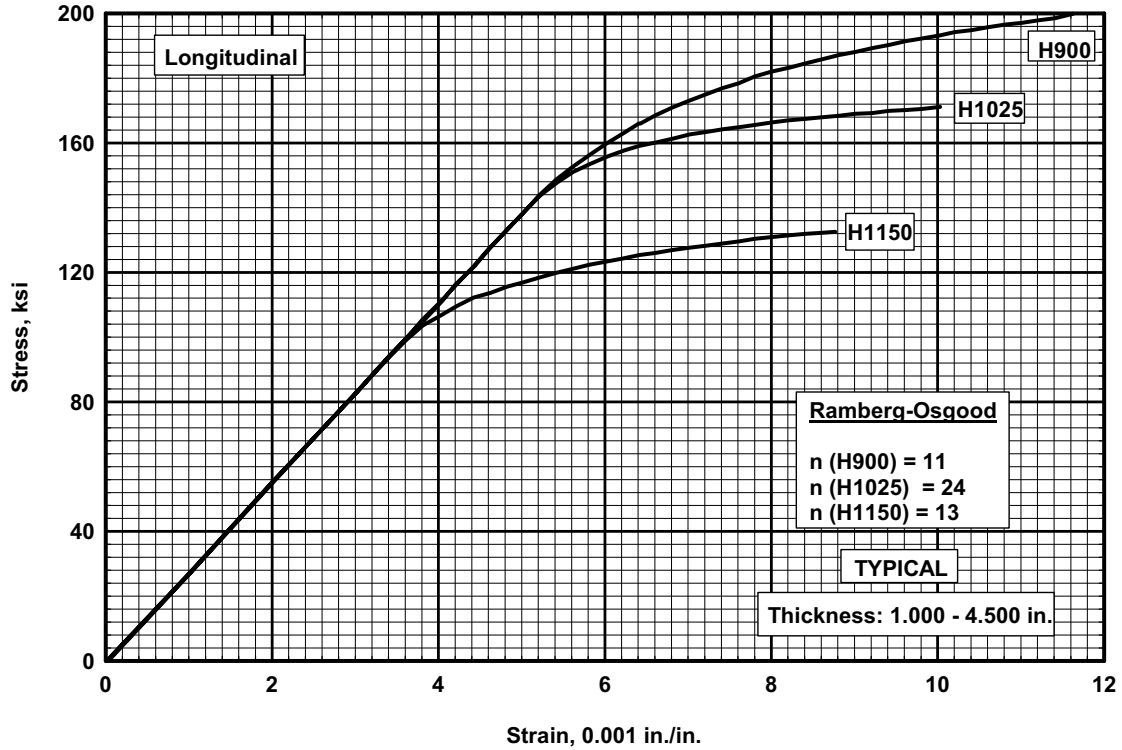

Figure 2.6.9.2.6(a). Typical tensile stress-strain curves at room temperature for various heat treated conditions of 17-4PH stainless steel bar.

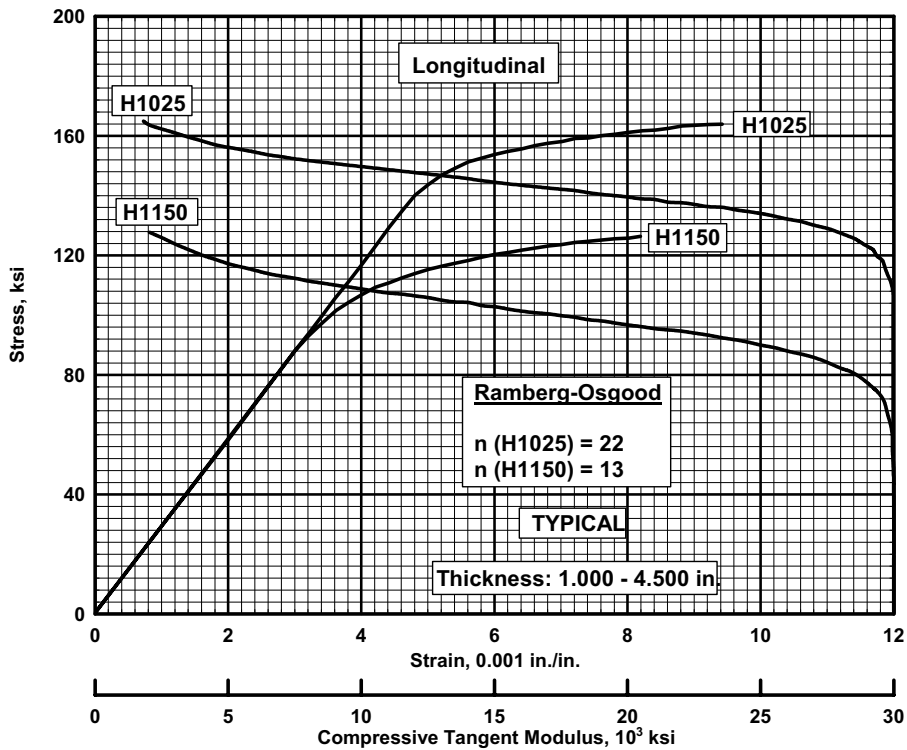

Figure 2.6.9.2.6(b). Typical compressive stress-strain and compressive tangent-modulus curves at room temperature for various heat treated conditions of 17-4PH stainless steel bar.

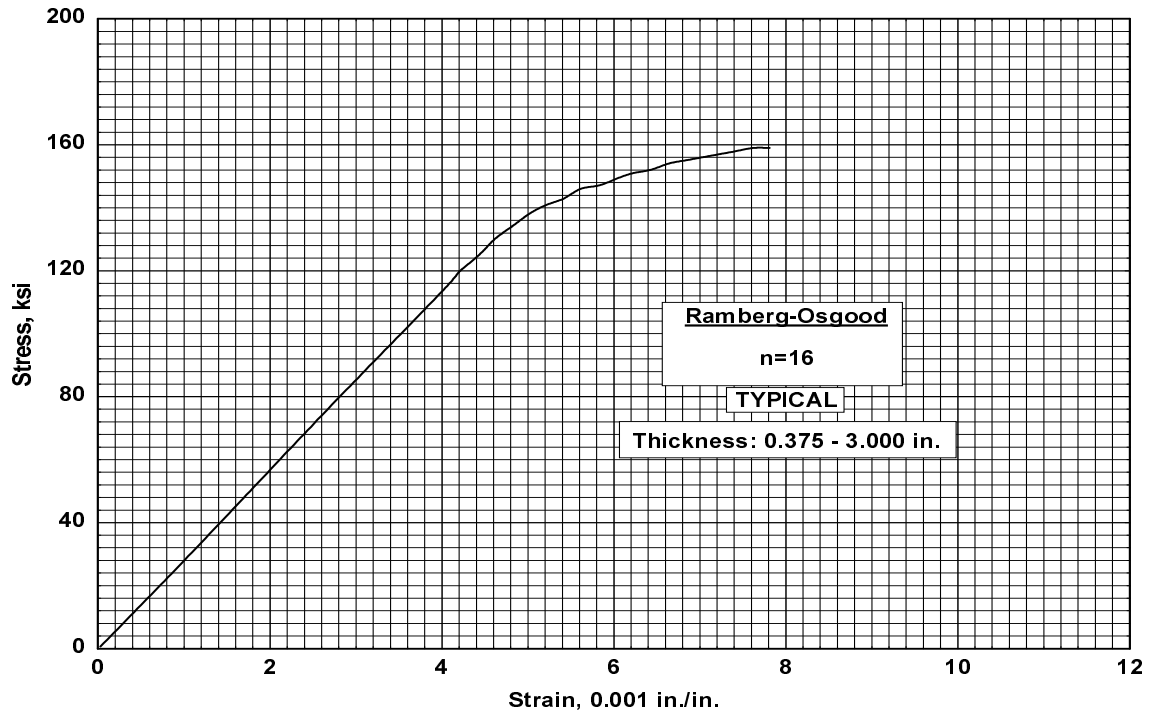

Figure 2.6.9.3.6(a). Typical tensile stress-strain curve for 17-4PH (H1000) stainless steel casting at room temperature.

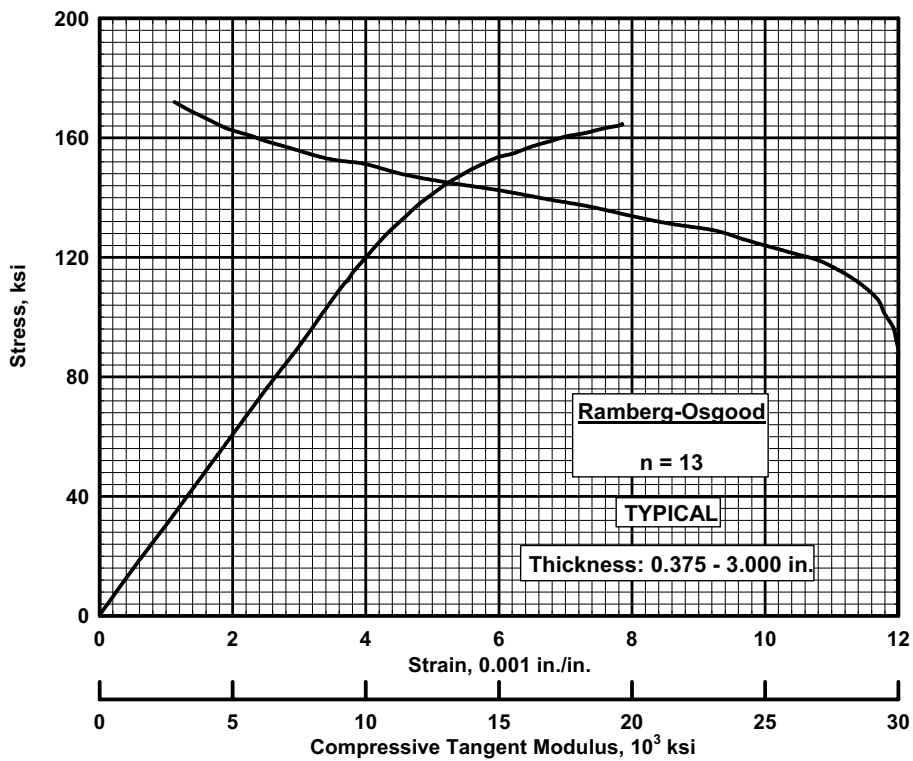

Figure 2.6.9.3.6(b). Typical compressive stress-strain and compressive tangent-modulus curves for 17-4PH (H1000) stainless steel casting at room temperature.

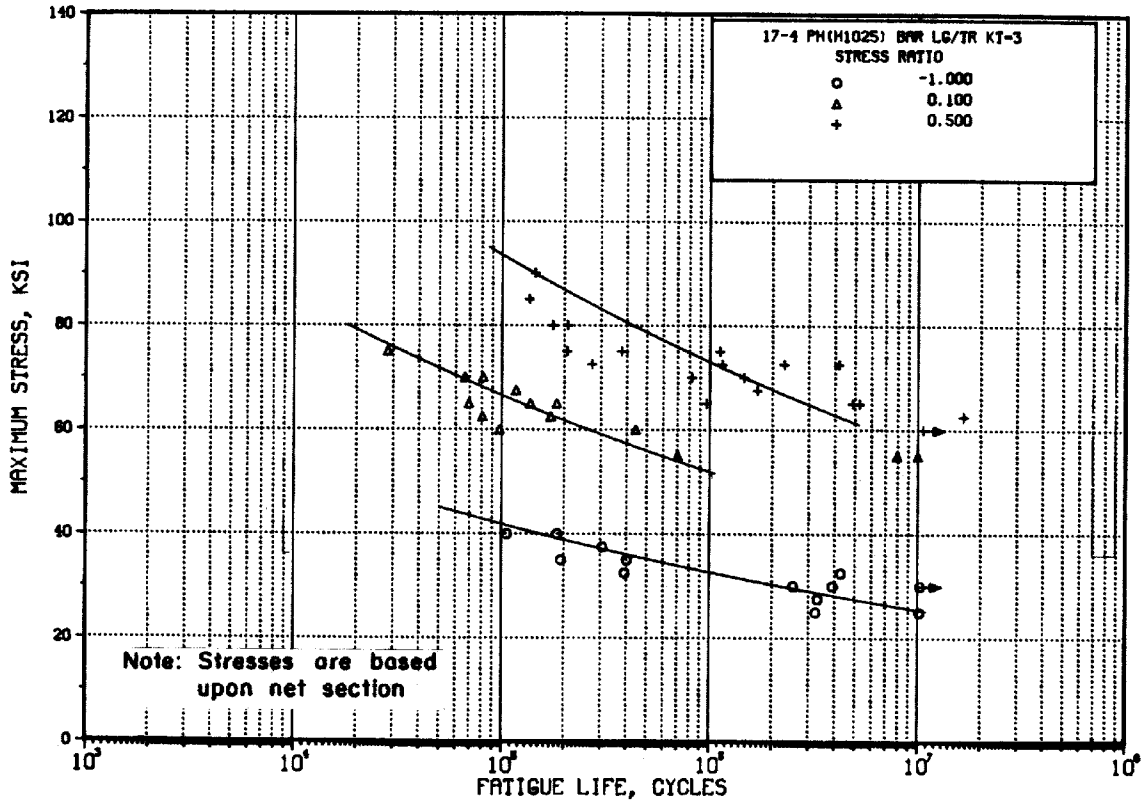

Figure 2.6.9.4.8. Best-fit S/N curves for notched, $K_t = 3.0$, fatigue behavior of 17-4PH (H1025) stainless steel bar, longitudinal and long transverse directions.

Correlative Information for Figure 2.6.9.4.8

Product Form: Bar, 2 x 6 inches

Test Parameters:

<u>Properties:</u>	<u>TUS, ksi</u>	<u>TYS, ksi</u>	<u>Temp, °F</u>
Longitudinal	165	161	RT
Long	164	158	RT
Transverse			
Longitudinal	280	—	RT (notched)
Long	275	—	RT
Transverse			(notched)

Loading - Axial
Frequency - 1800 cpm
Temperature - RT
Environment - Air

No. of Heats/Lots: 3

Specimen Details: Notched V-Groove, $K_t = 3.0$
0.375 inch gross diameter
0.250 inch net diameter
0.013 inch root radius, r
60° flank angle, ω

Equivalent Stress Equation:

$$\text{Log } N_f = 21.60 - 9.24 \log (S_{eq})$$

$$S_{eq} = S_{max} (1-R)^{0.581}$$

Std. Error of Estimate, $\text{Log}(\text{Life}) = 0.413$

Standard Deviation, $\text{Log}(\text{Life}) = 0.724$

$R^2 = 67\%$

Sample Size: = 44

Surface Condition: Notched: Ground notch

[Caution: The equivalent stress model may provide unrealistic life predictions for stress ratios beyond those represented above.]

Reference: 2.6.6.2.8

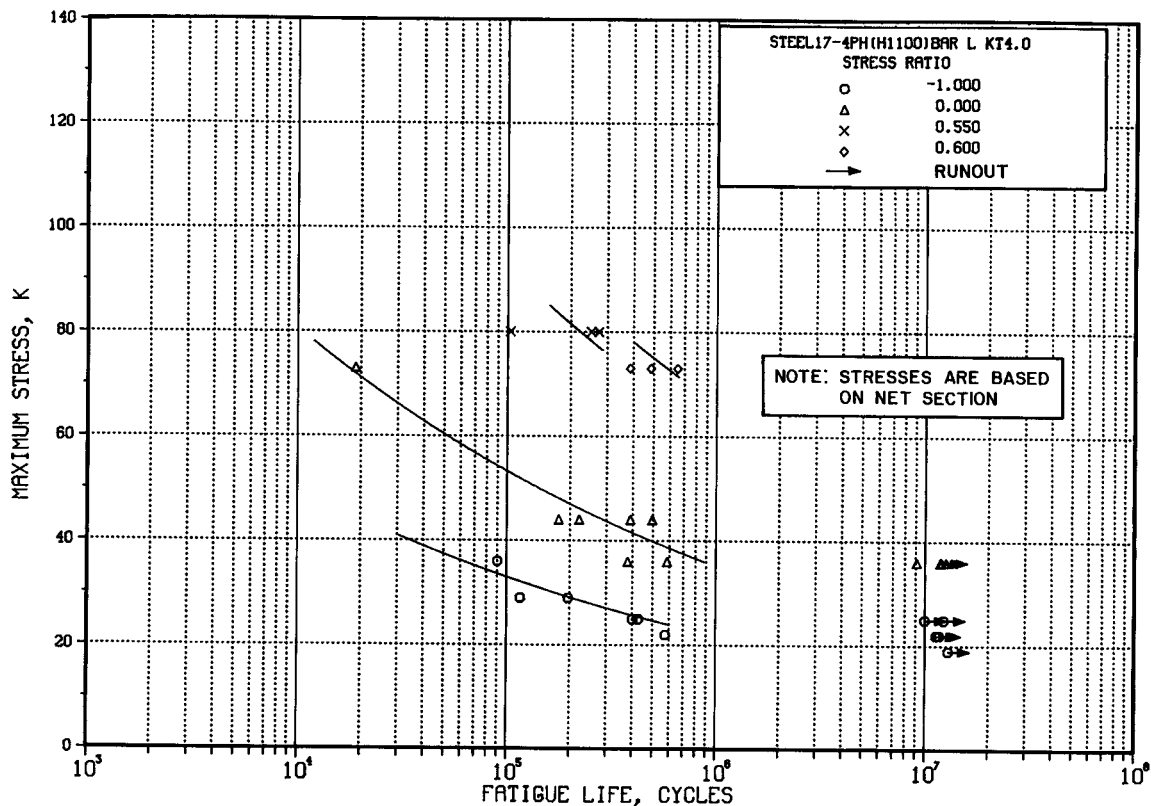

Figure 2.6.9.5.8. Best-fit S/N curves for notched, $K_t = 4.0$, 17-4PH (H1100) bar, longitudinal direction.

Correlative Information for Figure 2.6.9.5.8

Product Form: Bar, 0.787 inch diameter

Test Parameters:

Properties: TUS, ksi TYS, ksi Temp, °F
 151 — RT

Loading - Axial
Frequency - 2000 cpm
Temperature - RT
Environment - Air

Specimen Details: Circumferential V-Groove, $K_t=4.0$
0.492 inch gross diameter
0.256 inch net diameter
0.008 inch notch radius, r
60° flank angle, ω

No. of Heats/Lots: Not Specified

Surface Condition: Machined then aged

Equivalent Stress Equation:
 $\log N_f = 14.6 - 5.56 \log (S_{eq})$
 $S_{eq} = S_{max} (1-R)^{0.69}$
Std. Error of Estimate, $\log (\text{Life}) = 0.301$
Standard Deviation, $\log (\text{Life}) = 0.556$
 $R^2 = 71\%$

Reference: 2.6.9.1.8(b)

Sample Size: = 21

[Caution: The equivalent stress model may provide unrealistic life predictions for stress ratios beyond those represented above.]

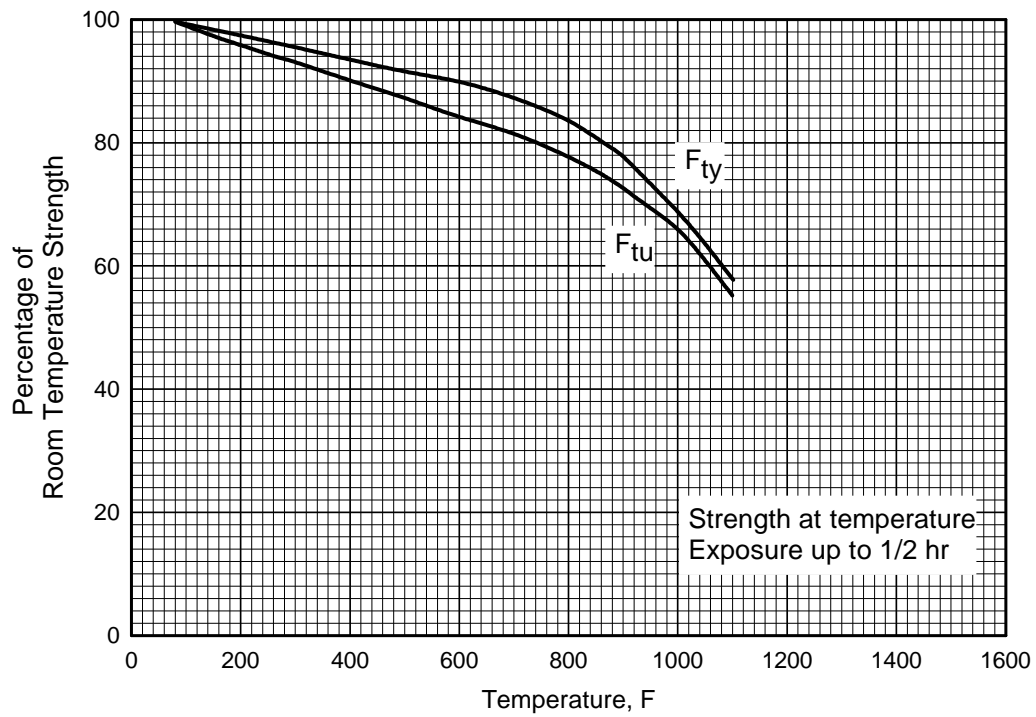

Figure 2.6.9.6.1. Effect of temperature on the tensile ultimate strength (F_{tu}) and the tensile yield strength (F_{ty}) of 17-4PH (H1150) stainless steel bar.

2.6.10 17-7PH

2.6.10.0 Comments and Properties — 17-7PH is a semiaustenitic stainless steel used where high strength and good corrosion and oxidation resistance are needed up to 600°F. This steel is supplied in Condition A for ease of forming.

Manufacturing Considerations — 17-7PH in Condition A is readily cold formed. Conventional inert-gas shielded arc and resistance techniques are generally used for welding. Vapor blasting of scaled Condition TH1050 parts is recommended because of the hazards of intergranular corrosion during pickling operations.

Heat Treatment — 17-7PH must be used in the heat-treated condition and should not be placed in service in Condition A or T. Condition A should be restored by resolution treating when this condition has been altered during processing operations such as hot working, welding, or brazing. The heat-treatment procedures for this steel are compatible with the cycles used for honeycomb panel brazing. In hardening this steel from Condition A to Condition TH1050 a net dimensional growth of 0.0045 in./in. will occur.

The heat treatment to anneal is:

<u>Treatment</u>	<u>Designation</u>
1950 ± 25°F and air cool	Condition A

The transformation treatment from Condition A is as follows:

<u>Treatment</u>	<u>Designation</u>
1400 ± 25°F - 90 minutes and cool to 55 ± 5°F for 30 minutes	Condition T

The aging treatment is:

<u>Treatment</u>	<u>Designation</u>
1050 ± 10°F - 90 minutes and air cool	TH1050

Environmental Considerations — The resistance of 17-7PH to stress-corrosion cracking in chloride environs has been evaluated and found to be superior to that of the alloy steels and the hardenable chromium steels. Strength properties are lowered by exposure to temperatures above about 975°F for periods longer than one-half hour.

Specifications and Properties — Material specifications for 17-7PH stainless steel is presented in Table 2.6.10.0(a). The room-temperature properties of 17-7PH are shown in Tables 2.6.10.0(b) and (c). The effect of temperature on the physical properties of this alloy are presented in Figure 2.6.10.0.

Table 2.6.10.0(a). Material Specification for 17-7PH Stainless Steel

Specification	Form
AMS 5528	Plate, sheet, and strip

Table 2.6.10.0(b). Design Mechanical and Physical Properties of 17-7PH Stainless Steel Sheet and Plate

Specification	AMS 5528			
	Sheet		Plate	
Form	TH1050			
Condition	TH1050			
Thickness, in.	0.015-0.187		0.188-0.500	0.501-1.000
Basis	A	B	S	S
Mechanical Properties:^a				
F_{tu} , ksi:				
L	177	183
LT	177	184	180	180
F_{ty} , ksi:				
L	150 ^b	167
LT	150 ^c	167	150	150
F_{cy} , ksi:				
L	160	179	160	...
LT	166	185	166	...
F_{su} , ksi	112	117	114	...
F_{bru} , ksi:				
(e/D = 1.5)	305	317	310	...
(e/D = 2.0)	351	365	357	...
F_{bry} , ksi:				
(e/D = 1.5)	228	254	228	...
(e/D = 2.0)	240	267	240	...
e , percent (S-basis):				
LT	d	...	6	6
E , 10 ³ ksi	29.0			
E_c , 10 ³ ksi	30.0			
G , 10 ³ ksi	11.5			
μ	0.28			
Physical Properties:				
ω , lb/in. ³	0.276			
C , K , and α	See Figure 2.6.10.0			

- a Design allowables were based upon data from samples of material, supplied in the solution treated condition, which were austenite conditioned and aged to demonstrate response to heat treatment by suppliers. Properties obtained by the user may be different if the material has been formed or otherwise cold worked.
- b The rounded T_{99} value of 158 ksi was reduced to agree with transverse specification value.
- c S-Basis. The rounded T_{99} value equals 159 ksi.
- d See Table 2.6.10.0(c).

2.6.10.1 TH1050 Condition — Elevated temperature curves for various mechanical properties are presented in Figures 2.6.10.1.1, 2.6.10.1.2, and 2.6.10.1.4(a) and (b). Tensile and compression stress-strain curves at room temperature and at several elevated temperatures are presented in Figures 2.6.10.1.6(a) and (b). Typical compressive tangent-modulus curves at various temperatures are presented in Figure 2.6.10.1.6(c).

Table 2.6.10.0(c). Minimum Elongation Values for 17-7PH (TH1050) Stainless Steel Sheet

Thickness, in.	Elongation (LT), percent
0.005 to 0.010	4
0.011 to 0.019	5
0.020 to 0.187	6

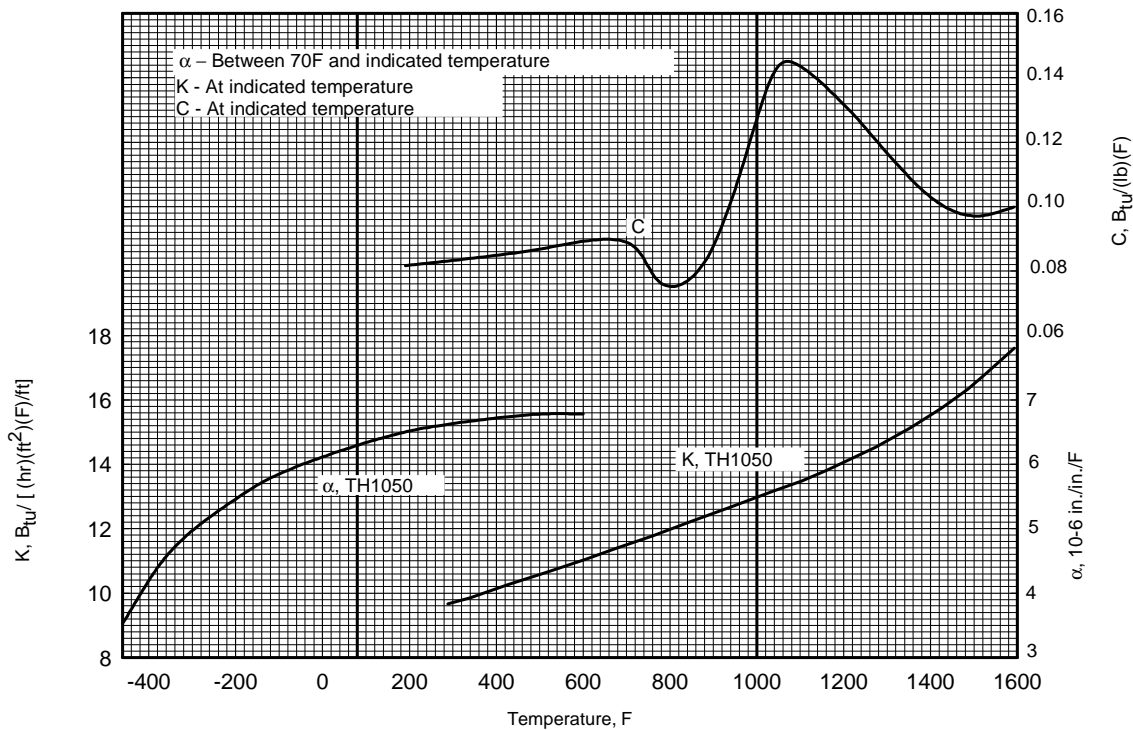

Figure 2.6.10.0. Effect of temperature on the physical properties of 17-7PH stainless steel.

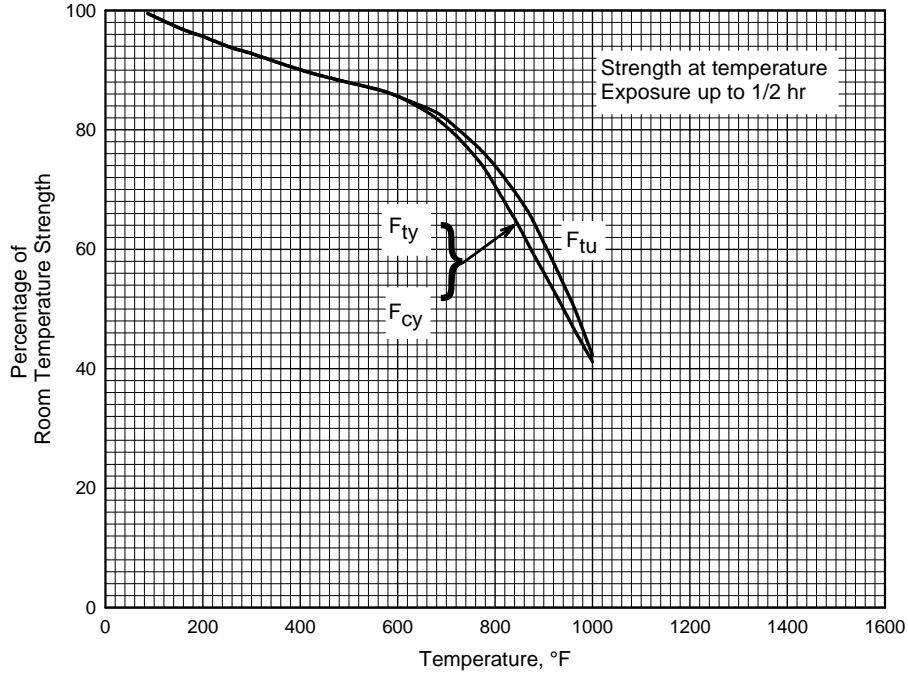

Figure 2.6.10.1.1. Effect of temperature on the tensile ultimate strength (F_{tu}), tensile yield strength (F_{ty}), and compressive yield strength (F_{cy}) of 17-7PH (TH1050) stainless steel sheet.

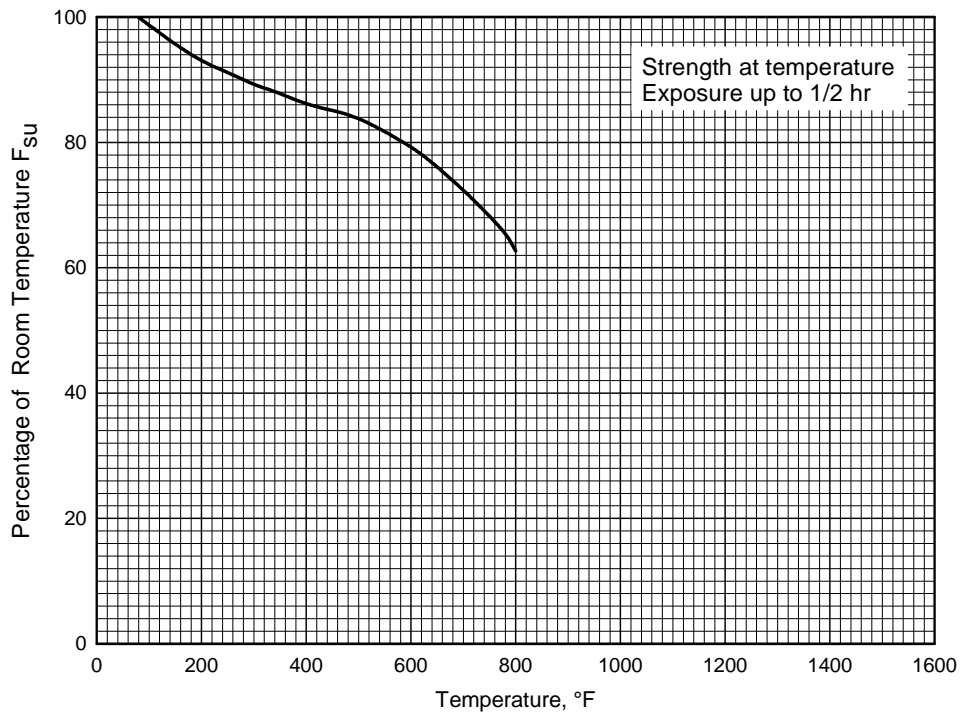

Figure 2.6.10.1.2. Effect of temperature on the ultimate shear strength (F_{su}) of 17-7PH (TH1050) stainless steel sheet.

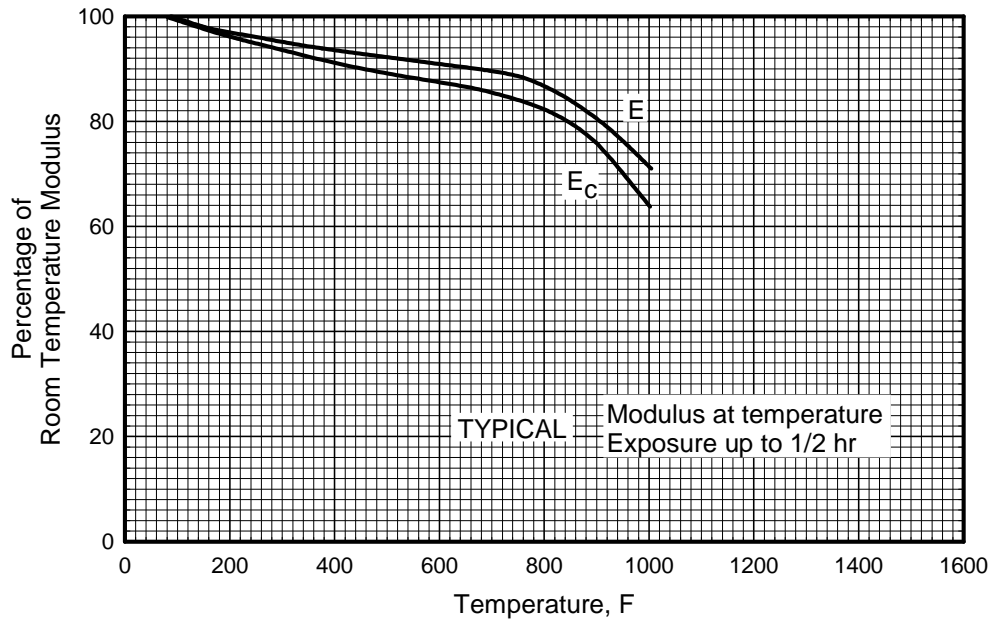

Figure 2.6.10.1.4(a). Effect of temperature on the tensile and compressive moduli (E and E_c) of 17-7PH (TH1050) stainless steel sheet.

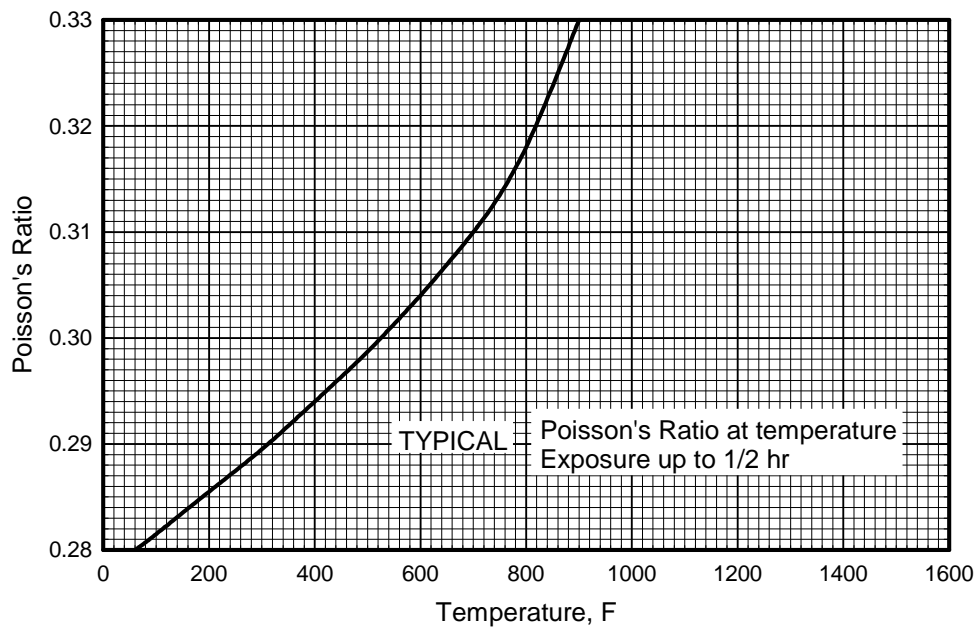

Figure 2.6.10.1.4(b). Effect of temperature on Poisson's ratio (μ) for 17-7PH (TH1050) stainless steel sheet.

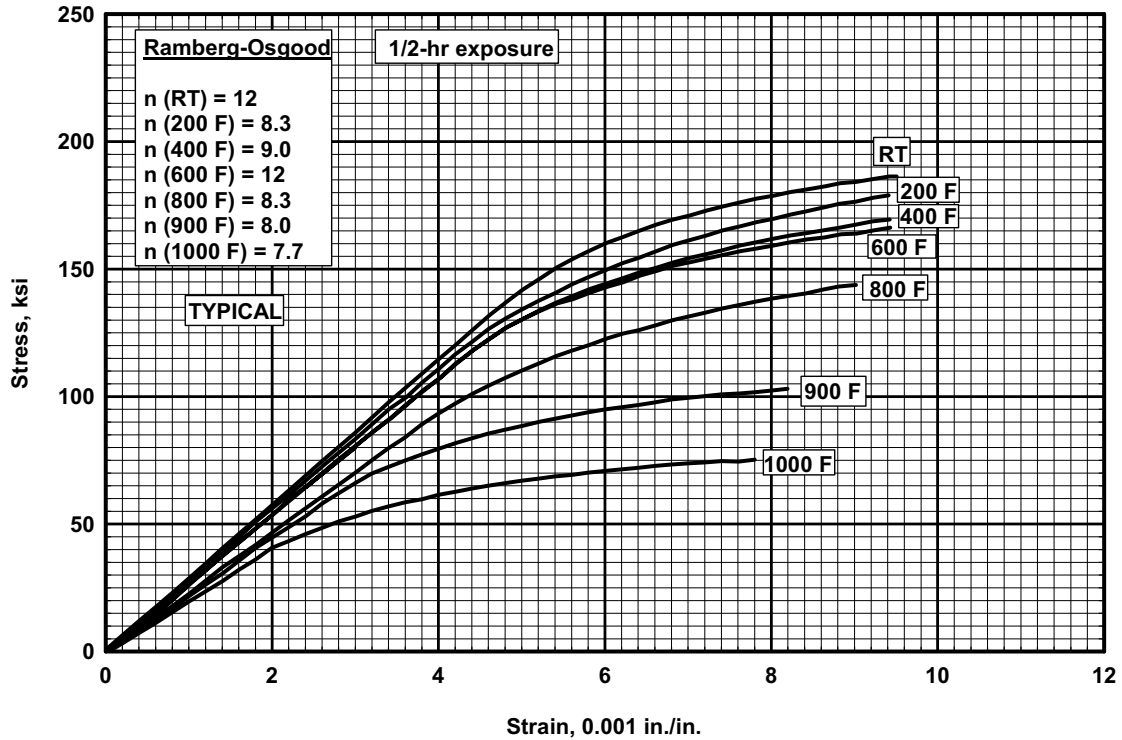

Figure 2.6.10.1.6(a). Typical tensile stress-strain curves at various temperatures for 17-7PH (TH1050) stainless steel sheet.

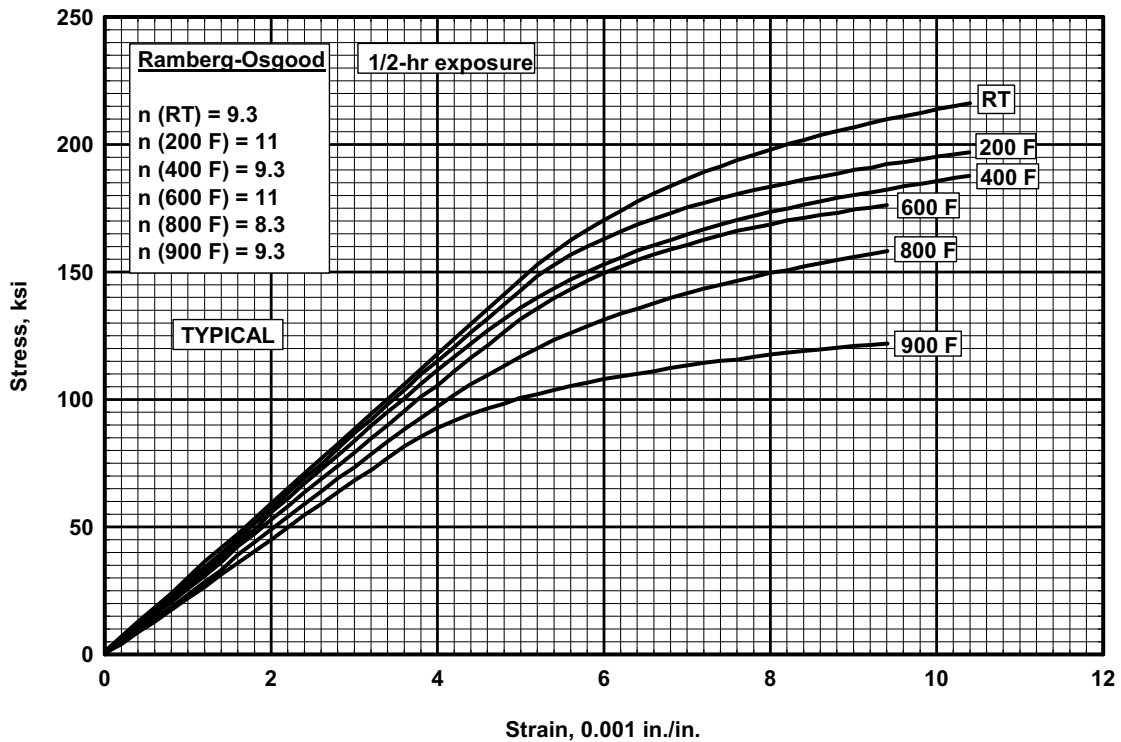

Figure 2.6.10.1.6(b). Typical compressive stress-strain curves at various temperatures for 17-7PH (TH1050) stainless steel sheet.

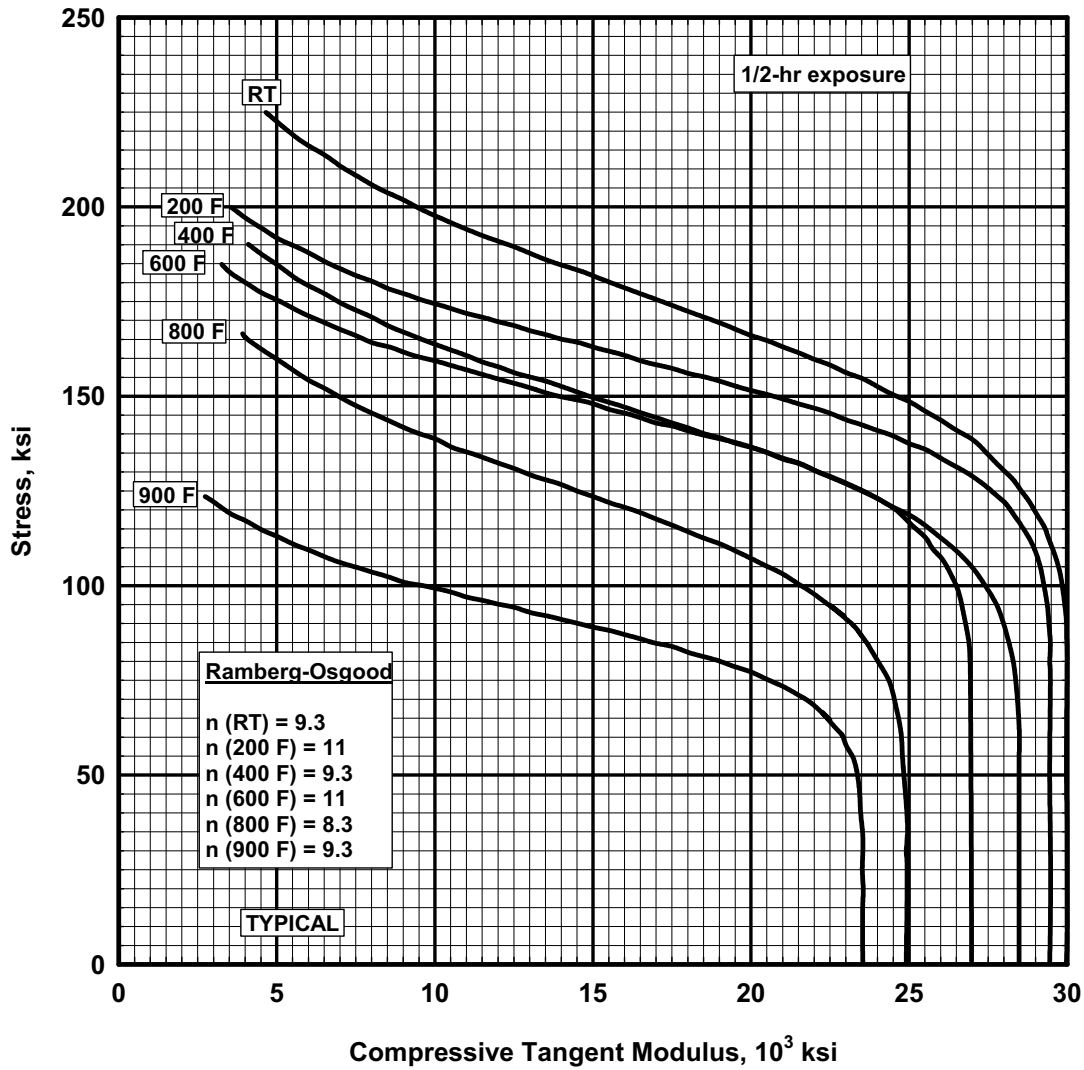

Figure 2.6.10.1.6(c). Typical compressive tangent-modulus curves at various temperatures for 17-7PH (TH1050) stainless steel sheet.

2.7 AUSTENITIC STAINLESS STEELS

2.7.0 COMMENTS ON AUSTENITIC STAINLESS STEEL

2.7.0.1 Metallurgical Considerations — The austenitic (“18-8”) stainless steels were developed as corrosion-resistant alloys. However, they possess excellent oxidation resistance and good creep strength at elevated temperatures, along with good cold formability and other properties in airframe and missile applications. They are used in sheet form for portions of the airframe having ambient temperatures too high for aluminum alloys and, with the development of sandwich structures, are gaining additional uses. These steels are also used extensively at cryogenic temperatures.

The two alloying elements in the austenitic stainless steels are chromium and nickel. Chromium adds corrosion and oxidation resistance and high-temperature strength, and nickel gives an austenitic structure, with its associated toughness and ductility. The AISI 300 series stainless steels constitute a wide variety of compositions designed for different applications. The basic grade, Type 302, contains 18 percent chromium and 8 percent nickel. Varying one or both of these elements creates special characteristics. Type 301 (17 percent chromium and 7 percent nickel) work hardens to very high strengths. Type 310 (25 percent chromium and 20 percent nickel) has higher elevated temperature strength and greater oxidation resistance than Type 302. Sulfur and selenium additions promote free machining. Low carbon and/or columbium or titanium additions minimize intergranular corrosion for elevated temperature applications and welded construction. The addition of molybdenum improves corrosion resistance in reducing environments and gives improved creep resistance over Type 302. The characteristics of some of the AISI 300 series stainless steels are presented in Table 2.7.0.1.

These alloys are not hardenable by heat treatment but can achieve high-strength levels through cold working. The strength imparted by cold working is decreased by exposure to temperatures above about 900°F.

2.7.0.2 Manufacturing Considerations —

Forging — The stainless steels have lower thermal conductivity than lower alloy steels and are susceptible to grain growth at forging temperatures. Hence, soaking times must be adequate to permit thorough heating of the billet but must be controlled carefully to limit grain growth when small reductions are involved during forging. At forging temperatures, the stainless steels are stronger than alloy steels, and forging must be conducted at higher temperatures and heavier forging equipment and more frequent reheating are required. The stainless steel billets forge much better when the surface is free of defects, and machine turning of the billets is advisable.

Cold Forming — Because of their austenitic structure at room temperature, the stainless steels have excellent ductility for cold-forming operations when in the annealed condition. These steels work harden rapidly, and intermediate anneals may be required in deep drawing.

Machining — The machining of the austenitic stainless steels is not difficult if proper steps are taken to combat the work-hardening tendencies of these steels. The use of heavy machines, slow speeds, deep cuts, and properly designed cutting tools with a fairly steep top rake produces the best results. Cold-worked material possesses somewhat better machinability than hot-finished, annealed material. These steels also are available in free-machining grades, containing sulfur or selenium.

Welding — The austenitic stainless steels can be welded by almost any usual technique except carbon arc, provided adequate steps are taken to prevent oxidation or carburization of the weldment. The stabilized grades are preferred for welded parts that are used in the as-welded condition under corrosive conditions. The free-machining grades are not recommended for welding. Filler rods should be the same composition, or slightly higher in alloy content, as the material to be welded. Special fluxes designed for use with stainless

Table 2.7.0.1. Characteristics of Some AISI 300 Series Stainless Steels

AISI	Characteristics
301	High work-hardening rate; applications requiring high strength and ductility.
302	Higher carbon modification of Type 304 for higher strength on cold rolling.
303	Free machining sulfur modification of Type 302.
303Se	Free machining selenium modification of Type 302.
304	General purpose austenitic grade for enhanced corrosion resistance.
304L	Low-carbon modification of Type 304 for welding applications.
305	Low work-hardening rate; spin forming and severe spin drawing operations.
309	High-temperature strength and oxidation resistance.
309S	Low-carbon modification of Type 309 for welded construction.
310	High-temperature strength and oxidation resistance greater than Type 309.
310S	Low-carbon modification of Type 310 for welded construction.
314	Increased oxidation resistance over Type 310.
316	Mo added to improve corrosion resistance in reducing environments; improved creep resistance over Type 302.
316L	Low-carbon modification of Type 316 for welded construction.
317	Increased Mo to improve corrosion resistance over Type 316 in reducing media.
321	Titanium stabilized for service in 800 to 1600°F range and to minimize carbide precipitation when welding for resistance to intergranular corrosion.
347	Columbium stabilized for service in 800 to 1600°F range and to minimize carbide precipitation when welding for resistance to intergranular corrosion.

steels should be employed, except in atomic hydrogen or inert-gas-shielded arc welding. Spot and roll seam welding also are used to a considerable extent.

Brazing — Special techniques have been developed for silver-soldering and brazing these steels. Solders and fluxes especially designed should be used, surfaces must be thoroughly cleaned, and close control of temperature must be followed.

2.7.0.3 Environmental Considerations — The austenitic stainless steels have excellent oxidation resistance at high temperatures, and their elevated-temperature service is usually limited by strength criteria. They also possess unusually good resistance to corrosion by most media. Prolonged exposure of the nonstabilized grades to temperatures between 700 and 1650°F makes them susceptible to intergranular corrosion.

2.7.1 AISI 301 and Related 300 Series Stainless Steels

2.7.1.0 Comments and Properties — Of the austenitic stainless steels, AISI 301 is the one most frequently used at high-strength levels in aircraft, mainly because of its greater work-hardening characteristics.

Type 301 is strengthened by cold working. If cold-worked Type 301 is subjected to temperatures above 900°F, its room-temperature strength is reduced.

Type 301 should not be used for extended periods at temperatures of 750 to 1650°F and should not be cooled slowly from higher temperatures through this range.

Material specifications for AISI 301 stainless steel are presented in Table 2.7.1.0(a). The room-temperature mechanical and physical properties for AISI 301 stainless steel are presented in Tables 2.7.1.0(b) and (c). The physical properties of this alloy at room and elevated temperatures are presented in Figure 2.7.1.0. Specifications for related 300 series alloys for which the properties are applicable are footnoted in Table 2.7.1.0(b).

Table 2.7.1.0(a). Material Specifications for AISI 301 Stainless Steel

Specification	Form
AMS 5517	Sheet and strip
AMS 5518	Sheet and strip
AMS 5519	Sheet and strip
AMS 5901	Plate, sheet, and strip
AMS 5902	Sheet and strip

2.7.1.1 Annealed Condition — Elevated temperature curves for tensile yield and ultimate strengths are presented in Figures 2.7.1.1.1(a) and (b).

2.7.1.2 1/4 Hard Condition — Typical room-temperature stress-strain and tangent-modulus curves are presented in Figures 2.7.1.2.6(a) and (b).

2.7.1.3 1/2 Hard Condition — Elevated temperature curves for various mechanical properties are presented in Figures 2.7.1.3.1 through 2.7.1.3.4. Typical stress-strain and tangent-modulus curves are presented in Figures 2.7.1.3.6(a) and (b).

2.7.1.4 3/4 Hard Condition — Typical room-temperature stress-strain and tangent-modulus curves are presented in Figures 2.7.1.4.6(a) and (b).

2.7.1.5 Full-Hard Condition — The full-hard condition is a standard AISI temper and is developed by cold rolling 40 to 50 percent. Elevated temperature curves for various mechanical properties are presented in Figure 2.7.1.5.1 through 2.7.1.5.4. Tensile and compressive stress-strain as well as tangent-modulus curves at room temperature and several elevated temperatures are presented in Figures 2.7.1.5.6(a) through (d).

MIL-HDBK-5J
31 January 2003

Table 2.7.1.0(b). Design Mechanical and Physical Properties of AISI 301 and Related^{a,b,c} Stainless Steels

Specification	AMS 5901	AMS 5517	AMS 5518	AMS 5902	AMS 5519				
Form	Sheet and strip								
Condition	Annealed	¼ Hard	½ Hard	¾ Hard	Full Hard				
Thickness, in.	≤0.187				
Basis	S	A	B	A	B	A	B	A	B
Mechanical Properties:									
<i>F_{tu}</i> , ksi:									
L	73	124	129	141	151	157	168	174	185
LT	75	122	127	142	152	163	173	175	186
<i>F_{ty}</i> , ksi:									
L	26	69	83	93	110	118	135	137	153
LT	30	67	82	92	105	113	133	125	142
<i>F_{cy}</i> , ksi:									
L	23	44	54	61	69	75	88	83	94
LT	29	71	88	100	116	127	152	142	164
<i>F_{su}</i> , ksi	50	66	69	77	82	88	93	95	100
<i>F_{bru}</i> , ksi:									
(e/D = 1.5)
(e/D = 2.0)	162	262	273	292	310	327	342	346	361
<i>F_{bry}</i> , ksi:									
(e/D = 1.5)
(e/D = 2.0)	55	123	149	167	189	202	234	222	249
<i>e</i> , percent (S basis):									
LT	40	25	...	d	...	d	...	d	...
<i>E</i> , 10 ³ ksi:									
L	29.0	27.0	26.0	26.0	26.0	26.0	26.0	26.0	26.0
LT	29.0	28.0	28.0	28.0	28.0	28.0	28.0	28.0	28.0
<i>E_c</i> , 10 ³ ksi:									
L	28.0	26.0	26.0	26.0	26.0	26.0	26.0	26.0	26.0
LT	28.0	27.0	27.0	27.0	27.0	27.0	27.0	27.0	27.0
<i>G</i> , 10 ³ ksi	11.2	10.6	10.5	10.5	10.5	10.5	10.5	10.5	10.5
<i>μ</i>	0.27	0.27	0.27	0.27	0.27	0.27	0.27	0.27	0.27
Physical Properties:									
<i>ω</i> , lb/in. ³	0.286								
<i>C</i> , <i>K</i> , and <i>α</i>	See Figure 2.7.1.0								

- a Properties also applicable to AISI 302 for the following; AMS 5516 for annealed condition, AMS 5903 for 1/4H condition, AMS 5904 for 1/2H condition, AMS 5905 for 3/4H condition, and AMS 5906 for full hard condition.
- b Properties also applicable to AISI 304 for the following; AMS 5513 for annealed condition, AMS 5910 for 1/4H condition, AMS 5911 for 1/2H condition, AMS 5912 for 3/4H condition, and AMS 5913 for full hard condition.
- c Properties also applicable to AISI 316 for the following; AMS 5524 for annealed condition and AMS 5907 for 1/4H condition.
- d See Table 2.7.1.0(c).

Note: Yield strength, particularly in compression, and modulus of elasticity in the longitudinal direction may be raised appreciably by thermal stress-relieving treatment in the range 500 to 800°F.

Table 2.7.1.0(c). Minimum Elongation Values for AISI 301 Stainless Steel Sheet and Strip

Condition	Thickness, inches	Elongation (LT), percent
½ hard	0.015 and under	15
	0.016 and over	18
¾ hard	0.030 and under	10
	0.031 and over	12
Full hard	0.015 and under	8
	0.016 and over	9

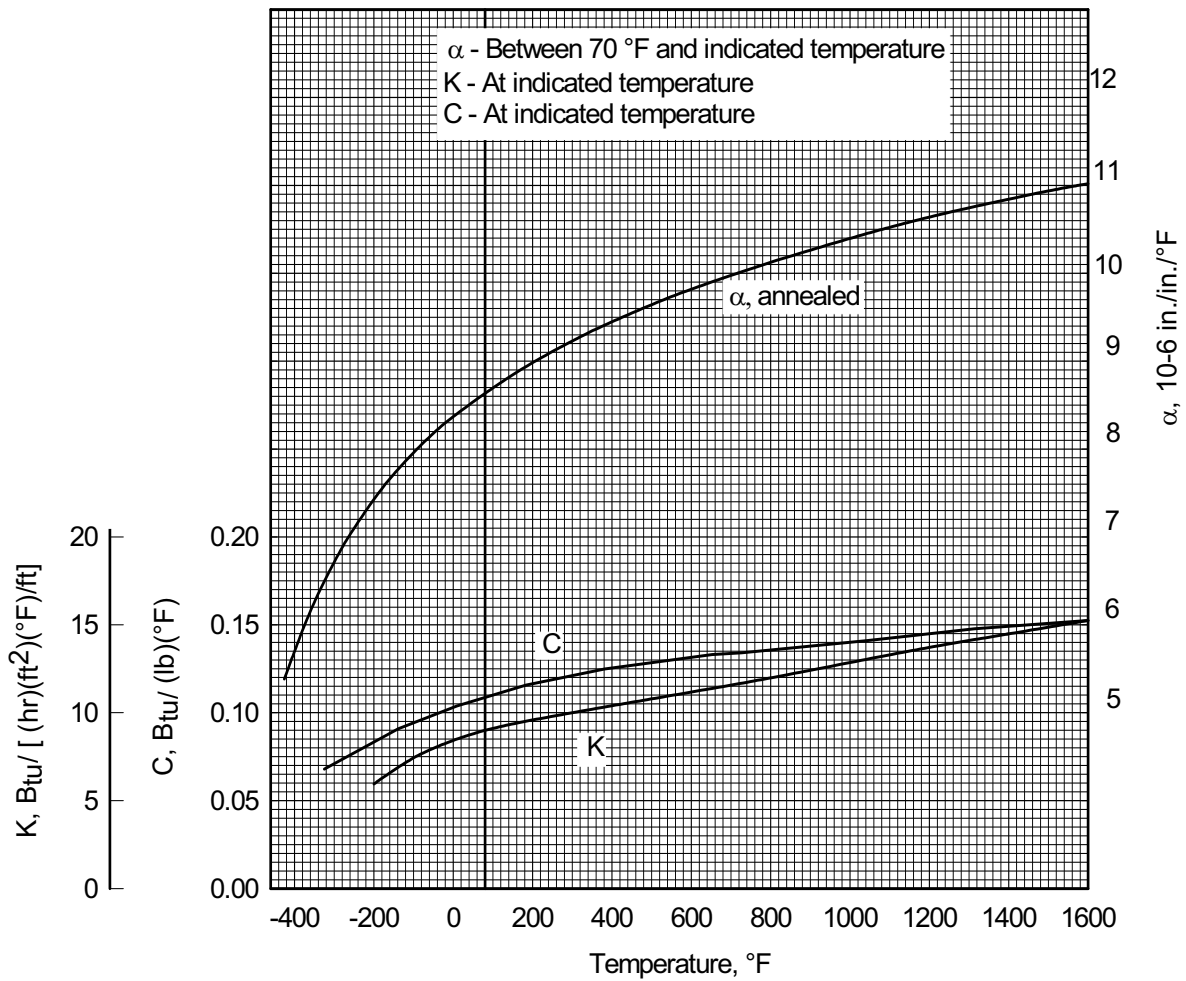

Figure 2.7.1.0. Effect of temperature on the physical properties of AISI 301 stainless steel.

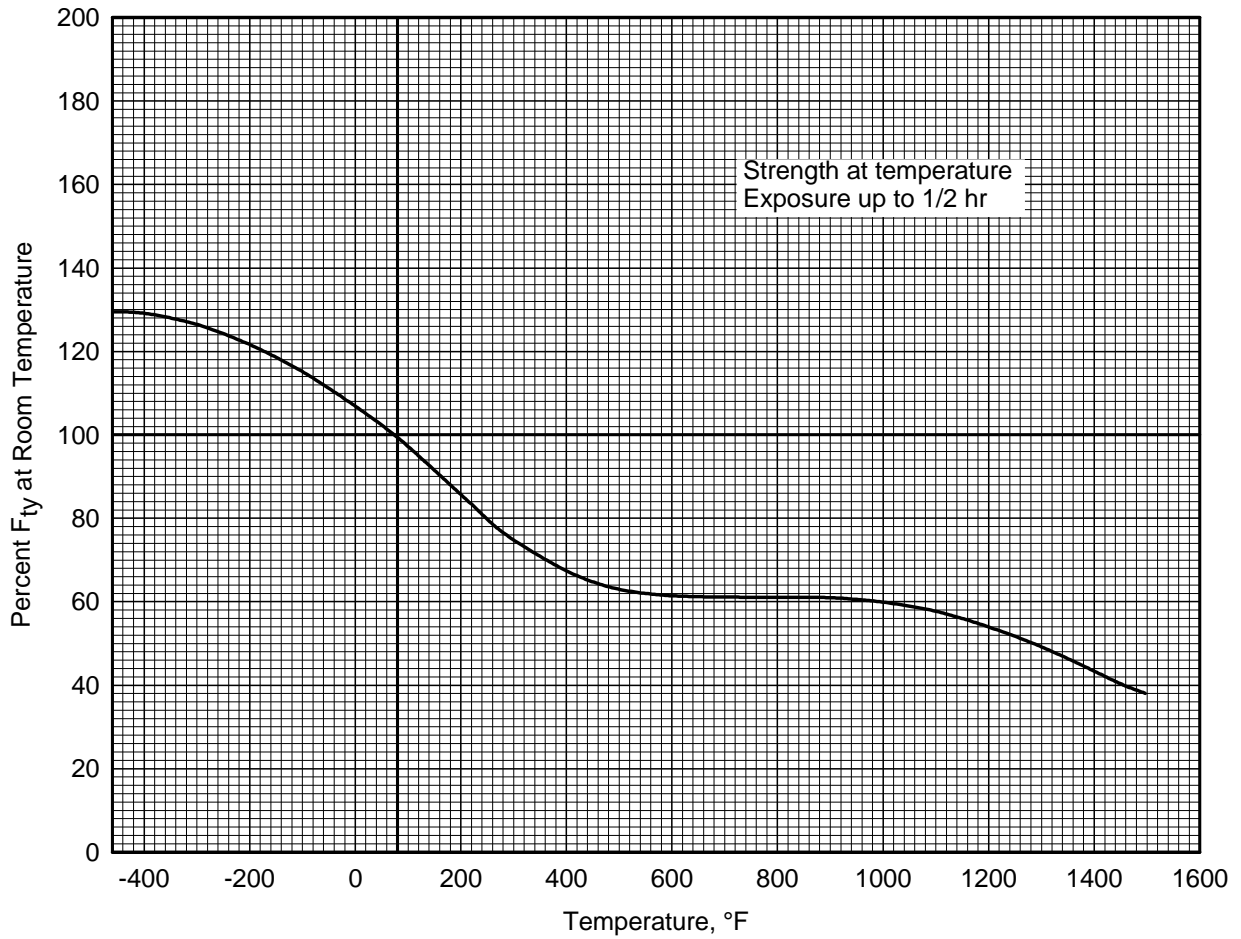

Figure 2.7.1.1.1(a). Effect of temperature on the tensile yield strength (F_{ty}) of AISI 301, 302, 304, 304L, 321, and 347 annealed stainless steel.

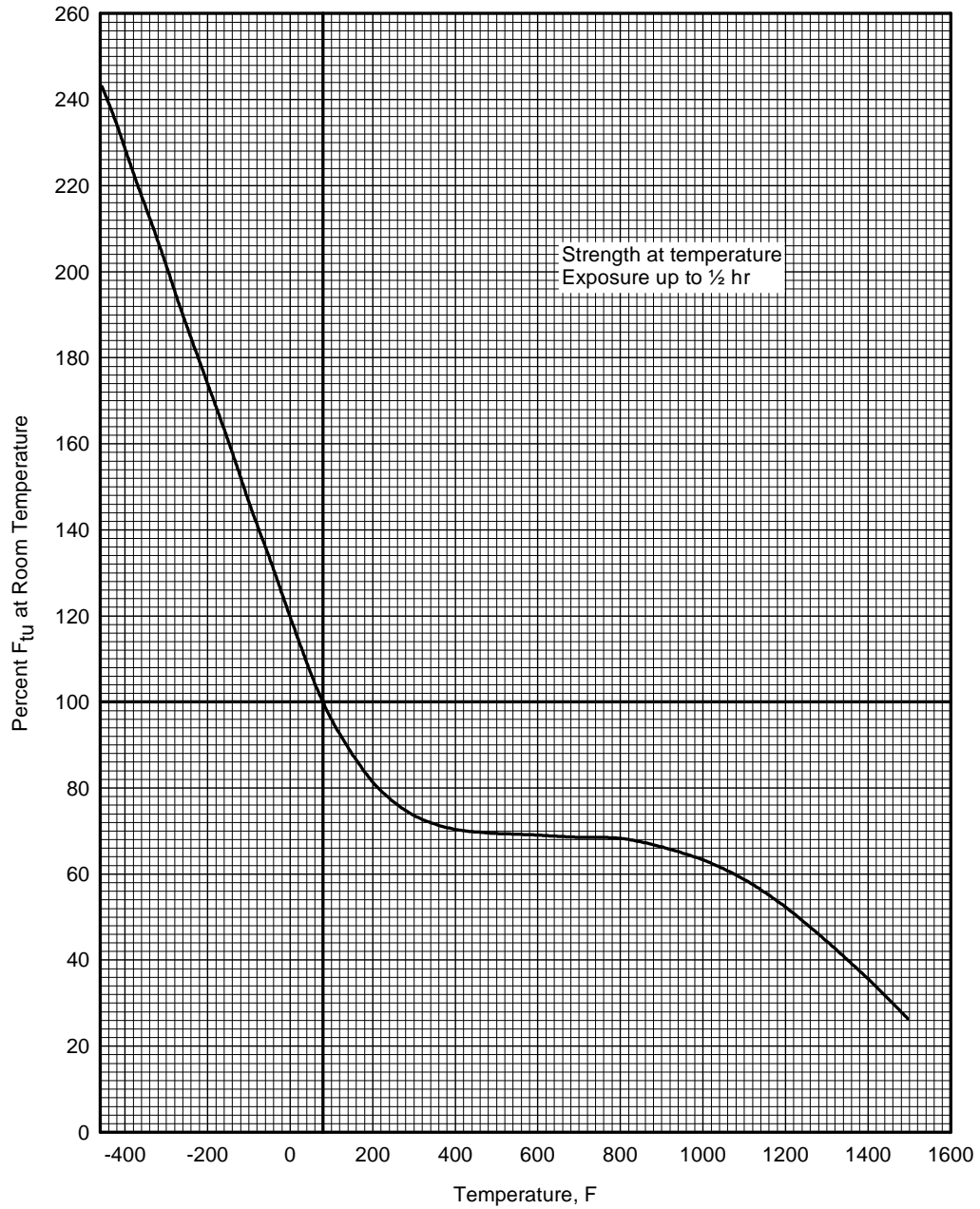

Figure 2.7.1.1.1(b). Effect of temperature on the tensile ultimate strength (F_{tu}) of AISI 301, 302, 304, 304L, 321, and 347 annealed stainless steel.

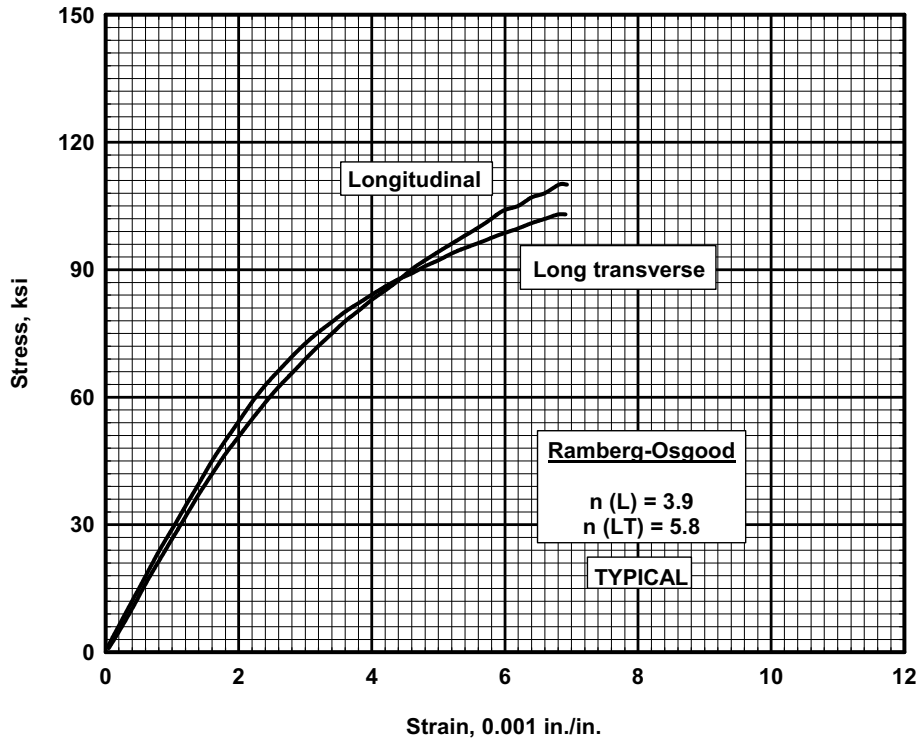

Figure 2.7.1.2.6(a). Typical tensile stress-strain curves at room temperature for AISI 301 1/4-hard stainless steel sheet.

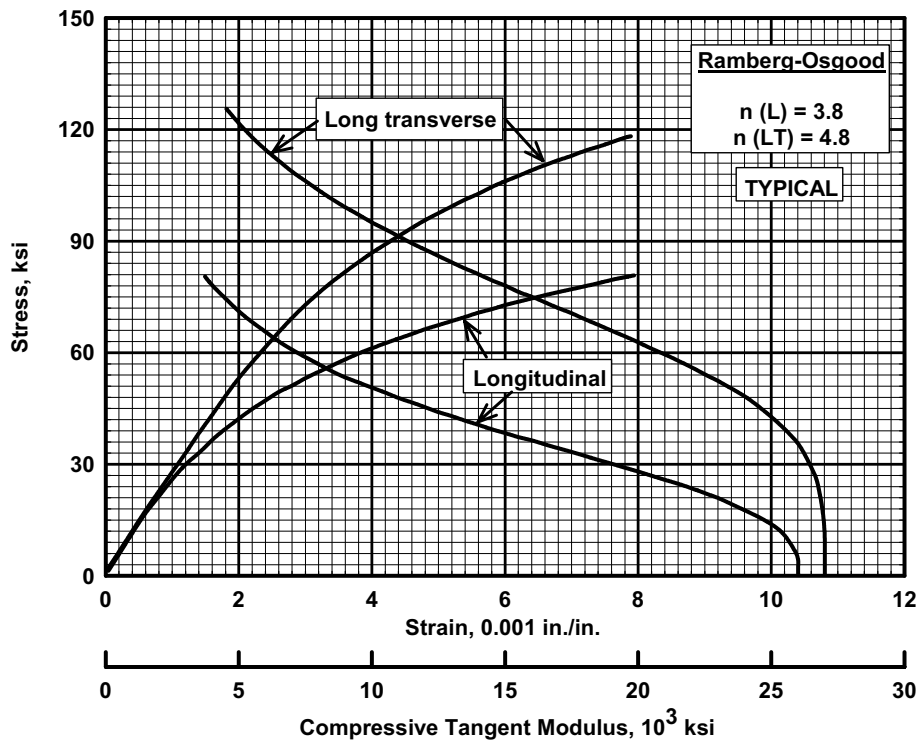

Figure 2.7.1.2.6(b). Typical compressive stress-strain and compressive tangent-modulus curves at room temperature for AISI 301 1/4-hard stainless steel sheet.

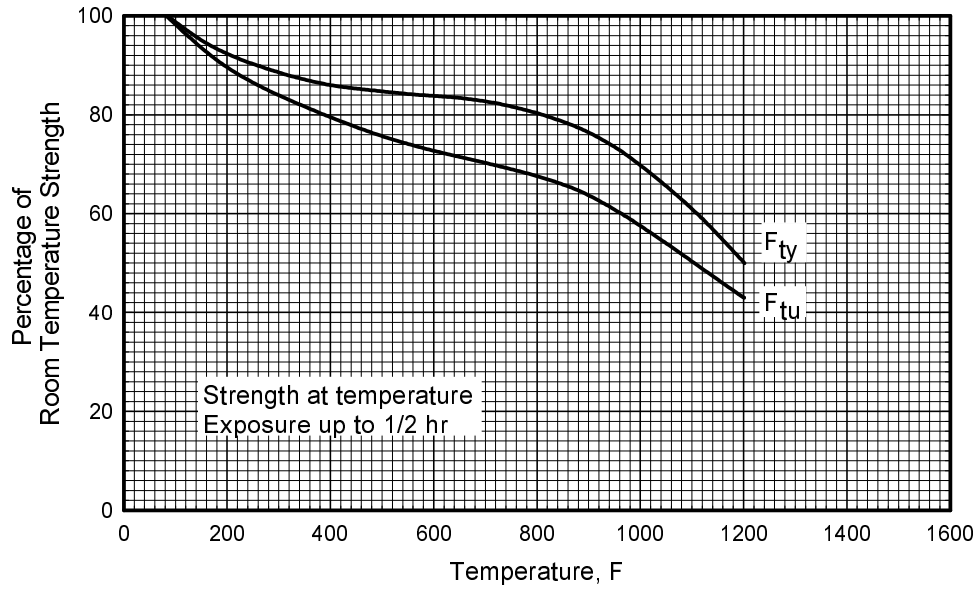

Figure 2.7.1.3.1. Effect of temperature on the tensile ultimate strength (F_{tu}) and the tensile yield strength (F_{ty}) of AISI 301 1/2-hard stainless steel sheet.

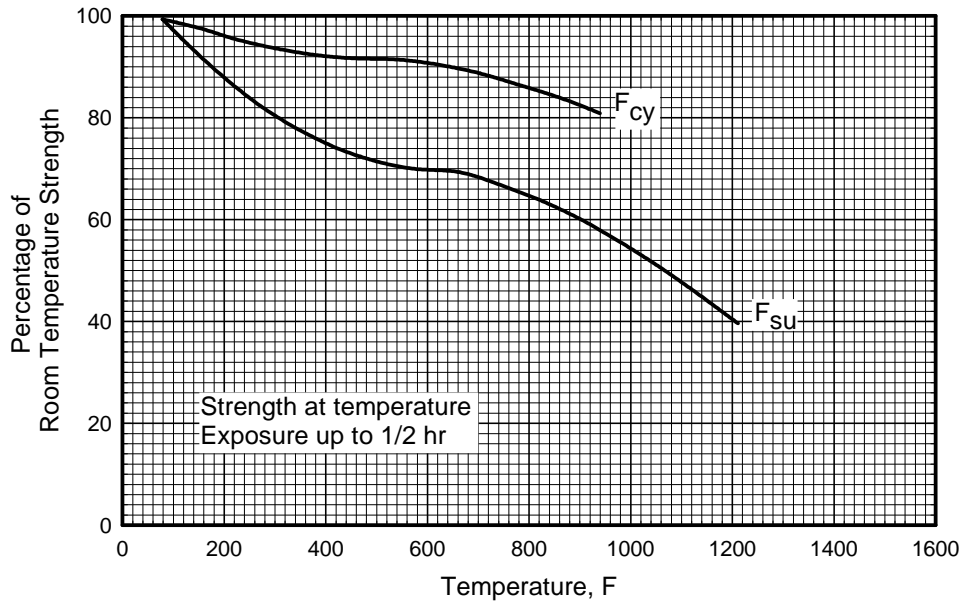

Figure 2.7.1.3.2. Effect of temperature on the compressive yield strength (F_{cy}) and the shear ultimate strength (F_{su}) of AISI 301 1/2-hard stainless steel sheet.

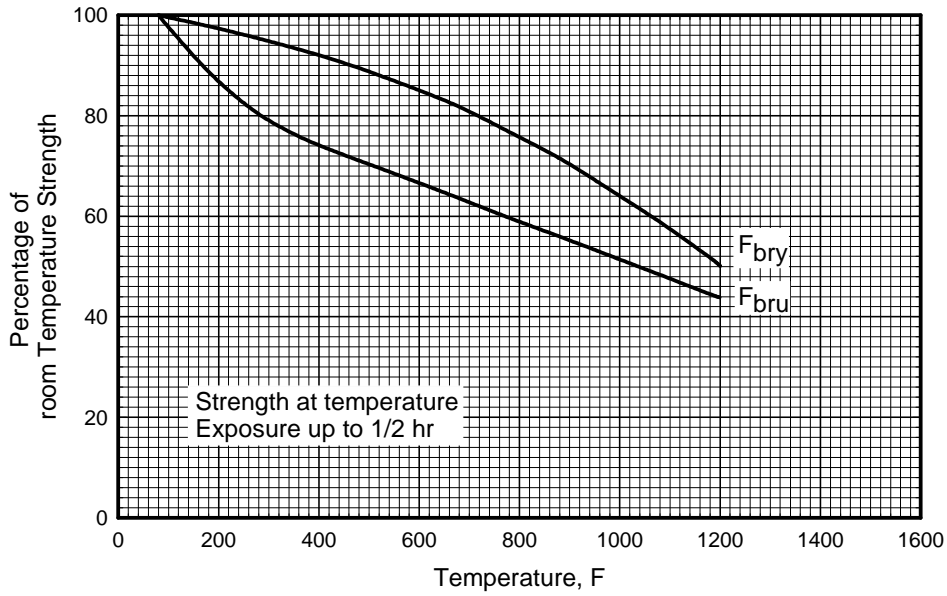

Figure 2.7.1.3.3. Effect of temperature on the bearing ultimate strength (F_{bru}) and the bearing yield strength (F_{bry}) of AISI 301 1/2-hard stainless steel sheet.

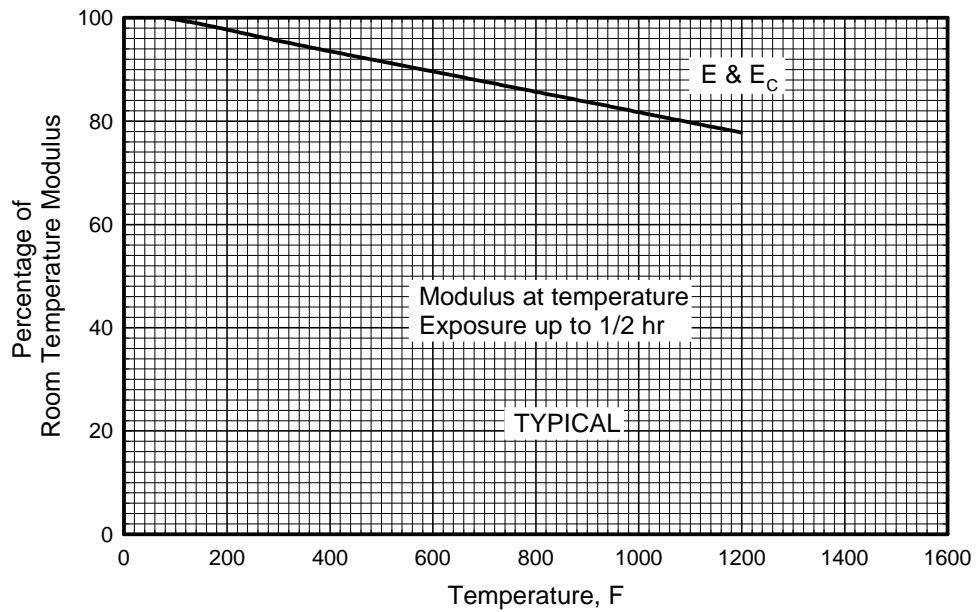

Figure 2.7.1.3.4. Effect of temperature on the tensile and compressive moduli (E and E_c) of AISI 301 1/2-hard stainless steel sheet.

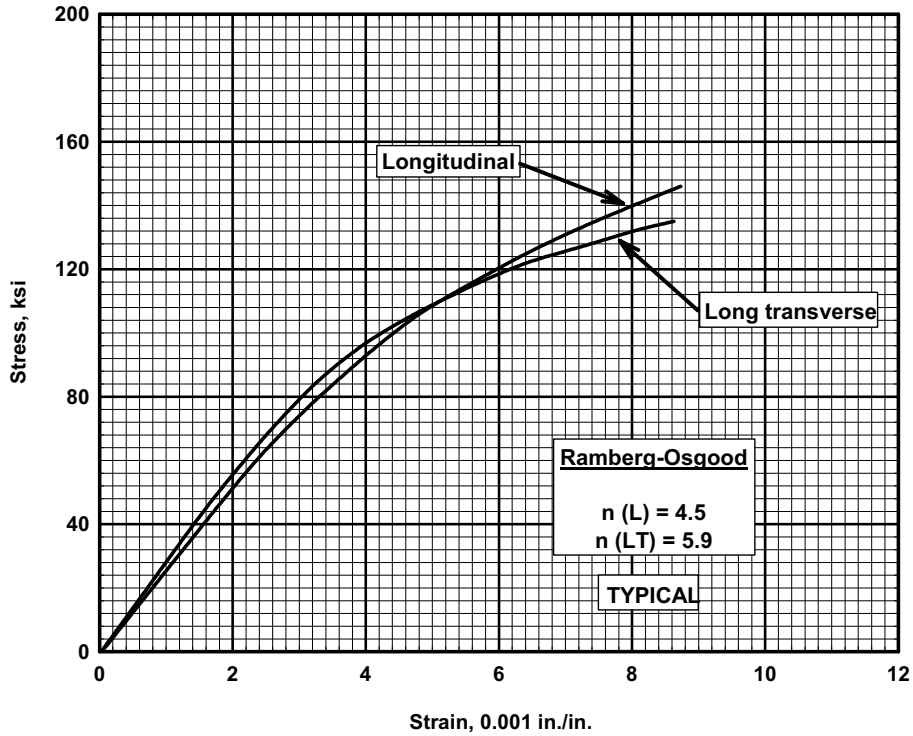

Figure 2.7.1.3.6(a). Typical tensile stress-strain curves at room temperature for AISI 301 1/2-hard stainless steel sheet.

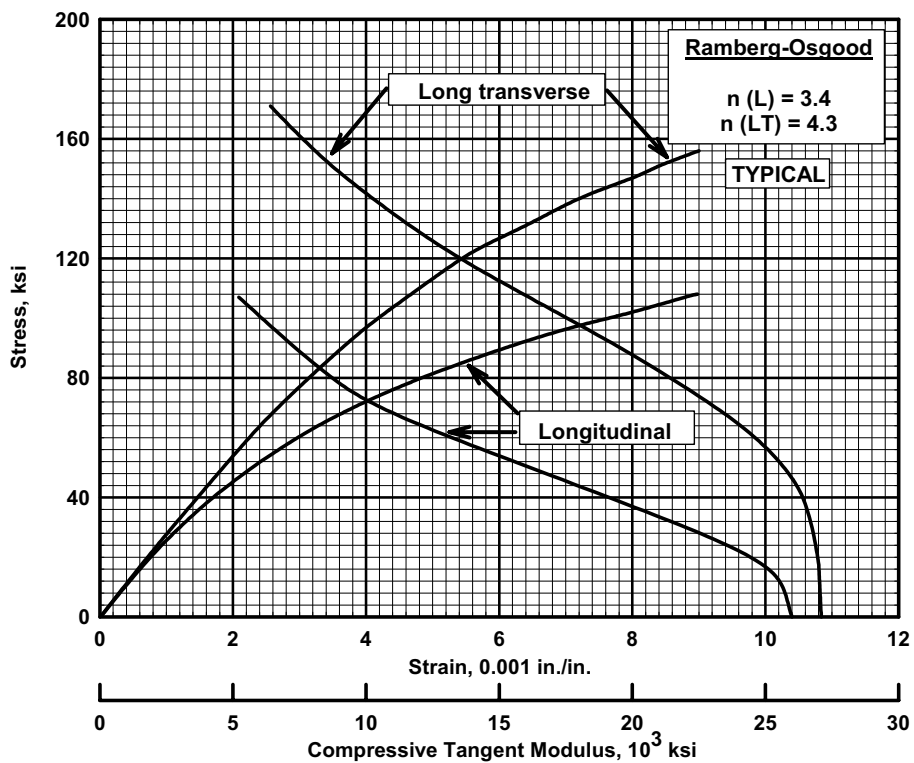

Figure 2.7.1.3.6(b). Typical compressive stress-strain and compressive tangent-modulus curves at room temperature for AISI 301 1/2-hard stainless steel sheet.

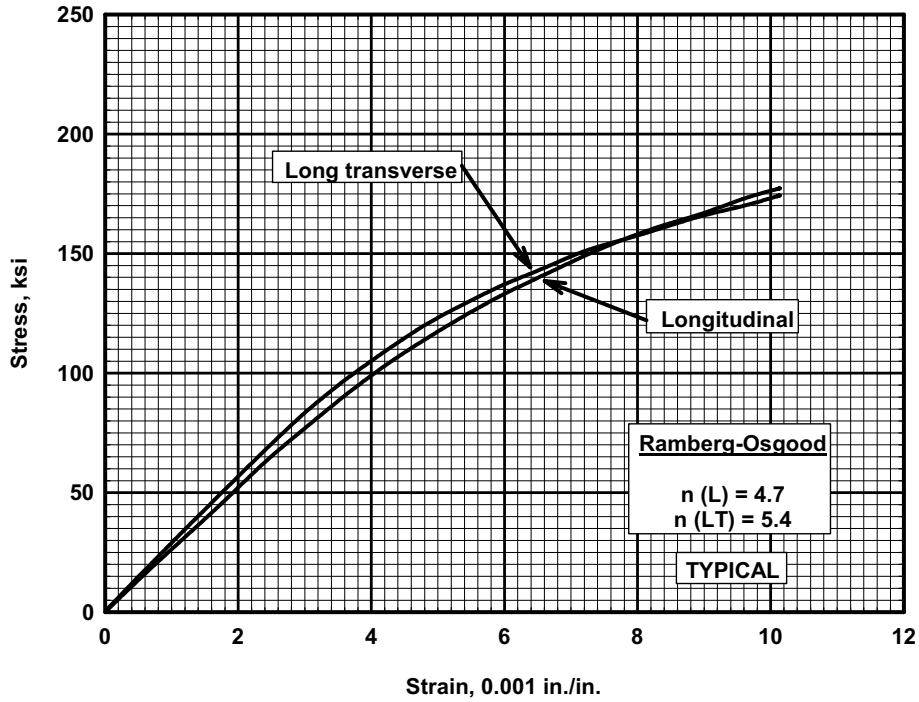

Figure 2.7.1.4.6(a). Typical tensile stress-strain curves at room temperature for AISI 301 3/4-hard stainless steel sheet.

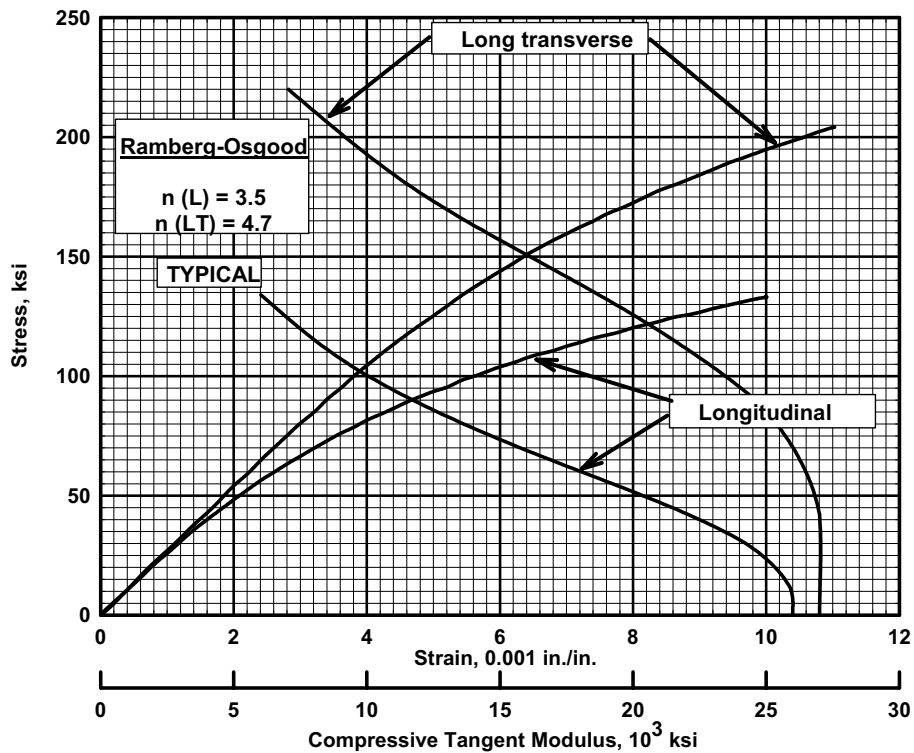

Figure 2.7.1.4.6(b). Typical compressive stress-strain and compressive tangent-modulus curves at room temperature for AISI 301 3/4-hard stainless steel sheet.

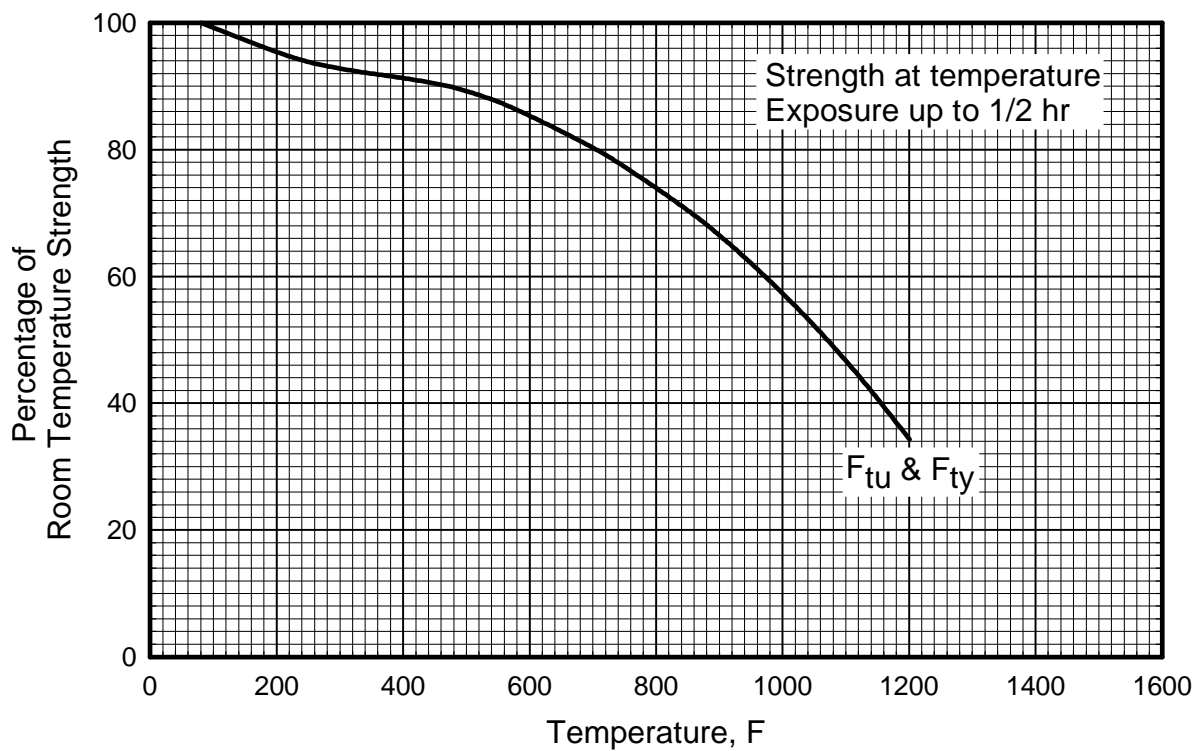

Figure 2.7.1.5.1. Effect of temperature on the tensile ultimate strength (F_{tu}) and the tensile yield strength (F_{ty}) of AISI 301 full-hard stainless steel sheet.

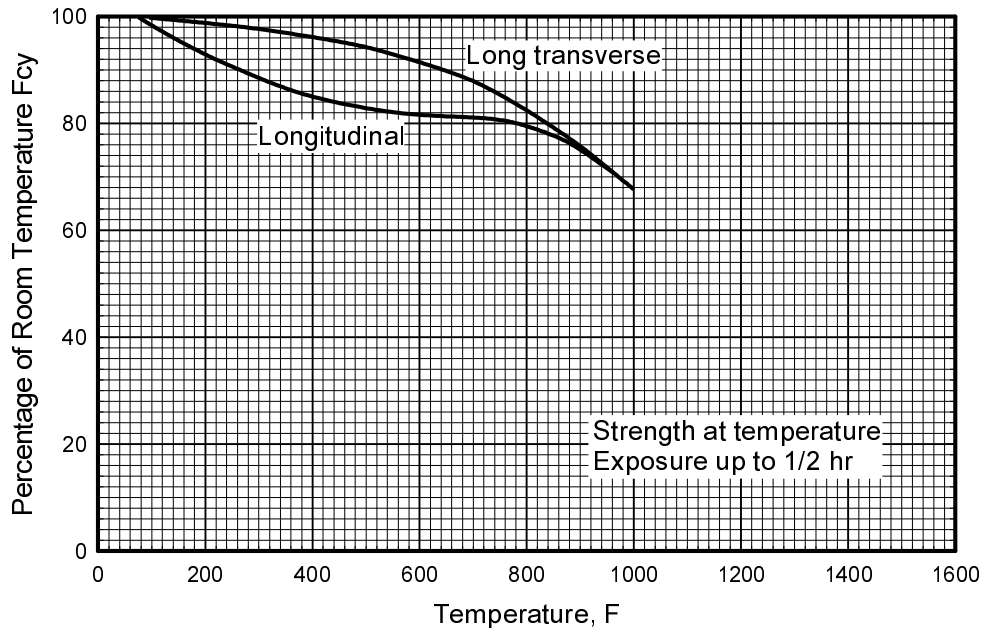

Figure 2.7.1.5.2(a). Effect of temperature on the compressive yield strength (F_{cy}) of AISI 301 (full-hard) stainless steel sheet.

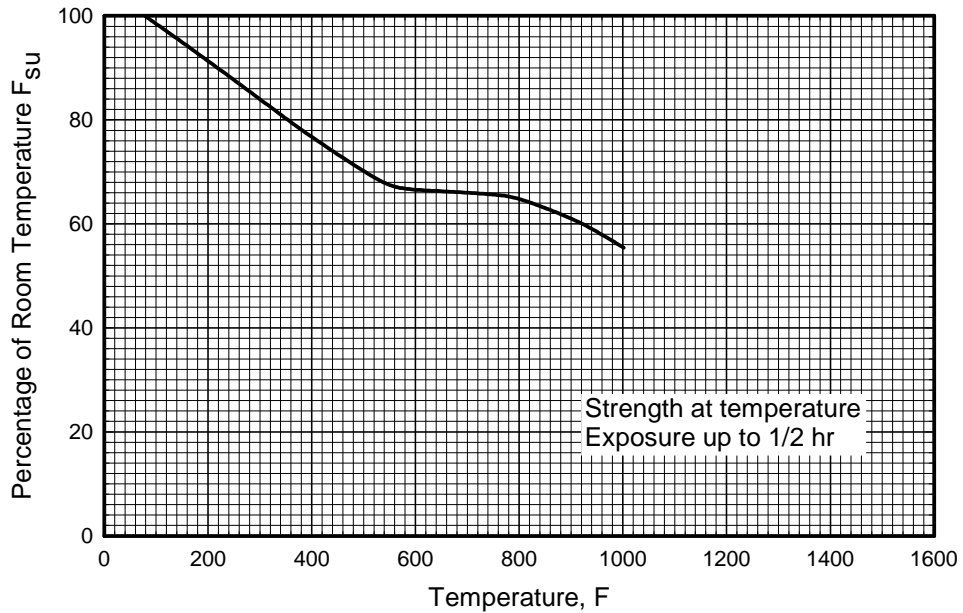

Figure 2.7.1.5.2(b). Effect of temperature on the ultimate shear strength (F_{su}) of AISI 301 (full-hard) stainless steel sheet.

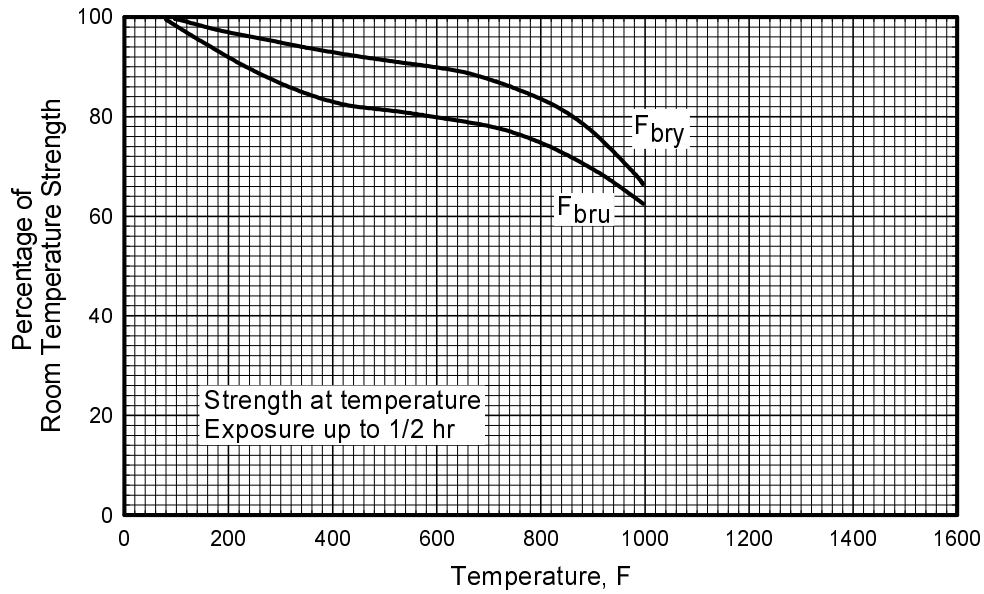

Figure 2.7.1.5.3. Effect of temperature on the bearing ultimate strength (F_{bru}) and the bearing yield strength (F_{bry}) of AISI 301 (full-hard) stainless steel sheet.

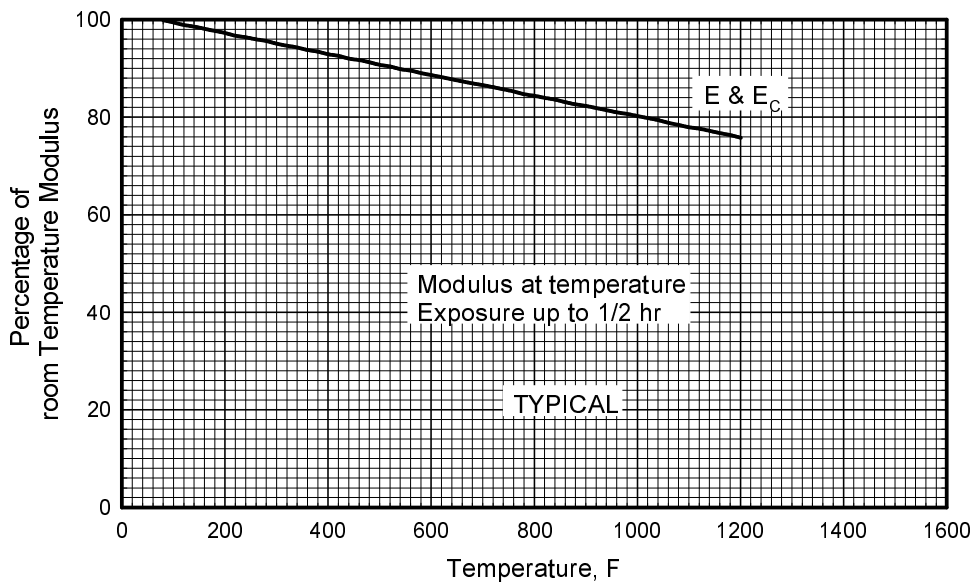

Figure 2.7.1.5.4. Effect of temperature on the tensile and compressive moduli (E and E_c) of AISI 301 (full-hard) stainless steel sheet.

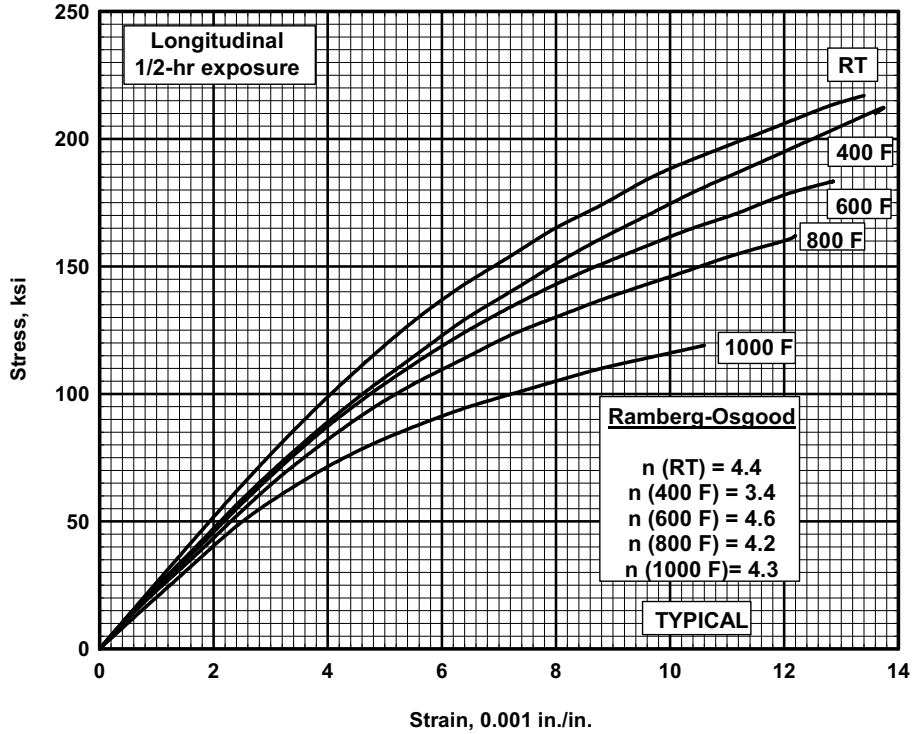

Figure 2.7.1.5.6(a). Typical tensile stress-strain curves at room and elevated temperatures for AISI 301 (full-hard) stainless steel sheet.

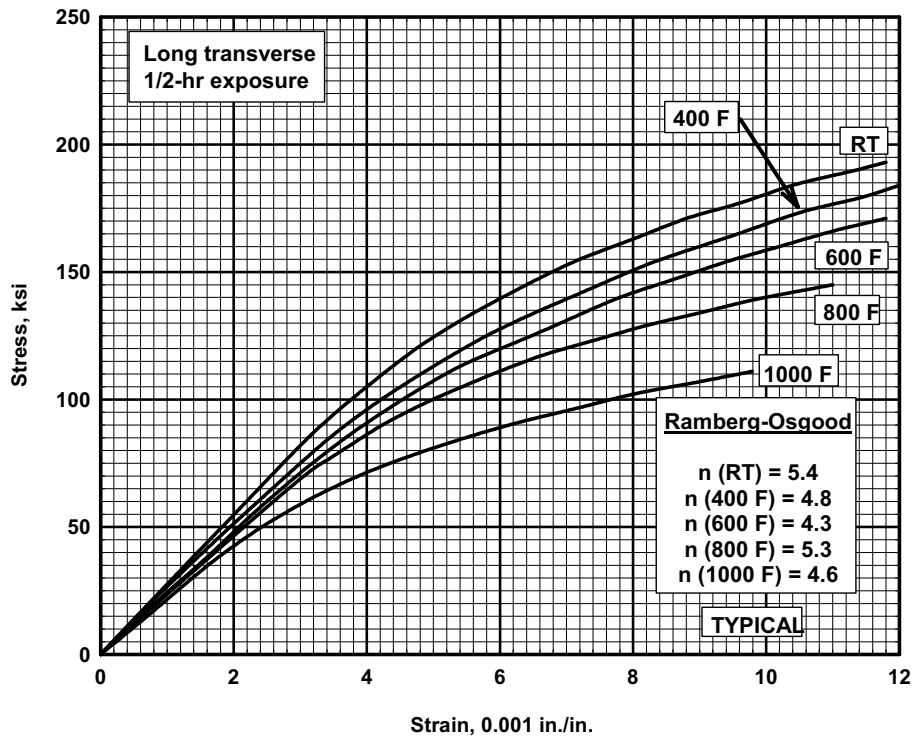

Figure 2.7.1.5.6(b). Typical tensile stress-strain curves at room and elevated temperatures for AISI 301 (full-hard) stainless steel sheet.

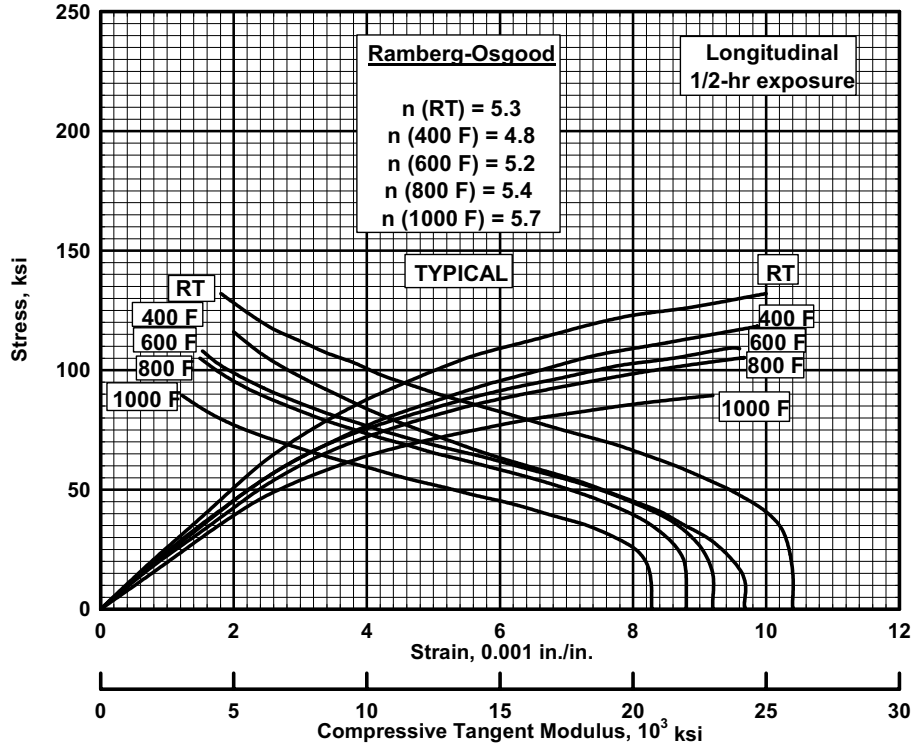

Figure 2.7.1.5.6(c). Typical compressive stress-strain and compressive tangent-modulus curves at room and elevated temperatures for AISI 301 (full-hard) stainless steel sheet.

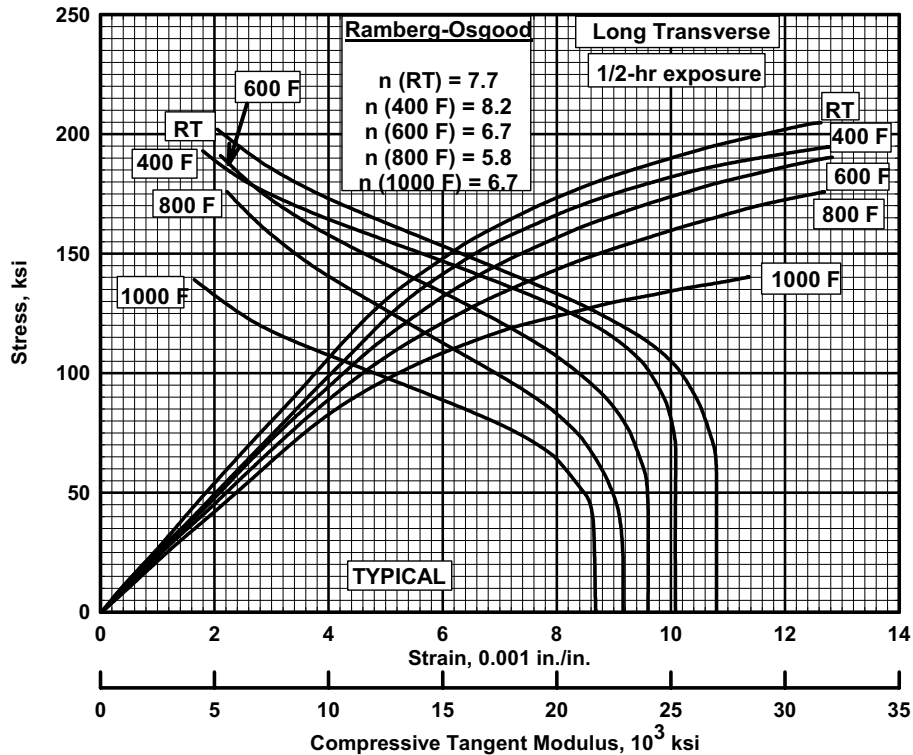

Figure 2.7.1.5.6(d). Typical compressive stress-strain and compressive tangent-modulus curves at room and elevated temperatures for AISI 301 (full-hard) stainless steel sheet.

2.8 ELEMENT PROPERTIES

2.8.1 BEAMS

See Equation 1.3.2.3, Section 1.5.2.5, and References 1.7.1(a) and (b) for general information on stress analysis of beams.

2.8.1.1 Simple Beams — Beams of solid, tubular, or similar cross sections, not subject to instability (buckling, crippling, column, lateral bending) can be assumed to fail through exceeding an allowable modulus of rupture in bending, F_b , the value of which will depend upon beam cross-section geometry and beam material stress-strain characteristics. The modulus of rupture in bending is further discussed in Section 1.5.2.5. See Reference 2.8.1.1.

Round Tubes — For round tubes, the value of F_b will depend on the D/t ratio, as well as the ultimate tensile stress. Figures 2.8.1.1(a) and (b) give the bending modulus of rupture for round alloy-steel tubing.

Unconventional Cross Sections — Sections other than solid or tubular should be tested to determine the allowable bending stress.

2.8.1.2 Built-Up Beams — Built-up beams usually fail because of local failures of the component parts. In welded steel tube beams, the allowable tensile stresses should be reduced properly for the effects of welding.

2.8.1.3 Thin-Web Beams — The allowable stresses for thin-web beams will depend on the nature of the failure and are determined from the allowable stresses of the web in tension and of the flanges and stiffeners in compression.

2.8.2 COLUMNS

2.8.2.1 General — The general formula for primary instability is given in Section 1.3.8. Both primary and local instability are discussed in Section 1.6.

2.8.2.2 Effects of Welding — The primary failure stress of a column having welded ends can be determined from column curves or the column formula with the restriction that the column stress will not exceed a “cut-off” stress which accounts for the effect of welding on the local failure of the column.

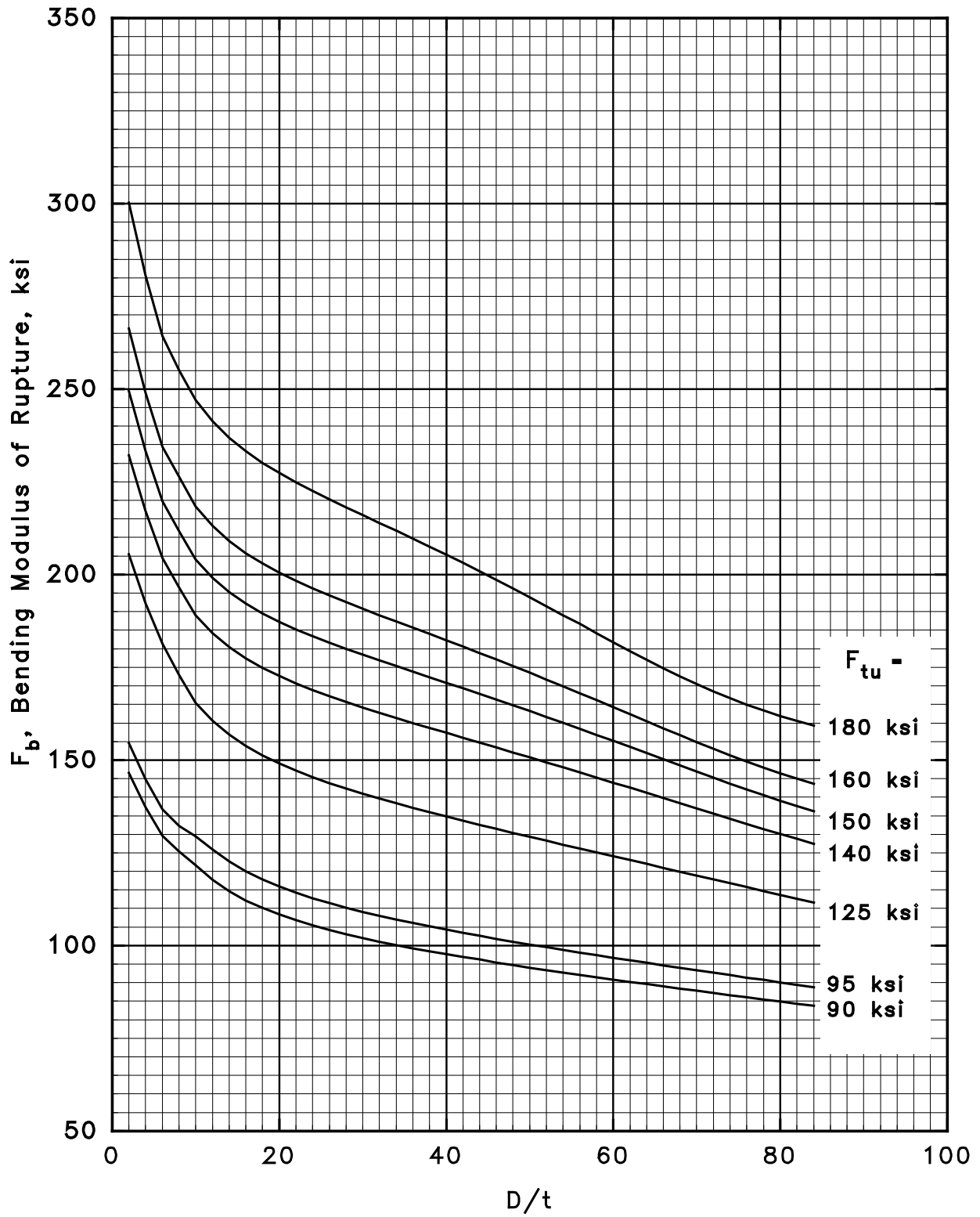

Figure 2.8.1.1(a). Bending modulus of rupture for round low-alloy steel tubing.

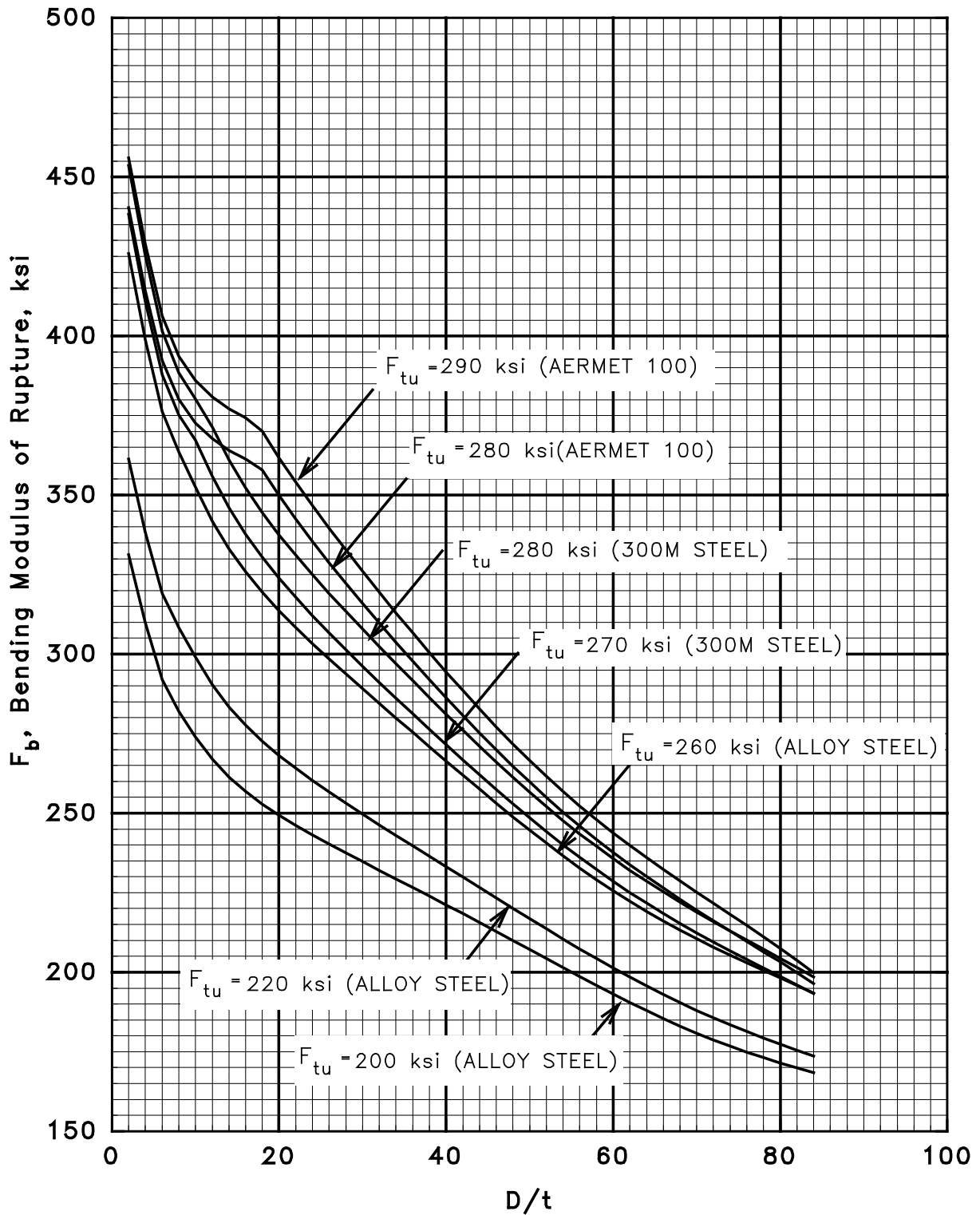

Figure 2.8.1.1(b). Bending modulus of rupture for round high-alloy steel tubing.

2.8.3 TORSION

2.8.3.1 General — The torsion failure of steel tubes may be due to material failure, or to elastic or plastic buckling. Pure shear failure usually will not occur within the range of wall thickness commonly used for aircraft tubing.

2.8.3.2 Torsion Properties — The curves of Figures 2.8.3.2(a) through (j) are derived from the method outlined in Reference 2.8.3.2 and take into account the parameter L/D ; the theoretical results set forth in Reference 2.8.3.2 have been found to be in good agreement with the experimental results.

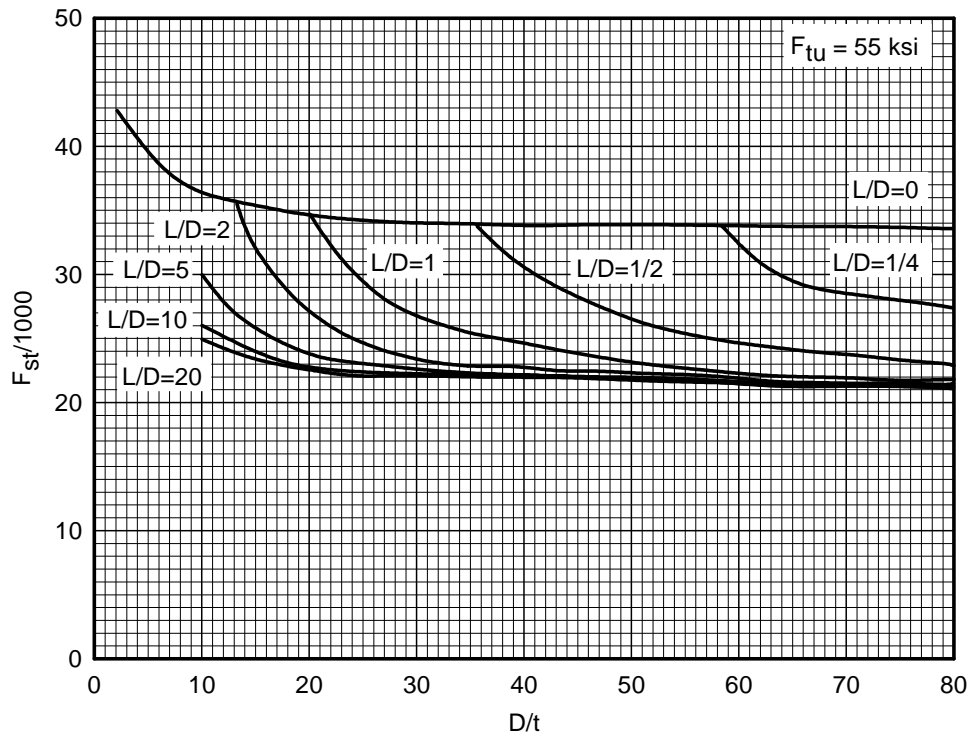

Figure 2.8.3.2(a). Torsional modulus of rupture—plain carbon steels $F_{tu} = 55$ ksi.

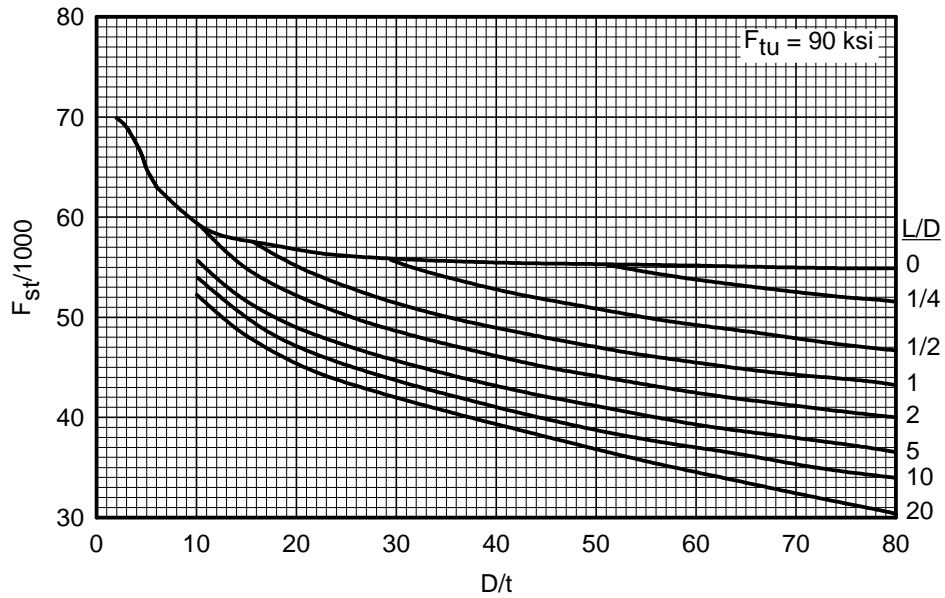

Figure 2.8.3.2(b). Torsional modulus of rupture—low-alloy steels treated to $F_{tu} = 90$ ksi.

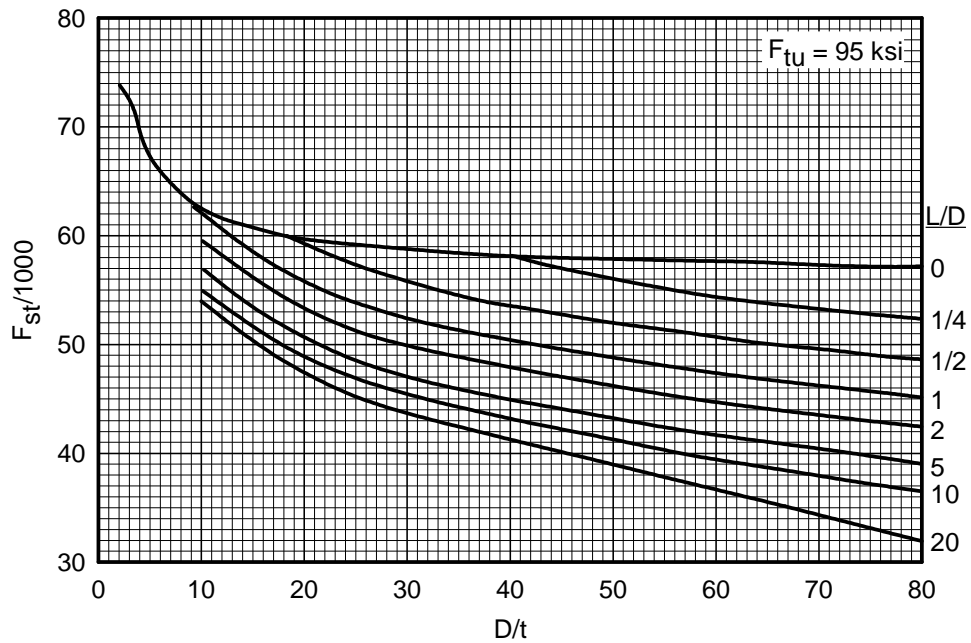

Figure 2.8.3.2(c). Torsional modulus of rupture—low-alloy steels heat treated to $F_{tu} = 95$ ksi.

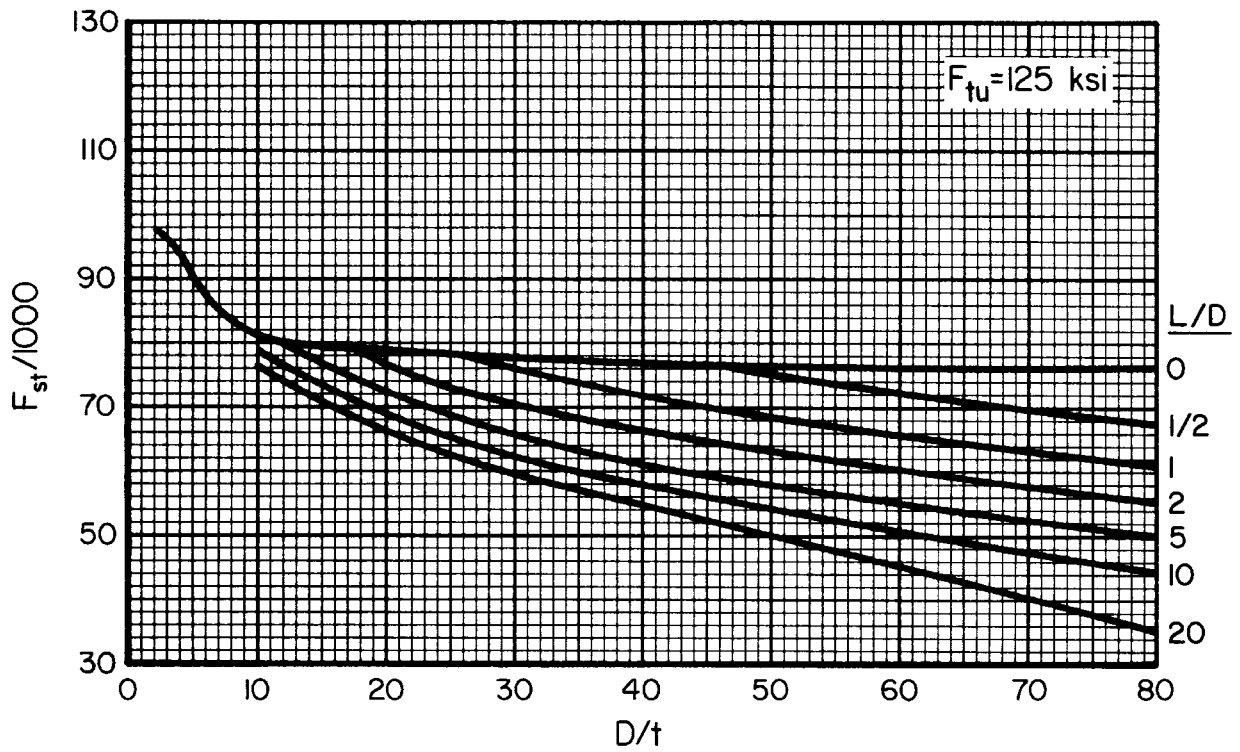

Figure 2.8.3.2(d). Torsional modulus of rupture—low-alloy steels, heat treated to $F_{tu} = 125$ ksi.

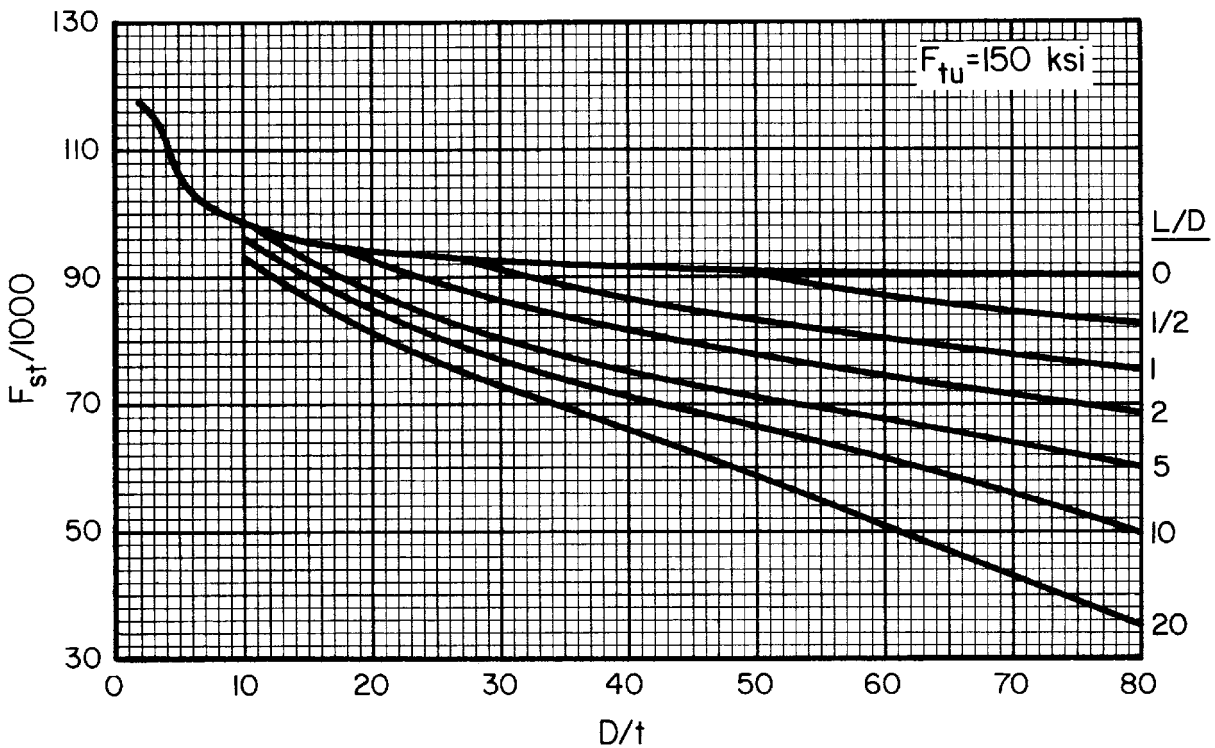

Figure 2.8.3.2(e). Torsional modulus of rupture—low-alloy steels heat treated to $F_{tu} = 150$ ksi.

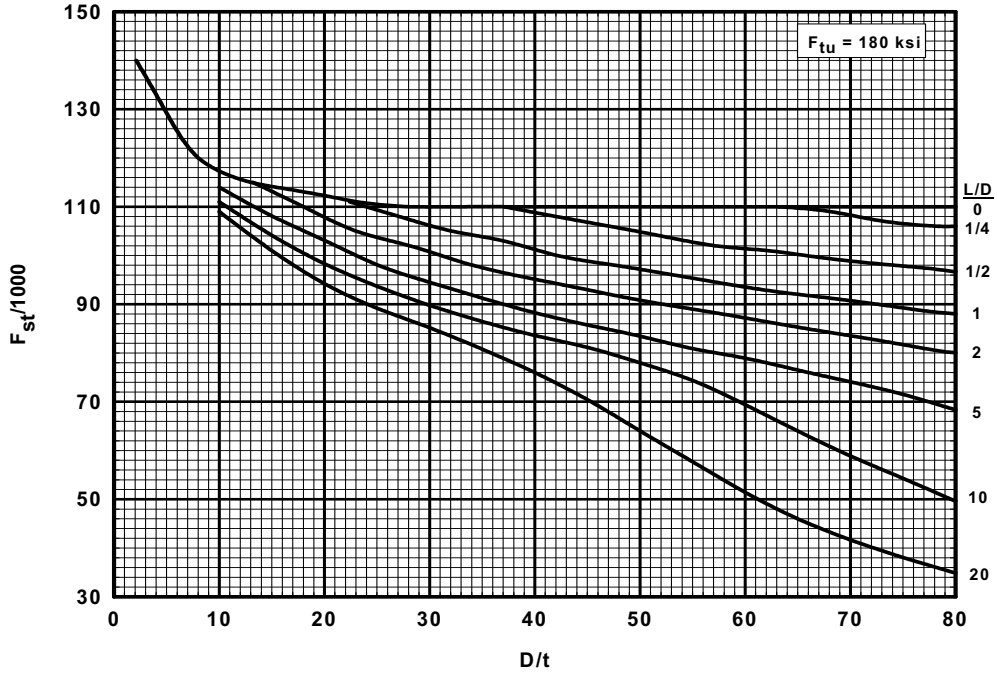

Figure 2.8.3.2(f). Torsional modulus of rupture—alloy steels heat treated to $F_{tu} = 180$ ksi.

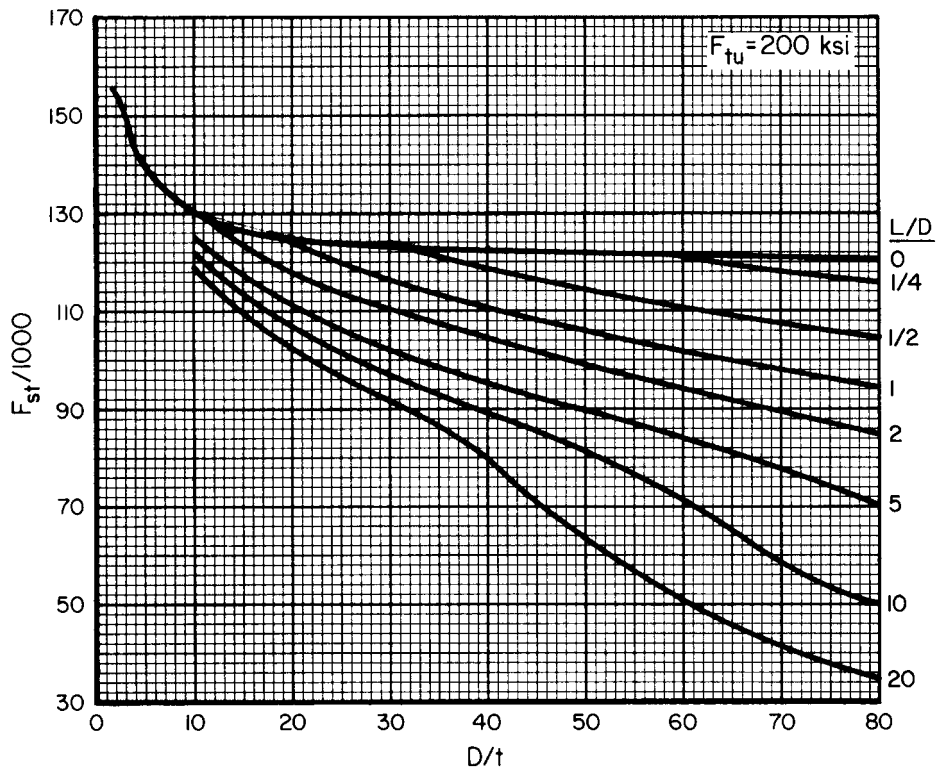

Figure 2.8.3.2(g). Torsional modulus of rupture—alloy steels heat treated to $F_{tu} = 200$ ksi.

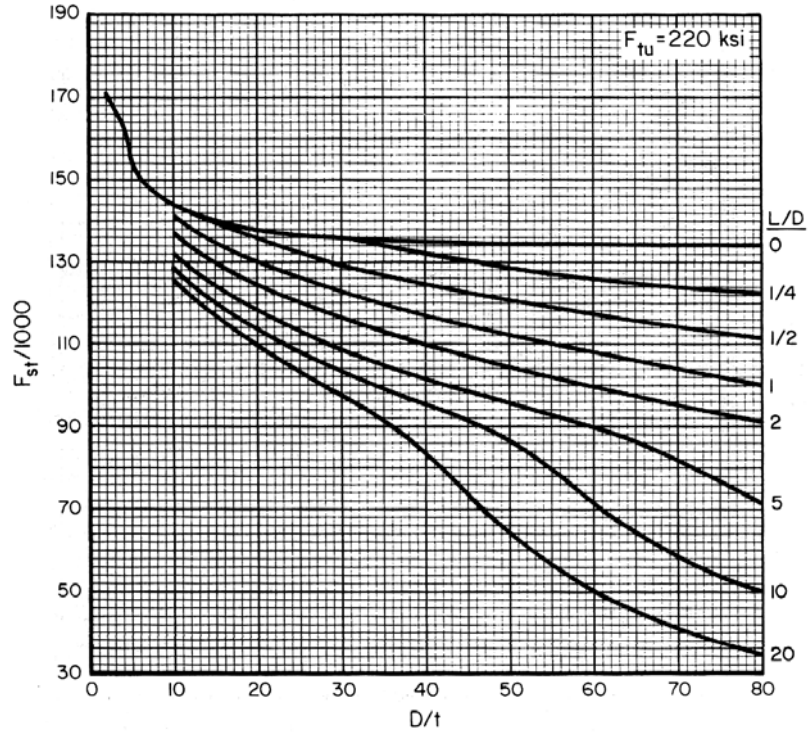

Figure 2.8.3.2(h). Torsional modulus of rupture—alloy steels heat treated to $F_{tu} = 220$ ksi.

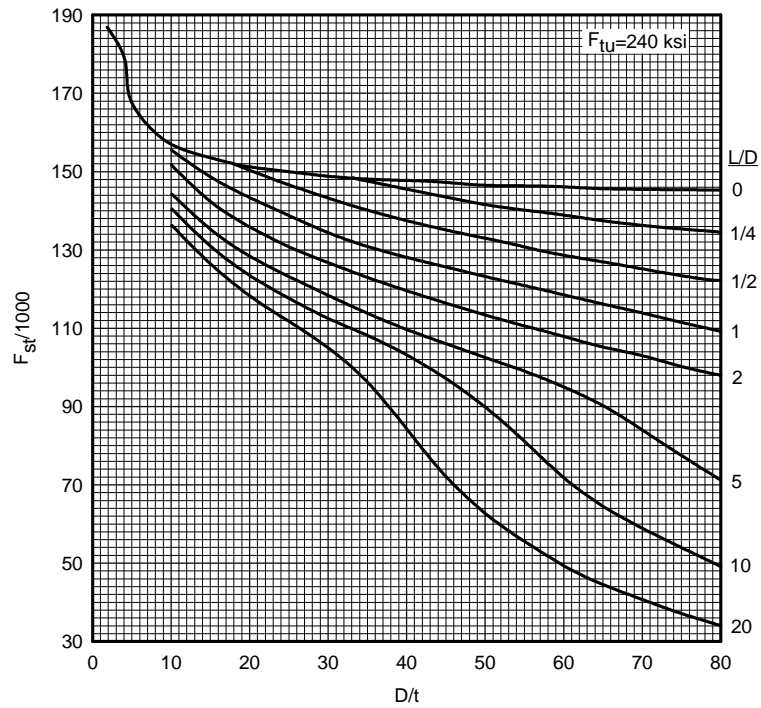

Figure 2.8.3.2(i). Torsional modulus of rupture—alloy steels heat treated to $F_{tu} = 240$ ksi.

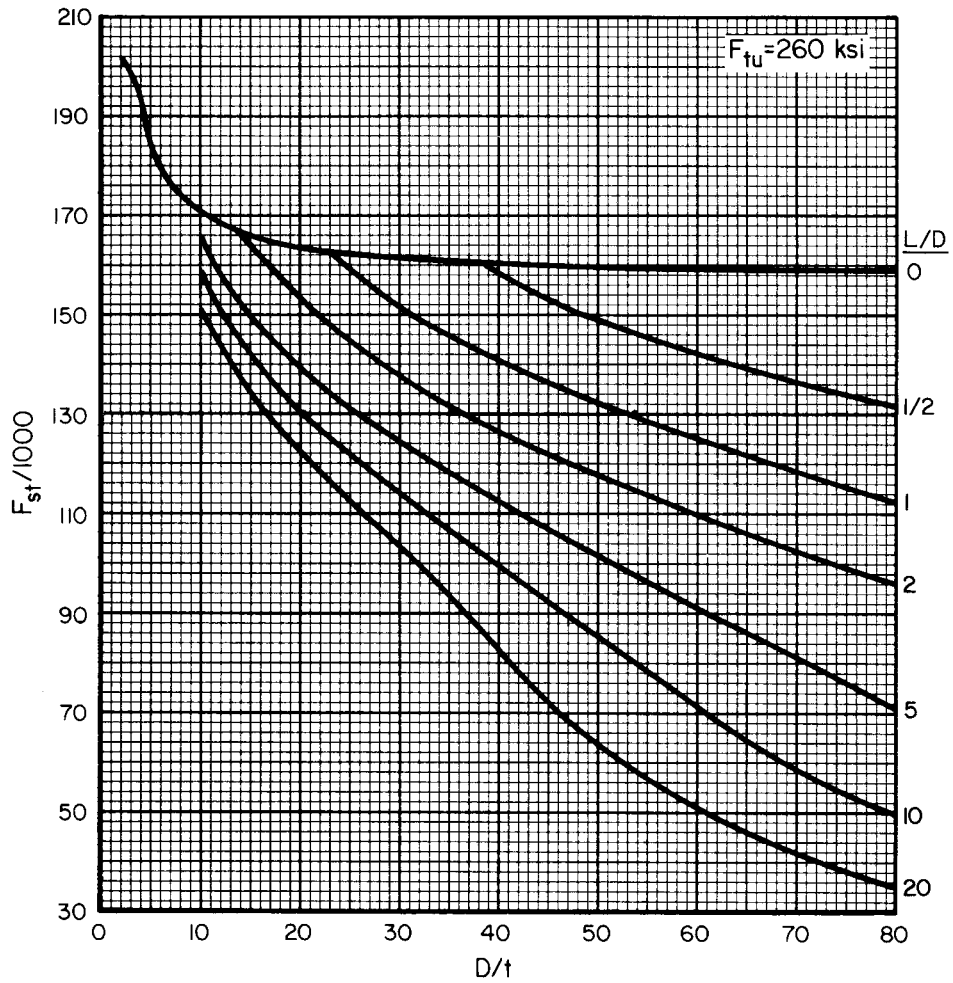

Figure 2.8.3.2(j). Torsional modulus of rupture—alloy steels heat treated to $F_{tu} = 260 \text{ ksi}$.

REFERENCES

- 2.2.0.3(a) "Low Temperature Properties of Ferrous Materials," Society of Automotive Engineers, Special Publication SP-61 (1950).
- 2.2.0.3(b) "The Selection of Steel for Notch Toughness," ASM Metals Handbook, 8th Edition, Vol. I, pp. 225-243 (1961).
- 2.3.0.2.5 "Heat Treating," ASM Handbook, Volume 4, 1991.
- 2.3.1.3.8(a) Brodrick, R. F., and Rich, E. L., "Evaluation of the Fatigue Properties of SAE 4340. Thermold J, and Tricent Steel Under Axial Loading Conditions," Technical Report No. 588/c39, Lessells and Associates (July 30, 1958) (MCIC 109748).
- 2.3.1.3.8(b) Trapp, W. J., "Elevated Temperature Fatigue Properties of SAE 4340 Steel," WADC TR 52-325, Part I (December 1952).
- 2.3.1.3.8(c) Oberg, T. T., and Ward, E. J., "Fatigue of Alloy Steels at High Stress Levels," Wright Air Dev. Center TR 53-256 (October 1953) (MCIC 108310).
- 2.3.1.3.8(d) Thrash, C. V., "Evaluation of High Strength Steels for Heavy Section Applications," Douglas Aircraft Engineering TR No. LB-32437 (November 29, 1965) (MCIC 70834).
- 2.3.1.4.8(a) Deel, O. L., and Mindlin, H., "Engineering Data on New and Emerging Structural Materials," AFML-TR-70-252 (October 1970) (MCIC 79662).
- 2.3.1.4.8(b) Bateh, E. J., "300M Steel Fatigue Program Structural Requirements," Lockheed-Georgia Report No. 72-26-591 (January 5, 1967) (MCIC 74342).
- 2.3.1.4.8(c) Harmsworth, C. L., "Low Cycle Fatigue Evaluation of Titanium 6Al-6V-2Sn and 300-M Steel for Landing Gear Applications," AFML-TR-69-48 (June 1969) (MCIC 75621).
- 2.3.1.4.8(d) Thrash, C. V., "Evaluation of High Strength Steels for DC-10," Douglas Aircraft Company Report No. ETR-DAC-67520 (May 27, 1969) (MCIC 110145).
- 2.3.1.4.8(e) Boswell, L. E., et al., "Fatigue Test for Landing Gear Material 300M Forgings," Vought Corporation Report No. 70-59910-047 (May 22, 1970) (MIL-HDBK-5 Source M-74).
- 2.3.1.4.9(a) Dill, D. H., "Evaluation of Steel Alloys 300M, HP-9Ni-4Co-0.20, HP-9Ni-4Co-0.30, and PH13-8Mo," Report MDC-A2639, McDonnell Aircraft Co., McDonnell Douglas Corp. (December 21, 1973) (MCIC 88136).
- 2.3.1.4.9(b) "B-1 Program da/dN Data for Steel Alloys," Rockwell International Corp., Memorandum to N. D. Moran from E. W. Cawthorne, Battelle, Columbus, Ohio (April 3, 1974) (MCIC 88579).
- 2.3.1.5.9 Feddersen, C. E., et al., "Crack Behavior in D6AC Steel," Report MCIC 72-04, Battelle, Columbus, Ohio (January 1972).
- 2.4.3.1.8 Bullock, D. E., et al., "Evaluation of Mechanical Properties of 9Ni-4Co Steel Forgings," AFML-TR-68-57 (March 1968).

MIL-HDBK-5J
31 January 2003

- 2.5.0.2 Kozol, J. and Neu, C.E., "Stress Corrosion Susceptibility of Ultra-High Strength Steels for Naval Aircraft Applications," Report No. NAWCADWAR-9208-60 (January 10, 1992) (MIL-HDBK-5 Source M-805).

- 2.6.3.1.8 Technical Memorandum (Progress Report), "Evaluation of Custom 455 and Custom 450 for MIL-HDBK-5," Carpenter Technology (November 14, 1974) (MIL-HDBK-5 Source M-350).

- 2.6.5.0 NACE Standard TM0177-96. TM0177-96, Laboratory Testing of Metals for Resistance to Sulfide Stress Cracking and Stress Corrosion Cracking in H₂S Environments.

- 2.6.6.1.8(a) Deel, O. L., and Mindlin, H., "Engineering Data on New Aerospace Structural Materials," AFML-TR-72-196, Vol. II (September, 1972) (MCIC 85292) (MIL-HDBK-5 Source M-466).

- 2.6.6.1.8(b) Deel, O. L., and Mindlin, H., "Fatigue Evaluation of PH13-8Mo Stainless Steel," Battelle Memorial Institute (July 31, 1970) (MCIC 79332) (MIL-HDBK-5 Source M-34).

- 2.6.6.1.8(c) Unpublished data, Lockheed-Georgia Company, Report No. ER 9347 (October 2, 1968) (MIL-HDBK-5 Source M-44).

- 2.6.6.1.8(d) Unpublished data, Letter report to Paul Ruff from ARMCO (March 29, 1972) (MIL-HDBK-5 Source M-141).

- 2.6.7.2.8(a) Unpublished data, Armco Research Lab, Armco Steel Corp., Baltimore, Maryland (April 11, 1977) (MIL-HDBK-5 Source M-364).

- 2.6.7.2.8(b) Doepfer, P. E., "Effect of Manufacturing Process on Structural Allowables," AFWAL-TR-85-4049 (May 1985) (MIAC 126632).

- 2.6.8.1.8(a) Illg, W., and Castle, C. B., "Fatigue of Four Stainless Steels and Three Titanium Alloys Before and After Exposure to 550 °F—Up to 8800 Hours," Langley Research Center, NASA TN D-2899 (July 1965) (MCIC 61319) (MIL-HDBK-5 Source M-579).

- 2.6.8.1.8(b) Illg, W., and Castle, C. B., "Axial-Load Fatigue Properties of PH15-7Mo Stainless Steel in Condition TH1050 at Ambient Temperature and 500 °F," Langley Research Center, NASA TN D-2358 (July 1964) (MCIC 56366).

- 2.6.8.1.8(c) Roach, T. A., "Development of Fatigue Data for Several Alloys for Use in Aerospace Design," Air Force Flight Dynamics Laboratory, Air Force Systems Command, Wright-Patterson Air Force Base, Ohio, Technical Report AFML-TR-69-175 (June 1969) (MCIC 76622) (MIL-HDBK-5 Source M-316).

- 2.6.9.1.8(a) Wolanski, Z. R., "Material Evaluation—17-4PH Cres, H-900 Condition Fatigue Characteristics," General Dynamics—Fort Worth (June 12, 1964) (MCIC 66105).

- 2.6.9.1.8(b) Larsson, N., "Fatigue Testing of Precipitating Steel 17-4PH With Aging as the Final Process," Aeronautical Research Institute of Sweden, Technical Note HU-1964 (August 1978) (MCIC 106285).

- 2.8.1.1 Ades, C. S., "Bending Strength of Tubing in the Plastic Range," Journal of the Aeronautical Sciences, Vol. 24, pp 605-610 (1957).

MIL-HDBK-5J
31 January 2003

- 2.8.3.2 Lee, L.H.N., and Ades, C. S., "Plastic Torsional Buckling Strength of Cylinders Including the Effects of Imperfections," *Journal of the Aeronautical Sciences*, Vol. 24, No. 4, pp 241-248 (April 1957).

CHAPTER 3

ALUMINUM

3.1 GENERAL

This chapter contains the engineering properties and related characteristics of wrought and cast aluminum alloys used in aircraft and missile structural applications.

General comments on engineering properties and the considerations relating to alloy selection are presented in Section 3.1. Mechanical and physical property data and characteristics pertinent to specific alloy groups or individual alloys are reported in Sections 3.2 through 3.9. Element properties are presented in Section 3.10.

Aluminum is a lightweight, corrosion-resistant structural material that can be strengthened through alloying and, dependent upon composition, further strengthened by heat treatment and/or cold working [Reference 3.1(a)]. Among its advantages for specific applications are: low density, high strength-to-weight ratio, good corrosion resistance, ease of fabrication and diversity of form.

Wrought and cast aluminum and aluminum alloys are identified by a four-digit numerical designation, the first digit of which indicates the alloy group as shown in Table 3.1. For structural wrought aluminum alloys the last two digits identify the aluminum alloy. The second digit indicates modifications of the original alloy or impurity limits. For cast aluminum and aluminum alloys the second and third digits identify the aluminum alloy or indicate the minimum aluminum percentage. The last digit, which is to the right of the decimal point, indicates the product form: XXX.0 indicates castings, and XXX.1 and XXX.2 indicate ingot.

Table 3.1. Basic Designation for Wrought and Cast Aluminum Alloys
[Reference 3.1(b)]

Alloy Group	Major Alloying Elements	Alloy Group	Major Alloying Groups
	Wrought Alloys		Cast Alloys
1XXX	99.00 percent minimum aluminum	1XX.0	99.00 percent minimum aluminum
2XXX	Copper	2XX.0	Copper
3XXX	Manganese	3XX.0	Silicon with added copper and/or magnesium
4XXX	Silicon	4XX.0	Silicon
5XXX	Magnesium	5XX.0	Magnesium
6XXX	Magnesium and Silicon	6XX.0	Unused Series
7XXX	Zinc	7XX.0	Zinc
8XXX	Other Elements	8XX.0	Tin
9XXX	Unused Series	9XX.0	Other Elements

3.1.1 ALUMINUM ALLOY INDEX — The layout of this chapter is in accordance with this four-digit number system for both wrought and cast alloys [Reference 3.1(b)]. Table 3.1.1 is the aluminum alloy index that illustrates both the general section layout as well as details of those specific aluminum alloys presently contained in this chapter. The wrought alloys are in Sections 3.2 through 3.7; whereas the cast alloys are in Sections 3.8 and 3.9.

Table 3.1.1. Aluminum Alloy Index

Section	Alloy Designation	Section	Alloy Designation
3.2	2000 series wrought alloys	3.6.2.	6061
3.2.1	2014	3.6.3	6151
3.2.2	2107	3.7	7000 series wrought alloys
3.2.3	2024	3.7.1	7010
3.2.4	2025	3.7.2	7040
3.2.5	2026	3.7.3	7049/7149
3.2.6	2090	3.7.4	7050
3.2.7	2124	3.7.5	7055
3.2.8	2219	3.7.6	7075
3.2.9	2297	3.7.7	7150
3.2.10	2424	3.7.8	7175
3.2.11	2519	3.7.9	7249
3.2.12	2524	3.7.10	7475
3.2.13	2618	3.8	200.0 series cast alloys
3.3	3000 series wrought alloys	3.8.1	A201.0
3.4	4000 series wrought alloys	3.9	300.0 series cast alloys
3.5	5000 series wrought alloys	3.9.1	354.0
3.5.1	5052	3.9.2	355.0
3.5.2	5083	3.9.3	C355.0
3.5.3	5086	3.9.4	356.0
3.5.4	5454	3.9.5	A356.0
3.5.5	5456	3.9.6	A357.0
3.6	6000 series wrought alloys	3.9.7	D357.0
3.6.1	6013	3.9.8	359.0

3.1.2 MATERIAL PROPERTIES — The properties of the aluminum alloys are determined by the alloy content and method of fabrication. Some alloys are strengthened principally by cold work, while others are strengthened principally by solution heat treatment and precipitation hardening [Reference 3.1(a)]. The temper designations, shown in Table 3.1.2 (which is based on Reference 3.1.2), are indicative of the type of strengthening mechanism employed.

Among the properties presented herein, some, such as the room-temperature, tensile, compressive, shear and bearing properties, are either specified minimum properties or derived minimum properties related directly to the specified minimum properties. They may be directly useful in design. Data on the effect of temperature on properties are presented so that percentages may be applied directly to the room-temperature minimum properties. Other properties, such as the stress-strain curve, fatigue and fracture toughness data, and modulus of elasticity values, are presented as average or typical values, which may be used in assessing the usefulness of the material for certain applications. Comments on the effect of temperature on properties are given in Sections 3.1.2.1.7 and 3.1.2.1.8; comments on the corrosion resistance are given in Section 3.1.2.3; and comments on the effects of manufacturing practices on these properties are given in Section 3.1.3.

Table 3.1.2. Temper Designation System for Aluminum Alloys

Temper Designation System^{a,b}	T thermally treated to produce stable tempers other than F, O, or H.
<p>The temper designation system is used for all forms of wrought and cast aluminum and aluminum alloys except ingot. It is based on the sequences of basic treatments used to produce the various tempers. The temper designation follows the alloy designation, the two being separated by a hyphen. Basic temper designations consist of letters. Subdivisions of the basic tempers, where required, are indicated by one or more digits following the letter. These designate specific sequences of basic treatments, but only operations recognized as significantly influencing the characteristics of the product are indicated. Should some other variation of the same sequence of basic operations be applied to the same alloy, resulting in different characteristics, then additional digits are added to the designation.</p>	<p>Applies to products which are thermally treated, with or without supplementary strain-hardening, to produce stable tempers. The T is always followed by one or more digits.</p>
<p>Basic Temper Designations</p>	<p>Subdivisions of H Temper: Strain-hardened.</p>
<p>F as fabricated. Applies to the products of shaping processes in which no special control over thermal conditions or strain-hardening is employed. For wrought products, there are no mechanical property limits.</p>	<p>The first digit following H indicates the specific combination of basic operations, as follows:</p>
<p>O annealed. Applies to wrought products which are annealed to obtain the lowest strength temper, and to cast products which are annealed to improve ductility and dimensional stability. The O may be followed by a digit other than zero.</p>	<p>H1 strain-hardened only. Applies to products which are strain-hardened to obtain the desired strength without supplementary thermal treatment. The number following this designation indicates the degree of strain-hardening.</p>
<p>H strain-hardened (wrought products only). Applies to products which have their strength increased by strain-hardening, with or without supplementary thermal treatments to produce some reduction in strength. The H is always followed by two or more digits.</p>	<p>H2 strain-hardened and partially annealed. Applies to products which are strain-hardened more than the desired final amount and then reduced in strength to the desired level by partial annealing. For alloys that age-soften at room temperature, the H2 tempers have the same minimum ultimate tensile strength as the corresponding H3 tempers. For other alloys, the H2 tempers have the same minimum ultimate tensile strength as the corresponding H1 tempers and slightly higher elongation. The number following this designation indicates the degree of strain-hardening remaining after the product has been partially annealed.</p>
<p>W solution heat-treated. An unstable temper applicable only to alloys which spontaneously age at room temperature after solution heat-treatment. This designation is specific only when the period of natural aging is indicated: for example, W ½ hr.</p>	<p>H3 strain-hardened and stabilized. Applies to products which are strain-hardened and whose mechanical properties are stabilized either by a low temperature thermal treatment or as a result of heat introduced during fabrication. Stabilization usually improves ductility. This designation is applicable only to those alloys which, unless stabilized, gradually age-soften at room temperature. The number following this designation indicates the degree of strain-hardening remaining after the stabilization treatment.</p>

a From reference 3.1.2.

b Temper designations conforming to this standard for wrought aluminum and wrought aluminum alloys, and aluminum alloy castings may be registered with the Aluminum Association provided: (1) the temper is used or is available for use by more than one user, (2) mechanical property limits are registered, (3) characteristics of the temper are significantly different from those of all other tempers which have the same sequence of basic treatments and for which designations already have been assigned for the same alloy and product, and (4) the following are also registered if characteristics other than mechanical properties are considered significant: (a) test methods and limits for the characteristics or (b) the specific practices used to produce the temper.

Table 3.1.2. Temper Designation System for Aluminum Alloys — Continued

The digit following the designations H1, H2, and H3 indicates the degree of strain hardening. Numeral 8 has been assigned to indicate tempers having an ultimate tensile strength equivalent to that achieved by a cold reduction (temperature during reduction not to exceed 120°F) of approximately 75 percent following a full anneal. Tempers between O (annealed) and 8 are designated by numerals 1 through 7. Material having an ultimate tensile strength about midway between that of the O temper and that of the 8 temper is designated by the numeral 4; about midway between the O and 4 tempers by the numeral 2; and about midway between 4 and 8 tempers by the numeral 6. Numeral 9 designates tempers whose minimum ultimate tensile strength exceeds that of the 8 temper by 2.0 ksi or more. For two-digit H tempers whose second digit is odd, the standard limits for ultimate tensile strength are exactly midway between those of the adjacent two digit H tempers whose second digits are even.

NOTE: For alloys which cannot be cold reduced an amount sufficient to establish an ultimate tensile strength applicable to the 8 temper (75 percent cold reduction after full anneal), the 6 temper tensile strength may be established by a cold reduction of approximately 55 percent following a full anneal, or the 4 temper tensile strength may be established by a cold reduction of approximately 35 percent after a full anneal.

The third digit^c, when used, indicates a variation of a two-digit temper. It is used when the degree of control of temper or the mechanical properties or both differ from, but are close to, that (or those) for the two-digit H temper designation to which it is added, or when some other characteristic is significantly affected.

NOTE: The minimum ultimate tensile strength of a three-digit H temper must be at least as close to that of the corresponding two-digit H temper as it is to the adjacent two-digit H tempers. Products of the H temper whose mechanical properties are below H_1 will be variations of H_1.

Three-digit H Tempers

- H_11** Applies to products which incur sufficient strain hardening after the final anneal that they fail to qualify as annealed but not so much or so consistent an amount of strain hardening that they qualify as H_1.
- H112** Applies to products which may acquire some temper from working at an elevated temperature and for which there are mechanical property limits.

**Subdivisions of T Temper:
Thermally Treated**

Numerals 1 through 10 following the T indicate specific sequences of basic treatments, as follows.^d

- T1 cooled from an elevated temperature shaping process and naturally aged to a substantially stable condition.** Applies to products which are not cold worked after cooling from an elevated temperature shaping process, or in which the effect of cold work in flattening or straightening may not be recognized in mechanical property limits.
- T2 cooled from an elevated temperature shaping process, cold worked and naturally aged to a substantially stable condition.** Applies to products which are cold worked to improve strength after cooling from an elevated temperature shaping process, or in which the effect of cold work in flattening or straightening is recognized in mechanical property limits.
- T3 solution heat-treated^e, cold worked, and naturally aged to a substantially stable condition.** Applies to products which are cold worked to improve strength after solution heat-treatment, or in which the effect of cold work in flattening or straightening is recognized in mechanical property limits.

c Numerals 1 through 9 may be arbitrarily assigned as the third digit and registered with The Aluminum Association for an alloy and product to indicate a variation of a two-digit H temper (see footnote b).

d A period of natural aging at room temperature may occur between or after the operations listed for the T tempers. Control of this period is exercised when it is metallurgically important.

e Solution heat treatment is achieved by heating cast or wrought products to a suitable temperature, holding at that temperature long enough to allow constituents to enter into solid solution and cooling rapidly enough to hold the constituents in solution. Some 6000 series alloys attain the same specified mechanical properties whether furnace solution heat-treated or cooled from an elevated temperature shaping process at a rate rapid enough to hold constituents in solution. In such cases the temper designations T3, T4, T6, T7, T8, and T9 are used to apply to either process and are appropriate designations.

Table 3.1.2. Temper Designation System for Aluminum Alloys — Continued

<p>T4 solution heat-treated^e and naturally aged to a substantially stable condition. Applies to products which are not cold worked after solution heat-treatment, or in which the effect of cold work in flattening or straightening may not be recognized in mechanical property limits.</p>	<p>T10 cooled from an elevated temperature shaping process, cold worked, and artificially aged. Applies to products which are cold worked to improve strength, or in which the effect of cold work in flattening or straightening is recognized in mechanical property limits.</p>
<p>T5 cooled from an elevated temperature shaping process and artificially aged. Applies to products which are not cold worked after cooling from an elevated temperature shaping process, or in which the effect of cold work in flattening or straightening may not be recognized in mechanical property limits.</p>	<p>Additional digits^f, the first of which will not be zero, may be added to designations T1 through T10 to indicate a variation in treatment which significantly alters the product characteristics^g that are or would be obtained using the basic treatment.</p> <p>The following specific additional digits have been assigned for stress-relieved tempers of wrought products:</p>
<p>T6 solution heat-treated^e and artificially aged. Applies to products which are not cold worked after solution heat-treatment or in which the effect of cold work in flattening or straightening may not be recognized in mechanical property limits.</p>	<p style="text-align: center;">Stress Relieved by Stretching</p>
<p>T7 solution heat-treated^e and overaged/stabilized. Applies to wrought products that are artificially aged after solution heat-treatment to carry them beyond a point of maximum strength to provide control of some significant characteristic. Applies to cast products that are artificially aged after solution heat-treatment to provide dimensional and strength stability.</p>	<p>T_51 Applies to plate and rolled or cold-finished rod and bar when stretched the indicated amounts after solution heat-treatment or after cooling from an elevated temperature shaping process. The products receive no further straightening after stretching.</p> <p>Plate 1½ to 3% permanent set. Rolled or Cold-Finished Rod and Bar 1 to 3% permanent set. Die or Ring Forgings and Rolled Rings 1 to 5% permanent set.</p>
<p>T8 solution heat-treated^e, cold worked, and artificially aged. Applies to products which are cold worked to improve strength, or in which the effect of cold work in flattening or straightening is recognized in mechanical property limits.</p>	<p>T_510 Applies to extruded rod, bar, shapes and tube and to drawn tube when stretched the indicated amounts after solution heat-treatment or after cooling from an elevated temperature shaping process. These products receive no further straightening after stretching.</p> <p>Extruded Rod, Bar, Shapes and Tube 1 to 3% permanent set. Drawn Tube ½ to 3% permanent set.</p>
<p>T9 solution heat-treated^e, artificially aged, and cold worked. Applies to products which are cold worked to improve strength.</p>	

e Solution heat treatment is achieved by heating cast or wrought products to a suitable temperature, holding at that temperature long enough to allow constituents to enter into solid solution and cooling rapidly enough to hold the constituents in solution. Some 6000 series alloys attain the same specified mechanical properties whether furnace solution heat-treated or cooled from an elevated temperature shaping process at a rate rapid enough to hold constituents in solution. In such cases the temper designations T3, T4, T6, T7, T8, and T9 are used to apply to either process and are appropriate designations.

f Additional digits may be arbitrarily assigned and registered with the Aluminum Association for an alloy and product to indicate a variation of tempers T1 through T10 even though the temper representing the basic treatment has not been registered (see footnote b). Variations in treatment which do not alter the characteristics of the product are considered alternate treatments for which additional digits are not assigned.

g For this purpose, characteristic is something other than mechanical properties. The test method and limit used to evaluate material for this characteristic are specified at the time of the temper registration.

Table 3.1.2. Temper Designation System for Aluminum Alloys — Continued

<p>T₅₁₁ Applies to extruded rod, bar, shapes and tube and to drawn tube when stretched the indicated amounts after solution heat-treatment or after cooling from an elevated temperature shaping process. These products may receive minor straightening after stretching to comply with standard tolerances.</p>	<p>Variations of O Temper: Annealed</p> <p>A digit following the O, when used, indicates a product in the annealed condition have special characteristics. NOTE: As the O temper is not part of the strain-hardened (H) series, variations of O temper will not apply to products which are strain-hardened after annealing and in which the effect of strain-hardening is recognized in the mechanical properties or other characteristics.</p>
<p>Stress Relieved by Compressing</p> <p>T₅₂ Applies to products which are stress-relieved by compressing after solution heat-treatment or cooling from an elevated temperature shaping process to produce a set of 1 to 3 percent.</p>	<p>Assigned O Temper Variations</p> <p>The following temper designation has been assigned for wrought products high temperature annealed to accentuate ultrasonic response and provide dimensional stability.</p>
<p>Stress Relieved by Combined Stretching and Compressing</p>	<p>O1 Thermally treated at approximately same time and temperature required for solution heat treatment and slow cooled to room temperature. Applicable to products which are to be machined prior to solution heat treatment by the user. Mechanical Property limits are not applicable.</p>
<p>T₅₄ Applies to die forgings which are stress relieved by restriking cold in the finish die.</p> <p>NOTE: The same digits (51, 52, 54) may be added to the designation W to indicate unstable solution heat-treated and stress-relieved treatment.</p> <p>The following temper designations have been assigned for wrought product test material heat-treated from annealed (O, O1, etc.) or F temper.^h</p>	<p>Designation of Unregistered Tempers</p> <p>The letter P has been assigned to denote H, T and O temper variations that are negotiated between manufacturer and purchaser. The letter P immediately follows the temper designation that most nearly pertains. Specific examples where such designation may be applied include the following:</p>
<p>T42 Solution heat-treated from annealed or F temper and naturally aged to a substantially stable condition.</p>	<p>The use of the temper is sufficiently limited so as to preclude its registration. (Negotiated H temper variations were formerly indicated by the third digit zero.)</p>
<p>T62 Solution heat-treated from annealed or F temper and artificially aged.</p> <p>Temper designations T42 and T62 may also be applied to wrought products heat-treated from any temper by the user when such heat-treatment results in the mechanical properties applicable to these tempers.</p>	<p>The test conditions (sampling location, number of samples, test specimen configuration, etc.) are different from those required for registration with the Aluminum Association.</p> <p>The mechanical property limits are not established on the same basis as required for registration with the Aluminum Association.</p>

^h When the user requires capability demonstrations from T-temper, the seller will note "capability compliance" adjacent to the specified ending tempers. Some examples are: "-T4 to -T6 Capability Compliance as for aging" or "-T351 to -T4 Capability Compliance as for resolution heat treating."

It should be recognized not all combinations of stress and environment have been investigated, and it may be necessary to evaluate an alloy under the specific conditions involved for certain critical applications.

3.1.2.1 Mechanical Properties —

3.1.2.1.1 Strength (Tension, Compression, Shear, Bearing) — The design strength properties at room temperature are listed at the beginning of the section covering the properties of an alloy. The effect of temperature on these properties is indicated in figures which follow the tables.

The A- and B-basis values for tensile properties for the direction associated with the specification requirements are based upon a statistical analysis of production quality control data obtained from specimens tested in accordance with procurement specification requirements. For sheet and plate of heat-treatable alloys, the specified minimum values are for the long-transverse (LT) direction, while for sheet and plate of nonheat treatable alloys and for rolled, drawn, or extruded products, the specified minimum values are for the longitudinal (L) direction. For forgings, the specified minimum values are stated for at least two directions. The design tensile properties in other directions and the compression, shear, and bearing properties are “derived” properties, based upon the relationships among the properties developed by tests of at least ten lots of material and applied to the appropriate established A, B, or S properties. All of these properties are representative of the regions from which production quality control specimens are taken, but may not be representative of the entire cross section of products appreciably thicker than the test specimen or products of complex cross sections.

Tensile and compressive strengths are given for the longitudinal, long-transverse, and short-transverse directions wherever data are available. Short-transverse strengths may be relatively low, and transverse properties should not be assumed to apply to the short-transverse direction unless so stated. In those instances where the direction in which the material will be used is not known, the lesser of the applicable longitudinal or transverse properties should be used.

Bearing strengths are given without reference to direction and may be assumed to be about the same in all directions, with the exception of plate, die forging, and hand forging. A reduction factor is used for edgewise bearing load in thick bare and clad plate of 2000 and 7000 series alloys. The results of bearing tests on longitudinal and long-transverse specimens taken edgewise from plate, die forging, and hand forging have shown that the edgewise bearing strengths are substantially lower than those of specimens taken parallel to the surface. The bearing specimen orientations in thick plate are shown in Figure 3.1.2.1.1(a). For plate, bearing specimens are oriented so that the width of the specimen is parallel to the surfaces of the plate (flatwise); consequently, in cases where the stress condition approximates that of the longitudinal or long-transverse edgewise orientations, the reductions in design values shown in Table 3.1.2.1.1 should be made.

It should be noted that in recent years, bearing data have been presented from tests made in accordance with ASTM E 238 which requires clean pins and specimens. See Reference 3.1.2.1.1 for additional information. Designers should consider a reduction factor in applying these values to structural analyses.

For die and hand forgings, bearing specimens are taken edgewise so that no reduction factor is necessary. In the case of die forgings, the location of bearing specimens is shown in Figures 3.1.2.1.1(b) and (c). For die forgings with cross-sectional shapes in the form of an I-beam or a channel, longitudinal

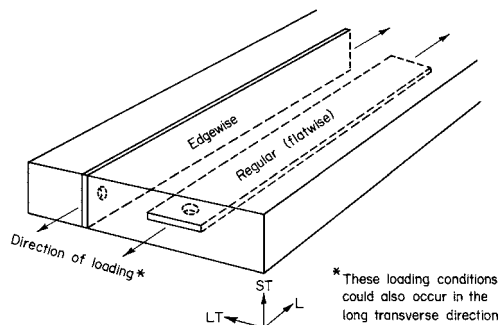

Figure 3.1.2.1.1(a). Bearing specimen orientation in thick plate.

Table 3.1.2.1.1. Bearing Property Reductions for Thick Plate of 2000 and 7000 Series Alloys

Thickness (in.) ...	Bearing Property Reduction, percent
	1.001-6.000
F_{bru} ($e/D = 1.5$)	15
F_{bru} ($e/D = 2.0$)	10
F_{bry} ($e/D = 1.5$)	5
F_{bry} ($e/D = 2.0$)	5

bearing specimens are oriented so the width of the specimens is normal to the parting plane (edgewise). The specimens are positioned so the bearing test holes are midway between the parting plane and the top of the flange. The severity of metal flow at the parting plane near the flash can be expected to vary considerably for web-flange type die forgings; therefore, for consistency, the bearing test hole should not be located on the parting plane. However, in the case of large, bulky-type die forgings, with a cross-sectional shape similar to a square, rectangle, or trapezoid, as shown in Figure 3.1.2.1.1(c), longitudinal bearing specimens are oriented edgewise to the parting plane, but the specimens are positioned so the bearing test holes are located on the parting plane. Similarly, for hand forgings, bearing specimens are oriented edgewise and the specimens are positioned at the $\frac{1}{2}$ thickness location.

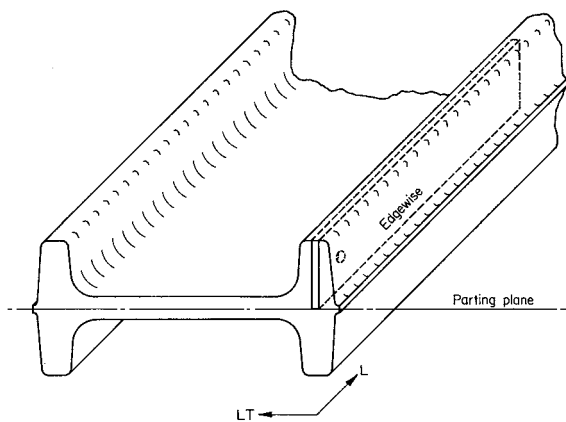

Figure 3.1.2.1.1(b). Bearing specimen orientation for web-flange type die forging.

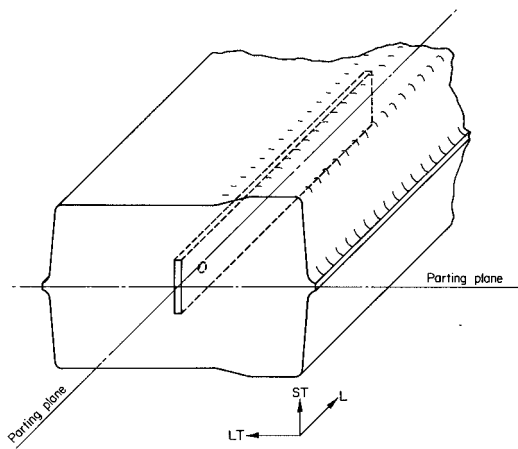

Figure 3.1.2.1.1(c). Bearing specimen orientation for thick cross-section die forging.

Shear strengths also vary to some extent with plane of shear and direction of loading but the differences are not so consistent [Reference 3.1.2.1.1(c)]. The standard test method for the determination of shear strength of aluminum alloy products, 3/16 inch and greater in thickness, is contained in ASTM B 769.

Shear strength values are presented without reference to grain direction, except for hand forgings. For products other than hand forgings, the lowest shear strength exhibited by tests in the various grain directions is the design value. For hand forgings, the shear strength in short-transverse direction may be significantly lower than for the other two grain directions. Consequently, the shear strength for hand forgings is presented for each grain direction.

For clad sheet and plate (i.e., containing thin surface layers of material of a different composition for added corrosion protection), the strength values are representative of the composite (i.e., the cladding and the core). For sheet and thin plate (≤ 0.499 inch), the quality-control test specimens are of the full thickness, so that the guaranteed tensile properties and the associated derived values for these products directly represent the composite. For plate ≥ 0.500 inch in thickness, the quality-control test specimens are machined from the core so the guaranteed tensile properties in specifications reflect the core material only, not the composite. Therefore, the design tensile properties for the thicker material are obtained by adjustment of the specification tensile properties and the other related properties to represent the composite, using the nominal total cladding thickness and the typical tensile properties of the cladding material.

For clad aluminum sheet and plate products, it is also important to distinguish between primary and secondary modulus values. The initial, or primary, modulus represents an average of the elastic moduli of the core and cladding; it applies only up to the proportional limit of the cladding. For example, the primary modulus of 2024-T3 clad sheet applies only up to about 6 ksi. Similarly, the primary modulus of 7075-T6 clad sheet applies only up to approximately 12 ksi. A typical use of primary moduli is for low amplitude, high frequency fatigue.

3.1.2.1.2 Elongation — Elongation values are included in the tables of room-temperature mechanical properties. In some cases where the elongation is a function of material thickness, a supplemental table is provided. Short-transverse elongations may be relatively low, and long-transverse values should not be assumed to apply to the short-transverse direction.

3.1.2.1.3 Stress-Strain Relationship — The stress-strain relationships presented, which include elastic and compressive tangent moduli, are typical curves based on three or more lots of test data. Being typical, these curves will not correspond to yield strength data presented as design allowables (minimum values). However, the stress-strain relationships are no less useful, since there are well-known methods for using these curves in design by reducing them to a minimum curve scaled down from the typical curve or by using Ramberg-Osgood parameters obtained from the typical curves.

3.1.2.1.4 Creep and Stress Rupture — Sustained stressing at elevated temperature sufficient to result in appreciable amounts of creep deformation (e.g., more than 0.2 percent) may result in decreased strength and ductility. It may be necessary to evaluate an alloy under its stress-temperature environment for critical applications where sustained loading is anticipated (see Reference 3.1.2.1.4).

3.1.2.1.5 Fatigue — Fatigue S/N curves are presented for those alloys for which sufficient data are available. Data for both smooth and notched specimens are presented. The data from which the curves were developed were insufficient to establish scatter bands and do not have the statistical reliability of the room-temperature mechanical properties; the values should be considered to be representative for the respective alloys.

The fatigue strengths of aluminum alloys, with both notched and unnotched specimens, are at least as high or higher at subzero temperatures than at room temperature [References 3.1.2.1.5(a) through (c)].

At elevated temperatures, the fatigue strengths are somewhat lower than at room temperature, the difference increasing with increase in temperature.

The data presented do not apply directly to the design of structures because they do not take into account the effect of stress raisers such as reentrant corners, notches, holes, joints, rough surfaces, and other similar conditions which are present in fabricated parts. The localized high stresses induced in fabricated parts by such stress raisers are of much greater importance for repeated loading than they are for static loading and may reduce the fatigue life of fabricated parts far below that which would be predicted by comparing the smooth-specimen fatigue strength directly with the nominal calculated stresses for the parts in question. See References 3.1.2.1.5 (d) through (q) for information on how to use high-strength aluminum alloys, Reference 3.1.2.1.5(r) for details on the static and fatigue strengths of high-strength aluminum-alloy bolted joints, Reference 3.1.2.1.5(s) for single-rivet fatigue-test data, and Reference 1.4.9.3(b) for a general discussion of designing for fatigue. Fatigue-crack-growth data are presented in the various alloy sections.

3.1.2.1.6 Fracture Toughness — Typical values of plane-strain fracture toughness, K_{Ic} , [Reference 3.1.2.1.6(a)] for the high-strength aluminum alloy products are presented in Table 3.1.2.1.6. Minimum, average, and maximum values as well as coefficient of variation are presented for the alloys and tempers for which valid data are available [References 3.1.2.1.6(b) through (j)]. Although representative, these values do not have the statistical reliability of the room-temperature mechanical properties.

Graphic displays of the residual strength behavior of middle tension panels are presented in the various alloy sections. The points denote the experimental data from which the curve of fracture toughness was derived.

3.1.2.1.7 Cryogenic Temperatures — In general, the strengths (including fatigue strengths) of aluminum alloys increase with decrease in temperature below room temperature [References 3.1.2.1.7(a) and (b)]. The increase is greatest over the range from about -100 to -423°F (liquid hydrogen temperature); the strengths at -452°F (liquid helium temperature) are nearly the same as at -423°F [References 3.1.2.1.7(c) and (d)]. For most alloys, elongation and various indices of toughness remain nearly constant or increase with decrease in temperature, while for the 7000 series, modest reductions are observed [References 3.1.2.1.7(d) and (e)]. None of the alloys exhibit a marked transition in fracture resistance over a narrow range of temperature indicative of embrittlement.

The tensile and shear moduli of aluminum alloys also increase with decreasing temperature so that at -100, -320, and -423°F, they are approximately 5, 12, and 16 percent, respectively, above the room temperature values [Reference 3.1.2.1.7(f)].

3.1.2.1.8 Elevated Temperatures — In general, the strengths of aluminum alloys decrease and toughness increases with increase in temperature and with time at temperature above room temperature; the effect is generally greatest over the temperature range from 212 to 400°F. Exceptions to the general trends are tempers developed by solution heat treatment without subsequent aging, for which the initial elevated temperature exposure results in some age hardening and reduction in toughness; further time at temperature beyond that required to achieve peak hardness results in the aforementioned decrease in strength and increase in toughness [Reference 3.1.2.1.8].

Table 3.1.2.1.6. Values of Room-Temperature Plane-Strain Fracture Toughness of Aluminum Alloys^a

Alloy/Temper ^b	Product Form	Orientation ^c	Product Thickness Range, inches	Number of Sources	Sample Size	Specimen Thickness Range, inches	K_{IC} , ksi $\sqrt{\text{in.}}$				Minimum Specification Value
							Max.	Avg.	Min.	Coefficient of Variation	
2014-T651	Plate	L-T	≥0.5	1	24	0.5-1.0	25	22	19	8.4	
2014-T651	Plate	T-L	≥0.5	2	34	0.5-1.0	23	21	18	6.5	
2014-T652	Hand Forging	L-T	≥0.5	2	15	0.8-2.0	48	31	24	21.8	
2014-T652	Hand Forging	T-L	≥0.8	2	15	0.8-2.0	30	21	18	14.4	
2024-T351	Plate	L-T	≥1.0	2	11	0.8-2.0	43	31	27	16.5	
2024-T851	Plate	L-S	1.4-3.0	4	11	0.5-0.8	32	25	20	17.8	
2024-T851	Plate	L-T	≥0.5	11	102	0.4-1.4	32	23	15	10.1	
2024-T851	Plate	T-L	0.4-4.0	9	80	0.4-1.4	25	20	18	8.8	
2024-T852	Forging	T-L	2.0-7.0	3	20	0.7-2.0	25	19	15	15.5	
2024-T852	Hand Forging	L-T	----	4	35	0.8-2.0	38	28	19	18.4	
2024-T852	Hand Forging	T-L	----	2	17	0.7-2.0	22	18	14	14.4	
2124-T851	Plate	L-T	≥0.8	13	497	0.5-2.5	38	29	18	10.4	24
2124-T851	Plate	T-L	0.6-6.0	10	509	0.5-2.0	32	25	19	9.7	20
2124-T851	Plate	S-L	≥0.5	6	489	0.3-1.5	27	21	16	9.8	18
2219-T851	Plate	L-T	----	4	67	1.0-2.5	38	33	30	7.2	
2219-T851	Plate	T-L	≥1.0	6	108	0.8-2.5	37	29	20	10.1	
2219-T851	Plate	S-L	≥0.8	3	24	0.5-1.5	26	22	20	9.6	
2219-T851	Forging	S-L	----	1	85	1.0-1.5	34	25	19	12.1	
2219-T851	Extrusion	T-L	----	1	19	1.8-2.0	34	29	23	12.3	
2219-T852	Forging	S-L	----	2	60	0.8-2.0	35	25	20	12.1	
2219-T852	Hand Forging	L-T	----	2	32	1.5-2.5	46	38	30	9.7	
2219-T852	Hand Forging	T-L	≥1.5	2	28	1.5-2.5	30	27	22	8.4	
2219-T87	Plate	L-T	≥1.5	3	11	0.8-2.0	34	27	25	9.3	
2219-T87	Plate	T-L	----	1	11	1.0	22	22	19	3.9	31
2297-T87	Plate	L-T	3-4	1	16	1.5	50	40	33	11.3	31
2297-T87	Plate	T-L	3-4	1	18	1.5	41	32	28	9.4	27
2297-T87	Plate	S-L	3-4	1	17	1.0	32	25	20	11.0	20
2297-T87	Plate	L-T	4-5	1	51	1.5	46	38	32	8.0	30
2297-T87	Plate	T-L	4-5	1	51	1.5	37	30	26	7.1	26
2297-T87	Plate	S-L	4-5	1	52	1.0	30	24	19	8.7	18
2297-T87	Plate	L-T	5-6	1	17	1.5	42	36	31	7.7	29
2297-T87	Plate	T-L	5-6	1	17	1.5	30	27	25	6.2	25
2297-T87	Plate	S-L	5-6	1	14	1.0	27	23	19	8.7	18

a These values are for information only.
b Products that do not receive a mechanical stress-relieving process (e.g. -T73 & -T74 tempers) have the potential for induced residual stresses. As a result, care must be taken to prevent fracture toughness properties from bias resulting from residual stresses.
c Refer to Figure 1.4.12.3 for definition of symbols.
d Varies with thickness.

Table 3.1.2.1.6. Values of Room-Temperature Plane-Strain Fracture Toughness of Aluminum Alloys^a—Continued

Alloy/Temper ^b	Product Form	Orientation ^c	Product Thickness Range, inches	Number of Sources	Sample Size	Specimen Thickness Range, inches	K _{IC} , ksi√in.				
							Max.	Avg.	Min.	Coefficient of Variation	Minimum Specification Value
7040-T7451	Plate	L-T	3-4	1	16	2	39	37	34	5.2	26
7040-T7451	Plate	T-L	3-4	1	16	2	31	30	28	2.8	24
7040-T7451	Plate	S-L	3-4	1	14	2	33	31	29	4.2	30
7040-T7451	Plate	L-T	4-5	1	17	2	34	32	31	2.0	25
7040-T7451	Plate	T-L	4-5	1	17	2	27	26	26	1.5	24
7040-T7451	Plate	S-L	4-5	1	17	2	28	26	26	2.2	29
7040-T7451	Plate	L-T	5-6	1	17	2	34	32	30	2.7	23
7040-T7451	Plate	T-L	5-6	1	14	2	28	25	25	3.5	24
7040-T7451	Plate	S-L	5-6	1	16	2	28	27	26	2.7	27
7040-T7451	Plate	L-T	6-7	1	21	2	37	34	30	5.9	22
7040-T7451	Plate	T-L	6-7	1	21	2	29	27	25	2.8	23
7040-T7451	Plate	S-L	6-7	1	21	2	30	29	27	4.0	26
7040-T7451	Plate	L-T	7-8	1	18	2	33	32	30	3.2	22
7040-T7451	Plate	T-L	7-8	1	16	2	29	28	26	2.7	23
7040-T7451	Plate	S-L	7-8	1	13	2	31	29	26	4.6	26
7040-T7451	Plate	L-T	8-8.5	1	17	2	34	31	28	4.6	22
7040-T7451	Plate	T-L	8-8.5	1	13	2	26	24	23	5.0	22
7040-T7451	Plate	S-L	8-8.5	1	17	2	27	26	25	2.1	22
7049-T73	Die Forging	L-T	1.4	3	21	2	34	30	27	7.4	
7049-T73	Die Forging	S-L	≥0.5	3	46	0.5-1.0	26	22	18	9.7	
7049-T73	Hand Forging	L-T	≥0.5	2	28	0.5-1.0	37	30	23	12.1	
7049-T73	Hand Forging	T-L	2.0-7.1	2	27	1.0	28	22	18	12.5	
7049-T73	Hand Forging	S-L	1.0	2	24	0.8-1.0	22	19	14	14.2	
7050-T7351	Plate	L-T	1.0-6.0	2	31	1.0-2.0	43	35	28	11.3	
7050-T7351	Plate	T-L	2.0-6.0	1	29	1.5-2.0	35	30	25	8.5	
7050-T7351	Plate	S-L	2.0-6.0	1	30	0.8-1.5	30	28	25	4.6	
7050-T74	Die Forging	S-L	0.6-7.1	3	12	0.6-2.0	27	24	21	8.8	d
7050-T7451	Plate	L-T	----	13	96	1.0-2.0	39	32	25	11.7	d
7050-T7451	Plate	T-L	≥1.0	9	97	0.5-2.0	38	28	21	15.6	d
7050-T7451	Plate	S-L	≥1.0	6	44	0.7-2.0	28	23	21	6.3	d

a These values are for information only.
b Products that do not receive a mechanical stress-relieving process (e.g. -T73 & -T74 tempers) have the potential for induced residual stresses. As a result, care must be taken to prevent fracture toughness properties from bias resulting from residual stresses.
c Refer to Figure 1.4.12.3 for definition of symbols.
d Varies with thickness.

Table 3.1.2.1.6. Values of Room-Temperature Plane-Strain Fracture Toughness of Aluminum Alloys^a—Continued

Alloy/Temper ^b	Product Form	Orientation ^c	Product Thickness Range, inches	Number of Sources	Sample Size	Specimen Thickness Range, inches	K _{IC} , ksi√in.				
							Max.	Avg.	Min.	Coefficient of Variation	Minimum Specification Value
7050-T7452	Hand Forging	L-T	3.5-5.5	1	11	1.5	34	31	26	8.0	d
7050-T7452	Hand Forging	T-L	3.5-7.5	1	13	1.5	22	21	18	6.7	d
7050-T7452	Hand Forging	S-L	3.5-7.5	1	17	0.8-1.5	21	19	16	7.5	
7050-T76511	Extrusion	L-T	----	2	38	0.6-2.0	40	31	27	7.8	
7075-T651	Plate	L-T	≥0.6	7	99	0.5-2.0	30	26	20	7.6	
7075-T651	Plate	T-L	≥0.5	5	135	0.4-2.0	27	22	18	8.9	
7075-T651	Plate	S-L	----	2	37	0.5-1.5	22	18	14	10.4	
7075-T6510	Extrusion	L-T	0.7-3.5	1	26	0.5-1.2	32	27	23	7.8	
7075-T6510	Extrusion	T-L	0.7-3.5	1	25	0.5-1.2	28	24	21	8.0	
7075-T6510	Forged Bar	L-T	0.7-5.0	1	13	0.6-2.0	35	29	24	11.6	
7075-T6510	Forged Bar	T-L	0.7-5.0	1	13	0.5-2.5	24	21	17	8.2	
7075-T73	Die Forging	T-L	≥0.5	1	22	0.5-0.8	25	21	18	9.9	
7075-T73	Hand Forging	L-T	----	2	10	1.0-1.5	39	31	29	8.8	
7075-T73	Hand Forging	T-L	≥1.0	2	14	1.0-1.5	27	23	20	9.0	
7075-T7351	Plate	L-T	≥1.0	8	65	0.5-2.0	36	30	25	8.2	
7075-T7351	Plate	T-L	≥0.5	6	56	0.5-2.0	47	27	21	20.1	
7075-T7351	Plate	S-L	≥0.5	3	20	0.5-1.5	38	22	17	32.5	
7075-T73511	Extrusion	T-L	1.0-7.0	1	19	0.9-1.0	22	20	19	3.7	
7075-T73511	Extrusion	L-T	≥0.9	3	28	0.7-2.0	43	35	31	9.4	
7075-T73511	Extrusion	T-L	≥0.7	3	35	0.5-1.8	35	23	12	20.3	
7075-T73511	Extrusion	S-L	≥0.5	3	15	0.4-1.0	22	20	17	9.0	
7075-T7352	Hand Forging	L-T	----	2	27	0.8-2.0	39	33	30	9.2	
7075-T7352	Hand Forging	T-L	≥0.8	3	20	0.8-2.0	33	26	23	9.9	
7075-T7651	Plate	L-T	≥0.8	6	82	0.5-2.0	43	29	22	17.8	
7075-T7651	Plate	T-L	≥0.5	7	96	0.5-2.0	28	23	20	7.6	
7075-T7651	Plate	S-L	≥0.5	5	28	0.4-0.8	20	18	15	7.7	
7075-T7651	Clad Plate	L-T	0.5-0.6	2	30	0.5-0.6	30	25	22	7.1	
7075-T7651	Clad Plate	T-L	0.5-0.6	2	56	0.5-0.6	28	24	21	7.7	

- a These values are for information only.
- b Products that do not receive a mechanical stress-relieving process (e.g. -T73 & -T74 tempers) have the potential for induced residual stresses. As a result, care must be taken to prevent fracture toughness properties from bias resulting from residual stresses.
- c Refer to Figure 1.4.12.3 for definition of symbols.
- d Varies with thickness.

Table 3.1.2.1.6. Values of Room-Temperature Plane-Strain Fracture Toughness of Aluminum Alloys^a—Concluded

Alloy/Temper ^b	Product Form	Orientation ^c	Product Thickness Range, inches	Number of Sources	Sample Size	Specimen Thickness Range, inches	K _{IC} , ksi√in.				
							Max.	Avg.	Min.	Coefficient of Variation	
7075-T76511	Extrusion	L-T	1.3-7.0	4	11	1.2-2.0	41	35	31	11.0	
7075-T76511	Extrusion	T-L	1.2	3	42	0.6-2.0	36	23	20	15.5	
7150-T77511	Extrusion	L-T	0.76	1	52	0.5	36	31	26	7.7	24
7150-T77511	Extrusion	T-L	0.76	1	52	0.5	27	24	21	5.1	20
7175-T6/T6511	Extrusion	T-L	----	2	25	0.8-1.0	24	21	18	7.9	
7175-T651	Plate	L-T	----	1	17	0.7-0.8	30	26	24	9.2	
7175-T651	Plate	T-L	----	1	10	0.7-0.8	26	22	20	9.8	
7175-T6511	Extrusion	L-T	----	2	14	0.8-1.0	36	32	24	13.8	
7175-T7351	Plate	L-T	----	2	30	0.7-1.6	36	33	32	3.3	
7175-T7351	Plate	T-L	----	2	32	0.7-1.6	30	27	25	4.5	
7175-T73511	Extrusion	L-T	≥0.7	5	43	0.5-1.5	47	33	23	16.0	30
7175-T73511	Extrusion	T-L	≥0.5	5	43	0.5-1.5	35	25	20	10.9	22
7175-T74	Die Forging	L-T	≥0.5	3	14	0.5-1.0	38	30	22	15.0	27
7175-T74	Die Forging	T-L	≥0.5	2	13	0.5-1.0	33	24	21	15.7	21
7175-T74	Die Forging	S-L	≥0.5	4	41	0.5-0.8	31	26	20	8.6	21
7175-T74	Hand Forging	T-L	3.0-5.0	2	10	1.0-1.5	29	26	24	4.8	25
7175-T7651	Clad Plate	L-T	----	1	53	1.5	33	32	30	4.3	
7175-T7651	Clad Plate	T-L	----	1	50	0.6	28	27	25	3.1	
7175-T7651	Plate	L-T	----	1	12	1.5	32	32	31	1.7	
7175-T7651	Plate	T-L	----	1	11	1.5	26	25	24	3.3	
7175-T76511	Extrusion	L-T	1.4-3.8	2	48	0.6-2.0	39	33	27	10.7	
7175-T76511	Extrusion	T-L	≥0.6	4	49	0.6-1.8	31	22	20	9.8	30
7475-T651	Plate	L-T	----	3	34	0.9-2.0	49	38	33	9.2	28
7475-T651	Plate	T-L	0.6-2.0	2	143	0.6-2.0	43	34	27	9.8	
7475-T651	Plate	S-L	≥0.6	1	23	0.5-1.0	36	28	20	14.9	d
7475-T7351	Plate	L-T	1.3-4.0	8	151	1.3-3.0	60	47	34	10.4	d
7475-T7351	Plate	T-L	≥1.3	7	132	0.7-3.0	50	37	29	10.4	
7475-T7351	Plate	S-L	≥0.7	7	74	0.5-1.5	36	30	25	8.7	25
7475-T7651	Plate	L-T	1.0-2.0	4	10	1.0-2.0	46	41	36	6.2	33
7475-T7651	Plate	T-L	≥1.0	2	15	0.9-2.0	50	36	29	14.5	30

a These values are for information only.
b Products that do not receive a mechanical stress-relieving process (e.g. -T73 & -T74 tempers) have the potential for induced residual stresses. As a result, care must be taken to prevent fracture toughness properties from bias resulting from residual stresses.
c Refer to Figure 1.4.12.3 for definition of symbols.
d Varies with thickness.

3.1.2.2 Physical Properties — Where available from the literature, the average values of certain physical properties are included in the room-temperature tables for each alloy. These properties include density, ω , in lb/in.³; the specific heat, C , in Btu/(lb)(°F); the thermal conductivity, K , in Btu/[(hr)(ft²)(°F)/ft]; and the mean coefficient of thermal expansion, α , in in./in./°F. Where more extensive data are available to show the effect of temperature on these physical properties, graphs of physical property as a function of temperature are presented for the applicable alloys.

3.1.2.3 Corrosion Resistance —

3.1.2.3.1 Resistance to Stress-Corrosion Cracking [see References 3.1.2.3.1(a) through (d)] — In-service stress-corrosion cracking failures can be caused by stresses produced from a wide variety of sources, including solution heat treatment, straightening, forming, fit-up, clamping, and sustained service loads. These stresses may be tensile or compressive, and the stresses due to Poisson effects should not be ignored because SCC failures can be caused by sustained shear stresses. Pin-hole flaws in some corrosion protection coatings may also be sufficient to allow SCC to occur. The high-strength heat treatable wrought aluminum alloys in certain tempers are susceptible to stress-corrosion cracking, depending upon product, section size, direction and magnitude of stress. These alloys include 2014, 2025, 2618, 7075, 7150, 7175, and 7475 in the T6-type tempers and 2014, 2024, 2124, and 2219 in the T3 and T4-type tempers. Other alloy-temper combinations, notably 2024, 2124, 2219, and 2519 in the T6- or T8-type tempers and 7010, 7049, 7050, 7075, 7149, 7175, and 7475 in the T73-type tempers, are decidedly more resistant and sustained tensile stresses of 50 to 75 percent of the minimum yield strength may be permitted without concern about stress corrosion cracking. The T74 and T76 tempers of 7010, 7075, 7475, 7049, 7149, and 7050 provide an intermediate degree of resistance to stress-corrosion cracking, i.e., superior to that of the T6 temper, but not as good as that of the T73 temper of 7075. To assist in the selection of materials, letter ratings indicating the relative resistance to stress-corrosion cracking of various mill product forms of the wrought 2000, 6000, and 7000 series heat-treated aluminum alloys are presented in Table 3.1.2.3.1(a). This table is based upon ASTM G 64 which contains more detailed information regarding this rating system and the procedure for determining the ratings. In addition, more quantitative information in the form of the maximum specified tension stresses at which test specimens will not fail when subjected to the alternate immersion stress-corrosion test described in ASTM G 47 are shown in Tables 3.1.2.3.1(b) through (e) for various heat-treated aluminum product forms, alloys, and tempers.

Where short times at elevated temperatures of 150 to 500°F may be encountered, the precipitation heat-treated tempers of 2024 and 2219 alloys are recommended over the naturally aged tempers.

Alloys 5083, 5086, and 5456 should not be used under high constant applied stress for continuous service at temperatures exceeding 150°F, because of the hazard of developing susceptibility to stress-corrosion cracking. In general, the H34 through H38 tempers of 5086, and the H32 through H38 tempers of 5083 and 5456 are not recommended, because these tempers can become susceptible to stress-corrosion cracking.

For the cold forming of 5083 sheet and plate in the H112, H321, H323, and H343 tempers and 5456 sheet and plate in the H112 and H321 tempers, a minimum bend radius of 5T should be used. Hot forming of the O temper for alloys 5083 and 5456 is recommended, and is preferred to the cold worked tempers to avoid excessive cold work and high residual stress. If the cold worked tempers are heat-treatable alloys are heated for hot forming, a slight decrease in mechanical properties, particularly yield strength, may result.

Table 3.1.2.3.1(a). Resistance to Stress-Corrosion Ratings^a for High-Strength Aluminum Alloy Products

Alloy and Temper ^b	Test Direction ^c	Rolled Plate	Rod and Bar ^d	Extruded Shapes	Forging
2014-T6	L	A	A	A	B
	LT	B ^e	D	B ^e	B ^e
	ST	D	D	D	D
2024-T3, T4	L	A	A	A	f
	LT	B ^e	D	B ^e	f
	ST	D	D	D	f
2024-T6	L	f	A	f	A
	LT	f	B	f	A ^e
	ST	f	B	f	D
2024-T8	L	A	A	A	A
	LT	A	A	A	A
	ST	B	A	B	C
2124-T8	L	A	f	f	f
	LT	A	f	f	f
	ST	B	f	f	f
2219-T351X, T37	L	A	f	A	f
	LT	B	f	B	f
	ST	D	f	D	f
2219-T6	L	A	A	A	A
	LT	A	A	A	A
	ST	A	A	A	A
2219-T85XX, T87	L	A	f	A	A
	LT	A	f	A	A
	ST	A	f	A	A
6061-T6	L	A	A	A	A
	LT	A	A	A	A
	ST	A	A	A	A
7040-T7451	L	A	f	f	f
	LT	A	f	f	f
	ST	B	f	f	f
7049-T73	L	A	f	A	A
	LT	A	f	A	A
	ST	A	f	B	A
7049-T76	L	f	f	A	f
	LT	f	f	A	f
	ST	f	f	C	f
7050-T74	L	A	f	A	A
	LT	A	f	A	A
	ST	B	f	B	B
7050-T76	L	A	A	A	f
	LT	A	B	A	f
	ST	C	B	C	f
7075-T6	L	A	A	A	A
	LT	B ^e	D	B ^e	B ^e
	ST	D	D	D	D
7075-T73	L	A	A	A	A
	LT	A	A	A	A
	ST	A	A	A	A

Table 3.1.2.3.1(a). Resistance to Stress-Corrosion Ratings^a for High-Strength Aluminum Alloy Products—Continued

Alloy and Temper ^b	Test Direction ^c	Rolled Plate	Rod and Bar ^d	Extruded Shapes	Forging
7075-T74	L	f	f	f	A
	LT	f	f	f	A
	ST	f	f	f	B
7075-T76	L	A	f	A	f
	LT	A	f	A	f
	ST	C	f	C	f
7149-T73	L	f	f	A	A
	LT	f	f	A	A
	ST	f	f	B	A
7175-T74	L	f	f	f	A
	LT	f	f	f	A
	ST	f	f	f	B
7475-T6	L	A	f	f	f
	LT	B ^e	f	f	f
	ST	D	f	f	f
7475-T73	L	A	f	f	f
	LT	A	f	f	f
	ST	A	f	f	f
7475-T76	L	A	f	f	f
	LT	A	f	f	f
	ST	C	f	f	f

a Ratings were determined from stress corrosion tests performed on at least ten random lots for which test results showed 90% conformance with 95% confidence when tested at the following stresses.

- A - Equal to or greater than 75% of the specified minimum yield strength. A very high rating. SCC not anticipated in general applications if the total sustained tensile stress* is less than 75% of the minimum specified yield stress for the alloy, heat treatment, product form, and orientation.
- B - Equal to or greater than 50% of the specified minimum yield strength. A high rating. SCC not anticipated if the total sustained tensile stress* is less than 50% of the specified minimum yield stress.
- C - Equal to or greater than 25% of the specified minimum yield stress or 14.5 ksi, whichever is higher. An intermediate rating. SCC not anticipated if the total sustained tensile stress* is less than 25% of the specified minimum yield stress. This rating is designated for the short transverse direction in improved products used primarily for high resistance to exfoliation corrosion in relatively thin structures where applicable short transverse stresses are unlikely.
- D - Fails to meet the criterion for the rating C. A low rating. SCC failures have occurred in service or would be anticipated if there is any sustained tensile stress* in the designated test direction. This rating currently is designated only for the short transverse direction in certain materials.

NOTE - The above stress levels are not to be interpreted as “threshold” stresses, and are not recommended for design. Other documents, such as MIL-STD-1568, NAS SD-24, and MSFC-SPEC-522A, should be consulted for design recommendations.

b The ratings apply to standard mill products in the types of tempers indicated, including stress-relieved tempers, and could be invalidated in some cases by application of nonstandard thermal treatments of mechanical deformation at room temperature by the user.

* The sum of all stresses, including those from service loads (applied), heat treatment, straightening, forming, etc.

Table 3.1.2.3.1(a). Resistance to Stress-Corrosion Ratings^a for High Strength Aluminum Alloy Products—Continued

- c Test direction refers to orientation of the stressing direction relative to the directional grain structure typical of wrought materials, which in the case of extrusions and forgings may not be predictable from the geometrical cross section of the product.
L—Longitudinal: parallel to the direction of principal metal extension during manufacture of the product.
LT—Long Transverse: perpendicular to direction of principal metal extension. In products whose grain structure clearly shows directionality (width to thickness ratio greater than two) it is that perpendicular direction parallel to the major grain dimension.
ST—Short Transverse: perpendicular to direction of principal metal extension and parallel to minor dimension of grains in products with significant grain directionality.
- d Sections with width-to-thickness ratio equal to or less than two for which there is no distinction between LT and ST.
- e Rating is one class lower for thicker sections: extrusion, 1 inch and over; plate and forgings, 1.5 inches and over.
- f Ratings not established because the product is not offered commercially.

NOTE: This table is based upon ASTM G 64.

3.1.2.3.2 Resistance to Exfoliation [Reference 3.1.2.3.2] — The high-strength wrought aluminum alloys in certain tempers are susceptible to exfoliation corrosion, dependent upon product and section size. Generally those alloys and tempers that have the lowest resistance to stress-corrosion cracking also have the lowest resistance to exfoliation. The tempers that provide improved resistance to stress-corrosion cracking also provide improved resistance or immunity to exfoliation. For example, the T76 temper of 7075, 7049, 7050, and 7475 provides a very high resistance to exfoliation, i.e., decidedly superior to the T6 temper, and almost the immunity provided by the T73 temper of 7075 alloy (see Reference 3.1.2.3.2).

3.1.3 MANUFACTURING CONSIDERATIONS

3.1.3.1 Avoiding Stress-Corrosion Cracking — In order to avoid stress-corrosion cracking (see Section 3.1.2.3), practices, such as the use of press or shrink fits; taper pins; clevis joints in which tightening of the bolt imposes a bending load on female lugs; and straightening or assembly operations; which result in sustained surface tensile stresses (especially when acting in the short-transverse grain orientation), should be avoided in these high-strength alloys: 2014-T451, T4, T6, T651, T652; 2024-T3, T351, T4; 7075-T6, T651, T652; 7150-T6151, T61511; and 7475-T6, T651.

Where straightening or forming is necessary, it should be performed when the material is in the freshly quenched condition or at an elevated temperature to minimize the residual stress induced. Where elevated temperature forming is performed on 2014-T4 T451, or 2024-T3 T351, a subsequent precipitation heat treatment to produce the T6 or T651, T81 or T851 temper is recommended.

It is good engineering practice to control sustained short-transverse tensile stress at the surface of structural parts at the lowest practicable level. Thus, careful attention should be given in all stages of manufacturing, starting with design of the part configuration, to choose practices in the heat treatment, fabrication, and assembly to avoid unfavorable combinations of end grain microstructure and sustained tensile stress. The greatest danger arises when residual, assembly, and service stress combine to produce high sustained tensile stress at the metal surface. Sources of residual and assembly stress have been the most contributory to stress-corrosion-cracking problems because their presence and magnitude were not recognized. In most cases, the design stresses (developed by functional loads) are not continuous and would not be involved in the summation of sustained tensile stress. It is imperative that, for materials with low resistance to stress-corrosion cracking in the short-transverse grain orientation, every effort be taken to keep the level of sustained tensile stress close to zero.

Table 3.1.2.3.1(b). Maximum Specified Tension Stress at Which Test Specimens Will Not Fail in 3½% NaCl Alternate Immersion Test^a for Various Stress Corrosion Resistant Aluminum Alloy Plate

Alloy and Temper	Test Direction	Thickness, inches	Stress, ksi	Referenced Specifications
2024-T851	ST	1.001-4.000	28 ^b	Company specification
		4.001-6.000	27 ^b	
2090-T81 ^c	ST	0.750-1.500	20	AMS 4303
2124-T851	ST	1.500-1.999	28 ^b	AMS 4101
		2.000-4.000	28 ^b	AMS-QQ-A-0025/29, ASTM B 209, AMS 4101
2124-T8151 ^c	ST	4.001-6.000	27 ^b	AMS 4221
		1.500-3.000	30 ^b	
2219-T851	ST	3.001-5.000	29 ^b	AMS-QQ-A-250/30
		5.001-6.000	28 ^b	
		0.750-2.000	34 ^d	
2219-T87	ST	2.001-4.000	33 ^d	AMS-QQ-A-250/30
		4.001-5.000	32 ^d	
		5.001-6.000	31 ^d	
2519-T87	ST	0.750-3.000	38 ^d	AMS-QQ-A-250/30
		3.001-4.000	37 ^d	
		4.001-5.000	36 ^d	
7010-T7351 ^c	ST	0.750-4.000	43 ^d	MIL-A-46192
		0.750-3.000	41 ^d	AMS 4203
7010-T7451	ST	3.001-5.000	40 ^d	AMS 4205
		5.001-5.500	39 ^d	
		0.750-3.000	31 ^b	
7010-T7651	ST	3.001-5.500	35	AMS 4204
		0.750-5.500	25	
7049-T7351	ST	0.750-5.000	45	AMS 4200
7050-T7451	ST	0.750-6.000	35	AMS 4050
7050-T7651	ST	0.750-3.000	25	AMS 4201
7075-T7351	ST	0.750-2.000	42 ^d	AMS-QQ-A-250/12, AMS 4078, ASTM B 209
		2.001-2.500	39 ^d	
		2.501-4.000	36 ^d	
7075-T7651	ST	0.750-1.000	25	AMS-QQ-A-00250/24, ASTM B 209
Clad 7075-T7651	ST	0.750-1.000	25	AMS-QQ-A-00250/25, ASTM B 209
7150-T7751	ST	0.750-3.000	25	AMS 4252
7475-T7351	ST	0.750-4.000	40	AMS 4202
7475-T7651	ST	0.750-1.500	25	AMS 4089

- a Most specifications reference ASTM G 47, which requires exposures of 10 days for 2XXX alloys and 20 days for 7XXX alloys in ST test direction.
- b 50% of specified minimum long transverse yield strength.
- c Design values are not included in MIL-HDBK-5.
- d 75% of specified minimum long transverse yield strength.

DO NOT USE STRESS VALUES FOR DESIGN

Table 3.1.2.3.1(c). Maximum Specified Tension Stress at Which Test Specimens Will Not Fail in 3½% NaCl Alternate Immersion Test^a for Various Stress Corrosion Resistant Aluminum Alloy Rolled Bars, Rods, and Extrusions

Alloy and Temper	Product Form	Test Direction	Thickness, inches	Stress, ksi	Referenced Specifications
7075-T73-T7351	Rolled Bar and Rod	ST	0.750-3.000	42 ^b	AMS-QQ-A-225/9, AMS 4124, ASTM B211
2219-T8511	Extrusion	ST	0.750-3.000	30	AMS 4162, AMS 4163
7049-T73511	Extrusion	ST	0.750-2.999	41 ^c	AMS 4157
			3.000-5.000	40 ^c	
7049-T76511 ^d	Extrusion	ST	0.750-5.000	20	AMS 4159
7050-T73511	Extrusion	ST	0.750-5.000	45	AMS 4341
7050-T74511	Extrusion	ST	0.750-5.000	35	AMS 4342
7050-T76511	Extrusion	ST	0.750-5.000	17	AMS 4340
7075-T73-T73510-T73511	Extrusion	ST	0.750-1.499	45 ^b	AMS-QQ-A-200/11, AMS 4166, AMS 4167, ASTM B 211
			1.500-2.999	44 ^b	
			3.000-4.999	42 ^b	
			3.000-4.999	41 ^{b,e}	
7075-T76-T76510-T76511	Extrusion	ST	0.750-1.000	25	AMS-QQ-A-200/15, ASTM B 221
7149-T73511 ^d	Extrusion	ST	0.750-2.999	41 ^c	AMS 4543
			3.000-5.000	40 ^c	
7150-T77511	Extrusion	ST	0.750-2.000	25	AMS 4345
7175-T73511	Extrusion	ST	0.750-2.000	44	AMS 4344

a Most specifications reference ASTM G 47, which requires exposures of 10 days for 2XXX alloys and 20 days for 7XXX alloys in ST test direction.

b 75% of specified minimum longitudinal yield strength.

c 65% of specified minimum longitudinal yield strength.

d Design values are not included in MIL-HDBK-5.

e Over 20 square inches cross-sectional area.

DO NOT USE STRESS VALUES FOR DESIGN

MIL-HDBK-5J
31 January 2003

Alloy and Temper	Test Direction	Thickness, inches	Stress, ksi	Referenced Specifications
7049-T73	ST	0.750-2.000	46 ^b	AMS-QQ-A-367, AMS 4111, ASTM B 247
		2.001-5.000	45 ^b	
7050-T74	ST	0.750-6.000	35	AMS 4107
7050-T7452	ST	0.750-4.000	35	AMS 4333
7075-T73	ST	0.750-3.000	42 ^b	AMS-A-22771, AMS-QQ-A-367
		3.001-4.000	41 ^b	AMS 4241, ASTM B 247
		4.001-5.000	39 ^b	AMS 4141
		5.001-6.000	38 ^b	
7075-T7352	ST	0.750-4.000	42 ^b	AMS-A-22771, AMS-QQ-A-367, AMS 4147, ASTM B 247
		3.001-4.000	39 ^b	
7075-T7354 ^c	ST	0.750-3.000	42	Company Specification
7075-T74 ^c	ST	0.750-3.000	35	AMS 4131
		3.001-4.000	31 ^d	
		4.001-5.000	30 ^d	
		5.001-6.000	29 ^d	
7149-T73	ST	0.750-2.000	46 ^b	AMS 4320
		2.001-5.000	45 ^b	
7175-T74	ST	0.750-3.000	35	AMS 4149, ASTM B 247
		3.001-4.000	31 ^d	AMS 4149
		4.001-5.000	30 ^d	
		5.001-6.000	29 ^d	
7175-T7452 ^c	ST	0.750-3.000	35	AMS 4179

- a Most specifications Reference ASTM G 47, which requires 20 days of exposure for 7XXX alloys in ST test direction.
b 75% of specified minimum longitudinal yield strength.
c Design values are not included in MIL-HDBK-5.
d 50% of specified minimum longitudinal yield strength.

DO NOT USE STRESS VALUES FOR DESIGN

Table 3.1.2.3.1(e). Maximum Specified Tension Stress at Which Test Specimens Will Not Fail in 3½% NaCl Alternate Immersion Test^a for Various Stress Corrosion Resistant Aluminum Hand Forgings

Alloy and Temper	Test Direction	Thickness, inches	Stress, ksi	Referenced Specifications
7049-T73	ST	2.001-3.000	45 ^b	AMS-QQ-A-367, AMS 4111, ASTM B 247
		3.001-4.000	44 ^b	
		4.001-5.000	42 ^b	
7049-T7352 ^c	ST	0.750-3.000	44 ^b	AMS 4247
		3.001-4.000	43 ^b	
		4.001-5.000	40 ^b	
7050-T7452	ST	0.750-8.000	35	AMS 4108
7075-T73	ST	0.750-3.000	42 ^b	AMS-A-22771, AMS-QQ-A-367, ASTM B 247
		3.001-4.000	41 ^b	
		4.001-4.000	39 ^b	
7075-T7352	ST	5.001-6.000	38 ^b	AMS 4147
		0.750-3.000	39 ^d	
		3.001-4.000	37 ^d	
		4.001-5.000	36 ^d	
7075-T74 ^e	ST	5.001-6.000	34 ^d	AMS 4131
		0.750-3.000	35	
		3.001-4.000	30 ^e	
7075-T7452 ^c	ST	4.001-5.000	28 ^e	AMS 4323
		5.001-6.000	27 ^e	
		0.750-2.000	35	
		2.001-3.000	29 ^f	
7149-T73	ST	3.001-4.000	28 ^f	AMS 4320
		4.001-5.000	26 ^f	
		5.001-6.000	24 ^f	
7175-T74	ST	2.000-3.000	44 ^d	AMS 4149
		3.001-4.000	43 ^d	
		4.001-5.000	42 ^d	
7175-T7452	ST	0.750-3.000	35	AMS 4179
		3.001-4.000	29 ^f	
		4.001-5.000	28 ^f	
		4.001-6.000	26 ^f	
		0.750-3.000	35	
		3.001-4.000	27 ^f	
		4.001-5.000	26 ^f	
		5.001-6.000	24 ^f	

a Most specifications Reference ASTM G 47, which requires 20 days of exposure for 7XXX alloys in ST test direction.

b 75% of specified minimum longitudinal yield strength.

c Design values are not included in MIL-HDBK-5.

d 75% of specified minimum long transverse yield strength.

e 50% of specified minimum longitudinal yield strength.

f 50% of specified minimum long transverse yield strength.

DO NOT USE STRESS VALUES FOR DESIGN

3.1.3.2 Cold-Formed Heat-Treatable Aluminum Alloys — Cold working such as stretch forming of aluminum alloy prior to solution heat treatment may result in recrystallization or grain growth during heat treatment. The resulting strength, particularly yield strength, may be significantly below the specified minimum values. For critical applications, the strength should be determined on the part after forming and heat treating including straightening operations. To minimize recrystallization during heat treatment, it is recommended that forming be done after solution heat treatment in the as-quenched condition whenever possible, but this may result in compressive yield strength in the direction of stretching being lower than MIL-HDBK-5 design allowables for user heat treat tempers.

3.1.3.3 Dimensional Changes — The dimensional changes that occur in aluminum alloy during thermal treatment generally are negligible, but in a few instances these changes may have to be considered in manufacturing. Because of many variables involved, there are no tabulated values for these dimensional changes. In the artificial aging of alloy 2219 from the T42, T351, and T37 tempers to the T62, T851, and T87 tempers, respectively, a net dimensional growth of 0.00010 to 0.0015 in./in. may be anticipated. Additional growth of as much as 0.0010 in./in. may occur during subsequent service of a year or more at 300°F or equivalent shorter exposures at higher temperatures. The dimensional changes that occur during the artificial aging of other wrought heat-treatable alloys are less than one-half that for alloy 2219 under the same conditions.

3.1.3.4 Welding — The ease with which aluminum alloys may be welded is dependent principally upon composition, but the ease is also influenced by the temper of the alloy, the welding process, and the filler metal used. Also, the weldability of wrought and cast alloys is generally considered separately.

Several weldability rating systems are established and may be found in publications by the Aluminum Association, American Welding Society, and the American Society for Metals. Handbooks from these groups can be consulted for more detailed information. Specification AA-R-566 also contains useful information. This document follows most of these references in adopting a four level rating system. An “A” level, or readily weldable, means that the alloy (and temper) is routinely welded by the indicated process using commercial procedures. A “B” level means that welding is accomplished for many applications, but special techniques are required, and the application may require preliminary trials to develop procedures and tests to demonstrate weld performance. A “C” level refers to limited weldability because crack sensitivity, loss of corrosion resistance, and/or loss of mechanical properties may occur. A “D” level indicates that the alloy is not commercially weldable.

The weldability of aluminum alloys is rated by alloy, temper, and welding process (arc or resistance). Tables 3.1.3.4(a) and (b) list the ratings in the alloy section number order in which they appear in Chapter 3.

When heat-treated or work-hardened materials of most systems are welded, a loss of mechanical properties generally occurs. The extent of the loss (if not reheat treated) over the table strength allowables will have to be established for each specific situation.

MIL-HDBK-5J
31 January 2003

Table 3.1.3.4(a). Fabrication Weldability of Wrought Aluminum Alloys

MIL-HDBK-5 Section No.	Alloy	Tempers	Weldability ^{a,b}	
			Inert Gas Metal or Tungsten Arc	Resistance Spot ^c
3.2.1	2014	O T6, T62, T651, T652, T6510, T6511	C B	D B
3.2.2	2017	T4, T42, T451	C	B
3.2.3	2024	O T3, T351, T361, T4, T42 T6, T62, T81, T851, T861 T8510, T8511, T3510, T3511	D C C C	D B B B
3.2.4	2025	T6	C	B
3.2.5	2090	T83	B	B
3.2.6	2124	T851	C	B
3.2.7	2219	O T62, T81, T851, T87, T8510, T8511	A A	B-D A
3.2.8	2618	T61	C	B
3.2.9	2519	T87	A	...
3.5.1	5052	O H32, H34, H36, H38	A A	B A
3.5.2	5083	O H321, H323, H343, H111, H112	A A	B A
3.5.3	5086	O H32, H34, H36, H38, H111, H112	A A	B A
3.5.4	5454	O H32, H34, H111, H112	A A	B A
3.5.5	5456	O H111, H321, H112	A A	B A
3.6.1	6013	T6	A	A
3.6.2	6061	O T4, T42, T451, T4510, T4511, T6 T62, T651, T652, T6510, T6511	A A A A	B A A A
3.6.3	6151	T6	A	A
3.7.1	7010	All	C	B
3.7.2	7040	All	C	B
3.7.3	7049	All	C	B
	7149			
3.7.4	7050	All	C	B
3.7.5	7055			
3.7.6	7075	All	C	B
3.7.7	7150	All	C	B
3.7.8	7175	All	C	B
3.7.9	7249			
3.7.10	7475	All	C	B

a Ratings A through D are relative ratings defined as follows:

A - Generally weldable by all commercial procedures and methods.

B - Weldable with special techniques or for specific applications which justify preliminary trials or testing to develop welding procedures and weld performance.

C - Limited weldability because of crack sensitivity or loss in resistance to corrosion and mechanical properties.

D - No commonly used welding methods have been developed.

b When using filler wire, the wire should contain less than 0.0008 percent beryllium to avoid toxic fumes.

c See AMS-W-6858 for permissible combinations.

Table 3.1.3.4(b). Fabrication Weldability^a of Cast Aluminum Alloys

MIL-HDBK-5 Section No.	Alloy	Weldability ^{b,c}	
		Inert Gas Metal or Tungsten Arc	Resistance Spot
3.8.1	A201.0	C	C
3.9.1	354.0	B	B
3.9.2	355.0	B	B
3.9.3	C355.0	B	B
3.9.4	356.0	A	A
3.9.5	A356.0	A	A
3.9.6	A357.0	A	B
3.9.7	D357.0	A	A
3.9.8	359.0	A	B

- a Weldability related to joining a casting to another part of same composition. The weldability ratings are not applicable to minor weld repairs. Such repairs will be governed by the contractors procedure for in-process welding of castings, after approval by the procuring agency.
- b Ratings A through D are relative ratings defined as follows:
- A - Generally weldable by all commercial procedures and methods.
 - B - Weldable with special techniques or for specific applications which justify preliminary trials or testing to develop welding procedure and weld performance.
 - C - Limited weldability because of crack sensitivity or loss in resistance to corrosion and mechanical properties.
 - D - No commonly used welding methods have been developed.
- c When using filler wire, the wire should contain less than 0.0008 percent beryllium to avoid toxic fumes.

3.2 2000 SERIES WROUGHT ALLOYS

Alloys of the 2000 series contain copper as the principal alloying element and are strengthened by solution heat treatment and aging. As a group, these alloys are noteworthy for their excellent strengths at elevated and cryogenic temperatures, and creep resistance at elevated temperatures.

3.2.1 2014 ALLOY

3.2.1.0 Comments and Properties — 2014 is an Al-Cu alloy available in a wide variety of product forms. As shown in Table 3.1.2.3.1(a), 2014-T6 rolled plate, rod and bar, extruded shapes, and forgings have a ‘D’ SCC rating. This is the lowest rating and means that SCC failures have occurred in service or would be anticipated if there is any sustained stress. In-service failures are caused by stresses produced by any combination of sources including solution heat treatment, straightening, forming, fit-up, clamping, sustained service loads, or high service compression stresses that produce residual tensile stresses. These stresses may be tension or compression as well as the stresses due to the Poisson effect, because the actual failures are caused by the resulting sustained shear stresses. Pin-hole flaws in corrosion protection are sufficient for SCC. Refer to Section 3.1.2.3 for comments regarding the resistance of the alloy to stress-corrosion cracking, and to Section 3.1.3.4 for comments regarding the weldability of the alloy.

The properties of extrusions should be based upon the thickness at the time of quenching prior to machining. Selection of the mechanical properties based upon its final machined thickness may be unconservative; therefore, the thickness at the time of quenching to achieve properties is an important factor in the selection of the proper thickness column. For extrusions having sections with various thicknesses, consideration should be given to the properties as a function of thickness.

Material specifications for 2014 aluminum alloy are presented in Table 3.2.1.0(a). Room-temperature mechanical and physical properties are shown in Tables 3.2.1.0(b) through (g). Stress-strain parameters in accordance with Section 9.3.2.5 are given in Table 3.2.1.0(h). Figure 3.2.1.0 shows the effect of temperature on the physical properties of 2014 alloy.

Table 3.2.1.0(a). Material Specifications for 2014 Aluminum Alloy

Specification	Form
AMS 4028	Bare sheet and plate
AMS 4029	Bare sheet and plate
AMS-QQ-A-250/3	Clad sheet and plate
AMS-QQ-A-225/4	Rolled or drawn bar, rod, and shapes
AMS 4121	Bar and rod, rolled or cold finished
AMS-QQ-A-200/2	Extruded bar, rod, and shapes
AMS 4153	Extrusion
AMS-A-22771	Forging
AMS - QQ-A-367	Forging
AMS 4133	Forging

The temper index for 2014 is as follows:

Section	Temper
3.2.1.1	T6, T62, T651, T652, T6510, and T6511

3.2.1.1 T6, T62, T651, T652, T6510, and T6511 Temper— Figures 3.2.1.1.1(a) through 3.2.1.1.5(b) present elevated-temperature curves for various mechanical properties. Figures 3.2.1.1.6(a) through (r) present tensile and compressive stress-strain and tangent-modulus curves for various tempers, product forms, and temperatures. Figures 3.2.1.1.6(s) through (v) are full-range tensile stress-strain curves for various products and tempers. Figures 3.2.1.1.8(a) through (e) contain S/N fatigue curves for various wrought products in the T6 temper.

Table 3.2.1.0(b₁). Design Mechanical and Physical Properties of 2014 Aluminum Alloy Sheet and Plate

Specification	AMS 4029															
	Sheet						Plate									
	T6						T651 ^a									
	0.020-0.039		0.040-0.249		0.250-0.499		0.500-1.000		1.001-2.000		2.001-2.500		2.501-3.000		3.001-4.000	
A	B	A	B	A	B	A	B	A	B	A	B	A	B	A	B	
Form																
Temper																
Thickness, in.																
Basis																
Mechanical Properties:																
F_{m2} , ksi:																
L	65	67	67	68	66	68	66	67	67	66	67	67	67	66	67	67
LT	64	66	66	67	67	69	67	68	68	67	68	68	68	67	68	68
ST
F_{m2} , ksi:																
L	58	60	59	60	60	62	60	61	61	60	62	59	61	59	61	59
LT	57	59	58	59	59	61	59	60	61	59	61	58	60	57	59	57
ST	54 ^b	56 ^b
F_{cp2} , ksi:																
L	58	60	59	60	58	60	58	59	59	58	60	57	59
LT	59	61	60	61	61	63	61	62	61	61	63	60	62
ST	59	61
F_{sp} , ksi	39	40	40	41	40	41	40	41	40	40	41	38	39
F_{bnp} , ksi:																
(e/D = 1.5)	97	100	100	102	105	108	105	107	107	105	107	102	104
(e/D = 2.0)	123	127	127	129	134	138	134	136	136	134	136	130	132
F_{bnp} , ksi:																
(e/D = 1.5)	81	84	83	84	90	93	90	92	93	90	93	88	92
(e/D = 2.0)	93	96	94	96	106	110	106	109	110	106	110	104	109
e , percent (S-basis):																
LT	6	...	7	...	7	...	6	...	4	4	...	2
E , 10 ³ ksi	10.5															
E_c , 10 ³ ksi	10.7															
G , 10 ³ ksi	4.0															
μ	0.33															
Physical Properties:																
ω , lb/in. ³	0.101															
C , K , and α	See Figure 3.2.1.0															

a Bearing values are "dry pin" values per Section 1.4.7.1. See Table 3.1.2.1.1.
 b Caution: This specific alloy, temper, and product form exhibits poor stress-corrosion cracking resistance in this grain direction. It corresponds to an SCC resistance rating of D, as indicated in Table 3.1.2.3.1(a).

Table 3.2.1.0(b₂). Design Mechanical and Physical Properties of 2014 Aluminum Alloy Sheet and Plate —Continued

Specification	AMS 4028							
	Sheet				Plate ^a			
Form	T62 ^b							
	0.020-0.039		0.040-0.249		0.250-0.499		0.500-1.000	
Temper	A	B	A	B	A	B	A	B
	0.020-0.039		0.040-0.249		0.250-0.499		0.500-1.000	
Thickness, in.	A	B	A	B	A	B	A	B
Basis	A	B	A	B	A	B	A	B
Mechanical Properties:								
F_{tu} , ksi:								
L	65	67	67	68	65	67	65	67
LT	64	66	66	67	67	69	67	69
F_{ty} , ksi:								
L	58	60	59	60	57	59	57	59
LT	57	59	58	59	59	61	59	61
F_{cy} , ksi:								
L	58	60	59	60	59	61	59	61
LT	59	61	60	61	60	62	60	62
F_{su} , ksi	39	40	40	41	37	39	37	39
F_{bru} , ksi:								
(e/D = 1.5) . . .	97	100	100	102	100	103	100	103
(e/D = 2.0) . . .	123	127	127	129	127	131	127	131
F_{brv} , ksi:								
(e/D = 1.5) . . .	81	84	83	84	84	87	84	87
(e/D = 2.0) . . .	93	96	95	96	99	103	99	103
e , percent (S-basis):								
LT	6	...	7	...	7	...	6	...
E , 10 ³ ksi	10.5				10.7			
E_c , 10 ³ ksi	10.7				10.9			
G , 10 ³ ksi	4.0				4.0			
μ	0.33				0.33			
Physical Properties:								
ω , lb/in. ³	0.101							
C , K , and α	See Figure 3.2.1.0							

a Bearing values are “dry pin” values per Section 1.4.7.1.

b Design allowables were based upon data obtained from testing samples of material, supplied in the O or F temper, which were heat treated to demonstrate response to heat treatment by suppliers. Properties obtained by the user may be lower than those listed if the material has been formed or otherwise cold or hot worked, particularly in the annealed temper, prior to solution heat treatment.

Table 3.2.1.0(c₁). Design Mechanical and Physical Properties of Clad 2014 Aluminum Alloy Sheet and Plate

Specification	AMS-QQ-A-250/3															
	Sheet						Plate									
	T6						T651 ^a									
Form	0.020-0.039		0.040-0.249		0.250-0.499		0.500-1.000 ^b		1.001-2.000 ^b		2.001-2.500 ^b		2.501-3.000 ^b		3.001-4.000 ^b	
Temper	A	B	A	B	A	B	A	B	A	B	A	B	A	B	A	B
Thickness, in.	62	64	65	67	63	65	63	64	63	64	64	62	61	60	61	57
Basis	61	63	64	66	64	66	64	65	64	65	65	63	62	60	61	56
Mechanical Properties:	60 ^c	59 ^c
F_{tp} ksi:	54	56	57	59	58	60	57	58	57	59	56	58	56	54	56	54
L	53	55	56	58	57	59	56	57	56	58	55	57	55	54	56	54
LT	56 ^c	54 ^c
ST
F_{cp} ksi:	54	56	57	59	58	60	57	58	57	59	56	58	56	54	56	54
L	53	55	56	58	57	59	56	57	56	58	55	57	55	54	56	54
LT
ST
F_{sp} ksi	37	38	39	40	38	39	38	38	38	38	38	37	37
F_{bp} ksi:	93	96	97	100	101	104	101	102	101	102	101	99	97
(e/D = 1.5)	117	121	123	127	128	132	128	130	128	130	128	126	124
(e/D = 2.0)	76	78	80	83	87	90	85	87	85	88	84	87	84
F_{bp} ksi:	86	89	91	94	102	106	100	102	100	104	98	102	98
(e/D = 1.5)	7	...	8	...	8	...	6	...	4	...	2	...	2	...	1	...
(e/D = 2.0)
e, percent (S-basis):
LT	10.5	10.7	10.7	10.9	4.0	0.33	0.101
E , 10 ³ ksi
E_c , 10 ³ ksi
G , 10 ³ ksi
μ
Physical Properties:
ω , lb/in. ³
C , K , and α

a Bearing values are "dry pin" values per Section 1.4.7.1. See Table 3.1.2.1.1.
b These values, except in the ST direction, have been adjusted to represent the average properties across the whole section, including the 2-1/2 percent per side nominal cladding thickness.
c Caution: This specific alloy, temper, and product form exhibits poor stress-corrosion cracking resistance in this grain direction. It corresponds to an SCC resistance rating of D, as indicated in Table 3.1.2.3.1(a).

Table 3.2.1.0(c₂). Design Mechanical and Physical Properties of Clad 2014 Aluminum Alloy Sheet and Plate—Continued

Specification	AMS-QQ-A-250/3									
	Sheet				Plate ^a					
	T62 ^b									
	0.020-0.039		0.040-0.249		0.250-0.499	0.500-1.000 ^c	1.001-2.000 ^c	2.001-2.500 ^c	2.501-3.000 ^c	3.001-4.000 ^c
A		B		A	B	S	S	S	S	S
Mechanical Properties:										
F_{tu} , ksi:										
L	62	64	65	67	62	62	62	60
LT	61	63	64	66	64	64	64	62	60	56
F_{ty} , ksi:										
L	54	56	57	59	55	54	54	53
LT	53	55	56	58	57	56	56	55	54	52
F_{cy} , ksi:										
L	54	56	57	59	57	56	56	55
LT	55	57	58	60	58	57	56	55
F_{su} , ksi	37	38	39	40	36	36	36	35
F_{bru} , ksi:										
(e/D = 1.5)	93	96	97	100	96	96	96	93
(e/D = 2.0)	117	121	123	127	121	121	121	118
F_{bry} , ksi:										
(e/D = 1.5)	76	78	80	83	81	79	79	78
(e/D = 2.0)	86	89	91	94	96	94	94	92
e , percent (S-basis):										
LT	7	...	8	...	8	6	4	2	2	1
E , 10 ³ ksi	10.5				10.7					
E_c , 10 ³ ksi	10.7				10.9					
G , 10 ³ ksi	4.0				4.0					
μ	0.33				0.33					
Physical Properties:										
ω , lb/in. ³	0.101									
C , K , and α									

- a Bearing values are “dry pin” values per Section 1.4.7.1. See Table 3.1.2.1.1.
- b Design allowables were based upon data obtained from testing samples of material, supplied in the O or F temper, which were heat treated to demonstrate response to heat treatment by suppliers. Properties obtained by the user may be lower than those listed if the material has been formed or otherwise cold or hot worked, particularly in the annealed temper, prior to solution heat treatment.
- c These values have been adjusted to represent the average properties across the whole section, including the 2-½ percent per side nominal cladding thickness.

Table 3.2.1.0(d). Design Mechanical and Physical Properties of 2014 Aluminum Alloy Bar, Rod, and Shapes; Rolled, Drawn, or Cold-Finished

Specification	AMS 4121 and AMS-QQ-A-225/4							AMS-QQ-A-225/4
Form	Bar, rod, and shapes, rolled, drawn, or cold-finished							
Temper	T6 and T651							T62 ^a
Thickness, in.	Up to 1.000	1.001-2.000	2.001-3.000	3.001-4.000	4.001-5.000 ^b	5.001-6.000 ^b	6.001-8.000 ^b	≤8.000 ^b
Basis	S	S	S	S	S	S	S	S
Mechanical Properties:								
<i>F_{tu}</i> , ksi:								
L	65	65	65	65	65	65	65	65
LT	64 ^c	63 ^c	62 ^c	61 ^c	60 ^c	59 ^c
<i>F_{ty}</i> , ksi:								
L	55	55	55	55	55	55	55	55
LT	53 ^c	52 ^c	51 ^c	50 ^c	49 ^c	48 ^c
<i>F_{cy}</i> , ksi:								
L	53	53	53	53	53	53	53	...
LT
<i>F_{su}</i> , ksi								
L	38	38	38	38	38	38	38	...
<i>F_{bru}</i> , ksi:								
(e/D = 1.5)	98
(e/D = 2.0)	124
<i>F_{bry}</i> , ksi:								
(e/D = 1.5)	77
(e/D = 2.0)	88
<i>e</i> , percent:								
L	8	8	8	8	8	8	8	8
<i>E</i> , 10 ³ ksi					10.5			
<i>E_c</i> , 10 ³ ksi					10.7			
<i>G</i> , 10 ³ ksi					4.0			
<i>μ</i>					0.33			
Physical Properties:								
<i>ω</i> , lb/in. ³					0.101			
<i>C</i> , <i>K</i> , and <i>α</i>					See Figure 3.2.1.0			

- a Design allowables were based upon data obtained from testing samples of material, supplied in the O or F temper, which were heat treated to demonstrate response to heat treatment by suppliers.
- b For square, rectangular, hexagonal, or octagonal bar, maximum thickness is 4 in., and maximum cross-sectional area is 36 sq. in.
- c Caution: This specific alloy, temper, and product form exhibits poor stress-corrosion cracking resistance in this grain direction. It corresponds to an SCC resistance rating of D, as indicated in Table 3.1.2.3.1(a).

Table 3.2.1.0(e). Design Mechanical and Physical Properties of 2014 Aluminum Alloy Die Forging

Specification	AMS 4133, AMS-A-22771, and AMS-QQ-A-367												AMS-A-22771 and AMS-QQ-A-367											
	Die forging												Die forging											
	T6 ^a						T652						T652						T652					
Form	Temper	Thickness ^b , in.	Basis	≤ 1.000		1.001-2.000		2.001-3.000		3.001-4.000		≤ 1.000		1.001-2.000		2.001-3.000		3.001-4.000						
				A	B	A	B	A	B	A	B	A	B	A	B	A	B	A	B	A	B			
Mechanical Properties:																								
<i>F_{mp}</i> , ksi:																								
L	65	67	65	67	65	67	63	63	65	67	65	67	65	67	65	67	65	67	65	67	63	63		
T ^c	64 ^d	...	64 ^d	...	63 ^d	63 ^d	63	63	64 ^d	...	64 ^d	...	64 ^d	...	64 ^d	...	63 ^d	63 ^d	63 ^d	...	63	63		
<i>F_{hp}</i> , ksi:																								
L	56	59	56	59	55	58	55	55	56	59	55	58	55	56	59	55	58	55	56	59	55	55		
T ^c	55 ^d	...	55 ^d	...	54 ^d	...	54	54	55 ^d	...	55 ^d	...	55 ^d	...	55 ^d	...	54 ^d	54 ^d	54 ^d	...	54	54		
<i>F_{exp}</i> , ksi:																								
L	59	62	59	62	58	61	58	58	56	59	56	61	58	56	59	55	58	55	56	59	55	55		
ST	56	59	56	59	55	58	55	55	59	59	55	58	55	59	62	58	58	55	59	62	58	58		
<i>F_{sp}</i> , ksi:																								
L	40	41	40	41	39	40	39	39	40	41	40	40	39	40	41	39	40	39	40	41	40	39		
<i>F_{brt}</i> , ksi:																								
(e/D = 1.5)	91	94	91	94	91	94	88	88	91	94	91	94	91	94	91	94	91	94	91	94	88	88		
(e/D = 2.0)	123	127	123	127	123	127	120	120	123	127	123	127	123	127	123	127	123	127	123	127	120	120		
<i>F_{brp}</i> , ksi:																								
(e/D = 1.5)	73	77	73	77	71	75	71	71	73	77	73	75	71	73	77	73	75	71	73	77	71	71		
(e/D = 2.0)	90	94	90	94	88	93	88	88	90	94	90	93	88	90	94	90	93	88	90	94	88	88		
<i>e</i> , percent (S-basis):																								
L	6	...	6	...	6	...	6	6	6	6	6	6	6	6	6	...	6	6		
T ^c	3	...	2	...	2	...	2	2	3	2	2	2	2	2	2	...	2	2		
<i>E</i> , 10 ³ ksi																								
10.5																								
<i>E_{sp}</i> , 10 ³ ksi																								
10.8																								
<i>G</i> , 10 ³ ksi																								
4.0																								
<i>μ</i>																								
0.33																								
Physical Properties:																								
<i>ω</i> , lb/in. ³																								
0.101																								
<i>C</i> , <i>K</i> , and <i>α</i>																								
See Figure 3.2.1.0																								

a When die forgings are machined before heat treatment, the mechanical properties are applicable, provided the as-forged thickness is not greater than twice the thickness at the time of heat treatment.
b Thickness at time of heat treatment.
c T indicates any grain direction not within ±15° of being parallel to the forging flow lines. *F_{sp}*(T) values are based upon short transverse (ST) test data.
d Specification value. T tensile properties are presented on S basis only.
e Bearing values are “dry pin” values per Section 1.4.7.1.

Table 3.2.1.0(f). Design Mechanical and Physical Properties of 2014 Aluminum Alloy Hand Forging

Specification	AMS 4133, AMS-A-22771, and AMS-QQ-A-367		AMS-A-22771 and AMS-QQ-A-367											
	Hand forging													
	T6 ^a		T652 ^b											
Form	≤ 256													
Temper	≤ 256													
Cross-Sectional Area, in. ²	≤ 256													
Thickness, in.	≤ 256													
Basis	≤2.000	2.001-3.000	3.001-4.000	4.001-5.000	5.001-6.000	6.001-7.000	7.001-8.000	≤2.000	2.001-3.000	3.001-4.000	4.001-5.000	5.001-6.000	6.001-7.000	7.001-8.000
	S	S	S	S	S	S	S	S	S	S	S	S	S	S
Mechanical Properties:														
F_{np} , ksi:														
L	65	64	63	62	61	60	59	65	64	63	62	61	60	59
LT	65	64	63	62	61	60	59	65	64	63	62	61	60	59
ST	...	62 ^c	61 ^c	60 ^c	59 ^c	58 ^c	57 ^c	...	62 ^c	61 ^c	60 ^c	59 ^c	58 ^c	57 ^c
F_{bp} , ksi:														
L	56	56	55	54	53	52	51	56	56	55	54	53	52	51
LT	56	55	55	54	53	52	51	56	55	55	54	53	52	51
ST	...	55 ^c	54 ^c	53 ^c	53 ^c	52 ^c	51 ^c	...	52 ^c	51 ^c	50 ^c	50 ^c	49 ^c	48 ^c
F_{op} , ksi:														
L	56	56	55	54	53	56	56	55	54	53
LT	56	55	55	54	53	57	56	56	55	54
ST	57	56	55	55
F_{sup} , ksi	40	39	39	38	38	38	37	37	36	36
F_{bnp} , ksi:														
(e/D = 1.5)	91	90	88	87	85	88	87	85	84	83
(e/D = 2.0)	117	115	113	112	110	115	113	111	110	108
F_{byp} , ksi:														
(e/D = 1.5)	78	78	77	76	74	77	76	76	74	73
(e/D = 2.0)	90	90	88	87	85	91	89	89	87	86
e, percent:														
L	8	8	8	7	7	6	6	8	8	8	7	7	6	6
LT	3	3	3	2	2	2	2	3	3	3	2	2	2	2
ST	...	2	2	1	1	1	1	...	2	2	1	1	1	1
E , 10 ³ ksi	10.5													
E_p , 10 ³ ksi	10.8													
G , 10 ³ ksi	4.0													
μ	0.33													
Physical Properties:														
ω , lb/in. ³	0.101													
C, K, and α	See Figure 3.2.1.0													

a When hand forgings are machined before heat treatment, the section thickness at time of heat treatment will determine the minimum mechanical properties as long as the original (as-forged) thickness does not exceed the maximum thickness for the alloy as shown in the table.

b Bearing values are "dry pin" values per Section 1.4.7.1.

c Caution: This specific alloy, temper, and product form exhibits poor stress-corrosion cracking resistance in this grain direction. It corresponds to an SCC resistance rating of D, as indicated in Table 3.1.2.3.1(a).

Table 3.2.1.0(g). Design Mechanical and Physical Properties of 2014 Aluminum Alloy Extrusion

Specification	AMS 4153 and AMS-QQ-A-200/2												AMS-QQ-A-200/2					
	Extruded bar, rod, and shapes																	
	T6, T6510, and T6511																	
Form	≤25															T62 ^a		
	0.125-0.499			0.500-0.749		0.750-1.499		1.500-1.750		1.751-2.999		3.000-4.499		>25-≤32		≤25		>25-≤32
Temper	A	B	A	B	A	B	A	B	A	B	S	S	S	S	S	S	S	S
Cross-Sectional Area, in. ²	60	62	64	68	68	70	68	71	68	68	68	68	68	68	68	60	60	60
Thickness or Dia., in. ^b	60 ^c	...	64 ^c	63 ^c	63 ^c	...	61 ^c	...	61 ^c	61	61	61	61	61	61
Basis	A	B	A	B	A	B	A	B	A	B	S	S	S	S	S	S	S	S
Mechanical Properties:																		
F_{m} , ksi:																		
L	60	62	64	68	68	70	68	71	68	68	68	68	68	68	68	60	60	60
LT (S-basis)	60 ^c	...	64 ^c	63 ^c	63 ^c	...	61 ^c	...	61 ^c	61	61	61	61	61	61
F_{σ} , ksi:																		
L	53	57	58	60	60	63	60	63	60	60	60	60	60	60	60	53	53	53
LT (S-basis)	53 ^c	...	55 ^c	54 ^c	54 ^c	...	52 ^c	...	52 ^c	52	52	52	52	52	52
$F_{\sigma p}$, ksi:																		
L	52	56	57	61	59	62	59	62	59	59	59	59	59	59	59
LT
$F_{\sigma w}$, ksi	35	36	37	39	39	41	39	41	39	39	39	39	39	39	39
F_{brw} , ksi:																		
(e/D = 1.5)	90	93	96	102	102	105	102	106	102	102	102	102	102	102	102
(e/D = 2.0)	116	120	124	132	132	136	132	138	132	132	136	132	138	132	132
F_{brd} , ksi:																		
(e/D = 1.5)	73	78	80	85	82	86	82	86	82	82	86	82	86	82	82
(e/D = 2.0)	85	91	93	99	96	101	96	101	96	96	101	96	101	96	96
e , percent (S-basis):																		
L	7	...	7	...	7	...	7	...	7	7	7	7	7	7	6	7	7	6
LT	5 ^c	...	5	...	2	...	2	...	2	2	2	2	2	2	1
E , 10 ³ ksi	10.8																	
E_{cs} , 10 ³ ksi	11.0																	
G , 10 ³ ksi	4.1																	
μ	0.33																	
Physical Properties:																		
ω , lb/in. ³	0.101																	
C , K , and α	See Figure 3.2.1.0																	

a Design allowables were based upon data obtained from testing samples of material, supplied in O or F temper, which were heat treated to demonstrate response to heat treatment by suppliers.
b The mechanical properties are to be based upon the thickness at the time of quench.
c S-basis.
d Bearing values are "dry pin" values per Section 1.4.7.1.
e For 0.375-0.499 in.

MIL-HDBK-5J
31 January 2003

Table 3.2.1.0(h). Typical Stress-Strain Parameters for 2014 Aluminum Alloy

Temper/Product Form	Condition	Temperature, °F	Grain Direction	Tension, ksi			Compression, ksi		
				n	TYS	TUS	n _c	CYS	
T6 Clad Sheet	0.02-0.039 in. thickness	RT	L	32	57		17	57	
			LT	17	57		13	60	
	0.04-0.249 in. thickness		L	27	62		15	62	
			LT	20	60		17	65	
	½ hr. exposure	200 °F	LT				9.5	60	
	100 hr. exposure						8.0	62	
	½ and 2 hr. exposure	300 °F					4.0	54	
	1000 hr. exposure						6.4	46	
	½ hr. exposure	400 °F					8.2	47	
	100 hr. exposure						10	20	
	1000 hr. exposure	500 °F					6.0	16	
	½ hr. exposure						7.0	22	
	½ hr. exposure			600 °F				4.3	9
	10 hr. exposure							6.0	8
100 hr. exposure						13	7		
T62 Clad Plate	0.250 - 2.000 in. thickness	RT		L	29	64		27	69
				LT	29	64		27	70
T651 Plate	0.250 - 2.000 in. thickness	RT		L	30	66		15	68
			LT	19	65		18	66	
T6 Bar, Rod and Shapes	> 3 in. thickness	RT	L	31	62		25	60	
T6 Forging		RT	L			70			
			LT			68			
T652 Hand Forging	2.001 - 3.000 in. thickness	RT	L	18	62	67	17	63	
			LT	18	62	66	18	65	
			ST	13	60		22	67	
T6 Extrusion	0.125 - 0.499 in. thickness	RT	L	23	62		15	64	
	> 0.500 in. thickness			26	68		14	72	
T62 Extrusion	< 0.499 in. thickness	RT	L	29	64	71	17	68	
			LT	29	64		32	68	
T651X Extrusion	0.500 - 0.749 in. thickness	RT	L	32	64	74	16	68	
			LT	18	64	70	18	68	

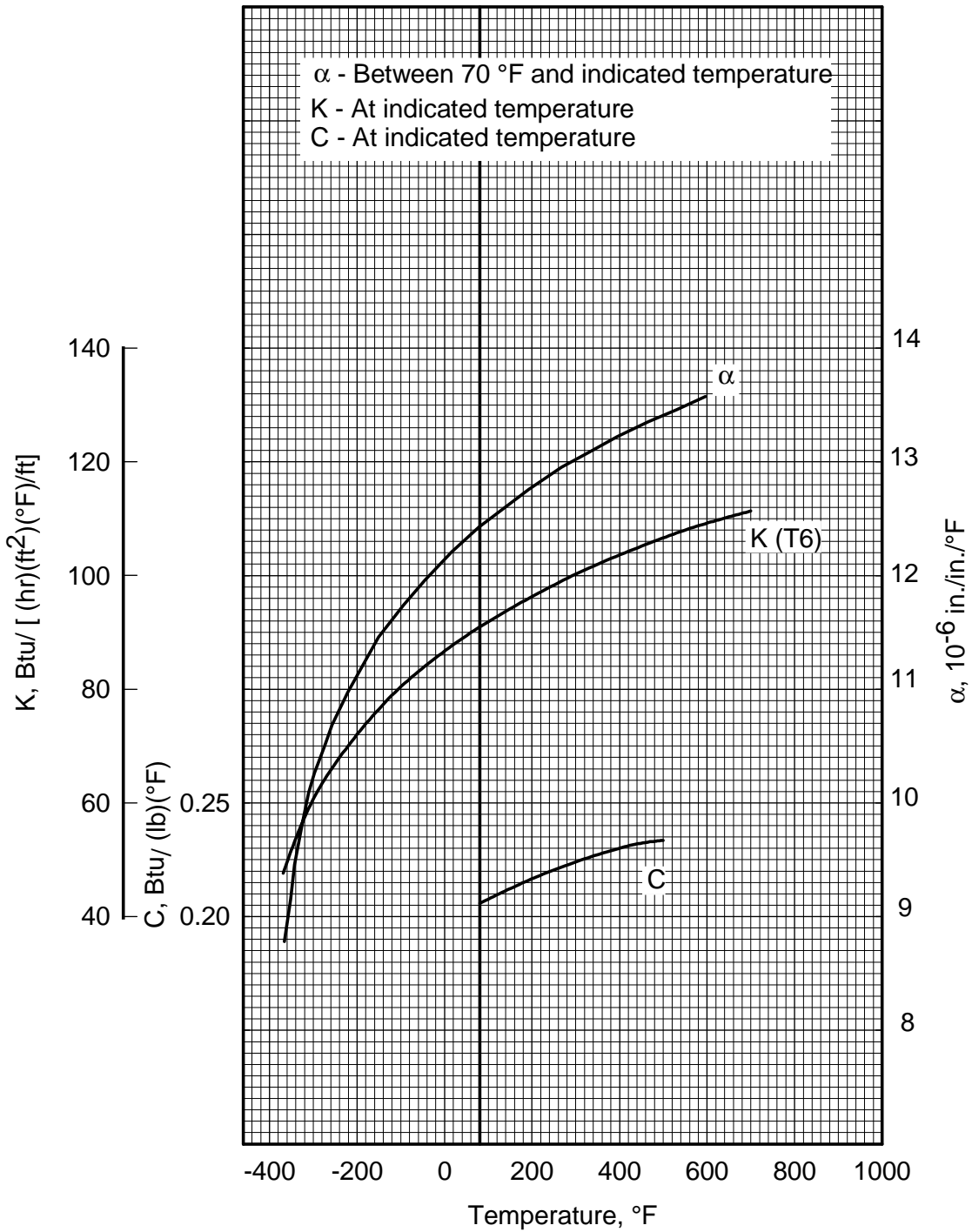

Figure 3.2.1.0. Effect of temperature on the physical properties of 2014 aluminum alloy.

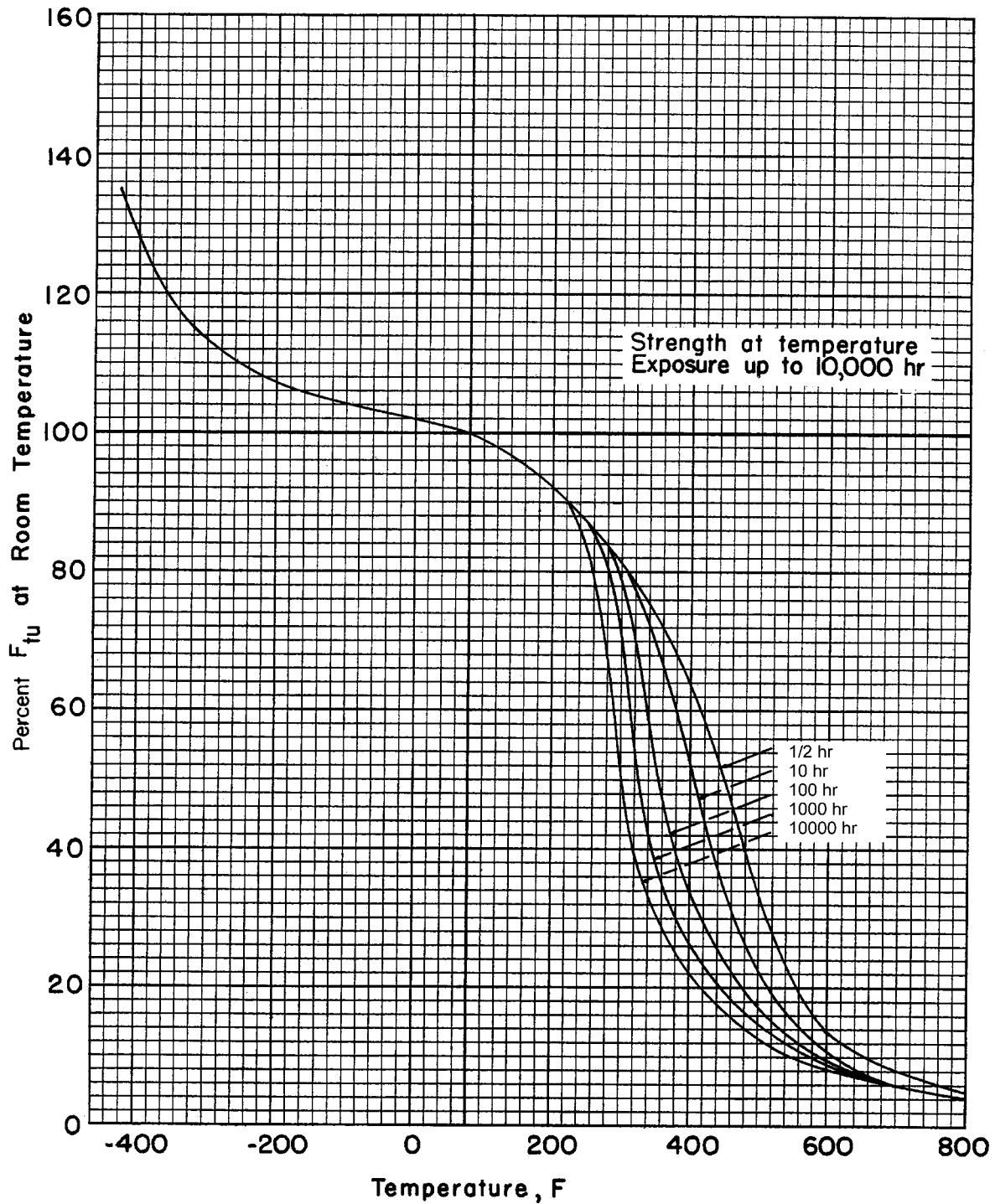

Figure 3.2.1.1.1(a). Effect of temperature on the tensile ultimate strength (F_{tu}) of 2014-T6, T651, T6510 and T6511 aluminum alloy (bare and clad sheet and plate 0.040-1.500 in. thick; extruded bar, rod and shapes ≥ 0.750 in. thick with cross-sectional area ≤ 32 sq. in.).

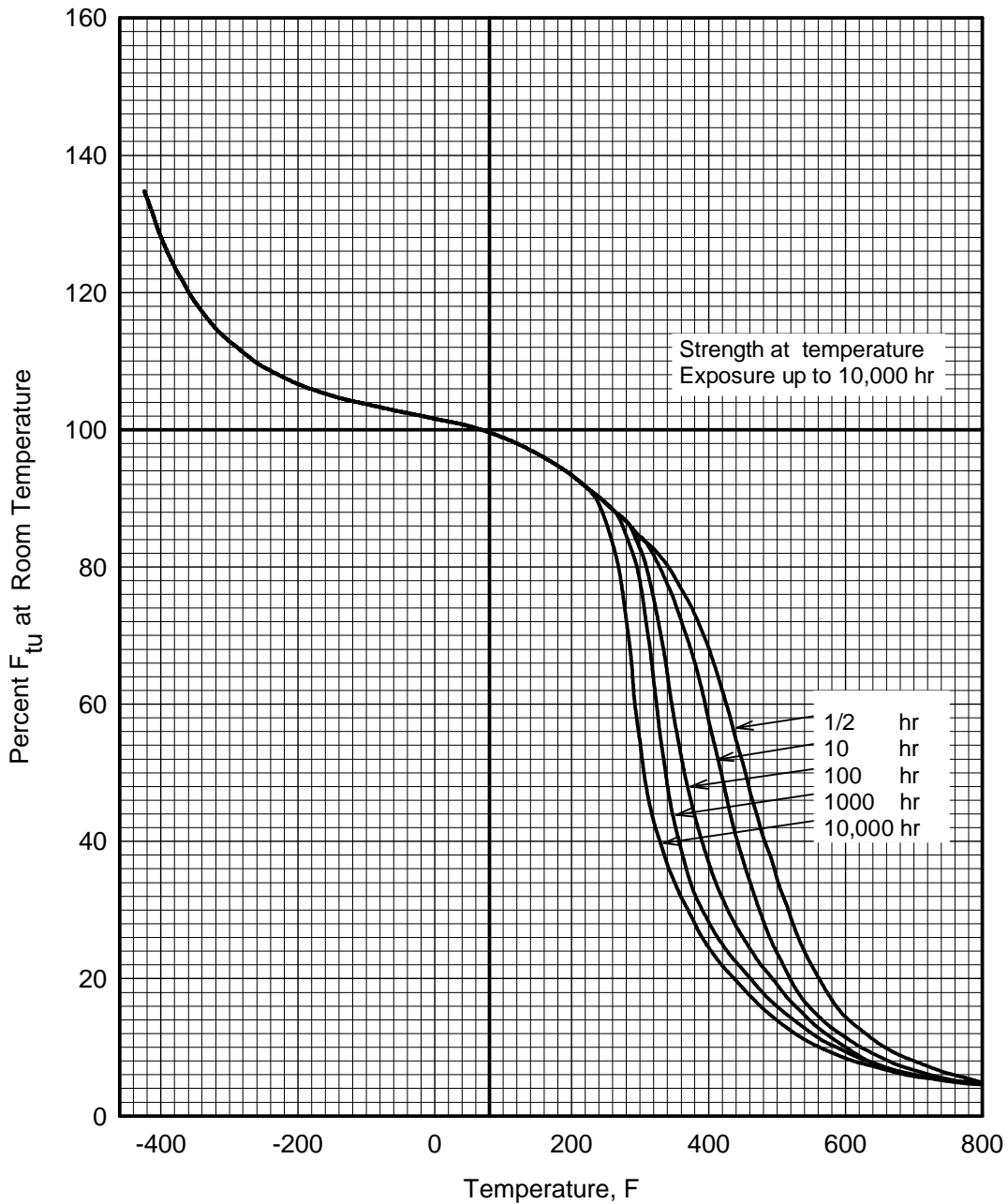

Figure 3.2.1.1(b). Effect of temperature on the ultimate strength (F_{tu}) of 2014-T6, T651, T6510 and T6511 aluminum alloy (bare and clad sheet 0.020-0.039 in. thick; bare and clad plate 1.501-4.000 in. thick; rolled bar, rod and shapes; hand and die forgings; extruded bar, rod and shapes 0.125-0.749 in. thick with cross-sectional area \leq 25 sq. in.).

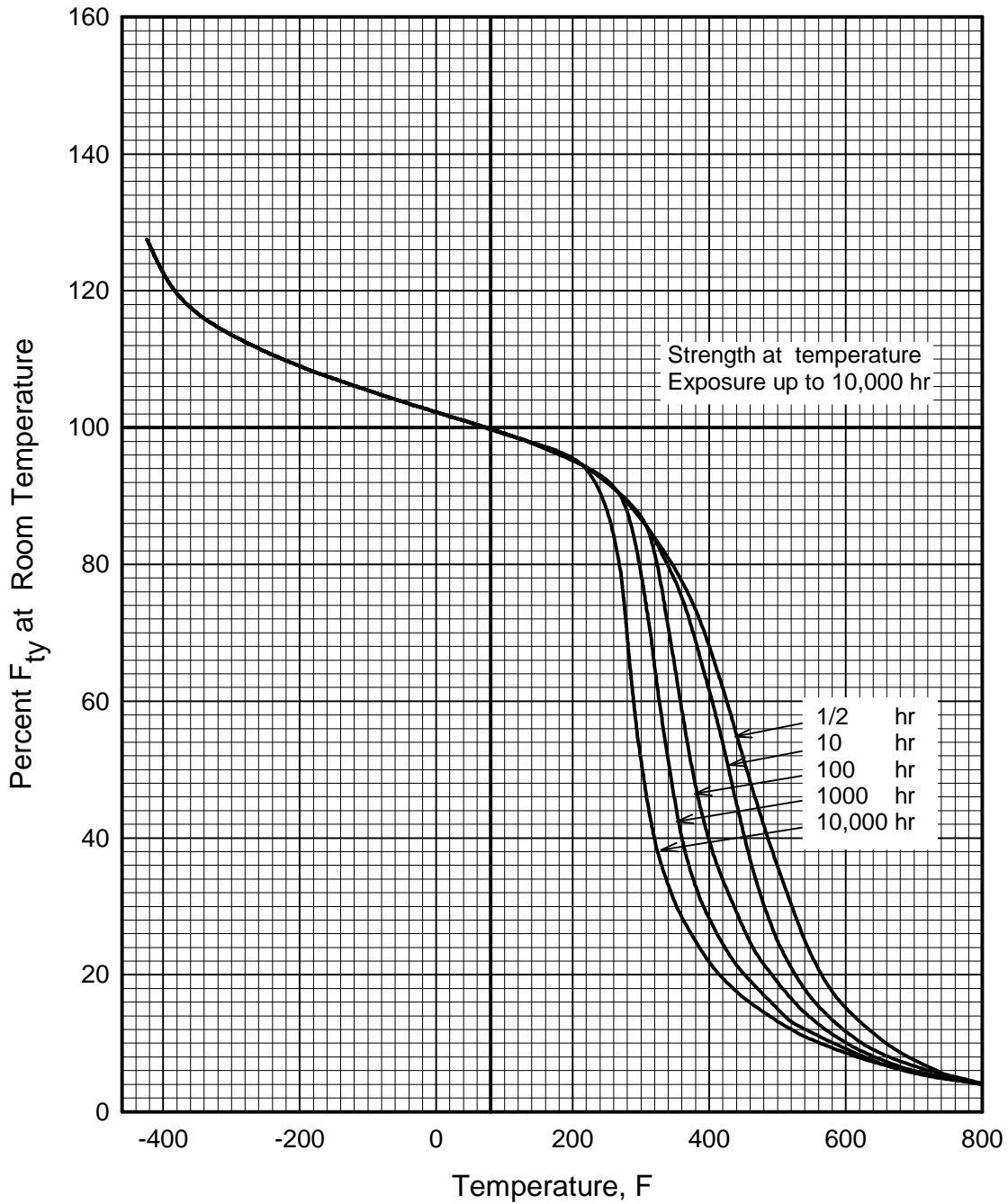

Figure 3.2.1.1(c). Effect of temperature on the tensile yield strength (F_{ty}) of 2014-T6, T651, T6510 and T6511 aluminum alloy (bare and clad plate 3.001-4.000 in. thick; rolled bar, rod and shapes; hand and die forgings; extruded bar, rod and shapes 0.125-0.499 in. thick with cross-sectional area ≤ 25 sq. in.).

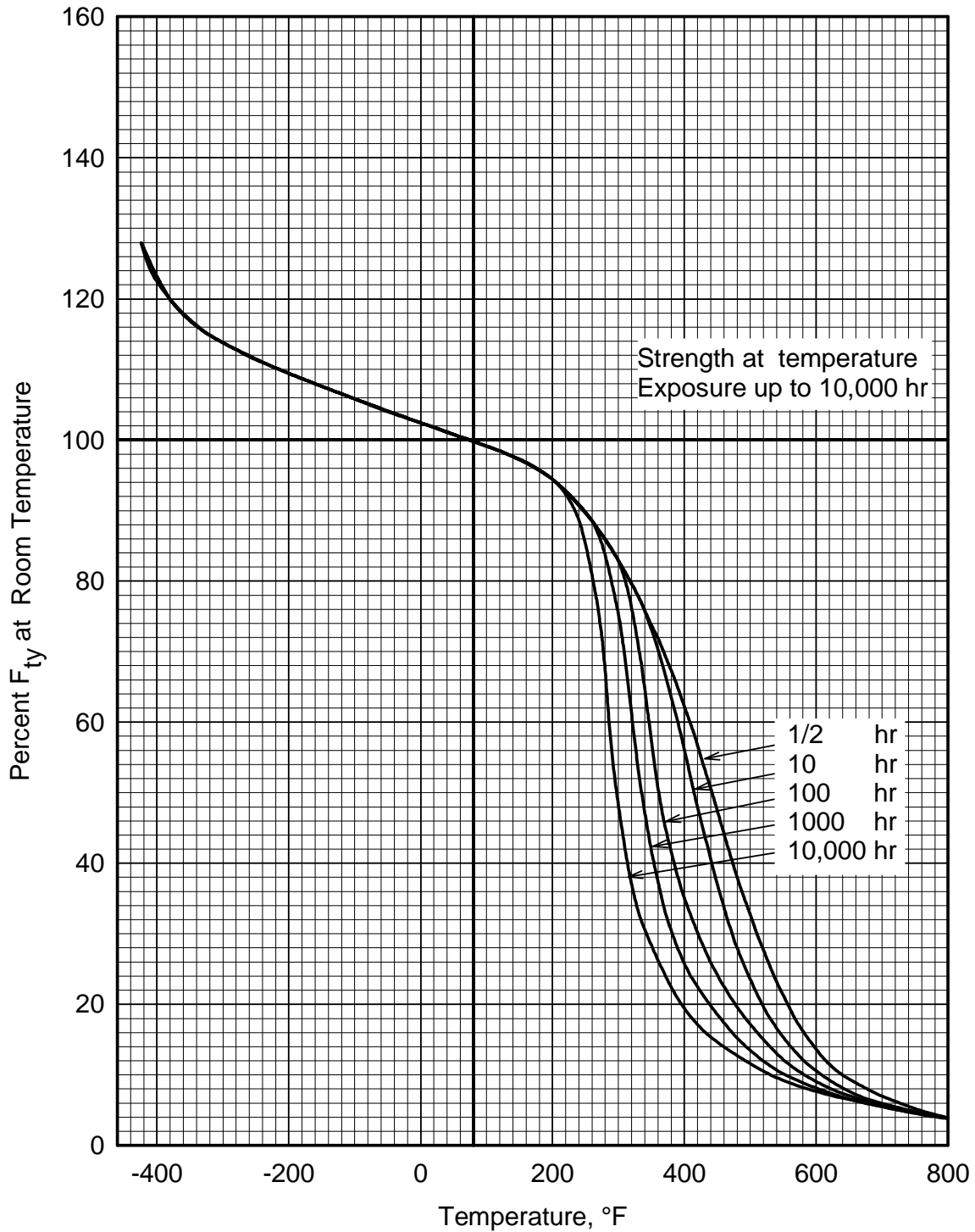

Figure 3.2.1.1.1(d). Effect of temperature on the tensile yield strength (F_{ty}) of 2014-T6, T651, T6510, and T6511 aluminum alloy (bare and clad sheet and plate 0.020-3.000 in. thick; extruded bar, rod and shapes 0.500-0.749 in. thick with cross-sectional area ≤ 25 sq. in. and ≥ 0.750 in. thick with cross-sectional area ≤ 32 sq. in.).

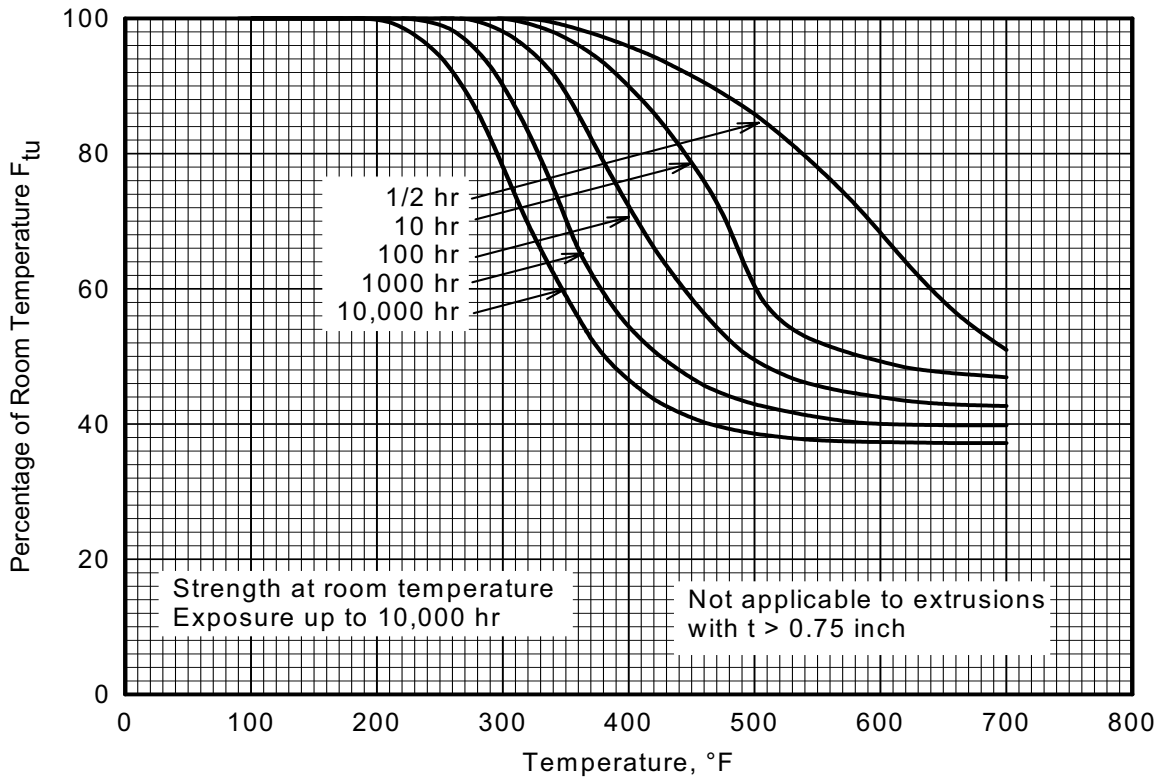

Figure 3.2.1.1(e). Effect of exposure at elevated temperatures on the room-temperature tensile ultimate strength (F_{tu}) of 2014-T6, T651, T6510, and T6511 aluminum alloy (all products except thick extrusions).

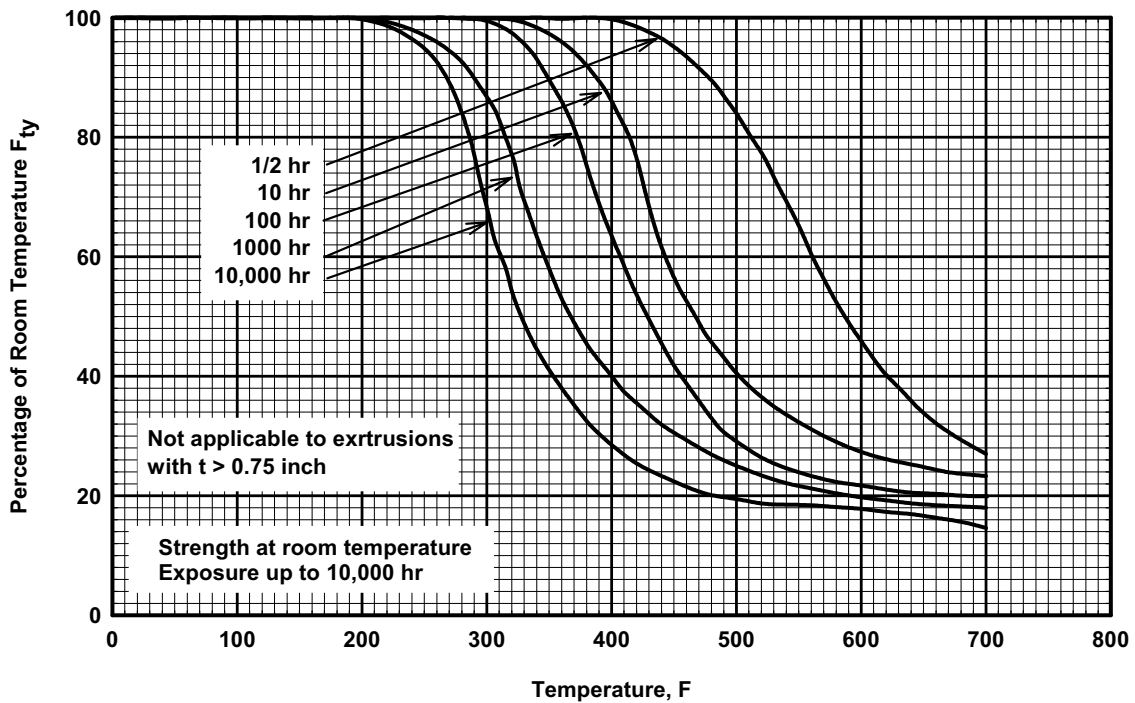

Figure 3.2.1.1(f). Effect of exposure at elevated temperature on the room-temperature tensile yield strength (F_{ty}) of 2014-T6, T651, T6510, and T6511 aluminum alloy (all products except thick extrusions).

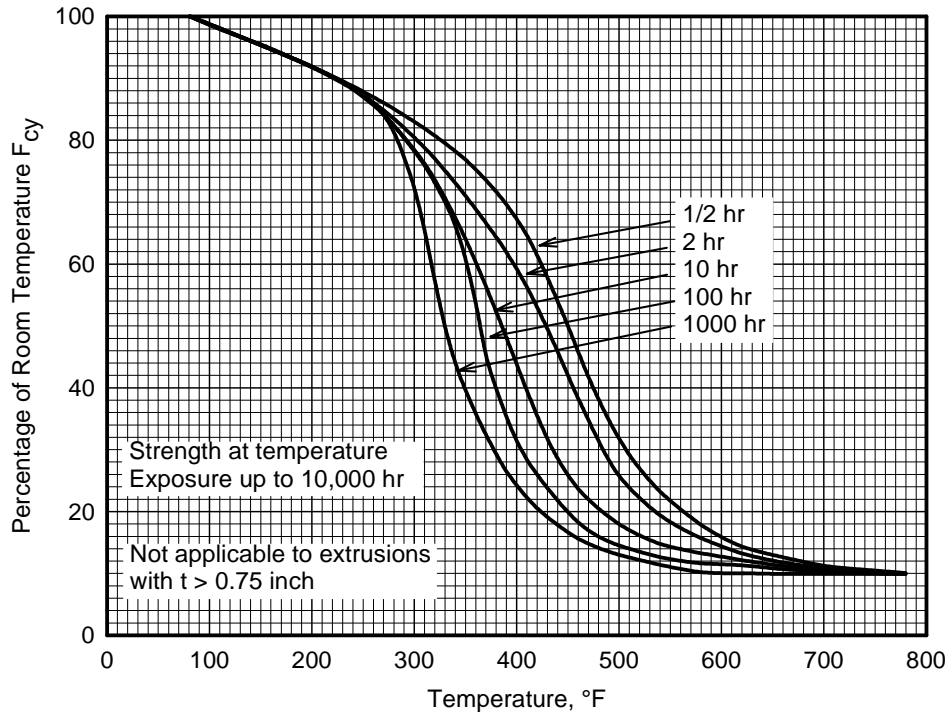

Figure 3.2.1.1.2(a). Effect of temperature on the compressive yield strength (F_{cy}) of 2014-T6, T651, T6510 and T6511 aluminum alloy (all products except thick extrusions).

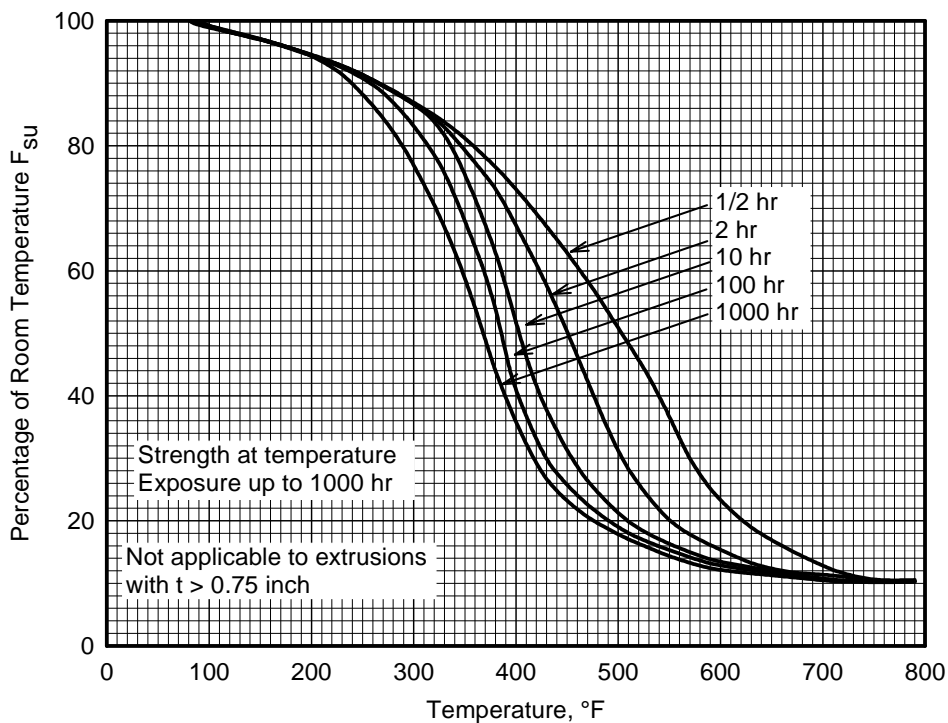

Figure 3.2.1.1.2(b). Effect of temperature on the shear ultimate strength (F_{su}) of 2014-T6, T651, T6510 and T6511 aluminum alloy (all products except thick extrusions).

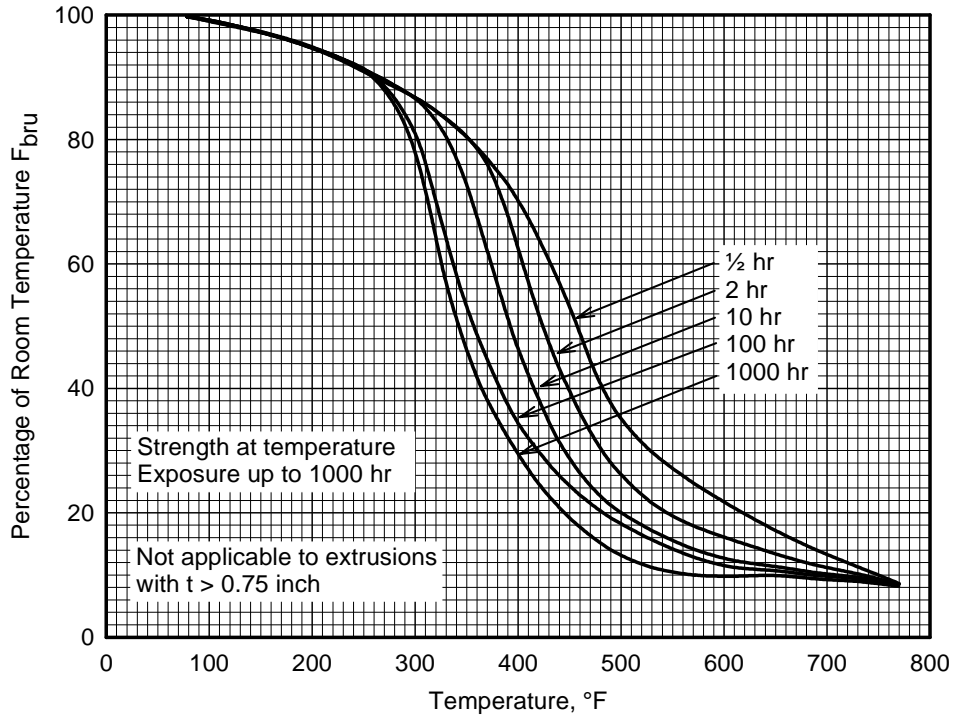

Figure 3.2.1.1.3(a). Effect of temperature on the bearing ultimate strength (F_{bru}) of 2014-T6, T651, T6510 and T6511 aluminum alloy (all products except thick extrusions).

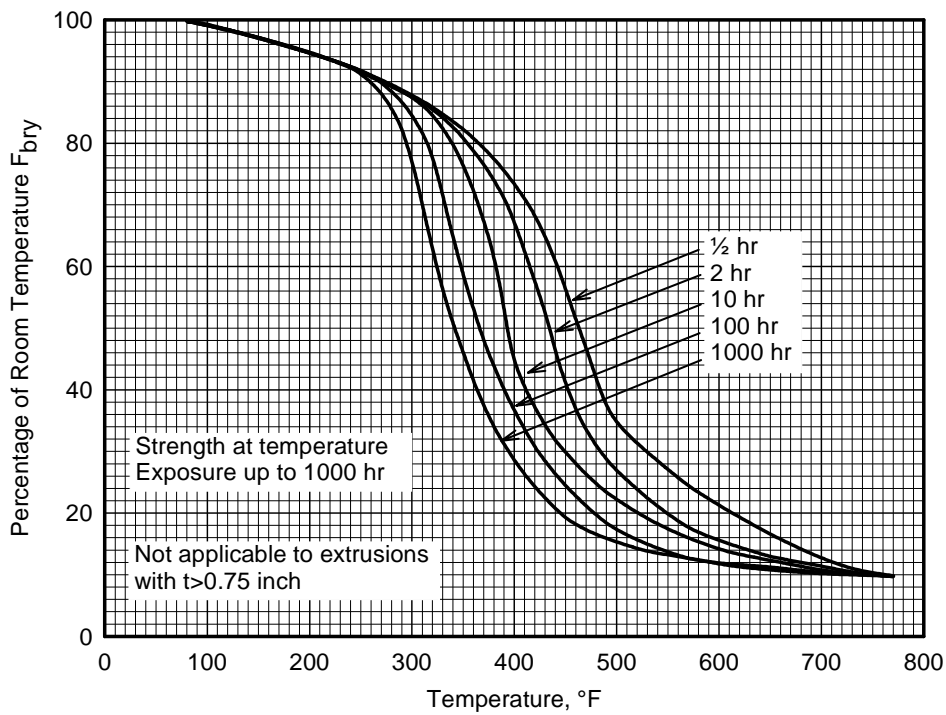

Figure 3.2.1.1.3(b). Effect of temperature on the bearing yield strength (F_{bry}) of 2014-T6, T651, T6510 and T6511 aluminum alloy (all products except thick extrusions).

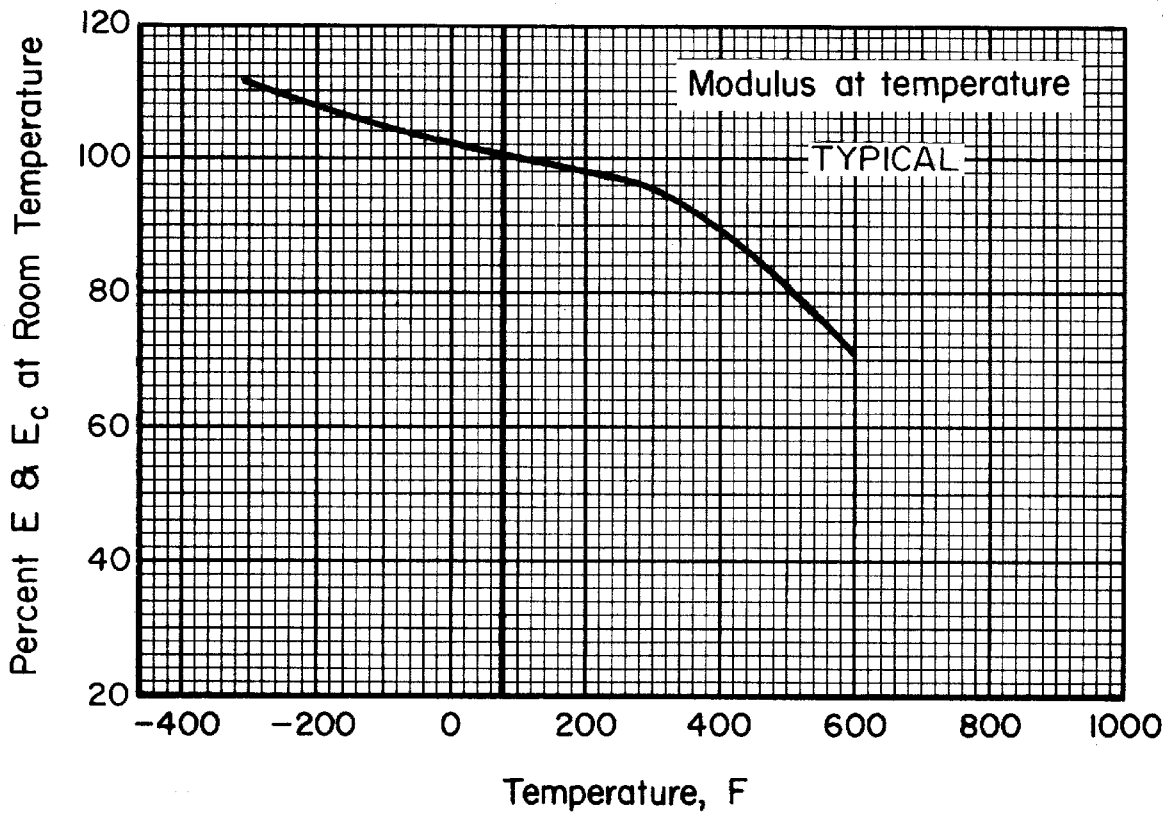

Figure 3.2.1.1.4. Effect of temperature on the tensile and compressive moduli (E and E_c) of 2014 aluminum alloy.

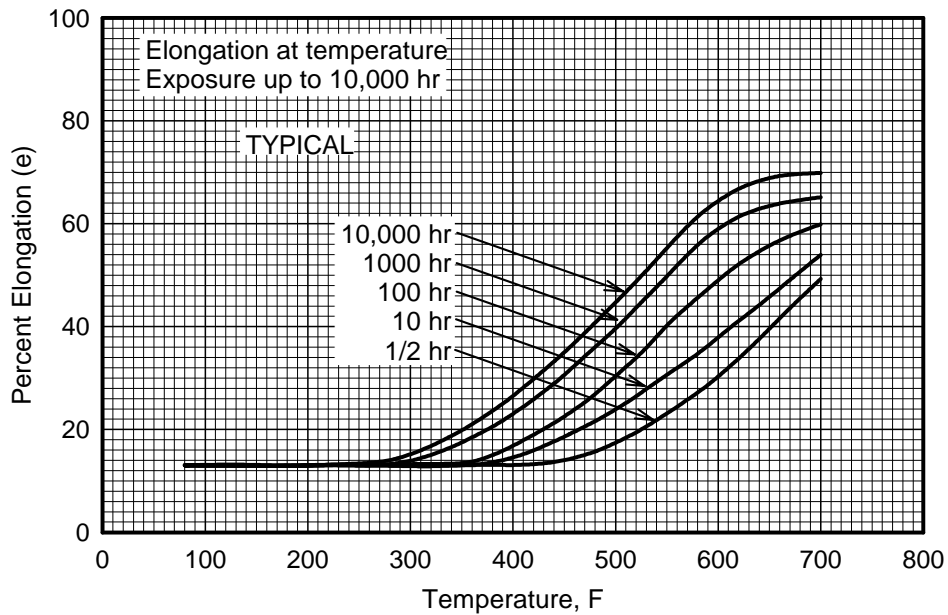

Figure 3.2.1.1.5(a). Effect of temperature on the elongation of 2014-T6, T651, T6510 and T6511 aluminum alloy (all products except thick extrusions).

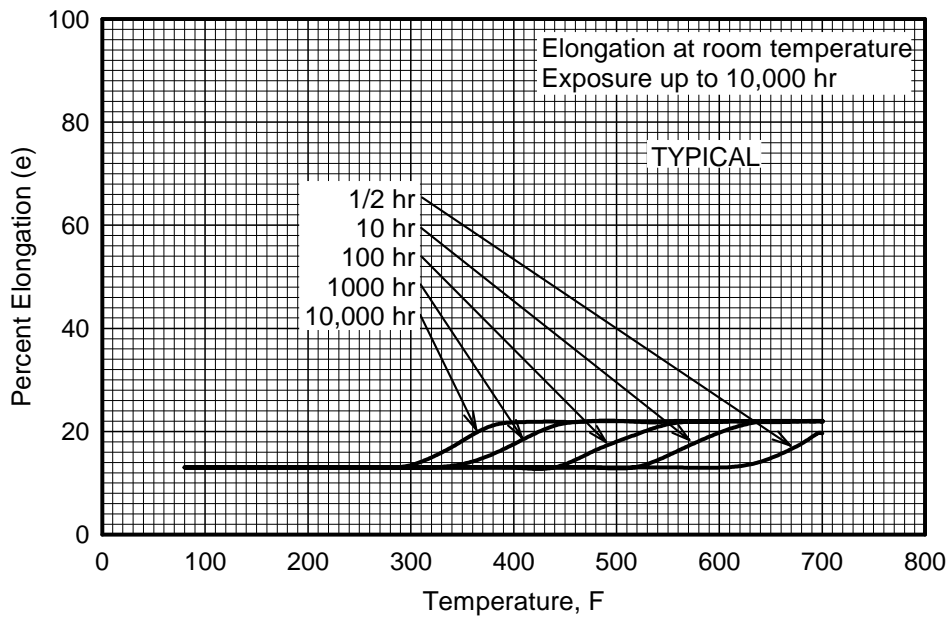

Figure 3.2.1.1.5(b). Effect of exposure at elevated temperatures on the room-temperature elongation of 2014-T6, T651, T6510 and T6511 aluminum alloy (all products except thick extrusions).

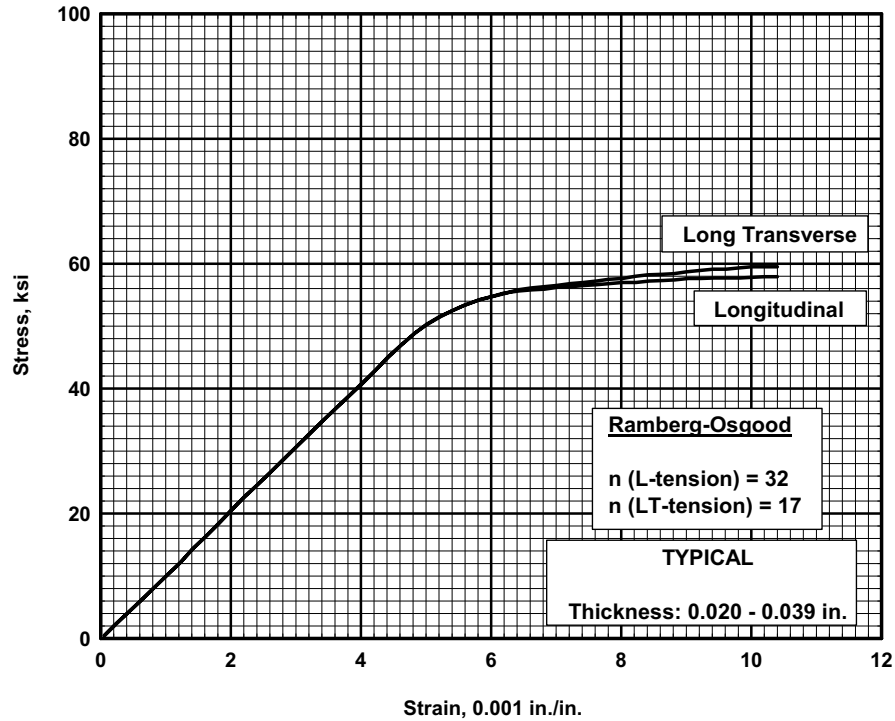

Figure 3.2.1.1.6(a). Typical tensile stress-strain curves for clad 2014-T6 aluminum alloy sheet at room temperature.

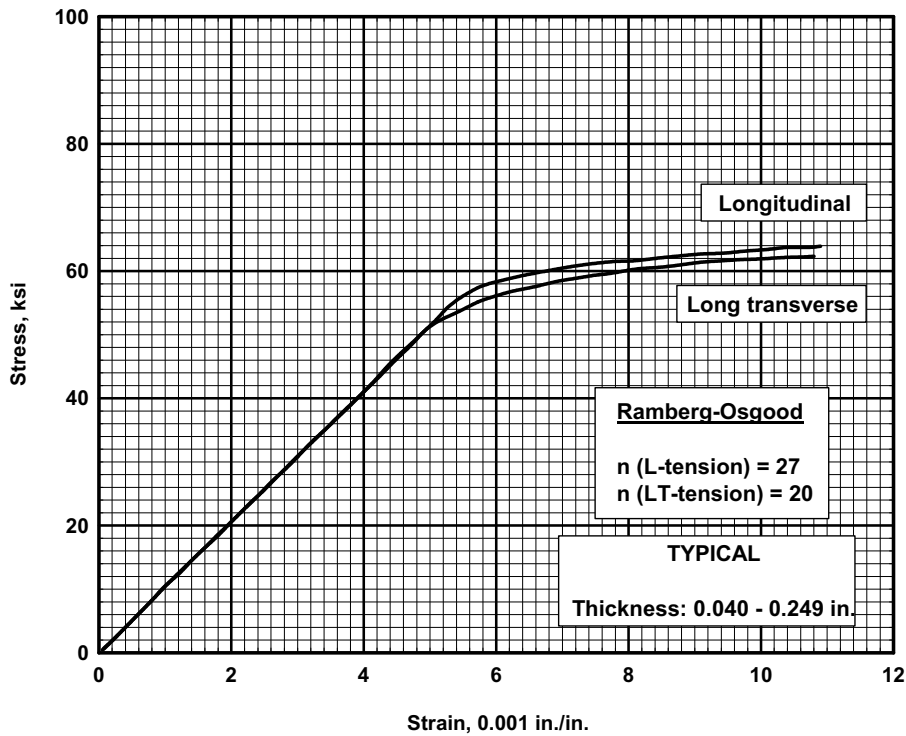

Figure 3.2.1.1.6(b). Typical tensile stress-strain curves for clad 2014-T6 aluminum alloy sheet at room temperature.

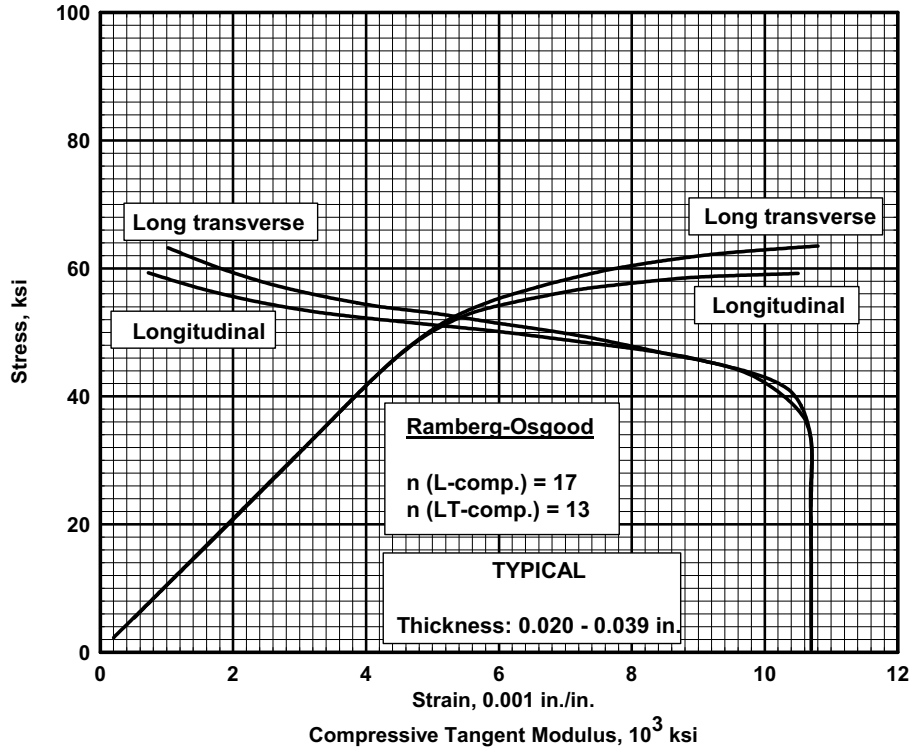

Figure 3.2.1.1.6(c). Typical compressive stress-strain and compressive tangent-modulus curves for clad 2014-T6 aluminum alloy sheet at room temperature.

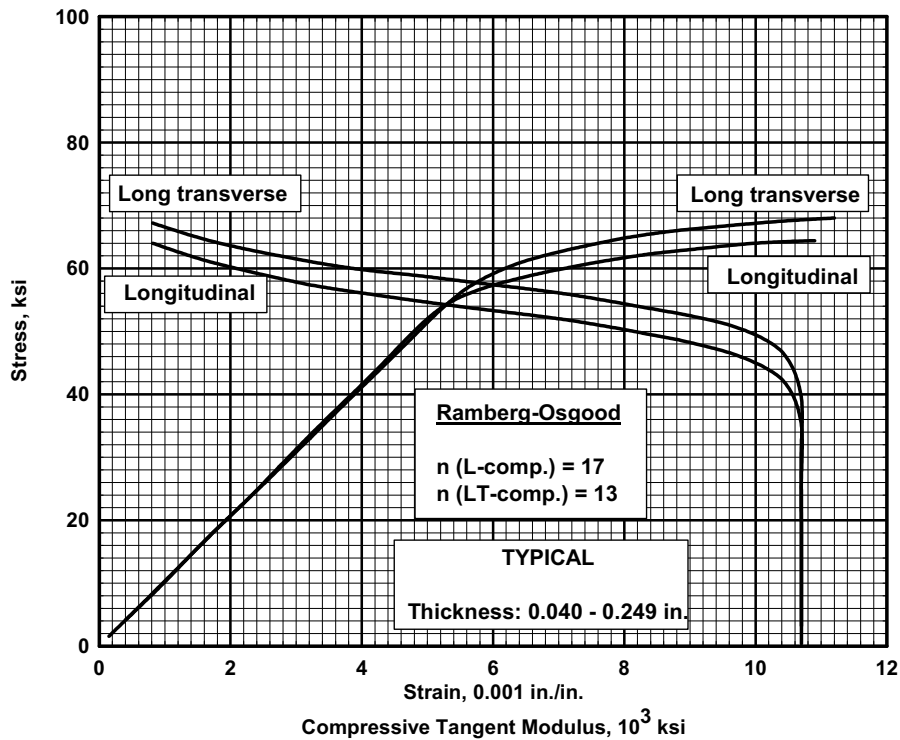

Figure 3.2.1.1.6(d). Typical compressive stress-strain and compressive tangent-modulus curves for clad 2014-T6 aluminum alloy sheet at room temperature.

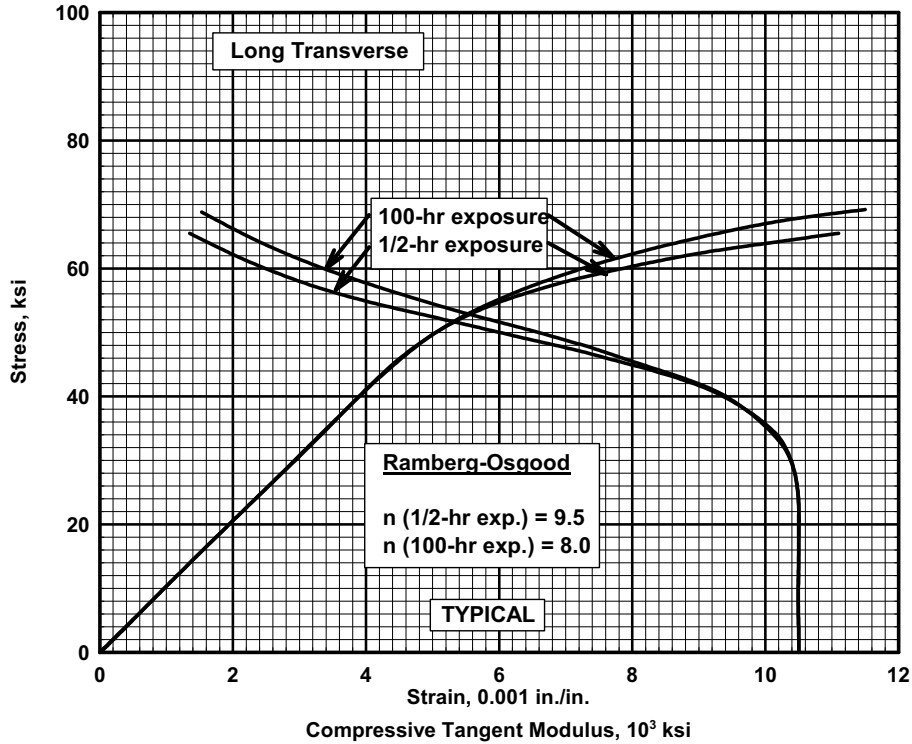

Figure 3.2.1.1.6(e). Typical compressive stress-strain and compressive tangent-modulus curves for clad 2014-T6 aluminum alloy sheet at 200°F.

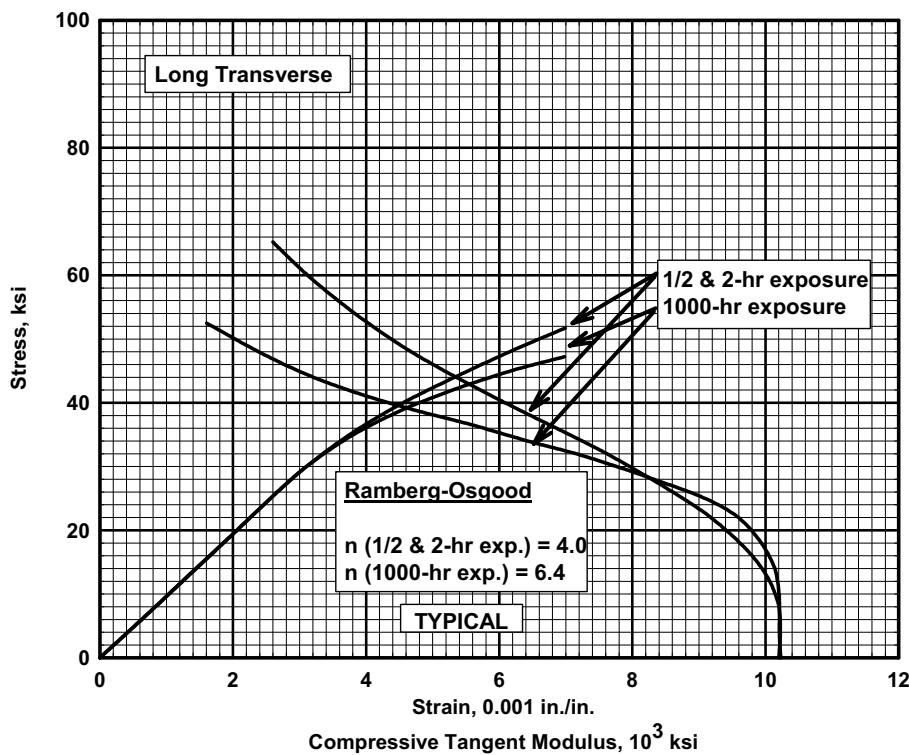

Figure 3.2.1.1.6(f). Typical compressive stress-strain and compressive tangent-modulus curves for clad 2014-T6 aluminum alloy sheet at 300°F.

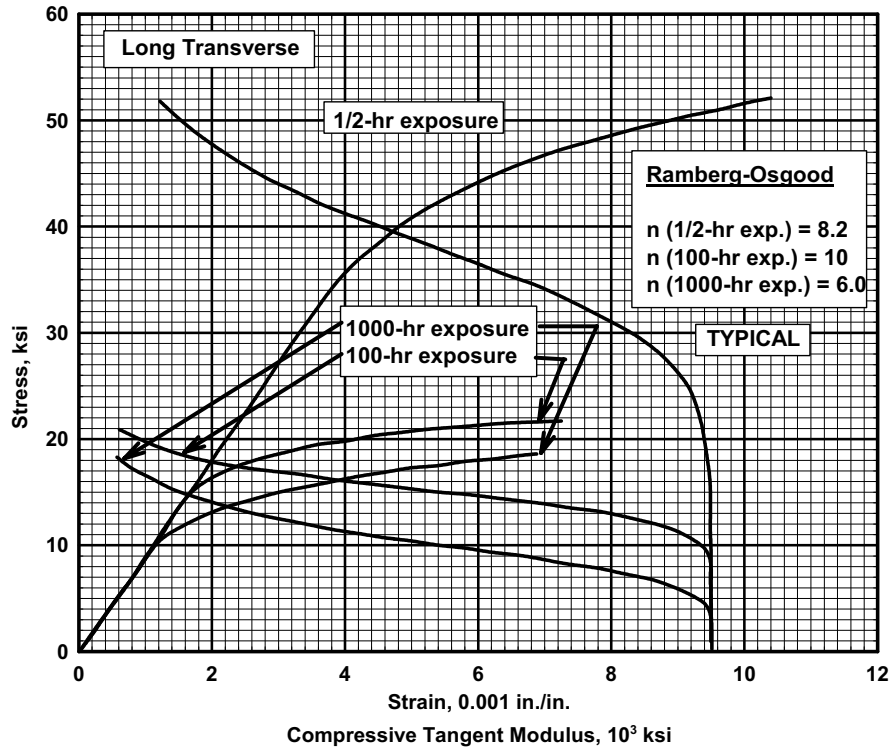

Figure 3.2.1.1.6(g). Typical compressive stress-strain and compressive tangent-modulus curves for clad 2014-T6 aluminum alloy sheet at 400°F.

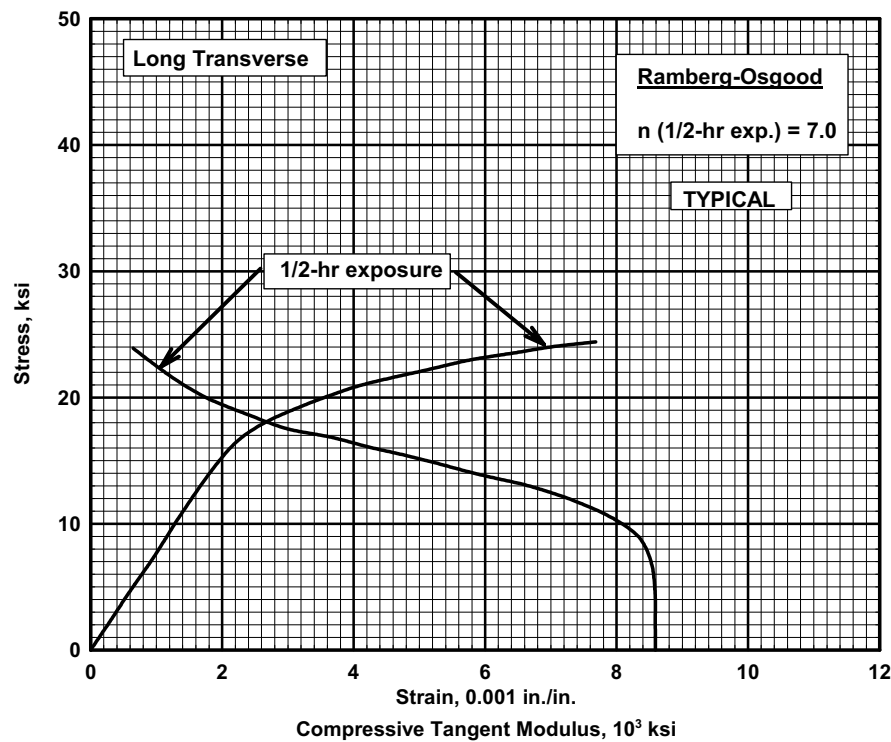

Figure 3.2.1.1.6(h). Typical compressive stress-strain and compressive tangent-modulus curves for clad 2014-T6 aluminum alloy sheet at 500°F.

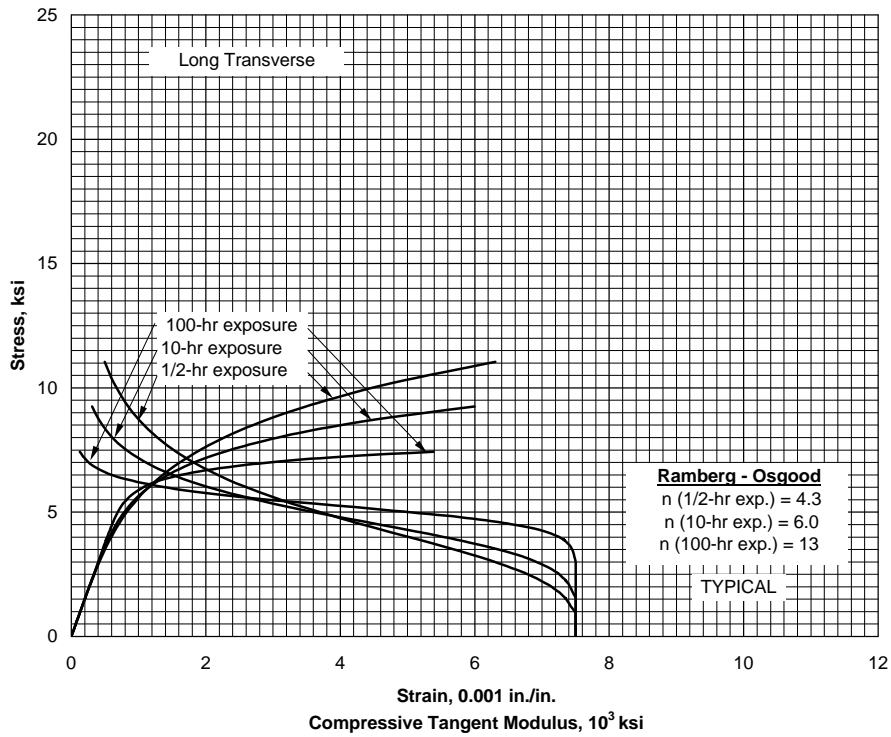

Figure 3.2.1.1.6(i). Typical compressive stress-strain and compressive tangent-modulus curves for clad 2014-T6 aluminum alloy sheet at 600°F.

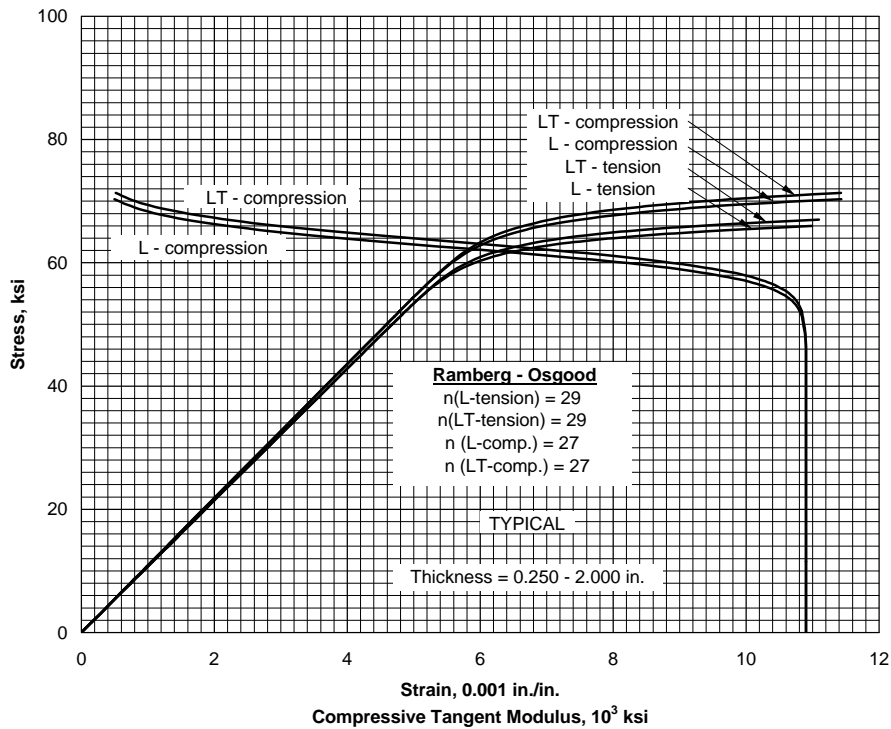

Figure 3.2.1.1.6(j). Typical tensile and compressive stress-strain and compressive tangent-modulus curves for clad 2014-T62 aluminum alloy plate at room temperature.

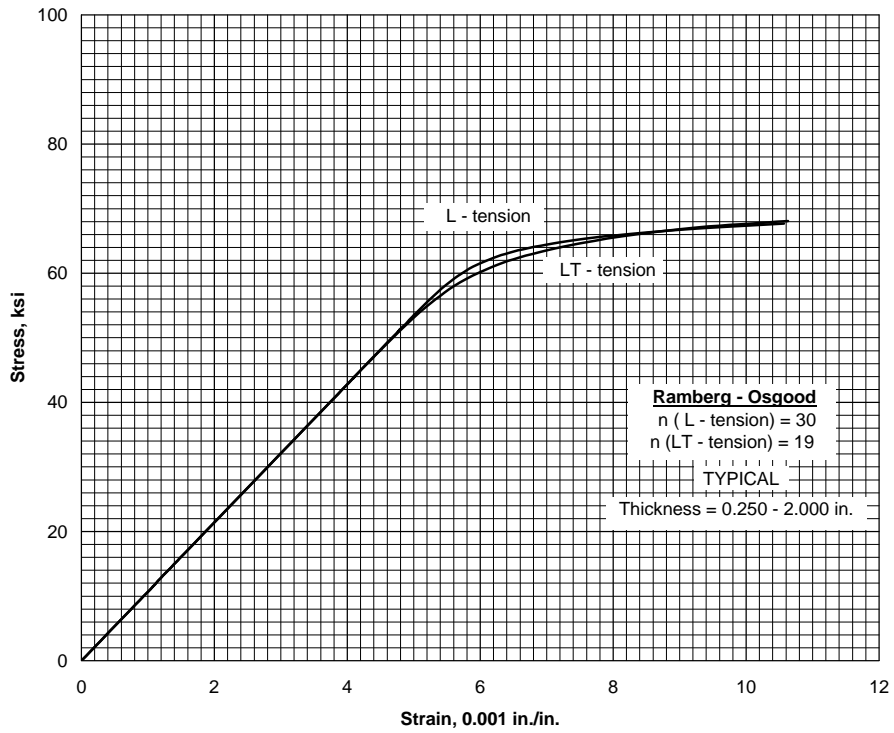

Figure 3.2.1.1.6(k). Typical tensile stress-strain curves for 2014-T651 aluminum alloy plate at room temperature.

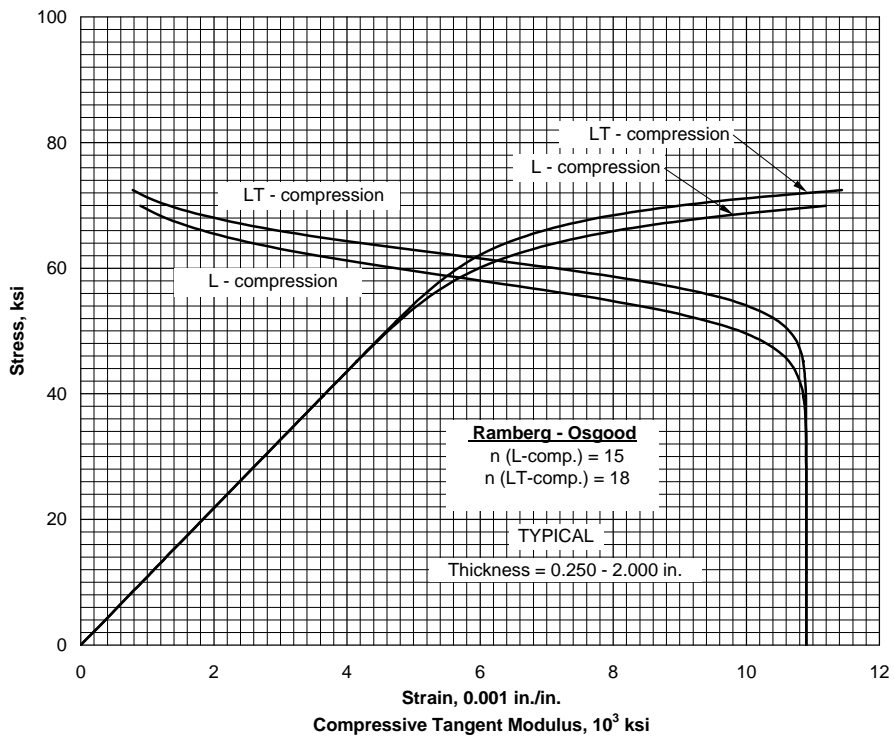

Figure 3.2.1.1.6(l). Typical compressive stress-strain and compressive tangent-modulus curves for 2014-T651 aluminum alloy plate at room temperature.

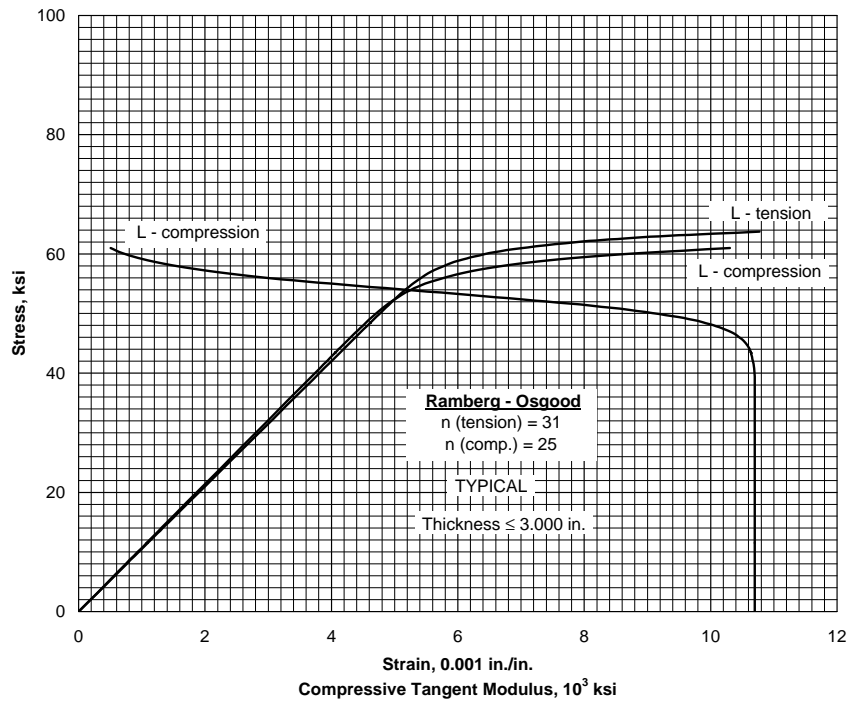

Figure 3.2.1.1.6(m). Typical tensile and compressive stress-strain and compressive tangent-modulus curves for 2014-T6 aluminum alloy rolled bar, rod, and shapes at room temperature.

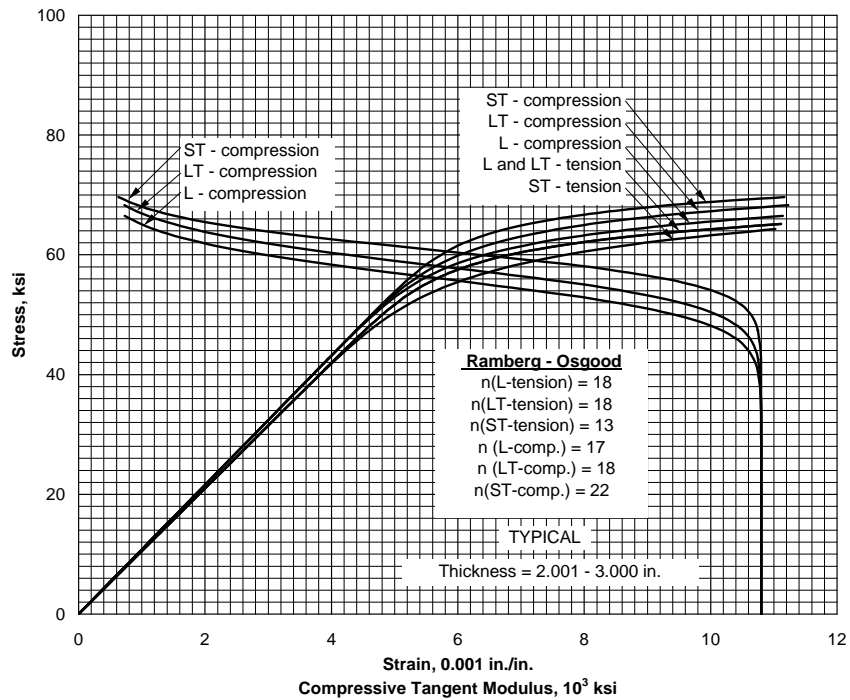

Figure 3.2.1.1.6(n). Typical tensile and compressive stress-strain and compressive tangent-modulus curves for 2014-T652 aluminum alloy hand forging at room temperature.

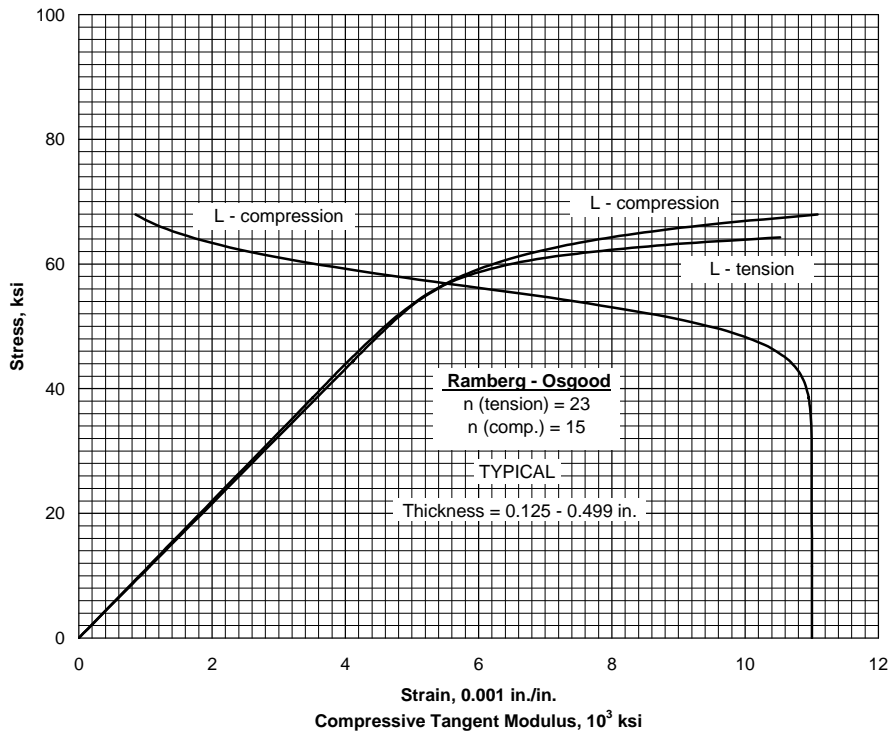

Figure 3.2.1.1.6(o). Typical tensile and compressive stress-strain and compressive tangent-modulus curves for 2014-T6 aluminum alloy extrusion at room temperature.

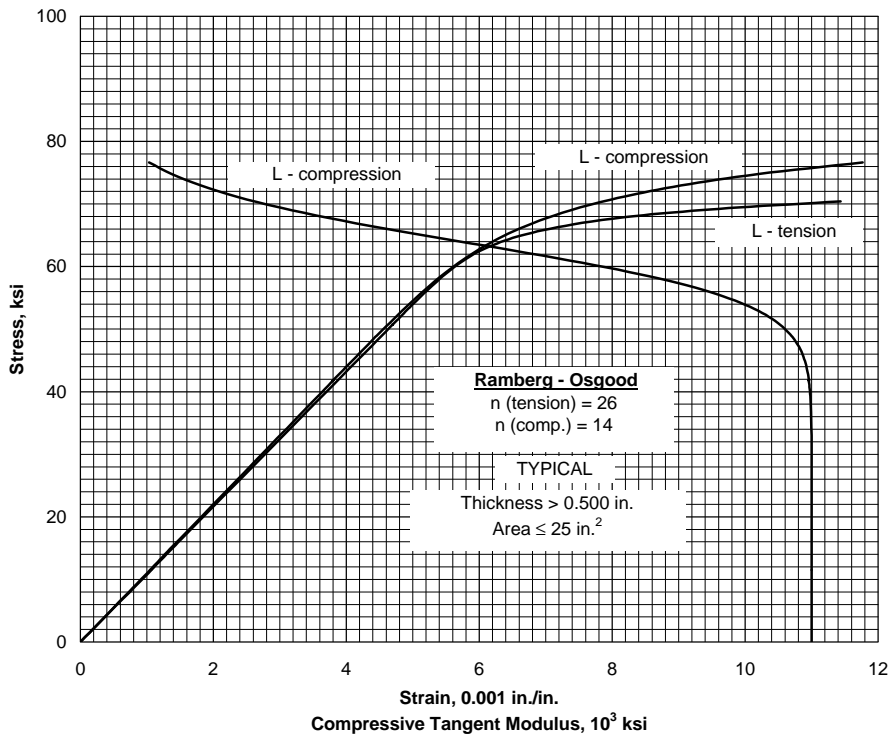

Figure 3.2.1.1.6(p). Typical tensile and compressive stress-strain and compressive tangent-modulus curves for 2014-T6 aluminum alloy extrusion at room temperature.

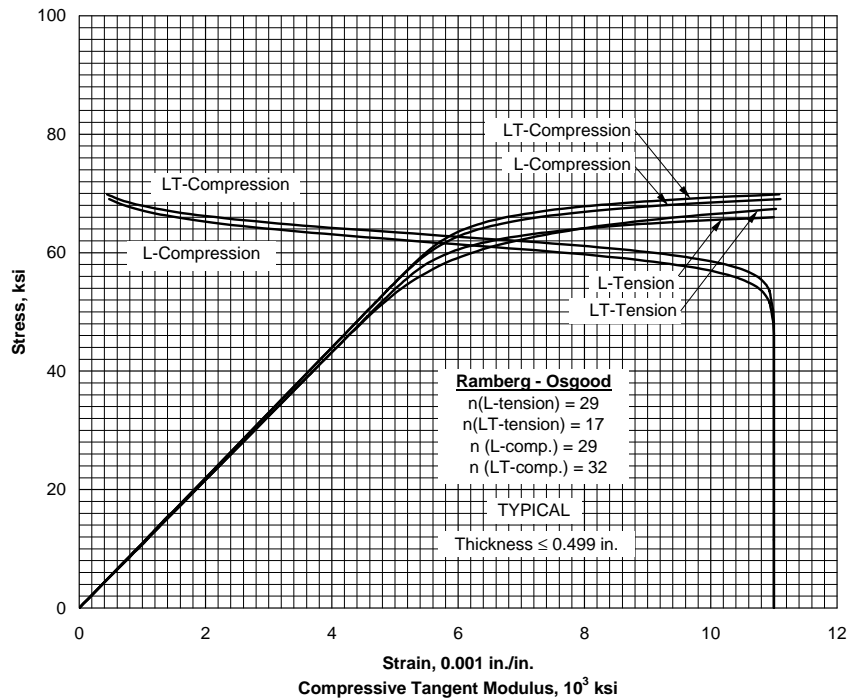

Figure 3.2.1.1.6(q). Typical tensile and compressive stress-strain and compressive tangent-modulus curves for 2014-T62 aluminum alloy extrusion at room temperature.

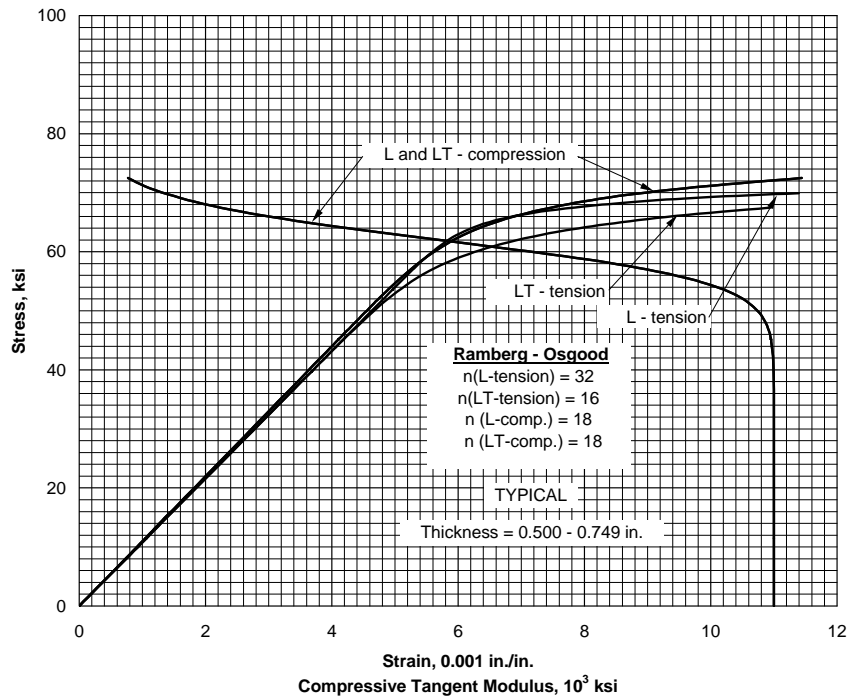

Figure 3.2.1.1.6(r). Typical tensile and compressive stress-strain and compressive tangent-modulus curves for 2014-T651X aluminum alloy extrusion at room temperature.

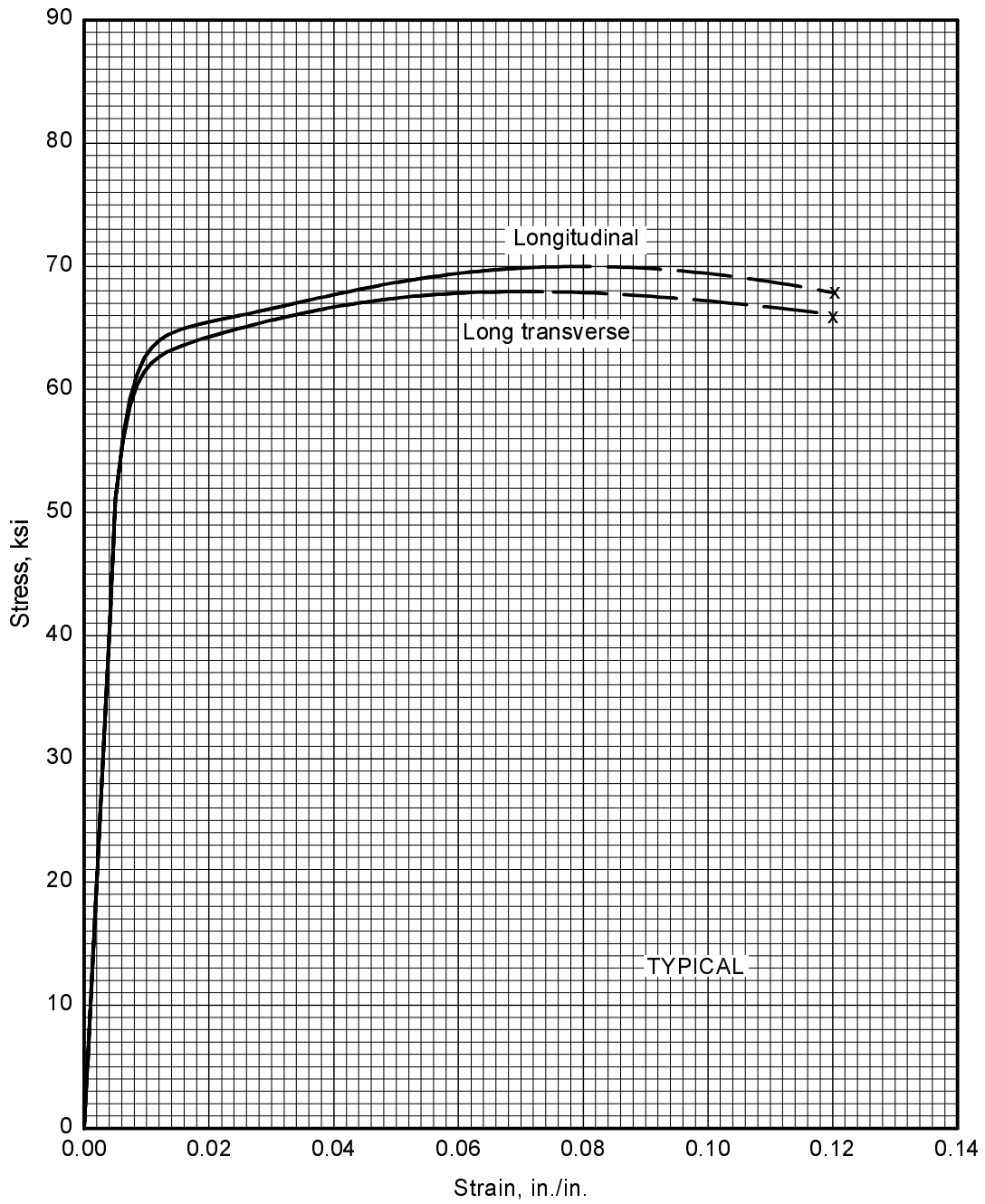

Figure 3.2.1.1.6(s). Typical tensile stress-strain curves (full range) for 2014-T6 aluminum alloy forging at room temperature.

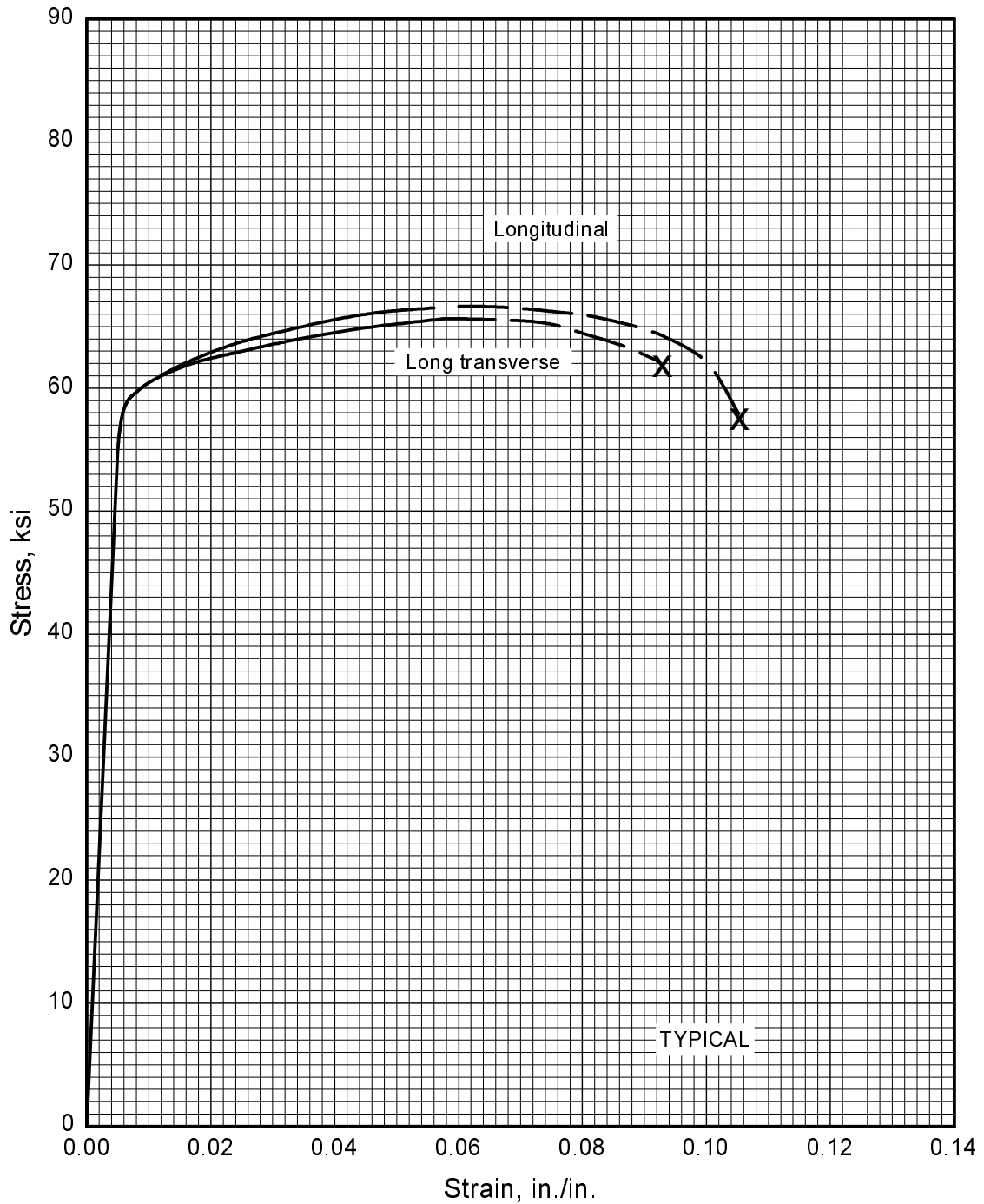

Figure 3.2.1.1.6(t). Typical tensile stress-strain curves (full range) for 2014-T652 aluminum alloy forging at room temperature.

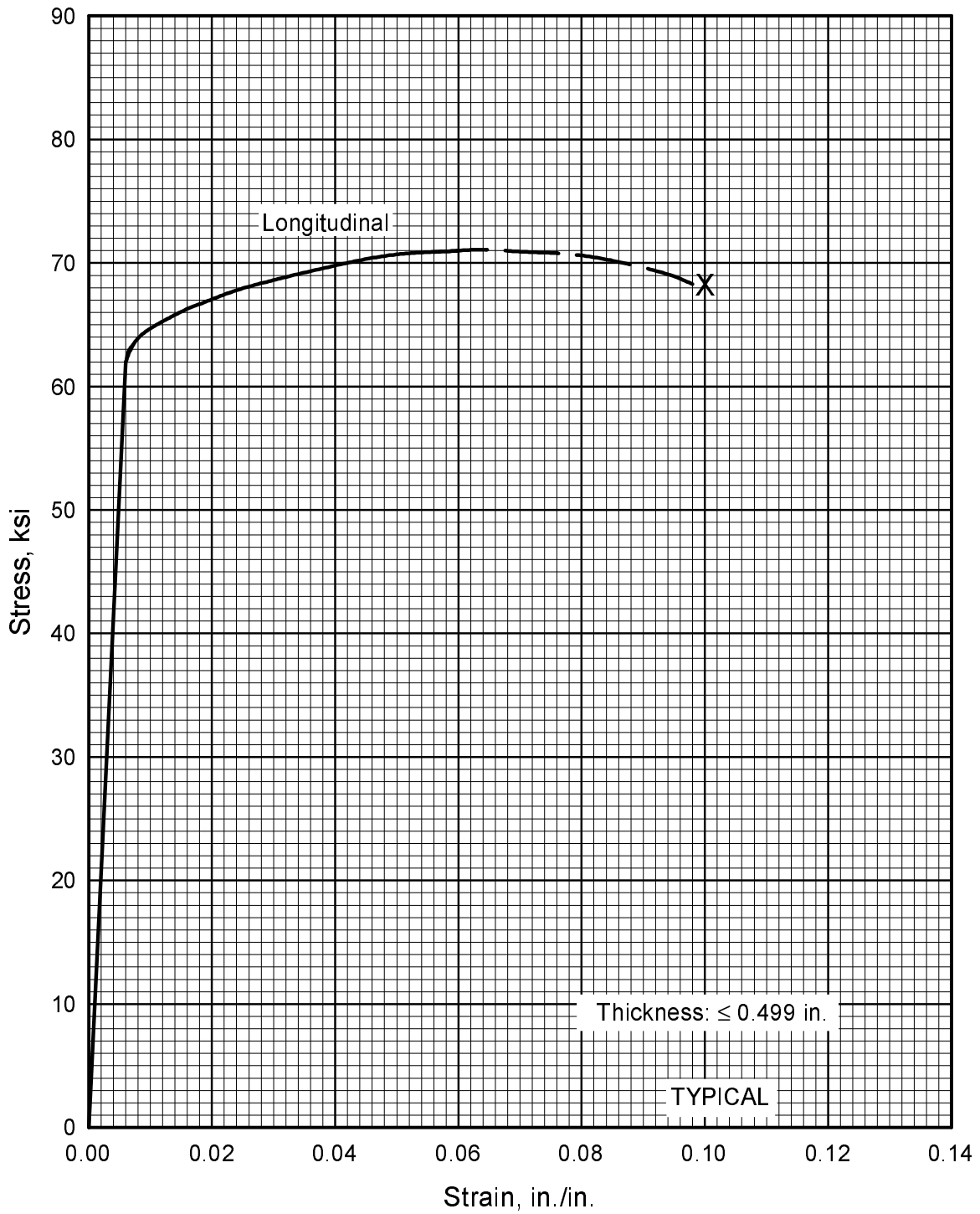

Figure 3.2.1.1.6(u). Typical tensile stress-strain curves (full range) for 2014-T62 aluminum alloy extrusion at room temperature.

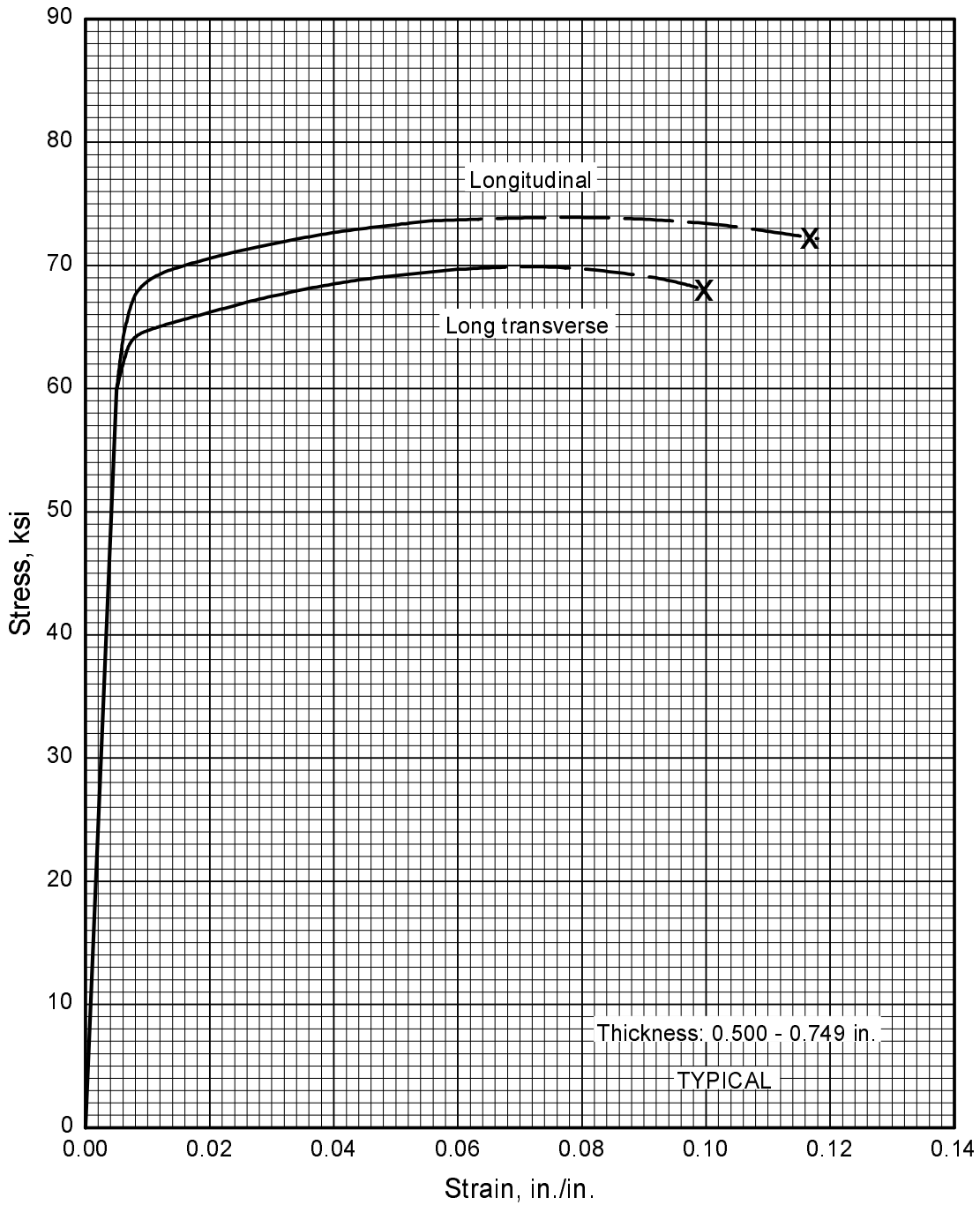

Figure 3.2.1.1.6(v). Typical tensile stress-strain curves (full range) for 2014-T651X aluminum alloy extrusion at room temperature.

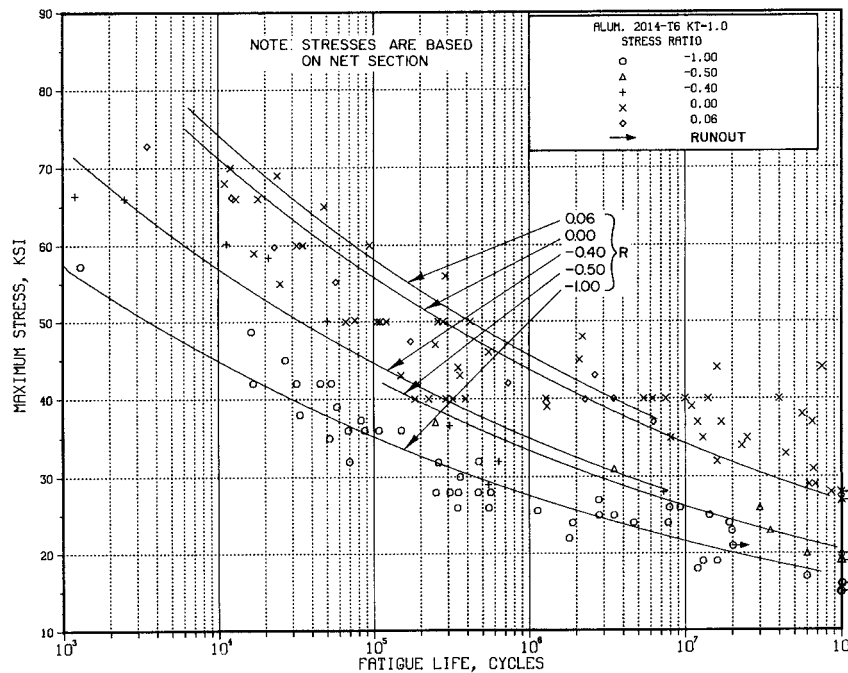

Figure 3.2.1.1.8(a). Best-fit S/N curves for unnotched 2014-T6 aluminum alloy, various wrought products, longitudinal direction.

Correlative Information for Figure 3.2.1.1.8(a)

Product Form: Drawn rod, 0.75 inch diameter
 Rolled bar, 1 x 7.5 inch and
 1.125 inch diameter
 Rolled rod, 4.5 inch diameter
 Extruded rod, 1.25 inch diameter
 Extruded bar, 1.25 x 4 inch
 Hand forging, 3 x 6 inch
 Die forging, 4.5 inch diameter
 Forged slab, 0.875 inch

Test Parameters:
 Loading - Axial
 Frequency - 1100 to 3600 cpm
 Temperature - RT
 Environment - Air

No. of Heats/Lots: Not specified

Properties: TUS, ksi TYS, ksi Temp., °F
 67-78 60-72 RT

Equivalent Stress Equation:
 $\log N_f = 21.49 - 9.44 \log (S_{eq})$
 $S_{eq} = S_{max} (1-R)^{0.67}$
 Std. Error of Estimate, $\log (\text{Life}) = 0.51$
 Standard Deviation, $\log (\text{Life}) = 1.25$
 $R^2 = 83\%$

Specimen Details: Unnotched

<u>Gross Diameter, inches</u>	<u>Net Diameter, inches</u>
1.00	0.400
0.273	0.100
---	0.200
---	0.160
1.00	0.500

Sample Size = 127

[Caution: The equivalent stress model may provide unrealistic life predictions for stress ratios beyond those represented above.]

Surface Condition:
 Mechanically polished and as-machined

References: 3.2.1.1.8(a), (b), (d), and (e)

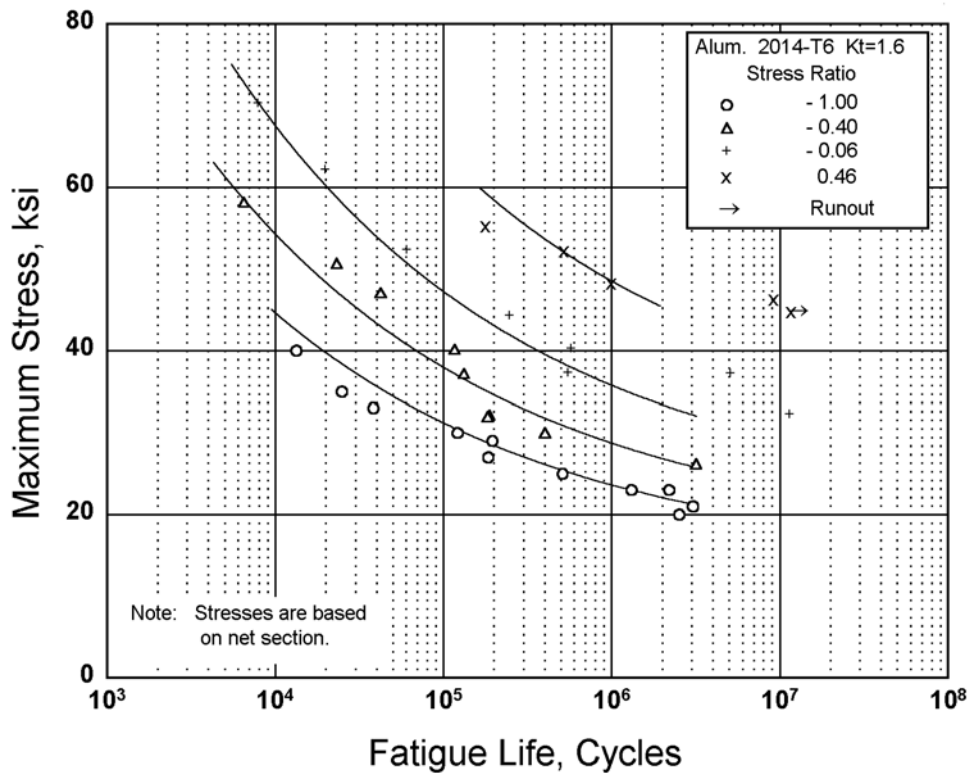

Figure 3.2.1.1.8(b). Best-fit S/N curves for notched, $K_t = 1.6$, 2014-T6 aluminum alloy rolled bar, longitudinal direction.

Correlative Information for Figure 3.2.1.1.8(b)

Product Form: Rolled bar, 1.125 inch diameter

Test Parameters:

Properties: TUS, ksi TYS, ksi Temp., °F
 72 64 RT

Loading - Axial
 Frequency - 3600 cpm
 Temperature - RT
 Environment - Air

Specimen Details: Semicircular circumferential notch, $K_t = 1.6$
 0.45 inch gross diameter
 0.4 inch net diameter
 0.01 inch root radius
 60° flank angle, ω

No. of Heats/Lots: Not specified

Equivalent Stress Equation:

$\log N_f = 10.65 - 4.02 \log (S_{eq} - 20.2)$
 $S_{eq} = S_{max} (1-R)^{0.55}$
 Std. Error of Estimate, $\log (\text{Life}) = 0.33$
 Standard Deviation, $\log (\text{Life}) = 0.87$
 $R^2 = 86\%$

Surface Condition: Polished

Reference: 3.2.1.1.8(b)

Sample Size = 33

[Caution: The equivalent stress model may provide unrealistic life predictions for stress ratios beyond those represented above.]

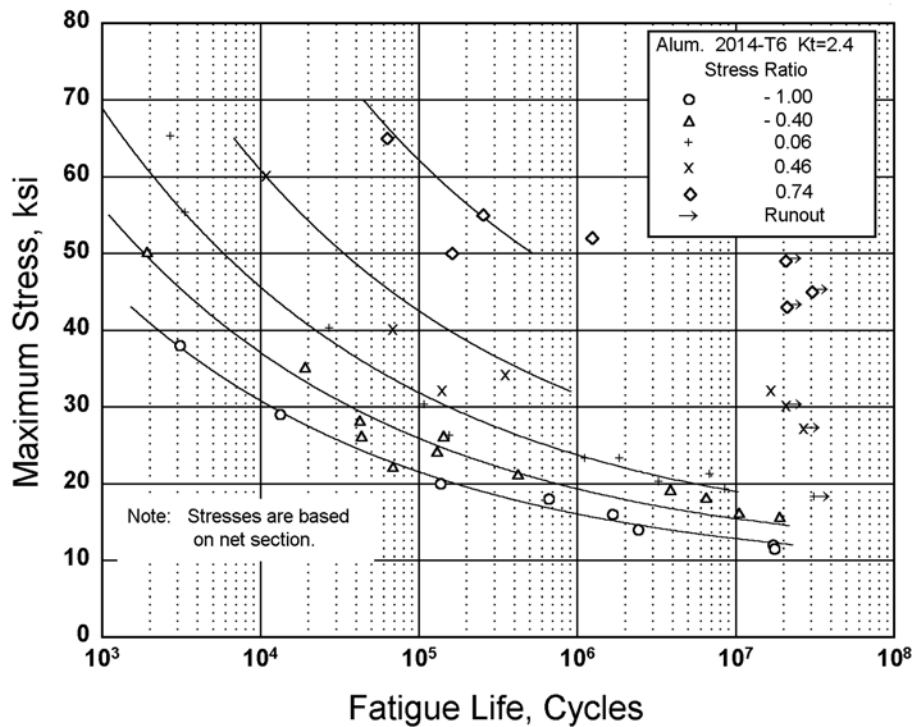

Figure 3.2.1.1.8(c). Best-fit S/N curves for notched, $K_t = 2.4$, 2014-T6 aluminum alloy rolled bar, longitudinal direction.

Correlative Information for Figure 3.2.1.1.8(c)

Product Form: Rolled bar, 1.125 inch diameter

Properties: $\frac{TUS, \text{ksi}}{72}$ $\frac{TYS, \text{ksi}}{64}$ $\frac{\text{Temp., } ^\circ\text{F}}{\text{RT}}$

Specimen Details: Circumferential V-notch,
 $K_t = 2.4$
0.500 inch gross diameter
0.400 inch net diameter
0.032 inch notch radius
60° flank angle, ω

Surface Condition: Polished

Reference: 3.2.1.1.8(b)

Test Parameters:

Loading - Axial
Frequency - 1800 cpm
Temperature - RT
Environment - Air

No. of Heats/Lots: Not specified

Equivalent Stress Equation:

$\text{Log } N_f = 10.59 - 4.36 \text{ log } (S_{eq} - 11.7)$
 $S_{eq} = S_{max} (1-R)^{0.52}$
Std. Error of Estimate, $\text{Log } (\text{Life}) = 0.38$
Standard Deviation, $\text{Log } (\text{Life}) = 1.18$
 $R^2 = 90\%$

Sample Size = 39

[Caution: The equivalent stress model may provide unrealistic life predictions for stress ratios beyond those represented above.]

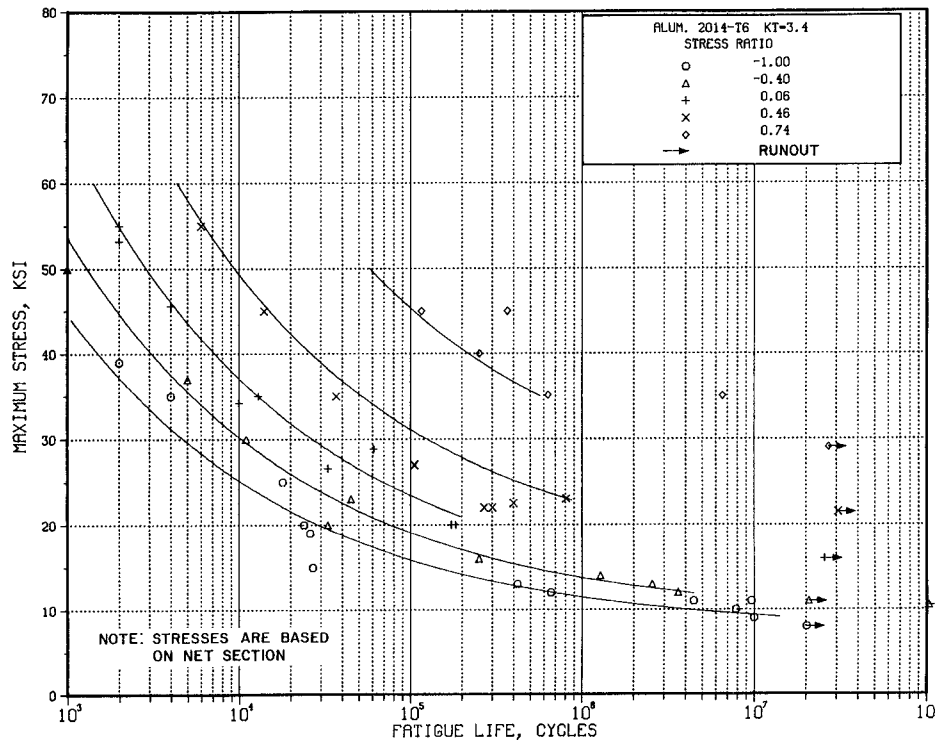

Figure 3.2.1.1.8(d). Best-fit S/N curves for notched, $K_t = 3.4$, 2014-T6 aluminum alloy rolled and extruded bar, longitudinal direction.

Correlative Information for Figure 3.2.1.1.8(d)

Product Form: Extruded bar, 1.125 inch diameter

Properties: $\frac{TUS, \text{ksi}}{75}$ $\frac{TYS, \text{ksi}}{67}$ $\frac{\text{Temp., } ^\circ\text{F}}{\text{RT}}$

Specimen Details: Circumferential V-notch,
 $K_t = 3.4$
0.450 inch gross diameter
0.400 inch net diameter
0.010 inch notch radius
60° flank angle, ω

Surface Condition: Smooth machine finish

References: 3.2.1.1.8(b) and (c)

Test Parameters:

Loading - Axial
Frequency - 3600 cpm
Temperature - RT
Environment - Air

No. of Heats/Lots: Not specified

Equivalent Stress Equation:

$$\log N_f = 8.35 - 3.10 \log (S_{eq} - 10.6)$$

$$S_{eq} = S_{max} (1-R)^{0.52}$$

Std. Error of Estimate, $\log (\text{Life}) = 0.34$

Standard Deviation, $\log (\text{Life}) = 1.10$

$R^2 = 90\%$

Sample Size = 45

[Caution: The equivalent stress model may provide unrealistic life predictions for stress ratios beyond those represented above.]

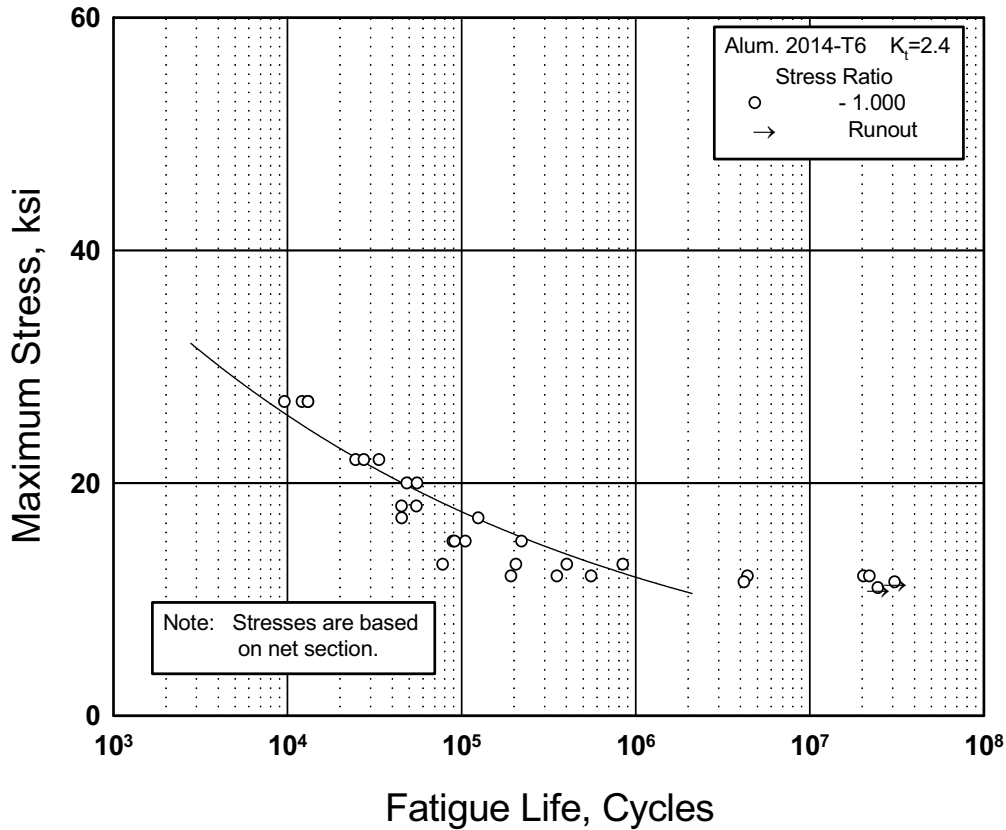

Figure 3.2.1.1.8(e). Best-fit S/N curves for notched, $K_t = 2.4$, 2014-T6 aluminum alloy hand forging, longitudinal and short transverse directions.

Correlative Information for Figure 3.2.1.1.8(e)

Product Form: Hand forging, 3 x 6 inch

Test Parameters:

Properties: TUS, ksi TYS, ksi Temp., °F
Not specified RT

Loading - Axial
Frequency - Not specified
Temperature - RT
Environment - Air

Specimen Details: Circumferential V-notch,
 $K_t = 2.4$
0.273 inch gross diameter
0.100 inch net diameter
0.010 inch notch radius
60° flank angle, ω

No. of Heats/Lots: Not specified

Maximum Stress Equation:
 $\log N_f = 12.4 - 5.95 \log (S_{max})$
Std. Error of Estimate, $\log (\text{Life}) = 0.53$
Standard Deviation, $\log (\text{Life}) = 0.91$
 $R^2 = 66\%$

Surface Condition: Mechanically polished

Reference: 3.2.1.1.8(d)

Sample Size = 28

3.2.2 2017 ALLOY

3.2.2.0 Comments and Properties — 2017 is a heat-treatable Al-Cu alloy available in the form of rolled bar, rod, and wire, and is used principally for fasteners. Refer to Section 3.1.3.4 for comments regarding the weldability of the alloy.

A material specification for 2017 aluminum alloy is presented in Table 3.2.2.0(a). Room-temperature mechanical and physical properties are shown in Table 3.2.2.0(b). Figure 3.2.2.0 shows the effect of temperature on thermal expansion.

Table 3.2.2.0(a). Material Specifications for 2017 Aluminum Alloy

Specification	Form
AMS-QQ-A-225/5	Rolled bar and rod
AMS 4118	Bar and rod, rolled or cold-finished

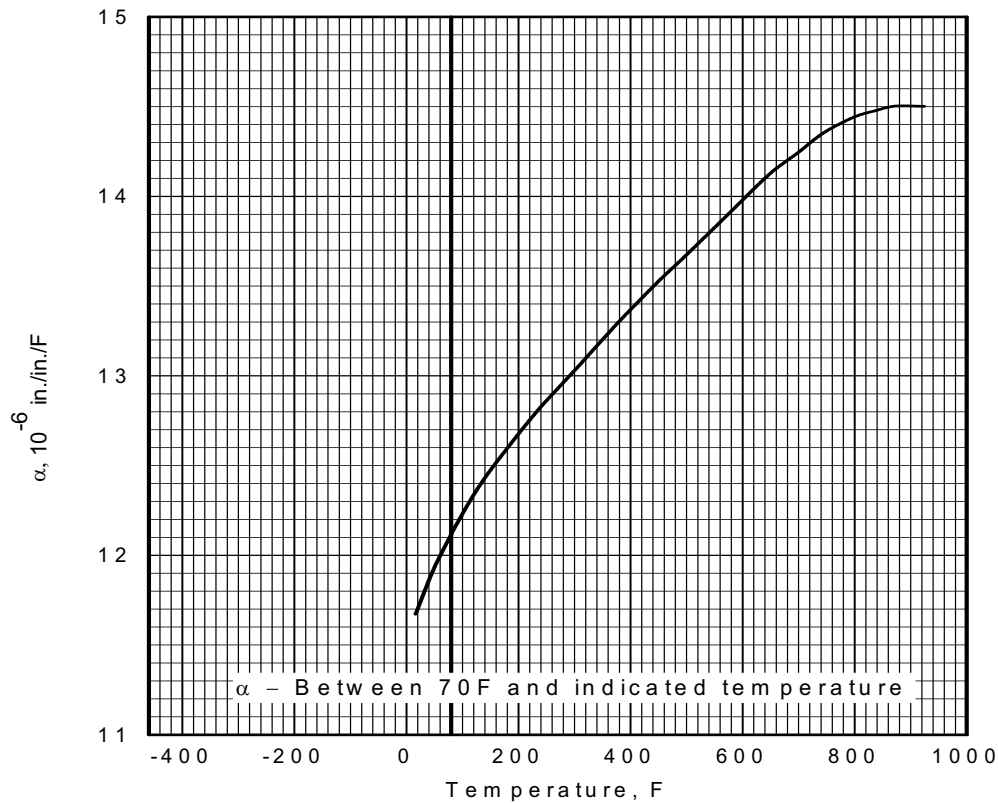

Figure 3.2.2.0. Effect of temperature on the thermal expansion of 2017 aluminum alloy.

The temper index for 2017 is as follows:

<u>Section</u>	<u>Temper</u>
3.2.2.1	T4, T451, and T42

3.2.2.1 T4, T451, and T42 Temper — The effect of temperature on modulus elasticity is presented in Figure 3.2.2.1.4.

Table 3.2.2.0(b). Design Mechanical and Physical Properties of 2017 Aluminum Alloy Bar and Rod; Rolled, Drawn, or Cold-Finished

Specification	AMS 4118 and AMS-QQ-A-225/5
Form	Bar and rod; rolled, drawn, or cold-finished
Temper	T4, T451, T42 ^a
Cross-Sectional Area, in. ² ...	≤50
Thickness or Diameter, in. ...	≤8.000
Basis	S
Mechanical Properties:	
F_{tu} , ksi:	
L	55
LT
F_{ly} , ksi:	
L	32
LT
F_{cy} , ksi:	
L	32 ^b
LT
F_{su} , ksi	33
F_{bru} , ksi:	
(e/D = 1.5)	83
(e/D = 2.0)	105
F_{bry} , ksi:	
(e/D = 1.5)	45
(e/D = 2.0)	51
e, percent (S-basis):	
L	12
E, 10 ³ ksi	10.4
E_c , 10 ³ ksi	10.6
G, 10 ³ ksi	3.95
μ	0.33
Physical Properties:	
ω , lb/in. ³	0.101
C, Btu/(lb)(°F)	0.23 (at 212 °F)
K, Btu/[(hr)(ft ²)(°F)/ft] ..	78 (at 77 °F)
α , 10 ⁻⁶ in./in./°F	See Figure 3.2.2.0

- a Design allowables were based upon data obtained from testing T4 material and from testing samples of bar and rod, supplied in the O or F temper, which were heat treated to T42 temper to demonstrate response to heat treatment by suppliers.
- b For the stress-relieved temper T451, the F_{cy} value may be somewhat lower.

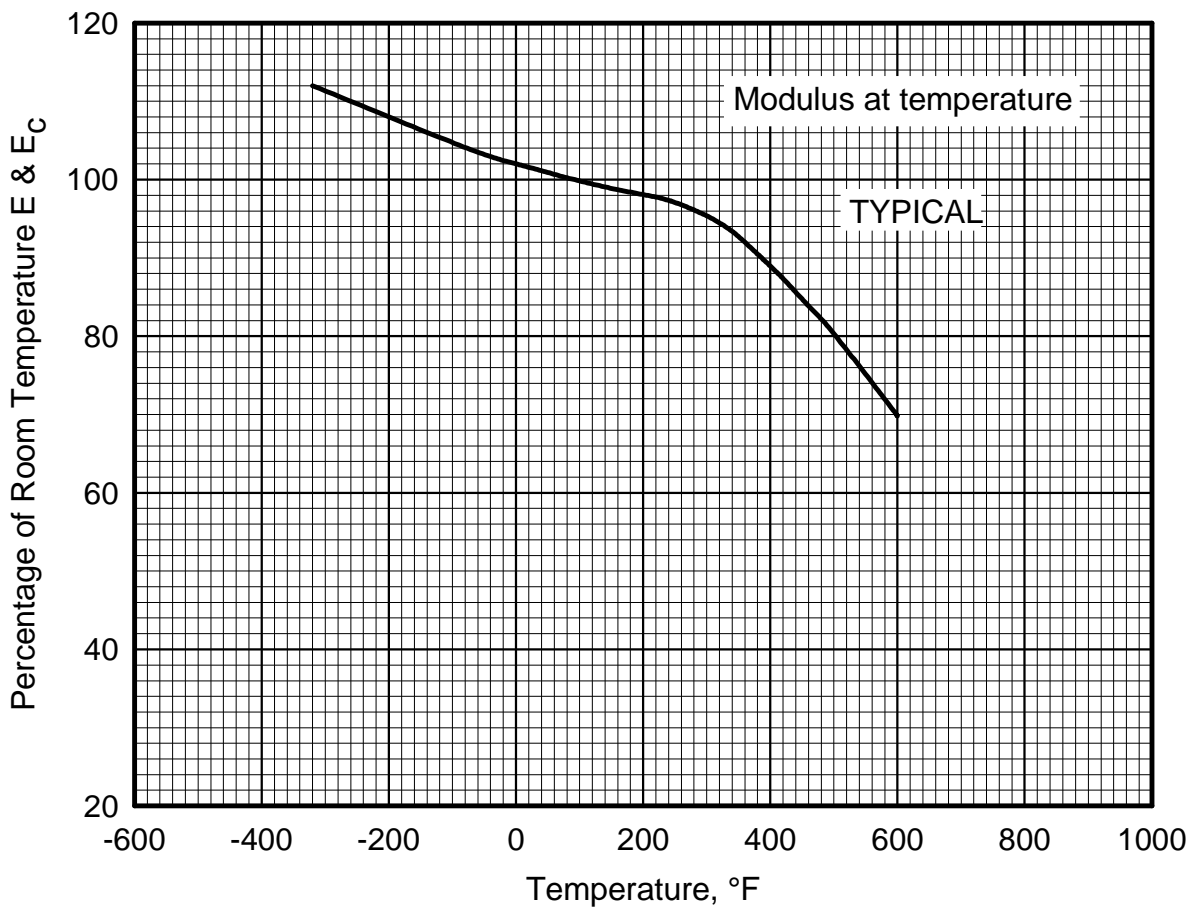

Figure 3.2.2.1.4. Effect of temperature on the tensile and compression moduli (E and E_c) of 2017 aluminum alloy.

3.2.3 2024 ALLOY

3.2.3.0 Comments and Properties — 2024 is a heat-treatable Al-Cu alloy which is available in a wide variety of product forms and tempers. The properties vary markedly with temper; those in T3 and T4 type tempers are noteworthy for their high toughness, while T6 and T8 type tempers have very high strength. This alloy has excellent properties and creep resistance at elevated temperatures. The T6 and T8 type tempers have very high resistance to corrosion. However, as shown in Table 3.1.2.3.1(a), 2024-T3, -T4, and -T42 rolled plate, rod and bar, and extruded shapes and 2024-T6 and -T62 forgings have a 'D' SCC rating. This is the lowest rating and means that SCC failures have occurred in service or would be anticipated if there is any sustained stress. In-service failures are caused by stresses produced by any combination of sources including solution heat treatment, straightening, forming, fit-up, clamping, sustained service loads or high service compression stresses that produce residual tensile stresses. These stresses may be tension or compression as well as the stresses due to the Poisson effect, because the actual failures are caused by the resulting sustained shear stresses. Pin-hole flaws in corrosion protection are sufficient for SCC. The weldability of the alloy is discussed in Section 3.1.3.4.

The properties of extrusions should be based upon the thickness at the time of quenching prior to machining. Selection of the mechanical properties based upon its final machined thickness may be unconservative; therefore, the thickness at the time of quenching to achieve properties is an important factor in the selection of the proper thickness column. For extrusions having sections with various thicknesses, consideration should be given to the properties as a function of thickness.

Material specifications for 2024 are presented in Table 3.2.3.0(a). Room-temperature mechanical properties are shown in Tables 3.2.3.0(b) through (j₂). The effect of temperature on the physical properties of this alloy is shown in Figure 3.2.3.0.

Table 3.2.3.0(a). Material Specifications for 2024 Aluminum Alloy

Specification	Form
AMS 4037	Bare sheet and plate
AMS 4035	Bare sheet and plate
AMS-QQ-A-250/4	Bare sheet and plate
AMS-QQ-A-250/5	Clad sheet and plate
AMS 4120	Bar and rod, rolled or cold-finished
AMS-QQ-A-225/6	Rolled or drawn bar, rod, and wire
AMS 4086	Tubing, hydraulic, seamless, drawn
AMS-WW-T-700/3	Tubing
AMS 4152	Extrusion
AMS 4164	Extrusion
AMS 4165	Extrusion
AMS-QQ-A-200/3	Extruded bar, rod, and shapes

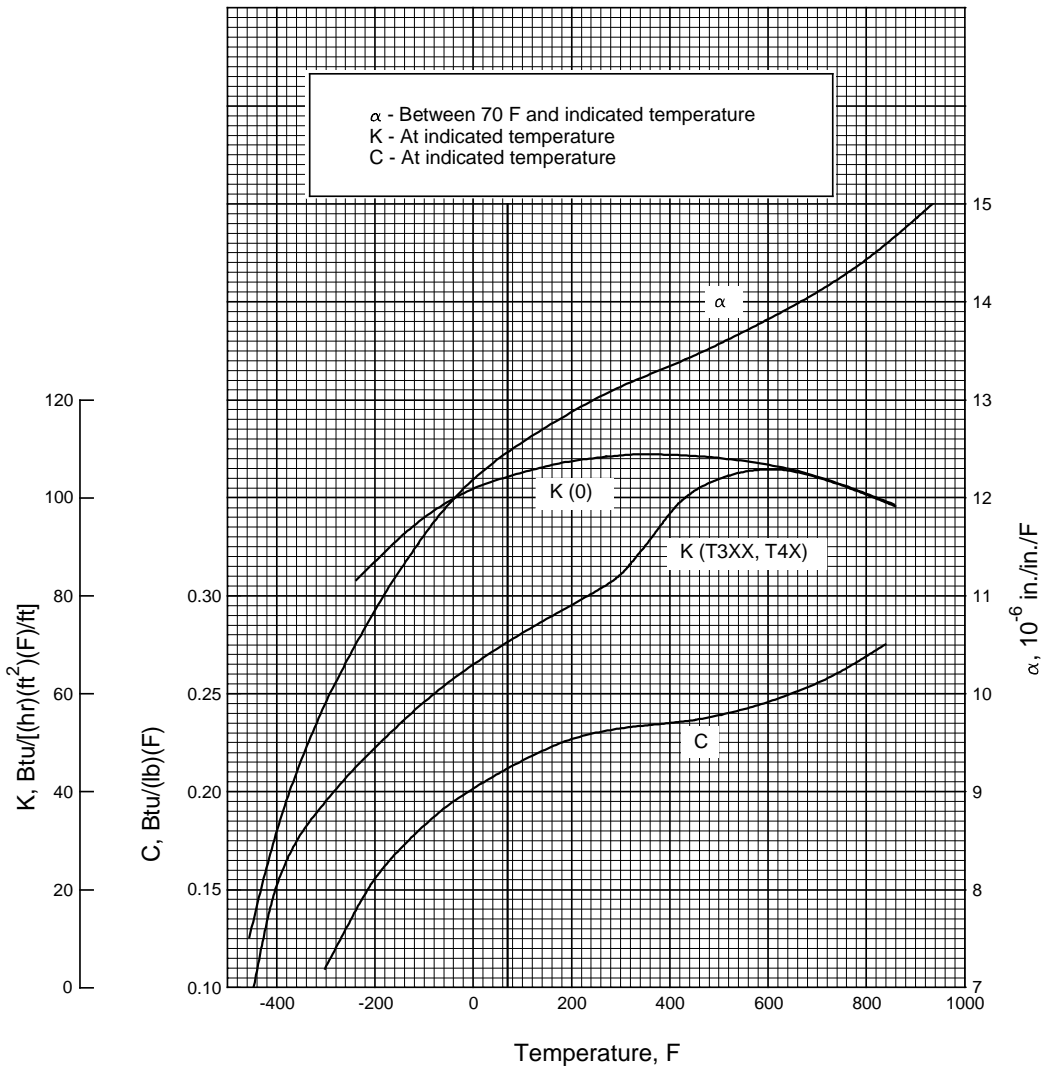

Figure 3.2.3.0. Effect of temperature on the physical properties of 2024 aluminum alloy.

The following temper designations are more specifically described than in Table 3.1.2.:

T81—The applicable designation for 2024-T3 sheet artificially aged to the required strength level.

T361—Solution heat treated and naturally aged followed by cold rolling and natural aging treatment.

T861—Solution heat treated and naturally aged followed by cold rolling and artificial aging treatment.

T72—Solution heat treated and aged by user in accordance with AMS 2770 to provide high resistance to stress-corrosion cracking, applicable only to sheet.

The temper index for 2024 is as follows:

<u>Section</u>	<u>Temper</u>
3.2.3.1	T3, T351, T3510, T3511, T4, and T42
3.2.3.2	T361 (supersedes T36)
3.2.3.3	T62 and T72
3.2.3.4	T81, T851, T8510, and T8511
3.2.3.5	T861 (supersedes T86)

3.2.3.1 T3, T351, T3510, T3511, T4, and T42 Temper — Figures 3.2.3.1.1(a) through 3.2.3.1.5(b) present elevated temperature curves for various properties. Figures 3.2.3.1.6(a) through (q) present tensile and compressive stress-strain curves and tangent-modulus curves for various product forms and tempers at various temperatures. Figures 3.2.3.1.6(r) through (w) are full-range, stress-strain curves at room temperature for various product forms. Figures 3.2.3.1.8(a) through (i) provide S/N fatigue curves for unnotched and notched specimens for T3 and T4 tempers.

3.2.3.2 T361 (supersedes T36) Temper —

3.2.3.3 T62 and T72 Temper — Figures 3.2.3.3.1(a) through (d) and 3.2.3.3.5(a) and (b) show the effect of temperature on the tensile properties of the T62 temper. Figure 3.2.3.1.4 can be used for the elevated temperature curve for elastic moduli for this temper. Tensile and compressive stress-strain and tangent-modulus curves at room temperature are shown in Figure 3.2.3.3.6.

3.2.3.4 T81, T851, T852, T8510, and T8511 Temper — Figures 3.2.3.4.1(a) through (d), 3.2.3.4.2(a) and (b), 3.2.3.4.3(a) and (b), and 3.2.3.4.5(a) and (b) present elevated temperature curves for various mechanical properties for the T8XXX temper. Figures 3.2.3.4.1(e) and (f) contain graphs for determining tensile properties after complex thermal exposure. See Section 3.7.4.1 for a detailed discussion of their use. Figures 3.2.3.4.6(a) through (g) present tensile and compressive stress-strain and tangent-modulus curves for various products and tempers. Figures 3.2.3.4.6(h) through (j) are full-range stress-strain curves at room temperature for various product forms.

3.2.3.5 T861 (T86) Temper — Figures 3.2.3.5.1(a) through (d), 3.2.3.5.2(a) and (b), 3.2.3.5.3(a) through (c), and 3.2.3.5.5(a) and (b) present effect-of-temperature curves for various mechanical properties. Figures 3.2.3.5.6(a) through (d) present compressive stress-strain and tangent-modulus curves for sheet material at various temperatures. Graphical displays of the residual strength behavior of center-cracked tension panels are presented in Figures 3.2.3.5.10(a) and (b).

Table 3.2.3.0(b₁). Design Mechanical and Physical Properties of 2024 Aluminum Alloy Sheet and Plate

Specification	AMS 4037 and AMS-QQ-A-250/4												AMS-QQ-A-250/4	
	Sheet				Plate				Plate				Sheet	Plate
	T3				T351				T351				T361	
Form	0.008-0.009	0.010-0.128	0.129-0.249	0.250-0.499	0.500-1.000	1.001-1.500	1.501-2.000	2.001-3.000	3.001-4.000	0.020-0.062	0.063-0.249	0.250-0.500		
Thickness, in.	S	A	B	A	B	A	B	A	B	A	B	A	B	S
Basis	64	64	65	64	63	62	64	60	57	68	69	67	67	S
Mechanical Properties:	63	63	64	64	63	62	64	60	57	67	68	66	66	S
F_{ms} , ksi:	52 ^a	49 ^a
L	47	47	48	48	48	47	49	46	43	56	56	54	54	...
LT	42	42	43	42	42	42	44	42	41	50	51	49	49	...
ST	38 ^a	38 ^a
F_{ps} , ksi:
L	39	39	40	39	39	39	40	37	35	47	48	46	46	...
LT	45	45	46	45	45	44	46	43	41	53	54	52	52	...
ST	46	44
F_{sp} , ksi:	39	39	40	38	37	37	38	35	34	42	42	41	41	...
F_{brn}^a , ksi:	104	104	106	97	95	94	97	91	86	111	112	109	109	...
(e/D = 1.5)	129	129	131	119	117	115	119	111	106	137	139	135	135	...
(e/D = 2.0)
F_{br}^b , ksi:	73	73	75	72	72	72	76	72	70	82	84	81	81	...
(e/D = 1.5)	88	88	90	86	86	86	90	86	84	97	99	96	96	...
(e/D = 2.0)
e , percent (S-basis):	10	c	...	12	8	7	...	4	4	8	9	9 ^d	9 ^d	...
LT	10.5	10.5	10.7	10.7	10.7	10.7	10.7	10.7	10.7	10.5	10.5	10.7	10.7	...
E , 10 ³ ksi	10.7	10.7	10.9	10.9	10.9	10.9	10.9	10.9	10.9	10.7	10.7	10.9	10.9	...
E_s , 10 ³ ksi	4.0	4.0	4.0	4.0	4.0	4.0	4.0	4.0	4.0	4.0	4.0	4.0	4.0	...
G , 10 ³ ksi	0.33	0.33	0.33	0.33	0.33	0.33	0.33	0.33	0.33	0.33	0.33	0.33	0.33	...
μ	0.33	0.33	0.33	0.33	0.33	0.33	0.33	0.33	0.33	0.33	0.33	0.33	0.33	...
Physical Properties:														
ω , lb/in.														
C , K , and α														

0.100
See Figure 3.2.3.0

a Caution: This specific alloy, temper, and product form exhibits poor stress-corrosion cracking resistance in this grain direction. It corresponds to an SCC resistance rating of D, as indicated in Table 3.1.2.3.1(a).
b Bearing values are "dry pin" values per Section 1.4.7.1. See Table 3.1.2.1.1.
c See Table 3.2.3.0(c).
d 10% for 0.500 inch.

Table 3.2.3.0(b₂). Design Mechanical and Physical Properties of 2024 Aluminum Alloy Sheet and Plate—Continued

Specification	AMS-QQ-A-250/4		AMS 4035 and AMS-QQ-A-250/4												AMS-QQ-A-250/4	
	Coiled Sheet		Flat Sheet and Plate												T72 ^a	
	T4		T42 ^a				T62 ^a				T72 ^a					
Form	0.010-0.249		0.010-0.249	0.250-0.499	0.500-1.000	1.001-2.000	2.001-3.000	0.010-0.249	0.250-0.499	0.500-2.000	2.001-3.000	0.010-0.249				
Temper	A	B	S	S	S	S	S	S	S	S	S	S	S			
Thickness, in.	62	64	62	62	61	60	63	63	63	63	63	63	63			
Basis	A	B	S	S	S	S	S	S	S	S	S	S	S			
Mechanical Properties:																
F_{ms} , ksi:																
L	62	64	62	62	61	60	63	63	63	63	63	63	63			
LT	62	64	62	62	61	60	63	63	63	63	63	63	63			
F_{sp} , ksi:																
L	40	42	38	38	38	38	50	50	50	50	50	50	50			
LT	40	42	38	38	38	38	50	50	50	50	50	50	50			
F_{cp} , ksi:																
L	40	42	42	42	40	37	52	52	52	52	52	52	52			
LT	40	42	41	41	41	41	53	52	48	48	48	48	48			
F_{ms} , ksi:																
F_{brt} , ksi:	37	38	37	37	36	36	38	38	37	37	37	37	37			
(e/D = 1.5)	93	96	99	98	94	85 ^c	103	103	102 ^c	102 ^c	103	103	103			
(e/D = 2.0)	118	122	123	123	121	119 ^c	134	134	132 ^c	132 ^c	134	134	134			
F_b , ksi:																
(e/D = 1.5)	56	59	67	67	67	67 ^c	80	80	80 ^c	80 ^c	80	80	80			
(e/D = 2.0)	64	67	80	80	80	80 ^c	95	95	95 ^c	95 ^c	95	95	95			
e , percent (S-basis):																
LT	d	...	d	12	8	d	4	5	5	5	5	5	5			
E , 10 ³ ksi	See Table 3.2.3.0(d)															
E_c , 10 ³ ksi	See Table 3.2.3.0(d)															
G , 10 ³ ksi	See Table 3.2.3.0(d)															
μ	See Table 3.2.3.0(d)															
Physical Properties:																
α , lb/in. ³	0.100															
C , Btu/(lb)(°F)	See Figure 3.2.3.0															
K , Btu/(hr)(ft ²)(°F/ft)	71 (at 77°F) for T4X and 87 (at 77°F) for T6X, T7X, See Figure 3.2.3.0															
α , 10 ⁻⁶ in./in./°F	See Figure 3.2.3.0															

a Design allowables in some cases were based upon data obtained from testing samples of material, supplied in the O or F temper, which were heat treated to demonstrate response to heat treatment by suppliers. Properties obtained by the user may be different than those listed if the material has been formed or otherwise cold or hot worked, particularly in the annealed temper, prior to solution heat treatment.

b Bearing values are "dry pin" values per Section 1.4.7.1.

c See Table 3.1.2.1.1.

d See Table 3.2.3.0(c).

Table 3.2.3.0(b₃). Design Mechanical and Physical Properties of 2024 Aluminum Alloy Sheet and Plate—Continued

Specification	AMS-QQ-A-250/4								
	Sheet		Plate				Sheet		Plate
Form	T81		T851				T861		
Temper	0.010-0.249		0.250-0.499		0.500-1.000	1.001-1.499	0.020-0.062	0.063-0.249	0.250-0.500
Thickness, in.	A	B	A	B	S	S	S	S	S
Basis									
Mechanical Properties:									
F_{tu} , ksi:									
L	67	68	67	68	66	66	71	72	70
LT	67	68	67	68	66	66	70	71	70
F_{ty} , ksi:									
L	59	61	58	60	58	57	63	67	64
LT	58	60	58	60	58	57	62	66	64
F_{cy} , ksi:									
L	59	61	58	60	58	56	63	67	64
LT	58	60	59	61	58	57	65	69	67
F_{su} , ksi	40	41	38	39	37	37	40	40	40
F_{bru}^a , ksi:									
(e/D = 1.5)	100	102	102	103	100	100 ^b	108	110	108
(e/D = 2.0)	127	129	131	133	129	129 ^b	140	142	140
F_{bry}^a , ksi:									
(e/D = 1.5)	83	86	86	89	86	85 ^b	90	96	93
(e/D = 2.0)	94	97	101	105	101	99 ^b	105	112	109
e , percent (S-basis):									
LT	5	...	5	...	5	5	3	4	4
E , 10 ³ ksi	See Table 3.2.3.0(d)								
E_c , 10 ³ ksi	See Table 3.2.3.0(d)								
G , 10 ³ ksi	See Table 3.2.3.0(d)								
μ	See Table 3.2.3.0(d)								
Physical Properties:									
ω , lb/in. ³	0.100								
C , Btu/(lb)(°F)	See Figure 3.2.3.0								
K , Btu/[(hr)(ft ²)(°F)/ft]	87 (at 77°F)								
α , 10 ⁻⁶ in./in./°F	See Figure 3.2.3.0								

a Bearing values are “dry pin” values per Section 1.4.7.1.
b See Table 3.1.2.1.1.

Table 3.2.3.0(c). Minimum Elongation Values for Bare 2024 Aluminum Alloy Sheet and Plate

Condition	Elongation (LT), percent
	T3, T4, and T42
Thickness, in.:	
0.010-0.020	12
0.021-0.249	15
0.250-0.499	12
0.500-1.000	8
1.001-1.500	7
1.501-2.000	6

Table 3.2.3.0(d). Modulus Values and Poisson's Ratio for Bare 2024 Aluminum Alloy Sheet and Plate, All Tempers

Property	E	E_c	G	μ
Thickness, in.:				
0.010-0.249	10.5	10.7	4.0	0.33
≥0.250	10.7	10.9	4.0	0.33

Table 3.2.3.3.0(e₁). Design Mechanical and Physical Properties of Clad 2024 Aluminum Alloy Sheet and Plate

Specification	AMS-QQ-A-250/5																							
	Flat sheet and plate																							
	T3							T351																
Form	Temper	Thickness, in.	Basis	0.008-0.009		0.010-0.062		0.063-0.128		0.129-0.249		0.250-0.499		0.500-1.000 ^a		1.001-1.500 ^a		1.501-2.000 ^a		2.001-3.000 ^a		3.001-4.000 ^a		
				A	B	A	B	A	B	A	B	A	B	A	B	A	B	A	B	A	B	A	B	
Mechanical Properties:																								
<i>F_m</i> , ksi:																								
L	59	60	61	62	63	64	62	64	61	63	60	62	60	62	58	60	57	57	55	57	51 ^b	49 ^b	55	57
LT	58	59	60	61	62	63	62	64	61	63	60	62	60	62	58	60	57	57	55	57	51 ^b	49 ^b	55	57
ST
<i>F_{sp}</i> , ksi:																								
L	44	45	44	45	47	45	46	48	45	48	45	47	45	48	44	46	41	41	39	41	39 ^b	38 ^b	39	41
LT	39	40	39	40	42	40	40	42	40	42	40	42	40	42	40	42	41	41	39	41	39 ^b	38 ^b	39	41
ST
<i>F_{cp}</i> , ksi:																								
L	36	37	36	37	39	37	37	39	37	39	37	37	39	37	37	39	35	35	33	35	35	33	35	35
LT	42	43	42	43	45	43	43	45	42	45	42	43	45	42	41	43	41	41	39	41	39 ^b	38 ^b	39	41
ST
<i>F_{spc}</i> , ksi:																								
(e/D = 1.5)	96	97	99	101	102	104	94	97	92	95	91	94	91	94	88	91	83	86	83	86	102	106	83	86
(e/D = 2.0)	119	121	123	125	127	129	115	119	113	117	111	115	111	115	107	111	102	106	102	106	111	102	106	106
<i>F_{bc}</i> , ksi:																								
(e/D = 1.5)	68	70	68	70	73	70	69	72	69	72	69	72	69	72	69	72	67	70	67	70	72	67	70	70
(e/D = 2.0)	82	84	84	84	88	84	82	86	82	86	82	86	82	86	82	86	80	84	80	84	86	80	84	84
<i>e</i> , percent (S-basis):																								
LT	10	15	...	15	12	...	8	...	7	...	6	...	4	...	4	...	4	4
<i>E</i> , 10 ³ ksi:																								
Primary	10.5							10.7							10.7									
Secondary	9.5							10.0							10.2									
<i>E_{cc}</i> , 10 ³ ksi:																								
Primary	10.7							10.9							10.9									
Secondary	9.7							10.2							10.4									
<i>G</i> , 10 ³ ksi																								
<i>μ</i>	...							0.33							...									
Physical Properties:																								
<i>ω</i> , lb/in. ³	0.100							0.100							0.100									
<i>C</i> , <i>K</i> , and <i>α</i>									

a These values, except in the ST direction, have been adjusted to represent the average properties across the whole section, including the 2-1/2 percent nominal cladding thickness.
b Caution: This specific alloy, temper, and product form exhibits poor stress-corrosion cracking resistance in this grain direction. It corresponds to an SCC resistance rating of D, as indicated in Table 3.1.2.3.1(a).
c Bearing values are "dry pin" values per Section 1.4.7.1. See Table 3.1.2.1.1.
d See Table 3.2.3.0(f).

Table 3.2.3.0(e₂). Design Mechanical and Physical Properties of Clad 2024 Aluminum Alloy Sheet and Plate—Continued

Specification	AMS-QQ-A-250/5							
	Flat sheet and plate				Coiled sheet			
Form	T361				T4			
	0.020-0.062	0.063-0.249	0.250-0.499	0.500 ^a	0.010-0.062		0.063-0.128	
Temper	S	S	S	S	A	B	A	B
Thickness, in.								
Basis	S	S	S	S	A	B	A	B
Mechanical Properties:								
F_{tu} , ksi:								
L	62	65	65	64	58	59	61	62
LT	61	64	64	63	58	59	61	62
F_{ty} , ksi:								
L	53	53	53	52	36	38	38	39
LT	47	48	48	47	36	38	38	39
F_{cy} , ksi:								
L	44	45	45	44	36	38	38	39
LT	50	51	51	50	36	38	38	39
F_{su} , ksi	38	40	40	39	37	37	38	39
F_{bru}^b , ksi:								
(e/D = 1.5)	101	105	105	104	96	97	101	102
(e/D = 2.0)	125	131	131	129	119	121	125	127
F_{bry}^b , ksi:								
(e/D = 1.5)	78	79	79	78	63	66	66	68
(e/D = 2.0)	92	94	94	92	76	80	80	82
e , percent (S-basis):								
LT	8	9	9	10	^c	...	15	...
E , 10 ³ ksi:								
Primary	10.5	10.5	10.7		10.5		10.5	
Secondary	9.5	10.0	10.2		9.5		10.0	
E_c , 10 ³ ksi:								
Primary	10.7	10.7	10.9		10.7		10.7	
Secondary	9.7	10.2	10.4		9.7		10.2	
G , 10 ³ ksi							
μ	0.33							
Physical Properties:								
ω , lb/in. ³	0.100							
C , K , and α							

a These values have been adjusted to represent the average properties across the whole section, including the 2-½ percent nominal cladding thickness.
b Bearing values are “dry pin” values per Section 1.4.7.1.
c See Table 3.2.3.0(f).

Table 3.2.3.0(e₃). Design Mechanical and Physical Properties of Clad 2024 Aluminum Alloy Sheet and Plate—Continued

Specification	AMS-QQ-A-250/5																						
	Flat sheet and plate																						
	T42 ^a						T62 ^a						T72 ^a										
Form	0.008-0.009		0.010-0.062		0.063-0.249		0.250-0.499		0.500-1.000 ^b		1.001-2.000 ^b		2.001-3.000 ^b		0.010-0.062		0.063-0.249		0.250-0.499		0.500-1.000 ^b		
	A	B	A	B	A ^c	B ^c	S ^c	S ^c	S ^c	S ^{c,d}	S	S	S	S	S	S	S	S	S	S	S	S	
Thickness, in.	55	57	57	59	60	62	60	60	59	58	58	58	56	60	60	62	62	62	62	62	62	62	62
Basis	L	LT	L	LT	L	LT	L	LT	L	LT	L	LT	L	LT	L	LT	L	LT	L	LT	L	LT	
Mechanical Properties:																							
F_{ts} , ksi:																							
L	55	57	57	59	60	62	60	60	59	58	58	58	56	60	60	62	62	62	62	62	62	62	62
LT	55	57	57	59	60	62	60	60	59	58	58	58	56	60	60	62	62	62	62	62	62	62	62
F_{tp} , ksi:																							
L	34	35	34	35	36	38	36	36	36	36	36	36	36	36	36	36	36	36	36	36	36	36	36
LT	34	35	34	35	36	38	36	36	36	36	36	36	36	36	36	36	36	36	36	36	36	36	36
F_{tp} , ksi:																							
L	38	39	38	39	40	42	39	39	38	35	35	35	35	49	49	51	51	51	51	51	51	51	51
LT	37	38	37	38	39	41	39	39	39	39	39	39	39	49	49	52	52	52	52	52	52	52	52
F_{ts} , ksi	33	34	34	35	36	37	36	36	35	35	35	35	35	35	35	36	36	36	36	36	36	36	36
F_{tp} , ksi:																							
(e/D = 1.5)	88	91	91	94	96	99	95	95	90	83	83	83	83	97	97	100	100	100	100	100	100	100	100
(e/D = 2.0)	109	113	113	117	119	123	119	119	117	115	115	115	115	126	126	130	130	130	130	130	130	130	130
F_{tp} , ksi:																							
(e/D = 1.5)	60	61	60	61	63	67	63	63	63	63	63	63	63	75	75	79	79	79	79	79	79	79	79
(e/D = 2.0)	72	74	72	74	76	80	76	76	76	76	76	76	76	89	89	93	93	93	93	93	93	93	93
e, percent (S-basis):																							
LT	10	...	e	...	15	...	12	8	8	e	e	e	4	5	5	5	5	5	5	5	5	5	5
E , 10 ³ ksi:																							
Primary	10.5	10.5	10.5	10.5	10.5	10.5	10.5	10.5	10.5	10.5	10.5	10.5	10.5	10.5	10.5	10.5	10.5	10.5	10.5	10.5	10.5	10.5	10.5
Secondary	9.5	9.5	9.5	9.5	9.5	9.5	9.5	9.5	9.5	9.5	9.5	9.5	9.5	9.5	9.5	9.5	9.5	9.5	9.5	9.5	9.5	9.5	9.5
E_s , 10 ³ ksi:																							
Primary	10.7	10.7	10.7	10.7	10.7	10.7	10.7	10.7	10.7	10.7	10.7	10.7	10.7	10.7	10.7	10.7	10.7	10.7	10.7	10.7	10.7	10.7	10.7
Secondary	9.7	9.7	9.7	9.7	9.7	9.7	9.7	9.7	9.7	9.7	9.7	9.7	9.7	9.7	9.7	9.7	9.7	9.7	9.7	9.7	9.7	9.7	9.7
G , 10 ³ ksi																							
μ	0.33																						
Physical Properties:																							
ω , lb/in. ³	0.100																						
C, K, and α	...																						

a Design allowables in some cases were based upon data obtained from testing samples of material, supplied in the O or F temper, which were heat treated to demonstrate response to heat treatment by suppliers. Properties obtained by the user may be different than those listed if the material has been formed or otherwise cold or hot worked, particularly in the annealed temper, prior to solution heat treatment.

b These values have been adjusted to represent the average properties across the whole section, including 2 1/2 percent per side nominal cladding thickness.

c Bearing values are "dry pin" values per Section 1.4.7.1.

d See Table 3.1.2.1.1.

e See Table 3.2.3.0(f).

Table 3.2.3.0(e₄). Design Mechanical and Physical Properties of Clad 2024 Aluminum Alloy Sheet and Plate—Continued

Specification	AMS-QQ-A-250/5								
	Flat sheet and plate								
Form	T81		T851 ^a			T861 ^a			
	0.010- 0.062	0.063- 0.249	0.250- 0.499	0.500- 1.000 ^b	0.020- 0.062	0.063- 0.249	0.250- 0.499	0.500 ^b	
Temper	S	S	A	B	S	S	S	S	S
Thickness, in.									
Basis									
Mechanical Properties:									
F_{tu} , ksi:									
L	64	67	65	66	63	65	70	68	67
LT	62	65	65	66	63	64	69	68	67
F_{ty} , ksi:									
L	57	59	56	58	56	59	65	62	61
LT	54	56	56	58	56	58	64	62	61
F_{cy} , ksi:									
L	55	57	56	58	56	59	65	62	61
LT	55	57	57	59	56	61	67	65	64
F_{su} , ksi	38	39	37	37	36	36	39	39	38
F_{bru} , ksi:									
(e/D = 1.5)	96	100	99	100	96	99	107	105	104
(e/D = 2.0)	122	127	127	129	123	128	138	136	134
F_{bry} , ksi:									
(e/D = 1.5)	78	83	83	86	83	84	93	90	88
(e/D = 2.0)	90	94	98	101	98	99	109	105	104
e , percent (S-basis):									
LT	5	5	5	...	5	3	4	4	4
E , 10 ³ ksi:									
Primary	10.5	10.5	10.7			10.5	10.5	10.5	
Secondary	9.5	10.0	10.2			9.5	10.0	10.2	
E_c , 10 ³ ksi:									
Primary	10.7	10.7	10.9			10.7	10.7	10.9	
Secondary	9.7	10.2	10.4			9.7	10.2	10.4	
G , 10 ³ ksi								
μ	0.33								
Physical Properties:									
ω , lb/in. ³	0.100								
C , K , and α								

a Bearing values are “dry pin” values per Section 1.4.7.1.

b These values have been adjusted to represent the average properties across the whole section, including the 2-½ percent nominal cladding thickness.

Table 3.2.3.0(f). Minimum Elongation Values for Clad 2024 Aluminum Alloy Sheet and Plate

Temper	Elongation (LT), percent
	T3, T4, T42
Thickness, in.:	
0.010-0.020	12
0.021-0.062	15
1.001-1.500	7
1.501-2.000	6

Table 3.2.3.0(g). Design Mechanical and Physical Properties of 2024 Aluminum Alloy Drawn Tubing

Specification	AMS 4086 and WW-T-700/3		WW-T-700/3	
	Drawn tubing			
Form	Drawn tubing			
Temper	T3		T42 ^a	T81
Wall Thickness, in.	0.018-0.500		0.018-0.500	0.010-0.249
Basis	A	B	S	S
Mechanical Properties:				
F_{tu} , ksi:				
L	64	66	62	66
LT
F_{ty} , ksi:				
L	42	45	38	58
LT
F_{cy} , ksi:				
L	42	45	38	...
LT
F_{su} , ksi	39	40	38	...
F_{bru} , ksi:				
(e/D = 1.5)	96	99	93	...
(e/D = 2.0)	122	126	118	...
F_{bry} , ksi:				
(e/D = 1.5)	59	63	53	...
(e/D = 2.0)	67	72	61	...
e , percent (S-basis):				
L	b	...	b	b
E , 10 ³ ksi	10.5			
E_c , 10 ³ ksi	10.7			
G , 10 ³ ksi	4.0			
μ	0.33			
Physical Properties:				
ω , lb/in. ³	0.100			
C , K , and α	See Figure 3.2.3.0			

a Design allowables were based upon data obtained from testing samples of material supplied in the O or F temper, which were heat treated to demonstrate response to heat treatment by suppliers. Properties obtained by the user, however, may be lower than those listed if the material has been formed or otherwise cold or hot worked, particularly in the annealed temper, prior to solution heat treatment.

b See Table 3.2.3.0(h).

Table 3.2.3.0(h). Minimum Elongation Values for 2024 Aluminum Alloy Drawn Tubing

	Elongation (L), percent ^a
Temper	T3, T42
Wall Thickness, in.:	
0.018-0.024	10
0.025-0.049	12
0.050-0.259	14
0.260-0.500	16
Temper	T81
0.010-0.024
0.025-0.049	5
0.050-0.249	6

a Full section specimen.

MIL-HDBK-5J
31 January 2003

Table 3.2.3.0(i₁). Design Mechanical and Physical Properties of 2024 Aluminum Alloy Bar and Rod; Rolled, Drawn, or Cold-Finished

Specification	AMS 4120 and AMS-QQ-A-225/6							AMS-QQ-A-225/6	
Form	Bar and rod; rolled, drawn, or cold-finished								
Temper	T351							T361	
Thickness, in.	0.500-1.000	1.001-2.000	2.001-3.000	3.001-4.000	4.001-5.000 ^a	5.001-6.000 ^a	6.001-6.500 ^a	≤0.375	
Basis	S	S	S	S	S	S	S	S	
Mechanical Properties:									
<i>F_m</i> , ksi:									
L	62	62	62	62	62	62	62	69	
LT	61 ^b	59 ^b	57 ^b	55 ^b	54 ^b	52 ^b	
<i>F_{ty}</i> , ksi:									
L	45	45	45	45	45	45	45	52	
LT	36 ^b	36 ^b	36 ^b	36 ^b	36 ^b	36 ^b	
<i>F_{cy}</i> , ksi:									
L	34	34	34	34	34	34	
LT	41	41	41	41	41	41	
<i>F_{su}</i> , ksi									
L	37	37	37	37	37	37	
<i>F_{brus}</i> , ksi:									
(e/D = 1.5)	90	90	90	90	90	90	
(e/D = 2.0)	115	115	115	115	115	115	
<i>F_{brys}</i> , ksi:									
(e/D = 1.5)	63	63	63	63	63	63	
(e/D = 2.0)	74	74	74	74	74	74	
<i>e</i> , percent:									
L	10	10	10	10	10	10	10	10	
<i>E</i> , 10 ³ ksi									
L						10.5			
<i>E_c</i> , 10 ³ ksi									
L						10.7			
<i>G</i> , 10 ³ ksi									
L						4.0			
<i>μ</i>									
L						0.33			
Physical Properties:									
<i>ω</i> , lb/in. ³									
L						0.100			
<i>C</i> , <i>K</i> , and <i>α</i>									
L	See Figure 3.2.3.0								

a For square, rectangular, hexagonal, or octagonal bar, minimum thickness is 4 inches, and maximum cross-sectional area is 36 square inches.

b Caution: This specific alloy, temper, and product form exhibits poor stress-corrosion cracking resistance in this grain direction. It corresponds to an SCC resistance rating of D, as indicated in Table 3.1.2.3.1(a).

Table 3.2.3.0(i₂). Design Mechanical and Physical Properties of 2024 Aluminum Alloy Bar and Rod; Rolled, Drawn, or Cold-Finished—Continued

Specification	AMS 4120 and AMS-QQ-A-225/6											AMS-QQ-A-225/6
	Bar and rod; rolled, drawn, or cold-finished											
	T4 ^a											T42 ^b
Form	0.125-0.499	0.500-1.000	1.001-2.000	2.001-3.000	3.001-4.000	4.001-4.500 ^e	4.501-5.000 ^d	5.001-6.000 ^c	6.001-6.500 ^d	6.501-8.000 ^d		
Temper	S	S	S	S	S	S	S	S	S	S	S	S
Thickness, in.	62	61 ^c	62	62	62	62	62	62	62	62	62	62
Basis	61 ^c	61 ^c	59 ^e	57 ^e	55 ^e	54 ^e	54 ^e	52 ^e
Mechanical Properties:												
$F_{t0.2}$ ksi:	62	62	62	62	62	62	62	62	62	62	62	62
L	61 ^c	61 ^c	59 ^e	57 ^e	55 ^e	54 ^e	54 ^e	52 ^e
$F_{t0.5}$ ksi:	45	42	42	42	42	42	40	40	40	40	40	40
L	45 ^c	42 ^c	41 ^e	40 ^e	39 ^e	39 ^e	37 ^e	36 ^e
$F_{0.2}$ ksi:	36	33	33	33	33	33	32	32
L
$F_{0.5}$ ksi:	37	37	37	37	37	37	37	37	37	37	37	37
L
$F_{0.7}$ ksi:	93	93	93	93	93	93	93	93	93	93	93	93
(e/D = 1.5)	118	118	118	118	118	118	118	118	118	118	118	118
(e/D = 2.0)	63	59	59	59	59	59	56	56
(e/D = 2.0)	72	67	67	67	67	67	64	64
e, percent:	10	10	10	10	10	10	10	10	10	10	10	10
L	10.5	10.7	4.0	0.33								
E , 10 ³ ksi												
E_p , 10 ³ ksi												
G , 10 ³ ksi												
μ												
Physical Properties:												
ω , lb/in. ³												
C and α												
K , Btu/[(hr)(ft ²)(°F)]												

a The T4 temper is obsolete and should not be specified for new designs.
 b These properties apply when samples of material supplied in the O or F temper are heat treated to demonstrate response to heat treatment. Properties obtained by the user, however, may be lower than those listed if the material has been formed or otherwise cold or hot worked, particularly in the annealed temper, prior to solution heat treatment.
 c F for square, rectangular, hexagonal, or octagonal bar, maximum thickness is 4 inches, and maximum cross-sectional area is 36 square inches.
 d Applies to rod only.
 e Caution: This specific alloy, temper, and product form exhibits poor stress-corrosion cracking resistance in this grain direction. It corresponds to an SCC resistance rating of D, as indicated in Table 3.1.2.3.1(a).

Table 3.2.3.0(i₃). Design Mechanical and Physical Properties of 2024 Aluminum Alloy Bar and Rod; Rolled, Drawn, or Cold-Finished—Continued

Specification	AMS-QQ-A-225/6		
	Bar and rod; rolled, drawn, or cold finished		
	T6 ^a	T62 ^b	T851
	≤6.500	≤6.500	0.500-6.500
Form			
Temper			
Thickness, ^c in.			
Basis	S	S	S
Mechanical Properties:			
F_{tu} , ksi:			
L	62	60	66
LT
F_{ty} , ksi:			
L	50	46	58
LT
F_{cy} , ksi:			
L
LT
F_{su} , ksi
F_{bru} , ksi:			
(e/D = 1.5)
(e/D = 2.0)
F_{bry} , ksi:			
(e/D = 1.5)
(e/D = 2.0)
e , percent:			
L	5	5	5
E , 10 ³ ksi		10.5	
E_c , 10 ³ ksi		10.7	
G , 10 ³ ksi		4.0	
μ		0.33	
Physical Properties:			
ω , lb/in. ³		0.100	
C and α		See Figure 3.2.3.0	
K , Btu/[(hr)(ft ²)(°F)/ft]		87 (at 77°F) for T6X and T8XX	

a The T6 temper is obsolete and should not be specified for new designs.

b These properties apply when samples of material supplied in the O or F temper are heat treated to demonstrate response to heat treatment. Properties obtained by the user, however, may be lower than those listed if the material has been formed or otherwise cold or hot worked, particularly in the annealed temper, prior to solution heat treatment.

c For square, rectangular, hexagonal, or octagonal bar, maximum thickness is 4 inches, and maximum cross-sectional area is 36 square inches.

Table 3.2.3.0(j₁). Design Mechanical and Physical Properties of 2024 Aluminum Alloy Extrusion

Specification	AMS 4152, AMS 4164, AMS 4165, and AMS-QQ-A-200/3												AMS-QQ-A-200/3									
	Extruded bar, rod, and shapes																					
	T3, T3510, and T3511						≤25						≤20		T81, T8510, and T8511							
Form	≤0.249		0.250-0.499		0.500-0.749		0.750-1.499		1.500-2.999		3.000-4.499		1.500-2.999		3.000-4.499		0.050-0.249		0.250-1.499		1.500-4.500	
Temper																						
Thickness, ^a in.																						
Cross-Section Area, in. ²																						
Basis	A		B		A		B		A		B		A		B		A		B		S	
Mechanical Properties:																						
F_{mp} , ksi:																						
L	57	61	60	62	65	70	70	74	70	74	70	74	68	68	64	64	66	66	66	66	66	66
LT	54	58	56	57	56	60	60	58	55	58	54	57	53	52	54	54	52	52	52	52	52	52
F_{fp} , ksi:																						
L	42	47	44	47	46	54	54	47	44	47	44	47	48	48	46	46	46	46	46	46	46	46
LT	37	41	38	40	37	43	43	39	39	41	39	41	36	36	39	39	39	39	39	39	39	39
F_{cp} , ksi:																						
L	34	38	37	39	41	48	48	40	38	40	41	48	45	45	49	49	49	49	49	49	49	49
LT	41	45	41	44	40	47	47	43	40	43	40	47	39	38	41	41	41	41	41	41	41	41
F_{mp} , ksi:																						
L	29	31	31	32	33	35	35	31	30	31	33	35	33	33	33	33	33	33	33	33	33	33
F_{br} , ksi:																						
(e/D = 1.5)	84	90	78	81	84	90	84	80	78	80	84	90	86	86	86	86	86	86	86	86	86	86
(e/D = 2.0)	108	114	98	101	105	113	101	101	97	101	105	113	108	108	109	115	106	106	106	106	106	106
F_{br} , ksi:																						
(e/D = 1.5)	61	68	55	59	57	67	67	59	55	59	57	67	65	65	62	65	65	65	65	65	65	65
(e/D = 2.0)	71	79	67	71	69	81	81	71	67	71	69	81	78	78	75	78	78	78	78	78	78	78
e , percent (S-basis):																						
L	12	...	12	...	10	12	...	10	8	10	...	8	8	8	8	8	8
E , 10 ³ ksi	10.8																					
E_c , 10 ³ ksi	11.0																					
G , 10 ³ ksi	4.1																					
μ	0.33																					
Physical Properties:																						
ω , lb/in. ³	0.100																					
C , K , and α	See Figure 3.2.3.0																					

^a The mechanical properties are to be based upon the thickness at the time of quench.

^b Bearing values are "dry pin" values per Section 1.4.7.1.

Table 3.2.3.0(i₂). Design Mechanical and Physical Properties of 2024 Aluminum Alloy Extrusion—Concluded

Specification	AMS-QQ-A-200/3										
	Extruded bar, rod, and shapes										
	T42 ^a										
Cross-Sectional Area, in. ²	≤ 25										
	≤ 0.249	0.250- 0.499	0.500- 0.749	0.750- 0.999	1.000- 1.249	1.250- 1.499	1.500- 1.749	1.750- 1.999	2.000- 2.249	2.250- 2.499	
Thickness or Diameter, ^b in.	S	S	S	S	S	S	S	S	S	S	S
Basis	S	S	S	S	S	S	S	S	S	S	S
Mechanical Properties:											
F_{up} , ksi:											
L	57	57	57	57	57	57	57	57	57	57	57
LT	55	54	52	51	49	47	45	43	41	39	38
F_{tp} , ksi:											
L	38	38	38	38	38	38	38	38	38	38	38
LT	36	35	34	33	32	31	30	29	28	27	27
F_{cp} , ksi:											
L	38	38	38	38	38	38	38	38	38	38	38
LT	39	38	37	36	35	34	33	31	30	29	29
F_{sp} , ksi	29	29	29	29	29	29	28	27	26	24	24
F_{brp} , ksi:											
(e/D = 1.5)	81	80	79	77	75	74	71	69	67	64	64
(e/D = 2.0)	99	98	97	95	93	91	89	86	83	81	81
F_{cp} , ksi:											
(e/D = 1.5)	56	55	53	51	49	47	44	41	39	36	36
(e/D = 2.0)	69	67	65	63	61	59	56	53	50	47	47
e , percent:											
L	12	12	12	10	10	10	10	10	10	10	10
E , 10 ³ ksi	10.8										
E_p , 10 ³ ksi	11.0										
G , 10 ³ ksi	4.1										
μ	0.33										
Physical Properties:											
ω , lb/in. ³	0.100										
C , K , and α	See Figure 3.2.3.0										

a Design allowables were based upon data obtained from testing samples of material supplied in the O or F temper, which were heat treated to demonstrate response to heat treatment by suppliers. Properties obtained by the user, however, may be lower than those listed if the material has been formed or otherwise cold or hot worked, particularly in the annealed temper, prior to solution heat treatment.

b The mechanical properties are to be based upon the thickness at the time of quench.

c Bearing values are "dry pin" values per Section 1.4.7.1.

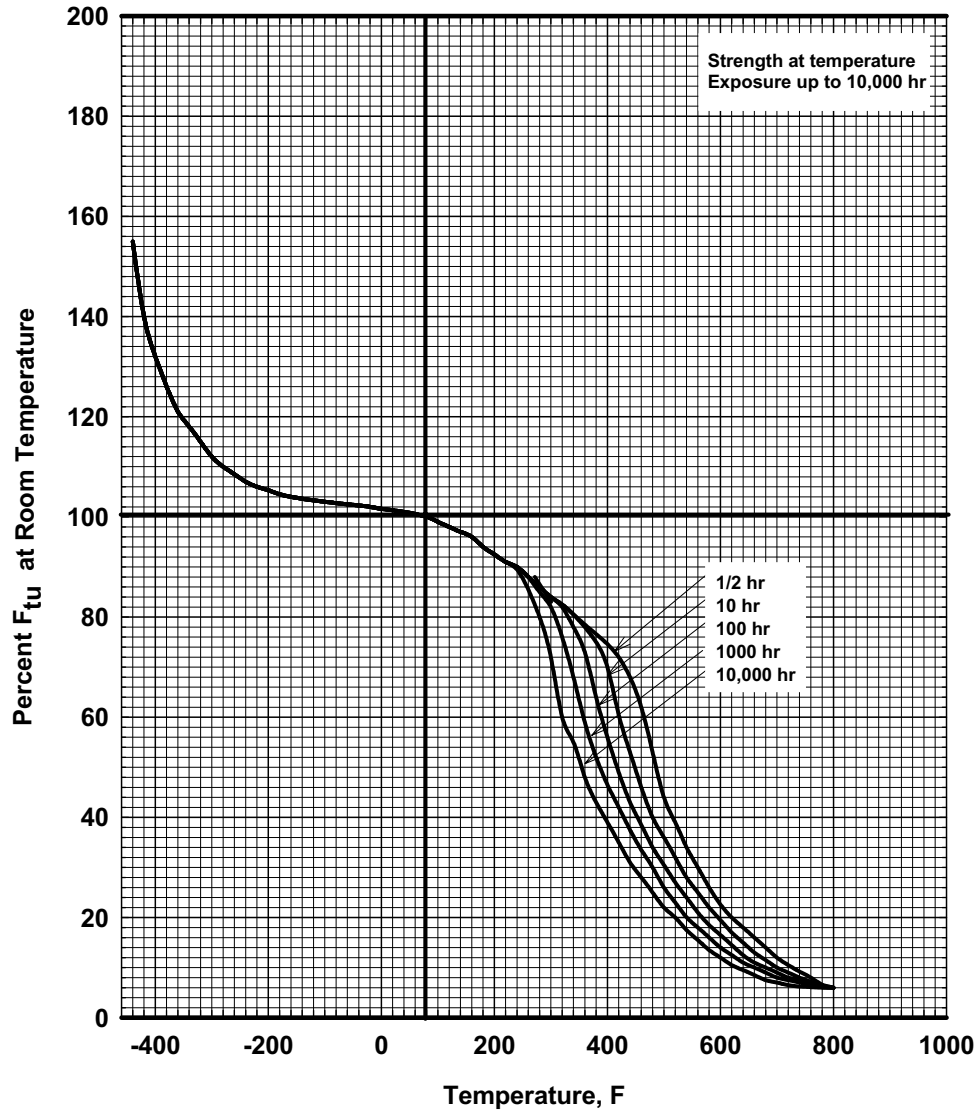

Figure 3.2.3.1.1(a). Effect of temperature on the tensile ultimate strength (F_{tu}) of 2024-T3, T351, and 2024-T4 aluminum alloy (all products except extrusions).

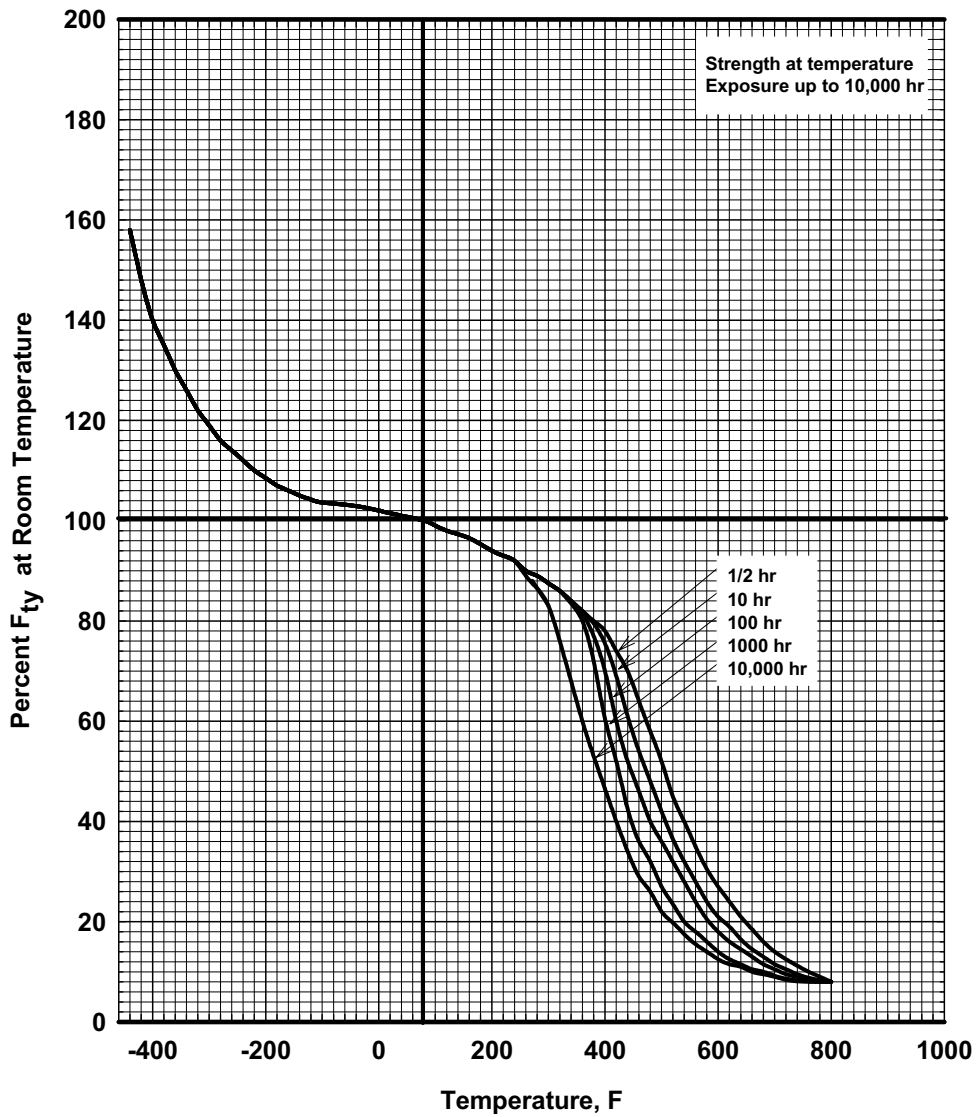

Figure 3.2.3.1.1(b). Effect of temperature on the tensile yield strength (F_{ty}) of 2024-T3, T351, and 2024-T4 aluminum alloy (all products except extrusions).

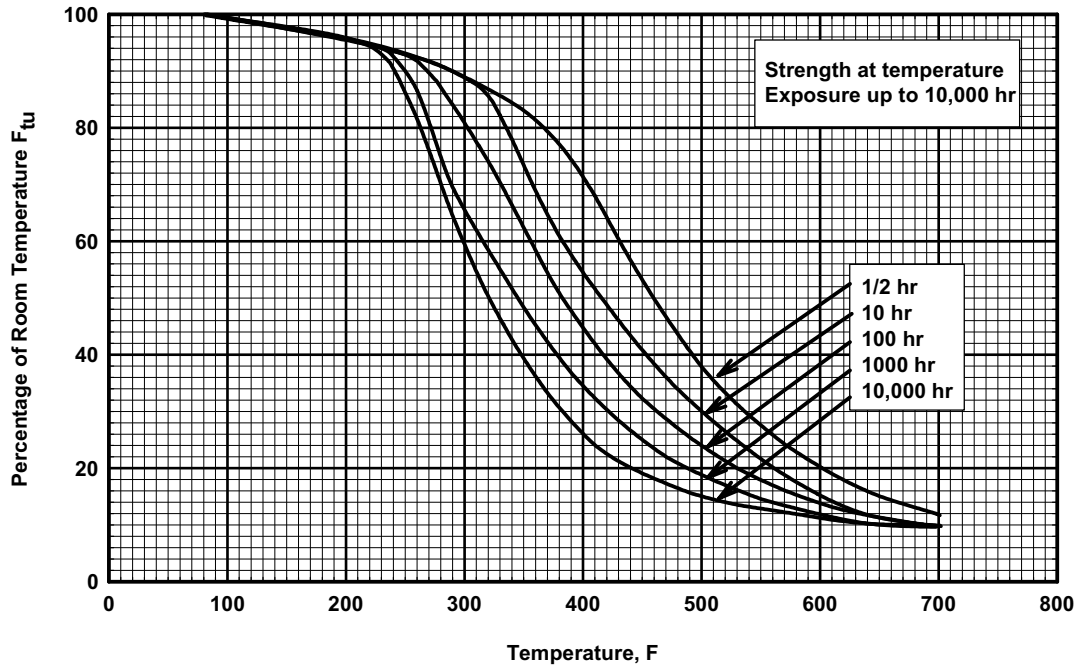

Figure 3.2.3.1.1(c). Effect of temperature on the tensile ultimate strength (F_{tu}) of 2024-T3, T3510, T3511, and T42 aluminum alloy extrusion.

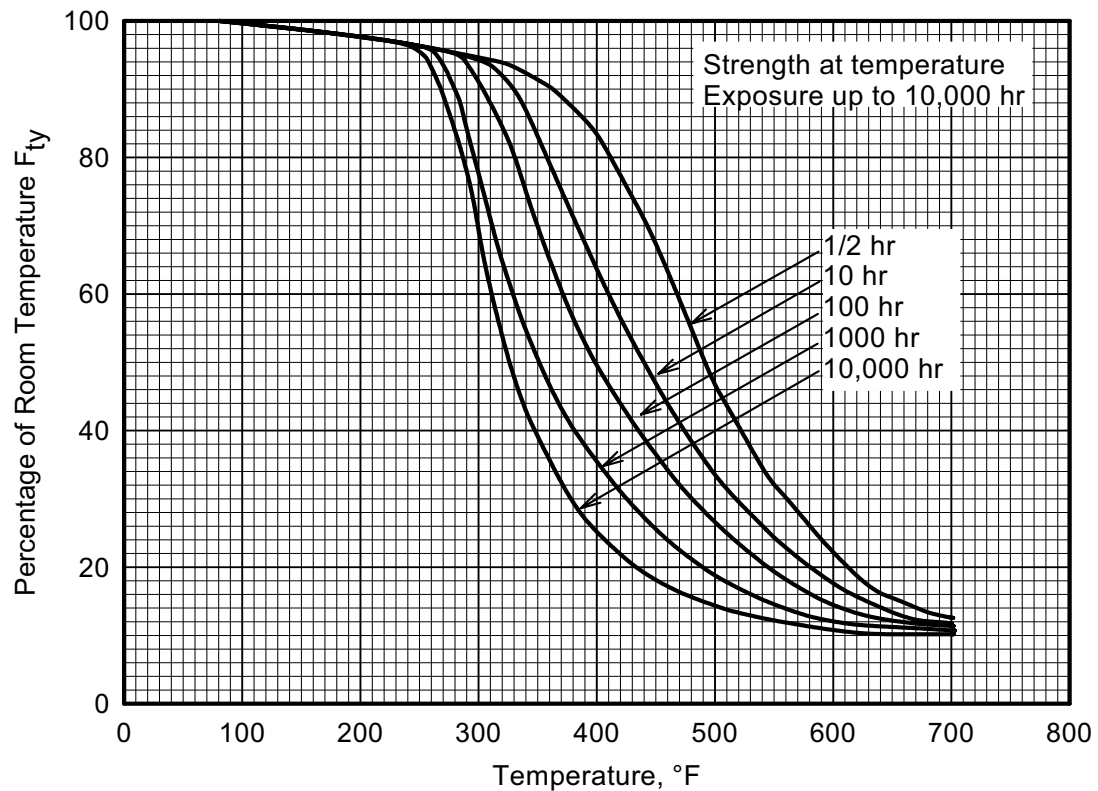

Figure 3.2.3.1.1(d). Effect of temperature on the tensile yield strength (F_{ty}) of 2024-T3, T3510, T3511, and T42 aluminum alloy extrusion.

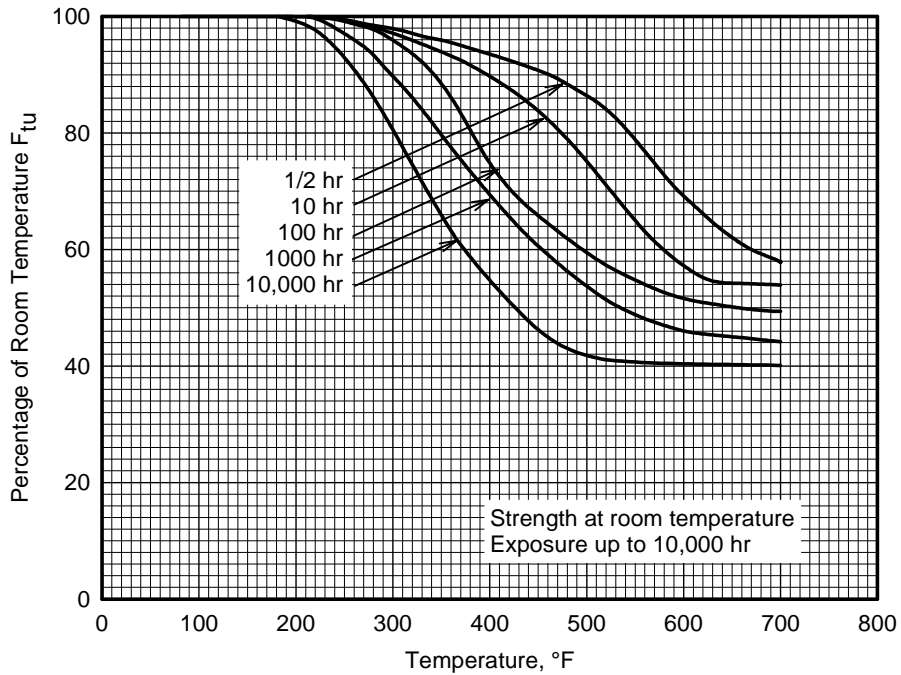

Figure 3.2.3.1.1(e). Effect of exposure at elevated temperatures on the room-temperature tensile ultimate strength (F_{tu}) of 2024-T3, T351, T3510, T3511, and T42 aluminum alloy (all products except thick extrusions).

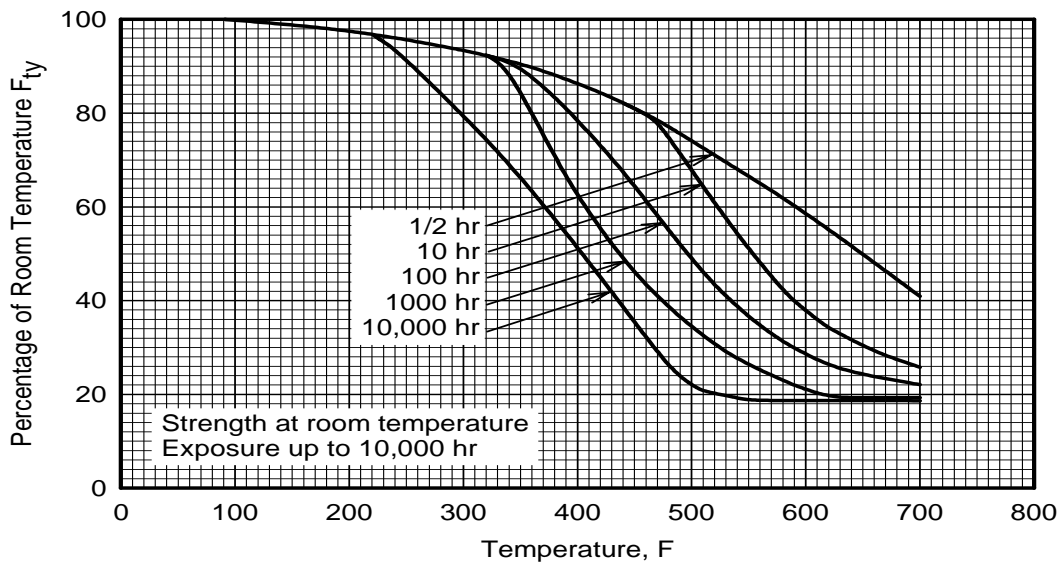

Figure 3.2.3.1.1(f). Effect of exposure at elevated temperatures on the room-temperature tensile yield strength (F_{ty}) of 2024-T3, T351, T3510, T3511, T4, and T42 aluminum alloy (all products except thick extrusions).

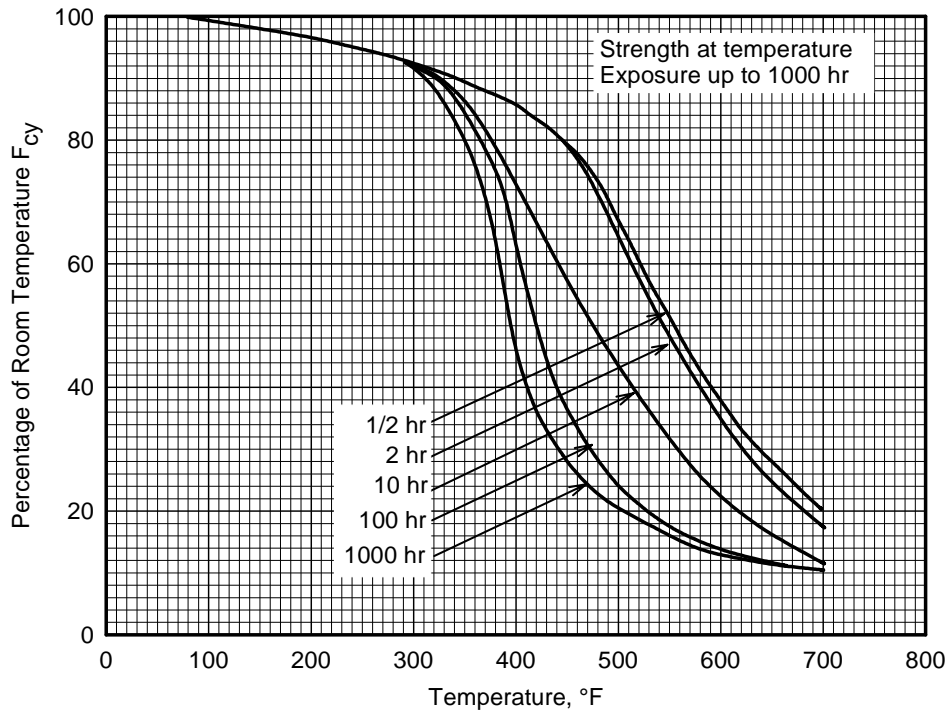

Figure 3.2.3.1.2(a). Effect of temperature on the compressive yield strength (F_{cy}) of flat clad 2024-T3, coiled clad 2024-T4 aluminum alloy sheet, and clad 2024-T351 aluminum alloy plate.

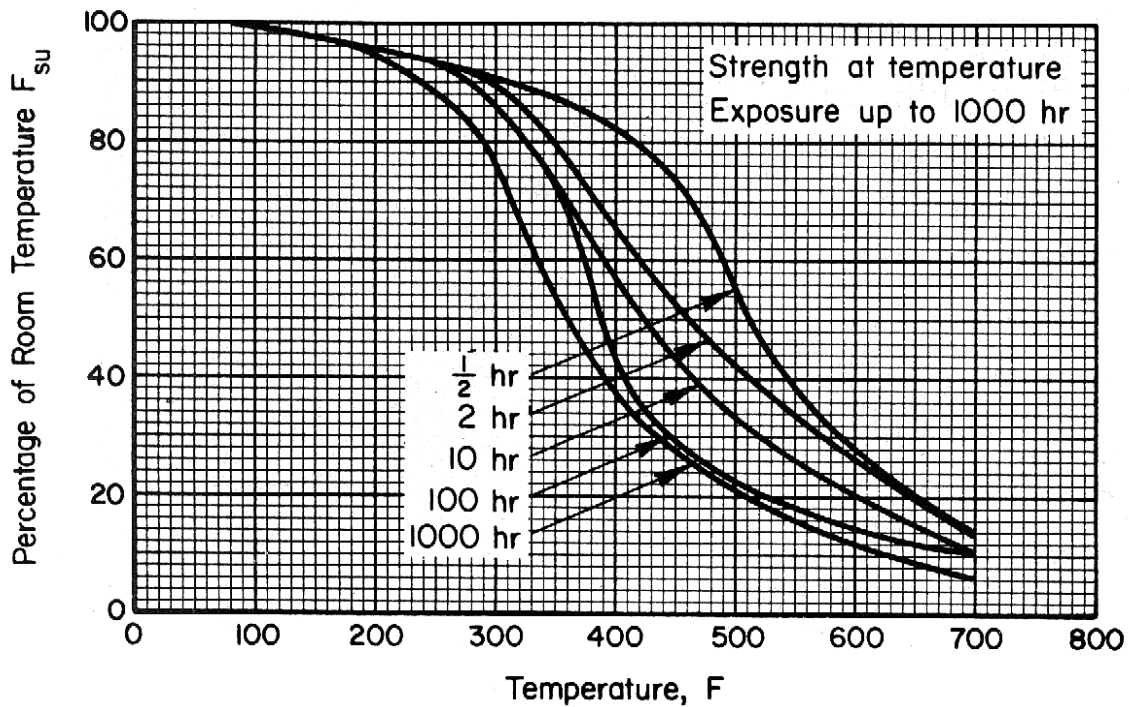

Figure 3.2.3.1.2(b). Effect of temperature on the shear ultimate strength (F_{su}) of flat clad 2024-T3, coiled clad 2024-T4 aluminum alloy sheet, and clad 2024-T351 aluminum alloy plate.

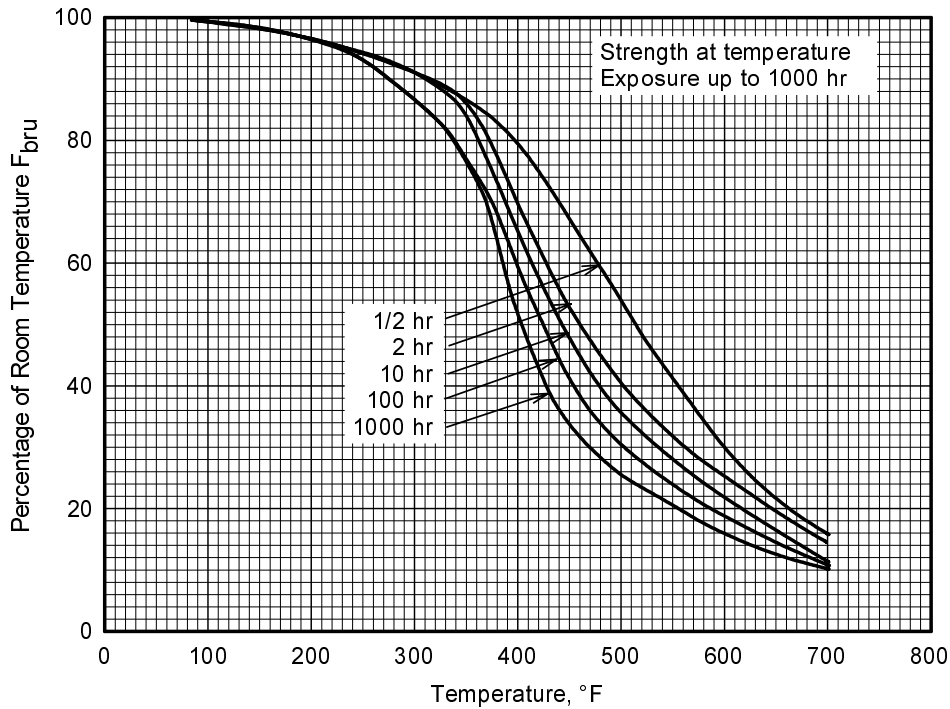

Figure 3.2.3.1.3(a). Effect of temperature on the bearing ultimate strength (F_{bru}) of flat clad 2024-T3, coiled clad 2024-T4 aluminum alloy sheet, and clad 2024-T351 aluminum alloy plate.

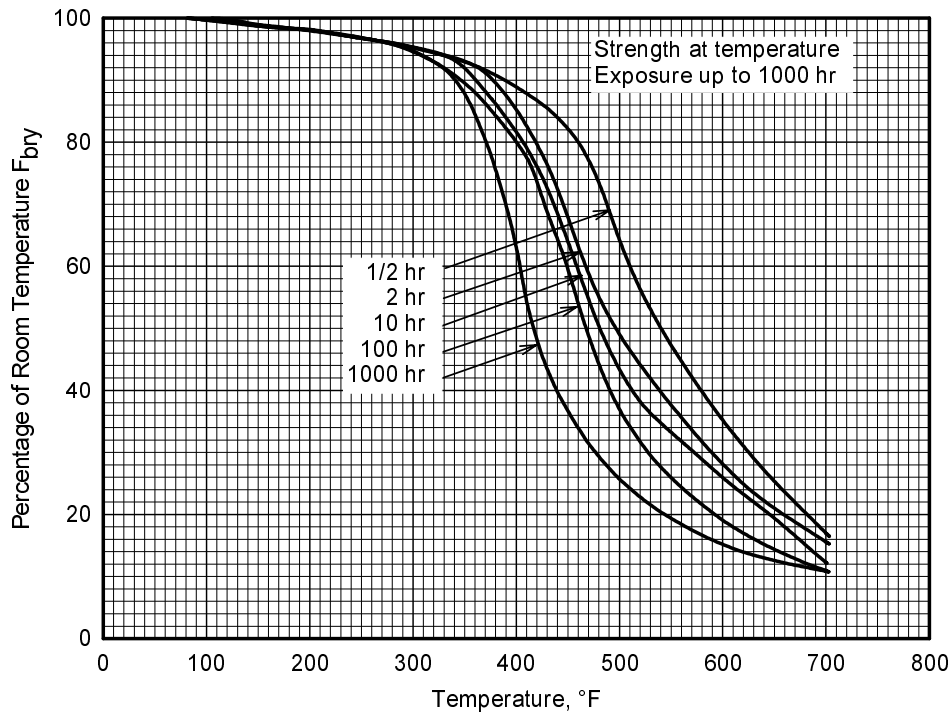

Figure 3.2.3.1.3(b). Effect of temperature on the bearing yield strength (F_{bry}) of flat clad 2024-T3, coiled clad 2024-T4 aluminum alloy sheet, and clad 2024-T351 aluminum alloy plate.

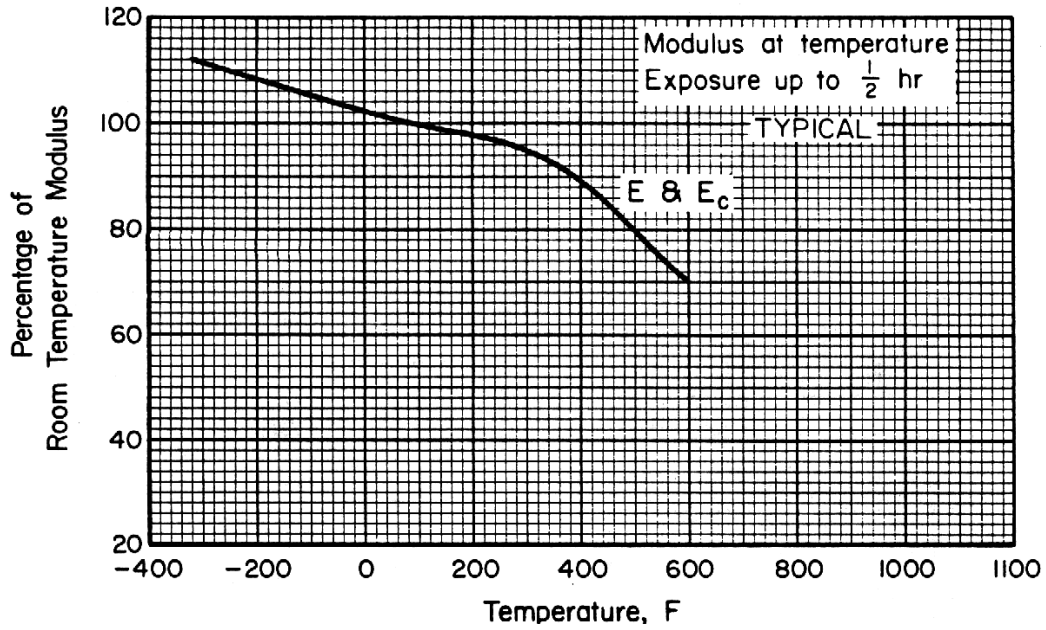

Figure 3.2.3.1.4. Effect of temperature on the tensile and compressive moduli (E and E_c) of 2024 aluminum alloy.

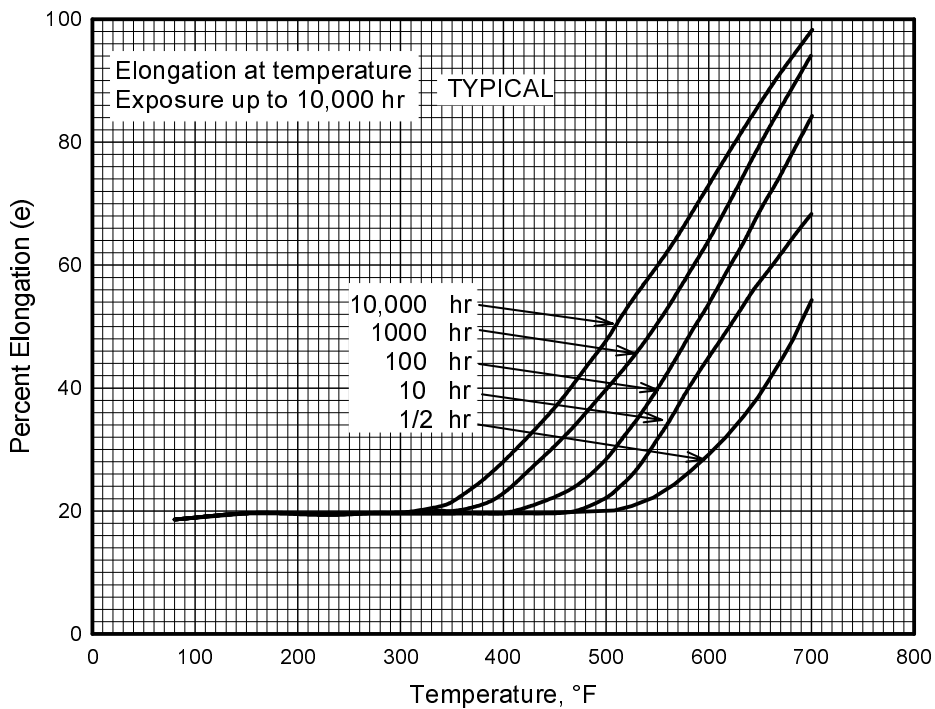

Figure 3.2.3.1.5(a). Effect of temperature on the elongation of 2024-T3, T351, T3510, T3511, T4, and T42 aluminum alloy (all products except thick extrusions).

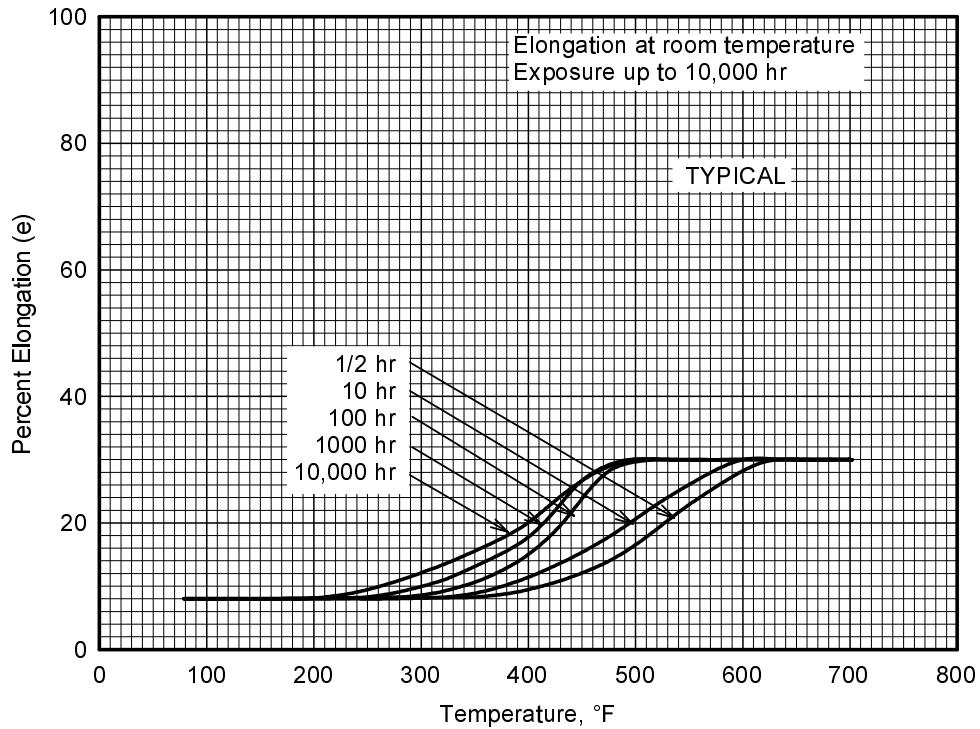

Figure 3.2.3.1.5(b). Effect of exposure at elevated temperature on the elongation (e) of 2024-T3, T351, T3510, T3511, T4, and T42 aluminum alloy (all products except thick extrusions).

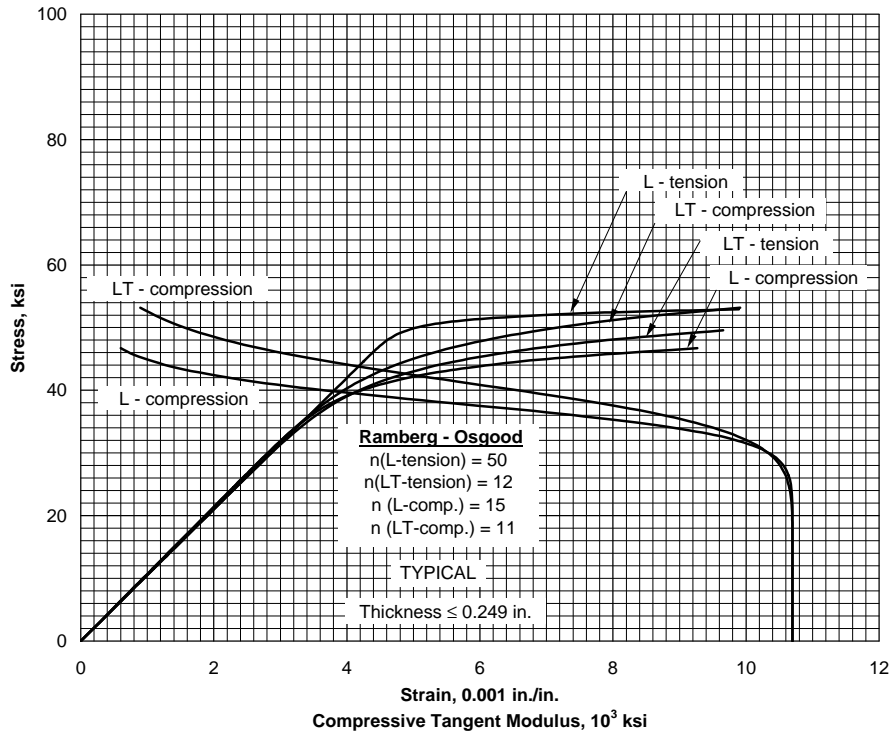

Figure 3.2.3.1.6(a). Typical tensile and compressive stress-strain and compressive tangent-modulus curves for 2024-T3 aluminum alloy sheet at room temperature.

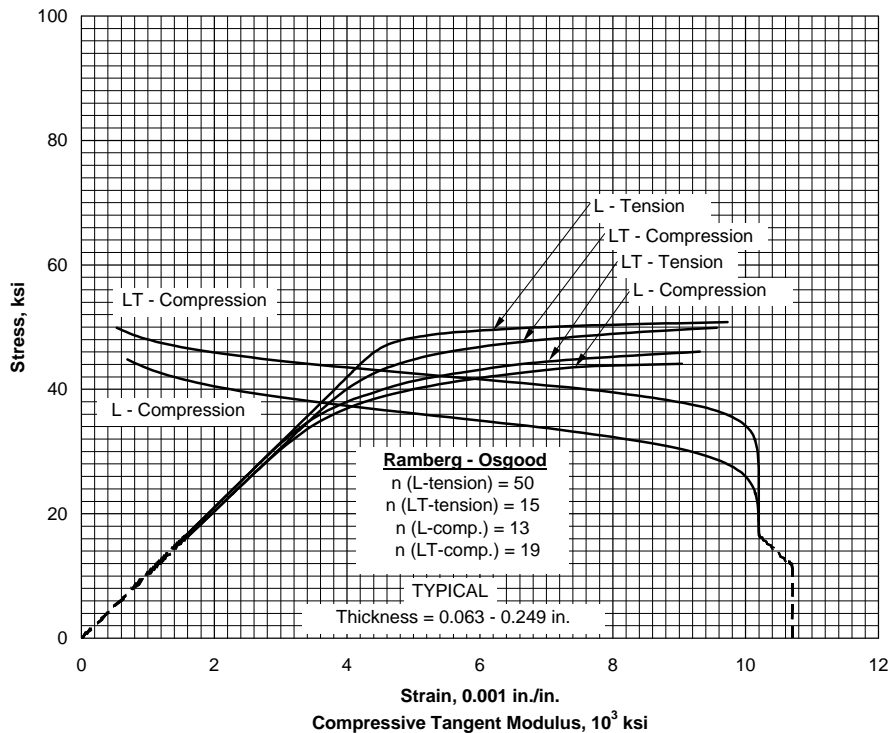

Figure 3.2.3.1.6(b). Typical tensile and compressive stress-strain and compressive tangent-modulus curves for clad 2024-T3 aluminum alloy sheet at room temperature.

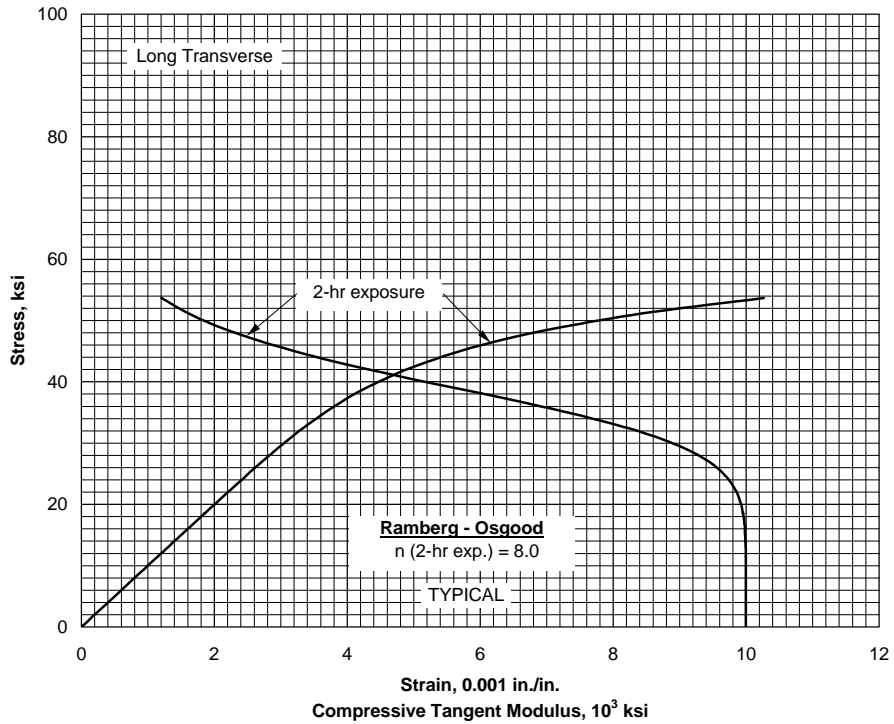

Figure 3.2.3.1.6(c). Typical compressive stress-strain and compressive tangent-modulus curves for clad 2024-T3 aluminum alloy sheet at 212°F.

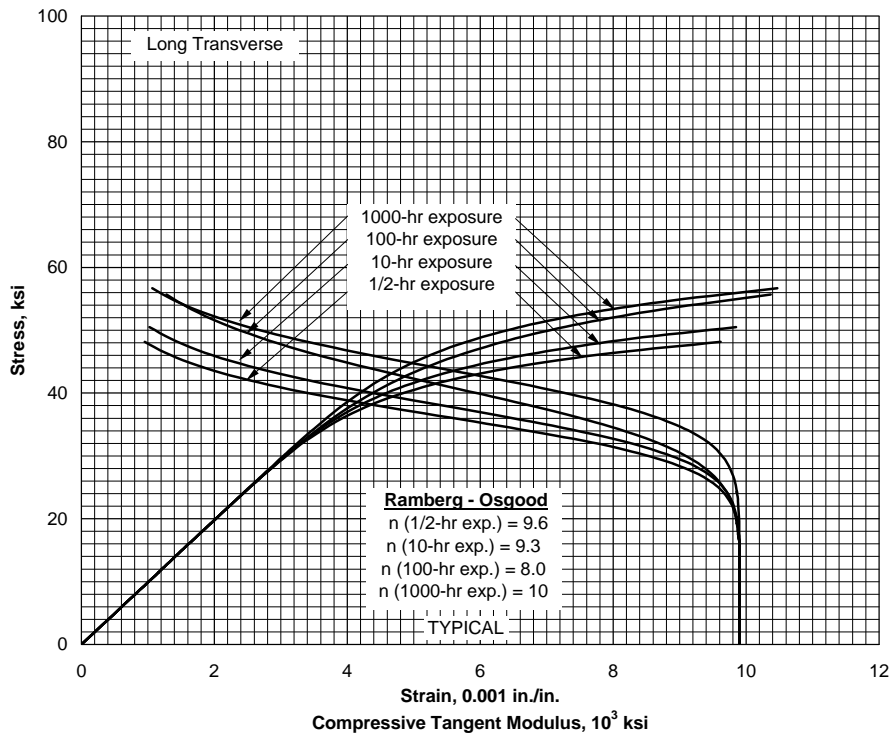

Figure 3.2.3.1.6(d). Typical compressive stress-strain and compressive tangent-modulus curves for clad 2024-T3 aluminum alloy sheet at 300°F.

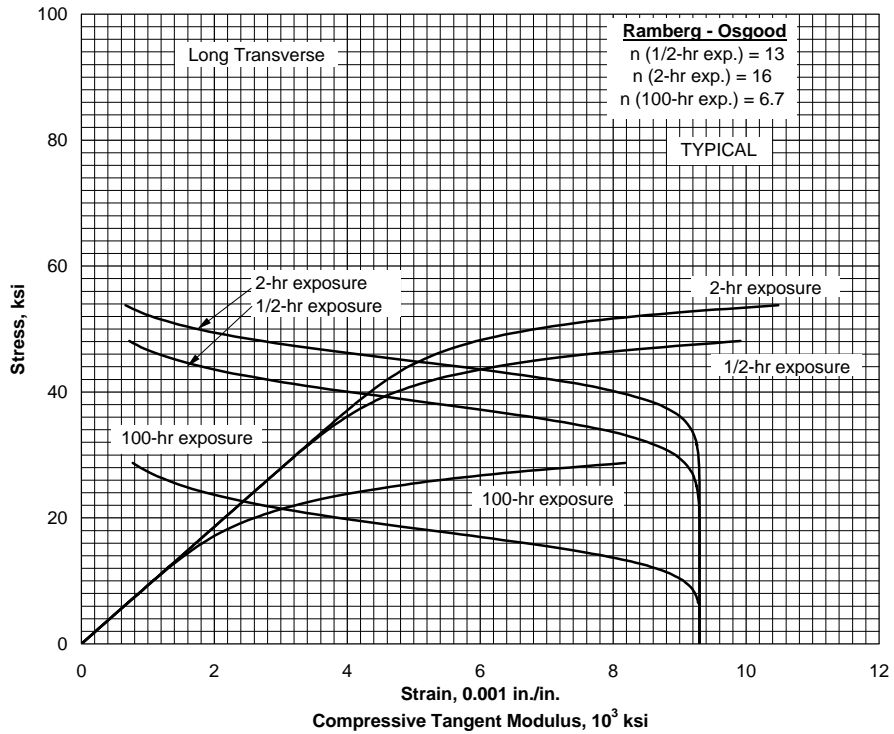

Figure 3.2.3.1.6(e). Typical compressive stress-strain and compressive tangent-modulus curves for clad 2024-T3 aluminum alloy sheet at 400°F.

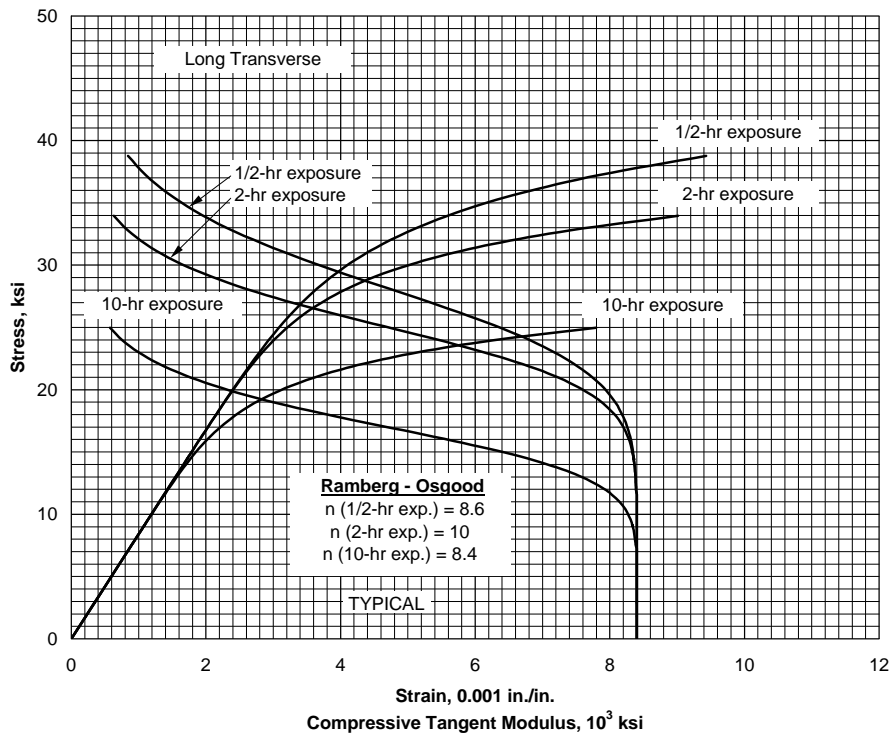

Figure 3.2.3.1.6(f). Typical compressive stress-strain and compressive tangent-modulus curves for clad 2024-T3 aluminum alloy sheet at 500°F.

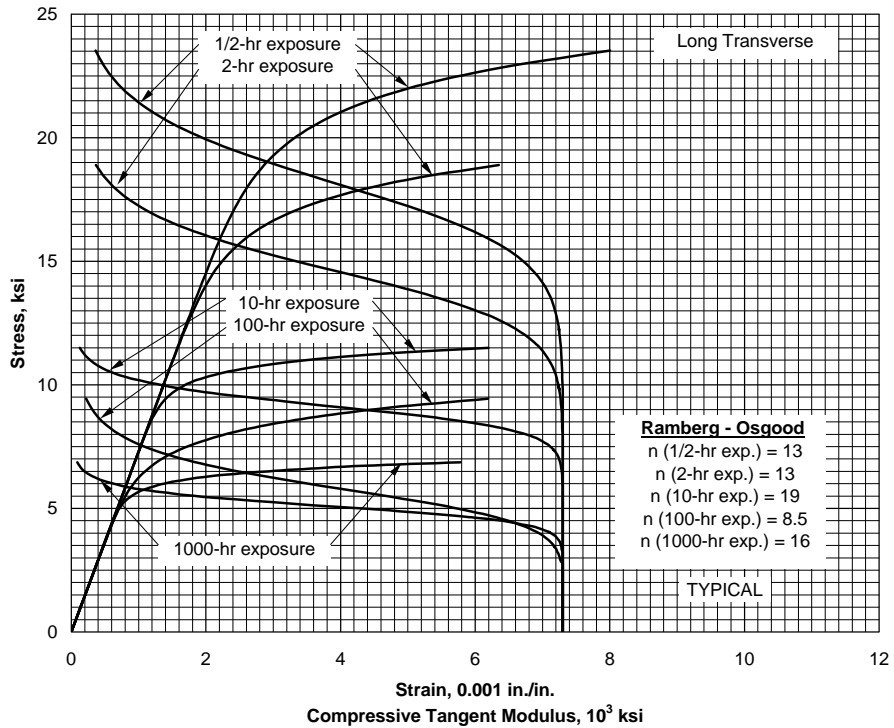

Figure 3.2.3.1.6(g). Typical compressive stress-strain and compressive tangent-modulus curves for clad 2024-T3 aluminum alloy sheet at 600°F.

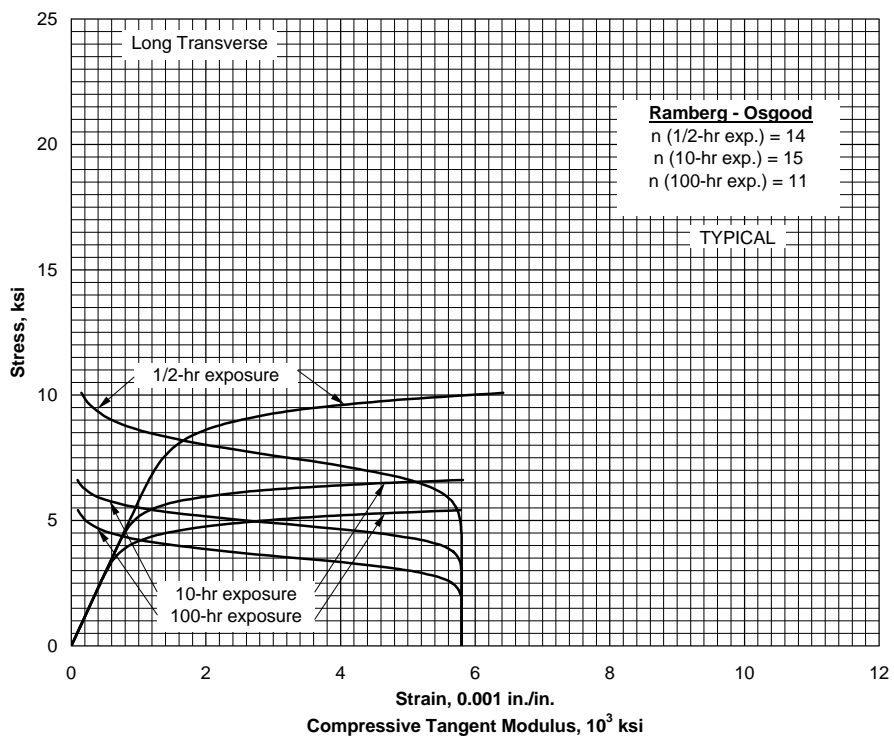

Figure 3.2.3.1.6(h). Typical compressive stress-strain and compressive tangent-modulus curves for clad 2024-T3 aluminum alloy sheet at 700°F.

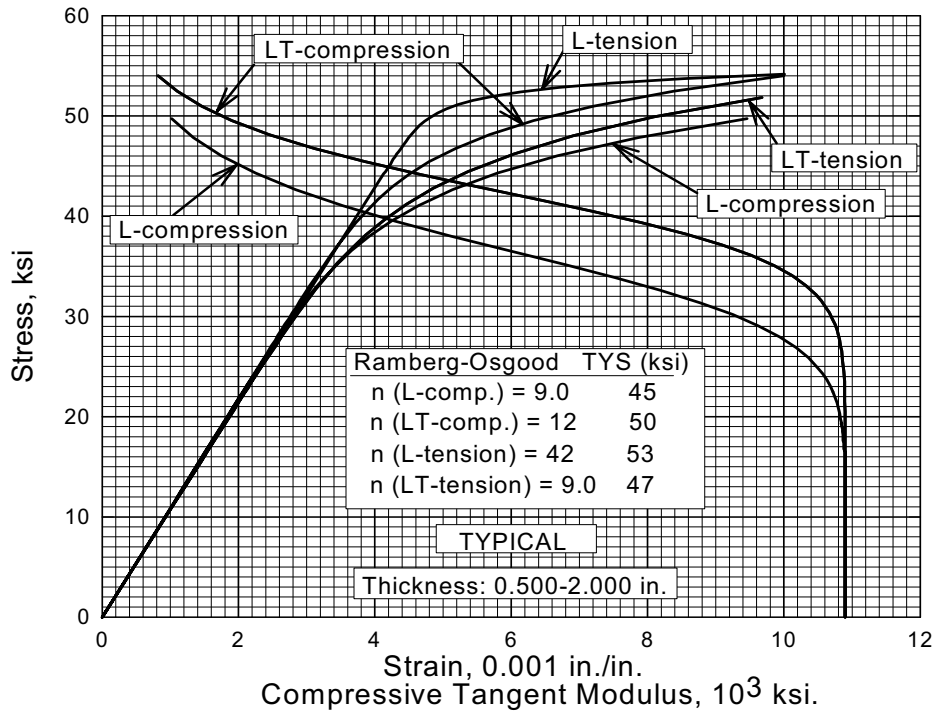

Figure 3.2.3.1.6(i). Typical tensile and compressive stress-strain and compressive tangent-modulus curves for 2024-T351 aluminum alloy plate at room temperature.

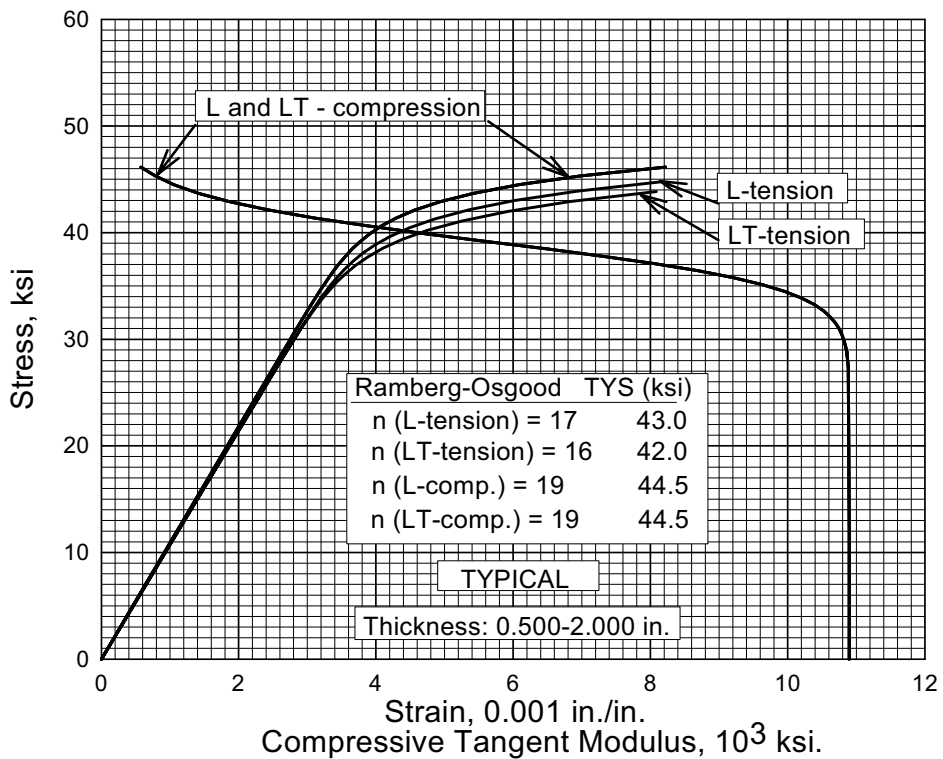

Figure 3.2.3.1.6(j). Typical tensile and compressive stress-strain and compressive tangent-modulus curves for 2024-T42 aluminum alloy plate at room temperature.

MIL-HDBK-5J
31 January 2003

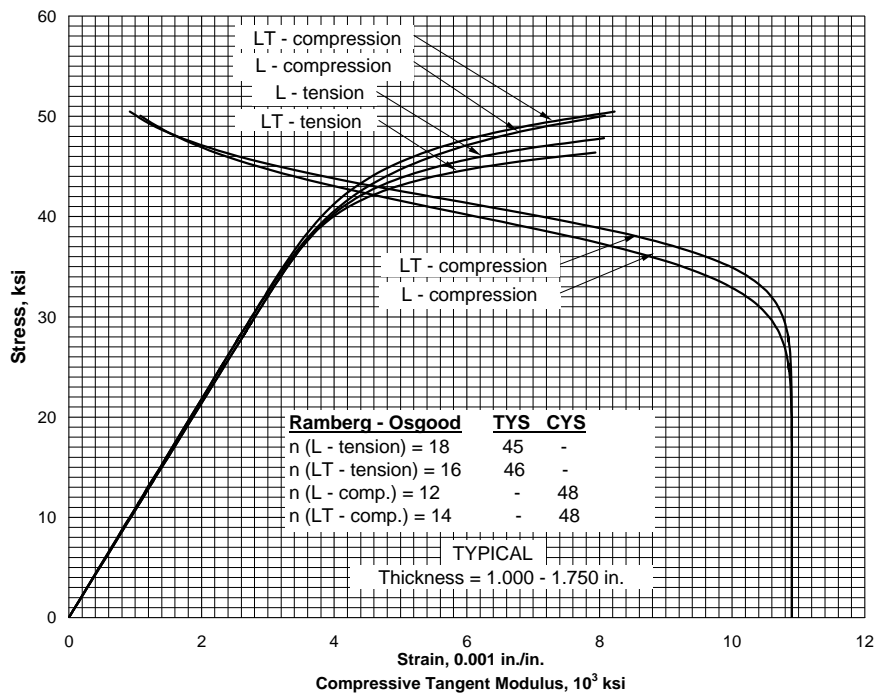

Figure 3.2.3.1.6(k) Typical tension and compression stress-strain and compression tangent modulus curves for 2024-T42 aluminum alloy plate at room temperature. Note, the data to generate these curves may have been from clad product, however, they are shown here without secondary modulus since it could not be positively confirmed the product was clad.

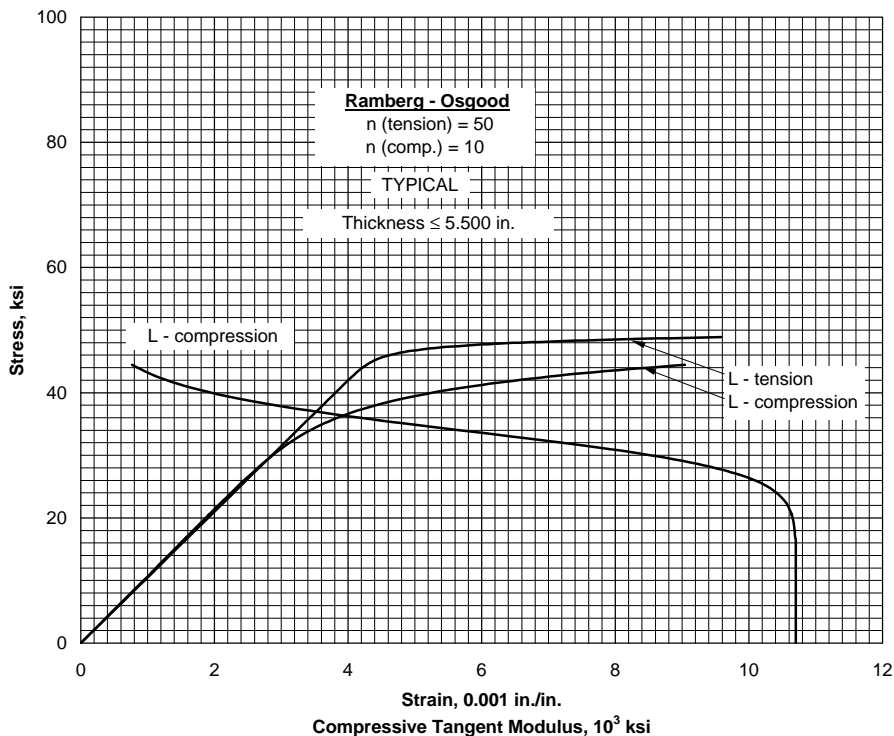

Figure 3.2.3.1.6(l). Typical tensile and compressive stress-strain and compressive tangent-modulus curves for 2024-T4 aluminum alloy rolled bar, rod, and shapes at room temperature.

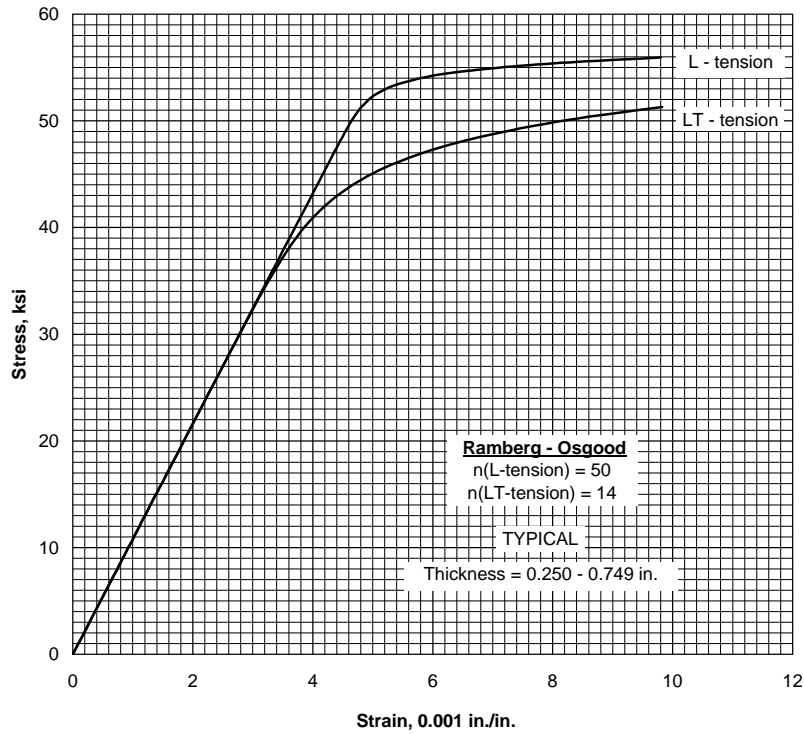

Figure 3.2.3.1.6(m). Typical tensile stress-strain curves for 2024-T351X aluminum alloy extrusion at room temperature.

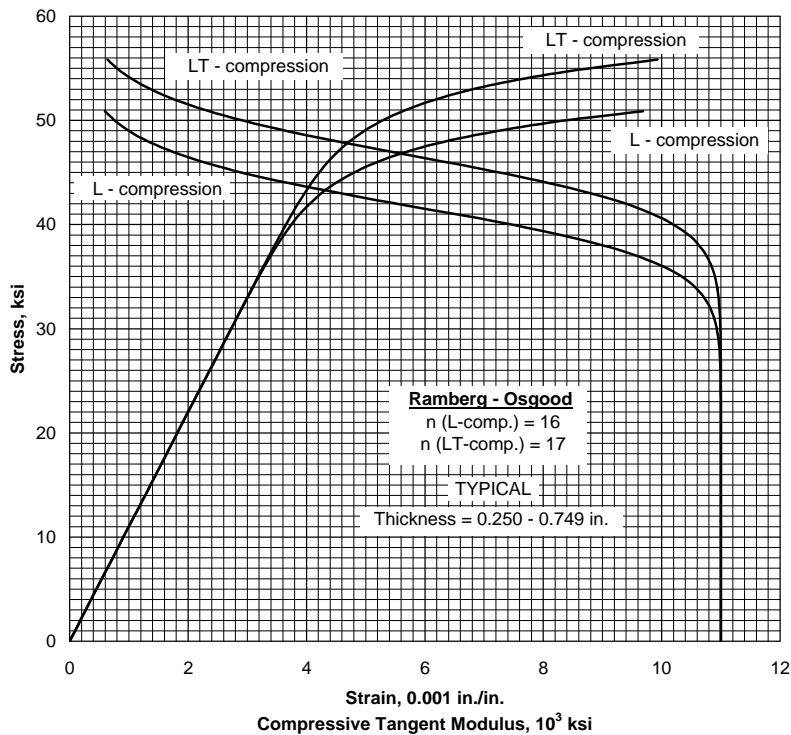

Figure 3.2.3.1.6(n). Typical compressive stress-strain and compressive tangent-modulus curves for 2024-T351X aluminum alloy extrusion at room temperature.

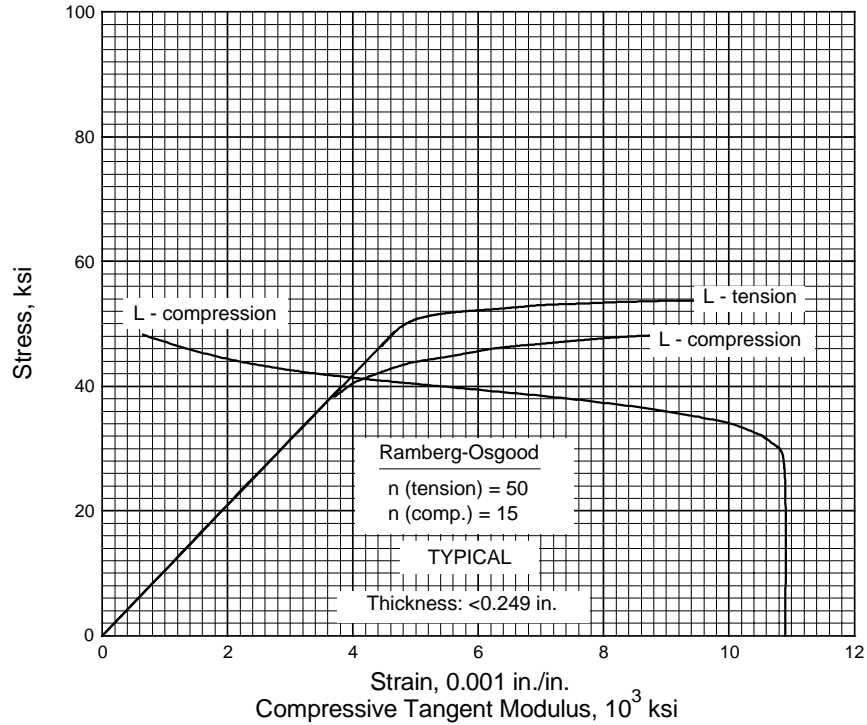

Figure 3.2.3.1.6(o). Typical tensile and compressive stress-strain and compressive tangent-modulus curves for 2024-T3 aluminum alloy extrusion at room temperature.

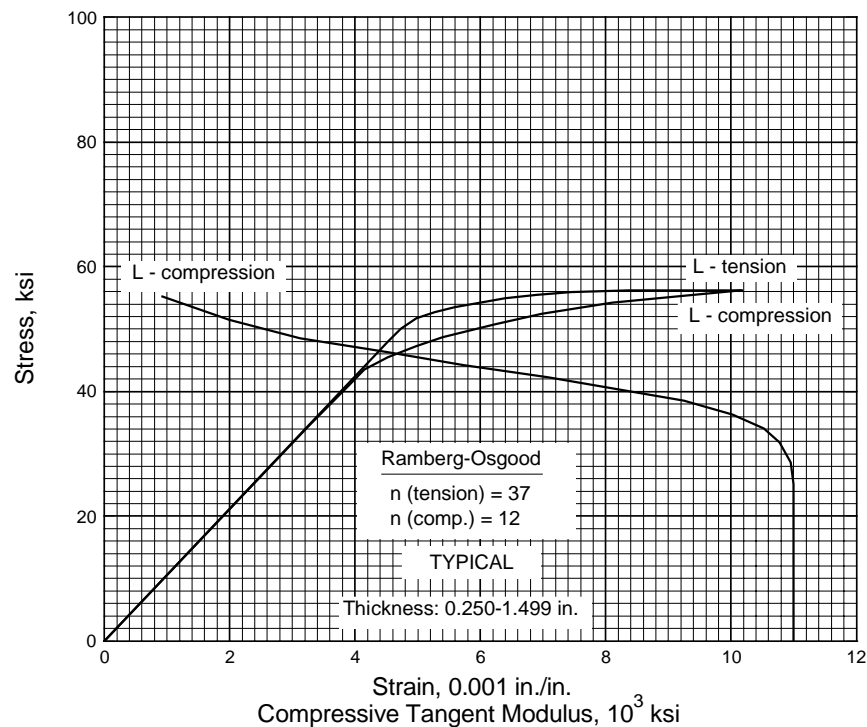

Figure 3.2.3.1.6(p). Typical tensile and compressive stress-strain and compressive tangent-modulus curves for 2024-T3 aluminum alloy extrusion at room temperature.

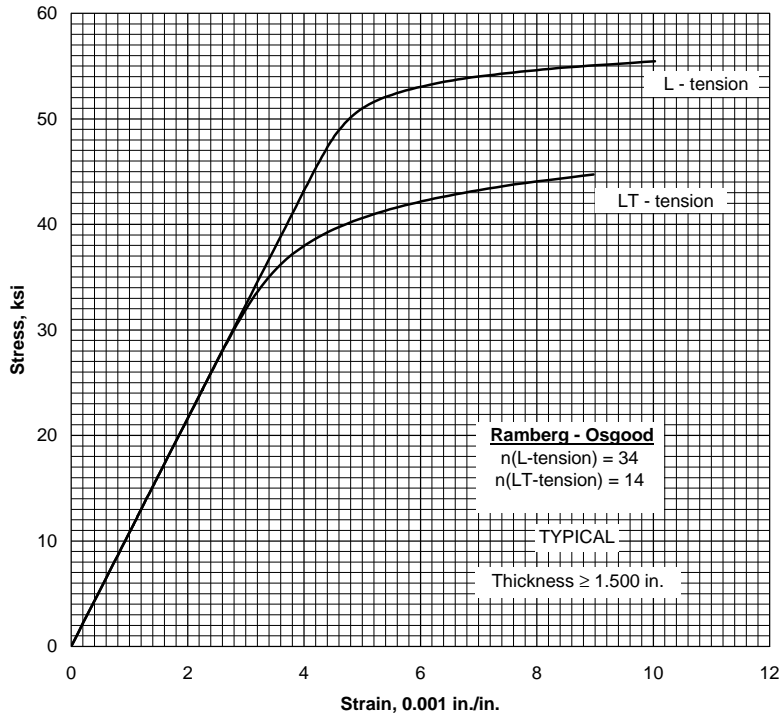

Figure 3.2.3.1.6(q). Typical tensile stress-strain curves for 2024-T42 aluminum alloy extrusion at room temperature.

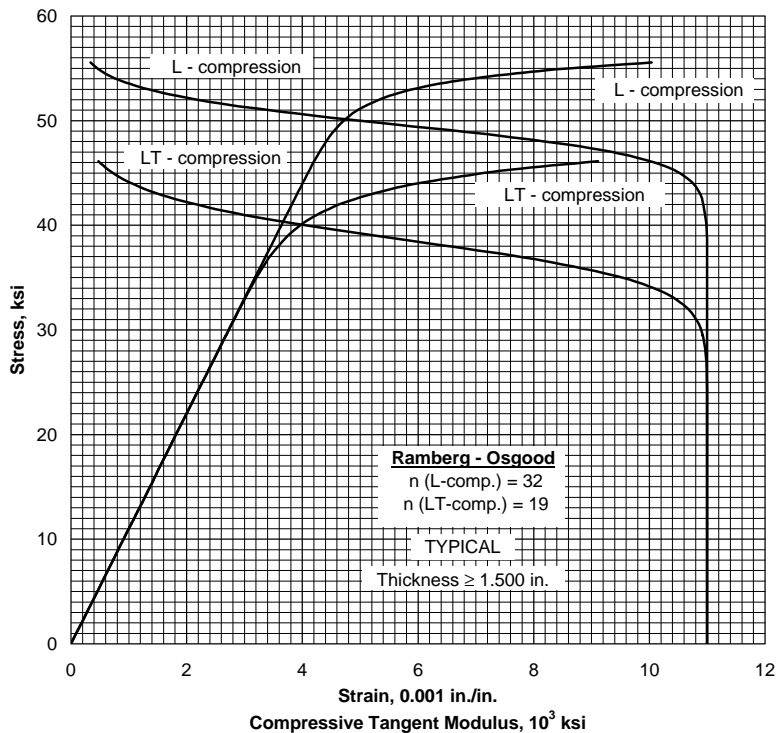

Figure 3.2.3.1.6(r). Typical compressive stress-strain and compressive tangent-modulus curves for 2024-T42 aluminum alloy extrusion at room temperature.

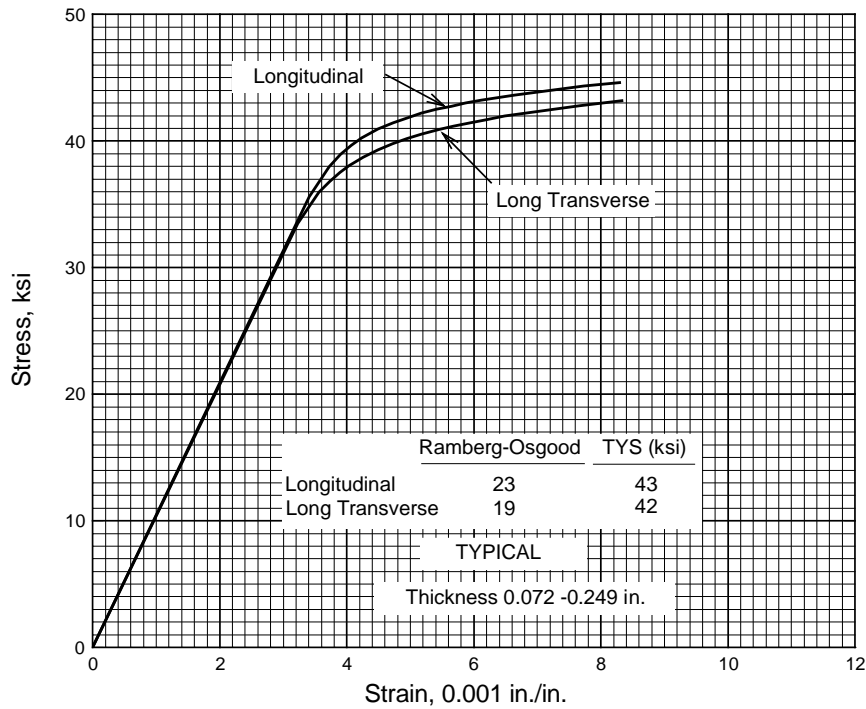

Figure 3.2.3.1.6(s). Typical tensile stress-strain curves for clad 2024-T42 aluminum alloy sheet at room temperature.

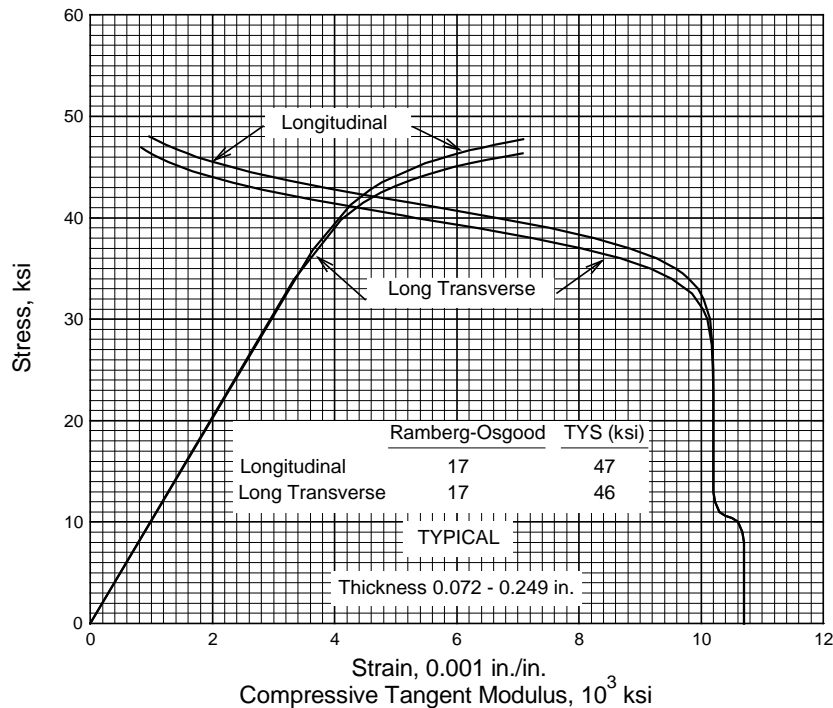

Figure 3.2.3.1.6(t). Typical compressive stress-strain and compressive tangent-modulus curves for clad 2024-T42 aluminum alloy sheet at room temperature.

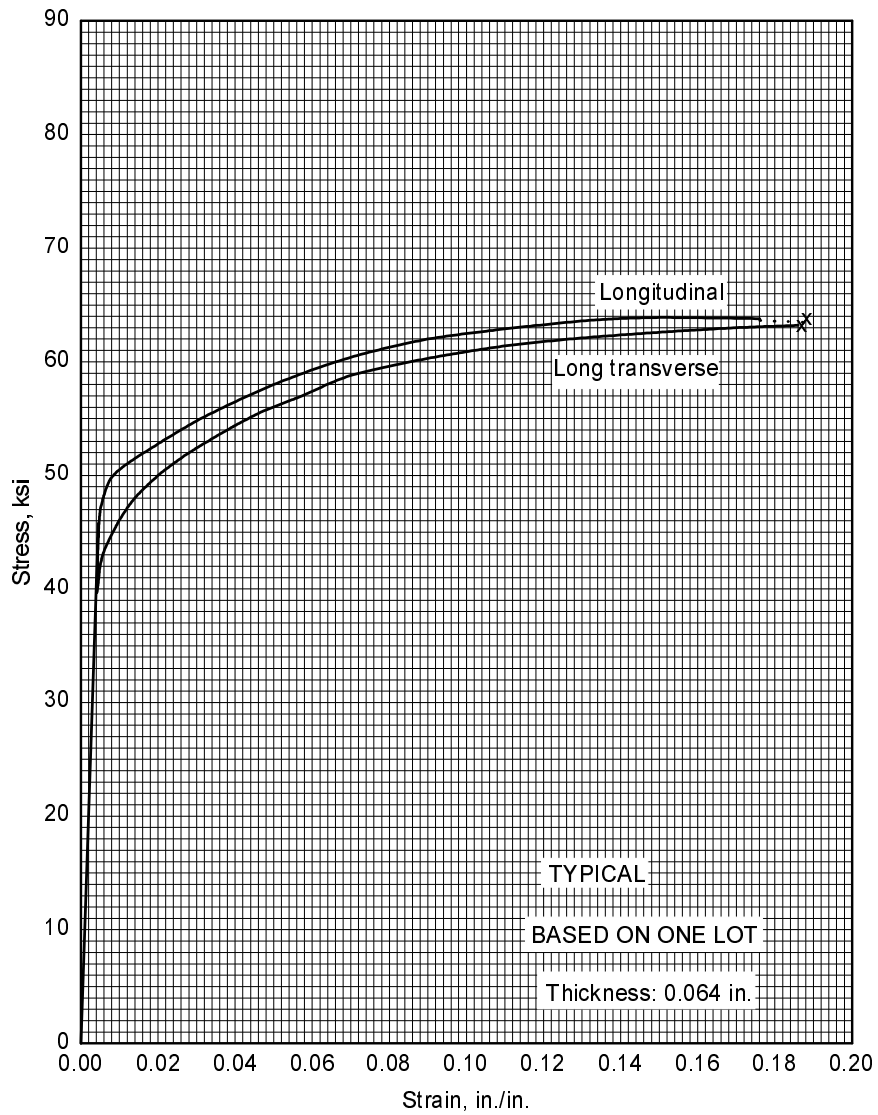

Figure 3.2.3.1.6(u). Typical tensile stress-strain curves (full range) for clad 2024-T3 aluminum alloy sheet at room temperature.

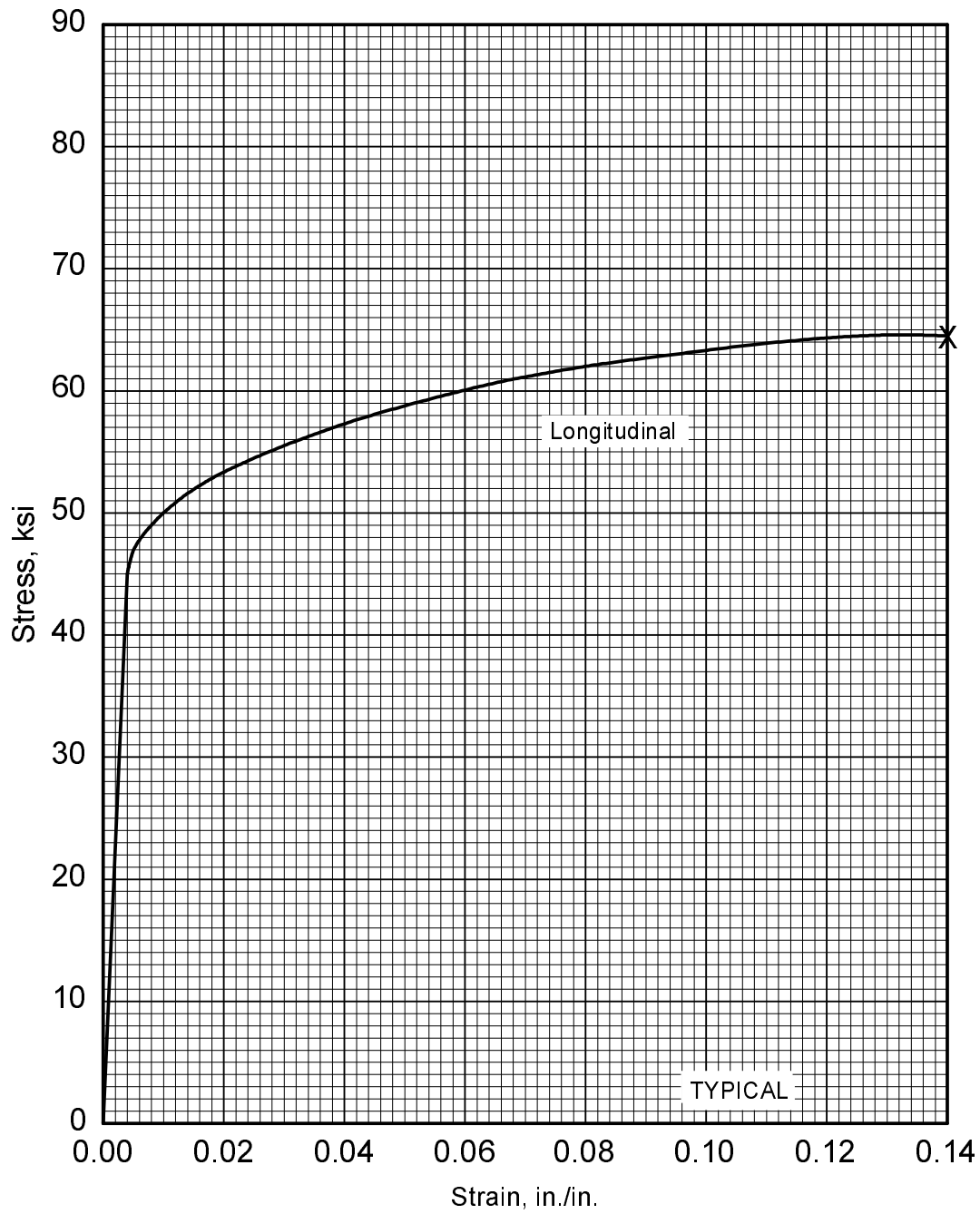

Figure 3.2.3.1.6(v). Typical tensile stress-strain curve (full range) for 2024-T351 aluminum alloy rolled rod at room temperature.

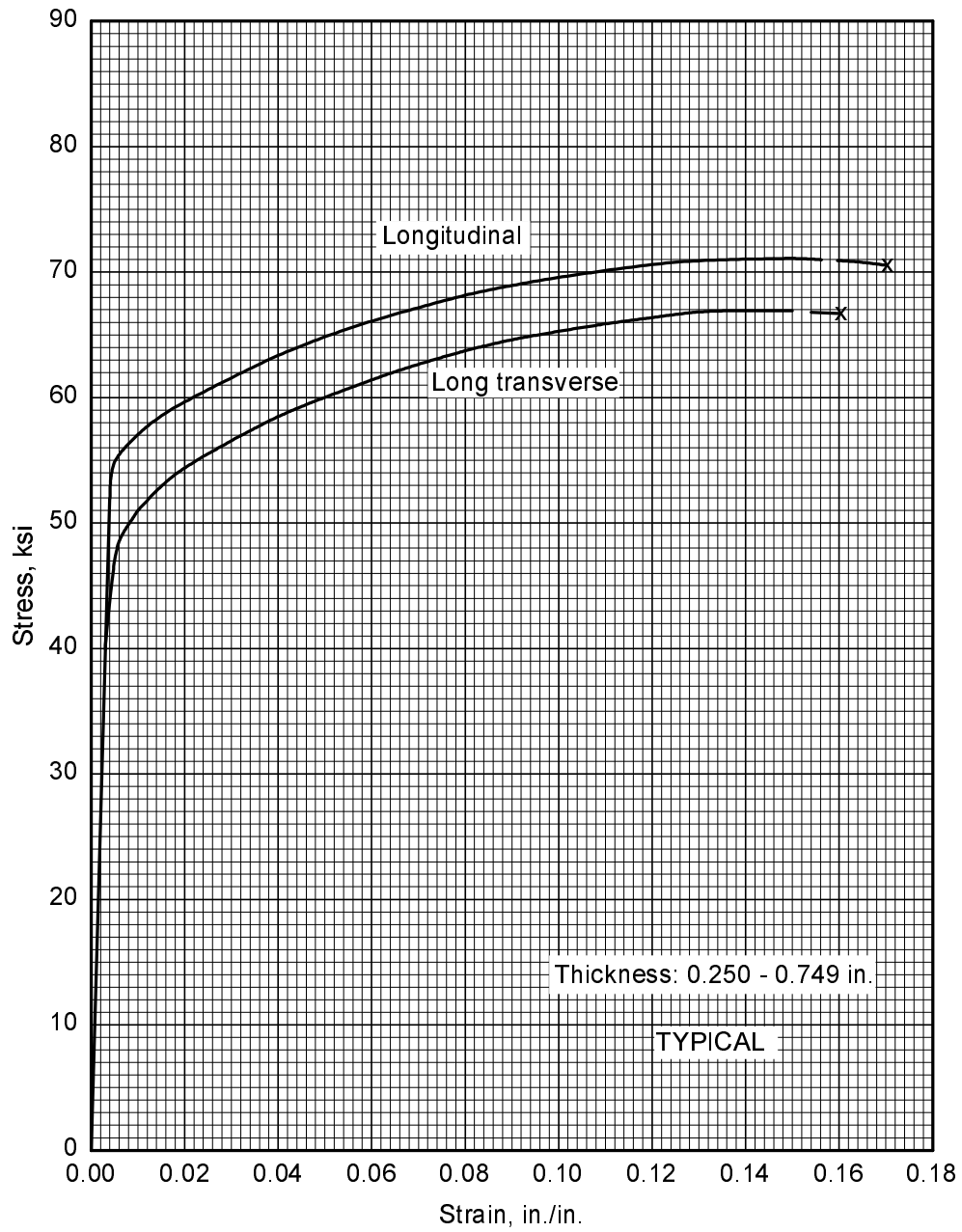

Figure 3.2.3.1.6(w). Typical tensile stress-strain curve (full range) for 2024-T351X aluminum alloy extrusion at room temperature.

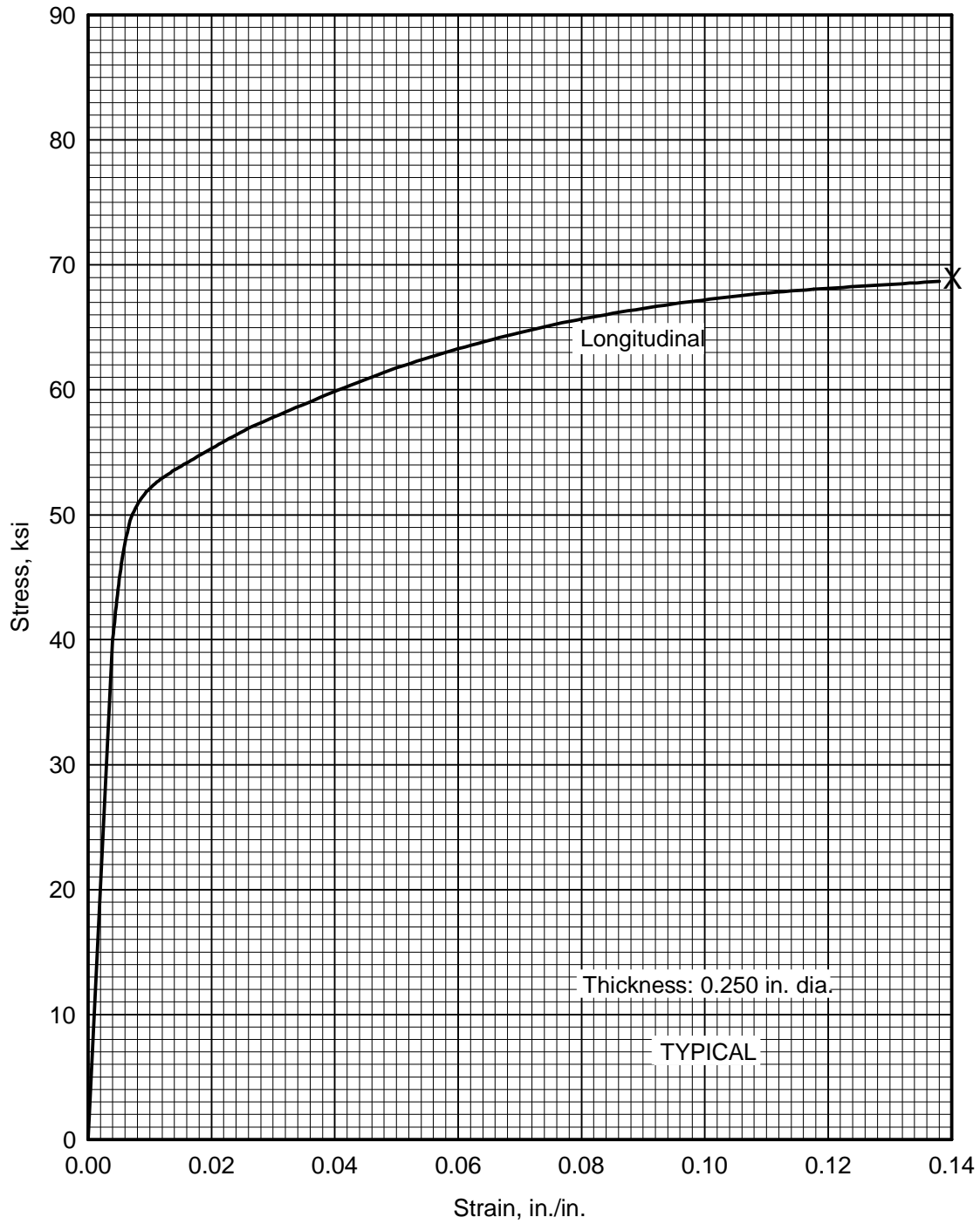

Figure 3.2.3.1.6(x). Typical stress-strain curve (full range) for 2024-T3 aluminum alloy extrusion at room temperature.

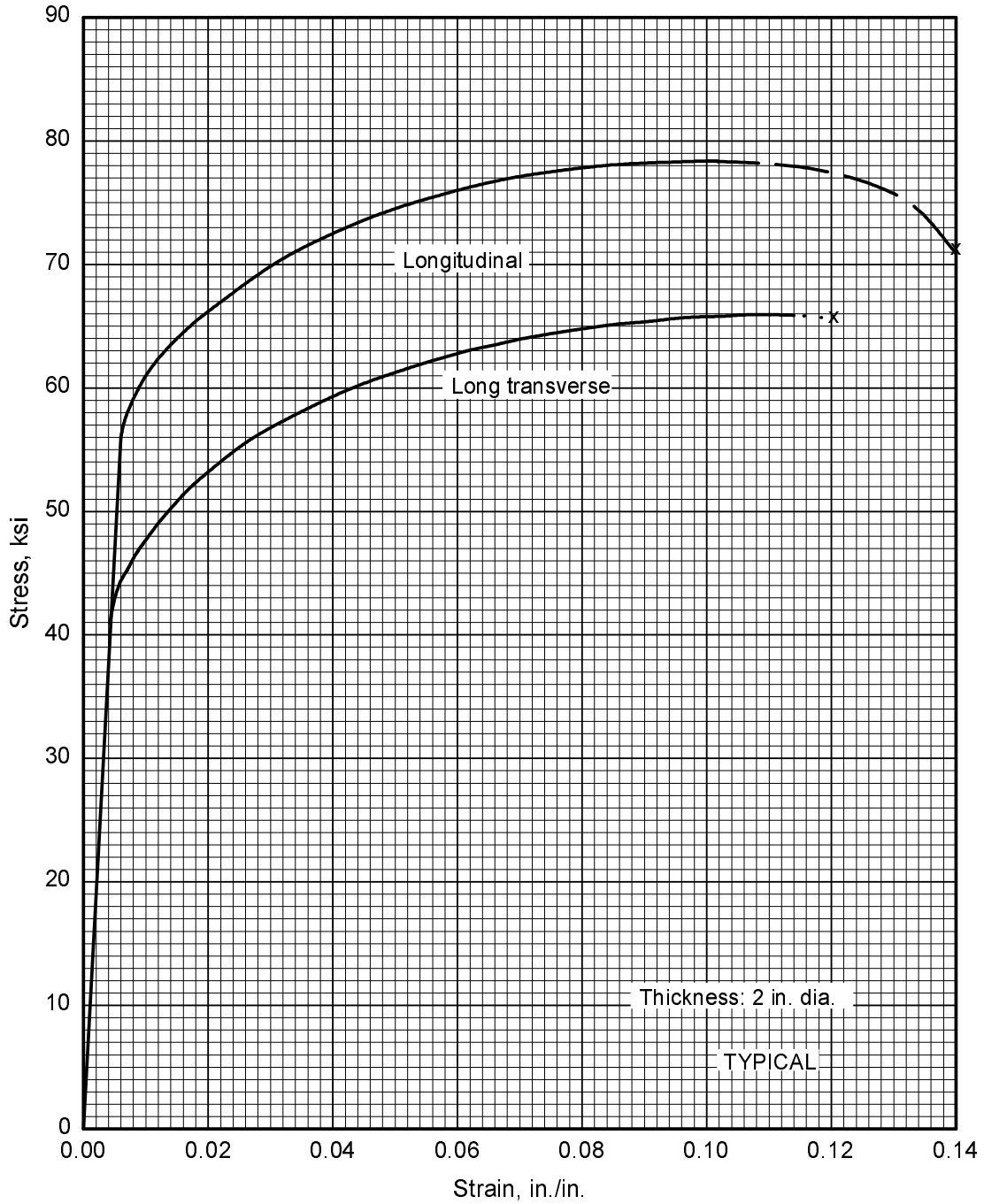

Figure 3.2.3.1.6(y). Typical tensile stress-strain curves (full range) for 2024-T3 aluminum alloy extrusion at room temperature.

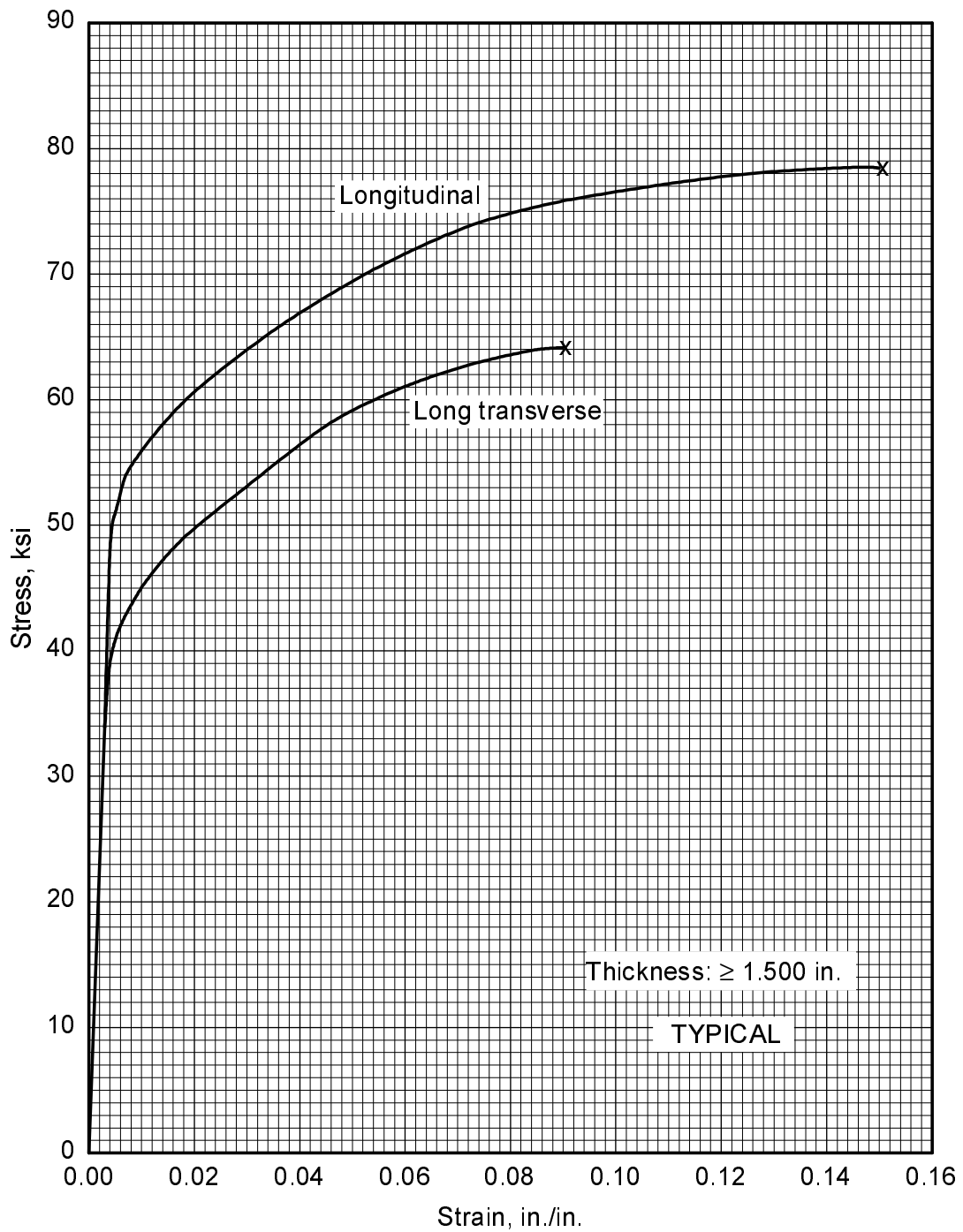

Figure 3.2.3.1.6(z). Typical tensile stress-strain curves (full range) for 2024-T42 aluminum alloy extrusion at room temperature.

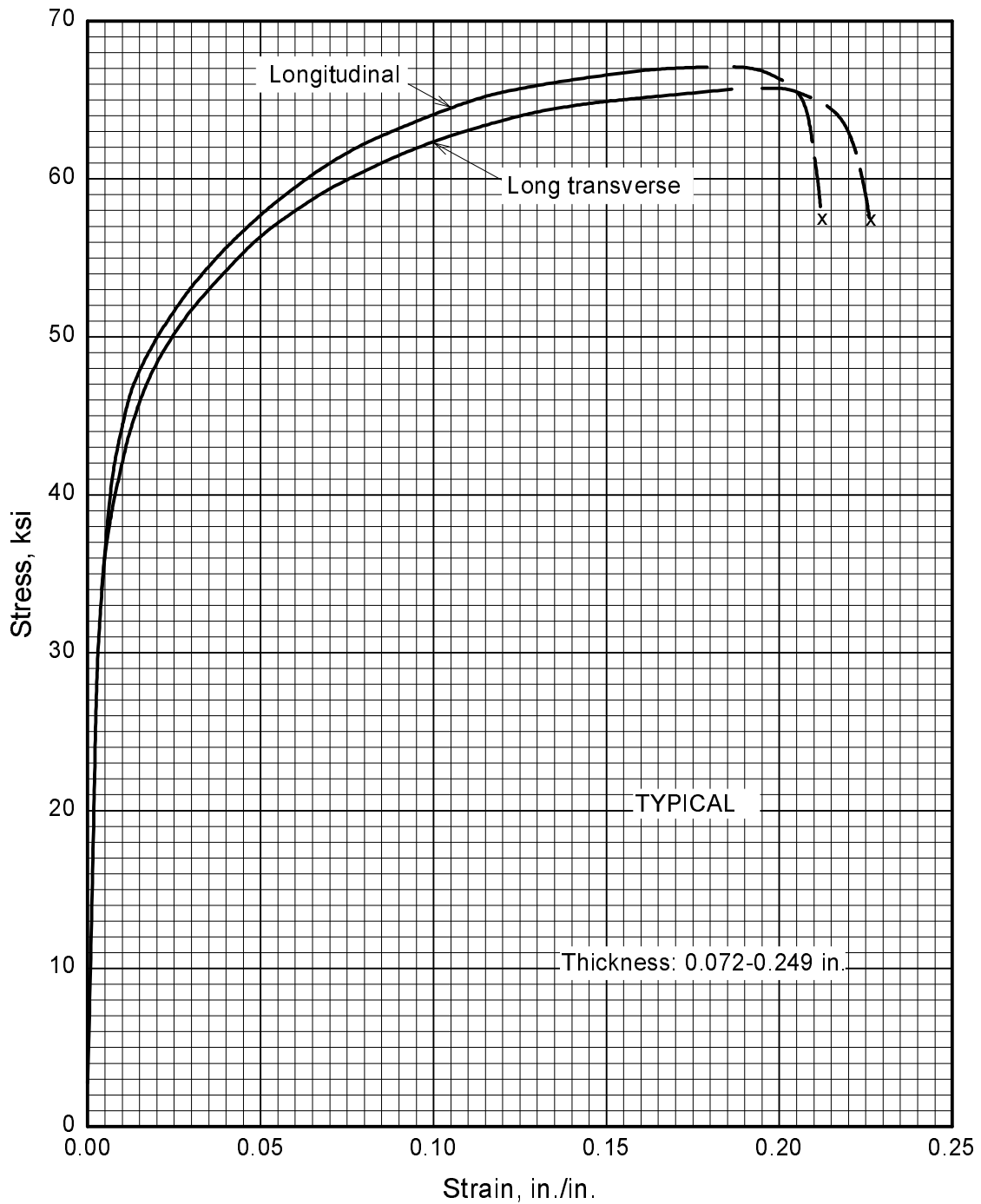

Figure 3.2.3.1.6(aa). Typical stress-strain curves (full range) for clad 2024-T42 aluminum alloy sheet at room temperature.

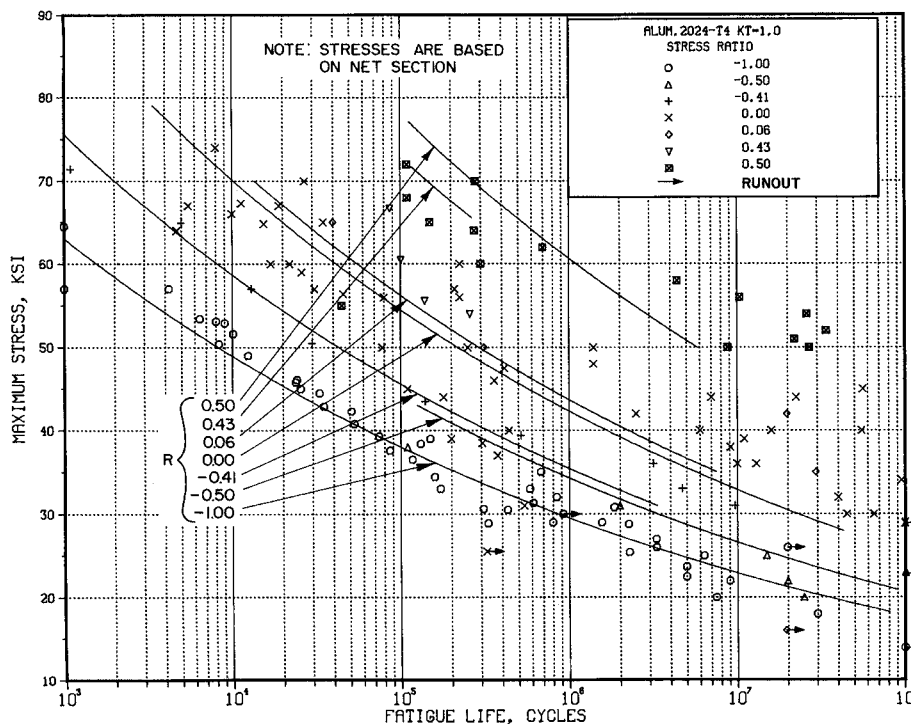

Figure 3.2.3.1.8(a). Best-fit S/N curves for unnotched 2024-T4 aluminum alloy, various wrought products, longitudinal direction.

Correlative Information for Figure 3.2.3.1.8(a)

Product Form: Rolled bar, 0.75 to 0.125 inch diameter
 Drawn rod, 0.75 inch diameter
 Extruded rod, 1.25 inch diameter
 Extruded bar, 1.25 x 4-inch

Test Parameters:
 Loading - Axial
 Frequency - 1800 to 3600 cpm
 Temperature - RT
 Environment - Air

Properties:

TUS, ksi	TYS, ksi	Temp., °F
69	45	RT (rolled)
71	44	RT (drawn)
85	65	RT (extruded)

No. of Heats/Lots: Not specified

Equivalent Stress Equation:
 $\log N_f = 20.83 - 9.09 \log (S_{eq})$
 $S_{eq} = S_{max} (1-R)^{0.52}$
 Std. Error of Estimate, $\log (\text{Life}) = 0.566$
 Standard Deviation, $\log (\text{Life}) = 1.324$
 $R^2 = 82\%$

Specimen Details: Unnotched
 0.160 to 0.400 inch diameter

Sample Size = 134

Surface Condition: Longitudinally polished

[Caution: The equivalent stress model may provide unrealistic life predictions for stress ratios beyond those represented above.]

References: 3.2.1.1.8(a) through (c) and 3.2.3.1.8(i)

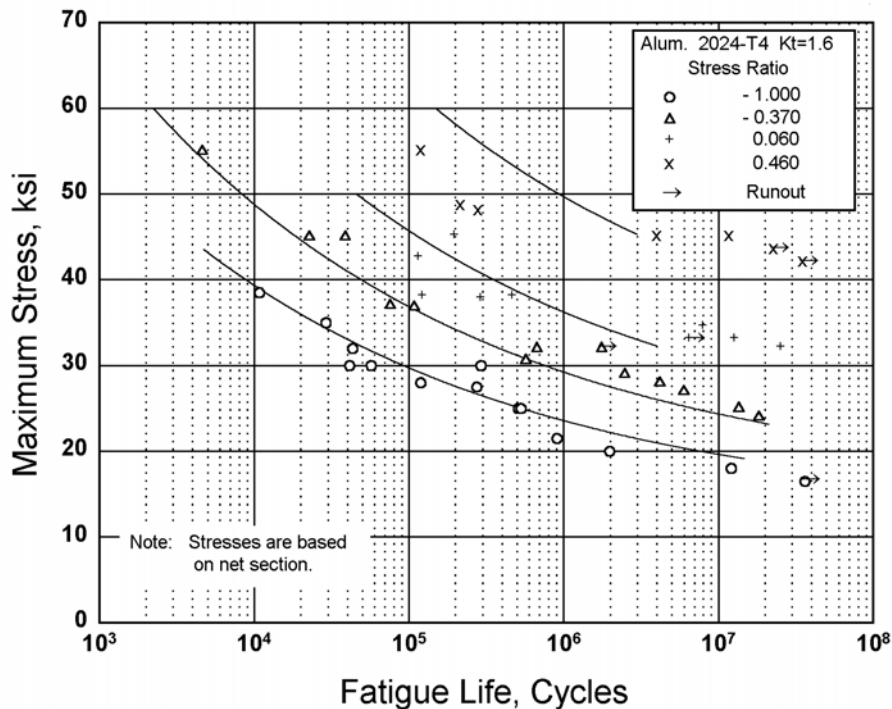

Figure 3.2.3.1.8(b). Best-fit S/N curves for notched, $K_t = 1.6$, 2024-T4 aluminum alloy bar, longitudinal direction.

Correlative Information for Figure 3.2.3.1.8(b)

Product Form: Rolled bar, 1.125 inch diameter

Test Parameters:

Loading - Axial
Frequency - 1800 to 3600 cpm
Temperature - RT
Environment - Air

Properties: $\frac{TUS, \text{ksi}}{73}$ $\frac{TYS, \text{ksi}}{49}$ $\frac{\text{Temp., } ^\circ\text{F}}{\text{RT}}$

Specimen Details: Semicircular
V-Groove, $K_t = 1.6$
0.450 inch gross diameter
0.400 inch net diameter
0.100 inch root radius, r
60° flank angle, ω

No. of Heats/Lots: Not specified

Equivalent Stress Equation:
 $\log N_f = 12.25 - 5.16 \log (S_{eq} - 18.7)$
 $S_{eq} = S_{max} (1-R)^{0.57}$
Std. Error of Estimate, $\log (\text{Life}) = 0.414$
Standard Deviation, $\log (\text{Life}) = 0.989$
 $R^2 = 82\%$

Surface Condition: As machined

Reference: 3.2.1.1.8(a)

Sample Size = 38

[Caution: The equivalent stress model may provide unrealistic life predictions for stress ratios beyond those represented above.]

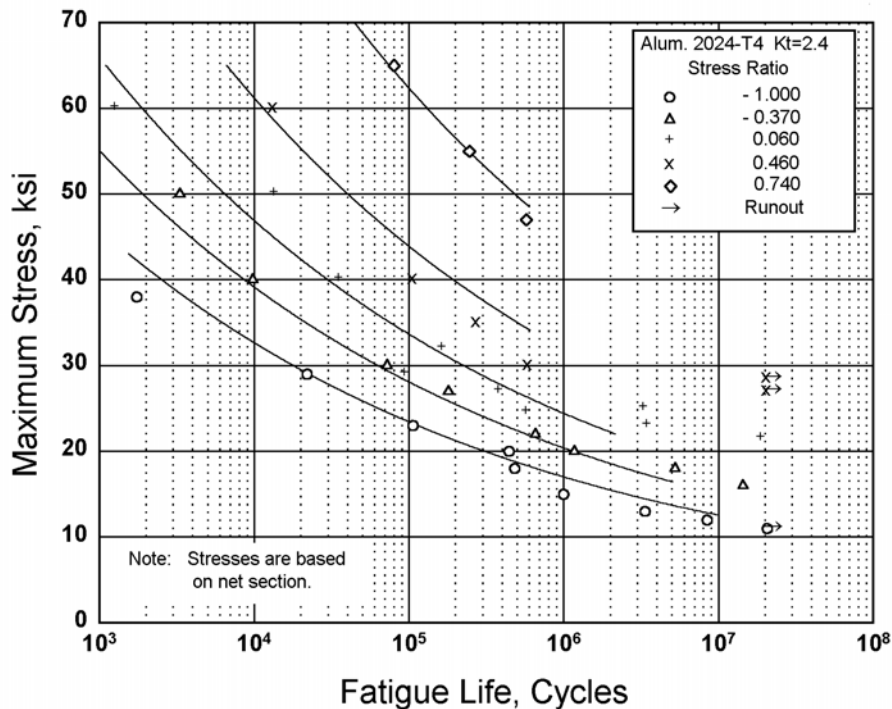

Figure 3.2.3.1.8(c). Best-fit S/N curves for notched, $K_t = 2.4$, 2024-T4 aluminum alloy bar, longitudinal direction.

Correlative Information for Figure 3.2.3.1.8(c)

Product Form: Rolled bar, 1.125 inch diameter

Test Parameters:

Loading - Axial
Frequency - 1800 to 3600 cpm
Temperature - RT
Environment - Air

Properties: TUS, ksi TYS, ksi Temp., °F
 73 49 RT

Specimen Details: Circumferential
V-Groove, $K_t = 2.4$
0.500 inch gross diameter
0.400 inch net diameter
0.032 inch root radius, r
60° flank angle, ω

No. of Heats/Lots: Not specified

Equivalent Stress Equation:
 $\log N_f = 14.33 - 6.35 \log (S_{eq} - 3.2)$
 $S_{eq} = S_{max} (1 - R)^{0.48}$
Std. Error of Estimate, $\log (\text{Life}) = 0.310$
Standard Deviation, $\log (\text{Life}) = 1.084$
 $R^2 = 92\%$

Surface Condition: As machined

Reference: 3.2.1.1.8(b)

Sample Size = 33

[Caution: The equivalent stress model may provide unrealistic life predictions for stress ratios beyond those represented above.]

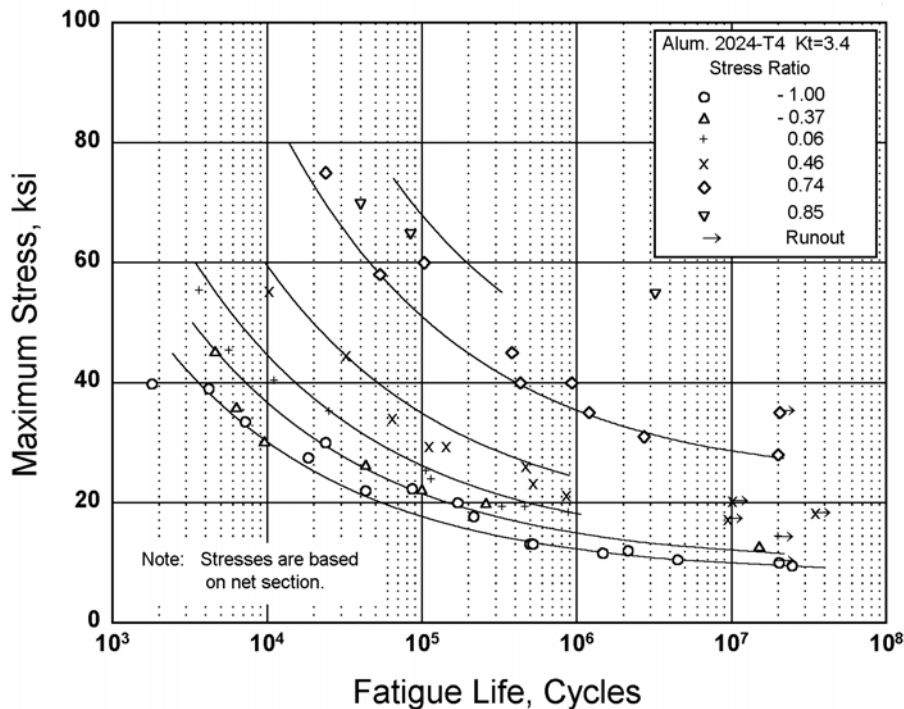

Figure 3.2.3.1.8(d). Best-fit S/N curves for notched, $K_t = 3.4$, 2024-T4 aluminum alloy, various wrought products, longitudinal direction.

Correlative Information for Figure 3.2.3.1.8(d)

Product Form: Rolled bar, 1.125 inch diameter
Extruded bar, 1.25 inch diameter

Properties:

TUS, ksi	TYS, ksi	Temp., °F
74.2	—	RT (rolled)
84.1	—	RT (extruded)

Specimen Details: Circumferential
V-Groove, $K_t = 3.4$
0.450 inch gross diameter
0.400 inch net diameter
0.010 inch root radius, r
60° flank angle, ω

Surface Condition: As machined

References: 3.2.1.1.8(b) and (c)

Test Parameters:

Loading - Axial
Frequency - 1800 to 3600 cpm
Temperature - RT
Environment - Air

No. of Heats/Lots: Not specified

Equivalent Stress Equation:

$\log N_f = 8.18 - 2.76 \log (S_{eq} - 11.6)$
 $S_{eq} = S_{max} (1-R)^{0.52}$
Std. Error of Estimate, $\log (\text{Life}) = 0.292$
Standard Deviation, $\log (\text{Life}) = 1.011$
 $R^2 = 92\%$

Sample Size = 51

[Caution: The equivalent stress model may provide unrealistic life predictions for stress ratios beyond those represented above.]

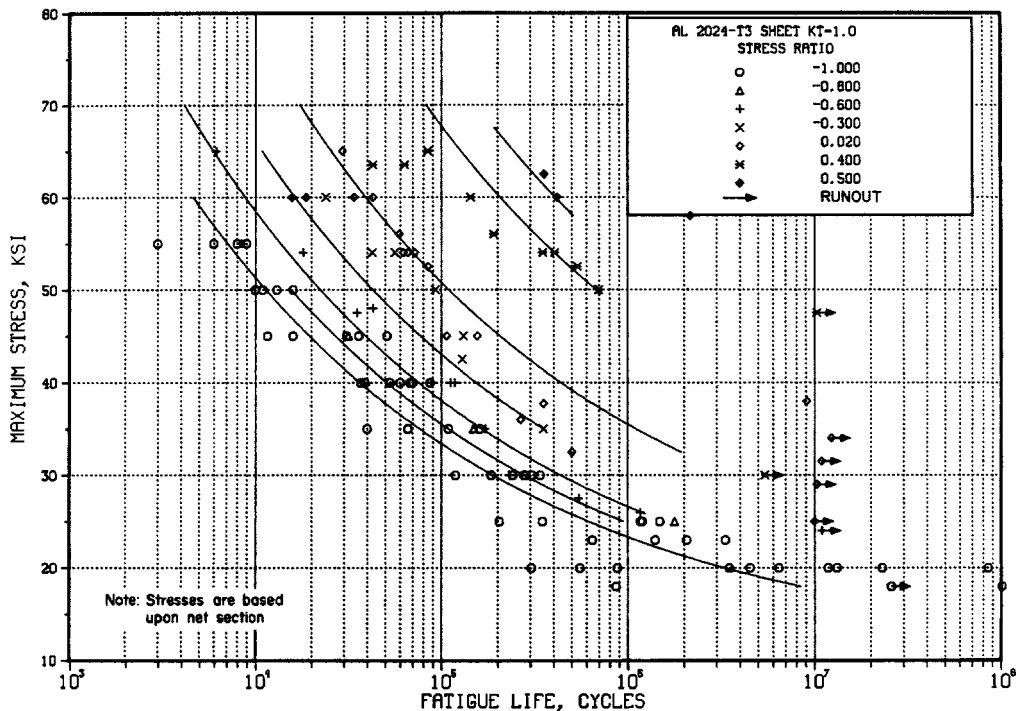

Figure 3.2.3.1.8(e). Best-fit S/N curves for unnotched, 2024-T3 aluminum alloy sheet, longitudinal direction.

Correlative Information for Figure 3.2.3.1.8(e)

Product Form: Bare sheet, 0.090 inch

Properties: $\frac{TUS, \text{ksi}}{72 - 73}$ $\frac{TYS, \text{ksi}}{52 - 54}$ $\frac{\text{Temp., } ^\circ\text{F}}{\text{RT}}$

Specimen Details: Unnotched
0.8 to 1.0 inch width

Surface Condition: Electropolished

References: 3.2.3.1.8(a) and (f)

Test Parameters:
Loading - Axial
Frequency - 1100 to 1800 cpm

No. of Heats/Lots: Not specified

Equivalent Stress Equation:
 $\log N_f = 11.1 - 3.97 \log (S_{eq} - 15.8)$
 $S_{eq} = S_{max} (1-R)^{0.56}$
 Std. Error of Estimate, $\log (\text{Life}) = 0.38$
 Standard Deviation, $\log (\text{Life}) = 0.90$
 $R^2 = 82\%$

Sample Size = 107

[Caution: The equivalent stress model may provide unrealistic life predictions for stress ratios beyond those represented above.]

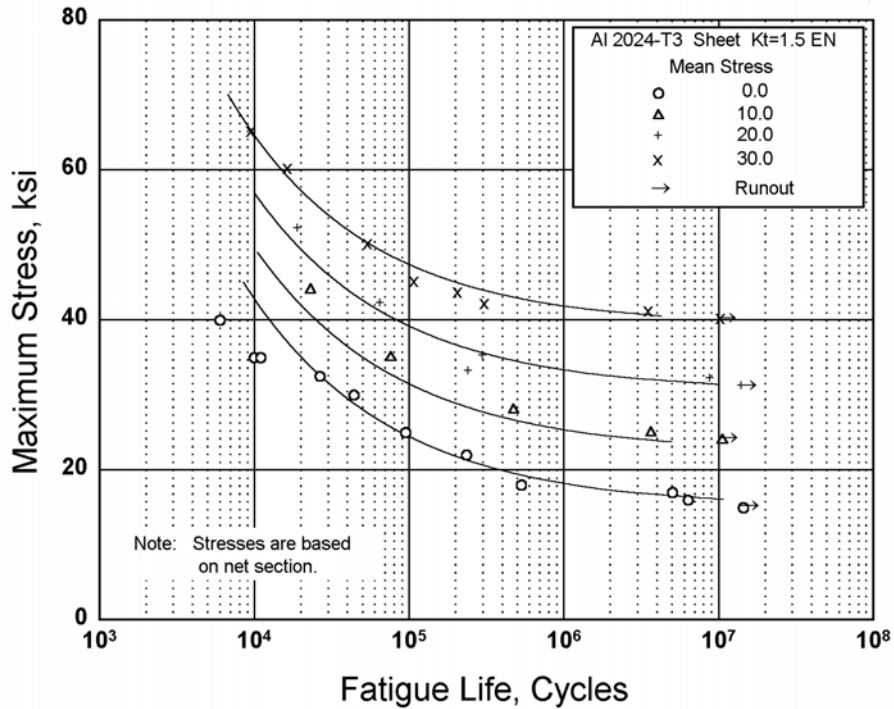

Figure 3.2.3.1.8(f). Best-fit S/N curves for notched, $K_t = 1.5$, 2024-T3 aluminum alloy sheet, longitudinal direction.

Correlative Information for Figure 3.2.3.1.8(f)

Product Form: Bare sheet, 0.090 inch

<u>Properties:</u>	<u>TUS, ksi</u>	<u>TYS, ksi</u>	<u>Temp., °F</u>
	73	54	RT
			(unnotched)
	76	—	RT
			(notched $K_t = 1.5$)

Test Parameters:
Loading - Axial
Frequency - 1100 to 1500 cpm
Temperature - RT
Environment - Air

No. of Heats/Lots: Not specified

Specimen Details: Edge notched, $K_t = 1.5$
3.00 inches gross width
1.500 inches net width
0.760 inch notch radius
0° flank angle

Equivalent Stress Equation:
 $\log N_f = 7.5 - 2.13 \log (S_{eq} - 23.7)$
 $S_{eq} = S_{max} (1-R)^{0.66}$
Std. Error of Estimate, $\log (\text{Life}) = 0.30$
Standard Deviation, $\log (\text{Life}) = 0.95$
 $R^2 = 90\%$

Surface Condition: Electropolished

Sample Size = 26

Reference: 3.2.3.1.8(d)

[Caution: The equivalent stress model may provide unrealistic life predictions for stress ratios beyond those represented above.]

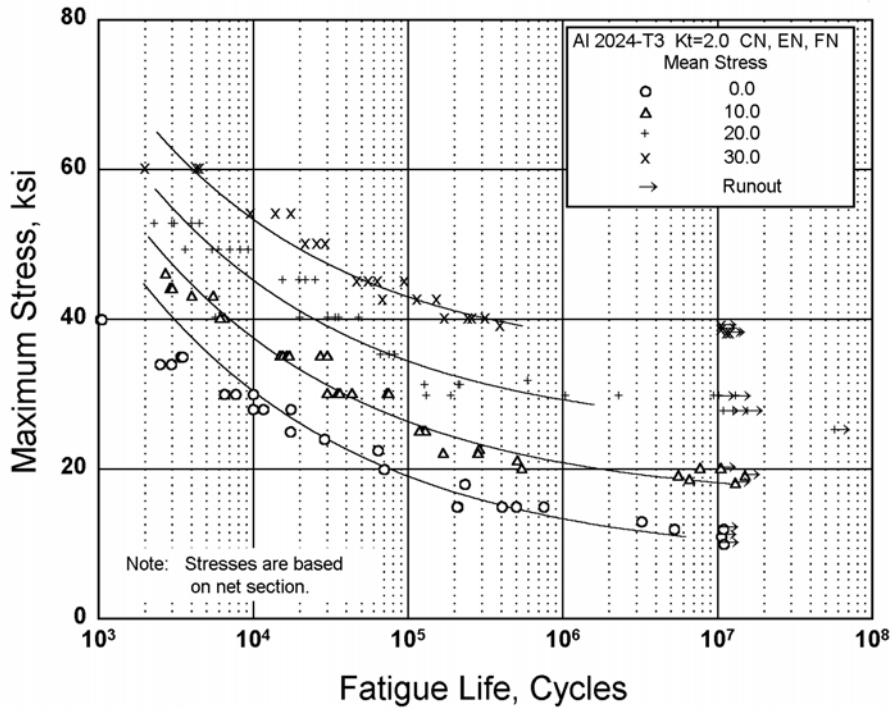

Figure 3.2.3.1.8(g). Best-fit S/N curves for notched, $K_t = 2.0$, 2024-T3 aluminum alloy sheet, longitudinal direction.

Correlative Information for Figure 3.2.3.1.8(g)

Product Form: Bare sheet, 0.090 inch

Properties:

TUS, ksi	TYS, ksi	Temp., °F
73	54	RT
		(unnotched)
73	—	RT
		(notched $K_t = 2.0$)

Test Parameters:
Loading - Axial
Frequency - 1100 to 1800 cpm
Temperature - RT
Environment - Air

No. of Heats/Lots: Not specified

Specimen Details: Notched, $K_t = 2.0$

Notch Type	Gross Width	Net Width	Notch Radius
Center	4.50	1.50	1.50
Edge	2.25	1.50	0.3175
Fillet	2.25	1.50	0.1736

Equivalent Stress Equation:
 $\log N_f = 9.2 - 3.33 \log (S_{eq} - 12.3)$
 $S_{eq} = S_{max} (1-R)^{0.68}$
Std. Error of Estimate, $\log (\text{Life}) = 0.27$
Standard Deviation, $\log (\text{Life}) = 0.89$
 $R^2 = 91\%$

Sample Size = 113

Surface Condition: Electropolished, machined and burrs removed with fine crocus cloth

[Caution: The equivalent stress model may provide unrealistic life predictions for stress ratios beyond those represented above.]

References: 3.2.3.1.8(b) and (f)

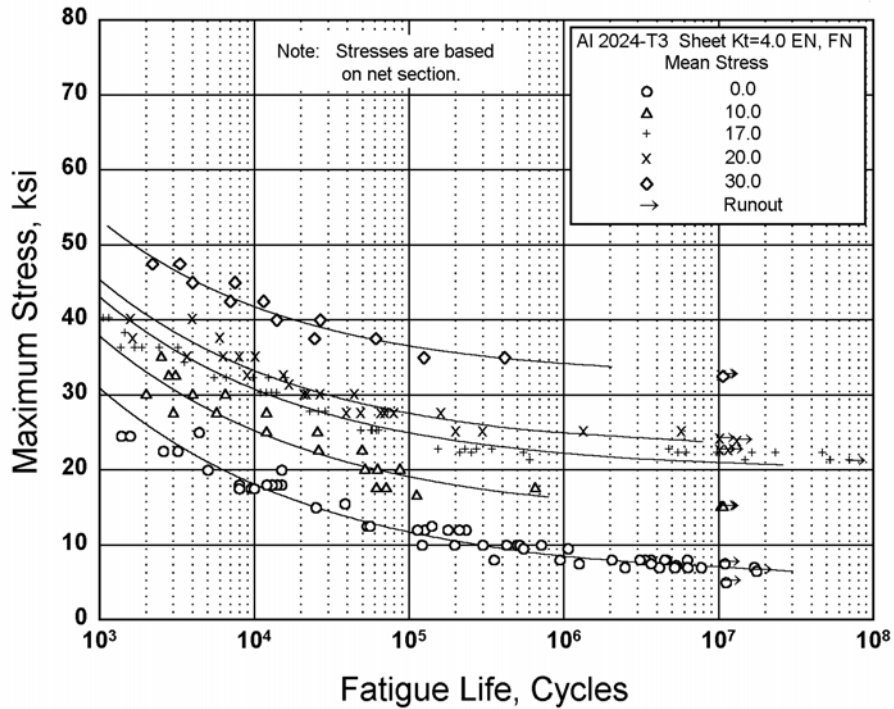

Figure 3.2.3.1.8(h). Best-fit S/N curves for notched, $K_t = 4.0$ of 2024-T3 aluminum alloy sheet, longitudinal direction.

Correlative Information for Figure 3.2.3.1.8(h)

Product Form: Bare sheet, 0.090-inch

Properties:

TUS, ksi	TYS, ksi	Temp., °F
73	54	RT (unnotched)
67	—	RT (notched $K_t = 2.0$)

Test Parameters:
 Loading - Axial
 Frequency - 1100 to 1800 cpm
 Temperature - RT
 Environment - Air

No. of Heats/Lots: Not specified

Specimen Details: Notched, $K_t = 2.0$

Notch Type	Gross Width	Net Width	Notch Radius
Center	2.25	1.50	0.057
Edge	4.10	1.50	0.070
Fillet	2.25	1.50	0.0195

Equivalent Stress Equation:
 $\log N_f = 8.3 - 3.30 \log (S_{eq} - 8.5)$
 $S_{eq} = S_{max} (1-R)^{0.66}$
 Std. Error of Estimate, $\log (\text{Life}) = 0.39$
 Standard Deviation, $\log (\text{Life}) = 1.24$
 $R^2 = 90\%$

Sample Size = 126

Surface Condition: Electropolished, machined, and burrs removed with fine crocus cloth

[Caution: The equivalent stress model may provide unrealistic life predictions for stress ratios beyond those represented above.]

References: 3.2.3.1.8(b), (e), (f), (g), and (h)

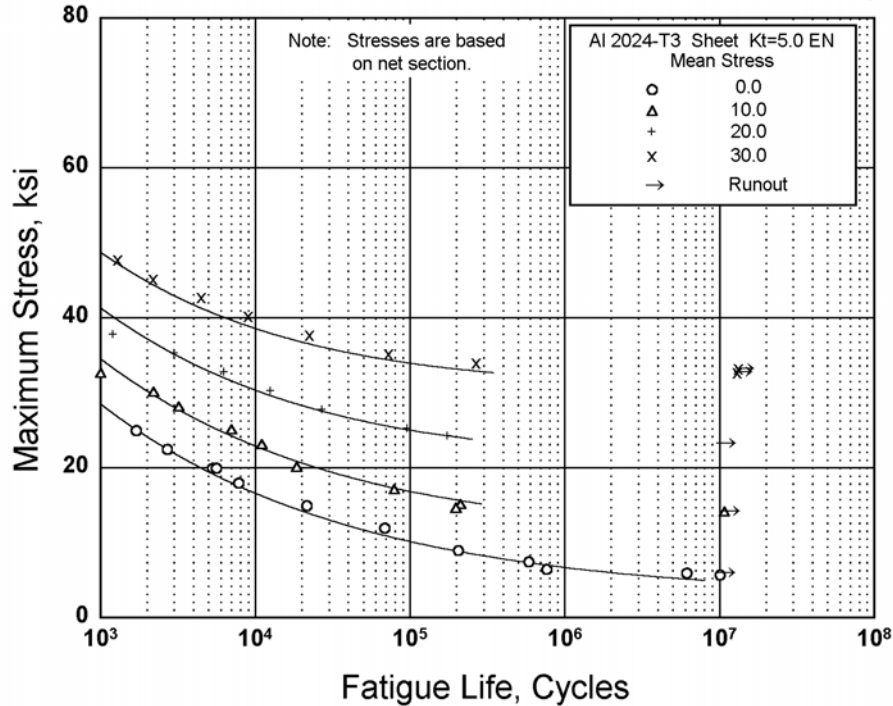

Figure 3.2.3.1.8(i). Best-fit S/N curves for notched, $K_t = 5.0$, 2024-T3 aluminum alloy sheet, longitudinal direction.

Correlative Information for Figure 3.2.3.1.8(i)

Product Form: Bare sheet, 0.090 inch

Test Parameters:

Properties:

TUS, ksi	TYS, ksi	Temp., °F
73	54	RT (unnotched)
62	—	RT (notched $K_t = 5.0$)

Loading - Axial
Frequency - 1100 to 1800 cpm
Temperature - RT
Environment - Air

No. of Heats/Lots: Not specified

Specimen Details: Edge notched, $K_t = 5.0$
2.25 inch gross width
1.500 inch net width
0.03125 inch notch radius
0° flank angle

Equivalent Stress Equation:
 $\log N_f = 8.9 - 3.73 \log (S_{eq} - 3.9)$
 $S_{eq} = S_{max} (1 - R)^{0.56}$
Std. Error of Estimate, $\log (\text{Life}) = 0.39$
Standard Deviation, $\log (\text{Life}) = 1.24$
 $R^2 = 90\%$

Surface Condition: Electropolished

Sample Size = 35

Reference: 3.2.3.1.8(c)

[Caution: The equivalent stress model may provide unrealistic life predictions for stress ratios beyond those represented above.]

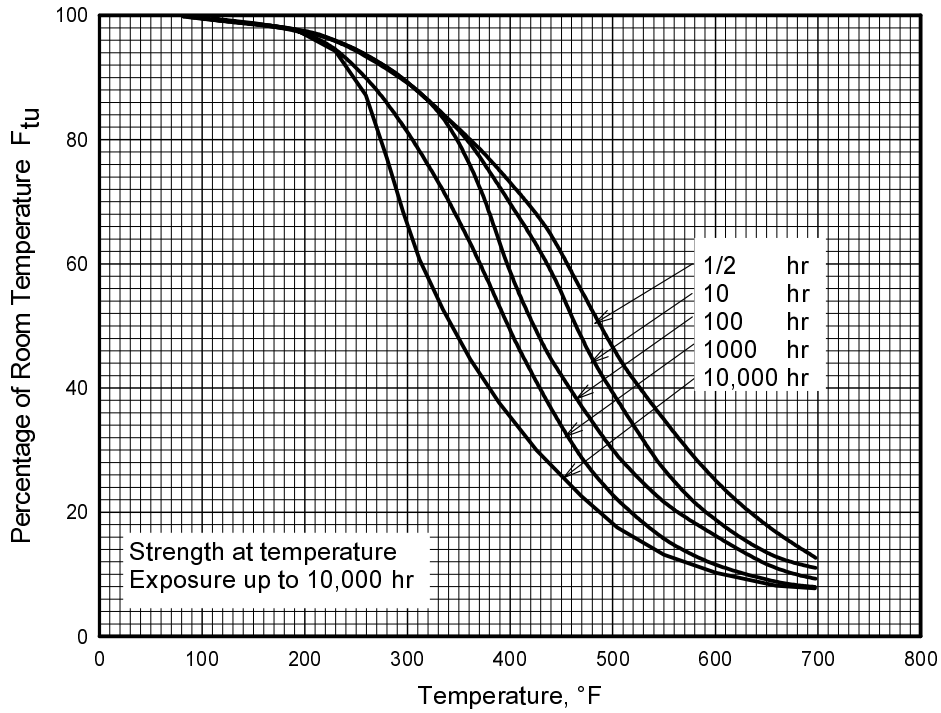

Figure 3.2.3.3.1(a). Effect of temperature on the tensile ultimate strength (F_{tu}) of 2024-T62 aluminum alloy (all products).

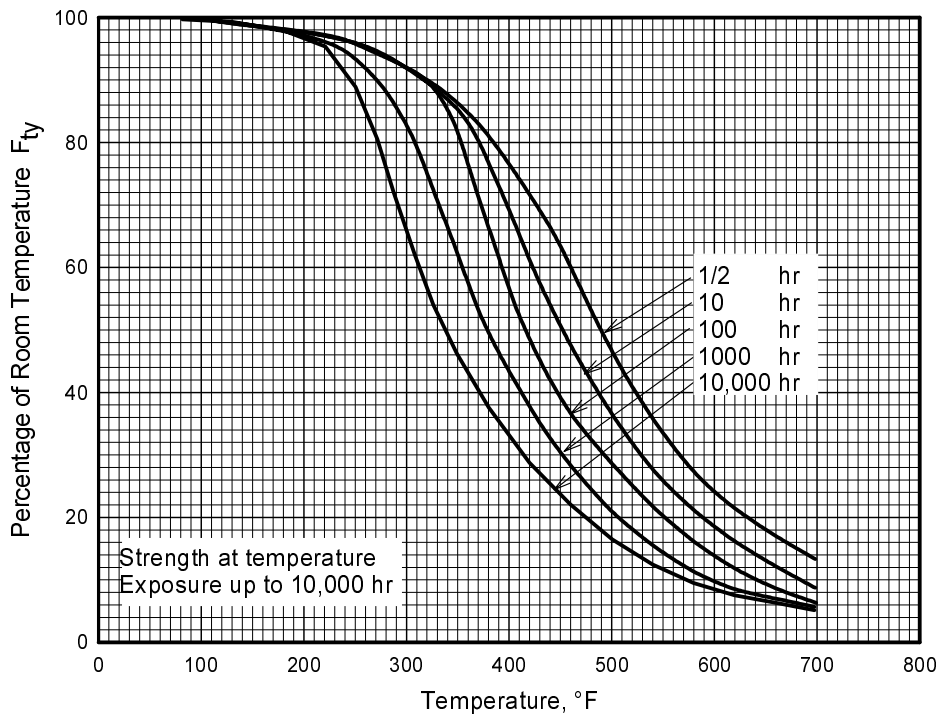

Figure 3.2.3.3.1(b). Effect of temperature on the tensile yield strength (F_{ty}) of 2024-T62 aluminum alloy (all products).

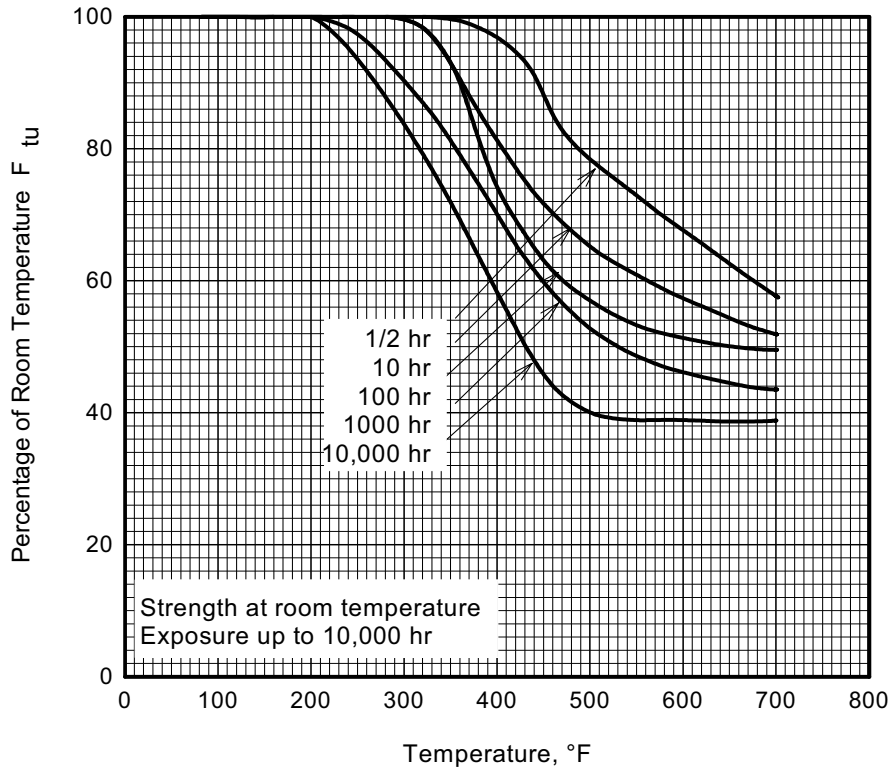

Figure 3.2.3.3.1(c). Effect of exposure at elevated temperatures on the room-temperature tensile ultimate strength (F_{tu}) of 2024-T62 aluminum alloy (all products).

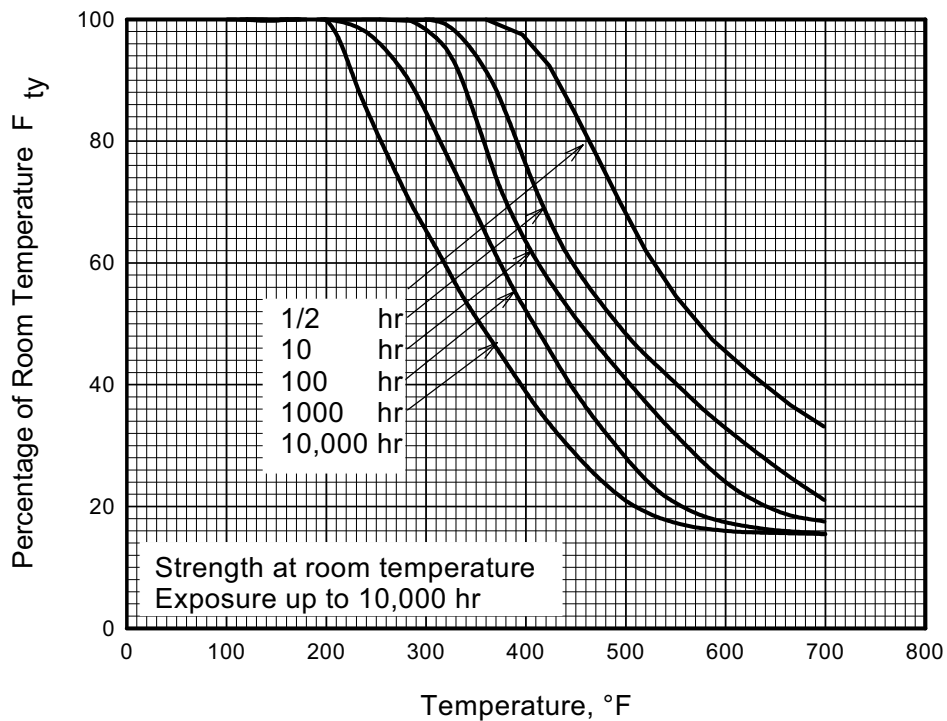

Figure 3.2.3.3.1(d). Effect of exposure at elevated temperatures on the room-temperature tensile yield strength (F_{ty}) of 2024-T62 aluminum alloy (all products).

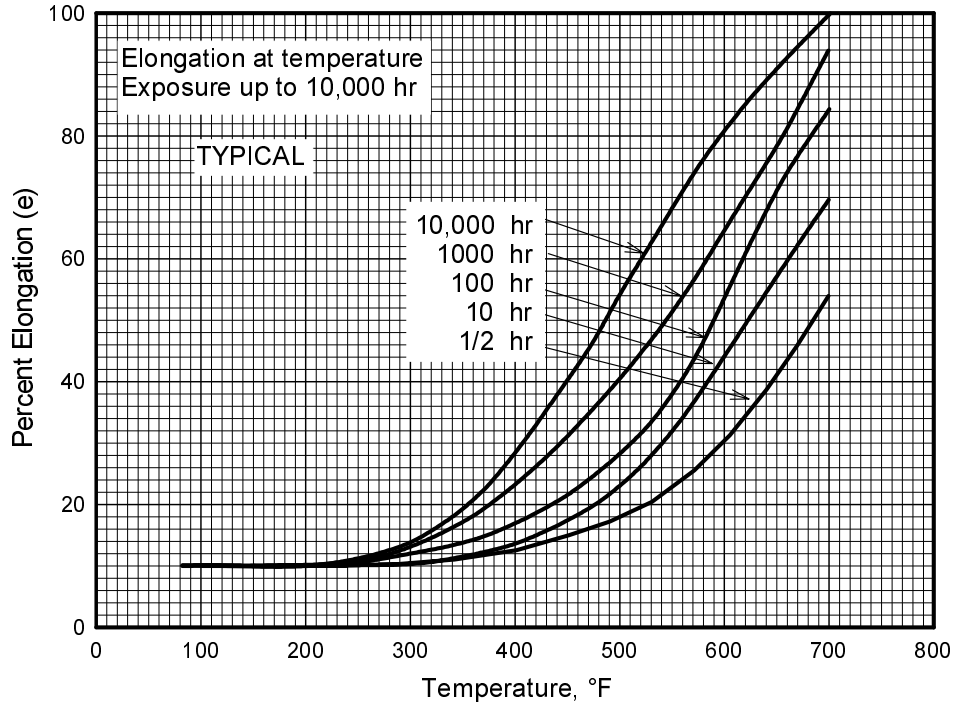

Figure 3.2.3.3.5(a). Effect of temperature on the elongation of 2024-T62 aluminum alloy (all products).

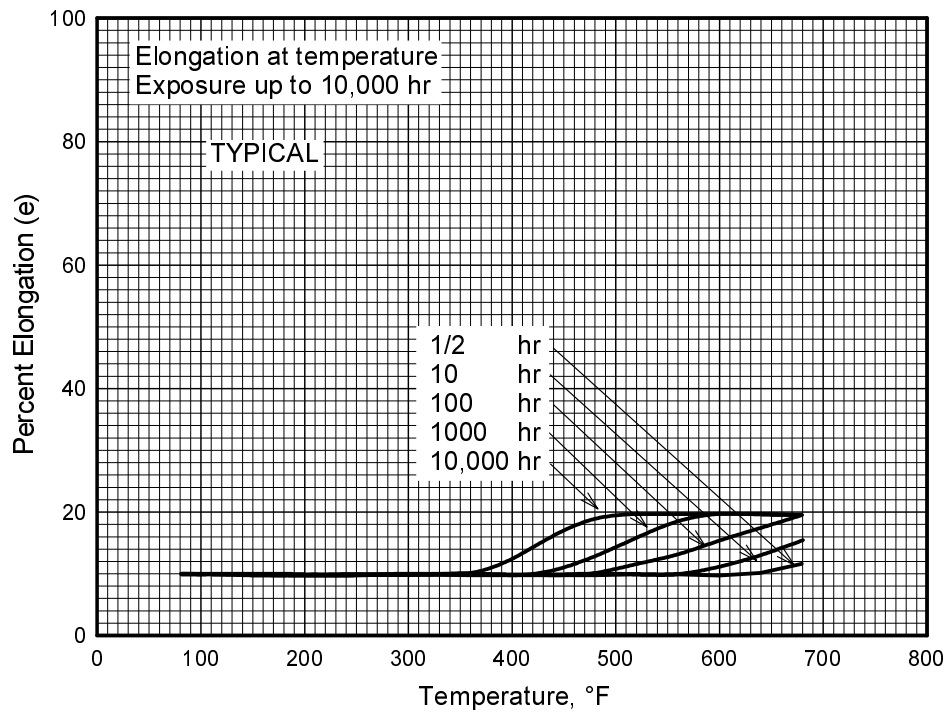

Figure 3.2.3.3.5(b). Effect of exposure at elevated temperatures on the elongation of 2024-T62 aluminum alloy (all products).

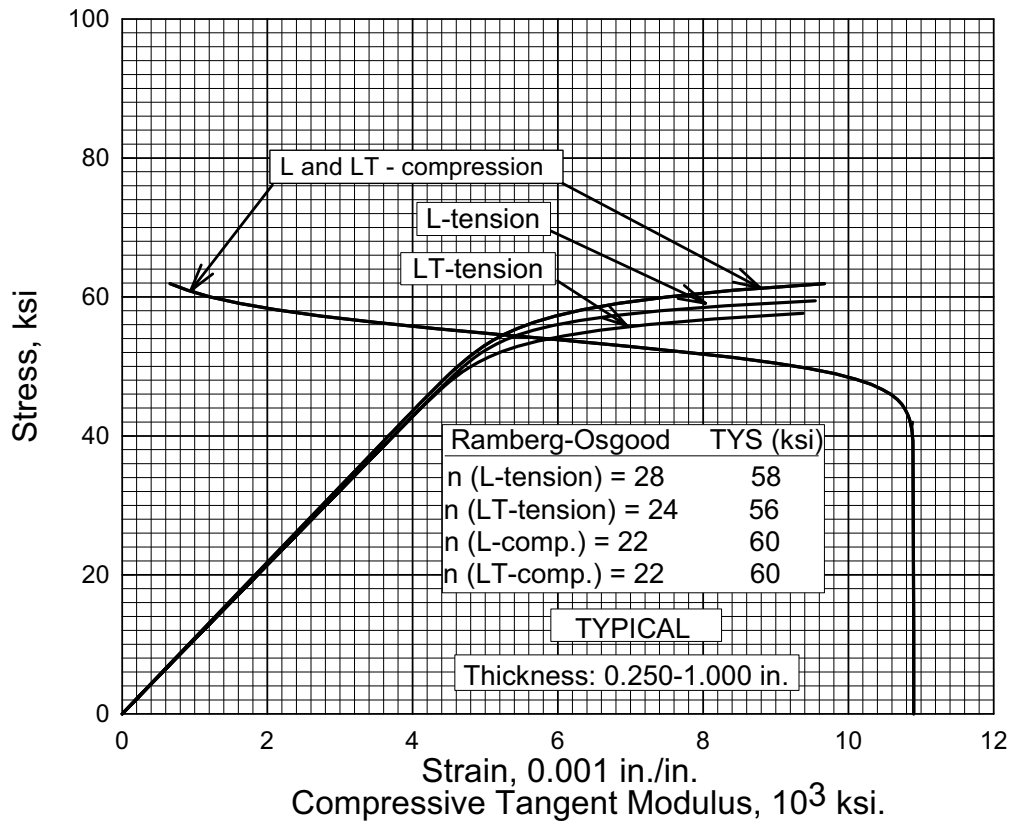

Figure 3.2.3.3.6(a). Typical tensile and compressive stress-strain and compressive tangent-modulus curves for 2024-T62 aluminum alloy plate at room temperature.

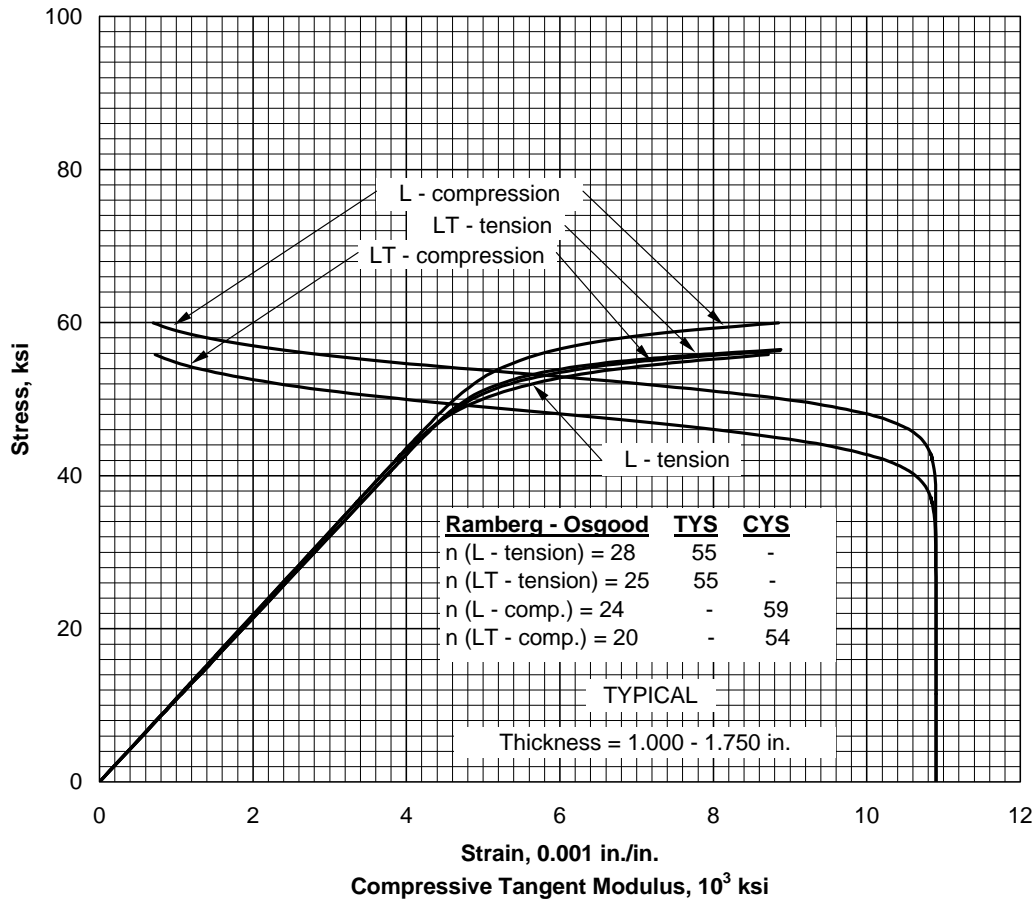

Figure 3.2.3.3.6(b) Typical tension and compression stress-strain and compression tangent modulus curves for 2024-T62 aluminum alloy plate at room temperature. Note, the data to generate these curves may have been from clad product, however, they are shown here without secondary modulus since it could not be positively confirmed the product was clad.

MIL-HDBK-5J
31 January 2003

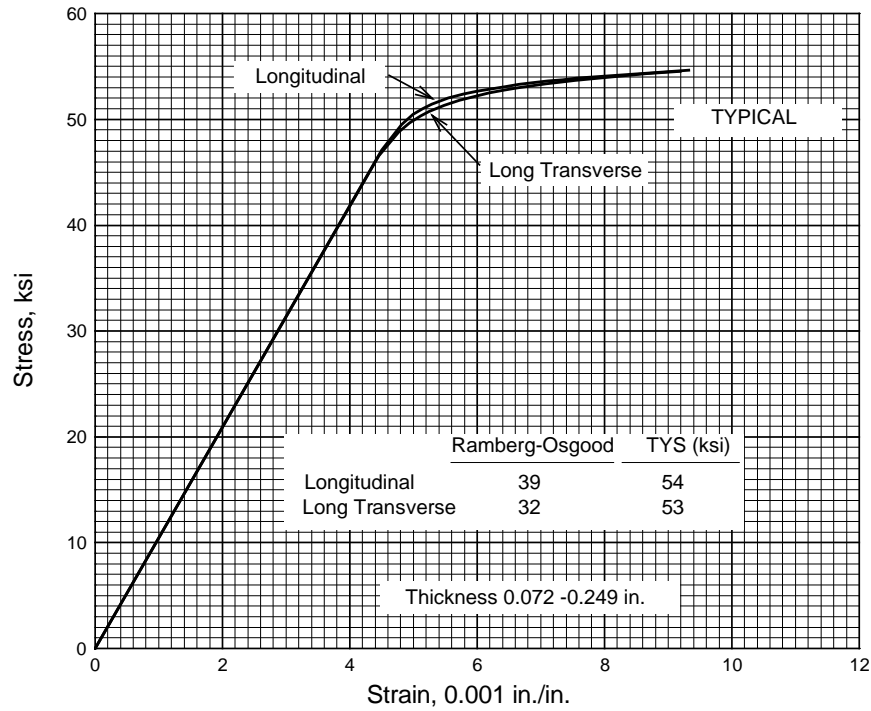

Figure 3.2.3.3.6(c). Typical tensile stress-strain curves for clad 2024-T62 aluminum alloy sheet at room temperature.

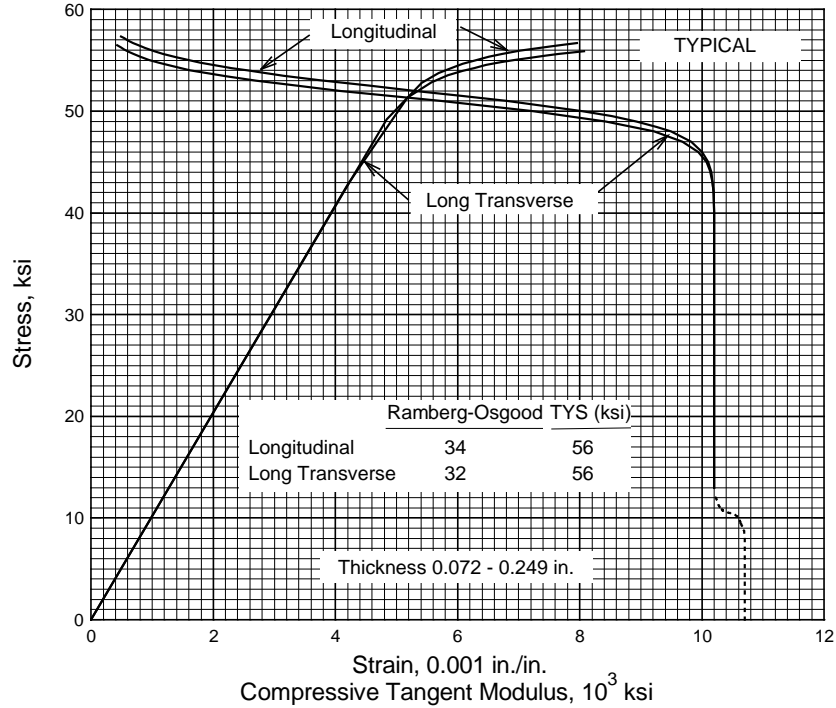

Figure 3.2.3.3.6(d). Typical compressive stress-strain and compressive tangent-modulus curves for clad 2024-T62 aluminum alloy sheet at room temperature.

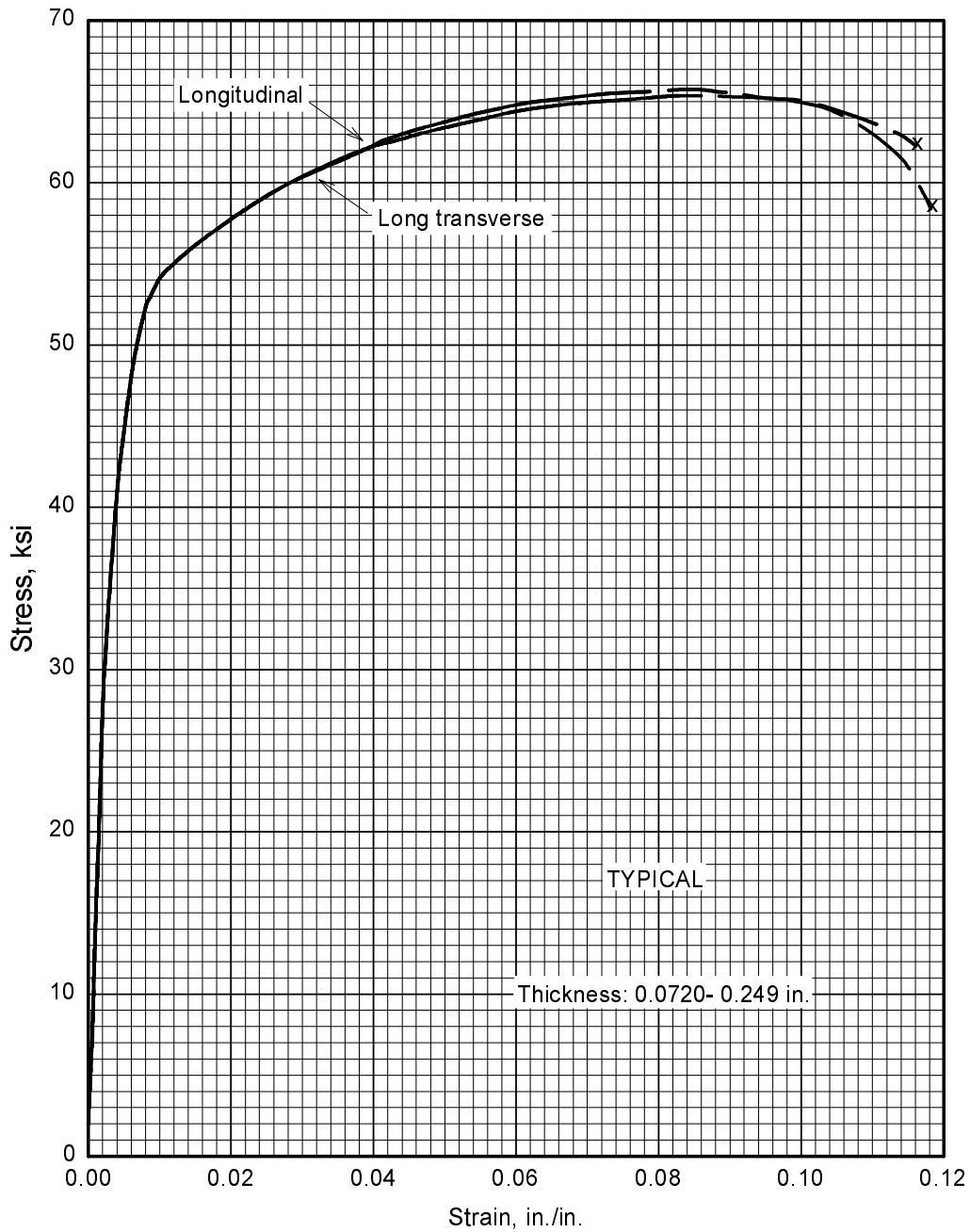

Figure 3.2.3.3.6(e). Typical stress-strain curves (full range) for clad 2024-T62 aluminum alloy sheet at room temperature.

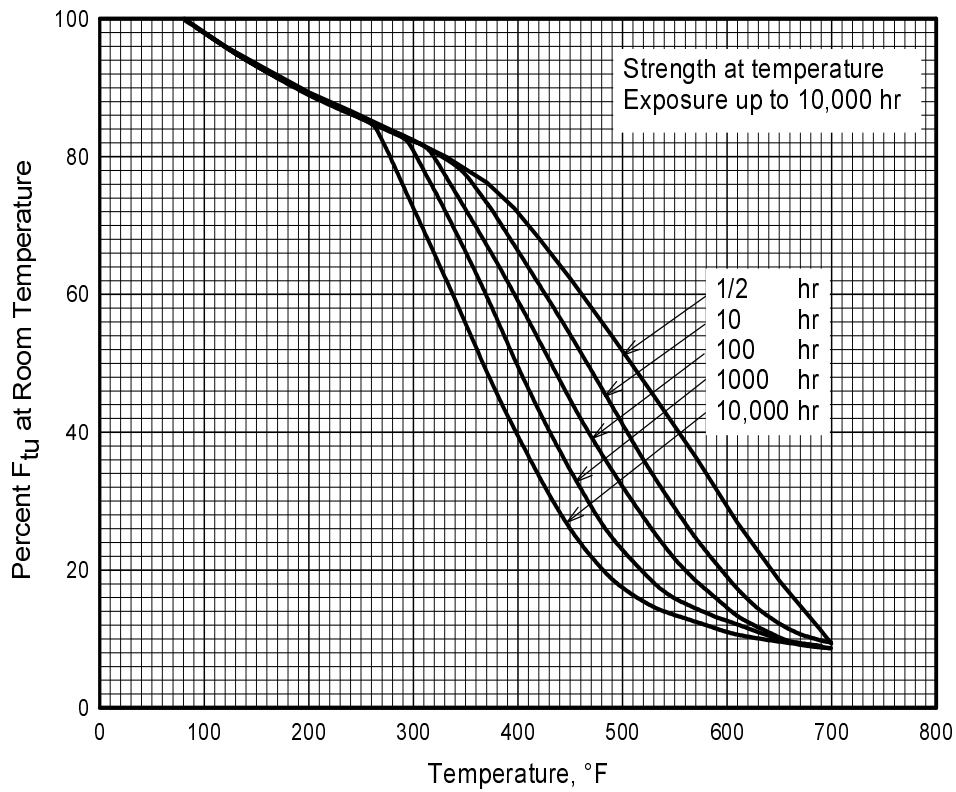

Figure 3.2.3.4.1(a). Effect of temperature on the tensile ultimate strength (F_{tu}) of 2024-T81, T851, T8510, and T8511 aluminum alloy (all products).

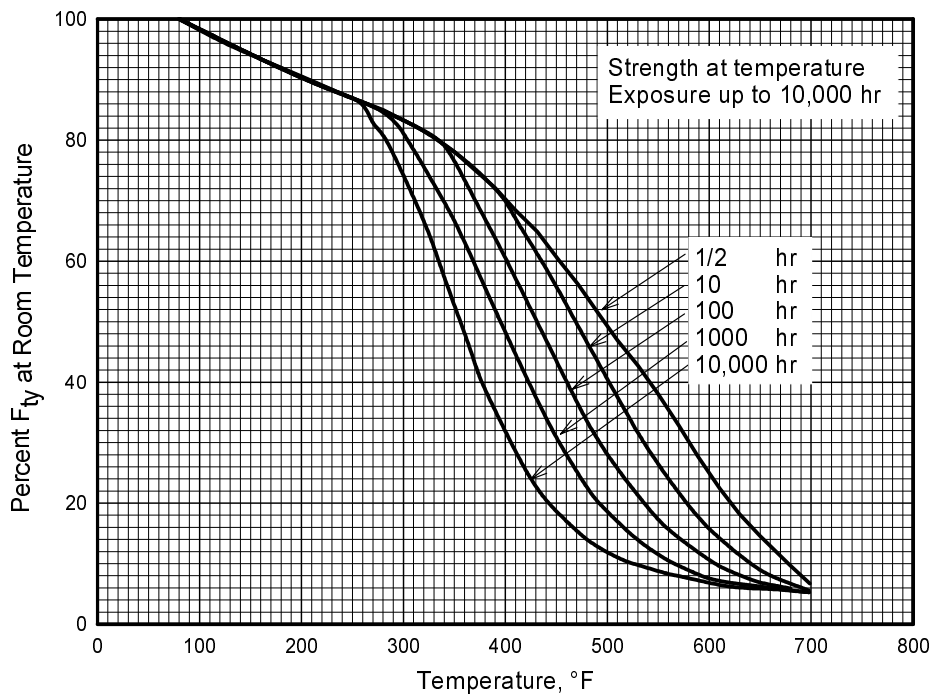

Figure 3.2.3.4.1(b). Effect of temperature on the tensile yield strength (F_{ty}) of 2024-T81, T851, T8510, and T8511 aluminum alloy (all products).

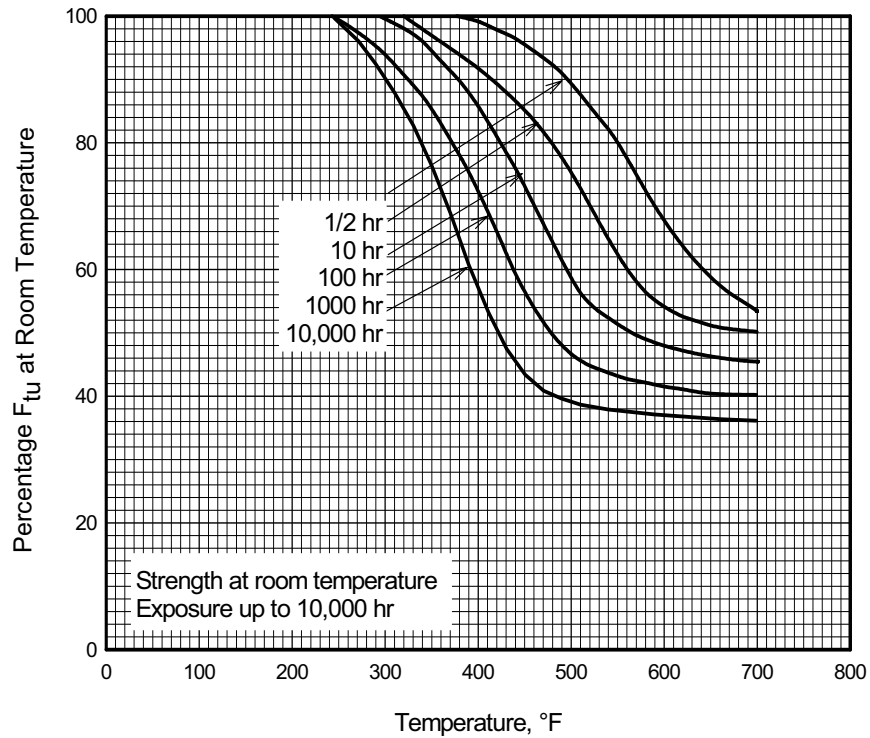

Figure 3.2.3.4.1(c). Effect of exposure at elevated temperatures on room-temperature tensile ultimate strength (F_{tu}) of 2024-T81 aluminum alloy sheet.

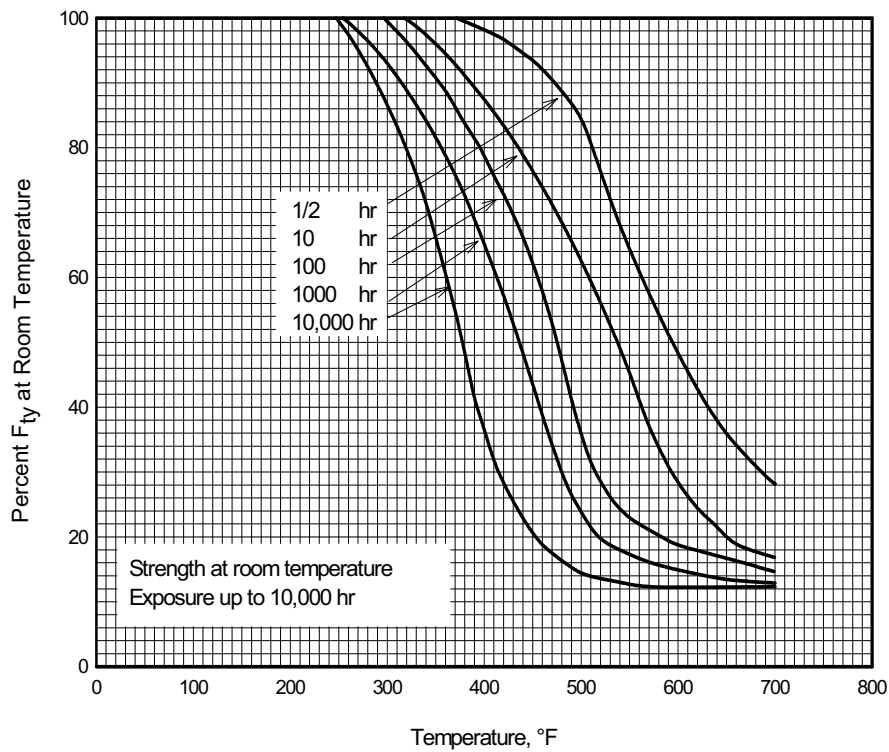

Figure 3.2.3.4.1(d). Effect of exposure at elevated temperatures on the room-temperature tensile yield strength (F_{ty}) of 2024-T81 aluminum alloy sheet.

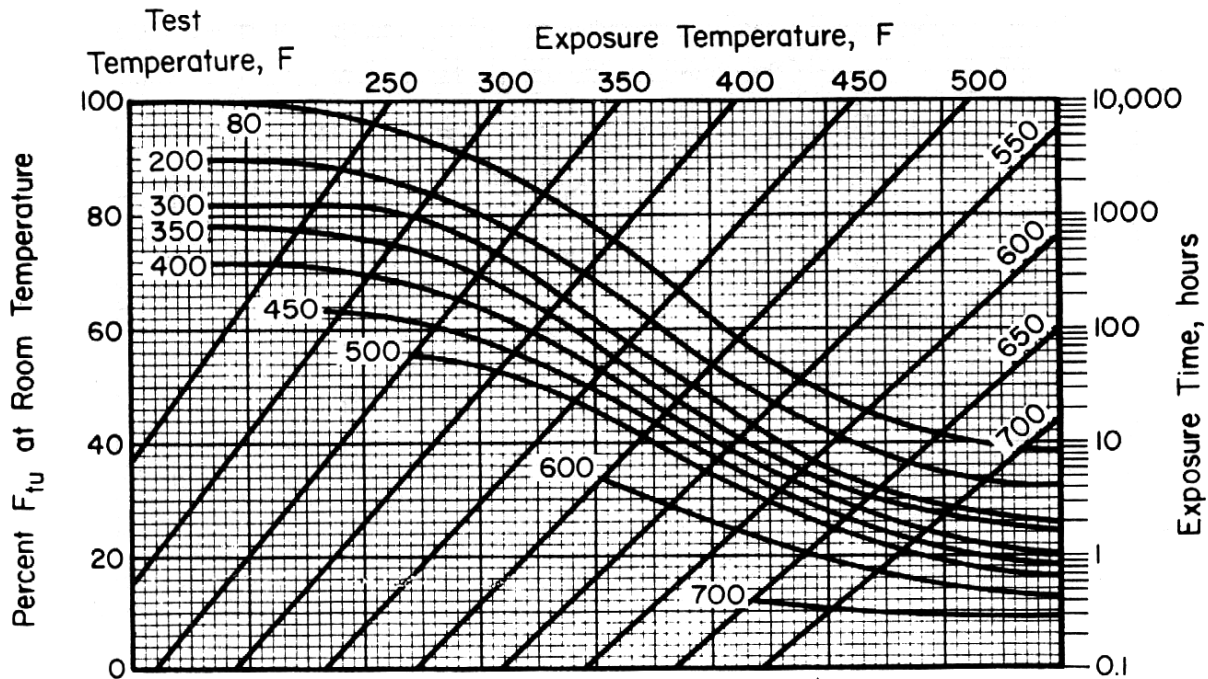

Figure 3.2.3.4.1(e). Effect of temperature on the tensile ultimate strength (F_{tu}) of 2024-T81 aluminum alloy clad sheet. Note: Instructions for use of these curves are presented in Section 3.7.4.1.

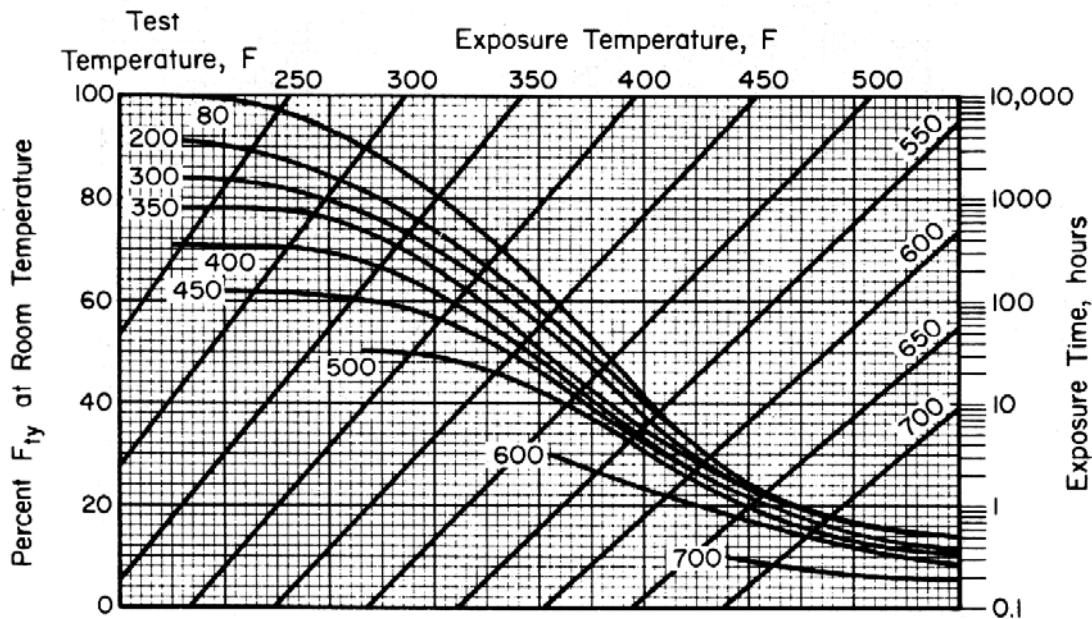

Figure 3.2.3.4.1(f). Effect of temperature on the tensile yield strength (F_{ty}) of 2024-T81 aluminum alloy clad sheet. Note: Instructions for use of these curves are presented in Section 3.7.4.1.

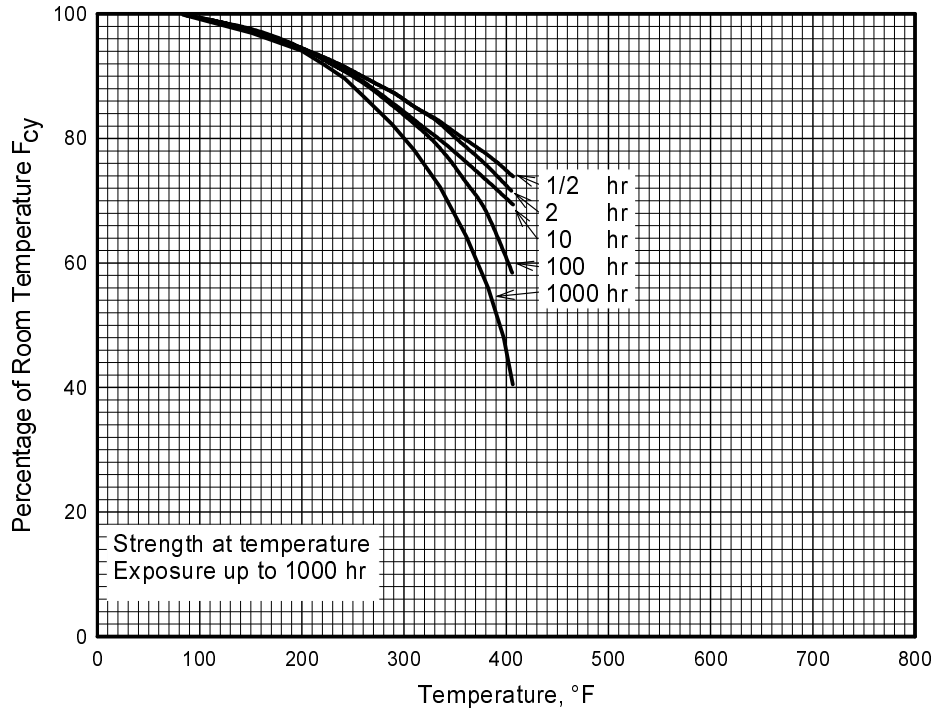

Figure 3.2.3.4.2(a). Effect of temperature on the compressive yield strength (F_{cy}) of 2024-T81, T851, T8510, and T8511 aluminum alloy (all products).

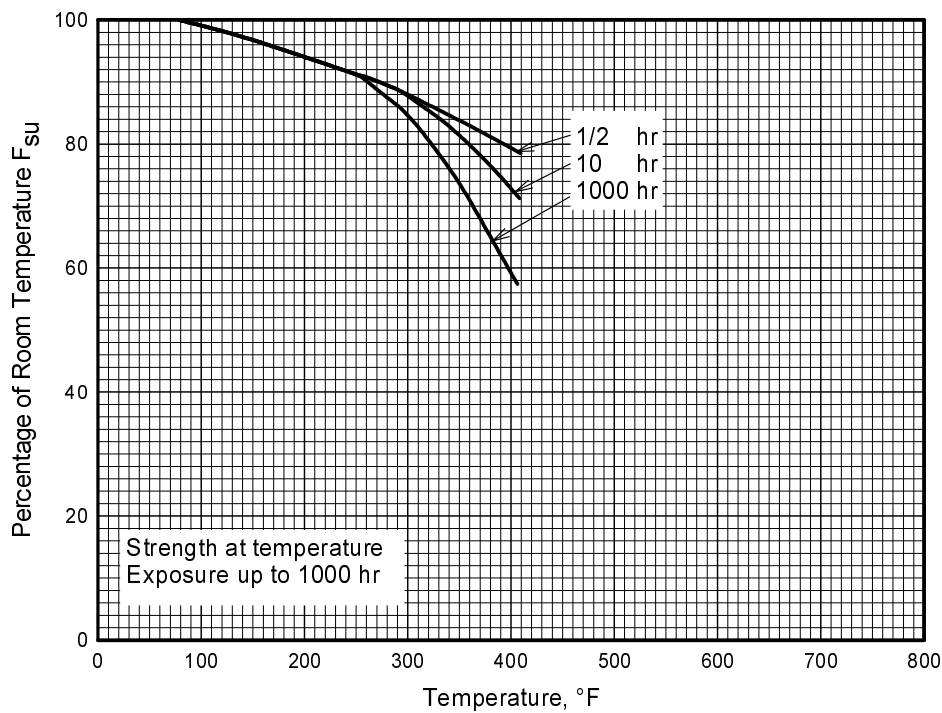

Figure 3.2.3.4.2(b). Effect of temperature on the shear ultimate strength (F_{su}) of 2024-T81, T851, T8510, and T8511 aluminum alloy (all products).

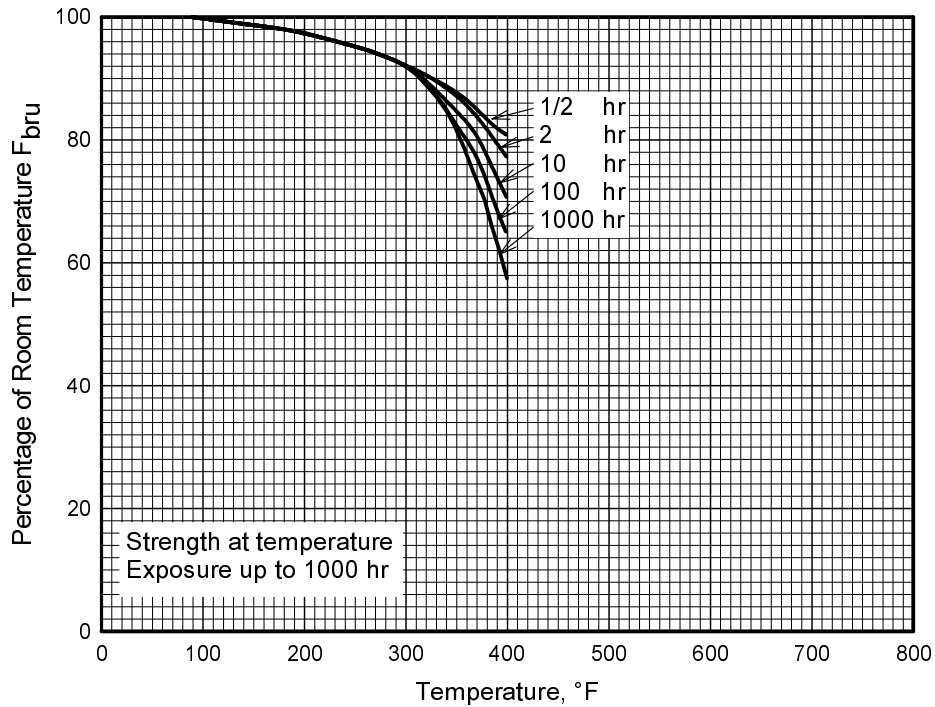

Figure 3.2.3.4.3(a). Effect of temperature on the bearing ultimate strength (F_{bru}) of 2024-T81, T851, T8510, and T8511 aluminum alloy (all products).

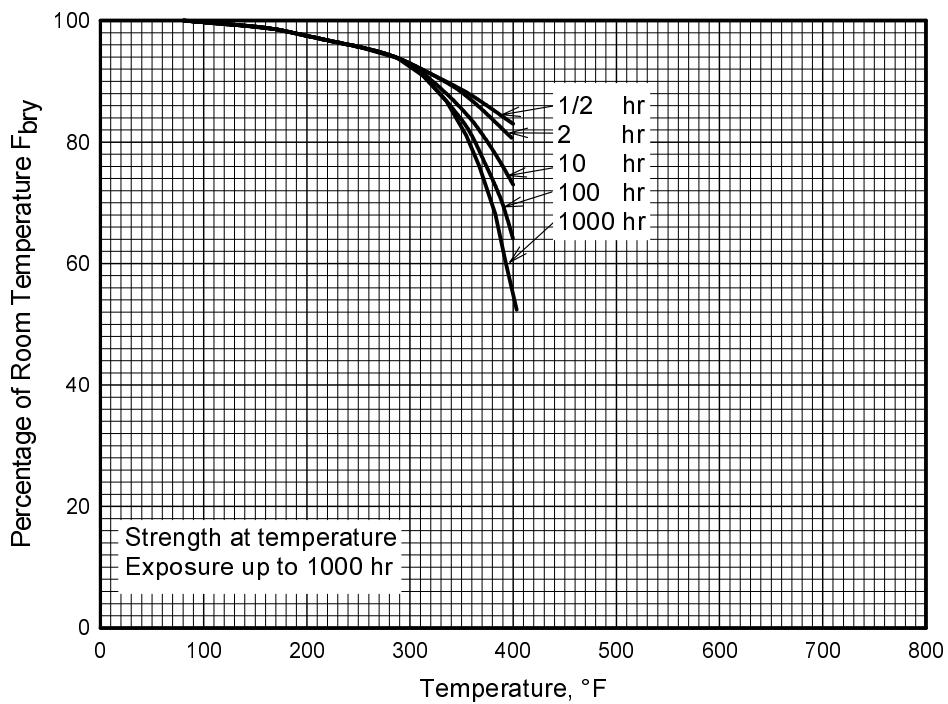

Figure 3.2.3.4.3(b). Effect of temperature on the bearing yield strength (F_{bry}) of 2024-T81, T851, T8510, and T8511 aluminum alloy (all products).

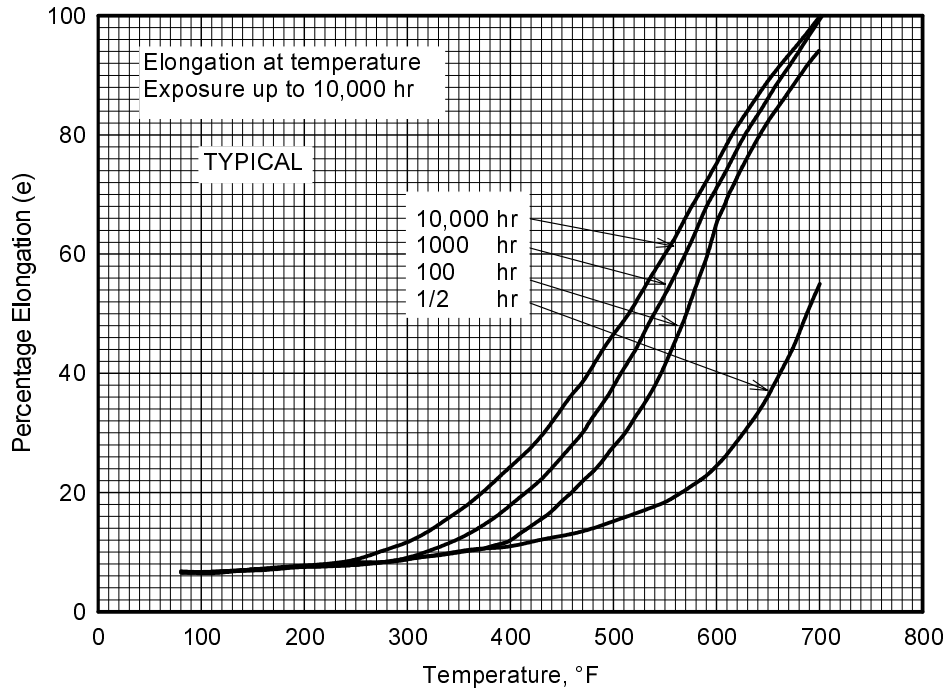

Figure 3.2.3.4.5(a). Effect of temperature on the elongation of 2024-T81, T851, T8510, and T8511 aluminum alloy (all products).

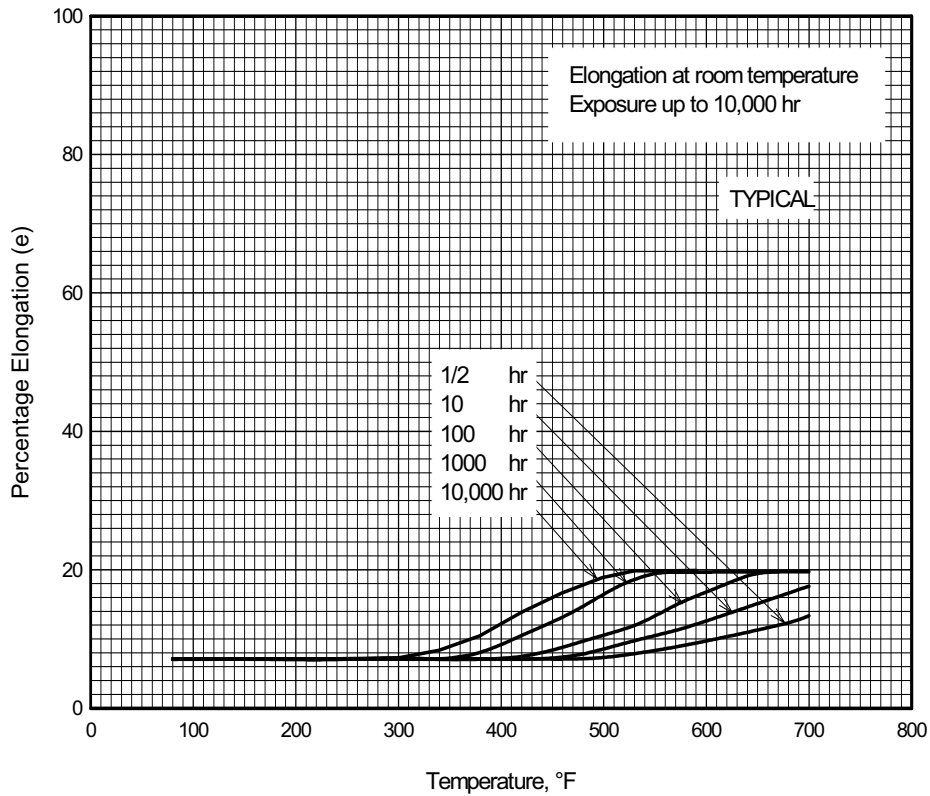

Figure 3.2.3.4.5(b). Effect of exposure at elevated temperatures on the room temperature elongation of 2024-T81, T851, T8510, and T8511 aluminum alloy (all products).

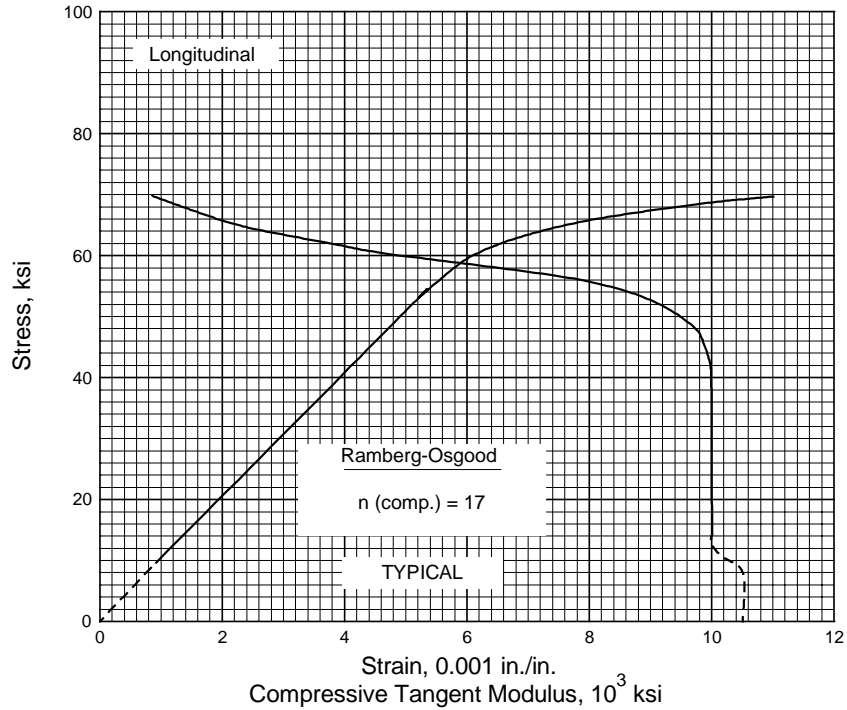

Figure 3.2.3.4.6(a). Typical compressive stress-strain and compressive tangent-modulus curves for clad 2024-T81 aluminum alloy sheet at room temperature.

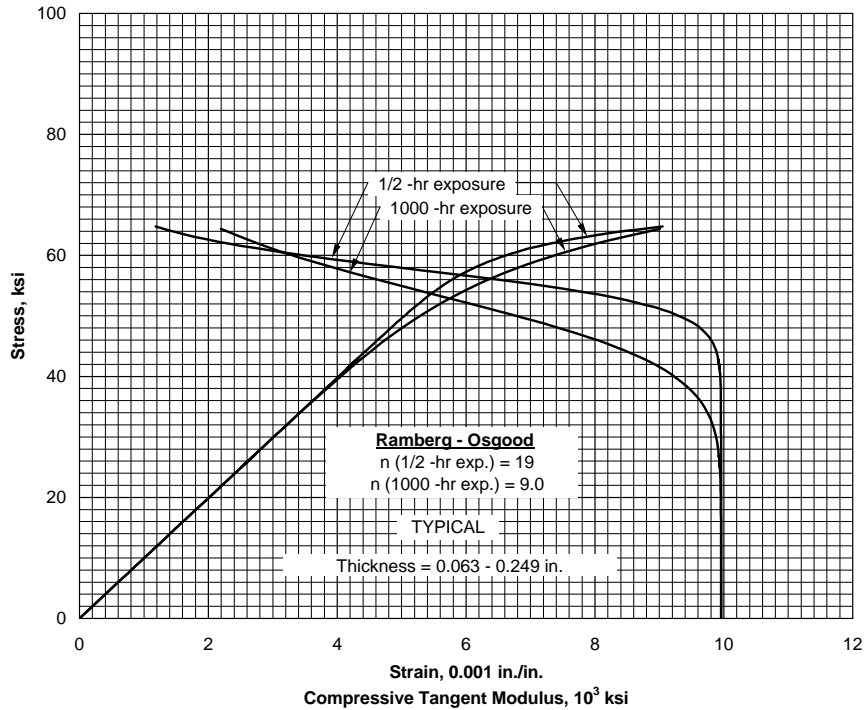

Figure 3.2.3.4.6(b). Typical compressive stress-strain and compressive tangent-modulus curves for clad 2024-T81 aluminum alloy sheet at 200°F.

MIL-HDBK-5J
31 January 2003

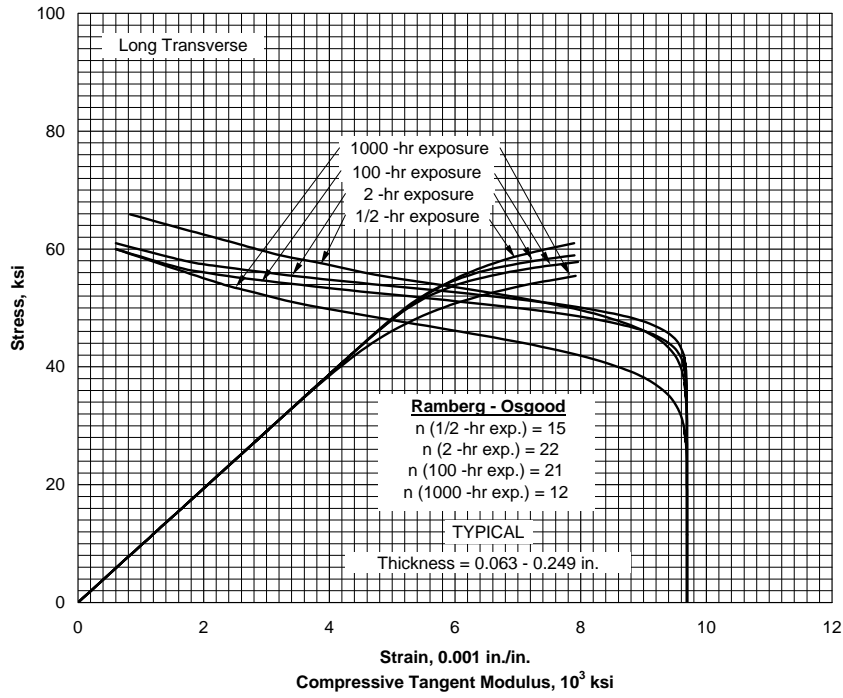

Figure 3.2.3.4.6(c). Typical compressive stress-strain and compressive tangent-modulus curves for clad 2024-T81 aluminum alloy sheet at 300°F.

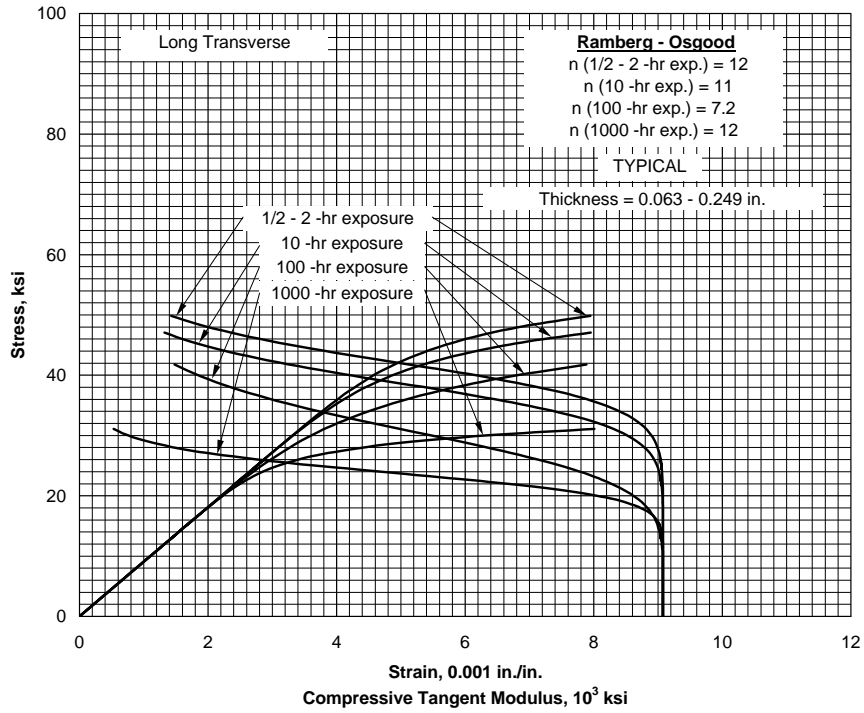

Figure 3.2.3.4.6(d). Typical compressive stress-strain and compressive tangent-modulus curves for clad 2024-T81 aluminum alloy sheet at 400°F.

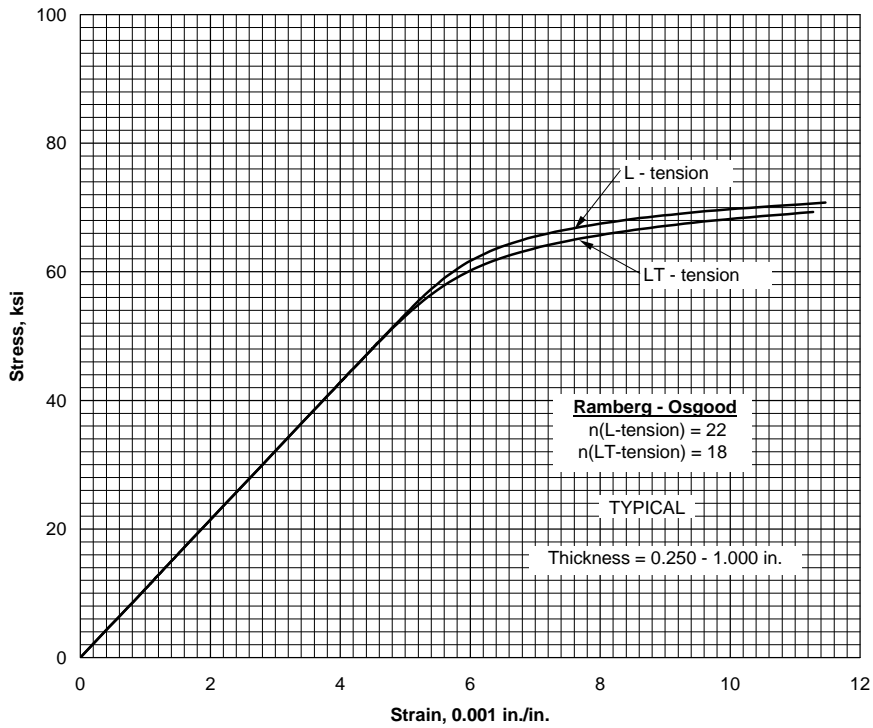

Figure 3.2.3.4.6(e). Typical tensile stress-strain curves for 2024-T851 aluminum alloy plate at room temperature.

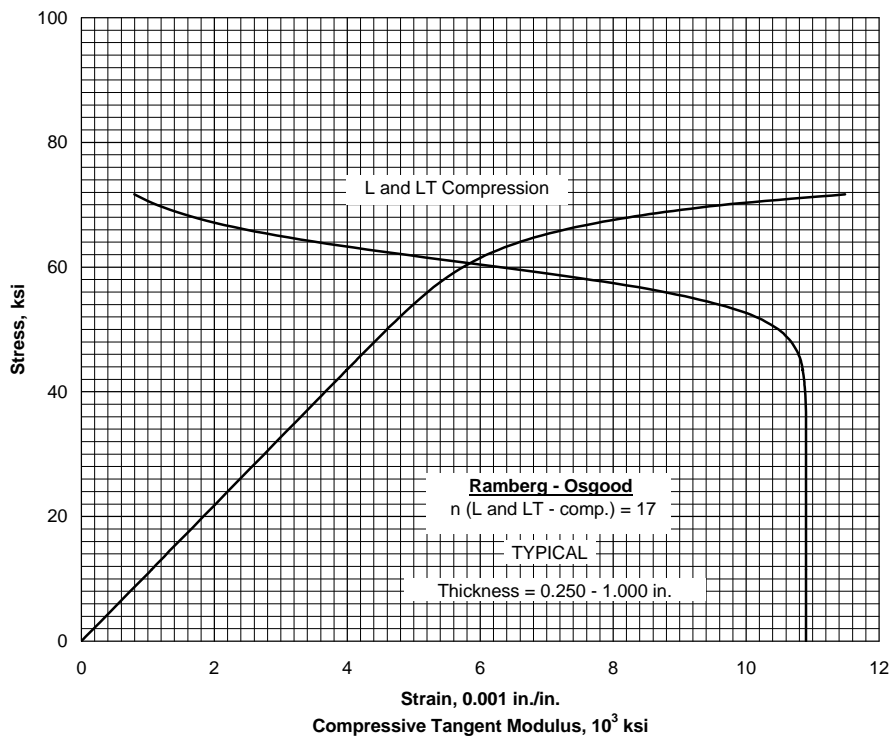

Figure 3.2.3.4.6(f). Typical compressive stress-strain and compressive tangent-modulus curves for 2024-T851 aluminum alloy plate at room temperature.

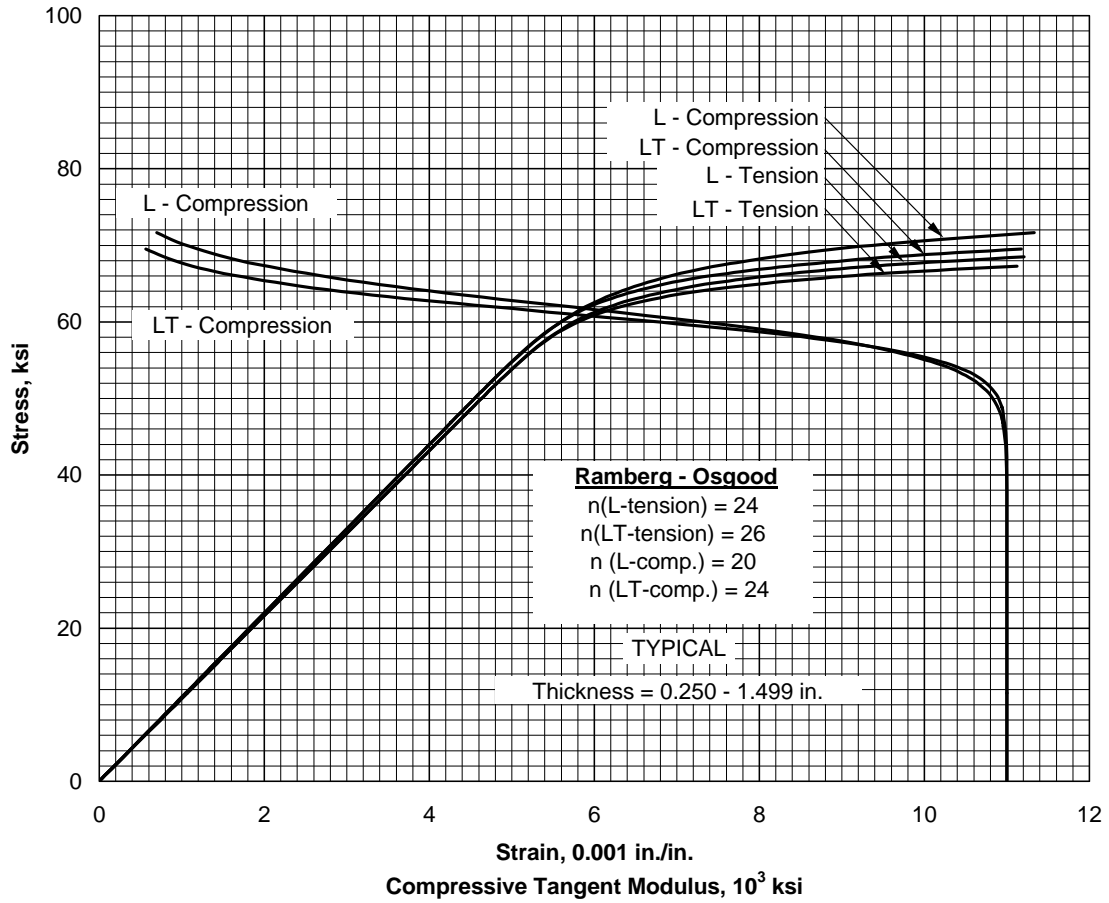

Figure 3.2.3.4.6(g). Typical tensile and compressive stress-strain and compressive tangent-modulus curves for 2024-T851X aluminum alloy extrusion at room temperature.

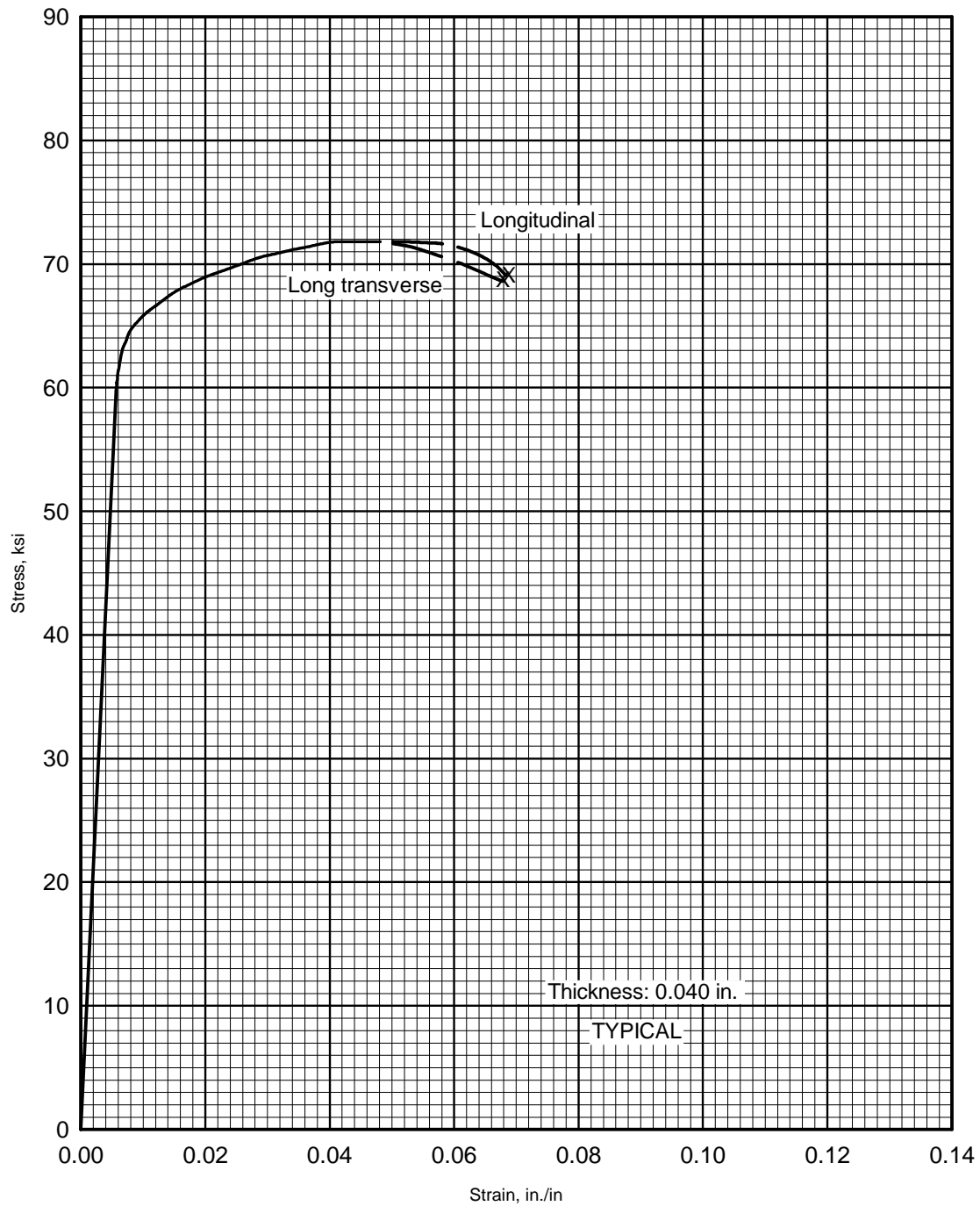

Figure 3.2.3.4.6(h). Typical tensile stress-strain curves (full range) for 2024-T81 aluminum alloy sheet at room temperature.

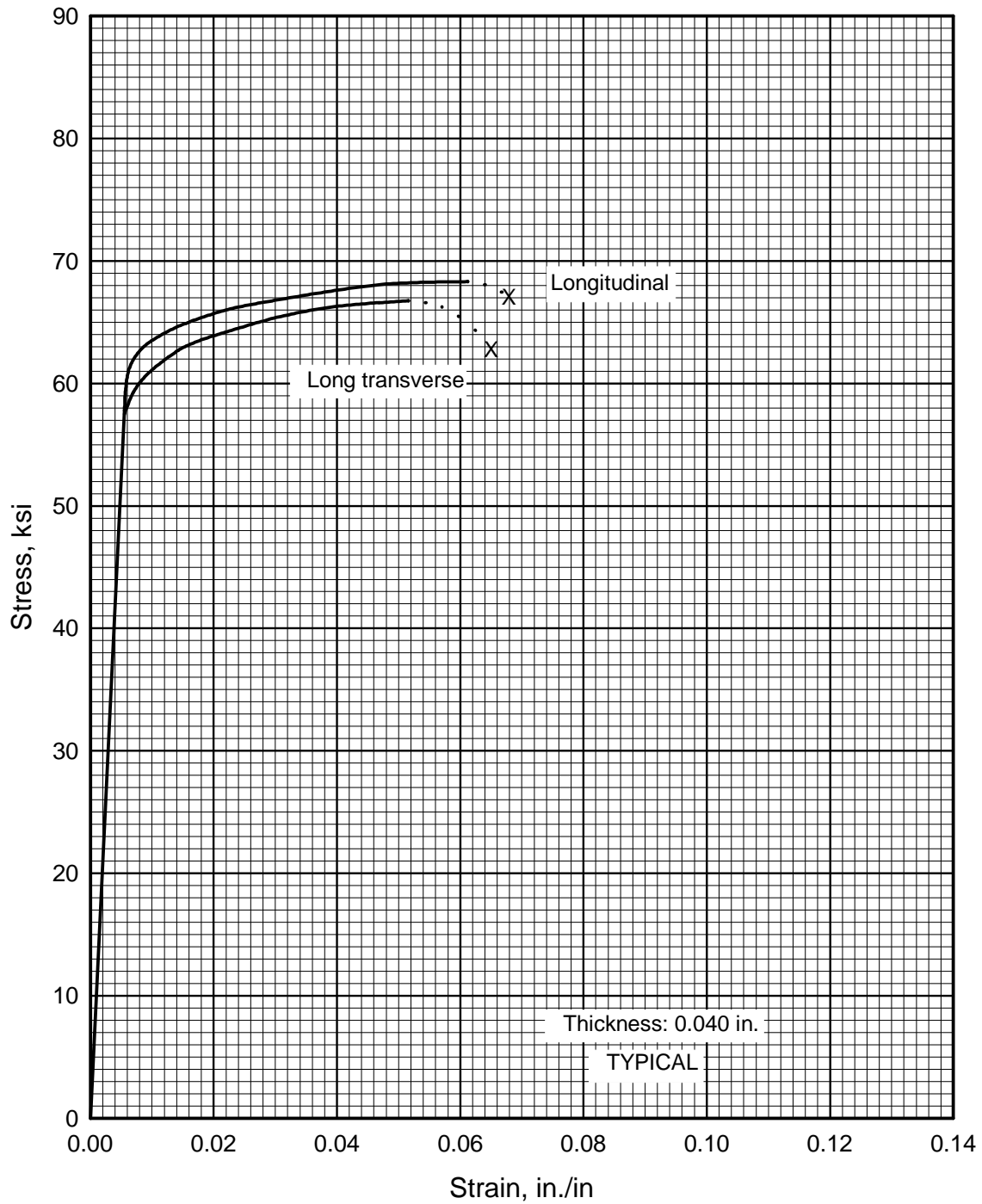

Figure 3.2.3.4.6(i). Typical tensile stress-strain curves (full range) for clad 2024-T81 aluminum alloy sheet at room temperature.

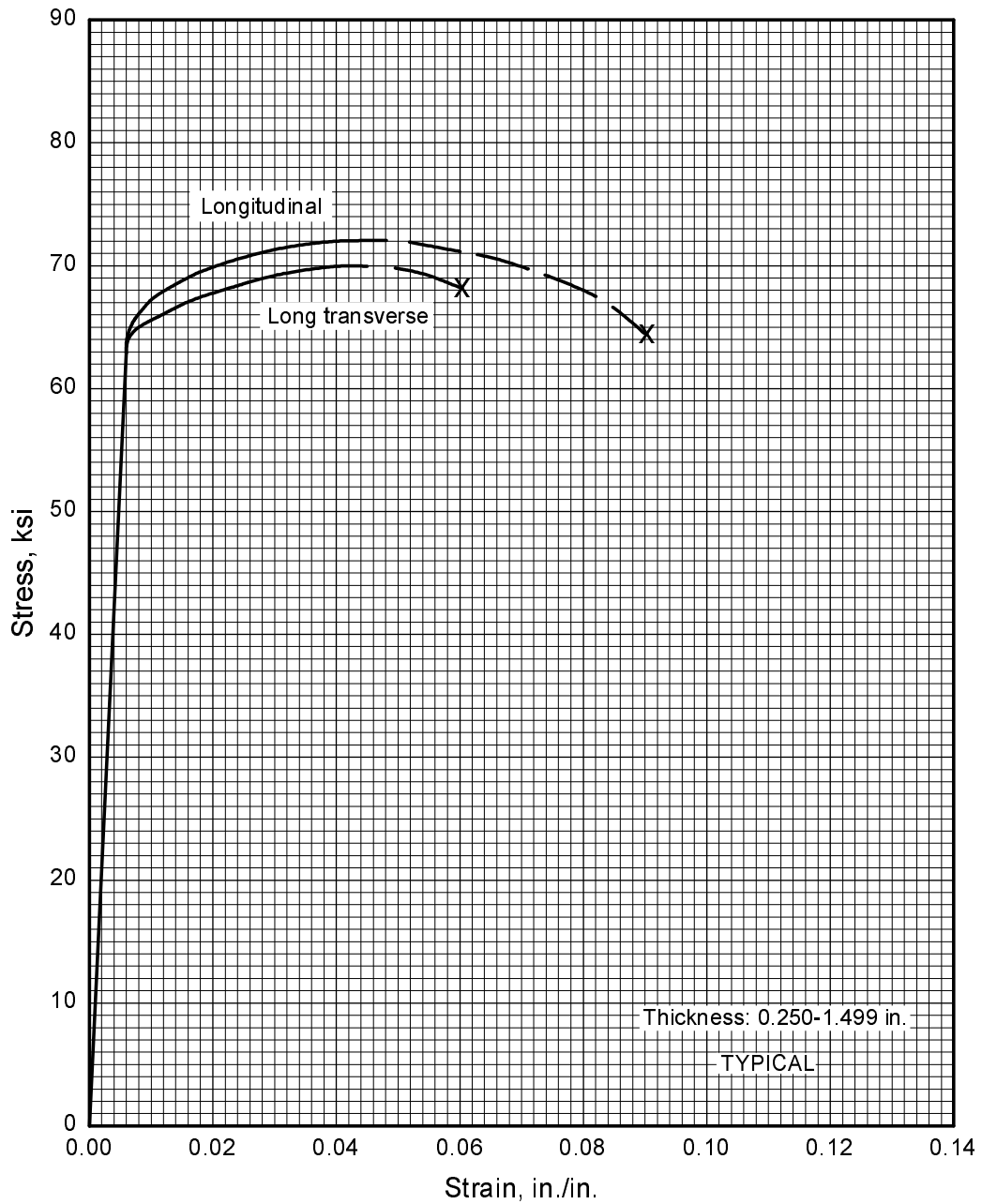

Figure 3.2.3.4.6(j). Typical tensile stress-strain curves (full range) for 2024-T851 aluminum alloy sheet at room temperature.

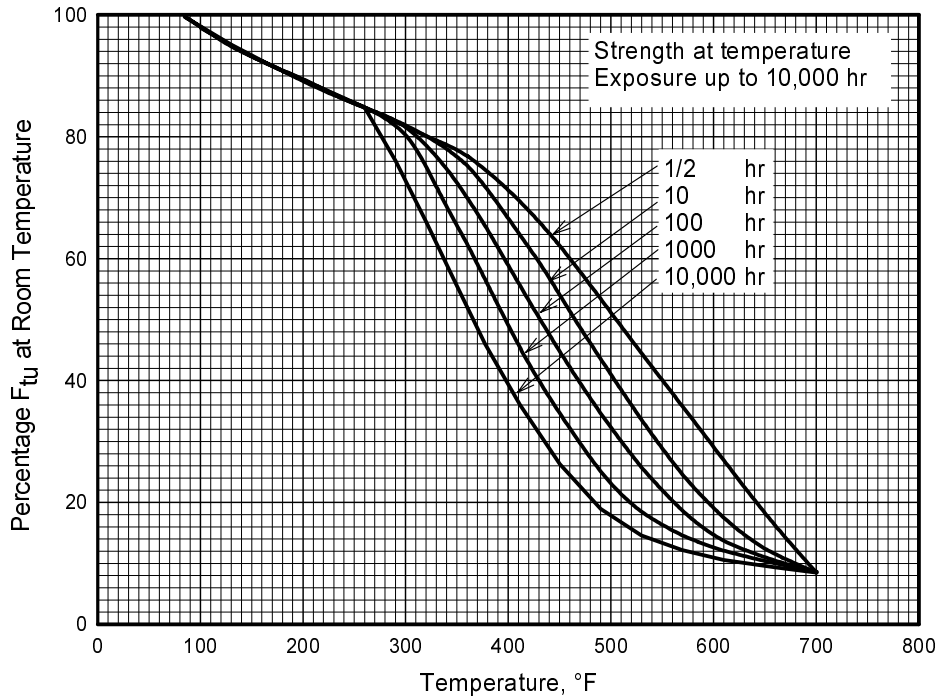

Figure 3.2.3.5.1(a). Effect of temperature on the tensile ultimate strength (F_{tu}) of 2024-T861 (T86) aluminum alloy sheet.

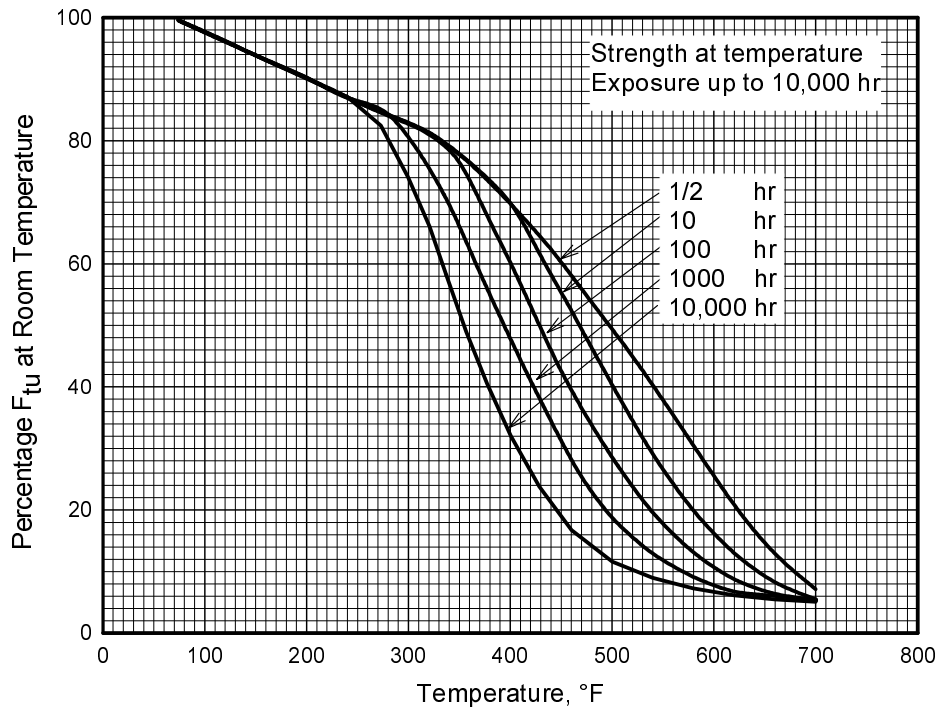

Figure 3.2.3.5.1(b). Effect of temperature on the tensile yield strength (F_{ty}) of 2024-T861 (T86) aluminum alloy sheet.

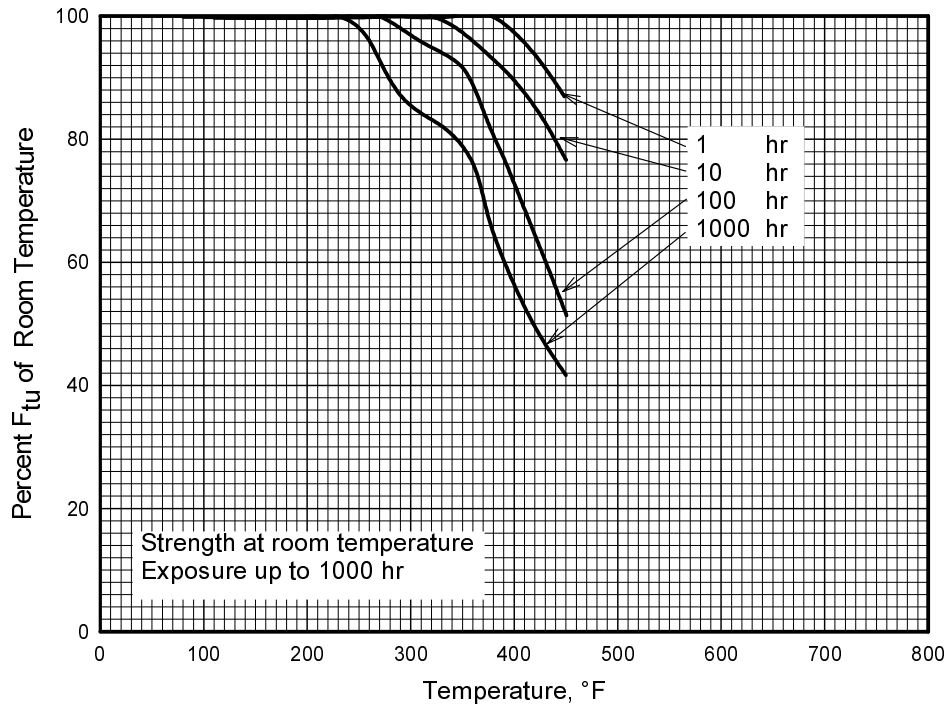

Figure 3.2.3.5.1(c). Effect of exposure at elevated temperatures on the room-temperature tensile ultimate strength (F_{tu}) of 2024-T861 (T86) aluminum alloy sheet.

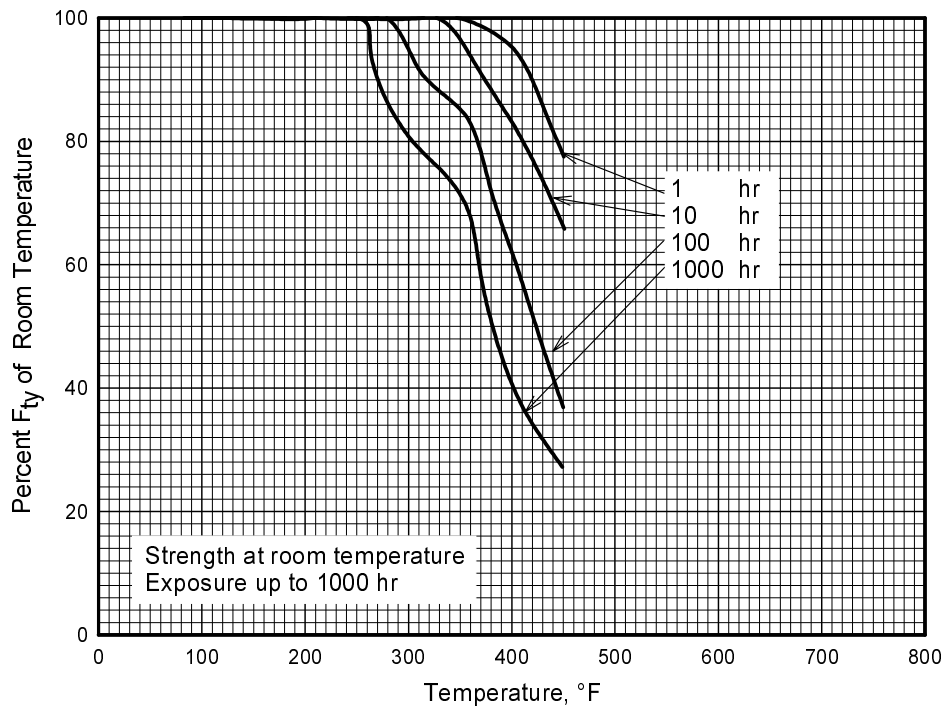

Figure 3.2.3.5.1(d). Effect of exposure at elevated temperatures on the room-temperature tensile yield strength (F_{ty}) of 2024-T861 (T86) aluminum alloy sheet.

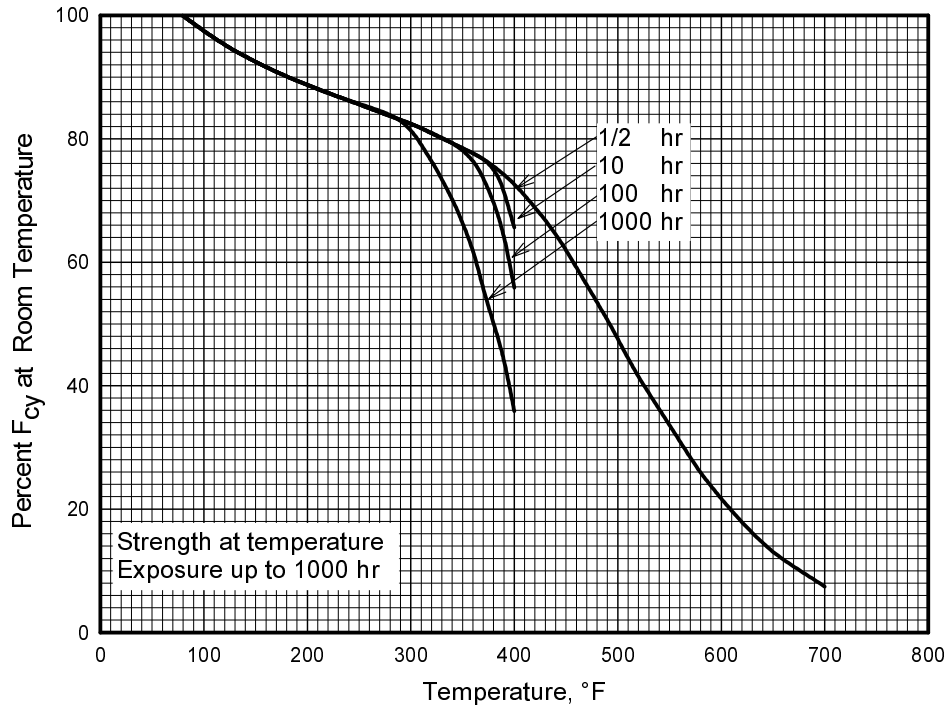

Figure 3.2.3.5.2(a). Effect of temperature on the compressive yield strength (F_{cy}) of 2024-T861 (T86) aluminum alloy sheet.

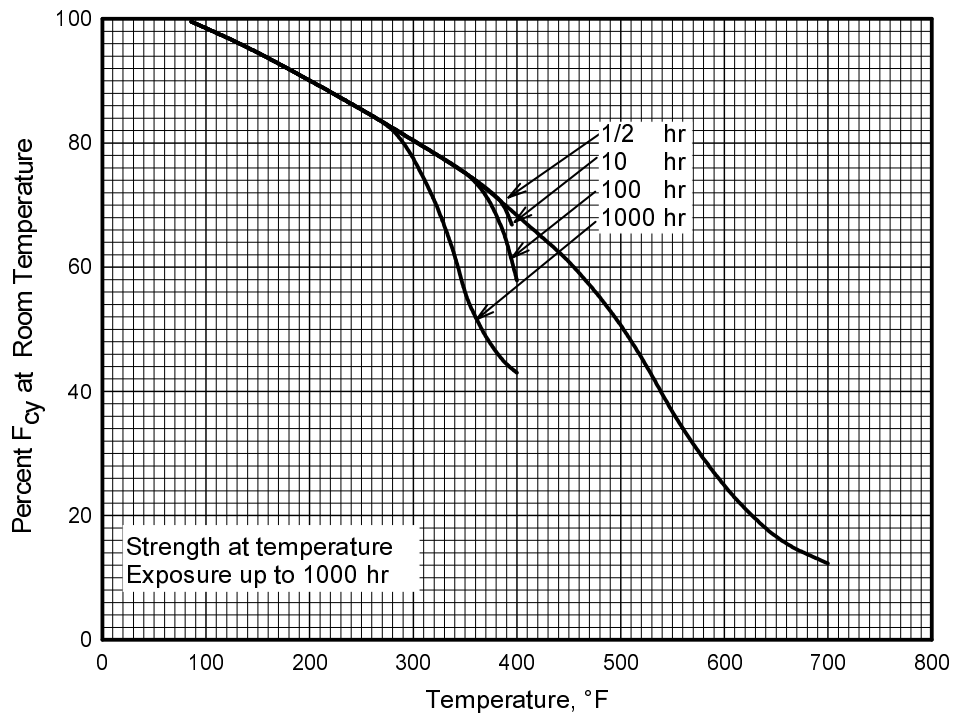

Figure 3.2.3.5.2(b). Effect of temperature on the shear ultimate strength (F_{su}) of 2024-T861 (T86) aluminum alloy sheet.

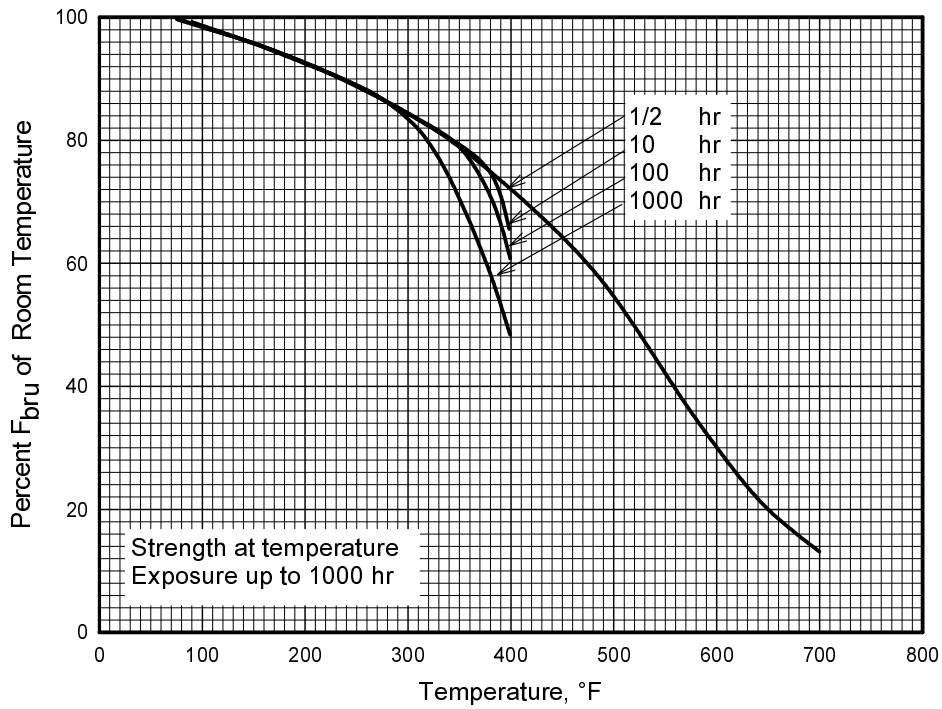

Figure 3.2.3.5.3(a). Effect of temperature on the bearing ultimate strength (F_{bru} , $e/D = 1.5$) of 2024-T861 (T86) aluminum alloy sheet.

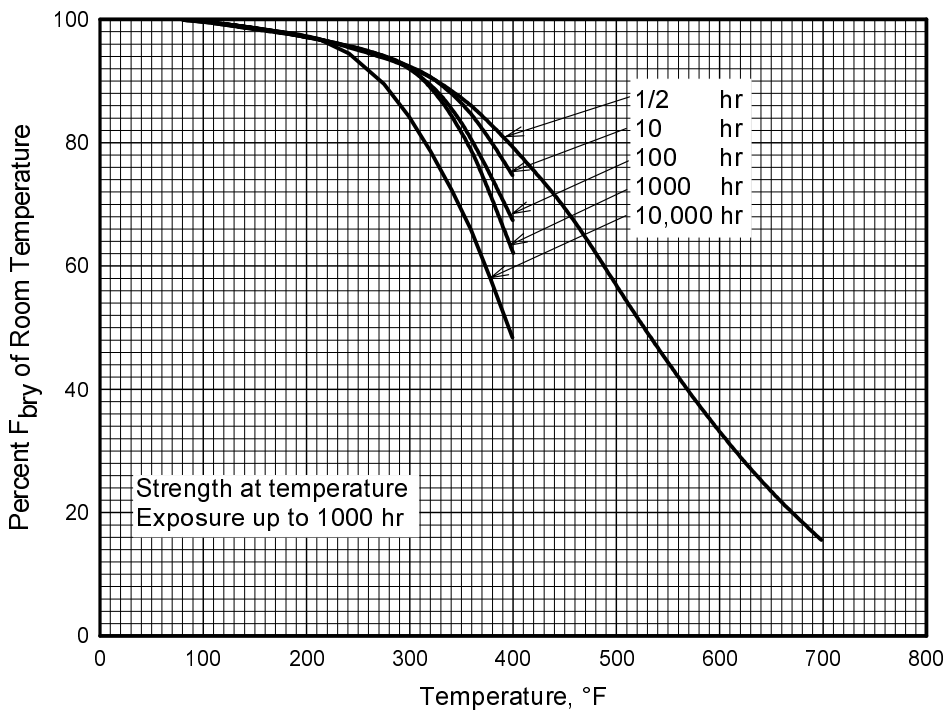

Figure 3.2.3.5.3(b). Effect of temperature on the bearing yield strength (F_{bry} , $e/D = 1.5$) of 2024-T861 (T86) aluminum alloy sheet.

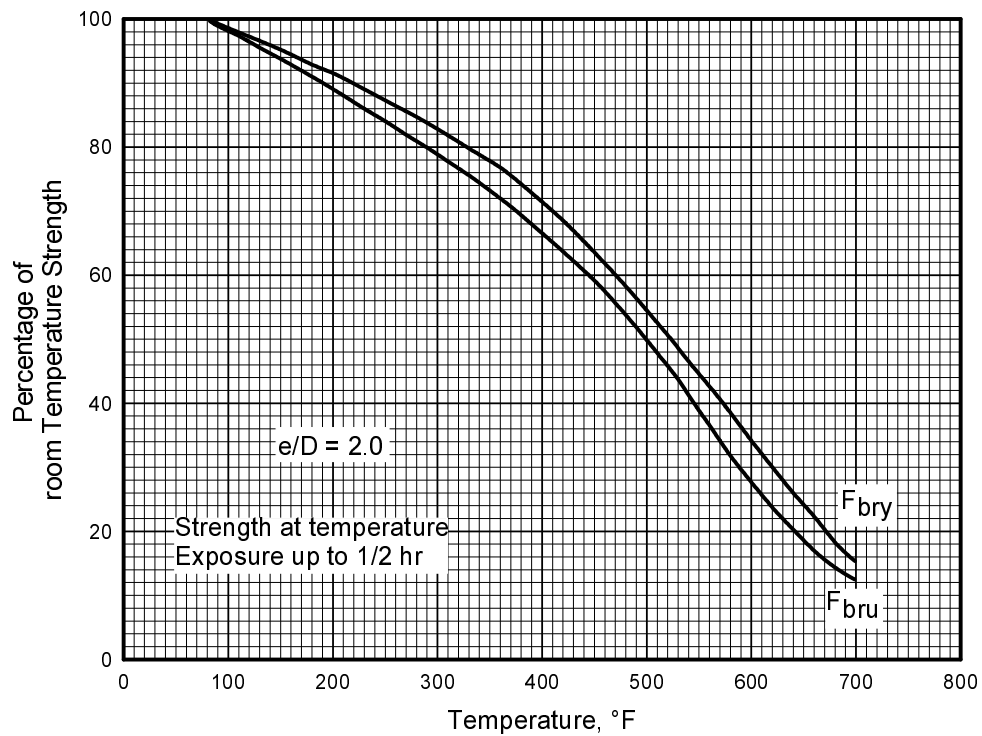

Figure 3.2.3.5.3(c). Effect of temperature on the bearing ultimate strength (F_{bru} , $e/D = 2.0$) and the bearing yield strength (F_{bry} , $e/D = 2.0$) of 2024-T861 (T86) aluminum alloy sheet.

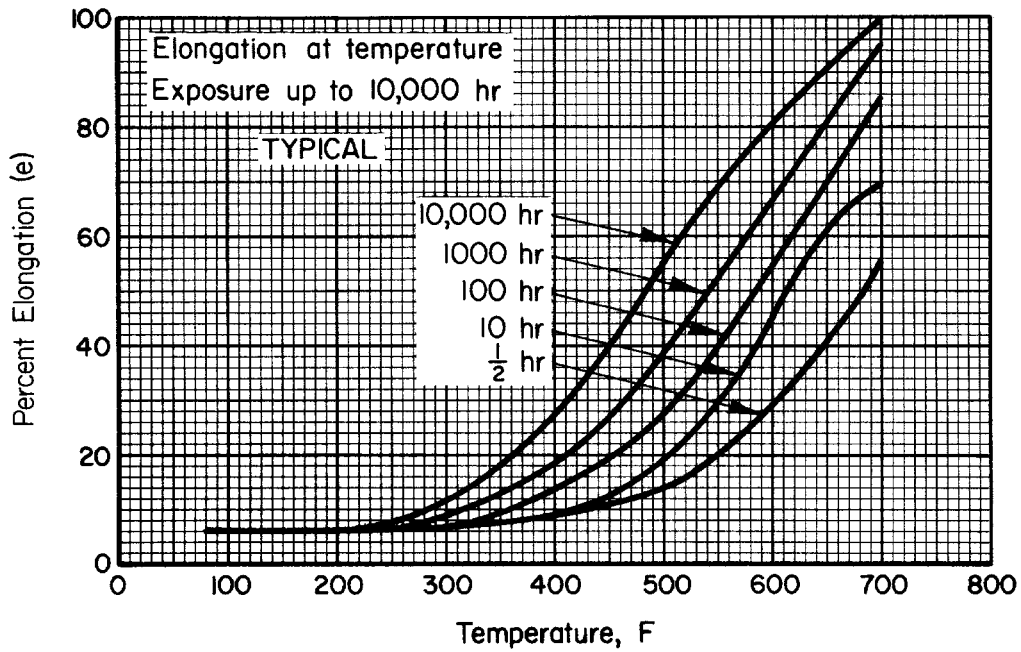

Figure 3.2.3.5(a). Effect of temperature on the elongation (e) of 2024-T861 (T86) aluminum alloy sheet.

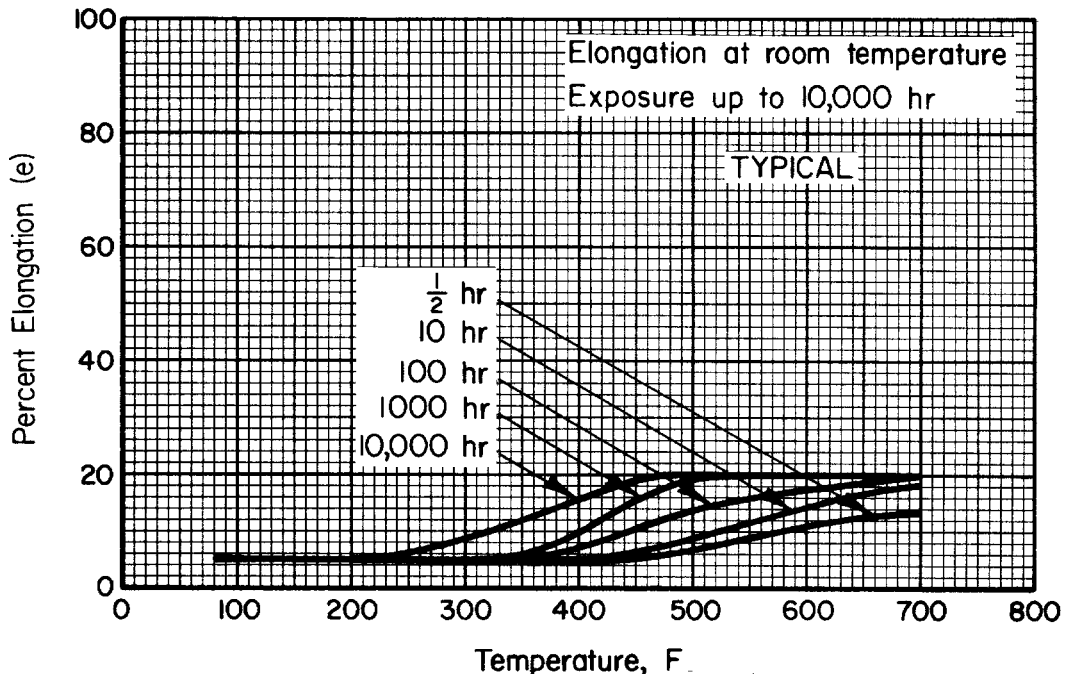

Figure 3.2.3.5(b). Effect of exposure at elevated temperatures on the room temperature elongation (e) of 2024-T861 (T86) aluminum alloy sheet.

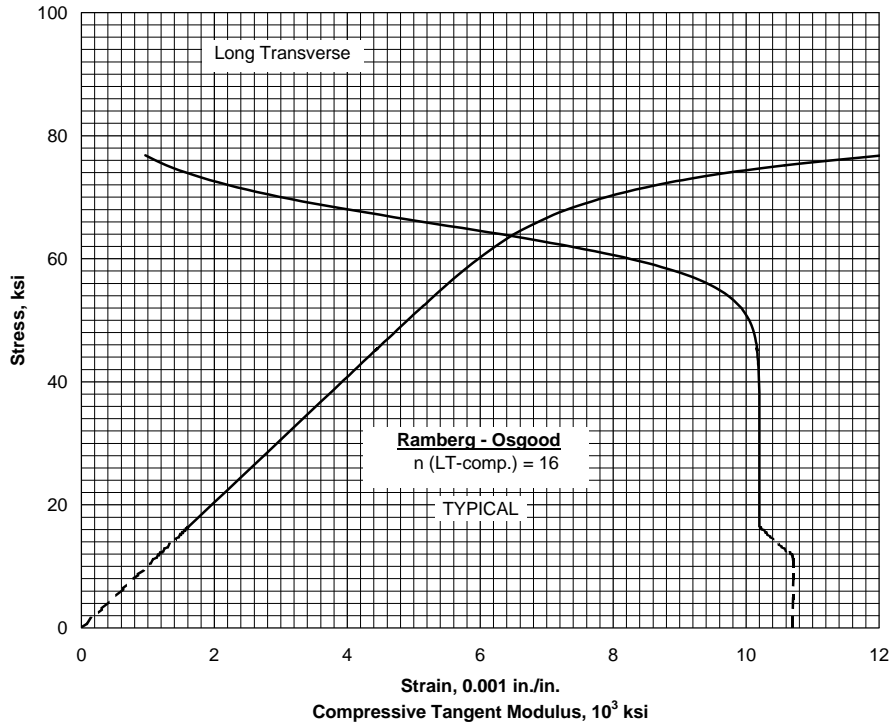

Figure 3.2.3.5.6(a). Typical compressive stress-strain and compressive tangent-modulus curves for clad 2024-T861 aluminum alloy sheet at room temperature.

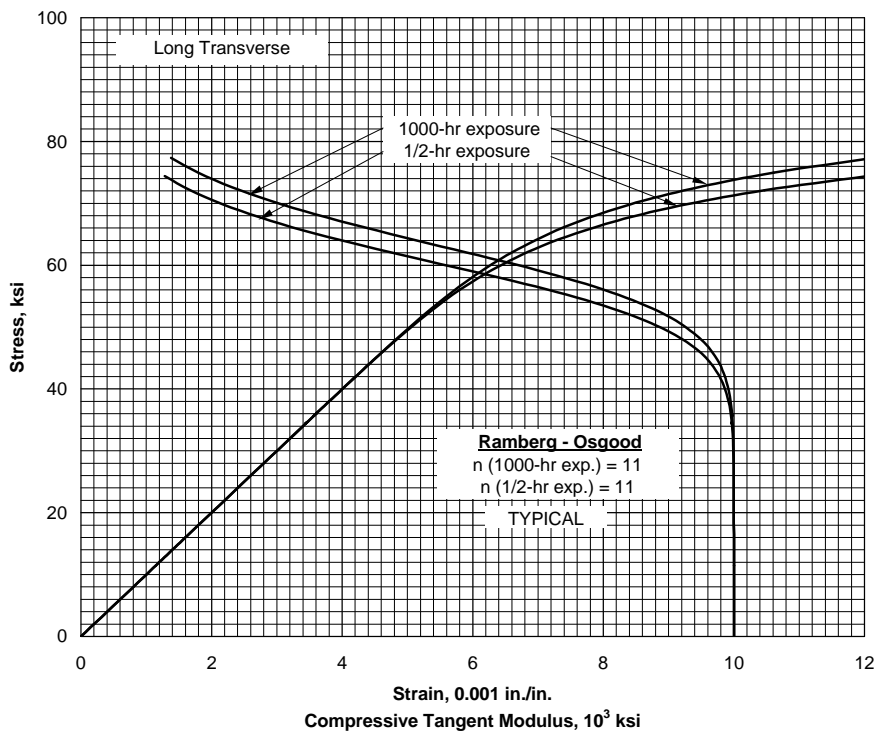

Figure 3.2.3.5.6(b). Typical compressive stress-strain and compressive tangent-modulus curves for clad 2024-T861 aluminum alloy sheet at 200°F.

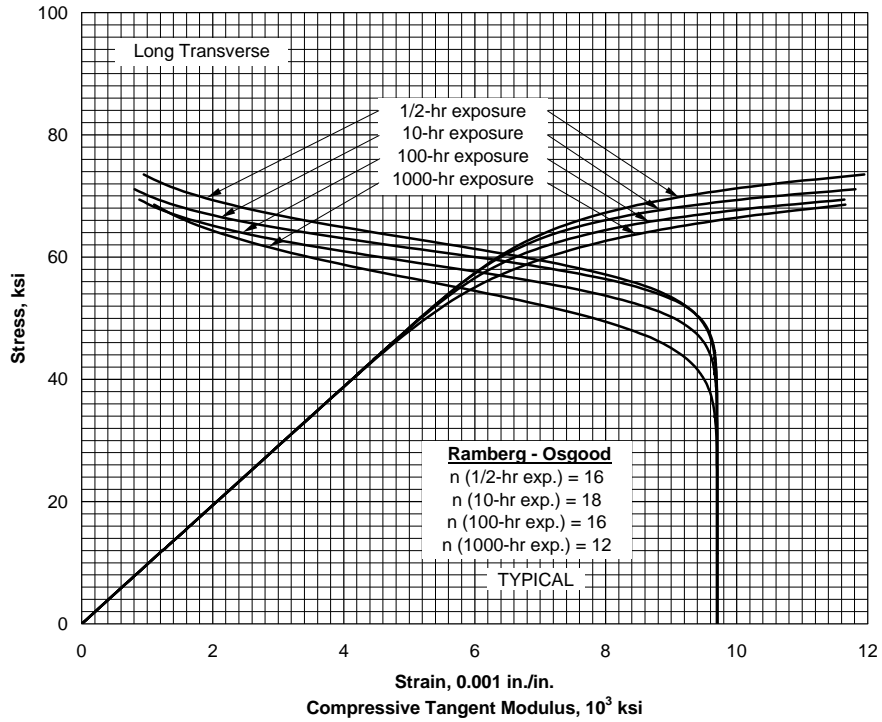

Figure 3.2.3.5.6(c). Typical compressive stress-strain and compressive tangent-modulus curves for clad 2024-T861 aluminum alloy sheet at 300°F.

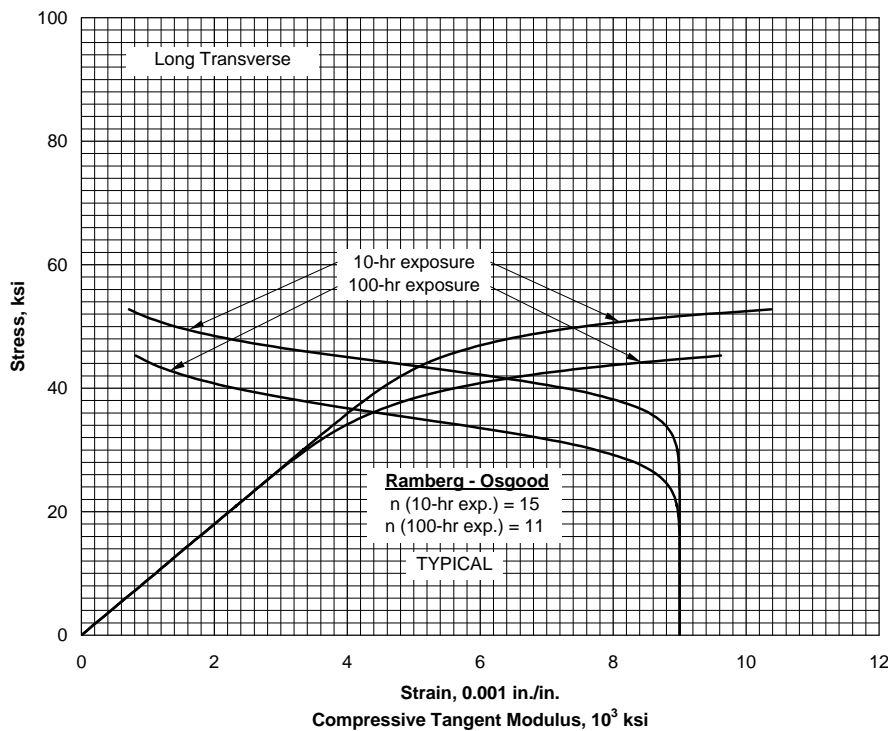

Figure 3.2.3.5.6(d). Typical compressive stress-strain and compressive tangent-modulus curves for clad 2024-T861 aluminum alloy sheet at 400°F.

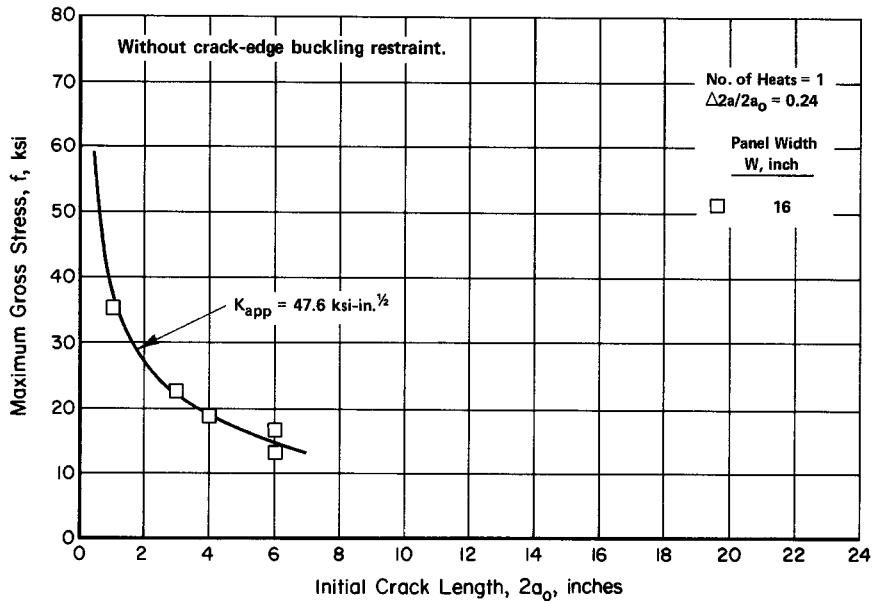

Figure 3.2.3.5.10(a). Residual strength behavior of 0.063-inch-thick 2024-T861 aluminum alloy sheet at room temperature. Crack orientation is T-L [Reference 3.1.2.1.6(d)].

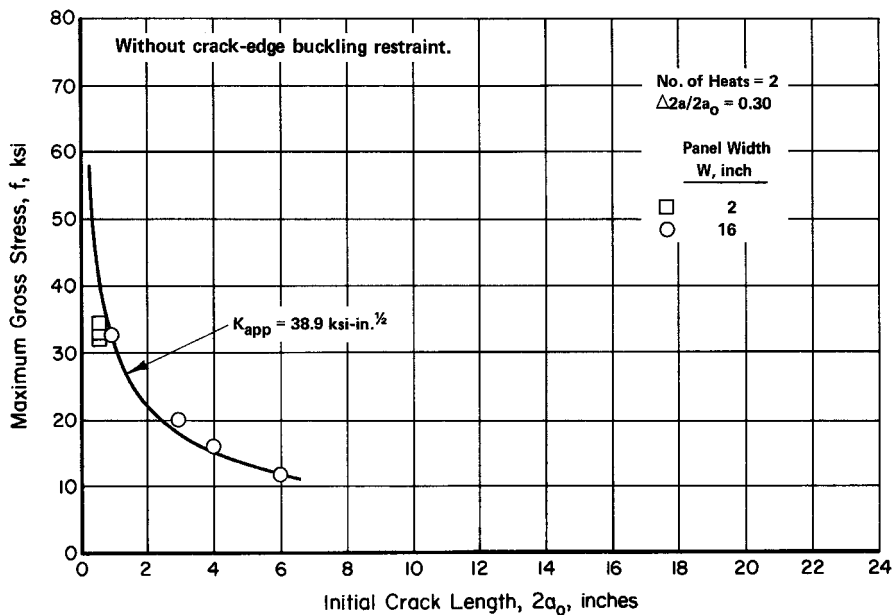

Figure 3.2.3.5.10(b). Residual strength behavior of 0.063-inch-thick 2024-T861 aluminum alloy sheet at room temperature. Crack orientation is L-T [Reference 3.1.2.1.6(d)].

3.2.4 2025 ALLOY

3.2.4.0 Comments and Properties — 2025 is a heat-treatable Al-Cu forging alloy for which applications have been limited primarily to propellers. Refer to Section 3.1.2.3 for comments regarding the resistance of the alloy to stress-corrosion cracking, and to Section 3.1.2.4 for comments regarding the weldability of the alloy.

A material specification for 2025 aluminum alloy is presented in Table 3.2.4.0(a). Room-temperature mechanical and physical properties are shown in Table 3.2.4.0(b). The effect of temperature on thermal expansion is shown in Figure 3.2.4.0.

Table 3.2.4.0(a). Material Specification for 2025 Aluminum Alloy

Specification	Form
AMS 4130	Die forging

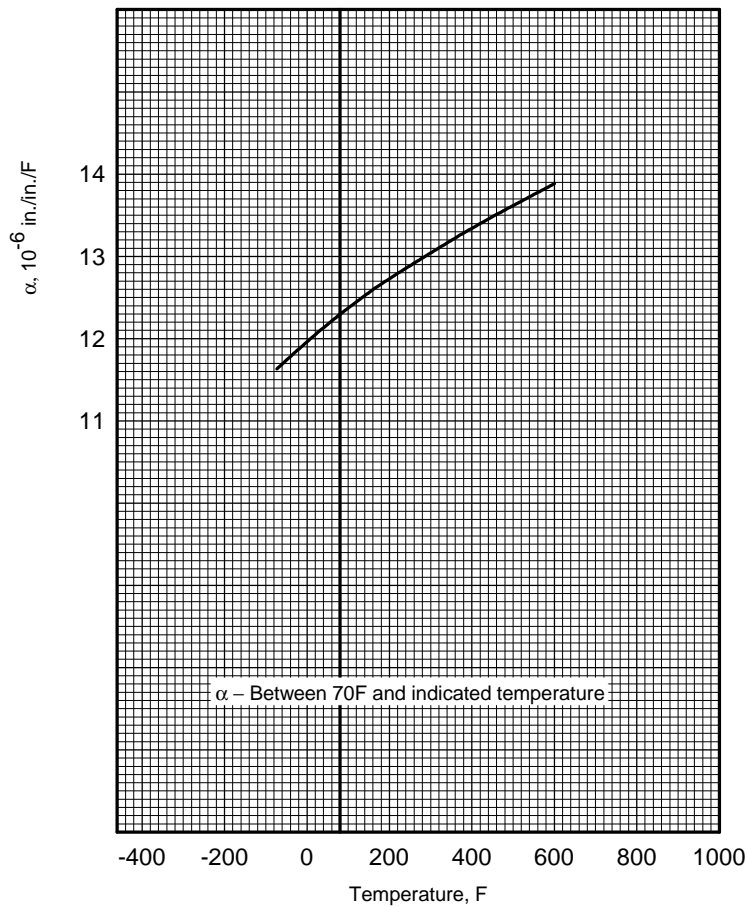

Figure 3.2.4.0. Effect of temperature on the thermal expansion of 2025 aluminum alloy.

Table 3.2.4.0(b). Design Mechanical and Physical Properties of 2025 Aluminum Alloy Die Forging

Specification	AMS 4130
Form	Die forging
Temper	T6
Thickness, in.	≤ 4.000
Basis	S
Mechanical Properties:	
F_{tu} , ksi:	
L	55
T ^a	52
F_{ty} , ksi:	
L	33
T ^a	32
F_{cy} , ksi:	
L
T ^a
F_{su} , ksi
F_{bru} , ksi:	
(e/D = 1.5)
(e/D = 2.0)
F_{bry} , ksi:	
(e/D = 1.5)
(e/D = 2.0)
e , percent:	
L	11
T ^a	8
<hr/>	
E , 10 ³ ksi	10.3
E_c , 10 ³ ksi	10.5
G , 10 ³ ksi	3.9
μ	0.33
<hr/>	
Physical Properties:	
ω , lb/in. ³	0.101
C , Btu/(lb)(°F)	0.23 (at 212°F)
K , Btu/[(hr)(ft ²)(°F)/ft] ..	90 (at 77°F)
α , 10 ⁻⁶ in./in./°F	See Figure 3.2.4.0

a T indicates any grain direction within ±15° of being perpendicular to the forging flow lines.

3.2.5 2026 ALLOY

3.2.5.0 COMMENTS AND PROPERTIES—2026 is a 4.0Cu-1.3Mg-0.60Mn aluminum alloy used for extrusion of bars, rods, and profiles. These extrusions have been used typically for parts subject to cracking during forming operations and excessive warpage during machining processes, and for parts requiring high strength and damage tolerance, where fabrication does not normally involve welding.

Certain processing procedures may cause these extrusions to become susceptible to stress-corrosion cracking; ARP823 (Reference 3.2.1.0) recommends practices to minimize such conditions.

Extruded, solution heat treated and stress-relieved by stretching to produce a nominal permanent set of 1.5%, but not less than 1% nor more than 3%, to the T3511 temper. Solution heat treatment will be performed in accordance with AMS 2772.

Material specifications are shown in Table 3.2.5.0(a). Room temperature mechanical and physical properties are shown in Table 3.2.5.0 (b).

Table 3.2.5.0(a). Material Specifications for 2026-T3511

Specification	Form
AMS 4338	Extruded bars, rods, and profiles

MIL-HDBK-5J
31 January 2003

Table 3.2.5.0(b). Design Mechanical and Physical Properties of 2026 Aluminum Alloy Bars, Rods, and Profiles

Specification	AMS 4338								
Form	Extrusions								
Temper	T3511								
Thickness, in.	≤0.249		0.250-0.499		0.500-1.499		1.500-2.249		2.250-3.250
Basis	A	B	A	B	A	B	A	B	S
Mechanical Properties:									
<i>F_{tu}</i> , ksi:									
L	66	69	70	72	72	75	73	76	73
LT	58	61	62	64	66	67	64	67	61
<i>F_{ty}</i> , ksi:									
L	48	51	52	53	53	56	54	57	54
LT	41	44	45	46	46	48	44	49	42
<i>F_{cy}</i> , ksi:									
L	43	45	46	47	47	47	49	52	50
LT	42	45	46	46	46	49	45	47	43
<i>F_{su}</i> , ksi									
.....	37	39	37	38	32	33	32	33	32
<i>F_{bru}</i> ^a , ksi:									
(e/D = 1.5)	90	94	92	95	87	90	85	89	85
(e/D = 2.0)	112	117	113	117	109	114	108	112	105
<i>F_{brv}</i> ^a , ksi:									
(e/D = 1.5)	62	66	66	67	61	64	61	64	61
(e/D = 2.0)	76	81	81	83	76	81	76	80	76
<i>e</i> , percent (S-basis):									
L	11	...	12	...	11	...	11	...	10
LT	8	...	8	...	8
<i>E</i> , 10 ³ ksi									
					10.7				
<i>E_c</i> , 10 ³ ksi									
					10.9				
<i>G</i> , 10 ³ ksi									
					4.0				
<i>μ</i>									
					0.33				
Physical Properties:									
<i>ω</i> , lb/in. ³									
					0.100				
<i>C</i> , Btu/(lb)(°F)									
					...				
<i>K</i> , Btu/[(hr)(ft ²)(°F)/ft]									
					...				
<i>α</i> , 10 ⁻⁶ in./in./°F									
					...				

a See Table 3.1.2.1.1. Bearing values are “dry pin” values per Section 1.4.7.1.

3.2.6 2090 ALLOY

3.2.6.0 Comments and Properties — 2090 is an Al-Cu-Li alloy developed for applications requiring the high strength of 7075-T6 but with 8 percent lower density and 10 percent higher elastic modulus than 7075-T6. Sheet is available in the T83 temper. 2090 sheet has strength properties nearly equivalent to 7075-T6 sheet with improved exfoliation resistance. Refer to Section 3.1.3.4 for information on weldability of the alloy.

A material specification for 2090 aluminum alloy is shown in Table 3.2.6.0(a). Room-temperature mechanical and physical properties are shown in Table 3.2.6.0(b).

Table 3.2.6.0(a). Material Specification for 2090 Aluminum Alloy

Specification	Form
AMS 4251	Sheet

The temper index is as follows:

<u>Section</u>	<u>Temper</u>
3.2.6.1	T83

3.2.6.1 T83 Temper — Stress-strain and tangent-modulus curves are represented in Figures 3.2.6.1.6(a) and (b).

Table 3.2.6.0(b). Design Mechanical and Physical Properties of 2090-T83 Aluminum Alloy Sheet

Specification	AMS 4251	
	Sheet	
	T83	
	0.040-0.125	0.126-0.249
Basis	S	S
Mechanical Properties:		
F_{tu} , ksi:		
L	77	75
45°	64	65
LT	73	73
F_{ty} , ksi:		
L	70	70
45°	56	57
LT	66	66
F_{cy} , ksi:		
L	67	63
45°	58	60
LT	71	71
F_{su} , ksi	37	37
F_{bru}^a , ksi:		
(e/D = 1.5)	100	100
(e/D = 2.0)	126	126
F_{bry}^a , ksi:		
(e/D = 1.5)	84	88
(e/D = 2.0)	98	104
e , percent:		
L	3	4
LT	5	5
E , 10 ³ ksi:		
L & LT	11.5	
45°	11.0	
E_c , 10 ³ ksi:		
L & LT	11.8	
45°	11.4	
G , 10 ³ ksi	4.3	
μ	0.34	
Physical Properties:		
ω , lb/in. ³	0.094	
C , K , and α	

a Bearing values are "dry pin" values per Section 1.4.7.1.

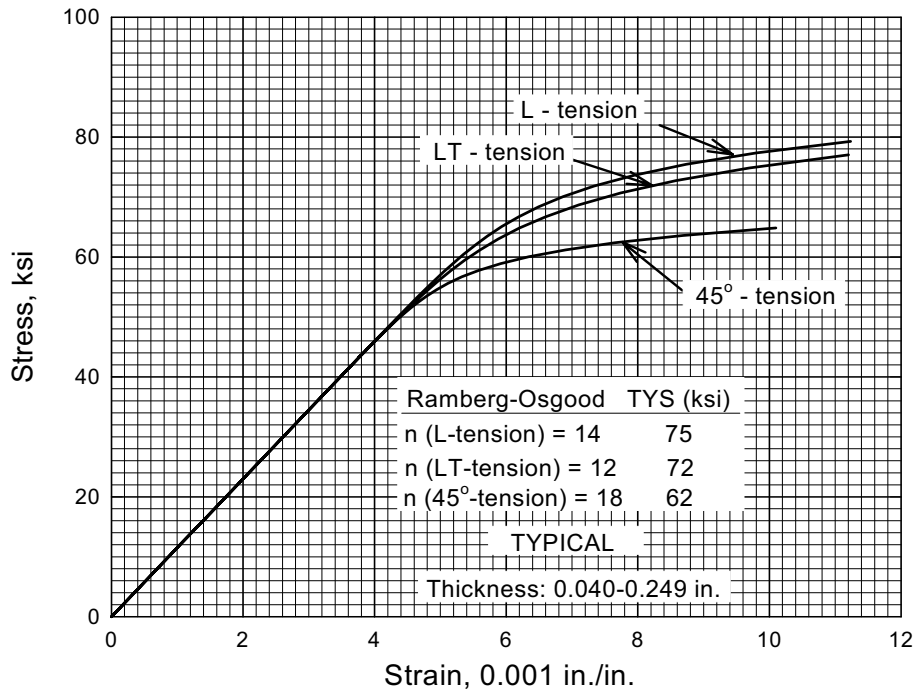

Figure 3.2.6.1.6(a). Typical tensile stress-strain curves for 2090-T83 aluminum alloy sheet at room temperature.

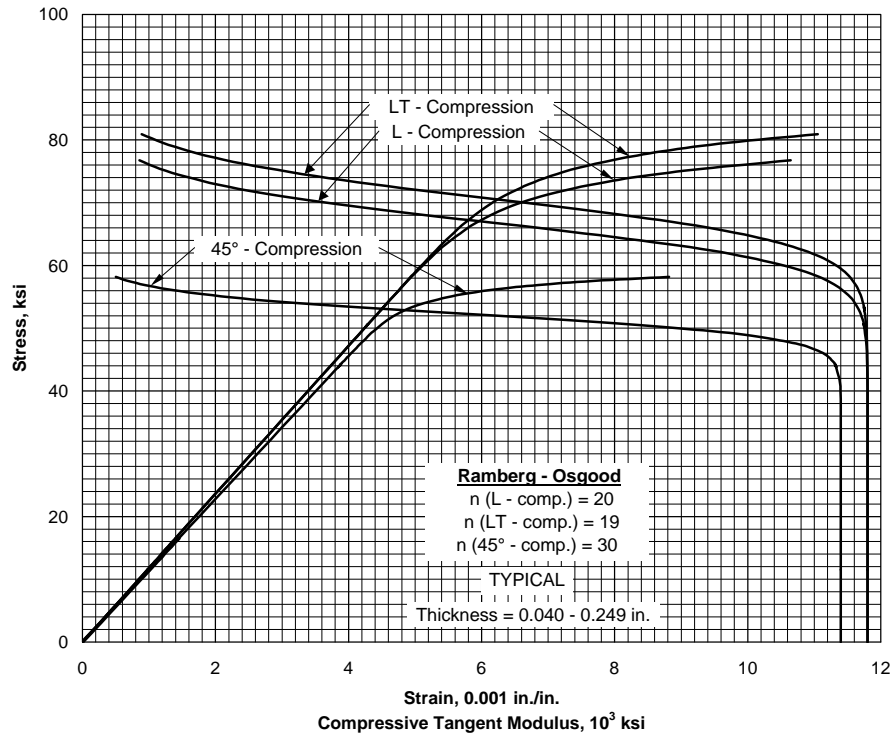

Figure 3.2.6.1.6(b). Typical compressive stress-strain and compressive tangent-modulus curves for 2090-T83 aluminum alloy sheet at room temperature.

3.2.7 2124 ALLOY

3.2.7.0 Comments and Properties — 2124 is an Al-Cu alloy available in the form of plate in thicknesses of 1 through 6 inches. This alloy is a high purity version of alloy 2024. The higher purity in conjunction with special production processing provides higher elongation in the short-transverse direction and improved fracture toughness over that exhibited by conventionally produced 2024 alloy. The alloy is currently only produced in the T851 temper. The alloy, like 2024 has excellent properties and creep resistance at elevated temperatures. The alloy in the T851 temper has good resistance to stress corrosion. Refer to Section 3.1.2.3.1 for information regarding resistance of the alloy to stress-corrosion cracking. Refer to Section 3.1.3.4 for comments regarding the weldability of the alloy. The physical properties are essentially the same as those for 2024-T851 plate.

Applicable material specification for 2124-T851 plate is presented in Table 3.2.7.0(a). Room-temperature mechanical properties are shown in Table 3.2.7.0(b).

Table 3.2.7.0(a). Material Specification for 2124 Aluminum Alloy

Specification	Form
AMS 4101	Plate
AMS-QQ-A-250/29	Plate

The temper index for 2124 is as follows:

<u>Section</u>	<u>Temper</u>
3.2.7.1	T851

3.2.7.1 T851 Temper — Elevated temperature data are presented in Figures 3.2.7.1.1(a) and (b). Typical tensile stress-strain, compressive stress-strain, and compressive tangent-modulus curves are presented in Figures 3.2.7.1.6(a) and (b). Fatigue crack-propagation data for plate are presented in Figures 3.2.7.1.9(a) through (e).

MIL-HDBK-5J
31 January 2003

Table 3.2.7.0(b). Design Mechanical and Physical Properties of 2124 Aluminum Alloy Plate

Specification	AMS 4101 and AMS-QQ-A-250/29										
	Plate										
Form	T851										
Temper											
Thickness, in.	1.000- 1.500	1.501- 2.000	2.001- 3.000	3.001- 4.000	4.001- 5.000	5.001- 6.000					
Basis	S	A	B	A	B	A	B	A	B	A	B
Mechanical Properties:											
<i>F_{tu}</i> , ksi:											
L	66	66	68	65	68	65	67	64	66	63	65
LT	66	66	68	65	68	65	67	64	66	63	65
ST	64 ^a	64	66	63	64	62	63	61	62	58	59
<i>F_{ty}</i> , ksi:											
L	57	57	61	57	61	56	60	55	58	54	56
LT	57	57	61	57	61	56	60	55	58	54	56
ST	55 ^a	55	59	55	59	54	57	53	55	51	53
<i>F_{cy}</i> , ksi:											
L	57	57	61	56	60	55	59	53	56	52	54
LT	57	57	61	57	61	56	60	55	58	54	56
ST	57	61	58	62	57	61	57	60	56	58
<i>F_{su}</i> , ksi:											
L	38	39	38	39	38	39	37	38	37	38
LT	38	39	38	39	38	39	37	38	37	38
ST	36	37	36	37	36	37	35	36	35	36
<i>F_{bru}</i> ^b , ksi:											
(e/D = 1.5)	97	100	96	100	96	99	94	97	93	96
(e/D = 2.0)	126	130	125	130	125	128	123	126	121	125
<i>F_{bry}</i> ^b , ksi:											
(e/D = 1.5)	79	84	80	85	80	85	79	84	79	82
(e/D = 2.0)	91	98	92	99	92	99	92	97	91	95
<i>e</i> , percent (S-basis):											
L	6	6	...	6	...	5	...	5	...	5	...
LT	5	5	...	4	...	4	...	4	...	4	...
ST	1.5 ^a	1.5	...	1.5	...	1.5	...	1.5	...	1.5	...
<i>E</i> , 10 ³ ksi											
						10.4					
<i>E_c</i> , 10 ³ ksi											
						10.9					
<i>G</i> , 10 ³ ksi											
						4.0					
<i>μ</i>											
						0.33					
Physical Properties:											
<i>ω</i> , lb/in. ³											
						0.100					
<i>C</i> , Btu/(lb)(°F)											
						0.21 (at 212°F)					
<i>K</i> , Btu/[(hr)(ft ³)(°F)/ft]											
						87 (at 77°F)					
<i>α</i> , 10 ⁻⁶ in./in./°F											
						12.6 (68°F to 212°F)					

a Applicable to 1.500-inch thickness only.

b Bearing values are "dry pin" values per Section 1.4.7.1. See Table 3.1.2.1.1.

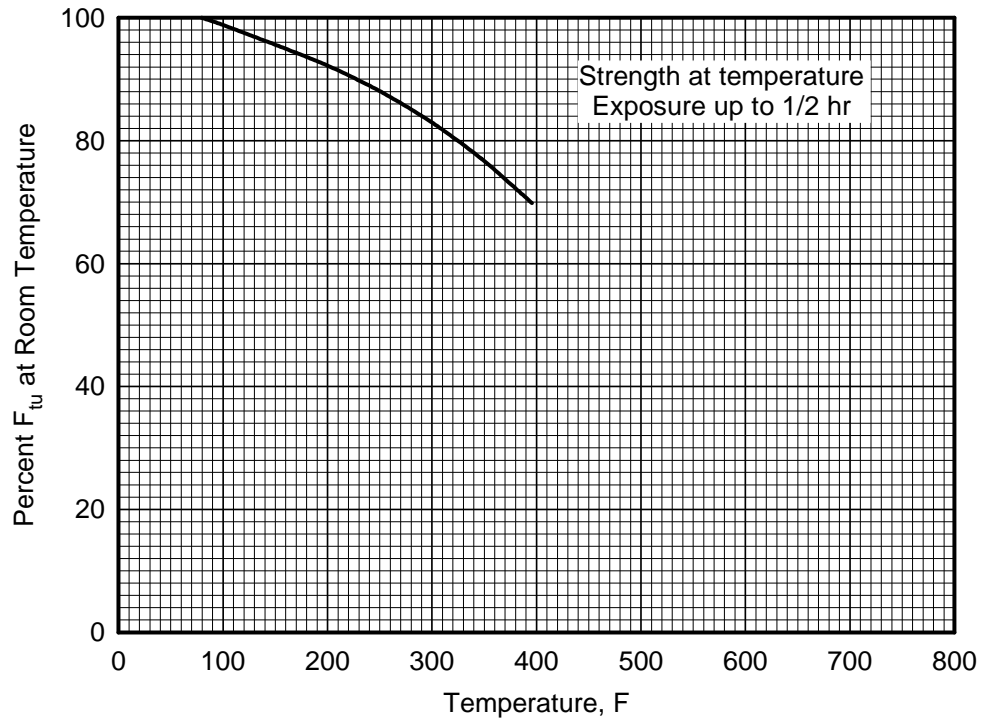

Figure 3.2.7.1.1(a). Effect of temperature on the tensile ultimate strength (F_{tu}) of 2124-T851 aluminum alloy plate.

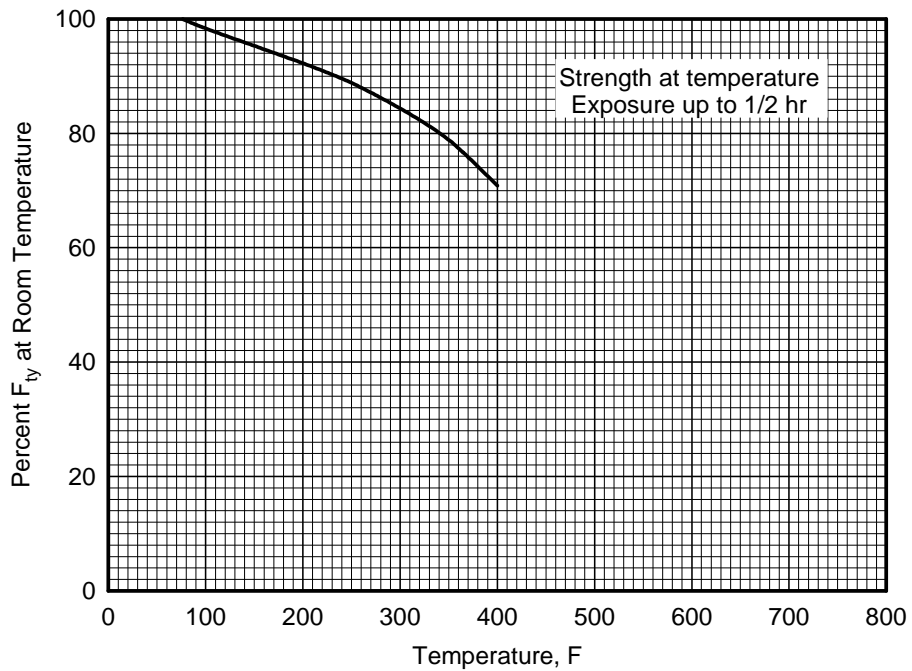

Figure 3.2.7.1.1(b). Effect of temperature on the tensile yield strength (F_{ty}) of 2124-T851 aluminum alloy plate.

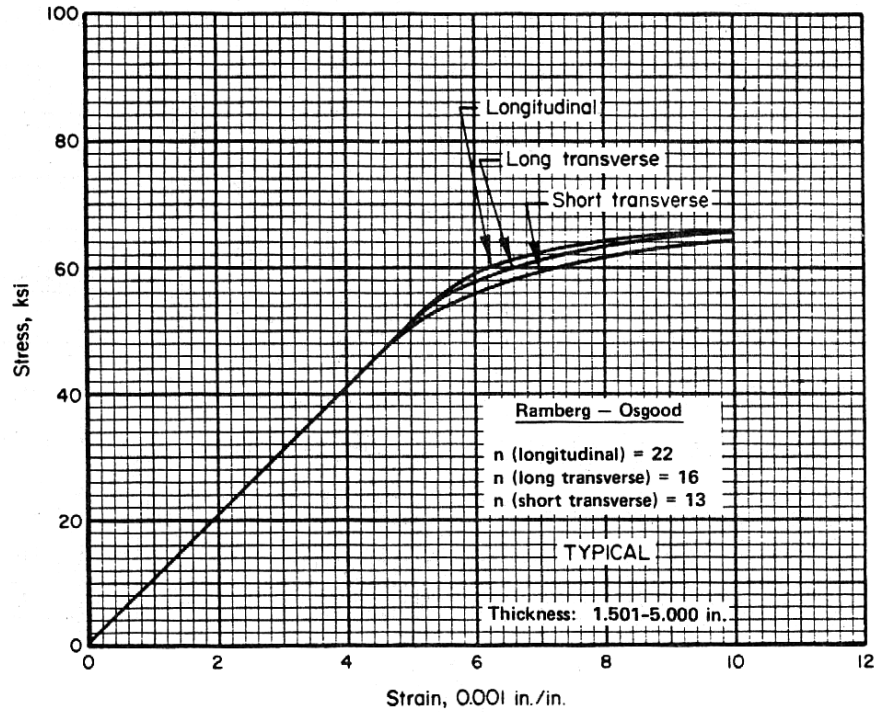

Figure 3.2.7.1.6(a). Typical tensile stress-strain curves for 2124-T851 aluminum alloy plate at room temperature.

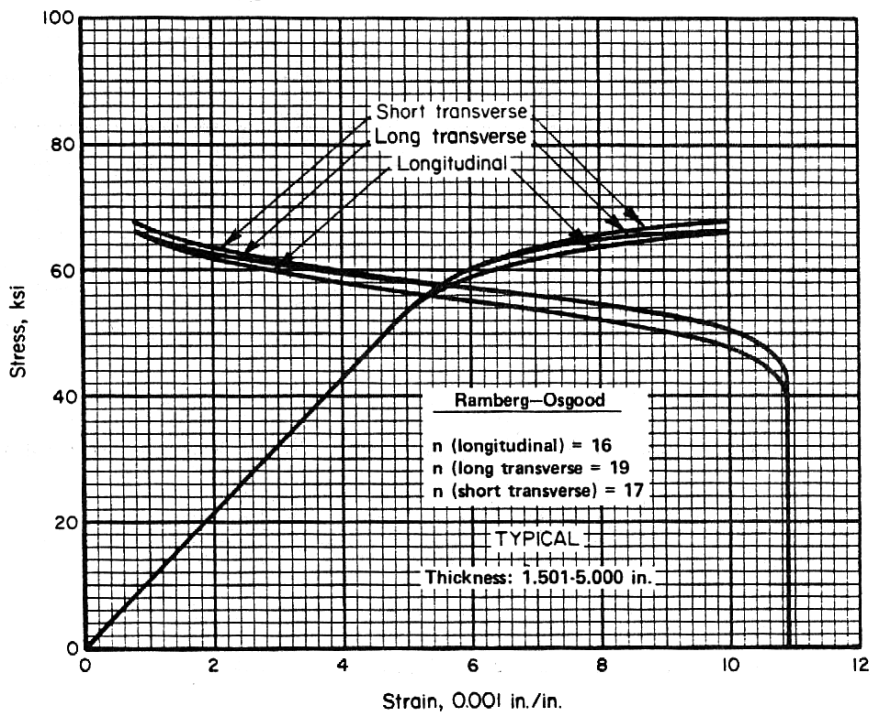

Figure 3.2.7.1.6(b). Typical compressive stress-strain and compressive tangent-modulus curves for 2124-T851 aluminum alloy plate at room temperature.

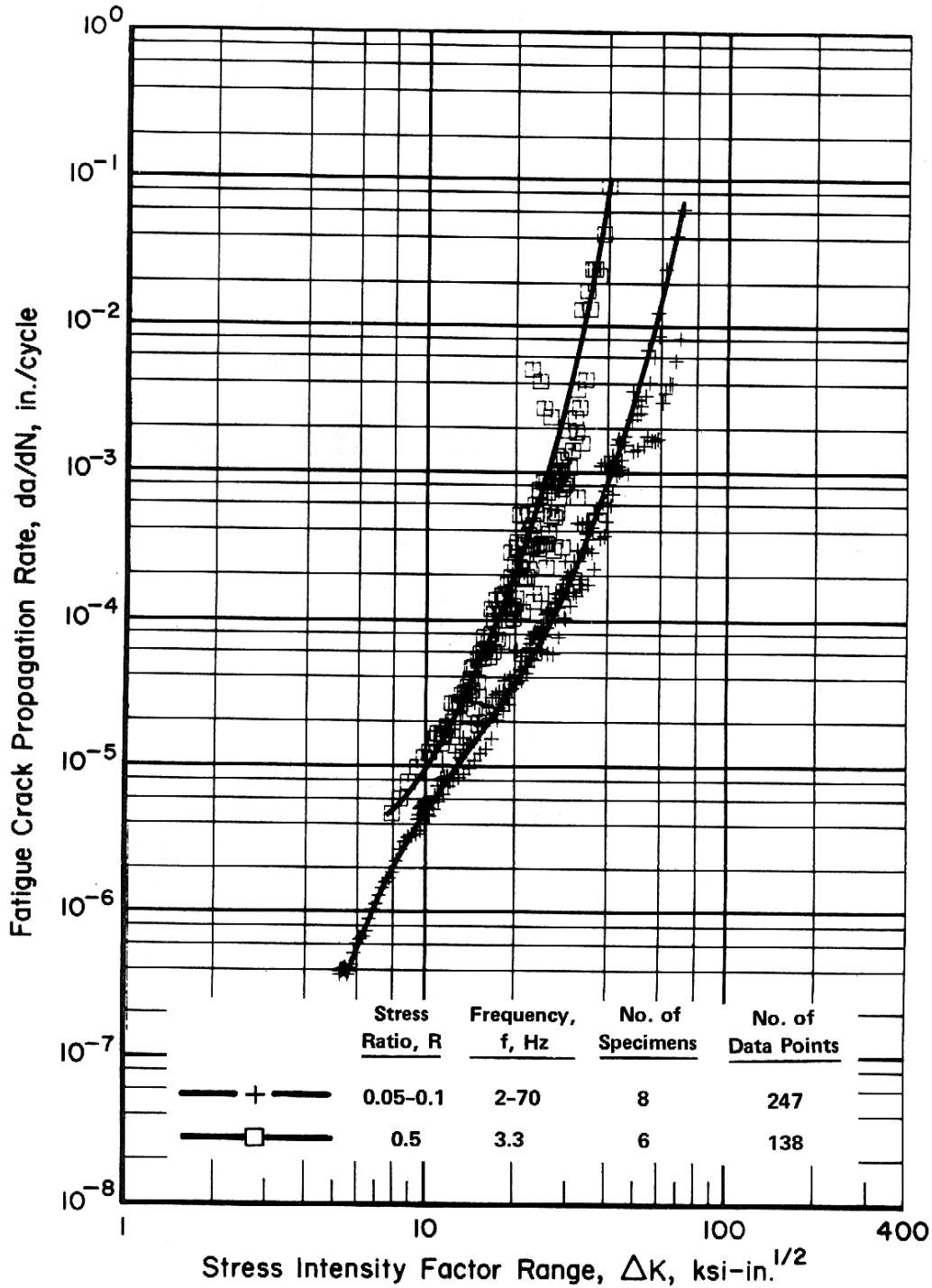

Figure 3.2.7.1.9(a). Fatigue-crack-propagation data for 2.0 to 5.5 inch thick, 2124-T851 aluminum alloy plate. [References 3.2.7.1.9(a), 3.2.7.1.9(c), and 3.2.7.1.9(d)].

Specimen Thickness: 0.25-0.45 and 0.15 inch
Specimen Width: 11.75 and 3.0 inches
Specimen Type: M(T) and C(T)

Environment: 95% R.H.
Temperature: RT
Orientation: L-T

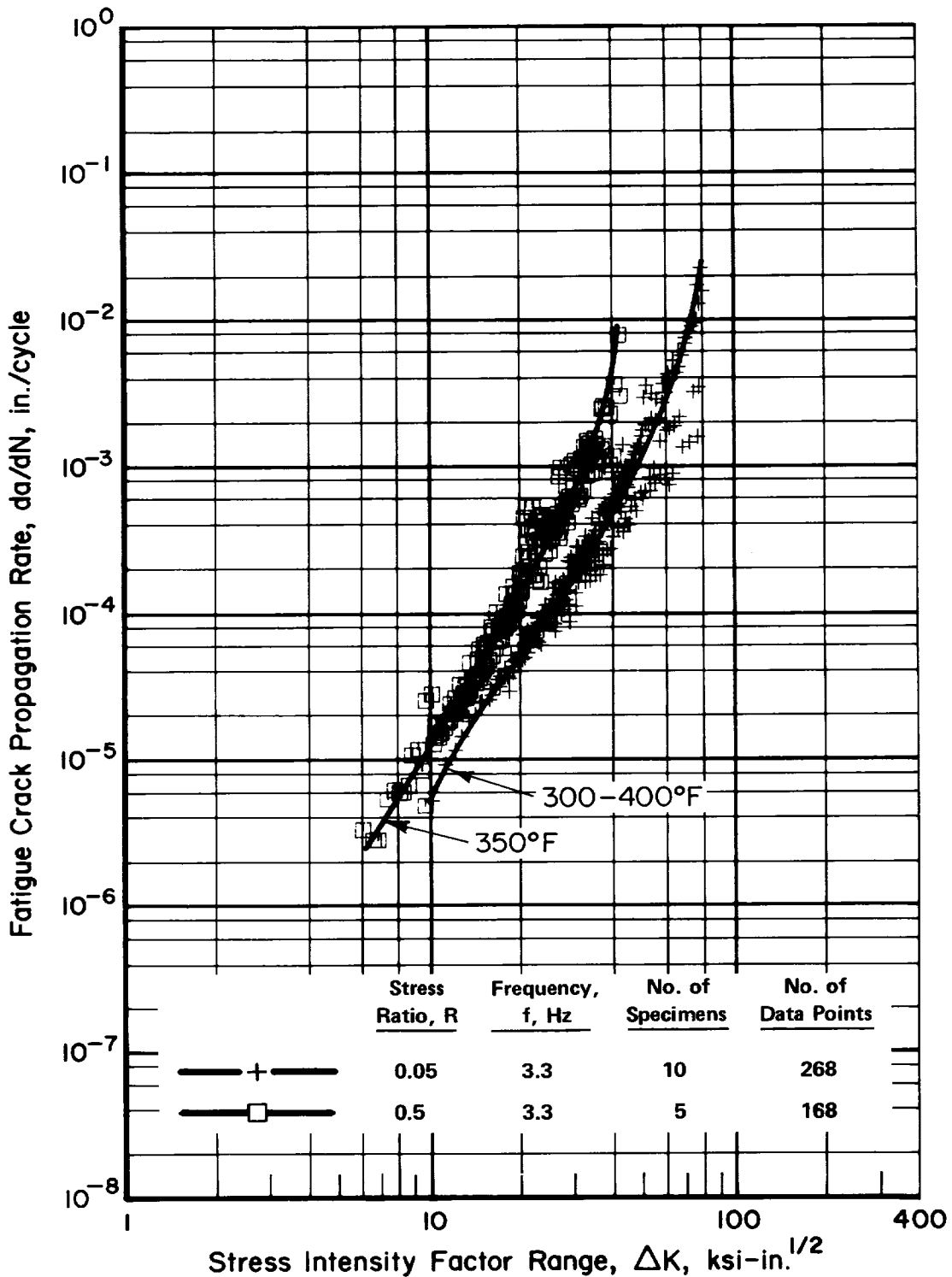

Figure 3.2.7.1.9(b). Fatigue-crack-propagation data for 2.0-inch thick, 2124-T851 aluminum alloy plate. [Reference 3.2.7.1.9(a)].

Specimen Thickness: 0.25-0.45 inch
Specimen Width: 11.75 inches
Specimen Type: M(T)

Environment: Lab air
Temperature: 300-400 °F
Orientation: L-T

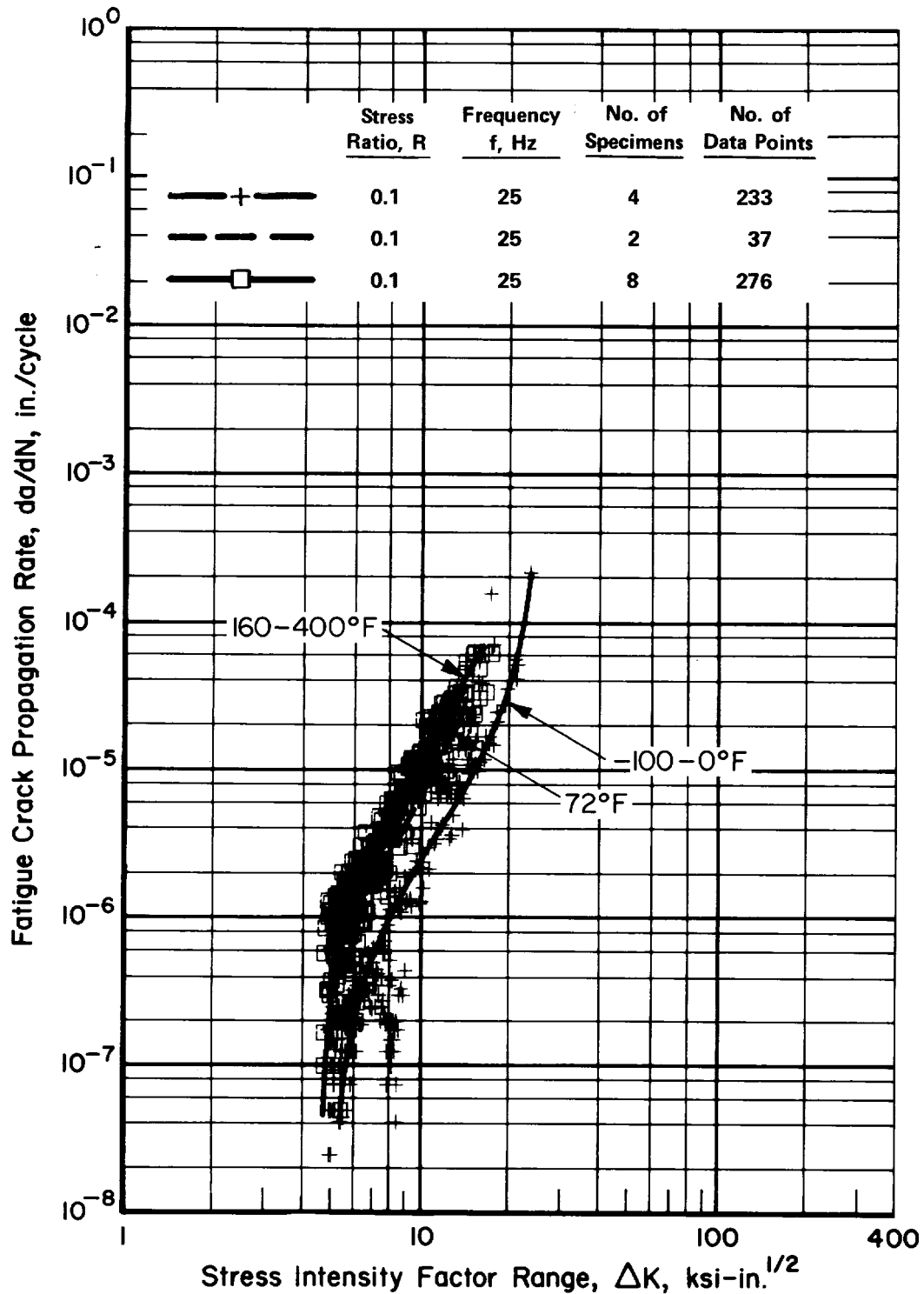

Figure 3.2.7.1.9(c). Fatigue-crack-propagation data for 2.5-inch thick, 2124-T851 aluminum alloy plate. [Reference 3.2.7.1.9(b)].

Specimen Thickness:	0.75 inch	Environment:	Lab air
Specimen Width:	1.75 inches	Temperature:	-100 through 400 °F
Specimen Type:	C(T)	Orientation:	L-T

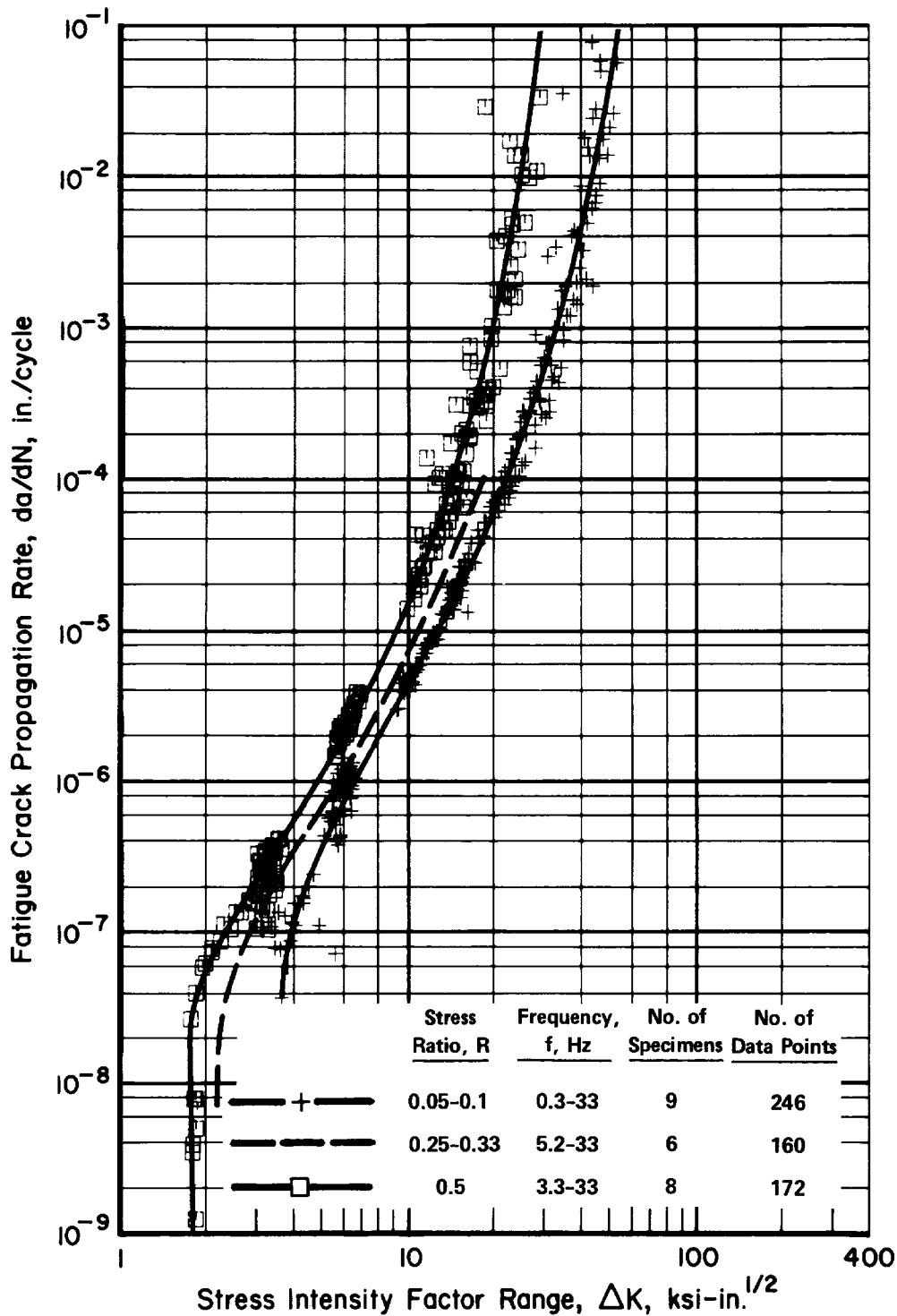

Figure 3.2.7.1.9(d). Fatigue-crack-propagation data for 2.0 to 5.5 inch thick, 2124-T851 aluminum alloy plate. [References 3.2.7.1.9(a), 3.2.7.1.9(d), and 3.7.4.2.9(c)].

<i>Specimen Thickness:</i>	0.25-0.75 inch	<i>Environment:</i>	90-95% R.H.
<i>Specimen Width:</i>	4.0-11.75 inches	<i>Temperature:</i>	RT
<i>Specimen Type:</i>	M(T)	<i>Orientation:</i>	T-L

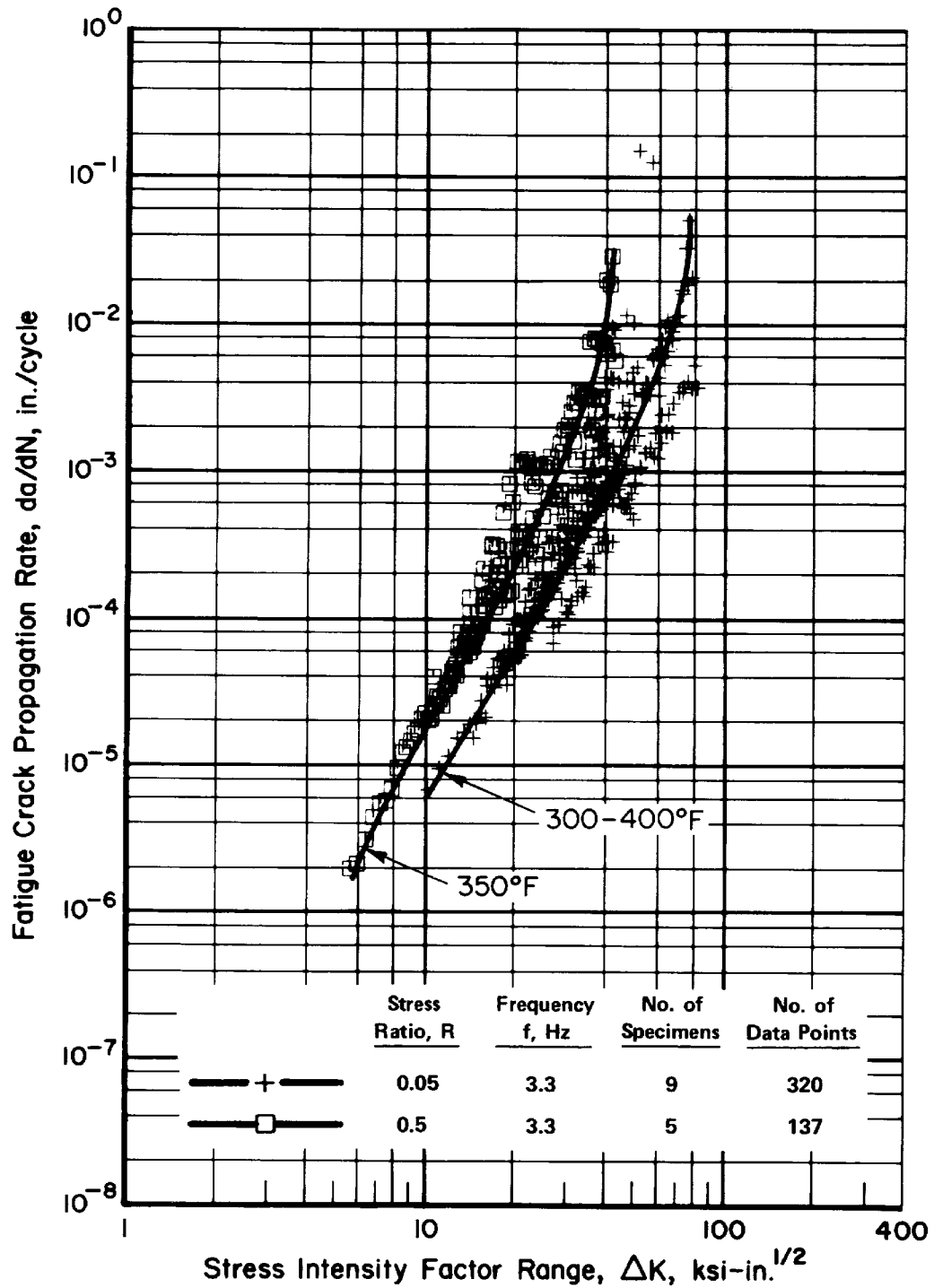

Figure 3.2.7.1.9(e). Fatigue-crack-propagation data for 2.0-inch thick, 2124-T851 aluminum alloy plate. [Reference 3.2.7.1.9(a)].

Specimen Thickness:	0.25-0.45 inch	Environment:	Lab air
Width:	11.75 inches	Temperature:	300-400 °F
Type:	M(T)	Orientation:	T-L

3.2.8 2219 ALLOY

3.2.8.0 Comments and Properties — 2219 is an Al-Cu alloy available in a wide variety of product forms. As shown in Table 3.1.2.3.1(a), 2219-T351X and -T37 rolled plate and extruded shapes have a 'D' SCC rating. This is the lowest rating and means that SCC failures have occurred in service or would be anticipated if there is any sustained stress. In-service failures are caused by stresses produced by any combination of sources including solution heat treatment, straightening, forming, fit-up, clamping, sustained service loads or high service compression stresses that produce residual tensile stresses. These stresses may be tension or compression as well as the stresses due to the Poisson effect, because the actual failures are caused by the resulting sustained shear stresses. Pin-hole flaws in corrosion protection are sufficient for SCC. Refer to Section 3.1.2.3 for comments regarding the resistance of the alloy to stress-corrosion cracking, and to Section 3.1.3.4 for comments regarding the weldability of the alloy. It has been used in critical cryogenic applications as well as those applications in which high strength and creep resistance at relatively high temperatures (400 to 600°F) are required.

The properties of extrusions should be based upon the thickness at the time of quenching prior to machining. Selection of the mechanical properties based upon its final machined thickness may be unconservative; therefore, the thickness at the time of quenching to achieve properties is an important factor in the selection of the proper thickness column. For extrusions having sections with various thicknesses, consideration should be given to the properties as a function of thickness.

Material specifications for 2219 are presented in Table 3.2.8.0(a). Room-temperature mechanical and physical properties are shown in Tables 3.2.8.0(b) through (d). The effect of temperature on the physical properties is shown in Figure 3.2.8.0.

Table 3.2.8.0(a). Material Specifications for 2219 Aluminum Alloy

Specification	Form
AMS 4031	Sheet and plate
AMS-QQ-A-250/30	Sheet and plate
AMS 4162	Extrusion
AMS 4163	Extrusion
AMS 4144	Hand forging

The temper index for 2219 is as follows:

<u>Section</u>	<u>Temper</u>
3.2.8.1	T62
3.2.8.2	T81, T851, T8510, and T8511
3.2.8.3	T852
3.2.8.4	T87

3.2.8.1 T62 Temper — Elevated temperature data for this temper are presented in Figures 3.2.8.1.1(a) and (b). Typical room-temperature tensile and compressive stress-strain, compressive tangent-modulus, and full-range tensile stress-strain curves for 2219 aluminum alloy sheet and plate for this temper are shown in Figures 3.2.8.1.6(a) and (b).

3.2.8.2 T81 and T851X Tempers — Elevated temperature data for these tempers are presented in Figures 3.2.8.2.1(a) and (b). Typical room-temperature tensile and compressive stress-strain, compressive

tangent-modulus, and full-range tensile stress-strain curves for 2219 aluminum alloy for this condition are shown in Figures 3.2.8.2.6(a) and (b). Notched fatigue data for plate are presented in Figures 3.2.8.2.8(a) through (d).

3.2.8.3 T852 Temper — Typical room-temperature tensile and compressive stress-strain, compressive tangent-modulus, and full-range tensile stress-strain curves for 2219 aluminum alloy for this temper are shown in Figures 3.2.8.3.6(a) through (e).

3.2.8.4 T87 Temper — Elevated temperature data for this temper are presented in Figures 3.2.8.4.1(a) and (b). Typical room-temperature tensile and compressive stress-strain, compressive tangent-modulus, and full-range tensile stress-strain curves for 2219 aluminum alloy sheet and plate for this temper are shown in Figures 3.2.8.4.6(a) through (e).

Table 3.2.8.0(b₁). Design Mechanical and Physical Properties of 2219 Aluminum Alloy Sheet and Plate

Specification	AMS 4031 & AMS-QQ-A- 250/30		AMS-QQ-A-250/30																
			Sheet and plate																
	T62 ^a		T81						T851										
Form			0.020-2.000		0.020-0.249		0.250-1.000		1.001-2.000		2.001-3.000		3.001-4.000		4.001-5.000		5.001-6.000		
Temper	A	B	A	B	A	B	A	B	A	B	A	B	A	B	A	B	A	B	
Thickness, in.																			
Basis																			
Mechanical Properties:																			
F_{up} , ksi:																			
L	54	55	61	62	61	62	61	62	61	62	62	63	62	63	62	63	62	63	62
LT	54	55	62	63	62	63	62	63	62	63	62	63	62	63	62	63	62	63	62
F_{yp} , ksi:																			
L	36	37	47	48	47	48	47	48	47	48	47	48	47	48	47	48	47	48	47
LT	36	37	46	47	46	47	46	47	46	47	46	47	46	47	46	47	46	47	46
F_{cp} , ksi:																			
L	37	39	47	48	47	48	47	48	47	48	47	48	47	48	47	48	47	48	47
LT	37	38	48	49	48	49	48	49	48	49	48	49	48	49	48	49	48	49	48
F_{sp} , ksi:																			
F_{brb} , ksi:	31	32	35	35	36	36	36	36	36	36	36	36	36	36	36	36	36	36	36
(e/D = 1.5)	84	85	95	96	95	96	95	96	95	96	95	96	95	96	95	96	95	96	95
(e/D = 2.0)	107	109	121	123	121	123	121	123	121	123	121	123	121	123	121	123	121	123	121
F_{brb} , ksi:																			
(e/D = 1.5)	62	64	76	78	76	78	76	78	76	78	76	78	76	78	76	78	76	78	76
(e/D = 2.0)	79	81	92	94	94	94	94	94	94	94	94	94	94	94	94	94	94	94	94
e , percent (S-basis):																			
LT	c		c		8	...	7	6	...	5	...	5	...	5	...	4	...
E , 10 ³ ksi																			
E_c , 10 ³ ksi																			
G , 10 ³ ksi																			
μ																			
ω , lb/in. ³																			
C , K , and α																			

a Design allowables were based upon data obtained from testing samples of material, supplied in O and F temper, which were heat treated to demonstrate response to heat treatment by suppliers. Properties obtained by user may be lower than those listed if the material has been formed or otherwise cold or hot worked, particularly in the annealed temper, prior to solution heat treatment.

b Bearing values are "dry pin" values per Section 1.4.7.1. See Table 3.1.2.1.1.

c T62 and T81: 0.020-0.039 in., 6 percent, 0.040-0.249 in., 7 percent; T62: 0.250-1.000 in., 8 percent, 1.001-2.000 in., 7 percent.

Table 3.2.8.0(b₂). Design Mechanical and Physical Properties of 2219 Aluminum Alloy Sheet — Continued

Specification	AMS-QQ-A-250\30			
Form	Sheet			
Condition	T87			
Thickness, in.	0.020-0.039		0.040-0.249	
Basis	A	B	A	B
Mechanical Properties:				
F_{tu} , ksi:				
L	63	64	63	64
LT	64	65	64	65
F_{ty} , ksi:				
L	51	52	51	52
LT	52	53	52	53
F_{cy} , ksi:				
L	52	53	52	53
LT	55	56	55	56
F_{su} , ksi	36	37	36	37
F_{bru}^a , ksi:				
(e/D = 1.5)	99	100	99	100
(e/D = 2.0)	126	128	126	128
F_{bry}^a , ksi:				
(e/D = 1.5)	83	85	83	85
(e/D = 2.0)	96	98	96	98
e , percent (S-basis):				
LT	5	...	6	...
E , 10 ³ ksi	10.5			
E_c , 10 ³ ksi	10.8			
G , 10 ³ ksi	4.0			
μ	0.33			
Physical Properties:				
ω , lb/in. ³	0.103			
C , K , and α	See Figure 3.2.8.0			

a See Table 3.1.2.1.1. Bearing values are “dry pin” values per Section 1.4.7.1.

MIL-HDBK-5J
31 January 2003

Table 3.2.8.0(b₃). Design Mechanical and Physical Properties of 2219 Aluminum Alloy Plate — Continued

Specification	AMS-QQ-A-250\30											
Form	Plate											
Condition	T87											
Thickness, in.	0.250-1.000		1.001-1.500		1.501-2.000		2.001-3.000		3.001-4.000		4.001-5.000	
Basis	A	B	A	B	A	B	A	B	A	B	A	B
Mechanical Properties:												
<i>F_{tu}</i> , ksi:												
L	63	64	63	64	63	64	63	64	61	62
LT	64	65	64	65	64	65	64	65	62	63	61	62
ST	59	60	56	57	52	53
<i>F_{ty}</i> , ksi:												
L	50	51	50	51	50	51	50	51	49	50
LT	51	52	51	52	51	52	51	52	51	51	49	50
ST	51	52	50	51	48	49
<i>F_{cy}</i> , ksi:												
L	51	52	51	52	51	52
LT	53	54	52	53	52	53
<i>F_{su}</i> , ksi	37	38	37	38	37	38
<i>F_{bru}^a</i> , ksi:												
(e/D = 1.5)	99	100	99	100	99	100
(e/D = 2.0)	126	128	126	128	126	128
<i>F_{bry}^a</i> , ksi:												
(e/D = 1.5)	82	83	82	83	82	83
(e/D = 2.0)	94	96	94	96	94	96
<i>e</i> , percent (S-basis):												
LT	7	...	6	...	6	...	6	...	4	...	3	...
<i>E</i> , 10 ³ ksi	10.5											
<i>E_e</i> , 10 ³ ksi	10.8											
<i>G</i> , 10 ³ ksi	4.0											
<i>μ</i>	0.33											
Physical Properties:												
<i>ω</i> , lb/in. ³	0.103											
<i>C</i> , <i>K</i> , and <i>α</i>	See Figure 3.2.8.0											

a See Table 3.1.2.1.1. Bearing values are “dry pin” values per Section 1.4.7.1.

MIL-HDBK-5J
31 January 2003

Table 3.2.8.0(c). Design Mechanical and Physical Properties of 2219 Aluminum Alloy Hand Forging

Specification	AMS 4144							
	Hand Forging							
Form	T852							
	<2.000	2.000-4.000	4.001-6.000	6.001-8.000	8.001-10.000	10.001-12.000	12.001-14.000	14.001-17.000
Temper	S	S	S	S	S	S	S	S
Thickness, in.								
Basis	S	S	S	S	S	S	S	S
Mechanical Properties:								
<i>F_{UT}</i> , ksi:								
L	62	62	58	57	56	54	53	51
LT	62	62	56	55	54	53	52	50
ST	60	56	55	54	53	52	50
<i>F_{ty}</i> , ksi:								
L	50	50	44	43	42	41	40	39
LT	49	49	42	41	41	40	40	39
ST	46	41	40	39	39	38	37
<i>F_{cy}</i> , ksi:								
L.....	...	46	40	39
LT	47	40	39
ST	47	41	40
<i>F_{su}</i> , ksi:								
L.....	...	37	35	35
LT	36	34	35
ST	32	32	33
<i>F_{bru}^a</i> , ksi:								
(e/D = 1.5)	80
(e/D = 2.0)	104	100	102
<i>F_{brv}^a</i> , ksi:								
(e/D = 1.5)	76	65	64
(e/D = 2.0)	89	76	75
<i>e</i> , percent:								
L.....	6	6	6	6	6	6	6	6
LT	4	4	4	4	3	3	3	3
ST	3	3	3	3	2	2	2
<i>E</i> , 10 ³ ksi								
					10.2			
<i>E_c</i> , 10 ³ ksi								
					10.4			
<i>G</i> , 10 ³ ksi								
					3.9			
<i>μ</i>								
					0.33			
Physical Properties:								
<i>ω</i> , lb/in. ³								
					0.103			
<i>C</i> , <i>K</i> , and <i>α</i>								
					See Figure 3.2.8.0			

^a Bearing values are “dry pin” values per Section 1.4.7.1.

Table 3.2.8.0(d). Design Mechanical and Physical Properties of 2219 Aluminum Alloy Extruded Shapes

Specification	AMS 4162 and AMS 4163 ^a	
Form	Extruded shapes	
Temper	T8511	
Cross-Sectional Area, in. ²	≤25	
Thickness or Diameter, ^b in.	≤0.499	0.500-2.999
Basis	S	S
Mechanical Properties:		
F_{tu} , ksi:		
L	58	58
LT ^c	56	56
F_{ty} , ksi:		
L	42	42
LT ^c	39	39
F_{cy} , ksi:		
L	43	42
LT	43	41
F_{su} , ksi	33	33
F_{bru}^d , ksi:		
(e/D = 1.5)	87	81
(e/D = 2.0)	113	107
F_{brv}^d , ksi:		
(e/D = 1.5)	69	67
(e/D = 2.0)	84	82
e , percent:		
L	6	6
LT ^c	4	4
E , 10 ³ ksi	10.5	
E_c , 10 ³ ksi	10.8	
G , 10 ³ ksi	4.0	
μ	0.33	
Physical Properties:		
ω , lb/in. ³	0.103	
C , K , and α	See Figure 3.2.8.0	

a Design allowables for extrusions procured to AMS 4163 were based upon data obtained from testing samples of material, supplied in T3511 temper, which were precipitation heat treated by suppliers to demonstrate response to aging treatment.

b The mechanical properties are to be based upon the thickness at the time of quench.

c Applicable providing LT dimension is ≥2.500 inches.

d Bearing values are “dry pin” values per Section 1.4.7.1.

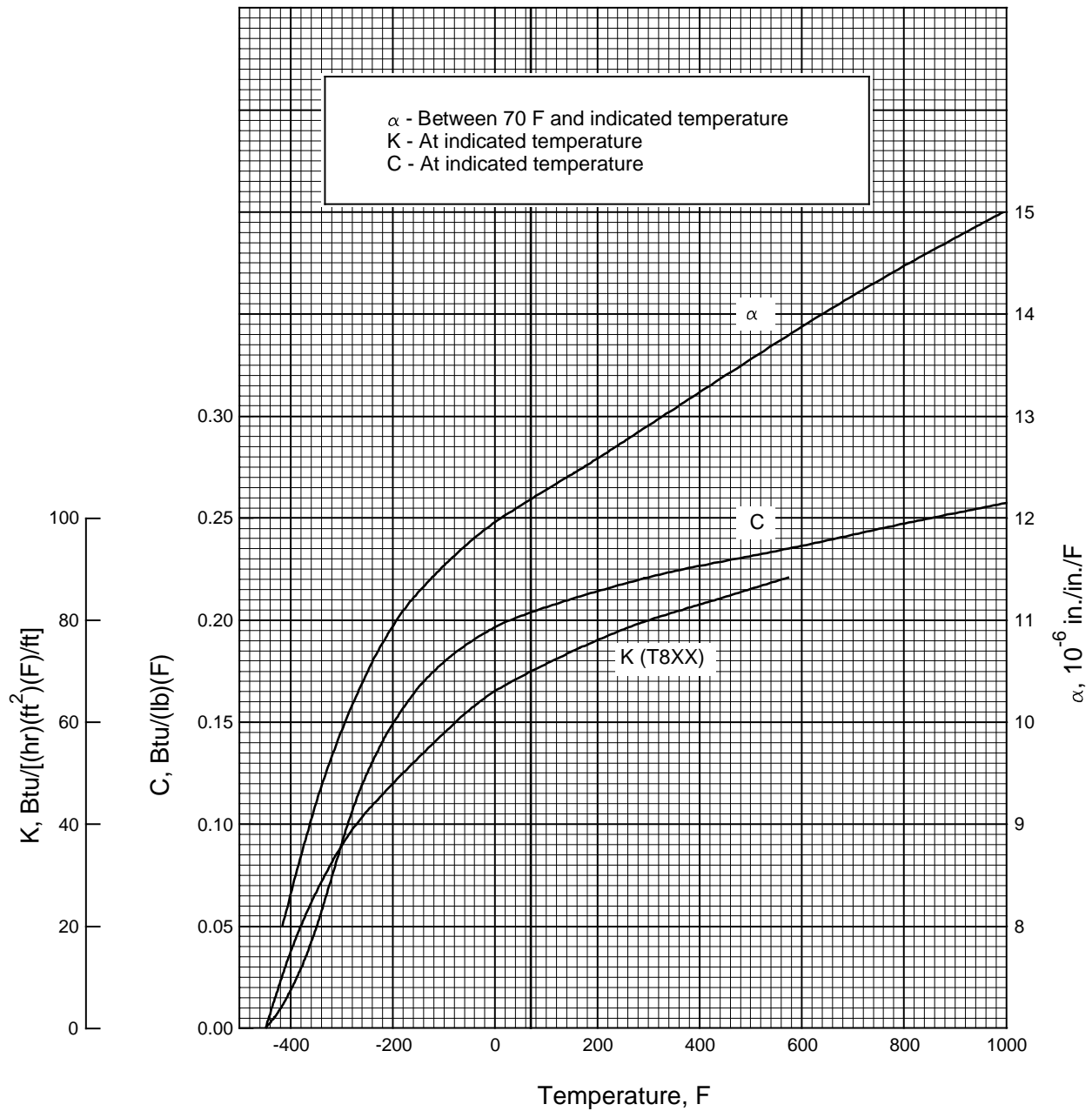

Figure 3.2.8.0. Effect of temperature on the physical properties of 2219 aluminum alloy.

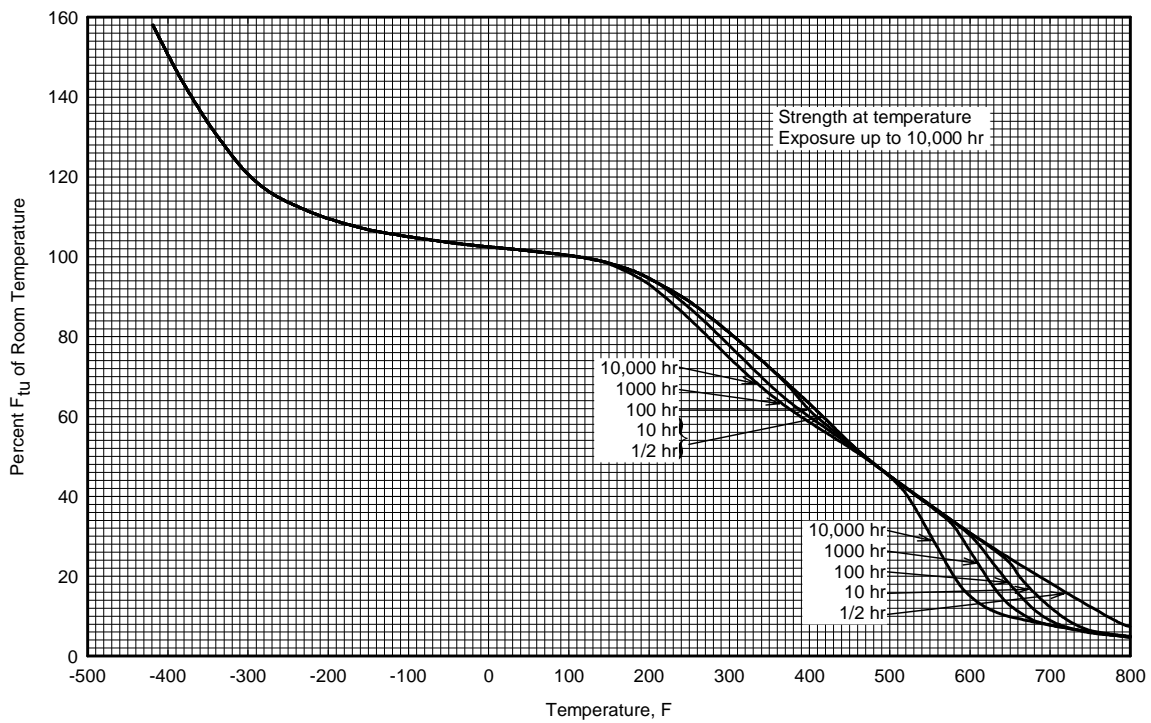

Figure 3.2.8.1.1(a). Effect of temperature on the tensile ultimate strength (F_{tu}) of 2219-T62 aluminum alloy sheet, 0.040-0.249, and plate, 0.250-1.000 in. thick.

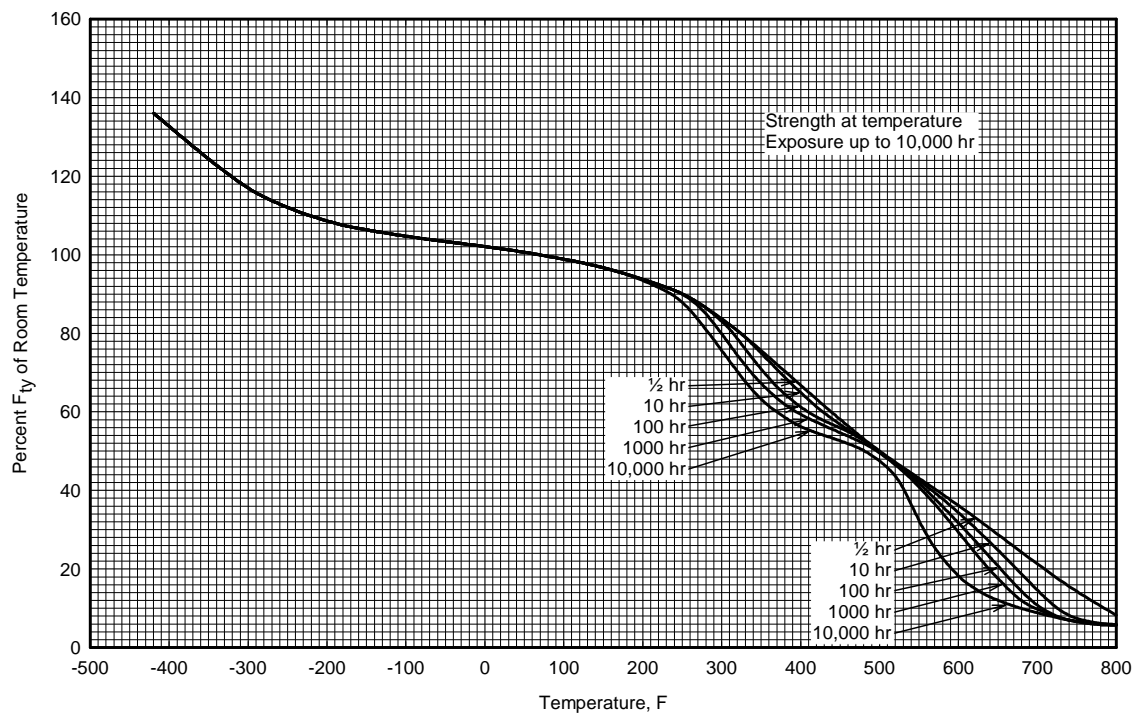

Figure 3.2.8.1.1(b). Effect of temperature on the tensile yield strength (F_{ty}) of 2219-T62 aluminum alloy sheet, 0.040-0.249 and plate, 0.250-1.000 in. thick.

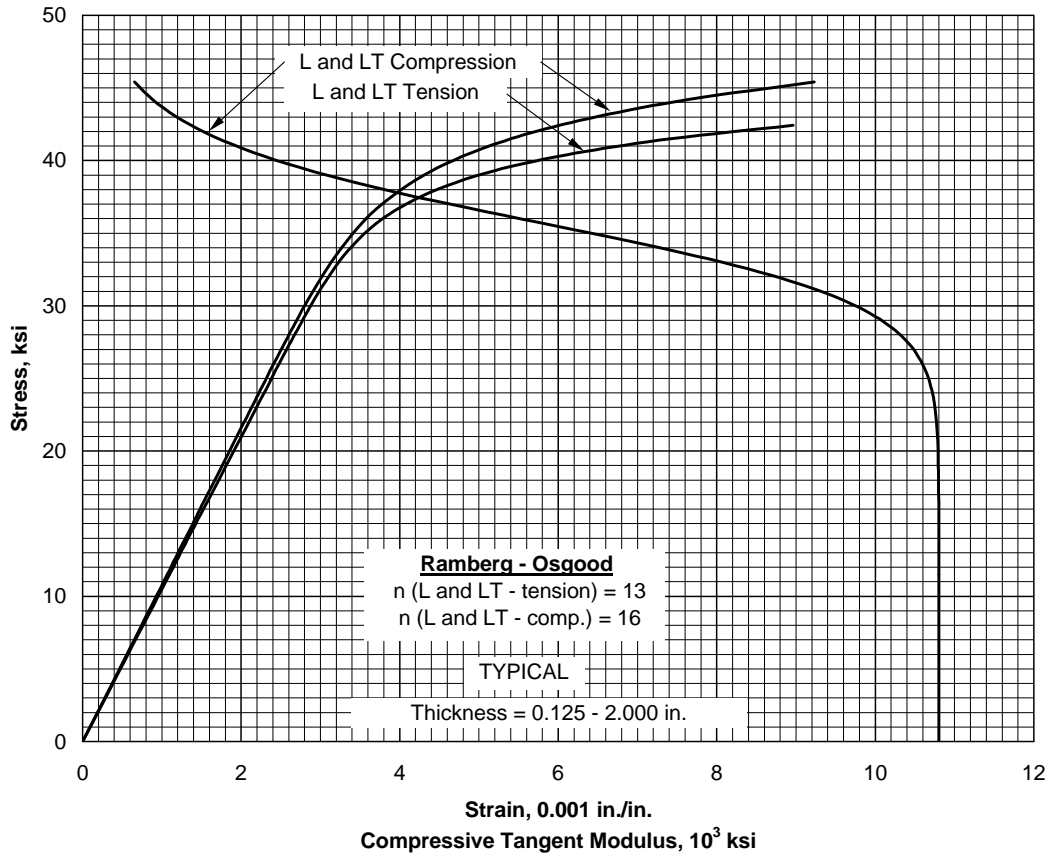

Figure 3.2.8.1.6(a). Typical tensile and compressive stress-strain and compressive tangent-modulus curves for 2219-T62 aluminum alloy sheet and plate at room temperature.

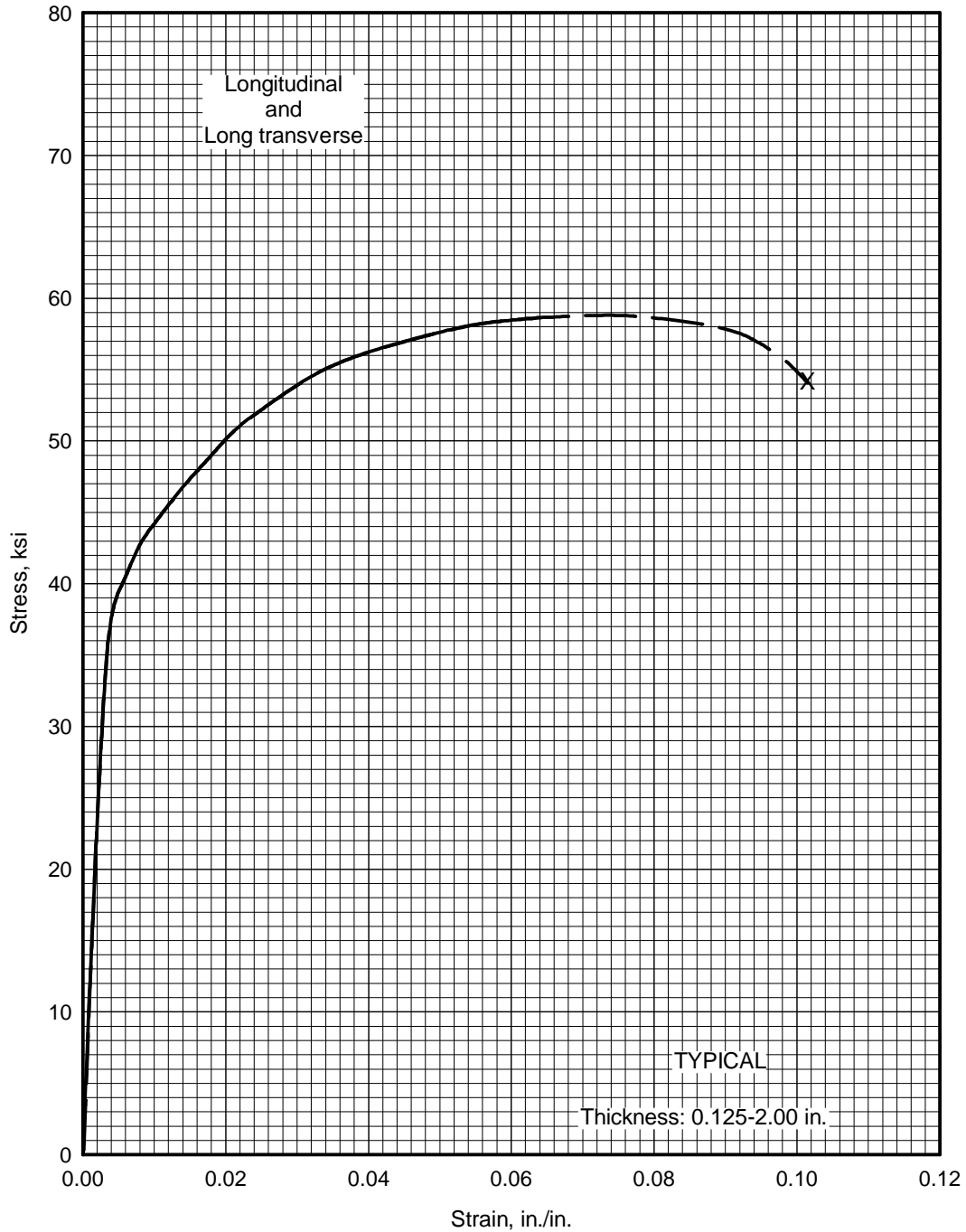

Figure 3.2.8.1.6(b). Typical tensile stress-strain (full range) curve for 2219-T62 aluminum alloy sheet and plate at room temperature.

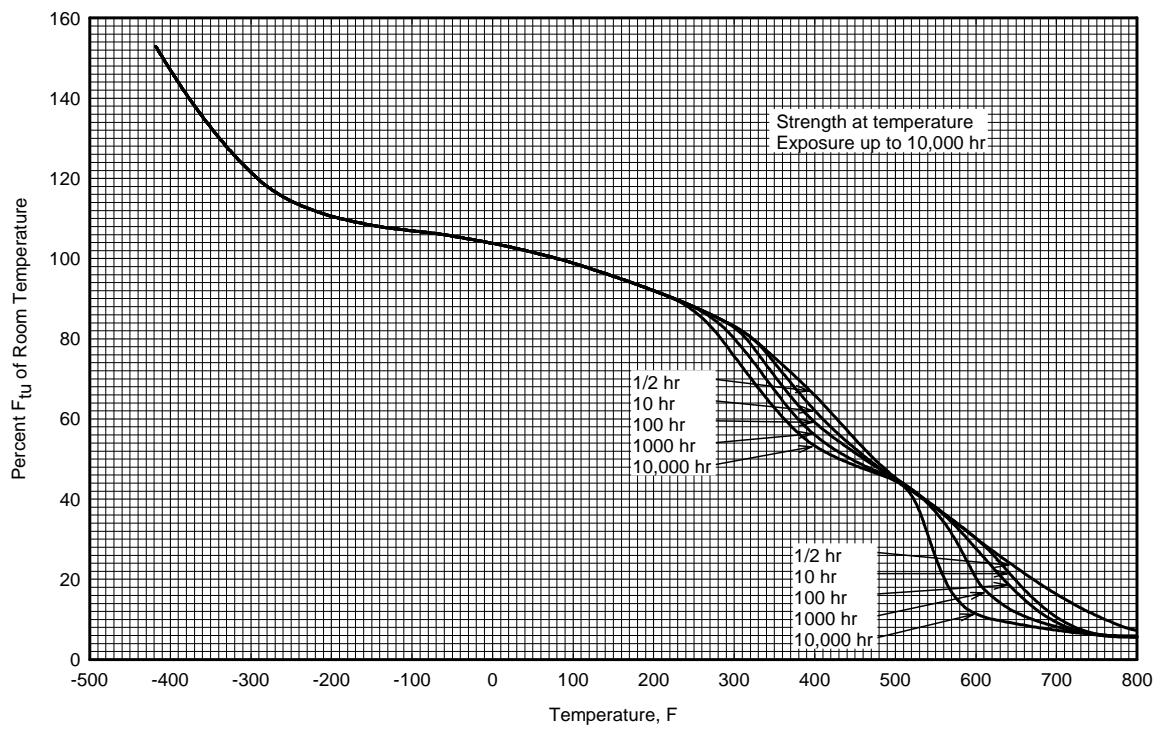

Figure 3.2.8.2.1(a). Effect of temperature on the tensile ultimate strength (F_{tu}) of 2219-T81 aluminum alloy sheet and 2219-T851 aluminum alloy plate.

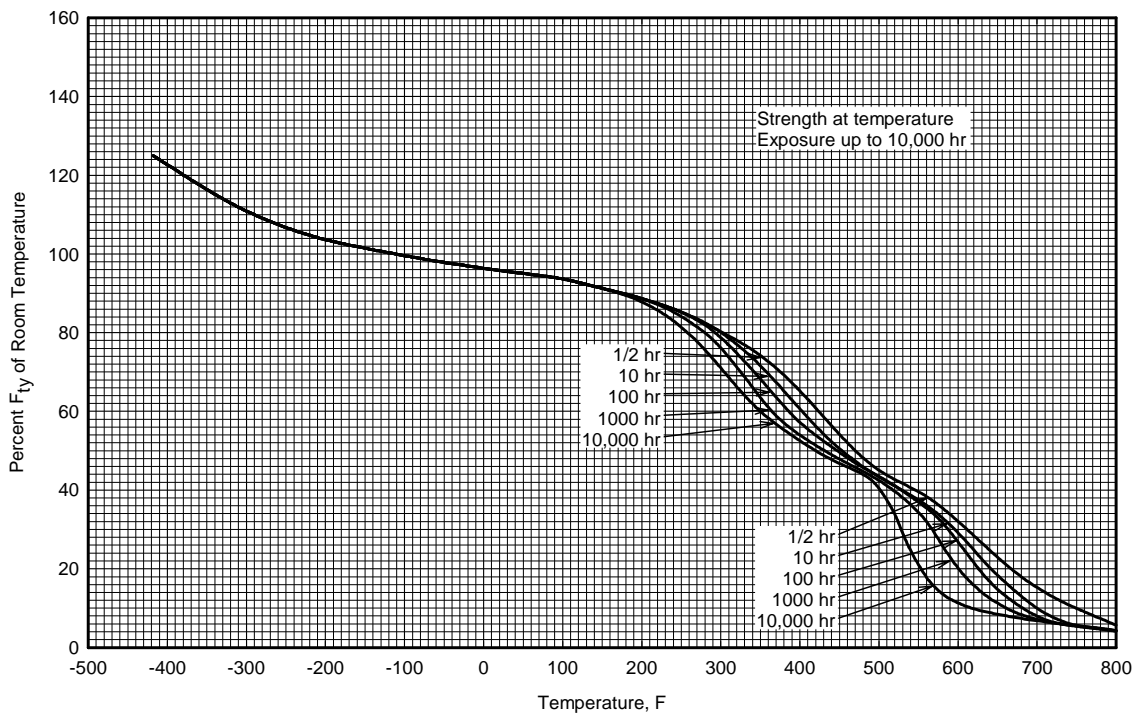

Figure 3.2.8.2.1(b). Effect of temperature on the tensile yield strength (F_y) of 2219-T81 aluminum alloy sheet and 2219-T851 aluminum alloy plate.

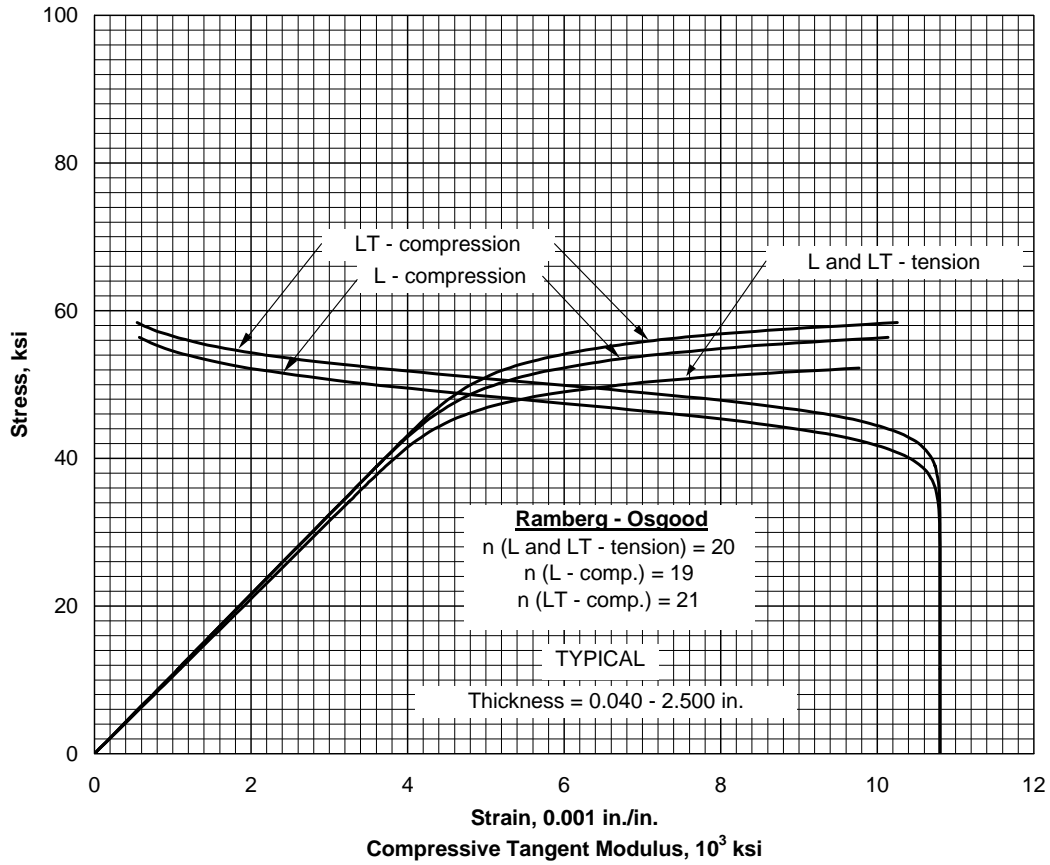

Figure 3.2.8.2.6(a). Typical tensile and compressive stress-strain and compressive tangent-modulus curves for 2219-T81 aluminum alloy sheet and 2219-T851 aluminum alloy plate at room temperature.

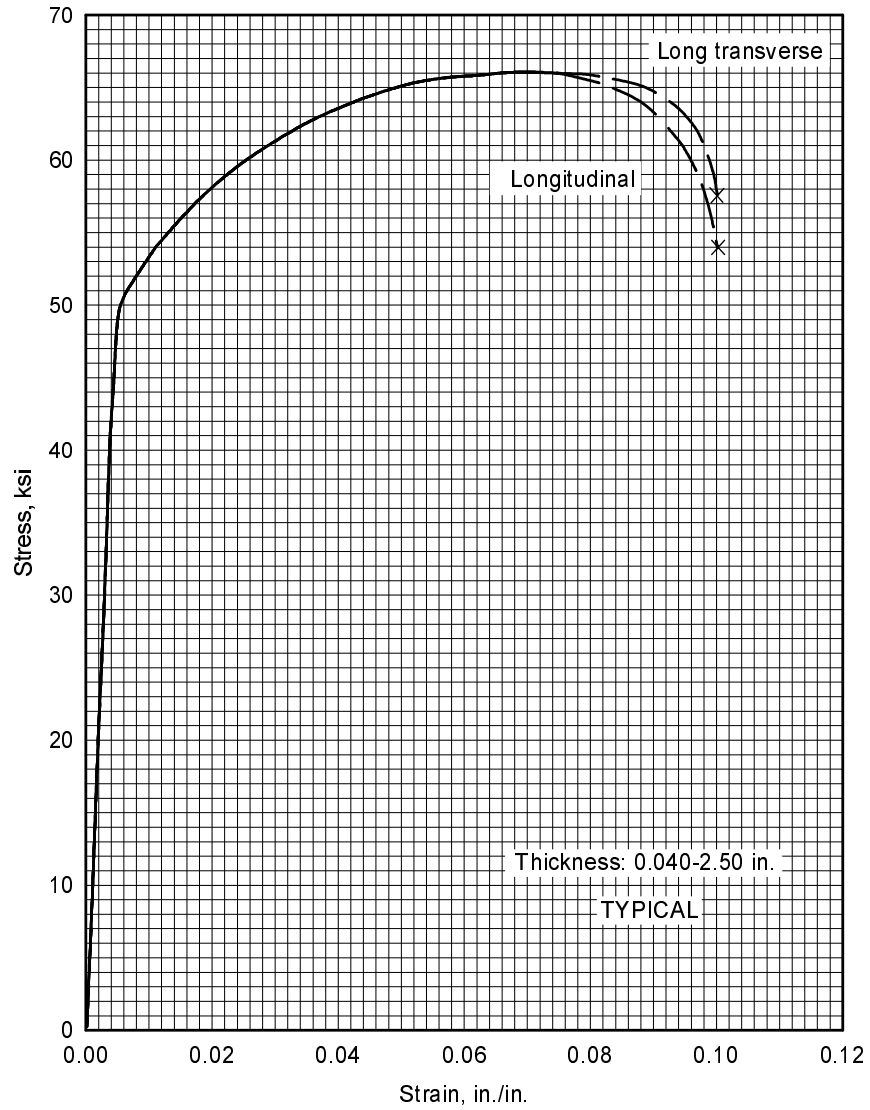

Figure 3.2.8.2.6(b). Typical tensile stress-strain curves (full range) for 2219-T81 aluminum alloy sheet and 2219-T851 aluminum alloy plate at room temperature.

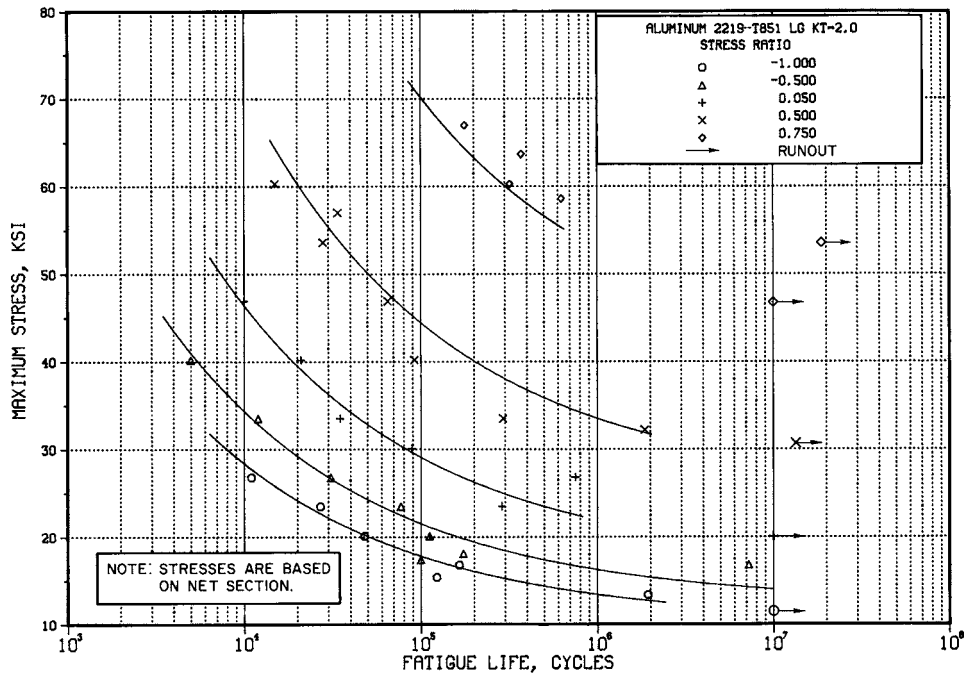

Figure 3.2.8.2.8(a). Best-fit S/N curves for notched, $K_t = 2.0$, 2219-T851 aluminum alloy plate, longitudinal direction.

Correlative Information for Figure 3.2.8.2.8(a)

Product Form: Plate, 2.00 inch thick

Test Parameters:

Properties:

TUS, ksi	TYS, ksi	Temp., °F
68	52	RT (unnotched)
94	—	RT (notched)

Loading - Axial
Frequency - 7000 to 8000 cpm
Temperature - RT
Environment - Air

No. of Heats/Lots: 1

Specimen Details: Notched, V-Groove, $K_t = 2.0$
0.195 inch gross diameter
0.136 inch net diameter
0.020 inch root radius, r
60° flank angle, ϵ

Equivalent Stress Equation:
 $\log N_f = 7.92 - 2.69 \log (S_{eq} - 16.0)$
 $S_{eq} = S_{max} (1-R)^{0.64}$ ksi
Std. Error of Estimate, $\log (\text{Life}) = 0.313$
Standard Deviation, $\log (\text{Life}) = 0.739$
 $R^2 = 82\%$

Surface Condition: As machined

Sample Size = 34

Reference: 3.2.8.2.8

[Caution: The equivalent stress model may provide unrealistic life predictions for stress ratios beyond those represented above.]

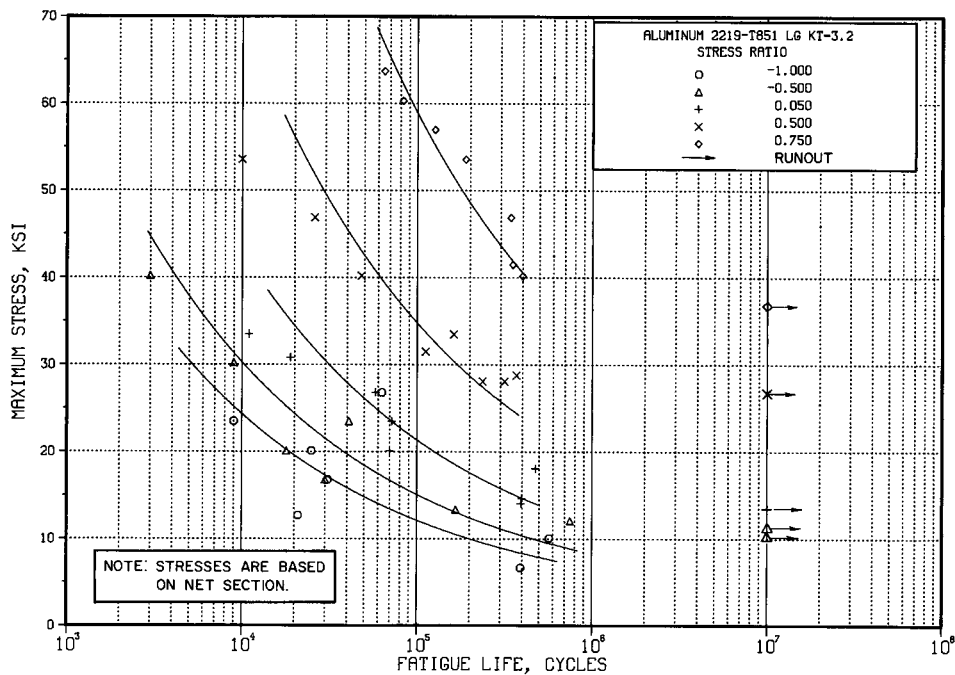

Figure 3.2.8.2.8(b). Best-fit S/N curves for notched, $K_t = 3.2$, 2219-T851 aluminum alloy plate, longitudinal direction.

Correlative Information for Figure 3.2.8.2.8(b)

Product Form: Plate, 2.00 inch thick

Test Parameters:

Properties:

TUS, ksi	TYS, ksi	Temp., °F
68	52	RT (unnotched)
92	—	RT (notched)

Loading - Axial
Frequency - 7000 to 8000 cpm
Temperature - RT
Environment - Air

No. of Heats/Lots: 1

Specimen Details: Notched, V-Groove, $K_t = 3.2$
0.195 inch gross diameter
0.136 inch net diameter
0.006 inch root radius, r
60° flank angle, ω

Equivalent Stress Equation:
 $\text{Log } N_f = 8.46 - 2.83 \text{ log } (S_{eq} - 3.93)$
 $S_{eq} = S_{max} (1 - R)^{0.76}$
Std. Error of Estimate, $\text{Log } (\text{Life}) = 0.292$
Standard Deviation, $\text{Log } (\text{Life}) = 0.64$
 $R^2 = 79\%$

Surface Condition: As machined

Sample Size = 39

Reference: 3.2.8.2.8

[Caution: The equivalent stress model may provide unrealistic life predictions for stress ratios beyond those represented above.]

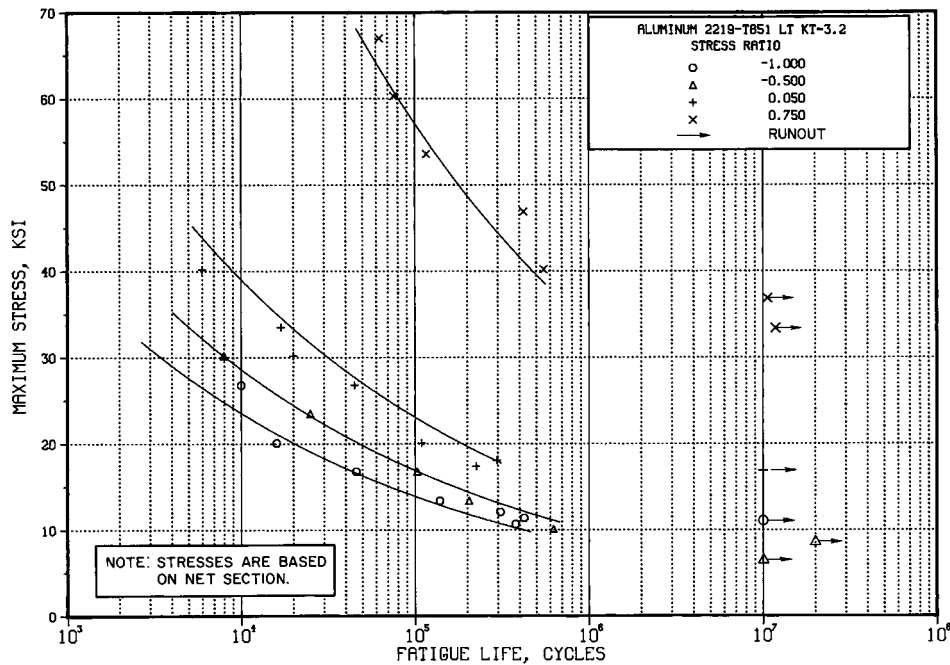

Figure 3.2.8.2.8(c). Best-fit S/N curves for notched, $K_t = 3.2$, 2219-T851 aluminum alloy plate, long transverse direction.

Correlative Information for Figure 3.2.8.2.8(c)

Product Form: Plate, 2.00 inch thick

Test Parameters:

Properties:

TUS, ksi	TYS, ksi	Temp., °F
68	51	RT (unnotched)
89	—	RT (notched)

Loading - Axial
Frequency - 7000 to 8000 cpm
Temperature - RT
Environment - Air

No. of Heats/Lots: 1

Specimen Details: Notched, V-Groove, $K_t = 3.2$
0.195 inch gross diameter
0.136 inch net diameter
0.006 inch root radius, r
60° flank angle, ω

Equivalent Stress Equation:
 $\log N_f = 10.85 - 4.34 \log (S_{eq})$
 $S_{eq} = S_{max} (1-R)^{0.686}$ ksi
Std. Error of Estimate, $\log (\text{Life}) = 0.153$
Standard Deviation, $\log (\text{Life}) = 0.610$
 $R^2 = 94\%$

Surface Condition: As machined

Sample Size = 25

Reference: 3.2.8.2.8

[Caution: The equivalent stress model may provide unrealistic life predictions for stress ratios beyond those represented above.]

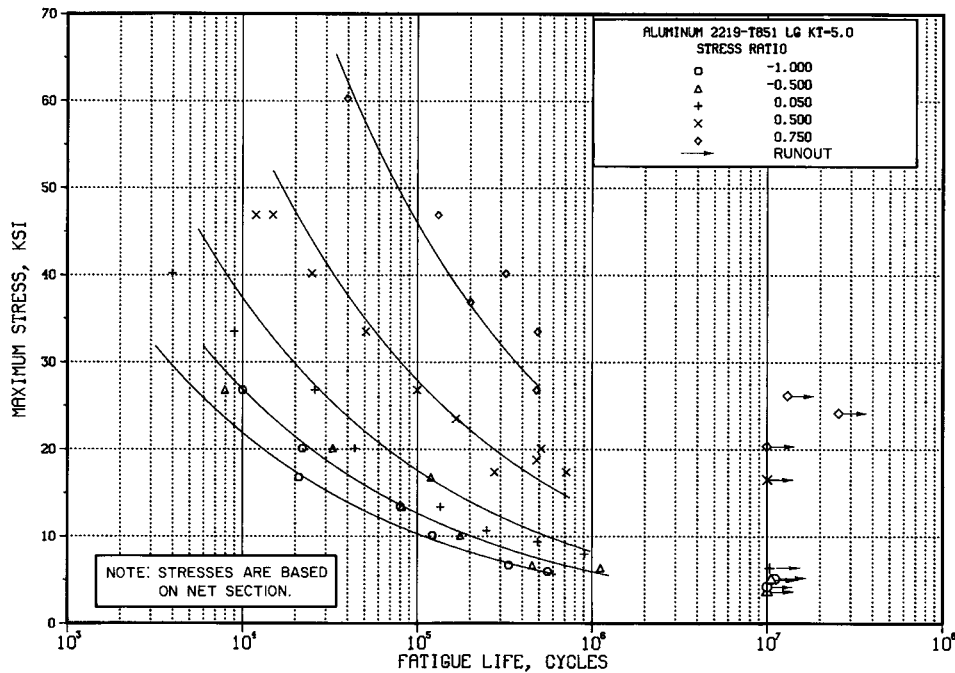

Figure 3.2.8.2.8(d). Best-fit S/N curves for notched, $K_t = 5.0$, 2219-T851 aluminum alloy plate, longitudinal direction.

Correlative Information for Figure 3.2.8.2.8(d)

Product Form: Plate, 2.00 inch thick

Test Parameters:

Properties: T_{US} , ksi T_{YS} , ksi $Temp.$, °F
68 (L) 52 (L) RT
(unnotched)
91 (L) — RT
(notched)

Loading - Axial
Frequency - 7000 to 8000 cpm
Temperature - RT
Environment - Air

No. of Heats/Lots: 1

Specimen Details: Notched, V-Groove, $K_t = 5.0$
0.300 inch gross diameter
0.210 inch net diameter
0.0035 inch root radius, r
60° flank angle, ω

Equivalent Stress Equation:
 $\log N_f = 8.76 - 3.05 \log (S_{eq})$
 $S_{eq} = S_{max} (1-R)^{0.722}$ ksi
Std. Error of Estimate, $\log (\text{Life}) = 0.194$
Standard Deviation, $\log (\text{Life}) = 0.660$
 $R^2 = 91\%$

Surface Condition: As machined

Sample Size = 38

Reference: 3.2.8.2.8

[Caution: The equivalent stress model may provide unrealistic life predictions for stress ratios beyond those represented above.]

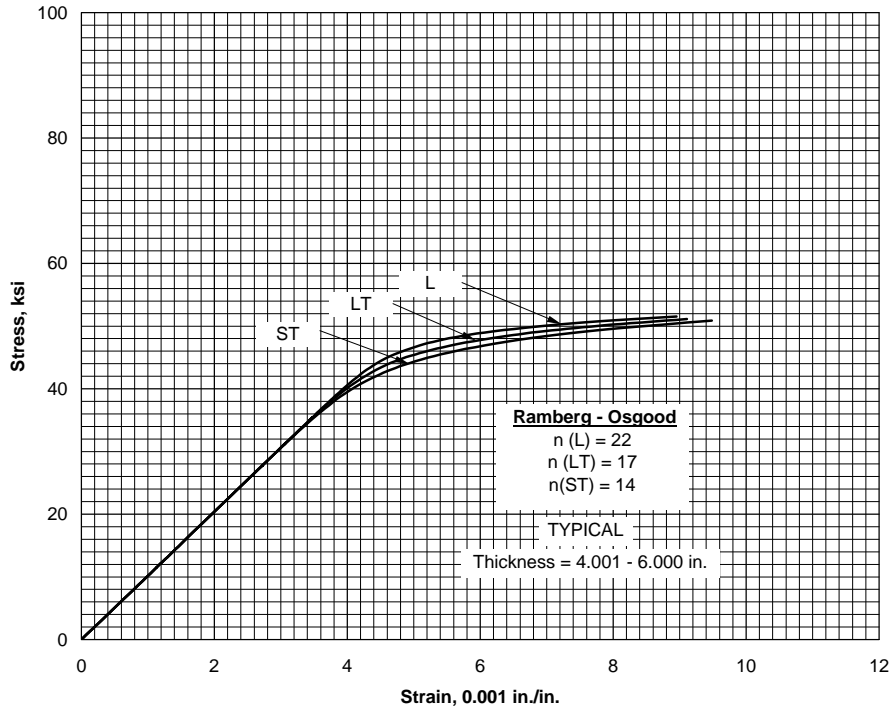

Figure 3.2.8.3.6(a). Typical tensile stress-strain curves for 2219-T852 aluminum alloy hand forging at room temperature.

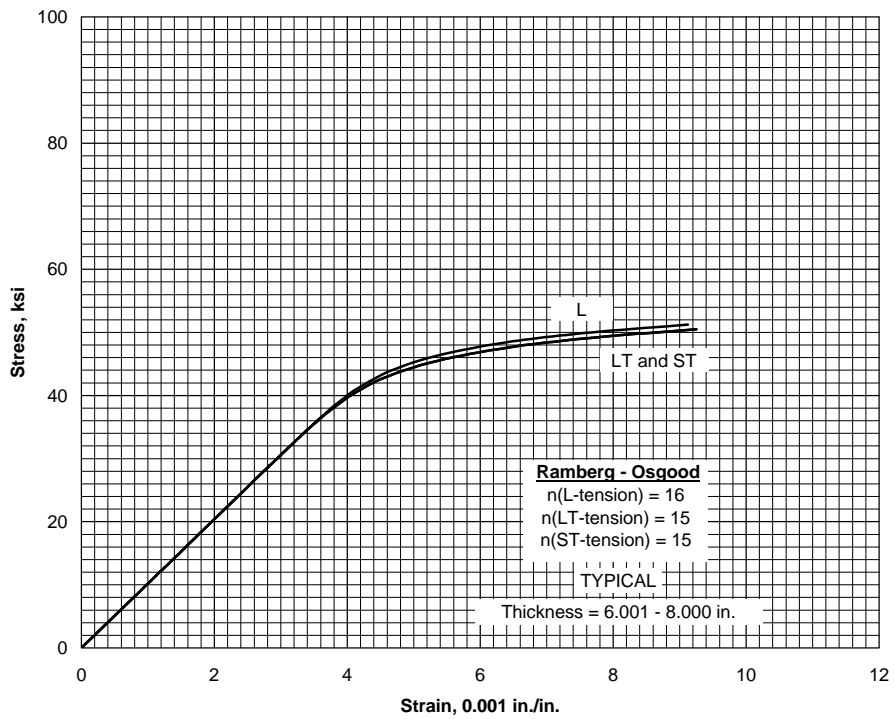

Figure 3.2.8.3.6(b). Typical tensile stress-strain curves for 2219-T852 aluminum alloy hand forging at room temperature.

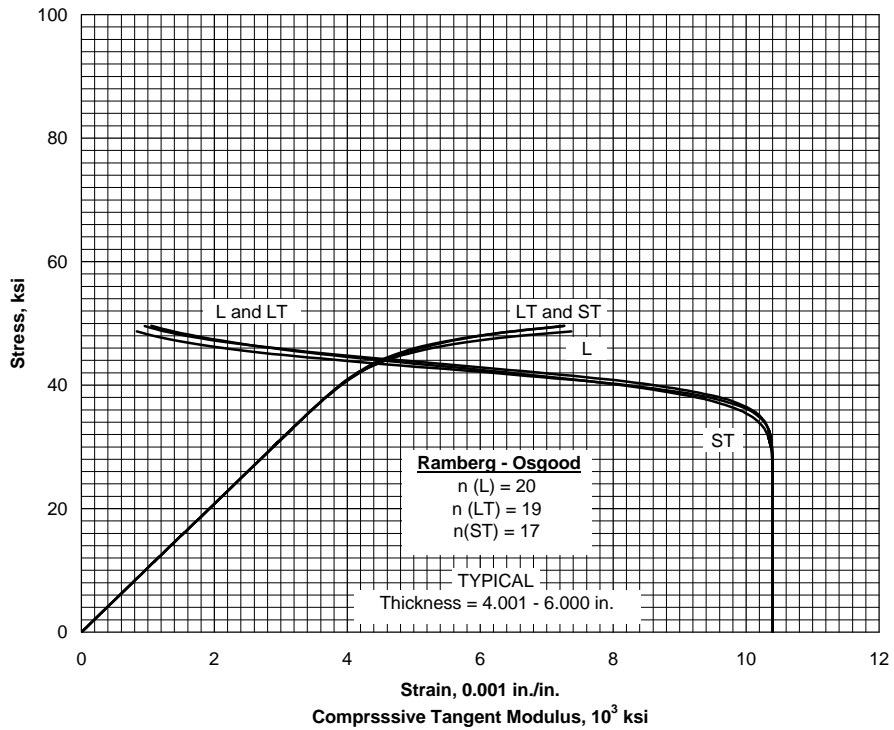

Figure 3.2.8.3.6(c). Typical compressive stress-strain and compressive tangent-modulus curves for 2219-T852 aluminum alloy hand forging at room temperature.

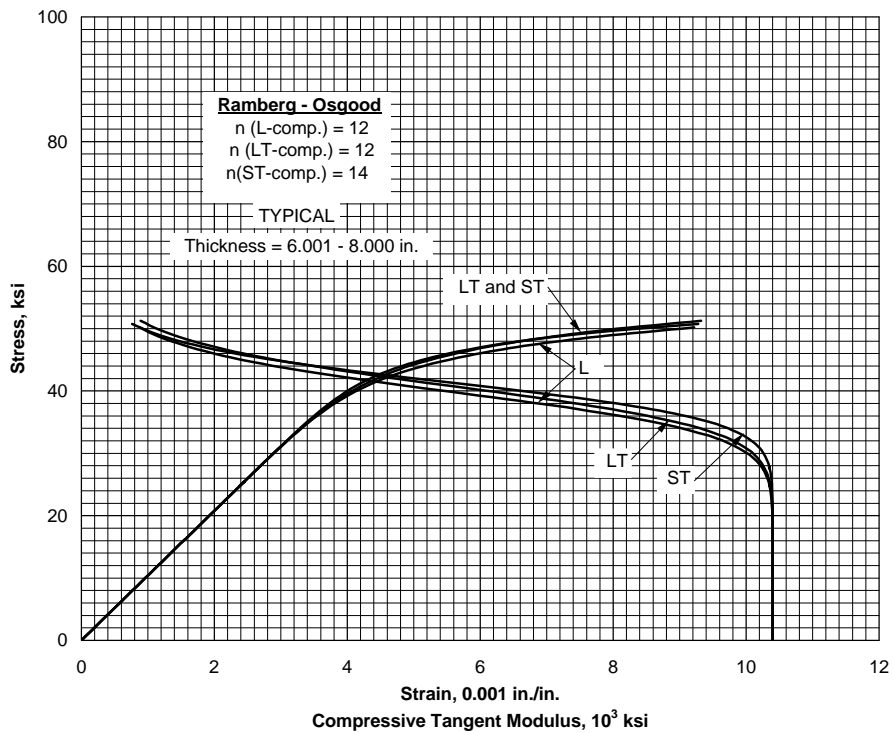

Figure 3.2.8.3.6(d). Typical compressive stress-strain and compressive tangent-modulus curves for 2219-T852 aluminum alloy hand forging at room temperature.

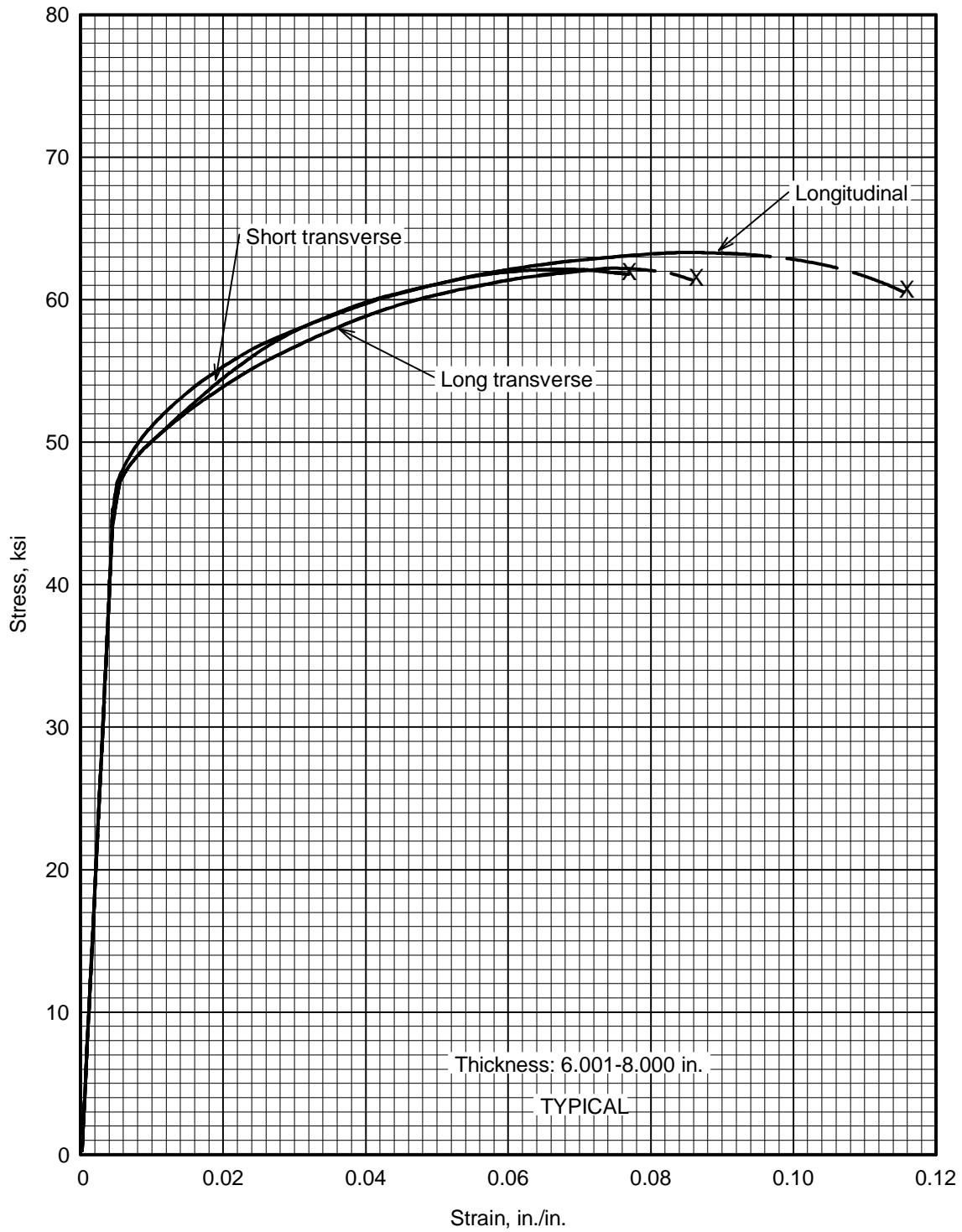

Figure 3.2.8.3.6(e). Typical tensile stress-strain curves (full range) for 2219-T852 aluminum alloy hand forging at room temperature.

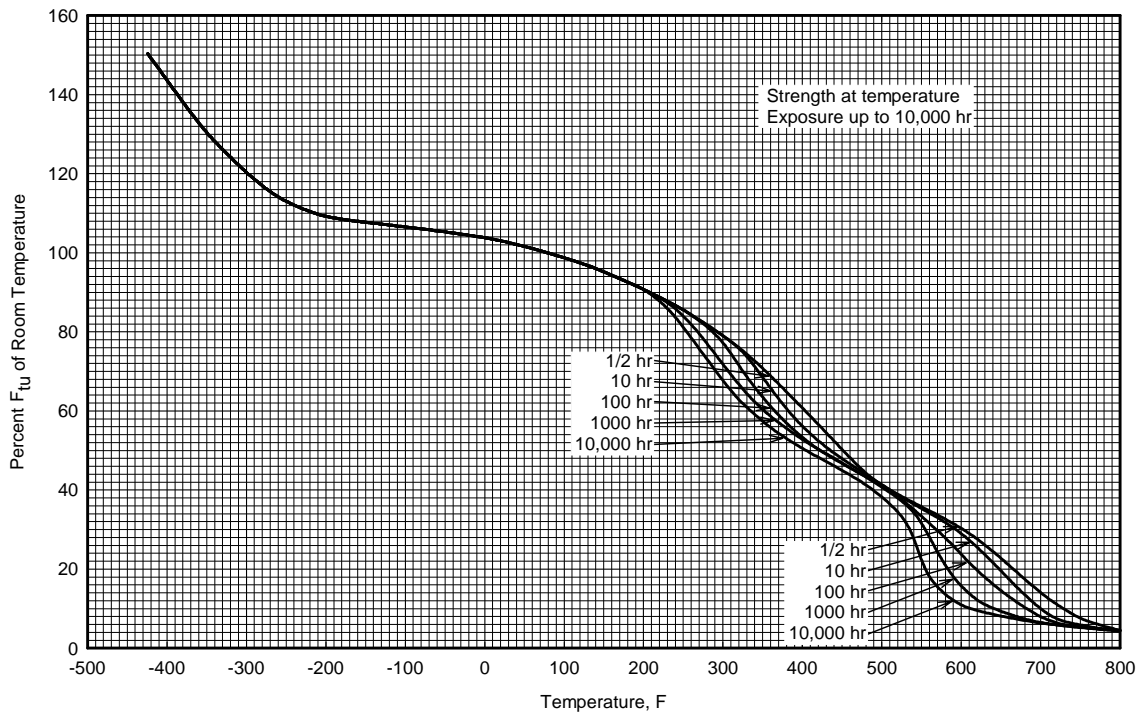

Figure 3.2.8.4.1(a). Effect of temperature on the tensile ultimate strength (F_{tu}) of 2219-T87 aluminum alloy sheet and plate.

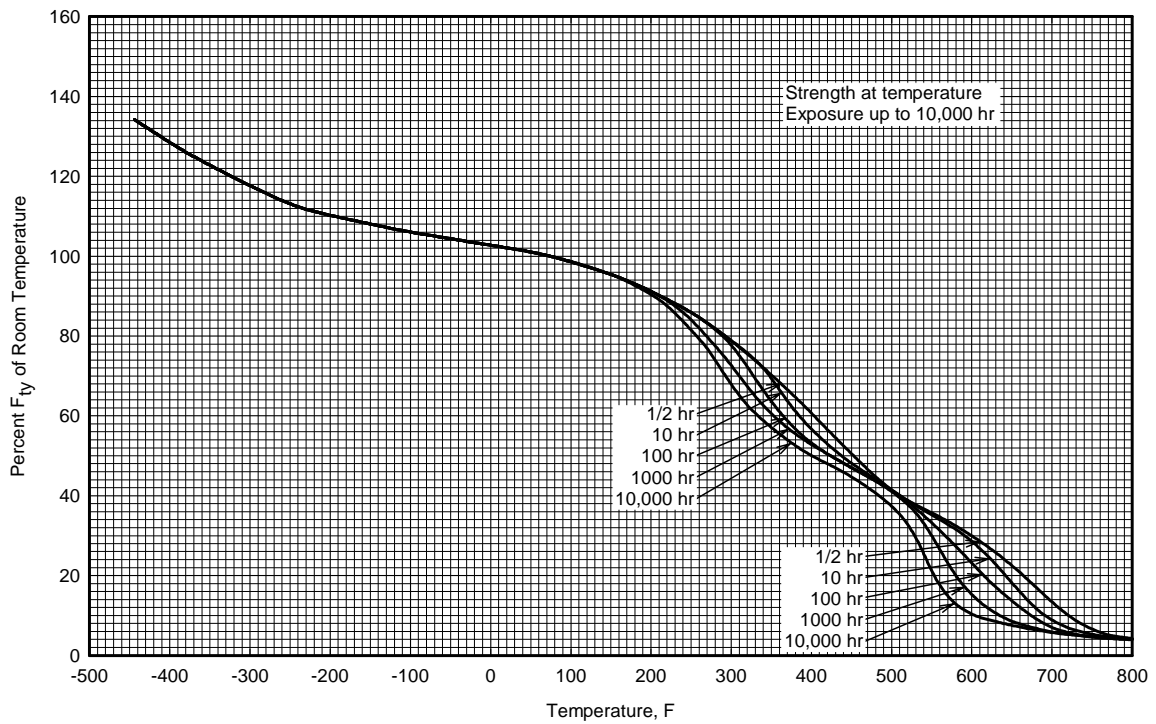

Figure 3.2.8.4.1(b). Effect of temperature on the tensile yield strength (F_{ty}) of 2219-T87 aluminum alloy sheet and plate.

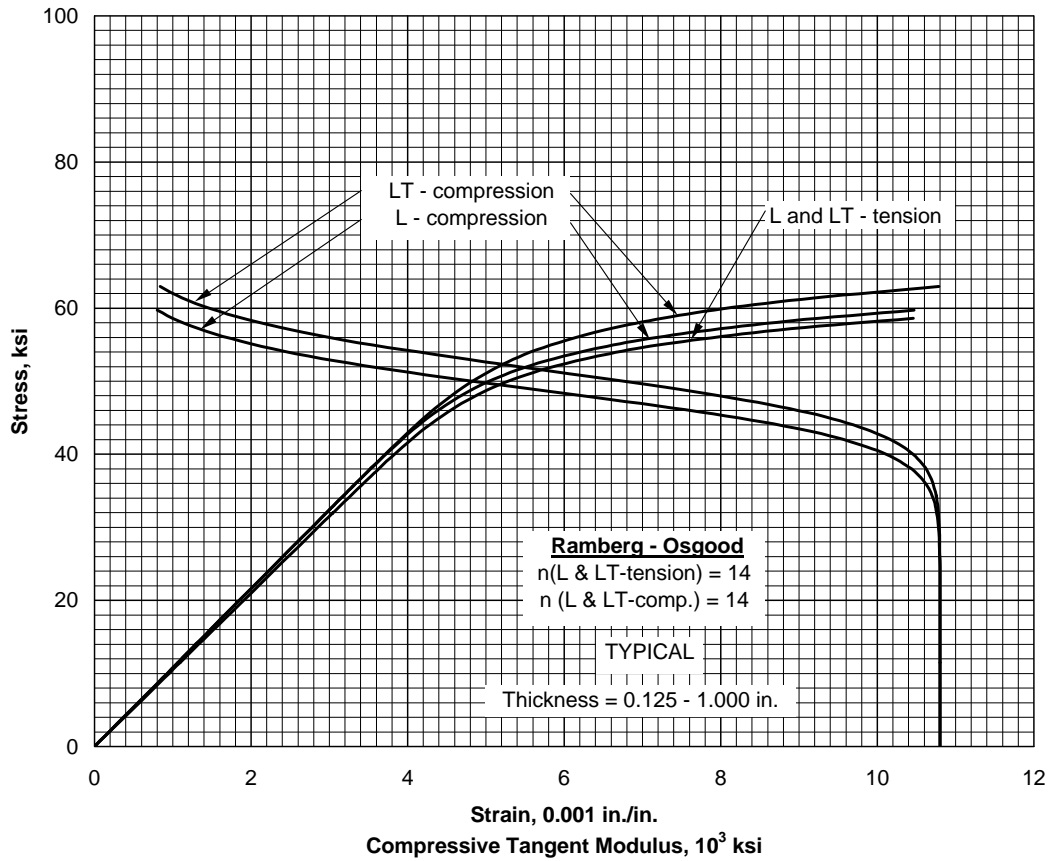

Figure 3.2.8.4.6(a). Typical tensile and compressive stress-strain and compressive tangent-modulus curves for 2219-T87 aluminum alloy sheet and plate at room temperature.

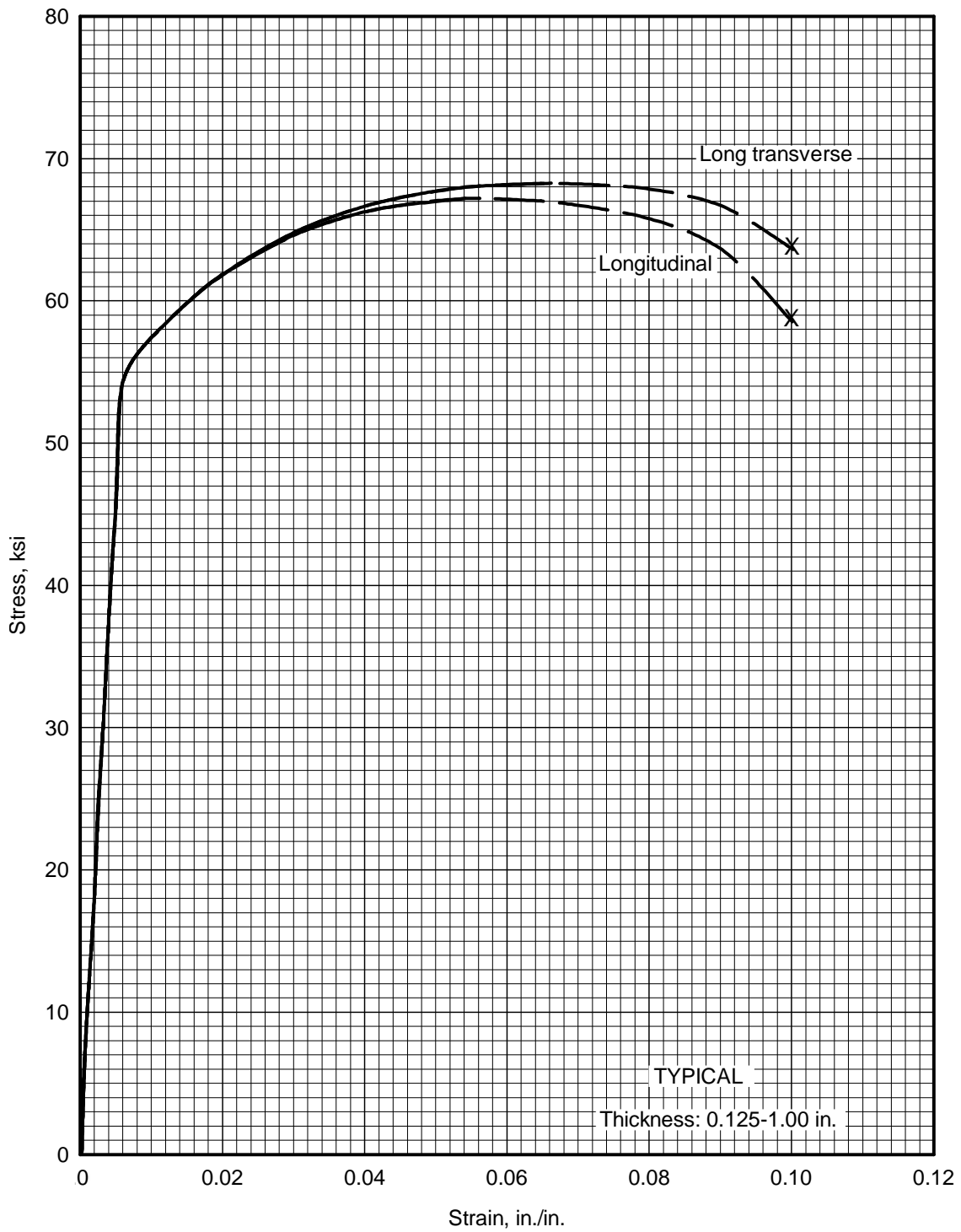

Figure 3.2.8.4.6(b). Typical tensile stress-strain curves (full range) for 2219-T87 aluminum alloy sheet and plate at room temperature.

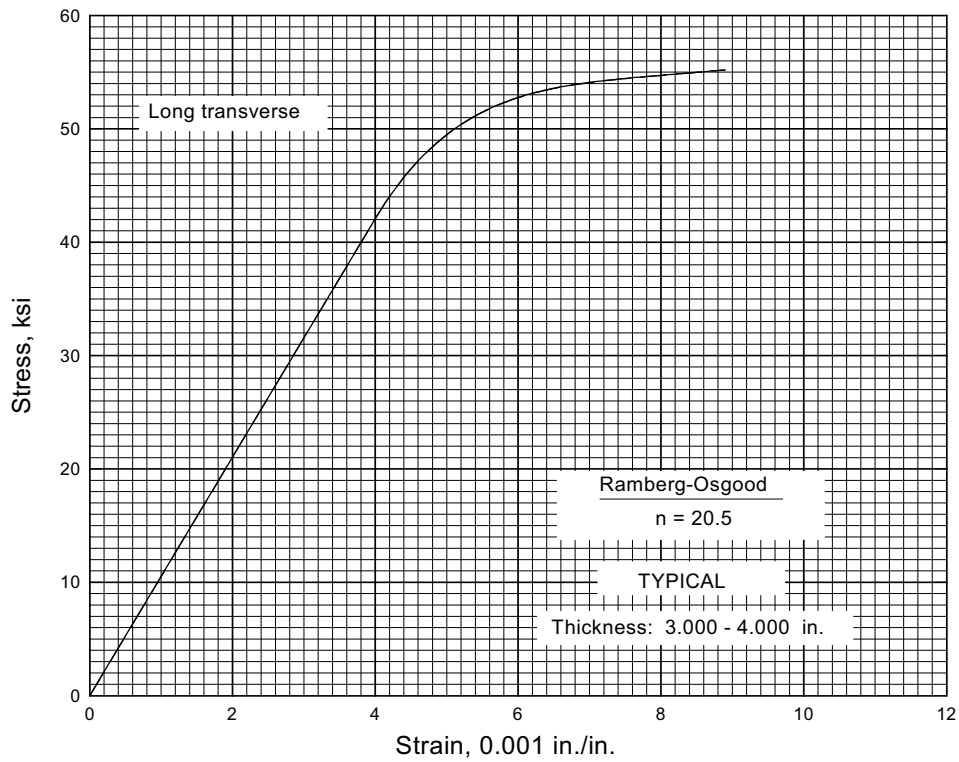

Figure 3.2.8.4.6(c). Typical tensile stress-strain curve for 2219-T87 aluminum alloy plate at room temperature.

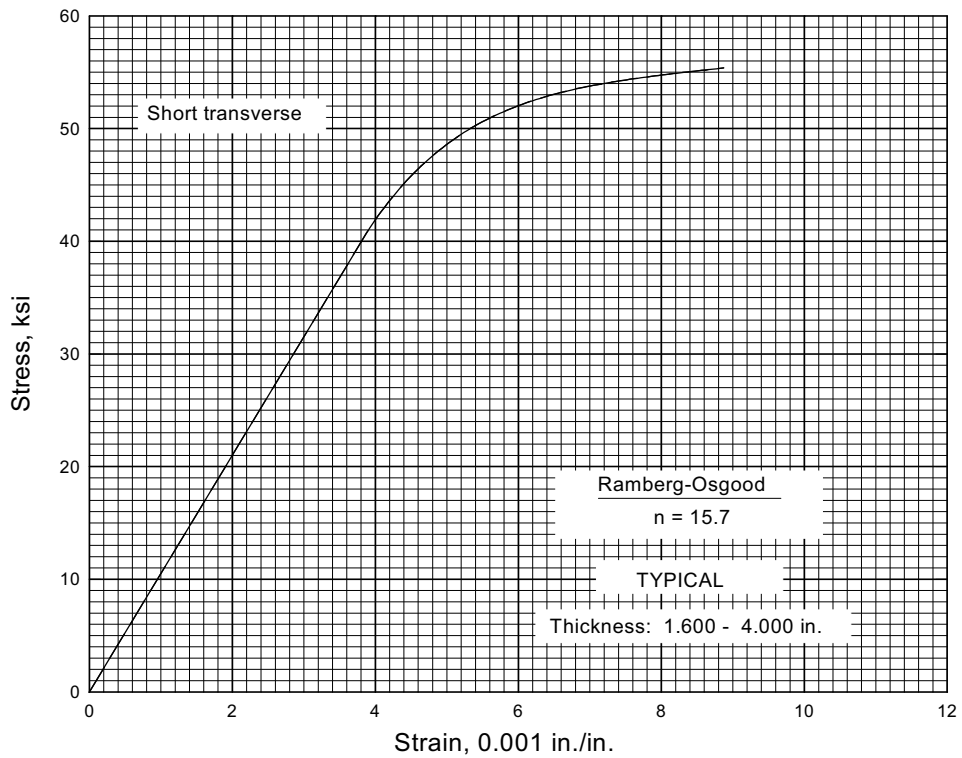

Figure 3.2.8.4.6(d). Typical tensile stress-strain curve for 2219-T87 aluminum alloy plate at room temperature.

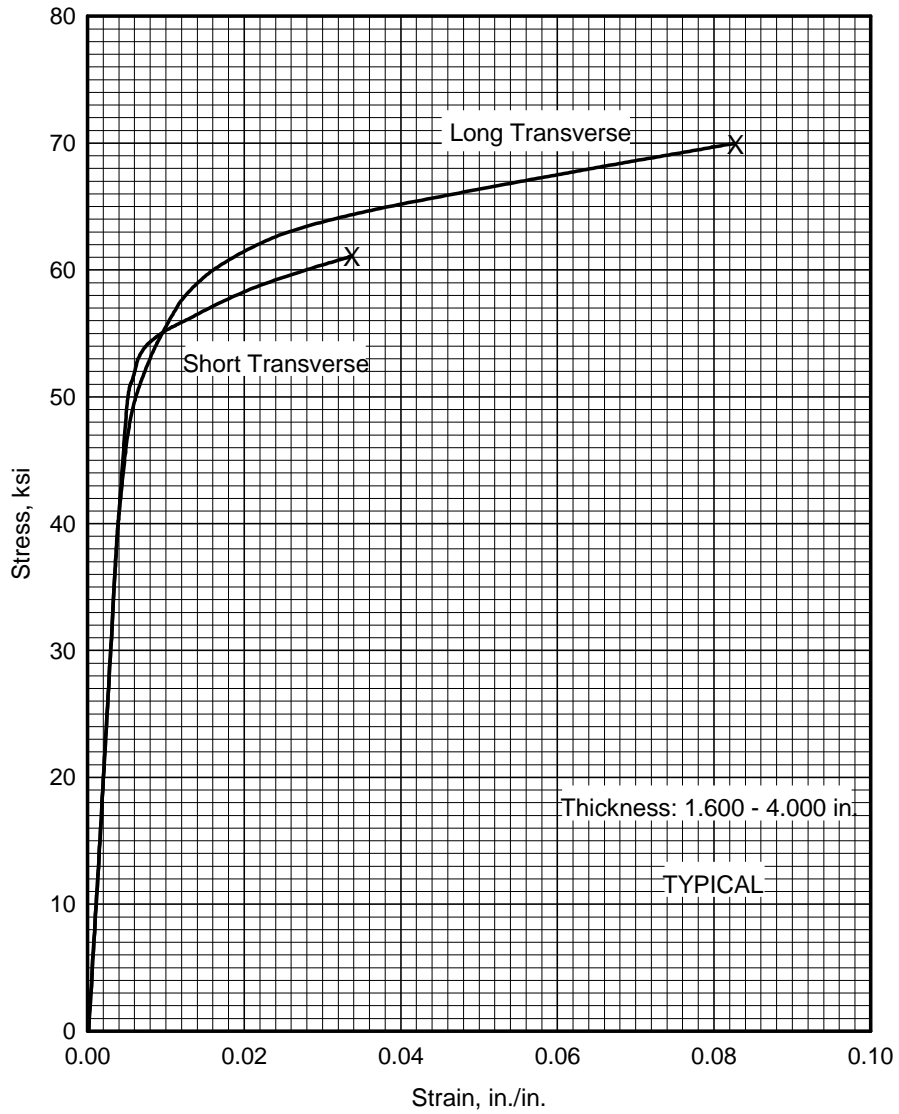

Figure 3.2.8.4.6(e). Typical tensile stress-strain curve (full range) for 2219-T87 aluminum alloy plate at room temperature.

3.2.9 2297 ALLOY

3.2.9.0 COMMENTS AND PROPERTIES — 2297 is an Al-Cu-Li-Mn-Zr plate alloy with moderately high strength and both high fatigue resistance and fracture toughness for durability and damage tolerant applications. The alloy shows excellent short-transverse mechanical properties and stress-corrosion cracking resistance in plate thicknesses to 6-inches. Tensile properties show good isotropy with only slightly lower strength in the in-plane 45° orientation, similar to the differences in in-plane properties usually found in Li-free high strength aluminum alloys.

The –T87 condition is obtained after solution heat treating, quenching, stress-relief by stretching, and artificial aging to peak strength. Little, or no, reduction in fracture toughness is found after elevated temperature exposure.

This alloy is not designed to be welded. Use of mechanical fasteners only is recommended.

This alloy has shown a sensitivity to cold-hole expansion for improved fatigue resistance when fastener holes, whose axes were perpendicular to the short transverse direction, were processed. Care should be taken to ensure that all of the processing parameters have been evaluated prior to the application of cold expansion to prevent cracking in the material.

Material specifications for 2297 are shown in Table 3.2.9.0(a). Room temperature mechanical and physical properties are shown in Table 3.2.9.0(b). Fracture toughness properties are shown in Table 3.1.2.1.6. Cyclic stress-strain and strain-life curves are shown in Figure 3.2.9.0.6. Fatigue crack propagation is shown in Figure 3.2.9.0.9.

Table 3.2.9.0(a). Material Specifications for 2297-T87 Aluminum Alloy

Specification	Form
AMS 4330	Plate

Table 3.2.9.0(b). Design Mechanical and Physical Properties of 2297-T87 Aluminum Alloy Plate

Specification	AMS 4330				
	Plate				
	T87				
	3.001-4.000	4.001-5.000		5.001-6.000	
Basis	S	A	B	A	B
Mechanical Properties:					
<i>F_{tu}</i> , ksi:					
L	62	61	62	60 ^a	62
LT	62	61 ^b	64	60 ^a	64
ST	59	58 ^b	61	57 ^a	61
45°	60	59	63	59	63
<i>F_{ty}</i> , ksi:					
L	57	56 ^b	58	55 ^a	58
LT	57	56	57	55 ^a	57
ST	54	52	54	52	54
45°	54	54	55	53	56
<i>F_{cy}</i> , ksi:					
L
LT
ST
<i>F_{su}</i> , ksi					
S-L ^c	30	31	33	32	34
T-S ^c	38	37	39	36	39
<i>F_{bru}^d</i> , ksi:					
(e/D = 1.5)	98	97	102	95	102
(e/D = 2.0)	128	126	132	123	132
<i>F_{bry}^d</i> , ksi:					
(e/D = 1.5)	85	84	85	82	85
(e/D = 2.0)	99	98	99	96	99
<i>e</i> , percent (S-basis):					
L	5	5	...	5	...
LT	4	4	...	4	...
ST	1.5	1.5	...	1.5	...
<i>E</i> , 10 ³ ksi			11.3		
<i>E_c</i> , 10 ³ ksi		
<i>G</i> , 10 ³ ksi		
<i>μ</i>		
Physical Properties:					
<i>ω</i> , lb/in. ³			0.096		
<i>C</i> , Btu/(lb)(°F)		
<i>K</i> , Btu/[(hr)(ft ²)(°F)/ft]		
<i>α</i> , 10 ⁻⁶ in./in./°F		

a S-basis. The rounded T₉₉ values are as follows; *F_{tu}*(L) = 61, *F_{tu}*(LT) = 62, *F_{tu}*(ST) = 59, *F_{ty}*(L) = 57, *F_{ty}*(LT) = 56.
b S-basis. The rounded T₉₉ values are as follows; *F_{tu}*(LT) = 62 ksi, *F_{tu}*(ST) = 59 ksi, *F_{ty}*(L) = 57 ksi.
c Standard letter designations for shear properties per ASTM B769: 1st letter refers to grain direction, 2nd letter refers to loading direction.
d Bearing values are “dry pin” values per Section 1.4.7.1.

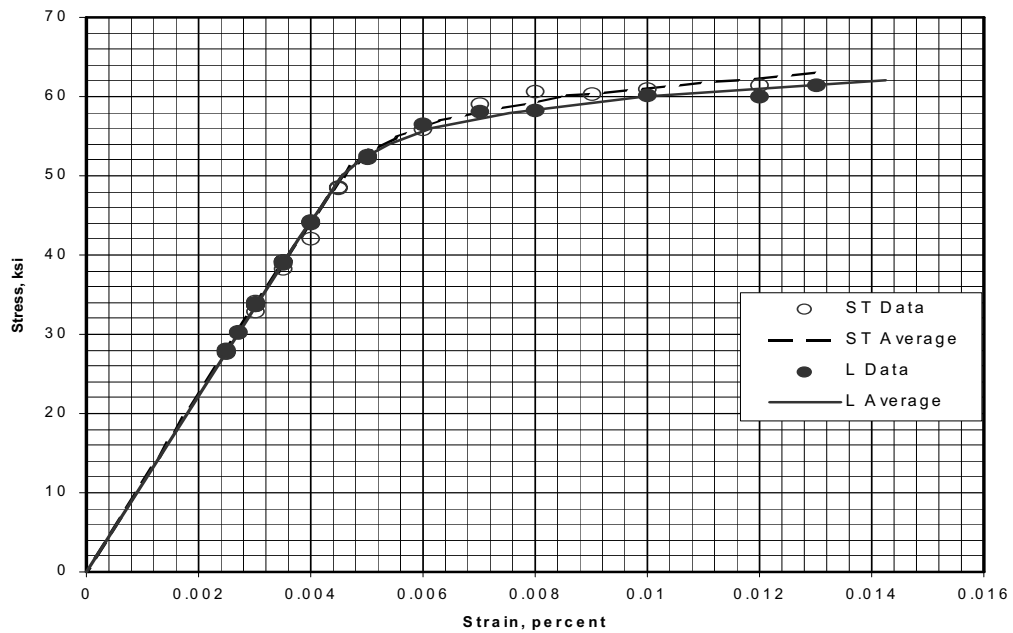
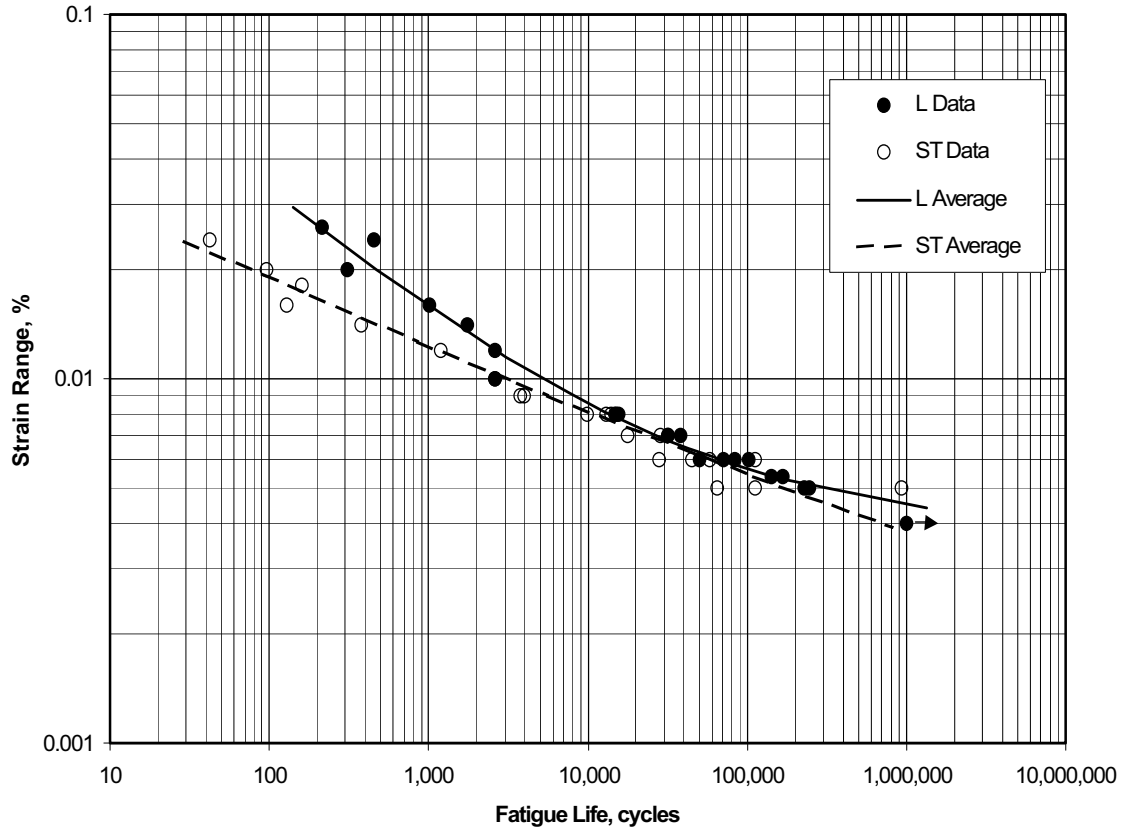

Figure 3.2.9.0.6. Strain-life and cyclic stress-strain curves for 2297-T87, 4 inch plate.

Correlative Information for Figure 3.2.9.0.6

Product Form: Plate, 4.00 inch thick

<u>Properties:</u>	<u>TUS, ksi</u>	<u>TYS, ksi</u>	<u>Temp., °F</u>
ST	63.5	56.0	RT
L	64.6	59.8	RT

Specimen Details:

Uniform gage test section
0.250-inch diameter

Surface Condition: Machined and polished along the length of the specimen using a commercial metal polishing paste called POL Metal Polish. The specimens had a mirror-like finish, estimated as an RMS of 4.

Reference: 3.2.9.0

Test Parameters:

Frequency - 0.5 - 5 Hz. (Higher frequencies typically used for the longer tests at the lower strains.)

Temperature - RT

Environment - Lab Air (approx. 50% relative humidity)

No. of Heats/Lots: 1

Strain Ratio = -1

Stress-Strain Equations:

ST Direction

$(\Delta\varepsilon)/2 = \sigma/E + \varepsilon_p$ where

$E = 11.3 \times 10^3$ ksi (reported),

$\varepsilon_p = 6.243 \times 10^{-10} \sigma^{3.187}$ for $\sigma < 50.86$ ksi, and

$\varepsilon_p = 1.606 \times 10^{-34} \sigma^{17.598}$ for $\sigma > 50.86$ ksi.

L Direction

$(\Delta\varepsilon)/2 = \sigma/E + \varepsilon_p$ where

$E = 11.3 \times 10^3$ ksi (reported),

$\varepsilon_p = 1.219 \times 10^{-10} \sigma^{3.566}$ for $\sigma < 50.03$ ksi, and

$\varepsilon_p = 1.074 \times 10^{-37} \sigma^{19.478}$ for $\sigma > 50.03$ ksi.

Equivalent Strain Equations:

ST Direction

$\text{Log } N_f = -6.66 - 4.96 \log(\varepsilon_t - 0.001)$

Standard Error of Estimate = 0.249

Standard Deviation in Life = 0.864

$R^2 = 96\%$

Sample Size = 21

L Direction

$\text{Log } N_f = -1.88 - 2.54 \log(\varepsilon_t - 0.0037)$

Standard Error of Estimate = 0.141

Standard Deviation in Life = 0.722

$R^2 = 98\%$

Sample Size = 21

3.2.10 2424 ALLOY

3.2.10.0 Comments and Properties — 2424 is a heat-treatable Al-Cu alloy which provides better ductility than 2024. 2424 is available in the form of bare and clad sheet.

Material specifications for 2424 are presented in Table 3.2.10.0(a). Room-temperature mechanical properties are presented in Tables 3.2.10.0(b₁) and 3.2.10.0(b₂).

Table 3.2.10.0(a). Material Specifications for 2424 Aluminum Alloy

Specification	Form
AMS 4270 (Clad)	Sheet
AMS 4273 (Bare)	Sheet

The temper index for 2424 is as follows:

<u>Section</u>	<u>Temper</u>
3.2.10.1	T3

Table 3.2.10.0(b₁). Design Mechanical and Physical Properties of Bare 2424-T3 Aluminum Alloy Sheet

Specification	AMS 4273	
Form	Sheet	
Temper	T3	
Thickness, in.	0.020 - 0.128	
Basis	A	B
Mechanical Properties:		
<i>F_{tu}</i> , ksi:		
L	65	66
LT	63	65
<i>F_{ty}</i> , ksi:		
L	49	51
LT	42 ^a	45
<i>F_{cy}</i> , ksi:		
L	42	45
LT	46	49
<i>F_{su}</i> ^b ksi		
.....	41	43
<i>F_{bru}</i> ^c ksi:		
(e/D = 1.5)	97	100
(e/D = 2.0)	129	133
<i>F_{bry}</i> ^c ksi:		
(e/D = 1.5)	62	66
(e/D = 2.0)	78	83
<i>e</i> , percent (S-basis):		
L
LT	15	...
<i>E</i> , 10 ³ ksi		
L	9.8	
LT	10.3	
<i>E_c</i> , 10 ³ ksi		
L	10.0	
LT	10.5	
<i>G</i> , 10 ³ ksi		
.....	...	
<i>μ</i>		
.....	0.34	
Physical Properties:		
<i>ω</i> , lb/in. ³		
.....	0.100	
<i>C</i> , Btu/(lb)(°F)		
.....	...	
<i>K</i> , Btu/[(hr)(ft ²)(°F)/ft]		
.....	...	
<i>α</i> , 10 ⁻⁶ in./in./°F		
.....	...	

a S-basis. The T₉₉ value is 44 ksi.

b Determined in accordance with ASTM B769.

c Bearing values are "dry pin" values per Section 1.4.7.1.

Table 3.2.10.0(b₂). Design Mechanical and Physical Properties of Clad 2424-T3 Aluminum Alloy Sheet

Specification	AMS 4270	
Form	Sheet	
Temper	T3	
Thickness, in.	0.063 - 0.128	
Basis	A	B
Mechanical Properties:		
F_{tu} , ksi:		
L	64	65
LT	61	64
F_{ty} , ksi:		
L	46	49
LT	40 ^a	44
F_{cy} , ksi:		
L	40	44
LT	43	47
F_{su} ^b ksi	41	43
F_{bru} ^c ksi:		
(e/D = 1.5)	94	98
(e/D = 2.0)	121	126
F_{bry} ^c ksi:		
(e/D = 1.5)	60	66
(e/D = 2.0)	70	77
e , percent (S-basis):		
L
LT	15	...
E , 10 ³ ksi		
L		9.8
LT		10.3
E_c , 10 ³ ksi		
L		10
LT		10.5
G , 10 ³ ksi
μ		0.34
Physical Properties:		
ω , lb/in. ³	0.100	
C , Btu/(lb)(°F)	
K , Btu/[(hr)(ft ²)(°F)/ft]	
α , 10 ⁻⁶ in./in./°F	

a S-basis. The T_{99} value is 43 ksi.
b Determined in accordance with ASTM B769.
c Bearing values are "dry pin" values per Section 1.4.7.1.

3.2.11 2519 ALLOY

3.2.11.0 Comments and Properties — 2519 is an Al-Cu weldable alloy available in plate. This armor plate has equivalent ballistic protection characteristics compared to 7039 and superior stress-corrosion cracking resistance compared to 5083. See Section 3.1.2.3 for comments regarding resistance of the alloy to stress-corrosion cracking. The general corrosion characteristics of 2519 are similar to 2219. 2519 in the T87 temper has approximately 20 percent higher yield strength than 2219-T87 plate. 2519-T87 is easily welded with filler alloy 2319. Yield strengths of welded butt joints are higher than other commercially available alloys. 2519 can be post weld aged or post weld heat treated and aged to obtain improved mechanical properties compared to “as welded” condition. See Section 3.1.3.4 for further information regarding the weldability of the alloy.

A material specification of 2519 is presented in Table 3.2.11.0(a). Room-temperature mechanical and physical properties are shown in Table 3.2.11.0(b).

**Table 3.2.11.0(a). Material Specification for
2519 Aluminum Alloy**

Specification	Form
MIL-DTL-46192	Plate

The temper index for 2519 is as follows:

<u>Section</u>	<u>Temper</u>
3.2.11.1	T87

3.2.11.1 T87 Temper — Typical room-temperature tensile and compressive stress-strain and compressive tangent-modulus curves are presented in Figures 3.2.11.1.6(a) and (b).

Table 3.2.11.0(b). Design Mechanical and Physical Properties of 2519 Aluminum Alloy Plate

Specification	MIL-DTL-46192			
	Plate			
	T87			
	0.250- 1.000	1.001- 2.000	2.001- 3.000	3.001- 4.000
Basis	S	S	S	S
Mechanical Properties:				
F_{tu} , ksi:				
L	66	66	67	68
LT	68	68	68	68
ST	63	62
F_{ty} , ksi:				
L	59	59	60	61
LT	58	58	59	59
ST	55	55
F_{cy} , ksi:				
L	57	57	58	58
LT	60	60	61	61
ST	58	58
F_{su} , ksi	42	41	41	40
F_{bru}^a , ksi:				
(e/D = 1.5)	105	105	104	103
(e/D = 2.0)	135	134	133	131
F_{bry}^a , ksi:				
(e/D = 1.5)	85	85	87	87
(e/D = 2.0)	99	99	100	100
e , percent:				
L	10	9	8	7
LT	7	7	6	5
E , 10^3 ksi	10.5			
E_c , 10^3 ksi	10.8			
G , 10^3 ksi	4.0			
μ	0.33			
Physical Properties:				
ω , lb/in. ³	0.102			
C , K , and α			

a See Table 3.1.2.1.1. Bearing values are "dry pin" per Section 1.4.7.1.

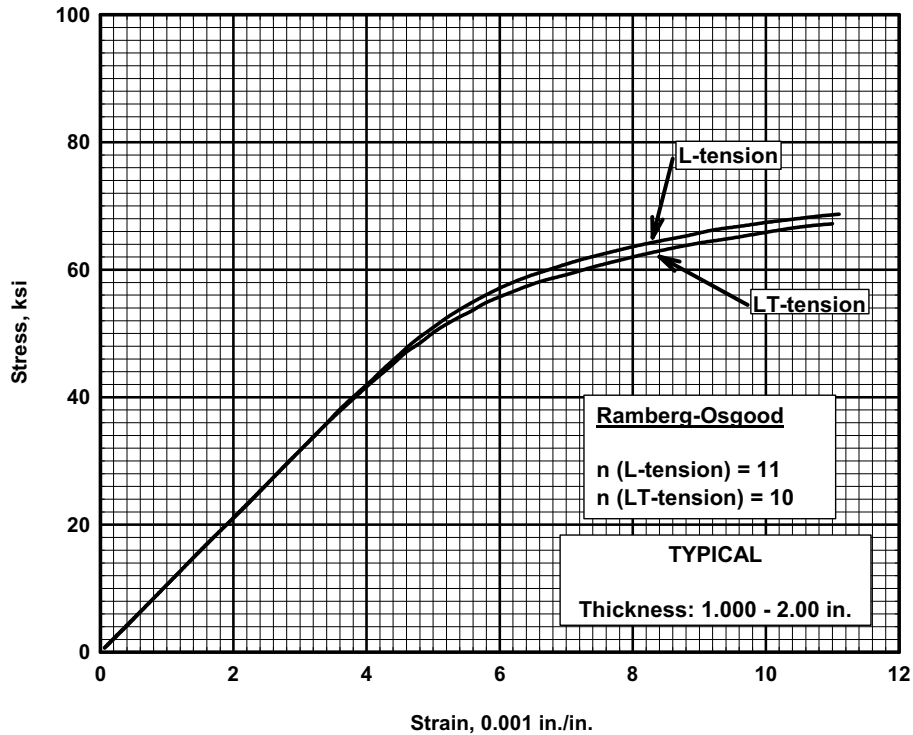

Figure 3.2.11.1.6(a). Typical tensile stress-strain curves for 2519-T87 aluminum alloy plate at room temperature.

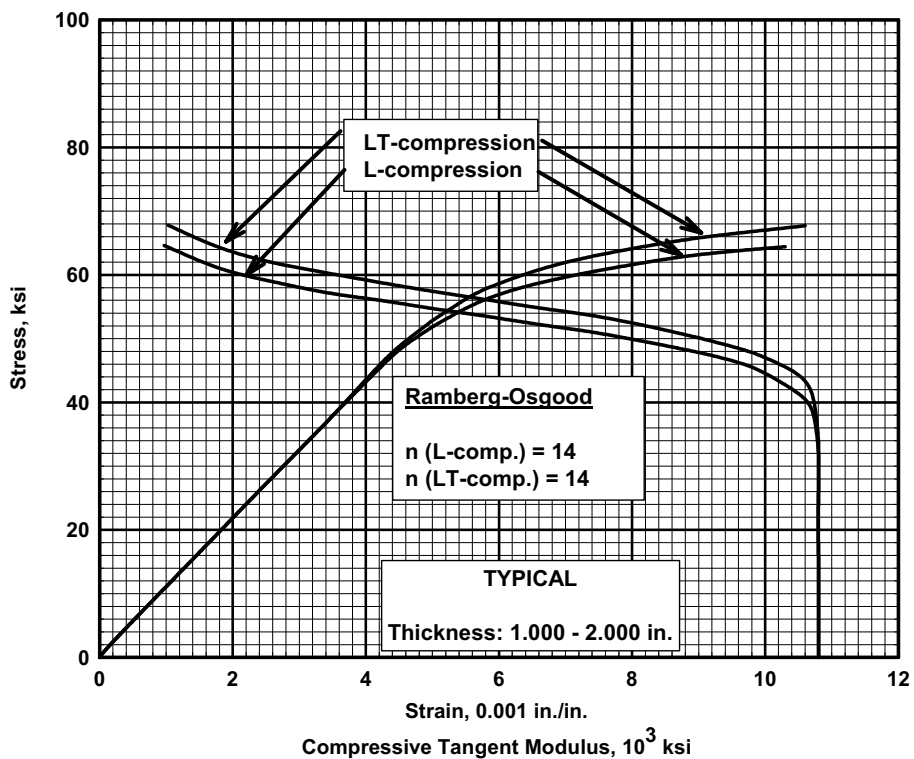

Figure 3.2.11.1.6(b). Typical compressive stress-strain and tangent-modulus curves for 2519-T87 plate at room temperature.

3.2.12 2524 ALLOY

3.2.12.0 Comments and Properties — 2524 is a heat-treatable Al-Cu alloy offering high toughness and improved resistance to fatigue crack growth relative to other available 2XXX sheet and plate materials. Sheet and plate is available in the T3 temper. Fatigue crack growth improvements are guaranteed through the material specification for Alclad 2524-T3 sheet and plate products. The static mechanical properties and general corrosion performance of Alclad 2524-T3 are similar to those of Alclad 2024-T3. This product has typically been used for formed structural aircraft parts requiring improved resistance to fatigue crack growth and high toughness with strength similar to Alclad 2024-T3, but usage is not limited to such applications.

A material specification for Alclad 2524-T3 sheet and plate is presented in Table 3.2.12.0(a). Room-temperature mechanical properties are shown in Table 3.2.12.0(b).

Table 3.2.12.0(a). Material Specifications for Alclad 2524-T3

Specification	Form
AMS 4296	Clad sheet and plate

The temper index for 2524 is as follows:

<u>Section</u>	<u>Temper</u>
3.2.12.1	T3

Table 3.2.12.0(b). Design Mechanical and Physical Properties of Alclad 2524-T3 Aluminum Alloy Sheet and Plate

Specification	AMS 4296						
	Sheet and Plate						
	T3						
	0.032-	0.063-0.128		0.129-0.249		0.250-0.310	
Basis	S	A	B	A	B	A	B
Mechanical Properties:							
F_{tu} , ksi:							
L	59	61	62	62	62	62	63
LT	59	61 ^a	62	62	62	62	63
F_{ly} , ksi:							
L	44	45	47	45	46	45	46
LT	39	40 ^b	42	40	41	40	41
F_{cy} , ksi:							
L	38	39	41	39	40	39	40
LT	42	43	45	43	44	43	44
F_{su} ^c ksi:	40	41	42	42	42	42	43
F_{bru} ^d ksi:							
(e/D = 1.5)	93	97	98	98	98	98	100
(e/D = 2.0)	117	121	123	123	123	123	125
F_{bry} ^d ksi:							
(e/D = 1.5)	65	67	70	67	69	67	69
(e/D = 2.0)	76	78	82	78	80	78	80
<i>e</i> , percent (S-basis):							
LT	15	15	...	15	...	15	...
Physical Properties:							
E , 10 ³ ksi:							
Primary				10.3			
Secondary				9.8			
E_c , 10 ³ ksi:							
Primary				10.5			
Secondary				10.0			
G , 10 ³ ksi			
μ				0.35			
ω , lb/in. ³				0.100			
C , K , and α				not available			

a S-basis value. The T₉₉ value is 62 ksi.
b S-basis value. The T₉₉ value is 41 ksi.
c Determined in accordance with ASTM B 831-93.
d Bearing values are "dry pin" values per Section 1.4.7.1. See Table 3.1.2.1.1.

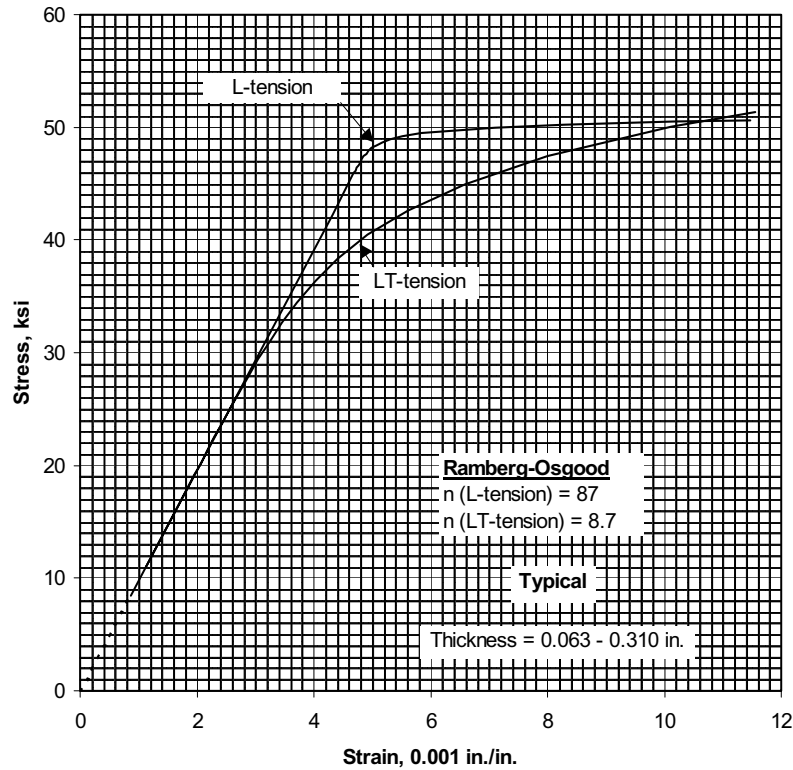

Figure 3.2.12.1.6(a). Typical tensile stress-strain curves for 2524-T3 clad aluminum alloy sheet and plate at room temperature.

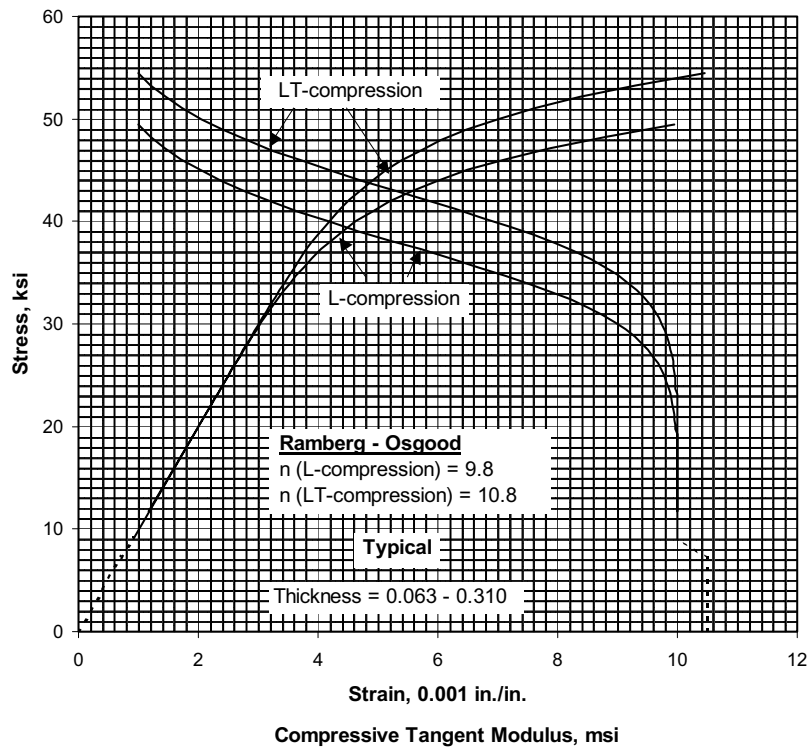

Figure 3.2.12.1.6(b). Typical compressive stress-strain and tangent modulus curves for 2524-T3 clad aluminum alloy sheet and plate at room temperature.

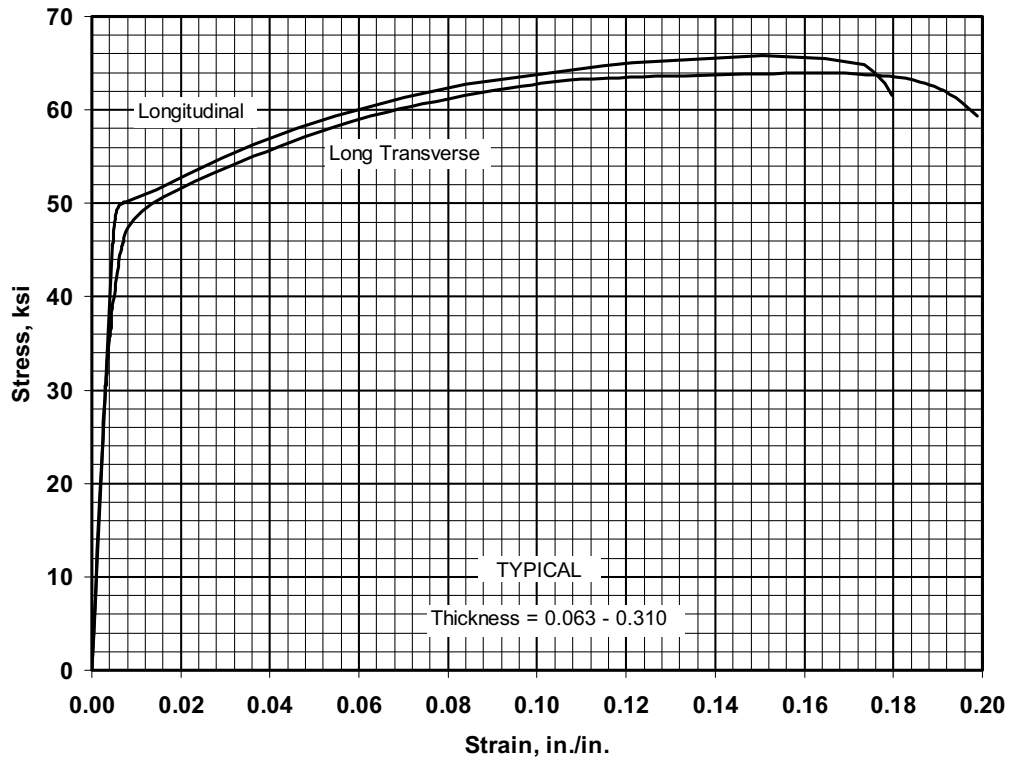

Figure 3.2.12.1.6(c). Typical tensile stress-strain curves (full range) for 2524-T3 clad aluminum alloy sheet and plate at room temperature.

3.2.13 2618 ALLOY

3.2.13.0 Comments and Properties — 2618 is an Al-Cu alloy which is available as hand and die forgings. It has excellent properties over a range of temperatures from -452 to 600°F and is usually used in applications where high strength and creep resistance are important considerations. Refer to Section 3.1.3.4 for comments regarding the weldability of the alloy. Refer to Section 3.1.2.3.1 for information regarding resistance of the alloy to stress-corrosion cracking.

Material specifications for 2618 aluminum alloy are presented in Table 3.2.13.0(a). Room-temperature mechanical and physical properties are shown in Table 3.2.13.0(b) and (c). The effect of temperature on the thermal expansion is shown in Figure 3.2.13.0.

Table 3.2.13.0(a). Material Specifications for 2618 Aluminum Alloy

Specification	Form
AMS 4132	Die and hand forgings
AMS-QQ-A-367	Forgings
AMS-A-22771	Die forging

The temper index for 2618 is as follows:

<u>Section</u>	<u>Temper</u>
3.2.13.1	T61

3.2.13.1 T61 Temper — Figures 3.2.13.1.1(a) through 3.2.13.1.5 present effect-of-temperature curves for various mechanical properties. Figure 3.2.13.1.6(a) presents tensile and compressive stress-strain and tangent-modulus curves at room temperature. Figure 3.2.13.1.6(b) is a full-range, tensile stress-strain curve at room temperature.

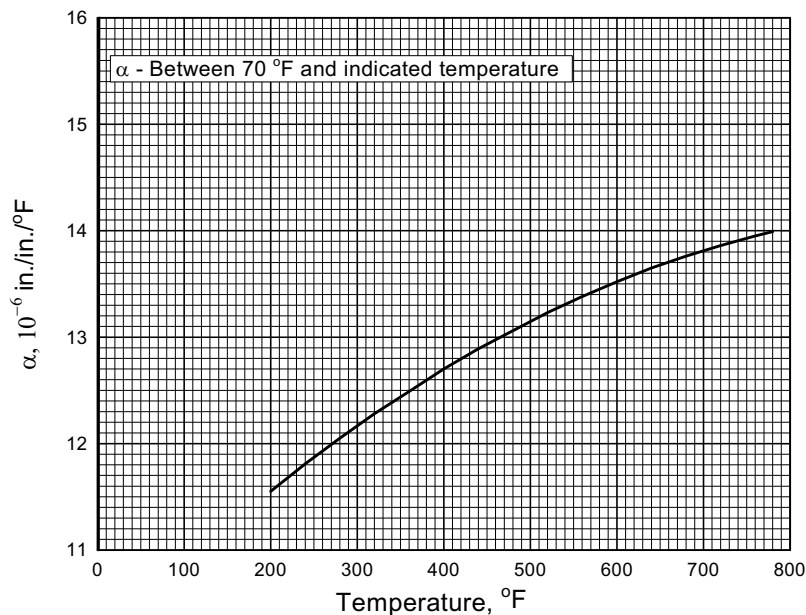

Figure 3.2.13.0. Effect of temperature on the thermal expansion of 2618 aluminum alloy.

Table 3.2.13.0(b). Design Mechanical and Physical Properties of 2618 Aluminum

Alloy Die Forging	
Specification	AMS-A-22771 and AMS-QQ-A-367
Form	Die forging
Temper	T61
Thickness, in.	≤ 4.000 ^a
Basis	S
Mechanical Properties:	
F_{tu} , ksi:	
L	58
T ^b	55
F_{ty} , ksi:	
L	45
T ^b	42
F_{cy} , ksi:	
L
T ^b
F_{su}
F_{bru} , ksi:	
(e/D = 1.5)
(e/D = 2.0)
F_{bry} , ksi:	
(e/D = 1.5)
(e/D = 2.0)
e , percent:	
L	4
T ^b	4
E , 10 ³ ksi	10.7
E_c , 10 ³ ksi	10.9
G , 10 ³ ksi	4.1
μ	0.33
Physical Properties:	
ω , lb/in. ³	0.100
C , Btu/(lb)(°F)	0.23 (at 212°F)
K , Btu/[(hr)(ft ³)(°F)/ft]	90 (at 77°F)
α , 10 ⁻⁶ in./in./°F	See Figure 3.2.13.0

- a Thickness at the time of heat treatment. When die forgings are machined before heat treatment, the mechanical properties are applicable provided the as-forged thickness is not greater than twice the thickness at the time of heat treatment.
- b T indicates any grain direction not within ±15° of being parallel to the forging flow lines.

Table 3.2.13.0(c). Design Mechanical and Physical Properties of 2618 Aluminum Alloy Hand Forging

Specification	AMS 4132, AMS-A-22771, and AMS-QQ-A-367		
Form	Hand forging		
Temper	T61		
Cross-Sectional Area, in. ²	≤ 144		
Thickness, ^a in	< 2.000	2.000-3.000	3.001-4.000
Basis	S	S	S
Mechanical Properties:			
<i>F_{tu}</i> , ksi:			
L	58	57	56
LT	55	55	53
ST	52	51
<i>F_{ty}</i> , ksi:			
L	47	46	45
LT	42	42	40
ST	42	39
<i>F_{cy}</i> , ksi:			
L	44
LT	42
ST	40
<i>F_{su}</i> , ksi			
...			
<i>F_{bru}</i> , ksi:			
(e/D=1.5)
(e/D=2.0)	106
<i>F_{bry}</i> , ksi:			
(e/D = 1.5)
(e/D = 2.0)	71
<i>e</i> , percent:			
L	7	7	7
LT	5	5	5
ST	4	4
<i>E</i> , 10 ³ ksi			
10.7			
<i>E_c</i> , 10 ³ ksi			
10.9			
<i>G</i> , 10 ³ ksi			
4.1			
<i>μ</i>			
0.33			
Physical Properties:			
<i>ω</i> , lb/in. ³			
0.100			
<i>C</i> , Btu/(lb)(°F)			
0.23 (at 212°F)			
<i>K</i> , Btu/[(hr)(ft ²)(°F)/ft]			
90 (at 77°F)			
<i>α</i> , 10 ⁻⁶ in./in./°F			
See Figure 3.2.13.0			

a When hand forgings are machined before heat treatment, the section thickness at time of heat treatment will determine the minimum mechanical properties as long as the original (as-forged) thickness does not exceed the maximum thickness for the alloy as shown in the table.

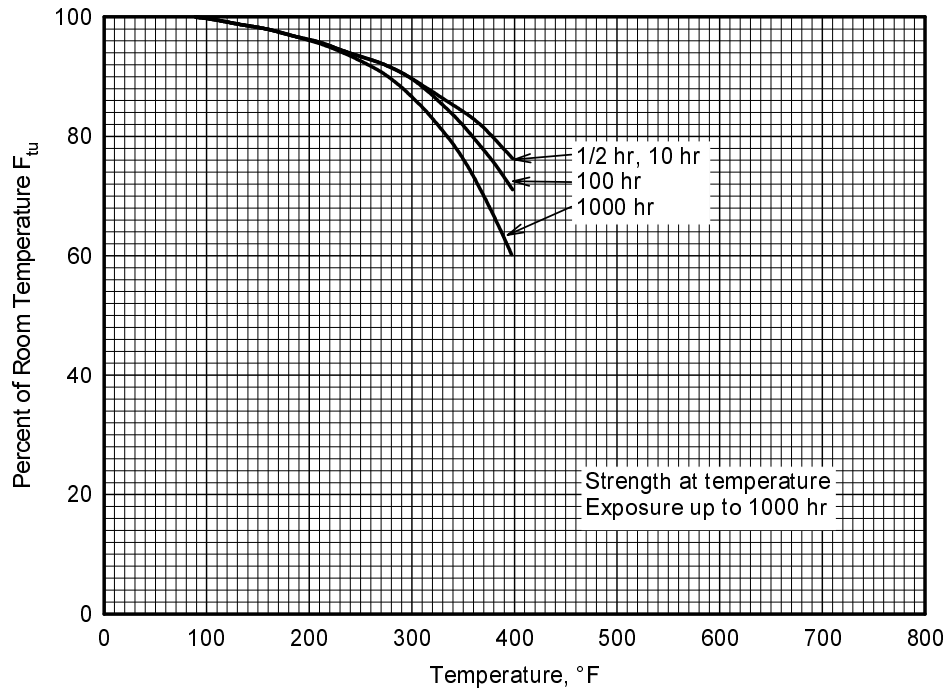

Figure 3.2.13.1.1(a). Effect of temperature on the tensile ultimate strength (F_{tu}) of 2618-T61 aluminum alloy hand forging.

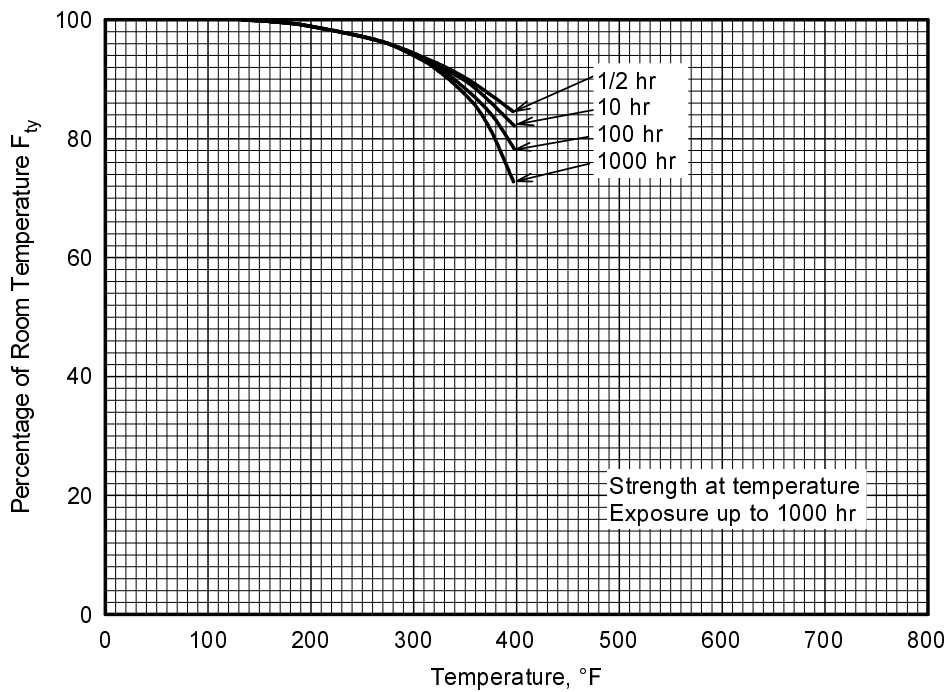

Figure 3.2.13.1.1(b). Effect of temperature on the tensile yield strength (F_{ty}) of 2618-T61 aluminum alloy hand forging.

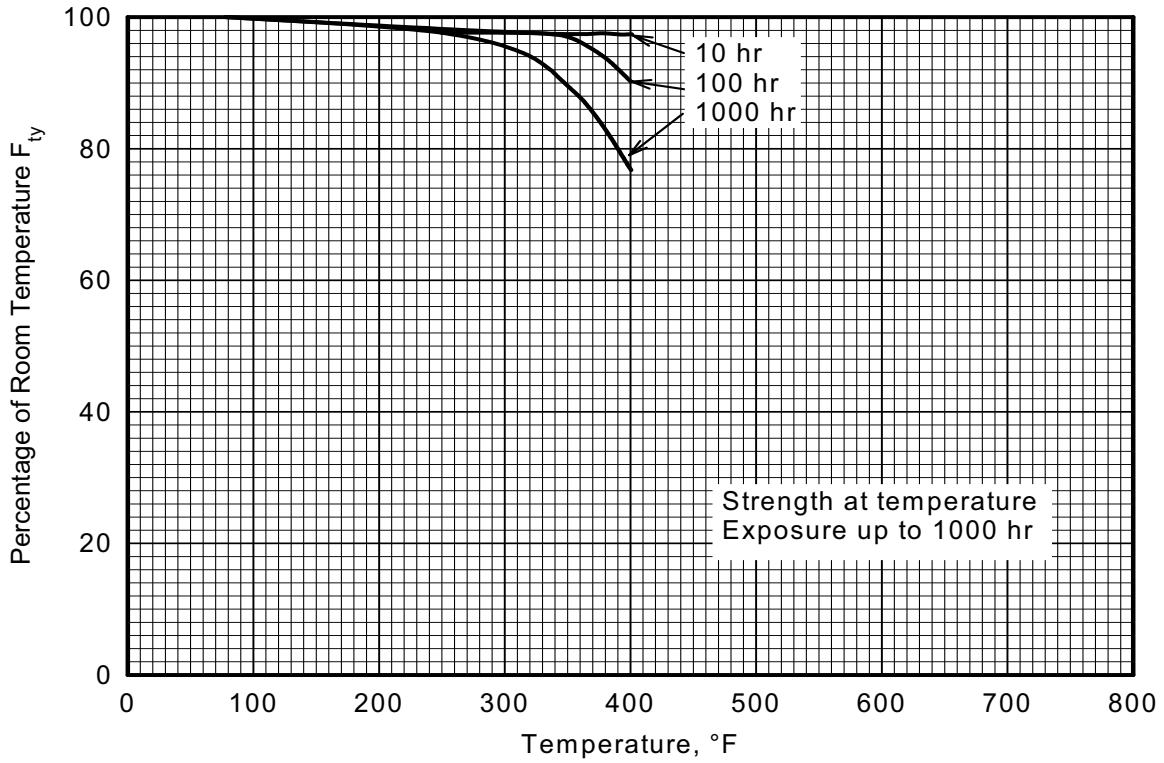

Figure 3.2.13.1.1(c). Effect of exposure at elevated temperatures on room-temperature tensile yield strength (F_{ty}) of 2618-T61 hand forging.

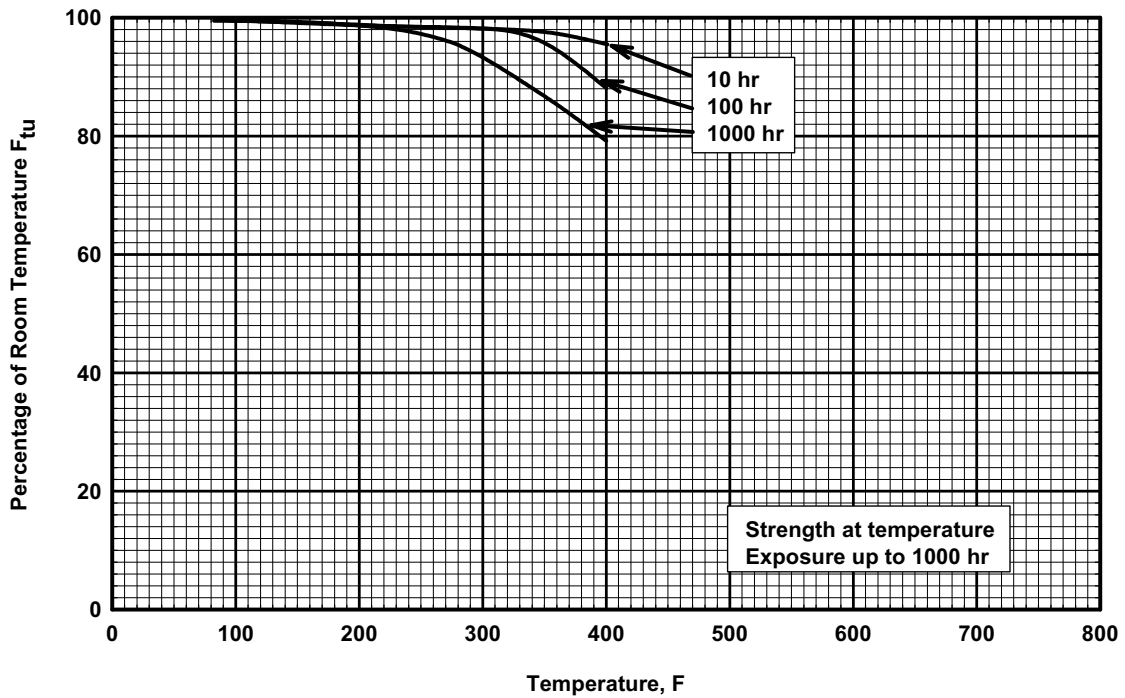

Figure 3.2.13.1.1(d). Effect of exposure at elevated temperatures on room-temperature tensile ultimate strength (F_{tu}) of 2618-T61 hand forging.

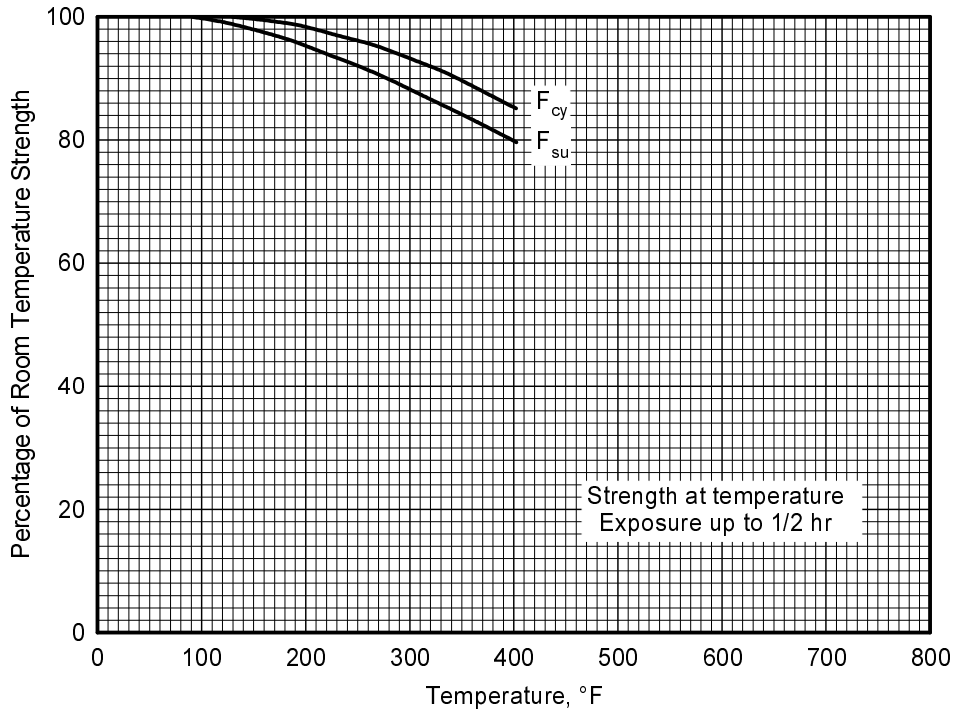

Figure 3.2.13.1.2. Effect of temperature on the compressive yield strength (F_{cy}) and ultimate shear strength (F_{su}) of 2618-T61 aluminum alloy hand forging.

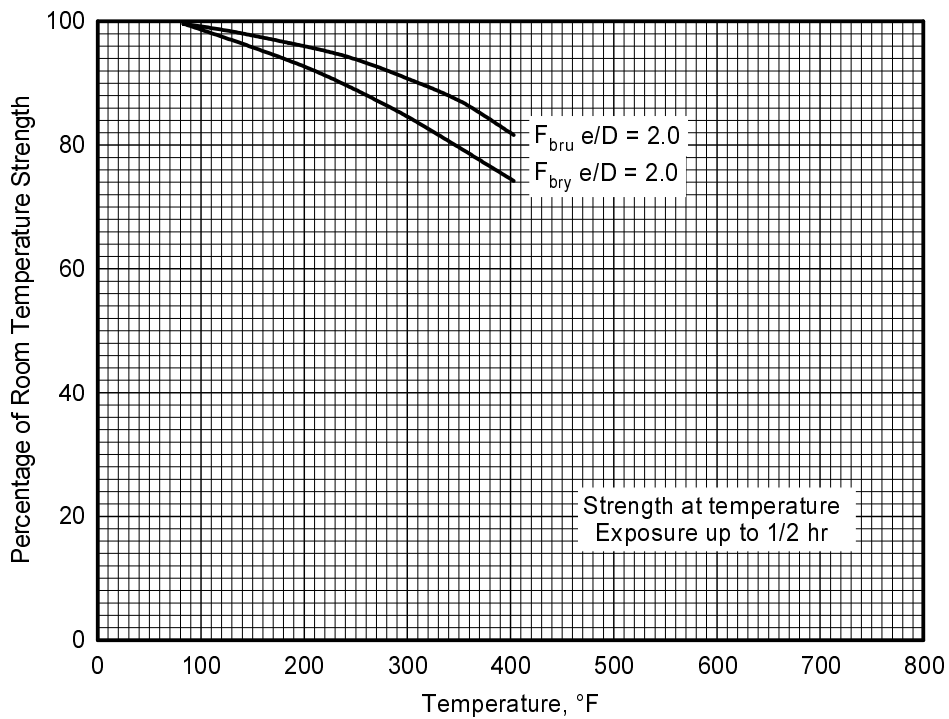

Figure 3.2.13.1.3. Effect of temperature on the bearing ultimate strength (F_{bru}) and bearing yield strength (F_{bry}) of 2618-T61 aluminum alloy hand forging.

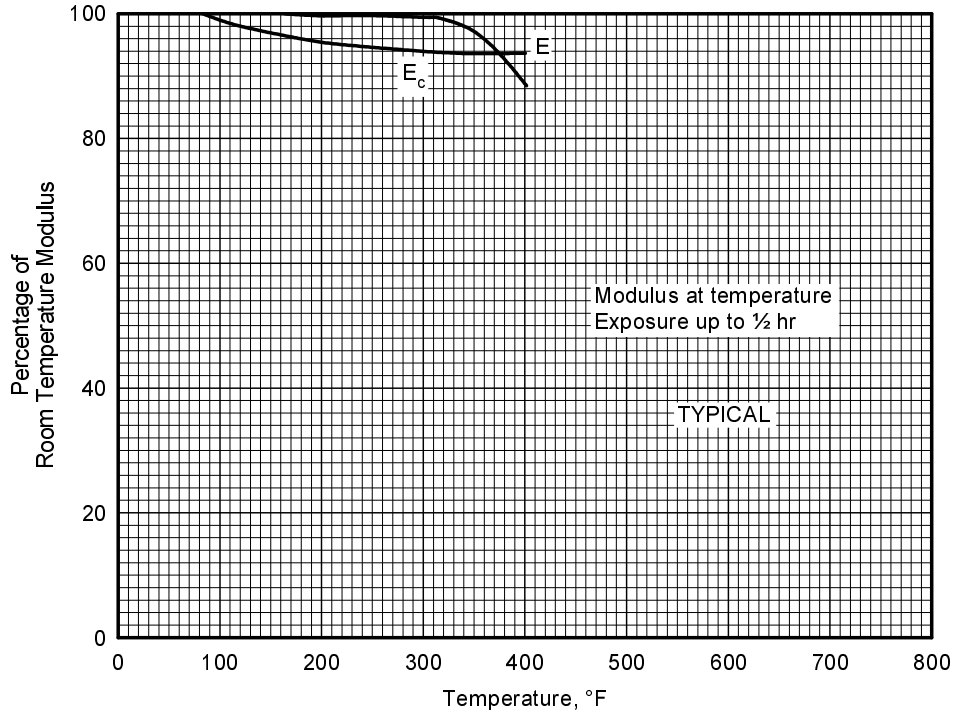

Figure 3.2.13.1.4. Effect of temperature on the tensile and compressive moduli (E and E_c) of 2618-T61 aluminum alloy hand forging.

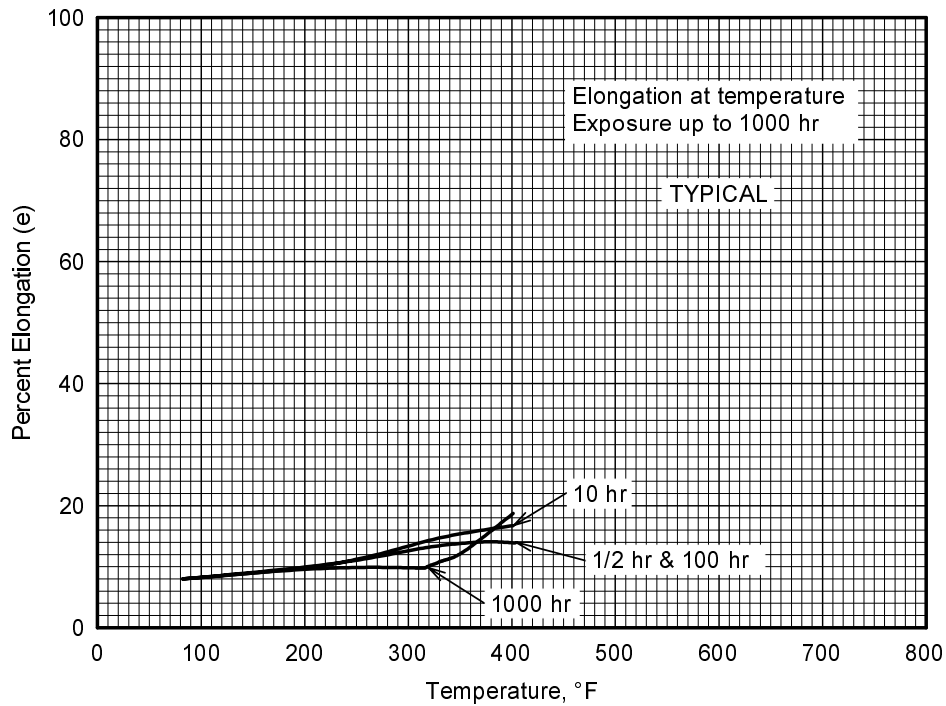

Figure 3.2.13.1.5. Effect of temperature on the elongation (e) of 2618-T61 aluminum alloy hand forging.

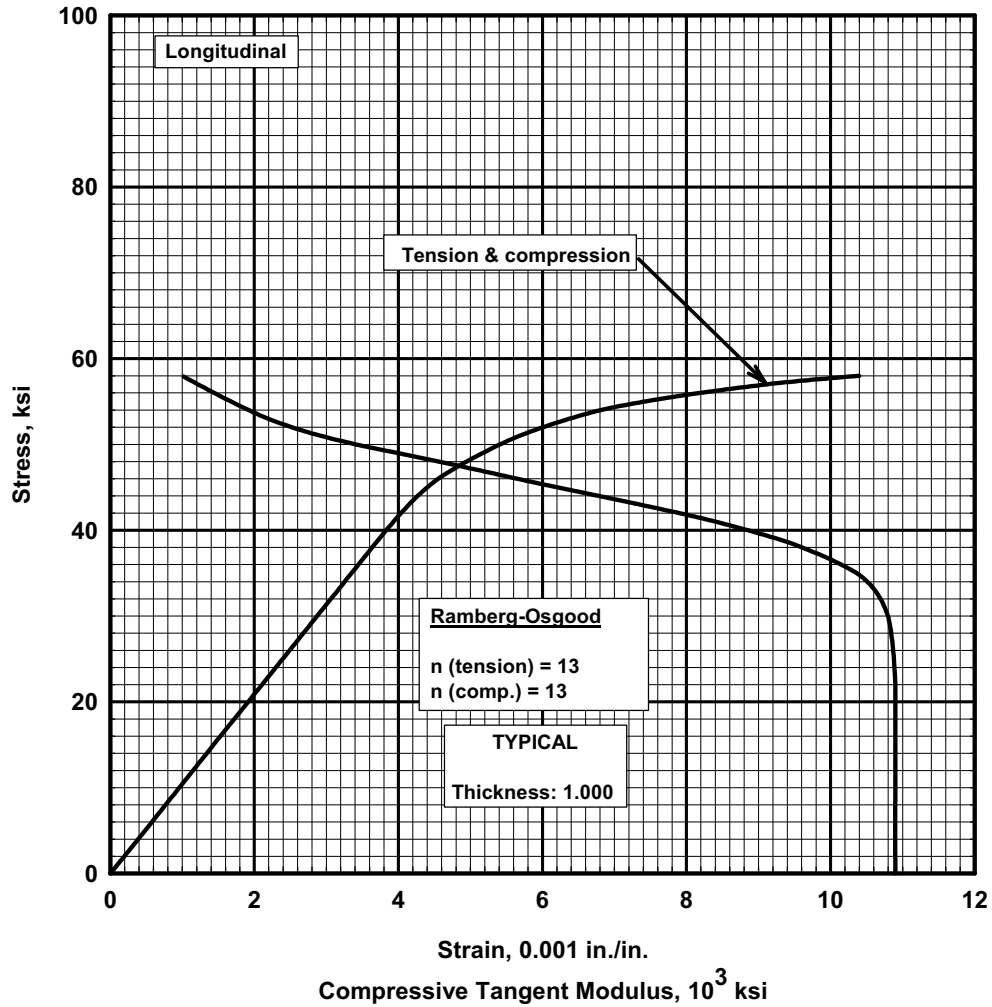

Figure 3.2.13.1.6(a). Typical tensile and compressive stress-strain and compressive tangent-modulus curves for 2618-T61 aluminum alloy forged bar at room temperature.

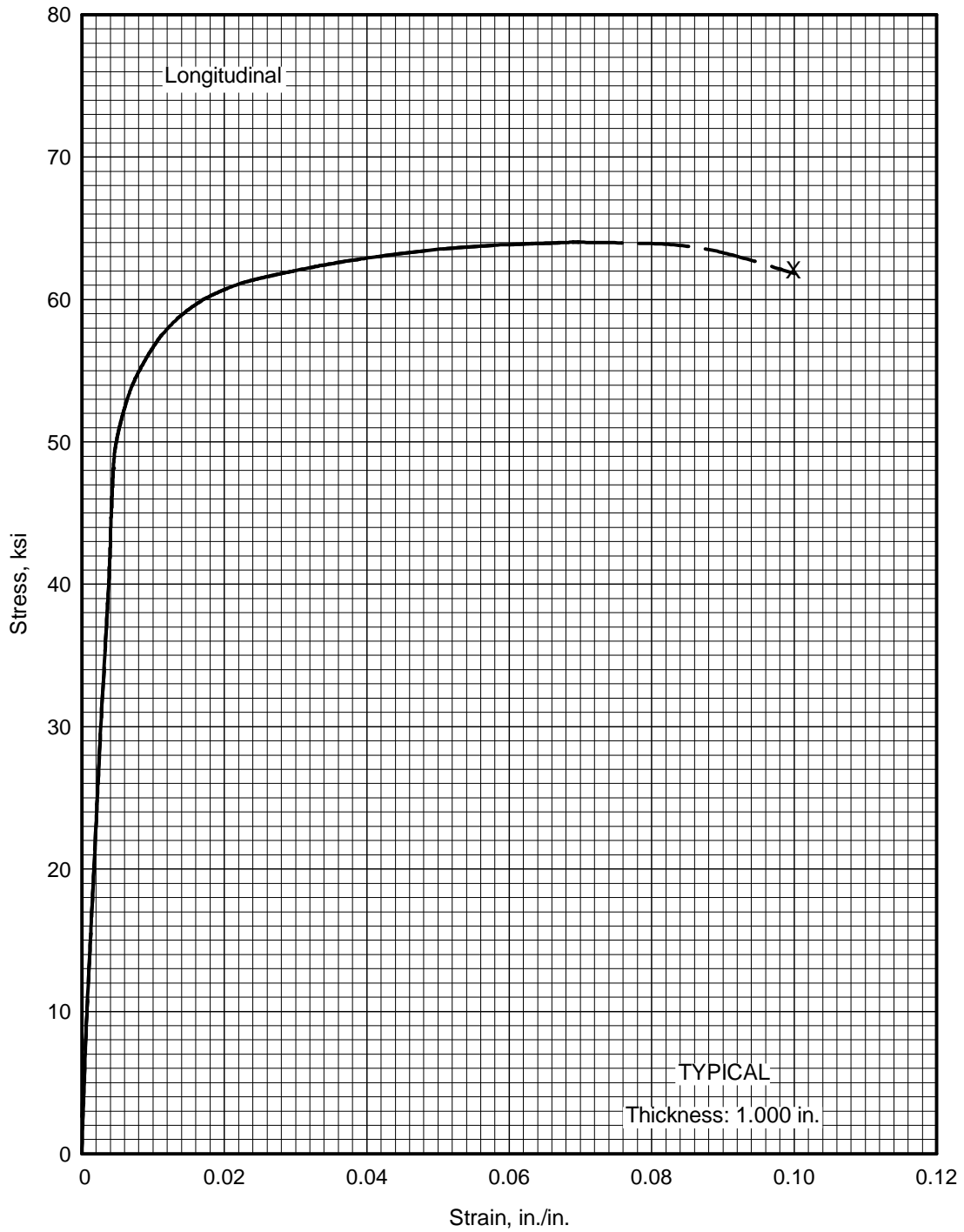

Figure 3.2.13.1.6(b). Typical tensile stress-strain curve (full range) at room temperature for 2618-T61 aluminum alloy forged bar.

3.3 3000 SERIES WROUGHT ALLOYS

3.4 4000 SERIES WROUGHT ALLOYS

3.5 5000 SERIES WROUGHT ALLOYS

Alloys of the 5000 series contain magnesium as the principal alloying element and are strengthened by cold work. Because of their high toughness at temperatures down to -452°F, they are widely used in cryogenic applications.

Magnesium in excess of that in solid solution forms a constituent that is anodic to the aluminum-magnesium matrix. This constituent may form a network of precipitates at grain boundaries or along slip planes. The formation of this continuous grain boundary precipitates, which is accelerated by prior cold work and by exposure to elevated temperatures, causes stress-corrosion cracking susceptibility. Therefore, it is recommended that the strain-hardened tempers of 5000 series alloys containing more than 3 percent magnesium not be used at temperatures above 150°F because susceptibility to SCC may result.

3.5.1 5052 ALLOY

3.5.1.0 Comments and Properties— 5052 is a low-strength Al-Mg alloy but extremely tough at low temperatures as well as at room temperature. It is highly resistant to corrosion; refer to Section 3.1.2.3 for comments regarding the resistance of the alloy to stress-corrosion cracking. Refer to Section 3.1.3.4 for comments regarding the weldability of the alloy.

Material specifications for 5052 aluminum alloy are presented in Table 3.5.1.0(a). Room-temperature mechanical and physical properties are shown in Tables 3.5.1.0(b₁) and (b₂). The effect of temperature on physical properties is shown in Figure 3.5.1.0.

Table 3.5.1.0(a). Material Specifications for 5052 Aluminum Alloy

Specification	Form
AMS 4015	Sheet and plate
AMS 4016	Sheet and plate
AMS 4017	Sheet and plate
AMS-QQ-A-250/8	Sheet and plate

The temper index for 5052 is as follows:

<u>Section</u>	<u>Temper</u>
3.5.1.1	O
3.5.1.2	H32
3.5.1.3	H34
3.5.1.4	H35
3.5.1.5	H38

3.5.1.1 O-Temper—Elevated temperature curves for this temper for various mechanical properties are presented in Figures 3.5.1.1.1, 3.5.1.1.4, and 3.5.1.1.5.

3.5.1.2 H32 Temper—Figure 3.5.1.1.4 may be used for the elevated temperature curve for modulus of elasticity.

3.5.1.3 H34 Temper—Elevated temperature curves for various mechanical properties are presented in Figures 3.5.1.3.1(a) through (d), and 3.5.1.3.5(a) and (b). Use Figure 3.5.1.1.4 for modulus values.

3.5.1.4 H36 Temper—Figure 3.5.1.1.4 may be used for the elevated temperature curve for modulus of elasticity.

3.5.1.5 H38 Temper—Elevated temperature curves for this temper for various mechanical properties are presented in Figures 3.5.1.5.1(a) through (d), and 3.5.1.5.5(a) and (b). Use Figure 3.5.1.1.4 for modulus values.

Table 3.5.1.0(b₁). Design Mechanical and Physical Properties of 5052 Aluminum Alloy Sheet and Plate

Specification	AMS 4015	AMS 4016	AMS 4017	AMS-QQ-A-250/8	
Form	Sheet and plate			Sheet	
Condition	O	H32	H34	H36	H38
Thickness, in.	0.006-3.000	0.017-2.000	0.009-1.000	0.006-0.162	0.006-0.128
Basis	S	S	S	S	S
Mechanical Properties:					
F_{tu} , ksi:					
L	25	31	34	37	39
LT	31	34	37	39
F_{ty} , ksi:					
L	9.5	23	26	29 ^a	32 ^a
LT	22	25	29	32
F_{cy} , ksi:					
L	22	25
LT	23	26
F_{su} , ksi	16	19	20	22	23
F_{bru} , ksi:					
(e/D = 1.5)	50	54	59	62
(e/D = 2.0)	65	71	78	82
F_{bry} , ksi:					
(e/D = 1.5)	32	37	41	44
(e/D = 2.0)	37	41	46	51
e , percent:					
L	b	b	b	b	b
E , 10 ³ ksi	10.1				
E_c , 10 ³ ksi	10.2				
G , 10 ³ ksi	3.85				
μ	0.33				
Physical Properties:					
ω , lb/in. ³	0.097				
C , Btu/(lb)(°F) . . .	0.23 (at 212°F)				
K and α	See Figure 3.5.1.0				

a From "Aluminum Standards and Data" dated 1982.
b See Table 3.5.1.0(b₂).

Table 3.5.1.0(b₂). Minimum Elongation Values for 5052 Aluminum Alloy Sheet and Plate

Temper	Thickness Range, inch	Elongation (L), percent
O	0.006-0.007	...
	0.008-0.012	14
	0.013-0.019	15
	0.020-0.031	16
	0.032-0.050	18
	0.051-0.113	19
	0.114-0.249	20
	0.250-3.000	18
H32	0.017-0.019	4
	0.020-0.050	5
	0.051-0.113	7
	0.114-0.249	9
	0.250-0.499	11
	0.500-2.000	12
H34	0.009-0.019	3
	0.020-0.050	4
	0.051-0.113	6
	0.114-0.249	7
	0.250-1.000	10
H36	0.006-0.007	2
	0.008-0.031	3
	0.032-0.162	4
H38	0.006-0.007	2
	0.008-0.031	3
	0.032-0.128	4

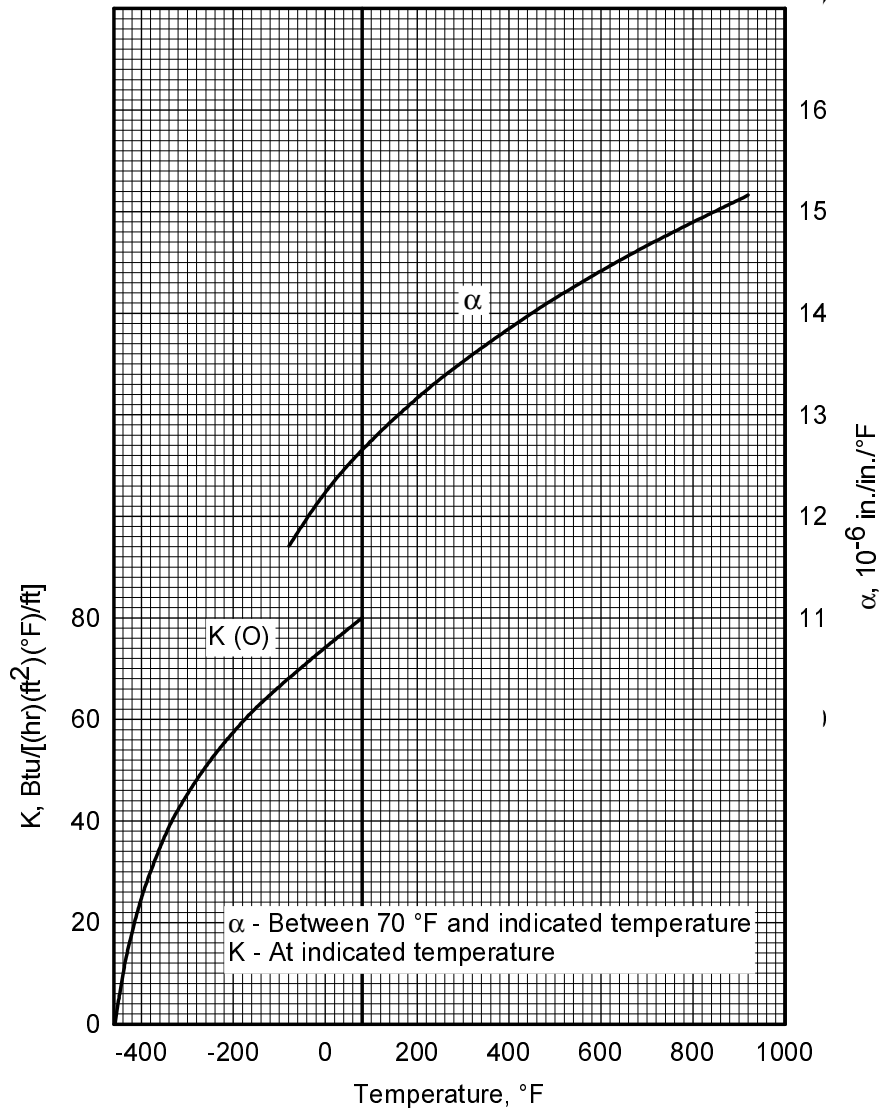

Figure 3.5.1.0. Effect of temperature on the physical properties of 5052 aluminum alloy.

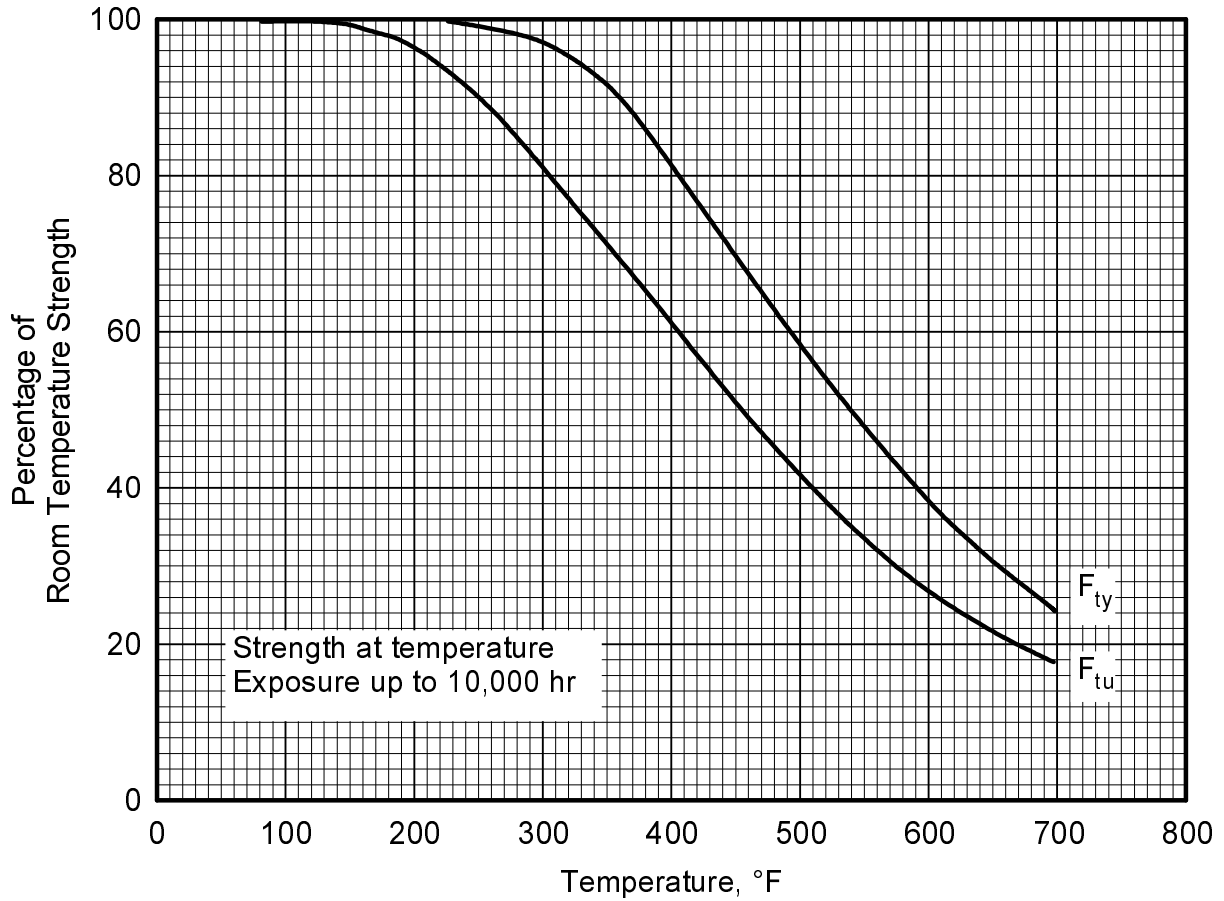

Figure 3.5.1.1.1. Effect of temperature on the tensile ultimate strength (F_{tu}) and the tensile yield strength (F_{ty}) of 5052-0 aluminum alloy (all products).

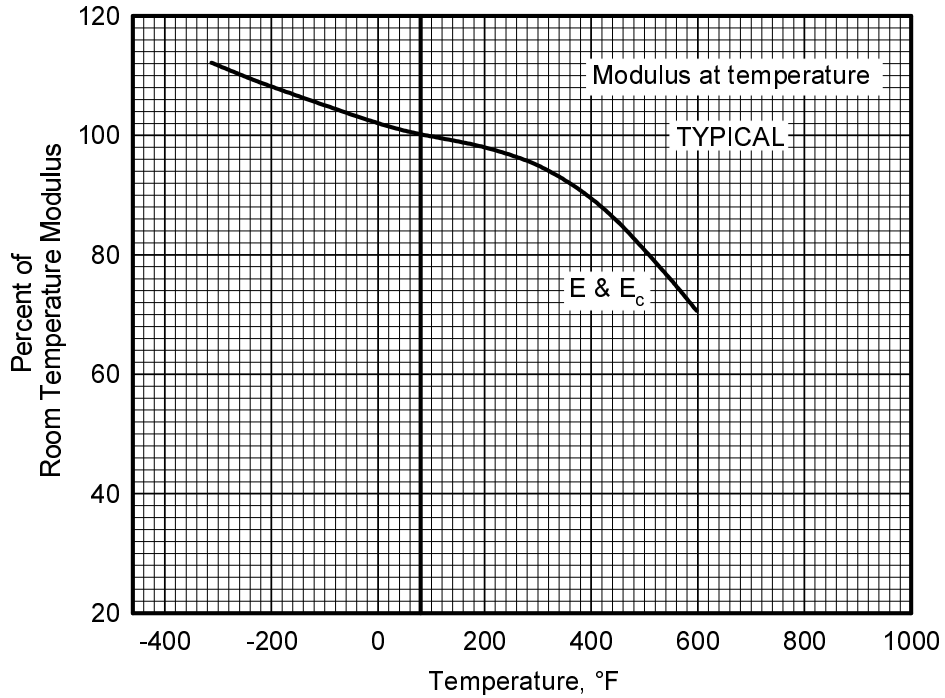

Figure 3.5.1.1.4. Effect of temperature on the tensile and compressive moduli (E and E_c) of 5052-0 aluminum alloy (all products).

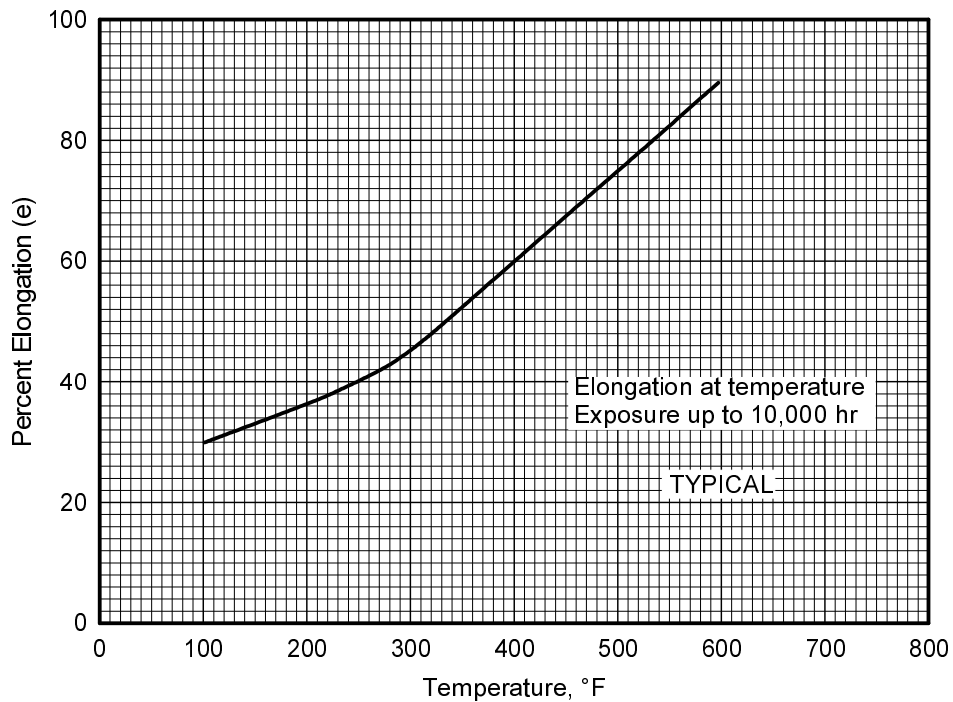

Figure 3.5.1.1.5. Effect of temperature on the elongation of 5052-0 aluminum alloy (all products).

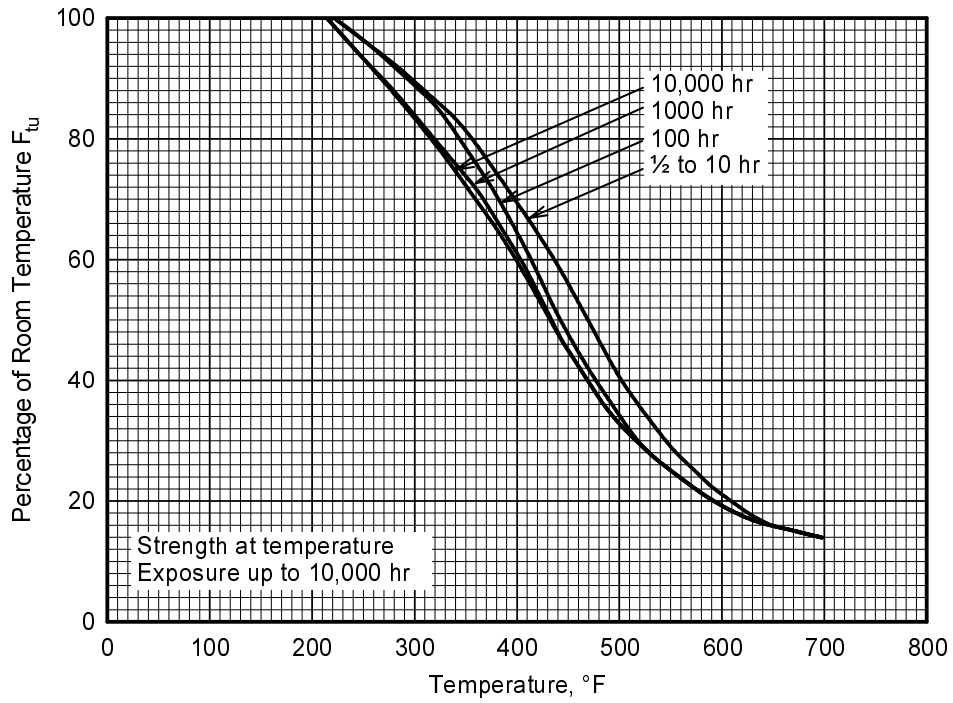

Figure 3.5.1.3.1(a). Effect of temperature on the tensile ultimate strength (F_u) of 5052-H34 aluminum alloy sheet and plate.

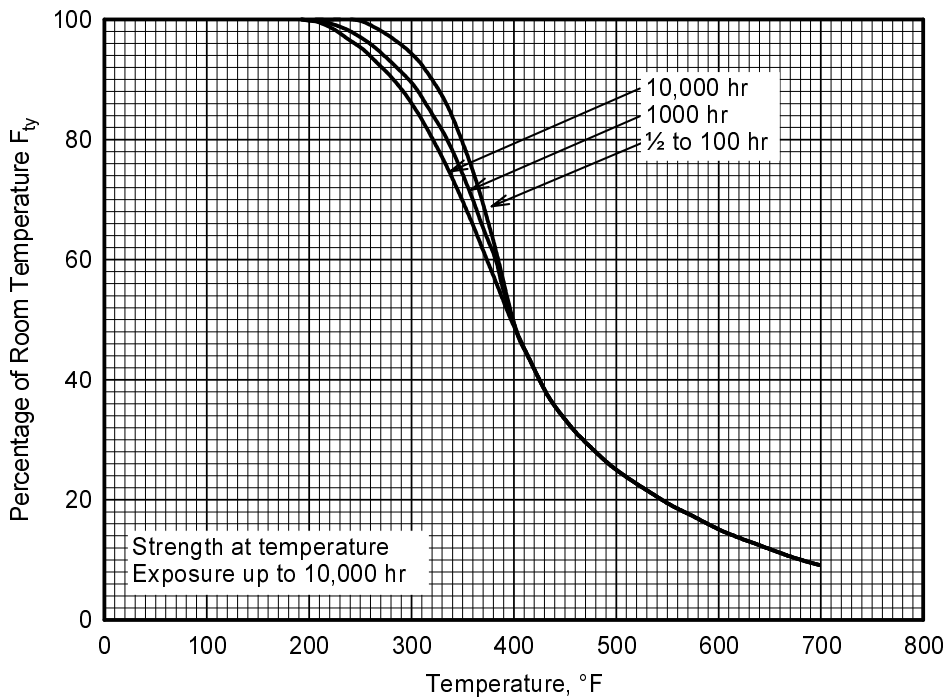

Figure 3.5.1.3.1(b). Effect of temperature on the tensile yield strength (F_y) of 5052-H34 aluminum alloy sheet and plate.

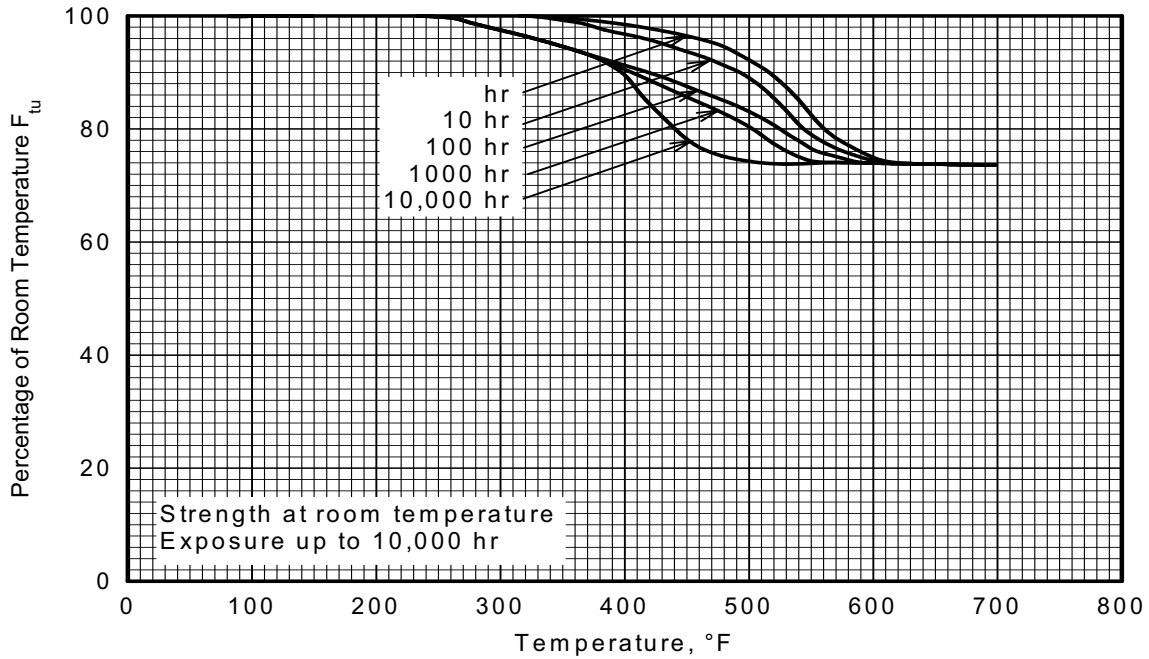

Figure 3.5.1.3.1(c). Effect of exposure at elevated temperatures on the room-temperature tensile ultimate strength (F_{tu}) of 5052-H34 aluminum alloy sheet and plate.

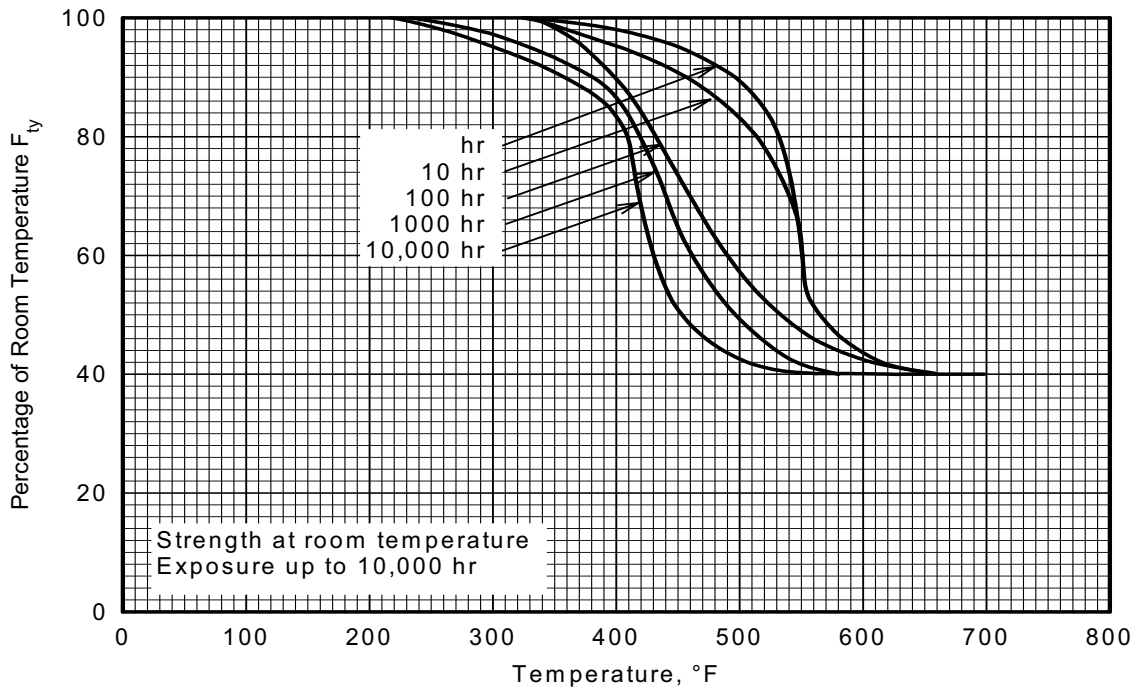

Figure 3.5.1.3.1(d). Effect of exposure at elevated temperatures on the room-temperature tensile yield strength (F_{ty}) of 5052-H34 aluminum alloy sheet and plate.

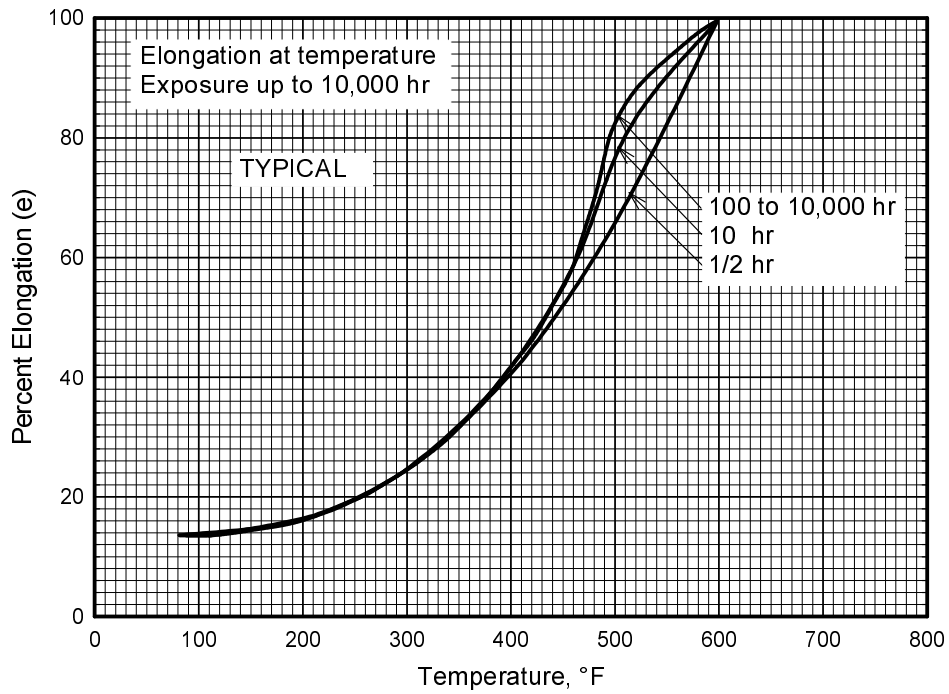

Figure 3.5.1.3.5(a). Effect of temperature on the elongation (e) of 5052-H34 aluminum alloy sheet and plate.

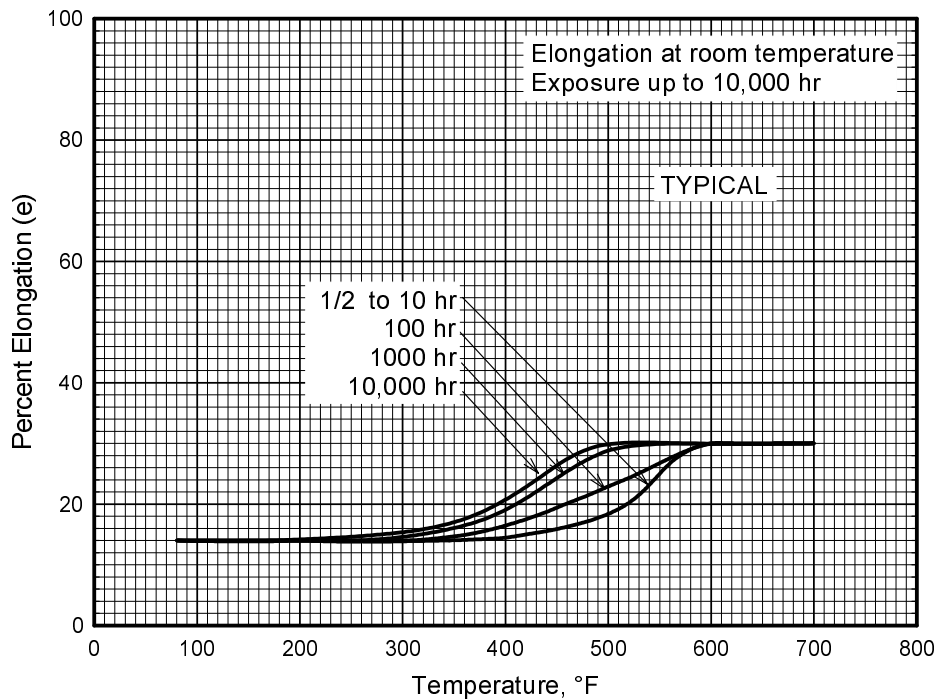

Figure 3.5.1.3.5(b). Effect of exposure at elevated temperatures on the room temperature elongation (e) of 5052-H34 aluminum alloy sheet and plate.

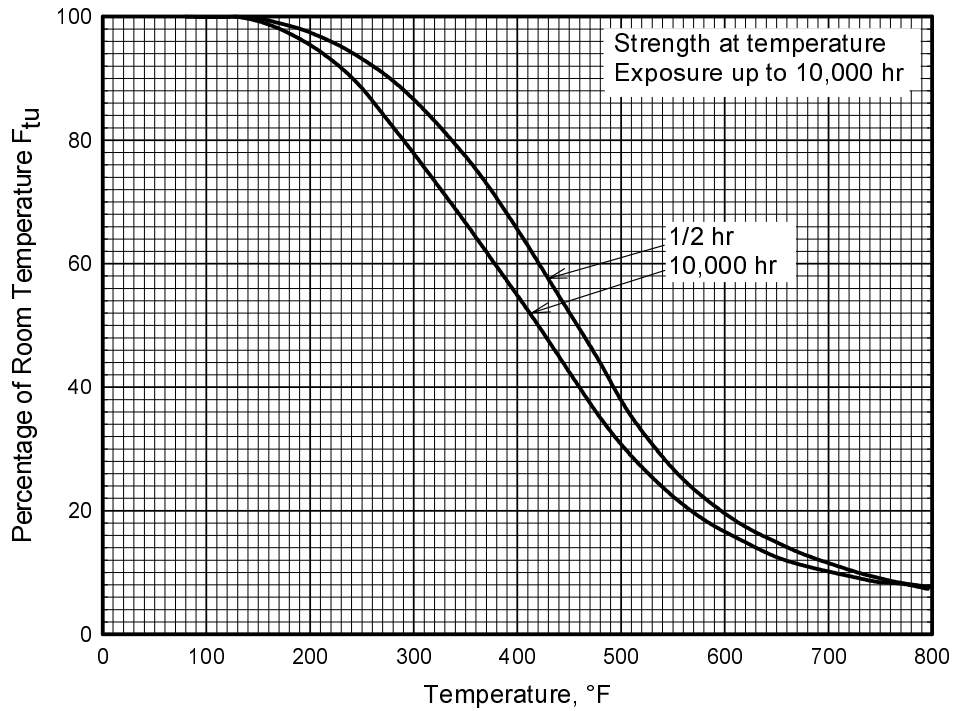

Figure 3.5.1.5.1(a). Effect of temperature on the tensile ultimate strength (F_{tu}) of 5052-H38 aluminum alloy (all products).

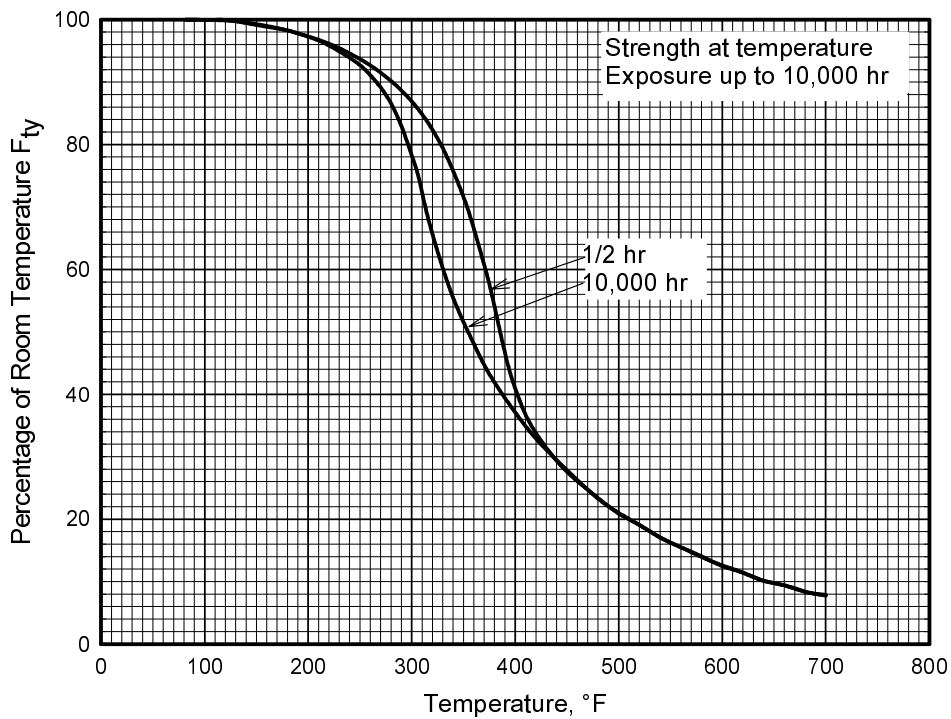

Figure 3.5.1.5.1(b). Effect of temperature on the tensile yield strength (F_{ty}) of 5052-H38 aluminum alloy (all products).

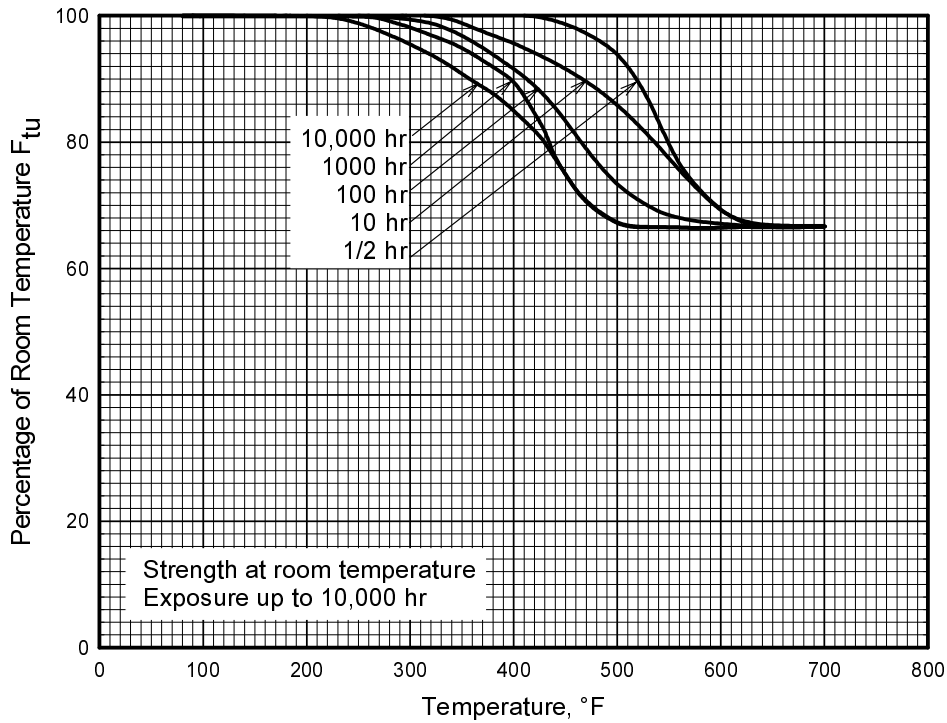

Figure 3.5.1.5.1(c). Effect of exposure at elevated temperatures on the room-temperature tensile ultimate strength (F_{tu}) of 5052-H38 aluminum alloy (all products).

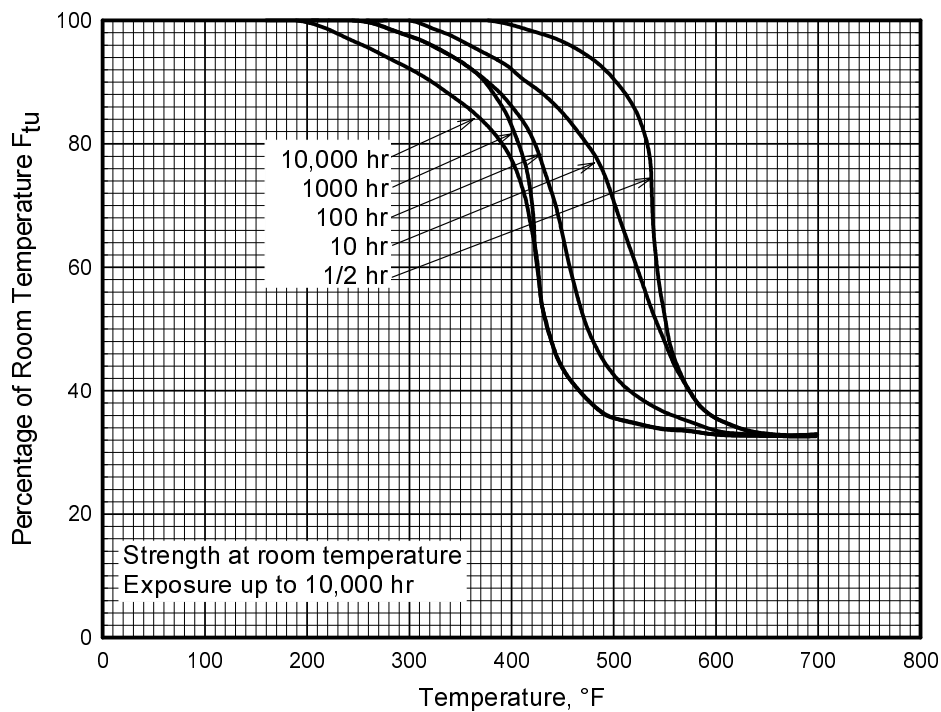

Figure 3.5.1.5.1(d). Effect of exposure at elevated temperatures on the room-temperature tensile yield strength (F_{ty}) of 5052-H38 aluminum alloy (all products).

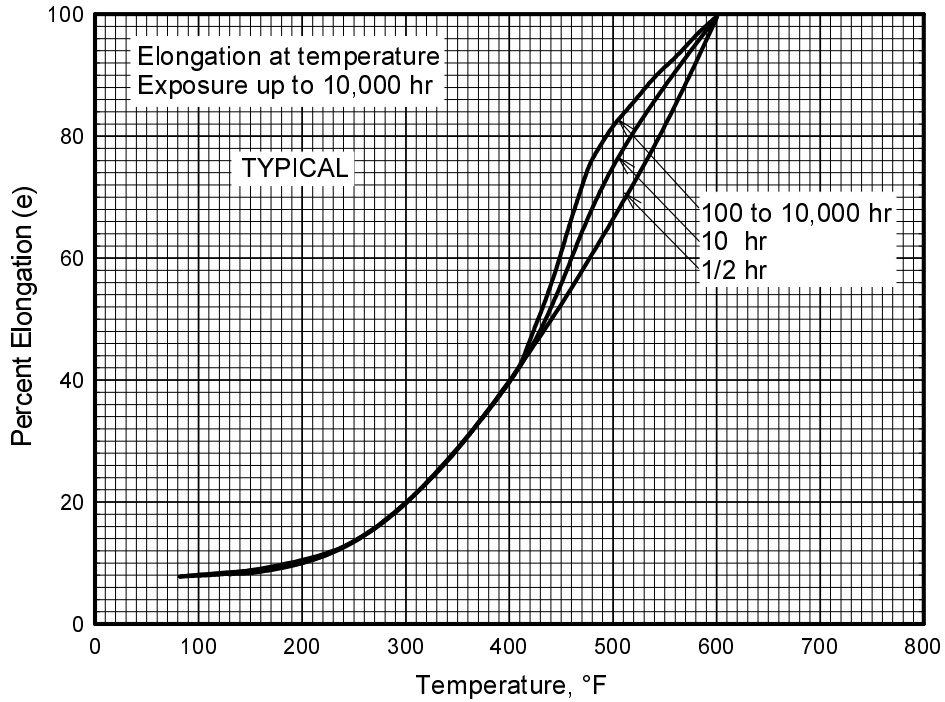

Figure 3.5.1.5.5(a). Effect of temperature on the elongation of 5052-H38 aluminum alloy (all products).

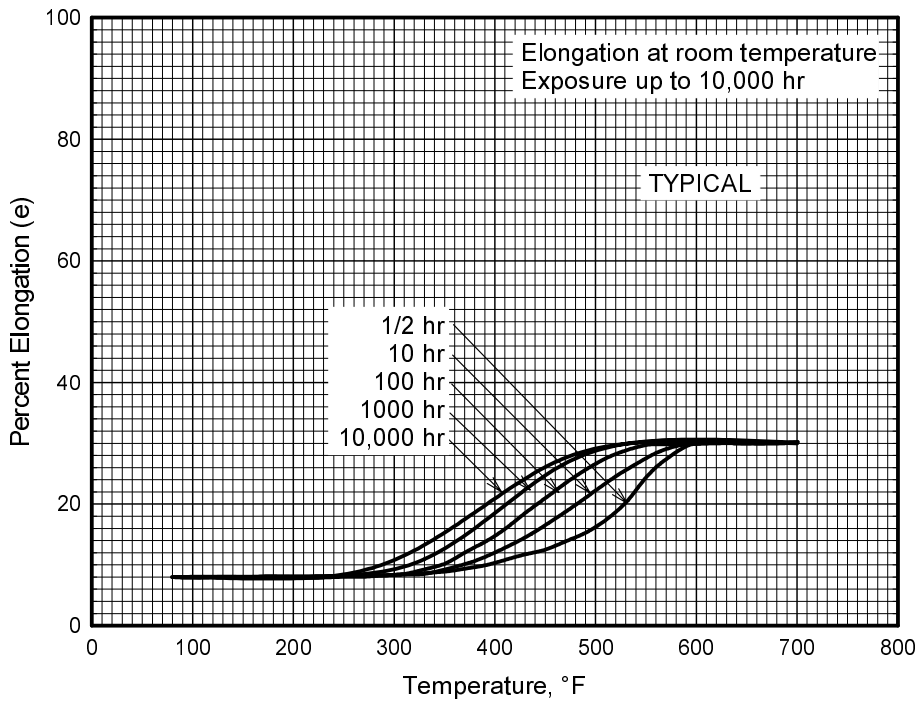

Figure 3.5.1.5.5(b). Effect of exposure at elevated temperatures on the room temperature elongation of 5052-H38 aluminum alloy (all products).

3.5.2 5083 ALLOY

3.5.2.0 Comments and Properties — 5083 is a high-strength Al-Mg alloy which has been widely used in cryogenic applications, because of its excellent combination of strength and toughness. It has high resistance to corrosion, but strain-hardened tempers should not be used at temperatures above 150°F because of possible sensitization to stress-corrosion cracking. Refer to Section 3.1.2.3 for comments regarding the resistance of the alloy to stress-corrosion cracking, and to Section 3.1.3.4 for comments regarding the weldability of the alloy.

Material specifications for 5083 aluminum alloy are presented in Table 3.5.2.0(a). Room-temperature mechanical and physical properties are shown in Tables 3.5.2.0(b) and (c). The effect of temperature on thermal expansion is shown in Figure 3.5.2.0.

Table 3.5.2.0(a). Material Specifications for 5083 Aluminum Alloy

Specification	Form
AMS 4056	Bare sheet and plate
AMS-QQ-A-250/6	Bare sheet and plate
AMS-QQ-A-200/4	Extruded bar, rod, and shapes

The temper index for 5083 is as follows:

<u>Section</u>	<u>Temper</u>
3.5.2.1	O
3.5.2.2	H111
3.5.2.3	H112
3.5.2.4	H321
3.5.2.5	H323
3.5.2.6	H343

3.5.2.1 O Temper — Tensile and compressive stress-strain and tangent-modulus curves at room temperature are presented in Figures 3.5.2.1.6(a) and (b). A full-range tensile stress-strain curve is shown in Figure 3.5.2.1.6(c) at room temperature.

Table 3.5.2.0(b). Design Mechanical and Physical Properties of 5083 Aluminum Alloy Sheet and Plate

	AMS 4056 and AMS-QQ-A-250/6										AMS-QQ-A-250/6																					
	Sheet and plate																															
	O					H112					H321					H323					H343											
Specification	1.501-3.000		3.001-4.000		4.001-5.000		5.001-7.000		7.001-8.000		0.250-1.500		1.501-3.000		0.188-1.500		1.501-3.000		0.051-0.125		0.126-0.249		0.051-0.125		0.126-0.249							
	A	B	S	S	S	S	S	S	S	S	S	S	S	A	B	A	B	A	B	A	B	A	B	A	B	A	B					
Form	Sheet and plate																															
Temper	Sheet and plate																															
Thickness, in.	Sheet and plate																															
Basis	Sheet and plate																															
Mechanical Properties:																																
F_{tu} , ksi:																																
L	40	41	39	38	38	38	37	36	36	36	40	39	44	44	46	46	41	41	45	47	45	45	45	50	50	50	50	50	50	50	50	
LT	40	41	
F_{ty} , ksi:																																
L	18	19	17	16	16	15	14	14	14	18	17	31	31	31	32	29	29	34	36	34	34	34	34	39	39	39	39	39	39	39	39	
LT	18	19
F_{cy} , ksi:																																
L	18	19
LT	18	19
F_{su} , ksi:																																
L	25	26
F_{btp} , ksi:																																
(e/D = 1.5)	60	62
(e/D = 2.0)	76	78
F_{btp} , ksi:																																
(e/D = 1.5)	32	34
(e/D = 2.0)	38	40
e_s , percent (S basis):																																
L	16	...	16	16	14	14	14	12	12	12	12	12	12	12	12	12	12	12	12	12	12	12	12	12	12	12	12	12	12	12	12	12
E , 10^3 ksi	10.2																															
E_c , 10^3 ksi	10.4																															
G , 10^3 ksi	3.85																															
μ	0.33																															
Physical Properties:																																
ω , lb/in. ³	0.096																															
C , Btu/(lb)(°F)	0.23 (at 212°F)																															
K , Btu/[(hr)(ft ²)(°F)/ft]	68 (at 77°F)																															
α , 10^{-6} in./in./°F	See Figure 3.5.2.0																															

Table 3.5.2.0(c). Design Mechanical and Physical Properties of 5083 Aluminum Alloy Extrusion

Specification	AMS-QQ-A-200/4			
	Extrusion			
Form	O	H111		H112
Temper				
Thickness, in.	$\leq 5.000^a$	$< 0.500^a$	0.501- 5.000 ^a	$\leq 5.000^a$
Basis	S	S	S	S
Mechanical Properties:				
F_{tu} , ksi:				
L	39	40	40	39
LT	40	32	...
F_{ty} , ksi:				
L	16	24	24	16
LT	24	19	...
F_{cy} , ksi:				
L
LT
F_{su} , ksi
F_{brv} , ksi:				
(e/D = 1.5)
(e/D = 2.0)
F_{brv} , ksi:				
(e/D = 1.5)
(e/D = 2.0)
e , percent:				
L	14	12	12	12
E , 10^3 ksi	10.2			
E_c , 10^3 ksi	10.4			
G , 10^3 ksi	3.35			
μ	0.33			
Physical Properties:				
ω , lb/in. ³	0.096			
C , Btu/(lb)(°F)	0.23 (at 212°F)			
K , Btu/[(hr)(ft ²)(°F)/ft]	68 (at 77°F)			
α , 10^{-6} in./in./°F	See Figure 3.5.2.0			

a Cross-sectional area ≤ 32 in².

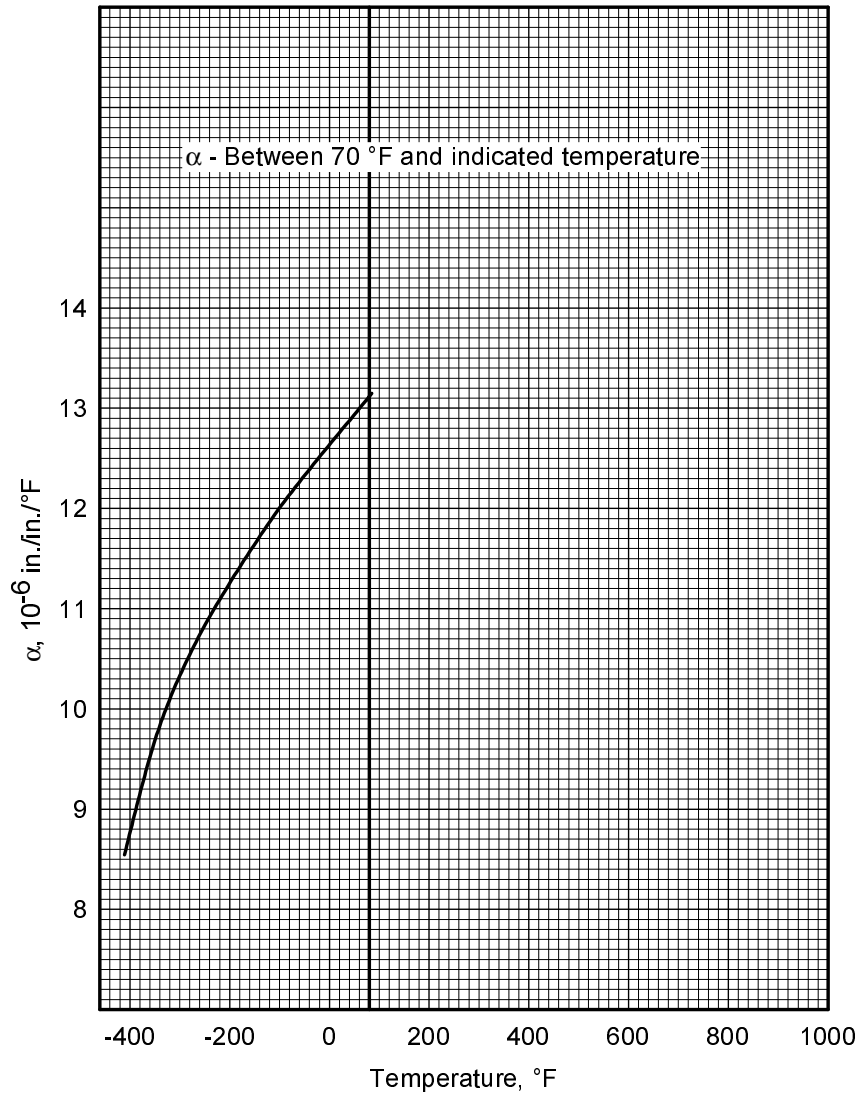

Figure 3.5.2.0. Effect of temperature on the thermal expansion of 5083 aluminum alloy.

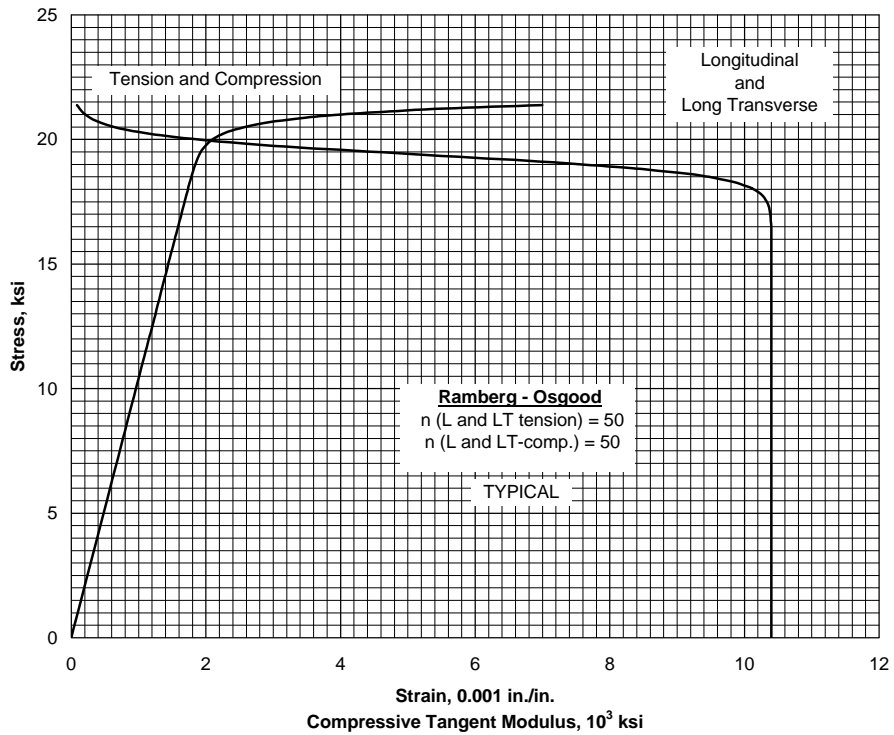

Figure 3.5.2.1.6(a). Typical tensile and compressive stress-strain and compressive tangent-modulus curves for 5083-0 aluminum alloy sheet at room temperature.

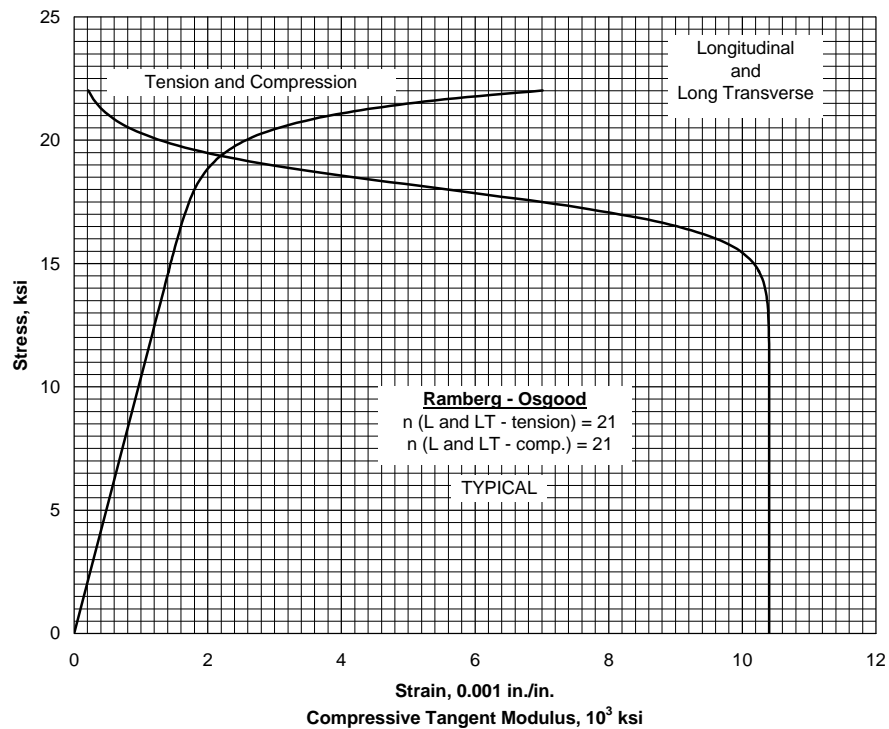

Figure 3.5.2.1.6(b). Typical tensile and compressive stress-strain and compressive tangent-modulus curves for 5083-0 aluminum alloy plate at room temperature.

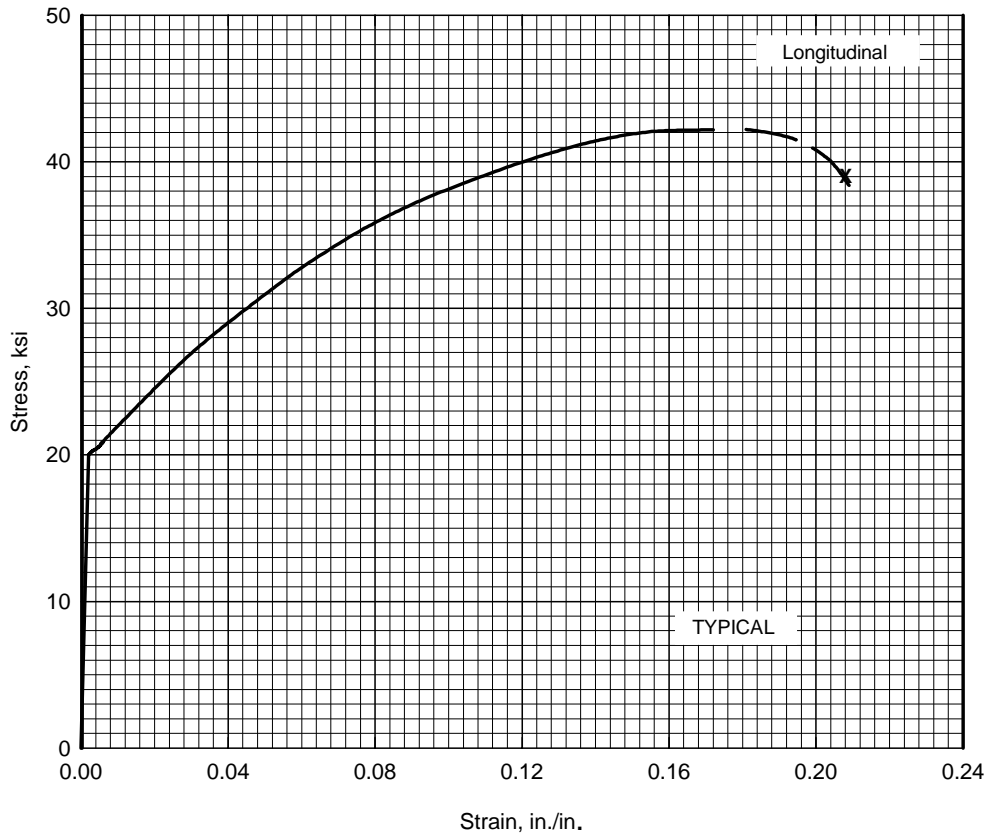

Figure 3.5.2.1.6(c). Typical tensile stress-strain curve (full range) for 5083-0 aluminum alloy plate at room temperature.

3.5.3 5086 ALLOY

3.5.3.0 Comments and Properties — 5086 is a tough, medium-strength Al-Mg alloy suitable for application over the range of temperatures from -452 to 150°F. Refer to Section 3.1.2.3 for comments regarding resistance of the alloy to stress-corrosion cracking, and to Section 3.1.3.4 for comments regarding the weldability of the alloy.

Material specifications for 5086 aluminum alloy are presented in Table 3.5.3.0(a). Room-temperature mechanical and physical properties are shown in Tables 3.5.3.0(b) and (c).

Table 3.5.3.0(a). Material Specifications for 5086 Aluminum Alloy

Specification	Form
AMS-QQ-A-250/7	Sheet and plate
AMS-QQ-A-200/5	Extruded bar, rod, and shapes

The temper index for 5086 is as follows:

<u>Section</u>	<u>Temper</u>
3.5.3.1	O
3.5.3.2	H32
3.5.3.3	H34
3.5.3.4	H36
3.5.3.5	H38
3.5.3.6	H111
3.5.3.7	H112

3.5.3.1 O Temper — Tensile, compressive stress-strain and tangent-modulus curves at room temperature are shown in Figures 3.5.3.1.6(a) and (b) for products with this temper. Figure 3.5.3.1.6(c) is a full-range tensile stress-strain curve.

3.5.3.2 H32 Temper — Figures 3.5.3.2.6(a) and (b) show tensile and compressive stress-strain and tangent-modulus curves at room temperature.

3.5.3.3 H34 Temper — Figures 3.5.3.3.6(a) and (b) show tensile, compressive stress-strain, and tangent-modulus curves for this temper. A full-range tensile stress-strain curve is shown in Figure 3.5.3.3.6(c).

3.5.3.4 H36 Temper — Figure 3.5.3.4.6 shows tensile, compressive stress-strain and tangent-modulus curves at room temperature.

3.5.3.5 H38 Temper —

3.5.3.6 H111 Temper —

3.5.3.7 H112 Temper — Figure 3.5.3.7.6 shows tensile, compressive stress-strain and tangent-modulus curves at room temperature.

Table 3.5.3.0(b). Design Mechanical and Physical Properties of 5086 Aluminum Alloy Sheet, Plate and Extrusion

Specification	AMS-QQ-A-250/7												AMS-QQ-A-200/5					
	Sheet and plate												Extrusion					
	O	H32		H34	H36	H38	H112				O	H111	H112					
Form																		
Condition																		
Thickness, in	0.020-2.000	0.020-2.000		0.009-1.000	0.006-0.162	0.006-0.020	0.188-0.499	0.500-1.00	1.001-2.000	2.001-3.000								
Basis	A B	A B	A B	S	S	S	S	S	S	S	S	S	S	S	S	S	S	S
Mechanical Properties:																		
F_{ut} , ksi:																		
L	35	36	40	41	44	47	50	36	35	34	35	36	35	35	36	35	36	35
LT	35	36	40	41	44	47	...	36	35	34	35	...	35	34
F_{op} , ksi:																		
L	14	15	28	30	34	38	41	18	16	14	16	17	15	14	14	14	21	14
LT	14	15	26	28	33	37	...	17	16	14	16	...	16	14
F_{cp} , ksi:																		
L	14	15	26	28	32	35	...	17	15	14	15	17	14	14
LT	14	15	28	30	34	38	...	18	16	14	16	...	16	14
F_{ut} , ksi:																		
L	21	22	24	25	26	27	...	22	21	20	21	...	20	20
F_{brp} , ksi:																		
(e/D=1.5)	52	53	58	61	64	68	...	54	52	51	52	...	51	51
(e/D=2.0)	70	72	80	82	88	94	...	72	70	68	70	...	68	68
F_{brp} , ksi:																		
(e/D=1.5)	24	26	39	42	48	53	...	25	24	24	24	...	24	24
(e/D=2.0)	28	30	48	51	58	65	...	31	28	28	28	...	28	28
e , percent (S basis):																		
L	b	...	b	...	b	b	3	8	10	14	10	...	14	14	12	14	12	12
E , 10^3 ksi																		
E_{cp} , 10^3 ksi																		
G , 10^3 ksi																		
μ																		
Physical Properties:																		
ω , lb/in. ³																		
C , Btu/(lb)(°F)																		
K , Btu/[(hr)(ft ²)(°F)ft]																		
α , 10^{-6} in/in/°F																		

a Cross-sectional area ≤ 32 .
b See Table 3.5.3.0(c).

**Table 3.5.3.0(c). Minimum Elongation Values for
5086 Aluminum Alloy Sheet and Plate**

Temper	Thickness Range, inch	Elongation (L), percent
O.....	0.020-0.050	15
	0.051-0.249	18
	0.250-2.000	16
H32.....	0.020-0.050	6
	0.051-0.249	8
	0.250-2.000	12
H34.....	0.009-0.019	4
	0.020-0.050	5
	0.051-0.249	6
	0.250-1.000	10
H36.....	0.006-0.019	3
	0.020-0.050	4
	0.051-0.162	6

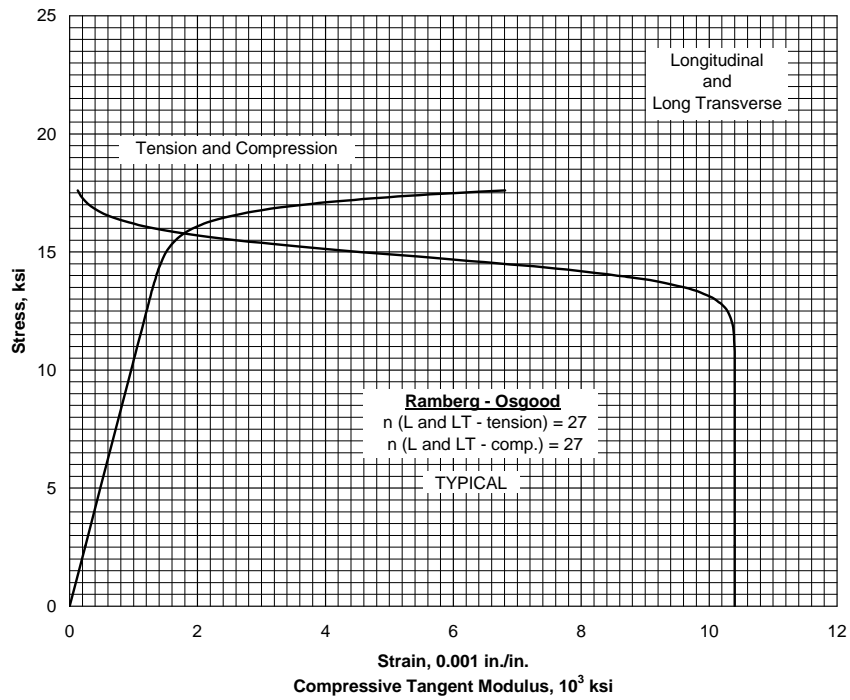

Figure 3.5.3.1.6(a). Typical tensile and compressive stress-strain and compressive tangent-modulus curves for 5086-0 aluminum alloy sheet at room temperature.

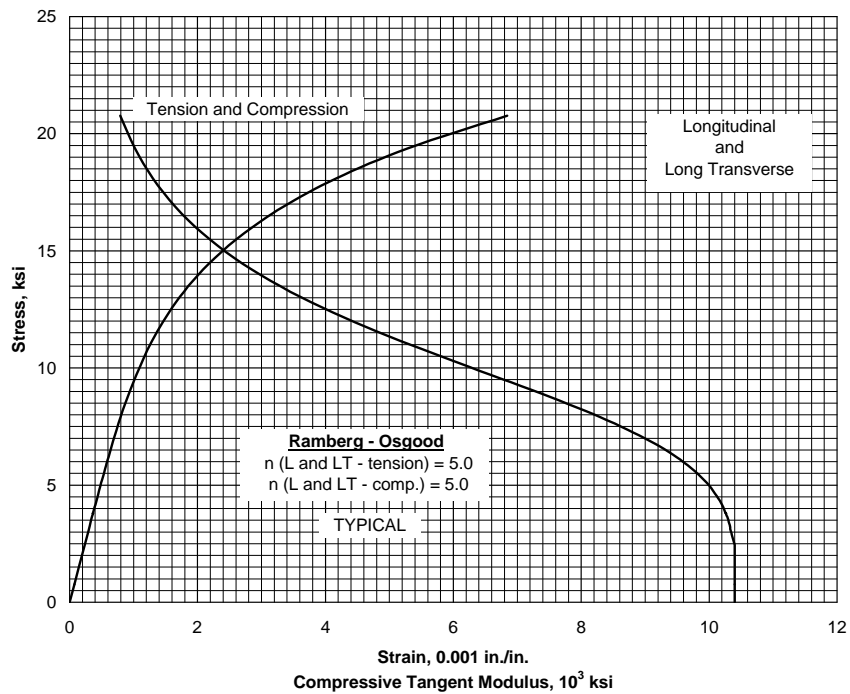

Figure 3.5.3.1.6(b). Typical tensile and compressive stress-strain and compressive tangent-modulus curves for 5086-0 aluminum alloy plate and extrusion at room temperature.

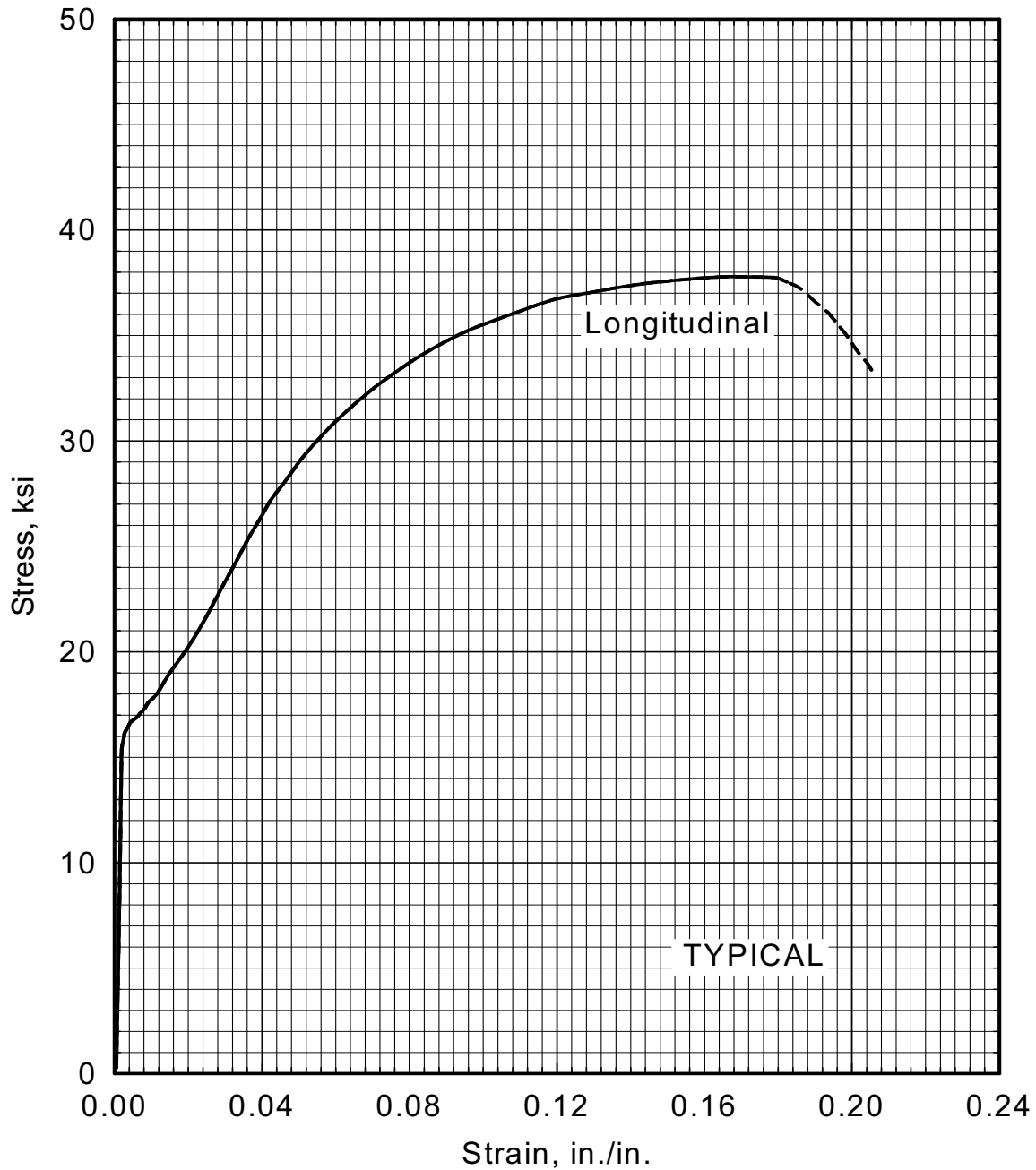

Figure 3.5.3.1.6(c). Typical tensile stress-strain curve (full range) for 5086-0 aluminum alloy sheet at room temperature.

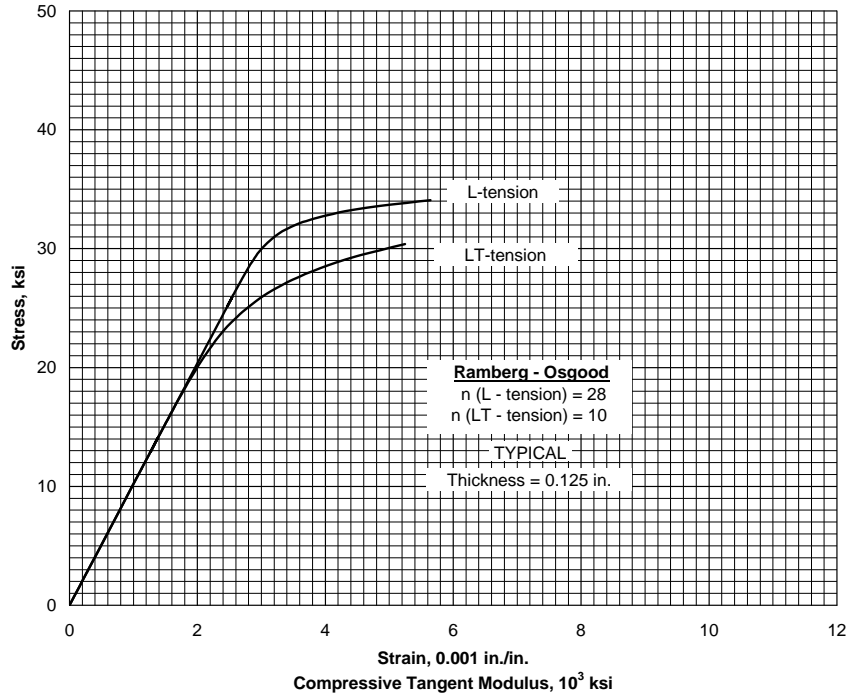

Figure 3.5.3.2.6(a). Typical tensile stress-strain curves for 5086-H32 aluminum alloy sheet at room temperature.

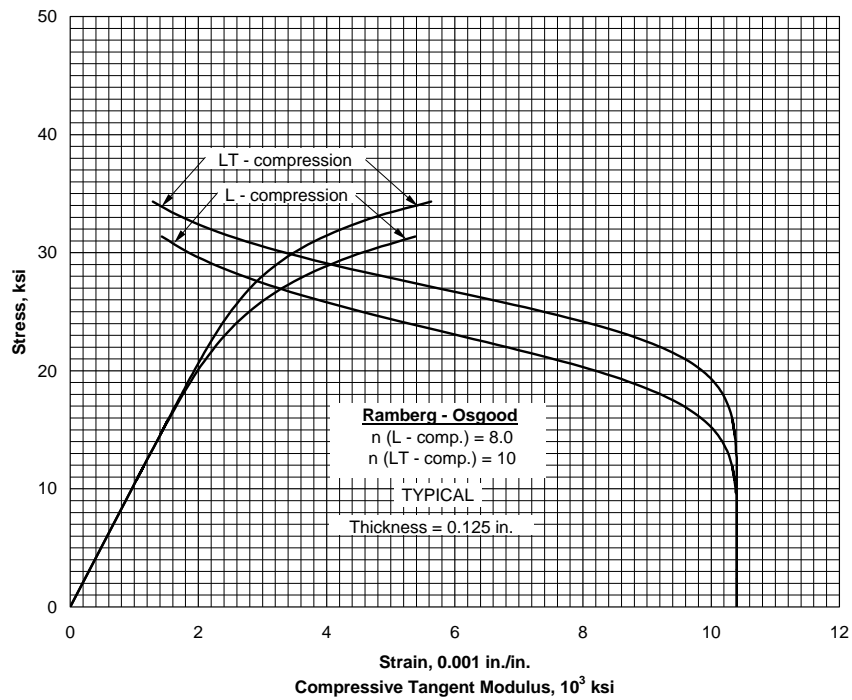

Figure 3.5.3.2.6(b). Typical compressive stress-strain and compressive tangent-modulus curves for 5086-H32 aluminum alloy sheet at room temperature.

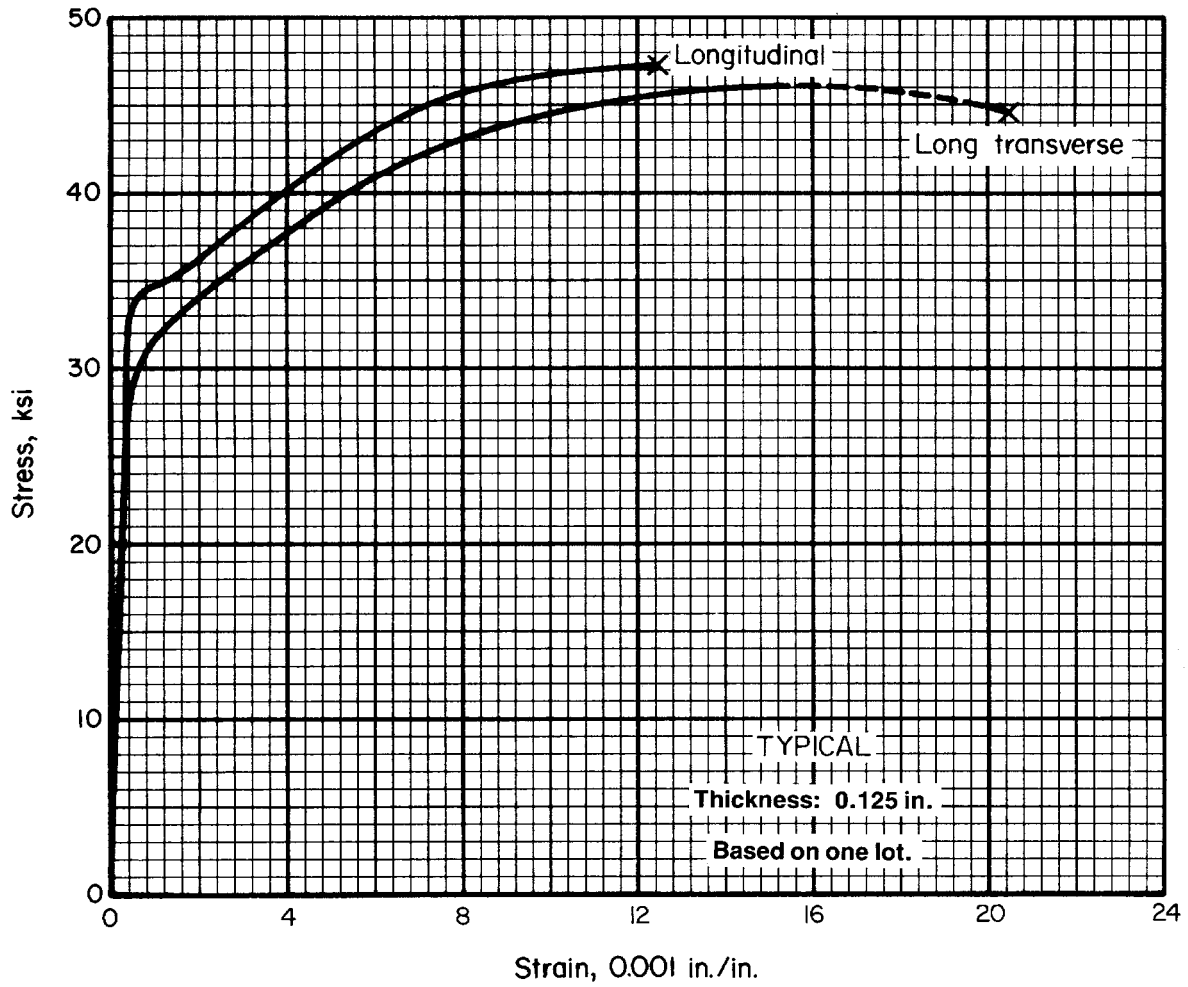

Figure 3.5.3.2.6(c). Typical tensile stress-strain curves (full range) for 5086-H32 aluminum alloy sheet at room temperature.

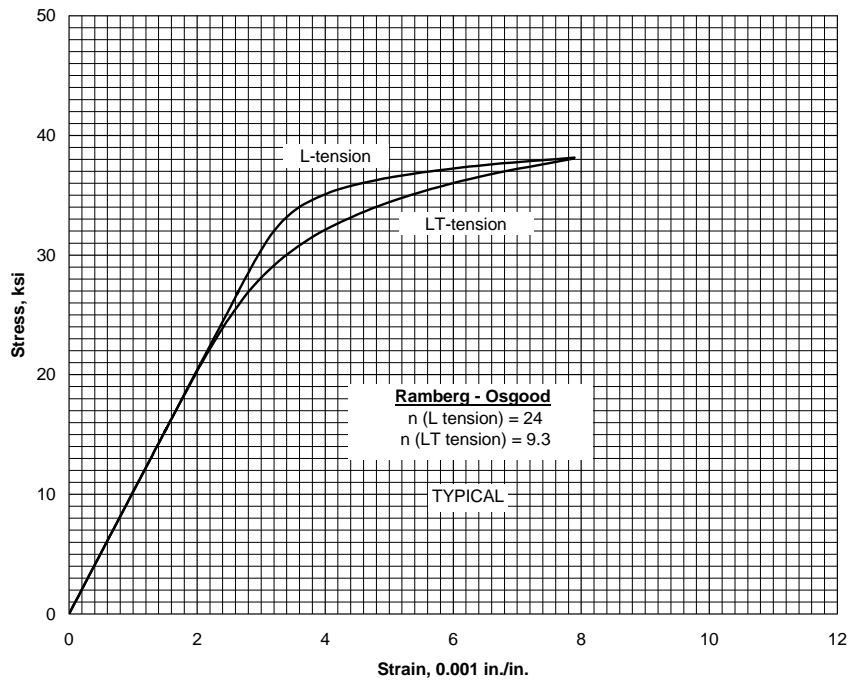

Figure 3.5.3.3.6(a). Typical tensile stress-strain curves for 5086-H34 aluminum alloy sheet at room temperature.

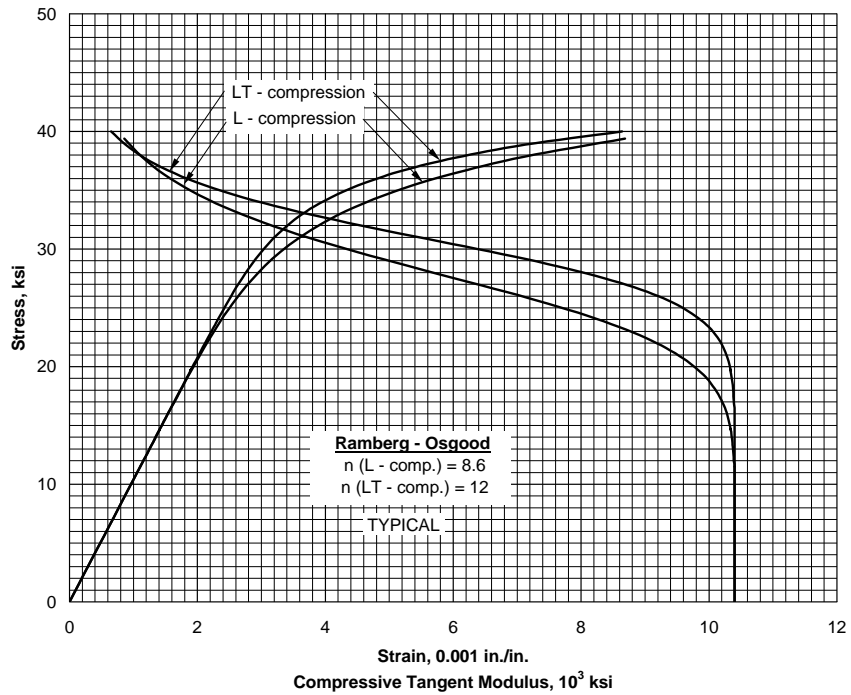

Figure 3.5.3.3.6(b). Typical compressive stress-strain and compressive tangent-modulus curves for 5086-H34 aluminum alloy sheet at room temperature.

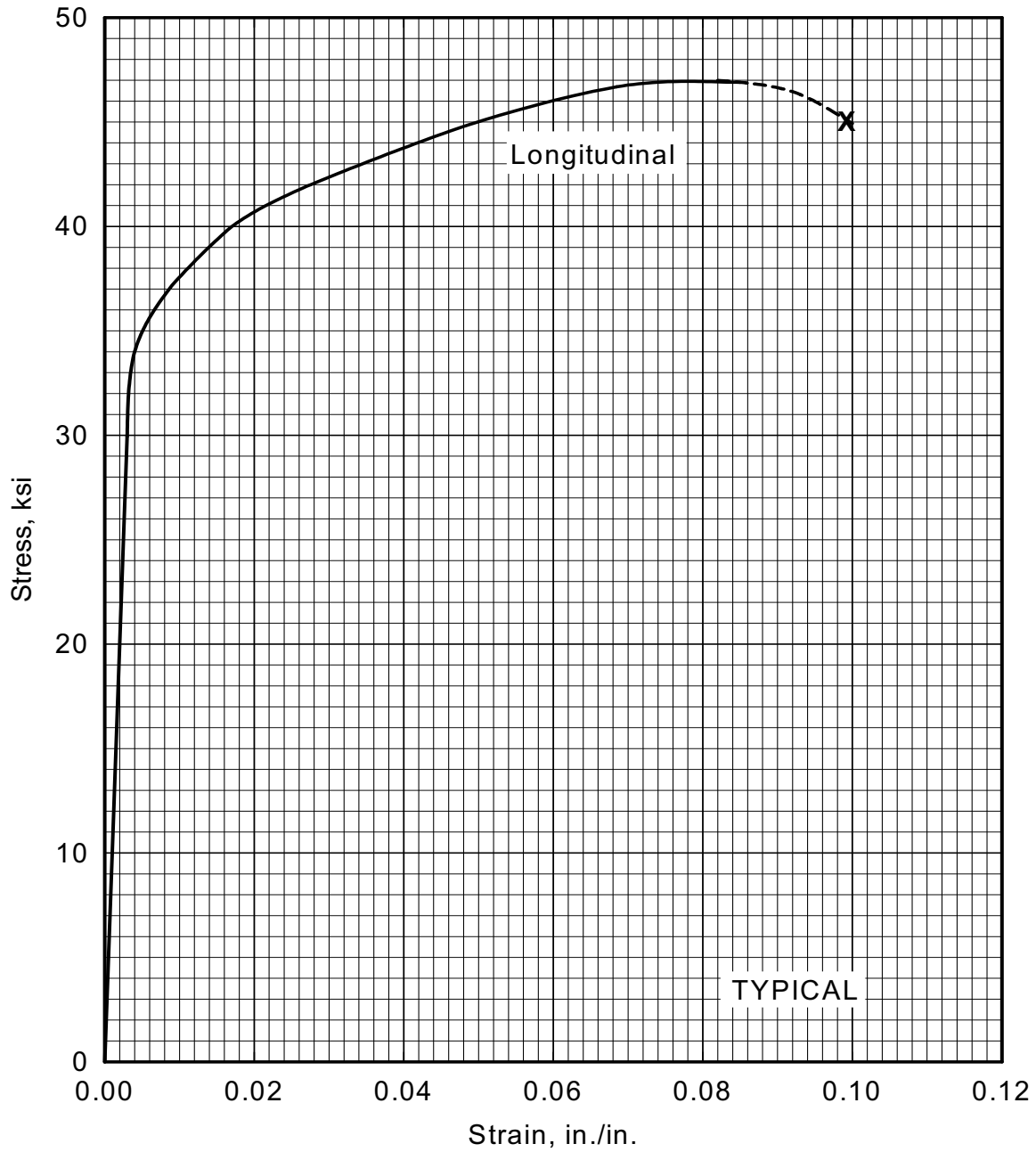

Figure 3.5.3.3.6(c). Typical tensile stress-strain curve (full range) for 5086-H34 aluminum alloy sheet at room temperature.

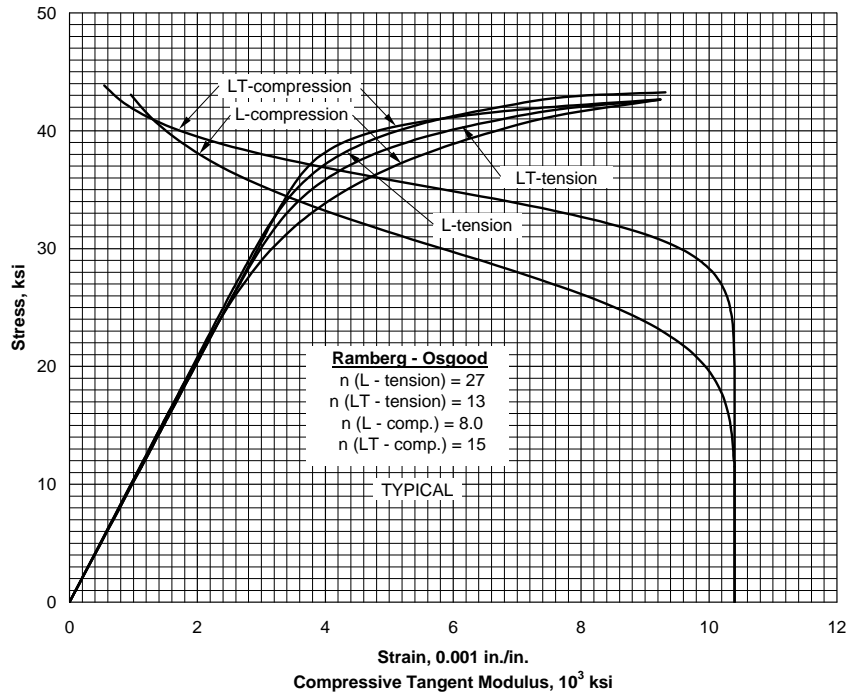

Figure 3.5.3.4.6. Typical tensile and compressive stress-strain and compressive tangent-modulus curves for 5086-H36 aluminum alloy sheet at room temperature.

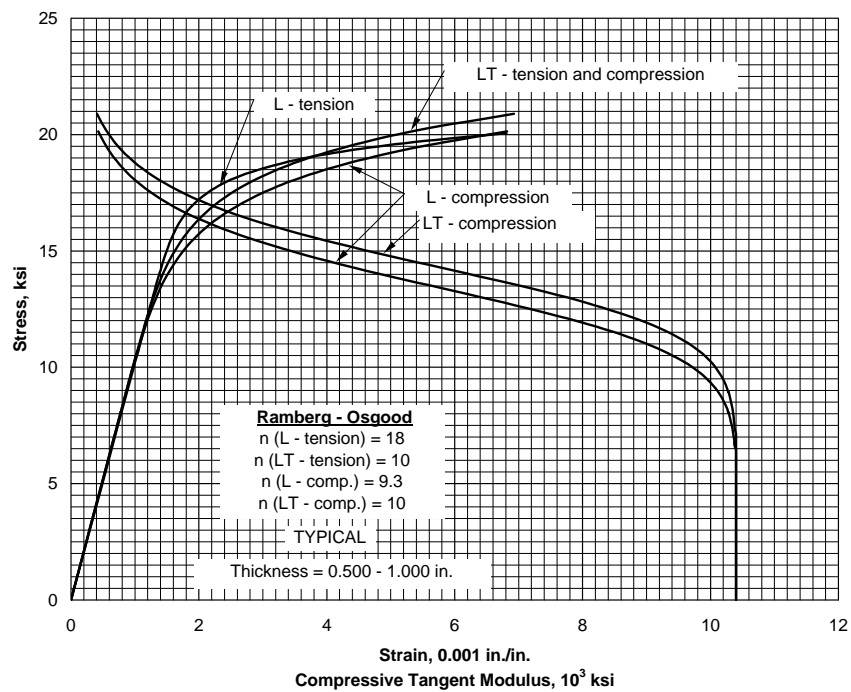

Figure 3.5.3.7.6. Typical tensile and compressive stress-strain and compressive tangent-modulus curves for 5086-H112 aluminum alloy plate at room temperature.

3.5.4 5454 ALLOY

3.5.4.0 Comments and Properties — 5454 is a tough medium-strength Al-Mg alloy. It is the highest strength alloy of the 5000 series which may be used at elevated temperatures without concern about resensitization to stress-corrosion cracking. Refer to Section 3.1.2.3 for comments regarding the resistance of the alloy to stress-corrosion cracking, and to Section 3.1.3.4 for comments regarding the weldability of the alloy.

Materials specifications for 5454 aluminum alloy are presented in Table 3.5.4.0(a). Room-temperature physical properties are shown in Table 3.5.4.0(b) and (c).

Table 3.5.4.0(a). Material Specifications for 5454 Aluminum Alloy

Specification	Form
AMS-QQ-A-250/10	Sheet and plate
AMS-QQ-A-200/6	Extruded bar, rod, and shapes

The temper index for 5454 is as follows:

<u>Section</u>	<u>Temper</u>
3.5.4.1	O
3.5.4.2	H32
3.5.4.3	H34

3.5.4.1 O Temper — Figure 3.5.4.1.6 presents tensile and compressive stress-strain curves and this temper.

3.5.4.2 H32 Temper — Figure 3.5.4.2.6 presents room-temperature tensile stress-strain curves for this temper.

3.5.4.3 H34 Temper — Figures 3.5.4.3.6(a) and (b) present room-temperature tensile and compressive stress-strain and tangent-modulus curves for this temper.

MIL-HDBK-5J
31 January 2003

Table 3.5.4.0(b). Design Mechanical and Physical Properties of 5454 Aluminum Alloy Sheet, Plate, and Extrusion

Specification	AMS-QQ-A-250/10						AMS-QQ-A-200/6			
	Sheet and plate						Extrusion			
Form										
Temper	O		H32		H34	H112		O	H111	H112
Thickness, in.	0.020-3.000		0.020-2.000		0.020-1.000	0.250-0.499	0.500-3.000	≤5.000 ^a	≤5.000 ^a	≤5.000 ^a
Basis	A	B	A	B	S	S	S	S	S	S
Mechanical Properties:										
<i>F_{tu}</i> , ksi:										
L	31	32	36	37	39	32	31	31	33	31
LT	31	32	36	37	39	32	31	31
<i>F_{ty}</i> , ksi:										
L	12	13	26	27	29	18	12	12	19	12
LT	12	13	24	25	28	18	12	12
<i>F_{cy}</i> , ksi:										
L	12	13	24	25	27	17	12	12	...	12
LT	12	13	26	27	29	18	12	12
<i>F_{su}</i> , ksi	19	20	21	22	23	20	19	19
<i>F_{bru}</i> , ksi:										
(e/D = 1.5)	46	48	52	54	57	48	46	43
(e/D = 2.0)	62	64	72	74	78	64	62	56
<i>F_{bry}</i> , ksi:										
(e/D = 1.5)	20	22	36	38	41	25	20	20
(e/D = 2.0)	24	26	44	46	49	31	24	24
<i>e</i> , percent (S-basis):										
L	b	...	b	...	b	8	b	14	12	12
<i>E</i> , 10 ³ ksi										
						10.2				
<i>E_c</i> , 10 ³ ksi										
						10.4				
<i>G</i> , 10 ³ ksi										
						3.85				
<i>μ</i>										
						0.33				
Physical Properties:										
<i>ω</i> , lb/in. ³										
						0.097				
<i>C</i> , Btu/(lb)(°F)										
						0.23 (at 212°F)				
<i>K</i> , Btu/[(hr)(ft ³)(°F)/ft]										
						78 (at 77°F)				
<i>α</i> , 10 ⁻⁶ in./in./°F										
						13.1 (68 to 212°F)				

a Cross-sectional area ≤32 in².
b See Table 3.5.4.0(c).

Table 3.5.4.0(c). Minimum Elongation Values for 5454 Aluminum Alloy Sheet and Plate

Temper	Thickness Range, inch	Elongation (L), percent
O	0.020-0.031	12
	0.030-0.050	14
	0.051-0.113	16
	0.114-3.000	18
H32	0.020-0.050	5
	0.051-0.249	8
	0.250-2.000	12
H34	0.020-0.050	4
	0.051-0.161	6
	0.162-0.249	7
	0.250-1.000	10
H112	0.500-2.000	11
	2.001-3.000	15

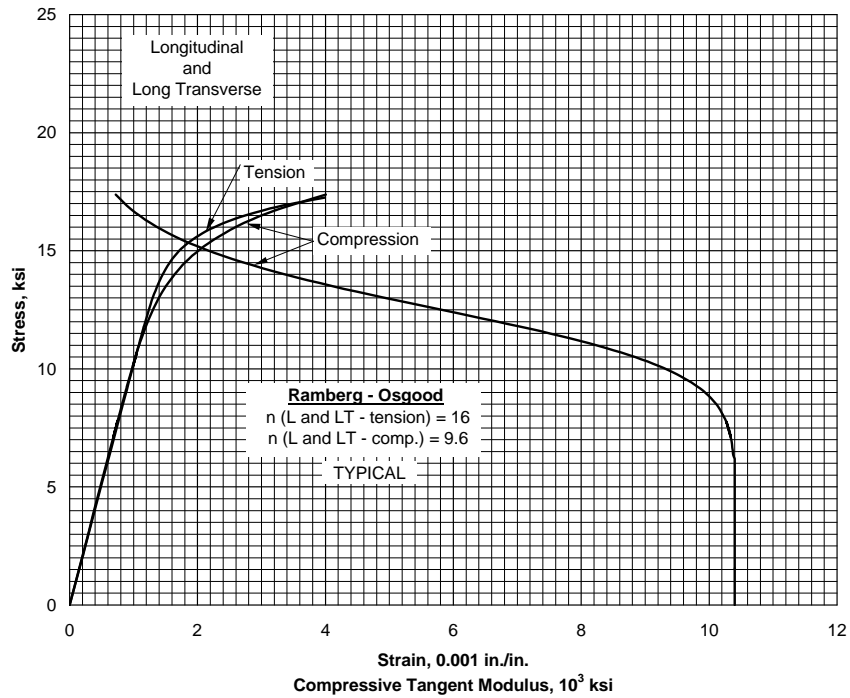

Figure 3.5.4.1.6. Typical tensile and compressive stress-strain and compressive tangent-modulus curves for 5454-0 aluminum alloy sheet, plate, extrusion at room temperature.

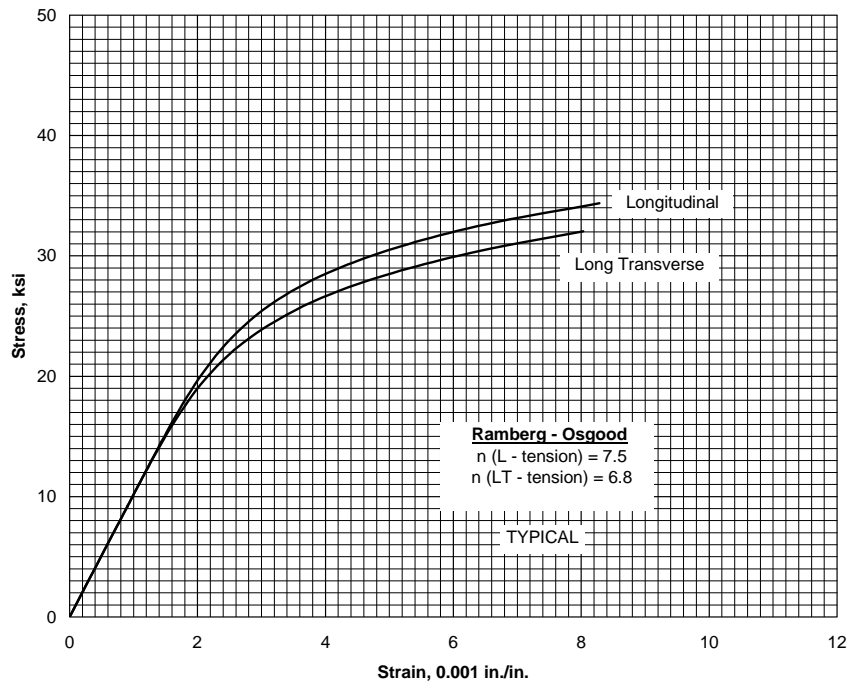

Figure 3.5.4.2.6. Typical tensile stress-strain curves for 5454-H32 aluminum alloy plate at room temperature.

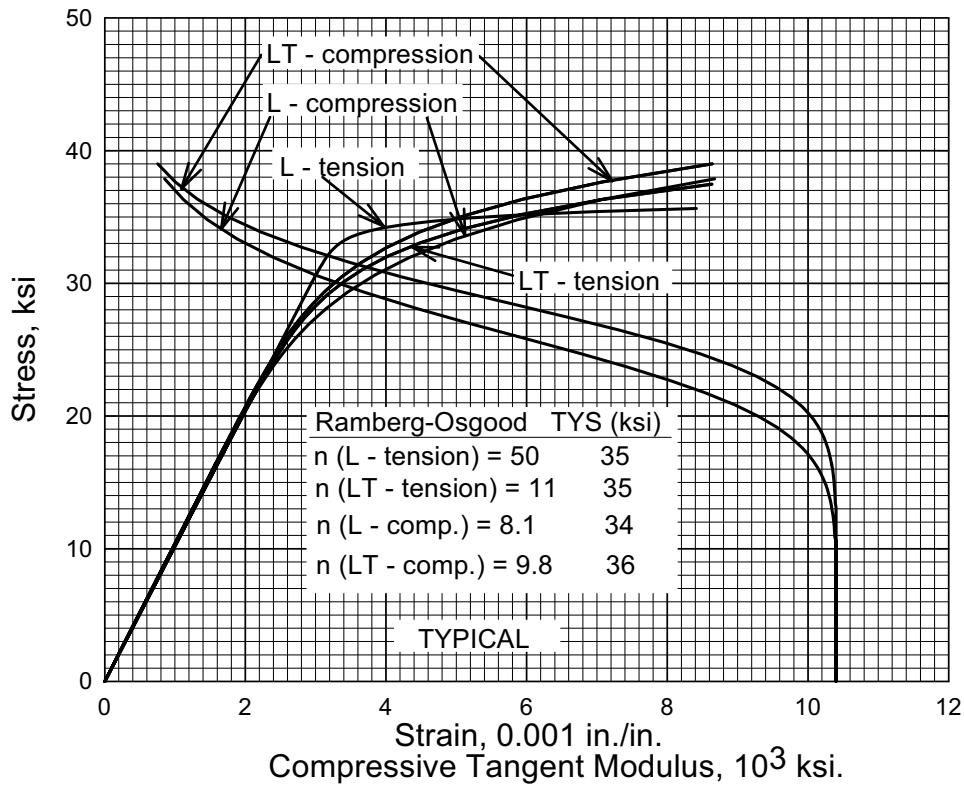

Figure 3.5.4.3.6(a). Typical tensile and compressive stress-strain and compressive tangent-modulus curves for 5454-H34 aluminum alloy sheet at room temperature.

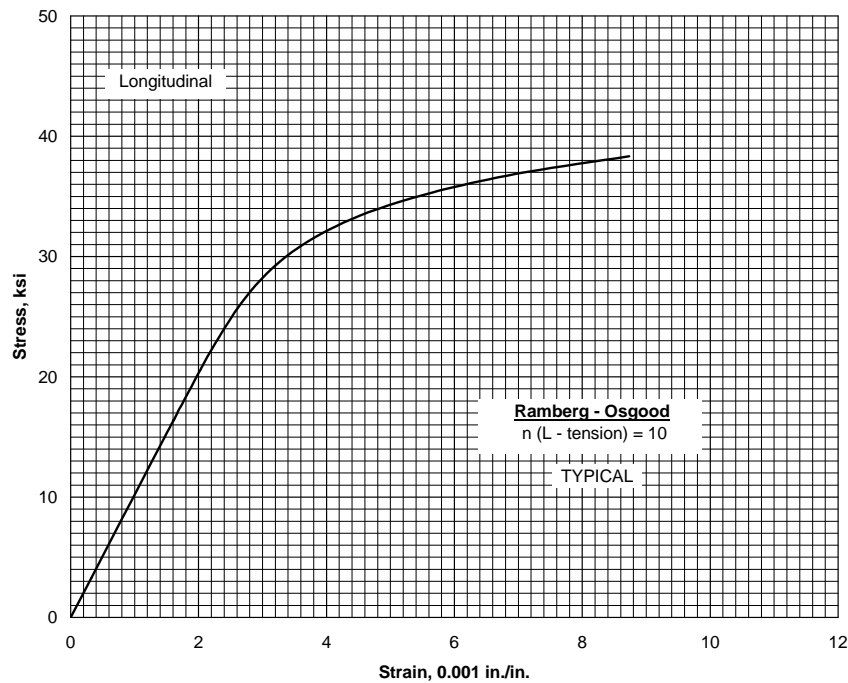

Figure 3.5.4.3.6(b). Typical tensile stress-strain curve for 5454-H34 aluminum alloy plate at room temperature.

3.5.5 5456 ALLOY

3.5.5.0 Comments and Properties — 5456 is the highest strength alloy of the Al-Mg group. It has high resistance to corrosion, but should not be used in strain-hardened tempers at temperatures above 150°F because of possible sensitization to stress-corrosion cracking. Refer to Section 3.1.2.3 for comments regarding the resistance of the alloy to stress-corrosion cracking, and to Section 3.1.3.4 for comments regarding the weldability of the alloy.

Some material specifications for 5456 aluminum alloy are presented in Table 3.5.5.0(a). Room-temperature mechanical and physical properties are shown in Tables 3.5.5.0(b) and (c). The effect of temperature on physical properties is shown in Figure 3.5.5.0.

Table 3.5.5.0(a). Material Specifications for 5456 Aluminum Alloy

Specification	Form
AMS-QQ-A-250/9	Sheet and plate
AMS-QQ-A-200/7	Extruded bar, rod, and shapes

The temper index for 5456 is as follows:

<u>Section</u>	<u>Temper</u>
3.5.5.1	O
3.5.5.2	H111
3.5.5.3	H112
3.5.5.4	H321

3.5.5.1 O Temper — Room-temperature tensile and compressive stress-strain and tangent-modulus curves for this temper are presented in Figures 3.5.5.1.6(a) and (b).

3.5.5.2 H111 Temper — Room-temperature tensile and compressive stress-strain and tangent-modulus curves for this temper are presented in Figure 3.5.5.2.6.

3.5.5.3 H112 Temper —

3.5.5.4 H321 Temper — Room-temperature tensile and compressive stress-strain and tangent-modulus curves for this temper are presented in Figure 3.5.5.4.6.

Table 3.5.5.0(b). Design Mechanical and Physical Properties of 5456 Aluminum Alloy Sheet and Plate

Specification	AMS-QQ-A-250/9											
	Sheet and plate											
	O				H112				H321			
	0.051- 1.500	1.501- 3.000	3.001- 5.000	5.001- 7.000	7.001- 8.000	0.250- 1.500	1.501- 3.000	0.188- 0.624	0.625- 1.250	1.251- 1.500	1.501- 3.000	
Form												
Temper												
Thickness, in.												
Basis	S	S	S	S	S	S	S	S	S	S	S	S
Mechanical Properties:												
F_{up} , ksi:												
L	42	41	40	39	38	42	41	46	46	44	41	41
LT	42	46	45	43
$F_{0.2p}$, ksi:												
L	19	18	17	16	15	19	18	33	33	31	29	29
LT	19	30	29	28
F_{cp} , ksi:												
L	19	27	26	24
LT	19	33	31	29
F_{ur} , ksi	26	27	27	25
F_{brys} , ksi:												
(e/D = 1.5)	63	67	67	64
(e/D = 2.0)	84	84	84	80
F_{byps} , ksi:												
(e/D = 1.5)	32	46	46	43
(e/D = 2.0)	38	53	53	50
e , percent:												
L	16	16	14	14	12	12	12	12	12	12	12	12
E , 10^3 ksi	10.2											
E_{cp} , 10^3 ksi	10.4											
G , 10^3 ksi	3.85											
μ	0.33											
Physical Properties:												
ω , lb/in. ³	0.096											
C , Btu/(lb)(°F)	0.23 (at 212°F)											
K , Btu/[hr)(ft ²)(°F/ft)]											
α , 10^{-6} in./in./°F	See Figure 3.5.5.0											

Table 3.5.5.0(c). Design Mechanical and Physical Properties of 5456 Aluminum Alloy Extrusion

Specification	AMS-QQ-A-200/7		
	Extruded bar, rod, and shapes		
Form	O	H111	H112
Temper			
Cross-Sectional Area, in. ²	≤32		
Thickness or Diameter, in.	≤5.000	≤5.000	≤5.000
Basis	S	S	S
Mechanical Properties:			
F_{tu} , ksi:			
L	41	42	41
LT	41
F_{ty} , ksi:			
L	19	26	19
LT	19
F_{cy} , ksi:			
L	19	...	19
LT	19
F_{su} , ksi	23
F_{bru} , ksi:			
(e/D = 1.5)	57
(e/D = 2.0)	74
F_{bry} , ksi:			
(e/D = 1.5)	34
(e/D = 2.0)	38
e , percent:			
L	14	12	12
E , 10 ³ ksi	10.2		
E_c , 10 ³ ksi	10.4		
G , 10 ³ ksi	3.85		
μ	0.33		
Physical Properties:			
ω , lb/in. ³	0.096		
C , Btu/(lb)(°F)	0.23 (at 212°F)		
K , Btu/[(hr)(ft ²)(°F)/ft]		
α , 10 ⁻⁶ in./in./°F	See Figure 3.5.5.0		

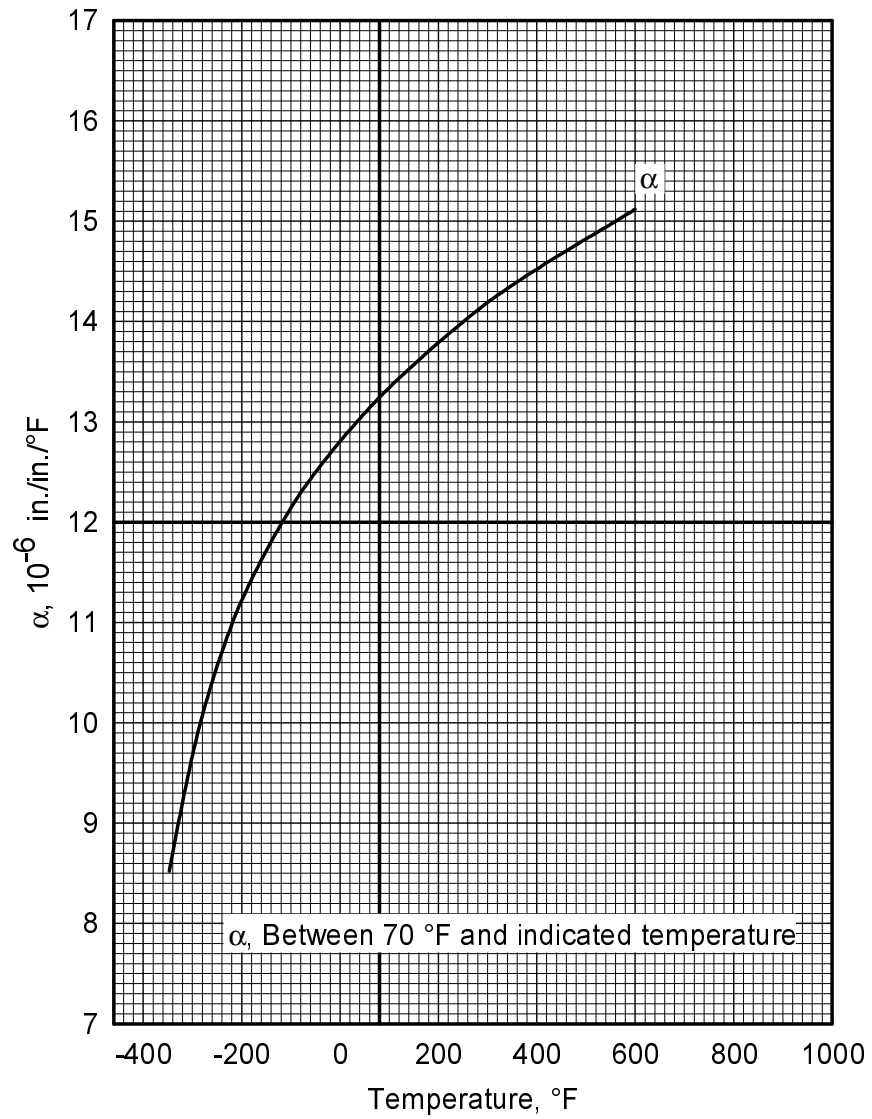

Figure 3.5.5.0. Effect of temperature on the physical properties of 5456 aluminum alloy.

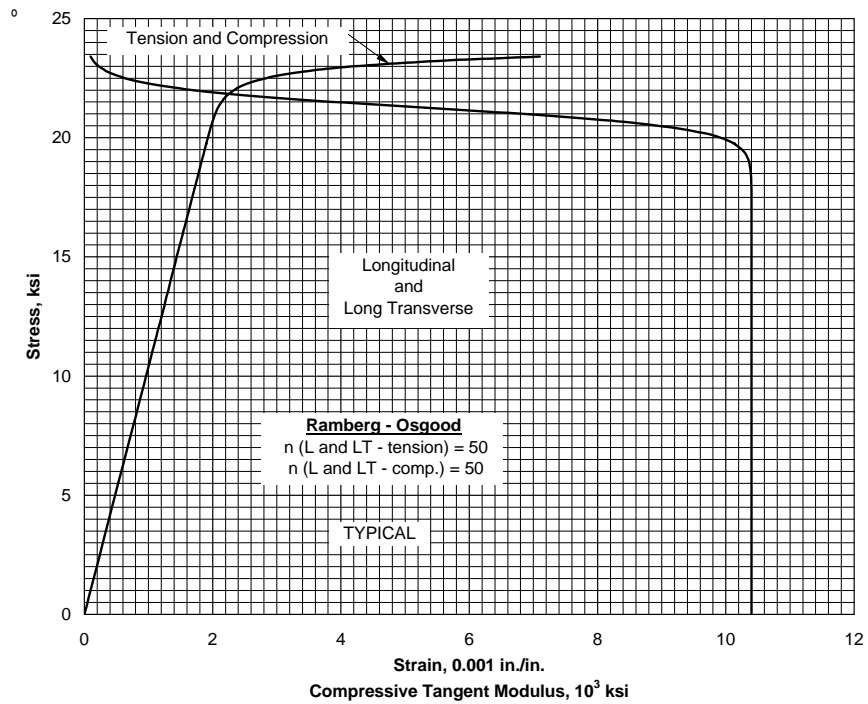

Figure 3.5.5.1.6(a). Typical tensile and compressive stress-strain and compressive tangent-modulus curves for 5456-0 aluminum alloy sheet and plate at room temperature.

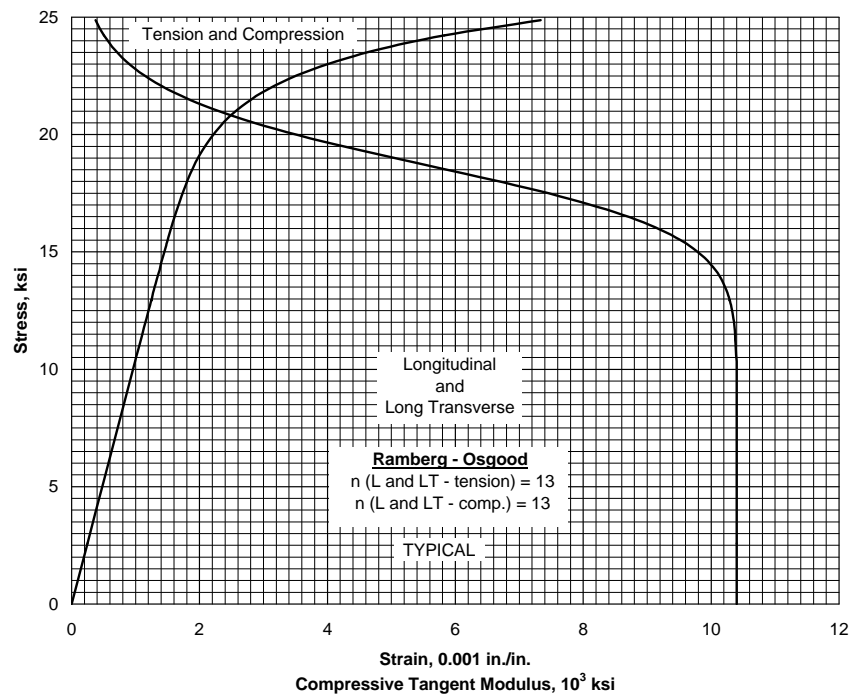

Figure 3.5.5.1.6(b). Typical tensile and compressive stress-strain and compressive tangent-modulus curves for 5456-0 aluminum alloy extrusion at room temperature.

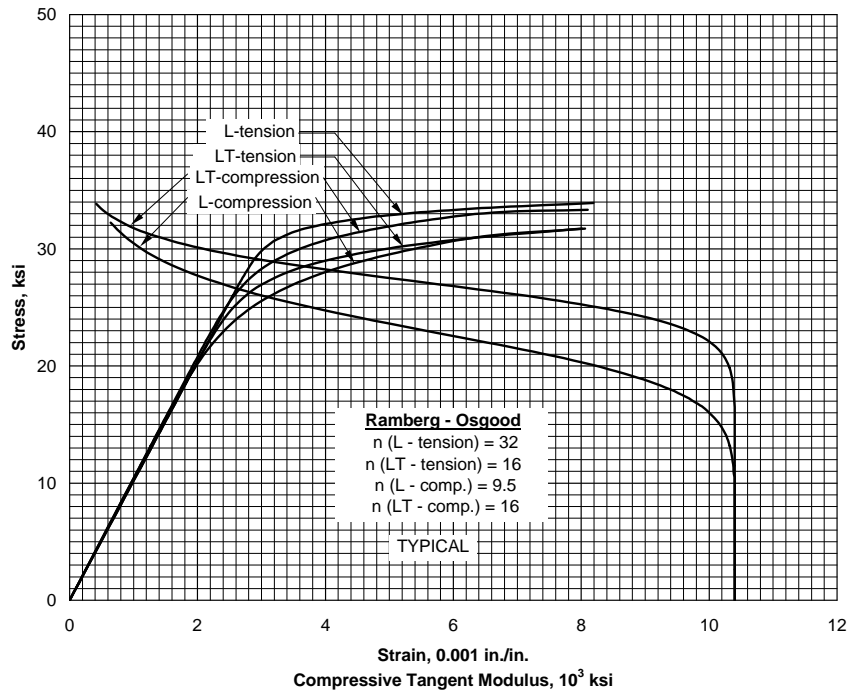

Figure 3.5.5.2.6. Typical tensile and compressive stress-strain and compressive tangent-modulus curves for 5456-H111 aluminum alloy extrusion at room temperature.

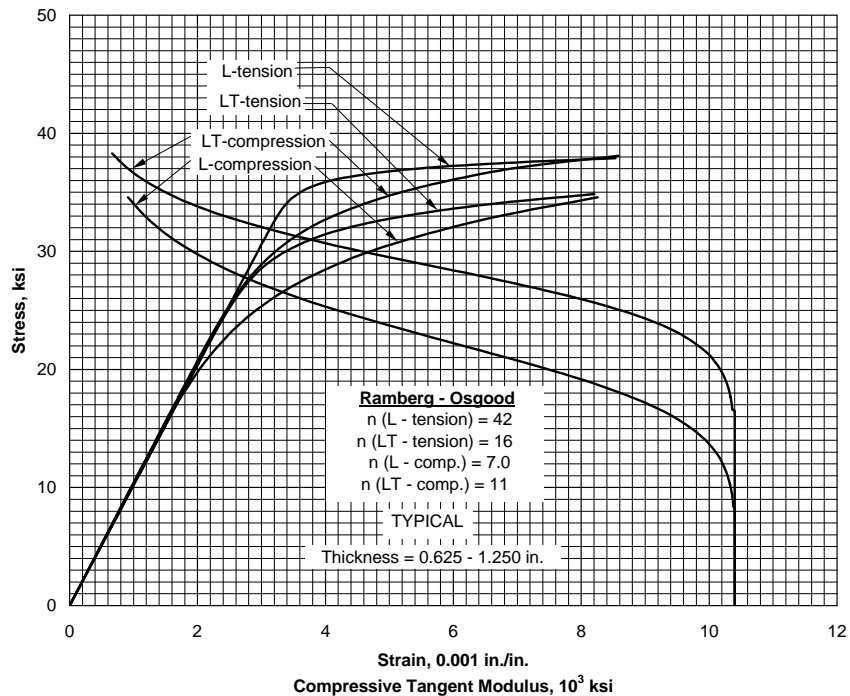

Figure 3.5.5.4.6. Typical tensile and compressive stress-strain and compressive tangent-modulus curves for 5456-H321 aluminum alloy plate at room temperature.

3.6 6000 SERIES WROUGHT ALLOYS

Alloys of the 6000 series contain magnesium and silicon as their principal alloying elements.

3.6.1 6013 ALLOY

3.6.1.0 Comments and Properties — 6013 is a Mg-Si-Cu-Mn alloy which is weldable. This alloy has 25 percent higher strength in the T6 temper than 6061-T6. It has improved toughness, fatigue strength, and stretch forming characteristics compared to 6061 with equivalent stress corrosion characteristics. Refer to 3.1.3.4 for comments regarding weldability of the alloy. Material specifications for 6013 are shown in Table 3.6.1.0(a). Room-temperature mechanical and physical properties are presented in Table 3.6.1.0(b).

Table 3.6.1.0(a). Material Specifications for 6013 Aluminum Alloy

Specification	Form
AMS 4347	Sheet (T4)
AMS 4216	Sheet (T6)

The temper index is as follows:

<u>Section</u>	<u>Temper</u>
3.6.1.1	T6

3.6.1.1 T6 Temper — Stress-strain and tangent-modulus curves are presented in Figures 3.6.1.1.6(a) and (b).

Table 3.6.1.0(b). Design Mechanical and Physical Properties of 6013 Aluminum Alloy Sheet

Specification	AMS 4216 and AMS 4347		
Form	Sheet		
Temper	T6		
Thickness, in.	0.010-0.062	0.063-0.125	0.126-0.249
Basis	S	S	S
Mechanical Properties:			
F_{tu} , ksi:			
L	52	52	52
LT	52	52	52
F_{ty} , ksi:			
L	47	47	48
LT	46	46	46
F_{cy} , ksi:			
L	48	48	48
LT	48	48	49
F_{su} , ksi			
L	32	32	32
F_{bru}^a , ksi:			
(e/D=1.5)	85	85	85
(e/D=2.0)	111	111	111
F_{bry}^a , ksi:			
(e/D=1.5)	66	69	71
(e/D=2.0)	76	80	82
e , percent:			
LT	8	8	8
<hr/>			
E , 10^3 ksi			
		9.9	
E_c , 10^3 ksi			
		10.1	
G , 10^3 ksi			
		3.8	
μ			
		0.33	
<hr/>			
Physical Properties:			
ω , lb/in ³			
		0.098	
C , K , and α			
		...	

a Bearing values are “dry pin” values per Section 1.4.7.1.

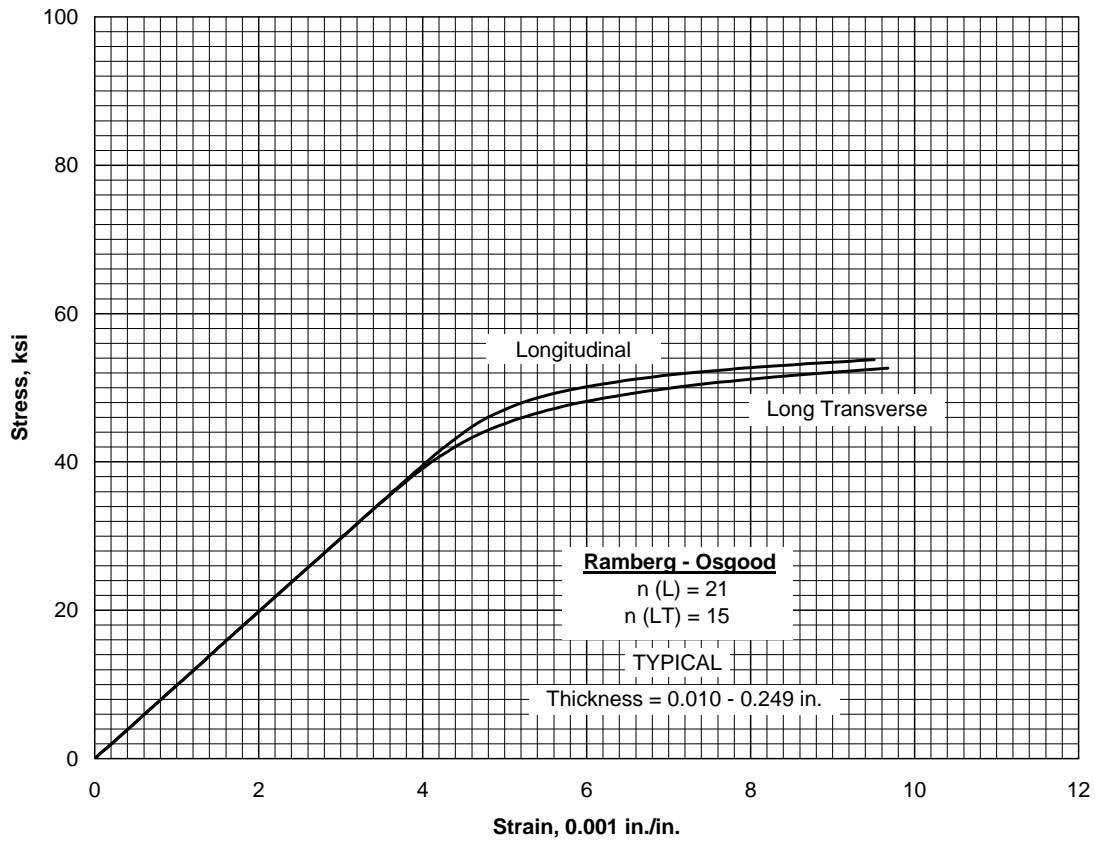

Figure 3.6.1.1.6(a). Typical tensile stress-strain curves for 6013-T6 aluminum alloy sheet at room temperature.

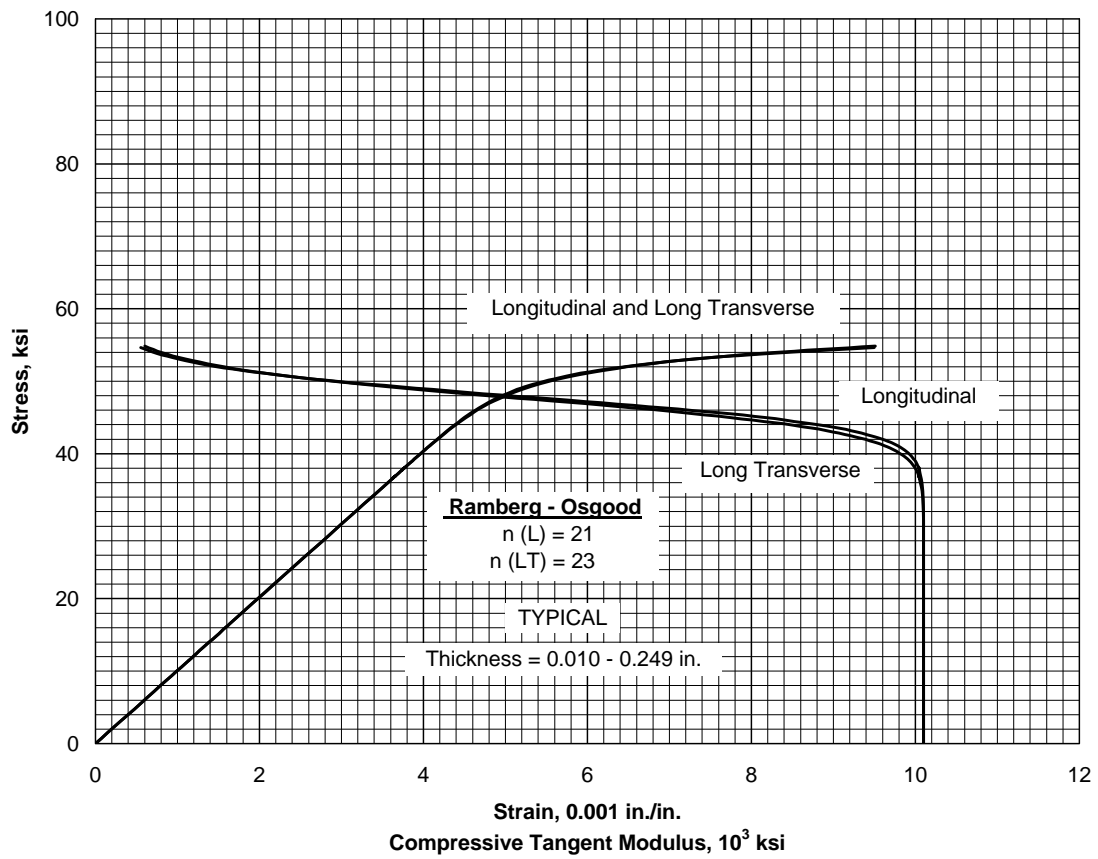

Figure 3.6.1.1.6(b). Typical compressive stress-strain and compressive tangent-modulus curves for 6013-T6 aluminum alloy sheet at room temperature.

3.6.2 6061 ALLOY

3.6.2.0 Comments and Properties — 6061 has been used in a wide range of applications, including cryogenic applications requiring high toughness. Refer to Section 3.1.3.4 for comments regarding the weldability of the alloy.

The properties of extrusions should be based upon the thickness at the time of quenching prior to machining. Selection of the mechanical properties based upon its final machined thickness may be unconservative; therefore, the thickness at the time of quenching to achieve properties is an important factor in the selection of the proper thickness column. For extrusions having sections with various thicknesses, consideration should be given to the properties as a function of thickness.

Material specifications for 6061 are presented in Table 3.6.2.0(a). Room-temperature mechanical and physical properties are shown in Tables 3.6.2.0(b) through (g). The effect of temperature on the physical properties is shown in Figure 3.6.2.0.

The temper index for 6061 is as follows:

<u>Section</u>	<u>Temper</u>
3.6.2.1	T4, T42, T451, T4510, and T4511
3.6.2.2	T6, T62, T651, T652, T6510, and T6511

3.6.2.1 T4, T42, T451, T4510, and T4511 Tempers — For effect of temperature on modulus values, use Figure 3.6.2.2.4.

3.6.2.2 T6, T62, T651, T652, T6510, and T6511 Tempers — Figures 3.6.2.2.1(a) through (d), 3.6.2.2.4, and 3.6.2.2.5(a) and (b) present elevated temperature curves for various mechanical properties. Figures 3.6.2.2.6(a) through (k) contain tensile and compression stress-strain curves at room temperature and elevated temperatures, and tangent-modulus curves at room temperature for various products and tempers. Figures 3.6.2.2.6(l) through (o) present full-range tensile stress-strain curves at room temperature for various products and tempers. Figure 3.6.2.2.8 contains unnotched fatigue data for various wrought products at room temperature.

Table 3.6.2.0(a). Material Specifications for 6061 Aluminum Alloy

Specification	Form
AMS 4025	Sheet and plate
AMS 4026	Sheet and plate
AMS 4027	Sheet and plate
AMS-QQ-A-250/11	Sheet and plate
AMS 4115	Bar and rod, rolled or cold-finished
AMS 4116	Bar and rod, cold-finished
AMS 4117	Bar and rod, rolled or cold-finished
AMS-QQ-A-225/8	Rolled bar, rod, and shapes
AMS 4150	Extruded rod, bar, and shapes
AMS 4160	Extrusion
AMS 4161	Extrusion
AMS 4172	Extrusion
AMS 4173	Extruded rod, bar, and shapes
AMS-QQ-A-200/8	Extruded rod, bar, shapes, and tubing
AMS-A-22771	Forging
AMS 4080	Tubing, seamless, drawn
AMS 4082	Tubing, seamless, drawn
AMS-WW-T-700/6	Seamless drawn tubing
AMS 4127	Forging
AMS 4248	Hand forging
AMS-QQ-A-367	Forging

Table 3.6.2.0(b₁). Design Mechanical and Physical Properties of 6061 Aluminum Alloy Sheet

Specification	AMS 4026 and AMS-QQ-A-250/11		AMS-QQ-A- 250/11	AMS 4025, AMS 4027 and AMS-QQ-A-250/11	
	Sheet				
Form	Sheet				
Temper	T4		T42 ^a	T6 and T62 ^b	
Thickness, in.	0.010-0.249		0.010-0.249	0.010-0.249	
Basis	A	B	S	A	B
Mechanical Properties:					
F_{tu} , ksi:					
L	42	43
LT	30	32	30	42	43
F_{ly} , ksi:					
L	36	38
LT	16	18	14	35	37
F_{cy} , ksi:					
L	35	37
LT	16	18	...	36	38
F_{su} , ksi	20	21	...	27	28
F_{bru} , ksi:					
(e/D = 1.5)	48	51	...	67	69
(e/D = 2.0)	63	67	...	88	90
F_{bry} , ksi:					
(e/D = 1.5)	22	25	...	50	53
(e/D = 2.0)	26	29	...	58	61
e , percent (S-basis):					
LT	c	...	c	c	...
E , 10 ³ ksi	9.9				
E_c , 10 ³ ksi	10.1				
G , 10 ³ ksi	3.8				
μ	0.33				
Physical Properties:					
ω , lb/in. ³	0.098				
C , K , and α	See Figure 3.6.2.0				

a Design allowables were based upon data obtained from testing samples of material, supplied in the O or F temper, which were heat treated to demonstrate response to heat treatment by suppliers. Properties obtained by the user may be lower than those listed if the material has been formed or otherwise cold or hot worked, particularly in the annealed temper, prior to solution heat treatment.

b Design allowables were based upon data obtained from testing T6 sheet and from testing samples of sheet, supplied in the O or F temper, which were heat treated to T62 temper to demonstrate response to heat treatment by suppliers. Properties obtained may be lower than those listed if the material has been formed or otherwise cold worked, particularly in the annealed temper, prior to solution heat treatment.

c See Table 3.6.2.0(b₃).

Table 3.6.2.0(b₂). Design Mechanical and Physical Properties of 6061 Aluminum Alloy Plate

Specification	AMS 4026 and AMS-QQ-A-250/11		AMS-QQ-A- 250/11		AMS 4025, AMS 4027 and AMS-QQ-A-250/11			
	Plate							
	T451		T42 ^a		T651 and T62 ^b			
Form	0.250-2.000	2.001-3.000	0.250- 1.000	1.001- 3.000	0.250-2.000	2.001-3.000	3.001- 4.000	4.001- 6.000 ^c
Temper	A	B	S	S	A	B	A	S
Thickness, in.
Basis
Mechanical Properties:								
$F_{t\theta}$, ksi:								
L	30	32	30	30	42	43	42	40
LT	42	43	42	40
F_{br} , ksi:								
L	16	18	14	14	36	38	35	35
LT	35	37	35	35
F_{cy} , ksi:								
L	16	18	35	37
LT	20	21	36	38
F_{su} , ksi:								
L	48	52	67	69
LT	63	67	88	90
F_{brp} , ksi:								
(e/D = 1.5)	22	25	50	53
(e/D = 2.0)	26	29	58	61
e , percent:								
L	16	...	18	16	d	...	6	6
E , 10 ³ ksi	9.9							
E_{cp} , 10 ³ ksi	10.1							
G , 10 ³ ksi	3.8							
μ	0.33							
Physical Properties:								
ω , lb/in. ³	0.098							
C , K , and α	See Figure 3.6.2.0							

a Design allowables were based upon data obtained from testing samples of material, supplied in the O temper, which were heat treated to demonstrate response to heat treatment by suppliers. Properties obtained by the user may be lower than those listed if the material has been formed or otherwise cold or hot worked, particularly in the annealed temper, prior to solution heat treatment.

b Design allowables were based upon data obtained from testing T651 plate and from testing samples of plate, supplied in the O temper, which were heat treated to demonstrate response to heat treatment by suppliers. Properties obtained may be lower than those listed if the material has been formed or otherwise cold worked, particularly in the annealed temper, prior to solution heat treatment.

c Properties for this thickness apply only to T651 temper.

d See Table 3.6.2.0(b₃).

Table 3.6.2.0(b₃). Minimum Elongation Values for 6061 Aluminum Alloy Sheet and Plate

Temper and Product	Thickness, inch	Elongation (LT), percent
T4 or T42 sheet	0.010-0.020	14
	0.021-0.249	16
T451 plate	0.250-1.000	18
	1.001-2.000	16
T6 or T62 sheet	0.010-0.020	8
	0.021-0.249	10
T651 or T62 plate	0.250-0.499	10
	0.500-1.000	9
	1.001-2.000	8

Table 3.6.2.0(c₁). Design Mechanical and Physical Properties of 6061 Aluminum Alloy Tube and Pipe

Specification	AMS-WW-T-700/6		AMS 4080, AMS 4082, and AMS-WW-T-700/6
	Drawn tube		
Form	T4	T42 ^a	T6 ^b and T62
Temper			
Wall Thickness, in. . .	0.025- 0.500	0.025-0.500	0.025- 0.500
Outside Diameter, in.	...		
Basis	S	S	S
Mechanical Properties:			
F_{tu} , ksi:			
L	30	30	42
F_{ty} , ksi:			
L	16	14	35
F_{cy} , ksi:			
L	14	...	34
F_{su} , ksi	20	...	27
F_{bru} , ksi:			
(e/D = 1.5)	48	...	67
(e/D = 2.0)	63	...	88
F_{bry} , ksi:			
(e/D = 1.5)	22	...	49
(e/D = 2.0)	26	...	56
e , percent:			
L	c	c	c
E , 10 ³ ksi	9.9		
E_c , 10 ³ ksi	10.1		
G , 10 ³ ksi	3.8		
μ	0.33		
Physical Properties:			
ω , lb/in. ³	0.098		
C , K , and α	See Figure 3.6.2.0		

a Design allowables were based upon data obtained from testing samples of material, supplied in the O temper, which were heat treated to demonstrate response to heat treatment by suppliers. Properties obtained by the user may be lower than those listed if the material has been formed or otherwise cold or hot worked, particularly in the annealed temper, prior to solution heat treatment.

b Design allowables were based upon data obtained from testing T6 temper tube and from testing samples of tube, supplied in the O temper, which were heat treated to demonstrate response to heat treatment by suppliers. Properties obtained by the user may be lower than those listed if the material has been formed or otherwise cold worked, particularly in the annealed temper, prior to solution heat treatment.

c See Table 3.6.2.0(c₂).

Table 3.6.2.0(c₂). Minimum Elongation Values for 6061 Aluminum Alloy Tubing

Temper	Wall Thickness, inch	Elongation (L), percent	
		Full-Section Specimen	Cut-Out Specimen
T4 or T42	0.025-0.049	16	14
	0.050-0.259	18	16
	0.260-0.500	20	18
T6 or T62	0.025-0.049	10	8
	0.050-0.259	12	10
	0.260-0.500	14	12

Table 3.6.2.0(d). Design Mechanical and Physical Properties of 6061 Aluminum Alloy Rolled, Drawn, or Cold-Finished Bar, Rod, and Shapes

Specification	AMS 4116 & AMS-QQ-A-225/8	AMS 4128 & AMS-QQ-A-225/8	AMS-QQ-A-225/8	AMS 4117 & AMS-QQ-A-225/8	AMS 4128 & AMS-QQ-A-225/8	AMS 4115, AMS 4116, & AMS-QQ-A-225/8
	T4	T451	T42 ^a	T6	T651	T62 ^a
Rolled, drawn, or cold-finished rod and special shapes						
Cross-Sectional Area, in ²	≤50					
Thickness, in.	≤50					
Basis	≤8,000	0.500-8,000	≤8,000	≤8,000	0.500-8,000	≤8,000
	S	S	S	S	S	S
Mechanical Properties:						
F_{tup} ksi:	30	30	30	42	42	42
L						
F_{yp} ksi:	16	16	14	35	35	35
L						
F_{cy} ksi:	14	14	...	34	34	...
L						
F_{sup} ksi:	20	20	...	27	27	...
L						
F_{brp} ksi:	48	48	...	67	67	...
(e/D = 1.5)						
F_{brp} ksi:	63	63	...	88	88	...
(e/D = 2.0)						
F_{brp} ksi:	22	22	...	49	49	...
(e/D = 1.5)						
F_{brp} ksi:	26	26	...	56	56	...
(e/D = 2.0)						
e, percent:						
L	18	18	18	10	10	10
E , 10 ³ ksi				9.9		
E_c , 10 ³ ksi				10.1		
G , 10 ³ ksi				3.8		
μ				0.33		
Physical Properties:						
ω , lb/in. ³				0.098		
C, K, and α_s				See Figure 3.6.2.0		

^a Design allowables were based upon data obtained from testing samples of material, supplied in the O or F temper, which were heat treated to demonstrate response to heat treatment by suppliers.

Table 3.6.2.0(e). Design Mechanical and Physical Properties of 6061 Aluminum Alloy Die Forging

Specification	AMS 4127, MIL-A-22771, and QQ-A-367
Form	Die forging
Temper	T6 and T652
Thickness, in.	≤ 4.000 ^a
Basis	S
Mechanical Properties:	
F_{tu} , ksi:	
L	38
T ^b	38
F_{ly} , ksi:	
L	35
T ^b	35
F_{cy} , ksi:	
L	36
T ^b	36
F_{su} , ksi	25
F_{bru} , ksi:	
(e/D = 1.5)	61
(e/D = 2.0)	76
F_{bry} , ksi:	
(e/D = 1.5)	54
(e/D = 2.0)	61
e , percent:	
L	7
T ^b	5
E , 10 ³ ksi	9.9
E_c , 10 ³ ksi	10.1
G , 10 ³ ksi	3.8
μ	0.33
Physical Properties:	
ω , lb/in. ³	0.098
C , K , and α	See Figure 3.6.2.0

a Thickness at the time of heat treatment. When die forgings are machined before heat treatment, the mechanical properties are applicable provided the as-forged thickness is not greater than twice the thickness at the time of heat treatment.

b T indicates any grain direction not within ± 15° of being parallel to the forging flow lines. $F_{cy}(T)$ values are based upon short transverse (ST) test data.

Table 3.6.2.0(f). Design Mechanical and Physical Properties of 6061 Aluminum Alloy Hand Forging

Specification	AMS 4127, AMS 4248, AMS-A-22771, and AMS-QQ-A-367		
Form	Hand forging		
Temper	T6 ^a and T652		
Cross-Sectional Area, in. ² .	≤256		
Thickness, in.	≤2.000	2.001-4.000	4.001-8.000
Basis	S	S	S
Mechanical Properties:			
F_{tu} , ksi:			
L	38	38	37
LT	38	38	37
ST	37	35
F_{ty} , ksi:			
L	35	35	34
LT	35	35	34
ST	33	32
F_{cy} , ksi:			
L	36	36	35
LT	36	36	35
ST	34	33
F_{su} , ksi	25	25	24
F_{bru} , ksi:			
(e/D = 1.5)	61	61	59
(e/D = 2.0)	76	76	74
F_{bry} , ksi:			
(e/D = 1.5)	54	54	53
(e/D = 2.0)	61	61	59
e , percent:			
L	10	10	8
LT	8	8	6
ST	5	4
E , 10 ³ ksi	9.9		
E_c , 10 ³ ksi	10.1		
G , 10 ³ ksi	3.8		
μ	0.33		
Physical Properties:			
ω , lb/in. ³	0.098		
C , K , and α	See Figure 3.6.2.0		

a When hand forgings are machined before heat treatment, the section thickness at time of heat treatment will determine the minimum mechanical properties as long as the original (as-forged) thickness does not exceed the maximum thickness for the alloy as shown in the table.

MIL-HDBK-5J
31 January 2003

Table 3.6.2.0(g). Design Mechanical and Physical Properties of 6061 Aluminum Alloy Extruded Rod, Bar, and Shapes

Specification	AMS 4161, AMS 4172, & AMS-QQ-A-200/8	AMS-QQ-A- 200/8	AMS 4160 & AMS-QQ-A- 200/8	AMS 4150, AMS 4173 & AMS-QQ-A-200/8			
Form	Extruded rod, bar, and shapes						
Temper	T4, T4510, and T4511	T42 ^a	T62 ^a	T6, T6510, and T6511			
Cross-sectional area, in. ²	≤32			
Thickness, ^b in.	≤3.000	All	All	≤1.000		1.001- 6.500	
Basis	S	S	S	A	B	A	B
Mechanical Properties:							
<i>F_{tu}</i> , ksi:							
L	26	26	38	38	41	38	41
LT	37	40	33	35
<i>F_{ty}</i> , ksi:							
L	16	12	35	35	38	35	38
LT	33	36	28	31
<i>F_{cy}</i> , ksi:							
L	14	34	37	34	37
LT	35	38	30	33
<i>F_{su}</i> , ksi	16	26	28	19	21
<i>F_{bru}</i> ^c , ksi:							
(e/D = 1.5)	42	64	69	52	57
(e/D = 2.0)	55	82	88	69	74
<i>F_{bry}</i> ^c , ksi:							
(e/D = 1.5)	22	54	58	42	46
(e/D = 2.0)	26	60	65	50	55
<i>e</i> , percent (S-basis):							
L	16	16	10 ^d	10 ^d	...	10	...
<i>E</i> , 10 ³ ksi	9.9						
<i>E_c</i> , 10 ³ ksi	10.1						
<i>G</i> , 10 ³ ksi	3.8						
<i>μ</i>	0.33						
Physical Properties:							
<i>ω</i> , lb/in. ³	0.098						
<i>C</i> , <i>K</i> , and <i>α</i>	See Figure 3.6.2.0						

a Design allowables were based upon data obtained from testing samples of material, supplied in the O to F temper which were heat treated to demonstrate response to heat treatment by suppliers. Properties obtained by the user, however, may be lower than those listed if the material has been formed or otherwise cold or hot worked, particularly in the annealed temper, prior to solution heat treatment.

b The mechanical properties are to be based upon the thickness at the time of quench.

c Bearing values are "dry pin" values per Section 1.4.7.1.

d For thicknesses ≤0.249 inch, *e* = 8%.

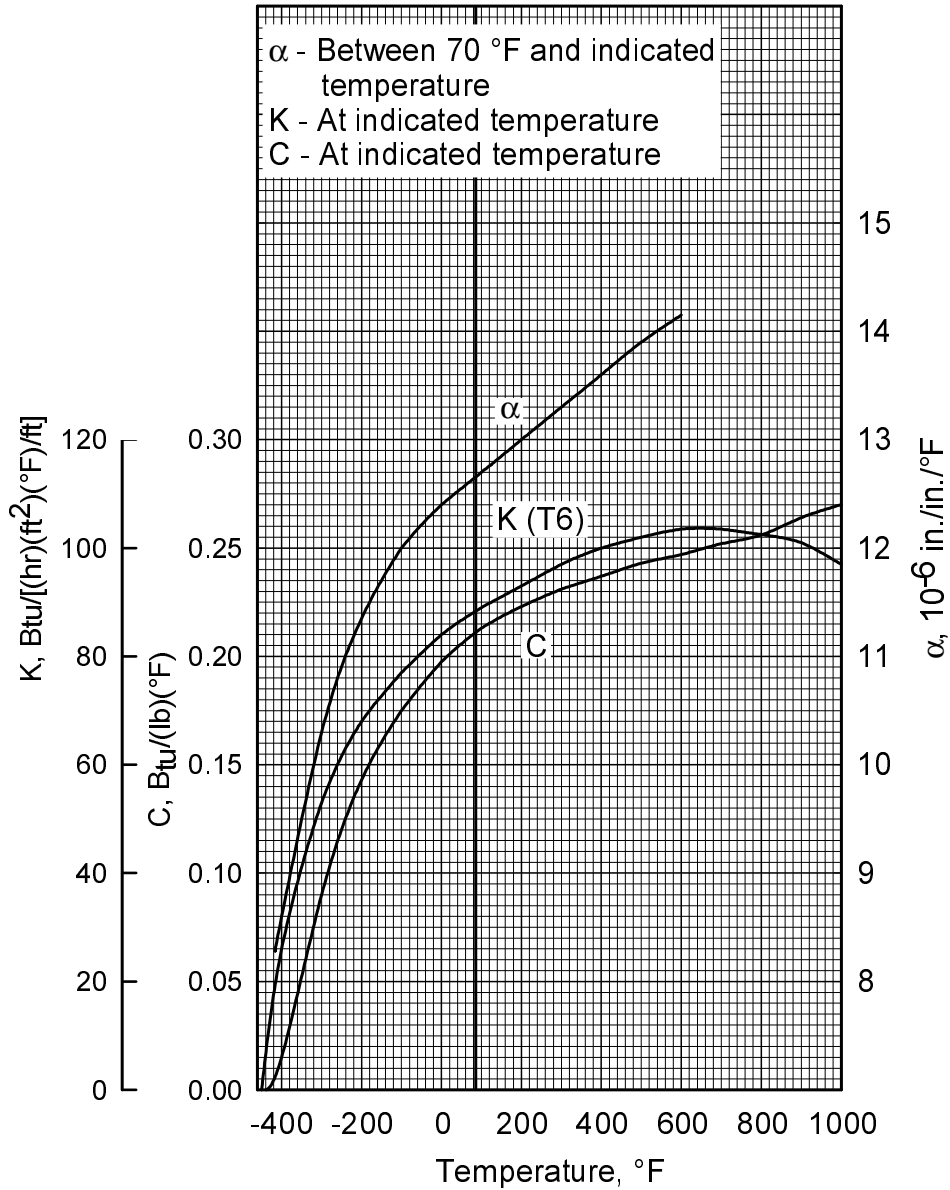

Figure 3.6.2.0. Effect of temperature on the physical properties of 6061 aluminum alloy.

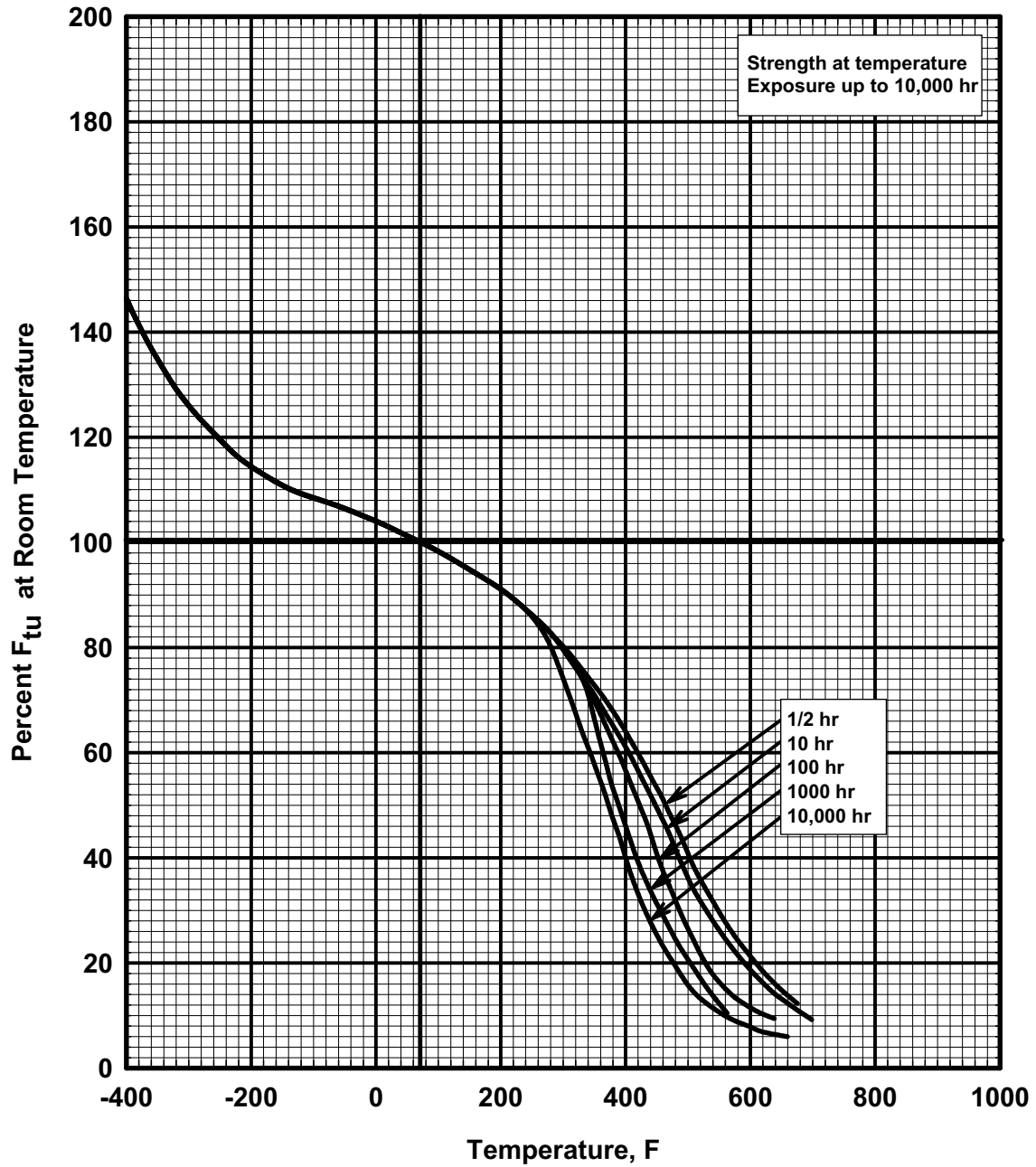

Figure 3.6.2.2.1(a). Effect of temperature on the tensile ultimate strength (F_{tu}) of 6061-T6 aluminum alloy (all products).

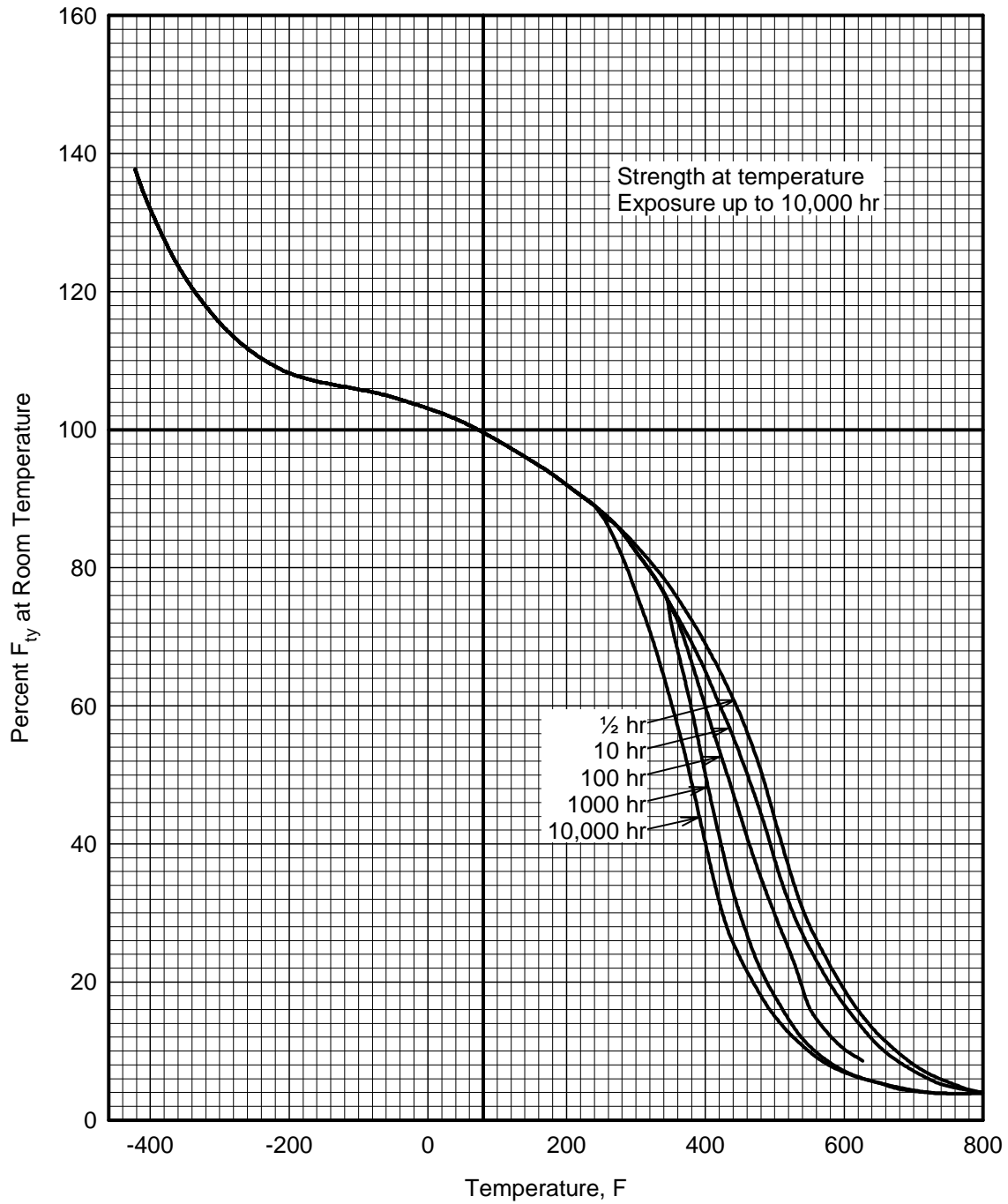

Figure 3.6.2.2.1(b). Effect of temperature on the tensile yield strength (F_{ty}) of 6061-T6 aluminum alloy (all products).

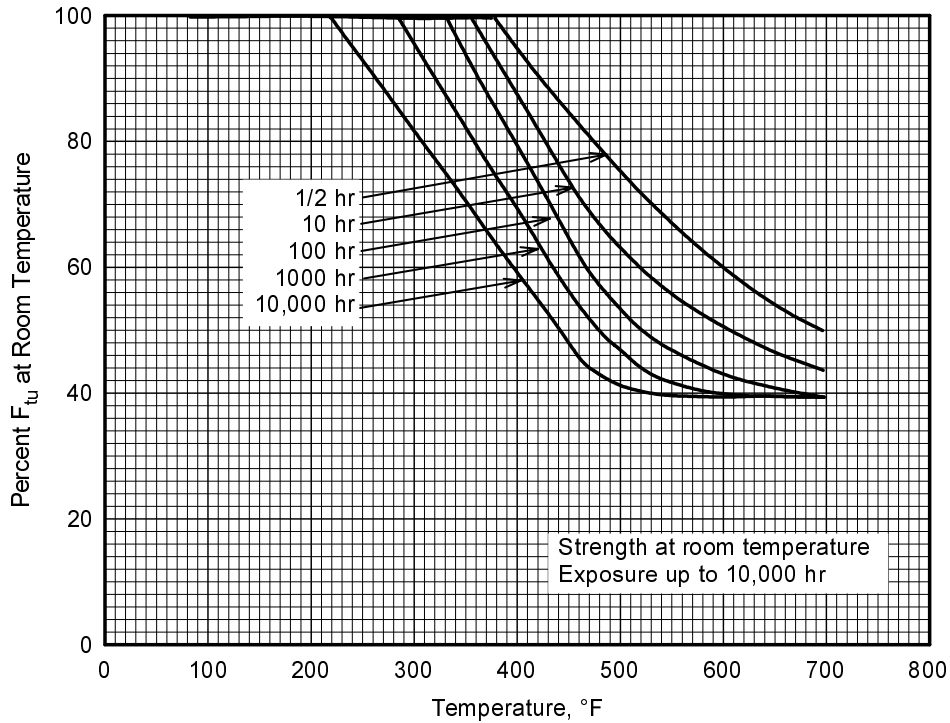

Figure 3.6.2.2.1(c). Effect of exposure at elevated temperatures on the room-temperature tensile ultimate strength (F_{tu}) of 6061-T6 aluminum alloy (all products).

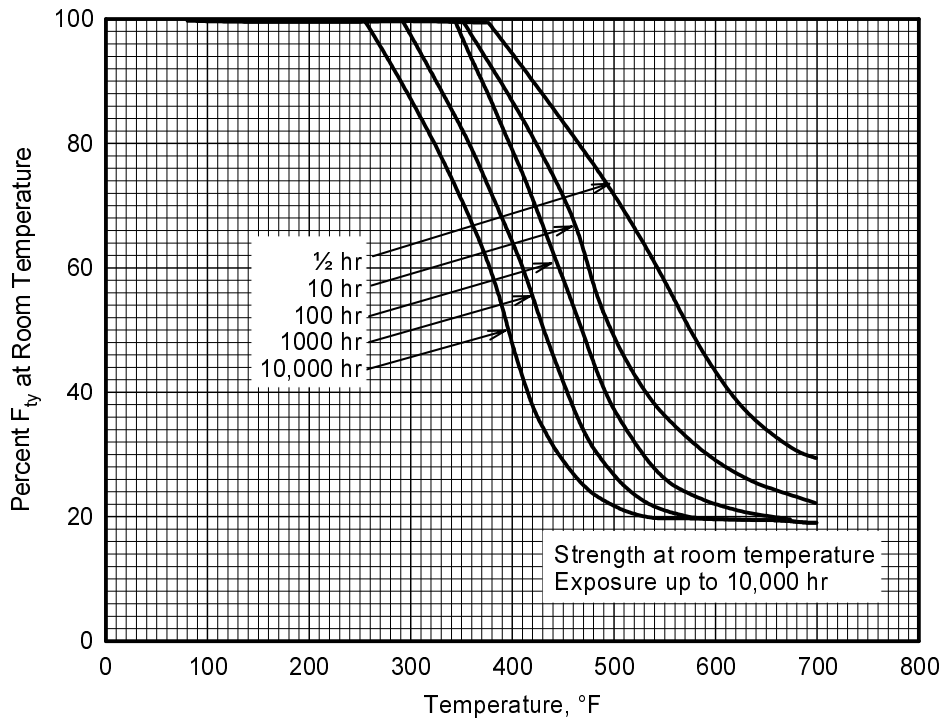

Figure 3.6.2.2.1(d). Effect of exposure at elevated temperatures on the room-temperature tensile yield strength (F_{ty}) of 6061-T6 aluminum alloy (all products).

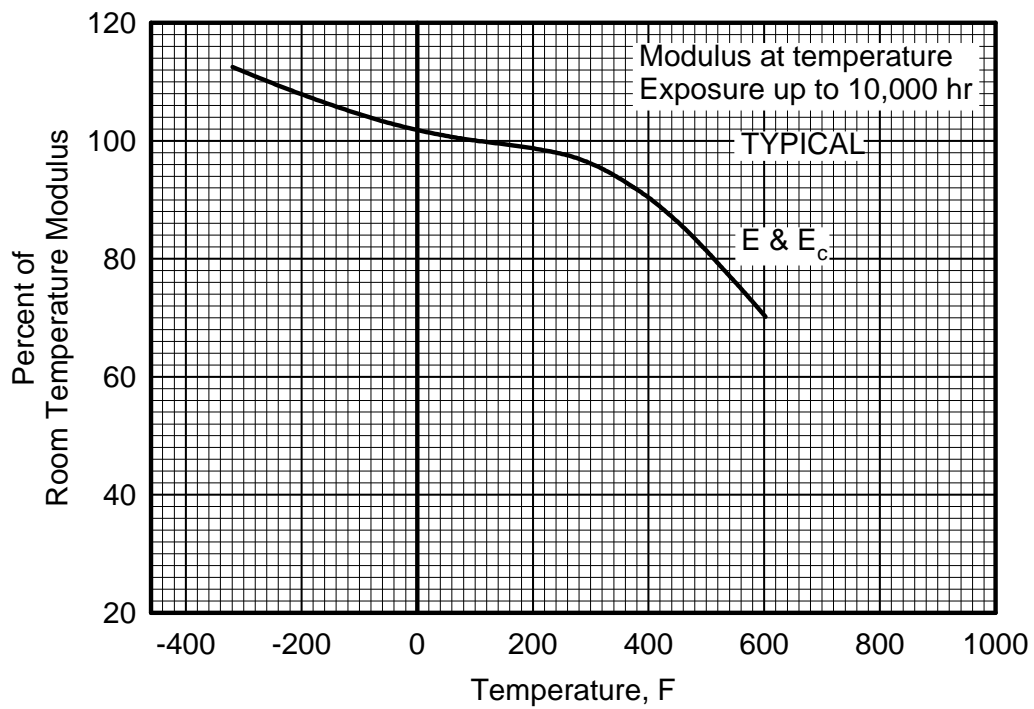

Figure 3.6.2.2.4. Effect of temperature on the tensile and compressive moduli (E and E_c) of 6061 aluminum alloy.

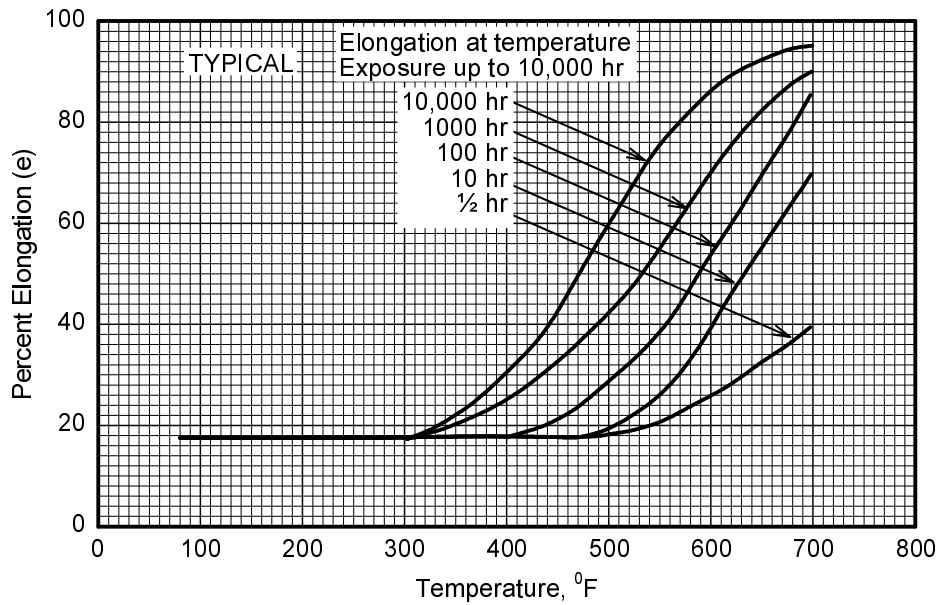

Figure 3.6.2.2.5(a). Effect of temperature on the elongation of 6061-T6 aluminum alloy (all products).

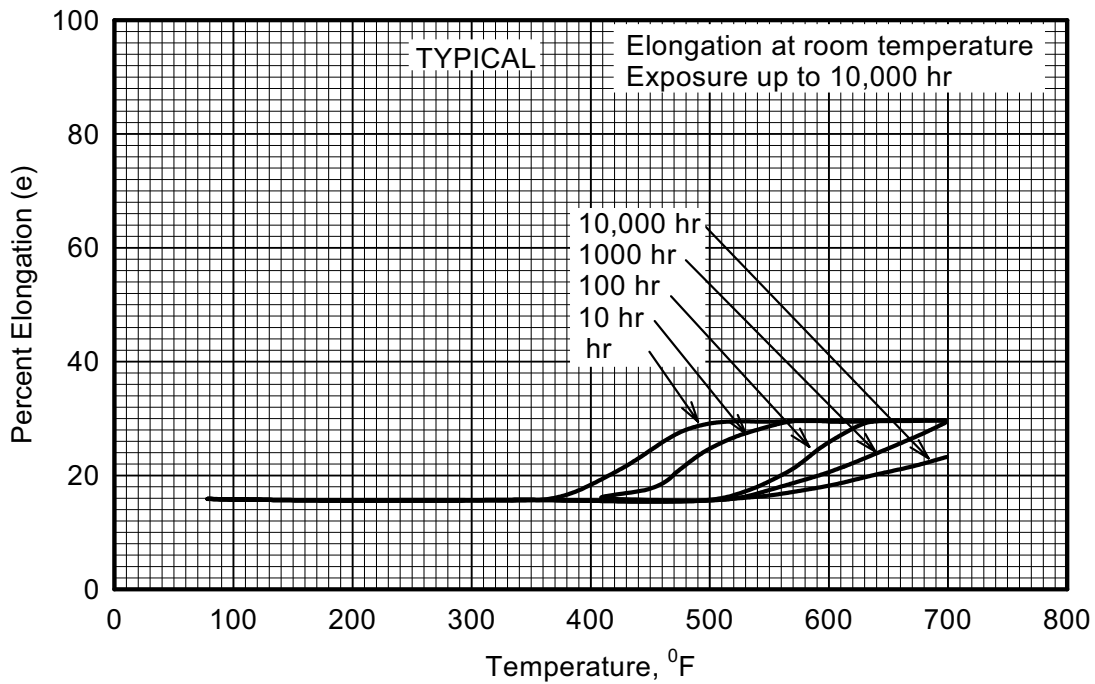

Figure 3.6.2.2.5(b). Effect of exposure at elevated temperatures on the room temperature elongation of 6061-T6 aluminum alloy (all products).

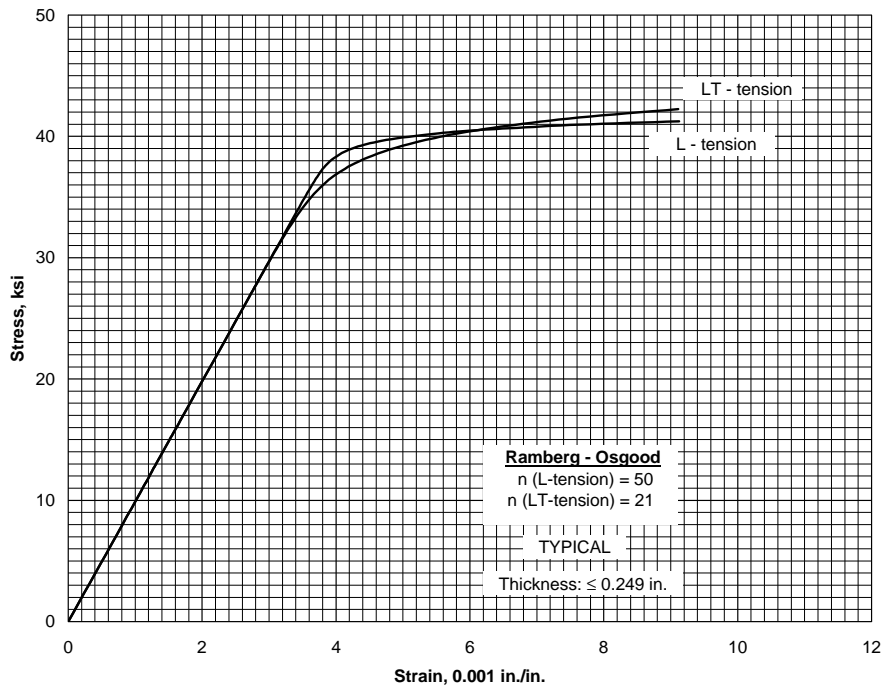

Figure 3.6.2.2.6(a). Typical tensile stress-strain curves for 6061-T6 aluminum alloy sheet at room temperature.

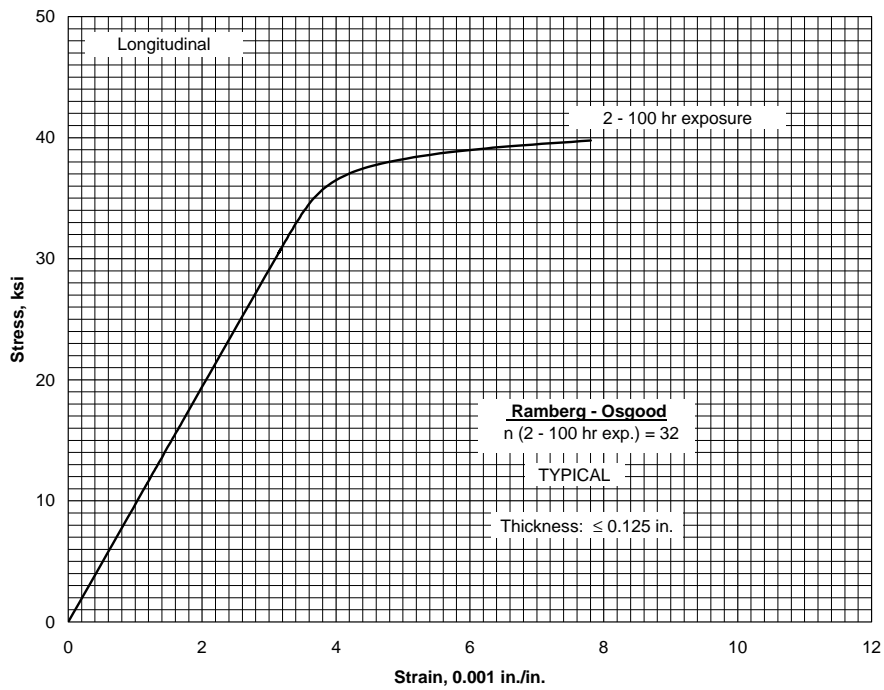

Figure 3.6.2.2.6(b). Typical tensile stress-strain curve for 6061-T6 aluminum alloy sheet at 200°F.

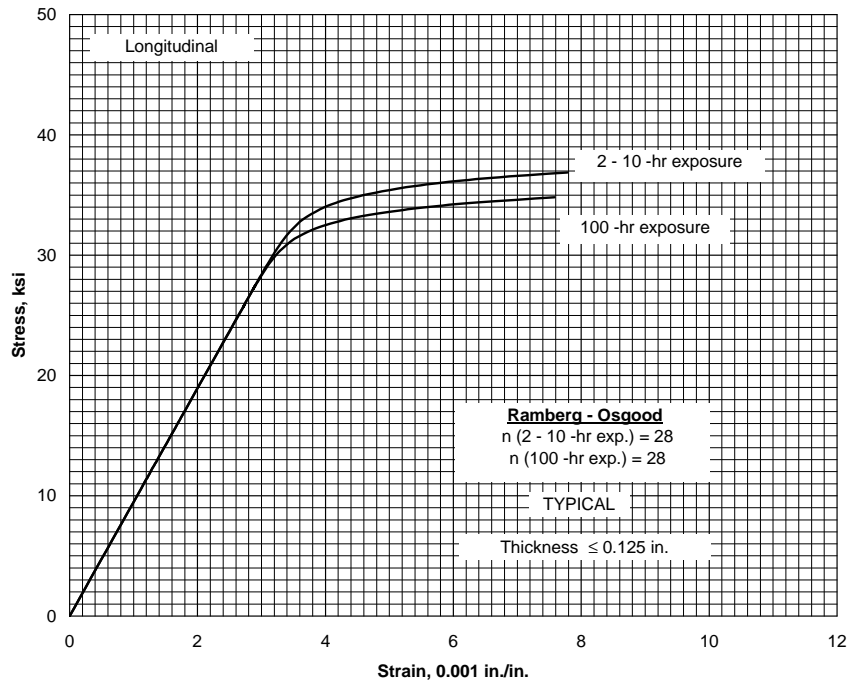

Figure 3.6.2.2.6(c). Typical tensile stress-strain curves for 6061-T6 aluminum alloy sheet at 300°F.

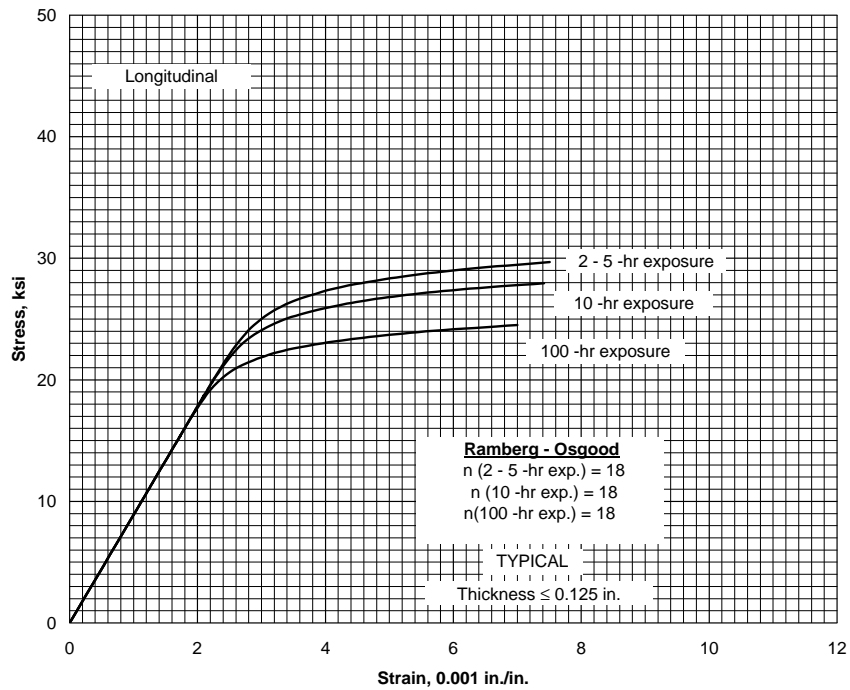

Figure 3.6.2.2.6(d). Typical tensile stress-strain curves for 6061-T6 aluminum alloy sheet at 400°F.

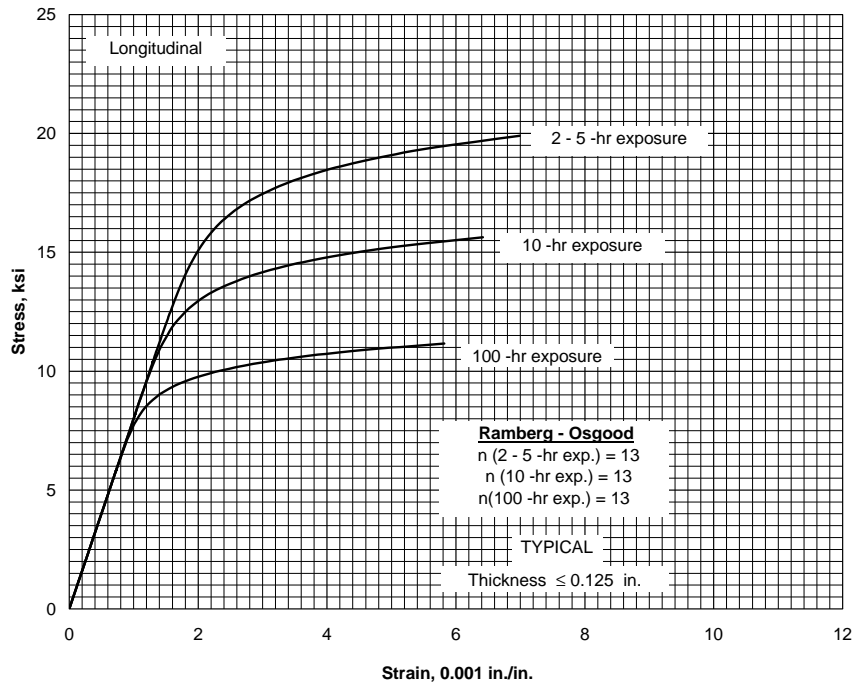

Figure 3.6.2.2.6(e). Typical tensile stress-strain curves for 6061-T6 aluminum alloy sheet at 500°F.

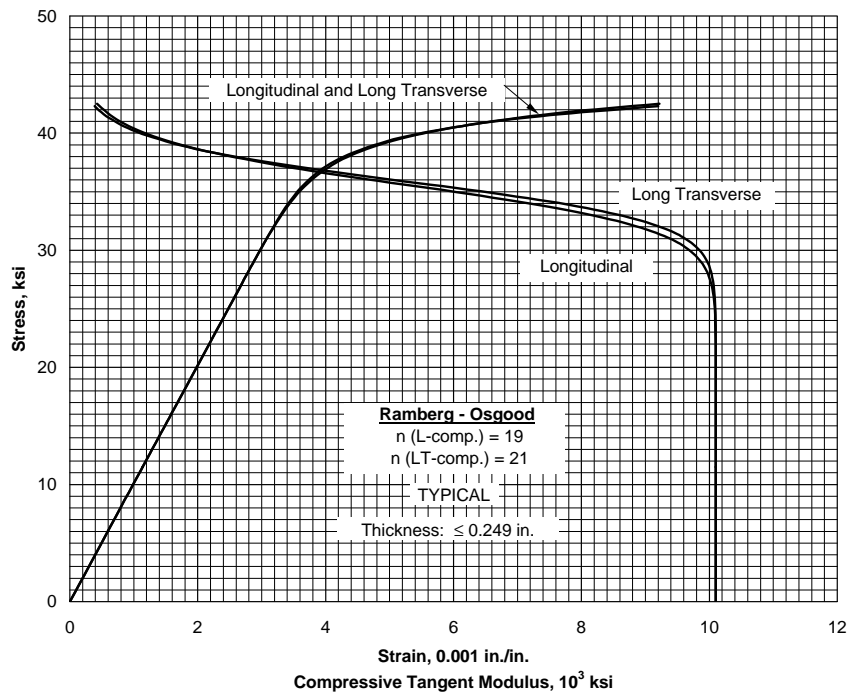

Figure 3.6.2.2.6(f). Typical compressive stress-strain and compressive tangent-modulus curves for 6061-T6 aluminum alloy sheet at room temperature.

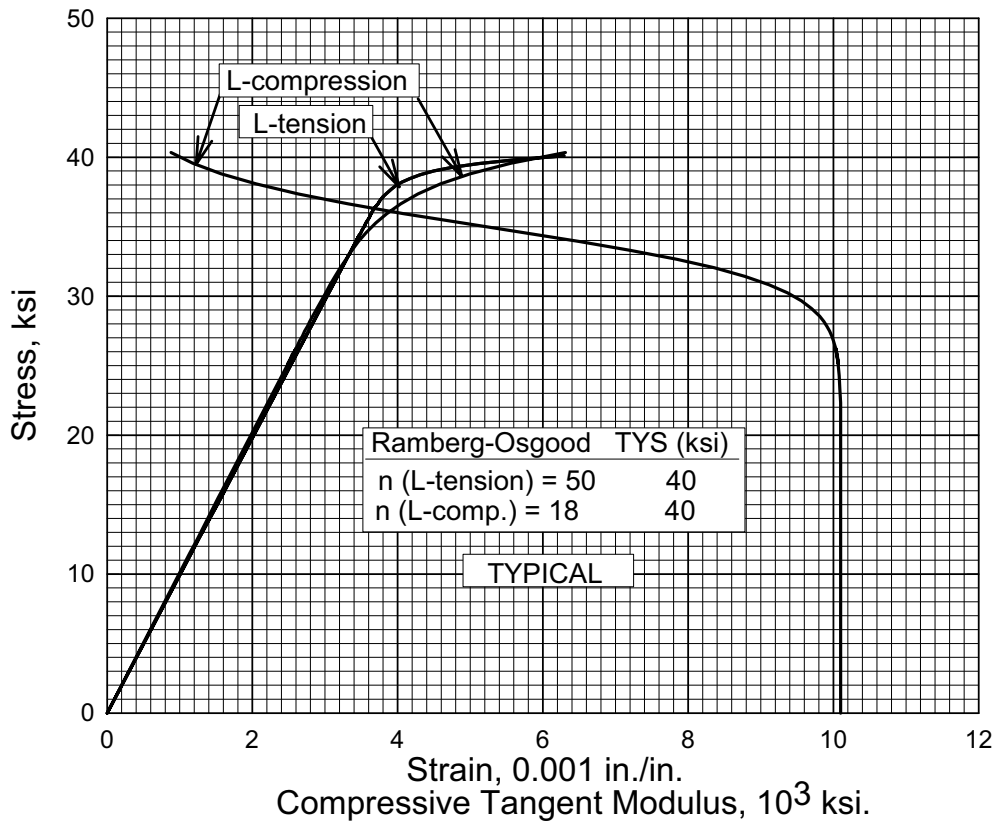

Figure 3.6.2.2.6(g). Typical tensile and compressive stress-strain and compressive tangent-modulus curves for 6061-T6 aluminum alloy sheet at room temperature.

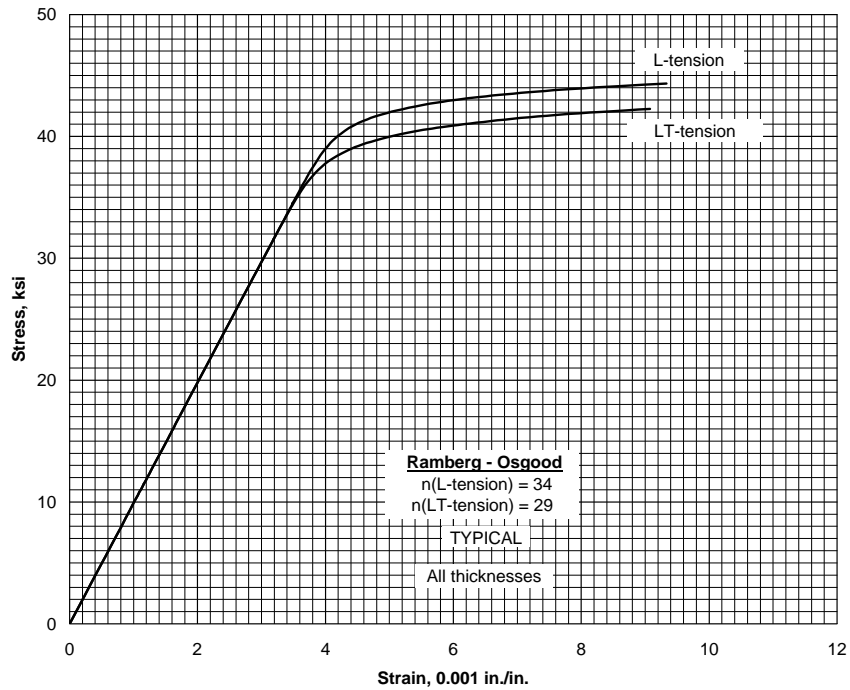

Figure 3.6.2.2.6(h). Typical tensile stress-strain curves for 6061-T6 aluminum alloy extrusion at room temperature.

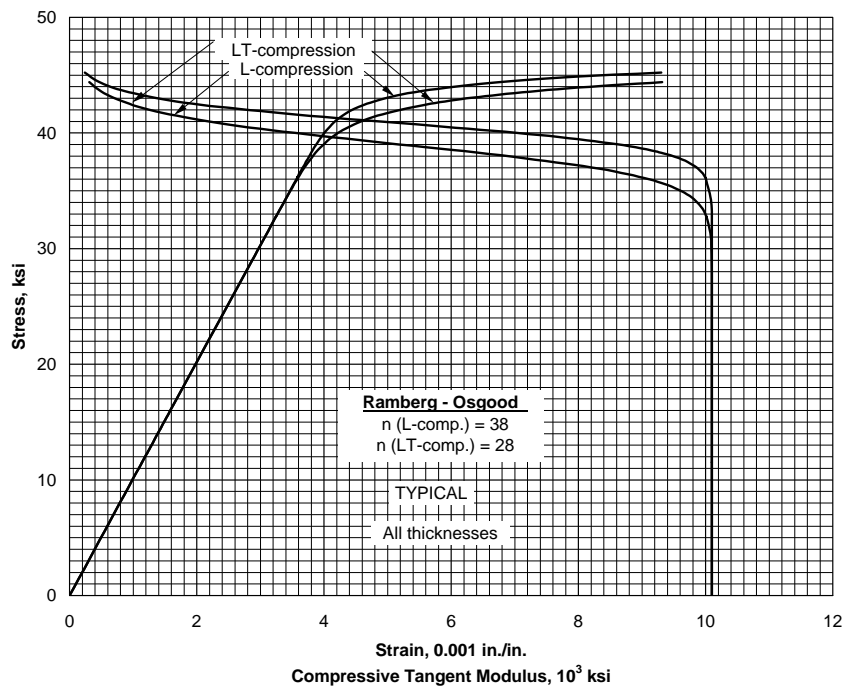

Figure 3.6.2.2.6(i). Typical compressive stress-strain and compressive tangent-modulus curves for 6061-T6 aluminum alloy extrusion at room temperature.

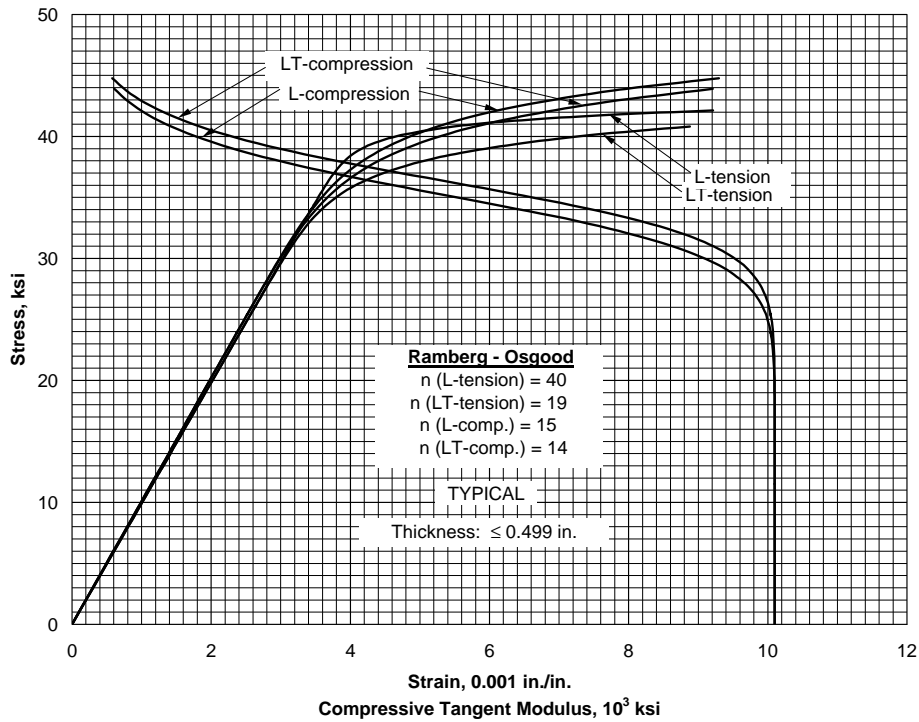

Figure 3.6.2.2.6(j). Typical tensile and compressive stress-strain and compressive tangent-modulus curves for 6061-T651X aluminum alloy extrusion at room temperature.

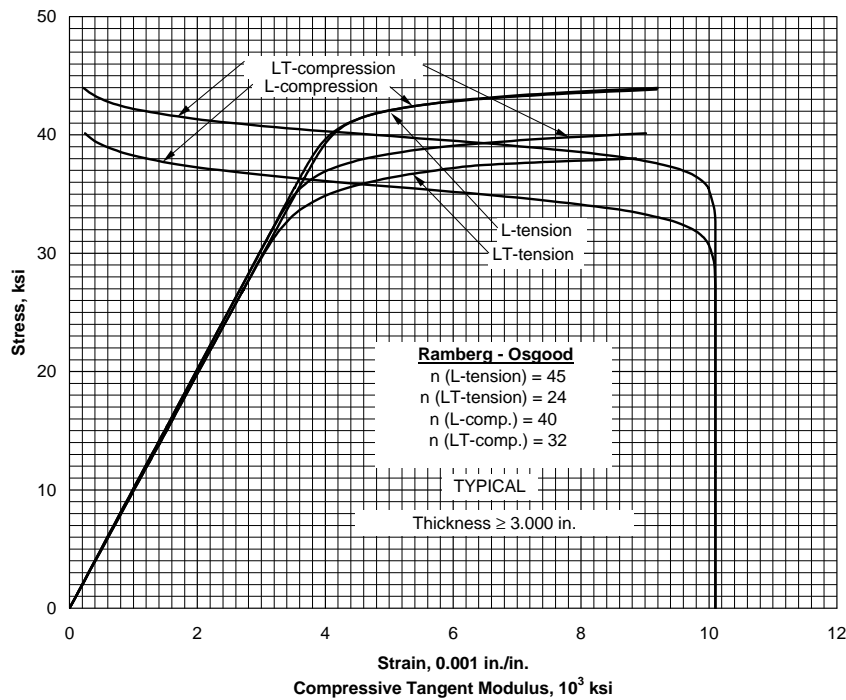

Figure 3.6.2.2.6(k). Typical tensile and compressive stress-strain and compressive tangent-modulus curves for 6061-T651X aluminum alloy extrusion at room temperature.

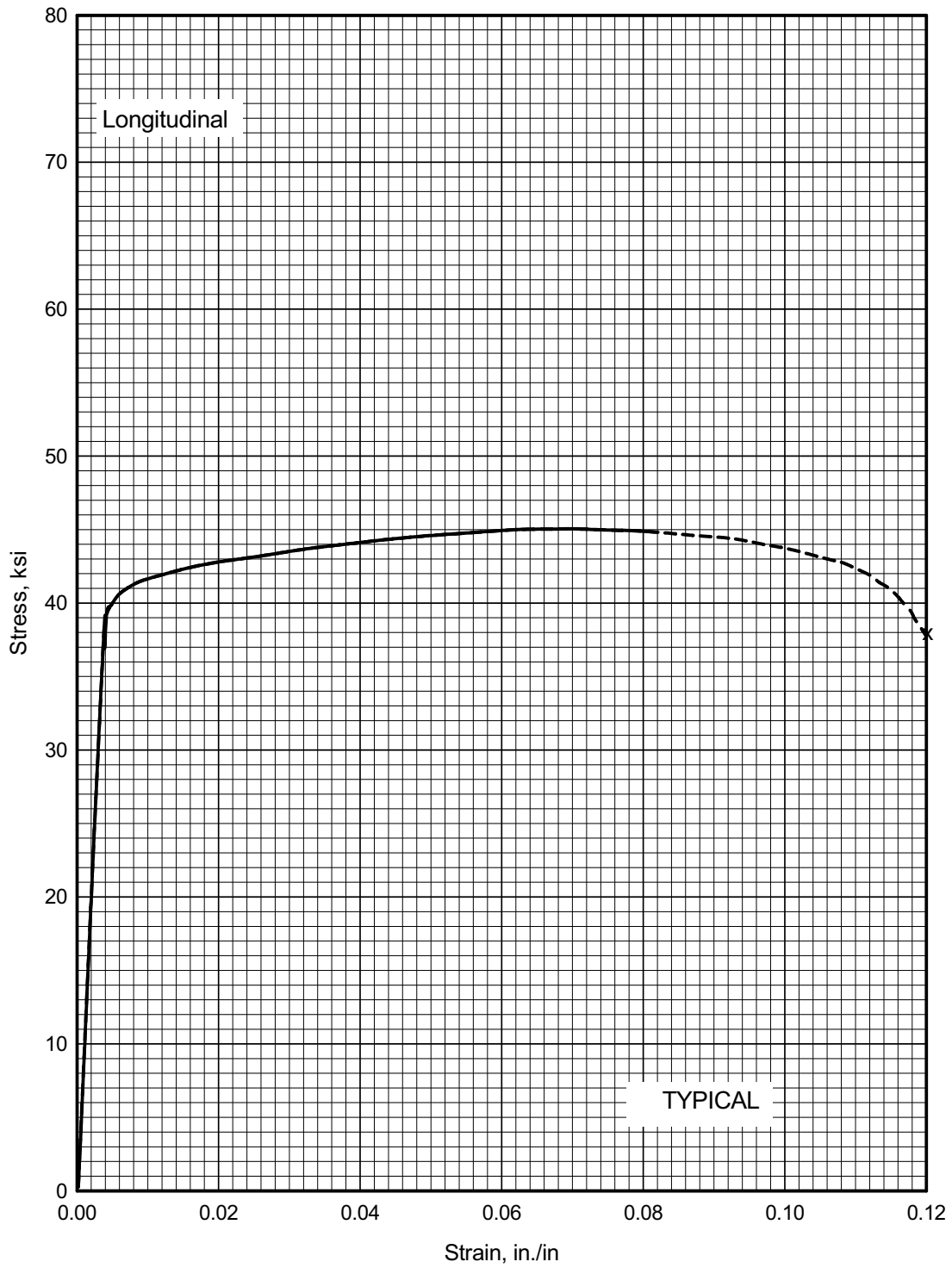

Figure 3.6.2.2.6(I). Typical tensile stress-strain (full range) for 6061-T6 aluminum alloy sheet at room temperature.

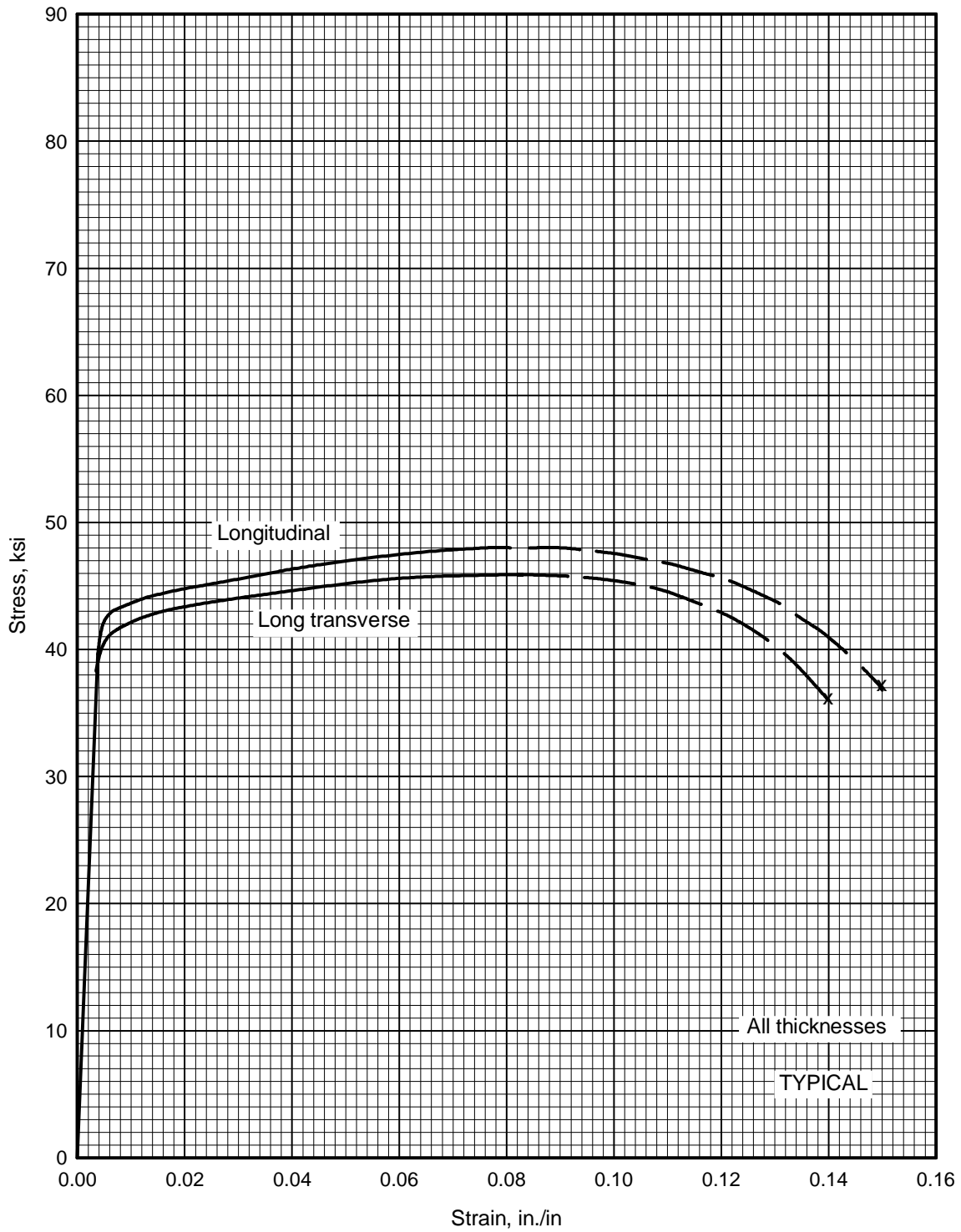

Figure 3.6.2.2.6(m). Typical tensile stress-strain curves (full range) for 6061-T62 aluminum alloy extrusion at room temperature.

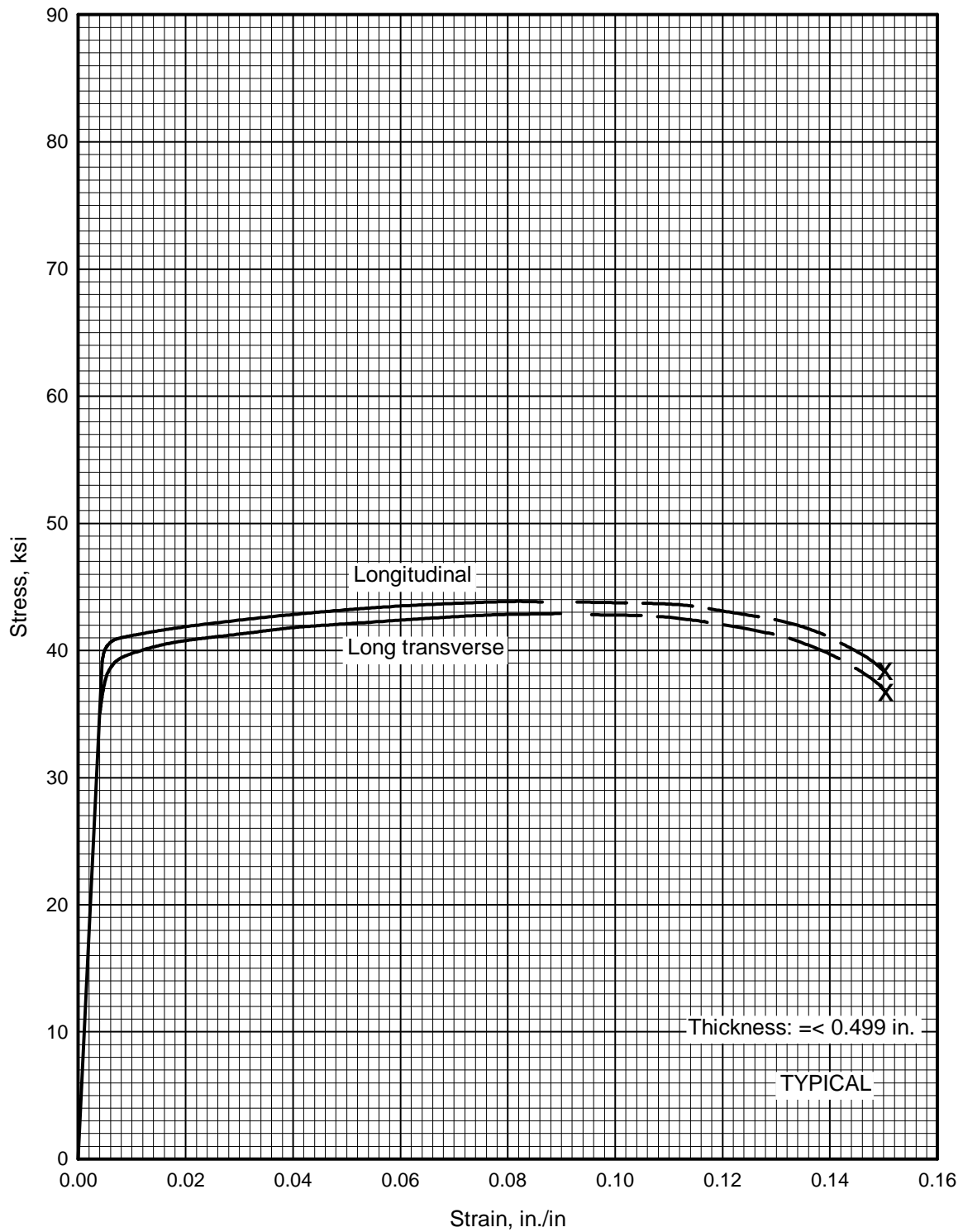

Figure 3.6.2.2.6(n). Typical tensile stress-strain curves (full range) for 6061-T651X aluminum alloy extrusion at room temperature.

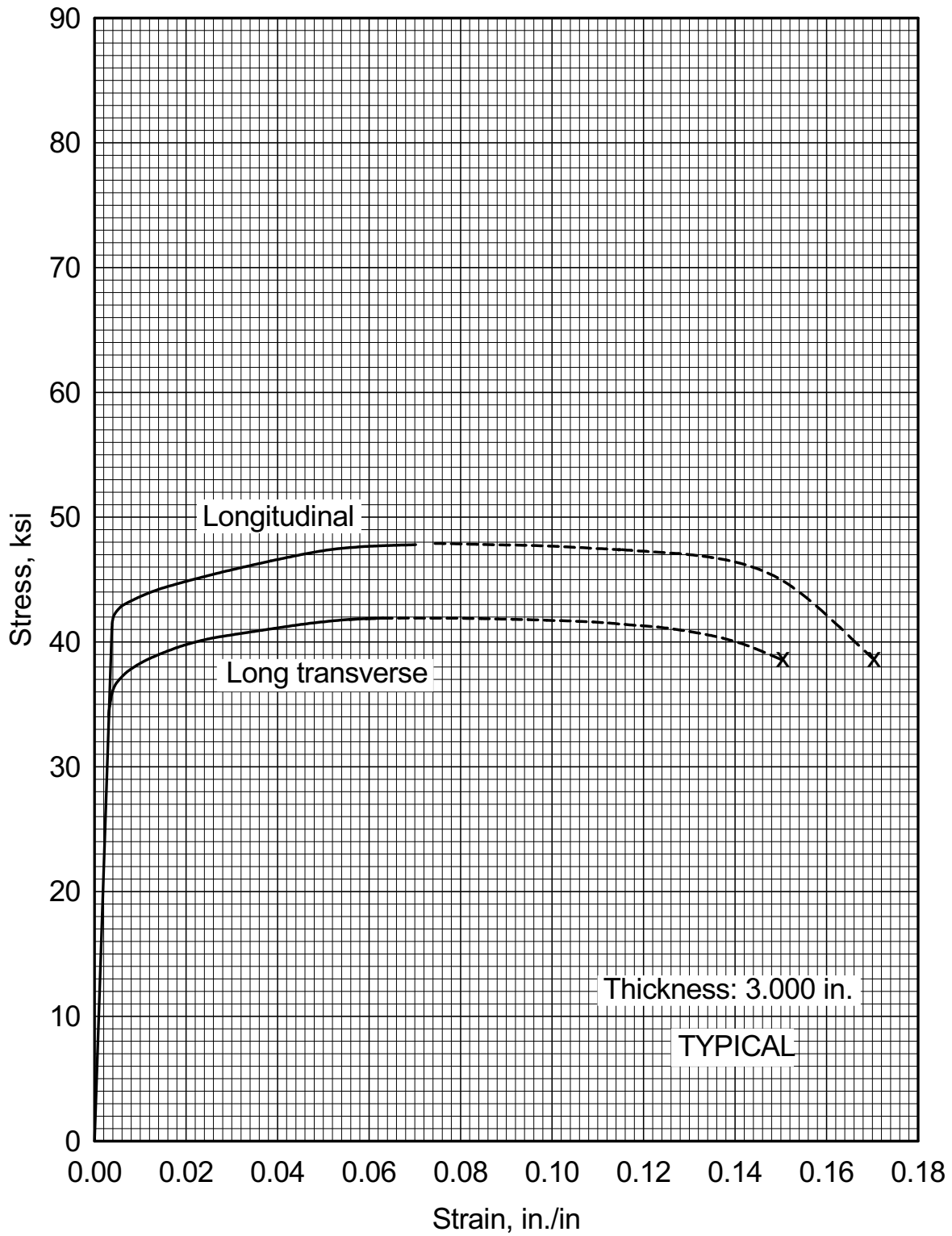

Figure 3.6.2.2.6(o). Typical tensile stress-strain curves (full range) for 6061-T651X aluminum alloy extrusion at room temperature.

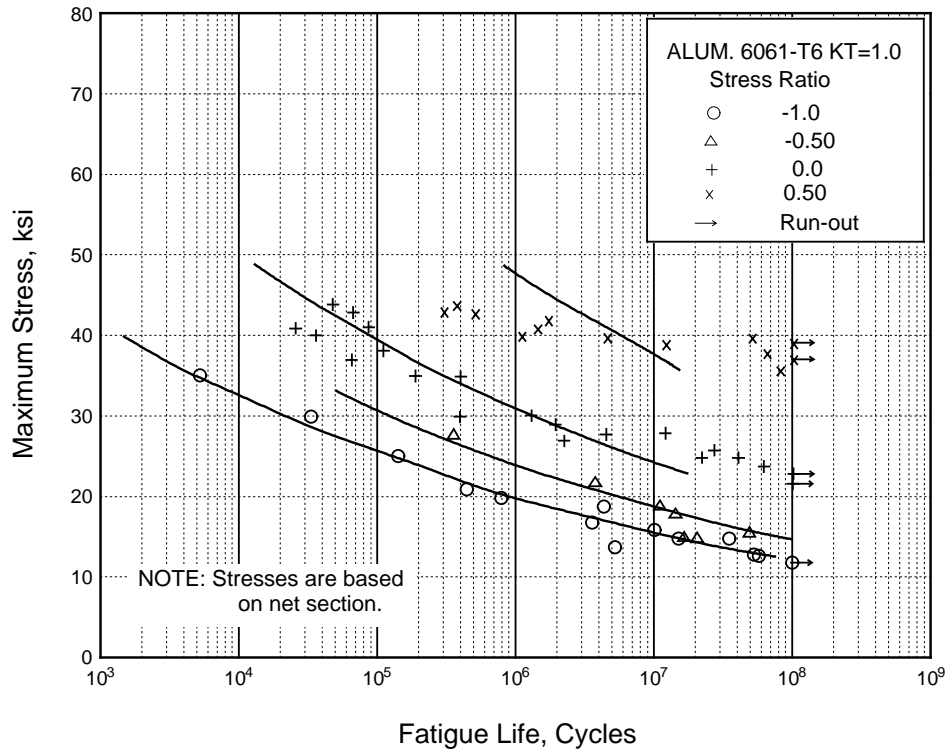

Figure 3.6.2.2.8. Best-fit S/N curves for unnotched 6061-T6 aluminum alloy, various wrought products, longitudinal direction.

Correlative Information for Figure 3.6.2.2.8

Product Form: Drawn rod, 0.75 inch diameter
Rolled bar, 1 x 7.5 inch

Test Parameters:
Loading - Axial
Frequency - 2000 cpm
Temperature - RT
Environment - Air

Properties: TUS, ksi TYS, ksi Temp., °F
 45 40 RT

Specimen Details: Unnotched
0.200 inch net diameter

No. of Heats/Lots: Not specified

Surface Condition: Not specified

Equivalent Stress Equation:
 $\log N_f = 20.68 - 9.84 \log (S_{eq})$
 $S_{eq} = S_{max} (1-R)^{0.63}$
Std. Error of Estimate, $\log (\text{Life}) = 0.48$
Standard Deviation, $\log (\text{Life}) = 1.18$
 $R^2 = 83\%$

Reference: 3.2.1.1.8(a)

Sample Size = 55

[Caution: The equivalent stress model may provide unrealistic life predictions for stress ratios beyond those represented above.]

3.6.3 6151 ALLOY

3.6.3.0 Comments and Properties — 6151 is an Al-Mg-Si alloy whose use has been restricted primarily to die forgings. It provides higher strengths than attainable with 6061, and has high resistance to corrosion. Refer to Section 3.1.3.4 for comments regarding the weldability of the alloy.

Material specifications for 6151 aluminum alloy are presented in Table 3.6.3.0(a). Room-temperature mechanical and physical properties are shown in Table 3.6.3.0(b). The effect of temperature on thermal expansion is shown in Figure 3.6.3.0.

Table 3.6.3.0(a). Material Specifications for 6151 Aluminum Alloy

Specification	Form
AMS 4125 AMS-A-22771	Die forging Forging

The temper index for 6151 is as follows:

<u>Section</u> 3.6.3.1	<u>Temper</u> T6
---------------------------	---------------------

3.6.3.1 T6 Temper — Elevated temperature modulus data from Figure 3.6.2.2.4 may be used for this alloy.

Table 3.6.3.0(b). Design Mechanical and Physical Properties of 6151 Aluminum Alloy Die Forging

Specification	AMS 4125 and AMS-A-22771
Form	Die forging
Temper	T6
Thickness ^a , in.	≤4.000
Basis	S
Mechanical Properties:	
<i>F_{uw}</i> , ksi:	
L	44
T ^b	44
<i>F_{ty}</i> , ksi:	
L	37
T ^b	37
<i>F_{cy}</i> , ksi:	
L	39
T ^b	35
<i>F_{su}</i> , ksi	28
<i>F_{bru}</i> , ksi:	
(e/D = 1.5)
(e/D = 2.0)
<i>F_{bry}</i> , ksi:	
(e/D = 1.5)
(e/D = 2.0)
<i>e</i> , percent:	
L	10
T ^b	6
<i>E</i> , 10 ³ ksi	10.1
<i>E_c</i> , 10 ³ ksi	10.3
<i>G</i> , 10 ³ ksi	3.85
<i>μ</i>	0.33
Physical Properties:	
<i>ω</i> , lb/in. ³	0.098
<i>C</i> , Btu/(lb)(°F)	0.23 (at 212°F)
<i>K</i> , Btu/[(hr)(ft ²)(°F)/ft]	100 (at 77°F)
<i>α</i> , 10 ⁻⁶ in./in./°F	See Figure 3.6.3.0

- a Thickness at the time of heat treatment. When die forgings are machined before heat treatment, the mechanical properties are applicable provided the as-forged thickness is not greater than twice the thickness at the time of heat treatment.
b T indicates any grain direction not within ±15° of being parallel to the forging flow lines.

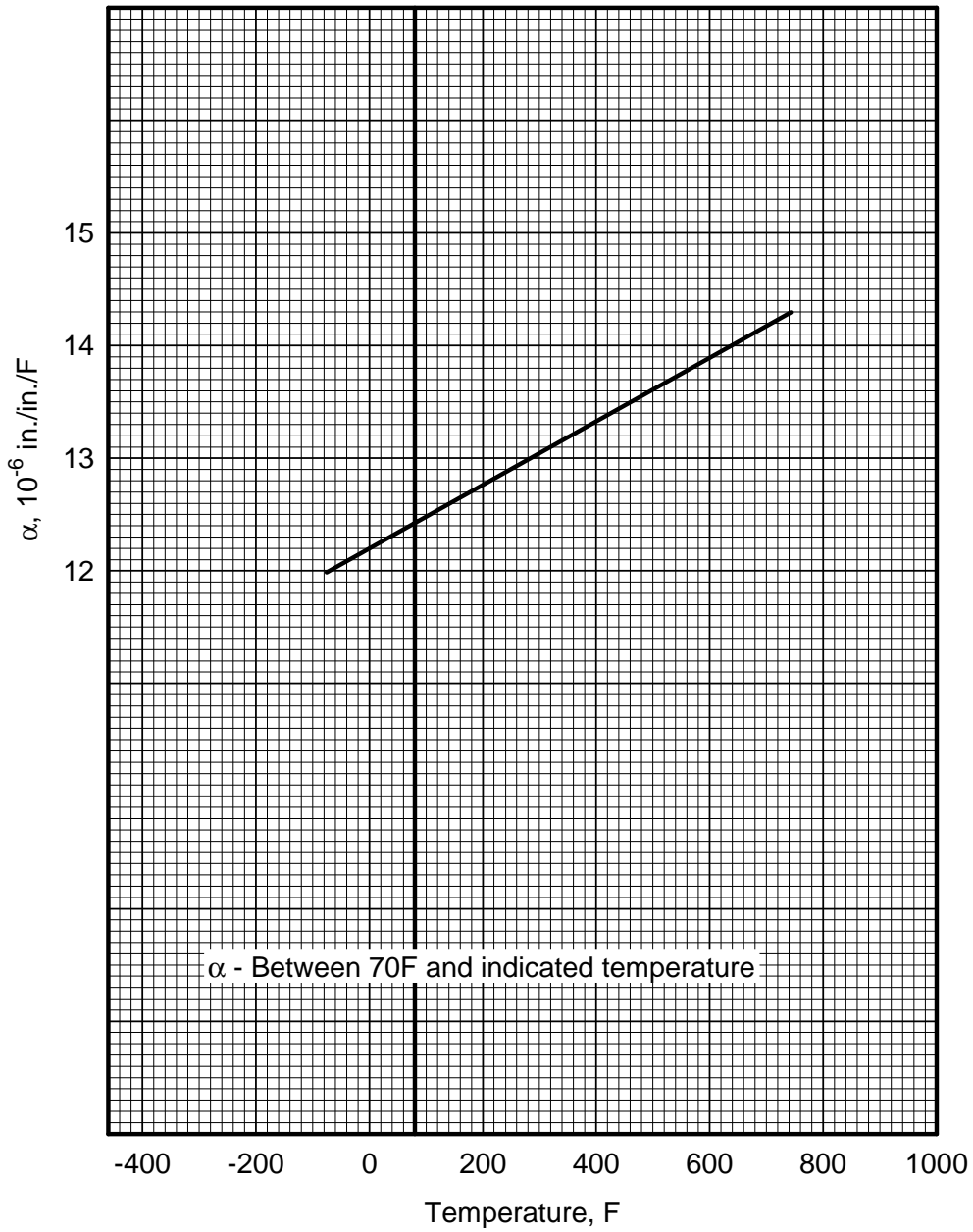

Figure 3.6.3.0. Effect of temperature on the thermal expansion of 6151 aluminum alloy.

3.7 7000 SERIES WROUGHT ALLOYS

The 7000 series of wrought alloys contain zinc as the principal alloying element and magnesium and copper as other major elements. They are available in a wide variety of product forms. They are strengthened principally by solution heat treatment and precipitation hardening and are among the highest-strength aluminum alloys.

The T6-type tempers of these alloys are susceptible to stress-corrosion cracking under certain conditions while the T7-type tempers are more resistant; these alloys should be considered in light of the corrosion resistance discussed in Sections 3.1.2.3 and 3.1.3.

3.7.1 7010 ALLOY

3.7.1.0 Comments and Properties — 7010 is an Al-Zn-Mg-Cu-Zr alloy developed to have a combination of high strength, high resistance to stress-corrosion cracking, and good fracture toughness, particularly in thick sections. The use of zirconium in lieu of chromium provides a low sensitivity to quench, which results in high strength in thick sections. The alloy is available only in plate. Plate, greater than 2 inches in thickness in the T7451 temper, has static strength equal to or greater than 7075-T651 plate with greater toughness.

Plate in the T7451 temper has a stress-corrosion resistance higher than 7075-T7651. The T73-type temper provides the highest resistance to stress-corrosion for this alloy. The T76-type temper provides for good exfoliation resistance and higher stress-corrosion resistance than T6-type tempers of 7075 and 7178. The T74-type temper provides stress-corrosion and strength characteristics intermediate to those of T76 and T73. Refer to Section 3.1.2.3 for information regarding the resistance of the alloy to stress-corrosion cracking.

Refer to Section 3.1.3.4 for comments regarding the weldability of the alloy.

Material specifications for 7010 are shown in Table 3.7.1.0(a). Room-temperature mechanical properties are shown in Tables 3.7.1.0(b₁) and (b₂).

Table 3.7.1.0(a). Material Specifications for 7010 Aluminum Alloy

Specification	Form
AMS 4205	Plate
AMS 4204	Plate

The temper index for 7010 is as follows:

<u>Section</u>	<u>Temper</u>
3.7.1.1	T7451
3.7.1.2	T7651

3.7.1.1 T7451 Temper — Elevated temperature curves for plate are presented in Figure 3.7.1.1.1. Figures 3.7.1.1.6(a) through (d) present stress-strain and tangent-modulus curves for plate.

3.7.1.2 T7651 Temper — Figures 3.7.1.2.6(a) through (d) present stress-strain and tangent-modulus curves for plate.

Table 3.7.1.0(b₁). Design Mechanical and Physical Properties of 7010 Aluminum Alloy Plate

Specification	AMS 4205									
	Plate									
	T7451									
Thickness, in.	0.250- 1.000	1.001- 2.000	2.001- 3.000		3.001- 4.000		4.001- 5.000		5.001- 6.000	
	S	S	A	B	A	B	A	B	A	B
Mechanical Properties:										
<i>F_m</i> , ksi:										
L	71	71	70	72	70	71	68 ^a	71	68	70
LT	72	72	71	72	70	72	69 ^a	71	67 ^a	71
ST	66	68	66	68	65 ^a	67	63 ^a	67
<i>F_{ty}</i> , ksi:										
L	62	62	60	62	60	62	59	61	57 ^a	61
LT	62	62	60	62	59	61	58	60	57 ^a	60
ST	55	57	54	56	53	55	52	54
<i>F_{cy}</i> , ksi:										
L	61	61	59	61	58	60	57	59	56	59
LT	63	63	62	64	61	63	60	62	59	63
ST	61	63	60	62	59	61	58	61
<i>F_{su}</i> , ksi										
L	41	41	42	42	42	43	42	43	41	43
<i>F_{bru}^b</i> , ksi:										
(e/D = 1.5)	100	101	101	102	100	103	100	103	97	103
(e/D = 2.0)	127	129	130	132	130	134	129	133	126	133
<i>F_{brv}^b</i> , ksi:										
(e/D = 1.5)	81	82	81	84	81	84	81	84	80	84
(e/D = 2.0)	94	97	97	100	98	101	98	101	97	102
<i>e</i> , percent (S-basis):										
L	9	9	9	...	9	...	9	...	8	...
LT	6	6	6	...	6	...	5	...	5	...
ST	2.5	...	2	...	2	...	2	...
<i>E</i> , 10 ³ ksi										
					10.2					
<i>E_c</i> , 10 ³ ksi										
					10.6					
<i>G</i> , 10 ³ ksi										
					3.9					
<i>μ</i>										
					0.33					
Physical Properties:										
<i>ω</i> , lb/in. ³										
					0.102					
<i>C</i> , Btu/(lb)(°F)										
					0.21 (at 214°F)					
<i>K</i> , Btu/[(hr)(ft ²)(°F)/ft]										
					95 (at 99°F)					
<i>α</i> , 10 ⁻⁶ in./in./°F										
					13.0 (68-212°F)					

a S-basis values. The rounded T₉₉ values are as follows: for 4.001-5.000-inch thickness, *F_m*(L) = 69, *F_m*(LT) = 70, and *F_m*(ST) = 66; for 5.001-6.000-inch thickness, *F_m*(LT) = 69, *F_m*(ST) = 65, *F_{ty}*(L) = 59, and *F_{ty}*(LT) = 58.
b See Table 3.1.2.1.1. Bearing values are “dry pin” values per Section 1.4.7.1.

Table 3.7.1.0(b₂). Design Mechanical Properties of 7010 Aluminum Alloy Plate—Continued

Specification	AMS 4204						
	Plate						
	T7651						
	0.250-1.000	1.001-2.000	2.001-2.500	2.501-3.000	3.001-4.000	4.001-5.000	5.001-5.500
Basis	S	S	S	S	S	S	S
Mechanical Properties:							
F_{tu} , ksi:							
L	76	76	75	73	72	72	71
LT	76	76	75	74	73	72	72
ST	71	70	69	68	66
F_{ty} , ksi:							
L	66	66	65	64	64	63	62
LT	66	66	65	64	63	62	61
ST	59	58	56	55	53
F_{cy} , ksi:							
L	65	65	64	63	62	61	60
LT	67	68	67	67	66	65	64
ST	68	67	65	64	62
F_{su} , ksi	42	44	44	44	44	45	46
F_{bru}^a , ksi:							
(e/D = 1.5)	105	106	106	105	105	105	105
(e/D = 2.0)	135	137	137	136	135	134	134
F_{bry}^a , ksi:							
(e/D = 1.5)	85	86	87	87	86	86	86
(e/D = 2.0)	103	104	103	102	101	100	99
e , percent:							
L	8	8	8	7	7	7	6
LT	6	6	6	5	5	5	4
ST	2.5	2.5	2	2	2
E , 10 ³ ksi	10.2						
E_c , 10 ³ ksi	10.6						
G , 10 ³ ksi	3.9						
μ	0.33						
Physical Properties:							
ω , lb/in. ³	0.102						
C , Btu/(lb)(°F)	0.21 (at 214°F)						
K , Btu/[(hr)(ft ²)(°F)/ft]	95 (at 104°F)						
α , 10 ⁻⁶ in./in./°F	12.9 (68 to 212°F)						

a See Table 3.1.2.1.1. Bearing values are “dry pin” values per Section 1.4.7.1.

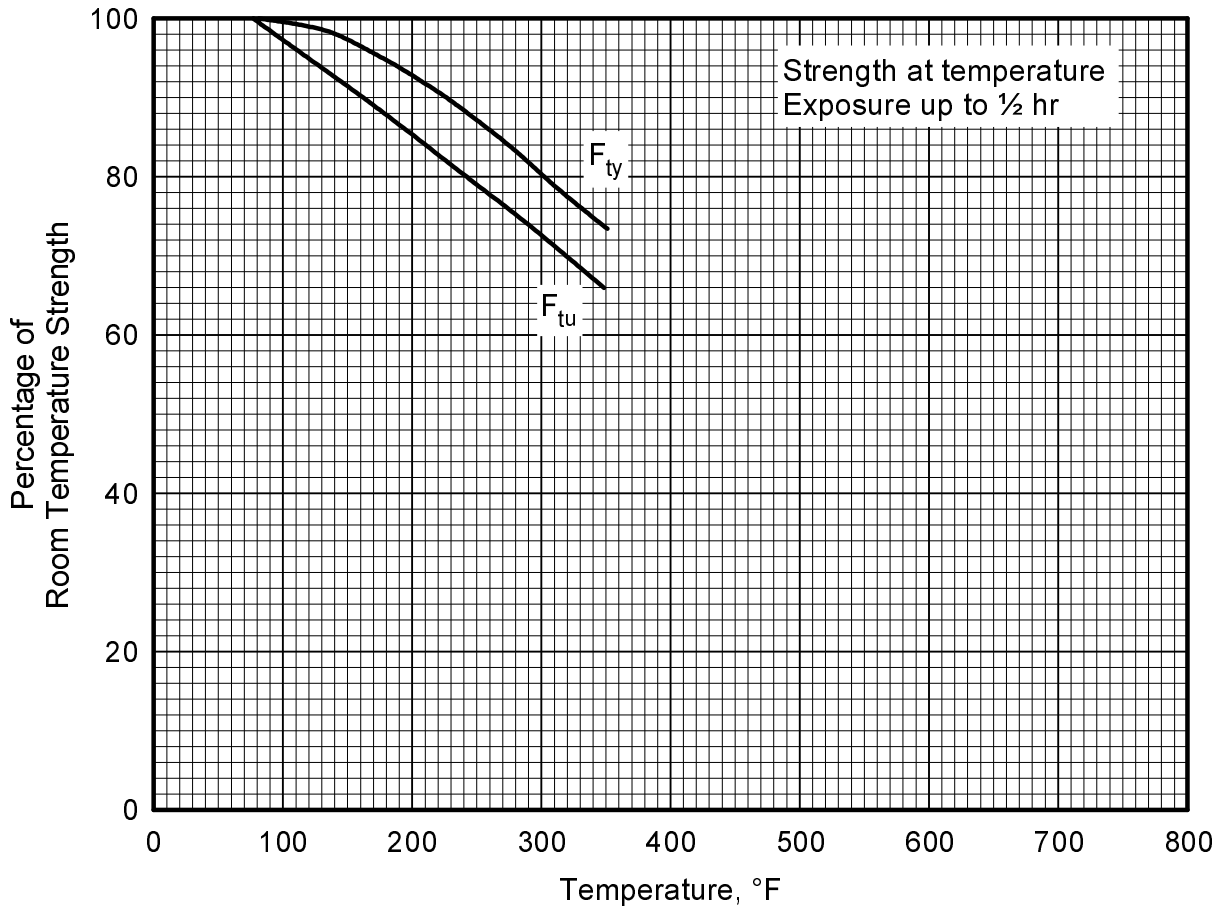

Figure 3.7.1.1.1. Effect of temperature on the tensile ultimate strength (F_{tu}) and the tensile yield strength (F_{ty}) of 7010-T7451 aluminum alloy plate.

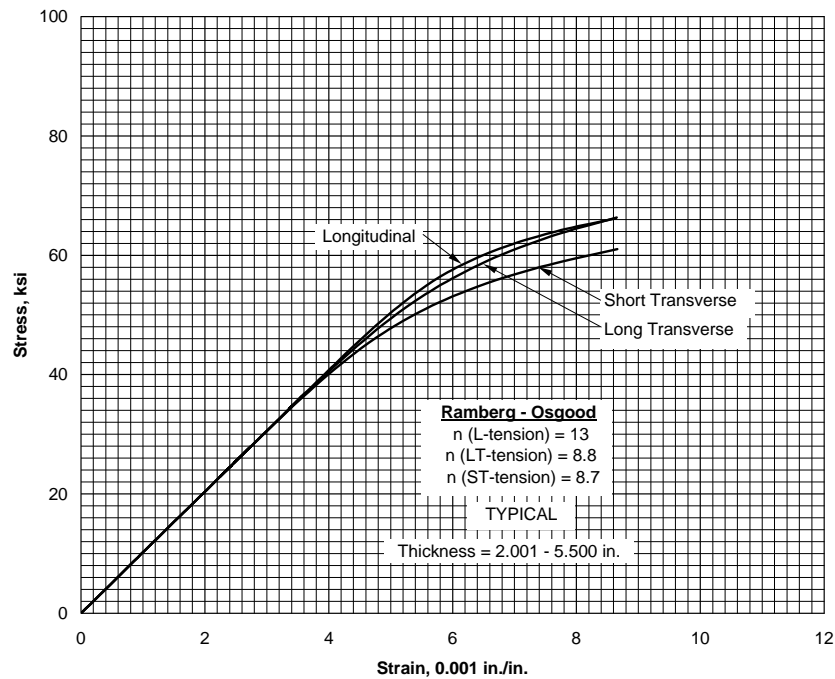

Figure 3.7.1.1.6(a). Typical tensile stress-strain curves for 7010-T7451 plate at room temperature.

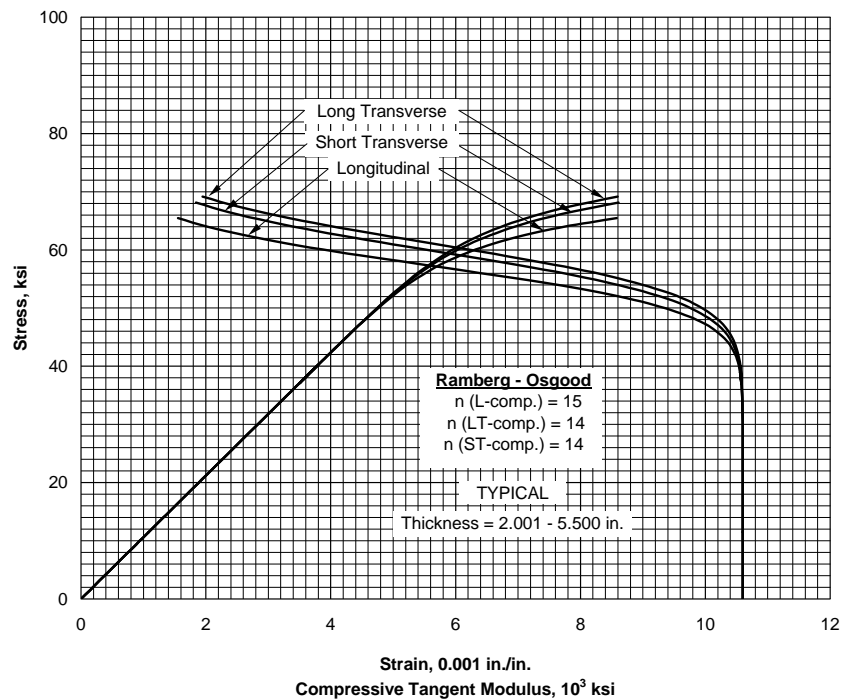

Figure 3.7.1.1.6(b). Typical compressive stress-strain and compressive tangent-modulus curves for 7010-T7451 plate at room temperature.

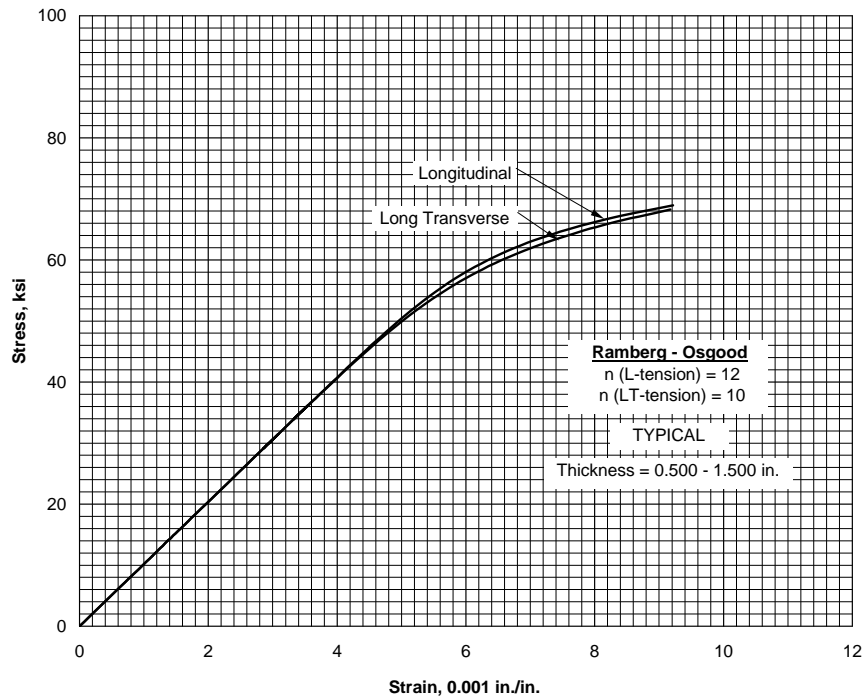

Figure 3.7.1.1.6(c). Typical tensile stress-strain curves for 7010-T7451 aluminum alloy plate at room temperature.

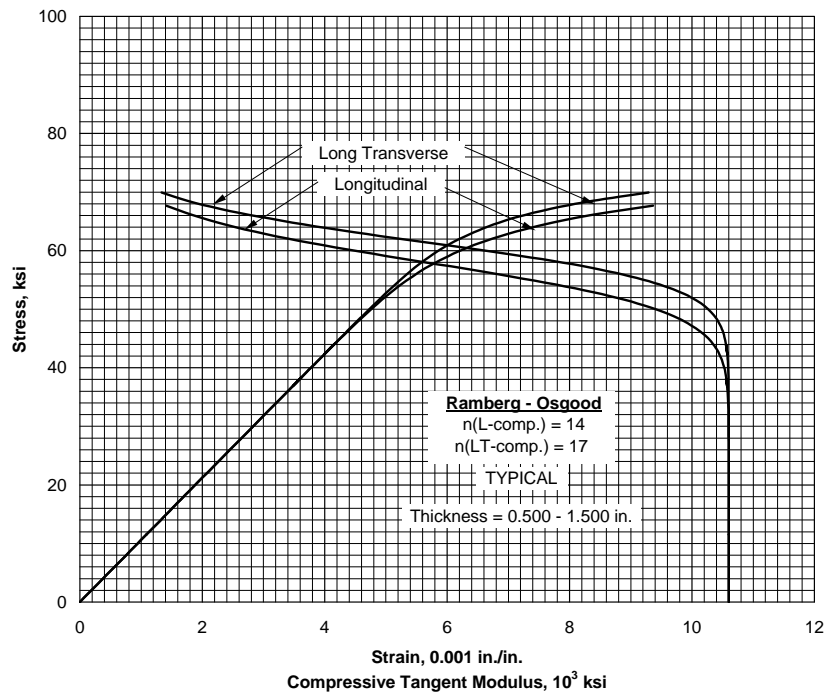

Figure 3.7.1.1.6(d). Typical compressive stress-strain and compressive tangent-modulus curves for 7010-T7451 aluminum alloy plate at room temperature.

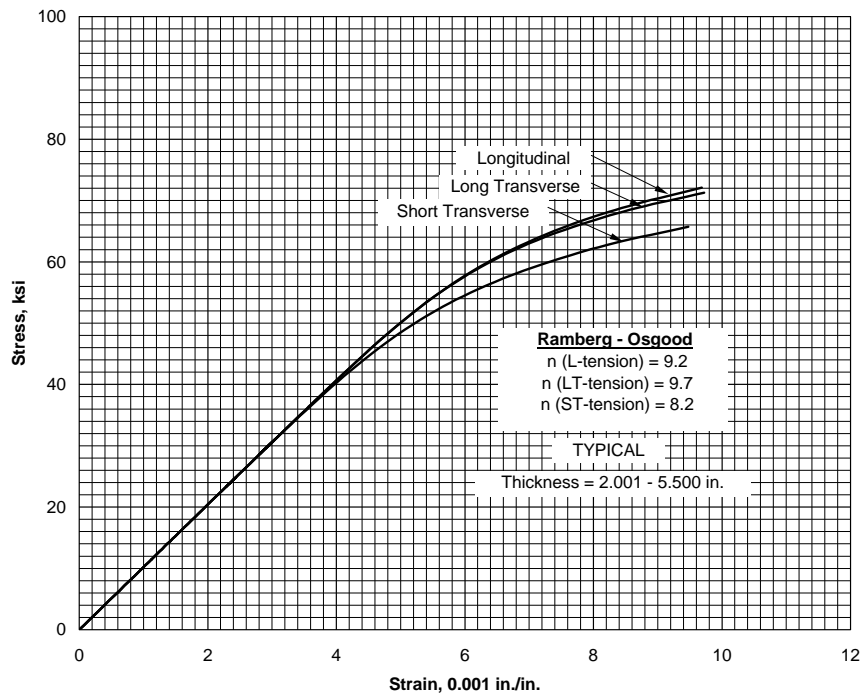

Figure 3.7.1.2.6(a). Typical tensile stress-strain curves for 7010-T7651 plate at room temperature.

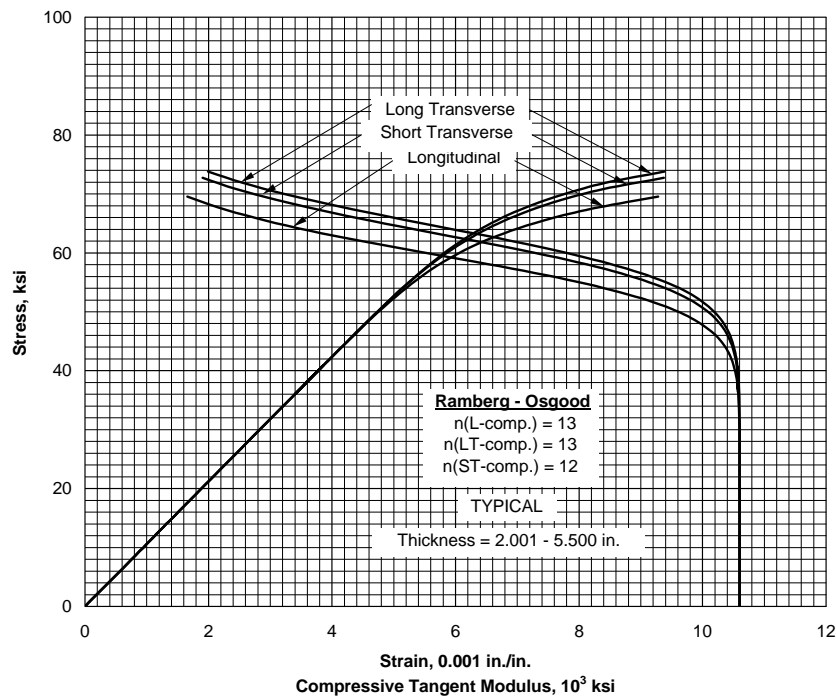

Figure 3.7.1.2.6(b). Typical compressive stress-strain and compressive tangent-modulus curves for 7010-T7651 plate at room temperature.

MIL-HDBK-5J
31 January 2003

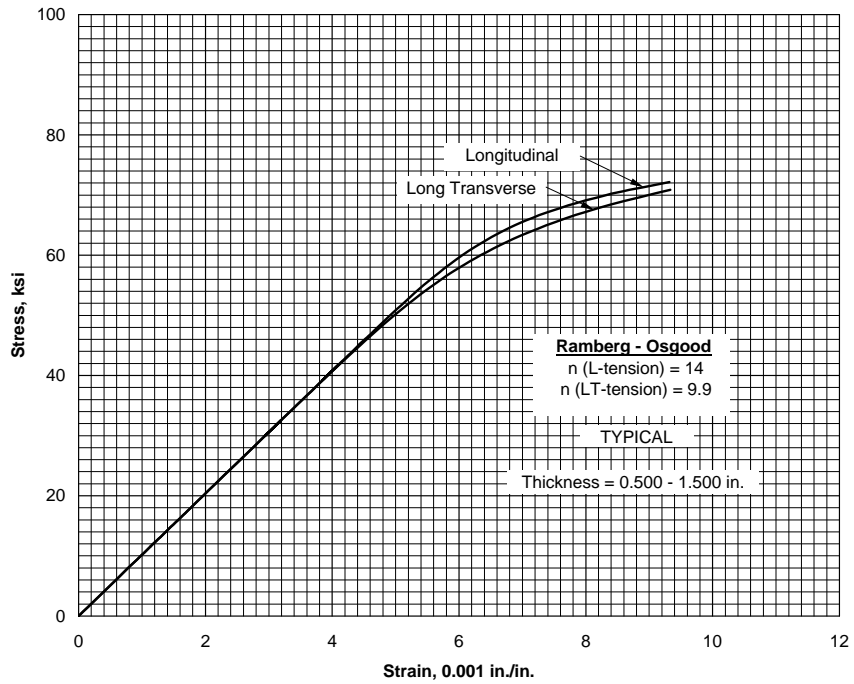

Figure 3.7.1.2.6(c). Typical tensile stress-strain curves for 7010-T7651 aluminum alloy plate at room temperature.

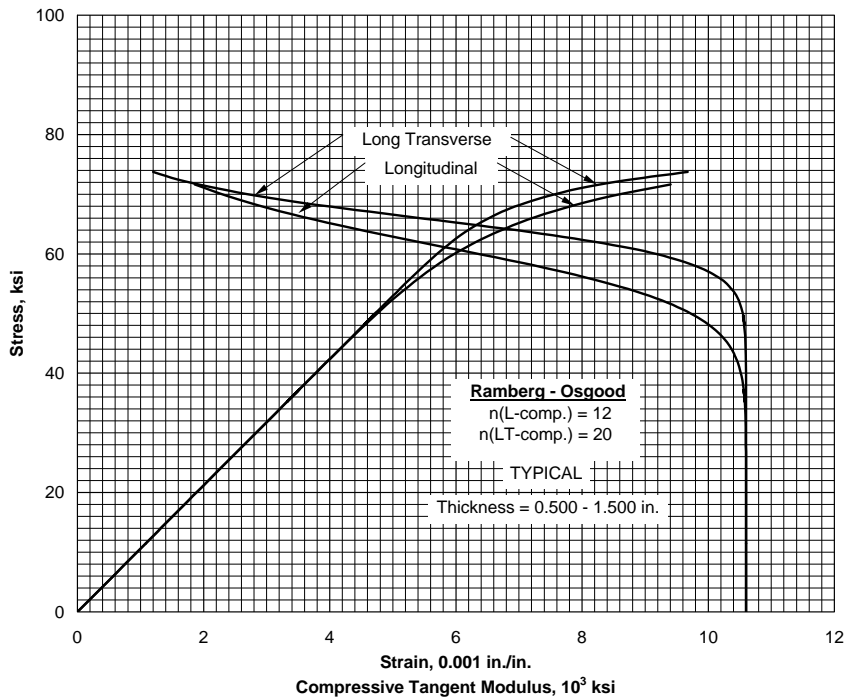

Figure 3.7.1.2.6(d). Typical compressive stress-strain and compressive tangent-modulus curves for 7010-T7651 aluminum alloy plate at room temperature.

3.7.2 7040 ALLOY

3.7.2.0 Comments and Properties — 7040 alloy is an Al-Mg-Zn-Cu-Zr alloy developed to provide a higher strength and toughness compromise than the currently available 7010 and 7050 alloys, particularly in heavy gauge plates up to 8.5 inch thickness. The use of a desaturated chemical composition in Mg and Cu together with a very close control of the Zr content and impurities, provide 7040 with a much lower quench sensitivity than that of 7050, resulting in high strength and toughness properties in very thick sections.

7040-T7451 plates are particularly suited for structures in which high strength, high toughness, and good corrosion resistance are the major requirements. Parts such as integrally machined spars, ribs, and main fuselage frames can benefit from this outstanding property combination.

7040 is available in the form of plates, range in thickness from 3.0 to 8.5 inches.

Manufacturing Considerations — Due to tight control of residual stress level, the 7040 plates exhibit a superior dimensional stability, thus offering a cost-efficient alternative to rolled or forged parts, which require distortion corrections after machining.

Refer to Section 3.1.3.4 for comments regarding the weldability of this alloy.

Specifications and Properties — Material specifications are shown in Table 3.7.2.0(a). Room-temperature properties are shown in Table 3.7.2.0(b₁). Figure 3.7.2.0 shows the effect of temperature on tensile properties.

Table 3.7.2.0(a). Material Specifications for 7040-T7451 Alloy Plate

Specification	Form
AMS 4211	Plate

Table 3.7.2.0(b₁). Design Mechanical and Physical Properties of 7040-T7451 Aluminum Alloy Plate

Specification	AMS 4211											
	Plate											
	T7451											
Thickness, in.	3.001-4.000		4.001-5.000		5.001-6.000		6.001 - 7.000		7.001 - 8.000		8.001 - 8.500	
Basis	A	B	A	B	A	B	A	B	A	B	A	B
Mechanical Properties:												
F_{tu} , ksi:												
L	72	72	71	72	70 ^a	71	69	70	68 ^b	70	68 ^c	70
LT	72 ^d	74	71 ^e	73	70 ^a	72	69	70	68 ^b	69	68	69
ST	69	70	68 ^e	70	68	69	66	67	66	67	66	67
F_{ty} , ksi:												
L	62 ^d	65	62 ^e	64	62 ^a	64	62	62	61	62	61	63
LT	62 ^d	65	62 ^e	65	61 ^a	63	60	62	60	61	59	61
ST	59 ^d	61	58 ^e	61	58 ^a	61	57	58	57	58	56	58
F_{cy} , ksi:												
L	60	63	60	62	59	61	58	60	59	60	59	61
LT	64	67	64	67	63	66	62	64	62	64	61	63
ST	63	66	63	66	62	65	61	63	61	63	60	63
F_{su} , ksi	45	47	44	46	44	45	43	44	43	44	43	44
F_{bru}^f , ksi:												
(e/D = 1.5)	114	117	112	115	110	114	108	110	105	108	105	106
(e/D = 2.0)	145	150	143	147	140	145	137	140	134	136	133	134
F_{bry}^f , ksi:												
(e/D = 1.5)	93	97	93	97	92	96	90	93	90	92	88	91
(e/D = 2.0)	114	119	114	119	112	117	110	113	110	113	108	112
e , percent (S-basis):												
L	9	...	9	...	8	...	7	...	6	...	6	...
LT	6	...	5	...	4	...	4	...	4	...	4	...
ST	3	...	3	...	3	...	3	...	3	...	3	...
E , 10 ³ ksi	10.4											
E_c , 10 ³ ksi	10.6											
G , 10 ³ ksi	3.9											
μ	0.33											
Physical Properties:												
ω , lb/in. ³	0.102											
C , Btu/(lb)(°F)	0.23											
K , Btu/[(hr)(ft ²)(°F)/ft]	91											
α , 10 ⁻⁶ in./in./°F	12.8											

- a S-basis values. Rounded T_{99} values are as follows: $F_{tu}(L) = 71$ ksi; $F_{tu}(LT) = 71$ ksi; $F_{ty}(L) = 63$ ksi; $F_{ty}(LT) = 62$ ksi; and $F_{ty}(ST) = 59$ ksi.
- b S-basis values. Rounded T_{99} values are as follows: $F_{tu}(L) = 69$ ksi; $F_{tu}(LT) = 69$ ksi.
- c S-basis values. Rounded T_{99} values are as follows: $F_{tu}(L) = 69$ ksi.
- d S-basis values. Rounded T_{99} values are as follows: $F_{tu}(LT) = 73$ ksi; $F_{ty}(L) = 64$ ksi; $F_{ty}(LT) = 64$ ksi; and $F_{ty}(ST) = 60$ ksi.
- e S-basis values. Rounded T_{99} values are as follows: $F_{tu}(LT) = 72$ ksi; $F_{tu}(ST) = 69$ ksi; $F_{ty}(L) = 63$ ksi; and $F_{ty}(LT) = 63$ ksi, $F_{ty}(ST) = 59$ ksi.
- f See Table 3.1.2.1.1. Bearing values are “dry pin” values per Section 1.4.7.1.

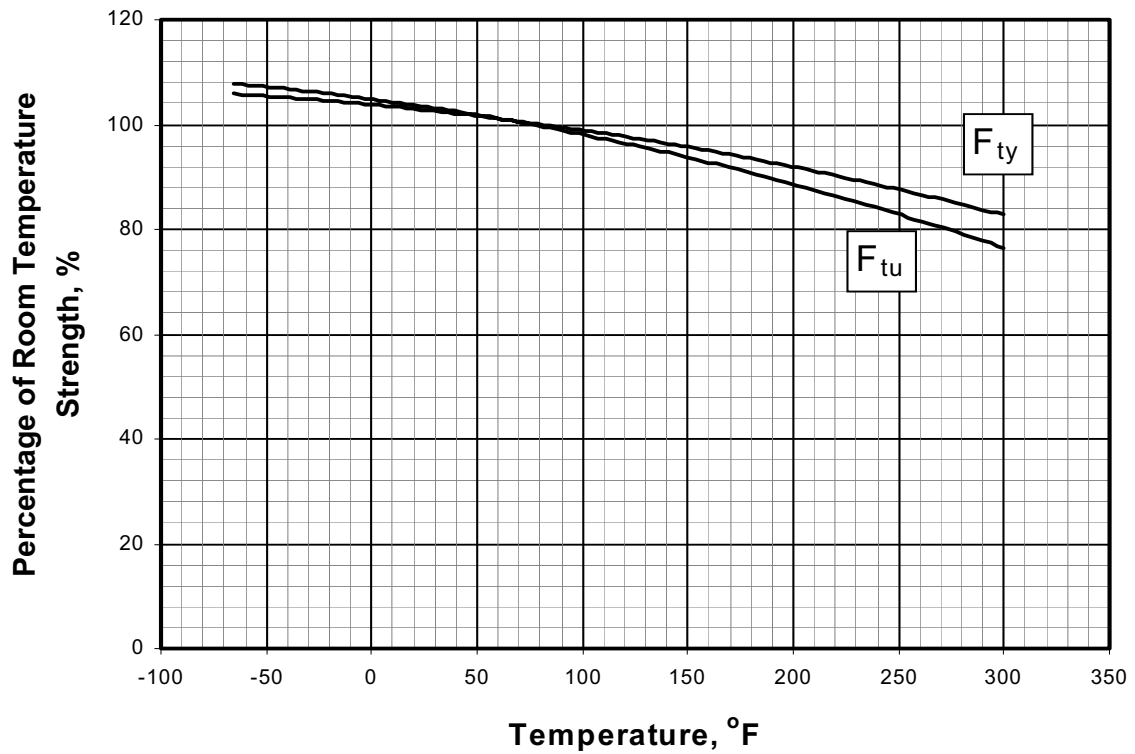

Figure 3.7.2.0 Effect of temperature on the tensile ultimate strength (F_{tu}) and the tensile yield strength (F_{ty}) of 7040-T7451 aluminum alloy plate, T/4 location.

3.7.3 7049/7149 ALLOY

3.7.3.0 Comments and Properties — Alloy 7049/7149 is available in the form of die forging, hand forging, plate, and extrusion. Alloy 7149 contains lower residual iron and silicon content than 7049. The T73XX temper provides good static strength with high resistance to stress-corrosion cracking. The fatigue strength of the T73XX temper is about equal to that of 7075-T6, while the toughness is somewhat higher. Refer to Section 3.1.2.3 for comments regarding the resistance of the alloys to stress-corrosion cracking and to Section 3.1.3.4 for comments regarding the weldability of the alloys.

The properties of extrusions should be based upon the thickness at the time of quenching prior to machining. Selection of the mechanical properties based upon its final machined thickness may be unconservative; therefore, the thickness at the time of quenching to achieve properties is an important factor in the selection of the proper thickness column. For extrusions having sections with various thicknesses, consideration should be given to the properties as a function of thickness.

Material specifications for 7049/7149 aluminum alloy are presented in Table 3.7.3.0(a). Room-temperature mechanical and physical properties are shown in Tables 3.7.3.0(b) through (e).

Table 3.7.3.0(a). Material Specifications for 7049/7149 Aluminum Alloy

Specification	Form
AMS-QQ-A-367 (7049)	Forging
AMS 4111 (7049)	Forging
AMS 4320 (7149)	Forging
AMS 4157 (7049)	Extrusion
AMS-A-22771	Forging
AMS 4200 (7049)	Plate
AMS 4343 (7149)	Extrusion

The temper index for 7049/7149 is as follows:

<u>Section</u>	<u>Temper</u>
3.7.3.1	T73 and T73511

3.7.3.1 T73 and T73511 Tempers — Figure 3.7.3.1.1 presents elevated temperature curves for various products. Figures 3.7.3.1.6(a) through (g) present tensile and compressive stress-strain and tangent-modulus curves. Fatigue data for 7049-T73 die and hand forgings are shown in Figures 3.7.3.1.8(a) through (g).

MIL-HDBK-5J
31 January 2003

Table 3.7.3.0(b). Design Mechanical and Physical Properties of 7049 Aluminum Alloy Plate

Specification	AMS 4200							
	Plate							
	T7351							
Thickness, in.	0.750- 1.000	1.001- 1.500	1.501- 2.000	2.001- 2.500	2.501- 3.000	3.001- 4.000	4.001- 4.500	4.501- 5.000
Basis	S	S	S	S	S	S	S	S
Mechanical Properties:								
F_{tu} , ksi:								
L	72	72	71	70	68	68
LT	74	73	73	73	72	70	68	68
ST	69	69	68	65	63	63
F_{ty} , ksi:								
L	64	63	62	60	58	58
LT	65	64	64	63	62	60	58	58
ST	59	58	57	56	54	54
F_{cy} , ksi:								
L	64	63	62	60	58	...
LT	69	68	67	64	62	...
ST	69	68	67	64	62	...
F_{su} , ksi	41	41	41	39	38	...
F_{bru}^a , ksi:								
(e/D = 1.5)	114	112	109	106	...
(e/D = 2.0)	146	144	140	136	...
F_{bry}^a , ksi:								
(e/D = 1.5)	91	89	86	83	...
(e/D = 2.0)	106	104	101	97	...
e , percent:								
L	6	6	5
LT	8	8	7	6	6	5	5	5
ST	2	2	2
E , 10^3 ksi	10.1							
E_c , 10^3 ksi	10.4							
G , 10^3 ksi	3.9							
μ	0.33							
Physical Properties:								
ω , lb/in. ³	0.103							
C , Btu/(lb)(°F)	0.23 (at 212°F)							
K , Btu/[(hr)(ft ²)(°F)/ft]	89 (at 77°F)							
α , 10^{-6} in./in./°F	13.0 (RT to 212°F)							

a Bearing values are "dry pin" values per Section 1.4.7.1. See Table 3.1.2.1.1.

Table 3.7.3.0(c). Design Mechanical and Physical Properties of 7049/7149 Aluminum Alloy Die Forging

Specification	AMS-QQ-A-367, AMS 4111, AMS 4320, and AMS-A-22771									
	Die forging									
	T73 ^a									
	≤1.000		1.001-2.000		2.001-3.000		3.001-4.000		4.001-5.000	
Basis	A	B	A	B	A	B	A	B	A	B
Mechanical Properties:										
F_{tu} , ksi:										
L	71	74	70	73	69	72	68	71	67	70
T ^c (S-basis)	71 ^d	...	70 ^d	...	70 ^d	...	70 ^d	...	68 ^d	...
F_{ty} , ksi:										
L	60	64	59	63	58	61	57	60	55	59
T ^c (S-basis)	61 ^d	...	60 ^d	...	60 ^d	...	60 ^d	...	58 ^d	...
F_{cy} , ksi:										
L	62	66	61	65	60	63	59	62	57	61
ST	56	60	55	59	54	57	53	56	51	55
F_{su} , ksi	40	41	39	41	39	40	38	40	37	39
F_{bru}^e , ksi:										
(ε/D = 1.5)	100	105	99	103	98	102	96	100	95	99
(ε/D = 2.0)	132	138	130	136	128	134	126	132	125	130
F_{bry}^e , ksi:										
(ε/D = 1.5)	76	82	75	80	74	78	73	76	70	75
(ε/D = 2.0)	93	99	91	97	90	94	88	93	85	91
e , percent (S-basis):										
L	7	...	7	...	7	...	7	...	7	...
T ^c	3	...	3	...	3	...	2	...	2	...
E , 10 ³ ksi	10.2									
E_c , 10 ³ ksi	10.7									
G , 10 ³ ksi	3.9									
μ	0.33									
Physical Properties:										
ω , lb/in. ³	0.103									
C , Btu/(lb)(°F)	0.25 (at 212°F)									
K , Btu/[(hr)(ft ²)(°F)/ft]	89 (at 77°F)									
α , 10 ⁻⁶ in./in./°F	13.0 (RT to 212°F)									

- a Design values were based upon data obtained from testing T73 die forgings, heat treated by suppliers and supplied in T73 temper.
- b Thickness at the time of heat treatment. When die forgings are machined before heat treatment, the mechanical properties are applicable provided the as-forged thickness is not greater than twice the thickness at the time of heat treatment.
- c T indicates any grain direction not within ±15° of being parallel to the forging flow lines. $F_{cy}(T)$ values are based upon short transverse (ST) test data.
- d Specification value. T tensile properties are presented on an S-basis only.
- e Bearing values are "dry pin" values per Section 1.4.7.1.

Table 3.7.3.0(d). Design Mechanical and Physical Properties of 7049/7149 Aluminum Alloy Hand Forging

Specification	AMS-QQ-A-367, AMS 4111, AMS 4320, and AMS-A-22771		
Form	Hand forging		
Temper	T73		
Thickness ^a , in.	2.001-3.000	3.001-4.000	4.001-5.000
Basis	S	S	S
Mechanical Properties:			
F_{tu} , ksi:			
L	71	69	67
LT	71	69	67
ST	69	67	66
F_{ly} , ksi:			
L	61	59	56
LT	59	57	56
ST	58	56	55
F_{cy} , ksi:			
L	60	58	57
LT	61	59	57
ST	61	59	58
F_{su} , ksi:			
L	42	41	39
LT	41	39	38
ST	41	40	39
F_{bru}^b , ksi:			
(e/D = 1.5)	102	100	97
(e/D = 2.0)	134	130	126
F_{bry}^b , ksi:			
(e/D = 1.5)	81	79	77
(e/D = 2.0)	96	92	91
e , percent:			
L	9	8	7
LT	4	3	3
ST	3	2	2
E , 10^3 ksi	10.2		
E_c , 10^3 ksi	10.6		
G , 10^3 ksi	3.9		
μ	0.33		
Physical Properties:			
ω , lb./in. ³	0.103		
C , Btu/(lb)(°F)	0.23 (at 212°F)		
K , Btu/[(hr)(ft ²)(°F)/ft]	89 (at 77°F)		
α , 10^{-6} in./in./°F	13.0 (RT to 212°F)		

- a When hand forgings are machined before heat treatment, section thickness at time of heat treatment will determine minimum mechanical properties as long as original (as-forged) thickness does not exceed maximum thickness for the alloy as shown in the table. The maximum cross-section area of hand forgings is 256 sq. in.
- b Bearing values are “dry pin” values per Section 1.4.7.1.

Table 3.7.3.0(e). Design Mechanical and Physical Properties of 7049/7149 Aluminum Alloy Extrusion

Specification	AMS 4157 and AMS 4343		
Form	Extrusion		
Temper	T73511		
Thickness, ^a in.	≤ 2.499	2.500-2.999	3.000-5.000
Basis	S	S	S
Mechanical Properties:			
F_{tu} , ksi:			
L	74	74	72
LT	70	70	68
ST	70	68
F_{ty} , ksi:			
L	64	64	62
LT	60	60	58
ST	60	58
F_{cy} , ksi:			
L	65	65	63
LT
ST
F_{su} , ksi	40	40	39
F_{bru}^b , ksi:			
(e/D = 1.5)	110	110	107
(e/D = 2.0)	144	144	140
F_{bry}^b , ksi:			
(e/D = 1.5)	85	85	83
(e/D = 2.0)	105	105	101
e , percent:			
L	7	7	7
LT	5	5	5
ST	5	5
E , 10 ³ ksi	10.5		
E_c , 10 ³ ksi	11.0		
G , 10 ³ ksi	4.0		
μ	0.33		
Physical Properties:			
ω , lb/in. ³	0.103		
C , Btu/(lb)(°F)	0.23 (at 212°F)		
K , Btu/[(hr)(ft ²)(°F)/ft] ..	89 (at 77°F)		
α , 10 ⁻⁶ in./in./°F	13.0 (RT to 212°F)		

a The mechanical properties are to be based upon the thickness at the time of quench.

b Bearing values are "dry pin" values per Section 1.4.7.1.

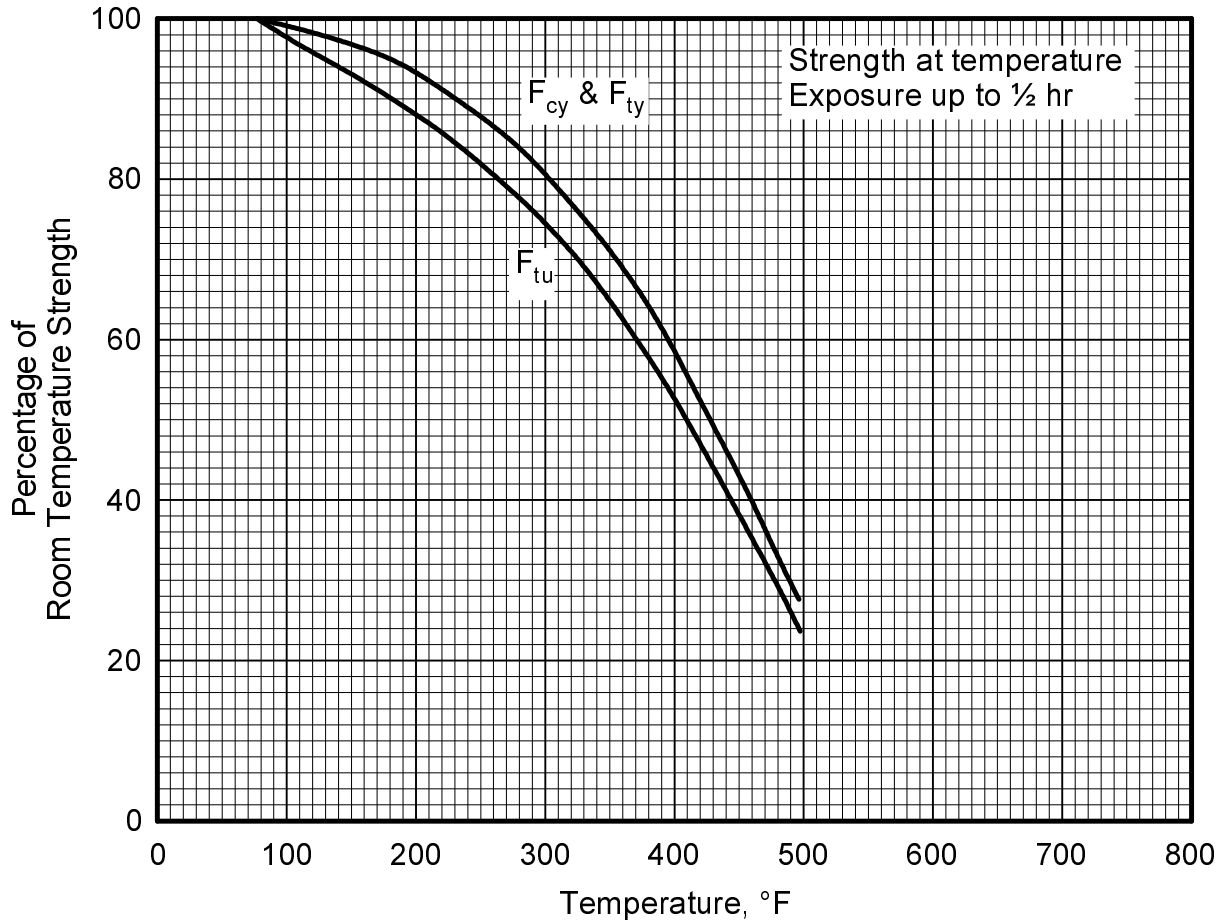

Figure 3.7.3.1.1. Effect of temperature on the tensile ultimate strength (F_{tu}), the tensile yield strength (F_{ty}), and the compressive yield strength (F_{cy}) of 7049-T7351 plate, 7049/7149-T73 hand forging, and 7049/7149-T7351 extrusion.

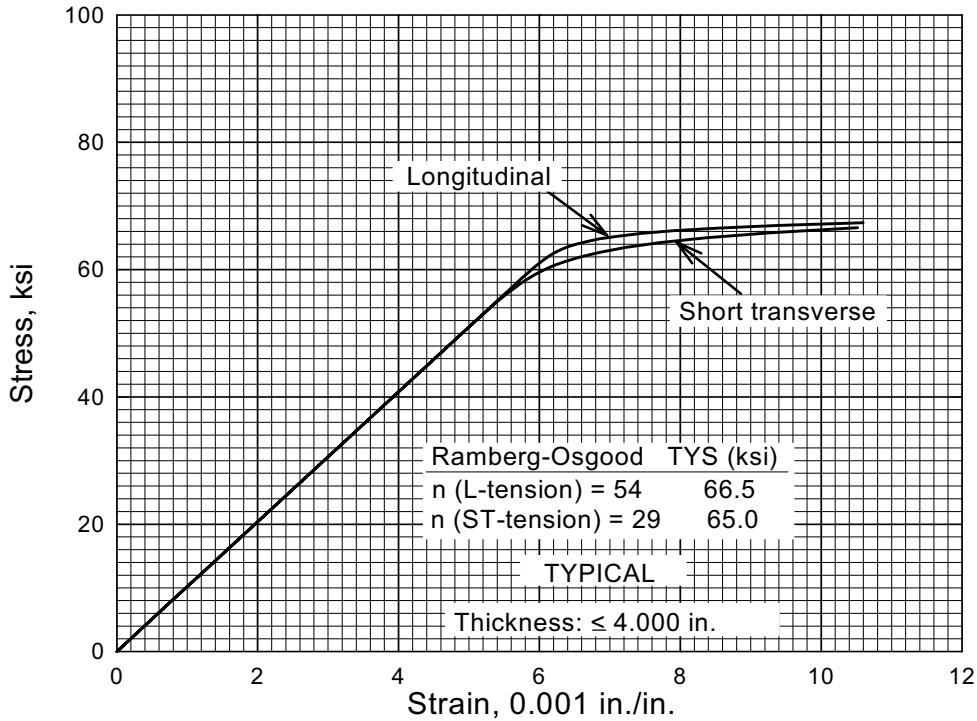

Figure 3.7.3.1.6(a). Typical tensile stress-strain curves for 7049/7149-T73 aluminum alloy die forging at room temperature.

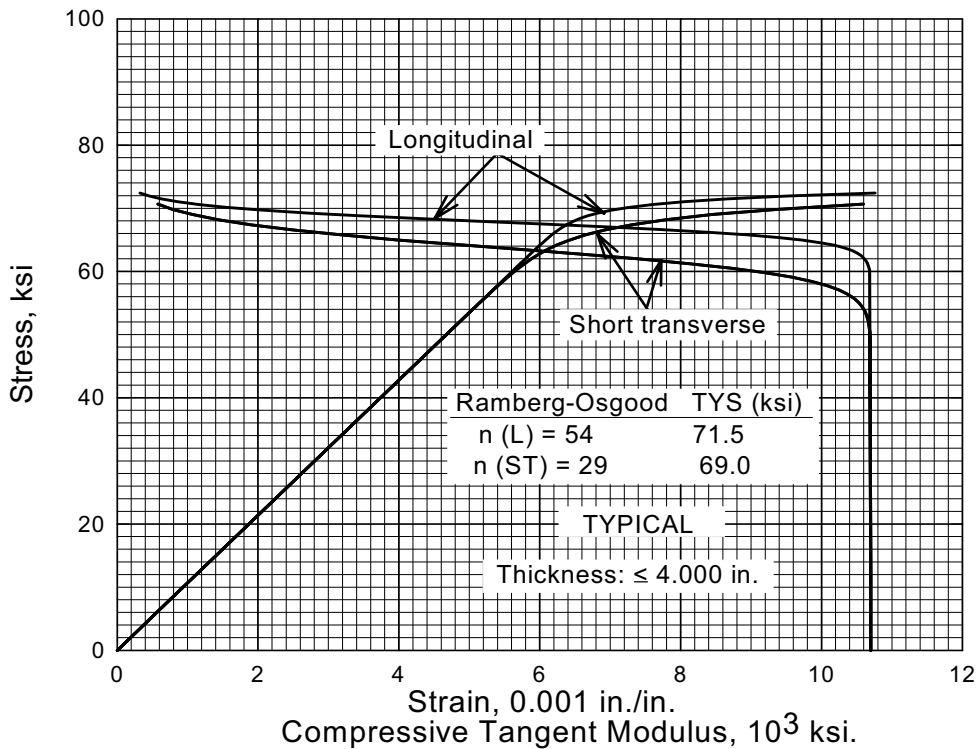

Figure 3.7.3.1.6(b). Typical compressive stress-strain and compressive tangent-modulus curves for 7049/7149-T73 aluminum alloy die forging at room temperature.

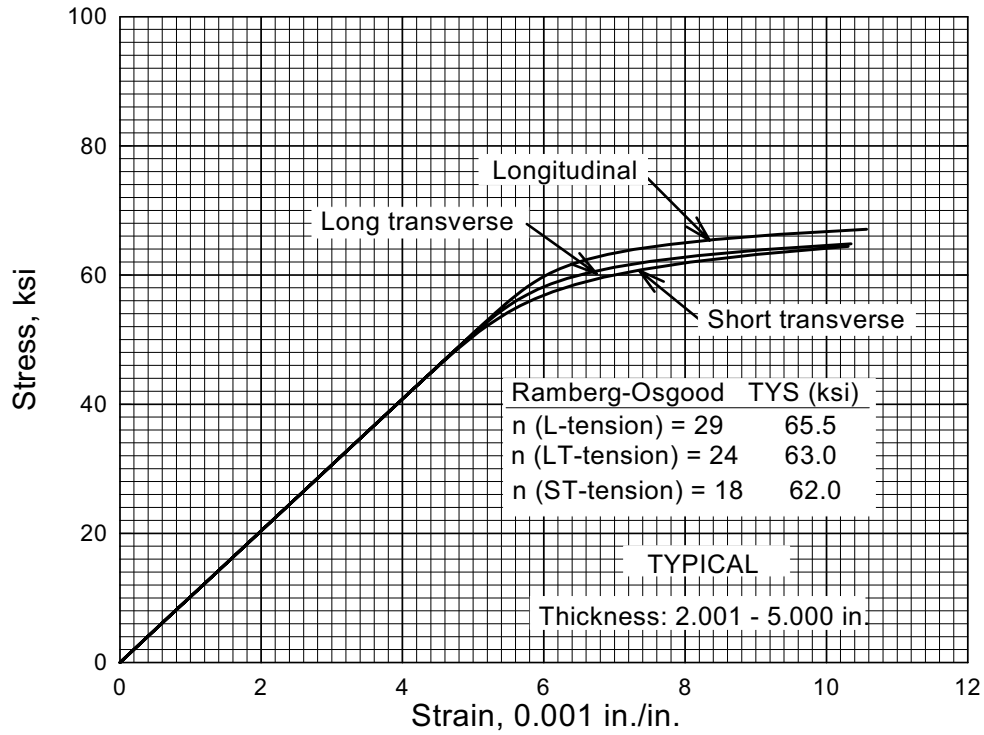

Figure 3.7.3.1.6(c). Typical tensile stress-strain curves for 7049/7149-T73 aluminum alloy hand forging at room temperature.

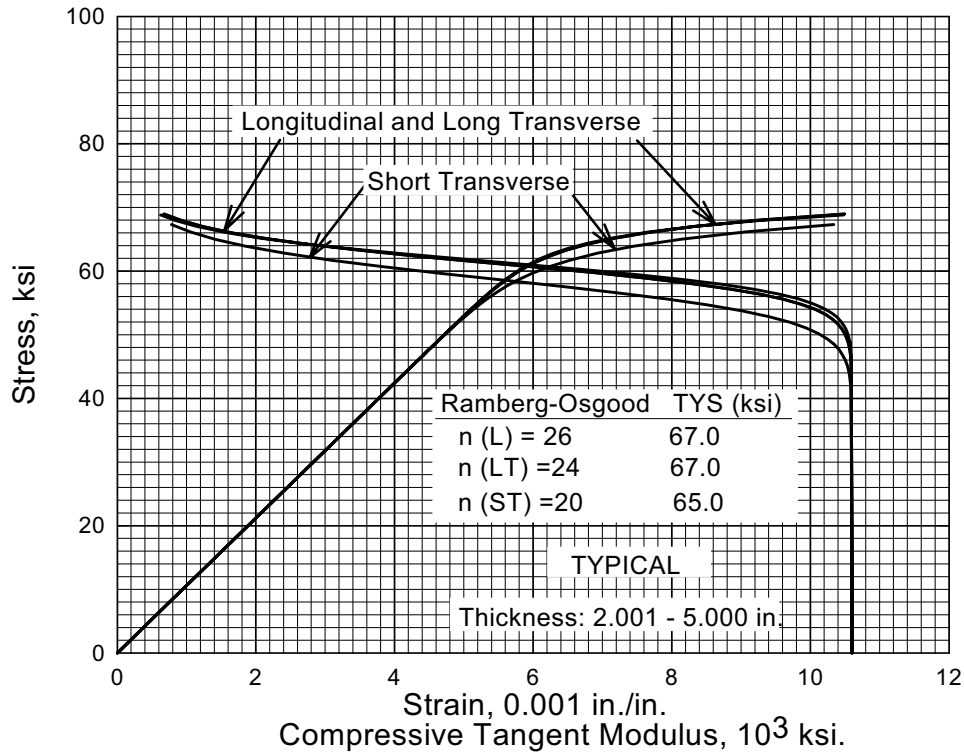

Figure 3.7.3.1.6(d). Typical compressive stress-strain and compressive tangent-modulus curves for 7049/7149-T73 aluminum alloy hand forging at room temperature.

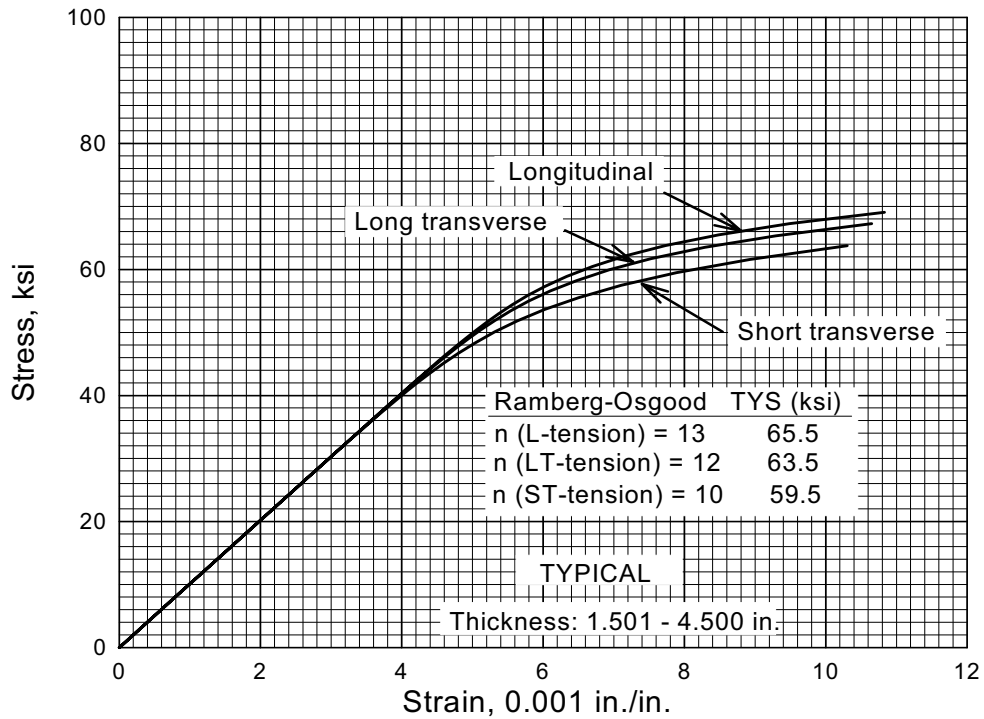

Figure 3.7.3.1.6(e). Typical tensile stress-strain curves for 7049-T7351 aluminum alloy plate at room temperature.

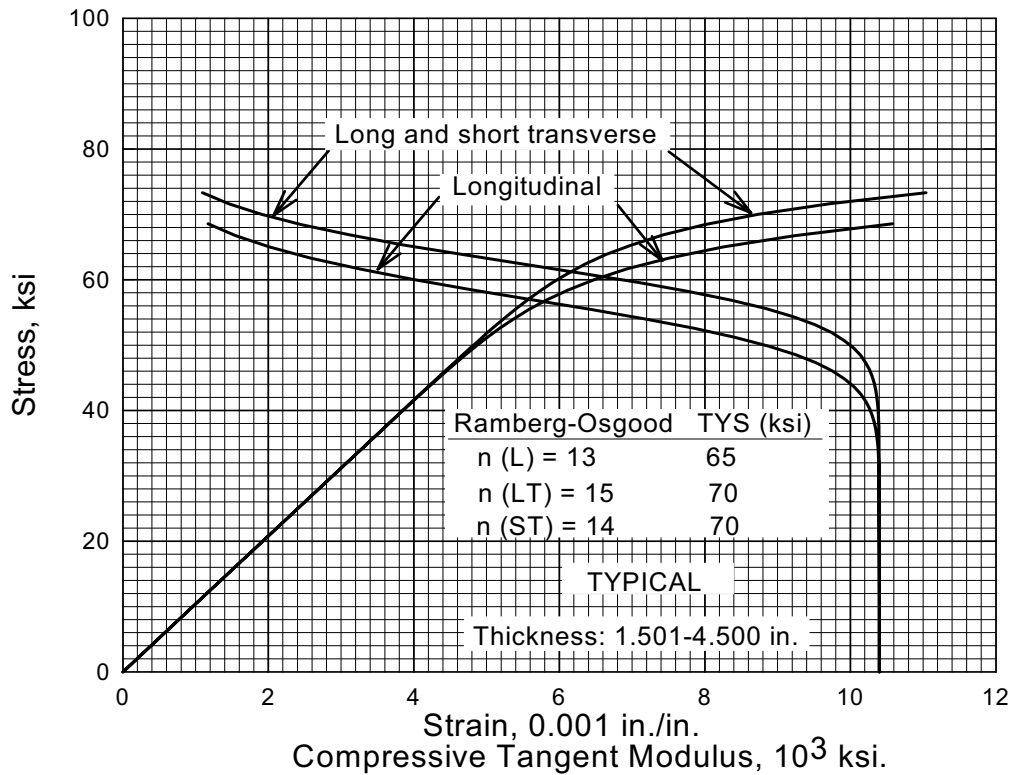

Figure 3.7.3.1.6(f). Typical compressive stress-strain and compressive tangent-modulus curves for 7049-T7351 aluminum alloy plate at room temperature.

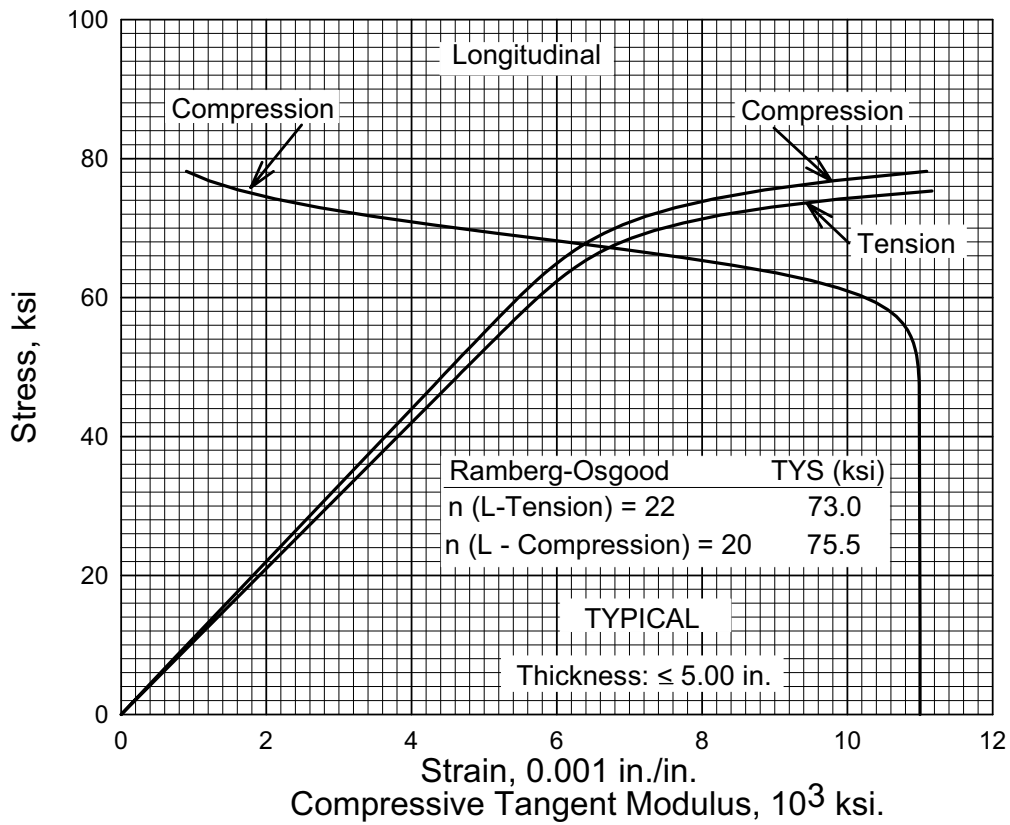

Figure 3.7.3.1.6(g). Typical tensile and compressive stress-strain and compressive tangent-modulus curves for 7049/7149-T73511 extrusion at room temperature.

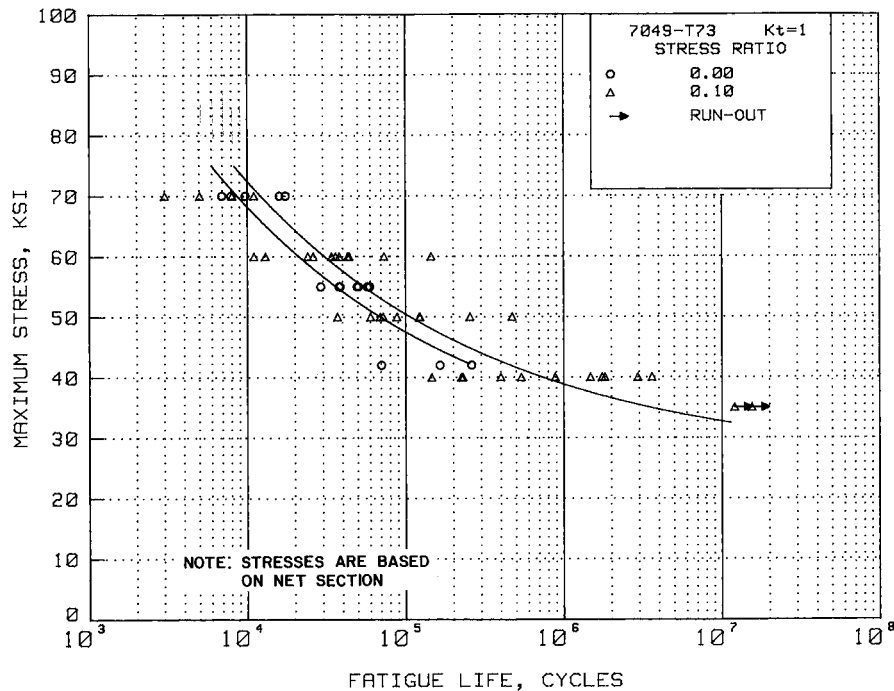

Figure 3.7.3.1.8(a). Best-fit S/N curves for unnotched 7049-T73 die and hand forgings, at room temperature, longitudinal and long-transverse directions.

Correlative Information for Figure 3.7.3.1.8(a)

Product Form: Die forging, 3 and 4.5 inches thick. Hand forging, 2, 3, 4, and 5 inches thick

Test Parameters:
Loading - Axial
Frequency - 1800 cpm
Temperature - RT
Environment - Lab air

Properties:

	TUS, ksi	TYS, ksi	Temp., °F
(L)	78	70	RT
(LT)	74	65	RT

No. of Heats/Lots: 6

Specimen Details: Unnotched
Uniform Gage,
0.200 inch net diameter
Hourglass,
0.225 inch net diameter
3.00 inch test section radius
Hourglass,
0.300 inch net diameter
9.875 inch test section radius

Stress Life Equation:
 $\log N_f = 9.95 - 3.62 \log (S_{eq} - 24.2)$
 $S_{eq} = S_{max} (1-R)^{0.57}$
Std. Error of Estimate, $\log (\text{Life}) = 0.346$
Standard Deviation, $\log (\text{Life}) = 0.736$
 $R^2 = 78\%$

Sample Size = 50

Surface Condition: Longitudinally polished to 4 RMS finish or better
Unspecified

[Caution: The equivalent stress model may provide unrealistic life predictions for stress ratios beyond those represented above.]

References: 3.7.3.1.8(a), (b), and 3.2.6.1.9(d)

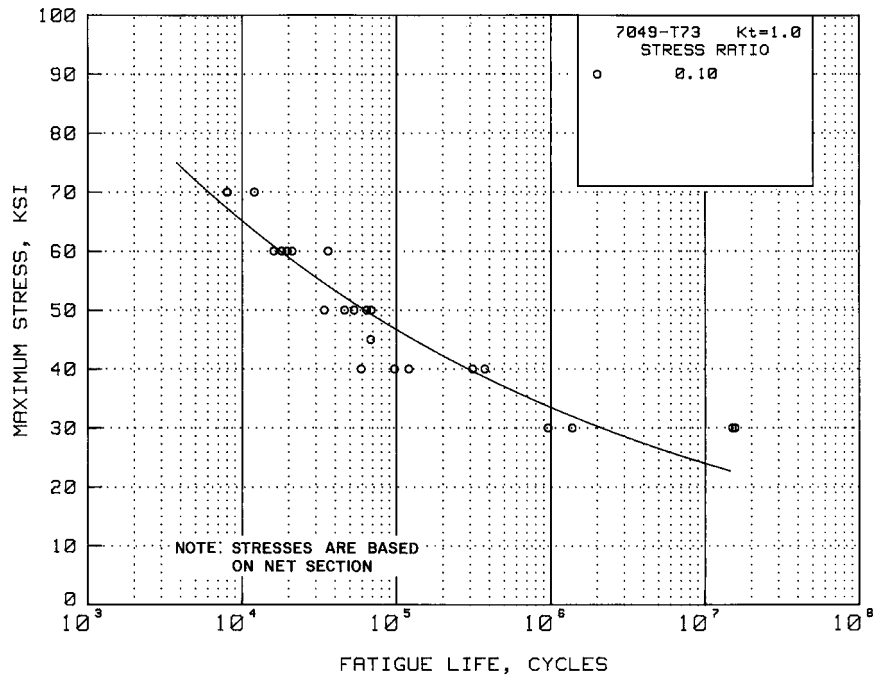

Figure 3.7.3.1.8(b). Best-fit curves for unnotched 7049-T73 die forging, at room temperature, short transverse direction.

Correlative Information for Figure 3.7.3.1.8(b)

Product Form: Die forging, 3 inches thick

Test Parameters:

Properties: TUS, ksi TYS, ksi Temp., °F
 73 64 RT

Loading - Axial
Frequency - 1800 cpm
Temperature - RT
Environment - Air

Specimen Details: Unnotched
 0.200 inch net diameter

No. of Heats/Lots: 1

Surface Condition: Longitudinally polished to 4μ in.
 finish with no circumferential
 marks

Maximum Stress Equation:
 $\log N_f = 16.55 - 6.92 \log (S_{max})$
Std. Error of Estimate, $\log (\text{Life}) = 0.371$
Standard Deviation, $\log (\text{Life}) = 0.917$
 $R^2 = 84\%$

Reference: 3.7.3.1.8(a)

Sample Size = 23

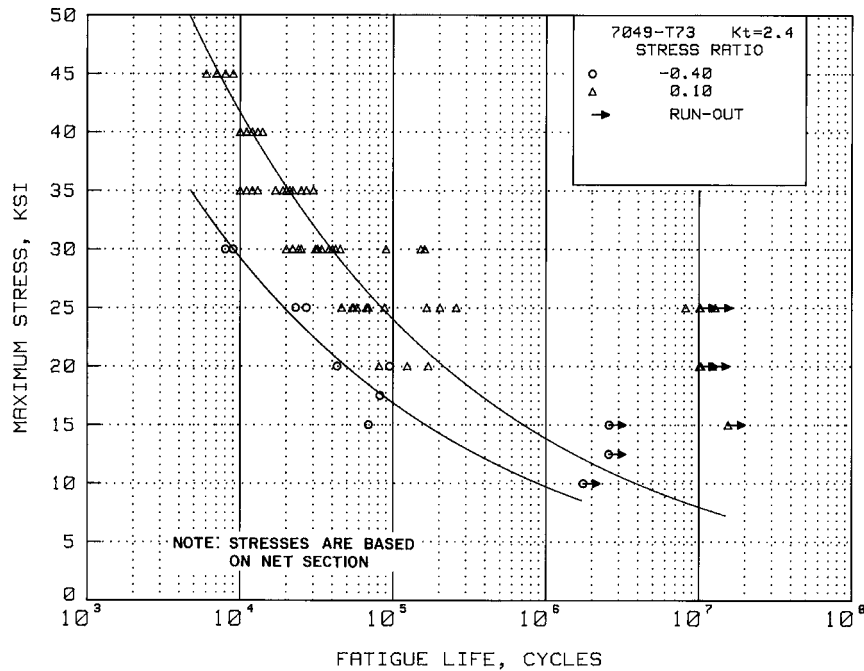

Figure 3.7.3.1.8(c). Best-fit S/N curves for notched, $K_t = 2.4$, 7049-T73 die forging, at room temperature, longitudinal, long-transverse and short-transverse directions.

Correlative Information for Figure 3.7.3.1.8(c)

Product Form: Die forging, 3 and 4.5 inches thick

Test Parameters:
Loading - Axial
Frequency - 1800 cpm
Temperature - RT
Environment - Lab air

<u>Properties:</u>	<u>TUS, ksi</u>	<u>TYS, ksi</u>	<u>Temp., °F</u>
(L)	77	68	RT Unnotched
	95	—	RT Notched
(LT)	73	64	RT Unnotched
	77	—	RT Notched
(ST)	75	66	RT Unnotched
	87	—	RT Notched

No. of Heats/Lots: 2

Stress Life Equation:

$$\log N_f = 10.6 - 4.18 \log (S_{eq})$$

$$S_{eq} = S_{max} (1-R)^{0.80}$$

Std. Error of Estimate, $\log (\text{Life}) = 0.320$

Standard Deviation, $\log (\text{Life}) = 0.500$

$R^2 = 59\%$

Specimen Details: Circumferentially notched,
 $K_t = 2.4$
0.150 or 2.00 inch net diameter
0.350 inch net diameter
0.500 inch gross diameter
0.032 inch notch root radius, r
60° flank angle, ω

Sample Size = 69

[Caution: The equivalent stress model may provide unrealistic life predictions for stress ratios beyond those represented above.]

Surface Condition: Machined notch

References: 3.7.3.1.8(a) and (c)

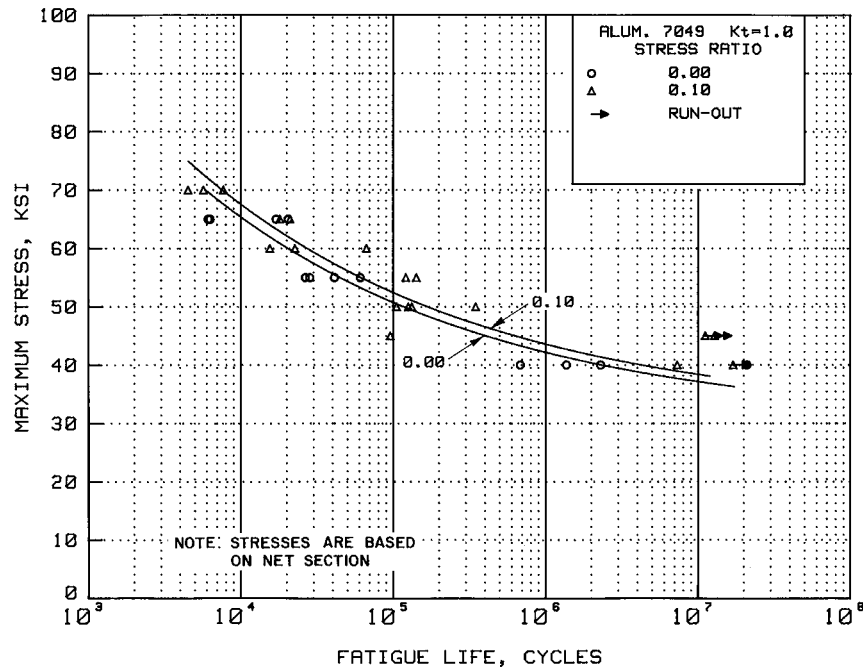

Figure 3.7.3.1.8(d). Best-fit S/N curves for unnotched 7049-T73 hand forging, longitudinal direction.

Correlative Information for Figure 3.7.3.1.8(d)

Product Form: Hand forging, 2.0 to 5.0 inches thick

Test Parameters:

Loading - Axial

Frequency - 800, 1500, or 1725 cpm

Temperature - RT

Environment - Air

Properties: TUS, ksi TYS, ksi Temp., °F
 70-80 60-73 RT

Specimen Details: Unnotched
 0.125 and 0.300 inch diameter

No. of Heats/Lots: 6

Surface Condition: Polished with increasingly finer grits of emery paper to surface roughness of 10 rms with polishing marks longitudinal, or not specified.

Equivalent Stress Equation:

$$\log N_f = 10.6 - 4.31 \log (S_{eq} - 30)$$

$$S_{eq} = S_{max} (1-R)^{0.31}$$

Std. Error of Estimate, Log (Life) = 0.348

Standard Deviation, Log (Life) = 0.944

$R^2 = 86\%$

References: 3.2.6.1.9(d) and 3.7.3.1.8(e)

Sample Size = 28

[Caution: The equivalent stress model may provide unrealistic life predictions for stress ratios beyond those represented above.]

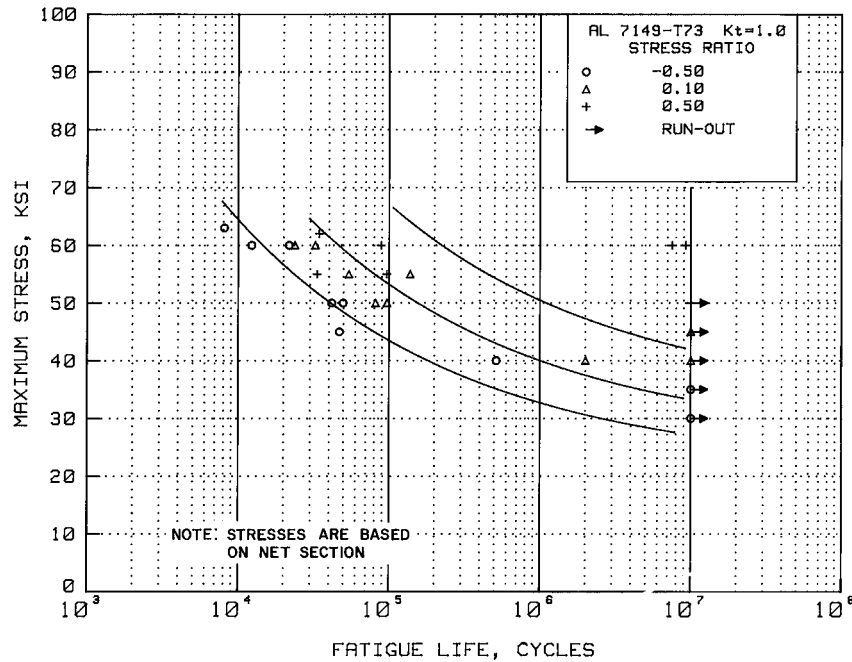

Figure 3.7.3.1.8(e). Best-fit S/N curves for unnotched 7149-T73 hand forging, long-transverse direction.

Correlative Information for Figure 3.7.3.1.8(e)

Product Form: Hand forging, 4.00 to 4.75 inches thick

Test Parameters:
Loading - Axial
Frequency - Not specified
Temperature - RT
Environment - Air

Properties: TUS, ksi TYS, ksi Temp., °F
 73 64 RT

Specimen Details: Unnotched
0.250 inch diameter

No. of Heats/Lots: 3

Surface Condition: Not specified.

Equivalent Stress Equation:
 $\log N_f = 9.9 - 3.46 \log (S_{eq} - 25)$
 $S_{eq} = S_{max} (1-R)^{0.39}$
Std. Error of Estimate, $\log (\text{Life}) = 0.689$
Standard Deviation, $\log (\text{Life}) = 0.845$
 $R^2 = 34\%$

Reference: 3.7.3.1.8(e)

Sample Size = 20

[Caution: The equivalent stress model may provide unrealistic life predictions for stress ratios beyond those represented above.]

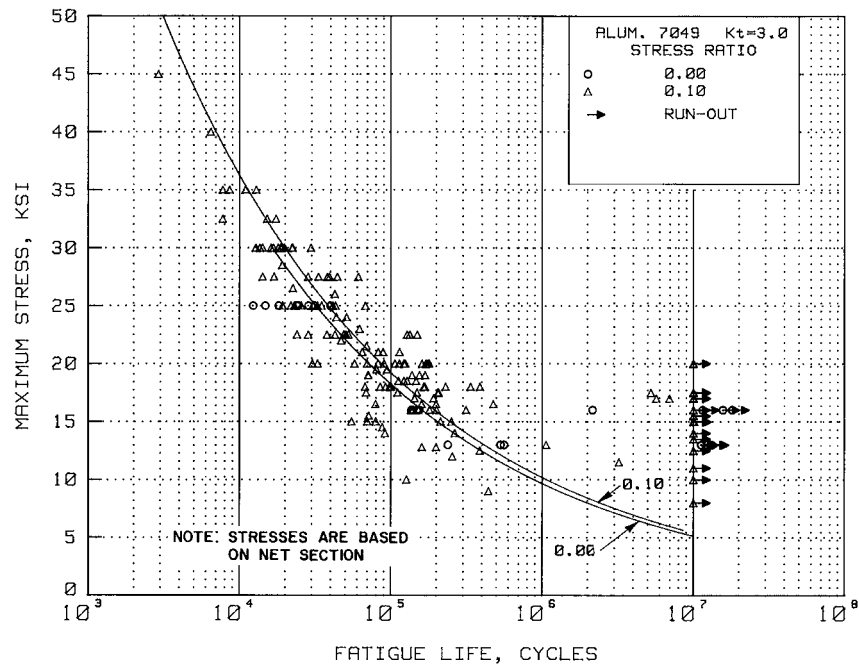

Figure 3.7.3.1.8(f). Best-fit S/N curves for notched, $K_t = 3.0$, 7049-T73 hand forging, longitudinal, long-transverse, and short-transverse directions.

Correlative Information for Figure 3.7.3.1.8(f)

Product Form: Hand forging, 2.0 to 5.0 inches thick

Test Parameters:

Properties: T_{US} , ksi T_{YS} , ksi $T_{emp.}$, °F
71-80 62-73 RT

Loading - Axial
Frequency - 800, 1500, or 1725 cpm
Temperature - RT
Environment - Air

Specimen Details: Circumferentially notched, $K_t=3.0$
0.200, 0.300, and 0.306 inch gross diameter
0.175, 0.200, and 0.253 inch net diameter
0.006, 0.010, and 0.013 inch root radius, r
60° flank angle, ω

No. of Heats/Lots: 8

Equivalent Stress Equation:

$\log N_f = 9.57 - 3.63 \log (S_{eq})$
 $S_{eq} = S_{max} (1-R)^{0.49}$
Std. Error of Estimate, $\log (\text{Life}) = 0.344$
Standard Deviation, $\log (\text{Life}) = 0.562$
 $R^2 = 63\%$

Surface Condition: Polished with oil and alumdum grit applied to a rotating wire, or not specified.

Sample Size = 151

References: 3.2.6.1.9(d), 3.7.3.1.8(d) and (e)

[Caution: The equivalent stress model may provide unrealistic life predictions for stress ratios beyond those represented above.]

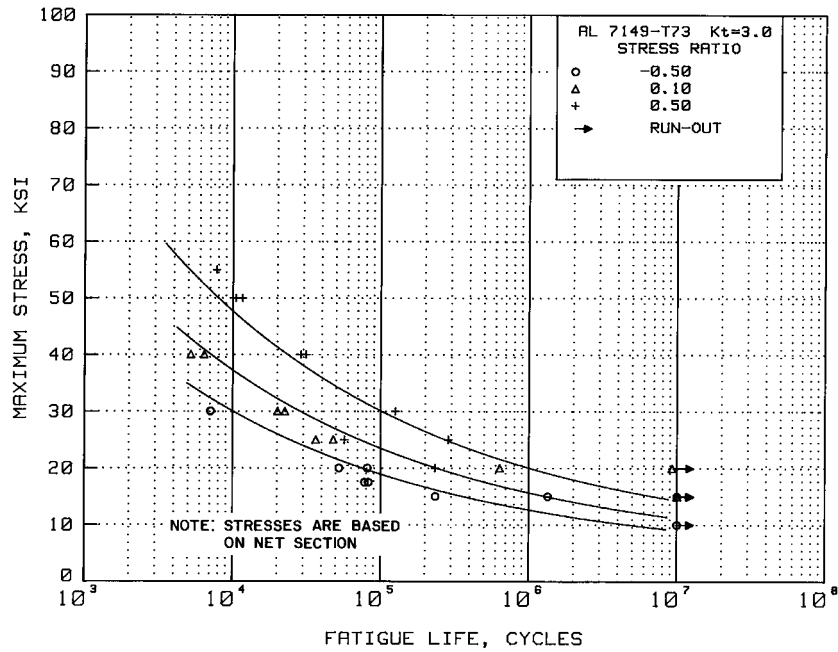

Figure 3.7.3.1.8(g). Best-fit S/N curves for notched, $K_t = 3.0$, 7149-T73 hand forging, long transverse direction.

Correlative Information for Figure 3.7.3.1.8(g)

Product Form: Hand forging, 4.00 to 4.75 inches thick

Test Parameters:
Loading - Axial
Frequency - Not specified
Temperature - RT
Environment - Air

Properties: TUS, ksi TYS, ksi Temp., °F
 73 64 RT

Specimen Details: Circumferentially notched,
 $K_t = 3.0$
0.375 inch gross diameter
0.253 inch net diameter
0.013 inch root radius, r
60° flank angle, ω

No. of Heats/Lots: 3

Equivalent Stress Equation:
 $\log N_f = 10.1 - 4.10 \log (S_{eq} - 5)$
 $S_{eq} = S_{max} (1-R)^{0.42}$
Std. Error of Estimate, $\log (\text{Life}) = 0.450$
Standard Deviation, $\log (\text{Life}) = 0.797$
 $R^2 = 68\%$

Surface Condition: Not specified

Reference: 3.7.3.1.8(e)

Sample Size = 25

[Caution: The equivalent stress model may provide unrealistic life predictions for stress ratios beyond those represented above.]

3.7.4 7050 ALLOY

3.7.4.0 Comments and Properties — 7050 is an Al-Zn-Mg-Cu-Zr alloy developed to have a combination of high strength, high resistance to stress-corrosion cracking, and good fracture toughness, particularly in thick sections. The use of zirconium in lieu of chromium provides a low sensitivity to quench, which results in high strengths in thick sections. Plate, hand, and die forgings in the T74 temper have static strengths about equivalent to those of corresponding products of 7079 in the T6 tempers and toughness levels equal to or higher than other conventional high-strength alloys.

The properties of extrusions should be based upon the thickness at the time of quenching prior to machining. Selection of the mechanical properties based upon its final machined thickness may be unconservative; therefore, the thickness at the time of quenching to achieve properties is an important factor in the selection of the proper thickness column. For extrusions having sections with various thicknesses, consideration should be given to the properties as a function of thickness.

Plate in the T7451 temper has stress-corrosion resistance higher than 7075-T7651, and hand and die forgings in the T7452 and T74 tempers, respectively, have stress-corrosion resistance similar to 7175-T74 forgings. The T73 temper provides the highest resistance to stress corrosion for this alloy. The T76 temper provides for good exfoliation resistance and higher stress-corrosion resistance than T6 tempers of 7075 and 7178. The T74 temper provides stress-corrosion and strength characteristics intermediate to those of T76 and T73. Refer to Section 3.1.2.3 for further comments regarding the resistance of the alloy to stress-corrosion cracking.

Refer to Section 3.1.3.4 for comments regarding the weldability of this alloy.

Material specifications for 7050 are shown in Table 3.7.4.0(a). Room-temperature properties are shown in Table 3.7.4.0(b₁) through (e₃).

Table 3.7.4.0(a). Material Specifications for 7050 Aluminum Alloy

Specification	Form
AMS 4050	Bare plate
AMS 4108	Hand forging
AMS 4107	Die forging
AMS 4333	Die forging
AMS 4340	Extruded shape
AMS 4341	Extruded shape
AMS 4342	Extruded shape
AMS 4201	Bare plate
AMS-A-22771	Forging

The temper index for 7050 is as follows:

<u>Section</u>	<u>Temper</u>
3.7.4.1	T73510 and T73511
3.7.4.2	T74, T7451, and T7452 (formerly T736, T73651, T73652)
3.7.4.3	T76510 and T76511

3.7.4.1 T73510 and T73511 Tempers — Figures 3.7.4.1.6(a) through (d) present stress-strain and tangent-modulus curves for extrusions. Fatigue data are presented in Figures 3.7.4.1.8(a) and (b).

3.7.4.2 T74, T7451, and T7452 Tempers — Elevated temperature curves for T7451 plate are presented in Figure 3.7.4.2.1. Figures 3.7.4.2.6(a) through (j) present stress-strain and tangent-modulus curves for various products and tempers. Fatigue data are presented in Figures 3.7.4.2.8(a) through (l). Fatigue-crack-propagation data for T7451 plate are presented in Figures 3.7.4.2.9(a) through (c).

3.7.4.3 T76510 and T76511 Tempers — Figures 3.7.4.3.6(a) through (f) present stress-strain and tangent-modulus curves for extruded shapes. Fatigue data are presented in Figure 3.7.4.3.8(a) and (b).

Table 3.7.4.0(b₁). Design Mechanical and Physical Properties of 7050 Aluminum Alloy Plate

Specification	AMS 4050															
	Plate															
	T7451															
Form	0.250-1.500		1.501-2.000		2.001-3.000		3.001-4.000		4.001-5.000		5.001-6.000		6.001-7.000		7.001-8.000	
Temper	A	B	A	B	A	B	A	B	A	B	A	B	A	B	A	B
Thickness, in.	74 ^a	76	74	76	73 ^a	75	72	74	71 ^a	73	70 ^a	72	69	72	68	71
Basis	74	76	74 ^a	76	73 ^a	75	68 ^a	71	71 ^a	74	70	73	69	72	68	71
Mechanical Properties:																
<i>F_m</i> , ksi:																
L	64 ^b	67	64 ^b	66	63 ^b	66	62 ^b	65	61 ^b	65	60	63	59	62	58 ^b	63
LT	64	66	64	66	63 ^b	66	62	65	61	64	60	62	59	62	58	61
ST	59	61	57	60	57 ^b	60	57	59	56	58	55 ^b	58
<i>F_{sp}</i> , ksi:																
L	63	64	62	64	61	64	60	63	58	61	57	59	56	59	55	57
LT	66	68	67	69	66	69	65	68	64	67	63	66	60	63	59	62
ST	63	66	63	66	63	66	62	64	60	63	59	62
<i>F_{br}</i> , ksi:																
L	42	43	43	44	43	44	43	45	43	45	43	45	44	46	44	46
(e/D = 1.5)	107	110	109	112	108	111	107	111	107	111	105	110	107	112	103	108
(e/D = 2.0)	140	144	142	146	141	144	140	144	138	144	137	142	136	143	132	138
<i>F_{br}</i> , ksi:																
(e/D = 1.5)	86	89	89	92	89	93	90	94	90	95	91	94	84	89	83	87
(e/D = 2.0)	101	104	104	107	104	109	104	109	105	110	105	108	99	105	98	102
<i>e</i> , percent (S-basis):																
L	10	..	10	..	9	..	9	..	9	..	8	..	7	..	6	..
LT	9	..	9	..	8	..	6	..	5	..	4	..	4	..	4	..
ST	3	..	3	..	3	..	3	..	3	..	3	..
<i>E</i> , 10 ³ ksi:																
<i>E_s</i> , 10 ³ ksi	10.3															
<i>E_c</i> , 10 ³ ksi	10.6															
<i>G</i> , 10 ³ ksi	3.9															
<i>μ</i>	0.33															
Physical Properties:																
<i>ω</i> , lb/in. ³	0.102															
<i>C</i> , Btu/(lb)(°F)	0.23 (at 212 °F)															
<i>K</i> , Btu/[(hr)(ft ²)(°F)/ft]	91 (at 77 °F)															
<i>α</i> , 10 ⁻⁶ in./in./°F	12.8 (68 to 212 °F)															

a S-basis values. Rounded *T₉₉* values for *F_m* are as follows: for 0.250-1.500 (L) = 75 ksi, for 1.502-2.000 (LT) = 75 ksi, for 2.001-3.000 (L) and (LT) = 74 ksi, for 3.001-4.000 (ST) = 69 ksi, for 4.001-5.000 (L) and (LT) = 72 ksi, for 5.001-6.000 (L) = 71ksi.

b S-basis values. Rounded *T₉₉* values for *F_y* are as follows: for 0.250-1.500 (L) = 65 ksi, for 1.502-2.000 (L) = 65 ksi, for 2.001-3.000 (L) = 64 ksi, for 3.001-4.000 (L) = 63 ksi, for 4.001-5.000 (L) = 62 ksi, (ST) = 58 ksi, for 7.001-8.000 (L) = 59 ksi, (ST) = 56 ksi.

c See Table 3.1.2.1.1. Bearing values are "dry pin" values per Section 1.4.7.1.

Table 3.7.4.0(b₂). Design Mechanical and Physical Properties of 7050 Aluminum Alloy Plate

Specification	AMS 4201							
	Plate							
Form	T7651							
Temper								
Thickness, in.	0.250- 1.000	1.001- 1.500		1.501- 2.000		2.001- 2.500		2.501- 3.000
Basis	S	A	B	A	B	A	B	S
Mechanical Properties:								
F_{tu} , ksi:								
L	76	77	79	76	78	75	78	76
LT	76	76	79	75	78	75	78	76
ST	72	75	70	73	70
F_{ty} , ksi:								
L	66	66	71	66	70	66	70	66
LT	66	66	70	65	69	65	69	66
ST	59	63	60	62	60
F_{cy} , ksi:								
L	64	64	68	64	67	64	67	64
LT	68	68	73	68	72	68	72	69
ST	67	71	67	71	68
F_{su} , ksi	43	44	46	44	46	45	47	46
F_{bru}^a , ksi:								
(e/D = 1.5)	110	112	117	112	117	114	118	116
(e/D = 2.0)	142	144	150	144	150	146	151	149
F_{bry}^a , ksi:								
(e/D = 1.5)	87	90	96	91	96	93	98	96
(e/D = 2.0)	102	105	111	105	112	107	114	110
e , percent (S-basis):								
L	9	9	...	9	...	8	...	8
LT	8	8	...	8	...	7	...	7
ST	1.5	...	1.5
E , 10 ³ ksi	10.3							
E_c , 10 ³ ksi	10.8							
G , 10 ³ ksi	4.0							
μ	0.33							
Physical Properties:								
ω , lb/in. ³	0.102							
C , Btu/(lb)(°F)	0.23 (at 212°F)							
K , Btu/[(hr)(ft ²)(°F)/ft]	89 (at 77°F)							
α , 10 ⁻⁶ in./in./°F	12.8 (68 to 212°F)							

a See Table 3.1.2.1.1. Bearing values are "dry pin" values per Section 1.4.7.1.

Table 3.7.4.0(c₁). Design Mechanical and Physical Properties of 7050 Aluminum Alloy Die Forging

Specification	AMS 4107 and AMS-A-22771			
	Die forging			
	T74 ^a			
	≤2.000	2.001-4.000	4.001-5.000	5.001-6.000
Form				
Temper				
Thickness ^b , in.				
Basis	S	S	S	S
Mechanical Properties:				
F_{tu} , ksi:				
L	72	71	70	70
T ^c	68	67	66	66
F_{ty} , ksi:				
L	62	61	60	59
T ^c	56	55	54	54
F_{cy} , ksi:				
L	63	63	63	62
ST	60	59	58	57
F_{su} , ksi	42	42	41	41
F_{bru}^d , ksi:				
(e/D = 1.5)	99	98	97	97
(e/D = 2.0)	131	129	127	127
F_{bry}^d , ksi:				
(e/D = 1.5)	82	81	78	78
(e/D = 2.0)	96	95	92	92
e , percent:				
L	7	7	7	7
T ^c	5	4	3	3
E , 10 ³ ksi	10.2			
E_c , 10 ³ ksi	10.7			
G , 10 ³ ksi	3.9			
μ	0.33			
Physical Properties:				
ω , lb/in. ³	0.102			
C , Btu/(lb)(°F)	0.23 (at 212°F)			
K , Btu/[(hr)(ft ²)(°F)/ft]	91 (at 77°F)			
α , 10 ⁻⁶ in./in./°F	12.8 (68 to 212°F)			

a Design values were based upon data obtained from testing T74 die forgings, heat treated by suppliers and supplied in T74 temper.

b Thickness at the time of heat treatment. When die forgings are machined before heat treatment, the mechanical properties are applicable provided the as-forged thickness is not greater than twice the thickness at the time of heat treatment.

c T indicates any grain direction not within ±15° of being parallel to the forging flow lines. $F_{cy}(T)$ values are based upon short transverse (ST) test data.

d Bearing values are “dry pin” values per Section 1.4.7.1.

Table 3.7.4.0(c₂). Design Mechanical and Physical Properties of 7050-T7452 Aluminum Alloy Die Forging

Specification	AMS 4333			
Form	Die forgings			
Temper	T7452			
Thickness ^b , in.	≤2.000		2.001-4.000	
Basis	A	B	A	B
Mechanical Properties:				
F_{tu} , ksi:				
L	71	73	71	72
T ^a	68 ^b	73	67 ^c	71
F_{cy} , ksi:				
L	60	63	59	61
T ^a	55 ^b	61	53 ^c	61
F_{cy} , ksi:				
L	63	66	62	64
ST	63	66	62	64
F_{su} , ksi	43	44	43	43
F_{bru} ^d , ksi:				
(e/D = 1.5)	101	104	101	103
(e/D = 2.0)	135	139	135	137
F_{bry} ^d , ksi:				
(e/D = 1.5)	87	92	86	89
(e/D = 2.0)	105	110	103	106
e , percent (S-basis):				
L	9		8	
T ^a	5		4	
E , 10 ³ ksi	10.2			
E_c , 10 ³ ksi	10.5			
G , 10 ³ ksi	3.9			
μ	0.33			
Physical Properties:				
ω , lb/in. ³	0.102			
C , Btu/(lb)(°F)	0.23 (at 212°F)			
K , Btu/[(hr)(ft ²)(°F)/ft]	91 (at 77°F)			
α , 10 ⁻⁶ in./in./°F	12.8 (68 to 212°F)			

a T indicates any grain direction not within ±15° of being perpendicular to the forging flow lines. $F_{cy}(T)$ values are based on short transverse (ST) test data.

b S-basis. The T_{99} values are higher than the specification minimum values as follows: $F_{tu}(T)=70.10$ ksi, $F_{cy}(t)=57.50$ ksi.

c S-basis. The T_{99} values are higher than the specification minimum values as follows: $F_{tu}(T)=69.36$ ksi, $F_{cy}(t)=57.38$ ksi.

d Bearing values are "dry pin" values per Section 1.4.7.1.

MIL-HDBK-5J
31 January 2003

Table 3.7.4.0(d). Design Mechanical and Physical Properties of 7050 Aluminum Alloy Hand Forging

Specification	AMS 4108 and AMS-A-22771							
Form	Hand Forging							
Temper	T7452							
Thickness, in.	≤2.000	2.001-3.000	3.001-4.000	4.001-5.000	5.001-6.000	6.001-7.000	7.001-8.000	
Basis	S	S	S	S	S	A	B	S
Mechanical Properties:								
F_{tu} , ksi:								
L	72	72	71	70	69	68	71	67
LT	71	70	70	69	68	67	70	66
ST	...	67	67	66	66	65	69	64
F_{ty} , ksi:								
L	63	62	61	60	59	56	61	57
LT	61	60	59	58	56	54 ^a	59	52
ST	...	55	55	54	53	51 ^a	56	50
F_{cy} , ksi:								
L	63	62	61	60	58	56	61	54
LT	64	63	62	61	59	57	62	55
ST	...	63	61	60	58	56	61	54
F_{su} , ksi	42	41	41	41	40	40	41	39
F_{bru}^b , ksi:								
(e/D = 1.5)	98	97	97	96	94	93	97	91
(e/D = 2.0)	131	129	129	127	125	123	129	121
F_{bry}^b , ksi:								
(e/D = 1.5)	86	84	83	82	79	76	83	73
(e/D = 2.0)	101	100	98	96	93	90	98	86
e , percent (S-basis):								
L	9	9	9	9	9	9	...	9
LT	5	5	5	4	4	4	...	4
ST	...	4	4	3	3	3	...	3
E , 10 ³ ksi	10.2							
E_c , 10 ³ ksi	10.6							
G , 10 ³ ksi	3.9							
μ	0.33							
Physical Properties:								
ω , lb/in. ³	0.102							
C , Btu/(lb)(°F)	0.23 (at 212°F)							
K , Btu/[(hr)(ft ²)(°F)/ft]	91 (at 77°F)							
α , 10 ⁻⁶ in./in./°F	12.8 (68 to 212°F)							

a S-basis values. The rounded T_{99} values for $F_{ty}(LT) = 56$ ksi and $F_{ty}(ST) = 52$ ksi.

b Bearing values are "dry pin" values per Section 1.4.7.1.

Table 3.7.4.0(e₁). Design Mechanical and Physical Properties of 7050 Aluminum Alloy Extrusion

Specification	AMS 4341				
Form	Extrusion				
Temper	T73511				
Cross-Sectional Area, in ²	≤32				
Thickness or Diameter, ^a in.	≤1.000	1.001-2.000	2.001-3.000	3.001-4.000	4.001-5.000
Basis	S	S	S	S	S
Mechanical Properties:					
<i>F_{tu}</i> , ksi:					
L	70	70	70	70	70
LT	68	66	65	63	62
<i>F_{ty}</i> , ksi:					
L	60	60	60	60	60
LT	57	56	55	53	52
<i>F_{cy}</i> , ksi:					
L	60	60	60	61	61
LT	60	59	58	56	55
<i>F_{su}</i> , ksi	39	39	38	37	36
<i>F_{bru}</i> ^b , ksi:					
(e/D = 1.5)	103	100	96	91	87
(e/D = 2.0)	133	129	124	120	115
<i>F_{bry}</i> ^b , ksi:					
(e/D = 1.5)	82	80	78	76	74
(e/D = 2.0)	97	95	93	91	88
<i>e</i> , percent:					
L	8	8	8	8	8
<i>E</i> , 10 ³ ksi	10.3				
<i>E_c</i> , 10 ³ ksi	10.7				
<i>G</i> , 10 ³ ksi	3.9				
<i>μ</i>	0.33				
Physical Properties:					
<i>ω</i> , lb/in. ³	0.102				
<i>C</i> , Btu/(lb)(°F)	0.23 (at 212°F)				
<i>K</i> , Btu/[(hr)(ft ²)(°F)/ft]	93 (at 77°F)				
<i>α</i> , 10 ⁻⁶ in./in./°F	12.8 (68 to 212°F)				

a The mechanical properties are to be based upon the thickness at the time of quench.

b Bearing values are "dry pin" values per Section 1.4.7.1.

Table 3.7.4.0(e₂). Design Mechanical and Physical Properties of 7050 Aluminum Alloy Extrusion

Specification	AMS 4342				
Form	Extrusion ^a				
Temper	T74511				
Cross-Sectional Area, in ²	≤32				
Thickness or Diameter, ^b in.	≤1.000	1.001-2.000	2.001-3.000	3.001-4.000	4.001-5.000
Basis	S	S	S	S	S
Mechanical Properties:					
<i>F_{tu}</i> , ksi:					
L	73	73	73	73	73
LT	71	69	68	64	64
<i>F_{ty}</i> , ksi:					
L	63	63	63	63	63
LT	60	59	58	56	54
<i>F_{cy}</i> , ksi:					
L	63	63	63	64	64
LT	63	62	61	59	57
<i>F_{su}</i> , ksi	41	40	40	39	38
<i>F_{bru}</i> ^c , ksi:					
(e/D = 1.5)	107	104	100	95	91
(e/D = 2.0)	139	135	130	125	121
<i>F_{bry}</i> ^c , ksi:					
(e/D = 1.5)	86	84	82	80	78
(e/D = 2.0)	106	100	98	95	92
<i>e</i> , percent:					
L	7	7	7	7	7
<i>E</i> , 10 ³ ksi	10.3				
<i>E_c</i> , 10 ³ ksi	10.7				
<i>G</i> , 10 ³ ksi	3.9				
<i>μ</i>	0.33				
Physical Properties:					
<i>ω</i> , lb/in. ³	0.102				
<i>C</i> , Btu/(lb)(°F)	0.23 (at 212°F)				
<i>K</i> , Btu/[(hr)(ft ²)(°F)/ft]	93 (at 77°F)				
<i>α</i> , 10 ⁻⁶ in./in./°F	12.8 (68 to 212°F)				

a Excluding tubing.

b The mechanical properties are to be based upon the thickness at the time of quench.

c Bearing values are "dry pin" values per Section 1.4.7.1.

Table 3.7.4.0(e₃). Design Mechanical and Physical Properties of 7050 Aluminum Alloy Extrusion

Specification	AMS 4340						
Form	Extrusion						
Temper	T76511						
Thickness, ^a in.	≤0.499	0.500-1.000	1.001-2.000	2.001-3.000	3.001-4.000	4.001-5.000	
Basis	A	B	S	S	S	S	S
Mechanical Properties:							
F_{tu} , ksi:							
L	77	79	79	79	79	79	79
LT	76	78	77	75	73	71	68
F_{ty} , ksi:							
L	68	71	69	69	69	69	69
LT	67	69	67	65	63	61	59
F_{cy} , ksi:							
L	68	71	69	69	69	69	69
LT	70	73	70	69	67	66	64
F_{su} , ksi	42	44	43	43	42	41	40
F_{bru}^b , ksi:							
(e/D = 1.5)	113	116	115	114	110	107	103
(e/D = 2.0)	147	151	150	148	144	140	136
F_{bry}^b , ksi:							
(e/D = 1.5)	94	98	94	92	89	86	82
(e/D = 2.0)	109	114	110	108	104	98	93
e , percent (S-basis):							
L	7	...	7	7	7	7	7
E , 10 ³ ksi	10.3						
E_c , 10 ³ ksi	10.7						
G , 10 ³ ksi	3.9						
μ	0.33						
Physical Properties:							
ω , lb/in. ³	0.102						
C , Btu/(lb)(°F)	0.23 (at 212°F)						
K , Btu/[(hr)(ft ²)(°F)/ft]	89 (at 77°F)						
α , 10 ⁻⁶ in./in./°F	12.8 (68 to 212°F)						

a The mechanical properties are to be based upon the thickness at the time of quench.

b Bearing values are "dry pin" values per Section 1.4.7.1.

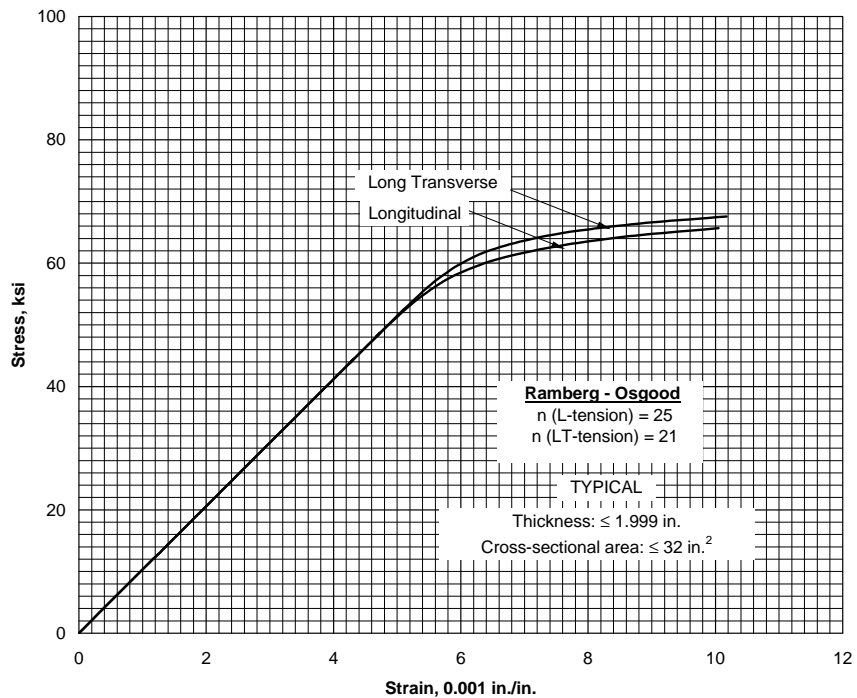

Figure 3.7.4.1.6(a). Typical tensile stress-strain curves for 7050-T7351X aluminum alloy extrusion at room temperature.

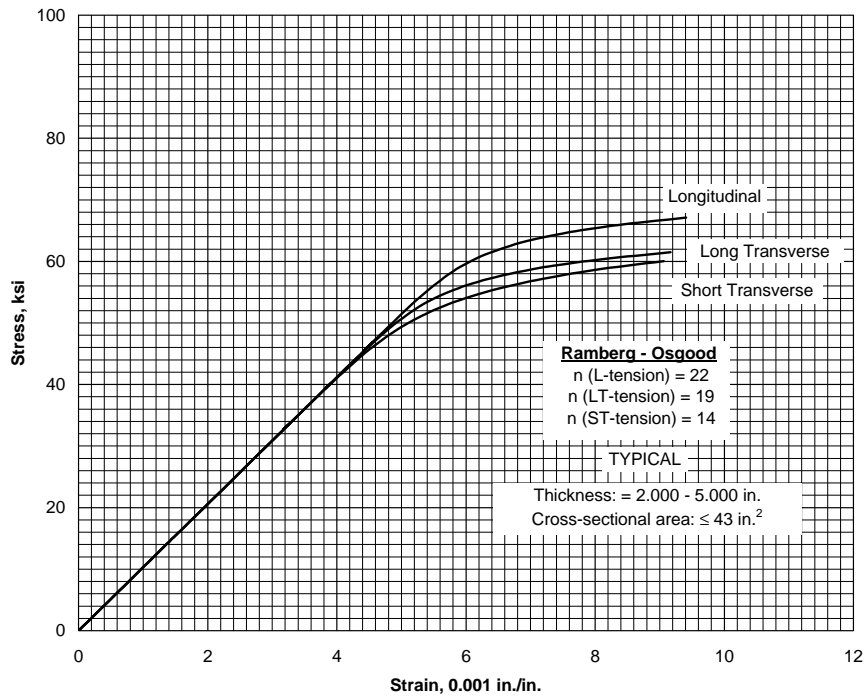

Figure 3.7.4.1.6(b). Typical tensile stress-strain curves for 7050-T7351X aluminum alloy extrusion at room temperature.

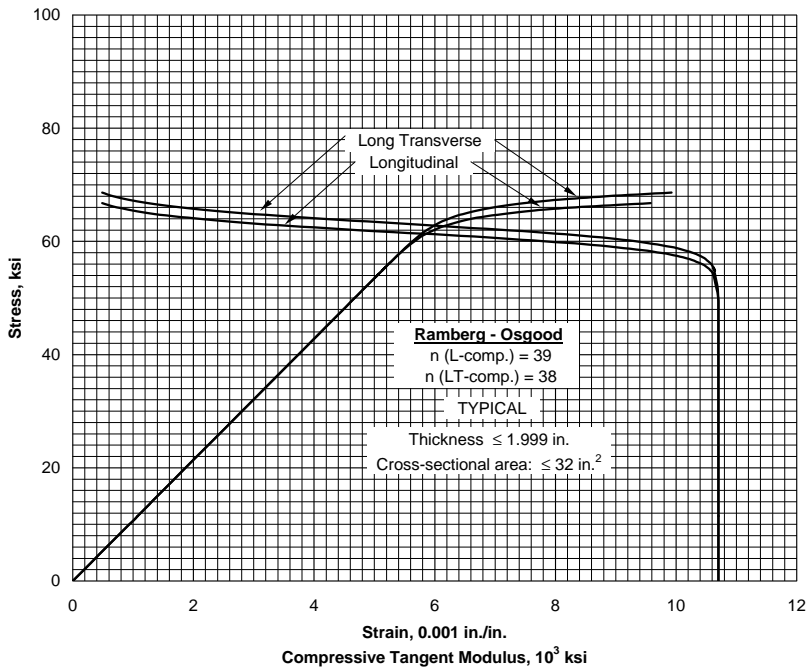

Figure 3.7.4.1.6(c). Typical compressive stress-strain and tangent-modulus curves for 7050-T7351X aluminum alloy extrusion at room temperature.

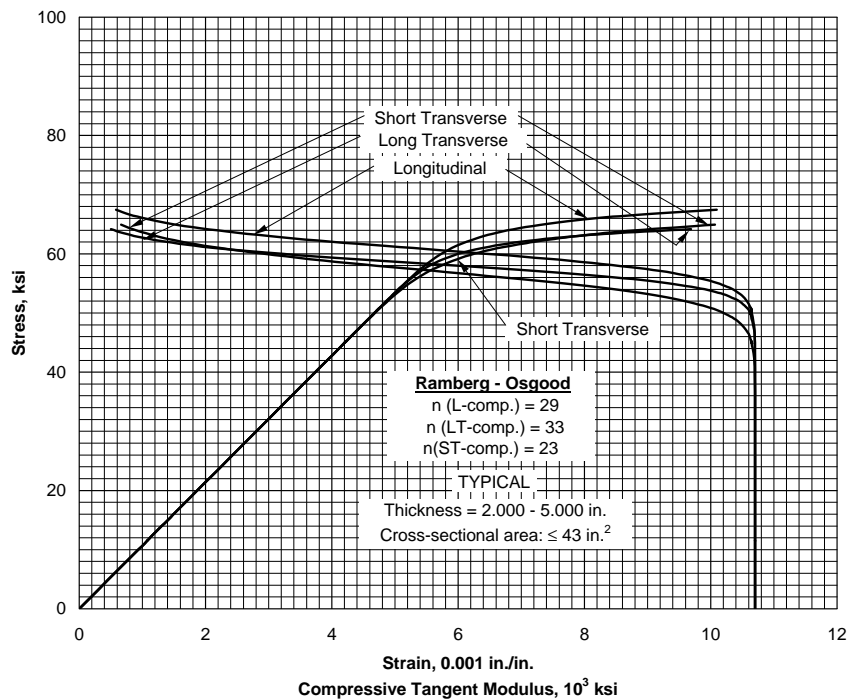

Figure 3.7.4.1.6(d). Typical compressive stress-strain and tangent-modulus curves for 7050-T7351X aluminum alloy extrusion at room temperature.

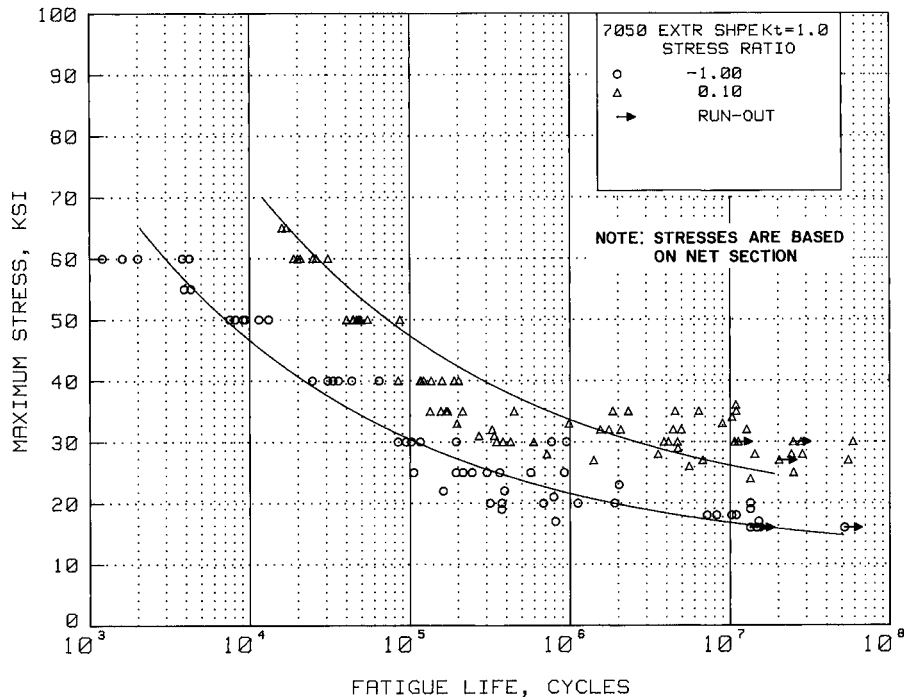

Figure 3.7.4.1.8(a). Best-fit S/N curves for unnotched 7050-T7351X extruded shape, longitudinal and long transverse directions.

Correlative Information for Figure 3.7.4.1.8(a)

Product Form: Extruded shape, 0.5 to 5.0 inch thick

Test Parameters:
Loading - Axial
Frequency - 800 cpm
Temperature - RT
Environment - Air

Properties: TUS, ksi TYS, ksi Temp., °F
 72-79 62-69 RT

Specimen Details: Unnotched
0.300 inch diameter

No. of Heats/Lots: Not specified

Surface Condition: Not specified

Equivalent Stress Equation:
 $\log N_f = 10.5 - 3.79 \log (S_{eq} - 16)$
 $S_{eq} = S_{max} (1-R)^{0.55}$
Std. Error of Estimate, $\log (\text{Life}) = 0.516$
Standard Deviation, $\log (\text{Life}) = 1.10$
 $R^2 = 78\%$

References: 3.7.4.2.9(b) and 3.7.7.2.8(b)

Sample Size = 128

[Caution: The equivalent stress model may provide unrealistic life predictions for stress ratios beyond those represented above.]

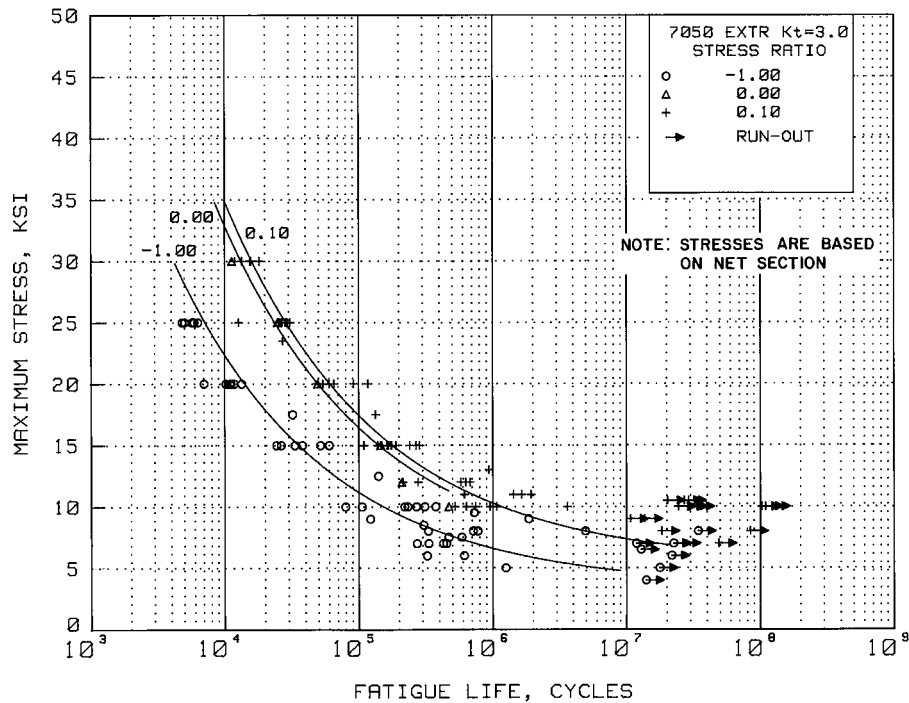

Figure 3.7.4.1.8(b). Best-fit S/N curves for notched, $K_t = 3.0$, 7050-T7351X extruded shape, longitudinal and long transverse directions.

Correlative Information for Figure 3.7.4.1.8(b)

Product Form: Extruded shape, 0.5 to 5.0 inch thick

Test Parameters:
Loading - Axial
Frequency - 800 cpm
Temperature - RT
Environment - Air

Properties: $\frac{TUS, \text{ksi}}{72-79}$ $\frac{TYS, \text{ksi}}{62-69}$ $\frac{\text{Temp., } ^\circ\text{F}}{\text{RT}}$

Specimen Details: Circumferentially notched,
 $K_t = 3.0$
0.359 inch gross diameter
0.253 inch net diameter
0.013 inch root radius, r
60° flank angle, ω

No. of Heats/Lots: Not specified

Equivalent Stress Equation:
 $\text{Log } N_f = 7.73 - 2.58 \text{ log } (S_{eq} - 5.0)$
 $S_{eq} = S_{max} (1-R)^{0.56}$
Std. Error of Estimate, $\text{Log } (\text{Life}) = 0.268$
Standard Deviation, $\text{Log } (\text{Life}) = 0.733$
 $R^2 = 87\%$

Surface Condition: Not specified

References: 3.7.4.2.9(b) and 3.7.7.2.8(b)

Sample Size = 103

[Caution: The equivalent stress model may provide unrealistic life predictions for stress ratios beyond those represented above.]

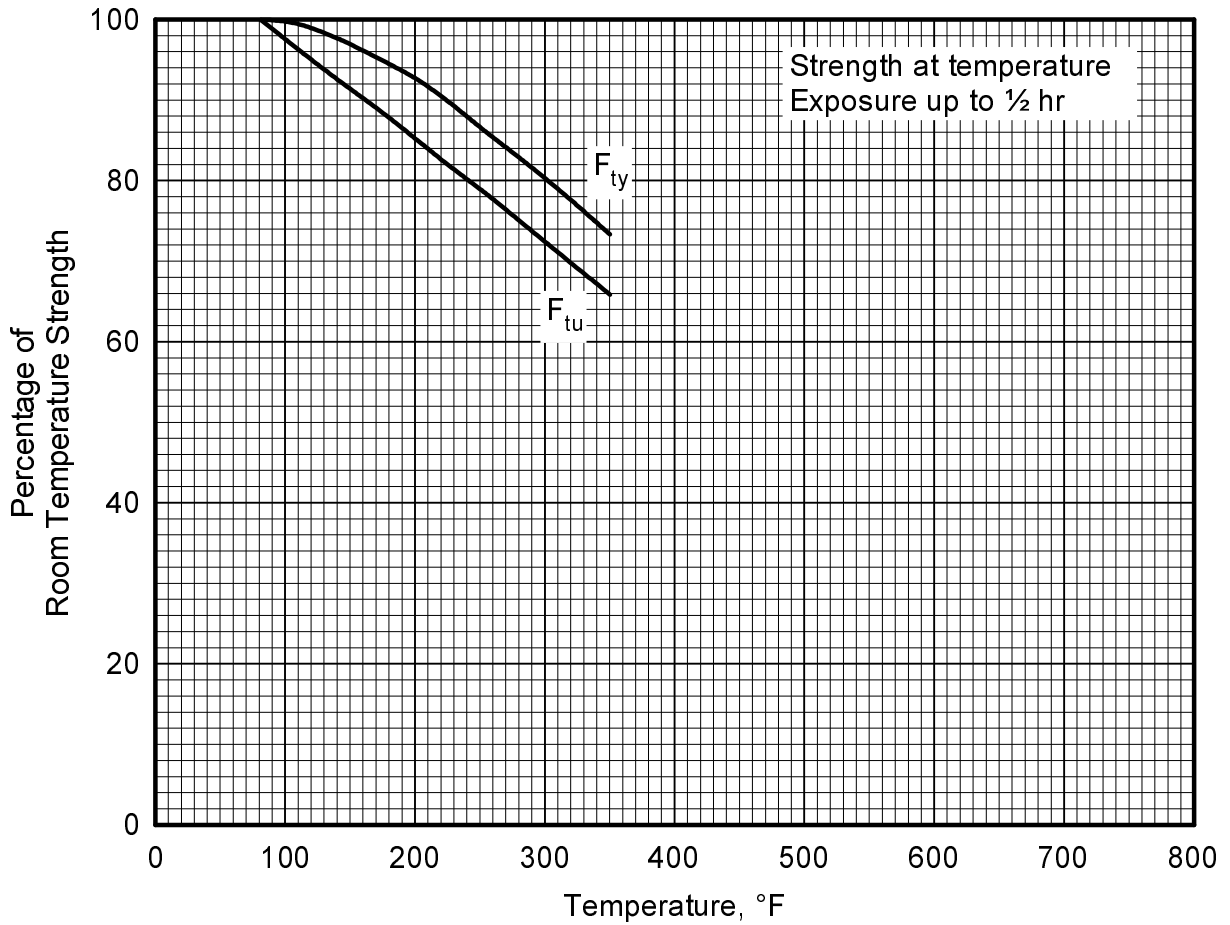

Figure 3.7.4.2.1. Effect of temperature on the tensile ultimate strength (F_{tu}) and the tensile yield strength (F_{ty}) of 7050-T7451 aluminum alloy plate.

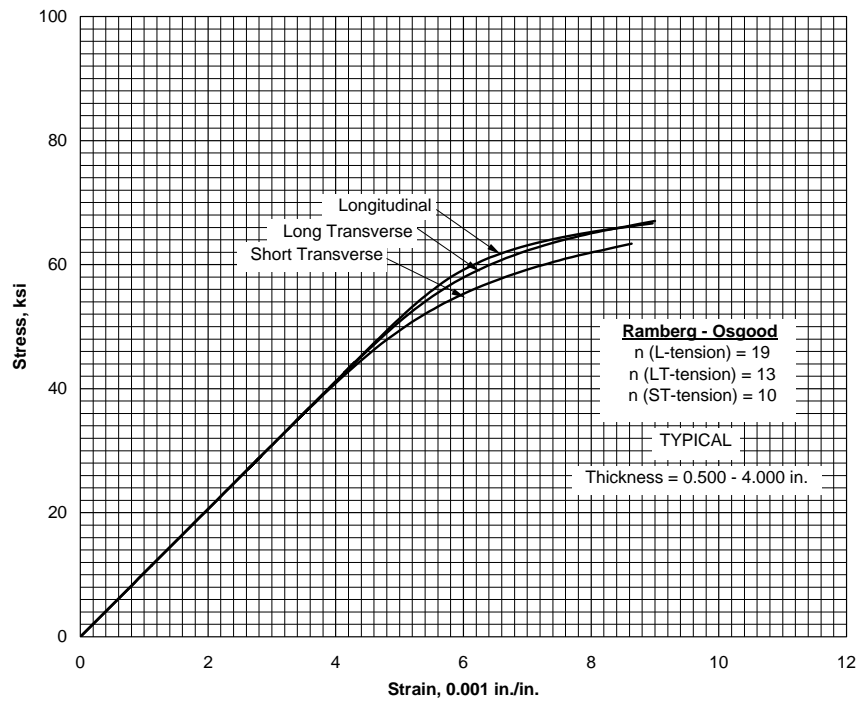

Figure 3.7.4.2.6(a). Typical tensile stress-strain curves for 7050-T7451 aluminum alloy plate at room temperature.

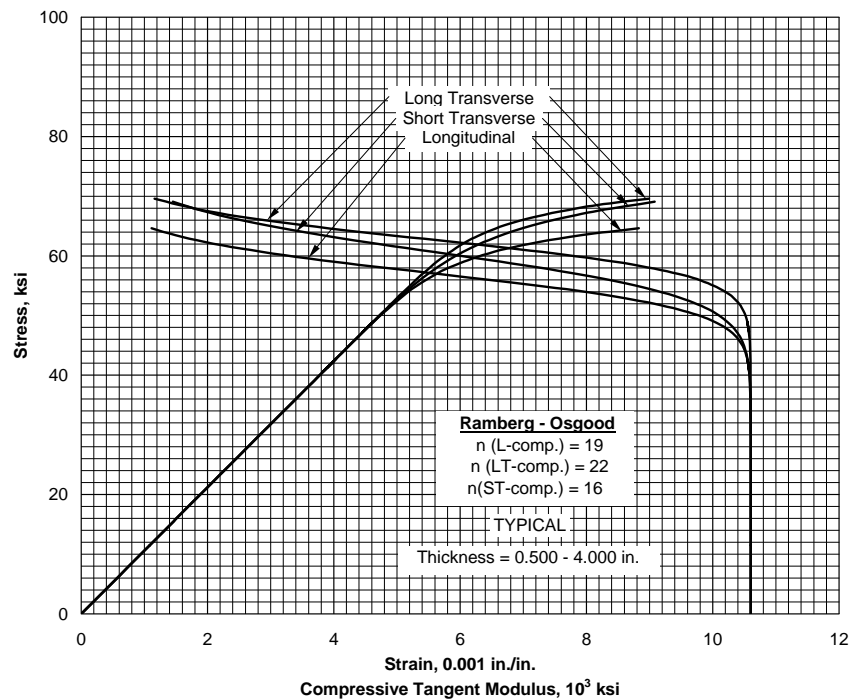

Figure 3.7.4.2.6(b). Typical compressive stress-strain and compressive tangent-modulus curves for 7050-T7451 aluminum alloy plate at room temperature.

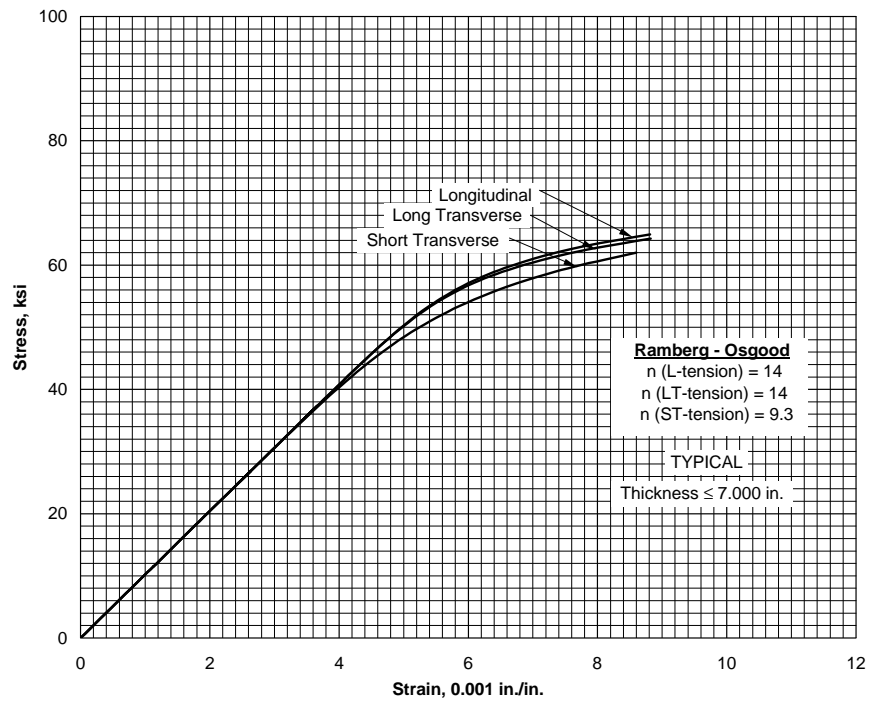

Figure 3.7.4.2.6(c). Typical tensile stress-strain curves for 7050-T7452 aluminum alloy hand forging at room temperature.

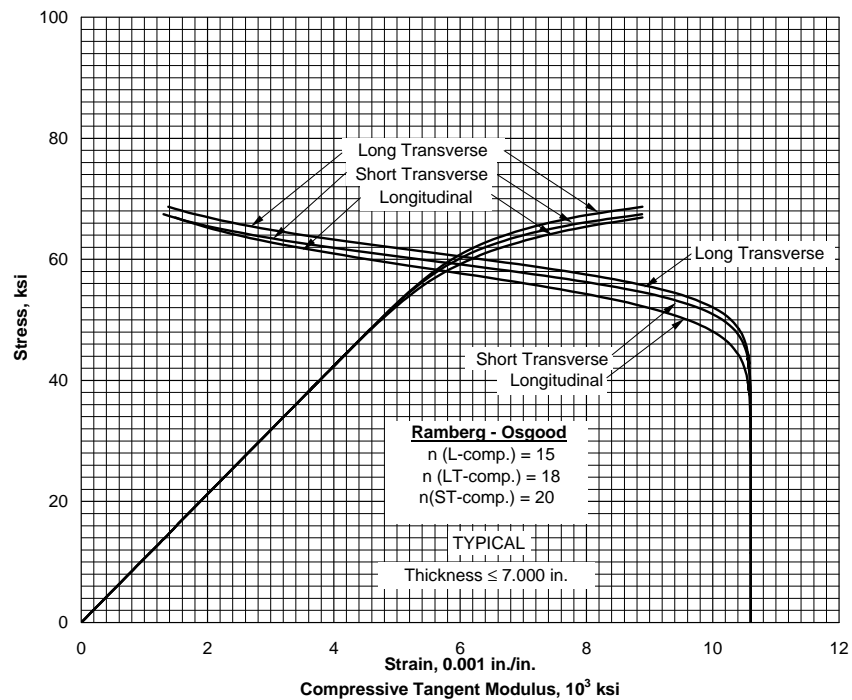

Figure 3.7.4.2.6(d). Typical compressive stress-strain and compressive tangent-modulus curves for 7050-T7452 aluminum alloy hand forging at room temperature.

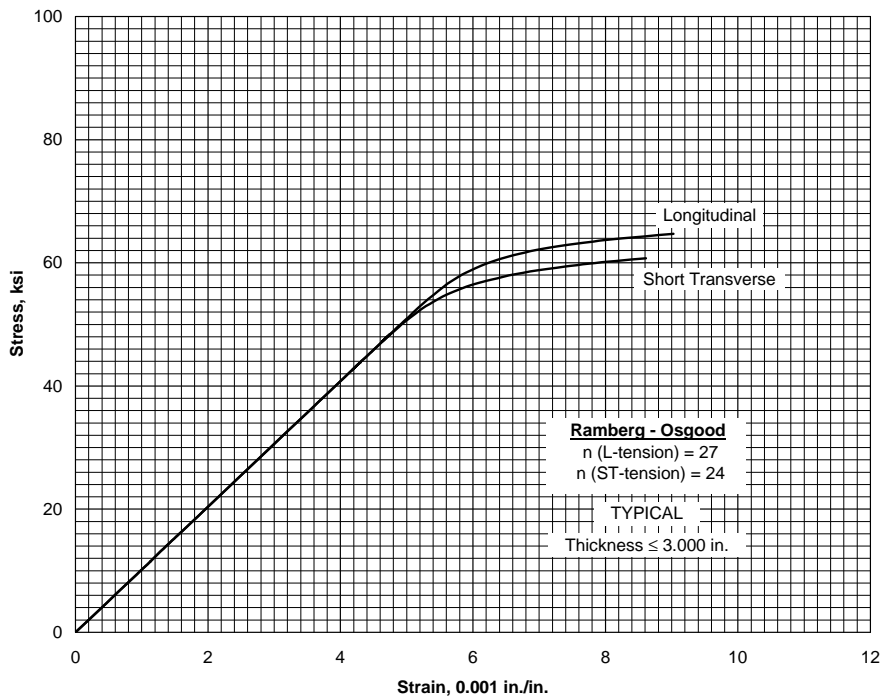

Figure 3.7.4.2.6(e). Typical tensile stress-strain curves for 7050-T74 aluminum alloy die forging at room temperature.

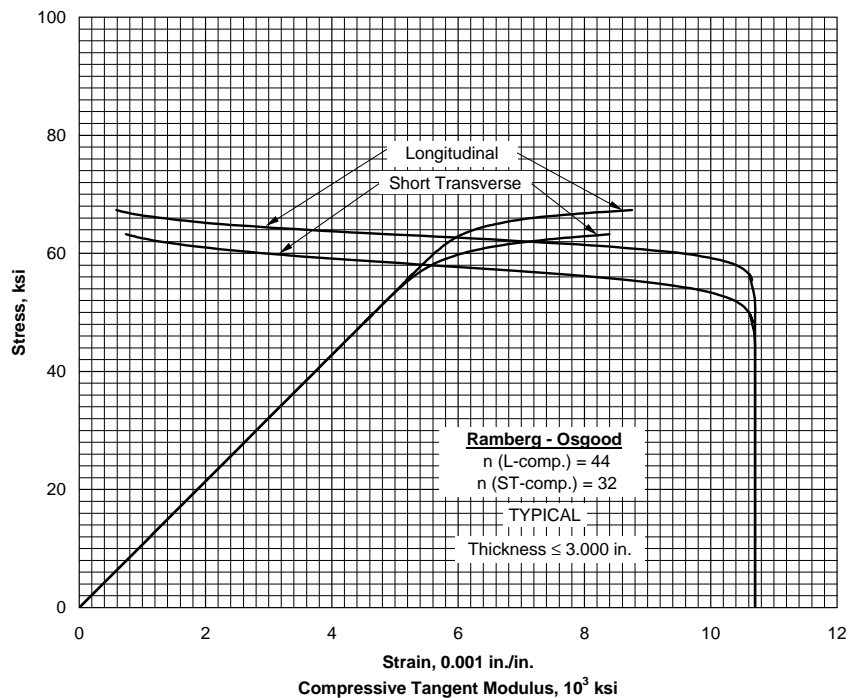

Figure 3.7.4.2.6(f). Typical compressive stress-strain and compressive tangent-modulus curves for 7050-T74 aluminum alloy die forging at room temperature.

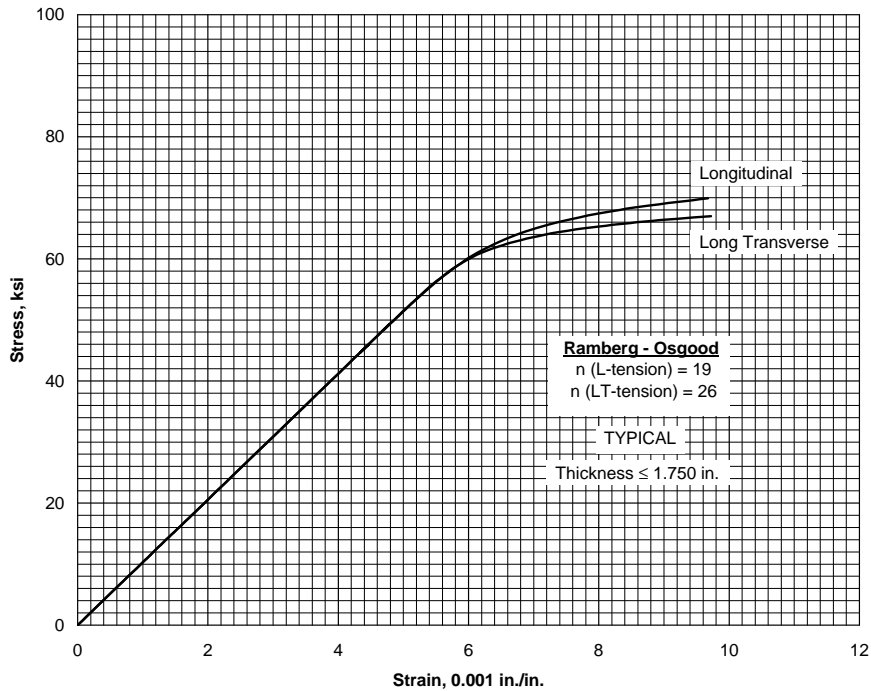

Figure 3.7.4.2.6(g). Typical tensile stress-strain curves for 7050-T74511 aluminum alloy extrusion at room temperature.

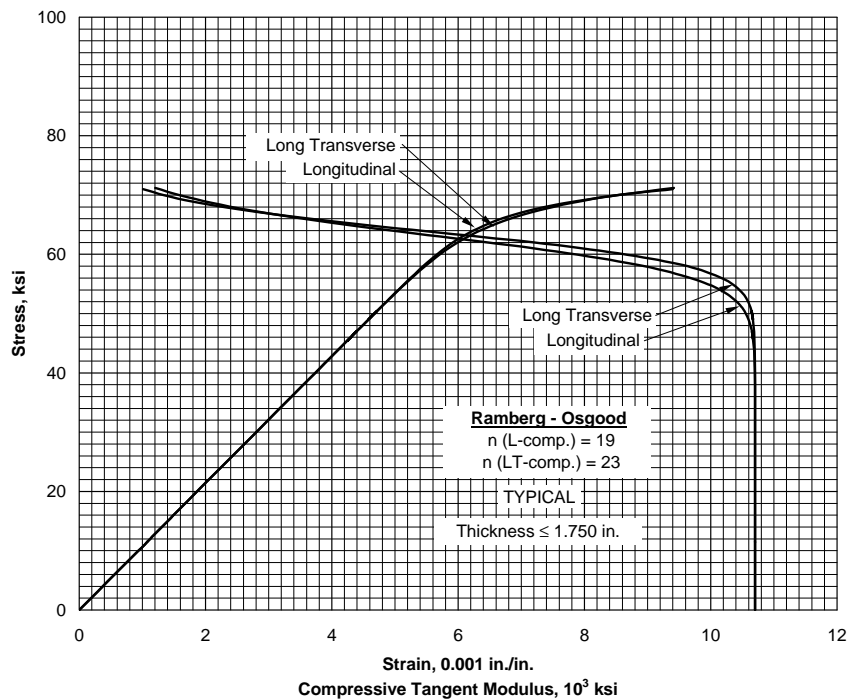

Figure 3.7.4.2.6(h). Typical compressive stress-strain and tangent-modulus curves for 7050-T74511 aluminum alloy extrusion at room temperature.

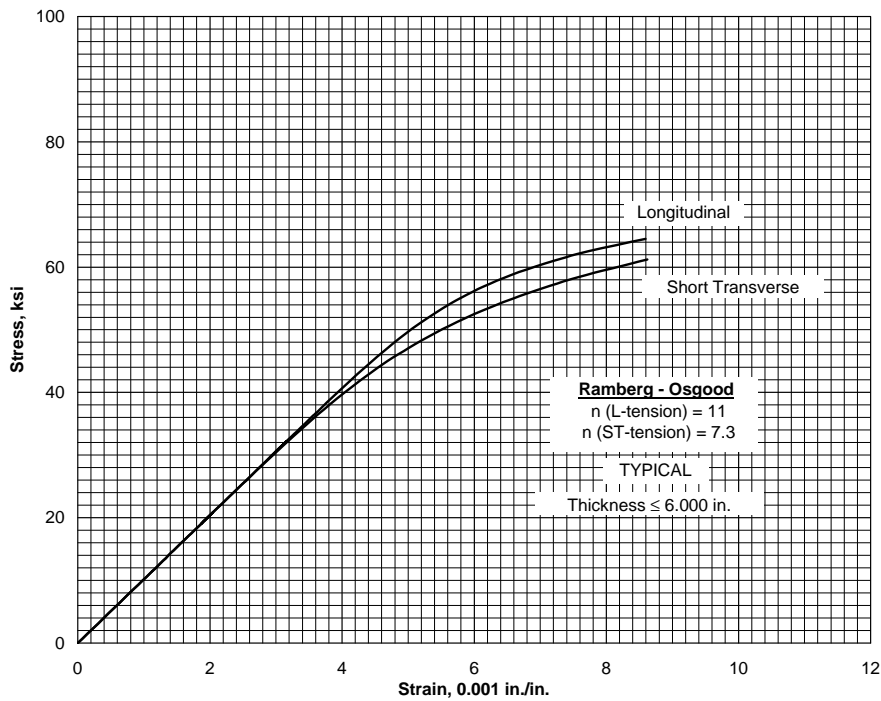

Figure 3.7.4.2.6(i). Typical tensile stress-strain curves for 7050-T7452 aluminum alloy die forging at room temperature.

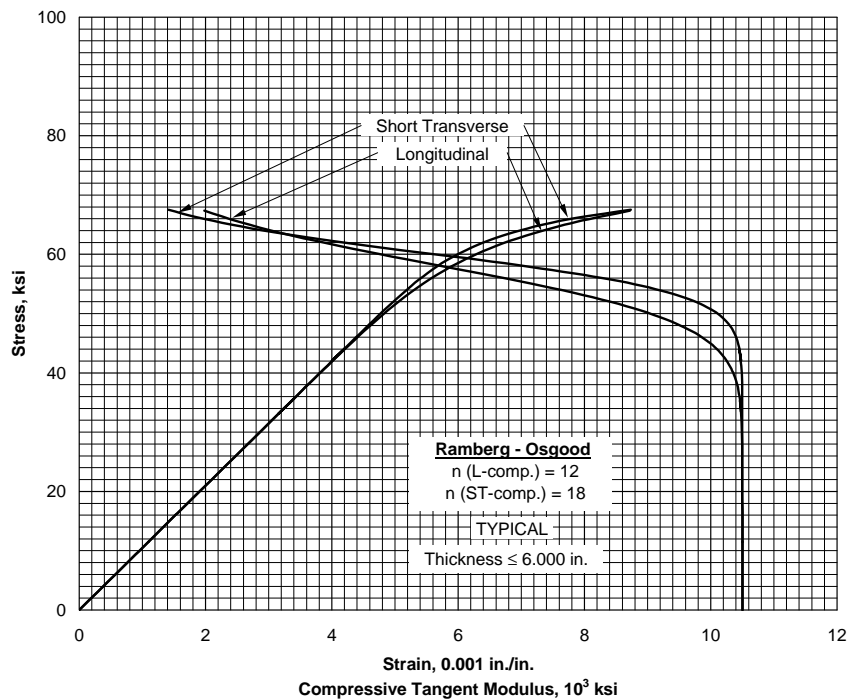

Figure 3.7.4.2.6(j). Typical compressive stress-strain and tangent-modulus curves for 7050-T7452 aluminum alloy die forging at room temperature.

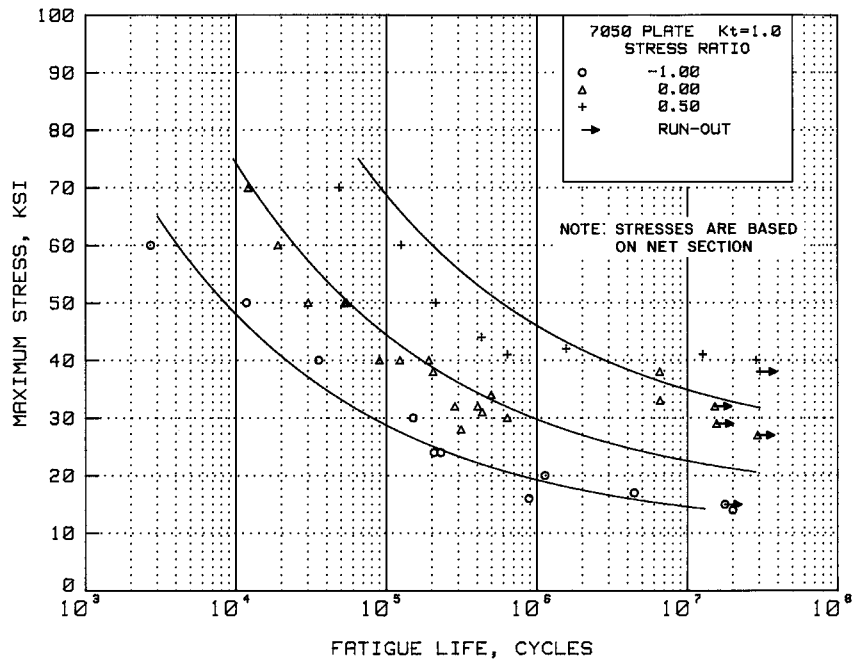

Figure 3.7.4.2.8(a). Best-fit S/N curves for unnotched 7050-T7451 plate, longitudinal direction and T/2 specimen location.

Correlative Information for Figure 3.7.4.2.8(a)

Product Form: Plate, 1.0 inch thick

Properties: TUS, ksi TYS, ksi Temp., °F
 79 72 RT

Specimen Details: Unnotched
 0.30 inch diameter

Surface Condition: Not specified

References: 3.7.4.2.9(b) and 3.7.8.2.8(b)

Test Parameters:

Loading - Axial
Frequency - 800 cpm
Temperature - RT
Environment - Air

No. of Heats/Lots: 10

Equivalent Stress Equation:

$\text{Log } N_f = 9.73 - 3.24 \text{ log } (S_{eq} - 15.5)$
 $S_{eq} = S_{max} (1-R)^{0.63}$
Std. Error of Estimate, $\text{Log } (\text{Life}) = 0.490$
Standard Deviation, $\text{Log } (\text{Life}) = 0.942$
 $R^2 = 73\%$

Sample Size = 35

[Caution: The equivalent stress model may provide unrealistic life predictions for stress ratios beyond those represented above.]

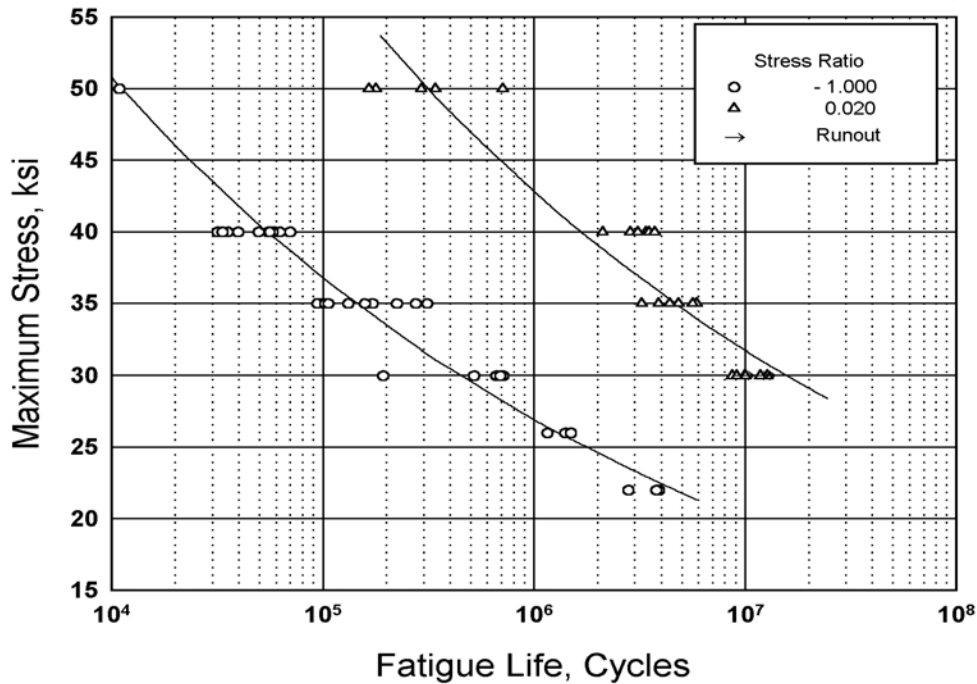

Figure 3.7.4.2.8(b). Best-fit S/N curves for unnotched 7050-T7451 plate, long transverse direction, t/4 specimen location.

Correlative Information for Figure 3.7.4.2.8(b)

Product Form: Plate, 4.25 to 8.50 inches thick

Loading – Axial
Frequency – 20 Hz
Temperature – RT
Environment – Air

Properties: TUS, ksi N/A
TYS, ksi 62-67
Temp., F RT

Equivalent Stress Equation:
 $\log(N_f) = 16.410 - 6.624 \log(S_{eq} - 5.0)$
 $S_{eq} = S_{max}(1 - R)^{0.65}$
Std. Error of Estimate, Log(Life) = 0.183
Standard Deviation, Log(Life) = 0.814
 $R^2 = 95.0\%$

Specimen Details: Unnotched
0.250 inch diameter

Surface Condition: Polished, final surface finish unspecified

References: 3.7.4.2.8(d) and (e)

Sample Size = 57

[Caution: The equivalent stress model may provide unrealistic life predictions for stress ratios beyond those represented above.]

Test Parameters:

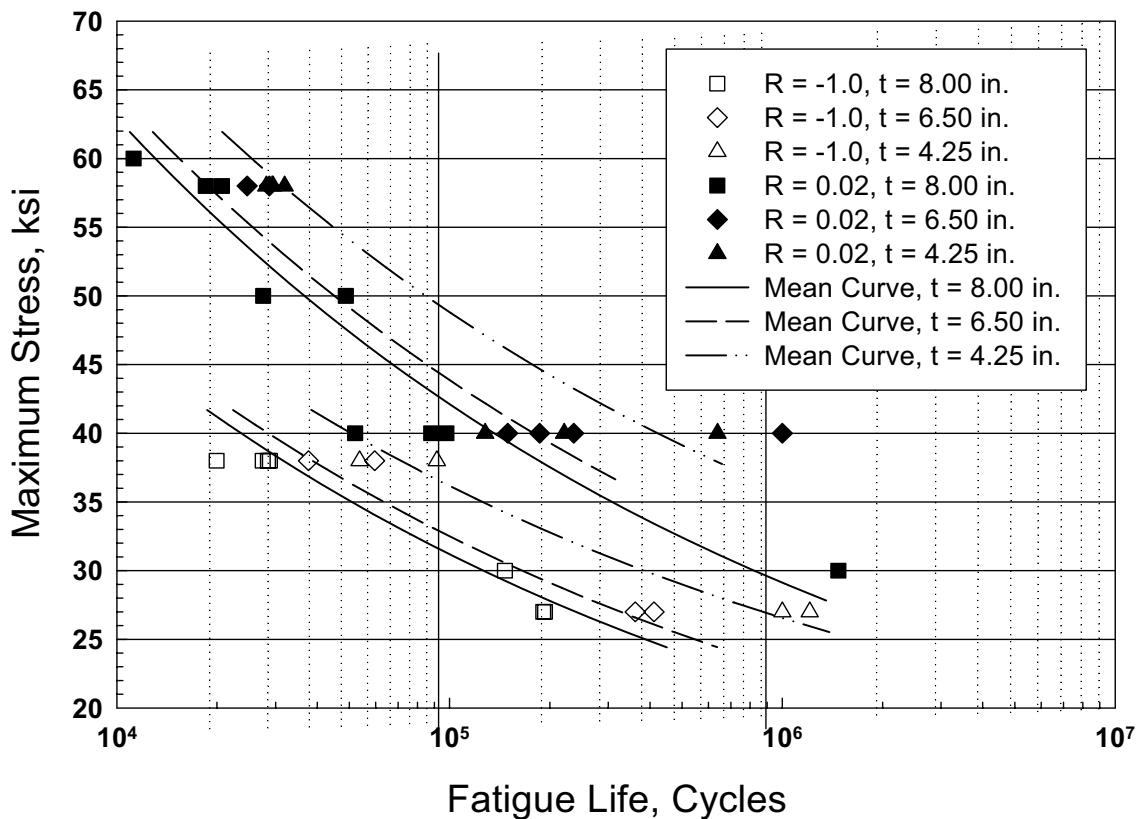

Figure 3.7.4.2.8(c). Best-fit S/N curves for unnotched 7050-T7451 plate, long transverse direction, t/2 specimen location.

Correlative Information for Figure 3.7.4.2.8(c)

Product Form: Plate, 4.25 to 8.50 inches thick

Properties: $\frac{TUS, ksi}{N/A}$ $\frac{TYS, ksi}{62-67}$ $\frac{Temp., F}{RT}$

Specimen Details: Unnotched
0.250 inch diameter

Surface Condition: Polished, final surface finish unspecified

References: 3.7.3.2.8(d) and (e)

Test Parameters:

Loading – Axial
Frequency – 20 Hz
Temperature – RT
Environment – Air

Equivalent Stress Equation:

$$\log(N_f) = 12.484 - 4.878 \log(S_{eq} - 60/t)$$

$$S_{eq} = S_{max} (1 - R)^{0.42}$$

t = plate thickness in inches.

Std. Error of Estimate, Log (Life) = 0.204

Standard Deviation, Log (Life) = 0.594

$$R^2 = 88.2\%$$

Sample Size = 36

[Caution: The equivalent stress model may provide unrealistic life predictions for stress ratios and plate thicknesses beyond those represented above.]

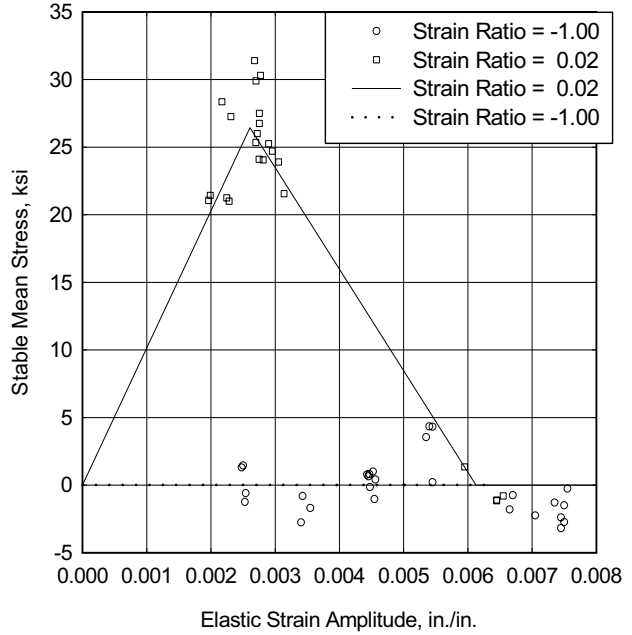
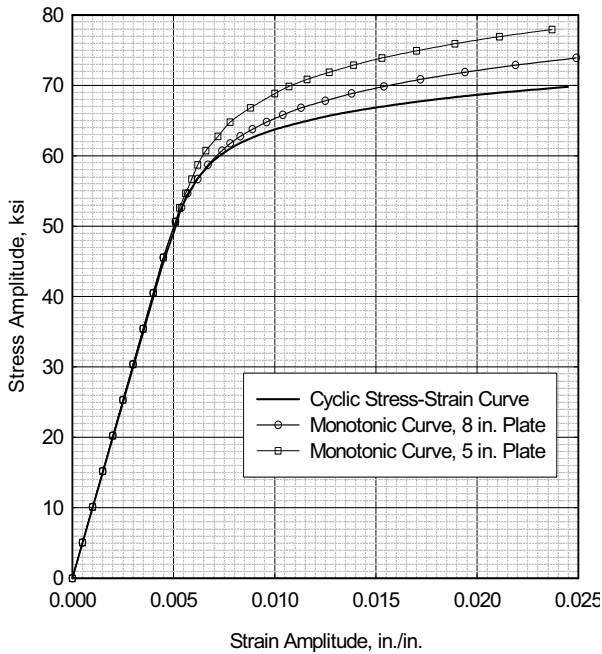
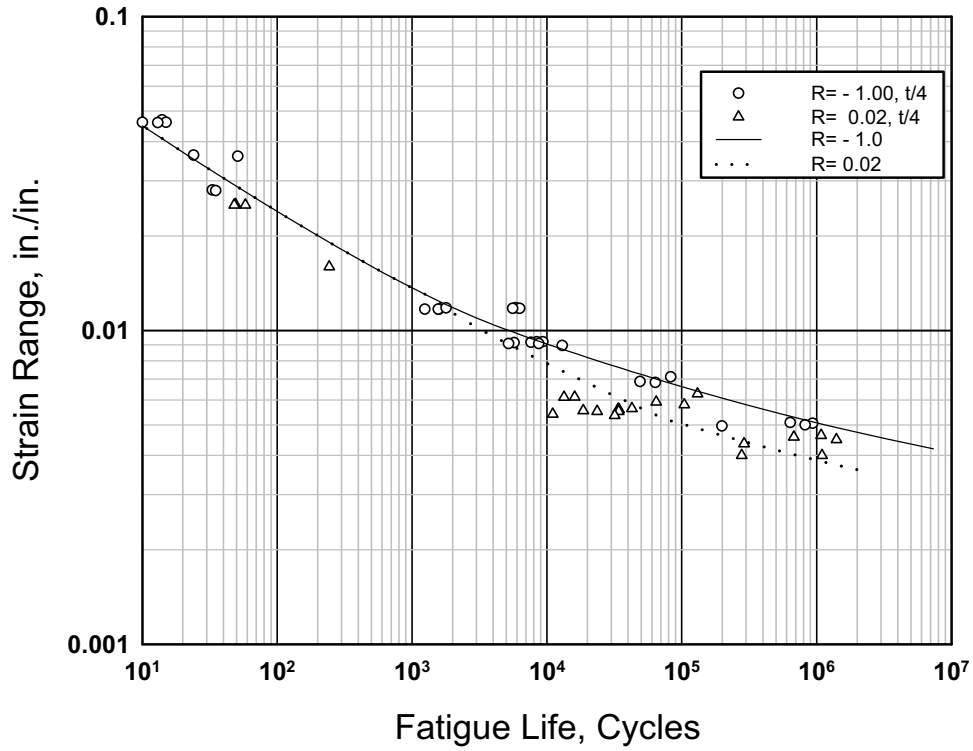

Figure 3.7.4.2.8(d). Best-fit strain-life curves, cyclic stress-strain curve, and mean stress relaxation curve for 7050-T7451 plate, long transverse direction, t/4 specimen location.

Correlative Information for Figure 3.7.4.2.8(d)

Product Form: Plate, 4.25 to 8.50 inches thick

References: 3.7.3.2.8(d) and (e)

Properties: TUS, ksi TYS, ksi Temp., F
 N/A 62-67 RT

Test Parameters:

Loading – Axial, Triangular Waveform

Frequency – 0.50 Hz

Temperature – RT

Environment – Air

Stress-Strain Equations:

Cyclic Stress Strain Curve

$$(\Delta\sigma/2) = 88.185 (\Delta\epsilon_p/2)^{0.0578}$$

Mean Stress Relaxation Curve

Minimal relaxation

$$\text{for } (\Delta\epsilon/2) < 0.00261$$

$$\sigma_m = 46.0 - 7500 (\Delta\epsilon/2)$$

$$\text{for } (\Delta\epsilon/2) < 0.00613$$

Nearly complete relaxation

$$\text{for } (\Delta\epsilon/2) \geq 0.00613$$

Equivalent Strain Equation:

$$\log(N_f) = -7.734 - 5.119 \log(\epsilon_{eq} - 0.0018)$$

$$\epsilon_{eq} = (\Delta\epsilon)^{0.61} (S_{max}/E)^{0.39}$$

Std. Error of Estimate, Log (Life) = 0.301

Standard Deviation, Log (Life) = 1.573

R² = 96.3%

Specimen Details: Unnotched
 0.250 inch diameter

Sample Size = 53

Surface Condition: Polished, final surface
 finish unspecified

[Caution: The equivalent strain model may provide unrealistic life predictions for strain ratios beyond those represented above.]

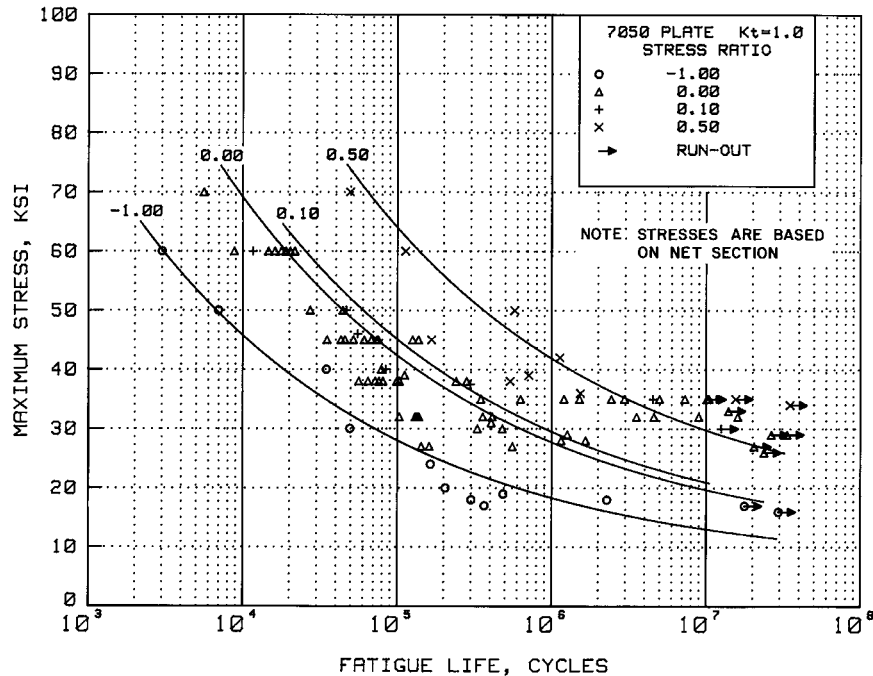

Figure 3.7.4.2.8(e). Best-fit S/N curves for unnotched 7050-T7451 plate, long transverse direction, t/4 specimen location.

Correlative Information for Figure 3.7.4.2.8(e)

Product Form: Plate, 1.0 to 6.0 inches thick

Test Parameters:

Properties: TUS, ksi TYS, ksi Temp., °F
 73-81 62-72 RT

Loading - Axial
Frequency - 800 cpm and unspecified
Temperature - RT
Environment - Air

Specimen Details: Unnotched
0.250 and 0.300 inch
diameter

No. of Heats/Lots: 15

Surface Condition: Not specified

Equivalent Stress Equation:
 $\log N_f = 10.7 - 3.81 \log (S_{eq} - 10)$
 $S_{eq} = S_{max} (1-R)^{0.59}$
Std. Error of Estimate, $\log (\text{Life}) = 0.507$
Standard Deviation, $\log (\text{Life}) = 0.794$
 $R^2 = 59\%$

References: 3.7.4.2.9(b), 3.7.8.2.8(b) and (e)

Sample Size = 85

[Caution: The equivalent stress model may provide unrealistic life predictions for stress ratios beyond those represented above.]

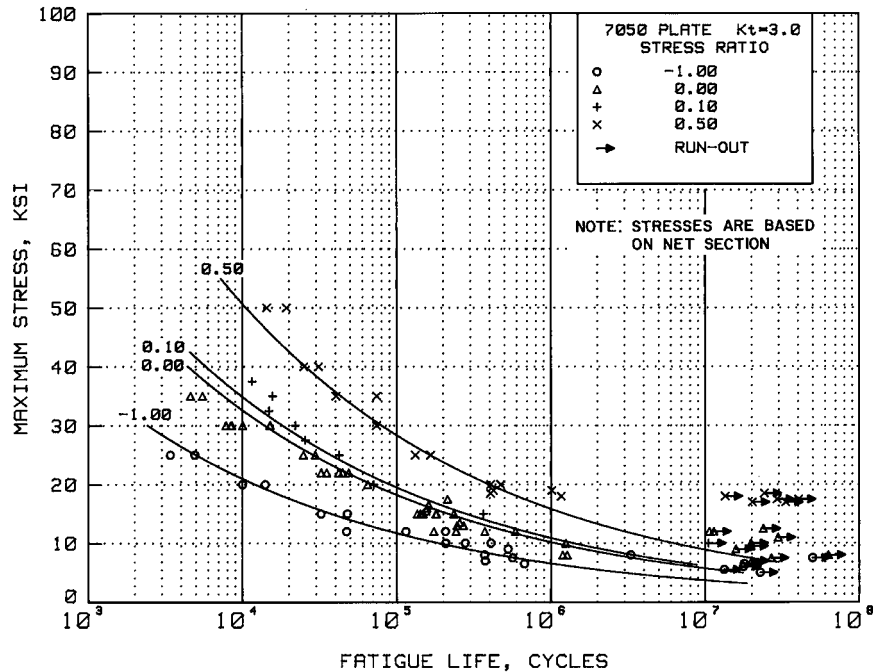

Figure 3.7.4.2.8(f). Best-fit S/N curves for notched, $K_t = 3.0$, 7050-T7451 plate, longitudinal and long transverse directions, $t/4$ specimen location.

Correlative Information for Figure 3.7.4.2.8(f)

Product Form: Plate, 1.0 to 6.0 inches thick

Test Parameters:

Properties: TUS, ksi TYS, ksi Temp., °F
 75-81 65-72 RT

Loading - Axial
Frequency - 800 cpm and unspecified
Temperature - RT
Environment - Air

Specimen Details: Circumferentially notched,
 $K_t = 3.0$
 0.306 and 0.373 inch gross
 diameter
 0.253 inch net diameter
 0.013 inch notch-tip radius, r
 60° flank angle, ω

No. of Heats/Lots: 11

Equivalent Stress Equation:
 $\log N_f = 10.0 - 3.96 \log (S_{eq})$
 $S_{eq} = S_{max} (1-R)^{0.64}$
Std. Error of Estimate, $\log (\text{Life}) = 0.248$
Standard Deviation, $\log (\text{Life}) = 0.728$
 $R^2 = 88\%$

Surface Condition: Not specified

References: 3.7.4.2.9(b) and 3.7.8.2.8(b) and (c)

Sample Size = 79

[Caution: The equivalent stress model may provide unrealistic life predictions for stress ratios beyond those represented above.]

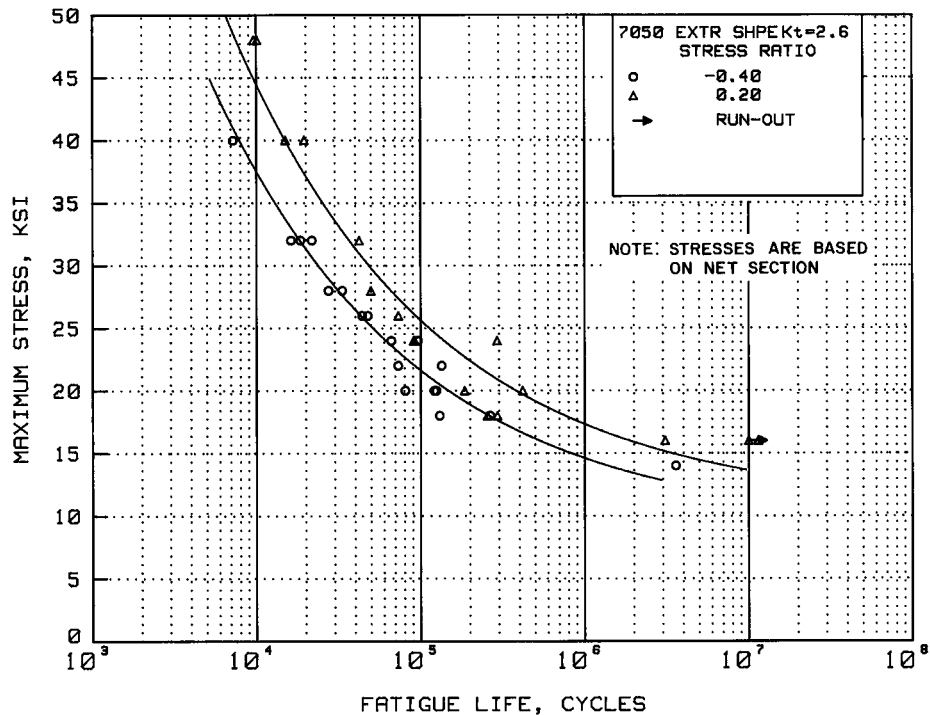

Figure 3.7.4.2.8(g). Best-fit S/N curves for notched, $K_t = 2.6$, 7050-T7451X extruded shape, longitudinal direction.

Correlative Information for Figure 3.7.4.2.8(g)

Product Form: Extruded shape, 0.5 to 5.0 inch thick

Test Parameters:

Loading - Axial
Frequency - Not specified
Temperature - RT
Environment - Air

Properties: $\frac{TUS, ksi}{76-77}$ $\frac{TYS, ksi}{67-68}$ $\frac{Temp., ^\circ F}{RT}$

Specimen Details: Notched, center hole,
 $K_t = 2.6$
0.150 inch diameter
0.250 inch thick
1.00 inch wide

No. of Heats/Lots: 6

Equivalent Stress Equation:

$$\log N_f = 8.23 - 2.82 \log (S_{eq} - 10)$$

$$S_{eq} = S_{max} (1-R)^{0.30}$$

Std. Error of Estimate, $\log (\text{Life}) = 0.243$

Standard Deviation, $\log (\text{Life}) = 0.724$

$R^2 = 89\%$

Surface Condition: Not specified

Reference: 3.7.4.2.8(a)

Sample Size = 34

[Caution: The equivalent stress model may provide unrealistic life predictions for stress ratios beyond those represented above.]

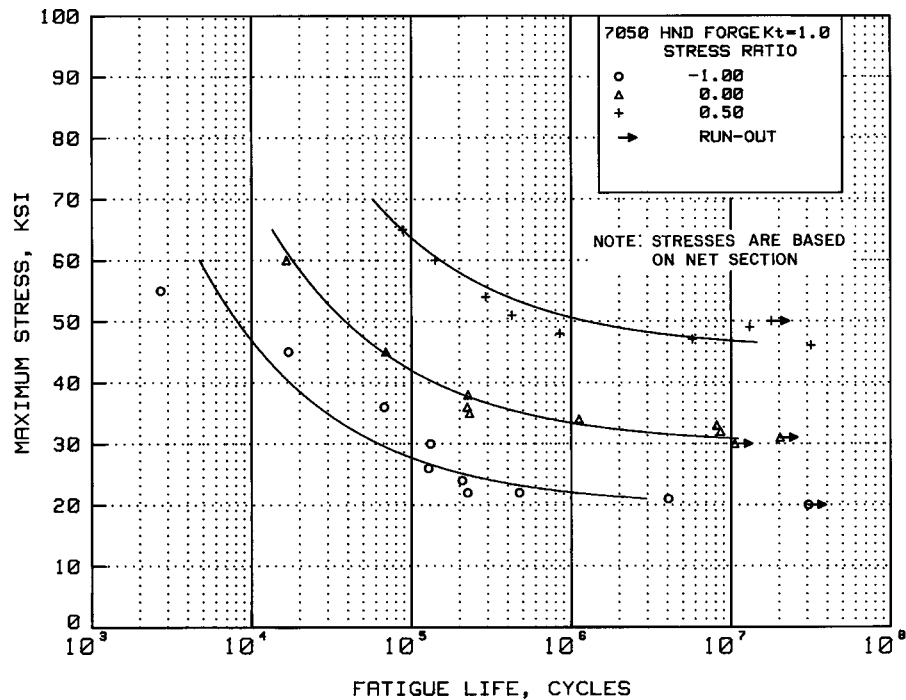

Figure 3.7.4.2.8(h). Best-fit S/N curves for unnotched 7050-T7452 hand forgings, longitudinal direction.

Correlative Information for Figure 3.7.4.2.8(h)

Product Form: Hand forgings, 2.0 to 8.0 inch thick

Test Parameters:
Loading - Axial
Frequency - 800 cpm
Temperature - RT
Environment - Air

Properties: TUS, ksi TYS, ksi Temp., °F
 76-81 66-72 RT

Specimen Details: Unnotched
 0.300 inch diameter

No. of Heats/Lots: 10

Surface Condition: Not specified

Equivalent Stress Equation:
 $\log N_f = 7.06 - 1.89 \log (S_{eq} - 30)$
 $S_{eq} = S_{max} (1-R)^{0.60}$
Std. Error of Estimate, $\log (\text{Life}) = 0.400$
Standard Deviation, $\log (\text{Life}) = 0.982$
 $R^2 = 83\%$

References: 3.7.4.2.9(b) and 3.7.7.2.8(b)

Sample Size = 25

[Caution: The equivalent stress model may provide unrealistic life predictions for stress ratios beyond those represented above.]

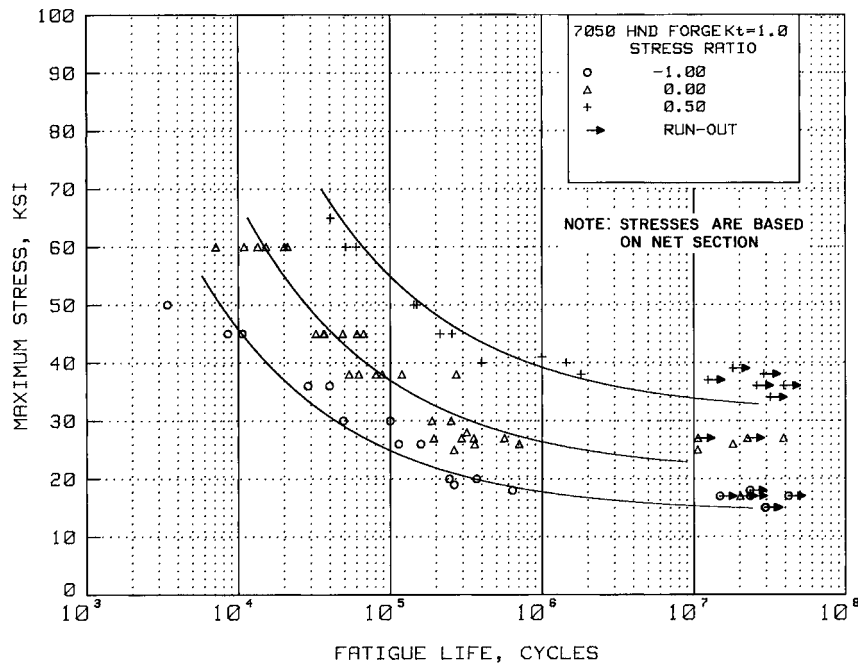

Figure 3.7.4.2.8(i). Best-fit S/N curves for unnotched 7050-T7452 hand forgings, long transverse and short transverse directions.

Correlative Information for Figure 3.7.4.2.8(i)

Product Form: Hand forgings, 2.0 to 8.0 inch thick

Test Parameters:

Loading - Axial

Frequency - 800 cpm and unspecified

Temperature - RT

Environment - Air

Properties: TUS, ksi TYS, ksi Temp., °F
 73-80 59-70 RT

Specimen Details: Unnotched
 0.300 inch diameter

No. of Heats/Lots: 10

Surface Condition: Not specified

Equivalent Stress Equation:

$$\log N_f = 7.58 - 2.14 \log (S_{eq} - 21)$$

$$S_{eq} = S_{max} (1-R)^{0.57}$$

Std. Error of Estimate, Log (Life) = 0.400

Standard Deviation, Log (Life) = 0.803

$R^2 = 75\%$

References: 3.7.4.2.9(b) and 3.7.8.2.8(b)

Sample Size = 55

[Caution: The equivalent stress model may provide unrealistic life predictions for stress ratios beyond those represented above.]

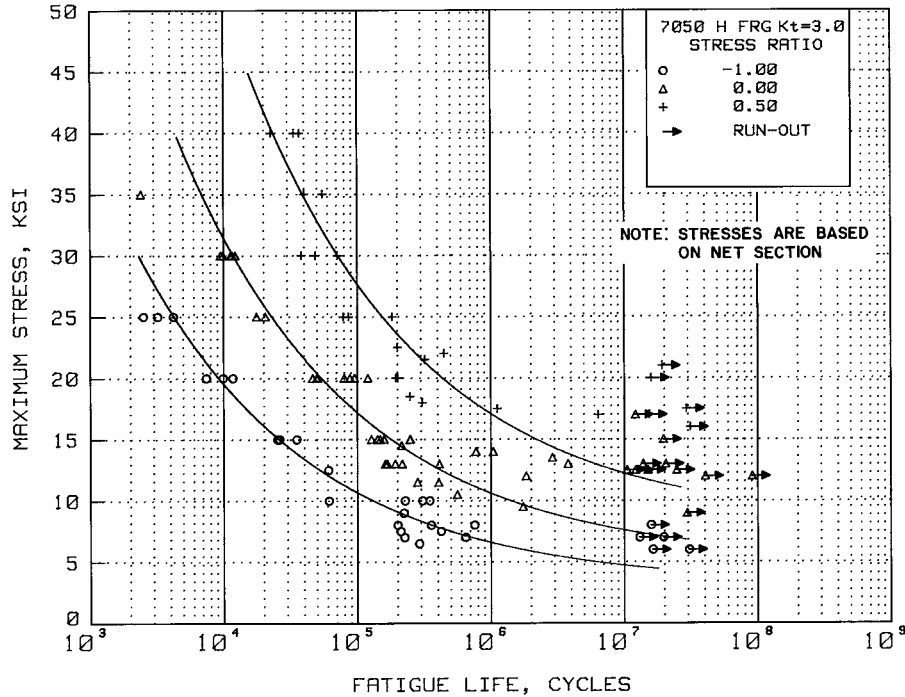

Figure 3.7.4.2.8(j). Best-fit S/N curves for notched, $K_t = 3.0$, 7050-T7452 hand forgings, longitudinal, long transverse, and short transverse directions.

Correlative Information for Figure 3.7.4.2.8(j)

Product Form: Hand forgings, 2.0 to 8.0 inch thick

Test Parameters:
Loading - Axial
Frequency - 800 cpm
Temperature - RT
Environment - Air

Properties: TUS, ksi TYS, ksi Temp., °F
 73-81 59-72 RT

Specimen Details: Circumferentially notched,
 $K_t = 3.0$
0.306 inch gross diameter
0.253 inch net diameter
0.013 inch root radius, r
60° flank angle, ω

No. of Heats/Lots: 10

Equivalent Stress Equation:
 $\log N_f = 8.21 - 2.96 \log (S_{eq} - 5)$
 $S_{eq} = S_{max} (1-R)^{0.68}$
Std. Error of Estimate, $\log (\text{Life}) = 0.307$
Standard Deviation, $\log (\text{Life}) = 0.735$
 $R^2 = 83\%$

Surface Condition: Not specified

References: 3.7.4.2.9(b) and 3.7.8.2.8(b)

Sample Size = 80

[Caution: The equivalent stress model may provide unrealistic life predictions for stress ratios beyond those represented above.]

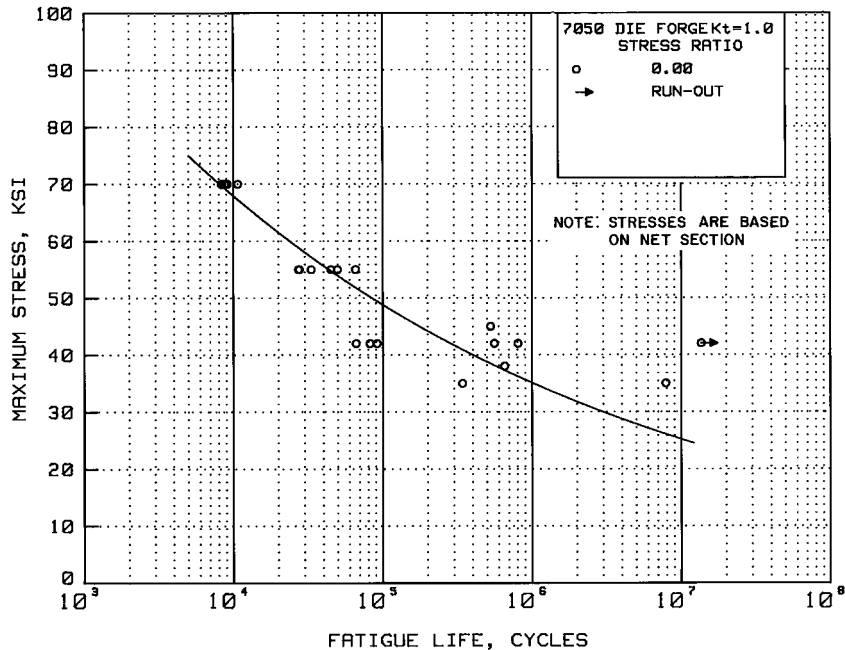

Figure 3.7.4.2.8(k). Best-fit S/N curves for unnotched 7050-T74 die forging, longitudinal directions.

Correlative Information for Figure 3.7.4.2.8(k)

Product Form: Die forging

Test Parameters:

Properties: TUS, ksi TYS, ksi Temp., °F
 74-81 68-71 RT

Loading - Axial
 Frequency - 800 cpm
 Temperature - RT
 Environment - Air

Specimen Details: Unnotched
 0.300 inch diameter

No. of Heats/Lots: 4

Surface Condition: Not specified

Equivalent Stress Equation:

References: 3.7.4.2.9(b) and 3.7.8.2.8(b)

$\log N_f = 16.8 - 6.97 \log (S_{max})$
 Std. Error of Estimate, $\log (\text{Life}) = 0.381$
 Standard Deviation, $\log (\text{Life}) = 0.820$
 $R^2 = 78\%$

Sample Size = 20

[Caution: The equivalent stress model may provide unrealistic life predictions for stress ratios beyond those represented above.]

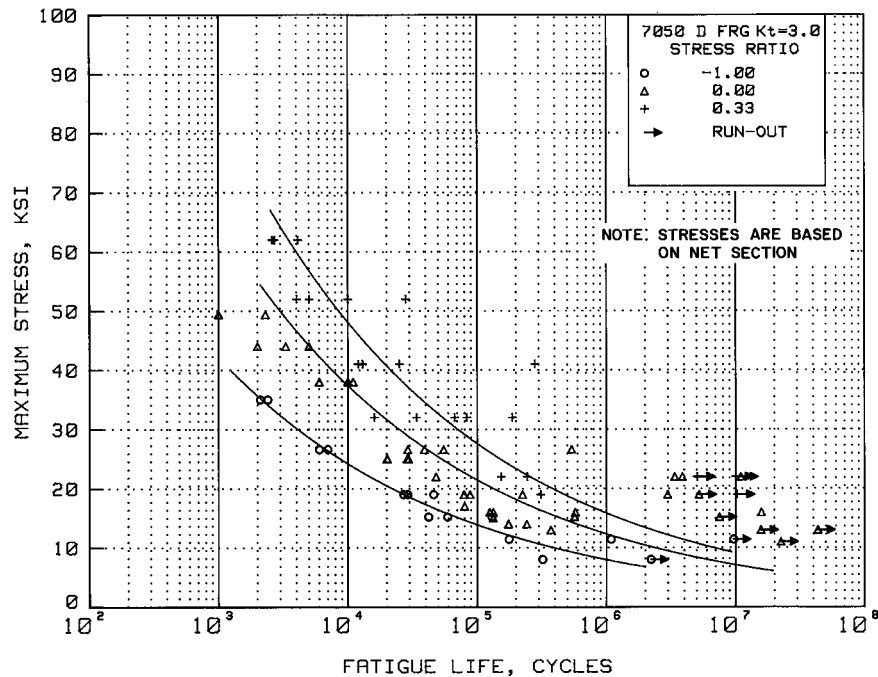

Figure 3.7.4.2.8(l). Best-fit S/N curves for notched, $K_t = 3.0$, 7050-T74 die forging, longitudinal direction.

Correlative Information for Figure 3.7.4.2.8(l)

Product Form: Die forging

Test Parameters:

Properties: TUS, ksi TYS, ksi Temp., °F
77-81 68-71 RT

Loading - Axial
Frequency - 800, 1800 cpm
Temperature - RT
Environment - Air

Specimen Details: Circumferentially notched,
 $K_t = 3.0$
0.306 and 0.305 inch
gross diameter
0.253 or 0.222 inch net
diameter
0.013 or 0.012 inch
root radius, r
60° flank angle, ω

No. of Heats/Lots: 6

Equivalent Stress Equation:
 $\log N_f = 10.5 - 4.14 \log (S_{eq})$
 $S_{eq} = S_{max} (1-R)^{0.629}$
Std. Error of Estimate, $\log (\text{Life}) = 0.506$
Standard Deviation, $\log (\text{Life}) = 0.896$
 $R^2 = 68\%$

Surface Condition: Not specified

Sample Size = 73

References: 3.7.4.2.8(b), 3.7.4.2.9(b), and
3.7.8.2.8(b)

[Caution: The equivalent stress model may provide unrealistic life predictions for stress ratios beyond those represented above.]

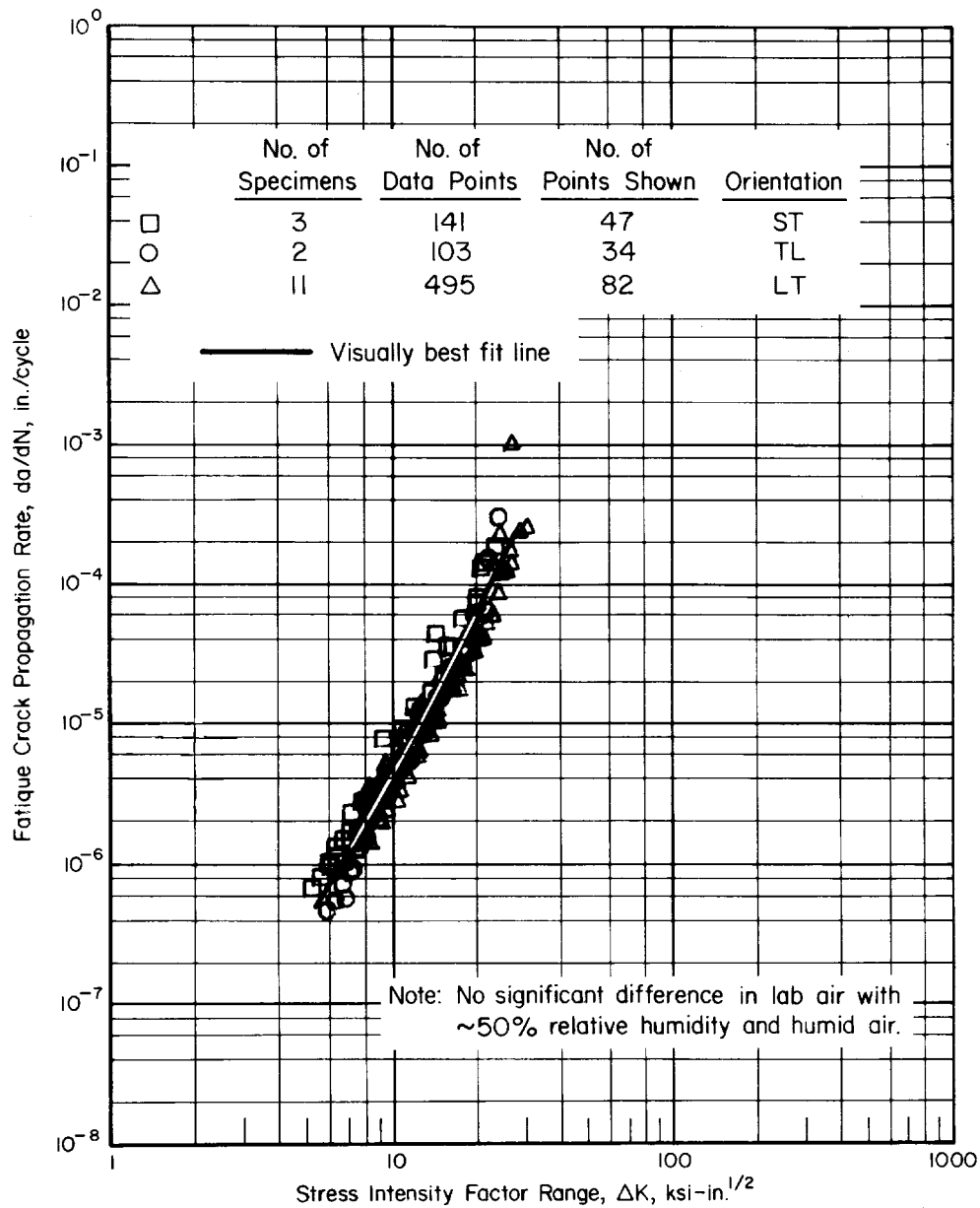

Figure 3.7.4.2.9(a). Fatigue-crack-propagation data for 3.15-inch-thick 7050-T7451 aluminum plate [Reference 3.7.4.2.9(a)].

<i>Specimen Thickness:</i>	0.499-0.500 inch	<i>Environment:</i>	Lab air (~50% humidity) and humid air (100% humidity)
<i>Specimen Width:</i>	2.989-3.000 inches	<i>Temperature:</i>	RT
<i>Specimen Type:</i>	C(T)	<i>Frequency, f:</i>	10-20 Hz
<i>Stress Ratio, R:</i>	0.1		

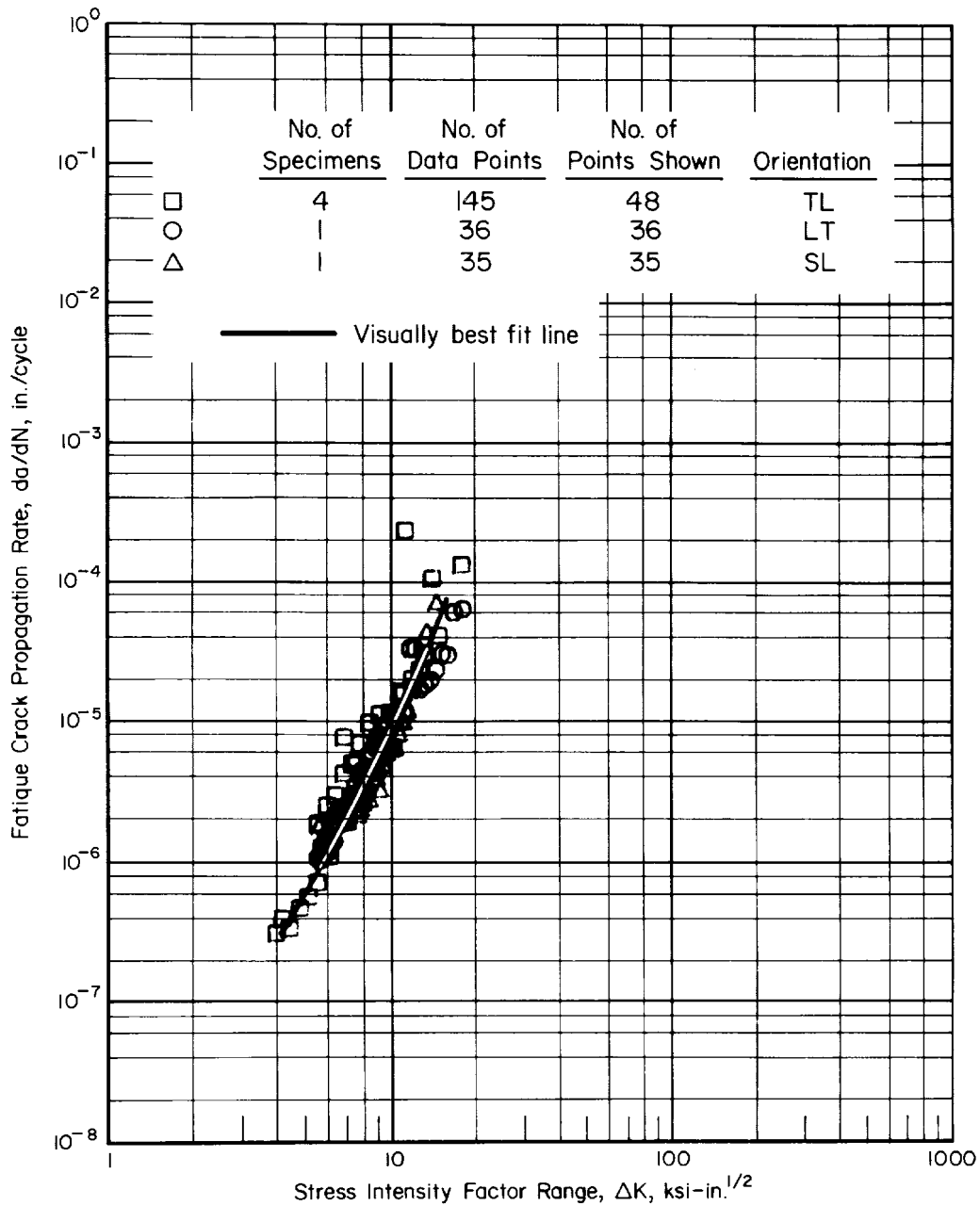

Figure 3.7.4.2.9(b). Fatigue-crack-propagation data for 1- and 6-inch-thick 7050-T7451 aluminum plate [Reference 3.7.4.2.9(b)].

<i>Specimen Thickness:</i>	0.999-1.000 inch	<i>Environment:</i>	Dry air (< 10% humidity)
<i>Specimen Width:</i>	3.805 inches	<i>Temperature:</i>	RT
<i>Specimen Type:</i>	C(T)	<i>Frequency, f:</i>	18.3 Hz
<i>Stress Ratio, R:</i>	0.33		

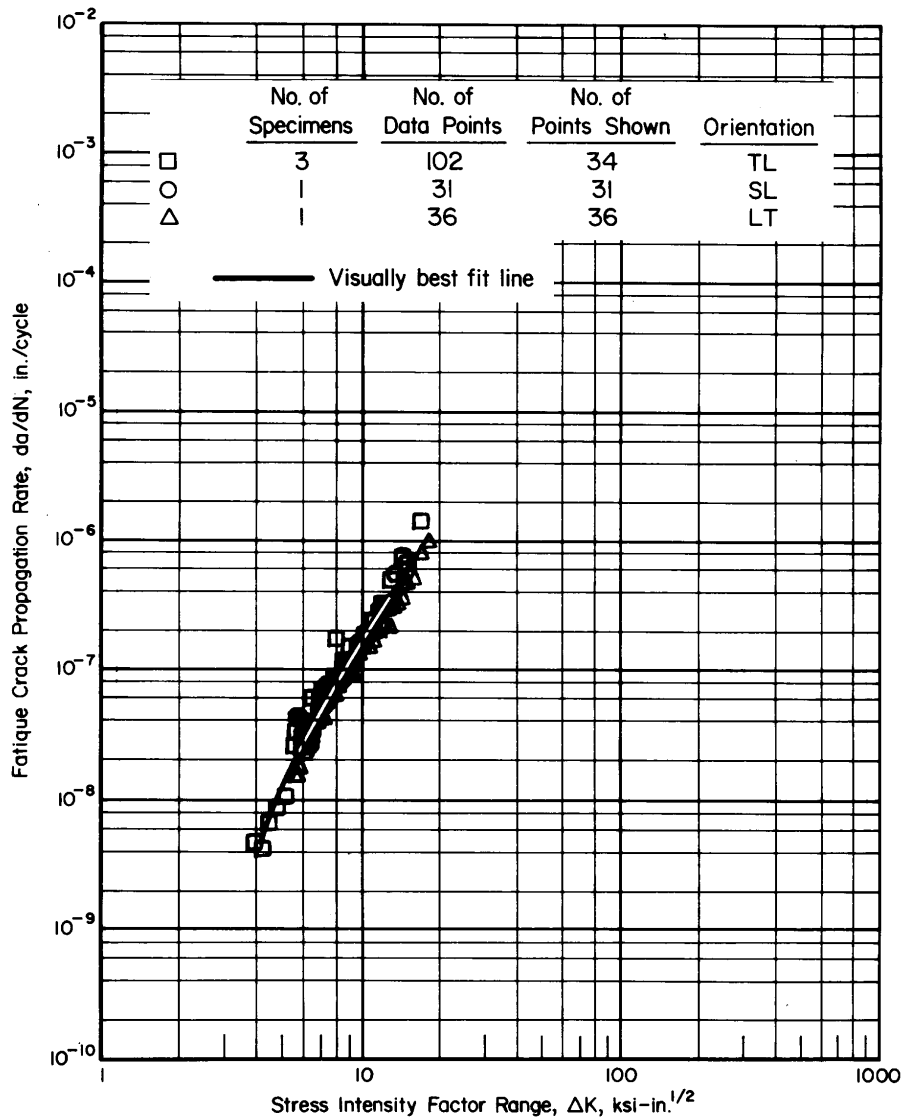

Figure 3.7.4.2.9(c). Fatigue-crack-propagation data for 1- and 6-inch-thick 7050-T7451 aluminum plate [Reference 3.7.4.2.9(b)].

<i>Specimen Thickness:</i>	0.998-1.000 inch	<i>Environment:</i>	Humid air (>90% humidity)
<i>Specimen Width:</i>	3.805 inches	<i>Temperature:</i>	RT
<i>Specimen Type:</i>	C(T)	<i>Frequency, f:</i>	18.3 Hz
<i>Stress Ratio, R:</i>	0.33		

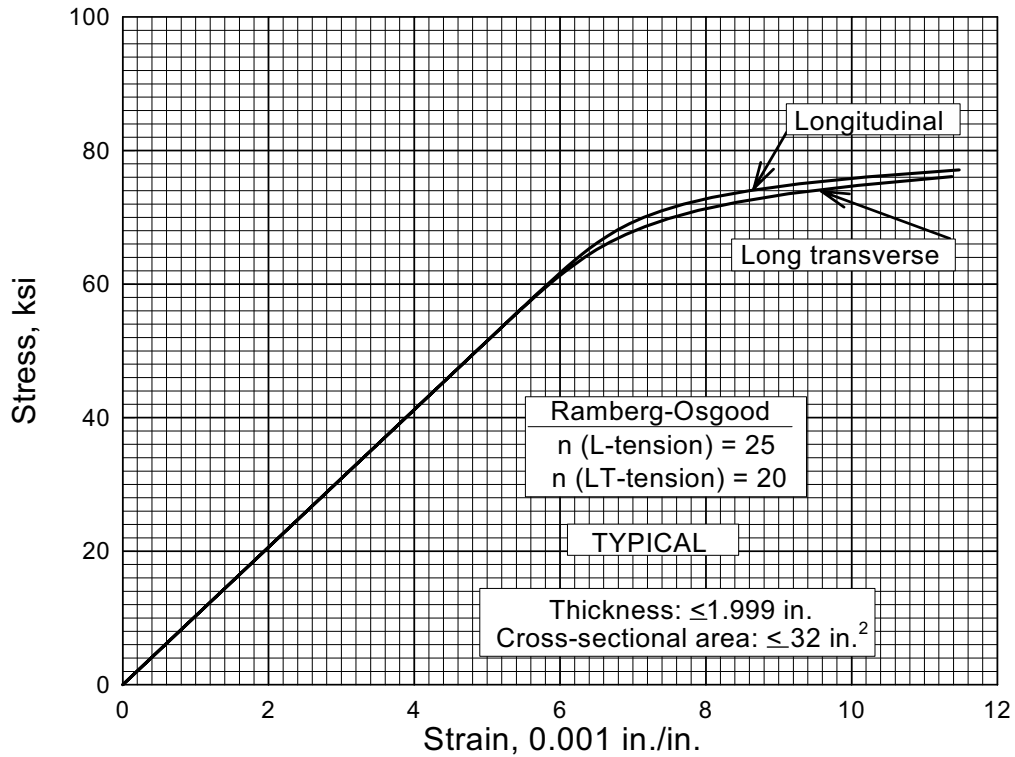

Figure 3.7.4.3.6(a). Typical tensile stress-strain curves for 7050-T7651X aluminum alloy extrusion at room temperature.

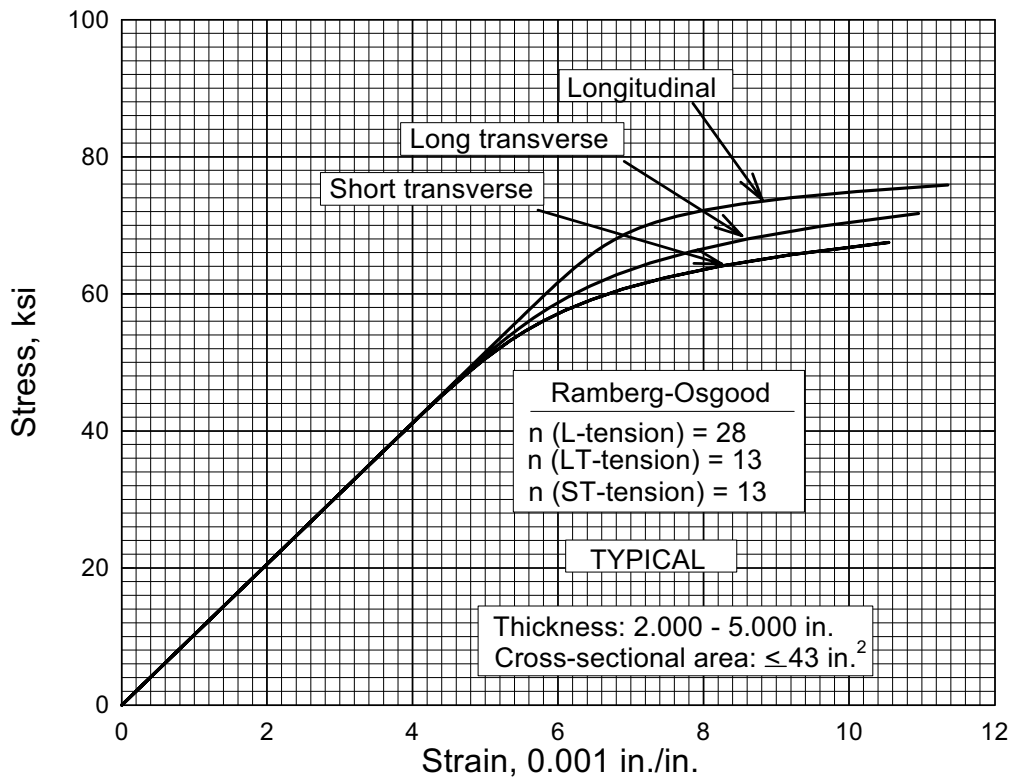

Figure 3.7.4.3.6(b). Typical tensile stress-strain curves for 7050-T7651X aluminum alloy extrusion at room temperature.

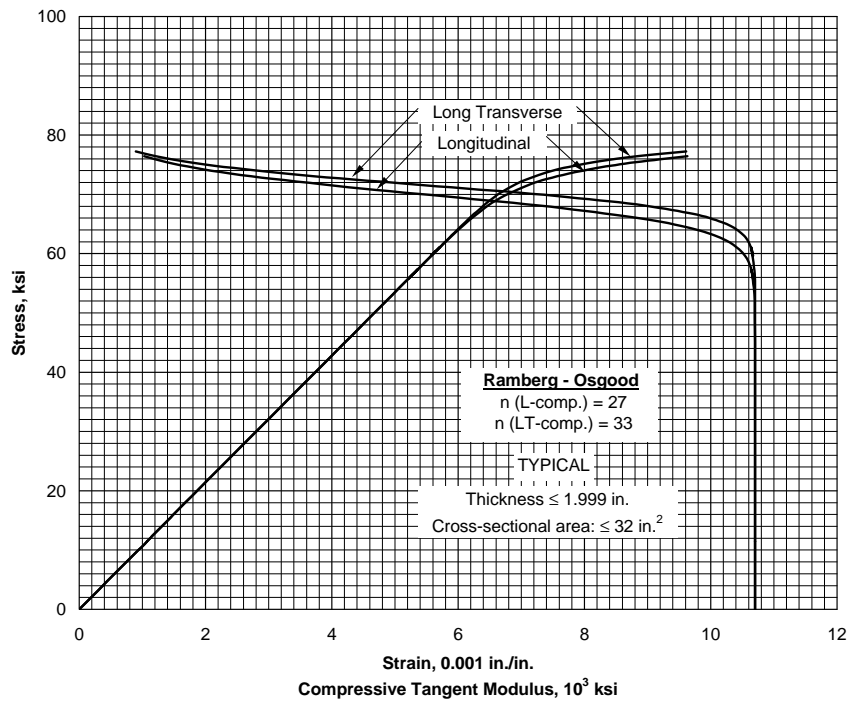

Figure 3.7.4.3.6(c). Typical compressive stress-strain and compressive tangent-modulus curves for 7050-T7651X aluminum alloy extrusion at room temperature.

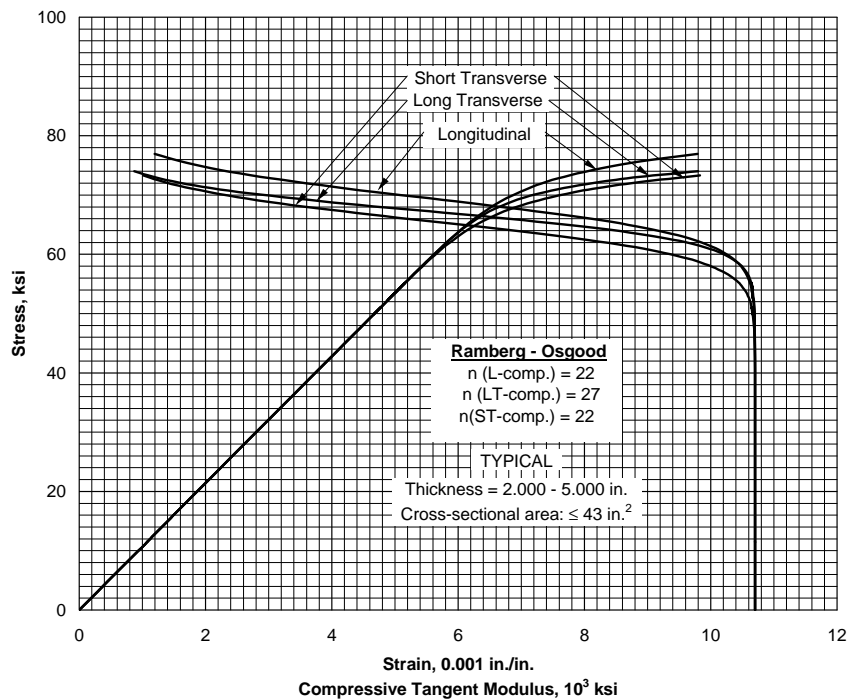

Figure 3.7.4.3.6(d). Typical compressive stress-strain and compressive tangent-modulus curves for 7050-T7651X aluminum alloy extrusion at room temperature.

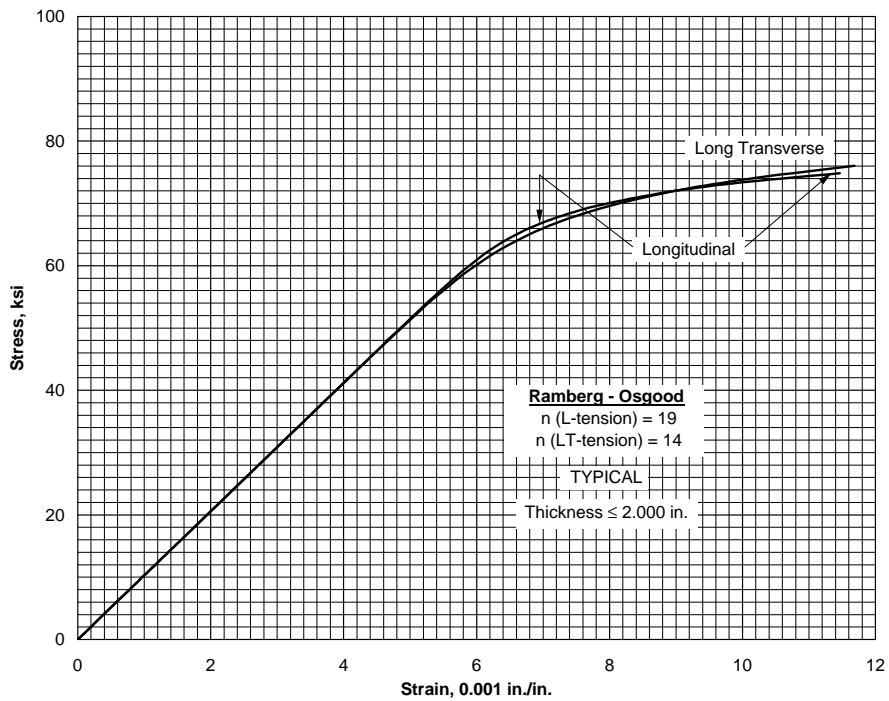

Figure 3.7.4.3.6(e). Typical tensile stress-strain curves for 7050-T7651 aluminum alloy plate at room temperature.

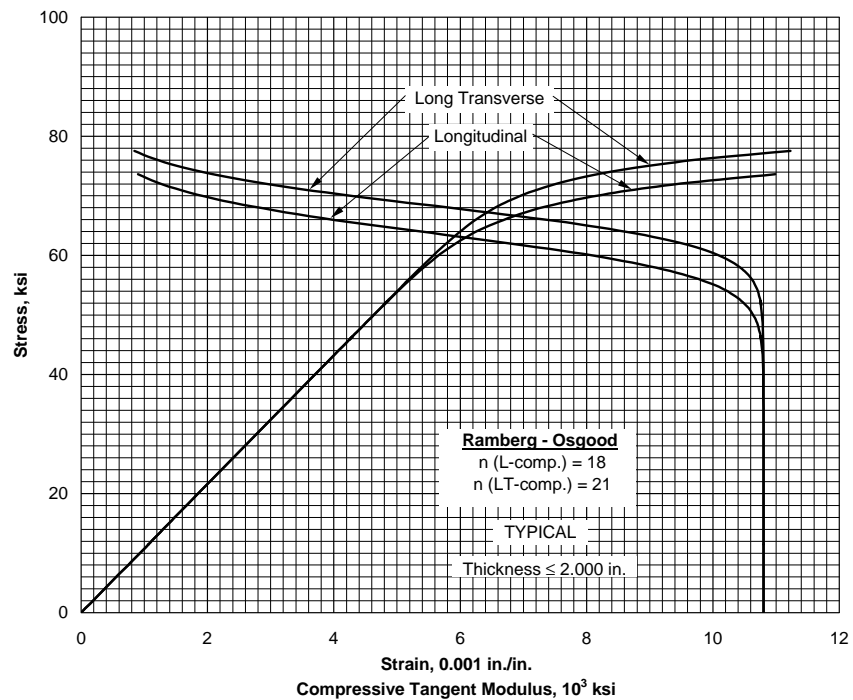

Figure 3.7.4.3.6(f). Typical compressive stress-strain and compressive tangent-modulus curves for 7050-T7651 aluminum alloy plate at room temperature.

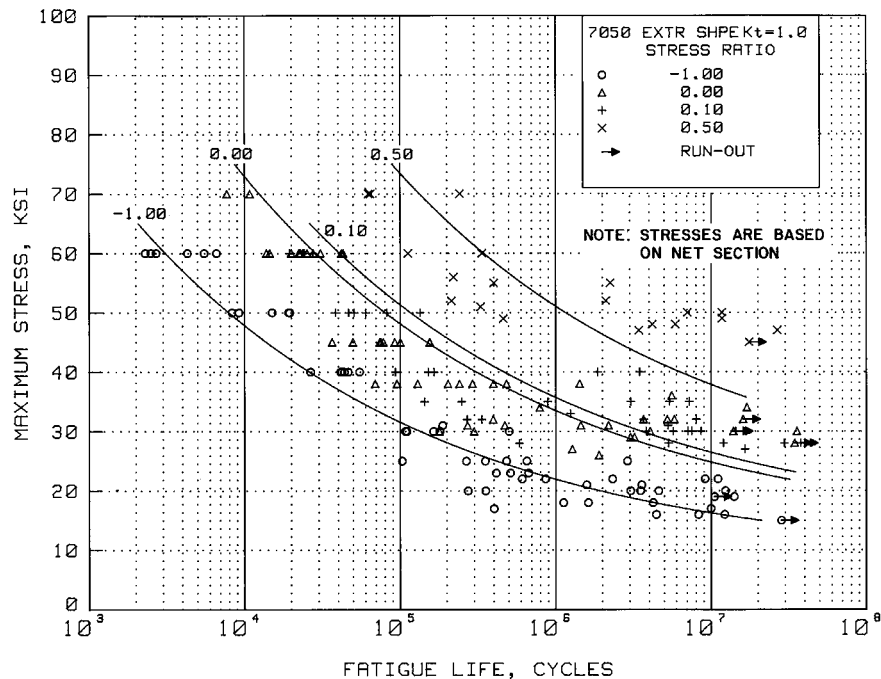

Figure 3.7.4.3.8(a). Best-fit S/N curves for unnotched 7050-T7651X extruded shape, longitudinal and long transverse directions.

Correlative Information for Figure 3.7.4.3.8(a)

Product Form: Extruded shape, 0.5 to 5.0 inch thick

Test Parameters:
Loading - Axial
Frequency - 800 cpm
Temperature - RT
Environment - Air

Properties: TUS, ksi TYS, ksi Temp., °F
 84-90 75-81 RT

Specimen Details: Unnotched
 0.300 inch diameter

No. of Heats/Lots: 10

Surface Condition: Not specified

Equivalent Stress Equation:
 $\log N_f = 11.8 - 4.38 \log (S_{eq} - 12)$
 $S_{eq} = S_{max} (1 - R)^{0.61}$
Std. Error of Estimate, $\log (\text{Life}) = 0.493$
Standard Deviation, $\log (\text{Life}) = 1.01$
 $R^2 = 76\%$

References: 3.7.4.3.8(b), 3.7.4.2.9(b), and
 3.7.7.2.8(b)

Sample Size = 161

[Caution: The equivalent stress model may provide unrealistic life predictions for stress ratios beyond those represented above.]

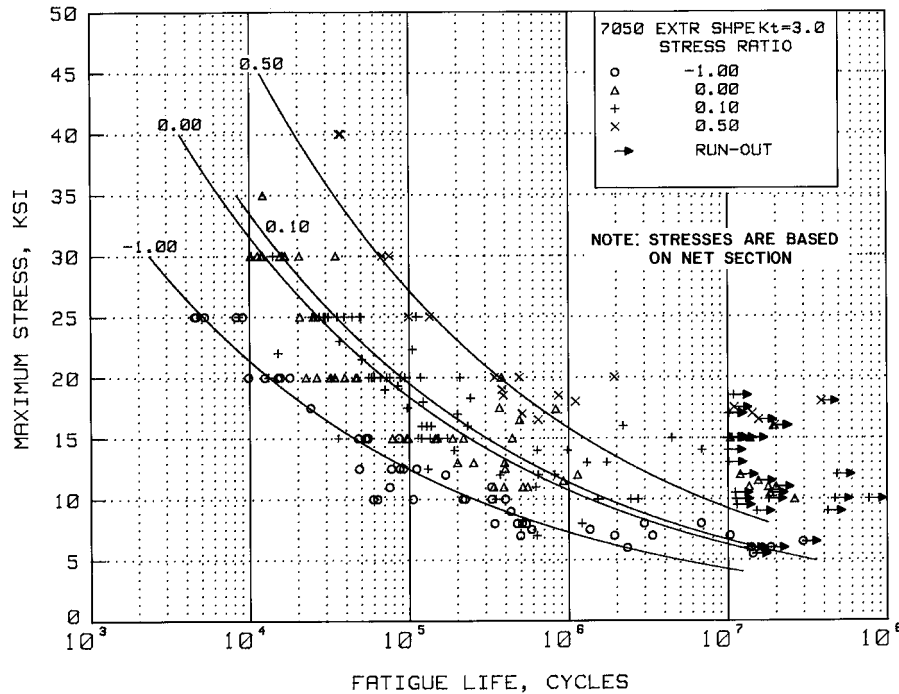

Figure 3.7.4.3.8(b). Best-fit S/N curves for notched, $K_t = 3.0$, 7050-T7651X extruded shape, longitudinal and long transverse directions.

Correlative Information for Figure 3.7.4.3.8(b)

Product Form: Extruded shape, 0.5 to 5.0 inch thick

Test Parameters:
Loading - Axial
Frequency - 800 cpm
Temperature - RT
Environment - Air

Properties: TUS, ksi TYS, ksi Temp., °F
 78-90 68-81 RT

Specimen Details:
Circumferentially notched, $K_t = 3.0$
0.359 inch gross diameter
0.253 inch net diameter
0.013 inch root radius, r
60° flank angle, ω

No. of Heats/Lots: 10

Equivalent Stress Equation:
 $\text{Log } N_f = 10.38 - 4.26 (\text{Seq})$
 $S_{eq} = S_{max} (1-R)^{0.563}$
Std. Error of Estimate, $\text{Log}(\text{Life}) = 0.398$
Standard Deviation, $\text{Log}(\text{Life}) = 0.778$
 $R^2 = 74\%$

Surface Condition: Not specified

References: 3.7.4.2.9(b), 3.7.4.3.8(a), and 3.7.7.2.8(b)

Sample Size = 179

[Caution: The equivalent stress model may provide unrealistic life predictions for stress ratios beyond those represented above.]

3.7.5 7055 ALLOY

3.7.5.0 Comments and Properties — 7055 is an Al-Zn-Mg-Cu-Zr alloy and provides higher strength properties than 7150. 7055 is available in the form of plate and extrusions. The T77-type temper provides high tensile and compressive strength with guaranteed toughness (plate only) and exfoliation corrosion resistance. The T77-type temper has exfoliation corrosion resistance comparable to the T76-type temper of other 7XXX series aluminum alloys.

The properties of extrusions should be based upon the thickness at the time of extrusion, solution heat treatment and quenching prior to machining. Selection of the mechanical properties based upon its final machined thickness may be overstated; therefore, the thickness at the time of extrusion, solution heat treatment and quenching to achieve properties is an important factor in the selection of the proper thickness column. For extrusions having sections with various thicknesses, consideration should be given to the properties as a function of thickness.

Materials specifications for 7055 are shown in Table 3.7.5.0(a). Room-temperature mechanical properties are presented in Tables 3.7.5.0(b) through (e).

Table 3.7.5.0(a). Material Specifications for 7055 Aluminum Alloy

Specification	Form
AMS 4206 (T7751)	Plate
AMS 4324 (T74511)	Extrusion
AMS 4336 (T76511)	Extrusion
AMS 4337 (T77511)	Extrusion

The temper index for 7055 is as follows:

<u>Section</u>	<u>Temper</u>
3.7.5.1	T74511
3.7.5.2	T76511
3.7.5.3	T7751 and T77511

Table 3.7.5.0(b) Design Mechanical and Physical Properties of 7055-T74511 Aluminum Alloy Extrusions

Specification	AMS 4324					
Form	Extrusion					
Temper	T74511					
Thickness, in.	≤ 0.249		0.250-0.499		0.500-3.000	
Basis	A	B	A	B	A	B
Mechanical Properties:						
F_{tu} , ksi:						
L	83	84	84	85	85 ^a	87
LT	78	79	79	80	80	82
F_{ly} , ksi:						
L	76	78	77	79	78 ^a	80
LT	72	74	73	75	74	76
F_{cy} , ksi:						
L	76	78	77	79	78	80
LT	77	79	78	80	79	81
F_{su} , ^b ksi	43	44	46	45	45	46
F_{bru} , ^c ksi:						
(e/D = 1.5)	115	116	116	117	117	120
(e/D = 2.0)	151	152	152	154	154	158
F_{bry} , ^c ksi:						
(e/D = 1.5)	96	99	97	100	99	101
(e/D = 2.0)	114	117	116	119	117	120
e , percent (S-basis):						
L	8	...	8	...	8	...
LT
E , 10 ³ ksi				10.3		
E_c , 10 ³ ksi				10.7		
G , 10 ³ ksi				3.9		
μ				0.33		
Physical Properties:						
ω , lb/in. ³				0.103		
C , Btu/(lb)(°F)				...		
K , Btu/[(hr)(ft ²)(°F)/ft]				...		
α , 10 ⁻⁶ in./in./°F				...		

a Rounded T_{99} values for F_{tu} = 86 ksi, for F_{ly} = 79 ksi.
b Determined in accordance with ASTM B769.
c Bearing values are “dry pin” values per Section 1.4.7.1.

Table 3.7.5.0(c) Design Mechanical and Physical Properties of 7055-T76511 Aluminum Alloy Extrusions

Specification	AMS 4336			
	Extrusion			
	T76511			
	≤ 0.249		0.250-0.499	
Basis	A	B	A	B
Mechanical Properties:				
F_{tu} , ^a ksi:				
L	89 ^a	91	90	94
LT	83	85	84	87
F_{ty} , ^a ksi:				
L	85	87	85	91
LT	79	81	79	85
F_{cy} , ^a ksi:				
L	84	86	85	91
LT	86	88	86	92
F_{su} , ^b ksi	46	47	47	49
F_{bru} , ^c ksi:				
(e/D = 1.5)	122	125	124	129
(e/D = 2.0)	160	163	161	169
F_{bry} , ^c ksi:				
(e/D = 1.5)	105	107	105	112
(e/D = 2.0)	124	127	124	132
e , percent (S-basis):				
L	7		9	
LT	
E , 10 ³ ksi	10.4			
E_c , 10 ³ ksi	10.8			
G , 10 ³ ksi	3.9			
μ	0.33			
Physical Properties:				
ω , lb/in. ³	0.103			
C , Btu/(lb)(°F)			
K , Btu/[(hr)(ft ²)(°F)/ft]			
α , 10 ⁻⁶ in./in./°F			

a Rounded T_{99} values for F_{tu} = 90 ksi
b Determined in accordance with ASTM B769.
c Bearing values are “dry pin” values per Section 1.4.7.1.

Table 3.7.5.0(d) Design Mechanical and Physical Properties of 7055-T7751 Aluminum Alloy Plate

Specification	AMS 4206	
Form	Plate	
Temper	T7751	
Thickness, in.	0.500 - 1.500	
Basis	A	B
Mechanical Properties:		
F_{tu} , ksi:		
L	89	91
LT	89	91
F_{ty} , ksi:		
L	86	88
LT	85	87
F_{cy} , ksi:		
L	86	88
LT	89	91
F_{su} ^a ksi	48	49
F_{bru} ^b ksi:		
(e/D = 1.5)	128	131
(e/D = 2.0)	167	170
F_{brt} ^b ksi:		
(e/D = 1.5)	112	115
(e/D = 2.0)	130	133
e , percent (S-basis):		
L	7	...
LT	8	...
E , 10 ³ ksi	10.4	
E_c , 10 ³ ksi	10.7	
G , 10 ³ ksi	3.9	
μ	0.32	
Physical Properties:		
ω , lb/in. ³	0.103	
C , Btu/(lb)(°F)	
K , Btu/[(hr)(ft ²)(°F)/ft]	
α , 10 ⁻⁶ in./in./°F	

a Determined in accordance with ASTM B769.

b Bearing values are "dry pin" values per Section 1.4.7.1.

Table 3.7.5.0(e) Design Mechanical and Physical Properties of 7055-T77511 Aluminum Alloy Extrusion

Specification	AMS 4337	
Form	Extrusion	
Cross-sectional area, in ²		
Temper	T77511	
Thickness, in.	0.500 - 1.500	
Basis	A	B
Mechanical Properties:		
F_{tu} , ksi:		
L	94	95
LT	88	90
F_{ty} , ksi:		
L	90	93
LT	84 ^a	88
F_{cy} , ksi:		
L	92	94
LT	89	92
F_{su} , ^b ksi	48	49
F_{bru} , ^c ksi:		
(e/D = 1.5)	128	131
(e/D = 2.0)	167	169
F_{bry} , ^c ksi:		
(e/D = 1.5)	109	113
(e/D = 2.0)	131	135
e , percent (S-basis):		
L	9	
LT	5	
E , 10 ³ ksi	10.4	
E_c , 10 ³ ksi	11.0	
G , 10 ³ ksi	
μ	0.33	
Physical Properties:		
ω , lb/in. ³	0.103	
C , Btu/(lb)(°F)	
K , Btu/[(hr)(ft ²)(°F)/ft]	
α , 10 ⁻⁶ in./in./°F	

a S-basis. The T_{99} value is 85.86 ksi.

b Determined in accordance with ASTM B769.

c Bearing values are "dry pin" values per Section 1.4.7.1.

3.7.6 7075 ALLOY

3.7.6.0 Comments and Properties — 7075 is a high-strength Al-Zn-Mg-Cu alloy and is available in a wide variety of product forms. It is also available in several types of tempers, the T6, T73, and T76 type. The T6 temper has the highest strength but lowest toughness and resistance to stress-corrosion cracking. Since toughness decreases with a decrease in temperature, the T6 temper is not generally recommended for cryogenic applications. As shown in Table 3.1.2.3.1(a), 7075-T6 rolled plate, rod and bar, extruded shapes, and forgings have a 'D' SCC rating. This is the lowest rating and means that SCC failures have occurred in service or would be anticipated if there is any sustained stress. In-service failures are caused by stressed produced by any combination of sources including solution heat treatment, straightening, forming, fit-up, clamping, sustained service loads or high service compression stresses that produce residual tensile stresses. These stresses may be tension or compression as well as the stresses due to the Poisson effect, because the actual failures are caused by the resulting sustained shear stresses. Pin-hole flaws in corrosion protection are sufficient for SCC. The T73 temper provides for much improved stress-corrosion resistance over T6 temper with a decrease in strength. The T76 temper provides for improved exfoliation resistance and limited stress-corrosion resistance over T6 temper with some decrease in strength. Refer to Section 3.1.2.3 for comments regarding the resistance of the alloy to stress-corrosion cracking and to Section 3.1.3.4 for comments regarding the weldability of this alloy.

The properties of extrusions should be based upon the thickness at the time of quenching prior to machining. Selection of the mechanical properties based upon its final machined thickness may be unconservative; therefore, the thickness at the time of quenching to achieve properties is an important factor in the selection of the proper thickness column. For extrusions having sections with various thicknesses, consideration should be given to the properties as a function of thickness.

Material specifications for 7075 aluminum alloy are presented in Table 3.7.6.0(a). Room-temperature mechanical and physical properties are shown in Tables 3.7.6.0(b₁) through (g₄). The effect of temperature on the physical properties of this alloy is presented in Figure 3.7.6.0.

Table 3.7.6.0(a). Material Specifications for 7075 Aluminum Alloy

Specification	Form
AMS 4044	Bare sheet and plate
AMS 4045	Bare sheet and plate
AMS 4078	Bare plate
AMS-QQ-A-250/12, 24	Bare sheet and plate
AMS-QQ-A-250/13, 25	Clad sheet and plate
AMS 4049	Clad sheet and plate
AMS 4122	Bar and rod, rolled or cold finished
AMS 4123	Bar and rod, rolled or cold finished
AMS 4124	Bar and rod, rolled or cold finished
AMS 4186	Bar and rod, rolled or cold finished
AMS 4187	Bar and rod, rolled or cold finished
AMS-QQ-A-225/9	Rolled or drawn bar and rod
AMS-QQ-A-200/11, 15	Extruded bar, rod, and shapes
AMS 4126	Forging

Table 3.7.6.0(a). Material Specifications for 7075 Aluminum Alloy Continued

Specification	Form
AMS 4141	Die forging
AMS 4147	Forging
AMS-A-22771	Forging
AMS-QQ-A-367	Forging

The temper index for 7075 is as follows:

<u>Section</u>	<u>Temper</u>
3.7.6.1	T6, T651, T652, T6510, T6511
3.7.6.2	T73, T7351, T7352, T73510, T73511

3.7.6.1 T6, T651, T652, T6510, T6511 Temper — Figures 3.7.6.1.1(a) and (b) permit calculation of residual tensile strengths for complex thermal exposure conditions. They are based upon the rate parameter $T(C + \log t)$, in which T is exposure temperature in degrees Rankine, t is exposure time in hours and C is a constant evaluated for each material. These curves have been verified for use only within the ranges of temperatures and exposure times covered in the figures. The following example illustrates their use.

Sample problem: Find F_{tu} at 250°F following a complex exposure of 300°F, 8 hours plus 350°F, 1 hour.

1. Reduce given complex exposure by converting 350°F exposure to equivalent exposure time at 300°F.*
 - a. On the 350°F single exposure temperature line find 350°F, 1 hour.
 - b. From this point move vertically to the 300°F exposure temperature line and then read right, 12 hours exposure.
 - c. Total equivalent exposure time at 300°F is therefore 8 hours + 12 hours or 20 hours.
2. Find F_{tu} at 250°F following 300°F, 20 hours exposure:
 - a. On the 300°F exposure temperature line find 300°F, 20 hours.
 - b. From this point move vertically to the 250°F test temperature curve and then read left, 76 percent F_{tu} .

Solution: F_{tu} is 76 percent of the original room temperature F_{tu} . F_{ty} is determined in like manner. F_{cy} can be closely estimated by using the percent reduction factor determined for F_{ty} . For specific data, see Reference 3.7.6.1.

Stressed Thermal Exposure — Stress applied during sample and complex thermal exposure of 7075-T6 can have additional effect in reducing material strength. However, the effect becomes significant only when exposure strains exceed 0.2 percent. For specific data, see Reference 3.7.6.1.

* Choice of reference temperature is optional as long as it permits computation within the bounds of the figures.

Figures 3.7.6.1.1(c) through 3.7.6.1.5(b) present elevated temperature curves for various mechanical properties. Figures 3.7.6.1.6(a) through (m) present tensile and compressive stress-strain and tangent-modulus curves at several temperatures. Figures 3.7.6.1.6(n) through (q) are full-range stress-strain curves for various products. Figures 3.7.6.1.8(a) through (h) provide room-temperature fatigue curves for T6 temper products. Fatigue-crack propagation data for sheet are presented in Figure 3.7.6.1.9. Graphical displays of the residual strength behavior of middle tension panels are presented in Figure 3.7.6.1.10(a) through (h).

3.7.6.2 T73, T7351, T7352, T73510, T73511 Tempers — Figures 3.7.6.2.6(a) through (d) present stress-strain and tangent-modulus curves for various products and tempers. Figures 3.7.6.2.6(e) and (f) are full-range stress-strain curves at room temperature for extrusion. Fatigue-crack-propagation data for plate are presented in Figures 3.7.6.2.9(a) through (c). Graphical displays of the residual strength behavior of middle tension panels are presented in Figures 3.7.6.2.10(a) and (b).

Table 3.7.6.0(b)₁. Design Mechanical and Physical Properties of 7075 Aluminum Alloy Sheet and Plate

Specification	AMS 4045 and AMS-QQ-A-250/12														
	Sheet						Plate								
	T6 and T62 ^a						T651								
Form	0.008-0.011	0.012-0.039	0.040-0.125	0.126-0.249	0.250-0.499	0.500-1.000	1.001-2.000	2.001-2.500	2.501-3.000	3.001-3.500	3.501-4.000				
Temper	A	B	A	B	A	B	A	B	A	B	A	B	A	B	
Thickness, in.	
Basis	S	A	B	A	B	A	B	A	B	A	B	A	B	A	B
Mechanical Properties:															
F_{up} , ksi:															
L	76	78	80	78	80	77	79	75	77	70	73	72	70	72	68
LT	76	78	80	80	80	78	80	76	78	71	74	72	71	73	69
ST	70 ^b	71 ^b	65 ^b	66 ^b	66 ^b	65 ^b	67 ^b	63 ^b
F_{up} , ksi:															
L	69	72	70	71	73	69	71	66	68	60	65	63	60	62	58
LT	67	70	68	70	71	67	69	64	66	58	63	61	58	60	56
ST	59 ^b	61 ^b	54 ^b	58 ^b	56 ^b	54 ^b	55 ^b	52 ^b
F_{cp} , ksi:															
L	68	71	69	70	72	67	69	62	64	55	60	58	55	57	52
LT	71	74	72	74	75	71	73	68	70	61	67	65	61	64	59
ST	67	70	61	66	64	61	63	59
F_{sp} , ksi	44	45	42	43	42	42	43	41
$F_{br,c}$, ksi:															
(e/D = 1.5)	118	121	121	124	124	117	120	114	117	108	111	108	107	110	104
(e/D = 2.0)	152	156	156	160	160	145	148	143	147	134	137	134	132	135	128
$F_{br,c}$, ksi:															
(e/D = 1.5)	100	105	102	103	106	97	100	98	98	94	97	94	89	93	87
(e/D = 2.0)	117	122	119	122	124	114	118	113	120	109	112	109	104	108	103
e , percent (S-basis):															
LT	5	7	8	8	...	9	...	6	...	5	...	5	5	...	3
E , 10 ³ ksi	...	10.3
E_c , 10 ³ ksi	...	10.5
G , 10 ³ ksi	...	3.9
μ	...	0.33
Physical Properties:															
ω , lb/in. ³
C , K , and α

0.101
See Figure 3.7.6.0

a Design allowables were based upon data obtained from testing T6 temper sheet and from testing samples of sheet, supplied in the O or F temper, which were heat treated to demonstrate response to heat treatment by suppliers. Properties obtained by the user may be lower than those listed if the material has been formed or otherwise cold worked, particularly in the annealed temper, prior to solution heat treatment.
b Caution: This specific alloy, temper, and product form exhibits poor stress-corrosion cracking resistance in this grain direction. It corresponds to an SCC resistance rating of D, as indicated in Table 3.1.2.3.1(a).
c Bearing values are "dry pin" values per Section 1.4.7.1. See Table 3.1.2.1.1.

Table 3.7.6.0(b₂). Design Mechanical and Physical Properties of 7075 Aluminum Alloy Plate—Continued

Specification	AMS-QQ-A-250/12													
	AMS 4044 and AMS-QQ-A-250/12						AMS-QQ-A-250/12							
	Plate													
Form	T62 ^a													
Temper														
Thickness, in.	0.250-0.499		0.500-1.000		1.001-2.000		2.001-2.500		2.501-3.000		3.001-3.500		3.501-4.000	
Basis	A	B	A	B	A	B	A	B	A	B	A	B	A	B
Mechanical Properties:														
F_{up} , ksi:														
L	74	76	74	76	73	75	72	74	69	71	68	70	64	66
LT	78	80	78	80	77	79	76	78	72	74	71	73	67	69
ST	70 ^b	71 ^b	66 ^b	68 ^b	65 ^b	67	61 ^b	63 ^b
F_{up} , ksi:														
L	65	67	66	68	64	65	60	62	56	58	52	54	48	49
LT	67	69	68	70	67	69	64	66	61	63	58	60	54	56
ST	59 ^b	61 ^b	56 ^b	58 ^b	54 ^b	55 ^b	50 ^b	52 ^b
F_{cp} , ksi:														
L	70	72	70	72	68	70	63	65	59	61	55	57	50	52
LT	70	72	71	73	68	71	65	67	61	63	57	59	52	54
ST	63	65	60	62	57	59	53	55
F_{sup} , ksi:														
F_{brt}^c , ksi:														
(e/D = 1.5)	43	44	44	45	44	45	44	45	42	43	42	43	39	41
(e/D = 2.0)	117	120	117	120	116	119	114	117	108	111	107	110	101	104
F_{bry} , ksi:														
(e/D = 1.5)	145	148	145	148	143	147	141	145	134	137	132	135	124	128
(e/D = 2.0)	97	100	100	103	100	103	98	101	94	97	89	93	84	87
e , percent (S-basis):														
LT	9	...	7	...	6	...	5	...	5	...	5	...	3	...
E , 10 ³ ksi	10.3													
E_c , 10 ³ ksi	10.6													
G , 10 ³ ksi	3.9													
μ	0.33													
Physical Properties:														
ω , lb/in. ³	0.101													
C , K , and α	See Figure 3.7.6.0													

a Design allowables were based upon data obtained from testing samples of plate, supplied in O or F temper, which were heat treated to demonstrate response to heat treatment by suppliers. Properties obtained by the user may be lower than those listed if the material has been formed or otherwise cold worked, particularly in the annealed temper, prior to solution heat treatment.

b Caution: This specific alloy, temper, and product form exhibits poor stress-corrosion cracking resistance in this grain direction. It corresponds to an SCC resistance rating of D, as indicated in Table 3.1.2.3.1(a).

c Bearing values are "dry pin" values per Section 1.4.7.1. See Table 3.1.2.1.1.

Table 3.7.6.0(b₃). Design Mechanical and Physical Properties of 7075 Aluminum Alloy Sheet and Plate—Continued

Specification	AMS 4078 and AMS-QQ-A-250/12													
	AMS-QQ-A-250/12													Plate
	Sheet	T7351												
Form	T7351													
Temper	T7351													
Thickness, in.	T7351													
Basis	0.250-0.499	0.500-1.000		1.001-1.500		1.501-2.000		2.001-2.500		2.501-3.000		3.001-3.500		3.501-4.000
	S	A	B	A	B	A	B	A	B	A	B	A	B	S
Mechanical Properties:														
F_{m^2} , ksi:														
L	68	68	70	67	69	66	68	65	65	67	63	65	62	60
LT	69	69	71	68	70	67	69	66	66	68	64 ^a	66	63	61
ST	63	65	62	62	64	60	62	59	57
F_{m^2} , ksi:														
L	57	57	59	57	59	55	57	52	52	55	49	53	49	48
LT	57	57	59	57	59	55	57	52 ^b	52	55	49 ^a	53	49	48
ST	52	54	49	49	52	47	50	47	46
F_{op^2} , ksi:														
L	56	56	58	56	58	53	55	50	50	53	47	51	47	45
LT	59	59	61	59	61	57	59	54	54	57	51	55	51	50
ST	39	40	39	39	40	38	39	38	37
F_{wp^2} , ksi:														
F_{br^2} , ksi:														
(e/D = 1.5)	102	103	106	103	106	102	106	102	102	105	100	103	99	96
(e/D = 2.0)	131	132	136	132	136	132	136	131	131	135	128	132	127	124
F_{br^2} , ksi:														
(e/D = 1.5)	79	81	83	83	86	82	85	79	79	83	76	81	76	76
(e/D = 2.0)	95	97	100	99	102	97	101	93	93	99	89	96	89	88
e , percent (S-basis):														
LT	7	7	...	6	...	6	...	6	6	...	6	...	6	6
E , 10 ³ ksi	10.3	10.3	10.3	10.3	10.3	10.3	10.3	10.3	10.3	10.3	10.3	10.3	10.3	10.3
E_p , 10 ³ ksi	10.5	10.5	10.5	10.5	10.5	10.5	10.5	10.5	10.5	10.5	10.5	10.5	10.5	10.5
G , 10 ³ ksi	3.9	3.9	3.9	3.9	3.9	3.9	3.9	3.9	3.9	3.9	3.9	3.9	3.9	3.9
μ	0.33	0.33	0.33	0.33	0.33	0.33	0.33	0.33	0.33	0.33	0.33	0.33	0.33	0.33
Physical Properties:														
ω , lb/in. ³	0.101	0.101	0.101	0.101	0.101	0.101	0.101	0.101	0.101	0.101	0.101	0.101	0.101	0.101
C , K , and α	See Figure 3.7.6.0	See Figure 3.7.6.0	See Figure 3.7.6.0	See Figure 3.7.6.0	See Figure 3.7.6.0	See Figure 3.7.6.0	See Figure 3.7.6.0	See Figure 3.7.6.0	See Figure 3.7.6.0	See Figure 3.7.6.0	See Figure 3.7.6.0	See Figure 3.7.6.0	See Figure 3.7.6.0	See Figure 3.7.6.0

a S-basis. The rounded T_{09} values are as follows: $F_{m}(LT) = 65$ ksi and $F_{p}(LT) = 52$ ksi.
b S-basis. The rounded T_{09} value is as follows: $F_{p}(LT) = 53$ ksi.
c Bearing values are "dry pin" values per Section 1.4.7.1. See Table 3.1.2.1.1.

Table 3.7.6.0(b₄). Design Mechanical and Physical Properties of 7075 Aluminum Alloy Sheet and Plate—Concluded

Specification	AMS-QQ-A-250/24				
Form	Sheet and plate				
Temper	T76	T7651			
Thickness, in.	0.063-0.249	0.250-0.499	0.500-1.000	1.001-1.500	1.501-2.000
Basis	S	S	S	S	S
Mechanical Properties:					
F_{tu} , ksi:					
L	72	71	70	70	70
LT	73	72	71	71	71
ST	65
F_{ly} , ksi:					
L	62	60	59	59	59
LT	62	61	60	60	60
ST	56
F_{cy} , ksi:					
L	61	60	59	59	59
LT	65	64	63	63	63
ST	63
F_{su} , ksi	42	40	41	42	43
F_{bru}^a , ksi:					
(e/D = 1.5)	112	109	108	108	108
(e/D = 2.0)	145	141	140	140	140
F_{bry}^a , ksi:					
(e/D = 1.5)	88	86	86	86	87
(e/D = 2.0)	102	99	99	99	100
e , percent:					
LT	8	8	6	5	5
E , 10 ³ ksi	10.3	10.3			
E_c , 10 ³ ksi	10.5	10.6			
G , 10 ³ ksi	3.9	3.9			
μ	0.33	0.33			
Physical Properties:					
ω , lb/in. ³	0.101				
C , K , and α	See Figure 3.7.6.0				

a Bearing values are “dry pin” values per Section 1.4.7.1. See Table 3.1.2.1.1.

Table 3.7.6.0(c₁). Design Mechanical and Physical Properties of Clad 7075 Aluminum Alloy Sheet

Specification	AMS 4049								
Form	Sheet								
Temper	T6								
Thickness, in.	0.008-0.011	0.012-0.039		0.040-0.062		0.063-0.187		0.188-0.249	
Basis	S	A	B	A	B	A	B	A	B
Mechanical Properties:									
<i>F_{tu}</i> , ksi:									
L	...	71	74	71	75	74	77	75	77
LT	68	71	74	71	75	74 ^a	77	75	77
<i>F_{ty}</i> , ksi:									
L	...	62	65	63	66	66	69	66	68
LT	58	60	63	61	64	64	67	64	66
<i>F_{cy}</i> , ksi:									
L	...	61	64	62	65	65	68	65	67
LT	...	64	67	65	68	68	71	68	70
<i>F_{su}</i> , ksi									
LT	...	42	44	42	45	44	46	45	46
<i>F_{bru}^b</i> , ksi:									
(e/D = 1.5)	...	110	115	110	116	115	119	116	119
(e/D = 2.0)	...	142	148	142	150	148	154	150	154
<i>F_{bry}^b</i> , ksi:									
(e/D = 1.5)	...	90	94	91	96	96	100	96	99
(e/D = 2.0)	...	105	110	106	112	112	117	112	115
<i>e</i> , percent (S-basis):									
LT	5	8	...	9	...	9	...	9	...
<i>E</i> , 10 ³ ksi:									
Primary	10.3				10.3		10.3		
Secondary	9.5				9.8		10.0		
<i>E_c</i> , 10 ³ ksi:									
Primary	10.5				10.5		10.5		
Secondary	9.7				10.0		10.2		
<i>G</i> , 10 ³ ksi									
		
<i>μ</i>									
	0.33				0.33		0.33		
Physical Properties:									
<i>ω</i> , lb/in. ³	0.101								
<i>C</i> , <i>K</i> , and <i>α</i>	...								

a S-Basis. The rounded T₉₉ value is 75 ksi.

b Bearing values are “dry pin” values per Section 1.4.7.1.

Table 3.7.6.0(c₂). Design Mechanical and Physical Properties of Clad 7075 Aluminum Alloy Sheet—Continued

Specification	AMS-QQ-A-250/13									
Form	Sheet									
Temper	T6 and T62 ^a									
Thickness, in.	0.008-0.011	0.012-0.039		0.040-0.062		0.063-0.187		0.188-0.249		
Basis	S	A	B	A	B	A	B	A	B	
Mechanical Properties:										
F_{tu} , ksi:										
L	70	74	71	75	73	77	75	77	
LT	68	70 ^b	74	71	75	73 ^c	77	75	77	
F_{ty} , ksi:										
L	62	65	63	66	65	69	66	68	
LT	58	60	63	61	64	63 ^d	67	64	66	
F_{cy} , ksi:										
L	61	64	62	65	64	68	65	67	
LT	64	67	65	68	67	71	68	70	
F_{su} , ksi	...	42	44	42	45	44	46	45	46	
F_{bru}^e , ksi:										
(e/D = 1.5)	108	115	110	116	113	119	116	119	
(e/D = 2.0)	140	148	142	150	146	154	150	154	
F_{bry}^e , ksi:										
(e/D = 1.5)	90	94	91	96	94	100	96	99	
(e/D = 2.0)	105	110	106	112	110	117	112	115	
e , percent (S-basis):										
LT	5	7	...	8	...	8	...	8	...	
E , 10 ³ ksi:										
Primary		10.3				10.3		10.3		
Secondary		9.5				9.8		10.0		
E_c , 10 ³ ksi:										
Primary		10.5				10.5		10.5		
Secondary		9.7				10.0		10.2		
G , 10 ³ ksi			
μ		0.33				0.33		0.33		
Physical Properties:										
ω , lb/in. ³		0.101								
C , K , and α								

- a Design allowables were based upon data obtained from testing T6 temper sheet and from testing samples of sheet, supplied in the O or F temper, which were heat treated to demonstrate response to heat treatment by suppliers. Properties obtained may be lower than those listed if the material has been formed or otherwise cold worked, particularly in the annealed temper, prior to solution heat treatment.
- b S-Basis. The rounded T_{99} value is 71 ksi.
- c S-Basis. The rounded T_{99} value is 75 ksi.
- d S-Basis. The rounded T_{99} value is 64 ksi.
- e Bearing values are “dry pin” values per Section 1.4.7.1.

Table 3.7.6.0(c₃). Design Mechanical and Physical Properties of Clad 7075 Aluminum Alloy Plate—Continued

Specification	AMS 4049 and AMS-QQ-A-250/13													
	Plate													
	T651													
Form	0.250-0.499		0.500-1.000 ^a		1.001-2.000 ^a		2.001-2.500 ^a		2.501-3.000 ^a		3.001-3.500 ^a		3.501-4.000 ^a	
Temper	A	B	A	B	A	B	A	B	A	B	A	B	A	B
Thickness, in.	74	76	74	76	73	75	69	71	68	70	64	66	64	66
Basis	75	77	75	77	74	76	70	72	71	73	61	63	54	56
Mechanical Properties:	70 ^b	71 ^b	65 ^b	68 ^b	58 ^b	60	52	52 ^b
F_{up} , ksi:	67	69	67	69	64	66	61	63	58	58	54	56	54	56
L	65	67	65	67	62	64	59	61	56	56	52	54	52	54
LT	59 ^b	...	56 ^b	58 ^b	54 ^b	54 ^b	50 ^b	52 ^b	50 ^b	52 ^b
ST
F_{cp} , ksi:	65	67	64	66	60	62	57	58	53	53	49	51	49	51
L	69	71	69	71	65	68	62	64	59	59	55	57	55	57
LT	67	70	64	66	61	61	57	59	57	59
ST	42	43	42	44	43	44	41	42	40	40	38	39	38	39
F_{su}^c , ksi:	113	116	113	116	111	114	105	108	104	104	98	101	98	101
F_{brt}^c , ksi:	139	143	139	143	137	141	130	134	128	132	121	124	121	124
(e/D = 1.5)	94	97	97	100	95	98	90	94	86	89	80	84	80	84
(e/D = 2.0)	111	114	113	117	110	113	105	109	100	104	93	97	93	97
F_{bc}^c , ksi:	9	...	6	...	5	...	5	...	5	...	3	...	3	...
(e/D = 1.5)
(e/D = 2.0)
e , percent (S-basis):
LT
E , 10 ³ ksi:
Primary
Secondary
E_s , 10 ³ ksi:
Primary
Secondary
G , 10 ³ ksi
μ
Physical Properties:
ω , lb/in. ³
C , K , and α

a These values, except in the ST direction, have been adjusted to represent the average properties across the whole section, including the 1-1/2 percent per side nominal cladding thickness.
b Caution: This specific alloy, temper, and product form exhibits poor stress-corrosion cracking resistance in this grain direction. It corresponds to an SCC resistance rating of D, as indicated in Table 3.1.2.3.1(a).
c Bearing values are “dry pin” values per Section 1.4.7.1. See Table 3.1.2.1.1

Table 3.7.6.0(c₄). Design Mechanical and Physical Properties of Clad 7075 Aluminum Alloy Plate—Continued

Specification	AMS-QQ-A-250/13													
	Plate													
	T62 ^a													
Form	0.250-0.499		0.500-1.000 ^b		1.001-2.000 ^b		2.001-2.500 ^b		2.501-3.000 ^b		3.001-3.500 ^b		3.501-4.000 ^b	
	A	B	A	B	A	B	A	B	A	B	A	B	A	B
Thickness, in.														
Basis														
Mechanical Properties:														
F_{np} , ksi:														
L	72	73	72	74	72	73	71	72	67	69	66	68	62	64
LT	75	77	76	78	75	77	74	76	70	72	69	71	50	52
ST	70 ^c	71 ^c	66 ^c	68 ^c	65 ^c	67 ^c	50	52
F_{np} , ksi:														
L	63	65	64	66	62	64	58	60	54	56	50	52	46	48
LT	65	67	66	68	65	67	62	64	59	61	56	58	52	54
ST	59 ^c	61 ^c	56 ^c	58 ^c	54 ^c	55 ^c	50 ^c	52 ^c
F_{cp} , ksi:														
L	68	70	68	70	66	68	62	63	57	59	53	55	48	50
LT	68	70	69	71	66	68	62	65	59	61	55	57	50	52
ST	63	65	60	62	57	59	53	55
F_{sp} , ksi:	42	43	42	44	42	44	43	44	41	42	40	42	38	39
F_{brd} , ksi:														
(e/D = 1.5)	113	116	114	117	113	116	111	114	105	108	104	107	98	101
(e/D = 2.0)	139	143	141	145	139	143	137	141	130	134	128	132	121	124
F_{bd} , ksi:														
(e/D = 1.5)	94	97	97	100	97	100	95	98	90	94	86	89	80	84
(e/D = 2.0)	111	114	113	116	113	117	110	113	105	109	100	104	93	97
e , percent (S-basis):														
LT	9	...	7	...	6	...	5	...	5	...	5	...	3	...
E , 10 ³ ksi:														
Primary														
Secondary														
E_c , 10 ³ ksi:														
Primary														
Secondary														
G , 10 ³ ksi														
μ														
Physical Properties:														
ω , lb/in. ³														
C , K , and α														

a Design allowables were based upon data obtained from testing samples of plate, supplied in the O or F temper, which were heat treated to demonstrate response to heat treatment by suppliers. Properties obtained may be lower than those listed if the material has been formed or otherwise cold worked, particularly in the annealed temper, prior to solution heat treatment.

b These values, except in the ST direction, have been adjusted to represent the average properties across the whole section.

c Caution: This specific alloy, temper, and product form exhibits poor stress-corrosion cracking resistance in this grain direction. It corresponds to an SCC resistance rating of D, as indicated in Table 3.1.2.3.1(a).

d Bearing values are "dry pin" values per Section 1.4.7.1. See Table 3.1.2.1.1.

Table 3.7.6.0(c₅). Design Mechanical and Physical Properties of Clad 7075 Aluminum Alloy Sheet and Plate—Continued

Specification	AMS-QQ-A-250/25				
	Sheet			Plate	
Form	T76			T7651	
Temper	0.040- 0.062	0.063- 0.187	0.188- 0.249	0.250- 0.499	0.500- 1.000 ^a
Thickness, in.,	S	S	S	S	S
Basis					
Mechanical Properties:					
F_{tu} , ksi:					
L	66	67	69	68	68
LT	67	68	70	69	68
F_{ty} , ksi:					
L	56	57	59	58	57
LT	56	57	59	58	57
F_{cy} , ksi:					
L	55	56	58	57	56
LT	59	60	62	60	59
F_{su} , ksi	41	40	40	40	40
F_{bru}^b , ksi:					
(e/D = 1.5)	103	104	107	105	103
(e/D = 2.0)	133	135	139	133	131
F_{bry}^b , ksi:					
(e/D = 1.5)	80	81	84	87	87
(e/D = 2.0)	92	94	97	104	103
e , percent:					
LT	8	8	8	8	6
E , 10 ³ ksi:					
Primary	10.3		10.3	10.3	
Secondary	9.8		10.0	10.0	
E_c , 10 ³ ksi:					
Primary	10.5		10.5	10.6	
Secondary	10.0		10.2	10.3	
G , 10 ³ ksi	
μ	0.33		0.33	0.33	
Physical Properties:					
ω , lb/in. ³	0.101				
C , K , and α				

a These values have been adjusted to represent the average properties across the whole section, including the 1-1/2 percent per side nominal cladding thickness.

b Bearing values are “dry pin” values per Section 1.4.7.1. See Table 3.1.2.1.1.

MIL-HDBK-5J
31 January 2003

Table 3.7.6.0(d). Design Mechanical and Physical Properties of 7075 Aluminum Alloy Bar, Rod, and Shapes: Rolled, Drawn, or Cold-Finished

Specification	AMS 4122, AMS 4123, AMS 4186, AMS 4187, and AMS-QQ-A-225/9								AMS 4124 and AMS-QQ-A-225/9	
Form	Bar, rod, and shapes: rolled, drawn, or cold-finished									
Temper	T6, T651, and T62 ^a								T73 ^b or T7351	
Thickness ^c , in.	≤1.000		1.001-2.000		2.001-3.000		3.001-4.000		0.375-2.000	2.001-3.000
Basis	A	B	A	B	A	B	A	B	S	S
Mechanical Properties:										
F_{tu} , ksi:										
L	77	79	77	79	77	79	77	79	68	68
LT	77 ^d	79 ^d	75 ^d	77 ^d	72 ^d	74 ^d	69 ^d	71 ^d	...	65 ^e
F_{ty} , ksi:										
L	66	68	66	68	66	68	66	68	56	56
LT	66 ^d	68 ^d	66 ^d	68 ^d	63 ^d	65 ^d	60 ^d	62 ^d	...	52 ^e
F_{cy} , ksi:										
L	64	66	64	66	64	66	64	66	54	54
LT	55 ^e
F_{su} , ksi	46	47	46	47	46	47	46	47	42	40
F_{bru}^f , ksi:										
(e/D = 1.5)	100	103	100	103	100	103	100	103	101	101
(e/D = 2.0)	123	126	123	126	123	126	123	126	131	131
F_{bry}^f , ksi:										
(e/D = 1.5)	86	88	86	88	86	88	86	88	81	81
(e/D = 2.0)	92	95	92	95	92	95	92	95	100	100
e , percent (S-basis):										
L	7	...	7	...	7	...	7	...	10	10
E , 10 ³ ksi	10.3									
E_c , 10 ³ ksi	10.5									
G , 10 ³ ksi	3.9									
μ	0.33									
Physical Properties:										
ω , lb/in. ³	0.101									
C , K , and α	See Figure 3.7.6.0									

- a Design allowables were based upon data obtained from testing of T6 and T651 material and from samples of material, supplied in the O or F temper, which were heat treated to T62 temper to demonstrate response to heat treatment by suppliers.
- b Design allowables were based upon data obtained from testing T73 and T7351 temper material and from testing samples of material, supplied in the O or F temper, which were heat treated to T73 temper to demonstrate response to heat treatment by suppliers.
- c For rounds (rod) maximum diameter is 4 inches; for square bar, maximum size is 3½ inches; for rectangular bar, maximum thickness is 3 inches with corresponding width of 6 inches; for rectangular bar less than 3 inches in thickness, maximum width is 10 inches.
- d Caution: This specific alloy, temper, and product form exhibits poor stress-corrosion cracking resistance in this grain direction. It corresponds to an SCC resistance rating of D, as indicated in Table 3.1.2.3.1(a).
ST grain direction.
- e ST grain direction.
- f Bearing values are “dry pin” values per Section 1.4.7.1.

Table 3.7.6.0(e). Design Mechanical and Physical Properties of 7075 Aluminum Alloy Die Forging

	AMS 4126, MIL-A-22771, and QQ-A-367						MIL-A-22771 and QQ-A-367									
	Die forging															
	T6 ^a						T652									
Specification	≤1,000		1,001-2,000		2,001-3,000		3,001-4,000		≤1,000		1,001-2,000		2,001-3,000		3,001-4,000	
	A	B	A	B	A	B	A	B	A	B	A	B	A	B	A	B
Form	Die forging															
Temper	T652															
Thickness ^b , in.	T652															
Basis	A	B	A	B	A	B	A	B	A	B	A	B	A	B	A	B
Mechanical Properties:																
F_{tp} , ksi:																
L	75	78	74	77	74	76	73	70	74	78	74	77	74	76	73	70
T^c	71 ^d	...	71 ^d	...	70 ^d	...	70	...	70 ^d	...	71 ^d	...	71 ^d	...	70	...
F_{fp} , ksi:																
L	64	67	63	66	63	65	62	60	64	67	63	66	63	65	62	60
T^c	61 ^d	...	61 ^d	...	60 ^d	...	60	...	60 ^d	...	61 ^d	...	60 ^d	...	59	...
F_{cp} , ksi:																
L	67	70	66	69	66	68	65	63	64	67	64	66	63	65	62	60
ST	64	68	64	67	63	66	63	63	65	69	65	68	64	67	64	64
F_{sp} , ksi:																
F_{br}^e , ksi:																
(e/D = 1.5)	105	109	104	108	104	106	102	102	105	109	104	108	104	106	102	102
(e/D = 2.0)	135	140	133	138	133	136	131	131	135	140	133	138	133	136	131	131
F_{bp}^e , ksi:																
(e/D = 1.5)	83	87	82	86	82	84	81	81	83	87	82	86	82	84	81	81
(e/D = 2.0)	96	100	94	99	94	97	93	93	96	100	94	99	94	97	93	93
e , percent (S-basis):																
L	7	...	7	...	7	...	7	7	7	...	7	...	7	...	7	7
T^c	3	...	3	...	3	...	2	2	3	...	3	...	3	...	3	2
E , 10 ³ ksi	10.0															
E_c , 10 ³ ksi	10.4															
G , 10 ³ ksi	3.8															
μ	0.33															
Physical Properties:																
ω , lb/in. ³	0.101															
C , K , and α	See Figure 3.7.6.0															

a When die forgings are machined before heat treatment, the mechanical properties are applicable provided the as-forged thickness is not greater than twice the thickness at time of heat treatment.
b Thickness at the time of heat treatment.
c T indicates any grain direction not within ±15° of being parallel to the forging flow lines. $F_{cy}(T)$ values are based upon short transverse (ST) test data.
d Specification value. T tensile properties are presented on an S basis only.
e Bearing values are "dry pin" values per Section 1.4.7.1.

Table 3.7.6.0(e₂). Design Mechanical and Physical Properties of 7075 Aluminum Alloy Die Forging—Continued

Specification	AMS 4141, AMS-A-22771, and AMS-QQ-A-367										AMS 4141		AMS 4147, AMS-A-22771, and AMS-QQ-A-367	
	Die forging													
	T73 ^{a,b}										T7352			
Thickness ^c , in.	≤1.000		1.001-2.000		2.001-3.000		3.001-4.000		4.001-5.000	5.001-6.000	≤3.000		3.001-4.000	
	A	B	A	B	A	B	A	B	S	S	A	B	S	
Mechanical Properties^d:														
<i>F_{tu}</i> , ksi:														
L	66 ^d	71	66 ^d	71	66	69	64 ^d	69	62	61	66 ^e	69	64	
T ^f	62 ^g	...	62 ^g	...	62 ^g	...	61 ^g	...	59	58	62 ^g	...	61	
<i>F_{ty}</i> , ksi:														
L	56 ^d	61	56	59	56	59	55 ^d	59	53	51	56	59	53	
T ^f	53 ^g	...	53 ^g	...	53 ^g	...	52 ^g	...	51	50	51 ^g	...	49	
<i>F_{cy}</i> , ksi:														
L	58	63	58	61	58	61	57	61	56	59	53	
T ^f	55	60	55	59	55	59	54	58	55	60	53	
<i>F_{su}</i> , ksi														
	39	42	39	42	39	41	38	41	39	41	38	
<i>F_{bru}</i> ^h , ksi:														
(e/D = 1.5)	96	103	96	103	96	100	93	100	96	100	93	
(e/D = 2.0)	125	135	125	135	125	131	122	131	125	131	122	
<i>F_{bry}</i> ^h , ksi:														
(e/D = 1.5)	78	85	78	83	78	83	77	83	78	83	74	
(e/D = 2.0)	90	98	90	94	90	94	88	94	90	94	85	
<i>e</i> , percent (S-basis):														
L	7	...	7	...	7	...	7	...	7	6	7	...	7	
T ^f	3	...	3	...	3	...	2	...	2	2	3	...	2	
<i>E</i> , 10 ³ ksi														
	10.0													
<i>E_c</i> , 10 ³ ksi														
	10.4													
<i>G</i> , 10 ³ ksi														
	3.8													
<i>μ</i>														
	0.33													
Physical Properties:														
<i>ω</i> , lb/in. ³														
	0.101													
<i>C</i> , <i>K</i> , and <i>α</i>														
	See Figure 3.7.6.0													

- a When die forgings are machined before heat treatment, the mechanical properties are applicable, provided the as-forged thickness is not greater than twice the thickness at the time of heat treatment.
- b Design allowables were based upon data obtained from testing die forgings, heat treated by suppliers, and supplied in T73 temper.
- c Thickness at the time of heat treatment.
- d Rounded T₉₉ values for T73 temper ≤1.000 in., F_{tu} = 68 ksi, for F_{ty} = 57 ksi; 1.001-2.000 in., F_{tu} = 68 ksi; 3.001-4.000 in., F_{tu} = 66 ksi, for F_{ty} = 56 ksi.
- e Rounded T₉₉ values for T7352 temper, F_{tu} ≤1.000 inch = 67 ksi.
- f When AMS-A-22771 or AMS-QQ-A-367 apply, T indicates any grain direction not within ±15° of being parallel to the forging flow lines. F_{cy}(T) values are based upon short transverse (ST) test data. When AMS 4141 applies, T indicates any grain direction within ±15° of being perpendicular to the forging flow lines.
- g Specification value. T tensile properties are presented on an S basis only.
- h Bearing values are “dry pin” values per Section 1.4.7.1.

Table 3.7.6.0(f₂). Design Mechanical and Physical Properties of 7075 Aluminum Alloy Hand Forging—Continued

Specification	AMS-A-22771 and AMS-QQ-A-367										AMS 4147, AMS-A-22771, and AMS-QQ-A-367									
	Hand forging										Hand forging									
Form	T73 ^a										T7352									
Temper	T73 ^a										T7352									
Thickness, in.	≤2.000	2.001-3.000	3.001-4.000	4.001-5.000	5.001-6.000	≤2.000	2.001-3.000	3.001-4.000	4.001-5.000	5.001-6.000	≤2.000	2.001-3.000	3.001-4.000	4.001-5.000	5.001-6.000					
Basis	S	S	S	S	S	S	S	S	S	S	S	S	A	B	S					
Mechanical Properties:																				
F_{up} , ksi:																				
L	66	66	64	62	61	66	66	64	64	61	66	66	64	67	62	61				
LT	64	64	63	61	59	64	64	63	61	59	64	64	63	66	61	59				
ST	...	61	60	58	57	60	58	57	...	61	63	58	57	57				
F_{cp} , ksi:																				
L	56	56	55	53	51	54	54	55	53	51	54	54	53	55	51	49				
LT	54	54	53	51	50	52	52	53	51	50	52	52	53	53	48	46				
ST	...	52	51	50	49	51	50	49	...	50	48	51	46	44				
F_{sp} , ksi:																				
L	56	56	56	56	55	55	52	55	49	46				
LT	52	52	52	52	55	55	52	55	49	46				
ST	55	55	53	56	51	49				
F_{br} , ksi:																				
L	39	39	39	39	39	39	38	40	37	36				
LT	36	36	37	38	36	35				
ST	38	38	37	39	36	35				
F_{brb} , ksi:																				
(e/D = 1.5)	86	88	89	93	86	84				
(e/D = 2.0)	120	120	118	123	114	110				
F_{brs} , ksi:																				
(e/D = 1.5)	71	73	73	77	71	68				
(e/D = 2.0)	90	90	87	92	83	80				
e , percent (S-basis):																				
L	7	7	7	7	6	7	7	7	7	6	7	7	7	7	7	6				
LT	4	4	3	3	3	4	4	3	3	3	4	3	...	3	3	3				
ST	...	3	2	2	2	3	3	2	2	2	3	2	...	2	2	2				
E , 10 ³ ksi	10.2																			
E_c , 10 ³ ksi	10.4																			
G , 10 ³ ksi	3.8																			
μ	0.33																			
Physical Properties:																				
ω , lb/in. ³	0.101																			
C , K , and α	See Figure 3.7.6.0																			

a When hand forgings are machined before heat treatment, the section thickness at time of heat treatment will determine the minimum mechanical properties as long as the original (as-forged) thickness does not exceed the maximum thickness for the alloy as shown in the table. The maximum cross-sectional area of hand forgings is 2.56 sq. in.
b Bearing values are "dry pin" values per Section 1.4.7.1.

Table 3.7.6.0(g₂). Design Mechanical and Physical Properties of 7075 Aluminum Alloy Extrusion—Continued

Specification	AMS-QQ-A-200/11													
	Extrusion (rod, bars, and shapes)													
	T73 ^a , T73510, T73511													
Temper	≤20		≤25		0.500-0.749		0.750-1.499		1.500-2.999		≤20		>20, ≤32	
Cross-Sectional Area, in. ²	A	B	A	B	A	B	A	B	A	B	A	B	A	B
Thickness, in. ^b	0.062-0.249	0.250-0.499	0.500-0.749	0.750-1.499	1.500-2.999	3.000-4.499	3.000-4.499	3.000-4.499	3.000-4.499	3.000-4.499	3.000-4.499	3.000-4.499	3.000-4.499	3.000-4.499
Mechanical Properties:														
F_{tub} , ksi:														
L	68 ^c	72	70 ^d	74	73	73	70 ^d	73	69 ^d	74	68 ^c	71	65 ^c	70
LT	66	70	68	72	69	66	66	69	62	67	58	61	56	60
F_{lv} , ksi:														
L	58	61	60	63	63	60	60	63	59 ^d	65	57 ^c	62	55 ^c	60
LT	56	59	57	60	60	56	56	58	51	56	46	50	44	48
F_{cv} , ksi:														
L	58	61	60	63	63	60	60	63	59	65	57	62	55	60
LT	59	62	60	63	63	58	58	61	54	59	49	53	47	51
F_{sv} , ksi:														
L	37	39	38	40	39	38	38	39	37	40	37	38	35	38
F_{brv} , ksi:														
(e/D = 1.5)	101	107	104	110	108	103	103	107	99	106	95	99	91	98
(e/D = 2.0)	129	137	133	141	139	132	132	138	128	138	124	130	119	128
F_{t} , ksi:														
(e/D = 1.5)	82	86	84	89	88	83	83	87	79	87	72	79	70	76
(e/D = 2.0)	97	102	100	105	105	98	98	103	93	103	86	94	83	91
e , percent (S-basis):														
L	7	...	8	8	8	...	8	...	7	...	7	...
E , 10 ³ ksi	10.4													
E_c , 10 ³ ksi	10.7													
G , 10 ³ ksi	4.0													
μ	0.33													
Physical Properties:														
ω , lb/in. ³	0.101													
C , K , and α	See Figure 3.7.6.0													

a Design allowables were based upon data obtained from testing T7351X temper extrusions and from testing samples of extrusions supplied in the O or F temper, which were heat treated to T73 temper to demonstrate response to treatment by suppliers. Properties obtained by the user may be lower than those listed if the material has been formed or otherwise cold worked, particularly in the annealed temper.

b The mechanical properties are to be based upon the thickness at the time of quench.

c S-basis. Rounded T_{90} values for cross sectional area ≤20 are as follows: for 0.062-0.249 $F_{ub}(L)$ = 69 ksi, 3.000-4.499 $F_{ub}(L)$ = 69 ksi, $F_{lv}(L)$ = 59 ksi.

d S-basis. Rounded T_{90} values for cross sectional area ≤25 are as follows: 0.250-1.499 $F_{ub}(L)$ = 71, 1.500-2.999 $F_{ub}(L)$ = 72 ksi and $F_{lv}(L)$ = 62 ksi.

e S-basis. Rounded T_{90} values for cross sectional area >20 and ≤32 are as follows: $F_{ub}(L)$ = 68 ksi and $F_{lv}(L)$ = 57 ksi.

f Bearing values are "dry pin" values per Section 1.4.7.1.

Table 3.7.6.0(g₃). Design Mechanical and Physical Properties of 7075 Aluminum Alloy Extrusion—Continued

Specification	AMS-QQ-A-200/15						
Form	Extrusion (rod, bar, and shapes)						
Temper	T76, T76510, T76511						
Cross-Sectional Area, in. ² ..	≤20						
Thickness, in. ^a	0.062-0.249	0.250-0.499	0.500-0.749	0.500-0.749		0.750-1.000	
Basis	A	B	S	A	B	A	B
Mechanical Properties:							
F_{tu} , ksi:							
L	71	74	75	75	76	75	76
LT	68	71	72	71	73	70	71
F_{ty} , ksi:							
L	61	65	65	65	67	65	67
LT	57	61	61	60	62	59	61
F_{cy} , ksi:							
L	61	65	65	65	67	65	67
LT	62	66	66	65	67	64	66
F_{su} , ksi	38	40	41	41	42	40	41
F_{bru}^b , ksi:							
(e/D = 1.5)	103	107	109	109	110	109	110
(e/D = 2.0)	131	137	139	139	141	139	141
F_{bry}^b , ksi:							
(e/D = 1.5)	82	88	88	88	90	88	90
(e/D = 2.0)	98	104	104	104	107	104	107
e , percent (S-basis):							
L	7	...	7	7	...	7	...
E , 10 ³ ksi				10.4			
E_c , 10 ³ ksi				10.7			
G , 10 ³ ksi				4.0			
μ				0.33			
Physical Properties:							
ω , lb/in. ³	0.101						
C , K , and α	See Figure 3.7.6.0						

a The mechanical properties are to be based upon the thickness at the time of quench.
b Bearing values are “dry pin” values per Section 1.4.7.1.

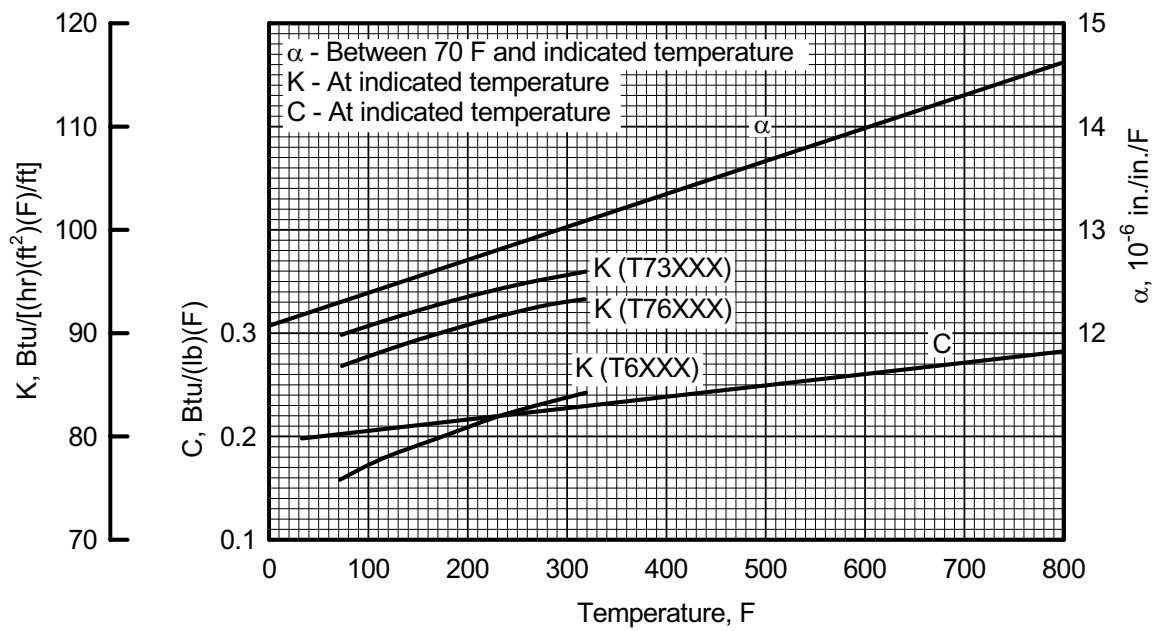

Figure 3.7.6.0. Effect of temperature on the physical properties of 7075 aluminum alloy.

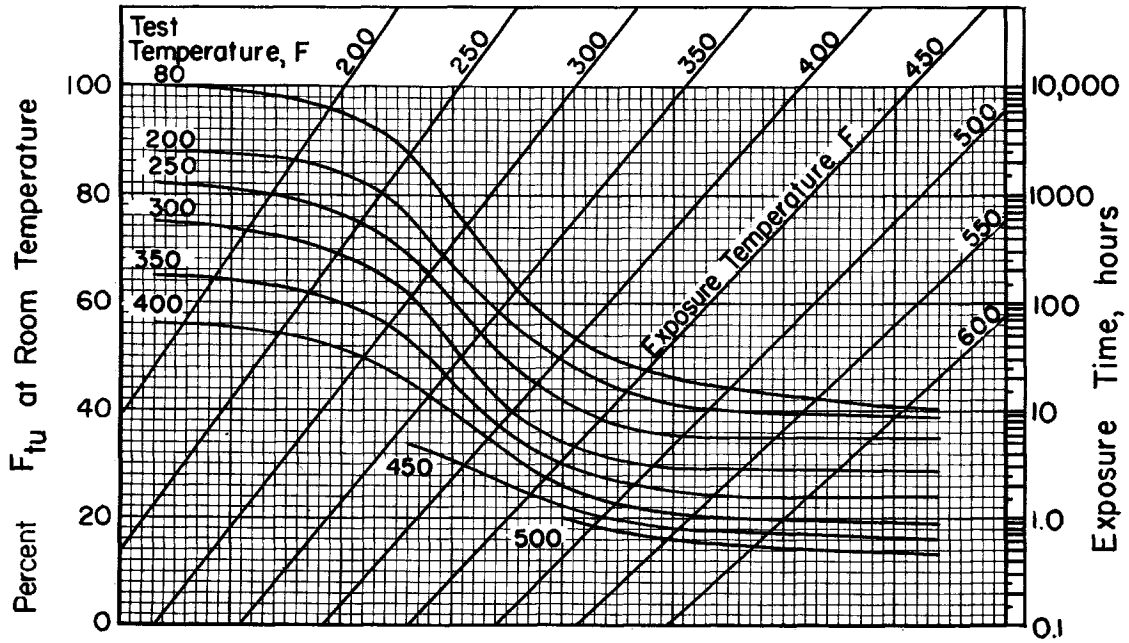

Figure 3.7.6.1.1(a). Effect of temperature on the tensile ultimate strength (F_{tu}) of 7075-T6, T651, T6510, and T6511 aluminum alloy (all products). Note: Instructions for use of these curves are presented in Section 3.7.6.1.

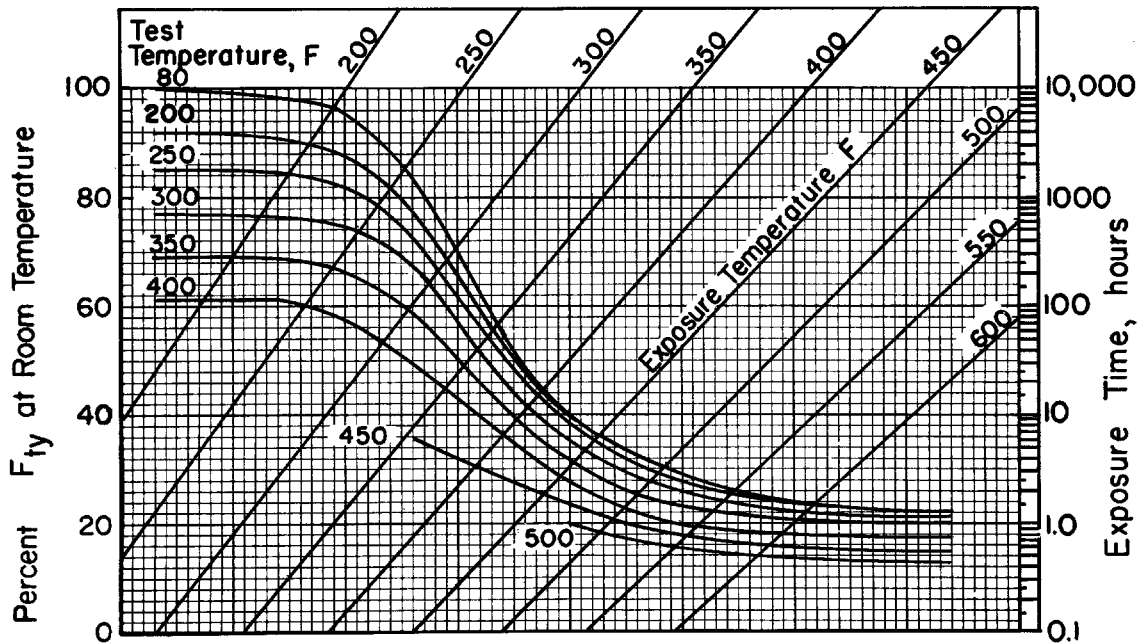

Figure 3.7.6.1.1(b). Effect of temperature on the tensile yield strength (F_{ty}) of 7075-T6, T651, T6510, and T6511 aluminum alloy (all products). Note: Instructions for use of these curves are presented in Section 3.7.6.1.

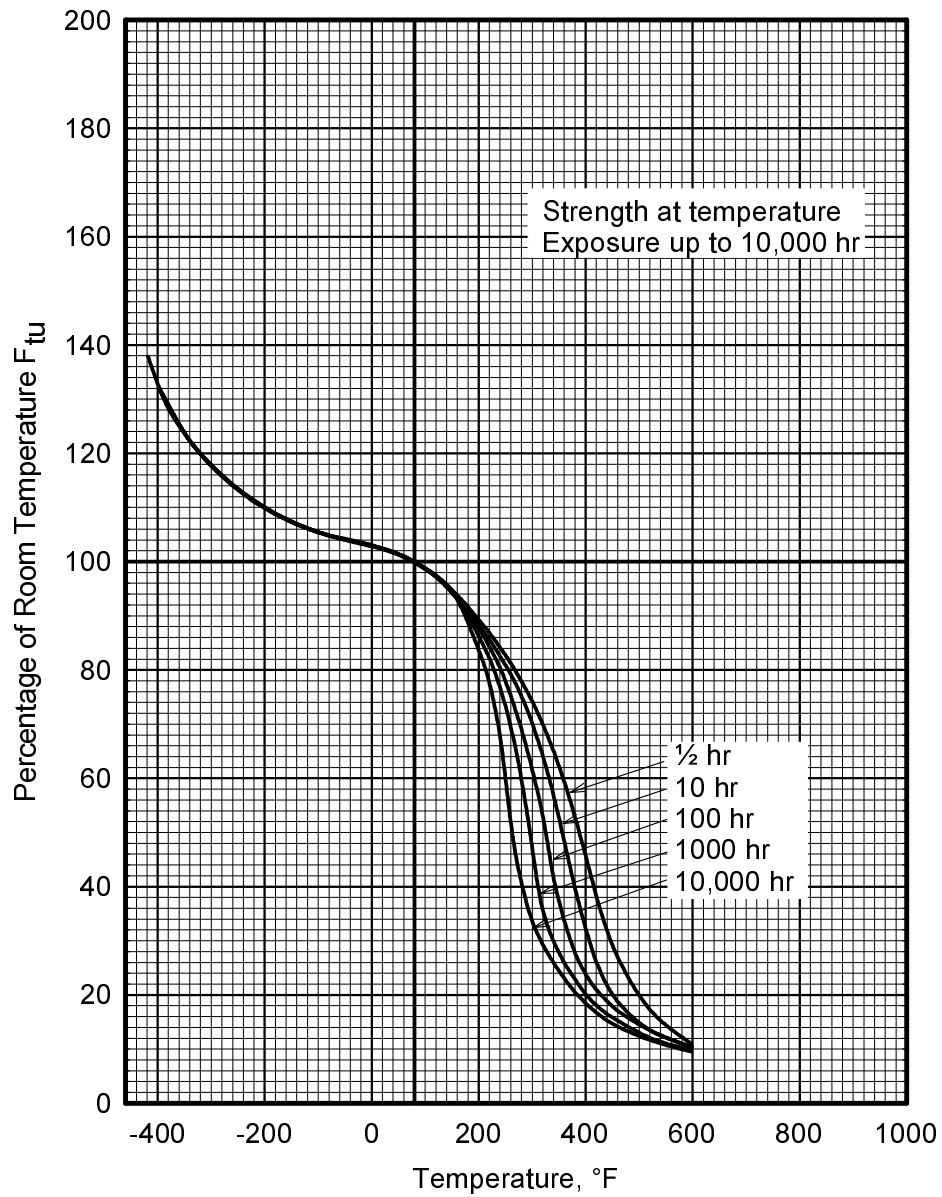

Figure 3.7.6.1.1(c). Effect of temperature on the tensile ultimate strength (F_{tu}) of 7075-T6, T651, T6510, and T6511 aluminum alloy (all products).

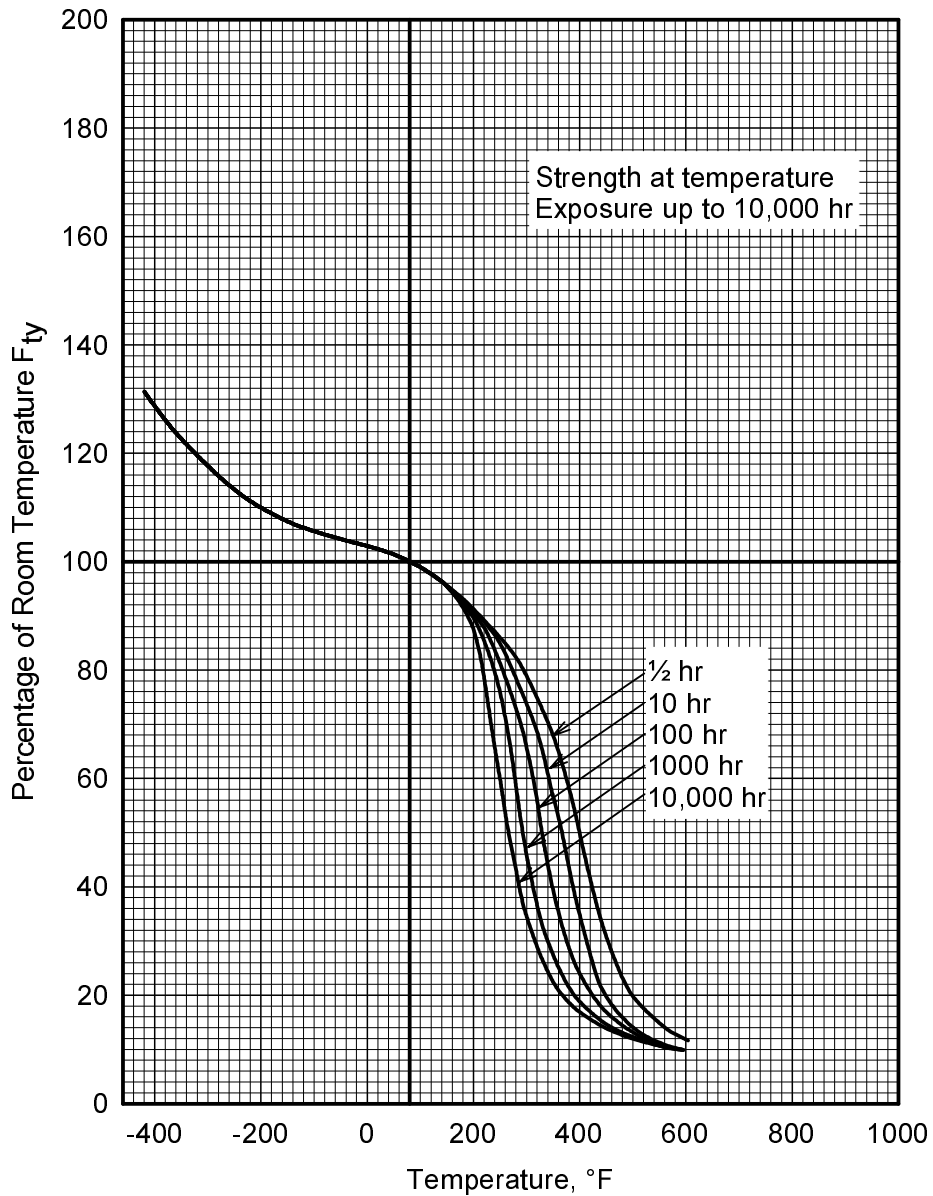

Figure 3.7.6.1.1(d). Effect of temperature on the tensile yield strength (F_{ty}) of 7075-T6, T651, T6510, and T6511 aluminum alloy (all products).

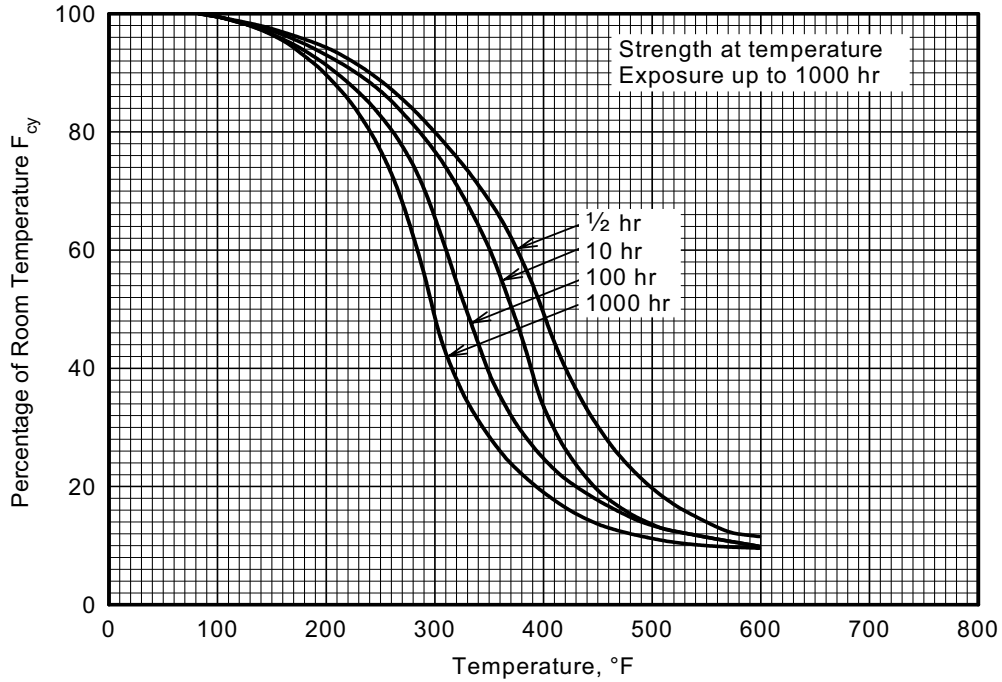

Figure 3.7.6.1.2(a). Effect of temperature on the compressive yield strength (F_{cy}) of 7075-T6, T651, T6510, and T6511 aluminum alloy (all products).

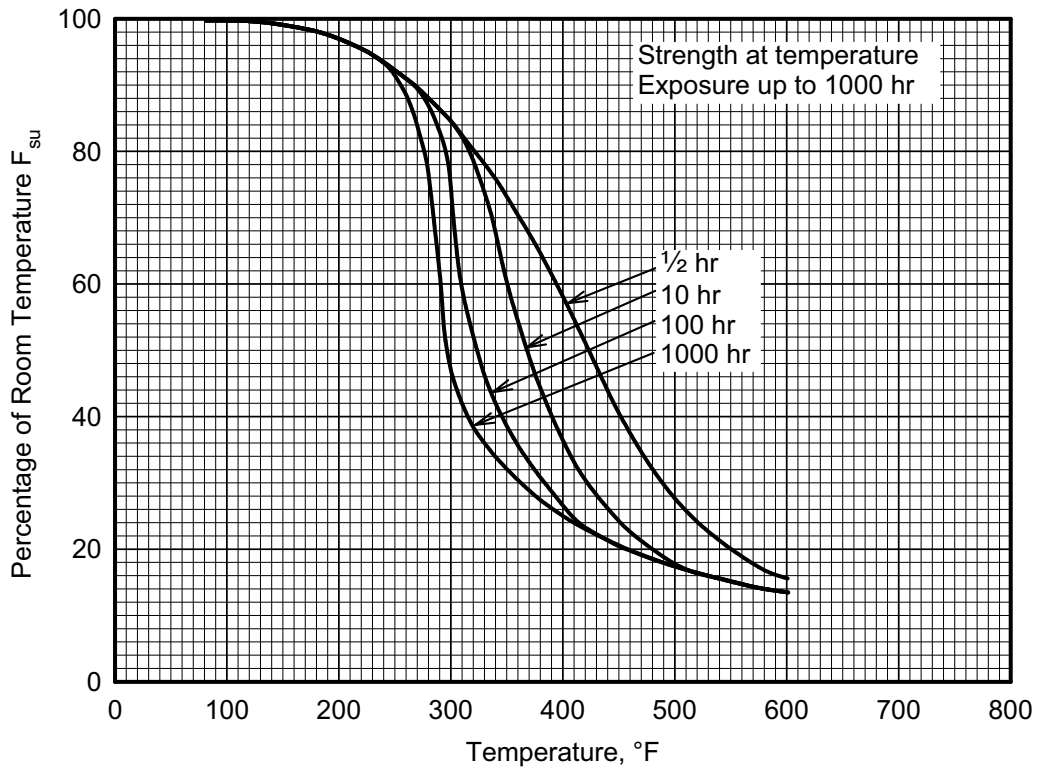

Figure 3.7.6.1.2(b). Effect of temperature on the shear ultimate strength (F_{su}) of 7075-T6, T651, T6510, and T6511 aluminum alloy (all products).

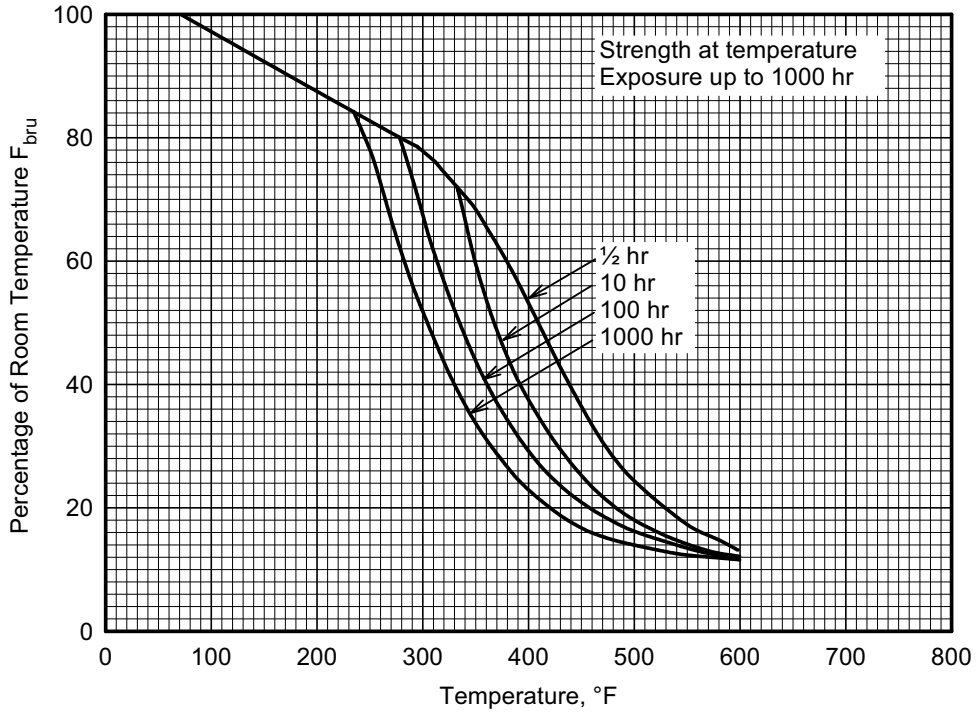

Figure 3.7.6.1.3(a). Effect of temperature on the bearing ultimate strength (F_{bru}) of 7075-T6, T651, T6510, and T6511 aluminum alloy (all products).

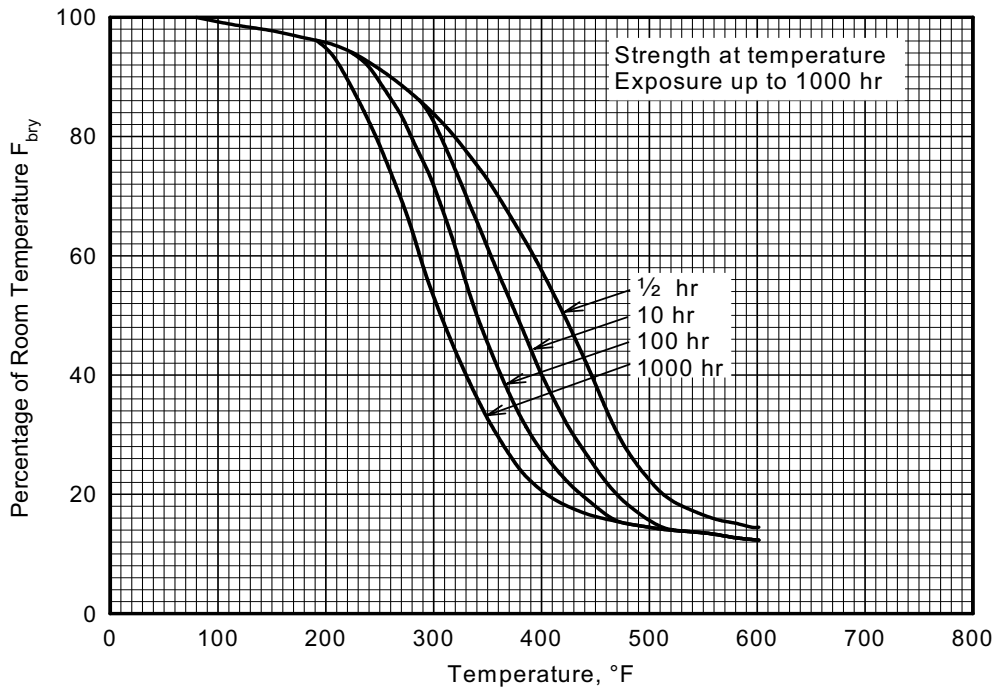

Figure 3.7.6.1.3(b). Effect of temperature on the bearing yield strength (F_{bry}) of 7075-T6, T651, T6510, and T6511 aluminum alloy (all products).

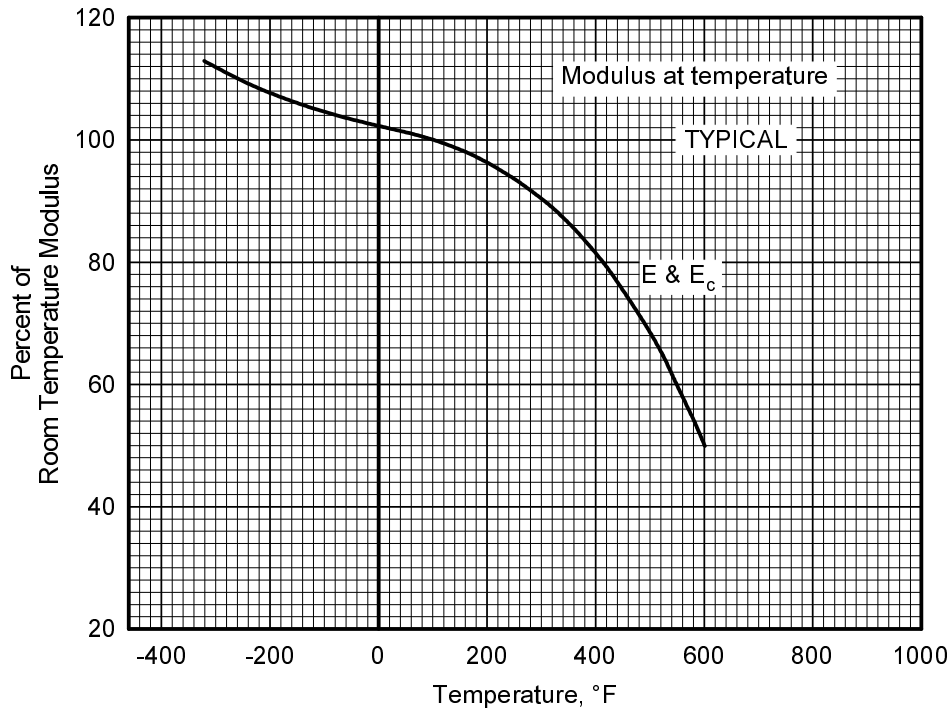

Figure 3.7.6.1.4. Effect of temperature on the tensile and compressive moduli (E and E_c) of 7075 aluminum alloy.

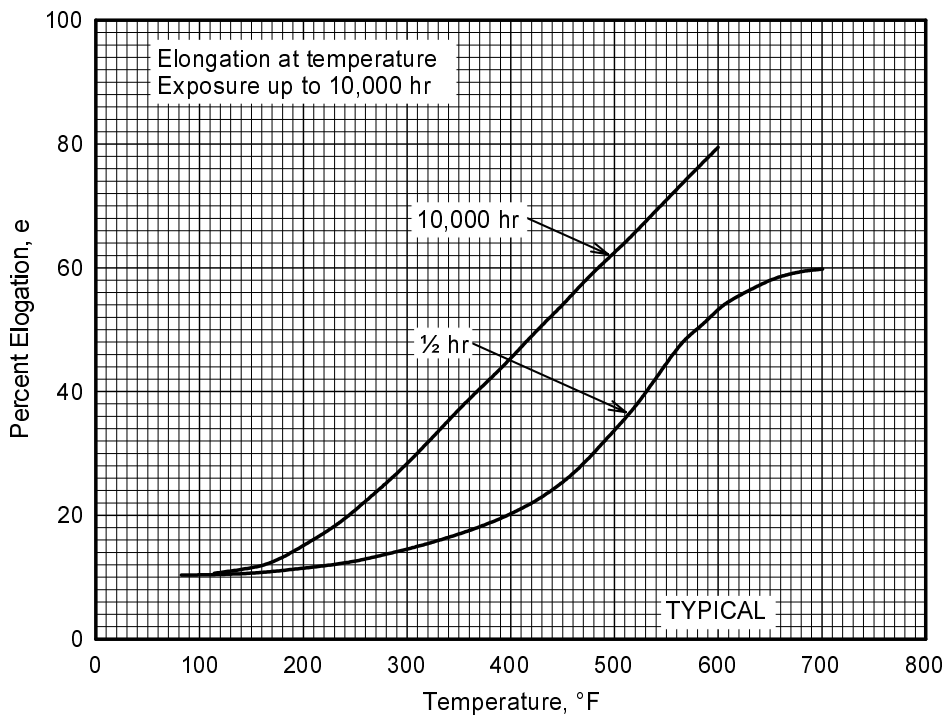

Figure 3.7.6.1.5(a). Effect of temperature on the elongation of 7075-T6, T651, T6510, and T6511 aluminum alloy (all products except thick extrusions).

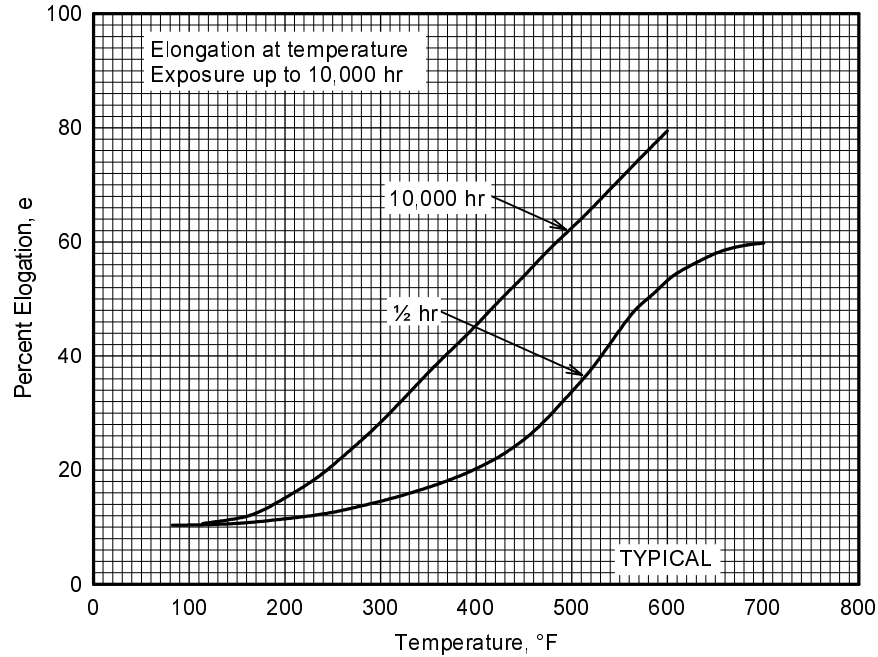

Figure 3.7.6.1.5(b). Effect of exposure at elevated temperatures on the elongation of 7075-T6, T651, T6510, and T6511 aluminum alloy (all products except thick extrusions).

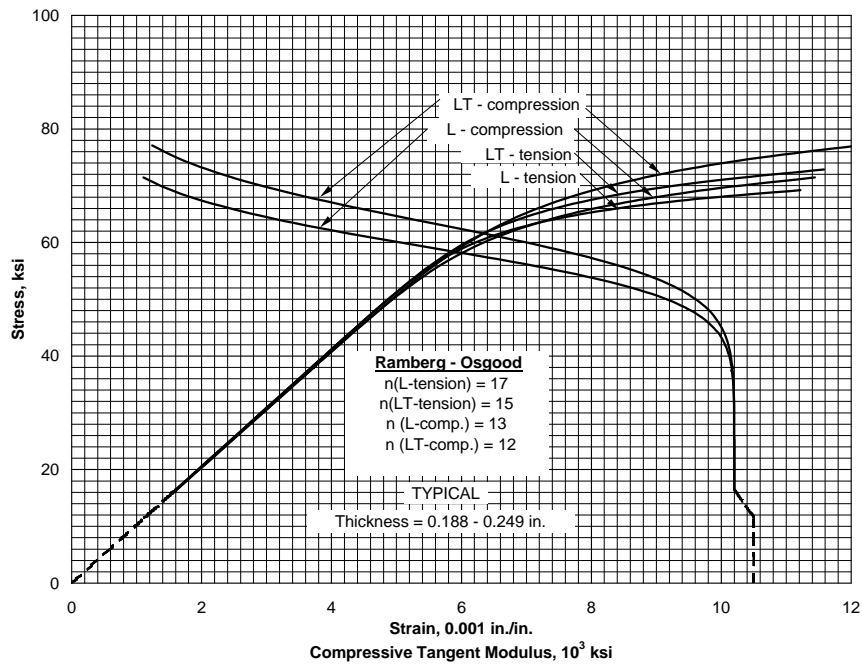

Figure 3.7.6.1.6(a). Typical tensile and compressive stress-strain and compressive tangent-modulus curves for clad 7075-T6 aluminum alloy sheet at room temperature.

MIL-HDBK-5J
31 January 2003

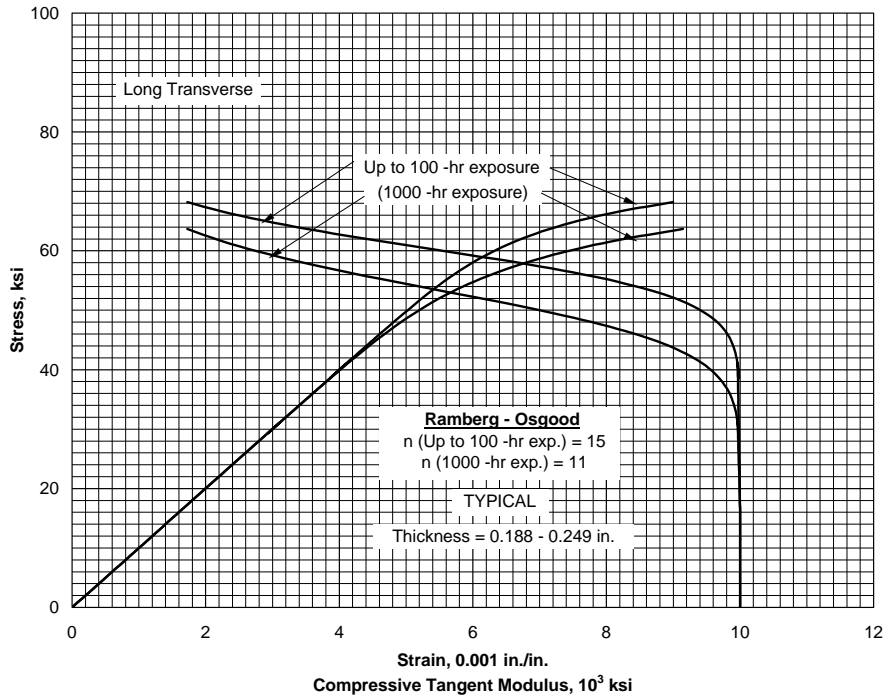

Figure 3.7.6.1.6(b). Typical compressive stress-strain and compressive tangent-modulus curves for clad 7075-T6 aluminum alloy sheet at 200°F.

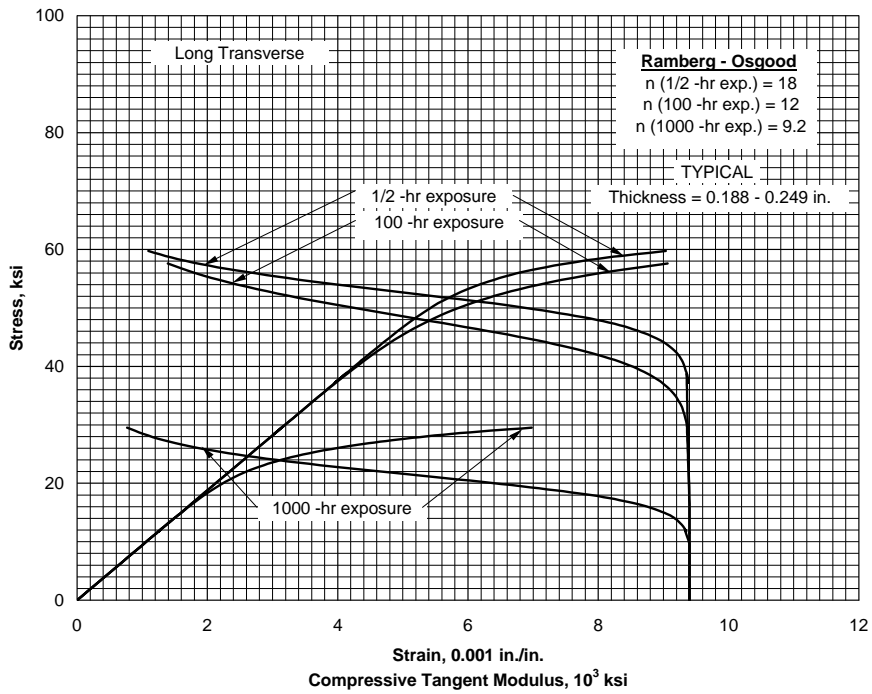

Figure 3.7.6.1.6(c). Typical compressive stress-strain and compressive tangent-modulus curves for clad 7075-T6 aluminum alloy sheet at 300°F.

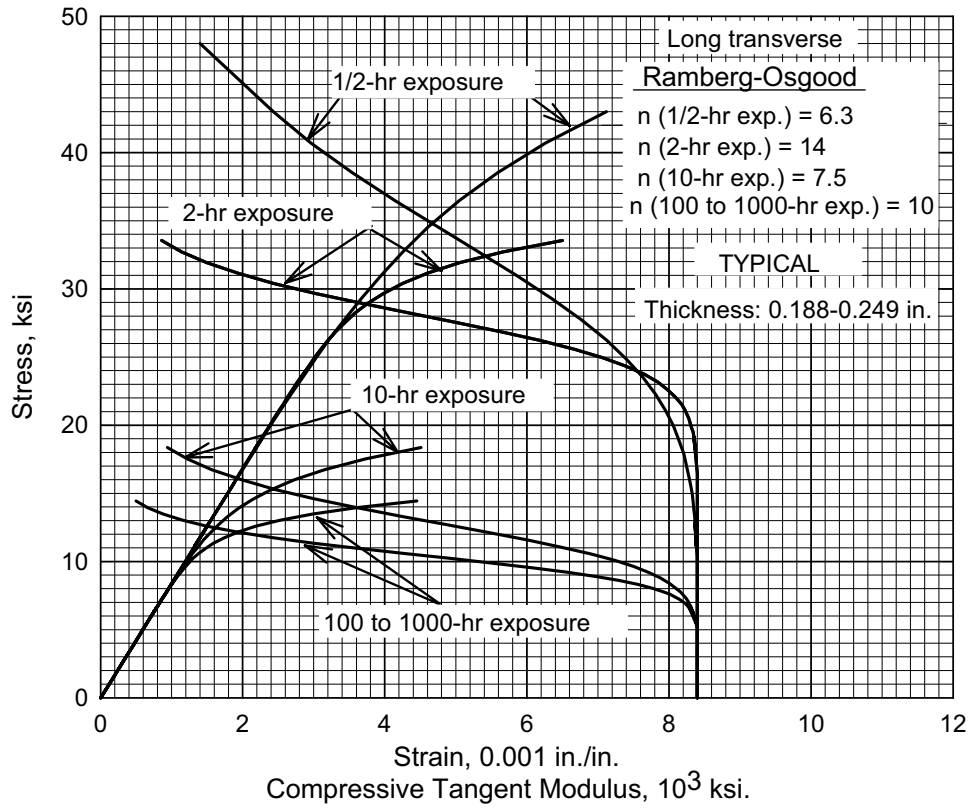

Figure 3.7.6.1.6(d). Typical compressive stress-strain and compressive tangent-modulus curves for clad 7075-T6 aluminum alloy sheet at 400°F.

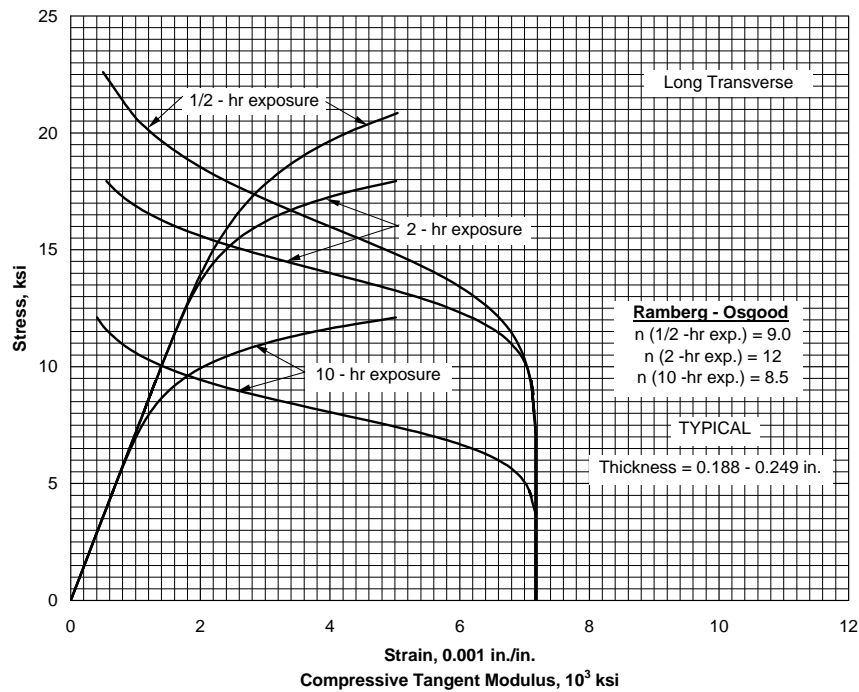

Figure 3.7.6.1.6(e). Typical compressive stress-strain and compressive tangent-modulus curves for clad 7075-T6 aluminum alloy sheet at 500°F.

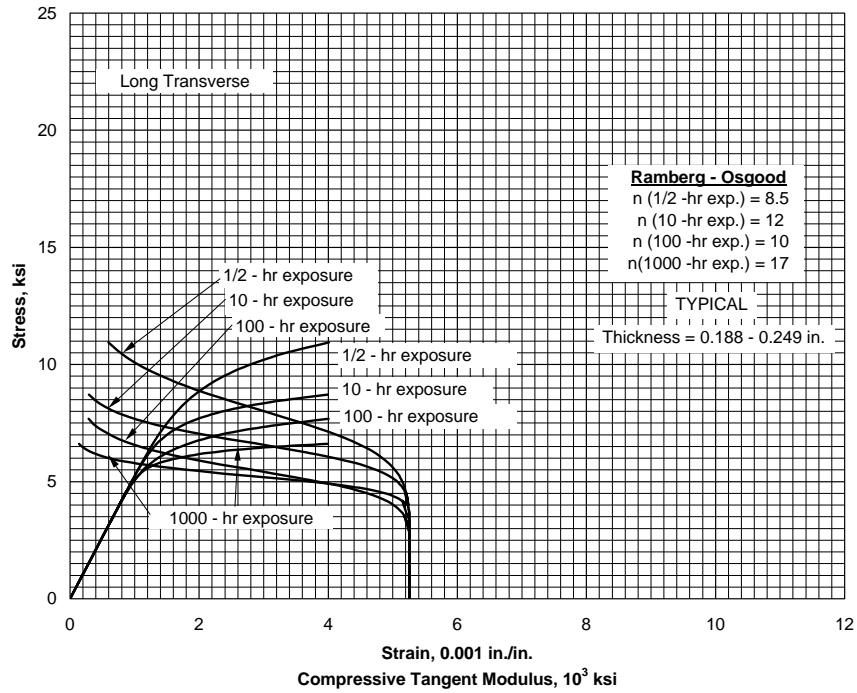

Figure 3.7.6.1.6(f). Typical compressive stress-strain and compressive tangent-modulus curves for clad 7075-T6 aluminum alloy sheet at 600°F.

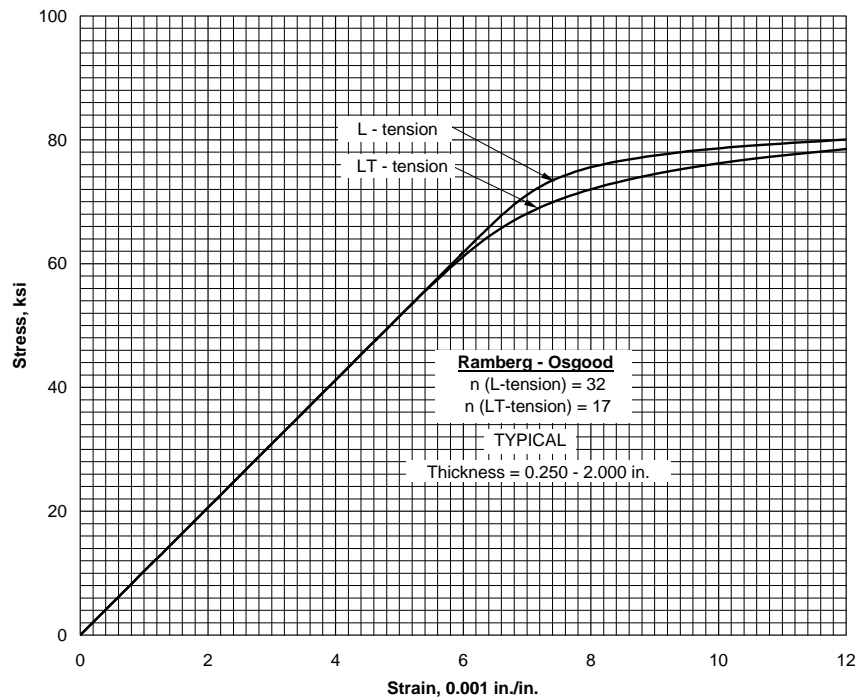

Figure 3.7.6.1.6(g). Typical tensile stress-strain curves for 7075-T651 aluminum alloy plate at room temperature.

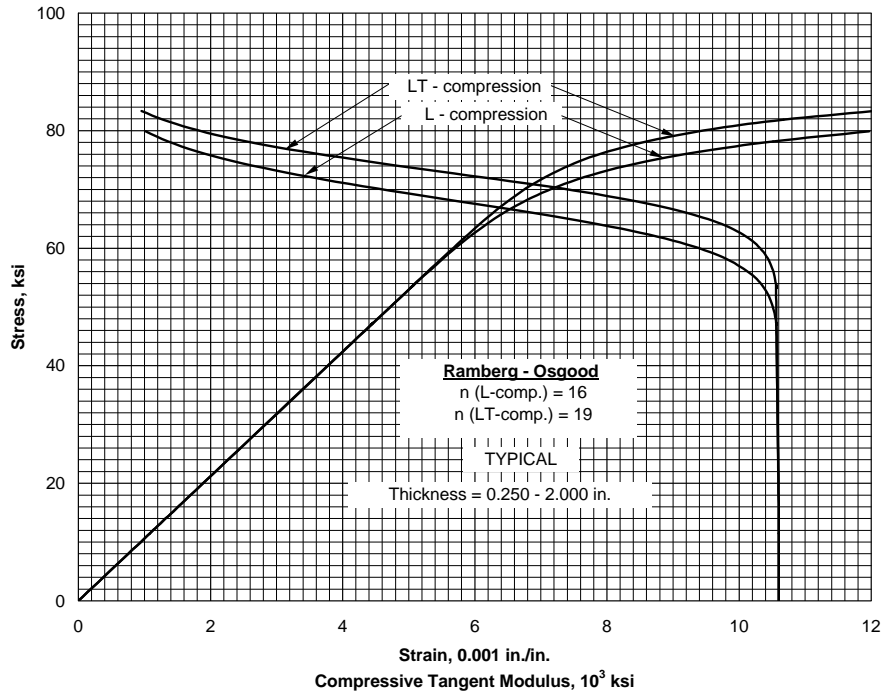

Figure 3.7.6.1.6(h). Typical compressive stress-strain and compressive tangent-modulus curves for 7075-T651 aluminum alloy plate at room temperature.

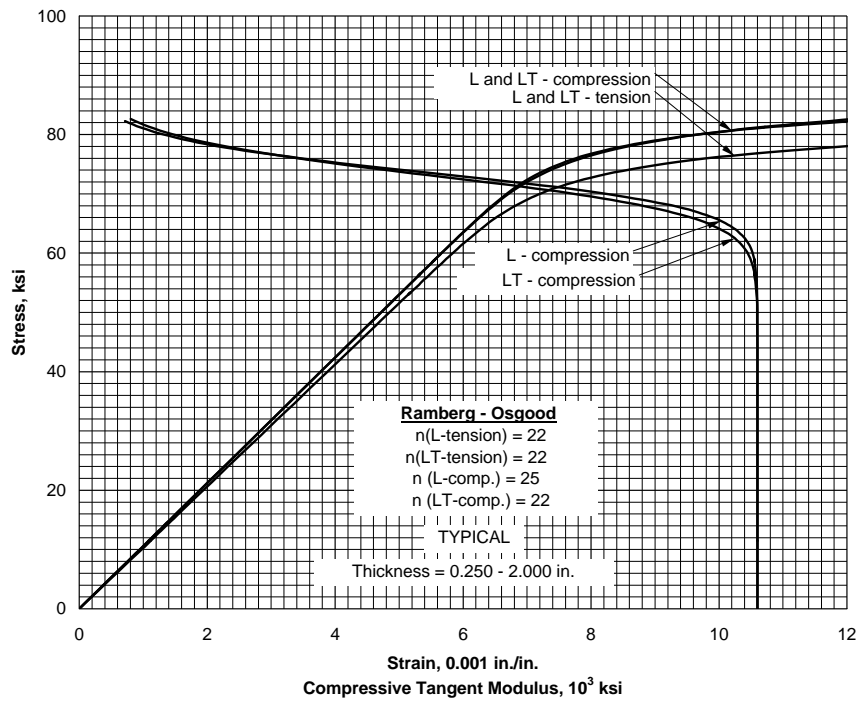

Figure 3.7.6.1.6(i). Typical tensile and compressive stress-strain and compressive tangent-modulus curves for 7075-T62 aluminum alloy plate at room temperature.

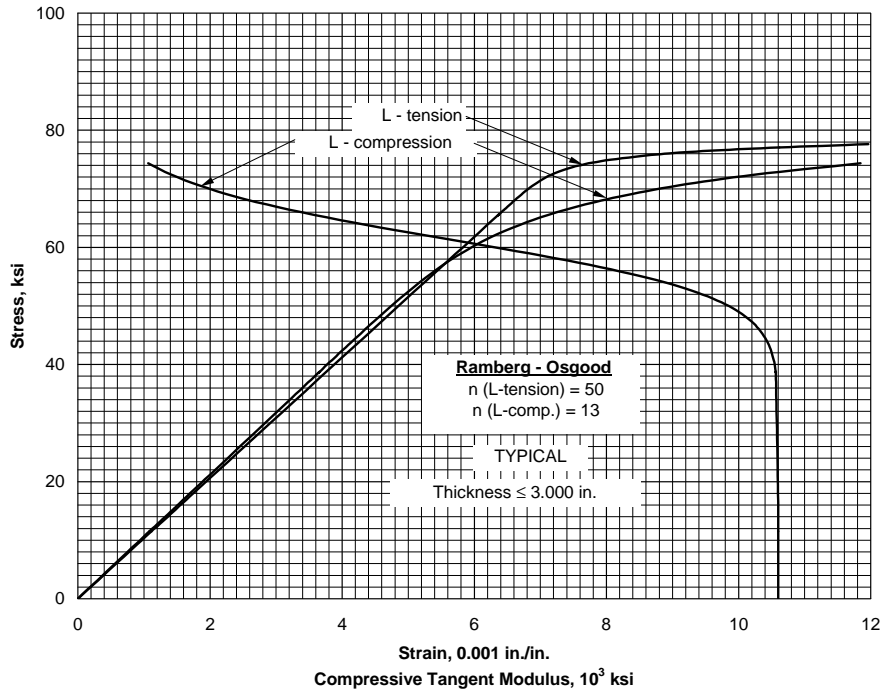

Figure 3.7.6.1.6(j). Typical tensile and compressive stress-strain and compressive tangent-modulus curves for 7075-T6 and T651 aluminum alloy rolled-bar, rod, and shape at room temperature.

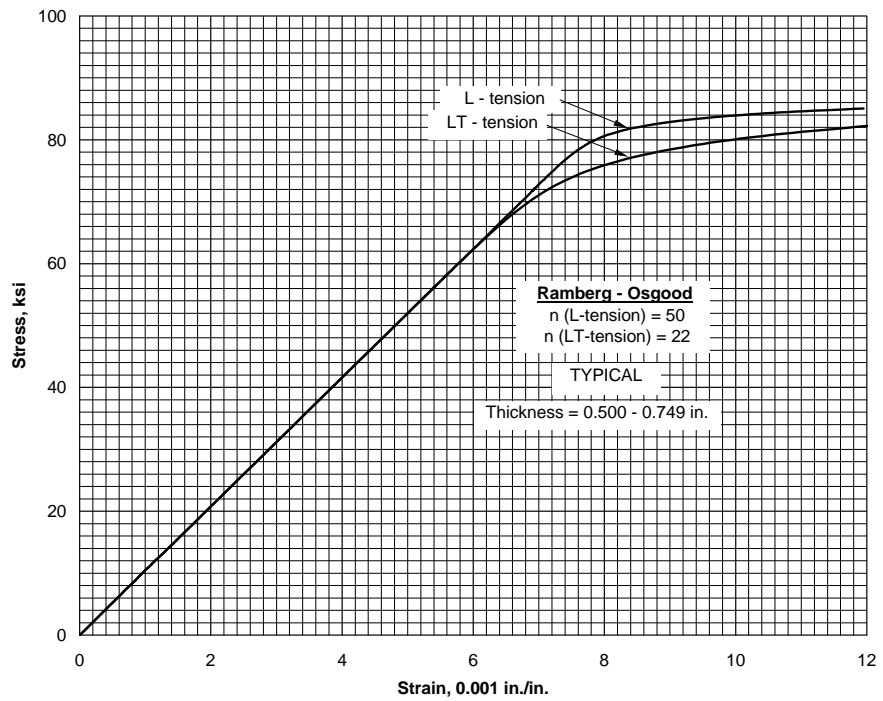

Figure 3.7.6.1.6(k). Typical tensile stress-strain curves for 7075-T651X aluminum alloy extrusion at room temperature.

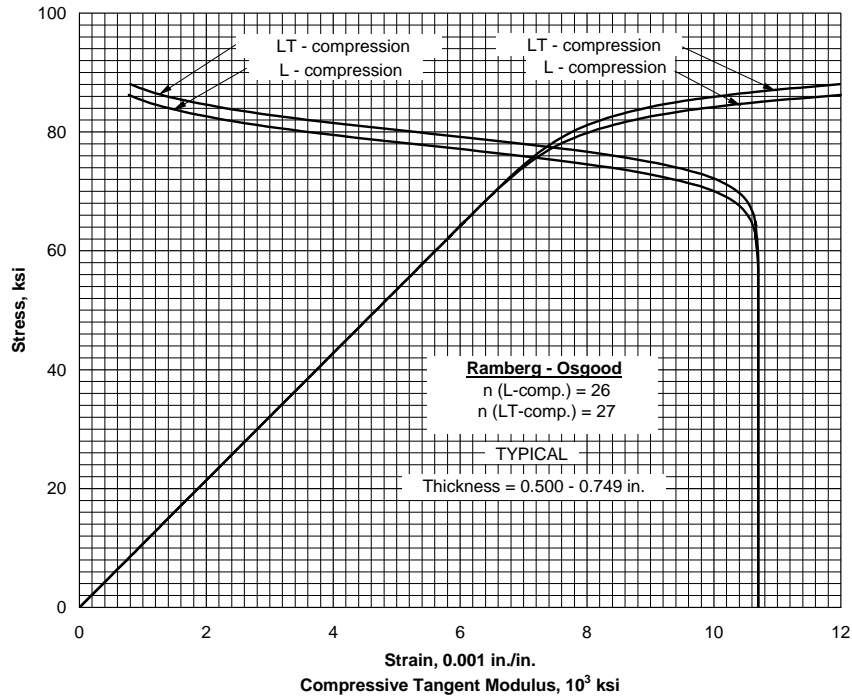

Figure 3.7.6.1.6(l). Typical compressive stress-strain and compressive tangent-modulus curve for 7075-T651X aluminum alloy extrusion at room temperature.

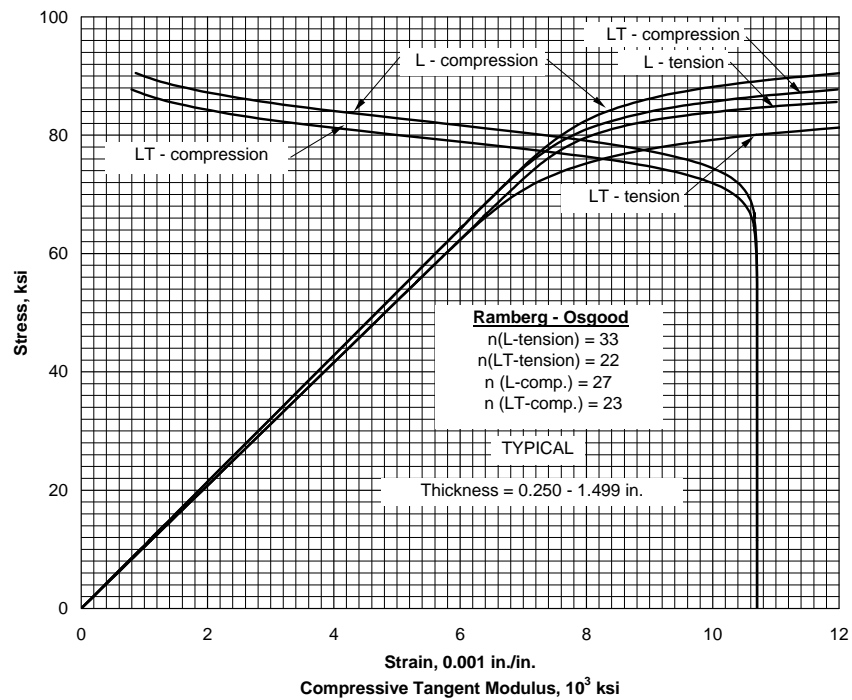

Figure 3.7.6.1.6(m). Typical tensile and compressive stress-strain and compressive tangent-modulus curves for 7075-T62 aluminum alloy extrusion at room temperature.

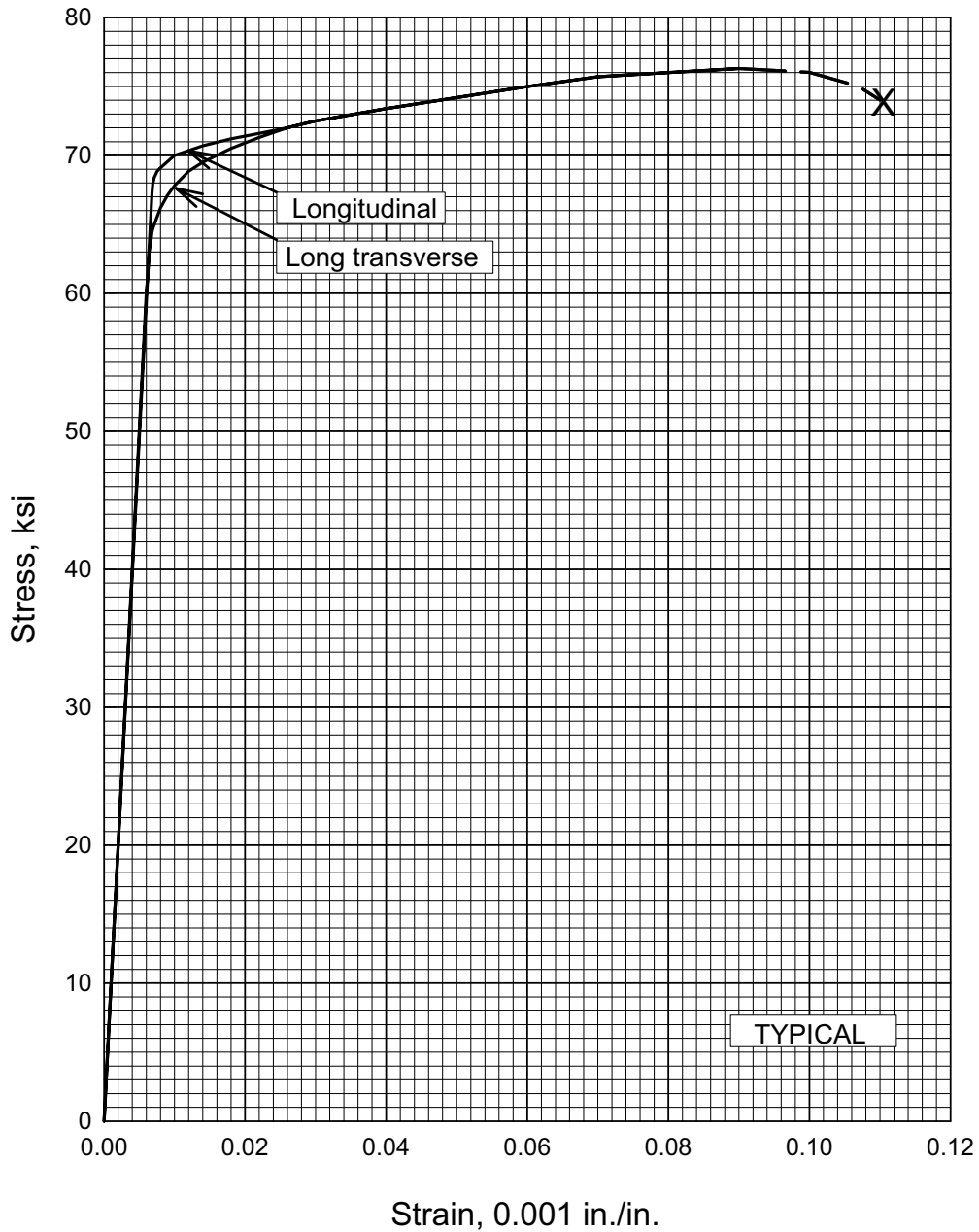

Figure 3.7.6.1.6(n). Typical tensile stress-strain curve (full range) for clad 7075-T6 aluminum alloy sheet at room temperature.

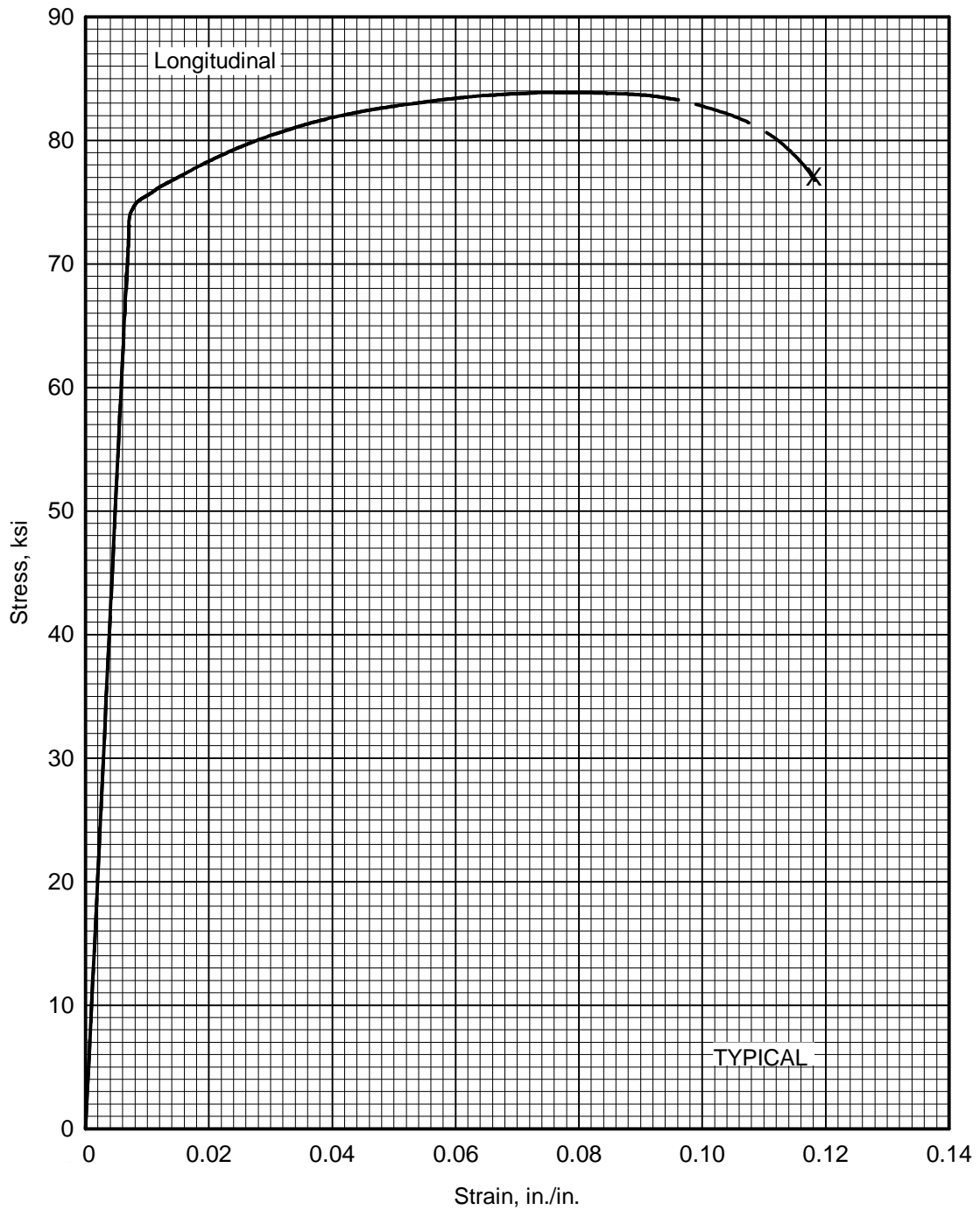

Figure 3.7.6.1.6(o). Typical tensile stress-strain curve (full range) for 7075-T6 and T651 aluminum alloy rolled or cold-finished bar at room temperature.

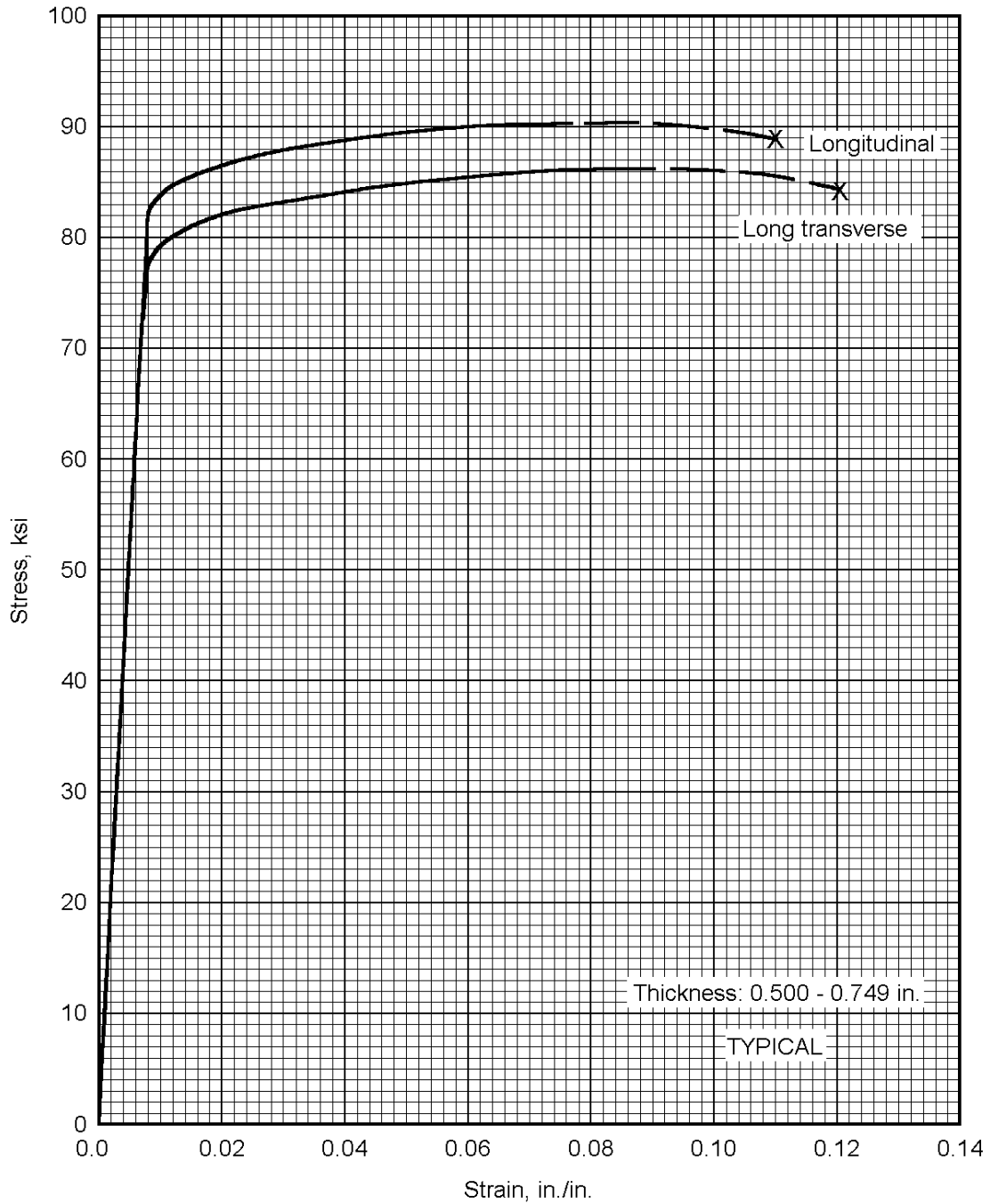

Figure 3.7.6.1.6(p). Typical tensile stress-strain curves (full range) for 7075-T651X aluminum alloy extrusion at room temperature.

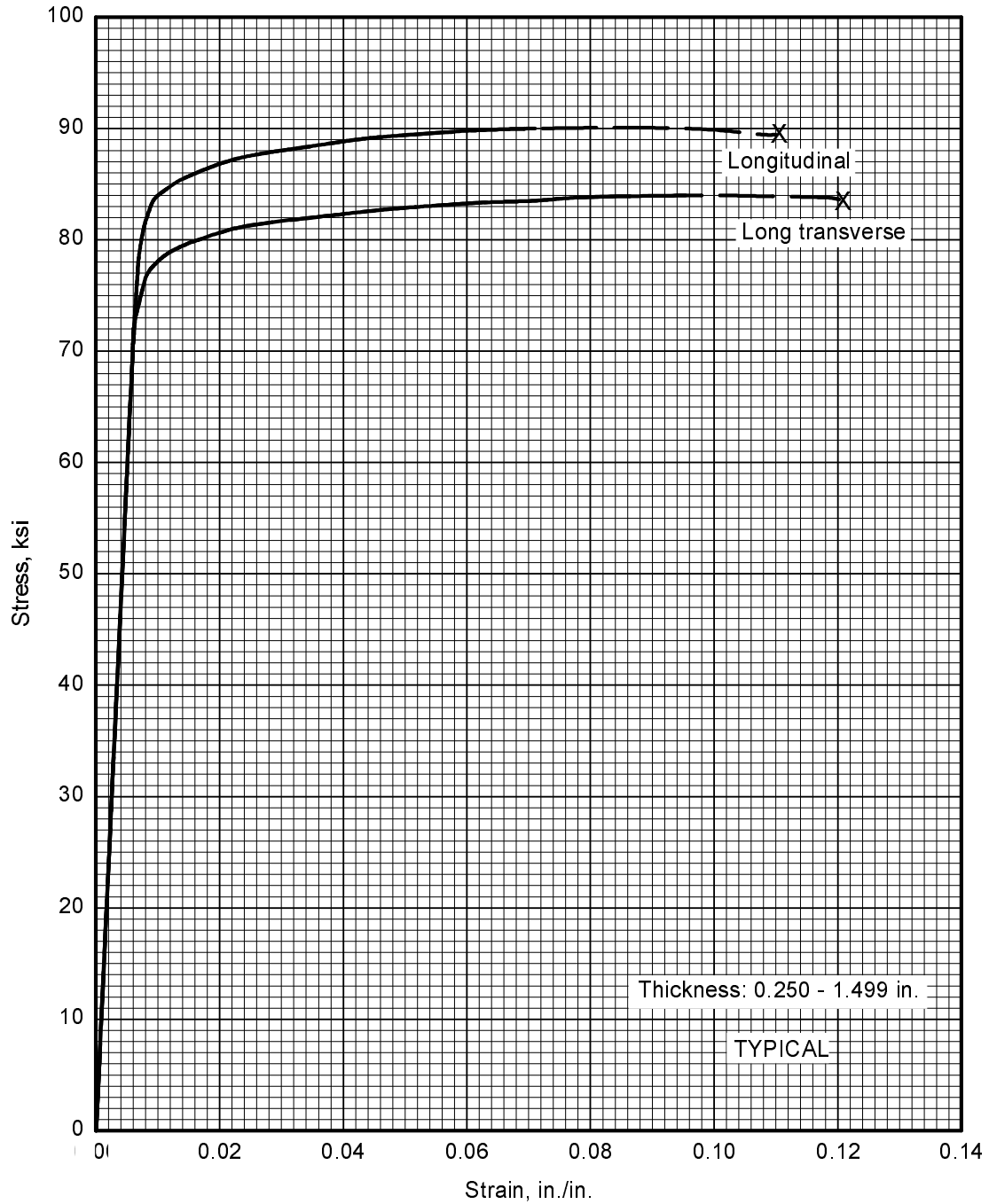

Figure 3.7.6.1.6(q). Typical tensile stress-strain curves (full range) for 7075-T62 aluminum alloy extrusion at room temperature.

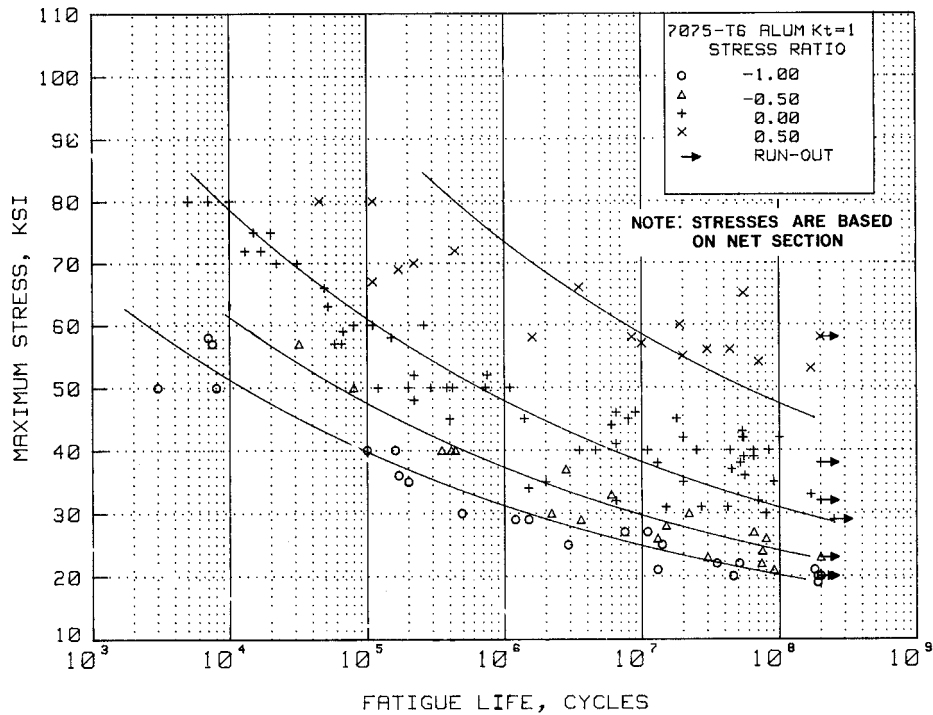

Figure 3.7.6.1.8(a). Best-fit S/N curves for unnotched 7075-T6 aluminum alloy, various product forms, longitudinal direction.

Correlative Information for Figure 3.7.6.1.8(a)

Product Form: 0.75 inch diam. drawn rod, 1.25 inch diam. rolled rod, and 1 x 7.5 inch bar, extruded 1.25 inch bar and 1.25 inch rod

Test Parameters:
Loading - Axial
Frequency - 30 Hz
Temperature - RT
Environment - Air

Properties: TUS, ksi TYS, ksi Temp., °F
 82 72 RT

No. of Heats/Lots: 8

Specimen Details: Unnotched
Minimum diameter 0.200 inch

Equivalent Stress Equation:
 $\log N_f = 18.22 - 7.77 \log (S_{eq} - 10.15)$
 $S_{eq} = S_{max} (1 - R)^{0.62}$
Std. Error of Estimate, $\log (\text{Life}) = 0.626$
Standard Deviation, $\log (\text{Life}) = 1.435$
 $R^2 = 81\%$

Surface Condition: Unspecified

Reference: 3.7.6.1.8

Sample Size = 130

[Caution: The equivalent stress model may provide unrealistic life predictions for stress ratios beyond those represented above.]

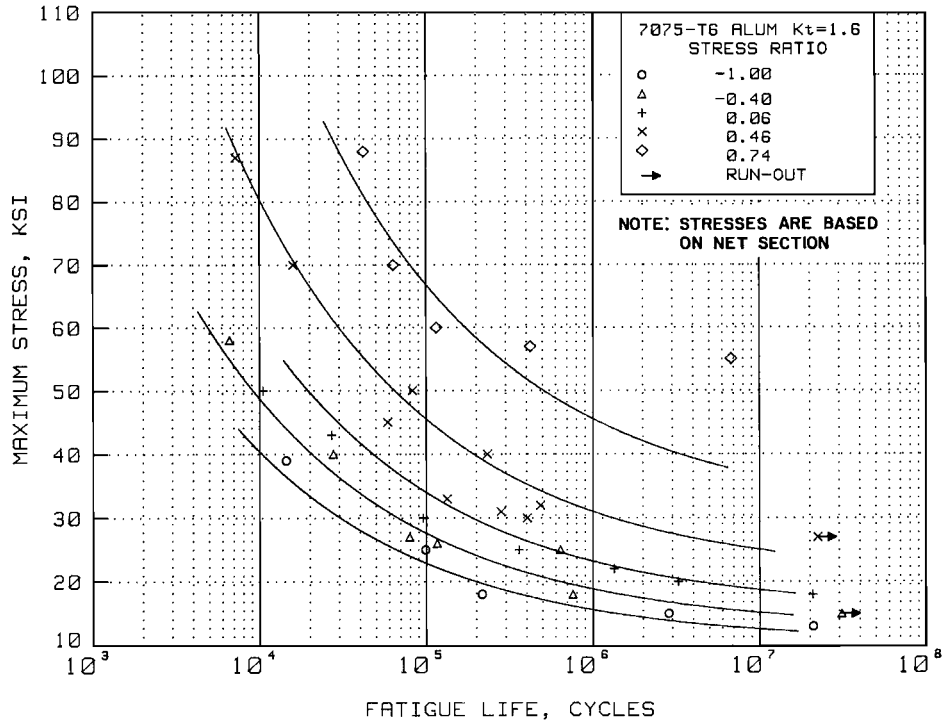

Figure 3.7.6.1.8(b). Best-fit S/N curve for notched, $K_t = 1.6$, 7075-T6 aluminum alloy rolled bar, longitudinal direction.

Correlative Information for Figure 3.7.6.1.8(b)

Product Form: 1.125 inch diam. rolled bar

Test Parameters:

Properties: $\frac{TUS, ksi}{99.2}$ $\frac{TYS, ksi}{—}$ $\frac{Temp., °F}{RT}$

Loading - Axial
Frequency - 60 Hz
Temperature - RT
Atmosphere - Air

Specimen Details: Notched, $K_t = 1.6$
Notch-root-radius = 0.100
Test section diameter (Net) = 0.400 inches
Gross diameter = 0.450 inch
60° groove

No. of Heats/Lots: 1

Equivalent Stress Equation:

$\log N_f = 8.26 - 2.62 \log (S_{eq} - 15.3)$
 $S_{eq} = S_{max} (1-R)^{0.525}$
Std. Error of Estimate, $\log (\text{Life}) = 0.418$
Standard Deviation, $\log (\text{Life}) = 0.985$
 $R^2 = 82\%$

Surface Condition: Polished to 10 micro-inches

Reference: 3.2.1.1.8(b)

Sample Size = 34

[Caution: The equivalent stress model may provide unrealistic life predictions for stress ratios beyond those represented above.]

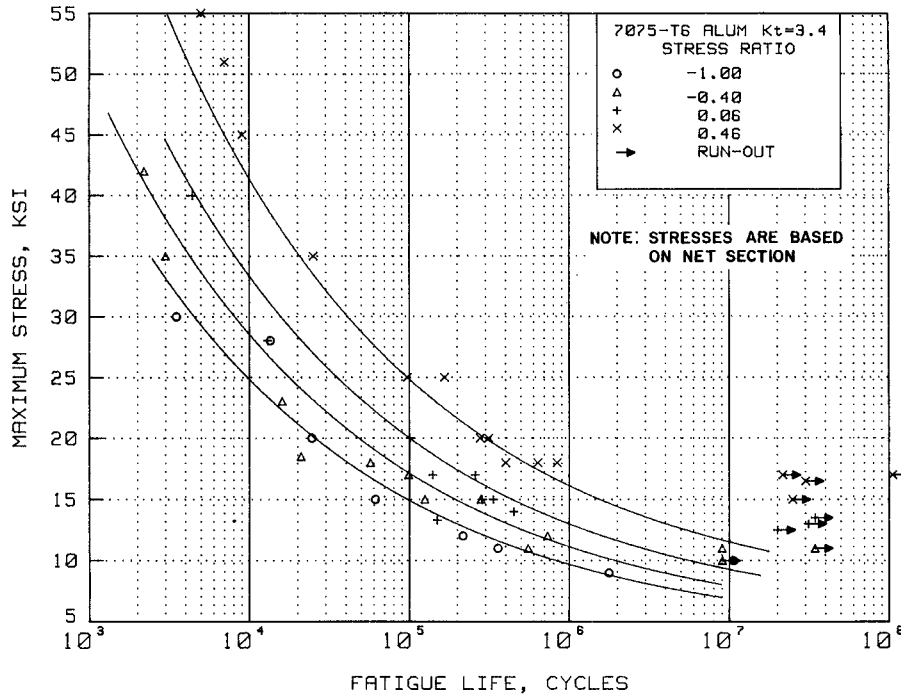

Figure 3.7.6.1.8(c). Best-fit S/N curves for notched, $K_t = 3.4$, 7075-T6 aluminum alloy rolled bar, longitudinal direction.

Correlative Information for Figure 3.7.6.1.8(c)

Product Form: 1.125 inch diam. rolled bar

Properties: T_{US} , ksi T_{YS} , ksi Temp., °F
96.5 — RT

Specimen Details: Notched, $K_t = 3.4$
Notch-root-radius = 0.010
Test section diameter (Net) = 0.400 inch
Gross diameter = 0.450 inch
60° groove

Surface Condition: Polished to 10 micro-inches

Reference: 3.2.1.1.8(b)

Test Parameters:

Loading - Axial
Frequency - 60 Hz
Temperature - RT
Atmosphere - Air

No. of Heats/Lots: 1

Equivalent Stress Equation:

$$\log N_f = 9.19 - 3.646 \log (S_{eq} - 5.36)$$

$$S_{eq} = S_{max} (1-R)^{0.386}$$

Std. Error of Estimate, $\log (\text{Life}) = 0.282$

Standard Deviation, $\log (\text{Life}) = 0.782$

$R^2 = 87\%$

Sample Size = 48

[Caution: The equivalent stress model may provide unrealistic life predictions for stress ratios beyond those represented above.]

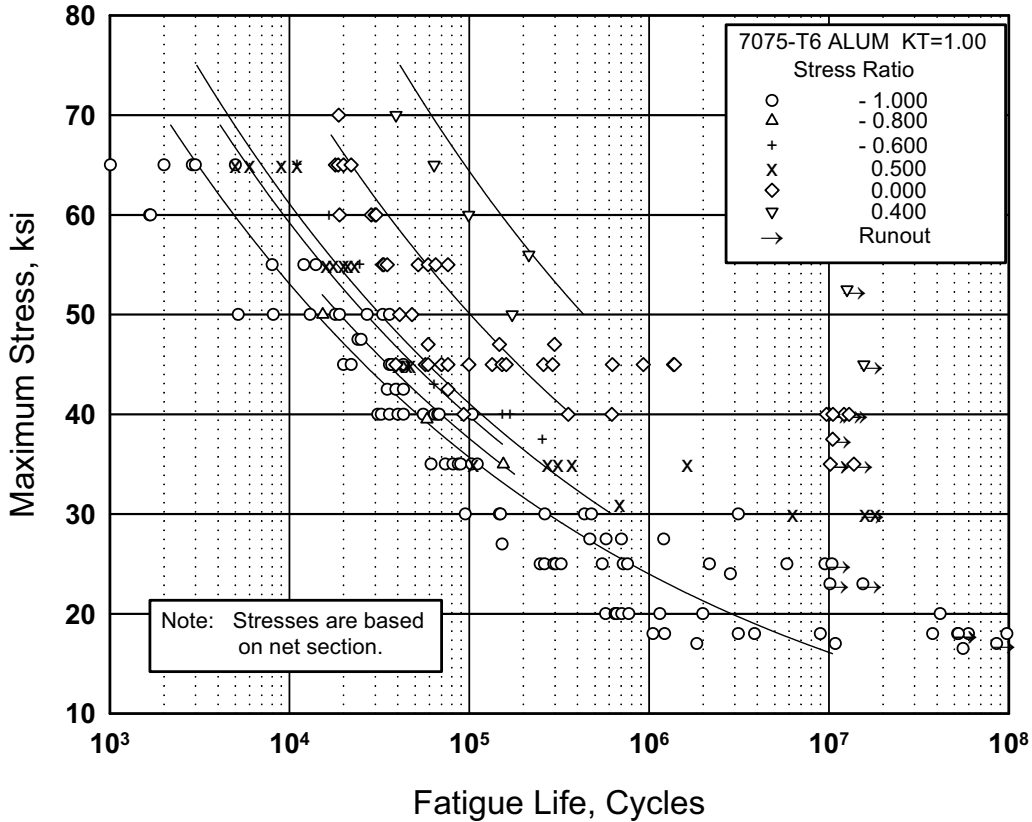

Figure 3.7.6.1.8(d). Best-fit S/N curves for unnotched 7075-T6 aluminum alloy sheet, longitudinal direction.

Correlative Information for Figure 3.7.6.1.8(d)

Product Form: Bare sheet, 0.090 inch

Test Parameters:

Properties: $\frac{TUS, \text{ksi}}{82}$ $\frac{TYS, \text{ksi}}{76}$ $\frac{\text{Temp., } ^\circ\text{F}}{\text{RT}}$

Loading - Axial
Frequency - 300 to 1800 cpm
Environment - Air

Specimen Details: Unnotched
0.5 to 1.0 inch width

No. of Heats/Lots: Not specified

Surface Condition: Electropolished
150 grit emery paper

Equivalent Stress Equation:
 $\text{Log } N_f = 14.86 - 5.80 \text{ log } (S_{eq})$
 $S_{eq} = S_{max} (1-R)^{0.49}$
Std. Error of Estimate, $\text{Log } (\text{Life}) = 0.41$
Standard Deviation, $\text{Log } (\text{Life}) = 0.92$
 $R^2 = 80\%$

References: 3.2.3.1.8(a) and (f)

Sample Size = 176

[Caution: The equivalent stress model may provide unrealistic life predictions for stress ratios beyond those represented above.]

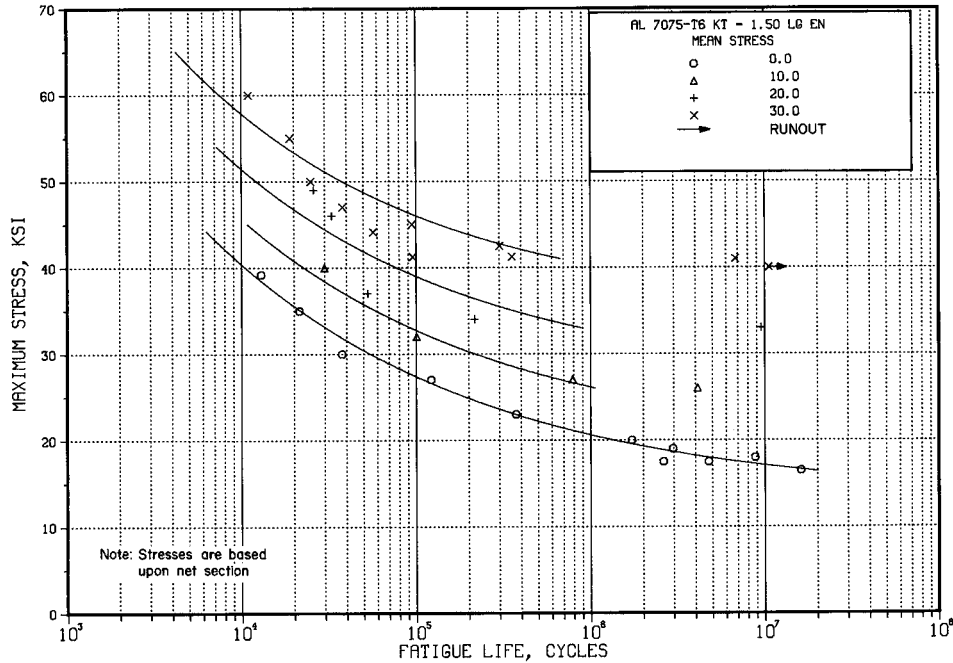

Figure 3.7.6.1.8(e). Best-fit S/N curves for notched, $K_t = 1.5$, 7075-T6 aluminum alloy sheet, longitudinal direction.

Correlative Information for Figure 3.7.6.1.8(e)

Product Form: Bare sheet, 0.090 inch

Test Parameters:

Properties:

TUS, ksi	TYS, ksi	Temp., °F
82	76	RT (unnotched)
87	—	RT (notched)

Loading - Axial
Frequency - 1100 to 1500 cpm
Temperature - RT
Environment - Air

No. of Heats/Lots: Not specified

Specimen Details: Edge Notched
3.000 inches gross width
1.500 inches net width
0.760 inch notch radius
60° flank angle

Equivalent Stress Equation:
 $\log N_f = 9.54 - 3.52 \log (S_{eq} - 18.7)$
 $S_{eq} = S_{max} (1-R)^{0.49}$
Std. Error of Estimate, $\log (\text{Life}) = 0.41$
Standard Deviation, $\log (\text{Life}) = 1.00$
 $R^2 = 83\%$

Surface Condition: Electropolished

Sample Size = 30

Reference: 3.2.3.1.8(d)

[Caution: The equivalent stress model may provide unrealistic life predictions for stress ratios beyond those represented above.]

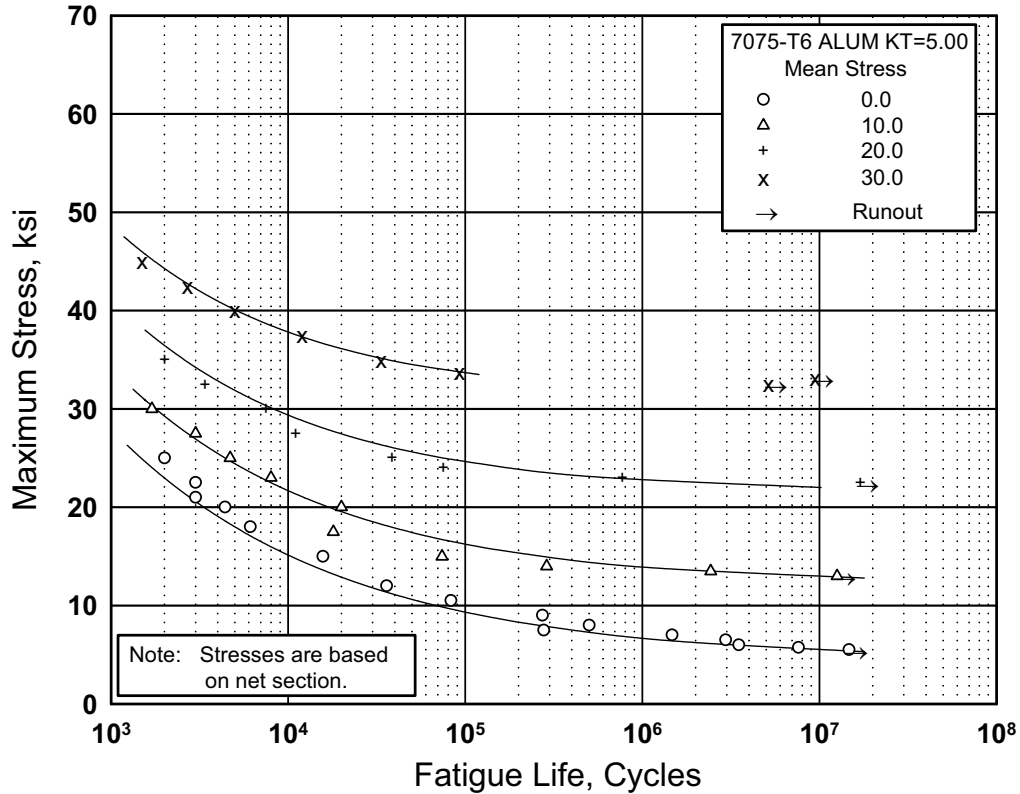

Figure 3.7.6.1.8(h). Best-fit S/N curves for notched, $K_t = 5.0$, 7075-T6 aluminum alloy sheet, longitudinal direction.

Correlative Information for Figure 3.7.6.1.8(h)

Product Form: Bare sheet, 0.090 inch

Test Parameters:

Properties:

TUS, ksi	TYS, ksi	Temp., °F
82	76	RT
		(unnotched)
77	—	RT
		(notched)

Loading - Axial
Frequency - 1100 to 1500 cpm
Temperature - RT
Environment - Air

No. of Heats/Lots: Not specified

Specimen Details: Edge Notched
2.25 inch gross width
1.500 inch net width
0.03125 inch notch radius

Equivalent Stress Equation:
 $\log N_f = 7.51 - 2.92 \log (S_{eq} - 6.7)$
 $S_{eq} = S_{max} (1-R)^{0.58}$
Std. Error of Estimate, Log (Life) = 0.23
Standard Deviation, Log (Life) = 1.08
 $R^2 = 95\%$

Surface Condition: Electropolished

Sample Size = 37

Reference: 3.2.3.1.8(c)

[Caution: The equivalent stress model may provide unrealistic life predictions for stress ratios beyond those represented above.]

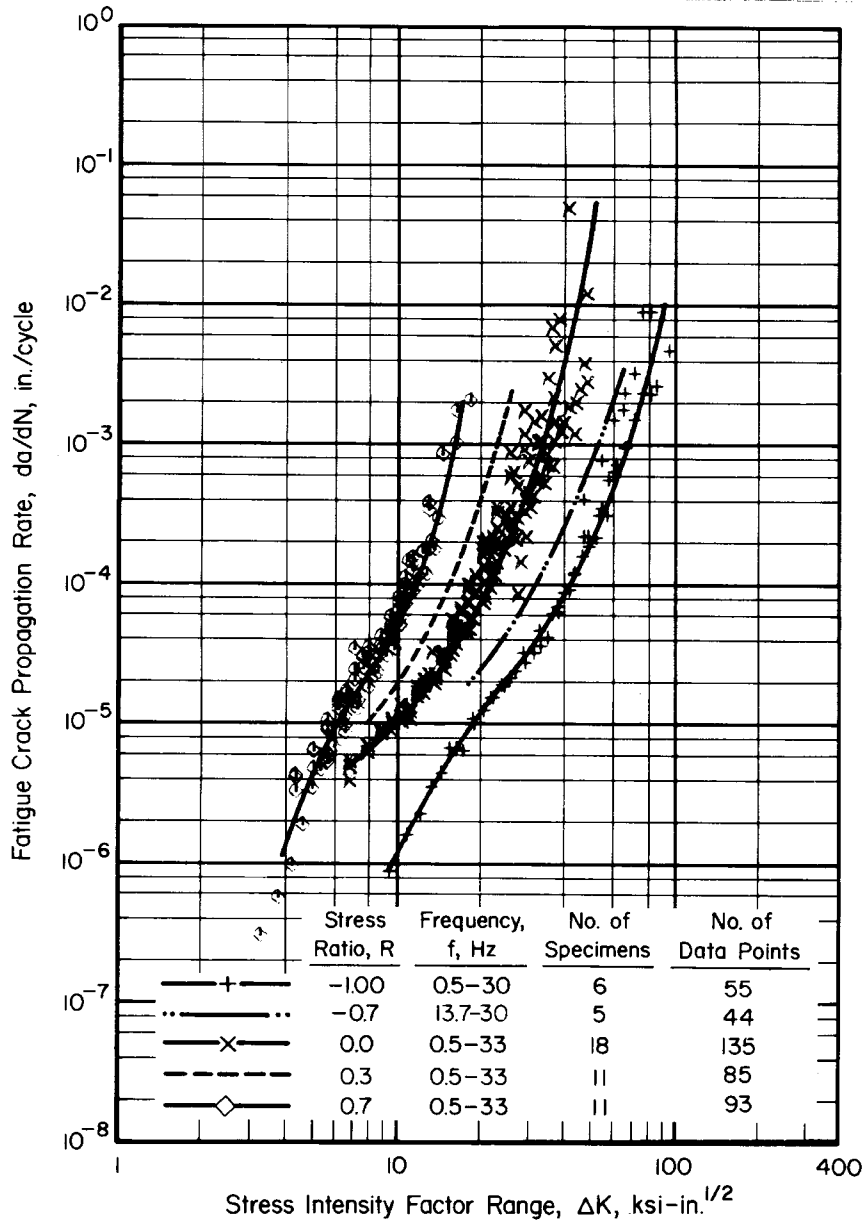

Figure 3.7.6.1.9. Fatigue-crack-propagation data for 0.090-inch-thick 7075-T6 aluminum alloy sheet with buckling restraint [References 3.7.6.1.9(a) through (e)].

Specimen Thickness: 0.090 inch
Specimen Width: 1-1/2 - 12 inches
Specimen Type: M(T)

Environment: Lab air
Temperature: RT
Orientation: L-T

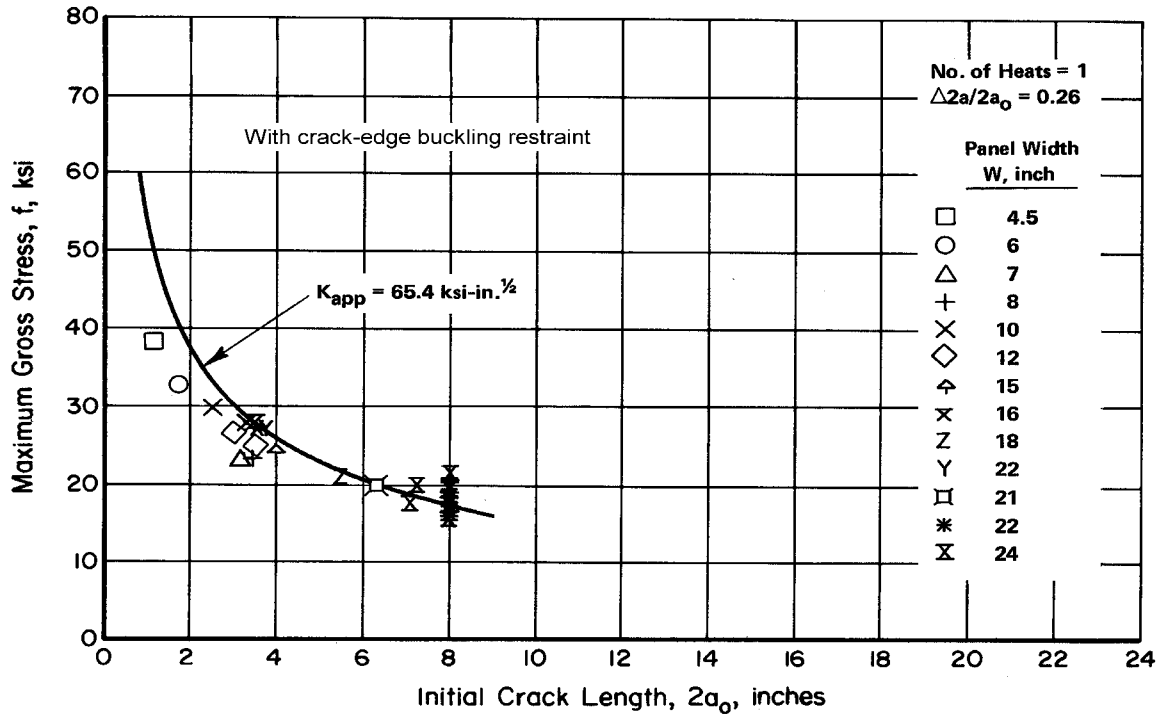

Figure 3.7.6.1.10(a). Residual strength behavior of 0.063-inch-thick 7075-T6 aluminum alloy sheet at room temperature. Crack orientation is T-L [Reference 3.1.2.1.6(f)].

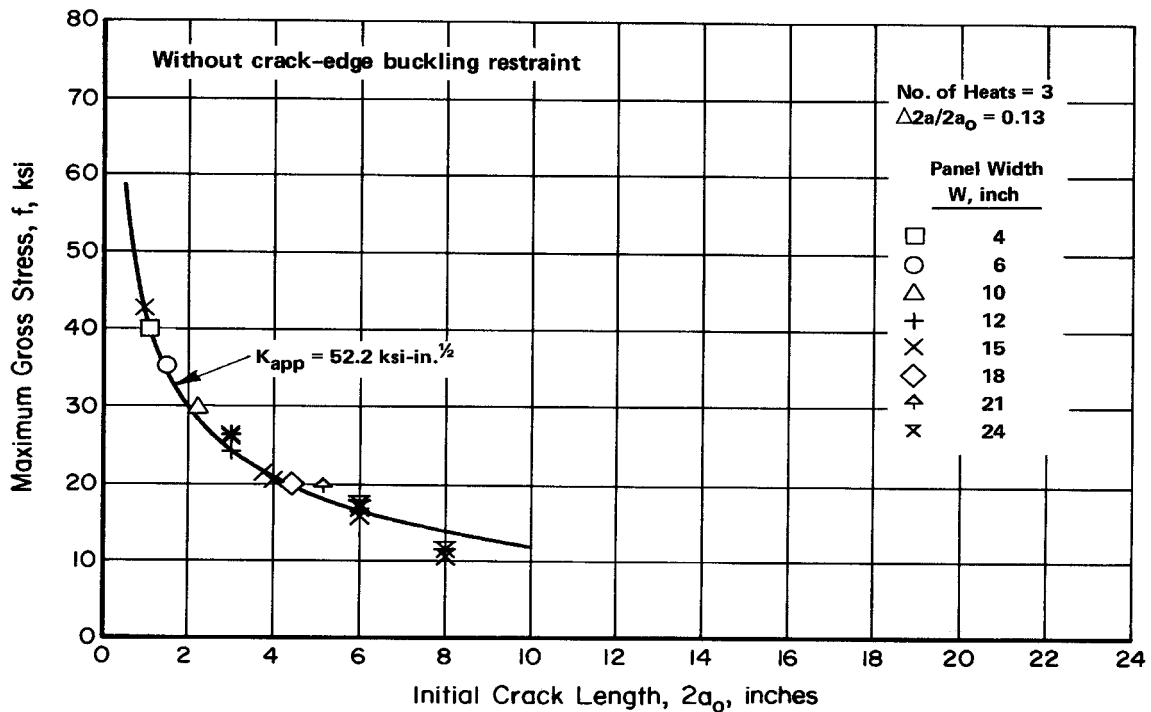

Figure 3.7.6.1.10(b). Residual strength behavior of 0.063-inch-thick 7075-T6 aluminum alloy sheet at room temperature. Crack orientation is T-L [References 3.1.2.1.6(d) and (f)].

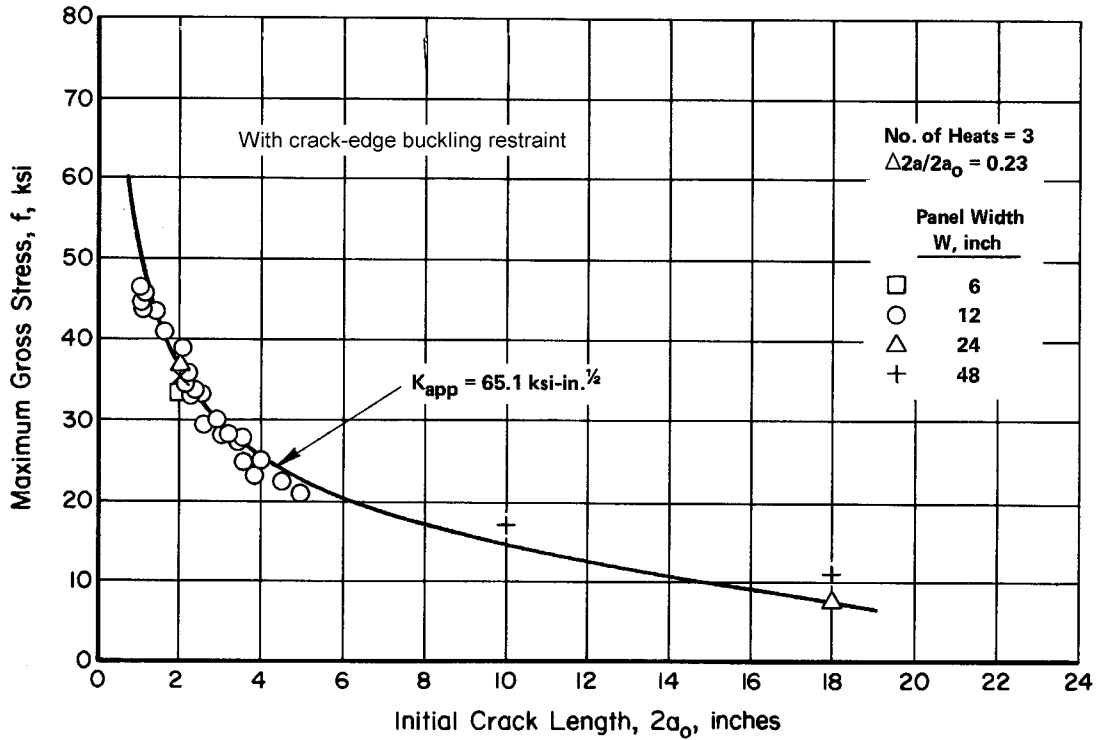

Figure 3.7.6.10(c). Residual strength behavior of 0.090- and 0.100-inch-thick 7075-T6 aluminum alloy sheet at room temperature. Crack orientation is L-T [References 3.1.2.1.6(e), (g), and 3.7.6.1.9(e)].

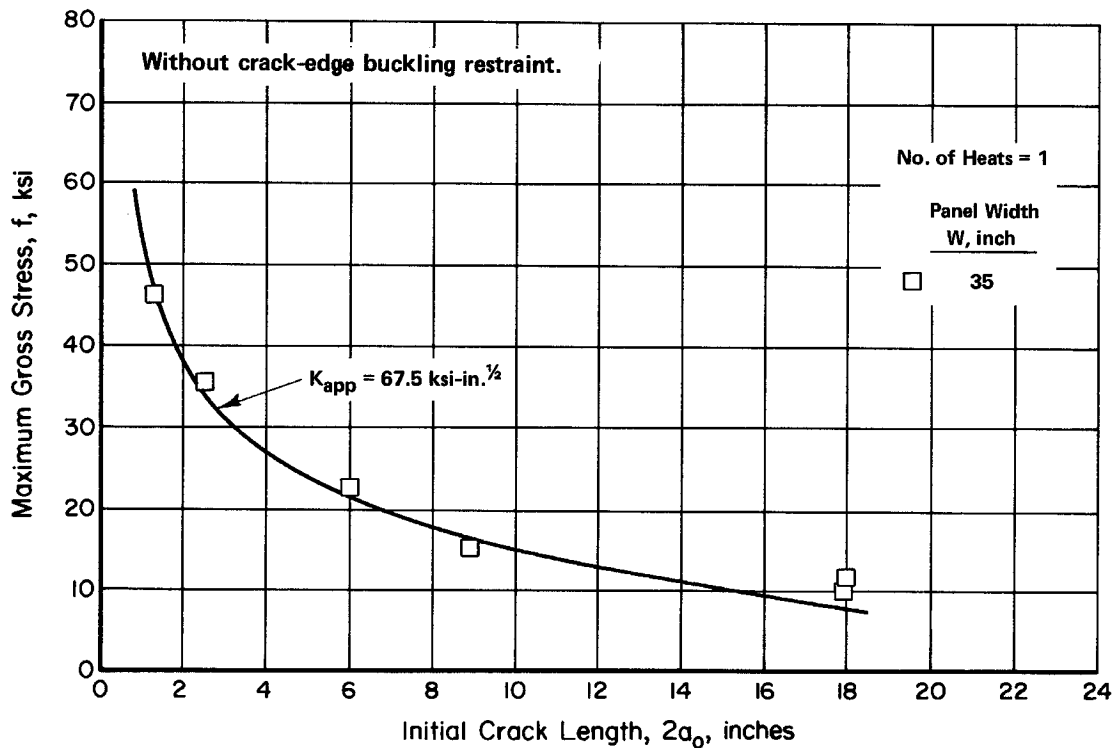

Figure 3.7.6.10(d). Residual strength behavior of 0.100-inch-thick 7075-T6 aluminum alloy sheet at room temperature. Crack orientation is L-T [Reference 3.1.2.1.6(g)].

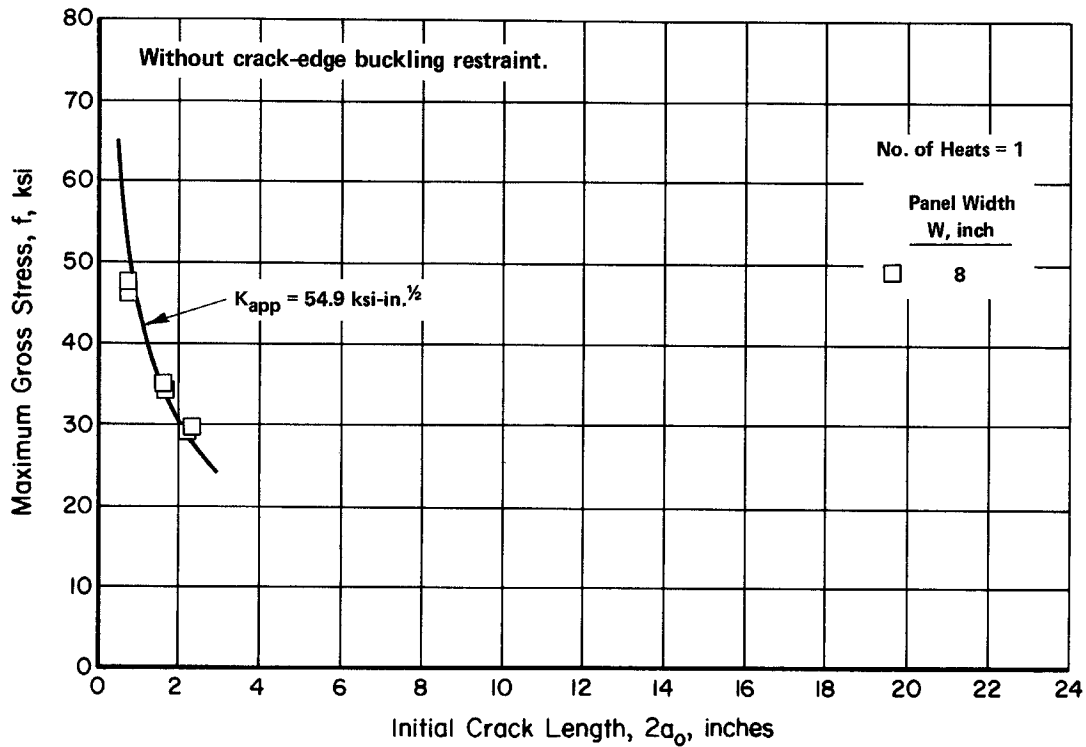

Figure 3.7.6.1.10(e). Residual strength behavior of 0.313-inch-thick 7075-T6 aluminum alloy plate at room temperature. Crack orientation is L-T [Reference 3.1.2.1.6(g)].

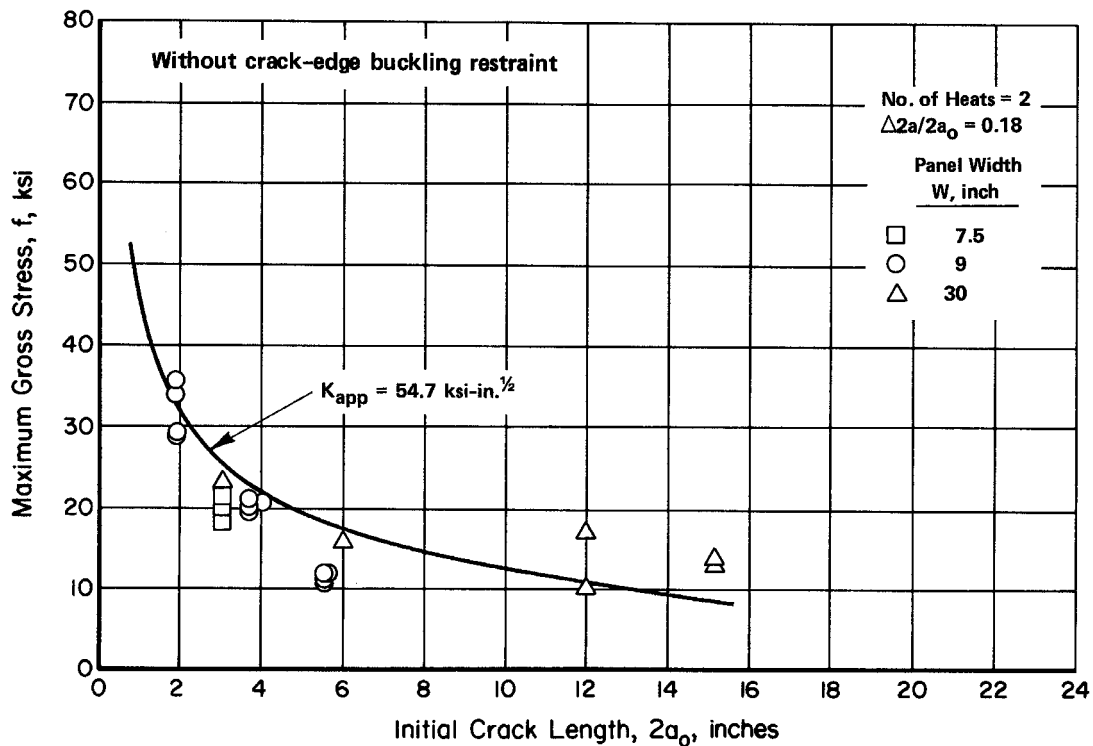

Figure 3.7.6.1.10(f). Residual strength behavior of 0.040-inch-thick 7075-T6 clad aluminum alloy sheet at room temperature. Crack orientation is L-T [References 3.1.2.1.6(f) and 3.7.6.1.10(f)].

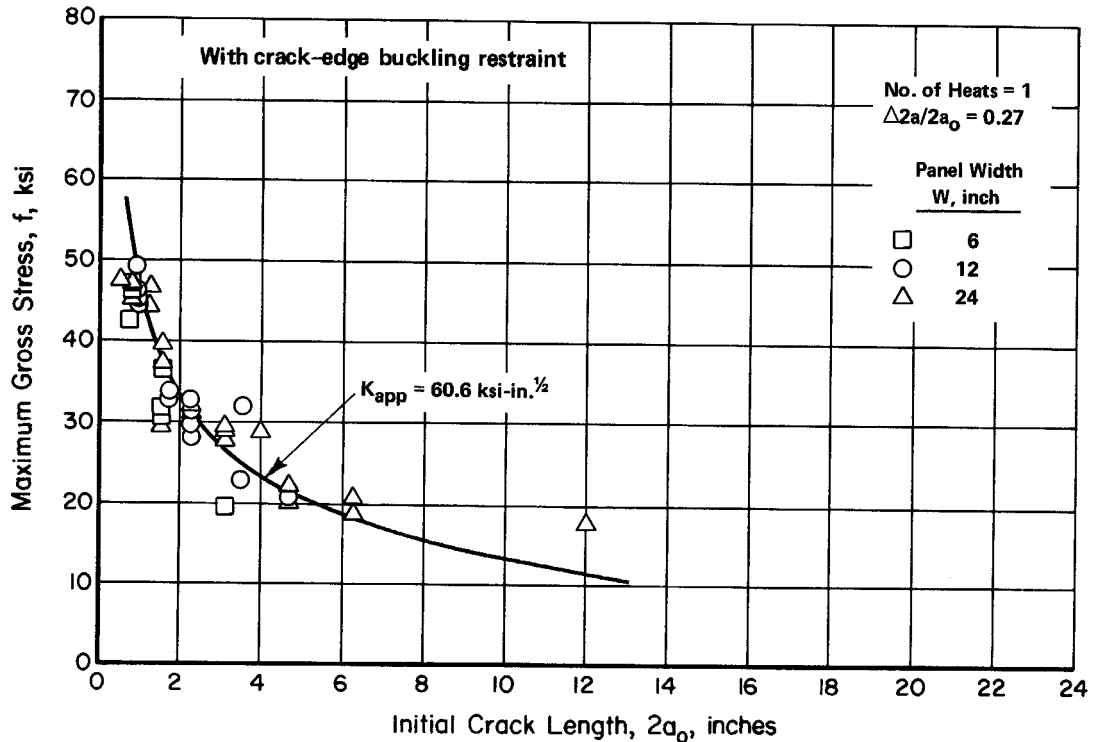

Figure 3.7.6.1.10(g). Residual strength behavior of 0.080-inch-thick 7075-T6 clad aluminum alloy sheet at room temperature. Crack orientation is L-T [References 3.1.2.1.6(h) and (i)].

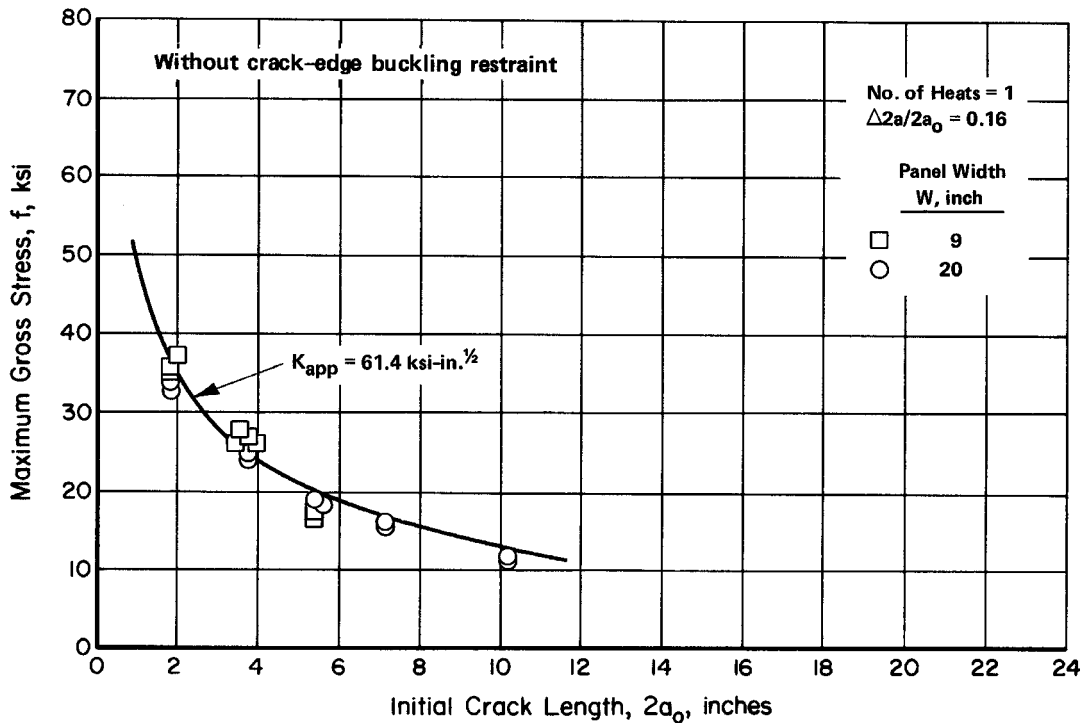

Figure 3.7.6.1.10(h). Residual strength behavior of 0.090-inch-thick 7075-T6 clad aluminum alloy sheet at room temperature. Crack orientation is L-T [Reference 3.7.6.1.10(f)].

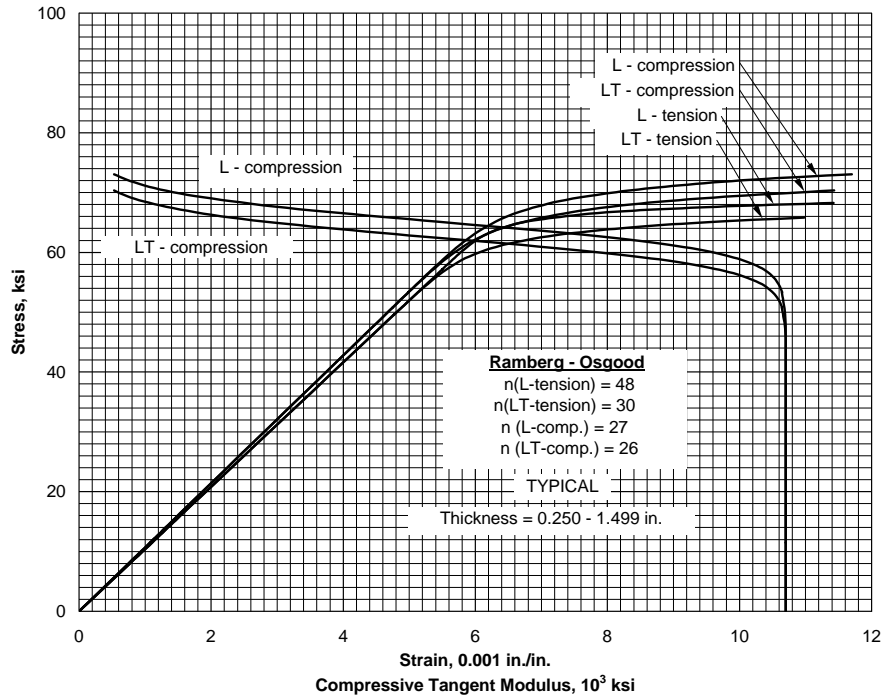

Figure 3.7.6.2.6(a). Typical tensile and compressive stress-strain and compressive tangent-modulus curves for 7075-T73 aluminum alloy extrusion at room temperature.

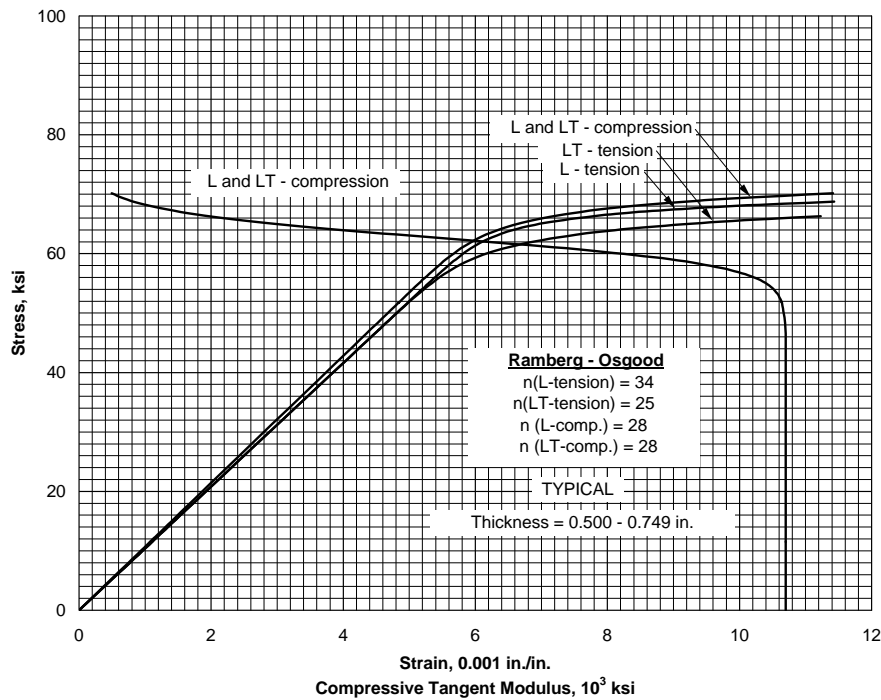

Figure 3.7.6.2.6(b). Typical tensile and compressive stress-strain and compressive tangent-modulus curves for 7075-T7351X aluminum alloy extrusion at room temperature.

MIL-HDBK-5J
31 January 2003

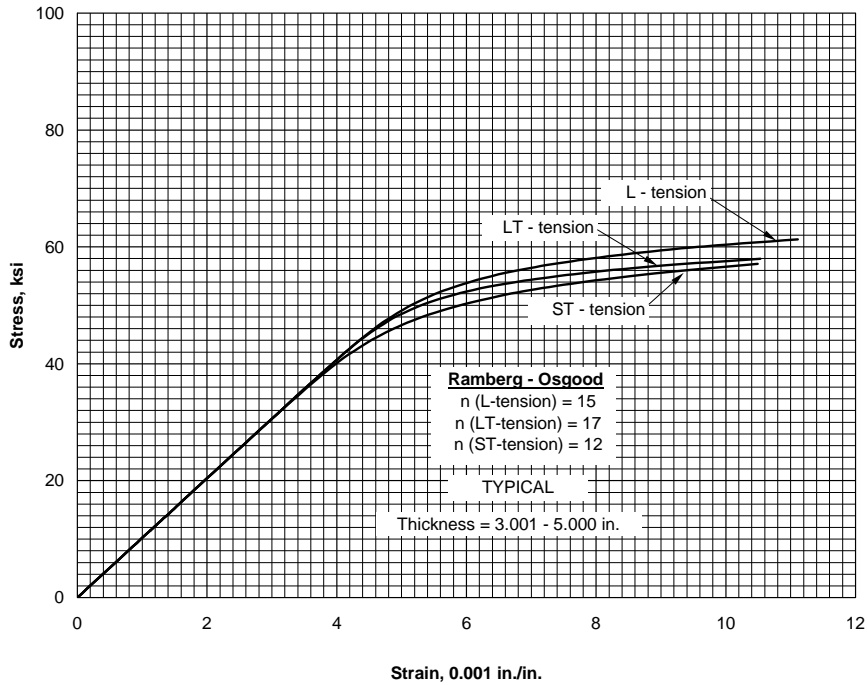

Figure 3.7.6.2.6(c). Typical tensile stress-strain curves for 7075-T7352 aluminum alloy hand forging at room temperature.

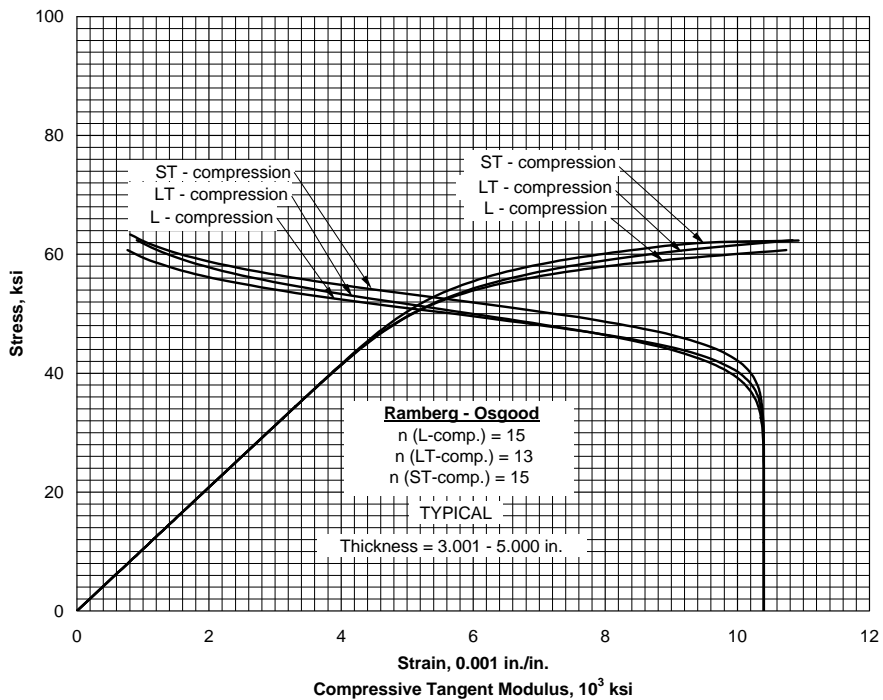

Figure 3.7.6.2.6(d). Typical compressive stress-strain and compressive tangent-modulus curves for 7075-T7352 aluminum alloy hand forging at room temperature.

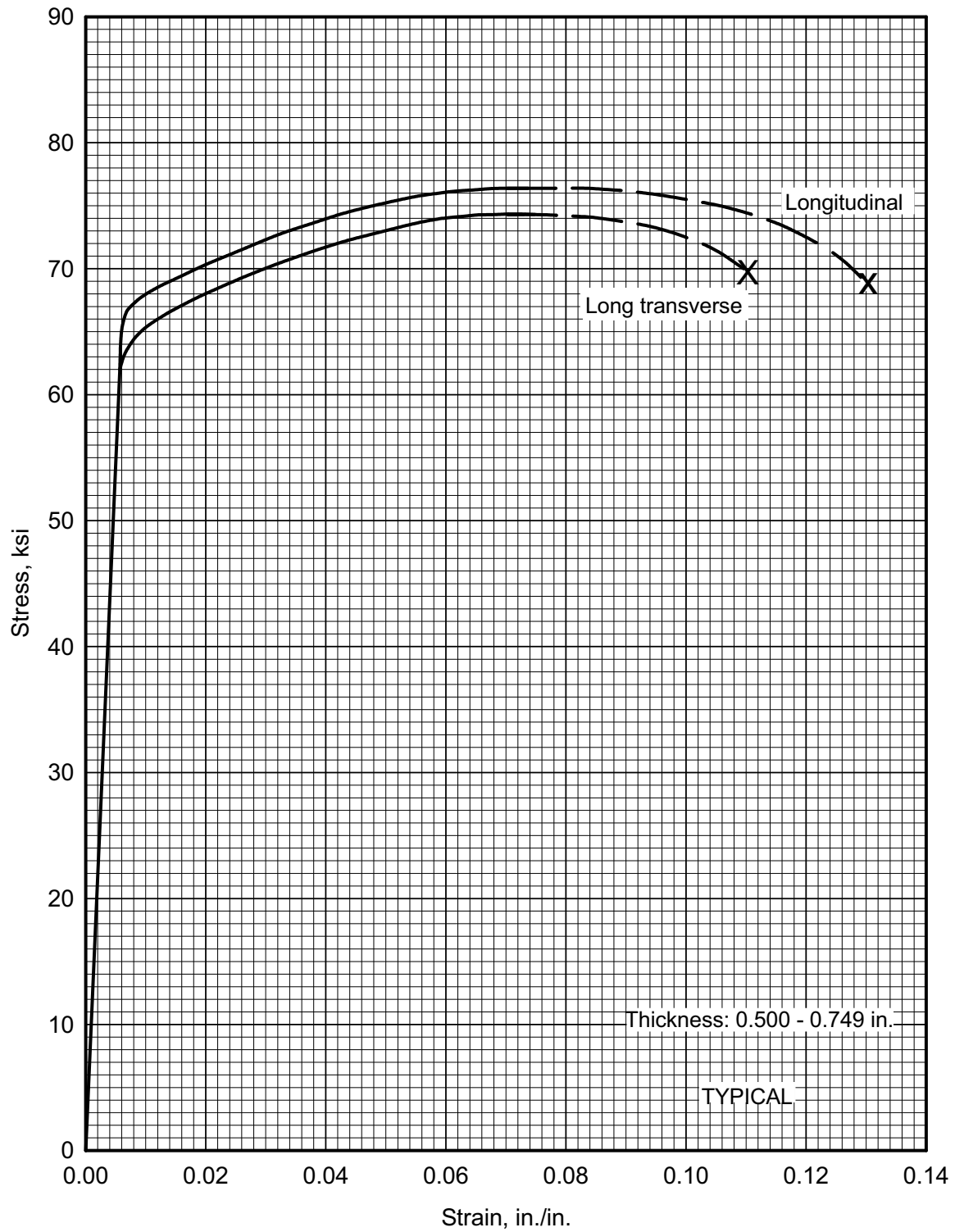

Figure 3.7.6.2.6(e). Typical tensile stress-strain curves (full range) for 7075-T7351X aluminum alloy extrusion at room temperature.

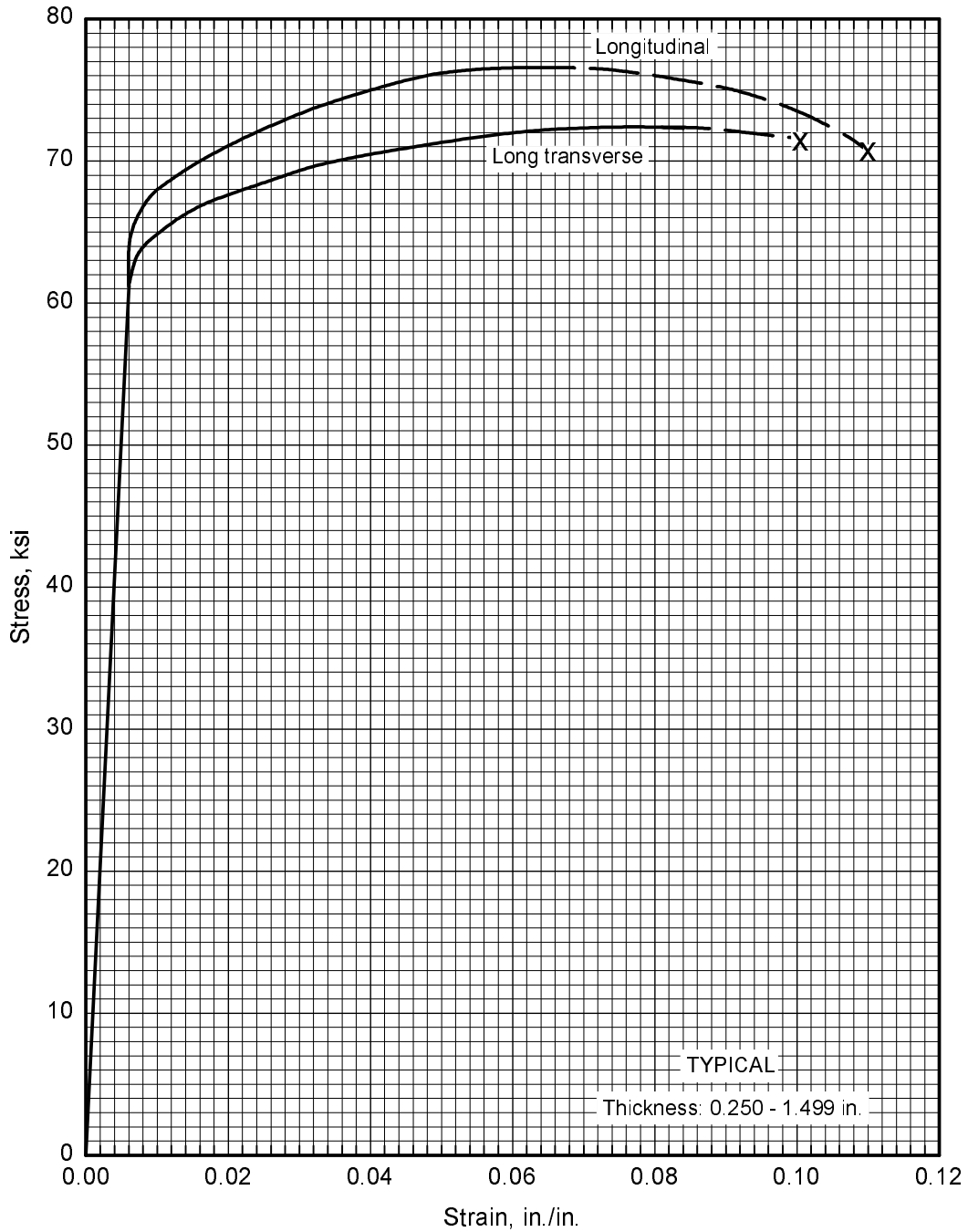

Figure 3.7.6.2.6(f). Typical tensile stress-strain curves (full range) for 7075-T73 aluminum alloy extrusion at room temperature.

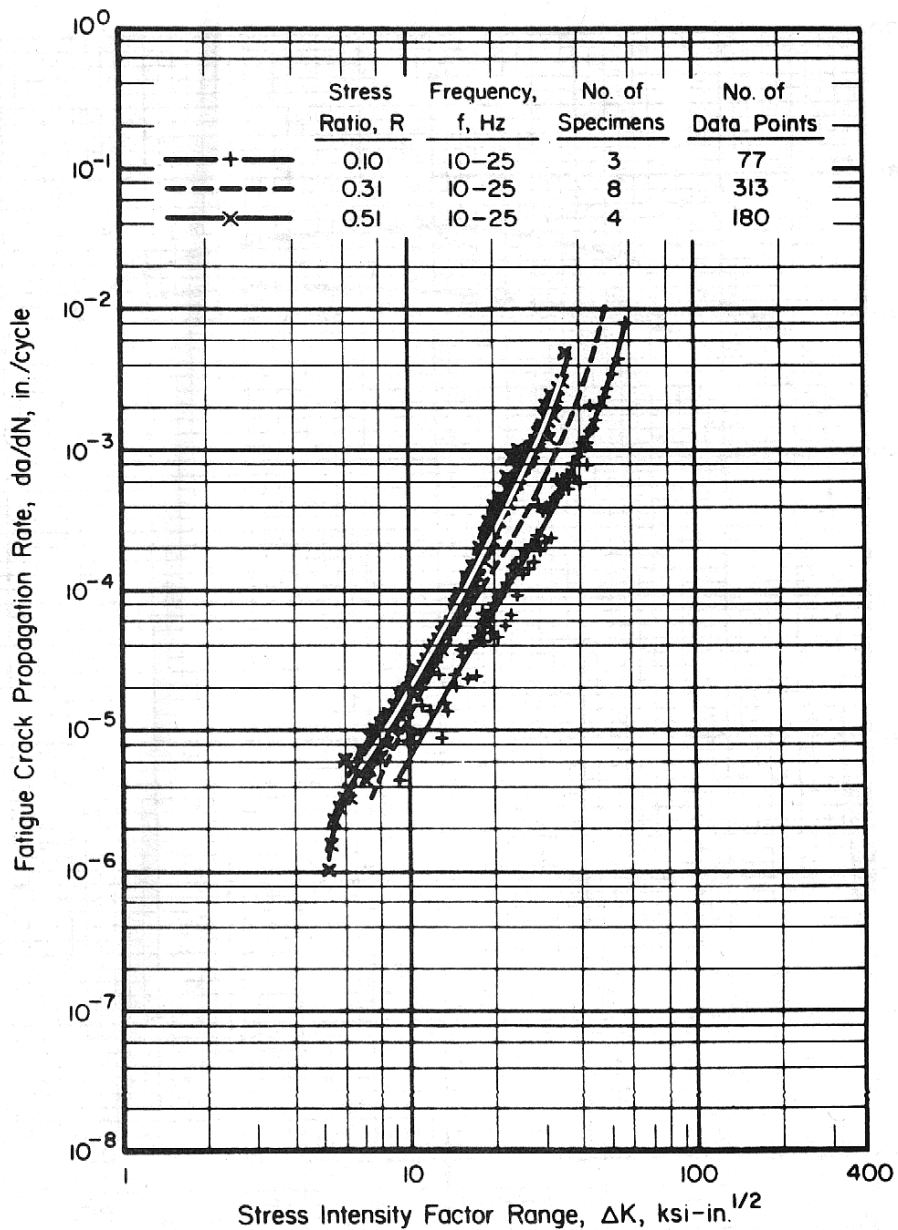

Figure 3.7.6.2.9(a). Fatigue-crack-propagation data for 0.250-inch-thick, 7075-T7351 aluminum alloy plate with buckling restraint [References 3.2.5.1.9(d) and 3.7.6.2.9(a)].

Specimen Thickness: 0.250-inch
Specimen Width: 8, 16, 36-inches
Specimen Type: M(T)

Environment: 50% R.H.
Temperature: RT
Orientation: L-T

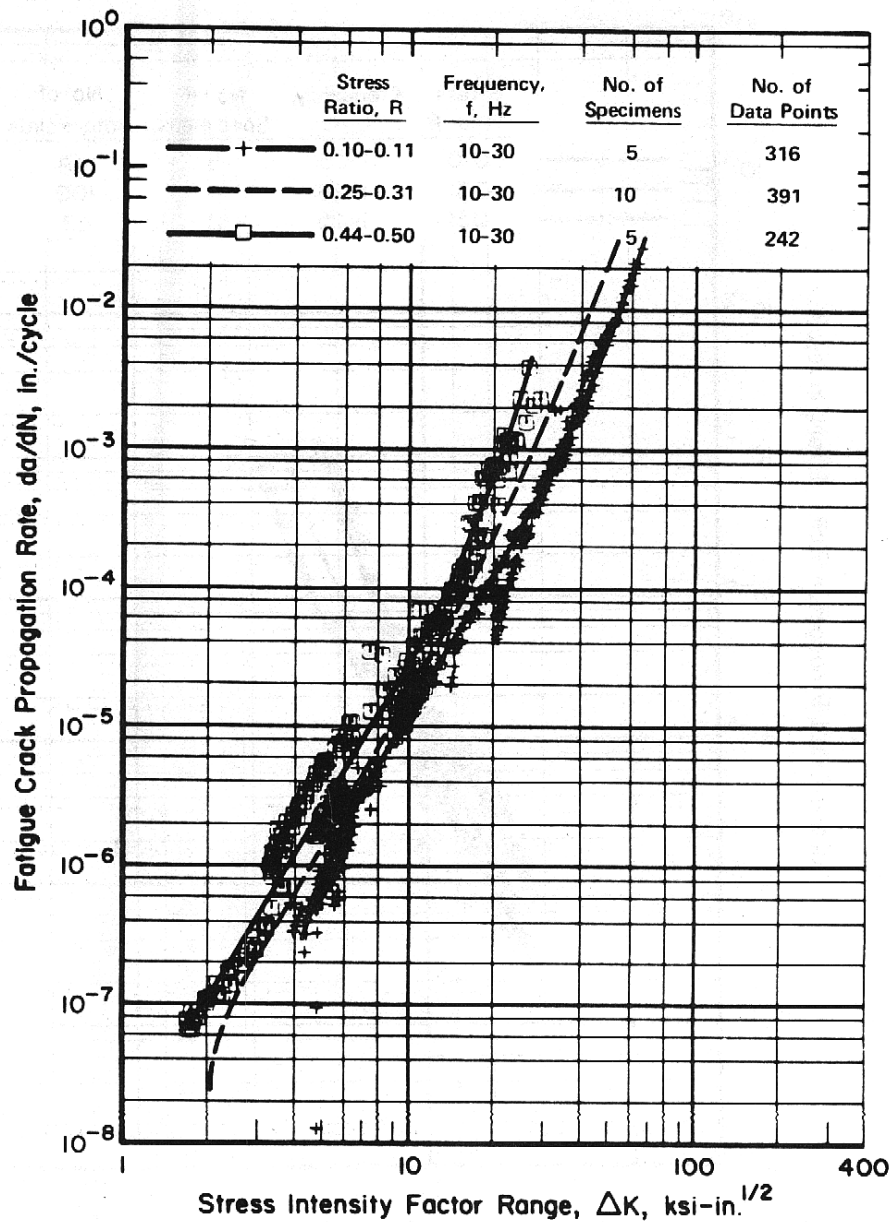

Figure 3.7.6.2.9(b). Fatigue-crack-propagation data for 0.500-inch-thick, 7075-T7351 aluminum alloy plate with buckling restraint [References 3.1.2.1.6(j) and 3.7.6.2.9(a) through (c)].

Specimen Thickness: 0.475 to 0.500-inch
Specimen Width: 6, 8, 16, 36-inches
Specimen Type: M(T)

Environment: 50-95% R.H.
Temperature: RT
Orientation: L-T

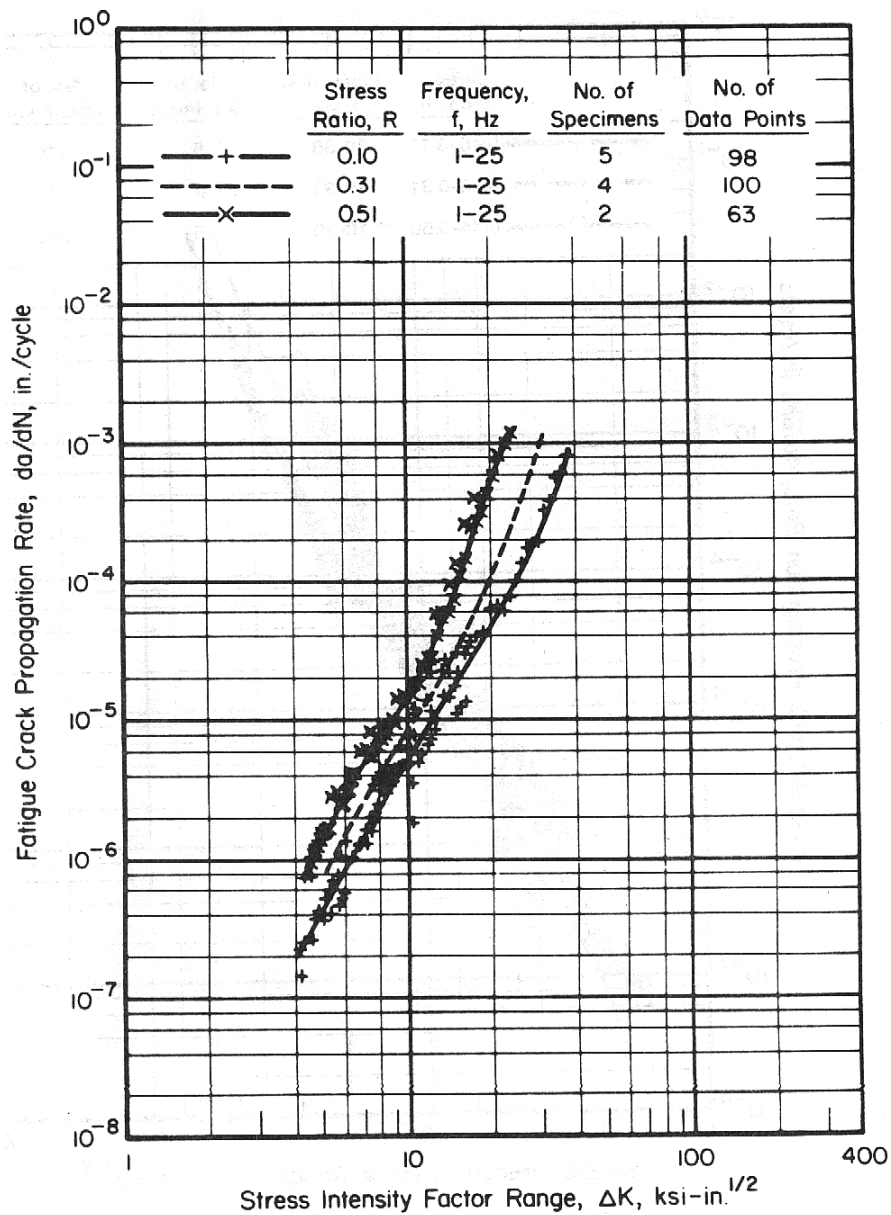

Figure 3.7.6.2.9(c). Fatigue-crack-propagation data for 1.00-inch-thick, 7075-T7351 aluminum alloy plate without buckling restraint [References 3.2.5.1.9(d) and 3.7.6.2.9(a) and (b)].

Specimen Thickness: 1.00-inch
Specimen Width: 6, 8, 16, 36-inches
Specimen Type: M(T), C(T)

Environment: 50% R.H.
Temperature: RT
Orientation: L-T

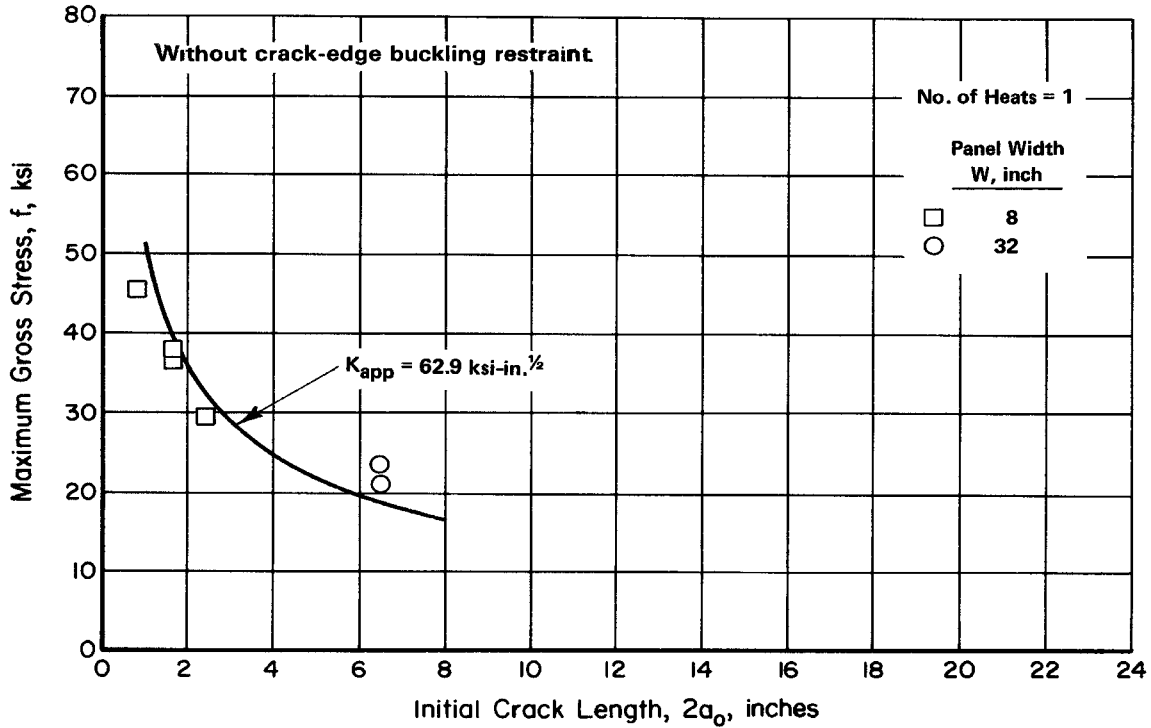

Figure 3.7.6.2.10(a). Residual strength behavior of 0.600-inch-thick 7075-T7351 aluminum alloy plate at room temperature. Crack orientation is L-T [Reference 3.1.2.1.6(g)].

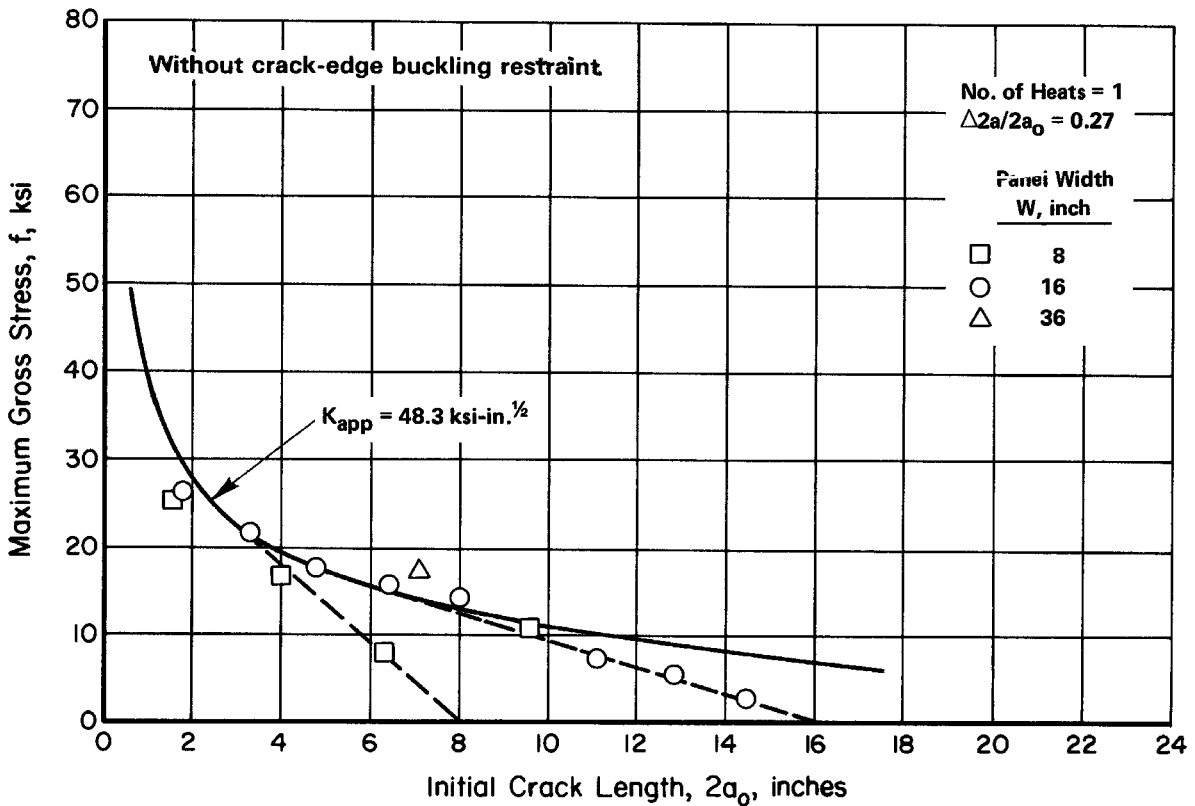

Figure 3.7.6.2.10(b). Residual strength behavior of 1.00-inch-thick 7075-T7351 aluminum alloy plate at room temperature. Crack orientation is L-T [Reference 3.1.2.1.6(i)].

3.7.7 7150 ALLOY

3.7.7.0 Comments and Properties — 7150, a second-generation version of 7050, is an Al-Zn-Mg-Cu-Zr alloy developed to provide higher strength properties than 7050 in thicknesses through 3 inches. 7150 is available in the form of plate and extrusion. The T61-type temper provides high strength with guaranteed levels of fracture toughness for plate. The T77-type temper provides high strength with guaranteed toughness and corrosion resistance. The T77-type temper has exfoliation and stress-corrosion resistance comparable to the T76-type temper of the other 7000 series aluminum alloys. Refer to Section 3.1.2.3 for further comments regarding resistance of the alloy to stress-corrosion cracking.

The properties of extrusions should be based upon the thickness at the time of quenching prior to machining. Selection of the mechanical properties based upon its final machined thickness may be unconservative; therefore, the thickness at the time of quenching to achieve properties is an important factor in the selection of the proper thickness column. For extrusions having sections with various thicknesses, consideration should be given to the properties as a function of thickness.

Refer to Section 3.1.3.4 for comments regarding the weldability of the alloy.

Material specifications for 7150 are shown in Table 3.7.7.0(a). Room-temperature mechanical properties are presented in Tables 3.7.7.0(b₁) through (c₂).

Table 3.7.7.0(a). Material Specifications for 7150 Aluminum Alloy

Specification	Form
AMS 4306	Bare plate
AMS 4252	Bare plate
AMS 4307	Extrusion
AMS 4345	Extrusion

The temper index for 7150 is as follows:

<u>Section</u>	<u>Temper</u>
3.7.7.1	T6151 and T61511
3.7.7.2	T7751 and T77511

3.7.7.1 T6151 and T61511 Tempers — Figures 3.7.7.1.6(a) and (b) present stress-strain and tangent-modulus curves for bare plate. Figures 3.7.7.1.6(c) and (d) depict stress-strain and tangent-modulus curves for extrusion.

3.7.7.2 T7751 and T77511 Tempers — Figures 3.7.7.2.6(a) and (b) present stress-strain and tangent-modulus curves for bare plate. Figures 3.7.7.2.6(c) and (d) depict stress-strain and tangent-modulus curves for extrusion.

Table 3.7.7.0(b₁). Design Mechanical and Physical Properties of 7150 Plate

Specification	AMS 4306			
Form	Plate			
Temper	T6151			
Thickness, in.	0.750-1.000		1.001-1.500	
Basis	A	B	A	B
Mechanical Properties:				
F_{tu} , ksi:				
L	85	87	86	87
LT	84	87	85	86
F_{ty} , ksi:				
L	79	81	80	81
LT	77	79	76	78
F_{cy} , ksi:				
L	77	80	75	77
LT	81	83	80	82
F_{su} , ksi	45	47	46	46
F_{bru}^a , ksi:				
(e/D = 1.5)	121	125	123	124
(e/D = 2.0)	155	160	156	158
F_{bry}^a , ksi:				
(e/D = 1.5)	102	105	101	104
(e/D = 2.0)	119	122	118	121
e , percent (S-basis):				
L	9	...	9	...
LT	9	...	9	...
E , 10 ³ ksi	10.2			
E_c , 10 ³ ksi	10.6			
G , 10 ³ ksi	3.9			
μ	0.33			
Physical Properties:				
ω , lb/in. ³	0.102			
C , Btu/(lb)(°F)	...			

a Bearing values are “dry pin” values per Section 1.4.7.1. See Table 3.1.2.1.1.

MIL-HDBK-5J
31 January 2003

Table 3.7.7.0(b₂). Design Mechanical and Physical Properties of 7150 Plate

Specification	AMS 4252				
Form	Plate				
Temper	T7751				
Thickness, in.	0.250-0.499	0.500-0.749	0.750-1.500	1.501-3.000	
Basis	S	S	S	A	B
Mechanical Properties:					
<i>F_{tu}</i> , ksi:					
L	80	83	84	82	84
LT	80	83	84	82 ^a	84
ST	77 ^a	81
<i>F_{ty}</i> , ksi:					
L	74	77	78	76	78
LT	74	76	77	75 ^a	77
ST	67 ^a	71
<i>F_{cy}</i> , ksi:					
L	74	76	77	75	77
LT	77	79	81	79	82
<i>F_{su}</i> , ksi					
L	46	47	48	47	48
<i>F_{bru}^b</i> , ksi:					
(e/D = 1.5)	119	124	125	122	125
(e/D = 2.0)	154	160	162	158	162
<i>F_{bry}^b</i> , ksi:					
(e/D = 1.5)	102	105	106	104	108
(e/D = 2.0)	117	120	121	118	123
<i>e</i> , percent: (S-basis)					
L	8	8	8	7	
LT	8	8	8	6	
ST	1	
<i>E</i> , 10 ³ ksi					
			10.3		
<i>E_c</i> , 10 ³ ksi					
			10.7		
<i>G</i> , 10 ³ ksi					
			3.9		
<i>μ</i>					
			0.33		
Physical Properties:					
<i>ω</i> , lb./in. ³					
			0.102		
<i>C</i> , <i>K</i> , and <i>α</i>					
			...		

a S-basis values. The rounded T₉₉ values are as follows: *F_{tu}*(LT)=83 ksi, *F_{tu}*(ST)=78 ksi, *F_{ty}*(LT)=76 ksi, *F_{ty}*(ST)=68 ksi.

b Bearing values are “dry pin” values per Section 1.4.7.1. See Table 3.1.2.1.1.

Table 3.7.7.0(c₁). Design Mechanical and Physical Properties of 7150 Aluminum Alloy Extrusion

Specification	AMS 4307					
Form	Extrusion					
Temper	T61511					
Thickness or Diameter, ^a in	0.250- 0.499	0.500- 0.749	0.750- 0.999	1.000- 1.499		1.500- 2.000
Basis	S	S	S	A	B	S
Mechanical Properties:						
F_{tu} , ksi:						
L	87	88	89	89	94	89
LT	80	79	79	85	86	74
F_{ty} , ksi:						
L	82	83	84	83	88	84
LT	73	73	73	77	78	68
F_{cy} , ksi:						
L	80	81	82	82	87	84
LT	80	80	80	77	81	75
F_{su} , ksi	44	45	45	44	46	42
F_{bru}^b , ksi:						
(e/D = 1.5)	119	120	120	118	125	116
(e/D = 2.0)	152	153	154	152	161	150
F_{bry}^b , ksi:						
(e/D = 1.5)	100	100	100	96	102	94
(e/D = 2.0)	118	120	120	117	124	117
e , percent (S-basis):						
L	8	9	8	8	...	8
E , 10 ³ ksi	10.4					
E_c , 10 ³ ksi	11.0					
G , 10 ³ ksi	4.0					
μ	0.33					
Physical Properties:						
ω , lb/in. ³	0.102					
C , K , and α					

a The mechanical properties are to be based upon the thickness at the time of quench.

b Bearing values are "dry pin" values per Section 1.4.7.1.

Table 3.7.7.0(c₂). Design Mechanical and Physical Properties of 7150 Aluminum Alloy Extrusion

Specification	AMS 4345					
Form	Extrusion					
Temper	T77511					
Cross-Sectional Area, in ²	≤20					
Thickness or Diameter, ^a in. ...	≤0.249		0.250-0.499		0.500-0.749	0.750-2.000
Basis	A	B	A	B	S	S
Mechanical Properties:						
<i>F_{tu}</i> , ksi:						
L	85 ^b	88	87 ^c	89	88	89
LT	81	84	82 ^c	86	83	83
<i>F_{ty}</i> , ksi:						
L	78 ^b	83	82 ^c	84	83	84
LT	74	79	76 ^c	79	79	78
<i>F_{cy}</i> , ksi:						
L	78 ^b	82	82 ^c	85	83	84
LT	76	81	80	82	81	82
<i>F_{su}</i> , ksi	44	46	45	46	46	46
<i>F_{bru}</i> ^d , ksi:						
(e/D = 1.5)	122	126	124	127	125	123
(e/D = 2.0)	158	163	161	165	162	159
<i>F_{bry}</i> ^d , ksi:						
(e/D = 1.5)	100	106	105	108	106	108
(e/D = 2.0)	118	125	124	127	125	127
<i>e</i> , percent (S-Basis):						
L	7	...	8	...	9	8
<i>E</i> , 10 ³ ksi	10.4					
<i>E_c</i> , 10 ³ ksi	10.9					
<i>G</i> , 10 ³ ksi	4.0					
<i>μ</i>	0.33					
Physical Properties:						
<i>ω</i> , lb/in. ³	0.102					
<i>C</i> , <i>K</i> , and <i>α</i>					

a The mechanical properties are to be based upon the thickness at the time of quench.

b S basis. The rounded T₉₉ values for *F_{tu}*(L) = 87 ksi, for *F_{ty}*(L) = 81 ksi, and for *F_{cy}*(L) = 79ksi.

c S basis. The rounded T₉₉ values for *F_{tu}*(L) = 88 ksi, for *F_{tu}*(LT) = 84 ksi, for *F_{ty}*(L) = 82 ksi, for *F_{ty}*(LT) = 77 ksi, and for *F_{cy}*(L) = 82 ksi.

d Bearing values are “dry pin” values per Section 1.4.7.1.

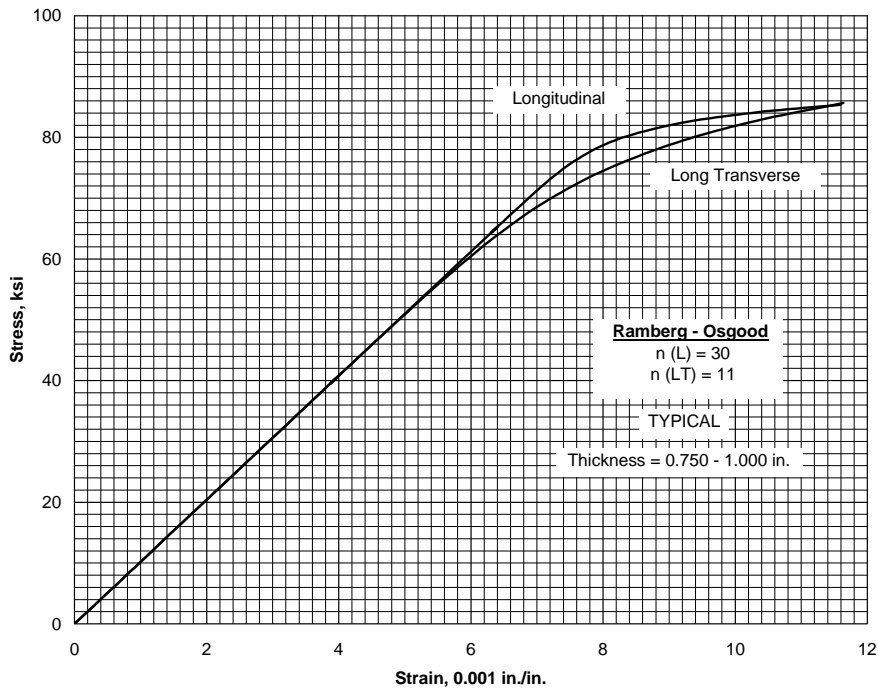

Figure 3.7.7.1.6(a). Typical tensile stress-strain curves for 7150-T6151 aluminum alloy plate at room temperature.

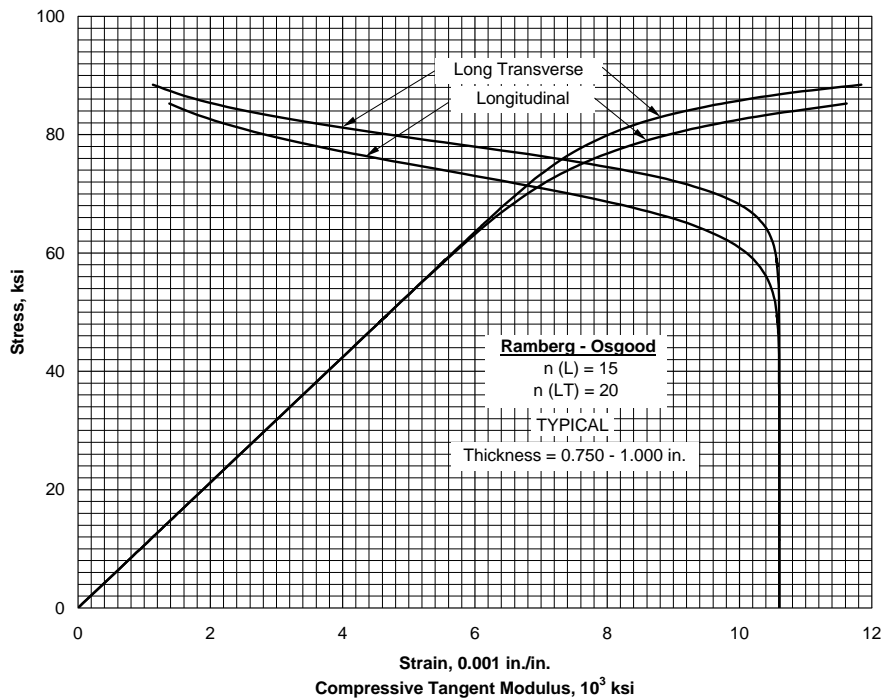

Figure 3.7.7.1.6(b). Typical compressive stress-strain and compressive tangent-modulus curves for 7150-T6151 aluminum alloy plate at room temperature.

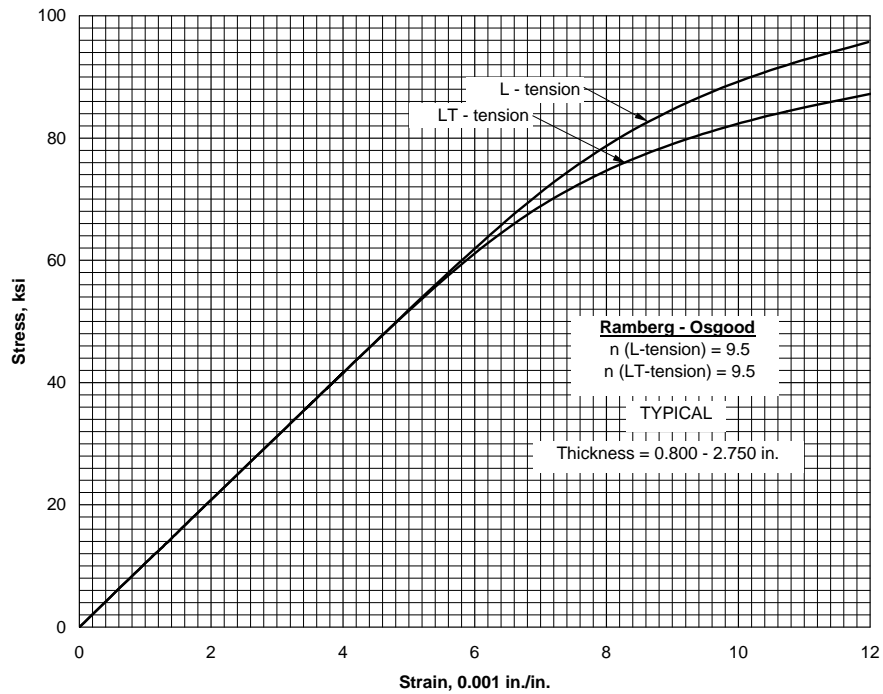

Figure 3.7.7.1.6(c). Typical tensile stress-strain curves for 7150-T61511 aluminum alloy extrusion at room temperature.

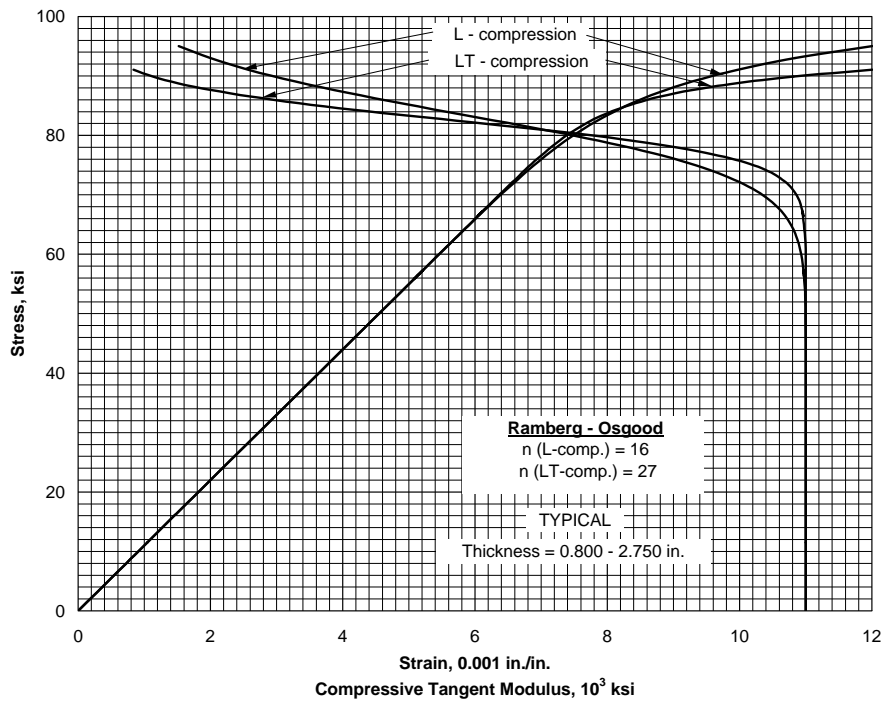

Figure 3.7.7.1.6(d). Typical compressive stress-strain and compressive tangent-modulus curves for 7150-T61511 aluminum alloy extrusion at room temperature.

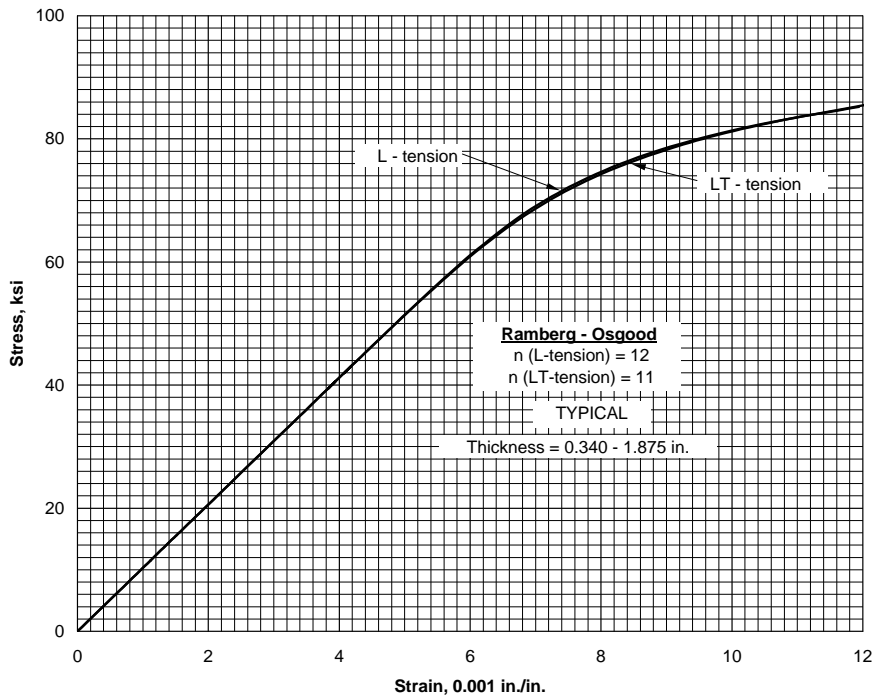

Figure 3.7.7.2.6(a). Typical tensile stress-strain curves for 7150-T7751 aluminum alloy plate at room temperature.

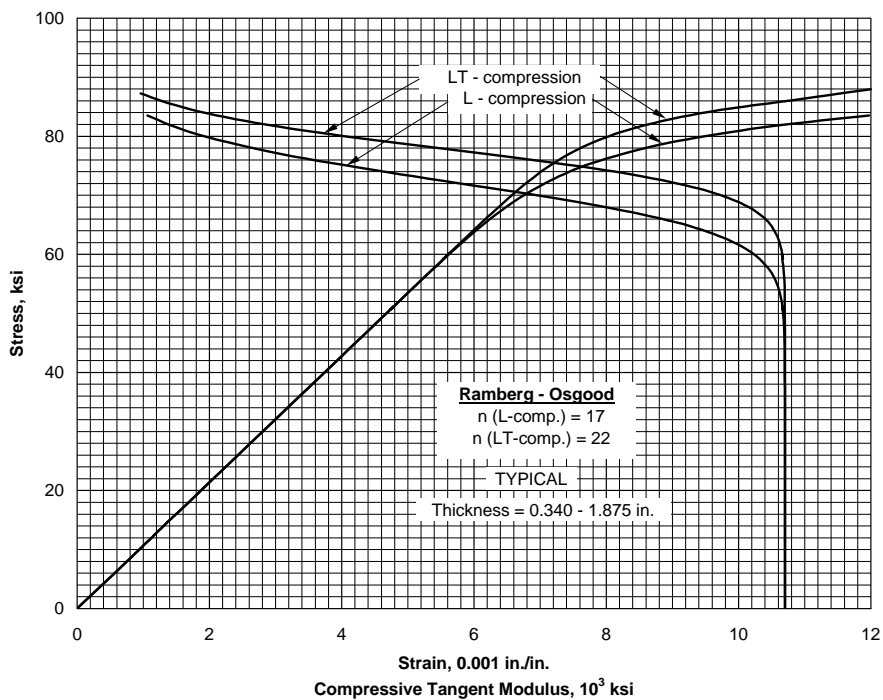

Figure 3.7.7.2.6(b). Typical compressive stress-strain and tangent-modulus curves for 7150-T7751 aluminum alloy plate at room temperature.

MIL-HDBK-5J
31 January 2003

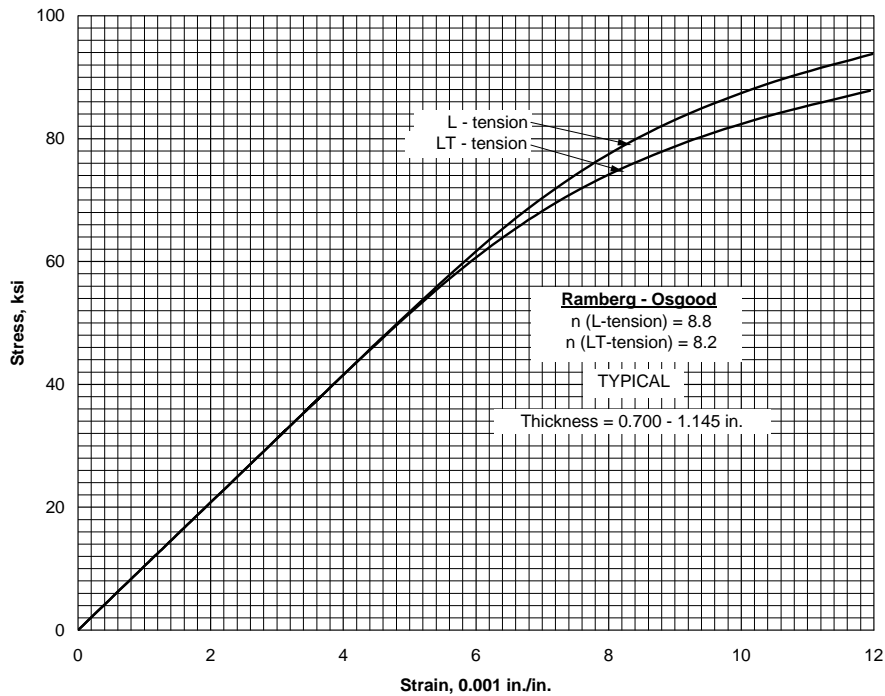

Figure 3.7.7.2.6(c). Typical tensile stress-strain curves for 7150-T77511 aluminum alloy extrusion at room temperature.

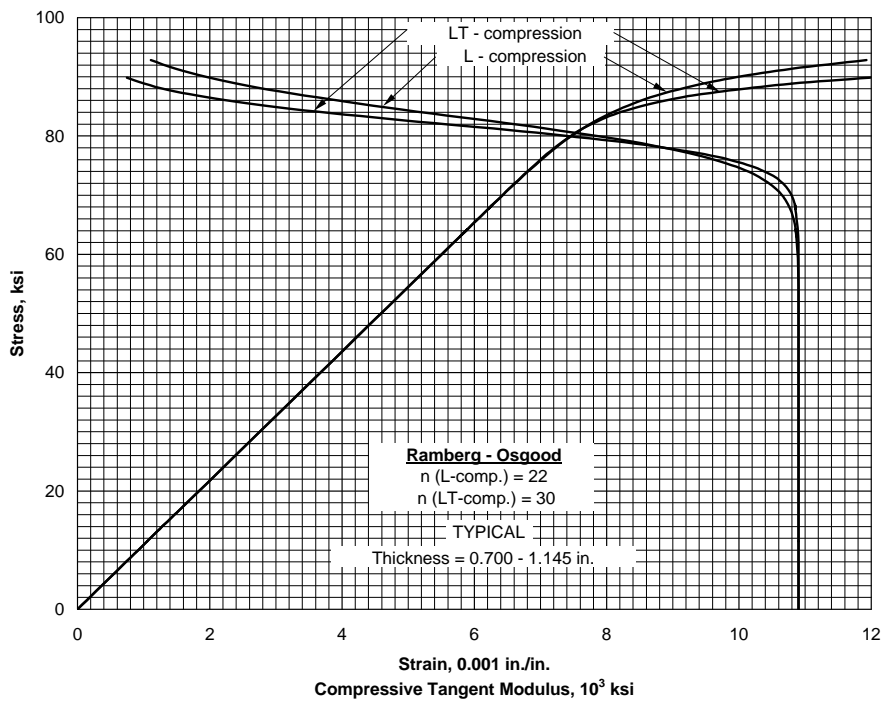

Figure 3.7.7.2.6(d). Typical compressive stress-strain and tangent-modulus curves for 7150-T77511 aluminum alloy extrusion.

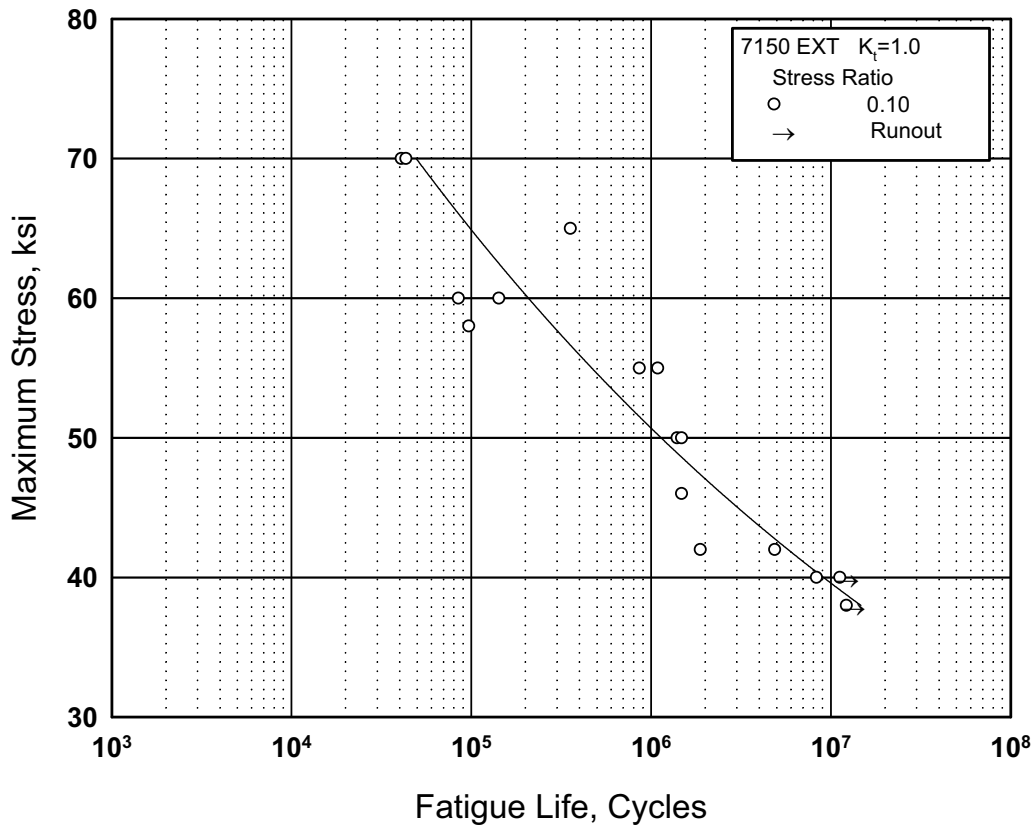

Figure 3.7.7.2.8(a). Best-fit S/N curves for unnotched 7150-T77511 aluminum alloy extrusion, longitudinal orientation.

Correlative Information for Figure 3.7.7.2.8(a).

Product Forms: Extruded shape, 1.125 inch, 1.45 inch

Test Parameters:
Loading - Axial
Frequency - 25 Hz
Temperature - RT
Environment - Air

Properties: TUS, ksi TYS, ksi Temp., °F
 89 84 RT

Specimen Details: Unnotched
 Round, 0.3 inch diameter,
 removed from center of
 section

No. of Heats/Lots: 2

Surface Condition: Polished to 10 micro-inch or
 better

Fatigue Life Equation:
 $\log N_f = 21.89 - 9.32 \log (S_{max})$
Std. Error of Estimate, $\log (\text{Life}) = 0.321$
Standard Deviation, $\log (\text{Life}) = 0.753$
 $R^2 = 81.8\%$

Reference: 3.7.7.2.8

Sample Size: 16

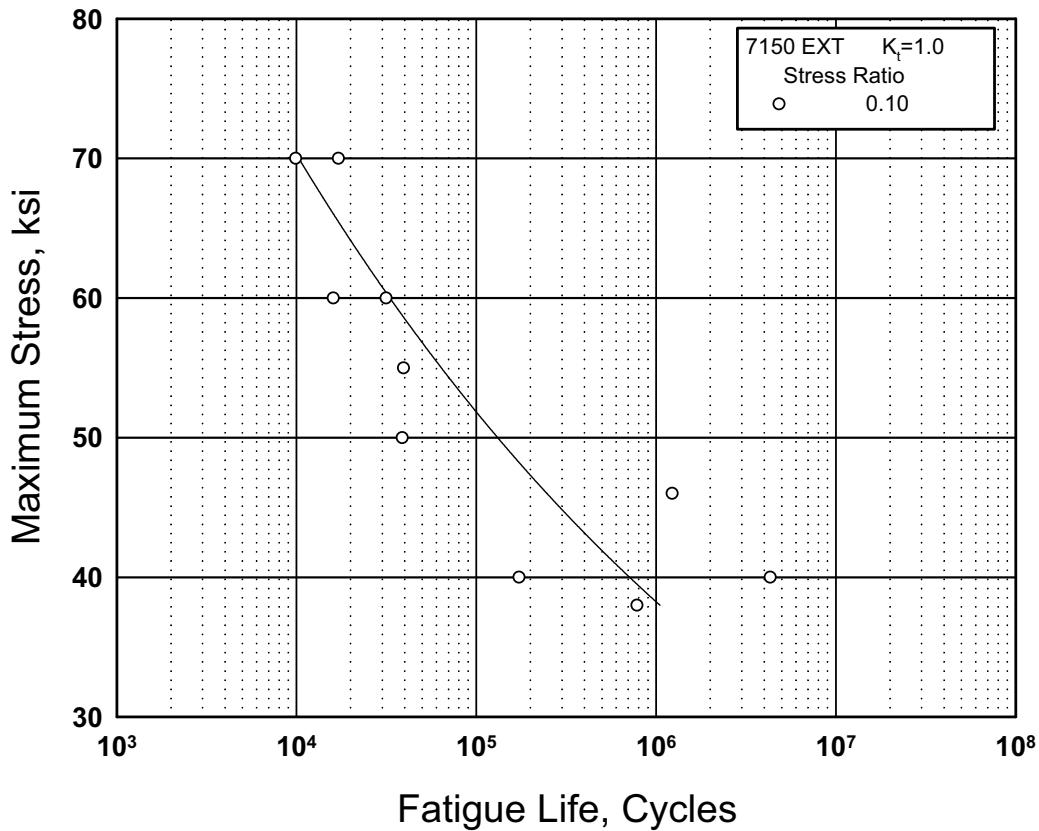

Figure 3.7.7.2.8(b). Best-fit S/N curves for unnotched 7150-T77511 aluminum alloy extrusion, long transverse orientation.

Correlative Information for Figure 3.7.7.2.8(b).

Product Forms: Extruded shape, 1.125 inch,
1.45 inch

Test Parameters:
Loading - Axial
Frequency - 25 Hz
Temperature - RT
Environment - Air

Properties: TUS, ksi TYS, ksi Temp., °F
 83 78 RT

Specimen Details: Unnotched
Round, 0.3 inch diameter,
removed from center of
section

No. of Heats/Lots: 2

Surface Condition: Polished to 10 micro-inch
or better

Fatigue Life Equation:
 $\log N_f = 17.98 - 7.57 \log (S_{max})$
Std. Error of Estimate, $\log (\text{Life}) = 22.53(1/S_{max})$
Standard Deviation, $\log (\text{Life}) = 0.977$
 $R^2 = 74.4 \%$

Reference: 3.7.7.2.8

Sample Size: 10

3.7.8 7175 ALLOY

3.7.8.0 Comments and Properties— 7175 is a high-purity, high-strength Al-Zn-Mg-Cu alloy. In the form of die forgings the alloy is available in the T66, T74, and T7452 tempers. Die forgings of 7175-T66 develop higher static strength than 7075-T6 forgings with fatigue, fracture, and stress-corrosion properties about equivalent to those of 7075-T6 forgings. 7175-T74-type die and hand forgings develop static strengths about equivalent to those of 7075-T6 forgings, with toughness and fatigue properties equal or superior to those of 7075-T73 forgings. The T74-type temper provides stress-corrosion resistance and strength characteristics intermediate to those of T76 and T73 in 7075. Refer to Section 3.1.2.3 for comments regarding the resistance of the alloy to stress-corrosion cracking, and to Section 3.1.3.4 for comments regarding the weldability of the alloy.

The properties of extrusions should be based upon the thickness at the time of quenching prior to machining. Selection of the mechanical properties based upon its final machined thickness may be unconservative; therefore, the thickness at the time of quenching to achieve properties is an important factor in the selection of the proper thickness column. For extrusions having sections with various thicknesses, consideration should be given to the properties as a function of thickness.

Material specifications for 7175 are presented in Table 3.7.8.0(a). Room-temperature mechanical and physical properties are shown in Tables 3.7.8.0(b) through (d).

Table 3.7.8.0(a). Material Specifications for 7175 Aluminum Alloy

Specification	Form
AMS 4148	Die forging
AMS 4149	Die and hand forging
AMS 4179	Hand forging
AMS-A-22771	Forging
AMS 4344	Extrusion

The temper index for 7175 is as follows:

<u>Section</u>	<u>Temper</u>
3.7.8.1	T73511
3.7.8.2	T74 and T7452 (formerly T736 and T73652)

3.7.8.1 T73511 Temper — Figures 3.7.8.1.6(a) and (b) show tensile and compressive stress-strain and tangent-modulus curves for extrusion. Figures 3.7.8.1.8(a) through (d) present fatigue curves for extrusion.

3.7.8.2 T74 and T7452 Tempers — Figures 3.7.8.2.6(a) through (f) present tensile and compressive stress-strain and tangent-modulus curves for die and hand forging. Figures 3.7.8.2.8(a) and (b) present fatigue curves for die and hand forging.

Table 3.7.8.0(b). Design Mechanical and Physical Properties of 7175 Aluminum Alloy Die Forging

Specification	AMS 4148	AMS 4149						
	Die forging							
Form								
Temper	T66	T74 ^{a,b}						
Thickness, in.	≤3.000	<1.000	1.001- 2.000		2.001- 3.000	3.001- 4.000	4.001- 5.000	5.001- 6.000
Basis	S	S	A	B	S	S	S	S
Mechanical Properties:								
F_{tu} , ksi:								
L	86	76	74	77	76	73	70	68
T ^c	77	71	71 ^d	...	71	70	68	65
F_{ty} , ksi:								
L	76	66	64	67	66	63	61	58
T ^c	66	62	62 ^d	...	62	60	58	55
F_{cy} , ksi:								
L	67	65	68	67
ST	63	61	64	63
F_{su} , ksi	43	42	44	43
F_{bru}^e , ksi:								
(e/D = 1.5)	106	105	109	106
(e/D = 2.0)	140	137	142	140
F_{bry}^e , ksi:								
(e/D = 1.5)	86	84	88	86
(e/D = 2.0)	102	99	103	102
<i>e</i> , percent (S-basis):								
L	7	7	7	...	7	7	7	7
T ^c	4	4	4	...	4	4	4	4
E , 10 ³ ksi					10.2			
E_c , 10 ³ ksi					10.7			
G , 10 ³ ksi					3.9			
μ					0.33			
Physical Properties:								
ω , lb/in. ³					0.101			
C , Btu/(lb)(°F)					0.23 (at 212°F)			
K , Btu/[(hr)(ft ²)(°F)/ft]					76 (at 77°F for T66); 90 (at 77°F for T736)			
α , 10 ⁻⁶ in./in./°F					12.9 (68 to 212°F)			

- a When die forgings are machined before heat treatment, section thickness at time of heat treatment will determine minimum mechanical properties as long as original (as-forged) thickness does not exceed maximum thickness for the alloy as shown in the table.
- b Design allowables were based upon data obtained from testing die forgings, heat treated by suppliers, and supplied in T74 temper.
- c T indicates any grain direction not within ±15° of being parallel to the forging flow lines. $F_{cy}(T)$ values are based upon short transverse (ST) test data.
- d Specification value. T tensile properties are presented on an S basis only.
- e Bearing values are “dry pin” values per Section 1.4.7.1.

Table 3.7.8.0(c₁). Design Mechanical and Physical Properties of 7175 Aluminum Alloy Hand Forging

Specification	AMS 4149 and AMS-A-22771				
Form	Hand forging				
Temper	T74				
Thickness or Diameter ^{a,b} , in. ...	1.001- 2.000	2.001- 3.000	3.001- 4.000	4.001- 5.000	5.001- 6.000
Basis	S	S	S	S	S
Mechanical Properties:					
F_{tu} , ksi:					
L	73	73	71	68	65
LT	71	71	70	67	64
ST	69	68	66	63
F_{ty} , ksi:					
L	63	63	61	57	54
LT	60	60	58	56	52
ST	60	57	55	52
F_{cy} , ksi:					
L	63	63	61	59	55
LT	62	63	61	60	56
ST	61	62	60	59	55
F_{su} , ksi:					
L	43	43	43	41	39
LT	42	42	41	39	38
ST	42	42	41	39	38
F_{bru}^c , ksi:					
(e/D = 1.5)	106	106	104	100	95
(e/D = 2.0)	138	138	136	131	125
F_{bry}^c , ksi:					
(e/D = 1.5)	73	78	80	81	76
(e/D = 2.0)	89	94	95	95	90
e , percent:					
L	9	9	9	8	8
LT	5	5	5	5	5
ST	4	4	4	4
E , 10 ³ ksi	10.2				
E_c , 10 ³ ksi	10.6				
G , 10 ³ ksi	3.9				
μ	0.33				
Physical Properties:					
ω , lb/in. ³	0.101				
C , Btu/(lb)(°F)	0.23 (at 212°F)				
K , Btu/[(hr)(ft ²)(°F)/ft]	90 (at 77°F)				
α 10 ⁻⁶ in./in./°F	12.9 (68 to 212°F)				

- a When hand forgings are machined before heat treatment, the section thickness at time of heat treatment will determine the minimum mechanical properties as long as the original (as-forged) thickness does not exceed the maximum thickness for the alloy as shown in the table.
- b The maximum cross-sectional area of hand forgings in 256 sq. in.
- c Bearing values are "dry pin" values per Section 1.4.7.1.

Table 3.7.8.0(c₂). Design Mechanical and Physical Properties of 7175 Aluminum Alloy Hand Forging

Specification	AMS 4149 and AMS-A-22771				
Form	Hand forging				
Temper	T7452				
Thickness or Diameter ^a , in.	1.001-2.000	2.001-3.000	3.001-4.000	4.001-5.000	5.001-6.000
Basis	S	S	S	S	S
Mechanical Properties:					
F_{tu} , ksi:					
L	71	71	68	65	63
LT	69	69	67	64	61
ST	...	67	65	63	60
F_{ty} , ksi:					
L	61	61	57	54	51
LT	58	58	55	52	49
ST	...	54	51	49	46
F_{cy} , ksi:					
L	58	58	55	52	49
LT	61	61	57	54	50
ST	60	60	57	54	51
F_{su} , ksi:					
L	38	39	39	38	37
LT	38	39	38	38	36
ST	40	41	40	39	38
F_{bru}^b , ksi:					
(e/D = 1.5)	102	102	99	95	90
(e/D = 2.0)	133	133	130	124	118
F_{bry}^b , ksi:					
(e/D = 1.5)	80	82	80	76	72
(e/D = 2.0)	95	98	95	92	87
e , percent:					
L	9	9	9	8	8
LT	5	5	5	5	5
ST	...	4	4	4	4
E , 10 ³ ksi	10.2				
E_c , 10 ³ ksi	10.5				
G , 10 ³ ksi	3.9				
μ	0.33				
Physical Properties:					
ω , lb/in. ³	0.101				
C , Btu/(lb)(°F)	0.23 (at 212°F)				
K , Btu/[(hr)(ft ²)(°F)/ft]	90 (AT 77°F)				
α , 10 ⁻⁶ in./in./°F	12.9 (68 to 212°F)				

a The maximum cross-sectional area of hand forgings is 256 sq.in.

b Bearing values are "dry pin" values per Section 1.4.7.1.

Table 3.7.8.0(d). Design Mechanical and Physical Properties of 7175 Aluminum Alloy Extrusion

Specification	AMS 4344	
Form	Extrusion	
Condition	T73511	
Cross-Sectional Area, in ²	32-65	
Thickness or Diameter, ^a in.	0.250-0.999	1.000-2.000
Basis	S	S
Mechanical Properties:		
<i>F_{tu}</i> , ksi:		
L	69	69
LT	63	63
<i>F_{ty}</i> , ksi:		
L	59	59
LT	52	52
<i>F_{cy}</i> , ksi:		
L	59
LT	59
<i>F_{su}</i> , ksi		
...		
<i>F_{bru}^b</i> , ksi:		
(<i>e</i> / <i>D</i> = 1.5)	97
(<i>e</i> / <i>D</i> = 2.0)	125
<i>F_{bry}^b</i> , ksi:		
(<i>e</i> / <i>D</i> = 1.5)	79
(<i>e</i> / <i>D</i> = 2.0)	95
<i>e</i> , percent:		
L	8
LT	4
<i>E</i> , 10 ³ ksi		
10.1		
<i>E_c</i> , 10 ³ ksi		
10.5		
<i>G</i> , 10 ³ ksi		
3.9		
<i>μ</i>		
0.33		
Physical Properties:		
<i>ω</i> , lb/in. ³		
0.101		
<i>C</i> , Btu/(lb)(°F)		
0.23 (at 212°F)		
<i>K</i> , Btu/[(hr)(ft ²)(°F)/ft]		
...		
<i>α</i> , 10 ⁻⁶ in./in./°F		
12.9 (68 to 212°F)		

a The mechanical properties are to be based upon the thickness at the time of quench.
b Bearing values are “dry pin” values per Section 1.4.7.1.

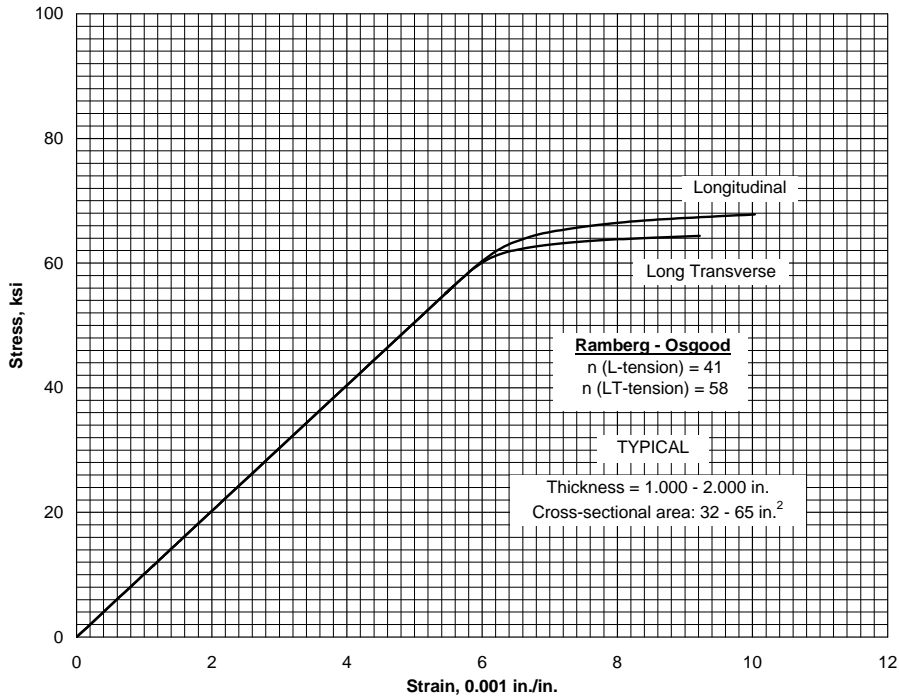

Figure 3.7.8.1.6(a). Typical tensile stress-strain curves for aluminum alloy 7175-T73511 extrusion at room temperature.

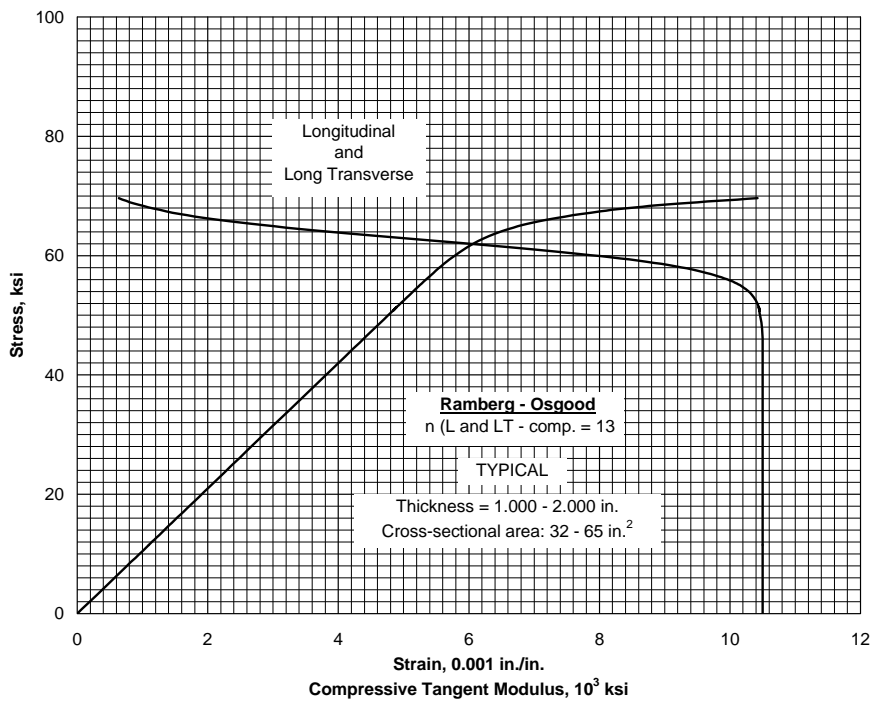

Figure 3.7.8.1.6(b). Typical compressive stress-strain and tangent-modulus curves for aluminum alloy 7175-T73511 extrusion at room temperature.

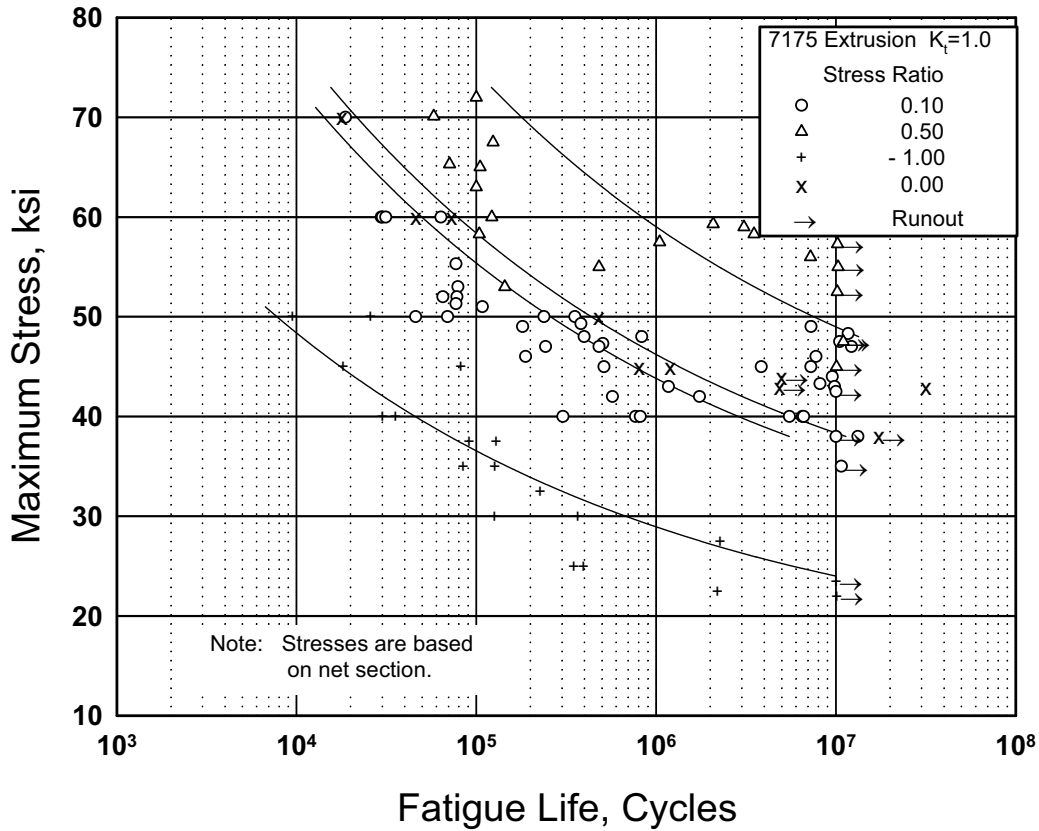

Figure 3.7.8.1.8(a). Best-fit S/N curves for unnotched 7175-T73511 alloy extrusion, longitudinal direction.

Correlative Information for Figure 3.7.8.1.8(a)

Product Form: Extrusion 1.8 inch thick, extruded round, 3.75 inch diameter, extruded rectangle, 2.5 x 5 inch thick, extrusion, unspecified size

Test Parameters:
Loading - Axial
Frequency - Not specified
Temperature - 70°F
Environment - Air

Properties: TUS, ksi TYS, ksi Temp., °F
 76 67 70

No. of Heats/Lots: 11

Specimen Details: 0.25 inch minimum diameter hourglass gage section
30 inch diameter

Equivalent Stress Equation:
 $\text{Log } N_f = 12.01 - 5.26 \log (S_{eq})$
 $S_{eq} = S_a + 0.32S_m - 15.04$
Std. Error of Estimate, $\text{Log (Life)} = 18.44(1/S_{eq})$
Standard Deviation, $\text{Log (Life)} = 1.35$
 $R^2 = 58\%$

Surface Condition: 32 RMS gage section specified

Sample Size = 96

References: 3.7.8.1.8(a), (b), and (c)

[Caution: The equivalent stress model may provide unrealistic life predictions for stress ratios beyond those represented above.]

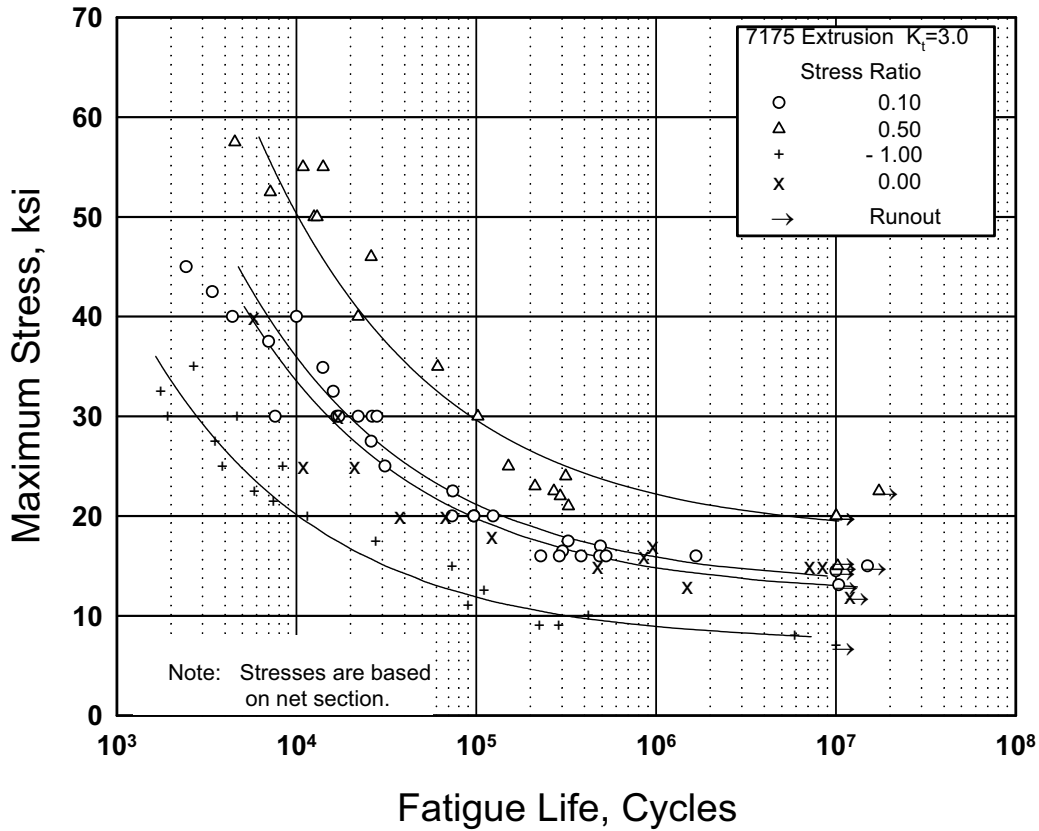

Figure 3.7.8.1.8(b). Best-fit S/N curves for notched, $K_t = 3.0$, 7175-T73511 alloy extrusion, longitudinal direction.

Correlative Information for Figure 3.7.8.1.8(b)

Product Form: Extrusion 1.8 inch thick, extruded round, 3.75 inch diameter, extruded rectangle, 2.5 x 5 inch thick, extrusion, unspecified size

Test Parameters:
Loading - Axial
Frequency - Not specified
Temperature - 70°F
Environment - Air

Properties: $\frac{TUS, \text{ksi}}{76}$ $\frac{TYS, \text{ksi}}{67}$ $\frac{\text{Temp., } ^\circ\text{F}}{70}$

No. of Heats/Lots: 11

Specimen Details: Circumferential notch, $K_t = 3$
0.50 inch gross diameter
0.36 inch net diameter
0.0005 inch notch radius
Circumferential 60° V notch

Equivalent Stress Equation:
 $\log N_f = 6.50 - 2.25 \log (S_{eq})$
 $S_{eq} = S_a + 0.20S_m - 7.21$
Std. Error of Estimate, $\log (\text{Life}) = 3.92(1/S_{eq})$
Standard Deviation, $\log (\text{Life}) = 1.51$
 $R^2 = 91\%$

References: 3.7.8.1.8(a), (b), and (c)

Sample Size = 86

[Caution: The equivalent stress model may provide unrealistic life predictions for stress ratios beyond those represented above.]

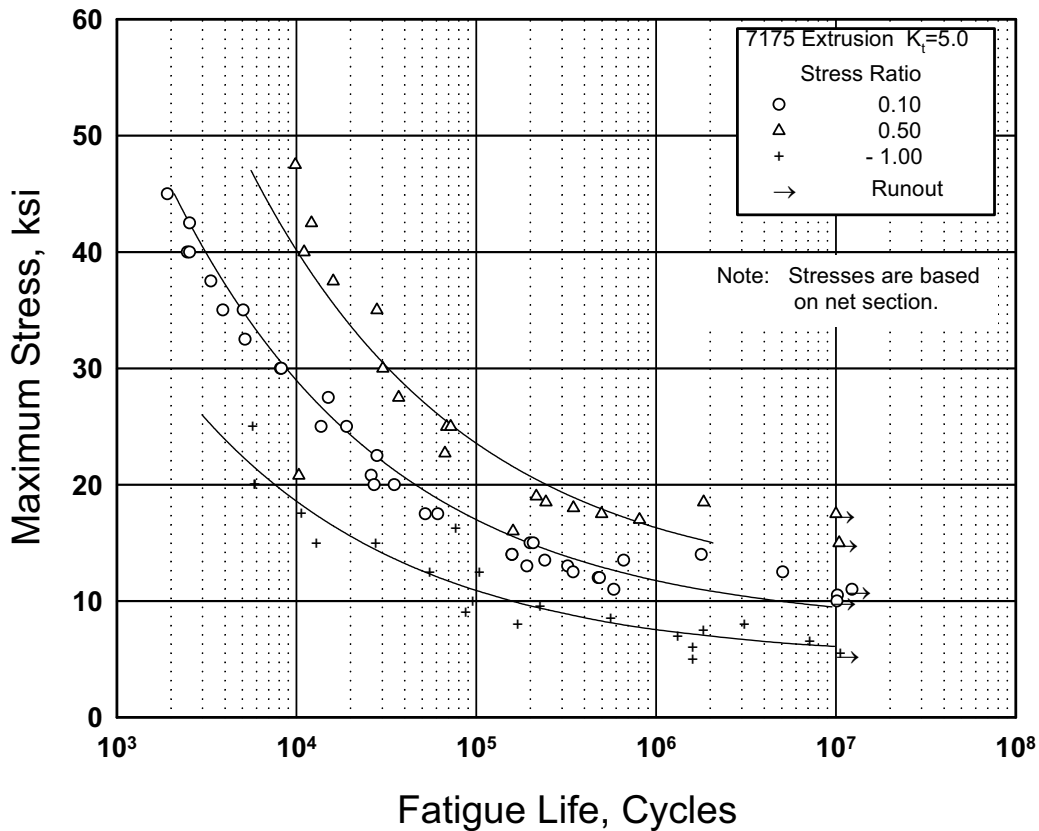

Figure 3.7.8.1.8(c). Best-fit S/N curves for notched, $K_t = 5.0$, 7175-T73511 alloy extrusion, longitudinal direction.

Correlative Information for Figure 3.7.8.1.8(c)

Product Form: Extrusion 1.8 inch thick

Test Parameters:

Properties: $\frac{TUS, \text{ksi}}{76}$ $\frac{TYS, \text{ksi}}{67}$ $\frac{Temp., ^\circ F}{70}$

Loading - Axial
Frequency - Not specified
Temperature - 70 $^\circ$ F
Environment - Air

Specimen Details: Circumferential notch, $K_t = 5$
0.50 inch gross diameter
0.36 inch net diameter
0.0005 inch notch radius

No. of Heats/Lots: 10

References: 3.7.8.1.8(a) and (b)

Equivalent Stress Equation:

$$\log N_f = 7.63 - 2.78 \log (S_{eq} - 7.3)$$

$$S_{eq} = S_{max} (1-R)^{0.56}$$

Std. Error of Estimate, $\log (\text{Life}) = 3.71(1/S_{eq})$

Standard Deviation, $\log (\text{Life}) = 1.45$

$R^2 = 90\%$

Sample Size = 136

[Caution: The equivalent stress model may provide unrealistic life predictions for stress ratios beyond those represented above.]

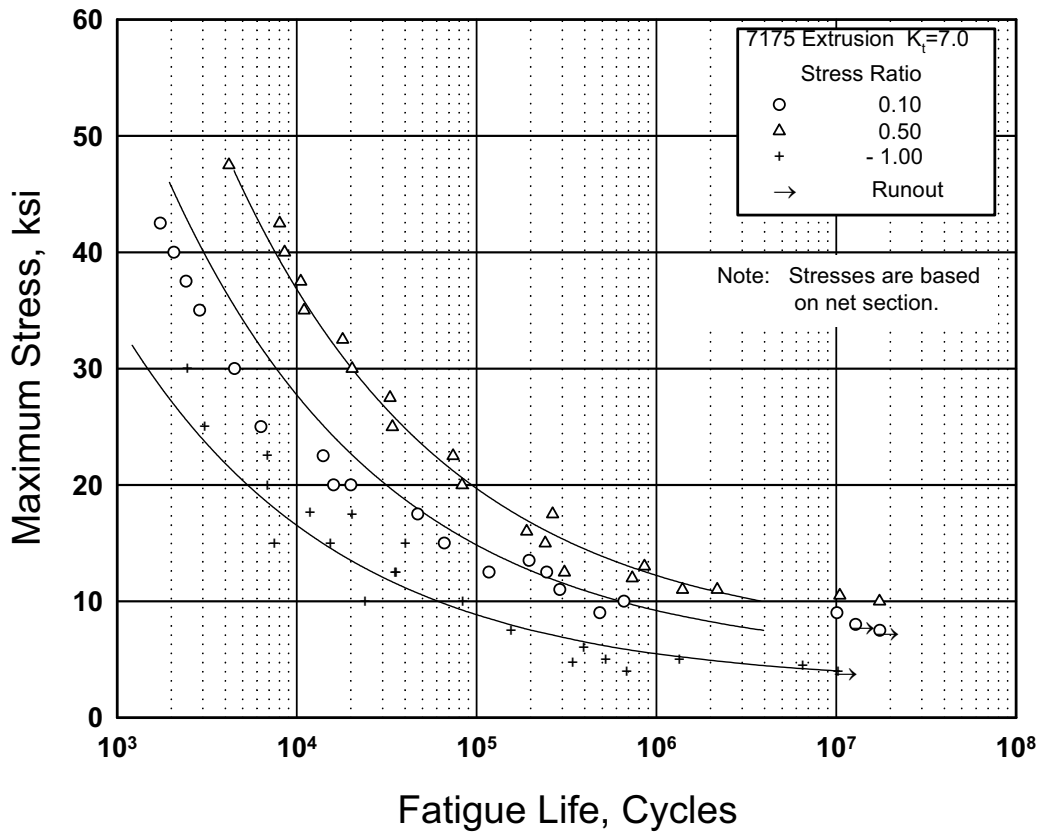

Figure 3.7.8.1.8(d). Best-fit S/N curves for notched, $K_t = 7.0$, 7175-T73511 alloy extrusion, longitudinal direction.

Correlative Information for Figure 3.7.8.1.8(d)

Product Form: Extrusion 1.8 inch thick

Test Parameters:

Properties: $\frac{TUS, \text{ksi}}{76}$ $\frac{TYS, \text{ksi}}{67}$ $\frac{\text{Temp., } ^\circ\text{F}}{70}$

Loading - Axial
Frequency - Not specified
Temperature - 70°F
Environment - Air

Specimen Details: Circumferential notch, $K_t = 7$
0.50 inch gross diameter
0.36 inch net diameter
0.0005 inch notch radius

No. of Heats/Lots: 9

References: 3.7.8.1.8(a) and (b)

Equivalent Stress Equation:
 $\log N_f = 7.15 - 2.78 \log (S_{eq})$
 $S_{eq} = S_a + 0.27S_m - 2.88$
Std. Error of Estimate, Log (Life) =
0.11 + 1.60 (1/ S_{eq})
Standard Deviation, Log (Life) = 1.55
 $R^2 = 92\%$

Sample Size = 63

[Caution: The equivalent stress model may provide unrealistic life predictions for stress ratios beyond those represented above.]

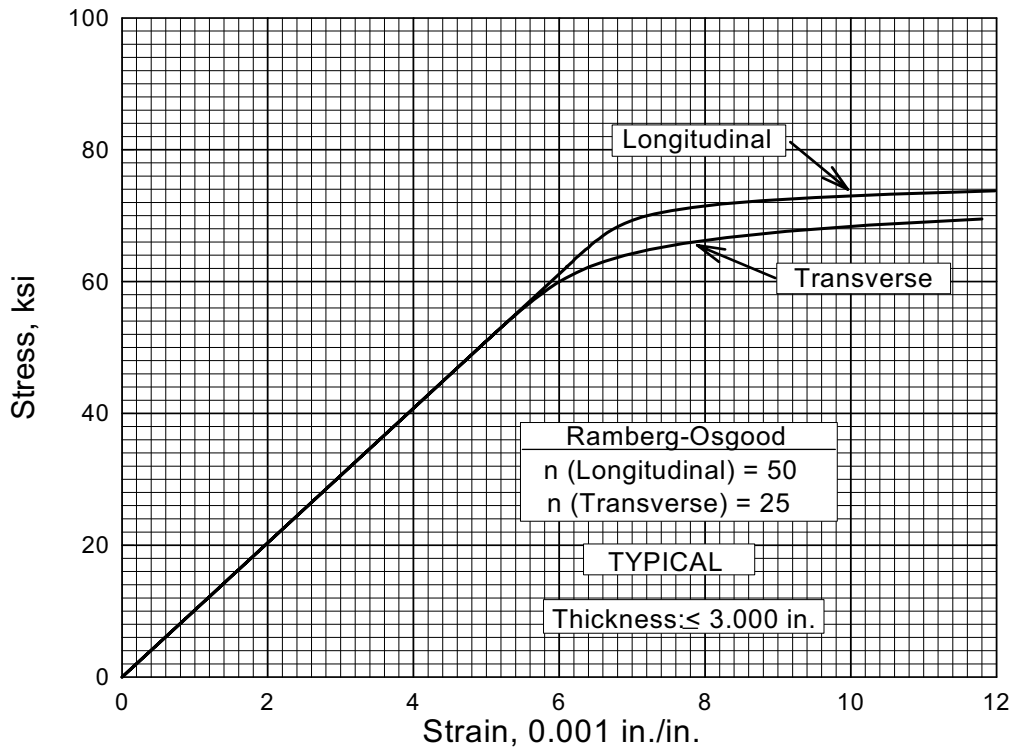

Figure 3.7.8.2.6(a). Typical tensile stress-strain curves for 7175-T74 aluminum alloy die forging at room temperature.

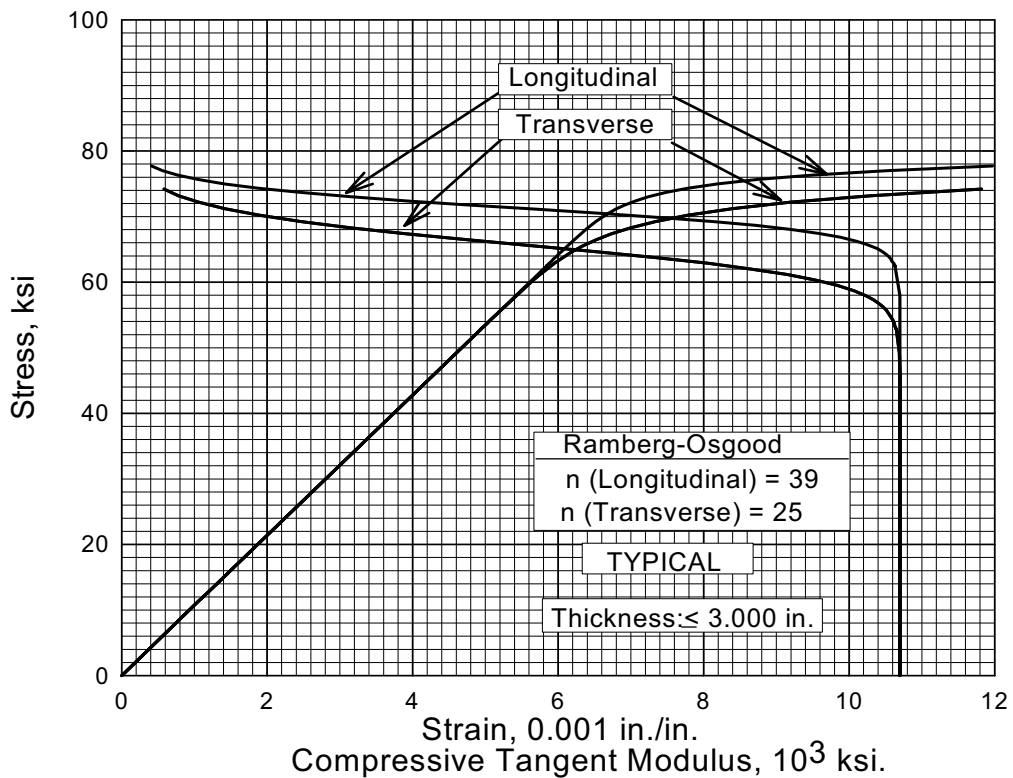

Figure 3.7.8.2.6(b). Typical compressive stress-strain and compressive tangent-modulus curves for 7175-T74 aluminum alloy die forging at room temperature.

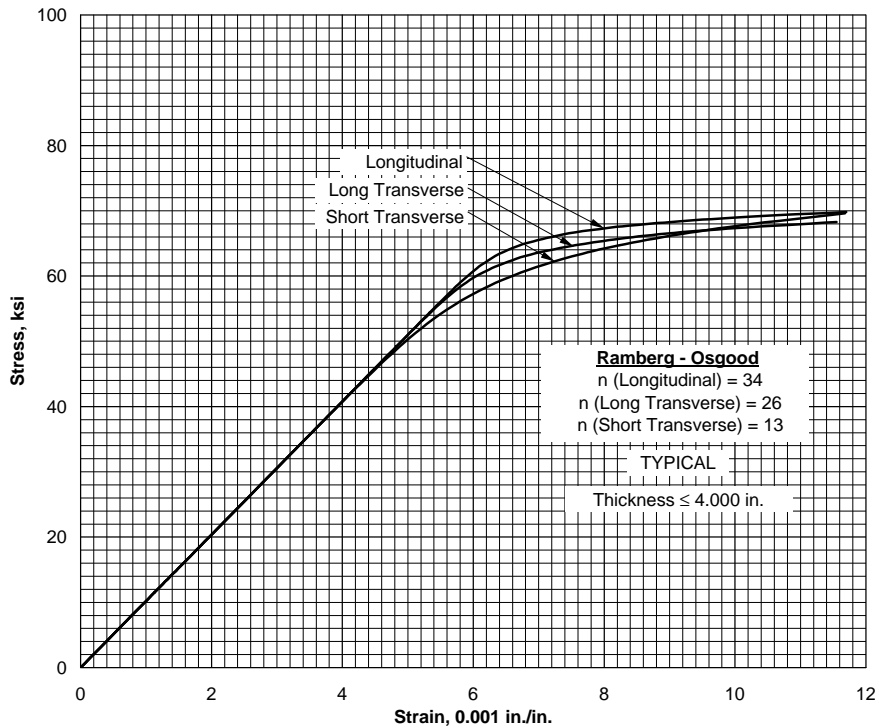

Figure 3.7.8.2.6(c). Typical tensile stress-strain curves for 7175-T74 aluminum alloy hand forging at room temperature.

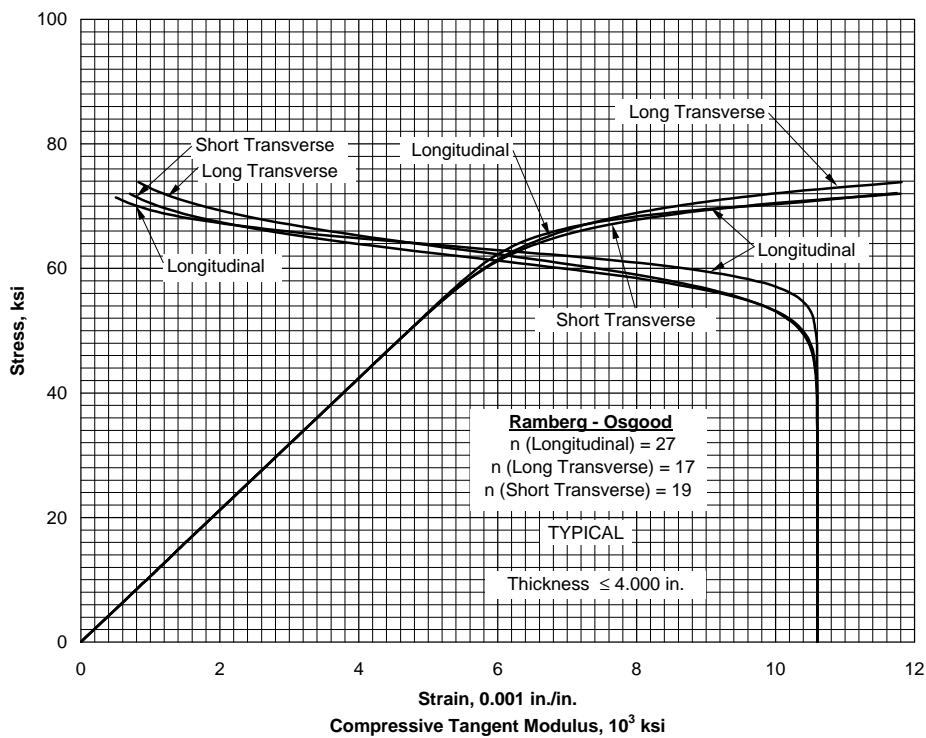

Figure 3.7.8.2.6(d). Typical compressive stress-strain and compressive tangent-modulus curves for 7175-T74 aluminum alloy hand forging at room temperature.

MIL-HDBK-5J
31 January 2003

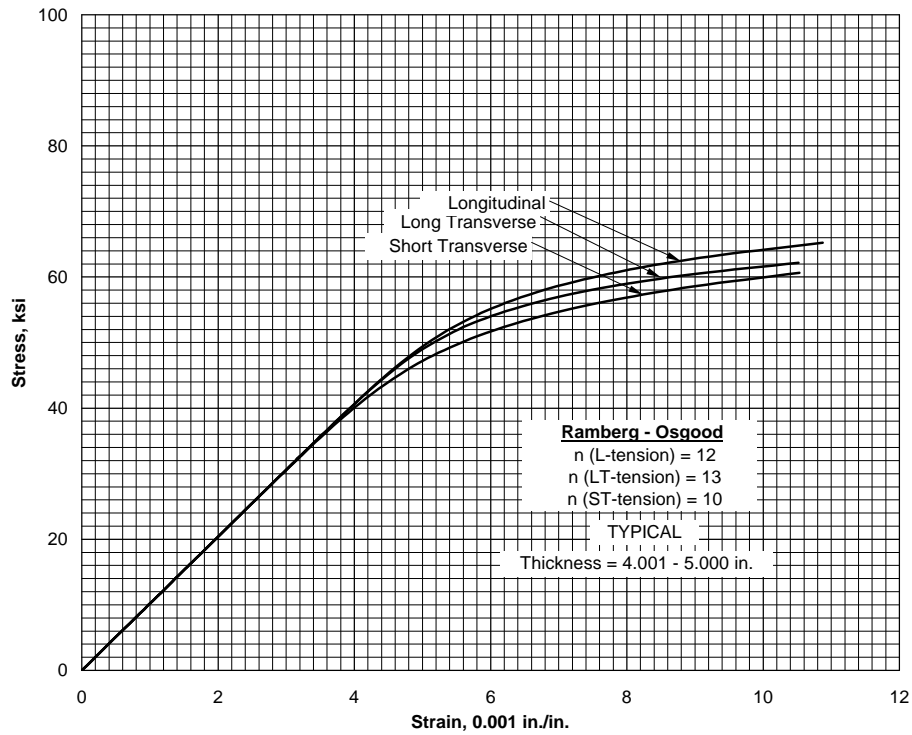

Figure 3.7.8.2.6(e). Typical tensile stress-strain curves for aluminum alloy 7175-T7452 hand forging at room temperature.

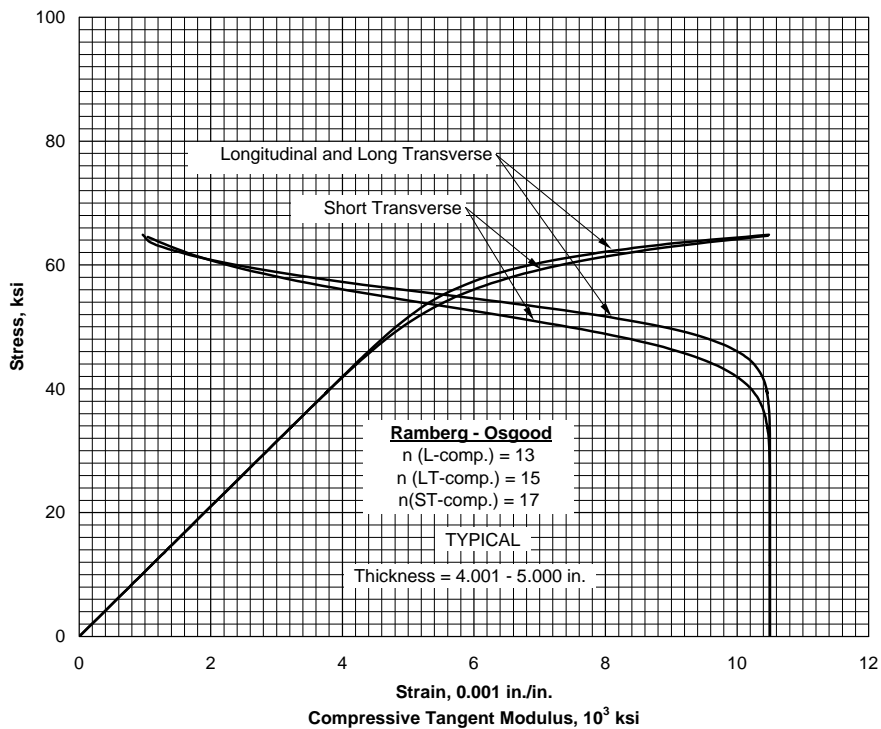

Figure 3.7.8.2.6(f). Typical compressive stress-strain and compressive tangent-modulus curves for aluminum alloy 7175-T7452 hand forging at room temperature.

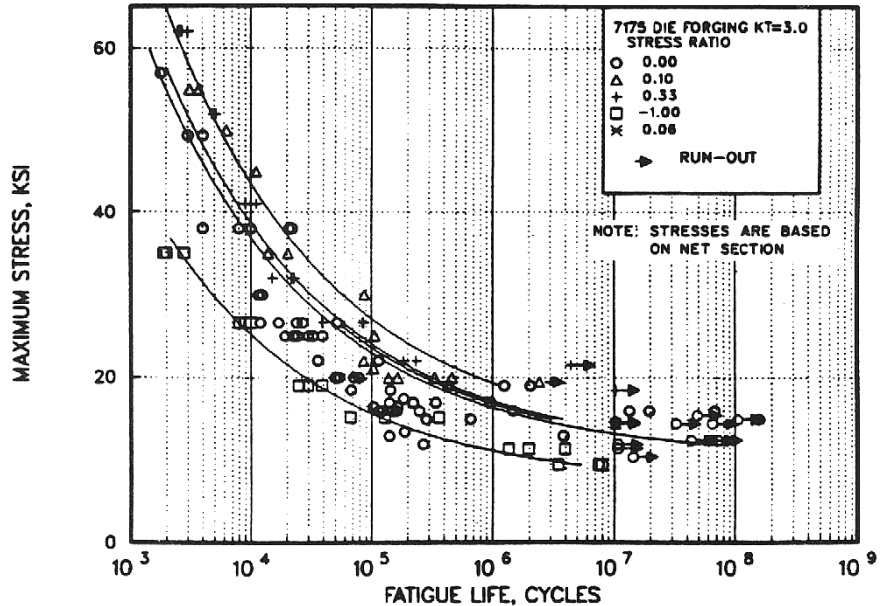

Figure 3.7.8.2.8(a). Best-fit S/N curves for notched, $K_t=3.0$, 7175-T74 alloy die forging, longitudinal direction.

Correlative Information for Figure 3.7.8.2.8(a)

Product Form: Die forging, 2.0 to 3.0 inch thick, unspecified thickness

Properties: $\frac{TUS, ksi}{77-82}$ $\frac{TYS, ksi}{69-75}$

Specimen Details: Circumferential notch, $K_t = 3$
0.30 inch gross diameter
0.25 inch net diameter
Rectangular notched 0.10 x 0.20 inch

Surface Condition: Not specified

References: 3.2.5.1.9(d), 3.7.2.1.8(c), (d), 3.7.8.2.8(a), (b), and (c)

Test Parameters:

Loading - Axial
Frequency - 1200 cpm unspecified
Temperature - 70°F
Environment - Air

No. of Heats/Lots: 13

Equivalent Stress Equation:

$\log N_f = 7.88 - 3.09 \log (S_{eq} - 7.15)$
 $S_{eq} = S_a + 0.37S_m$
Std. Error of Estimate, $\log (\text{Life}) = 7.38 (1/S_{eq})$
Standard Deviation, $\log (\text{Life}) = 1.95$
 $R^2 = 83\%$

Sample Size = 137

[Caution: The equivalent stress model may provide unrealistic life predictions for stress ratios beyond those represented above.]

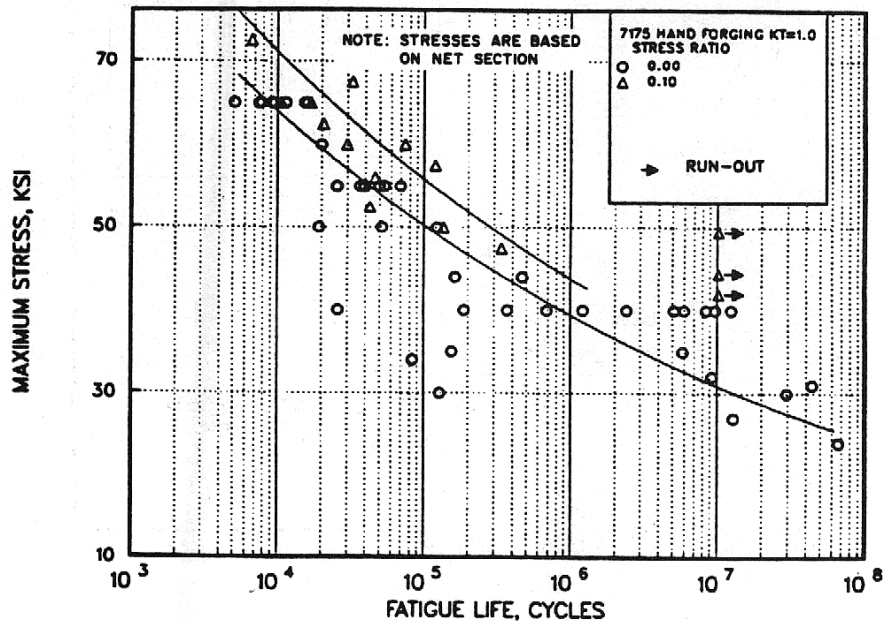

Figure 3.7.8.2.8(b). Best-fit S/N curves for unnotched 7175-T74 alloy hand forging, longitudinal and transverse directions.

Correlative Information for Figure 3.7.8.2.8(b)

Product Form: Hand forging, 2.0 to 6.25 inch thick

Test Parameters:
Loading - Axial
Frequency - 1200 cpm
Temperature - 20°F
Environment - Air

Properties: TUS, ksi TYS, ksi Temp., °F
 71-77 60-68 70

Specimen Details: Uniform gage length
3.0 inch diameter
Hourglass gage section
0.25 inch minimum diameter

No. of Heats/Lots: Not Specified

Equivalent Stress Equation:
 $\log N_f = 21.15 - 9.49 \log (S_{eq})$
 $S_{eq} = S_{max} (1-R)$
Std. Error of Estimate, $\log (\text{Life}) = 23.33(1/S_{eq})$
Standard Deviation, $\log (\text{Life}) = 1.55$
 $R^2 = 76\%$

References: 3.2.5.1.9(d) 3.7.2.1.8(c) and (d)

Sample Size: 50

[Caution: The equivalent stress model may provide unrealistic life predictions for stress ratios beyond those represented above.]

3.7.9 7249 ALLOY

3.7.9.0 Comments and Properties — 7249 is an Al-Zn-Mg-Cu-Cr alloy developed as a derivative from alloy 7149. Alloy 7249 has tighter compositional tolerances on its major constituents and lowered maximums on the interstitials such as Si, Fe, Mn, and Ti than alloy 7149.

7249-T7452 was developed as a replacement material for 7075-T6 forgings, which are susceptible to stress-corrosion cracking and exfoliation. 7249 also has higher strength at the higher thickness ranges and higher ductility than 7075-T6.

Material specifications for 7249 are shown in Table 3.7.9.0(a). Room temperature mechanical properties are shown in Table 3.7.9.0(b).

Table 3.7.9.0(a). Material Specification for 7249 Alloy

Specification	Form
AMS 4334	Hand forging

The temper index for 7249 is as follows:

<u>Section</u>	<u>Temper</u>
3.7.9.1	T7452

3.7.9.1 T7452 Temper — Figures 3.7.9.1.6(a) and (b) presents the typical tensile and compressive stress-strain curves and compressive tangent-modulus curves at room temperature. Figure 3.7.9.1.6(c) presents the full range stress-strain curves for hand forged material at room temperature.

MIL-HDBK-5J
31 January 2003

Table 3.7.9.0(b). Design Mechanical and Physical Properties of 7249 Aluminum Alloy Hand Forging

Specification	AMS 4334									
	Hand forging									
Form	T7452									
	≤1.500	1.501-2.000	2.001-2.500	2.501-3.000	3.001-3.500	3.501-3.900	3.901-4.500	4.501-5.000	5.001-5.500	5.501-6.000
Temper	S	S	S	S	S	S	S	S	S	S
Thickness, in.	S	S	S	S	S	S	S	S	S	S
Basis	S	S	S	S	S	S	S	S	S	S
Mechanical Properties:										
<i>F_{tu}</i> , ksi:										
L	76	75	74	73	72	71	69	68	67	66
LT	76	75	74	73	72	71	69	68	67	66
ST	72	71	69	68	67	66
<i>F_{ty}</i> , ksi:										
L	68	67	66	64	63	61	59	58	56	55
LT	68	67	66	64	63	61	59	58	56	55
ST	59	58	57	56	54	53
<i>F_{cy}</i> , ksi:										
L	66	65	64	62	61	59	57	56	54	53
LT	70	69	68	66	65	63	61	60	58	57
ST	73	72	71	68	67	65	63	62	60	59
<i>F_{su}</i> ^a , ksi:										
L ^a	49	48	47	47	46	46	44	44	43	42
LT ^a	47	46	46	45	45	44	43	42	41	41
<i>F_{bru}</i> ^b , ksi:										
(e/D = 1.5)	107	106	104	103	101	100	97	96	94	93
(e/D = 2.0)	137	135	134	132	130	128	125	123	121	119
<i>F_{brv}</i> ^b , ksi:										
(e/D = 1.5)	94	93	91	88	87	84	82	80	77	76
(e/D = 2.0)	109	107	106	102	101	98	94	93	90	88
<i>e</i> , percent:										
L	12				12					
LT	10				10					
ST				5					
<i>E</i> , 10 ³ ksi					10.1					
<i>E_c</i> , 10 ³ ksi					10.4					
<i>G</i> , 10 ³ ksi					3.8					
<i>μ</i>					0.33					
Physical Properties:										
<i>ω</i> , lb/in. ³									
<i>C</i> , <i>K</i> , and <i>α</i>									

a Determined in accordance with ASTM B769.
b Bearing values are “dry pin” values per Section 1.4.7.1.

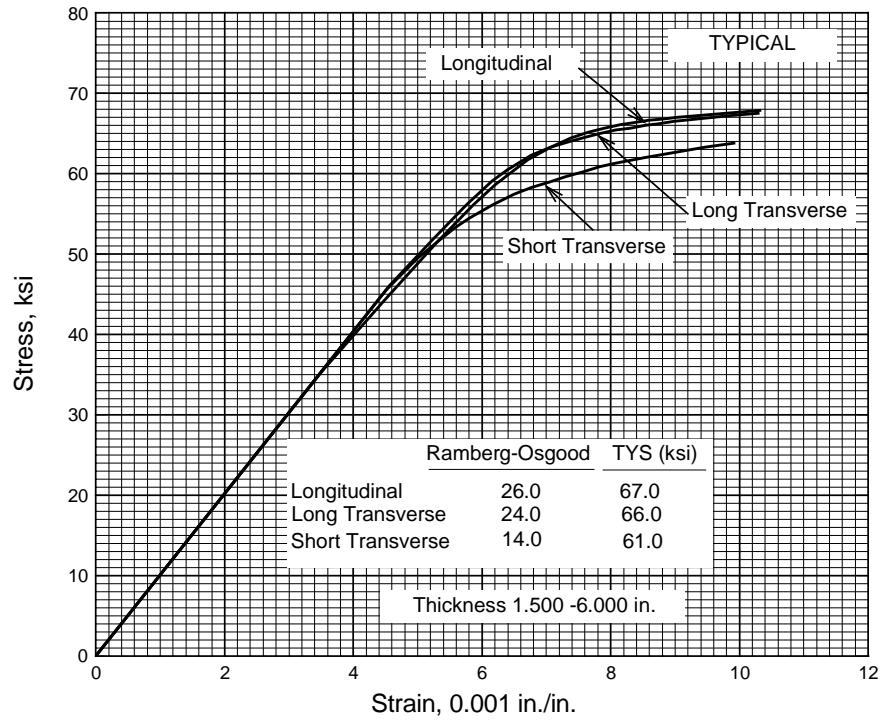

Figure 3.7.9.1.6(a). Typical tensile stress-strain curves for 7249-T7452 aluminum alloy hand forging at room temperature.

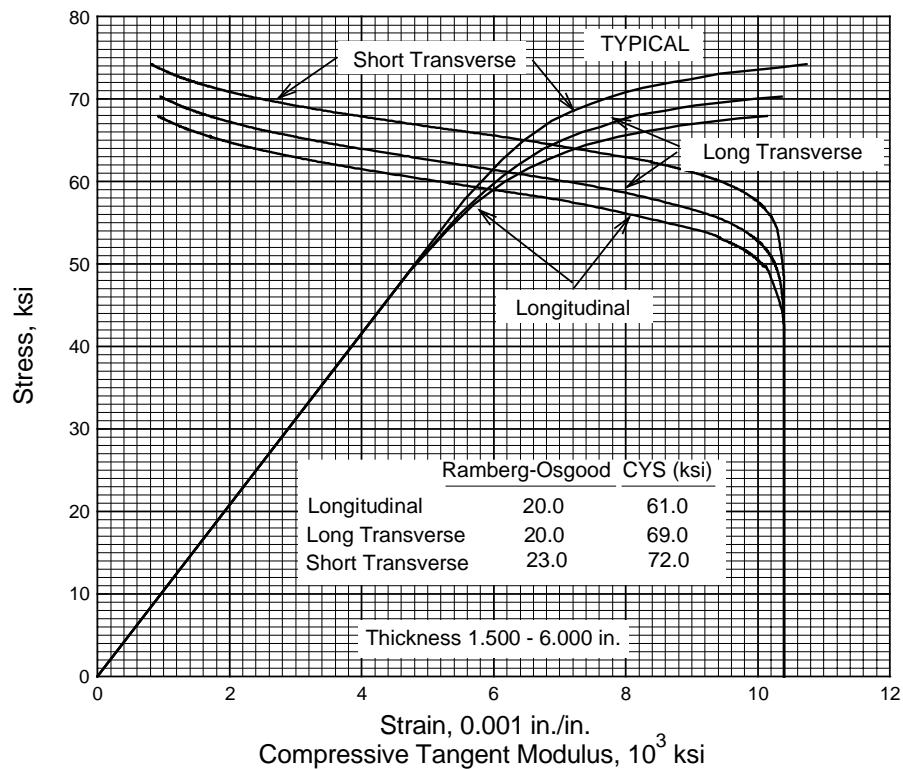

Figure 3.7.9.1.6(b). Typical compressive stress-strain and compressive tangent-modulus curves for 7249-T7452 aluminum alloy hand forging at room temperature.

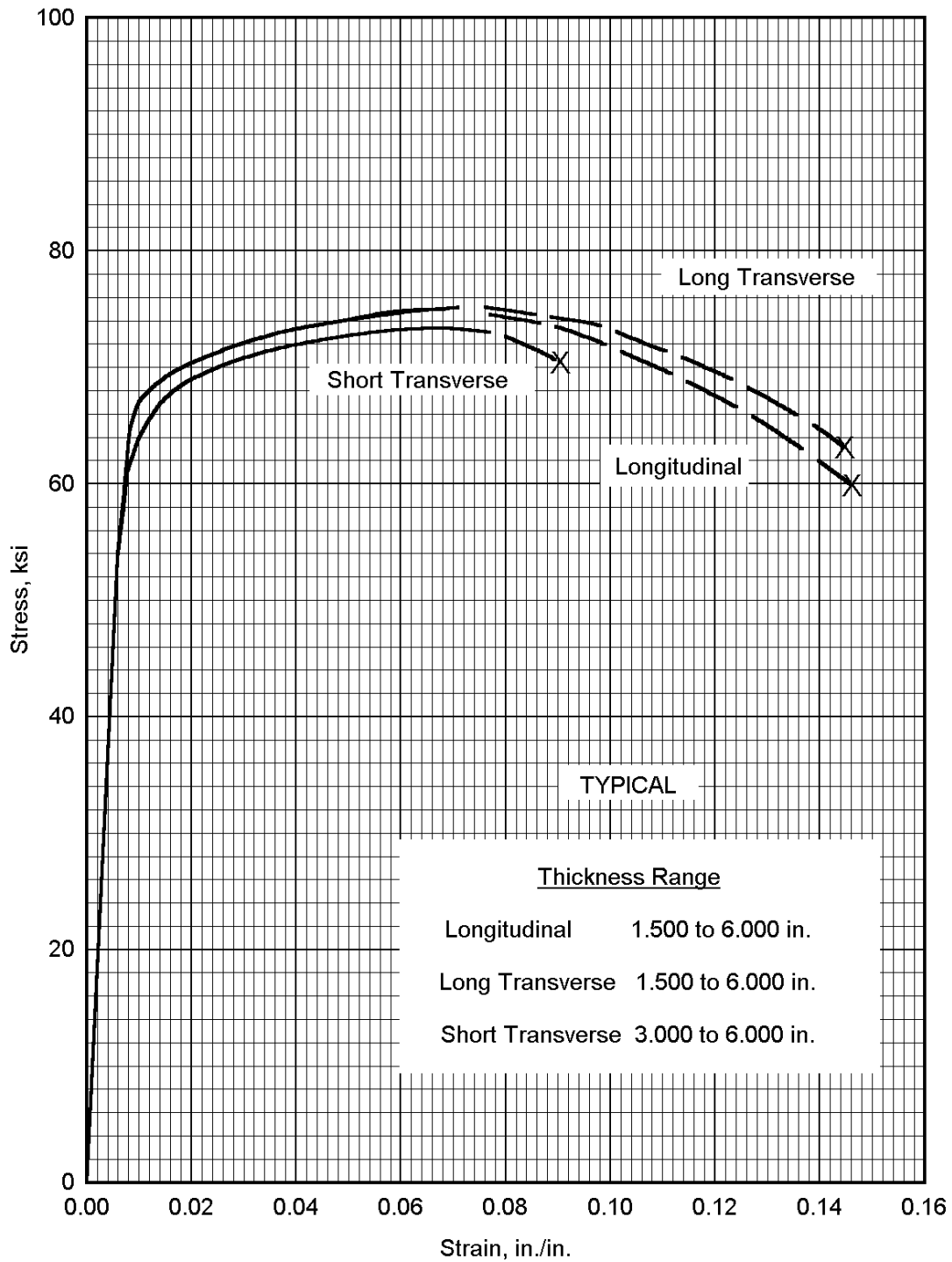

Figure 3.7.9.1.6(c). Typical tensile stress-strain curves (full range) for 7249-T7452 aluminum alloy hand forging at room temperature.

3.7.10 7475 ALLOY

3.7.10.0 Comments and Properties — 7475 is an Al-Zn-Mg-Cu alloy developed for applications requiring the high strength of 7075 but having fracture toughness superior to that of 7075. Sheet is available in the T61 and T761 tempers and plate in the T651 and T7651 tempers. Sheet has strength approximately the same as that of 7075 combined with toughness about the same as 2024-T3 at room temperature. Plate has strengths similar to those of corresponding tempers of 7075; the toughness of 7475-T651 equals or exceeds that of 7075-T7351.

Resistance to stress-corrosion cracking and exfoliation are comparable to that of 7075. The T73-type temper provides for much improved stress-corrosion resistance over T6-type temper with a decrease in strength. The T76-type temper provides for improved exfoliation resistance and stress-corrosion resistance over T6-type temper with some decrease in strength. Refer to Section 3.1.2.3.1 for information regarding resistance to stress-corrosion cracking.

Refer to Section 3.1.3.4 for comments regarding the weldability of the alloy.

Material specifications are shown in Table 3.7.10.0(a). Room-temperature mechanical and physical properties are shown in Tables 3.7.10.0(b) through (d).

Table 3.7.10.0(a). Material Specifications for 7475 Aluminum Alloy

Specification	Form
AMS 4084	Bare sheet
AMS 4085	Bare sheet
AMS 4090	Bare plate
AMS 4089	Bare plate
AMS 4202	Bare plate
AMS 4207	Clad sheet
AMS 4100	Clad sheet

The temper index for 7475 is as follows:

<u>Section</u>	<u>Temper</u>
3.7.10.1	T61 and T651
3.7.10.2	T7351
3.7.10.3	T761 and T7651

3.7.10.1 T61 and T651 Tempers — Figures 3.7.10.1.6(a) through (f) present tensile and compressive stress-strain and tangent-modulus curves for T61 sheet and T651 plate. Figure 3.7.10.1.6(g) contains full-range tensile curves for T61 sheet. Fatigue data for sheet are shown in Figures 3.7.10.1.8(a) through (c). Graphical displays of the residual behavior strength of middle-tension panels are presented in Figures 3.7.10.1.10(a) through (d).

3.7.10.2 T7351 Temper — Figures 3.7.10.2.6(a) and (b) present tensile and compressive stress-strain and tangent-modulus curves for T7351 plate. Fatigue data for 7475-T7351 plate are presented in

Figures 3.7.10.2.8(a) and (b). Figures 3.7.10.2.9(a) and (b) present fatigue-crack-propagation data for T7351 plate.

3.7.10.3 T761 and T7651 Tempers — Figures 3.7.10.3.6(a) through (j) present tensile and compressive stress-strain and tangent-modulus curves for T761 bare and clad sheet and T7651 plate. Figures 3.7.10.3.6(k) and (l) contain full-range tensile stress-strain curves for T761 bare and clad sheet, respectively. Fatigue data for 7475-T761 sheet are presented in Figures 3.7.10.1.8(a) through (c). Fatigue data for 7475-T7651 plate are shown in Figure 3.7.10.2.8(b). Graphical displays of the residual strength behavior of middle-tension panels are presented in Figures 3.7.10.3.10(a) and (b).

Table 3.7.10.0(b). Design Mechanical and Physical Properties of 7475 Aluminum Alloy Sheet and Plate

Specification	AMS 4084			AMS 4090			AMS 4085			AMS 4089		
	Sheet			Plate			Sheet			Plate		
	T61			T651			T761			T7651		
Thickness, in.	0.040-0.249	0.250-0.499	0.500-1.000	1.001-1.500	0.040-0.062	0.063-0.187	0.188-0.249	0.250-0.499	0.500-1.000	1.001-1.500		
Basis	S	S	S	S	S	S	S	S	S	S	S	S
Mechanical Properties:												
F_{up} , ksi:												
L	75	77	77	77	71	71	71	70	69	69		
LT	75	78	78	78	71	71	71	71	70	70		
F_{cp} , ksi:												
L	66	69	70	70	61	61	61	60	59	59		
LT	64	67	68	68	60	60	60	60	59	59		
F_{cp} , ksi:												
L	64	67	68	67	60	59	58	60	59	59		
LT	68	70	71	71	61	63	63	63	62	59		
F_{sup} , ksi:												
L	45	44	43	41	43	42	41	41	39	37		
F_{brut} , ksi:												
(e/D = 1.5)	120	113	113	113	112	112	111	104	103	103		
(e/D = 2.0)	154	144	144	144	143	143	142	136	134	134		
F_{brt} , ksi:												
(e/D = 1.5)	97	91	93	93	90	90	90	82	81	81		
(e/D = 2.0)	110	106	107	107	104	104	104	97	95	95		
e , percent:												
L	9	10	9	9	9	9	9	9	8	6		
LT	9	10	9	9	9	9	9	9	8	6		
E , 10^3 ksi	10.0	10.2	10.2	10.2	10.2	10.0	10.0	10.2	10.2	10.2		
E_c , 10^3 ksi	10.5	10.6	10.6	10.6	10.5	10.5	10.5	10.6	10.6	10.6		
G , 10^3 ksi	3.8	3.9	3.9	3.8	3.8	3.8	3.8	3.9	3.9	3.9		
μ	0.33	0.33	0.33	0.33	0.33	0.33	0.33	0.33	0.33	0.33		
Physical Properties:												
ω , lb/in. ³												
C , K , and α												
K , Btu/(hr)(ft ²)(°F)/ft]												
α , 10^{-6} in./in./°F												

a See Table 3.1.2.1.1. Bearing values are "dry pin" values per Section 1.4.7.1.

MIL-HDBK-5J
31 January 2003

Table 3.7.10.0(c). Design Mechanical and Physical Properties of 7475 Aluminum Alloy Plate

Specification	AMS 4202											
	Plate											
	T7351											
	0.250-1.500		1.501-2.000		2.001-2.500		2.501-3.000		3.001-3.500		3.501-4.000	
Basis	A	B	A	B	A	B	A	B	A	B	A	B
Mechanical Properties:												
<i>F_{tu}</i> , ksi:												
L	70	72	70	71	68	70	68	69	64	67	64	66
LT	71	73	70	72	68	70	68	69	64	68	64	67
ST	66 ^a	70 ^a	65	69	65	69	65	68	63	67	63	66
<i>F_{ty}</i> , ksi:												
L	59	62	58	60	56	59	56	58	52	56	52	54
LT	60	62	58 ^b	61	56	59	56	58	52	56	52	54
ST	54 ^a	57 ^a	53	56	53	56	53	55	50	53	50	52
<i>F_{cy}</i> , ksi:												
L	58	60	56	59	54	57	53	55	49	53	49	51
LT	61	63	60	63	58	61	58	60	54	58	54	56
ST	62 ^a	64 ^a	60	63	58	61	58	60	54	58	54	56
<i>F_{su}</i> , ksi	41	42	42	43	41	42	41	42	39	42	39	41
<i>F_{bru}</i> ^c , ksi:												
(e/D = 1.5)	102	105	103	106	101	104	101	103	97	102	97	101
(e/D = 2.0)	132	136	134	138	131	135	131	134	125	133	125	131
<i>F_{bry}</i> ^c , ksi:												
(e/D = 1.5)	81	84	82	86	81	84	81	84	77	82	77	80
(e/D = 2.0)	97	101	97	102	95	100	95	99	89	96	89	93
<i>e</i> , percent (S-basis):												
L	10	...	10	...	10	...	10	...	10	...	9	...
LT	9	...	8	...	8	...	8	...	8	...	7	...
ST	4 ^b	...	4	...	4	...	3	...	3	...	3	...
<i>E</i> , 10 ³ ksi	10.3											
<i>E_c</i> , 10 ³ ksi	10.6											
<i>G</i> , 10 ³ ksi	3.9											
<i>μ</i>	0.33											
Physical Properties:												
<i>ω</i> , lb/in. ³	0.101											
<i>C</i> , Btu/(lb)(°F)	0.21 (at 212°F)											
<i>K</i> , Btu/[(hr)(ft ²)(°F)/ft]	94 (at 77°F)											
<i>α</i> , 10 ⁻⁶ in./in./°F	13.0 (68 to 212°F)											

a Values applicable to 1.500-inch thickness only.
b S-basis. The rounded T₉₀ value for F_y(LT) = 59 ksi.
c See Table 3.1.2.1.1. Bearing values are “dry pin” values per Section 1.4.7.1.

Table 3.7.10.0(d). Design Mechanical and Physical Properties of Clad 7475 Aluminum Alloy Sheet

Specification	AMS 4207				AMS 4100				
	Sheet								
Form	T61				T761				
	0.040- 0.062	0.063- 0.187	0.188- 0.249	0.040- 0.062	0.063- 0.187	0.188- 0.249			
Temper	T61			T761					
	0.040- 0.062	0.063- 0.187	0.188- 0.249	0.040- 0.062	0.063- 0.187	0.188- 0.249			
Thickness, in.	T61			T761					
	0.040- 0.062	0.063- 0.187	0.188- 0.249	0.040- 0.062	0.063- 0.187	0.188- 0.249			
Basis	T61			T761					
	S	A	B	S	S	A	B	A	B
Mechanical Properties:									
F_{tu} , ksi:									
L	69	69	73	72	66	67	70	68	71
LT	69	70	73	72	66	68	70	70	72
F_{ty} , ksi:									
L	61	64	67	63	56	58	61	59	63
LT	59	60 ^a	64	61	55	57	60	60	62
F_{cy} , ksi:									
L	60	61	65	62	55	56	59	58	60
LT	63	64	68	65	58	59	62	61	63
F_{su} , ksi	42	40	41	39	41	40	41	40	41
F_{bru}^b , ksi:									
(e/D = 1.5)	110	111	116	115	104	107	110	108	111
(e/D = 2.0)	140	142	148	146	133	136	140	138	142
F_{bry}^b , ksi:									
(e/D = 1.5)	89	90	96	92	83	86	90	90	93
(e/D = 2.0)	102	104	111	106	97	101	106	106	110
e , percent (S-basis):									
LT	9	9	...	9	9	9	...	9	...
E , 10 ³ ksi:									
Primary	10.0	10.0	10.0	10.0	10.0	10.0	10.0	10.0	10.0
Secondary	9.2	9.4	9.7	9.7	9.2	9.4	9.7	9.7	9.7
E_c , 10 ³ ksi:									
Primary	10.5	10.5	10.5	10.5	10.5	10.5	10.5	10.5	10.5
Secondary	9.4	9.7	10.0	10.0	9.4	9.7	10.0	10.0	10.0
G , 10 ³ ksi	3.8	3.8	3.8	3.8	3.8	3.8	3.8	3.8	3.8
μ	0.33	0.33	0.33	0.33	0.33	0.33	0.33	0.33	0.33
Physical Properties:									
ω , lb/in. ³	0.101								
C, K, α								

a S-basis. The rounded T_{99} value is 61 ksi.
b Bearing values are "dry pin" values per Section 1.4.7.1.

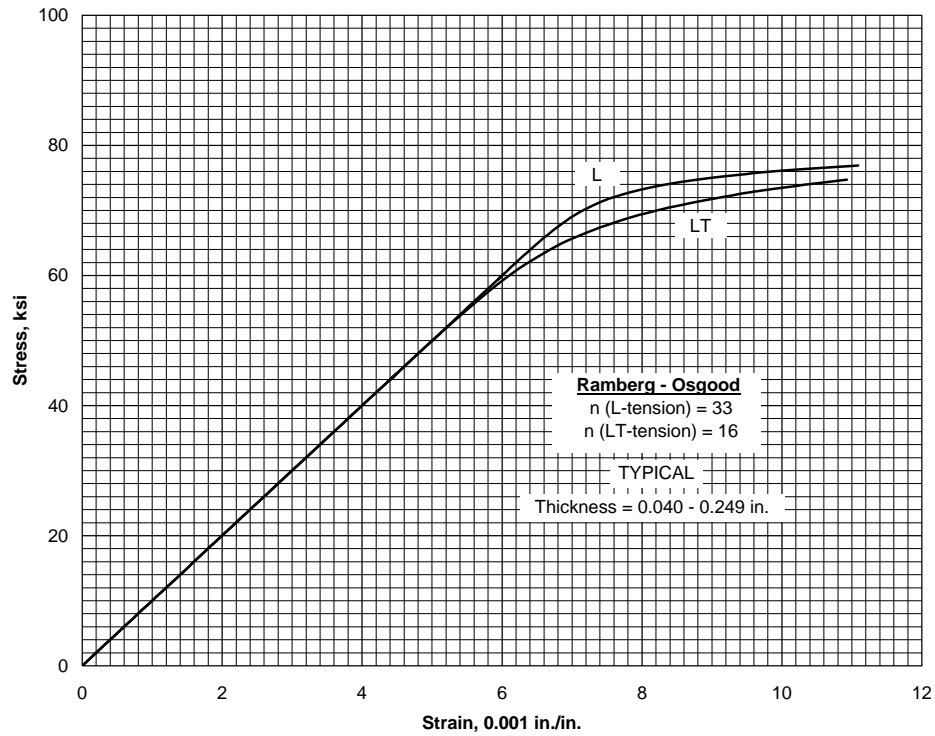

Figure 3.7.10.1.6(a). Typical tensile stress-strain curves for 7475-T61 aluminum alloy sheet at room temperature.

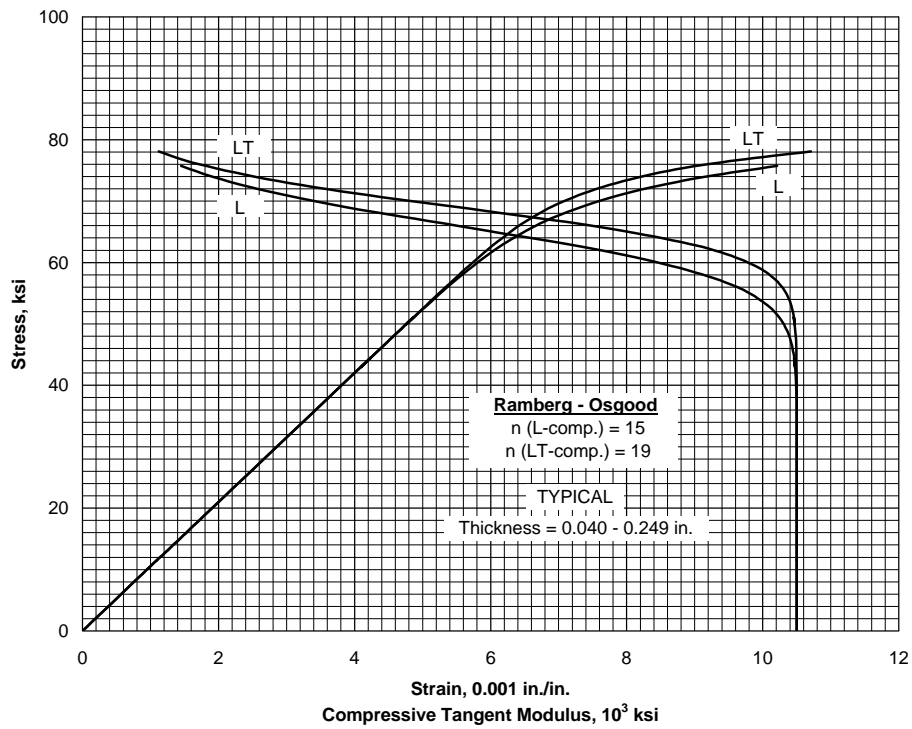

Figure 3.7.10.1.6(b). Typical compressive stress-strain and compressive tangent-modulus curves for 7475-T61 aluminum alloy sheet at room temperature.

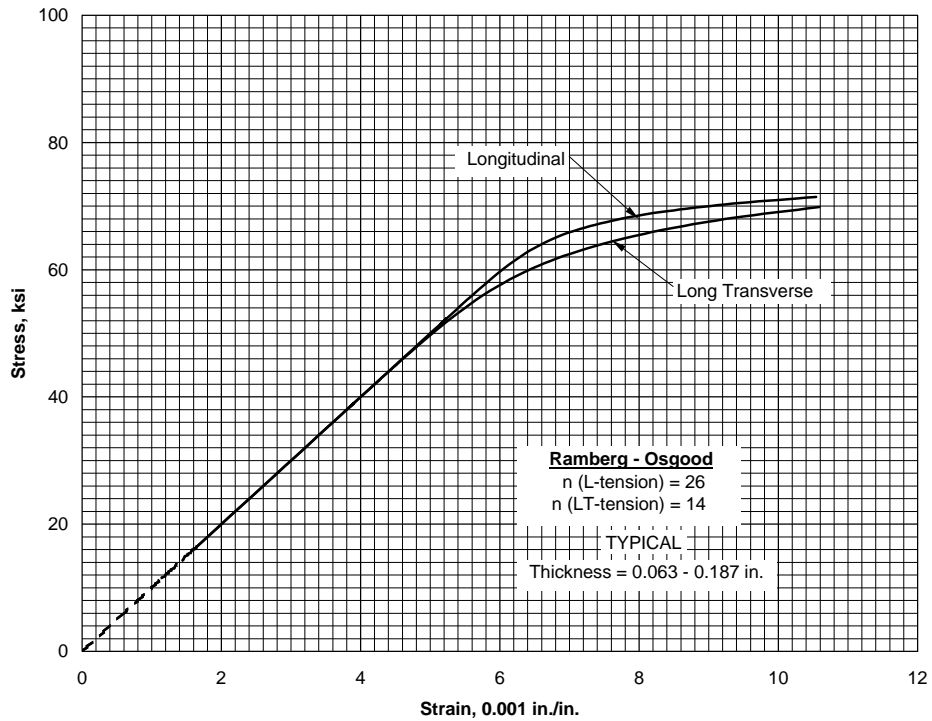

Figure 3.7.10.1.6(c). Typical tensile stress-strain curves for clad 7475-T61 aluminum alloy sheet at room temperature.

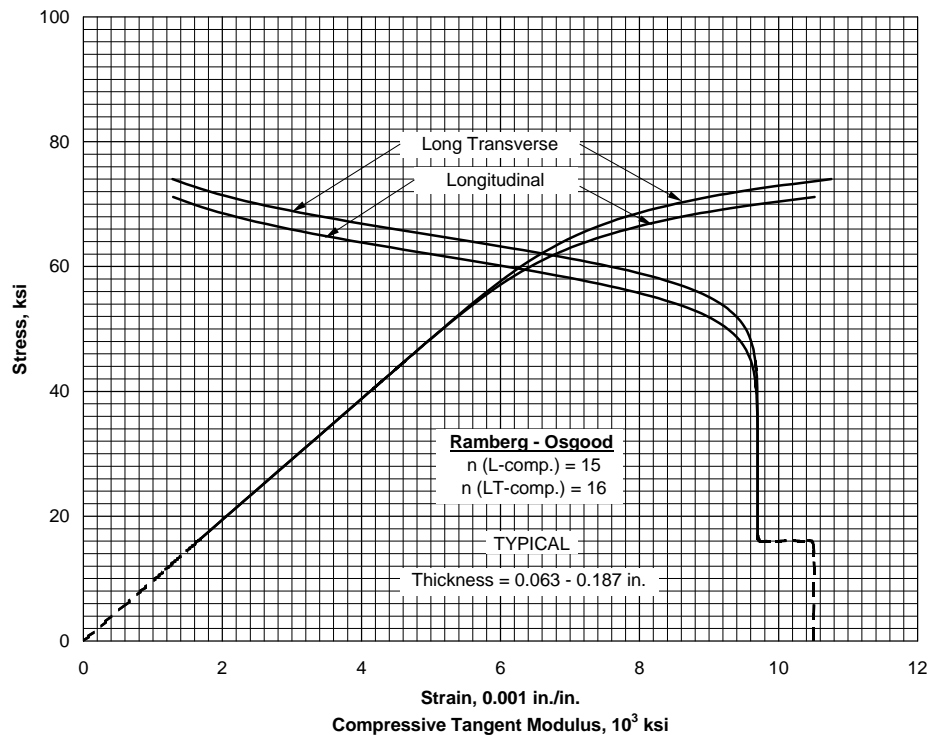

Figure 3.7.10.1.6(d). Typical compressive stress-strain and compressive tangent-modulus curves for clad 7475-T61 aluminum alloy sheet at room temperature.

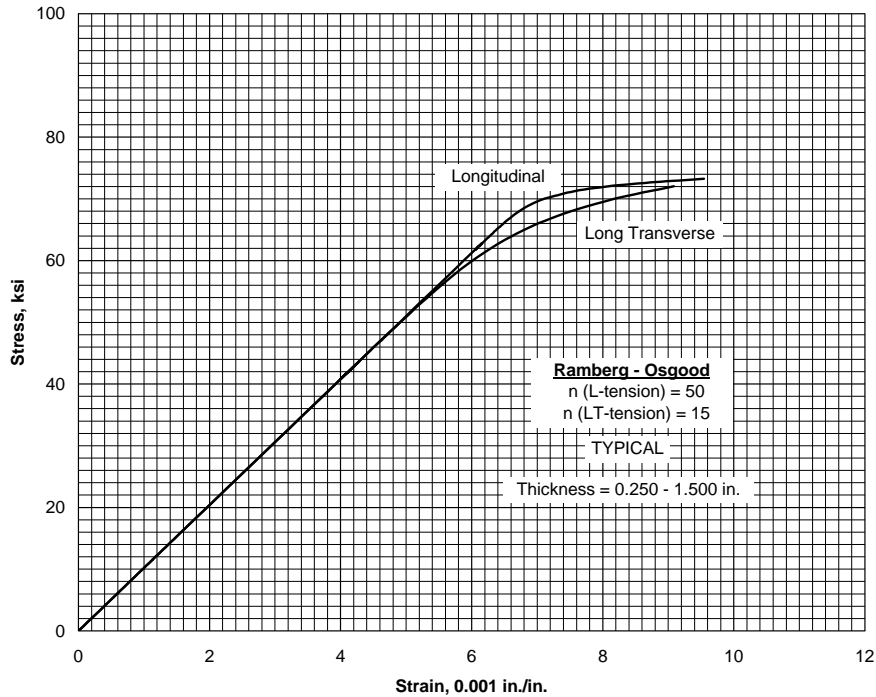

Figure 3.7.10.1.6(e). Typical tensile stress-strain curves for 7475-T651 aluminum alloy plate at room temperature.

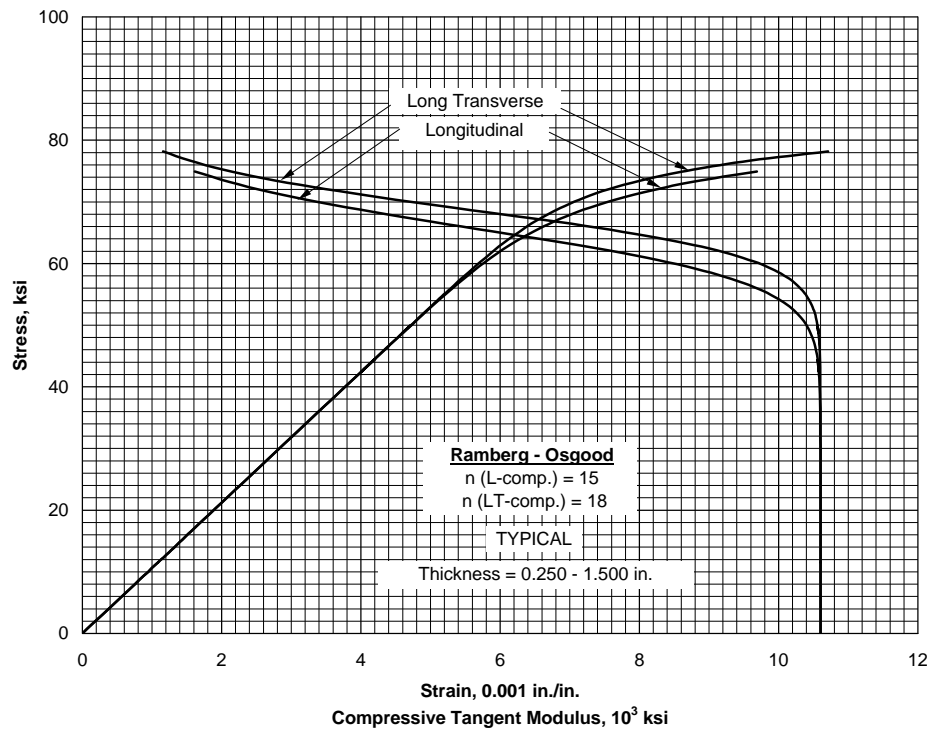

Figure 3.7.10.1.6(f). Typical compressive stress-strain and compressive tangent-modulus curves for 7475-T651 aluminum alloy plate at room temperature.

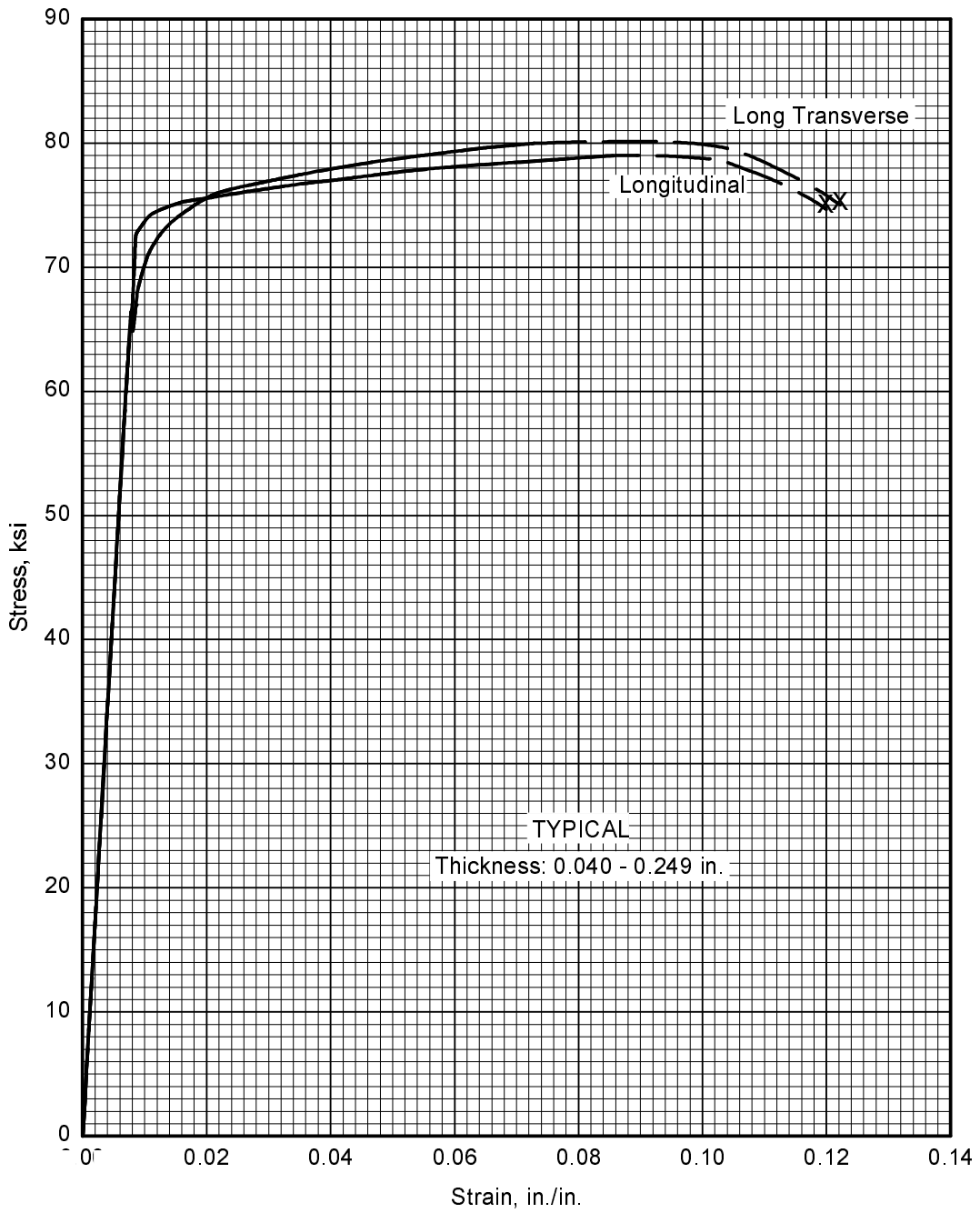

Figure 3.7.10.1.6(g). Typical tensile stress-strain curves (full range) for 7475-T61 aluminum alloy sheet at room temperature.

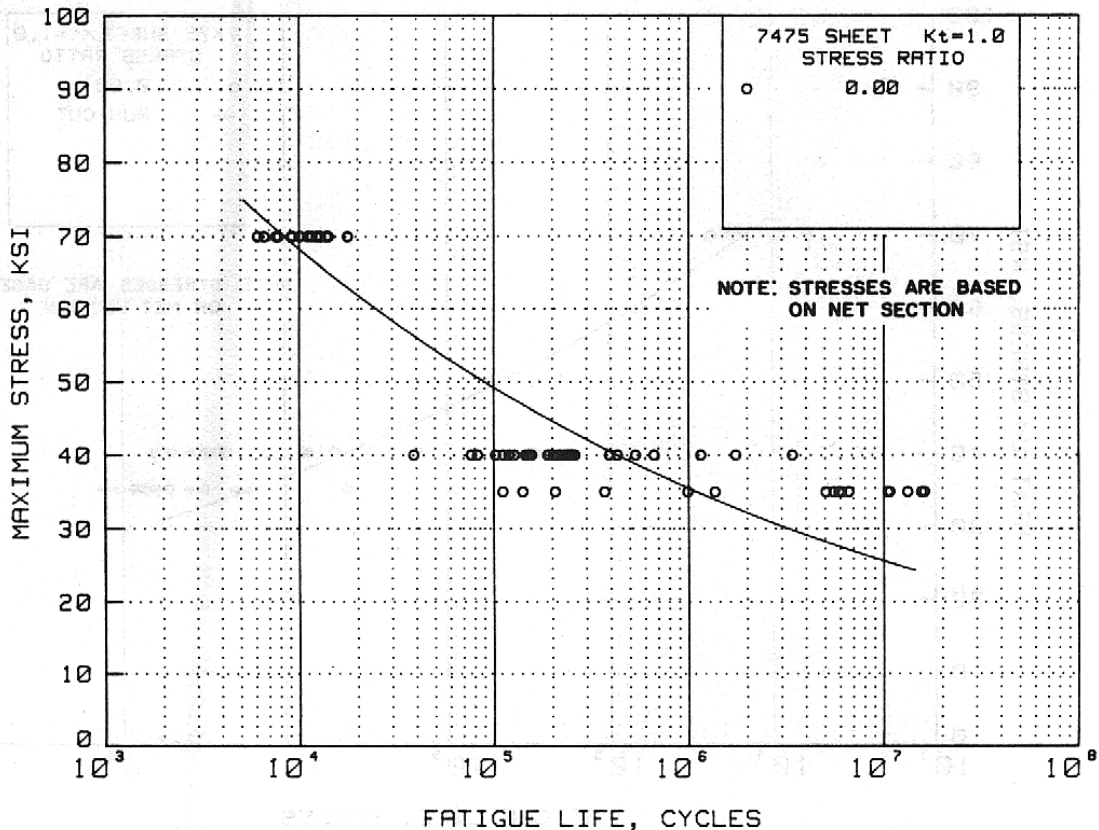

Figure 3.7.10.1.8(a). Best-fit S/N curve for unnotched 7475-T61 and T761 sheet, thickness ≤ 0.125 inch, longitudinal and long transverse directions.

Correlative Information for Figure 3.7.10.1.8(a)

Product Form: Sheet, 0.032 to 0.125 inch thick

Test Parameters:

<u>Properties:</u>	<u>TUS, ksi</u>	<u>TYS, ksi</u>	<u>Temp., °F</u>
T61	81	73-75	RT
T761	77	68-70	RT

Loading - Axial
Frequency - 798, 1500, or 1728 cpm
Temperature - RT
Environment - Air

Specimen Details: Unnotched, hourglass,
0.500 inch diameter
4.00 inch test section radius, r

No. of Heats/Lots: 2

Surface Condition: As machined

Maximum Stress Equation:

$\log N_f = 16.9 - 7.03 \log (S_{max})$
Std. Error of Estimate, $\log (\text{Life}) = 0.545$
Standard Deviation, $\log (\text{Life}) = 0.988$
 $R^2 = 70\%$

Reference: 3.2.6.1.9(d)

Sample Size = 67

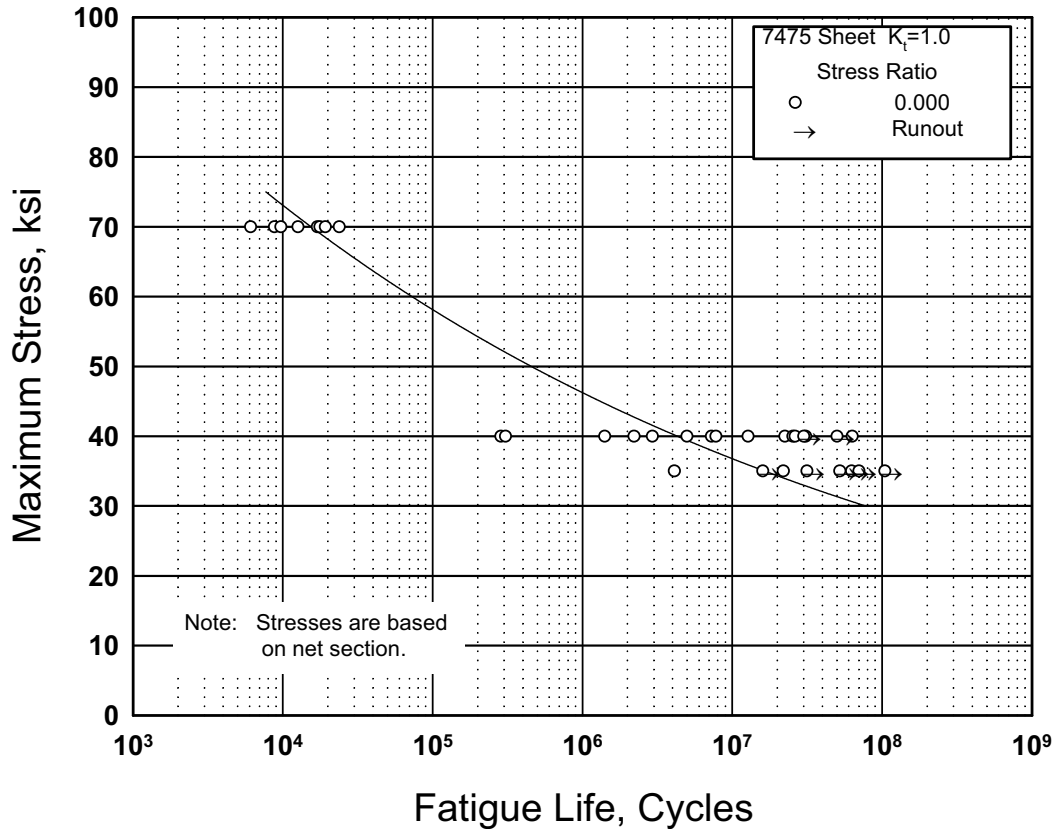

Figure 3.7.10.1.8(b). Best-fit S/N Curve for unnotched 7475-T61 and T761 sheet thickness > 0.125 inch, longitudinal and long transverse directions.

Correlative Information for Figure 3.7.10.1.8(b)

Product Form: Sheet, > 0.125 inch through
0.249 inch thick

Loading - Axial
Frequency - 798, 1500, or 1728 cpm
Temperature - RT
Environment - Air

<u>Properties:</u>	<u>TUS, ksi</u>	<u>TYS, ksi</u>	<u>Temp., °F</u>
T61	80-81	73-76	RT
T761	75	66-67	RT

No. of Heats/Lots: 2

Specimen Details: Unnotched, hourglass,
0.500 inch diameter
4.000 inch test section
radius, R

Maximum Stress Equation:
 $\log N_f = 22.7 - 10.1 \log (S_{max})$
Std. Error of Estimate, $\log (\text{Life}) = 0.657$
Standard Deviation, $\log (\text{Life}) = 1.380$
 $R^2 = 77\%$

Surface Condition: As machined

Sample Size = 24

Reference: 3.2.6.1.9(d)

Test Parameters:

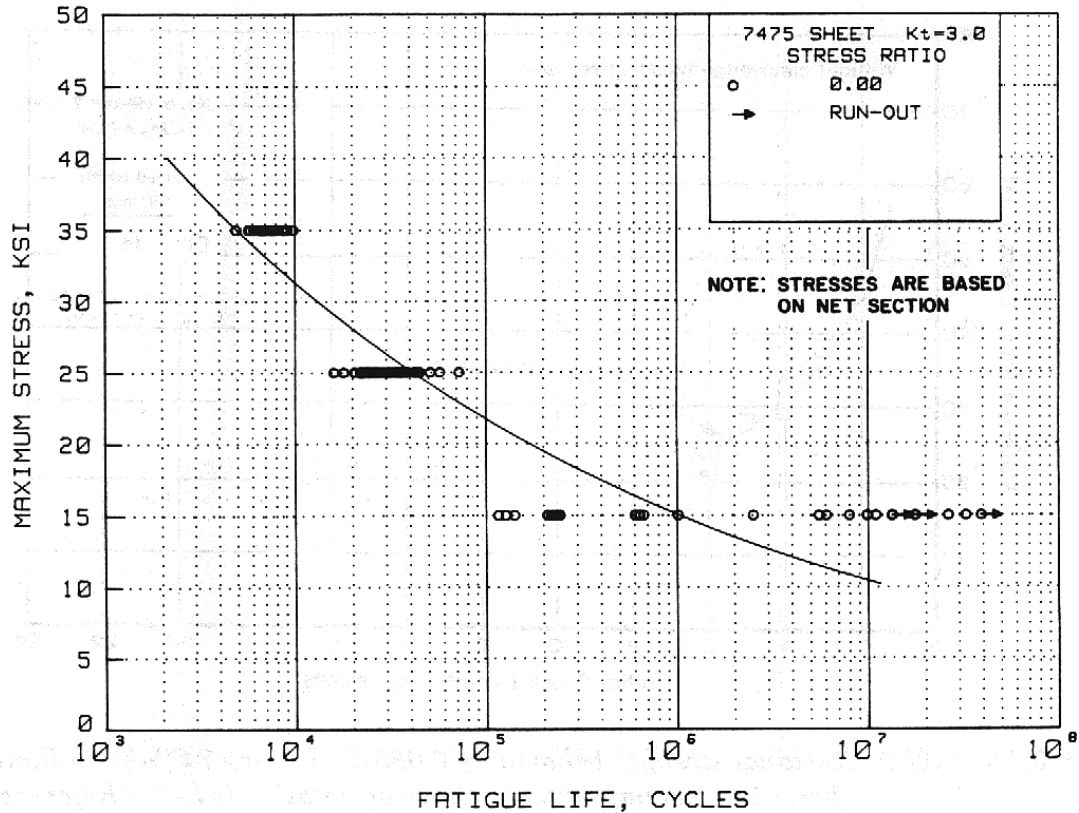

Figure 3.7.10.1.8(c). Best-fit S/N curve for notched, $K_t = 3.0$, 7475-T61 and T761 sheet, longitudinal and long transverse directions.

Correlative Information for Figure 3.7.10.1.8(c)

Product Form: Sheet, 0.032 to 0.249 inch thick

Test Parameters:

<u>Properties:</u>	<u>TUS, ksi</u>	<u>TYS, ksi</u>	<u>Temp., °F</u>
T61	81-82	73-76	RT
T761	75-77	67-70	RT

Loading - Axial
Frequency - 798, 1500, or 1728 cpm
Temperature - RT
Environment - Air

Specimen Details: Notched, edge notched
 $K_t = 3.0$
1.000 inch gross width
0.700 inch net width
0.050 inch root radius, r
60° flank angle, ω

No. of Heats/Lots: 2

Maximum Stress Equation:
 $\log N_f = 13.4 - 6.29 \log (S_{max})$
Std. Error of Estimate, $\log (\text{Life}) = 0.441$
Standard Deviation, $\log (\text{Life}) = 0.931$
 $R^2 = 78\%$

Surface Condition: As machined

Sample Size = 99

Reference: 3.2.6.1.9(d)

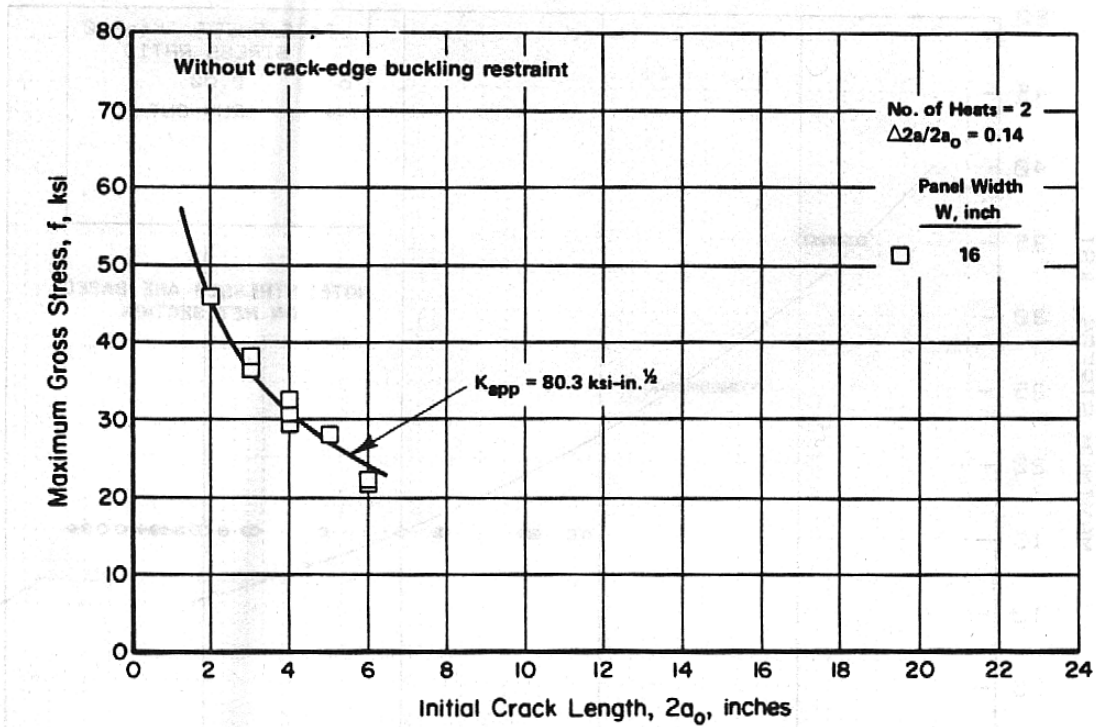

Figure 3.7.10.10(a). Residual strength behavior of 0.063-inch-thick 7475-T61 aluminum alloy sheet at room temperature. Crack orientation is L-T. [References 3.1.2.1.6(d) and 3.2.5.1.9(d).]

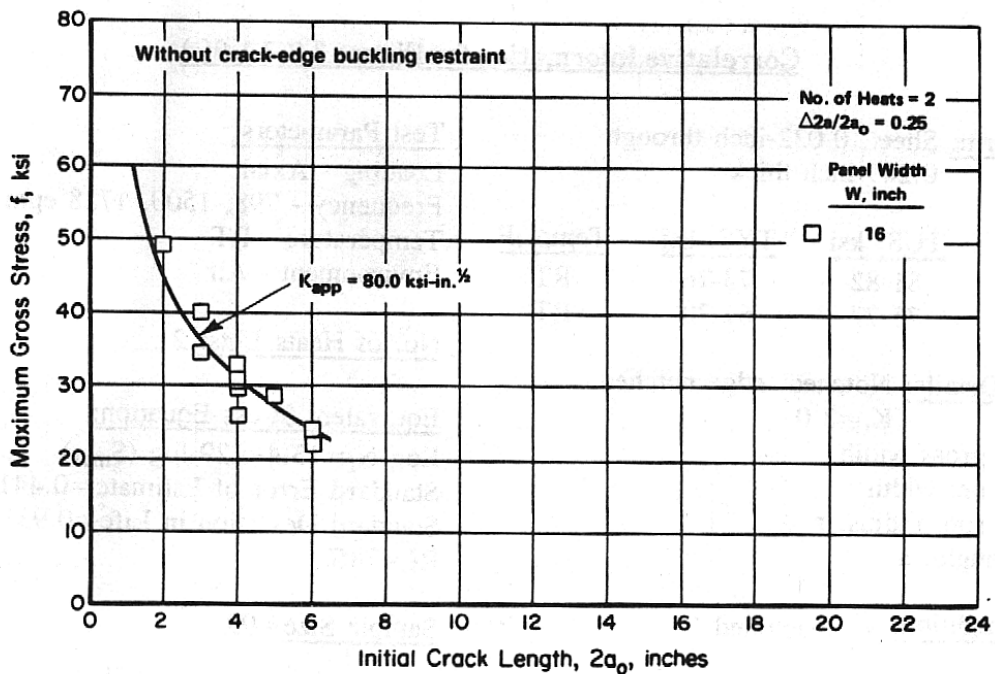

Figure 3.7.10.10(b). Residual strength behavior of 0.063-inch-thick 7475-T61 aluminum alloy sheet at room temperature. Crack orientation is T-L. [References 3.1.2.1.6(d) and 3.2.5.1.9(d).]

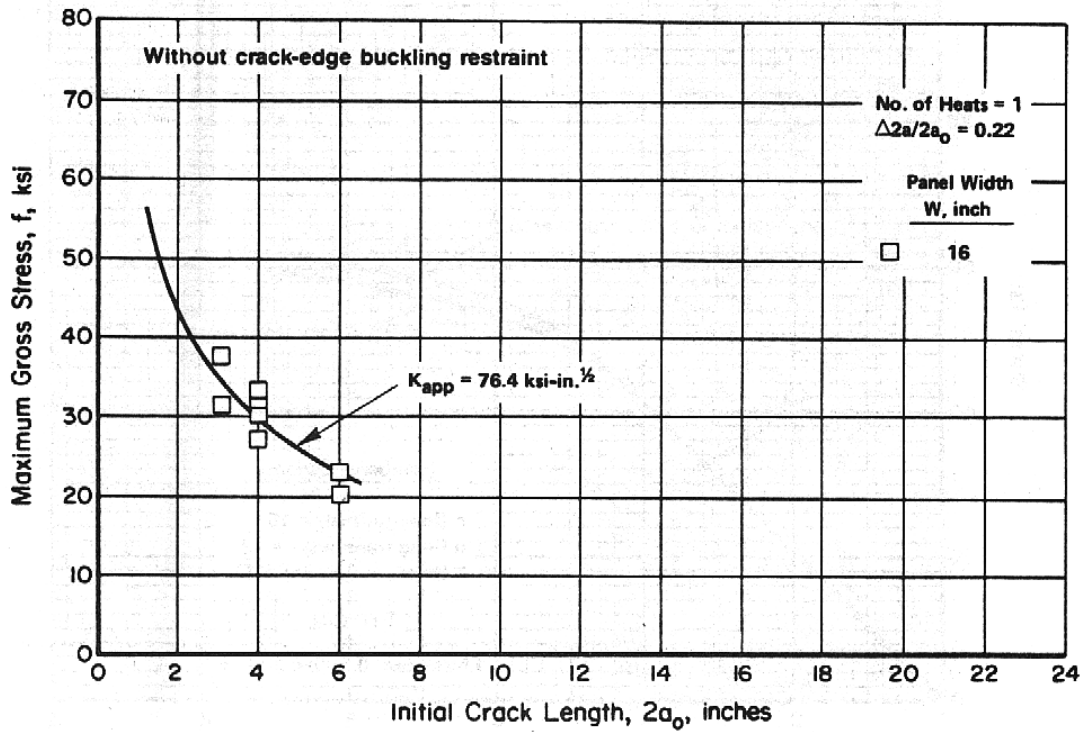

Figure 3.7.10.10(c). Residual strength behavior of 0.063-inch-thick 7475-T61 clad aluminum alloy sheet at room temperature. Crack orientation is L-T. [Reference 3.2.5.1.9(d).]

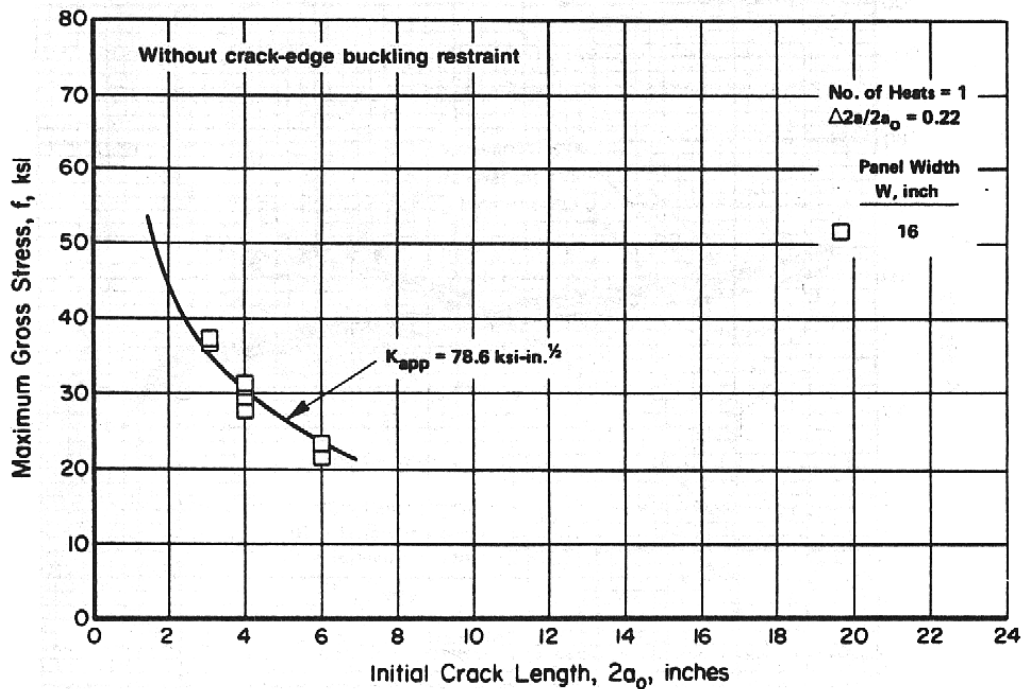

Figure 3.7.10.10(d). Residual strength behavior of 0.063-inch-thick 7475-T61 clad aluminum alloy sheet at room temperature. Crack orientation is T-L. [Reference 3.2.5.1.9(d).]

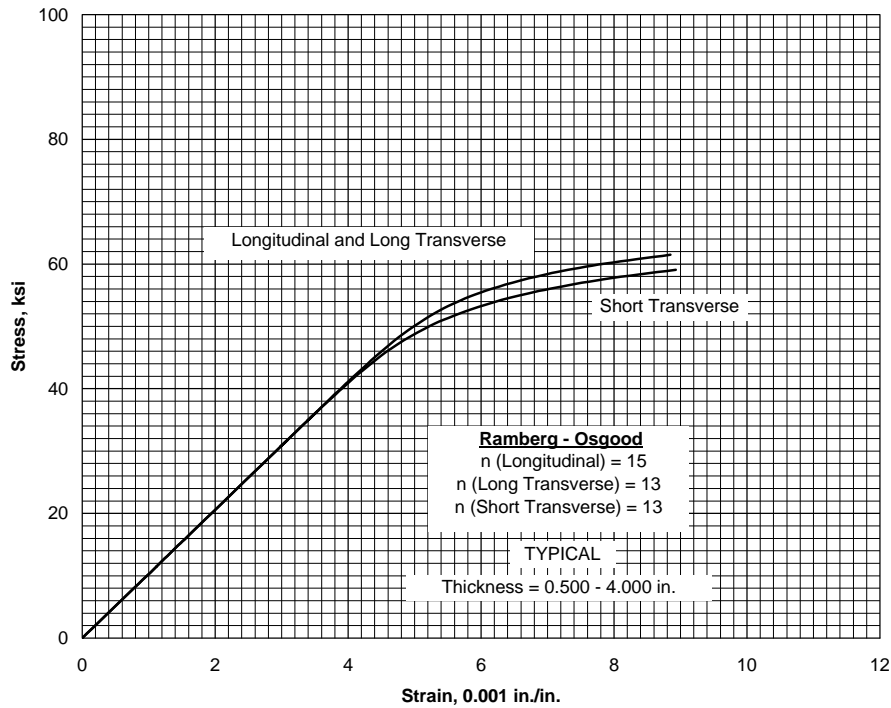

Figure 3.7.10.2.6(a). Typical tensile stress-strain curves for 7475-T7351 aluminum alloy plate at room temperature.

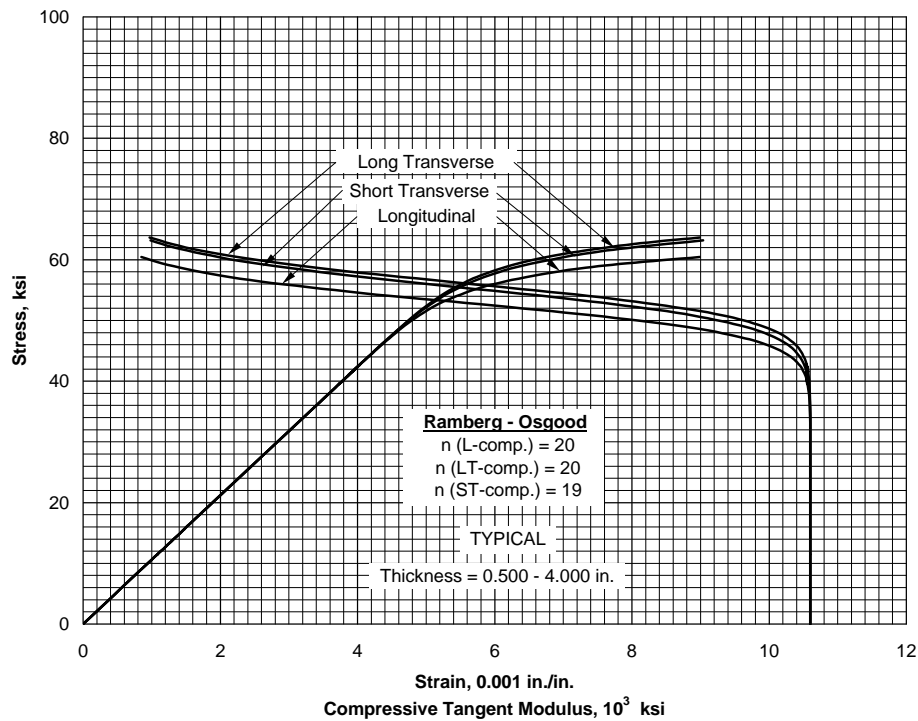

Figure 3.7.10.2.6(b). Typical compressive stress-strain and compressive tangent-modulus curves for 7475-T7351 aluminum alloy plate at room temperature.

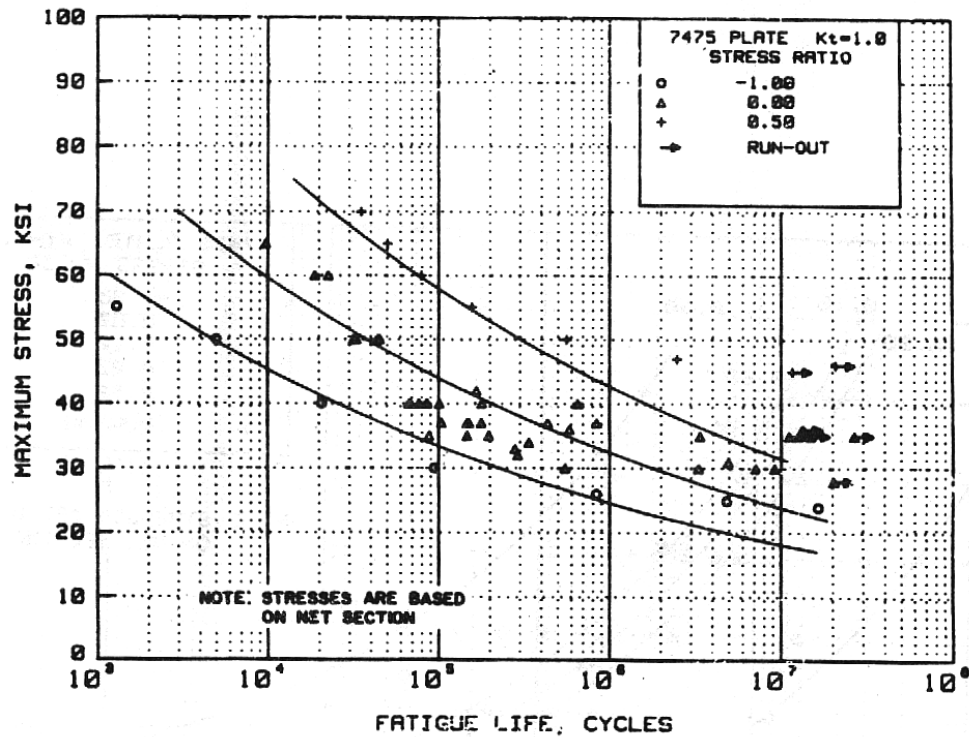

Figure 3.7.10.2.8(a). Best-fit S/N curves for unnotched 7475-T7351 plate, longitudinal and long transverse orientation.

Correlative Information for Figure 3.7.10.2.8(a)

Product Form: Plate, 0.5, 1.0, 2.0, 3.0, and 4.0-inches thick

<u>Properties:</u>	<u>TUS, ksi</u>	<u>TYS, ksi</u>	<u>Temp...°F</u>
L	70	60	RT
LT	71	60	RT

Specimen Details: Unnotched Hourglass, 0.300 inch net diameter, 9.875 inch test section radius

Surface Condition: As machined

References: 3.7.10.2.8(a) and (b)

Test Parameters:

Loading — Axial
Frequency — Not specified
Temperature — RT
Environment — Air

No. of Heats/Lots: 5

Equivalent Stress Equation:

$\log N_f = 17.42 - 7.56 \log (S_{eq})$
 $S_{eq} = S_{max}(1-R)^{0.40}$
Std. Error of Estimate, $\log (\text{Life}) = 0.433$
Standard Deviation, $\log (\text{Life}) = 0.857$
 $R^2 = 74\%$

Sample Size = 52

[Caution: The equivalent stress model may provide unrealistic life predictions for stress ratios beyond those represented above.]

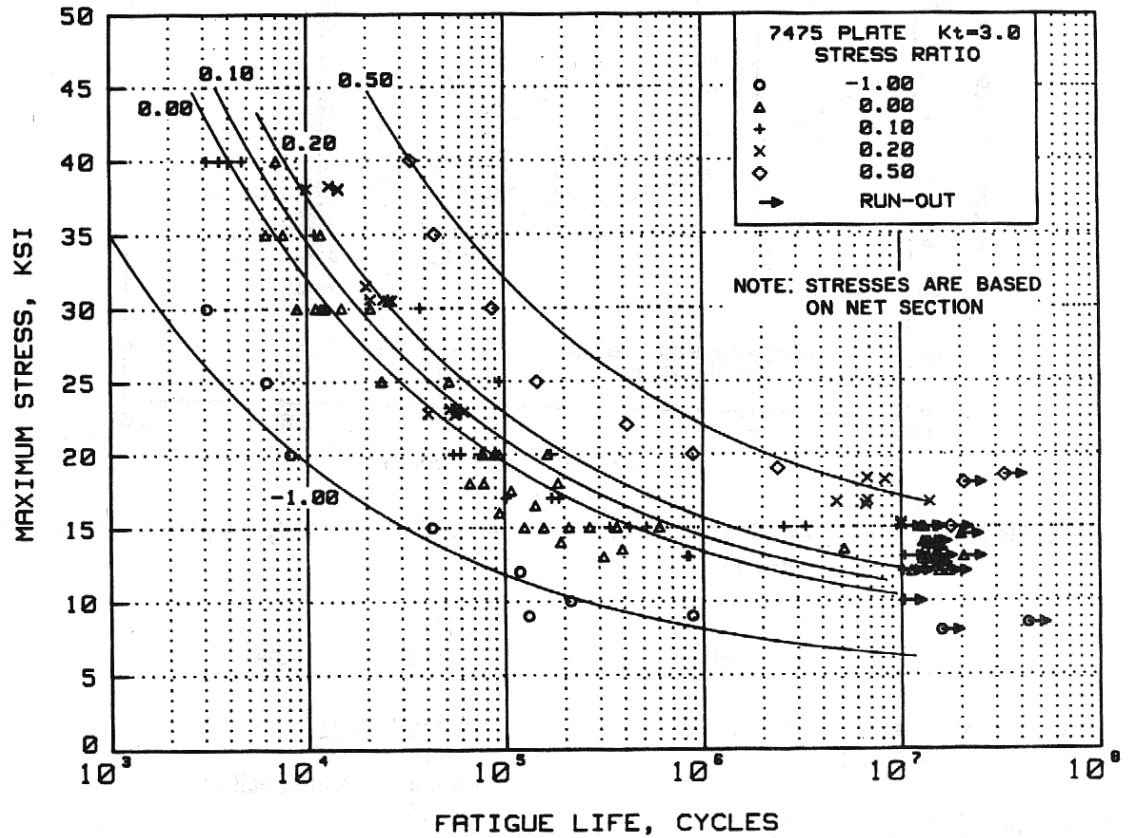

Figure 3.7.10.2.8(b). Best-fit S/N curves for notched, $K_t = 3.0$, 7475-T7351 and T7651 plate, longitudinal and long transverse direction.

(See following page for correlative information.)

Correlative Information for Figure 3.7.10.2.8(b)

Product Form: Plate, 0.5, 1.0, 1.5, 2.0, 3.0,
and 4.0 inches thick

<u>Properties:</u>	<u>TUS, ksi</u>	<u>TYS, ksi</u>	<u>Temp., °F</u>
L (T7351)	70	60	RT
LT (T7351)	71	61	RT
L (T7351)	72	62	RT
(T7651)	Not specified		
L (T7351)	72	63	RT
LT (T7351)	73	62	RT

Specimen Details: Notched, $K_t = 3.0$
Circumferentially notched
0.253 inch gross width
0.147 inch net width
0.013 inch root radius, r
60° flank angle, ω
Edge notched
1.00 inch gross width
0.70 inch net width
root radius not specified
60° flank angle, ω
Edge notched
2.25 inch gross width
1.50 inch net width
0.113 inch root radius, r
60° flank angle, ω
Circumferentially notched
1.375 inch gross width
0.25 inch net width
0.13 inch root radius, r
60° flank angle, ω

Surface Condition:

Not specified [Ref. (a) and (b)]
As machined and deburred [Ref. (c)]
32 RMS [Ref. (d)]
10 RMS [Ref. (e)]

Test Parameters:

Loading — Axial
Frequency
— Not specified [Ref. (a) and (b)]
— 1800 cpm [Ref. (c) and (d)]
— 1500 cpm [Ref. (e)]
Temperature — RT
Environment — Air

No. of Heats/Lots: 8

Equivalent Strain Equation:

$\text{Log } N_f = 8.46 - 3.21 \text{ log } (S_{eq} - 7.5)$
 $S_{eq} = S_{max}(1-R)^{0.72}$
Std. Error of Estimate, Log (Life) = 0.422
Standard Deviation, Log (Life) = 0.923
 $R^2 = 79\%$

Sample Size = 97

[Caution: The equivalent stress model may provide unrealistic life predictions for stress ratios beyond those represented above.]

References: 3.7.10.2.8 (a) through (e)

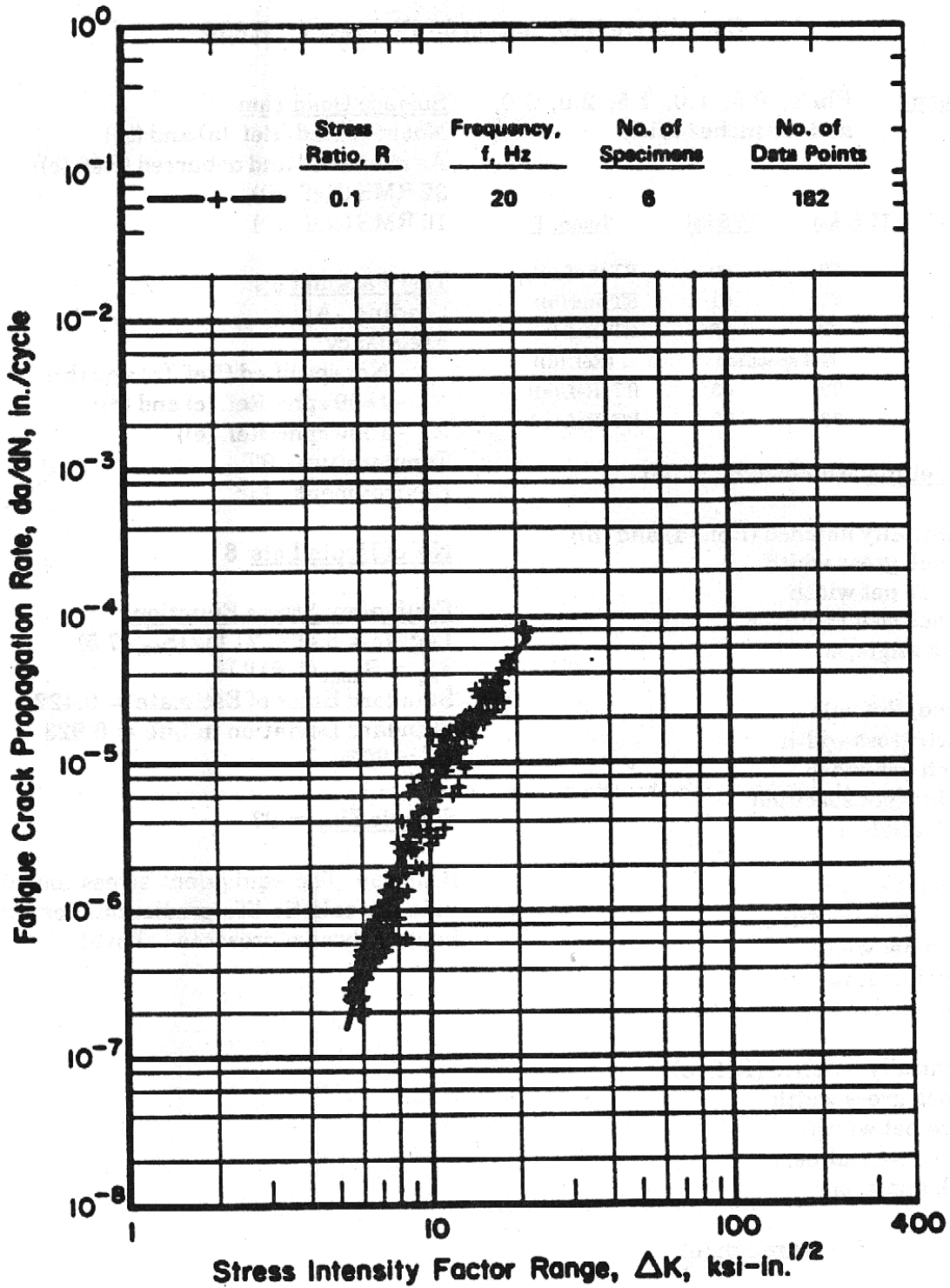

Figure 3.7.10.2.9(a). Fatigue-crack-propagation data for 1.5-inch-thick, 7475-T7351 aluminum alloy plate [References 3.7.10.2.9(a) and (b)].

Specimen Thickness:	0.650-inch	Environment:	Lab air
Specimen Width:	1.500-inches	Temperature:	RT
Specimen Type:	C(T)	Orientation:	L-T

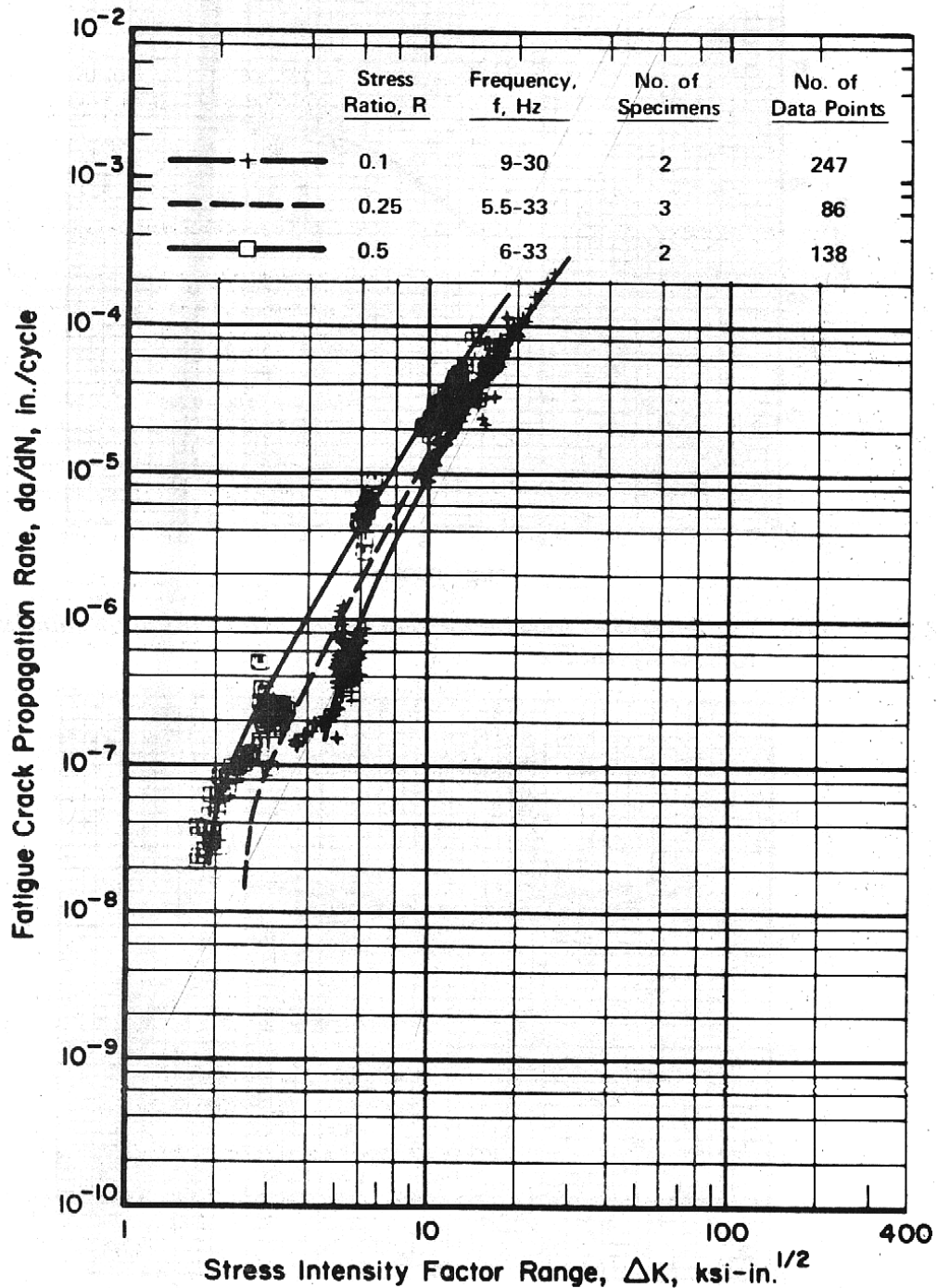

Figure 3.7.10.2.9(b). Fatigue-crack-propagation data for 0.500-inch-thick, 7475-T7351 aluminum alloy plate [Reference 3.7.10.2.9(c)].

Specimen Thickness:	0.528 to 0.530-inch	Environment:	95% R.H.
Specimen Width:	4.6-inches	Temperature:	RT
Specimen Type:	M(T)	Orientation:	L-T

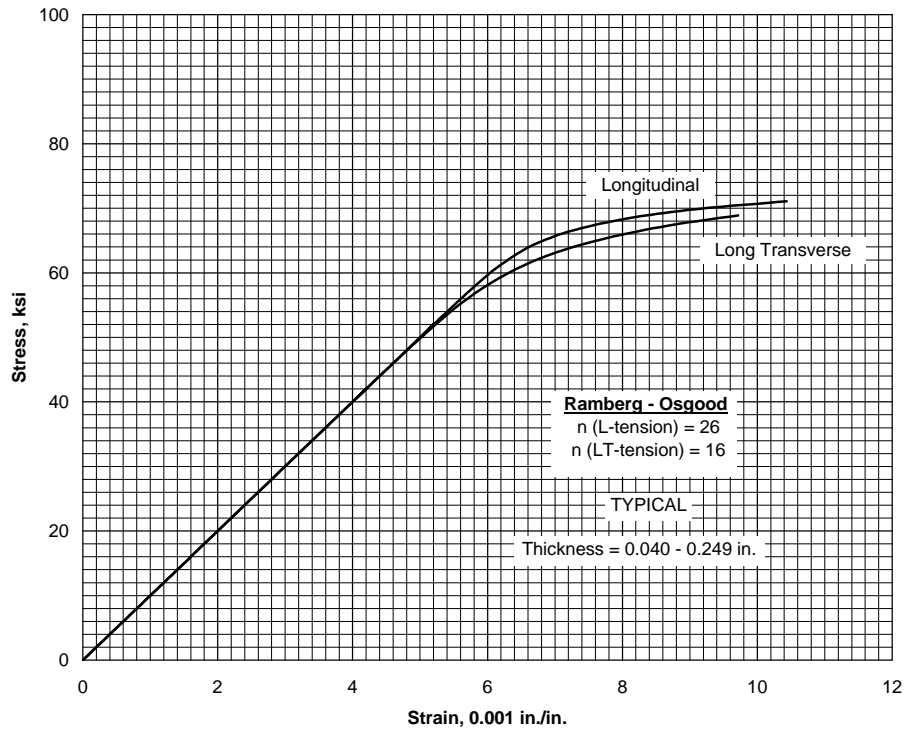

Figure 3.7.10.3.6(a). Typical tensile stress-strain curves for 7475-T761 aluminum alloy sheet at room temperature.

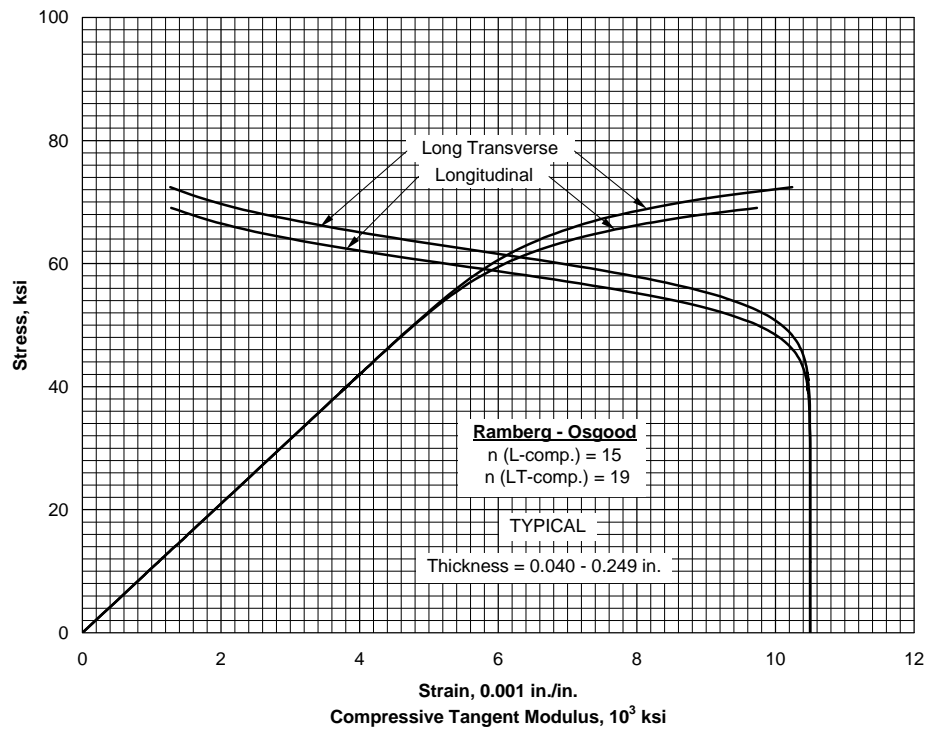

Figure 3.7.10.3.6(b). Typical compressive stress-strain and compressive tangent-modulus curves for 7475-T761 aluminum alloy sheet at room temperature.

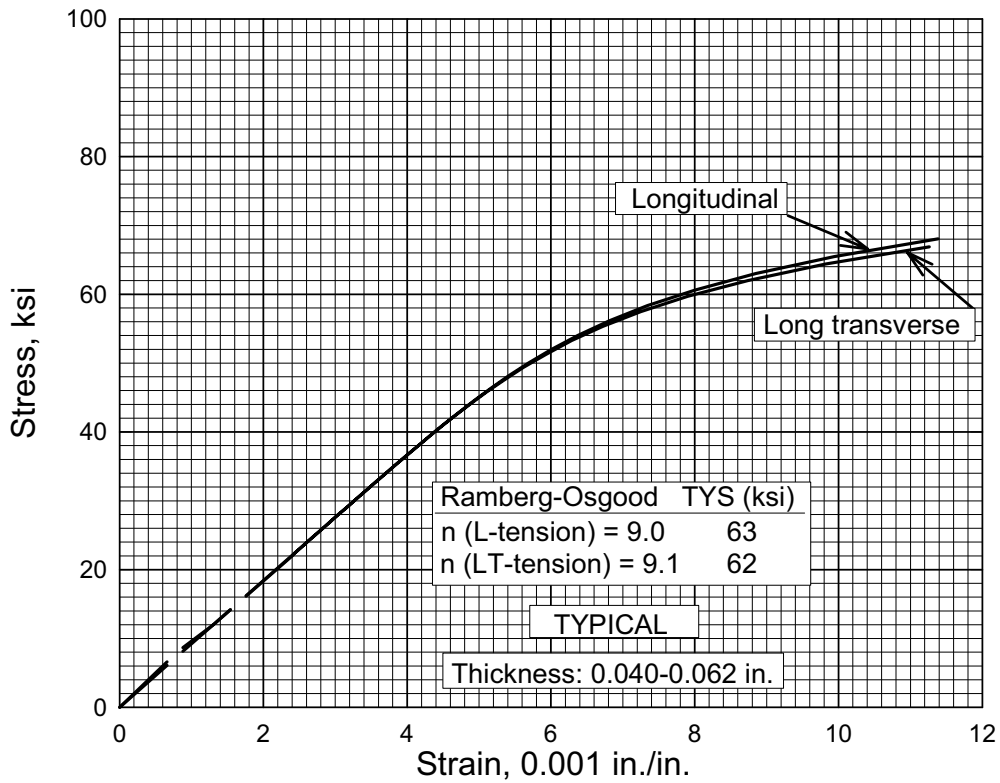

Figure 3.7.10.3.6(c). Typical tensile stress-strain curves for clad 7475-T761 aluminum alloy sheet at room temperature.

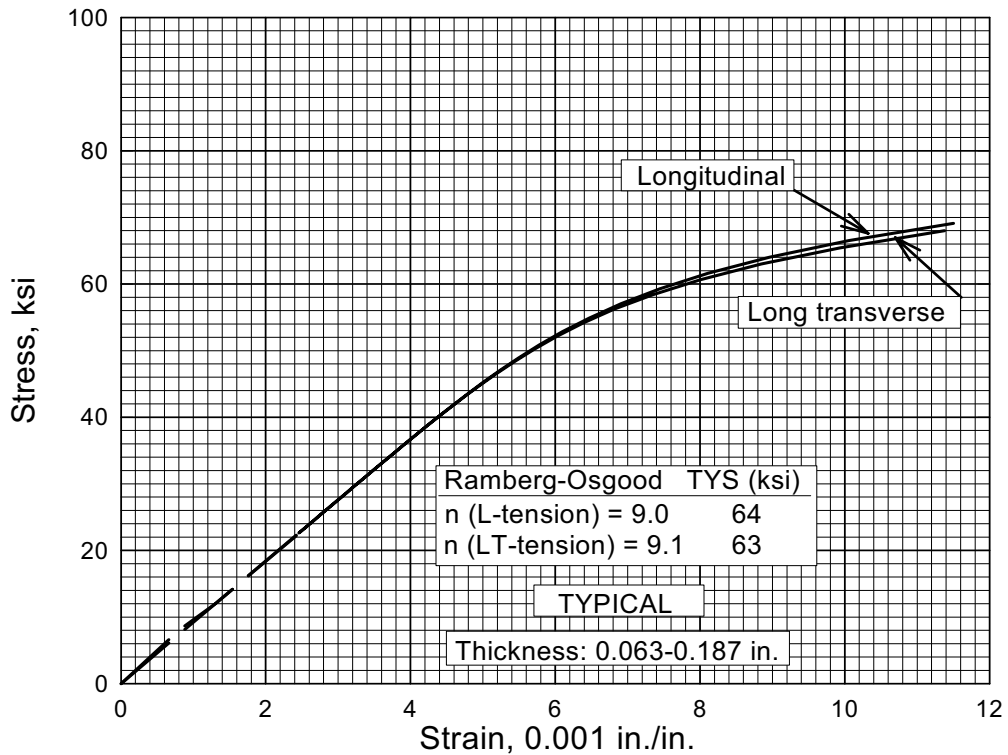

Figure 3.7.10.3.6(d). Typical tensile stress-strain curves for clad 7475-T761 aluminum alloy sheet at room temperature.

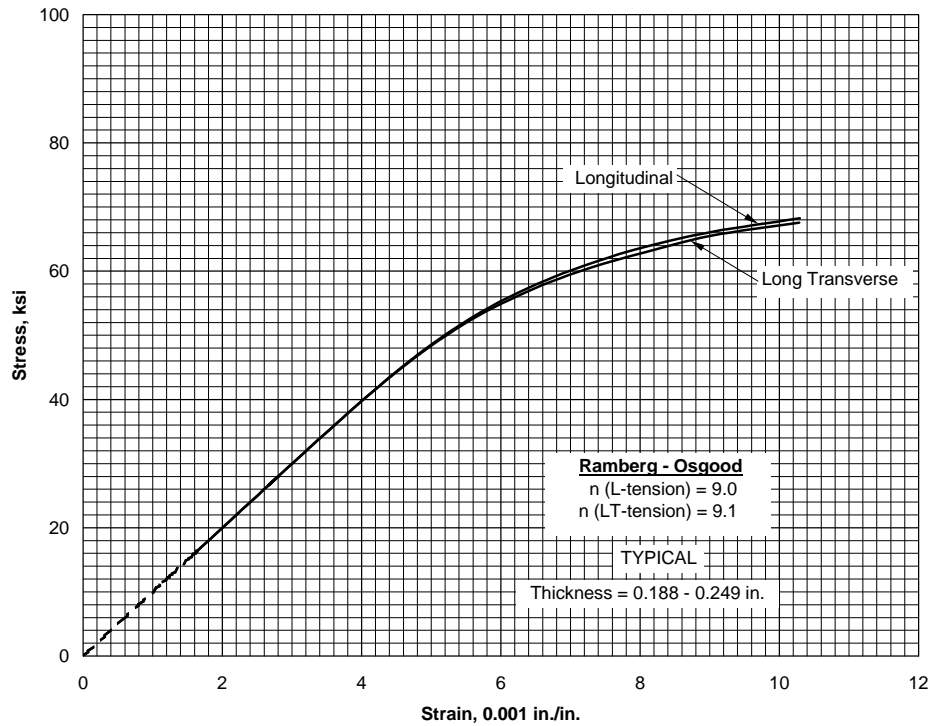

Figure 3.7.10.3.6(e). Typical tensile stress-strain curves for clad 7475-T761 aluminum alloy sheet at room temperature.

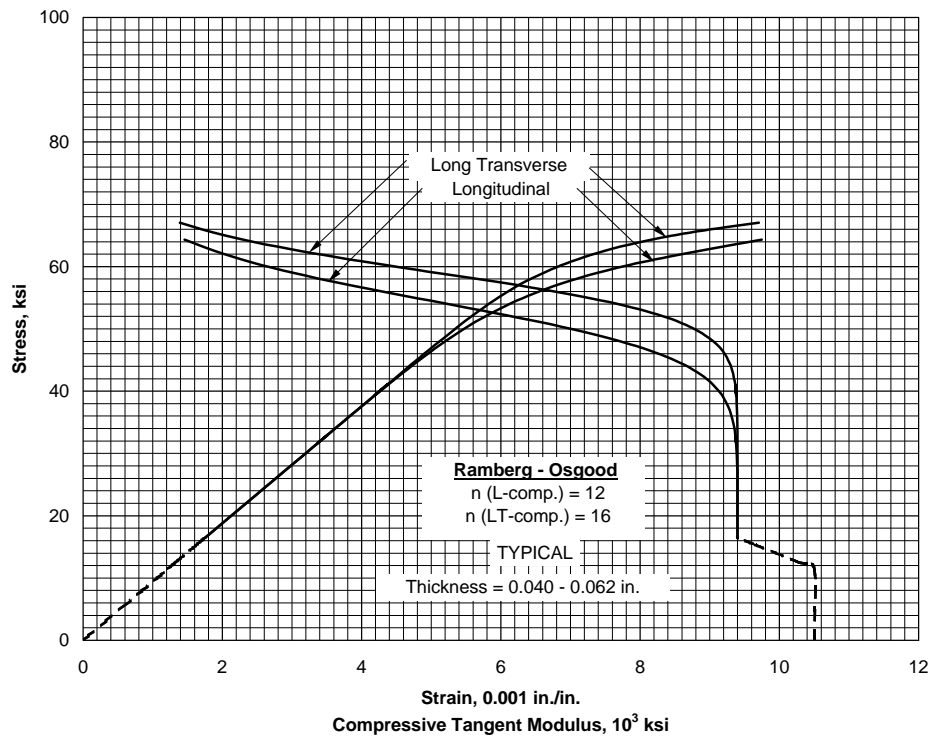

Figure 3.7.10.3.6(f). Typical compressive stress-strain and compressive tangent-modulus curves for clad 7475-T761 aluminum alloy sheet at room temperature.

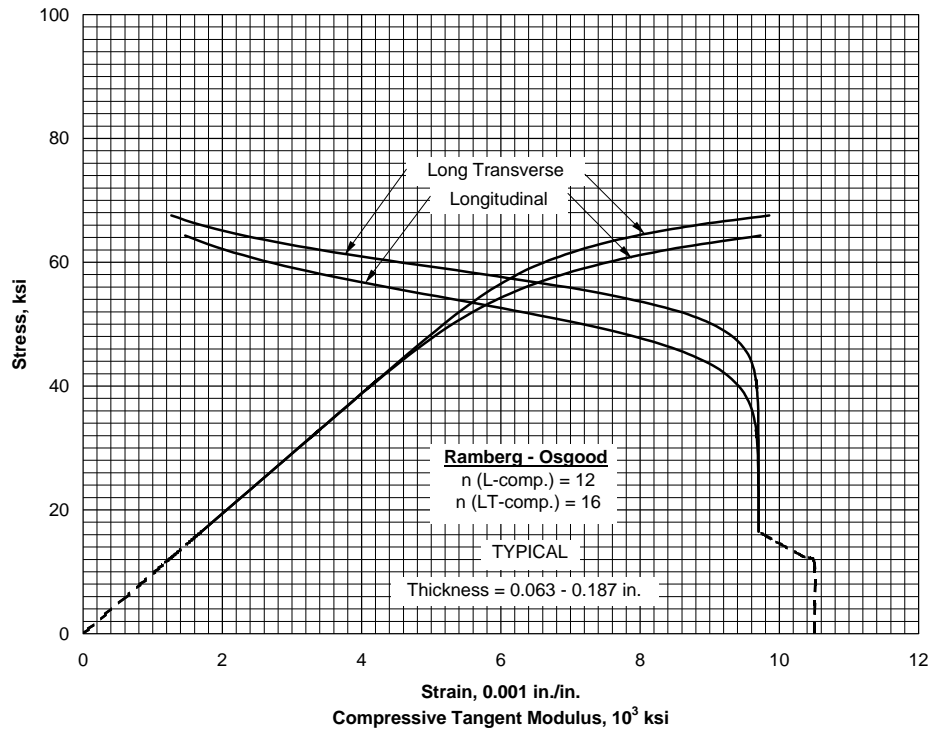

Figure 3.7.10.3.6(g). Typical compressive stress-strain and compressive tangent-modulus curves for clad 7475-T761 aluminum alloy sheet at room temperature.

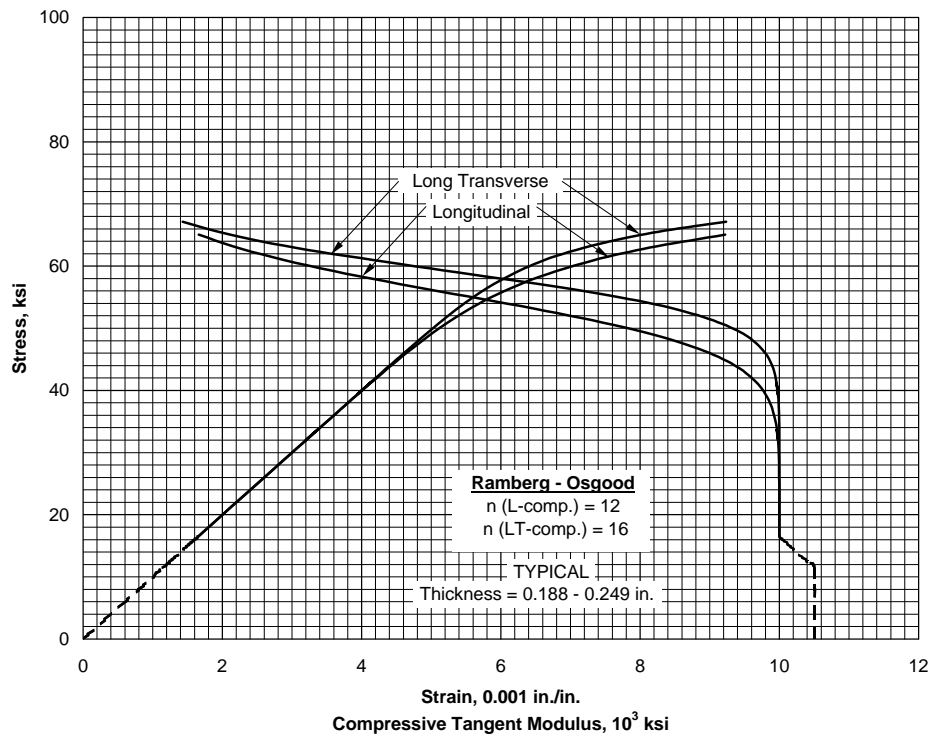

Figure 3.7.10.3.6(h). Typical compressive stress-strain and compressive tangent-modulus curves for clad 7475-T761 aluminum alloy sheet at room temperature.

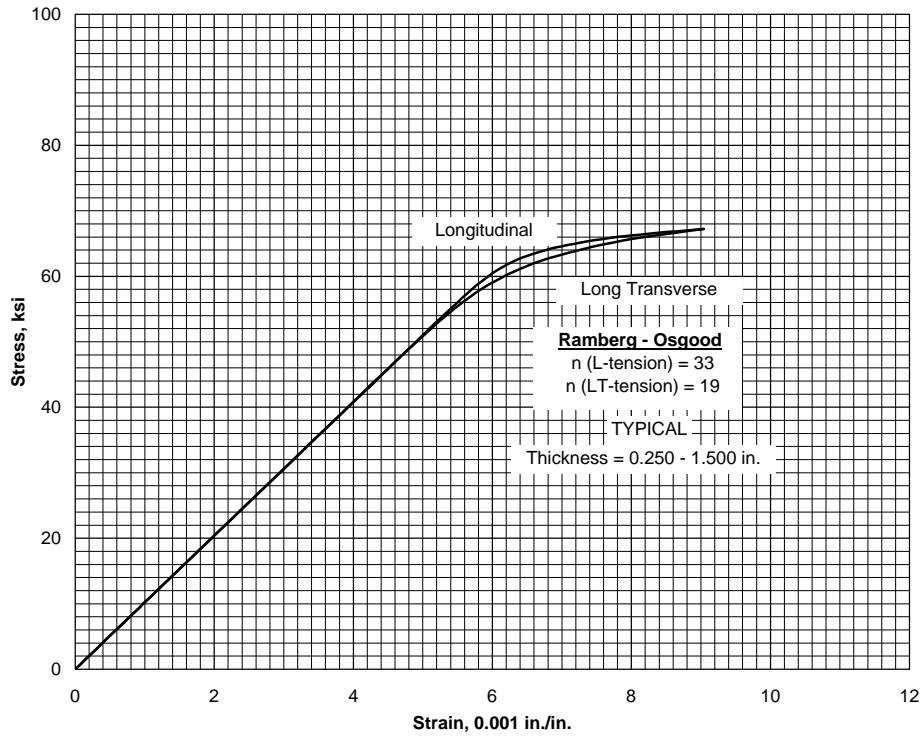

Figure 3.7.10.3.6(i). Typical tensile stress-strain curves for 7475-T7651 aluminum alloy plate at room temperature.

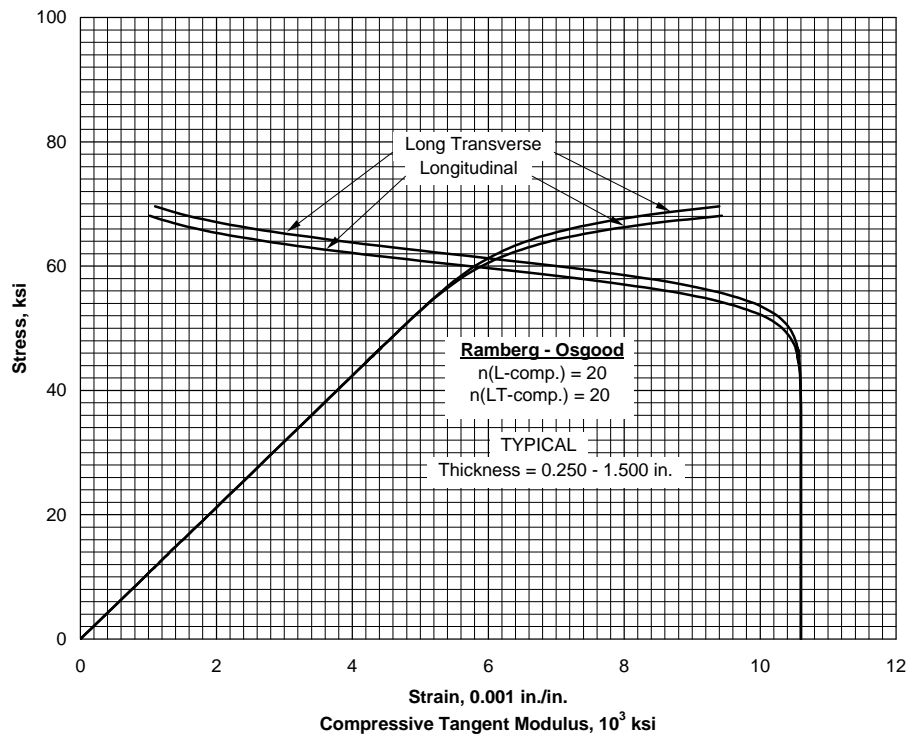

Figure 3.7.10.3.6(j). Typical compressive stress-strain and compressive tangent-modulus curves for 7475-T7651 aluminum alloy plate at room temperature.

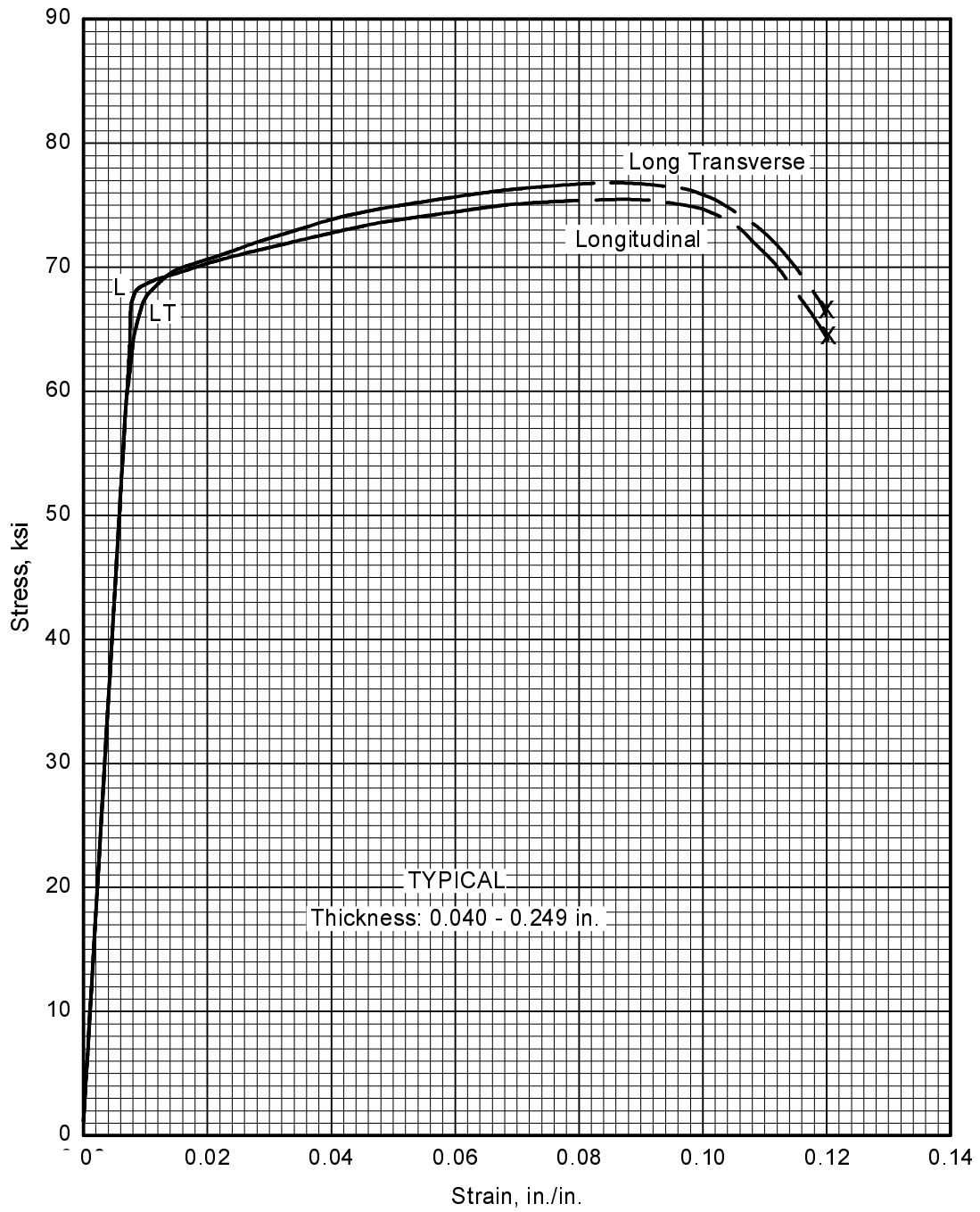

Figure 3.7.10.3.6(k). Typical tensile stress-strain (full range) curves for 7475-T761 aluminum alloy sheet at room temperature.

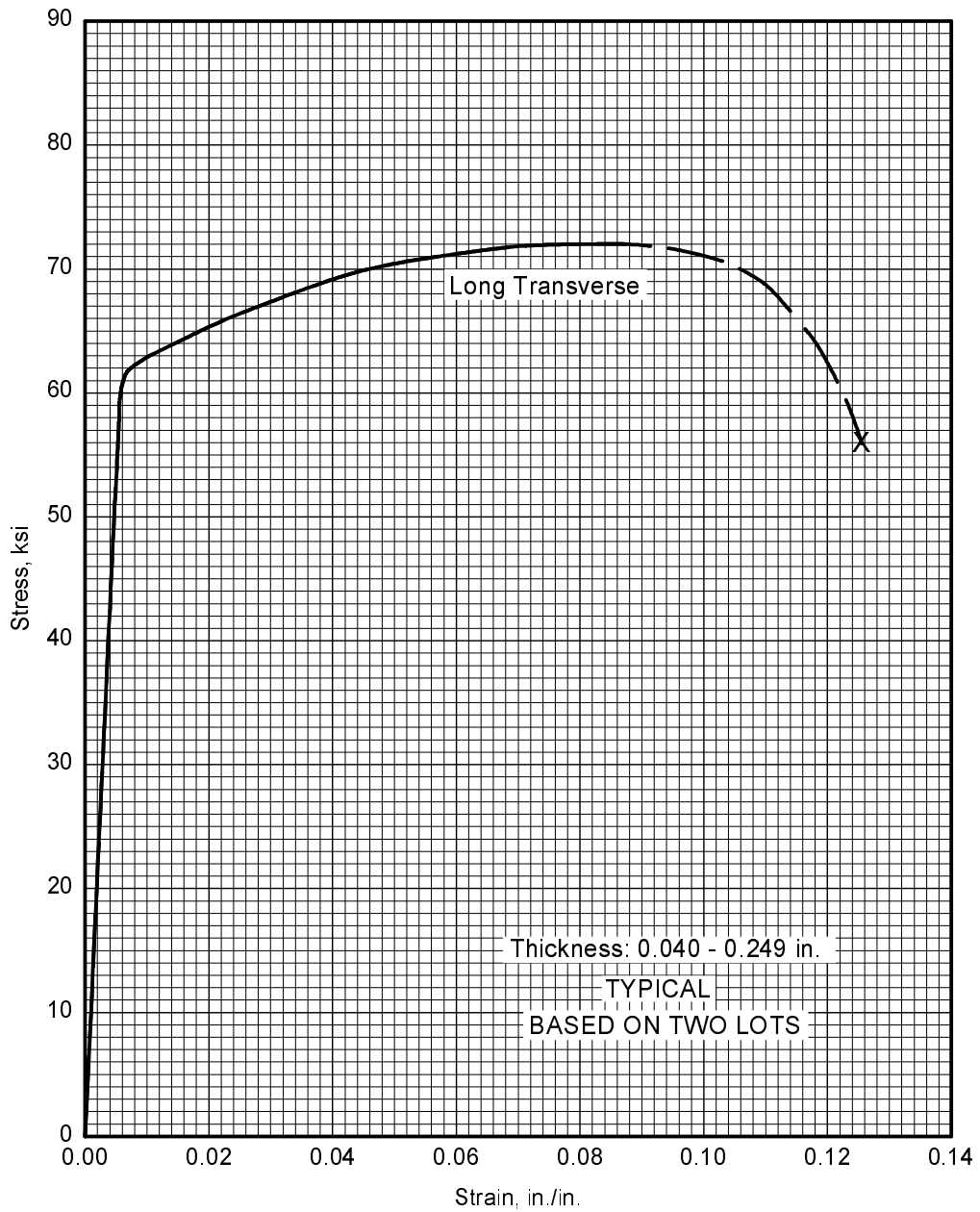

Figure 3.7.10.3.6(l). Typical tensile stress-strain (full range) curves for clad 7475-T761 aluminum alloy sheet at room temperature.

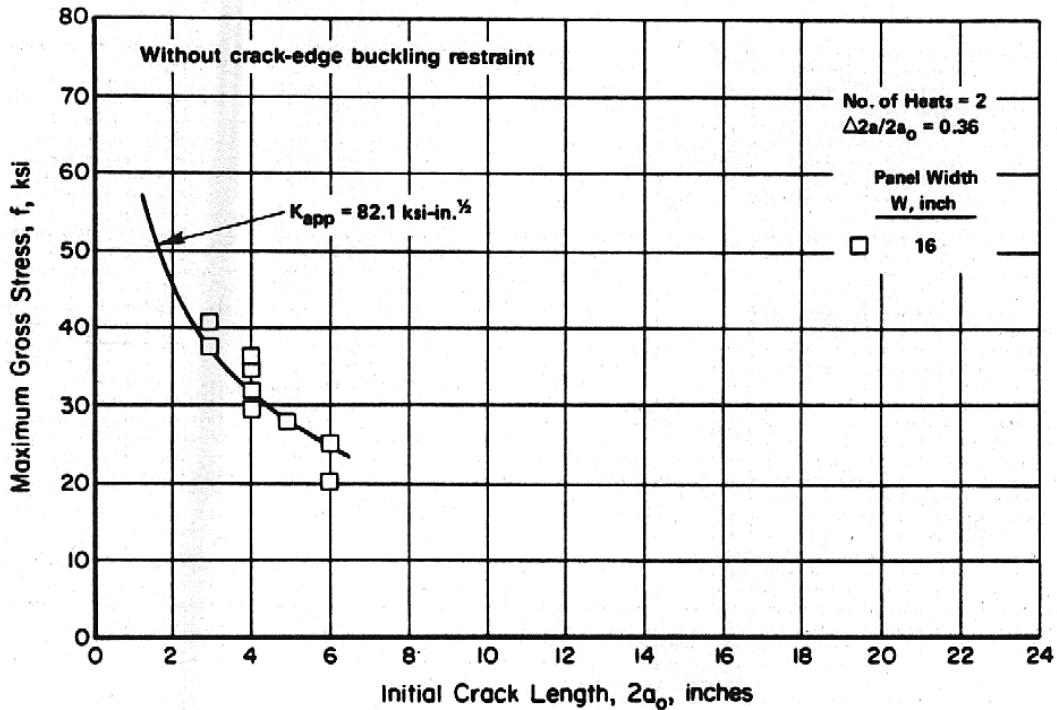

Figure 3.7.10.3.10(a). Residual strength behavior of 0.063-inch-thick 7475-T761 aluminum alloy sheet at room temperature. Crack orientation is L-T. [References 3.1.2.1.6(d) and 3.2.5.1.9(d).]

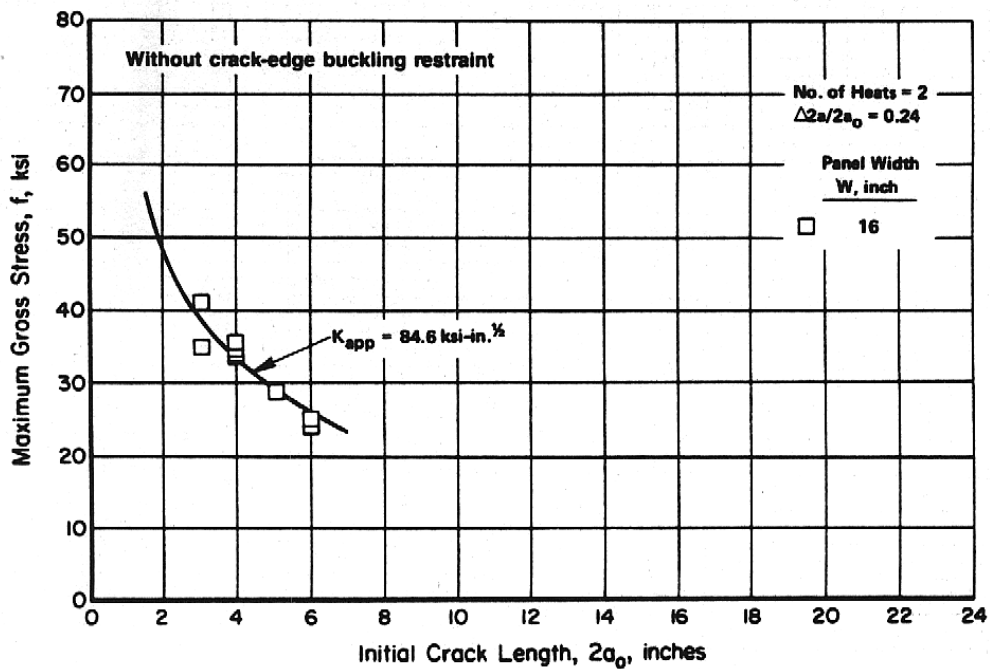

Figure 3.7.10.3.10(b). Residual strength behavior of 0.063-inch-thick 7475-T761 aluminum alloy sheet at room temperature. Crack orientation is T-L. [References 3.1.2.1.6(d) and 3.2.5.1.9(d).]

3.8 200.0 SERIES CAST ALLOYS

Alloys of the 200 series contain copper as the principal alloying element, and are particularly useful for elevated temperature applications.

3.8.1 A201.0 ALLOY

3.8.1.0 Comments and Properties— A201.0 is a high-strength, heat-treatable Al-Cu-Ag casting alloy. In the T7 (overaged) temper, it possesses high strength, moderate ductility and optimum resistance to stress-corrosion cracking. Refer to Section 3.1.3.4 for comments regarding the weldability of the alloy.

A material specification covering this alloy is presented in Table 3.8.1.0(a). Room-temperature mechanical and physical properties are presented in Table 3.8.1.0(b). The effect of temperature on thermal expansion is shown in Figure 3.8.1.0.

Table 3.8.1.0(a). Material Specification for A201.0 Aluminum Alloy

Specification	Form
AMS-A-21180	Casting (T7 temper)

The temper index for A201.0 is as follows:

<u>Section</u>	<u>Temper</u>
3.8.1.1	T7

3.8.1.1 T7 Temper— Figure 3.8.1.1.6 presents a typical tensile stress-strain curve. Strain control fatigue data are shown in Figures 3.8.1.1.8(a) through (c).

Table 3.8.1.0(b). Design Mechanical and Physical Properties of A201.0 Aluminum Alloy Casting

Specification	AMS-A-21180			
Form	Casting			
Temper	T7			
Location Within Casting	Designated area		Nondesignated area	
Strength Class Number ^a	1	2	10	11
Basis	S	S	S	S
Mechanical Properties^{b,c}:				
F_{tu} , ksi:	60	60	60	56
F_{ty} , ksi:	50	50	50	48
F_{cy} , ksi:	51	51	51	49
F_{su} , ksi:	36	36	36	34
F_{bru}^d , ksi:				
(e/D = 1.5)	95	95	95	88
(e/D = 2.0)	122	122	122	114
F_{bry}^d , ksi:				
(e/D = 1.5)	74	74	74	71
(e/D = 2.0)	87	87	87	83
e , percent	3	5	3	1.5
E , 10 ³ ksi	10.3			
E_c , 10 ³ ksi	10.7			
G , 10 ³ ksi	4.0			
μ	0.33			
Physical Properties:				
ω , lb/in. ³	0.101			
C , Btu/(lb)(°F)	0.22 (at 212°F)			
K , Btu/[(hr)(ft ²)(°F)/ft]	70 (at 77°F)			
α , 10 ⁻⁶ in./in./°F	See Figure 3.8.1.0			

- a The attainable strength class number is dependent on the casting configuration, complexity, and size (both weight and wall thickness). Favorable experience with a particular configuration may allow some foundries to produce a higher strength class number than others. In case of doubt regarding the strength class number, the designer should consult or negotiate with the foundry to determine the proper strength class number to assign for a specific casting.
- b For any casting process; i.e., special mold, permanent mold, or sand mold (including chilling).
- c The mechanical properties shown are reliably obtainable in castings of this alloy and heat-treat condition when produced under the quality assurance provisions of AMS-A-21180. These provisions require preproduction approval, documentation of foundry procedures, and specific destructive and nondestructive testing procedures for the acceptance of each production lot of castings. Strict adherence to these requirements is mandatory if these properties are to be reliably assured in each casting.
- d Bearing values are “dry pin” values per Section 1.4.7.1.

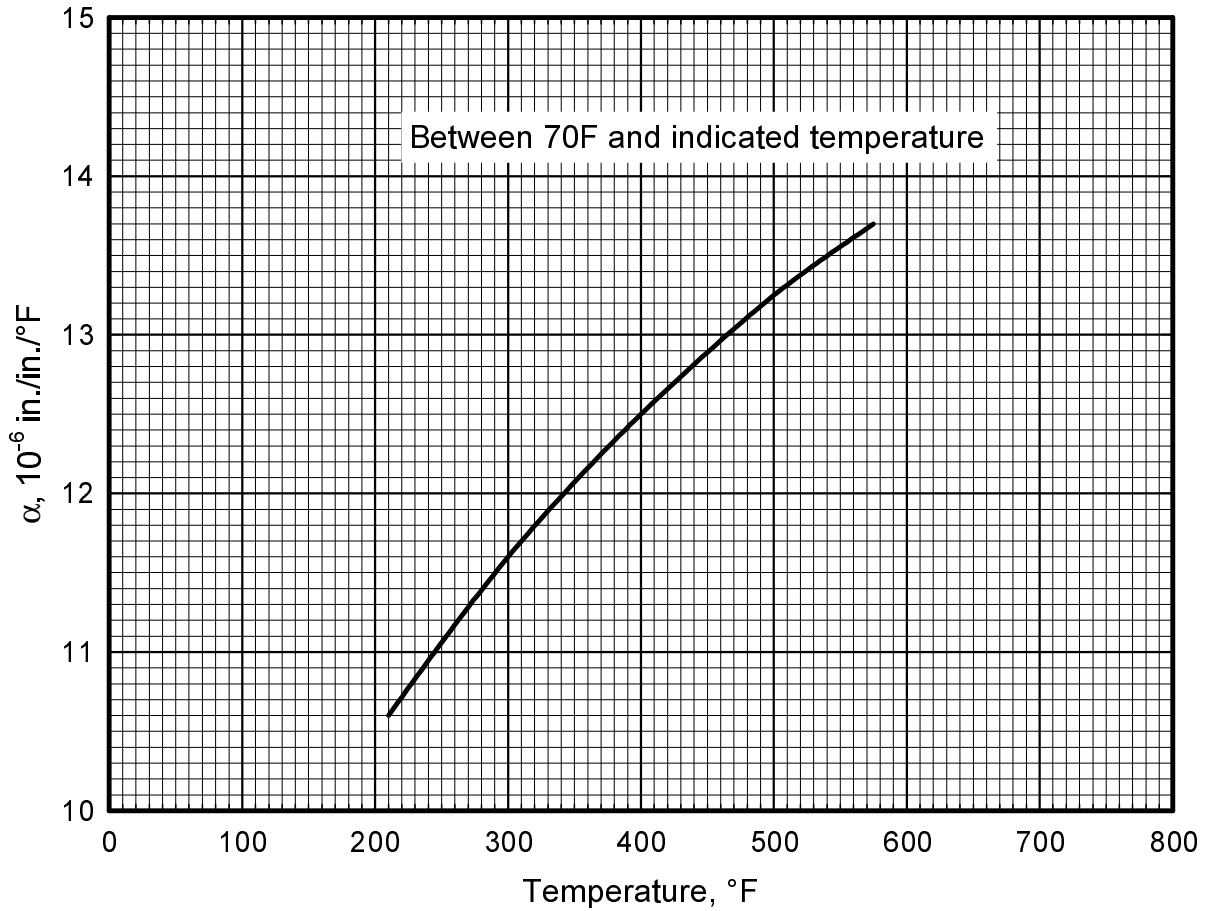

Figure 3.8.1.0. Effect of temperature on the thermal expansion of A201.0 aluminum alloy casting.

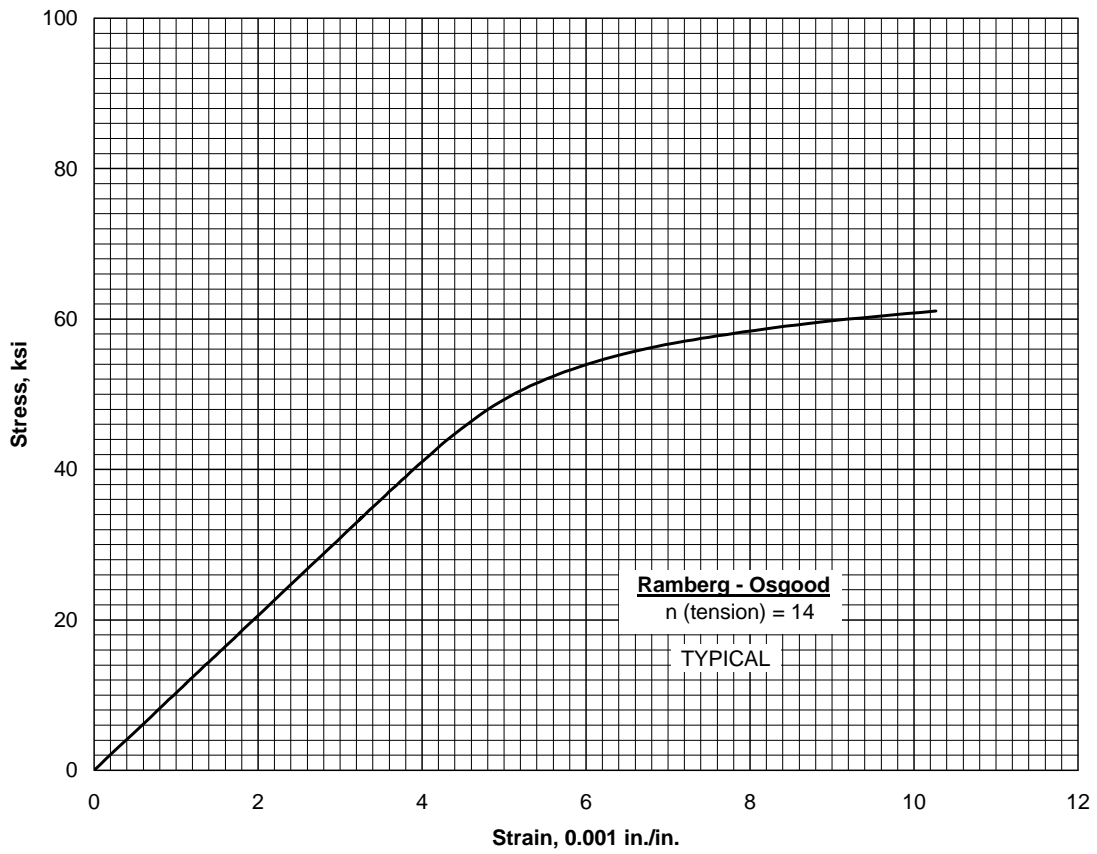

Figure 3.8.1.1.6. Typical tensile stress-strain curve for A201.0-T7 aluminum alloy casting, designated area, at room temperature.

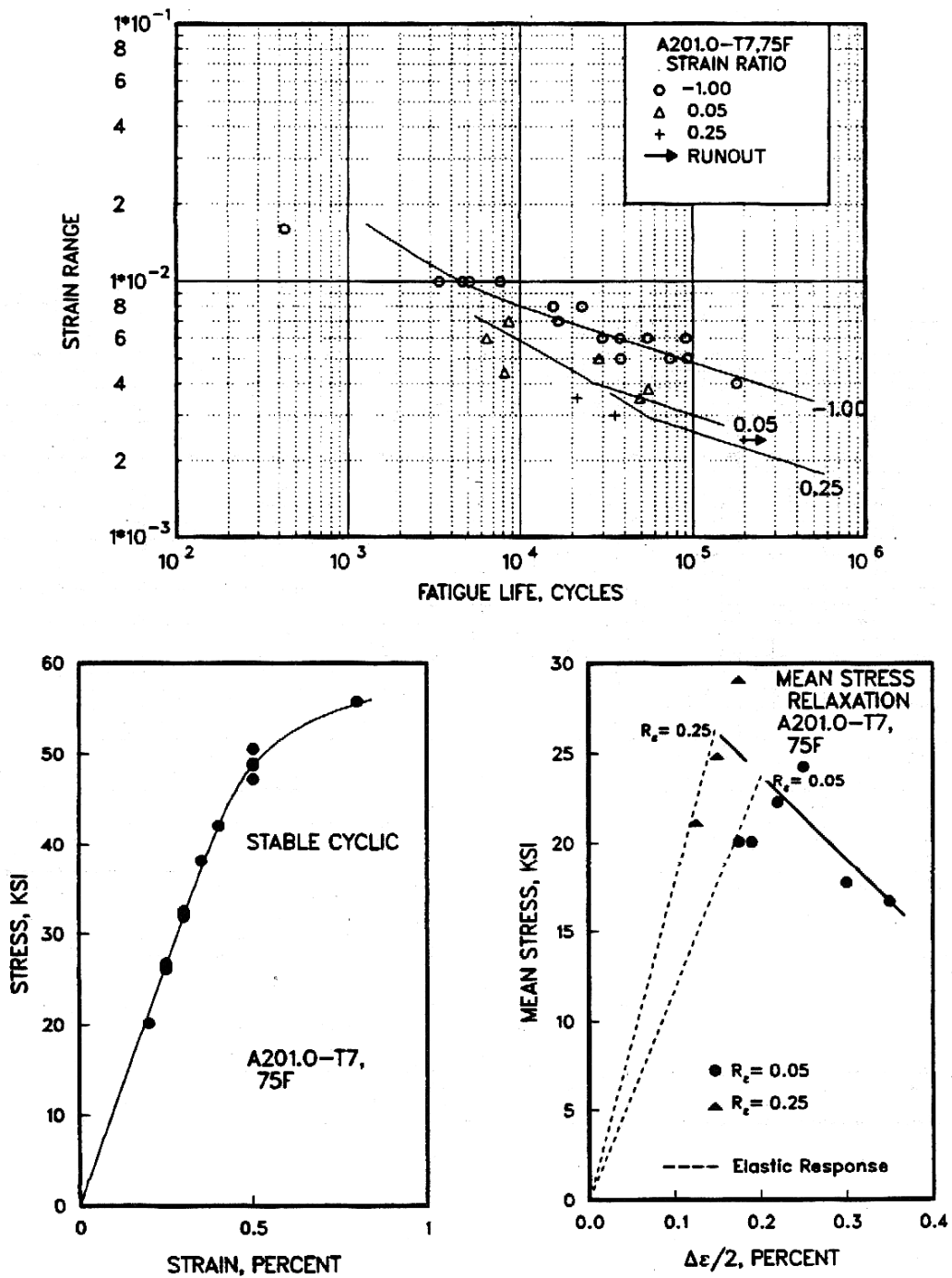

Figure 3.8.1.1.8(a). Best-fit ϵ/N curves, cyclic stress-strain curve, and mean stress relaxation curve for A201.0-T7 casting at 75°F.

Correlative Information for Figure 3.8.1.1.8(a)

Product Form/Thickness: Casting

Thermal Mechanical Processing History: T7, HIP

Properties:

<u>TUS, ksi</u>	<u>TYS, ksi</u>	<u>E, ksi</u>	<u>Temp., °F</u>
57-66	45-57	10,800	75

Stress-Strain Equations:

Cyclic (Companion Specimen)

Proportional Limit = 42 ksi

$$(\Delta\sigma/2) = 72(\Delta\varepsilon_p/2)^{0.058}$$

Mean Stress Relaxation, ksi

$$\sigma_m = 33.3 - 4755(\Delta\varepsilon/2)$$

Specimen Details: Uniform gage test section
0.250 inch diameter

References: 3.8.1.1.8(a) and (b)

Test Parameters:

Strain Rate/Frequency - 20 cpm

Wave Form - Triangular

Temperature - 75 °F

Atmosphere - Air

No. of Heats/Lots: 3

Equivalent Strain Equation:

$$\log N_f = -6.54 - 4.60 \log (\varepsilon_{eq})$$

$$\varepsilon_{eq} = (\Delta\varepsilon)^{0.37} (S_{max}/E)^{0.63}$$

Std. Error of Estimate, Log (Life) = 0.242

Standard Deviation, Log (Life) = 0.587

Adjusted R² Statistic: 83%

Sample Size: 26

[Caution: The equivalent strain model may provide unrealistic life predictions for strain ratios and ranges beyond those represented above.]

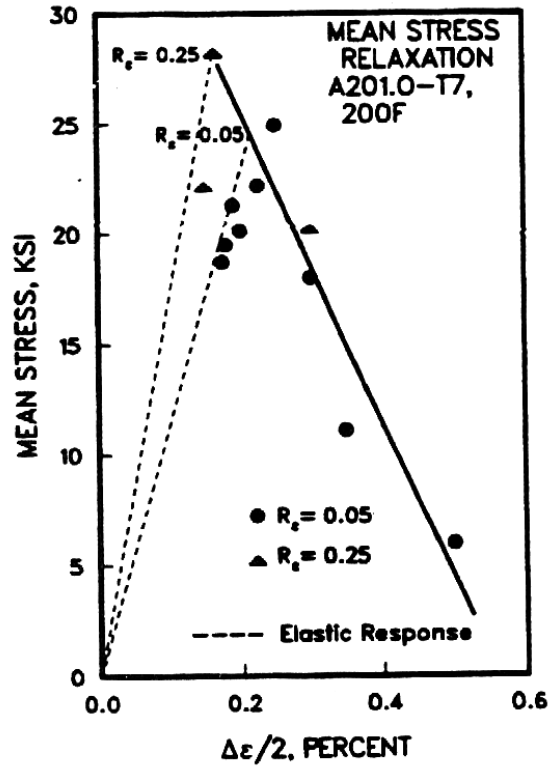
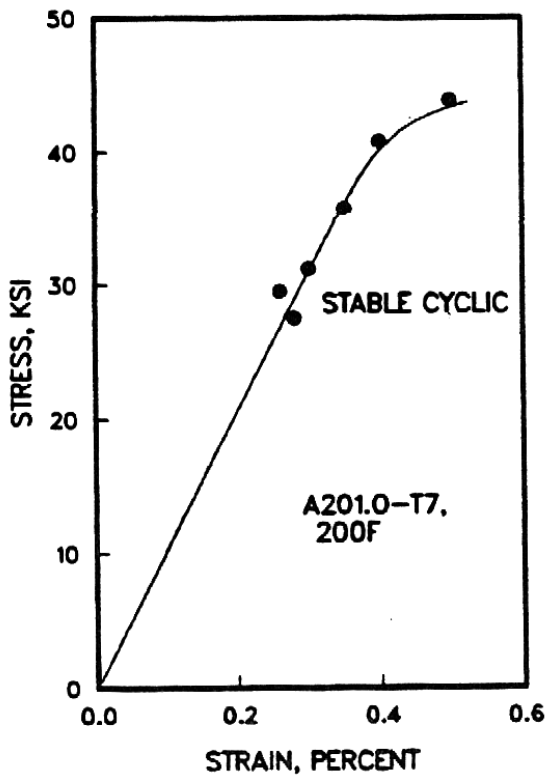
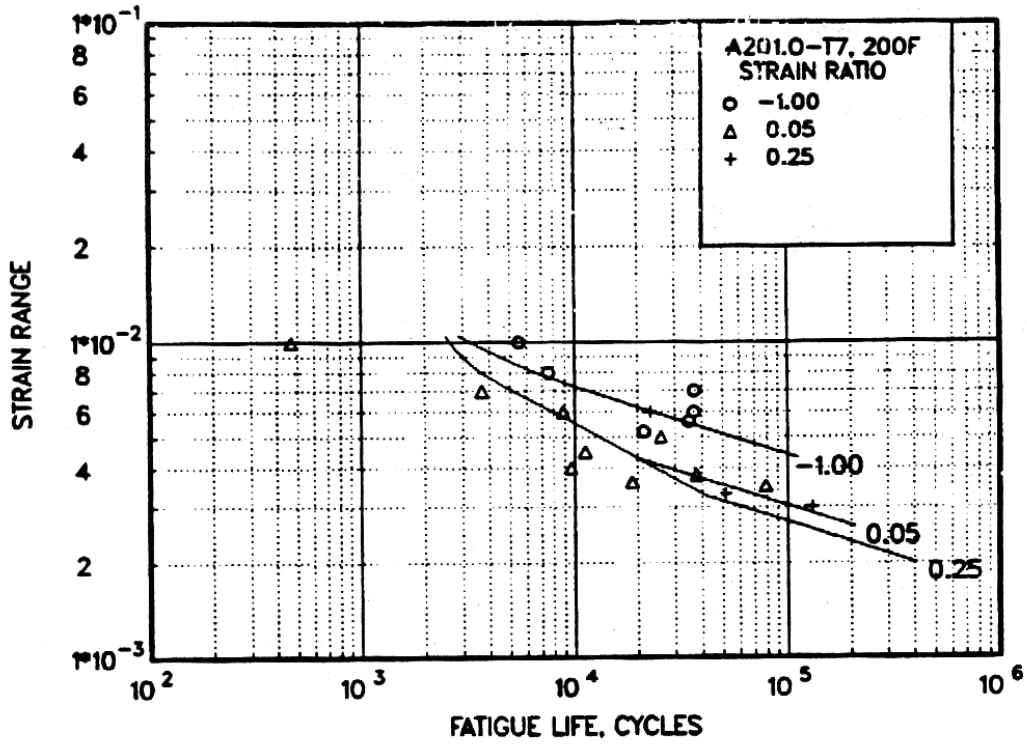

Figure 3.8.1.1.8(b). Best-fit ϵ/N curves, cyclic stress-strain curve, and mean stress reduction curve for A201.0-T7 casting at 200°F.

Correlative Information for Figure 3.8.1.1.8(b)

Product Form/Thickness: Casting

Thermal Mechanical Processing History: T7, HIP

Properties:

<u>TUS, ksi</u>	<u>TYS, ksi</u>	<u>E, ksi</u>	<u>Temp., °F</u>
53-59	47-55	10,339	200

Stress-Strain Equations:

Cyclic (Companion Specimen)

Proportional Limit = 39 ksi

$$(\Delta\sigma/2) = 58(\Delta\varepsilon_p/2)^{0.041}$$

Mean Stress Relaxation, ksi

$$\sigma_m = 39.7 - 7049(\Delta\varepsilon/2)$$

Specimen Details: Uniform gage test section
0.250 inch diameter

Reference: 3.8.1.1.8(a)

Test Parameters:

Strain Rate/Frequency - 20 cpm

Wave Form - Triangular

Temperature - 200 °F

Atmosphere - Air

No. of Heats/Lots: 3

Equivalent Strain Equation:

$$\text{Log } N_f = -6.68 - 4.66 \log (\varepsilon_{eq})$$

$$\varepsilon_{eq} = (\Delta\varepsilon)^{0.50} (S_{max}/E)^{0.50}$$

Std. Error of Estimate, Log (Life) = 0.359

Standard Deviation in Log (Life) = 0.561

Adjusted R² Statistic: 59%

Sample Size: 18

[Caution: The equivalent strain model may provide unrealistic life predictions for strain ratios and ranges beyond those represented above.]

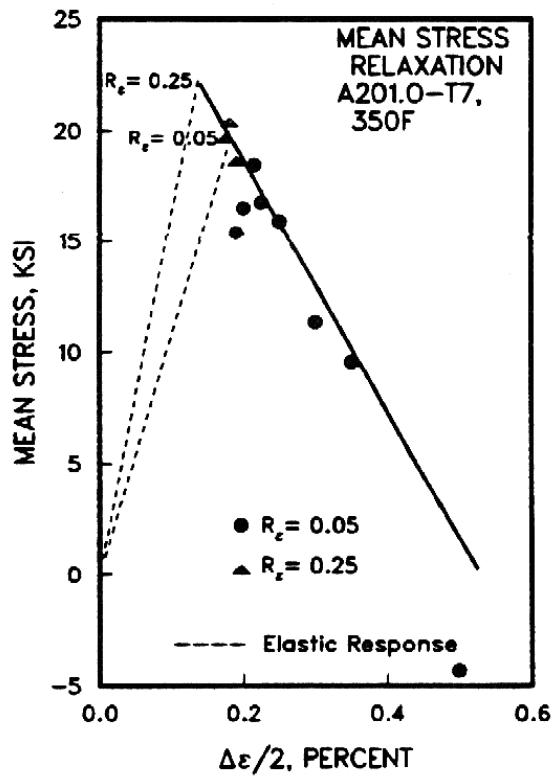
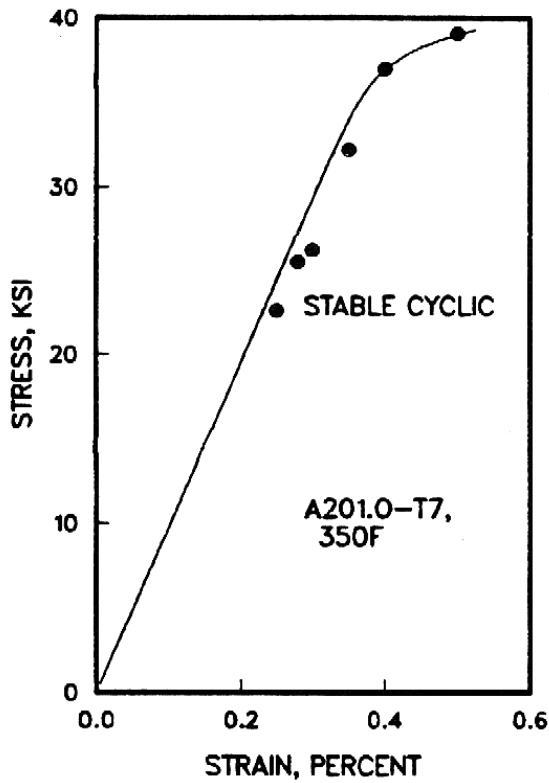
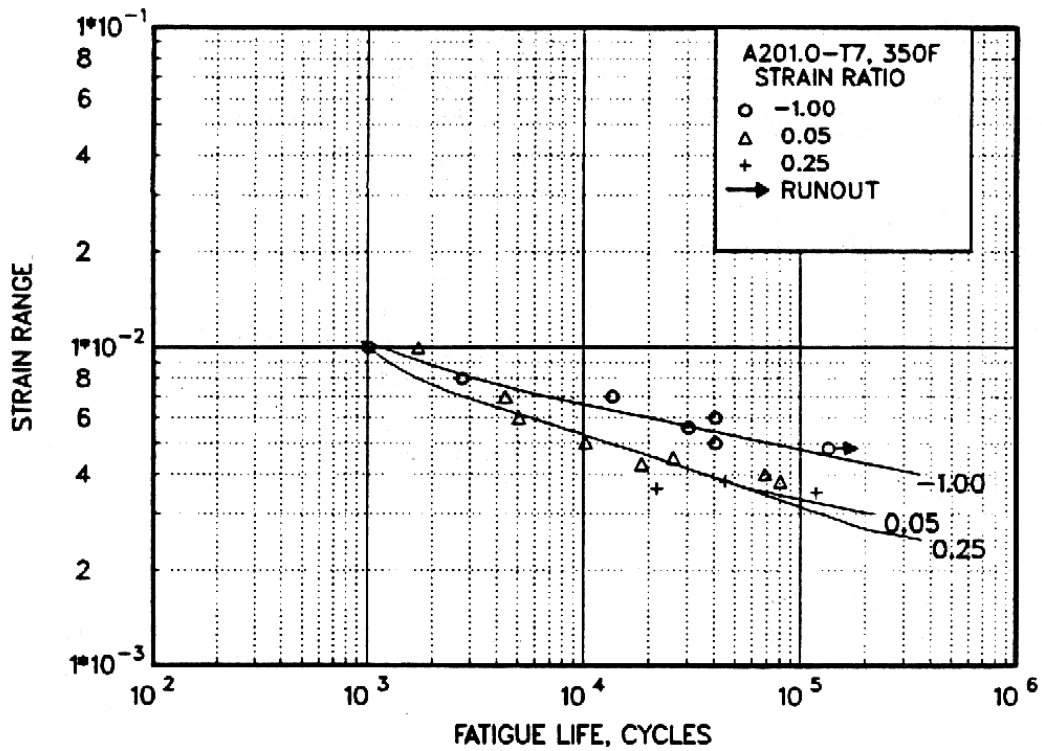

Figure 3.8.1.1.8(c). Best-fit ϵ/N curves, cyclic stress-strain curve, and mean stress relaxation curve for A201.0-T7 casting at 350°F.

Correlative Information for Figure 3.8.1.1.8(c)

Product Form/Thickness: Casting

Thermal Mechanical Processing History: T7, HIP

Properties:

<u>TUS, ksi</u>	<u>TYS, ksi</u>	<u>E, ksi</u>	<u>Temp., °F</u>
48-53	40-48	9,783	350

Stress-Strain Equations:

Cyclic (Companion Specimen)

Proportional Limit = 36 ksi

$$(\Delta\sigma/2) = 50(\Delta\varepsilon_p/2)^{0.036}$$

Mean Stress Relaxation, ksi

$$\sigma_m = 30.0 - 5664(\Delta\varepsilon/2)$$

Specimen Details: Uniform gage test section
0.250 inch diameter

Reference: 3.8.1.1.8(a)

Test Parameters:

Strain Rate/Frequency - 20 cpm

Wave Form - Triangular

Temperature - 350 °F

Atmosphere - Air

No. of Heats/Lots: 3

Equivalent Strain Equation:

$$\text{Log } N_f = -12.44 - 7.07 \log (\varepsilon_{eq})$$

$$\varepsilon_{eq} = (\Delta\varepsilon)^{0.52} (S_{max}/E)^{0.48}$$

Std. Error of Estimate, Log (Life) =

$$0.000817 (1/\varepsilon_{eq})$$

Standard Deviation, Log (Life) = 0.545

Adjusted R² Statistic: 93%

Sample Size: 18

[Caution: The equivalent strain model may provide unrealistic life predictions for strain ratios and ranges beyond those represented above.]

3.9 300.0 SERIES CAST ALLOYS

Casting alloys of the 300.0 series contain silicon with added copper and/or magnesium as the principal alloying elements. They are heat treatable. Because of the high silicon content, they are among the easiest to cast by a variety of techniques. They have high resistance to corrosion.

3.9.1 354.0 ALLOY

3.9.1.0 Comments and Properties — 354.0 is a heat-treatable Al-Si-Mg alloy being among the highest strength of commercial casting alloys. It has good casting characteristics; however, its use is generally restricted to permanent mold castings. Refer to Section 3.1.3.4 for comments regarding the weldability.

A material specification for 354.0 aluminum alloy is presented in Table 3.9.1.0(a). Room-temperature mechanical and physical properties are shown in Table 3.9.1.0(b).

Table 3.9.1.0(a). Material Specifications for 354.0 Aluminum Alloy

Specification	Form
AMS-A-21180	Casting

Table 3.9.1.0(b). Design Mechanical and Physical Properties of 354.0 Aluminum Alloy Casting

Specification	AMS-A-21180			
Form	Casting			
Temper	T6			
Location Within Casting	Designated area		Nondesignated area	
Strength Class Number ^a	1	2	10	11
Basis	S	S	S	S
Mechanical Properties^{b,c}:				
F_{tu} , ksi	47	50	47	43
F_{ty} , ksi	36	42	36	33
F_{cy} , ksi	36	42	36	33
F_{su} , ksi	29	31	29	27
F_{bru}^d , ksi:				
(e/D = 1.5)	81	86	81	74
(e/D = 2.0)	101	107	101	92
F_{bry}^d , ksi:				
(e/D = 1.5)	57	66	57	52
(e/D = 2.0)	67	78	67	62
e , percent	3	2	3	2
E , 10 ³ ksi	10.6			
E_c , 10 ³ ksi	10.8			
G , 10 ³ ksi	4.0			
μ	0.33			
Physical Properties:				
ω , lb/in. ³	0.098			
C , Btu/(lb)(°F)	0.23 (at 212 °F)			
K , Btu/[(hr)(ft ²)(°F)/ft]			
α , 10 ⁻⁶ in./in./°F	1.6 (68 to 212 °F)			

- a The attainable strength class number is dependent on the casting configuration, complexity, and size (both weight and wall thickness). Favorable experience with a particular configuration may allow some foundries to produce a higher strength class number than others. In case of doubt regarding the strength class number, the designer should consult or negotiate with the foundry to determine the proper strength class number to assign for a specific casting.
- b For any casting process; i.e., special mold, permanent mold, or sand mold (including chilling).
- c The mechanical properties shown are reliably obtainable in castings of this alloy and heat-treat condition when produced under the quality assurance provisions of AMS-A-21180. These provisions require preproduction approval, documentation of foundry procedures, and specific destructive and nondestructive testing procedures for the acceptance of each production lot of castings. Strict adherence to these requirements is mandatory if these properties are to be reliably assured in each casting.
- d Bearing values are “dry pin” values per Section 1.4.7.1.

3.9.2 355.0 ALLOY

3.9.2.0 Comments and Properties — 355.0 is a heat-treatable Al-Si-Mg alloy that is readily cast and has good pressure tightness. Refer to Section 3.1.3.4 for comments regarding the weldability of the alloy.

A material specification for 355.0 aluminum alloy is presented in Table 3.9.2.0(a). Room-temperature mechanical and physical properties are shown in Table 3.9.2.0(b). The effect of temperature on thermal expansion is shown in Figure 3.9.2.0.

Table 3.9.2.0(a). Material Specification for 355.0 Aluminum Alloy

Specification	Form
AMS 4281	Permanent mold casting

Table 3.9.2.0(b). Design Mechanical and Physical Properties of 355.0 Aluminum Alloy

Specification	AMS 4281
Form	Permanent mold casting
Temper	T6
Location Within Casting	As specified
Basis	S
Mechanical Properties:	
F_{tu} , ksi	27 ^a
F_{ty} , ksi	17 ^a
F_{cy} , ksi	17
F_{su} , ksi	17
F_{bru}^b , ksi:	
(e/D = 1.5)	46
(e/D = 2.0)	58
F_{bry}^b , ksi:	
(e/D = 1.5)	27
(e/D = 2.0)	32
e , percent	0.4 ^a
E , 10 ³ ksi	10.3
E_c , 10 ³ ksi	10.3
G , 10 ³ ksi	3.8
μ	0.33
Physical Properties:	
ω , lb/in. ³	0.098
C , Btu/(lb)(°F)	0.23 (at 212°F)
K , Btu/[(hr)(ft ²)(°F)/ft]	88 (at 77°F)
α , 10 ⁻⁶ in./in./°F	See Figure 3.9.2.0

a Conformance to tensile property requirements is determined by testing specimens cut from casting only when specified on drawing.

b Bearing values are "dry pin" values per Section 1.4.7.1.

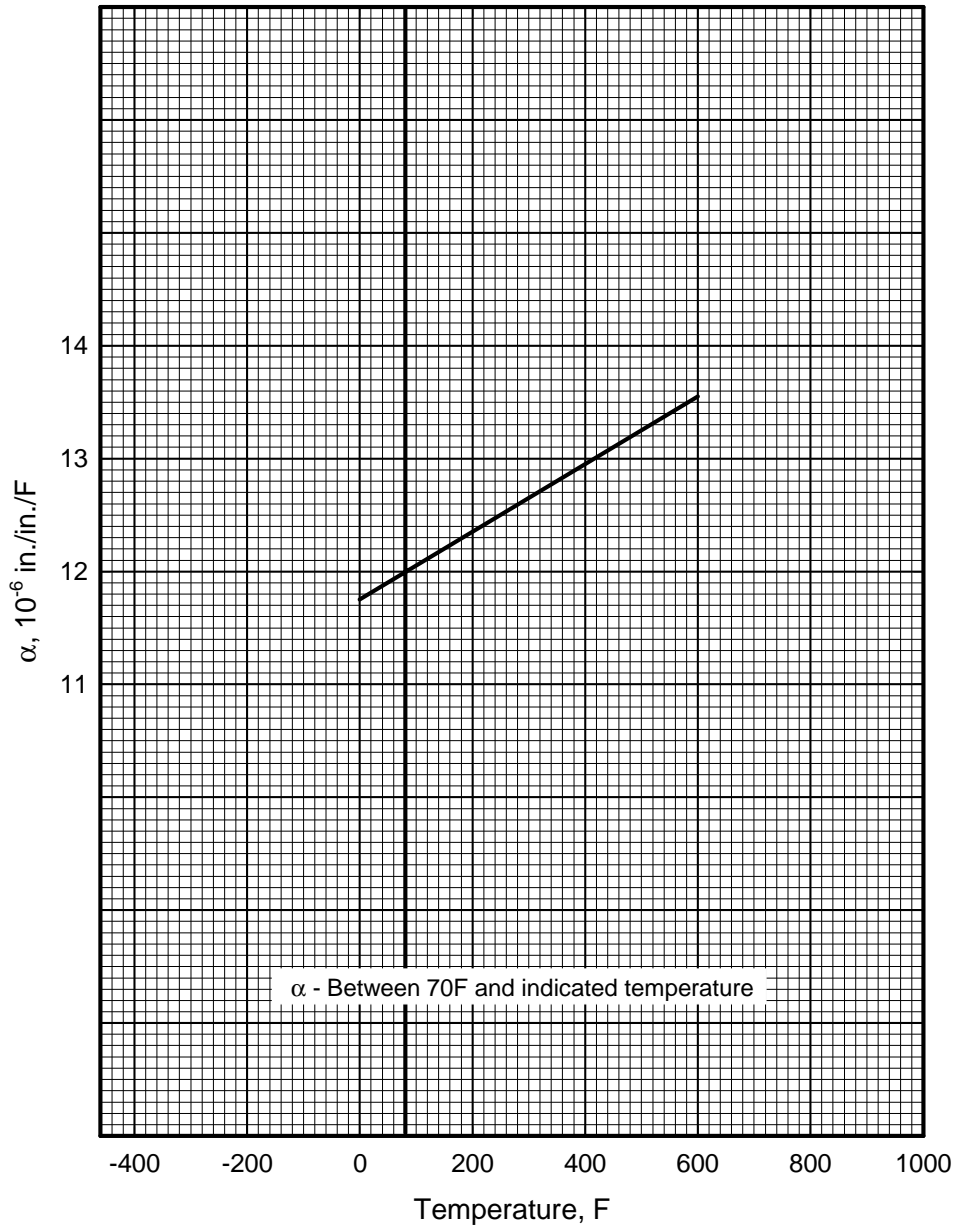

Figure 3.9.2.0. Effect of temperature on the thermal expansion of 355.0 aluminum alloy casting.

3.9.3 C355.0 ALLOY

3.9.3.0 Comments and Properties — C355.0 is an Al-Si-Mg alloy similar to 355.0 but has impurities controlled to lower limits resulting in higher strengths. It has good casting characteristics. Refer to Section 3.1.3.4 for comments regarding the weldability of the alloy.

A material specification for C355.0 aluminum alloy is presented in Table 3.9.3.0(a). Room-temperature mechanical and physical properties are shown in Table 3.9.3.0(b).

Table 3.9.3.0(a). Material Specification for C355.0 Aluminum Alloy

Specification	Form
AMS-A-21180	Casting

Table 3.9.3.0(b). Design Mechanical and Physical Properties of C355.0 Aluminum Alloy Casting

Specification	AMS-A-21180					
Form	Casting					
Location Within Casting	T6					
Strength Class Number ^a	1	2	3	10	11	12
Basis	S	S	S	S	S	S
Mechanical Properties^{b,c}:						
F_{tu} , ksi	41	44	50	41	37	35
F_{ty} , ksi	31	33	40	31	30	28
F_{cy} , ksi	31	33	40	31	30	28
F_{su} , ksi	26	28	31	26	23	22
F_{bru}^d , ksi:						
(e/D = 1.5)	70	75	86	70	63	60
(e/D = 2.0)	88	94	107	88	79	75
F_{bry}^d , ksi:						
(e/D = 1.5)	49	52	63	49	47	44
(e/D = 2.0)	58	62	75	58	59	52
e , percent	3	3	2	3	1	1
E , 10 ³ ksi	10.1					
E_c , 10 ³ ksi	10.3					
G , 10 ³ ksi	3.85					
μ	0.33					
Physical Properties:						
ω , lb/in. ³	0.098					
C , Btu/(lb)(°F)	0.23 (at 212°F)					
K , Btu/[(hr)(ft ²)(°F)/ft]	88 (at 77°F)					
α , 10 ⁻⁶ in./in./°F	12.4 (68 to 212°F)					

- a The attainable strength class number is dependent on the casting configuration, complexity, and size (both weight and wall thickness). Favorable experience with a particular configuration may allow some foundries to produce a higher strength class number than others. In case of doubt regarding the strength class number, the designer should consult or negotiate with the foundry to determine the proper strength class number to assign for a specific casting.
- b For any casting process; i.e., special mold, permanent mold, or sand mold (including chilling).
- c The mechanical properties shown are reliably obtainable in castings of this alloy and heat-treat condition when produced under the quality assurance provisions of AMS-A-21180. These provisions require preproduction approval, documentation of foundry procedures, and specific destructive and nondestructive testing procedures for the acceptance of each production lot of castings. Strict adherence to these requirements is mandatory if these properties are to be reliably assured in each casting.
- d Bearing values are "dry pin" values per Section 1.4.7.1.

3.9.4 356.0 ALLOY

3.9.4.0 Comments and Properties — 356.0 is among the easiest of alloys to cast by a variety of techniques. It is heat treatable, has intermediate strengths, and has high resistance to corrosion. Refer to Section 3.1.3.4 for comments regarding the weldability of the alloy.

Material specifications for 356.0 aluminum alloy are presented in Table 3.9.4.0(a). Room-temperature mechanical and physical properties are shown in Table 3.9.4.0(b). The effect of temperature on thermal expansion is given in Figure 3.9.4.0.

Table 3.9.4.0(a). Material Specifications for 356.0 Aluminum Alloy

Specification	Form
AMS 4284	Permanent mold casting
AMS 4217	Sand casting
AMS 4260	Investment casting

Table 3.9.4.0(b). Design Mechanical and Physical Properties of 356.0 Aluminum Alloy

Specification	AMS 4217	AMS 4260	AMS 4284
Form	Sand casting	Investment casting	Permanent mold casting
Temper	T6	T6	T6
Location Within Casting . .	Thick and thin areas	As specified	As specified
Basis	S	S	S
Mechanical Properties:			
F_{tu} , ksi	22 ^{a,b}	25 ^a	25 ^a
F_{ty} , ksi	15 ^{a,b}	16 ^a	16 ^a
F_{cy} , ksi	15	16	16
F_{su} , ksi	14	16	16
F_{bru}^c , ksi:			
(e/D = 1.5)	38	43	43
(e/D = 2.0)	47	53	53
F_{bry}^c , ksi:			
(e/D = 1.5)	24	25	25
(e/D = 2.0)	28	30	30
e , percent	0.7 ^{a,b}	1 ^a	0.7 ^a
E , 10 ³ ksi	10.3		
E_c , 10 ³ ksi	10.3		
G , 10 ³ ksi	3.85		
μ	0.33		
Physical Properties:			
ω , lb/in. ³	0.097		
C , Btu/(lb)(°F)	0.23 (at 212°F)		
K , Btu/[(hr)(ft ²)(°F)/ft] . .	88 (at 77°F)		
α , 10 ⁻⁶ in./in./°F	See Figure 3.9.4.0		

- a Conformance to tensile property requirements is determined by testing specimens cut from casting only when specified on drawing.
- b Not minimum values, but based upon average of not less than four specimens.
- c Bearing values are "dry pin" values per Section 1.4.7.1.

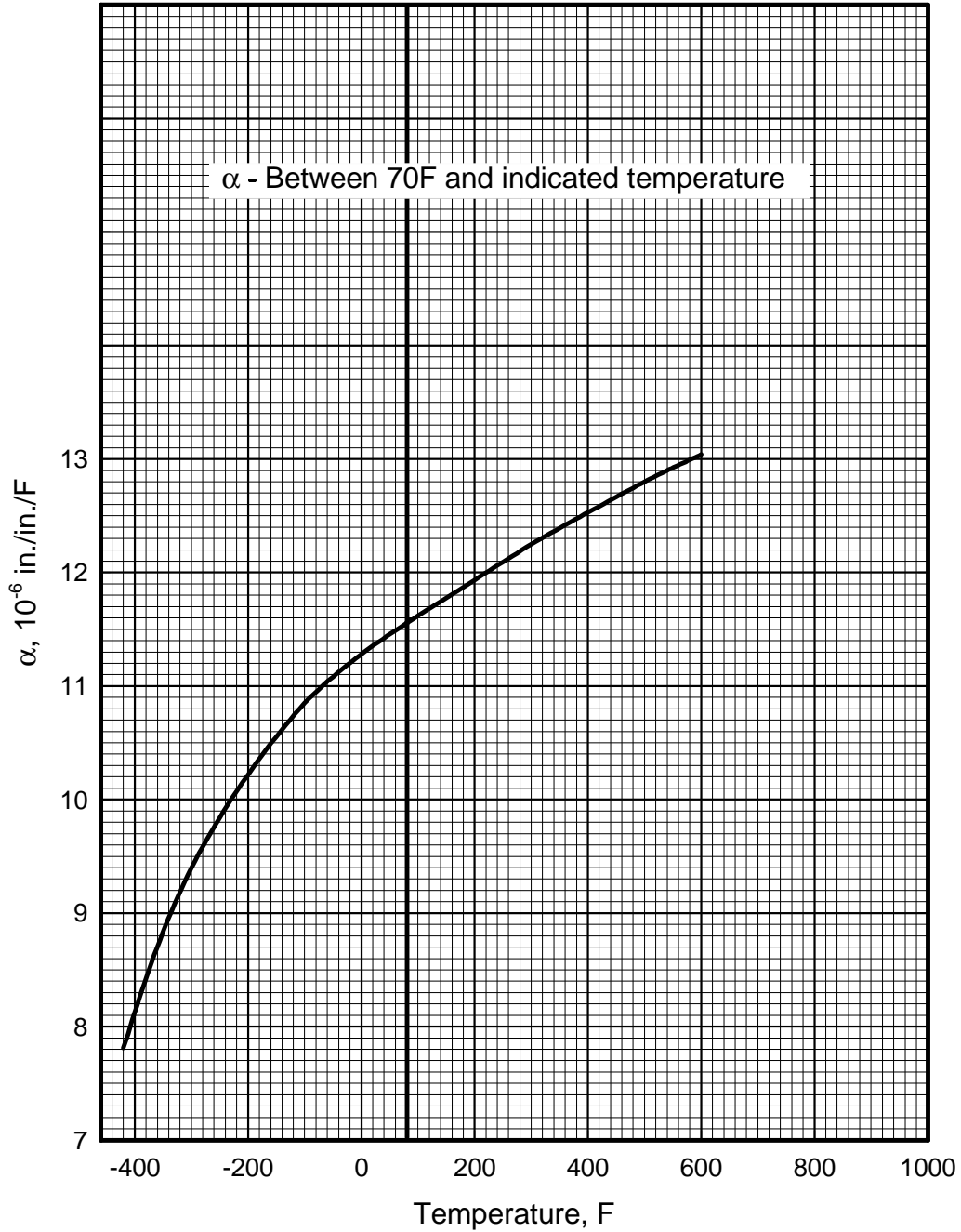

Figure 3.9.4.0. Effect of temperature on the thermal expansion of 356.0 aluminum alloy casting.

3.9.5 A356.0 ALLOY

3.9.5.0 Comments and Properties — A356.0 is an Al-Si-Mg alloy similar to 356.0, but with impurities controlled to lower limits resulting in higher strengths and ductility. It has good casting characteristics and high resistance to corrosion. Refer to 3.1.3.4 for comments regarding the weldability of the alloy.

Material specifications for A356.0 aluminum alloy are presented in Table 3.9.5.0(a). Room-temperature mechanical and physical properties are shown in Tables 3.9.5.0(b) and (c).

Table 3.9.5.0(a). Material Specifications for A356.0 Aluminum Alloy

Specification	Form
AMS-A-21180	Casting
AMS 4218	Casting

The temper index for A356.0 is as follows:

<u>Section</u>	<u>Temper</u>
3.9.5.1	T6P
3.9.5.2	T6

3.9.5.1 T6P Temper — Tensile stress-strain and full-range stress-strain curves at room temperature are presented in Figures 3.9.5.1.6(a) and (b), respectively.

Table 3.9.5.0(b). Design Mechanical and Physical Properties of A356.0 Aluminum Alloy Casting

Specification	AMS-A-21180					
Form	Casting					
Temper	T6					
Location Within Casting ..	Designated area			Nondesignated area		
Strength Class Number ^a ..	1	2	3	10	11	12
Basis	S	S	S	S	S	S
Mechanical Properties^{b,c}:						
F_{tu} , ksi	38	40	45	38	33	32
F_{ty} , ksi	28	30	34	28	27	22
F_{cy} , ksi	28	30	34	28	27	22
F_{su} , ksi	24	25	28	24	21	20
F_{bru}^d , ksi:						
(e/D = 1.5)	65	69	77	65	57	55
(e/D = 2.0)	81	86	96	81	71	68
F_{bry}^d , ksi:						
(e/D = 1.5)	44	47	54	44	43	35
(e/D = 2.0)	52	56	63	52	50	41
e , percent	5	3	3	5	3	2
E , 10^3 ksi	10.4					
E_c , 10^3 ksi	10.5					
G , 10^3 ksi	3.9					
μ	0.33					
Physical Properties:						
ω , lb/in. ³	0.097					
C , Btu/(lb)(°F)	0.23 (at 212°F)					
K , Btu/[(hr)(ft ²)(°F)/ft] ..	88 (at 77°F)					
α , 10^{-6} in./in./°F	See Figure 3.9.4.0					

- a The attainable strength class number is dependent on the casting configuration, complexity, and size (both weight and wall thickness). Favorable experience with a particular configuration may allow some foundries to produce a higher strength class number than others. In case of doubt regarding the strength class number, the designer should consult or negotiate with the foundry to determine the proper strength class number to assign for a specific casting.
- b For any casting process; i.e., special mold, permanent mold, or sand mold (including chilling).
- c The mechanical properties shown are reliably obtainable in castings of this alloy and heat-treat condition when produced under the quality assurance provisions of AMS-A-21180. These provisions require preproduction approval, documentation of foundry procedures, and specific destructive and nondestructive testing procedures for the acceptance of each production lot of castings. Strict adherence to these requirements is mandatory if these properties are to be reliably assured in each casting.
- d Bearing values are “dry pin” values per Section 1.4.7.1.

Table 3.9.5.0(c). Design and Physical Properties of A356.0 Aluminum Alloy Casting

Specification	AMS 4218
Form	Sand, investment, permanent mold, and composite castings
Temper	T6P ^a
Location Within Casting	Any
Basis	S
Mechanical Properties:^b	
F_{tu} , ksi	32
F_{ty} , ksi	22
F_{cy} , ksi	22
F_{su} , ksi	20
F_{bru} , ksi:	
(e/D = 1.5)	55
(e/D = 2.0)	68
F_{bry} , ksi:	
(e/D = 1.5)	35
(e/D = 2.0)	41
e , percent	2
E , 10^3 ksi	10.4
E_c , 10^3 ksi	10.5
G , 10^3 ksi	3.9
μ	0.33
Physical Properties:	
ω , lb/in. ³	0.097
C , Btu/(lb)(°F)	0.23 (at 212°F)
K Btu/[(hr)(ft ²)(°F)/ft]	88 (at 77°F)
α , 10^{-6} in./in./°F	See Figure 3.9.4.0

a The letter, P, indicates a variation compared to the standard heat treatment procedure of this temper and/or a difference in the minimum tensile property requirements compared to the Aluminum Association's registered limits.

b The mechanical properties shown are reliably obtainable when produced under the quality assurance provisions of AMS 4218. These procedures require radiographic control and specific destructive testing for acceptance of each production lot. Strict adherence to these requirements is mandatory if these properties are to be reliably assured in each casting.

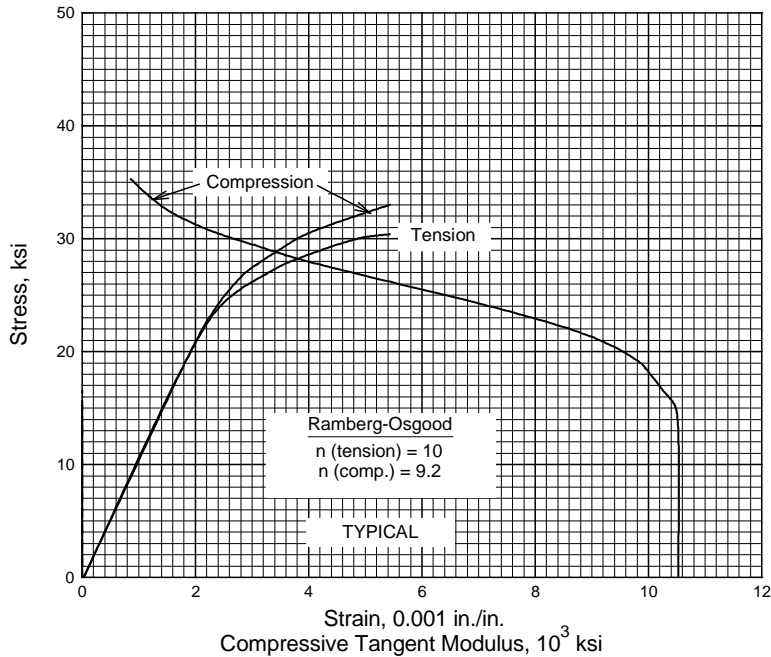

Figure 3.9.5.1.6(a). Typical tensile and compressive stress-strain and compressive tangent-modulus curves for A356.0-T6P aluminum alloy casting at room temperature.

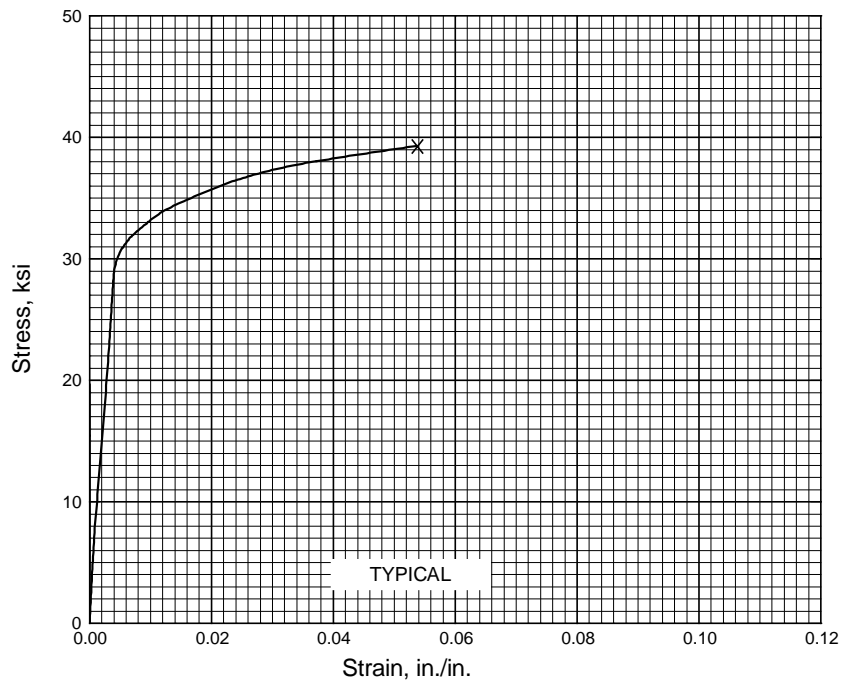

Figure 3.9.5.1.6(b). Typical tensile stress-strain (full-range) curve for A356.0-T6P aluminum alloy casting at room temperature.

3.9.6 A357.0 ALLOY

3.9.6.0 Comments and Properties — A357.0 is a heat-treatable Al-Si-Mg alloy generally used for permanent mold and premium quality castings in which special properties are developed by careful control of casting and chilling techniques. It has excellent casting characteristics, is heat treatable, and provides high strength, together with good toughness. The alloy also has excellent corrosion resistance. Refer to Section 3.1.3.4 for comments regarding the weldability of the alloy.

A material specification for A357.0 aluminum alloy is presented in Table 3.9.6.0(a). Room-temperature mechanical and physical properties are shown in Table 3.9.6.0(b).

Table 3.9.6.0(a). Material Specification for A357.0 Aluminum Alloy

Specification	Form
AMS-A-21180	Casting

The temper index for A357.0 is as follows:

<u>Section</u>	<u>Temper</u>
3.9.6.1	T6

3.9.6.1 T6 Temper — Figure 3.9.6.1.6 presents a typical tensile stress-strain curve.

Table 3.9.6.0(b). Design Mechanical and Physical Properties of A357.0 Aluminum Alloy Casting

Specification	AMS-A-21180				
	Casting ^a				
	T6				
	Designated area		Nondesignated area		
Form					
Temper					
Location Within Casting	1	2	10	11	12
Strength Class Number ^b	S	S	S	S	S
Basis	S	S	S	S	S
Mechanical Properties:^c					
F_{tu} , ksi	45	50	38	41	45
F_{ty} , ksi	35	40	28	31	35
F_{cy} , ksi	35	40	28	31	35
F_{su} , ksi	28	31	24	26	28
F_{bru}^d , ksi:					
(e/D = 1.5)	77	86	65	70	77
(e/D = 2.0)	96	107	81	88	96
F_{bry}^d , ksi:					
(e/D = 1.5)	55	63	44	49	55
(e/D = 2.0)	65	75	52	58	65
e , percent	3	5	5	3	3
E , 10^3 ksi	10.4				
E_c , 10^3 ksi	10.5				
G , 10^3 ksi	3.9				
μ	0.33				
Physical Properties:					
ω , lb/in. ³	0.097				
C , Btu/(lb)(°F)	0.23 (at 212°F)				
K , Btu/[(hr)(ft ²)(°F)/ft]	88 (at 77°F)				
α , 10^{-6} in./in./°F	12.0 (68 to 212°F)				

a For any casting process; i.e., special mold, permanent mold, or sand mold (including chilling).
b The attainable strength class number is dependent on the casting configuration, complexity, and size (both weight and wall thickness). Favorable experience with a particular configuration may allow some foundries to produce a higher strength class number than others. In case of doubt regarding the strength class number, the designer should consult or negotiate with the foundry to determine the proper strength class number to assign for a specific casting.
c The mechanical properties shown are reliably obtainable in castings of this alloy and heat-treat condition when produced under the quality assurance provisions of AMS-A-21180. These provisions require preproduction approval, documentation of foundry procedures, and specific destructive and nondestructive testing procedures for the acceptance of each production lot of castings. Strict adherence to these requirements is mandatory if these properties are to be reliably assured in each casting.
d Bearing values are “dry pin” values per Section 1.4.7.1.

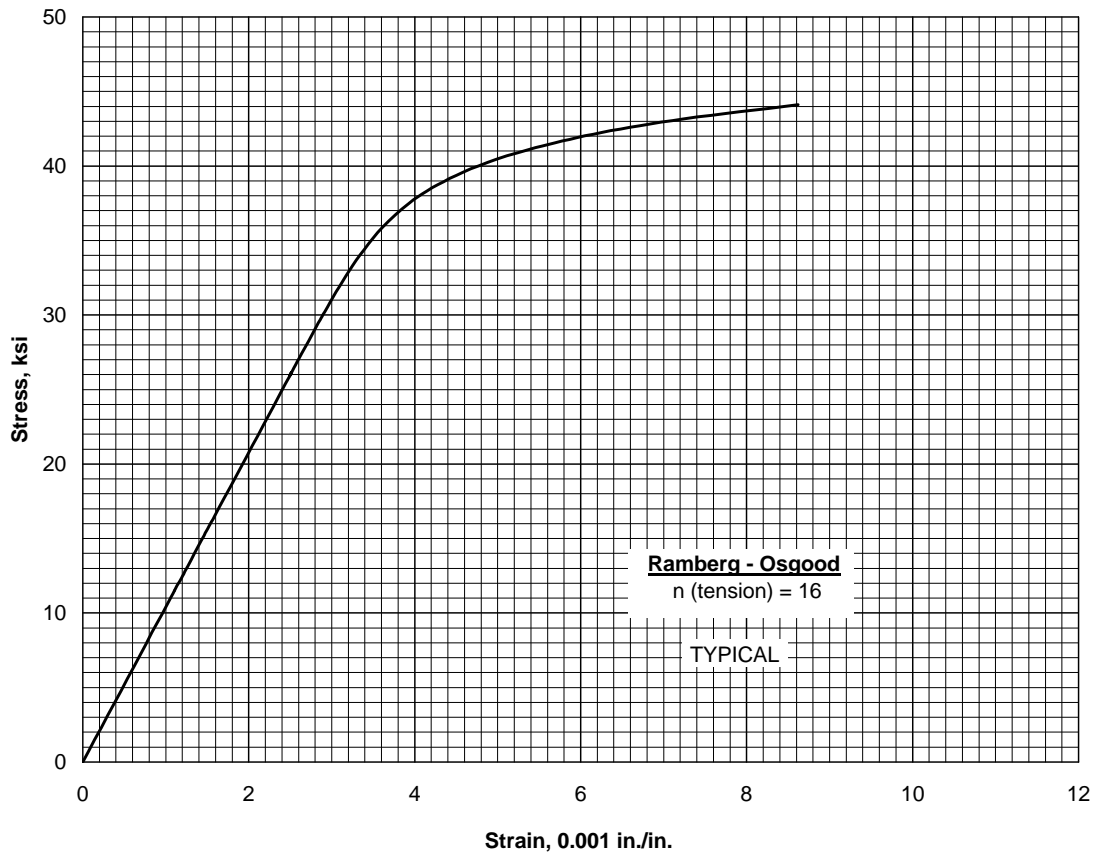

Figure 3.9.6.1.6. Typical tensile stress-strain curve for A357.0-T6 aluminum alloy casting, Class 2, designated area, at room temperature.

3.9.7 D357.0 ALLOY

3.9.7.0 Comments and Properties — D357.0 is a modification of A357.0 with narrower compositional limits and more stringent inspection requirements. These modifications were necessary to reduce variability in mechanical properties to a degree compatible with the determination of A- and B-basis values. D357.0 is a heat-treatable Al-Si-Mg alloy generally used for premium quality castings in which special properties are developed by careful control of casting and chilling techniques. It has excellent casting characteristics and provides high strength together with good toughness. The alloy also has excellent corrosion resistance. Refer to Section 3.1.3.4 for comments regarding the weldability of the alloy.

A material specification for D357.0 aluminum is presented in Table 3.9.7.0(a). Room temperature mechanical and physical properties are shown in Table 3.9.7.0(b).

Table 3.9.7.0(a). Material Specification for D357.0 Aluminum Alloy

Specification	Form
AMS 4241	Casting

The temper index for D357.0 is as follows:

<u>Section</u>	<u>Temper</u>
3.9.7.1	T6

3.9.7.1 T6 Temper — Figure 3.9.7.1.6 presents a typical tensile stress-strain curve.

Table 3.9.7.0(b). Design Mechanical and Physical Properties of D357.0 Aluminum Alloy Casting

Specification	AMS 4241		
Form	Casting		
Temper	T6		
Thickness, in.	≤2.500	...	
Location Within Casting	Designated area		Nondesignated area
Basis	A	B	S
Mechanical Properties^a:			
F_{tu} , ksi	46	49	45
F_{ty} , ksi	39	41	36
F_{cy} , ksi	39	41	36
F_{su} , ksi	29	31	28
F_{bru}^b , ksi:			
(e/D = 1.5)	79	84	77
(e/D = 2.0)	99	105	96
F_{bry}^b , ksi:			
(e/D = 1.5)	62	65	57
(e/D = 2.0)	73	77	67
e , percent (S-basis)	3	...	2
E , 10 ³ ksi	10.4		
E_c , 10 ³ ksi	10.5		
G , 10 ³ ksi	3.9		
μ	0.33		
Physical Properties:			
ω , lb/in. ³	0.097		
C , Btu/(lb)(°F)	0.23 (at 212°F)		
K , Btu/[(hr)(ft ²)(°F)/ft]	88 (at 77°F)		
α , 10 ⁻⁶ in./in./°F	12.0 (68 to 212°F)		

a The mechanical properties shown are reliably obtainable when castings are produced under the quality assurance provisions of AMS 4241. These provisions require preproduction approval, documentation of foundry procedures, and specific destructive and nondestructive testing procedures for the acceptance of each production lot of castings. Strict adherence to these requirements is mandatory if these properties are to be reliably assured in each casting.

b Bearing values are “dry pin” values per Section 1.4.7.1.

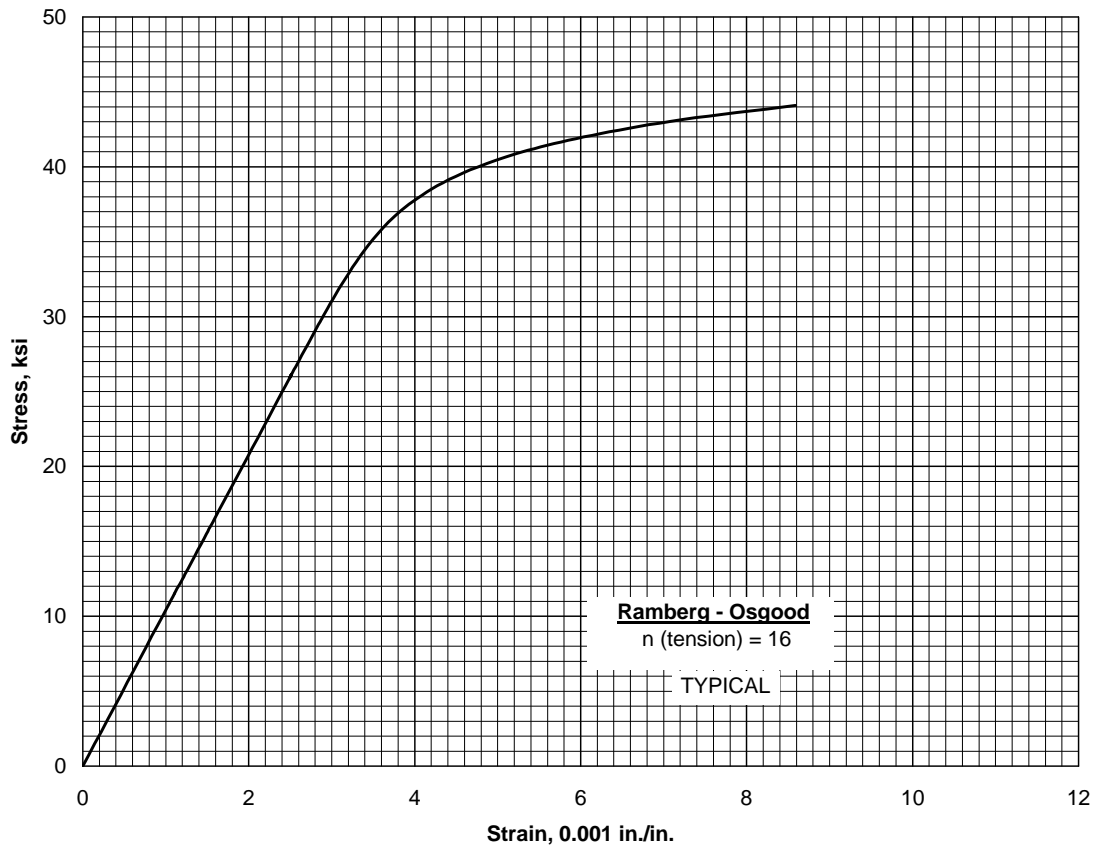

Figure 3.9.7.1.6. Typical tensile stress-strain curve for D357.0-T6 aluminum alloy casting, designated area, at room temperature.

3.9.8 359.0 ALLOY

3.9.8.0 Comments and Properties — 359.0 is a relatively high-strength permanent-mold casting alloy. It is heat treatable, and has good corrosion resistance. Refer to Section 3.1.3.4 for comments regarding the weldability of the alloy.

A material specification for 359.0 aluminum alloy is presented in Table 3.9.8.0(a). Room-temperature mechanical and physical properties are shown in Table 3.9.8.0(b).

Table 3.9.8.0(a). Material Specification for 359.0 Aluminum Alloy

Specification	Form
AMS-A-21180	Casting

Table 3.9.8.0(b). Design Mechanical and Physical Properties of 359.0 Aluminum Alloy Casting

Specification	AMS-A-21180			
Form	Casting			
Temper	T6			
Location Within Casting	Designated area		Nondesignated area	
Strength Class Number ^a	1	2	10	11
Basis	S	S	S	S
Mechanical Properties^{b,c}:				
F_{tu} , ksi:	45	47	45	40
F_{ty} , ksi:	35	38	34	30
F_{cy} , ksi:	35	38	34	30
F_{su} , ksi:	28	29	28	25
F_{bru}^d , ksi:				
(e/D = 1.5)	77	81	77	69
(e/D = 2.0)	96	101	96	86
F_{bry}^d , ksi:				
(e/D = 1.5)	55	60	54	47
(e/D = 2.0)	65	71	63	56
e , percent	4	3	4	3
E , 10 ³ ksi	10.5			
E_c , 10 ³ ksi	10.7			
G , 10 ³ ksi	4.0			
μ	0.33			
Physical Properties:				
ω , lb/in. ³	0.097			
C , Btu/(lb)(°F)	0.23 (at 212°F)			
K , Btu/[(hr)(ft ²)(°F)/ft]	88 (at 77°F)			
α , 10 ⁻⁶ in./in./°F	11.0 (68 to 212°F)			

a The attainable strength class number is dependent on the casting configuration, complexity, and size (both weight and wall thickness). Favorable experience with a particular configuration may allow some foundries to produce a higher strength class number than others. In case of doubt regarding the strength class number, the designer should consult or negotiate with the foundry to determine the proper strength class number to assign for a specific casting.

b For any casting process; i.e., special mold, permanent mold, or sand mold (including chilling).

c The mechanical properties shown are reliably obtainable in castings of this alloy and heat-treat condition when produced under the quality assurance provisions of AMS-A-21180. These provisions require preproduction approval, documentation of foundry procedures, and specific destructive and nondestructive testing procedures for the acceptance of each production lot of castings. Strict adherence to these requirements is mandatory if these properties are to be reliably assured in each casting.

d Bearing values are “dry pin” values per Section 1.4.7.1.

3.10 ELEMENT PROPERTIES

3.10.1 BEAMS — See Chapter 1 and Reference 1.7.1 for general information on stress analysis of beams.

3.10.1.1 Simple Beams — Beams of solid, tubular, or similar cross sections can be assumed to fail through exceeding an allowable modulus of rupture in bending (F_b). In the absence of specific data, the ratio F_b/F_{tu} can be assumed to be 1.25 for solid sections.

3.10.1.1.1 Round Tubes — For round tubes, the value of F_b will depend on the D/t ratio as well as the ultimate tensile stress. The bending moduli of rupture of round tubes of various aluminum alloys are given in Figure 3.10.1.1.1. It should be noted that these values apply only when the tubes are restrained against local buckling at the loading points.

3.10.1.1.2 Unconventional Cross Section — Sections other than solid or tubular should be tested to determine the allowable bending stress.

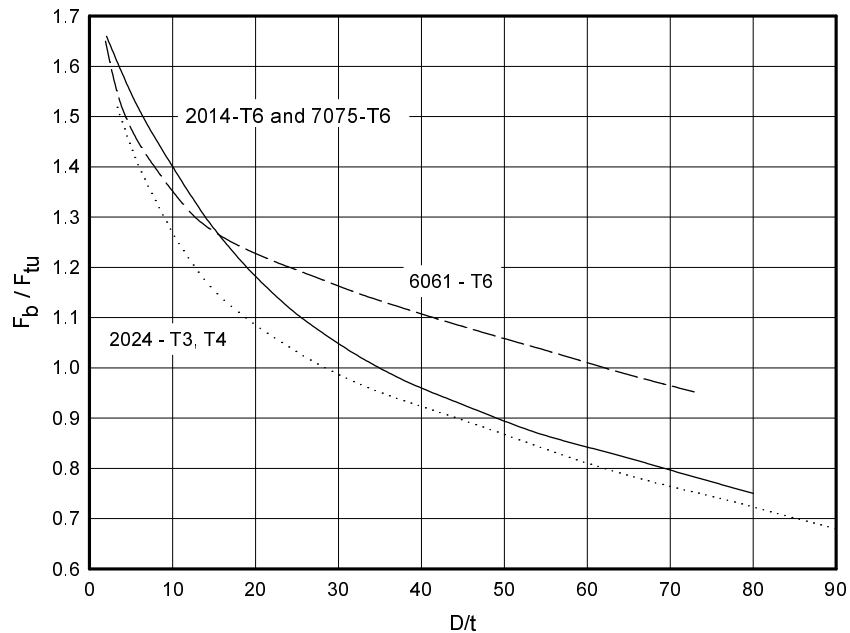

Figure 3.10.1.1.1. Bending modulus of rupture for aluminum alloy round tubing.

3.10.1.2 Built-Up Beams — Built-up beams will usually fail because of local failures of the component parts. In aluminum-alloy construction, the strength of fittings and joints is an important feature (see Reference 3.10.1.2).

3.10.1.3 Thin-Web Beams — The allowable stress for thin-web beams will depend on the nature of the failure and is determined from the allowable stresses of the web in tension and of the flanges or stiffeners in compression.

3.10.2 COLUMNS

3.10.2.1 Primary Failure — The general formula for primary instability is given in Section 1.3.8.

3.10.2.2 Local Failure — The local stability of aluminum alloy column sections may be determined using the methods outlined in References 3.10.2.2(a) through (e).

3.10.2.3 Column Properties — Curves of the allowable column stresses for round and streamline tubing are given in Figure 3.10.2.3. The allowable stress is plotted against the effective slenderness ratio, defined by the formula:

$$\frac{L'}{\rho} = \frac{L}{\rho\sqrt{c}} \quad (3.10.2.3)$$

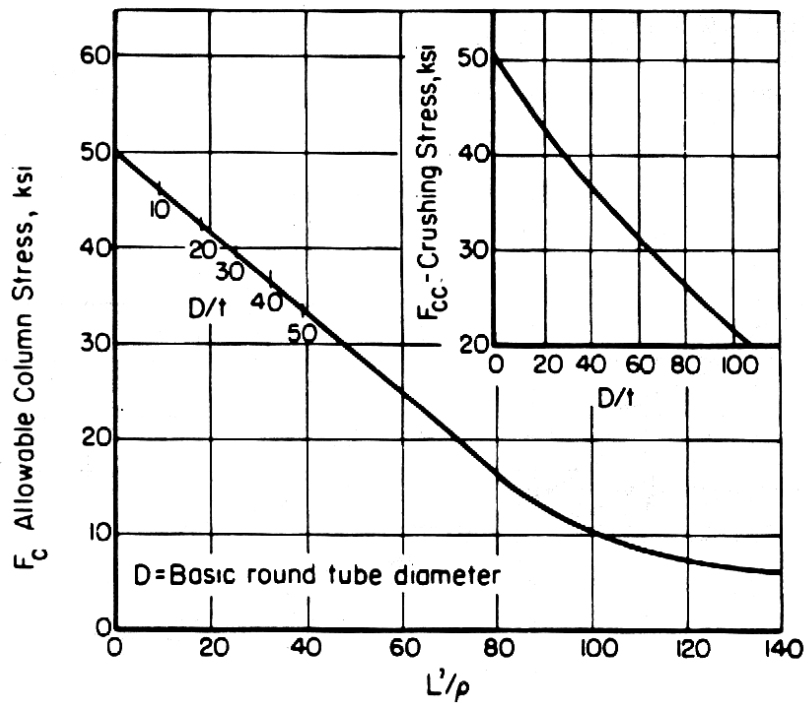
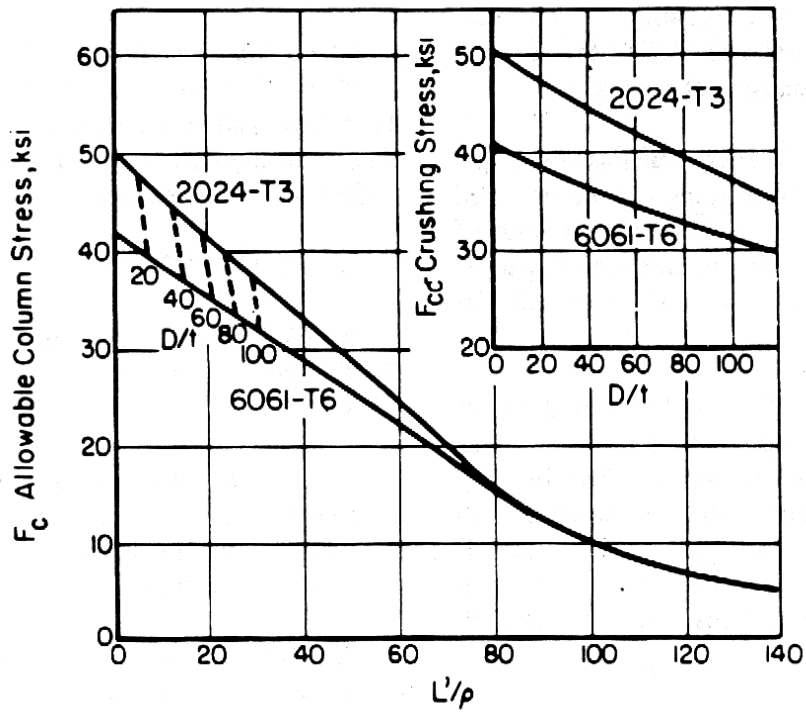

Figure 3.10.2.3. Allowable column and crushing stresses for 2024 and 6061 aluminum alloy tubing.

3.10.3 TORSION

3.10.3.1 General— The torsional failure of aluminum-alloy tubes may be due to plastic failure of metal, elastic instability of the walls, or an intermediate condition. Pure shear failure will not usually occur within the range of wall thicknesses commonly used for aircraft tubing.

3.10.3.2 Torsion Properties— The curves of Figures 3.10.3.2(a) through (g) are derived from the method outlined in Reference 2.8.1.1 and take into account the parameter L/D . The theoretical results set forth in Reference 2.8.3.2 have been found to be in good agreement with the experimental results.

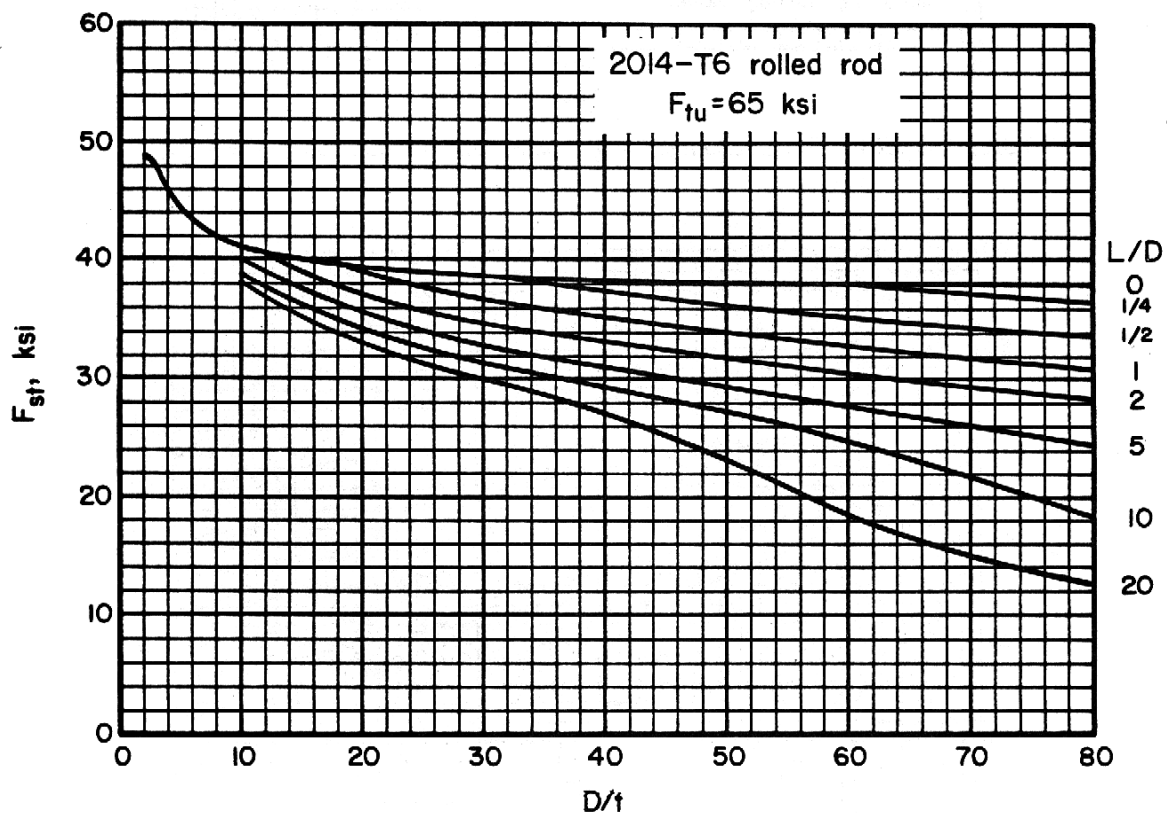

Figure 3.10.3.2(a). Torsional modulus of rupture—2014-T6 aluminum alloy rolled rod.

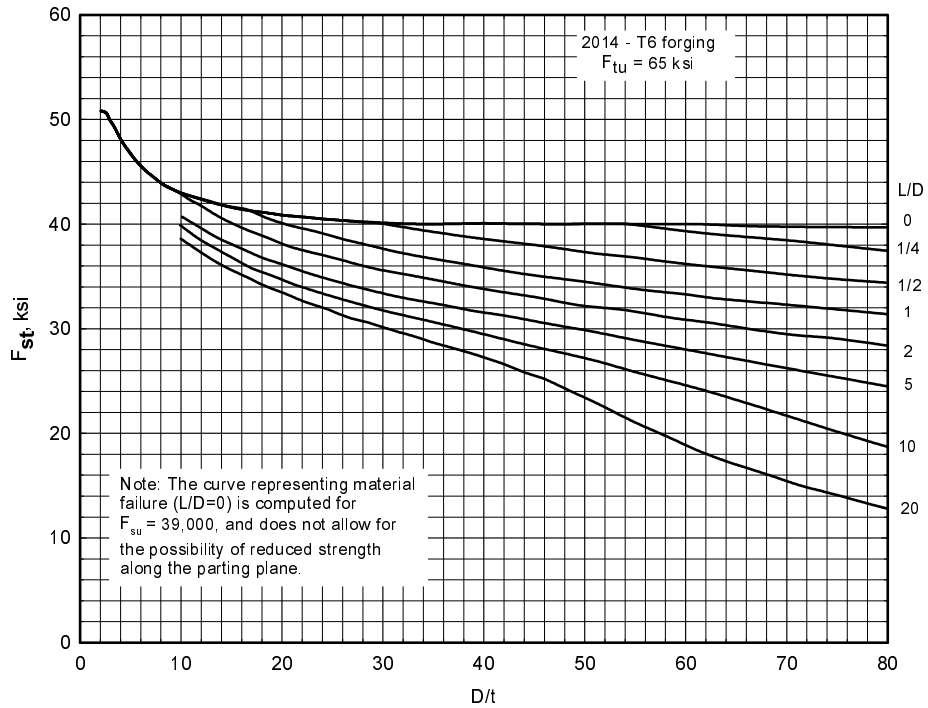

Figure 3.10.3.2(b). Torsional modulus of rupture—2014-T6 aluminum alloy forging.

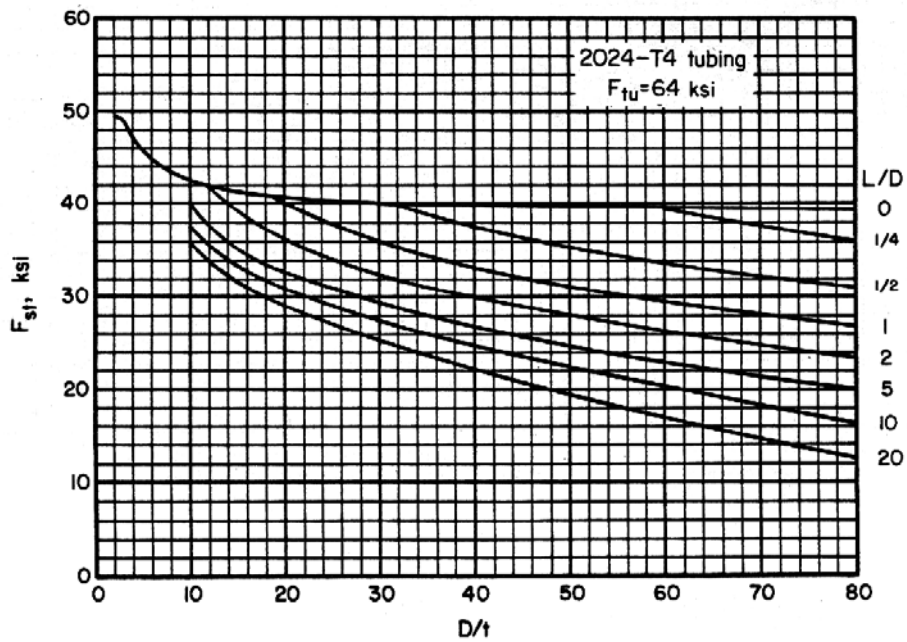

Figure 3.10.3.2(c). Torsional modulus of rupture—2024-T3 aluminum alloy tubing.

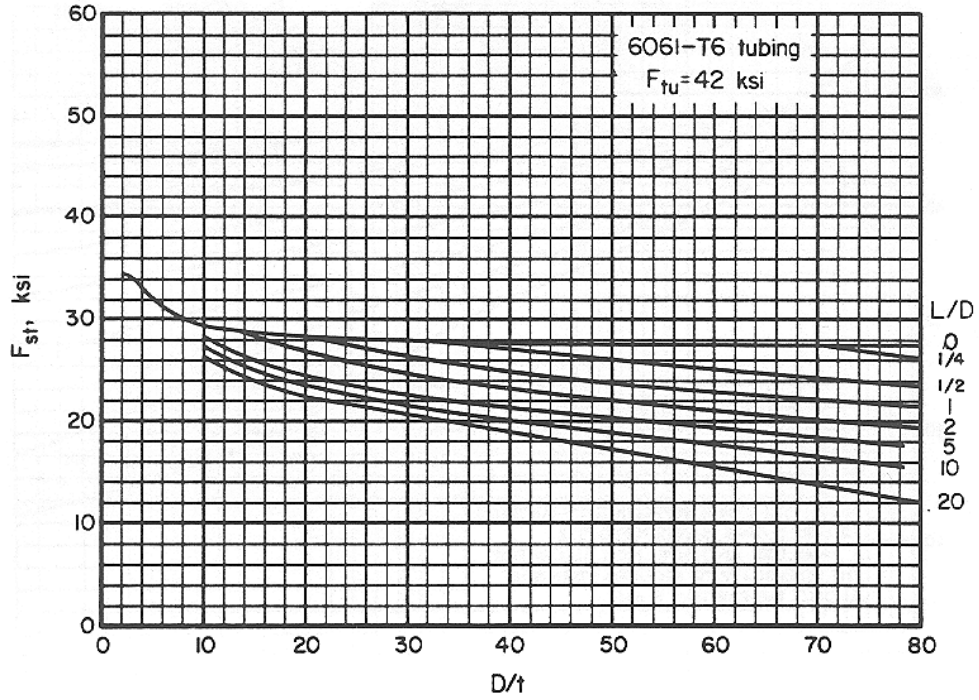

Figure 3.10.3.2(d). Torsional modulus of rupture—2024-T4 aluminum alloy tubing.

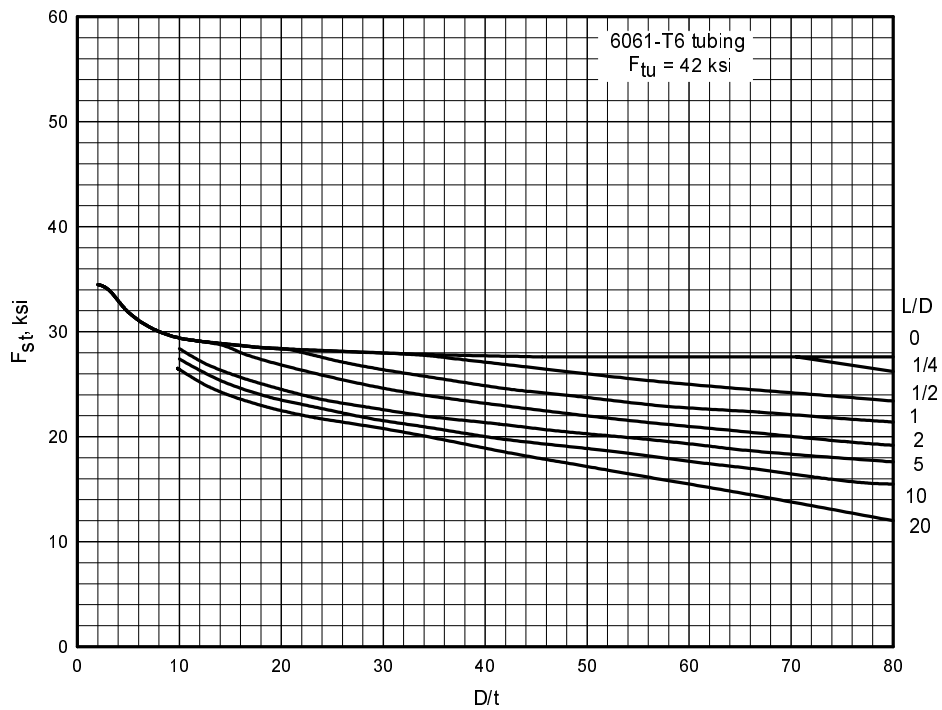

Figure 3.10.3.2(e). Torsional modulus of rupture—6061-T6 aluminum alloy tubing.

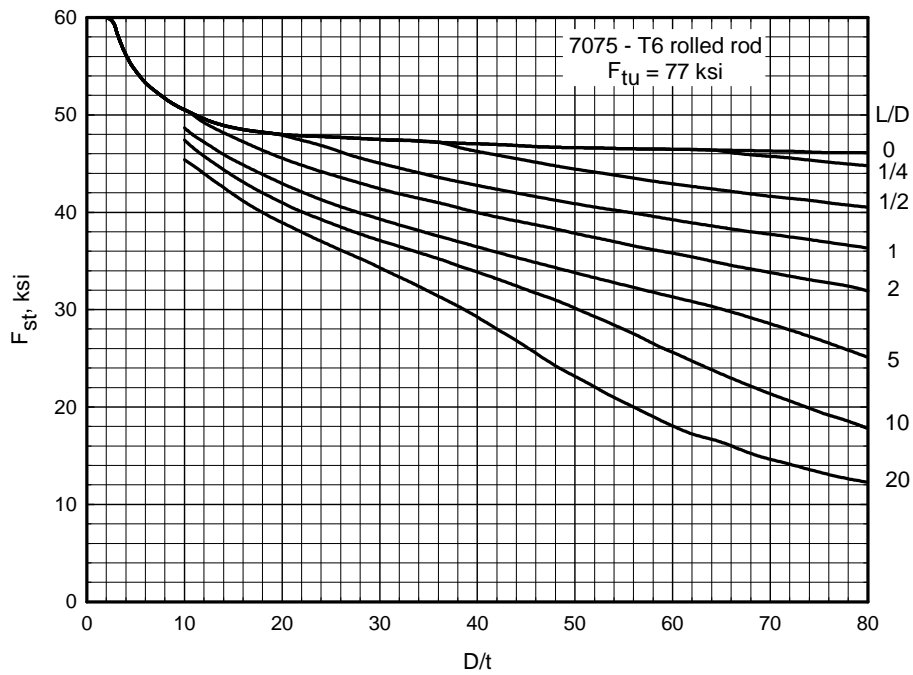

Figure 3.10.3.2(f). Torsional modulus of rupture—7075-T6 aluminum alloy rolled rod.

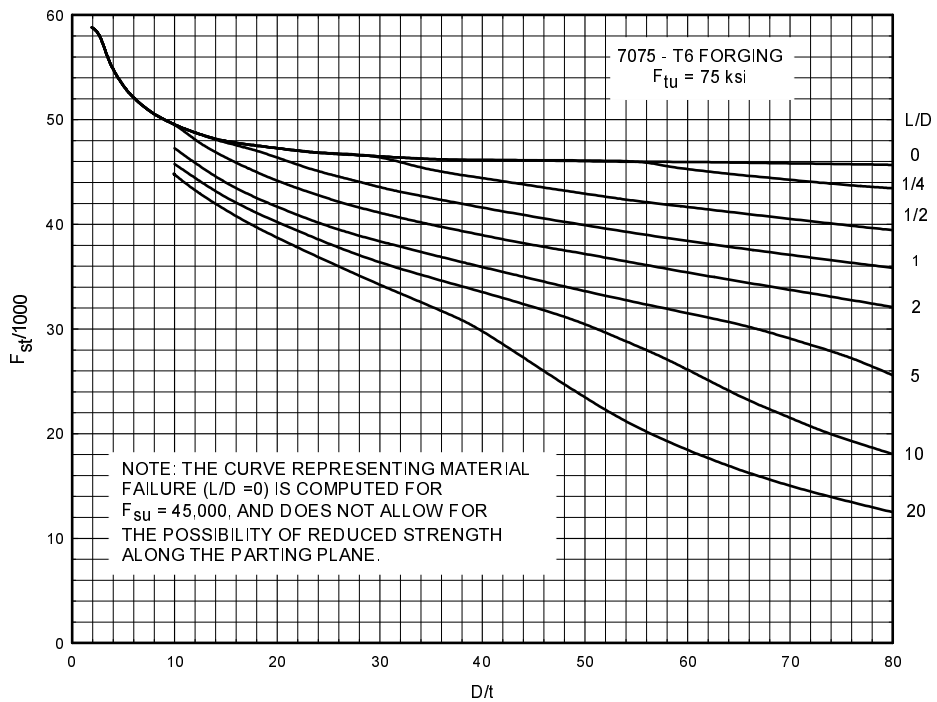

Figure 3.10.3.2(g). Torsional modulus of rupture—7075-T6 aluminum alloy forging.

REFERENCES

- 3.1(a) Aluminum, Vol. I, "Properties, Physical Metallurgy and Phase Diagrams," Vol. II, "Design and Application," Vol. III, "Fabrication and Finishing," American Society for Metals (1967).
- 3.1(b) Aluminum Standards and Data, The Aluminum Association.
- 3.1.2 ANSI/ASC H35.1—1988, "American National Standard Alloy and Temper Designation Systems for Aluminum."
- 3.1.2.1.1 Stickley, G. W., and Moore, A. A., "Effects of Lubrication and Pin Surface on Bearing Strengths of Aluminum and Magnesium Alloys," *Material Research & Standards*, Vol. 2, No. 9, pp. 747 (September 1962).
- 3.1.2.1.4 Van Echo, J. A., Page, L. C., Simmons, W. F., and Cross, H. C., Part I, "Short Time Creep Properties of Structural Sheet Materials for Aircraft and Missiles," WADC TR 6731, 65 pp. (August 1952).
- 3.1.2.1.5(a) Gideon, D. N., Favor, R. J., Grover, H. J., and McClure, G. M., "The Fatigue Behavior of Certain Alloys in the Temperature Range from Room Temperature to -423°F ," *Advances in Cryogenic Engineering*, Vol. 7, Plenum Press, New York, pp. 503-508 (1962).
- 3.1.2.1.5(b) Keys, R. D., Keifer, T. F., and Schwartzberg, F. R., "Fatigue Behavior of Aluminum and Titanium Sheet Materials Down to -423°F ," *Advances in Cryogenic Engineering*, Vol. 10, Plenum Press, New York, pp. 1-13 (1965).
- 3.1.2.1.5(c) DeMoney, F. W., and Wolfer, G. C., "The Fatigue Properties of Aluminum Alloy 5083-H113 and Butt Weldments at 70 and -300°F ," *Advances in Cryogenic Engineering*, Vol. 6, Plenum Press, New York, pp. 590-603 (1961).
- 3.1.2.1.5(d) "Fatigue Design Handbook," Vol. 4, Society of Automotive Engineers (1968).
- 3.1.2.1.5(e) Heywood, R. B., "Designing Against Fatigue of Metals," Reinhold Publishing Corp. (1962).
- 3.1.2.1.5(f) Grover, H. J., "Fatigue of Aircraft Structures," Naval Air Systems Command, NAVAIR 01-1A-13 (1966).
- 3.1.2.1.5(g) Harris, W. J., "Metallic Fatigue," International Series of Monographs in Aeronautics and Astronautics, Vol. I (1961).
- 3.1.2.1.5(h) "Effect of Environment and Complex Load History of Fatigue Life," ASTM STP 463 (1970).
- 3.1.2.1.5(i) "Fatigue Crack Propagation," ASTM STP 415 (1967).
- 3.1.2.1.5(j) Pope, J. A., "Metal Fatigue," London, Chapman and Hall (1959).
- 3.1.2.1.5(k) Rassweiler, G. M., and Grube, W. L., "Internal Stress and Fatigue in Metals," Elsevier Publishing Company (1959).
- 3.1.2.1.5(l) "Symposium on Fatigue of Aircraft Structures," WADC TR 59-507 (1959).

MIL-HDBK-5J
31 January 2003

- 3.1.2.1.5(m) “Symposium on Fatigue of Aircraft Structures: Low-Cycle, Full-Scale, and Helicopter,” ASTM STP 338 (1962).
- 3.1.2.1.5(n) Sines, G., and Waisman, J. L., “Metal Fatigue,” McGraw-Hill (1959).
- 3.1.2.1.5(o) “Symposium on the Basic Mechanisms of Fatigue,” ASTM STP 237 (1959).
- 3.1.2.1.5(p) Manson, S. S., “Fatigue: A Complex Subject—Some Simple Approximations,” *Experimental Mechanics*, Vol. 5, No. 7, pp. 193-226 (July 1965).
- 3.1.2.1.5(q) Morrow, J. D., “Cyclic Plastic Strain Energy and the Fatigue of Metals,” Symposium on Internal Friction, Damping and Cyclic Plasticity, ASTM STP 378 (1964).
- 3.1.2.1.5(r) Hartman, E. C., Holt, M., and Eaton, I. D., “Static and Fatigue Strength of High-Strength Aluminum-Alloy Bolted Joints,” National Advisory Committee for Aeronautics, Technical Note 2276, p. 61 (February 1952).
- 3.1.2.1.5(s) Holt, M., “Results of Shear Fatigue Tests of Joints with 3/16-Inch-Diameter 24-S T31 Rivets in 0.064-Inch-Thick Al Clad Sheet,” U.S. National Advisory Committee for Aeronautics, Technical Note No. 2012, p. 51 (February 1950).
- 3.1.2.1.6(a) “Standard Method of Test for Plane-Strain Fracture Toughness of Metallic Materials,” ASTM Designation E399 (Annual).
- 3.1.2.1.6(b) Kaufman, J. G., Shilling, P. E., and Nelson, F. G., “Fracture Toughness of Aluminum Alloys,” *Metals Engineering Quarterly*, pp. 39-47 (August 1969).
- 3.1.2.1.6(c) Kaufman, J. G., Moore, R. L., and Schilling, P. E., “Fracture Toughness of Structural Aluminum Alloys,” presented at 1969 ASM Materials Engineering Congress, Philadelphia, Pennsylvania (October 14, 1969).
- 3.1.2.1.6(d) Anon., “Fracture Mechanics Data on Aluminum,” from Aluminum Company of America (June 12, 1973) (MCIC 86213).
- 3.1.2.1.6(e) Eichenberger, T. W., “Fracture Resistance Data Summary,” Report D2-20947, The Boeing Company (June 1962) (MCIC 62306).
- 3.1.2.1.6(f) Smith, S. H., and Liu, A. F., “Fracture Mechanics Application to Materials Evaluation and Selection for Aircraft Structure and Fracture Analysis,” D6-17756.
- 3.1.2.1.6(g) Allen, F. C., “Effects of Thickness on the Fracture Toughness of 7075 Aluminum in the T6 and T73 Conditions,” *Damage Tolerance in Aircraft Structures*, ASTM STP 486, pp. 16-38 (1971).
- 3.1.2.1.6(h) Broek, D., “The Residual Strength of Aluminum Alloy Sheet Specimens Containing Fatigue Cracks or Saw Cuts,” NLR-TR M. 2143, National Aerospace Laboratory, Amsterdam (1966).
- 3.1.2.1.6(i) Broek, D., “The Effect of Finite Specimen Width on the Residual Strength of Light Alloy Sheet,” TR M. 2152, National Aero- and Astronautical Research Institute, Amsterdam (1965) (MCIC 70485).

MIL-HDBK-5J
31 January 2003

- 3.1.2.1.6(j) Feddersen, C. E., and Hyler, W. S., "Fracture and Fatigue-Crack-Propagation Characteristics of 7075-T7351 Aluminum Alloy Sheet and Plate," Report No. G-8902, Battelle Memorial Institute, Columbus, Ohio (March 1970) (MCIC 79089).
- 3.1.2.1.7(a) Campbell, J. E., "Aluminum Alloys for Cryogenic Service," *Materials Research & Standards*, Vol. 4, No. 10, pp. 540-548 (October 1964).
- 3.1.2.1.7(b) Bogardus, K. O., Stickley, G. W., and Howell, F. M., "A Review of Information on the Mechanical Properties of Aluminum Alloys at Low Temperatures," National Advisory Committee on Aeronautics, Technical Note 2082, 64 pp. (May 1950).
- 3.1.2.1.7(c) Kaufman, J. G., Bogardus, K. O., and Wanderer, E. T., "Tensile Properties and Notch Toughness of Aluminum Alloys at -452°F in Liquid Helium," *Advances in Cryogenic Engineering*, Vol. 13, Plenum Press, New York, pp. 294-308 (1968).
- 3.1.2.1.7(d) Kaufman, J. G., and Wanderer, E. T., "Tensile Properties and Notch Toughness of 7000 Series Aluminum Alloys, Notably 7005, at -452°F," *Advances in Cryogenic Engineering*, Vol. 15, Plenum Press, New York (to be published).
- 3.1.2.1.7(e) Kaufman, J. G., and Holt, M., "Evaluation of Fracture Characteristics of Aluminum Alloys at Cryogenic Temperatures," *Advances in Cryogenic Engineering*, Vol. 10, Plenum Press, New York, pp. 77-85 (1965).
- 3.1.2.1.7(f) Kaufman, J. G., and Johnson, E. W., "New Data from Alcoa Research Laboratories on Aluminum in Cryogenic Applications," *Advances in Cryogenic Engineering*, Vol. 6, Plenum Press, New York, pp. 637-649 (1960).
- 3.1.2.1.8 Holt, M., and Bogardus, K. O., "The 'Hot' Aluminum Alloys," *Product Engineering* (August 16, 1965).
- 3.1.2.3.1(a) Sprowls, D. O., and Brown, R. H., "Resistance of Wrought High-Strength Aluminum Alloys to Stress Corrosion," *Metal Progress*, Part I (April 1962), and Part II (May 1962).
- 3.1.2.3.1(b) Rutemiller, H. C., and Sprowls, D. O., "Susceptibility of Aluminum Alloys to Stress Corrosion," *Materials Protection* (June 1963).
- 3.1.2.3.1(c) Spuhler, E. H., and Burton, C. L., "Avoiding Stress-Corrosion Cracking in High Strength Aluminum Alloy Structures," Alcoa Green Letter Booklet No. 188 (April 1970).
- 3.1.2.3.1(d) Jackson, J. D., and Boyd, W. K., "Preventing Stress-Corrosion Cracking of High Strength Alloy Parts," *Materials in Design Engineering* (May 1966).
- 3.1.2.3.2 Lifka, B. W., Sprowls, D. O., and Kaufman, J. G., "Exfoliation and Stress-Corrosion Characteristics of High Strength, Heat Treatable Aluminum Alloy Plate," *Corrosion*, Vol. 23, No. 11, pp. 335-342 (November 1967).
- 3.2.1.1.8(a) Howell, F. M., and Miller, J. L., "Axial Stress, Fatigue Strength of Structural Aluminum Alloys," American Society for Testing Materials, Vol. 55 (1955) (MIL-HDBK-5 Item 62-17).
- 3.2.1.1.8(b) Lazan, B. J., and Blatherwick, A. A., "Fatigue Properties of Aluminum Alloys at Various Direct Stress Ratios, Part 1—Rolled Alloys," WADC Technical Report 52307 (December 1952) (MCIC 107775).

MIL-HDBK-5J
31 January 2003

- 3.2.1.1.8(c) Lazan, B. J., and Blatherwick, A. A., "Fatigue Properties of Aluminum Alloys at Various Direct Stress Ratios, Part 2—Extruded Alloys," WADC Technical Report 52-307 (December 1952) (MCIC 107776) (MIL-HDBK-5 Source M-535).
- 3.2.1.1.8(d) Wang, D. Y., "Axial Loading Fatigue Properties of 7079-T6, 7075-T6, and 2014-T6 Aluminum Alloy Hand Forgings," WADC Technical Report 58-59 (July 1958) (MCIC 108811).
- 3.2.1.1.8(e) Nordmark, G. E., Lifka, B. W., et al., "Stress-Corrosion and Corrosion-Fatigue Susceptibility of High-Strength Aluminum Alloys," Alcoa Technical Report 70-259 (November 1970) (MCIC 79945).
- 3.2.3.1.8(a) Grover, H. J., Bishop, S. M., and Jackson, L. R., "Fatigue Strengths of Aircraft Materials: Axial-Load Fatigue Tests on Unnotched Sheet Specimens of 24S-T3 and 75S-T6 Aluminum Alloys and of SAE 4130 Steel," National Advisory Committee for Aeronautics, Technical Note 2324 (March 1951) (MIL-HDBK-5 Source M-506).
- 3.2.3.1.8(b) Grover, H. J., Bishop, S. M., and Jackson, L. R., "Fatigue Strengths of Aircraft Materials: Axial-Load Fatigue Tests on Notched Sheet Specimens of 24S-T3 and 75S-T6 Aluminum Alloys and of SAE 4130 Steel with Stress-Concentration Factors of 2.0 and 4.0," National Advisory Committee for Aeronautics, Technical Note 2389 (June 1951) (MIL-HDBK-5 Source M-507).
- 3.2.3.1.8(c) Grover, H. J., Bishop, S. M., and Jackson, L. R., "Fatigue Strengths of Aircraft Materials; Axial-Load Fatigue Tests on Notched Specimens of 24S-T3 and 75S-T6 Aluminum Alloys and of SAE 4130 Steel with Stress-Concentration Factor of 5.0," National Advisory Committee for Aeronautics, Technical Note 2390 (June 1951) (MIL-HDBK-5 Source M-508).
- 3.2.3.1.8(d) Grover, H. J., Hyler, W. S., and Jackson, L. R., "Fatigue Strengths of Aircraft Materials; Axial-Load Fatigue Tests on Notched Sheet Specimens of 24S-T3 and 75S-T6 Aluminum Alloys and of SAE 4130 Steel with Stress-Concentration Factor of 1.5," National Advisory Committee for Aeronautics, Technical Note 2639 (February 1952) (MIL-HDBK-5 Source M-509).
- 3.2.3.1.8(e) Hardrath, H. F., and Ilig, W., "Fatigue Tests at Stresses Producing Failure in 2 to 10,000 Cycles 24S-T3 and 75S-T6 Aluminum Alloy Sheet Specimens with a Theoretical Stress Concentration Factor of 4.0 Subjected to Completely Reversed Axial Load," National Advisory Committee of Aeronautics, Technical Note 3132 (January 1954) (MIL-HDBK-5 Source M-510).
- 3.2.3.1.8(f) Ilig, W., "Fatigue Tests on Notched and Unnotched Sheet Specimens of 2024-T3 and 7075-T6 Aluminum Alloys and of SAE 4130 Steel with Special Consideration of the Life Range from 2 to 10,000 Cycles," National Advisory Committee for Aeronautics, Technical Note 3866 (December 1956) (MIL-HDBK-5 Source M-512).
- 3.2.3.1.8(g) Grover, H. J., Hyler, W. S., and Jackson, L. R., "Fatigue Strengths of Aircraft Materials; Axial-Load Fatigue Tests on Edge-Notched Sheet Specimens of 2024-T3 and 7075-T6 Aluminum Alloys and of SAE 4130 Steel with Notch Radii of 0.004 and 0.070 Inch," National Aeronautics and Space Administration, Technical Note D-111 (September 1959) (MIL-HDBK-5 Source M-513).
- 3.2.3.1.8(h) Naumann, E. C., Hardrath, H. F., and Guthrie, D. E., "Axial-Load Fatigue Tests of 2024-T3 and 7075-T6 Aluminum-Alloy Sheet Specimens Under Constant and Variable Amplitude Loads," National Aeronautics and Space Administration, Technical Note D-212 (December 1959) (MIL-HDBK-5 Source M-514).

MIL-HDBK-5J
31 January 2003

- 3.2.3.1.8(i) Topper, T. H., and Morrow, J., "Simulation of the Fatigue Behavior at the Notch Root in Spectrum Loaded Notch Member (u)," Naval Air Development Center, Final Report (January 1970).
- 3.2.7.1.9(a) Pionke, L. J., and Linback, R. K., "Fracture Mechanics Data for 2024-T861 and Aluminum," NASA CR, MDDC E1153, McDonnell Douglas Astronautics Company (October 25, 1974).
- 3.2.7.1.9(b) Cervay, R. R., "Temperature Effect on the Mechanical Properties of Aluminum Alloy 2124-T851," AFML-TR-75-208 (December 1975).
- 3.2.7.1.9(c) Thompson, D. S., and Zinkham, R. E., "Program to Improve the Fracture Toughness and Fatigue Resistance of Aluminum Sheet and Plate for Airframe Applications," AFML-TR-73-247, Vol. II (September 1974).
- 3.2.7.1.9(d) Babilion, C. F., Wygonik, R. H., Nordmark, G. E., and Lifka, B. W., "Mechanical Properties, Fracture Toughness, Fatigue, Environmental Fatigue Crack Growth Rates, and Corrosion Characteristics of High-Toughness Aluminum Alloy Forgings, Sheet, and Plate," AFML-TR-73-83 (April 1973) (MCIC 86842) (MIL-HDBK-5 Source M-118).
- 3.2.8.2.8 Ferguson, R. F., "Axial Stress Fatigue Strength of 2219-T851 Aluminum Alloy Plate," Report No. TFD-71-960, North American Rockwell, Los Angeles Division (July 29, 1971) (MIL-HDBK-5 Source M-216).
- 3.7.3.1.8(a) Rothweiler, C. E., and Maynard, P. S., "Evaluation of 7049-T73 Aluminum Alloy for RA-5C Wing Inner Panel Fold Rib," CMES Contract N00256-71-C-0064, Task No. NAR-18 (P046-10), Report No. NR72H-278, North American Rockwell, Columbus, Ohio (July 14, 1972) (MIL-HDBK-5 Source M-170).
- 3.7.3.1.8(b) Anon., "Boeing Test Data on X7049-T73," Submitted to Battelle to provide input data for Item 68-24 (1969) (MCIC 78639).
- 3.7.3.1.8(c) Mixon, W., and Turley, R. V., "Evaluation of Aluminum Alloys 7049-T73 and 7175-T736 Die Forging," Engineering Technical Report No. ETR-MDC-J0692, McDonnell Douglas (April 7, 1970) (MCIC 110111).
- 3.7.3.1.8(d) VanOrden, J. M., "Evaluation of 7049-T73 Aluminum Alloy Hand-Forged Billet," Lockheed California Company, Report No. LR 23447 (February 1970) (MIL-HDBK-5 Source M-43).
- 3.7.3.1.8(e) "Effect of Manufacturing Processes on Structural Allowables—Phase I," Battelle, Columbus, Ohio, AFWAL-TR-85-4128 (January 1986).
- 3.7.4.2.8(a) Guthorn, P. S., "Design Properties and Processing Limits for Improved Aluminum Alloys," McDonnell Douglas Corporation, MDC-J1912 (December 1983) (MIL-HDBK-5 Source M-629).
- 3.7.4.2.8(b) Garland, K., "Evaluation of X7050-T736 Die Forgings," McDonnell Aircraft Company, McDonnell Douglas Corporation, Report No. 514-131.10 (February 1973) (MCIC 85880).
- 3.7.4.2.8(c) Deel, O. L., Ruff, P. E., and Mindlin, H., "Engineering Data on New Aerospace Structural Materials," AFML-TR-114 (June 1973) (MIL-HDBK-5 Source M-467).

MIL-HDBK-5J
31 January 2003

- 3.7.4.2.8(d) Gallo, K. L., "Load Control Fatigue Data Reports," Westmoreland Mechanical Testing and Research, Inc., March 1997.
- 3.7.4.2.8(e) Deschappelles, J. B., "Improved Fatigue Resistance of 7050 Thick Plate Aluminum Through Minimization of Microporosity," Effects of Product Quality and Design Criteria on Structural Integrity, ASTM STP 1337, R. C. Rice and D. E. Tritsch, Eds., American Society for Testing and Materials, 1998.
- 3.7.4.2.9(a) Northrop, attachments to letter from V. C. Frost to D. J. Jones (March 4, 1981) (MIL-HDBK-5 Source M-482).
- 3.7.4.2.9(b) Davis, R. E., Nordmark, G. E., and Walsh, J. D., "Design Mechanical Properties, Fracture Toughness, Fatigue Properties, Exfoliation, and Stress-Corrosion Resistance of 7050 Sheet, Plate, Hand Forgings, Die Forgings, and Extrusions," Report N00019-72-C-0512, Aluminum Company of America (July 1975) (MIL-HDBK-5 Source M-322).
- 3.7.4.3.8(a) Staley, J. T., Jacoby, J. E., Davies, R. E., Nordmark, G. E., Walsh, J. D., and Rudolph, F. R., "Aluminum Alloy 7050 Extrusions," AFML-TR-76-129 (March 1977) (MCIC 99225) (MIL-HDBK-5 Source M-374).
- 3.7.6.1 Brownfield, C. D., and Badger, D. M., "Effects of Temperature-Time-Stress Histories on the Mechanical Properties of Aircraft Structural Metallic Materials," WADC TR 56-585, Part II (September 1960).
- 3.7.6.1.8 Howell, F. M., and Miller, J. L., "Axial Fatigue Strengths of Several Structural Aluminum Alloys," Proceedings of the American Society for Testing Materials, Philadelphia, PA (1956).
- 3.7.6.1.9(a) Hudson, C. M., and Hardrath, H. F., "Effects of Changing Stress Amplitude on the Rate of Fatigue-Crack-Propagation in Two Aluminum Alloys," National Aeronautics and Space Administration, Technical Note D-960 (1961).
- 3.7.6.1.9(b) McEvily, A. J., and Ilig, W., "The Rate of Fatigue-Crack Propagation in Two Aluminum Alloys," National Aeronautics and Space Administration, Technical Note 4394 (1958).
- 3.7.6.1.9(c) Broek, D., and Schijve, J., "The Influence of Mean Stress on the Propagation of Fatigue Cracks in Aluminum Alloy Sheet," NLR-TR, M. 2111, Reports and Transactions, National Aero- and Astronautical Research Institute, pp. 41-61 (1965).
- 3.7.6.1.9(d) Dubensky, R. G., "Fatigue-Crack Propagation in 2024-T3 and 7075-T6 Aluminum Alloys at High Stresses," NASA CR-1732 (1971).
- 3.7.6.1.9(e) Hudson, C. M., "Effect of Stress Ratios on Fatigue-Crack Growth in 7075-T6 and 2024-T3 Aluminum Alloy Specimens," National Advisory Committee for Aeronautics, Technical Note D-5390 (August 1969) (MCIC 75599).
- 3.7.6.1.9(f) Gurin, P. J., "Crack Propagation Tests for Some Aluminum Alloy Materials," LR 10498, Lockheed Aircraft Corporation (1955).
- 3.7.6.2.9(a) Unpublished Battelle, Columbus, Ohio data by C. F. Fedderson.

MIL-HDBK-5J
31 January 2003

- 3.7.6.2.9(b) “B-1 Program Data for Aluminum Alloys,” Rockwell International Corporation, Memorandum to H. D. Moran from E. W. Cawthorne, Battelle, Columbus, Ohio (April 3, 1974) (MCIC 88579).
- 3.7.6.2.9(c) Ruff, P. E., and Smith, S. H., “Development of MIL-HDBK-5 Design Allowable Properties and Fatigue-Crack-Propagation Data for Several Aerospace Materials,” AFML-TR-77-162 (October 1977).
- 3.7.7.2.8 Unpublished Letter to D. Lahrman, Battelle, from Alcoa, “Fatigue Properties of 7150-T77511 Extruded Shapes.” (December 9, 1993) (MIL-HDBK-5 Source M-798).
- 3.7.8.1.8(a) Unpublished Letter to P. Ruff, Battelle Memorial Institute, from Lockheed-Georgia, “Fatigue Data on 7175-T7351 Extrusions,” January 1982.
- 3.7.8.1.8(b) Carter, F. J., Bateh, E. J., and White, D. L., “C-5A Wing Modification Program, Material Characterization Program, 7175-T7511 Extrusions,” Lockheed-Georgia Company, Report No. LG75ER0186-2, September 1977 (MCIC 122032).
- 3.7.8.1.8(c) Unpublished Letter to P. Ruff, Battelle Memorial Institute, from Aluminum Company of America, “Fatigue Data on 7175-T73511 Extrusions and 7175-T74 Forgings,” January 24, 1990 (MIL-HDBK-5 Source M-748).
- 3.7.8.2.8(a) Schimmelbusch, H. W., “Metallurgical Evaluation of 7175-T736 and 7175-T66 Die Forgings,” Boeing Company Document No. D6-24480, May 1970 (MCIC 78656).
- 3.7.8.2.8(b) Newcomer, R., “Evaluation of Aluminum Forging Alloy 7175-T736,” McDonnell Aircraft Company Report No. MDC 70-024, 1970 (MCIC 85881).
- 3.7.8.2.8(c) Deel, O. L., and Mindlin, H., “Engineering Data on New and Emerging Structural Materials,” AFML Report No. AFML-TR-70-252, October 1970 (MIL-HDBK-5 Source M-464).
- 3.7.10.2.8(d) Doepker, P., “Effect of Manufacturing Process on Structural Allowables,” AFWAL Report No. AFWAL-TR-85-4049 (MIL-HDBK-5 Source M-626).
- 3.7.10.2.8(a) Brownhill, D. J., Davies, R. E., Nordmark, G. E., and Ponchel, B. M., “Exploratory Development for Design Data on Structural Aluminum Alloys in Representative Aircraft Environments,” AFML-TR-77-102 (July 1977) (MCIC 103463) (MIL-HDBK-5 Source M-397).
- 3.7.10.2.8(b) Unpublished letter to P. Vieth, Battelle, Columbus, Ohio from ALCOA, “Fatigue Data for 7050 and 7475 Products” (July 17, 1985) (MIL-HDBK-5 Source M-630).
- 3.7.10.2.8(c) Jones, R. L., and Coyle, T. E., “The Mechanical Stress Corrosion, Fracture Mechanics, and Fatigue Properties of 7050, 7475, and Ti-8Mo-8V-2Fe-3Al Plate and Sheet Alloys,” General Dynamics, Report No. FGT-5791 (July 24, 1973) (MCIC 100670).
- 3.7.10.2.8(d) Figge, F. A., “Advanced Metallic Structure: Air Superiority Fighter Wind Design for Improved Cost, Weight, and Integrity,” AFFDL-TR-73-52, Vol. III (June 1973) (MCIC 86574) (MIL-HDBK-5 Source M-278).
- 3.7.10.2.8(e) Deel, O. L., Ruff, P. E., and Mindlin, H., “Engineering Data on New Aerospace Structural Materials,” AFML-TR-75-97 (June 1975) (MCIC 95044) (MIL-HDBK-5 Source M-468).

MIL-HDBK-5J
31 January 2003

- 3.7.10.2.9(a) Cervay, R. R., "Engineering Design Data for Aluminum Alloy 7475 in the T761 and T61 Conditions," AFML-TR-72-173 (September 1972) (MCIC 85363).
- 3.7.10.2.9(b) Cervay, R. R., "Static and Dynamic Fracture Properties for Aluminum Alloy 7475-T651 and T7351," AFML-TR-75-20 (April 1975).
- 3.8.1.1.8(a) Unpublished data from Garrett Turbine Engine Company, 1986 (MIL-HDBK-5 Source M-690).
- 3.8.1.1.8(b) Unpublished data from Northrop Corporation, 1988 (MIL-HDBK-5 Source M-701).
- 3.10.1.2 Eato, I. D., and Holt, M., "Flexural Fatigue Strengths of Riveted Box Beams—Alclad 14S-T6, Alclad 75S-T6, and Various Tempers of Alclad 24S," National Advisory Committee for Aeronautics, Technical Note 2452, 25 pp. (November 1951).
- 3.10.2.2(a) Gerard, G., and Becker, H., Handbook of Structural Stability, "Part I—Buckling of Flat Plates," National Advisory Committee for Aeronautics, Technical Note 3781 (July 1957).
- 3.10.2.2(b) Becker, H., Handbook of Structural Stability, "Part II—Buckling of Composite Elements," National Advisory Committee for Aeronautics, Technical Note 3782 (July 1957).
- 3.10.2.2(c) Gerard, G., and Becker, H., Handbook of Structural Stability, "Part III—Buckling of Curved Plates and Shells," National Advisory Committee for Aeronautics, Technical Note 3783 (1957).
- 3.10.2.2(d) Gerard, G., Handbook of Structural Stability, "Part IV—Failure of Plates and Composite Elements," National Advisory Committee for Aeronautics, Technical Note 3784 (1957).
- 3.10.2.2(e) Gerard, G., Handbook of Structural Stability, "Part V—Compressive Strengths of Flat Stiffened Panels," National Advisory Committee for Aeronautics, Technical Note 3785 (August 1957).

CHAPTER 4**MAGNESIUM ALLOYS****4.1 GENERAL**

This chapter contains the engineering properties and characteristics of wrought and cast magnesium alloys used in aircraft and missile applications. Magnesium is a lightweight structural metal that can be strengthened greatly by alloying, and in some cases by heat treatment or cold work or by both.

4.1.1 ALLOY INDEX — The magnesium alloys in this chapter are listed in alphanumeric sequence in each of two parts, the first one being wrought forms of magnesium and the second cast forms. These sections and the alloys covered under each are shown in Table 4.1.

Table 4.1. Magnesium Alloys Index

Section	Designation
4.2	Magnesium-Wrought Alloys
4.2.1	AZ31B
4.2.2	AZ61A
4.2.3	ZK60A
4.3	Magnesium-Cast Alloys
4.3.1	AM100A
4.3.2	AZ91C/AZ91E
4.3.3	AZ92A
4.3.4	EZ33A
4.3.5	QE22A
4.3.6	ZE41A

4.1.2 MATERIAL PROPERTIES

4.1.2.1 Mechanical Properties — The mechanical properties are given either as design values or for information purposes. The tensile strength (F_u), tensile yield strength (F_{ly}), elongation (e), and sometimes the compressive yield strength (F_{cy}) are guaranteed by procurement specifications. The properties obtained reflect the location of sample, type of test specimen and method of testing required by the product specification. The remaining design values are “derived” values; that is, sufficient tests have been made to ascertain that if a given material meets the requirements of the product specification, the material will have the compression (F_{cy}), shear (F_{su}) and bearing (F_{bru} and F_{bry}) strengths listed.

4.1.2.1.1 Tension Testing — Room-temperature tension tests are made according to ASTM E 8. The yield strength (F_{ly}) is obtained by the “offset method” using an offset of 0.2 percent. The speed of testing for room-temperature tests has a small effect on the strength and elongation values obtained on most magnesium alloys. The rate of stressing generally specified to the yield strength is less than 100,000 psi per minute and the rate of straining from the yield strength to fracture is less than 0.5 in./in./min. It can be

expected that the speed of testing used for room-temperature tension tests will approach the maximum permitted.

Elevated-temperature tension tests are made according to ASTM E 21. The speed of testing has a considerable effect on the results obtained and no one standard rate of straining is given in ASTM E 21. The strain rates most commonly used on magnesium are 0.005 in./in./min. to the yield and 0.10 in./in./min. from yield to fracture [see References 4.1.2.1.1(a) to (d)].

4.1.2.1.2 Compression Testing — Compression test methods used for magnesium are specified in ASTM E 9. The values given for the compressive yield strength (F_{cy}), are taken at an offset of 0.2 percent. References 4.1.2.1.2(a) and (b) provide information on test techniques.

4.1.2.1.3 Bearing Testing — Bearing tests of magnesium alloys are made according to ASTM E 238. The size of pin used has a significant effect on the values obtained, especially the bearing ultimate strength (F_{bru}). On tests made to obtain the data on magnesium alloys shown in this document, pin diameters of 0.187 and 0.250 inch were used. For pin diameters significantly larger than 0.250 inch lower values may be obtained. Additional information on bearing testing is given in References 4.1.2.1.3(a) and (b). Bearing values in the property tables are considered to be “dry pin” values in accordance with the discussion in Section 1.4.7.1.

4.1.2.1.4 Shear Testing — The shear strength values used in this document were obtained by the “double shear” method using a pin-type specimen, the “punch shear” method and the “tension shear” method as applicable. Just as tensile ultimate strength (F_{tu}) values vary with location and direction of sample in relation to the method of fabrication, the shear strength (F_{su}) may be expected to reflect the effect of orientation, either as a function of the sampling or the maximum stresses imposed by the method of test. Information on shear testing is given in Reference 4.1.2.1.4.

4.1.2.1.5 Stress Raisers — The effect of notches, holes, and stress raisers on the static properties of magnesium alloys is described in References 4.1.2.1.5(a) through (c). Additional data on the strength properties of magnesium alloys are presented in References 4.1.2.1.5(d) through (h).

4.1.2.1.6 Creep — Some creep data on magnesium alloys are summarized in Reference 4.1.2.1.6.

4.1.2.1.7 Fatigue — Room-temperature axial load fatigue data for several magnesium alloys are presented in appropriate alloy sections. References 4.1.2.1.7(a) and (b) provide additional data on fatigue of magnesium alloys.

4.1.3 PHYSICAL PROPERTIES — Selected experimental data from the literature were used in determining values for physical properties. In other cases, enough information was available to calculate the constants. Estimated values of some of the remaining constants were also included. Estimated values are noted.

4.1.4 ENVIRONMENTAL CONSIDERATIONS — Corrosion protection must be considered for all magnesium applications. Protection can be provided by anodic films, chemical conversion coatings, paint systems, platings, or a combination of these methods. Proper drainage must be provided to prevent entrapment of water or other fluids. Dissimilar metal joints must be properly and completely insulated, including barrier strips and sealants.

Strain-hardened or age-hardened alloys may be annealed or overaged by prolonged exposure to elevated temperatures, with a resulting decrease in strength. Maximum recommended temperatures for prolonged service are reported, where available, for specific alloys.

4.1.5 ALLOY AND TEMPER DESIGNATIONS— Standard ASTM nomenclature is used for the alloys listed. Temper designations are given in ASTM B 296. A summary of the temper designations is given in Table 4.1.5.

Table 4.1.5. Temper Designation System for Magnesium Alloys^a

Basis of Codification

The designations for temper are used for all forms of magnesium and magnesium alloy products except ingots and are based on the sequence of basic treatments used to produce the various tempers. The temper designation follows the alloy designation, the two being separated by a dash. Basic temper designations consist of letters. Subdivisions of the basic tempers, where required, are indicated by a digit or digits following the letter. These designate specific sequences of basic treatments, but only operations recognized as significantly influencing the characteristics of the product are indicated. Should some other variation of the same sequence of basic operations be applied to the same alloy, resulting in different characteristics, then additional digits are added to the designation.

NOTE—In material specifications containing reference to two or more tempers of the same alloy which result in identical mechanical properties, the distinction between the tempers should be covered in suitable explanatory notes.

Basic Temper Designations

F *As Fabricated.* Applies to the products that acquire some temper from shaping processes not having special control over the amount of strain-hardening or thermal treatment.

O *Annealed Recrystallized (wrought products only).* Applies to the softest temper of wrought products.

H *Strain-Hardened (wrought products only).* Applies to products that have their strength increased by strain-hardening with or without supplementary thermal treatments to produce partial softening. The H is always followed by two or more digits.

H1 *Strain-Hardened Only.* Applies to products that are strain-hardened to obtain the desired mechanical properties without supplementary thermal treatment. The number following this designation indicates the degree of strain-hardening.

H2 *Strain-Hardened and Then Partially Annealed.* Applies to products which are strain-hardened more than the desired final amount and then reduced in strength to the desired final amount by partial annealing. The number following this designation indicates the degree of strain-hardening remaining after the product has been partially annealed.

H3 *Strain-Hardened and Stabilized.* Applies to products that are strain-hardened and then stabilized by a low temperature heating to slightly lower their strength and increase ductility. This designation applies only to alloys which, unless stabilized, gradually age soften at room temperature. The number following this designation indicates the degree of strain-hardening remaining after the product has been strain-hardened a specific amount and then stabilized.

Subdivisions of the “H1”, “H2” and “H3” Tempers: The digit following the designations “H1”, “H2”, and “H3” indicates the final degree of strain hardening. Tempers between 0 (annealed) and 8 (full hard) are designated by numerals 1 through 7. Material having a strength about midway between that of the 0 temper and that of the 8 temper is designated by the numeral 4 (half hard); between 0 and 4 by the numeral 2 (quarter hard); between 4 and 8 by the numeral 6 (three-quarter

^a From ASTM B 296-96.

Table 4.1.5. Temper Designation System for Magnesium Alloys (Continued)^a

hard), etc. The third digit, when used, indicates a variation of a two-digit H temper. It is used when the degree of control of temper or the mechanical properties are different from but close to those for the two-digit H temper to which it is added. Numerals 1 through 9 may be arbitrarily assigned as the third digit for an alloy and product to indicate a specific degree of control of temper or special mechanical property limits.

- W** ***Solution Heat-Treated.*** An unstable temper applicable only to alloys which spontaneously age at room temperature after solution heat-treatment. This designation is specific only when the period of natural aging is indicated: for example, W ½ hr.
- T** ***Thermally Treated to Product Stable Tempers Other Than F, O, or H.*** Applies to products which are thermally treated, with or without supplementary strain-hardening, to product stable tempers. The T is always followed by one or more digits. Numerals 1 through 10 have been assigned to indicate specific sequences of basic treatments, as follows.
- T1** ***Cooled from an Elevated Temperature Shaping Process and Naturally Aged to a Substantially Stable Condition.*** Applies to products for which the rate of cooling from an elevated temperature shaping process, such as casting or extrusion, is such that their strength is increased by room temperature aging.
- T3** ***Solution Heat-treated and Then Cold Worked.*** Applies to products that are cold worked to improve strength, or in which the effect of cold work in flattening and straightening is recognized in applicable mechanical properties.
- T4** ***Solution Heat-treated and Naturally Aged to a Substantially Stable Condition.*** Applies to products that are not cold worked after solution heat-treatment, or in which the effect of cold work in flattening or straightening may not be recognized in applicable mechanical properties.
- T5** ***Cooled from an Elevated-Temperature Shaping Process and Then Artificially Aged.*** Applies to products which are cooled from an elevated-temperature shaping process, such as casting or extrusion, and then artificially aged to improve mechanical properties or dimensional stability or both.
- T6** ***Solution Heat-treated and Then Artificially Aged.*** Applies to products that are not cold worked after solution heat-treatment, or in which the effect of cold work is flattening or straightening may not be recognized in applicable mechanical properties.
- T7** ***Solution Heat-treated and Then Stabilized.*** Applies to products that are stabilized to carry them beyond the point of maximum strength to provide control of some special characteristics.
- T8** ***Solution Heat-treated, Cold Worked, and Then Artificially Aged.*** Applies to products which are cold worked to improve strength, or in which the effect of cold work in flattening or straightening is recognized in applicable mechanical properties.
- T9** ***Solution Heat-treated, Artificially Aged, and Then Cold Worked.*** Applies to products that are cold worked to improve strength.

^a From ASTM B 296-96.

Table 4.1.5. Temper Designation System for Magnesium Alloys (Continued)^a

T10 *Cooled from an Elevated Temperature Shaping Process, Artificially Aged, and Then Cold Worked.* Applies to products which are artificially aged after cooling from an elevated temperature shaping process, such as extrusion, and then cold worked to further improve strength.

A period of natural aging at room temperature may occur between or after the operations listed for tempers T3 through T10. Control of this period is exercised when it is metallurgically important.

Additional digits, may be added to designations T1 through T10 to indicate a variation in treatment that significantly alters the characteristics of the product.

a From ASTM B 296-96.

4.1.6 JOINING METHODS — Most magnesium alloys may be welded; refer to “Comments and Properties” in individual alloy sections. Adhesive bonding and brazing may be used to join magnesium to itself or other alloys. All types of mechanical fasteners may be used to join magnesium. Refer to Section 4.1.4 when using mechanical fasteners or joining of dissimilar materials with magnesium alloys.

4.2 MAGNESIUM-WROUGHT ALLOYS

4.2.1 AZ31B

4.2.1.0 Comments and Properties — AZ31B is a wrought magnesium-base alloy containing aluminum and zinc. It is available in the form of sheet, plate, extruded sections, forgings, and tubes. AZ31B has good room-temperature strength and ductility and is used primarily for applications where the temperature does not exceed 300°F. Increased strength is obtained in the sheet and plate form by strain hardening with a subsequent partial anneal (H24 and H26 temper). No treatments are available for increasing the strength of this alloy after fabrication.

Forming of AZ31B must be done at elevated temperatures if small radii or deep draws are required. If the temperatures used are too high or the times too great, H24 and H26 temper material will be softened. This alloy is readily welded but must be stress relieved after welding to prevent stress corrosion cracking.

Material specifications covering AZ31B wrought products are given in Table 4.2.1.0(a). Room-temperature mechanical and physical properties are shown in Tables 4.2.1.0(b) through (d). The effect of temperature on physical properties is shown in Figure 4.2.1.0.

Table 4.2.1.0(a). Material Specifications for AZ31B Magnesium Alloy

Specification	Form
AMS 4375	Sheet and plate
AMS 4376	Plate
AMS 4377	Sheet and plate
ASTM B 107	Extrusion
ASTM B 91	Forging

The temper index for AZ31B is as follows:

<u>Section</u>	<u>Temper</u>
4.2.1.1	O
4.2.1.2	H24
4.2.1.3	H26
4.2.1.4	F

4.2.1.1 AZ31B-O Temper — Effect of temperature on the tensile modulus of sheet and plate is presented in Figure 4.2.1.1.4. Typical room-temperature stress-strain and tangent-modulus curves are presented in Figure 4.2.1.1.6.

4.2.1.2 AZ31B-H24 Temper — Effect of temperature on the mechanical properties of sheet and plate is shown in Figures 4.2.1.2.1 through 4.2.1.2.4, and 4.2.1.2.6. Typical room-temperature tension and compression stress-strain and tangent-modulus curves for sheet are shown in Figure 4.2.1.2.6.

4.2.1.3 AZ31B-H26 Temper

4.2.1.4 AZ31B-F Temper — Figures 4.2.1.4.8 (a) and (b) contain fatigue data for forged disk at room temperature.

MIL-HDBK-5J
31 January 2003

Table 4.2.1.0(b). Design Mechanical and Physical Properties of AZ31B Magnesium Alloy Sheet and Plate

Specification	AMS 4375					AMS 4377						
	Sheet		Plate			Sheet		Plate				
Form	0					H24						
Temper												
Thickness, in.	0.016-0.060	0.061-0.249	0.250-0.500	0.501-2.000	2.001-3.000	0.016-0.062	0.063-0.249	0.250-0.374	0.375-0.500	0.501-1.000	1.001-2.000	2.001-3.000
Basis	S	S	S	S	S	S	S	S	S	S	S	S
Mechanical Properties:												
F_m , ksi:												
L	32	32	32	32	32	39	39	38	37	36	34	34
LT	40	40	39	38	37	35	...
F_{ty} , ksi:												
L	18	15	15	15	15	29	29	26	24	22	20	18
LT	32	32	29	27	25	23	...
F_{cy} , ksi:												
L	12	10	10	8	...	24	20	16	13	10	9
LT ^a
F_{su} , ksi	17	17	17	18	18	18	18
F_{bru}^b , ksi:												
(e/D = 1.5)	50	50	50	58	58	56	54
(e/D = 2.0)	60	60	60	68	68	65	63
F_{bry}^b , ksi:												
(e/D = 1.5)	29	29	27	43	43	38	34
(e/D = 2.0)	29	29	27	43	43	38	34
e , percent												
L	12	12	12	10	9	6	6	8	8	8	8	8
E , 10 ³ ksi						6.5						
E_c , 10 ³ ksi						6.5						
G , 10 ³ ksi						2.4						
μ						0.35						
Physical Properties:												
ω , lb/in. ³						0.0639						
C , K , and α						See Figure 4.2.1.0						

a F_{cy} (LT) allowables are equal to or greater than F_{cy} (L) allowables.
b Bearing values are “dry pin” values per Section 1.4.7.1.

Table 4.2.1.0(c). Design Mechanical and Physical Properties of AZ31B Magnesium Alloy Plate

Specification	AMS 4376						
Form	Plate						
Temper	H26						
Thickness, in.	0.250-0.375	0.376-0.438	0.439-0.500	0.501-0.750	0.751-1.000	1.001-1.500	1.501-2.000
Basis	S	S	S	S	S	S	S
Mechanical Properties:							
F_u , ksi:							
L	39	38	38	37	37	35	35
LT	40	39	39	38	38	36	36
F_{ty} , ksi:							
L	27	26	26	25	23	22	21
LT	30	29	29	28	26	25	24
F_{cy} , ksi:							
L	22	21	18	17	16	15	14
LT ^a
F_{su} , ksi	18	18	18
F_{bru}^b , ksi:							
(e/D = 1.5)	58	56	56
(e/D = 2.0)	68	65	65
F_{bry}^b , ksi:							
(e/D = 1.5)	40	39	36
(e/D = 2.0)	40	39	36
e , percent:							
L	6	6	6	6	6	6	6
E , 10 ³ ksi	6.5						
E_c , 10 ³ ksi	6.5						
G , 10 ³ ksi	2.4						
μ	0.35						
Physical Properties:							
ω , lb/in. ³	0.0639						
C , K , and α	See Figure 4.2.1.0						

a $F_{cy}(LT)$ allowables are equal to or greater than $F_{cy}(L)$ values.
b Bearing values are "dry pin" values per Section 1.4.7.1.

Table 4.2.1.0(d). Design Mechanical and Physical Properties of AZ31B Magnesium Alloy Extrusion and Forging

Specification	ASTM B 107							ASTM B 91
	Extruded bar, rod, and solid shapes				Extruded hollow shapes	Extruded tube	Forging	
Temper	F							
Thickness, in.	≤0.249	0.250-1.499	1.500-2.499	2.500-4.999	All	0.028-0.250 ^b	0.251-0.750 ^b	...
Basis	S	S	S	S	S	S	S	S
Mechanical Properties:								
F_{tu} , ksi:								
L	35	35	34	32	32	32	32	34
LT
F_{ty} , ksi:								
L	21	22	22	20	16	16	16	19
LT
F_{cy} , ksi:								
L	12	12	10	10	10	10	...
LT
F_{su} , ksi	17	17	17
F_{bru}^b , ksi:								
(e/D = 1.5)	36	36	36
(e/D = 2.0)	45	45	45
F_{bry}^b , ksi:								
(e/D = 1.5)	23	23	23
(e/D = 2.0)	23	23	23
e , percent:								
L	7	7	7	7	8	8	4	6
E , 10 ³ ksi	6.5							
E_c , 10 ³ ksi	6.5							
G , 10 ³ ksi	2.4							
μ	0.35							
Physical Properties:								
ω , lb/in. ³	0.0639							
C , K , and α	See Figure 4.2.1.0							

a Wall thickness for tube; for outside diameter ≤ 6.000 inches.
b Bearing values are “dry pin” values per Section 1.4.7.1.

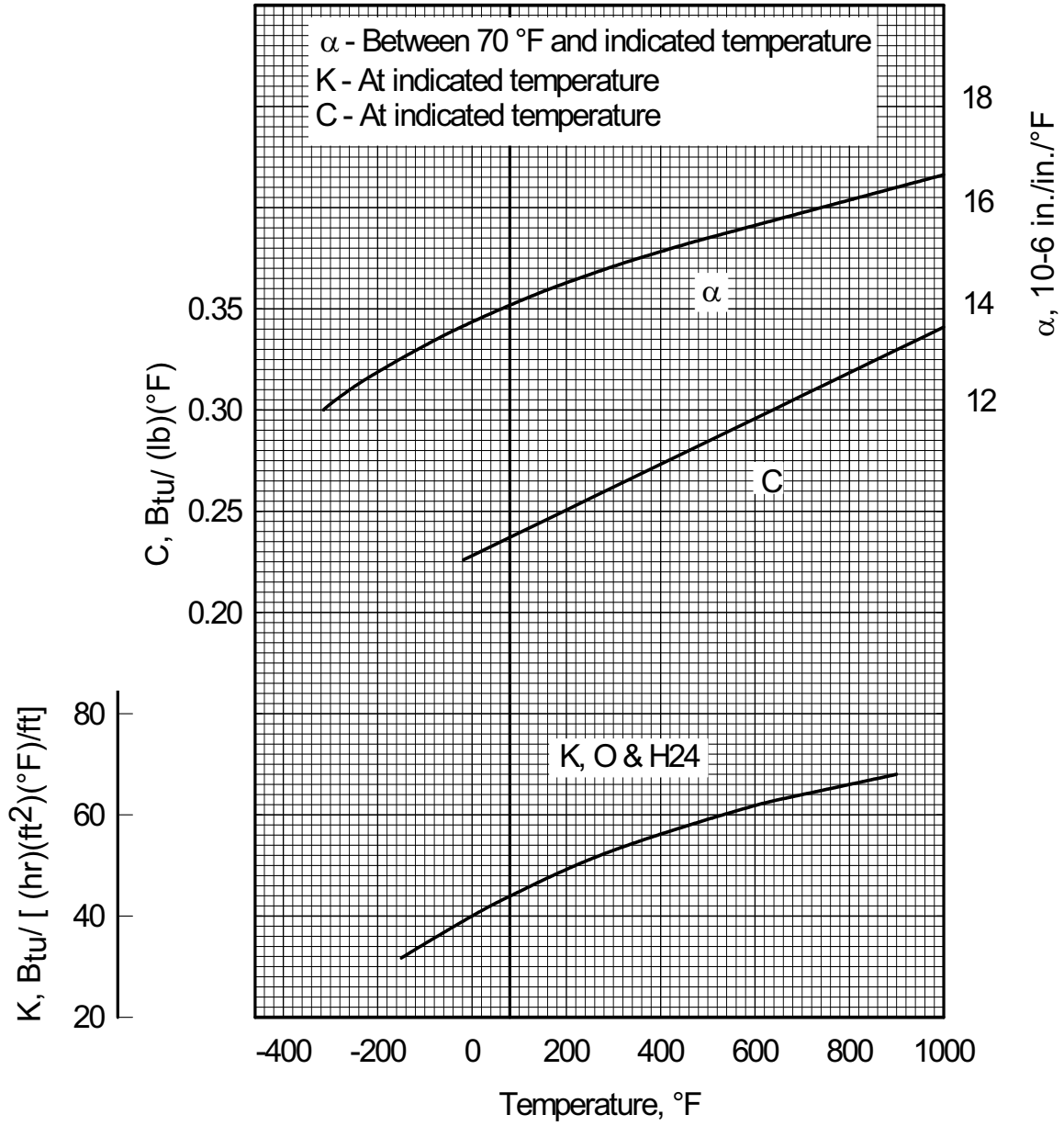

Figure 4.2.1.0. Effect of temperature on the physical properties of AZ31B.

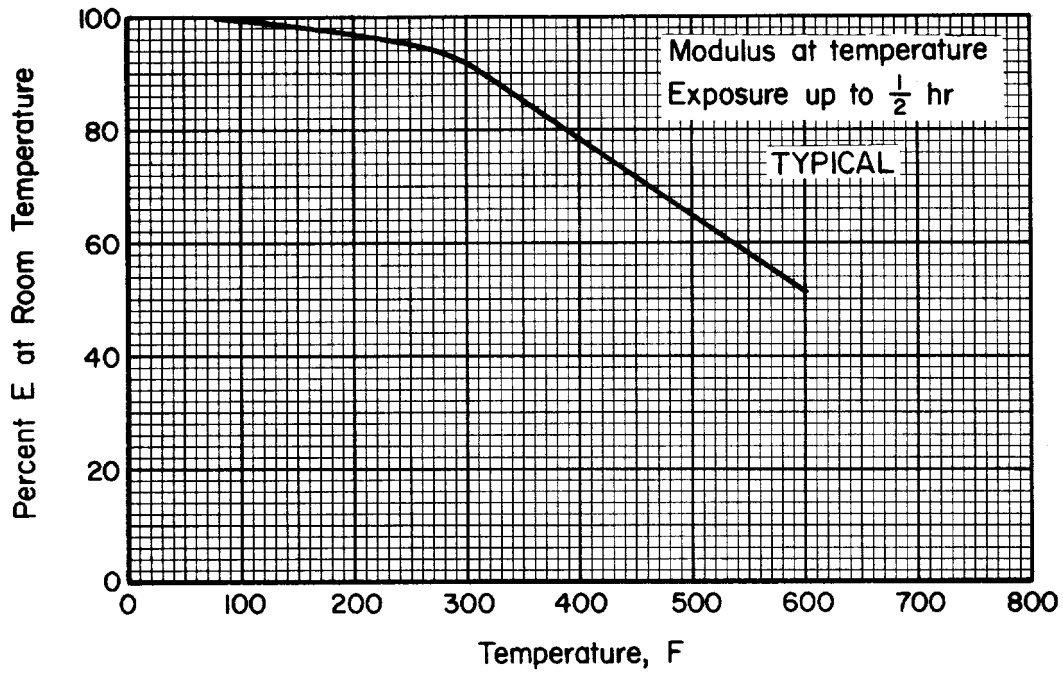

Figure 4.2.1.1.4. Effect of temperature on the tensile modulus (E) of AZ31B-O sheet and plate.

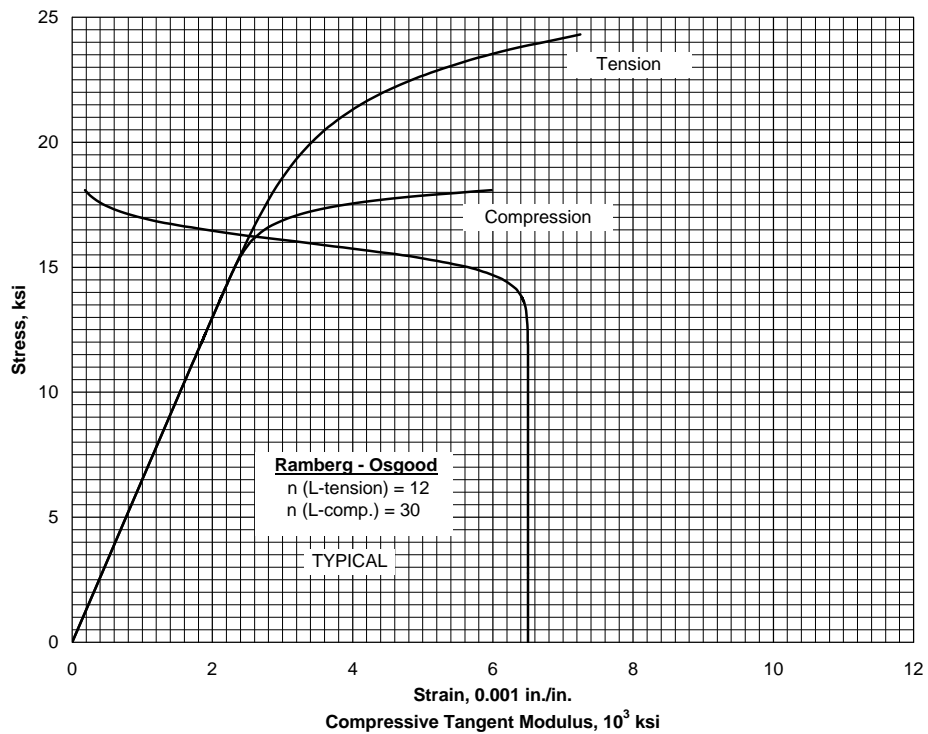

Figure 4.2.1.1.6. Typical tensile and compressive stress-strain and compressive tangent-modulus curves for AZ31B-O sheet and plate at room temperature.

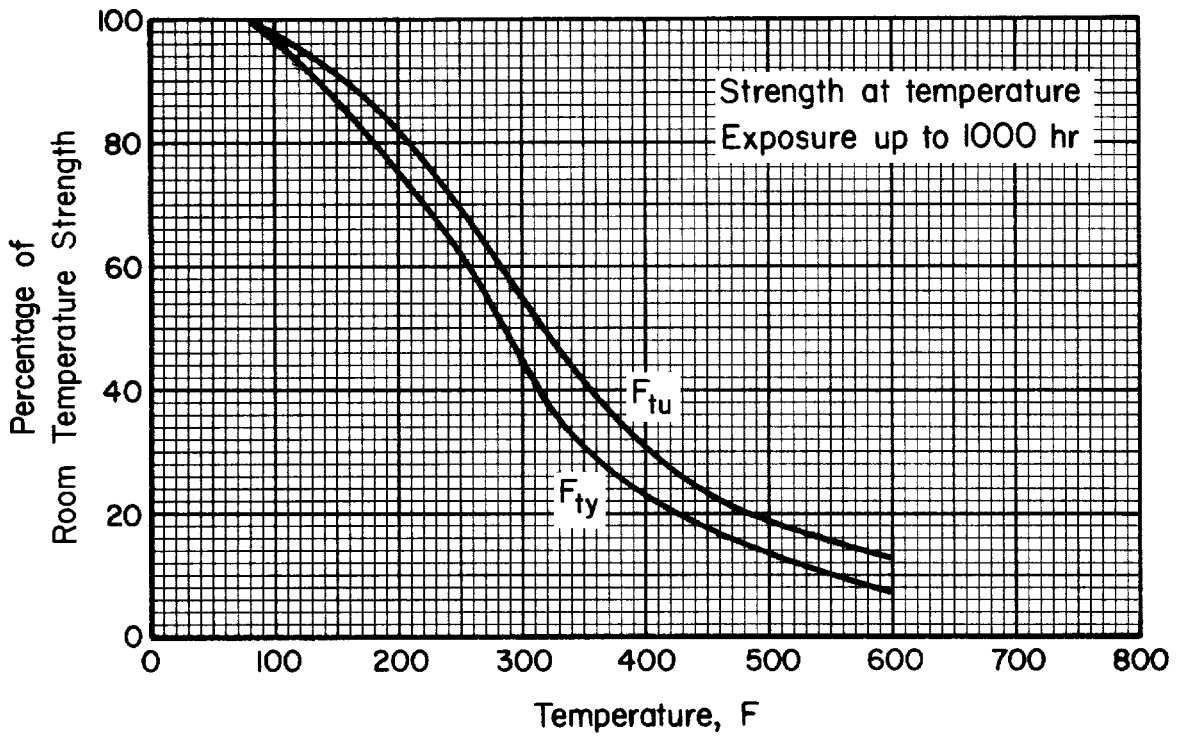

Figure 4.2.1.2.1. Effect of temperature on the tensile ultimate strength (F_{tu}) and the tensile yield strength (F_{ty}) of AZ31B-H24 sheet and plate.

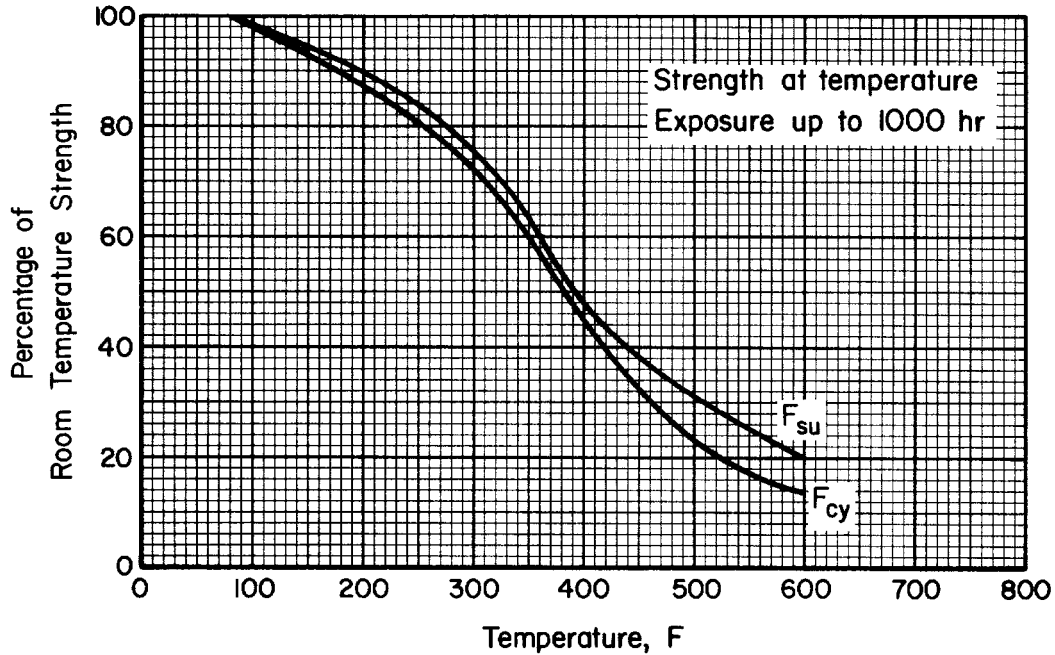

Figure 4.2.1.2.2. Effect of temperature on the compressive yield strength (F_{cy}) and the shear ultimate strength (F_{su}) of AZ31B-H24 sheet and plate.

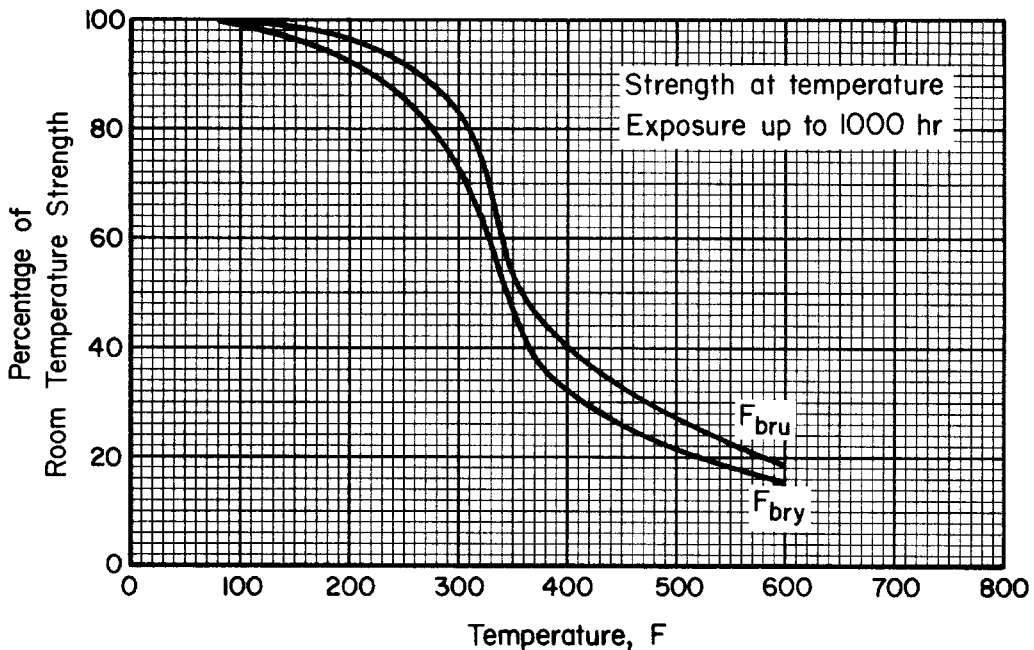

Figure 4.2.1.2.3. Effect of temperature on the bearing ultimate strength (F_{bru}) and the bearing yield strength (F_{bry}) of AZ31B-H24 sheet and plate.

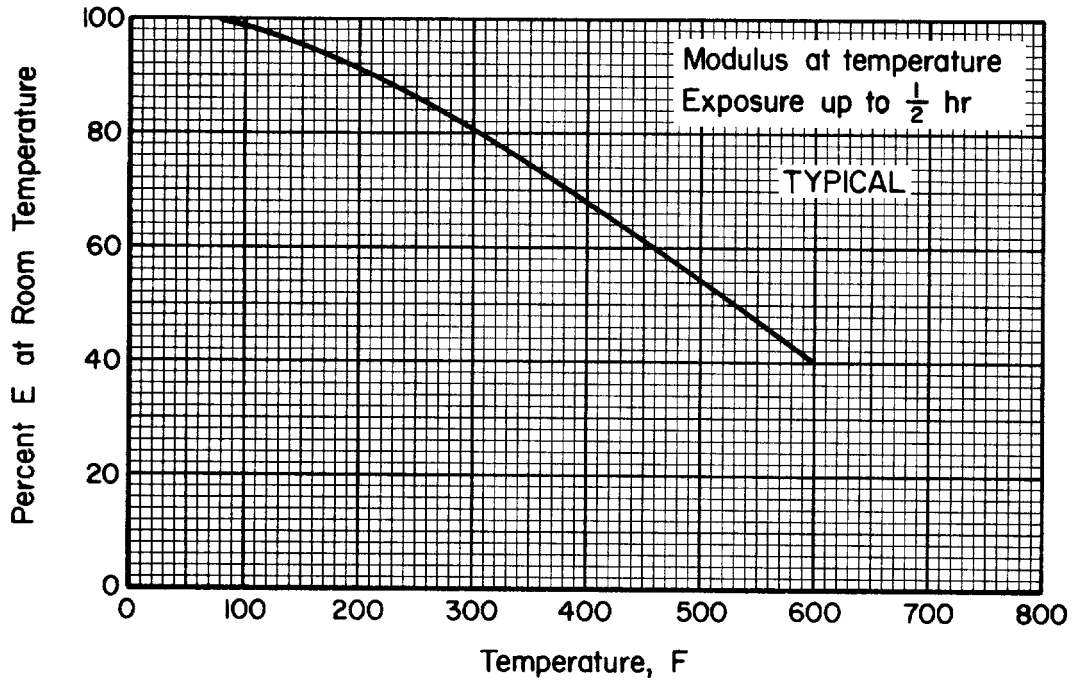

Figure 4.2.1.2.4. Effect of temperature on the tensile modulus (E) of AZ31B-H24 sheet and plate.

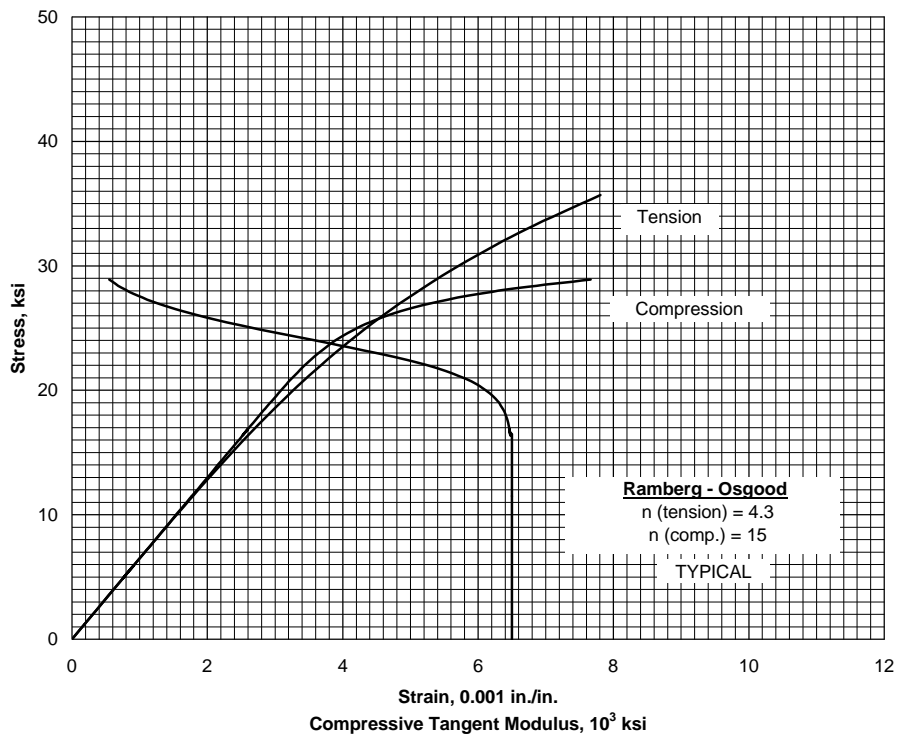

Figure 4.2.1.2.6. Typical tensile and compressive stress-strain and compressive tangent-modulus curves for AZ31B-H24 sheet at room temperature.

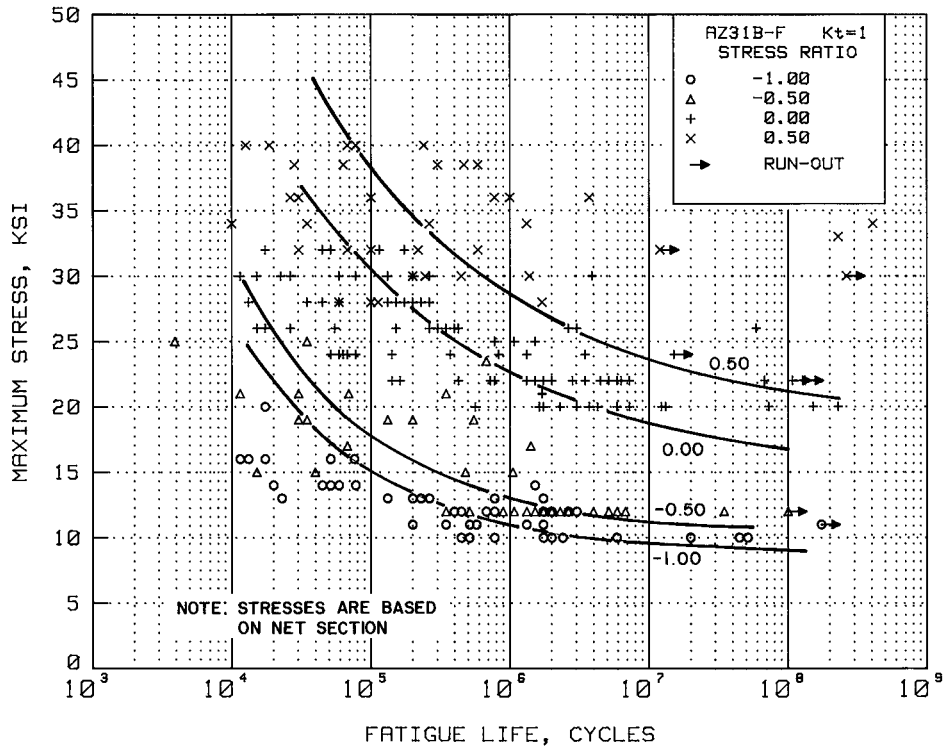

Figure 4.2.1.4.8(a). Best-fit S/N curves for unnotched AZ31B-F magnesium alloy forged disk, transverse direction.

Correlative Information for Figure 4.2.1.4.8(a)

Product Form: Forged disk, 1 inch thick

No. of Heats/Lots: 1

Properties: TUS, ksi 38 TYS, ksi 26 Temp., °F RT

Equivalent Stress Equation:

Specimen Details: Unnotched
0.75 inch gross diameter
0.30 inch net diameter

For R values between -1.0 and -0.50
 $\log N_f = 7.13 - 2.20 \log (S_{eq} - 12.9)$
 $S_{eq} = S_{max}(1-R)^{0.56}$
 Std. Error of Estimate, Log (Life) = 0.613
 Standard Deviation, Log (Life) = 0.916
 $R^2 = 55.2\%$

Surface Condition: Polished sequentially with
No. 320 aluminum oxide
cloth, No. 0, 00, and 000
emery paper and finally No.
600 aluminum oxide
powder in water

For R values between 0.0 and 0.50
 $\log N_f = 8.87 - 3.26 \log (S_{eq} - 15.0)$
 $S_{eq} = S_{max}(1-R)^{0.33}$
 Std. Error of Estimate, Log (Life) = 0.829
 Standard Deviation, Log (Life) = 1.014
 $R^2 = 33.2\%$

References: 4.2.1.1.8

Sample Size = 194

Test Parameters:
Loading - Axial
Frequency - 1500 cpm
Temperature - RT
Environment - Air

[Caution: The equivalent stress model may provide unrealistic life predictions for stress ratios beyond those represented above.]

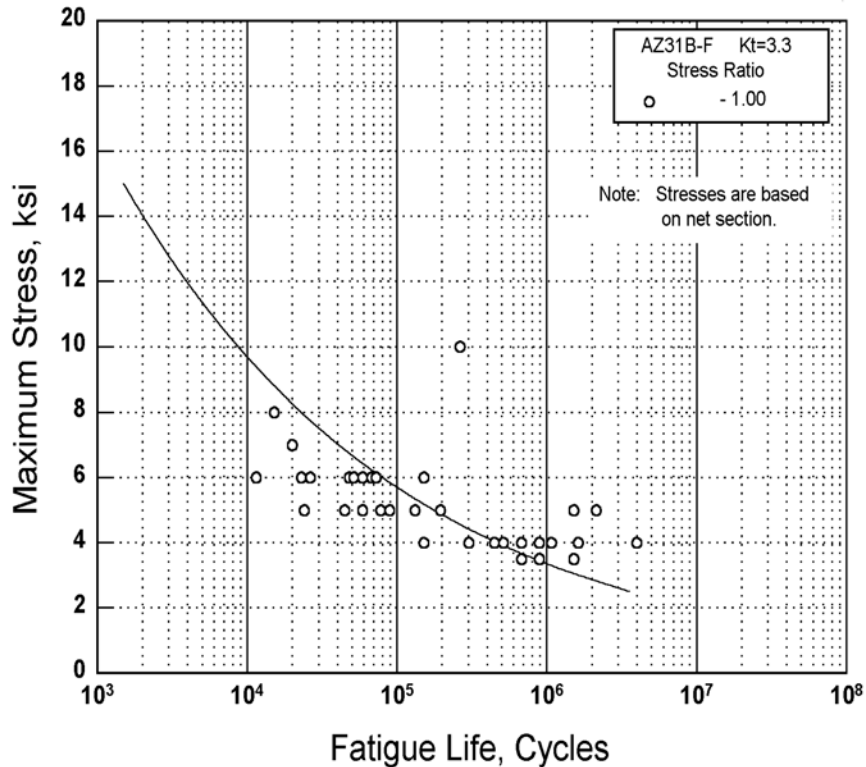

Figure 4.2.1.4.8(b). Best-fit S/N curves for notched, $K_t = 3.3$, AZ31B-F magnesium alloy forged disk, transverse direction.

Correlative Information for Figure 4.2.1.4.8(b)

Product Form: Forged disk, 1 inch thick

Properties: TUS, ksi TYS, ksi Temp., °F
 38 26 RT

Specimen Details: Notched, $K_t = 3.3$
0.350 inch gross diameter
0.280 inch net diameter
0.010 inch root radius, r
60° flank angle, ω

Reference: 4.2.1.1.8

Test Parameters:

Loading - Axial
Frequency - 1500 cpm
Temperature - RT
Environment - Air

No. of Heats/Lots: 1

Maximum Stress Equation:

$\log N_f = 8.28 - 4.34 \log (S_{max})$
Std. Error of Estimate, $\log (\text{Life}) = 0.534$
Standard Deviation, $\log (\text{Life}) = 0.707$
 $R^2 = 43\%$

Sample Size = 34

4.2.2 AZ61A

4.2.2.0 Comments and Properties — AZ61A is a wrought magnesium-base alloy containing aluminum and zinc. It is available in the form of extruded sections, tubes, and forgings in the as-fabricated (F) temper. AZ61A is much like AZ31B in general characteristics. The increased aluminum content increases the strength and decreases the ductility slightly.

Severe forming must be done at elevated temperatures. This alloy is readily welded but must be stress relieved after welding to prevent stress corrosion cracking.

Material specifications covering AZ61A are given in Table 4.2.2.0(a). Room-temperature mechanical and physical properties are shown in Table 4.2.2.0(b).

Table 4.2.2.0(a). Material Specifications for AZ61A Magnesium Alloy

Specification	Form
AMS 4350	Extrusion
ASTM B 91	Forging

Table 4.2.2.0(b). Design Mechanical and Physical Properties of AZ61A Magnesium Alloy Extrusion and Forging

Specification	AMS 4350					ASTM B 91
	Extruded bar, rod, and solid shapes			Extruded hollow shapes	Extruded tube	Forging
Form						
Temper	F					
Thickness, in.	≤0.249	0.250-2.499	2.500-4.499 ^a	All	0.028-0.750 ^b	...
Basis	S	S	S	S	S	S
Mechanical Properties:						
F_{tu} , ksi:						
L	38	40	40	36	36	38
LT
F_{ty} , ksi:						
L	21	24	22	16	16	22
LT
F_{cy} , ksi:						
L	14	14	14	11	11	14
LT
F_{su} , ksi	19	19	19
F_{bru}^c , ksi:						
(e/D = 1.5)	45	45	50
(e/D = 2.0)	55	55	60
F_{bry}^c , ksi:						
(e/D = 1.5)	28	28	28
(e/D = 2.0)	32	32	32
e , percent:						
L	8	9	7	7	7	6
E , 10 ³ ksi	6.3					
E_c , 10 ³ ksi	6.3					
G , 10 ³ ksi	2.4					
μ	0.31					
Physical Properties:						
ω , lb/in. ³	0.0647					
C , Btu/(lb)(°F)	0.25 (at 78 °F) ^d					
K , Btu/[(hr)(ft ²)(°F)/ft]	46 (212 to 572 °F)					
α , 10 ⁻⁶ in./in./°F	14 (65 to 212 °F)					

a For cross-sectional area ≤25 square inches.
b Wall thickness for outside diameters ≤6.000 inches.
c Bearing values are “dry pin” values per Section 1.4.7.1.
d Estimated.

4.2.3 ZK60A

4.2.3.0 Comments and Properties — ZK60A is a wrought magnesium-base alloy containing zinc and zirconium. It is available as extruded sections, tubes, and forgings. Increased strength is obtained by artificial aging (T5) from the as-fabricated (F) temper. ZK60A has the best combination of high room-temperature strength and ductility of the wrought magnesium-base alloys. It is used primarily at temperatures below 300°F.

ZK60A has good ductility as compared with other high-strength magnesium alloys and can be formed or bent cold into shapes not possible with those alloys having less ductility. It is not considered a weldable alloy.

Material specifications for ZK60A are given in Table 4.2.3.0(a). Room-temperature mechanical and physical properties are shown in Tables 4.2.3.0(b) and (c). Elevated temperature curves for physical properties are shown in Figures 4.2.3.0.

Table 4.2.3.0(a). Material Specifications for ZK60A Magnesium Alloy

Specification	Form
ASTM B 107	Extrusion
AMS 4352	Extrusion
AMS 4362	Die and hand forgings

The temper index for ZK60A is as follows:

<u>Section</u>	<u>Temper</u>
4.2.3.1	F
4.2.3.2	T5

4.2.3.1 ZK60A-F Temper

4.2.3.2 ZK60A-T5 Temper — Typical room-temperature tension and compression stress-strain curves for extrusions are shown in Figures 4.2.3.2.6(a) and (b). Fatigue curves are presented in Figure 4.2.3.2.8(a) through (c).

Table 4.2.3.0(b). Design Mechanical and Physical Properties of ZK60A Magnesium Alloy Extrusion

Specification	ASTM B 107					
	Extruded rod, bar, and solid shapes				Extruded hollow shapes	Extruded tube
Form	F					
Temper	F					
Cross-sectional area, in. ²	<2.000	2.000-2.999	3.000-4.999	5.000-39.999	All	≤3.000 in. O.D.
Thickness, in.	All	All	All	All	All	0.028-0.750 wall
Basis	S	S	S	S	S	S
Mechanical Properties:						
F_{tu} , ksi:						
L	43	43	43	43	40	40
LT
F_{ty} , ksi:						
L	31	31	31	31	28	28
LT
F_{cy} , ksi:						
L	27	26	25	20	20	20
LT
F_{su} , ksi	22	22	22
F_{bru}^a , ksi:						
(e/D = 1.5)
(e/D = 2.0)	70	70	70
F_{bry}^a , ksi:						
(e/D = 1.5)
(e/D = 2.0)	45	45	45
e , percent:						
L	5	5	5	4	5	5
E , 10 ³ ksi	6.5					
E_c , 10 ³ ksi	6.5					
G , 10 ³ ksi	2.4					
μ	0.35					
Physical Properties:						
ω , lb/in. ³	0.0659					
C , K , and α	See Figure 4.2.3.0					

a Bearing values are “dry pin” values per Section 1.4.7.1.

MIL-HDBK-5J
31 January 2003

Table 4.2.3.0(c). Design Mechanical and Physical Properties of ZK60A Magnesium Alloy Extrusion and Forging

Specification	AMS 4352							AMS 4362				
	Extruded rod, bar, and solid shapes						Extruded hollow shapes	Extruded tube		Die forging	Hand forging	
Temper	T5											
Cross-sectional area, in. ²	<2.000	2.000-2.999	3.000-4.999	5.000-9.999	10.000-24.999	25.000-39.999	All	≤3.000 in. O.D.	3.000-8.500 in. O.D.	
Thickness, in.	All	All	All	All	All	All	All	0.028-0.250 wall	0.094-1.188 wall	≤3.000	≤6.000	
Basis	S	S	S	S	S	S	S	S	S	S	S	
Mechanical Properties:												
F_{tw} , ksi:												
L	45	45	45	45	45	43	46	46	44	42	38	
LT	
F_{ly} , ksi:												
L	36	36	36	34	34	31	38	38	33	26	20	
LT	
F_{cy} , ksi:												
L	30	28	25	23	22	20	26	26	21	
LT	
F_{su} , ksi	22	22	22	
F_{bru}^a , ksi:												
(e/D = 1.5)	
(e/D = 2.0)	71	71	71	
F_{bry}^a , ksi:												
(e/D = 1.5)	
(e/D = 2.0)	47	47	47	
e , percent:												
L	4	4	4	6	6	6	4	4	4	7	7	
E , 10 ³ ksi							6.5					
E_c , 10 ³ ksi							6.5					
G , 10 ³ ksi							2.4					
μ							0.35					
Physical Properties:												
ω , lb/in. ³							0.0659					
C , K , and α							See Figure 4.2.3.0					

a Bearing values are “dry pin” values per Section 1.4.7.1.

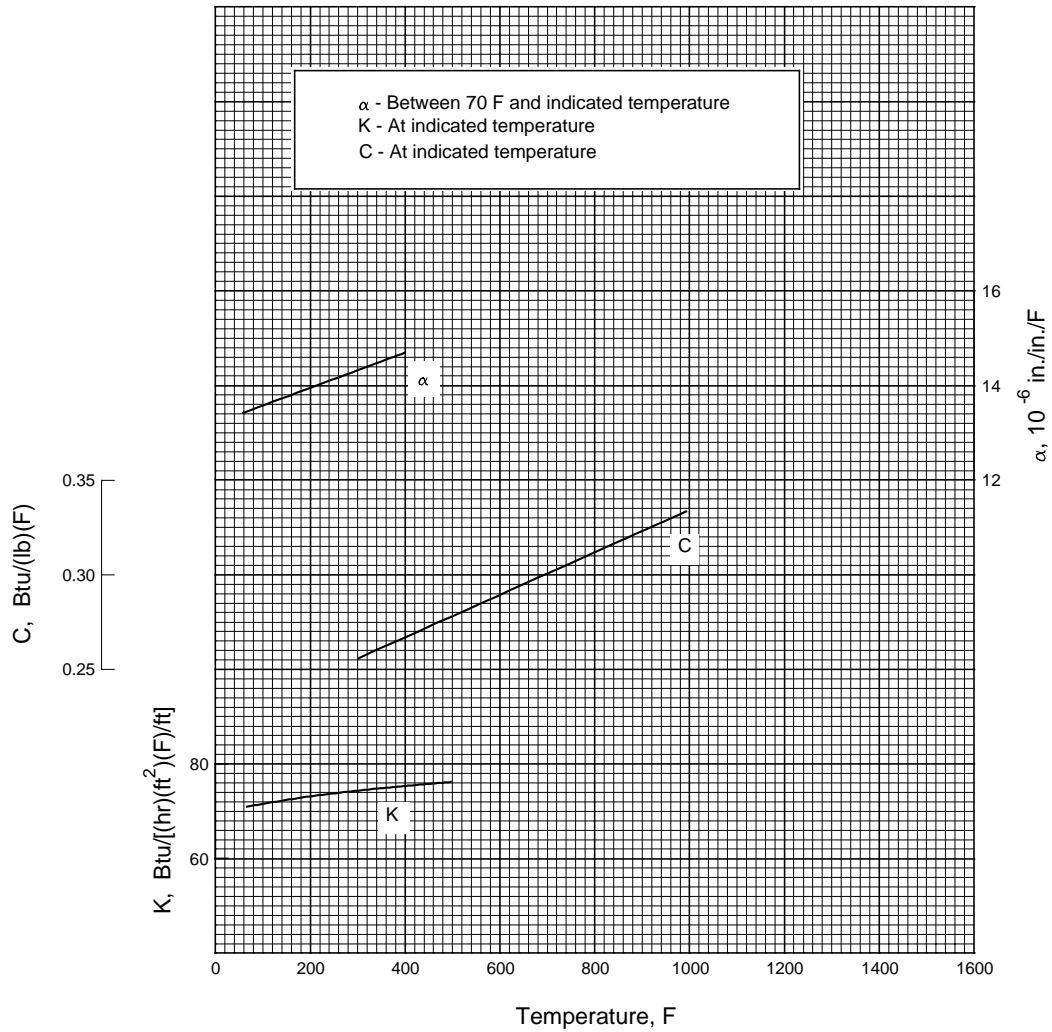

Figure 4.2.3.0. Effect of temperature on the physical properties of ZK60A magnesium alloy.

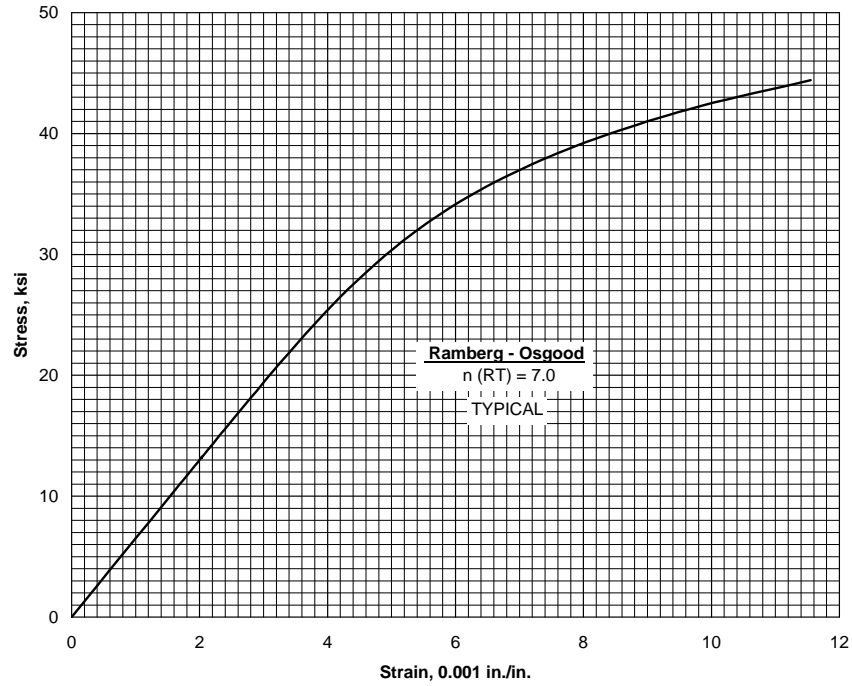

Figure 4.2.3.2.6(a). Typical tensile stress-strain curve for ZK60A-T5 extrusion at room temperature.

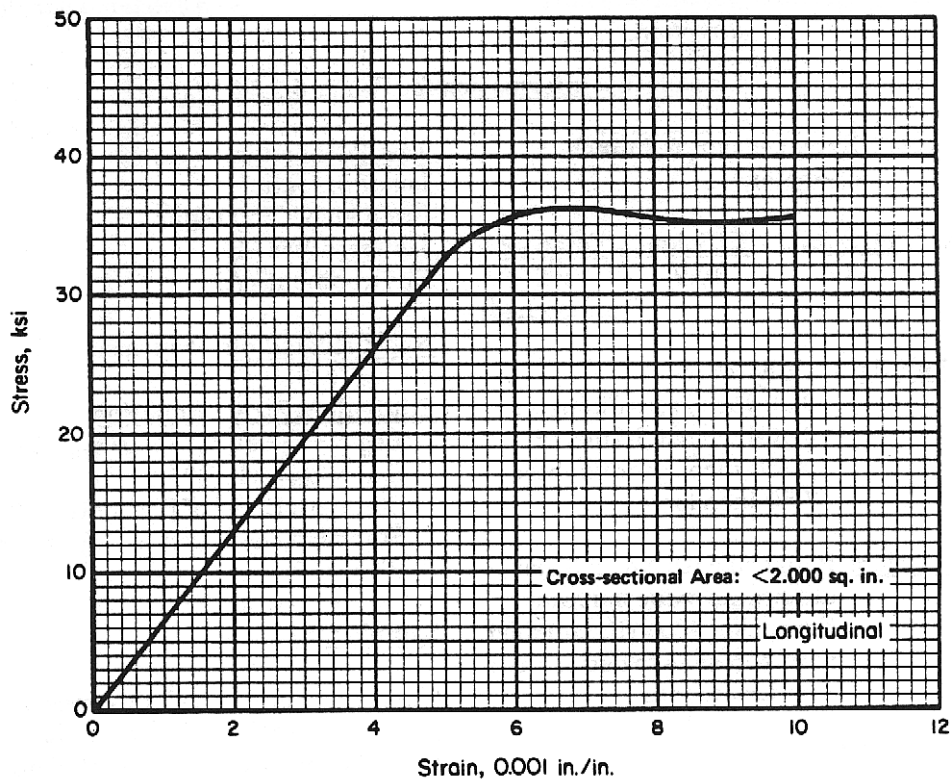

Figure 4.2.3.2.6(b). Typical compressive stress-strain curve for ZK60A-T5 extrusion at room temperature.

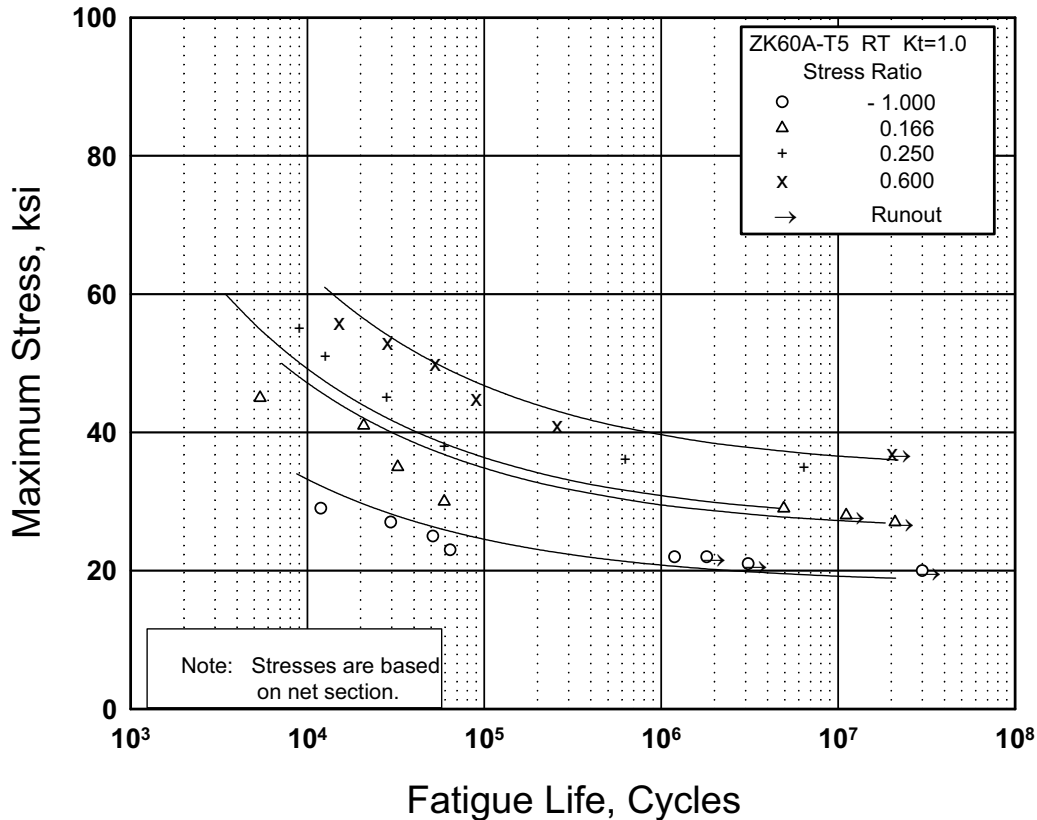

Figure 4.2.3.2.8(a). Best-fit S/N curves for unnotched ZK60A-T5 extruded bar, longitudinal direction.

Correlative Information for Figure 4.2.3.2.8(a)

Product Form: Extruded bar, 0.50 inch diameter

Test Parameters:
Loading - Axial
Frequency - 3600 cpm
Temperature - RT
Environment - Air

Properties: TUS, ksi TYS, ksi Temp., °F
47.5 40.9 RT
(unnotched)

No. of Heats/Lots: Not specified

Specimen Details: Unnotched
0.500 inch gross diameter
0.400 inch net diameter
0.750 inch root diameter
7.500 inch long

Equivalent Stress Equation:
 $\log N_f = 7.56 - 2.73 \log (S_{eq} - 23.7)$
 $S_{eq} = S_{max}(1-R)^{0.40}$
Std. Error of Estimate, Log (Life) = 0.60
Standard Deviation, Log (Life) = 0.85
 $R^2 = 51\%$

Surface Condition: Polished with No. 240 grit aluminum oxide belt and then a No. 400 grit; polished with kerosene to better than 10 micro-inches

Sample Size = 21

Reference: 4.2.3.2.8

[Caution: The equivalent stress model may provide unrealistic life predictions for stress ratios beyond those represented above.]

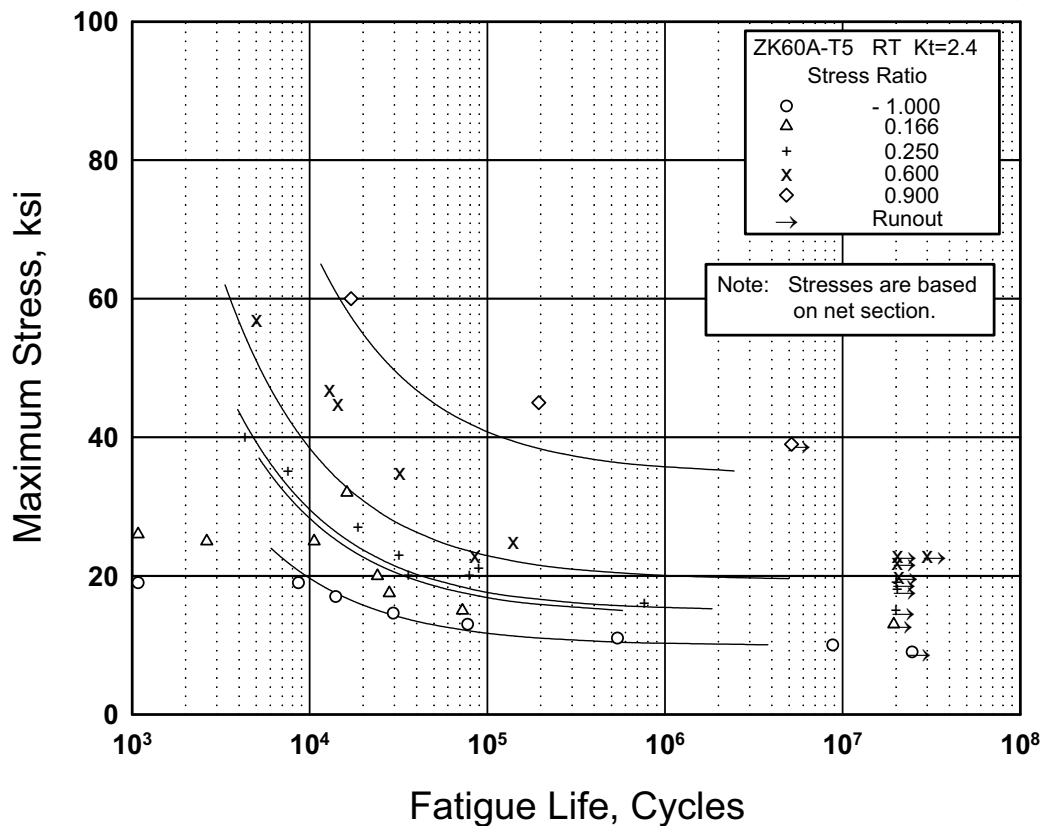

Figure 4.2.3.2.8(b). Best-fit S/N curves for notched, $K_t = 2.4$, ZK60A-T5 extruded bar, longitudinal direction.

Correlative Information for Figure 4.2.3.2.8(b)

Product Form: Extruded bar, 0.50 inch diameter

Test Parameters:

Properties: TUS, ksi TYS, ksi Temp., °F
63.7 40.9 RT
(notched)

Loading - Axial
Frequency - 3600 cpm
Temperature - RT
Environment - Air

Specimen Details: Circumferential notched,
 $K_t = 2.4$
0.500 inch gross diameter
0.400 inch net diameter
0.032 inch notch radius
60° flank angle, ω

No. of Heats/Lots: Not specified

Equivalent Stress Equation:

$$\log N_f = 5.51 - 1.36 \log (S_{eq} - 13.2)$$

$$S_{eq} = S_{max}(1-R)^{0.42}$$

Std. Error of Estimate, $\log(\text{Life}) = 0.46$

Standard Deviation, $\log(\text{Life}) = 0.82$

$R^2 = 69\%$

Surface Condition: Ground with aluminum oxide
wheel lubricated with sulfur
cutting oil; lapped with a
copper rod and No. 600 grit
alundum lapping compound

Sample Size = 30

Reference: 4.2.3.2.8

[Caution: The equivalent stress model may provide unrealistic life predictions for stress ratios beyond those represented above.]

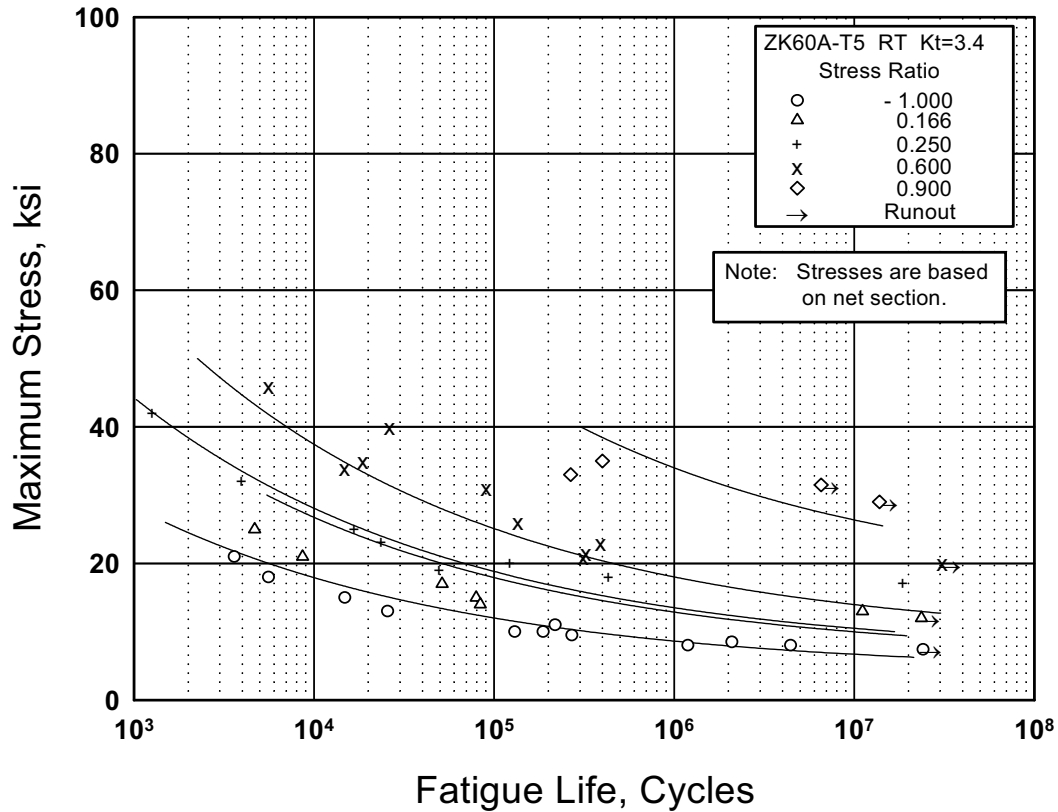

Figure 4.2.3.2.8(c). Best-fit S/N curves for notched, $K_t = 3.4$, ZK60A-T5 extruded bar, longitudinal direction.

Correlative Information for Figure 4.2.3.2.8(c)

Product Form: Extruded bar, 0.50 inch diameter

Frequency - 3600 cpm

Temperature - RT

Properties: T_{US} , ksi 58.2 T_{YS} , ksi 40.9 T_{emp} , °F RT (notched)

Environment - Air

No. of Heats/Lots: Not specified

Specimen Details: Circumferential notched, $K_t = 4$
0.500 inch gross diameter
0.400 inch net diameter
0.010 inch notch radius
60° flank angle, ω

Equivalent Stress Equation:
 $\log N_f = 9.27 - 4.13 \log (S_{eq} - 5.63)$
 $S_{eq} = S_{max}(1-R)^{0.46}$
Std. Error of Estimate, $\log (\text{Life}) = 0.55$
Standard Deviation, $\log (\text{Life}) = 0.99$
 $R^2 = 70\%$

Surface Condition: Ground with aluminum oxide wheel lubricated with sulfur cutting oil; lapped with a copper rod and No. 600 grit aluminum lapping compound

Sample Size = 36

[Caution: The equivalent stress model may provide unrealistic life predictions for stress ratios beyond those represented above.]

Reference: 4.2.3.2.8

Test Parameters:

Loading - Axial

4.3 MAGNESIUM CAST ALLOYS

4.3.1 AM100A

4.3.1.0 Comments and Properties— AM100A is a magnesium-base casting alloy containing aluminum and a small amount of manganese. It is primarily used as permanent mold castings. AM100A has about the same characteristics as AZ92A. AM100A has less tendency to microshrinkage and hot shortness than the Mg-Al-Zn alloys. It has good weldability and fair pressure tightness.

Material specifications for AM100A are given in Table 4.3.1.0(a). Room-temperature mechanical and physical properties are shown in Table 4.3.1.0(b).

**Table 4.3.1.0(a). Material Specifications for AM100A
Magnesium Alloy**

Specification	Form
AMS 4455	Investment casting
AMS 4483 ^a	Permanent mold casting

a Noncurrent specification.

Table 4.3.1.0(b). Design Mechanical and Physical Properties of AM100A Magnesium Alloy Casting

Specification	AMS 4455	AMS 4483 ^a
Form	Investment casting	Permanent mold casting
Temper	T6	T6
Location within casting	Any area	
Basis	S	S
Mechanical Properties^c:		
F_{tu} , ksi	17 ^c	17 ^c
F_{ty} , ksi	9.5 ^c	10 ^c
F_{cy} , ksi	9.5	10
F_{su} , ksi
F_{bru} , ksi:		
(e/D = 1.5)
(e/D = 2.0)
F_{bry} , ksi:		
(e/D = 1.5)
(e/D = 2.0)
e , percent	1 ^b	...
E , 10 ³ ksi	6.5	
E_c , 10 ³ ksi	6.5	
G , 10 ³ ksi	2.4	
μ	0.35	
Physical Properties:		
ω , lb./in. ³	0.0651	
C , K , and α	

a Noncurrent specification.

b Reference should be made to the specific requirements of the procuring or certifying agency with regard to the use of the above values in the design of castings.

c When specified on drawing, conformance to tensile property requirements is determined by testing specimens cut from castings.

4.3.2 AZ91C/AZ91E

4.3.2.0 Comments and Properties — AZ91C is a magnesium-base casting alloy containing aluminum and zinc. AZ91E is a version which contains a significantly lower level of impurities resulting in improved corrosion resistance. These alloys have good castability with a good combination of ductility and strength. AZ91C and AZ91E are the most commonly used sand castings for temperatures under 300°F. AZ91C is available as sand and investment castings, while AZ91E is available as a sand casting. AZ91C and AZ91E have fair weldability and pressure tightness.

Some material specifications covering AZ91C/AZ91E are presented in Table 4.3.2.0(a). Room-temperature mechanical and physical properties are shown in Tables 4.3.2.0(b) and (c).

Table 4.3.2.0(a). Material Specifications for AZ91C/AZ91E Magnesium Alloy

Specification	Form
AMS 4437	Sand casting
AMS 4452	Investment casting
AMS 4446	Sand casting

The temper index for AZ91C/AZ91E is as follows:

<u>Section</u>	<u>Temper</u>
4.3.2.1	T6

4.3.2.1 T6 Temper — Figure 4.3.2.1.4 contains an elevated temperature curve for tension and compression moduli. Typical tensile stress-strain curves at room temperature and several elevated temperatures are presented in Figure 4.3.2.1.6.

Table 4.3.2.0(b). Design Mechanical and Physical Properties of AZ91C Magnesium Alloy Casting

Specification	AMS 4437	AMS 4452
Form	Sand casting	Investment casting
Temper	T6	T6
Location within casting	Any area	
Basis	S	S
Mechanical Properties^a:		
F_{tu} , ksi	17 ^b	17 ^b
F_{ty} , ksi	12 ^b	12 ^b
F_{cy} , ksi	12	12
F_{su} , ksi
F_{bru} , ksi:		
(e/D = 1.5)
(e/D = 2.0)
F_{bry} , ksi:		
(e/D = 1.5)
(e/D = 2.0)
e, percent	0.75 ^b	1 ^b
E , 10 ³ ksi	6.5	
E_c , 10 ³ ksi	6.5	
G , 10 ³ ksi	2.4	
μ	0.35	
Physical Properties:		
ω , lb./in. ³	0.0652	
C, Btu/(lb)(°F)	0.25 ^c	
K, Btu/[(hr)(ft ²)(°F)/ft] ..	41 (212°F to 572°F)	
α , 10 ⁻⁶ in./in./°F	14 (65°F to 212°F)	

a Reference should be made to the specific requirements of the procuring or certifying agency with regard to the use of the above values in the design of castings.

b When specified on drawing, conformance to tensile property requirements is determined by testing specimens cut from castings.

c Estimated.

Table 4.3.2.0(c). Design Mechanical and Physical Properties of AZ91E Magnesium Alloy Casting

Specification	AMS 4446
Form	Sand casting
Condition	T6
Location within casting	Any area
Basis	S
Mechanical Properties ^a :	
F_{tu} , ksi	17 ^b
F_{ty} , ksi	12 ^b
F_{cy} , ksi	12
F_{su} , ksi
F_{bru} , ksi:	
(e/D = 1.5)
(e/D = 2.0)
F_{bry} , ksi:	
(e/D = 1.5)
(e/D = 2.0)
e , percent
E , 10 ³ ksi	6.5
E_c , 10 ³ ksi	6.5
G , 10 ³ ksi	2.4
μ	0.35
Physical Properties:	
ω , lb/in. ³	0.0652
C , Btu/(lb)(°F)	0.25 ^c
K , Btu/[(hr)(ft ²)(°F)/ft]	41 (212°F to 572°F)
α , 10 ⁻⁶ in./in./F	14 (65°F to 212°F)

- a Reference should be made to the specific requirements of the procuring or certifying agency with regard to the use of the above values in the design of castings.
- b When specified on drawing, conformance to tensile property requirements is determined by testing specimens cut from castings.
- c Estimated.

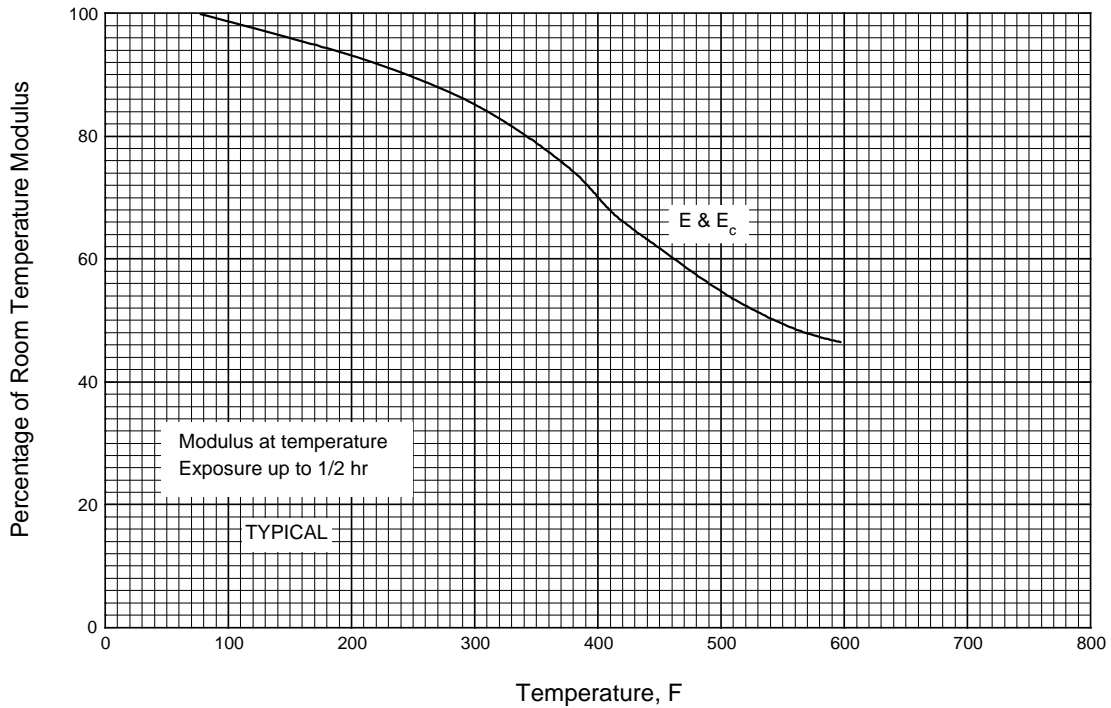

Figure 4.3.2.1.4. Effect of temperature on the tensile and compressive moduli (E and E_c) of cast AZ91C-T6/AZ91E-T6.

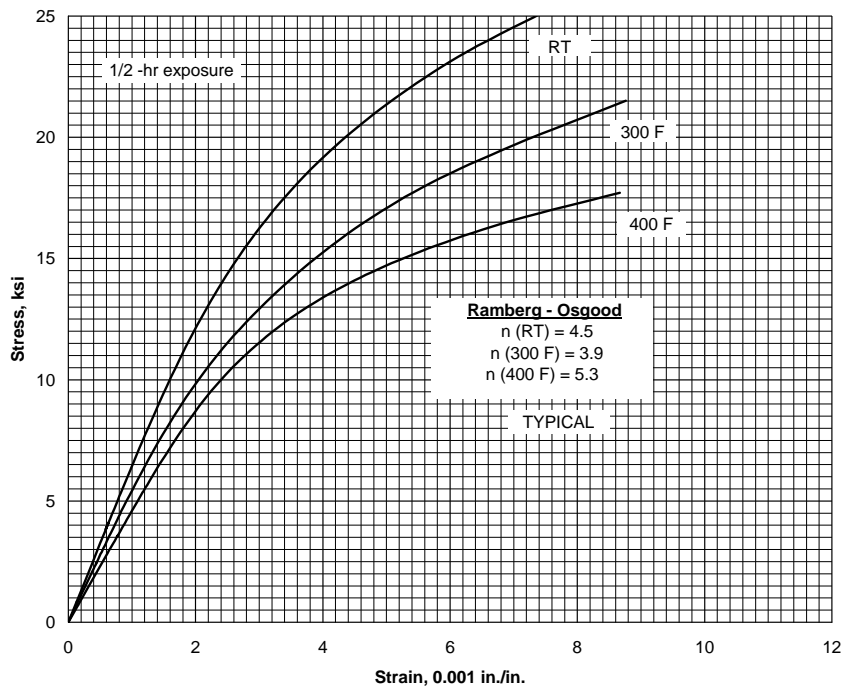

Figure 4.3.2.1.6. Typical tensile stress-strain curves for cast AZ91C-T6/AZ91E-T6 at room and elevated temperatures.

4.3.3 AZ92A

4.3.3.0 Comments and Properties — AZ92A is a magnesium-base casting alloy containing aluminum and zinc. It is slightly stronger and less ductile than AZ91C but is much like it in other characteristics. It is available as sand and permanent-mold casting. AZ92A has fair weldability and pressure tightness.

Material specifications for AZ92A are presented in Table 4.3.3.0(a). Room-temperature mechanical and physical properties are shown in Table 4.3.3.0(b). Elevated temperature curves for physical properties are shown in Figure 4.3.3.0.

Table 4.3.3.0(a). Material Specifications for AZ92A Magnesium Alloy

Specification	Form
AMS 4434	Sand casting
AMS 4484 ^a	Permanent-mold casting
AMS 4453	Investment casting

^a Noncurrent specification.

The temper index for AZ92A is as follows:

<u>Section</u>	<u>Temper</u>
4.3.3.1	T6

4.3.3.1 AZ92A-T6 Temper — Elevated temperature curves for various mechanical properties are presented in Figures 4.3.3.1.1(a) through (c), and 4.3.3.1.4. Typical stress-strain and tangent-modulus curves at room temperature and several elevated temperatures are shown in Figures 4.3.3.1.6(a) and (b).

Table 4.3.3.0(b). Design Mechanical and Physical Properties of AZ92A Magnesium Alloy Casting

Specification	AMS 4484 ^a	AMS 4434	AMS 4453
Form	Permanent mold casting	Sand casting	Investment Casting
Temper	T6	T6	T6
Location within casting	Any area		
Basis	S	S	S
Mechanical Properties ^b :			
F_{tu} , ksi	17 ^c	17 ^c	19
F_{ty} , ksi	13.5 ^c	13.5 ^c	15
F_{cy} , ksi	13.5	13.5	...
F_{su} , ksi
F_{bru} , ksi:			
(e/D = 1.5)
(e/D = 2.0)
F_{bry} , ksi:			
(e/D = 1.5)
(e/D = 2.0)
e , percent	0.7
E , 10 ³ ksi	6.5		
E_c , 10 ³ ksi	6.5		
G , 10 ³ ksi	2.4		
μ	0.35		
Physical Properties:			
ω , lb./in. ³	0.0659		
C , Btu/(lb)(°F)	0.25 ^d		
K and α	See Figure 4.3.3.0		

a Noncurrent specification.

b Reference should be made to the specific requirements of the procuring or certifying agency with regard to the use of the above values in the design of castings.

c When specified on drawing, conformance to tensile property requirements is determined by testing specimens cut from castings.

d Estimated.

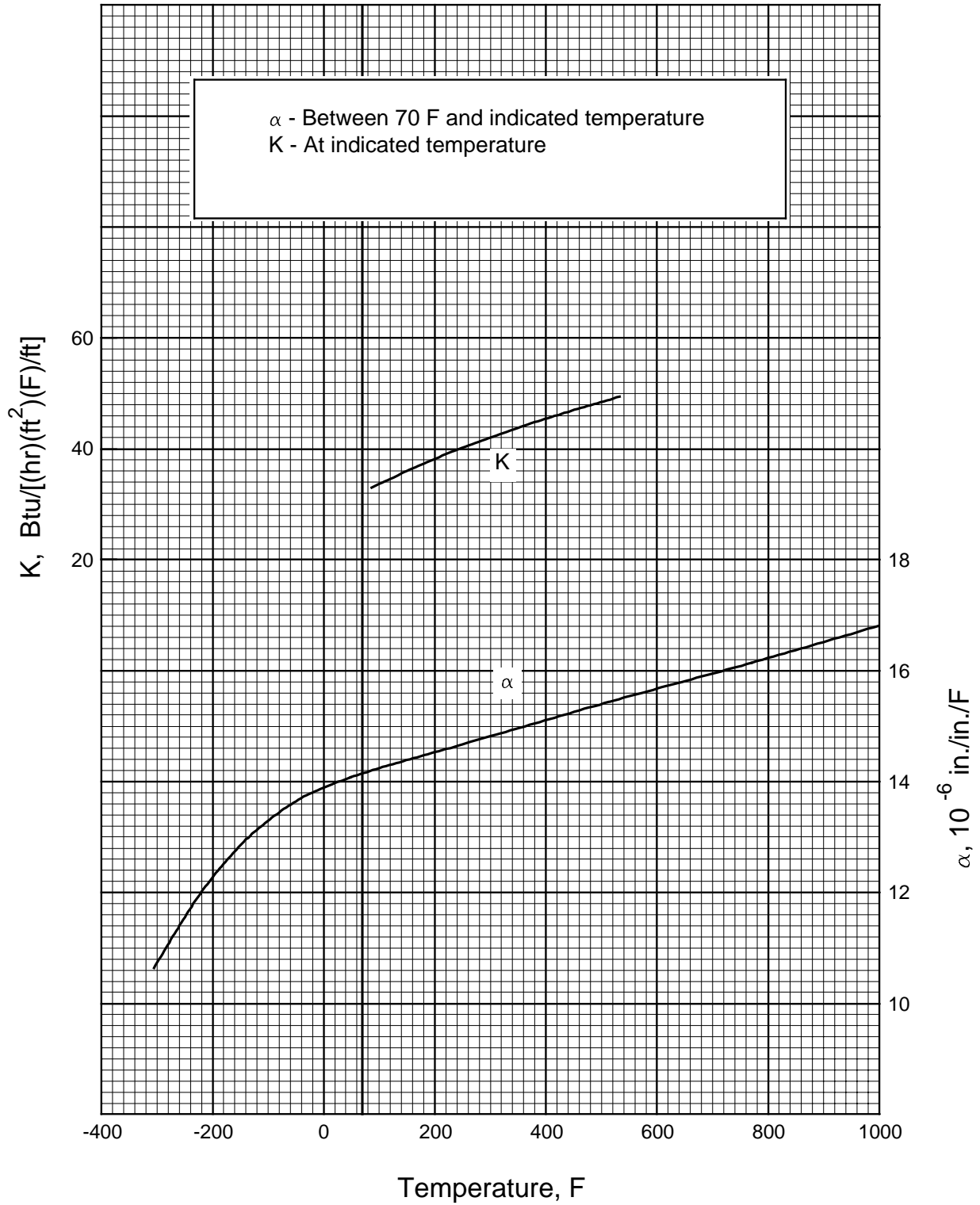

Figure 4.3.3.0. Effects of temperature on the physical properties of cast AZ92A-T6.

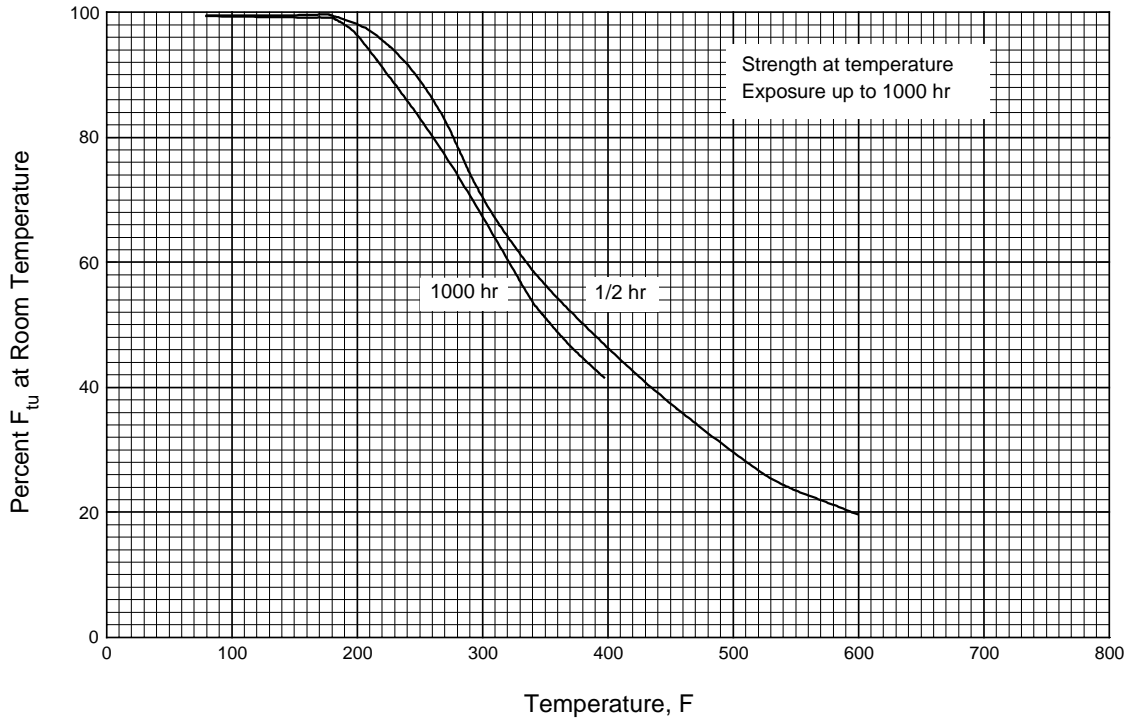

Figure 4.3.3.1(a). Effect of temperature on the tensile ultimate strength (F_{tu}) of cast AZ92A-T6.

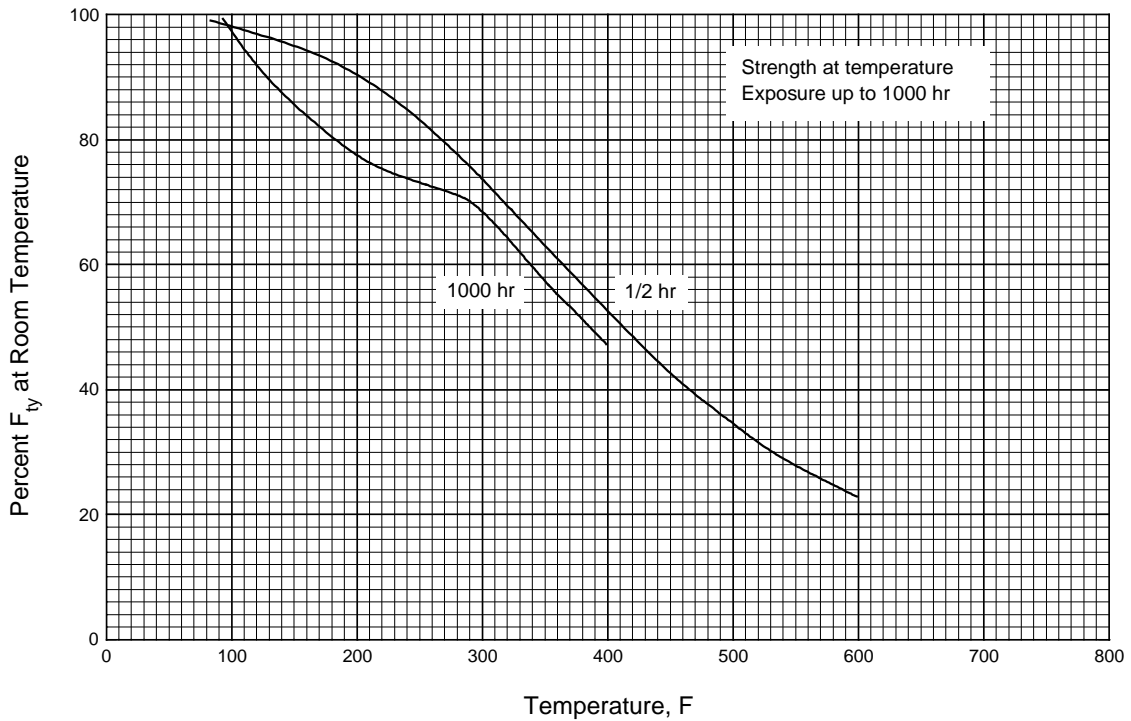

Figure 4.3.3.1(b). Effect of temperature on the tensile yield strength (F_{ty}) of cast AZ92A-T6.

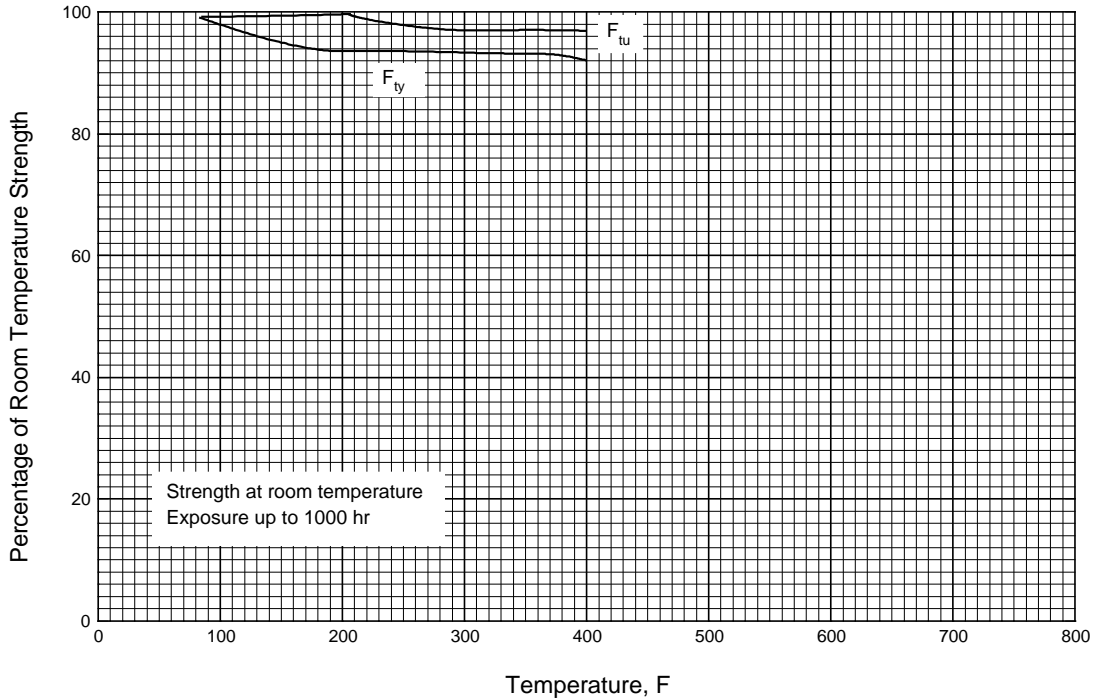

Figure 4.3.3.1.1(c). Effect of exposure at elevated temperature on the room-temperature tensile ultimate strength (F_{tu}) and the tensile yield strength (F_{ty}) of cast AZ92A-T6.

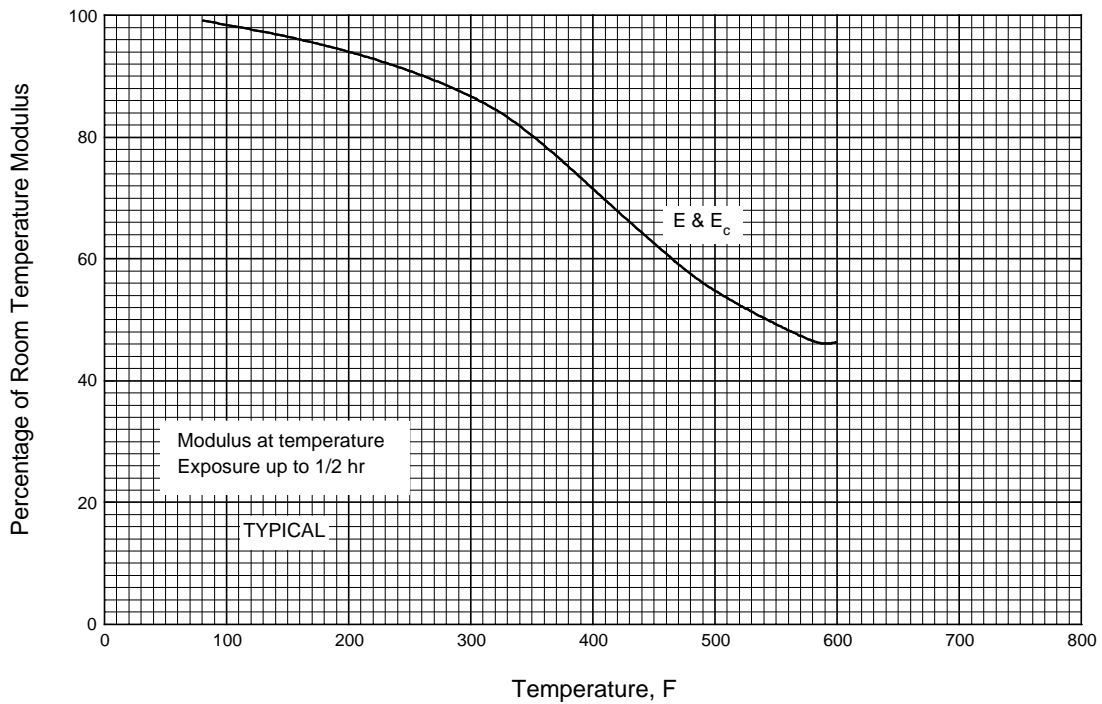

Figure 4.3.3.1.4. Effect of temperature on the tensile and compressive moduli (E and E_c) of cast AZ92A-T6.

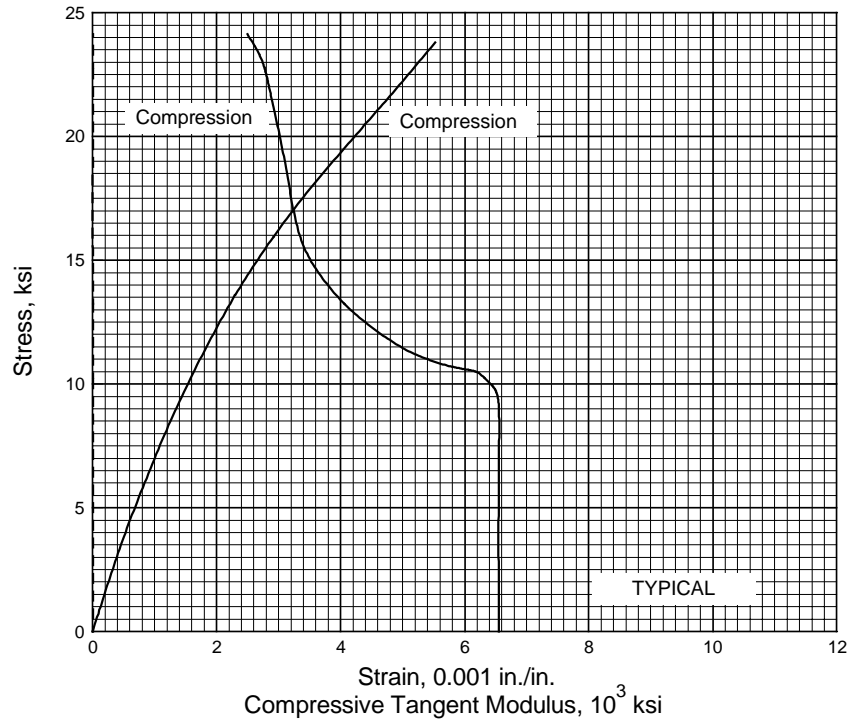

Figure 4.3.3.1.6(a). Typical compressive stress-strain and compressive tangent-modulus curves for cast AZ92A-T6 at room temperature.

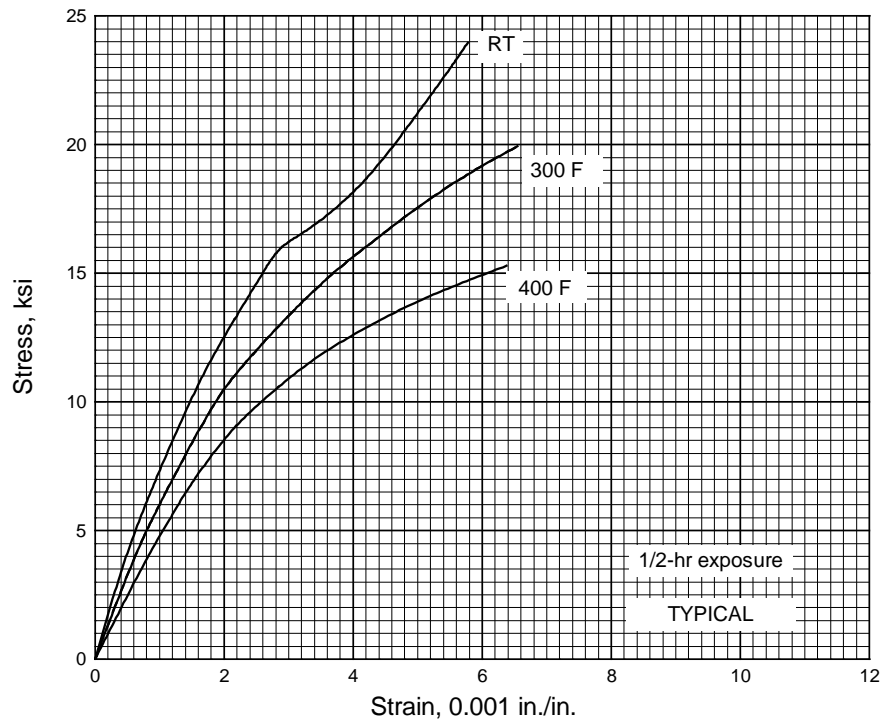

Figure 4.3.3.1.6(b). Typical tensile stress-strain curves for cast AZ92A-T6 at room and elevated temperatures.

4.3.4 EZ33A

4.3.4.0 Comments and Properties — EZ33A is a magnesium-base casting alloy containing rare earths, zinc, and zirconium. It is available as sand castings in the artificially aged (T5) temper. EZ33A has lower strength than the Mg-Al-Zn alloys at room temperature but is less affected by increasing temperature. It is generally used for applications at temperatures of 300 to 500°F. EZ33A castings are very sound and are sometimes used for pressure tightness. It has good stability in the T5 temper and excellent weldability. It is sometimes used for applications requiring good damping ability.

A material specification for EZ33A is presented in Table 4.3.4.0(a). Room-temperature mechanical and physical properties are shown in Table 4.3.4.0(b). The effect of temperature on physical properties is shown in Figure 4.3.4.0.

Table 4.3.4.0(a). Material Specification for EZ33A Magnesium Alloy

Specification	Form
AMS 4442	Sand casting

The temper index for EZ33A is as follows:

<u>Section</u>	<u>Temper</u>
4.3.4.1	T5

4.3.4.1 EZ33A-T5 Temper — Elevated temperature curves for tensile properties are presented in Figures 4.3.4.1.1(a) through (c). A typical tensile stress-strain curve at room temperature is presented in Figure 4.3.4.1.6.

Table 4.3.4.0(b). Design Mechanical and Physical Properties of EZ33A Magnesium Alloy Casting

Specification	AMS 4442
Form	Sand casting
Temper	T5
Location within casting	Any area
Basis	S
Mechanical Properties^a:	
F_{tu} , ksi	13 ^b
F_{ty} , ksi	11 ^b
F_{cy} , ksi	11
F_{su} , ksi
F_{bru} , ksi:	
(e/D = 1.5)
(e/D = 2.0)
F_{bry} , ksi:	
(e/D = 1.5)
(e/D = 2.0)
e , percent	1.5
E , 10 ³ ksi	6.5
E_c , 10 ³ ksi	6.5
G , 10 ³ ksi	2.4
μ	0.35
Physical Properties:	
ω , lb/in. ³	0.0659
C , Btu/(lb)(°F)	0.25
K and α	See Figure 4.3.4.0

a Reference should be made to the specific requirements of the procuring or certifying agency with regard to the use of the above values in the design of castings.

b When specified on drawing, conformance to tensile property requirements is determined by testing specimens cut from castings.

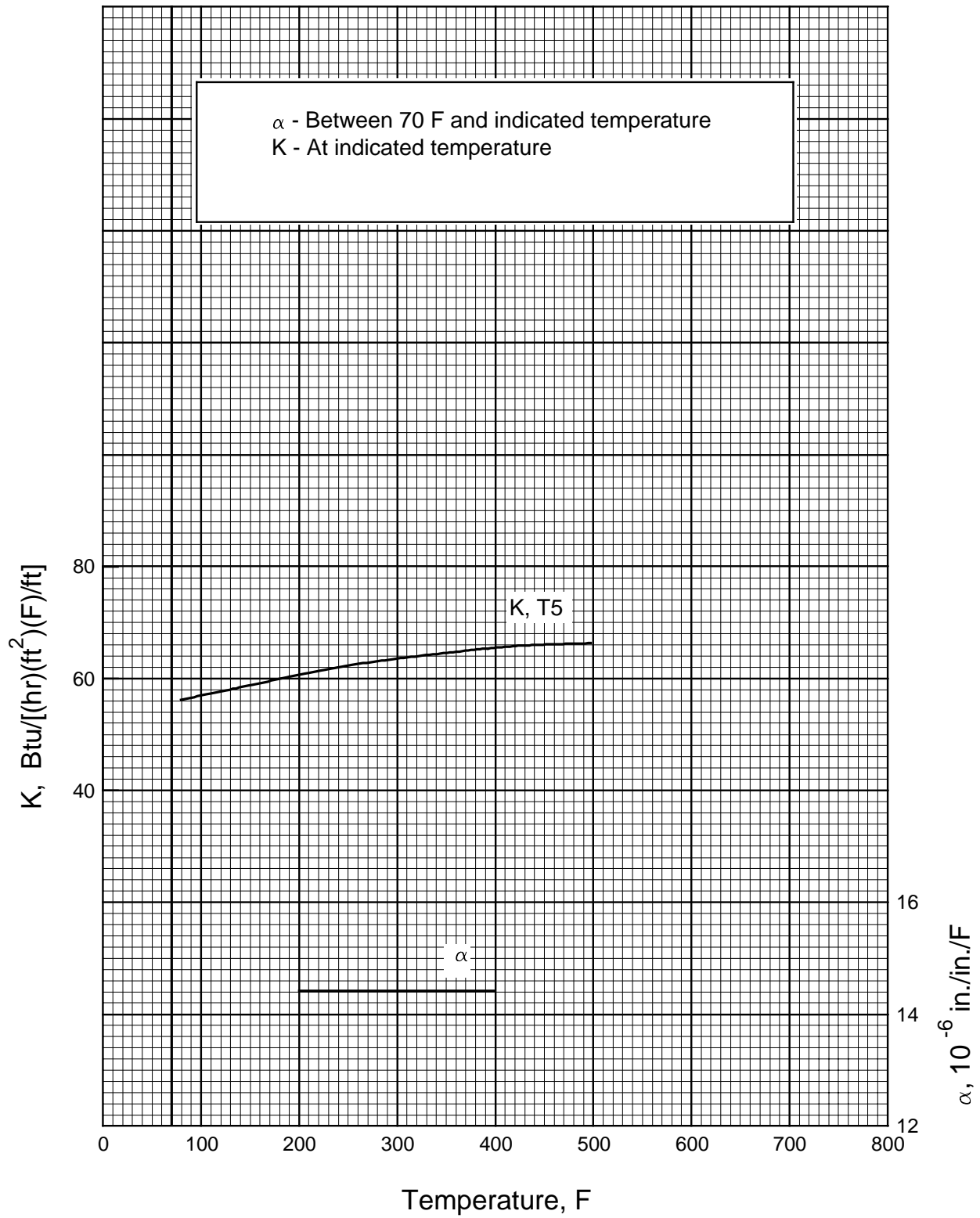

Figure 4.3.4.0. Effect of temperature on the physical properties of cast EZ33A.

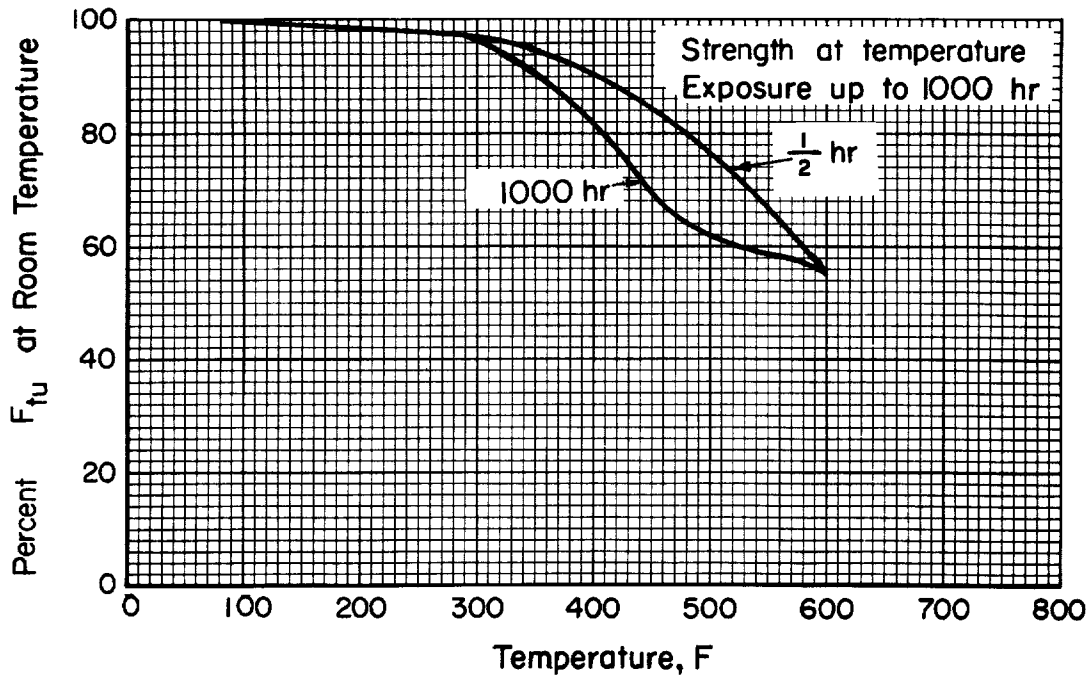

Figure 4.3.4.1.1(a). Effect of temperature on the tensile ultimate strength (F_{tu}) of cast EZ33A-T5.

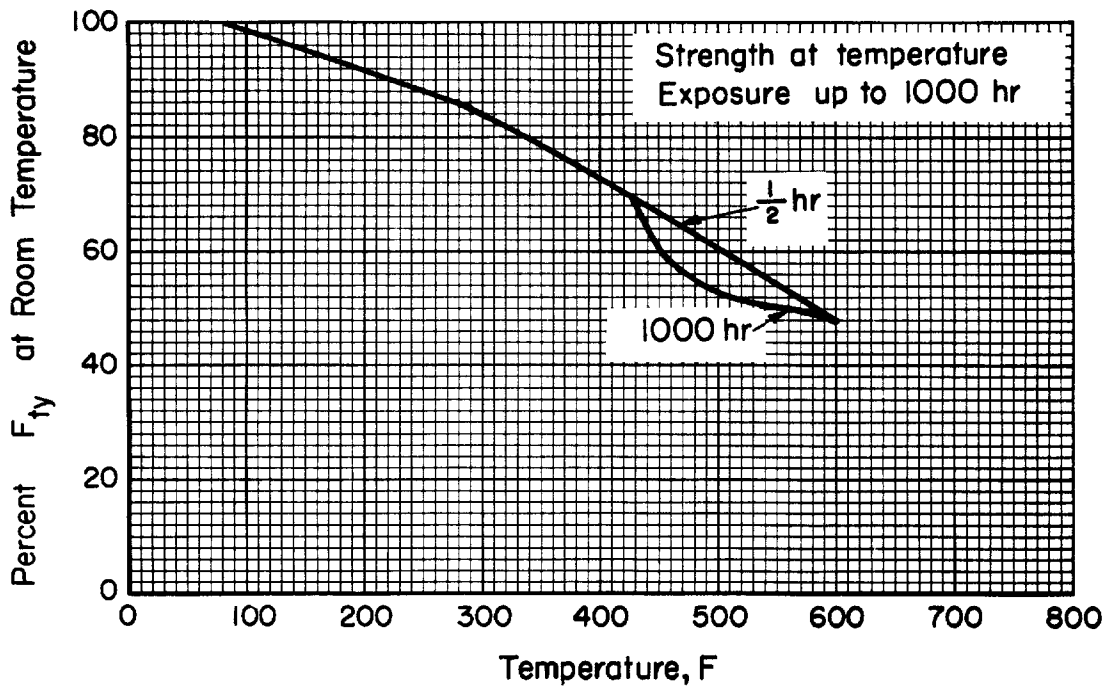

Figure 4.3.4.1.1(b). Effect of temperature on the tensile yield strength (F_{ty}) of cast EZ33A-T5.

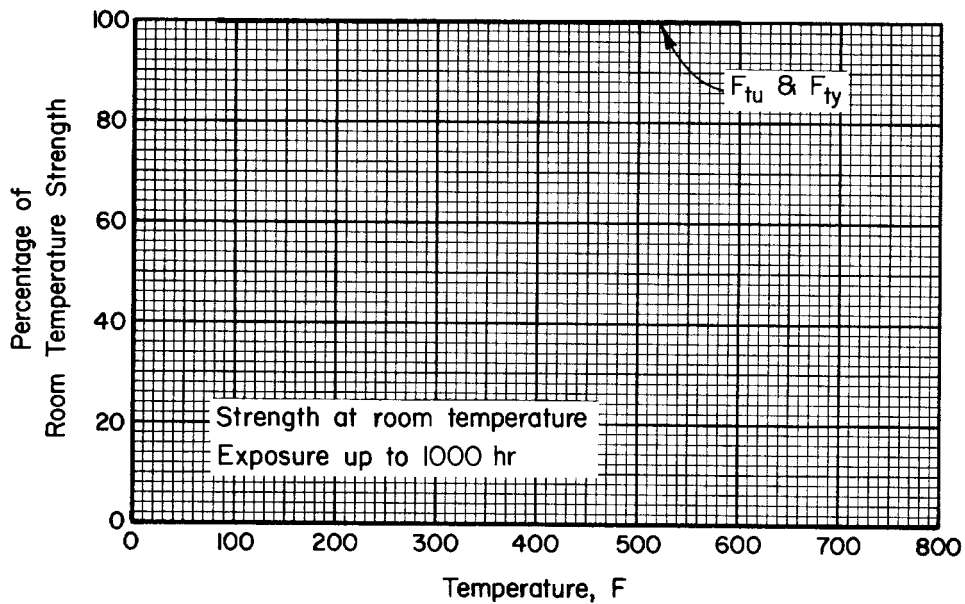

Figure 4.3.4.1.1(c). Effect of exposure at elevated temperatures on the room temperature tensile ultimate strength (F_{tu}) and the tensile yield strength (F_{ty}) of cast EZ33A-T5.

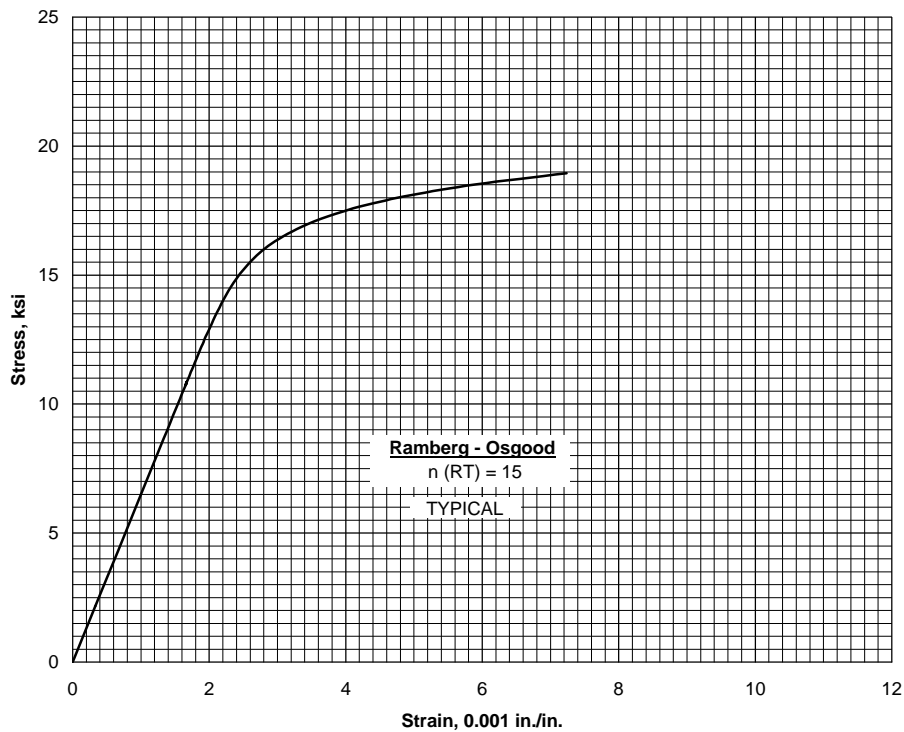

Figure 4.3.4.1.6. Typical tensile stress-strain curve for cast EZ33A-T5 at room temperature.

4.3.5 QE22A

4.3.5.0 Comments and Properties — QE22A is a magnesium-base alloy containing silver, rare earths in the form of didymium, and zirconium. It is available as sand and permanent-mold castings. It is used in the solution heat-treated and artificially aged (T6) condition where a high yield strength is needed at temperatures up to 600°F. QE22A has good weldability and fair pressure tightness.

Material specifications for QE22A are presented in Table 4.3.5.0(a). Room-temperature mechanical and physical properties are shown in Table 4.3.5.0(b).

Table 4.3.5.0(a). Material Specifications for QE22A Magnesium Alloy

Specification	Form
AMS 4418	Sand casting

The temper index for QE22A is as follows:

<u>Section</u>	<u>Temper</u>
4.3.5.1	T6

4.3.5.1 QE22A-T6 Temper — Elevated temperature curves for various tensile properties and modulus of elasticity are presented in Figures 4.3.5.1.1 and 4.3.5.1.4. Typical tensile stress-strain curves at various temperatures from room temperature through 700°F are shown in Figure 4.3.5.1.6.

Table 4.3.5.0(b). Design Mechanical and Physical Properties of QE22A Magnesium Alloy Casting

Specification	AMS 4418
Form	Sand casting
Temper	T6
Location within casting	Any area
Basis	S
Mechanical Properties^a:	
F_{tu} , ksi	32 ^b
F_{ty} , ksi	23 ^b
F_{cy} , ksi	23
F_{su} , ksi
F_{bru} , ksi:	
(e/D = 1.5)
(e/D = 2.0)
F_{bry} , ksi:	
(e/D = 1.5)
(e/D = 2.0)
e, percent	2 ^b
E , 10 ³ ksi	6.5
E_c , 10 ³ ksi	6.5
G, 10 ³ ksi	2.4
μ	0.35
Physical Properties:	
ω , lb/in. ³	0.0653
C, Btu/(lb)(°F)	0.25 ^c
K, Btu/[(hr)(ft ²)(°F)/ft]	59
α , 10 ⁻⁶ in./in./°F	14 (68°F to 392°F)

a Reference should be made to the specific requirements of the procuring or certifying agency with regard to the use of the above values in the design of castings.

b When specified on drawing, conformance to tensile property requirements is determined by testing specimens cut from castings.

c Estimated.

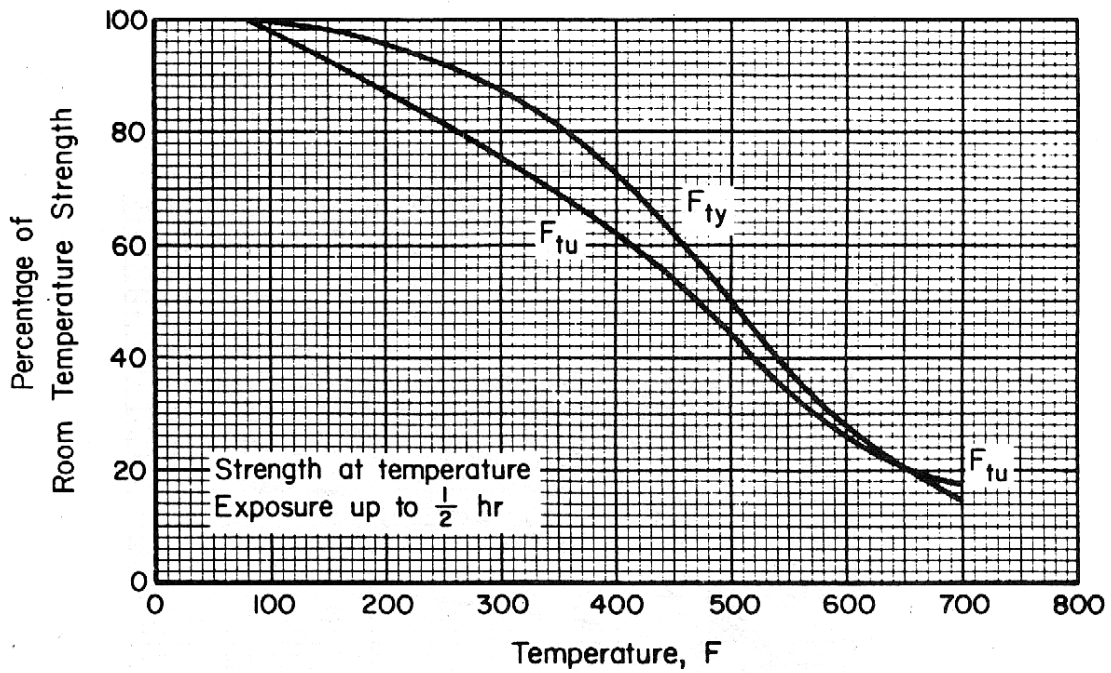

Figure 4.3.5.1.1. Effect of temperature on the tensile ultimate strength (F_{tu}) and the tensile yield strength (F_{ty}) of cast QE22A-T6.

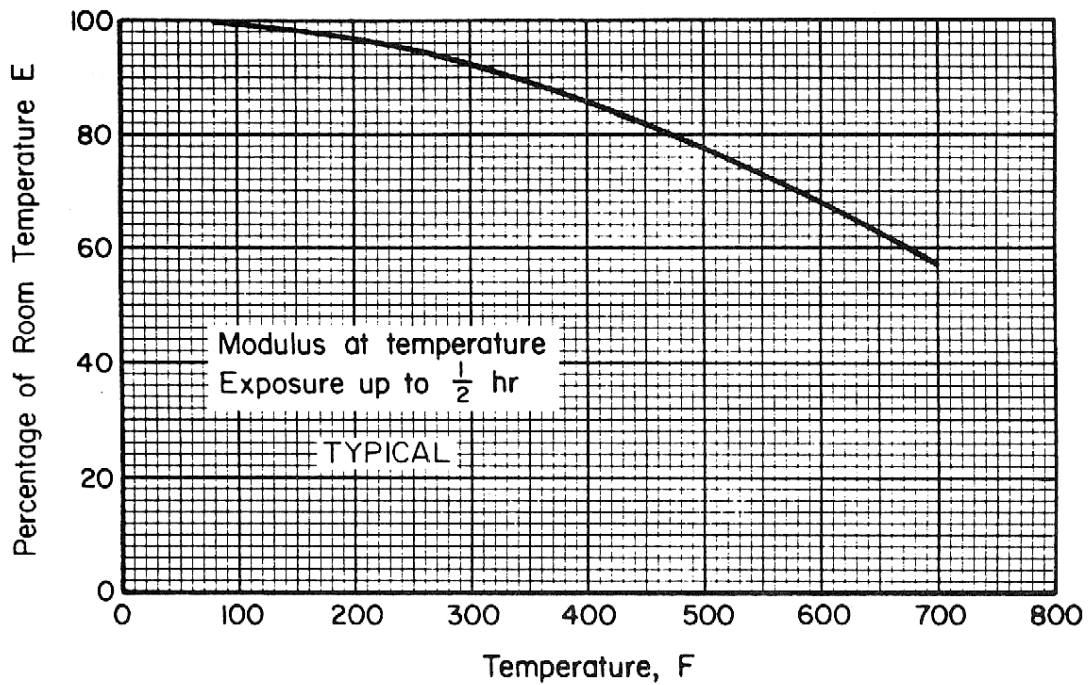

Figure 4.3.5.1.4. Effect of temperature on the tensile modulus (E) of cast QE22A-T6.

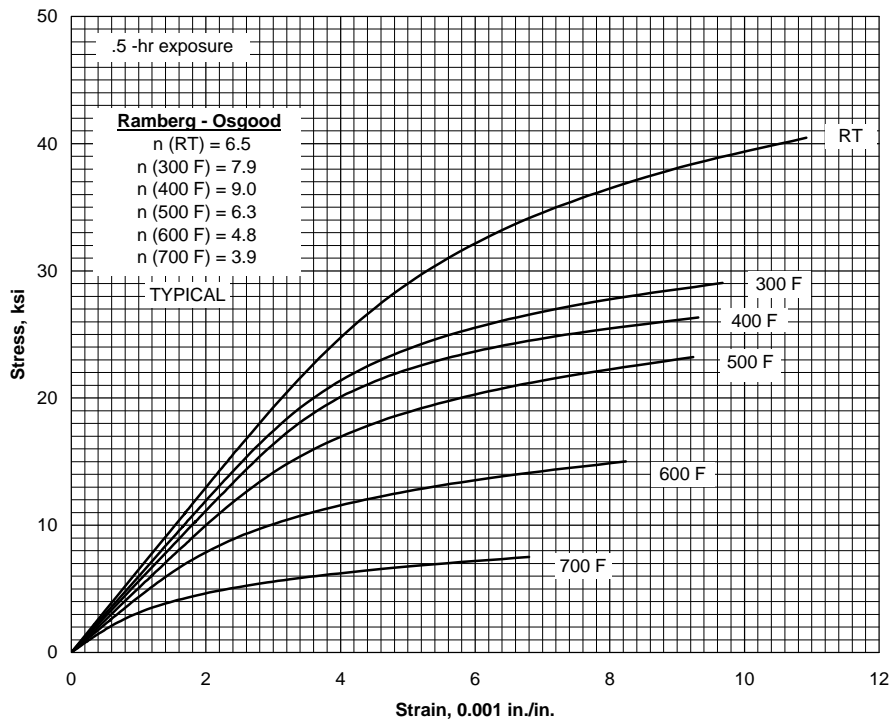

Figure 4.3.5.1.6. Typical tensile stress-strain curves for cast QE22A-T6 at room and elevated temperatures.

4.3.6 ZE41A

4.3.6.0 Comments and Properties — ZE41A is a magnesium-base casting alloy containing zinc, zirconium, and rare earth elements. It is available as sand or permanent-mold castings in the artificially aged temper (T5). ZE41A has a higher yield strength than the Mg-Al-Zn alloys at room temperature and is more stable at elevated temperatures. It is useful for applications at temperatures up to 320°F. ZE41A castings possess good weldability and are pressure tight.

A material specification for ZE41A is presented in Table 4.3.6.0(a). Room temperature mechanical and physical properties are shown in Table 4.3.6.0(b). The effect of temperature on thermal conductivity is shown in Figure 4.3.6.0.

Table 4.3.6.0(a). Material Specification for ZE41A Magnesium Alloy

Specification	Form
AMS 4439	Sand casting

The temper index for ZE41A is as follows:

<u>Section</u>	<u>Temper</u>
4.3.6.1	T5

4.3.6.1 T5 Temper — Elevated temperature curves for tensile yield and ultimate strengths are presented in Figure 4.3.6.1.1. The effect of temperature on the tensile modulus of elasticity is shown in Figure 4.3.6.1.4. Figures 4.3.6.1.6(a) and (b) contain tensile and compressive stress-strain curves as well as a compressive tangent-modulus curve.

Table 4.3.6.0(b). Design Mechanical and Physical Properties of ZE41A Magnesium Alloy Casting

Specification	AMS 4439
Form	Sand casting
Temper	T5
Thickness, in.	Any area
Basis	S
Mechanical Properties^a:	
F_{tu} , ksi	26 ^b
F_{ty} , ksi	17.5 ^b
F_{cy} , ksi	15
F_{su} , ksi	17
F_{bru}^c , ksi:	
(e/D = 1.5)	38
(e/D = 2.0)	49
F_{bry}^c , ksi:	
(e/D = 1.5)	31
(e/D = 2.0)	35
e , percent	2 ^b
E , 10 ³ ksi	6.5
E_c , 10 ³ ksi	6.5
G , 10 ³ ksi	2.4
μ	0.35
Physical Properties:	
ω , lb/in. ³	0.0656
C , Btu/(lb)(°F)	0.234 (at 68°F)
K , Btu/[(hr)(ft ²)(°F)/ft]	See Figure 4.3.6.0
α , 10 ⁻⁶ in./in./°F	15.5 (68 to 212°F)

a The mechanical properties shown are reliably obtainable when castings are produced under the quality assurance provisions of AMS 4439. These provisions require preproduction approval, documentation of foundry procedures, and specific testing procedures for the acceptance of each production lot of castings. Strict adherence to these requirements is mandatory if these properties are to be reliably assured in each casting.

b Conformance to tensile property requirements is determined by testing specimens cut from casting only when specified on drawing.

c Bearing values are “dry pin” values per Section 1.4.7.1.

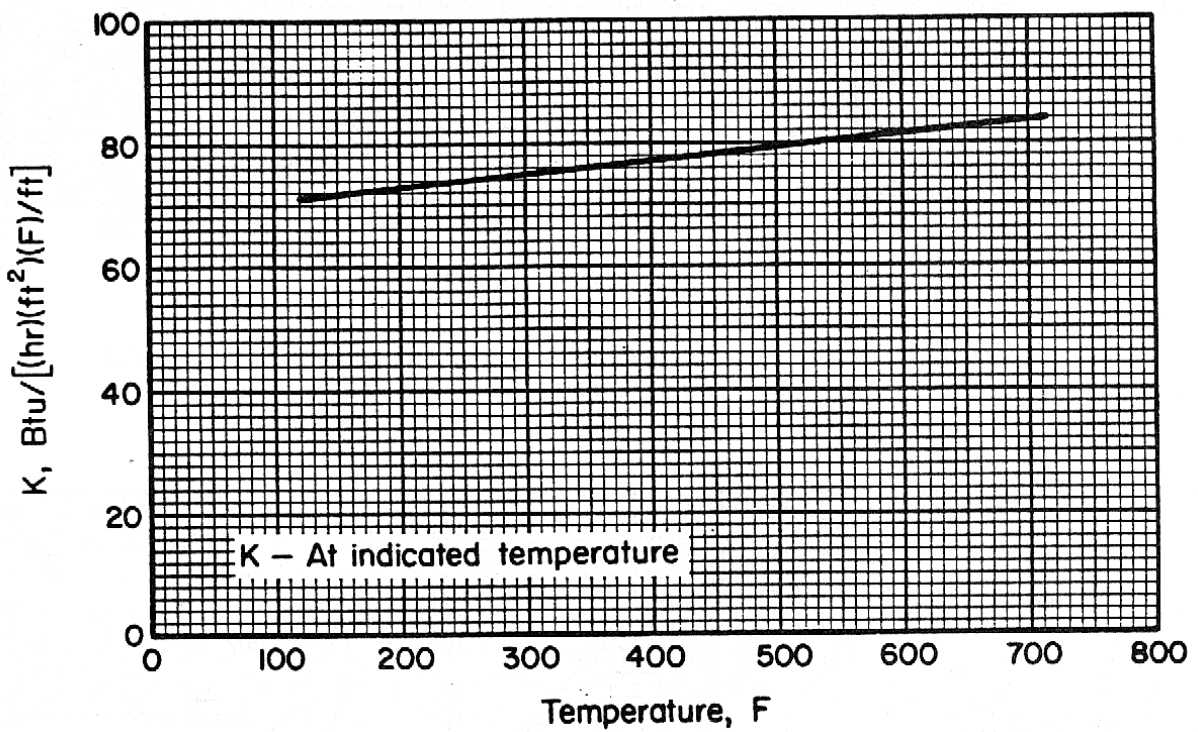

Figure 4.3.6.0. Effect of temperature on the thermal conductivity (K) of ZE41A-T5 sand casting.

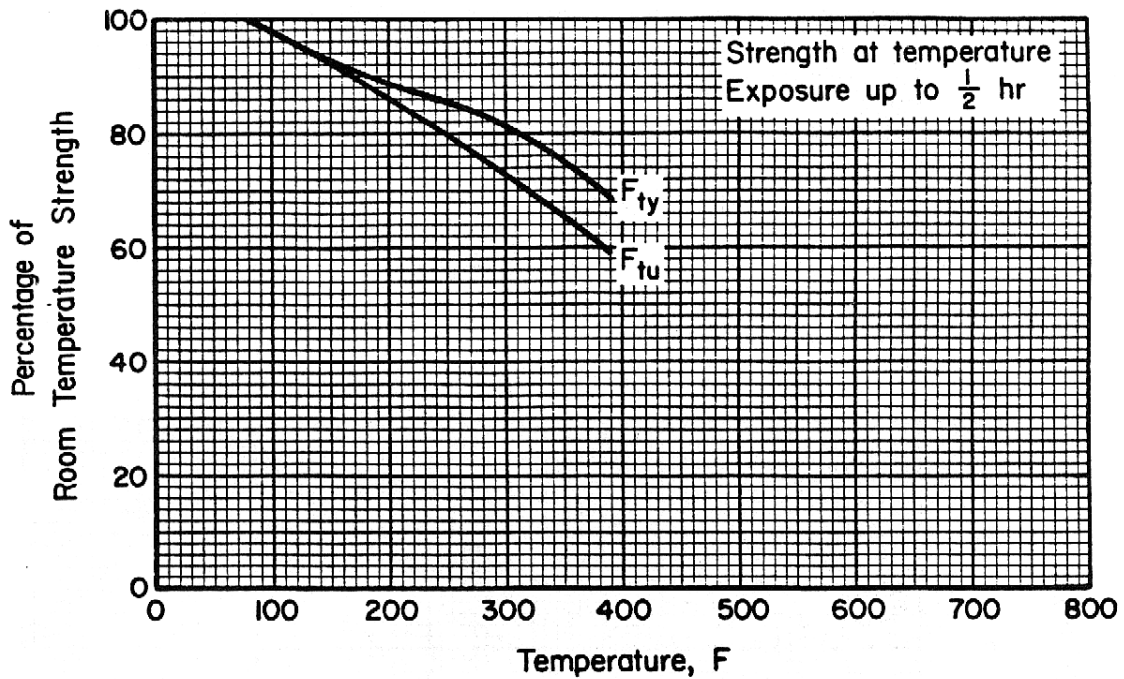

Figure 4.3.6.1.1. Effect of temperature on the tensile ultimate strength (F_{tu}) and tensile yield strength (F_{ty}) of ZE41A-T5 sand casting.

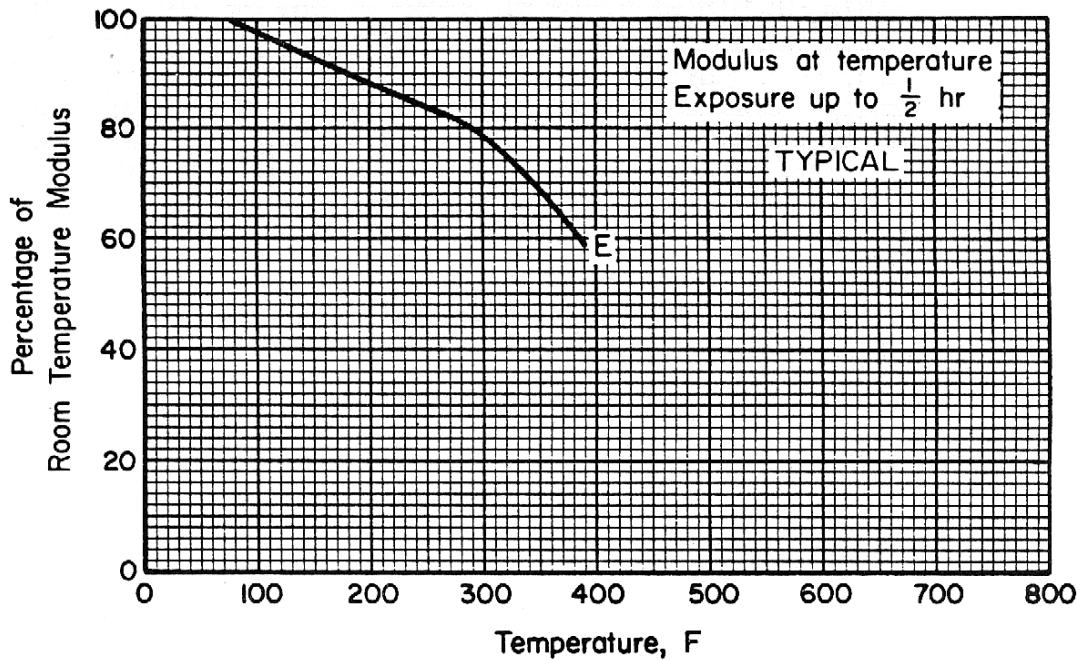

Figure 4.3.6.1.4. Effect of temperature on the tensile modulus (E) of ZE41A-T5 sand casting.

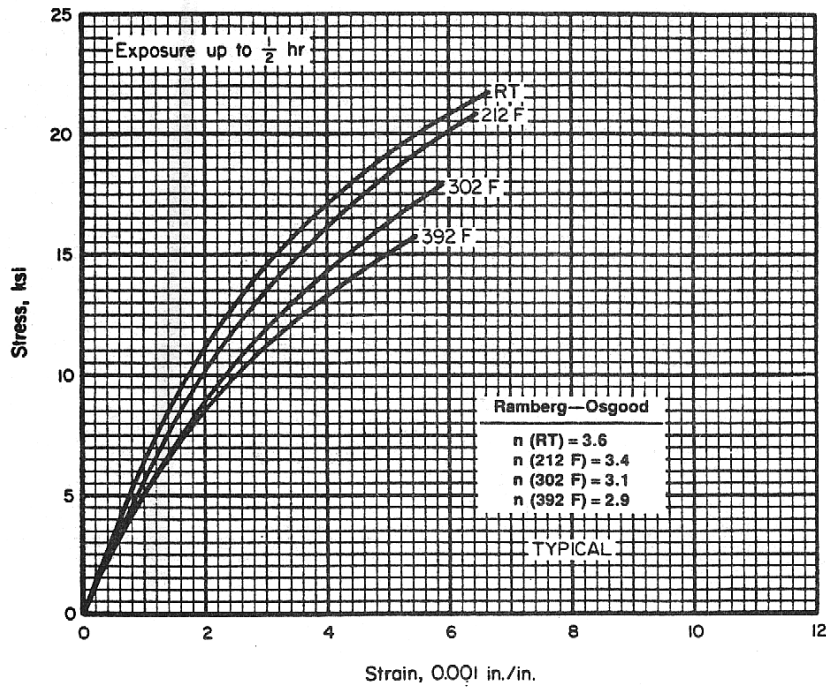

Figure 4.3.6.1.6(a). Typical tensile stress-strain curves for ZE41A-T5 sand casting at room and elevated temperatures.

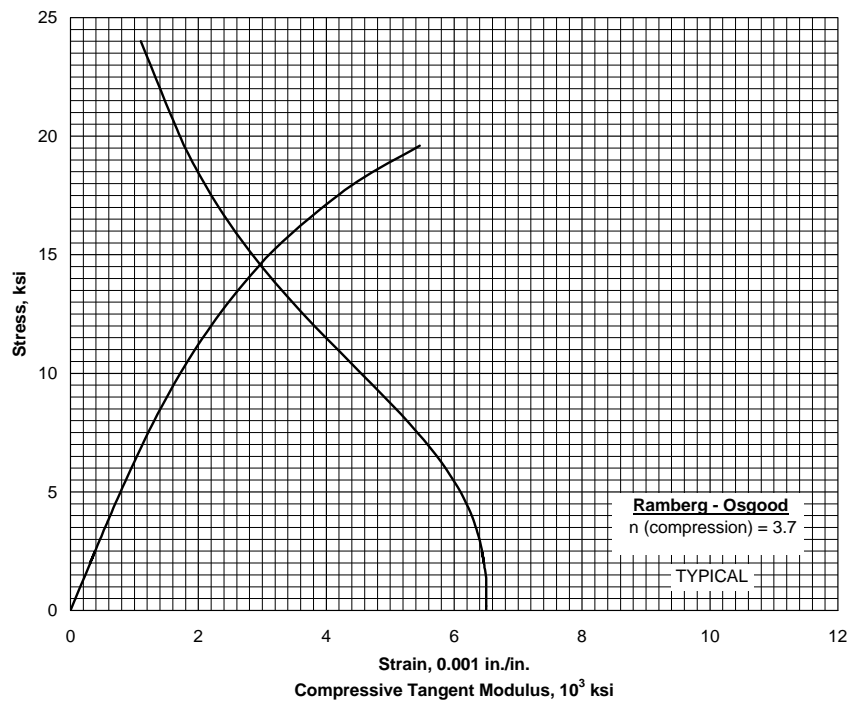

Figure 4.3.6.1.6(b). Typical compressive stress-strain and tangent-modulus curves for ZE41A-T5 sand casting at room temperature.

4.4 ELEMENT PROPERTIES

4.4.1 BEAMS — Refer to Chapter 1 and References 1.7.1(a) and (b) for general information on stress analysis of beams.

4.4.1.1 Simple Beams — Beams of solid tubular, or similar cross sections can be assumed to fail through exceeding an allowable modulus of rupture in bending (F_b). In the absence of specific data, the ratio F_b/F_{tu} can be assumed to be 1.25 for solid sections.

4.4.1.1.1 Round Tubes — For round tubes, the value of F_b will depend on the D/t ratio as well as the compressive yield stress.

4.4.1.1.2 Unconventional Cross Sections — Sections other than solid or tubular should be tested to determine allowable bending stress.

4.4.1.2 Built-Up Beams — Built-up beams will usually fail because of local failure of component parts.

4.4.1.3 Thin-Web Beams — The allowable stress for thin-web beams will depend on the nature of the failure and are determined from the allowable stress of the web in tension and of the flanges or stiffeners in compression.

4.4.2 COLUMNS

4.4.2.1 Primary Failure — The general formula for primary instability is given in Section 1.3.8. Formulas applicable to magnesium-alloy columns are given in Tables 4.4.2.1(a) and (b). See References 4.4.2(a) and (b).

Table 4.4.2.1(a). Column Formula for Magnesium-Alloy Extruded Open Shapes

General Formula^a

$$\frac{P}{A} = \frac{K(F_{cy})^n}{(L'/\rho)^m}$$

(Stress values are in ksi)

Alloy	K	n	m	Max. P/A
AZ31B, AZ61A	2,900	1/4	1.5	F_{cy}
ZK60A-T5	3,300	1/4	1.5	$0.96 F_{cy}$

^aFormula is for members that do not fail by local buckling.
See Figure 4.4.2.3(a).

**Table 4.4.2.1(b). Column Formula for AZ31B-H24
Magnesium-Alloy Sheet**

$$\frac{P}{A} = 1.05 F_{cy} - \frac{(1.05 F_{cy})^2 (L'/\rho)^2}{4 \pi^2 E}$$

$$\text{MAX } \frac{P}{A} = F_{cy}$$

See Figure 4.4.2.3(b).

4.4.2.2 Local Failure

4.4.2.3 Column Properties — Curves of the allowable column stresses for various magnesium alloy columns are given in Figures 4.4.2.3(a) and (b). The allowable stress is plotted against the effective slenderness ratio defined by Equation 3.10.2.3.

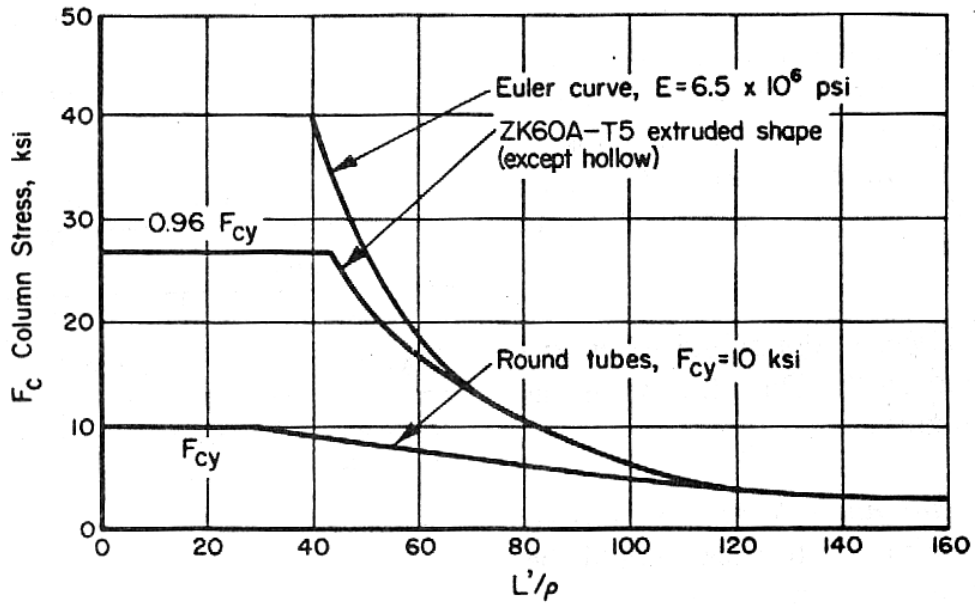

Figure 4.4.2.3(a). Allowable column stresses for magnesium-alloy columns.

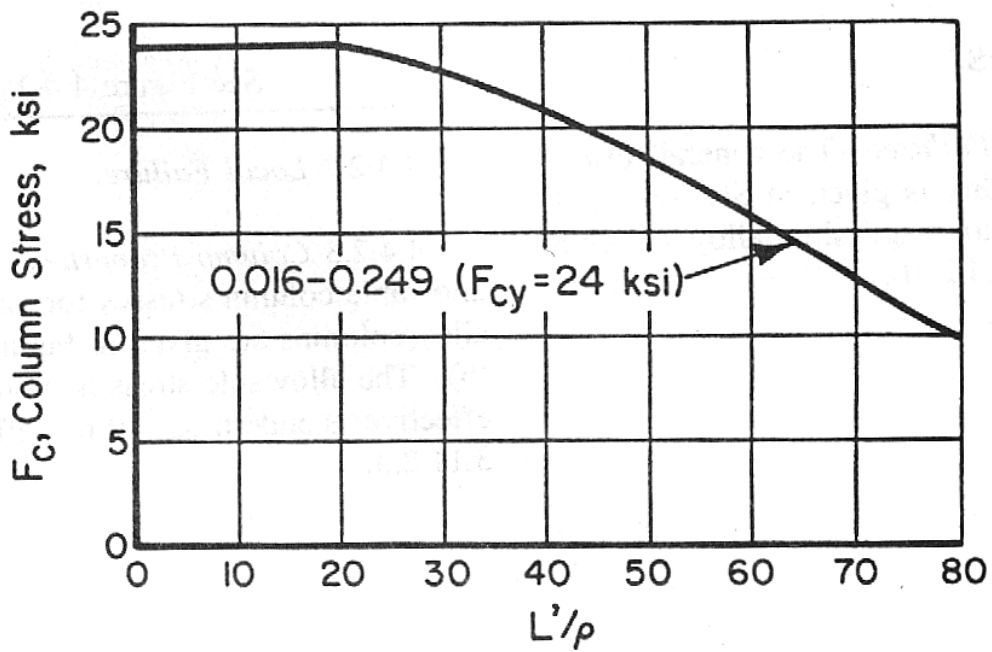

Figure 4.4.2.3(b). Allowable column stresses for AZ31B-H24 magnesium-alloy sheet.

4.4.3 TORSION

4.4.3.1 General — The general statements relating to aluminum-alloy tubing in 3.10.3 are applicable to magnesium tubing.

4.4.3.2 Torsion Properties — An empirical curve of the allowable torsional modulus of rupture for AZ62A-F magnesium-alloy round tubing (specification WW-T-825) is given in Figure 4.4.3.2.

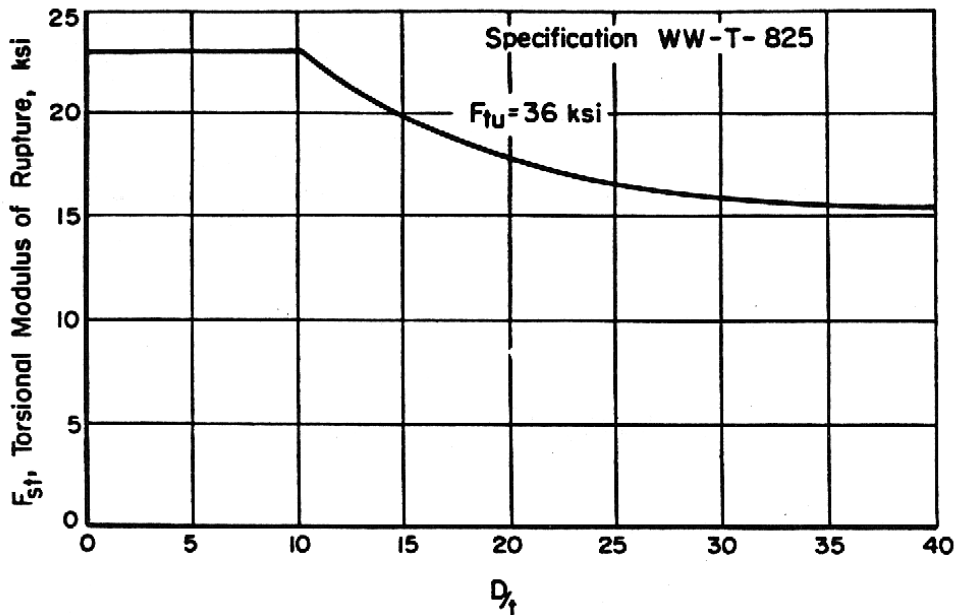

Figure 4.4.3.2. Torsional modulus of rupture for AZ61A-F magnesium-alloy round tubing.

REFERENCES

- 4.1.2.1.1(a) Eastman, E. J., McDonald, J. C., and Moore, A. A., "The Relation of Stress to Strain in Magnesium Alloys", *Journal of the Aeronautical Sciences*, pp 273-280 (July 1945).
- 4.1.2.1.1(b) Moore, A. A., "The Effect of Speed of Testing of Magnesium-Base Alloys", *American Society for Testing and Materials, Proceedings 48*, pp 1133-1138 (1948).
- 4.1.2.1.1(c) Fenn, R. W., Jr., and Gusack, J. C., "Effect of Strain Rate and Temperature on the Strength of Magnesium Alloys", *American Society of Testing and Materials, Proceedings 58*, pp 685-696 (1958).
- 4.1.2.1.1(d) Fenn, R. W., Jr., and Lockwood, L. F., "Low-Temperature, Properties of Welded Magnesium Alloys", *The Welding Journal Research Supplement* (August 1960).
- 4.1.2.1.2(a) Moore, A. A., and McDonald, J. C., "Compression Testing of Magnesium Alloy Sheet", *American Society for Testing and Materials, Bulletin No. 135*, pp 27-30 (August 1945).
- 4.1.2.1.2(b) Fenn, R. W., Jr., "Compression Testing of Sheet Magnesium Utilizing Rapid Heating", *American Society for Testing and Materials, Proceedings 60*, pp 940-956 (1960).
- 4.1.2.1.3(a) Gusack, J. A., and Moore, A. A., "An Autographic Bearing-Strength Test Method, and Typical Test Values on Some Magnesium Alloys at Room and Elevated Temperatures", *American Society for Testing and Materials, Proceedings 56*, pp 834-841 (1956).
- 4.1.2.1.3(b) Stickley, G. W., and Moore, A. A., "Effects of Lubrication and Pin Surface on Bearing Strengths of Aluminum and Magnesium Alloys", *American Society for Testing and Materials, Materials, Research and Standards, Vol. 2, No. 2*, pp 747-751 (September 1962).
- 4.1.2.1.4 Fenn, R. W., Jr., and Clapper, R. B., "Evaluation of Test Variables in the Determination of Shear Strength", *American Society for Testing and Materials, Proceedings 56*, pp 842-858 (1956).
- 4.1.2.1.5(a) Dorn, J. E., and Meriam, J. L., "Properties and Heat Treatment of Magnesium Alloys, Part II, Notch Sensitivity of Magnesium Alloys", *OSRD No. 1819, Report M-104*, pp 68 (September 1943).
- 4.1.2.1.5(b) Dorn, J. E., and others, "Properties and Heat Treatment of Magnesium Alloys, Part V, Section I, The Sensitivity of Magnesium Alloy Sheet to Drilled, Reamed, and Punched Holes. Part V, Section II, The Notch Sensitivity of Magnesium Alloy Extrusions and the Influence of Various Factors", *OSRD No. 3043 (NRC Research Project NRC-21), Final Report M-177*, pp 202 (December 1943).
- 4.1.2.1.5(c) Doan, J. P., and McDonald, J. C., "The Notch Sensitivity in Static and Impact Loading of Some Magnesium-Base and Aluminum-Base Alloys", *American Society for Testing and Materials, Proceedings 46*, pp 1097-1118 (1946).

MIL-HDBK-5J
31 January 2003

- 4.1.2.1.5(d) Moore, A. A., and McDonald, J. C., “Tensile and Creep Strengths of Some Magnesium-Base Alloys at Elevated Temperatures”, American Society for Testing and Materials, Proceedings 46, pp 970-989 (1946).
- 4.1.2.1.5(e) McDonald, J. C., “Tensile, Creep and Fatigue Properties of Some Magnesium-Base Alloys”, American Society for Testing and Materials, Proceedings 48, pp 737-754 (1948).
- 4.1.2.1.5(f) Wyman, L. L., “High-Temperature Properties of Light Alloys (NA-137). Part II, Magnesium”, U.S. Office of Scientific Research and Development Report No. 4150, M-292, pp 101 (1944).
- 4.1.2.1.5(g) Craighead, C. M., Grube, K. P., Eastwood, L. W., and Lorig, C. H., “The Effects of Temperature on the Mechanical Properties of Magnesium Alloy”, Rand Corporation Report R-146, pp 210 (October 1949).
- 4.1.2.1.5(h) Wyman, L. L., “High-Temperature Properties of Light Alloys (NA-137). Part II, Magnesium”, U.S. Office of Scientific Research and Development Report No. 4150, M-292, pp 101 (1944).
- 4.1.2.1.6 Clapper, R. W., “Isochronous Stress-Strain Curves for Some Magnesium Alloys Showing the Effects of Varying Exposure Time on Their Creep Resistance”, American Society for Testing and Materials, Proceedings 58, pp 812-825 (1958).
- 4.1.2.1.7(a) Found, G. H., “The Notch Sensitivity in Fatigue Loading of Some Magnesium-Base and Aluminum-Base Alloys”, American Society for Testing and Materials, Proceedings 46, pp 715-740 (1946).
- 4.1.2.1.7(b) Schuette, E. H., “Fatigue Properties of Magnesium Alloy Forgings”, Wright-Patterson Air Force Base Technical Report No. 60-854, pp 112 (December 1960) (MCIC 43549).
- 4.2.3.2.8 Blatherwick, A. A., and Lazan, B. J., “Fatigue Properties of Extruded Magnesium Alloy ZK60A Under Various Combinations of Alternating and Mean Axial Stresses”, WADC Tech Report 53-181, pp 27 (August 1953) (MCIC 108173).
- 4.4.2(a) Schuette, E. H., “Hyperbolic Column Formulas for Magnesium Alloy Extrusions”, Journal of the Aeronautical Sciences, 15, pp 523-529 (1948).
- 4.4.2(b) Schuette, E. H., “Column Curves for Magnesium Alloy Sheet”, Journal of the Aeronautical Sciences, 16, pp 301-305 (1949).

CHAPTER 5

TITANIUM

5.1 GENERAL

This chapter contains the engineering properties and related characteristics of titanium and titanium alloys used in aircraft and missile structural applications.

General comments on engineering properties and the considerations relating to alloy selection are presented in Section 5.1. Mechanical- and physical-property data and characteristics pertinent to specific alloy groups or individual alloys are reported in Sections 5.2 through 5.5.

Titanium is a relatively lightweight, corrosion-resistant structural material that can be strengthened greatly through alloying and, in some of its alloys, by heat treatment. Among its advantages for specific applications are: good strength-to-weight ratio, low density, low coefficient of thermal expansion, good corrosion resistance, good oxidation resistance at intermediate temperatures, good toughness, and low heat-treating temperature during hardening, and others.

5.1.1 TITANIUM INDEX — The coverage of titanium and its alloys in this chapter has been divided into four sections for systematic presentation. The system takes into account unalloyed titanium and three groups of alloys based on metallurgical differences which in turn result in differences in fabrication and property characteristics. The sections and the individual alloys covered under each are shown in Table 5.1.

Table 5.1. Titanium Alloys Index

Section	Alloy Designation
5.2	Unalloyed Titanium
5.2.1	Commercially Pure Titanium
5.3	Alpha and Near-Alpha Titanium Alloys
5.3.1	Ti-5Al-2.5Sn (Alpha)
5.3.2	Ti-8Al-1Mo-1V (Near-Alpha)
5.3.3	Ti-6Al-2Sn-4Zr-2Mo (Near-Alpha)
5.4	Alpha-Beta Titanium Alloys
5.4.1	Ti-6Al-4V
5.4.2	Ti-6Al-6V-2Sn
5.4.3	Ti - 4.5Al-3V-2Fe-2Mo
5.5	Beta, Near-Beta, and Metastable Titanium Alloys
5.5.1	Ti-13V-11Cr-3Al
5.5.2	Ti-15V-3Cr-3Sn-3Al
5.5.3	Ti-10V-2Fe-3Al

5.1.2 MATERIAL PROPERTIES — The material properties of titanium and its alloys are determined mainly by their alloy content and heat treatment, both of which are influential in determining the allotropic forms in which this material will be bound. Under equilibrium conditions, pure titanium has an “alpha” structure up to 1620°F, above which it transforms to a “beta” structure. The inherent properties of these two structures are quite different. Through alloying and heat treatment, one or the other or a combination of these two structures can be made to exist at service temperatures, and the properties of the material vary accordingly. References 5.1.2(a) and (b) provide general discussion of titanium microstructures and associated metallography.

Titanium and titanium alloys of the alpha and alpha-beta type exhibit crystallographic textures in sheet form in which certain crystallographic planes or directions are closely aligned with the direction of prior working. The presence of textures in these materials lead to anisotropy with respect to many mechanical and physical properties. Poisson's ratio and Young's modulus are among those properties strongly affected by texture. Wide variations experienced in these properties both within and between sheets of titanium alloys have been qualitatively related to variations of texture. In general, the degree of texturing, and hence the variation of Young's modulus and Poisson's ratio, that is developed for alpha-beta alloys tends to be less than that developed in all alpha titanium alloys. Rolling temperature has a pronounced effect on the texturing of titanium alloys which may not in general be affected by subsequent thermal treatments. The degree of applicability of the effect of textural variations discussed above on the mechanical properties of products other than sheet is unknown at present. The values of Young's modulus and Poisson's ratio listed in this document represent the usual values obtained on products resulting from standard mill practices. References 5.1.2(c) and (d) provide further information on texturing in titanium alloys.

5.1.2.1 Mechanical Properties

5.1.2.1.1 Fracture Toughness — The fracture toughness of titanium alloys is greatly influenced by such factors as chemistry variations, heat treatment, microstructure, and product thickness, as well as yield strength. For fracture critical applications, these factors should be closely controlled. Typical values of plane-strain fracture toughness for titanium alloys are presented in Table 5.1.2.1.1. Minimum, average, and maximum values, as well as coefficient of variation, are presented for various products for which valid data are available, but these values do not have the statistical reliability of the room-temperature mechanical properties.

5.1.3 MANUFACTURING CONSIDERATIONS — Comments relating to formability, weldability, and final heat treatment are presented under individual alloys. These comments are necessarily brief and are intended only to aid the designer in the selection of an alloy for a specific application. In practice, departures from recommended practices are very common and are based largely on in-plant experience. Springback is nearly always a factor in hot or cold forming.

Final heat treatments that are indicated as "specified" heat treatments do not necessarily coincide with the producers' recommended heat treatments. Rather, these treatments, along with the specified room-temperature minimum tensile properties, are contained in the heat treating-capability requirements of applicable specifications, for example, MIL-H-81200. Departures from the specified aging cycles are often necessary to account for aging that may take place during hot working or hot sizing or to obtain more desirable mechanical properties, for example, improved fracture toughness. More detailed recommendations for specific applications are generally available from the material producers.

5.1.4 ENVIRONMENTAL CONSIDERATIONS — Comments relating to temperature limitations in the application of titanium and titanium alloys are presented under the individual alloys.

Below about 300°F, as well as above about 700°F, creep deformation of titanium alloys can be expected at stresses below the yield strength. Available data indicate that room-temperature creep of unalloyed titanium may be significant (exceed 0.2 percent creep-strain in 1,000 hours) at stresses that exceed approximately 50 percent F_{ty} , room-temperature creep of Ti-5Al-1.5Sn ELI may be significant at stresses above approximately 60 percent F_{ty} , and room-temperature creep of the standard grades of titanium alloys may be significant at stresses above approximately 75 percent F_{ty} . References 5.1.4(a) through (c) provide some limited data regarding room-temperature creep of titanium alloys.

The use of titanium and its alloys in contact with either liquid oxygen or gaseous oxygen at cryogenic temperatures should be avoided, since either the presentation of a fresh surface (such as produced by tensile rupture) or impact may initiate a violent reaction [Reference 5.1.4(d)]. Impact of the surface in contact with

MIL-HDBK-5J
31 January 2003

liquid oxygen will result in a reaction at energy levels as low as 10 ft-lb. In gaseous oxygen, a partial pressure of about 50 psi is sufficient to ignite a fresh titanium surface over the temperature range from -250°F to room temperature or higher.

Titanium is susceptible to stress-corrosion cracking in certain anhydrous chemicals including methyl alcohol and nitrogen tetroxide. Traces of water tend to inhibit the reaction in either environment. However, in N₂O₄, NO is preferred and inhibited N₂O₄ contains 0.4 to 0.8 percent NO. Red fuming nitric acid with less than 1.5 percent water and 10 to 20 percent NO₂ can crack the metal and result in a pyrophoric reaction.

Titanium alloys are also susceptible to stress corrosion by dry sodium chloride at elevated temperatures. This problem has been observed largely in laboratory tests at 450 to 500°F and higher and occasionally in fabrication shops. However, there have been no reported failures of titanium components in service by hot salt stress corrosion. Cleaning with a nonchlorinated solvent (to remove salt deposits, including fingerprints) of parts used above 450°F is recommended.

In laboratory tests, with a fatigue crack present in the specimen, certain titanium alloys show an increased crack propagation rate in the presence of water or salt water as compared with the rate in air. These alloys also may show reduced sustained load-carrying ability in aqueous environments in the presence of fatigue cracks. Crack growth rates in salt water are a function of sheet or section thickness. These alloys are not susceptible in the form of thin-gauge sheet, but become susceptible as thickness increases. The thickness at which susceptibility occurs varies over a visual range with the alloy and processing. Alloys of titanium found susceptible to this effect include some from alpha, alpha-beta, and beta-type microstructures. In some cases, special processing techniques and heat treatments have been developed that minimize this effect. References 5.1.4(e) through (g) present detailed summaries of corrosion and stress corrosion of titanium alloys.

Under certain conditions, titanium, when in contact with cadmium, silver, mercury, or certain of their compounds, may become embrittled. Refer to MIL-HDBK-1568 for restrictions concerning applications with titanium in contact with these metals or their compounds.

Table 5.1.2.1.1. Values of Room Temperature Plane-Strain Fracture Toughness of Titanium Alloys^a

Alloy	Heat Treat Condition	Product Form	Orientation ^b	Yield Strength Range, ksi	Product Thickness Range, inches	Number of Sources	Sample Size	Specimen Thickness Range, inches	K _{Ic} , ksi √in.			Coefficient of Variation
									Max.	Avg.	Min.	
Ti-6Al-4V	Mill Annealed	Forged Bar	L-T	121-143	<3.5	2	43	0.6-1.1	77	60	38	10.5
Ti-6Al-4V	Mill Annealed	Forged Bar	T-L	124-145	<3.5	2	64	0.5-1.3	81	57	33	11.7

^a These values are for information only.

^b Refer to Figure 1.4.12.3 for definition of symbols.

5.2 UNALLOYED TITANIUM

Several grades of unalloyed titanium are offered and are classified on the basis of manufacturing method, degree of purity, or strength, there being a close relationship among these. The unalloyed titanium grades most commonly used are produced by the Kroll process, are intermediate in purity, and are commonly referred to as being of commercial purity.

5.2.1 COMMERCIALLY PURE TITANIUM

5.2.1.0 Comments and Properties — Unalloyed titanium is available in all familiar product forms and is noted for its excellent formability. Unalloyed titanium is readily welded or brazed. It has been used primarily where strength is not the main requirement.

Manufacturing Considerations — Unalloyed titanium is supplied in the annealed condition permitting extensive forming at room temperature. Severe forming operations also can be accomplished at elevated temperatures (300 to 900°F). Property degradation can be experienced after severe forming if as-received material properties are not restored by re-annealing.

Commercially pure titanium can be welded readily by the several methods employed for titanium joining. Atmospheric shielding is preferable although spot or seam welding may be accomplished without shielding. Brazing requires protection from the atmosphere which may be obtained by fluxing as well as by inert gas or vacuum shielding.

Environmental Considerations — Titanium has an unusually high affinity for oxygen, nitrogen, and hydrogen at temperatures above 1050°F. This results in embrittlement of the material, thus usage should be limited to temperatures below that indicated. Additional chemical reactivity between titanium and selected environments such as methyl alcohol, chloride salt solutions, hydrogen, and liquid metal, can take place at lower temperatures, as discussed in Section 5.1.4 and its references.

Under certain conditions, titanium, when in contact with cadmium, silver, mercury, or certain of their compounds, may become embrittled. Refer to MIL-HDBK-1568 for restrictions concerning applications with titanium in contact with these metals or their compounds.

Heat Treatment — Commercially pure titanium is fully annealed by heating to 1000 to 1300°F for 10 to 30 minutes. It is stress relieved by heating to 900 to 1000°F for 30 minutes. Commercially pure titanium cannot be hardened by heat treatment.

Specifications and Properties — Some material specifications for commercially pure titanium are presented in Table 5.2.1.0(a). Room-temperature mechanical properties for commercially pure titanium are shown in Tables 5.1.2.0(b) and (c). The effect of temperature on physical properties is shown in Figure 5.2.1.0.

5.2.1.1 Annealed Condition — Elevated-temperature data for annealed commercially pure titanium are presented in Figures 5.2.1.1.1(a) through 5.2.1.1.3(b). Typical full-range stress-strain curves for the 40 and 70 ksi yield strength commercially pure titanium are shown in Figures 5.2.1.1.6(a) and (b).

**Table 5.2.1.0(a). Material Specifications for
Commercially Pure Titanium**

Specification	Form
AMS 4900	Sheet, strip, and plate
AMS 4901	Sheet, strip, and plate
AMS 4902	Sheet, strip, and plate
AMS-T-9046	Sheet, strip, and plate
MIL-T-9047 ^a	Bar
AMS 4921	Bar
AMS-T-81556	Extruded bars and shapes

a Inactive for new design

MIL-HDBK-5J
31 January 2003

Table 5.2.1.0(b). Design Mechanical and Physical Properties of Commercially Pure Titanium

Specification	AMS-T-9046	AMS 4902 and AMS-T- 9046	AMS 4900 and AMS-T- 9046	AMS 4901 and AMS-T- 9046	AMS 4921 and MIL-T- 9047	MIL-T- 9047 ^a
Designation	CP-4	CP-3	CP-2	CP-1	CP-70	
Form	Sheet, strip, and plate				Bar	
Condition	Annealed				Annealed	
Thickness or diameter, in.	≤1.000				≤2.999 ^b	3.000- 4.000 ^b
Basis	S	S	S	S	S	S
Mechanical Properties:						
F_{tu} , ksi:						
L	35	50	65	80	80	80
LT	35	50	65	80	80 ^c	80
ST	80
F_{ty} , ksi:						
L	25	40	55	70	70	70
LT	25	40	55	70	70 ^c	70
ST	70
F_{cy} , ksi:						
L	70
LT	70
F_{su} , ksi	42
F_{bru} , ksi:						
($e/D = 1.5$)	120
($e/D = 2.0$)
F_{bry} , ksi:						
($e/D = 1.5$)	101
($e/D = 2.0$)
e , percent:						
L	24 ^d	20 ^d	18 ^d	15 ^d	15	15
LT	24 ^d	20 ^d	18 ^d	15 ^d	15 ^c	15
ST	15
RA , percent:						
L	30	30
LT	30 ^c	30
ST	30
E , 10 ³ ksi				15.5		
E_c , 10 ³ ksi				16.0		
G , 10 ³ ksi				6.5		
μ		
Physical Properties:						
ω , lb/in. ³				0.163		
C , K , and α				See Figure 5.2.1.0		

a Inactive for new design.

b Maximum of 16-square-inch cross-sectional area.

c Long transverse properties apply to rectangular bar only for thickness >0.500 inches and widths >3.000 inches.
For AMS 4921, (e) (LT) = 12% and RA (LT) = 25%.

d Thickness of 0.025 inch and above.

Table 5.2.1.0(c). Design Mechanical and Physical Properties of Commercially Pure Titanium Extruded Bars and Shapes

Specification	AMS-T-81556			
	Comp. CP-4	Comp. CP-3	Comp. CP-2	Comp. CP-1
Form	Extruded bars and shapes			
Condition	Annealed			
Thickness or diameter, in. . .	0.188-3.000			
Basis	S	S	S	S
Mechanical Properties:				
F_{tu} , ksi:				
L	40	50	65	80
LT
F_{ty} , ksi:				
L	30	40	55	70
LT
F_{cy} , ksi:				
L
LT
F_{su} , ksi
F_{bru} , ksi:				
(e/D = 1.5)
(e/D = 2.0)
F_{bry} , ksi:				
(e/D = 1.5)
(e/D = 2.0)
e , percent:				
L	a	a	a	a
E , 10^3 ksi	15.5			
E_c , 10^3 ksi	16.0			
G , 10^3 ksi	6.5			
μ			
Physical Properties:				
ω , lb/in. ³	0.163			
C , K , and α	See Figure 5.2.1.0			

a Elongation in percent as follows:

Thickness, inches	Comp. CP-4	Comp. CP-3	Comp. CP-2	Comp. CP-1
0.188-1.000	25	20	18	15
1.001-2.000	20	18	15	12
2.001-3.000	18	15	12	10

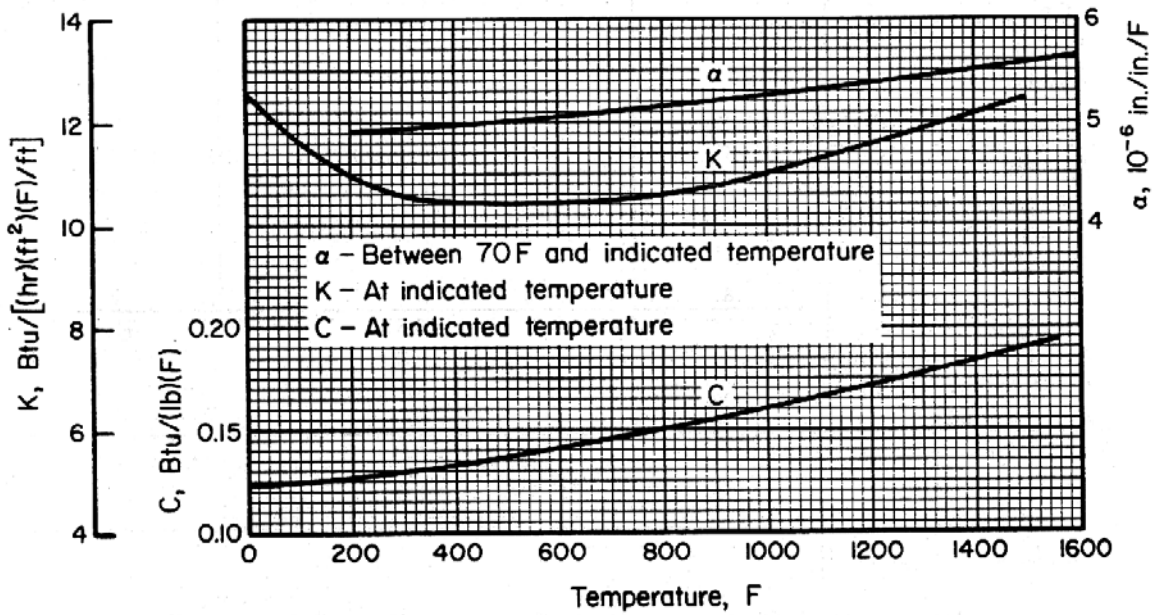

Figure 5.2.1.0. Effect of temperature on the physical properties of commercially pure titanium.

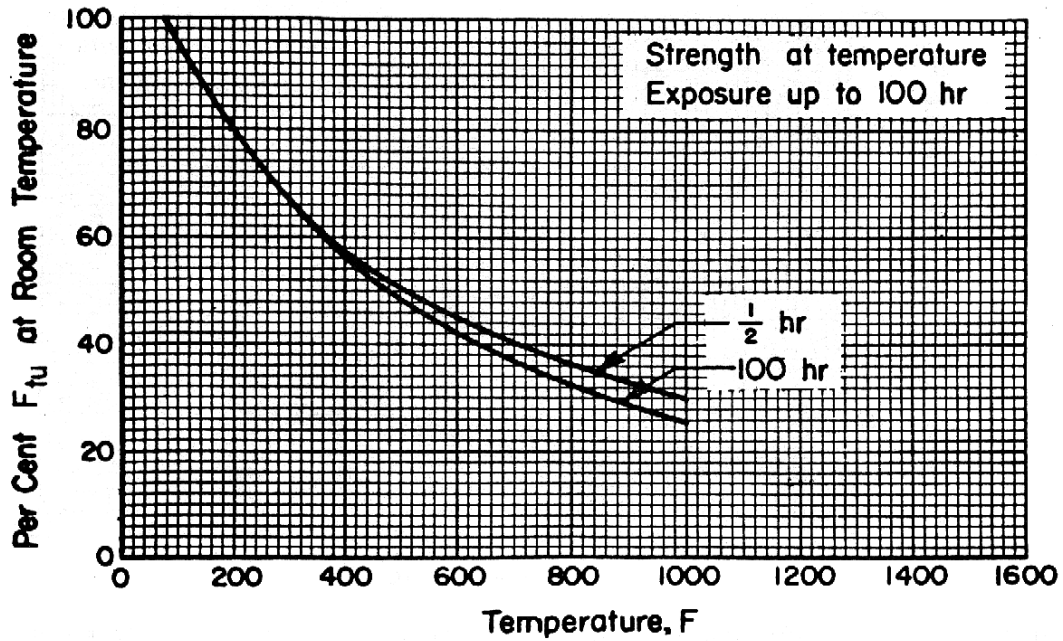

Figure 5.2.1.1.1(a). Effect of temperature on the tensile ultimate strength (F_{tu}) of annealed commercially pure titanium.

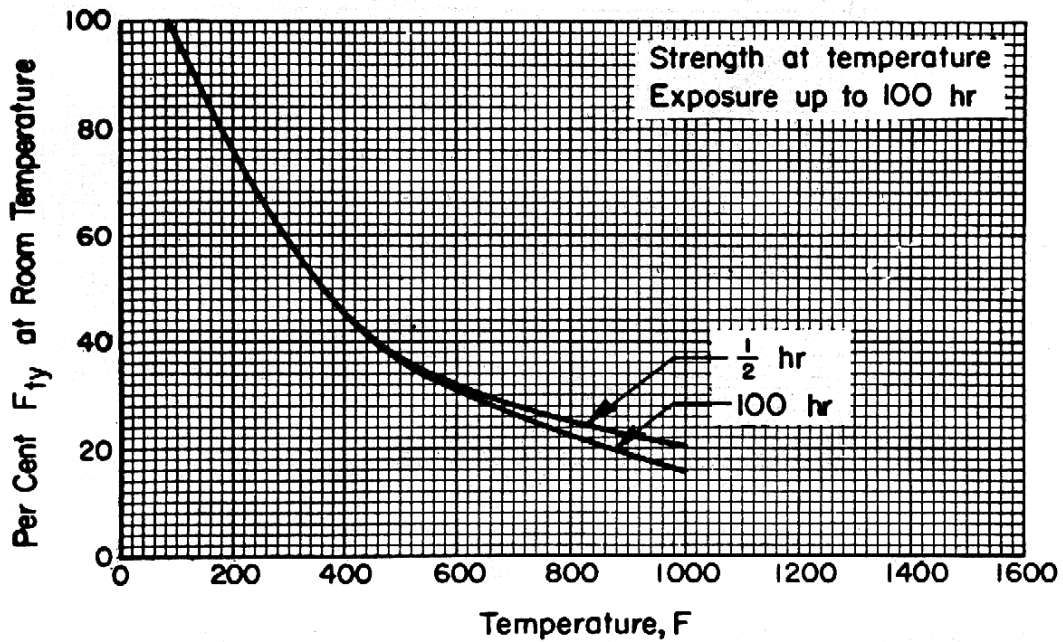

Figure 5.2.1.1.1(b). Effect of temperature on the tensile yield strength (F_{ty}) of annealed commercially pure titanium.

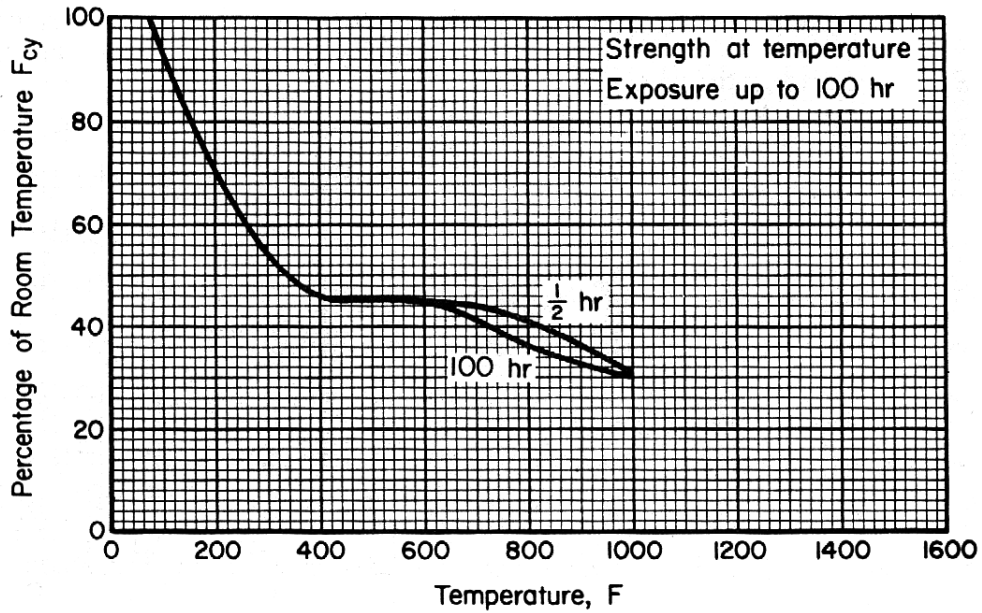

Figure 5.2.1.1.2(a). Effect of temperature on the compressive yield strength (F_{cy}) of annealed commercially pure titanium.

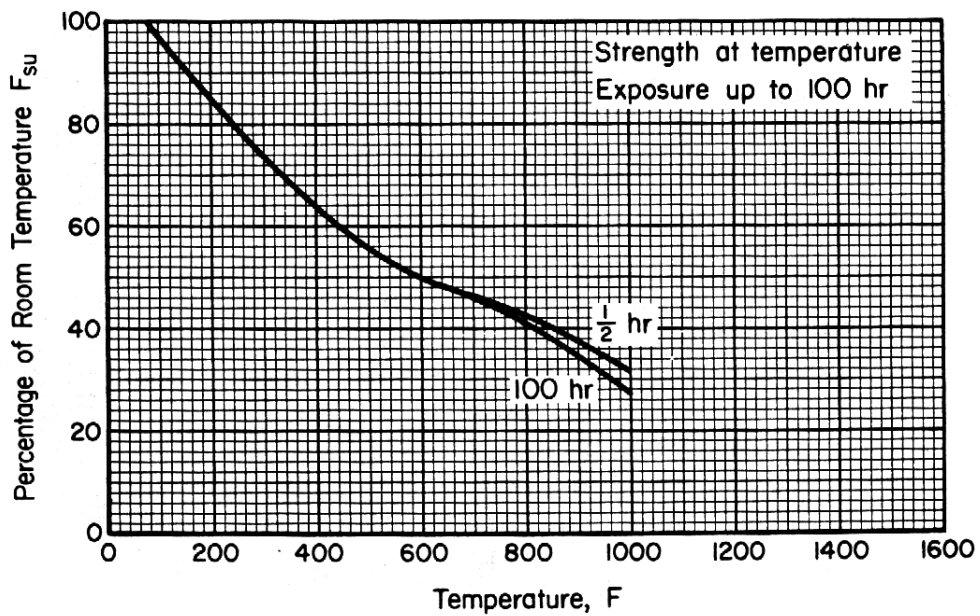

Figure 5.2.1.1.2(b). Effect of temperature on the shear ultimate strength (F_{su}) of annealed commercially pure titanium.

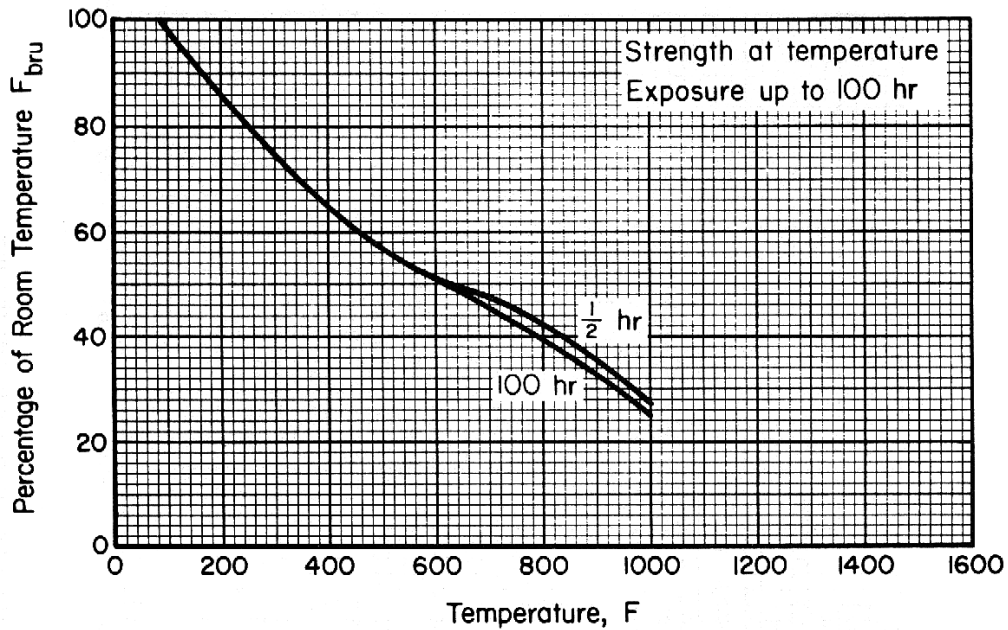

Figure 5.2.1.1.3(a). Effect of temperature on the bearing ultimate strength (F_{bru}) of annealed commercially pure titanium.

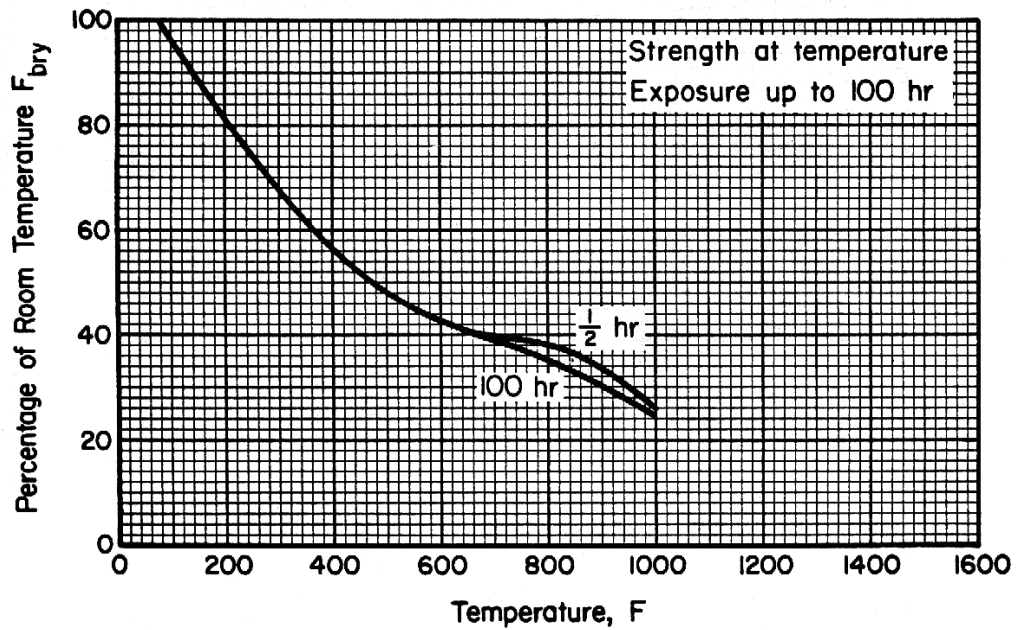

Figure 5.2.1.1.3(b). Effect of temperature on the bearing yield strength (F_{bry}) of annealed commercially pure titanium.

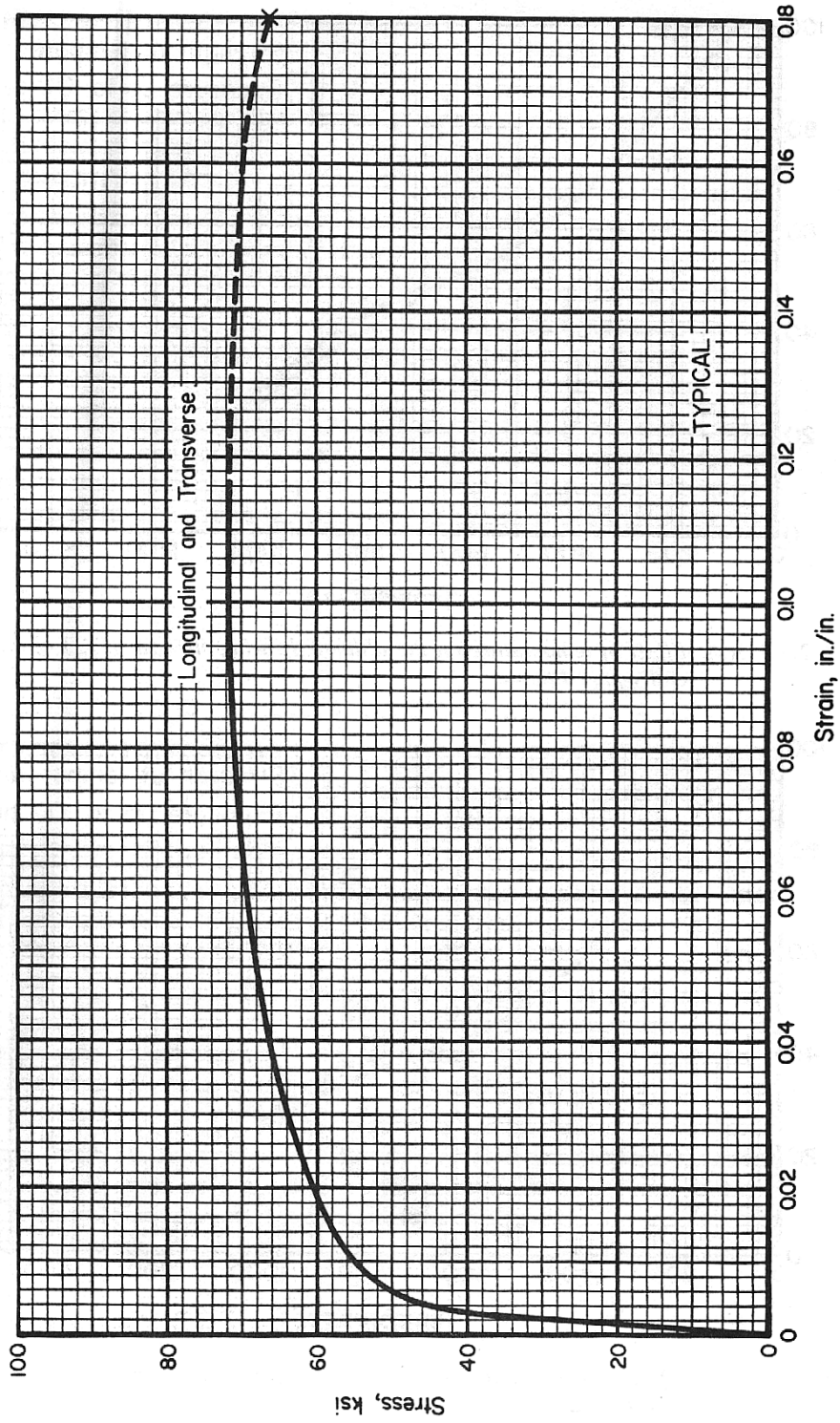

Figure 5.2.1.1.6(a). Typical full-range tensile stress-strain curve for commercially pure titanium sheet (40 ksi yield at room temperature).

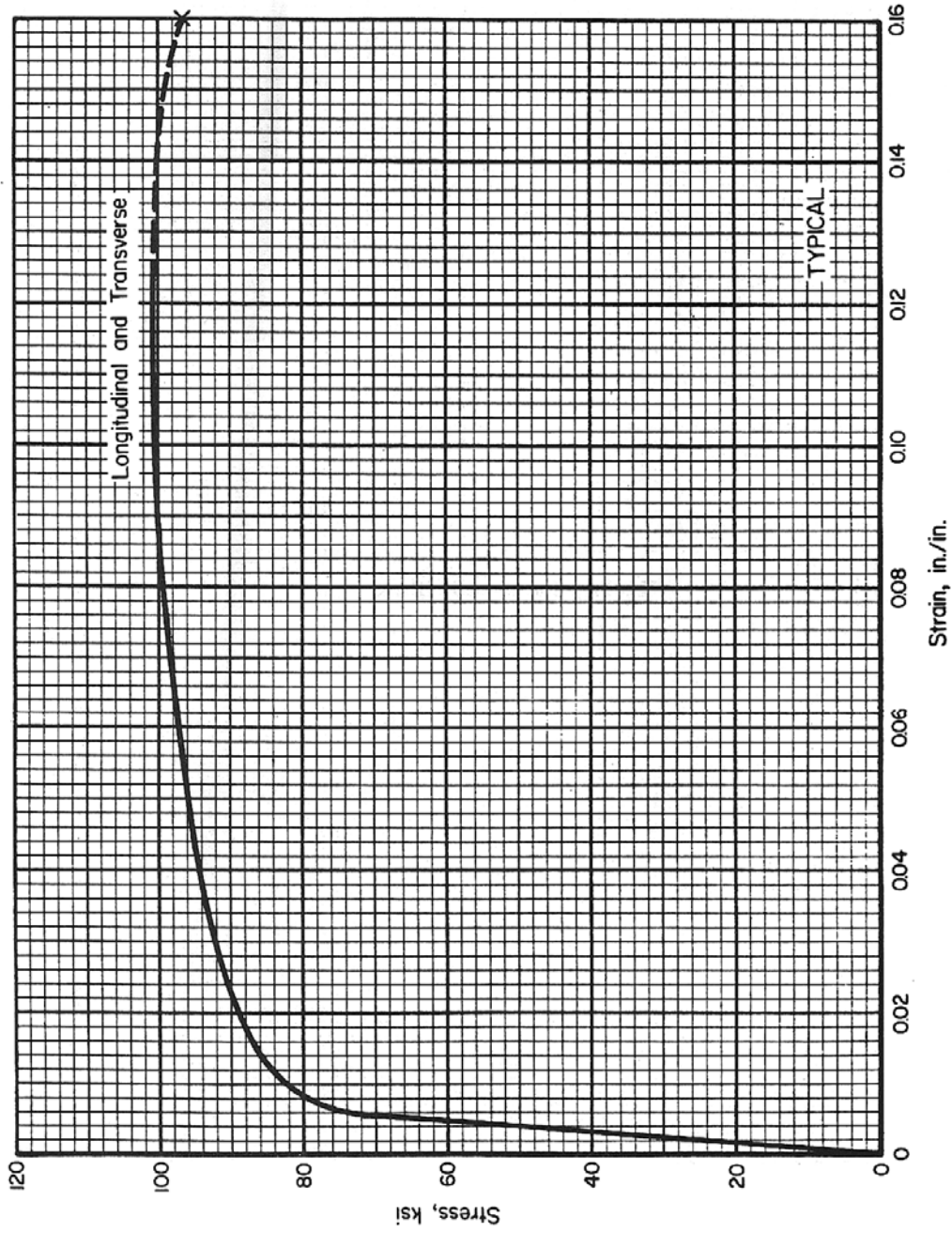

Figure 5.2.1.1.6(b). Typical full-range tensile stress-strain curve for commercially pure titanium sheet (70 ksi yield at room temperature).

5.3 ALPHA AND NEAR-ALPHA TITANIUM ALLOYS

The alpha titanium alloys contain essentially a single phase at room temperature, similar to that of unalloyed titanium. Alloys identified as near-alpha titanium have principally an all-alpha structure but contain small quantities of a beta phase because the composition contains some beta stabilizing elements. In both alloy types, alpha phase is stabilized by aluminum, tin, and zirconium. These elements, especially aluminum, contribute greatly to strength. The beta stabilizing additions (e.g., molybdenum and vanadium) improve fabricability and metallurgical stability of highly alpha-alloyed materials.

All alpha alloys have excellent weldability, toughness at low temperatures, and long-term elevated-temperature strength. They are well suited to cryogenic applications and to uses requiring good elevated-temperature creep strength. The characteristics of near-alpha alloys are predictably between those of all alpha and alpha-beta alloys in regard to fabricability, weldability, and elevated-temperature strength. The hot workability of both alpha and near-alpha alloys is inferior to that of the alpha-beta or beta alloys and the cold workability is very limited at the high-strength level of these grades. However, considerable forming is possible if correct forming temperatures and procedures are used.

5.3.1 Ti-5Al-2.5Sn

5.3.1.0 Comments and Properties — Ti-5Al-2.5Sn is an all-alpha alloy available in many product forms and at two purity levels. The high purity grade of this composition is used principally for cryogenic applications and may be characterized as having lower strength but higher ductility and toughness than the standard grade. The normal purity grade also may be used at low temperatures but it is primarily suitable for room to elevated temperature applications (up to 900°F or to 1100°F for short times) where weldability is an important consideration.

Manufacturing Considerations — Ti-5Al-2.5Sn is not so readily formed into complex shapes as other alloys with similar room-temperature properties, but far surpasses them in weldability. Except for some forging operations, fabrication of Ti-5Al-2.5Sn is conducted at temperatures where the structure remains all alpha. Severe forming operations may be accomplished at temperatures up to 1200°F. Moderately severe forming can be done at 300 to 600°F and simple forming may be done at room temperature. Most forming and welding operations are followed by an annealing treatment to relieve residual stresses imposed by the prior operation.

Ti-5Al-2.5Sn can be welded readily by inert-gas or vacuum-shielded arc methods or by spot or seam welding without atmospheric shielding. Brazing requires protection from the atmosphere; however, this is accomplished by fluxing as well as by inert gas or vacuum shielding.

Environmental Considerations — Ti-5Al-2.5Sn is metallurgically stable at moderate elevated temperatures. The material is susceptible to hot-salt stress corrosion as well as aqueous chloride solution stress corrosion. Care should be exercised in applications involving such environments. The alloy has good oxidation resistance up to 1050°F. Standard grade material has been used at moderately low cryogenic temperatures; however, the ELI grade has higher toughness and has been used in cryogenic applications down to -423°F. Under certain conditions, titanium, when in contact with cadmium, silver, mercury, or certain of their compounds, may become embrittled. Refer to MIL-HDBK-1568 for restrictions concerning applications with titanium in contact with these metals or their compounds.

Heat Treatment — This alloy is annealed by heating 1400°F for 60 minutes and 1600°F for 10 minutes and cooling in air. Stress relieving requires 1 or 2 hours at 1000 to 1200°F. Ti-5Al-2.5Sn cannot be hardened by heat treatment.

Specifications and Properties — Some material specifications for Ti-5Al-2.5Sn are shown in Table 5.3.1.0(a). Room-temperature mechanical properties for Ti-5Al-2.5Sn are shown in Tables 5.3.1.0(b) through (d). The effect of temperature on physical properties is shown in Figure 5.3.1.0.

Table 5.3.1.0(a). Material Specifications for Ti-5Al-2.5Sn

Specification	Form
AMS-T-9046	Sheet, strip, and plate
AMS 4926	Bar
MIL-T-9047 ^a	Bar
AMS-T-81556	Extruded bar and shapes
AMS 4910	Sheet, strip, and plate
AMS 4966	Forging

^a Inactive for new design

5.3.1.1 Annealed Condition — Elevated temperature curves for annealed Ti-5Al-2.5Sn are shown in Figures 5.3.1.1.1 through 5.3.1.1.5. Tensile properties cover the range -423 °F to 1000 °F; whereas other properties are for the range room temperature to 1000 °F. Fatigue-crack-propagation data for sheet are shown in Figures 5.3.1.1.9(a) through (c).

Table 5.3.1.0(b). Design Mechanical and Physical Properties of Ti-5Al-2.5Sn Sheet, Strip, and Plate

Specification	AMS 4910 and AMS-T-9046, Comp. A-1								
	Strip	Sheet				Plate			
Form	Annealed								
Condition	Annealed								
Thickness, in.	<0.187	0.015-0.079		0.080-0.187		0.188-0.250		0.251-1.500	1.501-4.000
Basis	S	A	B	A	B	A	B	S	S
Mechanical Properties:									
F_{tu} , ksi:									
L	120	120 ^a	128	120 ^a	131	120 ^a	135	120	115
LT	120	120 ^a	129	120 ^a	132	120 ^a	137	120	115
F_{ty} , ksi:									
L	113	110	115	113	118	113 ^a	123	113	110
LT	113	113	118	113 ^a	121	113 ^a	125	113	110
F_{cy} , ksi:									
L	115	115	120	118	123	118	128	118	...
LT	118	118	123	118	126	118	130	118	...
F_{su} , ksi	75	75	80	75	82	75	85	75	...
F_{bru} , ksi:									
(e/D = 1.5) . . .	167	167	179	167	183	167	190	167	...
(e/D = 2.0) . . .	250	250	268	250	275	250	285	250	...
F_{bry} , ksi:									
(e/D = 1.5) . . .	133	133	139	133	142	133	147	133	...
(e/D = 2.0) . . .	190	190	198	190	203	190	210	190	...
e , percent (S-basis):									
L	10	10 ^b	...	10	...	10	...	10	10
LT	10	10 ^b	...	10	...	10	...	10	10
E , 10 ³ ksi	15.5								
E_c , 10 ³ ksi	15.5								
G , 10 ³ ksi								
μ								
Physical Properties:									
ω , lb/in. ³	0.162								
C , K , and α	See Figure 5.3.1.0								

a S-basis. The rounded T_{99} values are higher than specification values as follows:

	<u>0.015-0.079</u>	<u>0.080-0.187</u>	<u>0.188-0.250</u>
F_{tu} L.....	123	126	130
LT.....	123	126	131
F_{ty} L.....	118
LT.....	...	115	120

b Thickness 0.025 inch and above.

Table 5.3.1.0(c). Design Mechanical and Physical Properties of Ti-5Al-2.5Sn Bar and Forging

Specification	AMS 4926 ^a and MIL-T-9047 ^b			AMS 4966
	Bar			Forging
Condition	Annealed			Annealed
Thickness or diameter, in. . .	≤2.999 ^c		3.000-4.000 ^c	...
Basis	A	B	S	
Mechanical Properties:				
F_{tu} , ksi:				
L	115 ^d	126	115	115
LT	115 ^e	...	115	115 ^f
ST	115	115 ^f
F_{ty} , ksi:				
L	110 ^d	120	110	110
LT	110 ^e	...	110	110 ^f
ST	110	110 ^f
F_{cy} , ksi:				
L
LT
F_{su} , ksi
F_{bru} , ksi:				
(e/D = 1.5)
(e/D = 2.0)
F_{bry} , ksi:				
(e/D = 1.5)
(e/D = 2.0)
e , percent (S-basis):				
L	10	...	10	10
LT	10 ^e	...	10	10 ^f
ST	8	10 ^f
RA , percent (S-basis):				
L	25	...	25	25
LT	25 ^e	...	25	25 ^f
ST	20	25 ^f
E , 10 ³ ksi	15.5			
E_c , 10 ³ ksi	15.5			
G , 10 ³ ksi			
μ			
Physical Properties:				
ω , lb/in. ³	0.162			
C , K , and α	See Figure 5.3.1.0			

- a For AMS 4926, LT and ST values for e and RA may be different than those shown.
- b Inactive for new design.
- c Maximum of 16-square-inch cross-sectional area.
- d The rounded T_{90} values are higher than S values as follows: $F_{tu} = 117$ ksi, $F_{ty} = 113$ ksi.
- e S-basis. Applicable providing LT dimension is >3.000 inches.
- f Applicable, providing LT or ST dimension is ≥2.500 inches.

MIL-HDBK-5J
31 January 2003

Table 5.3.1.0(d). Design Mechanical and Physical Properties of Ti-5Al-2.5Sn Extrusion

Specification	AMS-T-81556, Comp. A-1			
Form	Extruded bars and shapes			
Condition	Annealed			
Thickness or diameter, in. ...	0.188- 1.000	1.001- 2.000	2.001- 3.000	3.001- 4.000
Basis	S	S	S	S
Mechanical Properties:				
F_{tu} , ksi:				
L	120	115	115	115
LT
F_{ty} , ksi:				
L	115	110	110	110
LT
F_{cy} , ksi:				
L
LT
F_{su} , ksi
F_{bru} , ksi:				
(e/D = 1.5)
(e/D = 2.0)
F_{bry} , ksi:				
(e/D = 1.5)
(e/D = 2.0)
e , percent:				
L	10	10	8	6
LT
E , 10^3 ksi	15.5			
E_c , 10^3 ksi	15.5			
G , 10^3 ksi			
μ			
Physical Properties:				
ω , lb/in. ³	0.162			
C , K , and α	See Figure 5.3.1.0			

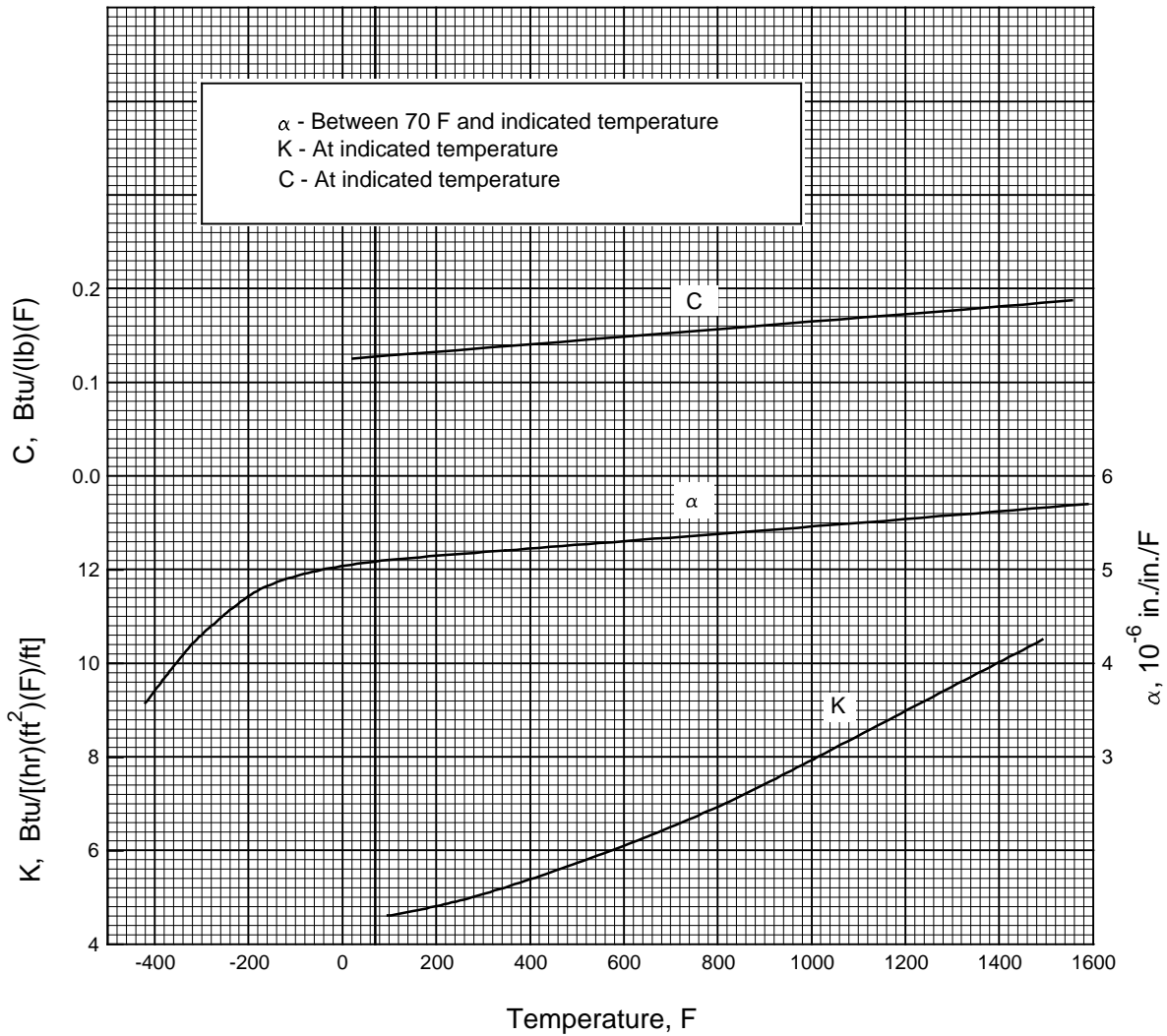

Figure 5.3.1.0. Effect of temperature on the physical properties of Ti-5Al-2.5Sn alloy.

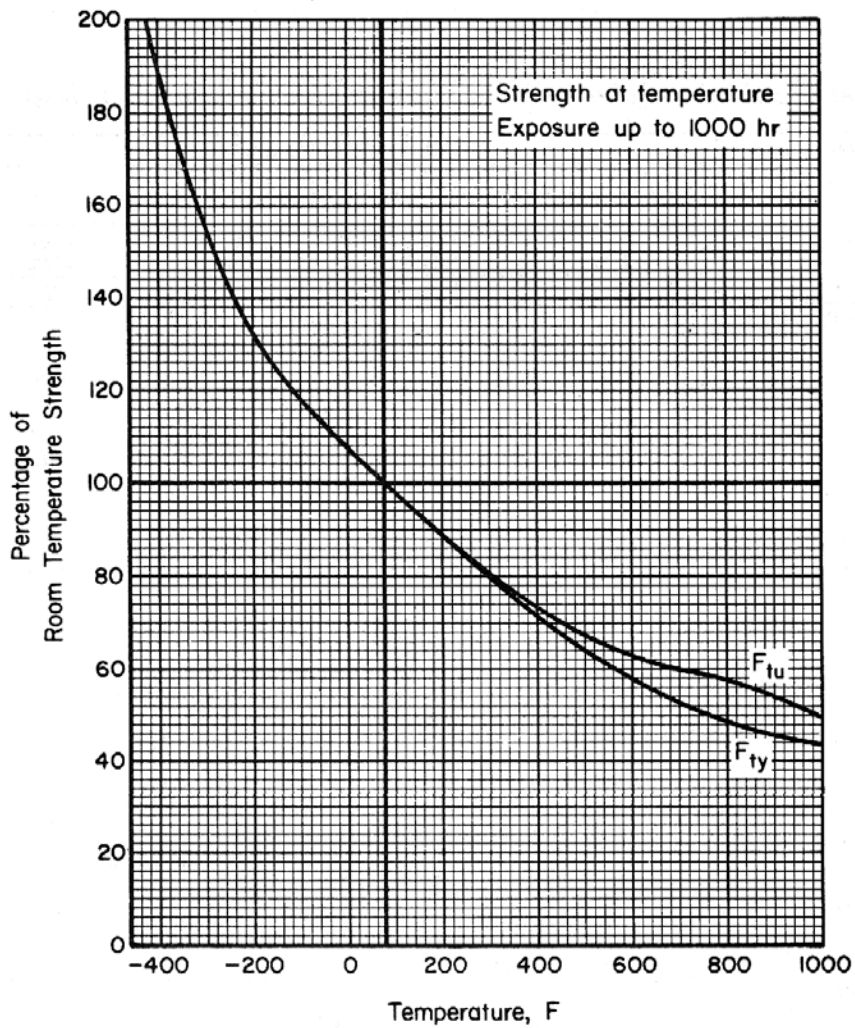

Figure 5.3.1.1.1. Effect of temperature on the tensile ultimate strength (F_{tu}) and the tensile yield strength (F_{ty}) of annealed Ti-5Al-2.5Sn alloy sheet.

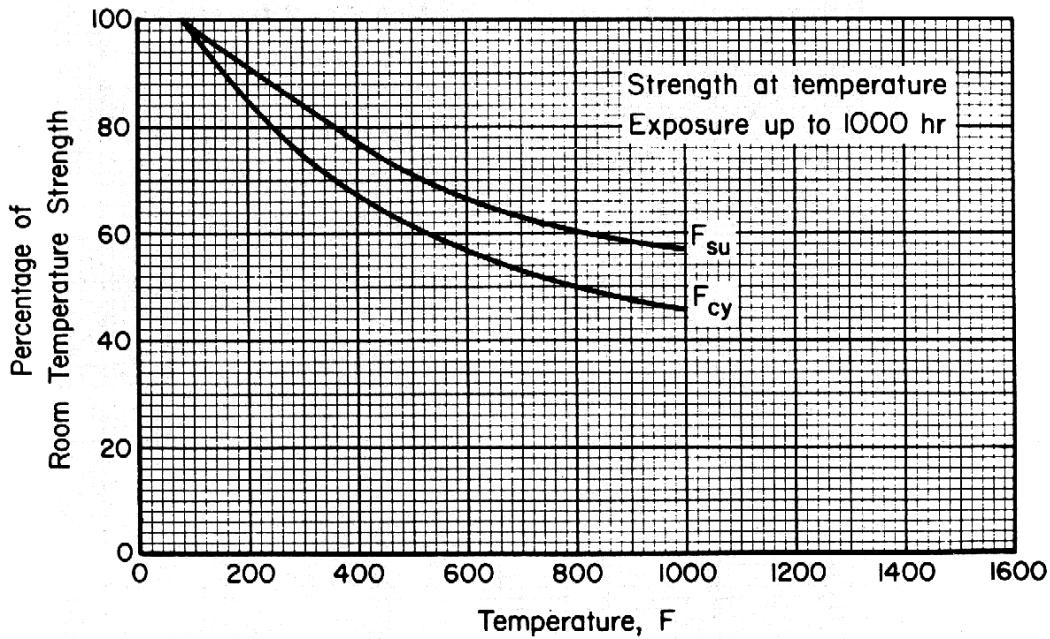

Figure 5.3.1.1.2. Effect of temperature on the compressive yield strength (F_{cy}) and the shear ultimate strength (F_{su}) of annealed Ti-5Al-2.5Sn alloy sheet.

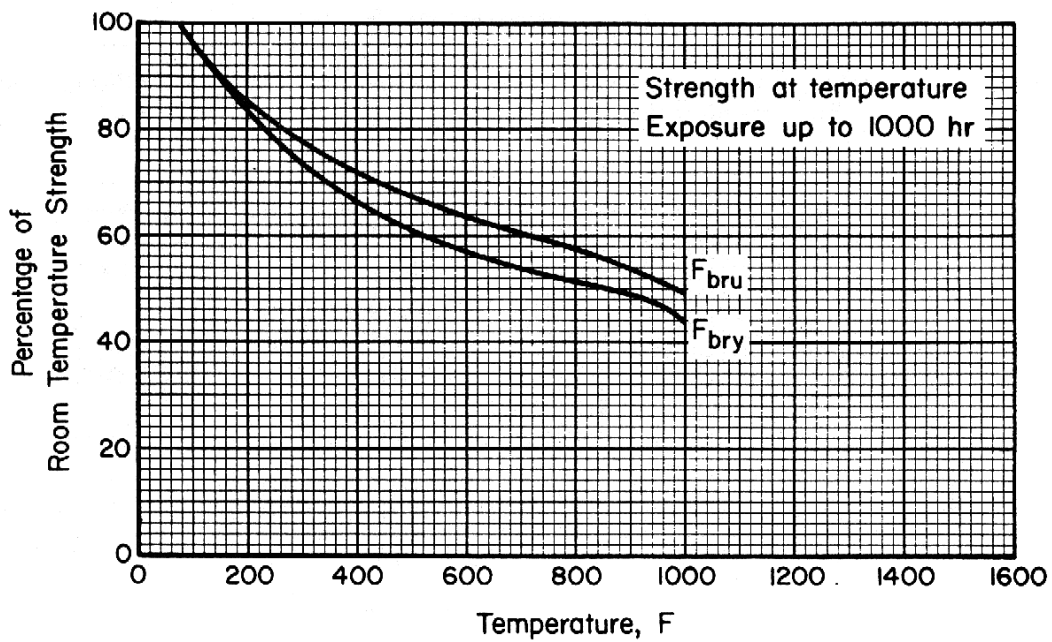

Figure 5.3.1.1.3. Effect of temperature on the bearing ultimate strength (F_{bru}) and the bearing yield strength (F_{bry}) of annealed Ti-5Al-2.5Sn alloy sheet.

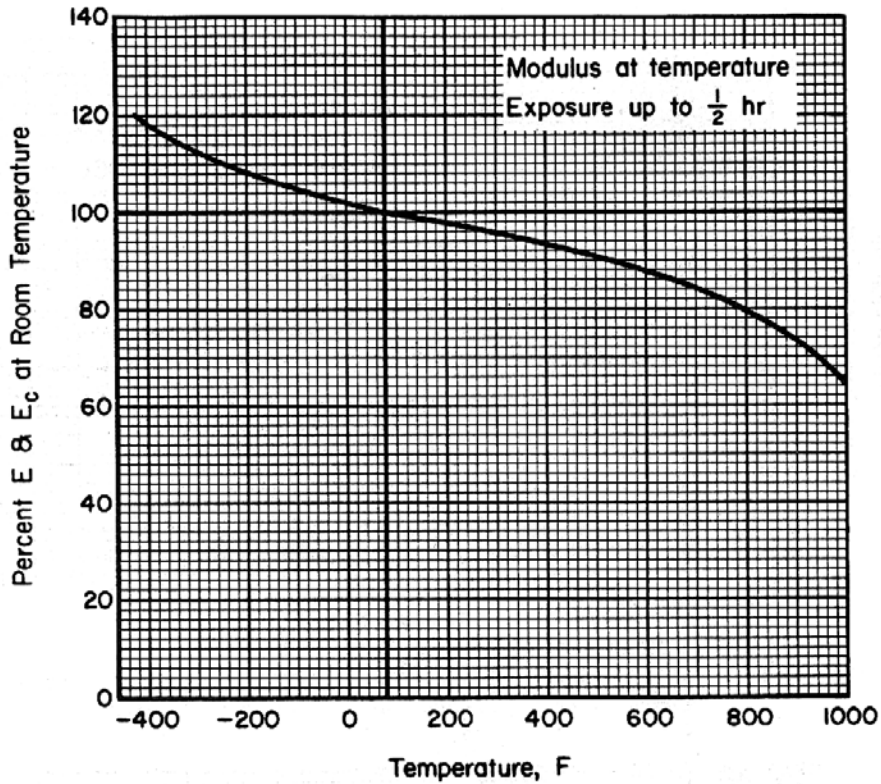

Figure 5.3.1.1.4. Effect of temperature on the tensile and compressive moduli (E and E_c) of annealed Ti-5Al-2.5Sn alloy sheet.

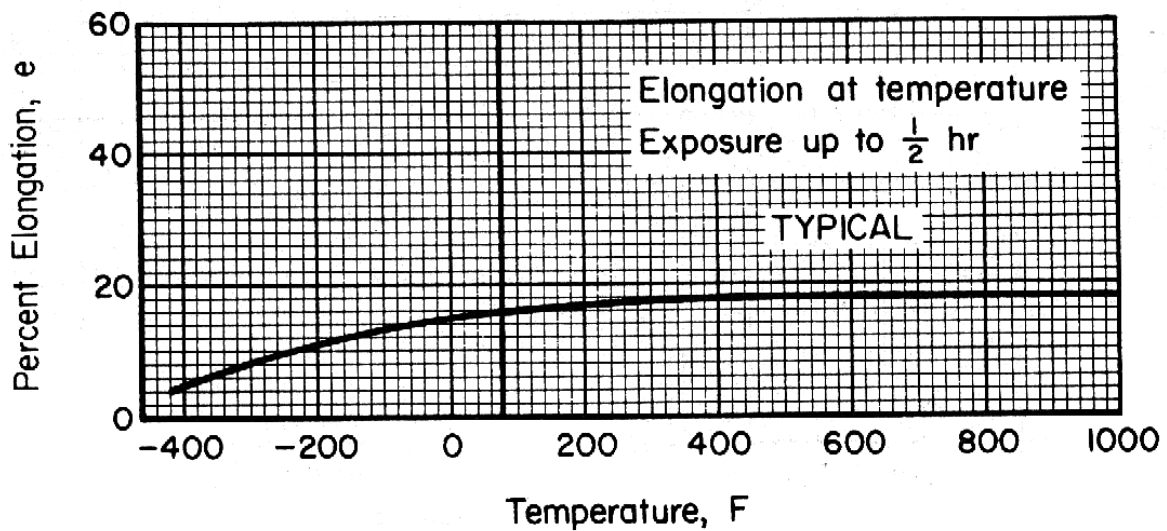

Figure 5.3.1.1.5. Effect of temperature on the elongation (e) of annealed Ti-5Al-2.5Sn alloy sheet.

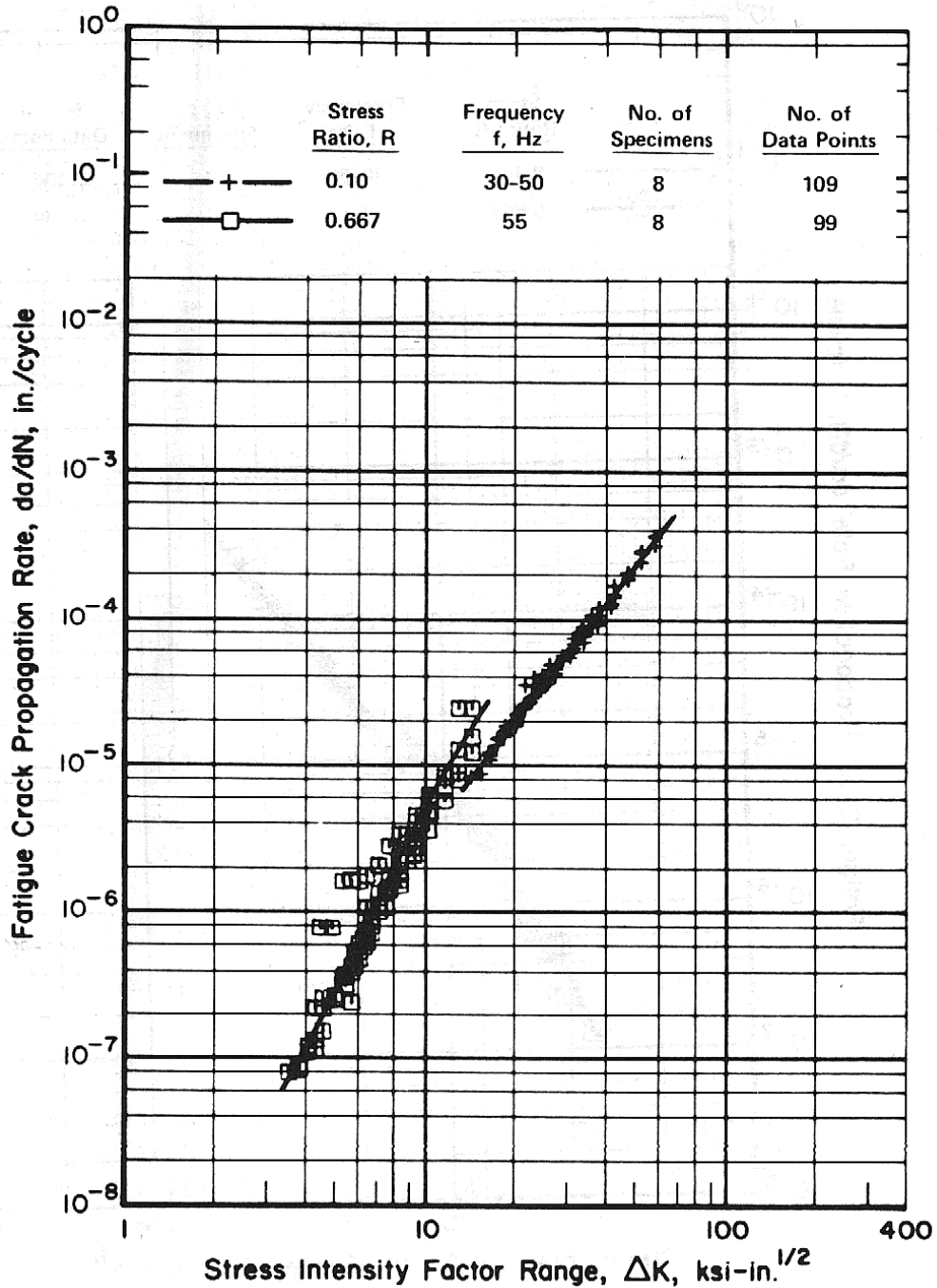

Figure 5.3.1.1.9(a). Fatigue-crack-propagation data for 0.084-inch-thick Ti-5Al-2.5Sn titanium alloy mill-annealed sheet. [Reference 5.3.1.1.9].

Specimen Thickness: 0.08 inch
Specimen Width: 2.76 inches
Specimen Type: M(T)

Environment: Lab air
Temperature: RT
Orientation: L-T and T-L

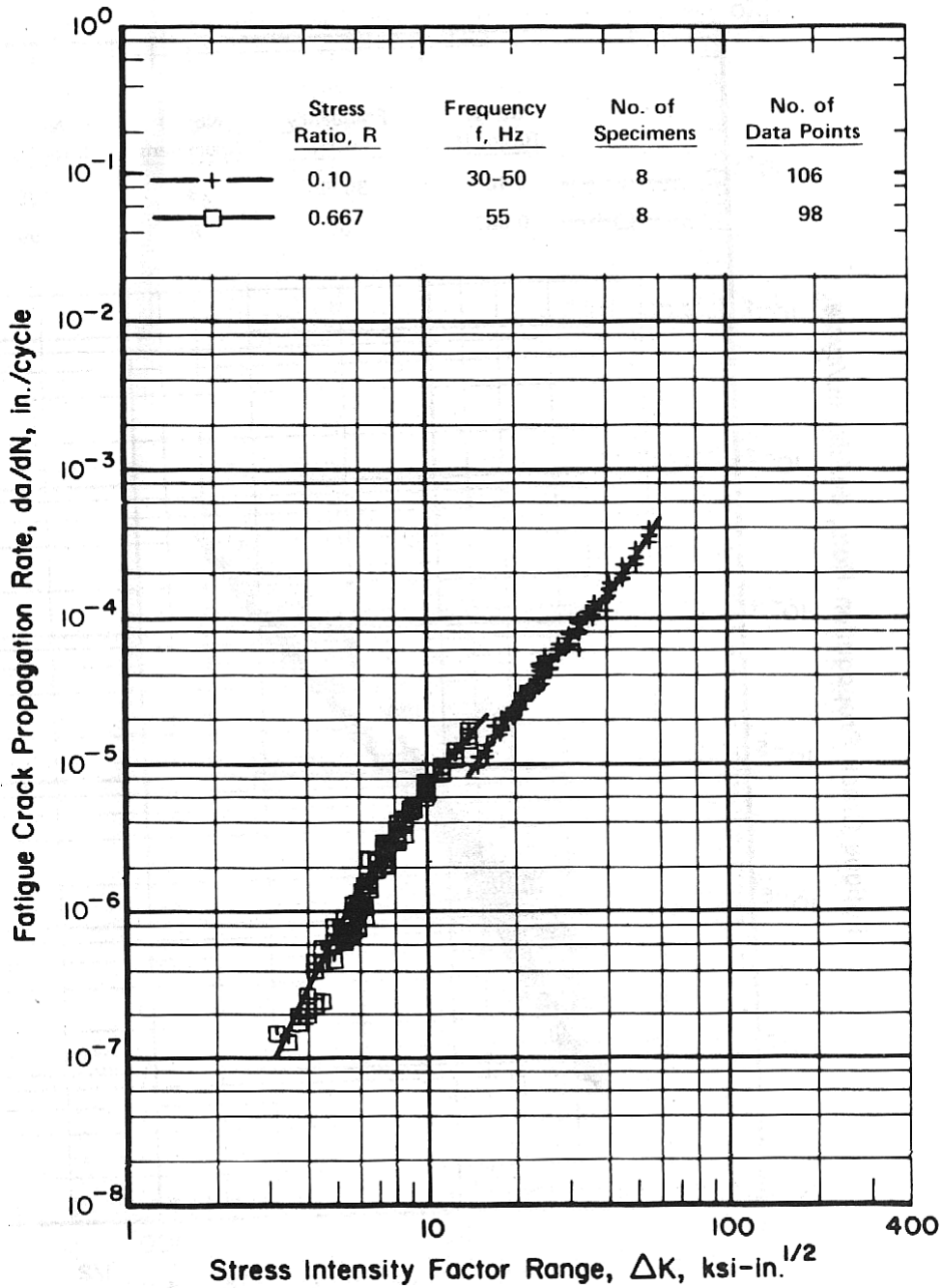

Figure 5.3.1.1.9(b). Fatigue-crack-propagation data for 0.084-inch-thick Ti-5Al-2.5Sn titanium alloy mill-annealed sheet. [Reference 5.3.1.1.9].

Specimen Thickness: 0.08 inch
Specimen Width: 2.76 inches
Specimen Type: M(T)

Environment: Distilled water
Temperature: RT
Orientation: L-T and T-L

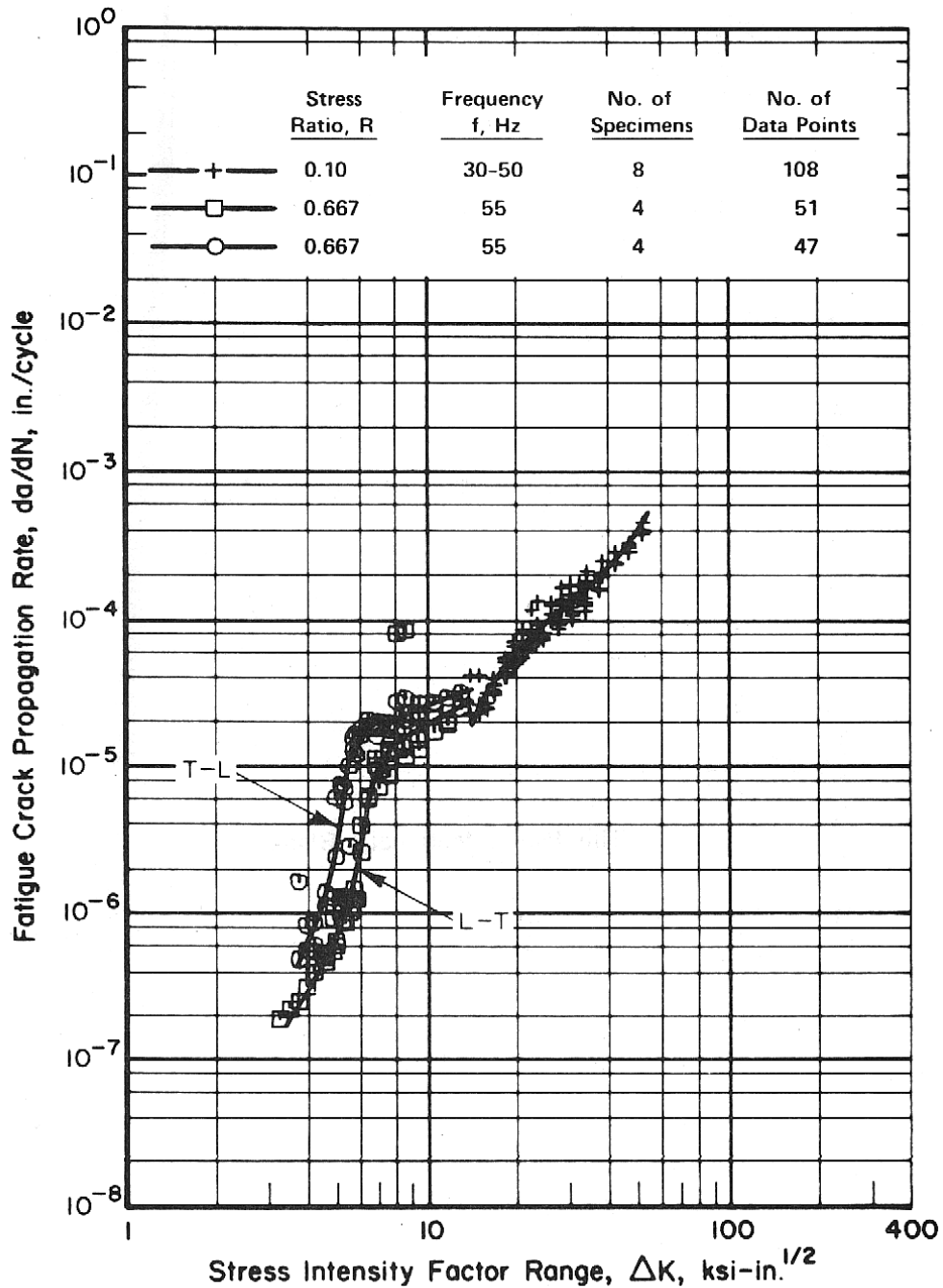

Figure 5.3.1.1.9(c). Fatigue-crack-propagation data for 0.084-inch-thick Ti-5Al-2.5Sn titanium alloy mill-annealed sheet. [Reference 5.3.1.1.9].

Specimen Thickness: 0.08 inch
Specimen Width: 2.76 inches
Specimen Type: M(T)

Environment: 3.5% NaCl
Temperature: RT
Orientation: L-T and T-L

5.3.2 Ti-8Al-1Mo-1V

5.3.2.0 Comments and Properties — Ti-8Al-1Mo-1V alloy is a near-alpha composition developed for improved creep resistance and thermal stability up to about 850°F. The alloy is available as billet, bar, plate, sheet, strip, extrusions, and forgings.

Manufacturing Considerations — Room temperature forming of Ti-8Al-1Mo-1V sheet is somewhat more difficult than in Ti-6Al-4V, and for severe operations hot forming is required. Ti-8Al-1Mo-1V can be fusion welded readily with inert-gas protection or spot welding without atmospheric protection. Weld strengths are comparable to those of the parent metal although ductility is somewhat lower in the weldment.

Environmental Considerations — Ti-8Al-1Mo-1V exhibits good oxidation resistance and thermal stability up to 850°F. A decrease in tensile elongation has been reported for single-annealed sheet following 150 hours stressed exposure at 1000°F. Extended exposure to temperatures exceeding 600°F adversely affects room-temperature spot-weld tension strength. This alloy is not recommended for structural applications at liquid-hydrogen temperatures (-423°F). The Ti-8Al-1Mo-1V alloy also is susceptible to chloride stress-corrosion attack in either elevated-temperature (hot-salt stress-corrosion) or ambient-temperature (aqueous stress-corrosion) chloride environments. Thus, care should be exercised in applying the material in chloride containing environments. Under certain conditions, titanium, when in contact with cadmium, silver, mercury, or certain of their compounds, may become embrittled. Refer to MIL-S-5002 and MIL-STD-1568 for restrictions concerning applications with titanium in contact with these metals or their compounds.

Heat Treatment — Three treatments are used with Ti-8Al-1Mo-1V. These are:

Single Anneal: 1450°F for 8 hours, furnace cool.

Duplex Anneal: 1450°F for 8 hours, furnace cool, followed by 1450°F for 15 to 20 minutes, air cool.

Solution Treated and Stabilized: 1825°F for 1 hour, air cool, 1075°F for 8 hours, air cool.

As a general guide, the single anneal is used to obtain highest room-temperature mechanical properties and the duplex anneal to obtain highest fracture toughness. Both the single anneal and the duplex anneal are compatible with hot-forming operations. The solution treated and stabilized condition is used for forgings.

Specifications and Properties — Material specifications for Ti-8Al-1Mo-1V are presented in Table 5.3.2.0(a). Room-temperature mechanical and physical properties for Ti-8Al-1Mo-1V are shown in Tables 5.3.2.0(b) and (c). The effect of temperature on physical properties is shown in Figure 5.3.2.0.

Table 5.3.2.0(a). Material Specifications for Ti-8Al-1Mo-1V

Specification	Form
AMS-T-9046	Sheet, strip, and plate
MIL-T-9047	Bar
AMS 4973	Forging
AMS 4915	Sheet, strip, and plate
AMS 4916	Sheet, strip, and plate

5.3.2.1 Single-Annealed Condition — Cryogenic, room-temperature, and elevated temperature property curves for this condition are shown in Figures 5.3.2.1.1 and 5.3.2.1.4. Typical tensile and compressive stress-strain and tangent-modulus curves are shown in Figures 5.3.2.1.6(a) and (b) for room temperature and several elevated temperatures.

5.3.2.2 Duplex-Annealed Condition — Cryogenic, room temperature, and elevated temperature curves for this condition are shown in Figure 5.3.2.2.1. Typical tensile and compressive stress-strain and tangent-modulus curves are shown in Figures 5.3.2.2.6(a) and (b) for room temperature and several elevated temperatures. Fatigue S/N curves for unnotched and notched specimens at room temperature and several elevated temperatures are shown in Figures 5.3.2.2.8(a) through (f).

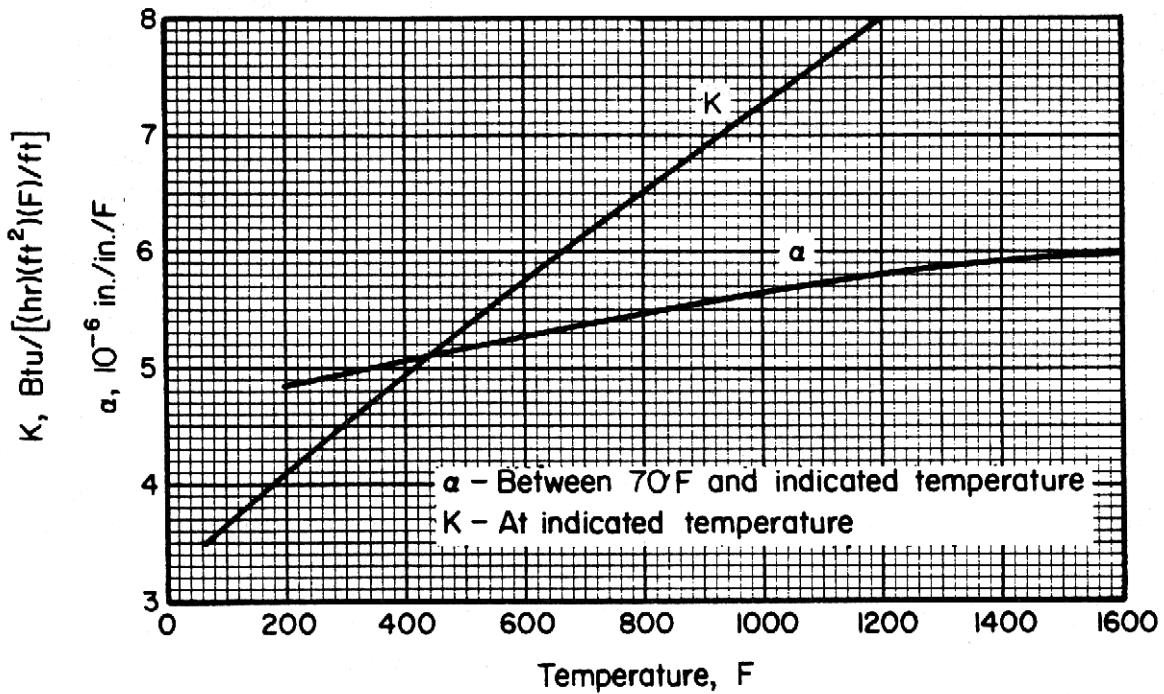

Figure 5.3.2.0. Effect of temperature on the physical properties of Ti-8Al-1Mo-1V alloy.

Table 5.3.2.0(b₁). Design Mechanical and Physical Properties of Ti-8Al-1Mo-1V Sheet and Plate

Specification	AMS 4915, AMS-T-9046, and Comp A-4				
	Sheet	Plate			
Form	Single Annealed				
Condition					
Thickness, in.	≤ 0.1875	0.1875- 0.500	0.501- 1.000	1.001- 2.500	2.501- 4.000
Basis	S	S	S	S	S
Mechanical Properties:					
<i>F_{tu}</i> , ksi:					
L	145	145	140	130	120
LT	145	145	140	130	120
ST	120 ^b
<i>F_{ty}</i> , ksi:					
L	135	135	130	120	110
LT	135	135	130	120	110
ST	110 ^b
<i>F_{cy}</i> , ksi:					
L	144
LT	149
ST
<i>F_{su}</i> , ksi					
	93
<i>F_{bru}</i> , ksi:					
(e/D = 1.5)	239
(e/D = 2.0)	294
<i>F_{bry}</i> , ksi:					
(e/D = 1.5)	196
(e/D = 2.0)	214
<i>e</i> , percent:					
L	a	10	10	10	8
LT	a	10	10	10	8
ST	8 ^b
<i>E</i> , 10 ³ ksi					
	17.5 ^c				
<i>E_c</i> , 10 ³ ksi					
	18.0 ^c				
<i>G</i> , 10 ³ ksi					
	6.7				
<i>μ</i>					
	0.32				
Physical Properties:					
<i>ω</i> , lb/in. ³					
	0.158				
<i>C</i> , Btu/(lb)(°F)					
	0.12				
<i>K</i> and <i>α</i>					
	See Figure 5.3.2.0				

a 0.008-0.014 in. thickness, 6 percent; 0.015-0.024 in. thickness, 8 percent; > 0.025 in. thickness, 10 percent.

b Applicable, providing ST dimension is > 3.000 inches.

c Average, values may vary with test direction.

Table 5.3.2.0(b₂). Design Mechanical and Physical Properties of Ti-8Al-1Mo-1V Sheet and Plate

Specification	AMS 4916, AMS-T-9046, and Comp. A-4					
Form	Sheet			Plate		
Condition	Duplex Annealed					
Thickness, in.	0.015-0.024	0.025-0.1875	0.1875-0.500	0.501-1.000	1.001-2.000	2.001-4.000
Basis	S	S	S	S	S	S
Mechanical Properties:						
F_{tu} , ksi:						
L	135	135	130	130	125	120
LT	135	135	130	130	125	120
F_{ty} , ksi:						
L	120	120	120	120	115	110
LT	120	120	120	120	115	110
F_{cy} , ksi:						
L	126	126
LT	126	126
F_{su} , ksi	84	84
F_{bru} , ksi:						
(e/D = 1.5)	223	223
(e/D = 2.0)	269	269
F_{bry} , ksi:						
(e/D = 1.5)	174	174
(e/D = 2.0)	191	191
e , percent:						
L	8	10	10	10	10	8
LT	8	10	10	10	10	8
E , 10 ³ ksi	17.5 ^a					
E_c , 10 ³ ksi	18.0 ^a					
G , 10 ³ ksi	6.7					
μ	0.32					
Physical Properties:						
ω , lb/in. ³	0.158					
C, Btu/(lb)(°F)	0.12					
K and α	See Figure 5.3.2.0					

a Average, L and LT; values may vary with test direction.

Table 5.3.2.0(c). Design Mechanical and Physical Properties of Ti-8Al-1Mo-1V Bar and Forging

Specification	MIL-T-9047		AMS 4973	
	Bar		Forging	
Form	Duplex annealed		Solution treated and stabilized	
Condition	Duplex annealed		Solution treated and stabilized	
Thickness or diameter, in. . .	≤ 2.500 ^a	2.501-4.000 ^a	≤ 2.499	2.500-4.000
Basis	S	S	S	S
Mechanical Properties:				
<i>F_{tu}</i> , ksi:				
L	130	120	130	120
LT	130 ^b	120 ^b	130 ^c	120
ST	120 ^b	...	120
<i>F_{ty}</i> , ksi:				
L	120	110	120	110
LT	120 ^b	110 ^b	120 ^c	110
ST	110 ^b	...	110
<i>F_{cy}</i> , ksi:				
L
LT
ST
<i>F_{su}</i> , ksi				
...
<i>F_{bru}</i> , ksi:				
(e/D = 1.5)
(e/D = 2.0)
<i>F_{bry}</i> , ksi:				
(e/D = 1.5)
(e/D = 2.0)
<i>e</i> , percent:				
L	10	10	10	10
LT	10 ^b	10 ^b	10 ^c	10
ST	8 ^b	...	10
<i>E</i> , 10 ³ , ksi				
...	17.5 ^d			
<i>E_c</i> , 10 ³ ksi				
...	18.0 ^d			
<i>G</i> , 10 ³ ksi				
...	6.7			
<i>μ</i>				
...	0.32			
Physical Properties:				
<i>ω</i> , lb/in. ³				
...	0.158			
<i>C</i> , Btu/(lb)(°F)				
...	0.12			
<i>K</i> and <i>α</i>				
...	See Figure 5.3.2.0			

- a Maximum of 16 square-inch cross-sectional area.
- b Applicable, providing LT or ST dimension is > 3.000 inches.
- c Applicable, providing LT dimension is ≥ 2.500 inches.
- d Average, values may vary with test direction.

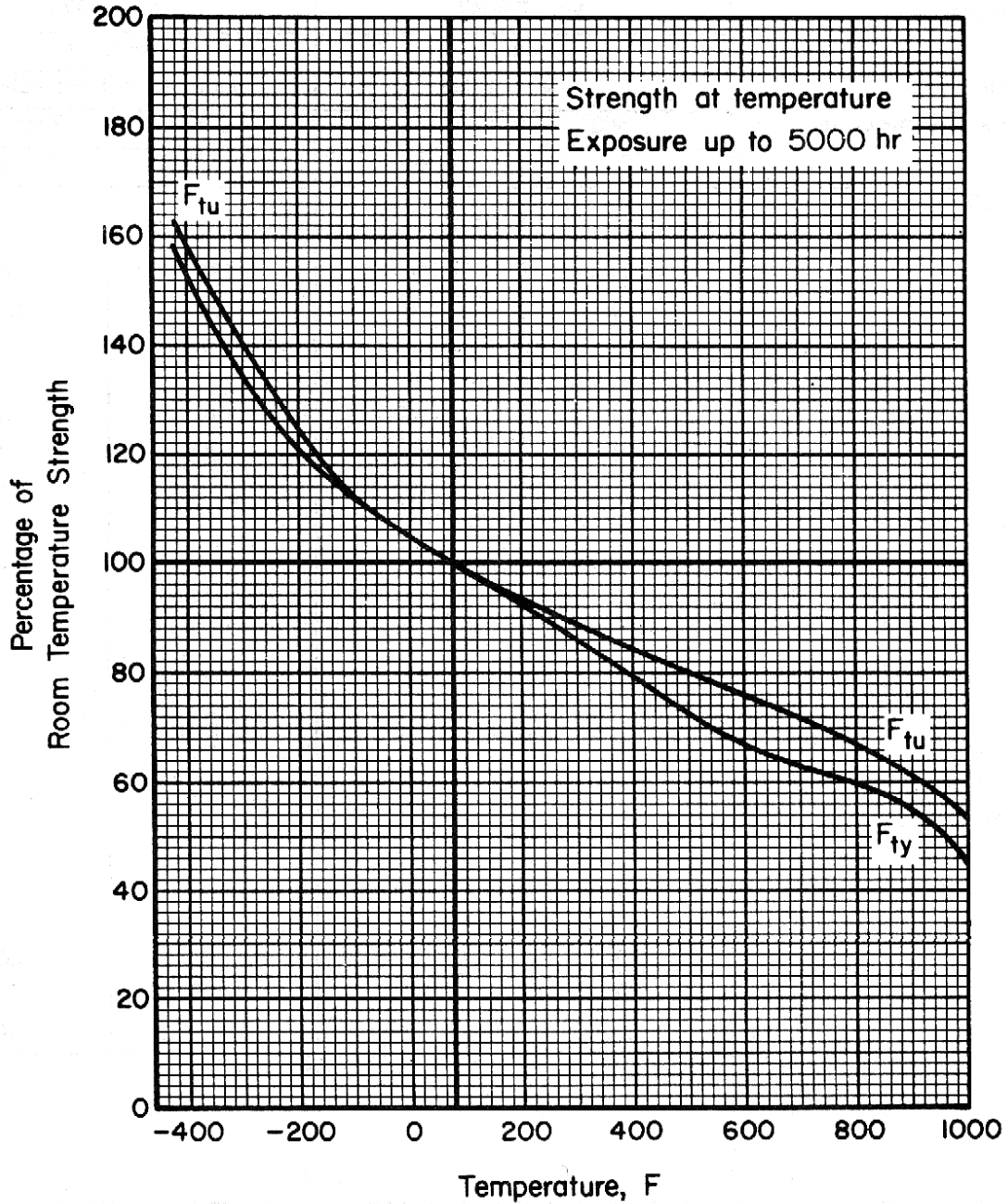

Figure 5.3.2.1.1. Effect of temperature on the tensile ultimate strength (F_{tu}) and the tensile yield strength (F_{ty}) of single-annealed Ti-8Al-1Mo-1V alloy sheet.

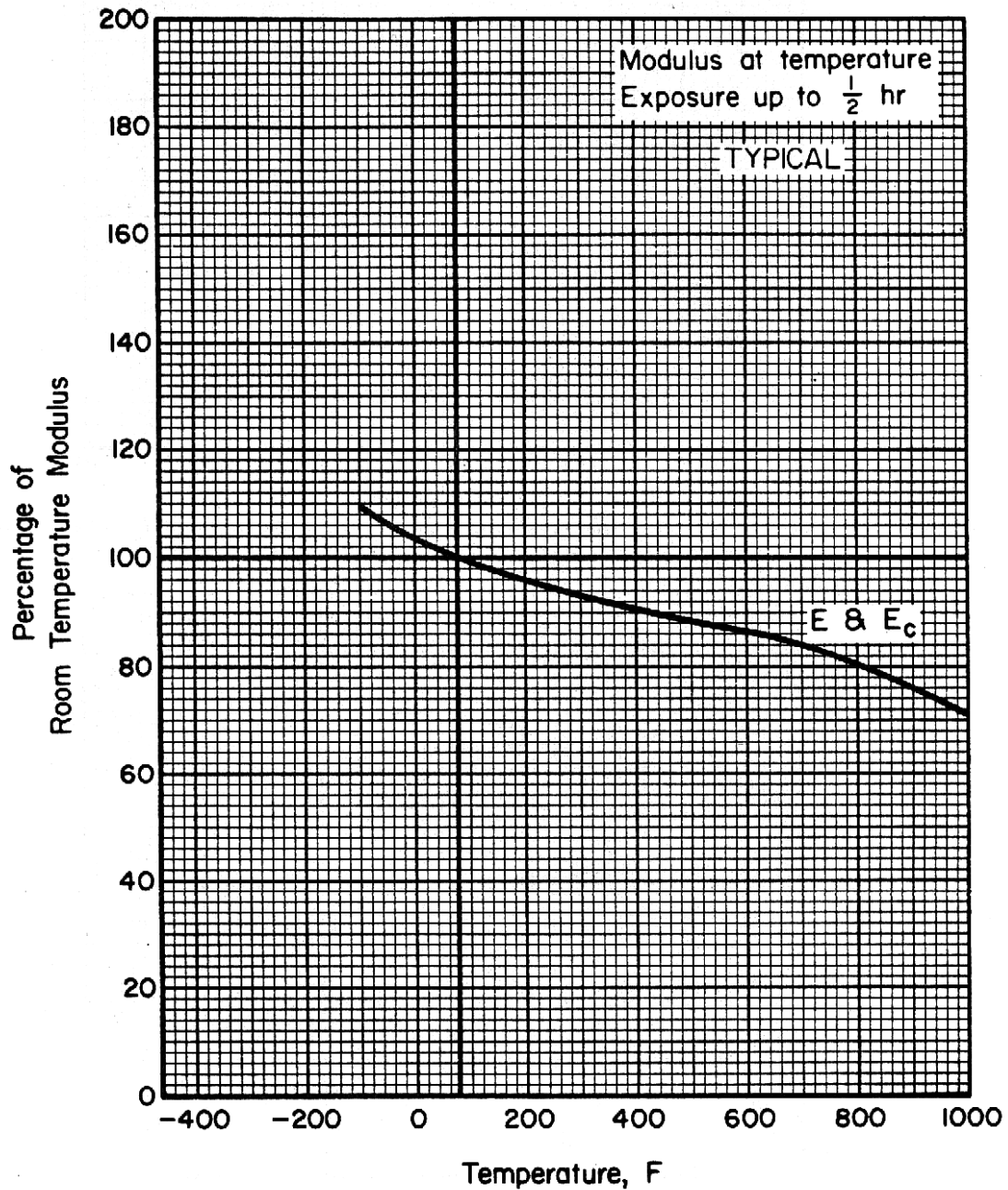

Figure 5.3.2.1.4. Effect of temperature on the tensile and compressive moduli (E and E_c) of Ti-8Al-1Mo-1V alloy sheet.

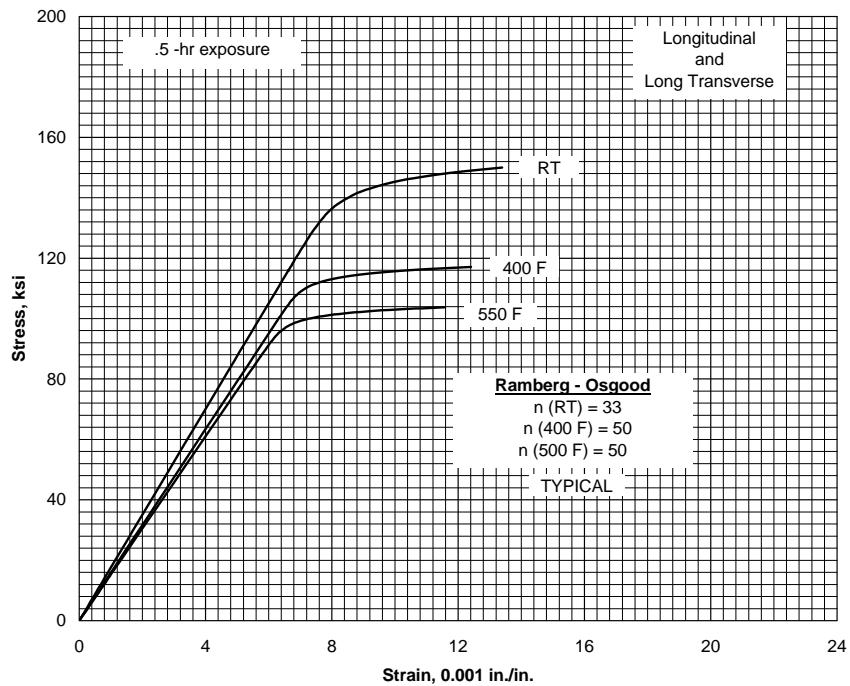

Figure 5.3.2.1.6(a). Typical tensile stress-strain curves for single-annealed Ti-8Al-1Mo-1V alloy sheet at room and elevated temperatures.

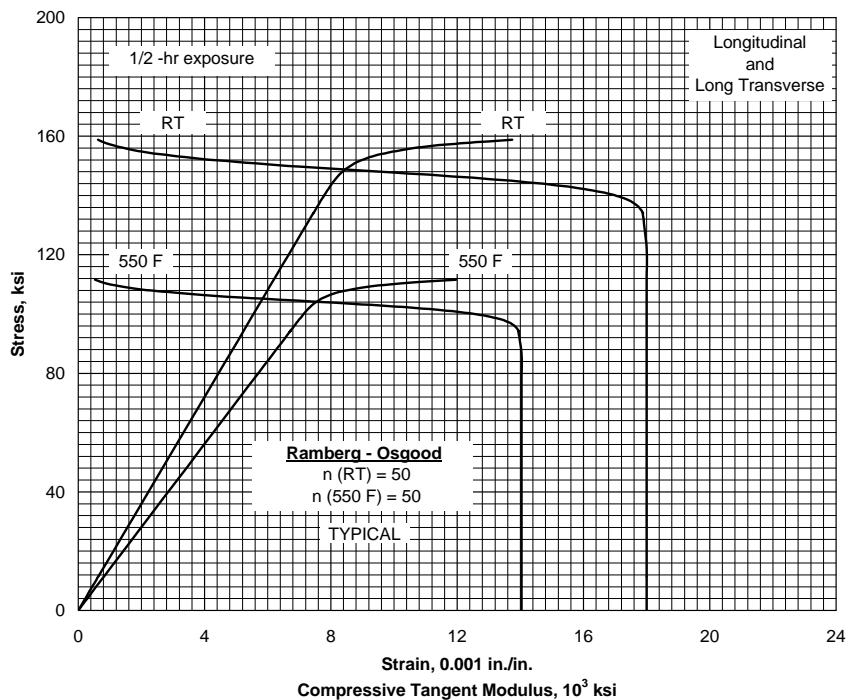

Figure 5.3.2.1.6(b). Typical compressive stress-strain and compressive tangent-modulus curves for single-annealed Ti-8Al-1Mo-1V alloy sheet at room and elevated temperatures.

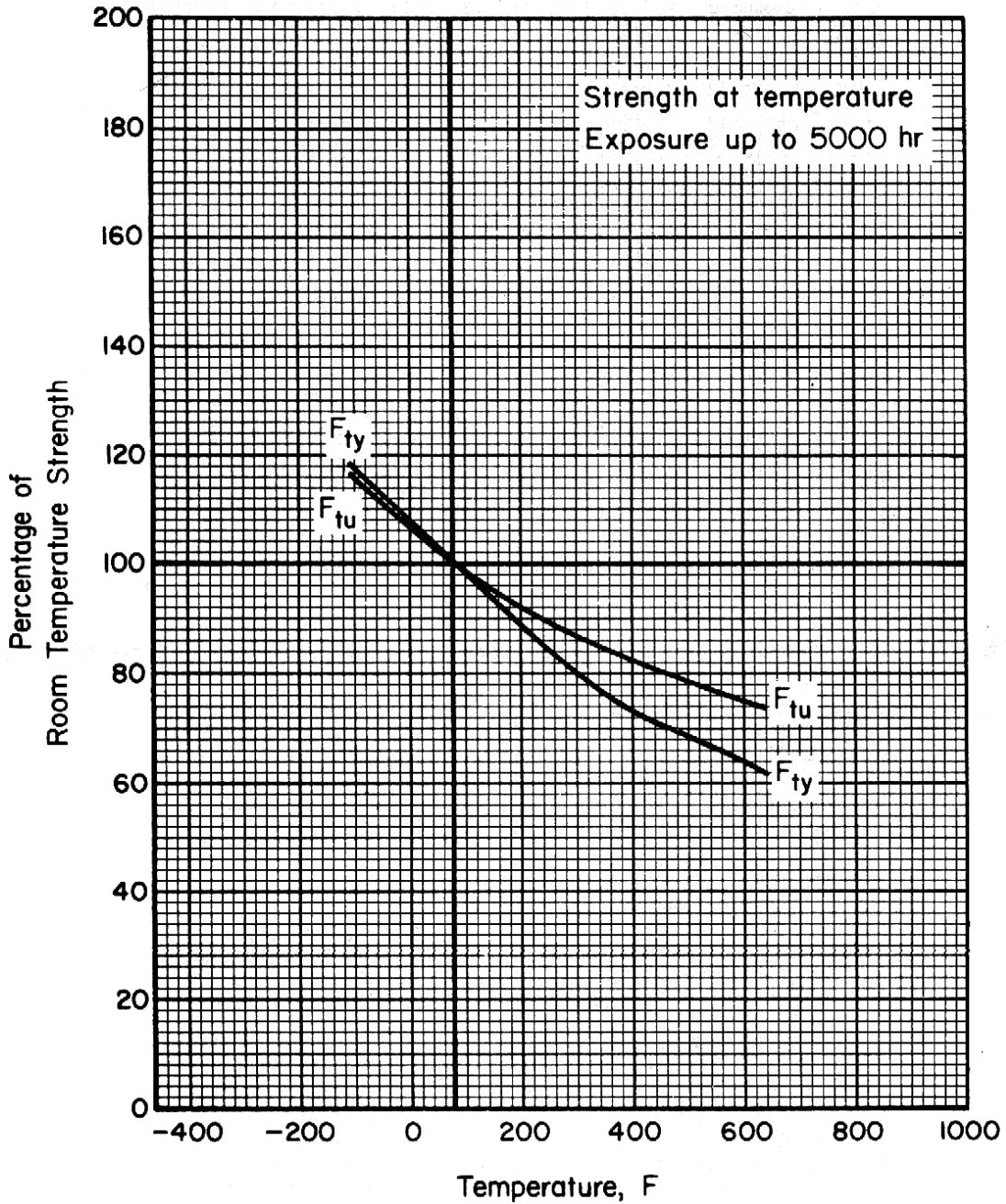

Figure 5.3.2.2.1. Effect of temperature on the tensile ultimate strength (F_{tu}) and the tensile yield strength (F_{ty}) of duplex-annealed Ti-8Al-1Mo-1V alloy sheet.

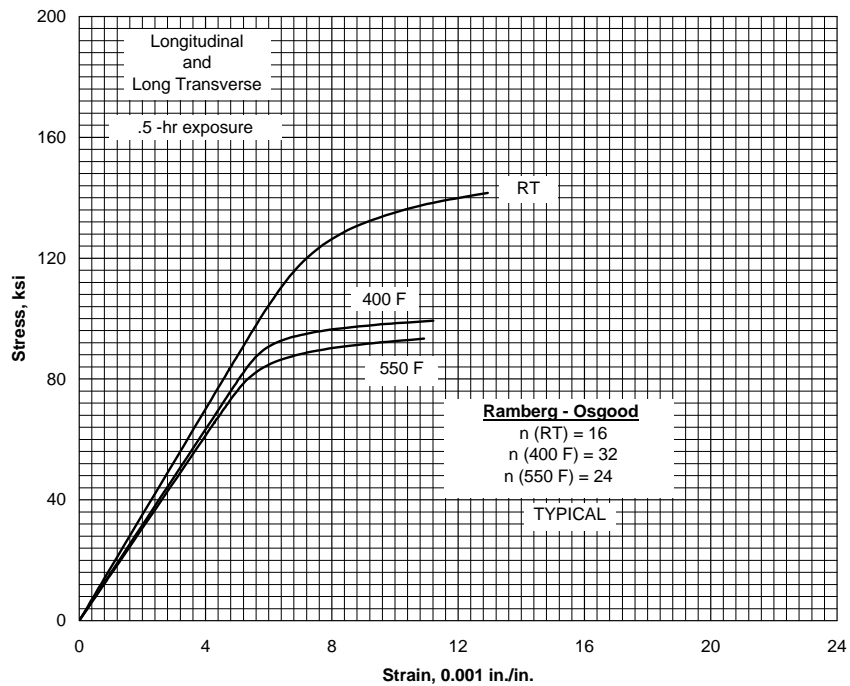

Figure 5.3.2.2.6(a). Typical tensile stress-strain curves for duplex-annealed Ti-8Al-1Mo-1V alloy sheet at room and elevated temperatures.

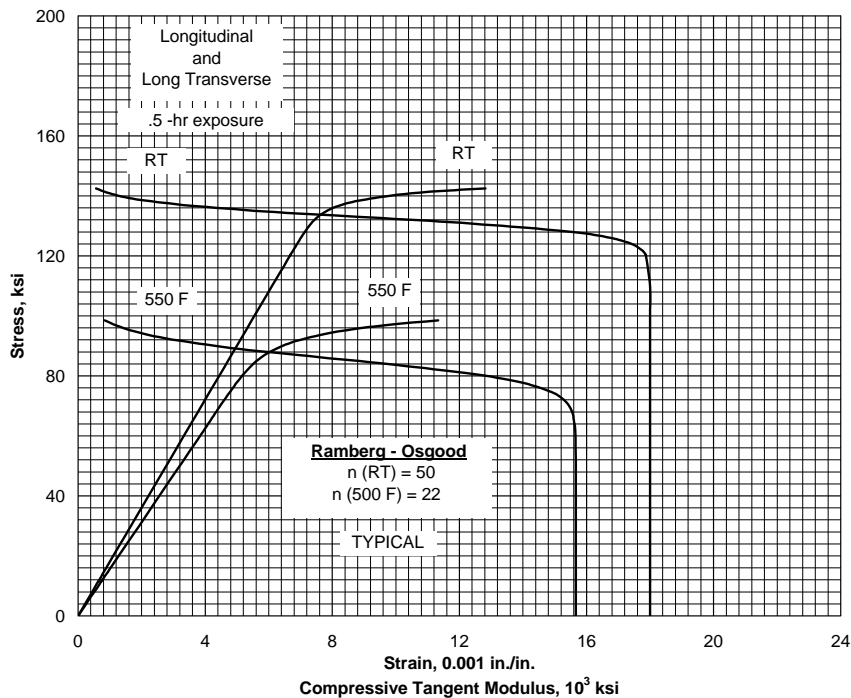

Figure 5.3.2.2.6(b). Typical compressive stress-strain and compressive tangent-modulus curves for duplex-annealed Ti-8Al-1Mo-1V alloy sheet at room and elevated temperatures.

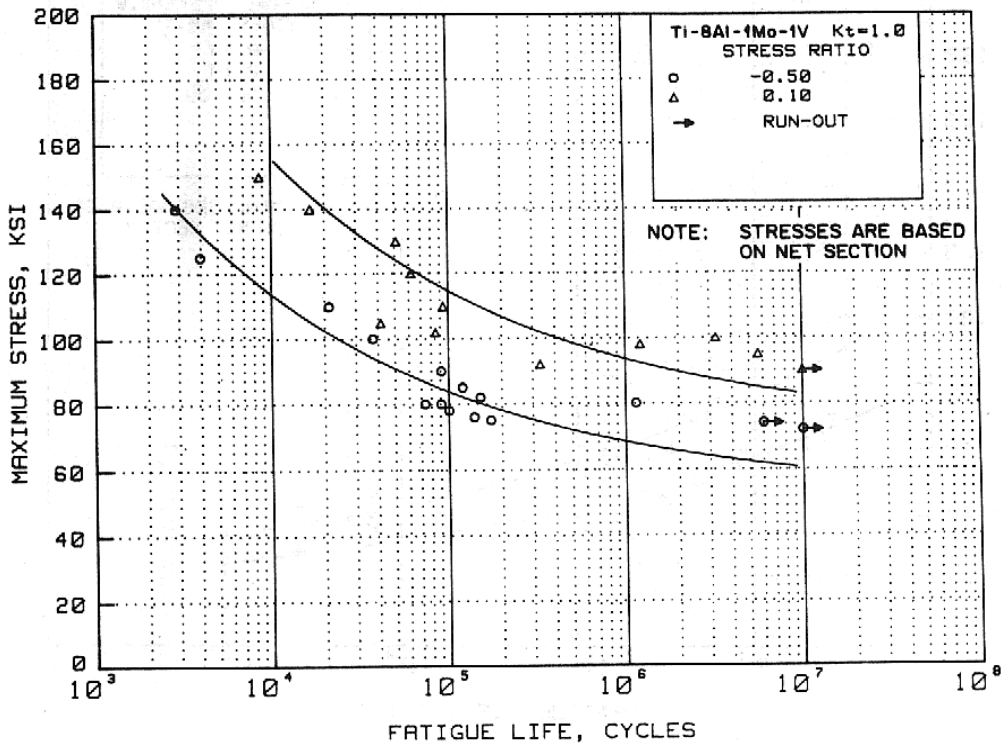

Figure 5.3.2.2.8(a). Best-fit S/N curves for unnotched, duplex annealed Ti-8Al-1Mo-1V sheet at room temperature, long transverse direction.

Correlative Information for Figure 5.3.2.2.8(a)

Product Form: Sheet, 0.050 inch thick

Test Parameters:

Properties: TUS, ksi TYS, ksi Temp., °F
 147.2 135.6 RT

Loading - Axial
Frequency - 1800 cpm
Temperature - RT
Environment - Air

Specimen Details: Unnotched
 0.750 inch net width

No. of Heats/Lots: 1

Surface Condition: HNO₃/HF pickled

Equivalent Stress Equation:

$$\text{Log } N_f = 10.57 - 3.46 \text{ log } (S_{eq} - 66.7)$$

$$S_{eq} = S_{max} (1-R)^{0.61}$$

Std. Error of Estimate, Log (Life) = 0.47

Standard Deviation, Log (Life) = 0.81

R² = 66.7%

References: 5.3.2.2.8(a) and (b)

Sample Size = 24

[Caution: The equivalent stress model may provide unrealistic life predictions for stress ratios beyond those represented above.]

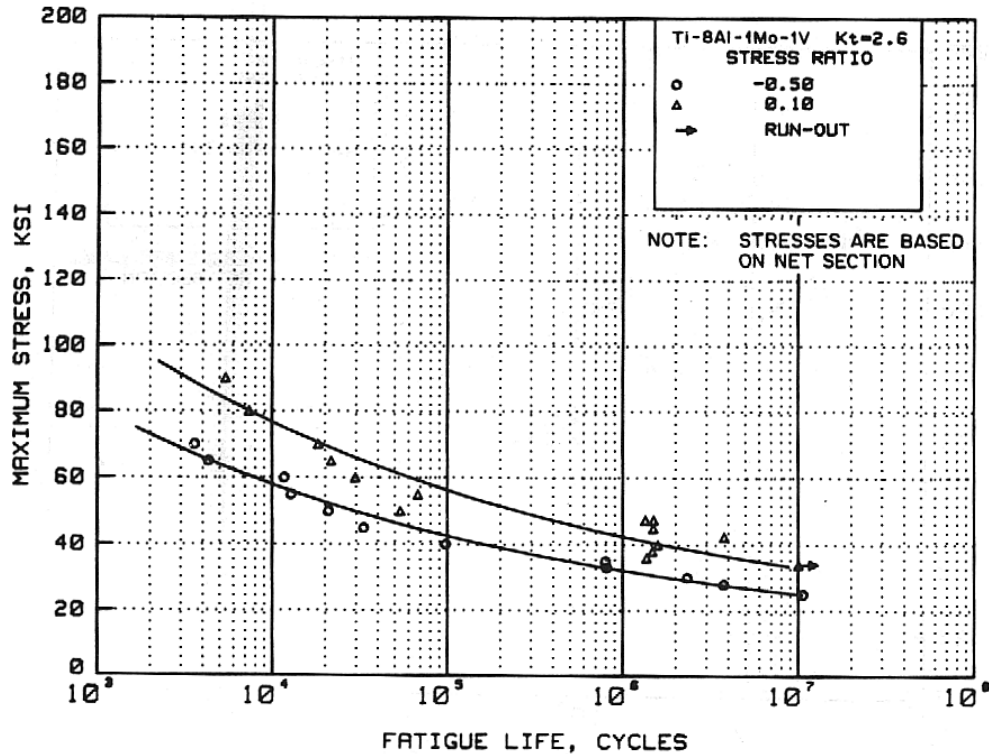

Figure 5.3.2.2.8(b). Best-fit S/N curves for notched, $K_t = 2.6$, duplex annealed Ti-8Al-1Mo-1V sheet at room temperature, long transverse direction.

Correlative Information for Figure 5.3.2.2.8(b)

Product Form: Sheet, 0.050 inch thick

Test Parameters:

Properties: $\frac{TUS, ksi}{147.2}$ $\frac{TYS, ksi}{135.6}$ $\frac{Temp., ^\circ F}{RT}$
Unnotched

Loading - Axial
Frequency - 1800 cpm
Temperature - RT
Environment - Air

Specimen Details: Notched, hole type, $K_t = 2.6$
1.500 inch, gross width
1.250 inch, net width
0.250 inch, diameter hole

No. of Heats/Lots: 1

Surface Condition: HNO₃/HF pickled

Equivalent Stress Equation:

$$\log N_f = 14.49 - 5.90 \log (S_{eq} - 12.7)$$

$$S_{eq} = S_{max} (1-R)^{0.55}$$

Std. Error of Estimate, Log (Life) = 0.33

Standard Deviation, Log (Life) = 1.10

$R^2 = 90.9\%$

References: 5.3.2.2.8(a) and (b)

Sample Size = 26

[Caution: The equivalent stress model may provide unrealistic life predictions for stress ratios beyond those represented above.]

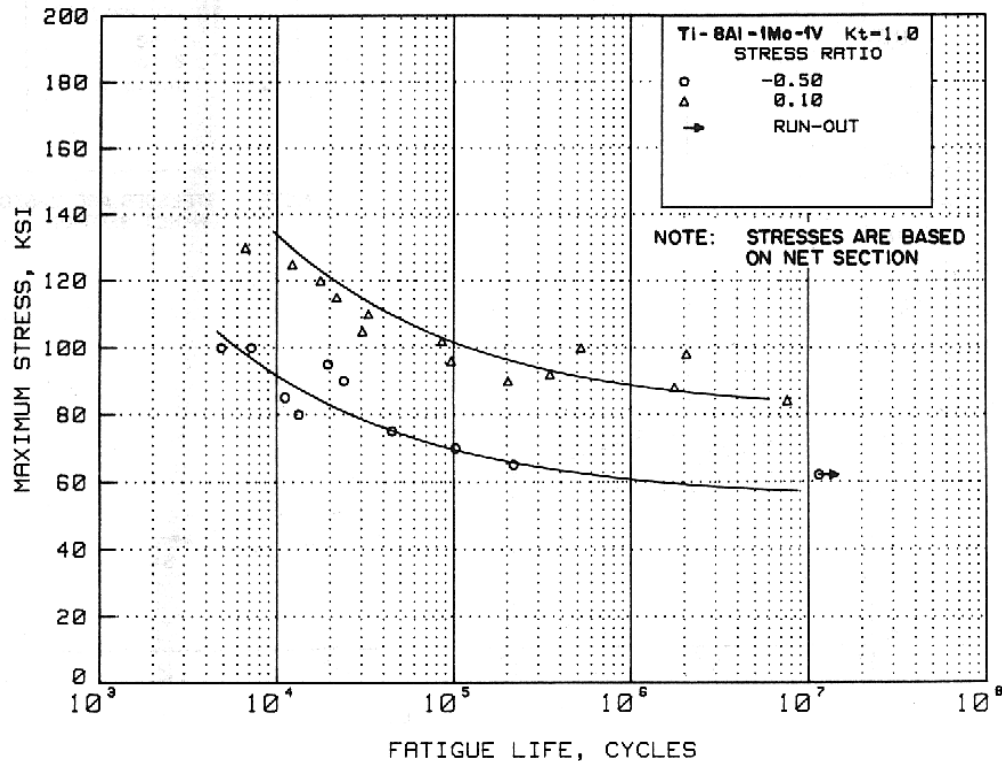

Figure 5.3.2.2.8(c). Best-fit S/N curves for unnotched duplex annealed Ti-8Al-1Mo-1V sheet at 400°F, long transverse direction.

Correlative Information for Figure 5.3.2.2.8(c)

Product Form: Sheet, 0.050 inch thick

Test Parameters:

Properties: TUS, ksi TYS, ksi Temp., °F
 119.5 100.8 400

Loading - Axial
Frequency - 1800 cpm
Temperature - 400°F
Environment - Air

Specimen Details: Unnotched
 0.750 inch net width

No. of Heats/Lots: 1

Surface Condition: HNO₃/HF pickled

Equivalent Stress Equation:

References: 5.3.2.2.8(a) and (b)

Log N_f = 8.30 - 2.53 log (S_{eq} - 73.9)
S_{eq} = S_{max} (1 - R)^{0.74}
Std. Error of Estimate, Log (Life) = 0.38
Standard Deviation, Log (Life) = 0.87
R² = 80.9%

Sample Size = 23

[Caution: The equivalent stress model may provide unrealistic life predictions for stress ratios beyond those represented above.]

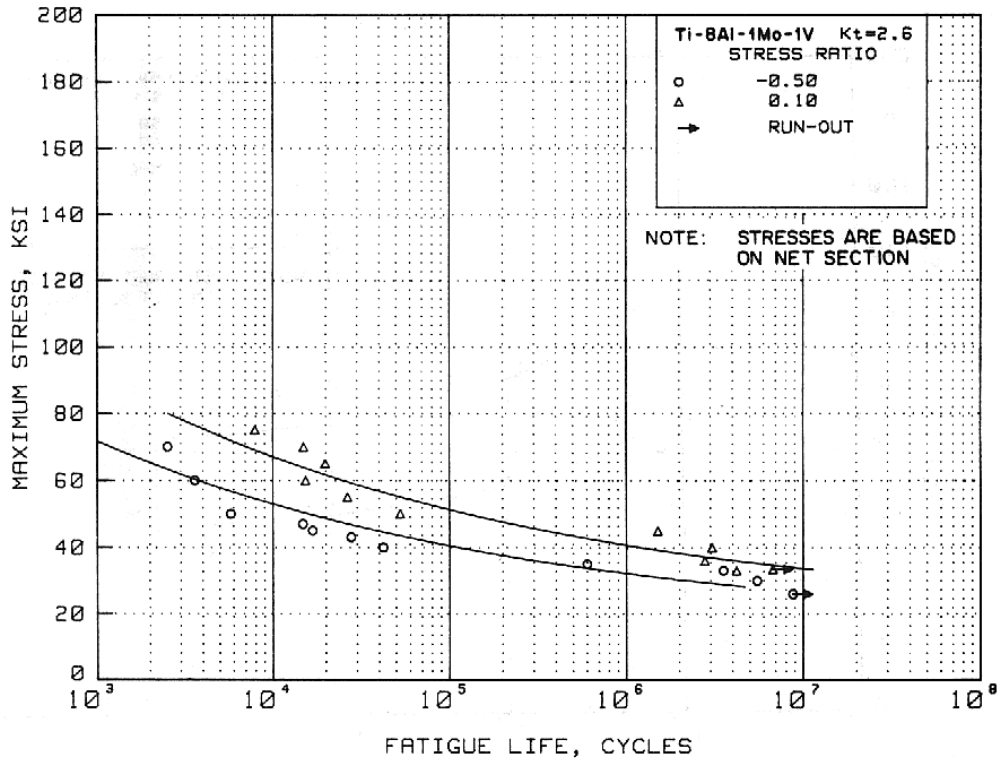

Figure 5.3.2.2.8(d). Best-fit S/N curves for notched, $K_t = 2.6$, duplex annealed Ti-8Al-1Mo-1V sheet at 400°F, long transverse direction.

Correlative Information for Figure 5.3.2.2.8(d)

Product Form: Sheet, 0.050 inch thick

Properties:

TUS, ksi	TYS, ksi	Temp., °F
119.5	100.8	400

 Unnotched

Specimen Details: Notched, hole type, $K_t = 2.6$
1.500 inch, gross width
1.250 inch, net width
0.250 inch, diameter hole

Surface Condition: HNO₃/HF pickled

References: 5.3.2.2.8(a) and (b)

Test Parameters:

Loading - Axial
Frequency - 1800 cpm
Temperature - 400°F
Environment - Air

No. of Heats/Lots: 1

Equivalent Stress Equation:

$\log N_f = 13.39 - 5.68 \log (S_{eq} - 18.7)$
 $S_{eq} = S_{max} (1-R)^{0.46}$
Std. Error of Estimate, Log (Life) = 0.41
Standard Deviation, Log (Life) = 1.16
 $R^2 = 87.2\%$

Sample Size = 20

[Caution: The equivalent stress model may provide unrealistic life predictions for stress ratios beyond those represented above.]

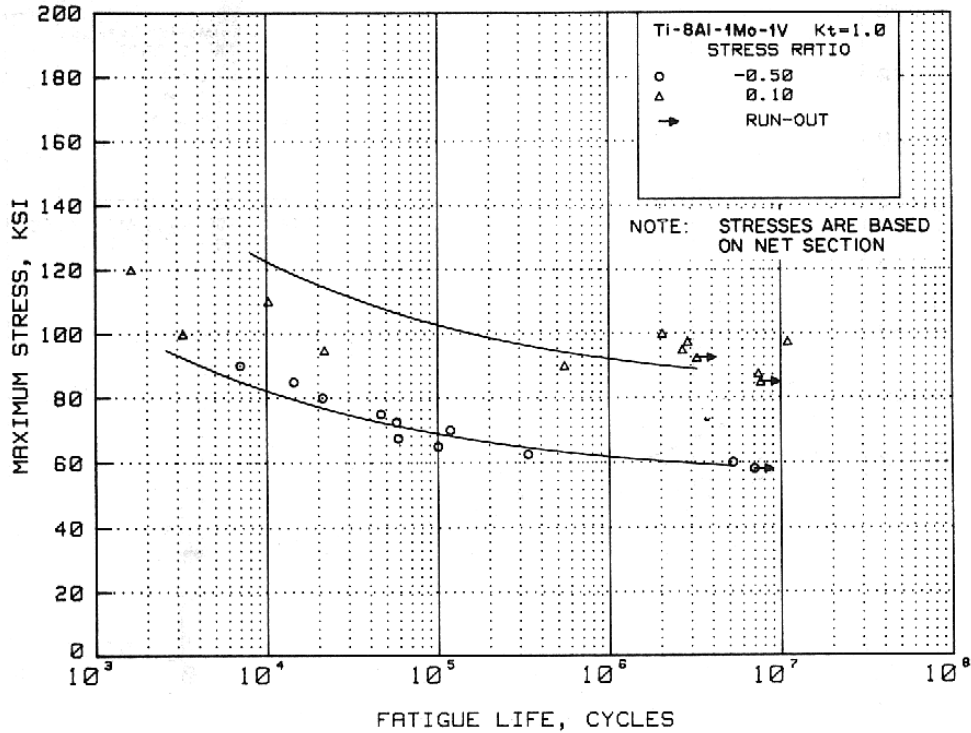

Figure 5.3.2.2.8(e). Best-fit S/N curves for unnotched duplex annealed Ti-8Al-1Mo-1V sheet at 650°F, long transverse direction.

Correlative Information for Figure 5.3.2.2.8(e)

Product Form: Sheet, 0.050 inch thick

Properties: $\frac{TUS, ksi}{110.2}$ $\frac{TYS, ksi}{86.8}$ $\frac{Temp., °F}{650}$

Specimen Details: Unnotched
0.750 inch, net width

Surface Condition: HNO₃/HF pickled

References: 5.3.2.2.8(a) and (b)

Test Parameters:

Loading - Axial
 Frequency - 1800 cpm
 Temperature - 650°F
 Environment - Air

No. of Heats/Lots: 1

Equivalent Stress Equation:

$\log N_f = 9.83 - 3.66 \log (S_{eq} - 73)$
 $S_{eq} = S_{max} (1-R)^{0.78}$
 Std. Error of Estimate, $\log (\text{Life}) = 0.88$
 Standard Deviation, $\log (\text{Life}) = 1.18$
 $R^2 = 44.3\%$

Sample Size = 20

[Caution: The equivalent stress model may provide unrealistic life predictions for stress ratios beyond those represented above.]

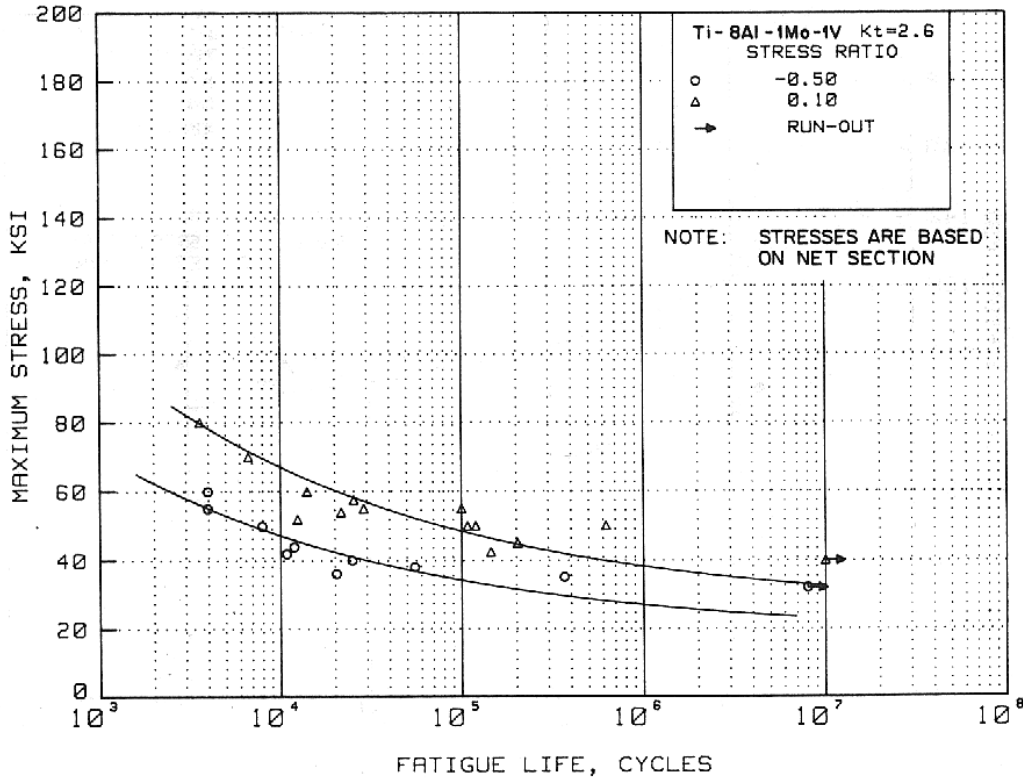

Figure 5.3.2.2.8(f). Best-fit S/N curves for notched, $K_t = 2.6$, duplex annealed Ti-8Al-1Mo-1V sheet at 650°F, long transverse direction.

Correlative Information for Figure 5.3.2.2.8(f)

Product Form: Sheet, 0.050 inch thick

Test Parameters:

Properties: TUS, ksi TYS, ksi Temp., °F
110.2 86.8 650
Unnotched

Loading - Axial
Frequency - 1800 cpm
Temperature - 650°F
Environment - Air

Specimen Details: Notched, hole type, $K_t = 2.6$
1.500 inch, gross width
1.250 inch, net width
0.250 inch, diameter hole

No. of Heats/Lots: 1

Surface Condition: HNO₃/HF pickled

Equivalent Stress Equation:

$$\log N_f = 10.16 - 3.88 \log (S_{eq} - 23)$$

$$S_{eq} = S_{max} (1-R)^{0.69}$$

Std. Error of Estimate, Log (Life) = 0.38

Standard Deviation, Log (Life) = 0.65

$R^2 = 66.0\%$

References: 5.3.2.2.8(a) and (b)

Sample Size = 22

[Caution: The equivalent stress model may provide unrealistic life predictions for stress ratios beyond those represented above.]

5.3.3 Ti-6Al-2Sn-4Zr-2Mo

5.3.3.0 Comments and Properties— Ti-6Al-2Sn-4Zr-2Mo is a near-alpha titanium composition developed for improved elevated-temperature performance. The alloy has a titanium-aluminum base that is solid solution strengthened by additions of tin and zirconium. Molybdenum improves both room and elevated temperature strength, creep and thermal stability. Introduction of this alloy initially met the requirements for certain advanced performance gas turbine engine applications. Some of the more recent applications, however, require better creep strength than the alloy initially provided. Development work showed that a small addition of silicon, approximately 0.08 percent, substantially improved the creep strength of the alloy without significantly affecting the thermal stability. The alloy is creep resistant and relatively stable to about 1050°F. Creep and thermal stability of the alloy are further enhanced by solution treating high in the alpha-beta phase field. The alloy is available in bar, billet, plate, sheet, strip, and extrusions.

Manufacturing Conditions— Forging of Ti-6Al-2Sn-4Zr-2Mo at temperatures below the beta transus temperature is recommended. For optimum creep properties beta forging or a modification of it is recommended with some loss in ductility to be expected. Elevated temperatures may be used for severe sheet forming operations while room-temperature forming may be used for mild contouring. Stress relief annealing may be combined with a final hot-sizing operation. The material can be welded using TIG or MIG fusion processes to achieve 100 percent joint efficiencies but with limited weld zone ductility. As in welding any titanium alloy, shielding from atmospheric contamination is required except for spot or seam welding.

Environmental Considerations— Ti-6Al-2Sn-4Zr-2Mo is somewhat more resistant to hot-salt cracking than either Ti-8Al-1Mo-1V or Ti-6Al-4V alloys. The material is marginally susceptible to aqueous chloride solution stress-corrosion cracking. Surface oxides formed during exposure to service temperature (~950°F) do not adversely affect properties. Under certain conditions, titanium, when in contact with cadmium, silver, mercury, or certain of their compounds, may become embrittled. Refer to MIL-S-5002 and MIL-STD-1568 for restrictions concerning applications with titanium in contact with these metals or their compounds.

Heat Treatment— Several different annealing treatments, which are described below, are available for Ti-6Al-2Sn-4Zr-2Mo.

For sheet and strip:

Duplex Anneal: 1650°F for ½ hour, air cool, followed by 1450°F for ¼ hour, and air cool.

Triplex Anneal: 1650°F for ½ hour, air cool, followed by 1450°F for ¼ hour, air cool, followed by 1100°F for 2 hours and air cool.

For plate:

Duplex Anneal: 1650°F for 1 hour, air cool, followed by 1100°F for 8 hours and air cool.

Triplex Anneal: 1650°F for ½ hour, air cool, followed by 1450°F for ¼ hour, air cool, followed by 1100°F for 2 hours and air cool.

For bars and forgings:

Duplex Anneal: Solution anneal 25 to 50°F below beta transus temperature for 1 hour, air cool or faster, followed by 1100°F for 8 hours and air cool.

Table 5.3.3.0(a). Material Specifications for Ti-6Al-2Sn-4Zr-2Mo

Specification	Form
AMS-T-9046	Sheet and strip
AMS 4975	Bar
AMS 4976	Forging
AMS 4919	Sheet, strip, and plate

Specifications and Properties — Material specifications for Ti-6Al-2Sn-4Zr-2Mo are given in Table 5.3.3.0(a). Room-temperature mechanical and physical properties for Ti-6Al-2Sn-4Zr-2Mo are presented in Table 5.3.3.0(b) and (c). The effect of temperature on physical properties is shown in Figure 5.3.3.0.

5.3.3.1 Single, Duplex, and Triplex Annealed — Room and elevated temperature property curves are shown in Figures 5.3.3.1.1, 5.3.3.1.2, and 5.3.3.1.4. Typical stress-strain curves at room and elevated temperatures are shown in Figures 5.3.3.1.6(a) and (b). Full range stress-strain curves at room and elevated temperatures are shown in Figure 5.3.3.1.6(c).

Table 5.3.3.0(b). Design Mechanical and Physical Properties of Ti-6Al-2Sn-4Zr-2Mo

Specification	AMS 4919										AMS-T-9046, Comp. AB-4
	Sheet										
	Duplex annealed					Triplex annealed					
Condition	≤0.046		0.047-0.093		0.094-0.140		0.141-0.187		≥0.187		S ^a
	A	B	A	B	A	B	A	B	A	B	
Form											
Thickness or diameter, in. . .											
Mechanical Properties:											
F_{m2} , ksi:											
L	135 ^b	143	135 ^b	143	135 ^b	143	135 ^b	143	135 ^b	143	145
LT	135 ^b	143	135 ^b	143	135 ^b	143	135 ^b	143	135 ^b	143	145
F_{yp} , ksi:											
L	125 ^c	136	125 ^c	136	125 ^c	136	125 ^c	136	125 ^c	136	135
LT	125 ^c	134	125 ^c	134	125 ^c	134	125 ^c	134	125 ^c	134	135
$F_{0.2}$, ksi:											
L	132	142	132	142	132	142	132	142	132	142	...
LT	132	142	132	142	132	142	132	142	132	142	...
F_{su} , ksi:											
F_{br} , ksi:											
(e/D=1.5)	195	206	205	217	214	227	219	232	219	232	...
(e/D=2.0)	217	230	243	258	266	282	279	295	279	295	...
F_{bry} , ksi:											
(e/D=1.5)	171	183	171	183	171	183	171	183	171	183	...
(e/D=2.0)	202	217	202	217	202	217	202	217	202	217	...
e , percent (S-basis):											
L	8 ^e	...	e	...	10	...	10	...	10	...	e
LT	8 ^e	...	e	...	10	...	10	...	10	...	e
E , 10 ³ ksi	16.5										
E_c , 10 ³ ksi	18.0										
G , 10 ³ ksi	6.2										
μ	0.32										
Physical Properties:											
ω , lb/in. ³	0.164										
C , K and α	See Figure 5.3.3.0										

a S-basis values are representative of test specimens excised from duplex annealed material and thermally treated to triplex annealed condition in a laboratory furnace.
b S-basis. The rounded T_{99} values are as follows: $F_{u}(L<) = 139$ ksi.
c S-basis. The rounded T_{99} values are as follows: $F_{y}(L) = 131$ ksi and $F_{y}(LT) = 129$ ksi.
d Bearing values are "dry pin" values per Section 1.4.7.1.
e 8% for 0.025 through 0.062 inch and 10% for >0.062 inch.

Table 5.3.3.0(c). Design Mechanical and Physical Properties of Ti-6Al-2Sn-4Zr-2Mo

Specification	AMS 4975		AMS 4976
Form	Bar		Forging
Condition	STA (Duplex annealed)		STA (Duplex annealed)
Cross-Sectional area, in. ²	≤16		≤9
Thickness, or diameter, in.	≤3.000		≤3.000
Basis	A	B	S
Mechanical Properties:			
<i>F_{tu}</i> , ksi:			
L.	130 ^a	144	130
LT	130 ^b	...	130 ^b
ST	130 ^b	...	130 ^b
<i>F_{ty}</i> , ksi:			
L.	120 ^a	131	120
LT.	120 ^b	...	120 ^b
ST	120 ^b	...	120 ^b
<i>F_{cy}</i> , ksi:			
L.
LT
ST
<i>F_{su}</i> , ksi			
...			
<i>F_{bru}</i> , ksi:			
(e/D=1.5)
(e/D=2.0)
<i>F_{bry}</i> , ksi:			
(e/D=1.5)
(e/D=2.0)
<i>e</i> , percent(S basis):			
L.	10	...	10
LT	10 ^b	...	10 ^b
ST	10 ^b	...	10 ^b
<i>RA</i> , percent (S basis):			
L.	25	...	25
LT	25 ^b	...	25 ^b
ST	25 ^b	...	25 ^b
<i>E</i> , 10 ³ ksi			
		16.5	
<i>E_c</i> , 10 ³ ksi			
		18.0	
<i>G</i> , 10 ³ ksi			
		6.2	
<i>μ</i>			
		0.32	
Physical Properties:			
<i>ω</i> , lb/in. ³			
		0.164	
<i>C</i> , <i>K</i> , and <i>α</i>			
		See Figure 5.3.3.0	

a S basis. The rounded T₉₉ values are as follows: *F_{tu}*(L) = 138 ksi and *F_{ty}*(L) = 125 ksi.

b S basis. Applicable providing transverse dimension is ≥2.500 in.

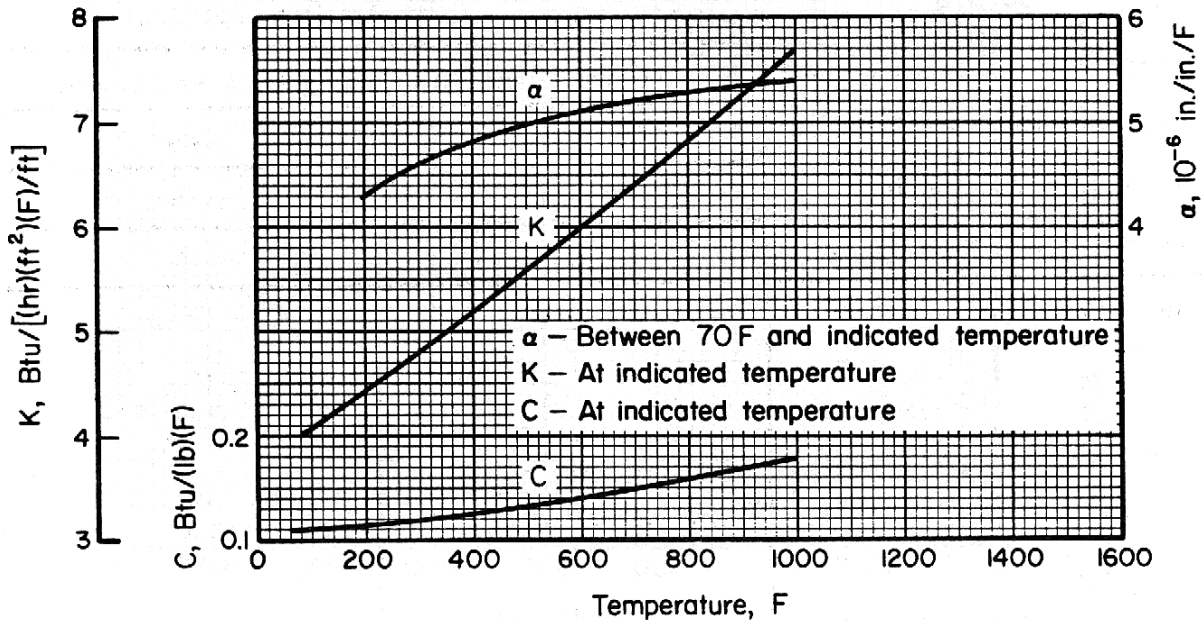

Figure 5.3.3.0. Effect of temperature on the physical properties of Ti-6Al-2Sn-4Zr-2Mo alloy.

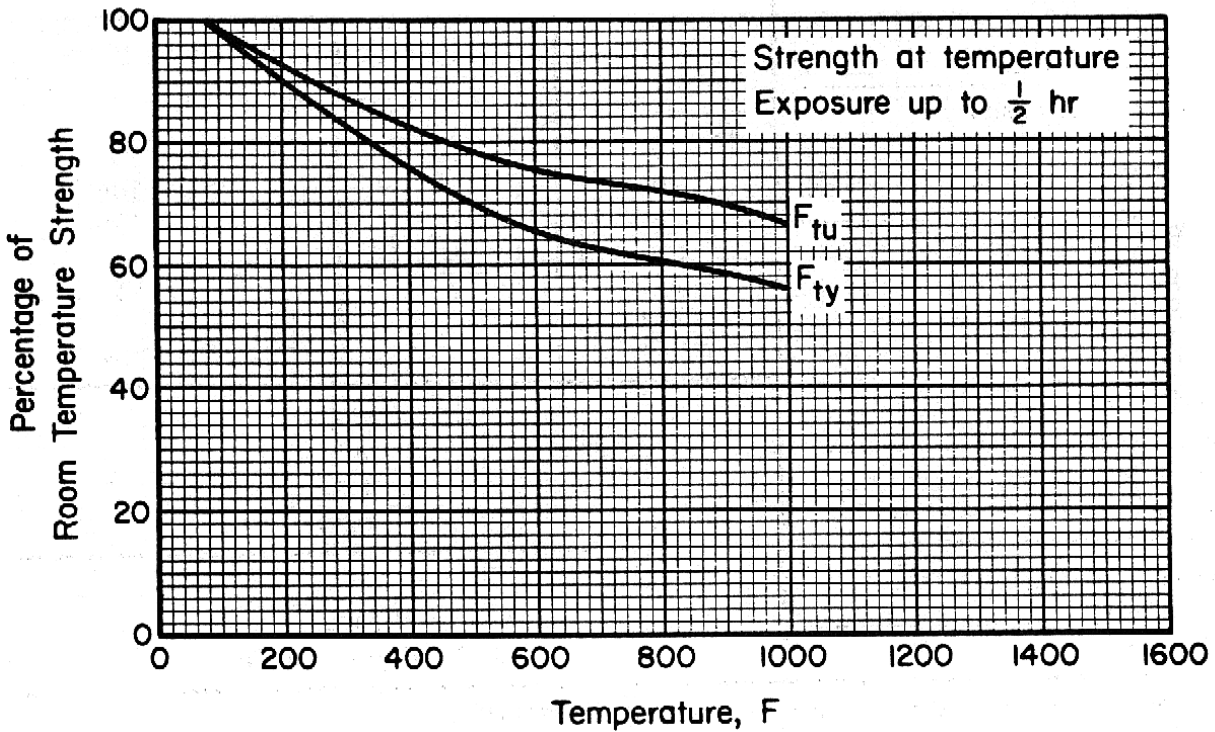

Figure 5.3.3.1.1. Effect of temperature in the tensile ultimate strength (F_{tu}) and tensile yield strength (F_{ty}) of duplex- and triplex-annealed Ti-6Al-2Sn-4Zr-2Mo (all products).

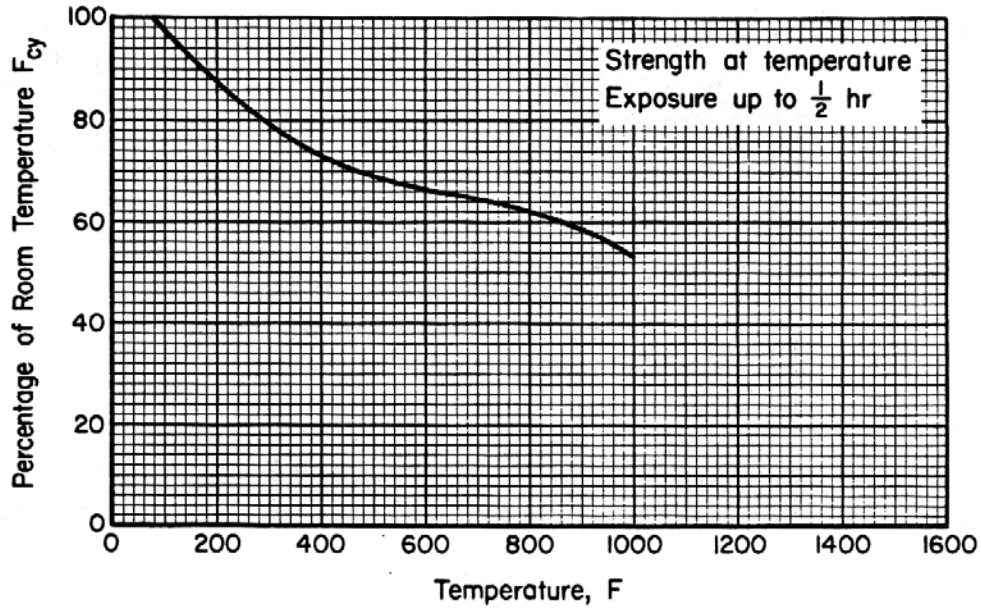

Figure 5.3.3.1.2. Effect of temperature on the compressive yield strength (F_{cy}) of duplex annealed Ti-6Al-2Sn-4Zr-2Mo alloy sheet.

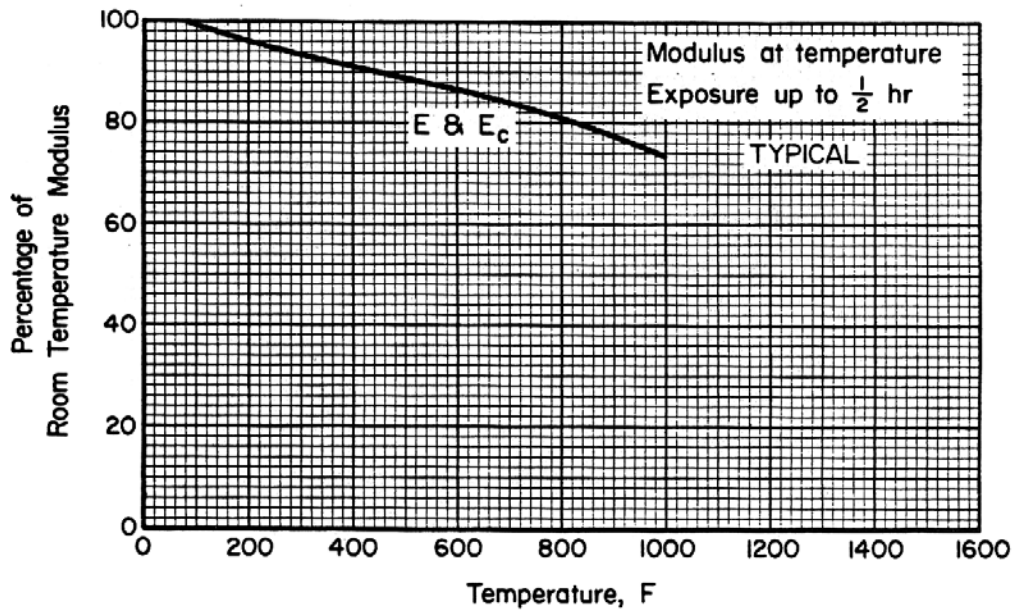

Figure 5.3.3.1.4. Effect of temperature on the tensile and compressive moduli (E and E_c) of duplex- and triplex-annealed Ti-6Al-2Sn-4Zr-2Mo alloy.

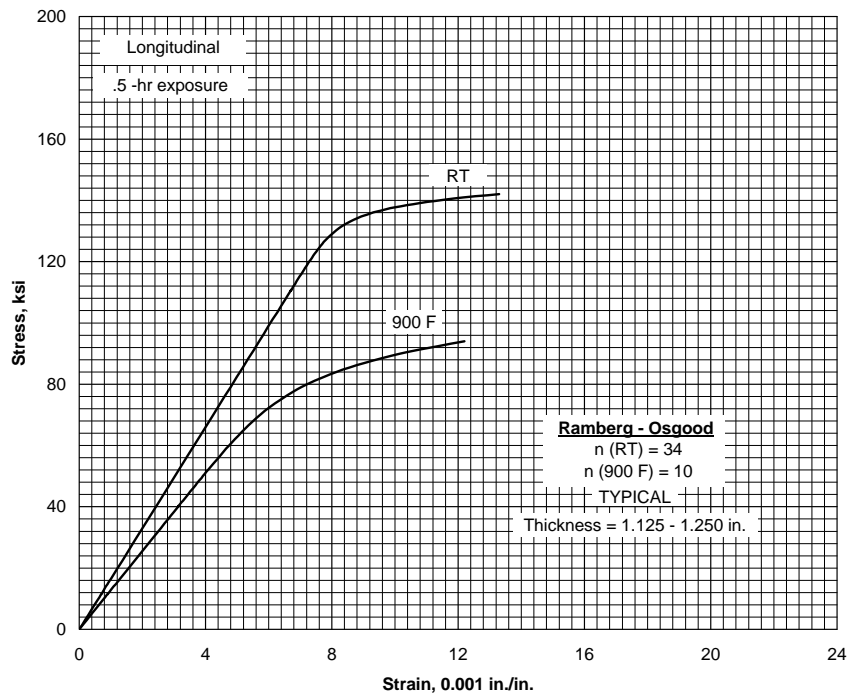

Figure 5.3.3.1.6(a). Typical tensile stress-strain curves for duplex annealed Ti-6Al-2Sn-4Zr-2Mo alloy bar at various temperatures.

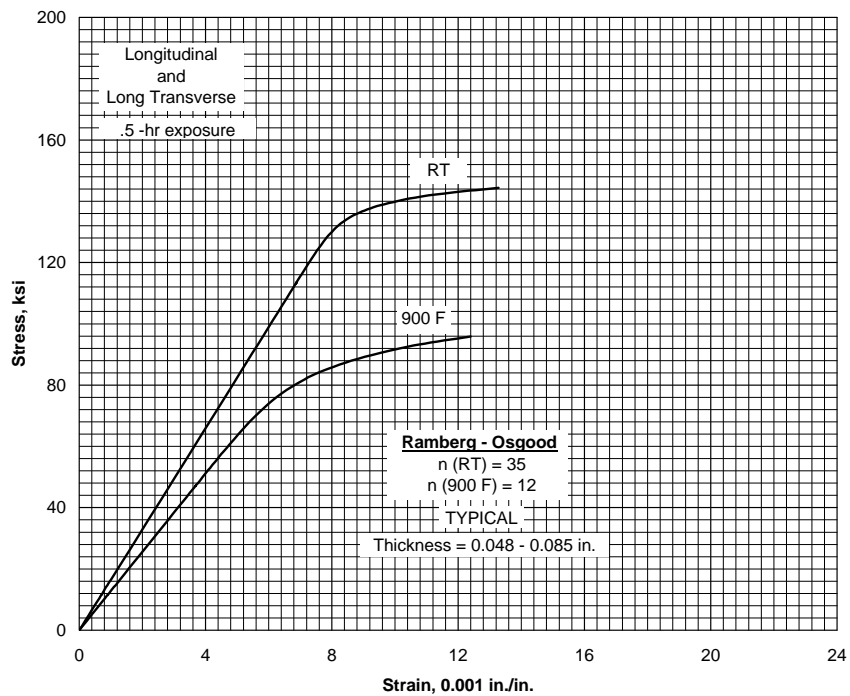

Figure 5.3.3.1.6(b). Typical tensile stress-strain curves for duplex- and triplex-annealed Ti-6Al-2Sn-4Zr-2Mo alloy sheet at various temperatures.

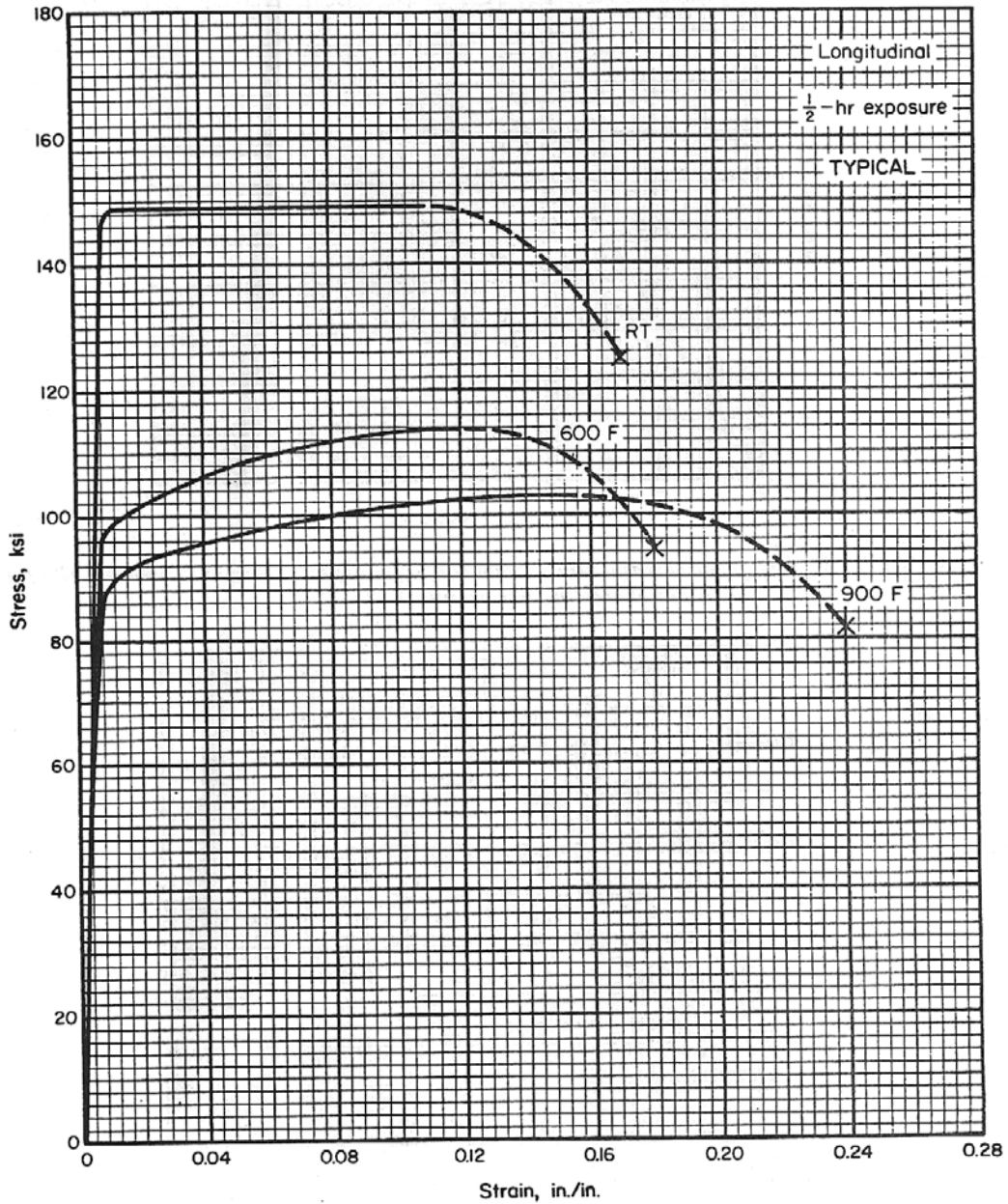

Figure 5.3.3.1.6(c). Typical tensile stress-strain curves (full range) for duplex-annealed Ti-6Al-2Sn-4Zr-2Mo alloy sheet at room and elevated temperatures.

5.4 ALPHA-BETA TITANIUM ALLOYS

The alpha-beta titanium alloys contain both alpha and beta phases at room temperature. The alpha phase is similar to that of unalloyed titanium but is strengthened by alpha stabilizing additions (e.g., aluminum). The beta phase is the high-temperature phase of titanium but is stabilized to room temperature by sufficient quantities of beta stabilizing elements such as vanadium, molybdenum, iron, or chromium. In addition to strengthening of titanium by the alloying additions, alpha-beta alloys may be further strengthened by heat treatment. The alpha-beta alloys have good strength at room temperature and for short times at elevated temperature. They are not noted for long-time creep strength. With the exception of annealed Ti-6Al-4V, these alloys are not recommended for cryogenic applications. The weldability of many of these alloys is poor because of the two-phase microstructure. However, some of them can be welded successfully with special precautions.

5.4.1 Ti-6Al-4V

5.4.1.0 Comments and Properties — Ti-6Al-4V is available in all mill product forms as well as castings and powder metallurgy forms. It can be used in either the annealed or solution treated plus aged (STA) conditions and is weldable. Useful temperature range is from -320 to 750°F. For maximum toughness, Ti-6Al-4V should be used in the annealed or duplex-annealed conditions whereas for maximum strength, the STA condition is used. The full strength potential for this alloy is not available in sections greater than 1 inch.

Manufacturing Considerations — Ti-6Al-4V alloy may be forged above the beta transus temperature using procedures to promote a high toughness material. The material is routinely finished below beta transus temperature for good combinations of fabricability, strength, ductility, and toughness. Elevated temperatures are usually used for form flat-rolled products although extensive forming may be accomplished at room temperature. Flat-rolled products are usually formed and used in the annealed condition although some forming in the STA condition is possible.

This alloy can be spot welded and is being fusion welded extensively in certain applications. Established titanium-welding techniques must be employed and special design considerations may be involved in fusion weldments. Stress-relief annealing after welding is recommended.

Environmental Considerations — Ti-6Al-4V can withstand prolonged exposure to temperatures up to 750°F without loss of ductility. Its toughness in the annealed condition is adequate at temperatures down to -320°F. (A special low interstitial grade may be used down to -423°F.) Ti-6Al-4V is resistant to hot-salt stress corrosion to about its maximum use temperature depending on exposure time and exposure stress. The material is marginally susceptible to aqueous chloride solution stress corrosion, but is considered to have good resistance to this reaction compared with other commonly used alloys. Under certain conditions, titanium, when in contact with cadmium, silver, mercury, or certain of their compounds, may become embrittled. Refer to MIL-S-5002 and MIL-STD-1568 for restrictions concerning applications with titanium in contact with these metals or their compounds.

Heat Treatment — This alloy is commonly specified in either the annealed condition or in the fully heat-treated condition. Annealing requires 1 hour at 1300°F followed by furnace cooling if maximum ductility is required.

The specified fully heat-treated, or solution-treated and aged condition for sheet is as follows:

Solution treat at 1700°F for 5 to 25 minutes, quench in water.

Age at 975°F for 4 to 6 hours, air cool.

For bars and forgings:

Solution treat at 1700°F for 1 hour, quench in water.

Age at 1000°F for 3 hours, air cool.

Specifications and Properties — Some material specifications for Ti-6Al-4V are shown in Table 5.4.1.0(a). Room-temperature mechanical properties for Ti-6Al-4V are shown in Tables 5.4.1.0(b) through (g). The effect of temperature on physical properties is shown in Figure 5.4.1.0.

Table 5.4.1.0(a). Material Specifications for Ti-6Al-4V

Specification	Form
AMS-T-9046	Sheet, strip, and plate
MIL-T-9047 ^a	Bar
AMS 4934	Extrusion
AMS 4935	Extrusion
AMS 4965	Bar
AMS 4928	Bar and die forging
AMS 4911	Sheet, strip, and plate
AMS 4920	Die forging
AMS 4962	Investment casting

^a Inactive for new design

5.4.1.1 Annealed Condition — Elevated temperature curves for annealed Ti-6Al-4V are shown in Figures 5.4.1.1.1 through 5.4.1.1.5. Typical stress-strain curves at several temperatures are shown in Figures 5.4.1.1.6(a) through (c). Typical full-range stress-strain curves at room temperature are shown in Figure 5.4.1.1.6(d). Unnotched and notched fatigue data are shown in Figures 5.4.1.1.8(a) through (g). Fatigue crack-propagation data for plate are shown in Figure 5.4.1.1.9.

5.4.1.2 Solution-Treated and Aged Condition — Elevated temperature curves for solution-treated and aged alloy are shown in Figures 5.4.1.2.1 through 5.4.1.2.4. Typical tensile and compressive stress-strain and tangent-modulus curves are shown in Figures 5.4.1.2.6(a) through (g). Typical full-range stress-strain curves at several temperatures up to 1000°F are shown in Figure 5.4.1.2.6(h). A nomograph of typical creep properties of solution-treated and aged sheet for the temperature range 600°F through 800°F is shown in Figure 5.4.1.2.7. Fatigue data at room and elevated temperatures are shown in Figures 5.4.1.2.8(a) through (i).

MIL-HDBK-5J
31 January 2003

Table 5.4.1.0(b). Design Mechanical and Physical Properties of Ti-6Al-4V Sheet, Strip, and Plate

Specification	AMS 4911 and AMS-T-9046 ^a , Comp. AB-1						AMS-T-9046 ^a , Comp. AB-1			
	Sheet		Plate				Sheet, strip, and plate			
Condition	Annealed						Solution treated and aged			
Thickness, in.	≤ 0.1875		0.1875- 2.000		2.001-4.000		≤ 0.1875	0.1875- 0.750	0.751- 1.000	1.001- 2.000
Basis	A	B	A	B	A	B	S	S	S	S
Mechanical Properties:										
F_{tu} , ksi:										
L	134	139	130 ^b	135	130 ^c	137	160	160	150	145
LT	134	139	130 ^b	138	130 ^c	137	160	160	150	145
F_{ty} , ksi:										
L	126	131	120	125	118	123	145	145	140	135
LT	126	131	120 ^b	131	118	129	145	145	140	135
F_{cy} , ksi:										
L	133	138	124	129	122	127	154	150	145	...
LT	135	141	130	142	128	140	162
F_{su} , ksi	87	90	79	84	79	84	100	93	87	...
F_{bru} , ksi:										
(e/D = 1.5)	213 ^d	221 ^d	206 ^d	214 ^d	206 ^d	217 ^d	236	248	233	...
(e/D = 2.0)	272 ^d	283 ^d	260 ^d	276 ^d	260 ^d	274 ^d	286	308	289	...
F_{bry} , ksi:										
(e/D = 1.5)	171 ^c	178 ^d	164 ^d	179 ^d	161 ^d	176 ^d	210	210	203	...
(e/D = 2.0)	208 ^d	217 ^d	194 ^d	212 ^d	191 ^d	209 ^d	232	243	235	...
e , percent (S-basis):										
L	8 ^e	...	10	...	10	...	5 ^f	8	6	6
LT	8 ^e	...	10	...	10	...	5 ^f	8	6	6
E , 10 ³ ksi							16.0			
E_c , 10 ³ ksi							16.4			
G , 10 ³ ksi							6.2			
μ							0.31			
Physical Properties:										
ω , lb/in. ³							0.160			
C , K , and α							See Figure 4.5.1.0			

a MIL-T-9046 was canceled and superseded by AMS-T-9046

b The rounded T_{99} values are higher than specification values as follows: $F_{tu}(L) = 131$ ksi, $F_{tu}(LT) = 132$ ksi, and $F_{ty}(LT) = 123$ ksi.

c The rounded T_{99} values are higher than specification values as follows: $F_{tu}(L) = 133$ ksi and $F_{tu}(LT) = 133$ ksi.

d Bearing values are “dry pin” values per Section 1.4.7.1.

e 8%—0.025 to 0.062 in. and 10%—0.063 in. and above.

f 5%—0.050 in. and above; 4%—0.033 to 0.049 in. and 3%—0.032 in. and below.

Table 5.4.1.0(c₁). Design Mechanical and Physical Properties of Ti-6Al-4V Bar

Specification	AMS 4928													
	Bar													
	Annealed													
Form	<0.500		0.500-1.000		1.001-2.000		2.001-3.000		3.001-4.000		4.001-5.000		5.001-6.000	
Condition	S	A	B	A	B	A	B	A	B	A	B	A	B	
Thickness or diameter, in.														
Basis														
Mechanical Properties:														
F_{up} , ksi:														
L	135	135 ^a	142	134	140	138	130 ^a	138	130	135	128	125	131	
LT	135 ^b	135 ^a	144	135 ^a	143	142	130 ^a	142	130 ^a	141	130 ^a	139	138	
$F_{0.2p}$, ksi:														
L	125	125 ^c	134	125 ^c	131	128	120 ^c	128	120	125	117	114	119	
LT	125 ^b	125 ^c	134	125 ^c	132	131	120 ^c	131	120 ^c	129	120 ^c	119	125	
$F_{0.5p}$, ksi:														
L	129	129	138	129	135	135	
LT	
F_{sup} , ksi														
L	83	83	87	82	86	86	
F_{brp} , ksi:														
(e/D = 1.5)	201	201	212	200	209	209	
(e/D = 2.0)	253	253	266	251	262	262	
F_{brp} , ksi:														
(e/D = 1.5)	177	177	190	177	186	186	
(e/D = 2.0)	205	205	220	205	215	215	
e , percent (S-basis):														
L	10	10	...	10	10	...	10	...	10	10	...	
LT	10 ^b	10 ^b	...	10 ^b	10 ^b	...	10	...	10	10	...	
ST	10 ^b	...	10	...	8	8	...	
R_A , percent (S-basis):														
L	25	25	...	25	25	...	25	...	20	20	...	
LT	20 ^b	20 ^b	...	20 ^b	20 ^b	...	20	...	20	20	...	
ST	15 ^b	...	15	...	15	15	...	
E , 10 ³ ksi	16.9													
E_c , 10 ³ ksi	17.2													
G , 10 ³ ksi	6.2													
μ	0.31													
Physical Properties:														
ω , lb/in. ³	0.160													
C , K , and α	See Figure 5.4.1.0													

a S-basis. The rounded T_{90} values for $F_{0.2p}$ are as follows: 0.500-1.000 (L) = 137 ksi and (LT) = 140 ksi, 1.001-2.000 (LT) = 139 ksi, 2.001-3.000 (L) = 132 ksi and (LT) = 138 ksi, 3.001-4.000 (LT) = 136 ksi, 4.001-5.000 (LT) = 135 ksi, and 5.001-6.000 (LT) = 134 ksi.
b Applicable, providing LT or ST dimension is ≥ 2.500 inches.
c S-basis. The rounded T_{90} values for $F_{0.5p}$ are as follows: 0.500-1.000 (L) and (LT) = 129 ksi, 1.001-2.000 (L) = 126 ksi and (LT) = 127 ksi, 2.001-3.000 (L) = 123 ksi and (LT) = 127 ksi, 3.001-4.000 (LT) = 123 ksi, and 4.001-5.000 (LT) = 121 ksi.

Table 5.4.1.0(c₂). Design Mechanical and Physical Properties of Ti-6Al-4V Bar

Specification	MIL-T-9047 ^b																
	Bar																
	Annealed																
	≤48																
		<0.500		0.500-1.000		1.001-2.000		2.001-3.000		3.001-4.000		4.001-5.000		5.001-6.000			
Basis	S	A	B	A	B	A	B	A	B	A	B	A	B				
Mechanical Properties:																	
<i>F_m</i> , ksi:																	
L	130	130 ^b	142	130 ^b	140	138	130 ^b	138	130	135	128	133	125	131			
LT	130 ^c	130 ^b	144	130 ^b	143	142	130 ^b	142	130 ^b	141	130 ^b	139	130 ^b	138			
<i>F_{0.2}</i> , ksi:																	
L	120	120 ^d	134	120 ^d	131	128	120 ^d	128	120	125	117	122	114	119			
LT	120 ^c	120 ^d	134	120 ^d	132	131	120 ^d	131	120 ^d	129	120	127	119	125			
<i>F_{0.01}</i> , ksi:																	
L	124	124	138	124	135			
LT			
<i>F_{0.005}</i> , ksi:																	
L	80	80	87	80	86			
LT			
<i>F_{0.002}</i> , ksi:																	
L	194	194	212	194	209			
LT	244	244	266	244	262			
<i>F_{0.001}</i> , ksi:																	
L	170	170	190	170	186			
LT	197	197	220	197	215			
<i>e_L</i> , percent (S basis):																	
L	10	10	...	10	10	10	...	10	...			
LT	10 ^c	10 ^c	...	10 ^c	10	10	...	10	...			
ST	8	8	...	8	...			
<i>RA</i> , percent (S-basis):																	
L	25	25	...	25	25	25	...	20	...			
LT	25 ^c	25 ^c	...	25 ^c	25	25	...	20	...			
ST	15	15	...	15	...			
<i>E</i> , 10 ³ ksi															16.9		
<i>E_c</i> , 10 ³ ksi															17.2		
<i>G</i> , 10 ³ ksi															6.5		
<i>μ</i>															0.31		
Physical Properties:																	
<i>ω</i> , lb/in. ³															0.160		
<i>C, K, and α</i>															See Figure 5.4.1.0		

a Inactive for new design.
b S-basis. The rounded *T₉₉* values for *F_m* are as follows: 0.500-1.000 (L) = 137 ksi and (LT) = 140 ksi, 1.001-2.000 (L) = 134 ksi and (LT) = 139 ksi, 2.001-3.000 (L) = 132 ksi and (LT) = 138 ksi, 3.001-4.000 (LT) = 136 ksi, 4.001-5.000 (LT) = 135 ksi, and 5.001-6.000 (LT) = 134 ksi.
c Applicable, providing LT dimension is ≥ 3,000 inches.
d S-basis. The rounded *T₉₉* values for *F_{0.2}* are as follows: 0.500-1.000 (L)and (LT) = 129 ksi, 1.001-2.000 (L) = 126 ksi and (LT) = 127 ksi, 2.001-3.000 (L) = 123 ksi and (LT) = 123 ksi, 3.001-4.000 (LT) = 123 ksi, and 4.001-5.000 (LT) = 121 ksi.

Table 5.4.1.0(d). Design Mechanical and Physical Properties of Ti-6Al-4V Bar

Specification	AMS 4965 ^a and MIL-T-9047 ^b													
	Rectangular bar						Round, square, and hexagon bar							
Form	Solution treated and aged													
Condition														
Width, in.	0.501-8.000	1.001-4.000	4.001-8.000	1.501-4.000	4.001-8.000	2.001-4.000	4.001-8.000	3.001-8.000	4.001-8.000	
Thickness, in.	≤0.500	0.501-1.000	1.001-1.500	1.501-2.000	2.001-4.000	4.001-8.000	2.001-3.000	3.001-4.000	3.001-4.000	0.501-1.000	1.001-1.500	1.501-2.000	2.001-3.000	3.001-4.000
Basis	S	S	S	S	S	S	S	S	S	S	S	S	S	S
Mechanical Properties:														
F_{ms} , ksi:	160	155	150	150	145	140	145	135	130	165	160	155	150	140
L	160	155	150	150	145	140	145	135	130	165	160	155	150	140
LT	150	145	140	140	135	130	135	125	120	155	150	145	140	130
L	150	145	140	140	135	130	135	125	120	155	150	145	140	130
LT
F_{cyp} , ksi:
L
LT	92
F_{sup} , ksi:
F_{brp} , ksi:
(e/D = 1.5)
(e/D = 2.0)
F_{brp} , ksi:
(e/D = 1.5)
(e/D = 2.0)
e , percent:	10	10	10	10	10	10	10	10	8	10	10	10	10	10
L	10	10	10	10	10	10	10	10	8	10	10	10	10	10
LT	25	20	20	20	20	20	20	20	15	20	20	20	20	20
RA , percent:	25	20	20	20	20	20	20	20	15	20	20	20	20	20
L
LT	16.9	17.2	6.2	0.31	0.160	16.9	17.2	6.2	0.31	0.160	16.9	17.2	6.2	0.31
E , 10^3 ksi
E_c , 10^3 ksi
G , 10^3 ksi
μ
Physical Properties:														
ω , lb/in. ³
C , K , and α

a For AMS 4965, e and RA values may be different than those shown.

b Inactive for new design.

Table 5.4.1.0(e). Design Mechanical and Physical Properties of Ti-6Al-4V Extrusion

	AMS 4935						AMS 4934							
	Extrusion													
	Annealed						Solution treated and aged							
	≤2.000		2.001-3.000		<0.500		0.501-0.750		0.751-1.000		1.001-2.000		2.001-3.000	
A	B	A	B	A	B	A	B	A	B	A	B	A	B	
Mechanical Properties:														
F_{tu} , ksi:														
L	137	130 ^b	135	139	155	163	151	157	147	153	140	147	140	130
LT ^c	139	130 ^b	139	139	155	163	151	157	147	155	140	147	140	130
F_{yp} , ksi:														
L	124	118	122	128	138	147	138	143	133	140	130	133	130	120
LT ^c	128	120	125	128	138	147	138	145	133	142	130	133	130	120
F_{cy} , ksi:														
L	128	133	128	128	147	157	147	153	142	150	139	142	139	128
LT ^c	129	138	147	157	147	155	139	152	139	139	139	128
F_{su} , ksi:														
L	83	89	94	99	92	96	89	93	85	89	85	79
F_{bru} , ksi:														
(e/D = 1.5)	214	226	243	256	237	246	231	240	220	231	220	204
(e/D = 2.0)	264	278	311	327	303	315	295	307	281	295	281	261
F_{bry} , ksi:														
(e/D = 1.5)	180	186	208	222	208	216	201	212	196	201	196	182
(e/D = 2.0)	210	217	242	257	242	250	233	245	228	233	228	210
e, percent (S-basis):														
L	10	...	10	...	6	...	6	...	6	...	6	6	6	6
LT ^c	8	...	8	...	6	...	6	...	6	...	6	6	6	6
RA, percent (S-basis):														
L	20	...	20	...	12	...	12	...	12	...	12	12	12	12
LT ^c	15	...	15	...	12	...	12	...	12	...	12	12	12	12
E , 10 ³ ksi														
16.9														
E_c , 10 ³ ksi														
17.2														
G , 10 ³ ksi														
6.5														
μ														
0.31														
Physical Properties:														
ω , lb/in. ³														
0.160														
C, K, and α														
See Figure 5.4.1.0														

a S-basis. The rounded T_{99} values are higher than specification values as follows: F_m (L) and (LT) = 132 ksi and F_y (LT) = 121 ksi.
b S-basis. The rounded T_{99} values are higher than specification values as follows: F_m (L) = 132 ksi and F_m (LT) = 136 ksi.
c Applicable, providing LT dimension is ≥2.500 inches.
d Bearing values are “dry pin” values per Section 1.4.7.1.

MIL-HDBK-5J
31 January 2003

Table 5.4.1.0(f). Design Mechanical and Physical Properties of Ti-6Al-4V Die Forging

Specification	AMS 4928			AMS 4920	
	Die forging				
Form	Alpha-beta processed, annealed			Alpha-beta or beta processed, annealed	
	≤2.000	2.001-4.000	4.001-6.000	≤2.000	2.001-6.000
Thickness, in.	≤2.000	2.001-4.000	4.001-6.000	≤2.000	2.001-6.000
Basis	S	S	S	S	S
Mechanical Properties:					
F_{tu} , ksi:					
L	135	130	130	130	130
LT	135 ^a	130 ^a	130	130 ^a	130 ^a
ST	130 ^a	130	...	130 ^a
F_{ty} , ksi:					
L	125	120	120	120	120
LT	125 ^a	120 ^a	120	120 ^a	120 ^a
ST	120 ^a	120	...	120 ^a
F_{cy} , ksi:					
L	123	123	...	123
LT	128	128	...	128
ST
F_{su} , ksi	79	79	...	79
F_{bru} , ksi:					
(e/D = 1.5)	203	203	...	203
(e/D = 2.0)	257	257	...	257
F_{bry} , ksi:					
(e/D = 1.5)	171	171	...	171
(e/D = 2.0)	201	201	...	201
e , percent:					
L	10	10	10	8	8
LT	10 ^a	10 ^a	10	8 ^a	8 ^a
ST	10 ^a	8	...	8 ^a
RA , percent:					
L	25	25	20	15	15
LT	20 ^a	20 ^a	20	15 ^a	15 ^a
ST	15 ^a	15	...	15 ^a
E , 10 ³ ksi				16.9	
E_c , 10 ³ ksi				17.2	
G , 10 ³ ksi				6.5	
μ				0.31	
Physical Properties:					
ω , lb/in. ³	0.160				
C , K , and α	See Figure 5.4.1.0				

a Applicable providing LT or ST dimension is ≥2.500 inches.

Table 5.4.1.0(g). Design Mechanical and Physical Properties of Ti-6Al-4V Titanium Alloy Casting

Specification	AMS 4962	
Form	HIP Casting	
Temper	Annealed	
Thickness, in.	≤1.000	
Location within casting	Designated area	
Basis	A	B
Mechanical Properties:		
F_{tu} , ksi	125 ^a	128
F_{ty} , ksi	119	122
F_{cy} , ksi
F_{su} , ksi
F_{bru} , ksi:		
(e/D = 1.5)
(e/D = 2.0)
F_{bry} , ksi:		
(e/D = 1.5)
(e/D = 2.0)
e , percent (S-basis)	5	...
E , 10 ³ ksi	16.9	
E_c , 10 ³ ksi	16.9	
G , 10 ³ ksi	
μ	
Physical Properties:		
ω , lb/in. ³	
C , Btu/(lb)(°F)	
K , Btu/[(hr)(ft ²)(°F)/ft]	
α , 10 ⁻⁶ in./in./°F	

a S-basis. The rounded T_{99} value is 126 ksi.

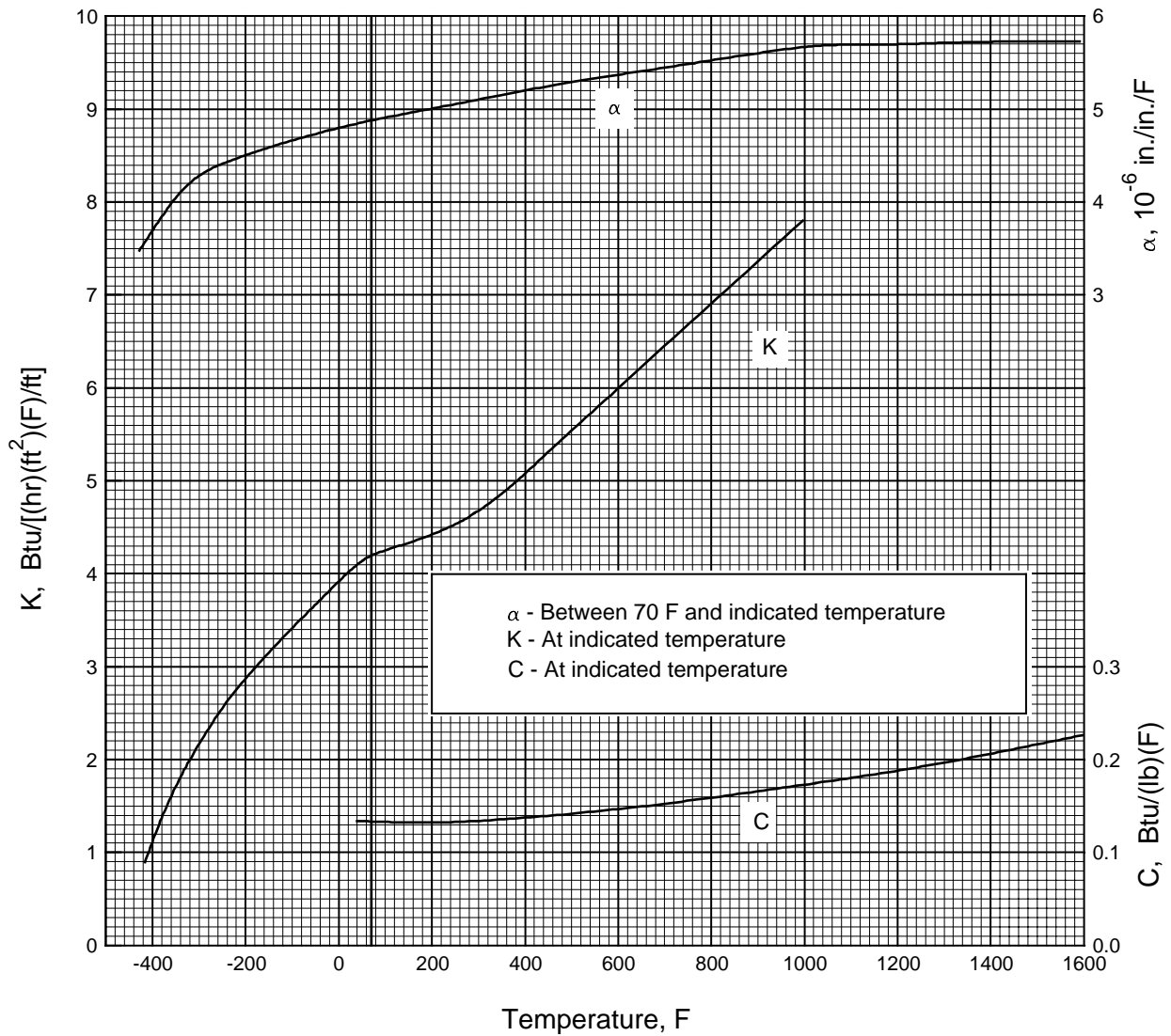

Figure 5.4.1.0. Effect of temperature on the physical properties of Ti-6Al-4V alloy (wrought products).

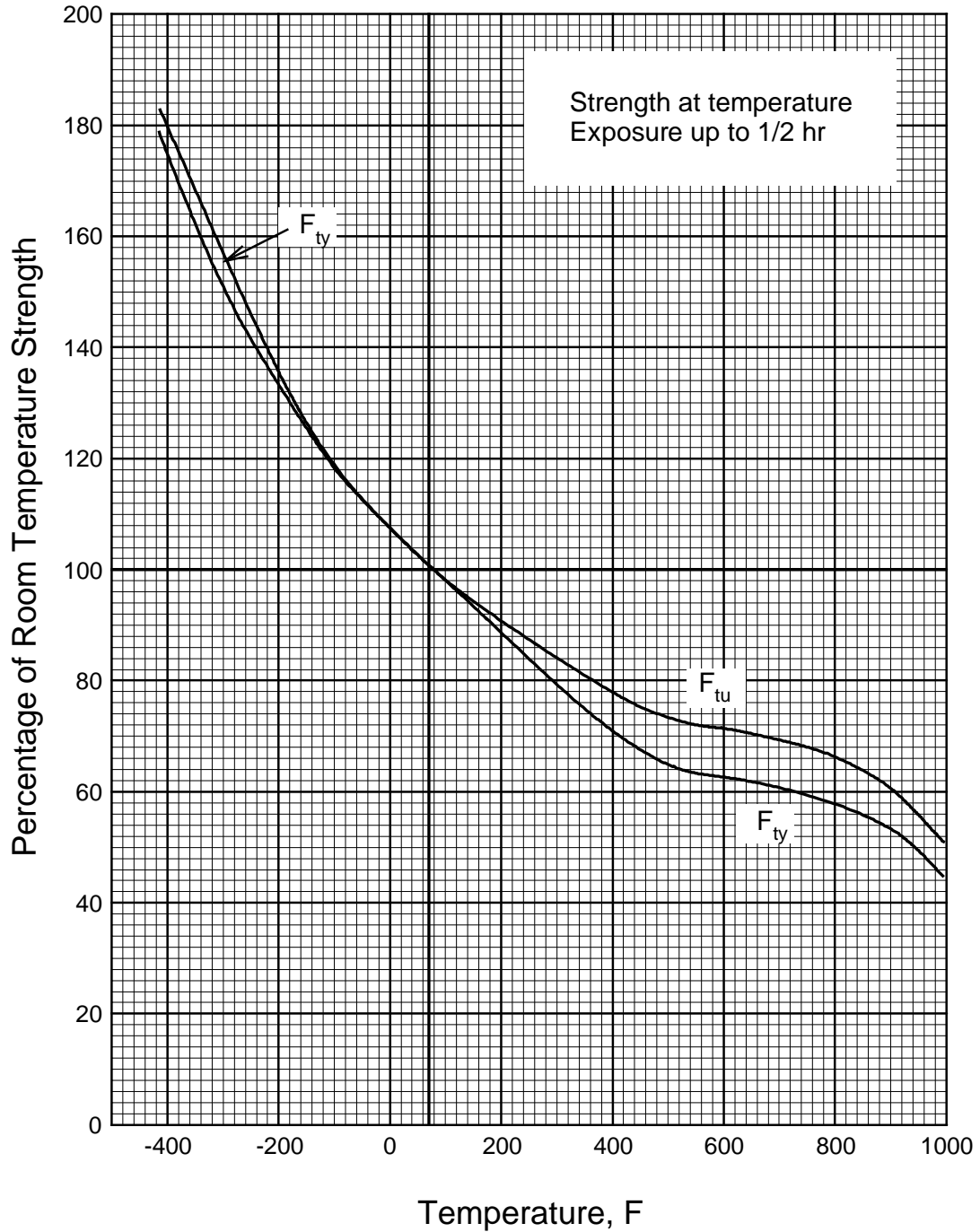

Figure 5.4.1.1.1. Effect of temperature on the tensile ultimate strength (F_{tu}) and the tensile yield strength (F_{ty}) of annealed Ti-6Al-4V alloy (all wrought products).

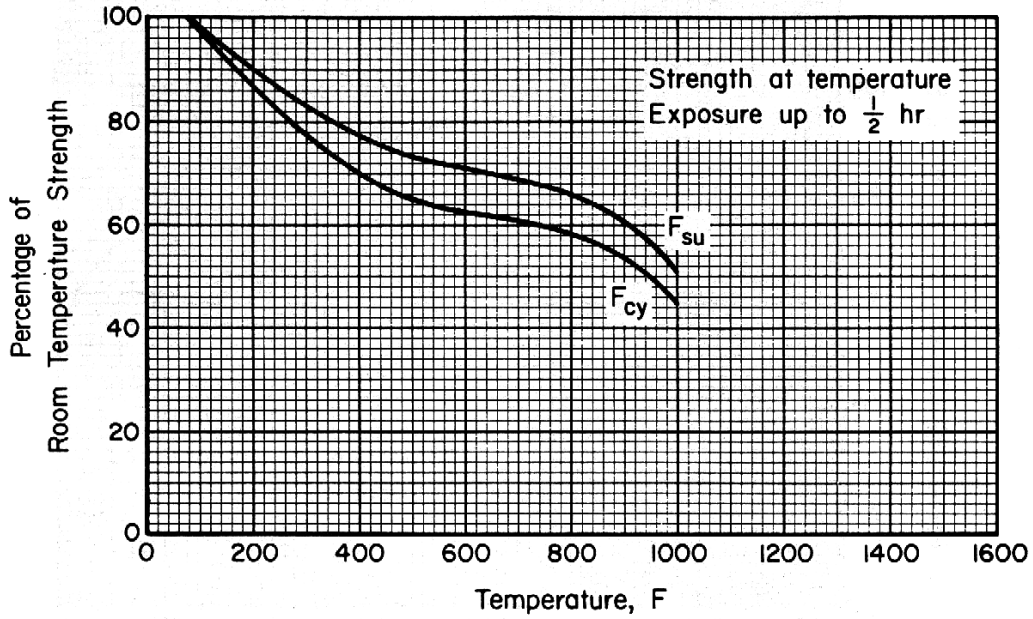

Figure 5.4.1.1.2. Effect of temperature on the compressive yield strength (F_{cy}) and the shear ultimate strength (F_{su}) of annealed Ti-6Al-4V alloy (all wrought products).

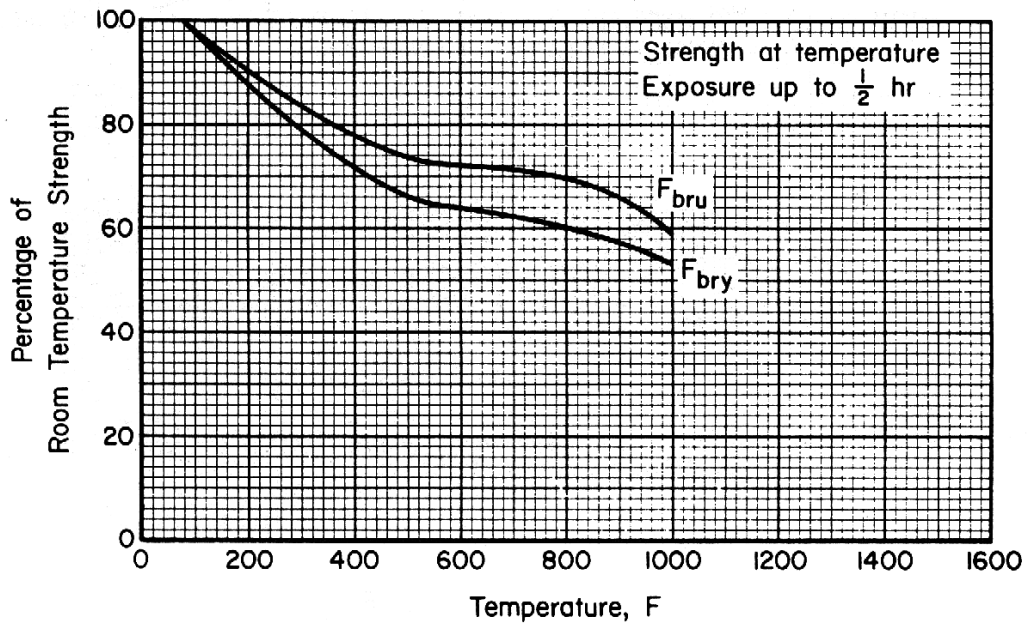

Figure 5.4.1.1.3. Effect of temperature on the bearing ultimate strength (F_{bru}) and the bearing yield strength (F_{bry}) of annealed Ti-6Al-4V alloy (all wrought products).

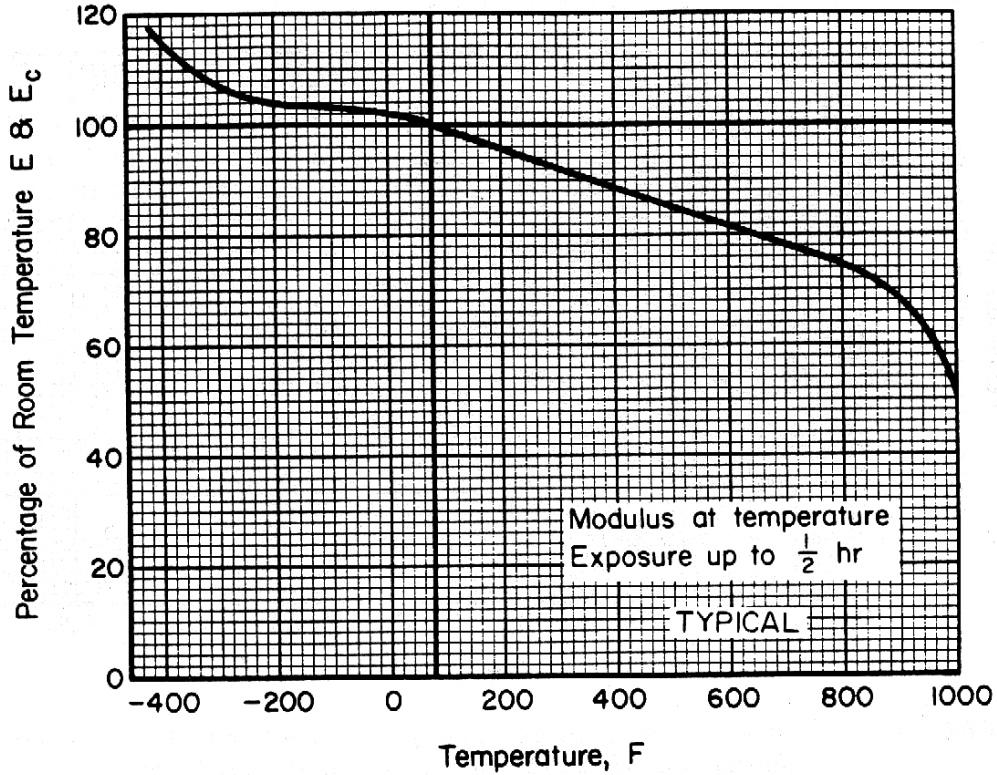

Figure 5.4.1.1.4. Effect of temperature on the tensile and compressive moduli (E and E_c) of annealed Ti-6Al-4V alloy sheet and bar.

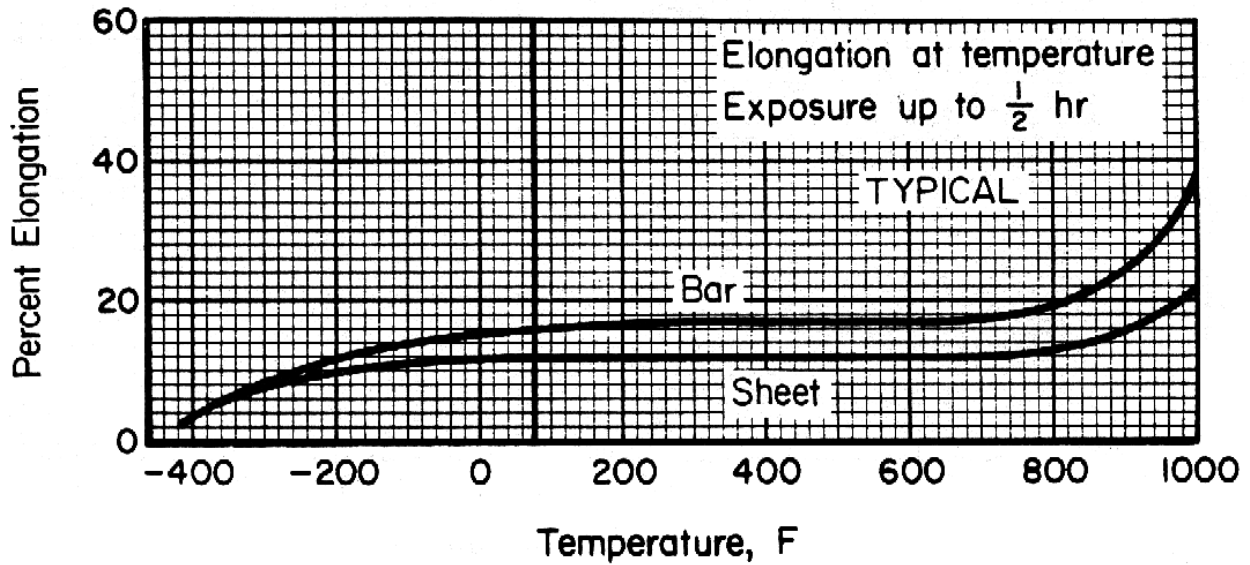

Figure 5.4.1.1.5. Effect of temperature on the elongation of annealed Ti-6Al-4V alloy sheet and bar.

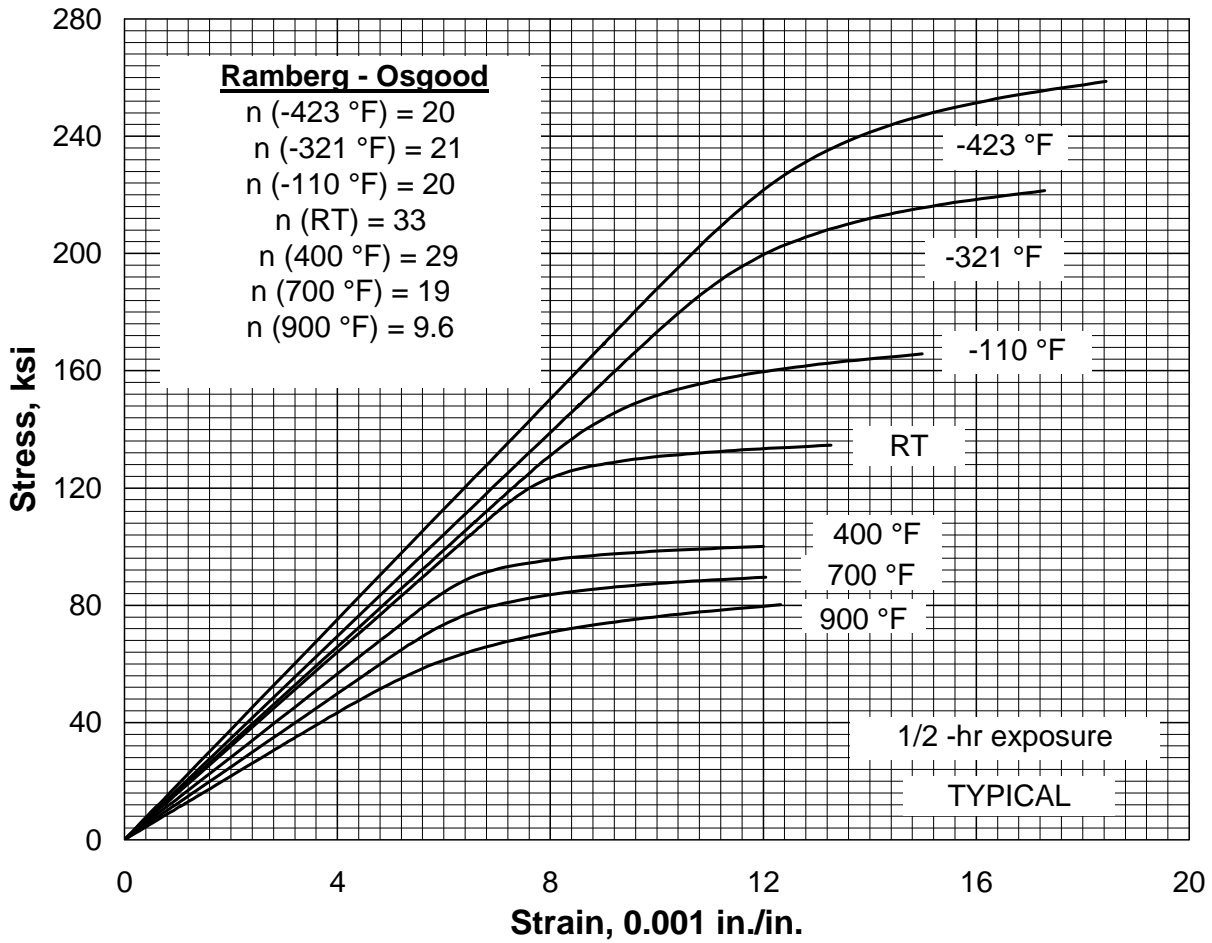

Figure 5.4.1.1.6(a). Typical tensile stress-strain curves at cryogenic, room, and elevated temperatures for annealed Ti-6Al-4V alloy extrusion.

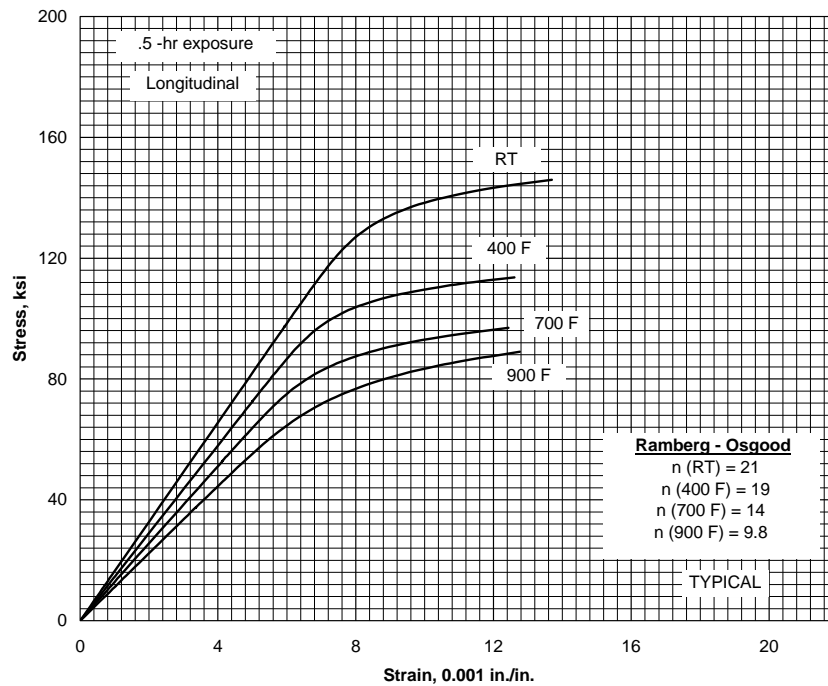

Figure 5.4.1.1.6(b). Typical compressive stress-strain curves at room and elevated temperatures for annealed Ti-6Al-4V alloy extrusion.

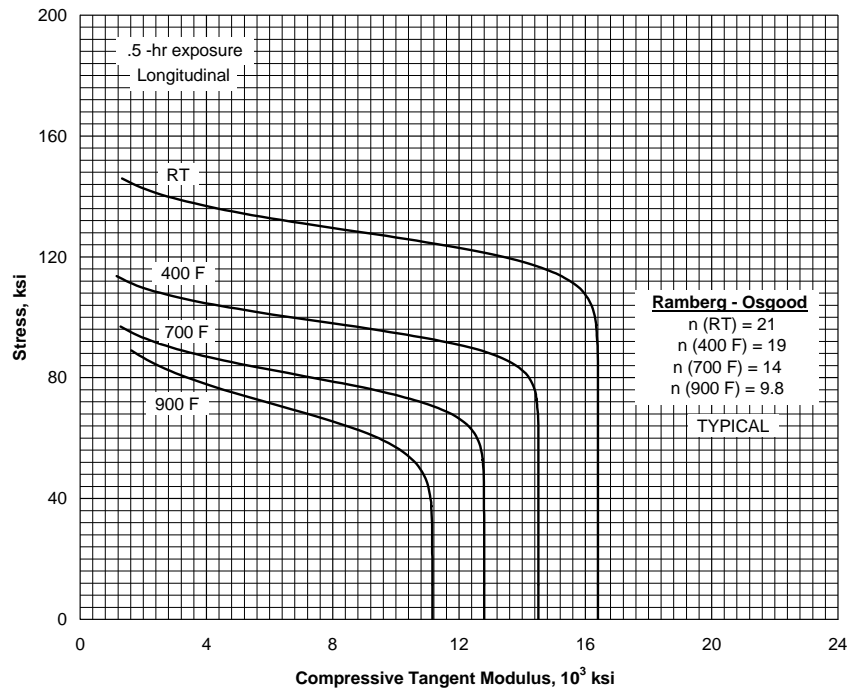

Figure 5.4.1.1.6(c). Typical compressive tangent-modulus curves at room and elevated temperatures for annealed Ti-6Al-4V alloy extrusion.

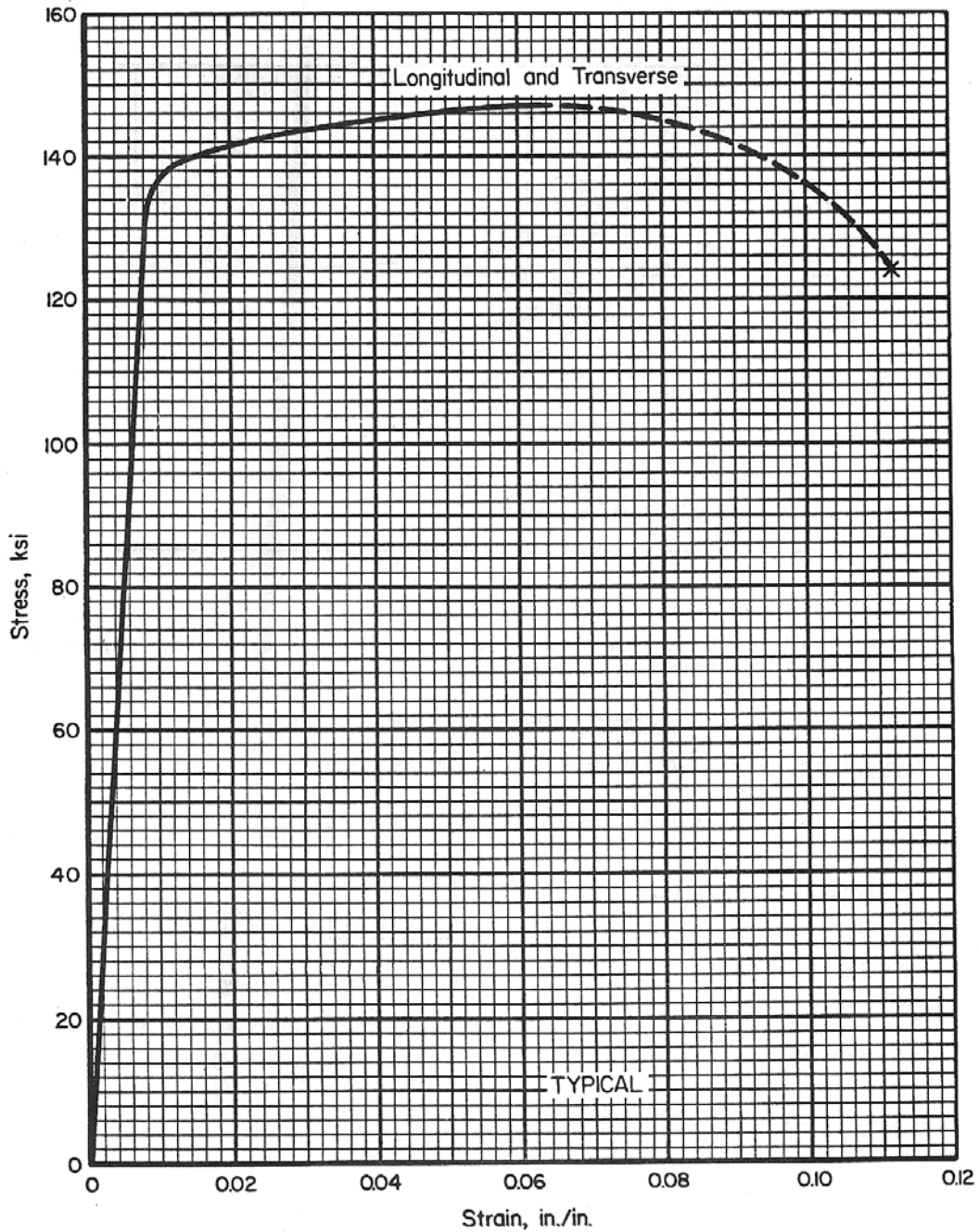

Figure 5.4.1.1.6(d). Typical tensile stress-strain curves (full range) for annealed Ti-6Al-4V sheet at room temperature.

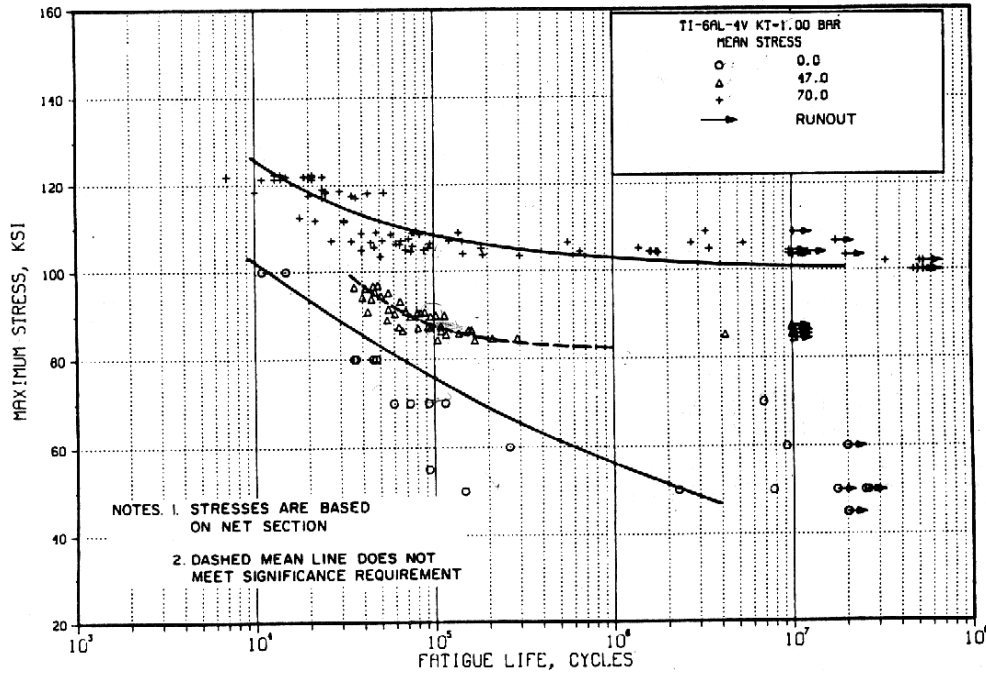

Figure 5.4.1.1.8(a). Best-fit S/N curves for unnotched Ti-6Al-4V annealed bar, longitudinal direction.

Correlative Information for Figure 5.4.1.1.8(a)

Product Form: Bar, 1.25 inch diameter

Test Parameters:

Properties: TUS, ksi TYS, ksi Temp., °F
137 129 RT

Loading — Axial
Frequency — 1800 cpm
Temperature — RT
Environment — Air

Specimen Details: Unnotched
0.280 inch diameter

No. of Heats/Lots: Not specified

Surface Conditions:
0 ksi mean stress—32 RMS ground
47 ksi mean stress—100 RMS machined
70 ksi mean stress—32 RMS ground and
100 RMS machined

Equivalent Strain Equation:
 $\text{Log } N_f = 19.18 - 7.55 \text{ log } S_{\text{max}} S_m = 0$
 $= 5.70 - 0.94 \text{ Log } (S_{\text{max}} - 82.3), S_m = 47$
 $= 7.08 - 2.18 \text{ Log } (S_{\text{max}} - 99.6), S_m = 70$

Reference: 5.4.1.1.8(a)

Sample Size = 134

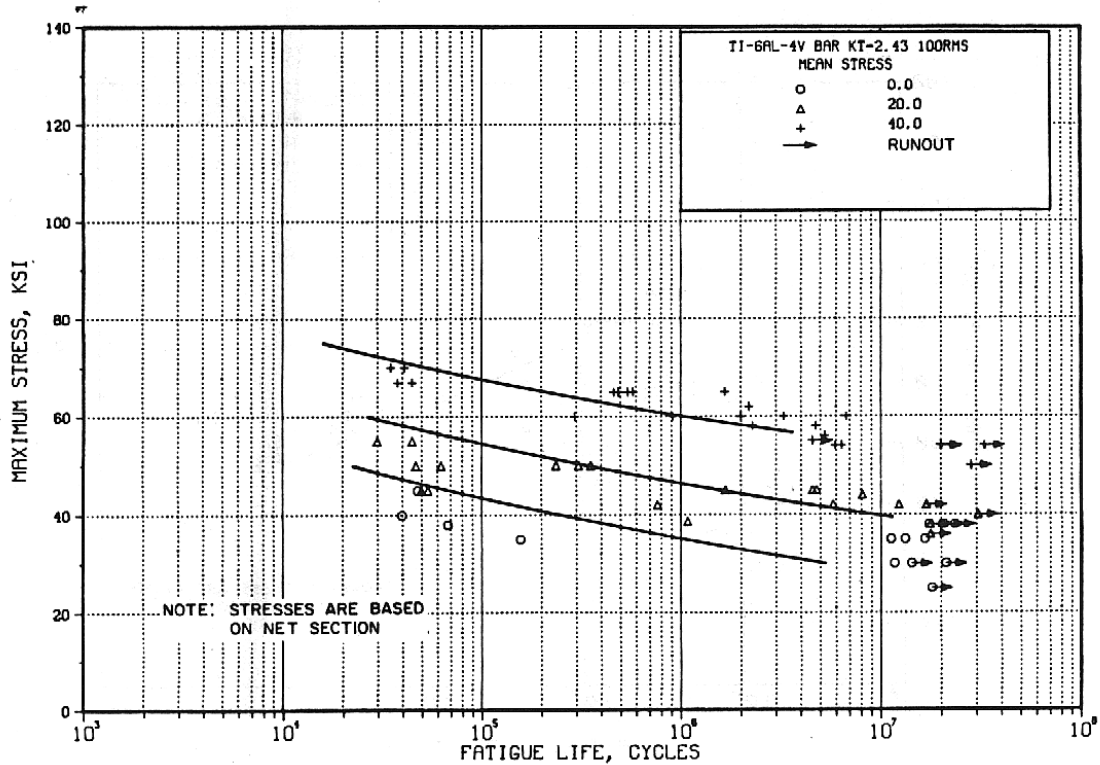

Figure 5.4.1.1.8(b). Best-fit S/N curves for notched, $K_t = 2.43$, Ti-6Al-4V annealed bar, longitudinal direction.

Correlative Information for Figure 5.4.1.1.8(b)

Product Form: Bar, 1 inch diameter

Properties: $\frac{TUS, ksi}{150}$ $\frac{TYS, ksi}{143}$ $\frac{Temp., ^\circ F}{RT}$

Specimen Details: 60° V-notch
0.025 inch notch radius
0.260 inch test section
diameter at notch

Surface Condition: RMS 100 machined

Reference: 5.4.1.1.8(a)

Test Parameters:

Loading — Axial
Frequency — 1800 cpm
Temperature — RT
Environment — Air

No. of Heats/Lots: Not specified

Equivalent Strain Equation:

$\log N_f = 24.1 - 10.7 \log S_{eq}$
 $S_{eq} = S_{max}(1-R)^{0.49}$
Std. Error of Estimate, $\log(\text{Life}) = 0.677$
Standard Deviation, $\log(\text{Life}) = 0.920$
 $R^2 = 46\%$

Sample Size = 46

[Caution: The equivalent stress model may provide unrealistic life predictions for stress ratios beyond those represented above.]

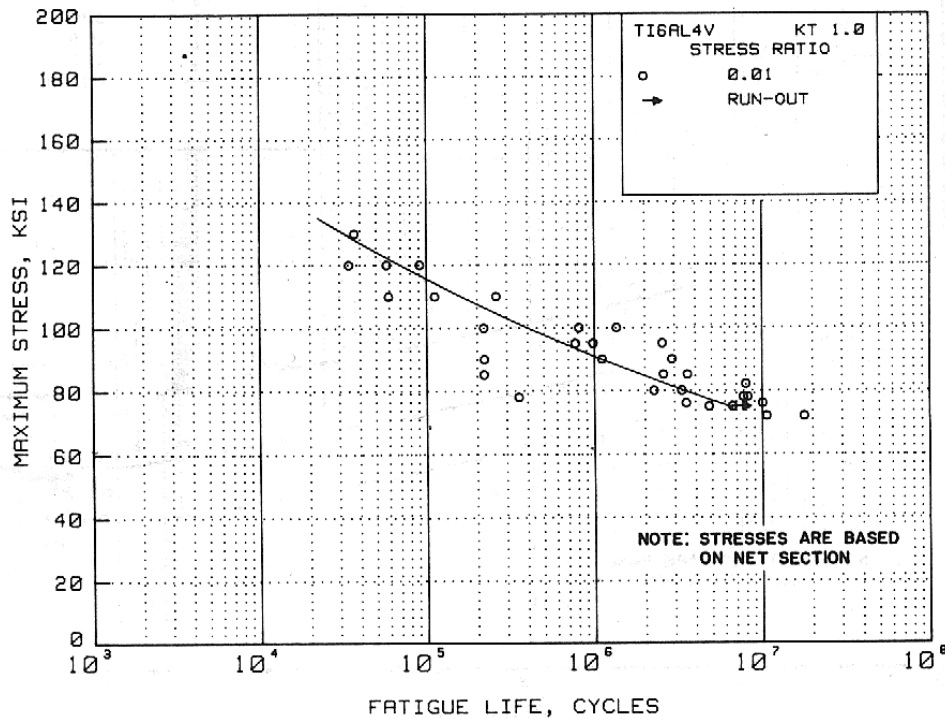

Figure 5.4.1.1.8(c). Best-fit S/N curves for unnotched annealed Ti-6Al-4V extrusion at room temperature, longitudinal direction.

Correlative Information for Figure 5.4.1.1.8(c)

Product Form: Extrusion, 0.300 and 0.560 inch thick

Test Parameters:
Loading — Axial
Frequency — 1800 cpm
Temperature — RT
Environment — Air

Properties: TUS, ksi TYS, ksi Temp., °F
 143 127 RT

Specimen Details: Unnotched
 1.50 inch gross width
 0.75 inch net width
 4.00 inch net section radius

No. of Heats/Lots: Not specified

Equivalent Strain Equation:
 $\log N_f = 24.8 - 9.6 \log (S_{max})$
Std. Error of Estimate, $\log (\text{Life}) = 0.41$
Standard Deviation, $\log (\text{Life}) = 0.81$
 $R^2 = 75\%$

Surface Conditions: RMS 63

Reference: 5.4.1.1.8(b)

Sample Size = 30

[Caution: The equivalent stress model may provide unrealistic life predictions for stress ratios beyond those represented above.]

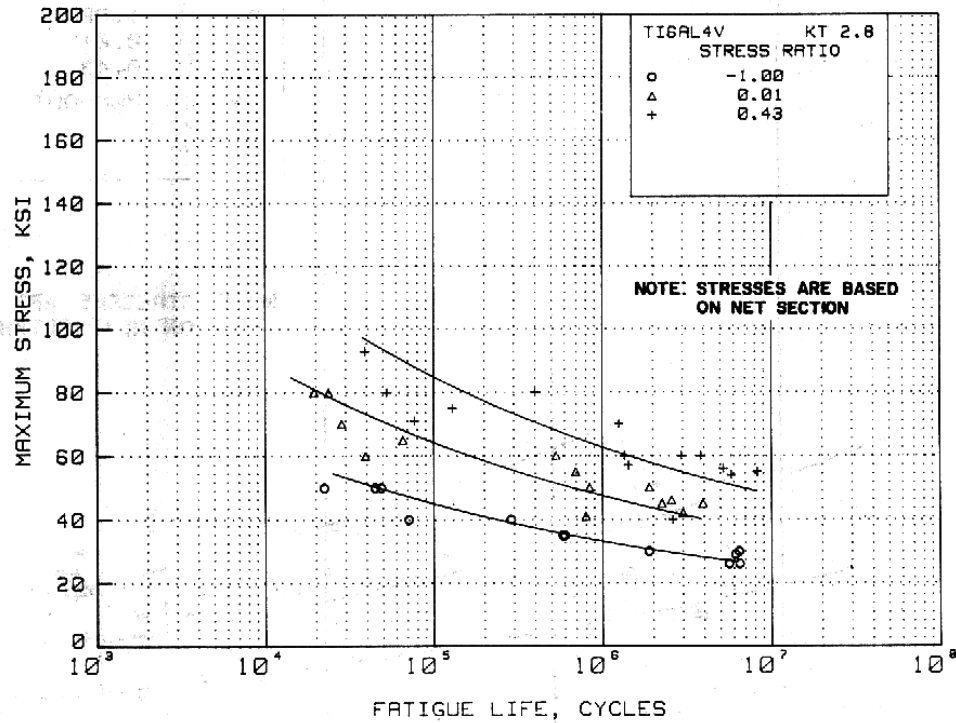

Figure 5.4.1.1.8(d). Best-fit S/N curves for notched, $K_t = 2.8$, annealed Ti-6Al-4V extrusion at room temperature, longitudinal direction.

Correlative Information for Figure 5.4.1.1.8(d)

Product Form: Extrusion, 0.300 and 0.560 inch thick

Properties: TUS, ksi 143 TYS, ksi 127 Temp., °F RT

Specimen Details: Notched, hole type, $K_t = 2.8$
0.250 inch hole diameter
1.50 inch gross width
1.25 inch net width

Surface Conditions: RMS 63

Reference: 5.4.1.1.8(b)

Test Parameters:

Loading — Axial
Frequency — 1800 cpm
Temperature — RT
Environment — Air

No. of Heats/Lots: Not specified

Equivalent Strain Equation:

$\log N_f = 14.8 - 5.8 \log (S_{eq} - 14)$

$S_{eq} = S_{max}(1-R)^{0.50}$

Std. Error of Estimate, $\log (\text{Life}) = 0.41$

Standard Deviation, $\log (\text{Life}) = 0.86$

$R^2 = 78\%$

Sample Size = 40

[Caution: The equivalent stress model may provide unrealistic life predictions for stress ratios beyond those represented above.]

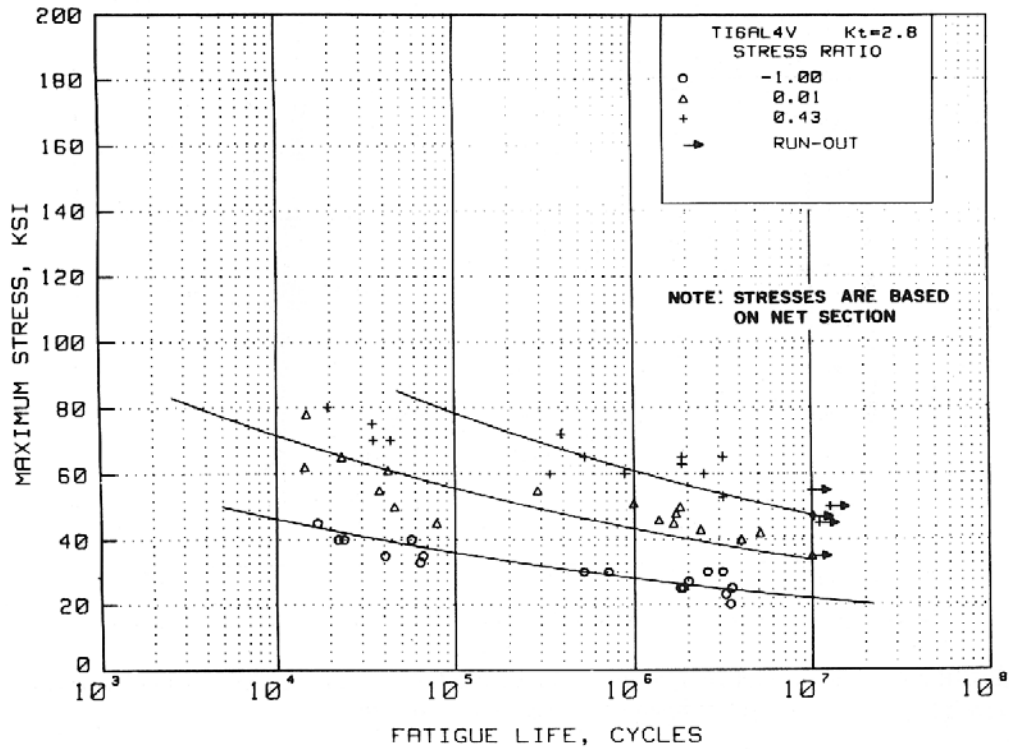

Figure 5.4.1.1.8(e). Best-fit S/N curves for notched, $K_t = 2.8$, annealed Ti-6Al-4V extrusion at 400 and 600°F, longitudinal direction.

Correlative Information for Figure 5.4.1.1.8(e)

Product Form: Extrusion, 0.300 and 0.560 inch thick

Properties:

TUS, ksi	TYS, ksi	Temp., °F
112	92	400
101	77	600

Specimen Details: Notched, hole type, $K_t = 2.8$
0.250 inch hole diameter
1.250 inch net width
1.500 inch gross width

Surface Conditions: RMS 63

Reference: 5.4.1.1.8(b)

Test Parameters:

Loading — Axial
Frequency — 1800 cpm
Temperature — 400°F and 600°F
Environment — Air

No. of Heats/Lots: Not specified

Equivalent Strain Equation:

$$\log N_f = 21.0 - 9.18 \log (S_{eq})$$

$$S_{eq} = S_{max}(1-R)^{0.62}$$

Std. Error of Estimate, $\log (\text{Life}) = 0.50$

Standard Deviation, $\log (\text{Life}) = 0.89$

$R^2 = 68\%$

Sample Size = 47

[Caution: The equivalent stress model may provide unrealistic life predictions for stress ratios beyond those represented above.]

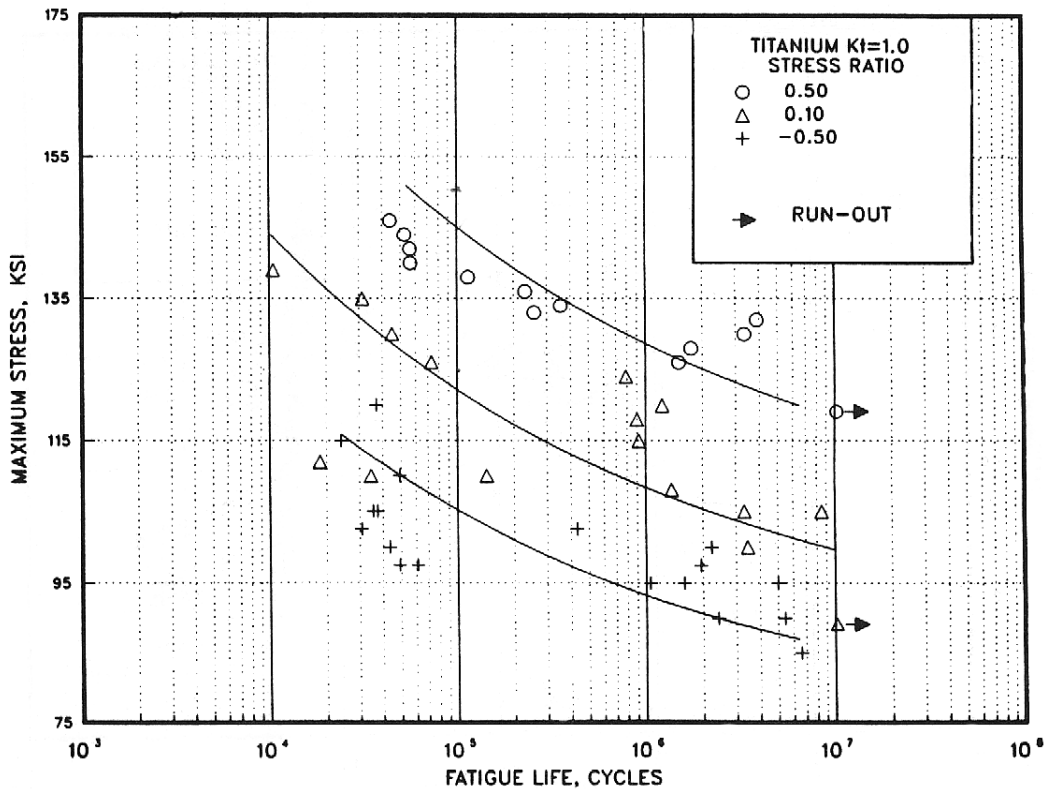

Figure 5.4.1.1.8(f). Best-fit S/N curves for unnotched Ti-6Al-4V annealed sheet, long transverse direction.

Correlative Information for Figure 5.4.1.1.8(f)

Product Form: Sheet, 0.063, 0.070, 0.078 inch thick

Test Parameters:
Loading — Axial
Frequency — 10-95 Hz
Temperature — RT
Environment — Air

Properties: TUS, ksi TYS, ksi Temp., °F
147-152 136-143 RT

Specimen Details: Unnotched, 0.375 inch width

No. of Heats/Lots: 3

Surface Conditions: Machined to 32 RMS, lightly polished with 400 grit emery paper

Equivalent Strain Equation:
 $\log N_f = 12.59 - 4.89 \log (S_{eq} - 82.8)$
 $S_{eq} = S_{max}(1-R)^{0.29}$
Std. Error of Estimate, $\log (\text{Life}) = 0.62$
Standard Deviation, $\log (\text{Life}) = 0.88$
 $R^2 = 50.6\%$

Reference: 5.4.1.1.8(c)

Sample Size = 47

[Caution: The equivalent strain model may provide unrealistic life predictions for strain ratios and ranges beyond those represented above.]

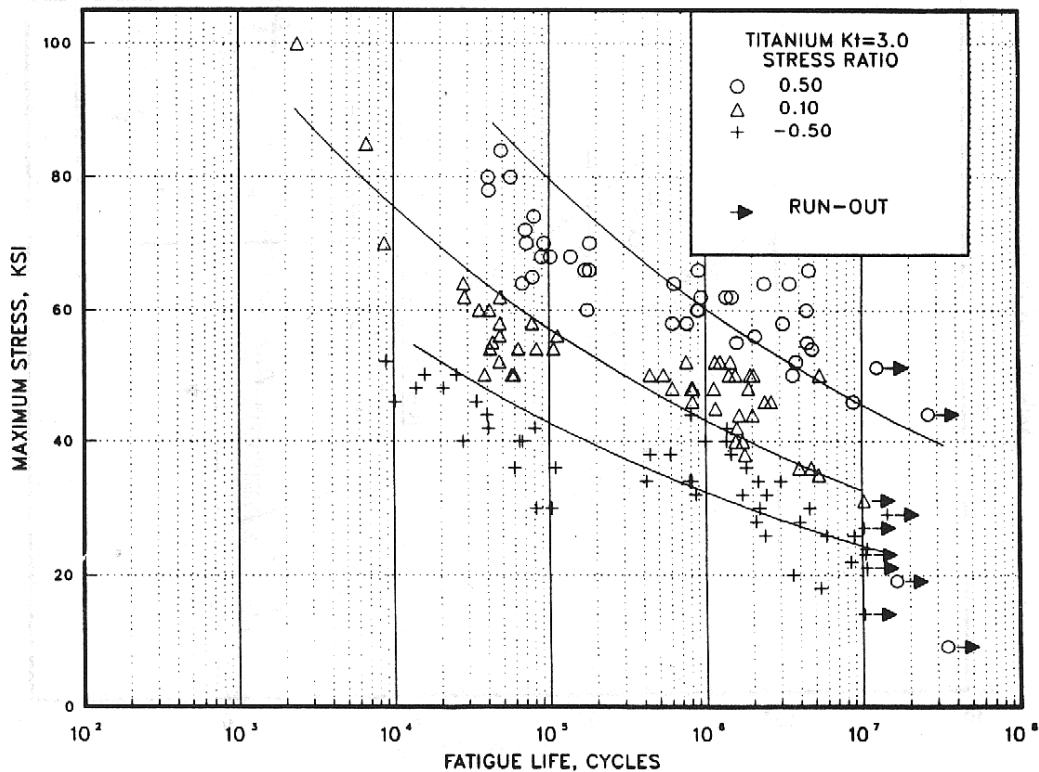

Figure 5.4.1.1.8(g). Best-fit S/N curves for notched, $K_t = 3.0$, Ti-6Al-4V annealed sheet, longitudinal and long transverse direction.

Correlative Information for Figure 5.4.1.1.8(g)

Product Form: Sheet, 0.063, 0.070, 0.078 inch thick

Test Parameters:
Loading — Axial
Frequency — 10-95 Hz
Temperature — RT
Environment — Air

Properties: TUS, ksi TYS, ksi Temp., °F
145-152 136-146 RT

Specimen Details: Notched, $K_t = 3.0$
0.487 inch net section

No. of Heats/Lots: 3

Surface Conditions: Machined to 32 RMS,
lightly polished with
400 grit emery paper

Equivalent Strain Equation:
 $\log N_f = 19.28 - 8.25 \log (S_{eq})$
 $S_{eq} = S_{max}(1-R)^{0.57}$
Std. Error of Estimate, $\log (\text{Life}) = 0.53$
Standard Deviation, $\log (\text{Life}) = 0.87$
 $R^2 = 62.5\%$

Reference: 5.4.1.1.8(c)

Sample Size = 141

[Caution: The equivalent strain model may provide unrealistic life predictions for strain ratios and ranges beyond those represented above.]

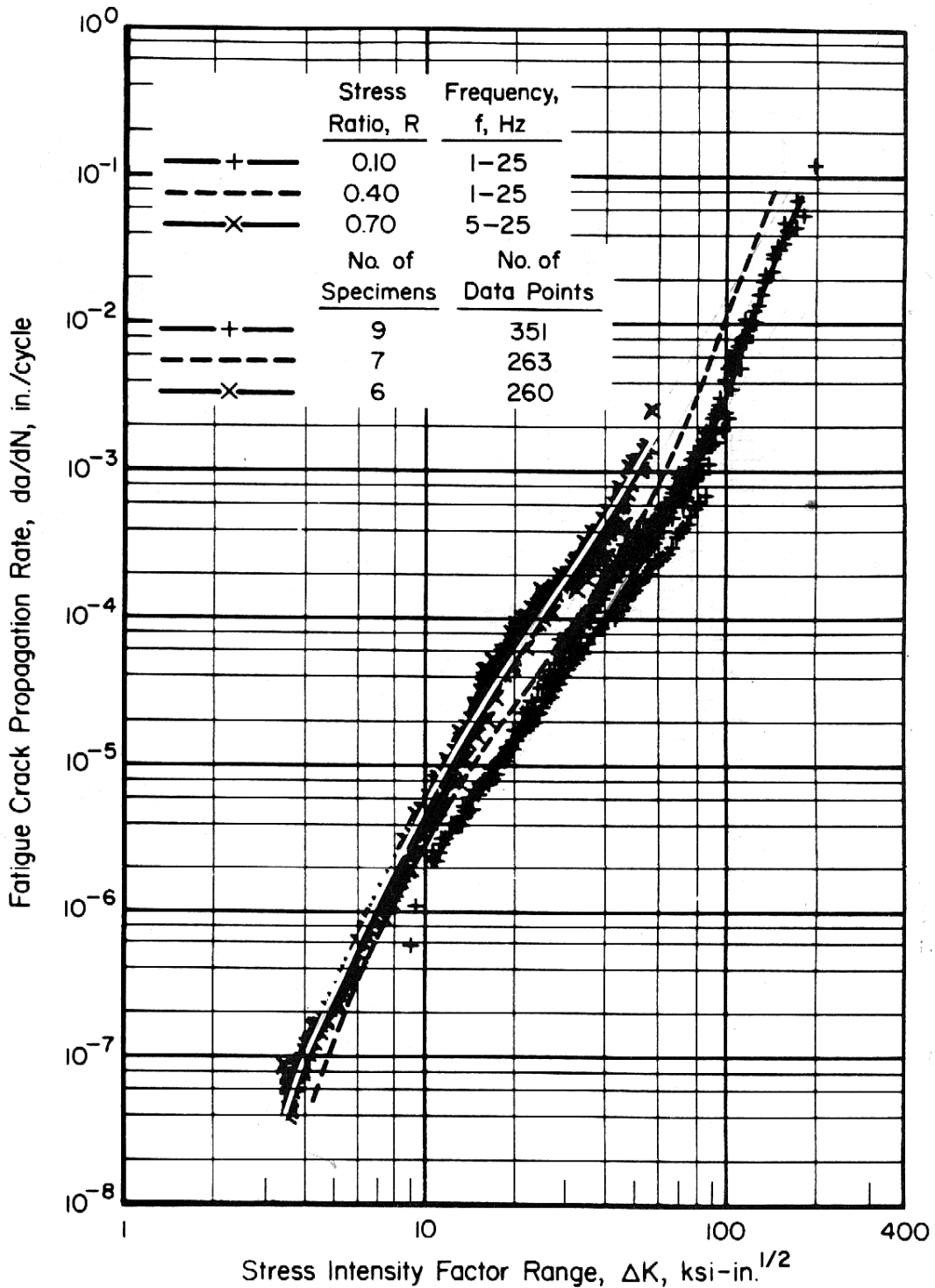

Figure 5.4.1.1.9. Fatigue-crack-propagation data for 0.250-inch-thick Ti-6Al-4V mill-annealed titanium alloy plate with buckling restraint. [Reference 5.4.1.1.9.]

<i>Specimen Thickness:</i>	0.250 inch	<i>Environment:</i>	50% R.H.
<i>Specimen Width:</i>	9.6, 16, 32 inches	<i>Temperature:</i>	RT
<i>Specimen Type:</i>	M(T)	<i>Orientation:</i>	L-T

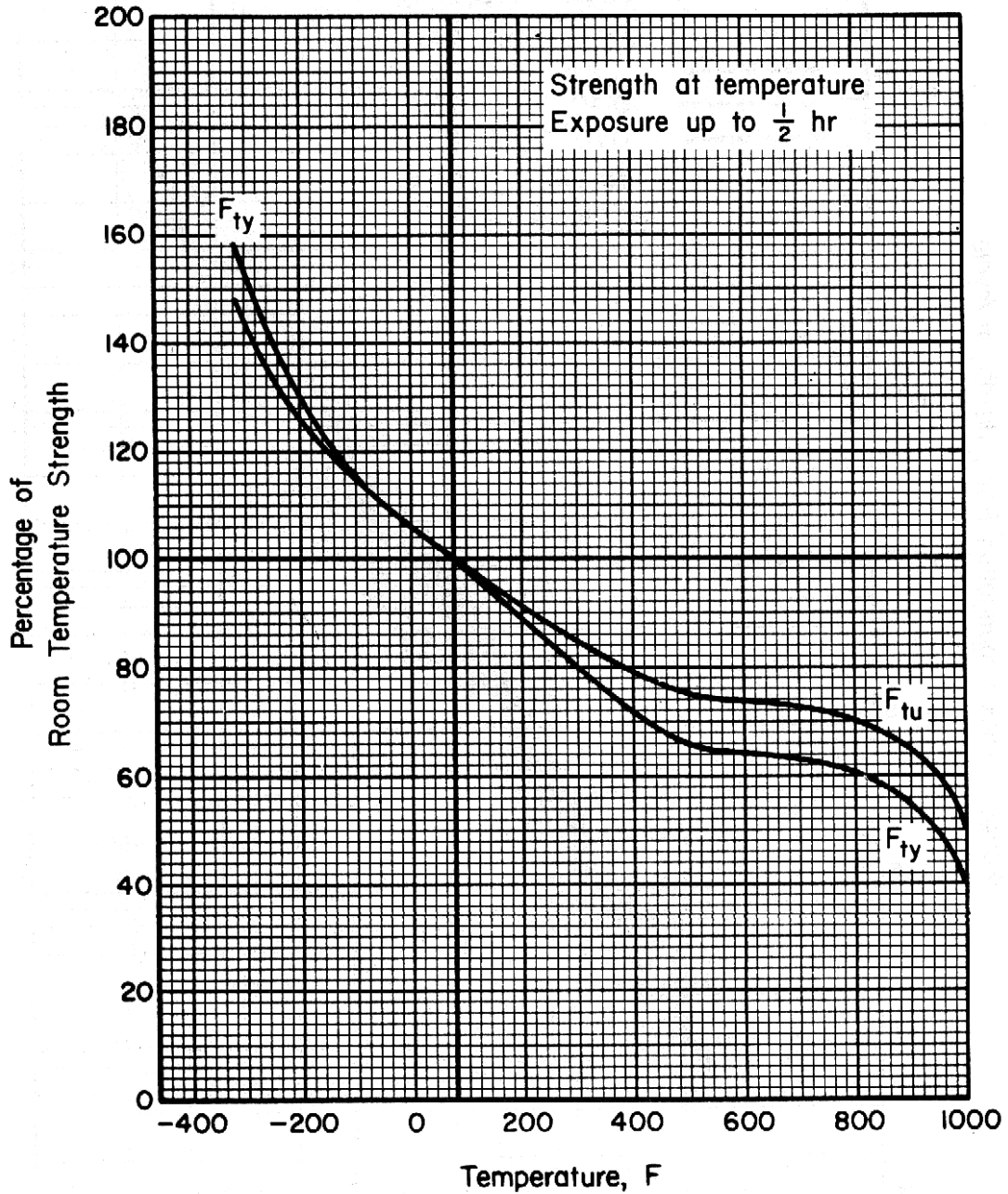

Figure 5.4.1.2.1. Effect of temperature on the tensile ultimate strength (F_{tu}) and the tensile yield strength (F_{ty}) of solution-treated and aged Ti-6Al-4V alloy (all products).

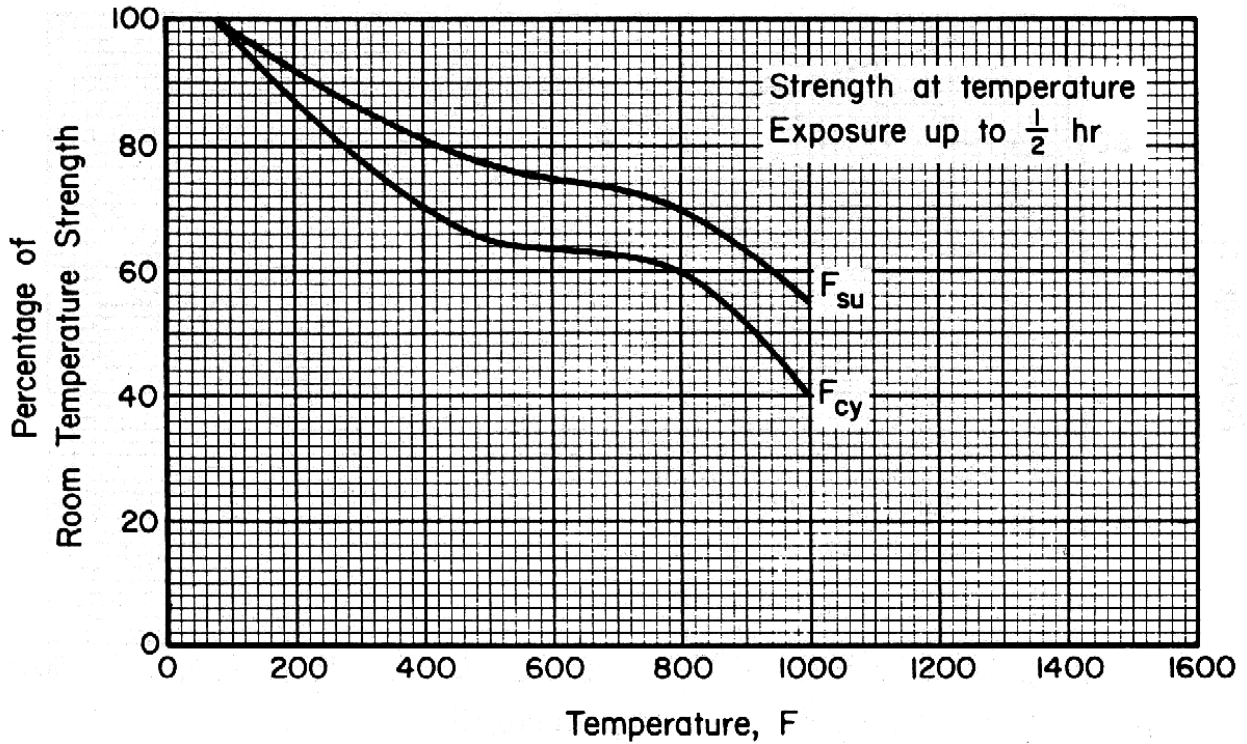

Figure 5.4.1.2.2. Effect of temperature on the compressive yield strength (F_{cy}) and the shear ultimate strength (F_{su}) of solution-treated and aged Ti-6Al-4V alloy (all products).

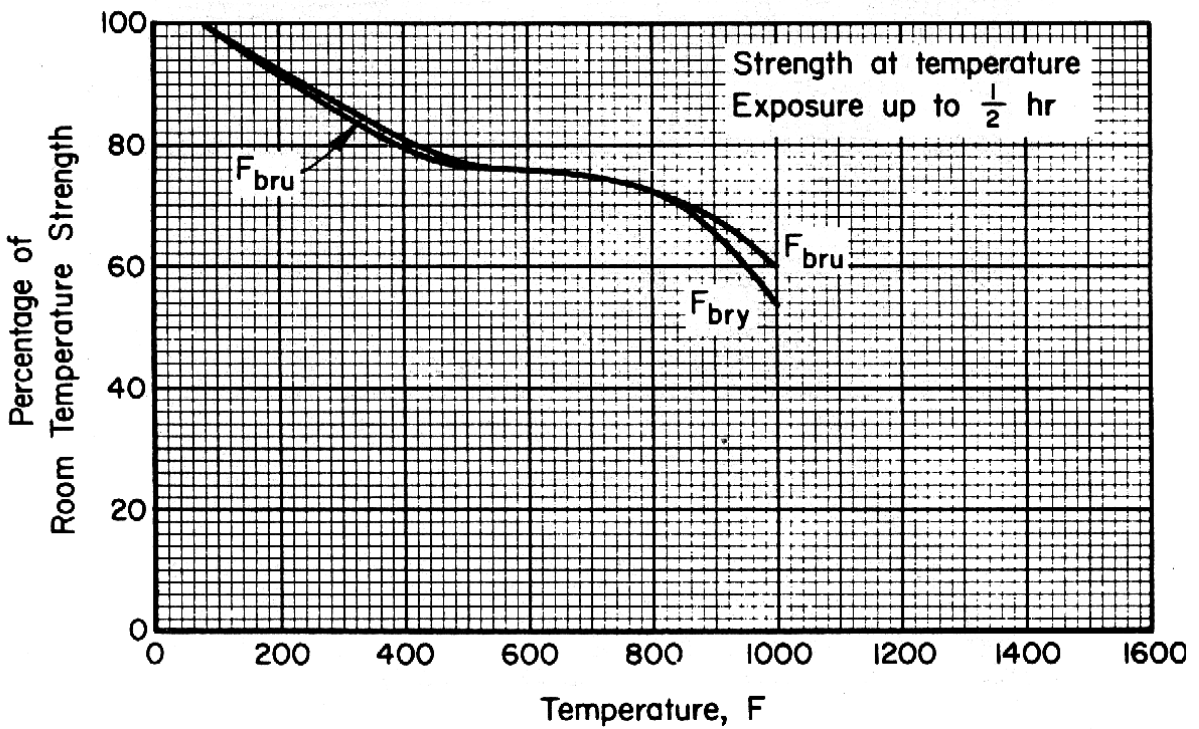

Figure 5.4.1.2.3. Effect of temperature on the bearing ultimate strength (F_{bru}) and the bearing yield strength (F_{bry}) of solution-treated and aged Ti-6Al-4V alloy (all products).

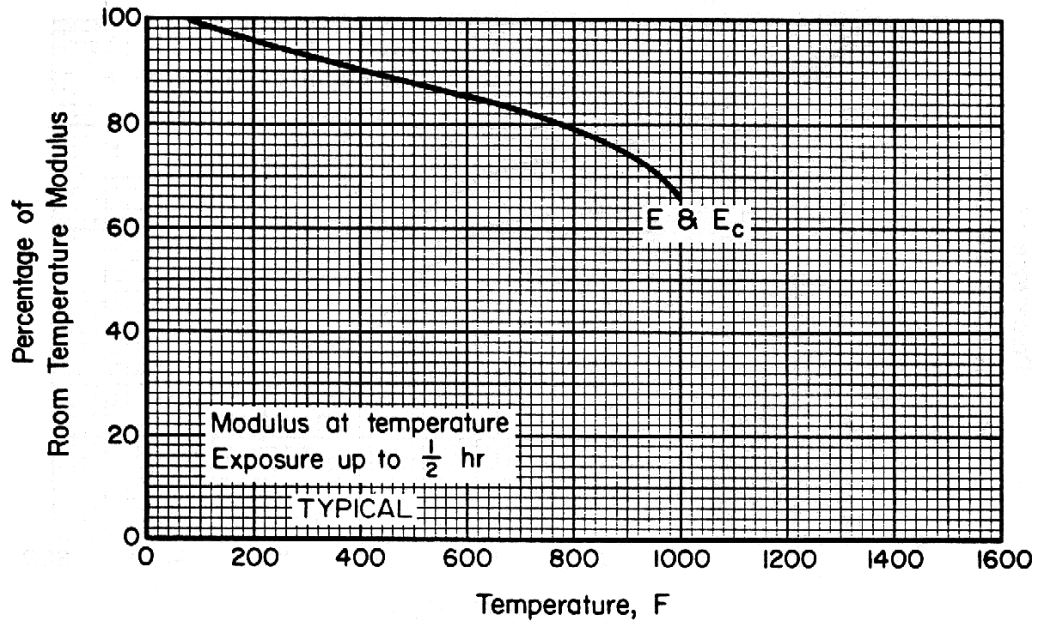

Figure 5.4.1.2.4. Effect of temperature on the tensile and compressive moduli (E and E_c) of solution-treated and aged Ti-6Al-4V alloy.

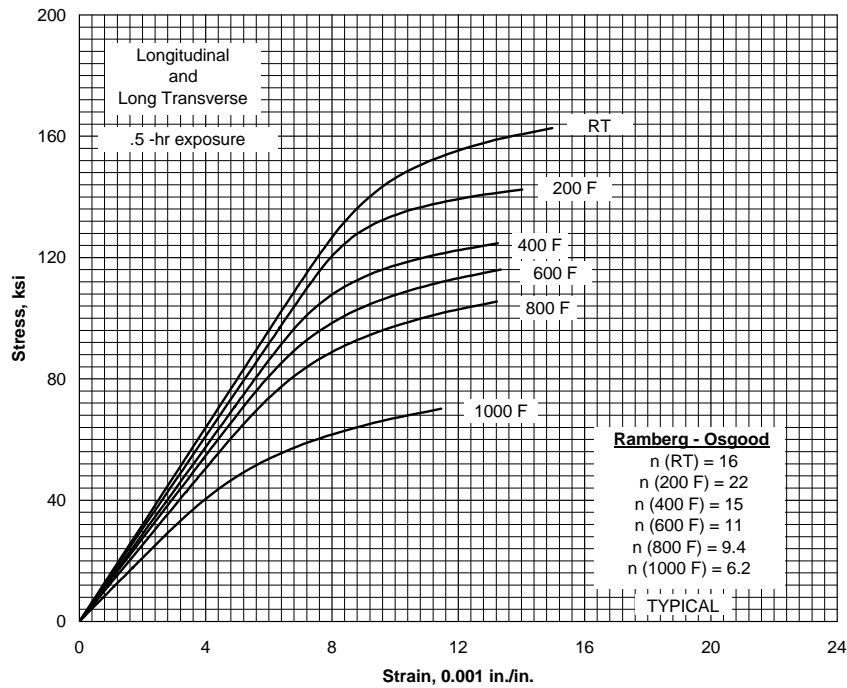

Figure 5.4.1.2.6(a). Typical tensile stress-strain curves for solution-treated and aged Ti-6Al-4V alloy sheet at room and elevated temperatures.

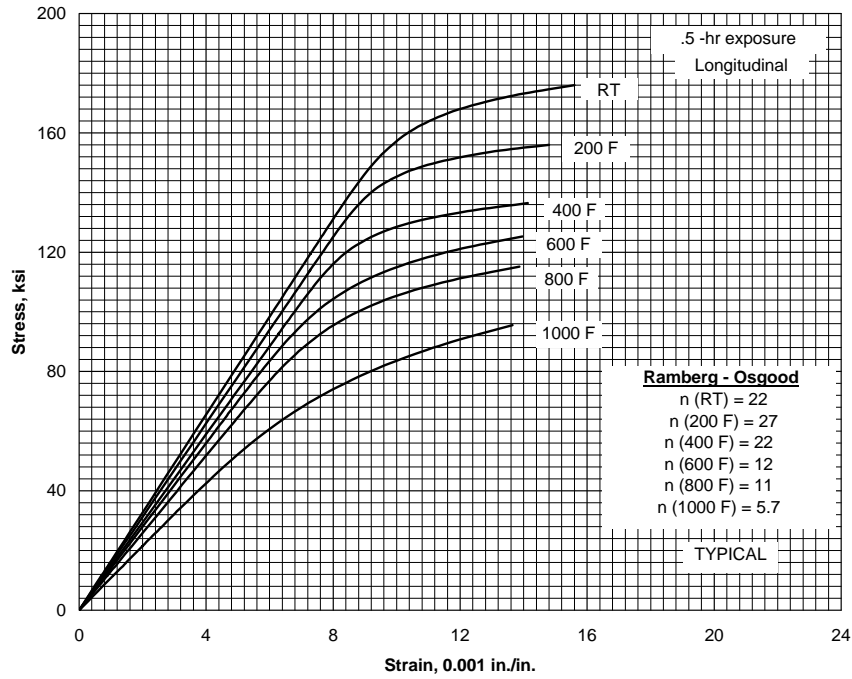

Figure 5.4.1.2.6(b). Typical compressive stress-strain curves for solution-treated and aged Ti-6Al-4V alloy sheet at room and elevated temperatures.

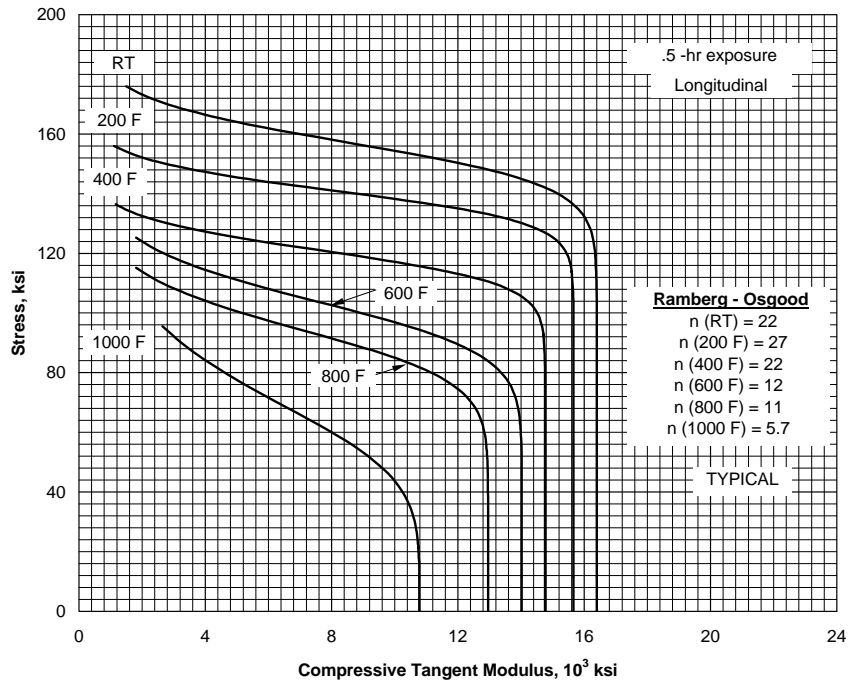

Figure 5.4.1.2.6(c). Typical compressive tangent-modulus curves for solution-treated and aged Ti-6Al-4V alloy sheet at room and elevated temperatures.

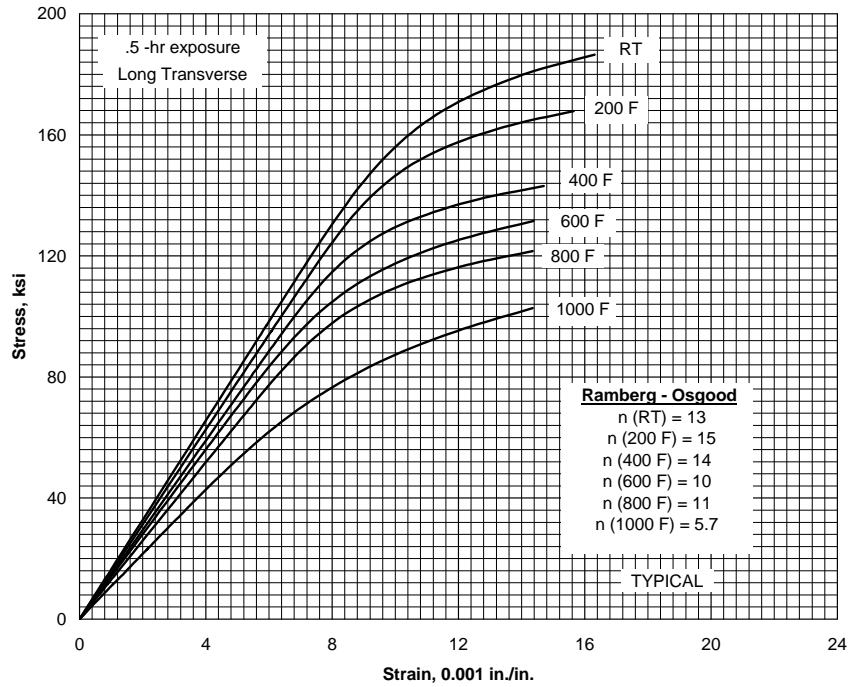

Figure 5.4.1.2.6(d). Typical compressive stress-strain curves for solution-treated and aged Ti-6Al-4V alloy sheet at room and elevated temperatures.

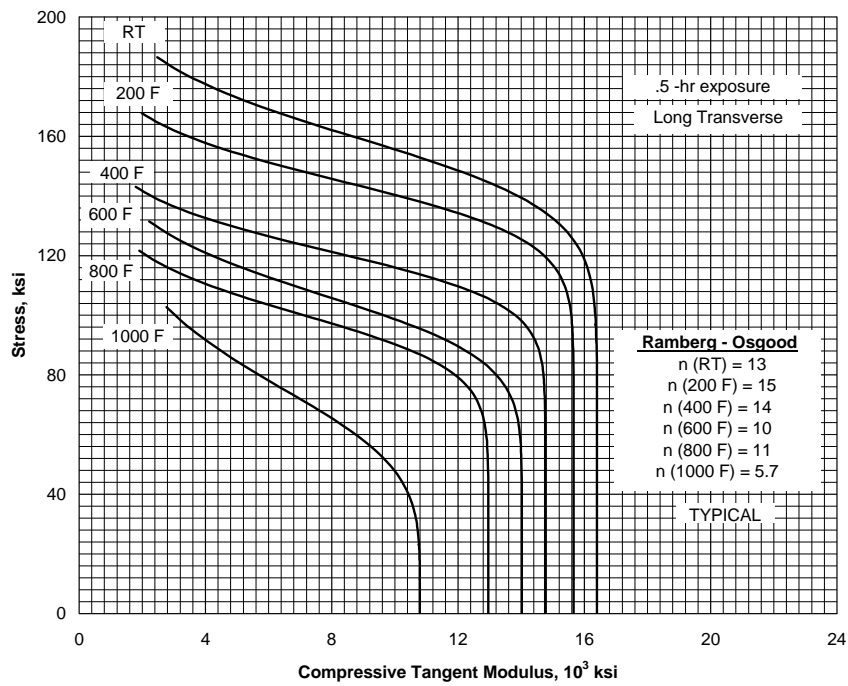

Figure 5.4.1.2.6(e). Typical compressive tangent-modulus curves for solution-treated and aged Ti-6Al-4V alloy sheet at room and elevated temperatures.

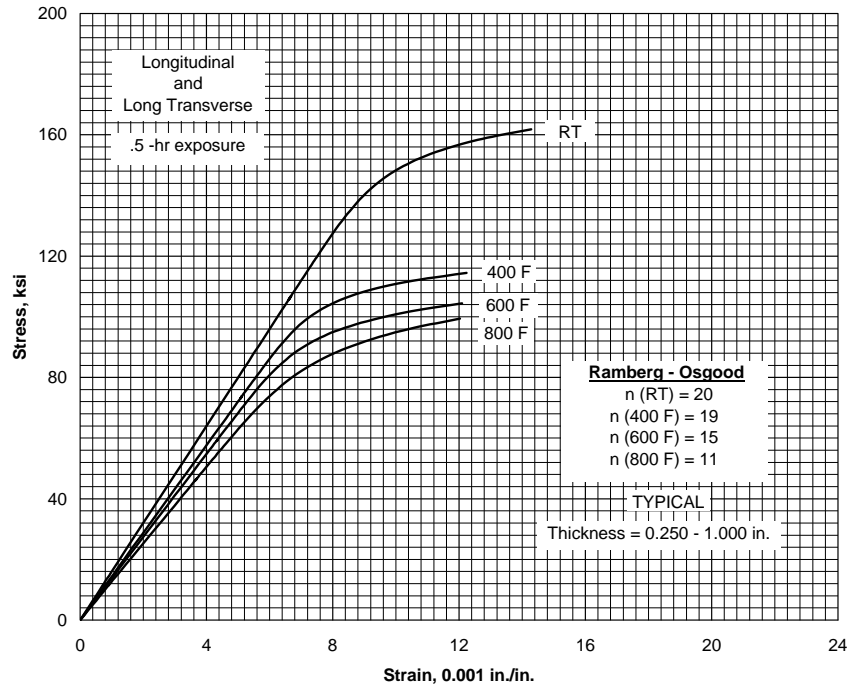

Figure 5.4.1.2.6(f). Typical tensile stress-strain curves for solution-treated and aged Ti-6Al-4V alloy plate at room and elevated temperatures.

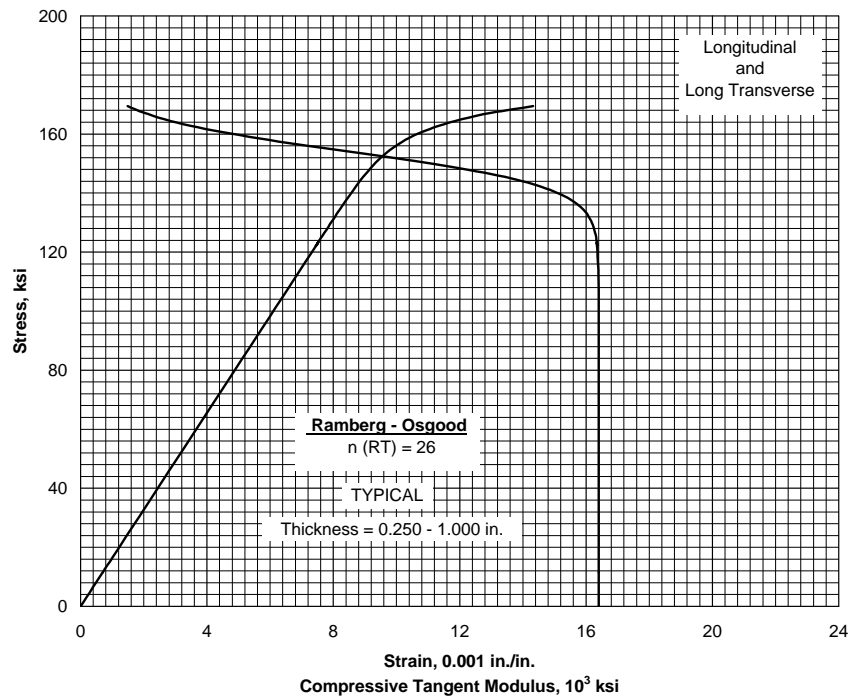

Figure 5.4.1.2.6(g). Typical compressive stress-strain and tangent-modulus curves for solution-treated and aged Ti-6Al-4V alloy plate at room temperature.

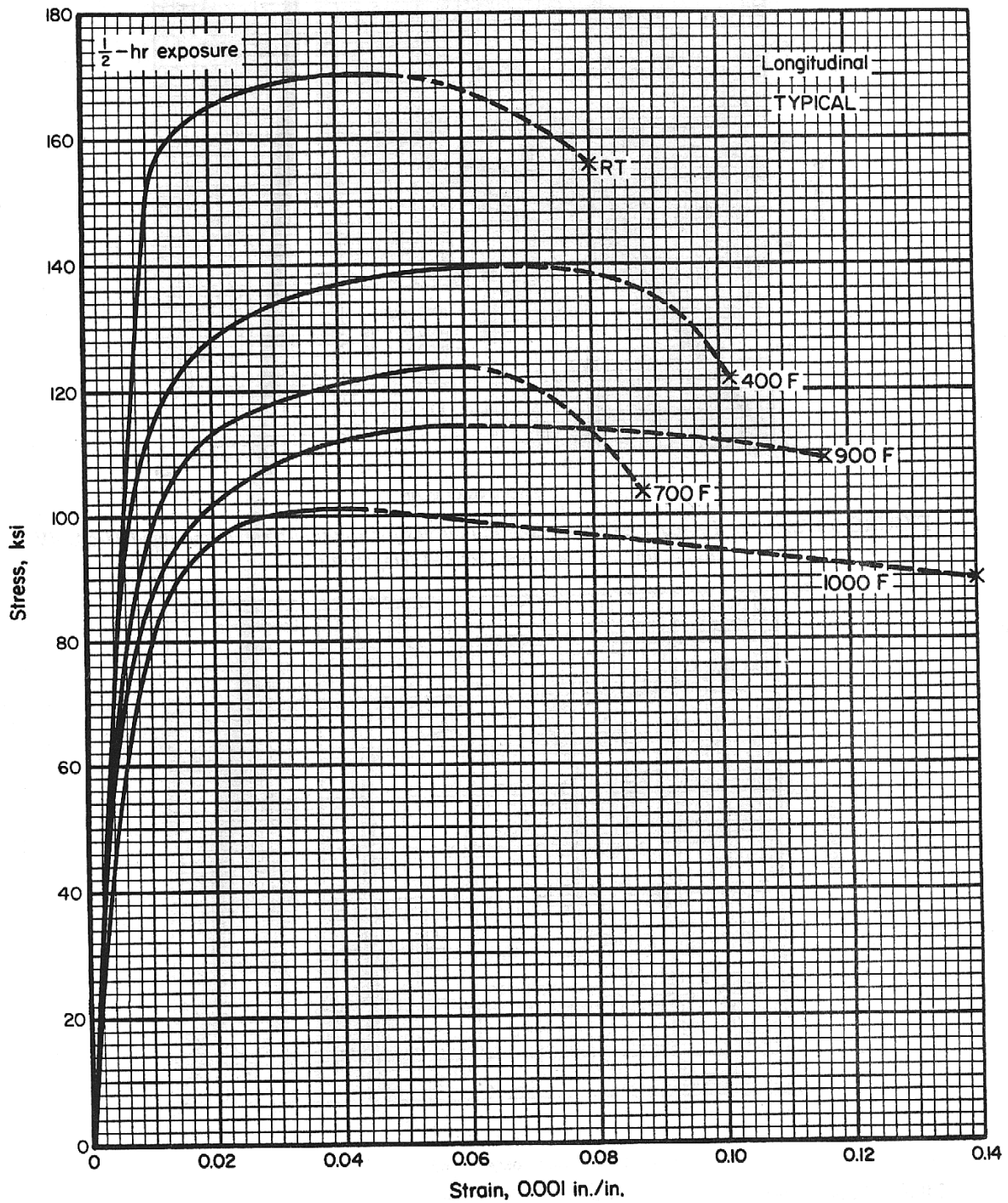
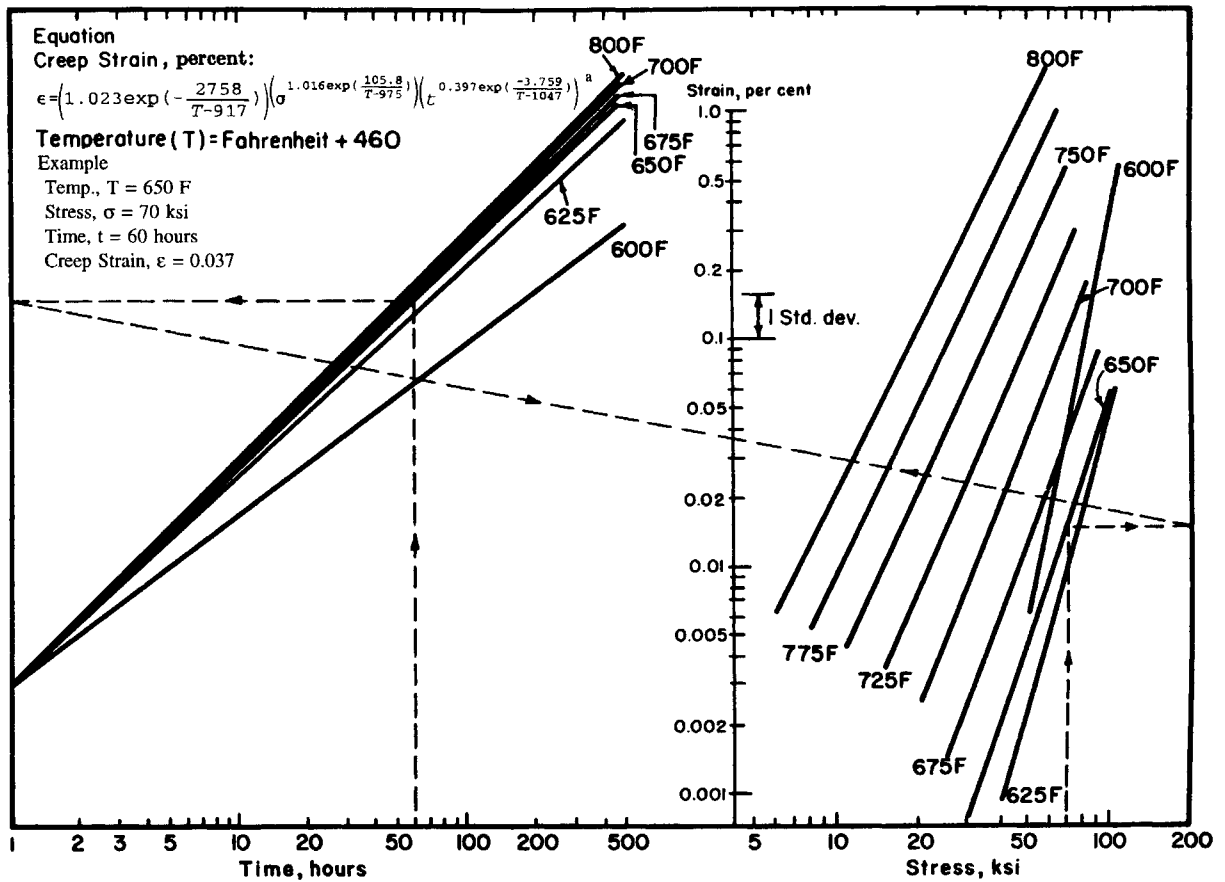

Figure 5.4.1.2.6(h). Typical tensile stress-strain curves (full range) for solution-treated and aged Ti-6Al-4V alloy at room and elevated temperatures.



- a This equation should only be used in the same temperature ranges indicated in the nomograph. Creep strains computed outside these temperature ranges may yield unreasonable values.

Figure 5.4.1.2.7. Typical creep properties of solution-treated and aged Ti-6Al-4V alloy sheet for temperature range 600°F through 800°F.

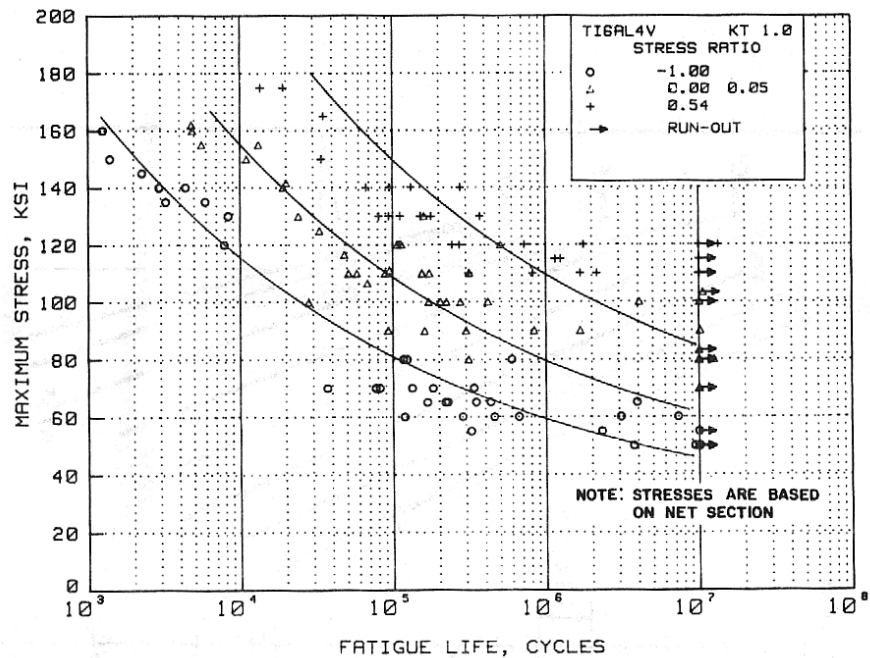

Figure 5.4.1.2.8(a). Best-fit S/N curves for unnotched solution-treated and aged Ti-6Al-4V sheet at room temperature, longitudinal direction.

Correlative Information for Figure 5.4.1.2.8(a)

Product Forms: Sheet, 0.063 inch and 0.125 inch thick

Properties: TUS, ksi TYS, ksi Temp., °F
166-177 153-167 RT

Specimen Details: Unnotched
Ref. 5.4.3.2.8(a)
Specimen details not available
Ref. 5.4.3.2.8(b)
1.000 inch net width
8.000 inch test section radius
3.00 inch gross width

Surface Conditions:
Ref. 5.4.3.2.8(a). Edges finished with a crocus cloth.
Ref. 5.4.3.2.8(b). Machined specimens were cleaned with methyl ethyl ketone. Edges polished with number 1 and 00 grit emery paper, recleaned with methyl ethyl ketone.

References: 5.4.1.2.8(a) and (b)

Test Parameters:
Loading — Axial
Frequency —
Ref. 5.4.3.2.8(a), not specified
Ref. 5.4.3.2.8(b), 1500-2200 cpm
Temperature — RT
Environment — Air

No. of Heats/Lots: 4

Equivalent Strain Equation:
 $\log N_f = 14.29 - 4.91 \log (S_{eq} - 30.6)$
 $S_{eq} = S_{max}(1-R)^{0.42}$
Std. Error of Estimate, $\log (\text{Life}) = 0.48$
Standard Deviation, $\log (\text{Life}) = 0.90$
 $R^2 = 72\%$

Sample Size = 99

[Caution: The equivalent stress model may provide unrealistic life predictions for stress ratios beyond those represented above.]

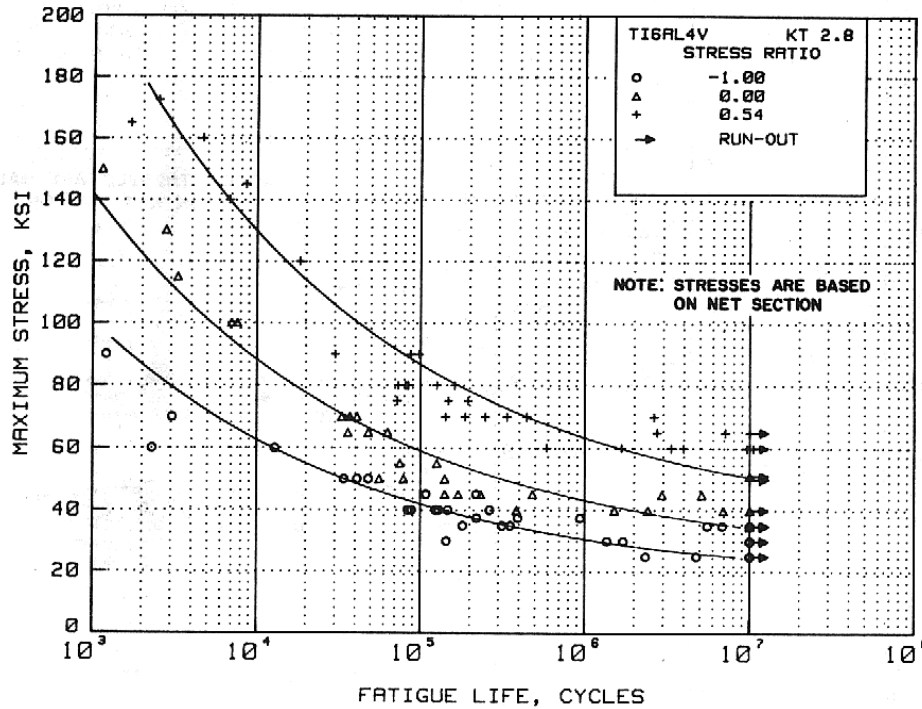

Figure 5.4.1.2.8(b). Best-fit S/N curves for notched, $K_t = 2.8$, solution-treated and aged Ti-6Al-4V sheet at room temperature, longitudinal direction.

Correlative Information for Figure 5.4.1.2.8(b)

Product Forms: Sheet, 0.063 inch and 0.125 inch thick

Properties: TUS, ksi 166-177 TYS, ksi 153-167 Temp., °F RT

Specimen Details: Notched, hole type, $K_t = 2.8$
0.9375 inch net width
1.000 inch gross width
8.000 inch test section radius
0.0625 inch-diameter hole

Surface Conditions: Machined specimens were cleaned with methyl ethyl ketone. Edges polished with number 1 and 00 grit emery paper and recleaned with methyl ethyl ketone.

Reference: 5.4.1.2.8(b)

Test Parameters:

Loading — Axial
Frequency — 1500-2200 cpm
Temperature — RT
Environment — Air

No. of Heats/Lots: 3

Equivalent Strain Equation:

$\log N_f = 10.87 - 3.80 \log (S_{eq} - 24.0)$
 $S_{eq} = S_{max} (1-R)^{0.50}$
Std. Error of Estimate, $\log (\text{Life}) = 0.43$
Standard Deviation, $\log (\text{Life}) = 0.98$
 $R^2 = 81\%$

Sample Size = 87

[Caution: The equivalent stress model may provide unrealistic life predictions for stress ratios beyond those represented above.]

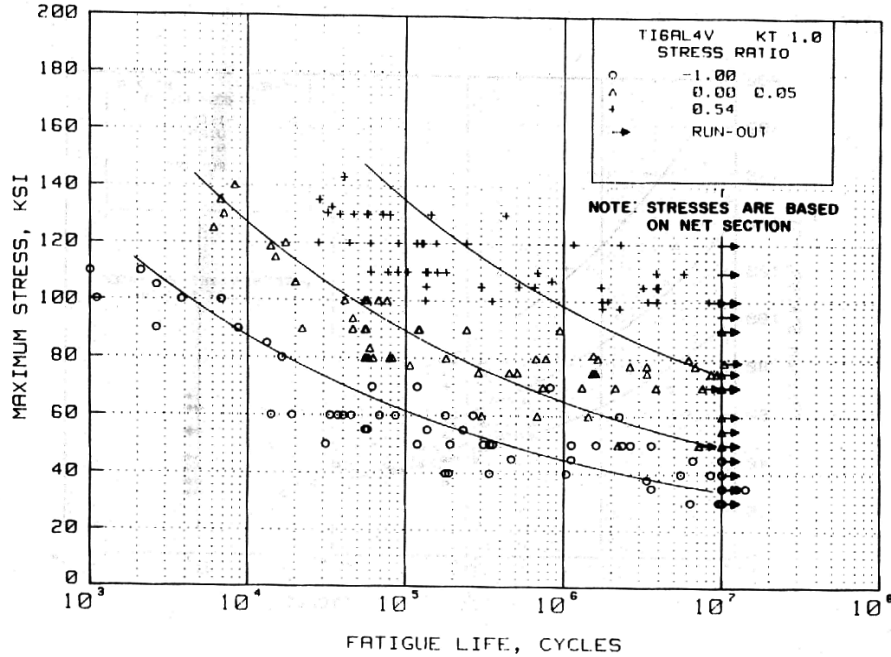

Figure 5.4.1.2.8(c). Best-fit S/N curves for unnotched solution-treated and aged Ti-6Al-4V sheet at 400°F and 600°F, longitudinal direction.

Correlative Information for Figure 5.4.1.2.8(c)

Product Forms: Sheet, 0.063 inch and 0.125 inch thick

Properties: TUS, ksi TYS, ksi Temp., °F
142-143 117-121 400°F
125-134 102-113 600°F

Specimen Details: Unnotched
Ref. 5.4.3.2.8(a)
Specimen details not available
Ref. 5.4.3.2.8(b)
1.000 inch gross width
8.000 inch test section radius
3.00 inch gross width
0.9375 inch net width

Surface Conditions:
Ref. 5.4.3.2.8(a). Edges finished with a crocus cloth
Ref. 5.4.3.2.8(b). Machined specimens were cleaned with methyl ethyl ketone. Edges polished with number 1 and 00 grit emery paper, re-cleaned with methyl ethyl ketone.

References: 5.4.1.2.8(a) and (b)

Test Parameters:
Loading — Axial
Frequency —
Ref. 5.4.3.2.8(a), not specified
Ref. 5.4.3.2.8(b), 1500-2200 cpm
Temperature — 400°F and 600°F
Environment — Air

No. of Heats/Lots: 4

Equivalent Strain Equation:
 $\log N_f = 14.7 - 5.31 \log (S_{eq} - 21.8)$
 $S_{eq} = S_{max}(1-R)^{0.54}$
Std. Error of Estimate, Log (Life) = 0.58
Standard Deviation, Log (Life) = 0.93
 $R^2 = 61\%$

Sample Size = 163

[Caution: The equivalent stress model may provide unrealistic life predictions for stress ratios beyond those represented above.]

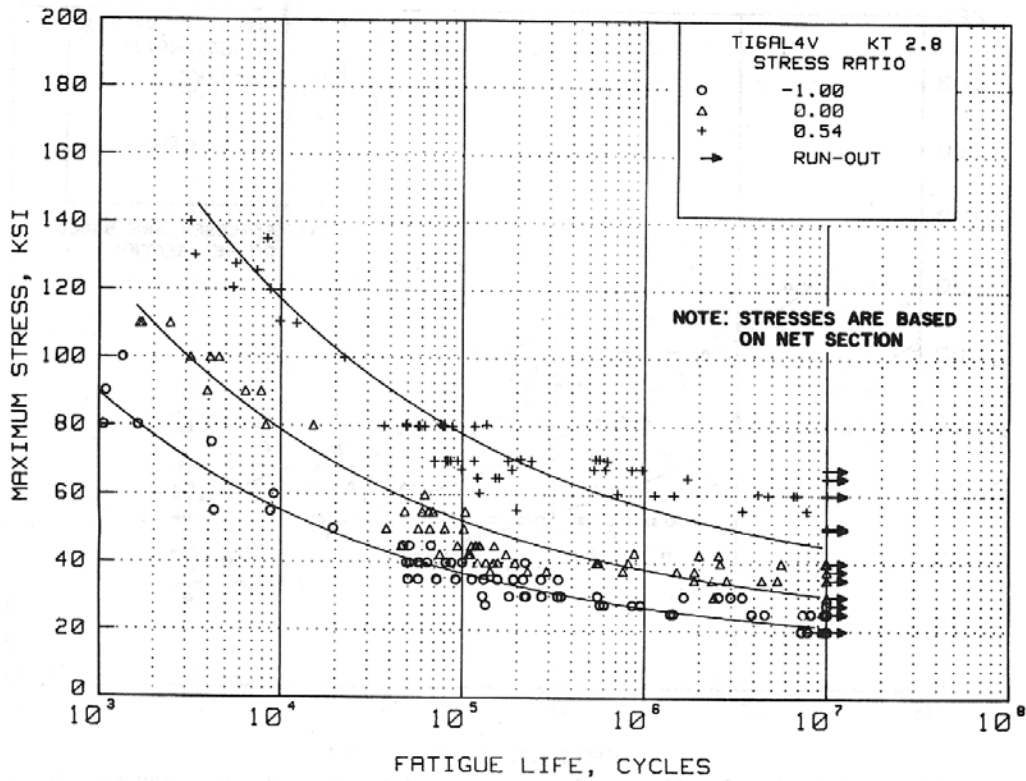

Figure 5.4.1.2.8(d). Best-fit S/N curves for notched, $K_t = 2.8$, solution-treated and aged Ti-6Al-4V sheet at 400 F and 600 F, longitudinal direction.

Correlative Information for Figure 5.4.1.2.8(d)

Product Forms: Sheet, 0.063 inch and 0.125 inch thick

Properties:

TUS, ksi	TYS, ksi	Temp., °F
142-143	117-121	400°F
129-133	103-105	600°F

Specimen Details: Notched, hole type, $K_t = 2.8$
1.000 inch gross width
8.000 inch test section radius
0.0625 inch-diameter hole
0.9375 inch net width

Surface Conditions: Machined specimens were cleaned with methyl ethyl ketone. Edges polished with number 1 and 00 grit emery paper and re-cleaned with methyl ethyl ketone.

Reference: 5.4.1.2.8(b)

Test Parameters:

Loading — Axial
Frequency — 1500-2200 cpm
Temperature — 400°F and 600°F
Environment — Air

No. of Heats/Lots: 3

Equivalent Stress Equation:

$\log N_f = 10.64 - 3.77 \log (S_{eq} - 20.9)$
 $S_{eq} = S_{max}(1-R)^{0.51}$
Std. Error of Estimate, $\log (\text{Life}) = 0.42$
Standard Deviation, $\log (\text{Life}) = 0.93$
 $R^2 = 80\%$

Sample Size = 175

[Caution: The equivalent stress model may provide unrealistic life predictions for stress ratios beyond those represented above.]

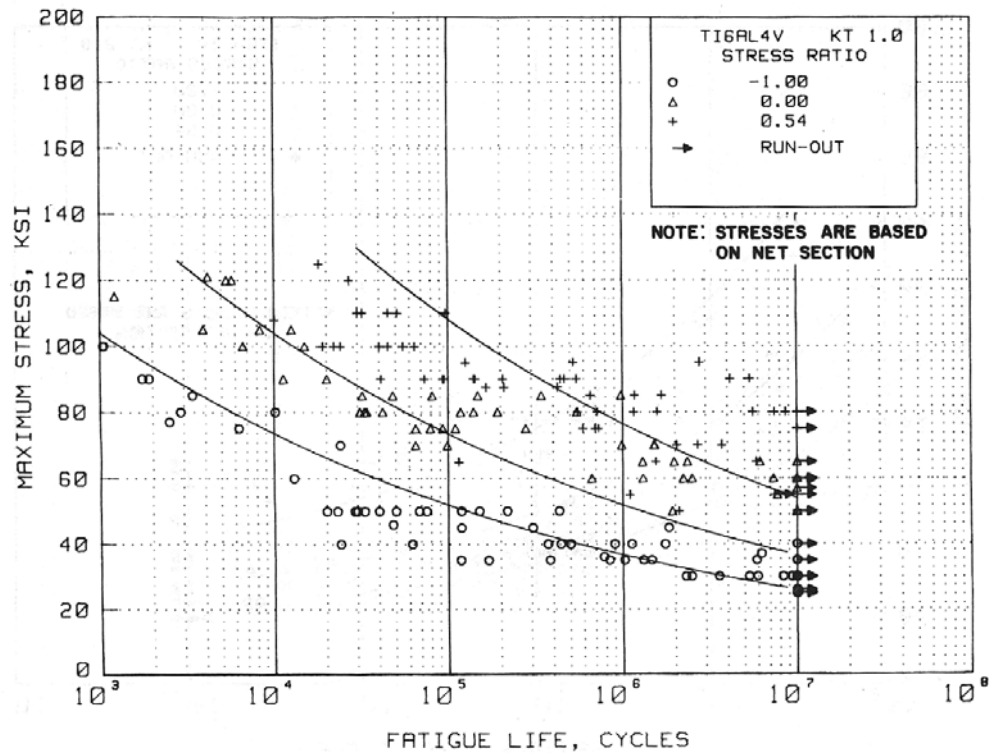

Figure 5.4.1.2.8(e). Best-fit S/N curves for unnotched solution-treated and aged Ti-6Al-4V sheet at 800°F and 900°F, longitudinal direction.

Correlative Information for Figure 5.4.1.2.8(e)

Product Forms: Sheet, 0.063 inch and
0.125 inch thick

Properties:

TUS, ksi	TYS, ksi	Temp., °F
120-125	93-96	800°F
110-111	84-86	900°F

Specimen Details: Unnotched
1.000 inch gross width
8.000 inch test section radius
3.00 inch gross width
0.9375 inch net width

Surface Conditions: Machined specimens were cleaned with methyl ethyl ketone. Edges polished with number 1 and 00 grit emery paper and re-cleaned with methyl ethyl ketone.

References: 5.4.1.2.8(b)

Test Parameters:

Loading — Axial
Frequency — 1500-2200 cpm
Temperature — 800°F and 900°F
Environment — Air

No. of Heats/Lots: 3

Equivalent Stress Equation:

$\text{Log } N_f = 17.34 - 6.61 \text{ log } (S_{eq})$
 $S_{eq} = S_{max}(1-R)^{0.50}$
Std. Error of Estimate, $\text{Log } (\text{Life}) = 0.51$
Standard Deviation, $\text{Log } (\text{Life}) = 0.99$
 $R^2 = 73\%$

Sample Size = 154

[Caution: The equivalent stress model may provide unrealistic life predictions for stress ratios beyond those represented above.]

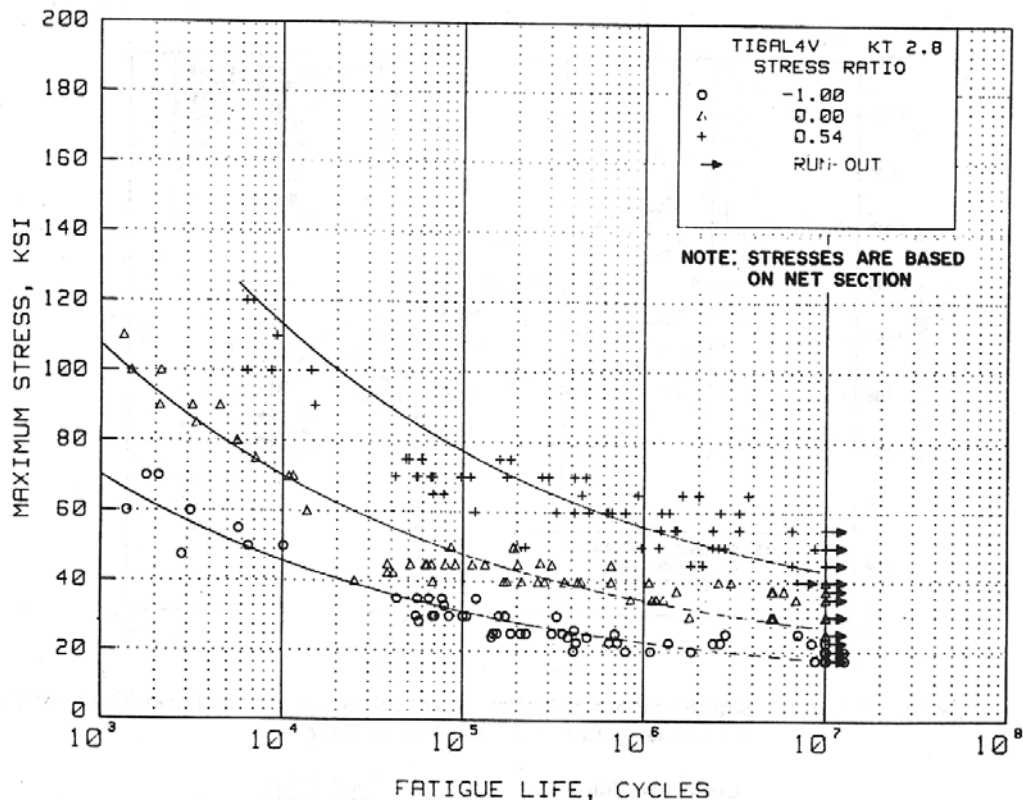

Figure 5.4.1.2.8(f). Best-fit S/N curves for notched, $K_t = 2.8$, solution-treated and aged Ti-6Al-4V sheet at 800°F and 900°F, longitudinal direction.

Correlative Information for Figure 5.4.1.2.8(f)

Product Forms: Sheet, 0.063 inch and 0.125 inch thick

Properties:

TUS, ksi	TYS, ksi	Temp., °F
120-124	93-96	800°F
110-111	84-88	900°F

Specimen Details: Notched, hole type, $K_t = 2.8$
1.000 inch gross width
8.000 inch test section radius
0.0625 inch-diameter hole
0.9375 inch net width

Surface Conditions: Machined specimens were cleaned with methyl ethyl ketone. Edges polished with number 1 and 00 grit emery paper and re-cleaned with methyl ethyl ketone.

Reference: 5.4.1.2.8(b)

Test Parameters:

Loading — Axial
Frequency — 1500-2200 cpm
Temperature — 800°F and 900°F
Environment — Air

No. of Heats/Lots: 3

Equivalent Stress Equation:

$$\log N_f = 11.75 - 4.45 \log (S_{eq} - 15.0)$$

$$S_{eq} = S_{max} (1 - R)^{0.62}$$

Std. Error of Estimate, $\log (\text{Life}) = 0.43$

Standard Deviation, $\log (\text{Life}) = 0.96$

$R^2 = 79\%$

Sample Size = 173

[Caution: The equivalent stress model may provide unrealistic life predictions for stress ratios beyond those represented above.]

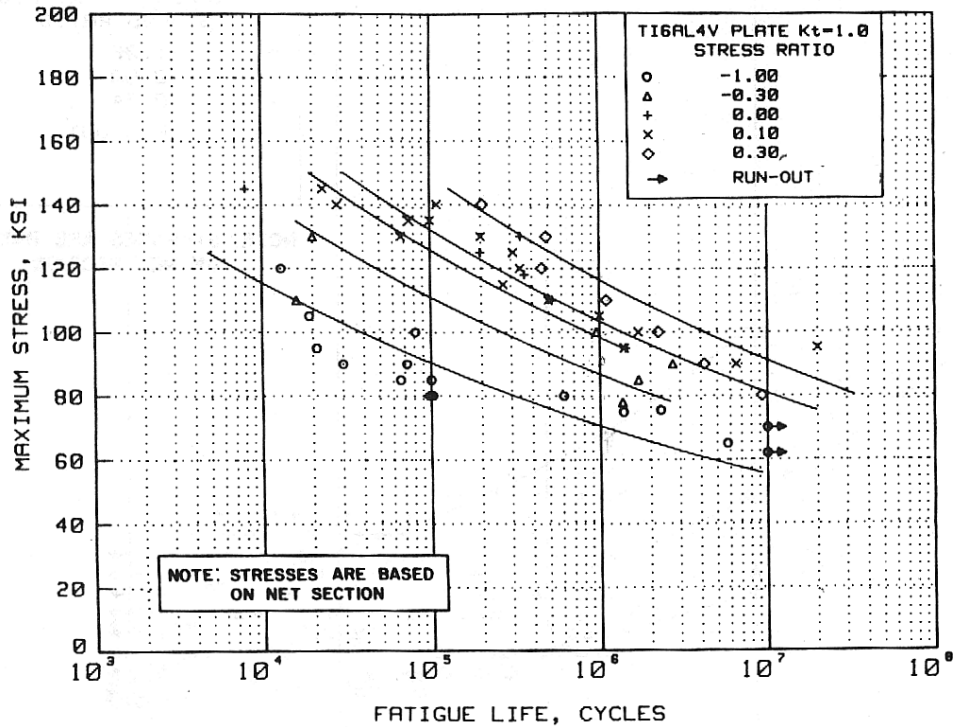

Figure 5.4.1.2.8(g). Best-fit S/N curves for unnotched solution-treated and aged Ti-6Al-4V plate at room temperature, longitudinal direction.

Correlative Information for Figure 5.4.1.2.8(g)

Product Form: Plate, 1.00 inch

Test Parameters:

Properties:

TUS, ksi	TYS, ksi	Temp., °F
158	149	RT
155	145	RT

Loading — Axial
Frequency — 1,800-18,000 cpm
Temperature — RT
Environment — Air

Specimen Details: Unnotched, rounded

No. of Heats/Lots: 2

Uniform

Equivalent Stress Equation:

Gage	Hourglass	
---	3.25	Reduced section radius of curvature, inch
0.195	0.250	Diameter, inch

$\log N_f = 24.6 - 9.35 \log (S_{max})$
 $S_{eq} = S_{max}(1-R)^{0.48}$
Std. Error of Estimate, $\log (\text{Life}) = 0.39$
Standard Deviation, $\log (\text{Life}) = 0.83$
 $R^2 = 79\%$

Surface Condition: Longitudinally polished with No. 000 emery paper removing all circumferential marks.

Sample Size = 49

References: 5.4.1.2.8(c) and (d)

[Caution: The equivalent stress model may provide unrealistic life predictions for stress ratios beyond those represented above.]

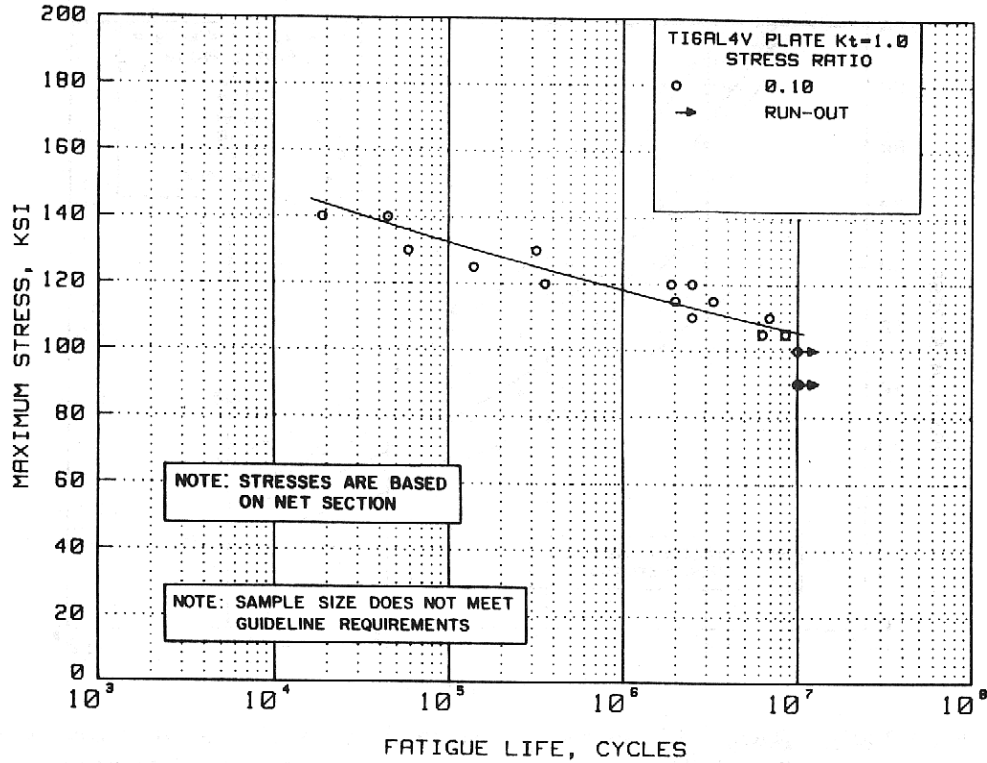

Figure 5.4.1.2.8(h). Best-fit S/N curves for unnotched solution-treated and aged Ti-6Al-4V plate at room temperature, long transverse direction.

Correlative Information for Figure 5.4.1.2.8(h)

Product Form: Plate, 0.50 inch thick

Test Parameters:

Properties: TUS, ksi TYS, ksi Temp., °F
 173 164 RT

Loading — Axial
Frequency — Unspecified
Temperature — RT
Environment — Air

Specimen Details: Unnotched, flat hourglass
10 inch reduced section radius
of curvature
1 inch net section width
0.156 inch net section
thickness

No. of Heats/Lots: 1

Maximum Stress Equation:
 $\log N_f = 47.9 - 20.2 \log (S_{max})$
Std. Error of Estimate, $\log (\text{Life}) = 0.33$
Standard Deviation, $\log (\text{Life}) = 0.89$
 $R^2 = 87\%$

Surface Conditions: Machined to 63 RMS

Reference: 5.4.1.2.8(d)

Sample Size = 14

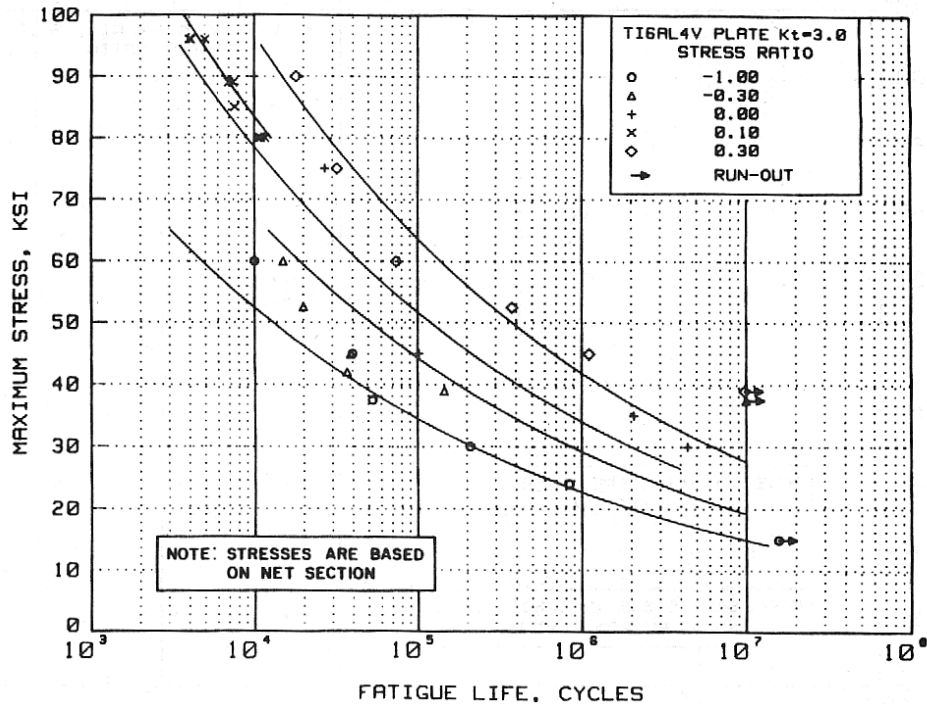

Figure 5.4.1.2.8(i). Best-fit S/N curves for notched, $K_t = 3.0$, solution-treated and aged Ti-6Al-4V plate at room temperature, longitudinal direction.

Correlative Information for Figure 5.4.1.2.8(i)

Product Form: Plate, 1.025 and 0.750 inch thick

Properties:

TUS, ksi	TYS, ksi	Temp., °F
155	145	RT (unnotched)
187	—	RT (notched)

Specimen Details: Circumferentially notched,
 $K_t = 3.0$

Ref. (c)	Ref. (e)	
0.195	0.430	Gross diameter, inch
0.136	0.300	Net section, inch
0.005	0.016	Notch radius, r, inch
60°	60°	Flank angle, ω

Surface Condition:
Ref. (c) notch made with light finishing cuts
Ref. (e) notch polished in lathe

References: 5.4.1.2.8(c) and (e)

Test Parameters:

Loading — Axial
Frequency — 1,800-18,000 cpm
Temperature — RT
Environment — Air

No. of Heats/Lots: 2

Equivalent Stress Equation:

$\log N_f = 14.4 - 5.51 \log (S_{eq})$
 $S_{eq} = S_{max}(1-R)^{0.58}$
Std. Error of Estimate, $\log (\text{Life}) = 0.24$
Standard Deviation, $\log (\text{Life}) = 0.81$
 $R^2 = 92\%$

Sample Size = 31

[Caution: The equivalent stress model may provide unrealistic life predictions for stress ratios beyond those represented above.]

5.4.2 Ti-6Al-6V-2Sn

5.4.2.0 Comments and Properties — Ti-6Al-6V-2Sn alloy is similar to Ti-6Al-4V alloy in many respects but has higher strength and deeper hardenability (i.e., use of thicker sections possible). A variety of mill product forms are available including billet, bar, plate, sheet, strip, and extrusions and these may be used in either the annealed or the solution-treated and aged (STA) conditions. The maximum strength is developed in the STA condition in sections up to about 2 inches in thickness.

Manufacturing Considerations — To ensure optimum mechanical properties in Ti-6Al-6V-2Sn forgings, at least 50 percent reduction should be done at temperatures below the beta transus temperature (i.e., <1735°F). The Ti-6Al-6V-2Sn is readily formable in the annealed condition. In the sheet or plate forms the alloy is generally used in the annealed condition, although the alloy is capable of heat treatment to higher strength levels with some loss of toughness. When the Ti-6Al-6V-2Sn sheet and plate are hot formed at any temperature over 1000°F and air cooled, the material should be stabilized by reheating to 1000°F followed by air cooling. Welding is not usually recommended although limited weld joining operations are possible if the assembly is amenable to post-weld thermal treatments for the restoration of ductility to the weld and heat-affected zones.

Environmental Considerations — While the short-time elevated-temperature properties and stability of Ti-6Al-6V-2Sn alloy are good, creep strength above 650°F and long-term stability at temperatures above 800°F are not. The material ages during prolonged exposures around 800°F and above, particularly when under stress. Oxidation resistance of Ti-6Al-6V-2Sn is satisfactory in short-term exposures to 1000°F. The material is nearly equivalent to the Ti-6Al-4V alloy in terms of hot-salt and aqueous chloride solution stress-corrosion resistance. Under certain conditions, titanium, when in contact with cadmium, silver, mercury, or certain of their compounds, may become embrittled. Refer to MIL-S-5002 and MIL-STD-1568 for restrictions concerning applications with titanium in contact with these metals or their compounds.

Heat Treatment — This alloy is commonly specified in either the annealed condition or the solution-treated and aged condition. The solution-treated and aged condition is as follows:

Solution treat at 1625°F for ½ to 1 hour, quench in water.

Age at 1000 ± 25°F for 4 to 8 hours, air cool.

Specifications and Properties — Material specifications for Ti-6Al-6V-2Sn are shown in Table 5.4.2.0(a). Room-temperature mechanical properties are shown in Tables 5.4.2.0(b) through (e). The effect of temperature on physical properties is shown in Figure 5.4.2.0.

5.4.2.1 Annealed Condition — Elevated temperature curves for annealed condition are shown in Figures 5.4.2.1.1(a) through 5.4.2.1.3(b). Typical stress-strain and tangent-modulus curves for this condition are shown in Figures 5.4.2.1.6(a) and (b). A typical full range tensile stress-strain curve is shown in Figure 5.4.2.1.6(c). Unnotched and notched fatigue data are presented in Figures 5.4.2.1.8(a) and (b).

5.4.2.2 Solution-Treated and Aged Condition — Elevated temperature curves are shown in Figures 5.4.2.2.1 and 5.4.2.2.2.

Table 5.4.2.0(a). Material Specifications for Ti-6Al-6V-2Sn

Specification	Form
AMS-T-9046	Sheet, strip, and plate
AMS 4979	Bar and forging
MIL-T-81556, AMS-T-81556	Extruded bar and shapes
AMS 4971	Bar and forging
AMS 4978	Bar and forging
AMS 4918	Sheet, strip, and plate

Table 5.4.2.0(b). Design Mechanical and Physical Properties of Ti-6Al-6V-2Sn Sheet, Strip, and Plate

Specification	AMS-T-9046, Comp. AB-3, and AMS 4918		AMS-T-9046, Comp. AB-3					
	Sheet, strip, and plate							
	Annealed		Solution treated and aged					
Form	Sheet, strip, and plate							
Condition								
Thickness, in.	<0.1875	0.1875-0.500	1.001-1.500	1.501-2.000	2.001-4.000	0.1875-1.500	1.501-2.500	2.501-4.000
	A	B	S	S	S	S	S	S
Mechanical Properties:								
F_{10^3} ksi:								
L	155	160	150	150	145	170	160	150
LT	155	150	150	150	145	170	160	150
F_{10^3} ksi:								
L	145 ^a	152	140	140	135	160	150	140
LT	145 ^a	154	140	140	135	160	150	140
F_{10^3} ksi:								
L	139	142	...	170
LT	151	147	...	170
F_{10^3} ksi:								
L	91	93	...	101
F_{10^3} ksi:								
(e/D = 1.5)	236	241	...	264
(e/D = 2.0)	294	303	...	324
F_{10^3} ksi:								
(e/D = 1.5)	193	196	...	237
(e/D = 2.0)	215	223	...	266
e , percent (S-basis):								
L	10 ^b	...	10	10	8	8	6	6
LT	8 ^b	...	8	8	6	6	6	6
E , 10 ³ ksi	16.0							
E_c , 10 ³ ksi	16.4							
G , 10 ³ ksi	6.2							
μ	0.31							
Physical Properties:								
ω , lb/in. ³	0.164							
C , K , and α	See Figure 5.4.2.0							

a The rounded T_{99} values are higher than specification values as follows: F_y (L) = 147 ksi, F_y (LT) = 149 ksi.

b Longitudinal <0.025 in. = 8 percent. Long transverse <0.025 in. = 6 percent.

MIL-HDBK-5J
31 January 2003

Table 5.4.2.0(c). Design Mechanical and Physical Properties of Ti-6Al-6V-2Sn Bar

Specification	AMS 4978						AMS 4971 and AMS 4979			
	Bar						Bar and forging			
Form	Air-cool annealed ^a						Solution treated and aged			
Condition	≤1.500		1.501-3.000		3.001-4.000		≤1.000	1.001-2.000	2.001-3.000	3.001-4.000
Thickness or diameter, in.	A	B	A	B	A	B	S	S	S	S
Basis	A	B	A	B	A	B	S	S	S	S
Mechanical Properties:										
F_u , ksi:										
L	144	150	139	145	136	142	175	170	155	150
LT ^b	147	152	143	148	140	145	175	170	155	150
ST ^b	155	150
F_{ty} , ksi:										
L	131	138	126	132	123	129	160	155	145	140
LT ^b	136	141	131	136	127	132	160	155	145	140
ST ^b	145	140
F_{cy} , ksi:										
L
LT ^b
ST ^b
F_{su} , ksi
F_{bru} , ksi:										
(e/D = 1.5)
(e/D = 2.0)
F_{bry} , ksi:										
(e/D = 1.5)
(e/D = 2.0)
e , percent (S-basis):										
L	10	...	10	...	10	...	8	8	8	8
LT ^b	8	...	8	...	8	...	6	6	6	6
ST ^b	8	...	8	6	6
RA , percent (S-basis):										
L	20	...	20	...	15	...	20	20	20	20
LT ^b	15	...	15	...	15	...	15	15	15	15
ST ^b	15	...	15	15	15
E , 10 ³ ksi							16.0			
E_c , 10 ³ ksi							16.4			
G , 10 ³ ksi							6.2			
μ							0.31			
Physical Properties:										
ω , lb/in. ³							0.164			
C , K , and α							See Figure 5.4.2.0			

a 1300 to 1350°F for 1-3 hours, air cool to room temperature.
b Applicable, providing LT or ST dimension is ≥2.500 inches.

Table 5.4.2.0(d). Design Mechanical and Physical Properties of Ti-6Al-6V-2Sn Forging

Specification	AMS 4978	
	Forging	
	Annealed	
	≤2.000	2.001-4.000
Basis	S	S
Mechanical Properties:		
F_{tu} , ksi:		
L	150	145
LT ^a	150	145
ST ^a	145
F_{ty} , ksi:		
L	140	135
LT ^a	140	135
ST ^a	135
F_{cy} , ksi:		
L
LT ^a
ST ^a
F_{su} , ksi
F_{bru} , ksi:		
(e/D=1.5)
(e/D=2.0)
F_{bry} , ksi:		
(e/D=1.5)
(e/D=2.0)
e , percent:		
L	10	10
LT ^a	8	8
ST ^a	7
RA , percent:		
L	20	20
LT ^a	15	15
ST ^a	15	15
E , 10 ³ ksi	16.0	
E_e , 10 ³ ksi	16.4	
G , 10 ³ ksi	6.2	
μ	0.31	
Physical Properties:		
ω , lb/in. ³	0.164	
C , K , and α	See Figure 5.4.2.0	

a Applicable, providing LT or ST dimension is ≥2.500 inches.

MIL-HDBK-5J
31 January 2003

Table 5.4.2.0(e). Design Mechanical and Physical Properties of Ti-6Al-6V-2Sn Extruded Bar and Shapes

Specification	MIL-T-81556 & AMS-T-81556, Comp. AB-3							
	Extruded bar and shapes							
	Annealed				Solution treated and aged			
	≤2.000		2.001-3.000	3.001-4.000	0.188-0.500	0.501-1.500	1.501-2.500	2.501-4.000
Basis	A	B	S	S	S	S	S	S
Mechanical Properties:								
<i>F_{tu}</i> , ksi:								
L	142	148	145	140	170	165	160	150
LT	141	148	145	140	170	165	160	150
<i>F_{ty}</i> , ksi:								
L	129	135	135	130	160	155	150	140
LT	128	135	135	130	160	155	150	140
<i>F_{cy}</i> , ksi:								
L	137	144	140	135	165	160	155	145
LT	136	142	140	135	165	160	155	145
<i>F_{su}</i> ^a , ksi								
	93	97
<i>F_{bru}</i> ^a , ksi:								
(e/D=1.5)	218	229
(e/D=2.0)	268	281
<i>F_{brv}</i> ^a , ksi:								
(e/D=1.5)	196	203
(e/D=2.0)	227	235
<i>e</i> , percent (S-basis):								
L	10	...	10	10	8	8	8	8
LT	8	...	8	8	6	6	6	6
<i>RA</i> , percent (S-basis):								
L	20	...	20	20	15	15	15	15
LT	15	...	15	15	12	12	12	12
<i>E</i> , 10 ³ ksi								
					16.0			
<i>E_c</i> , 10 ³ ksi								
					16.4			
<i>G</i> , 10 ³ ksi								
					6.2			
<i>μ</i>								
					0.31			
Physical Properties:								
<i>ω</i> , lb/in. ³								
					0.164			
<i>C</i> , <i>K</i> , and <i>α</i>								
					See Figure 5.4.2.0			

^a Bearing values are “dry pin” values per Section 1.4.7.1.

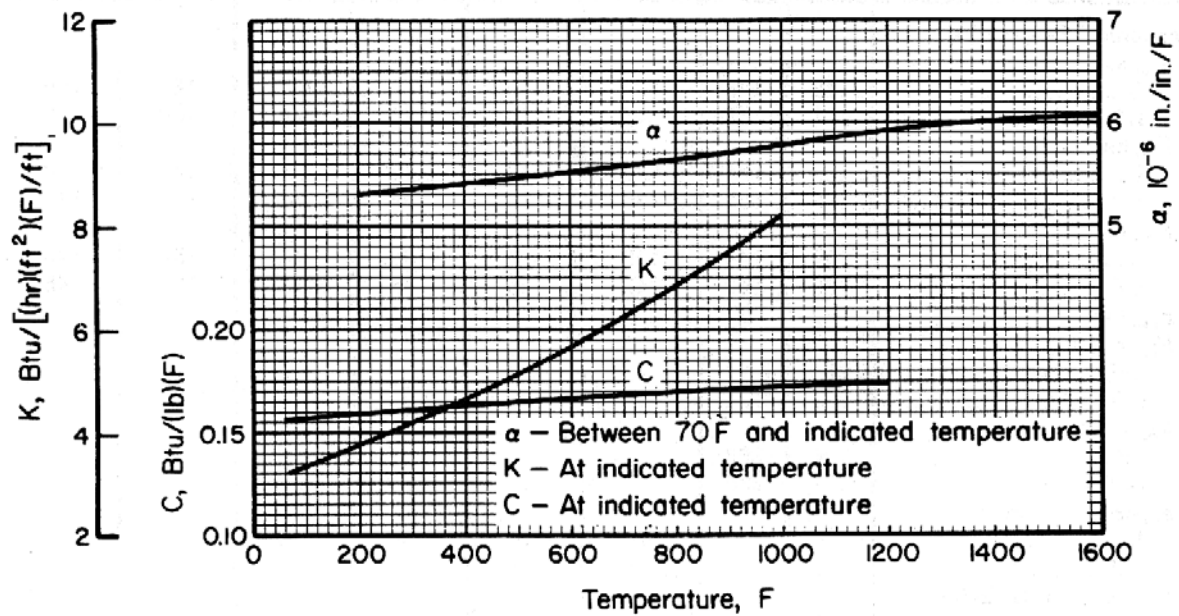

Figure 5.4.2.0. Effect of temperature on the physical properties of Ti-6Al-6V-2Sn alloy.

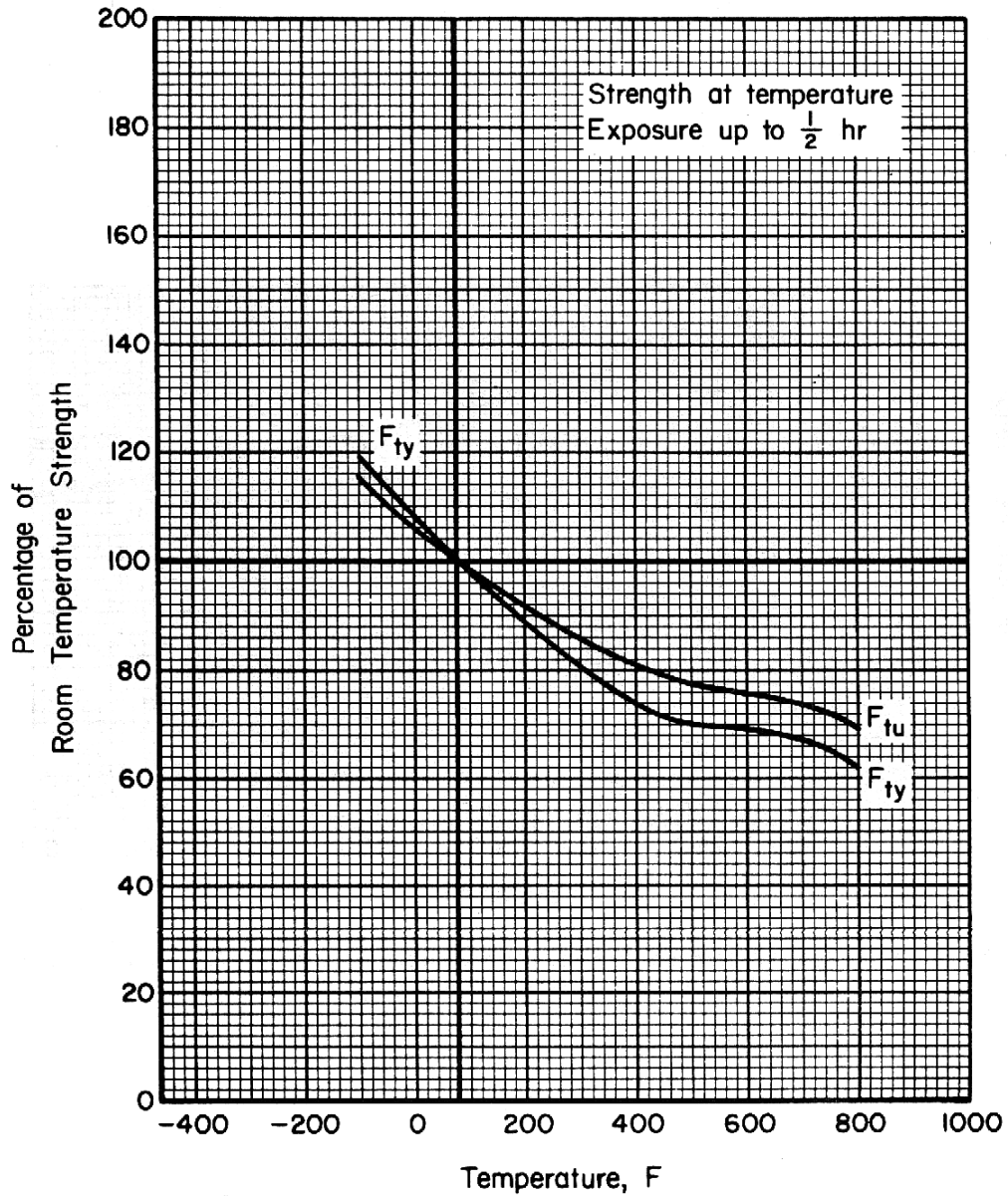

Figure 5.4.2.1.1(a). Effect of temperature on the tensile ultimate strength (F_{tu}) and the tensile yield strength (F_{ty}) of annealed Ti-6Al-6V-2Sn extrusion.

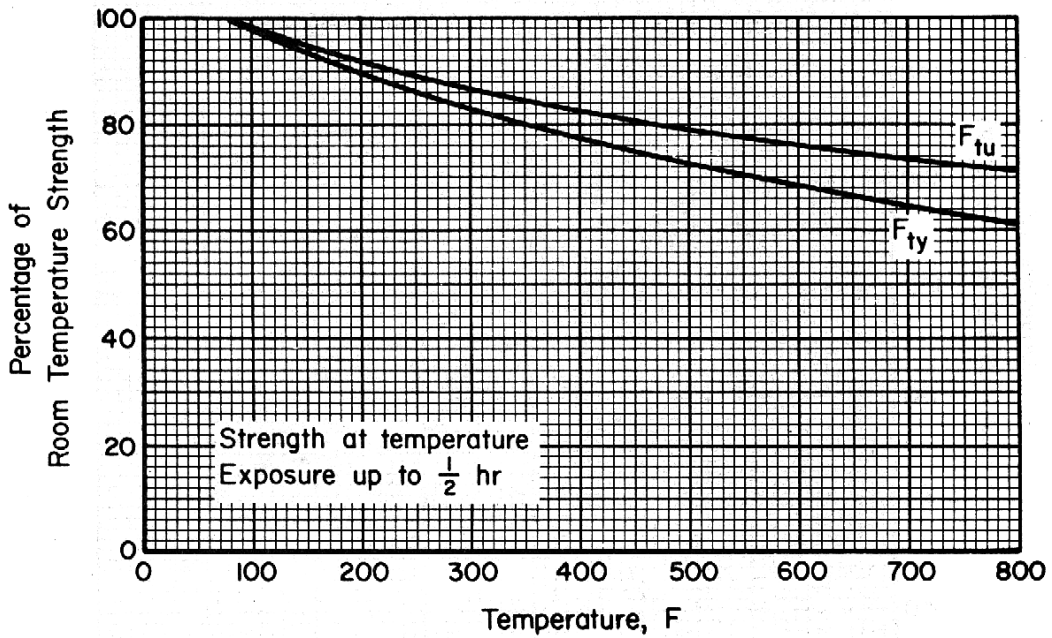

Figure 5.4.2.1.1(b). Effect of temperature on the tensile ultimate strength (F_{tu}) and the tensile yield strength (F_{ty}) of annealed Ti-6Al-6V-2Sn plate.

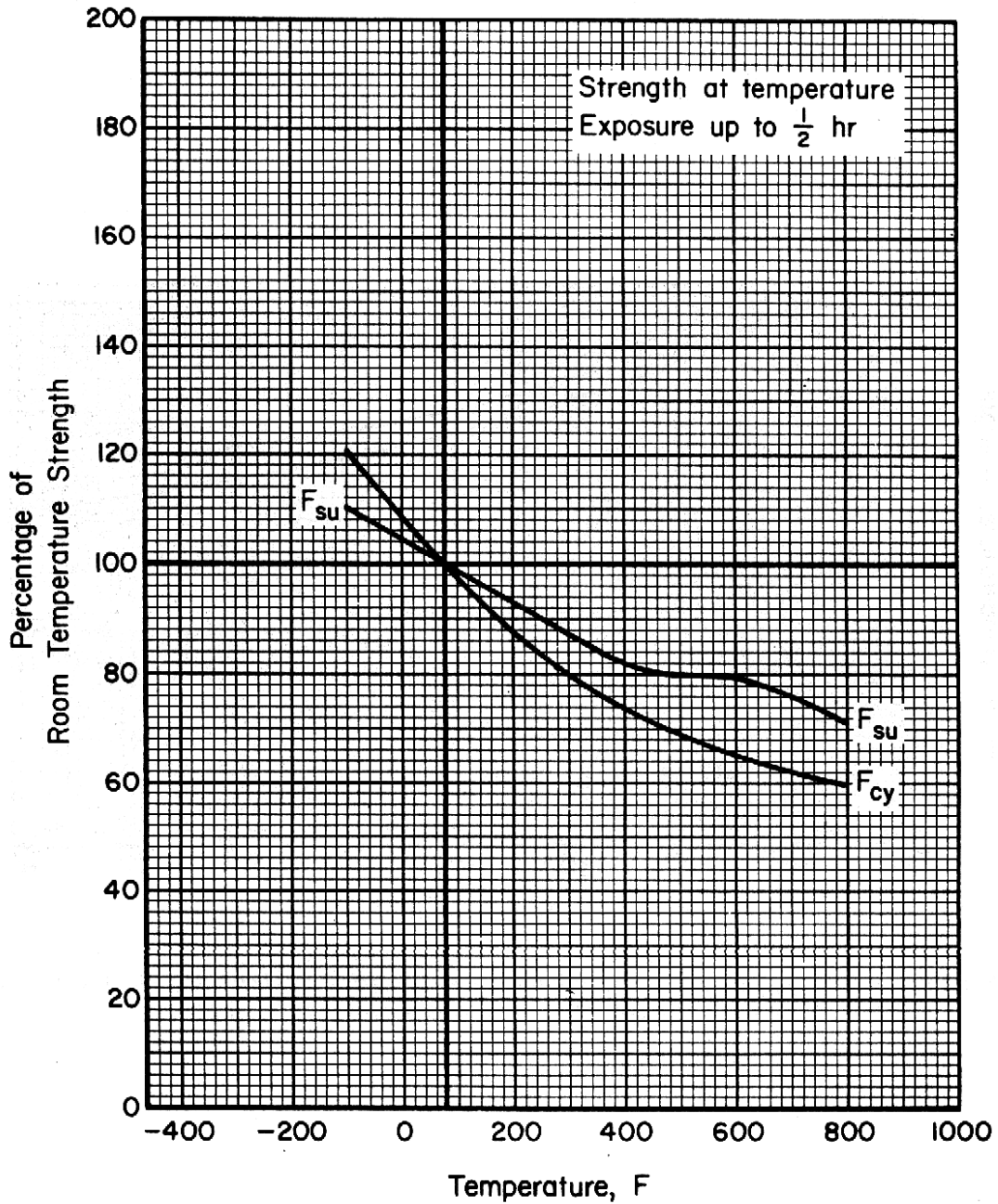

Figure 5.4.2.1.2(a). Effect of temperature on the compressive yield strength (F_{cy}) and the shear ultimate strength (F_{su}) of annealed Ti-6Al-6V-2Sn extrusion.

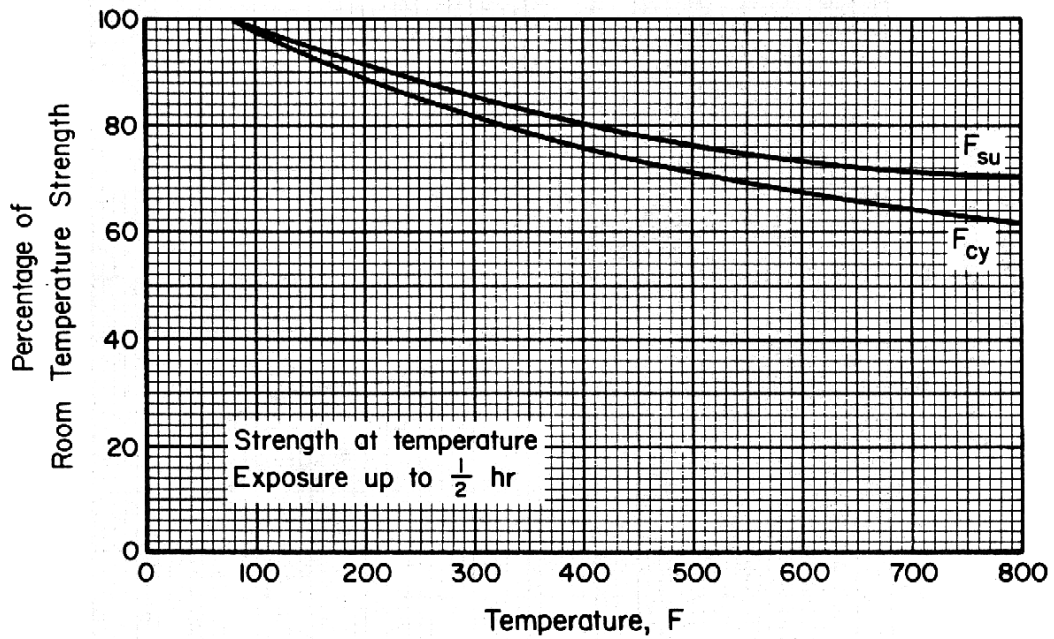

Figure 5.4.2.1.2(b). Effect of temperature on the compressive yield strength (F_{cy}) and the shear ultimate strength (F_{su}) of annealed Ti-6Al-6V-2Sn plate.

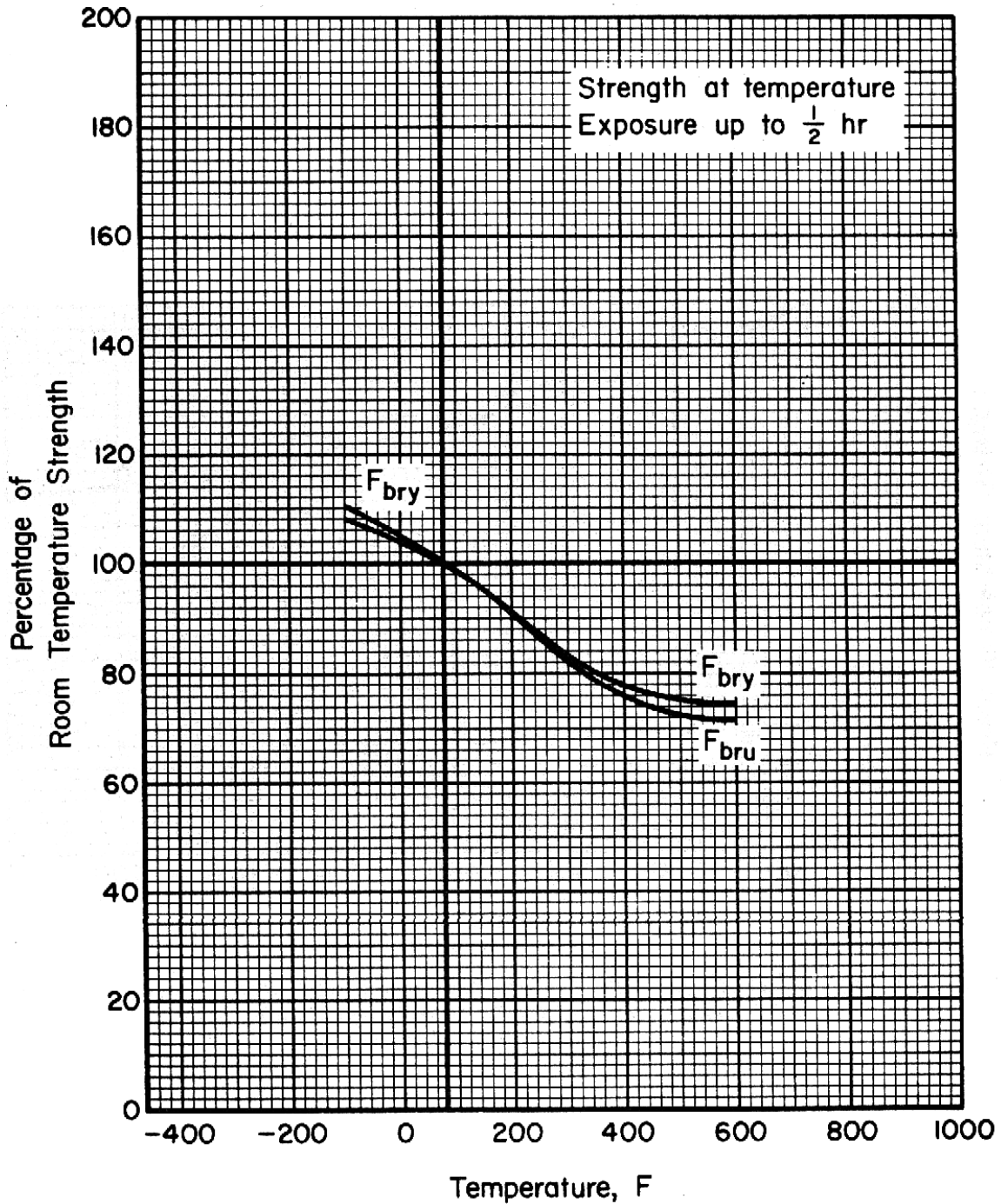

Figure 5.4.2.1.3(a). Effect of temperature on the bearing ultimate strength (F_{bru}) and the bearing yield strength (F_{bry}) of annealed Ti-6Al-6V-2Sn extrusion.

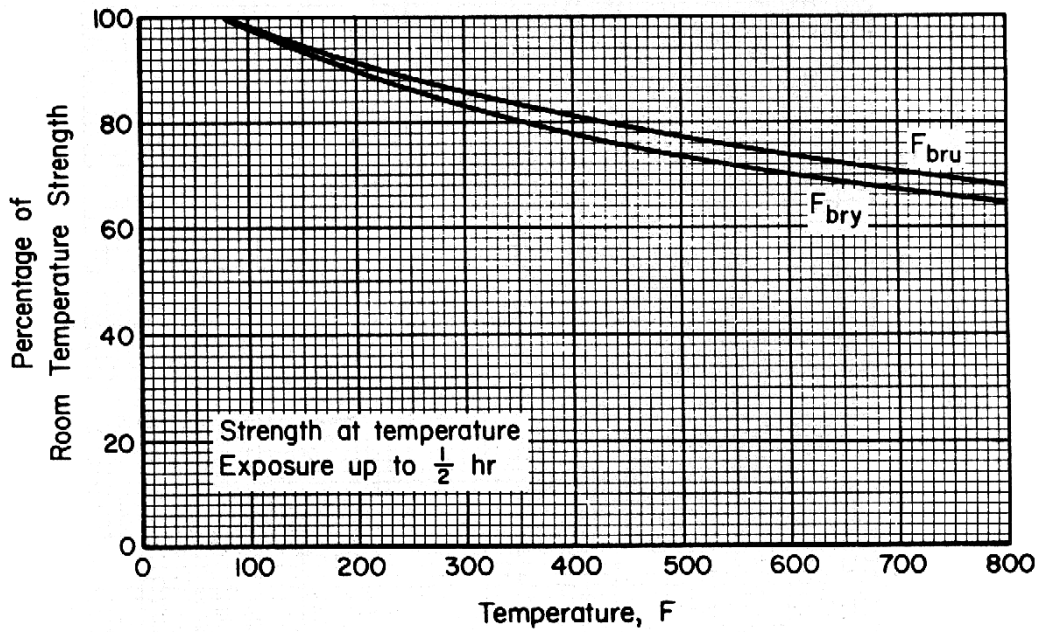

Figure 5.4.2.1.3(b). Effect of temperature on the bearing ultimate strength (F_{bru}) and the bearing yield strength (F_{bry}) of annealed Ti-6Al-6V-2Sn plate.

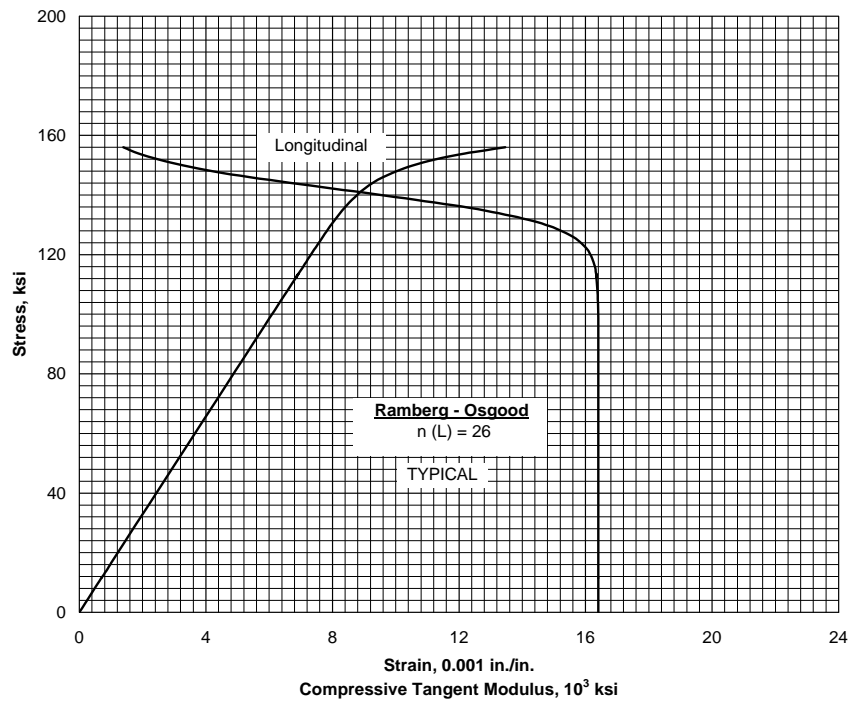

Figure 5.4.2.1.6(a). Typical compressive stress-strain and tangent-modulus curves at room temperature for annealed Ti-6Al-6V-2Sn extrusion.

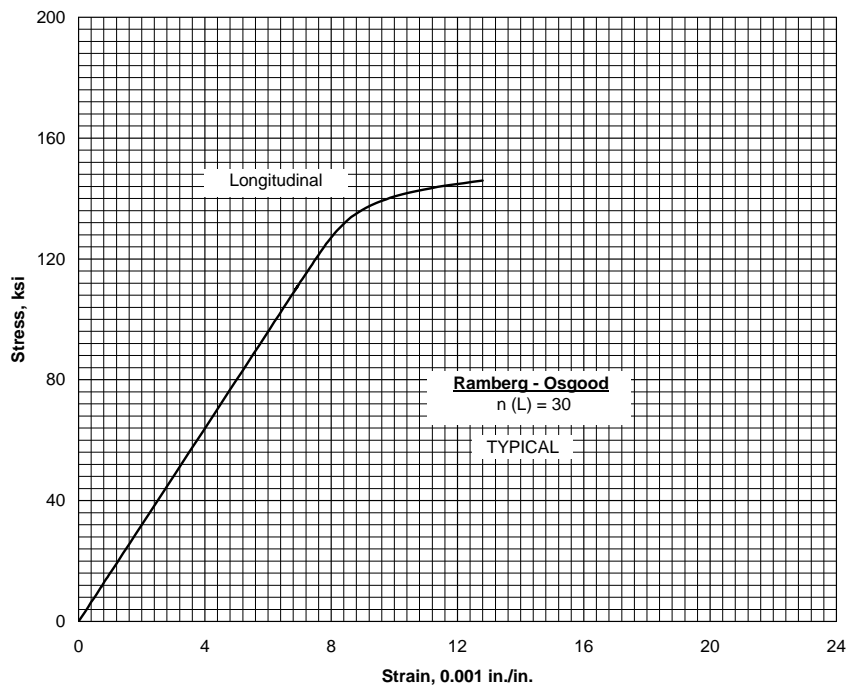

Figure 5.4.2.1.6(b). Typical tensile stress-strain curve at room temperature for annealed Ti-6Al-6V-2Sn extrusion.

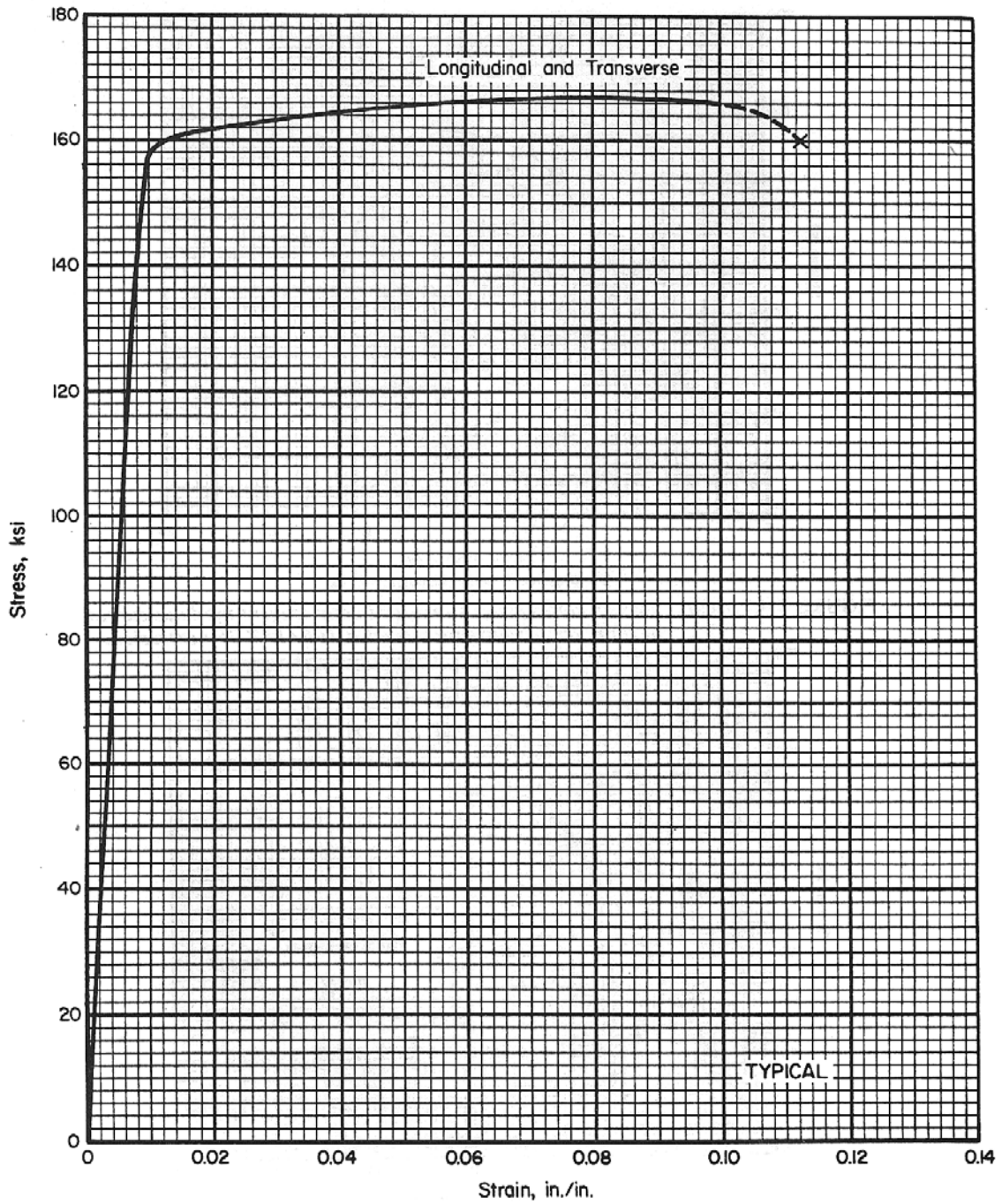

Figure 5.4.2.1.6(c). Typical tensile stress-strain curve (full range) for annealed Ti-6Al-6V-2Sn sheet at room temperature.

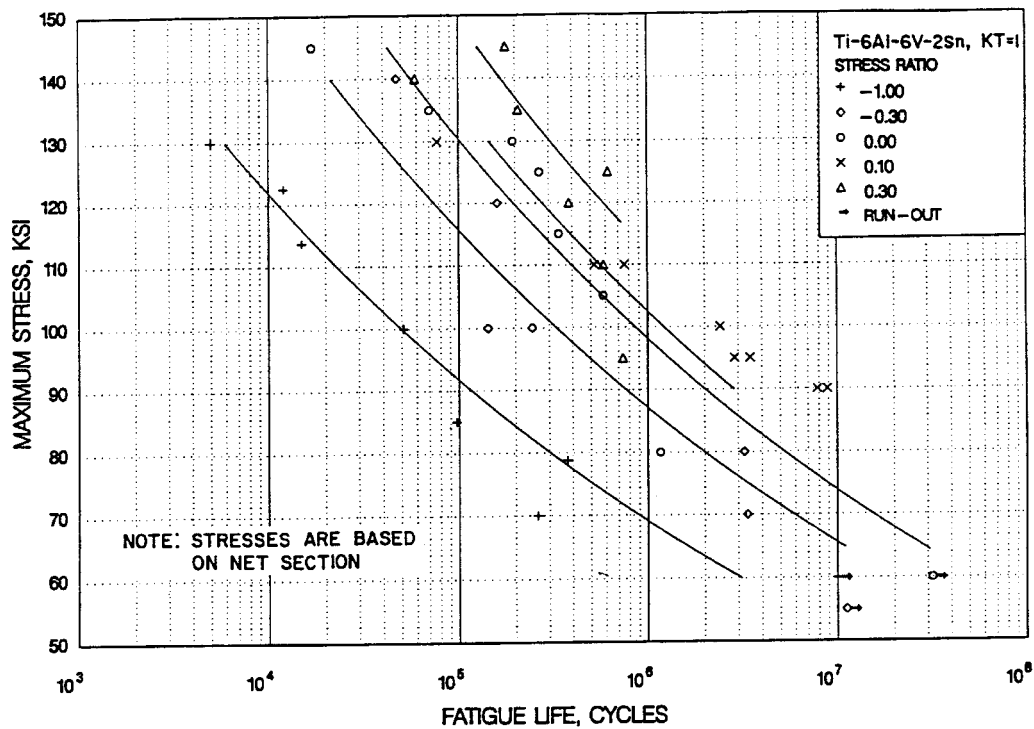

Figure 5.4.2.1.8(a). Best-fit S/N curves for annealed Ti-6Al-6V-2Sn plate and die forging, $K_t = 1.0$, longitudinal direction.

Correlative Information for Figure 5.4.2.1.8(a)

Product Form: Plate, 1.57 inch thick; die forging, thickness not specified

Properties:

TUS, ksi	TYS, ksi	Temp., °F
154.5	148.5	RT
159.9	151.5	RT

Specimen Details: Unnotched
0.195 inch diameter
Unspecified diameter from forging

Surface Condition: RMS 32
Unspecified from forging

References: 5.4.1.2.8(c) and 5.4.2.1.8

Test Parameters:
Loading—Axial
Frequency—Unspecified
Temperature—RT
Atmosphere—Air

No. of Heats/Lot: 3

Equivalent Stress Equation:
 $\log N_f = 20.90 - 8.10 \log (S_{eq})$
 $S_{eq} = S_a + 0.41 S_m$
Std. Error of Estimate, $\log (\text{Life}) = 23.5 (1/S_{eq})$
Standard deviation, $\log (\text{Life}) = 0.884$
 $R^2 = 89\%$

Sample Size = 38

[Caution: The equivalent stress model may provide unrealistic life predictions for stress ratios beyond those represented above.]

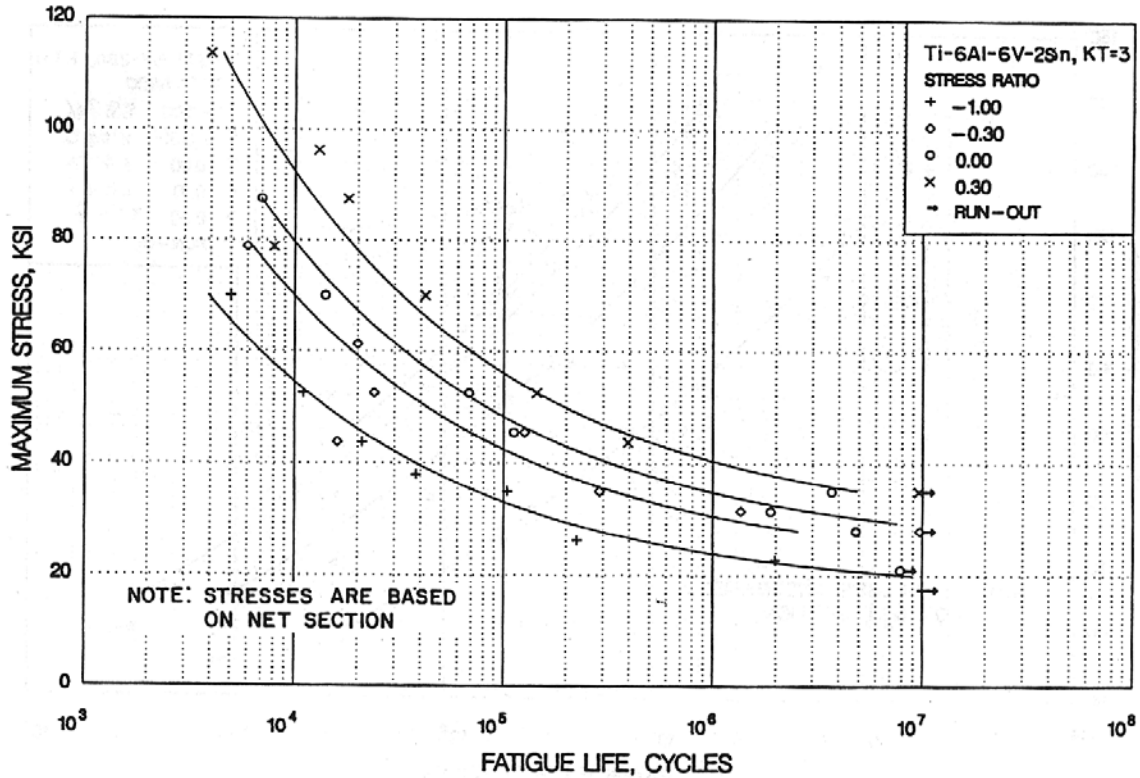

Figure 5.4.2.1.8(b). Best-fit S/N curves for annealed Ti-6Al-6V-2Sn plate, K_t = 3.0, longitudinal direction.

Correlative Information for Figure 5.4.2.1.8(b)

Product Form: Plate, 1.57 inch thick

Properties: TUS, ksi TYS, ksi Temp., °F
 154.6 148.5 RT

Specimen Details: V-Groove, K_t = 3.0
 0.195 inch gross diameter
 0.136 inch net diameter
 0.005 inch root radius
 60° flank angle

Surface Condition: RMS 32

References: 5.4.1.2.8(c)

Test Parameters:

Loading—Axial
Frequency—Unspecified
Temperature—RT
Atmosphere—Air

No. of Heats/Lot: 1

Equivalent Stress Equation:

Log N_f = 8.31 - 2.73 log (S_{cq} - 16.9)
S_{cq} = S_a + 0.37 S_m
Std. Error of Estimate, Log (Life) = 8.87 (1/S_{cq})
Standard Deviation, Log (Life) = 0.947
R² = 92%

Sample Size = 32

[Caution: The equivalent stress model may provide unrealistic life predictions for stress ratios beyond those represented above.]

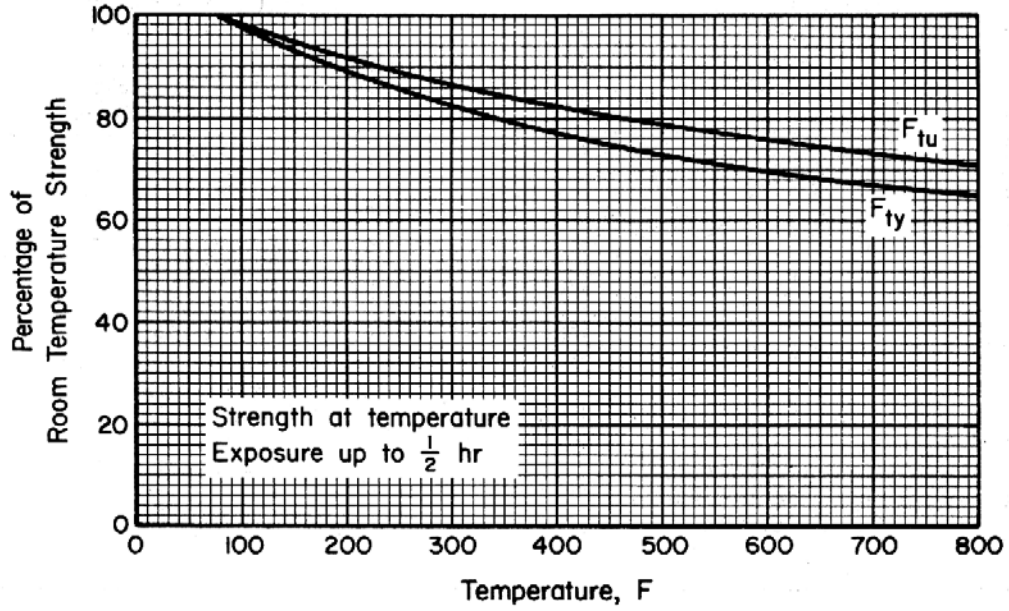

Figure 5.4.2.2.1. Effect of temperature on the tensile ultimate strength (F_{tu}) and the tensile yield strength (F_{ty}) of solution-treated and aged Ti-6Al-6V-2Sn plate.

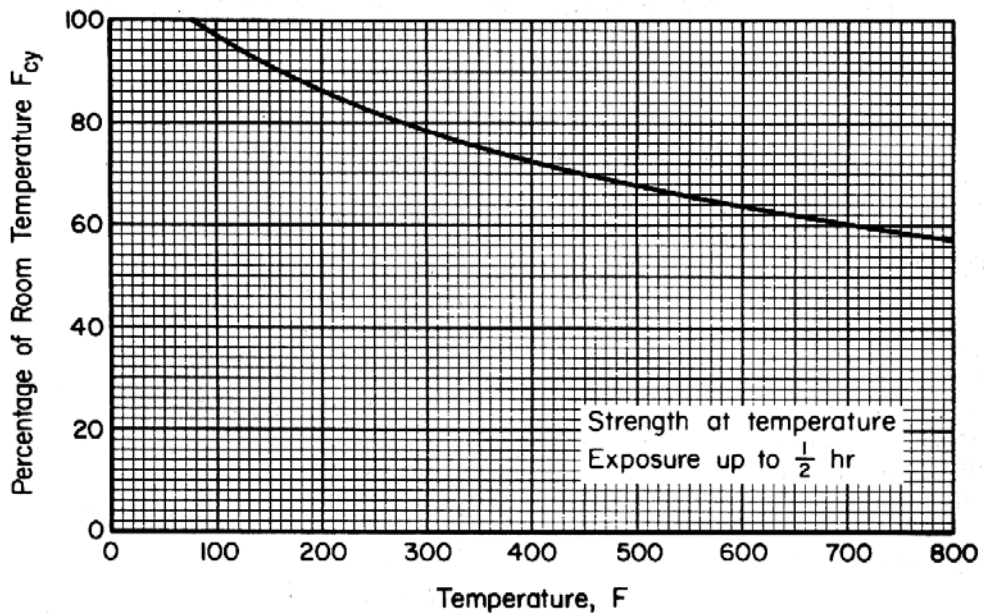

Figure 5.4.2.2.2. Effect of temperature on compressive yield strength (F_{cy}) of solution-treated and aged Ti-6Al-6V-2Sn plate.

5.4.3 Ti-4.5Al-3V-2Fe-2Mo

5.4.3.0 Comments and Properties —Ti-4.5Al-3V-2Fe-2Mo alloy is a beta rich alpha-beta titanium composition developed for improved hot formability and fatigue resistance. The alloy consists of fine microstructure and has excellent superplastic formability at temperatures below 1475°F. This alloy also shows significantly improved cold formability over Ti-6Al-4V. Although this alloy was originally developed for flat product applications in the annealed condition, it has expanded into other areas such as billets, bars, and forgings. This alloy has been reported to possess significantly better hardenability than Ti-6Al-4V.

Manufacturing Considerations – Superplastic forming of Ti-4.5Al-3V-2Fe-2Mo at temperatures between 1380F-1425°F is recommended. At these forming temperatures the formation of alpha case is not observed and the thickness of oxygen enriched layer is generally less than 0.001”. Diffusion bonding at 1425°F is possible but slightly higher temperatures than the superplastic forming temperature e.g., 1470°F are recommended to ensure perfect bonding. Ti-4.5Al-3V-2Fe-2Mo is weldable by standard titanium welding techniques. This alloy shows an increase in hardness in the welded zone but with limited ductility loss. Stress relief annealing after welding is recommended.

Environmental Considerations – Ti-4.5Al-3V-2Fe-2Mo exhibits significantly improved resistance to aqueous chloride solution stress-corrosion cracking over Ti-6Al-4V. The alloy is nearly equivalent to Ti-6Al-4V hot - salt stress corrosion cracking.

Heat Treatment – This alloy is commonly specified in the annealed condition, but is also used in the solution-treated and aged condition.

Annealing : 1325°F for a time commensurate with product thickness.

Annealing requires 1 hour at 1475°F followed by furnace cooling if maximum ductility is required.

The solution treated and aged conditions commonly employed are as follows :

Solution treat at 1500-1580°F for 1/2 –1hour followed by air cooling.

Age at 900-1060°F followed by air cooling.

Specifications and Properties – Some material specifications for Ti-4.5Al-3V-2Fe-2Mo are shown in Table 5.4.3.0(a). Room temperature mechanical properties and physical properties are shown in Table 5.4.3.0(b) through (d).

Table 5.4.3.0(a). Material Specification for Ti-4.5Al-3V-2Fe-2Mo Titanium Alloy

Specification	Form
AMS 4899	Sheet, Strip, and Plate
AMS 4964	Bars, Wire, Forgings, and Rings

5.4.3.1 Anneal Condition – Typical tensile stress-strain and full-range stress-strain curves are shown in Figures 5.4.3.1.6(a) and (b). Compressive stress-strain and tangent modulus curves are shown in Figure 5.4.3.1.6(c). Unnotched and notched fatigue data as well as fatigue crack propagation data are presented in Figures 5.4.3.1.8(a), (b) and 5.4.3.1.9.

Table 5.4.3.0 (b). Design Mechanical and Physical Properties of Ti-4.5Al-3V-2Fe-2Mo Titanium Alloy Sheet

Specification	AMS 4899			
	Sheet			
	Annealed			
	0.025 to 0.063, exclusive		0.063 to 0.187, exclusive	
Basis	A	B	A	B
Mechanical Properties:				
F_{tu} , ksi:				
L	134 ^a	145	134 ^b	144
LT	134 ^a	147	134 ^b	144
F_{ty} , ksi:				
L	126 ^a	134	126 ^b	132
LT	126 ^a	137	126 ^b	134
F_{cy} , ksi:				
L	128	136	130	139
LT	131	143	132	141
F_{su} ^c ksi:				
LT	90	99	91	98
F_{bru} ^d ksi: LT				
(e/D = 1.5)	196	215	207	223
(e/D = 2.0)	258	283	276	296
F_{bry} ^d ksi: LT				
(e/D = 1.5)	157	171	165	176
(e/D = 2.0)	190	207	198	210
e , percent (S-basis):				
L	8	...	10	...
LT	8	...	10	...
E , 10 ³ ksi	16.0			
E_c , 10 ³ ksi	16.2			
G , 10 ³ ksi	...			
μ	...			
Physical Properties:				
ω , lb/in. ³	0.164			
C , Btu/(lb)(°F)	0.12			
K , Btu/[(hr)(ft ²)(°F)/ft]	4.00			
α , 10 ⁻⁶ in./in./°F	5.17 (60-932 °F)			

- a S-basis. Rounded T_{99} values for thickness range 0.025 - 0.063 in. are as follows; F_{tu} (L) and (LT) = 140 ksi, F_{ty} (L) = 129 ksi and F_{ty} (LT) = 131 ksi.
- b S-basis. Rounded T_{99} values for thickness range 0.063 - 0.187 in. are as follows; F_{tu} (L) = 141 ksi, F_{tu} (LT) = 140 ksi, F_{ty} (L) = 128 ksi and F_{ty} (LT) = 127 ksi.
- c Determined in accordance with ASTM B769.
- d Bearing values are "dry pin" values per Section 1.4.7.1.

Table 5.4.3.0 (c). Design Mechanical and Physical Properties of Ti-4.5Al-3V-2Fe-2Mo Titanium Alloy Bar

Specification	AMS 4964					
	Bar					
	Annealed					
	≤ 2.000		2.001-4.000		4.001-6.000	
Basis	A	B	A	B	A	B
Mechanical Properties:						
F_{tu} , ksi:						
L	135	139	130 ^a	135	130	133
LT (S-basis)	135	...	130	...	130	...
F_{ty} , ksi:						
L	124	128	119	123	119	123
LT (S-basis)	125	...	120	...	120	...
F_{cy} , ksi:						
L	124	128
LT (S-basis)
F_{su}^b , ksi						
L -R	81	84
F_{bru}^c ksi:						
(e/D = 1.5)
(e/D = 2.0)
F_{bry}^c ksi:						
(e/D = 1.5)
(e/D = 2.0)
<i>e</i> , percent (S-basis):						
L	10	...	10	...	10	...
LT	10 ^d	...	10 ^d	...	10	...
<i>Red. in Area</i> , percent (S-basis):						
L	25	...	20	...	20	...
LT	20 ^d	...	20 ^d	...	20	...
E , 10 ³ ksi	16.0					
E_c , 10 ³ ksi	16.2					
G , 10 ³ ksi					
μ					
Physical Properties:						
ω , lb/in. ³	0.164					
C , Btu/(lb)(°F)	0.12					
K , Btu/[(hr)(ft ²)(°F)/ft]	4.00					
α , 10 ⁻⁶ in./in./°F	5.17 (60-932°F)					

- a Rounded T_{99} for $F_{tu} = 131$ ksi.
- b Determined in accordance with ASTM B769.
- c Bearing values are “dry pin” values per Section 1.4.7.1.
- d Applicable, providing LT dimension is no less than 2.500 inches.

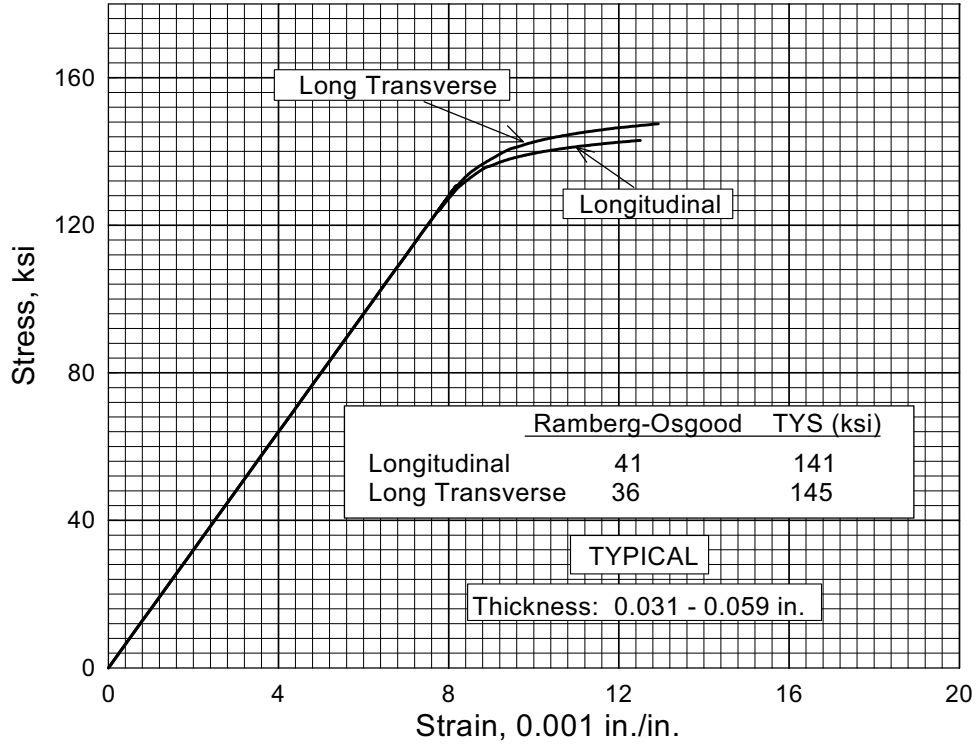

Figure 5.4.3.1.6(a). Typical tensile stress-strain curves at room temperature for annealed Ti-4.5Al-3V-2Fe-2Mo alloy sheet.

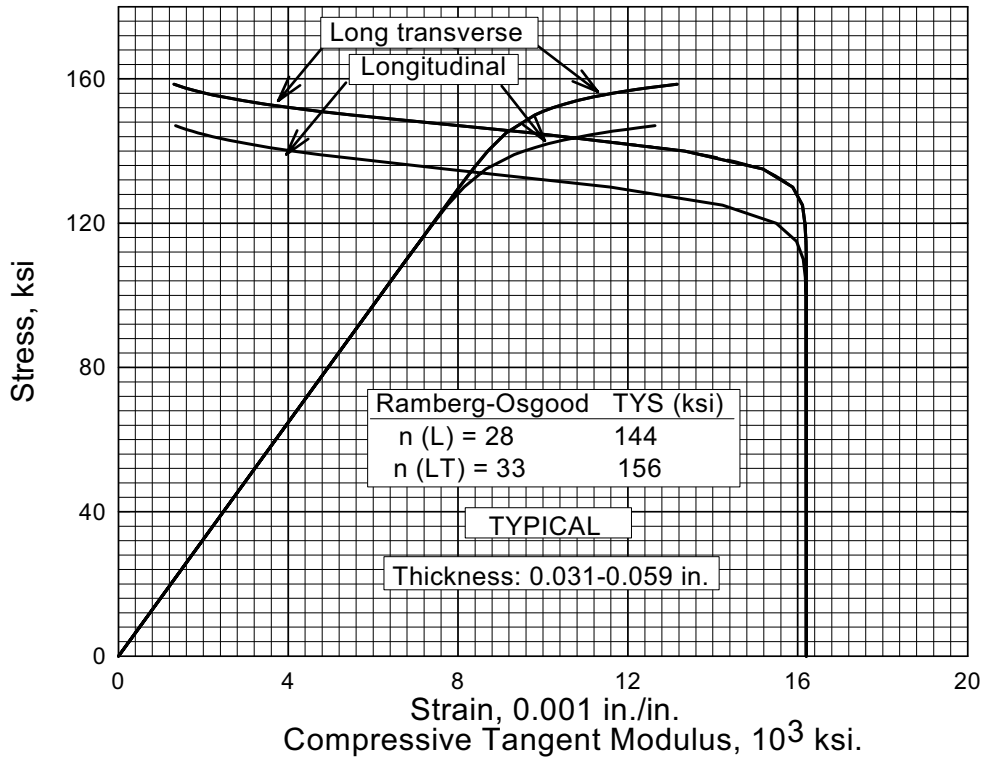

Figure 5.4.3.1.6(b). Typical compressive stress-strain and tangent-modulus curves at room temperature for annealed Ti-4.5Al-3V-2Fe-2Mo alloy sheet.

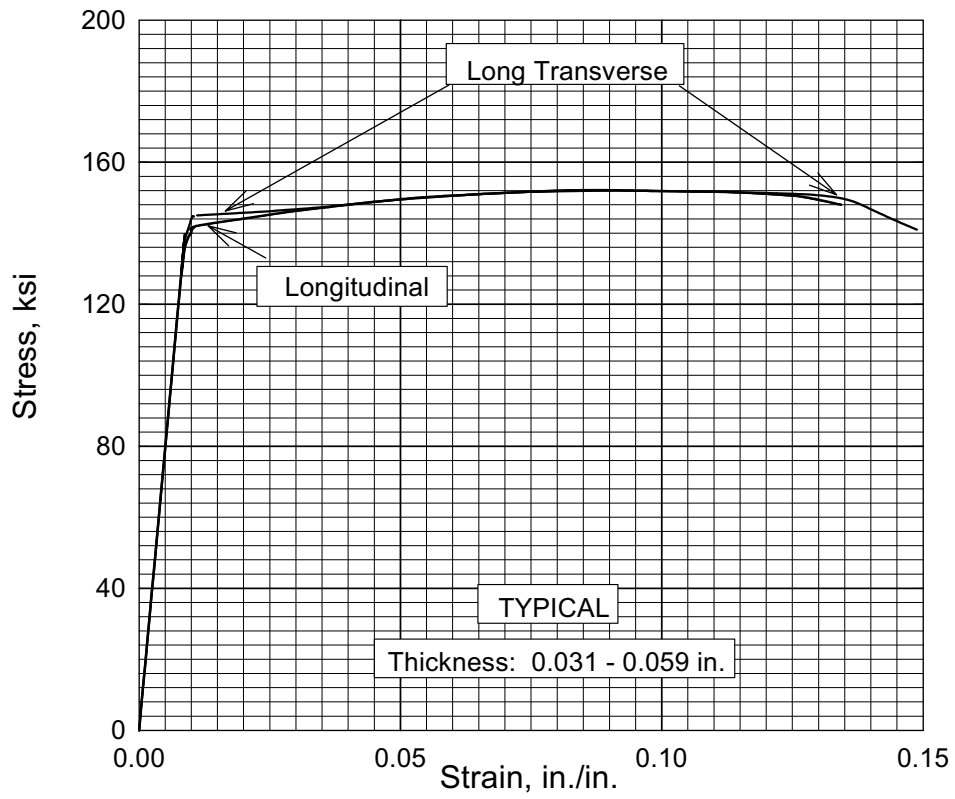

Figure 5.4.3.1.6(c). Typical tensile stress-strain curves (full-range) for annealed Ti-4.5Al-3V-2Fe-2Mo alloy sheet.

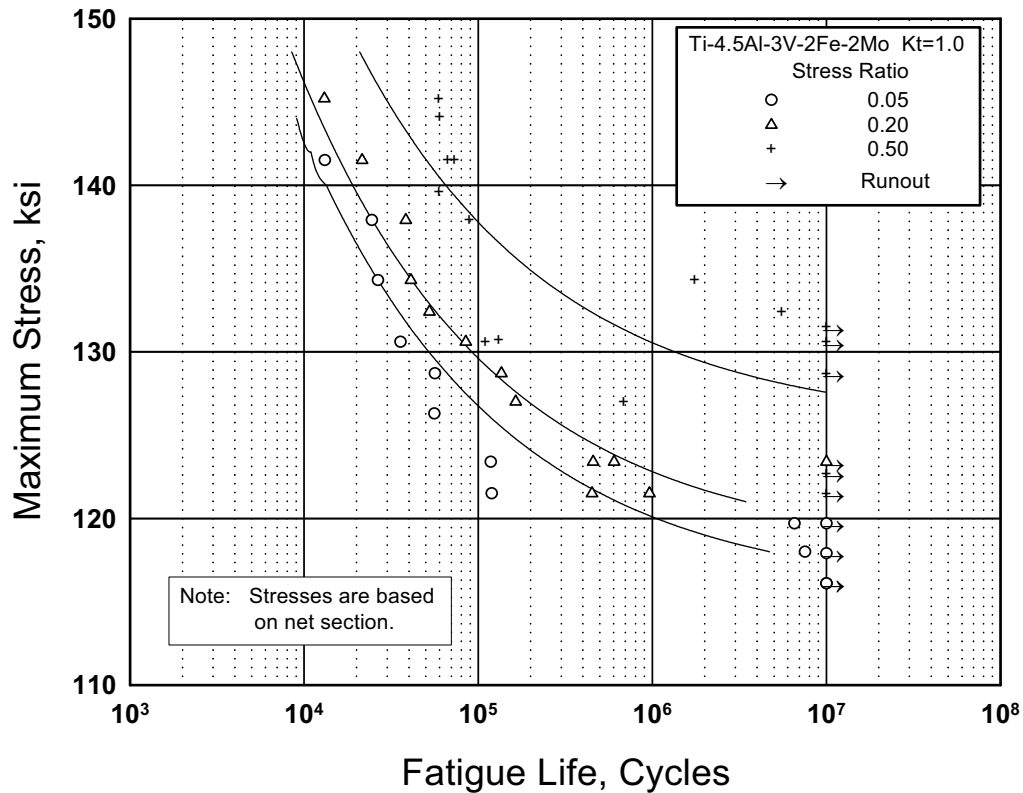

Figure 5.4.3.1.8 (a) Best-fit S/N curves for unnotched Ti-4.5Al-3V-2Fe-2Mo annealed sheet.

Correlative Information for Figure 5.4.3.1.8 (a)

Product Form: 0.059, 0.118, 0.157 inch thick

Test Parameter:

Properties: TUS, ksi TYS, ksi Temp., °F
148 - 149 135 - 138 RT

Loading - Axial
Frequency - 10Hz
Temperature - RT
Environment - Air

Specimen Details: Unnotched, 0.252 inch width

No. of Heats : 3

Surface Conditions: Lightly polished with
400 grit emery paper

Equivalent Stress Equation:

$$\log N_f = 7.72 - 2.59 \log (S_{eq} - 114.68)$$

$$S_{eq} = S_{max} (1 - R)^{0.13}$$

Std. Error of Estimate, Log (Life) = 0.40

Standard Deviation, Log (Life) = 0.60

Adjusted R² = 56.5%

References: 5.4.3.1.8

Sample Size = 43

[Caution: The equivalent stress model may provide unrealistic life predictions for stress ratios beyond those represented above.]

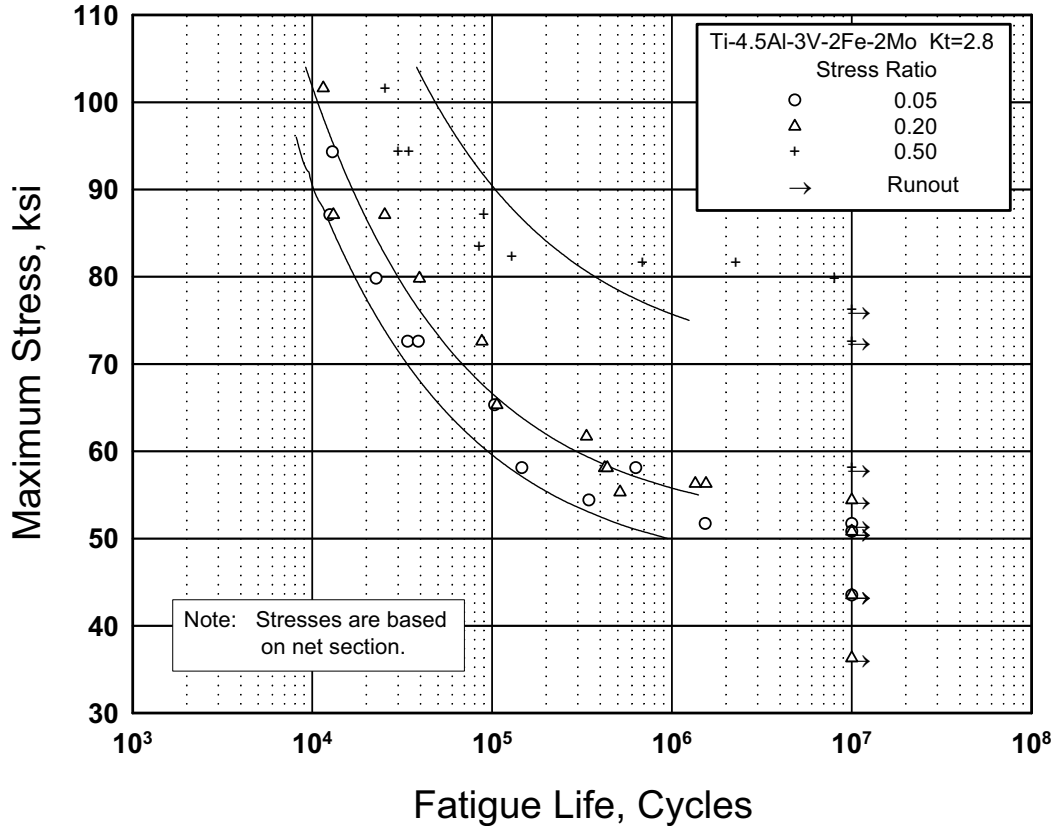

Figure 5.4.3.1.8 (b) Best-fit S/N curves for notched, Kt = 2.8, Ti-4.5Al-3V-2Fe-2Mo annealed sheet.

Correlative Information for Figure 5.4.3.1.8 (b)

Product Form: 0.059, 0.118, 0.157 inch thick

Test Parameter:

Properties: TUS, ksi TYS, ksi Temp., °F
148 - 149 135 - 138 RT

Loading - Axial
Frequency - 10Hz
Temperature - RT
Environment - Air

Specimen Details: Notched, Kt = 2.8
0.466 inch net width

No. of Heats: 3

Surface Conditions: HF/HNO₃ pickled

Equivalent Stress Equation:

References: 5.4.3.1.8

$\log N_f = 7.22 - 1.96 \log (S_{eq} - 44.05)$
 $S_{eq} = S_{max} (1 - R)^{0.65}$
Std. Error of Estimate, Log (Life) = 0.24
Standard Deviation, Log (Life) = 0.47
Adjusted R² = 72.9%

Sample Size = 41

[Caution: The equivalent stress model may provide unrealistic life predictions for stress ratios beyond those represented above.]

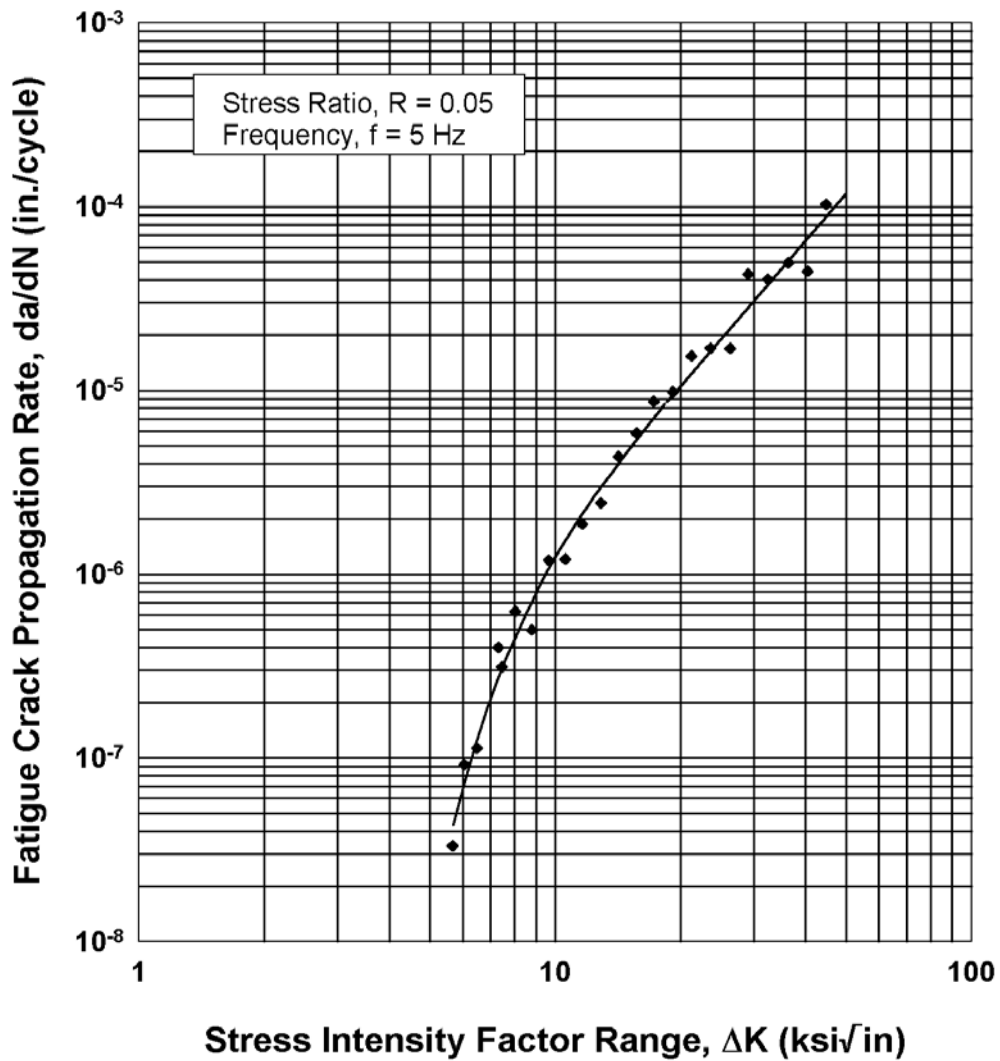

Figure 5.4.3.1.9 Fatigue-crack-propagation data for 1 inch thick Ti-4.5Al-3V-2Fe-2Mo mill annealed titanium alloy plate.

Specimen Thickness:	0.25 inch	Environment:	50% RH
Specimen Width:	2.0 inches	Temperature:	RT
Specimen Type:	C(T)	Orientation:	L-T

5.5 BETA, NEAR-BETA, AND METASTABLE-BETA TITANIUM ALLOYS

There is no clear-cut definition for beta titanium alloys. Conventional terminology usually refers to near-beta alloys and metastable-beta alloys as classes of beta titanium alloys. A near-beta alloy is generally one which has appreciably higher beta stabilizer content than a conventional alpha-beta alloy such as Ti-6Al-4V, but is not quite sufficiently stabilized to readily retain an all-beta structure with an air cool of thin sections. For such alloys, a water quench even of thin sections is required. Due to the marginal stability of the beta phase in these alloys, they are primarily solution treated below the beta transus to produce primary alpha phase which in turn results in an enriched, more stable beta phase. This enriched beta phase is more suitable for aging. The Ti-10V-2Fe-3Al alloy is an example of a near-beta alloy.

On the other hand, the metastable-beta alloys are even more heavily alloyed with beta stabilizers than near-beta alloys and, as such, readily retain an all-beta structure upon air cooling of thin sections. Due to the added stability of these alloys, it is not necessary to heat treat below the beta transus to enrich the beta phase. Therefore, these alloys do not normally contain primary alpha since they are usually solution treated above the beta transus. These alloys are termed “metastable” because the resultant beta phase is not truly stable—it can be aged to precipitate alpha for strengthening purposes. Alloys such as Ti-15-3, B120VCA, Beta C, and Beta III are considered metastable-beta alloys.

Unfortunately, the classification of an alloy as either near-beta or metastable beta is not always obvious. In fact, the “metastable” terminology is not precise since a near-beta alloy is also metastable—i.e., it also decomposes to alpha plus beta upon aging.

There is one obvious additional category of beta alloys—the stable beta alloys. These alloys are so heavily alloyed with beta stabilizers that the beta phase will not decompose to alpha plus beta upon subsequent aging. There are no such alloys currently being produced commercially. An example of such an alloy is Ti-30Mo.

The interest in beta alloys stems from the fact that they contain a high volume fraction of beta phase which can be subsequently hardened by alpha precipitation. Thus, these alloys can generate quite high-strength levels (in excess of 200 ksi) with good ductilities. Also, such alloys are much more deep hardenable than alpha-beta alloys such as Ti-6Al-4V. Finally, many of the more heavily alloyed beta alloys exhibit excellent cold formability and as such offer attractive sheet metal forming characteristics.

5.5.1 Ti-13V-11Cr-3Al

5.5.1.0 Comments and Properties — Ti-13V-11Cr-3Al is a heat-treatable alloy possessing good workability and toughness in the annealed condition and high strength in the heat-treated condition. It is noted for its exceptional ability to harden in heavy sections (up to 6-inch diameter or greater) to tensile strength of 170 ksi F_{ur} .

Manufacturing Considerations — This alloy possesses very good formability at room temperature; stretch forming is usually conducted at 500°F. Ti-13V-11Cr-3Al is readily fusion or spot welded. Arc-welded joints are very ductile in the as-welded condition, but have low strengths.

Environmental Considerations — Ti-13V-11Cr-3Al is stable for times up to 1000 hours in the annealed condition at 550°F and in the solution treated and aged condition up to 600°F. Prolonged exposure above these temperatures may result in ductility losses. If welding is employed, the stability of the weld should be investigated under the particular exposure conditions to be encountered. While the material is not noted for good creep performance, Ti-13V-11Cr-3Al has exceptional short-time strength at temperatures to 1200°F and above. Oxidation resistance is satisfactory at such temperatures for short-time exposure and for long-time exposure at the lower elevated temperatures. Hot-salt stress corrosion has been shown to be possible in this alloy at temperatures as low as 500°F in highly stressed applications (e.g., rivet heads). It is generally thought that the

MIL-HDBK-5J
31 January 2003

material is moderately susceptible to aqueous chloride solution stress corrosion. Ti-13V-11Cr-3Al is not noted for good fracture toughness in the aged or high-strength condition and is not recommended in any condition for cryogenic temperature applications. Under certain conditions, titanium, when in contact with cadmium, silver, mercury, or certain of their compounds, may become embrittled. Refer to MIL-S-5002 and MIL-STD-1568 for restrictions concerning applications with titanium in contact with these metals or their compounds.

Heat Treatment — This alloy is commonly specified in either the annealed condition or in the fully heat-treated condition. The specified fully heat-treated, or solution-treated and aged, condition is as follows:

Solution treat at 1450°F for 15 to 60 minutes, air cool (water quench if material is over 2 inches thick).

Age at 900°F for 2 to 60 hours, dependent on strength level. (Note: typical aging time to achieve $F_{tu} = 170$ ksi is 24 to 36 hours.)

Specifications and Properties — Material specifications for Ti-13V-11Cr-3Al are shown in Table 5.5.1.0(a). Room-temperature mechanical and physical properties for Ti-13V-11Cr-3Al are shown in Table 5.5.1.0(b). The effect of temperature on physical properties is shown in Figure 5.5.1.0.

Table 5.5.1.0(a). Material Specifications for Ti-13V-11Cr-3Al

Specification	Form
AMS-T-9046	Sheet, strip, and plate
MIL-T-9047 ^a	Bar

^a Inactive for new design

5.5.1.1 Annealed Condition — Elevated temperature curves for annealed Ti-13V-11Cr-3Al are shown in Figures 5.5.1.1.1 through 5.5.1.1.4. Typical tensile stress-strain curves for annealed material at temperatures ranging from room temperature to 1000°F are shown in Figure 5.5.1.1.6. Unnotched and notched fatigue data at room and elevated temperatures for annealed sheet are shown in Figures 5.5.1.1.8(a) through (d).

5.5.1.2 Solution-Treated and Aged Condition — Elevated temperature curves for solution-treated and aged Ti-13V-11Cr-3Al are shown in Figures 5.5.1.2.1 through 5.5.2.1.4. Typical tensile stress-strain curves at various temperatures are shown in Figure 5.5.1.2.6. Unnotched fatigue data at room and elevated temperatures for solution-treated and aged sheet are shown in Figures 5.5.1.2.8(a) through (c).

MIL-HDBK-5J
31 January 2003

Table 5.5.1.0(b). Design Mechanical and Physical Properties of Ti-13V-11Cr-3Al

Specification	AMS-T-9046, Comp. B-1			MIL-T-9047 ^a	
	Sheet, strip, and plate			Bar	
Condition	Annealed		Solution treated and aged	Annealed	Solution treated and aged
	0.012-0.049	0.050-4.000			
Basis	S	S	S	S	S
Mechanical Properties:					
F_{tu} , ksi:					
L	132	125	170	125	170
LT	132	125	170	125 ^c	170 ^c
ST	125	170	125 ^c	170 ^c
F_{ly} , ksi:					
L	126	120	160	120	160
LT	126	120	160	120 ^c	160 ^c
ST	120	160	120 ^c	160 ^c
F_{cy} , ksi:					
L	120	162
LT	120	162
ST	120	162
F_{su} , ksi	92	105
F_{bru} , ksi:					
(e/D = 1.5)	207	248
(e/D = 2.0)	270	313
F_{bry} , ksi:					
(e/D = 1.5)	169	217
(e/D = 2.0)	200	247
e , percent:					
L	8	10	4 ^d	10	6
LT	8	10	4 ^d	10 ^c	2 ^c
ST	10	4 ^d	10 ^c	2 ^c
RA , percent:					
L	25	10
LT	25 ^c	5 ^c
ST	25 ^c	5 ^c
E , 10 ³ ksi	14.5		15.5	14.5	15.5
E_c , 10 ³ ksi
G , 10 ³ ksi
μ
Physical Properties:					
ω , lb/in. ³	0.174				
C, K , and α	See Figure 5.5.1.0				

- a Inactive for new design
- b Maximum of 16 square-inch cross-sectional area.
- c Applicable, providing LT or ST dimension is ≥3.000 inches
- d Thickness 0.025 inch and above: 3 percent below 0.025 inch.

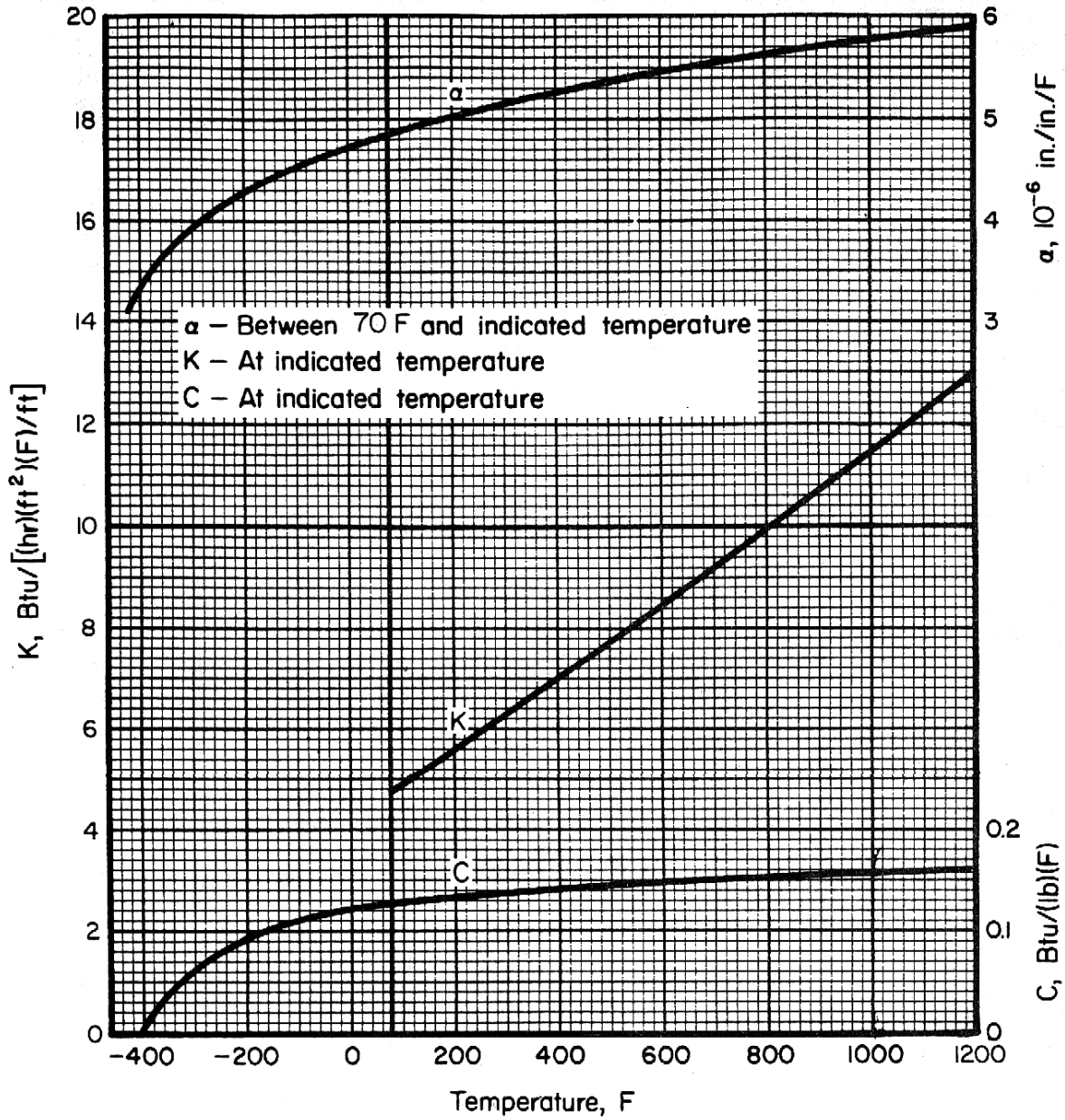

Figure 5.5.1.0. Effect of temperature on the physical properties of Ti-13V-11Cr-3Al alloy.

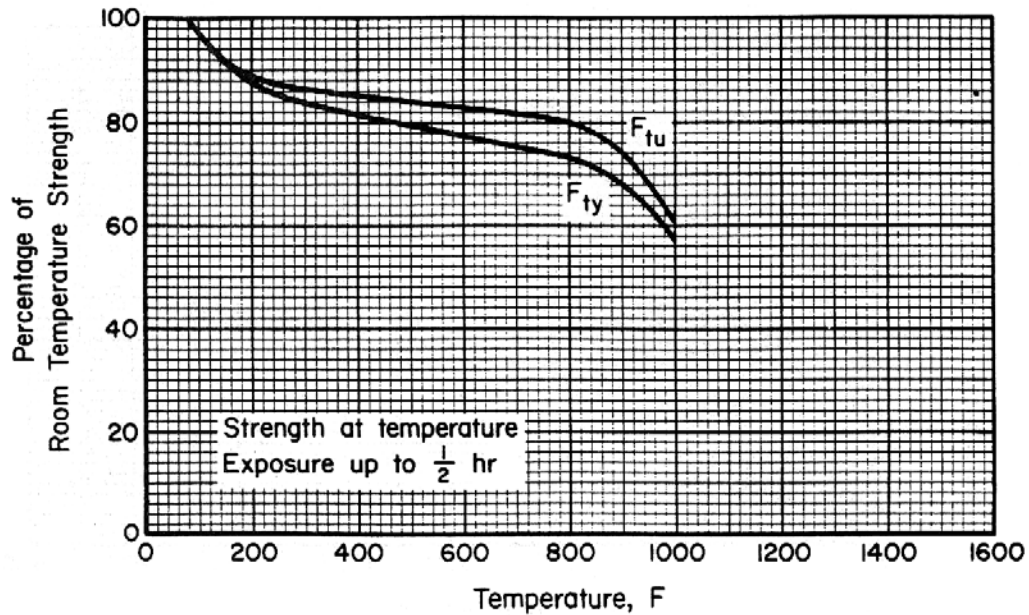

Figure 5.5.1.1.1. Effect of temperature on the tensile ultimate strength (F_{tu}) and the tensile yield strength (F_{ty}) of annealed Ti-13V-11Cr-3Al alloy sheet.

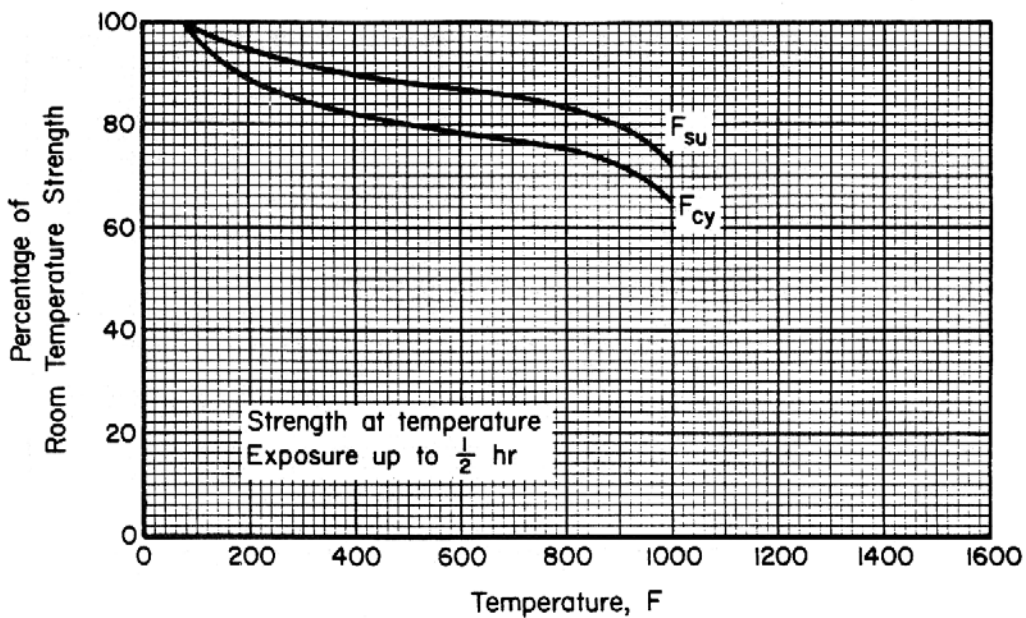

Figure 5.5.1.1.2. Effect of temperature on the compressive yield strength (F_{cy}) and the shear ultimate strength (F_{su}) of annealed Ti-13V-11Cr-3Al alloy sheet.

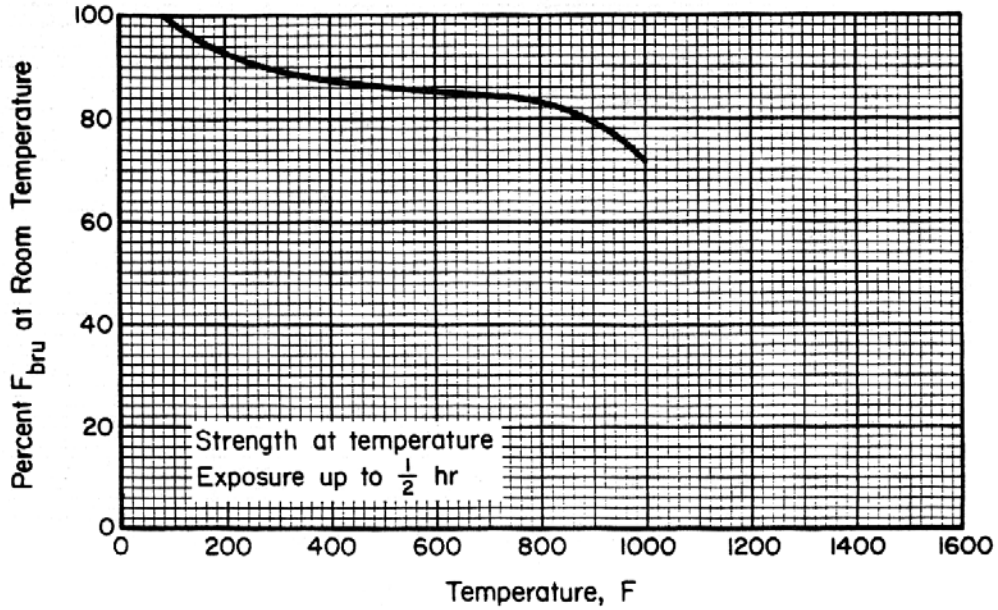

Figure 5.5.1.1.3(a). Effect of temperature on the bearing ultimate strength (F_{bru}) of annealed Ti-13V-11Cr-3Al alloy sheet.

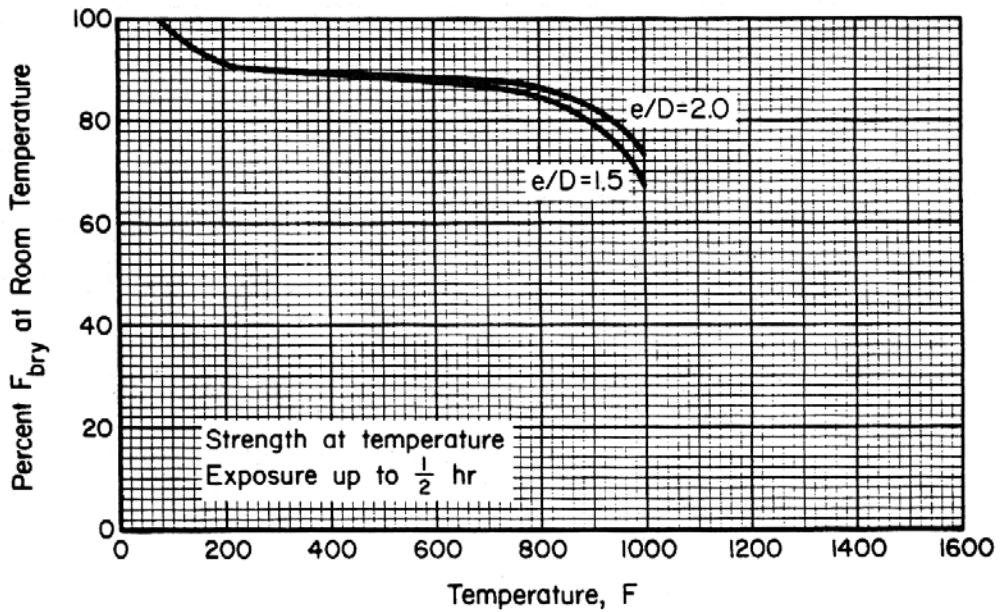

Figure 5.5.1.1.3(b). Effect of temperature on the bearing yield strength (F_{bry}) of annealed Ti-13V-11Cr-3Al alloy sheet.

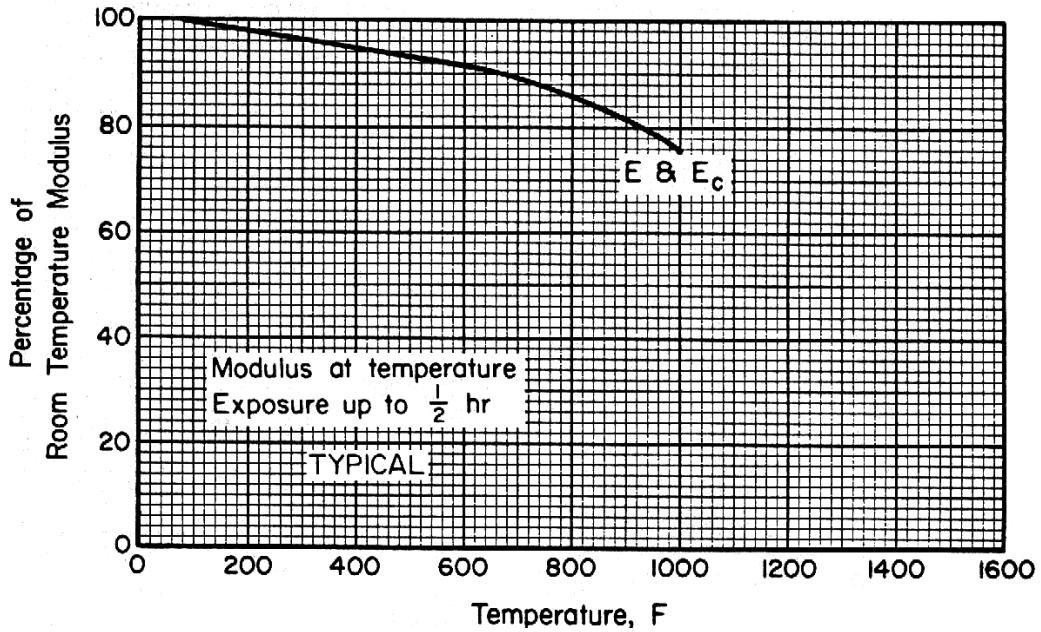

Figure 5.5.1.1.4. Effect of temperature on the tensile and compressive moduli (E and E_c) of annealed Ti-13V-11Cr-3Al alloy sheet.

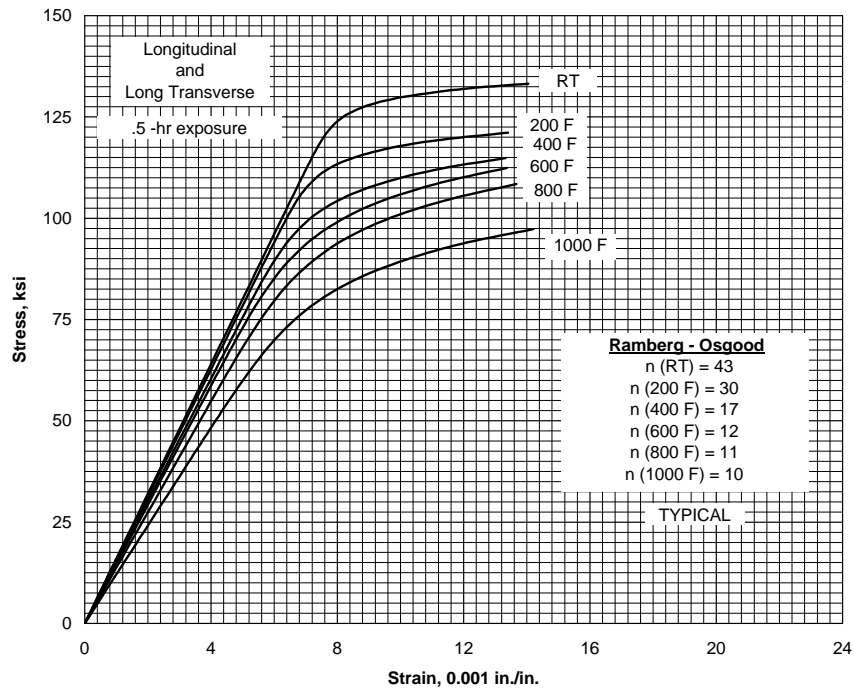

Figure 5.5.1.1.6. Typical tensile stress-strain curves for annealed Ti-13V-11Cr-3Al alloy sheet at room and elevated temperatures.

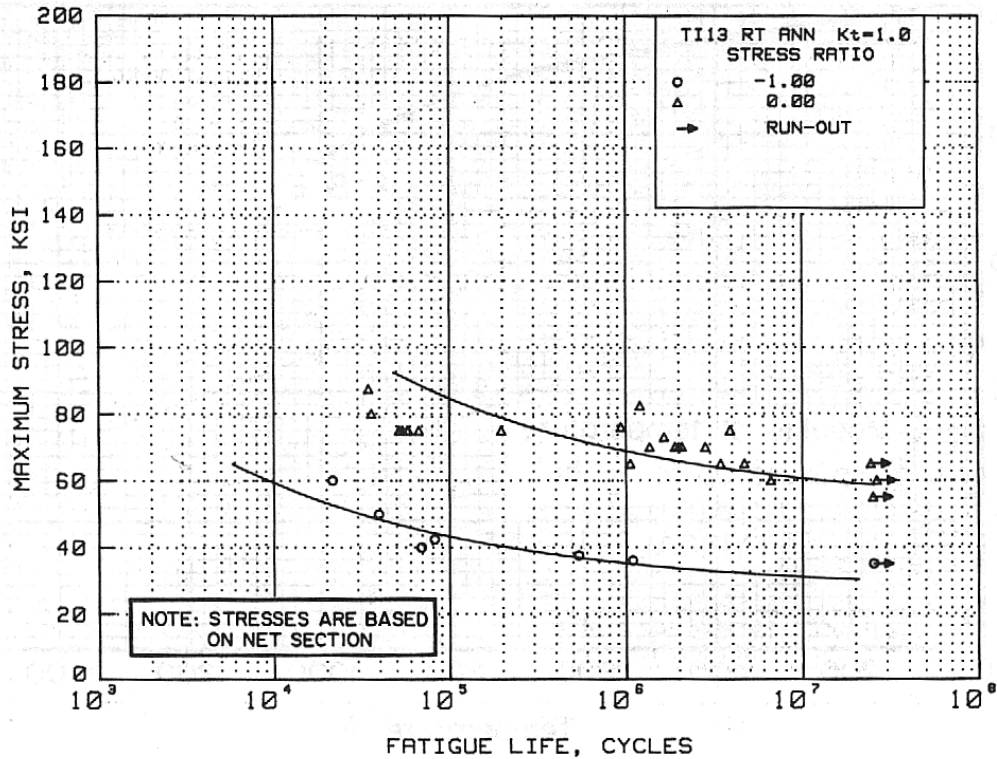

Figure 5.5.1.1.8(a). Best-fit S/N curves for unnotched, annealed Ti-13V-11Cr-3Al alloy sheet, longitudinal direction.

Correlative Information for Figure 5.5.1.1.8(a)

Product Form: Sheet, 0.043 inch thick

Test Parameters:

Properties: TUS, ksi TYS, ksi Temp., °F
 138.50 132.80 RT

Loading—Axial
Frequency—3600 cpm
Temperature—RT
Atmosphere—Air

Specimen Details: Unnotched, 0.30 inch wide

No. of Heats/Lot: Not specified

Surface Condition: As machined, edges
 polished with emery paper.

Equivalent Stress Equation:

$\log N_f = 10.15 - 3.41 \log (S_{eq} - 52.2)$
 $S_{eq} = S_{max} (1 - R)^{0.97}$
Std. Error of Estimate, $\log (\text{Life}) = 0.58$
Standard Deviation, $\log (\text{Life}) = 0.82$
 $R^2 = 50\%$

Reference: 5.5.1.1.8

Sample Size = 27

[Caution: The equivalent stress model may provide unrealistic life predictions for stress ratios beyond those represented above.]

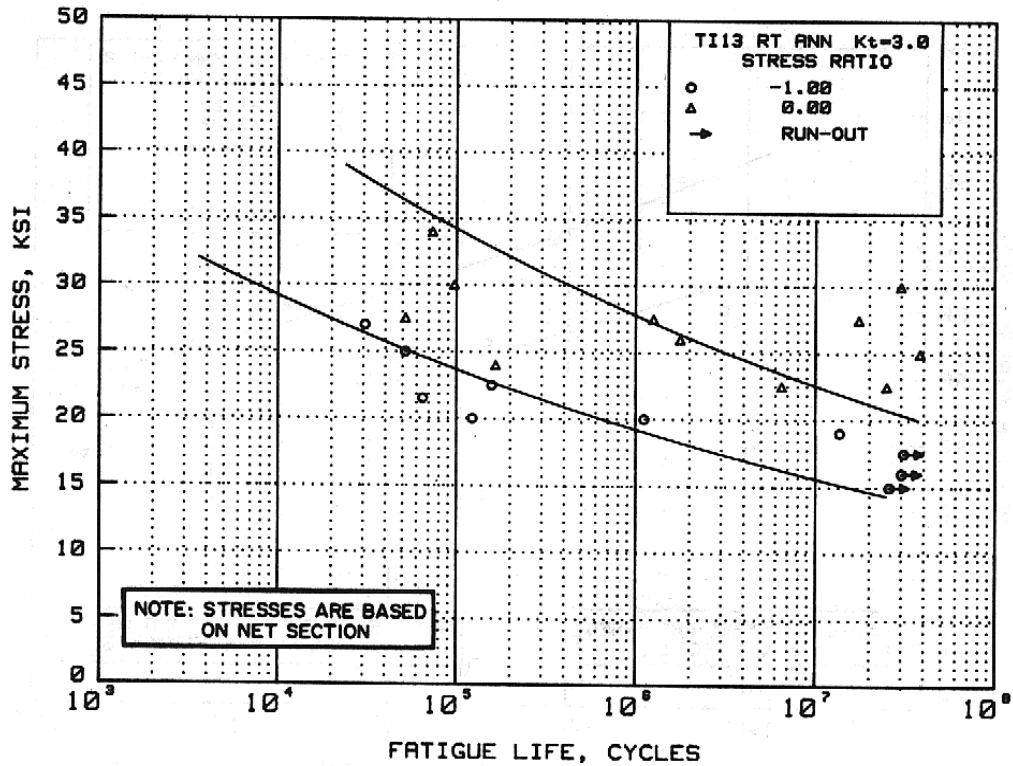

Figure 5.5.1.1.8(b). Best-fit S/N curves for notched, $K_t = 3.0$, annealed Ti-13V-11Cr-3Al alloy sheet, longitudinal direction.

Correlative Information for Figure 5.5.1.1.8(b)

Product Form: Sheet, 0.043 inch thick

Properties: TUS, ksi TYS, ksi Temp., °F
138.50 132.80 RT

Specimen Details: Notched, edge, $K = 3.0$
0.448 inch gross width
0.300 inch net width
0.022 inch root radius, r
60° flank angle, ω

Surface Condition: As machined, edges polished with emery paper.

Reference: 5.5.1.1.8

Test Parameters:

Loading—Axial
Frequency—3600 cpm
Temperature—RT
Atmosphere—Air

No. of Heats/Lots: Not specified

Equivalent Stress Equation:

$\log N_f = 21.93 - 11.03 \log (S_{eq})$
 $S_{eq} = S_{max} (1-R)^{0.53}$
Std. Error of Estimate, $\log (\text{Life}) = 0.91$
Standard Deviation, $\log (\text{Life}) = 1.11$
 $R^2 = 33\%$

Sample Size = 19

[Caution: The equivalent stress model may provide unrealistic life predictions for stress ratios beyond those represented above.]

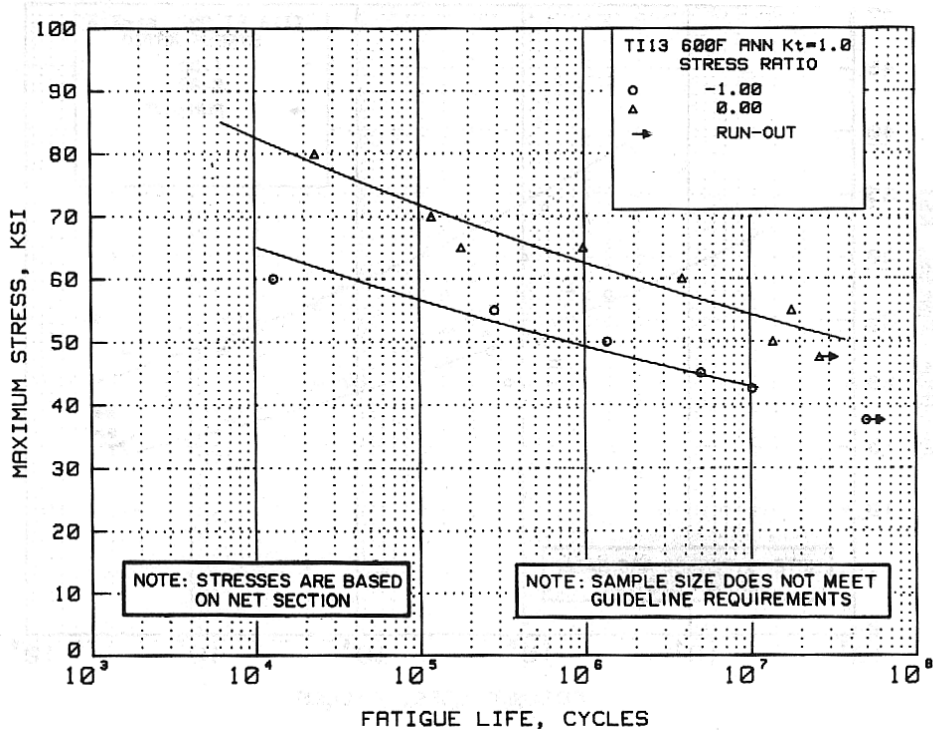

Figure 5.5.1.1.8(c). Best-fit S/N curves for unnotched, annealed Ti-13V-11Cr-3Al alloy sheet at 600°F, longitudinal direction.

Correlative Information for Figure 5.5.1.1.8(c)

Product Form: Sheet, 0.043 inch thick

Properties: TUS, ksi TYS, ksi Temp., °F
116.00 102.61 600°F

Specimen Details: Unnotched, 0.300 inch wide

Surface Condition: As machined, edges polished with emery paper.

Reference: 5.5.1.1.8

Test Parameters:

Loading—Axial

Frequency—3600 cpm

Temperature—600°F

Atmosphere—Air

No. of Heats/Lot: Not specified

Equivalent Stress Equation:

$$\log N_f = 35.63 - 16.50 \log (S_{eq})$$

$$S_{eq} = S_{max} (1-R)^{0.34}$$

Std. Error of Estimate, Log (Life) = 0.35

Standard Deviation, Log (Life) = 1.07

R² = 90%

Sample Size = 12

[Caution: The equivalent stress model may provide unrealistic life predictions for stress ratios beyond those represented above.]

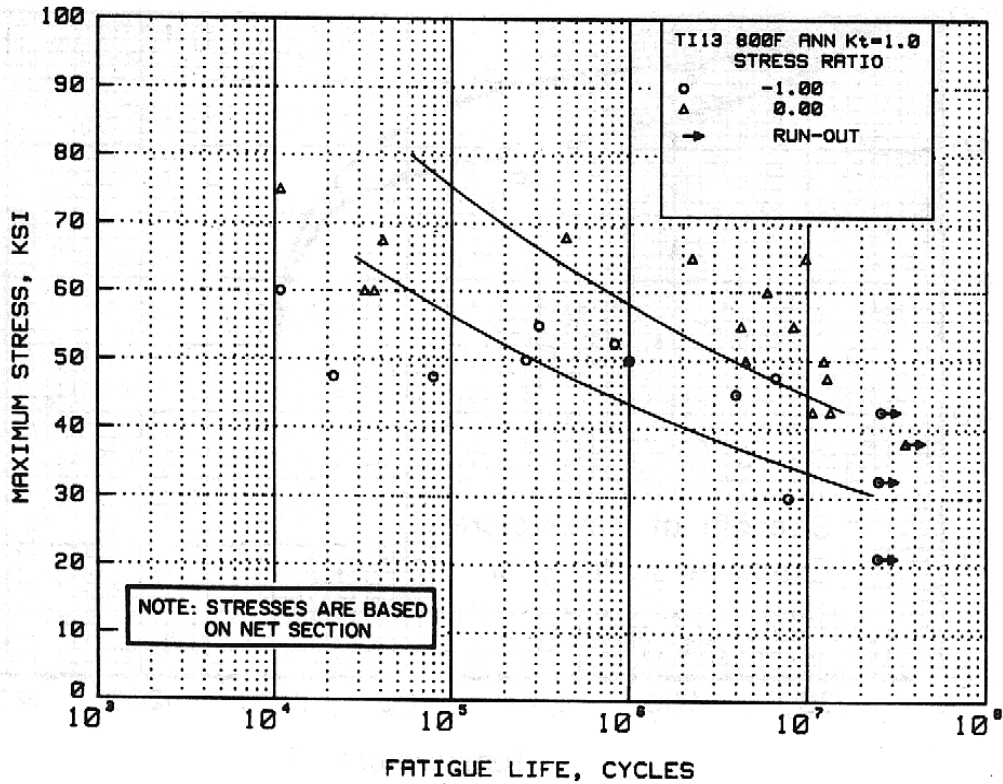

Figure 5.5.1.1.8(d). Best-fit S/N curves for unnotched annealed Ti-13V-11Cr-3Al alloy sheet at 800°F, longitudinal direction.

Correlative Information for Figure 5.5.1.1.8(d)

Product Form: Sheet, 0.043-inch thick

Properties: TUS, ksi TYS, ksi Temp., °F
115.80 98.61 800°F

Specimen Details: Unnotched, 0.300-inch wide

Surface Condition: As machined, edges polished with emery paper.

Reference: 5.5.1.1.8

Test Parameters:

Loading—Axial
Frequency—3600 cpm
Temperature—800°F
Atmosphere—Air

No. of Heats/Lot: Not specified

Equivalent Stress Equation:

$\log N_f = 21.67 - 8.88 \log (S_{eq})$
 $S_{eq} = S_{max} (1-R)^{0.42}$
Std. Error of Estimate, $\log (\text{Life}) = 0.84$
Standard Deviation, $\log (\text{Life}) = 1.07$
 $R^2 = 39\%$

Sample Size = 26

[Caution: The equivalent stress model may provide unrealistic life predictions for stress ratios beyond those represented above.]

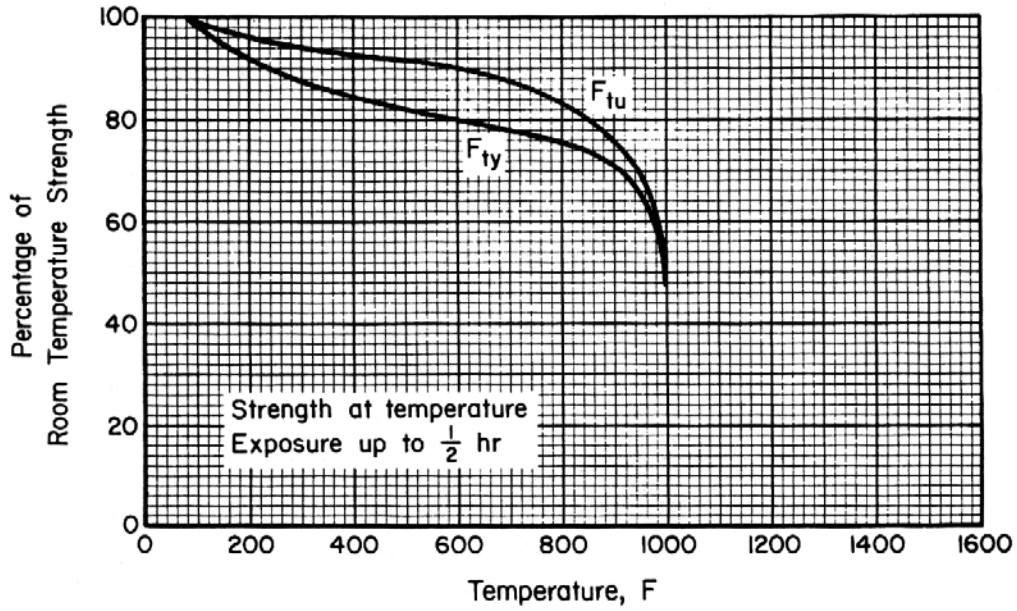

Figure 5.5.1.2.1. Effect of temperature on the tensile ultimate strength (F_{tu}) and the tensile yield strength (F_{ty}) of solution-treated and aged Ti-13V-11Cr-3Al alloy sheet.

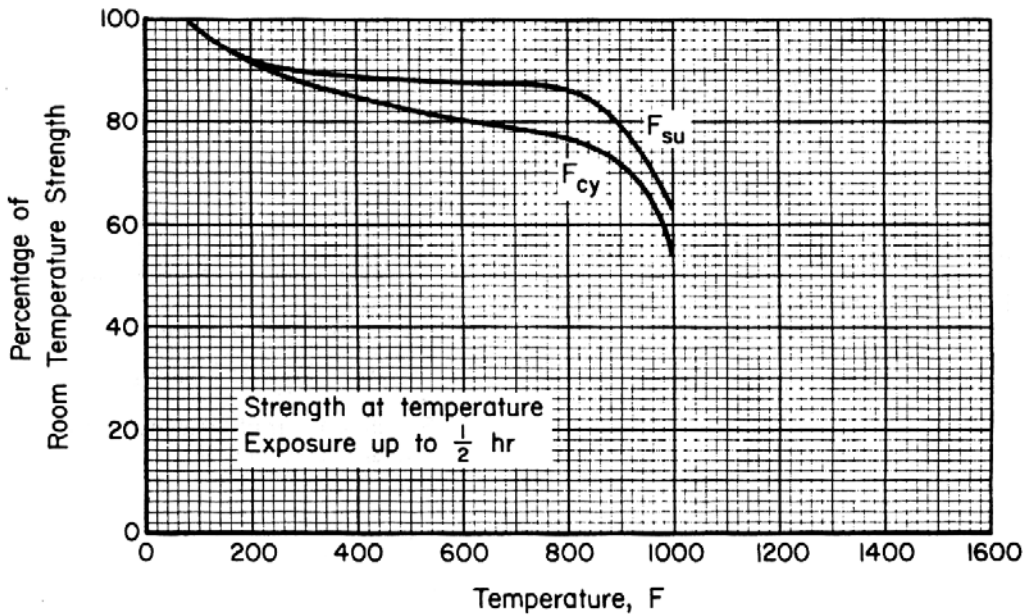

Figure 5.5.1.2.2. Effect of temperature on the compressive yield strength (F_{cy}) and the shear ultimate strength (F_{su}) of solution-treated and aged Ti-13V-11Cr-3Al alloy sheet.

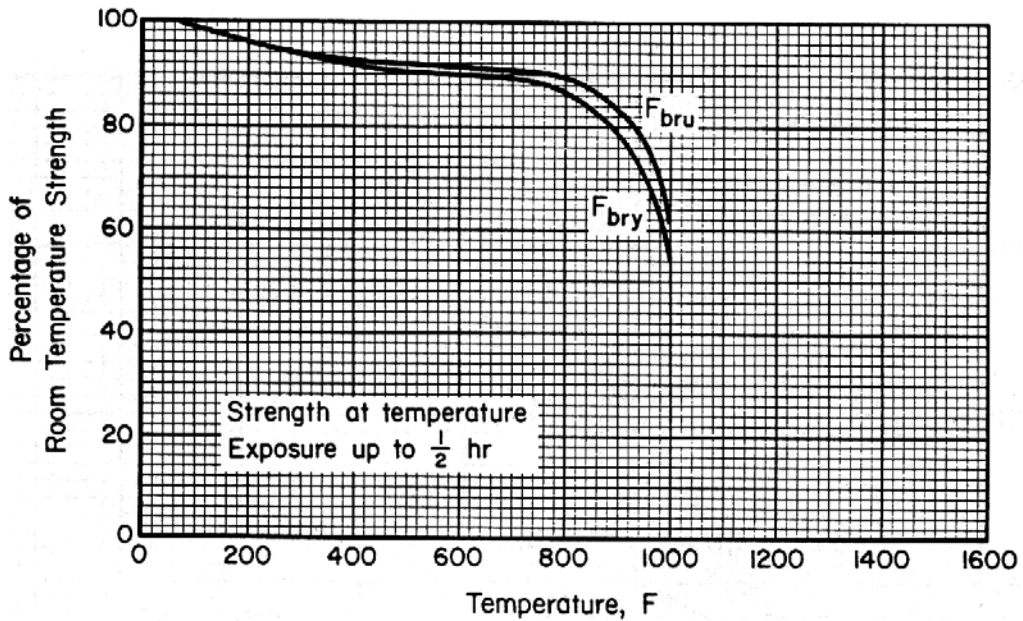

Figure 5.5.1.2.3. Effect of temperature on the bearing ultimate strength (F_{bru}) and the bearing yield strength (F_{bry}) of solution-treated and aged Ti-13V-11Cr-3Al alloy sheet.

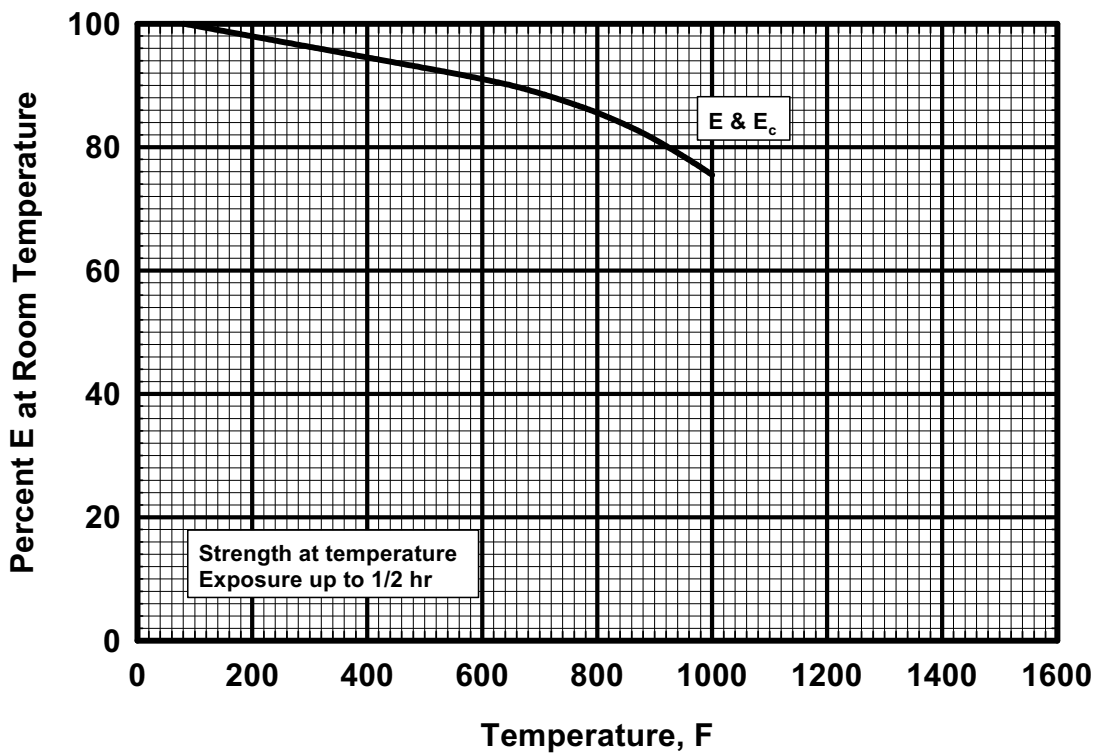

Figure 5.5.1.2.4. Effect of temperature on the tensile and compressive moduli (E and E_c) of solution-treated and aged Ti-13V-11Cr-3Al alloy sheet.

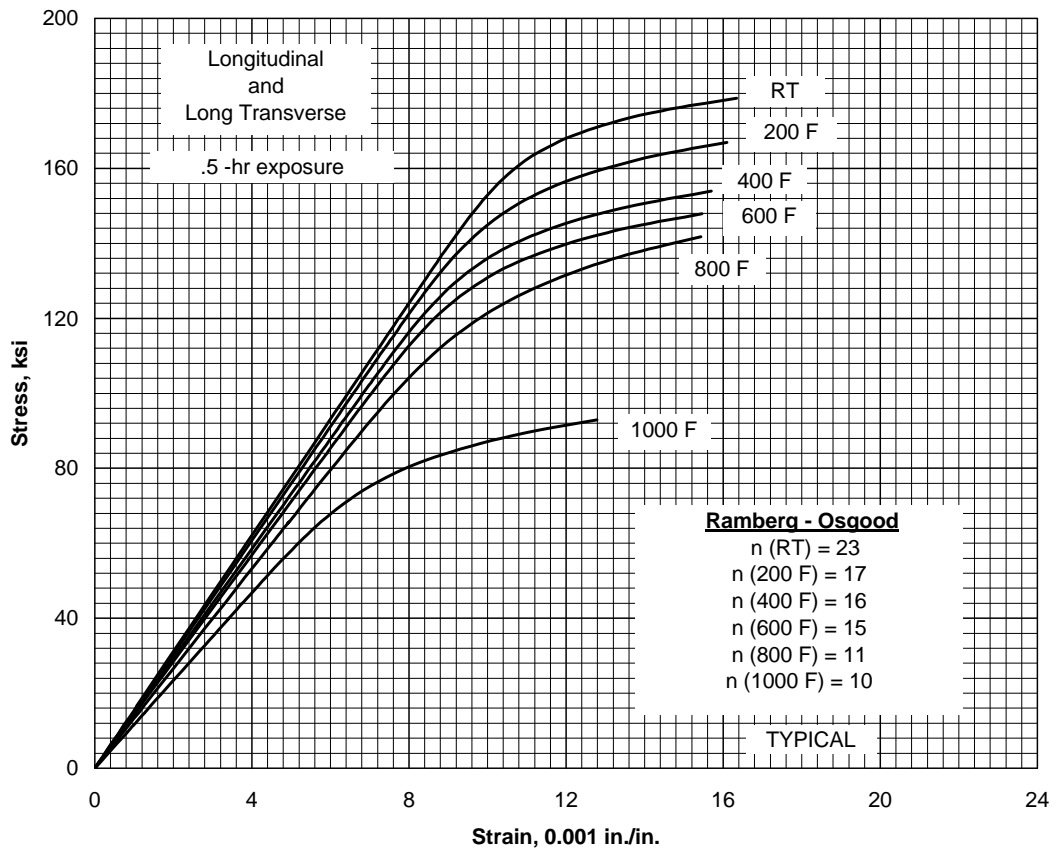

Figure 5.5.1.2.6. Typical tensile stress-strain curves for solution-treated and aged Ti-13V-11Cr-3Al alloy sheet at room and elevated temperatures.

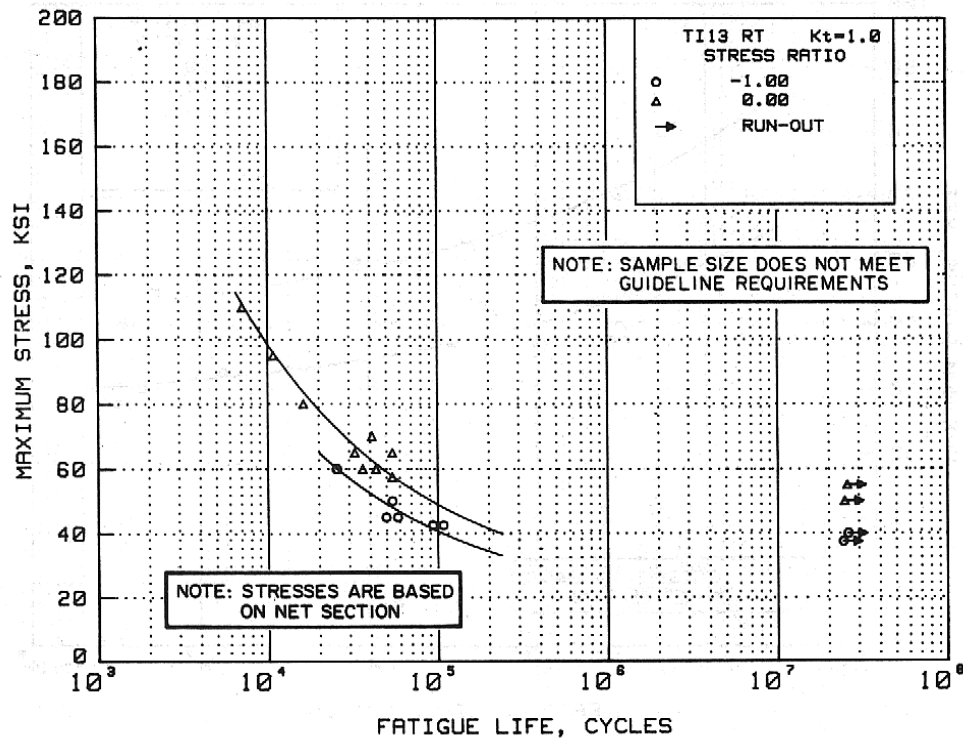

Figure 5.5.1.2.8(a). Best-fit S/N curves for unnotched, solution treated and aged Ti-13V-11Cr-3Al alloy sheet and plate, longitudinal direction.

Correlative Information for Figure 5.5.1.2.8(a)

Product Form: Sheet, 0.043 inch thick and plate, 1.00 inch thick

Properties: TUS, ksi TYS, ksi Temp., °F
 174.5 156.7 RT

Specimen Details: Unnotched, 0.30 inch wide
 Unnotched, 0.20 inch wide

Surface Condition: As machined, edges polished with emery paper.
 As machined, edges were hand-polished.

References: 5.5.1.1.8 and 5.5.1.2.8

Test Parameters:

Loading—Axial

Frequency—3600 cpm, 10,000 cpm

Temperature—RT

Atmosphere—Air

No. of Heats/Lot: Not specified

Equivalent Stress Equation:

$$\log N_f = 8.37 - 2.30 \log (S_{eq} - 20)$$

$$S_{eq} = S_{max} (1 - R)^{0.27}$$

Std. Error of Estimate, Log (Life) = 0.093

Standard Deviation, Log (Life) = 0.31

$R^2 = 91\%$

Sample Size = 17

[Caution: The equivalent stress model may provide unrealistic life predictions for stress ratios beyond those represented above.]

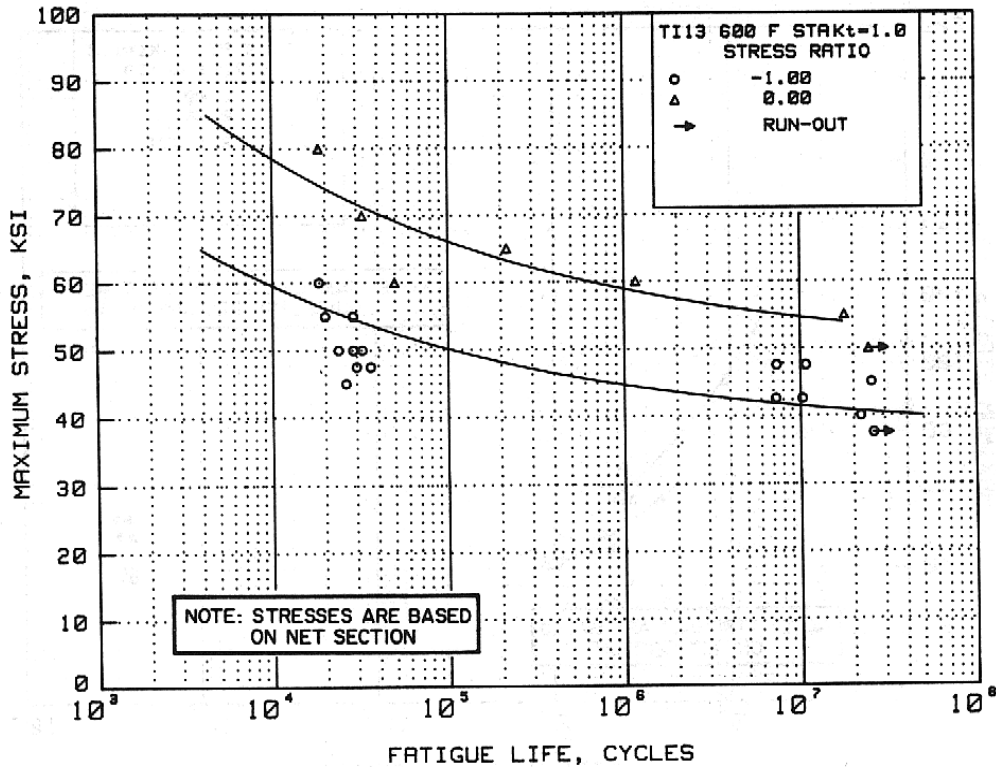

Figure 5.5.1.2.8(b). Best-fit S/N curves for unnotched, solution treated and aged Ti-13V-11Cr-3Al alloy sheet at 600°F, longitudinal direction.

Correlative Information for Figure 5.5.1.2.8(b)

Product Form: Sheet, 0.043 inch thick

Properties: TUS, ksi TYS, ksi Temp., °F
156.30 127.0 600°F

Specimen Details: Unnotched, 0.310 inch wide

Surface Condition: As machined, edges polished with emery paper.

Reference: 5.5.1.1.8

Test Parameters:

Loading—Axial

Frequency—3600 cpm

Temperature—600°F

Atmosphere—Air

No. of Heats/Lots: Not specified

Equivalent Stress Equation:

$$\log N_f = 10.39 - 4.33 \log (S_{eq} - 48.5)$$

$$S_{eq} = S_{max} (1-R)^{0.40}$$

Std. Error of Estimate, Log (Life) = 0.90

Standard Deviation, Log (Life) = 1.27

R² = 50%

Sample Size = 21

[Caution: The equivalent stress model may provide unrealistic life predictions for stress ratios beyond those represented above.]

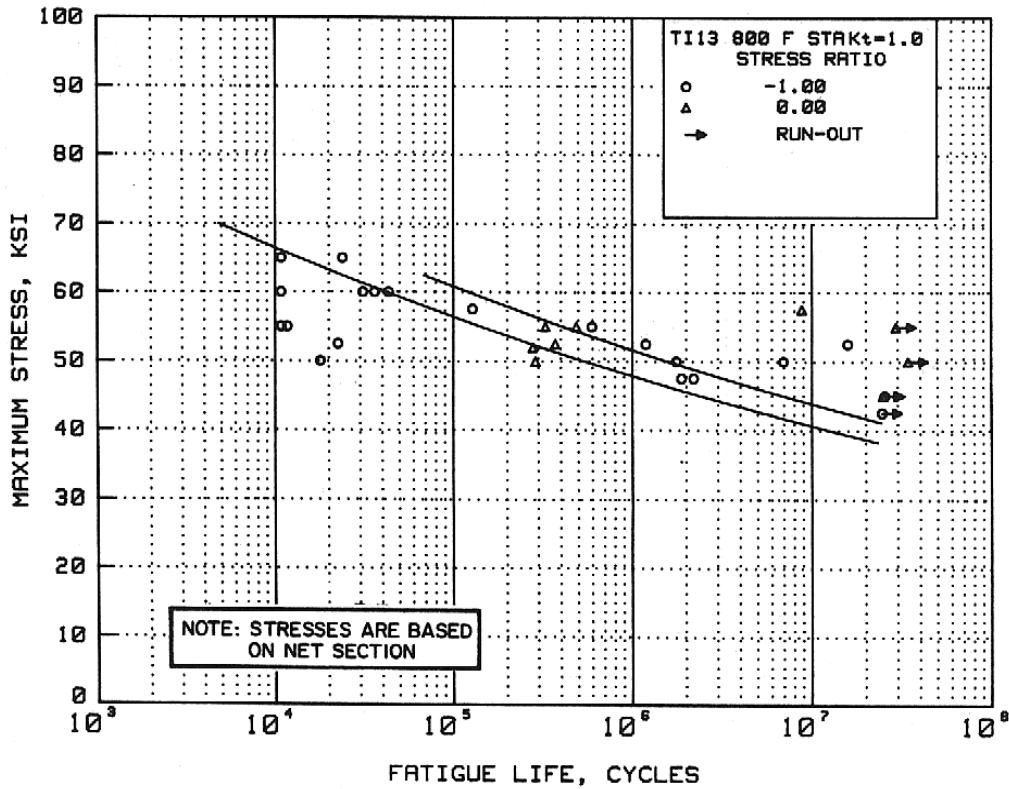

Figure 5.5.1.2.8(c). Best-fit S/N curves for unnotched, solution treated and aged Ti-13V-11Cr-3Al alloy sheet at 800°F, longitudinal direction.

Correlative Information for Figure 5.5.1.2.8(c)

Product Form: Sheet, 0.043 inch thick

Properties: TUS, ksi TYS, ksi Temp., °F
149.40 122.30 800°F

Specimen Details: Unnotched, 0.30 inch wide

Surface Condition: As machined, edges polished with emery paper.

Reference: 5.5.1.1.8

Test Parameters:

Loading—Axial

Frequency—3600 cpm

Temperature—800°F

Atmosphere—Air

No. of Heats/Lots: Not specified

Equivalent Stress Equation:

$$\log N_f = 30.03 - 14.03 \log (S_{eq})$$

$$S_{eq} = S_{max} (1-R)^{0.11}$$

Std. Error of Estimate, Log (Life) = 0.85

Standard Deviation, Log (Life) = 1.01

$R^2 = 29\%$

Sample Size = 24

[Caution: The equivalent stress model may provide unrealistic life predictions for stress ratios beyond those represented above.]

5.5.2 Ti-15V-3Cr-3Sn-3Al (Ti-15-3)

5.5.2.0 Comments — Ti-15V-3Cr-3Sn-3Al is a solute rich (metastable) beta titanium alloy. It was developed primarily to lower the cost of titanium sheet metal parts by reducing materials and processing cost. Contrary to conventional alpha-beta alloys, this alloy is strip producible and has excellent room temperature formability characteristics. It can also be aged to a wide range of strength levels to meet a variety of application needs. Although this alloy was originally developed as a sheet alloy, it has expanded into other areas such as fasteners, foil, plate, tubing, castings, and forgings.

Manufacturing Considerations — Ti-15V-3Cr-3Sn-3Al is usually supplied in the solution-annealed condition. In this condition, the alloy has a single phase (beta) structure and, hence, is readily cold formed. After cold forming, the alloy can be resolution-treated in the 1450°F to 1550°F range and subsequently aged in the 900°F to 1100°F range, depending upon desired strength. Care should be exercised to ensure that no surface contamination results from the solution treatment. The alloy can be directly aged after forming; however, strength will vary depending upon the amount of cold work in the part. The alloy can also be hot formed. Heating times prior to hot forming should be minimized in order to prevent appreciable aging prior to forming. Ti-15V-3Cr-3Sn-3Al alloy is readily welded by standard titanium welding techniques.

Environmental Considerations — In the aged condition, Ti-15V-3Cr-3Sn-3Al appears to be immune to hot-salt stress corrosion cracking below the 500°F to 440°F range. However, some susceptibility has been noted after 100-hour stressed exposures at 600°F. The presence of salt water does not appear to affect the room temperature crack growth behavior of aged material. Alloy Ti-15V-3Cr-3Sn-3Al should not be used in the solution treated condition. Long time exposure of solution treated and cold worked material to service temperatures above approximately 300°F or solution treated material to service temperatures above approximately 400°F can result in low ductility. Under certain conditions, titanium, when in contact with cadmium, silver, mercury, or certain of their compounds, may become embrittled. Refer to MIL-S-5002 and MIL-STD-1568 for restrictions concerning such applications.

Heat Treatment — This alloy should be solution treated for 10-30 minutes in the 1450°F to 1550°F range, cooled at a rate approximating an air cool of 0.125 inch thick sheet and subsequently aged. Aging is generally conducted in the 900°F to 1100°F range, followed by an air cool. Aging times will vary depending upon aging temperature. The material can be used in service in the solution treated condition subject to the temperature limitations described above.

Specifications and Properties — A material specification for Ti-15V-3Cr-3Sn-3Al is shown in Table 5.5.2.0(a). Room-temperature mechanical properties for Ti-15V-3Cr-3Sn-3Al are shown in Table 5.5.2.0(b). The effect of temperature on physical properties is shown in Figure 5.5.2.0.

5.5.2.1 Solution-Treated and Aged (1000°F) Condition — Typical tensile and compressive

Table 5.5.2.0(a). Material Specification for Ti-15V-3Cr-3Sn-3Al

Specification	Form
AMS 4914	Sheet and strip

stress-strain and compressive tangent-modulus curves are presented in Figures 5.5.2.1.6(a) and (b).

Table 5.5.2.0(b). Design Mechanical and Physical Properties of Ti-15V-3Cr-3Sn-3Al Sheet

Specification	AMS 4914
Form	Sheet
Condition	STA (1000°F/8 Hrs.)
Thickness, in.	≤0.125
Basis	S
Mechanical Properties:	
F_{tu} , ksi:	
L	145
LT	145
F_{ty} , ksi:	
L	140
LT	140
F_{cy} , ksi:	
L	139
LT	144
F_{su} , ksi	92
F_{bru}^a , ksi:	
(e/D = 1.5)	216
(e/D = 2.0)	276
F_{bry}^a , ksi:	
(e/D = 1.5)	203
(e/D = 2.0)	233
e , percent:	
L	7
LT	7
E , 10^3 ksi:	
L	15.2
LT	15.7
E_c , 10^3 ksi:	
L	15.3
LT	16.0
G , 10^3 ksi
μ
Physical Properties:	
ω , lb/in. ³	0.172
C , K , and α	See Figure 5.5.2.0

a Bearing values are “dry pin” values per Section 1.4.7.1.

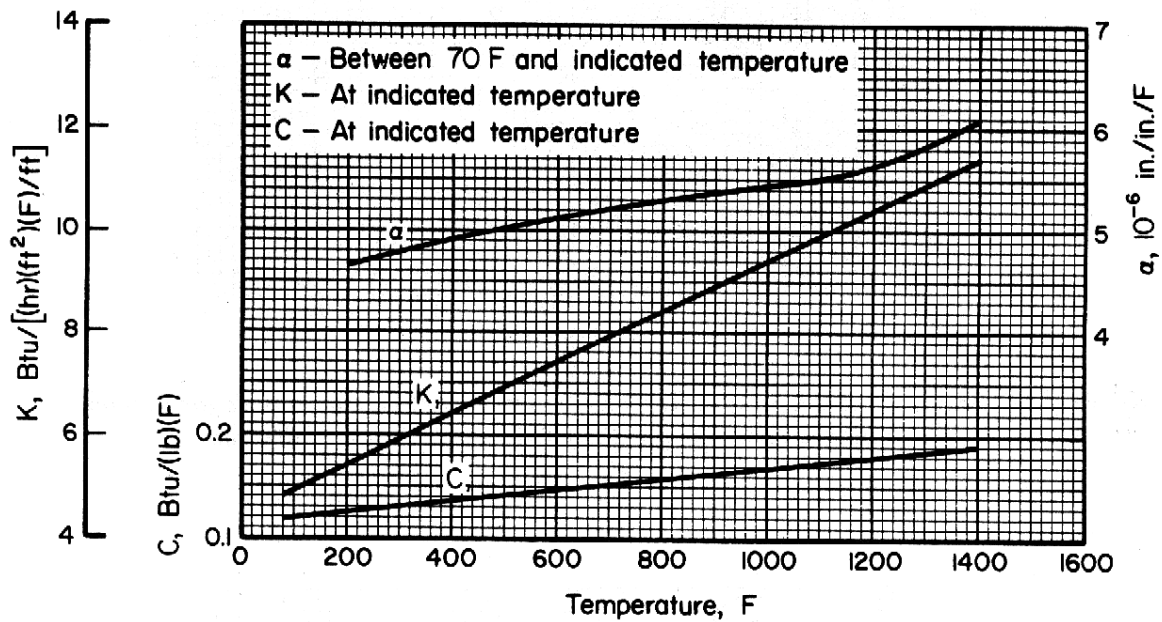

Figure 5.5.2.0. Effect of temperature on the physical properties of Ti-15V-3Cr-3Sn-3Al alloy.

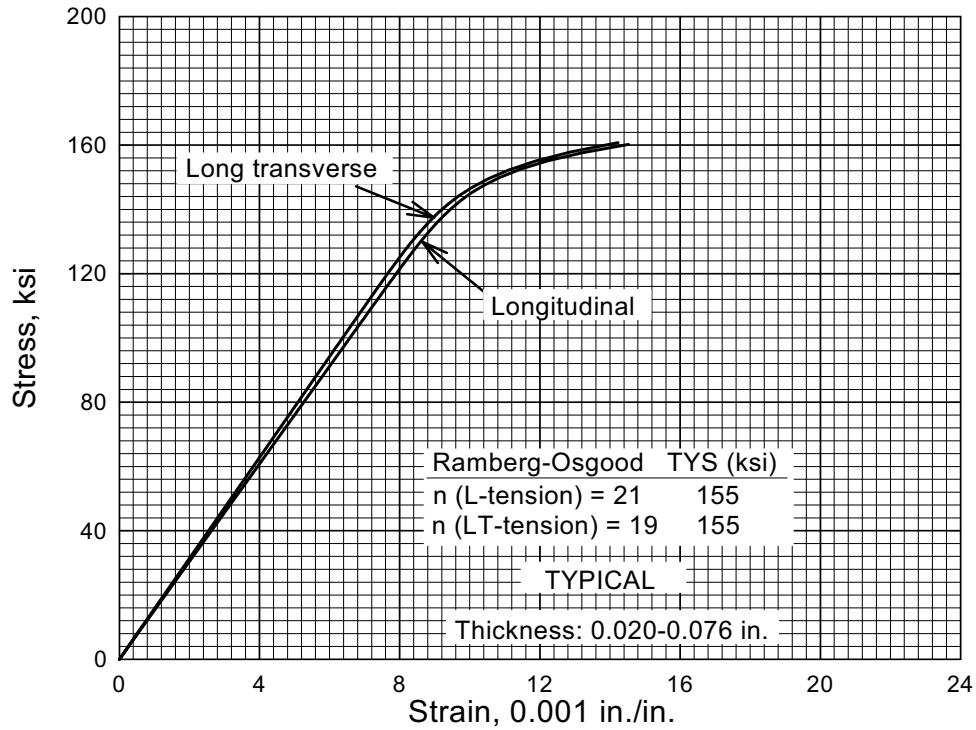

Figure 5.5.2.1.6(a). Typical tensile stress-strain curves at room temperature for solution treated and aged (1000°F) Ti-15V-3Cr-3Sn-3Al alloy sheet.

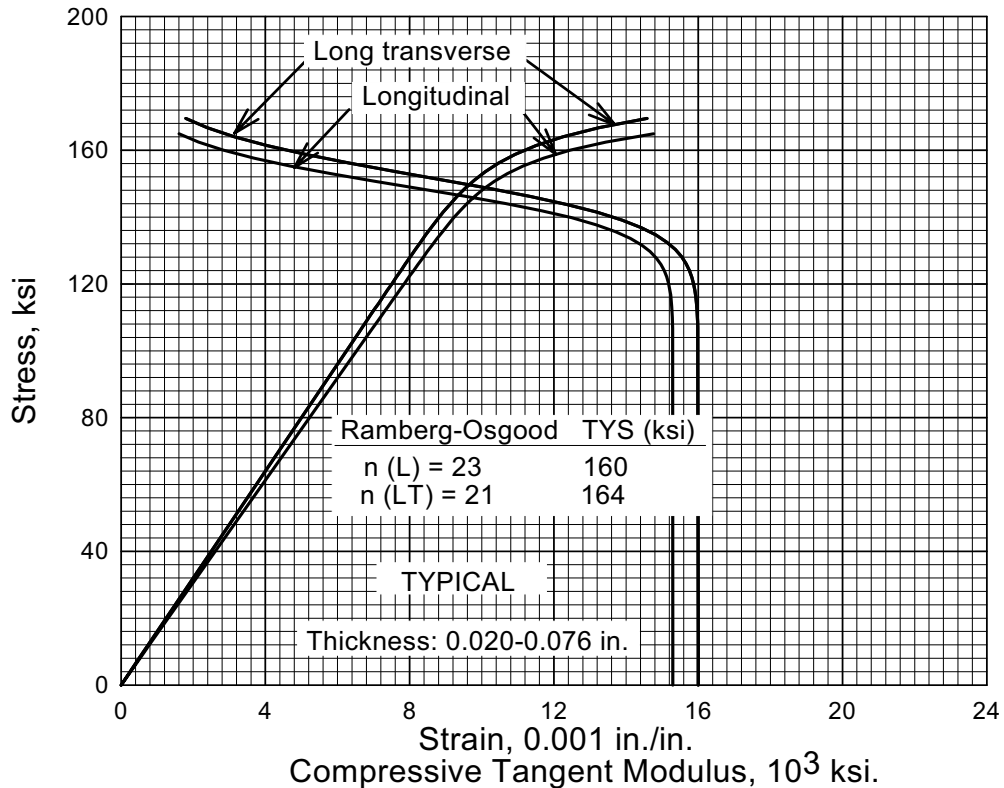

Figure 5.5.2.1.6(b). Typical compressive stress-strain and compressive tangent-modulus curves at room temperature for solution treated and aged (1000°F) Ti-15V-3Cr-3Sn-3Al alloy sheet.

5.5.3 Ti-10V-2Fe-3Al (Ti-10-2-3)

5.5.3.0 Comments and Properties — Ti-10V-2Fe-3Al is a solute lean beta (near beta) titanium alloy that was developed primarily as a high-strength forging alloy. It has excellent forging characteristics, possessing flow properties at 1500°F similar to Ti-6Al-4V at 1700°F. This characteristic provides advantages, such as lower die cost and better die fill capability. This alloy also provides the best combination of strength and toughness of any of the commercially available titanium alloys. For example, at the 180 ksi tensile ultimate strength level, the alloy has a K_{Ic} value of 40 ksi-in.^{1/2} minimum.

In addition to this high-strength condition, the alloy can also be processed to intermediate strength levels for higher fracture toughness. This alloy has also been reported to exhibit a shape-memory effect.

Manufacturing Considerations — Ti-10V-2Fe-3Al is usually supplied as bar or billet product which has been finish forged (or rolled) in the alpha-beta field. In order to optimize the microstructure for the high-strength condition, the forging is usually given a pre-form forge above the beta transus, followed by a 15 to 25 percent reduction below the beta transus. Ideally, the beta forging operation is finished through the beta transus, followed by a quench. The intent of the two-step forging process is to develop a structure without grain boundary alpha, but with elongated primary alpha needles in an aged beta matrix. The alloy is considered to be deep hardenable, capable of generating high strengths in section thicknesses up to approximately 5 inches. The alloy is also readily weldable by conventional titanium welding techniques.

Environmental Consideration — In the solution treated plus aged condition, the material exhibits excellent resistance to stress corrosion cracking, typically exhibiting a $K_{Isc} > 0.8 K_{Ic}$. In the solution-treated condition, the material should not be subjected to long-term exposure in the 500°F to 800°F range, since such exposure could result in high-strength, low-ductility conditions. Exposure to cadmium, silver, mercury, or certain other compounds should be avoided. Refer to MIL-STD-1568 and MIL-S-5002.

Heat Treatment — For the high-strength condition, the alloy is generally solution treated approximately 65°F below the beta transus (which is typically 1460 to 1480°F), followed by a water quench and an 8-hour age at 900°F to 950°F. Overaging in the 950°F to 1150°F range may also be used to obtain lower strength levels.

Beta Flecks — Ti-10V-2Fe-3Al is a segregation prone alloy which can exhibit a microstructural phenomenon known as “beta-flecks”. Certain areas may possess a lower beta transus than the matrix (due primarily to beta stabilizer enrichment) and, as such, can fully transform during heat treatment just below the matrix transus. In severe cases, this condition can lead to lower ductility and a reduction in fatigue strength due to grain boundary alpha formation in the “flecked” region. Care should be exercised to procure only material which has been melted under strict control to prevent severe “fleck” formation.

Specifications and Properties — Material specifications for Ti-10V-2Fe-3Al are shown in Table 5.5.3.0(a). Room temperature mechanical properties for Ti-10V-2Fe-3Al are presented in Table 5.5.3.0(b) and (c) for die and hand forging.

5.5.3.1 Solution Treated and Aged (900 to 950°F) Condition — Typical tensile and compressive stress-strain and compressive tangent-modulus curves are presented in Figure 5.5.3.1.6.

Table 5.5.3.0(a). Material Specifications for Ti-10V-2Fe-3Al

Specification	Form
AMS 4983	Forging
AMS 4984	Forging
AMS 4986	Forging

5.5.3.2 Solution Treated and Aged (950 to 1000°F) Condition—Typical tensile and compressive stress-strain and compressive tangent-modulus curves are shown in Figure 5.5.3.2.6.

MIL-HDBK-5J
31 January 2003

Table 5.5.3.0(b). Design Mechanical and Physical Properties of Ti-10V-2Fe-3Al Die Forging

Specification	AMS 4983	AMS 4984
Form	Conventional die forging	
Condition	Solution treated and aged (900-950°F)	
Thickness, in.	<1.000	≤3.000
Basis	S	S
Mechanical Properties:		
F_{tu} , ksi:		
L	180	173
LT	180 ^a	173 ^a
ST	173 ^a
F_{ty} , ksi:		
L	160	160
LT	160 ^a	160 ^a
ST	160 ^a
F_{cy} , ksi:		
L	168	168
LT	166	166
ST	166
F_{su} , ksi	101	97
F_{bru}^b , ksi:		
(e/D = 1.5)	244	234
(e/D = 2.0)	295	284
F_{bry}^b , ksi:		
(e/D = 1.5)	227	227
(e/D = 2.0)	261	261
e, percent:		
L	4	4
LT	4 ^a	4 ^a
ST	4 ^a
E , 10 ³ ksi		15.9
E_c , 10 ³ ksi		16.3
G , 10 ³ ksi
μ
Physical Properties:		
ω , lb/in. ³		0.168
a , 10 ⁻⁶ in./in./°F		5.4 (68-800°F)
C and K

a Applicable providing LT or ST dimension is ≥2.500 inches.

b Bearing values are “dry pin” values per Section 1.4.7.1.

Table 5.5.3.0(c). Design Mechanical and Physical Properties of Ti-10V-2Fe-3Al Hand Forging

Specification	AMS 4986	
Form	Hand forging	
Condition	Solution treated and aged (950-1000°F)	
Thickness, in.	≤3.000	3.001-4.000
Basis	S	S
Mechanical Properties:		
F_{tu} , ksi:		
L	160	160
LT	160 ^a	160
F_{ty} , ksi:		
L	145	145
LT	145 ^a	145
F_{cy} , ksi:		
L	154	...
LT
F_{su} , ksi	97 ^b	...
F_{bru}^c , ksi:		
(e/D = 1.5)	241	...
(e/D = 2.0)	293	...
F_{bry}^c , ksi:		
(e/D = 1.5)	218	...
(e/D = 2.0)	245	...
e , percent:		
L	6	6
LT	6 ^a	6
RA , percent:		
L	10	10
LT	10 ^a	10
E , 10 ³ ksi	15.9	
E_c , 10 ³ ksi	16.3	
G , 10 ³ ksi	
μ	
Physical Properties:		
ω , lb/in. ³	0.168	
a , 10 ⁻⁶ in./in./°F	5.4 (68-800°F)	
C and K	

a Applicable providing LT dimension is ≥2.500 inches.
b Shear strength determined in accordance with ASTM B 769.
c Bearing values are “dry pin” per Section 1.4.7.1.

MIL-HDBK-5J
31 January 2003

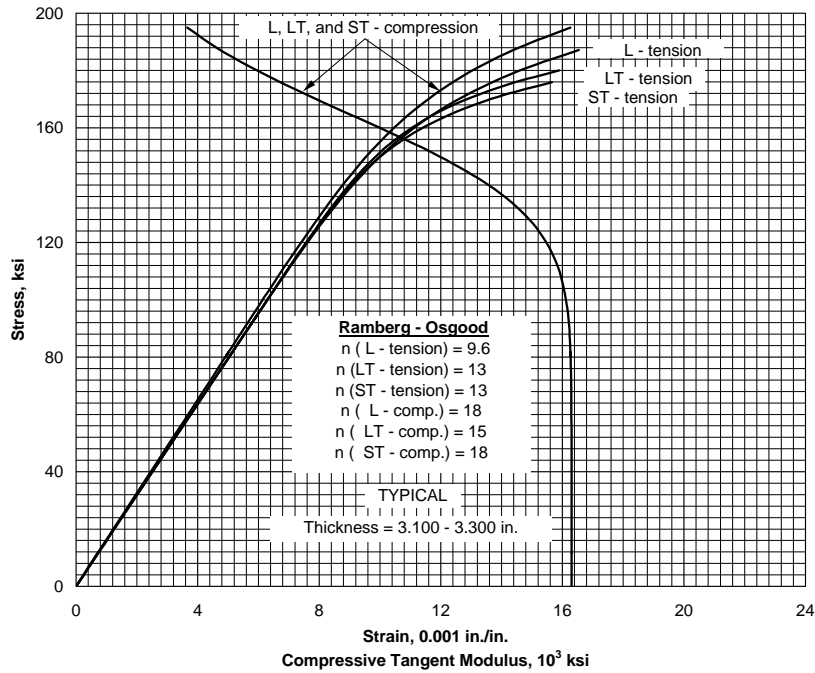

Figure 5.5.3.1.6. Typical tensile stress-strain, compressive stress-strain, and compressive tangent-modulus curves for solution treated and aged (900-950°F) Ti-10V-2Fe-3Al die forging.

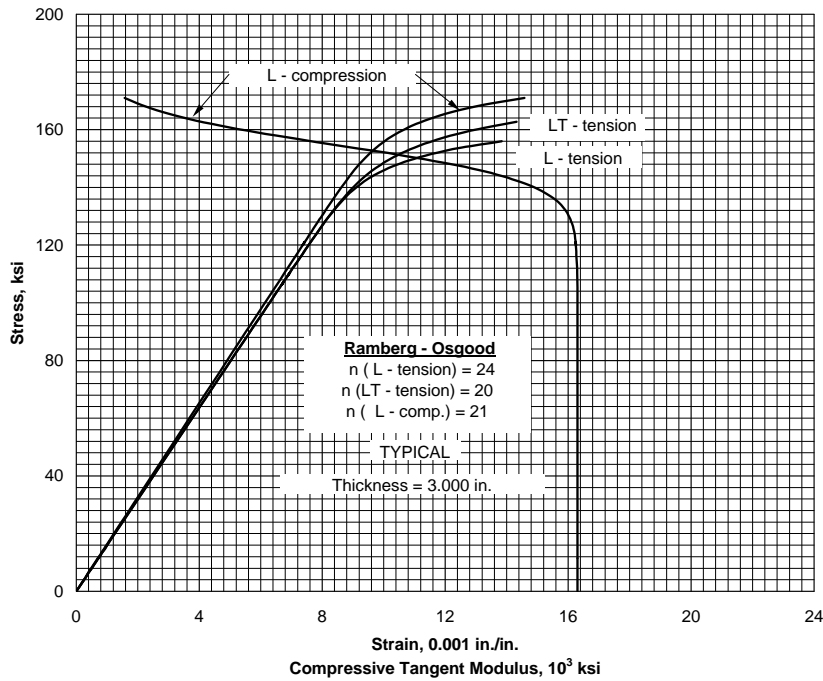

Figure 5.5.3.2.6. Typical stress-strain, compressive stress-strain, and compressive tangent-modulus curves for solution treated and aged (950-1000°F) Ti-10V-2Fe-3Al hand forging.

5.6 ELEMENT PROPERTIES

5.6.1 BEAMS — See Equation 1.3.2.3, Section 1.5.2.5, and References 1.7.1(a) and (b) for general information on stress analysis of beams.

5.6.1.1 Simple Beams — Beams of solid, tubular, or similar cross sections can be assumed to fail through exceeding an allowable modulus of rupture in bending (F_b). In the absence of specific data, the ratio F_b/F_{tu} can be assumed to be 1.25 for solid sections.

5.6.1.1.1 Round Tubes — For round tubes, the value of F_b will depend on the D/t ratio as well as the ultimate tensile stress. The bending modulus of rupture of 6Al-4V titanium alloy is given in Figure 5.6.1.1.1.

5.6.1.1.2 Unconventional Cross Sections — Sections other than solid or tubular should be tested to determine the allowable bending stress.

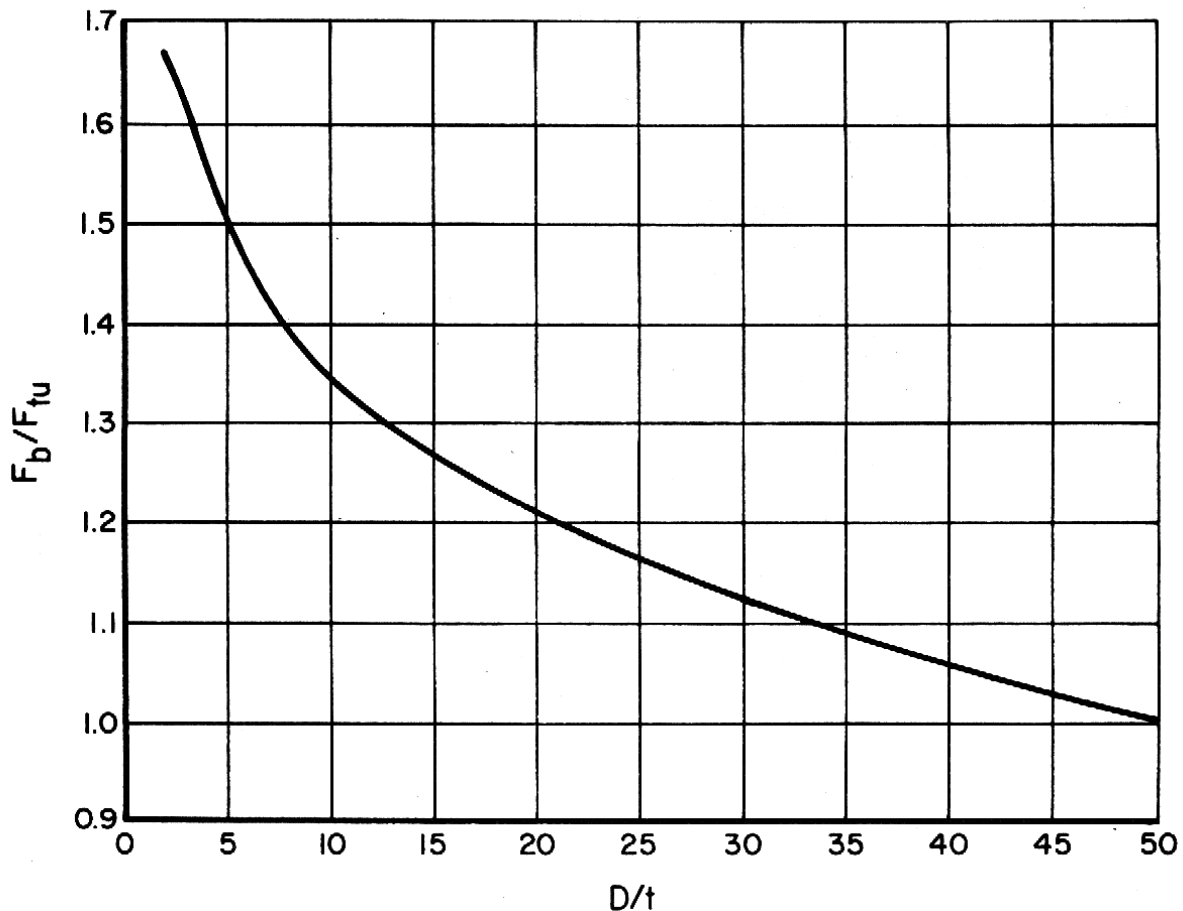

Figure 5.6.1.1.1. Bending modulus of rupture for solution-treated and aged Ti-6Al-4V alloy round tubing manufactured from bar material.

REFERENCES

- 5.1.2(a) Jaffe, R. I., "The Physical Metallurgy of Titanium Alloys", Progress in Metal Physics, Vol. 7, Pergamon Press, Oxford, England, pp 65-167 (1958).
- 5.1.2(b) "Aircraft Designer's Handbook for Titanium and Titanium Alloys", AFML-TR-67-142 (March 1967).
- 5.1.2(c) Larson, F. R., "Anisotropy in Titanium Sheet in Uniaxial Tension", *ASM Transactions*, **57**, pp 620-631 (1964).
- 5.1.2(d) Larson, F. R., "Textures in Titanium Sheet and Its Effects on Plastic Flow Properties", Army Materials Research Agency, AMRA-TR-65-24 (October 1965).
- 5.1.4(a) VanEcho, J. A., "Low Temperature Creep Characteristics of Ti-5Al-2.4Sn and Ti-6Al-4V Alloys", DMIC Technical Note, Defense Metals Information Center, Battelle Memorial Institute, Columbus, Ohio (June 8, 1964).
- 5.1.4(b) Broadwell, R. G., Hatch, A. J., Partridge, J. M., "The Room Temperature Creep and Fatigue Properties of Titanium Alloys", *Journal of Materials*, **2**, (1), pp 111-119 (March 1967).
- 5.1.4(c) Reimann, W. H., "Room Temperature Creep in Ti-6Al-4V", AFML-TR-68-171 (June 1968).
- 5.1.4(d) White, E. L., and Ward, J. J., "Ignition of Metals in Oxygen", DMIC Report 224, Defense Metals Information Center, Battelle Memorial Institute, Columbus, Ohio (February 1, 1966).
- 5.1.4(e) Jackson, J. D., and Boyd, W. K., "Corrosion of Titanium", DMIC Memorandum 218, Defense Metals Information Center, Battelle Memorial Institute, Columbus, Ohio (September 1, 1966).
- 5.1.4(f) "Accelerated Crack Propagation of Titanium by Methanol, Halogenated Hydrocarbons, and Other Solutions", DMIC Memorandum 228, Defense Metals Information Center, Battelle Memorial Institute, Columbus, Ohio (March 6, 1967).
- 5.1.4(g) Lectures from AICE Materials Conference, "Titanium for the Chemical Engineer", DMIC Memorandum 234, Defense Metals Information Center, Battelle Memorial Institute, Columbus, Ohio (April 1, 1968).
- 5.3.1.1.9 Wanhill, R. J. et al, "Fatigue Crack Propagation Data for Titanium Sheet Alloys", Interim Report NLR-TR-72093U, National Aerospace Laboratory, The Netherlands (July 1972) (MCIC 88911).
- 5.3.2.2.8(a) McCulloch, A. J., Melcon, M. A., and Young, L., "Fatigue Behavior of Sheet Materials for the Supersonic Transport, Volume 1—Summary and Analysis of Fatigue and Static Test Data", Lockheed-California Company, AFML-TR-64-399, Volume 1, January 1965 (MCIC 62421).
- 5.3.2.2.8(b) McCulloch, A. J., Melcon, M. A., and Young, L., "Fatigue Behavior of Sheet Materials for the Supersonic Transport: Volume 11—Static Test Data, S/N Test Data and S/N Diagrams", Lockheed-California Company, AFML-TR-64-399, Volume II, January 1965 (MCIC 62422).
- 5.4.1.1.8(a) "Fatigue Evaluation of Ti-6Al-4V Bar Stock", Sikorsky Aircraft, Report No. SER-50631 (MIL-HDBK-5 Source M-459) (March 1970).

MIL-HDBK-5J
31 January 2003

- 5.4.1.1.8(b) Brockett, R. M., and Gottbrath, J. A., "Development of Engineering Data on Titanium Extrusion for Use in Aerospace Design", Lockheed-California Co., Technical Report AFML-TR-67-189 (July 1967) (MCIC 69807, MIL-HDBK-5 Source M-543).
- 5.4.1.1.8(c) Rhode, T. M., and Ertel, P. W., "Constant Amplitude Fatigue Life Data for Notched and Unnotched Annealed Ti-6Al-4V Sheet", AFWAL-TR-88-4081, January 1988 (MIL-HDBK-5 Source M-696).
- 5.4.1.1.9 Fedderson, C. E., and Hyler, W. S., "Fracture and Fatigue-Crack Propagation Characteristics of ¼-Inch Mill Annealed Ti-6Al-4V Titanium Alloy Plate", Report No. G9706, Battelle, Columbus, Ohio (1971).
- 5.4.1.2.8(a) "Fatigue Strength Properties for Heat Treated Ti-4Al-30Mo-1V and Ti-6Al-4V Titanium Alloys (LP-69-132 and LP-69-129)", North American Aviation, Report No. TFD-60-521 (July 18, 1960) (MCIC 65737).
- 5.4.1.2.8(b) "Determination of Design Data for Heat Treated Titanium Alloy Sheet", Lockheed-Georgia Co., Report No. ASD-TDR-62-335, Vol. 3, Contract No. AF33(616)-6346 (May 1962) (MCIC 90172).
- 5.4.1.2.8(c) Sommer, A. W., and Martin, G. R., "Design Allowables for Titanium Alloys", North American Rockwell, AFML-TR-69-161 (June 1969) (MCIC 75727).
- 5.4.1.2.8(d) Marrocco, A. G., "Fatigue Characteristics of Ti-6Al-4V and Ti-6Al-6V-2Sn Sheet and Plate", Grumman Aircraft Engineering Corp., EMG-81 (November 18, 1968) (MCIC 76303).
- 5.4.1.2.8(e) Sargent, M. R., "Fatigue Characteristics of Ti-6Al-4V Plate and Forgings (SWIP)", General Dynamics, FGT-3218 (September 22, 1965) (MIL-HDBK-5 Source M-457).
- 5.4.2.1.8 Marrocco, A. G., "Evaluation of Ti-6Al-4V and Ti-6Al-6V-2Sn Forgings", Grumman Aircraft Engineering Corporation, EMG-82, November 1968 (MIL-HDBK-5 Source M-522).
- 5.4.3.1 Unpublished data from NKK, January 2001, (MIL-HDBK-5 Source M-914).
- 5.5.1 Henning, R. G., "Mechanical Properties of Solution-Treated Titanium Sheet Alloy B120VCA", ASD TR 61-337 (September 1961).
- 5.5.1.1.8 Blatherwick, A. A., "Fatigue, Creep, and Stress-Rupture Properties of Ti-13V-11Cr-3Al Titanium Alloy (B120VCA)", AFML-TR-66-293 (September 1966).
- 5.5.1.2.8 Schwartzberg, F. R., Kiefer, T. F., and Keys, R. D., "Determination of Low-Temperature Fatigue Properties of Structural Metal Alloys 1 April 1962 through 30 September 1964", Martin-Cr-64-74 (October 1964), pp 158 (MCIC 58024).
- 5.6(a) "Theoretical and Experimental Determination of the Bending Modulus of Rupture for Round Titanium Tubing", Bendix Products Division (July 31, 1958).
- 5.6(b) Cozzone, F. P., "Bending Strength in Plastic Range", *Journal of the Aeronautical Sciences* (May 1943).
- 5.6(c) Ades, C. S., "Bending Strength of Tubing in the Plastic Range", *Journal of Aeronautical Sciences* (August 1957).

MIL-HDBK-5J
31 January 2003

- 5.6(d) “Theoretical and Experimental Determination of the Bending Modulus of Rupture of Round Titanium Tubing”, Systems Engineering Report, Bendix Energy Controls Division, South Bend, Indiana, MS-58-3 (July 1958).

THIS PAGE INTENTIONALLY BLANK

CHAPTER 6

HEAT-RESISTANT ALLOYS

6.1 GENERAL

Heat-resistant alloys are arbitrarily defined as iron alloys richer in alloy content than the 18 percent chromium, 8 percent nickel types, or as alloys with a base element other than iron and which are intended for elevated-temperature service. These alloys have adequate oxidation resistance for service at elevated temperatures and are normally used without special surface protection. So-called “refractory” alloys that require special surface protection for elevated-temperature service are not included in this chapter.

This chapter contains strength properties and related characteristics of wrought heat-resistant alloy products used in aerospace vehicles. The strength properties are those commonly used in structural design, such as tension, compression, bearing, and shear. The effects of elevated temperature are presented. Factors such as metallurgical considerations influencing the selection of metals are included in comments preceding the specific properties of each alloy or alloy group. Data on creep, stress-rupture, and fatigue strength, as well as crack-growth characteristics, are presented in the applicable alloy section.

There is no standardized numbering system for the alloys in this chapter. For this reason, each alloy is identified by its most widely accepted trade designation.

For convenience in presenting these alloys and their properties, the heat-resistant alloys have been divided into three groups, based on alloy composition. These groups and the alloys for which specifications and properties are included are shown in Table 6.1.

The heat treatments applied to the alloys in this chapter vary considerably from one alloy to another. For uniformity of presentation, the heat-treating terms are defined as follows:

Stress-Relieving — Heating to a suitable temperature, holding long enough to reduce residual stresses, and cooling in air or as prescribed.

Annealing — Heating to a suitable temperature, holding, and cooling at a suitable rate for the purpose of obtaining minimum hardness or strength.

Solution-Treating — Heating to a suitable temperature, holding long enough to allow one or more constituents to enter into solid solution, and cooling rapidly enough to hold the constituents in solution.

Aging, Precipitation-Hardening — Heating to a suitable temperature and holding long enough to obtain hardening by the precipitation of a constituent from the solution-treated condition.

The actual temperatures, holding times, and heating and cooling rates used in these treatments vary from alloy to alloy and are described in the applicable specifications.

Table 6.1. Heat-Resistant Alloys Index

Section	Designation
6.2	Iron-Chromium-Nickel-Base Alloys
	A-286
6.2.1	N-155
6.2.2	
6.3	Nickel-Base Alloys
6.3.1	Hastelloy X
6.3.2	Inconel 600 (Inconel)
6.3.3	Inconel 625
6.3.4	Inconel 706
6.3.5	Inconel 718
6.3.6	Inconel X-750 (Inconel X)
6.3.7	René 41
6.3.8	Waspaloy
6.3.9	Haynes 230
6.3.10	Haynes HR-120
6.4	Cobalt-Base Alloys
6.4.1	L-605 (Haynes Alloy 25)
6.4.2	HS 188

6.1.1 MATERIAL PROPERTIES

6.1.1.1 Mechanical Properties — The mechanical properties of the heat-resistant alloys are affected by relatively minor variations in chemistry, processing, and heat treatment. Consequently, the mechanical properties shown for the various alloys in this chapter are intended to apply only to the alloy, form (shape), size (thickness), and heat treatment indicated. When statistical values are shown, these are intended to represent a fair cross section of all mill production within the indicated scope.

Strength Properties — Room-temperature strength properties for alloys in this chapter are based primarily on minimum tensile property requirements of material specifications. Values for nonspecification strength properties are derived. The variation of properties with temperature and other data of interest are presented in figures or tables, as appropriate.

The strength properties of the heat-resistant alloys generally decrease with increasing temperatures or increasing time at temperature. There are exceptions to this statement, particularly in the case of age-hardening alloys; these alloys may actually show an increase in strength with temperature or time, within a limited range, as a result of further aging. In most cases, however, this increase in strength is temporary and, furthermore, cannot usually be taken advantage of in service. For this reason, this increase in strength has been ignored in the preparation of elevated temperature curves as described in Chapter 9.

At cryogenic temperatures, the strength properties of the heat-resistant alloys are generally higher than at room temperature, provided some ductility is retained at the low temperatures. For additional information on mechanical properties at cryogenic temperatures, other references, such as the Cryogenic Materials Data Handbook (Reference 6.1.1.1), should be consulted.

Ductility — Specified minimum ductility requirements are presented for these alloys in the room-temperature property tables. The variation in ductility with temperature is somewhat erratic for the heat-resistant alloys. Generally, ductility decreases with increasing temperature from room temperature up to about 1200°F to 1400°F, where it reaches a minimum value, then it increases with higher temperatures. Prior creep exposure may also affect ductility adversely. Below room temperature, ductility decreases with decreasing temperature for some of these alloys.

Stress-Strain Relationships — The stress-strain relationships presented are typical curves prepared as described in Section 9.3.2.

Creep — Data covering the temperatures and times of exposure and the creep deformations of interest are included as typical information in individual material sections. These presentations may be in the form of creep stress-lifetime curves for various deformation criteria as specified in Chapter 9 or as creep nomographs.

Fatigue — Fatigue S/N curves for unnotched and notched specimens at room temperature and elevated temperatures are shown in each alloy section. Fatigue crack propagation data are also presented.

6.1.1.2 Physical Properties — Selected physical-property data are presented for these alloys. Processing variables and heat treatment have only a slight effect on these values; thus, the properties listed are applicable to all forms and heat treatments.

6.2 IRON-CHROMIUM-NICKEL-BASE ALLOYS

6.2.0 GENERAL COMMENTS — The alloys in this group, in terms of cost and in maximum service temperature, generally fall between the austenitic stainless steels and the nickel- and cobalt-base alloys. They are used in airframes, principally, in the temperature range 1000 to 1200°F, in those applications in which the stainless steels are inadequate and service requirements do not justify the use of the more costly nickel or cobalt alloys.

6.2.0.1 Metallurgical Considerations

Composition — The complex-base alloys comprising this group range from those in which iron is considered the base element to those which border on the nickel-base alloys. All of them contain sufficient alloying elements to place them in the “Superalloy” category, yet contain enough iron to reduce their cost considerably.

Chromium, in amounts ranging from 10 to 20 percent or higher, primarily increases oxidation resistance and contributes to strengthening of these alloys. Nickel and cobalt strengthen and toughen these materials. Molybdenum, tungsten, and columbium contribute to hardness and strength, particularly at elevated temperatures. Titanium and aluminum are added to provide age-hardening.

Heat Treatment — The complex-base alloys are heat treated with conventional equipment and fixtures such as would be used for austenitic stainless steels. Since these alloys are susceptible to carburization during heat treatment, it is good practice to remove all grease, oil, cutting, lubricant, etc., from the surface before heating. A low-sulfur and neutral or slightly oxidizing furnace atmosphere is recommended for heating.

6.2.0.2 Manufacturing Considerations — The iron-chromium-nickel-base alloys closely resemble the austenitic stainless steels insofar as forging, cold forming, machining, welding, and brazing are concerned. Their higher strength may require the use of heavier forging or forming equipment, and machining is somewhat more difficult than for the stainless steels. Pertinent comments are included under the individual alloys.

6.2.1 A-286

6.2.1.0 Comments and Properties — A-286 is a precipitation-hardening iron-base alloy designed for parts requiring high strength up to 1300°F and oxidation resistance up to 1500°F. It is used in jet engines and gas turbines for parts such as turbine buckets, bolts, and discs, and sheet metal assemblies. A-286 is available in the usual mill forms.

A-286 is somewhat harder to hot or cold work than the austenitic stainless steels. Its forging range is 2150 to 1800°F; when finishing below 1800°F, light reductions (under 15 percent) must be avoided to prevent grain coarsening during subsequent heat treatment. A-286 is readily machined in the partially or fully aged condition but is soft and “gummy” in the solution-treated condition. A-286 should be welded in the solution-treated condition. Fusion welding is difficult for large section sizes and moderately difficult for small cross sections and sheet. Cracking may be encountered in the welding of heavy sections or parts under high restraint. A dimensional contraction of 0.0008 inch per inch is experienced during aging. Oxidation resistance of A-286 is equivalent to that of Type 310 stainless steel up to 1800°F.

Some material specifications for A-286 alloy are presented in Table 6.2.1.0(a). Room-temperature mechanical and physical properties are shown in Table 6.2.1.0(b). The effect of temperature on physical properties is shown in Figure 6.2.1.0.

31 January 2003

6.2.1.1 Solution-Treated and Aged Condition — Elevated-temperature data are presented in Figures 6.2.1.1.1, 6.2.1.1.3, and 6.2.1.1.4(a) through (c). Stress rupture properties are specified at 1200 °F; the appropriate specifications should be consulted for detailed requirements. Figures 6.2.1.1.8(a) through (e) are fatigue S/N curves for several elevated temperatures.

Table 6.2.1.0(a). Material Specifications for A-286 Alloy

Specification	Form	Condition
AMS 5525	Sheet, strip, and plate	Solution treated (1800 °F)
AMS 5731	Bar, forging, tubing, and ring	Solution treated (1800 °F)
AMS 5732	Bar, forging, tubing, and ring	Solution treated (1800 °F) and aged
AMS 5734	Bar, forging, and tubing	Solution treated (1650 °F)
AMS 5737	Bar, forging, and tubing	Solution treated (1650 °F) and aged

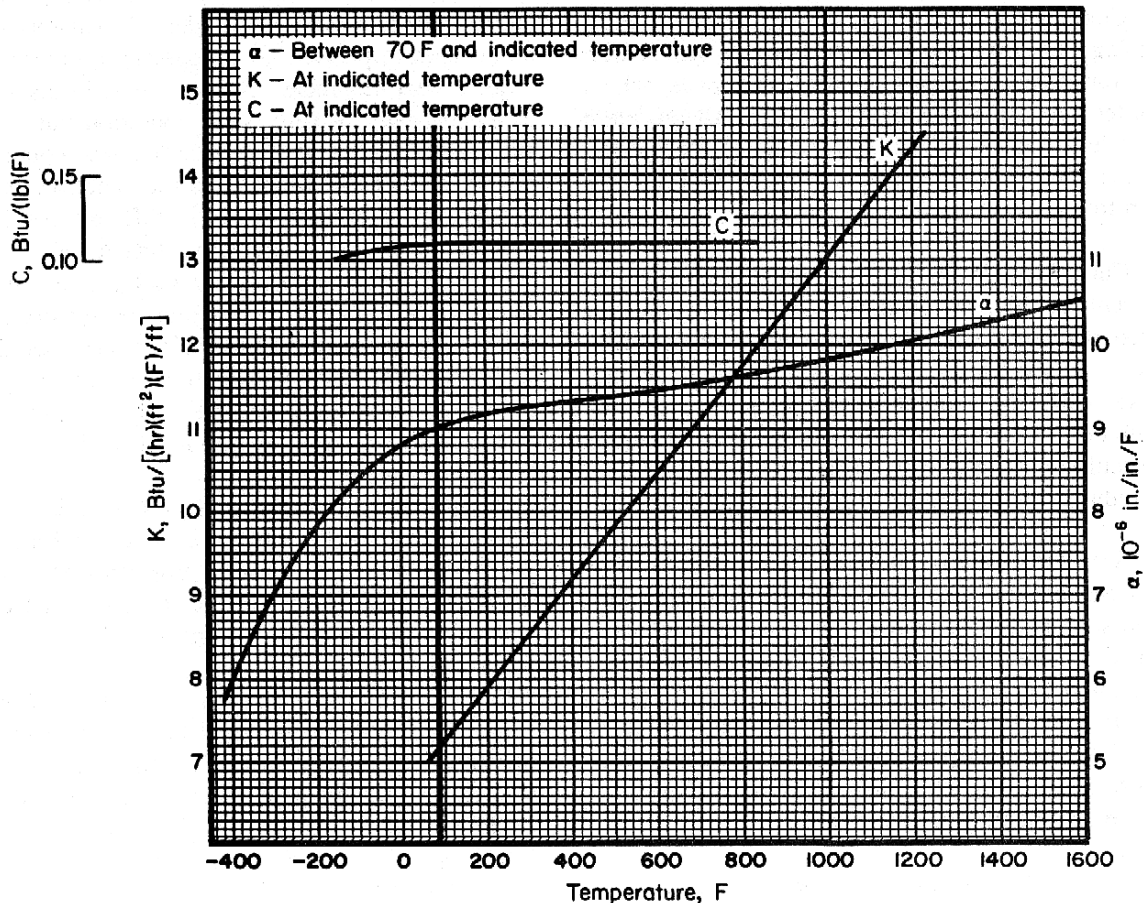

Figure 6.2.1.0. Effect of temperature on the physical properties of A-286.

MIL-HDBK-5J
31 January 2003

Table 6.2.1.0(b). Design Mechanical and Physical Properties of A-286 Alloy

Specification	AMS 5525	AMS 5731 AMS 5732		AMS 5734 AMS 5737	
Form	Sheet, strip, and plate	Bar			
Condition	Solution treated and aged				
Thickness or diameter, in.	>0.004	≤2.499	2.500-5.000	≤2.499	2.500-5.000
Basis	S ^a	S	S	S	S
Mechanical Properties:					
<i>F_{tu}</i> , ksi:					
L	130	130	140	140
LT	140	130 ^b	130	140 ^b	140
ST	130	...	140
<i>F_{ly}</i> , ksi:					
L	85	85	95	95
LT	95	85 ^b	85	95 ^b	95
ST	85	...	95
<i>F_{cy}</i> , ksi:					
L	85	85	95	95
LT	95
<i>F_{su}</i> , ksi					
	91	85	85	91	91
<i>F_{bru}</i> , ksi:					
(e/D = 1.5)	210	195	195	210	210
(e/D = 2.0)	266	247	247	266	266
<i>F_{bry}</i> , ksi:					
(e/D = 1.5)	142	127	127	142	142
(e/D = 2.0)	171	153	153	171	171
<i>e</i> , percent:					
L	15	15	12	12
LT	15	15 ^b	15	12 ^b	12
ST	15	...	12
<i>RA</i> , percent:					
L	20	20	15	15
LT	20 ^b	20	15 ^b	15
ST	20	...	15
<i>E</i> , 10 ³ ksi			29.1		
<i>E_c</i> , 10 ³ ksi			29.1		
<i>G</i> , 10 ³ ksi			11.1		
<i>μ</i>			0.31		
Physical Properties:					
<i>ω</i> , lb/in. ³			0.287		
<i>C, K, and α</i>			See Figure 6.2.1.0		

a Test direction longitudinal for widths less than 9 inches; transverse for widths 9 inches and over.
b Applicable to widths ≥2.500 inches only.

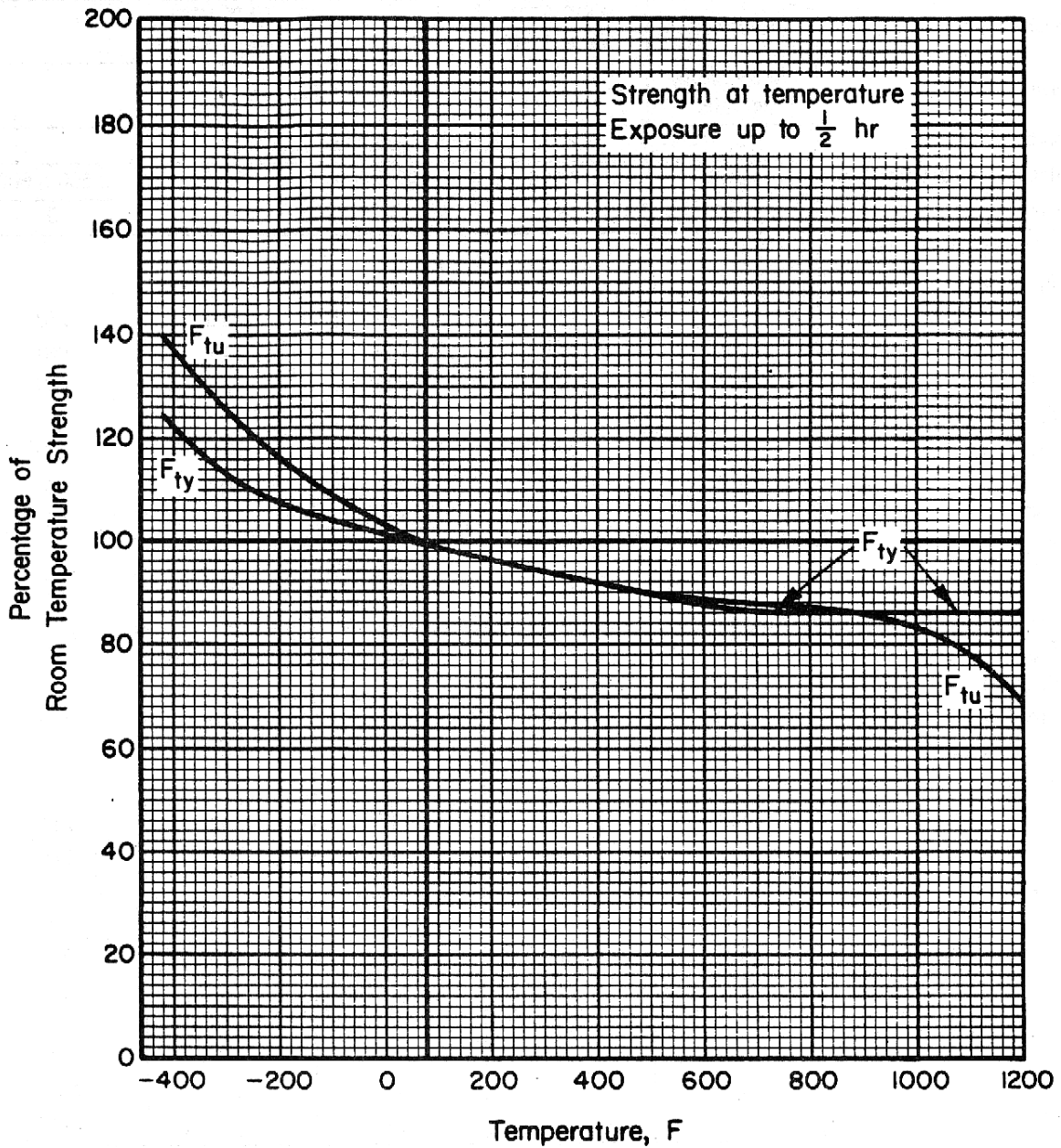

Figure 6.2.1.1.1. Effect of temperature on the tensile yield strength (F_{ty}) and tensile ultimate strength (F_{tu}) of A-286 alloy (1800°F solution treatment temperature).

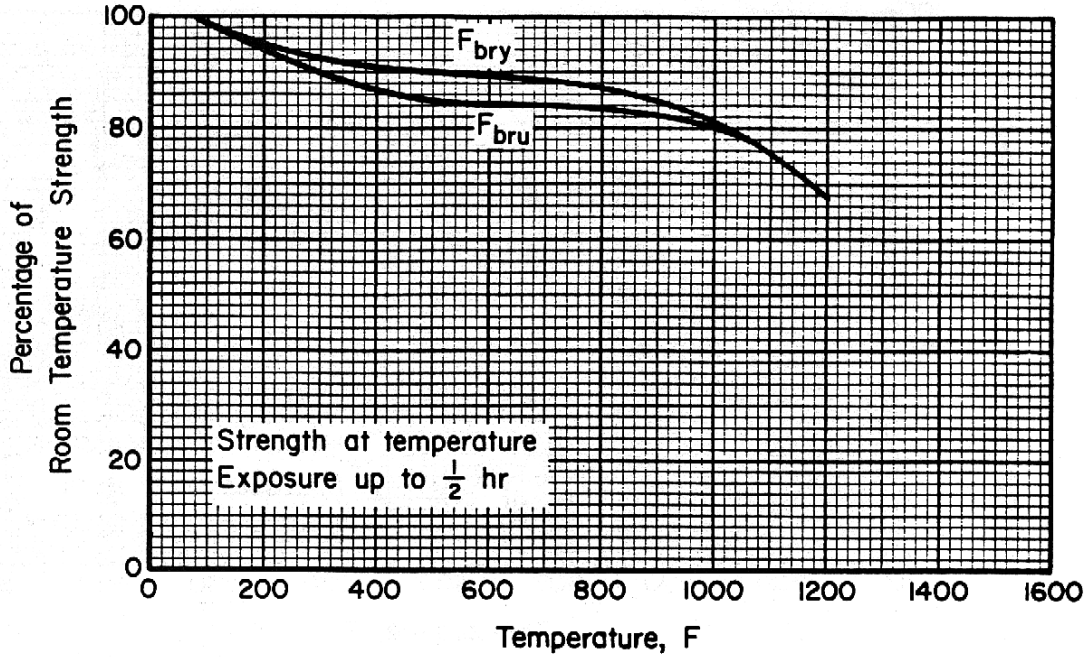

Figure 6.2.1.1.3. Effect of temperature on the bearing ultimate strength (F_{bru}) and the bearing yield strength (F_{bry}) for A-286 alloy (1800°F solution treatment temperature).

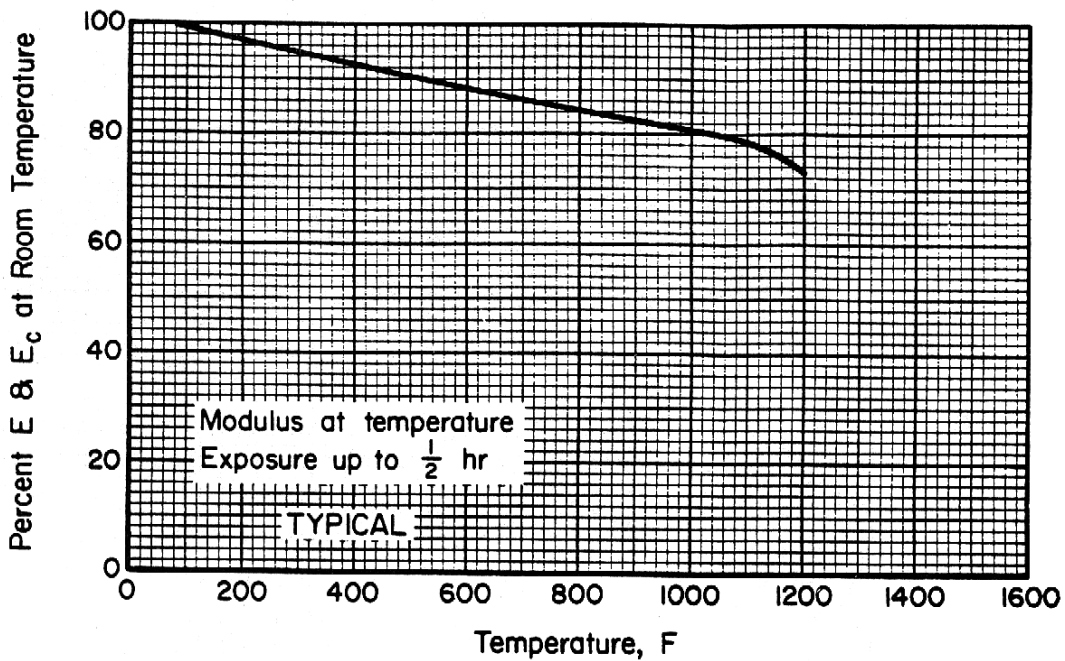

Figure 6.2.1.1.4(a). Effect of temperature on the tensile and compressive moduli (E and E_c) for A-286 alloy (1800°F solution treatment temperature).

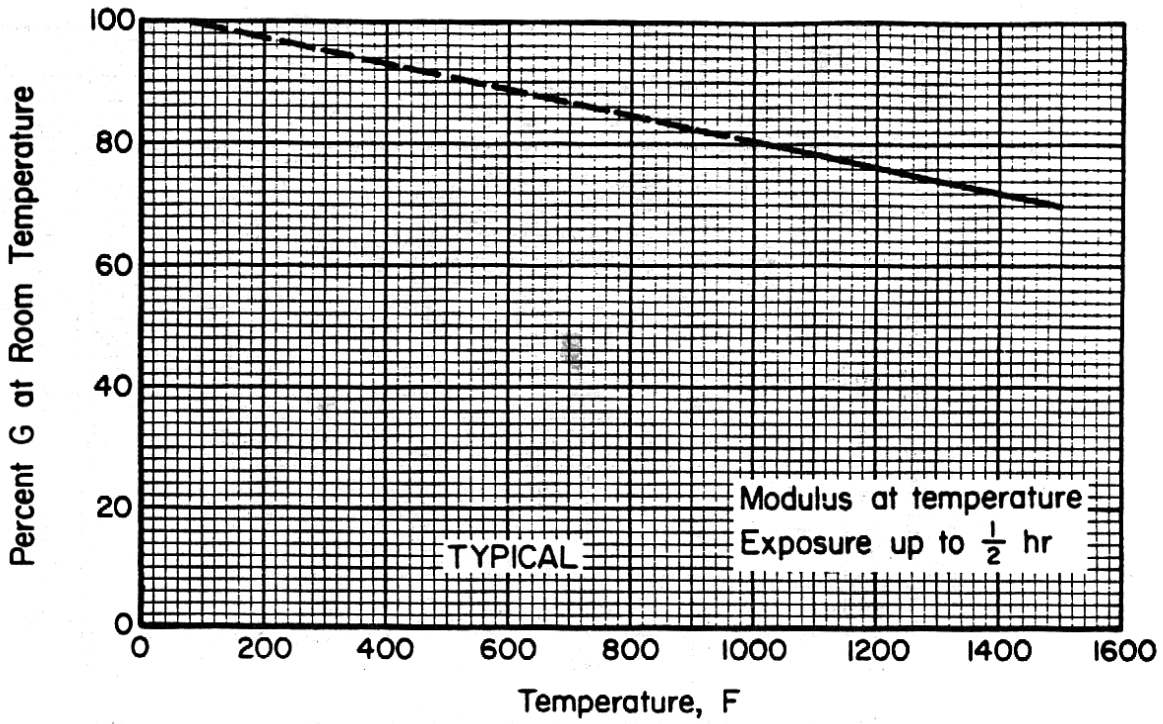

Figure 6.2.1.1.4(b). Effect of temperature on the shear modulus (G) of A-286 alloy.

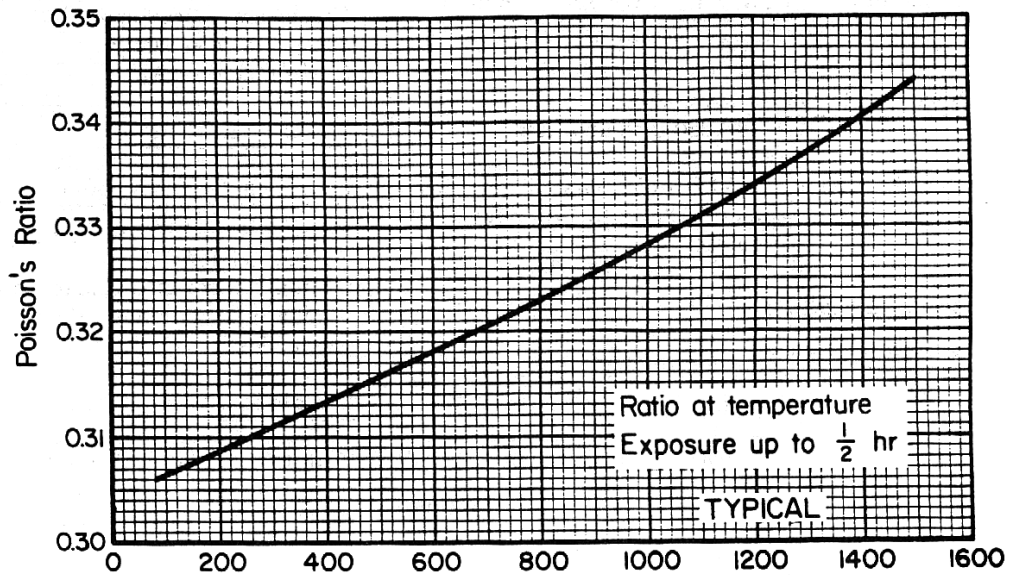

Figure 6.2.1.1.4(c). Effect of temperature on Poisson's ratio (μ) for A-286 alloy.

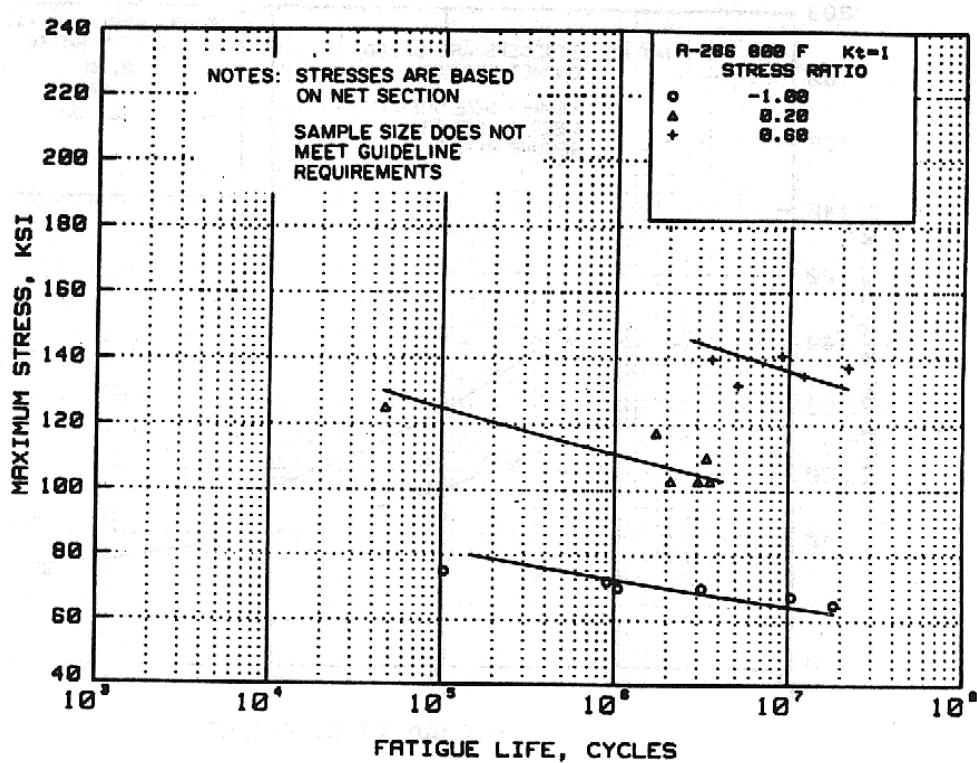

Figure 6.2.1.1.8(a). Best-fit S/N curves for unnotched A-286 bar at 800°F, longitudinal direction.

Correlative Information for Figure 6.2.1.1.8(a)

Product Form: Bar, air melted

Test Parameters:

Properties: TUS, ksi TYS, ksi Temp., °F
141.4 95.3 800

Loading - Axial
Frequency - 3600 cpm
Temperature - 800°F
Environment - Air

Specimen Details: Unnotched
0.250 inch diameter

No. of Heats/Lots: 1

Heat Treatment: 1650°F for 2 hours, oil quenched and 1300°F for 16 hours, air cooled.

Equivalent Stress Equation:
 $\log N_f = 45.1 - 19.5 \log (S_{eq})$
 $S_{eq} = S_{max} (1-R)^{0.47}$
Std. Error of Estimate, Log (Life) = 0.418
Standard Deviation, Log (Life) = 0.717
 $R^2 = 65.9\%$

Surface Condition: Not given

Reference: 6.2.1.1.8

Sample Size = 17

[Caution: The equivalent stress model may provide unrealistic life predictions for stress ratios beyond those represented above.]

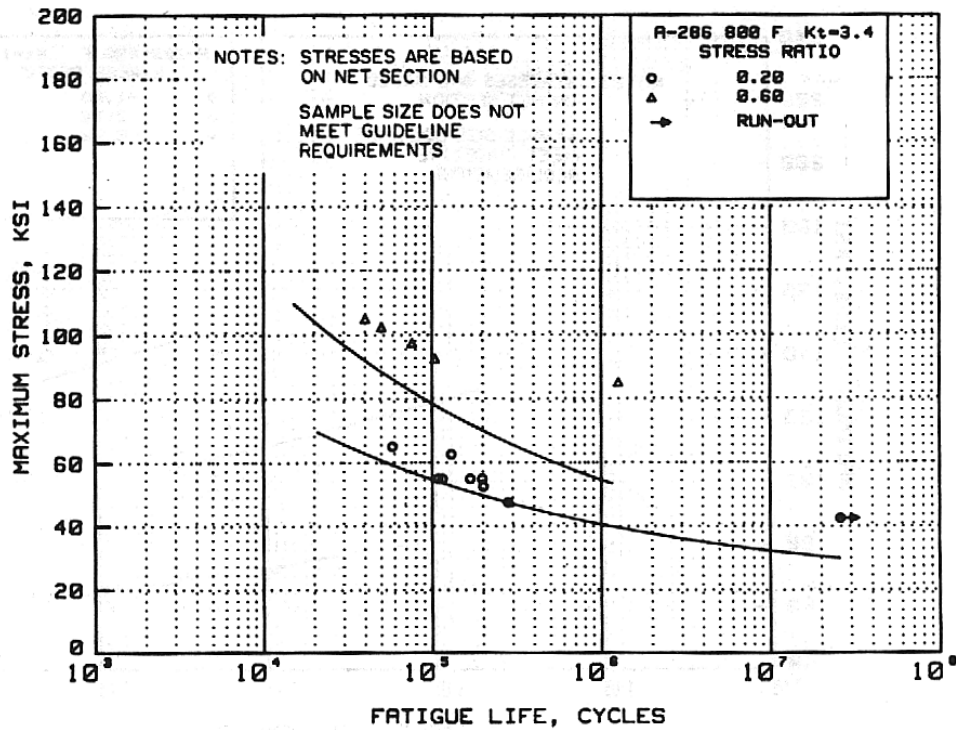

Figure 6.2.1.1.8(b). Best-fit S/N curves for notched, $K_t = 3.4$, A-286 alloy bar at 800°F, longitudinal direction.

Correlative Information for Figure 6.2.1.1.8(b)

Product Form: Bar, air melted

Test Parameters:

Properties: TUS, ksi TYS, ksi Temp., °F
141.4 95.3 800
Unnotched

Loading - Axial
Frequency - 3600 cpm
Temperature - 800°F
Environment - Air

Specimen Details: Notched, V-Groove,
 $K_t = 3.4$
0.375 inch gross diameter
0.250 inch net diameter
0.010 inch root radius, r
60° flank angle, ω

No. of Heats/Lots: 1

Equivalent Stress Equation:

$\log N_f = 11.4 - 4.4 \log (S_{eq} - 20)$
 $S_{eq} = S_{max} (1-R)^{0.75}$
Std. Error of Estimate, $\log (\text{Life}) = 0.271$
Standard Deviation, $\log (\text{Life}) = 0.387$
 $R^2 = 50.9\%$

Heat Treatment: 1650°F for 2 hours, oil quenched and 1300°F for 16 hours, air cooled.

Sample Size = 13

Surface Condition: As machined

[Caution: The equivalent stress model may provide unrealistic life predictions for stress ratios beyond those represented above.]

Reference: 6.2.1.1.8

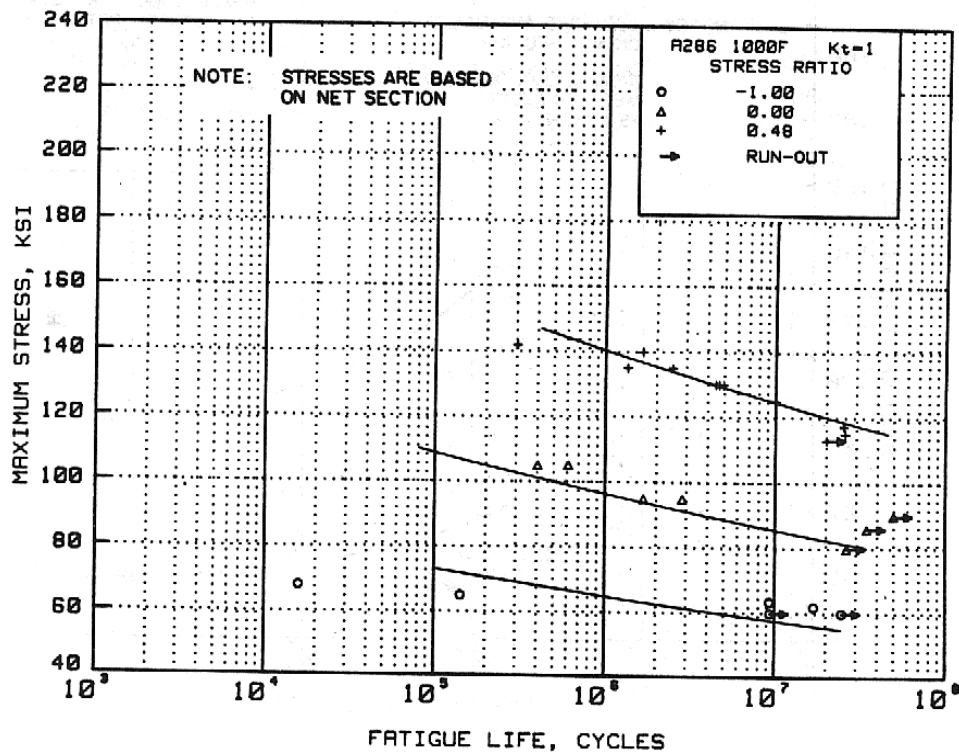

Figure 6.2.1.1.8(c). Best-fit S/N curves for unnotched A-286 bar at 1000°F, longitudinal direction.

Correlative Information for Figure 6.2.1.1.8(c)

Product Form: Bar, air melted

Test Parameters:

Properties: TUS, ksi TYS, ksi Temp., °F
 137.2 100.6 1000

Loading - Axial
Frequency - 3600 cpm
Temperature - 1000°F
Environment - Air

Specimen Details: Unnotched
0.250 inch diameter

No. of Heats/Lots: 1

Heat Treatment: 1650°F for 2 hours, oil
quenched and 1300°F for
16 hours, air cooled.

Equivalent Stress Equation:
 $\text{Log } N_f = 44.2 - 19.3 \text{ log } (S_{eq})$
 $S_{eq} = S_{max} (1-R)^{0.57}$
Std. Error of Estimate, $\text{Log } (\text{Life}) = 0.566$
Standard Deviation, $\text{Log } (\text{Life}) = 0.835$
 $R^2 = 54.0\%$

Surface Condition: Not given

Reference: 6.2.1.1.8

Sample Size = 18

[Caution: The equivalent stress model may provide unrealistic life predictions for stress ratios beyond those represented above.]

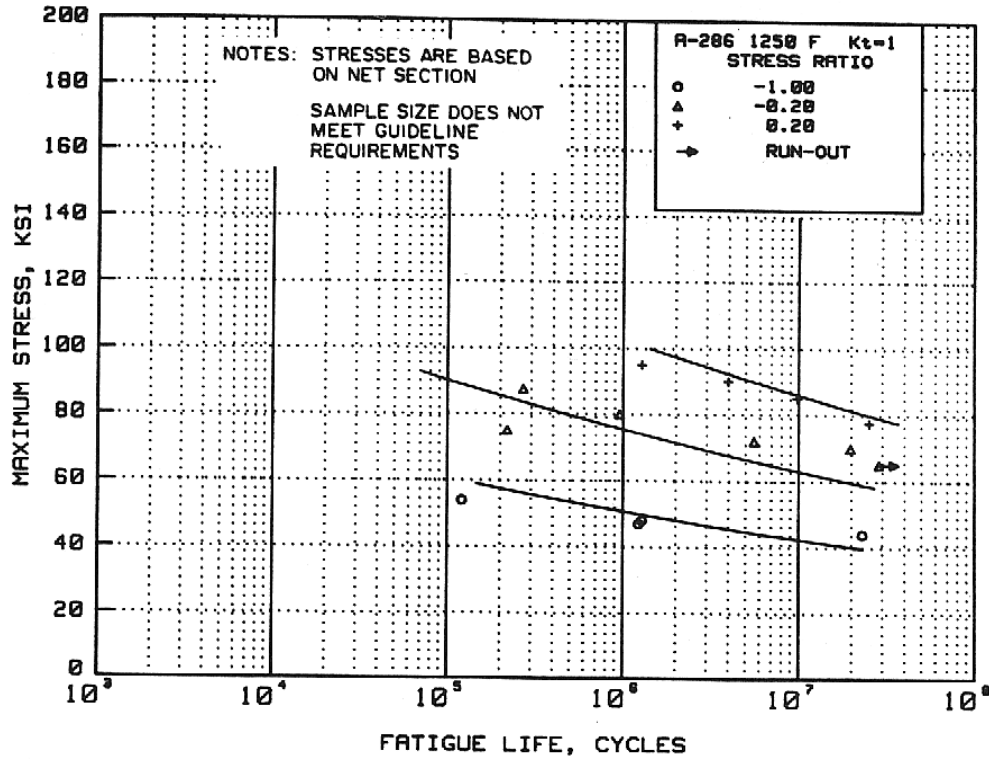

Figure 6.2.1.1.8(e). Best-fit S/N curves for unnotched A-286 bar at 1250°F, longitudinal direction.

Correlative Information for Figure 6.2.1.1.8(e)

Product Form: Bar, air melted

Test Parameters:

Properties: TUS, ksi TYS, ksi Temp., °F
 109.6 96.5 1250

Loading - Axial
 Frequency - 3600 cpm
 Temperature - 1250 °F
 Environment - Air

Specimen Details: Unnotched
 0.250 inch diameter

No. of Heats/Lots: 1

Heat Treatment: 1650 °F for 2 hours, oil
 quenched and 1300 °F for
 16 hours, air cooled.

Equivalent Stress Equation:
 $\log N_f = 30.8 - 12.8 \log (S_{eq})$
 $S_{eq} = S_{max} (1-R)^{0.77}$
 Std. Error of Estimate, $\log (\text{Life}) = 0.513$
 Standard Deviation, $\log (\text{Life}) = 0.788$
 $R^2 = 57.6\%$

Surface Condition: Not given

Reference: 6.2.1.1.8

Sample Size = 13

[Caution: The equivalent stress model may provide unrealistic life predictions for stress ratios beyond those represented above.]

6.2.2 N-155

6.2.2.0 Comments and Properties — N-155 alloy, also known as Multimet, is designed for applications involving high stress up to 1500°F. It has good oxidation properties and good ductility and can be fabricated readily by conventional methods. This alloy has been used in many aircraft applications, including afterburner parts, combustion chambers, exhaust assemblies, turbine parts, and bolting.

N-155 is forged readily between 1650°F and 2200°F. It is easily formed by conventional methods; intermediate anneals may be required to restore its ductility. This alloy is machinable in all conditions; low cutting speeds and ample flow of coolant are required. The weldability of N-155 is comparable to that of the austenitic stainless steels. The oxidation resistance of N-155 sheet is good up to 1500°F.

Some materials specifications for N-155 are presented in Table 6.2.2.0(a). Room-temperature mechanical and physical properties for N-155 sheet and tubing in the solution-treated (annealed) condition are presented in Table 6.2.2.0(b). Bars and forgings are not specified by room-temperature properties but have specific elevated-temperature requirements. The effect of temperature on physical properties is shown in Figure 6.2.2.0.

Table 6.2.2.0(a). Material Specifications for N-155 Alloy

Specification	Form	Condition
AMS 5532	Sheet	Solution treated
AMS 5585	Tubing (welded)	Solution treated
AMS 5768	Bar and forging	Solution treated and aged
AMS 5769	Bar and forging	Solution treated

6.2.2.1 Solution-Treated Condition — Elevated-temperature curves are presented in Figures 6.2.2.1.1(a) and (b), as well as 6.2.2.1.4(a) and (b). Stress-rupture properties are specified at 1500°F for sheet and at 1350°F for bars and forgings; the appropriate specifications should be consulted for detailed requirements.

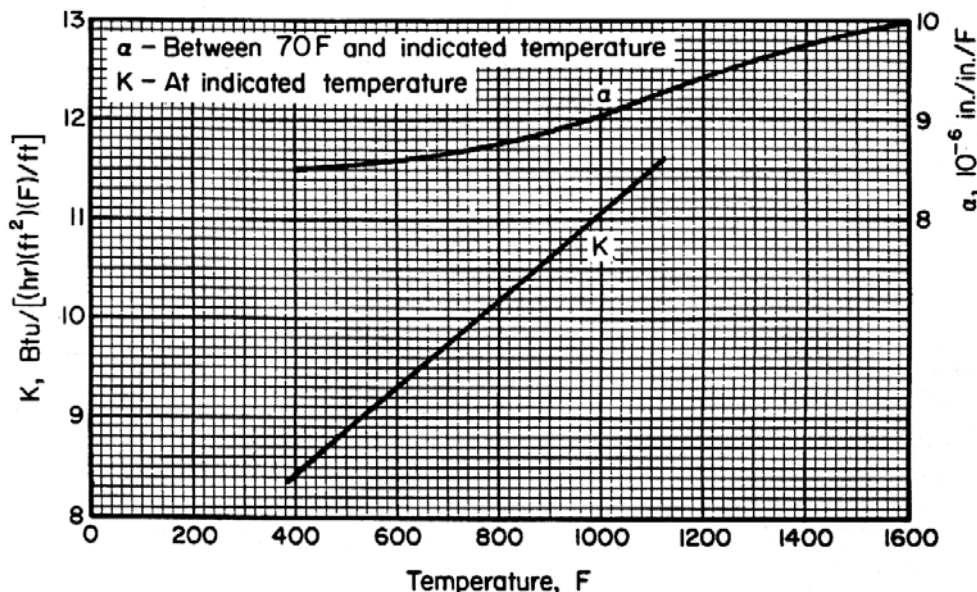

Figure 6.2.2.0. Effect of temperature on the physical properties of N-155 alloy.

MIL-HDBK-5J
31 January 2003

Table 6.2.2.0(b). Design Mechanical and Physical Properties of N-155 Alloy

Specification	AMS 5532		AMS 5585
	Sheet	Strip and plate	Tubing
Condition	Solution treated		
Thickness, in.	≤0.187
Basis	S ^a	S ^a	S
Mechanical Properties:			
<i>F_{tu}</i> , ksi:			
L	100
LT	100	100	...
<i>F_{ty}</i> , ksi:			
L	49 ^b
LT	49 ^b
<i>F_{cy}</i> , ksi:			
L
LT
<i>F_{su}</i> , ksi
<i>F_{bru}</i> , ksi:			
(<i>e</i> / <i>D</i> = 1.5)
(<i>e</i> / <i>D</i> = 2.0)
<i>F_{bry}</i> , ksi:			
(<i>e</i> / <i>D</i> = 1.5)
(<i>e</i> / <i>D</i> = 2.0)
<i>e</i> , percent:			
L	c
LT	40	40	...
<i>E</i> , 10 ³ ksi	29.2		
<i>E_c</i> , 10 ³ ksi	29.2		
<i>G</i> , 10 ³ ksi	11.2		
<i>μ</i>	See Figure 6.2.2.1.4(b)		
Physical Properties:			
<i>ω</i> , lb/in. ³	0.300		
<i>C</i> , Btu/(lb)(°F)	0.103 (70 to 212°F)		
<i>K</i> , Btu/[(hr)(ft ²)(°F)/ft]	See Figure 6.2.2.0		
<i>α</i> , 10 ⁻⁶ in./in./°F	See Figure 6.2.2.0		

- a Test direction longitudinal for widths less than 9 inches; transverse for widths 9 inches and over.
- b Typical value reduced to minimum.
- c Strip = 35.
Full section 0.625 thick = 40.
Full section >0.625 thick = 30.

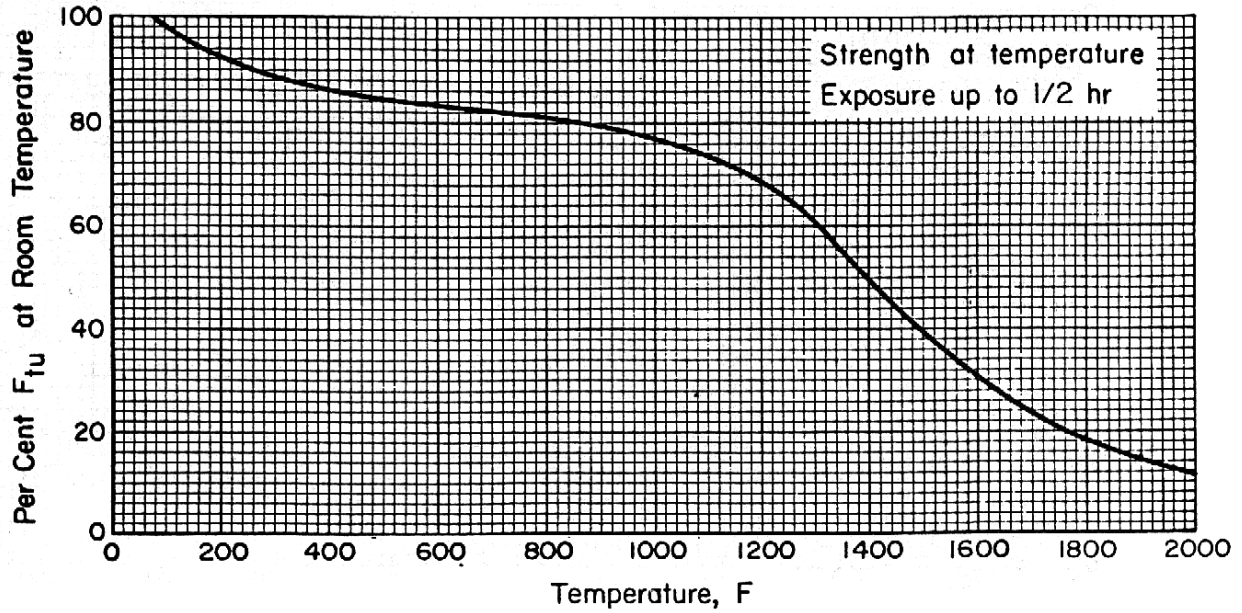

Figure 6.2.2.1.1(a). Effect of temperature on the tensile ultimate strength (F_{tu}) of N-155 alloy.

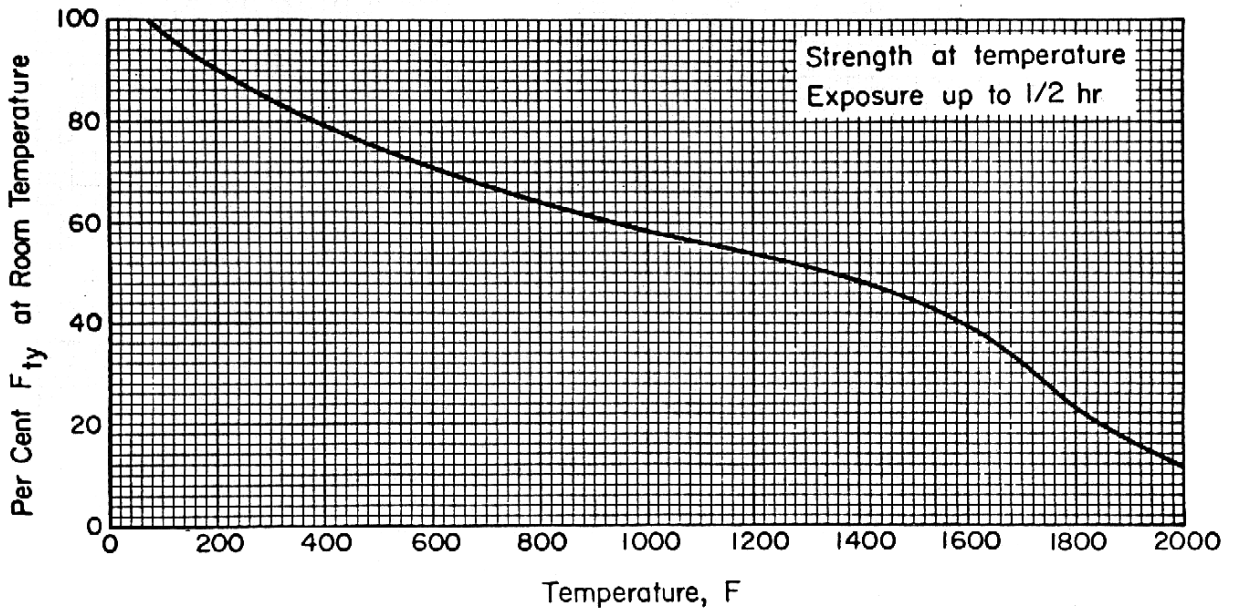

Figure 6.2.2.1.1(b). Effect of temperature on the tensile yield strength (F_{ty}) of N-155 alloy.

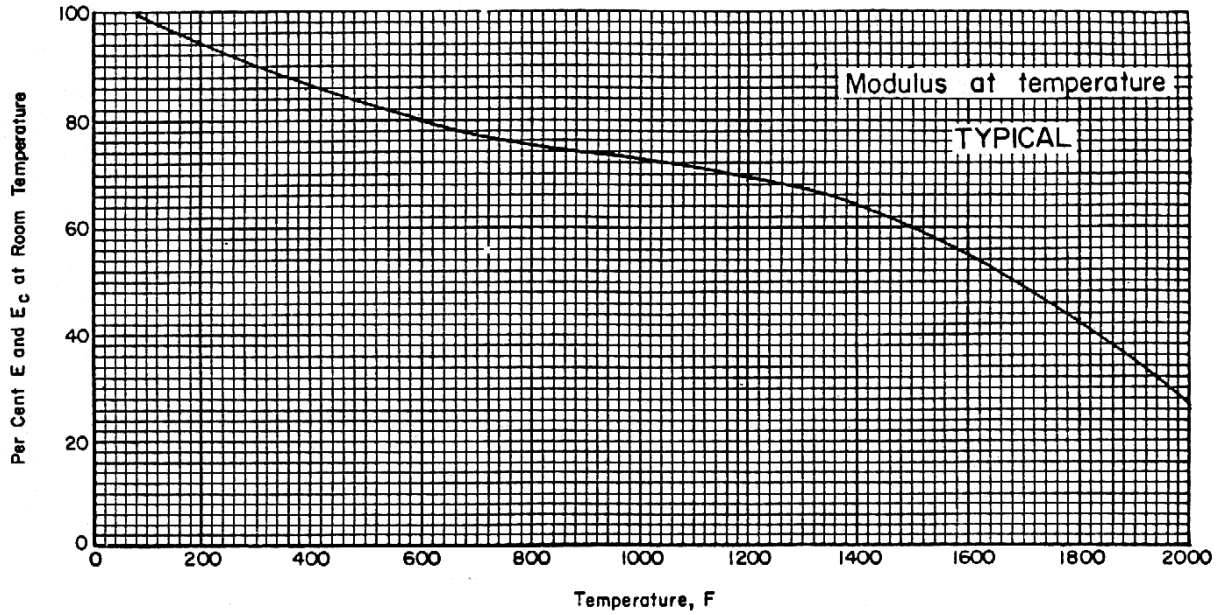

Figure 6.2.2.1.4(a). Effect of temperature on the tensile and compressive moduli (E and E_c) of N-155 alloy.

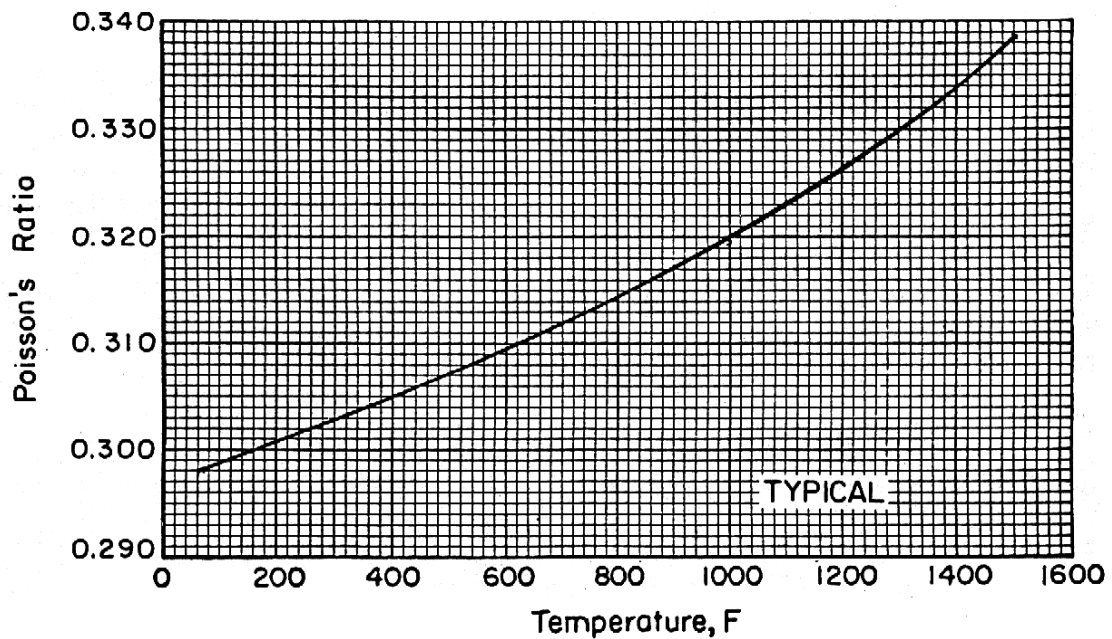

Figure 6.2.2.1.4(b). Effect of temperature on Poisson's ratio (μ) for N-155 alloy.

6.3 NICKEL-BASE ALLOYS

6.3.0 GENERAL COMMENTS— Nickel is the base element for most of the higher temperature heat-resistant alloys. While it is more expensive than iron, nickel provides an austenitic structure that has greater toughness and workability than ferritic structures of the same strength level.

6.3.0.1 Metallurgical Considerations

Composition— The common alloying elements for nickel are cobalt, iron, chromium, molybdenum, titanium, and aluminum. Cobalt, when substituted for a portion of the nickel in the matrix, improves high-temperature strength; small additions of iron tend to strengthen the nickel matrix and reduce the cost; chromium is added to increase strength and oxidation resistance at very high temperatures; molybdenum contributes to solid solution strengthening. Titanium and aluminum are added to most nickel-base heat resistant alloys to permit age-hardening by the formation of Ni₃ (Ti, Al) precipitates; aluminum also contributes to oxidation resistance.

The nature of the alloying elements in the age-hardenable nickel-base alloys makes vacuum melting of these alloys advisable, if not mandatory. However, the additional cost of vacuum melting is more than compensated for by the resulting improvements in elevated-temperature properties.

Heat Treatment— The nickel-base alloys are heat treated with conventional equipment and fixtures such as would be used with austenitic stainless steels. Since nickel-base alloys are more susceptible to sulfur embrittlement than are iron-base alloys, it is essential that sulfur-bearing materials such as grease, oil, cutting lubricants, marking paints, etc., be removed before heat treatment. Mechanical cleaning, such as wire brushing, is not adequate and if used should be followed by washing with a suitable solvent or by vapor degreasing. A low-sulfur content furnace atmosphere should be used. Good furnace control with respect to time and temperature is desirable since overheating some of the alloys as little as 35 °F impairs strength and corrosion resistance.

When it is necessary to anneal the age-hardenable-type alloys, a protective atmosphere (such as argon) lessens the possibility of surface contaminations or depletion of the precipitation-hardening elements. This precaution is not so critical in heavier sections since the oxidized surface layer is a smaller percentage of the cross section. After solution annealing, the alloys are generally quenched in water. Heavy sections may require air cooling to avoid cracking from thermal stresses.

In stress-relief annealing of a structure or assembly composed of an aluminum-titanium hardened alloy, it is vitally important to heat the structure rapidly through the age-hardening temperature range, 1200 °F to 1400 °F (which is also the low ductility range) so that stress relief can be achieved before any aging takes place. Parts which are to be used in the fully heat-treated condition would have to be solution treated, air cooled, and subsequently aged. In this case, the stress-relief treatment would be conducted in the solution-temperature range. Little difficulty has been encountered with distortion under rapid heating conditions, and distortion of weldments of substantial size has been less than that observed with conventional slow heating methods.

6.3.0.2 Manufacturing Considerations

Forging— All of the alloys considered, except for the casting compositions, can be forged to some degree. The matrix-strengthened alloys can be forged with proper consideration of cooling rates, atmosphere, etc. Most of the precipitation-hardenable grades can be forged, although heavier equipment is required and a smaller range of reductions can be safely attained.

Cold Forming — Almost all of the wrought-nickel-base alloys in sheet form are cold formable. The lower strength alloys offer few problems, but the higher strength alloys require higher forming pressures and more frequent anneals.

Machining — All of the alloys in this section are readily machinable, provided the optimum conditions of heat treatment, type of tool speed, feed, depth of cut, etc., are achieved. Specific recommendations on these points are available from various producers of these alloys.

Welding — The matrix-strengthening-type alloys offer no serious problems in welding. All of the common resistance- and fusion-welding processes (except submerged arc) have been successfully employed. For the age-hardenable type of alloy, it is necessary to observe some further precautions:

- (1) Welding should be confined to annealed material where design permits. In full age-hardened material, the hazard of cracking in the weld and/or the parent metal is great.
- (2) If design permits joining some portions only after age hardening, the parts to be joined should be “safe ended” with a matrix-strengthened-type alloy (with increased cross section) and then age hardened; welding should then be carried out on the “safe ends.”
- (3) Parts severely worked or deformed should be annealed before welding.
- (4) After welding, the weldment will often require stress relieving before aging.
- (5) Material must be heated rapidly to the stress-relieving temperature.
- (6) In a number of the age-hardenable alloys, fusion welds may exhibit only 70 to 80 percent of the rupture strength of the parent metal. The deficiency can often be minimized by design, such as locating welds in areas of lowest temperature and/or stress. The use of special filler wires to improve weld-rupture properties is under investigation.

Brazing — The solid-solution-type chromium-containing alloys respond well to brazing, using techniques and brazing alloys applicable to the austenitic stainless steels. Generally, it is necessary to braze annealed material and to keep stresses low during brazing, especially when brazing with low melting alloys, to avoid embrittlement. As with the stainless steels, dry hydrogen, argon, or helium atmospheres (-80°F dew point or lower) are used successfully, and vacuum brazing is now receiving increasing attention.

The aluminum-titanium age-hardened nickel-base alloys are difficult to braze, even using extremely dry reducing- and inert-gas atmospheres, unless some method of fluxing, solid or gaseous, is used. An alternative technique which is commonly used is to preplate the areas to be brazed with ½ to 1 mil of nickel. For some metal combinations, a few fabricators prefer to apply an iron preplate. In either case, the plating prevents the formation of aluminum or titanium oxide films and results in better joints.

Most of the high-temperature alloys of the nickel-base type are brazed with Ni-Cr-Si-B and Ni-Cr-Si types of brazing alloy. Silver brazing alloys can be used for lower temperature applications. However, since the nickel-base alloys to be brazed are usually employed for higher temperature applications, the higher melting point, stronger, and more oxidation-resistant brazing alloys of the Microbraz type are generally used. Some of the gold-base and palladium-base brazing alloys may be useful under some circumstances in intermediate-temperature applications.

6.3.1 HASTELLOY X

6.3.1.0 Comments and Properties — Hastelloy X is a nickel-base alloy used for combustor-liner parts, turbine-exhaust weldments, afterburner parts, and other parts requiring oxidation resistance and moderately high strength above 1450°F. It is not hardenable except by cold working and is used in the solution-treated (annealed) condition. Hastelloy X is available in all the usual mill forms.

Hastelloy X is somewhat difficult to forge; forging should be started at 2150°F to 2200°F and continued as long as the material flows freely. It should be in the annealed condition for optimum cold forming, and severely formed detail parts should be solution treated at 2150°F for 7 to 10 minutes and cooled rapidly after forming. Machinability of Hastelloy X is similar to that of austenitic stainless steel; the alloy is tough and requires low cutting speeds and ample cutting fluids. Hastelloy X can be resistance or fusion welded or brazed; large or complex fusion weldments require stress relief at 1600°F for 1 hour. Hastelloy X has good oxidation resistance up to 2100°F. It age hardens somewhat during long exposure between 1200°F and 1800°F.

Some material specifications for Hastelloy X are presented in Table 6.3.1.0(a). Room-temperature mechanical and physical properties for Hastelloy X sheet are presented in Table 6.3.1.0(b). AMS 5754 does not specify tensile properties for bars and forgings. Figure 6.3.1.0 shows the effect of temperature on physical properties.

Table 6.3.1.0(a). Material Specifications for Hastelloy X

Specification	Form	Condition
AMS 5536	Sheet and plate	Solution heat treated (annealed)
AMS 5754	Bar and forging	Solution heat treated (annealed)

6.3.1.1 Annealed Condition — The effect of temperature on various mechanical properties is presented in Figures 6.3.1.1.1 and 6.3.1.1.4. In addition, certain stress-rupture requirements at 1500°F are specified in AMS 5536 and 5754 for Hastelloy X. Typical tensile stress-strain curves at room and elevated temperatures are presented in Figure 6.3.1.1.6(a). Typical compressive stress-strain and tangent-modulus curves at room and elevated temperatures are presented in Figure 6.3.1.1.6(b).

MIL-HDBK-5J
31 January 2003

Table 6.3.1.0(b). Design Mechanical and Physical Properties of Hastelloy X Sheet and Plate

Specification	AMS 5536						
Form	Sheet ^a and plate						
Condition	Solution treated (annealed)						
Thickness, in.	<0.010	0.010-0.019	0.020-0.100		0.101-0.187	0.188-2.000	>2.000
Basis	S	S	A	B	S	S	S
Mechanical Properties:							
F_{tu} , ksi:							
L
LT	105	105	102	106	105	100	95
F_{ly} , ksi:							
L
LT	45	45	44	47	45	40	40
F_{cy} , ksi:							
L
LT
F_{su} , ksi
F_{bu} , ksi:							
($e/D = 1.5$)
($e/D = 2.0$)
F_{by} , ksi:							
($e/D = 1.5$)
($e/D = 2.0$)
e , percent (S-basis):							
L
LT	29	35	...	35	35	35
E , 10^3 ksi	29.8						
E_c , 10^3 ksi	29.8						
G , 10^3 ksi	11.3						
μ	0.32						
Physical Properties:							
ω , lb/in. ³	0.297						
C , Btu/(lb)(°F)	See Figure 6.3.1.0						
K , Btu/[(hr)(ft ²)(°F)/ft]	See Figure 6.3.1.0						
α , 10^{-6} in./in./°F	See Figure 6.3.1.0						

a Test direction longitudinal for widths less than 9 inches; transverse for widths 9 inches and over.

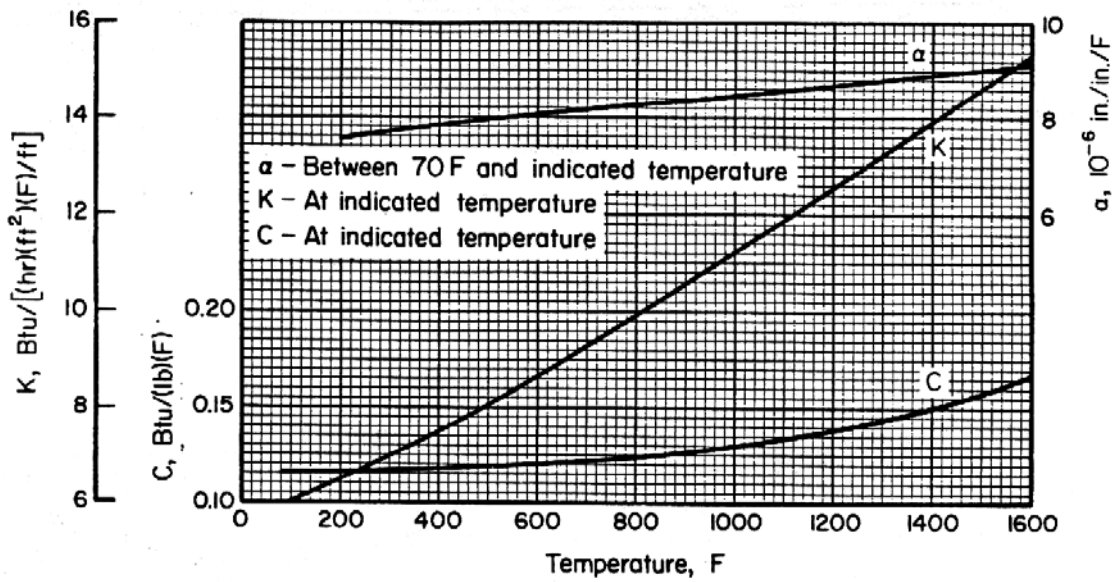

Figure 6.3.1.0. Effect of temperature on the physical properties of Hastelloy X.

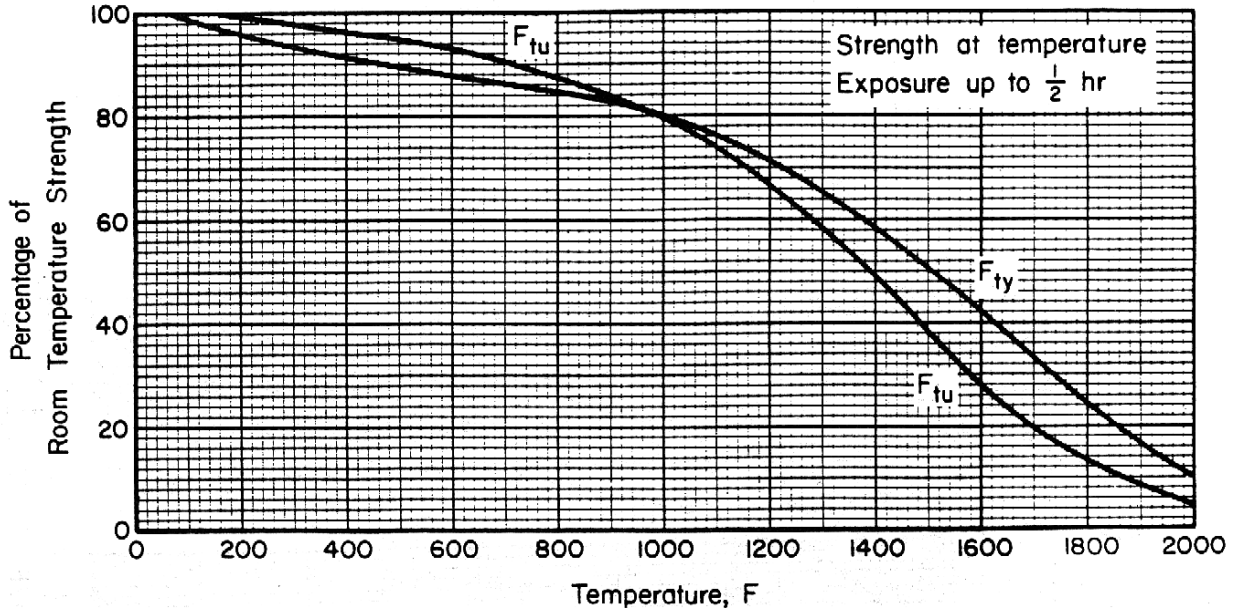

Figure 6.3.1.1.1. Effect of temperature on the tensile ultimate strength (F_{tu}) and the tensile yield strength (F_{ty}) of Hastelloy X sheet.

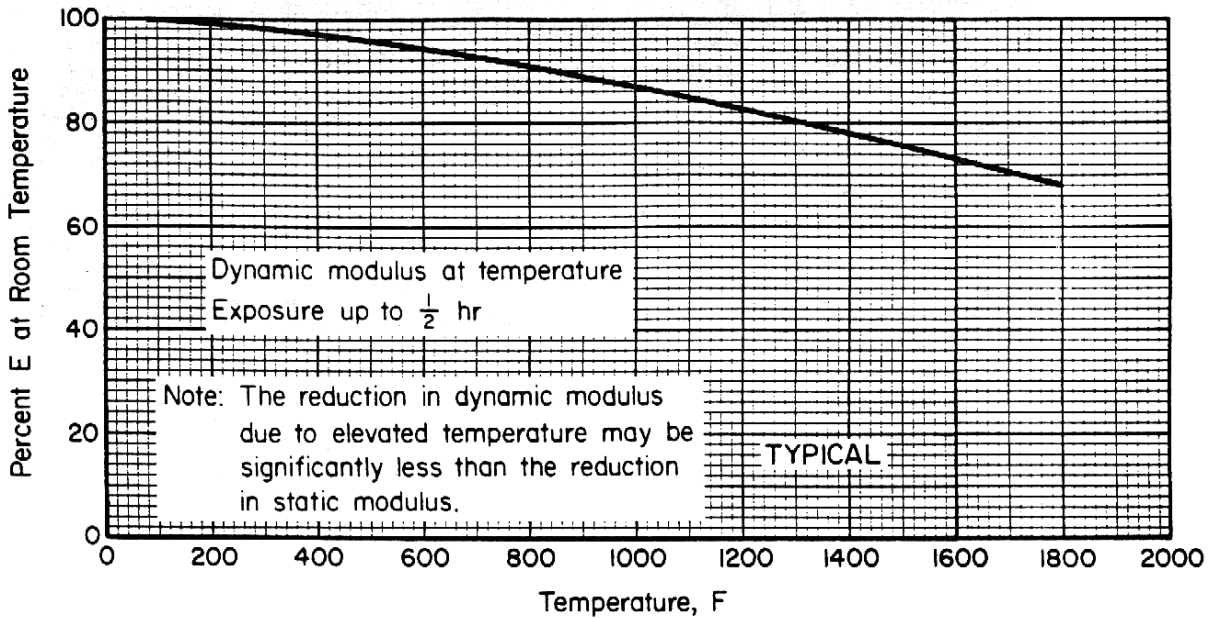

Figure 6.3.1.1.4. Effect of temperature on dynamic modulus (E) of Hastelloy X sheet.

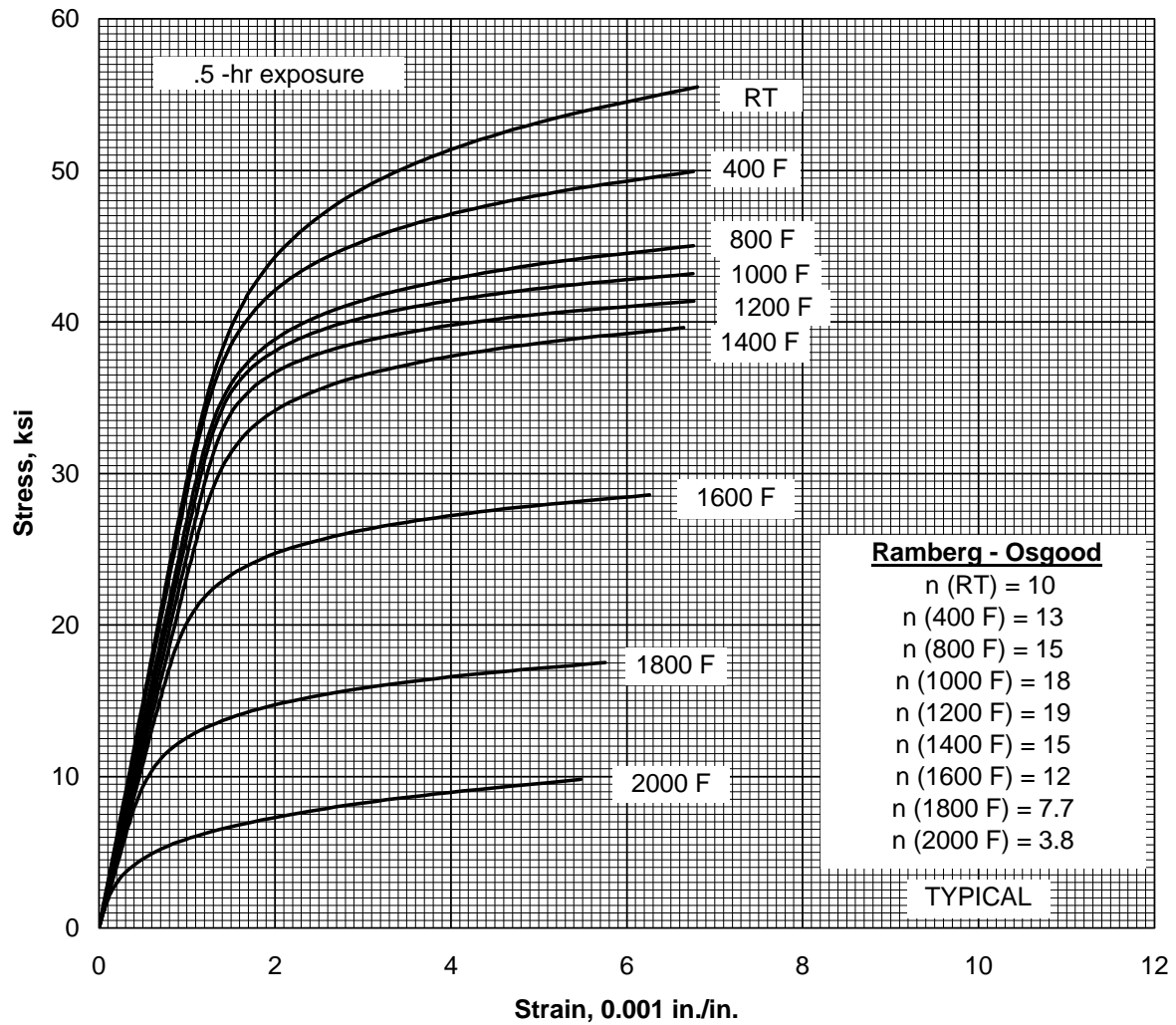

Figure 6.3.1.1.6(a). Typical tensile stress-strain curves for Hastelloy X sheet at room and elevated temperatures.

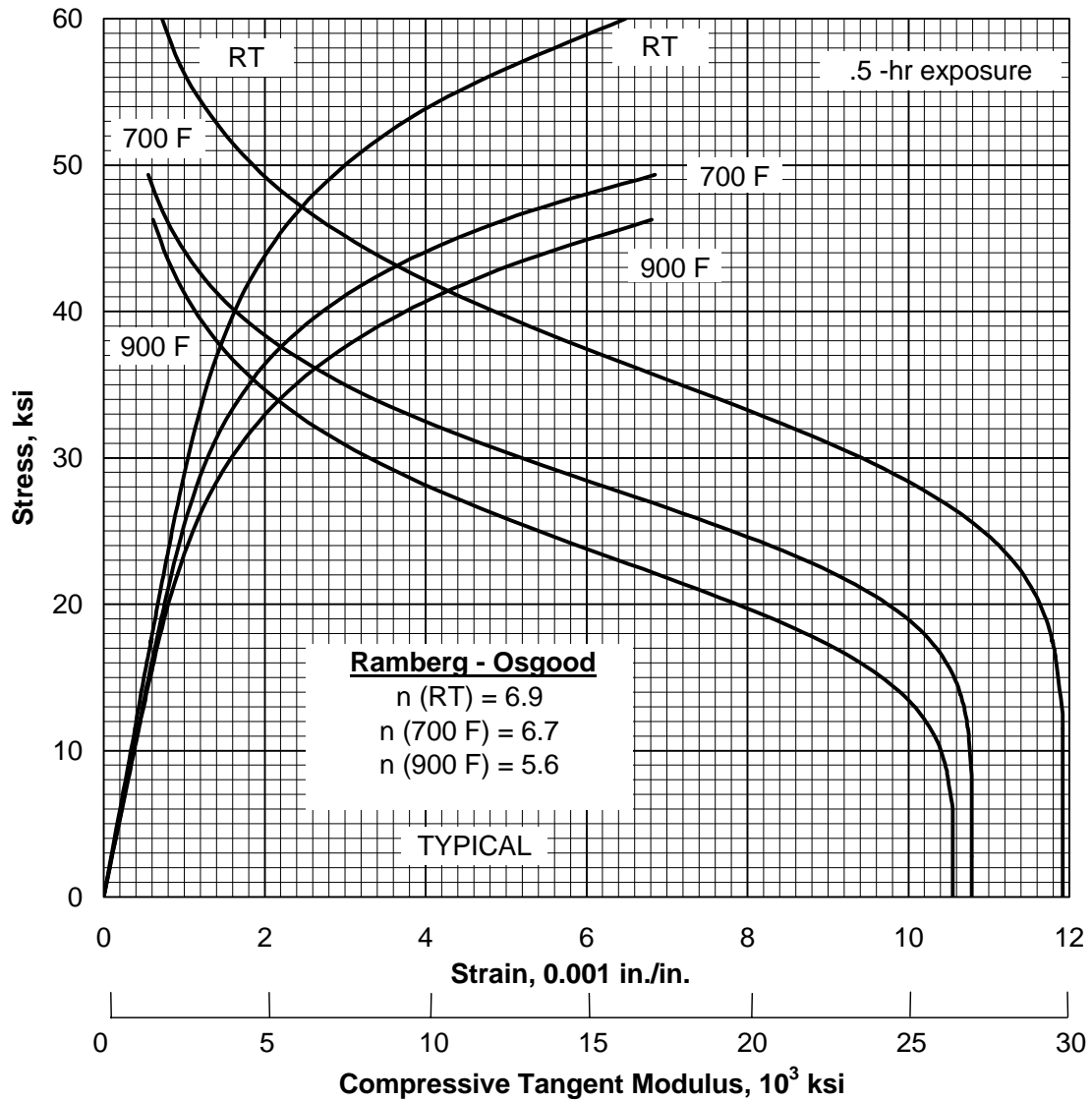

Figure 6.3.1.1.6(b). Typical compressive stress-strain and compressive tangent-modulus curves for Hastelloy X bar at room and elevated temperatures.

6.3.2 INCONEL 600

6.3.2.0 Comments and Properties — Inconel 600 is a corrosion- and heat-resistant nickel-base alloy used for low-stressed parts operating up to 2000°F. It is not hardenable except by cold working and is usually used in the annealed condition. Inconel 600 is available in all the usual mill forms.

Inconel 600 is readily forged between 1900°F and 2250°F; “hot-cold” working between 1200°F and 1600°F is harmful and should be avoided; cold working below 1200°F results in improved properties. This alloy is readily formed but should be annealed after severe forming operations. The maximum annealing temperature is 1800°F if minimum yield-strength requirements are to be met consistently. Inconel 600 is susceptible to rapid grain growth at 1800°F or higher, and exposures at these temperatures should be brief if large grain size is objectionable.

Inconel 600 is somewhat difficult to machine because of its toughness and capacity for work hardening; high-speed steel or cemented-carbide tools should be used, and tools should be kept sharp. This alloy can be resistance or fusion welded or brazed (using nonsilver containing brazing alloy); large or complex fusion weldments should be stress relieved at 1600°F for 1 hour. Oxidation resistance of Inconel 600 is excellent up to 2000°F in sulfur-free atmospheres. This alloy is subject to attack in sulfur-containing atmospheres.

Table 6.3.2.0(a). Material Specifications for Inconel 600

Specification	Form	Condition
AMS 5540	Plate, sheet, and strip	Annealed
ASTM B166	Bar and rod	Various
AMS 5580	Tubing, seamless	Annealed
ASTM B564	Forging	Annealed

Some material specifications for Inconel 600 are presented in Table 6.3.2.0(a). Room-temperature mechanical and physical properties are shown in Tables 6.3.2.0(b), (c), and (d). Figure 6.3.2.0 shows the effect of temperature on the physical properties.

6.3.2.1 Annealed Condition — Elevated-temperature data for this condition are shown in Figures 6.3.2.1.1 through 6.3.2.1.4.

Table 6.3.2.0(b). Design Mechanical and Physical Properties of Inconel 600

Specification	AMS 5540	AMS 5580		ASTM B564
Form	Sheet, strip, and plate	Tubing		Forging
Condition	Annealed	Cold drawn		Annealed
Thickness, in.	0.020-2.000
Outside Diameter, in.	...	≤5.000	5.001-6.625	...
Basis	S	S	S	S
Mechanical Properties:				
<i>F_{tu}</i> , ksi:				
L	...	80	80	80
LT	80
<i>F_{ly}</i> , ksi:				
L	...	35	30	35
LT	35
<i>F_{cy}</i> , ksi:				
L	...	35	30	35
LT	35
<i>F_{su}</i> , ksi	51	51	51	51
<i>F_{bru}</i> , ksi:				
(e/D = 1.5)
(e/D = 2.0)	152	152	152	152
<i>F_{bry}</i> , ksi:				
(e/D = 1.5)
(e/D = 2.0)
<i>e</i> , percent:				
L	...	30	35	30
LT	30
<i>E</i> , 10 ³ ksi	30.0			
<i>E_c</i> , 10 ³ ksi	30.0			
<i>G</i> , 10 ³ ksi	11.0			
<i>μ</i>	0.29			
Physical Properties:				
<i>ω</i> , lb/in. ³	0.304			
<i>C</i> , <i>K</i> , and <i>α</i>	See Figure 6.3.2.0			

Table 6.3.2.0(c). Design Mechanical and Physical Properties of Inconel 600 Bar and Rod

Specification	ASTM B166				
	Round			Square, hexagon, and rectangle	
Form					
Condition	Cold-worked				
Thickness, in.	≤0.499	0.500-1.000	1.001-2.500	≤0.250	0.251-0.499
Basis	S	S	S	S	S
Mechanical Properties ^a :					
F_{tu} , ksi:					
L	120	110	105	100	95
LT
F_{ty} , ksi:					
L	90	85	80	80	70
LT
F_{cy} , ksi:					
L
LT
F_{su} , ksi
F_{bru} , ksi:					
(e/D = 1.5)
(e/D = 2.0)
F_{bry} , ksi:					
(e/D = 1.5)
(e/D = 2.0)
e , percent:					
L	7 ^b	10	12	5 ^b	7
E , 10 ³ ksi	30.0				
E_c , 10 ³ ksi	30.0				
G , 10 ³ ksi	11.0				
μ	0.29				
Physical Properties:					
ω , lb/in. ³	0.304				
C , K , and α	See Figure 6.3.2.0				

a Mechanical property requirements apply only when specified by purchaser.

b Not applicable to thickness <0.094 inch.

Table 6.3.2.0(d). Design Mechanical and Physical Properties of Inconel 600 Bar and Rod

Specification	ASTM B166				
	Round			Square, hexagon, and rectangle	Bar and rod
Form	Hot-worked			Annealed	
Condition	Hot-worked			Annealed	
Thickness, in.	0.250-0.500	0.501-3.000	>3.000	All	All
Basis	S	S	S	S	S
Mechanical Properties^a:					
F_{tu} , ksi:					
L	95	90	85	85	80
LT
F_{ly} , ksi:					
L	45	40	35	35	35
LT
F_{cy} , ksi:					
L	35
LT
F_{su} , ksi	51
F_{bru} , ksi:					
(e/D = 1.5)
(e/D = 2.0)	152
F_{bry} , ksi:					
(e/D = 1.5)
(e/D = 2.0)
e , percent:					
L	20	25	30	...	30 ^b
E , 10 ³ ksi	30.0				
E_c , 10 ³ ksi	30.0				
G , 10 ³ ksi	11.0				
μ	0.29				
Physical Properties:					
ω , lb/in. ³	0.304				
C , K , and α	See Figure 6.3.2.0				

a Mechanical property requirements apply only when specified by purchaser.
b Not applicable to thickness >0.094 inch.

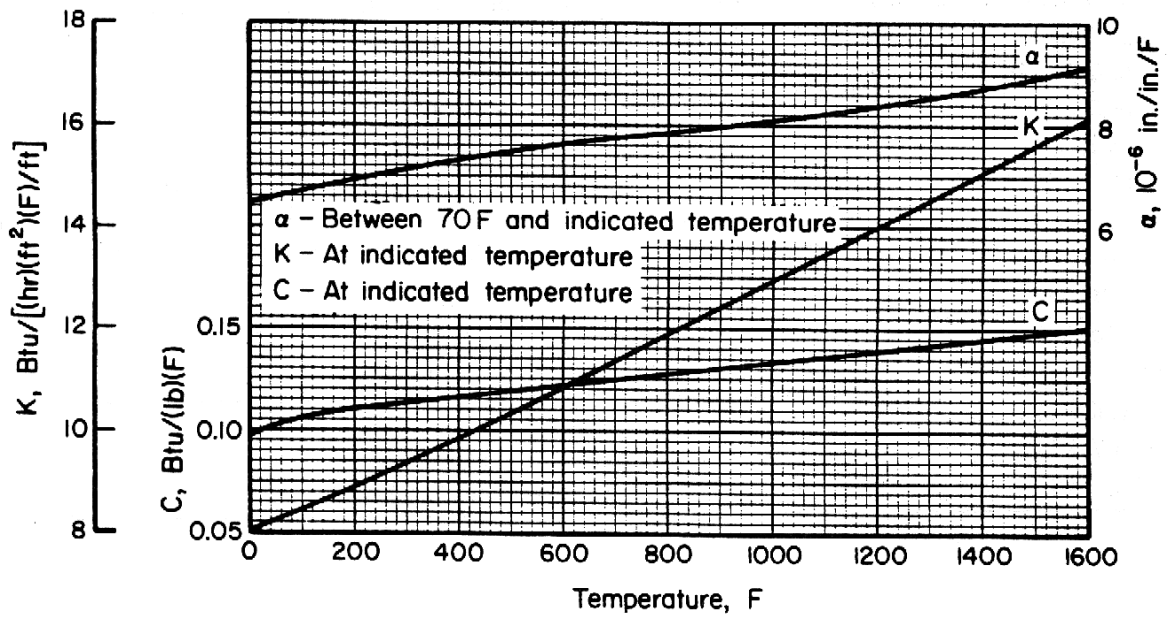

Figure 6.3.2.0. Effect of temperature on the physical properties of Inconel 600.

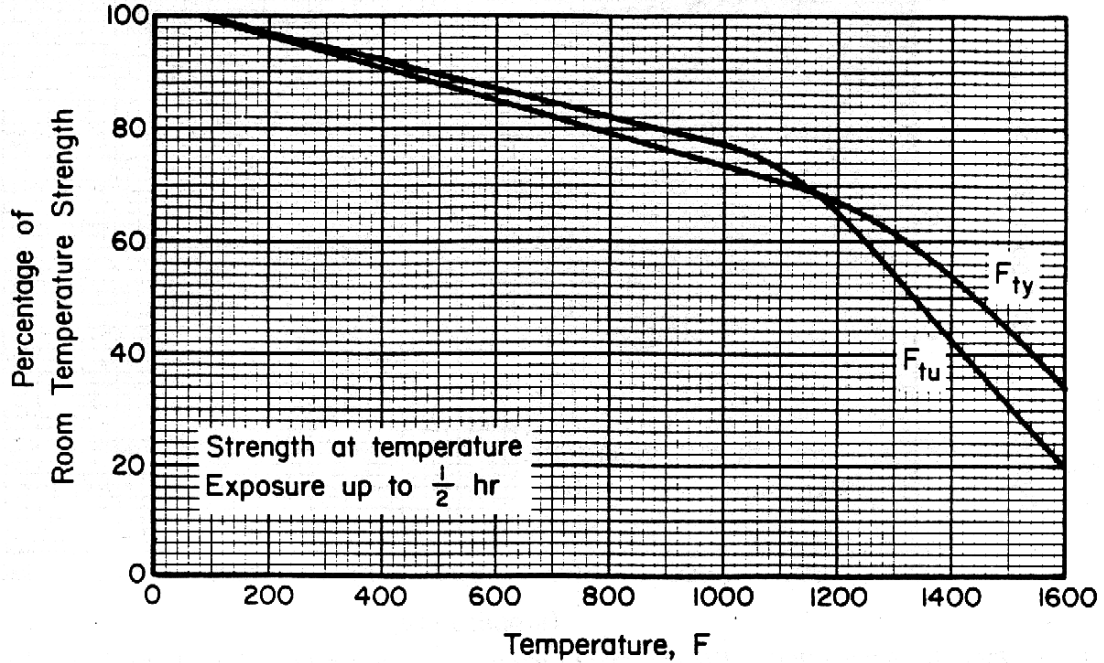

Figure 6.3.2.1.1. Effect of temperature on the tensile ultimate strength (F_{tu}) and the tensile yield strength (F_{ty}) of Inconel 600.

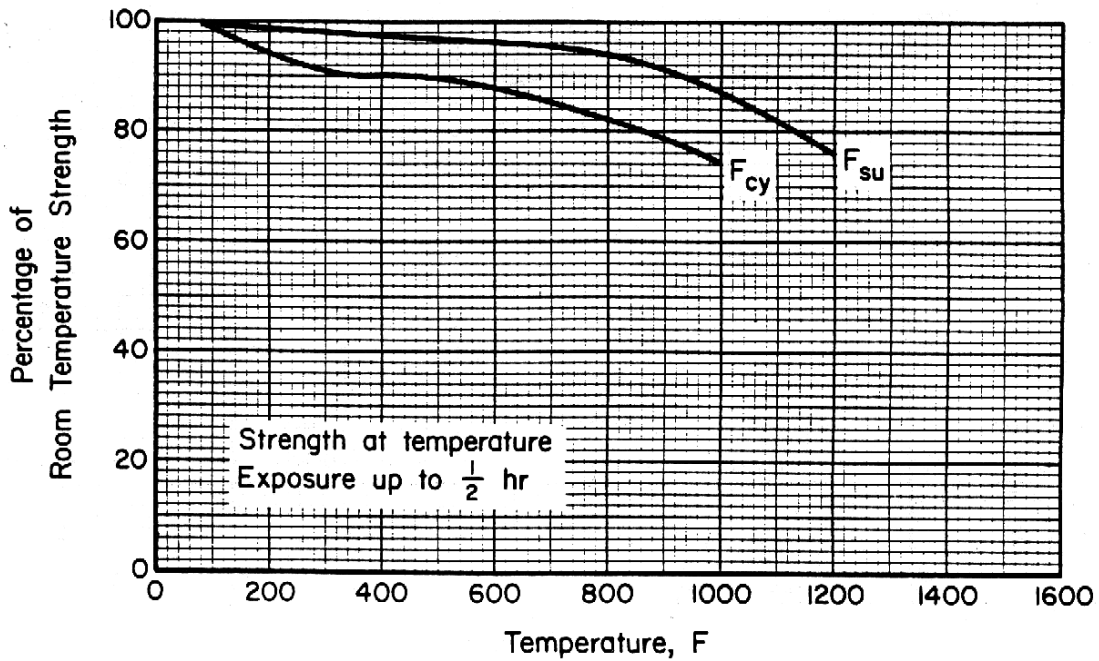

Figure 6.3.2.1.2. Effect of temperature on the compressive yield strength (F_{cy}) and the shear ultimate strength (F_{su}) of Inconel 600.

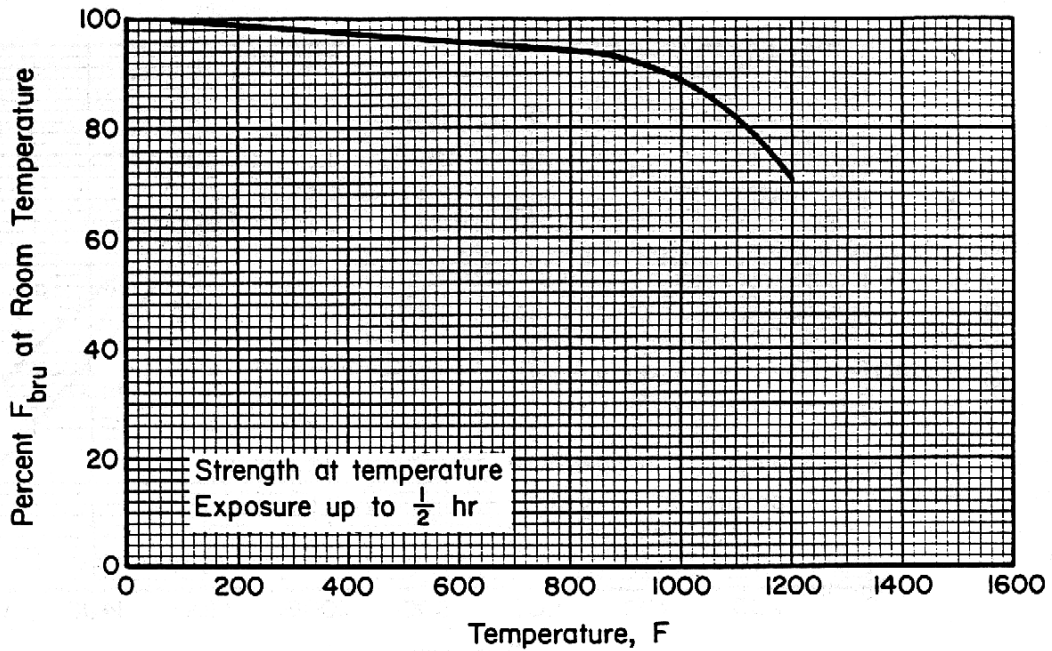

Figure 6.3.2.1.3. Effect of temperature on the bearing ultimate strength (F_{bru}) of Inconel 600.

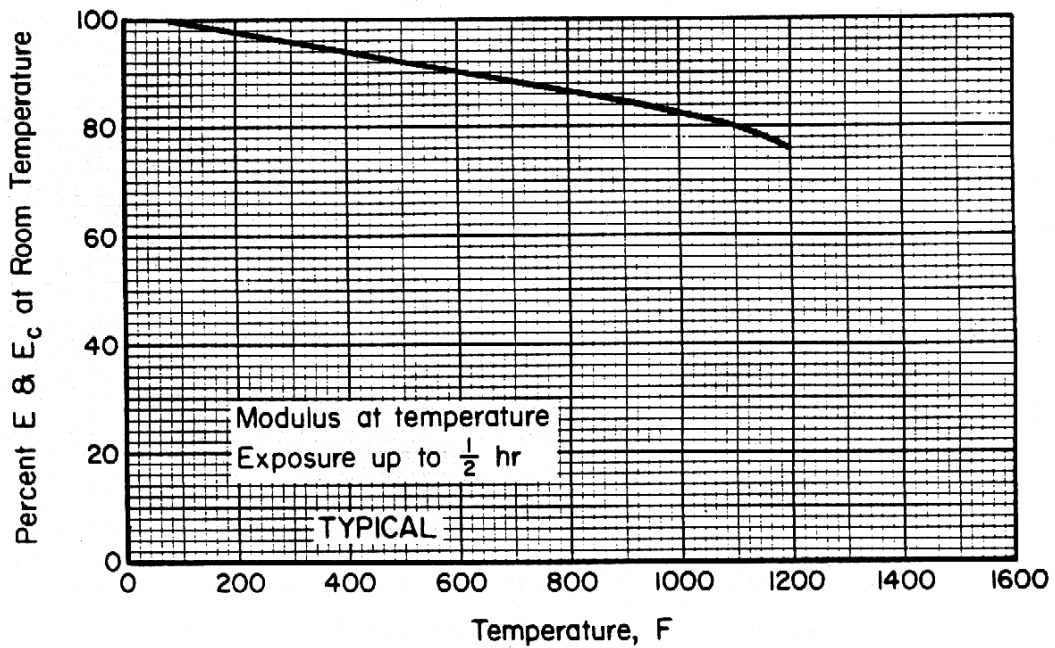

Figure 6.3.2.1.4. Effect of temperature on the tensile and compressive moduli (E and E_c) of Inconel 600.

6.3.3 INCONEL 625

6.3.3.0 Comments and Properties — Inconel 625 is a solid-solution, matrix strengthened nickel-base alloy primarily for applications requiring good corrosion and oxidation resistance at temperatures up to approximately 1800°F and also where such parts may require welding.

The strength of the alloy is derived from the strengthening effect of molybdenum and columbium; thus, precipitation hardening is not required and the alloy is used in the annealed condition. The strength is greatly affected by the amount of cold work prior to annealing and by the annealing temperature. The material is usually annealed at 1700 to 1900°F for time commensurate with thickness. The properties in this section are restricted to that annealing range.

Because the alloy was developed to retain high strength at elevated temperatures, it resists deformation at hot working temperatures but can be readily fabricated with adequate equipment. The combination of strength, corrosion resistance, and ability to be fabricated, including welding by common industrial practices, are the alloy's outstanding features.

Some material specifications for Inconel 625 are listed in Table 6.3.3.0(a). Room-temperature mechanical and physical properties for Inconel 625 are listed in Tables 6.3.3.0(b) and (c). Figure 6.3.3.0 shows the effect of temperature on the physical properties.

Table 6.3.3.0(a). Material Specifications for Inconel 625

Specification	Form	Condition
AMS 5599	Sheet, strip, and plate	Annealed
AMS 5666	Bar, forging, and ring	Annealed

6.3.3.1 Annealed Condition — Elevated-temperature curves for tensile ultimate strength, tensile yield strength, tensile and compressive moduli, and Poisson's ratio are presented in Figures 6.3.3.1.1(a) and (b), as well as 6.3.3.1.4(a) and (b). Typical stress-strain and tangent-modulus curves are shown in Figures 6.3.3.1.6(a) through (d). Fatigue S/N curves are presented in Figures 6.3.3.1.8(a) through (d).

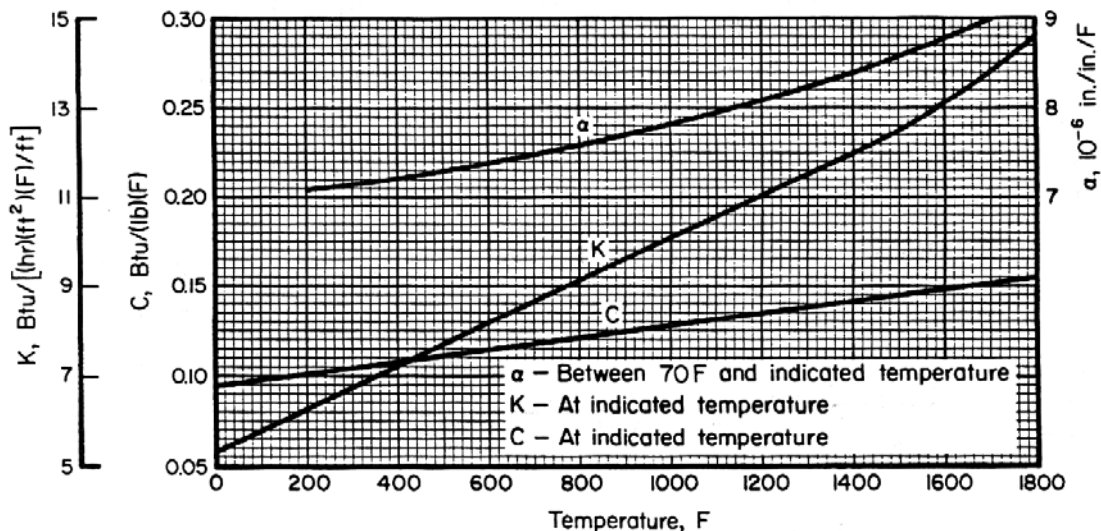

Figure 6.3.3.0. Effect of temperature on the physical properties of Inconel 625.

Table 6.3.3.0(b). Design Mechanical and Physical Properties of Inconel 625 Sheet and Plate

Specification	AMS 5599									
Form	Sheet and plate									
Condition	Annealed									
Thickness, in.	≤0.062		0.063-0.109		0.110-0.140		0.141-0.187		0.188-0.250	0.251-1.000
Basis	A	B	A	B	A	B	A	B	S	S
Mechanical Properties:										
<i>F_{tu}</i> , ksi:										
L	119	127	119	126	119	125	118	123	119	...
LT	120 ^a	128	120 ^a	127	120 ^a	126	119	124	120	120
<i>F_{ty}</i> , ksi:										
L	56	62	55	61	54	60	53	59	59	...
LT	57	63	56	62	55	61	54	60	60	60
<i>F_{cy}</i> , ksi:										
L	59	65	58	64	57	63	55	62	62	...
LT	59	66	58	65	57	64	56	63	63	...
<i>F_{su}</i> , ksi										
LT	79	84	79	84	79	83	79	82	79	...
<i>F_{bru}</i> , ksi:										
(e/D = 1.5)	202	216	202	214	202	212	201	209	202	...
(e/D = 2.0)	263	281	263	279	263	276	261	272	263	...
<i>F_{bry}^b</i> , ksi:										
(e/D = 1.5)	88	97	86	95	84	94	83	92	92	...
(e/D = 2.0)	109	121	107	119	105	117	103	115	115	...
<i>e</i> , percent (S-basis):										
LT	30	...	30	...	30	...	30	...	30	30
<i>E</i> , 10 ³ ksi										
					29.8					
<i>E_c</i> , 10 ³ ksi										
					29.8					
<i>G</i> , 10 ³ ksi										
					11.8					
<i>μ</i>										
					0.28					
Physical Properties:										
<i>ω</i> , lb/in. ³										
					0.305					
<i>C</i> , <i>K</i> , and <i>α</i>										
					See Figure 6.3.3.0					

a S-basis. The rounded T₉₉ values are higher than specification values as follows: *F_{tu}*(≤0.062) = 123 ksi, *F_{tu}*(0.063-0.109) = 122 ksi, and *F_{tu}*(0.110-0.140) = 121 ksi.

b Bearing values are “dry pin” values per Section 1.4.7.1.

Table 6.3.3.0(c). Design Mechanical and Physical Properties of Inconel 625 Bar

Specification	AMS 5666			
Form	Bar			
Condition	Annealed			
Thickness or diameter, in.	0.500-0.999	1.000-1.999	2.000-2.999	3.000-3.999
Basis	S	S	S	S
Mechanical Properties:				
<i>F_{tu}</i> , ksi:				
L	120	120	120	120
ST	118	118
<i>F_{ly}</i> , ksi:				
L	60	60	60	60
ST	57	57
<i>F_{cy}</i> , ksi:				
L	60	59	56	53
ST	60	60
<i>F_{su}</i> , ksi	79	79	79	79
<i>F_{bru}^a</i> , ksi:				
(e/D = 1.5)	192	192	192	192
(e/D = 2.0)	234	234	234	234
<i>F_{bry}^a</i> , ksi:				
(e/D = 1.5)	88	88	88	88
(e/D = 2.0)	102	102	102	102
<i>e</i> , percent (S-basis):				
L	30	30	30	30
<i>E</i> , 10 ³ ksi	29.8			
<i>E_c</i> , 10 ³ ksi	29.8			
<i>G</i> , 10 ³ ksi	11.8			
<i>μ</i>	0.28			
Physical Properties:				
<i>ω</i> , lb/in. ³	0.305			
<i>C</i> , <i>K</i> , and <i>α</i>	See Figure 6.3.3.0			

a Bearing values are “dry pin” values per Section 1.4.7.1.

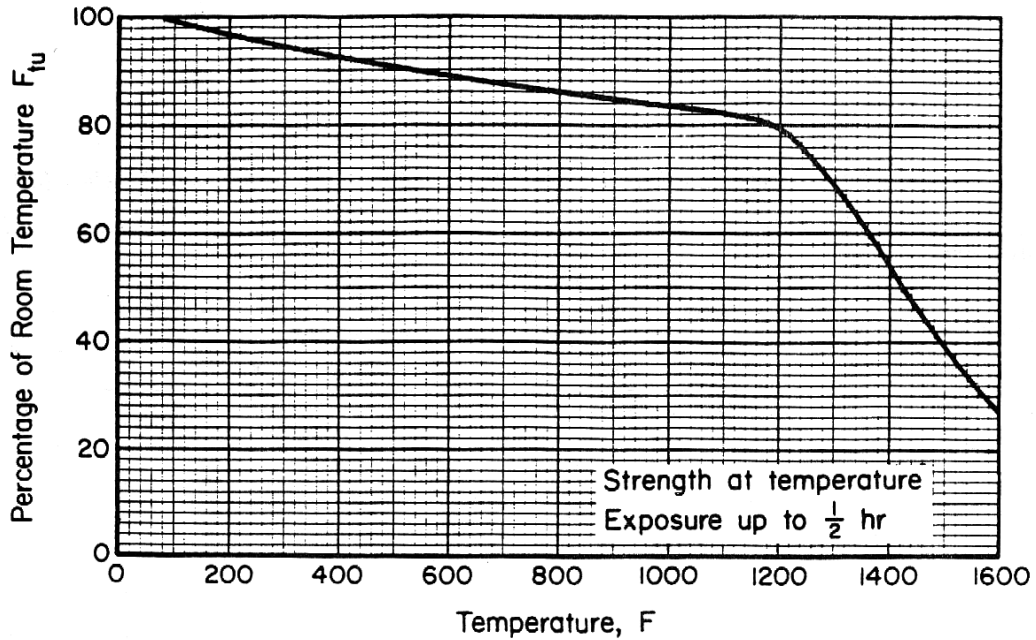

Figure 6.3.3.1.1(a). Effect of temperature on the tensile ultimate strength (F_{tu}) of annealed Inconel 625 sheet and bar.

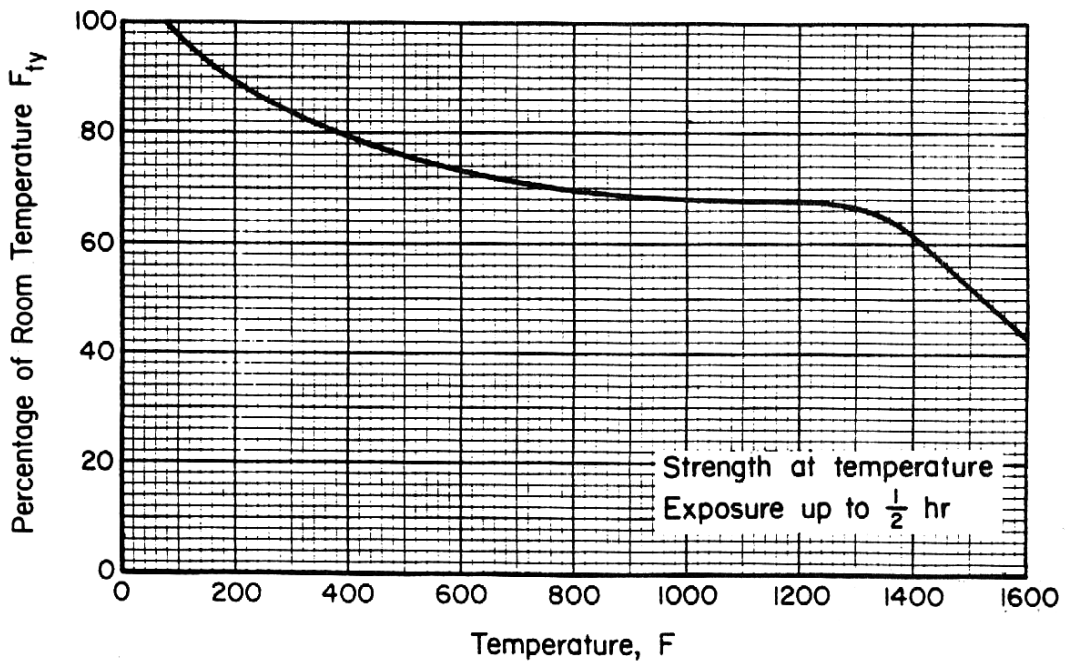

Figure 6.3.3.1.1(b). Effect of temperature on the tensile yield strength (F_{ty}) of annealed Inconel 625 sheet and bar.

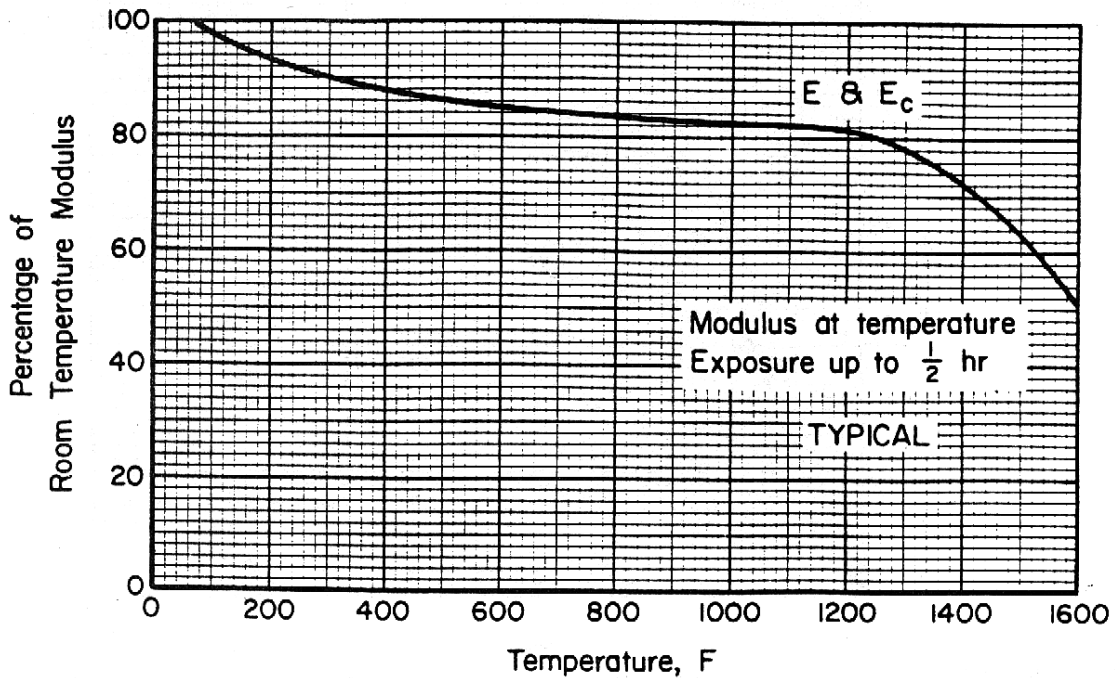

Figure 6.3.3.1.4(a). Effect of temperature on the tensile and compressive moduli (E and E_c) of annealed Inconel 625.

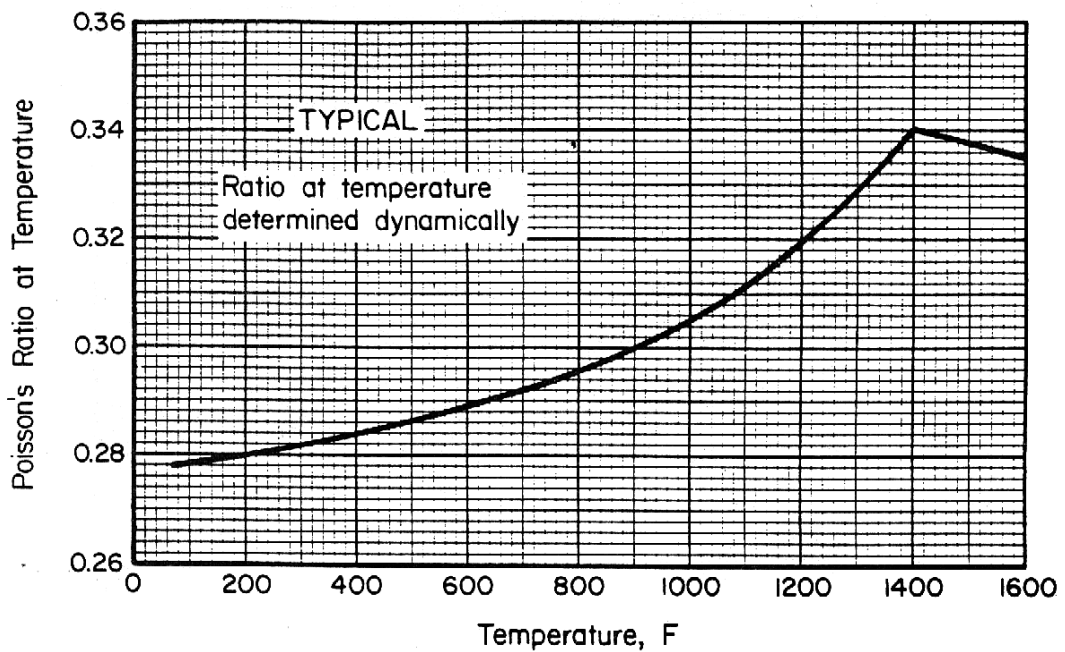

Figure 6.3.3.1.4(b). Effect of temperature on Poisson's ratio (μ) for annealed Inconel 625 bar.

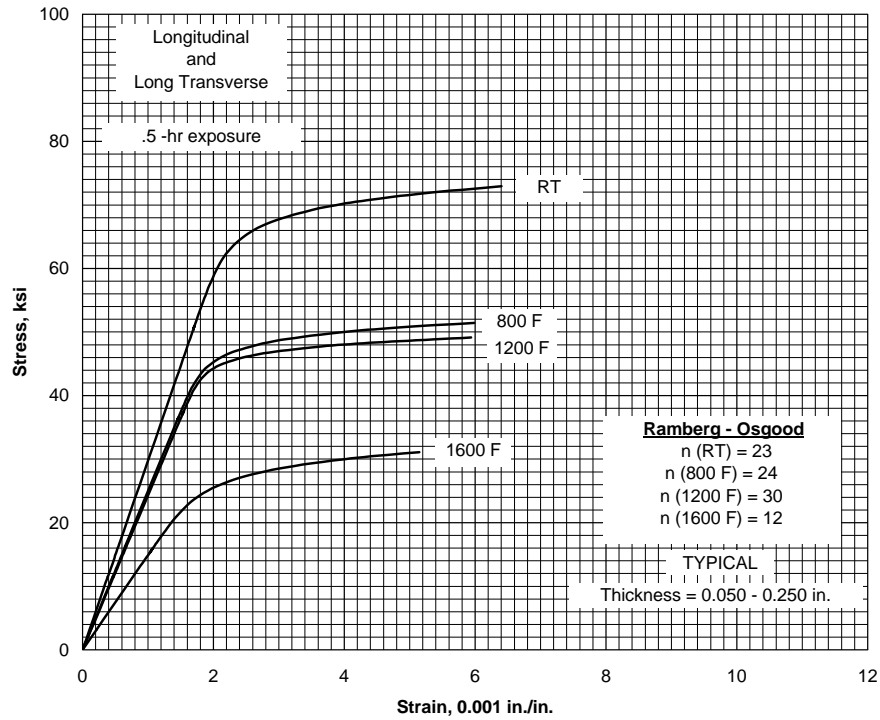

Figure 6.3.3.1.6(a). Typical tensile stress-strain curves for annealed Inconel 625 sheet at room and elevated temperatures.

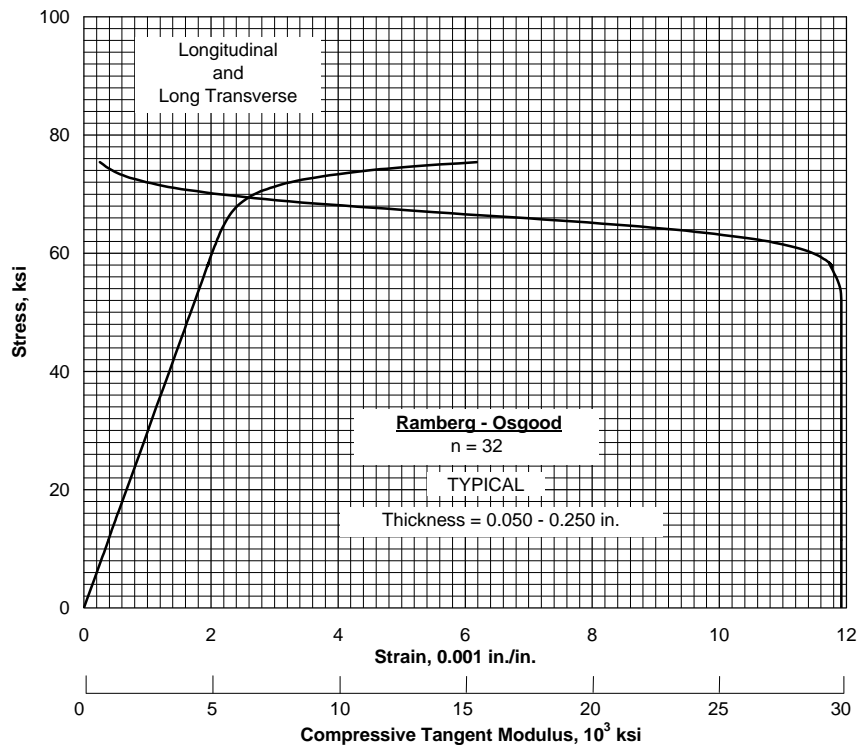

Figure 6.3.3.1.6(b). Typical compressive stress-strain and compressive tangent-modulus curves for annealed Inconel 625 sheet at room temperature.

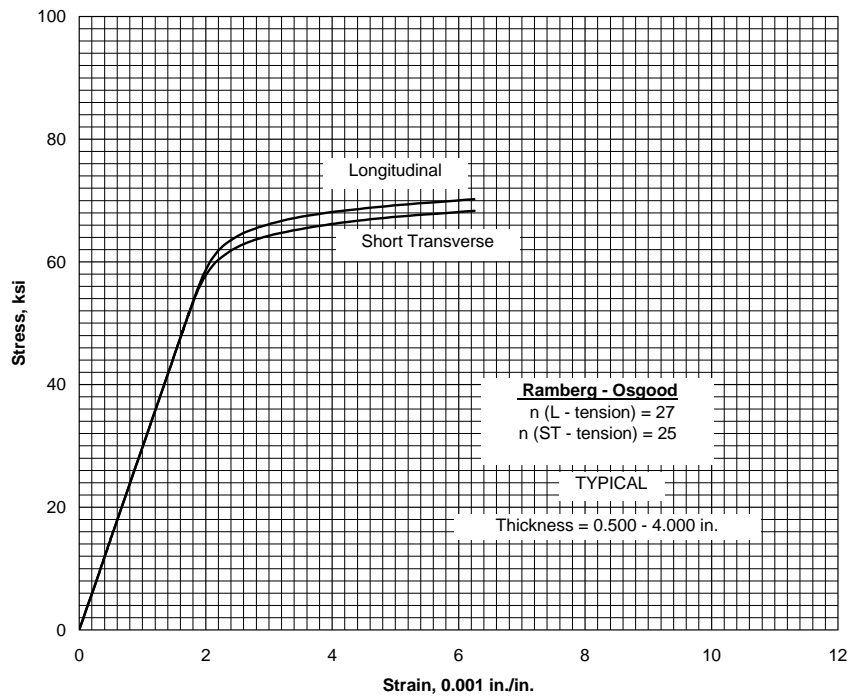

Figure 6.3.3.1.6(c). Typical tensile stress-strain curves for annealed Inconel 625 bar at room temperature.

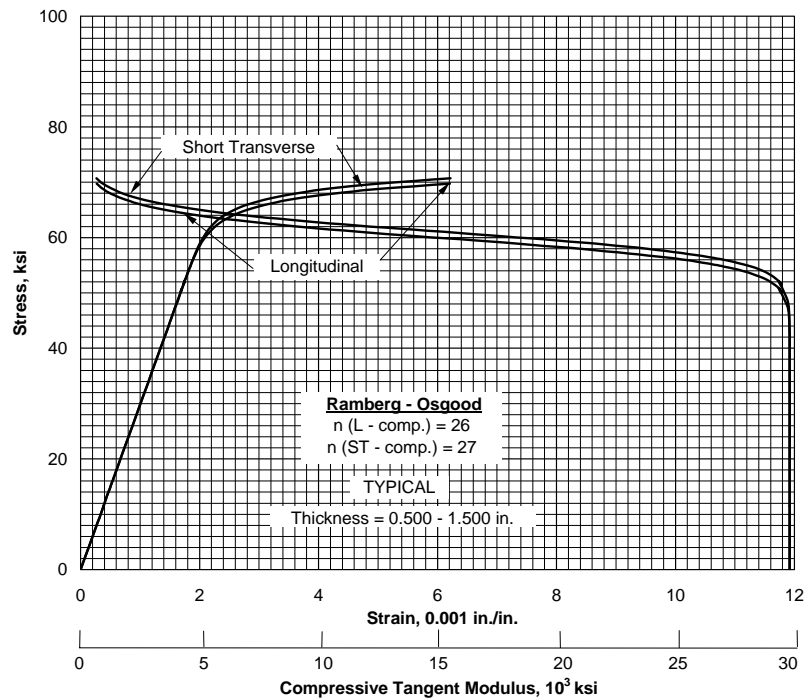

Figure 6.3.3.1.6(d). Typical compressive stress-strain and compressive tangent-modulus curves for annealed Inconel 625 bar at room temperature.

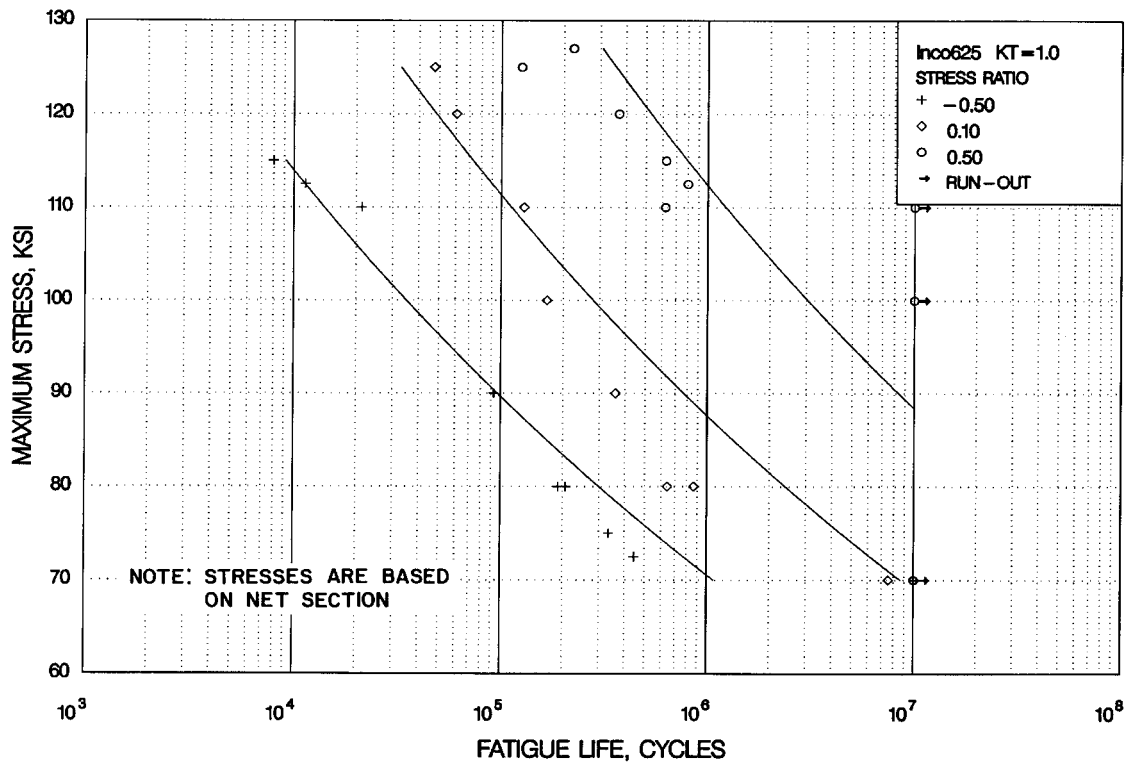

Figure 6.3.3.1.8(a). Best-fit S/N curves for annealed unnotched Inconel 625 bar, longitudinal direction.

Correlative Information for Figure 6.3.3.1.8(a)

Product Form: Bar, 0.75 inch diameter

No. of Heats/Lots: 1

Properties: TUS, ksi 133.2 TYS, ksi 73.8 Temp., °F RT

Equivalent Stress Equation:
 $\log N_f = 24.49 - 9.62 \log (S_{eq})$
 $S_{eq} = S_{max} (1-R)^{0.42}$

Specimen Details: Unnotched
0.250 inch diameter

Std. Error of Estimate, Log (Life) =
22.71 (1/S_{eq})

Surface Condition: Longitudinally polished

Standard Deviation, Log (Life) = 0.985
R² = 90%

Reference: 6.3.3.1.8(a)

Sample Size = 27

Test Parameters:
 Loading - Axial
 Frequency - Unspecified
 Temperature - RT
 Environment - Air

[Caution: The equivalent stress model may provide unrealistic life predictions for stress ratios beyond those represented above.]

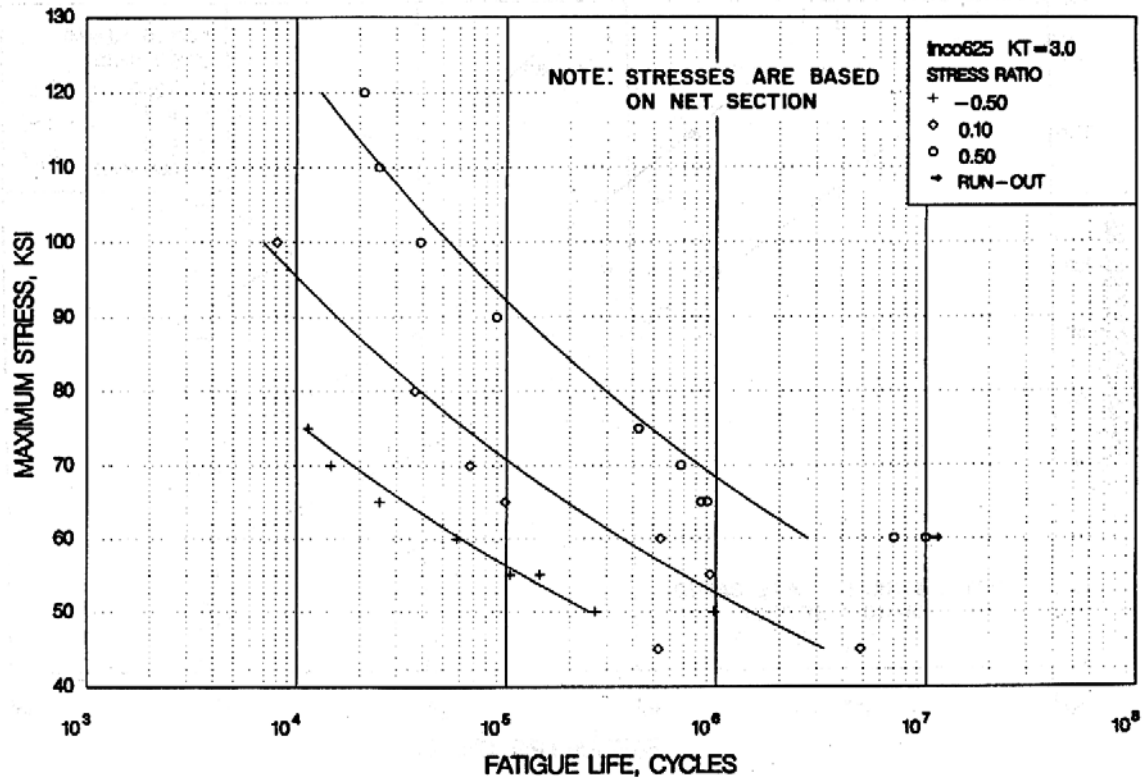

Figure 6.3.3.1.8(b). Best-fit S/N curves for annealed notched Inconel 625 bar, $K_t = 3.0$, longitudinal direction.

Correlative Information for Figure 6.3.3.1.8(b)

Product Form: Bar, 0.75 inch diameter

No. of Heats/Lots: 1

Properties: TUS, ksi 133.2 TYS, ksi 73.8 Temp., °F RT

Equivalent Stress Equation:
 $\log N_f = 19.08 - 7.70 \log (S_{eq})$

$$S_{eq} = S_{max} (1-R)^{0.45}$$

Specimen Details: V-Groove, $K_t = 3.0$
 0.375 inch gross diameter
 0.250 inch net diameter
 0.013 inch root radius
 60° flank angle

Std. Error of Estimate, $\log (\text{Life}) = 14.31 (1/S_{eq})$

Standard Deviation, $\log (\text{Life}) = 0.959$
 $R^2 = 92\%$

Sample Size = 26

Surface Condition: Polished

[Caution: The equivalent stress model may provide unrealistic life predictions for stress ratios beyond those represented above.]

Reference: 6.3.3.1.8(a)

Test Parameters:
 Loading - Axial
 Frequency - Unspecified
 Temperature - RT
 Atmosphere - Air

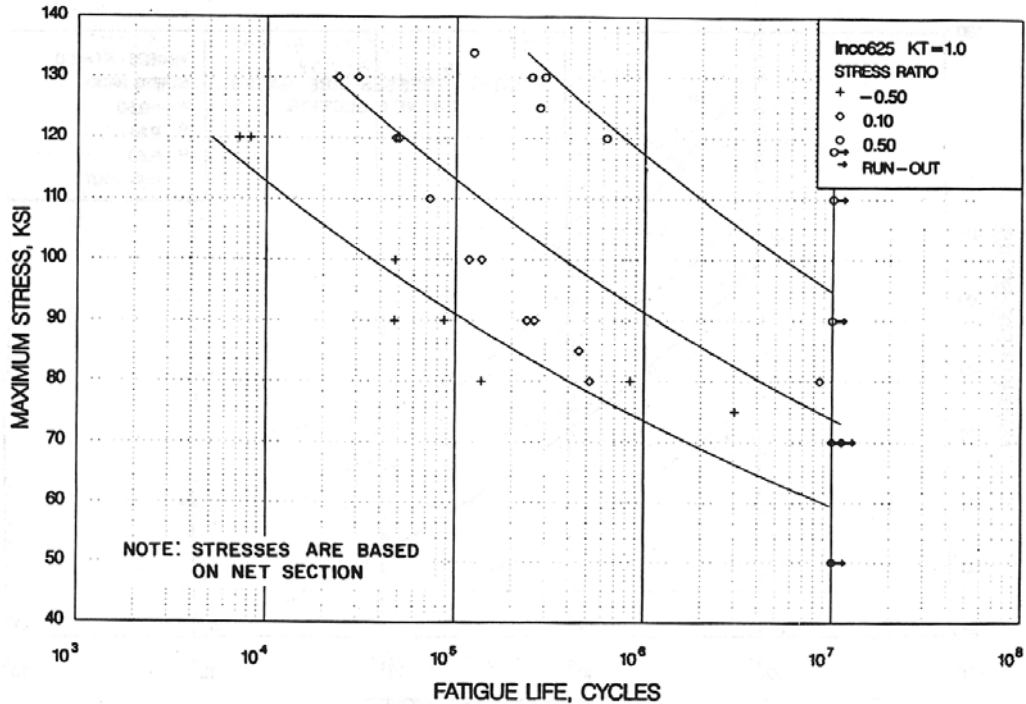

Figure 6.3.3.1.8(c). Best-fit S/N curves for annealed unnotched Inconel 625 sheet, long-transverse direction.

Correlative Information for Figure 6.3.3.1.8(c)

Product Form: Sheet, 0.093 and 0.125 inch thick

No. of Heats/Lots: 2

Properties: TUS, ksi TYS, ksi Temp., °F
135.4 74.6 RT
136.7 69.8

Equivalent Stress Equation:
 $\log N_f = 26.91 - 10.77 \log (S_{eq})$
 $S_{eq} = S_{max} (1-R)^{0.43}$
Std. Error of Estimate, Log (Life) =
37.39 (1/S_{eq})

Standard Deviation, Log (Life) = 0.933
R² = 75%

Specimen Details: Unnotched
0.500 inch wide
0.250 inch wide

Surface Condition: As ground

Sample Size = 34

References: 6.3.3.1.8(a) and (b)

[Caution: The equivalent stress model may provide unrealistic life predictions for stress ratios beyond those represented above.]

Test Parameters:
Loading - Axial
Frequency - Unspecified
Temperature - RT
Environment - Air

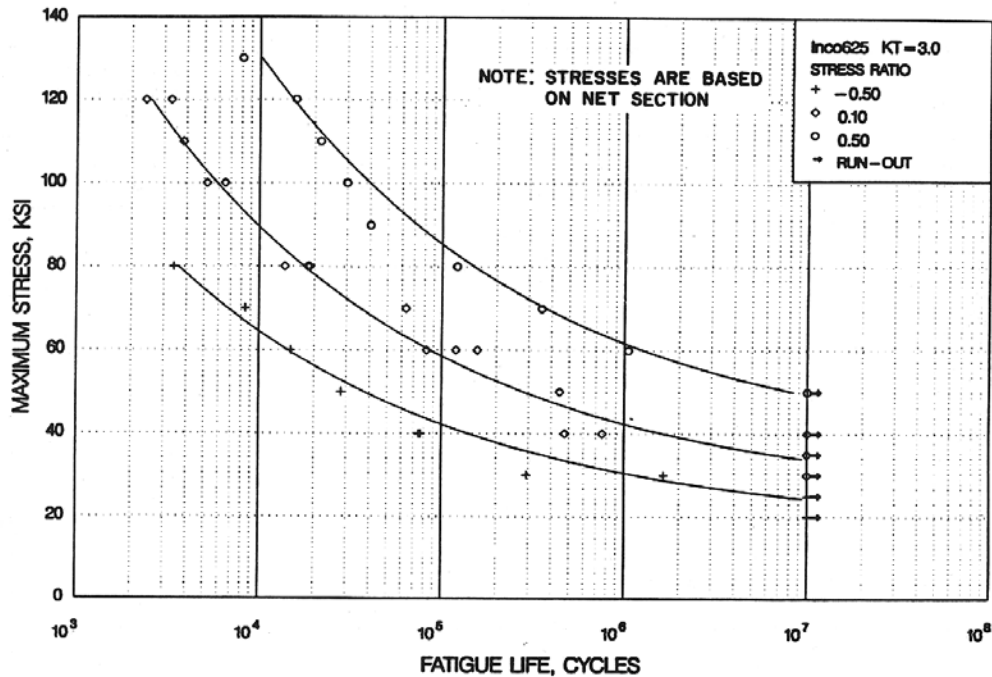

Figure 6.3.3.1.8(d). Best-fit S/N curves for annealed notched Inconel 625 sheet, $K_t = 3.0$, long transverse direction.

Correlative Information for Figure 6.3.3.1.8(d)

Product Form: Sheet, 0.093 and 0.125 inch thick

No. of Heats/Lots: 2

Properties:

TUS, ksi	TYS, ksi	Temp., °F
135.4	74.6	RT
136.7	69.8	

Equivalent Stress Equation:

$$\text{Log } N_f = 10.35 - 3.56 \text{ Log } (S_{eq} - 22.89)$$

$$S_{eq} = S_{max} (1-R)^{0.64}$$

$$\text{Std. Error of Estimate, Log (Life)} = 10.52 (1/S_{eq})$$

$$\text{Standard Deviation, Log (Life)} = 0.816$$

$$R^2 = 96\%$$

Specimen Details: Edge notched, $K_t = 3.0$
0.625 inch gross width
0.030 inch root radius
0.375 inch net width
60° flank angle

Sample Size = 37

Surface Condition: As ground

[Caution: The equivalent stress model may provide unrealistic life predictions for stress ratios beyond those represented above.]

References: 6.3.3.1.8(a) and (b)

Test Parameters:

Loading - Axial

Frequency - Unspecified

Temperature - RT

Atmosphere - Air

6.3.4 INCONEL 706

6.3.4.0 Comments and Properties — Inconel 706 is a vacuum-melted precipitation-hardened, nickel-base alloy with characteristics similar to Inconel 718 except that Inconel 706 has greatly improved machinability. The alloy has good formability and weldability. Like Inconel 718, Inconel 706 has excellent resistance to postweld strain-age cracking.

Depending upon choice of heat treatment, this alloy may be used for applications requiring either (1) high resistance to creep and stress rupture up to 1300°F or (2) high-tensile strength at cryogenic temperatures or elevated temperatures for short times. The creep-resistant heat treatment is characterized by an intermediate stabilizing treatment before precipitation hardening. Inconel 706 also has good resistance to oxidation and corrosion over a broad range of temperatures and environments.

Because of close relationship between heat treatment properties and application, the form and applications are listed with specifications in Table 6.3.4.0(a). Room-temperature mechanical and physical properties are in Table 6.3.4.0(b). The effect of temperature on physical properties is shown in Figure 6.3.4.0.

Table 6.3.4.0(a). Material Specifications for Inconel 706

Specification	Form	Application	
AMS 5605	Sheet, strip, and plate	Tensile	1800°F solution treated
AMS 5606	Sheet, strip, and plate	Creep-rupture	1750°F solution treated
AMS 5701	Bar, forging, and ring	Tensile	1800°F solution treated
AMS 5702	Bar, forging, and ring	Creep-rupture	1750°F solution treated
AMS 5703	Bar, forging, and ring	Creep-rupture	1750°F solution treated, stabilized and precipitation treated

6.3.4.1 Solution-Treated and Aged Condition (Creep Rupture Heat Treatment) — Effect of temperature on mechanical properties is shown in Figures 6.3.4.1.1, 6.3.4.1.4, and 6.3.4.1.5. Typical tensile stress-strain curves are shown in Figure 6.3.4.1.6(a) and typical compressive stress-strain and tangent-modulus curves in Figure 6.3.4.1.6(b). A full-range tensile stress-strain curve is shown in Figure 6.3.4.1.6(c). Stress-rupture properties are specified at 1200°F; the appropriate specification should be consulted for detailed requirements.

MIL-HDBK-5J
31 January 2003

Table 6.3.4.0(b). Design Mechanical and Physical Properties of Inconel 706

Specification	AMS 5605		AMS 5606	AMS 5701		AMS 5702 and AMS 5703	
	Sheet, strip, and plate			Bar and forging			
Form	Heat treated per indicated specification						
Condition	Heat treated per indicated specification						
Thickness or diameter, in.	≤0.187	0.188-1.000	All	<2.500	2.500-4.000	<2.500	2.500-4.000
Basis	S	S	S	S	S	S	S
Mechanical Properties:							
F_{tu} , ksi:							
L	170	170	170	165
LT	175	170	170
F_{ly} , ksi:							
L	140	135	130	130
LT	145	140	135
F_{cy} , ksi:							
L	146	141	136	136
LT	152	146	141
F_{su} , ksi	109	106	106	106	106	106	103
F_{bru}^a , ksi:							
(e/D = 1.5)	271	263	263	263	263	263	256
(e/D = 2.0)	344	334	334	334	334	334	325
F_{bry}^a , ksi:							
(e/D = 1.5)	202	195	188	195	188	181	181
(e/D = 2.0)	243	234	226	234	226	218	218
e , percent:							
L	12	12	12	12
LT	12	12	12
RA , percent:							
L	15	15	15	15
E , 10^3 ksi	30.4						
E_c , 10^3 ksi	30.4						
G , 10^3 ksi	11.0						
μ	0.38						
Physical Properties:							
ω , lb/in. ³	0.292						
C , K , and α	See Figure 6.3.4.0						

a Bearing values are “dry pin” values per Section 1.4.7.1.

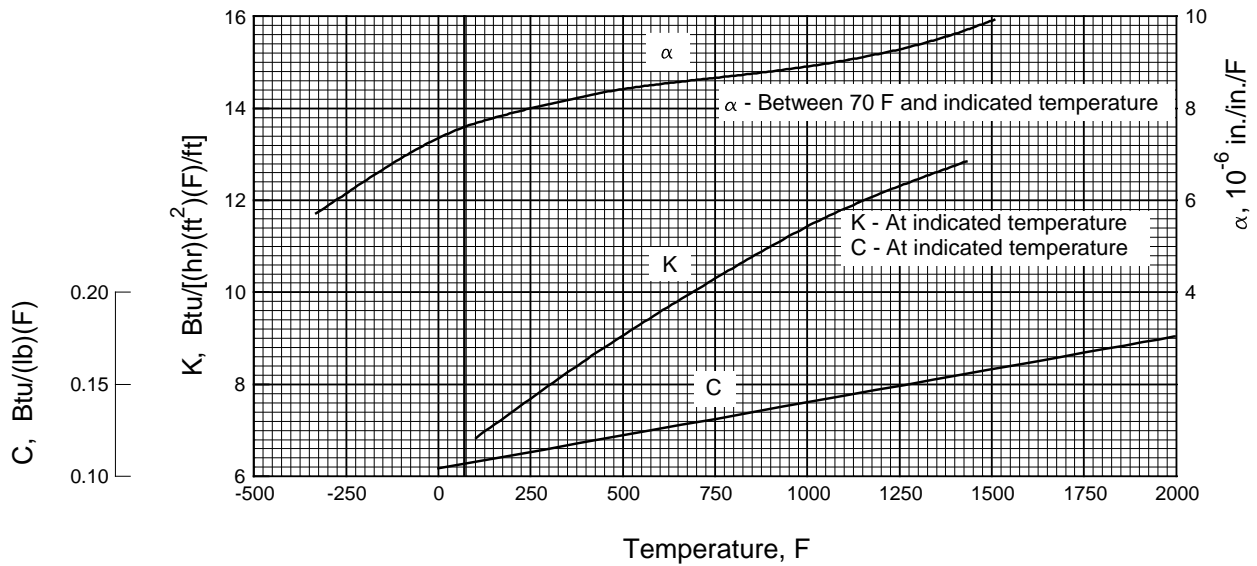

Figure 6.3.4.0. Effect of temperature on the physical properties of solution-treated and aged Inconel 706.

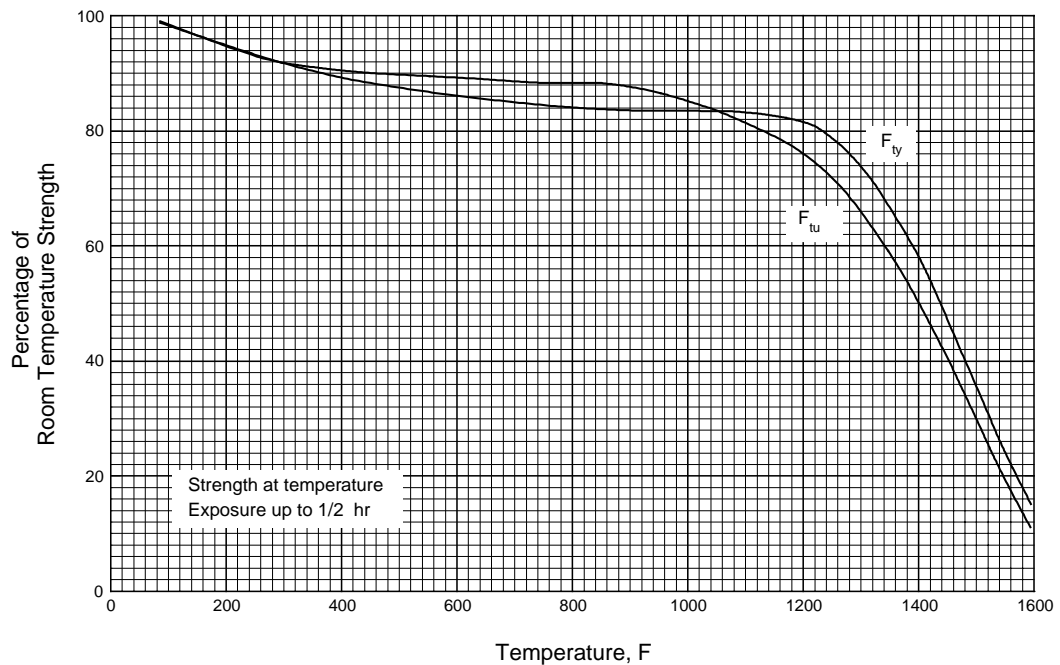

Figure 6.3.4.1.1. Effect of temperature on the tensile ultimate strength (F_{tu}) and the tensile yield strength (F_{ty}) of solution treated and aged (creep rupture heat treatment) of Inconel 706.

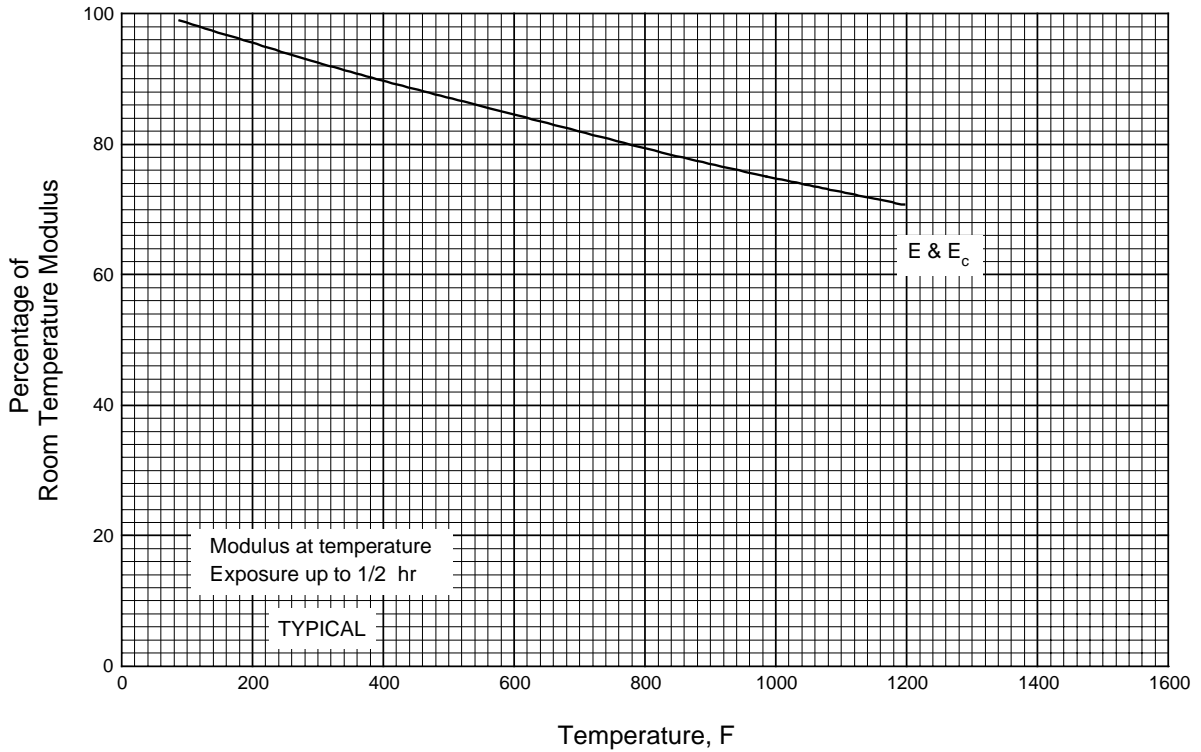

Figure 6.3.4.1.4. Effect of temperature on the tensile and compressive moduli (E and E_c) of Inconel 706.

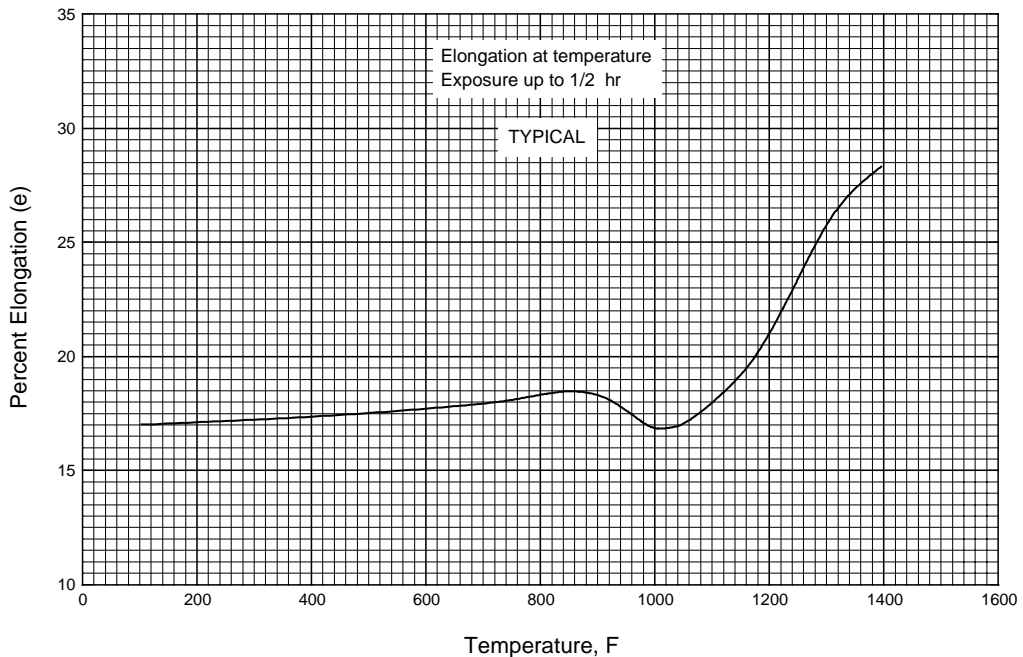

Figure 6.3.4.1.5. Effect of temperature on the elongation (e) of solution treated and aged Inconel 706 (creep rupture heat treatment).

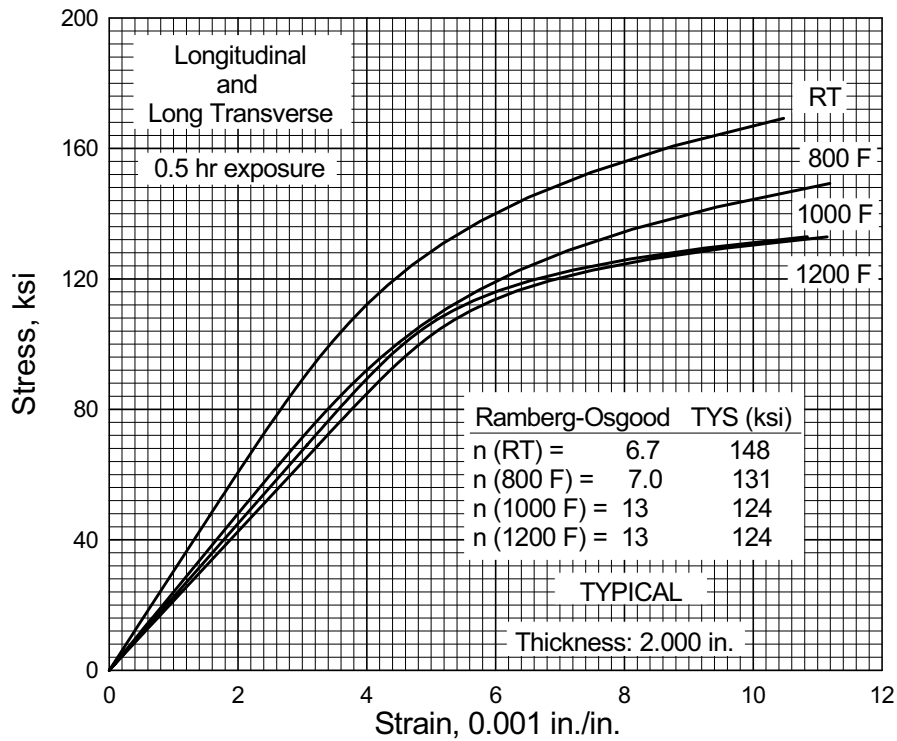

Figure 6.3.4.1.6(a). Typical tensile stress-strain curves for solution-treated and aged Inconel 706 (creep rupture heat treatment) forged bar.

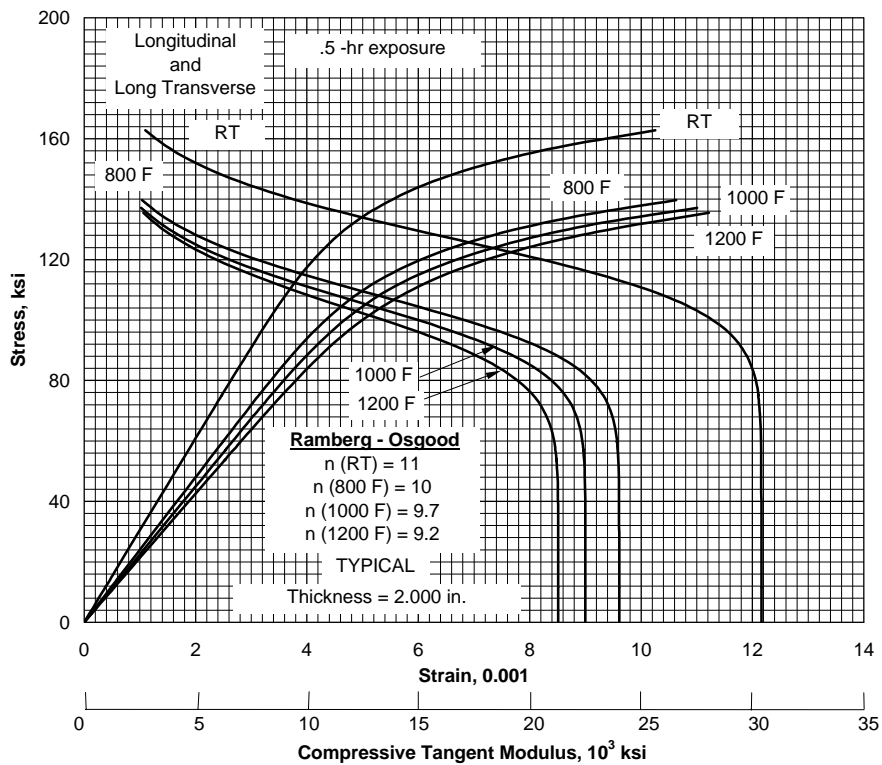

Figure 6.3.4.1.6(b). Typical compressive stress-strain and compressive tangent-modulus curves for solution-treated and aged Inconel 706 (creep rupture heat treatment) forged bar.

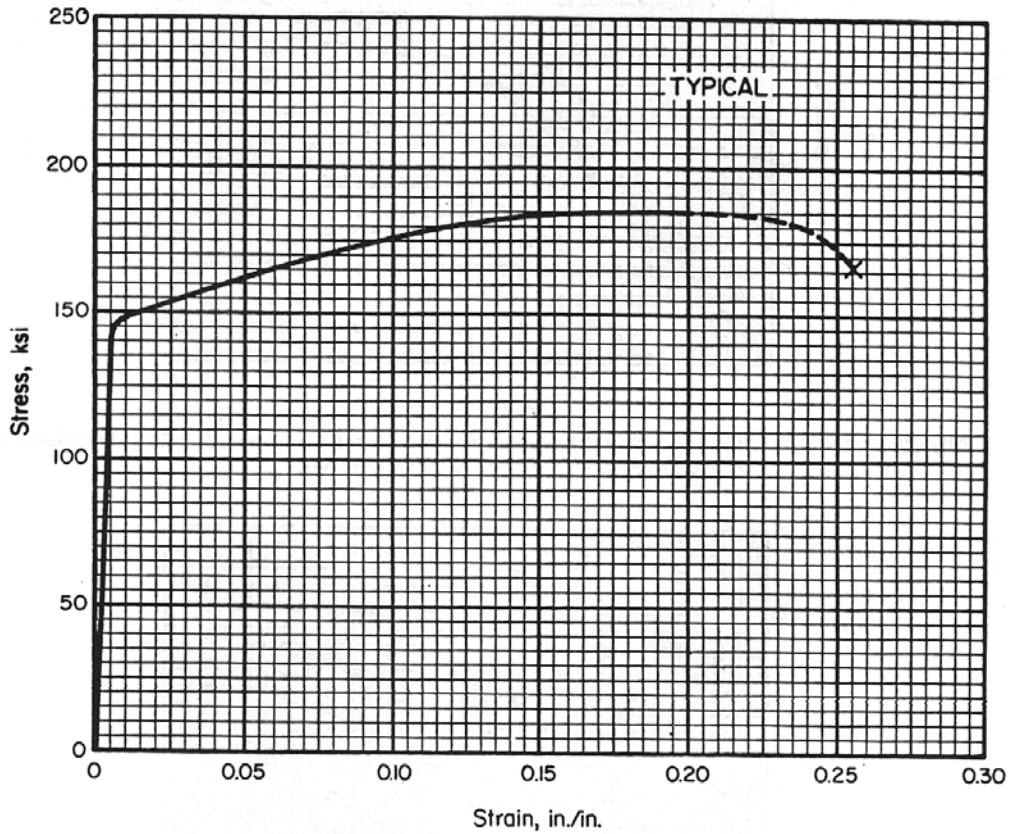

Figure 6.3.4.1.6(c). Typical tensile stress-strain curve (full range) for Inconel 706 bar and sheet at room temperature (creep rupture heat treatment).

6.3.5 INCONEL 718

6.3.5.0 Comments and Properties — Inconel 718 is a vacuum-melted, precipitation-hardened nickel-base alloy. It can be welded easily and excels in its resistance to strain-age cracking. It is also readily formable. Depending on choice of heat treatments, this alloy finds applications requiring either (1) high resistance to creep and stress rupture to 1300°F or (2) high strength at cryogenic temperatures. It also has good oxidation resistance up to 1800°F. Inconel 718 is available in all wrought forms and investment castings.

Because of the close relationship between heat treatment, properties, and applications, both the product form and application are listed with the specifications in Table 6.3.5.0(a). Room-temperature mechanical and physical properties are presented in Tables 6.3.5.0(b) through (d). The effect of temperature on physical properties is presented in Figure 6.3.5.0.

Table 6.3.5.0(a). Material Specifications for Inconel 718

Specification	Form	Application
AMS 5589	Tubing	Creep-rupture
AMS 5590	Tubing	Short-time
AMS 5596	Sheet, strip, plate	Creep-rupture
AMS 5597	Sheet, strip, plate	Short-time
AMS 5662, 5663	Bar, forging	Creep-rupture
AMS 5664	Bar, forging	Short-time
AMS 5383	Investment castings	Short-time

6.3.5.1 Solution-Treated and Aged Condition — Elevated-temperature curves are presented in Figures 6.3.5.1.1 and 6.3.5.1.4(a) through (c). Typical tensile and compressive stress-strain curves as well as typical compressive tangent-modulus curves for sheet and castings are shown in Figures 6.3.5.1.6(a) through (c). Figure 6.3.5.1.6(d) is a typical stress-strain curve (full range) for Inconel 718 investment casting. Creep and stress-rupture curves for forging are shown in Figures 6.3.5.1.7(a) through (e). Supplemental creep and stress-rupture information for forging is presented in Table 6.3.5.1.7. Fatigue S/N curves are presented in Figures 6.3.5.1.8(a) through (g). Fatigue-crack-propagation data for die forging and plate are presented in Figures 6.3.5.1.9(a) through (c).

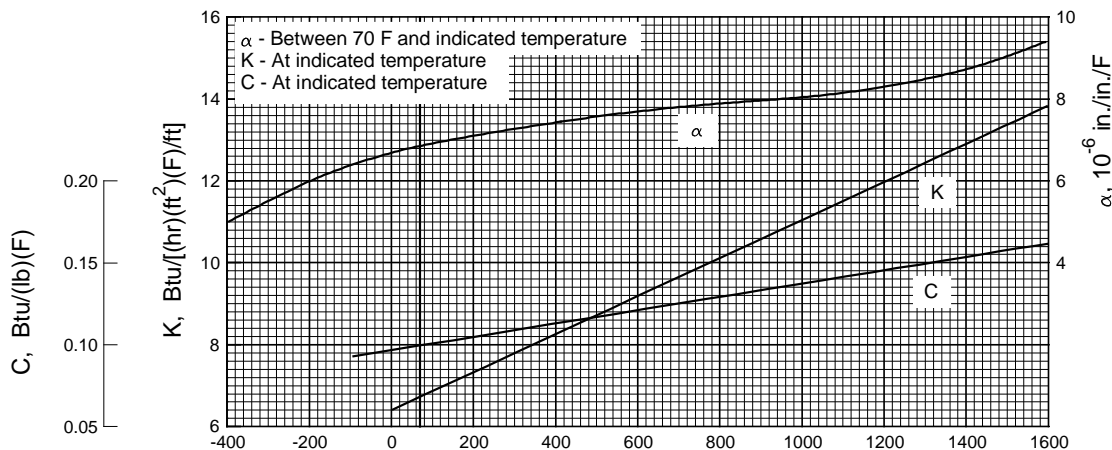

Figure 6.3.5.0. Effect of temperature on the physical properties of Inconel 718.

Table 6.3.5.0(b). Design Mechanical and Physical Properties of Inconel 718

Specification	AMS 5596				AMS 5597	AMS 5589	AMS 5590
	Sheet		Plate		Sheet and plate	Tubing	
Form	Solution treated and aged per indicated specification						
Condition							
Thickness, in.	0.010-0.187		0.188-0.249	0.250-1.000	0.010-1.000	O.D. > 0.125 Wall > 0.015	
Basis	A	B	S	S	S	S	S
Mechanical Properties^a:							
<i>F_{tu}</i> , ksi:							
L	180	192	180	185	170
LT	180 ^b	191	180	180	180
<i>F_{ty}</i> , ksi:							
L	145	156	148	150	145
LT	147	158	150	150	150
<i>F_{cy}</i> , ksi:							
L	155	167	158
LT	158	170	161
<i>F_{su}</i> , ksi							
L	124	132	124
<i>F_{bru}</i> ^c , ksi:							
(e/D = 1.5)	291	309	291
(e/D = 2.0)	380	403	380
<i>F_{bry}</i> ^c , ksi:							
(e/D = 1.5)	208	223	212
(e/D = 2.0)	241	259	246
<i>e</i> , percent (S-basis):							
L	12	15
LT	12	...	12	12	12
<i>E</i> , 10 ³ ksi							
					29.4		
<i>E_c</i> , 10 ³ ksi							
					30.9		
<i>G</i> , 10 ³ ksi							
					11.4		
<i>μ</i>							
					0.29		
Physical Properties:							
<i>ω</i> , lb/in. ³							
					0.297		
<i>C</i> , <i>K</i> , and <i>α</i>							
					See Figure 6.3.5.0		

- a Design allowables were based upon data from samples of material, supplied in the solution treated condition, which were aged to demonstrate heat treatment response by suppliers. Properties obtained by the user may be different, if the material has been formed or otherwise cold worked.
- b S-basis. The rounded T₉₉ value is 183 ksi.
- c Bearing values are “dry pin” values per Section 1.4.7.1.

MIL-HDBK-5J
31 January 2003

Table 6.3.5.0(c). Design Mechanical and Physical Properties of Inconel 718 Bar and Forging

Specification	AMS 5662 and AMS 5663							AMS 5664		
	Bar							Forging	Bar	Forging
Form	Solution treated and aged per indicated specification									
Condition										
Thickness, in.	0.250-1.000	1.001-1.500	1.501-2.000	2.001-2.500	2.501-3.000	3.001-4.000	4.001-5.000	≤5.000	≤10.000	≤10.000
Basis	S	S	S	S	S	S	S	S	S	S
Mechanical Properties:										
<i>F_m</i> , ksi:										
L	185	185	185	185	185	185	185	185	185	180
LT ^a	180	180	180	180	180	180	180	180	180	180
ST ^a	180	180	180	180
<i>F_{ty}</i> , ksi:										
L	150	150	150	150	150	150	150	150	150	150
LT ^a	150	150	150	150	150	150	150	150	150	150
ST ^a	146	150	150	150
<i>F_{cy}</i> , ksi:										
L	156	156	156	156	156	156	156
ST	156	156	156	156
<i>F_{su}</i> , ksi										
L	111	114	116	118	119	121	123
<i>F_{bru}^b</i> , ksi:										
(e/D = 1.5)	309	309	309	309	309	309	309
(e/D = 2.0)	394	394	394	394	394	394	394
<i>F_{bry}^b</i> , ksi:										
(e/D = 1.5)	216	216	216	216	216	216	216
(e/D = 2.0)	257	257	257	257	257	257	257
<i>e</i> , percent:										
L	12	12	12	12	12	12	12	12	10	12
LT ^b	6	6	6	6	6	6	6	10	10	12
ST ^b	6	6	6	...	10	12
<i>RA</i> , percent:										
L	15	15	15	15	15	15	15	15	12	15
LT ^b	8	8	8	8	8	8	8	12	12	15
ST ^b	8	8	8	...	12	15
<i>E</i> , 10 ³ ksi:										
						29.4				
<i>E_c</i> , 10 ³ ksi:										
						30.9				
<i>G</i> , 10 ³ ksi										
						11.4				
<i>μ</i>										
						0.29				
Physical Properties:										
<i>ω</i> , lb/in. ³										
						0.297				
<i>C</i> , <i>K</i> , and <i>α</i>										
						See Figure 6.3.5.0				

a Applicable providing LT or ST direction is ≥2.500 inches.

b Bearing values are “dry pin” values per Section 1.4.7.1.

Table 6.3.5.0(d). Design Mechanical and Physical Properties of Inconel 718 Investment Castings

Specification	AMS 5383
Form	Investment Casting
Condition	ST
Location within casting	Any
Thickness, in.	≤0.500
Basis	S
Mechanical Properties:	
F_{tu} , ksi	120
F_{ly} , ksi	105
F_{cy} , ksi	105
F_{su} , ksi	88 ^a
F_{bru}^b , ksi:	
($e/D = 1.5$)	202
($e/D = 2.0$)	248
F_{bry}^b , ksi:	
($e/D = 1.5$)	161
($e/D = 2.0$)	188
e , percent	3
RA , percent	8
E , 10 ³ ksi	29.4
E_c , 10 ³ ksi	30.9
G , 10 ³ ksi	11.4
μ	0.29
Physical Properties:	
ω , lb/in. ³	0.297
C , K , and α	See Figure 6.3.5.0

a Determined in accordance with ASTM Procedure B769.

b Bearing values are “dry pin” values per Section 1.4.7.1.

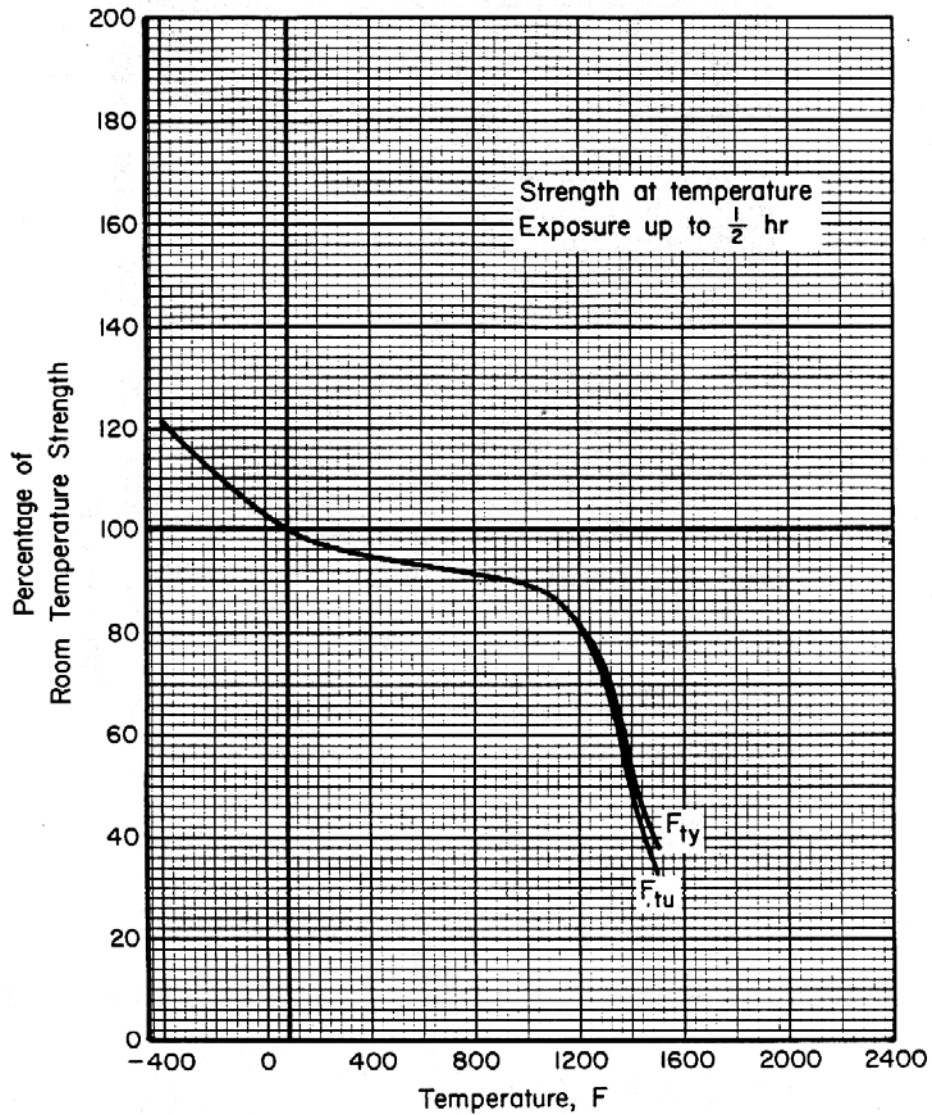

Figure 6.3.5.1.1. Effect of temperature on the tensile ultimate strength (F_{tu}) and tensile yield strength (F_{ty}) of solution-treated and aged Inconel 718.

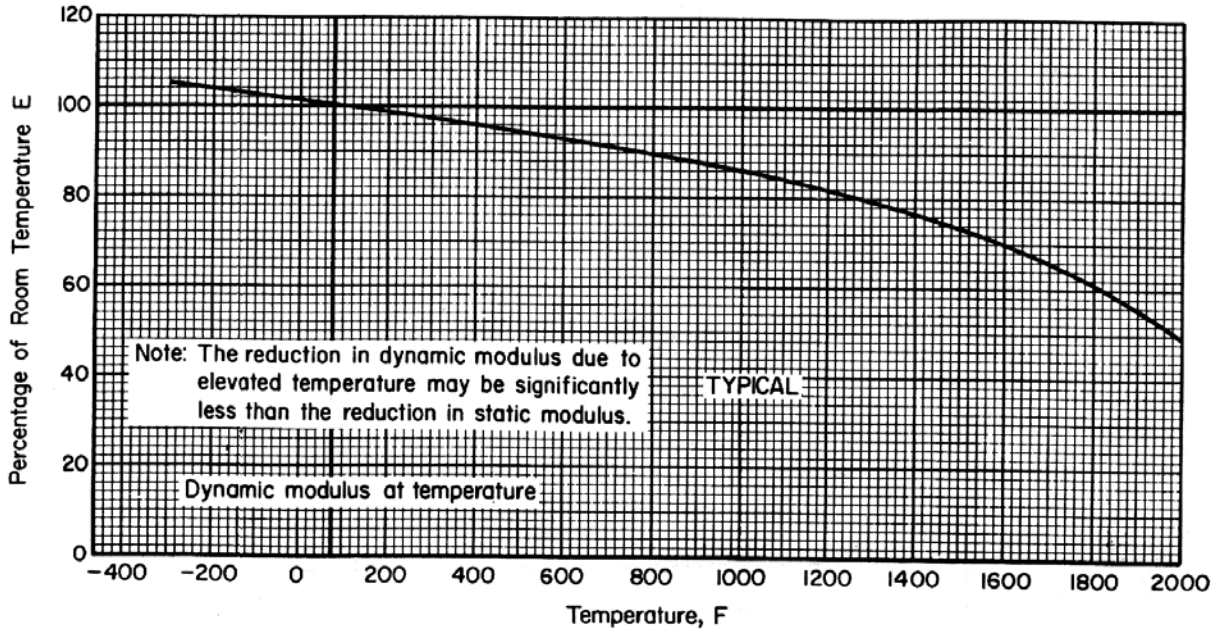

Figure 6.3.5.1.4(a). Effect of temperature on dynamic tensile modulus (E) of solution-treated and aged Inconel 718.

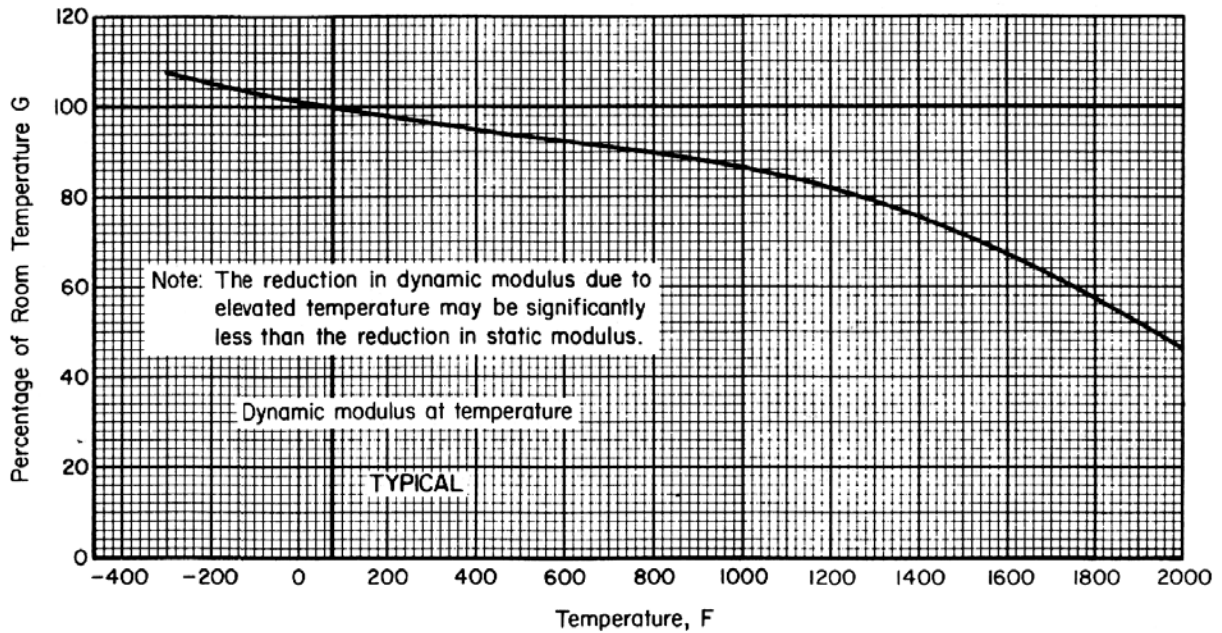

Figure 6.3.5.1.4(b). Effect of temperature on dynamic shear modulus (G) of solution-treated and aged Inconel 718.

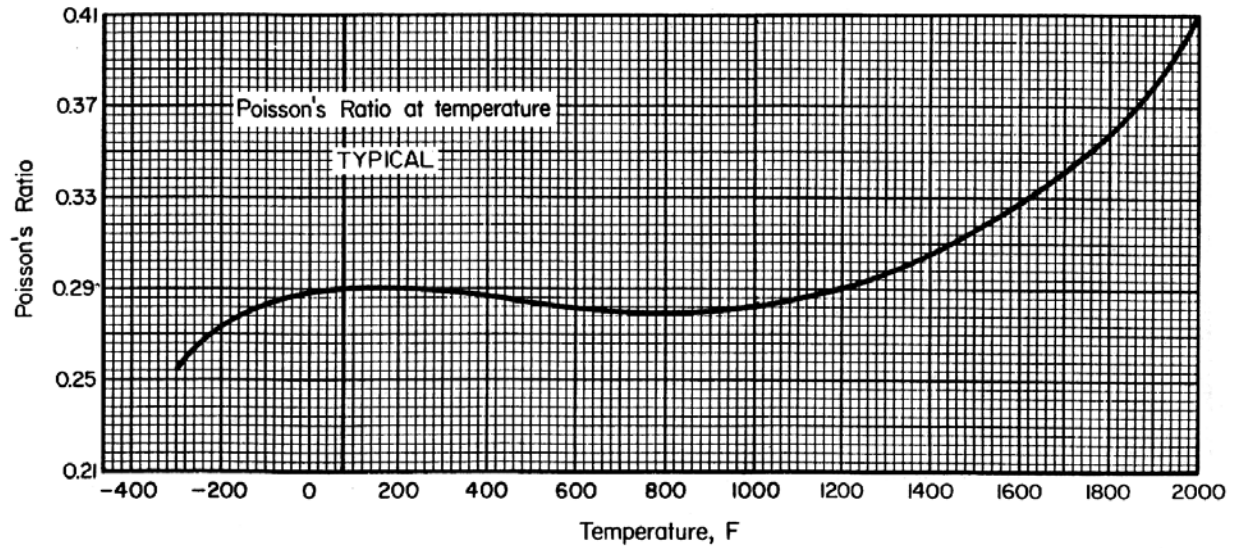

Figure 6.3.5.1.4(c). Effect of temperature on Poisson's ratio (μ) for solution-treated and aged Inconel 718.

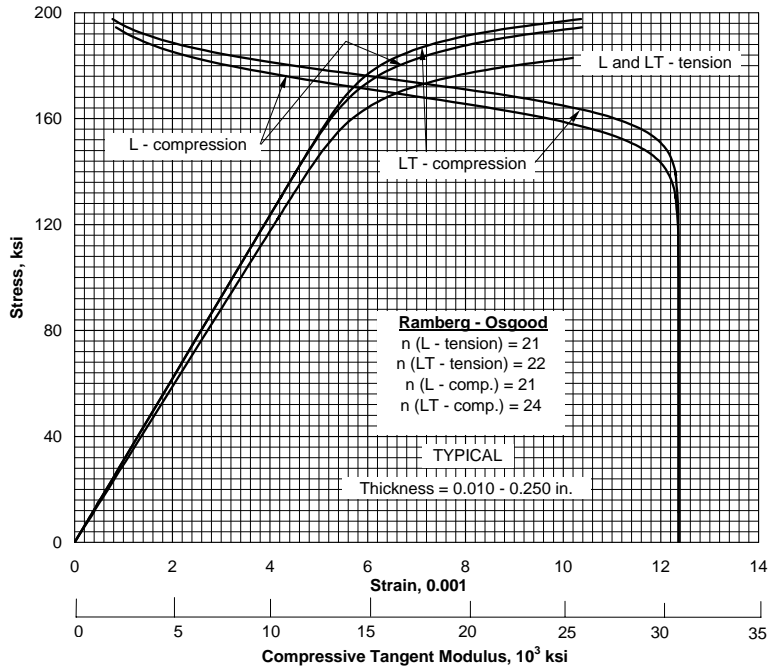

Figure 6.3.5.1.6(a). Typical tensile stress-strain, compressive stress-strain, and compressive tangent-modulus curves for solution-treated and aged Inconel 718 sheet (AMS 5596) at room temperature.

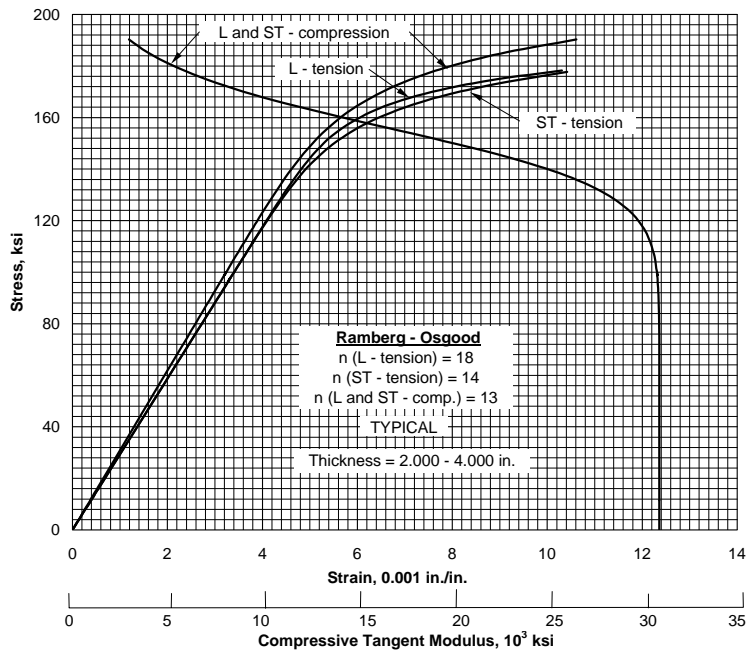

Figure 6.3.5.1.6(b). Typical tensile and compressive stress-strain and compressive tangent-modulus curves for solution-treated and aged (creep-rupture application) Inconel 718 bar (AMS 5662 and AMS 5663) at room temperature.

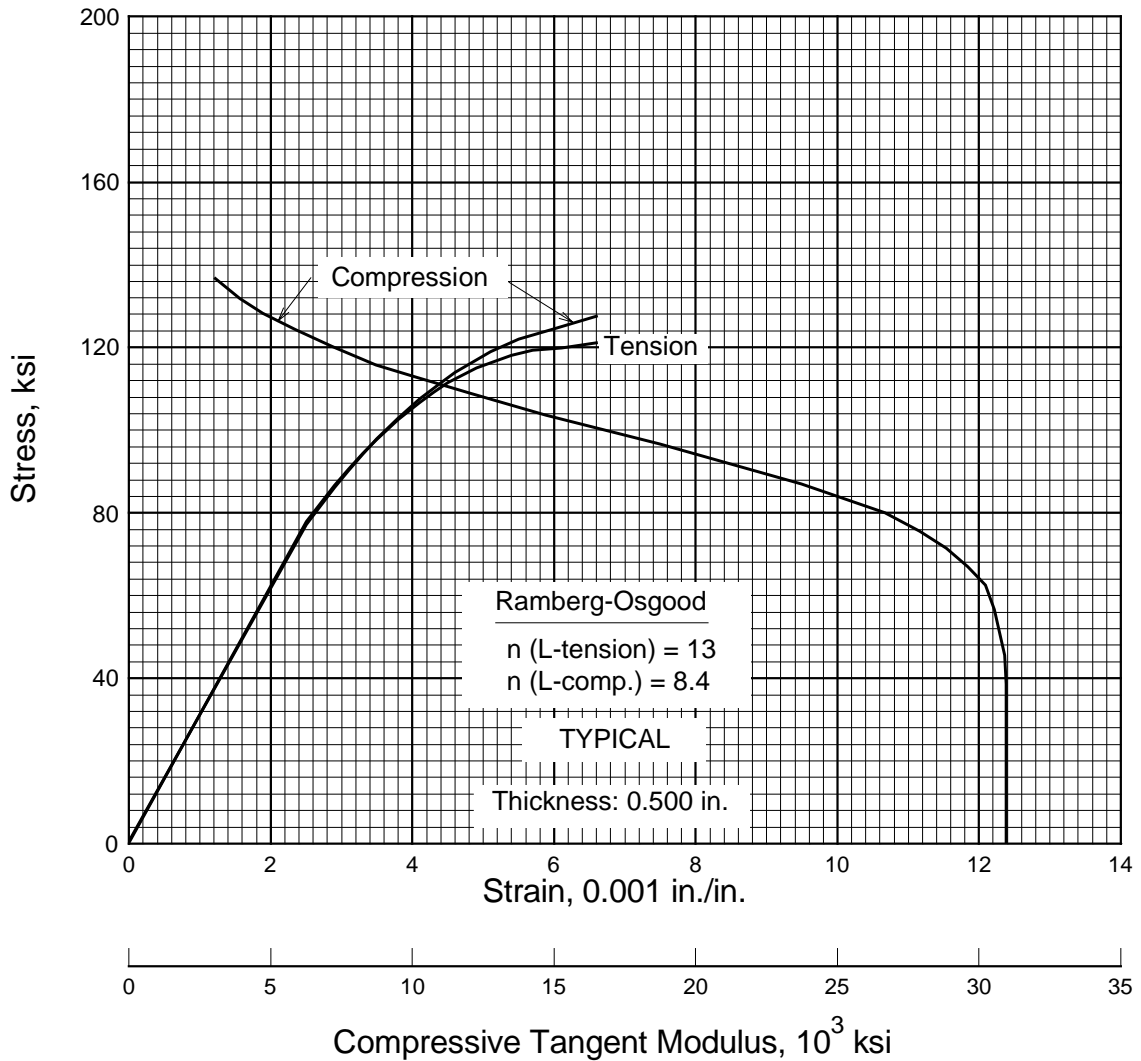

Figure 6.3.5.1.6(c). Typical tensile stress-strain, compressive stress-strain, and compressive tangent-modulus curves for solution treated and aged Inconel 718 investment casting (AMS 5383) at room temperature.

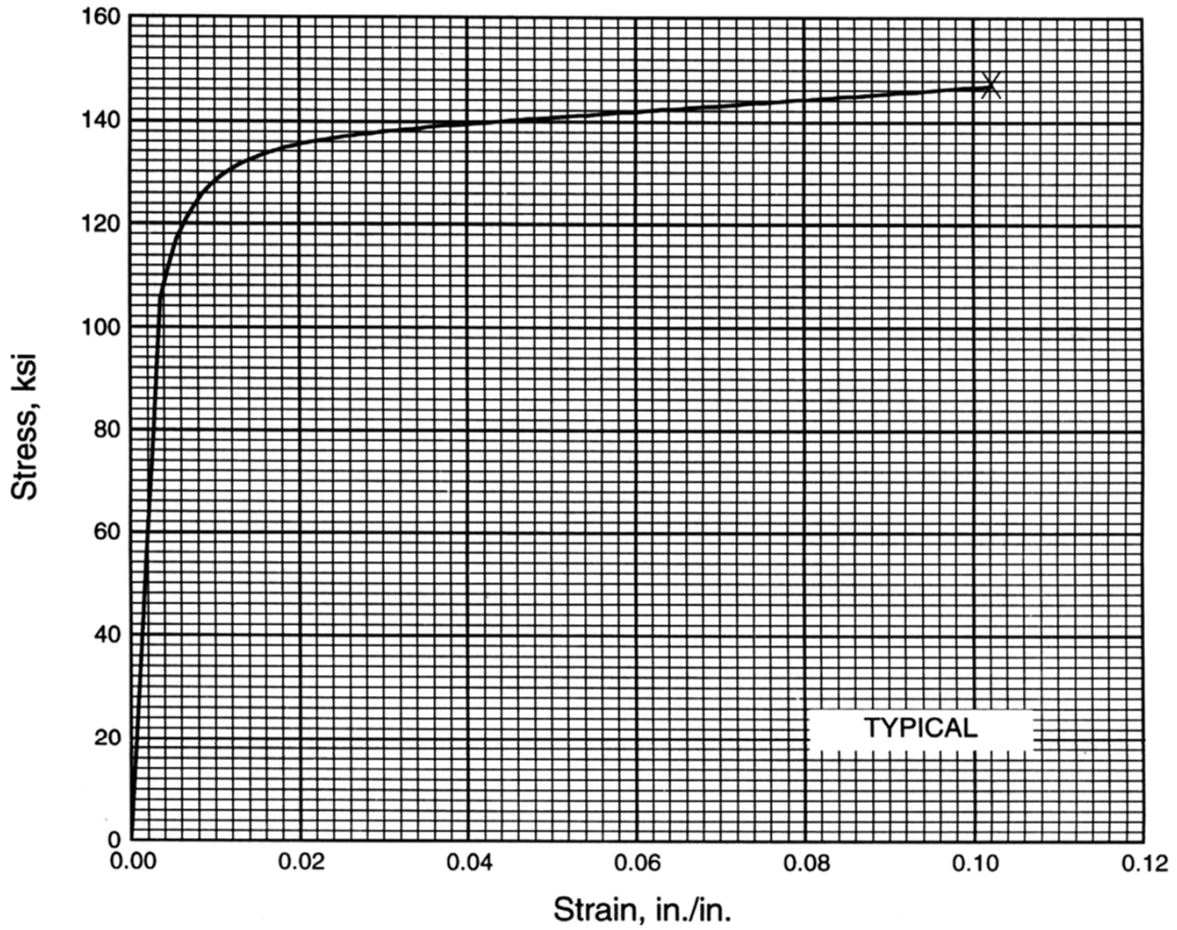

Figure 6.3.5.1.6(d). Typical tensile stress-strain curve (full range) for solution treated and aged Inconel 718 investment casting (AMS 5383) at room temperature.

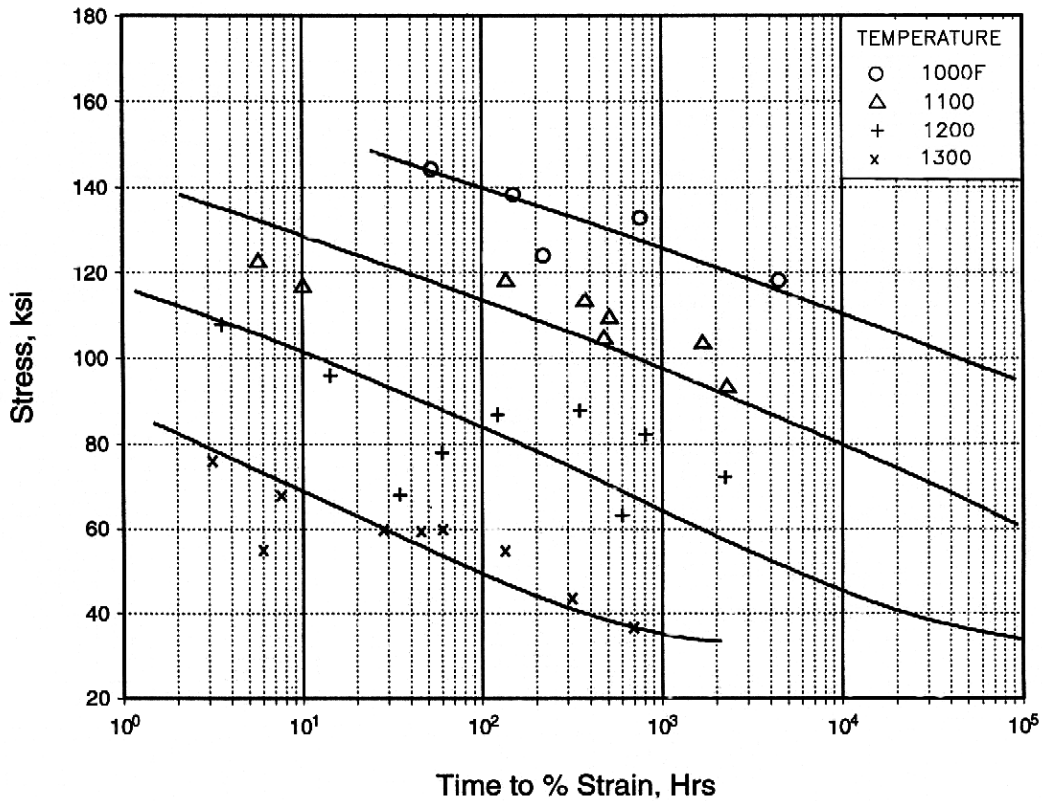

Figure 6.3.5.1.7(a). Average isothermal 0.10% creep curves for Inconel 718 forging.

Correlative Information for Figure 6.3.5.1.7(a)

Makeup of Data Collection:

Heat Treatment: 2 [See Table 6.3.5.1.7(f)]
 Number of Vendors = Unknown
 Number of Lots = 2
 Number of Test Laboratories = 1
 Number of Tests = 32

Specimen Details:

Type - Unnotched round bar
 Gage Length - N.A.
 Gage Thickness - 0.25 inch to 0.375 inch

0.10 Percent Creep Equation:

$$\text{Log } t = c + b_1 T + b_2 X + b_3 X^2 + b_4 X^3$$

T = °R
 X = log (stress, ksi)
 c = 185.16
 b₁ = -0.01778
 b₂ = -255.25
 b₃ = 146.28
 b₄ = -28.65

Analysis Details:

Inverse Matrix = [See Table 6.3.5.1.7(f)]
 Std. Error of Estimate, Log (Hrs) = 0.56
 Standard Deviation, Log (Hrs) = 0.99
 R² = 68%

[Caution: The creep rupture model may provide unrealistic predictions for temperatures and stresses beyond those represented above.]

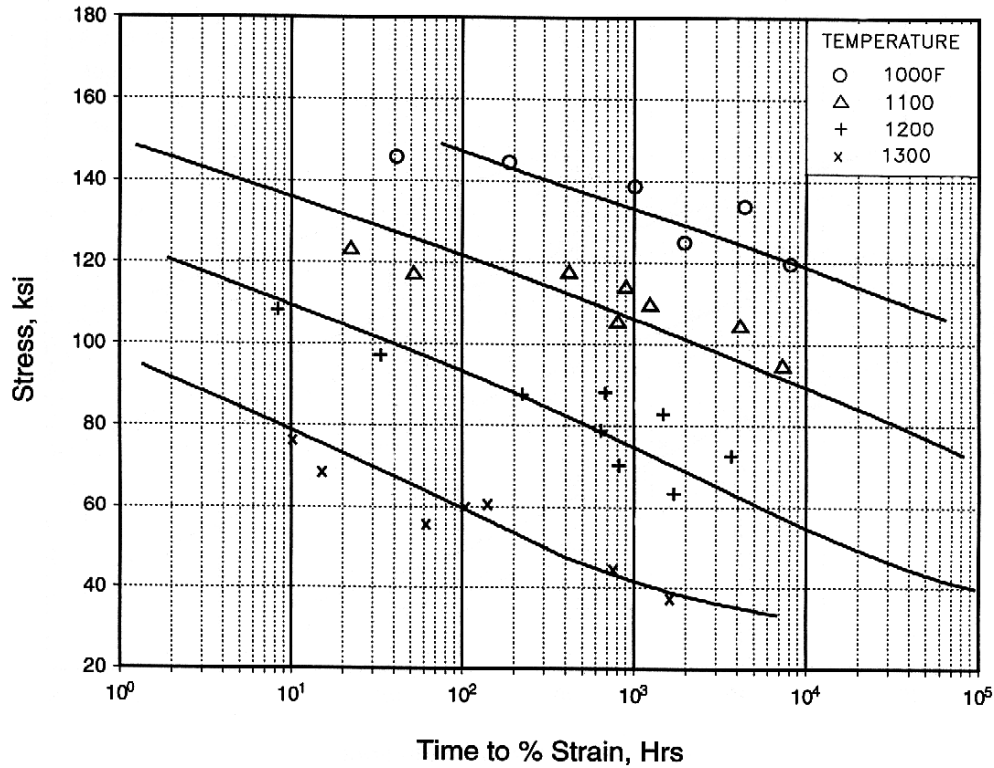

Figure 6.3.5.1.7(b). Average isothermal 0.20% creep curves for Inconel 718 forging.

Correlative Information for Figure 6.3.5.1.7(b)

Makeup of Data Collection:

Heat Treatment: 2 [See Table 6.3.5.1.7(f)]
Number of Vendors = Unknown
Number of Lots = 2
Number of Test Laboratories = 1
Number of Tests = 31

Specimen Details:

Type - Unnotched round bar
Gage Length - N.A.
Gage Thickness - 0.25. inch - 0.375 inch

0.20 Percent Creep Equation:

$$\text{Log } t = c + b_1 T + b_2 X + b_3 X^2 + b_4 X^3$$

T = °R
X = log (stress, ksi)
c = 185.67
b₁ = -0.01778
b₂ = -255.25
b₃ = 146.28
b₄ = -28.65

Analysis Details:

Inverse Matrix = [See Table 6.3.5.1.7(f)]
Std. Error of Estimate, Log (Hrs) = 0.41
Standard Deviation, Log (Hrs) = 0.98
R² = 82%

[Caution: The creep rupture model may provide unrealistic predictions for temperatures and stresses beyond those represented above.]

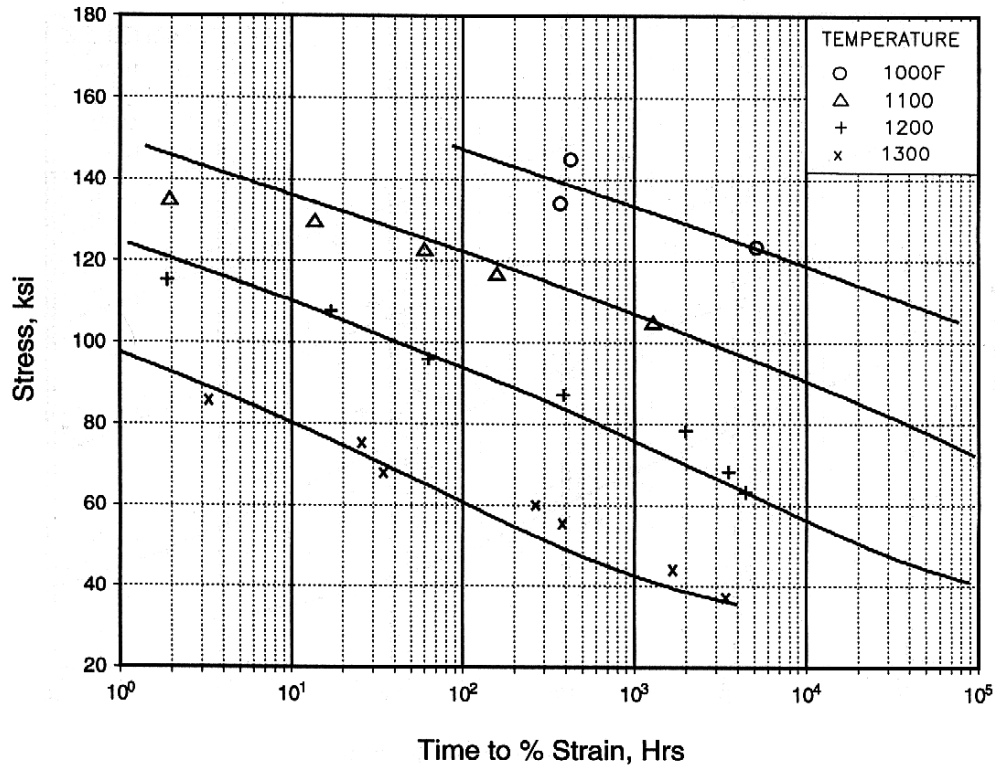

Figure 6.3.5.1.7(c). Average isothermal 0.50% creep curves for Inconel 718 forging.

Correlative Information for Figure 6.3.5.1.7(c)

Makeup of Data Collection:

Heat Treatment: 2 [See Table 6.3.5.1.7(f)]
 Number of Vendors = Unknown
 Number of Lots = 2
 Number of Test Laboratories = 1
 Number of Tests = 22

Specimen Details:

Type - Unnotched round bar
 Gage Length - N.A.
 Gage Thickness - 0.250 inch - 0.375 inch

0.50 Percent Creep Equation:

$$\text{Log } t = c + b_1 T + b_2 X + b_3 X^2 + b_4 X^3$$

$T = \text{°R}$
 $X = \text{log (stress, ksi)}$
 $c = 185.75$
 $b_1 = -0.01778$
 $b_2 = -255.25$
 $b_3 = 146.28$
 $b_4 = -28.65$

Analysis Details:

Inverse Matrix = [See Table 6.3.5.1.7(f)]
 Std. Error of Estimate, Log (Hrs) = 0.34
 Standard Deviation, Log (Hrs) = 1.10

[Caution: The creep rupture model may provide unrealistic predictions for temperatures and stresses beyond those represented above.]

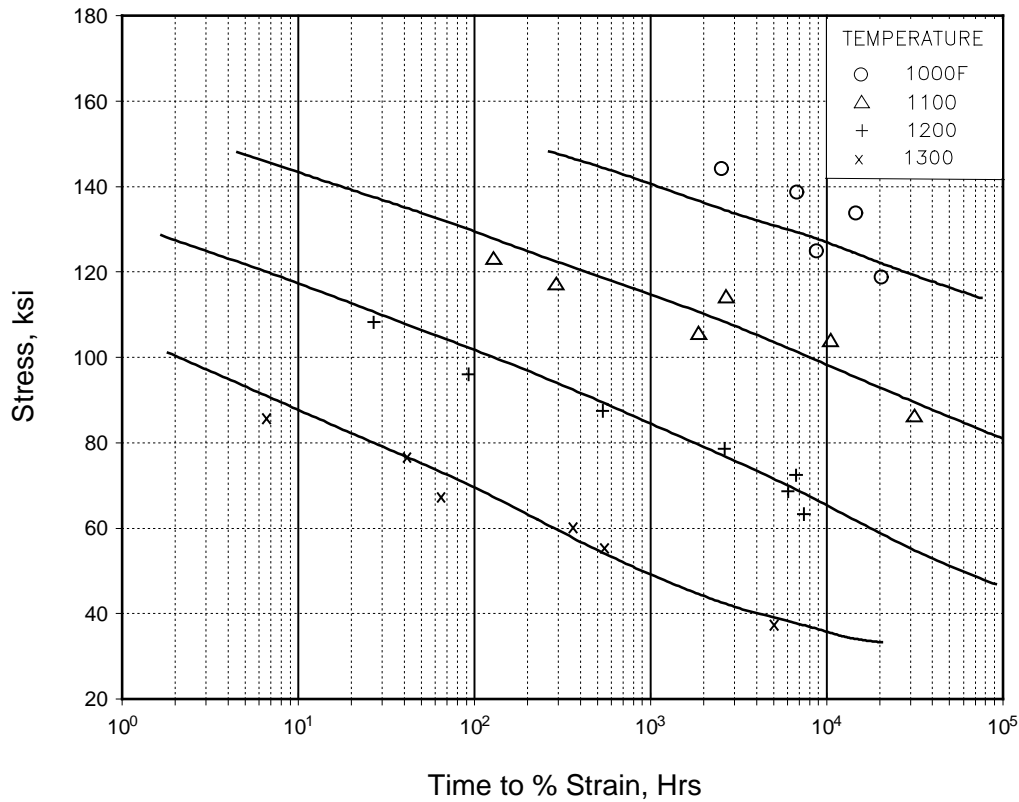

Figure 6.3.5.1.7(d). Average isothermal 5.00% creep curves for Inconel 718 forging.

Correlative Information for Figure 6.3.5.1.7(d)

Makeup of Data Collection:

Heat Treatment: 2 [See Table 6.3.5.1.7(f)]
 Number of Vendors = Unknown
 Number of Lots = 2
 Number of Test Laboratories = 1
 Number of Tests = 24

Specimen Details:

Type - Unnotched round bar
 Gage Length - N.A.
 Gage Thickness - 0.250 inch - 0.375 inch

5.00 Percent Creep Equation:

$$\text{Log } t = c + b_1 T + b_2 X + b_3 X^2 + b_4 X^3$$

T = °R
 X = log (stress, ksi)
 c = 186.16
 b₁ = -0.01778
 b₂ = -255.25
 b₃ = 146.28
 b₄ = -28.65

Analysis Details:

Inverse Matrix = [See Table 6.3.5.1.7(f)]
 Std. Error of Estimate, Log (Hrs) = 0.37
 Standard Deviation, Log (Hrs) = 1.02

[Caution: The creep rupture model may provide unrealistic predictions for temperatures and stresses beyond those represented above.]

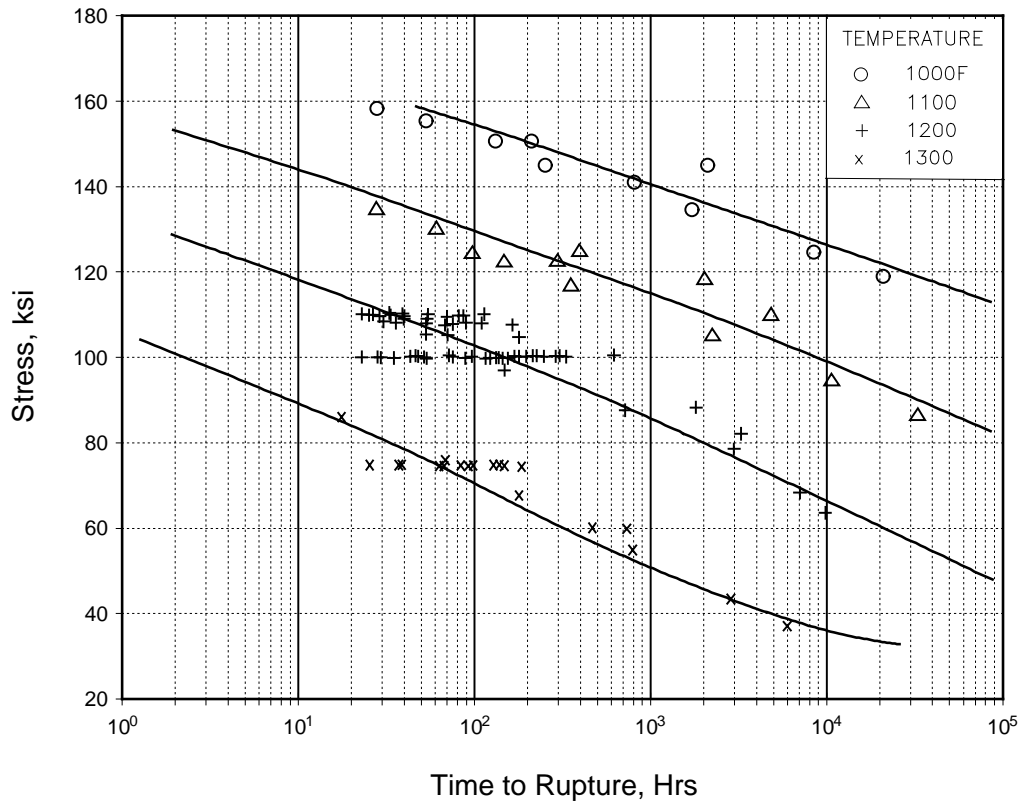

Figure 6.3.5.1.7(e). Average isothermal stress rupture curves for Inconel 718 forging.

Correlative Information for Figure 6.3.5.1.7(e)

Makeup of Data Collection:

Heat Treatment: 2 [See Table 6.3.5.1.7(f)]
 Number of Vendors = Unknown
 Number of Lots = 7
 Number of Test Laboratories = 2
 Number of Tests = 162

Specimen Details:

Type - Unnotched round bar
 Gage Length - N.A.
 Gage Thickness - 0.250 inch - 0.375 inch

Stress Rupture Creep Equation:

$$\text{Log } t = c + b_1 T + b_2 X + b_3 X^2 + b_4 X^3$$

T = °R
 X = log (stress, ksi)
 c = 186.27
 b₁ = -0.01778
 b₂ = -255.25
 b₃ = 146.28
 b₄ = -28.65

Analysis Details:

Std. Error of Estimate, Log (Hrs) = 0.29
 Standard Deviation, Log (Hrs) = 0.63
 Within Heat Treatment Variance = 0.071
 Ratio of Between to Within Heat Treatment Variance = (at spec pt.) <0.10

[Caution: The creep rupture model may provide unrealistic predictions for temperatures and stresses beyond those represented above.]

Table 6.3.5.1.7. Supplemental Information on the Creep and Stress Rupture Properties of Inconel 718 Forging

Heat Treatment Details					
Heat Treatment No.	Cycle No.	Temperature, °F	Time, Hours	Cool	
2	1	1800	1	AC, WQ	
	2	1325	8	FC (100°F/hr)	
	3	1150	8	AC	
21	1	1700-1850	1	AC	
	2	1325	8	FC (100°F/hr)	
	3	1150	8	AC	

Stress Rupture Equation and Inverse Matrix for the Creep Stress = 0.10, 0.20, 0.50, and 5.00% and Stress Rupture Conditions

$$\log t = c + b_1T + b_2X + b_3X^2 + b_4X^3 + b_5Y_1 + b_6Y_2 + b_7Y_5 + b_8Y_4 + b_9Y_5$$

where $Y_1 = 1; Y_2, Y_3, Y_4, Y_5 = 0$ for Creep Strain = 0.10% Data
 $Y_2 = 1; Y_1, Y_3, Y_4, Y_5 = 0$ for Creep Strain = 0.20% Data
 $Y_3 = 1; Y_1, Y_2, Y_4, Y_5 = 0$ for Creep Strain = 0.50% Data
 $Y_4 = 1; Y_1, Y_2, Y_3, Y_5 = 0$ for Creep Strain = 5.00% Data
 $Y_1, Y_2, Y_3, Y_4, Y_5 = 0$ for Stress Rupture Data

Column Row	1	2	3	4	5	6	7	8	9
1	1.809E+00	-1.108E-03	-1.978E+00	6.499E-01	-5.748E-02	-1.606E+00	-1.444E+00	-1.015E+00	-9.777E-01
2	-1.108E-03	6.834E-07	1.212E-03	-3.979E-04	3.517E-05	9.843E-04	8.852E-04	6.219E-04	5.993E-04
3	-1.978E+00	1.212E-03	3.482E+00	-1.657E+00	2.032E-01	1.634E+00	1.359E+00	6.886E-01	5.921E-01
4	6.499E-01	-3.979E-04	-1.657E+00	9.145E-01	-1.220E-01	-4.892E-01	-3.610E-01	-6.305E-02	3.594E-03
5	-5.748E-02	3.517E-05	2.032E-01	-1.220E-01	1.697E-02	3.801E-02	2.248E-02	-1.245E-02	-2.618E-02
6	-1.606E+00	9.843E-04	1.634E+00	-4.892E-01	3.801E-02	1.471E+00	1.303E+00	9.401E-01	9.124E-01
7	-1.444E+00	8.852E-04	1.359E+00	-3.610E-01	2.248E-02	1.303E+00	1.222E+00	8.806E-01	8.600E-01
8	-1.015E+00	6.219E-04	6.886E-01	-6.305E-02	-1.245E-02	9.401E-01	8.806E-01	7.491E-01	6.987E-01
9	-9.777E-01	5.993E-04	5.921E-01	3.594E-03	-2.618E-02	9.124E-01	8.600E-01	6.987E-01	1.195E+00

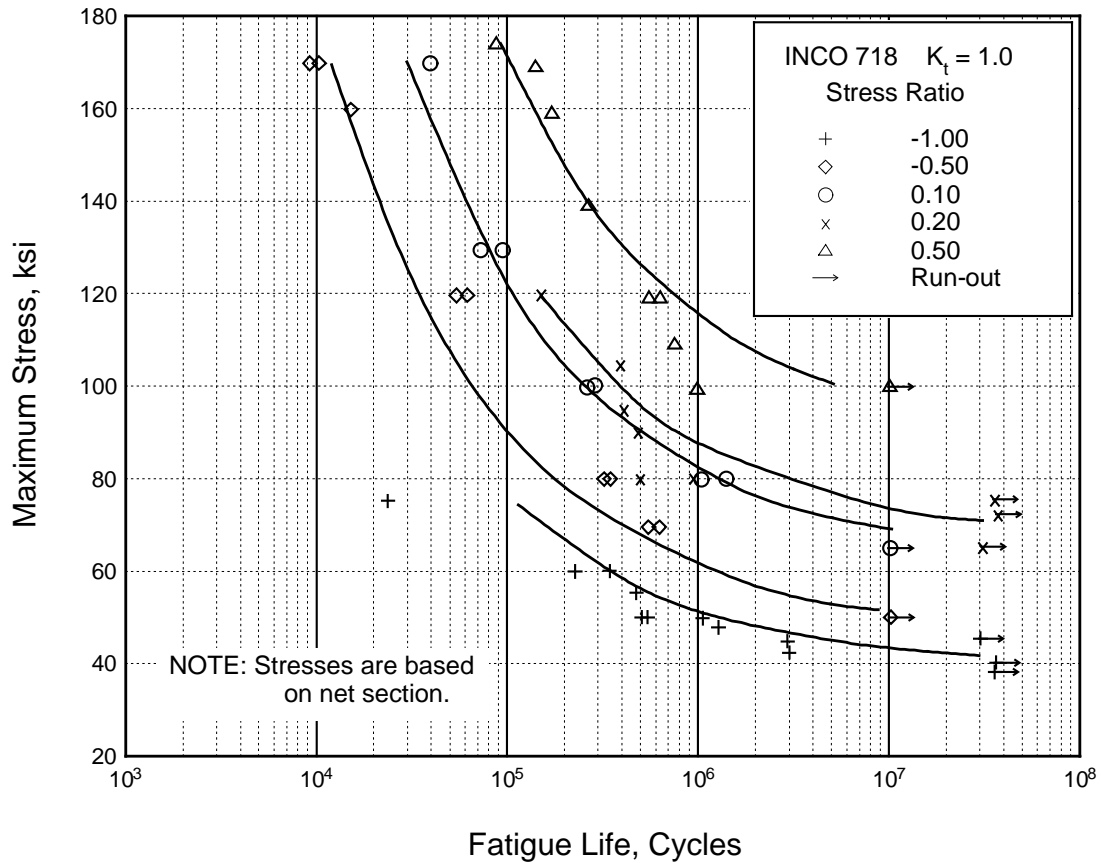

Figure 6.3.5.1.8(a). Best-fit S/N curves for unnotched Inconel 718 sheet at room temperature, long transverse direction.

Correlative Information for Figure 6.3.5.1.8(a)

Product Form: Sheet, 0.066 inch and 0.109 inch

<u>Properties:</u>	<u>TUS, ksi</u>	<u>TYS, ksi</u>	<u>Temp., °F</u>
	197.0	164.0	RT
	208.7	184.2	RT

Specimen Details: Unnotched
0.30 inch net width
0.50 inch net width

Heat Treatment: See AMS 5596

Surface Condition: #400 grit belt polished

References: 6.2.1.1.8 and 6.3.5.1.8(a)

Test Parameters:

Loading—Axial
Frequency—Unspecified
Temperature—RT
Environment—Air

No. of Heats/Lots: 2

Equivalent Stress Equation:

$\text{Log } N_f = 8.63 - 2.07 \text{ Log } (S_{eq} - 58.48)$
 $S_{eq} = S_{max}(1-R)^{.58}$
 Std. Error of Est., $\text{Log } (\text{Life}) = 26.73 (1/S_{eq})$
 Standard Deviation, $\text{Log } (\text{Life}) = 0.904$
 $R^2 = 90.3\%$

Sample Size = 53

[Caution: The equivalent stress model may provide unrealistic life predictions for stress ratios beyond those represented above.]

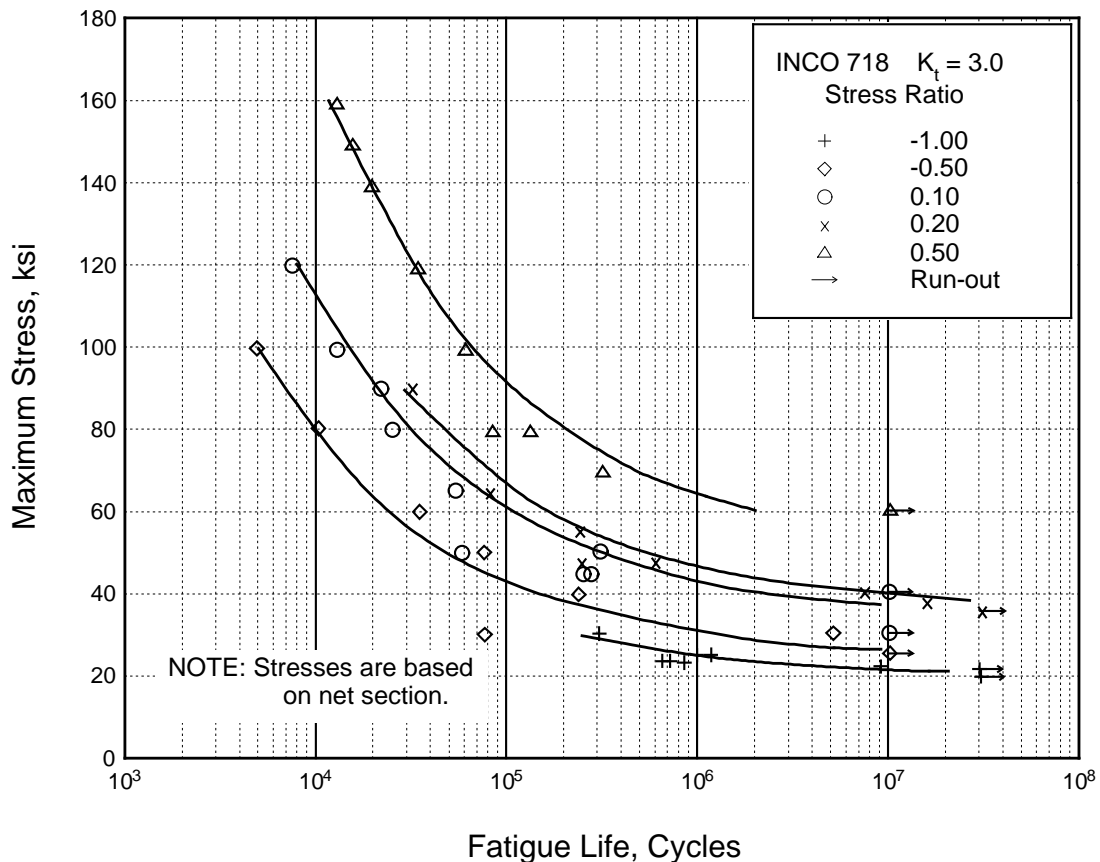

Figure 6.3.5.1.8(b). Best-fit S/N curves for notched, $K_t = 3.0$, Inconel 718 sheet at room temperature, long transverse direction.

Correlative Information for Figure 6.3.5.1.8(b)

Product Form: Sheet, 0.066 inch and 0.109 inch

Properties:

TUS, ksi	TYS, ksi	Temp., °F
197.0	164.0	RT
208.7	184.2	RT

Specimen Details: Notched 60° V-Groove
 $K_t = 3.0$
 0.300 inch net width
 0.220 inch root width
 0.625 inch net width
 0.030 inch root radius

Heat Treatment: See AMS 5596

Surface Condition: As machined

References: 6.2.1.1.8 and 6.3.5.1.8(a)

Test Parameters:

Loading—Axial
 Frequency—Unspecified
 Temperature—RT
 Environment—Air

No. of Heats/Lots: 2

Equivalent Stress Equation:

$\log N_f = 8.17 - 2.23 \log (S_{eq} - 30.58)$
 $S_{eq} = S_{max}(1-R)^{.68}$
 Std. Error of Est., $\log (\text{Life}) = 14.07 (1/S_{eq})$
 Standard Deviation, $\log (\text{Life}) = 0.977$
 $R^2 = 93.7\%$

Sample Size = 49

[Caution: The equivalent stress model may provide unrealistic life predictions for stress ratios beyond those represented above.]

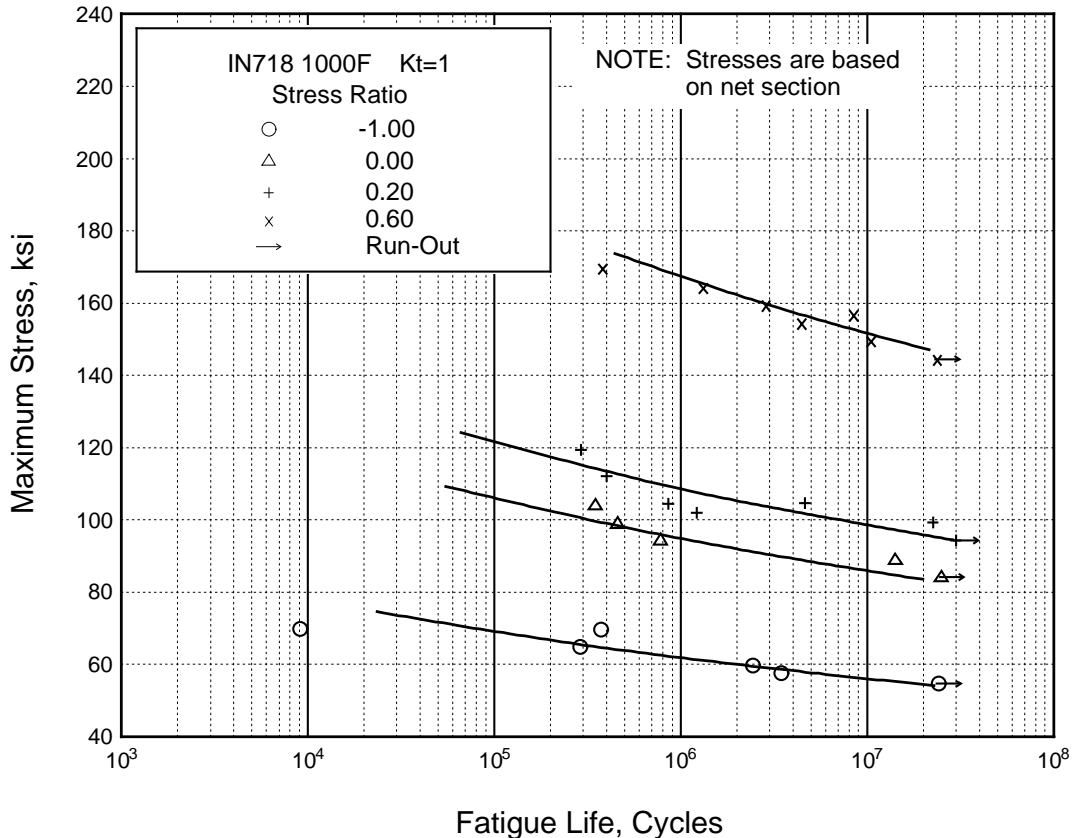

Figure 6.3.5.1.8(c). Best-fit S/N curves for unnotched Inconel 718 sheet at 1000 F, long transverse direction.

Correlative Information for Figure 6.3.5.1.8(c)

Product Form: Sheet, 0.066 inch

Properties: TUS, ksi TYS, ksi Temp., °F
 165.0 141.8 1000

Specimen Details: Unnotched
 0.30 inch net width

Heat Treatment: See AMS 5596

Surface Condition: #400 grit belt polished

Reference: 6.2.1.1.8

Test Parameters:

Loading—Axial
Frequency—60 Hz
Temperature—1000 °F
Environment—Air

No. of Heats/Lots: 1

Equivalent Stress Equation:

$\log N_f = 23.51 - 10.57 \log (S_{eq} - 50)$
 $S_{eq} = S_{max}(1-R)^{0.62}$
Std. Error of Estimate, $\log (\text{Life}) = 0.414$
Standard Deviation, $\log (\text{Life}) = 0.776$
 $R^2 = 71.5\%$

Sample Size = 21

[Caution: The equivalent stress model may provide unrealistic life predictions for stress ratios beyond those represented above.]

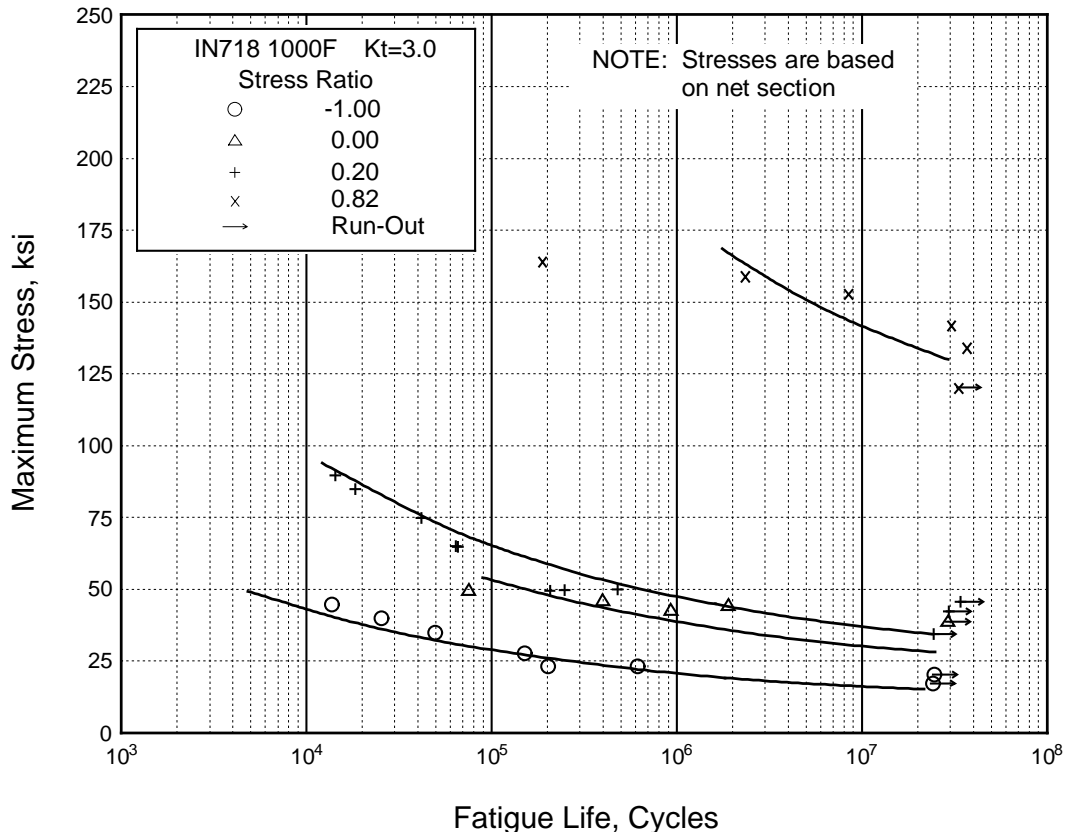

Figure 6.3.5.1.8(d). Best-fit S/N curves for notched, $K_t = 3.0$, Inconel 718 sheet at 1000°F, long transverse direction.

Correlative Information for Figure 6.3.5.1.8(d)

Product Form: Sheet, 0.066 inch

Properties: $\frac{TUS, \text{ksi}}{165.0}$ $\frac{TYS, \text{ksi}}{141.8}$ $\frac{\text{Temp., } ^\circ\text{F}}{1000}$
Unnotched

Specimen Details: Notched, V-Groove, $K_t = 3.0$
0.448 inch gross width
0.300 inch net width
0.022 inch root radius, r
60° flank angle, ω

Heat Treatment: See AMS 5596

Surface Condition: As machined

Reference: 6.2.1.1.8

Test Parameters:

Loading—Axial
Frequency—60 Hz
Temperature—1000°F
Environment—Air

No. of Heats/Lots: 1

Equivalent Stress Equation:

$\text{Log } N_f = 11.02 - 3.93 \text{ Log } (S_{eq} - 20)$
 $S_{eq} = S_{max} (1-R)^{0.91}$
Std. Error of Estimate, $\text{Log } (\text{Life}) = 0.404$
Standard Deviation, $\text{Log } (\text{Life}) = 0.988$
 $R^2 = 83.3\%$

Sample Size = 23

[Caution: The equivalent stress model may provide unrealistic life predictions for stress ratios beyond those represented above.]

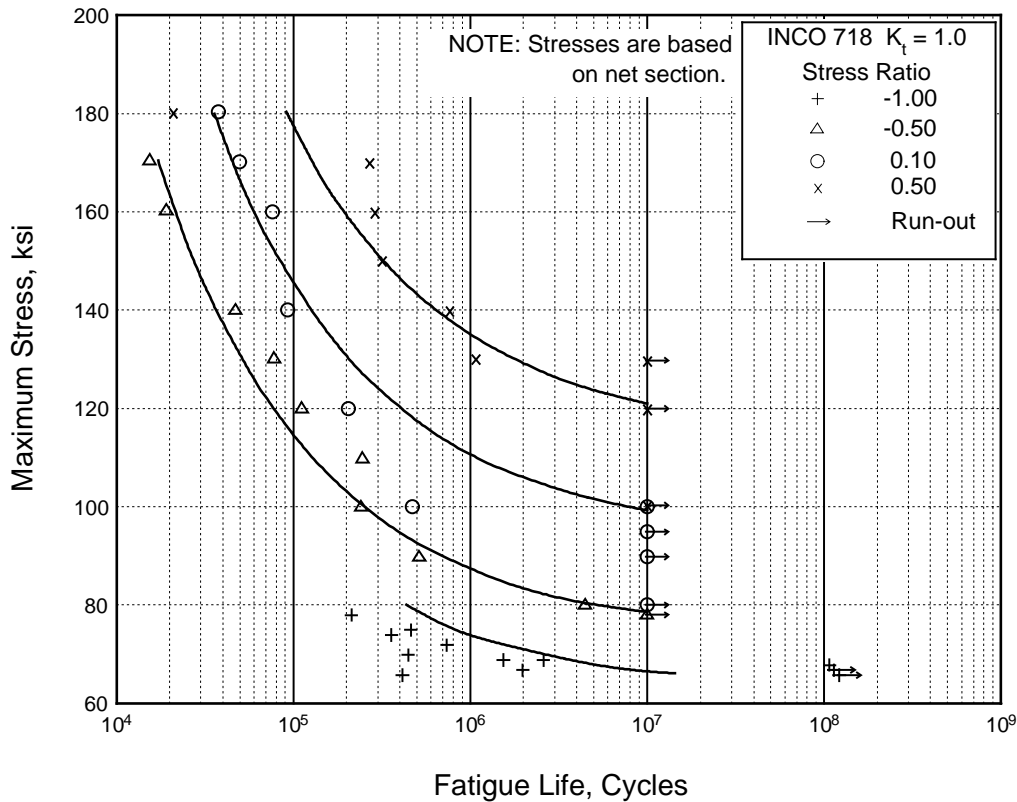

Figure 6.3.5.1.8(f). Best-fit S/N curves for unnotched Inconel 718 bar and plate at room temperature, longitudinal direction.

Correlative Information for Figure 6.3.5.1.8(f)

Product Form: Bar, 0.75 inch diameter; plate, 0.5, 0.75, and 1.0 inch thick

Properties:

TUS, ksi	TYS, ksi	Temp., °F
204.4	177.7	RT
200.0	166.7	RT

Specimen Details: Unnotched
0.250 inch diameter
0.200 inch diameter

Heat Treatment: See AMS 5662 and AMS 5596

Surface Condition: Unspecified, RMS 8-11

References: 6.3.3.1.8(a) and 6.3.5.1.8(b)

Test Parameters:

Loading - Axial
Frequency - Unspecified
Temperature - RT
Environment - Air

No. of Heats/Lots: 4

Equivalent Stress Equation:

$$\log N_f = 8.18 - 2.07 \log (S_{eq} - 63.0)$$

$$S_{eq} = S_a + 0.40 S_m$$

Std. Error of Est., $\log (\text{Life}) = 38.56 (1/S_{eq})$

Standard Deviation, $\log (\text{Life}) = 0.980$

$R^2 = 67.7\%$

Sample Size = 44

[Caution: The equivalent stress model may provide unrealistic life predictions for stress ratios beyond those represented above.]

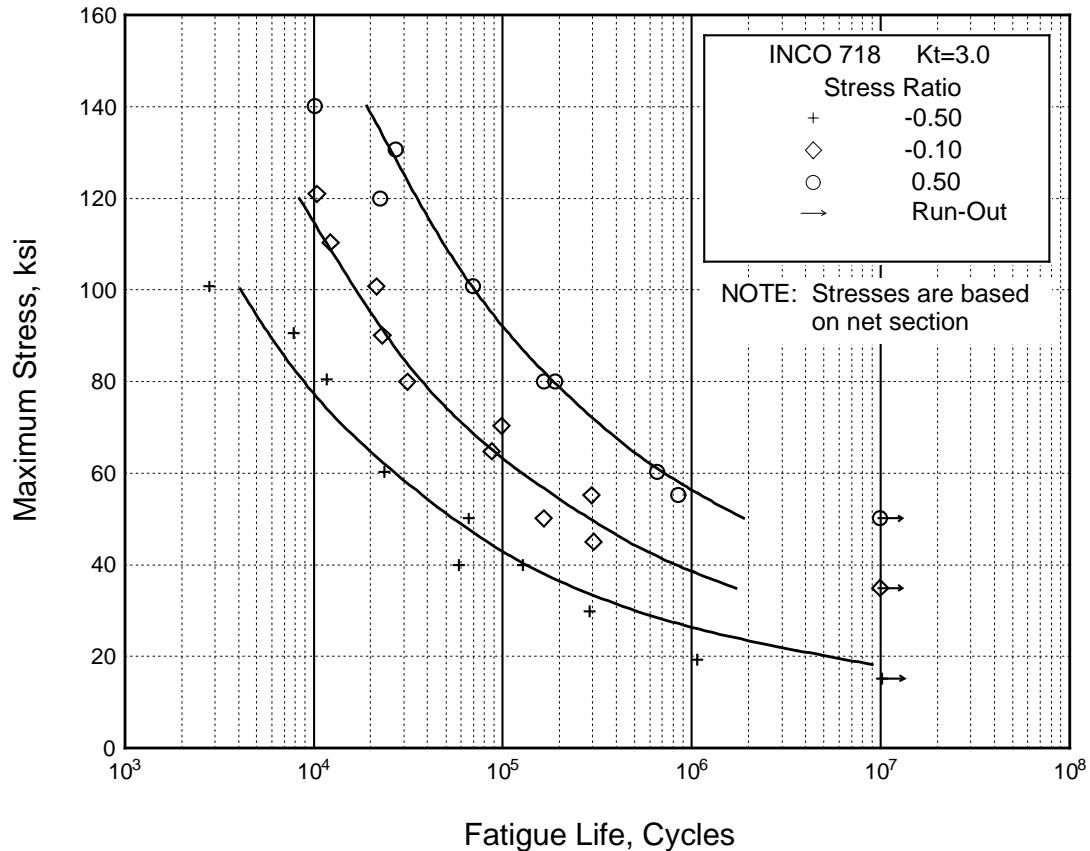

Figure 6.3.5.1.8(g). Best-fit S/N curves for notched, $K_t = 3.0$, Inconel 718 bar at room temperature, longitudinal direction.

Correlative Information for Figure 6.3.5.1.8(g)

Product Form: Bar, 0.75 inch diameter

Properties:

<u>TUS, ksi</u>	<u>TYS, ksi</u>	<u>Temp., °F</u>
204.4	177.7	RT

Specimen Details: Notched, 60° V Notch
0.252 inch diameter
0.013 inch diameter

Heat Treatment: See AMS 5662 and AMS 5596

Surface Condition: Unspecified

Reference: 6.3.3.1.8(a)

Test Parameters:

Loading—Axial
Frequency—Unspecified
Temperature—RT
Environment—Air

No. of Heats/Lots: 1

Equivalent Stress Equation:

$\log N_f = 9.45 - 3.17 \log (S_{cq} - 8.6)$
 $S_{cq} = S_a + 0.16 S_m$
Std. Error of Est., $\log (\text{Life}) = 6.97 (1/S_{cq})$
Standard Deviation, $\log (\text{Life}) = 0.945$
 $R^2 = 93.6\%$

Sample Size = 31

[Caution: The equivalent stress model may provide unrealistic life predictions for stress ratios beyond those represented above.]

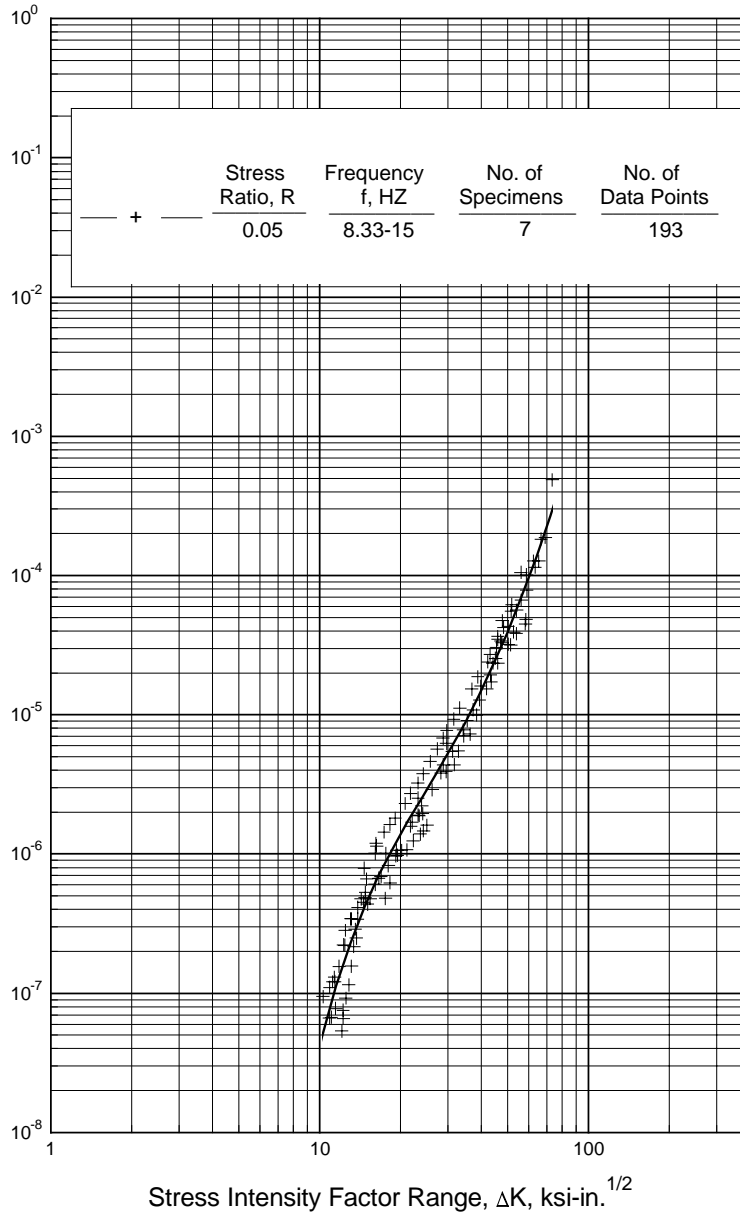

Figure 6.3.5.1.9(a). Fatigue-crack-propagation data for Inconel 718 die forging (upset ratio = 5) and 0.5-inch thick plate. [References—6.3.5.1.9(a) through (e).]

Specimen Thickness: 0.298-0.502 inch
Specimen Width: 1.153-2.000 inches
Specimen Type: C(T)

Environment: Lab air
Temperature: RT
Orientation: L-T and T-L

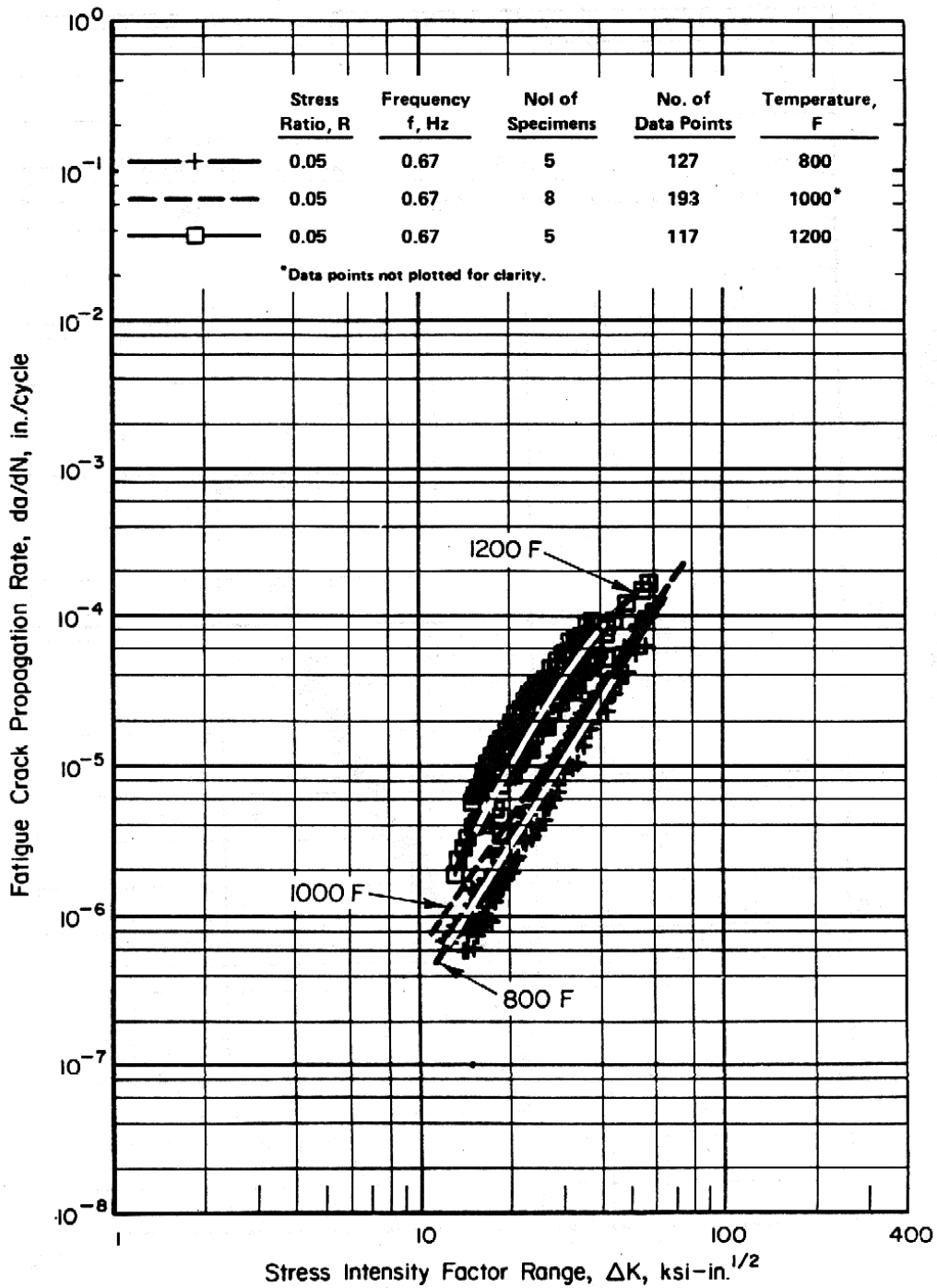

Figure 6.3.5.1.9(b). Fatigue-crack-propagation data for Inconel 718 die forging (upset ratio = 5) and 0.5-inch thick plate. [References—6.3.5.1.9(b) and 6.3.5.1.9(d) through (g).]

Specimen Thickness: 0.298-0.502 inch
 Specimen Width: 1.157-2.001 inches
 Specimen Type: C(T)

Environment: Lab air
 Temperature: 800-1200 °F
 Orientation: L-T and T-L

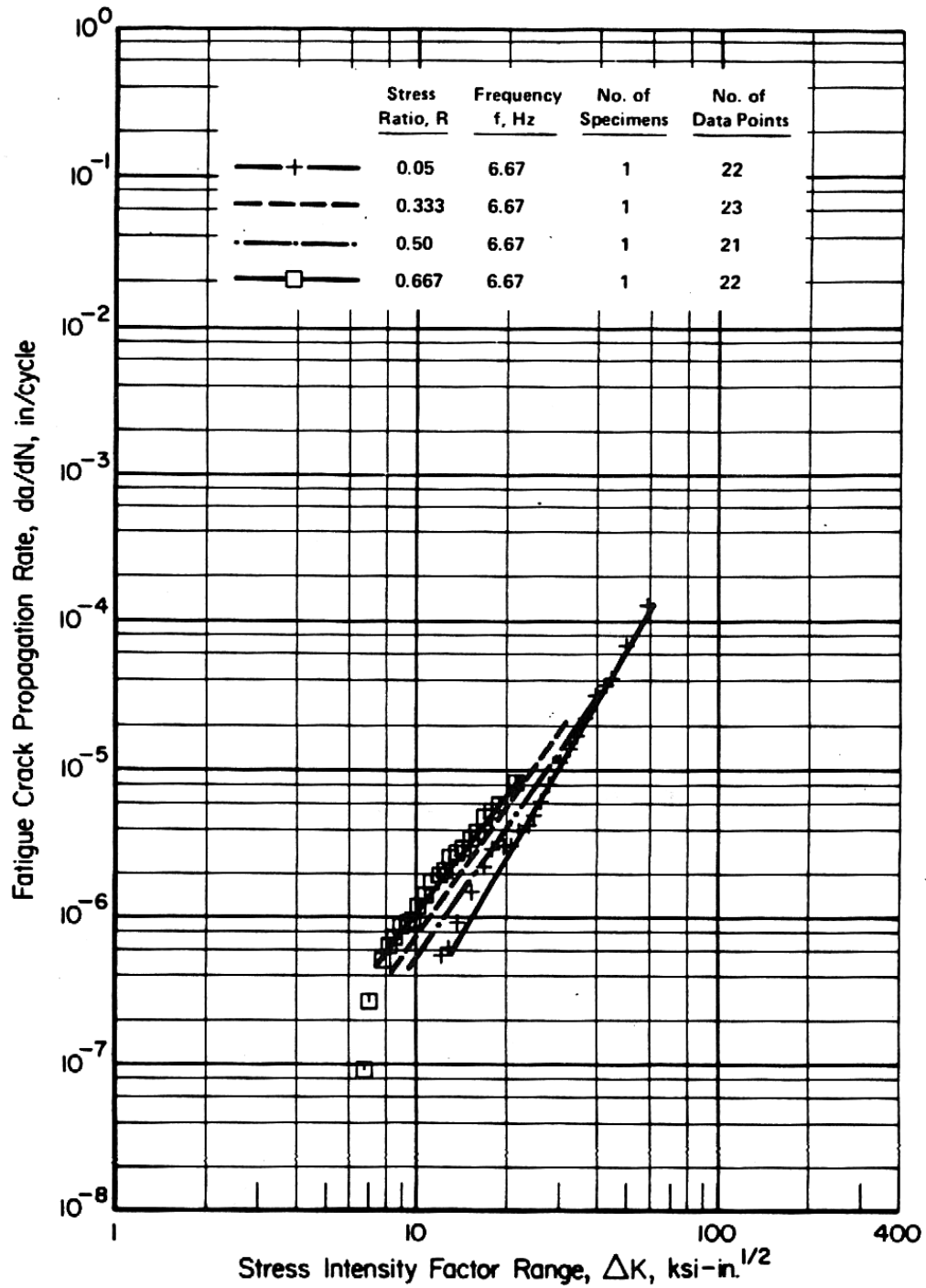

Figure 6.3.5.1.9(c). Fatigue-crack-propagation data for Inconel 718 0.5-inch thick plate. [Reference—6.3.5.1.9(f).]

Specimen Thickness: 0.298-0.479 inch
Specimen Width: 1.151-1.993 inches
Specimen Type: C(T)

Environment: Lab air
Temperature: 1000 °F
Orientation: L-T and T-L

6.3.6 INCONEL X-750

6.3.6.0 Comments and Properties — Inconel X-750 is a high-strength oxidation-resistant nickel-base alloy. It is used for parts requiring high strength up to 1000°F or high creep strength up to 1500°F and for low-stressed parts operating up to 1900°F. It is hardenable by various combinations of solution treatment and aging, depending on its form and application. Inconel X-750 is available in all the usual wrought mill forms.

Inconel X-750 can be readily forged between 1900°F and 2225°F; “hot-cold” working between 1200°F and 1600°F is harmful and should be avoided. This alloy is readily formed but should be solution treated at 1925°F for 7 to 10 minutes after severe forming operations. It is somewhat more difficult to machine than austenitic stainless steels. Rough machining is easier in the solution-treated condition; finish machining in the partly or fully aged condition. Fusion welding is difficult for large section sizes and moderately difficult for small cross sections and sheet. It must be welded in the annealed or solution-treated condition; weldments should be stress relieved at 1650°F for 2 hours before aging. Nickel brazing, followed by precipitation heat treatment of the brazed assembly, results in strength nearly equal to fully heat-treated material.

Oxidation resistance of Inconel X-750 is good to 1900°F; but the beneficial effects of aging are lost above 1500°F. This alloy is subject to attack in sulfur-containing atmospheres.

A variety of heat treatments has been developed for Inconel X-750. Each provides special properties and renders the material in the best metallurgical condition for the intended application. Only two of these heat treatments, for applications requiring high strength up to 1100°F, are described below.

Annealed and Aged for Sheet, Strip, and Plate — Mill annealed plus 1300°F for 20 hours, and A.C. per AMS 5542.

Equalized and Aged for Bar and Forging — 1625°F for 4 hours, A.C., plus 1300°F for 24 hours, and A.C. per AMS 5667.

Other heat treatments are available for maximum creep-rupture strength.

Some material specifications for Inconel X-750 are shown in Table 6.3.6.0(a). Room-temperature mechanical and physical properties are shown in Table 6.3.6.0(b).

Table 6.3.6.0(a). Material Specifications for Inconel X-750

Specification	Form	Condition
AMS 5542	Sheet, strip, and plate	Annealed
AMS 5667	Bar and forging	Equalized

The effect of temperature on the physical properties of this alloy is shown in Figure 6.3.6.0.

6.3.6.1 Annealed and Aged — Elevated-temperature curves for tensile and yield ultimate strengths are shown in Figures 6.3.6.1.1 through 6.3.6.1.3.

6.3.6.2 Equalized and Aged — Elevated-temperature curves are presented in Figures 6.3.6.2.1(a) and (b), as well as 6.3.6.2.4(a) and (b).

Table 6.3.6.0(b). Design Mechanical and Physical Properties of Inconel X-750

Specification	AMS 5542				AMS 5667	
	Strip		Sheet	Plate	Bars and forgings	
Form	Annealed and aged				Equalized and aged	
Condition			0.010- 0.187	0.188- 4.000	<4.000	4.000- 10.000
Thickness or diameter, in. ...	≤0.009	≥0.010				
Basis	S	S	S	S	S	S
Mechanical Properties:						
F_{tu} , ksi:						
L	165	160
LT	150	155	165	155
F_{ty} , ksi:						
L	105	100
LT	105	100
F_{cy} , ksi:						
L	105	100
LT	105	100
F_{su} , ksi	107	100	102	99
F_{bru} , ksi:						
(e/D = 1.5)	247	232	247	240
(e/D = 2.0)	313	294	313	304
F_{bry} , ksi:						
(e/D = 1.5)	157	150	157	150
(e/D = 2.0)	189	180	189	180
e , percent:						
L	20	15
LT	15	20	20
RA , percent:						
L	25	17
E , 10^3 ksi				30.6		
E_c , 10^3 ksi				30.6		
G , 10^3 ksi				11.8		
μ				0.30		
Physical Properties:						
ω , lb/in. ³				0.298		
C , K , and α				See Figure 6.3.6.0		

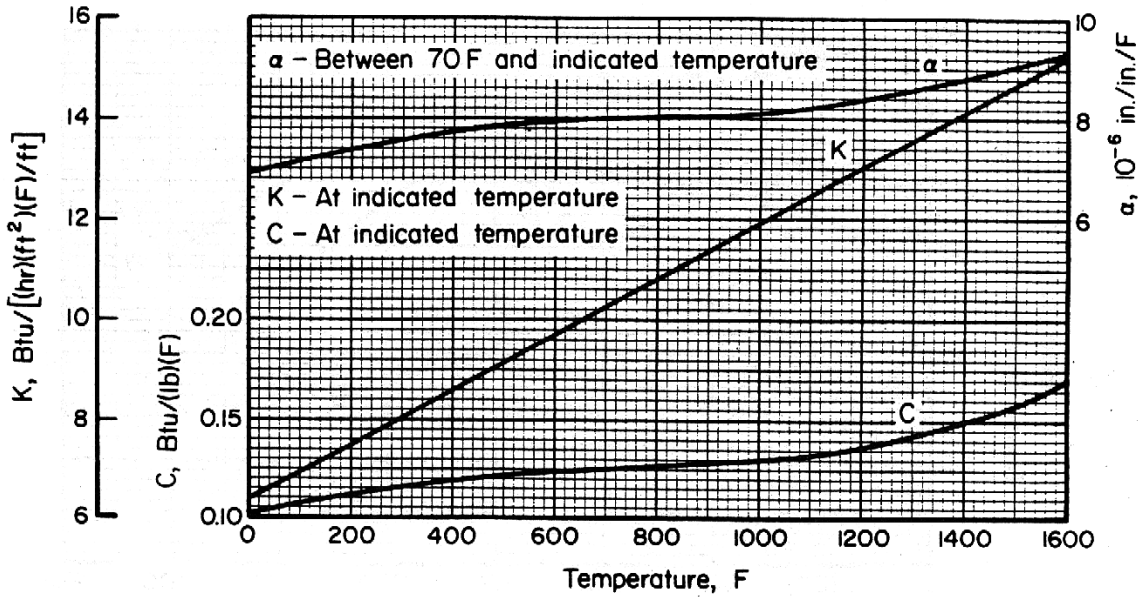

Figure 6.3.6.0. Effect of temperature on the physical properties of Inconel X-750.

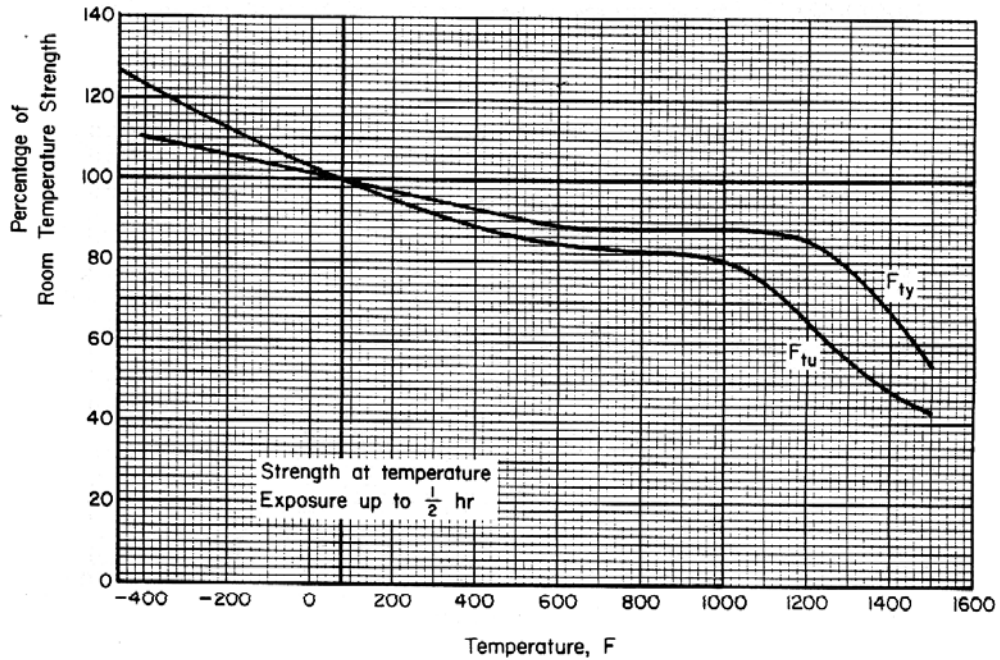

Figure 6.3.6.1.1. Effect of temperature on the tensile ultimate strength (F_{tu}) and tensile yield strength (F_{ty}) of Inconel X-750 sheet and plate (AMS 5542).

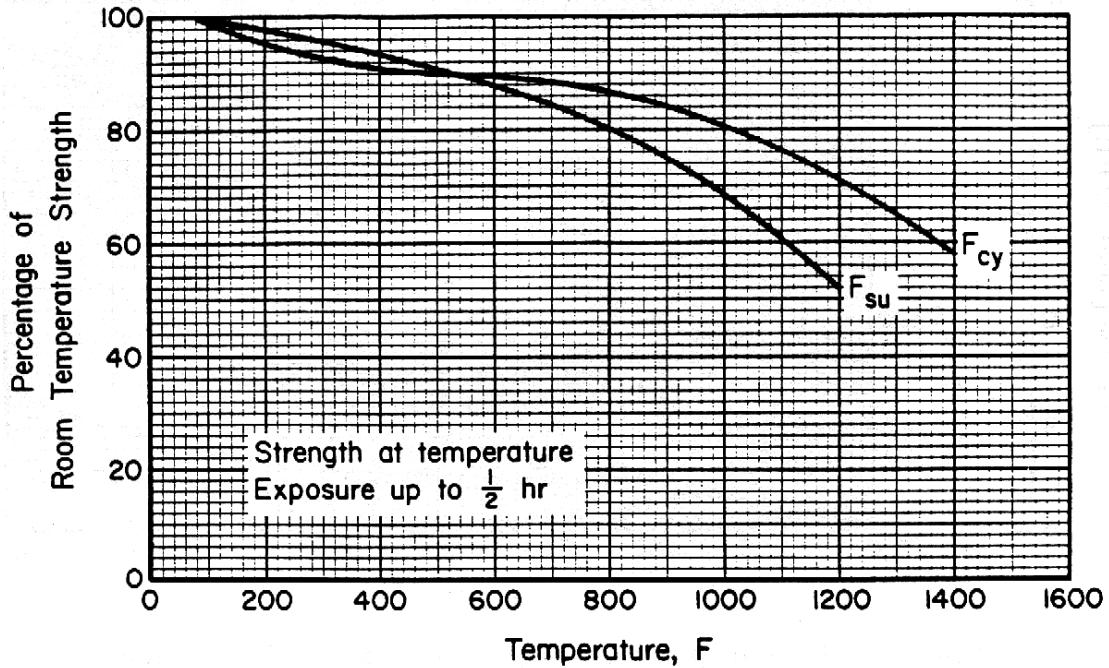

Figure 6.3.6.1.2. Effect of temperature on the compressive yield strength (F_{cy}) and the shear ultimate strength (F_{su}) of Inconel X-750.

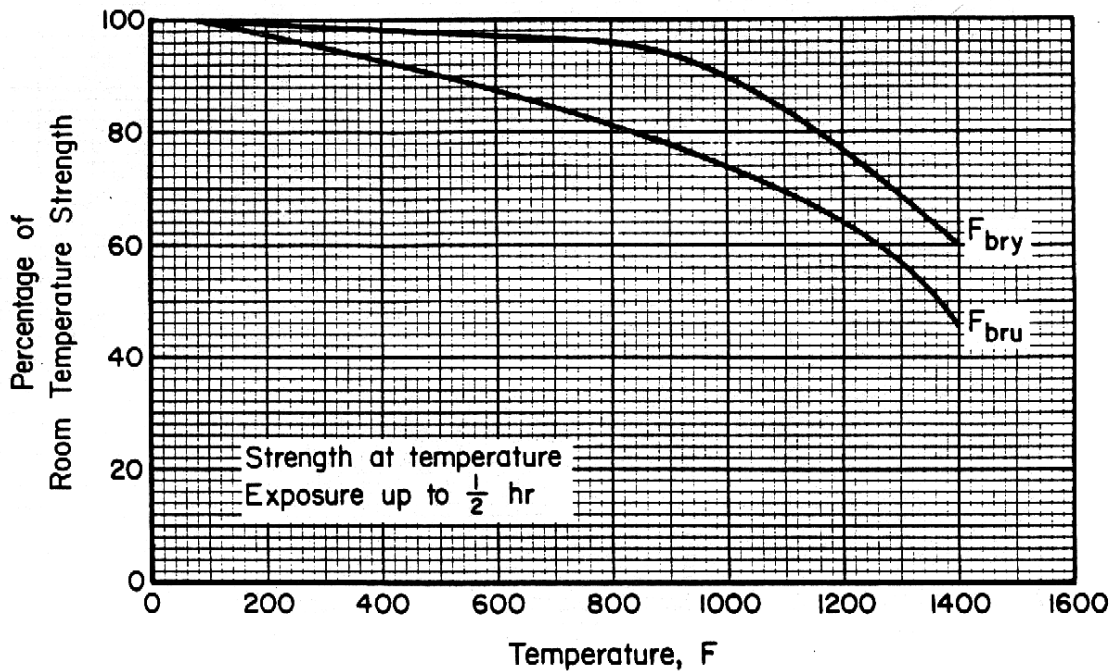

Figure 6.3.6.1.3. Effect of temperature on the bearing ultimate strength (F_{bru}) and the bearing yield strength (F_{bry}) of Inconel X-750.

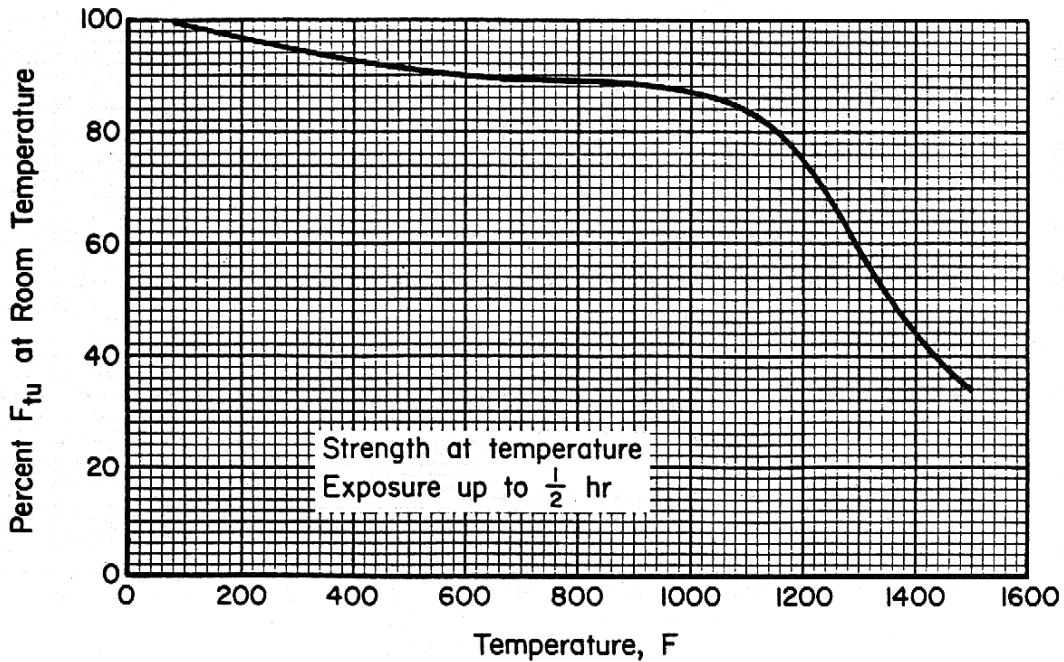

Figure 6.3.6.2.1(a). Effect of temperature on the tensile ultimate strength (F_{tu}) of Inconel X-750 bar (AMS 5667).

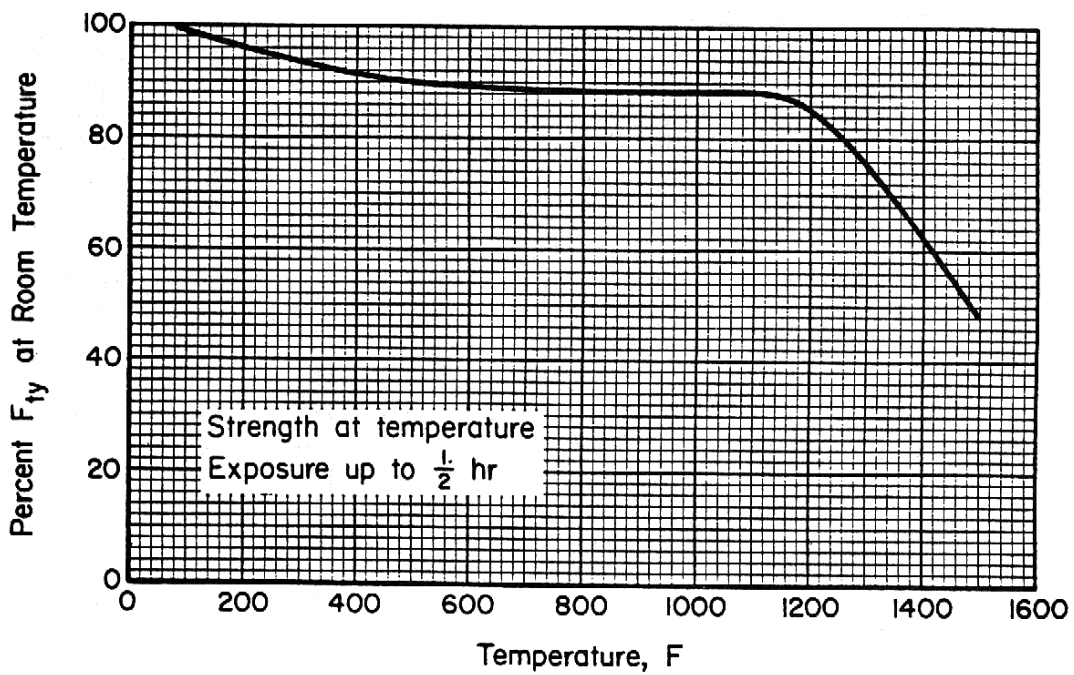

Figure 6.3.6.2.1(b). Effect of temperature on the tensile yield strength (F_{ty}) of Inconel X-750 bar (AMS 5667).

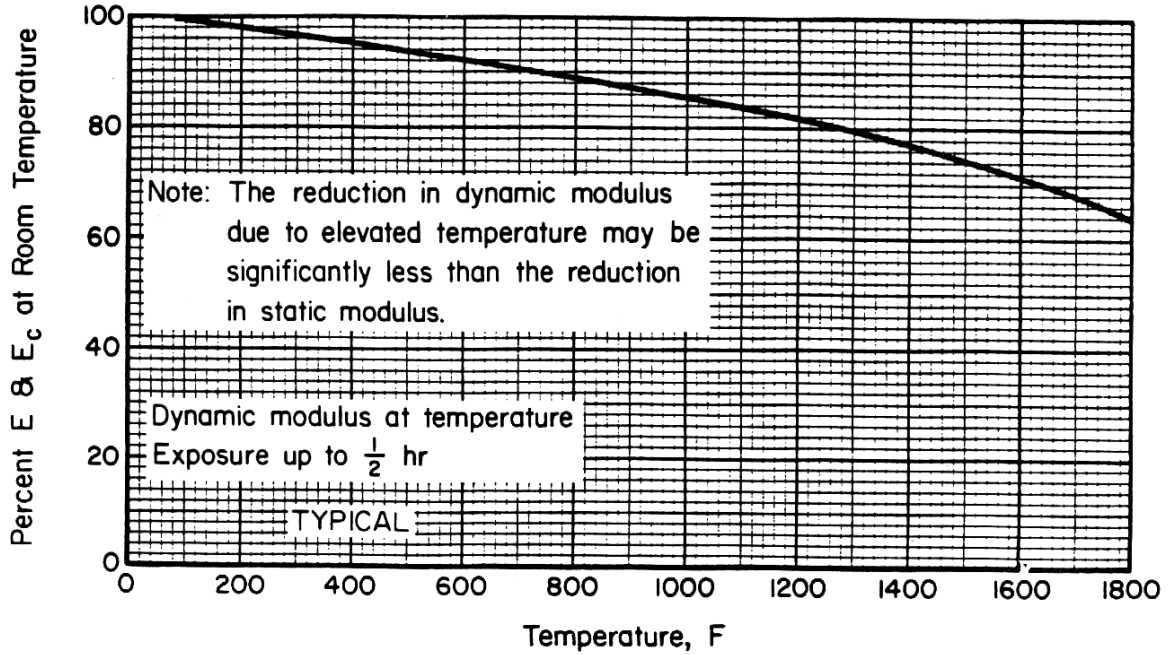

Figure 6.3.6.2.4(a). Effect of temperature on the tensile and compressive moduli (E and E_c) of Inconel X-750.

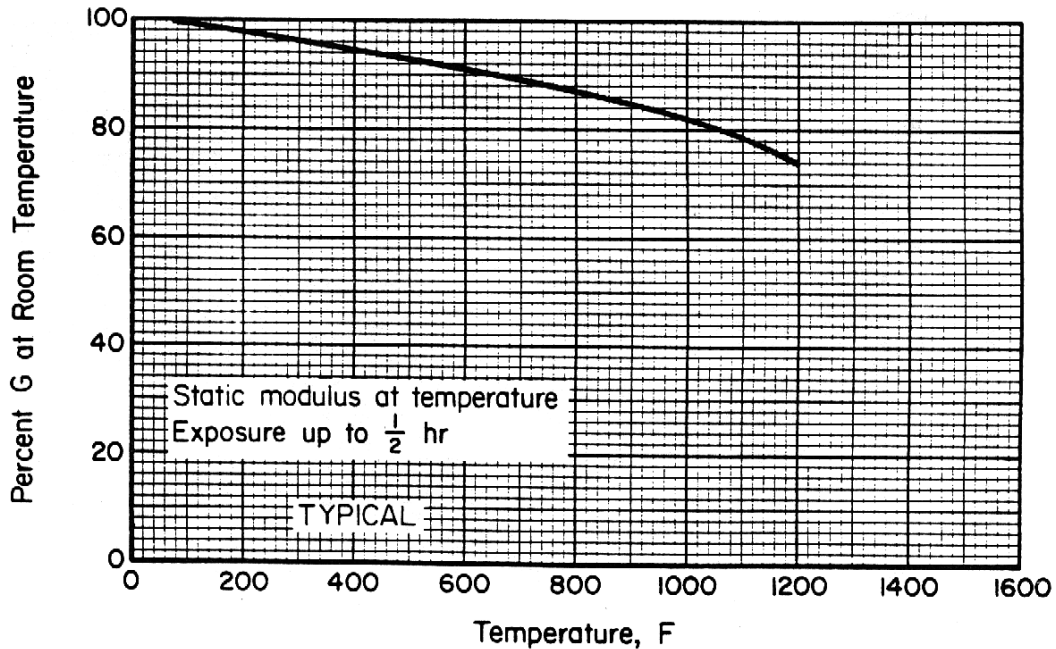

Figure 6.3.6.2.4(b). Effect of temperature on the shear modulus (G) of Inconel X-750.

6.3.7 RENÉ 41

6.3.7.0 Comments and Properties — René 41 is a vacuum-melted precipitation-hardening nickel-base alloy designed for highly stressed parts operating between 1200°F and 1800°F. Its applications include afterburner parts, turbine castings, wheels, buckets, and high-temperature bolts and fasteners. René 41 is available in the form of sheet, bars, and forgings.

René 41 is forged between 1900°F and 2150°F; small reductions must be made when breaking up an as-cast structure; cracking may be encountered in finishing below 1850°F. René 41 work hardens rapidly, and frequent anneals are required; to anneal, heat rapidly to 1950°F for 30 minutes and quench.

René 41 is difficult to machine. In the soft solution-annealed condition it is gummy; therefore, it should be in the fully aged condition for optimum machinability, and tungsten carbide cutting tools should be used. René 41 can be welded satisfactorily in the solution-treated condition; after welding, the parts should be solution treated for stress relief.

René 41 should not be exposed to temperatures above 2050°F during latter stages of hot working or during subsequent operations, otherwise severe intergranular cracking may be encountered.

The oxidation resistance of René 41 is good to 1800°F. Lengthy exposure above the aging temperature (1400°F to 1650°F) results in loss of strength and room-temperature ductility.

Some material specifications for René 41 are shown in Table 6.3.7.0(a). Room temperature mechanical and physical properties are shown in Table 6.3.7.0(b). The effect of temperature on physical properties is shown in Figure 6.3.7.0.

Table 6.3.7.0(a). Material Specifications for René 41

Specification	Form	Condition
AMS 5545	Plate, sheet, and strip	Vacuum melted, solution treated
AMS 5712	Bar and forging	Vacuum melted, solution treated and aged
AMS 5713	Bar and forging	Vacuum melted, solution treated and aged

6.3.7.1 Solution Treated at 1975 °F and Aged at 1400 °F Condition — Tensile and stress-rupture requirements at elevated temperatures are specified for René 41. The appropriate specification should be consulted for detailed requirements. Other elevated-temperature data for René 41 in this condition are presented in Figures 6.3.7.1.1 through 6.3.7.1.5. A creep nomograph for René 41 alloy sheet is shown in Figure 6.3.7.1.7.

MIL-HDBK-5J
31 January 2003

Table 6.3.7.0(b). Design Mechanical and Physical Properties of René 41

Specification	AMS 5545			AMS 5712 and AMS 5713	
	Sheet		Plate	Bar and forging	
Form	Solution treated and aged (1400°F)				
Condition	Solution treated and aged (1400°F)				
Thickness or diameter, in. ...	≤0.020	0.021-0.187		0.188-0.375	≤1.000
Basis	S	A ^a	B ^a	S	S
Mechanical Properties:					
<i>F_{tu}</i> , ksi:					
L	170 ^b	185	...	170
LT	160	170 ^b	185	170	...
<i>F_{ty}</i> , ksi:					
L	123	132	...	130
LT	120	123	132	130	...
<i>F_{cy}</i> , ksi:					
L	132	142	...	133
LT	135	145
<i>F_{su}</i> , ksi					
...	...	105	114	105	110
<i>F_{bru}</i> , ksi:					
(e/D = 1.5)	244	266	244	...
(e/D = 2.0)	310	338	310	...
<i>F_{bry}</i> , ksi:					
(e/D = 1.5)	197	211	208	...
(e/D = 2.0)	245	263	259	...
<i>e</i> , percent (S-basis):					
L	8
LT	6	10	...	10	...
<i>RA</i> , percent (S-basis):					
L	10
<i>E</i> , 10 ³ ksi					
...	31.6				
<i>E_c</i> , 10 ³ ksi					
...	31.6				
<i>G</i> , 10 ³ ksi					
...	12.1				
<i>μ</i>					
...	0.31				
Physical Properties:					
<i>ω</i> , lb/in. ³					
...	0.298				
<i>C</i> , <i>K</i> , and <i>α</i>					
...	See Figure 6.3.7.0				

a Design allowables were based upon data from samples of material, supplied in solution treated condition, which were aged to demonstrate heat treat response by suppliers. Properties obtained by the user may be different if the material has been formed or otherwise cold worked.

b S-basis. The rounded T₉₉ value is 178 ksi.

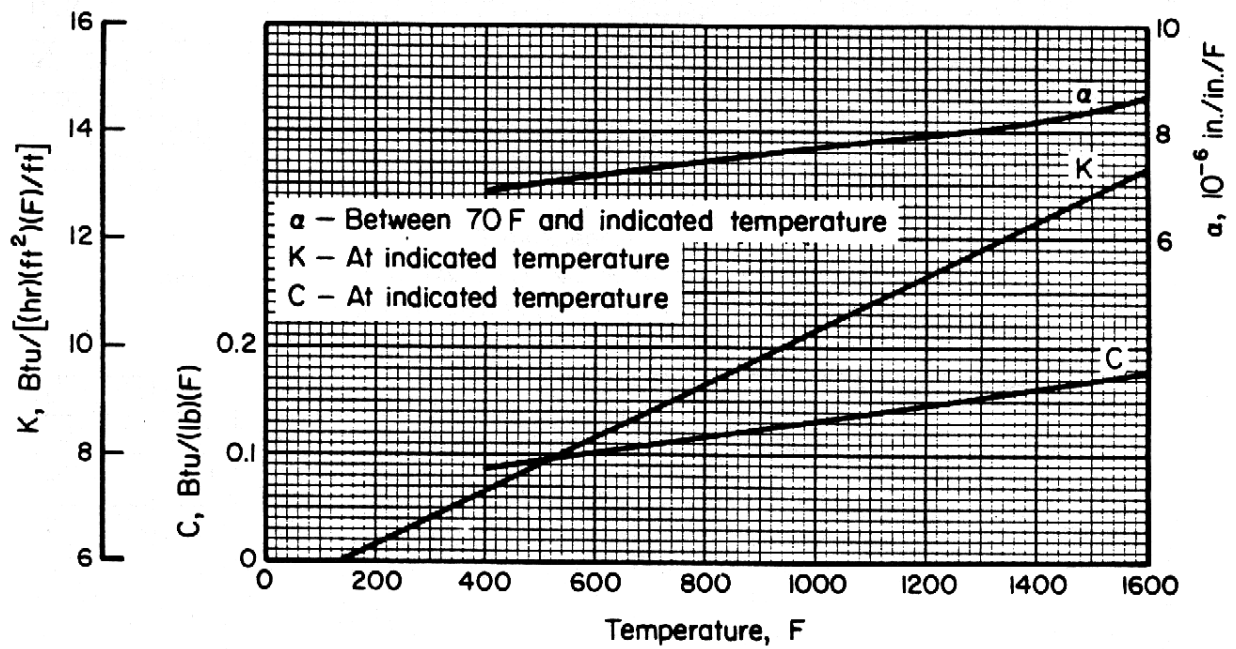

Figure 6.3.7.0. Effect of temperature on the physical properties of René 41.

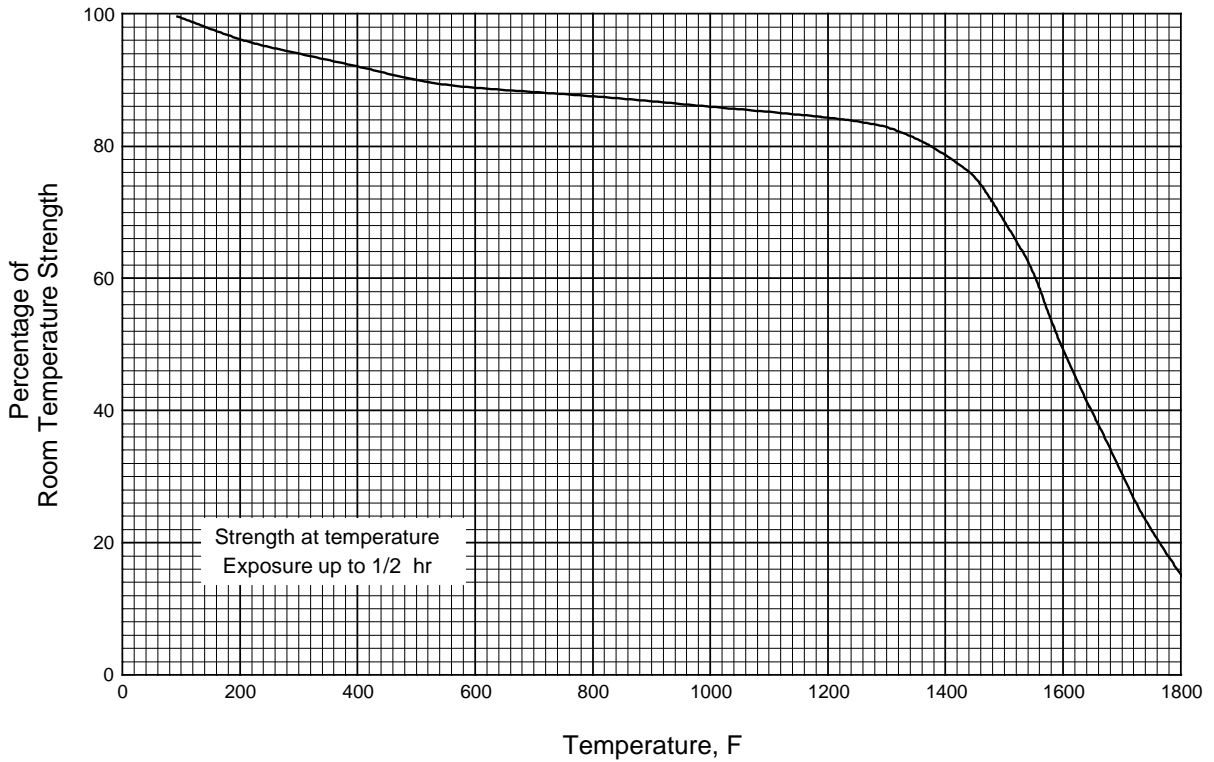

Figure 6.3.7.1.1. Effect of temperature on the tensile ultimate strength (F_{tu}) and the tensile yield strength (F_{ty}) of René 41.

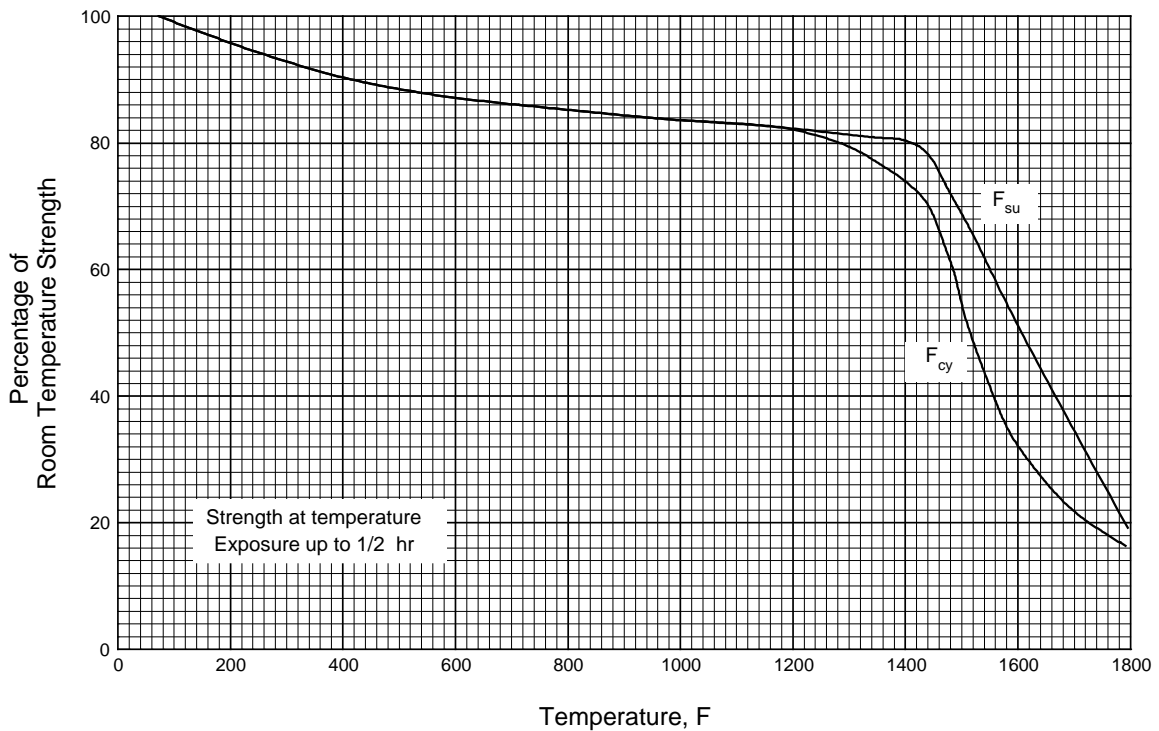

Figure 6.3.7.1.2. Effect of temperature on the compressive yield strength (F_{cy}) and the shear ultimate strength (F_{su}) of René 41.

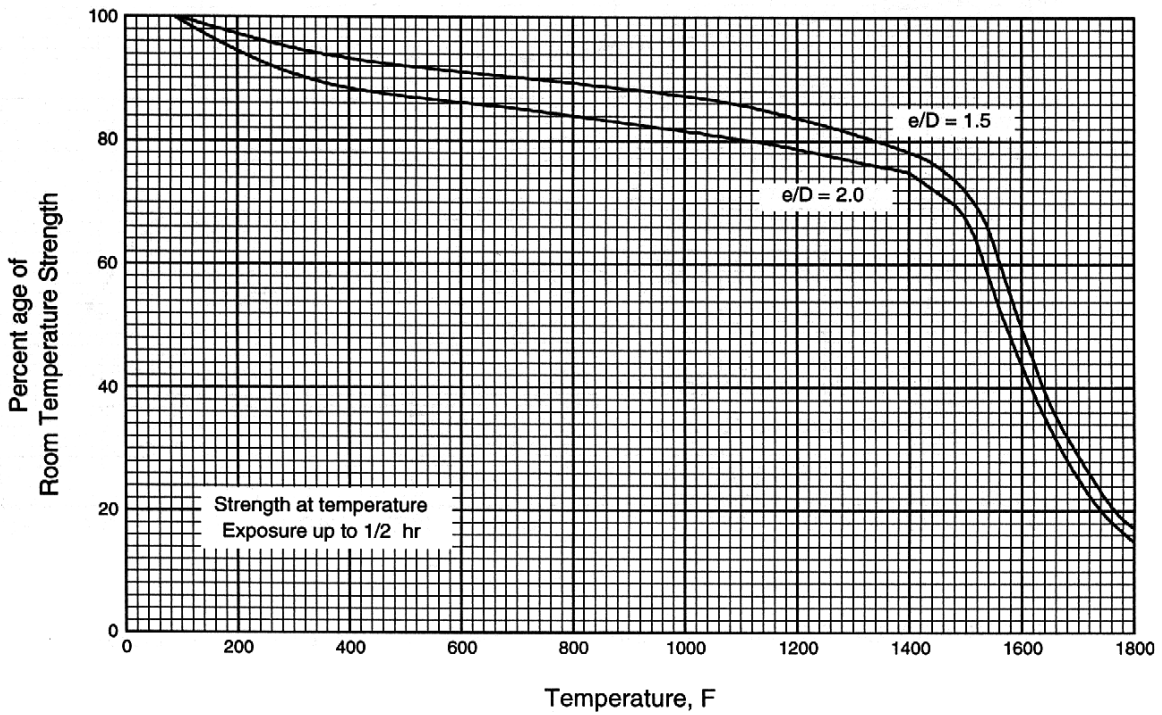

Figure 6.3.7.1.3(a). Effect of temperature on the bearing ultimate strength (F_{bru}) of René 41.

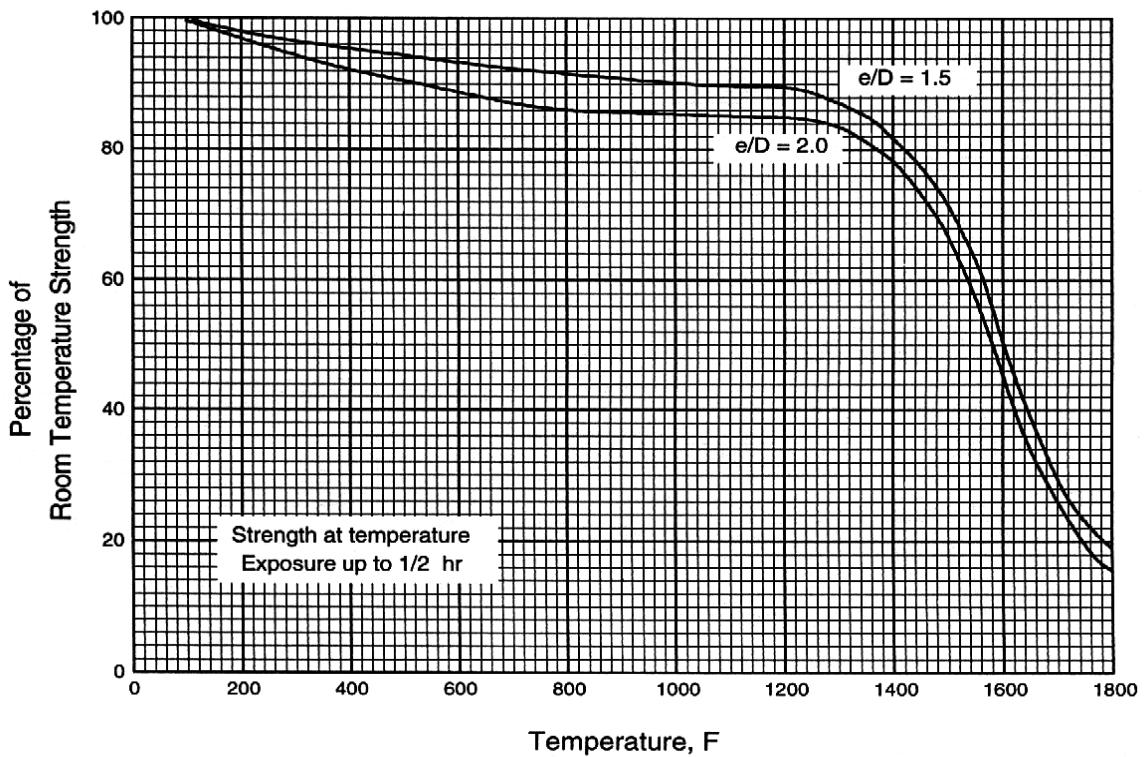

Figure 6.3.7.1.3(b). Effect of temperature on the bearing yield strength (F_{bry}) of René 41.

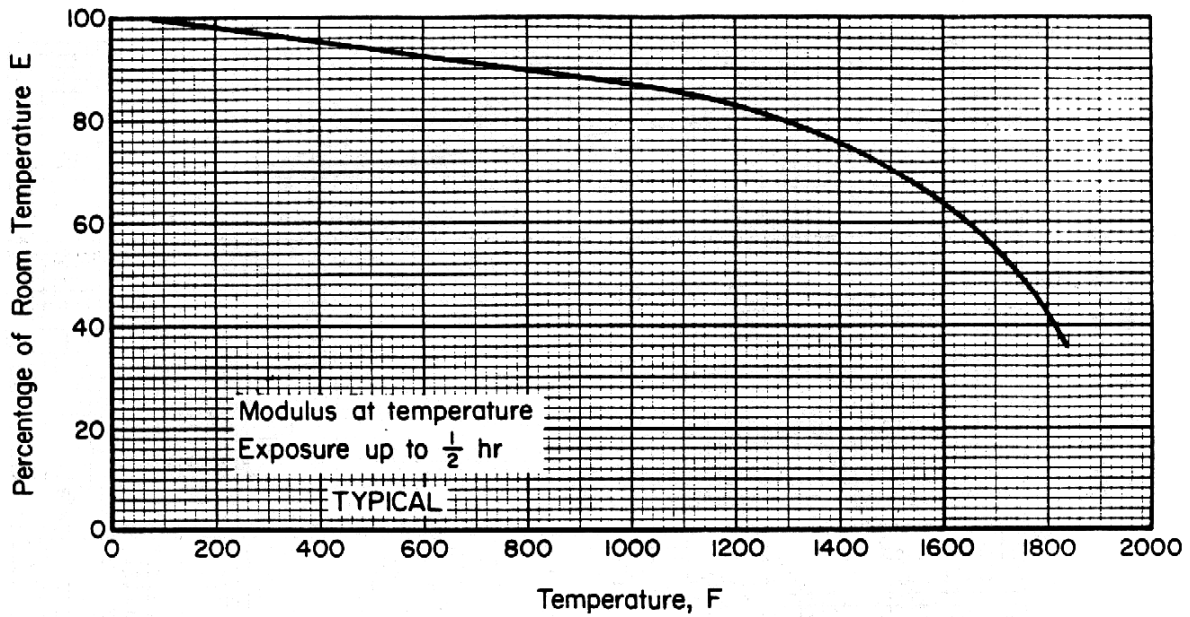

Figure 6.3.7.1.4. Effect of temperature on the tensile modulus (E) of René 41.

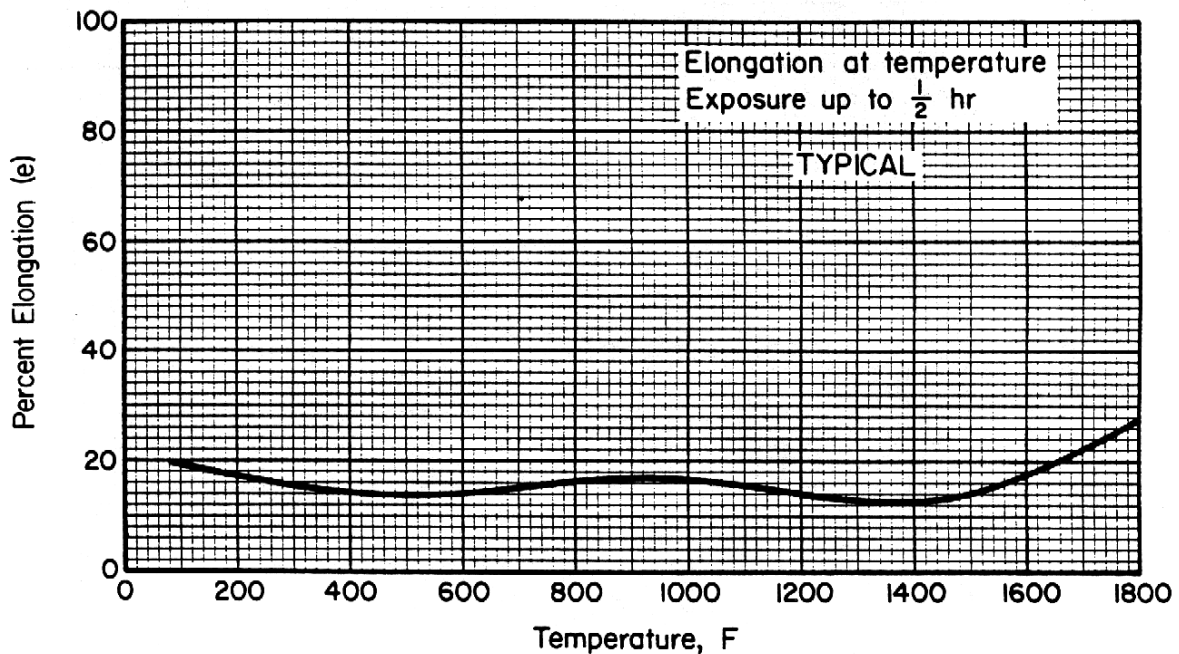

Figure 6.3.7.1.5. Effect of temperature on the elongation (e) of René 41 (>0.020 thickness) sheet.

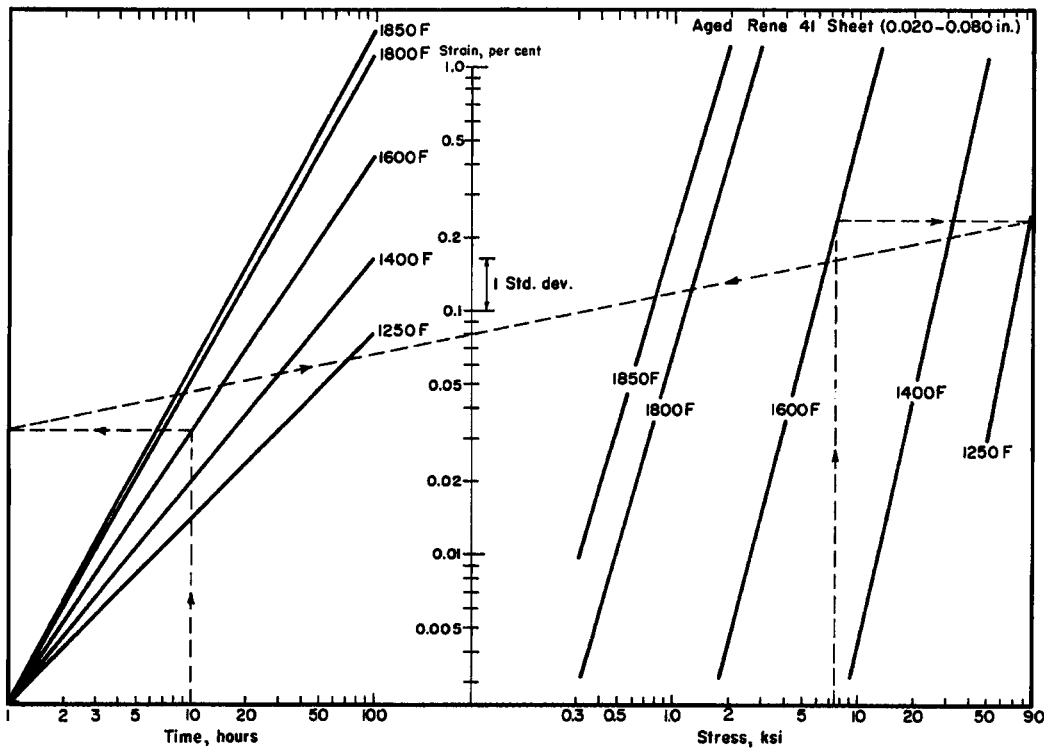

Figure 6.3.7.1.7. Typical creep properties of René 41 sheet.

Correlative Information for Figure 6.3.7.1.7

Equation

Creep Strain, percent:

$$\epsilon = \left(6.223 \times 10^7 \exp\left(-\frac{50760}{T}\right) \right) \left(\sigma^{0.3928 \exp\left(\frac{2554}{T}\right)} \right) \left(t^{4.1557 \exp\left(\frac{-3934}{T}\right)} \right)^a$$

Temperature (T) = Fahrenheit + 460

Example

Temp., T = 1600°F
Stress, σ = 7.5 ksi
Time, t = 10 hours
Creep Strain, ϵ = 0.080

a This equation should only be used in the same temperature ranges indicated in the nomograph. Creep strains computed outside these temperature ranges may yield unreasonable values.

6.3.8 WASPALOY

6.3.8.0 Comments and Properties — Waspaloy is a vacuum-melted precipitation-hardened nickel-base alloy which is strengthened by the precipitation of titanium and aluminum compounds and the solid-solution strengthening effects of chromium, molybdenum, and cobalt. The alloy is designed for highly stressed parts operating at temperatures up to 1550°F, such as aircraft gas turbine blades and discs and rocket engine parts. It is available in all the usual mill forms.

The optimum range for forging is 1900°F to 2050°F. Avoid working the alloy below 1900°F due to danger of cracking and also decreasing the stress-rupture life. Sufficient soaking time between heating is necessary to ensure complete recrystallization; however, avoid excessive long-time soaking at the high forging temperature. Furnace atmospheres should be either neutral or slightly oxidizing to prevent carburization and to minimize scaling.

Waspaloy is relatively difficult to machine. Drilling, turning, etc., can best be accomplished in solution-treated and partially aged condition. Generally, carbide tools are preferred, and positive feeds are required to avoid work hardening. For finish machining, grinding is preferable.

Waspaloy is susceptible to hot cracking or “hot-shortness” above 2150°F; therefore, extreme care should be exercised in the design of weldments so that restraint can be minimized. Waspaloy should be welded in the annealed condition, with minimum heat input, and with rapid cooling by means of chill bars and gas backup. This alloy has good resistance to oxidation at temperatures up to 1750°F and to combustion products encountered in aircraft gas turbines.

Two heat treatments are used for this material. One is for optimum tensile strength (solution treated 1825°F to 1900°F, stabilize 1550°F, 24 hours air cool, and age 16 hours at 1400°F air cool), and the other for stress-rupture properties (solution treated 1975°F, stabilized 1550°F, 24 hours air cool, age 1400°F, 16 hours air cool).

Some material specifications for Waspaloy are shown in Table 6.3.8.0(a). Room-temperature mechanical properties are shown in Table 6.3.8.0(b). Physical properties at room and elevated temperatures are shown in Figure 6.3.8.0.

Table 6.3.8.0(a). Material Specifications for Waspaloy

Specification	Form
AMS 5544	Plate, sheet, and strip
AMS 5704	Forgings
AMS 5706	Bar, forging, ring
AMS 5707	Bar, forging, ring
AMS 5708	Bar, forging, ring
AMS 5709	Bar, forging, ring ^a

^a Primarily for applications requiring high stress-rupture strength.

6.3.8.1 Aged Condition — Stress rupture requirements at elevated temperatures are specified in material specifications. The appropriate specification should be consulted for detailed requirements. The effect of temperature on various mechanical properties is shown in Figures 6.3.8.1.1, 6.3.8.1.4, as well as 6.3.8.1.5(a) and (b). The effect of temperature on the Ramberg-Osgood parameter, *n* (tension), is shown in Figure 6.3.8.1.6(a). Typical tensile stress-strain curves are shown in Figure 6.3.8.1.6(b).

Table 6.3.8.0(b). Design Mechanical and Physical Properties of Waspaloy

Specification	AMS 5544		AMS 5704	AMS 5706 and AMS 5707
Form	Sheet, strip, and plate		Forging	Bar, forging, and ring
Condition	Solution, stabilization, and precipitation heat treated			
Thickness, in.	≤0.020	>0.020	≤3.500	≤3.500
Basis	S	S	S	S
Mechanical Properties:				
F_{tu} , ksi:				
L	175	160
LT	170	175
F_{ty} , ksi:				
L	120	110
LT	110	115
F_{cy} , ksi:				
L
LT
F_{su} , ksi
F_{bru} , ksi:				
(e/D = 1.5)
(e/D = 2.0)
F_{bry} , ksi:				
(e/D = 1.5)
(e/D = 2.0)
e , percent:				
L	15	15
LT	15	20
RA , percent:				
L	18	18
E , 10 ³ ksi	30.6			
E_c , 10 ³ ksi			
G , 10 ³ ksi			
μ			
Physical Properties:				
ω , lb/in. ³	0.298			
C , Btu/(lb)(°F)	See Figure 6.3.8.0			
K , Btu/[(hr)(ft ²)(°F)/ft]	See Figure 6.3.8.0			
α , 10 ⁻⁶ in./in./°F	See Figure 6.3.8.0			

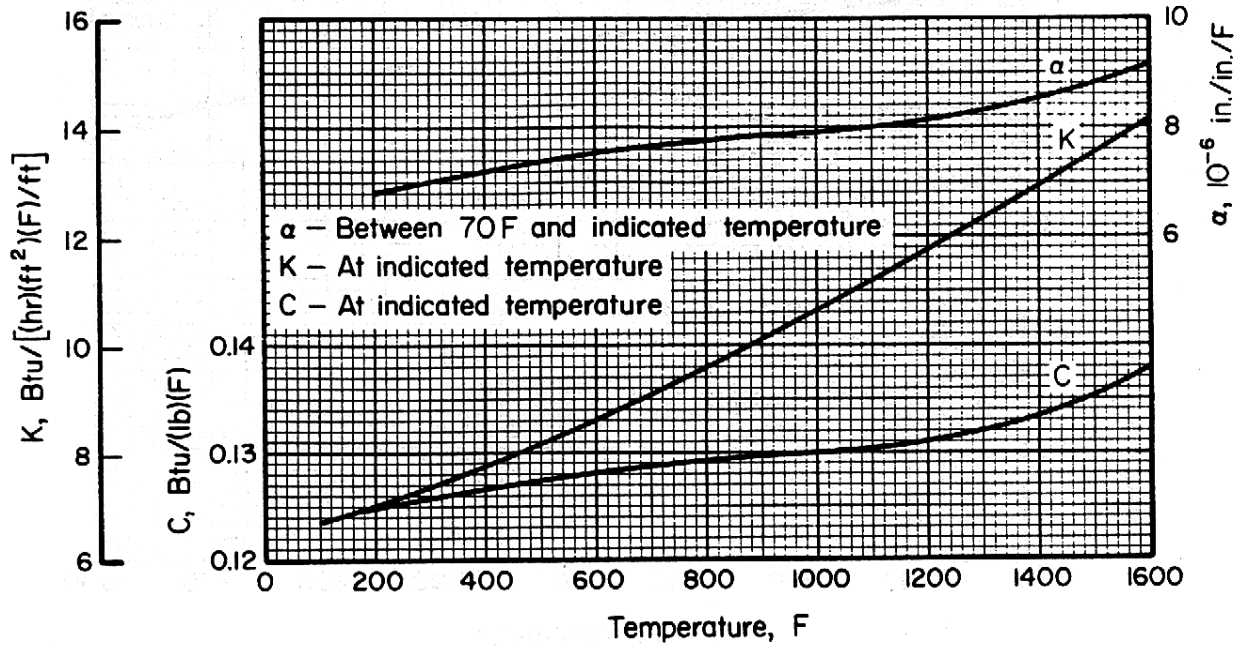

Figure 6.3.8.0. Effect of temperature on the physical properties of Waspaloy.

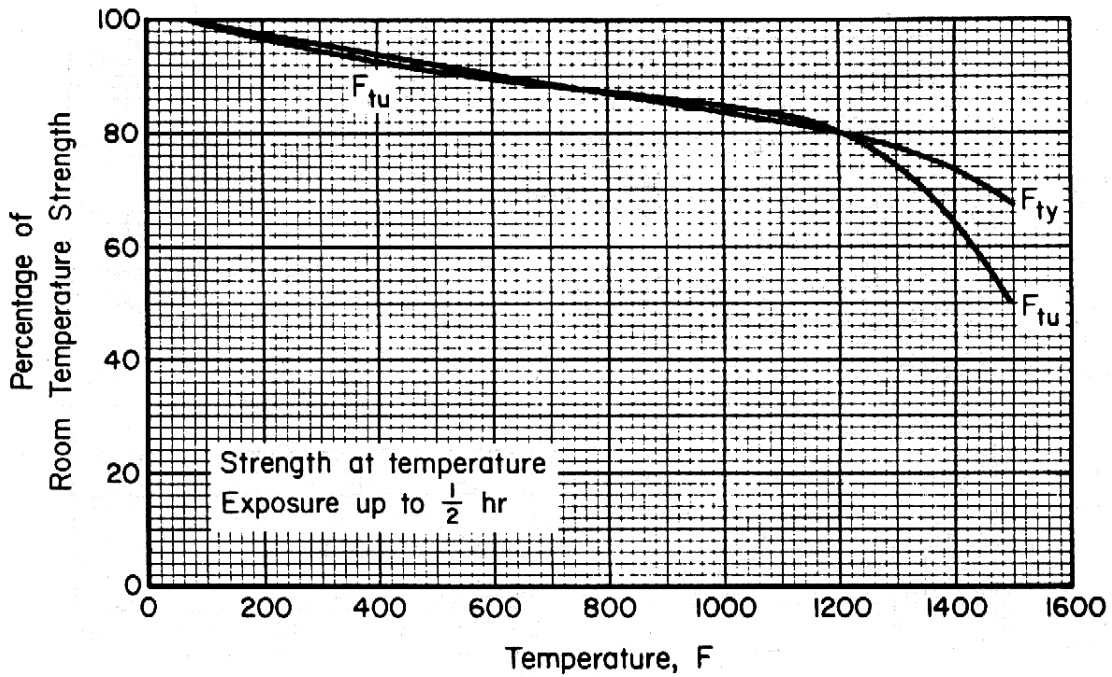

Figure 6.3.8.1.1. Effect of temperature on the tensile ultimate strength (F_{tu}) and the tensile yield strength (F_{ty}) of Waspaloy.

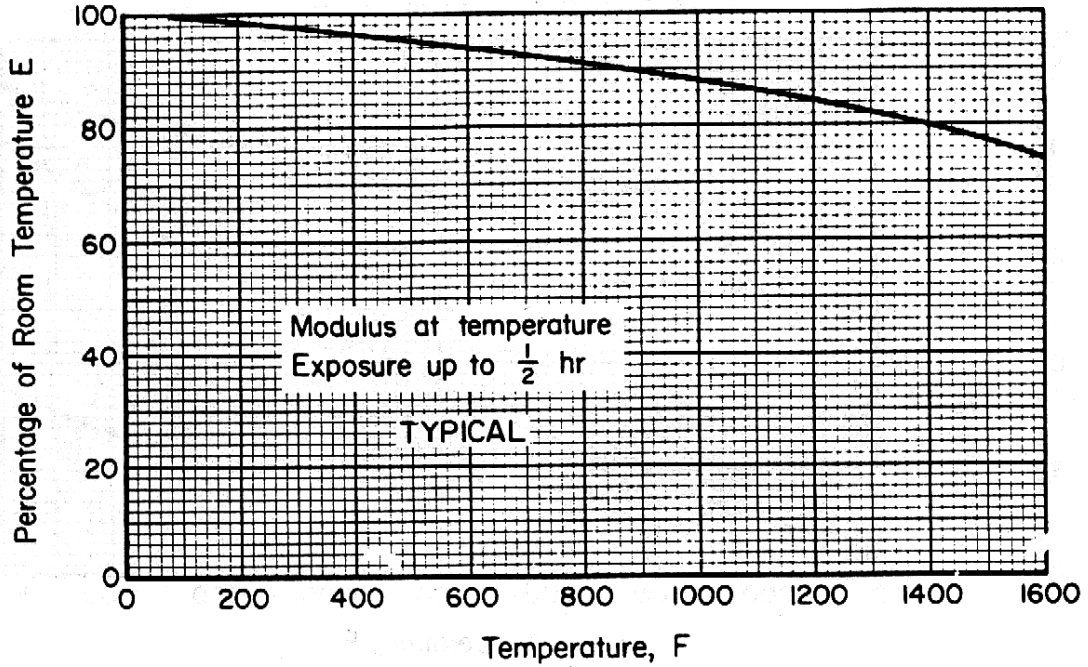

Figure 6.3.8.1.4. Effect of temperature on the modulus of elasticity (E) of Waspaloy.

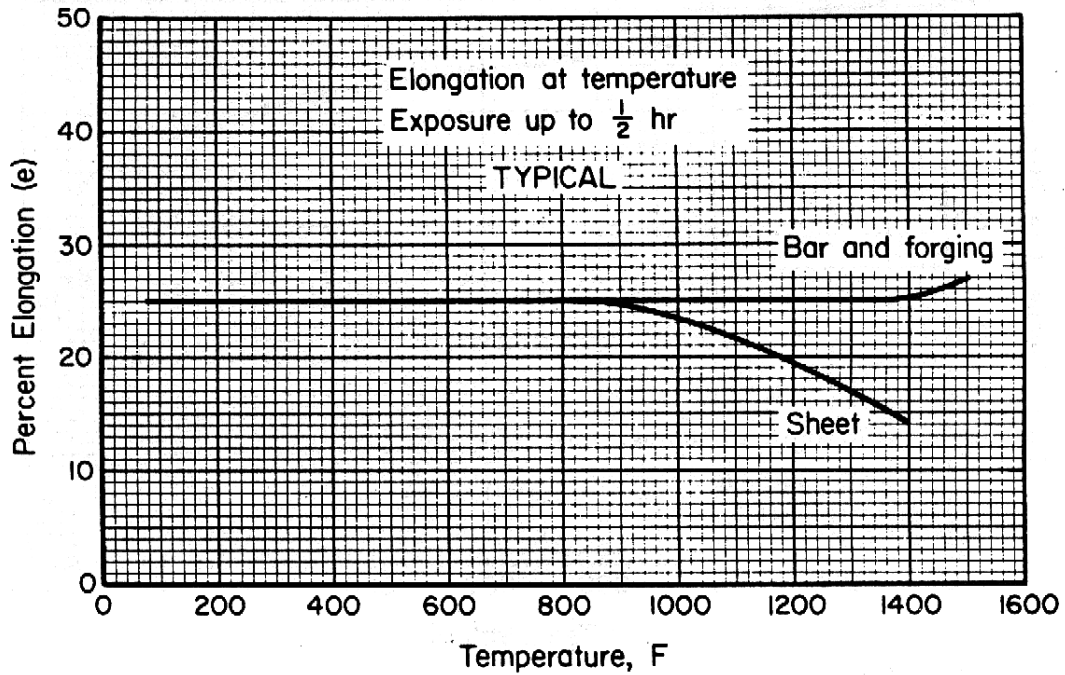

Figure 6.3.8.1.5(a). Effect of temperature on elongation (e) of Waspaloy.

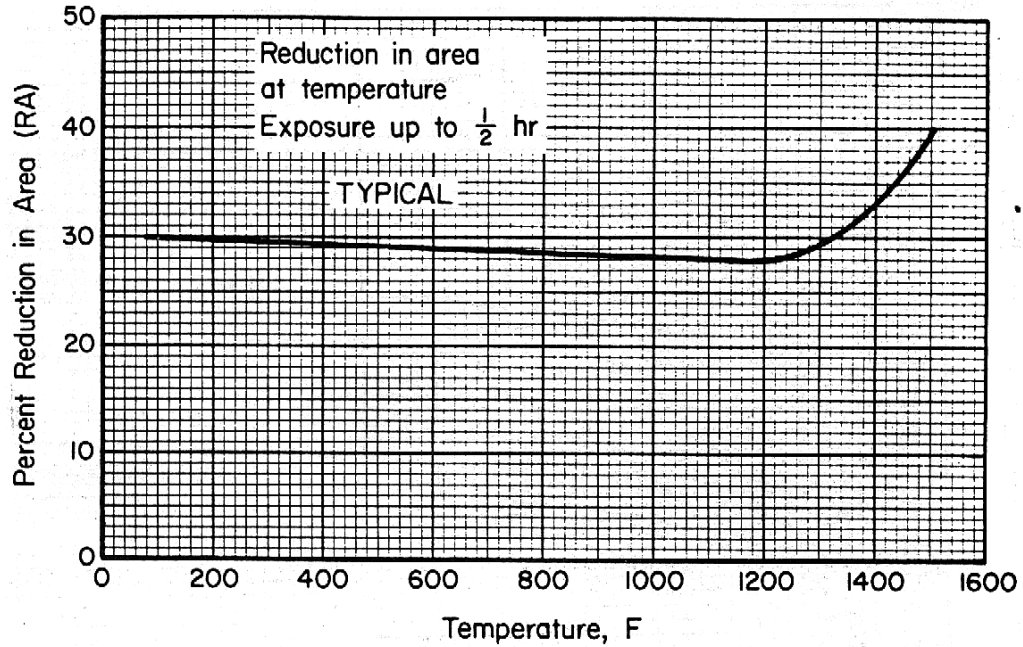

Figure 6.3.8.1.5(b). Effect of temperature on reduction in area (RA) of Waspaloy bar and forging.

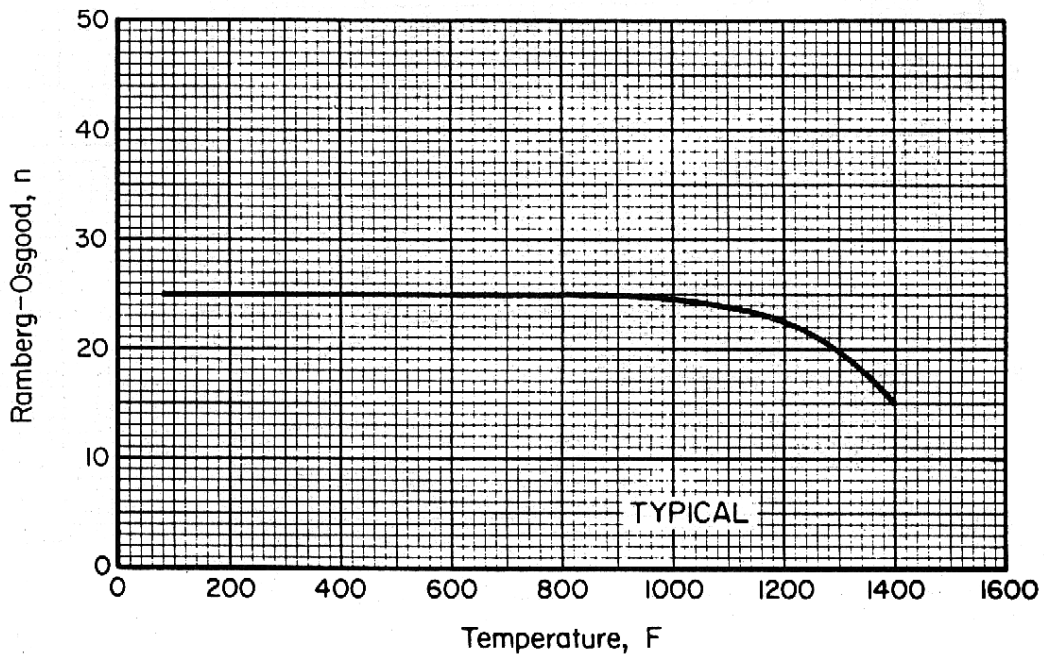

Figure 6.3.8.1.6(a). Effect of temperature on Ramberg-Osgood parameter (n in tension) of Waspaloy.

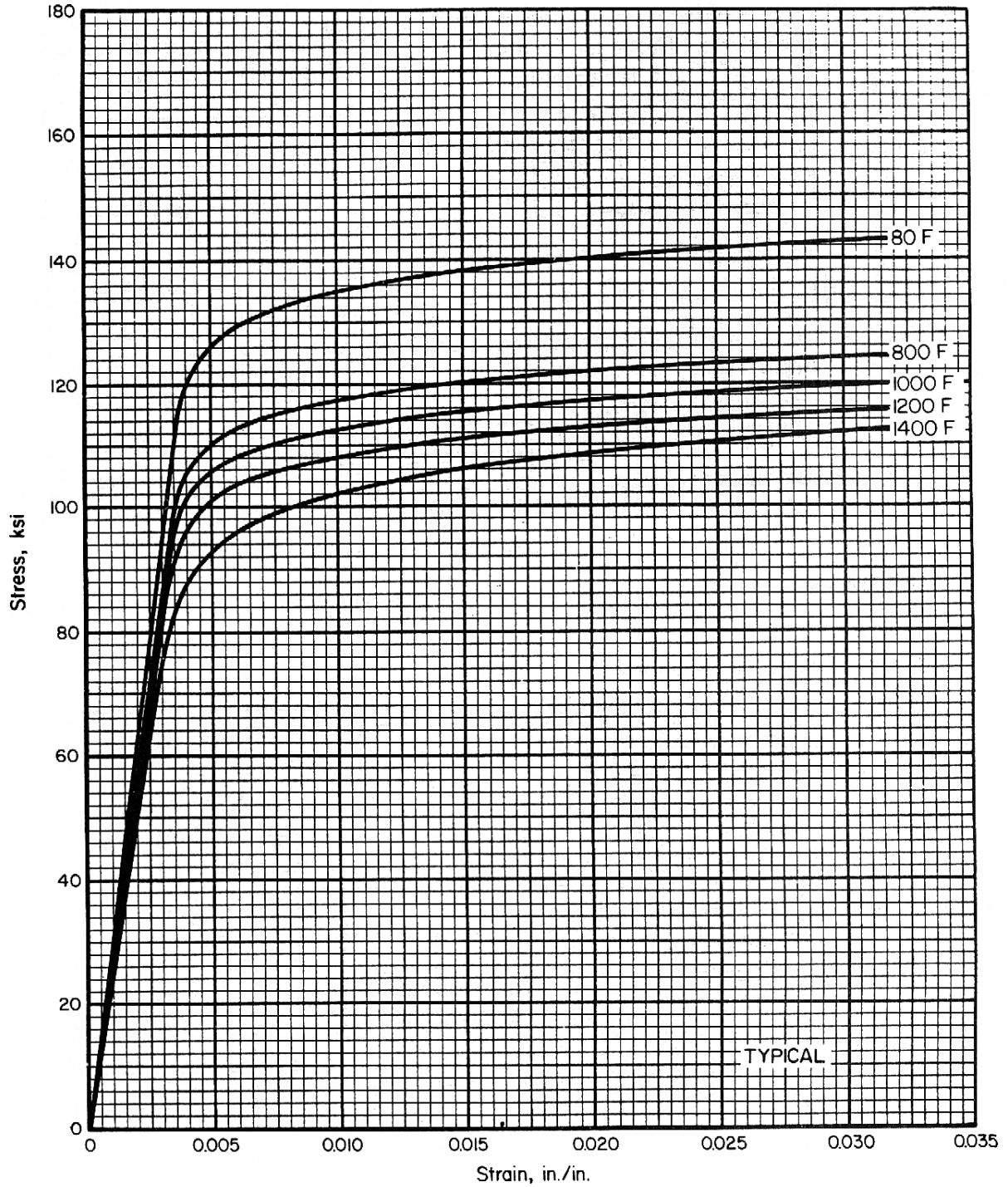

Figure 6.3.8.1.6(b). Typical tensile stress-strain curves for Waspaloy at room and elevated temperatures (all products).

6.3.9. HAYNES® 230®*

6.3.9.0. Comments and Properties — HAYNES® 230® alloy provides excellent oxidation resistance up to 2100°F for prolonged exposures with superior long term stability, high temperature strength and good fabricability. It is produced in the form of plate, sheet, strip, foil, billet, bar, wire welding products, pipe, tubing, remelt bar, and may be cast using traditional air-melt sand mold or vacuum-melt investment foundry techniques. Products are used for gas turbine components in the aerospace industry, catalyst grid supports in the chemical process industry, and various other high-temperature applications.

Environmental Considerations — HAYNES 230 alloy has excellent corrosion resistance to both air and combustion gas oxidizing environments. It also exhibits excellent nitriding resistance and good resistance to carburization and hydrogen embrittlement.

Machining — HAYNES 230 alloy has similar machining characteristics to other solid-solution-strengthened nickel-based alloys. This group of materials is classified moderate to difficult to machine, however, they can be machined using conventional methods at satisfactory rates. They work-harden rapidly, requiring slower speeds and feeds with heavier cuts than would be used for machining stainless steels. See HAYNES publication H-3159 for more detailed information.

Joining — HAYNES 230 alloy has excellent forming and welding characteristics similar to HASTELLOY® X alloy. It is readily welded using GTAW (Gas Tungsten-Arc Welding), GMAW (Gas Metal-Arc Welding), SMAW (Shielded Metal-Arc Welding), and resistance techniques. HAYNES 230-W™ alloy is the recommended filler metal.

Heat Treatment — This alloy is normally final solution heat-treated between 2150°F and 2275°F. Annealing during fabrication can be performed at slightly lower temperatures, but a final subsequent solution heat treatment followed by rapid cooling is needed to produce optimum properties and structure.

Specifications and Properties — Material specifications are shown in Table 6.3.9.0(a).

Table 6.3.9.0(a). Material Specifications for HAYNES 230 Alloy Wrought

Specification	Form
AMS 5878	Plate, sheet, and strip
AMS 5891	Bar and forging

Room temperature mechanical and physical properties are shown in Tables 6.3.9.0(b) and (c).

6.3.9.1. Annealed Condition — Elevated temperature mechanical properties are shown in Figures 6.3.9.1.1(a) and (b). Typical stress-strain and full-range curves are shown in Figure 6.3.9.1.6(a) and (b).

*HAYNES® and HASTELLOY® are registered trademarks of HAYNES International.

Table 6.3.9.0(b). Design Mechanical and Physical Properties of HAYNES 230 Alloy Sheet and Plate

Specification	AMS 5878					
	Sheet		Plate			
	2250 Anneal		2200 Anneal			
	≤0.125		≤0.400		0.401 to 1.500	
Basis	A	B	A	B	A	B
Mechanical Properties:						
F_{tu} , ksi:						
L
LT	114	117	115 ^a	120	111	114
F_{ly} , ksi:						
L
LT	49	53	50	55	48	51
F_{cy} , ksi:						
L
LT
F_{su} , ksi						
F_{bru} , ksi:						
(e/D = 1.5)
(e/D = 2.0)
F_{bry} , ksi:						
(e/D = 1.5)
(e/D = 2.0)
e , percent:						
LT	39	42	40	43	39	42
E , 10 ³ ksi					
E_c , 10 ³ ksi					
G , 10 ³ ksi					
μ					
Physical Properties:						
ω , lb/in. ³	0.324					
C , K , and α	See Figures 6.3.9.0(a),(b), and (c)					

a S-basis. The rounded T_{90} value for F_{tu} (L) = 117 ksi.

Table 6.3.9.0(c). Design Mechanical and Physical Properties of HAYNES230 Bar

	AMS 5891											
	Bar											
	2250 Anneal											
	≤ 1.000		1.001 to 2.000		2.001 to 3.000		3.001 to 4.000		4.001 to 5.000		5.001 to 6.000	
	A	B	A	B	A	B	A	B	A	B	A	B
Specification	AMS 5891											
Form	Bar											
Condition	2250 Anneal											
Thickness, in.	2250 Anneal											
Basis	2250 Anneal											
Mechanical Properties:												
$F_{t0.2}$ ksi: L	110	118	110	117	110	115	110	114	109	112	107	110
$F_{t0.5}$ ksi: L	45 ^a	51	45 ^a	51	45 ^a	51	45 ^a	51	45 ^a	51	45 ^a	51
F_{cy} ksi
F_{su} ksi
$F_{br0.2}$ ksi:
(e/D = 1.5)
(e/D = 2.0)
$F_{br0.5}$ ksi:
(e/D = 1.5)
(e/D = 2.0)
e, percent: L	35	46	35	46	35	46	35	46	35	46	35	46
E , 10 ³ ksi	...											
E_c , 10 ³ ksi	...											
G , 10 ³ ksi	...											
μ	...											
Physical Properties:												
ω , lb/in. ³	0.324											
C, K and α	See Figures 6.3.9.0(a), (b), and (c)											

^a S-basis. The rounded T_{99} values for $F_y(L) = 48$ ksi.

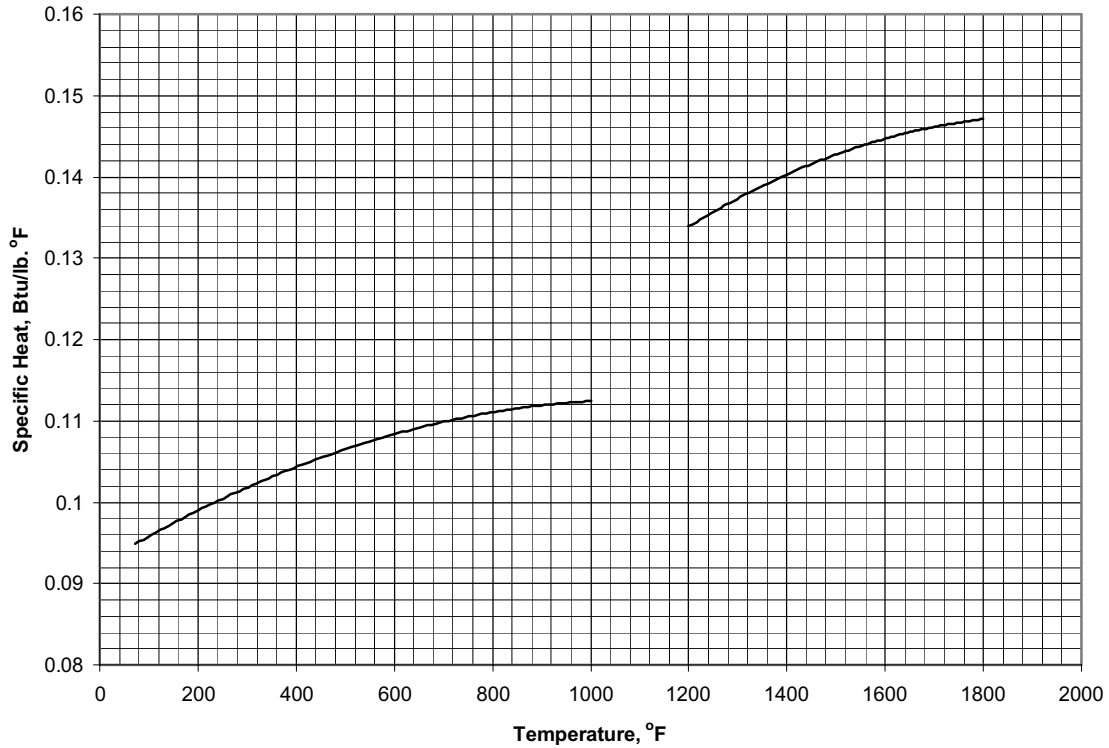

Figure 6.3.9.0(a). Effect of temperature on specific heat of HAYNES 230 alloy.

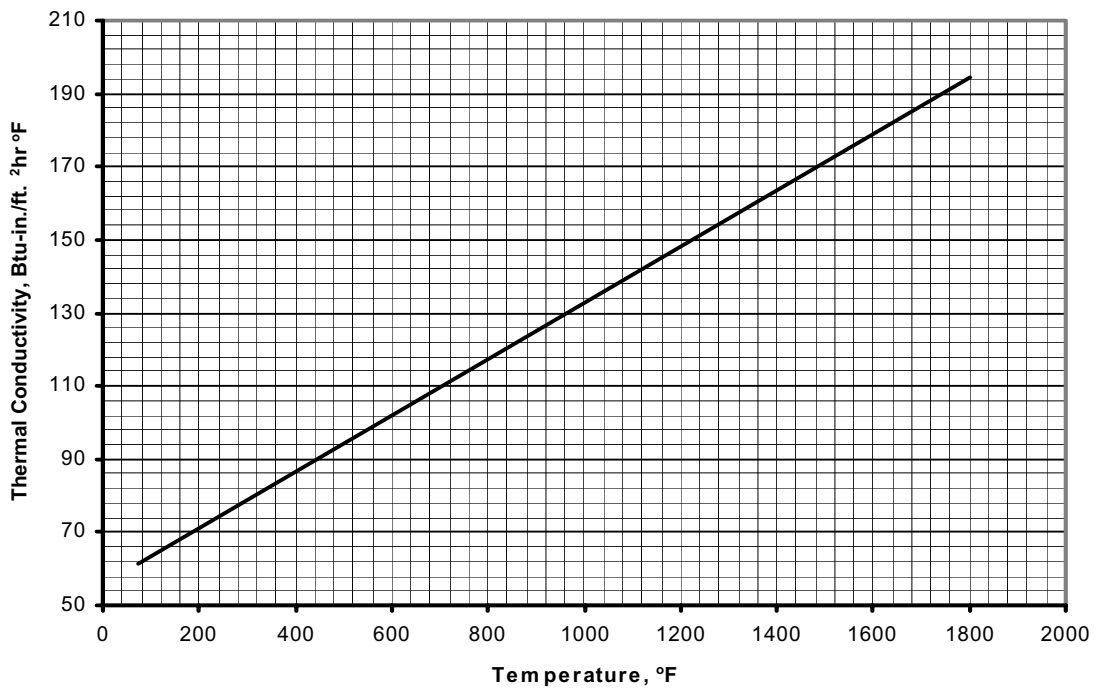

Figure 6.3.9.0(b). Effect of temperature on thermal conductivity of HAYNES 230 alloy.

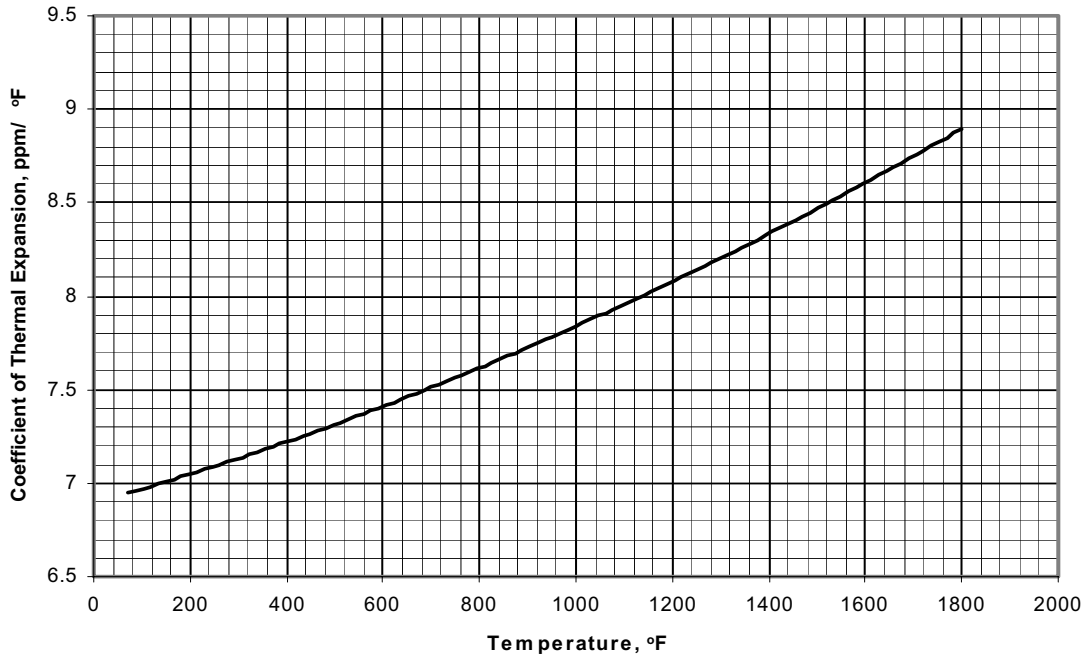

Figure 6.3.9.0(c). Effect of temperature on mean coefficient of thermal expansion of HAYNES 230 alloy between 70° F and the temperature indicated.

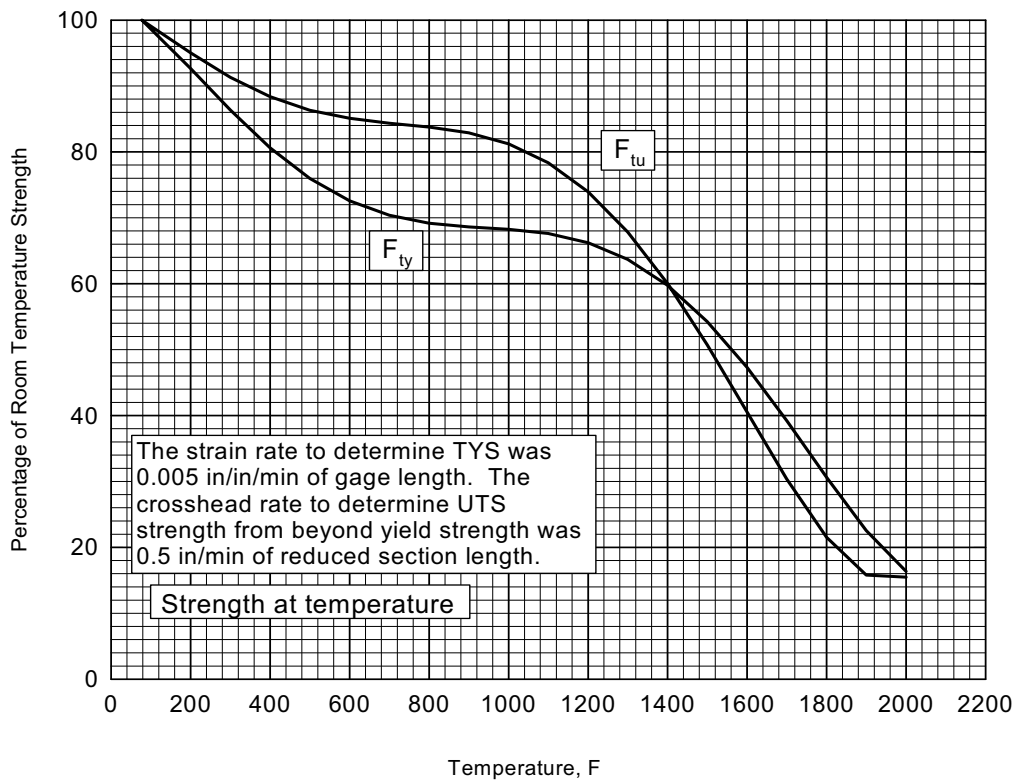

Figure 6.3.9.1.1(a). Effect of temperature on tensile properties of Haynes 230 alloy plate.

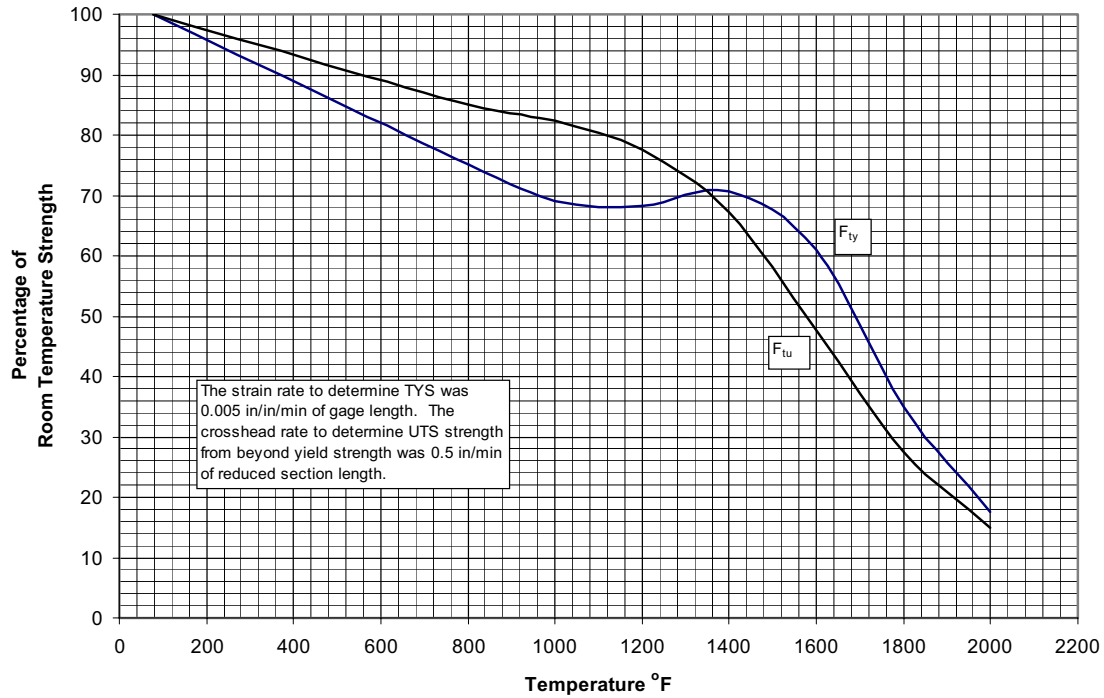

Figure 6.3.9.1.1(b). Effect of temperature on tensile properties of HAYNES 230 alloy bar ranging up to 1.3 inches in diameter.

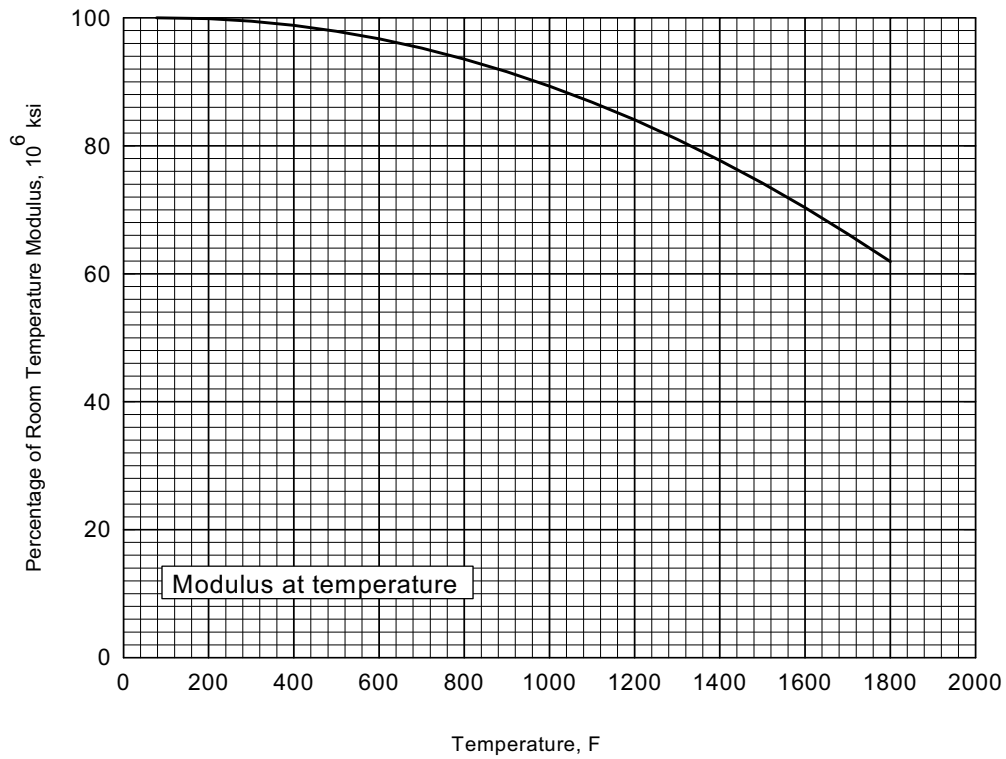

Figure 6.3.9.1.4. Effect of temperature on modulus of Haynes 230 alloy plate.

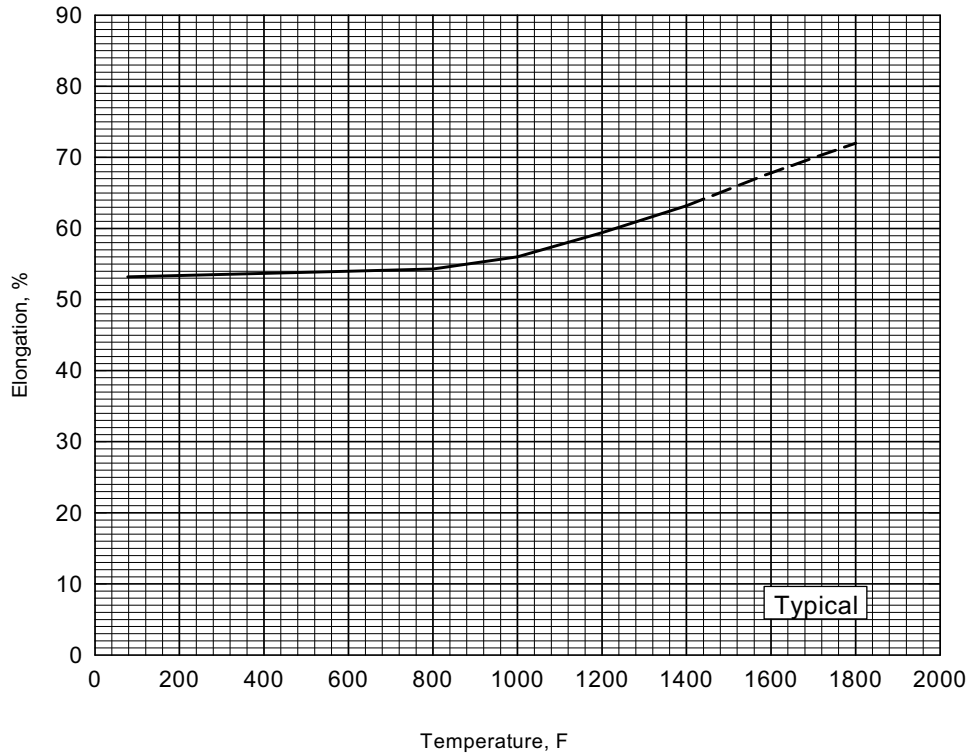

Figure 6.3.9.1.5. Effect of temperature on elongation of Haynes 230 alloy plate.

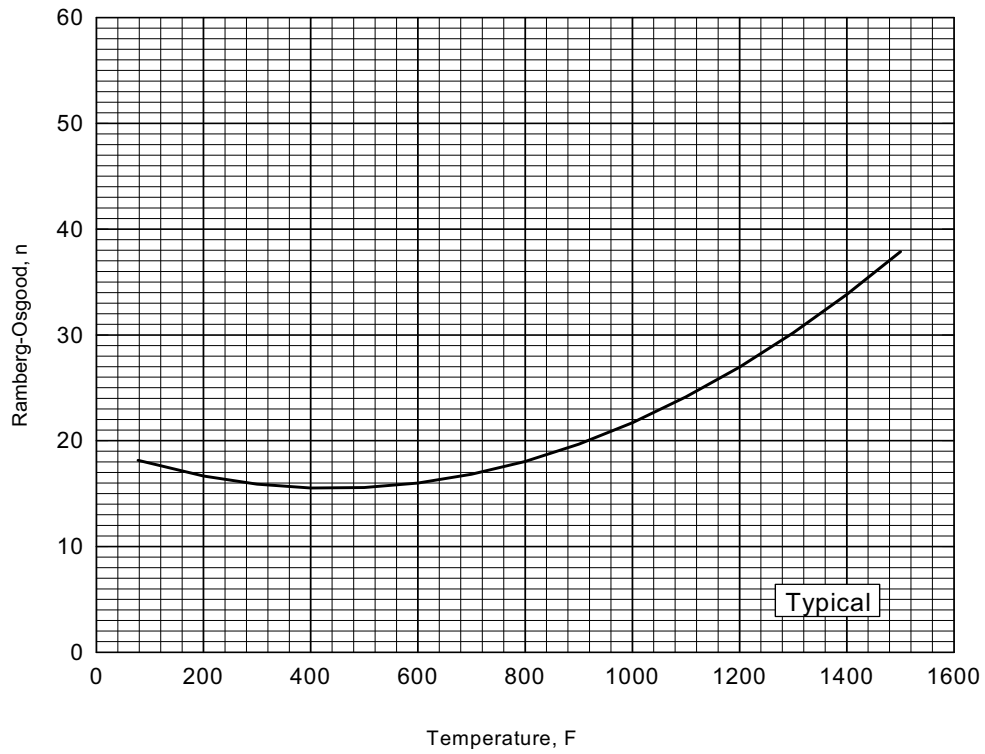

Figure 6.3.9.1.6(a). Effect of temperature on Ramberg-Osgood parameter (n in tension) of Haynes 230 alloy plate.

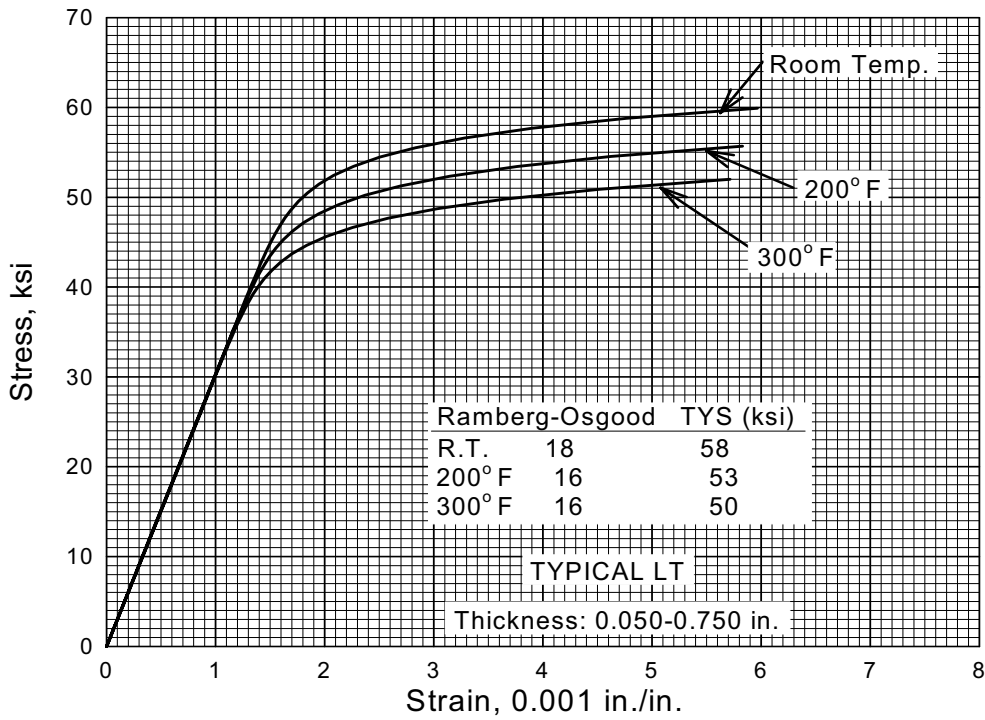

Figure 6.3.9.1.6(b). Typical tensile stress-strain curves for Haynes 230 plate at room temperature, 200°F, and 300°F.

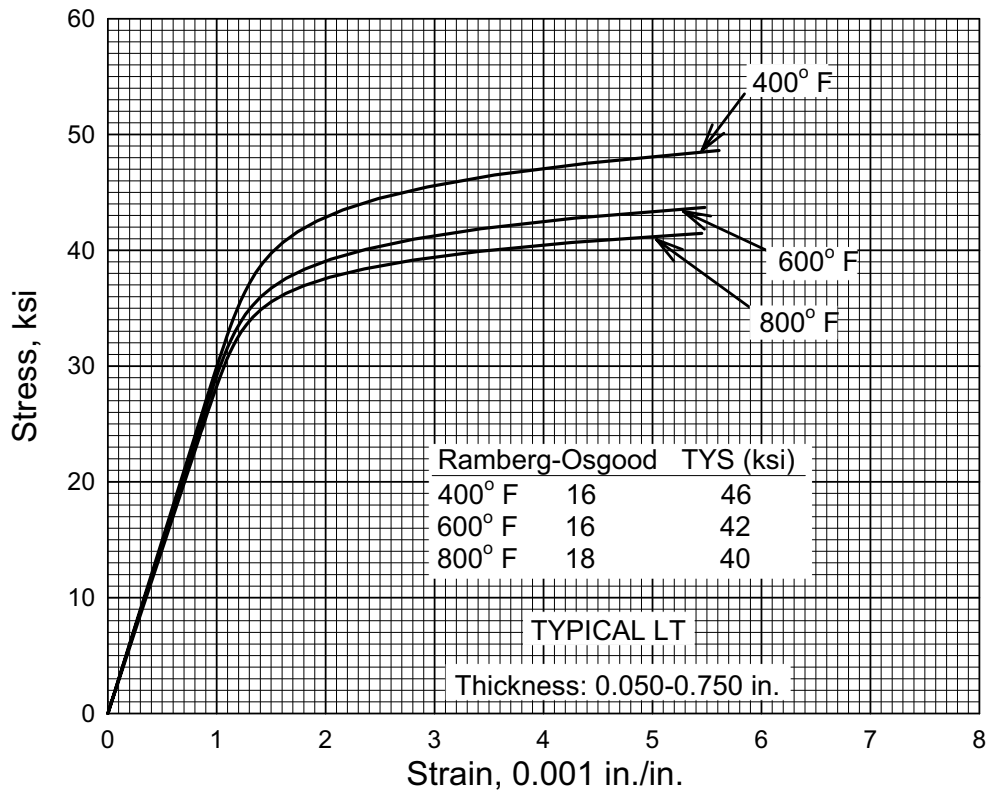

Fig 6.3.9.1.6(c). Typical tensile stress-strain curves for Haynes 230 plate at 400°F, 600°F, and 800°F.

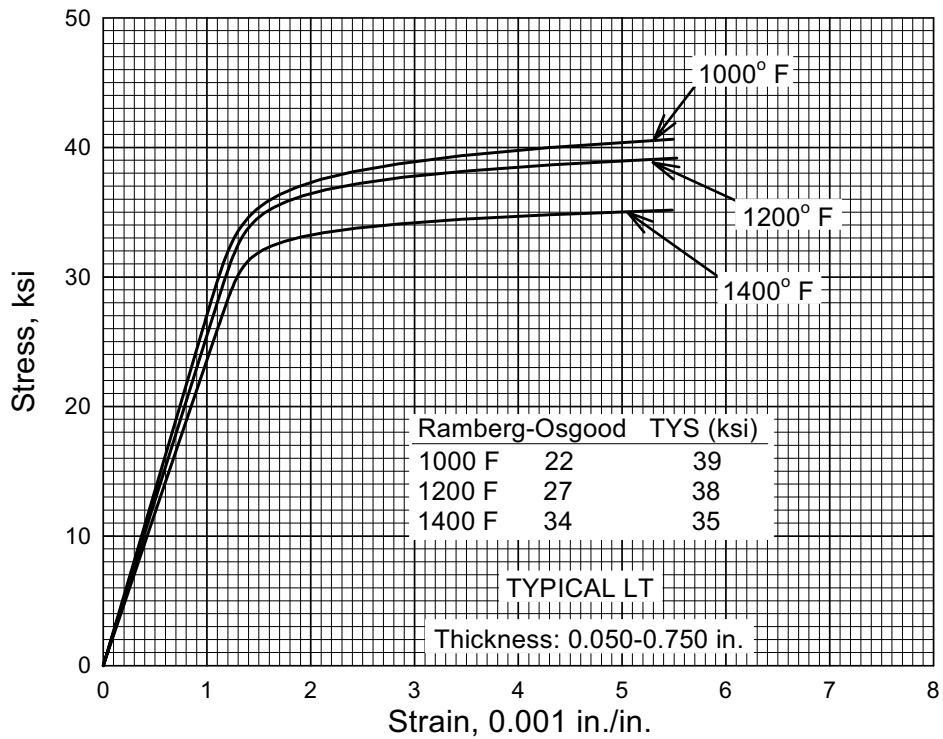

Figure 6.3.9.1.6(d). Typical tensile stress-strain curves for Haynes 230 plate at 1000°F, 1200°F, and 1400°F.

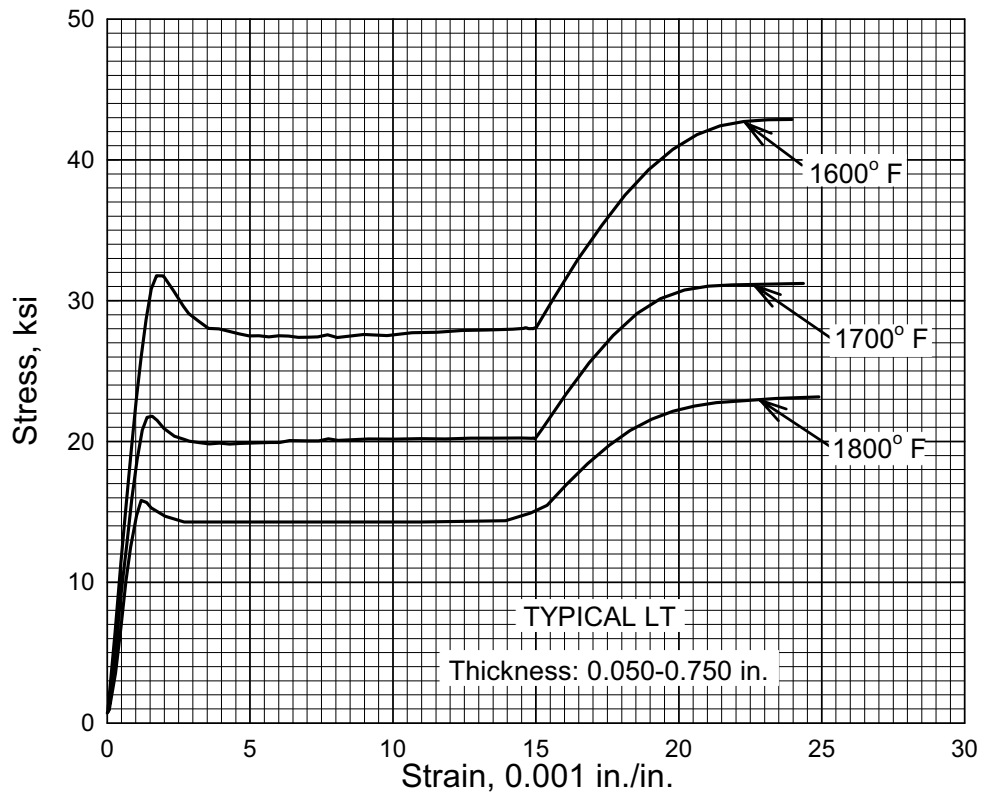

Figure 6.3.9.1.6(e). Typical tensile stress-strain curves for Haynes 230 plat at 1600°F, 1700°F, and 1800°F.

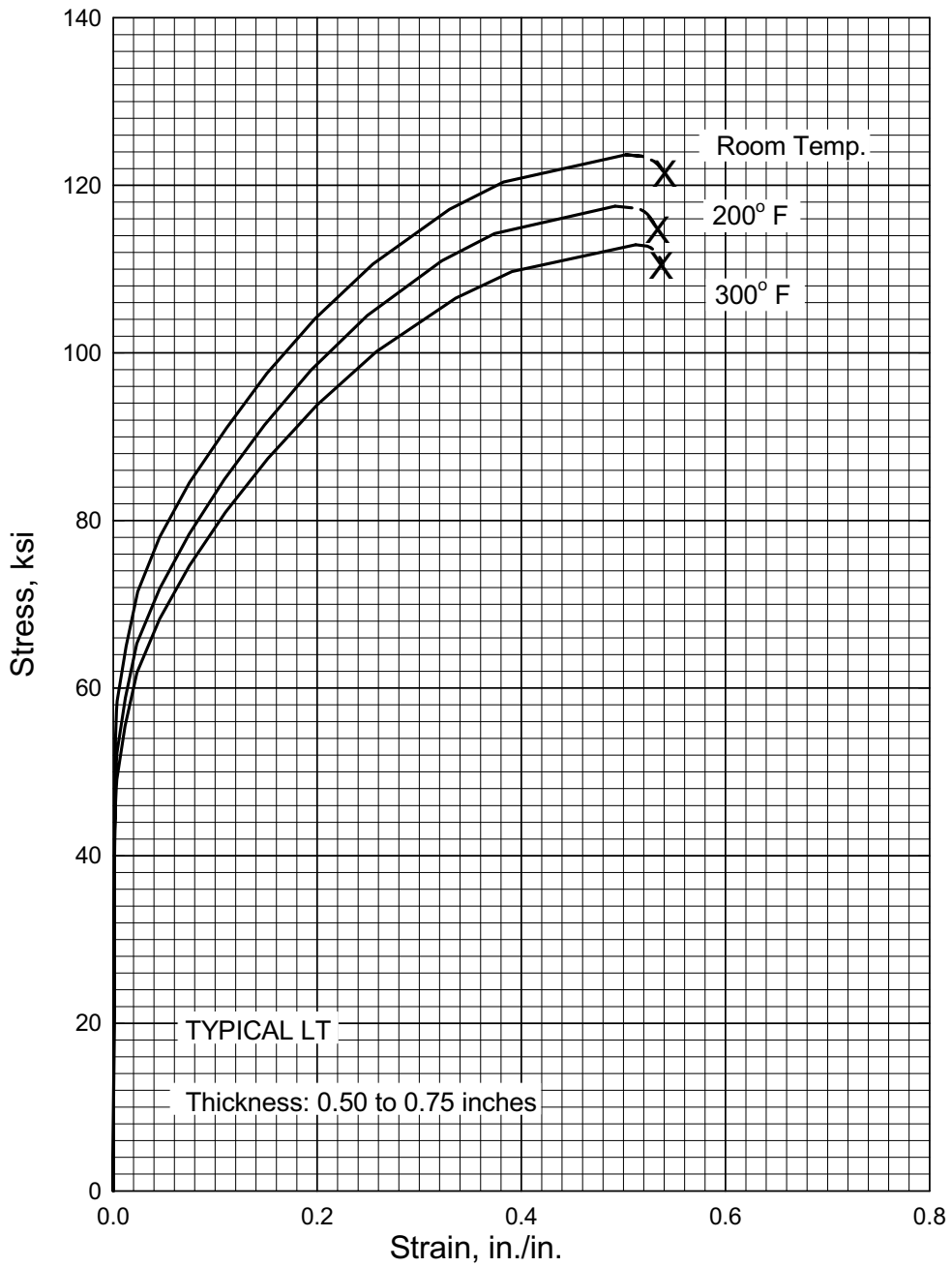

Figure 6.3.9.1.6(f). Full range tensile stress-strain curves for Haynes 230 plate at room temperature, 200°F, and 300°F.

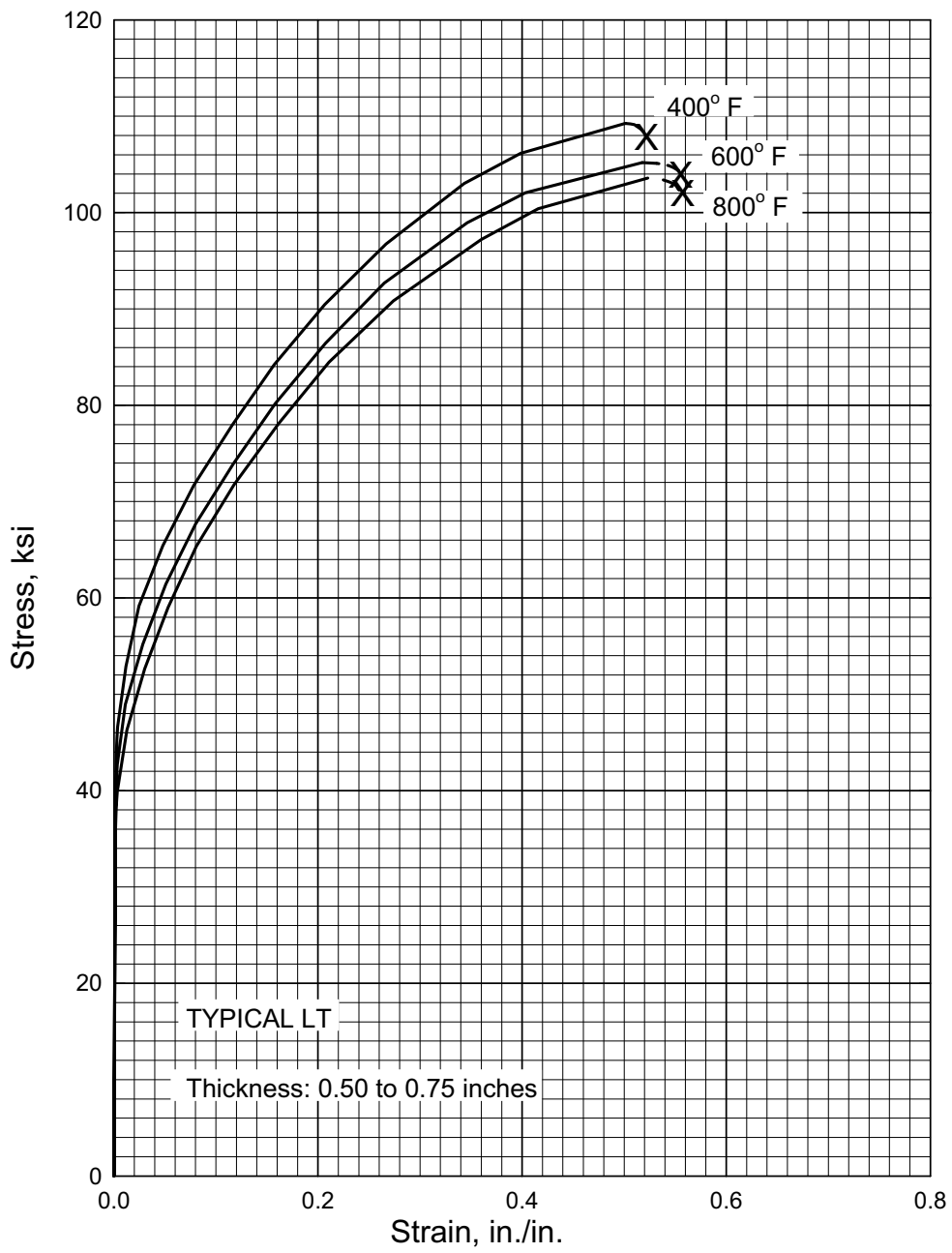

Figure 6.3.9.1.6(g). Full range tensile stress-strain curves for Haynes 230 plate at 400°F, 600°F, and 800°F.

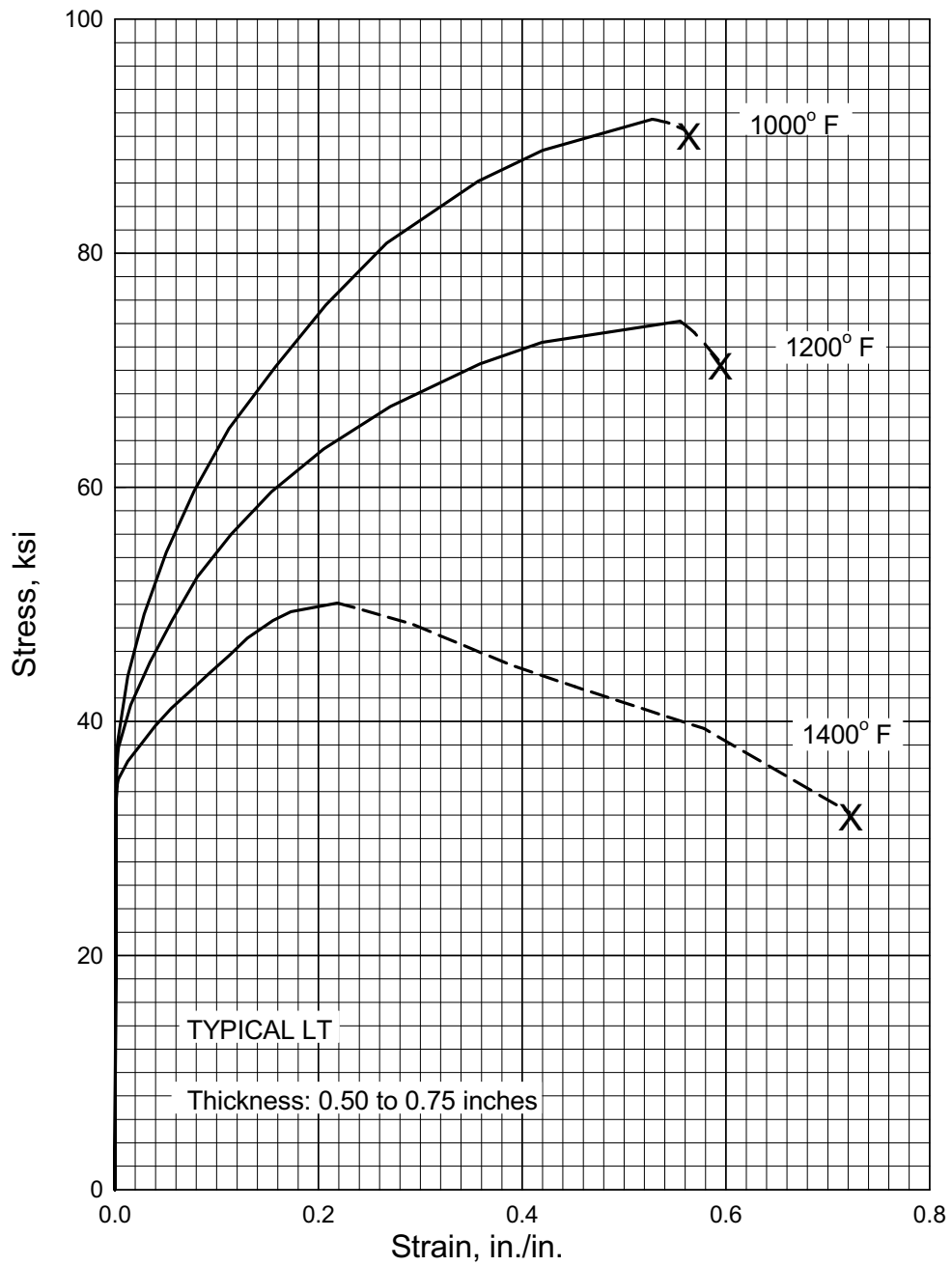

Figure 6.3.9.1.6(h). Full range tensile stress-strain curves for Haynes 230 plate at 1000°F, 1200°F, and 1400°F.

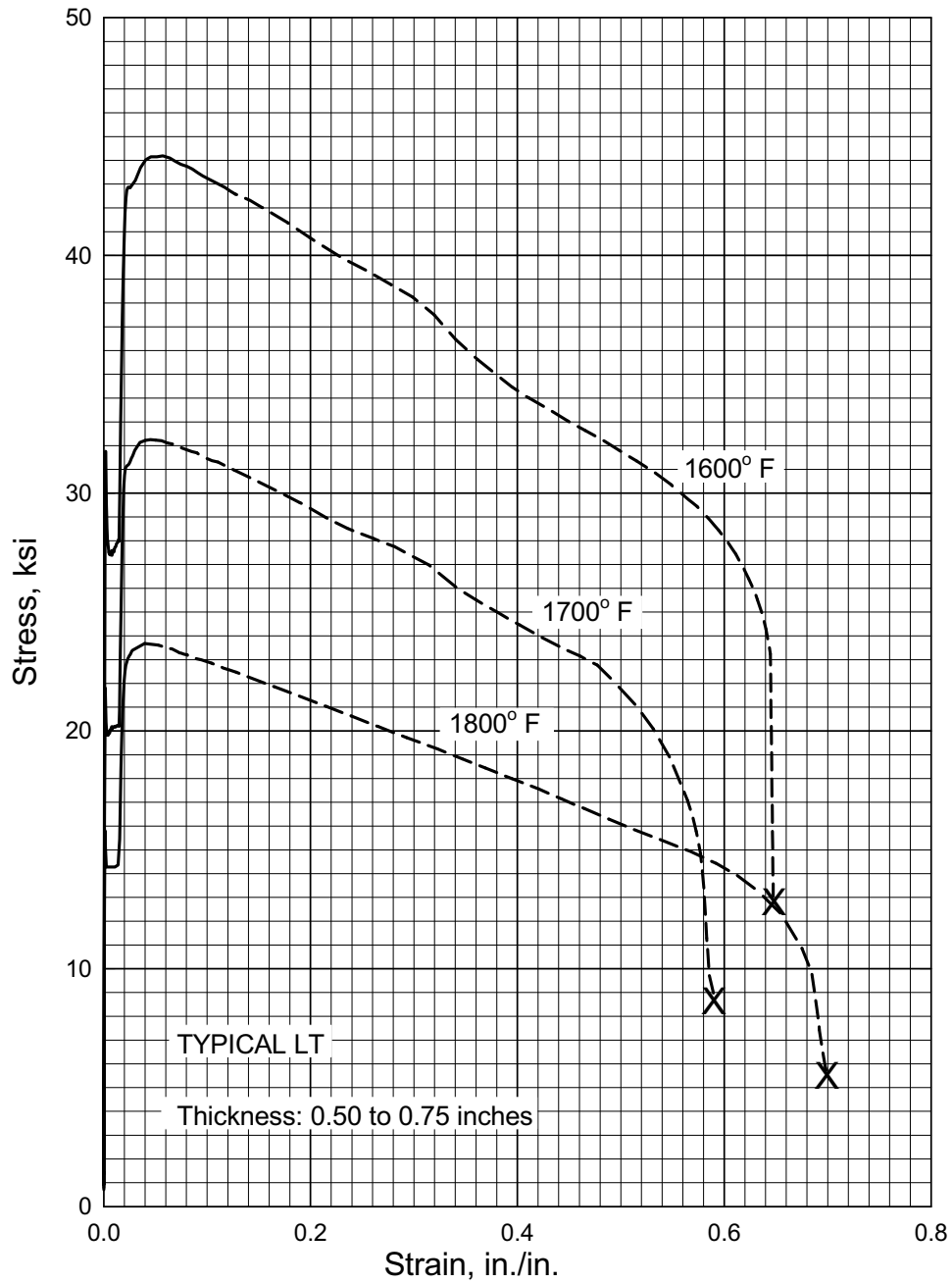

Figure 6.3.9.1.6(i). Full range tensile stress-strain curves for Haynes 230 plate at 1600°F, 1700°F, and 1800°F.

6.3.10 HAYNES® HR-120®*

6.3.10.0 Comments and Properties — HAYNES HR-120 alloy is a solid-solution strengthened Fe-Ni-Cr alloy with excellent high temperature strength, very good resistance to carburizing and sulfiding environments, and readily formed hot or cold.

Environmental Considerations — HAYNES HR-120 alloy has very good sulfide and carburization resistance. Oxidation resistance is comparable to other Fe-Ni-Cr materials such as alloys 330 and 800H, yet with a greater strength at temperatures up to 2000°F.

Machining — This alloy is readily machinable using conventional practices similar to those for 300 series austenitic stainless steels. Minor adjustments may be required to yield optimum results. See HAYNES publication H-3125B for more detailed information.

Joining — Welding characteristics are similar to the HASTELLOY® alloys. The alloy is readily welded using GTAW (Gas Tungsten-Arc Welding), GMAW (Gas Metal-Arc Welding), and SMAW (Shielded Metal-Arc Welding) techniques. HAYNES® 556™ alloy is the recommended filler wire (AMS5831) for GTAW and GMAW processes. Multimet® alloy covered electrode (AMS 5795) is recommended for SMAW processes. HASTELLOY® X alloy filler wire (AMS 5798) and covered electrode (AMS 5799) may also be used.

Heat Treatment — This alloy is solution annealed between 2150°F and 2250°F and rapidly cooled.

Specifications and Properties — Material specifications are shown in Table 6.3.10.0(a).

Table 6.3.10.0(a). Material Specifications for HAYNES HR-120 Alloy Wrought Products

Specification	Form
AMS 5916	Sheet, strip and plate

Room temperature mechanical and physical properties are shown in Table 6.3.10.0(b).

6.3.10.1 Annealed Condition — Elevated temperature tensile properties are shown in Figure 6.3.10.1.1(a). Stress rupture curves are shown in Figures 6.3.10.1.7(a) and (b)

* HAYNES® and HASTELLOY® are registered trademarks of HAYNES International.

Table 6.3.10.0(b). Design Mechanical and Physical Properties of HAYNES HR-120 Alloy Sheet, Strip and Plate

Specification	AMS 5916		
Form	Sheet, Strip, and Plate		
Condition	Annealed		
Thickness or diameter, in.	>0.015 to 0.749		0.750 to 2.000
Basis	A	B	S
Mechanical Properties:			
F_{tu} , ksi:			
L
LT	90 ^a	101	90
F_{ty} , ksi:			
L
LT	40 ^a	44	40
F_{cy} , ksi:			
L
LT
F_{su} , ksi
F_{bru}^b , ksi:			
(e/D = 1.5)
(e/D = 2.0)
F_{bry}^a , ksi:			
(e/D = 1.5)
(e/D = 2.0)
e , percent (S-basis):			
LT	30	...	30
E , 10 ³ ksi	see Figure 6.3.10.0(a)		
E_c , 10 ³ ksi		
G , 10 ³ ksi		
μ		
Physical Properties:			
ω , lb/in. ³	0.324		
C , K , and α	See Figures 6.3.9.0(b),(c), and (d)		

a S-basis. The rounded T_{99} value for F_u (LT) = 94 ksi, F_y (LT) = 41 ksi
b Bearing values are “dry pin” values per Section 1.4.7.1.

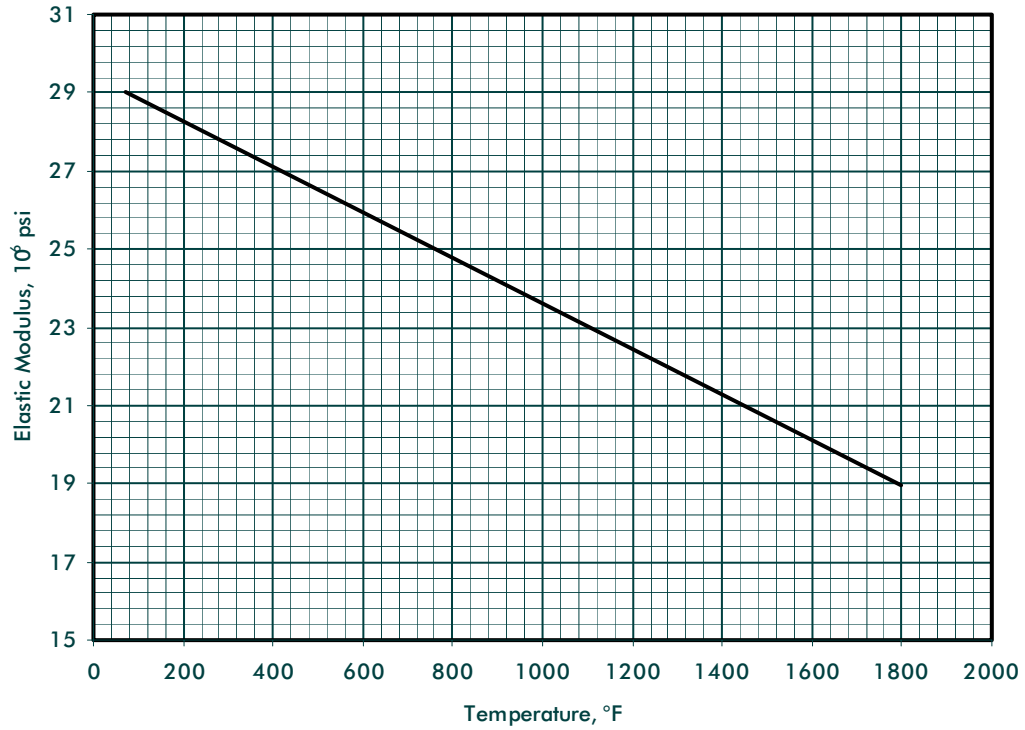

Figure 6.3.10.0(a). Effect of temperature on elastic modulus of HAYNES HR-120 alloy.

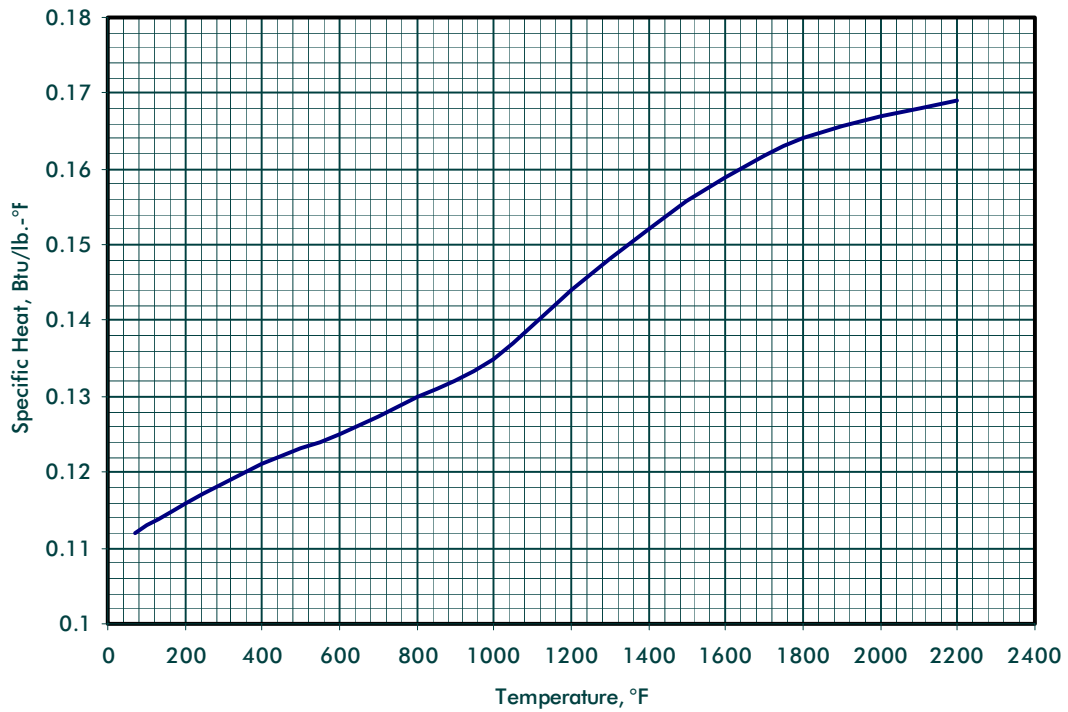

Figure 6.3.10.0(b). Effect of temperature on specific heat of HAYNES HR-120 alloy.

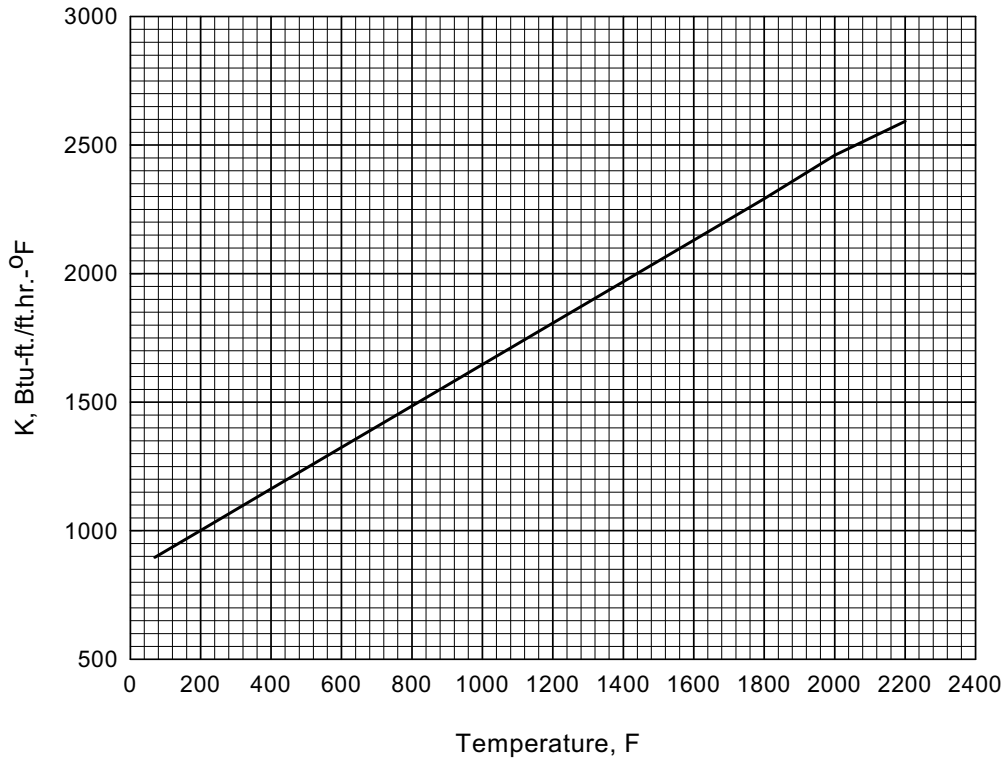

Figure 6.3.10.0(c). Effect of temperature on thermal conductivity of HAYNES HR-120 alloy.

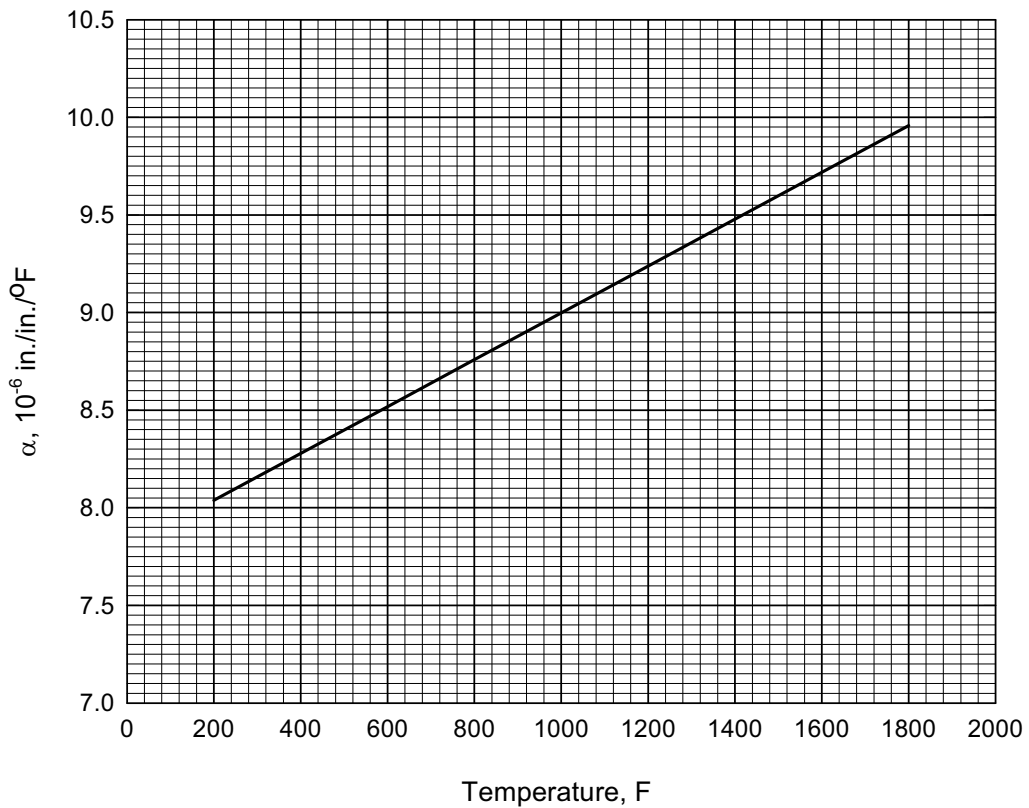

Figure 6.3.10.0(d). Effect of temperature on coefficient of thermal expansion of HAYNES HR-120 alloy.

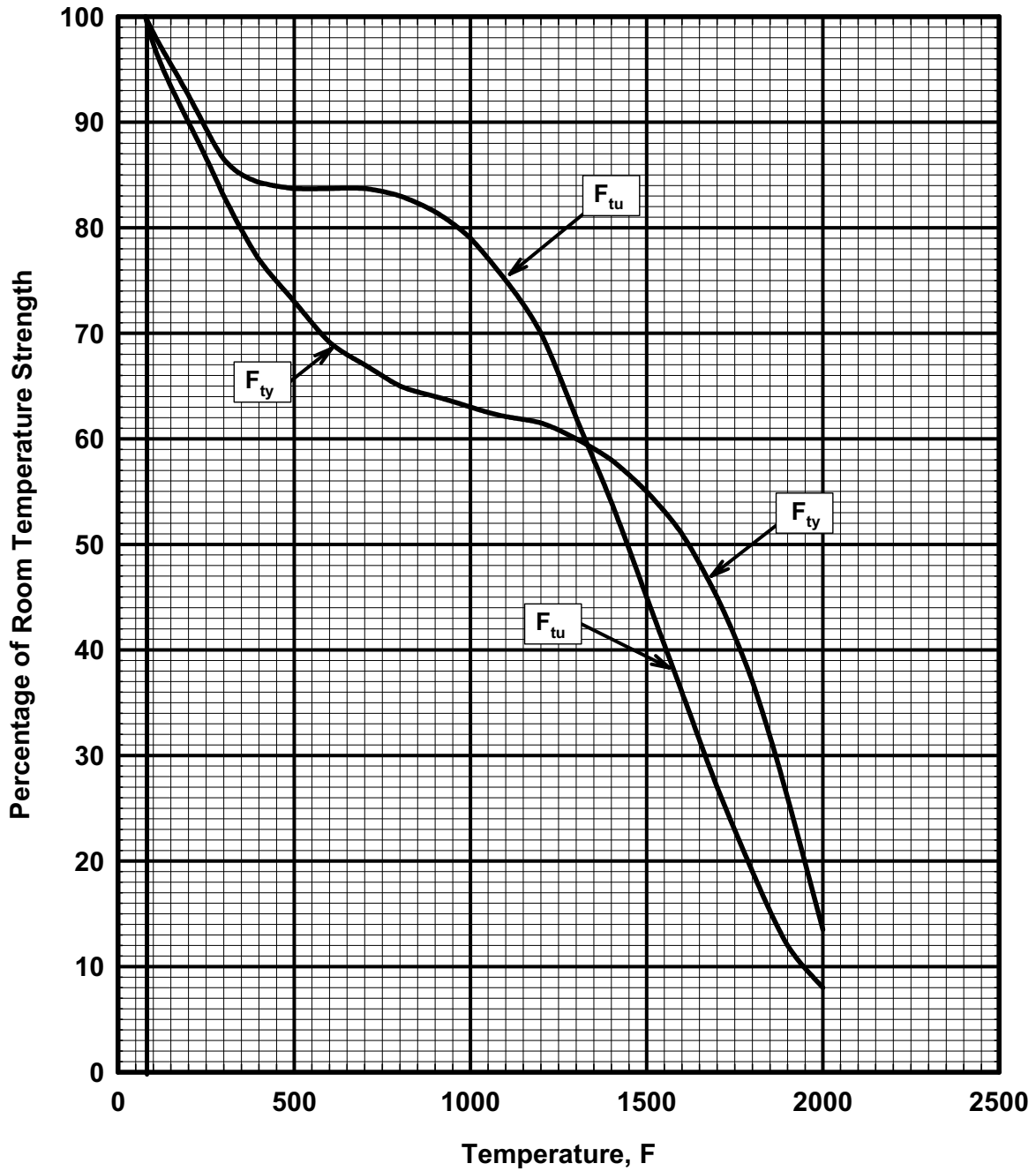

Figure 6.3.10.1.1(a). Effect of temperature on tensile properties of HAYNES HR-120 alloy.

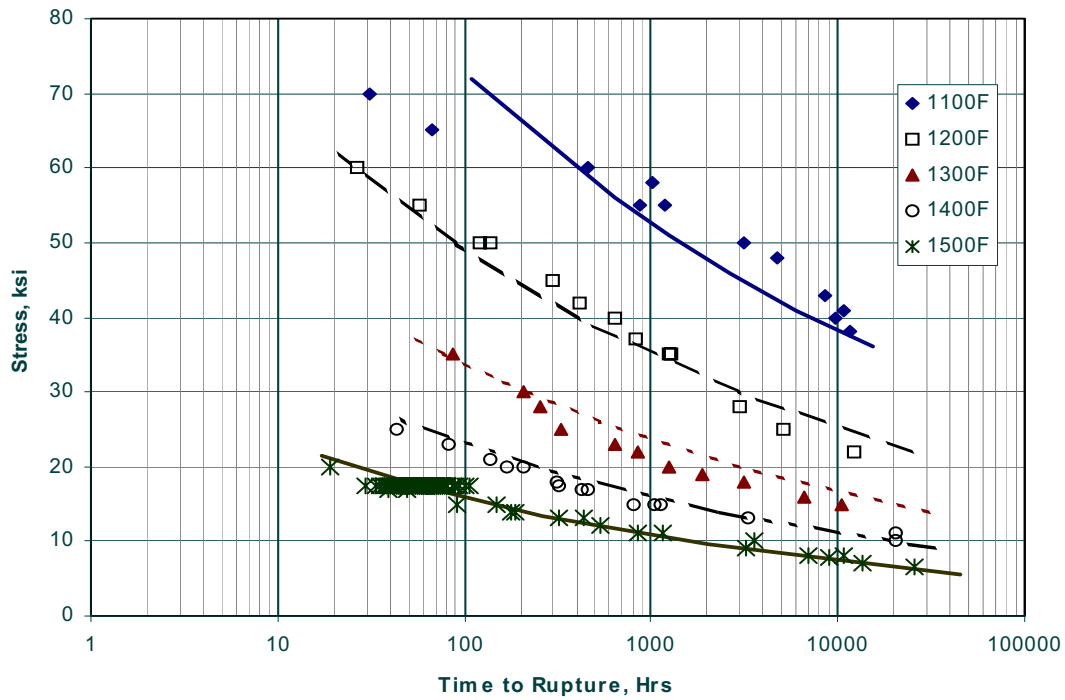

Figure 6.3.10.1.7(a). Average isothermal stress rupture curves for HAYNES HR-120 alloy for temperatures from 1100°F to 1500°F.

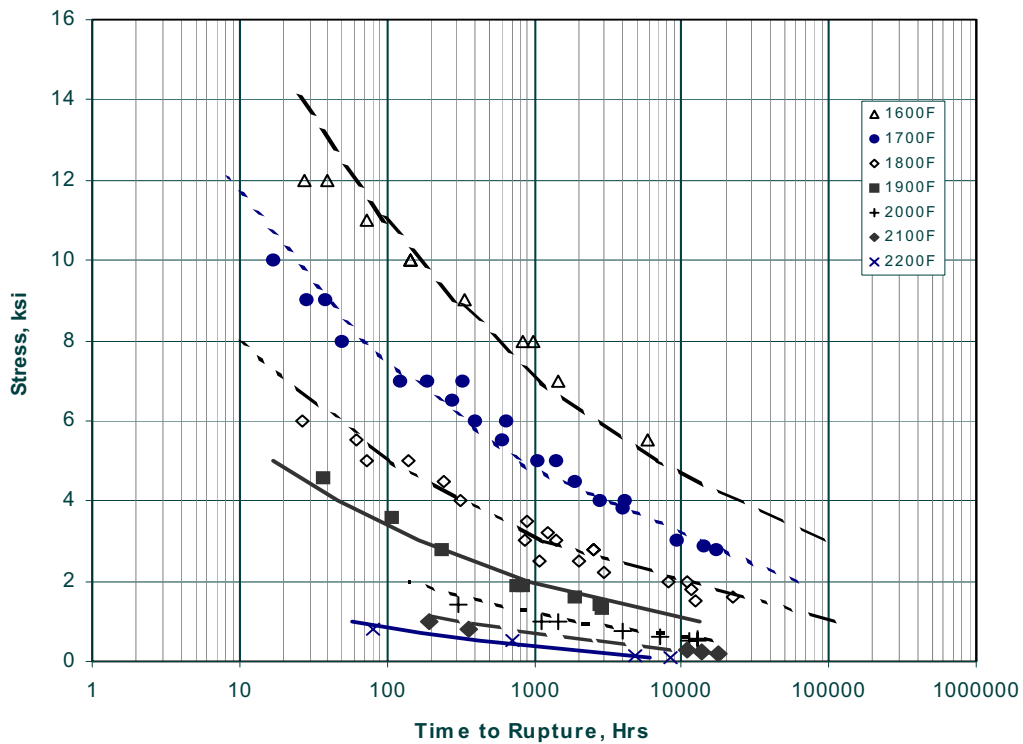

Figure 6.3.10.1.7(b). Average isothermal stress rupture curves for HAYNES HR-120 alloy for temperatures from 1600°F to 2200°F.

Corr
elativ

MIL-HDBK-5J
31 January 2003

e Information for Figures 6.3.10.1.7(a) and (b)

Makeup of Data Collection:

Heat Treatment: Annealed
Number of Vendors = 1
Number of Lots =
Number of Test Laboratories = 1
Number of Tests = 283

Specimen Details:

Type - ≤ 0.375 inch thick - Flat
 > 0.375 inch thick -
 0.25 inch rd reduced section
Adjusted Gage Length -
 2.6 inches for flat specimens
 1.35 inches for rd. specimens
Gage Thickness - 0.125" for flat specimens for
sheets with thickness of 0.125" or greater.
Sheet thickness for specimens from sheet with
thickness < 0.125 ".

Stress Rupture Equation:

$$\text{Log } t = c + b_1/T + b_2X/T + b_3X^2/T + b_4X^3/T$$

$T = \text{ }^\circ\text{R}$
 $X = \text{log (stress, ksi)}$
 $c = -16.671$
 $b_1 = 49,051$
 $b_2 = -8,375.3$
 $b_3 = -2,403.7$
 $b_4 = 619.59$

Analysis Details:

Standard Deviation = 0.598
Standard Error of Estimate = 0.155
Ratio of Between to Within Heat Treatment
Variance = < 0.10 (at spec pt.)
 $R^2 = 96.6\%$

[Caution: The stress rupture model may
provide unrealistic times to rupture for stresses
beyond those represented above.]

6.4 COBALT-BASE ALLOYS

6.4.0 GENERAL COMMENTS — The use of cobalt in wrought heat-resistant alloys is usually limited to additions of cobalt to alloys of other bases. Very few of the heat-resistant alloys can be considered as cobalt base, since cobalt is seldom the predominating element. For airframe applications, some workability is usually required; the alloys considered in this section are limited to those available in wrought form.

6.4.0.1 Metallurgical Considerations

Composition — The common alloying elements for cobalt are chromium, nickel, carbon, molybdenum, and tungsten. Chromium is added to increase strength and oxidation resistance at very high temperatures; nickel to increase toughness; carbon to increase the hardness and strength, especially when combined with chromium and the other carbide formers, molybdenum and tungsten; molybdenum and tungsten also contribute to solid-solution strengthening.

Vacuum melting is not required for these alloys. For this reason, the cobalt-base alloys are often competitively priced with vacuum-melted nickel-base alloys although the price of cobalt is higher than that of nickel.

Heat Treatment — The cobalt-base alloys are heat treated with conventional equipment and fixtures such as those used with austenitic stainless steels. The use of good heat-treating practices is recommended, although this is not so critical as in the case of the nickel-based alloys.

6.4.0.2 Manufacturing Considerations

Forging — Because these alloys are designed to have very high strength at temperatures near the forging range, they require the use of heavy forging equipment. However, the forgeability of these alloys is good over a fairly wide range of temperatures. Hot-cold working is neither required nor recommended for these alloys.

Cold Forming — These alloys, when in the solution-treated condition, have excellent ductility and are readily cold formed. Because of their capacity for work hardening, they require higher forming pressures and frequent anneals.

Machining — These alloys are tough and they work harden rapidly; consequently, heavy-duty vibration-free machine tools, sharp cutting tools (high-speed steel or carbide tipped), and low cutting speeds are required.

Welding — The weldability of the cobalt-base alloys is comparable with that of the austenitic stainless steels. Welding may be accomplished by all commonly used welding processes. Large or complex weldments require stress relief.

Brazing — These alloys can be brazed using the same techniques and precautions applicable to stainless steels and nickel-base alloys. Alloys which contain aluminum or titanium require extremely dry, inert gas atmospheres, very high vacuum or a thin (0.002 to 0.0010 inch thick) nickel plating to prevent surface oxidation. It is also necessary to braze the material in the annealed condition and to keep the stresses low during brazing to avoid embrittlement, especially when brazing with low melting alloys.

6.4.0.3 Special Precautions — If the cobalt-base alloys have not been exposed to neutron radiation, no special safety precautions in handling are required. However, neutron irradiation creates a very dangerous radioactive isotope, cobalt 60, which has a half life of about 5.2 years. Special precautions must be employed to protect personnel from the radioactive material.

6.4.1 L-605

6.4.1.0 Comments and Properties — L-605, also known as Haynes Alloy 25, is a corrosion and heat-resistant cobalt-base alloy used for moderately stressed parts operating between 1000 and 1900°F. Its applications include gas turbine blades and rotors, combustion chambers, and afterburner parts. L-605 is not hardenable except by cold working and is usually used in the annealed condition. It is available in all the usual mill forms.

L-605 forges moderately well between 1900°F and 2250°F. In the annealed condition, it has excellent formability at room temperature; severely formed parts should be annealed at 2225°F for 7 to 10 minutes. L-605 is difficult to machine. Its toughness and capacity for work hardening necessitate the use of sharp tools and low cutting speeds; high-speed steel or carbide cutting tools are recommended. L-605 can be fusion or resistance welded or brazed; large or complex fusion weldment should be stress relieved at 1300°F for 2 hours. This alloy has excellent oxidation resistance up to 1900°F.

Some material specifications for L-605 are shown in Table 6.4.1.0(a). Room-temperature mechanical and physical properties are shown in Table 6.4.1.0(b). The effect of temperature on physical properties is shown in Figure 6.4.1.0.

Table 6.4.1.0(a). Material Specifications for L-605

Specification	Form	Condition
AMS 5537	Sheet	Solution treated (annealed)
AMS 5759	Bar and forging	Solution treated (annealed)

6.4.1.1 Solution Treated Condition — Elevated temperature properties for this condition are shown in Figures 6.4.1.1.1 through 6.4.1.1.5. A creep nomograph is shown in Figure 6.4.1.1.7. Stress-rupture requirements at elevated temperatures are specified in material specifications. The appropriate specification should be consulted for detailed requirements.

Table 6.4.1.0(b). Design Mechanical and Physical Properties of L-605

Specification	AMS 5537			AMS 5759
	Sheet	Plate	Bar and forging	
Form	Solution treated			
Condition				
Thickness, in.	0.010-0.187	0.188-0.375	≤1.000	
Basis	A	B	S	S
Mechanical Properties:				
F_{tu} , ksi:				
L	126	131	...	125
LT	130	135	130	...
F_{ty} , ksi:				
L	57	62	...	45
LT	55 ^a	60	55	...
F_{cy} , ksi:				
L	41	45	...	42
LT	56	61
F_{su} , ksi	91	95	91	88
F_{bru} , ksi:				
(e/D = 1.5)	186	193	186	...
(e/D = 2.0)	232	241	232	...
F_{bry} , ksi:				
(e/D = 1.5)	88	96	88	...
(e/D = 2.0)	113	123	113	...
e , percent (S-basis):				
L	30
LT	^b	...	45	...
E , 10 ³ ksi	32.6			
E_c , 10 ³ ksi	32.6			
G , 10 ³ ksi	12.6			
μ	0.29			
Physical Properties:				
ω , lb/in. ³	0.330			
C , Btu/(lb)(°F)	0.090 (70-212°F)			
C , K , and α	See Figure 6.4.1.0			

a S-basis. The rounded T_{99} value: $F_{ty} = 56$ ksi.
b 30 - ≤0.020; 35 - 0.021 to 0.032; 40 - 0.033 to 0.043; 45 - ≥0.043.

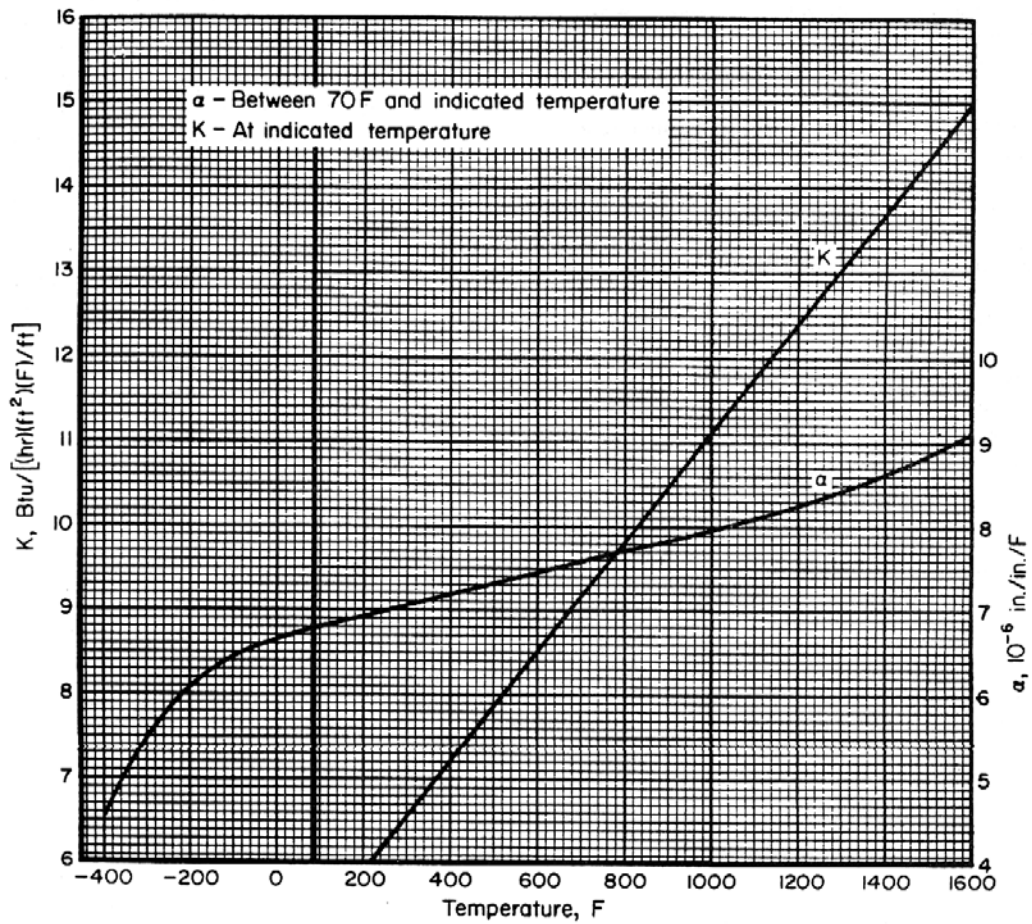

Figure 6.4.1.0. Effect of temperature on the physical properties of L-605.

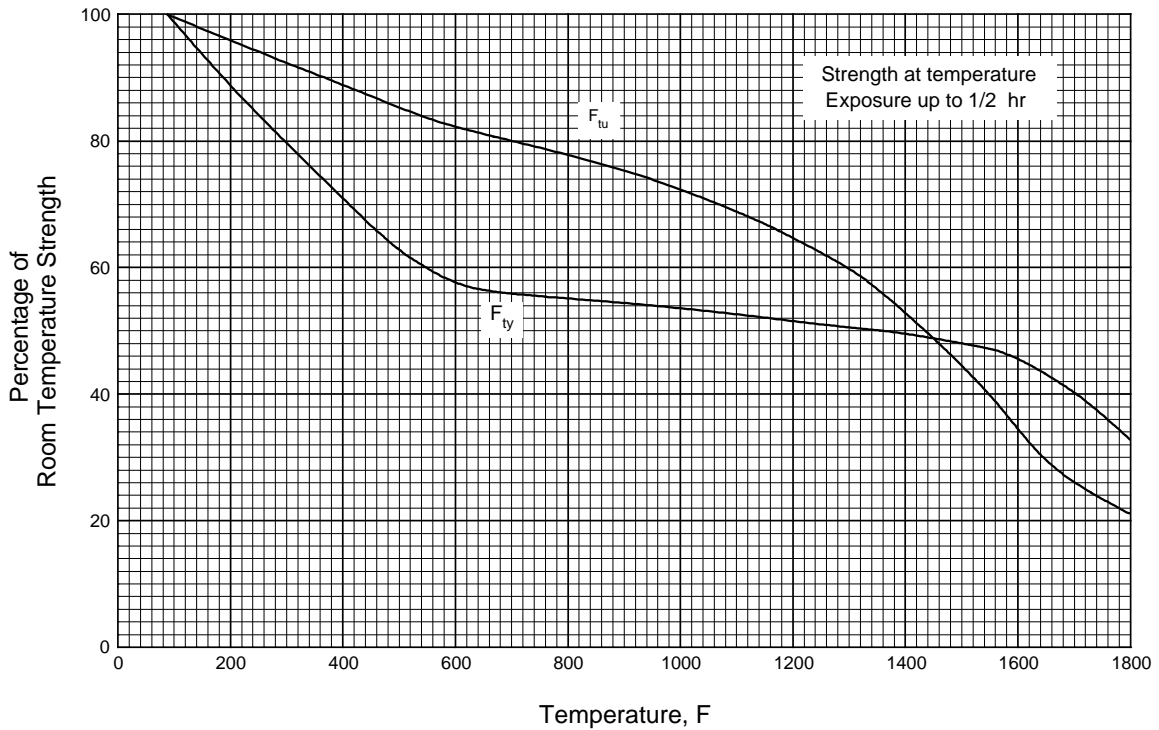

Figure 6.4.1.1.1. Effect of temperature on the tensile ultimate strength (F_{tu}) and the tensile yield strength (F_{ty}) of L-605.

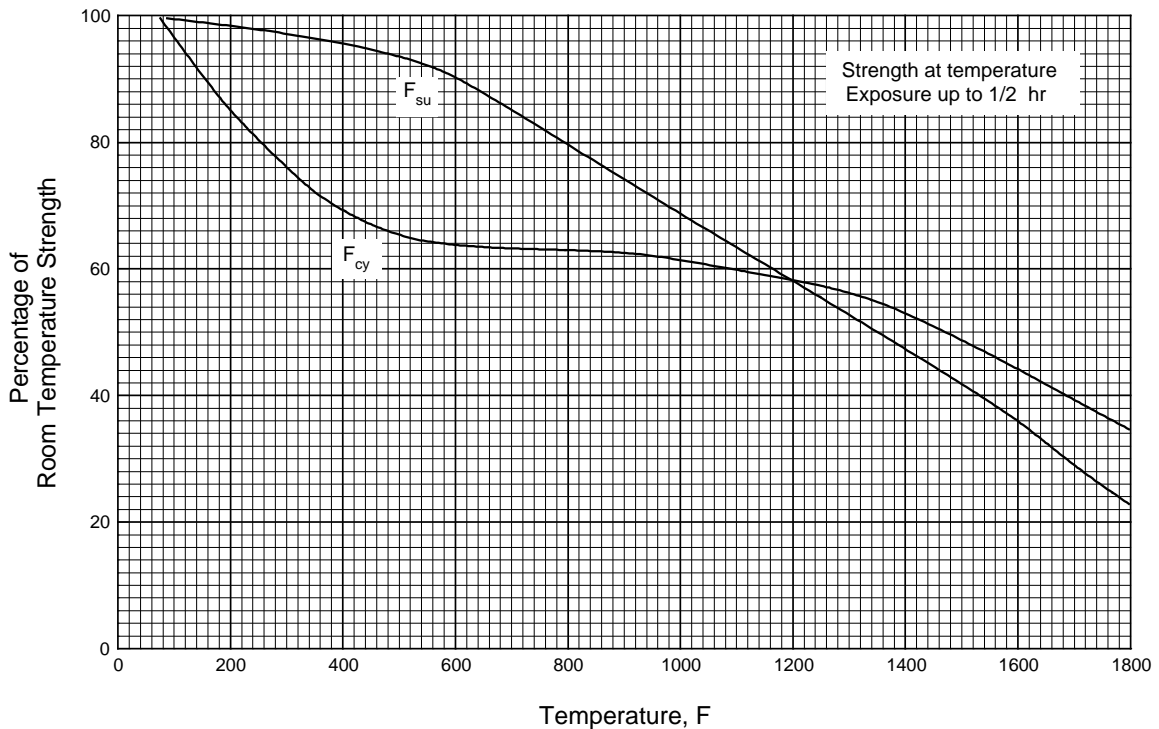

Figure 6.4.1.1.2. Effect of temperature on the compressive yield strength (F_{cy}) and the shear ultimate strength (F_{su}) of L-605.

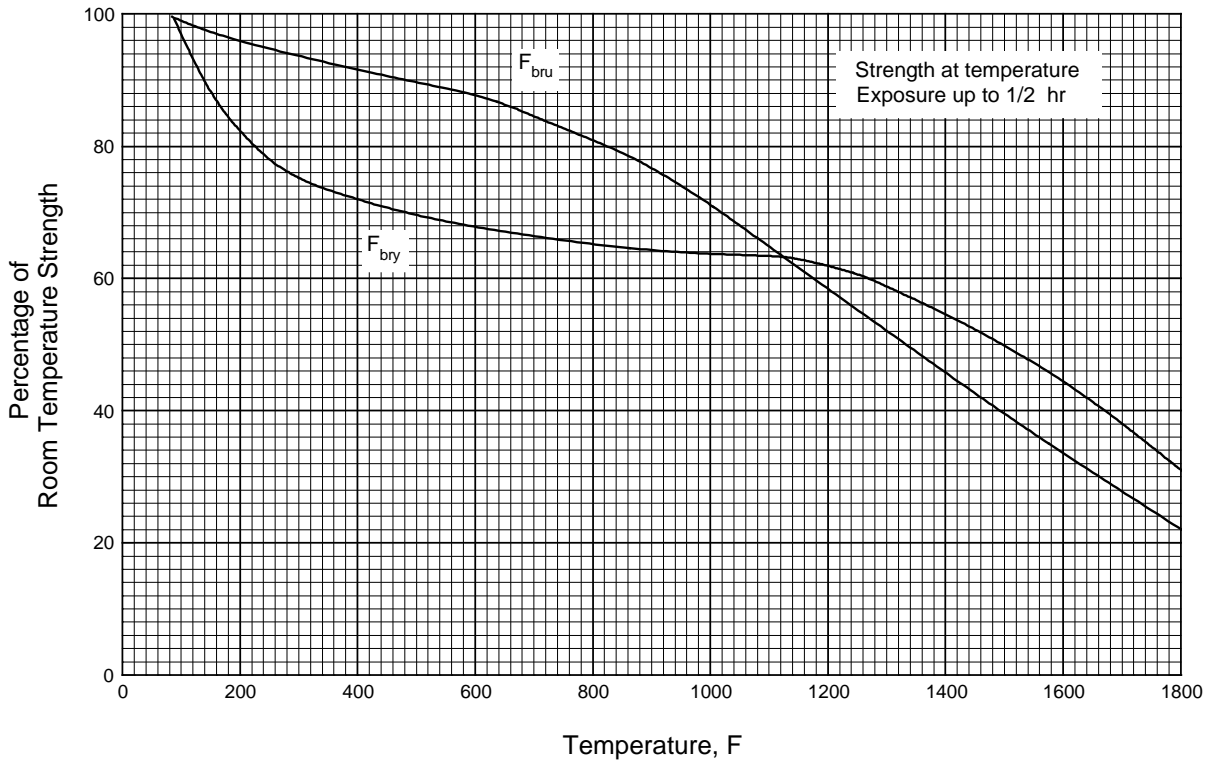

Figure 6.4.1.1.3. Effect of temperature on the bearing ultimate strength (F_{bru}) and the bearing yield strength (F_{bry}) of L-605 sheet.

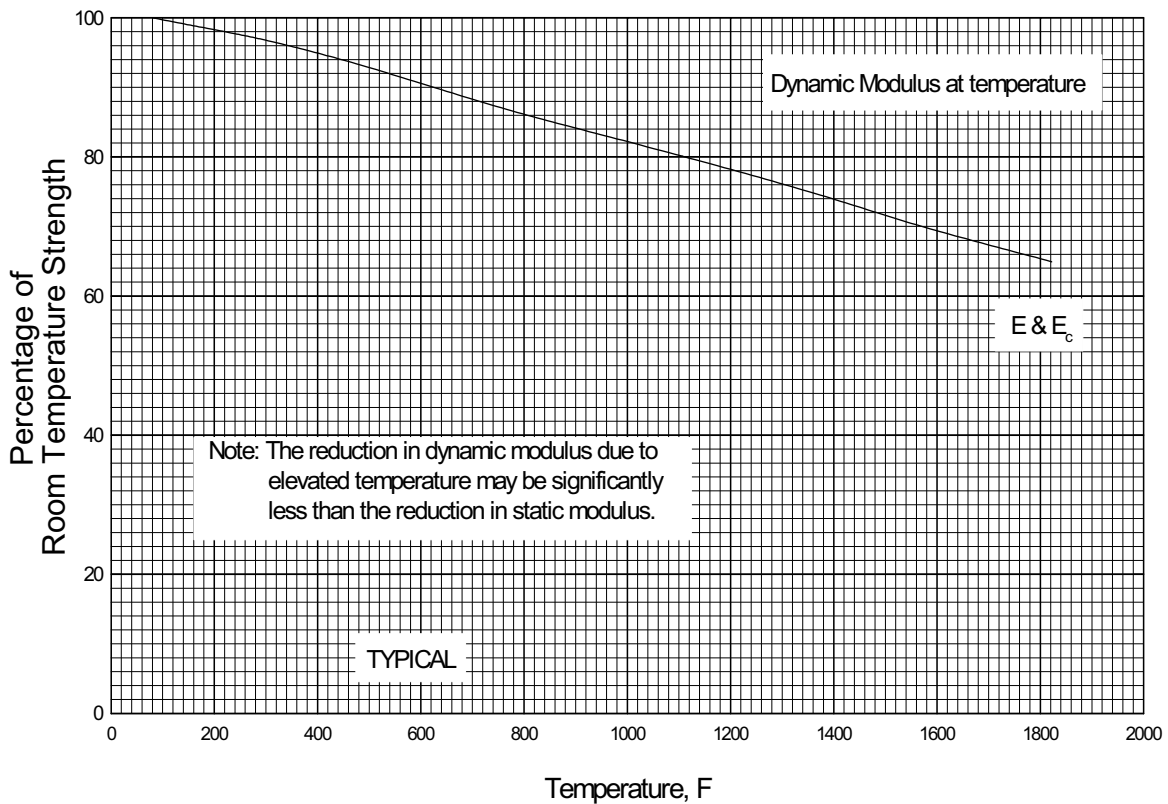

Figure 6.4.1.1.4(a). Effect of temperature on dynamic moduli (E and E_c) of L-605 sheet.

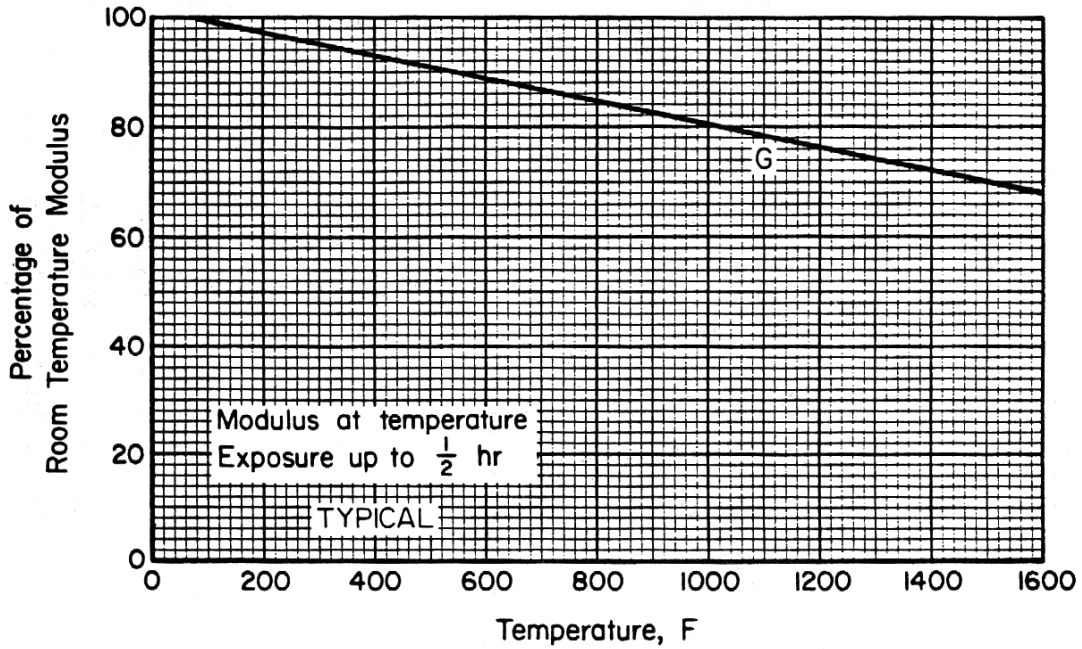

Figure 6.4.1.1.4(b). Effect of temperature on the shear modulus (G) of L-605 sheet.

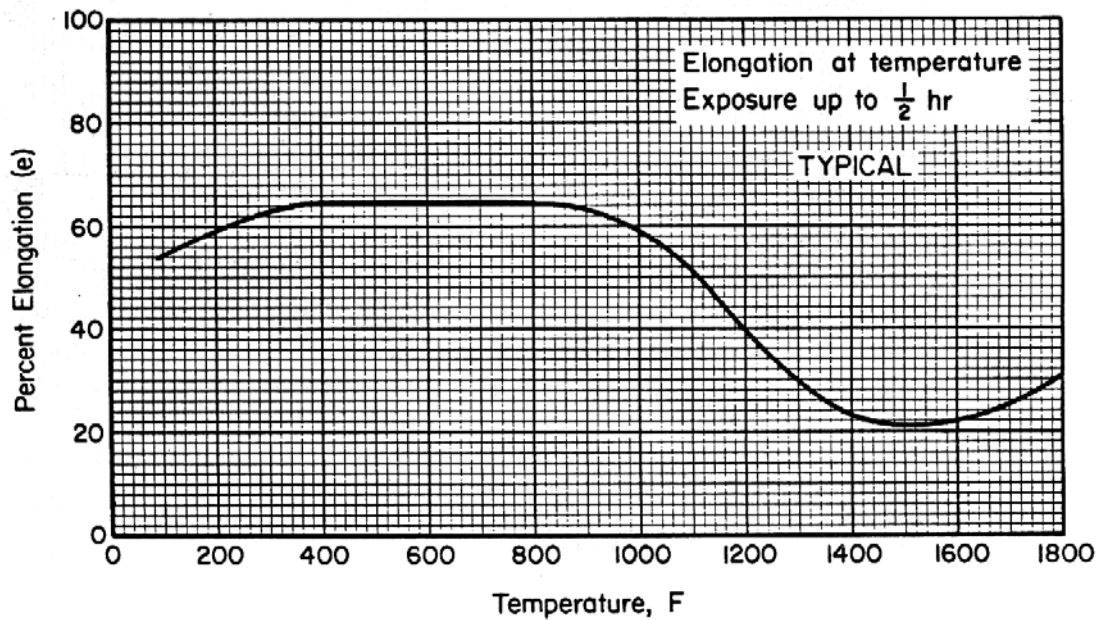

Figure 6.4.1.1.5. Effect of temperature on the elongation (e) of L-605 (>0.020 thickness) sheet.

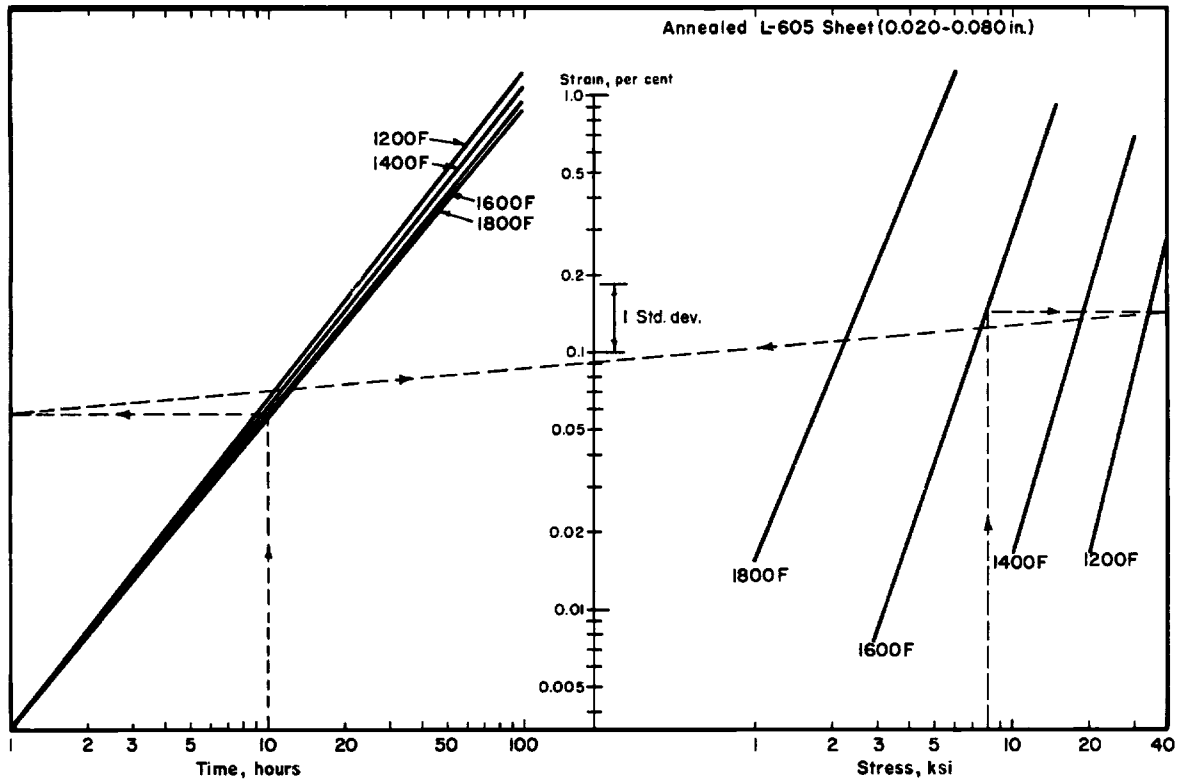

Figure 6.4.1.1.7. Typical creep properties of L-605 sheet.

Correlative Information for Figure 6.4.1.1.7

Equation
Creep Strain, percent:

$$\epsilon = \left(3.516 \times 10^8 \exp\left(-\frac{56040}{T}\right) \right) \left(\sigma^{0.2791 \exp\left(\frac{3943}{T}\right)} \right) \left(t^{0.4172 \exp\left(\frac{413.4}{T}\right)} \right)^a$$

Temperature (T) = Fahrenheit + 460

Example

Temp., T = 1600°F
Stress, σ = 8 ksi
Time, t = 10 hours
Creep Strain, ϵ = 0.091

a This equation should only be used in the same temperature ranges indicated in the nomograph. Creep strains computed outside these temperature ranges may yield unreasonable values.

6.4.2 HS 188

6.4.2.0 Comments and Properties — HS 188 is a corrosion- and heat-resistant cobalt-base alloy used for moderately stressed parts up to 2100°F. The alloy exhibits outstanding oxidation resistance up to 2100°F resulting from the addition of minute amounts of lanthanum to the alloy system. The alloy exhibits excellent post-aged ductility after prolonged heating of 1000 hours at temperatures up to 1600°F inclusive.

HS 188 is not hardenable except by cold working and is used in the solution-treated condition. The alloy can be forged and welded. Welding can be accomplished by both manual and automatic welding methods including electron beam, gas tungsten air, and resistance welding. Like other cobalt base alloys, machining is difficult necessitating the use of sharp tools and low cutting speeds; high speed steel or carbide cutting tools are recommended. Gas turbine applications include transition ducts, combustion cans, spray bars, flame--holders, and liners.

Material specifications for HS 188 are presented in Table 6.4.2.0(a). Room-temperature mechanical and physical properties are shown in Table 6.4.2.0(b). The effect of temperature on physical properties is shown in Figure 6.4.2.0.

Table 6.4.2.0(a). Material Specifications for HS 188

Specification	Form	Condition
AMS 5608	Sheet and plate	Solution treated (annealed)
AMS 5772	Bar and forging	Solution treated (annealed)

6.4.2.1 Solution-Treated Condition — Elevated-temperature properties are presented in Figures 6.4.2.1.1(a) and (b), 6.4.2.1.2, 6.4.2.1.4(a) through (c), and 6.4.2.1.5. Typical tensile stress-strain curves at room temperature are presented in Figure 6.4.2.1.6(a). Typical compressive stress-strain and tangent-modulus curves at room and elevated temperatures are presented in Figure 6.4.2.1.6(b). Strain control fatigue data for bar are presented in Figures 6.4.2.1.8(a) through (d).

Table 6.4.2.0(b). Design Mechanical and Physical Properties of HS 188 Sheet

Specification	AMS 5608	
Form	Sheet	
Condition	Solution Treated	
Thickness, in.	<0.020	0.020-0.187
Basis	S	S
Mechanical Properties:		
F_{tu} , ksi:		
L	125	125
LT	125	125
F_{ty} , ksi:		
L	57	57
LT	55	55
F_{cy} , ksi:		
L
LT	55	55
F_{su} , ksi	111	111
F_{bru} , ksi:		
($e/D = 1.5$)
($e/D = 2.0$)
F_{bry} , ksi:		
($e/D = 1.5$)
($e/D = 2.0$)
e , percent:		
LT	40	45
E , 10^3 ksi	33.6	
E_c , 10^3 ksi	33.6	
G , 10^3 ksi	12.8	
μ	0.31	
Physical Properties:		
ω , lb/in. ³	0.324	
C , K , and α	See Figure 6.4.2.0	

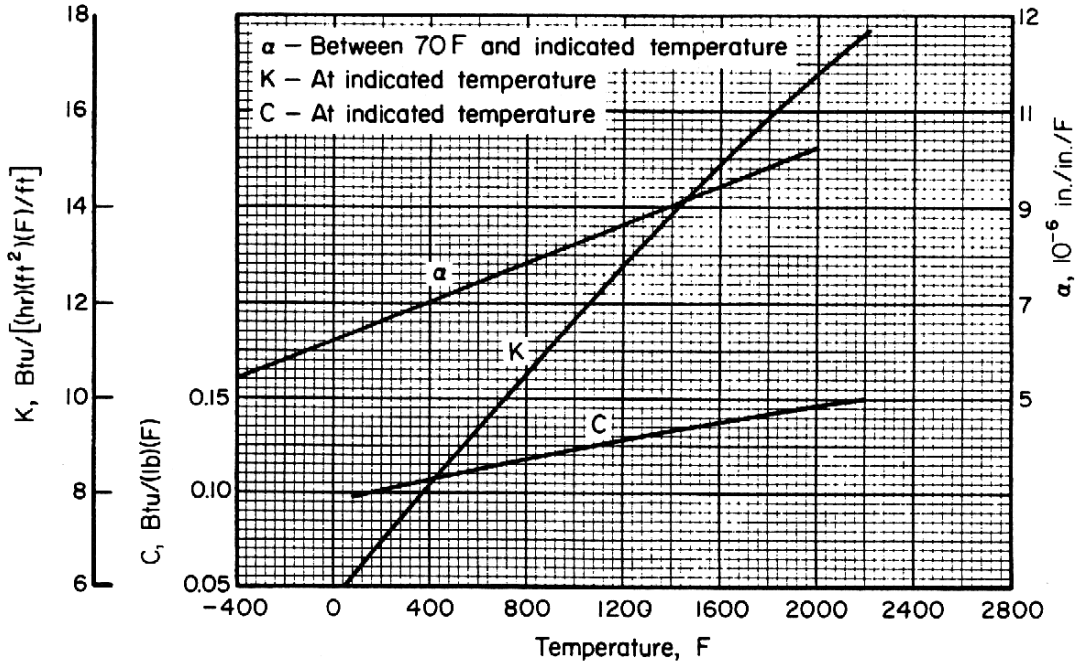

Figure 6.4.2.0. Effect of temperature on the physical properties of HS 188.

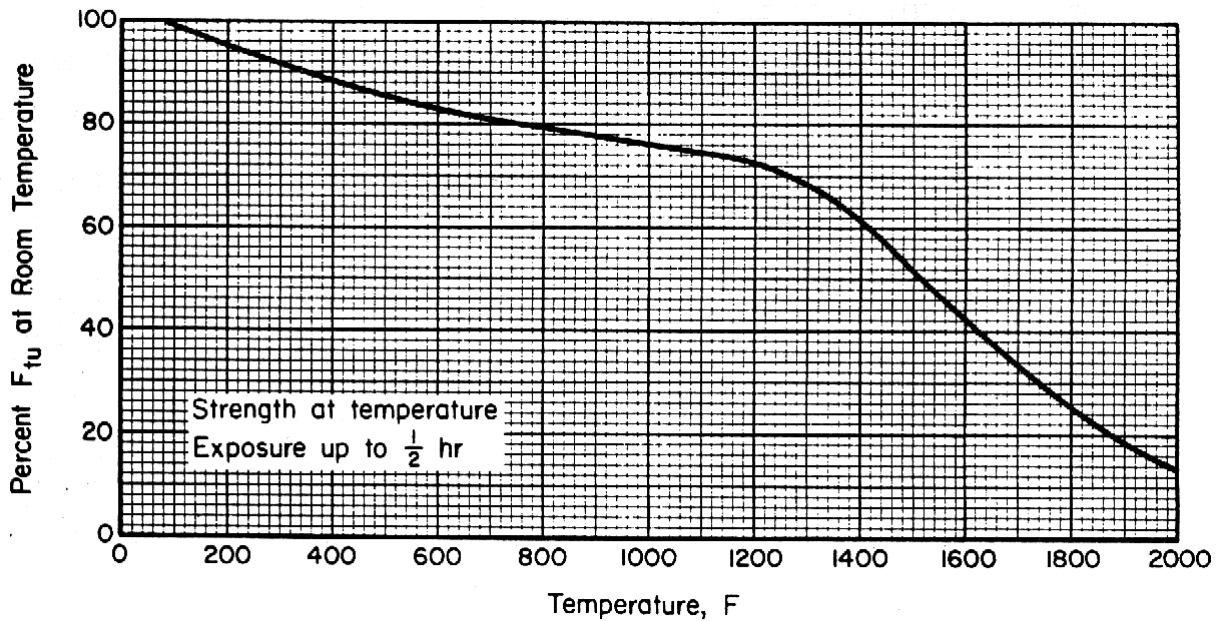

Figure 6.4.2.1.1(a). Effect of temperature on tensile ultimate strength (F_{tu}) of HS 188 sheet.

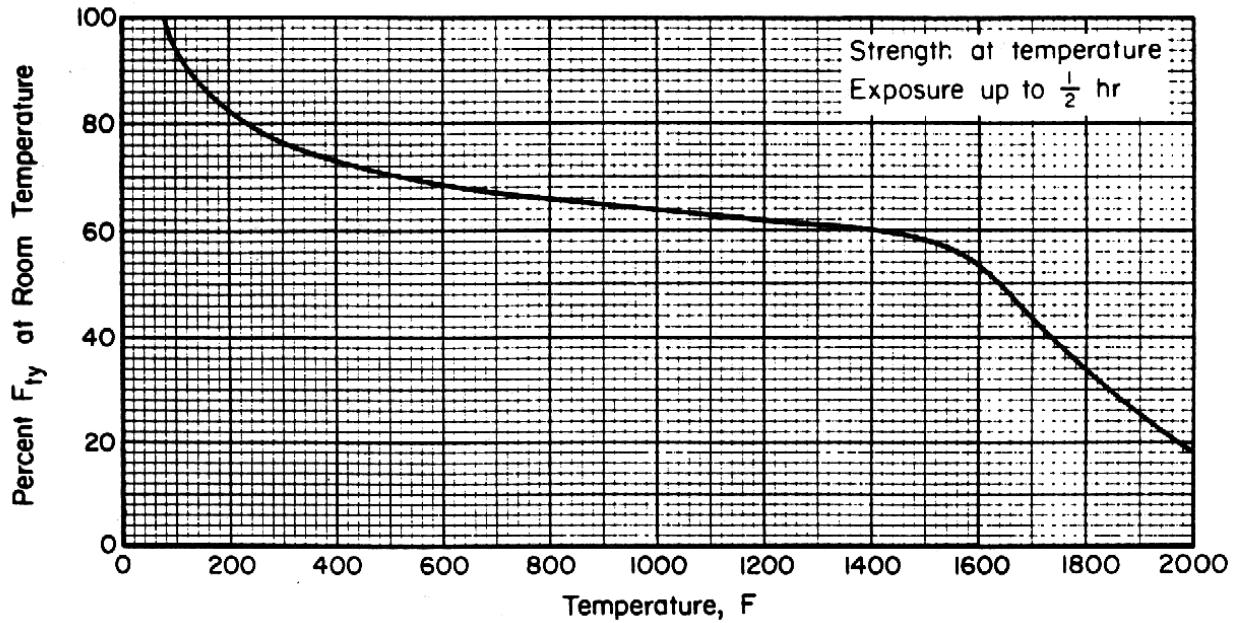

Figure 6.4.2.1.1(b). Effect of temperature on tensile yield strength (F_{ty}) of HS 188 sheet.

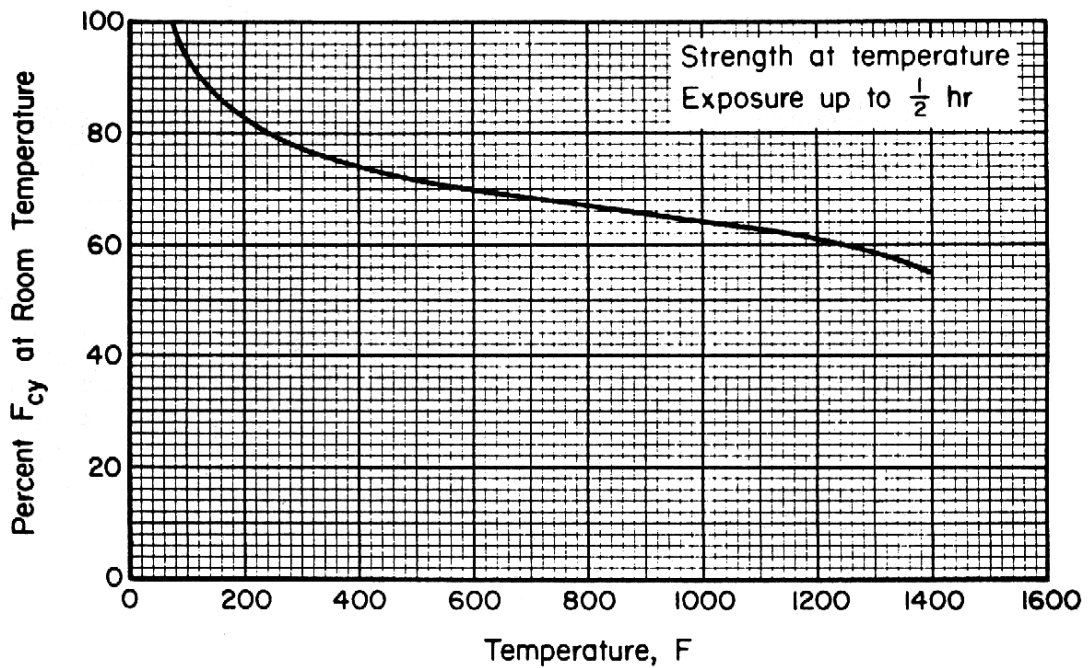

Figure 6.4.2.1.2. Effect of temperature on compressive yield strength (F_{cy}) of HS 188 sheet.

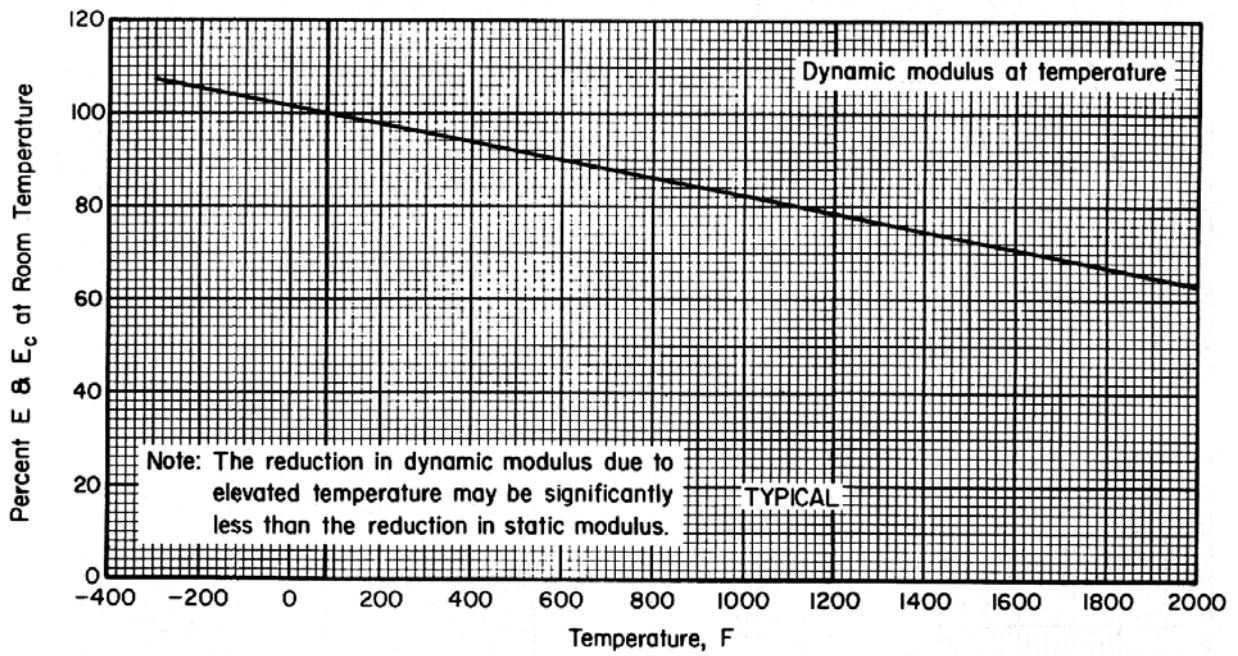

Figure 6.4.2.1.4(a). Effect of temperature on dynamic moduli (E and E_c) of HS 188.

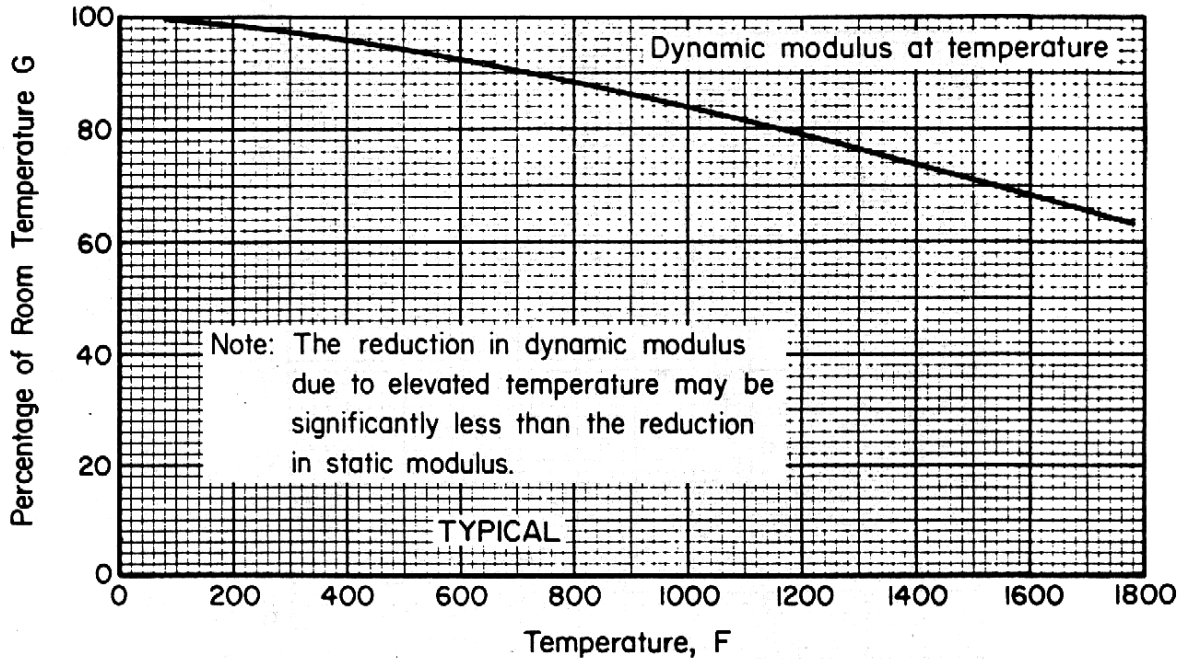

Figure 6.4.2.1.4(b). Effect of temperature on dynamic shear modulus (G) for HS 188.

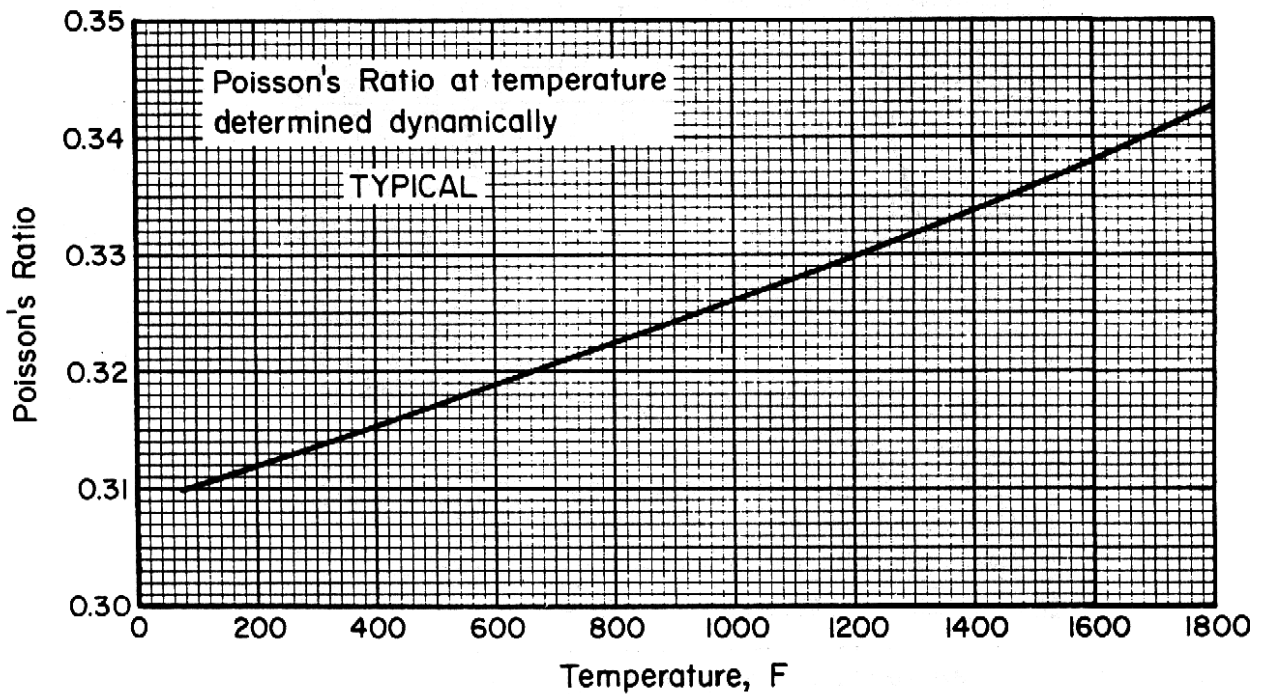

Figure 6.4.2.1.4(c). Effect of temperature on Poisson's ratio (μ) for HS 188.

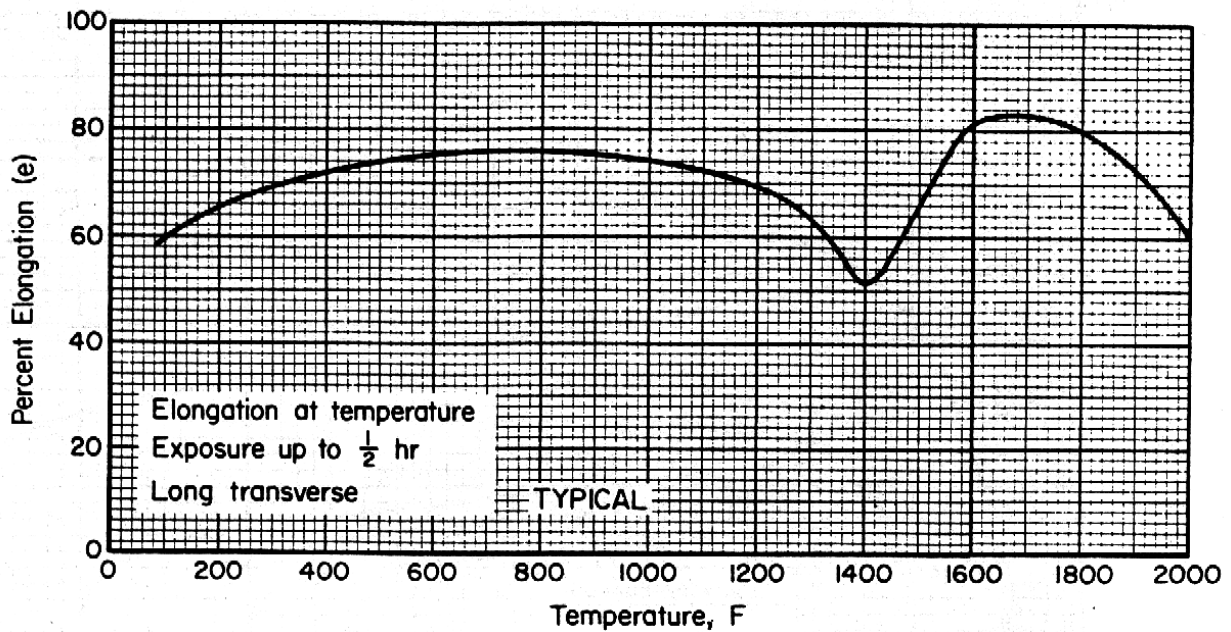

Figure 6.4.2.1.5. Effect of temperature on elongation (e) of HS 188 sheet.

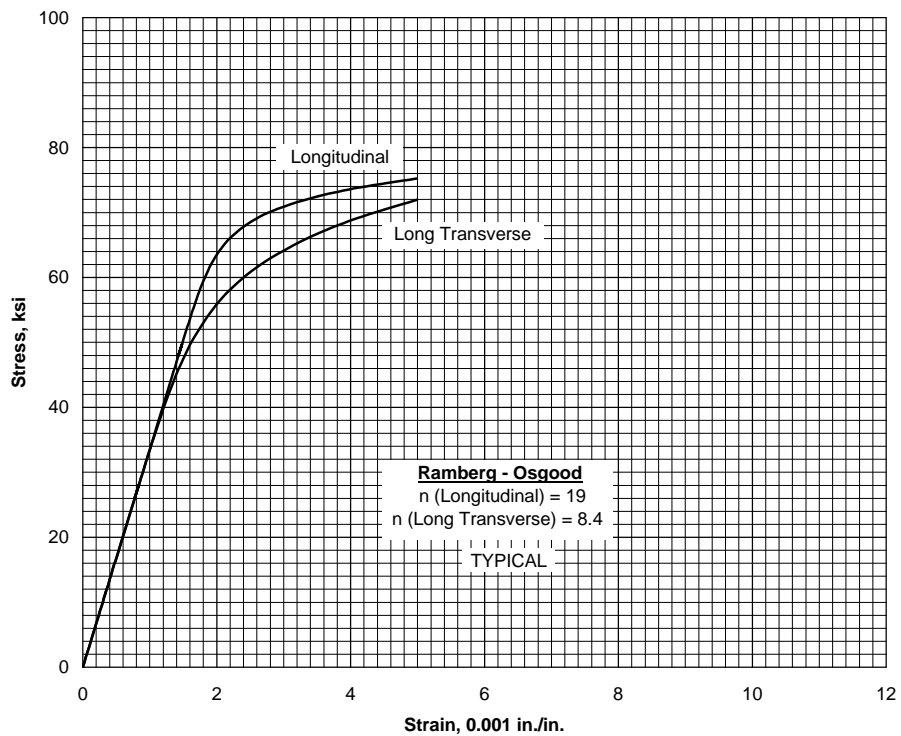

Figure 6.4.2.1.6(a). Typical tensile stress-strain curves for HS 188 sheet at room temperature.

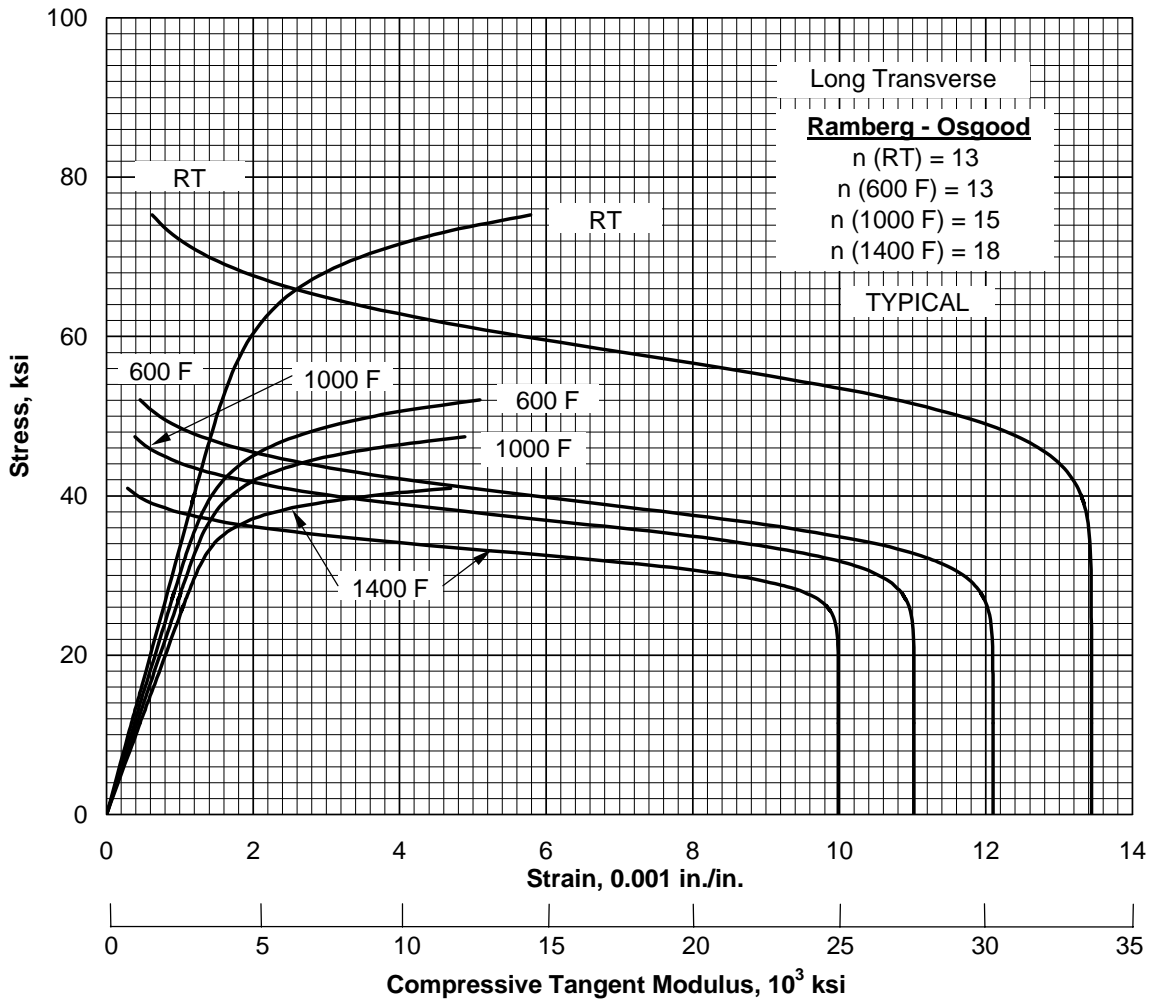

Figure 6.4.2.1.6(b). Typical compressive stress-strain and compressive tangent-modulus curves for HS 188 sheet at various temperatures.

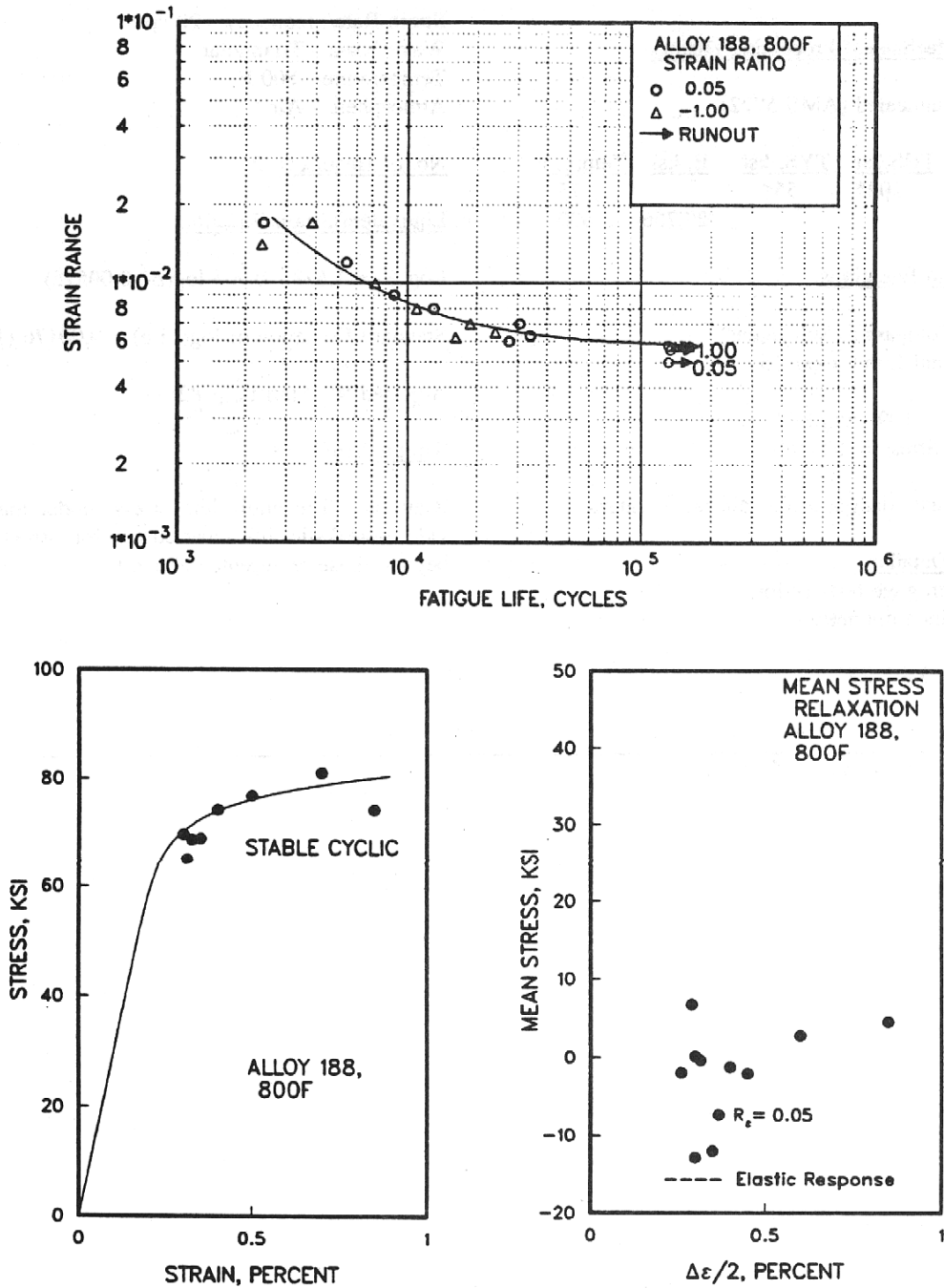

Figure 6.4.2.1.8(a). Best-fit ϵ/N curve, cyclic stress-strain curve, and mean stress relaxation curve for HS 188 bar, longitudinal orientation at 800°F.

MIL-HDBK-5J
31 January 2003

Correlative Information for Figure 6.4.2.1.8(a)

Product Form/Thickness: Bar, 0.5 inch thick
diameter

Thermal Mechanical Processing History:
Solution annealed (AMS 5772)

Properties:

<u>TUS, ksi</u>	<u>TYS, ksi</u>	<u>E, ksi</u>	<u>Temp., °F</u>
102*	55*	29,766	800

Stress-Strain Equations:

Cyclic (Companion Specimens)
Proportional Limit = 60 ksi

$$(\Delta\sigma/2) = 109 (\Delta\varepsilon_p/2)^{0.06}$$

Mean Stress Relaxation

Inadequate data at low strain range values

Specimen Details: Uniform gage test section
0.250 inch diameter

Reference: 3.8.1.1.8

Test Parameters:

Strain Rate/Frequency - 20 cpm
Wave Form - Triangular
Temperature - 800 °F
Atmosphere - Air

No. of Heats/Lots: 2

Equivalent Strain Equation:

Log $N_f = 1.678 - 0.905 \log (\Delta\varepsilon - 0.00572)$
Std. Error of Est., Log (Life) = 0.00176 ($1/\varepsilon_{cq}$)
Standard Deviation, Log (Life) = 0.65
 $R^2 = 82\%$

Sample Size: 18

[Caution: The equivalent strain model may provide unrealistic life predictions for strain ratios and ranges beyond those represented above.]

* Minimum values from AMS 5772.

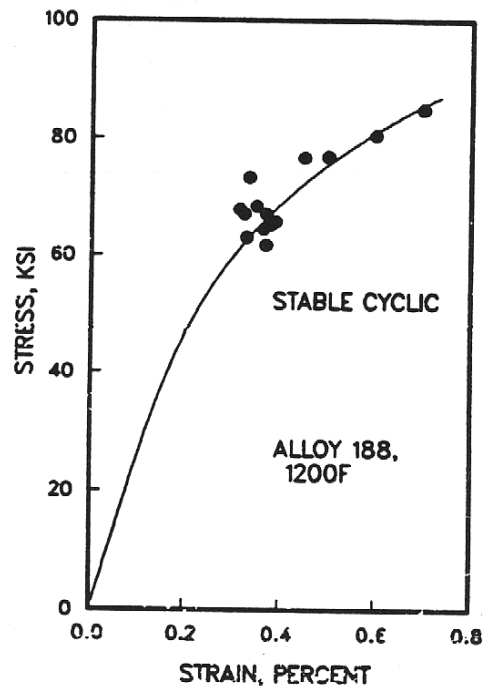
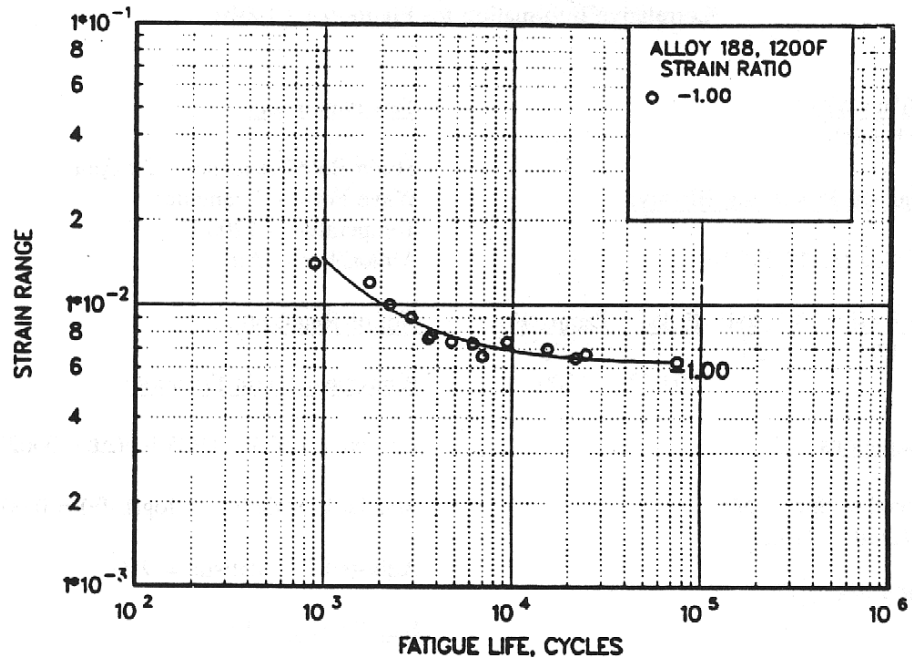

Figure 6.4.2.1.8(b). Best-fit ϵ/N curve and cyclic stress-strain curve for HS 188 bar, longitudinal orientation at 1200°F.

MIL-HDBK-5J
31 January 2003

Correlative Information for Figure 6.4.2.1.8(b)

Product Form/Thickness: Bar, 1.5 inch thick

Thermal Mechanical Processing History:
Solution annealed (AMS 5772)

Properties:

<u>TUS, ksi</u>	<u>TYS, ksi</u>	<u>E, ksi</u>	<u>Temp., °F</u>
120*	55*	20,050	75 1200

Stress-Strain Equations:

Cyclic (Companion Specimens)
Proportional Limit = 45 ksi

$$(\Delta\sigma/2) = 293 (\Delta\epsilon_p/2)^{0.22}$$

Specimen Details: Uniform gage test section
0.250 inch diameter

Reference: 3.8.1.1.8

Test Parameters:

Strain Rate/Frequency - 20 cpm
Wave Form - Triangular
Temperature - 1200°F
Atmosphere - Air

No. of Heats/Lots: 1

Equivalent Strain Equation:

$\log N_f = 1.073 - 0.925 \log (\Delta\epsilon - 0.00622)$
Std. Error of Est., $\log (\text{Life}) = 0.00134 (1/\epsilon_{eq})$
Standard Deviation, $\log(\text{Life}) = 0.61$
 $R^2 = 91\%$

Sample Size: 14

[Caution: The equivalent strain model may provide unrealistic life predictions for strain ratios and ranges beyond those represented above.]

* Minimum values from AMS 5772.

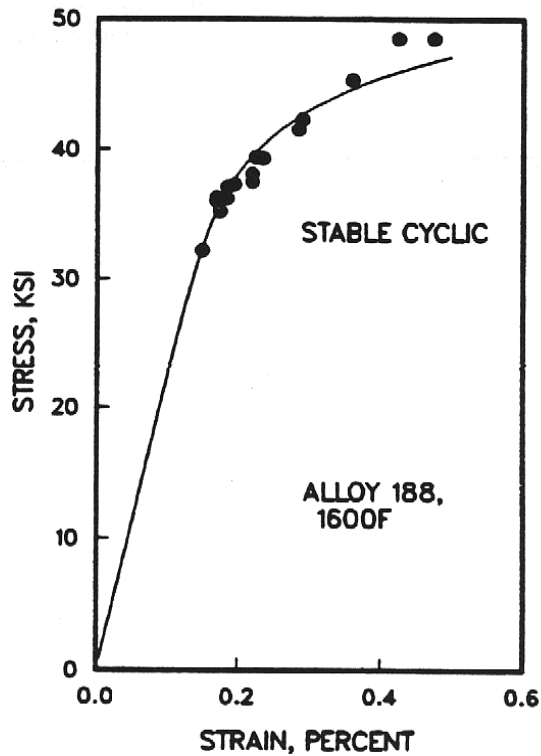
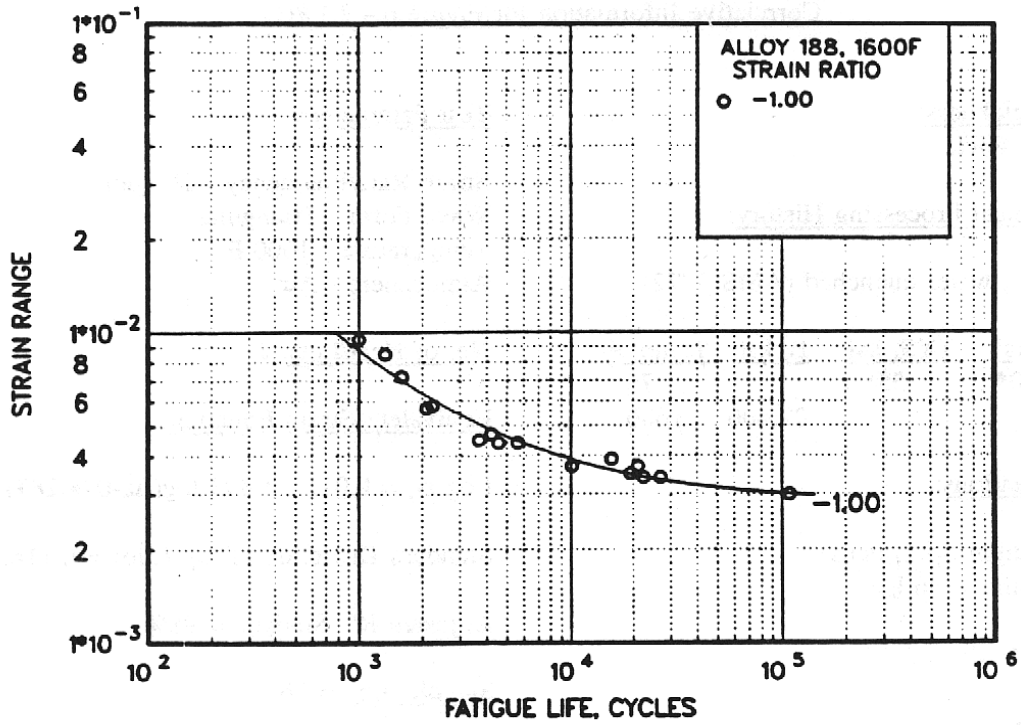

Figure 6.4.2.1.8(c). Best-fit ϵ/N curve and cyclic stress-strain curve for HS 188 bar, longitudinal orientation at 1600°F.

MIL-HDBK-5J
31 January 2003

Correlative Information for Figure 6.4.2.1.8(c)

Product Form/Thickness: Bar, 1.5 inch thick

Thermal Mechanical Processing History:

Solution treated, water quenched (AMS 5772)

Properties:

<u>TUS, ksi</u>	<u>TYS, ksi</u>	<u>E, ksi</u>	<u>Temp., °F</u>
120*	55*	22,406	75
			1600

Stress-Strain Equations:

Cyclic (Companion Specimens)

Proportional Limit = 36 ksi

$$(\Delta\sigma/2) = 81.6 (\Delta\epsilon_p/2)^{0.094}$$

Specimen Details: Uniform gage test section
0.250 inch diameter

Reference: 3.8.1.1.8

Test Parameters:

Strain Rate/Frequency - 20 cpm

Wave Form - Triangular

Temperature - 1600°F

Atmosphere - Air

No. of Heats/Lots: 1

Equivalent Strain Equation:

$\log N_f = 0.011 - 1.343 \log (\Delta\epsilon - 0.00283)$

Std. Error of Estimate, Log (Life) = 0.116

Standard Deviation, Log(Life) = 0.582

$R^2 = 96\%$

Sample Size: 16

[Caution: The equivalent strain model may provide unrealistic life predictions for strain ratios and ranges beyond those represented above.]

* Minimum values from AMS 5772.

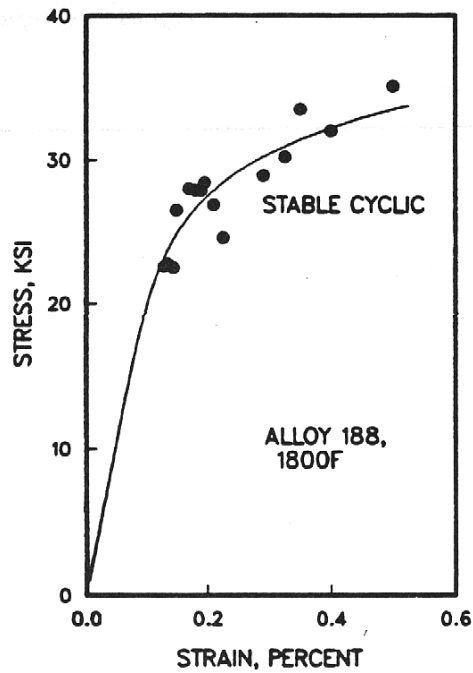
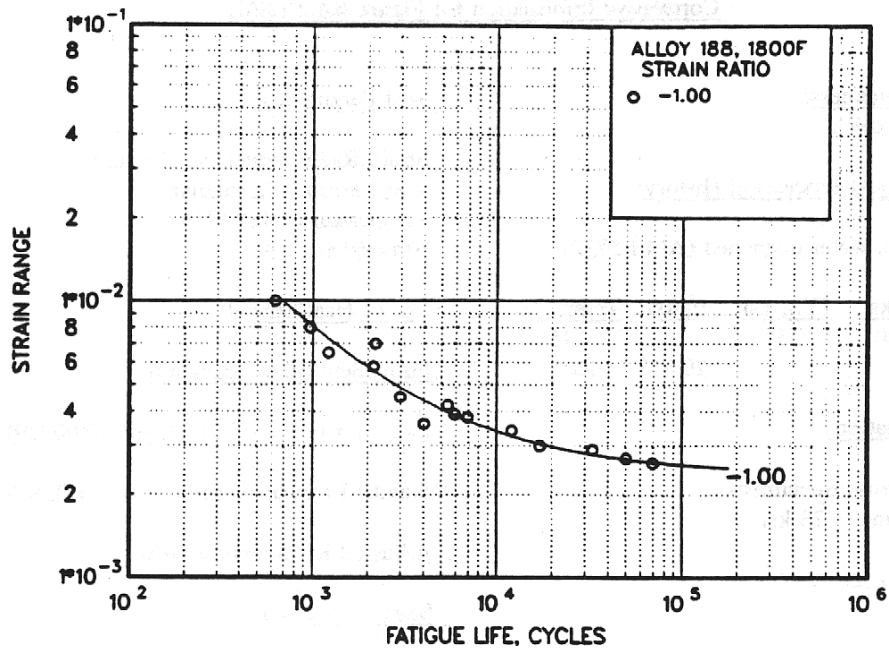

Figure 6.4.2.1.8(d). Best-fit ϵ/N curve and cyclic stress-strain curve for HS 188 bar, longitudinal orientation at 1800°F.

MIL-HDBK-5J
31 January 2003

Correlative Information for Figure 6.4.2.1.8(d)

Product Form/Thickness: Bar, 1.5 inch thick

Thermal Mechanical Processing History:

Solution treated, water quenched (AMS 5772)

Properties:

<u>TUS, ksi</u>	<u>TYS, ksi</u>	<u>E, ksi</u>	<u>Temp., °F</u>
120*	55*	20,353	75 1800

Stress-Strain Equations:

Cyclic (Companion Specimens)

Proportional Limit = 23 ksi

$$(\Delta\sigma/2) = 66.3 (\Delta\varepsilon_p/2)^{0.12}$$

Specimen Details: Uniform gage test section
0.250 inch diameter

Reference: 3.8.1.1.8

Test Parameters:

Strain Rate/Frequency - 20 cpm

Wave Form - Triangular

Temperature - 1800°F

Atmosphere - Air

No. of Heats/Lots: 1

Equivalent Strain Equation:

$$\text{Log } N_f = 0.047 - 1.317 \log (\Delta\varepsilon - 0.00239)$$

Std. Error of Estimate, Log (Life) = 0.0126

Standard Deviation, Log(Life) = 0.063

$$R^2 = 96\%$$

Sample Size: 15

[Caution: The equivalent strain model may provide unrealistic life predictions for strain ratios and ranges beyond those represented above.]

* Minimum values from AMS 5772.

REFERENCES

- 6.1.1.1 “Cryogenic Materials Data Handbook,” Air Force Materials Laboratory, Wright-Patterson Air Force Base, Ohio, AFML-TDR-64-280, 1970.
- 6.2.1.1.8 Blatherwick, A. A. and Cers, A., “Fatigue, Creep and Stress-Rupture Properties of Nicrotung, Super A-286, and Inconel 718”, AFML-TR-65-4447 (June 1966) (MCIC 65927).
- 6.3.3.1.8(a) Ruff, P. E., “Effect of Manufacturing Processes on Structural Allowables—Phase II”, AFWAL-TR-86-4120, Battelle (November 1986) (MIL-HDBK-5 Source M-656).
- 6.3.3.1.8(b) Deel, O. L., and Mindlin, H., “Engineering Data on New Aerospace Structural Materials”, AFML-TR-71-249, Battelle (December 1971) (MIL-HDBK-5 Source M-465).
- 6.3.5.1.8(a) Ruff, P. E., “Effect of Manufacturing Processes on Structural Allowables—Phase I,” AFWAL-TR-85-4128, Battelle (January 1986) (MIL-HDBK-5 Source M-654).
- 6.3.5.1.8(b) Korth, G. E. and Smokik, G. R., “Status Report of Physical and Mechanical Test Data of Alloy 718”, EG&G Idaho Inc., TREE-1254 (March 1978) (MIL-HDBK-5 Source M-603).
- 6.3.5.1.9(a) James, L. A., “Heat-to-Heat and/or Melt Practice Variations in Crack Growth Behavior of Inconel 718”, Mechanical Properties Test Data for Structural Materials, Quarterly Report for Period Ending October 31, 1977, Report ORNL-5349, pp. 196-199, Oak Ridge National Laboratory (December 1977).
- 6.3.5.1.9(b) Mills, W. J. and James, L. A., “Effect of Heat-Treatment on Elevated Temperature Fatigue-Crack Growth Behavior of Two Heats of Alloy 718”, ASME Paper 78-WA-PVP-3 (December 1978).
- 6.3.5.1.9(c) James, L. A., “Investigation of Potential Product Form Effects Upon the Fatigue-Crack Growth Behavior of Alloy 718”, Mechanical Properties Test Data for Structural Materials, Semiannual Progress Report for Period Ending July 31, 1979, Report ORNL/BRP-79/5, pp. 5.1-5.4, Oak Ridge National Laboratory (October 1979).
- 6.3.5.1.9(d) James, L. A., “The Effect of Product Form Upon Fatigue-Crack Growth Behavior in Alloy 718”, Report HEDL-TME-80-11, Hanford Engineering Development Laboratory (March 1980).
- 6.3.5.1.9(e) James, L. A. and Mills, W. J., “Effect of Heat-Treatment and Heat-to-Heat Variations in the Fatigue-Crack Growth Response of Alloy 718—Phase I: Macroscopic Variation”, Report HEDL-TME-80-9, Hanford Engineering Development Laboratory (March 1980).
- 6.3.5.1.9(f) James, L. A., “Fatigue-Crack Propagation Behavior of Inconel 718”, Report HEDL-TME-75-80, Hanford Engineering Development Laboratory (September 1975).
- 6.3.5.1.9(g) James, L. A., “Heat-to-Heat and/or Melt Practice Variations in Crack Growth Behavior of Alloy 718”, Mechanical Properties Test Data for Structural Materials, Quarterly Progress Report for Period Ending January 31, 1978, Report ORNL-5380, pp. 153-160, Oak Ridge National Laboratory (March 1978).

CHAPTER 7

MISCELLANEOUS ALLOYS AND HYBRID MATERIALS

7.1 GENERAL

This chapter contains the engineering properties and related characteristics of miscellaneous alloys and hybrid materials. In addition to the usual properties, some characteristics relating to the special uses of these alloys are described. For example, the electrical conductivity is reported for the bronzes and information is included on toxicity of particles of beryllium and its compounds, such as beryllium oxide.

The organization of this chapter is in sections by base metal and subdivided as shown in Table 7.1.

Table 7.1. Miscellaneous Alloys Index

Section	Designation
7.2	Beryllium
7.2.1	Standard Grade Beryllium
7.3	Copper and Copper Alloys
7.3.1	Manganese Bronzes
7.3.2	Copper Beryllium
7.4	Multiphase Alloys
7.4.1	MP35N Alloy
7.4.2	MP159 Alloy
7.5	Aluminum Alloy Sheet Laminates
7.5.1	2024-T3 Aramid Fiber Reinforced Sheet Laminate
7.5.2	7475-T761 Aramid Fiber Reinforced Sheet Laminate

7.2 BERYLLIUM

7.2.0 GENERAL

This section contains the engineering properties and related characteristics of beryllium used in aerospace structural applications. Beryllium is a lightweight, high modulus, moderate temperature capability metal that is used for specific aerospace applications. Structural designs utilizing beryllium sheet should allow for anisotropy, particularly the very low short transverse properties. Additional information on the fabrication of beryllium may be found in References 7.2.0(a) through (i).

7.2.1 STANDARD GRADE BERYLLIUM

7.2.1.0 Comments and Properties — Standard grade beryllium bars, rods, tubing, and machined shapes are produced from vacuum hot-pressed powder with 1½ percent maximum beryllium oxide content. These products are also available in numerous other compositions for special purposes but are not covered in this document. Sheet and plate are fabricated from vacuum hot-pressed powder with 2 percent maximum beryllium oxide content.

7.2.1.1 Manufacturing Considerations

Hot Shaping — Beryllium hot-pressed block can be forged and rolled but requires temperatures of 700°F and higher because of brittleness. A temperature range of 1000°F to 1400°F is recommended. Hot shaping procedures are given in more detail in Reference 7.2.0(b).

Forming — Beryllium sheet should be formed at 1300°F to 1350°F, holding at temperature no more than 1.5 hours, for minimum springback. Forming above 1450°F will result in a reduction in strength.

Machining — Carbide tools are most often used in machining beryllium. Mechanical metal removal techniques generally cause microcracks and metallographic twins. Finishing cuts are usually 0.002 to 0.005 inch in depth to minimize surface damage. Although most machining operations are performed without coolant, to avoid contamination of the chips, the use of coolant can reduce the depth of damage and give longer tool life. See Reference 7.2.0(c) for more information. Finish machining should be followed by chemical etching at least 0.002-inch from the surface to remove machining damage. See References 7.2.0(h) and (i). A combination of 1350°F stress relief followed by an 0.0005-inch etch may be necessary for close-tolerance parts. Damage-free metal removal techniques include chemical milling and electrochemical machining. The drilling of sheet may lead to delamination and breakout unless the drillhead is of the controlled torque type and the drills are carbide burr type.

Joining — Parts may be joined mechanically by riveting, but only by squeeze riveting to avoid damage to the beryllium, by bolting, threading, or by press fitting specifically designed to avoid damage. Parts also may be joined by brazing, soldering, braze welding, adhesive bonding, and diffusion bonding. Fusion welding is not recommended. Brazing may be accomplished with zinc, aluminum-silicon, or silver-base filler metals. Many elements, including copper, may cause embrittlement when used as brazing filler metals. However, specific manufacturing techniques have been developed by various beryllium fabricators to use many of the common braze materials. For each method of joining specific detailed procedures must be followed, Reference 7.2.0(f).

Surface Treatment — A surface treatment such as chemical etching to remove the machined surface of metal is recommended to ensure the specified properties. All design allowables herein represent material so treated. This surface treatment is especially important when beryllium is to be mechanically joined. References 7.2.0(d), (h), and (i) contain information on etching solutions and procedures.

Toxicity Hazard — Particles of beryllium and its compounds, such as beryllium oxide, are toxic, so special precautions to prevent inhalation must be taken. References 7.2.1.1(a) through (e) outline the hazard and methods to control it.

Specifications and Properties — Material specifications for standard grade beryllium are presented in Table 7.2.1.0(a).

Table 7.2.1.0(a). Material Specifications for Standard Grade Beryllium

Specification	Form
AMS 7906	Bar, rod, tubing, and mechanical shapes
AMS 7902	Sheet and plate

Room-temperature mechanical and physical properties are shown in Tables 7.2.1.0(b) and (c). Notch tensile test data are available in Reference 7.2.1.1(g). The effect of temperature on physical properties is shown in Figure 7.2.1.0.

7.2.1.1 Hot-Pressed Condition — The effect of temperature on the mechanical properties of hot-pressed beryllium is presented in Figures 7.2.1.1.1 and 7.2.1.1.4.

Table 7.2.1.0(b). Design Mechanical and Physical Properties of Beryllium Bar, Rod, Tubing, and Mechanical Shapes

Specification	AMS 7906
Form	Bar, rod, tubing, and machined shapes
Condition	Hot pressed (ground and etched)
Thickness or diameter, in.
Basis	S
Mechanical Properties:	
F_{tu} , ksi:	
L	47
LT	47
F_{ty} , ksi:	
L	35
LT	35
F_{cy} , ksi:	
L
LT
F_{su} , ksi
F_{bru} , ksi:	
(e/D = 1.5)
(e/D = 2.0)
F_{bry} , ksi:	
(e/D = 1.5)
(e/D = 2.0)
e , percent:	
L	2
LT	2
E , 10^3 ksi	42
E_c , 10^3 ksi	42
G , 10^3 ksi	20
μ	0.10
Physical Properties:	
ω , lb/in. ³	0.067
C , K , and α	See Figure 7.2.1.0

Table 7.2.1.0(c). Design Mechanical and Physical Properties of Beryllium Sheet and Plate

Specification	AMS 7902			
	Sheet	Plate		
	Stress relieved (ground and etched)			
	0.020-0.250	0.251-0.450	0.451-0.600	≥0.601
Basis	S	S	S	S
Mechanical Properties:				
F_{tu} , ksi:				
L	70	65	60	40
LT	70	65	60	40
F_{ty} , ksi:				
L	50	45	40	30
LT	50	45	40	30
F_{cy} , ksi:				
L
LT
F_{su} , ksi
F_{bru} , ksi:				
(e/D = 1.5)
(e/D = 2.0)
F_{bry} , ksi:				
(e/D = 1.5)
(e/D = 2.0)
e , percent:				
L	10	4	3	1
LT	10	4	3	1
E , 10 ³ ksi	42.5			
E_c , 10 ³ ksi	42.5			
G , 10 ³ ksi	20.0			
μ	0.10 (L and LT)			
Physical Properties:				
ω , lb/in. ³	0.067			
C , K , and α	See Figure 7.2.1.0			

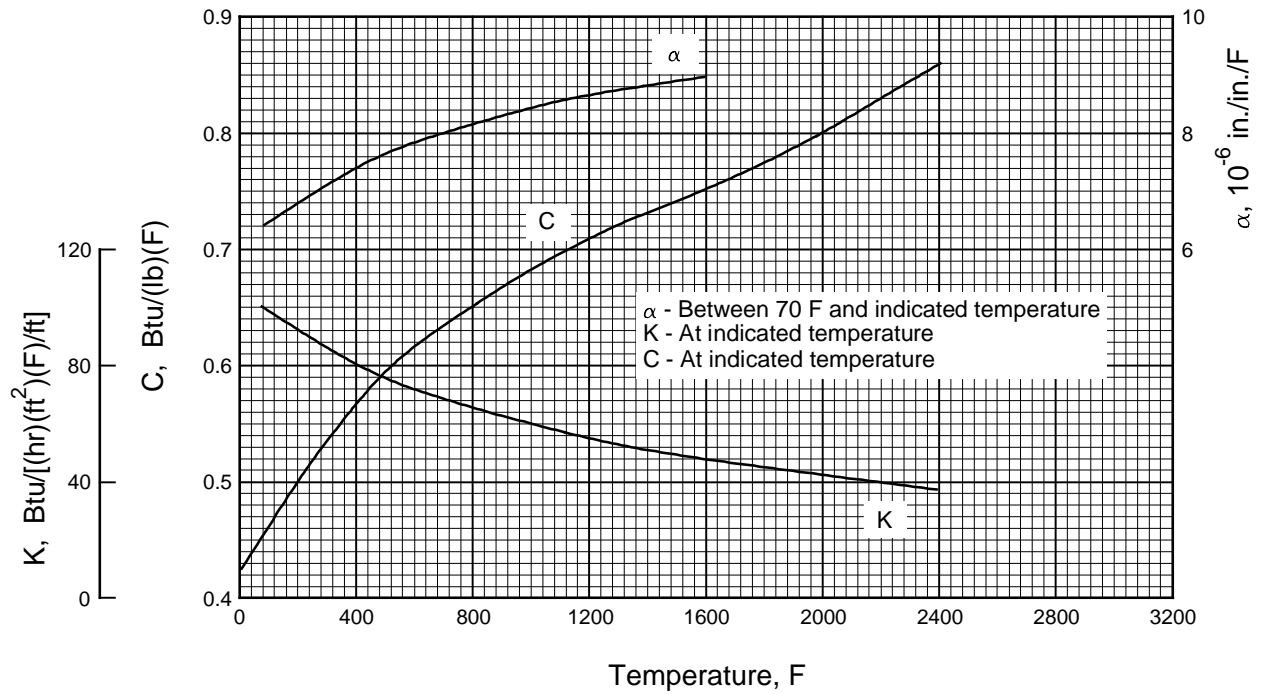

Figure 7.2.1.0. Effect of temperature on the physical properties of beryllium (2% maximum BeO).

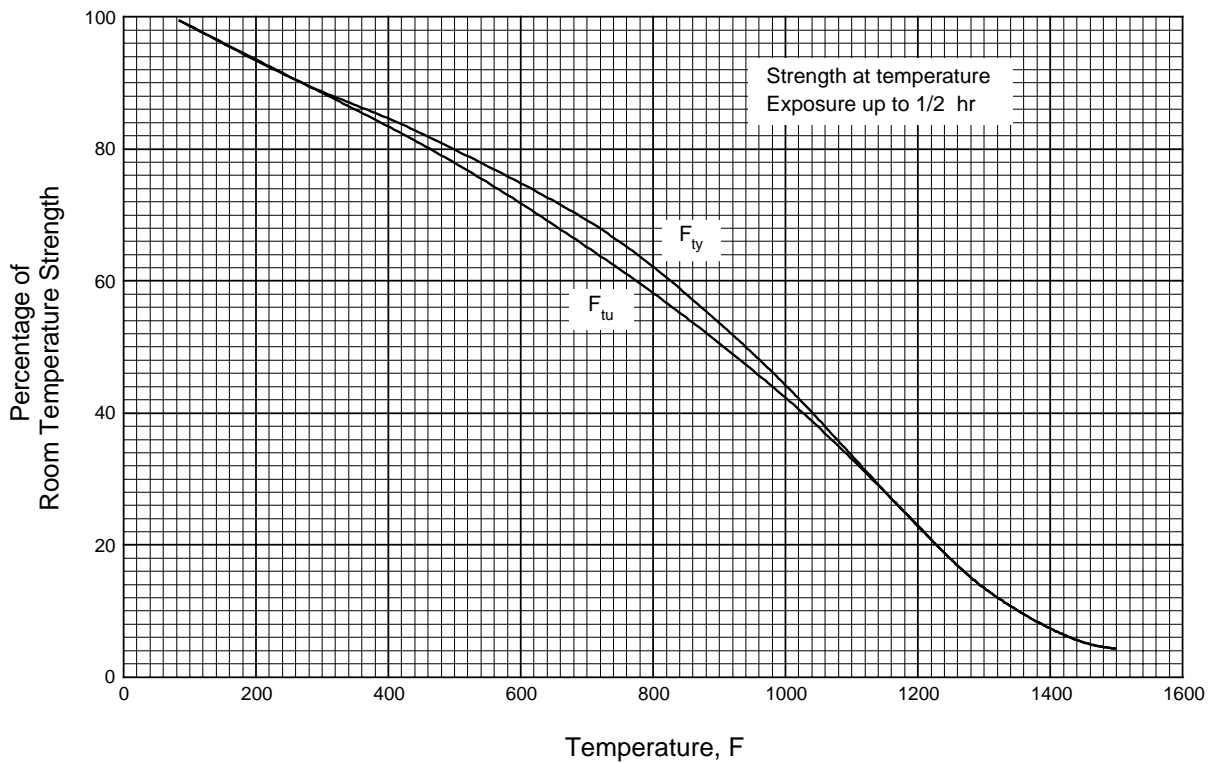

Figure 7.2.1.1.1. Effect of temperature on the tensile ultimate strength (F_{tu}) and tensile yield strength (F_{ty}) of hot-pressed beryllium bar, rod, tubing, and machined shapes.

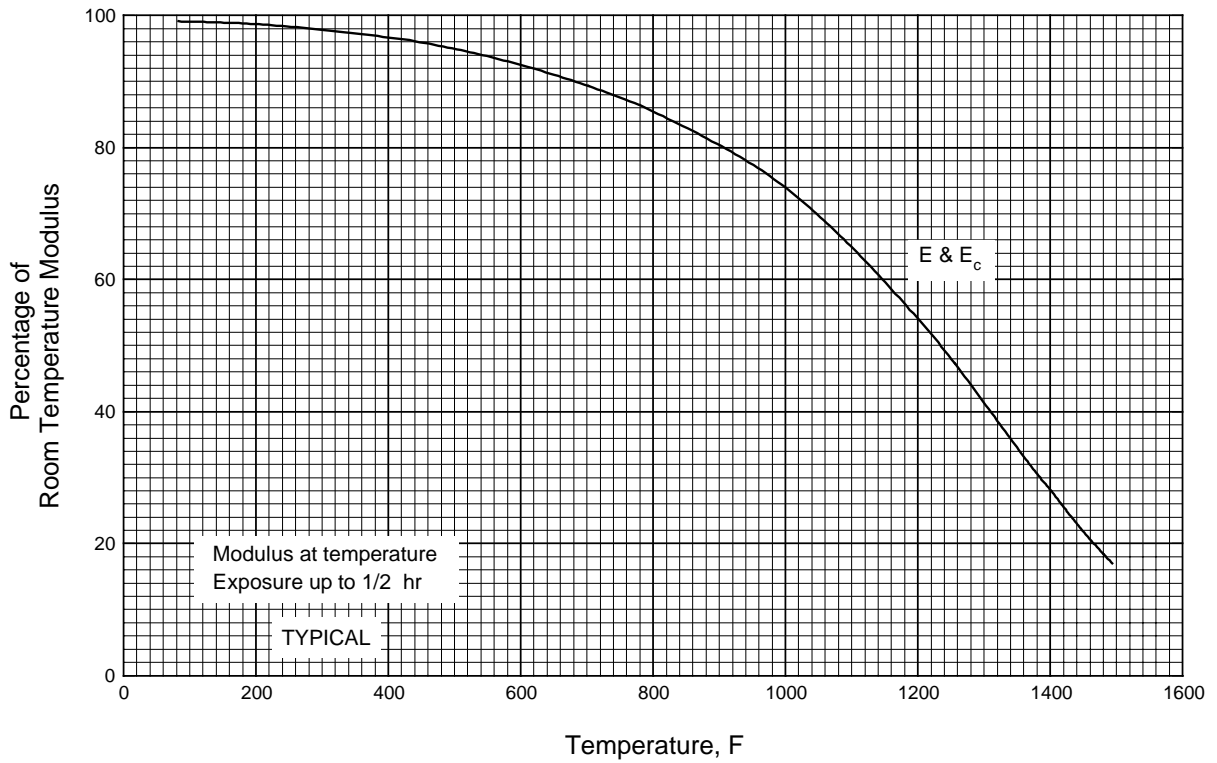

Figure 7.2.1.1.4. Effect of temperature on the tensile and compressive moduli (E and E_c) of hot-pressed beryllium bar, rod, tubing, and machined shapes.

7.3 COPPER AND COPPER ALLOYS

7.3.0 GENERAL

The properties of major significance in designing with copper and copper alloys are electrical and thermal conductivity, corrosion resistance, and good bearing qualities (antigalling). Copper and copper alloys are non-magnetic and can be readily joined by welding, brazing and soldering. The use of copper alloys is usually predicated upon two or more of the above properties plus the ease of casting and hot and cold working into desirable shapes.

The thermally unstable range for copper and copper alloys generally begins somewhat above room temperature (150°F). Creep, stress relaxation and diminishing stress rupture strength are factors of concern above 150°F. Copper alloys frequently are used at temperatures up to 480°F. The range between 480°F and 750°F is considered very high for copper alloys, since copper and many of its alloys begin to oxidize slightly above 350°F and protection may be required. Bronzes containing Al, Si, and Be oxidize to a lesser extent than the red copper alloys. Precipitation hardened alloys such as copper beryllium retain strength up to their aging temperatures of 500°F to 750°F.

Copper alloys used for bearing and wear resistance applications include, in the order of their increasing strength and load-carrying capacity, copper-tin-lead, copper-tin, silicon bronze, manganese bronze, aluminum bronze, and copper beryllium. Copper beryllium and manganese bronzes are included in MIL-HDBK-5.

Copper-base bearing alloys are readily cast by a number of techniques: statically sand cast, centrifugally cast into tubular shapes, and continuously cast into various shapes. Tin bronze, sometimes called phosphor bronze because phosphorous is used to deoxidize the melt and improve castability, is a low-strength alloy. It is generally supplied as a static (sand) casting or centrifugal casting (tubular shapes from rotating graphite molds). Manganese bronze is considerably stronger than tin bronze, is easily cast in the foundry, has good toughness and is not heat treated. Aluminum bronze alloys, especially those with nickel, silicon, and manganese over 2 percent, respond to heat treatment, resulting in greater strength, and higher galling and fatigue limits than manganese bronze. Aluminum bronze is used in the static and centrifugal cast form or parts may be machined from wrought rod and bar stock. Copper beryllium is the highest strength copper-base bearing material, due to its response to precipitation hardening. Copper beryllium is also available in static and centrifugal cast form but is generally used as wrought shapes, such as extrusions, forgings, and mill shapes.

Copper beryllium, because of its high strength, is also useful as a spring material. In this application its high elastic limit, high fatigue strength as well as good electrical conductivity are significant. Copper beryllium resists softening up to 500°F, which is higher than other common copper alloys. Copper beryllium springs are usually fabricated from strip or wire. Consult References 7.3.0(a) through (c) for more information.

7.3.1 MANGANESE BRONZES

7.3.1.0 Comments and Properties — The manganese bronzes are also known as the high-strength yellow brasses and leaded high-strength yellow brasses. These alloys contain zinc as the principal alloying element with smaller amounts of iron, aluminum, manganese, nickel, and lead present. These bronzes are easily cast.

Some material specifications for manganese bronzes are presented in Table 7.3.1.0(a). A cross index to CDA and former QQ-C-390 designations is presented in Table 7.3.1.0(b). Room-temperature mechanical properties are shown in Tables 7.3.1.0(c) and (d).

Table 7.3.1.0(a). Material Specifications for Manganese Bronzes

Specification	Form
AMS 4860	Casting
AMS 4862	Casting

Table 7.3.1.0(b). Cross Index

Copper Alloy UNS No.	CDA Alloy No.	Former QQ-C-390 Alloy No.
C86300	863	C7
C86500	865	C3

Table 7.3.1.0(c). Design Mechanical and Physical Properties of C86500 Manganese Bronze

Specification	AMS 4860
Form	Sand and centrifugal casting
Condition	As cast
Location within casting	Any area
Basis	S
Mechanical Properties:	
F_{tu} , ksi	65 ^a
F_{ty} , ksi	25 ^a
F_{cy} , ksi
F_{su} , ksi
F_{bru} , ksi:	
(e/D = 1.5)
(e/D = 2.0)
F_{bry} , ksi:	
(e/D = 1.5)
(e/D = 2.0)
e , percent	20 ^a
E , 10 ³ ksi	15.0
E_c , 10 ³ ksi
G , 10 ³ ksi
μ
Physical Properties:	
ω , lb/in. ³	0.301
C , Btu/(lb)(°F)	0.09 (at 68°F)
K , Btu/[(hr)(ft ²)(°F)/ft]	50 (at 68°F)
α , 10 ⁻⁶ in./in/°F	11.3 (68 to 212°F)
Electrical conductivity, % IACS	22.0

a When specified, conformance to tensile property requirements is determined by testing specimens cut from casting.

Table 7.3.1.0(d). Design Mechanical and Physical Properties of C86300 Manganese Bronze

Specification	AMS 4862
Form	Sand and centrifugal casting
Condition	As cast
Location within casting	Any area
Basis	S
Mechanical Properties:	
F_{tu} , ksi	110 ^a
F_{ly} , ksi	60 ^a
F_{cy} , ksi
F_{su} , ksi
F_{bru} , ksi:	
(e/D = 1.5)
(e/D = 2.0)
F_{bry} , ksi:	
(e/D = 1.5)
(e/D = 2.0)
e , percent	12 ^a
E , 10 ³ ksi	14.2
E_c , 10 ³ ksi
G , 10 ³ ksi
μ
Physical Properties:	
ω , lb/in. ³	0.283
C , Btu/(lb)(°F)	0.09 (at 68°F)
K , Btu/[(hr)(ft ²)(°F)/ft]	20.5 (at 68°F)
α , 10 ⁻⁶ in./in/°F	12.0 (68 to 500°F)
Electrical conductivity, % IACS	8.0

a When specified, conformance to tensile property requirements is determined by testing specimens cut from casting.

7.3.2 COPPER BERYLLIUM

7.3.2.0 Comments and Properties — Copper beryllium refers to a family of copper-base alloys containing beryllium and cobalt or nickel which cause the alloys to be precipitation hardenable. Data for only one high-strength alloy, designated C17200, which contains 1.90 percent (nominal) beryllium, are presented in this section. This alloy is suitable for parts requiring high strength, good wear, and corrosion resistance. Alloy C17200 is available in the form of rod, bar, shapes, mechanical tubing, strip, and casting.

Manufacturing Considerations — The heat treatable tempers of rod and bar are designated TB00 (AMS 4650) for solution-treated or TD04 (AMS 4651) for solution-treated plus cold worked conditions. After fabrication operations, the material may be strengthened by precipitation heat treatment (aging). Rod and bar are also available from the mill in the TF00 (AMS 4533) and TH04 (AMS 4534) conditions. Mechanical tubing is available from the mill in TF00 (AMS 4535) condition. Machining operations on rod, bar, and tubing are usually performed on material in the TF00 or (TH04) conditions. This eliminates the volumetric shrinkage of 0.02 percent, which occurs during precipitation hardening, as a factor in maintaining final dimensional tolerances. This material has good machinability in all conditions.

Strip is also available in the heat treatable condition. Parts are stamped or formed in a heat treatable temper and subsequently precipitation heat treated. For strip, the heat treatable tempers are designated TB00 (AMS 4530, ASTM B194), TD01 (ASTM B194), TD02 (AMS 4532, ASTM B194), and TD04 (ASTM B194), indicating a progressively greater amount of cold work by the mill. When parts produced from these tempers are precipitation heat treated by the user, the designations become TF00, TH01, TH02, and TH04, respectively. Strip is also available from the mill for the hardened conditions. Design values for these conditions are not included.

Environmental Considerations — The copper beryllium alloys have good corrosion resistance and are not susceptible to hydrogen embrittlement. The maximum service temperature for C17200 copper beryllium products is 500°F for up to 100 hours.

Specifications and Properties — A cross-index to previous and current temper designations for C17200 alloy is presented in Table 7.3.2.0(a).

Table 7.3.2.0(a). Cross-Index to Previous and Current Temper Designations for C17200 Copper Beryllium

Previous Temper	Current ASTM Temper
A	TB00
AT	TF00
¼H	TD01
¼HT	TH01
½H	TD02
½HT	TH02
H	TD04
HT	TH04

Material specifications for alloy C17200 are presented in Table 7.3.2.0(b). Room-temperature mechanical properties are shown in Tables 7.3.2.0(c) through (g). The effect of temperature on physical properties is depicted in Figure 7.3.2.0.

Table 7.3.2.0(b). Material Specifications for C17200 Copper Beryllium Alloy

Specification	Form
ASTM B194	Strip (TB00, TD01, TD02, TD04)
AMS 4530 ^a	Strip (TB00)
AMS 4532 ^a	Strip (TD02)
AMS 4650	Bar, rod, shapes, and forgings (TB00)
AMS 4533	Bar and rod (TF00)
AMS 4535	Mechanical tubing (TF00)
AMS 4651	Bar and rod (TD04)
AMS 4534	Bar and rod (TH04)

a Noncurrent specification.

The temper index for C17200 alloy is as follows:

<u>Section</u>	<u>Temper</u>
7.3.2.1	TF00
7.3.2.2	TH04

7.3.2.1 TF00 Temper — Typical tensile and compressive stress-strain and tangent-modulus curves are presented in Figures 7.3.2.1.6(a) and (b).

7.3.2.2 TH04 Temper — Typical tensile and compressive stress-strain and tangent-modulus curves are presented in Figure 7.3.2.2.6.

Table 7.3.2.0(c). Design Mechanical and Physical Properties of Copper Beryllium Strip

Specification	ASTM B194 AMS 4530 ^a	ASTM B194	ASTM B194 AMS 4532 ^a	ASTM B194
Form	Strip			
Condition	TF00	TH01	TH02	TH04
Thickness, in.	≤0.188	≤0.188	≤0.188	≤0.188
Basis	S	S	S	S
Mechanical Properties:				
<i>F_{tu}</i> , ksi:				
L	165	175	185	190
LT
<i>F_{ty}</i> , ksi:				
L	140	150	160	165
LT
<i>F_{cy}^b</i> , ksi: (Estimate)				
L	140	150	160	165
LT	140	150	160	165
<i>F_{su}^b</i> , ksi: (Estimate)				
	90	90	92	95
<i>F_{bru}^b</i> , ksi: (Estimate)				
(e/D = 1.5)	214	227	240	247
(e/D = 2.0)	280	297	314	323
<i>F_{bry}^b</i> , ksi: (Estimate)				
(e/D = 1.5)	196	210	224	231
(e/D = 2.0)	210	225	240	247
<i>e</i> , percent:				
L	3	2.5	1	1
<i>E</i> , 10 ³ ksi				
	18.5			
<i>E_c</i> , 10 ³ ksi				
	...			
<i>G</i> , 10 ³ ksi				
	7.3			
<i>μ</i>				
	0.27			
Physical Properties:				
<i>ω</i> , lb/in. ³				
	0.298			
<i>C</i> , <i>K</i> , and <i>α</i>				
	See Figure 7.3.2.0 for TF00 temper			

a Noncurrent specification.

b These properties do not represent values derived from tests, but are estimates.

Table 7.3.2.0(d). Design Mechanical and Physical Properties of C17200 Copper Beryllium Rod and Bar

Specification	AMS 4650 and AMS 4533				
	Rod and bar				
	TF00				
Thickness, in.	≤1.500	1.501-2.000	2.001-3.000	3.001-3.500	3.501-4.000
Basis	S	S	S	S	S
Mechanical Properties:					
F_{tu} , ksi:					
L	165	165	165	165	165
ST	158	158	158	158
F_{ty} , ksi:					
L	140	140	140	140	140
ST	137	137	137	137
F_{cy} , ksi:					
L	150	149	145	143	139
ST	142	142	142	142
F_{su} , ksi	94	94	94	94
F_{bru}^a , ksi:					
(e/D = 1.5)	226	226	226	226	226
(e/D = 2.0)	290	290	290	290	290
F_{bry}^a , ksi:					
(e/D = 1.5)	200	200	200	200	200
(e/D = 2.0)	225	225	225	225	225
e , percent:					
L	4 ^b	4 ^b	4 ^b	3	3
E , 10 ³ ksi	18.5				
E_c , 10 ³ ksi	18.7				
G , 10 ³ ksi	7.3				
μ	0.27				
Physical Properties:					
ω , lb/in. ³	0.298				
C , K , and α	See Figure 7.3.2.0				

a Bearing values are "dry pin" values per Section 1.4.7.1.

b AMS 4650 specifies $e = 3$ percent.

Table 7.3.2.0(e). Design Mechanical and Physical Properties of C17200 Copper Beryllium Rod and Bar

Specification	AMS 4651			
Form	Rod and bar			
Condition	TH04			
Thickness, in.	≤0.375	0.376-1.000	1.001-1.500	1.501-2.000
Basis	S	S	S	S
Mechanical Properties:				
F_{tu} , ksi:				
L	185	180	175	175
ST	169
F_{ty} , ksi:				
L	145	145	145	145
ST	140
F_{cy} , ksi:				
L	148	148	148
ST	154
F_{su} , ksi	89	90	93
F_{bru}^a , ksi:				
(e/D = 1.5)	242	235	235
(e/D = 2.0)	306	298	298
F_{bry}^a , ksi:				
(e/D = 1.5)	207	207	207
(e/D = 2.0)	225	225	225
e , percent:				
L	1	1	2	2
E , 10 ³ ksi	18.5			
E_c , 10 ³ ksi	18.7			
G , 10 ³ ksi	7.3			
μ	0.27			
Physical Properties:				
ω , lb/in. ³	0.298			
C , K , and α			

a Bearing values are “dry pin” values per Section 1.4.7.1.

MIL-HDBK-5J
31 January 2003

Table 7.3.4.0(f). Design Mechanical and Physical Properties of C17200 Copper Beryllium Rod and Bar

Specification	AMS 4534											
	Rod and bar											
Form	TH04											
	≤0.375		0.376-0.999		1.000-1.499		1.500-1.999		2.000-2.499		2.500-3.000	
Thickness, in.	A	B	A	B	A	B	A	B	A	B	A	B
Basis												
Mechanical Properties:												
F_{tu} , ksi:												
L	182	188	180	186	177 ^a	184	177	183	175	181	172	178
ST	167	173	168	174	167	173
F_{ty} , ksi:												
L	157	165	154	162	150 ^a	162	150	158	147	155	145	152
ST	145	153	142	150	140	147
F_{cy} , ksi:												
L	157	166	153	164	153	162	150	158	148	155
ST	160	168	156	165	154	162
F_{su} , ksi	89	92	91	95	94	97	95	98	94	96
F_{bru}^b , ksi:												
(e/D = 1.5)	242	250	238	247	238	246	235	243	231	239
(e/D = 2.0)	306	317	302	313	302	312	298	308	293	303
F_{bry}^b , ksi:												
(e/D = 1.5)	220	231	214	228	214	226	210	221	207	217
(e/D = 2.0)	239	251	233	248	233	245	228	240	225	236
e , percent (S-basis):												
L	3	...	3	...	3	...	3	...	3	...	3	...
E , 10 ³ ksi							18.5					
E_c , 10 ³ ksi							18.7					
G , 10 ³ ksi							7.3					
μ							0.27					
Physical Properties:												
ω , lb/in. ³							0.298					
C , K , and α											

a S-basis. A values are $F_{tu}(L) = 178$ ksi and $F_{ty} = 152$ ksi.
b Bearing values are “dry pin” values per Section 1.4.7.1.

Table 7.3.2.0(g). Design Mechanical and Physical Properties of C17200 Copper Beryllium Mechanical Tubing

Specification	AMS 4535			
Form	Mechanical tubing			
Condition	TF00			
Outside Diameter, in.	≤2.499		2.500-12.000	
Wall Thickness, in.	≤0.749		0.750-2.000	
Basis	A	B	A	B
Mechanical Properties:				
<i>F_{tu}</i> , ksi:				
L	161	167	161	167
LT	157	163
<i>F_{ty}</i> , ksi:				
L	126	136	126	136
LT	124	134
<i>F_{cy}</i> , ksi:				
L	134	145	134	145
LT	135	146
<i>F_{su}</i> , ksi	92	95	92	95
<i>F_{bru}^a</i> , ksi:				
(e/D = 1.5)	228	237	228	237
(e/D = 2.0)	287	298	287	298
<i>F_{bry}^a</i> , ksi:				
(e/D = 1.5)	183	197	183	197
(e/D = 2.0)	206	222	206	222
<i>e</i> , percent (S-basis):				
L	3	...	3	...
<i>E</i> , 10 ³ ksi				
		18.5		
<i>E_c</i> , 10 ³ ksi				
		18.7		
<i>G</i> , 10 ³ ksi				
		7.3		
<i>μ</i>				
		0.27		
Physical Properties:				
<i>ω</i> , lb/in. ³				
		0.298		
<i>C</i> , Btu/(lb)(°F)				
		See Figure 7.3.4.0		

a Bearing values are “dry pin” values per Section 1.4.7.1.

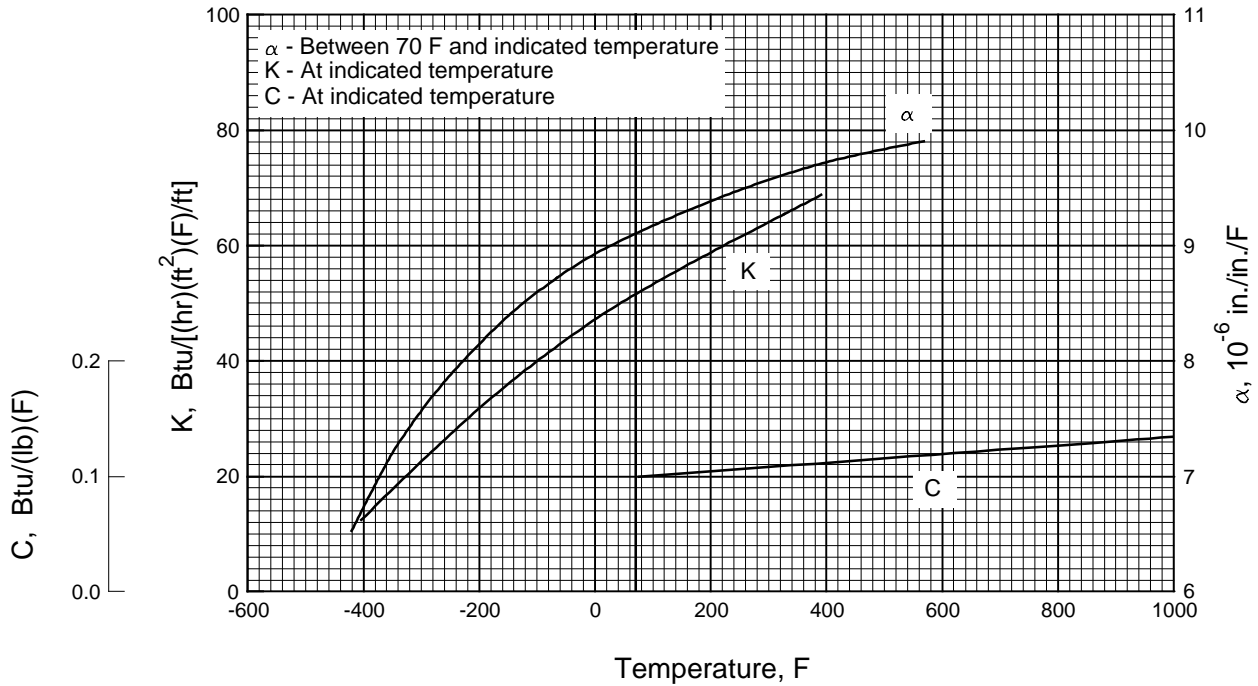

Figure 7.3.2.0. Effect of temperature on the physical properties of copper beryllium (TF00).

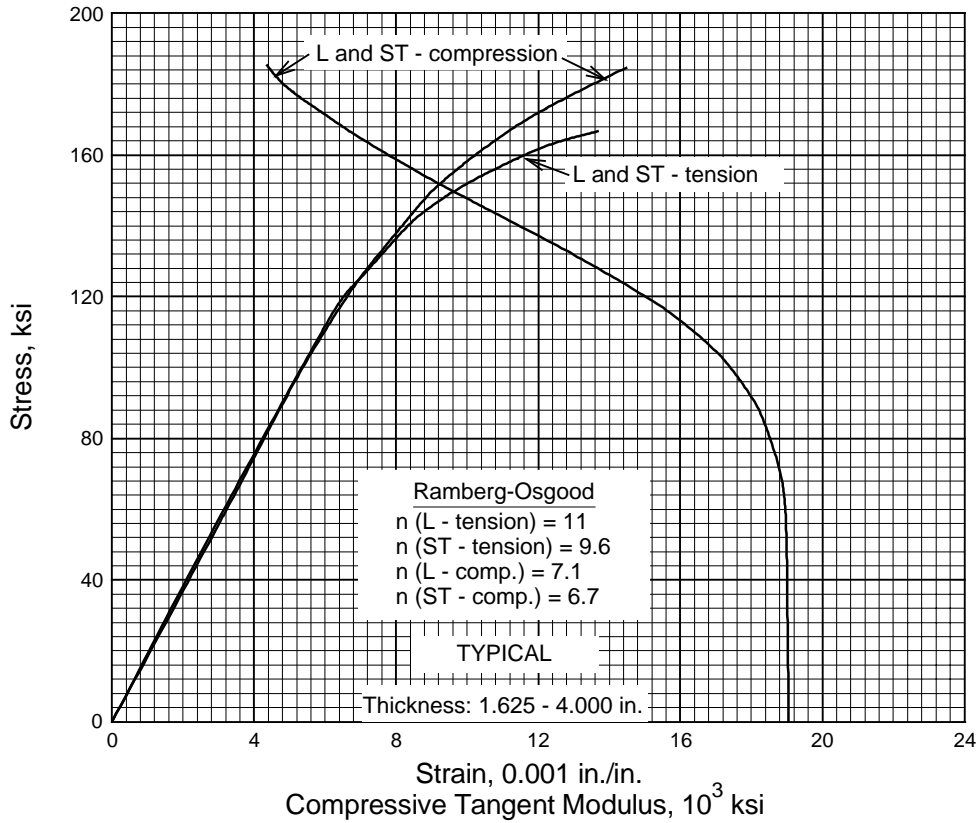

Figure 7.3.2.1.6(a). Typical tensile and compressive stress-strain and compressive tangent-modulus curves for C17200 copper beryllium bar and rod in TF00 temper.

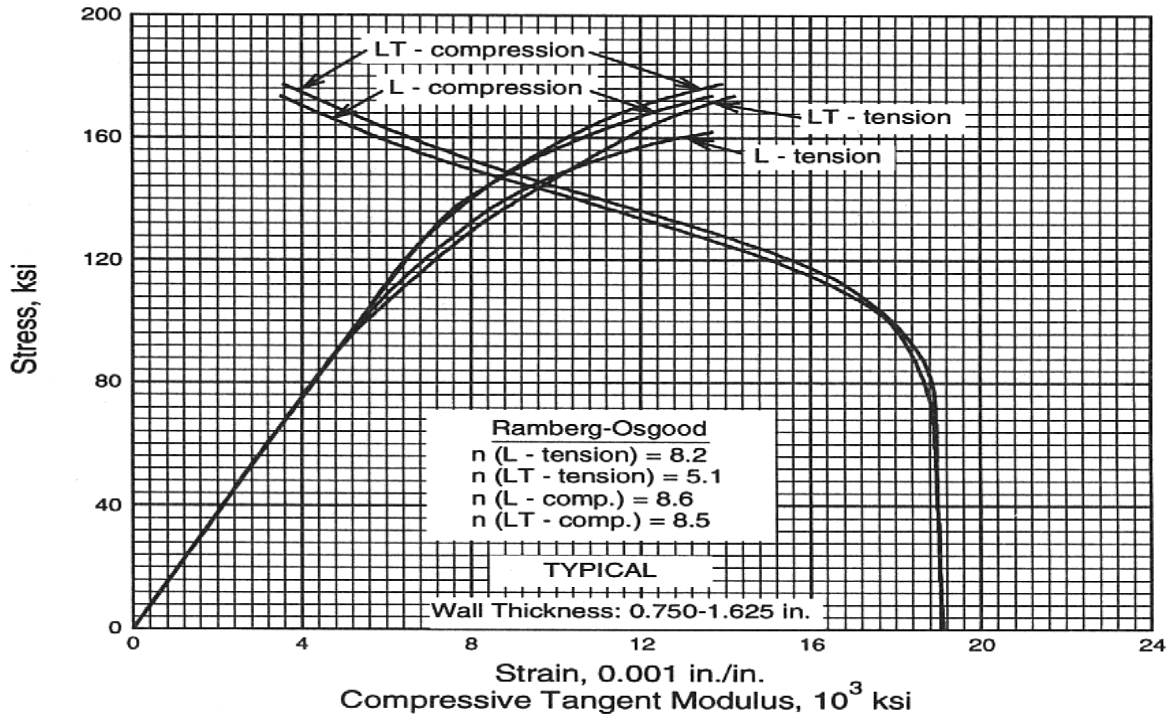

Figure 7.3.2.1.6(b). Typical tensile and compressive stress-strain and compressive tangent-modulus curves for C17200 copper beryllium mechanical tubing in TF00 temper.

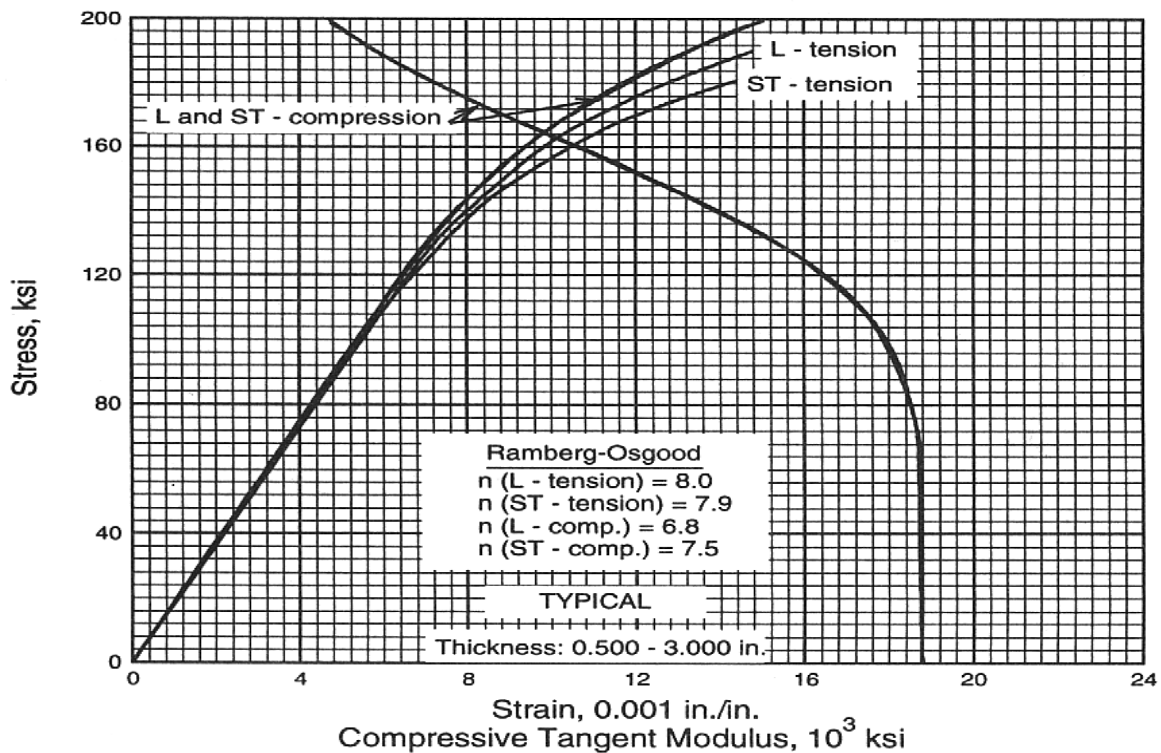

Figure 7.3.2.2.6. Typical tensile and compressive stress-strain and compressive tangent-modulus curves for C17200 copper beryllium bar and rod in TH04 temper.

7.4 MULTIPHASE ALLOYS

7.4.0 GENERAL

This section contains the engineering properties of the “Multiphase” alloys. These alloys, based on the quaternary of cobalt, nickel, chromium, and molybdenum, can be work-strengthened and aged to ultrahigh strengths with good ductility and corrosion resistance.

7.4.1 MP35N ALLOY

7.4.1.0 Comments and Properties — MP35N is a vacuum induction, vacuum arc remelted alloy which can be work-strengthened and aged to ultrahigh strengths. This alloy is suitable for parts requiring ultrahigh strength, good ductility and excellent corrosion and oxidation resistance up to 700°F.

Manufacturing Considerations — The work hardening characteristics of MP35N are similar to 304 stainless steel. Drawing, swaging, rolling, and shear forming are excellent deforming methods for work strengthening the alloy. The machinability of MP35N is similar to the nickel-base alloys.

Environmental Considerations — MP35N has excellent corrosion, crevice corrosion and stress corrosion resistance in seawater. Due to the passivity of MP35N, a galvanically active coating, such as aluminum or cadmium, may be required to prevent galvanic corrosion of aluminum joints. Initial tests have indicated that MP35N does not appear to be susceptible to hydrogen embrittlement.

Short time exposure to temperatures above 700°F causes a decrease in ductility (elongation and reduction of area) at temperature. Mechanical properties at room temperature are not affected significantly by unstressed exposure to temperatures up to 50 degrees below the aging temperature (1000 to 2000°F) for up to 100 hours.

Heat Treatment — After work strengthening, MP35N is aged at 1000 to 1200°F for 4 to 4½ hours and air cooled.

Material specifications for MP35N are presented in Table 7.4.1.0(a). The room-temperature mechanical and physical properties for MP35N are presented in Tables 7.4.1.0(b) and (c). The effect of temperature on physical properties is shown in Figure 7.4.1.0.

Table 7.4.1.0(a). Material Specifications for MP35N Alloy

Specification	Form
AMS 5844	Bar (solution treated, and cold drawn)
AMS 5845	Bar (solution treated, cold drawn and aged)

7.4.1.1 Cold Worked and Aged Condition — Elevated temperature curves for various mechanical properties are shown in Figures 7.4.1.1.1, 7.4.1.1.4 (a) and (b), and 7.4.1.1.5. Typical tensile stress-strain curves at room and elevated temperatures are shown in Figure 7.4.1.1.6.

Table 7.4.1.0(b). Design Mechanical and Physical Properties of MP35N Alloy Bar

Specification	AMS 5845			
Form	Bar			
Condition	Solution treated, cold drawn, and aged			
Diameter, in. ^a	≤0.800	0.801-1.000	1.001-1.750	
Basis	A	B	S	S
Mechanical Properties:				
F_{tu} , ksi:				
L	260 ^b	275	260	260
LT
F_{ty} , ksi:				
L	230 ^c	266	230	230
LT
F_{cy} , ksi:				
L
LT
F_{su} , ksi	145	147	145	...
F_{bru} , ksi:				
(e/D = 1.5)
(e/D = 2.0)
F_{bry} , ksi:				
(e/D = 1.5)
(e/D = 2.0)
e , percent (S basis):				
L	8	...	8	8
RA , percent (S basis):				
L	35	...	35	35
E , 10 ³ ksi	34.0			
E_c , 10 ³ ksi			
G , 10 ³ ksi	11.7			
μ			
Physical Properties:				
ω , lb/in. ³	0.304			
C , Btu/(lb)(°F)	0.18 (32 to 70°F)			
K and α	See Figure 7.4.1.0			

a Tensile specimens are located at T/2 location for bars 0.800 inch and under in diameter or distance between parallel sides and at T/4 location of larger size bars. The strength of bar, especially large diameter, may vary significantly from center to surface; consequently, caution should be exercised in machining parts from bars over 0.800 inch in diameter since strengths may be lower than design values depending on depth of material removed from surface.

b The T_{99} value of 266 ksi is higher than specification minimum.

c The T_{99} value of 256 ksi is higher than specification minimum.

Table 7.4.1.0(c). Design Mechanical and Physical Properties of MP35N Alloy Bar

Specification	AMS 5844	
Form	Bar	
Condition	Solution treated and cold drawn	
Diameter, in. ^a	≤1.000	1.001-1.750
Basis	S	S
Mechanical Properties:		
F_{tu} , ksi:		
L	260	260
LT
F_{ty} , ksi:		
L	230	230
LT
F_{cy} , ksi:		
L
LT
F_{su} , ksi	145	...
F_{bru} , ksi:		
(e/D = 1.5)
(e/D = 2.0)
F_{bry} , ksi:		
(e/D = 1.5)
(e/D = 2.0)
e , percent:		
L	8	8
RA , percent:		
L	35	35
E , 10 ³ ksi	34.0	
E_c , 10 ³ ksi	
G , 10 ³ ksi	11.7	
μ	
Physical Properties:		
ω , lb/in. ³	0.304	
C , Btu/(lb)(°F)	0.18 (32 to 70°F)	
K and α	See Figure 7.4.1.0	

^a Tensile specimens are located at T/2 location for bars 0.800 inch and under in diameter or distance between parallel sides and at T/4 location for larger size bars. The strength of bar, especially large diameter may vary significantly from center to surface; consequently, caution should be exercised in machining parts from bars over 0.800 inch in diameter since strengths may be lower than design values depending on depth of material removed from surface.

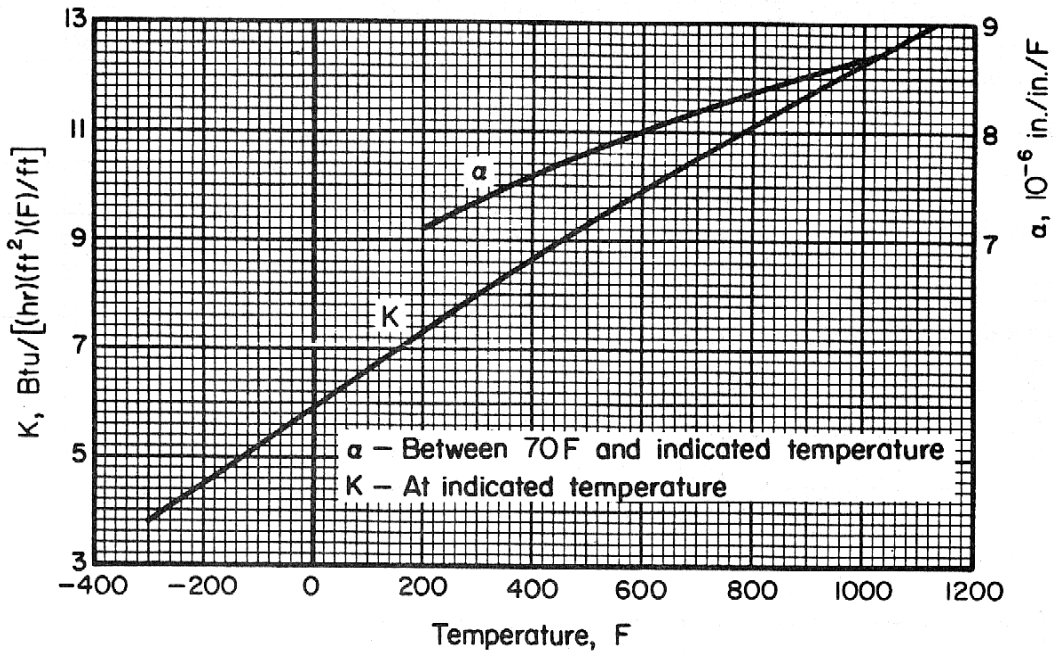

Figure 7.4.1.0. Effect of temperature on the physical properties of MP35N alloy.

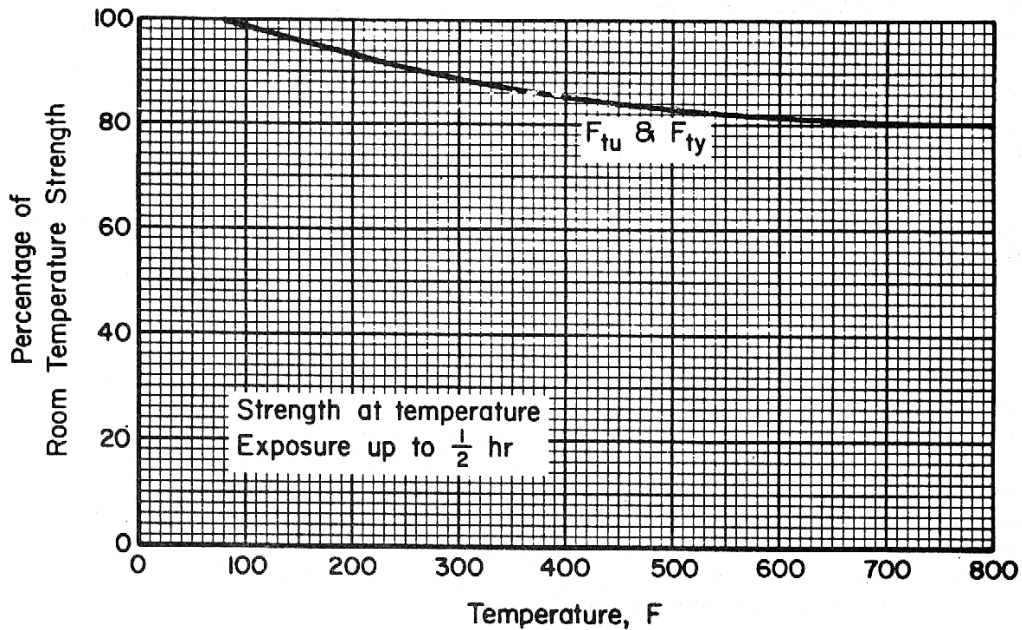

Figure 7.4.1.1.1. Effect of temperature on the tensile ultimate strength (F_{tu}) and the tensile yield strength (F_{ty}) of cold worked and aged MP35N bar, $F_{tu} = 260$ ksi.

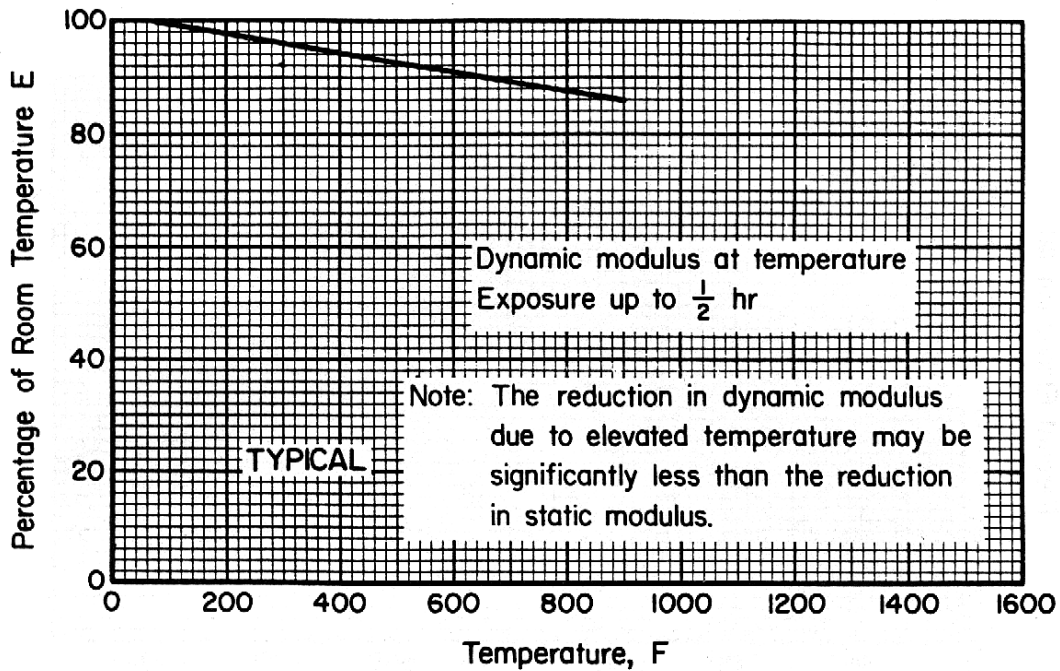

Figure 7.4.1.1.4(a). Effect of temperature on the dynamic tensile modulus (E) of MP35N alloy bar.

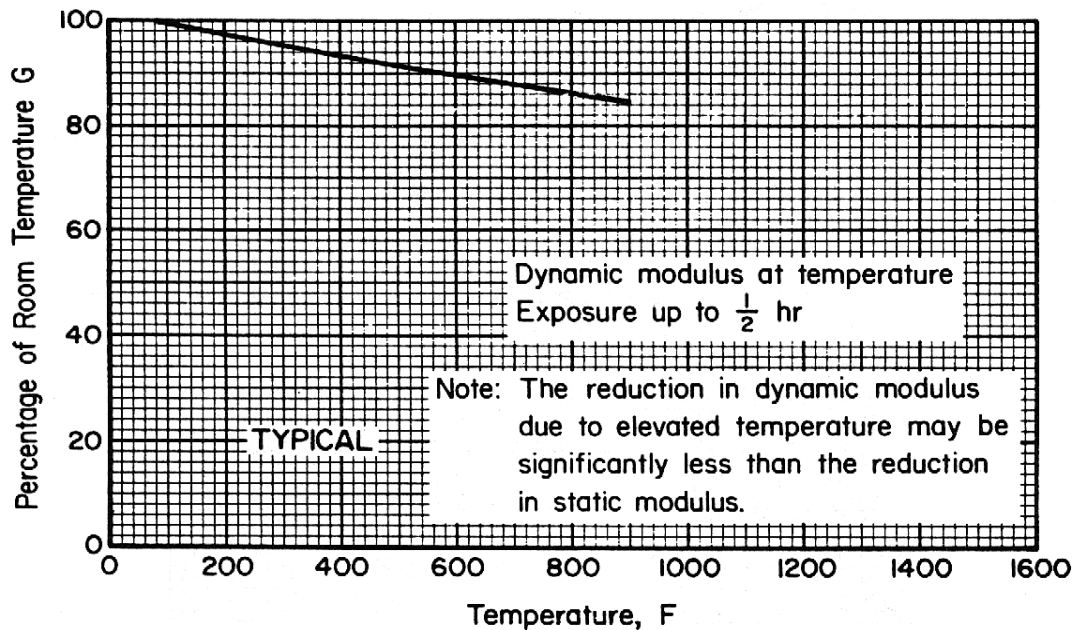

Figure 7.4.1.1.4(b). Effect of temperature on the dynamic shear modulus (G) of MP35N alloy bar.

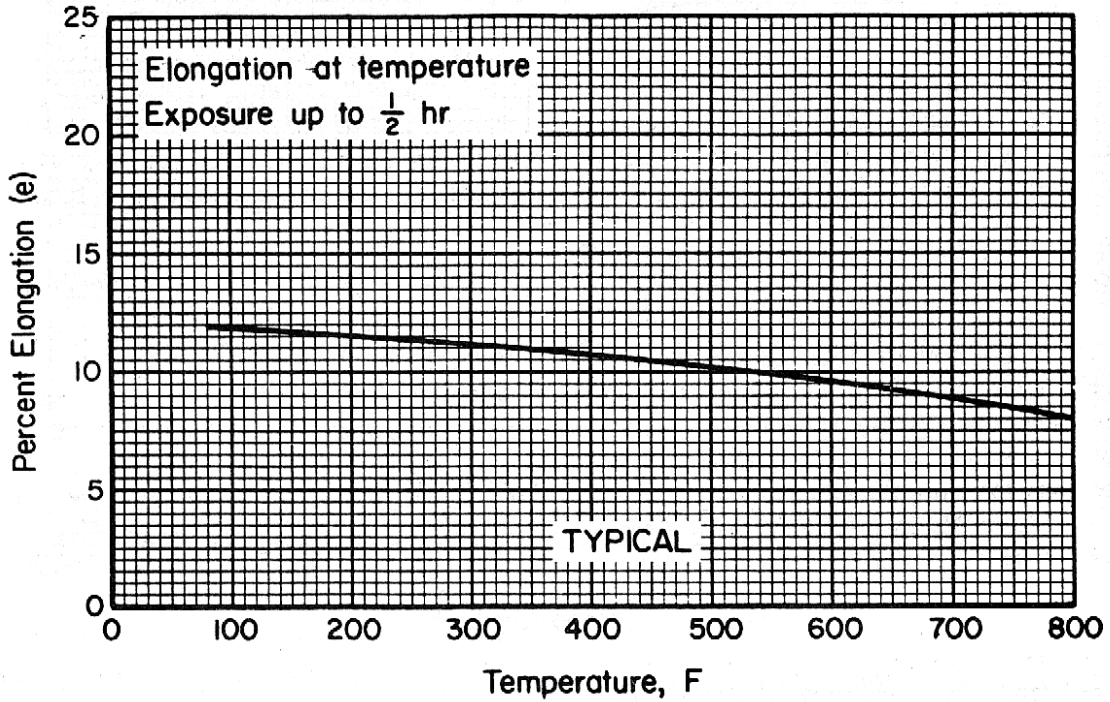

Figure 7.4.1.1.5. Effect of temperature on the elongation (e) of cold worked and aged MP35N bar, $F_{iu} = 260$ ksi.

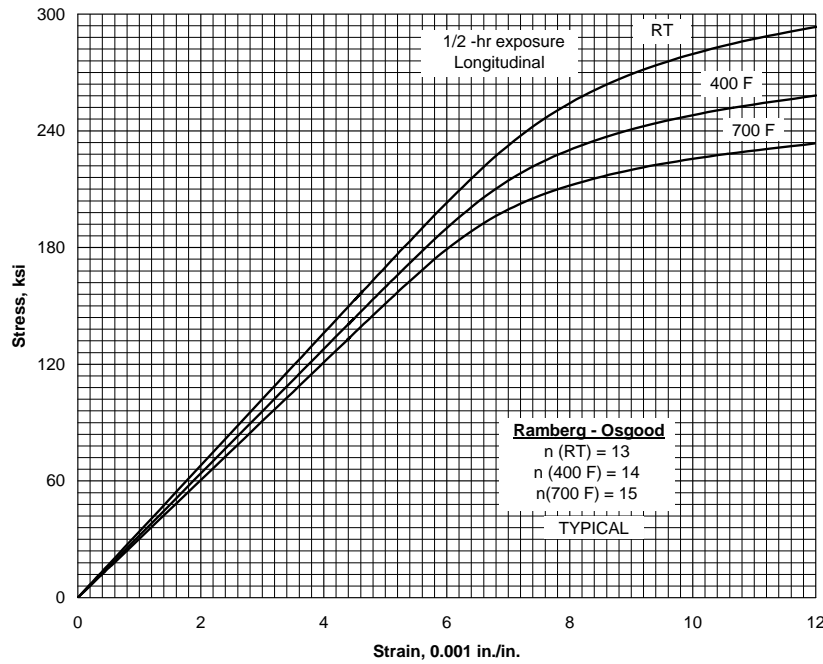

Figure 7.4.1.1.6. Typical tensile stress-strain curves at room and elevated temperatures for cold worked and aged MP35N bar, $F_{iu} = 260$ ksi.

7.4.2 MP159 ALLOY

7.4.2.0 Comments and Properties — MP159 is a vacuum induction, vacuum arc remelted alloy, based on cobalt, nickel, chromium, iron, and molybdenum, which can be work-strengthened and aged to ultrahigh strength. This alloy is suitable for parts requiring ultrahigh strength, good ductility, and excellent corrosion and oxidation resistance up to 1100°F. The alloy maintains its ultrahigh strength very well at temperatures up to 1100°F.

Manufacturing Considerations — The work hardening characteristics of MP159 are similar to MP35N and 304 stainless steel. Drawing, swaging, rolling, and shear forming are excellent deforming methods for work strengthening the alloy. The machinability of MP159 is similar to MP35N and the nickel-base alloys.

Environmental Considerations — MP159 has excellent corrosion, crevice corrosion, and stress corrosion resistance in various hostile environments. Due to the passivity of MP159, a galvanically active coating, such as aluminum or cadmium, may be required to prevent galvanic corrosion of aluminum joints. Initial tests have indicated that MP159 does not appear to be susceptible to hydrogen embrittlement.

Heat Treatment — After work strengthening, MP159 is aged at 1200 to 1250°F ± 25°F for 4 to 4½ hours and air cooled.

Material specifications for MP159 are presented in Table 7.4.2.0(a). The room temperature mechanical and physical properties for MP159 are presented in Tables 7.4.2.0(b) and (c). The effect of temperature on thermal expansion is shown in Figure 7.4.2.0.

Table 7.4.2.0(a). Material Specifications for MP159 Alloy

Specification	Form
AMS 5842	Bar (solution treated and cold drawn)
AMS 5843	Bar (solution treated, cold drawn, and aged)

7.4.2.1 Cold Worked and Aged Condition — The effect of temperature on tension modulus of elasticity and shear modulus is presented in Figure 7.4.2.1.4. A typical stress-strain curve at room temperature is shown in Figure 7.4.2.1.6.

Table 7.4.2.0(b). Design Mechanical and Physical Properties of MP159 Alloy Bar

Specification	AMS 5843				
	Bar				
	Solution treated, cold drawn, and aged				
	≤0.500		0.501-0.800		0.801-1.750
Basis	A	B	A	B	S
Mechanical Properties:					
F_{tu} , ksi:					
L	260 ^b	269	260 ^b	269	260
LT
F_{ty} , ksi:					
L	250 ^c	262	250 ^c	262	250
LT
F_{cy} , ksi:					
L
LT
F_{su} , ksi	131	144
F_{bru} , ksi:					
(e/D = 1.5)
(e/D = 2.0)
F_{bry} , ksi:					
(e/D = 1.5)
(e/D = 2.0)
e , percent (S basis):					
L	6	...	6	...	6
RA , percent (S basis):					
L	32	...	32	...	32
E , 10 ³ ksi	35.3				
E_c , 10 ³ ksi				
G , 10 ³ ksi	11.3				
μ	0.37 (solution treated condition)				
Physical Properties:					
ω , lb/in. ³	0.302				
C and K				
α , 10 ⁻⁶ in./in./°F	See Figure 7.4.2.0				

a Tensile specimens are located at T/2 location for bars 0.800 inch and under in diameter or distance between parallel sides and at T/4 location for larger size bars. The strength of bar, especially large diameter, may vary machining parts from bars over 0.800-inch in diameter since strengths may be lower than design values depending on depth of material removed from surface.

b S-Basis. The rounded T_{99} value of 265 ksi is higher than specification minimum.

c S-Basis. The rounded T_{99} value of 253 ksi is higher than specification minimum.

Table 7.4.2.0(c). Design Mechanical and Physical Properties of MP159 Alloy Bar

Specification	AMS 5842	
	Bar	
	Solution treated, cold drawn, and aged	
	≤0.500	0.501-1.750
	S	S
Mechanical Properties:		
F_{tu} , ksi:		
L	260	260
LT
F_{ty} , ksi:		
L	250	250
LT
F_{cy} , ksi:		
L
LT
F_{su} , ksi	131	...
F_{bru} , ksi:		
(e/D = 1.5)
(e/D = 2.0)
F_{bry} , ksi:		
(e/D = 1.5)
(e/D = 2.0)
e , percent:		
L	6	6
RA , percent:		
L	32	32
E , 10^3 ksi	35.3	
E_c , 10^3 ksi	
G , 10^3 ksi	11.3	
μ	0.37 (solution treated condition)	
Physical Properties:		
ω , lb/in. ³	0.302	
C and K	
α , 10^{-6} in./in./°F	See Figure 7.4.2.0	

a Tensile specimens are located at T/2 location for bars 0.800 inch and under in diameter or distance between parallel sides and at T/4 location for larger size bars. The strength of bar, especially large diameter may vary significantly from center to surface; consequently, caution should be exercised in machining parts from bars over 0.800 inch in diameter since strengths may be lower than design values depending on depth of material removed from surface.

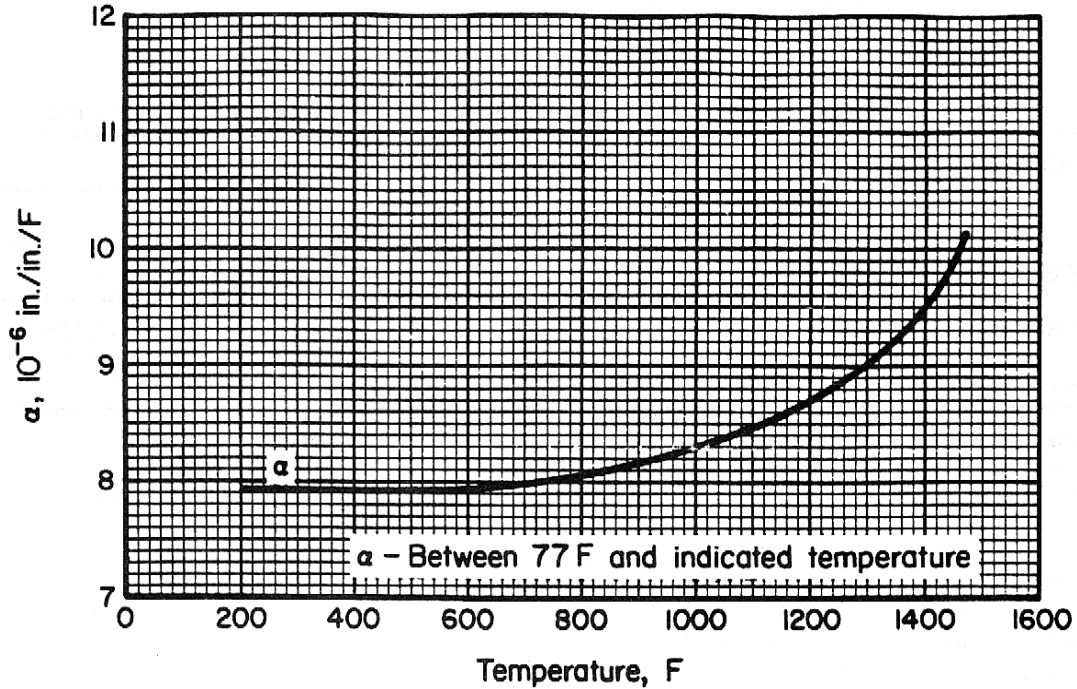

Figure 7.4.2.0. Effect of temperature on thermal expansion (α) of MP159 alloy bar.

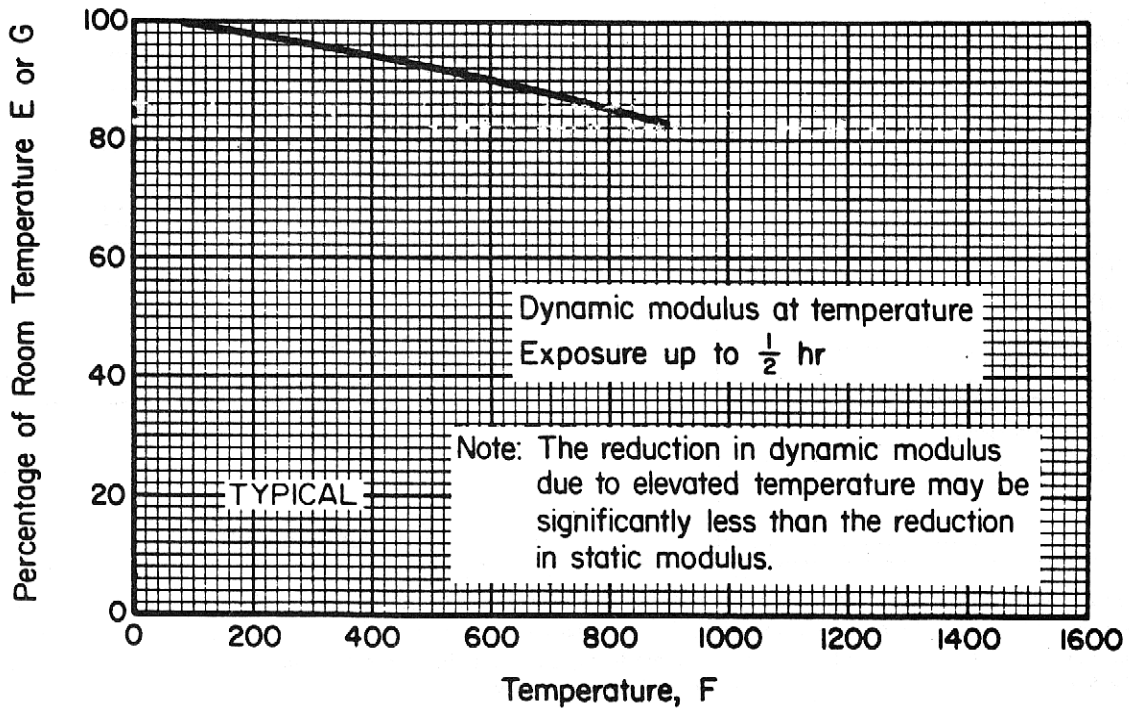

Figure 7.4.2.1.4. Effect of temperature on the tensile modulus (E) and shear modulus (G) of MP159 alloy bar.

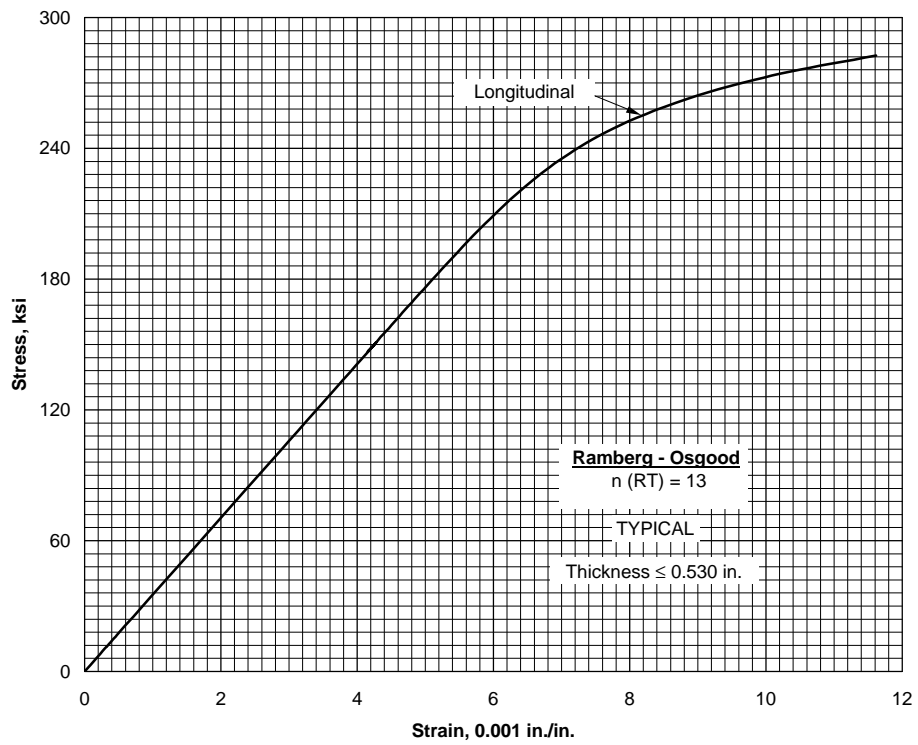

Figure 7.4.2.1.6. Typical tensile stress-strain curve at room temperature for cold worked and aged MP159 alloy bar.

7.5 ALUMINUM ALLOY SHEET LAMINATES

7.5.0 GENERAL

This section contains the engineering properties of aluminum alloy sheet laminates. These products consist of thin high-strength aluminum alloy sheets alternating with fiber layers impregnated with adhesive. These sheet laminates provide a very efficient structure for certain applications and exhibit excellent fatigue resistance.

Tensile and compressive properties for the aluminum alloy sheet laminates were determined using test specimens similar to those used for testing conventional aluminum alloy sheet with one exception. The Iosipescu shear specimen was the most appropriate configuration for the determination of shear strength. Shear yield strength and shear ultimate strength were determined using the Iosipescu test procedure. Shear yield strength was determined at 0.2% offset from load-deformation curves. Bearing tests were conducted according to ASTM E 238, which is applicable to conventional aluminum alloy products. Bearing specimens exhibited several different types of failure and bearing strength was influenced by failure mode. Consequently, a more suitable bearing test procedure for aramid fiber reinforced aluminum alloy sheet laminates is currently being developed. However, the design values for bearing strength determined according to ASTM E 238 are conservative and are considered suitable for design. These sheet laminates exhibit low elongation as measured by the tensile test. Consequently, a more realistic measure of ductility is total strain at failure, ϵ_t , defined as the measure of strain determined from the tensile load-deformation curve at specimen failure. This measurement includes both elastic and plastic strains. The minimum total strain at failure value from the material specification will be presented in the room temperature design allowable table. These sheet laminates are generally anisotropic. Therefore, design values for each grain orientation of the aluminum alloy sheet will be presented for all mechanical properties, except F_{su} and F_{sy} . The longitudinal direction is parallel to the rolling direction of the aluminum alloy sheet or length of sheet laminate, while the long transverse direction is 90° to the longitudinal direction or parallel to the width of the sheet laminate. The design values for F_{cy} , F_{sy} , F_{su} , F_{bry} , and F_{bru} were derived conventionally in accordance with the guidelines.

7.5.1 2024-T3 ARAMID FIBER REINFORCED SHEET LAMINATE

7.5.1.0 Comments and Properties — This product consists of thin 2024-T3 sheets alternating with aramid fiber layers embedded in a special resin. Nominal thickness of aluminum sheet is 0.012 inch with a prepreg nominal thickness of 0.0085 inch. The primary advantage of this product is the significant improvement in fatigue and fatigue crack growth properties compared to conventional aluminum alloy structures. The product also has good damping capacity and resistance to impact. Compared to 7475-T761 aramid fiber-reinforced sheet laminate, this product has better formability and damage tolerance characteristics.

Manufacturing Considerations — This product can be fabricated by conventional metal practices for machining, sawing, drilling, joining with fasteners and can be inspected by conventional procedures.

Environmental Considerations — This product has good corrosion resistance. The maximum service temperature is 200°F.

Specification and Properties — A material specification is presented in Table 7.5.1.0(a). Room-temperature mechanical properties are presented in Table 7.5.1.0(b).

**Table 7.5.1.0(a). Material Specifications for 2024-T3
Aramid Fiber Reinforced Sheet Laminate**

Specification	Form
AMS 4254	Sheet laminate

7.5.1.1 T3 Temper — Typical tensile and compressive stress-strain and tangent-modulus curves are shown in Figures 7.5.1.1.6(a) through (l).

Table 7.5.1.0(b). Design Mechanical and Physical Properties of 2024-T3 Aluminum Alloy, Aramid Fiber Reinforced, Sheet Laminate

Specification	AMS 4254			
Form	Aramid fiber reinforced sheet laminate			
Laminate lay-up	2/1	3/2	4/3	5/4
Nominal thickness, in.	0.032	0.053	0.074	0.094
Basis	S	S	S	S
Mechanical Properties:				
F_{tu} , ksi:				
L	90	96	101	101
LT	48	44	43	42
F_{ty} , ksi:				
L	48	49	49	49
LT	33	30	30	30
F_{cy} , ksi:				
L	35	35	34	33
LT	33	30	30	30
F_{su}^a , ksi				
	b	b	b	b
F_{sy}^a , ksi				
	16	15	14	14
F_{bru}^c , ksi:				
L (e/D = 1.5)	78	73	73	68
LT (e/D = 1.5)	89	84	80	75
L (e/D = 2.0)	93	86	83	77
LT (e/D = 2.0)	95	89	81	76
F_{bry}^c , ksi:				
L (e/D = 1.5)	53	52	51	50
LT (e/D = 1.5)	56	52	52	52
L (e/D = 2.0)	63	63	61	59
LT (e/D = 2.0)	66	61	61	60
ϵ_t^d , percent:				
L	2	2	2	2
LT	12	12	12	14
E_s , 10 ³ ksi:				
L	9.9	9.9	9.7	9.6
LT	8.1	7.5	7.1	7.0
E_c , 10 ³ ksi:				
L	9.5	9.4	9.3	9.1
LT	8.0	7.5	7.2	7.0
G_s , 10 ³ ksi:				
L	2.7	2.5	2.4	2.2
LT	2.6	2.4	2.4	2.2
μ :				
L	0.33	0.34	0.34	0.32
LT	0.29	0.27	0.26	0.25
Physical Properties:				
ω , lb/in. ³	0.086	0.084	0.082	0.081
C, K, and α

a Shear values determined from data obtained using Iosipescu shear specimens.
b Shear ultimate strengths not determinable due to excessive deflection of specimen.
c Bearing values are "dry pin" values per Section 1.4.7.1 determined in accordance with ASTM E238.
d Total (elastic plus plastic) strain at failure determined from stress-strain curve.

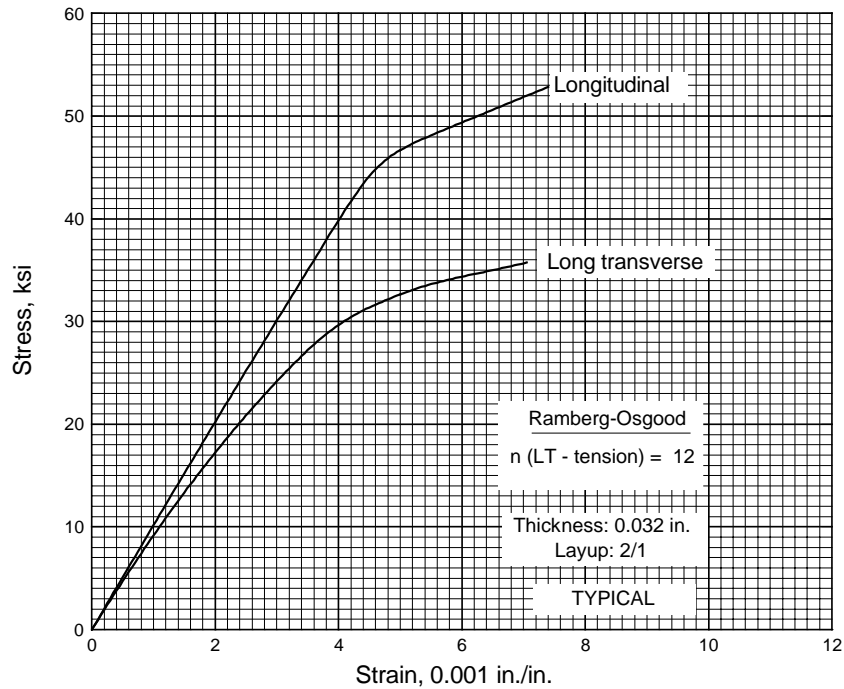

Figure 7.5.1.1.6(a). Typical tensile stress-strain curves for 2024-T3 aluminum alloy, aramid fiber-reinforced, sheet laminate.

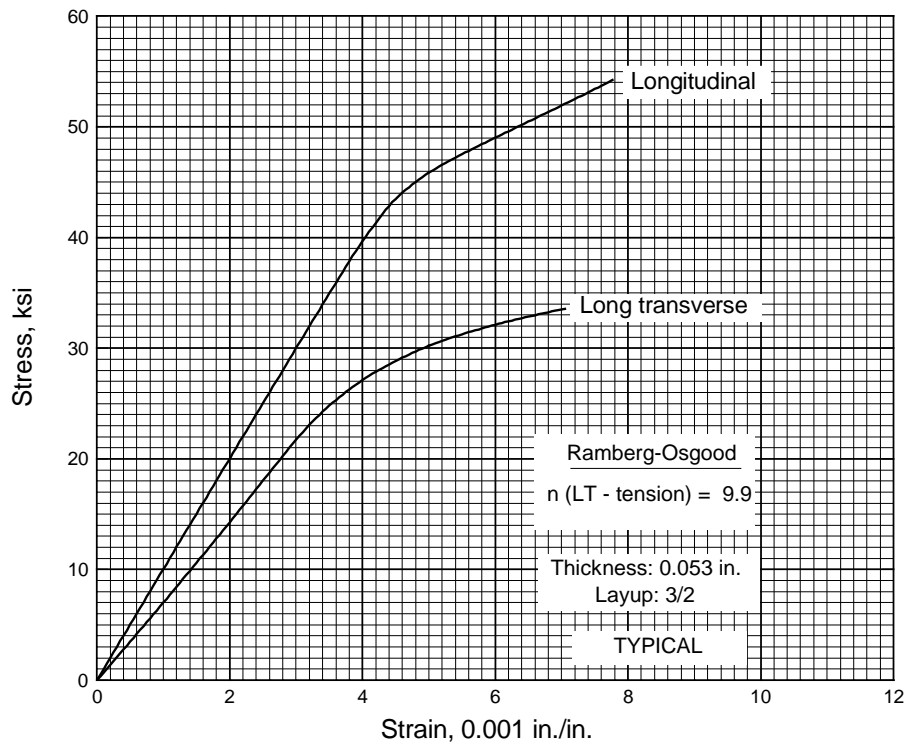

Figure 7.5.1.1.6(b). Typical tensile stress-strain curves for 2024-T3 aluminum alloy, aramid fiber-reinforced, sheet laminate.

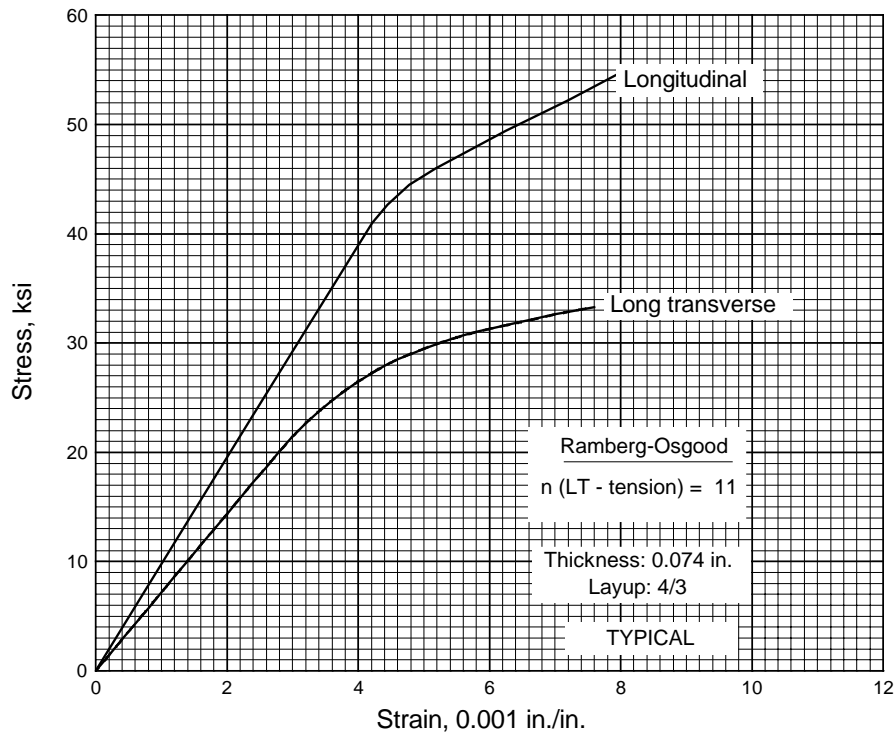

Figure 7.5.1.1.6(c). Typical tensile stress-strain curves for 2024-T3 aluminum alloy, aramid fiber-reinforced, sheet laminate.

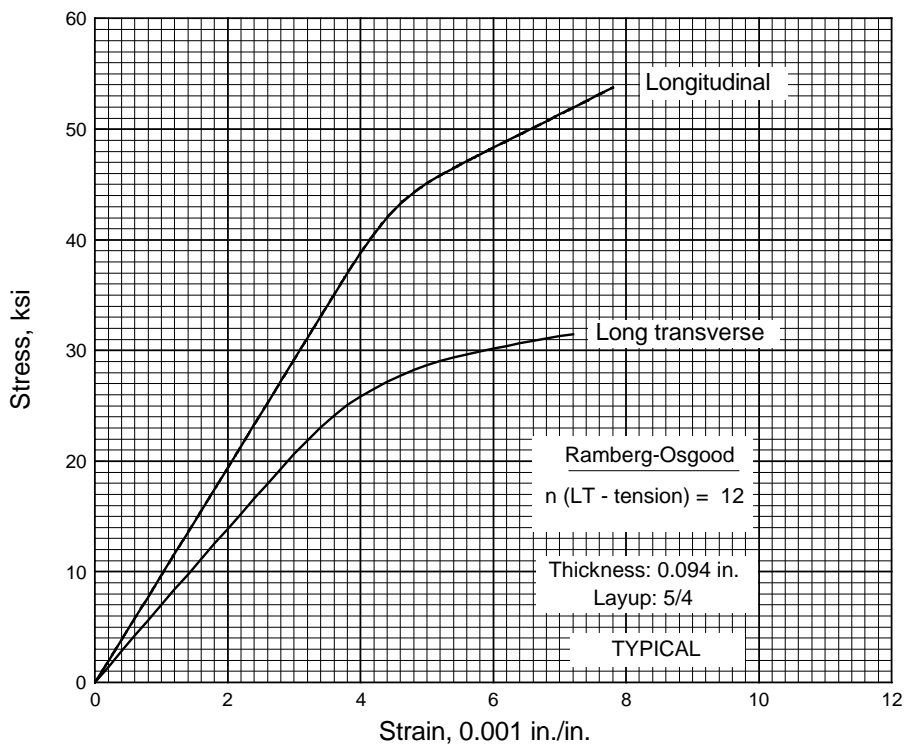

Figure 7.5.1.1.6(d). Typical tensile stress-strain curves for 2024-T3 aluminum alloy, aramid fiber-reinforced, sheet laminate.

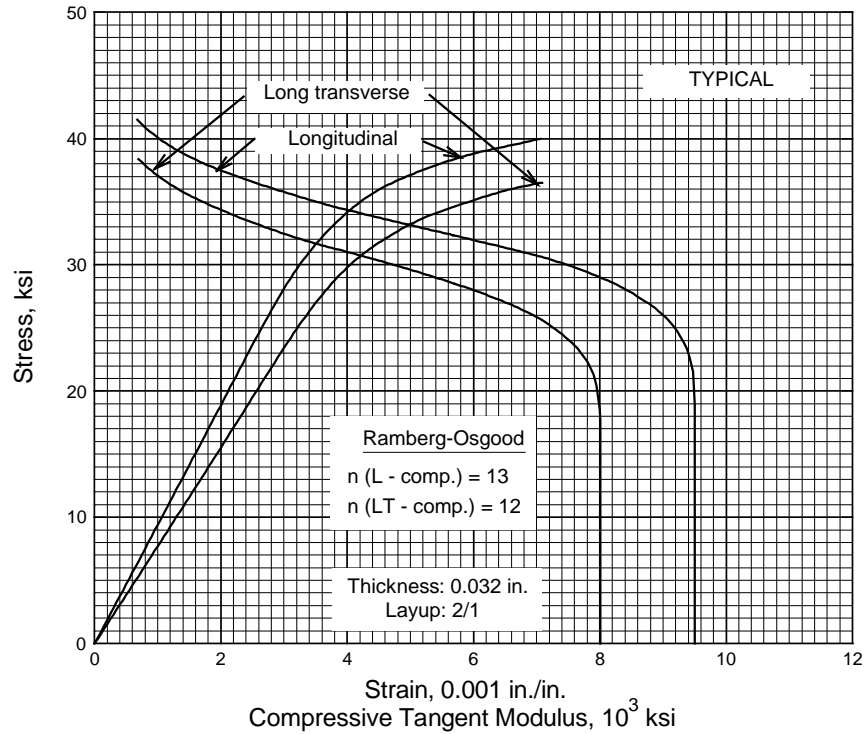

Figure 7.5.1.1.6(e). Typical compressive stress-strain and compressive tangent-modulus curves for 2024-T3 aluminum alloy, aramid fiber-reinforced, sheet laminate.

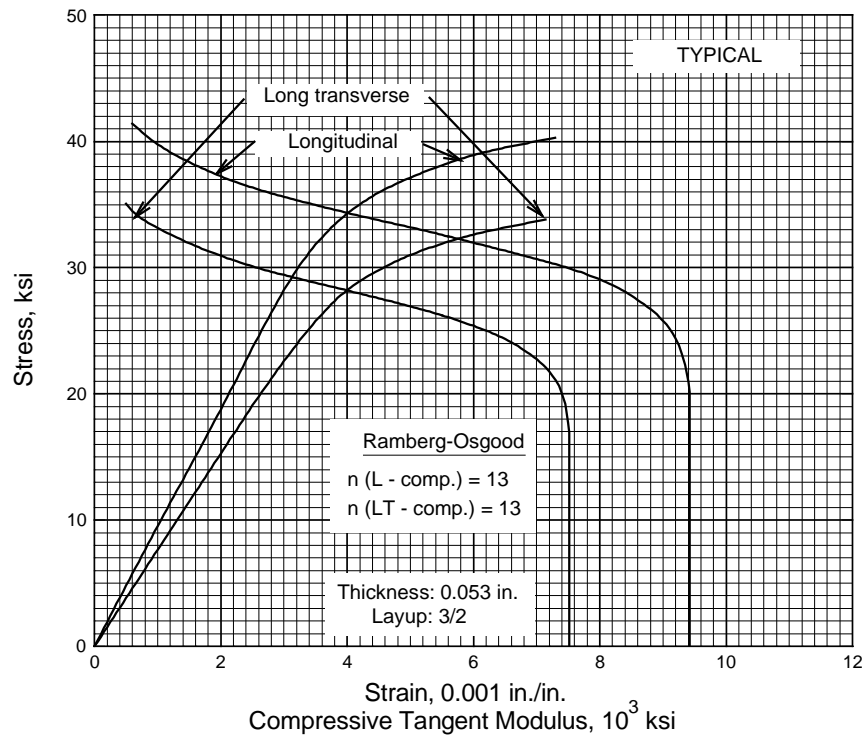

Figure 7.5.1.1.6(f). Typical compressive stress-strain and compressive tangent-modulus curves for 2024-T3 aluminum alloy, aramid fiber-reinforced, sheet laminate.

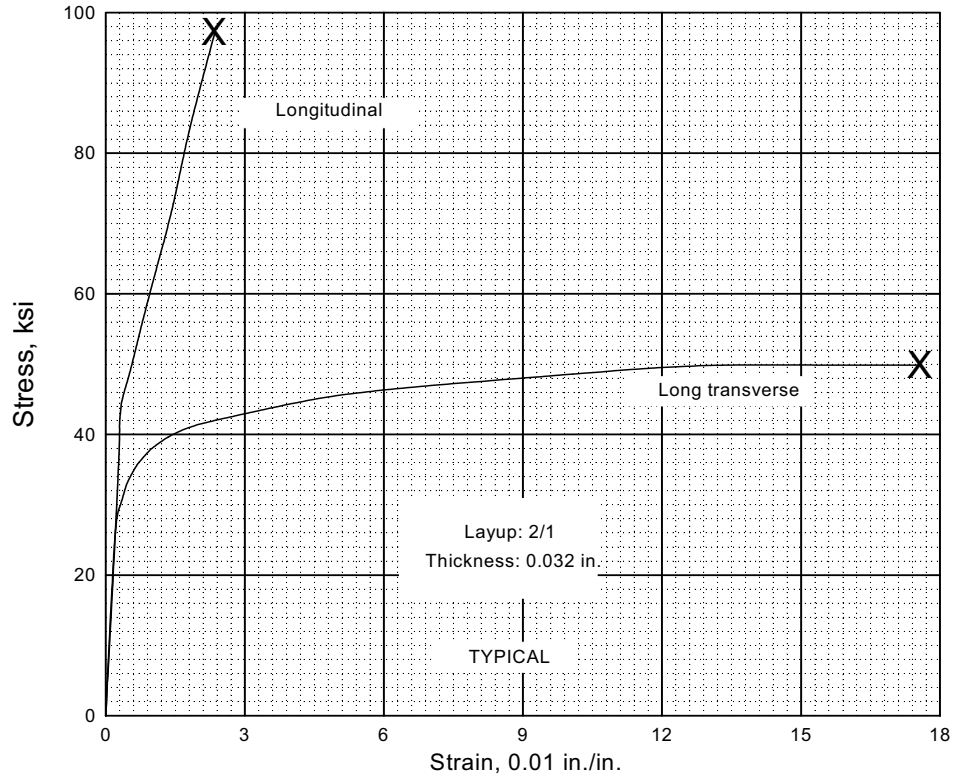

Figure 7.5.1.1.6(i). Typical tensile stress-strain curves (full range) for 2024-T3 aluminum alloy, aramid fiber-reinforced, sheet laminate.

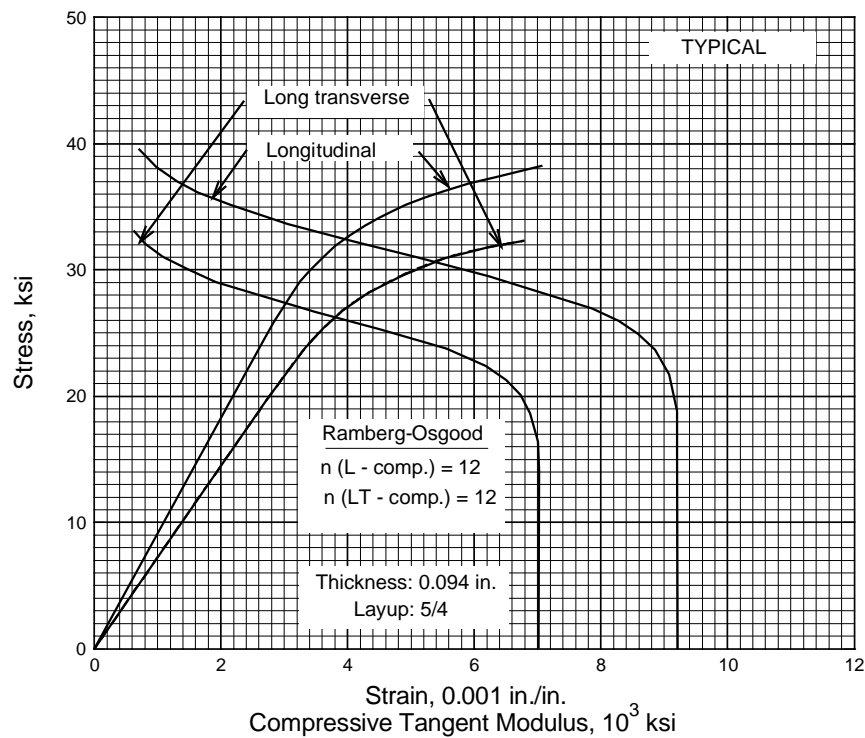

Figure 7.5.1.1.6(h). Typical compressive stress-strain and compressive tangent modulus curves for 2024-T3 aluminum alloy, aramid fiber-reinforced, sheet laminate.

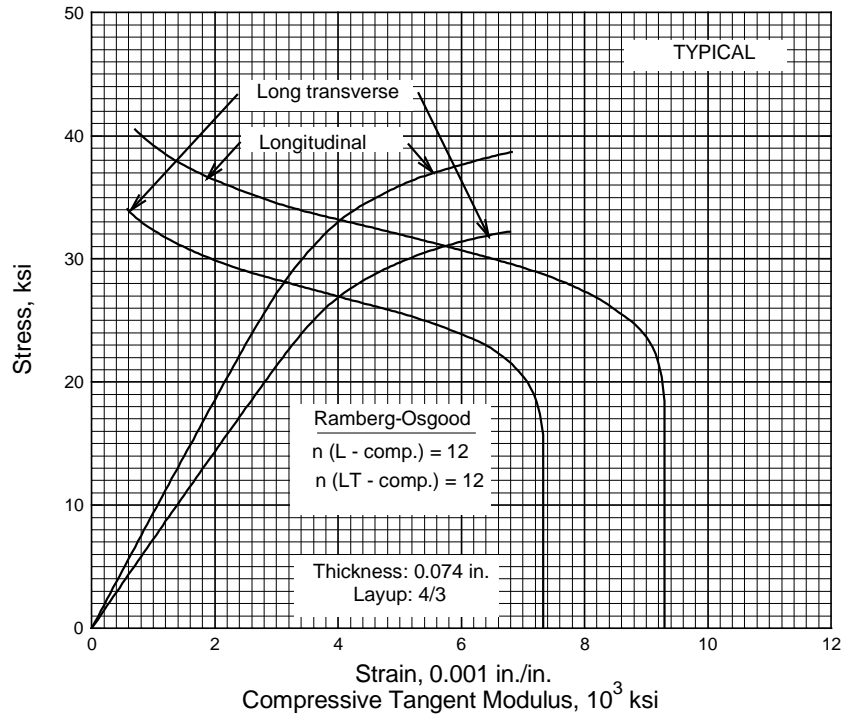

Figure 7.5.1.1.6(g). Typical compressive stress-strain and compressive tangent-modulus curves for 2024-T3 aluminum alloy, aramid fiber-reinforced, sheet laminate.

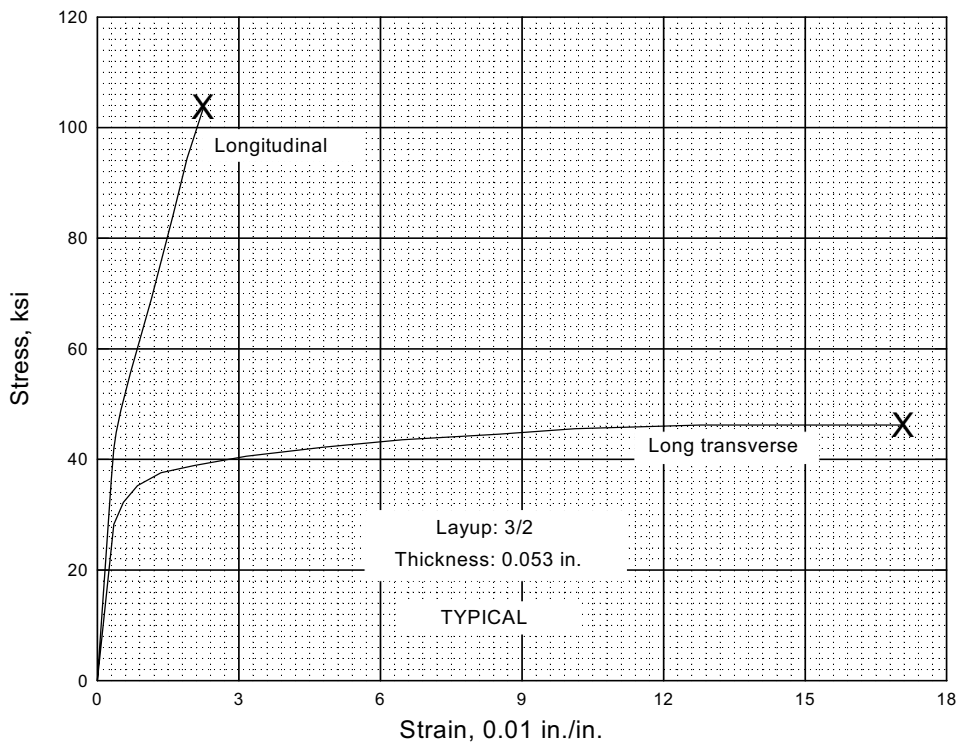

Figure 7.5.1.1.6(j). Typical tensile stress-strain curves (full range) for 2024-T3 aluminum alloy, aramid fiber-reinforced, sheet laminate.

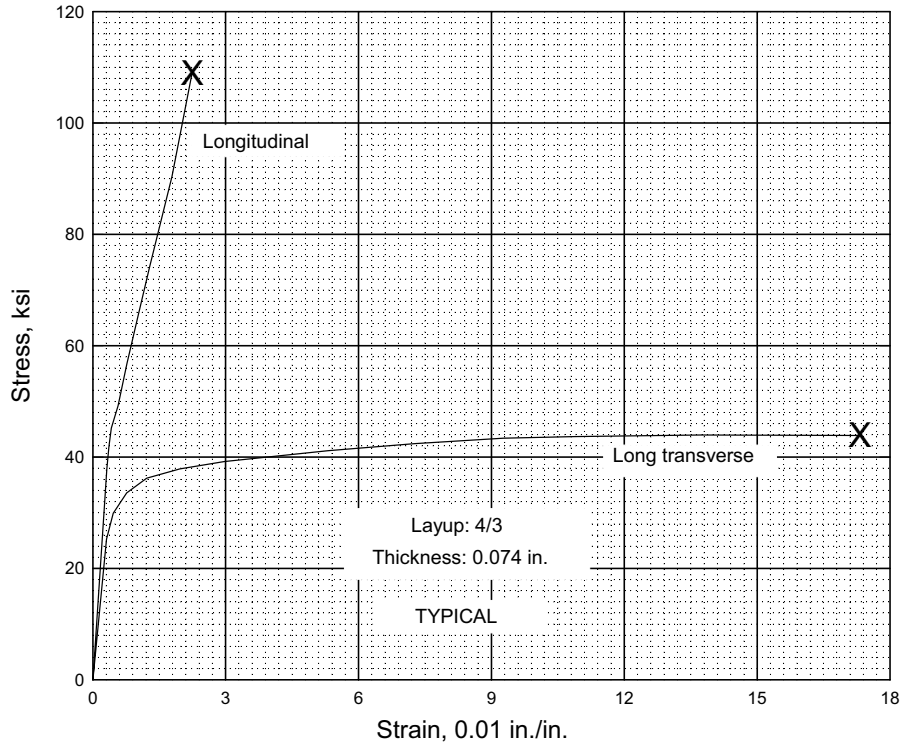

Figure 7.5.1.1.6(k). Typical tensile stress-strain curves (full range) for 2024-T3 aluminum alloy, aramid fiber-reinforced, sheet laminate.

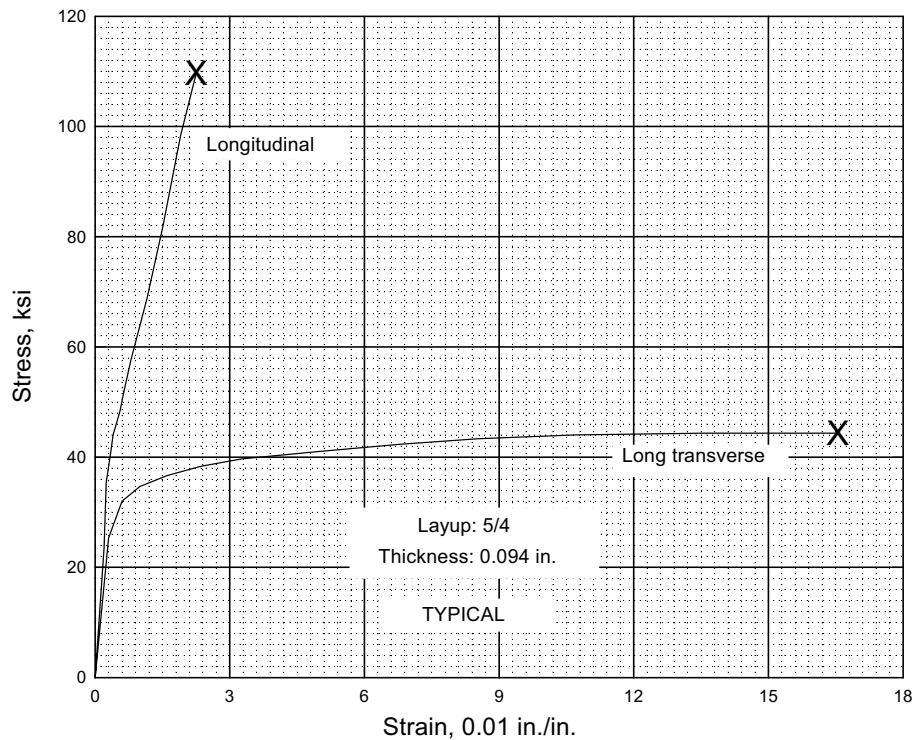

Figure 7.5.1.1.6(l). Typical tensile stress-strain curves (full range) for 2024-T3 aluminum alloy, aramid fiber-reinforced, sheet laminate.

7.5.2 7475-T761 ARAMID FIBER REINFORCED SHEET LAMINATE

7.5.2.0 Comments and Properties — This product consists of thin 7475-T761 sheets alternating with aramid fiber layers embedded in a special resin. Nominal thickness of aluminum sheet is 0.012 inch with a prepreg nominal thickness of 0.0085 inch. The primary advantage of this product is the significant improvement in fatigue and fatigue crack growth properties compared to conventional aluminum alloy structures. The product also has good damping capacity and resistance to impact.

Manufacturing Considerations — This product can be fabricated by conventional metal practices for machining, sawing, drilling, joining with fasteners and can be inspected by conventional procedures.

Environmental Considerations — This product has good corrosion resistance. The maximum service temperature is 200°F.

Specifications and Properties — A material specification is presented in Table 7.5.2.0(a). Room-temperature mechanical properties are presented in Table 7.5.2.0(b).

**Table 7.5.2.0(a). Material Specifications for 7475-T761
Aramid Fiber Reinforced Sheet Laminate**

Specification	Form
AMS 4302	Sheet laminate

7.5.2.1 T761 Temper — Tensile and compressive stress-strain and tangent modulus curves are shown in Figures 7.5.2.1.6(a) through (f). Full-range tensile stress-strain curves are presented in Figures 7.5.2.1.6(g) through (j).

Table 7.5.2.0(b). Design Mechanical and Physical Properties of 7475-T761 Aluminum Alloy, Aramid Fiber Reinforced, Sheet Laminate

Specification	AMS 4302			
	Aramid fiber reinforced sheet laminate			
	2/1	3/2	4/3	5/4
Form				
Laminate lay-up	2/1	3/2	4/3	5/4
Nominal thickness, in. ...	0.032	0.053	0.074	0.094
Basis	S	S	S	S
Mechanical Properties:				
<i>F_{tu}</i> , ksi:				
L	103	111	114	116
LT	56	51	50	48
<i>F_{ty}</i> , ksi:				
L	76	82	82	84
LT	48	43	42	40
<i>F_{cy}</i> , ksi:				
L	46	46	44	44
LT	51	48	47	45
<i>F_{su}^a</i> , ksi	35	33	33	32
<i>F_{sy}^a</i> , ksi	24	23	22	21
<i>F_{bru}^b</i> , ksi:				
L (e/D = 1.5)	91	83	84	82
LT (e/D = 1.5)	96	85	86	80
L (e/D = 2.0)	104	87	88	84
LT (e/D = 2.0)	108	88	86	80
<i>F_{bry}^b</i> , ksi:				
L (e/D = 1.5)	73	70	66	69
LT (e/D = 1.5)	76	69	69	67
L (e/D = 2.0)	83	81	77	79
LT (e/D = 2.0)	84	76	75	72
<i>e_t^c</i> , percent:				
L	1.5	1.8	1.7	1.8
LT	6.1	6.4	6.3	6.6
<i>E</i> , 10 ³ ksi:				
L	9.8	9.9	10.0	9.8
LT	7.7	7.1	6.7	6.7
<i>E_c</i> , 10 ³ ksi:				
L	9.6	9.6	9.6	9.7
LT	7.8	7.3	7.0	6.9
<i>G</i> , 10 ³ ksi:				
L	2.8	2.6	2.3	2.3
LT	2.6	2.4	2.3	2.3
<i>μ</i> :				
L	0.35	0.35	0.35	0.35
LT	0.25	0.25	0.25	0.25
Physical Properties:				
<i>ω</i> , lb/in. ³	0.085	0.083	0.082	0.081
<i>C</i> , <i>K</i> , and <i>α</i>

a Shear values determined from data obtained using Iosipescu shear specimens.

b Bearing values are "dry pin" values per Section 1.4.7.1 determined in accordance with ASTM E 238.

c Total (elastic plus plastic) strain at failure determined from stress-strain curve. Values are minimum but not included in AMS 4302.

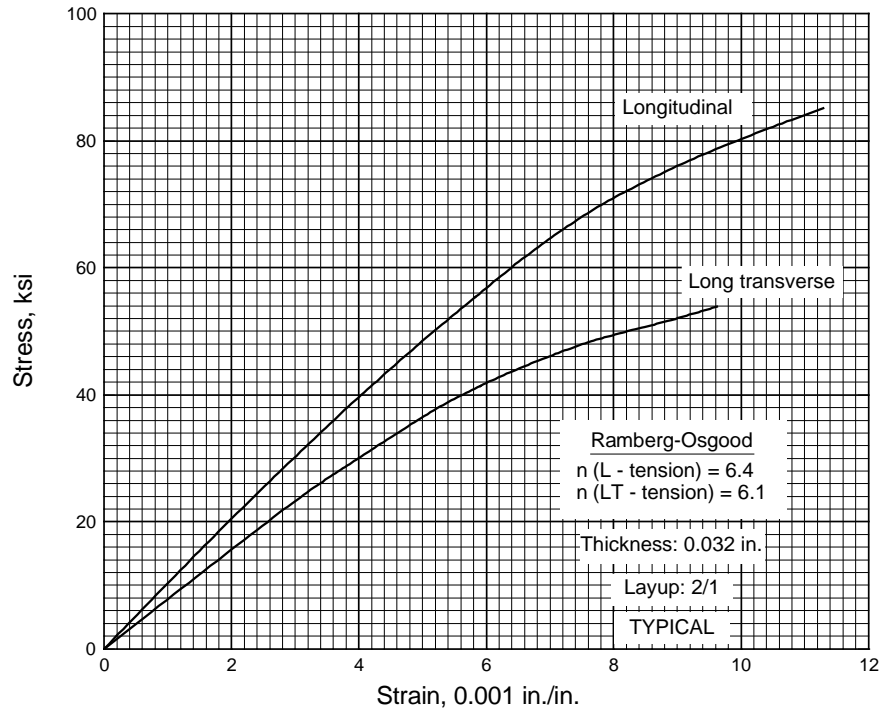

Figure 7.5.2.1.6(a). Typical tensile stress-strain curves for 7475-T761 aluminum alloy, aramid fiber-reinforced, sheet laminate.

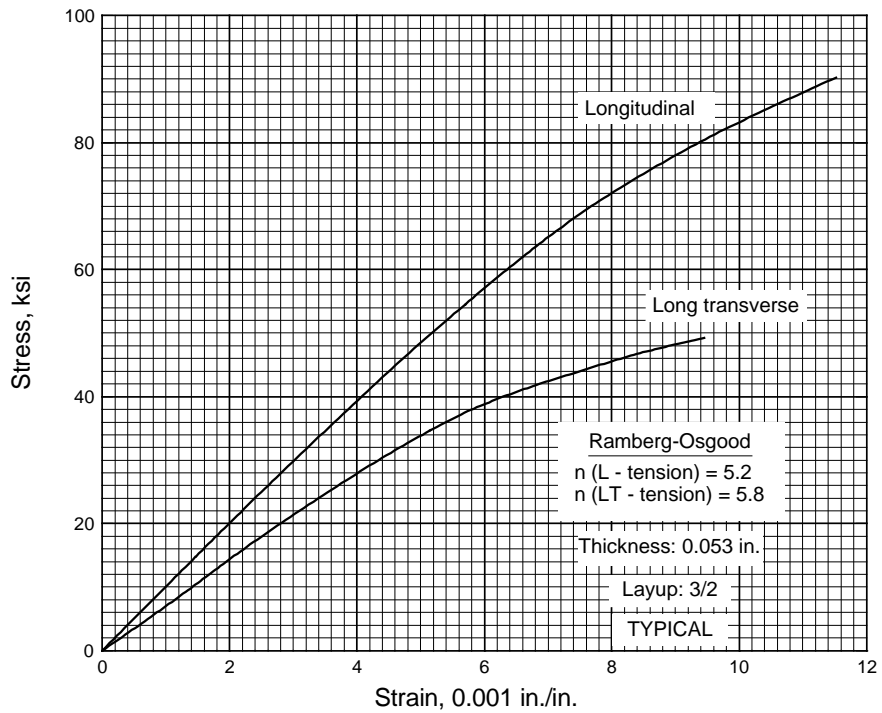

Figure 7.5.2.1.6(b). Typical tensile stress-strain curves for 7475-T761 aluminum alloy, aramid fiber-reinforced, sheet laminate.

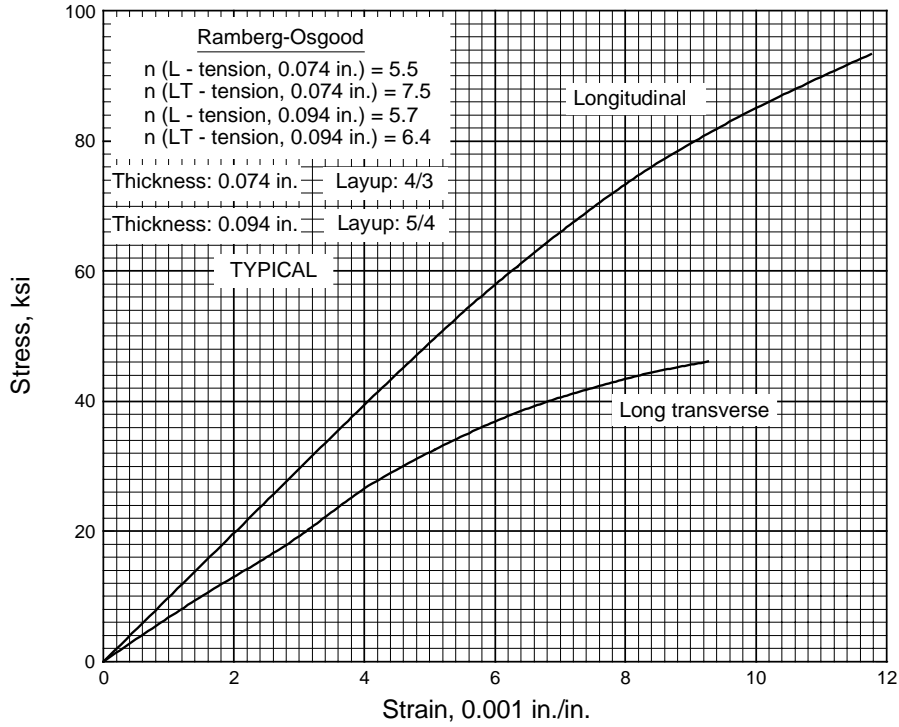

Figure 7.5.2.1.6(c). Typical tensile stress-strain curves for 7475-T761 aluminum alloy, aramid fiber-reinforced, sheet laminate.

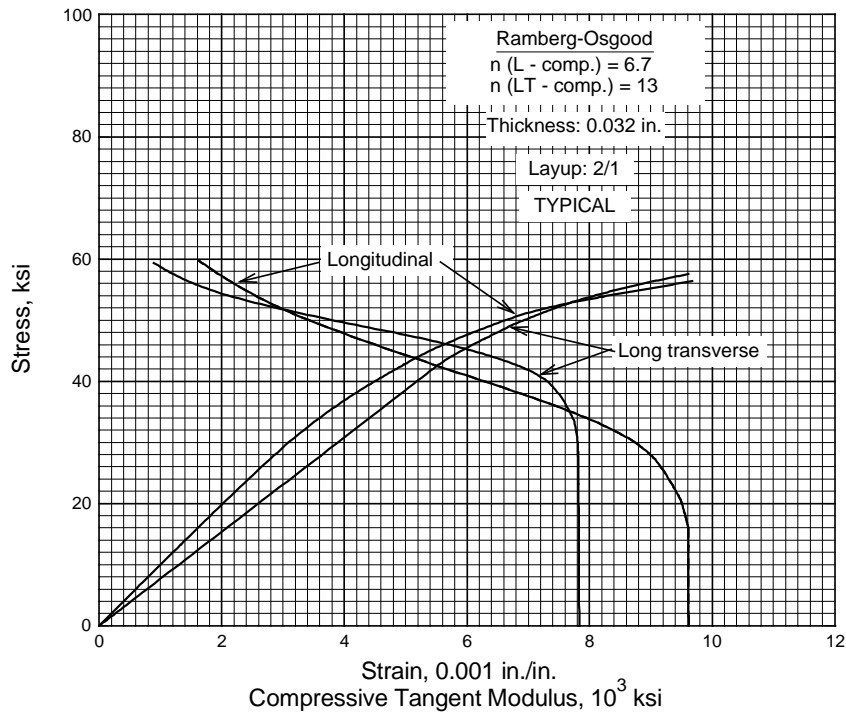

Figure 7.5.2.1.6(d). Typical compressive stress-strain and compressive tangent modulus curves for 7475-T761 aluminum alloy, aramid fiber-reinforced, sheet laminate.

MIL-HDBK-5J
31 January 2003

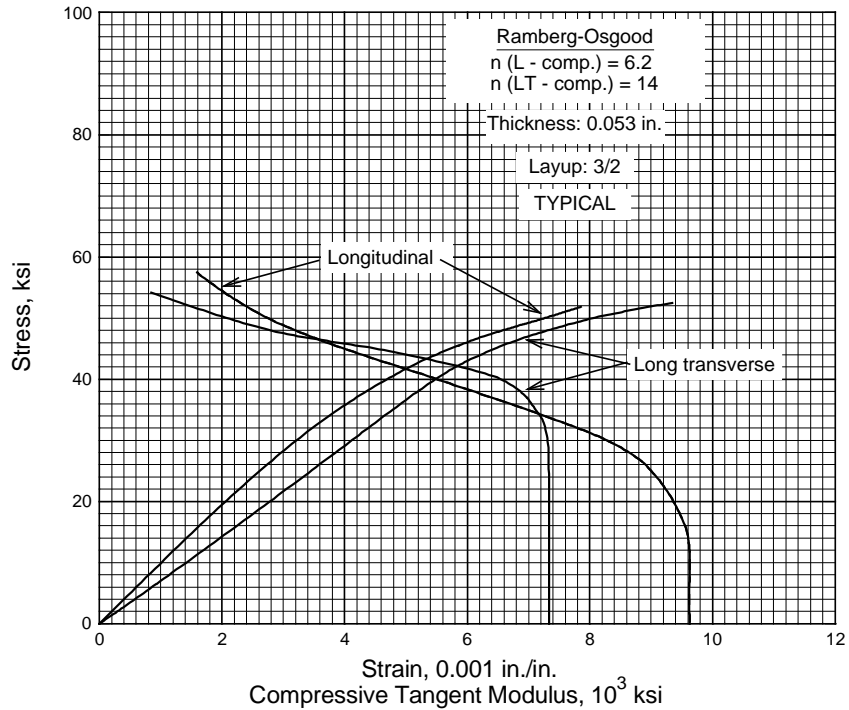

Figure 7.5.2.1.6(e). Typical compressive stress-strain and compressive tangent-modulus curves for 7475-T761 aluminum alloy, aramid fiber-reinforced, sheet laminate.

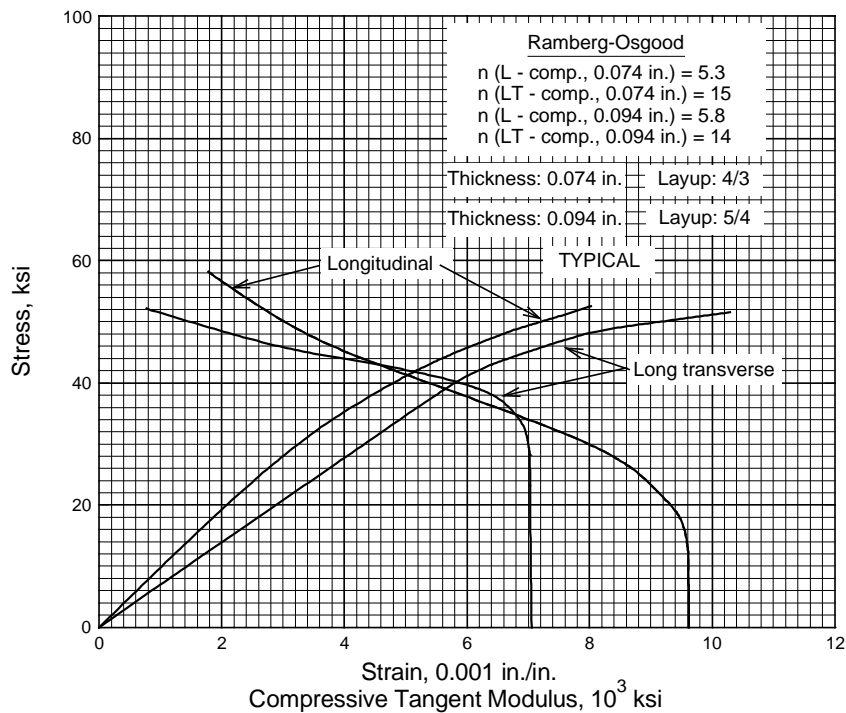

Figure 7.5.2.1.6(f). Typical compressive stress-strain and compressive tangent-modulus curves for 7475-T761 aluminum alloy, aramid fiber-reinforced, sheet laminate.

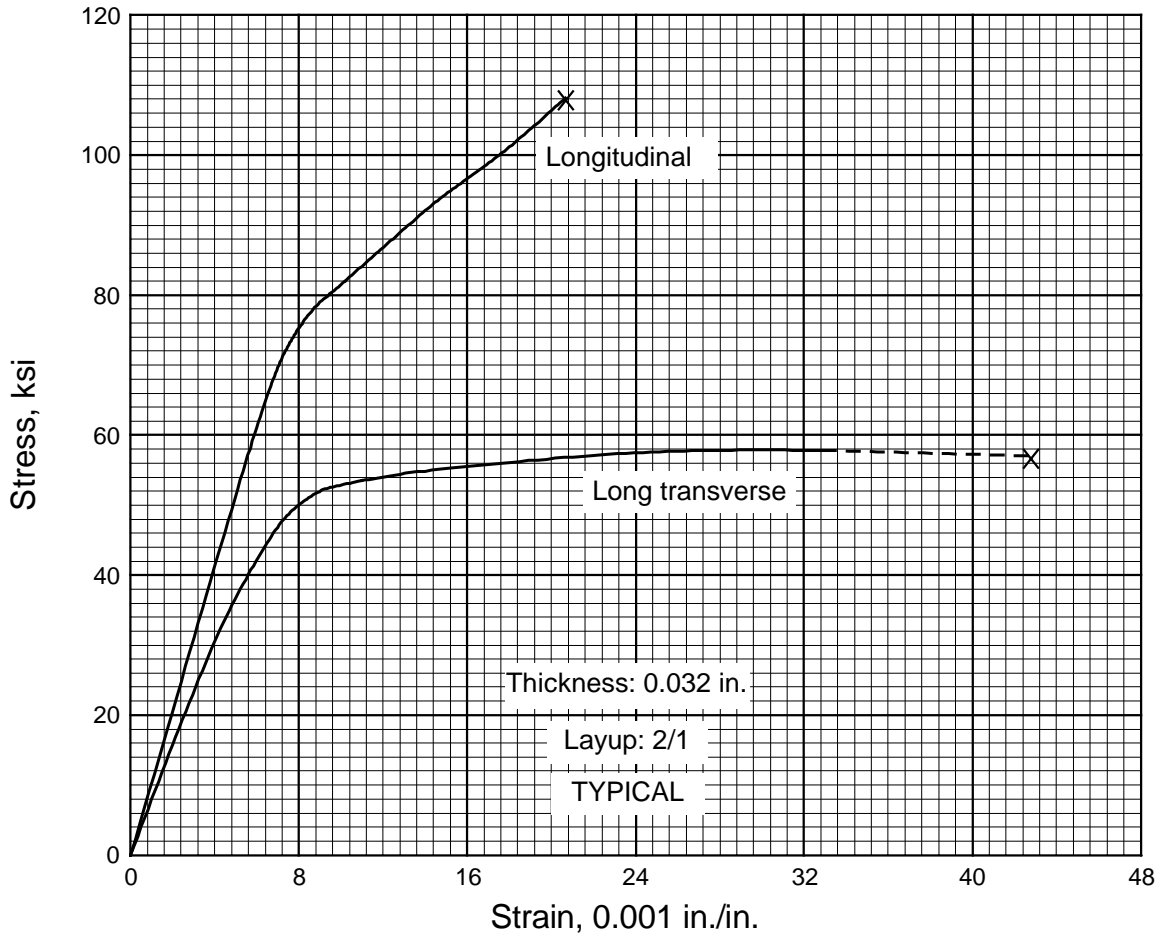

Figure 7.5.2.1.6(g). Typical tensile stress-strain curves (full range) for 7475-T761 aluminum alloy, aramid fiber-reinforced, sheet laminate.

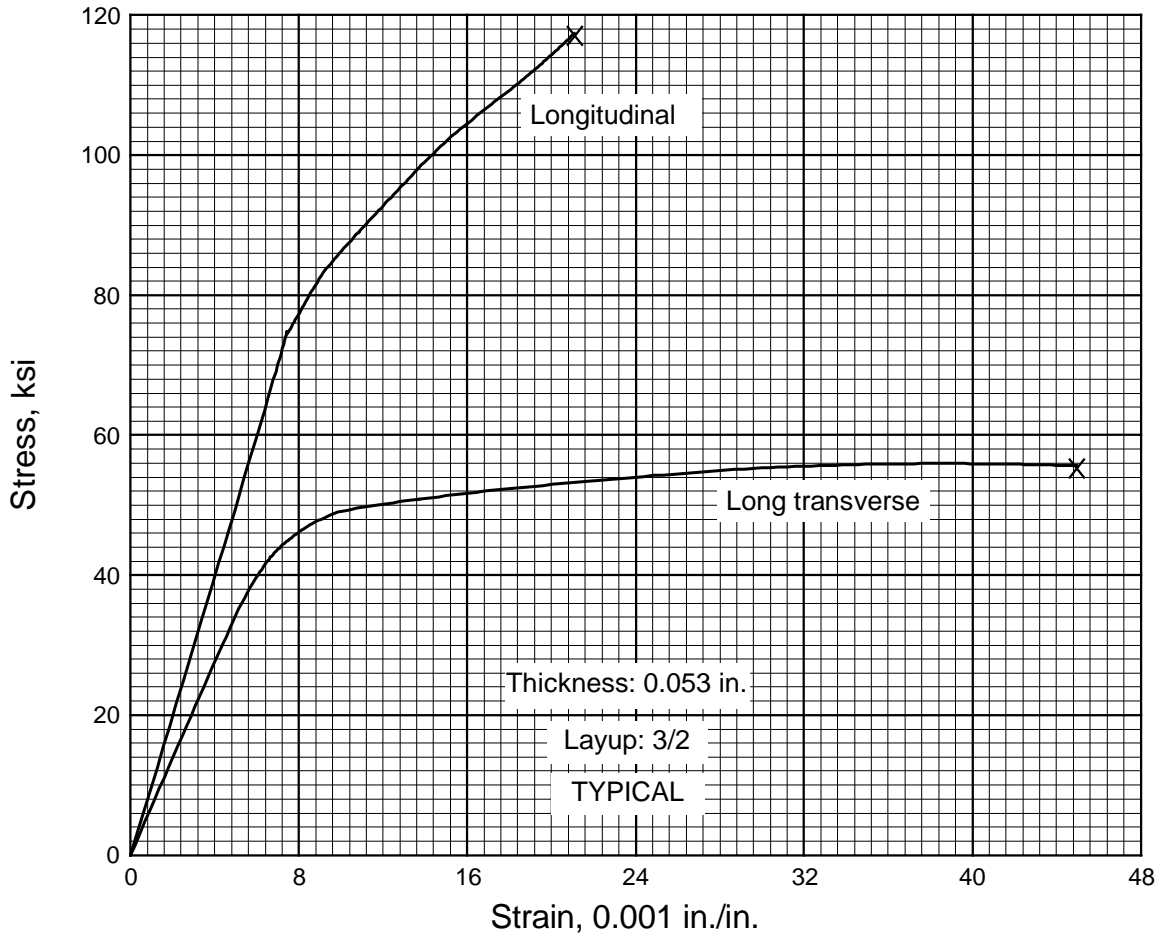

Figure 7.5.2.1.6(h). Typical tensile stress-strain curves (full range) for 7475-T761 aluminum alloy, aramid fiber-reinforced, sheet laminate.

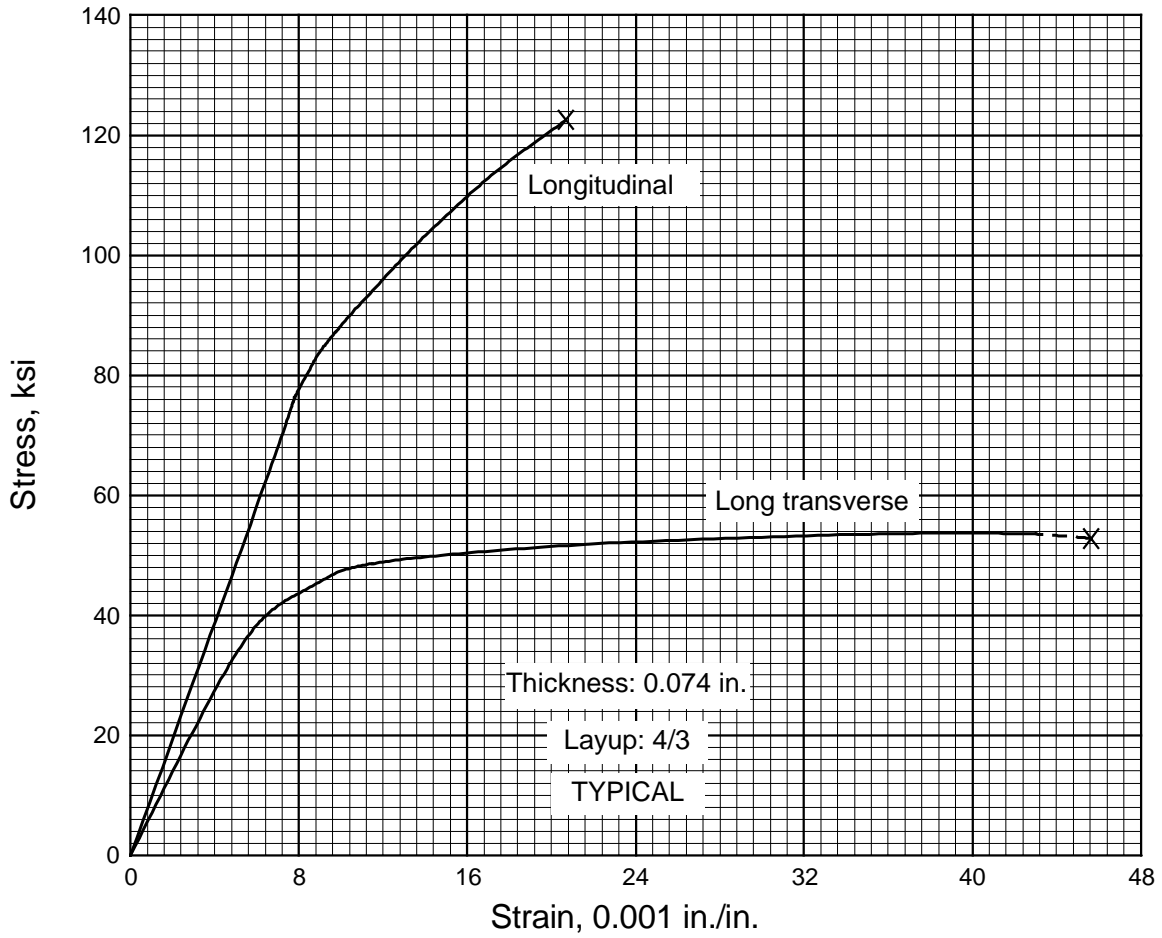

Figure 7.5.2.1.6(i). Typical tensile stress-strain curves (full range) for 7475-T761 aluminum alloy, aramid fiber-reinforced, sheet laminate.

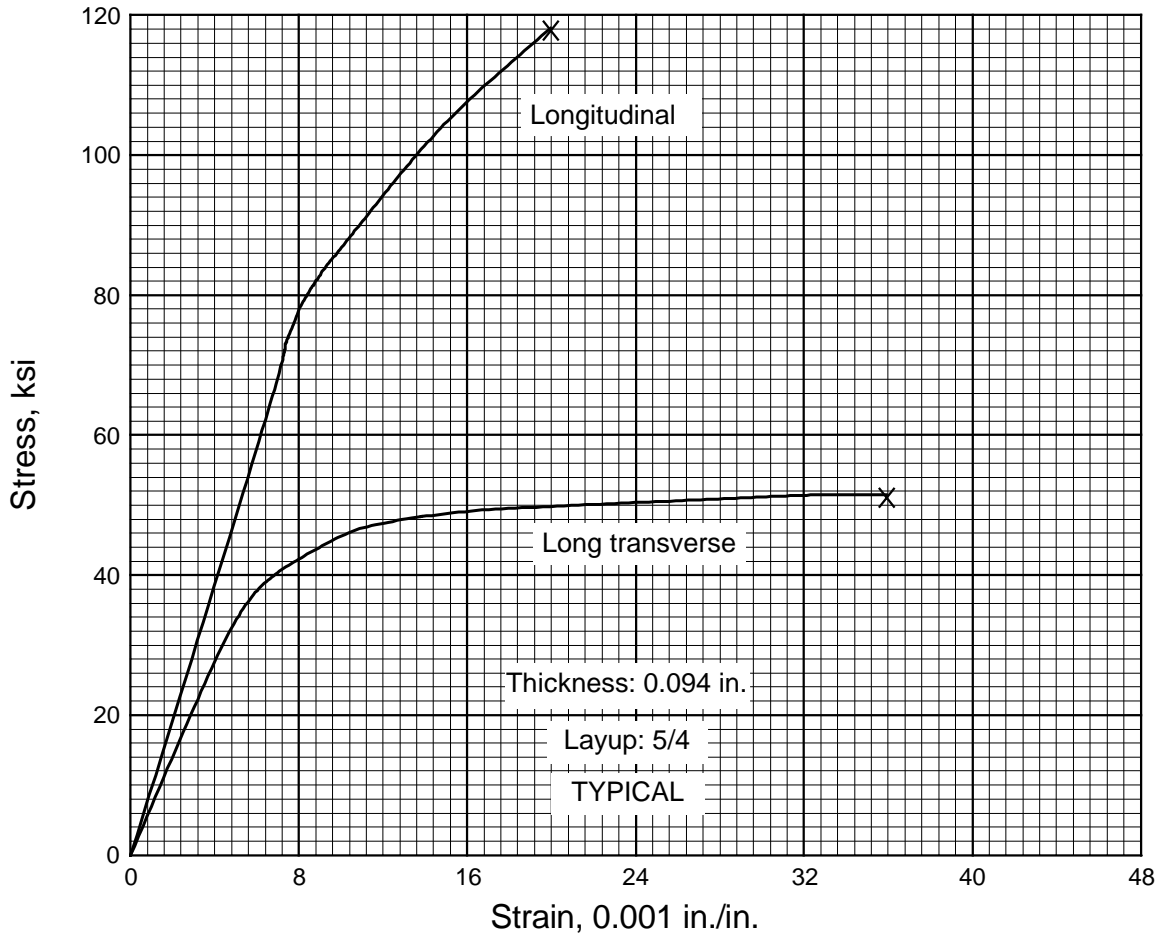

Figure 7.5.2.1.6(j). Typical tensile stress-strain curves (full range) for 7475-T761 aluminum alloy, aramid fiber-reinforced, sheet laminate.

REFERENCES

- 7.2.0(a) Williams, R. F., and Ingels, S. E., "The Fabrication of Beryllium—Volume I: A Survey of Current Technology," NASA TM X-53453 (July 1966).
- 7.2.0(b) Williams, R. F., and Ingels, S. E., "The Fabrication of Beryllium Alloys—Volume II: Forming Techniques for Beryllium Alloys," NASA TM X-43453 (July 1966).
- 7.2.0(c) Williams, R. F., and Ingels, S. E., "The Fabrication of Beryllium—Volume III: Metal Removal Techniques," NASA TM X-53453 (August 1966).
- 7.2.0(d) Williams, R. F., and Ingels, S. E., "The Fabrication of Beryllium—Volume IV: Surface Treatments for Beryllium Alloys," NASA TM X-53453 (July 1966).
- 7.2.0(e) Williams, R. F., and Ingels, S. E., "The Fabrication of Beryllium—Volume V: Thermal Treatments for Beryllium Alloys," NASA TM X-53453 (July 1966).
- 7.2.0(f) Williams, R. F., and Ingels, S. E., "The Fabrication of Beryllium—Volume VI: Joining Techniques for Beryllium Alloys," NASA TM X-53453 (July 1966).
- 7.2.0(g) Stonehouse, A. J., and Marder, J. M., "Beryllium," ASM Metals Handbook, Tenth Edition, Vol. 2, pp. 683-687, 1990.
- 7.2.0(h) Hanafee, J. E., "Effect of Annealing and Etching on Machine Damage In Structural Beryllium," J. Applied Metal Working, Vol. 1, No. 3, pp. 41-51 (1980).
- 7.2.0(i) Corle, R. R., Leslie, W. W., and Brewer, A. W., "The Testing and Heat Treating of Beryllium for Machine Damage Removal," RFP-3084, Rockwell International, Rocky Flats Plant, DOE, Sept. 1981.
- 7.2.1.1(a) Breslen, A. U., and Harris, W. B., "Health Protection in Beryllium Facilities, Summary of Ten Years' Experience," U.S. Atomic Energy Commission, Health and Safety Laboratory, New York Operations Office, Report HASL-36 (May 1, 1958).
- 7.2.1.1(b) Breslen, A. U., and Harris, W. B., "Practical Ways to Collect Beryllium Dust," Air Engineering, 2(7), p. 34 (July 1960).
- 7.2.1.1(c) Cholak, J., et al., "Toxicity of Beryllium, Final Technical Engineering Report," ASD TR 62-7-665 (April 1962).
- 7.2.1.1(d) "Beryllium Disease and Its Control," AMA Arch. Ind. Health, 19(2), pp. 91-267 (February 1959).
- 7.2.1.1(e) Stokinger, H. E., "Beryllium, Its Industrial Hygiene Aspect," Academic Press (1966).
- 7.2.1.1(f) Rossman, M. D., Preuss, O. P., and Powers, M. B., *Beryllium-Biomedical and Environmental Aspects*, Williams and Wilkins, Baltimore, Hong Kong, London, Munich, San Francisco, Sydney, and Tokyo, 319 pages (1991).
- 7.2.1.1(g) Crawford, R. F., and Barnes, A. B., "Strength Efficiency and Design Data for Beryllium Structures," ASD TR 61-692 (1961).
- 7.3.0(a) "The Selection and Application of Wrought Copper and Copper Alloy," by the ASM Committee on Applications of Copper, ASM Metals Handbook, Vol. 1, 8th Edition, pp. 960-972 (1961).

MIL-HDBK-5J
31 January 2003

- 7.3.0(b) “The Selection and Application of Copper Alloy Castings,” by the ASM Committee on Copper Alloy Castings, ASM Metals Handbook, Vol. 1, 8th Edition, pp. 972-983 (1961).
- 7.3.0(c) CDA Standard Handbook, “Part 2—Wrought Mill Producers Alloy Data,” and “Part 7—Cast Products Data,” Copper Development Association, New York.

THIS PAGE INTENTIONALLY BLANK

CHAPTER 8

STRUCTURAL JOINTS

This chapter, while comprising three major sections, primarily is concerned with joint allowables. Section 8.1 is concerned with mechanically fastened joints; Section 8.2, with metallurgical joints (various welding and brazing processes). Section 8.3 contains information for structural component data; it is concerned with bearings, pulleys, and cables.

With particular reference to Section 8.1, the introductory section (8.1.1) contains fastener indexes that can be used as a quick reference to locate a specific table of joint allowables. Following this introductory section are five sections comprising the five major fastener categories, as shown in Table 8.0.1.

Table 8.0.1. Structural Joints Index (Fastener Type)

Section	Fastener Type
8.1.2	Solid Rivets
8.1.2.1	Protruding head
8.1.2.2	Flush head
8.1.3	Blind fasteners
8.1.3.1	Protruding head
8.1.3.2	Flush head
8.1.4	Swaged collar fasteners
8.1.4.1	Protruding head
8.1.4.2	Flush head
8.1.5	Threaded fasteners
8.1.5.1	Protruding head
8.1.5.2	Flush head
8.1.6	Special fasteners
8.1.6.1	Fastener sleeves

In each of the five major sections, there are subsections that describe the factors to be considered in determining the strength of fasteners and joints. After each major section, pertinent tables are presented.

Similarly, Section 8.2 has an introductory section (8.2.1), followed by two major sections comprising different metallurgical joints as shown in Table 8.0.2.

Table 8.0.2. Structural Joints Index (Joining Methods)

Section	Joining Methods
8.2.2	Welded joints
8.2.2.1	Fusion
8.2.2.2	Flush and pressure
8.2.2.3	Spot and seam
8.2.3	Brazing
8.2.3.1	Copper
8.2.3.2	Silver

Following each 4-digit section, applicable tables and figures for the particular section are presented.

8.1 MECHANICALLY FASTENED JOINTS

To determine the strength of mechanically fastened joints, it is necessary to know the strength of the individual fasteners (both by itself, and when installed in various thicknesses of the various materials). In most cases, failures in such joints occur by tensile failure of the fasteners, shearing of the fasteners and by bearing and/or tearing of the sheet or plate.

8.1.1 INTRODUCTION AND FASTENER INDEXES — Five categories of mechanical fasteners are presently contained in this Handbook, generically defined as follows:

Solid Rivets — Solid rivets are defined as one piece fasteners installed by mechanically upsetting one end.

Blind Fasteners — Blind fasteners are usually multiple piece devices that can be installed in a joint which is accessible from one side only. When a blind fastener is being installed, a self-contained mechanical, chemical, or other feature forms an upset on its inaccessible or blind side. These fasteners must be destroyed to be removed. This fastener category includes such fasteners as blind rivets, blind bolts, etc.

Swaged Collar Fasteners — Swaged collar fasteners are multiple piece fasteners, usually consisting of a solid pin and a malleable collar which is swaged or formed onto the pin to clamp the joint. This fastener usually is permanently installed. This fastener class includes such fasteners as “Hi-Shear” rivets, “Lockbolts”, and “Cherrybucks”.

Threaded Fasteners — Fasteners in this category are considered to be any threaded part (or parts) that after assembly in a joint can be easily removed without damage to the fastener or to the material being joined. This classification includes bolts, screws, and a wide assortment of proprietary fasteners.

Special Fasteners — As the name implies, this category of fastener is less commonly used in primary aircraft structure than the four categories listed above. Examples of such fastening systems are sleeves, inserts, panel fasteners, etc.

In the following 3-digit sections, descriptive information is presented relative to the establishment of design allowables in joints containing these four categories of fasteners. Following each such section are the various tables of joint allowables or associated information for computing joint allowables as described.

MIL-HDBK-5J
31 January 2003

Tables 8.1.1(a) through (e) are fastener indexes that list the joint allowables tables for each fastener category. These indexes are provided to make it easier to locate the allowables table for a given fastener and sheet material combination. Each of the indexes generally is similarly structured in the following manner. The left-hand column describes the fastener by referring to the NASM part number or to a vendor part number when the fastener is not covered by either series. The second column contains the table number for the allowables table for each fastener. The fastener column has been so arranged that when protruding head and countersunk head fasteners are included in a given fastener index table, the protruding head tables appear first in the second column. The third column identifies generally the base material of the fastener. Generic terms usually are used, such as steel, aluminum, titanium, etc. The fourth column identifies the specific sheet or plate material.

It is recommended that Section 9.7 be reviewed in its entirety since it contains detailed information on the generation and analysis of joint data that results in the joint allowables tables contained in this section.

8.1.1.1 Data Sources — The data shown in subsequent tables are provided by one or more manufacturers as listed in the table. There may be more than one producer of a fastener type, but data support is provided by only the footnoted source. **Warning: Caution should be exercised to ensure that use of static joint strength data is applicable only for the data producer(s) indicated by the footnote on each table.**

8.1.1.2 Fastener Shear Strengths — Fastener shear strengths accepted and documented by the aerospace industry and government agencies are listed in Table 8.1.1.1. Some existing tables in MIL-HDBK-5 may reflect other values; however, new fastener proposals will be classified in accordance with the above-noted table.

8.1.1.3 Edge Distance Requirements — The joint allowables in MIL-HDBK-5 are based on joint tests having edge distances of twice the nominal hole diameter, 2D. Therefore, the allowables are applicable only to joints having 2D edge distance.

Table 8.1.1(a). Fastener Index for Solid Rivets

Fastener Identification ^a	Table Number	Rivet Material	Sheet Material	Page No.
Rivet Hole Size	8.1.2(a)	8-12
Shear Strength of Solid Rivets	8.1.2(b)	8-13
Unit Bearing Strength	8.1.2.1(a)	8-14
Shear Strength Corection Factors	8.1.2.1(b)	Aluminum	...	8-15
NAS1198 (MC) ^b	8.1.2.1(c)	A-286	A-286	8-16
MS20427M (MC)	8.1.2.2(a)	Monel	AISI 301/302	8-17
MS20427M (D) ^b	8.1.2.2(b)	Monel	AISI 301/302	8-18
MS20426AD (D)	8.1.2.2(c)	Aluminum	Aluminum	8-19
MS20426D (D)	8.1.2.2(d)	Aluminum	Aluminum	8-20
MS20426DD (D)	8.1.2.2(e)	Aluminum	Aluminum	8-21
MS20426 (MC)	8.1.2.2(f)	Aluminum	Clad 2024-T42	8-22
MS20426B (MC)	8.1.2.2(g)	Aluminum	AZ31B-H24	8-23
MS20427M (MC)	8.1.2.2(h)	Monel	Com Pure Titanium	8-24
BRFS-D (MC)	8.1.2.2(i)	Aluminum	Clad 2024-T3	8-25
BRFS-AD (MC)	8.1.2.2(j)	Aluminum	Clad 2024-T3	8-26
BRFS-DD (MC)	8.1.2.2(k)	Aluminum	Clad 2024-T3	8-27
BRFS-T (MC)	8.1.2.2(l)	Ti-45Cb	Clad 7075-T6/Ti-6Al-4V	8-28
MS14218E (MC)	8.1.2.2(m)	Aluminum	Clad 2024-T3	8-29
NAS1097E (MC)	8.1.2.2(n)	Aluminum	Clad 2024-T3/7075-T6	8-30
MS14218AD (MC)	8.1.2.2(o)	Aluminum	Clad 2024-T3	8-31
MS14219E (MC)	8.1.2.2(p)	Aluminum	Clad 2024-T3	8-32
MS14219E (MC)	8.1.2.2(q)	Aluminum	Clad 7075-T6	8-33
MS20426E (MC)	8.1.2.2(r)	Aluminum	Clad 2024-T3	8-34
MS20426E (MC)	8.1.2.2(s)	Aluminum	Clad 7075-T6	8-35
AL905KE (MC)	8.1.2.2(t)	Aluminum	Clad 2024-T3	8-36

a In some cases, entries in this table identify the subject matter in certain tables.

b MC, machine countersunk holes; D, dimpled holes.

Table 8.1.1(b). Fastener Index for Blind Fasteners

Fastener Identification	Table Number	Fastener Sleeve Material	Sheet or Plate Material	Page No.
<u>Protruding-head, Friction-Lock Blind Rivets</u>				
CR 6636	8.1.3.1.1(a)	A-286	Various	8-38
MS20600M	8.1.3.1.1(b)	Monel	AISI 301	8-39
MS20600M	8.1.3.1.1(c)	Monel	Clad 2024-T3/7075-T6	8-40
MS20600AD and MS20602AD	8.1.3.1.1(d)	Aluminum	Clad 2024-T3	8-41
MS20600B	8.1.3.1.1(e)	Aluminum	AZ31B-H24	8-42
<u>Protruding-head, Mechanical-Lock Blind Rivets</u>				
NAS1398C	8.1.3.1.2(a)	A-286	Alloy Steel	8-43
CR 2643	8.1.3.1.2(a)	A-286	Alloy Steel	8-43
NAS1398 MS or MW	8.1.3.1.2(b)	Monel	AISI 301-½ Hard	8-44
NAS1398 MS or MW	8.1.3.1.2(c)	Monel	Clad 7075-T6	8-45
NAS1398B	8.1.3.1.2(d) ₁	Aluminum	Clad 2024-T3	8-46
NAS1398D	8.1.3.1.2(d) ₁	Aluminum	Clad 2024-T3	8-46
NAS1738B and NAS1738E	8.1.3.1.2(d) ₂	Aluminum	Clad 2024-T3	8-47
NAS1398B	8.1.3.1.2(e)	Aluminum	AZ31B-H24	8-48
NAS1738B and NAS1738E	8.1.3.1.2(e)	Aluminum	AZ31B-H24	8-48
CR 2A63	8.1.3.1.2(f)	Aluminum	Clad 2024-T81	8-49
CR 4623	8.1.3.1.2(g)	A-286	Clad 7075-T6	8-50
CR 4523	8.1.3.1.2(h)	Monel	Clad 7075-T6	8-51
NAS1720KE and NAS1720KE () L	8.1.3.1.2(i)	Aluminum	Clad 7075-T6	8-52
NAS1720C and NAS1720C () L	8.1.3.1.2(j)	A-286	Clad 2024-T3	8-53
AF3243	8.1.3.1.2(k)	Aluminum	Clad 2024-T3	8-54
HC3213	8.1.3.1.2(l)	Aluminum	Clad 2024-T3	8-55
HC6223	8.1.3.1.2(m)	Aluminum	Clad 2024-T3	8-56
HC6253	8.1.3.1.2(n)	Aluminum	Clad 2024-T3	8-57
AF3213	8.1.3.1.2(o)	Aluminum	Clad 2024-T3	8-58
CR3213	8.1.3.1.2(p)	Aluminum	Clad 2024-T3	8-59
CR3243	8.1.3.1.2(q)	Aluminum	Clad 2024-T3	8-60
HC3243	8.1.3.1.2(r)	Aluminum	Clad 2024-T3	8-61
AF3223	8.1.3.1.2(s)	Aluminum	Clad 2024-T3	8-62
CR3223	8.1.3.1.2(t)	Aluminum	Clad 2024-T3	8-63

Table 8.1.1(b). Fastener Index for Blind Fasteners (Continued)

Fastener Identification	Table Number	Fastener Sleeve Material	Sheet or Plate Material	Page No.
<u>Flush-head, Friction-Lock Blind Rivets</u>				
CR 6626 (MC) ^a	8.1.3.2.1(a)	A-286	Various	8-64
MS20601M (MC)	8.1.3.2.1(b)	Monel	17-7PH (TH1050)	8-65
MS20601M (D) ^a	8.1.3.2.1(c)	Monel	AISI 301	8-66
MS20601M (MC)	8.1.3.2.1(d ₁)	Monel	AISI 301-Ann	8-67
MS20601M (MC)	8.1.3.2.1(d ₂)	Monel	AISI 301-¼ Hard	8-68
MS20601M (MC)	8.1.3.2.1(d ₃)	Monel	AISI 301-½ Hard	8-69
MS20601M (MC)	8.1.3.2.1(e)	Monel	7075-T6	8-70
MS20601AD and MS20603AD (MC)	8.1.3.2.1(f)	Aluminum	Clad 2024-T3	8-71
MS20601B (MC)	8.1.3.2.1(g)	Aluminum	AZ31B-H24	8-72
<u>Flush-head, Mechanical-Lock Spindle Blind Rivets</u>				
NAS1399C (MC)	8.1.3.2.2(a)	A-286	Alloy Steel	8-73
CR 2642 (MC)	8.1.3.2.2(a)	A-286	Alloy Steel	8-73
NAS1399 MS or MW (MC)	8.1.3.2.2(b)	Monel	AISI 301-½ Hard	8-74
NAS1921C (MC)	8.1.3.2.2(c)	A-286	Clad 7075-T6	8-75
NAS1399 MS or MW (MC)	8.1.3.2.2(d)	Monel	Clad 7075-T6	8-76
NAS1921M (MC)	8.1.3.2.2(e)	Monel	Clad 7075-T6	8-77
CR 2A62 (MC)	8.1.3.2.2(f)	Aluminum	Clad 2024-T81	8-78
NAS1921B (MC)	8.1.3.2.2(g)	Aluminum	Clad 7075-T6	8-79
NAS1399B (MC)	8.1.3.2.2(h)	Aluminum	Clad 2024-T3	8-80
NAS1399D (MC)	8.1.3.2.2(h)	Aluminum	Clad 2024-T3	8-80
NAS1739B and NAS1739E (MC)	8.1.3.2.2(i)	Aluminum	Clad 2024-T3	8-81
NAS1739B and NAS1739E (D)	8.1.3.2.2(i)	Aluminum	Clad 2024-T3	8-81
NAS1399B (MC)	8.1.3.2.2(j)	Aluminum	AZ31B-H24	8-82
NAS1739B and NAS1739E (MC)	8.1.3.2.2(j)	Aluminum	AZ31B-H24	8-82
CR 4622 (MC)	8.1.3.2.2(k)	A-286	Clad 7075-T6	8-83
CR 4522 (MC)	8.1.3.2.2(l)	Monel	Clad 7075-T6/T651	8-84
NAS1721KE and NAS1721KE ()L (MC)	8.1.3.2.2(m)	Aluminum	Clad 2024-T3	8-85
NAS1721C and NAS1721C () L (MC)	8.1.3.2.2(n)	A-286	Clad 7075-T6	8-86
HC3212 (MC)	8.1.3.2.2(o)	Aluminum	Clad 2024-T3	8-87
MBC 4807 and MBC 4907 (MC)	8.1.3.2.2(p)	Aluminum	Clad 2024-T3	8-88
MBC 4801 and MBC 4901	8.1.3.2.2(q)	Aluminum	Clad 2024-T3	8-89
HC6222 (MC)	8.1.3.2.2(r)	Aluminum	Clad 2024-T3	8-90
HC6252 (MC)	8.1.3.2.2(s)	Aluminum	Clad 2024-T3	8-91
HC6224 (MC) (A-286 pin)	8.1.3.2.2(t ₁)	5056 Al	Clad 2024-T3	8-92
HC3214 (MC) (8740 pin)	8.1.3.2.2(t ₂)	5056 Al	Clad 2024-T3	8-93
AF3212 (MC)	8.1.3.2.2(u)	Aluminum	Clad 2024-T3	8-94
CR3212 (MC)	8.1.3.2.2(v)	Aluminum	Clad 2024-T3	8-95
AF3242 (MC)	8.1.3.2.2(w)	Aluminum	Clad 2024-T3	8-96
CR3242 (MC)	8.1.3.2.2(x)	Aluminum	Clad 2024-T3	8-97
HC3242 (MC)	8.1.3.2.2(y)	Aluminum	Clad 2024-T3	8-98
AF3222 (MC)	8.1.3.2.2(z)	Aluminum	Clad 2024-T3	8-99
CR3222 (MC)	8.1.3.2.2(aa)	Aluminum	Clad 2024-T3	8-100

a MC, machine countersunk holes; D, dimpled holes.

Table 8.1.1(b). Fastener Index for Blind Fasteners (Continued)

Fastener Identification	Table Number	Fastener Sleeve Material	Sheet or Plate Material	Page No.
<u>Flush-head Blind Bolts</u>				
MS21140 (MC)	8.1.3.2.3(a)	A-286	Clad 7075-T6/T651	8-101
MS90353 (MC)	8.1.3.2.3(b ₁)	Alloy Steel	Clad 2024-T3/T351	8-102
MS90353 (MC)	8.1.3.2.3(b ₂)	Alloy Steel	Clad or Bare 7075-T6 or T651	8-103
FF-200, FF-260 and FF-312 (MC)	8.1.3.2.3(c)	Alloy Steel	Clad 2024-T42/ 7075-T6	8-104
NS 100 (MC)	8.1.3.2.3(d)	Alloy Steel	Clad 7075-T6	8-105
SSHFA-200 and SSHFA-260(MC)	8.1.3.2.3(e)	Aluminum	Clad 2024-T42/ 7075-T6	8-106
PLT-150 (MC)	8.1.3.2.3(f)	Alloy Steel	Clad 7075-T6/T651	8-107
NAS1670-L (MC)	8.1.3.2.3(g)	Alloy Steel	Clad 7075-T6/T651	8-108
NAS1674-L (MC)	8.1.3.2.3(h)	Aluminum	Clad 7075-T6	8-109

a MC, machine countersunk holes; D, dimpled holes.

Table 8.1.1(c). Fastener Index for Swaged-Collar/Upset-Pin Fasteners

Fastener Identification	Table Number	Fastener Pin Material	Sheet or Plate Material	Page No.
Ultimate Single-Shear and Tensile Strengths	8.1.4	Alloy Steel and Alum.	...	8-112
CSR 925	8.1.4.1(a)	Titanium	Clad 7075-T6	8-113
CSR 925	8.1.4.1(b)	Titanium	Clad 2024-T3	8-114
NAS1436-NAS1442 (MC) ^a	8.1.4.2(a)	Alloy Steel	Clad 7075-T6/T651	8-115
NAS7024-NAS7032 (MC)	8.1.4.2(b)	Alloy Steel	Clad 7075-T6/T651	8-116
CSR 924 (MC)	8.1.4.2(c)	Titanium	Clad 7075-T6	8-117
CSR 924 (MC)	8.1.4.2(d)	Titanium	Clad 2024-T3	8-118
HSR 201 (MC)	8.1.4.2(e)	A-286	Clad 7075-T6	8-119
HSR 101 (MC)	8.1.4.2(f)	Titanium	Clad 7075-T6	8-120
GPL 3SC-V (MC)	8.1.4.2(g)	Titanium	Clad 7075-T6	8-121
GPL 3SC-V (MC)	8.1.4.2(h)	Titanium	Clad 2024-T3	8-122
LGPL 2SC-V (MC)	8.1.4.2(i)	Titanium	Clad 7075-T6	8-123
LGPL 2SC-V (MC)	8.1.4.2(j)	Titanium	Clad 2024-T3	8-124

a MC, machine countersunk holes.

MIL-HDBK-5J
31 January 2003

Table 8.1.1(d). Fastener Index for Threaded Fasteners

Fastener Identification ^a	Table Number	Fastener		Page No.
		Sleeve Material	Sheet	
Single Shear Strength	8.1.5(a)	Steel	...	8-127
Tensile Strength	8.1.5(b ₁)	Steel	...	8-128
Tensile Strength	8.1.5(b ₂)	8-129
Unit Bearing Strength	8.1.5.1	Alloy Steel	...	8-130
AN 509 Screws (MC) ^b	8.1.5.2(a ₁)	Alloy Steel	Clad 2024-T3	8-131
AN 509 Screws (MC)	8.1.5.2(a ₂)	CRES	Clad 7075-T6	8-132
PBF 11 (MC)	8.1.5.2(b)	Alloy Steel	Ti-6Al-4V	8-133
TL 100 (MC)	8.1.5.2(c)		Clad 7075-T6	8-134
TLV 10 (MC)	8.1.5.2(d)	Titanium	Clad 7075-T6	8-135
HPB-V (MC)	8.1.5.2(e)	Titanium	Clad 7075-T6	8-136
KLBHV with KFN 600 (MC)	8.1.5.2(f)	Titanium	Clad 7075-T6	8-137
HL-61-70 (MC)	8.1.5.2(g)	CRES	Clad 7075-T6	8-138
HL-719-79 (MC)	8.1.5.2(h)	Alloy Steel	Clad 7075-T6	8-139
HL-11 (MC)	8.1.5.2(i)	Titanium	Clad 7075-T6	8-140
HL-911 (MC)	8.1.5.2(j)	Titanium	Clad 7075-T6	8-141
NAS4452S and KS 100-FV with NAS4445DD (MC)	8.1.5.2(k)	Alloy Steel or Titanium	Clad 7075-T6	8-142
HPG-V (MC)	8.1.5.2(l)	Titanium	Clad 7075-T6	8-143
NAS4452V with NAS4445 DD (MC)	8.1.5.2(m)	Titanium	Clad 7075-T6	8-144
HL18Pin, HL70 Collar (MC)	8.1.5.2(n)	Alloy Steel	Clad 7075-T6	8-145
HL19 Pin, HL70 Collar (MC)	8.1.5.2(o)	Alloy Steel	Clad 7075-T6	8-146

a In some cases entries in this table identify the subject matter in certain tables.

b MC, machine countersunk holes; D, dimpled holes.

Table 8.1.1(e). Fastener Index for Special Fasteners

Fastener Identification	Table Number	Fastener Pin Material	Sheet or Plate Material	Page No.
ACRES Sleeves	...	A-286	Clad 7075-T6	8-147
MIL-B-8831/4 (MC) ^a	8.1.6.2(a)	Steel Pin, Aluminum Sleeve	Clad 7075-T6	8-148
MIL-B-8831/4 (MC)	8.1.6.2(b)	Steel Pin, Aluminum Sleeve	Clad 2024-T3	8-149

a MC, machine countersunk holes.

Table 8.1.1.1. Fastener Shear Strengths

F _{su} , ksi	Examples of Current Alloys Which Meet Level ^a	Current Usage		
		Driven Rivets	Blind Fasteners	Solid Shank Fasteners
28	5056	X	X	
30	2117	X	X	
34	2017	X	X	
36	2219	X	X	
38	2017	X	X	
41	2024 and 7050-T73	X		
43	7050-T731	X	X	X
46	7075		X	
49	Monel	Undriven		
50	Ti/Cb	X		
55	Monel		X	
75	Alloy Steel and CRES		X	X
78	A-286			X
90	A-286	Undriven		
95	Alloy Steel, A-286, Ti-6Al-4V	X	X	X
108	Alloy Steel and Ti-6Al-2Sn			X
110	A-286			X
112	Alloy Steel		X	X
125	Alloy Steel and CRES			X
132	Alloy Steel			X
145	MP35N			X
156	Alloy Steel			X
180	Alloy Steel			X

a Different tempers and thermal treatments are used to obtain desired fastener shear strengths.

8.1.2 SOLID RIVETS — The recommended diameter dimensions of the upset tail on solid rivets will be at least 1.5 times the nominal shank diameter except for 2024-T4 rivets which will be at least 1.4 times the nominal shank diameter. Tail heights will be a minimum of 0.3 diameter. Shear strengths for driven rivets may be based on areas corresponding to the nominal hole diameter provided that the nominal hole diameter is not larger than the values listed in Table 8.1.2(a). If the nominal hole diameter is larger than the listed value, the listed value will be used. Shear strength values for solid rivets of a number of rivet materials are given in Table 8.1.2(b).

8.1.2.1 Protruding-Head Solid Rivet Joints — The unit load at which shear or bearing type of failure occurs is calculated separately and the lower of the two governs the design.

The design bearing stress for various materials at both room and elevated temperatures is given in the strength properties stated for each alloy or group of alloys and is applicable to riveted joints wherein cylindrical holes are used and where t/D is greater than or equal to 0.18; where t/D is less than 0.18, tests to substantiate yield and ultimate bearing strengths must be performed. These bearing stresses are applicable only for the design of rigid joints where there is no possibility of relative motion of the parts joined without deformation of such parts. Design bearing stresses at low temperatures will be higher than those specified for room temperature; however, no quantitative data are available.

For convenience, “unit” sheet bearing strengths for rivets, based on a bearing stress of 100 ksi and nominal hole diameters, are given in Table 8.1.2.1(a).

In computing protruding-head rivet design shear strengths, the shear strength values obtained from Table 8.1.2(b) should be multiplied by the correction factors given in Table 8.1.2.1(b). This compensates for the reduction in rivet shear strength resulting from high bearing stresses on the rivet at t/D ratios less than 0.33 for single-shear joints and 0.67 for double-shear joints.

For those rivet material sheet material combinations where test data shows the above to be unconservative or for rivet materials other than those shown in Table 8.1.2(b), joint allowables should be established by test in accordance with Section 9.7. From such tests tabular presentation of ultimate load and yield load allowables are made.

Unless otherwise specified, yield load is defined in Section 9.7.1.1 as the load which results in a joint permanent set equal to $0.04D$, where D is the decimal equivalent of the hole diameter defined in Table 9.7.1.1(a).

Table 8.1.2.1(c) provides ultimate and yield strength data on protruding-head A-286 solid rivets in aged A-286 sheet, for a variety of conditions of exposure.

8.1.2.2 Flush-Head Solid Rivet Joints — Tables 8.1.2.2(a) through (t) contain joint allowables for various flush-head solid rivet/sheet material combinations. Prior to 2003 the allowable ultimate loads were established from test data using the average ultimate test load divided by a factor of 1.15. (See Section 9.7 for current statistical procedures and possible variations.) Shear strength cutoff values may be either the procurement specification shear strength (S value) of the fastener, or if no specification exists, a statistical value determined from test results as described in Section 9.7.

Yield load allowables are established from test data. Unless otherwise specified, the yield load is defined as the load which results in a joint permanent set equal to $0.04D$, where D is the decimal equivalent of the hole diameter defined in Table 9.7.1.1.

MIL-HDBK-5J
31 January 2003

For machine countersunk joints, the sheet gage specified in the tables is that of the countersunk sheet. When the noncountersunk sheet is thinner than the countersunk sheet, the bearing allowable for the noncountersunk sheet-fastener combination should be computed, compared to the table value, and the lower of the two values selected. Increased attention should be paid to detail design in cases where $t/D < 0.25$ because of possibly greater incidence of difficulty in service life.

Table 8.1.2(a). Standard Rivet-Hole Drill Sizes and Nominal Hole Diameters

Rivet Size, in.	1/16	3/32	1/8	5/32	3/16	1/4	5/16	3/8
Drill No.	51	41	30	21	11	F	P	W
Nominal Hole Diameter, in.	0.067	0.096	0.1285	0.159	0.191	0.257	0.323	0.386

Table 8.1.2(b). Single Shear Strength of Solid Rivets^a

Rivet Material	Undriven		Driven		Rivet Designation	Rivet Size							
	F _{su} (ksi)		Rivet Material	F ^b _{su} (ksi)		Driven Single Shear Strength, lbs ^c							
	Min	Max				1/16	3/32	1/8	5/32	3/16	1/4	5/16	3/8
5056-H32	24	n/a	5056-H321 ^d	28 ^e	B ^f	99	203	363	556	802	1450	2290	3275
2117-T4	26	n/a	2117-T3	30 ^e	AD	106	217	389	596	860	1555	2455	3510
2017-T4	35	42	2017-T3	38 ^e	D	134	275	493	755	1085	1970	3115	4445
2024-T4	37	n/a	2024-T31	41 ^g	DD	145	297	532	814	1175	2125	3360	4795
7050-T73	41	46	7050-T731 ^d	43 ^e	E ^h	152	311	558	854	1230	2230	3520	5030
Monel	49	59	Monel	52 ^e	M	183	376	674	1030	1490	2695	4260	6085
Ti-45Cb	50	59	Ti-45Cb	53 ^e	T	187	384	687	1050	1515	2745	4340	6200
A-286	85	95	A-286	90 ^e	-	317	651	1165	1785	2575	4665	7375	10500

- a All rivets must be sufficiently driven to fill the rivet hole at the shear plane. Driving changes the rivet strength from the undriven to the driven condition and thus provides the above driven shear strengths.
- b Shear stresses are for the as driven condition on B-basis probability.
- c Based on nominal hole diameter specified in Table 8.1.2(a).
- d The temper designations last digit (1), indicates recognition of strengthening derived from driving.
- e The bucktail's minimum diameter is 1.5 times the nominal hole diameter in Table 8.1.2(a).
- f Should not be exposed to temperatures over 150 °F.
- g Driven in the W (fresh or ice box) condition to minimum 1.4D bucktail diameter.
- h E (or KE, as per NAS documents).

Table 8.1.2.1(a). Unit Bearing Strength of Sheet on Rivets, $F_{br} = 100$ ksi

Sheet thickness, in.	Unit Bearing Strength for Indicated Rivet Diameter, lbs							
	1/16	3/32	1/8	5/32	3/16	1/4	5/16	3/8
0.012	80
0.016	107
0.018	121	173
0.020	134	192
0.025	168	240	321
0.032	214	307	411	509
0.036	241	346	462	572	688
0.040	268	384	514	636	764
0.045	302	432	578	716	860
0.050	335	480	642	795	955	1285
0.063	422	605	810	1002	1203	1619	2035	...
0.071	476	682	912	1129	1356	1825	2293	2741
0.080	536	768	1028	1272	1528	2056	2584	3088
0.090	603	864	1156	1431	1719	2313	2907	3474
0.100	670	960	1285	1590	1910	2570	3230	3860
0.125	838	1200	1606	1988	2388	3212	4038	4825
0.160	1072	1536	2056	2544	3056	4112	5168	6176
0.190	1273	1824	2442	3021	3629	4883	6137	7334
0.250	1670	2400	3210	3975	4775	6425	8075	9650

Table 8.1.2.1(b). Shear Strength Correction Factors for Solid Protruding Head Rivets^a

Rivet Diameter, in.	1/16	3/32	1/8	5/32	3/16	1/4	5/16	3/8
	Single-Shear Rivet Strength Factors							
Sheet thickness, in.:								
0.016	0.964
0.018	0.981	0.912
0.020	0.995	0.933
0.025	1.000	0.970	0.920
0.032	1.000	0.964	0.925
0.036	0.981	0.946	0.912
0.040	0.995	0.964	0.933
0.045	1.000	0.981	0.953
0.050	0.995	0.970	0.920
0.063	1.000	1.000	0.961	0.922	...
0.071	0.979	0.944	0.909
0.080	0.995	0.964	0.933
0.090	1.000	0.981	0.953
0.100	0.995	0.972
0.125	1.000	1.000
	Double-Shear Rivet Strength Factors							
Sheet thickness, in.:								
0.016	0.687
0.018	0.744	0.518
0.020	0.789	0.585
0.025	0.870	0.708	0.545
0.032	0.941	0.814	0.687	0.560
0.036	0.969	0.857	0.744	0.630	0.518
0.040	0.992	0.891	0.789	0.687	0.585
0.045	1.000	0.924	0.834	0.744	0.653
0.050	0.951	0.870	0.789	0.708	0.545
0.063	1.000	0.937	0.872	0.808	0.679	0.550	...
0.071	0.966	0.909	0.852	0.737	0.622	0.508
0.080	0.992	0.941	0.891	0.789	0.687	0.585
0.090	1.000	0.969	0.924	0.834	0.744	0.653
0.100	0.992	0.951	0.870	0.789	0.708
0.125	1.000	1.000	0.935	0.870	0.805
0.160	0.992	0.941	0.891
0.190	1.000	0.981	0.939
0.250	1.000	1.000

^a Sheet thickness is that of the thinnest sheet in single-shear joints and the middle sheet in double-shear joints. Values based on tests of aluminum rivets, Reference 8.1.

Table 8.1.2.1(c). Static Joint Strength of Protruding Head A-286 Solid Rivets in A-286 Alloy Sheet at Various Temperatures

Rivet Type		NAS1198 ($F_{su} = 90$ ksi)									
		A-286, solution treated and aged, $F_{tu} = 140$ ksi					1200°F, Rapid Heating in 20 Seconds, Tested in 15 Seconds				
Sheet Material		Room Temperature		1200°F, Stabilized 15 Minutes		1200°F, Rapid Heating in 20 Seconds, Tested in 15 Seconds		1200°F, Rapid Heating in 20 Seconds, Tested in 15 Seconds		1200°F, Rapid Heating in 20 Seconds, Tested in 15 Seconds	
		1/8 (0.1285)	5/32 (0.159)	3/16 (0.191)	1/8 (0.1285)	5/32 (0.159)	3/16 (0.191)	1/8 (0.1285)	5/32 (0.159)	3/16 (0.191)	1/8 (0.1285)
Temperature		Ultimate Strength ^a , lbs.									
Rivet Diameter, in. (Nominal Hole Diameter, in.)		Ultimate Strength ^a , lbs.									
Sheet thickness, in.:		Ultimate Strength ^a , lbs.									
0.020	...	478	331	470 ^b
0.025	...	590	740	...	426	626	...	587 ^b	726 ^b
0.032	...	745	932	1132	560	801	962	752 ^b	930 ^b	1117 ^b	...
0.040	...	923	1152	1397	682	1002	1204	783	1164 ^b	1397 ^b	...
0.050	...	1023	1428	1677	...	1044	1505	...	1198	1729 ^b	...
0.063	...	1131	1578	1821	1507
0.071	...	1170	1660	1909
0.080	1752	2008
0.090	1790	2118
0.100	2229
0.125	2504
0.160	2580
Rivet shear strength ^c	...	1170	1790	2580	682	1044	1507	783	1198	...	1729
Sheet thickness, in.:		Yield Strength ^{a,d} , lbs.									
0.020	...	447	300	300
0.025	...	590	695	...	374	464	...	374	464
0.032	...	745	932	974	479	593	713	478	593	712	...
0.040	...	867	1152	1167	598	741	890	598	740	889	...
0.050	...	938	1331	1407	...	925	1112	...	924	1110	...
0.063	...	1031	1447	1649	1400
0.071	...	1089	1518	1723
0.080	1597	1806
0.090	1686	1898
0.100	1990
0.125	2221
0.160	2543

^a Test data from which the yield and ultimate strengths were derived can be found in Reference 8.1.2.1.
^b Yield value is less than 2/3 of indicated ultimate.
^c Rivet shear strength is documented in NAS1198 as 90 ksi.
^d Permanent set at yield load: 0.005 inch.

Note: Because of difficulties encountered upsetting countersunk head rivets in thin A-286 sheet, such conditions should be avoided in design.

Table 8.1.2.2(a). Static Joint Strength of 100° Flush Head Monel Solid Rivets in Machine-Countersunk Stainless Steel Sheet

Rivet Type	MS20427M ($F_{su} = 49$ ksi)									
	AISI 302-Annealed			AISI 301-¼ Hard			AISI 301-½ Hard AISI 301-Full Hard			
Sheet Material	AISI 302-Annealed			AISI 301-¼ Hard			AISI 301-½ Hard AISI 301-Full Hard			
Rivet Diameter, in. (Nominal Hole Diameter, in.)	1/8 (0.1285)	5/32 (0.159)	3/16 (0.191)	1/8 (0.1285)	5/32 (0.159)	3/16 (0.191)	3/32 (0.096)	1/8 (0.1285)	5/32 (0.159)	3/16 (0.191)
Ultimate Strength, lbs										
Sheet thickness, in.:										
0.040	439 ^{a,b}	439 ^b	251 ^b	439 ^b
0.050	526 ^a	673 ^{a,b}	...	468	673 ^b	...	322	447	673 ^b	...
0.063	635 ^a	820 ^a	...	595	732	...	355	538	688	...
0.071	...	915 ^a	1110 ^{a,b}	635	830	990 ^b	...	615	741	984 ^b
0.080	...	973 ^a	1246 ^a	...	936	1118	...	635	850	995
0.090	1380 ^a	...	973	1255	973	1132
0.100	1400	1400	1280
0.125	1400
Rivet shear strength ^c	635	973	1400	635	973	1400	355	635	973	1400
Yield Strength ^d , lbs										
Sheet thickness, in.:										
0.040	259	368	212	324
0.050	324	402	...	442	570	...	293	360	498	...
0.063	408	506	...	492	686	...	355	480	557	...
0.071	...	570	685	561	714	958	...	561	630	780
0.080	...	643	771	...	764	1012	...	635	765	848
0.090	865	...	893	1062	893	1000
0.100	965	1160	1160
0.125	1400
Head height (ref.), in.	0.048	0.061	0.077	0.048	0.061	0.077	0.042	0.048	0.061	0.077

- a Yield value is less than 2/3 of the indicated ultimate strength value.
- b Values above line are for knife-edge condition and the use of fasteners in this condition is undesirable. The use of knife-edge condition in design of military aircraft requires specific approval of the procuring agency.
- c Rivet shear strength is documented in MS20427M.
- d Permanent set at yield load: 0.005 inch.

Table 8.1.2.2(b). Static Joint Strength of 100° Flush Head Monel Solid Rivets in Dimpled Stainless Steel Sheet

	MS20427M ($F_{su} = 49$ ksi)										
	AISI 302 - annealed		AISI 301 - 1/4 hard		AISI 301 - 1/2 hard		AISI 301 - 1/8		AISI 301 - 1/2 hard		
	1/8 (0.1285)	5/32 (0.159)	3/16 (0.191)	1/4 (0.257)	1/8 (0.1285)	5/32 (0.159)	3/16 (0.191)	3/32 (0.096)	1/8 (0.1285)	5/32 (0.159)	3/16 (0.191)
Rivet Type	MS20427M ($F_{su} = 49$ ksi)										
Sheet Material	AISI 302 - annealed										
Rivet Diameter, in.	1/8	5/32	3/16	1/4	1/8	5/32	3/16	3/32	1/8	5/32	3/16
(Nominal Hole Diameter, in.)	(0.1285)	(0.159)	(0.191)	(0.257)	(0.1285)	(0.159)	(0.191)	(0.096)	(0.1285)	(0.159)	(0.191)
	Ultimate Strength, lbs.										
Sheet thickness, in.:	348	497	348	497
0.020
0.025	441	536	595	766	...	355	595	766	...
0.032	568	698	846	...	635	931	1163	...	635	931	1163
0.040	635	884	1046	1370	...	973	1382	973	1382
0.050	...	973	1320	1730	1405	1405
0.063	1405	2240
0.071	2490
0.080	2540
Rivet shear strength ^a	635	973	1405	2540	635	973	1405	355	635	973	1405
	Yield Strength ^b , lbs.										
Sheet thickness, in.:	336	449	329	449
0.020
0.025	427	518	533	681	...	355	533	681	...
0.032	550	679	801	...	635	842	1049	...	635	842	1049
0.040	635	856	1020	1326	...	973	1252	973	1252
0.050	...	973	1280	1678	1405	1405
0.063	1405	2140
0.071	2420
0.080	2540
Head height (max.), in.	0.048	0.061	0.077	0.103	0.048	0.061	0.077	0.042	0.048	0.061	0.077

a Rivet shear strength from Table 8.1.2(b).

b Permanent set at yield load: 0.005 inch.

Table 8.1.2.2(c). Static Joint Strength of 100° Flush Head Aluminum Alloy (2117-T3) Solid Rivets in Dimpled Aluminum Alloy Sheet^{a,b}

		MS20426AD ($F_{su} = 30$ ksi)								
		2024-T3 2024-T42 2024-T62 2024-T81		2024-T3 2024-T42		2024-T62 2024-T81		2024-T86 7075-T6		
Rivet Type		3/32 (0.096)	1/8 (0.1285)	5/32 (0.159)	3/16 (0.191)	5/32 (0.159)	3/16 (0.191)	1/8 (0.1285)	5/32 (0.159)	3/16 (0.191)
Sheet Material										
Rivet Diameter, in.										
(Nominal Hole Diameter, in.)										
Ultimate Strength, lbs.										
Sheet thickness, in.:		177
0.016		209	299	302
0.020		217	360	474	...	462	...	383	462	...
0.025		...	388	568	722	596	725	388	596	725
0.032		596	839	...	862	862
0.040		862
0.050		596	862	596	862	388	596	862
Rivet shear strength ^c		217	388	596	862	596	862	388	596	862
Yield Strength ^d , lbs.										
Sheet thickness, in.:		154
0.016		184	257	257
0.020		209	315	324	...	324	...	315	410	...
0.025		...	367	430	512	430	512	367	525	640
0.032		506	644	...	644	782
0.040		757
0.050	
Head height (max.), in.		0.036	0.042	0.055	0.070	0.055	0.070	0.042	0.055	0.070

a These allowables apply to double dimpled sheets and to the upper sheet dimpled into a machine-countersunk lower sheet. Sheet gage is that of the thinnest sheet for double dimpled joints and of the upper dimpled sheet for dimpled, machine-countersunk joints. The thickness of machine-countersunk sheet must be at least one tabulated gage thicker than the upper sheet. In no case will allowables be obtained by extrapolation for gages other than those shown.

b Test data from which the yield strengths listed were derived and can be found in Reference 8.1.2.2.

c Rivet shear strength from Table 8.1.2(b).

d Permanent set at yield load: the greater of 0.005 inch or 2.5% of nominal diameter.

Table 8.1.2.2(d). Static Joint Strength of 100° Flush Head Aluminum Alloy (2017-T3) Solid Rivets in Dimpled Aluminum Alloy Sheet^{a,b}

	MS20426D ($F_{su} = 38$ ksi)									
	2024-T3 and 2024-T42		2024-T86 and 7075-T6		2024-T62 and 2024-T81					
	5/32 (0.159)	3/16 (0.191)	1/4 (0.257)	5/32 (0.159)	3/16 (0.191)	1/4 (0.257)	5/32 (0.159)	3/16 (0.191)	1/4 (0.257)	1/4 (0.257)
Rivet Type	Ultimate Strength, lbs.									
Sheet Material	Ultimate Strength, lbs.									
Rivet Diameter, in. (Nominal Hole Diameter, in.)	Ultimate Strength, lbs.									
Sheet thickness, in.:	Yield Strength ^d , lbs.									
0.025	419	530	419
0.032	600	681	...	672	822	...	600	681
0.040	738	905	845	755	1000	1108	738	905	1108	1108
0.050	755	1090	1332	...	1090	1508	755	1090	1508	1508
0.063	1695	1803	1803
0.071	1853	1930	1930
0.080	1970	1970	1970
Rivet shear strength ^c	755	1090	1970	755	1090	1970	755	1090	1970	1970
Sheet thickness, in.:	Yield Strength ^d , lbs.									
0.025	336	450	336
0.032	483	546	...	581	483	546
0.040	589	730	845	675	705	978	589	730	845	845
0.050	681	888	1187	...	867	1508	681	888	1187	1187
0.063	1415	...	1007	1803	1415
0.071	1656	1930	1656
0.080	1870	1970	1870
Head height (max.), in.	0.055	0.070	0.095	0.055	0.070	0.095	0.055	0.070	0.095	0.095

a These allowables apply to double dimpled sheets and to the upper sheet dimpled into a machine-countersunk lower sheet. Sheet gage is that of the thinnest sheet for double dimpled joints and of the upper dimpled sheet for dimpled, machine-countersunk joints. The thickness of machine-countersunk sheet must be at least one tabulated gage thicker than the upper sheet. In no case will allowables be obtained by extrapolation for gages other than those shown.

b Test data from which the yield strengths listed were derived and can be found in Reference 8.1.2.2.

c Rivet shear strength from Table 8.1.2(b).

d Permanent set at yield load: the greater of 0.005 inch or 2.5% of nominal diameter.

Table 8.1.2.2(e). Static Joint Strength of 100° Flush Head Aluminum Alloy (2024-T31) Solid Rivets in Dimpled Aluminum Alloy Sheet^{a,b}

Rivet Type	MS20426DD ($F_{su} = 41$ ksi)					
	2024-T3 2024-T42		2024-T62 2024-T81		2024-T86 7075-T6	
Rivet Diameter, in. (Nominal Hole Diameter, in.) . .	3/16 (0.191)	1/4 (0.257)	3/16 (0.191)	1/4 (0.257)	3/16 (0.191)	1/4 (0.257)
	Ultimate Strength, lbs.					
Sheet thickness, in.:						
0.032	744	...	786	...	786	...
0.040	941	879	982	1300	982	1300
0.050	1110	1359	1152	1705	1152	1705
0.063	1175	1727	1175	2010	1175	2010
0.071	1883	...	2125	...	2125
0.080	2025
0.090	2125
Rivet shear strength ^c	1175	2125	1175	2125	1175	2125
	Yield Strength ^d , lbs.					
Sheet thickness, in.:						
0.032	582	...	649	...	786	...
0.040	666	879	816	962	982	978
0.050	738	1308	961	1308	1152	1543
0.063	925	1564	1068	1564	1175	1958
0.071	1711	...	1711	...	2125
0.080	1928
0.090	2121
Head height (max.), in.	0.070	0.095	0.070	0.095	0.070	0.095

a These allowables apply to double dimpled sheets and to the upper sheet dimpled into a machine-countersunk lower sheet. Sheet gage is that of the thinnest sheet for double dimpled joints and of the upper dimpled sheet for dimpled, machine-countersunk joints. The thickness of machine-countersunk sheet must be at least one tabulated gage thicker than the upper sheet. In no case will allowables be obtained by extrapolation for gages other than those shown.

b Test data from which the yield strengths listed were derived and can be found in Reference 8.1.2.2.

c Rivet shear strength from Table 8.1.2(b).

d Permanent set at yield load: the greater of 0.005 inch or 2.5% of nominal diameter.

MIL-HDBK-5J
31 January 2003

Table 8.1.2.2(f). Static Joint Strength of 100° Flush Head Aluminum Alloy Solid Rivets in Machine-Countersunk Aluminum Alloy Sheet

Rivet Type	MS20426AD (2117-T3) ($F_{su} = 30$ ksi)				MS20426D (2017-T3) ($F_{su} = 38$ ksi)			MS20426DD (2024-T31) ($F_{su} = 41$ ksi)	
	Clad 2024-T42								
Sheet Material									
Rivet Diameter, in. (Nominal Hole Diameter, in.)	3/32 (0.096)	1/8 (0.1285)	5/32 (0.159)	3/16 (0.191)	5/32 (0.159)	3/16 (0.191)	1/4 (0.257)	3/16 (0.191)	1/4 (0.257)
	Ultimate Strength ^a , lbs								
Sheet thickness, in.:									
0.032	178 ^b
0.040	193	309 ^b
0.050	206	340	479 ^b	...	580 ^{b,c}
0.063	216	363	523	705 ^b	657 ^c	859 ^{b,c}	...	886 ^b	...
0.071	373	542	739	690	917 ^c	...	942	...
0.080	560	769	720	969 ^c	...	992	...
0.090	575	795	746	1015	1552 ^{b,c}	1035	1647 ^{b,c}
0.100	818	...	1054	1640 ^c	1073	1738 ^c
0.125	853	...	1090	1773	1131	1877
0.160	1891	...	2000
0.190	1970	...	2084
Rivet shear strength ^d	217	388	596	862	755	1090	1970	1175	2125
	Yield Strength ^{a,c} , lbs								
Sheet thickness, in.:									
0.032	132
0.040	153	231
0.050	188	261	321	...	345
0.063	213	321	402	471	401	515	...	614	...
0.071	348	453	538	481	557	...	669	...
0.080	498	616	562	623	...	761	...
0.090	537	685	633	746	861	842	1053
0.100	745	...	854	1017	913	1115
0.125	836	...	1018	1313	1021	1357
0.160	1574	...	1694
0.190	1753	...	1925
Head height (ref.), in.	0.036	0.042	0.055	0.070	0.055	0.070	0.095	0.070	0.095

- a Test data from which the yield and ultimate strength listed were derived can be found in Reference 8.1.2.2.
- b Values above line are for knife-edge condition and the use of fasteners in this condition is undesirable. The use of knife-edge condition in design of military aircraft requires specific approval of the procuring agency.
- c Yield value is less than 2/3 of the indicated ultimate strength value.
- d Rivet shear strength is documented in MS20426.
- e Permanent set at yield load: the greater of 0.005 inch or 2.5% of nominal diameter.

Table 8.1.2.2(g). Static Joint Strength of 100° Flush Head Aluminum Alloy (5056-H321) Solid Rivets in Machine-Countersunk Magnesium Alloy Sheet

Rivet Type	MS20426B ($F_{su} = 28$ ksi)				
Sheet Material	AZ31B-H24				
Rivet Diameter, in. (Nominal Hole Diameter, in.)	3/32 (0.096)	1/8 (0.1285)	5/32 (0.159)	3/16 (0.191)	1/4 (0.257)
	Ultimate Strength, lbs				
Sheet thickness, in.:					
0.032	172 ^{a,b}
0.040	180	304 ^{a,b}
0.050	190	318	467 ^{a,b}
0.063	203	337	490	679 ^{a,b}	...
0.071	...	348	503	697 ^a	...
0.080	...	360	519	715	...
0.090	...	363	536	737	1244 ^b
0.100	554	757	1271
0.125	556	802	1343
0.160	1440
0.190	1450
Rivet shear strength ^c	203	363	556	802	1450
	Yield Strength ^d , lbs				
Sheet thickness, in.:					
0.032	104
0.040	127	172
0.050	152	214	268
0.063	186	259	334	409	...
0.071	...	287	369	459	...
0.080	...	318	406	504	...
0.090	...	353	450	555	792
0.100	491	606	856
0.125	556	735	1030
0.160	1273
0.190	1450
Head height (ref.), in.	0.036	0.042	0.055	0.070	0.095

a Yield value is less than 2/3 of the indicated ultimate strength value.

b Values above line are for knife-edge condition and the use of fasteners in this condition is undesirable. The use of knife-edge condition in design of military aircraft requires specific approval of the procuring agency.

c Rivet shear strength is documented in MS20426.

d Permanent set at yield load: the greater of 0.005 inch or 2.5% of nominal diameter.

Table 8.1.2.2(h). Static Joint Strength of 100° Flush Head Monel Solid Rivets in Machine-Countersunk Titanium Alloy Sheet

Rivet Type	MS20427M ($F_{su} = 49$ ksi)			
Sheet Material	Commercially Pure Titanium, $F_{tu} = 80$ ksi			
Rivet Diameter, in. (Nominal Hole Diameter, in.)	1/8 (0.1285)	5/32 (0.159)	3/16 (0.191)	1/4 (0.257)
	Ultimate Strength, lbs			
Sheet thickness, in.:				
0.040	531 ^a
0.050	573	818 ^a
0.063	626	885
0.071	635	926	1242 ^a	...
0.080	...	973	1302	...
0.090	1360	...
0.100	1400	2260 ^a
0.125	2460
0.160	2540
Rivet shear strength ^b	635	973	1400	2540
	Yield Strength ^c , lbs			
Sheet thickness, in.:				
0.040	376
0.050	472	582
0.063	598	736
0.071	635	835	933	...
0.080	...	945	1130	...
0.090	1268	...
0.100	1400	1860
0.125	2340
0.160	2540
Head height (max.), in.	0.048	0.061	0.077	0.103

a Values above line are for knife-edge condition and the use of fasteners in this condition is undesirable. The use of knife-edge condition in design of military aircraft requires specific approval of the procuring agency.

b Rivet shear strength is documented in MS20427.

c Permanent set at yield load: the greater of 0.005 inch or 2.5% of nominal diameter.

Table 8.1.2.2(i). Static Joint Strength of 120° Flush Shear Head Aluminum Alloy (2017-T3) Solid Rivets in Machine-Countersunk Aluminum Alloy Sheet

Rivet Type	BRFS-D ^a ($F_{su} = 38$ ksi)				
	Clad 2024-T3				
Sheet Material					
Rivet Diameter, in. (Nominal Hole Diameter, in.) ^b	3/32 (0.096)	1/8 (0.1285)	5/32 (0.159)	3/16 (0.191)	1/4 (0.257)
	Ultimate Strength, lbs				
Sheet thickness, in.:					
0.020	139
0.025	176	233
0.032	226	300	367
0.040	275	378	465	552	...
0.050	477	585	697	930
0.063	494	741	886	1182
0.071	755	1005	1338
0.080	1090	1513
0.090	1711
0.100	1902
0.125	1970
Rivet shear strength ^c	275	494	755	1090	1970
	Yield Strength ^d , lbs				
Sheet thickness, in.:					
0.020	137
0.025	171	229
0.032	207	294	359
0.040	231	357	453	547	...
0.050	398	550	680	918
0.063	451	614	814	1149
0.071	655	857	1295
0.080	914	1430
0.090	1513
0.100	1592
0.125	1790
Head height (ref.), in.	0.018	0.023	0.030	0.039	0.049

a Data supplied by Briles Rivet Corp.

b Fasteners installed in hole diameters of 0.0975, 0.1285, 0.1615, 0.1945, 0.257, +0.0005, -0.001, respectively.

c Shear strength based on Table 8.1.2(b) and $F_{su} = 38$ ksi.

d Permanent set at yield load: 4% of nominal diameter.

Table 8.1.2.2(j). Static Joint Strength of 120° Flush Shear Head Aluminum Alloy (2117-T3) Solid Rivets in Machine-Countersunk Aluminum Alloy Sheet

Rivet Type	BRFS-AD ^a ($F_{su} = 30$ ksi)				
Sheet Material	Clad 2024-T3				
Rivet Diameter, in. (Nominal Hole Diameter, in.) ^b	3/32 (0.096)	1/8 (0.1285)	5/32 (0.159)	3/16 (0.191)	1/4 (0.257)
	Ultimate Strength, lbs				
Sheet thickness, in.:					
0.020	119
0.025	144	201
0.032	171	250	316
0.040	204	292	386	474	...
0.050	217	343	451	571	806
0.063	...	388	536	675	987
0.071	596	737	1073
0.080	812	1169
0.090	862	1278
0.100	1371
0.125	1550
Rivet shear strength ^c	217	388	596	862	1550
	Yield Strength ^d , lbs				
Sheet thickness, in.:					
0.020	119
0.025	144	201
0.032	171	250	316
0.040	204	292	386	474	...
0.050	217	343	451	571	806
0.063	...	388	536	675	987
0.071	596	737	1073
0.080	812	1169
0.090	862	1278
0.100	1371
0.125	1550
Head height (ref.), in.	0.018	0.023	0.030	0.039	0.049

a Data supplied by Briles Rivet Corp.

b Fasteners installed in hole diameters of 0.0975, 0.1285, 0.1615, 0.1945, 0.257, +0.0005, -0.001, respectively.

c Shear strength based on Table 8.1.2(b) and $F_{su} = 38$ ksi.

d Permanent set at yield load: 4% of nominal diameter.

Table 8.1.2.2(k). Static Joint Strength of 120° Flush Shear Head Aluminum Alloy (2024-T31) Solid Rivets in Machine-Countersunk Aluminum Alloy Sheet

Rivet Type	BRFS-DD ^a ($F_{su} = 41$ ksi)	
Sheet Material	Clad 2024-T3	
Rivet Diameter, in. (Nominal Hole Diameter, in.) ^b	3/16 (0.191)	1/4 (0.257)
	Ultimate Strength, lbs	
Sheet thickness, in.:		
0.040	598	...
0.050	772	1000
0.063	994	1300
0.071	1130	1480
0.080	1180	1690
0.090	1920
0.100	2120
Rivet shear strength ^c	1180	2120
	Yield Strength ^d , lbs	
Sheet thickness, in.:		
0.040	598	...
0.050	772	1000
0.063	949	1300
0.071	1000	1480
0.080	1060	1680
0.090	1760
0.100	1850
Head height (ref.), in.	0.039	0.049

a Data supplied by Briles Rivet Corp.

b Fasteners installed in hole diameters of 0.1935 and 0.257, ± 0.0005 .

c Shear strength based on Table 8.1.2(b) and $F_{su} = 41$ ksi.

d Permanent set at yield load: 4% of nominal diameter.

Table 8.1.2.2(I). Static Joint Strength of 120° Flush Shear Head Ti-45 Cb Solid Rivets in Machine-Countersunk Aluminum Alloy and Titanium Sheet

Rivet Type	BRFS-T ^a ($F_{su} = 53$ ksi)					
	Clad 7075-T6			Annealed Ti-6Al-4V		
Sheet Material						
Rivet Diameter, in. (Nominal Hole Diameter, in.) ^b	1/8 (0.1285)	5/32 (0.159)	3/16 (0.191)	1/8 (0.1285)	5/32 (0.159)	3/16 (0.191)
	Ultimate Strength, lbs					
Sheet thickness, in.:						
0.025	288	400
0.032	369	456	...	513	635	...
0.040	461	572	685	564	796	952
0.050	577	713	858	602	867	1190
0.063	610	891	1080	650	927	1270
0.071	628	914	1220	680	964	1310
0.080	649	939	1300	687	1005	1360
0.090	671	967	1330	...	1050	1420
0.100	687	996	1370	1470
0.125	1050	1450	1520
0.160	1520
Rivet shear strength ^c	687	1050	1520	687	1050	1520
	Yield Strength ^d , lbs					
Sheet thickness, in.:						
0.025	288	400
0.032	369	456	...	513	635	...
0.040	461	572	685	564	796	952
0.050	577	713	858	602	867	1190
0.063	610	891	1080	650	927	1270
0.071	628	914	1220	680	964	1310
0.080	649	939	1300	687	1005	1360
0.090	671	967	1330	...	1050	1420
0.100	687	996	1370	1470
0.125	1050	1450	1520
0.160	1520
Head height (ref.), in.	0.023	0.030	0.039	0.023	0.030	0.039

a Data supplied by Briles Rivet Corp.

b Allowables developed from tests with hole diameters noted, except 5/32 and 3/16 diameters were 0.161 and 0.1935 ±0.0005, respectively.

c Rivet shear strength based on Table 8.1.2(b) and $F_{su} = 53$ ksi.

d Permanent set at yield load: 4% of nominal hole diameter.

Table 8.1.2.2(m). Static Joint Strength of 120° Flush Shear Head Aluminum Alloy (7050-T731) Solid Rivets in Machine-Countersunk Aluminum Alloy Sheet

Rivet Type	MS14218E ^a ($F_{su} = 43$ ksi)						
Sheet Material	Clad 2024-T3						
Rivet Diameter, in. (Nominal Hole Diameter, in.) ^b	1/8 (0.1285)	5/32 (0.159)	3/16 (0.191)	7/32 (0.228)	1/4 (0.257)	9/32 (0.290)	5/16 (0.323)
	Ultimate Strength, lbs						
Sheet thickness, in.:							
0.025	215 ^c
0.032	307	346 ^c
0.040	434	478	529 ^c
0.050	508	673	732	806 ^c
0.063	536	781	1045	1135	1200	1285 ^c	...
0.071	554	803	1110	1365	1445	1530	1630 ^c
0.080	558	827	1140	1565	1735	1835	1930
0.090	...	854	1175	1605	1990	2200	2320
0.100	1205	1645	2030	2525	2725
0.125	1230	1740	2140	2650	3205
0.160	1755	2230	2820	3400
0.190	2840	3525
Rivet shear strength ^d	558	854	1230	1755	2230	2840	3525
	Yield Strength ^e , lbs						
Sheet thickness, in.:							
0.025	215
0.032	307	346
0.040	388	478	529
0.050	487	601	721	806
0.063	536	760	912	1085	1200	1285	...
0.071	552	803	1030	1225	1377	1530	1630
0.080	558	827	1140	1385	1554	1755	1930
0.090	...	854	1175	1560	1750	1970	2200
0.100	1205	1645	1950	2200	2445
0.125	1230	1735	2140	2650	3060
0.160	1755	2230	2810	3400
0.190	2840	3525
Head height (ref.), in.	0.027	0.035	0.044	0.053	0.061	0.069	0.077

a Data supplied by Briles Rivet Corp.

b Allowables developed from tests with hole diameters noted, except 5/32, 3/16, and 5/16 diameters were 0.161, 0.1935, and 0.316, respectively. Hole tolerances were +0.0005, -0.001 inch.

c Values above line are for knife-edge condition and the use of fasteners in this condition is undesirable. The use of knife-edge condition in design of military aircraft requires specific approval of the procuring agency.

d Shear strength based on Table 8.1.2(b) and $F_{su} = 43$ ksi.

e Permanent set at yield load: 4% of nominal hole diameter.

Table 8.1.2.2(n). Static Joint Strength of 100° Flush Shear Head Aluminum Alloy (7050-T73) Solid Rivets in Machine-Countersunk Aluminum Alloy Sheet

Rivet Type	NAS1097-E ^a ($F_{su} = 41$ ksi)							
	Clad 2024-T3				Clad 7075-T6			
Sheet Material								
Nominal Rivet Diameter, in. (Nominal Hole Diameter, in.) ^b	1/8 (0.1285)	5/32 (0.159)	3/16 (0.191)	1/4 (0.257)	1/8 (0.1285)	5/32 (0.159)	3/16 (0.191)	1/4 (0.257)
	Ultimate Strength, lbs							
Sheet thickness, in.:								
0.025	227 ^c	278 ^c
0.032	326	367 ^c	354	441 ^c
0.040	437	505	561 ^c	...	439	547	661 ^c	...
0.050	466	679	773	908 ^c	456	674	823	1120 ^c
0.063	485	717	1005	1275	477	700	980	1330
0.071	497	731	1025	1500	490	716	999	1570
0.080	507	747	1045	1750	505	734	1020	1760
0.090	521	765	1065	1840	520	754	1045	1790
0.100	531	781	1085	1870	531	774	1070	1825
0.125	814	1135	1935	...	814	1130	1905
0.160	1175	2030	1175	2020
0.190	2110	2115
0.250	2125	2125
Rivet shear strength ^d	531	814	1175	2125	531	814	1175	2125
	Yield Strength ^e , lbs							
Sheet thickness, in.:								
0.025	192	222
0.032	283	311	307	356
0.040	349	439	479	...	372	475	542	...
0.050	398	538	674	767	398	572	724	894
0.063	462	617	799	1105	431	612	836	1205
0.071	497	665	857	1310	451	638	867	1400
0.080	507	720	921	1400	474	666	900	1490
0.090	521	765	995	1500	499	698	938	1540
0.100	531	781	1065	1595	525	729	976	1595
0.125	814	1135	1835	...	808	1070	1720
0.160	1175	2030	1175	1895
0.190	2110	2050
0.250	2125	2125
Head height (ref.), in.	0.029	0.037	0.046	0.060	0.029	0.037	0.046	0.060

a Data supplied by Lockheed-Georgia Company.
b Fasteners installed in hole diameters of 0.130, 0.158, 0.191, and 0.254 ± 0.003 inch, respectively.
c Values above line are for knife-edge condition and the use of fasteners in this condition is undesirable. The use of knife-edge condition in design of military aircraft requires specific approval of the procuring agency.
d Shear strength based on Table 8.1.2(b) and $F_{su} = 41$ ksi.
e Permanent set at yield load: 4% of nominal hole diameter.

Table 8.1.2.2(o). Static Joint Strength of 120° Flush Shear Head Aluminum Alloy (2117-T3) Solid Rivets in Machine-Countersunk Aluminum Alloy Sheet

Rivet Type	MS14218AD ^a ($F_{su} = 30$ ksi)					
Sheet Material	Clad 2024-T3					
Rivet Diameter, in. (Nominal Hole Diameter, in.) ^b	3/32 (0.096)	1/8 (0.1285)	5/32 (0.159)	3/16 (0.191)	7/32 (0.228)	1/4 (0.257)
	Ultimate Strength, lbs					
Sheet thickness, in.:						
0.020	125 ^c
0.025	153	212 ^c
0.032	188	263	334 ^c
0.040	216	322	408	498 ^c
0.050	217	380	498	609	740 ^c	849 ^c
0.063	...	388	588	751	910	1040
0.071	596	817	1015	1155
0.080	842	1125	1290
0.090	862	1205	1425
0.100	1225	1520
0.125	1555
Rivet shear strength ^d	217	388	596	862	1225	1555
	Yield Strength ^e , lbs					
Sheet thickness, in.:						
0.020	125
0.025	153	212
0.032	188	263	334
0.040	216	319	408	498
0.050	217	370	492	609	740	849
0.063	...	388	574	733	910	1040
0.071	596	794	1005	1155
0.080	842	1090	1275
0.090	862	1180	1380
0.100	1225	1480
0.125	1555
Head height (ref.), in.	0.022	0.027	0.035	0.044	0.053	0.061

a Data supplied by Briles Rivet Corp.

b Load allowables developed from tests with hole diameters noted, except 3/32, 5/32, and 3/16 diameters were 0.098, 0.161, and 0.1935, respectively. Hole tolerance was +0.0005, -0.001 inch.

c Values above line are for knife-edge condition and the use of fasteners in this condition is undesirable. The use of knife-edge condition in design of military aircraft requires specific approval of the procuring agency.

d Shear strength based on Table 8.1.2(b) and $F_{su} = 30$ ksi.

e Permanent set at yield load: 4% of nominal hole diameter.

MIL-HDBK-5J
31 January 2003

Table 8.1.2.2(p). Static Joint Strength of 120° Flush Tension Type Head Aluminum Alloy (7050-T731) Solid Rivets in Machine-Countersunk Aluminum Alloy Sheet

Rivet Type	MS14219 E ^a ($F_{su} = 43$ ksi)							
Sheet Material	Clad 2024-T3							
Rivet Diameter, in. (Nominal Hole Diameter, in.) ^b	3/32 (0.096)	1/8 (0.1285)	5/32 (0.159)	3/16 (0.191)	7/32 (0.228)	1/4 (0.257)	9/32 (0.290)	5/16 (0.523)
	Ultimate Strength, lbs							
Sheet thickness, in.:								
0.032	210 ^c
0.040	279	339 ^c
0.050	310	473	527 ^c
0.063	311	538	743	819 ^c
0.071	...	558	788	979	1065 ^c
0.080	834	1105	1280
0.090	854	1165	1520	1625 ^c
0.100	1230	1605	1890	2020 ^c	2120 ^c
0.125	1755	2145	2580	2965
0.160	2230	2840	3415
0.190	3525
Rivet shear strength ^d	311	588	854	1230	1755	2230	2840	3525
	Yield Strength ^e , lbs							
Sheet thickness, in.:								
0.032	210
0.040	277	339
0.050	301	468	527
0.063	309	538	728	819
0.071	...	543	788	979	1065
0.080	823	1100	1280
0.090	833	1165	1490	1625
0.100	1190	1605	1875	2020	2120
0.125	1705	2145	2580	2945
0.160	2200	2765	3390
0.190	3455
Head height (ref.), in.	0.034	0.041	0.053	0.068	0.077	0.090	0.100	0.104

a Data supplied by Briles Rivet Corp.

b Load allowables developed from tests with hole diameters noted, except 5/32, 3/16, and 5/16 diameter were 0.161, 0.1935, and 0.316, respectively. Hole tolerances were + 0.0005, -0.001 inch.

c Values above line are for knife-edge condition and the use of fasteners in this condition is undesirable. The use of knife-edge condition in design of military aircraft requires specific approval of the procuring agency.

d Rivet shear strength based on Table 8.1.2(b) and $F_{su} = 43$ ksi.

e Permanent set at yield load: 4% of nominal hole diameter.

MIL-HDBK-5J
31 January 2003

Table 8.1.2.2(q). Static Joint Strength of 120° Flush Tension Type Head Aluminum Alloy (7050-T731) Solid Rivets in Machine-Countersunk Aluminum Alloy Sheet

Rivet Type	MS14219 E ^a ($F_{su} = 43$ ksi)							
Sheet Material	Clad 7075-T6							
Rivet Diameter, in. (Nominal Hole Diameter, in.) ^b	3/32 (0.096)	1/8 (0.1285)	5/32 (0.159)	3/16 (0.191)	7/32 (0.228)	1/4 (0.257)	9/32 (0.290)	5/16 (0.523)
	Ultimate Strength, lbs							
Sheet thickness, in.:								
0.032	272 ^c
0.040	297	455 ^c
0.050	311	522	704 ^c
0.063	...	558	803	1065 ^c
0.071	832	1140	1435 ^c
0.080	854	1180	1600
0.090	1220	1650	2030 ^c
0.100	1230	1700	2090	2565 ^c	2860 ^c
0.125	1755	2230	2740	3295
0.160	2840	3525
Rivet shear strength ^d	311	558	854	1230	1755	2230	2840	3525
	Yield Strength ^e , lbs							
Sheet thickness, in.:								
0.032	272
0.040	296	455
0.050	308	522	704
0.063	...	550	802	1065
0.071	823	1140	1435
0.080	845	1170	1600
0.090	1205	1650	2030
0.100	1220	1685	2090	2565	2860
0.125	1740	2195	2715	3295
0.160	2815	3480
Head height (ref.), in.	0.034	0.041	0.053	0.068	0.077	0.090	0.100	0.104

a Data supplied by Briles Rivet Corp.

b Allowables developed from tests with hole diameters noted, except 3/32, 5/32, 3/16, and 5/16 diameters were 0.098, 0.161, 0.1935, and 0.316, respectively. Hole tolerances were +0.0005, -0.001 inch.

c Values above line are for knife-edge condition and the use of fasteners in this condition is undesirable. The use of knife-edge condition in design of military aircraft requires specific approval of the procuring agency.

d Rivet shear strength based on Table 8.1.2(b) and $F_{su} = 43$ ksi.

e Permanent set at yield load: 4% of nominal hole diameter.

Table 8.1.2.2(r). Static Joint Strength of Solid 100° Flush Head Aluminum Alloy (7050-T73) Solid Rivets in Machine Countersunk Aluminum Alloy Sheet

Rivet Type	MS20426E ($F_{su} = 41$ ksi) ^a			
Sheet Material	Clad 2024-T3			
Rivet Diameter, in.	1/8	5/32	3/16	1/4
(Nominal Hole Diameter, in.) ^b	(0.1285)	(0.159)	(0.191)	(0.257)
	Ultimate Strength, lbs			
Sheet thickness, in.:				
0.040	386 ^c
0.050	419	592 ^c
0.063	463	647	870 ^c	...
0.071	491	680	910	...
0.080	521	718	955	...
0.090	531	760	1005	1610 ^c
0.100	...	802	1055	1680
0.125	...	814	1175	1845
0.160	2085
0.190	2125
Rivet shear strength ^d	531	814	1175	2125
	Yield Strength ^e , lbs			
Sheet thickness, in.:				
0.040	262
0.050	327	404
0.063	412	510	612	...
0.071	464	574	690	...
0.080	517	647	777	...
0.090	531	728	875	1175
0.100	...	794	972	1310
0.125	...	814	1160	1635
0.160	2070
0.190	2125
Head Height (ref.), in.	0.042	0.055	0.070	0.095

a Data supplied by Lockheed Ga. Co. and Air Force Materials Laboratory.

b Load allowables developed from tests with hole diameters of 0.130, 0.158, 0.191, and 0.256 ± 0.003 inch.

c The values in the table above the horizontal line in each column are for knife-edge condition and the use of fasteners in this condition is undesirable. The use of knife-edge condition in design of military aircraft requires the specific approval of the procuring agency.

d Shear strength based on area computed from nominal hole diameters in Table 8.1.2(b) and $F_{su} = 41$ ksi.

e Permanent set at yield load: 4% of the nominal hole diameter.

Table 8.1.2.2 (s). Static Joint Strength of Solid 100° Flush Head Aluminum Alloy (7050-T73) Solid Rivets in Machine Countersunk Aluminum Alloy Sheet

Rivet Type	MS20426E ($F_{su} = 41$ ksi) ^a			
Sheet Material	Clad 7075-T6			
Rivet Diameter, in.	1/8	5/32	3/16	1/4
(Nominal Hole Diameter, in.) ^b	(0.1285)	(0.159)	(0.191)	(0.257)
	Ultimate Strength, lbs			
Sheet thickness, in.:				
0.040	318 ^c
0.050	393	492 ^c
0.063	440	606	745 ^c	...
0.071	469	642	840	...
0.080	502	683	898	...
0.090	531	728	952	1430 ^c
0.100	...	773	1005	1570
0.125	...	814	1140	1755
0.160	1175	2010
0.190	2125
Rivet shear strength ^d	531	814	1175	2125
	Yield Strength ^e , lbs			
Sheet thickness, in.:				
0.040	257
0.050	330	399
0.063	423	515	607	...
0.071	469	586	693	...
0.080	502	666	789	...
0.090	531	728	896	1175
0.100	...	773	1005	1320
0.125	...	814	1140	1680
0.160	1175	2010
0.190	2125
Head height (ref.), in.	0.042	0.055	0.070	0.095

a Data supplied by Lockheed Ga. Co., Air Force Materials Laboratory, Allfast, Cherry Fasteners, Douglas Aircraft Co., and Huck Mfg. Co.

b Load allowables developed from tests with hole diameters of 0.130, 0.158, 0.191, and 0.256 ± 0.003 inch.

c The values in the table above the horizontal line in each column are for knife-edge condition and the use of fasteners in this condition is undesirable. The use of knife-edge condition in design of military aircraft requires the specific approval of the procuring agency.

d Shear strength based on area computed from nominal hole diameters in Table 8.1.2(b) and $F_{su} = 41$ ksi.

e Permanent set at yield load: 4% of the nominal hole diameter.

Table 8.1.2.2(f). Static Joint Strength of 105 degree Flush Shear Head Aluminum Alloy (7050) Solid Rivet in 100 degree Machine-Countersunk Alloy Sheet

Rivet Type	AL 905 KE ^a (F _{su} = 41 ksi)			
Sheet Material	Clad 2024-T3			
Rivet Diameter, in. (Nominal Hole Diameter, in.) ^b	1/8 (0.1285)	5/32 (0.159)	3/16 (0.191)	1/4 (0.257)
	Ultimate Strength, lbs.			
Sheet thickness, in.:				
0.032	325 ^c	---	---	---
0.040	396	502 ^c	---	---
0.050	452	612	750 ^c	---
0.063	498	696	923	1280 ^c
0.071	526	731	980	1425
0.080	531	771	1030	1585
0.090	---	814	1080	1735
0.125	---	---	1175	1985
0.160	---	---	---	2125
Rivet Shear Strength ^d	531	814	1175	2125
	Yield Strength, lbs ^e			
Sheet thickness, in.:				
0.032	268	---	---	---
0.040	326	415	---	---
0.050	399	504	619	---
0.063	493	620	759	1060
0.071	526	692	845	1175
0.080	531	771	942	1305
0.090	---	814	1050	1450
0.125	---	---	1175	1955
0.160	---	---	---	2125
Head height [ref.], ^f in.	0.029	0.037	0.046	0.060

- a Data supplied by Ateliers De La Haute Garonne SARL.
- b Loads developed from tests with hole diameters of 0.1285, 0.161, 0.193, and 0.257, +/- 0.001 inch.
- c The values above the horizontal line in each column are for knife-edge condition and the use of fasteners in this condition is undesirable. The use of knife-edge condition in design of military aircraft requires specific approval of the procuring activity.
- d Rivet shear strength is based upon Table 8.1.2(b) and F_{su} = 41 ksi.
- e Permanent set at yield load: 4% of nominal diameter.
- f Head height values reflect driven rivet configuration.

8.1.3 BLIND FASTENERS— The strengths shown in the following tables are applicable only for the grip lengths and hole tolerances recommended by the respective fastener manufacturers. For some fastener systems, permanent set at yield load may be increased if hole sizes greater than those listed in the applicable table are used. This condition may exist even though the test hole size lies within the manufacturer's recommended hole size range.

The strength values were established from test data and are applicable to "joints" with $e/D \geq 2.0$. For joints with e/D ratios less than 2.0, tests to substantiate the use of yield and ultimate strength allowables must be made. Ultimate strength values of protruding- and flush-head blind fasteners were obtained as described in Section 9.7. The analyses prior to 2003 included dividing the average ultimate load from test data by 1.15. This factor was not applicable to shear strength cutoff values which represented either the procurement specification shear strength (S values) of the fastener, or if no specification existed, a statistical value determined from test results as described in Chapter 9.

Unless otherwise specified, prior to 2003 the yield load was defined as the load which resulted in a joint permanent set equal to $0.04D$, where D is the decimal equivalent of the hole or fastener shank diameter, as defined in Table 9.7.1.1. Some tables are footnoted to show the previous criteria used for those particular tables.

For machine countersunk joints, the sheet gage specified in the tables is that of the countersunk sheet. When the noncountersunk sheet is thinner than the countersunk sheet, the bearing allowable for the noncountersunk sheet-fastener combination should be computed, compared to the table value, and the lower of the two values selected. Increased attention should be paid to detail design in cases where $t/D < 0.25$ because of the possibility of unsatisfactory service life.

Joint allowable strengths of blind fasteners in double-dimpled or dimpled into machine countersunk applications should be established on the basis of specific tests acceptable to the procuring or certifying agency.

Reference should be made to the requirements of the applicable procuring or certifying agency relative to the use of blind fasteners such as the limitations of usage in design standard MS33522.

8.1.3.1 Protruding-Head Blind Fasteners

8.1.3.1.1 Friction-Lock Blind Rivets — Tables 8.1.3.1.1(a) through 8.1.3.1.1(e) contain joint allowables for various protruding-head, friction-lock blind rivet/sheet material combinations.

8.1.3.1.2 Mechanical-Lock Spindle Blind Rivets — Tables 8.1.3.1.2(a) through (t) contain joint allowables for various protruding-head, mechanical-lock spindle blind rivet/sheet material combinations.

8.1.3.2 Flush-Head Blind Fasteners

8.1.3.2.1 Friction-Lock Blind Rivets — Tables 8.1.3.2.1(a) through (g) contain joint allowables for various flush-head, friction-lock blind rivet/sheet material combinations.

8.1.3.2.2 Mechanical-Lock Spindle Blind Rivets — Tables 8.1.3.2.2(a) through (aa) contain joint allowables for various flush-head, mechanical-lock spindle blind rivet/sheet material combinations.

8.1.3.2.3 Flush-Head Blind Bolts — Tables 8.1.3.2.3(a) through (h) contain joint allowables for various flush-head blind bolt/sheet material combinations.

Table 8.1.3.1.1(a). Static Joint Strength of Blind Protruding Head A-286 Rivets in Alloy Steels, Titanium Alloy and A-286 Alloy Sheet

Rivet Type	CR 6636 ^a ($F_{su} = 75$ ksi)			
Sheet Material	Alloy Steel, $F_{tu} = 125$ ksi, Titanium Alloys, $F_{tu} = 120$ ksi, and A-286 Alloy, $F_{tu} = 140$ ksi			
Rivet Diameter, in. (Nominal Hole Diameter, in.)	1/8 (0.130)	5/32 (0.162)	3/16 (0.194)	1/4 (0.258)
	Ultimate Strength ^b , lbs			
Sheet thickness, in.:				
0.008	169
0.012	290	341
0.016	412	493	566	...
0.020	532	645	748	924
0.025	688	816	967	1221
0.032	796	1050	1278	1650
0.040	879	1233	1570	2129
0.050	945	1354	1807	2673
0.063	970	1461	1980	3168
0.071	...	1490	2062	3350
0.080	2150	3515
0.090	3663
0.100	3779
0.112	3890
Rivet shear strength ^c	970	1490	2150	3890

a Data supplied by Cherry Fasteners.

b Yield strength is in excess of 80% of ultimate. This is based on a previous Navy "BuAer" definition that yield strength would not be considered to be critical if it exceeded 1.15 x 2.3 of design ultimate strength. There was no requirement for submission of the yield data for inclusion in ANC-5.

c Shear strength based on areas computed from nominal hole diameters in Table 8.1.2(a) and $F_{su} = 75$ ksi.

MIL-HDBK-5J
31 January 2003

Table 8.1.3.1.1(b). Static Joint Strength of Protruding Head Monel Rivets in Stainless Steel Sheet

Rivet Type	MS20600M ($F_{su} = 55$ ksi)							
	ANSI 301-Annealed				AISI 301-½ Hard			
	1/8 (0.130)	5/32 (0.162)	3/16 (0.154)	1/4 (0.258)	1/8 (0.130)	5/32 (0.162)	3/16 (0.194)	1/4 (0.258)
	Ultimate Strength, lbs							
Sheet thickness, in.:								
0.010	195
0.012	225	287
0.016	290	367	453	...
0.020	332 ^a	358	450	552	774
0.025	396 ^a	494 ^a	440	552	675	940
0.032	472 ^a	627 ^a	768 ^a	...	522	690	1040	1163
0.040	526 ^a	729 ^a	942 ^a	1290 ^a	580	810	1200	1430
0.050	594 ^a	810 ^a	1070 ^a	1585 ^a	635	903	1325	1760
0.063	681 ^a	919 ^a	1280 ^a	1875 ^a	678	980	1385	2090
0.071	700 ^a	984 ^a	1370 ^a	1980 ^a	701	1013	1438	2220
0.080	713	1055 ^a	1470 ^a	2110 ^a	713	1050	1486	2340
0.090	1080 ^a	1530 ^a	2240 ^a	...	1081	1540	2450
0.100	1090	1580	2380 ^a	...	1090	1580	2540
0.125	2700 ^a	2710
0.160	2855	2855
Rivet shear strength ^b	713	1090	1580	2855	713	1090	1580	2855
	Yield Strength ^c , lbs							
Sheet thickness, in.:								
0.010	195
0.012	225	287
0.016	290	367	453	...
0.020	128	358	450	551	774
0.025	160	199	440	552	675	940
0.032	205	254	306	...	522	690	836	1163
0.040	257	318	382	514	580	810	1040	1430
0.050	321	397	477	642	635	903	1200	1760
0.063	405	501	601	810	678	980	1325	2090
0.071	456	564	678	912	701	1013	1385	2220
0.080	514	635	764	1025	713	1050	1438	2340
0.090	715	860	1155	...	1081	1486	2450
0.100	795	955	1285	...	1090	1540	2540
0.125	1605	2710
0.160	2055	2855

a Yield value is less than 2/3 of the indicated ultimate strength value.
b Rivet shear strength based on areas computed from nominal hole diameters in Table 8.1.2(a) and $F_{su} = 55$ ksi.
c Permanent set at yield load: the greater of 0.005 inch or 2.5% of nominal diameter.

MIL-HDBK-5J
31 January 2003

Table 8.1.3.1.1(c). Static Joint Strength of Blind Protruding Head Monel Rivets in Aluminum Alloy Sheet

Rivet Type	MS20600M ($F_{su} = 55$ ksi)							
	2024-T3				7075-T6			
Sheet Material								
Rivet Diameter, in.	1/8	5/32	3/16	1/4	1/8	5/32	3/16	1/4
(Nominal Hole Diameter, in.) ..	(0.130)	(0.162)	(0.194)	(0.258)	(0.130)	(0.162)	(0.194)	(0.258)
Ultimate Strength, lbs								
Sheet thickness, in.:								
0.025	268	297
0.032	365	429	405	472
0.040	478	569	650	...	485	631	720	...
0.050	545	738	860	1070	545	747	955	1190
0.063	622	844	1110	1430	622	844	1110	1590
0.071	652	903	1180	1665	652	903	1180	1840
0.080	684	968	1255	1910	684	968	1255	1940
0.090	713	1010	1345	2060	713	1010	1345	2060
0.100	1050	1415	2180	...	1050	1415	2180
0.125	1090	1545	2480	...	1090	1545	2480
0.160	1580	2735	1580	2735
0.190	2855	2855
Rivet shear strength ^a	713	1090	1580	2855	713	1090	1580	2855
Yield Strength ^b , lbs								
Sheet thickness, in.:								
0.025	234	272
0.032	297	370	343	430
0.040	368	460	556	...	425	533	644	...
0.050	458	570	688	936	492	657	797	1090
0.063	529	715	863	1170	529	759	996	1350
0.071	552	786	970	1315	552	786	1075	1520
0.080	577	818	1090	1470	577	818	1110	1700
0.090	605	853	1155	1650	605	853	1155	1915
0.100	888	1200	1830	...	888	1200	1970
0.125	976	1300	2110	...	976	1300	2110
0.160	1450	2310	1450	2310
0.190	2480	2480

a Shear strength based on areas computed from nominal hole diameters in Table 8.1.2(a) and $F_{su} = 55$ ksi.

b Permanent set at yield load: the greater of 0.005 inch or 2.5% of nominal diameter.

Table 8.1.3.1.1(d). Static Joint Strength of Blind Protruding Head Alloy (2117-T3) Rivets in Aluminum Alloy Sheet

Rivet Type	MS20600AD and MS20602AD ($F_{su} = 30$ ksi)			
Sheet Material	Clad 2024 T3			
Rivet Diameter, in. (Nominal Hole Diameter, in.)	1/8 (0.130)	5/32 (0.162)	3/16 (0.194)	1/4 (0.258)
	Ultimate Strength, lbs			
Sheet thickness, in.:				
0.025	233
0.032	277	368
0.040	321	425	544	...
0.050	388	506	643	961
0.063	596	753	1110
0.071	823	1200
0.080	862	1305
0.090	1415
0.100	1550
Rivet shear strength ^a	388	596	862	1550
	Yield Strength ^b , lbs			
Sheet thickness, in.:				
0.025	226
0.032	264	356
0.040	304	406	523	...
0.050	362	475	610	925
0.063	388	560	709	1058
0.071	596	771	1135
0.080	862	1230
0.090	1330
0.100	1450

a Rivet shear strength based on areas computed from nominal hole diameters in Table 8.1.2(a) and $F_{su} = 30$ ksi.

b Permanent set at yield load: the greater of 0.005 inch or 2.5% of nominal diameter.

Table 8.1.3.1.1(e). Static Joint Strength of Blind Protruding Head Aluminum Alloy (5056) Rivets in Magnesium Alloy Sheet

Rivet Type	MS20600B ($F_{su} = 28$ ksi)			
Sheet Material	AZ31B-H24			
Rivet Diameter, in. (Nominal Hole Diameter, in.)	1/8 (0.130)	5/32 (0.162)	3/16 (0.194)	1/4 (0.258)
	Ultimate Strength ^a , lbs			
Sheet thickness, in.:				
0.025	178
0.032	218	282
0.040	256	339	420	...
0.050	290	392	502	714
0.063	330	449	584	870
0.071	352	481	627	942
0.080	363	512	667	1025
0.090	...	550	714	1090
0.100	...	556	757	1160
0.125	802	1315
0.160	1450
Rivet shear strength ^b	363	556	802	1450

a Yield strength is in excess of 80% of ultimate. This is based on a previous Navy "Bureau of Aeronautics" definition that yield strength was not considered to be critical if it exceeded $1.15 \times 2/3$ of design ultimate strength. There was no requirement for submission of the yield data for inclusion in ANC-5.

b Shear strength based on areas computed from nominal hole diameters in Table 8.1.2(a) and $F_{su} = 28$ ksi.

Table 8.1.3.1.2(a). Static Joint Strength of Blind Protruding Head Locked Spindle A-286 Rivets in Alloy Steel Sheet

Rivet Type	NAS1398C ^a and NAS1398C, Code A ^b ($F_{su} = 75$ ksi)			CR 2643 ^a ($F_{su} = 95$ ksi)		
	Alloy Steel $F_{tu} = 180$ ksi					
Sheet Material						
Rivet Diameter, in. (Nominal Hole Diameter, in.)	1/8 (0.130)	5/32 (0.162)	3/16 (0.194)	1/8 (0.130)	5/32 (0.162)	3/16 (0.194)
	Ultimate Strength ^c , lbs					
Sheet thickness, in.:						
0.025	697	697
0.032	785	1112	...	807	1112	...
0.040	860	1211	1628	911	1246	1639
0.050	956	1325	1772	1043	1406	1833
0.063	970	1480	1958	1215	1615	2090
0.071	1490	2070	1230	1748	2240
0.080	2150	...	1885	2420
0.090	2610
0.100	2720
Rivet shear strength	970 ^d	1490 ^d	2150 ^d	1230 ^e	1885 ^e	2720 ^e

a Data supplied by Cherry Fasteners.

b Confirmatory data supplied by Olympic Fastening Systems, Inc.

c Yield strength is in excess of 80% of ultimate. This is based on a previous Navy "Bureau of Aeronautics" definition that yield strength would not be considered to be critical if it exceeded $1.15 \times 2/3$ of design ultimate strength. There was no requirement for submission of the yield data for inclusion in ANC-5.

d Rivet shear strength is documented in NAS1400.

e Shear strength based on areas computed from nominal hole diameters in Table 8.1.2(a) and $F_{su} = 95$ ksi.

Table 8.1.3.1.2(b). Static Joint Strength of Blind Protruding Head Locked Spindle Monel Rivets in Stainless Steel Sheet

Rivet Type	NAS1398 MS or MW ^a and NAS1398 MS or MW, Code A ^b ($F_{su} = 55$ ksi)		
	AISI 301-½ Hard		
Sheet Material	AISI 301-½ Hard		
Rivet Diameter, in. (Nominal Hole Diameter, in.)	1/8 (0.130)	5/32 (0.162)	3/16 (0.194)
Ultimate Strength ^c , lbs			
Sheet thickness, in.:			
0.025	462
0.032	568	734	...
0.040	594	870	1094
0.050	632	915	1270
0.063	678	971	1335
0.071	706	1009	1380
0.080	710	1048	1428
0.090	1090	1532
0.100	1580
Rivet shear strength ^d	710	1090	1580

a Data supplied by Cherry Fasteners.

b Confirmatory data supplied by Olympic Fastening Systems, Inc.

c Yield strength is in excess of 80% of ultimate strength. This is based on a previous Navy "Bureau of Aeronautics" definition that yield strength was not considered to be critical if it exceeded 1.15 x 2/3 of design ultimate strength. There was no requirement for submission of the yield strength data for inclusion in ANC-5.

d Rivet shear strength is documented in NAS1400.

Table 8.1.3.1.2(c). Static Joint Strength of Blind Protruding Head Locked Spindle Monel Rivets in Aluminum Alloy Sheet

Rivet Type	NAS1398 MS or MW ^a and NAS1398 MS or MW, Code A ^b ($F_{su} = 55$ ksi)		
Sheet Material	Clad 7075-T6		
Rivet Diameter, in. (Nominal Hole Diameter, in.)	1/8 (0.130)	5/32 (0.162)	3/16 (0.194)
	Ultimate Strength ^c , lbs		
Sheet thickness, in.:			
0.025	318
0.032	404	506	...
0.040	466	624	774
0.050	546	720	922
0.063	647	845	1072
0.071	710	921	1168
0.080	1009	1272
0.090	1090	1387
0.100	1507
0.125	1580
Rivet shear strength ^d	710	1090	1580

a Data supplied by Cherry Fasteners.

b Confirmatory data supplied by Olympic Fastening Systems, Inc.

c Yield strength is in excess of 80% of ultimate. This is based on a previous Navy "Bureau of Aeronautics" definition that yield strength would not be considered to be critical if it exceeded 1.15 x 1/3 of design ultimate strength. There was no requirement for submission of the yield data for inclusion in ANC-5.

d Rivet shear strength is documented in NAS1400.

Table 8.1.3.1.2(d₁). Static Joint Strength of Blind Protruding Head Locked Spindle Aluminum Alloy Rivets in Aluminum Alloy Sheet

Rivet Type	NAS1398B ^a ($F_{su} = 30$ ksi)				NAS1398D ^a ($F_{su} = 38$ ksi)			
	Clad 2024-T3							
Sheet Material								
Rivet Diameter, in. (Nominal Hole Diameter, in.)	1/8 (0.130)	5/32 (0.162)	3/16 (0.194)	1/4 (0.258)	1/8 (0.130)	5/32 (0.162)	3/16 (0.194)	1/4 (0.258)
	Ultimate Strength, lbs.							
Sheet thickness, in.:								
0.025	228	228
0.032	289	364	412	...	304	364
0.040	337	448	553	670	355	470	553	...
0.050	388	521	662	914	418	548	696	914
0.063	596	781	1145	494	647	816	1205
0.071	854	1240	...	710	894	1303
0.080	862	1350	...	755	975	1420
0.090	1475	1069	1545
0.100	1550	1090	1670
0.125	1970
Rivet shear strength ^b	388	596	862	1550	494	755	1090	1970

a Data supplied by Cherry Fasteners.

b Rivet shear strength documented in NAS1400.

Table 8.1.3.1.2(d₂). Static Joint Strength of Blind Protruding Head Locked Spindle Aluminum Alloy Rivets in Aluminum Alloy Sheet

Rivet Type	NAS1738B and NAS1738E ^a (F_{su} = 34 ksi)		
	Clad 2024-T3		
Sheet Material			
Rivet Diameter, in.	1/8	5/32	3/16
(Nominal Hole Diameter, in.)	(0.144)	(0.178)	(0.207)
	Ultimate Strength, lbs		
Sheet thickness, in.:			
0.025	267	305	330
0.032	368	428	473
0.040	427	567	636
0.050	480	650	815
0.063	547 ^b	735	912
0.071	554 ^b	785 ^b	976
0.080	837 ^b	1042 ^b
0.090	1115 ^b
0.100	1128 ^b
Rivet shear strength ^c	554	837	1128
	Yield Strength ^d , lbs		
Sheet thickness, in.:			
0.020	185	213	228
0.025	242	285	317
0.032	298	386	433
0.040	321	453	568
0.050	336	489	625
0.063	336	508	680
0.071	336	508	684
0.080	508	684
0.090	684
0.100	684

a Data supplied by Cherry Fasteners.

b Yield value is less than 2/3 of the indicated ultimate.

c Rivet shear strength was documented in NAS1740 prior to Revision (1), dated January 15, 1974.

d Permanent set at yield load: the greater of 0.005 inch or 2.5% of nominal diameter.

Table 8.1.3.1.2(e). Static Joint Strength of Blind Protruding Head Locked Spindle Aluminum Alloy Rivets in Magnesium Alloy Sheet

Rivet Type	NAS1398B ^a ($F_{su} = 30$ ksi)				NAS1738B and NAS1738E ^a ($F_{su} = 34$ ksi)		
	AZ31B-H24						
Sheet Material	AZ31B-H24						
Rivet Diameter, in. (Nominal Hole Diameter, in.) ...	1/8 (0.130)	5/32 (0.162)	3/16 (0.194)	1/4 (0.258)	1/8 (0.144)	5/32 (0.178)	3/16 (0.207)
	Ultimate Strength, lbs.						
Sheet thickness, in.:							
0.025	163	202
0.032	208	256	310	...	261	321	372
0.040	255	324	388	519	325	401	465
0.050	298	394	485	654	372	501	579
0.063	352	461	588	822	425	570	708
0.071	385	501	639	924	458	609	756
0.080	388	550	695	1020	495	656	809
0.090	596	755	1109	536 ^b	709	866
0.100	820	1191	554 ^b	759	925
0.125	862	1397	...	837 ^b	1072 ^b
0.160	1550	1128 ^b
Rivet shear strength	388 ^c	596 ^c	862 ^c	1550 ^c	554 ^d	837 ^d	1128 ^d
	Yield Strength ^e , lbs.						
Sheet thickness, in.:							
0.025	155
0.032	198	243	282
0.040	248	304	353
0.050	302	380	441
0.063	325	460	556
0.071	336	478	614
0.080	336	499	638
0.090	336	508	664
0.100	336	508	684
0.125	508	684
0.160	684

a Data supplied by Cherry Fasteners.

b Yield value is less than 2/3 of the indicated ultimate strength value.

c Rivet shear strength is documented in NAS1400.

d Rivet shear strength was documented in NAS1740 prior to Revision (1), dated January 15, 1974.

e Permanent set at yield load: the greater of 0.005 inch or 2.5% of nominal diameter.

Table 8.1.3.1.2(f). Static Joint Strength of Blind Protruding Head Locked Spindle Aluminum Alloy (2219) Rivets in Aluminum Alloy Sheet

Rivet Type	CR 2A63 ^a ($F_{su} = 36$ ksi)		
Sheet Material	Clad 2024-T81		
Rivet Diameter, in. (Nominal Hole Diameter, in.) .	1/8 (0.130)	5/32 (0.162)	3/16 (0.194)
	Ultimate Strength, lbs		
Sheet thickness, in.			
0.025	256
0.032	295	404	...
0.040	340	458	592
0.050	395	527	675
0.063	467	617	783
0.071	478	672	848
0.080	734	922
0.090	741	1005
0.100	1063
Rivet shear strength ^b	478	741	1063
	Yield Strength ^c , lbs		
Sheet thickness, in.:			
0.025	256
0.032	295	404	...
0.040	336	458	592
0.050	383	521	675
0.063	440	598	770
0.071	445	646	827
0.080	683	890
0.090	690	963
0.100	984

a Data supplied by Cherry Fasteners.

b Shear strength values based on indicated nominal hole diameters and $F_{su} = 36$ ksi.

c Permanent set at yield load: 4% of nominal hole diameter.

Table 8.1.3.1.2(g). Static Joint Strength of Blind Protruding Head Locked Spindle A-286 Rivets in Aluminum Alloy Sheet

Rivet Type	CR4623 ^a ($F_{su} = 75$ ksi)			
	Clad 7075-T6			
Sheet Material				
Rivet Diameter, in. (Nominal Hole Diameter, in.) ^b	1/8 (0.130)	5/32 (0.162)	3/16 (0.194)	1/4 (0.258)
Sheet thickness, in.:	Ultimate Strength, lbs.			
0.020	237
0.025	298	367
0.032	385	478	566	...
0.040	486	601	714	939
0.050	610	757	902	1185
0.063	772	958	1145	1505
0.071	856	1080	1290	1705
0.080	903	1220	1455	1925
0.090	956	1340	1645	2175
0.100	995	1405	1830	2425
0.125	1545	2055	3035
0.160	2215	3570
0.190	3885
0.250	3920
Rivet shear strength ^c	995	1545	2215	3920
Sheet thickness, in.:	Yield Strength ^d , lbs.			
0.020	237
0.025	296	367
0.032	381	475	565	...
0.040	478	594	709	938
0.050	596	745	890	1180
0.063	690	932	1125	1490
0.071	747	1005	1270	1680
0.080	812	1085	1385	1895
0.090	857	1175	1495	2140
0.100	879	1265	1600	2360
0.125	1365	1870	2715
0.160	1995	3215
0.190	3425
0.250	3690

a Data supplied by Cherry Fasteners.

b Allowable loads developed from test with hole diameters as listed.

c Fastener shear strength based on nominal hole diameters and $F_{su} = 75$ ksi from data analysis.

d Permanent set at yield load: 4% of nominal hole diameter.

MIL-HDBK-5J
31 January 2003

Table 8.1.3.1.2(h). Static Joint Strength of Blind Protruding Head Locked Spindle Monel Rivets in Aluminum Alloy Sheet

Rivet Type	CR 4523 ^a ($F_{su} = 65$ ksi)			
	Clad 7075-T6			
Sheet Material				
Rivet Diameter, in	1/8	5/32	3/16	1/4
(Nominal Hole Diameter, in.) ^b	(0.130)	(0.162)	(0.194)	(0.258)
Sheet thickness, in.:	Ultimate Strength, lbs.			
0.020	221
0.025	284	344
0.032	373	456	533	...
0.040	475	582	684	878
0.050	602	740	875	1130
0.063	701	945	1120	1455
0.071	729	1055	1270	1655
0.080	760	1095	1440	1885
0.090	796	1140	1540	2135
0.100	831	1180	1590	2390
0.125	863	1290	1725	2760
0.160	1340	1905	3005
0.190	1920	3215
0.250	3400
Rivet shear strength ^c	863	1340	1920	3400
Sheet thickness, in.:	Yield Strength ^d , lbs.			
0.020	221
0.025	279	344
0.032	360	447	530	...
0.040	453	561	667	878
0.050	569	706	841	1110
0.063	659	893	1065	1405
0.071	707	965	1205	1590
0.080	729	1035	1340	1795
0.090	752	1105	1430	2030
0.100	776	1135	1520	2260
0.125	834	1205	1645	2590
0.160	1305	1765	2880
0.190	1870	3015
0.250	3290

a Data supplied by Cherry Fasteners.

b Allowable loads developed from test with hole diameters as listed.

c Fastener shear strength based on nominal hole diameters and $F_{su} = 65$ ksi from data analysis.

d Permanent set at yield load: 4% of nominal hole diameter.

Table 8.1.3.1.2(i). Static Joint Strength of Blind Protruding Head Locked Spindle Aluminum Alloy (7050) Rivets in Aluminum Alloy Sheet

Rivet Type	NAS 1720KE and NAS 1720KE()L ^{a,b} ($F_{su} = 33$ ksi)		
Sheet Material	Clad 2024-T3		
Rivet Diameter, in. (Nominal Hole Diameter, in.) ^c	1/8 (0.130)	5/32 (0.162)	3/16 (0.194)
Sheet thickness, in.:	Ultimate Strength, lbs.		
0.020	174
0.025	219	272	...
0.032	282	350	417
0.040	354	440	525
0.050	376	552	659
0.063	392	585	816
0.071	402	597	831
0.080	413	611	847
0.090	425	626	866
0.100	437	641	884
0.125	450	680	929
0.160	700	950
Rivet shear strength ^d	450	700	950
Sheet thickness, in.:	Yield Strength ^e , lbs.		
0.020	174
0.025	215	272	...
0.032	261	340	417
0.040	314	406	504
0.050	366	489	603
0.063	382	570	732
0.071	391	582	809
0.080	402	595	825
0.090	414	610	843
0.100	426	625	861
0.125	450	662	905
0.160	700	950

a Data supplied by Avdel Corp.

b Fasteners should not be used for structural applications where the t/D is less than 0.15.

c Loads developed from tests with hole diameters of 0.130, 0.162, and 0.194, +0.0005, -0.0000 inch.

d Rivet shear strength is documented in NAS 1722.

e Permanent set at yield load: 4% of nominal diameter.

Table 8.1.3.1.2(j). Static Joint Strength of Blind Protruding Head Locked Spindle A-286 Rivets in Aluminum Alloy Sheet

Rivet Type	NAS1720C and NAS1720C(L) ^{a,b} ($F_{su} = 75$ ksi)		
Sheet Material	Clad 7075-T6		
Rivet Diameter, in. (Nominal Hole Diameter, in.) ^c ..	1/8 (0.130)	5/32 (0.162)	3/16 (0.194)
Ultimate Strength, lbs.			
Sheet thickness, in.:			
0.025	329
0.032	399	528	...
0.040	499	621	799
0.050	625	778	930
0.063	789	982	1170
0.071	847	1105	1320
0.080	870	1245	1490
0.090	896	1320	1680
0.100	921	1350	1865
0.125	985	1430	1955
0.160	1000	1500	2090
0.190	2200
Rivet shear strength ^d	1000	1500	2200
Yield Strength ^e , lbs.			
Sheet thickness, in.:			
0.025	329
0.032	390	386	...
0.040	453	607	779
0.050	531	704	895
0.063	632	831	1045
0.071	687	909	1140
0.080	701	996	1245
0.090	717	1070	1360
0.100	733	1090	1475
0.125	773	1140	1575
0.160	829	1210	1655
0.190	1730

a Data supplied by Avdel Corp.
b Fasteners should not be used for structural applications where the t/D is less than 0.15.
c Loads developed from tests with hole diameters of 0.130, 0.162, and 0.194, ± 0.0001 inch.
d Rivet shear strength is documented in NAS1722.
e Permanent set at yield load: 4% of nominal diameter.

Table 8.1.3.1.2(k). Static Joint Strength of Blind Protruding Head Locked Spindle Aluminum Alloy Rivets in Aluminum Alloy Sheet

Rivet Type	AF3243 (F _{su} = 51 ksi approx.) ^a		
Sheet Material	Clad 2024-T3		
Rivet Diameter, in. (Nominal Hole Diameter, in.) ^b	1/8 (0.144)	5/32 (0.178)	3/16 (0.207)
	Ultimate Strength, lbs.		
Sheet thickness, in.:			
0.025	242	---	---
0.032	302	382	453
0.040	371	467	551
0.050	456	572	674
0.063	538	710	834
0.071	556	795	932
0.080	577	828	1040
0.090	600	856	1110
0.100	622	885	1140
0.125	679	955	1225
0.160	759	---	1335
Rivet shear strength ^c	814	1245	1685
	Yield Strength, lbs ^d		
Sheet thickness, in.:			
0.025	242	---	---
0.032	302	382	453
0.040	371	467	551
0.050	456	572	674
0.063	538	710	834
0.071	556	795	932
0.080	577	828	1040
0.090	600	856	1110
0.100	622	885	1140
0.125	679	955	1225
0.160	759	---	1335

THIS FASTENER HAS ONLY BEEN TESTED IN THE SHEET GAGES SHOWN IN THIS TABLE. DESIGN DATA FOR SHEET GAGES OR DIAMETERS OTHER THAN THOSE SHOWN HERE CANNOT BE EXTRAPOLATED.

a Data supplied by Allfast Fastening Systems Inc.
b Loads developed from tests with hole diameters of 0.144, 0.178, and 0.207, +/-0.001 inch.
c Rivet shear strength is documented on AF3243 standards drawing.
d Permanent set at yield load: 4% of nominal diameter.

Table 8.1.3.1.2(I). Static Joint Strength of Blind Protruding Head Locked Spindle Aluminum Alloy Rivets in Aluminum Alloy Sheet

Rivet Type	HC3213 ($F_{su} = 51$ ksi approx.) ^a		
	Clad 2024-T3		
Sheet Material			
Rivet Diameter, in. (Nominal Hole Diameter, in.) ^b	1/8 (0.130)	5/32 (0.162)	3/16 (0.194)
	Ultimate Strength, lbs.		
Sheet thickness, in.:			
0.020	225	---	---
0.025	265	351	---
0.032	320	419	527
0.040	383	498	621
0.050	461	596	738
0.063	538	723	891
0.071	558	801	985
0.080	581	840	1090
0.090	607	872	1180
0.100	632	904	1220
0.125	664	983	1315
0.160	---	1030	1445
0.190	---	---	1480
Rivet shear strength ^c	664	1030	1480
	Yield Strength, lbs ^d		
Sheet thickness, in.:			
0.020	182	---	---
0.025	222	284	---
0.032	278	354	431
0.040	343	434	527
0.050	423	534	647
0.063	436	658	803
0.071	444	668	898
0.080	453	679	951
0.090	463	691	965
0.100	473	704	980
0.125	497	734	1015
0.160	---	777	1065
0.190	---	---	1110

a Data supplied by Huck International Inc.

b Loads developed from tests with hole diameters of 0.130, 0.162, and 0.194, +/- 0.001 inch.

c Rivet shear strength is documented on HC3213 standards drawing.

d Permanent set at yield load: 4% of nominal diameter.

Table 8.1.3.1.2(m). Static Joint Strength of Protruding Head Locked Spindle Aluminum Alloy Blind Rivets in Aluminum Alloy Sheet

Rivet Type	HC6223 ^a ($F_{su} = 50$ ksi) Nominal		
Sheet and Plate Material	Clad 2024-T3		
Rivet Diameter, in. (Nominal Hole Diameter, in.)	1/8 (0.130)	5/32 (0.162)	3/16 (0.194)
	Ultimate Strength, lbs		
Sheet thickness, in.:			
0.016
0.020
0.025	272
0.032	367	437	...
0.040	427	573	661
0.050	476	664	864
0.063	539	743	975
0.071	578	792	1033
0.080	622	846	1099
0.090	664	907	1171
0.100	...	967	1244
0.125	...	1030	1425
0.160	1480
0.190
Rivet shear strength ^b	664	1030	1480
	Yield Strength ^c , lbs		
Sheet thickness, in.:			
0.016
0.020
0.025	255
0.032	320	406	...
0.040	394	498	605
0.050	417	613	743
0.063	437	648	901
0.071	449	664	920
0.080	463	681	940
0.090	478	700	963
0.100	...	720	986
0.125	...	768	1044
0.160	1125
0.190

a Data supplied by Huck International, Inc.
b Rivet shear strength is documented in MIL-R-7885D.
c Permanent set at yield load: 4% of nominal hole diameter.

Table 8.1.3.1.2(n). Static Joint Strength of Protruding Head Locked Spindle Aluminum Alloy Blind Rivets in Aluminum Alloy Sheet

Rivet Type	HC6253 ^a ($F_{su} = 50$ ksi)		
	Clad 2024-T3		
Sheet Material			
Rivet Diameter, in. (Nominal Hole Diameter, in.)	1/8 (0.144)	5/32 (0.178)	3/16 (0.207)
	Ultimate Strength, lbs		
Sheet thickness, in.:			
0.016
0.020
0.025
0.032	344	419	...
0.040	436	532	613
0.050	513	674	777
0.063	559	789	992
0.071	588	824	1055
0.080	620	864	1101
0.090	656	908	1152
0.100	691	952	1204
0.125	781	1063	1332
0.160	814	1217	1512
0.190	1245	1666
0.250	1685
Rivet shear strength ^b	814	1245	1685
	Yield Strength ^c , lbs		
Sheet thickness, in.:			
0.016
0.020
0.025
0.032	344 ^d	419 ^d	...
0.040	403	532 ^d	613 ^d
0.050	462	619	731
0.063	523	715	879
0.071	541	774	948
0.080	560	805	1025
0.090	583	832	1079
0.100	605	859	1110
0.125	660	928	1190
0.160	738	1024	1302
0.190	1245	1397
0.250	1588

a Data supplied by Huck International, Inc.
b Rivet shear strength is documented in MIL-R-7885D.
c Permanent set at yield load: 4% of nominal hole diameter.
d Calculated yield reduced to match ultimate strength.

Table 8.1.3.1.2(o). Static Joint Strength of Blind Protruding Head Locked Spindle Aluminum Alloy Rivets in Aluminum Alloy Sheet

Rivet Type	AF3213 ($F_{su} = 51$ ksi approx.) ^a		
Sheet Material	Clad 2024-T3		
Rivet Diameter, in. (Nominal Hole Diameter, in.) ^b	1/8 (0.130)	5/32 (0.162)	3/16 (0.194)
	Ultimate Strength, lbs.		
Sheet thickness, in.:			
0.020	223	---	---
0.025	262	347	---
0.032	317	416	522
0.040	380	494	616
0.050	411	592	733
0.063	441	640	875
0.071	459	663	902
0.080	480	689	933
0.090	503	717	968
0.100	526	746	1000
0.125	583	818	1085
0.160	---	918	1205
0.190	---	---	1310

THIS FASTENER HAS ONLY BEEN TESTED IN THE SHEET GAGES SHOWN IN THIS TABLE. DESIGN DATA FOR SHEET GAGES OR DIAMETERS OTHER THAN THOSE SHOWN HERE CANNOT BE EXTRAPOLATED.

Rivet shear strength ^c	664	1030	1480
	Yield Strength, lbs ^d		
Sheet thickness, in.:			
0.020	223	---	---
0.025	262	347	---
0.032	317	416	522
0.040	362	494	616
0.050	378	562	733
0.063	398	588	814
0.071	411	604	833
0.080	425	622	854
0.090	441	641	878
0.100	457	661	901
0.125	496	710	960
0.160	---	779	1040
0.190	---	---	1110

a Data supplied by Allfast Fastening Systems Inc.
b Loads developed from tests with hole diameters of 0.130, 0.162, and 0.194, +/- 0.001 inch.
c Rivet shear strength is documented on AF3213 standards drawing.
d Permanent set at yield load: 4% of nominal diameter.

Table 8.1.3.1.2(p). Static Joint Strength of Blind Protruding Head Locked Spindle Aluminum Alloy Rivets in Aluminum Alloy Sheet

Rivet Type	CR3213 ($F_{su} = 51$ ksi approx.) ^a		
Sheet Material	Clad 2024-T3		
Rivet Diameter, in. (Nominal Hole Diameter, in.) ^b	1/8 (0.130)	5/32 (0.162)	3/16 (0.194)
	Ultimate Strength, lbs.		
Sheet thickness, in.:			
0.020	250	---	---
0.025	280	389	---
0.032	322	441	576
0.040	370	501	648
0.050	430	576	737
0.063	492	673	853
0.071	513	733	925
0.080	536	769	1005
0.090	562	801	1080
0.100	587	833	1115
0.125	652	913	1215

THIS FASTENER HAS ONLY BEEN TESTED IN THE SHEET GAGES SHOWN IN THIS TABLE. DESIGN DATA FOR SHEET GAGES OR DIAMETERS OTHER THAN THOSE SHOWN HERE CANNOT BE EXTRAPOLATED.

Rivet shear strength ^c	664	1030	1480
	Yield Strength, lbs ^d		
Sheet thickness, in.:			
0.020	214	---	---
0.025	238	332	---
0.032	272	375	491
0.040	298	424	550
0.050	315	463	623
0.063	338	491	672
0.071	351	508	692
0.080	367	527	716
0.090	384	549	741
0.100	401	570	767
0.125	445	624	831

- a Data supplied by Textron Aerospace Fasteners.
- b Loads developed from tests with hole diameters of 0.130, 0.162, and 0.194, +/- 0.001 inch.
- c Rivet shear strength is documented on CR3213 standards drawing.
- d Permanent set at yield load: 4% of nominal diameter.

MIL-HDBK-5J
31 January 2003

Table 8.1.3.1.2(q). Static Joint Strength of Blind Protruding Head Locked Spindle Aluminum Alloy Rivets in Aluminum Alloy Sheet

Rivet Type	CR3243 ($F_{su} = 51$ ksi approx.) ^a		
Sheet Material	Clad 2024-T3		
Rivet Diameter, in. (Nominal Hole Diameter, in.) ^b	1/8 (0.144)	5/32 (0.178)	3/16 (0.207)
	Ultimate Strength, lbs.		
Sheet thickness, in.:			
0.025	317	---	---
0.032	366	494	617
0.040	421	562	696
0.050	489	647	795
0.063	579	758	924
0.071	623	826	1000
0.080	640	902	1090
0.090	660	957	1190
0.100	679	981	1280
0.125	728	1040	1350
	<div style="border: 1px solid black; padding: 5px; text-align: center;"> THIS FASTENER HAS ONLY BEEN TESTED IN THE SHEET GAGES SHOWN IN THIS TABLE. DESIGN DATA FOR SHEET GAGES OR DIAMETERS OTHER THAN THOSE SHOWN HERE CANNOT BE EXTRAPOLATED. </div>		
Rivet shear strength ^c	814	1245	1685
	Yield Strength, lbs ^d		
Sheet thickness, in.:			
0.025	272	---	---
0.032	317	425	527
0.040	368	488	600
0.050	432	567	692
0.063	451	664	811
0.071	462	677	884
0.080	475	693	911
0.090	489	710	931
0.100	503	728	951
0.125	538	771	1000

- a Data supplied by Textron Aerospace Fasteners.
b Loads developed from tests with hole diameters of 0.144, 0.178, and 0.207, +/-0.001 inch.
c Rivet shear strength is documented on CR3243 standards drawing.
d Permanent set at yield load: 4% of nominal diameter.

Table 8.1.3.1.2(r). Static Joint Strength of Blind Protruding Head Locked Spindle Aluminum Alloy Rivets in Aluminum Alloy Sheet

Rivet Type	HC3243 ($F_{su} = 51$ ksi approx.) ^a		
	Clad 2024-T3		
Sheet Material			
Rivet Diameter, in. (Nominal Hole Diameter, in.) ^b	1/8 (0.144)	5/32 (0.178)	3/16 (0.207)
	Ultimate Strength, lbs.		
Sheet thickness, in.:			
0.025	252	---	---
0.032	312	397	473
0.040	380	481	571
0.050	465	586	693
0.063	546	723	852
0.071	576	803	950
0.080	610	844	1060
0.090	647	891	1125
0.100	685	937	1175
0.125	779	1050	1310
0.160	814	1215	1500
0.190	---	1245	1665
0.250	---	---	1685
Rivet shear strength ^c	814	1245	1685
	Yield Strength, lbs ^d		
Sheet thickness, in.:			
0.025	252	---	---
0.032	312	397	473
0.040	371	481	571
0.050	401	569	693
0.063	440	617	790
0.071	464	646	824
0.080	491	680	863
0.090	521	717	906
0.100	551	754	949
0.125	626	846	1055
0.160	730	976	1205
0.190	---	1085	1335
0.250	---	---	1595

a Data supplied by Huck International Inc.

b Loads developed from tests with hole diameters of 0.144, 0.178, and 0.207, +/-0.001 inch.

c Rivet shear strength is documented on HC3243 standards drawing.

d Permanent set at yield load: 4% of nominal diameter.

Table 8.1.3.1.2(s). Static Joint Strength of Blind Protruding Head Locked Spindle Aluminum Alloy Rivets in Aluminum Alloy Sheet

Rivet Type	AF3223 ($F_{su} = 50$ ksi approx.) ^a		
Sheet Material	Clad 2024-T3		
Rivet Diameter, in. (Nominal Hole Diameter, in.) ^b	1/8 (0.130)	5/32 (0.162)	3/16 (0.194)
	Ultimate Strength, lbs.		
Sheet thickness, in.:			
0.025	272
0.032	331	431	...
0.040	390	516	640
0.050	421	606	767
0.063	461	656	883
0.071	486	687	920
0.080	514	722	962
0.090	545	760	1005
0.100	576	799	1050
0.125	653	896	1170
0.160	664	1030	1330
0.190	1460
Rivet shear strength ^c	664	1030	1460
	Yield Strength ^d , lbs.		
Sheet thickness, in.:			
0.025	243
0.032	312	387	...
0.040	390	485	580
0.050	421	606	727
0.063	448	656	883
0.071	463	678	920
0.080	481	700	958
0.090	500	723	987
0.100	519	747	1015
0.125	566	806	1085
0.160	633	889	1185
0.190	1270

a Data supplied by Allfast Fastening Systems Inc.
b Loads developed from tests with hole diameters of 0.130, 0.162, and 0.194, +/- 0.001 inch.
c Rivet shear strength as documented in Allfast Fastening Systems Inc P-127.
d Permanent set at yield load: 4% of nominal diameter.

Table 8.1.3.1.2(t). Static Joint Strength of Protruding Head 5056 Aluminum Alloy Rivets in Clad Aluminum Alloy Sheet

Rivet Type	CR3223 ($F_{su} = 50$ ksi approx.) ^a		
Sheet Material	Clad 2024-T3		
Rivet Diameter, in.	1/8	5/32	3/16
(Nominal Hole Diameter, in.) ^b	(0.130)	(0.162)	(0.194)
Ultimate Strength, lbs.			
Sheet thickness, in.:			
0.025	257
0.032	316	408	...
0.040	383	492	606
0.050	450	596	731
0.063	486	701	894
0.071	509	729	987
0.080	534	760	1025
0.090	562	795	1065
0.100	590	830	1105
0.125	659 ^c	917	1210
0.160	664 ^c	1030 ^c	1355 ^c
0.190	1480 ^c
Rivet shear strength ^d	664	1030	1480
Yield Strength ^e , lbs.			
Sheet thickness, in.:			
0.025	221
0.032	279	351	...
0.040	321	434	525
0.050	333	498	649
0.063	350	519	720
0.071	360	531	736
0.080	371	545	752
0.090	384	561	771
0.100	396	577	790
0.125	428	616	837
0.160	472	671	903
0.190	959

- a Data supplied by Textron Aerospace Fasteners.
- b Loads developed from tests with hole diameters of 0.130, 0.162, and 0.194, +/- 0.0005 inch.
- c Yield value is less than 2/3 of indicated ultimate strength value.
- d Rivet shear strength as documented in Textron Aerospace Fasteners PS-CMR-3000.
- e Permanent set at yield load: 4% of nominal diameter.

Table 8.1.3.2.1(a). Static Joint Strength of Blind 100° Flush Head A-286 Rivets in Machine-Countersunk Alloy Steel, Titanium Alloy, and A-286 Alloy Sheet

Rivet Type	CR 6626 ^a ($F_{su} = 75$ ksi)			
Sheet Material	Alloy Steel, $F_{tu} = 125$ ksi, Titanium Alloy, $F_{tu} = 120$ ksi, and A-286 Alloy, $F_{tu} = 140$ ksi			
Rivet Diameter, in. (Nominal Hole Diameter, in.)	1/8 (0.130)	5/32 (0.162)	3/16 (0.194)	1/4 (0.258)
	Ultimate Strength, lbs			
Sheet thickness, in.:				
0.040	582 ^{b,c}
0.050	693	898 ^{b,c}
0.063	842	1082	1351 ^{b,c}	...
0.071	891	1189	1478	...
0.080	949	1303	1633	...
0.090	970	1379	1798	2558 ^{b,c}
0.100	...	1461	1916	2772
0.112	...	1490	2026	3036
0.125	2150	3333
0.140	3531
0.160	3795
0.190	3890
Rivet shear strength ^d	970	1490	2150	3890
	Yield Strength ^e , lbs			
Sheet thickness, in.:				
0.040	355
0.050	499	557
0.063	681	784	858	...
0.071	771	923	1031	...
0.080	858	1082	1223	...
0.090	920	1202	1424	1700
0.100	...	1297	1643	1997
0.112	...	1417	1779	2327
0.125	1925	2690
0.140	3053
0.160	3432
0.190	3845
Head height (ref.), in.	0.042	0.055	0.070	0.095

- a Data supplied by Cherry Fasteners.
- b Yield value is less than 2/3 of the indicated ultimate strength value.
- c Values above line are for knife-edge condition and the use of fasteners in this condition is undesirable. The use of knife-edge condition in design of military aircraft requires specific approval of the procuring agency.
- d Rivet shear strength based on areas computed from nominal hole diameters in Table 8.1.2(a) and $F_{su} = 75$ ksi.
- e Permanent set at yield load: the greater of 0.005 inch or 2.5% of nominal diameter.

MIL-HDBK-5J
31 January 2003

Table 8.1.3.2.1(c). Static Joint Strength of Blind 100° Flush Head Monel Rivets in Dimpled Stainless Steel Sheet

Rivet Type	MS20601M ($F_{su} = 55$ ksi)							
	AISI 301-Annealed				AISI 301-1/4 Hard			
	1/8 (0.130)	5/32 (0.162)	3/16 (0.194)	1/4 (0.258)	1/8 (0.130)	5/32 (0.162)	3/16 (0.194)	1/4 (0.258)
	Ultimate Strength, lbs.							
Sheet thickness, in.:								
0.010	224	277	377
0.012	254	338	302	428	560	...
0.016	313	412	519	...	358	485	632	...
0.020	375	486	610	...	415	542	705	1135
0.025	447	576	722	1045	482	642	808	1230
0.032	516	705	876	1255	543	750	963	1400
0.040	536	793	1055	1490	585	833	1110	1660
0.050	565	825	1150 ^a	1790	628	910	1240	1930
0.063	868	1200 ^a	2065	...	964	1330	2175
0.071	2100	...	973	1375	2275
0.080	2150	1405	2340
0.090	2200	2440
0.100	2510
Rivet shear strength ^a	635	973	1405	2540	635	973	1405	2540
	Yield Strength ^b , lbs.							
Sheet thickness, in.:								
0.010	188	244	291
0.012	214	281	259	335	423	...
0.016	270	352	438	...	333	428	535	...
0.020	328	422	518	...	398	528	639	896
0.025	397	506	627	873	443	612	774	1080
0.032	498	627	770	1070	505	689	912	1330
0.040	536	772	939	1310	576	779	1015	1590
0.050	565	825	1150	1590	619	883	1145	1770
0.063	868	1200	1970	...	954	1305	2000
0.071	2100	...	973	1350	2140
0.080	2150	1400	2305
0.090	2200	2395
0.100	2475
Head height (ref.), in.	0.042	0.055	0.070	0.095	0.042	0.055	0.070	0.095

a Rivet shear strength from Table 8.1.2(b).

b Permanent set at yield load: the greater of 0.005 inch or 2.5% of nominal diameter.

Table 8.1.3.2.1(d₁). Static Joint Strength of Blind 100° Flush Head Monel Rivets in Machine-Countersunk Stainless Steel Sheet

Rivet Type	MS20601M ($F_{su} = 55$ ksi)			
Sheet Material	AISI 301-Annealed			
Rivet Diameter, in. (Nominal Hole Diameter, in.)	1/8 (0.130)	5/32 (0.162)	3/16 (0.194)	1/4 (0.258)
	Ultimate Strength, lbs			
Sheet thickness, in.:				
0.040	469 ^{a,b}
0.050	555 ^a	721 ^{a,b}
0.063	...	864 ^a	1075 ^{a,b}	...
0.071	1187 ^a	...
0.080
0.090	2040 ^b
Rivet shear strength ^c	713	1090	1580	2855
	Yield Strength ^d , lbs			
Sheet thickness, in.:				
0.040	231
0.050	321	359
0.063	...	500	566	...
0.071	678	...
0.080
0.090	1135
Head height (ref.), in.	0.042	0.055	0.070	0.095

- a Yield value is less than 2/3 of the indicated ultimate strength value.
- b Values above line are for knife-edge condition and the use of fasteners in this condition is undesirable. The use of knife-edge condition in design of military aircraft requires specific approval of the procuring agency.
- c Rivet shear strength based on areas computed from nominal hole diameters in Table 8.1.2(a) and $F_{su} = 55$ ksi.
- d Permanent set at yield load: the greater of 0.005 inch or 2.5% of nominal diameter.

Table 8.1.3.2.1(d₂). Static Joint Strength of Blind 100° Flush Head Monel Rivets in Machine-Countersunk Stainless Steel Sheet

Rivet Type	MS20601M (R.T. $F_{su} = 55$ ksi)																	
	Room						500°F						700°F					
	AISI 301-1/4 Hard																	
Sheet Material	AISI 301-1/4 Hard																	
Temperature	Room																	
Rivet Diameter, in. (Nominal Hole Diameter, in.)	1/8 (0.130)	5/32 (0.162)	3/16 (0.194)	1/4 (0.258)	1/8 (0.130)	5/32 (0.162)	3/16 (0.194)	1/4 (0.258)	1/8 (0.130)	5/32 (0.162)	3/16 (0.194)	1/4 (0.258)	1/8 (0.130)	5/32 (0.162)	3/16 (0.194)	1/4 (0.258)		
Sheet thickness, in.:	Ultimate Strength, lbs																	
0.040	373 ^{ab}	373 ^{ab}	373 ^{ab}	373 ^{ab}		
0.050	450	574 ^{ab}	450 ^a	574 ^{ab}	450 ^a	574 ^{ab}	450 ^a	574 ^{ab}		
0.063	538	704	866 ^{ab}	...	538	704	866 ^{ab}	...	538	704	866 ^{ab}	...	538	704	866 ^{ab}	...		
0.071	584	773	960	...	584	773	960 ^a	...	584	773	960 ^a	...	584	773	960 ^a	...		
0.080	637	838	1065	...	637	838	1065 ^a	...	590	838	1065 ^a	...	590	838	1065 ^a	...		
0.090	695	910	1155	1645 ^b	648	910	1155	1645 ^{ab}	...	904	1155	1645 ^{ab}	...	904	1155	1645 ^{ab}		
0.100	713	984	1240	1800	...	984	1240	1800 ^a	...	984	1240	1800 ^a	...	984	1240	1800 ^a		
0.125	...	1090	1460	2135	...	993	1430	2135	...	993	1430	2135	...	993	1430	2135		
0.160	1580	2550	2550	2550	2360		
0.180	2780	2590	2590	2360		
Rivet shear strength ^c	713	1090	1580	2855	648	993	1430	2590	590	904	1305	2360	590	904	1305	2360		
Sheet thickness, in.:	Yield Strength ^d , lbs																	
0.040	231	192	192	192		
0.050	336	359	279	298	279	298	279	298		
0.063	459	531	566	...	425	440	471	...	425	440	471	...	425	440	471	...		
0.071	530	625	698	...	525	546	576	...	525	546	576	...	525	546	576	...		
0.080	607	725	835	...	607	683	690	...	590	683	690	...	590	683	690	...		
0.090	693	832	966	1135	648	832	872	945	...	832	872	945	...	832	872	945		
0.100	713	943	1095	1345	...	943	1060	1115	...	943	1060	1115	...	943	1060	1115		
0.125	...	1090	1420	1815	...	993	1420	1670	...	993	1420	1670	...	993	1420	1670		
0.160	1580	2430	2430	2430	2360		
0.180	2775	2590	2590	2360		
Head height (ref.), in.	0.042	0.055	0.070	0.095	0.042	0.055	0.070	0.095	0.042	0.055	0.070	0.095	0.042	0.055	0.070	0.095		

a Yield value is less than 2/3 of the indicated ultimate strength value.
b Values above line are for knife-edge condition and the use of fasteners in this condition is undesirable. The use of knife-edge condition in design of military aircraft requires specific approval of the procuring agency.
c Rivet shear strength based on areas computed from nominal hole diameters in Table 8.1.2(a) and $F_{su} = 55$ ksi at R.T., $F_{su} = 50$ ksi at 500°F, and $F_{su} = 45$ ksi at 700°F.
d Permanent set at yield load: the greater of 0.005 inch or 2.5% of nominal diameter.

Table 8.1.3.2.1(d₃). Static Joint Strength of Blind 100° Flush Head Monel Rivets in Machine-Countersunk Stainless Steel Sheet

	MS20601M (R.T. $F_{su} = 55$ ksi)											
	AISI 301-1/2 Hard											
	Room				500°F				700°F			
Rivet Type	1/8 (0.130)	5/32 (0.162)	3/16 (0.194)	1/4 (0.258)	1/8 (0.130)	5/32 (0.162)	3/16 (0.194)	1/4 (0.258)	1/8 (0.130)	5/32 (0.162)	3/16 (0.194)	1/4 (0.258)
Sheet Material	Ultimate Strength, lbs											
Temperature	Yield Strength ^d , lbs											
Rivet Diameter, in. (Nominal Hole Diameter, in.)	350 ^{ab}	350 ^{ab}	350 ^{ab}
Sheet thickness, in.:	350 ^{ab}	350 ^{ab}	350 ^{ab}
0.040	444	540 ^{ab}	821 ^b	...	444	540 ^{ab}	821 ^b	...	444	540 ^{ab}	821 ^b	...
0.050	538	694	935	...	538	694	935	...	538	694	935	...
0.063	584	773	1065	...	584	773	1065	...	584	773	1065	...
0.071	637	838	1155	1585 ^b	624	838	1065	...	586	838	1065	...
0.080	695	910	1155	1585 ^b	648	910	1155	1585 ^b	590	886	1155	1585 ^b
0.090	713	984	1240	1780	...	962	1240	1780	...	904	1240	1780
0.100	...	1090	1460	2135	...	993	1410	2135	1305	2135
0.125	1580	2550	1430	2500	2345
0.160	2780	2590	2360
0.180
Rivet shear strength ^c	713	1090	1580	2855	648	993	1430	2590	590	904	1305	2360
Sheet thickness, in.:	Yield Strength ^d , lbs											
0.040	231	231	231
0.050	336	359	336	359	336	359
0.063	459	531	566	...	459	531	566	...	459	531	566	...
0.071	530	625	698	...	530	625	698	...	530	625	698	...
0.080	607	725	835	...	607	725	835	...	586	725	835	...
0.090	693	832	966	1135	648	832	966	1135	590	832	966	1135
0.100	713	943	1095	1345	...	943	1095	1345	...	904	1095	1345
0.125	...	1090	1420	1815	...	993	1410	1815	1305	1815
0.160	1580	2430	1430	2430	2345
0.180	2775	2590	2360
Head height (ref.), in.	0.042	0.055	0.070	0.095	0.042	0.055	0.070	0.095	0.042	0.055	0.070	0.095

a Yield value is less than 2/3 of the indicated ultimate strength value.
b Values above line are for knife-edge condition and the use of fasteners in this condition is undesirable. The use of knife-edge condition in design of military aircraft requires specific approval of the procuring agency.
c Rivet shear strength based on areas computed from nominal hole diameters in Table 8.1.2(a) and $F_{su} = 55$ ksi at R.T., $F_{su} = 50$ ksi at 500°F, and $F_{su} = 45$ ksi at 700°F.
d Permanent set at yield load: the greater of 0.005 inch or 2.5% of nominal diameter.

Table 8.1.3.2.1(e). Static Joint Strength of Blind 100° Flush-Head Monel Rivets in Machine-Countersunk Aluminum Alloy Sheet

Rivet Type	MS20601M ($F_{su} = 55$ ksi)			
Sheet Material	7075-T6			
Rivet Diameter, in. (Nominal Hole Diameter, in.)	1/8 (0.130)	5/32 (0.162)	3/16 (0.194)	1/4 (0.258)
	Ultimate Strength, lbs			
Sheet thickness, in.:				
0.040	320 ^{a,b}
0.050	393	494 ^{a,b}
0.063	487	612 ^a	747 ^{a,b}	...
0.071	545	684	832 ^a	...
0.080	565	766	930 ^a	...
0.090	587	840	1040	1425 ^{a,b}
0.100	610	867	1150	1570 ^a
0.125	937	1270	1940
0.160	1385	2260
0.190	2390
Rivet shear strength ^c	713	1090	1580	2855
	Yield Strength ^d , lbs			
Sheet thickness, in.:				
0.040	146
0.050	228	226
0.063	395	369	343	...
0.071	496	495	444	...
0.080	526	640	615	...
0.090	561	769	806	660
0.100	595	811	1000	912
0.125	918	1195	1560
0.160	1375	2105
0.190	2310
Head height (ref.), in.	0.042	0.055	0.070	0.095

- a Yield value is less than 2/3 of the indicated ultimate strength value.
- b Values above line are for knife-edge condition and the use of fasteners in this condition is undesirable. The use of knife-edge condition in design of military aircraft requires specific approval of the procuring agency.
- c Rivet shear strength based on areas computed from nominal hole diameters in Table 8.1.2(a) and $F_{su} = 55$ ksi.
- d Permanent set at yield load: the greater of 0.005 inch or 2.5% of nominal diameter.

Table 8.1.3.2.1(f). Static Joint Strength of Blind 100° Flush Head Aluminum Alloy (2117-T3) Rivets in Machine-Countersunk Aluminum Alloy Sheet

Rivet Type	MS20601AD and MS20603AD ($F_{su} = 30$ ksi)			
Sheet Material	Clad 2024-T3			
Rivet Diameter, in. (Nominal Hole Diameter, in.)	1/8 (0.130)	5/32 (0.162)	3/16 (0.194)	1/4 (0.258)
	Ultimate Strength, lbs			
Sheet thickness, in.:				
0.040	159 ^a
0.050	236	258 ^a
0.063	327	369	398 ^a	...
0.071	360	439	485	...
0.080	388	511	577	...
0.090	...	561	684	795 ^a
0.100	...	596	768	945
0.125	862	1270
Rivet shear strength ^b	388	596	862	1550
	Yield Strength ^c , lbs			
Sheet thickness, in.:				
0.040	110
0.050	198	185
0.063	300	308	296	...
0.071	336	384	391	...
0.080	377	468	497	...
0.090	...	524	614	621
0.100	...	592	709	793
0.125	862	1150
Head height (ref.), in.	0.042	0.055	0.070	0.095

- a Values above line are for knife-edge condition and the use of fasteners in this condition is undesirable. The use of knife-edge condition in design of military aircraft requires specific approval of the procuring agency.
- b Rivet shear strength based on areas computed from nominal hole diameters in Table 8.1.2(a) and $F_{su} = 30$ ksi.
- c Permanent set at yield load: the greater of 0.005 inch or 2.5% of nominal diameter.

Table 8.1.3.2.1(g). Static Joint Strength of Blind 100° Flush Head Aluminum Alloy (5056-H321) Rivets in Machine-Countersunk Magnesium Alloy Sheet

Rivet Type	MS20601B ($F_{su} = 28$ ksi)			
Sheet Material	AZ31B-H24			
Rivet Diameter, in. (Nominal Hole Diameter, in.)	1/8 (0.130)	5/32 (0.162)	3/16 (0.194)	1/4 (0.258)
	Ultimate Strength, lbs			
Sheet thickness, in.:				
0.040	167 ^a
0.050	208	257 ^a
0.063	262	324	390 ^a	...
0.071	295	366	440	...
0.080	333	413	495	...
0.090	363	464	557	749 ^a
0.100	...	516	620	833
0.125	...	556	774	1040
0.160	802	1332
0.190	1450
Rivet shear strength ^b	363	556	802	1450
	Yield Strength ^c , lbs			
Sheet thickness, in.:				
0.040	158
0.050	197	244
0.063	248	308	370	...
0.071	279	346	417	...
0.080	315	391	469	...
0.090	354	440	527	710
0.100	...	489	587	789
0.125	...	556	734	986
0.160	802	1262
0.190	1450
Head height (ref.), in.	0.042	0.055	0.070	0.095

- a Values above line are for knife-edge condition and the use of fasteners in this condition is undesirable. The use of knife-edge condition in design of military aircraft requires specific approval of the procuring agency.
- b Rivet shear strength based on areas computed from nominal hole diameters in Table 8.1.2(a) and $F_{su} = 28$ ksi.
- c Permanent set at yield load: the greater of 0.005 inch or 2.5% of nominal diameter.

Table 8.1.3.2.2(a). Static Joint Strength of Blind 100° Flush Head Locked Spindle A-286 Rivets in Machine-Countersunk Alloy Steel Sheet

Rivet Type	NAS1399C ^a ($F_{su} = 75$ ksi)			CR 2642 ^a ($F_{su} = 95$ ksi)		
Sheet Material	Alloy Steel, $F_{su} = 180$ ksi					
Rivet Diameter, in. (Nominal Hole Diameter, in.) ..	1/8 (0.130)	5/32 (0.162)	3/16 (0.194)	1/8 (0.130)	5/32 (0.162)	3/16 (0.194)
	Ultimate Strength, lbs.					
Sheet thickness, in.:						
0.040	380 ^{b,c}	380 ^{b,c}
0.050	475 ^b	588 ^{b,c}	...	475	588 ^{b,c}	...
0.063	698	741 ^b	890 ^{b,c}	698	741	890 ^{b,c}
0.071	840	908	1004 ^b	840	908	1004 ^b
0.080	970	1108	1171 ^b	1002	1108	1171
0.090	1333	1438	1185	1333	1438
0.100	1490	1710	1230	1559	1710
0.125	2150	...	1885	2380
0.160	2720
Rivet shear strength	970 ^d	1490 ^d	2150 ^d	1230 ^e	1885 ^e	2720 ^e
	Yield Strength ^f , lbs.					
Sheet thickness, in.:						
0.040	137	180
0.050	292	219	...	320	278	...
0.063	494	468	387	536	513	432
0.071	614	620	570	665	675	628
0.080	755	793	776	816	860	847
0.090	983	1003	981	1063	1090
0.100	1176	1236	1144	1267	1337
0.125	1809	...	1777	1950
0.160	2720
Head height (ref.), in.	0.042	0.055	0.070	0.042	0.055	0.070

- a Data supplied by Cherry Fasteners.
- b Yield value is less than 2/3 of the indicated ultimate strength value.
- c Values above line are for knife-edge condition and the use of fasteners in this condition is undesirable. The use of knife-edge condition in design of military aircraft requires specific approval of the procuring agency.
- d Rivet shear strength is documented in NAS1400.
- e Shear strength is based on areas computed from nominal hole diameters in Table 8.1.2(a) and $F_{su} = 95$ ksi.
- f Permanent set at yield load: the greater of 0.005 inch or 2.5% of nominal diameter.

Table 8.1.3.2.2(b). Static Joint Strength of Blind 100° Flush Head Locked Spindle Monel Rivets in Machine-Countersunk Stainless Steel Sheet

Rivet Type	NAS1399 MS or MW ^a ($F_{su} = 55$ ksi)		
Sheet Material	AISI 301-1/2 Hard		
Rivet Diameter, in. (Nominal Hole Diameter, in.) ..	1/8 (0.130)	5/32 (0.162)	3/16 (0.194)
Ultimate Strength, lbs.			
Sheet thickness, in.:			
0.040	287 ^{b,c}
0.050	363	445 ^{b,c}	...
0.063	491	569	671 ^{b,c}
0.071	569	668	755 ^b
0.080	657	776	886
0.090	710	898	1032
0.100	1019	1182
0.125	1090	1580
Rivet shear strength ^d	710	1090	1580
Yield Strength ^e , lbs.			
Sheet thickness, in.:			
0.040	163
0.050	243	253	...
0.063	348	384	401
0.071	413	463	496
0.080	487	554	606
0.090	568	655	726
0.100	753	846
0.125	1004	1156
Head height (ref.), in.	0.042	0.055	0.070

a Data supplied by Cherry Fasteners.

b Yield value is less than 2/3 of the indicated ultimate strength value.

c Values above line are for knife-edge condition and the use of fasteners in this condition is undesirable. The use of knife-edge condition in design of military aircraft requires specific approval of the procuring agency.

d Rivet shear strength is documented in NAS1400.

e Permanent set at yield load: the greater of 0.005 inch or 2.5% of nominal diameter.

Table 8.1.3.2.2(c). Static Joint Strength of 100° Flush Head Locked Spindle A-286 Blind Rivets in Machine-Countersunk Aluminum Alloy Sheet

Rivet Type	NAS1921C ^a ($F_{su} = 80$ ksi)		
Sheet Material	Clad 7075-T6		
Rivet Diameter, in. (Nominal Hole Diameter, in.)	1/8 (0.130)	5/32 (0.162)	3/16 (0.194)
	Ultimate Strength, lbs		
Sheet thickness, in.			
0.050	612 ^b
0.063	749 ^b	956 ^b	...
0.071	831 ^b	1060 ^b	...
0.080	923 ^b	1180 ^b	1450 ^b
0.090	1110 ^b	1305 ^b	1605 ^b
0.100	1090 ^b	1435 ^b	1755 ^b
0.125	1670 ^b	2130 ^b
0.160	2400 ^b
Rivet shear strength ^c	1090	1670	2400
	Yield Strength ^d , lbs		
Sheet thickness, in.:			
0.050	365
0.063	466	571	...
0.071	528	649	...
0.080	598	737	873
0.090	639	835	990
0.100	686	931	1105
0.125	804	1065	1325
0.160	1605
Head height (ref.), in.	0.042	0.055	0.070

a Data supplied by Huck Manufacturing Company.

b Yield value is less than 2/3 of indicated ultimate strength value.

c Rivet shear strength is documented in NAS1900.

d Permanent set at yield load: 4% of nominal diameter (revised May 1, 1985 from the greater of 0.012 inch or 4% of nominal diameter).

Table 8.1.3.2.2(d). Static Joint Strength of Blind 100° Flush Head Locked Spindle Monel Rivets in Machine-Countersunk Aluminum Alloy Sheet

Rivet Type	NAS1399 MS or MW ^a ($F_{su} = 55$ ksi)		
Sheet Material	Clad 7075-T6		
Rivet Diameter, in. (Nominal Hole Diameter, in.)	1/8 (0.130)	5/32 (0.162)	3/16 (0.194)
	Ultimate Strength, lbs.		
Sheet thickness, in.:			
0.040	323 ^{b,c}
0.050	404 ^b	499 ^{b,c}	...
0.063	500 ^b	631 ^b	757 ^{b,c}
0.071	557	703 ^b	855 ^b
0.080	610	784	958 ^b
0.090	636	873	1065 ^b
0.100	662	937	1175
0.125	710	1015	1370
0.160	...	1090	1505
0.190	1580
Rivet shear strength ^d	710	1090	1580
	Yield Strength ^e , lbs.		
Sheet thickness, in.:			
0.040	139
0.050	223	218	...
0.063	331	353	351
0.071	397	436	451
0.080	472	529	563
0.090	556	633	687
0.100	562	737	811
0.125	574	873	1120
0.160	...	894	1260
0.190	1280
Head height (ref.), in.	0.042	0.055	0.070

a Data supplied by Cherry Fasteners.

b Yield value is less than 2/3 of the indicated ultimate strength value.

c Values above line are for knife-edge condition and the use of fasteners in this condition is undesirable. The use of knife-edge condition in design of military aircraft requires specific approval of the procuring agency.

d Rivet shear strength is documented in NAS1400.

e Permanent set at yield load: 4% of nominal diameter (revised May 1, 1985, from the greater of 0.005 inch or 2.5% of nominal diameter).

Table 8.1.3.2.2(e). Static Joint Strength of 100° Flush Head Locked Spindle Monel Blind Rivets in Machine-Countersunk Aluminum Alloy Sheet

Rivet Type	NAS 1921 M ^a ($F_{su} = 75$ ksi)		
Sheet Material	Clad 7075-T6		
Rivet Diameter, in. (Nominal Hole Diameter, in.)	1/8 (0.130)	5/32 (0.162)	3/16 (0.194)
	Ultimate Strength, lbs		
Sheet thickness, in.			
0.050	595 ^b
0.063	732 ^b	927 ^b	...
0.071	816 ^b	1035 ^b	...
0.080	913 ^b	1158 ^b	1400 ^b
0.090	946 ^b	1289 ^b	1570 ^b
0.100	980 ^b	1415 ^b	1720 ^b
0.125	1020	1525 ^b	2055 ^b
0.160	...	1565 ^b	2245 ^b
0.190	2260
Rivet shear strength ^c	1020	1565	2260
	Yield Strength ^d , lbs		
Sheet thickness, in.:			
0.050	354
0.063	447	554	...
0.071	504	625	...
0.080	569	707	843
0.090	607	796	952
0.100	626	885	1060
0.125	686	972	1265
0.160	...	1080	1430
0.190	1540
Head height (ref.), in.	0.042	0.055	0.070

a Data supplied by Huck Manufacturing Company.

b Yield value is less than 2/3 of indicated ultimate strength value.

c Rivet shear strength is documented in NAS 1900.

d Permanent set at yield load: 4% of nominal diameter (revised May 1, 1985 from the greater of 0.012 inch or 4% of nominal diameter).

Table 8.1.3.2.2(f). Static Joint Strength of Blind 100° Flush Head Aluminum Alloy (2219) Rivets in Machine-Countersunk Aluminum Alloy Sheet

Rivet Type	CR 2A62 ^a ($F_{su} = 36$ ksi)		
Sheet Material	Clad 2024-T81		
Rivet Diameter, in. (Nominal Hole Diameter, in.)	1/8 (0.130)	5/32 (0.162)	3/16 (0.194)
	Ultimate Strength, lbs		
Sheet thickness, in.			
0.050	203
0.063	289	319	...
0.071	342	385	...
0.080	393	461	503
0.090	416	542	603
0.100	439	610	701
0.125	478	682	894
0.160	...	741	1013
0.190	1063
Rivet shear strength ^b	478	741	1063
	Yield Strength ^c , lbs		
Sheet thickness, in.:			
0.050	169
0.063	247	267	...
0.071	295	326	...
0.080	349	394	423
0.090	409	468	514
0.100	424	544	603
0.125	448	658	827
0.160	...	670	960
0.190	1002
Head height (ref.), in.	0.042	0.055	0.070

a Data supplied by Cherry Fasteners.

b Shear strength values are based on indicated nominal hole diameters and $F_{su} = 36$ ksi.

c Permanent set at yield load: 4% of nominal diameter.

Table 8.1.3.2.2(g). Static Joint Strength of Blind 100 degree Flush Head Locked Aluminum Alloy Rivets in Machine-Countersunk Aluminum Alloy Sheet

Rivet Type	NAS1921B0()-0(), NAS1921B0()S0(), NAS1921B0()S0()U ^a (F _{su} = 36 ksi)		
Sheet Material	Clad 7075-T6		
Rivet Diameter, in. (Nominal Hole Diameter, in.)	1/8 (0.130)	5/32 (0.162)	3/16 (0.194)
	Ultimate Strength, lbs.		
Sheet thickness, in.:			
0.040	171 ^b	---	---
0.050	232	267 ^b	---
0.063	313	366	411 ^b
0.071	360	427	484
0.080	416	498	566
0.090	477	571	658
0.100	494	647	748
0.125	---	755	978
0.160	---	---	1090
Rivet shear strength ^c	495	755	1090
	Yield Strength, lbs ^d		
Sheet thickness, in.:			
0.040	110	---	---
0.050	161	171	---
0.063	247	254	270
0.071	303	315	330
0.080	354	395	399
0.090	373	484	506
0.100	393	549	611
0.125	---	610	803
0.160	---	---	906
Head height [ref.], in.	0.042	0.055	0.070

a Data supplied by Huck Manufacturing Company.

b Values above the horizontal line in each column are for knife-edge condition and the use of fasteners in this condition is undesirable. The use of knife-edge condition in design of military aircraft requires specific approval of the procuring activity.

c Rivet shear strength is documented in NAS1900.

d Permanent set at yield load: 4% of nominal diameter.

Table 8.1.3.2.2(h). Static Joint Strength of Blind 100° Flush Head Locked Spindle Aluminum Alloy Rivets in Machine-Countersunk Aluminum Alloy Sheet

Rivet Type	NAS1399B ^a (5056) ($F_{su} = 30$ ksi)			NAS1399D ^a (2017) ($F_{su} = 36$ ksi)		
Sheet Material	Clad 2024-T3					
Rivet Diameter, in. (Nominal Hole Diameter, in.)	1/8 (0.130)	5/32 (0.162)	3/16 (0.194)	1/8 (0.130)	5/32 (0.162)	3/16 (0.194)
	Ultimate Strength, lbs.					
Sheet thickness, in.:						
0.040	149 ^{b,c}	149 ^{b,c}
0.050	223 ^b	230 ^{b,c}	...	223 ^b	230 ^{b,c}	...
0.063	310 ^b	349 ^b	356 ^{b,c}	319 ^b	349 ^b	356 ^{b,c}
0.071	366	415 ^b	448 ^b	379 ^b	420 ^b	448 ^b
0.080	388	492 ^b	544 ^b	423	506 ^b	547 ^b
0.090	...	578	646 ^b	459	600 ^b	660 ^b
0.100	...	596	751 ^b	494	652	775 ^b
0.125	862	...	755	969
0.160	1090
Rivet shear strength ^d	388	596	862	494	755	1090
	Yield Strength ^c , lbs.					
Sheet thickness, in.:						
0.040	72	72
0.050	114	113	...	114	113	...
0.063	197	182	170	197	182	170
0.071	247	245	220	247	245	220
0.080	304	316	304	304	316	304
0.090	...	396	399	367	396	399
0.100	...	473	493	431	473	493
0.125	729	...	672	729
0.160	1060
Head height (ref.), in.	0.042	0.055	0.070	0.042	0.055	0.070

a Data supplied by Cherry Fasteners.

b Yield value is less than 2/3 of the indicated ultimate strength value.

c Values above line are for knife-edge condition and the use of fasteners in this condition is undesirable. The use of knife-edge condition in design of military aircraft requires specific approval of the procuring agency.

d Rivet shear strength is documented in NAS1900.

e Permanent set at yield load: 4% of nominal diameter (revised May 1, 1985, from the greater of 0.005 inch or 2.5% of nominal diameter).

Table 8.1.3.2.2(i). Static Joint Strength of Blind 100° Flush Head Locked Spindle Aluminum Alloy Rivets in Machine-Countersunk and Dimpled Aluminum Alloy Sheet

Rivet Type	NAS1739B ^a and NAS1739E ^{a,b} ($F_{su} = 34$ ksi)			NAS1739B ^c and NAS1739E ^{b,c} ($F_{su} = 34$ ksi)		
	Clad 2024-T3					
Sheet Material	Clad 2024-T3					
Rivet Diameter, in.	1/8	5/32	3/16	1/8	5/32	3/16
(Nominal Hole Diameter, in.) ...	(0.144)	(0.178)	(0.207)	(0.144)	(0.178)	(0.207)
	Ultimate Strength, lbs.					
Sheet thickness, in.:						
0.020	246	334	418
0.025	281	376	465
0.032	212 ^d	330	436	536
0.040	266	326 ^d	...	386	506	616
0.050	344	410	...	456	592	716
0.063	441	533	606 ^d	546	703	845
0.071	504	608	696	...	771	926
0.080	554	693	794	...	837	1015
0.090	787	900	1110
0.100	837	1015
0.125	1128
Rivet shear strength ^e	554	837	1128	554	837	1128
	Yield Strength ^f , lbs.					
Sheet thickness, in.:						
0.020
0.025
0.032	159
0.040	212	247
0.050	279	331
0.063	365	437	492
0.071	418	503	568
0.080	448	577	654
0.090	659	750
0.100	689	845
0.125	960
Head height (ref.), in.	0.035	0.047	0.063	0.035	0.047	0.063

- a Machine-countersunk holes.
- b Data supplied by Cherry Fasteners. Confirmatory data for machine-countersunk holes provided by Allfast Fastening Systems, Inc.
- c Dimpled holes. These allowables apply to double dimpled sheets and to the upper sheet dimpled into a machine-countersunk lower sheet. Sheet gauge is that of the thinnest sheet for double dimpled joints and of the upper dimpled, machine-countersunk joints. The thickness of the machine-countersunk sheet must be at least one tabulated gauge thicker than the upper sheet. In no case will allowables be obtained by extrapolation for gauges other than those shown.
- d The values in the table above the horizontal line in each column are for knife-edge condition and the use of fasteners in this condition is undesirable. The use of knife-edge condition in design of military aircraft requires specific approval of the procuring agency.
- e Rivet shear strength is documented in NAS1740.
- f Permanent set at yield load: 4% of nominal diameter (revised May 1, 1985, from the greater of 0.005 inch or 2.5% of nominal diameter).

Table 8.1.3.2.2(j). Static Joint Strength of Blind 100° Flush Head Locked Spindle Aluminum Alloy Rivets in Machine-Countersunk Magnesium Alloy Sheet

Rivet Type	NAS1399B ^a ($F_{su} = 30$ ksi)				NAS1739B and NAS 1739E ^a ($F_{su} = 34$ ksi)		
	AZ31B-H24						
Sheet Material	AZ31B-H24						
Rivet Diameter, in. (Nominal Hole Diameter, in.)	1/8 (0.130)	5/32 (0.162)	3/16 (0.194)	1/4 (0.258)	1/8 (0.144)	5/32 (0.178)	3/16 (0.207)
Ultimate Strength, lbs.							
Sheet thickness, in.:							
0.032	188 ^{b,c}
0.040	178 ^{b,c}	235 ^b	292 ^{b,c}	...
0.050	223 ^b	274 ^{b,c}	295	362 ^b	...
0.063	292 ^b	349 ^b	418 ^{b,c}	...	371	457	530 ^{b,c}
0.071	334 ^b	399 ^b	471 ^b	...	418	514	600 ^b
0.080	383 ^b	459 ^b	536 ^b	...	471	580	671
0.090	388	526 ^b	613 ^b	803 ^{b,c}	531	651	756
0.100	593 ^b	693 ^b	892 ^b	554	725 ^b	843
0.125	596	862	1153 ^b	...	837 ^b	1052 ^b
0.160	1532 ^b
Rivet shear strength	388 ^d	596 ^d	862 ^d	1550 ^d	554 ^e	837 ^e	1128 ^e
Yield Strength ^f , lbs.							
Sheet thickness, in.:							
0.032	106
0.040	49	147	164	...
0.050	94	76	197	227	...
0.063	158	152	128	...	262	307	340
0.071	197	200	186	...	300	355	399
0.080	242	254	250	...	314	414	462
0.090	291	315	323	277	330	459	534
0.100	375	396	376	336	478	608
0.125	530	580	621	...	508	667
0.160	968
Head height (ref.), in.	0.042	0.055	0.070	0.095	0.035	0.047	0.063

a Data supplied by Cherry Fasteners.
b Yield value is less than 2/3 of the indicated ultimate strength value.
c Values above line are for knife-edge condition and the use of fasteners in this condition is undesirable. The use of knife-edge condition in design of military aircraft requires specific approval of the procuring agency.
d Rivet shear strength is documented in NAS1400.
e Rivet shear strength is documented in NAS1740 dated March 1968.
f Permanent set at yield load: the greater of 0.005 inch or 2.5% of nominal diameter.

Table 8.1.3.2.2(k). Static Joint Strength of Blind 100° Flush Head Locked Spindle A-286 Rivets in Machine-Countersunk Aluminum Alloy Sheet

Rivet Type	CR 4622 ^a ($F_{su} = 75$ ksi)			
Sheet Material	Clad 7075-T6			
Rivet Diameter (Nominal Hole Diameter, in.) ^b	1/8 (0.130)	5/32 (0.162)	3/16 (0.194)	1/4 (0.258)
	Ultimate Strength, lbs			
Sheet thickness, in.:				
0.050	595 ^c
0.063	733 ^c	932 ^c
0.071	817 ^c	1035 ^c
0.080	913	1160 ^c	1410 ^c	...
0.090	947	1290 ^c	1570 ^c	...
0.100	982	1420	1725 ^c	2360 ^c
0.125	995	1525	2060	2880 ^c
0.160	...	1545	2215	3605
0.190	3810
0.250	3920
Rivet shear strength ^d	995	1545	2215	3920
	Yield Strength ^e , lbs			
Sheet thickness, in.:				
0.050	211
0.063	348	339
0.071	489	470
0.080	608	620	574	...
0.090	664	787	774	...
0.100	720	947	970	853
0.125	860	1120	1400	1505
0.160	...	1365	1695	2410
0.190	2740
0.250	3405
Head height (ref.), in.	0.041	0.054	0.069	0.095

- a Data supplied by Cherry Fasteners.
- b Allowable loads developed from test with nominal hole diameters as listed.
- c Yield value is less than 2/3 of the indicated ultimate strength value.
- d Fastener shear strength based upon nominal hole diameters and $F_{su} = 75$ ksi from data analysis.
- e Permanent set at yield load: 4% of nominal diameter.

Table 8.1.3.2.2(I). Static Joint Strength of Blind 100° Flush Head Locked Spindle Monel Rivets in Machine-Countersunk Aluminum Alloy Sheet and Plate

Rivet Type	CR 4522 ^a ($F_{su} = 65$ ksi)			
Sheet and Plate Material	Clad 7075-T6 and T651			
Rivet Diameter (Nominal Hole Diameter, in.) ^b	1/8 (0.130)	5/32 (0.162)	3/16 (0.194)	1/4 (0.258)
	Ultimate Strength, lbs			
Sheet or plate thickness, in.:				
0.050	529 ^c
0.063	632 ^c	828 ^c
0.071	694 ^c	906 ^c
0.080	754	995 ^c	1240 ^c	...
0.090	776	1095	1360 ^c	...
0.100	797	1170	1475 ^c	...
0.125	852	1240	1695	2485 ^c
0.160	863	1335	1810	2975
0.190	...	1340	1910	3105
0.250	1920	3365
0.312	3400
Rivet shear strength ^d	863	1340	1920	3400
	Yield Strength ^e , lbs			
Sheet or plate thickness, in.:				
0.050	169
0.063	346	273
0.071	454	408
0.080	561	562	483	...
0.090	621	732	688	...
0.100	682	874	888	...
0.125	833	1060	1300	1355
0.160	863	1325	1615	2225
0.190	...	1340	1885	2585
0.250	1920	3300
0.312	3400
Head height (ref.), in.	0.042	0.055	0.070	0.095

- a Data supplied by Cherry Fasteners.
- b Allowable loads developed from test with nominal hole diameters as listed.
- c Yield value is less than 2/3 of the indicated ultimate strength value.
- d Fastener shear strength based upon nominal hole diameters and $F_{su} = 65$ ksi from data analysis.
- e Permanent set at yield load: 4% of nominal diameter.

Table 8.1.3.2.2(m). Static Joint Strength of Blind 100° Flush Head Locked Spindle Aluminum Alloy (7050) Rivets in Machine-Countersunk Aluminum Alloy Sheet

Rivet Type	NAS1721KE and NAS1721KE ()L ^a ($F_{su} = 33$ ksi)		
Sheet Material	Clad 2024-T3		
Rivet Diameter, in. (Nominal Hole Diameter, in.) ^b ..	1/8 (0.130)	5/32 (0.162)	3/16 (0.194)
	Ultimate Strength, lbs.		
Sheet thickness, in.:			
0.040	221 ^{c,d}
0.050	277 ^d	342 ^{c,d}	...
0.063	351	435 ^d	518 ^{c,d}
0.071	396	491 ^d	586 ^d
0.080	448	555	662 ^d
0.090	450	626	747
0.100	697	832
0.125	700	950
Rivet shear strength ^e	450	700	950
	Yield Strength ^f , lbs.		
Sheet thickness, in.:			
0.040	62
0.050	150	99	...
0.063	263	240	182
0.071	333	327	287
0.080	386	425	404
0.090	403	534	534
0.100	600	665
0.125	653	874
Head height (ref.), in.	0.042	0.055	0.070

a Data supplied by Avdel Corp.

b Loads developed from tests with hole diameters of 0.130, 0.162, and 0.194, ±0.001 inch.

c The values in the table above the horizontal line in each column are for knife-edge conditions, and the use of fasteners in this condition is undesirable. The use of knife-edge conditions in the design of military aircraft requires the specific approval of the procuring agency.

d Yield value is less than 2/3 of indicated ultimate value.

e Rivet shear strength is documented in NAS1722.

f Permanent set at yield load: 4% of nominal diameter.

Table 8.1.3.2.2(n). Static Joint Strength of Blind 100° Flush Head Locked Spindle A-286 Rivets in Machine-Countersunk Aluminum Alloy Sheet

Rivet Type	NAS1721C and NAS1721C(L) ^a ($F_{su} = 75$ ksi)		
Sheet Material	Clad 7075-T6		
Rivet Diameter, in. (Nominal Hole Diameter, in.) ^b	1/8 (0.130)	5/32 (0.162)	3/16 (0.194)
Ultimate Strength, lbs.			
Sheet thickness, in.:			
0.040	454 ^{c, d}
0.050	585 ^d	707 ^{c, d}	...
0.063	751 ^d	919 ^d	1075 ^{c, d}
0.071	853 ^d	1045 ^d	1230 ^d
0.080	881 ^d	1190 ^d	1405 ^d
0.090	896	1345 ^d	1595 ^d
0.100	912	1365 ^d	1785 ^d
0.125	951	1415	1970
0.160	1000	1485	2055
0.190	...	1500	2125
0.250	2200
Rivet shear strength ^c	1000	1500	2200
Yield Strength ^f , lbs.			
Sheet thickness, in.:			
0.040	77
0.050	220	122	...
0.063	375	352	246
0.071	470	471	425
0.080	578	604	585
0.090	615	753	763
0.100	641	902	942
0.125	707	997	1330
0.160	799	1110	1470
0.190	...	1210	1585
0.250	1820
Head height (ref.), in.	0.042	0.055	0.070

- a Data supplied by Avdel Corp.
- b Loads developed from tests with hole diameters of 0.130, 0.162, and 0.194, ± 0.001 inch.
- c The values in the table above the horizontal line in each column are for knife-edge conditions and the use of fasteners in this condition is undesirable. The use of knife-edge conditions in the design of military aircraft requires the specific approval of the procuring agency.
- d Yield value is less than 2/3 of indicated ultimate value.
- e Rivet shear strength is documented in NAS1722.
- f Permanent set at yield load: 4% of nominal diameter.

Table 8.1.3.2.2(o). Static Joint Strength of Blind Flush Head Locked Aluminum Alloy Rivets in Machine-Countersunk Aluminum Alloy Sheets

Rivet Type	HC3212 ($F_{su} = 51$ ksi approx.) ^a		
	Clad 2024-T3		
Sheet Material			
Rivet Diameter, in. (Nominal Hole Diameter, in.) ^b	1/8 (0.130)	5/32 (0.162)	3/16 (0.194)
	Ultimate Strength, lbs.		
Sheet thickness, in.:			
0.040	280 ^{c,d}	---	---
0.050	318	436 ^{c,d}	---
0.063	367	497	643 ^{c,d}
0.071	397	535	688
0.080	431	577	739
0.090	469	624	795
0.100	507	671	851
0.125	602	789	992
0.160	664	954	1190
0.190	---	1030	1355
0.250	---	---	1480
Rivet shear strength ^e	664	1030	1480
	Yield Strength, lbs ^f		
Sheet thickness, in.:			
0.040	151	---	---
0.050	244	236	---
0.063	366	387	382
0.071	397	480	494
0.080	431	577	619
0.090	454	624	758
0.100	476	671	851
0.125	532	740	979
0.160	610	837	1095
0.190	---	921	1195
0.250	---	---	1395
Head height [ref.], in.	0.042	0.055	0.070

- a Data supplied by Huck International Inc.
- b Loads developed from tests with hole diameters of 0.130, 0.162, and 0.194, +/- 0.001 inch.
- c The values in the table above the horizontal line in each column are for knife-edge conditions and the use of fasteners in this condition is undesirable. The use of knife-edge conditions in the design of military aircraft requires specific approval of the procuring activity.
- d Yield value is less than 2/3 of indicated ultimate strength value.
- e Rivet shear strength is documented on HC3212 standards drawing.
- f Permanent set at yield load: 4% of nominal diameter.

Table 8.1.3.2.2(p). Static Joint Strength of Blind 100° Flush Head Locked Spindle 2014 Aluminum Alloy Rivets in Machine Countersunk Aluminum Alloy Sheet

Rivet Type	MBC 4807 and 4907 ($F_{su} = 33$ ksi approx.) ^a		
Sheet Material	Clad 2024-T3		
Rivet Diameter, in.	1/8	5/32	3/16
(Nominal Hole Diameter, in.) ^b	(0.130)	(0.162)	(0.194)
	Ultimate Strength, lbs.		
Sheet thickness, in.:			
0.040	183 ^c
0.050	243	286 ^c	...
0.063	320	382	437 ^c
0.071	368	441	508
0.080	412	508	588
0.090	435	582	677
0.100	450	641	766
0.125	...	700	937
0.160	950
Rivet shear strength ^d	450	700	950
	Yield Strength, lbs. ^e		
Sheet thickness, in.:			
0.040	102
0.050	173	160	...
0.063	264	274	263
0.071	309	345	347
0.080	333	423	441
0.090	360	486	546
0.100	387	519	651
0.125	...	602	765
0.160	904
Head height (ref.), in.	0.041	0.053	0.068

a Data supplied by Avdel Systems Ltd.

b Loads developed from tests with hole diameters of 0.130, 0.162, and 0.194, +/- 0.001 inch.

c The values in the table above the horizontal line in each column are for knife-edge conditions, and the use of fasteners in this condition is undesirable. The use of knife-edge conditions in the design of military aircraft requires the specific approval of the procuring agency.

d Rivet shear strength is documented in NAS 1722, and rivets meet the requirements of NAS 1721.

e Permanent set at yield load: 4% of nominal diameter.

Table 8.1.3.2.2(q). Static Joint Strength of Blind Protruding Head Locked Spindle 2014 Aluminum Alloy Rivets in Aluminum Alloy Sheet

Rivet Type	MBC 4801 and 4901 ($F_{su} = 33$ ksi approx.) ^a		
Sheet Material	Clad 2024-T3		
Rivet Diameter, in. (Nominal Hole Diameter, in.) ^b ..	1/8 (0.130)	5/32 (0.162)	3/16 (0.194)
	Ultimate Strength, lbs.		
Sheet thickness, in.:			
0.025	247
0.032	284	389	...
0.040	326	441	571
0.050	378	507	650
0.063	415	589	751
0.071	437	617	814
0.080	450	649	864
0.090	684	906
0.100	700	948
0.125	950
Rivet shear strength ^c	450	700	950
	Yield Strength, lbs. ^d		
Sheet thickness, in.:			
0.025	238
0.032	277	375	...
0.040	321	431	552
0.050	368	500	635
0.063	381	572	743
0.071	389	583	810
0.080	399	594	828
0.090	607	843
0.100	619	858
0.125	896

a Data supplied by Avdel Systems Ltd.

b Loads developed from tests with hole diameters of 0.130, 0.162, and 0.194, ± 0.001 inch.

c Rivet shear strength is documented in NAS 1722, and rivets meet the requirements of NAS 1720.

d Permanent set at yield load: 4% of nominal diameter.

Table 8.1.3.2.2(r). Static Joint Strength of 100° Flush Head Locked Spindle Aluminum Alloy Blind Rivets in Machine-Countersunk Aluminum Alloy Sheet

Rivet Type	HC6222 ^a ($F_{su} = 50$ ksi) Nominal		
Sheet Material	Clad 2024-T3		
Rivet Diameter, in. (Nominal Hole Diameter, in.)	1/8 (0.130)	5/32 (0.162)	3/16 (0.194)
	Ultimate Strength, lbs		
Sheet thickness, in.:			
0.040	270 ^b
0.050	317	420 ^b	...
0.063	377	496	624 ^b
0.071	414	542	680
0.080	456	594	743
0.090	503	652	812
0.100	550	711	882
0.125	664	856	1055
0.160	...	1030	1299
0.190	1480
0.250
Rivet shear strength ^d	664	1030	1480
	Yield Strength ^e , lbs		
Sheet thickness, in.:			
0.040	196	237 ^c	...
0.050	252	306	...
0.063	323	395	464
0.071	368	451	530
0.080	417	512	605
0.090	445	581	687
0.100	459	650	770
0.125	494	714	972
0.160	...	775	1045
0.190	1108
0.250
Head height (ref.), in.	0.042	0.055	0.070

- a Data supplied by Huck International, Inc.
- b Values above line are for knife-edge condition and the use of fasteners in this condition is undesirable. The use of knife-edge condition in design of military aircraft requires specific approval of the procuring agency.
- c Yield value is less than 2/3 of the indicated ultimate.
- d Rivet shear strength is documented in MIL-R-7885D.
- e Permanent set at yield load: 4% of nominal hole diameter.

Table 8.1.3.2.2(s). Static Joint Strength of 100° Flush Head Locked Spindle Aluminum Alloy Blind Rivets in Machine-Countersunk Aluminum Alloy Sheet

Rivet Type	HC6252 ^a ($F_{su} = 50$ ksi)		
	Clad 2024-T3		
Rivet Diameter, in. (Nominal Hole Diameter, in.) ...	1/8 (0.144)	5/32 (0.178)	3/16 (0.207)
	Ultimate Strength, lbs		
Sheet thickness, in.:			
0.032	265 ^{b,c}
0.040	304	408 ^{b,c}	...
0.050	352	467	...
0.063	414	544	665 ^c
0.071	452	591	720
0.080	495	645	782
0.090	543	704	851
0.100	591	763	920
0.125	701	911	1092
0.160	814	1097	1332
0.190	1237	1505
0.250	1245	1685
Rivet shear strength ^d	814	1245	1685
	Yield Strength ^e , lbs		
Sheet thickness, in.:			
0.032	154
0.040	214	240	...
0.050	288	332	...
0.063	384	451	500
0.071	444	524	586
0.080	494	607	682
0.090	513	698	788
0.100	531	758	895
0.125	576	814	1048
0.160	640	893	1139
0.190	961	1218
0.250	1096	1376
Head height (ref.), in.	0.035	0.047	0.063

- a Data supplied by Huck International, Inc.
- b Yield value is less than 2/3 of the indicated ultimate.
- c Values above line are for knife-edge condition and the use of fasteners in this condition is undesirable. The use of knife-edge condition in design of military aircraft requires specific approval of the procuring activity.
- d Rivet shear strength is documented in MIL-R-7885D.
- e Permanent set at yield load: 4% of nominal hole diameter.

Table 8.1.3.2.2(t₁). Static Joint Strength of 100° Flush Shear Head Locked Spindle Aluminum Alloy Blind Rivets in Machine-Countersunk Aluminum Alloy Sheet

Rivet Type	HC6224 ^a (F _{su} = 50 ksi) Nominal		
Sheet Material	Clad 2024-T3		
Rivet Diameter, in. (Nominal Hole Diameter, in.) ^b . .	1/8 (0.130)	5/32 (0.162)	3/16 (0.194)
	Ultimate Strength, lbs		
Sheet thickness, in.:			
0.032	230	294 ^c	
0.040	282	358	437 ^c
0.050	347	439	534
0.063	431	544	660
0.071	456	608	737
0.080	493	681	824
0.090	535	716	921
0.100	576	768	979
0.125	664	897	1135
0.160	1030	1350
0.190	1480
Rivet shear strength ^d	664	1030	1480
	Yield Strength ^e , lbs		
Sheet thickness, in.:			
0.032	185	209	
0.040	248	288	320
0.050	328	387	438
0.063	431	516	592
0.071	448	595	687
0.080	457	681	794
0.090	467	697	912
0.100	477	710	979
0.125	503	742	1030
0.160	786	1080
0.190	1125
Head height (ref.), in.	0.028	0.037	0.046

- a Data supplied by Huck International, Inc.
- b Loads developed from tests with hole diameters of 0.130, 0.162, and 0.194 ± 0.0002.
- c Values above line are for knife-edge condition and the use of fasteners in this condition is undesirable. The use of knife-edge condition in design of military aircraft requires specific approval of the procuring activity.
- d Rivet shear strength is documented in MIL-R-7885D.
- e Permanent set at yield load: 4% of nominal hole diameter.

TABLE 8.1.3.2.2(t₂). Static Joint Strength of 100° Flush Shear Head Locked Spindle Aluminum Alloy Blind Rivets in Machine-Countersunk Aluminum Alloy Sheet

Rivet Type	HC3214 ^a (F _{su} = 50 ksi)Nominal		
	Clad 2024-T3		
Sheet Material			
Rivet Diameter, in	1/8	5/32	3/16
(Nominal Hole Diameter, in)	(0.130)	(0.162)	(0.194)
Ultimate Strength, lbs.			
Sheet thickness, in:			
0.032	214	272 ^b	
0.040	264	333	405 ^b
0.050	325	410	497
0.063	406	511	617
0.071	427	572	691
0.080	464	621	774
0.090	504	671	856
0.100	544	721	916
0.125	644	846	1066
0.160	664	1020	1275
0.190	1030	1455
0.250	1480
Rivet shear strength ^c	664	1030	1480
Yield Strength ^d , lbs			
Sheet thickness, in:			
0.032	196	230	
0.040	256	305	348
0.050	325	399	461
0.063	406	511	607
0.071	427	572	691
0.080	453	621	774
0.090	475	678	856
0.100	497	705	916
0.125	552	773	1030
0.160	628	868	1140
0.190	950	1240
0.250	1435
Head height (ref), in	0.028	0.037	0.046

- a Data supplied by Huck International Inc.
- b Values above the horizontal line in each column are for knife-edge conditions, the use of fasteners in this condition is undesirable. The use of knife-edge conditions in the design of military aircraft requires the specific approval of the procuring activity.
- c Rivet shear strength is based upon nominal hole diameter and F_{su} = 50 ksi.
- d Permanent set at yield: 4% of nominal hole diameter.

Table 8.1.3.2.2(u). Static Joint Strength of Blind Flush Head Locked Spindle Aluminum Alloy Rivets in Machine-Countersunk Aluminum Alloy Sheets

Rivet Type	AF3212 ($F_{su} = 51$ ksi approx.) ^a		
Sheet Material	Clad 2024-T3		
Rivet Diameter, in. (Nominal Hole Diameter, in.) ^b	1/8 (0.130)	5/32 (0.162)	3/16 (0.194)
	Ultimate Strength, lbs.		
Sheet thickness, in.:			
0.040	143 ^c	---	---
0.050	247	224 ^c	---
0.063	383	393	370 ^c
0.071	414	497	494
0.080	435	614	634
0.090	457	647	790
0.100	480	676	902
0.125	537	746	987
0.160	616	846	1105
0.190	---	931	1205
0.250	---	---	1410

THIS FASTENER HAS ONLY BEEN TESTED IN THE SHEET GAGES SHOWN IN THIS TABLE. DESIGN DATA FOR SHEET GAGES OR DIAMETERS OTHER THAN THOSE SHOWN HERE CANNOT BE EXTRAPOLATED.

Rivet shear strength ^d	664	1030	1480
	Yield Strength, lbs ^e		
Sheet thickness, in.:			
0.040	143	---	---
0.050	235	224	---
0.063	310	371	370
0.071	330	431	491
0.080	353	486	572
0.090	379	518	662
0.100	404	549	713
0.125	468	629	808
0.160	557	740	914
0.190	---	835	1055
0.250	---	---	1280
Head height [ref.], in.	0.042	0.055	0.070

- a Data supplied by Allfast Fastening Systems Inc.
- b Loads developed from tests with hole diameters of 0.130, 0.162, and 0.194, +/- 0.001 inch.
- c The values in the table above the horizontal line in each column are for knife-edge conditions, and the use of fasteners in this condition is undesirable. The use of knife-edge conditions in the design of military aircraft requires specific approval of the procuring activity.
- d Rivet shear strength is documented on AF3212 standards drawing.
- e Permanent set at yield load: 4% of nominal diameter.

Table 8.1.3.2.2(v). Static Joint Strength of Blind Flush Head Locked Spindle Aluminum Alloy Rivets in Machine-Countersunk Aluminum Alloy Sheet

Rivet Type	CR3212 ($F_{su} = 51$ ksi approx.) ^a		
Sheet Material	Clad 2024-T3		
Rivet Diameter, in. (Nominal Hole Diameter, in.) ^b	1/8 (0.130)	5/32 (0.162)	3/16 (0.194)
	Ultimate Strength, lbs.		
Sheet thickness, in.:			
0.040	297 ^{c, d}	---	---
0.050	342 ^d	462 ^{c, d}	---
0.063	401 ^d	535 ^d	683 ^{c, d}
0.071	437 ^d	580 ^d	737 ^d
0.080	477	630 ^d	798 ^d
0.090	513	687 ^d	865 ^d
0.100	536	743	932
0.125	594	834	1100

THIS FASTENER HAS ONLY BEEN TESTED IN THE SHEET GAGES SHOWN IN THIS TABLE. DESIGN DATA FOR SHEET GAGES OR DIAMETERS OTHER THAN THOSE SHOWN HERE CANNOT BE EXTRAPOLATED.

Rivet shear strength ^e	664	1030	1480
	Yield Strength, lbs ^f		
Sheet thickness, in.:			
0.040	131	---	---
0.050	181	204	---
0.063	247	286	317
0.071	287	336	377
0.080	333	393	444
0.090	361	456	520
0.100	371	518	595
0.125	394	576	783
Head height [ref.], in.	0.042	0.055	0.070

- a Data supplied by Textron Aerospace Fasteners.
- b Loads developed from tests with hole diameters of 0.130, 0.162, and 0.194, +/- 0.001 inch.
- c The values in the table above the horizontal line in each column are for knife-edge conditions, and the use of fasteners in this condition is undesirable. The use of knife-edge conditions in the design of military aircraft requires specific approval of the procuring activity.
- d Yield value is less than 2/3 of indicated ultimate strength value.
- e Rivet shear strength is documented on CR3212 standards drawing.
- f Permanent set at yield load: 4% of nominal diameter.

Table 8.1.3.2.2(w). Static Joint Strength of Blind Flush Head Locked Spindle Aluminum Alloy Rivets in Machine-Countersunk Aluminum Alloy Sheet

Rivet Type	AF3242 ($F_{su} = 51$ ksi approx.) ^a		
Sheet Material	Clad 2024-T3		
Rivet Diameter, in. (Nominal Hole Diameter, in.) ^b	1/8 (0.144)	5/32 (0.178)	3/16 (0.207)
	Ultimate Strength, lbs.		
Sheet thickness, in.:			
0.032	193 ^c	---	---
0.040	250	299 ^c	---
0.050	321	387	---
0.063	414	501	573 ^c
0.071	470	571	654
0.080	524	651	746
0.090	550	738	849
0.100	577	804	951
0.125	643	886	1120
0.160	736	1000	1250
0.190	814	---	1365

THIS FASTENER HAS ONLY BEEN TESTED IN THE SHEET GAGES SHOWN IN THIS TABLE. DESIGN DATA FOR SHEET GAGES OR DIAMETERS OTHER THAN THOSE SHOWN HERE CANNOT BE EXTRAPOLATED.

Rivet shear strength ^d	814	1245	1685
	Yield Strength, lbs ^e		
Sheet thickness, in.:			
0.032	192	---	---
0.040	250	298	---
0.050	321	387	---
0.063	414	501	573
0.071	470	571	654
0.080	524	651	746
0.090	550	738	849
0.100	577	804	951
0.125	643	886	1120
0.160	736	1000	1250
0.190	814	---	1365
Head height (ref.), in.	0.035	0.047	0.063

- a Data supplied by Allfast Fastening Systems Inc.
- b Loads developed from tests with hole diameters of 0.144, 0.178, and 0.207, +/-0.001 inch.
- c The values in the table above the horizontal line in each column are for knife-edge conditions, and the use of fasteners in this condition is undesirable. The use of knife-edge conditions in the design of military aircraft requires the specific approval of the procuring activity.
- d Rivet shear strength is documented on AF3242 standards drawing.
- e Permanent set at yield load: 4% of nominal diameter.

Table 8.1.3.2.2(x). Static Joint Strength of Blind Flush Head Locked Spindle Aluminum Alloy Rivets in Machine-Countersunk Aluminum Alloy Sheet

Rivet Type	CR3242 ($F_{su} = 51$ ksi approx.) ^a		
Sheet Material	Clad 2024-T3		
Rivet Diameter, in. (Nominal Hole Diameter, in.) ^b	1/8 (0.144)	5/32 (0.178)	3/16 (0.207)
	Ultimate Strength, lbs.		
Sheet thickness, in.:			
0.032	245 ^{c,d}	---	---
0.040	302	378 ^{c,d}	---
0.050	374	467	---
0.063	467	582	681 ^c
0.071	568	653	764
0.080	584	732	856
0.090	602	872	959
0.100	620	894	1165
0.125	664	950	1230
Rivet shear strength ^e	814	1245	1685
	Yield Strength, lbs ^f		
Sheet thickness, in.:			
0.032	158	---	---
0.040	206	245	---
0.050	265	318	---
0.063	330	413	472
0.071	361	471	540
0.080	395	514	616
0.090	434	562	678
0.100	473	609	734
0.125	569	729	873
Head height (ref.), in.	0.035	0.047	0.063

THIS FASTENER HAS ONLY BEEN TESTED IN THE SHEET GAGES SHOWN IN THIS TABLE. DESIGN DATA FOR SHEET GAGES OR DIAMETERS OTHER THAN THOSE SHOWN HERE CANNOT BE EXTRAPOLATED.

- a Data supplied by Textron Aerospace Fasteners.
- b Loads developed from tests with hole diameters of 0.144, 0.178, and 0.207, +/-0.001 inch.
- c The values in the table above the horizontal line in each column are for knife-edge conditions, and the use of fasteners in this condition is undesirable. The use of knife-edge conditions in the design of military aircraft requires the specific approval of the procuring activity.
- d Yield value is less than 2/3 of indicated ultimate strength value.
- e Rivet shear strength is documented on CR3242 standards drawing.
- f Permanent set at yield load: 4% of nominal diameter.

Table 8.1.3.2.2(y). Static Joint Strength of Blind Flush Head Locked Spindle Aluminum Alloy Rivets in Machine-Countersunk Aluminum Alloy Sheet

Rivet Type	HC3242 ($F_{su} = 51$ ksi approx.) ^a		
Sheet Material	Clad 2024-T3		
Rivet Diameter, in. (Nominal Hole Diameter, in. ^b	1/8 (0.144)	5/32 (0.178)	3/16 (0.207)
	Ultimate Strength, lbs.		
Sheet thickness, in.:			
0.032	267 ^{c,d}	---	---
0.040	310	411 ^{c,d}	---
0.050	363	477	---
0.063	433	563	682 ^c
0.071	475	616	744
0.080	522	675	813
0.090	560	741	889
0.100	597	803	966
0.125	690	918	1130
0.160	814	1075	1320
0.190	---	1215	1480
0.250	---	---	1685

THIS FASTENER HAS ONLY BEEN TESTED IN THE SHEET GAGES SHOWN IN THIS TABLE. DESIGN DATA FOR SHEET GAGES OR DIAMETERS OTHER THAN THOSE SHOWN HERE CANNOT BE EXTRAPOLATED.

Rivet shear strength ^e	814	1245	1685
	Yield Strength, lbs ^f		
Sheet thickness, in.:			
0.032	138	---	---
0.040	218	217	---
0.050	317	340	---
0.063	433	500	529
0.071	475	598	643
0.080	510	675	772
0.090	527	741	889
0.100	543	781	966
0.125	585	833	1075
0.160	644	906	1160
0.190	---	968	1235
0.250	---	---	1375
Head height (ref.), in.	0.035	0.047	0.063

- a Data supplied by Huck International Inc.
- b Loads developed from tests with hole diameters of 0.144, 0.178, and 0.207, +/-0.001 inch.
- c The values in the table above the horizontal line in each column are for knife-edge conditions, and the use of fasteners in this condition is undesirable. The use of knife-edge conditions in the design of military aircraft requires the specific approval of the procuring activity.
- d Yield value is less than 2/3 of indicated ultimate strength value.
- e Rivet shear strength is documented on HC3242 standards drawing.
- f Permanent set at yield load: 4% of nominal diameter.

MIL-HDBK-5J
31 January 2003

Table 8.1.3.2.2(z). Static Joint Strength of Blind Flush Head Locked Spindle Aluminum Alloy Rivets in Aluminum Alloy Sheet

Rivet Type	AF3222 ($F_{su} = 50$ ksi approx.) ^a		
Sheet Material	Clad 2024-T3		
Rivet Diameter, in. (Nominal Hole Diameter, in.) ^b	1/8 (0.130)	5/32 (0.162)	3/16 (0.194)
	Ultimate Strength, lbs.		
Sheet thickness, in.:			
0.040	202 ^c
0.050	287	316 ^c	...
0.063	388	452	492 ^c
0.071	412	536	593
0.080	439	608	706
0.090	469	645	832
0.100	498	683	891
0.125	573	775	1000
0.160	664	905	1155
0.190	...	1015	1290
0.250	...	1030	1480
Rivet shear strength ^d	664	1030	1480
	Yield Strength ^e , lbs.		
Sheet thickness, in.:			
0.040	160
0.050	216	249	...
0.063	290	341	383
0.071	335	397	451
0.080	379	460	527
0.090	421	531	611
0.100	462	591	696
0.125	566	720	880
0.160	664	901	1095
0.190	...	1015	1280
0.250	...	1030	1480
Head height (ref.), in.	0.042	0.055	0.070

a Data supplied by Allfast Fastening Systems Inc.

b Loads developed from tests with hole diameters of 0.130, 0.162, and 0.194, +/- 0.001 inch.

c Values above line are for knife-edge condition and the use of fasteners in this condition is undesirable. The use of knife-edge condition in the design of military aircraft requires specific approval of the procuring agency.

d Rivet shear strength as documented in Allfast Fastening Systems Inc. P-127.

e Permanent set at yield load: 4% of nominal diameter.

MIL-HDBK-5J
31 January 2003

Table 8.1.3.2.2(aa). Static Joint Strength of Flush Head 5056 Aluminum Alloy Rivets in Clad Aluminum Alloy Sheet

Rivet Type	CR3222 ($F_{su} = 50$ ksi approx.) ^a		
Sheet Material	Clad 2024-T3		
Rivet Diameter, in. (Nominal Hole Diameter, in.) ^b	1/8 (0.130)	5/32 (0.162)	3/16 (0.194)
	Ultimate Strength, lbs.		
Sheet thickness, in.:			
0.040	286 ^{c,d}
0.050	328 ^d	445 ^{c,d}	...
0.063	382 ^d	513 ^d	658 ^{c,d}
0.071	416	555 ^d	708 ^d
0.080	454	602 ^d	764 ^d
0.090	496	654	827 ^d
0.100	528	706	889
0.125	589	821	1045
0.160	664	928	1215
0.190	1020	1325
0.250	1030	1480
Rivet shear strength ^e	664	1030	1480
	Yield Strength ^f , lbs.		
Sheet thickness, in.:			
0.040	158
0.050	199	247	...
0.063	252	313	373
0.071	285	354	422
0.080	322	399	476
0.090	362	450	537
0.100	384	501	598
0.125	425	597	750
0.160	483	669	881
0.190	731	955
0.250	854	1100
Head height (ref.), in.	0.041	0.054	0.069

a Data supplied by Textron Aerospace Fasteners.

b Loads developed from tests with hole diameters of 0.130, 0.162, and 0.194, +/- 0.0005 inch.

c Values above line are for knife-edge condition and the use of fasteners in this condition is undesirable. The use of knife-edge condition in the design of military aircraft requires the specific approval of the procuring agency.

d Yield values is less than 2/3 of indicated ultimate strength value.

e Rivet shear strength as documented in Textron Aerospace Fasteners PS-CMR-3000.

f Permanent set at yield load: 4% of nominal diameter.

Table 8.1.3.2.3(a). Static Joint Strength of Blind 100° Flush Head A-286 Bolts in Machine-Countersunk Aluminum Alloy Sheet and Plate

Fastener Type	MS21140 ^a ($F_{su} = 95$ ksi)				
Sheet and Plate Material	Clad 7075-T6 and T651				
Fastener Diameter, in. (Nominal Shank Diameter, in.)	5/32 (0.163)	3/16 (0.198)	1/4 (0.259)	5/16 (0.311)	3/8 (0.373)
	Ultimate Strength, lbs				
Sheet or plate thickness, in.:					
0.071	1165 ^{b,c}
0.080	1330 ^b	1600 ^{b,c}
0.090	1515 ^b	1805 ^b
0.100	1700 ^b	2020 ^b	2615 ^{b,c}
0.125	1980 ^b	2595 ^b	3295 ^b	3935 ^{b,c}	...
0.160	2925 ^b	4335 ^b	5080 ^b	6010 ^{b,c}
0.190	5005 ^b	6150 ^b	7205 ^b
0.200	6520 ^b	6580 ^b
0.250	7215 ^b	9810 ^b
0.312	10380 ^b
Fastener shear strength ^d	1980	2925	5005	7215	10380
	Yield Strength ^e , lbs				
Sheet or plate thickness, in.:					
0.071	478
0.080	584	627
0.090	702	730
0.100	819	901	1025
0.125	1115	1260	1435	1540	...
0.160	1760	2090	2285	2430
0.190	2655	2965	3235
0.200	3190	3510
0.250	4320	4860
0.312	6460
Head height (ref.), in.	0.074	0.082	0.108	0.140	0.168

- a Data supplied by Huck Manufacturing Company.
- b Yield value is less than 2/3 of the indicated ultimate strength value.
- c Values above line are for knife-edge condition and the use of fasteners in this condition is undesirable. The use of knife-edge condition in design of military aircraft requires specific approval of the procuring agency.
- d Fastener shear strength is documented in MIL-F-8975.
- e Permanent set at yield load: 4% of nominal diameter (revised May 1, 1986, from the greater of 0.012 inch or 4% of nominal diameter).

MIL-HDBK-5J
31 January 2003

Table 8.1.3.2.3(b.). Static Joint Strength of Blind 100° Flush Head Alloy Steel Fasteners in Machine-Countersunk Aluminum Alloy Sheet and Plate

Fastener Type	MS90353, MS90353S, and MS90353U ^a ($F_{su} = 112$ ksi)				
Sheet and Plate Material	Clad 2024-T3 and T351				
Fastener Diameter, in. (Nominal Shank Diameter, in.)	5/32 (0.163)	3/16 (0.198)	1/4 (0.259)	5/16 (0.311)	3/8 (0.373)
	Ultimate Strength, lbs				
Sheet or plate thickness, in.:					
0.071	1120 ^{b,c}
0.080	1305 ^b	1480 ^{b,c}
0.090	1510 ^b	1735 ^b
0.100	1740 ^b	2000 ^b	2380 ^{b,c}
0.125	2080 ^b	2670 ^b	3210 ^b	3625 ^{b,c}	...
0.160	2340 ^b	3195 ^b	4440 ^b	5060 ^b	5700 ^{b,c}
0.190	3450 ^b	5090 ^b	6310 ^b	7180 ^b
0.250	5900 ^b	7860 ^b	9890 ^b
0.312	8500 ^b	11600 ^b
0.375	12200 ^b
Fastener shear strength ^d	2340	3450	5900	8500	12200
	Yield Strength ^e , lbs				
Sheet or plate thickness, in.:					
0.071	403
0.080	513	501
0.090	636	652
0.100	759	799	1045
0.125	989	1170	1525	1620	...
0.160	1170	1510	2200	2430	2610
0.190	1700	2700	3120	3440
0.250	3330	4170	5095
0.312	4955	6175
0.375	7135
Head height (ref.), in.	0.072	0.080	0.105	0.137	0.165

- a Data supplied by Huck Manufacturing Company.
- b Yield strength value is less than 2/3 of indicated ultimate strength value.
- c Values above line are for knife-edge condition and the use of fasteners in this condition is undesirable. The use of knife-edge condition in design of military aircraft requires specific approval of the procuring agency.
- d Fastener shear strength is documented in MIL-F-81177.
- e Permanent set at yield load: 4% of nominal diameter.

MIL-HDBK-5J
31 January 2003

Table 8.1.3.2.3(b₂). Static Joint Strength of Blind 100° Flush Head Alloy Steel Fasteners in Machine-Countersunk Aluminum Alloy Sheet and Plate

Rivet Type	MS90353 ^a ($F_{su} = 112$ ksi)				
Sheet and Plate Material	Clad or Bare 7075-T6 and T651				
Fastener Diameter, in. (Nominal Hole Diameter, in.)	5/32 (0.163)	3/16 (0.198)	1/4 (0.259)	5/16 (0.311)	3/8 (0.373)
	Ultimate Strength, lbs				
Sheet or plate thickness, in.:					
0.071	1360 ^{b,c}
0.080	1535 ^c	1830 ^{b,c}
0.090	1710 ^c	2090 ^c
0.100	1880 ^c	2330 ^c	2970 ^{b,c}
0.125	2200 ^c	2825 ^c	3805 ^c	4490 ^{b,c}	...
0.160	2340	3365	4760 ^c	5850 ^c	6960 ^{b,c}
0.190	...	3450	5370 ^c	6790 ^c	8310 ^c
0.250	5900	8290 ^c	10450 ^c
0.312	8500	12200
0.375	12200
Fastener shear strength ^d	2340	3450	5900	8500	12200
	Yield Strength ^e , lbs				
Sheet or plate thickness, in.:					
0.071	557
0.080	666	757
0.090	787	875
0.100	909	1025	1240
0.125	1215	1395	1640	1860	...
0.160	1640	1910	2315	2590	2850
0.190	...	2355	2895	3290	3675
0.250	4055	4680	5345
0.312	6125	7075
0.375	8830
Head height (ref.), in.	0.072	0.080	0.105	0.137	0.165

- a Data supplied by Huck Manufacturing Company.
- b Values above line are for knife-edge condition and the use of fasteners in this condition is undesirable. The use of knife-edge condition in design of military aircraft requires specific approval of the procuring agency.
- c Yield value is less than 2/3 of indicated ultimate strength value.
- d Fastener shear strength is documented in MIL-F-81177.
- e Permanent set at yield load: 4% of nominal diameter revised May 1, 1986, from the greater of 0.012 inch or 4% of nominal diameters.

MIL-HDBK-5J
31 January 2003

Table 8.1.3.2.3(c). Static Joint Strength of Blind 100° Flush Head Alloy Steel Fasteners in Machine-Countersunk Aluminum Alloy Sheet and Plate

Fastener Type	FF-200 ^a		FF-260 ^a		FF-312 ^a	
	Clad 2024-T42	Clad 7075-T6	Clad 2024-T42	Clad 7075-T6	Clad 2024-T42	Clad 7075-T6
Sheet and Plate Material						
Fastener Diameter, in. (Nominal Shank Diameter, in.)	3/16 (0.198)	3/16 (0.198)	1/4 (0.259)	1/4 (0.259)	5/16 (0.311)	5/16 (0.311)
	Ultimate Strength, lbs					
Sheet or plate thickness, in.:						
0.071	1220 ^{b,c}	1360 ^{b,c}
0.080	1380 ^b	1500 ^b
0.090	1520 ^b	1620 ^b
0.100	1650 ^b	1740 ^b	2250 ^{b,c}	2700 ^{b,c}
0.125	1890 ^b	1960	2940 ^b	3220 ^b	2720 ^c	3080 ^{b,c}
0.160	2160	2200	3390 ^b	3570 ^b	3600 ^b	3940 ^b
0.190	2400	2420	3730 ^b	2860 ^b	4490 ^b	4810 ^b
0.250	2620	2620	4260 ^b	4320	5550 ^b	6000 ^b
0.312	4500	4500	6000 ^b	...
Fastener shear strength ^d	2620	2620	4500	4500	6000	6000
	Yield Strength ^e , lbs					
Sheet or plate thickness, in.:						
0.071	685	850
0.080	770	930
0.090	870	1025
0.100	980	1130	1120	1280
0.125	1200	1350	1380	1600	1440	1540
0.160	1500	1640	1700	2050	1820	1980
0.190	1800	1960	2010	2470	2200	2520
0.250	2400	2550	2600	3190	2950	3710
0.312	3200	3880	3690	...
Head height (ref.), in.	0.077		0.102		0.134	

- a Data supplied by Monogram Aerospace Fasteners.
- b Yield value is less than 2/3 of indicated ultimate strength value.
- c Values above line are for knife-edge condition and the use of fasteners in this condition is undesirable. The use of knife-edge condition in design of military aircraft requires specific approval of the procuring agency.
- d Fastener shear strength is documented in NAS1675.
- e Permanent set at yield load: the greater of 0.012 inch or 4% of nominal diameter.

Table 8.1.3.2.3(d). Static Joint Strength of Blind 100° Flush Head Alloy Steel Fasteners in Machine-Countersunk Aluminum Alloy Sheet

Fastener Type	NS 100 ^a		
Sheet Material	Clad 7075-T6		
Fastener Diameter, in. (Nominal Shank Diameter, in.)	5/32 (0.163)	3/16 (0.198)	1/4 (0.259)
	Ultimate Strength, lbs		
Sheet thickness, in.:			
0.063	1085 ^{b,c}
0.071	1295 ^b	1400 ^{b,c}	...
0.080	1525 ^b	1710 ^b	...
0.090	1695 ^b	2020 ^b	...
0.100	1830 ^b	2335 ^b	2715 ^{b,c}
0.125	2170 ^b	2745 ^b	3765 ^b
0.160	2190	3325 ^b	4615 ^b
0.190	3325 ^b	5280 ^b
0.250	5690 ^b
Fastener shear strength ^d	2190	3325	5690
	Yield Strength ^e , lbs		
Sheet thickness, in.:			
0.063	516
0.071	602	690	...
0.080	698	805	...
0.090	804	936	...
0.100	911	1065	1300
0.125	1180	1390	1725
0.160	1500	1835	2320
0.190	2165	2830
0.250	3725
Head height (ref.), in.	0.069	0.077	0.102

- a Data supplied by Monogram Aerospace Fasteners.
- b Yield value is less than 2/3 of the indicated ultimate strength value.
- c Values above line are for knife-edge condition and the use of fasteners in this condition is undesirable. The use of knife-edge condition in design of military aircraft requires specific approval of the procuring agency.
- d Fastener shear strength values are A basis from analysis of test data.
- e Permanent set at yield load: 4% of nominal diameter (revised May 1, 1985, from the greater of 0.012 inch or 4% of nominal diameter).

MIL-HDBK-5J
31 January 2003

Table 8.1.3.2.3(e). Static Joint Strength of Blind 100° Flush Head Aluminum Alloy Fasteners in Machine-Countersunk Aluminum Alloy Sheet

Fastener Type	SSHFA-200 ^a ($F_{su} = 50$ ksi)		SSHFA-260 ^a ($F_{su} = 50$ ksi)	
	Clad 2024-T42	Clad 7075-T6	Clad 2024-T42	Clad 7075-T6
Sheet Material				
Fastener Diameter, in. (Nominal Shank Diameter, in.)	3/16 (0.198)	3/16 (0.198)	1/4 (0.259)	1/4 (0.259)
	Ultimate Strength, lbs			
Sheet thickness, in.:				
0.050	500 ^b	590 ^b
0.063	640	750
0.071	790	880
0.080	1040	1060	1310 ^b	1480 ^b
0.090	1270	1270	1480	1650
0.100	1450	1450	1680	1850
0.125	1550	1550	2010	2250
0.160	2300	2650
0.190	2520	...
0.250	2650	...
Fastener shear strength ^c	1550	1550	2650	2650
	Yield Strength ^d , lbs			
Sheet thickness, in.:				
0.050	500	520
0.063	630	700
0.071	740	800
0.080	860	915	940	1160
0.090	990	1040	1080	1300
0.100	1130	1180	1230	1460
0.125	1340	1420	1550	1790
0.160	1980	2240
0.190	2420	...
0.250	2650	...
Head height (ref.), in.	0.061	0.061	0.088	0.088

a Data supplied by Monogram Aerospace Fasteners.

b Values above line are for knife-edge condition and the use of fasteners in this condition is undesirable. The use of knife-edge condition in design of military aircraft requires specific approval of the procuring agency.

c Fastener shear strength is documented in NAS1675.

d Permanent set at yield load: the greater of 0.012 inch or 4% of nominal diameter.

Table 8.1.3.2.3(f). Static Joint Strength of Blind 100° Flush Head Alloy Steel Fasteners in Machine-Countersunk Aluminum Alloy Sheet and Plate

Fastener Type	PLT-150 ^a ($F_{su} = 112$ ksi) (H-11 Nut and screw, Inconel X-750 or A-286 Sleeve)			
	Clad 7075-T6 and T651			
Sheet or Plate Material				
Fastener Diameter, in. (Nominal Shank Diameter, in.)	5/32 (0.163)	3/16 (0.198)	1/4 (0.259)	3/8 (0.373)
Ultimate Strength, lbs				
Sheet or plate thickness, in.:				
0.063	1120 ^{b,c}
0.071	1320 ^b	1470 ^{b,c}
0.080	1550 ^b	1755 ^b
0.090	1730 ^b	2060 ^b
0.100	1885 ^b	2350 ^b	2820 ^{b,c}	...
0.125	2300 ^b	2850 ^b	3825 ^b	...
0.160	2340 ^b	3450 ^b	4790 ^b	6695 ^{b,c}
0.190	5570 ^b	8440 ^b
0.250	5900 ^b	10700 ^b
0.312	12250 ^b
Fastener shear strength ^d	2340	3450	5900	12250
Yield Strength ^e , lbs				
Sheet or plate thickness, in.:				
0.063	534
0.071	615	730
0.080	705	830
0.090	805	953
0.100	906	1075	1345	...
0.125	1235	1390	1750	...
0.160	1545	1910	2310	3160
0.190	2965	3850
0.250	3840	5395
0.312	6985
Head height (ref.), in.	0.069	0.077	0.102	0.160

- a Data supplied by Voi-Shan Industries (Inconel X-750 Sleeve) and Monogram Aerospace Fasteners (A-286 Sleeve).
- b Yield value is less than 2/3 of the indicated ultimate strength value.
- c Values above line are for knife-edge condition and the use of fasteners in this condition is undesirable. The use of knife-edge condition in design of military aircraft requires specific approval of the procuring agency.
- d Fastener shear strength based on area computed from nominal shank diameter in Table 9.4.1.2(a) and $F_{su} = 112$ ksi.
- e Permanent set at yield load: 4% of nominal diameter (revised May 1, 1985, from the greater of 0.012 inch or 4% of nominal diameter).

Table 8.1.3.2.3(g). Static Joint Strength of Blind 100° Flush Head Alloy Steel Fasteners in Machine-Countersunk Aluminum Alloy Sheet and Plate

Fastener Type	NAS1670-L ^a				
Sheet and Plate Material	Clad 7075-T6 and T651				
Fastener Diameter, in. ^b (Nominal Shank Diameter, in.)	5/32 (0.163)	3/16 (0.198)	1/4 (0.259)	5/16 (0.311)	3/8 (0.373)
	Ultimate Strength, lbs				
Sheet or plate thickness, in.:					
0.063	1110 ^{c,d}
0.071	1230 ^c	1530 ^{c,d}
0.080	1365 ^c	1700 ^c
0.090	1525 ^c	1885 ^c
0.100	1678 ^c	2065 ^c	2800 ^{c,d}
0.125	1678	2530 ^c	3400 ^c	4165 ^{c,d}	...
0.160	1678	2620 ^c	4255 ^c	5190 ^c	6350 ^{c,d}
0.190	2620	4500 ^c	6000 ^c	7395 ^c
0.250	4500	6000	9625 ^c
0.312	9750
0.375	9750
Fastener shear strength ^e	1678	2620	4500	6000	9750
	Yield Strength ^f , lbs				
Sheet or plate thickness, in.:					
0.063	500
0.071	601	647
0.080	711	788
0.090	802	941
0.100	887	1085	1255
0.125	1105	1340	1770	1930	...
0.160	1405	1700	2250	2720	3055
0.190	2020	2655	3200	3890
0.250	3480	4185	5020
0.312	6280
0.375	7520
Head height (ref.), in.	0.069	0.077	0.102	0.134	0.160

- a Data supplied by Monogram Aerospace Fasteners.
- b Fasteners installed in 0.165/0.166, 0.200/0.201, 0.261/0.262, 0.312/0.313, 0.375/0.376 inch holes.
- c Yield value is less than 2/3 of the indicated ultimate strength value.
- d Values above line are for knife-edge condition and the use of fasteners in this condition is undesirable. The use of knife-edge condition in design of military aircraft requires specific approval of the procuring agency.
- e Fastener shear strength is documented in NAS1675.
- f Permanent set at yield load: 4% of nominal diameter.

Table 8.1.3.2.3(h). Static Joint Strength of Blind 100° Flush Head Aluminum Alloy Fasteners in Machine-Countersunk Aluminum Alloy Sheet

Fastener Type	NAS1674-L ^a		
Sheet Material	Clad 7075-T6		
Fastener Diameter, in. (Nominal Shank Diameter, in.) ^b	5/32 (0.163)	3/16 (0.198)	1/4 (0.259)
	Ultimate Strength, lbs		
Sheet thickness, in.:			
0.050	548 ^c
0.063	756 ^c	853	...
0.071	882 ^c	1010	...
0.080	960	1185	...
0.090	1375	1645
0.100	1550	1900
0.125	2535
0.160	2650
Fastener shear strength ^d	960	1550	2650
	Yield Strength ^e , lbs		
Sheet thickness, in.:			
0.050	356
0.063	481	666	...
0.071	561	774	...
0.080	650	892	...
0.090	1025	1275
0.100	1155	1450
0.125	1880
0.160	2480
Head height (ref.), in.	0.049	0.061	0.088

- a Data supplied by Monogram Aerospace Fasteners.
- b Fasteners installed in 0.165/0.166, 0.199/0.200, 0.260/0.261 inch holes.
- c Yield value is less than 2/3 of the indicated ultimate strength value.
- d Fastener shear strength is documented in NAS1675.
- e Permanent set at yield load: 4% of nominal diameter.

8.1.4 SWAGED COLLAR/UPSET-PIN FASTENERS— The strengths shown in the following tables are applicable only when grip lengths and hole tolerances are as recommended by respective fastener manufacturers. For some fastener systems, permanent set at yield load may be increased if hole sizes greater than those listed in the applicable table are used. This condition may exist even though the test hole size lies within the manufacturer's recommended hole size range (refer to Section 9.4.1.3.3).

The ultimate allowable shear load for lockbolts and lockbolt stumps may be obtained from Table 8.1.4 for the appropriate shear stress level. Tensile strengths of lockbolts and lockbolt stumps also are contained in Table 8.1.4.

For lockbolts under combined loading of shear and tension installed in material having a thickness large enough to make the shear cutoff strength critical for shear loading, the following interaction equations are applicable:

$$\begin{aligned} \text{Steel lockbolts, } R_t + R_s^{10} &= 1.0 \\ \text{7075-T6 lockbolts, } R_t + R_s^5 &= 1.0 \end{aligned}$$

where R_t and R_s are the ratios of applied load to allowable load in tension and shear, respectively.

Unless otherwise specified, yield load is defined in Section 9.4.1.3.3 as the load which results in a joint permanent set equal to 4% D, where D is the decimal equivalent of the fastener shank diameter, as defined in 9.4.1.2(a).

8.1.4.1 Protruding-Head Swaged Collar Fastener Joints— Tables 8.1.4.1(a) and (b) contain joint allowables for various protruding-head swaged collar fastener/sheet material combinations. It has been shown that protruding shear head (representative configurations are NAS 2406 to NAS 2412 and M43859/1) fastener joints may not develop the full bearing strength of joint material. Therefore, static allowable loads for protruding shear head fasteners must be established from test data using the criteria specified in Section 9.4.1. For shear joints with protruding tension head fasteners, the load per fastener at which shear or bearing type of failure occurs is calculated separately and the lower of the two governs the design. Allowable shear loads are obtained from Table 8.1.4.

The design bearing stresses for various materials at room and other temperatures are given in strength properties stated for each alloy or group of alloys, and are applicable to joints with pins in cylindrical holes and where $t/D \geq 0.18$. Where $t/D < 0.18$, tests to substantiate yield and ultimate bearing strengths must be performed. These bearing stresses are applicable only for design of rigid joints where there is no possibility of relative motion of the parts joined without deformation of such parts.

For convenience, "unit" sheet bearing strengths for pins, based on bearing stress of 100 ksi and nominal fastener diameters, are given in Table 8.1.5.1. The strength for a specific combination of fastener, sheet thickness, and sheet material is obtained by multiplying the proper "unit" strength by the ratio of material allowable bearing stress (ksi) to 100.

8.1.4.2 Flush-Head Swaged Collar Fastener Joints— Tables 8.1.4.2(a) through (j) contain joint allowables for various flush-head swaged collar fastener/sheet material combinations. The allowable loads for flush-head swaged collar fasteners were established from test data using the following criteria, unless otherwise noted in the footnotes of individual tables.

Ultimate Load— Design allowable ultimate load as defined in Section 9.7.1.5. Prior to 2003 this value was computed as the average ultimate test load divided by a factor of 1.15. This factor is not applicable to shear strength cutoff values which may be either the procurement specification shear strength (S value) of the fastener or, if no specification exists, a statistical value determined from test results.

MIL-HDBK-5J
31 January 2003

The allowable loads shown for flush-head swaged collar fasteners are applicable to joints having e/D equal to or greater than 2.0.

For machine countersunk joints, the sheet gage specified in the tables is that of countersunk sheet. When the noncountersunk sheet is thinner than the countersunk sheet, the bearing allowable for the noncountersunk sheet-fastener combination should be computed, compared to the table value, and the lower of the two values selected.

Table 8.1.4. Ultimate Single-Shear and Tensile Strengths of Lockbolts and Lockbolt Stumps^a

Nominal Diameter (inches)	Heat Treated Alloy Steel ^b (160 ksi)				7075-T6 ^c	
	Single-Shear Strength, lbs.	Tensile Strength, lbs.		Single-Shear Strength, lbs.	Tensile Strength, lbs.	
		Tensile Type ^d	Shear Type ^e			Tensile Type ^d
5/32	2007 ^f /1822 ^g	NAS 1456 thru 1462	NAS 1414 thru 1422	960 ^f	740 ^f	
3/16	2623	NAS 1465 thru 1472	NAS 1424 thru 1432	1260	1195	
1/4	4660	NAS 1475 thru 1482	NAS 1436 thru 1442	2185	2200	
5/16	7290	NAS 1486 thru 1492	NAS 1446 thru 1452	3450	3500	
3/8	10490	NAS 1496 thru 1502		4970	5455	

a Lockbolts are pull-gun driven; lockbolt stumps are hammer or squeeze driven.

b Used with 2024-T4 aluminum alloy collar, NAS 1080.

c Used with 6061-T6 aluminum alloy collar.

d Tensile type have a higher head and more grooves than the shear type and can be either protruding or 100° flush head. Strength value listed refers to lowest strength fastener configuration within this type.

e Shear type have shorter head and less grooves than the tensile type and can be either protruding or 100° flush head. Strength values listed refer to lowest strength fastener configuration within this type.

f Available as lockbolt only (0.164 dia. for #8 lockbolts).

g Available as lockbolt stump only (0.156 dia. for 5/32 stumps).

h Five groove design on lockbolts.

Table 8.1.4.1(a). Static Joint Strength of Protruding Shear Head Ti-6Al-4V Cherrybuck Fasteners in Aluminum Alloy Sheet

Fastener Type	CSR 925 ^a ($F_{su} = 95$ ksi)		
	Clad 7075-T6		
Sheet Material			
Fastener Diameter, in. (Nominal Shank Diameter, in.) ^b . . .	5/32 (0.164)	3/16 (0.190)	1/4 (0.250)
Ultimate Strength, lbs.			
Sheet thickness, in.:			
0.050	995
0.063	1227	1442	...
0.071	1371	1607	...
0.080	1532	1792	2415
0.090	1711	2001	2688
0.100	1890	2205	2960
0.125	2007	2694	3641
0.160	4595
0.190	4660
Fastener shear strength ^c	2007	2694	4660
Yield Strength ^d , lbs.			
Sheet thickness, in.:			
0.050	861
0.063	1013	1225	...
0.071	1107	1334	...
0.080	1213	1455	2067
0.090	1331	1592	2246
0.100	1448	1727	2425
0.125	1741	2068	2873
0.160	3499
0.190	4036

a Data supplied by Cherry Fasteners.

b Fasteners installed in clearance holes (0.0005" - 0.002").

c Fastener shear strength based on area computed from nominal shank diameters in Table 9.7.1.1 and $F_{su} = 95$ ksi.

d Permanent set at yield load: 4% of nominal diameter.

Table 8.1.4.1(b). Static Joint Strength of Protruding Shear Head Ti-6Al-4V Cherrybuck Fasteners in Aluminum Alloy Sheet

Fastener Type	CSR 925 ^a (F_{su} = 95 ksi)		
	Clad 2024-T3		
Sheet Material			
Fastener Diameter, in. (Nominal Shank Diameter, in.) ^b ..	5/32 (0.164)	3/16 (0.190)	1/4 (0.250)
	Ultimate Strength, lbs.		
Sheet thickness, in.:			
0.050	807
0.063	1020	1180	...
0.071	1150	1335	...
0.080	1300	1505	1970
0.090	1465	1695	2220
0.100	1630	1885	2470
0.125	2007	2360	3095
0.160	2694	3975
0.190	4660
Fastener shear strength ^c	2007	2694	4660
	Yield Strength ^d , lbs.		
Sheet thickness, in.:			
0.050	619
0.063	747	889	...
0.071	827	981	...
0.080	916	1085	1495
0.090	1015	1200	1645
0.100	1115	1315	1795
0.125	1360	1600	2175
0.160	2000	2705
0.190	3155

a Data supplied by Cherry Fasteners.

b Fasteners installed in clearance holes (0.0005" - 0.002").

c Fastener shear strength based on area computed from nominal diameters in Table 9.7.1.1 and F_{su} = 95 ksi.

d Permanent set at yield load: 4% of nominal diameter.

MIL-HDBK-5J
31 January 2003

Table 8.1.4.2(a). Static Joint Strength of 100° Flush Shear Head Alloy Steel Lockbolt Fasteners in Machine-Countersunk Aluminum Alloy Sheet and Plate

Fastener Type	NAS 1436-1442 ^a ($F_{su} = 95$ ksi)			
	Clad 7075-T6 and T651			
Sheet and Plate Material				
Fastener Diameter, in. (Nominal Shank Diameter, in.) . .	3/16 (0.190)	1/4 (0.250)	5/16 (0.312)	3/8 (0.375)
Ultimate Strength, lbs				
Sheet or plate thickness, in.:				
0.071	1684
0.080	1875
0.090	2077
0.100	2286	3075
0.125	2620	3750	4811	...
0.160	4625	5994 ^b	7350
0.190	4650	6993	8554
0.250	7300	10435
0.312	10500
Fastener shear strength ^c	2620	4650	7300	10500
Yield Strength ^d , lbs				
Sheet or plate thickness, in.:				
0.071	1405
0.080	1598
0.090	1717
0.100	1850	2395
0.125	2232	2790	3327	...
0.160	3415	3851	5656
0.190	3765	4666	6342
0.250	5248	7910
0.312	8946
Head height (max.), in.	0.049	0.063	0.071	0.081

- a Data supplied by Huck Manufacturing Company.
- b Yield value is less than 2/3 of the indicated ultimate strength value.
- c Fastener shear strength is documented in NAS 1413.
- d Permanent set at yield load: the greater of 0.012 inch or 4% of nominal diameter.

MIL-HDBK-5J
31 January 2003

Table 8.1.4.2(b). Static Joint Strength of 100° Flush Shear/Tension Head Alloy Steel Lockbolt Fasteners in Machine-Countersunk Aluminum Alloy Sheet and Plate

Fastener Type	NAS 7024-7032 ^{a,b} ($F_{su} = 108$ ksi)					
	Clad 7075-T6 and T651					
Sheet and Plate Material						
Fastener Diameter, in. (Nominal Shank Diameter, in.) .	1/8 (0.125)	5/32 (0.156)	3/16 (0.190)	1/4 (0.250)	5/16 (0.312)	3/8 (0.375)
	Ultimate Strength, lbs					
Sheet or plate thickness, in.:						
0.040	563 ^c
0.050	846 ^d	881 ^c	1071 ^c
0.063	1040 ^d	1341 ^d	1398
0.071	1147	1494 ^d	1743 ^d	2001 ^c
0.080	1231	1645 ^d	2083 ^d	2256
0.090	1289	1813	2288 ^d	2823	3071 ^c	...
0.100	1325	1921	2493 ^d	3390 ^d	3425	4225 ^c
0.125	2070	2878	4140 ^d	5200 ^d	5500
0.160	3060	4930	6490	8080 ^d
0.190	5280	7530	8725 ^d
0.250	5300	7870	10010
0.312	8220	11270
0.324	8280	11340
0.375	11620
0.433	11930
Fastener shear strength ^e	1325	2070	3060	5300	8280	11930
	Yield Strength ^f , lbs					
Sheet or plate thickness, in.:						
0.040	426
0.050	537	666	804
0.063	682	846	1024
0.071	770	957	1159	1508
0.080	870	1082	1311	1708
0.090	981	1221	1430	1931	2392	...
0.100	1092	1360	1649	2152	2669	3177
0.125	1705	2071	2709	3363	4010
0.160	2595	3486	4340	4975
0.190	4050	5170	5760
0.250	4140	6210	7340
0.312	7040	8730
0.324	7200	8810
0.375	9160
0.433	9560
Head height (ref.), in.	0.042	0.050	0.060	0.077	0.094	0.111

- a Data supplied by Huck Manufacturing Company.
- b Used with NAS1080K aluminum alloy collar.
- c Values above line are for knife-edge condition and the use of fasteners in this condition is undesirable. The use of knife-edge condition in design of military aircraft requires specific approval of the procuring agency.
- d Yield value is less than 2/3 of indicated ultimate strength value.
- e Fastener shear strength is documented in NAS1413.
- f Permanent set at yield load: the greater of 0.012 inch or 4% of nominal diameter.

Table 8.1.4.2(c). Static Joint Strength of 100° Flush Shear Head Ti-6Al-4V Cherrybuck Fasteners in Machine-Countersunk Aluminum Alloy Sheet

Fastener Type	CSR 924 ^a ($F_{su} = 95$ ksi)		
	Clad 7075-T6		
Sheet Material			
Fastener Diameter, in. (Nominal Shank Diameter, in.) ^b . .	5/32 (0.164)	3/16 (0.190)	1/4 (0.250)
	Ultimate Strength, lbs.		
Sheet thickness, in.:			
0.050	941
0.063	1207	1383	...
0.071	1385	1588	...
0.080	1557	1779	2281
0.090	1775	2050	2594
0.100	1876	2263	2919
0.125	1950	2542	3765
0.160	2007	2660	4387
0.190	2694	4525
0.250	4660
Fastener shear strength ^b	2007	2694	4660
	Yield Strength ^c , lbs.		
Sheet thickness, in.:			
0.050	659
0.063	887	985	...
0.071	1022	1148	...
0.080	1116	1325	1625
0.090	1189	1480	1894
0.100	1257	1545	2162
0.125	1393	1733	2619
0.160	1608	1978	2950
0.190	2191	3231
0.250	3794
Head height (ref.), in.	0.034	0.046	0.060

a Data supplied by Cherry Fasteners.

b Fastener shear strength based on area computed from nominal shank diameter in Table 9.7.1.1 and $F_{su} = 95$ ksi.

c Permanent set at yield load: 4% of nominal diameter.

Table 8.1.4.2(d). Static Joint Strength of 100° Flush Shear Head Ti-6Al-4V Cherrybuck Fasteners in Machine-Countersunk Aluminum Alloy Sheet

Fastener Type	CSR 924 ^a ($F_{su} = 95$ ksi)		
	Clad 2024-T3		
Sheet Material			
Fastener Diameter, in. (Nominal Shank Diameter, in.) ^b	5/32 (0.164)	3/16 (0.190)	1/4 (0.250)
	Ultimate Strength, lbs.		
Sheet thickness, in.:			
0.050	737
0.063	1019	1118	...
0.071	1152	1319	...
0.080	1279 ^c	1509	1837
0.090	1419 ^c	1673 ^c	2168
0.100	1560 ^c	1834 ^c	2500
0.125	1898 ^c	2242 ^c	3036 ^c
0.160	2007 ^c	2680 ^c	3786 ^c
0.190	2694	4404 ^c
0.250	4660
Fastener shear strength ^d	2007	2694	4660
	Yield Strength ^e , lbs.		
Sheet thickness, in.:			
0.050	511
0.063	712	778	...
0.071	786	922	...
0.080	840	1039	1276
0.090	900	1109	1513
0.100	960	1178	1750
0.125	1110	1352	1979
0.160	1321	1596	2300
0.190	1805	2575
0.250	3125
Head height (ref.), in.	0.034	0.046	0.060

- a Data supplied by Cherry Fasteners.
- b Fasteners installed in clearance holes (0.0005 - 0.002).
- c Yield load is less than 2/3 of indicated ultimate.
- d Fastener shear strength based on area computed from nominal shank diameter in Table 9.7.1.1 and $F_{su} = 95$ ksi.
- e Permanent set at yield load: 4% of nominal diameter.

Table 8.1.4.2(e). Static Joint Strength of 100° Flush Shear Head A-286 Rivets in Machine-Countersunk Aluminum Alloy Sheet

Fastener Type	HSR201 ^a ($F_{su} = 95$ ksi)		
	7075-T6		
Sheet Material			
Fastener Diameter, in. (Nominal Shank Diameter, in.) ^b . .	5/32 (0.164)	3/16 (0.190)	1/4 (0.250)
	Ultimate Strength, lbs.		
Sheet thickness, in.:			
0.050	1055	1095	...
0.063	1330	1545	2030
0.071	1500	1740	2285
0.080	1690	1955	2575
0.090	1900	2200	2895
0.100	2007	2445	3220
0.125	2694	4025
0.160	4660
Fastener shear strength ^c	2007	2694	4660
	Yield Strength ^d , lbs.		
Sheet thickness, in.:			
0.050	835	870	...
0.063	1055	1225	1605
0.071	1185	1380	1810
0.080	1340	1550	2040
0.090	1505	1745	2295
0.100	1675	1940	2550
0.125	2420	3190
0.160	4180
Head height (nom.), in.	0.040	0.046	0.060

a Data supplied by Hi-Shear Corporation.

b Hole Size: Fastener installed in 0.000 interference to 0.005 clearance.

c Fastener shear strength based on area computed from nominal shank diameter in Table 9.7.1.1 and $F_{su} = 95$ ksi.

d Permanent set at yield load: 4% of nominal diameter.

Table 8.1.4.2(f). Static Joint Strength of 100° Flush Shear Head Ti-8Mo-8V-2Fe-3Al Rivets in Machine-Countersunk Aluminum Alloy Sheet

Rivet Type	HSR101 ^a ($F_{su} = 95$ ksi)		
Sheet Material	7075-T6		
Rivet Diameter, in. (Nominal Shank Diameter, in.) ^b . .	5/32 (0.164)	3/16 (0.190)	1/4 (0.250)
	Ultimate Strength, lbs.		
Sheet thickness, in.:			
0.050	1040	1205	...
0.063	1310	1520	2000
0.071	1480	1715	2255
0.080	1665	1930	2540
0.090	1875	2170	2855
0.100	2007	2410	3175
0.125	2694	3965
0.160	4660
Rivet shear strength ^c	2007	2694	4660
	Yield Strength ^d , lbs.		
Sheet thickness, in.:			
0.050	797	921	...
0.063	1005	1165	1530
0.071	1130	1310	1725
0.080	1275	1475	1945
0.090	1435	1660	2185
0.100	1595	1845	2430
0.125	2310	3035
0.160	3885
Head height (nom.), in.	0.040	0.046	0.060

a Data supplied by Hi-Shear Corporation.

b Hole Size: Fastener installed in 0.000 interference to 0.005 clearance.

c Fastener shear strength based on area computed from nominal shank diameter in Table 9.7.1.1 and $1/4 = 0.250$ and $F_{su} = 95$ ksi.

d Permanent set at yield load: 4% of nominal diameter.

MIL-HDBK-5J
31 January 2003

Table 8.1.4.2(g). Static Joint Strength of 100° Flush Shear Head Ti-6Al-4V Lockbolt Fasteners in Machine-Countersunk Aluminum Alloy Sheet

Rivet Type	GPL3SC-V Pin ^{a,b} ($F_{su} = 95$ ksi), 2SC-3C Collar			
Sheet Material	Clad 7075-T6			
Rivet Diameter, in. (Nominal Shank Diameter, in) ^c . . .	3/16 (0.190)	1/4 (0.250)	5/16 (0.312)	3/8 (0.375)
	Ultimate Strength, lbs.			
Sheet thickness, in.:				
0.050	1105
0.063	1500	1800 ^d
0.071	1740	2125	2430	...
0.080	2020	2485	2865	3170 ^d
0.090	2200	2885	3365	3780
0.100	2355	3310	3865	4390
0.125	2694	3945	5135	5880
0.160	4660	6245	8005
0.190	7010	8955
0.250	7290	10490
Rivet shear strength ^e	2694	4660	7290	10490
	Yield Strength ^f , lbs.			
Sheet thickness, in.:				
0.050	948
0.063	1160	1585
0.071	1290	1755	2265	...
0.080	1435	1945	2500	3090
0.090	1600	2160	2765	3415
0.100	1760	2375	3030	3740
0.125	2095	2910	3705	4535
0.160	3585	4640	5670
0.190	5440	6635
0.250	6270	8230
Head height (ref.), in.	0.048	0.063	0.070	0.081

- a Data supplied by Huck Manufacturing Company and Voi-Shan Industries.
- b Aluminum coated per NAS 4006.
- c Hole Size: Fastener installed in 0.005" interference to 0.0005" clearance.
- d Values above line are for knife-edge condition and the use of fasteners in this condition is undesirable. The use of knife-edge condition in design of military aircraft requires specific approval of the procuring agency.
- e Fastener shear strength based on area computed from nominal shank diameter in Table 9.7.1.1 and 1/4 = 0.250 and $F_{su} = 95$ ksi.
- f Permanent set at yield load: 4% of nominal diameter.

MIL-HDBK-5J
31 January 2003

Table 8.1.4.2(h). Static Joint Strength of 100° Flush Shear Head Ti-6Al-4V Lockbolt Fasteners in Machine-Countersunk Aluminum Alloy Sheet and Plate

Rivet Type	GPL3SC-V Pin ^{a,b} ($F_{su} = 95$ ksi), 2SC-3C Collar			
	Clad 2024-T3			
Rivet Diameter, in. (Nominal Shank Diameter, in.) ^c .	3/16 (0.190)	1/4 (0.250)	5/16 (0.312)	3/8 (0.375)
Sheet thickness, in.:	Ultimate Strength, lbs.			
0.050	938
0.063	1255	1535 ^d
0.071	1455	1795	2085	...
0.080	1680	2085	2440	2740 ^f
0.090	1920 ^e	2410	2845	3230
0.100	2080 ^e	2735	3245	3725
0.125	2460 ^e	3470 ^e	4270	4930
0.160	2694	4175 ^e	5505 ^e	6645
0.190	4590 ^e	6260 ^e	7885 ^e
0.250	4660	7230	9705 ^e
0.312	7290	10490
0.375
Rivet shear strength ^f	2694	4660	7290	10490
Sheet thickness, in.:	Yield Strength ^g , lbs.			
0.050	777
0.063	945	1285
0.071	1050	1435	1810	...
0.080	1140	1590	2030	2440
0.090	1230	1760	2260	2750
0.100	1320	1910	2475	3065
0.125	1545	2205	2975	3705
0.160	1860	2620	3495	4475
0.190	2975	3935	5010
0.250	3685	4820	6075
0.312	5740	7175
Head height (ref.), in.	0.048	0.063	0.070	0.081

a Data supplied by Huck Manufacturing Company and Voi-Shan Industries.

b Aluminum coated per NAS 4006.

c Hole size: Fasteners installed in 0.005" interference to 0.0005" clearance.

d Values above line are for knife-edge condition and the use of fasteners in this condition is undesirable. The use of knife-edge condition in design of military aircraft requires specific approval of the procuring agency.

e Yield load is less than 2/3 of indicated ultimate.

f Fastener shear strength based on area computed from nominal shank diameter in Table 9.7.1.1 and $F_{su} = 95$ ksi.

g Permanent set at yield load: 4% of nominal diameter.

MIL-HDBK-5J
31 January 2003

Table 8.1.4.2(i). Static Joint Strength of 100° Flush Shear Head Ti-6Al-4V Lockbolt Fasteners in Machine-Countersunk Aluminum Alloy Sheet and Plate

Rivet Type	LGPL2SC-V Pin ^{a,b} ($F_{su} = 95$ ksi), 3SLC-C Collar			
Sheet Material	Clad 7075-T6			
Rivet Diameter, in. (Nominal Shank Diameter, in.) ^c .	3/16 (0.190)	1/4 (0.250)	5/16 (0.312)	3/8 (0.375)
Sheet thickness, in.:	Ultimate Strength, lbs.			
0.050	1040
0.063	1370	1710 ^d
0.071	1575	1980	2345	...
0.080	1805	2280	2715	3105 ^d
0.090	2060	2615	3130	3620
0.100	2315	2950	3550	4130
0.125	2590	3790	4605	5375
0.160	2694	4430	6070	7150
0.190	4660	6750	8660
0.250	7290	10154
0.312	10490
Rivet shear strength ^e	2694	4660	7290	10490
Sheet thickness, in.:	Yield Strength ^f , lbs.			
0.050	948
0.063	1160	1585
0.071	1290	1755	2265	...
0.080	1435	1945	2500	3090
0.090	1600	2160	2765	3415
0.100	1760	2375	3030	3740
0.125	2095	2910	3705	4535
0.160	2395	3585	4640	5670
0.190	3900	5440	6635
0.250	6270	8230
0.312	9255
Head height (ref.), in.	0.048	0.063	0.070	0.081

a Data supplied by Huck Manufacturing Company and Voi-Shan Industries.

b Aluminum coated per NAS 4006.

c Hole size: Fasteners installed in 0.005" interference to 0.0005" clearance.

d Values above line are for knife-edge condition and the use of fasteners in this condition is undesirable. The use of knife-edge condition in design of military aircraft requires specific approval of the procuring agency.

e Fastener shear strength based on area computed from nominal shank diameter in Table 9.7.1.1 and $F_{su} = 95$ ksi.

f Permanent set at yield load: 4% of nominal diameter.

Table 8.1.4.2(j). Static Joint Strength of 100° Flush Shear Head Ti-6Al-4V Lockbolt Fasteners in Machine-Countersunk Aluminum Alloy Sheet and Plate

Rivet Type	LGPL2SC-V Pin ^{a,b} ($F_{su} = 95$ ksi), 3SLC-C Collar			
	Clad 2024-T3			
Rivet Diameter, in. (Nominal Shank Diameter, in.) ^c .	3/16 (0.190)	1/4 (0.250)	5/16 (0.312)	3/8 (0.375)
Sheet thickness, in.:	Ultimate Strength, lbs.			
0.050	836
0.063	1180	1350 ^d
0.071	1395	1630	1775	...
0.080	1640	1950	2155	2270 ^d
0.090	1900 ^e	2300	2595	2800
0.100	2115 ^e	2650	3035	3335
0.125	2340	3530 ^e	4140	4640
0.160	2655	4000	5645 ^e	6500
0.190	2694	4355	6085	8080 ^e
0.250	4660	6965	9180
0.312	7290	10270
0.375	10490
Rivet shear strength ^f	2694	4660	7290	10490
Sheet thickness, in.:	Yield Strength ^g , lbs.			
0.050	733
0.063	901	1220
0.071	1005	1360	1745	...
0.080	1125	1515	1930	2270
0.090	1250	1685	2140	2635
0.100	1380	1855	2355	2895
0.125	1640	2280	2895	3530
0.160	1910	2795	3640	4430
0.190	2140	3100	4230	5200
0.250	3700	4985	6440
0.312	5760	7375
0.375	8325
Head height (ref.), in.	0.048	0.063	0.070	0.081

- a Data supplied by Huck Manufacturing Company and Voi-Shan Industries.
- b Aluminum coated per NAS 4006.
- c Hole size: Fasteners installed in 0.0005" interference to 0.0005" clearance.
- d Values above line are for knife-edge condition and the use of fasteners in this condition is undesirable. The use of knife-edge condition in design of military aircraft requires specific approval of the procuring agency.
- e Yield load is less than 2/3 of indicated ultimate.
- f Fastener shear strength based on area computed from nominal shank diameter in Table 9.7.1.1 and $F_{su} = 95$ ksi.
- g Permanent set at yield load: 4% of nominal diameter.

8.1.5 THREADED FASTENERS — The strengths shown in the following tables are applicable only when grip lengths and hole tolerances are as recommended by the respective fastener manufacturers. For some fastener systems, permanent set at yield load may be increased if hole sizes greater than those listed in the applicable table are used. This condition may exist even though the test hole size lies within the manufacturer's recommended hole size range (refer to Section 9.7.1.1).

The ultimate single shear strength of threaded fasteners at full diameter is shown in Table 8.1.5(a). The ultimate tensile strength of threaded fasteners is shown in Tables 8.1.5(b₁) and (b₂). In both tables values shown are a product of the indicated strength and area, with the area based on the following:

Shear — Based on basic shank diameter.

Tension — Based on the nominal minor diameter of the thread as published in Table 2.21 of Handbook H-28.

For any given threaded fastener the allowable load will be chosen using an appropriate category corresponding to minimum tensile strength, shear strength, or other requirements of the pertinent procurement specification.

It is recognized that some procurement specifications may provide higher tensile strengths than those reported in Tables 8.1.5(b₁) and (b₂), since they may be based on a larger effective area than shown in the table. The values listed herein have been judged acceptable for design, acknowledging that they may be slightly conservative since they are based on the nominal minor diameter area.

Unless otherwise specified, the yield load is defined in Section 9.7.1.1 for threaded fasteners as the load at which the joint permanent is set equal to 0.04D, where D is the decimal equivalent of the fastener shank diameter as defined in Table 9.4.1.2(a).

8.1.5.1 Protruding-Head Threaded Fastener Joints — It has been shown that protruding shear head (representative configuration is NAS 1982) fastener joints may not develop the full bearing strength of the joint material. Therefore, static allowable loads for protruding shear head fasteners must be established from test data using the criteria specified in Section 9.7. For shear joints with protruding tension head fasteners, the load per fastener at which shear or bearing type of failure occurs is separately calculated, and the lower of the two values so determined governs the design. Allowable shear loads may be obtained from Table 8.1.5(a).

The design bearing stresses for various materials at room and other temperatures are given in the properties for each alloy or group of alloys, and are applicable to joints with fasteners in cylindrical holds and where $t/D \geq 0.18$. Where $t/D < 0.18$, tests to substantiate yield and ultimate bearing strengths must be performed. These bearing stresses are applicable only for design of rigid joints where there is no possibility of relative motion of the parts joined without deformation of such parts.

For convenience, "unit" sheet bearing strengths for threaded fasteners, based on a strength of 100 ksi and nominal fastener diameters, are given in Table 8.1.5.1. The strength for a specific combination of fasteners, sheet thickness, and sheet material is obtained by multiplying the proper "unit" strength by the ratio of material allowable bearing stress (ksi) to 100.

The following interaction formula is applicable to AN3 series bolts under combined shear and tension loading: $R_s^3 + R_t^2 = 1.0$, where R_s and R_t are ratios of applied load to allowable load in shear and tension, respectively.

8.1.5.2 Flush-Head Threaded Fastener Joints— Tables 8.1.5.2(a) through (o) contain joint allowables for various flush-head threaded fastener/sheet material combinations. Unless otherwise noted, the allowable loads for flush-head threaded fasteners were established from test data using the following criteria;

Ultimate Load— Design allowable ultimate load as defined in Section 9.7.1.5. Prior to 2003 this value was computed as the average ultimate test load divided by a factor of 1.15. This factor is not applicable to shear strength cutoff values which may be either procurement specification shear strength (S value) of the fastener or, if no specification exists, a statistical value determined from test results. It should coincide with shear values from Table 8.1.5(a).

The allowables shown for flush-head threaded fasteners are applicable to joints having e/D equal to or greater than 2.0.

For machine countersunk joints, the sheet gage specified in the tables is that of the countersunk sheet. When the noncountersunk sheet is thinner than the countersunk sheet, the bearing allowable for the noncountersunk sheet-fastener combination should be computed, compared to the table value, and the lower of the two values selected.

Table 8.1.5(a). Ultimate Single Shear Strength of Threaded Fasteners

Shear Stress of Fastener, ksi		35	38	75	90	95	108	125	132	145	156	
Fastener Diameter in.	Fastener Diameter Size ^a	Ultimate Single Shear Strength, lbs.										
		Basic Shank Area	345	374	739	887	936	1060	1230	1300	1425	1535
0.112	#4	0.0098520	345	374	739	887	936	1060	1230	1300	1425	1535
0.125	1/8	0.012272	430	466	920	1105	1165	1325	1530	1620	1775	1910
0.138	#6	0.014957	523	568	1120	1345	1420	1615	1870	1970	2165	2330
0.156	5/32	0.019175	671	729	1435	1725	1820	2070	2395	2530	2780	2990
0.164	#8	0.021124	739	803	1580	1900	2005	2280	2640	2785	3060	3295
0.188	3/16	0.027612	966	1045	2070	2485	2620	2980	3450	3645	4005	4310
0.190	#10	0.028353	992	1075	2125	2550	2690	3060	3540	3740	4110	4420
0.216	#12	0.036644	1280	1390	2745	3295	3480	3955	4580	4840	5315	5720
0.219	7/32	0.037582	1315	1425	2815	3380	3570	4060	4700	4960	5445	5860
0.250	1/4	0.049087	1715	1865	3680	4420	4660	5300	6140	6480	7115	7660
0.312	5/16	0.076699	2680	2915	5750	6900	7290	8280	9590	10100	11100	11950
0.375	3/8	0.11045	3865	4200	8280	9935	10450	11900	13800	14550	16000	17200
0.438	7/16	0.15033	5260	5710	11250	13500	14250	16200	18750	19800	21750	23450
0.500	1/2	0.19635	6870	7460	14700	17650	18650	21200	24500	25900	28450	30600
0.562	9/16	0.24850	8700	9440	18600	22350	23600	26800	31050	32800	36000	38750
0.625	5/8	0.30680	10700	11650	23000	27600	29150	33100	38350	40500	44500	47900
0.750	3/4	0.44179	15450	16750	33100	39750	42000	47700	55200	58300	64000	68900
0.875	7/8	0.60132	21050	22850	45100	54100	57100	64900	75200	79400	87200	93800
1.000	1	0.78540	27450	29850	58900	70700	74600	84800	98200	103500	113500	122500
1.125	1-1/8	0.99402	34750	37750	74600	89500	94400	107000	124000	131000	144000	155000
1.250	1-1/4	1.2272	43000	46600	92000	110000	116500	132500	153000	162000	177500	191000
1.375	1-3/8	1.4849	52000	56400	111000	133500	141000	160000	185500	196000	215000	231500
1.500	1-1/2	1.7671	61800	67100	132500	159000	167500	190500	220500	233000	256000	275500

^a Fractional equivalent or screw number.

Table 8.1.5(b₁). Ultimate Tensile Strength of Threaded Fasteners

Tensile Stress of Fastener, ksi		55	62	62.5	125	140	160	180
Fastener Diameter in.	Nominal Minor Area ^b	MIL-S-7742 Ultimate Tensile Strength, lbs. ^{c,d}						
	Size ^a	280	316	318	636	713	814	916
0.112	0.0050896	280	316	318	636	713	814	916
0.138	0.0076821	423	476	480	960	1075	1225	1380
0.164	0.012233	673	758	765	1525	1710	1955	2200
0.190	0.018074	994	1120	1130	2255	2530	2890	3250
0.250	0.033394	1835	2070	2085	4170	4680	5340	6010
0.312	0.053666	2950	3325	3350	6710	7510	8590	9660
0.375	0.082397	4530	5110	5150	10300	11500	13150	14800
0.438	0.11115	6110	6890	6950	13850	15550	17750	20000
0.500	0.15116	8310	9370	9450	18900	21150	24150	27200
0.562	0.19190	10550	11900	11950	23950	26850	30700	34500
0.625	0.24349	13350	15100	15200	30400	34050	38950	43800
0.750	0.35605	19550	22050	22250	44500	49800	57000	64100
0.875	0.48695	26750	30150	30400	60900	68200	77900	87700
1.000	0.63307	34800	39250	39550	79100	88600	101000	114000
1.125	0.82162	45200	50900	51400	102500	115000	131500	147500
1.250	1.0347	56900	64200	64700	129000	144500	165500	186000
1.375	1.2724	70000	78900	79500	159000	178000	203500	229000
1.500	1.5345	84400	95100	95900	191500	214500	245500	276000

a Fractional equivalent or number and threads per inch.

b The tension fastener allowables above are based on the nominal minor diameter thread area for MIL-S-7742 threads from Table 2.2.1 of Handbook H-28.

c Values shown above heavy line are for 2A threads, all other values are for 3A threads.

d Nuts and fastener heads designed to develop the ultimate tensile strength of the fastener are required to develop the tabulated tension loads.

Table 8.1.5(b₂). Ultimate Tensile Strength of Threaded Fasteners (Continued)

Fastener Diameter in.		Maximum Minor Area ^b	Tensile Stress of Fastener, ksi			
			160	180	220	260
Size ^a			MIL-S-8879 Ultimate Tensile Strength, lbs. ^{c,d}			
0.112	4-40	0.0054367	869	979	1195	1410
0.138	6-32	0.0081553	1305	1465	1790	2120
0.164	8-32	0.012848	2055	2310	2825	3340
0.190	10-32	0.018602	2975	3345	4090	4840
0.250	1/4-28	0.034241	5480	6160	7530	8900
0.312	5/16-24	0.054905	8780	9880	12050	14250
0.375	3/8-24	0.083879	13400	15100	18450	21800
0.438	7/16-20	0.11323	18100	20350	24900	29400
0.500	1/2-20	0.15358	24550	27600	33750	39900
0.562	9/16-18	0.19502	31200	35100	42900	50700
0.625	5/8-18	0.24700	39500	44500	54300	64200
0.750	3/4-16	0.36082	57700	64900	79400	93800
0.875	7/8-14	0.49327	78900	88800	108500	128000
1.000	1-12	0.64156	102500	115500	141000	166500
1.125	1-1/8-12	0.83129	133000	149500	182500	216000
1.250	1-1/4-12	1.0456	167000	188000	230000	271500
1.375	1-3/8-12	1.2844	205500	231000	282500	333500
1.500	1-1/2-12	1.5477	247500	278500	340500	402000

a Fractional equivalent or number and threads per inch.

b The tension fastener allowables above are based on the maximum minor diameter thread area for MIL-S-8879 threads from Tables II and III of MIL-S-8879.

c Values are for 3A threads.

d Nuts and fastener heads designed to develop the ultimate tensile strength of the fastener are required to develop the tabulated tension loads.

Table 8.1.5.1. Unit Bearing Strength of Sheet and Plate in Joints With Threaded Fasteners or Pins; $F_{br} = 100$ ksi

Fastener, Diameter, in.	Unit Bearing Strength of Sheet for Fastener Diameter Indicated, lbs. ^a													
	0.156	0.164	0.188	0.190	0.250	0.312	0.375	0.438	0.500	0.562	0.625	0.750	0.875	1.000
Thickness, in.														
0.032	500	525
0.036	563	590	675	684
0.040	625	656	750	760
0.045	704	738	845	855
0.050	781	820	940	950	1250
0.063	985	1033	1180	1197	1575	1969
0.071	1110	1164	1330	1349	1775	2219	2662
0.080	1250	1312	1500	1520	2000	2500	3000	3500
0.090	1407	1476	1690	1710	2250	2812	3375	3938	4500
0.100	1562	1640	1875	1900	2500	3125	3750	4375	5000
0.125	1953	2050	2340	2375	3125	3906	4688	5469	6250	7030	7812
0.160	2500	2624	3000	3040	4000	5000	6000	7000	8000	9000	10000	12000
0.200	3125	3280	3750	3800	5000	6250	7500	8750	10000	11250	12500	15000	17500	20000
0.250	3916	4100	4688	4750	6250	7812	9375	10940	12500	14060	15625	18750	21875	25000
0.312	4867	5117	5866	5928	7800	9734	11700	13670	15600	17530	19500	23400	27300	31200
0.375	5850	6150	7050	7125	9375	11700	14063	16425	18750	21075	23400	28125	32810	37500
0.500	7800	8200	9400	9500	12500	15600	18750	21900	25000	28100	31250	37500	43750	50000
0.625	9750	10250	11750	11875	15625	19500	23440	27375	31250	35125	39062	46875	54690	62500
0.750	11700	12300	14100	14250	18750	23400	28125	32850	37500	42150	46875	56250	65625	75000
0.875	13650	14350	16450	16625	21875	27300	32810	38325	43750	49175	56690	65625	76560	87500
1.000	15600	16400	18800	19000	25000	31200	37600	43800	50000	56200	62500	75000	87500	100000

^a Bearing strengths shown are based on nominal fastener diameter.

Table 8.1.5.2(a₁). Static Joint Strength of 100° Flush Head Alloy Steel Screws in Machine-Countersunk Aluminum Alloy Sheet and Plate

Fastener Type	AN509 ^a steel screw ($F_{su} = 75$ ksi) w/MS20365 or equiv. steel nut				
Sheet and Plate Material	Clad 2024-T3 and T351				
Fastener Diameter, in. (Nominal Shank Diameter, in.)	3/16 (0.190)	1/4 (0.250)	5/16 (0.312)	3/8 (0.375)	1/2 (0.500)
	Ultimate Strength ^c , lbs				
Sheet or plate thickness, in.:					
0.080	1576 ^{b,c}
0.090	1726 ^b
0.100	1877 ^b	2567 ^{b,c}
0.125	2126 ^b	3054 ^b	3922 ^{b,c}	4579 ^{b,c}	...
0.160	...	3536 ^b	4722 ^b	5878 ^b	...
0.190	...	3682	5405 ^b	6872 ^b	9408 ^{b,c}
0.250	5750	8280 ^b	12201 ^b
0.312	8280 ^b	14141 ^b
0.375	14730
Fastener shear strength ^d	2126	3682	5750	8280	14730
	Yield Strength ^{e,f} , lbs				
Sheet or plate thickness, in.:					
0.080	903
0.090	989
0.100	1084	1490
0.125	1296	1748	2001	2559	...
0.160	1615	2116	2334	2939	...
0.190	...	2484	2702	3361	6012
0.250	3404	4197	7306
0.312	5092	8452
0.375	9996
Head height (ref.), in.	0.080	0.106	0.133	0.159	0.213

a This fastener is no longer manufactured; do not specify for new designs.

b Yield value is less than 2/3 of the indicated ultimate strength value.

c Values above line are for knife-edge condition and the use of fasteners in this condition is undesirable. The use of knife-edge condition in design of military aircraft requires specific approval of the procuring agency.

d Fastener shear strength based on area computed from nominal shank diameters in Table 9.7.1.1 and $F_{su} = 75$ ksi.

e Test data from which the yield and ultimate strengths were derived can be found in Reference 8.1.5.2.

f Permanent set at yield load: the greater of 0.012 inch or 4% of nominal diameter.

Table 8.1.5.2(a₂). Static Joint Strength of 100° Flush Head Alloy Steel Screws in Machine-Countersunk Aluminum Alloy Sheet and Plate

Fastener Type	AN509 ^a steel screw ($F_{su} = 75$ ksi) w/MS20365 or equiv. steel nut				
	Clad 7075-T6 and T651				
Sheet and Plate Material					
Fastener Diameter, in. (Nominal Shank Diameter, in.) .	3/16 (0.190)	1/4 (0.250)	5/16 (0.312)	3/8 (0.375)	1/2 (0.500)
Ultimate Strength ^b , lbs					
Sheet or plate thickness, in.:					
0.080	1632 ^{c,d}
0.090	1762 ^c
0.100	1892	2723 ^{c,d}
0.125	2126	3109 ^c	4180 ^{c,d}	5216 ^{c,d}	...
0.160	3551 ^c	4858 ^c	6193 ^c	...
0.190	3682	5433 ^c	6996 ^c	...
0.250	5750	8280 ^c	12421 ^{c,d}
0.312	8280	14185 ^c
0.375	14730
Fastener shear strength ^e	2126	3682	5750	8280	14730
Yield Strength ^{b,f} , lbs					
Sheet or plate thickness, in.:					
0.080	965
0.090	1063
0.100	1179	1600
0.125	1462	1895	2098	2699	...
0.160	2363	2501	3088	...
0.190	2926	3018	3601	...
0.250	4312	4868	8041
0.312	6624	9437
0.375	11686
Head height (ref.), in.	0.080	0.106	0.133	0.159	0.213

- a This fastener is no longer manufactured; do not specify for new designs.
- b Test data from which the yield and ultimate strengths were derived can be found in Reference 8.1.5.2.
- c Yield value is less than 2/3 of the indicated ultimate strength value.
- d Values above line are for knife-edge condition and the use of fasteners in this condition is undesirable. The use of knife-edge condition in design of military aircraft requires specific approval of the procuring agency.
- e Fastener shear strength based on area computed from nominal shank diameters in Table 9.7.1.1 and $F_{su} = 75$ ksi.
- f Permanent set at yield load: the greater of 0.012 inch or 4% of nominal diameter.

Table 8.1.5.2(b). Static Joint Strength of 100° Flush Head Stainless Steel (PH13-8Mo-H1000) Fasteners in Machine-Countersunk Titanium Alloy Sheet and Plate

Fastener Type	PBF 11 ^a ($F_{su} = 125$ ksi)			
Sheet and Plate Material	Annealed Ti-6Al-4V			
Rivet Diameter, in. (Nominal Shank Diameter, in.) ^b	5/32 (0.164)	1/4 (0.250)	3/8 (0.375)	1/2 (0.500)
	Ultimate Strength, lbs			
Sheet or plate thickness, in.:				
0.040	1535 ^c
0.050	1963
0.063	2528	3656
0.071	2640	4213
0.080	...	4813	6820	...
0.090	...	5438	7818	...
0.100	...	6140	8775	11250 ^c
0.125	11264	14575
0.160	13810	19250
0.190	23200
0.200	24540
Fastener shear strength ^d	2640	6140	13810	24540
	Yield Strength ^e , lbs			
Sheet or plate thickness, in.:				
0.040	1237
0.050	1543
0.063	1947	2969
0.071	2049	3350
0.080	...	3756	5667	...
0.090	...	4219	6370	...
0.100	...	4600	7101	9500
0.125	8789	11825
0.160	10645	15025
0.190	17825
0.200	18400
Head height (nom.), in.	0.040	0.060	0.077	0.101

- a Data supplied by Huck Manufacturing Company and PB Fasteners.
- b Fasteners installed in clearance holes (0.0025-0.0030).
- c Values above line are for knife-edge condition and the use of fasteners in this condition is undesirable. The use of knife-edge condition in design of military aircraft requires specific approval of the procuring agency.
- d Fastener shear strength based on areas computed from indicated nominal shank diameter $F_{su} = 125$ ksi.
- e Permanent set at yield load: 4% of nominal diameter.

MIL-HDBK-5J
31 January 2003

Table 8.1.5.2(c). Static Joint Strength of 100° Flush Head Tapered Alloy Steel Fasteners in Machine-Countersunk Aluminum Alloy Sheet and Plate

Fastener Type	TL 100 ^a ($F_{su} = 108$ ksi)					
	Clad 7075-T6 and T651					
Sheet and Plate Material						
Fastener Diameter, in. (Nominal Shank Diameter, in.) . .	3/16 (0.1969)	1/4 (0.2585)	5/16 (0.3214)	3/8 (0.3860)	7/16 (0.4490)	1/2 (0.5122)
	Ultimate Strength, lbs					
Sheet or plate thickness, in.:						
0.100	2435
0.125	2913	3745	4443
0.160	3290	4831	6017	7016	7993	...
0.190	5269	7017	8511	9737	10900
0.250	5670	8148	11120	13220	14890
0.285	8760	11360	15000	17240
0.312	11570	15280	19000
0.344	11800	15560	19800
0.375	12030	15820	20110
0.500	12640	16870	21320
Fastener shear strength ^b	3290	5670	8760	12640	17100	22250
	Yield Strength ^c , lbs					
Sheet or plate thickness, in.:						
0.100	1960
0.125	2350	2990	3818
0.160	2840	3550	4650	5650	6703	...
0.190	3970	5308	6596	7806	9045
0.250	4830	6450	8209	9903	11560
0.285	7060	9090	10930	12840
0.312	9680	11780	13930
0.344	10010	12710	14930
0.375	10430	13200	16000
0.500	15160	18490
Head height (max.), in.	0.048	0.063	0.070	0.081	0.100	0.110

a Data supplied by Briles Manufacturing Company.

b Fastener shear strength based on areas computed from indicated nominal shank diameter and $F_{su} = 108$ ksi.

c Permanent set at yield load: the greater of 0.012 inch or 4% of nominal diameter.

Table 8.1.5.2(d). Static Joint Strength of 100° Flush Head Tapered STA Ti-6Al-4V Fasteners in Machine-Countersunk Aluminum Alloy Sheet

Fastener Type	TLV 10 ^a ($F_{su} = 95$ ksi)			
	Clad 7075-T6			
Sheet Material				
Fastener Diameter, in. (Nominal Shank Diameter, in.)	1/8 (0.1437)	5/32 (0.1688)	3/16 (0.1965)	1/4 (0.2583)
Ultimate Strength, lbs				
Sheet thickness, in.:				
0.032	488 ^b
0.040	610	713 ^b	826 ^b	...
0.050	768	896	1050	...
0.063	967	1145	1312	1730 ^b
0.071	1120	1290	1491	1960
0.080	1260	1470	1690	2223
0.090	1377	1670	1910	2505
0.100	1441	1845	2130	2800
0.125	1530	2010	2580	3540
0.160	1540	2125	2800	4410
0.190	2880	4750
0.250	4980
Fastener shear strength ^c	1540	2125	2880	4980
Yield Strength ^d , lbs				
Sheet thickness, in.:				
0.032	488
0.040	610	713	826	...
0.050	753	890	1050	...
0.063	925	1118	1301	1730
0.071	1035	1240	1467	1960
0.080	1138	1377	1637	2192
0.090	1238	1522	1806	2455
0.100	1321	1639	1976	2711
0.125	1480	1880	2331	3304
0.160	1540	2111	2683	3986
0.190	2880	4437
0.250	4980
Head height (max.), in.	0.033	0.041	0.048	0.063

a Data supplied by Lockheed Georgia Company.

b Values above line are for knife-edge condition and the use of fasteners in this condition is undesirable. The use of knife-edge condition in design of military aircraft requires specific approval of the procuring agency.

c Fastener shear strength based on areas computed from indicated nominal shank diameter and $F_{su} = 95$ ksi.

d Permanent set at yield load: the greater of 0.012 inch or 4% of fractional diameter.

MIL-HDBK-5J
31 January 2003

Table 8.1.5.2(e). Static Joint Strength of 70° Flush Head Tapered Ti-6Al-4V Fasteners in Non-Matching Machine-Countersunk Aluminum Alloy Sheet and Plate

Fastener Type	HPB-V ^a ($F_{su} = 95$ ksi)			
	Clad 7075-T6 and T651			
Sheet and Plate Material				
Fastener Diameter (Nominal Shank Diameter, in.) ^b	3/16 (0.1976)	1/4 (0.2587)	5/16 (0.3211)	3/8 (0.3850)
Sheet Countersink Angle	82°	82°	82°	75°
	Ultimate Strength, lbs			
Sheet or plate thickness, in.:				
0.063	1355
0.071	1554	2041
0.080	1710	2296
0.090	1847	2583	3207	...
0.100	1984	2864	3567	4269
0.125	2319	3293	4454	5336
0.160	2792	3908	5176	6611
0.190	2913	4444	5836	7396
0.250	4993	7155	8968
0.312	7692	10613
0.375	11058
0.500	11058
Fastener shear strength ^c	2913	4993	7692	11058
	Yield Strength ^d , lbs			
Sheet or plate thickness, in.:				
0.063	1269
0.071	1429	1874
0.080	1613	2108
0.090	1812	2376	2949	...
0.100	1984	2637	3279	3928
0.125	2319	3299	4093	4906
0.160	2718	3908	5176	6285
0.190	2913	4397	5836	7396
0.250	4993	6980	8968
0.312	7692	10257
0.375	11058
0.500	11058
Head height (max.), in.	0.057	0.067	0.076	0.086

a Data supplied by PB Fasteners.

b Fasteners installed in interference holes (0.0015-0.0048).

c Fastener shear strength based on areas computed from the indicated nominal shank diameter and $F_{su} = 95$ ksi.

d Permanent set at yield load: the greater of 0.012 inch or 4% of nominal diameter.

MIL-HDBK-5J
31 January 2003

Table 8.1.5.2(f). Static Joint Strength of 100° Flush Shear Head Ti-6Al-4V Fasteners in Machine-Countersunk Aluminum Alloy Sheet

Fastener Type	KLBHV Pin ($F_{su} = 95$ ksi), KFN 600 Nut ^a				
Sheet Material	Clad 7075-T6				
Fastener Diameter, in. (Nominal Shank Diameter, in.) ^b	5/32 (0.164)	3/16 (0.190)	1/4 (0.250)	5/16 (0.3125)	3/8 (0.375)
	Ultimate Strength, lbs				
Sheet thickness, in.:					
0.040	748 ^c
0.050	987	1112
0.063	1291	1462	1813 ^c
0.071	1428	1679	2100
0.080	1571	1888	2438	2902	...
0.090	1722	2058	2794	3322	3867
0.100	1883	2231	3150	3810	4402
0.125	2007	2694	3725	4924	5724
0.160	4531	4901	7397
0.190	4660	6790	8452
0.200	7083	8789
0.250	7290	10490
Fastener shear strength ^d	2007	2694	4660	7290	10490
	Yield Strength ^e , lbs				
Sheet thickness, in.:					
0.040	594
0.050	740	859
0.063	931	1079	1419
0.071	1049	1213	1600
0.080	1176	1368	1806	2267	...
0.090	1283	1534	2031	2540	3052
0.100	1375	1675	2250	2824	3375
0.125	1606	1942	2813	3517	4219
0.160	3306	4455	5386
0.190	3725	4983	6385
0.200	5168	6581
0.250	6038	7636
Head height (ref.), in.	0.043	0.048	0.063	0.070	0.081

a Data supplied by Kaynar Manufacturing Co., Inc.

b Fasteners installed in interference holes (0.003-0.055).

c Values above line are for knife-edge condition and the use of fasteners in this condition is undesirable. The use of knife-edge condition in design of military aircraft requires specific approval of the procuring agency.

d Fastener shear strength based on areas computed from indicated nominal shank diameter and $F_{su} = 95$ ksi.

e Permanent set at yield load: 4% of the nominal diameter.

MIL-HDBK-5J
31 January 2003

Table 8.1.5.2(g). Static Joint Strength of 100° Flush Shear AISI 431^a Hi-Lok Fasteners in Aluminum Alloy Sheet and Plate

Rivet Type	HL 61 Pin ($F_{su} = 125$ ksi), HL 70 Collar ^b			
Sheet and Plate Material	Clad 7075-T6 and T651			
Rivet Diameter (Nominal Shank Diameter, in.) . .	3/16 (0.190)	1/4 (0.250)	5/16 (0.312)	3/8 (0.375)
	Ultimate Strength, lbs			
Sheet or plate thickness, in.:				
0.090	2327
0.100	2430	3740
0.125	2695	4080
0.160	3070	4560	6500 ^c	...
0.190	3390	4970	7160	9100
0.250	3544	5800	8320	10230
0.312	6140	9590	11390
0.375	12580
0.500	13810
Fastener shear strength ^d	3544	6140	9590	13810
	Yield Strength ^e , lbs			
Sheet or plate thickness, in.:				
0.090	1840
0.100	1943	2900
0.125	2195	3240
0.160	2540	3700	4030	...
0.190	2840	4020	5430	7120
0.250	3110	4870	6590	8500
0.312	5350	7580	9700
0.375	7890	10410
0.500	12070
Head height (max.), in.	0.049	0.063	0.077	0.051

- a AISI 431 is prohibited from use in Air Force and Navy structure by MIL-STD-1568 and SD-24, respectively, because of its sensitivity to heat treatment. Use of fasteners made of this material in design of military aerospace structures requires the specific approval of the procuring agency.
- b Data supplied by Hi-Shear Corporation.
- c Yield value is less than 2/3 of the indicated ultimate strength value.
- d Fastener shear strength based on areas computed from the indicated nominal shank diameter and $F_{su} = 125$ ksi.
- e Permanent set at yield load: the greater of 0.012 inch or 4% of nominal diameter.

MIL-HDBK-5J
31 January 2003

Table 8.1.5.2(h). Static Joint Strength of 100° Flush Shear Head Alloy Steel Hi-Lok Fasteners in Machine-Countersunk Aluminum Alloy Sheet and Plate

Fastener Type	HL 719 Pin ($F_{su} = 108$ ksi), HL 79 Collar ^a				
	7075-T6 and T651				
Sheet and Plate Material					
Fastener Diameter, in. (Nominal Shank Diameter, in.) ^b	5/32 (0.164)	3/16 (0.190)	1/4 (0.250)	5/16 (0.312)	3/8 (0.375)
	Ultimate Strength, lbs				
Sheet or plate thickness, in.:					
0.040	734 ^c
0.050	1044	1131
0.063	1384	1565	1813
0.071	1518	1820	2216
0.080	1668	1998	2594	2916	...
0.090	1764	2193	3015	3532	3724
0.100	1825	2345	3338	4059	4516
0.125	1979	2524	3980	5229	6167
0.160	2195	2774	4350	6347	7928
0.190	2989	4634	6702	9087
0.250	3062	5200	7512	9985
0.312	5300	8146	10870
0.375	8280	11760
Fastener shear strength ^d	2281	3062	5300	8280	11930
	Yield Strength ^e , lbs				
Sheet or plate thickness, in.:					
0.040	690
0.050	861	1000
0.063	1086	1261	1664
0.071	1224	1421	1876
0.080	1346	1601	2114	2647	...
0.090	1478	1771	2378	2978	3578
0.100	1610	1924	2642	3309	3976
0.125	1845	2308	3210	4136	4970
0.160	2022	2583	3920	5124	6362
0.190	2750	4344	5886	7330
0.250	3062	4785	6925	9160
0.312	7496	10130
0.375	8158	10820
Head height (nom.), in.	0.040	0.046	0.060	0.067	0.077

a Data supplied by Hi-Shear Corporation.

b Fasteners installed in interference holes (0.001-0.002).

c Values above line are for knife-edge condition and the use of fasteners in this condition is undesirable. The use of knife-edge condition in design of military aircraft requires specific approval of the procuring agency.

d Fastener shear strength based on areas computed from indicated nominal shank diameter and $F_{su} = 108$ ksi.

e Permanent set at yield load: the greater of 0.012 inch or 4% of nominal diameter.

MIL-HDBK-5J
31 January 2003

Table 8.1.5.2(i). Static Joint Strength of 100° Flush Shear Head Ti-6Al-4V Fasteners in Machine-Countersunk Aluminum Alloy Sheet and Plate

Fastener Type	HL 11 Pin ($F_{su} = 95$ ksi), HL 70 Collar ^a			
	Clad 7075-T6 and T651			
Sheet and Plate Material				
Fastener Diameter, in. (Nominal Shank Diameter, in.)	5/32 (0.164)	3/16 (0.190)	1/4 (0.250)	5/16 (0.312)
	Ultimate Strength, lbs			
Sheet or plate thickness, in.:				
0.040	734 ^b	837 ^b
0.050	941	1083	1343 ^b	...
0.063	1207	1393	1762	2170 ^b
0.071	1385	1588	2012	2463
0.080	1557	1779	2281	2823
0.090	1775	2050	2594	3193
0.100	1876	2263	2919	3631
0.125	1950	2542	3765	4594
0.160	2007	2660	3970	5890
0.190	2694	4165	6105
0.250	4530	6580
0.312	4660	7050
0.375	7290
Fastener shear strength ^c	2007	2694	4660	7290
	Yield Strength ^d , lbs			
Sheet or plate thickness, in.:				
0.040	674	794
0.050	835	982	1325	...
0.063	1038	1230	1655	2141
0.071	1130	1355	1813	2338
0.080	1230	1480	2062	2620
0.090	1342	1625	2250	2880
0.100	1440	1750	2470	3420
0.125	1670	2020	2930	3860
0.160	1891	2360	3480	4620
0.190	2560	3840	5150
0.250	4440	6170
0.312	4660	6900
0.375	7290
Head height (nom.), in.	0.040	0.046	0.060	0.067

- a Data supplied by Hi-Shear Corporation.
- b Values above line are for knife-edge condition and the use of fasteners in this condition is undesirable. The use of knife-edge condition in design of military aircraft requires specific approval of the procuring agency.
- c Fastener shear strength based on areas computed from indicated nominal shank diameter and $F_{su} = 95$ ksi.
- d Permanent set at yield load: the greater of 0.012 inch or 4% of nominal diameter.

MIL-HDBK-5J
31 January 2003

Table 8.1.5.2(j). Static Joint Strength of 100° Flush Shear Head Ti-6Al-6V-2Sn Fasteners in Machine-Countersunk Aluminum Alloy Sheet and Plate

Fastener Type	HL 911 Pin ($F_{su} = 108$ ksi), HL 70 Collar ^a				
	Clad 7075-T6 and T651				
Sheet and Plate Material					
Fastener Diameter, in.	5/32	3/16	1/4	5/16	3/8
(Nominal Shank Diameter, in.)	(0.164)	(0.190)	(0.250)	(0.312)	(0.375)
Ultimate Strength, lbs					
Sheet or plate thickness, in.:					
0.040	780 ^b
0.050	982	1137	1456 ^b
0.063	1264	1458	1863	2287 ^b	...
0.071	1426	1642	2094	2570	3096 ^b
0.080	1622	1866	2425	2920	3473
0.090	1740	2105	2750	3339	3965
0.100	1794	2310	3063	3777	4415
0.125	1915	2455	3875	4770	5666
0.160	2098	2660	4219	6181	7339
0.190	2252	2840	4450	6483	8788
0.250	2281	3062	4925	7067	9589
0.312	5300	7670	10362
0.375	8280	11079
0.500	11930
Fastener shear strength ^c	2281	3062	5300	8280	11930
Yield Strength ^d , lbs					
Sheet or plate thickness, in.:					
0.040	734
0.050	882	1044	1394
0.063	1076	1300	1750	2190	...
0.071	1184	1406	1938	2472	2995
0.080	1320	1540	2188	2774	3332
0.090	1392	1680	2375	3066	3768
0.100	1480	1810	2569	3358	4120
0.125	1700	2085	3031	4010	5019
0.160	1870	2380	3563	4818	6074
0.190	1978	2530	3937	5354	6749
0.250	2178	2740	4375	6269	8183
0.312	4687	6883	9209
0.375	7418	9870
0.500	11039
Head height (nom.), in.	0.040	0.046	0.060	0.067	0.077

- a Data supplied by Hi-Shear Corporation.
- b Values above line are for knife-edge condition and the use of fasteners in this condition is undesirable. The use of knife-edge condition in design of military aircraft requires specific approval of the procuring agency.
- c Fastener shear strength based on areas computed from indicated nominal shank diameter and $F_{su} = 108$ ksi.
- d Permanent set at yield load: the greater of 0.012 inch or 4% of nominal diameter.

MIL-HDBK-5J
31 January 2003

Table 8.1.5.2(k). Static Joint Strength of 100° Flush Head Ti-6Al-6V-2Sn or Alloy Steel, Shear Type Fasteners in Machine-Countersunk Aluminum Alloy Sheet

Fastener Type	NAS 4452S and KS 100-FV Pins ^a ($F_{su} = 108$ ksi), NAS 4445DD Nut			
	7075-T6			
Sheet Material				
Fastener Diameter, in. (Nominal Shank Diameter, in.)	1/8 (0.138)	5/32 (0.164)	3/16 (0.190)	1/4 (0.250)
Ultimate Strength, lbs				
Sheet thickness, in.:				
0.040	644
0.050	857	976	1065	...
0.063	1131	1305	1458	1750 ^b
0.071	1268	1512	1697	2062
0.080	1428	1703	1964	2406
0.090	1499	1910	2227	2794
0.100	1539	2084	2458	3181
0.125	1615	2200	2848	4063
0.160	2281	3036	4900
0.190	3062	5113
0.250	5300
Fastener shear strength ^c	1615	2281	3062	5300
Yield Strength ^d , lbs				
Sheet thickness, in.:				
0.040	609
0.050	766	906	1029	...
0.063	946	1157	1325	1706
0.071	1044	1278	1505	1956
0.080	1152	1412	1668	2219
0.090	1261	1555	1848	2500
0.100	1320	1694	2014	2762
0.125	1444	1904	2397	3350
0.160	2106	2661	4100
0.190	2845	4419
0.250	4925
Head height (max.), in.	0.037	0.040	0.049	0.063

a Data supplied by Huck Manufacturing Company.

b Values above line are for knife-edge condition and the use of fasteners in this condition is undesirable. The use of knife-edge condition in design of military aircraft requires specific approval of the procuring agency.

c Fastener shear strength is documented in NAS 4444.

d Permanent set at yield load: the greater of 0.012 inch or 4% of nominal diameter.

Table 8.1.5.2(l). Static Joint Strength of 70° Flush Head Straight Shank Ti-6Al-4V Fasteners in Non-Matching Machine-Countersunk Aluminum Alloy Sheet and Plate

Fastener Type	HPT-V ^a ($F_{su} = 95$ ksi)			
	Clad 7075-T6 and T651			
Sheet and Plate Material				
Fastener Diameter (Nominal Shank Diameter, in.) ^b	3/16 (0.193)	1/4 (0.255)	5/16 (0.3175)	3/8 (0.380)
Sheet Countersink Angle	82°	82°	82°	75°
	Ultimate Strength, lbs			
Sheet or plate thickness, in.:				
0.063	1348
0.071	1546	1970
0.080	1704	2275
0.090	1814	2580	3125	...
0.100	1948	2873	3528	4100
0.125	2265	3282	4465	5270
0.160	2700	3868	5171	6642
0.190	2779	4361	5826	7393
0.250	4851	7056	8880
0.312	7521	10396
0.375	10774
Fastener shear strength ^c	2779	4851	7521	10774
	Yield Strength ^d , lbs			
Sheet or plate thickness, in.:				
0.063	1180
0.071	1378	1651
0.080	1590	1944
0.090	1702	2321	2631	...
0.100	1818	2620	3024	3350
0.125	2112	3055	4133	4664
0.160	2496	3601	4848	6209
0.190	2734	4062	5413	6902
0.250	4745	6552	8288
0.312	7378	9631
0.375	10584
Head height (max.), in.	0.060	0.070	0.080	0.090

- a Data supplied by PB Fasteners.
- b Fasteners installed in interference holes (0.0045-0.0055).
- c Fastener shear strength based on areas computed from the indicated nominal shank diameter and $F_{su} = 95$ ksi.
- d Permanent set at yield load: the greater of 0.012 inch or 4% of nominal diameter.

MIL-HDBK-5J
31 January 2003

Table 8.1.5.2(m). Static Joint Strength of 100° Flush Shear Head STA Ti-6Al-4V Fasteners in Machine-Countersunk Aluminum Alloy Sheet

Fastener Type	NAS 4452V Pin ($F_{su} = 95$ ksi), NAS 4445D Nut ^a				
Sheet Material	Clad 7075-T6				
Fastener Diameter, in. (Nominal Shank Diameter, in.)	5/32 (0.164)	3/16 (0.190)	1/4 (0.250)	5/16 (0.312)	3/8 (0.375)
	Ultimate Strength, lbs				
Sheet or plate thickness, in.:					
0.040	766 ^b
0.050	1092	1173
0.063	1450	1639	1886 ^b
0.071	1633	1889	2290
0.080	1805	2136	2710	3028	...
0.090	1955	2368	3135	3651	...
0.100	2007	2557	3515	4230	4669
0.125	...	2694	4273	5485	6428
0.160	4660	6776	8426
0.190	7290	9708
0.250	10490
Fastener shear strength ^c	2007	2694	4660	7290	10490
	Yield Strength ^d , lbs				
Sheet thickness, in.:					
0.040	712
0.050	891	1034
0.063	1103	1295	1712
0.071	1223	1445	1932
0.080	1349	1604	2169	2715	...
0.090	1475	1768	2420	3056	...
0.100	1489	1920	2658	3383	4082
0.125	...	2241	3196	4145	5072
0.160	3812	5076	6321
0.190	5746	7265
0.250	8802
Head height (max.), in.	0.040	0.049	0.063	0.077	0.091

a Data supplied by Huck Manufacturing Company.

b Values above line are for knife-edge condition and the use of fasteners in this condition is undesirable. The use of knife-edge condition in design of military aircraft requires specific approval of the procuring agency.

c Fastener shear strength is documented in NAS 4444.

d Permanent set at yield load: the greater of 0.012 inch or 4% of nominal diameter.

Table 8.1.5.2(n). Static Joint Strength of Protruding Shear Head Alloy Steel Hi-Lok Fasteners in Aluminum Alloy Sheet

Fastener Type	HL 18 Pin ($F_{su} = 95$ ksi), HL 70 Collar ^a			
	Clad 7075-T6			
Sheet Material				
Fastener Diameter, in. (Nominal Shank Diameter, in.) ^b . . .	5/32 (0.164)	3/16 (0.190)	1/4 (0.250)	5/16 (0.312)
Ultimate Strength, lbs.				
Sheet thickness, in.:				
0.050	1078
0.063	1353	1559
0.071	1520	1776
0.080	1718	1957	2593	...
0.090	1890	2224	2937	...
0.100	1930	2473	3250	4050
0.125	2007	2580	4063	5075
0.160	2694	4450	6509
0.190	4620	6880
0.250	4660	7290
Rivet shear strength ^c	2007	2694	4660	7290
Yield Strength ^d , lbs.				
Sheet thickness, in.:				
0.050	976
0.063	1251	1426
0.071	1430	1624
0.080	1589	1848	2344	...
0.090	1746	2065	2687	...
0.100	1875	2242	3031	3660
0.125	2563	3750	4734
0.160	4406	6051
0.190	6686

- a Data supplied by Hi-Shear Corporation.
- b Fasteners installed in clearance holes (0.0005-0.0025).
- c Fastener shear strength based on areas computed from indicated nominal shank diameter and $F_{su} = 95$ ksi.
- d Permanent set at yield load: the greater of 0.012 inch or 4% of nominal diameter.

Table 8.1.5.2(o). Static Joint Strength of 100° Flush Shear Head Alloy Steel Hi-Lok Fasteners in Machine-Countersunk Aluminum Alloy Sheet

Fastener Type	HL 19 Pin ($F_{su} = 95$ ksi), HL 70 Collar ^a			
	Clad 7075-T6			
Sheet Material	Clad 7075-T6			
Fastener Diameter, in. (Nominal Shank Diameter, in.) ^b . . .	5/32 (0.164)	3/16 (0.190)	1/4 (0.250)	5/16 (0.312)
Sheet thickness, in.:	Ultimate Strength, lbs.			
0.050	968
0.063	1251	1408
0.071	1400	1606
0.080	1595	1823	2344	...
0.090	1815	2050	2675	...
0.100	1903	2300	3000	3660
0.125	2005	2570	3781	4685
0.160	2694	4420	6051
0.190	4625	6832
0.250	4660	7290
Rivet shear strength ^c	2007	2694	4660	7290
Sheet thickness, in.:	Yield Strength ^d , lbs.			
0.050	839
0.063	1031	1191
0.071	1141	1336
0.080	1279	1480	2013	...
0.090	1416	1632	2219	...
0.100	1540	1805	2420	3143
0.125	1807	2173	3000	3777
0.160	2545	3670	4800
0.190	4144	5514
0.250	6686
Head height (nom.), in.	0.040	0.046	0.060	0.067

- a Data supplied by Hi-Shear Corporation.
- b Fasteners installed in clearance holes (0.0005-0.0025).
- c Fastener shear strength based on areas computed from indicated nominal shank diameter and $F_{su} = 95$ ksi.
- d Permanent set at yield load: the greater of 0.012 inch or 4% of nominal diameter.

MIL-HDBK-5J
31 January 2003

8.1.6 SPECIAL FASTENERS — Due to the special nature of this classification of fastener, care must be exercised in their application. Consideration should be given to the proposed fastener application and its compatibility with data presented in this section. In particular, test and analysis methods used for fasteners in this section may necessarily be different than those used in preceding sections.

8.1.6.1 Fastener Sleeves — Fastener sleeves are precision-formed, tubular elements designed to replace oversize fasteners used in the repair of damaged or enlarged holes.

8.1.6.1.1 A-286 ACRES Sleeves in 7075-T6 Aluminum Alloy Sheet and Plate — Analysis of static lap joint data indicates that a single 100° low profile head, A-286 [ACRES Sleeve (part number JK5512C)] installed with titanium or steel Hi-Loks and alloy steel lockbolts (up to 108 ksi F_{su}) provided static joint allowable shear loads equivalent to those developed by the above-noted fasteners when tested without sleeves. Fasteners and sleeves were installed to the same comparable hole tolerance and fit condition as fasteners when tested alone. The analysis was restricted to static lap joint data (in accordance with MIL-STD-1312 Test 4) and equivalency to fastener systems other than those listed above is not implied. Other properties such as tensile strength, preload, fatigue strength, and corrosion characteristics should be verified by test data. When using sleeves, knife-edge conditions should be avoided.

8.1.6.2 Sleeve Bolts — Tables 8.1.6.2(a) and (b) contain joint allowables for various sleeve bolt/sheet material combinations. Sleeve bolts are made of precision-formed aluminum alloy sleeve elements assembled on standard taper shank bolts. When the assembly is placed in a cylindrical hole and the bolt is drawn into the sleeve, the sleeve expands, thus filling the hole and causing an interference-fit condition.

The allowable loads were established from test data using the following criteria:

Ultimate Load — Design allowable ultimate load as defined in Section 9.7.1.5. Prior to 2003 this value was computed as the average ultimate test load divided by a factor of 1.15. This factor is not applicable to shear strength cutoff values which are defined by the procurement specification.

Yield Load — Design allowable yield load as defined in Section 9.7.1.5. Prior to 2003 this value was computed as the average yield test load or the load which results in a joint permanent set equal to 0.04D, where D is the hole size.

The allowable loads shown for flush-head fasteners are applicable to joints having e/D equal to or greater than 2.0.

For machine countersunk joints, the sheet gage specified in the tables herein is that of the countersunk sheet. When the noncountersunk sheet is thinner than the countersunk sheet, the bearing allowable for the noncountersunk sheet-fastener combination should be computed, compared to the table value, and the lower of the two values selected.

MIL-HDBK-5J
31 January 2003

Table 8.1.6.2(a). Static Joint Strength of 100° Reduced Flush Head, Alloy Steel Pin, Aluminum Alloy Sleeve, Fastener in Machine-Countersunk Aluminum Alloy Sheet and Plate

Fastener Type	MIL-B-8831/4 ^a ($F_{su} = 108$ ksi)					
	Clad 7075-T6					
Sheet Material						
Fastener Diameter, in. (Nominal Hole Diameter, in.) ^{b,c}	3/16 (0.2390)	1/4 (0.3032)	5/16 (0.3695)	3/8 (0.4350)	7/16 (0.5022)	1/2 (0.5735)
Sheet thickness, in.:	Ultimate Strength, lbs.					
0.100	2585
0.125	3205	4100	5035
0.160	3290	5205	6385	7560	8790	...
0.190	5670	7535	8925	10360	11900
0.250	8760	11640	13495	15480
0.312	12395	16195	19180
0.375	12640	16625	21265
0.500	17100	22250
Rivet shear strength ^d	3290	5670	8760	12640	17100	22250
Sheet thickness, in.:	Yield Strength ^e , lbs.					
0.100	2080
0.125	2570	3300	4075
0.160	3255	4170	5135	6105	7125	...
0.190	4915	6040	7175	8360	9635
0.250	7855	9310	10825	12450
0.312	11520	13375	15360
0.375	12355	15620	18320
0.500	21570
Sleeve head height (ref.), in. . .	0.062	0.075	0.082	0.093	0.115	0.120

a Data supplied by P.B. Fasteners.

b Nominal hole diameter based on $\left(\frac{\text{max. expanded sleeve} - \text{min. hole}}{2} \right) + \text{min. hole}$ using larger expanded diameter from MIL-B-8831/4 dated 23 August 1982.

c Fasteners installed to interference levels of 0.0025-0.008 in.

d Fastener shear strength is documented in NAS 1724 as 108 ksi.

e Permanent set at yield load: 4% of nominal hole diameter.

MIL-HDBK-5J
31 January 2003

Table 8.1.6.2(b). Static Joint Strength of 100° Reduced Flush Head, Alloy Steel Pin, Aluminum Alloy Sleeve, Fastener in Machine-Countersunk Aluminum Alloy Sheet and Plate

Fastener Type	MIL-B-8831/4 ^a ($F_{su} = 108$ ksi)					
	Clad 2024-T3					
Sheet Material						
Fastener Diameter, in. (Nominal Hole Diameter, in.) ^{b,c}	3/16 (0.2390)	1/4 (0.3032)	5/16 (0.3695)	3/8 (0.4350)	7/16 (0.5022)	1/2 (0.5735)
Sheet thickness, in.:	Ultimate Strength, lbs.					
0.100	2175
0.125	2720	3450	4205
0.160	3290	4415	5380	6335	7315	...
0.190	5240	6390	7525	8685	9920
0.250	5480	7945	9895	11425	13050
0.312	5655	8165	11085	14260	16285
0.375	5670	8385	11345	14845	19070
0.500	8760	11865	15445	19755
0.625	12385	16045	20440
0.750	12640	16645	21225
0.875	17100	21805
1.000	22250
Rivet shear strength ^d	3290	5670	8760	12640	17100	22250
Sheet thickness, in.:	Yield Strength ^e , lbs.					
0.100	1575
0.125	1880	2505	3200
0.160	2310	3050	3865	4720	5655	...
0.190	3515	4435	5395	6430	7595
0.250	4450	5570	6735	7980	9360
0.312	5055	6745	8115	9580	11185
0.375	5560	7460	9525	11205	13040
0.500	8680	11010	13655	16720
0.625	12385	15315	18625
0.750	12640	16645	20520
0.875	17100	21805
1.000	22250
Sleeve head height (ref.), in. . . .	0.062	0.075	0.082	0.093	0.115	0.120

a Data supplied by P.B. Fasteners.

b Nominal hole diameter based on $\left(\frac{\text{max. expanded sleeve} - \text{min. hole}}{2}\right) + \text{min. hole}$ using larger expanded diameter from MIL-B-8831/4 dated 23 August 1982.

c Fasteners installed to interference levels of 0.002-0.008 in.

d Fastener shear strength is documented in NAS 1724 as 108 ksi.

e Permanent set at yield load: 4% of nominal hole diameter.

8.2 METALLURGICAL JOINTS

In the design of metallurgical joints, the strength of the joining material (for example, weld metal) and the adjacent parent material must be considered. The joint should be analyzed on the basis of its loading, the specified allowable strengths, dimensions and geometry.

8.2.1 INTRODUCTION AND DEFINITIONS — The allowable strength for both the adjacent parent metal and the weld metal is given below in the particular section dealing with the method of forming used, and the material being joined. The following subparagraphs define certain joining processes.

Welding — Welding consists of joining two or more pieces of metal by applying heat, pressure or both, with or without filler material, to produce a localized union through fusion or recrystallization across the joint interface. Examples of common welding processes include: fusion [inert-gas, shielded-arc welding with tungsten electrode (TIG) and inert-gas shielded metal-arc welding using covered electrodes (MIG)], resistance (spot and seam), and flash. Several terms used in describing various sections of a welded joint are illustrated in Figure 8.2.1.

Brazing — Brazing consists of joining metals by the application of heat causing the flow of a thin layer, capillary thickness, of nonferrous filler metal into the space between the pieces. Bonding results from the intimate contact produced by the dissolution of a small amount of base metal in the molten filler metal, without fusion of the base metal.

8.2.2 WELDED JOINTS — The weld metal section of a joint should be analyzed on the basis of its loading, specified allowable strength, dimensions and geometry. The effects of the parent metal are to be accounted for as specified herein.

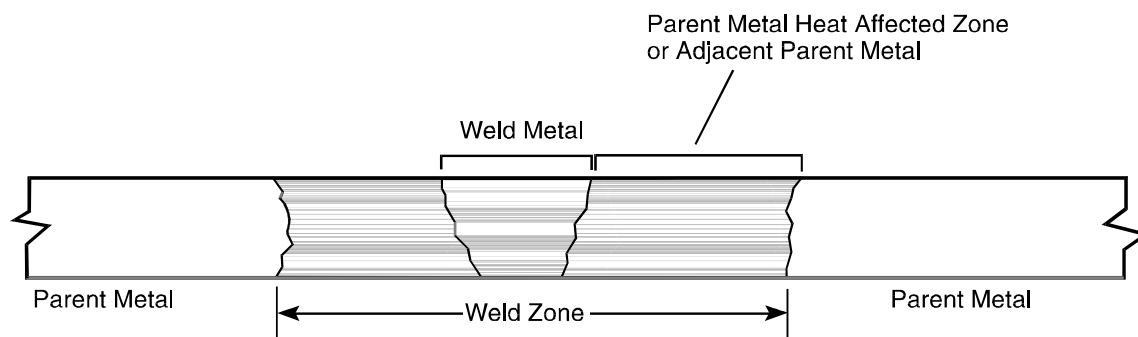

Figure 8.2.1. Schematic diagram of weld and parent metal.

8.2.2.1 Fusion Welding—Arc and Gas — Section 9.4.2 contains a detailed discussion of one acceptable method of establishing fusion welding allowables. As stated in that section, other methods can be employed as approved by certifying agencies. The following subsections contain specific information for a number of materials.

8.2.2.1.1 Strength of Fusion Welded Joints of Steel Alloys — Allowable fusion weld-metal strengths of steel alloys are shown in Table 8.2.2.1.1(a). Design allowable stresses for the weld metal are based on 85 percent of the respective minimum tensile ultimate test values.

For steel joints welded after heat treatment, the allowable strengths near the weld are given in Tables 8.2.2.1.1(b) and (c).

Table 8.2.2.1.1(a). Strength of Fusion Welded Joints of Steel Alloys

Material	Heat Treatment Subsequent to Welding	Welding Rod or Electrode	F_{su} , ksi	F_{tu} , ksi
Carbon and alloy steels . . .	None	AMS 6457	32	51
		AWSA5.1 classes E6010 and E6013	32	51
Alloy steels	None	AMS 6452	43	72
Alloy steels	Stress relieved	AWSA5.5 class E10013 MIL-E-22200/10, classes MIL-10018-M1	50	85

Table 8.2.2.1.1(b). Allowable Ultimate Tensile Stresses Near Fusion Welds in 4130, 4140, or 8630 Steels^a

Section Thickness ¼ inch or less	
Type of Joint	Ultimate Tensile Stress, ksi
Tapered joints of 30° or less ^b	90
All others	80

- a Welded after heat treatment or normalized after weld.
- b Gussets or plate inserts considered 0° taper with centerline.

Table 8.2.2.1.1(c). Allowable Bending Modulus of Rupture Near Fusion Weld in 4130, 4140, 4340, or 8630 Steels^a

Type of Joint	Bending Modulus of Rupture, ksi
Tapered joints of 30° or less ^b	F_b from Figure 2.8.1.1 for $F_{tu} = 90$ ksi
All others	0.9 of the values of F_b from Figure 2.8.1.1 for $F_{tu} = 90$ ksi

- a Welded after heat treatment or normalized after weld.
- b Gussets or plate inserts considered 0° taper with centerline.

For materials heat treated after welding, the allowable strength in the parent metal near a welded joint may equal the allowable strength for the material in the heat treated condition as given in the tables of design mechanical properties of the specific alloys; however, it should be noted that the weld metal allowables are based on 85 percent of these values.

8.2.2.2 Flash and Pressure Welding — The ultimate tensile allowable strength and bending allowable modulus of rupture for flash and pressure welds are given in Tables 8.2.2.2(a) and (b). A higher efficiency may be permitted in special cases by the applicable procuring or certifying agency upon approval of the manufacturer's process specification.

8.2.2.3 Spot and Seam Welding — Permission to use spot and seam welding on structural parts is governed by the requirements of the procuring or certifying agency. Table 8.2.2.3 gives the recommended allowable edge distance for spot and seam welds.

8.2.2.3.1 Design Shear Strengths for Spot and Seam Welds in Uncoated Steels and Nickel and Cobalt Alloys — The design shear strength for spot welds for these materials are given in Tables 8.2.2.3.1(a) and (b). The thickness ratio of the thickest sheet to the thinnest outer sheet in the combination should not exceed 4:1.

8.2.2.3.1.1 Effects of Spot-Welds on the Parent Metal Strength of 300 Series Stainless Steel — In applications of spot welding where ribs, intercostals, or doublers are attached to sheet, either at splices or at other joints on the sheet panels, the allowable ultimate strength of the spot-welded stainless steel sheet will be determined by multiplying the ultimate tensile strength of the sheet (A or S-value) by the appropriate efficiency factors shown in Figures 8.2.2.3.1.1(a) through (c). Efficiencies for gages under 0.012 will be determined by test.

8.2.2.3.2 Design Shear Strengths for Spot and Seam Weldings in Aluminum Alloys — The acceptable aluminum and aluminum alloy combinations for spot and seam welding are given in Table 8.2.2.3.2(a).

Design shear-strength for spot welds in aluminum alloys are given in Tables 8.2.2.3.2(b) and (c). The thickness ratio of the thickest to the thinnest outer sheet in the combination should not exceed 4:1.

Design shear-strength for spot-welded joints, based on tearing of the sheet, is given in Table 8.2.2.3.2(d) for some aluminum alloys, together with the "maximum" pitches that permit attainment of these strengths. Joints having larger pitches fail in the spot welds rather than by tearing of the sheet, and are governed by Tables 8.2.2.3.2(b) and (c). The design shear strengths listed are also applicable to seam welds.

8.2.2.3.2.1 Effects of Spot Welds on Parent Metal Strength of Aluminum Alloys — In applications of spot welding other than splices, where ribs, intercostals, or doublers are attached to sheet, the allowable ultimate strength of the spot-welded sheet may be determined by multiplying the ultimate tensile strength of the sheet (A or S-values) by the appropriate efficiency factor shown on Figure 8.2.2.3.2.1. Efficiencies for gages under 0.020 will be determined by test.

8.2.2.3.2.2 Fatigue Strength of Spot-Welded Joints in Aluminum Alloys — The fatigue strength of spot-welded joints in aluminum alloy are given in Figures 8.2.2.3.2.2(a) through 8.2.2.3.2.2(e).

MIL-HDBK-5J
31 January 2003

8.2.2.3.3 Design Shear Strengths for Spot and Seam Welds in Magnesium Alloys— Design shear-strength for spot welds in magnesium alloys are given in Table 8.2.2.3.3. The thickness ratio of the thickest sheet to the thinnest outer sheet in the combination should not exceed 4:1.

8.2.2.3.4 Design Shear Strengths for Spot and Seam Welds in Titanium and Titanium Alloys— Design shear strength for spot welds in titanium and titanium alloys are given in Tables 8.2.2.3.4(a) and (b). The thickness ratio of the thickest sheet to the thinnest outer sheet in the combination should not exceed 4:1.

Table 8.2.2.2(a). Allowable Ultimate Tensile Stress for Flash Welds in Steel Tubing

Tubing	Allowable Ultimate Tensile Stress of Welds
Normalized tubing — not heat treated (including normalizing) after welding	1.0 F_{tu} (based on F_{tu} of normalized tubing)
Heat-treated tubing welded after heat treatment	1.0 F_{tu} (based on F_{tu} of normalized tubing)
Tubing heat treated (including normalizing) after welding. F_{tu} of unwelded material in heat-treated condition:	
< 100 ksi	0.9 F_{tu}
100 to 150 ksi	0.6 F_{tu} + 30
> 150 ksi	0.8 F_{tu}

Table 8.2.2.2(b). Allowable Bending Modulus of Rupture for Flash Welds in Steel Tubing

Tubing	Allowable Bending Modulus of Rupture of Welds (F_b from Figure 2.8.1.1 using values of F_{tu} listed)
Normalized tubing — not heat treated (including normalizing after welding)	1.0 F_{tu} (based on F_{tu} of normalized tubing)
Heat-treated tubing welded after heat treatment	1.0 F_{tu} (based on F_{tu} of normalized tubing)
Tubing heat treated (including normalizing) after welding. F_{tu} of unwelded material in heat-treated condition:	
< 100 ksi	0.9 F_{tu}
100 to 150 ksi	0.6 F_{tu} + 30
> 150 ksi	0.8 F_{tu}

Table 8.2.2.3. Recommended Minimum Edge Distance and Spacing for Spot-Welded Joints^a

Nominal Thickness ^b of Thinner Sheet, inch	Minimum Lap Joint ^{c,d} Edge Distance, inch	Minimum Spacing ^e , inch
0.016	0.19	0.19
0.020	0.20	0.30
0.025	0.22	0.38
0.032	0.25	0.46
0.040	0.28	0.52
0.050	0.31	0.58
0.063	0.38	0.67
0.071	0.41	0.73
0.080	0.44	0.79
0.090	0.47	0.89
0.100	0.50	1.00
0.125	0.56	1.25
0.160	0.69	1.60

- a Reference Aluminum Association and American Welding Society Handbook.
- b Intermediate gages will require interpolation between adjacent gages.
- c Edge distances are measured materials in contact; this can be to a free edge or to a sheet metal radius where one material bends away from another. Edge distances less than those specified above may be used provided there is no expulsion of weld material or bulging of the edge of the sheet; however, these joints may have less static strength and shorter fatigue life.

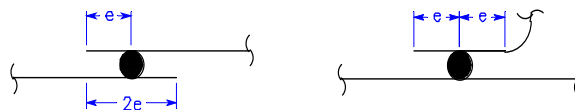

- d Minimum contacting overlap is twice the minimum edge distance.
- e Less than minimum recommended spacing may cause shunting that leads to deterioration of weld strengths and joint life.

Table 8.2.2.3.1(a). Spot-Weld Design Shear Strength^{a,b} in Thin Sheet and Foil for Uncoated Steels^c and Nickel and Cobalt Alloys (Welding Specification MIL-W-6858)

Thickness of Thinnest Outer Sheet, in.	Spots/inch		Material Ultimate Tensile Strength, ksi			
	Standard (Ns) ^d	Range ^{e,f}	Above 185	150 to 185	90 to 149	Below 90
			Design Shear Strength, pounds per linear inch (Xm)			
0.001	40	1-50	72	64	52	36
0.002	20	1-30	144	128	104	72
0.003	12	1-17	240	208	164	120
0.004	10	1-14	324	280	228	152
0.005	9	1-13	392	340	272	188
0.006	7	1-10	432	380	304	220
0.007	6	1-8	504	440	352	256
0.008	5	1-7	552	488	392	284

- a Strength based on 80 percent of minimum values specified in Specification MIL-W-6858.
b The allowable tensile strength of spot-welds is 25 percent of the design shear strength. Higher values may be used, however, if these are substantiated by tests acceptable to the procuring or certifying agency.
c Refers to plain carbon steels containing not more than 0.15 percent carbon, austenitic, heat and corrosion resistant, and precipitation hardening steels. The reduction in strength of spot-welds due to the cumulative effects of time-temperature-stress factors is not greater than the reduction in strength of the parent metal.
d When the number of spots per inch is within 15 percent of the standard spot per inch requirement, the design shear strengths tabulated above will apply.
e When the number of spots differs from the standard spots per inch by 15 percent or greater, but does not exceed the noted range of spots per inch, applicable design strength will be determined as noted below:

$$\frac{X_m}{N_s} (K) N_r = X_r$$

where

- X_m = design shear strength in accordance with the above table
N_s = standard spots per inch in accordance with the above table
N_r = required spots per inch (production part)
X_r = actual design shear strength requirement
K = 1.15 when number of spots per inch is reduced more than 15 percent of the standard spacing of the above table
K = 0.90 when number of spots is increased more than 15 percent of the standard spacing but within range of the tabular spacing.

- f When the number of spots per inch is above the range indicated in the table, the design shear strength will remain constant at the value obtained at the top of the range.

Table 8.2.2.3.1(b). Spot-Weld Design Shear Strength^{a,b} in Panels for Uncoated Steels^c and Nickel and Cobalt Alloys (Welding Specification MIL-W-6858)

Material Ultimate Tensile Strength, ksi	Design Shear Strength, pounds per spot			
	Above 185	150 to 185	90 to 149	Below 90
Nominal thickness of thinner sheet, in.:				
0.009.....	160	140	104	80
0.010.....	196	164	128	92
0.012.....	280	220	160	120
0.016.....	384	320	236	172
0.018.....	472	392	272	200
0.020.....	508	424	312	224
0.022.....	584	488	360	264
0.025.....	696	580	424	320
0.028.....	820	684	508	372
0.032.....	1000	836	620	452
0.036.....	1200	1004	736	552
0.040.....	1400	1168	852	652
0.045.....	1680	1436	1028	804
0.050.....	1960	1700	1204	956
0.056.....	2304	2040	1416	1168
0.063.....	2840	2472	1688	1408
0.071.....	3360	2984	2028	1664
0.080.....	3880	3528	2404	1964
0.090.....	4480	4072	2812	2308
0.100.....	5040	4576	3200	2640
0.112.....	5600	5092	3636	3036
0.125.....	6228	5664	4052	3440

- a Strength based on 80 percent of minimum values specified in Specification MIL-W-6858.
- b The allowable tensile strength of spot-welds is 25 percent of the design shear strength. Higher values may be used, however, if these are substantiated by tests acceptable to the procuring or certifying agency.
- c Refers to plain carbon steels containing not more than 0.15 percent carbon and to austenitic heat and corrosion resistant, precipitation hardening steels. The reduction in strength of spot-welds due to the cumulative effects of time-temperature-stress factors is not greater than the reduction in strength of the parent metal.

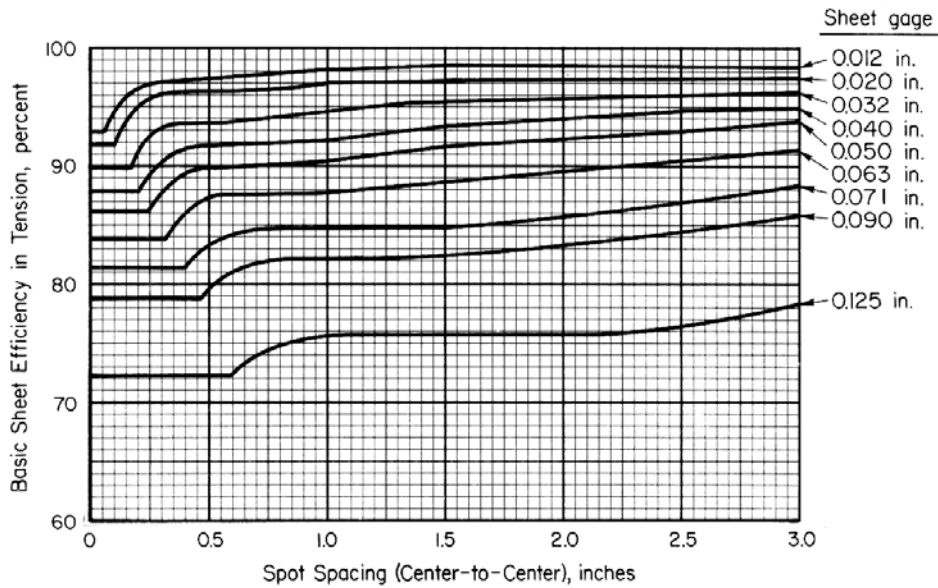

Figure 8.2.2.3.1.1(a). Efficiency of the parent metal in tension for spot-welded AISI 301-A, and AISI 347-A, and AISI 301-1/4 stainless steel.

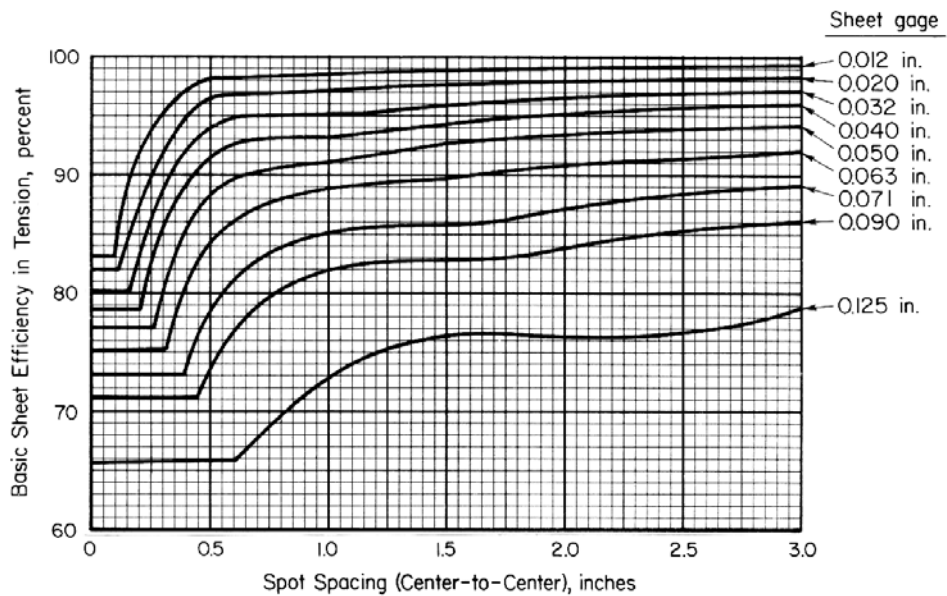

Figure 8.2.2.3.1.1(b). Efficiency of the parent metal in tension for spot-welding AISI 301-1/2H stainless steel.

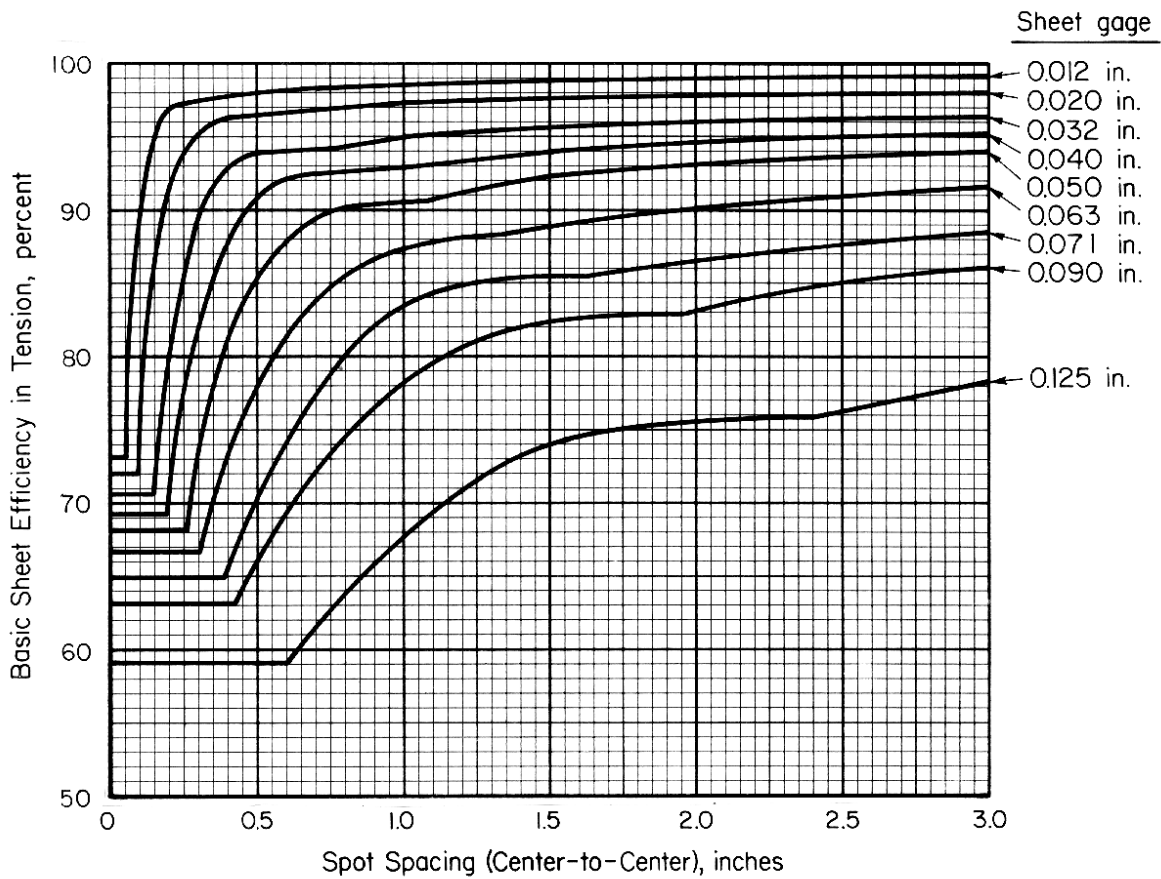

Figure 8.2.2.3.1.1(c). Efficiency of the parent metal in tension for spot-welded AISI 301-H stainless steel.

Table 8.2.2.3.2(a). Acceptable Aluminum and Aluminum Alloy Combination^a for Spot and Seam Welding

Specification	Material	AMS- QQ-A- 250/1	AMS- 4029 ^b	AMS- QQ-A- 250/3	AMS- QQ-A- 250/4 ^b	AMS- QQ-A- 250/5	AMS- QQ-A- 250/8	AMS- QQ-A- 250/11	AMS- QQ-A- 250/12 ^b	AMS- QQ-A- 250/13 ^c
Specification	Material	AMS- QQ-A- 250/1	AMS- 4029 ^b	AMS- QQ-A- 250/3	AMS- QQ-A- 250/4 ^b	AMS- QQ-A- 250/5	AMS- QQ-A- 250/8	AMS- QQ-A- 250/11	AMS- QQ-A- 250/12 ^b	AMS- QQ-A- 250/13 ^c
AMS-QQ-A-250/1	1100	...	Bare 2014	Clad 2014	Bare 2024	Clad 2024	5052	6061	Bare 7075	Clad 7075
AMS-4029	Bare 2014 ^b	...	Bare 2014	Clad 2014	Bare 2024 ^b	Clad 2024	3003	3003	3003	3003
AMS-QQ-A-250/3	Clad 2014	...	Bare 2014	Clad 2014	Bare 2024 ^b	Clad 2024	5052	6061	Bare 7075 ^b	Clad 7075 ^b
AMS-QQ-A-250/4	Bare 2024 ^b	...	Bare 2014	Clad 2014	Bare 2024 ^b	Clad 2024	3003	3003	3003	3003
AMS-QQ-A-250/5	Clad 2024	...	Bare 2014	Clad 2014	Bare 2024 ^b	Clad 2024	5052	6061	Bare 7075 ^b	Clad 7075 ^b
AMS-QQ-A-250/2	3003	...	Bare 2014	Clad 2014	Bare 2024 ^b	Clad 2024	5052	6061	Bare 7075 ^b	Clad 7075 ^b
AMS-QQ-A-250/8	5052	...	Bare 2014	Clad 2014	Bare 2024 ^b	Clad 2024	3003	3003	3003	3003
AMS-QQ-A-250/11	6061	...	Bare 2014	Clad 2014	Bare 2024 ^b	Clad 2024	5052	6061	Bare 7075 ^b	Clad 7075 ^b
AMS-QQ-A-250/12	Bare 7075 ^b	...	Bare 2014	Clad 2014	Bare 2024 ^b	Clad 2024	3003	3003	3003	3003
AMS-QQ-A-250/13	Clad 7075 ^b	...	Bare 2014	Clad 2014	Bare 2024 ^b	Clad 2024	5052	6061	Bare 7075 ^b	Clad 7075 ^b

a The various aluminum and aluminum-alloy materials referred to in this table may be spot-welded in any combinations except the combinations indicated by the asterisk(*) in the table. The combinations indicated by the asterisk (*) may be spot-welded only with the specific approval of the procuring or certifying agency.
b This table applies to construction of land- and carrier-based aircraft only. The welding of bare, high-strength alloys in construction of seaplanes and amphibians is prohibited unless specifically authorized by the procuring or certifying agency.
c Clad heat-treated and aged 7075 material in thicknesses less than 0.020 inch will not be welded without specific approval of the procuring or certifying agency.

Table 8.2.2.3.2(b). Spot-Weld Design Shear Strength in Thin Sheet and Foil for Bare and Clad Aluminum Alloys^{a,b,c} (Welding Specification MIL-W-6858)

Thickness of Thinnest Outer Sheet, in.	Spots/inch		Material Ultimate Tensile Strength, ksi	
	Standard (Ns) ^d	Range ^{e,f}	56 and Above	Below 56
			Design Shear Strength, pounds per linear inch (Xm)	
0.001.....	40	1-50	24	16
0.002.....	20	1-30	48	32
0.003.....	12	1-17	80	52
0.004.....	10	1-14	108	72
0.005.....	9	1-13	132	92
0.006.....	7	1-10	148	100
0.007.....	6	1-8	168	112
0.008.....	5	1-7	188	128

- a The reduction in strength of spot-welds due to the cumulative effects of time-temperature-stress factors is not greater than the reduction in strength of the parent metal.
- b Strength based on 80 percent of minimum values specified in Specification MIL-W-6858.
- c The allowable tensile strength of spot-welds is 25 percent of the design shear strength. Higher values may be used, however, if these are substantiated by tests acceptable to the procuring or certifying agency.
- d When the number of spots per inch is within 15 percent of the standard spot per inch requirement, the design shear strengths tabulated above will apply.
- e When the number of spots differs from the standard spots per inch by 15 percent or greater, but does not exceed the noted range of spots per inch, applicable design strength will be determined as noted below:

$$\frac{Xm}{Ns} (K) Nr = Xr$$

where

- Xm = design shear strength in accordance with the above table
- Ns = standard spots per inch in accordance with the above table
- Nr = required spots per inch (production part)
- Xr = actual design shear strength requirement
- K = 1.15 when number of spots per inch is reduced more than 15 percent of the standard spacing of the above table
- K = 0.90 when number of spots is increased more than 15 percent of the standard spacing but within range of the tabular spacing.

- f When the number of spots per inch is above the range indicated in the table, the design shear strength will remain constant at the value obtained at the top of the range.

Table 8.2.2.3.2(c). Spot-Weld Design Shear Strength in Panels for Bare and Clad Aluminum Alloys^{a,b,c} (Welding Specification MIL-W-6858)

Material Ultimate Tensile Strength, ksi...	Design Shear Strength, pounds per spot			
	56 and Above	35 to 56	19.5 to 34.9	Below 19.5
Nominal thickness of thinner sheet, in.:				
0.010	48	40
0.012	60	52	24	16
0.016	88	80	56	40
0.018	100	92	68	52
0.020	112	108	80	64
0.022	128	124	96	76
0.025	148	140	116	88
0.028	172	164	140	108
0.032	208	188	168	132
0.036	244	220	204	156
0.040	276	248	240	180
0.045	324	296	280	208
0.050	372	344	320	236
0.056	444	412	380	272
0.063	536	488	456	316
0.071	660	576	516	360
0.080	820	684	612	420
0.090	1004	800	696	476
0.100	1192	936	752	540
0.112	1424	1072	800	588
0.125	1696	1300	840	628
0.140	2020	1538
0.160	2496	1952
0.180	2980	2400
0.190	3228	2592
0.250	5880	5120

- a The reduction in strength of spot-welds due to the cumulative effects of time-temperature-stress factors is not greater than the reduction in strength of the parent metal.
- b Strength based on 80 percent of minimum values specified in Specification MIL-W-6858.
- c The allowable tensile strength of spot-welds is 25 percent of the design shear strength. Higher values may be used, however, if these are substantiated by tests acceptable to the procuring or certifying agency.

Table 8.2.2.3.2(d). Maximum Static Strength of Spot-Welded Joints in Aluminum Alloys and Corresponding Maximum Design Spot-Weld Pitch^{a,b}

Material..... Thickness of Thinnest Sheet, in.	Single Row Joints						Multiple Row Joints					
	7075-T6 clad		2024-T3 clad		6061-T6		7075-T6 clad		2024-T3 clad		6061-T6	
	Strength, lbs/in.	Pitch, in.	Strength, lbs/in.	Pitch, in.	Strength, lbs/in.	Pitch, in.	Strength, lbs/in.	Pitch of Rows, in.	Strength, lbs/in.	Pitch-No. of Rows, in.	Strength, lbs/in.	Pitch-No. of Rows, in.
0.010.....	288	0.167	250	0.192	210	0.190	438	0.110	384	0.125	329	0.122
0.012.....	346	0.173	300	0.200	252	0.206	526	0.114	461	0.130	395	0.132
0.016.....	461	0.191	400	0.220	336	0.238	701	0.126	614	0.143	526	0.152
0.020.....	577	0.194	500	0.224	420	0.257	876	0.128	768	0.146	658	0.164
0.025.....	721	0.205	625	0.237	525	0.267	1095	0.135	960	0.154	822	0.170
0.032.....	923	0.225	800	0.260	672	0.280	1402	0.148	1229	0.169	1053	0.179
0.040.....	1059	0.261	918	0.301	778	0.319	1752	0.158	1536	0.180	1316	0.188
0.050.....	1230	0.302	1067	0.349	910	0.378	2190	0.170	1920	0.194	1645	0.209
0.063.....	1452	0.369	1259	0.426	1082	0.451	2759	0.194	2419	0.222	2073	0.235
0.071.....	1589	0.415	1378	0.479	1187	0.485	3110	0.212	2726	0.242	2336	0.247
0.080.....	1742	0.471	1511	0.543	1306	0.524	3504	0.234	3072	0.267	2632	0.260
0.090.....	1913	0.525	1660	0.605	1438	0.556	3942	0.255	3456	0.290	2961	0.270
0.100.....	2084	0.572	1808	0.659	1580	0.596	4380	0.272	3840	0.310	3290	0.284
0.112.....	2289	0.622	1986	0.717	1728	0.620	4906	0.290	4301	0.331	3685	0.291
0.125.....	2511	0.675	2179	0.788	1900	0.684	5475	0.310	4800	0.353	4112	0.316

a For multiple row joints row spacing is at minimum and same pitch in all rows.

b For pitches greater than those shown, strength is governed by Tables 8.2.2.3.2(b) and (c).

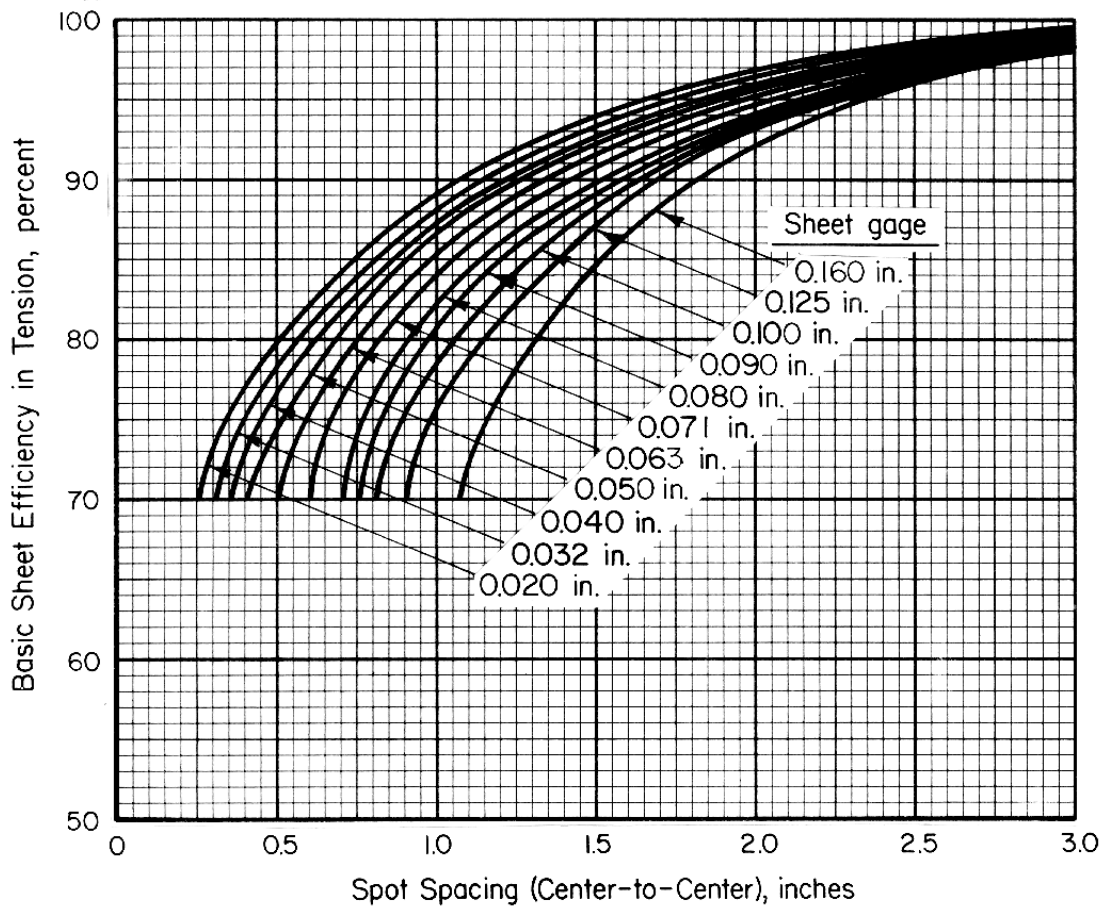

Figure 8.2.2.3.2.1. Efficiency of the parent metal in tension for spot-welded aluminum alloys.

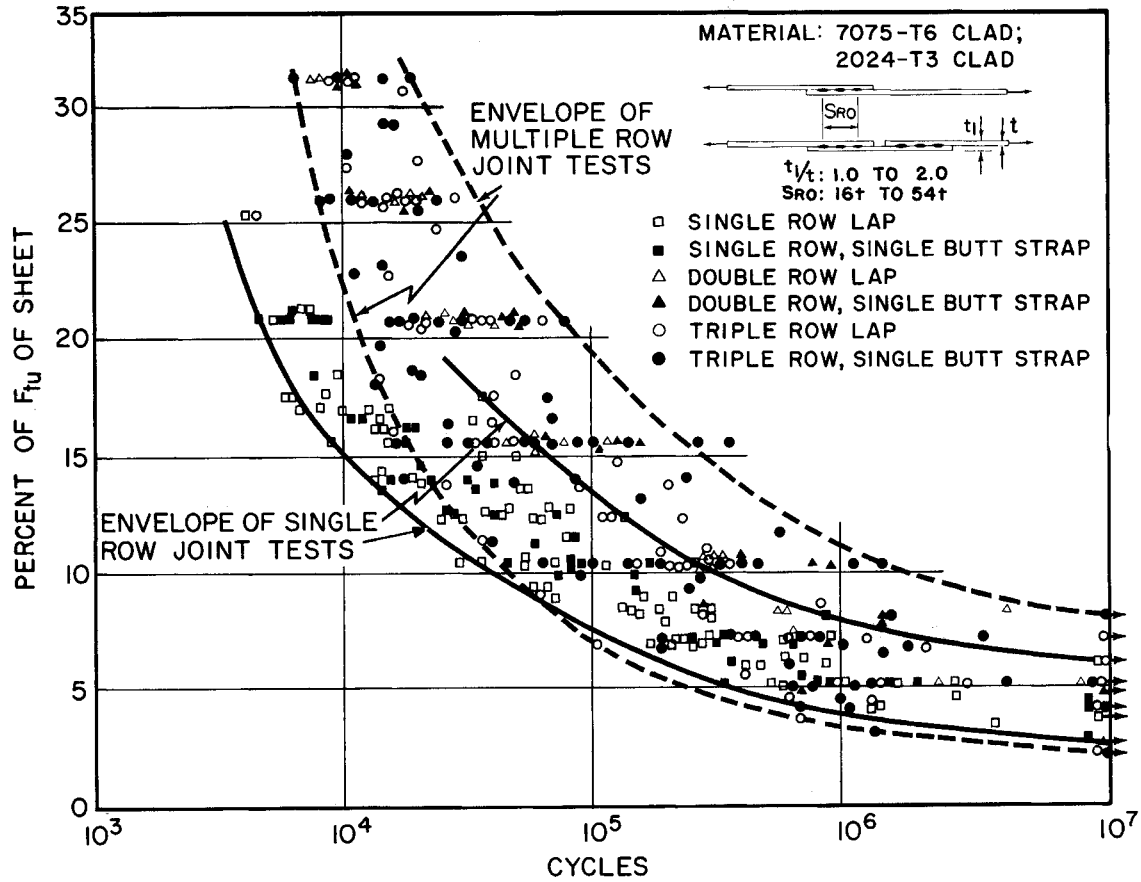

Figure 8.2.2.3.2.2(a). Fatigue strength of spot-welded joints in aluminum alloy sheet. Load Ratio = 0.05 (static failure by tearing sheet).

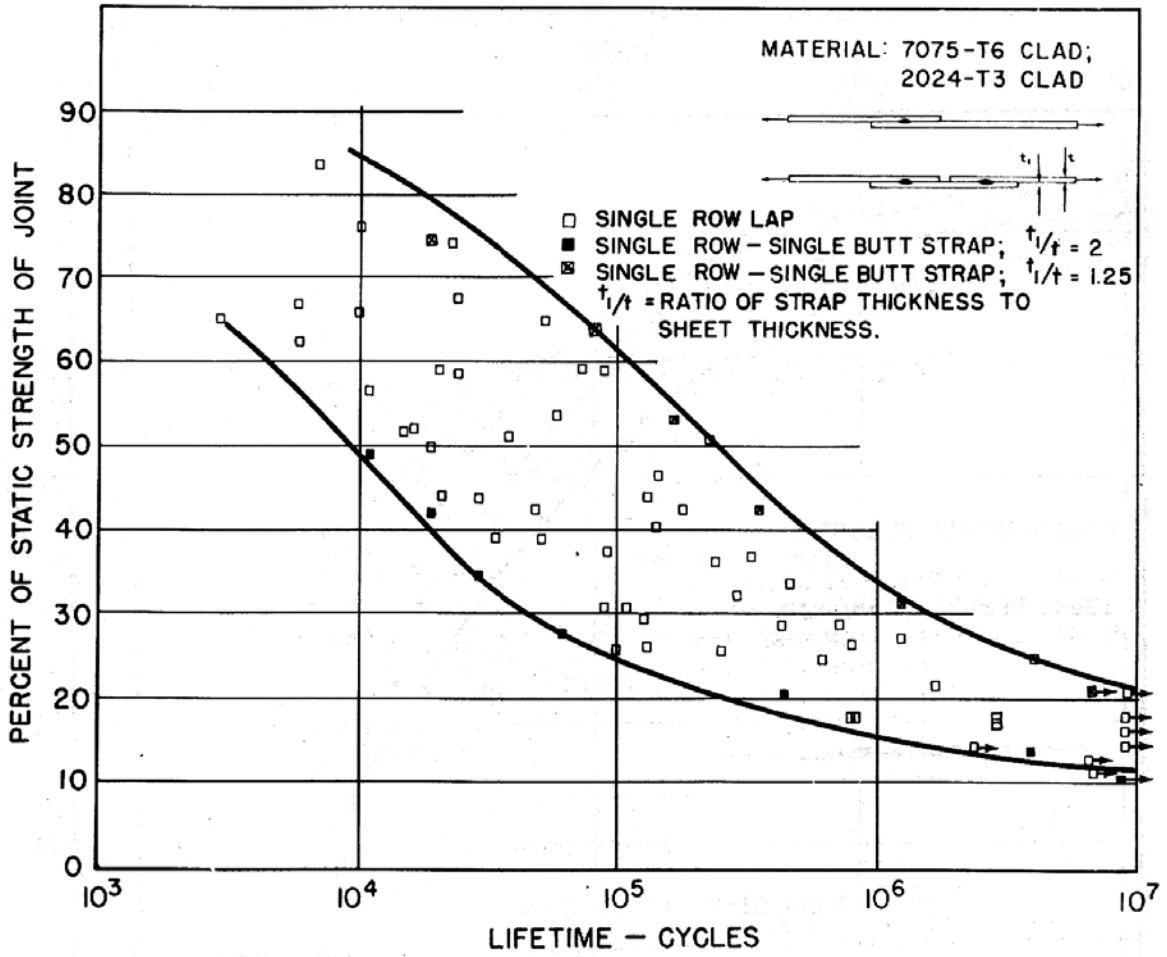

Figure 8.2.2.3.2.2(b). Fatigue strength of spot-welded joints in aluminum alloy sheet. Load Ratio = 0.05 (static failure by shear in the spot welds).

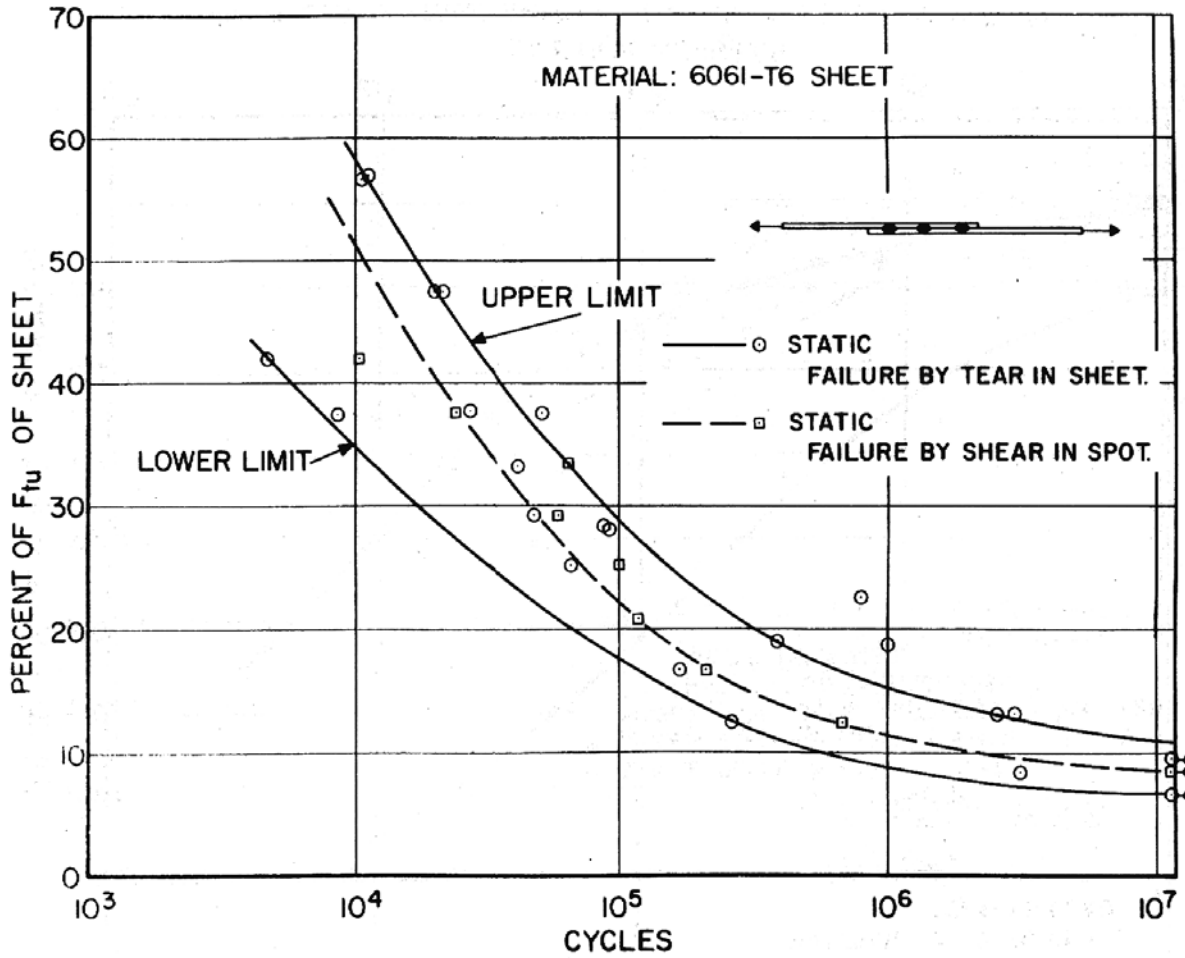

Figure 8.2.2.3.2.2(c). Fatigue strength of triple row spot-welded lap joints in 6061-T6 aluminum alloy sheet. Load Ratio = 0.05.

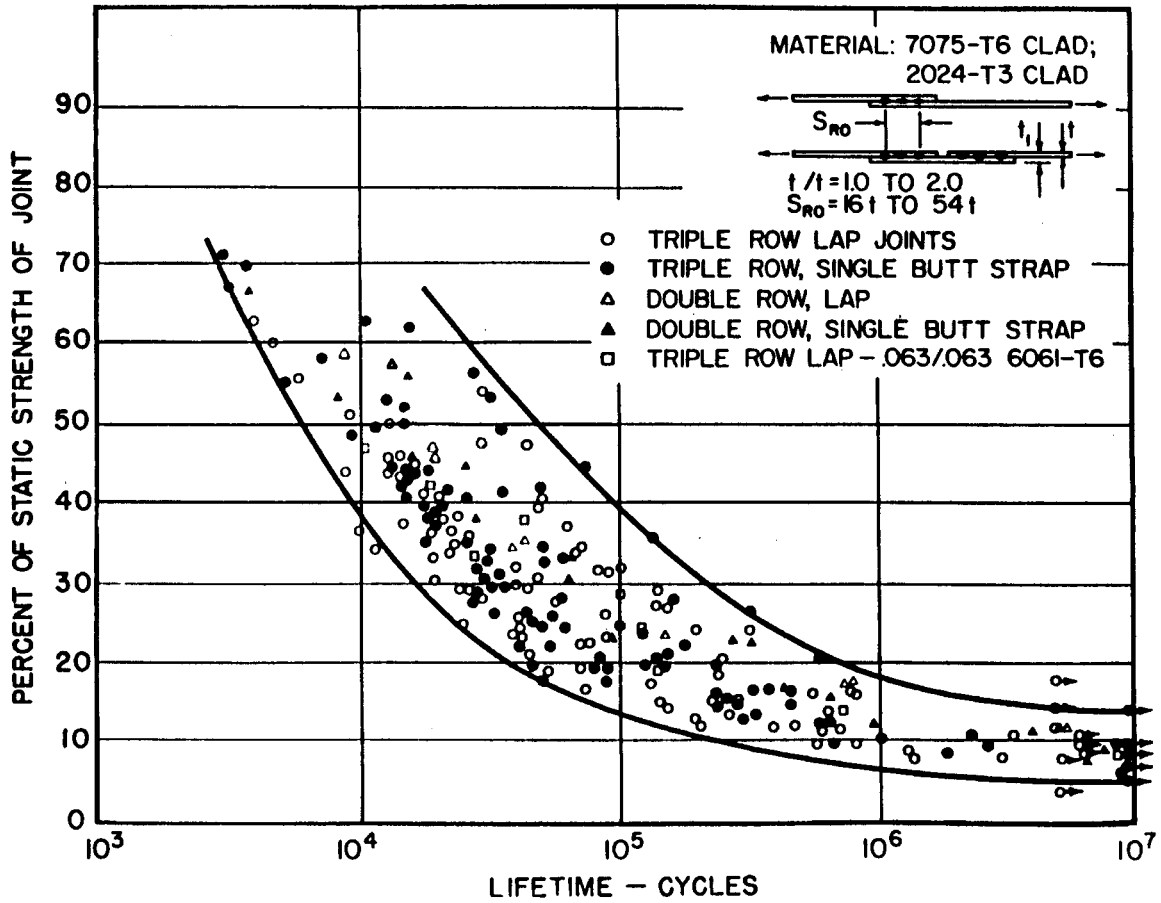

Figure 8.2.2.3.2.2(d). Fatigue strength of spot-welded multiple row joints in aluminum alloy sheet. Load Ratio = 0.05 (static failure by shear in the spot welds).

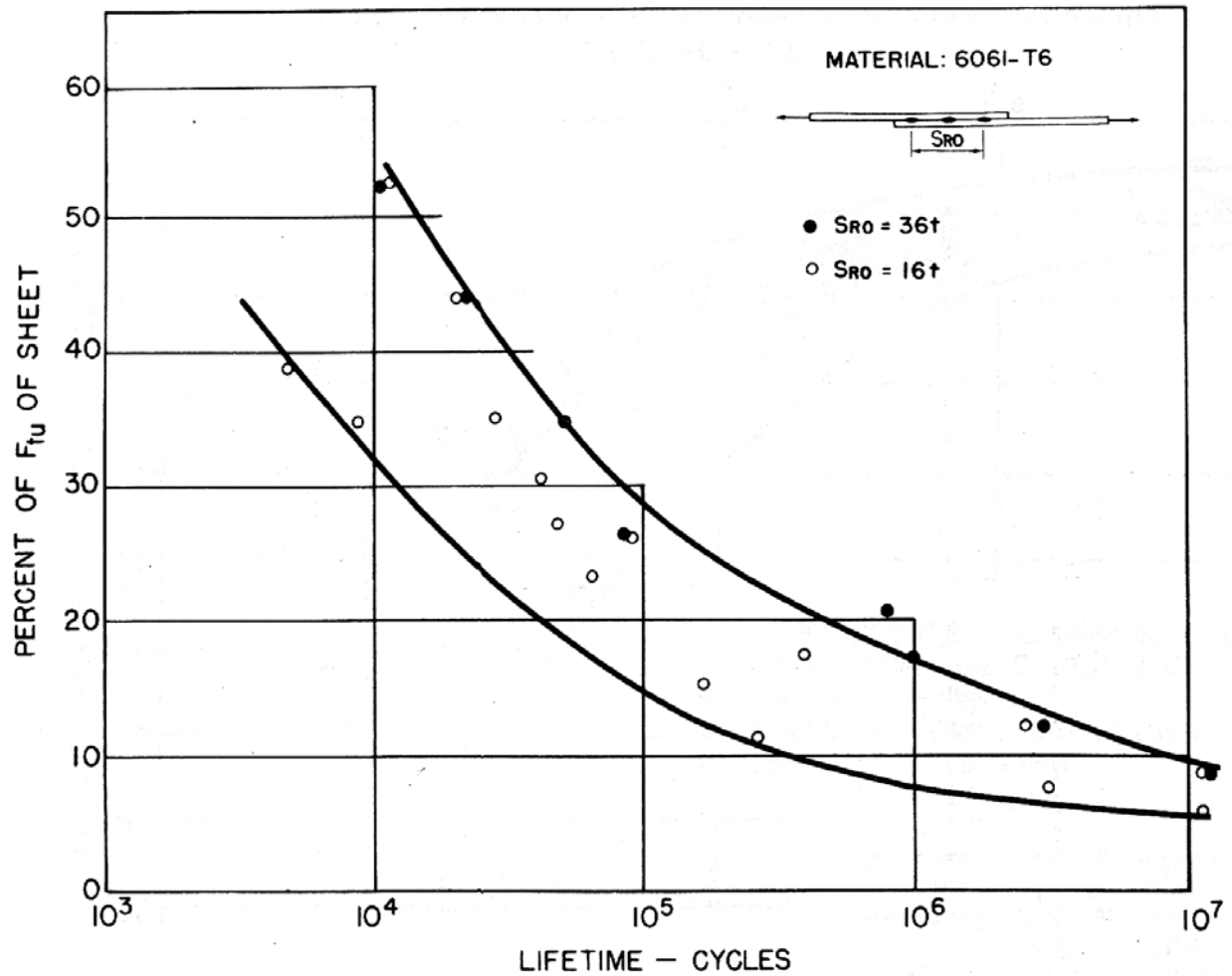

Figure 8.2.2.3.2.2(e). Fatigue strength of triple row spot-welded lap joints in 6061-T6 aluminum alloy sheet. Load Ratio = 0.05 (static failure by tear in sheets).

Table 8.2.2.3.3. Spot-Weld Design Shear Strength in Panels for Magnesium Alloys^{a,b,c} (Welding Specification MIL-W-6858)

Material Ultimate Tensile Strength, ksi...	Design Shear Strength, pounds per spot	
	Greater than 19.5	Less than 19.5
Nominal thickness of thinner sheet, in.:		
0.012	24	16
0.016	56	40
0.018	68	52
0.020	80	64
0.022	96	76
0.025	116	88
0.028	140	108
0.032	168	132
0.036	204	156
0.040	240	180
0.045	280	208
0.050	320	236
0.056	380	272
0.063	456	316
0.071	516	360
0.080	612	420
0.090	696	476
0.100	752	540
0.112	800	588
0.125	840	628

- a Strength based on 80 percent of minimum values specified in Specification MIL-W-6858.
- b The allowable tensile strength of spot-welds is 25 percent of the design shear strength. Higher values may be used, however, if these are substantiated by tests acceptable to the procuring or certifying agency.
- c Magnesium alloys AZ31B and HK31A may be spot-welded in any combination.

Table 8.2.2.3.4(a). Spot-Weld Design Shear Strength in Thin Sheet and Foils for Titanium and Titanium Alloys^{a,b,c} (Welding Specification MIL-W-6858)

Thickness of Thinnest Outer Sheet, in.	Spots/inch		Materials Ultimate Tensile Strength, ksi			
	Standard (Ns) ^d	Range ^{e,f}	Above 185	150 to 185	90 to 149	Below 90
			Design Shear Strength, pounds per linear inch (Xm)			
0.001	40	1-50	72	64	52	36
0.002	20	1-30	144	128	104	72
0.003	12	1-17	240	208	164	120
0.004	10	1-14	324	280	228	152
0.005	9	1-13	392	340	272	188
0.006	7	1-10	432	380	304	220
0.007	6	1-8	504	440	352	256
0.008	5	1-7	552	488	392	284

- a The reduction in strength of spot-welds due to the cumulative effects of time-temperature-stress factors is not greater than the reduction in strength of the parent metal.
- b Strength based on 80 percent of minimum values specified in Specification MIL-W-6858.
- c The allowable tensile strength of spot-welds is 25 percent of the design shear strength. Higher values may be used, however, if these are substantiated by tests acceptable to the procuring or certifying agency.
- d When the number of spots per inch is within 15 percent of the standard spot per inch requirement, the design shear strengths tabulated above will apply.
- e When the number of spots differs from the standard spots per inch by 15 percent or greater, but does not exceed the noted range of spots per inch, applicable design strength will be determined as noted below:

$$Xm/Ns(K)Nr = Xr$$

where

- Xm = design shear strength in accordance with the above table
- Ns = standard spots per inch in accordance with the above table
- Nr = required spots per inch (production part)
- Xr = actual design shear strength requirement
- K = 1.15 when number of spots per inch is reduced more than 15 percent of the standard spacing of the above table
- K = 0.90 when number of spots is increased more than 15 percent of the standard spacing but within range of the tabular spacing.

- f When the number of spots per inch is above the range indicated in the table, the design shear strength will remain constant at the value obtained at the top of the range.

Table 8.2.2.3.4(b). Spot-Weld Design Shear Strength in Panels for Titanium and Titanium Alloy^{a,b,c} (Welding Specification MIL-W-6858)

Material Ultimate Tensile Strength, ksi	Design Shear Strength, pounds per spot	
	Above 100	100 and Below
Nominal thickness of thinner sheet, in.:		
0.010	164	128
0.012	220	160
0.016	320	236
0.018	392	272
0.020	424	312
0.022	488	360
0.025	580	424
0.028	684	508
0.032	836	620
0.036	1004	736
0.040	1168	852
0.045	1438	1028
0.050	1702	1204
0.056	2040	1416
0.063	2400	1688
0.071	2702	1914
0.080	3048	2160
0.090	3430	2435
0.100	3810	2702
0.112	4260	3030
0.125	4760	3380

- a The reduction in strength of spot-welds due to the cumulative effects of time-temperature-stress factors is not greater than the reduction in strength of the parent metal.
- b Strength based on 80 percent of minimum value specified in Specification MIL-W-6858.
- c The allowable tensile strength of spot-wells is 25 percent of the design shear strength. Higher values may be used, however, if these are substantiated by tests acceptable to the procuring or certifying agency.

8.2.3 BRAZING

8.2.3.1 Copper Brazing — The allowable shear strength for copper brazing of steel alloys will be 15 ksi, for all conditions of heat treatment. Higher values may be allowed upon approval of the procuring or certifying agency.

The effect of the brazing process on the strength of the parent or base metal of steel alloys will be considered in the structural design. Where copper furnace brazing is employed, the calculated allowable strength of the base metal which is subjected to the temperatures of the brazing process will be in accordance with the following:

Material	Allowable Strength
Heat-treated material (including normalized) used in "as-brazed" condition	Mechanical properties of normalized material
Heat-treated material (including normalized) reheat-treated during or after brazing	Mechanical properties corresponding to heat treatment performed

8.2.3.2 Silver Brazing — Silver-brazed areas should not be subjected to temperatures exceeding 900°F. Silver brazing alloys are listed in specification QQ-B-654. Deviation from this specification may be allowed upon approval of the procuring or certifying agency.

The allowable shear strength for silver brazing of steel alloys will be 15 ksi, provided that clearances or gaps between parts to be brazed do not exceed 0.010 in. Deviation from this specified allowable value may be allowed upon approval of the procuring or certifying agency.

The effect of silver brazing on the strength of the parent or base metal is the same as shown for copper brazing in Section 8.2.3.1.

8.3 BEARINGS, PULLEYS, AND WIRE ROPE

Bearings — Design, strengths, selection criteria, and other data for plain and antifriction bearings are found in AFSC Design Handbook AFSC DH-2-1, Chapters 3 and 6.

Pulleys — Pulley strengths and design data are to be utilized in accordance with Specification MIL-P-7034.

Wire Rope — Strengths and design data for wire rope are to be selected from the following specifications, whichever is appropriate: MIL-W-83420 or MIL-W-87161.

REFERENCES

- 8.1 Hartman, E. C. and Westcoat, C., "The Shear Strength of Aluminum Alloy Driven Rivets as Affected by Increasing D/t Ratios," U.S. National Advisory Committee for Aeronautics, Technical Note No. 942, 23 pp (July 1944).
- 8.1.2.1 Fugazzi, G. R., "Results of Test Evaluation Program to Develop Design Joint Strength Load Allowable Values for A-286 Solid Rivets Under Room and Elevated Temperature Conditions," Almay Research and Testing Corporation Report No. G8058, 63 pp (November 1964).
- 8.1.2.2 "Report on Flush Riveted Joint Strength," Airworthiness Requirements Committee, A/C Industries Association of America, Inc., Airworthiness Project 12 (Revised May 25, 1948).
- 8.1.5.2 "Report on Flush Screw Joint Strength," Airworthiness Requirements Committee, A/C Industries Association of American, Inc., Airworthiness Project 20 (Revised April 6, 1953).

THIS PAGE INTENTIONALLY BLANK

CHAPTER 9

GUIDELINES FOR THE PRESENTATION OF DATA

This chapter contains Guidelines for judging adequacy of data, procedures for analyzing data in determining property values for inclusion in previous chapters, and formats for submitting results of analyses to the MIL-HDBK-5 Coordination Group for approval. The index that follows should be helpful in locating sections of these Guidelines applicable to specific properties:

Section	Description	Page
9.1	General Information	5
9.1.1	Introduction	5
9.1.2	Applicability	5
9.1.3	Approval Procedures	5
9.1.4	Documentation Requirements	5
9.1.5	Summary	6
9.1.6	Data Basis	8
9.1.7	Rounding Procedures	10
9.2	Material, Specification, Testing, and Data Requirements	11
9.2.1	Material Requirements	11
9.2.2	Specification Requirements	11
9.2.3	Required Test Methods/Procedures	11
9.2.3.1	Mechanical Property Terms	14
9.2.3.2	Testing Direction and Specimen Location	14
9.2.3.3	Tension, Compression, Shear and Bearing	15
9.2.3.4	Other Static Properties	16
9.2.3.5	Dynamic and Time Dependent Properties	17
9.2.3.6	Mechanically Fastened Joints	22
9.2.3.7	Fusion-Welded Joints	23
9.2.4	Data Requirements	24
9.2.4.1	S-Basis Values	24
9.2.4.2	A- and B-Basis Values	25
9.2.4.3	Derived Property Values	30
9.2.4.4	Other Static Properties	30
9.2.4.5	Dynamic and Time Dependent Properties	32
9.2.4.6	Mechanically Fastened Joints	36
9.2.4.7	Fusion-Welded Joints	40
9.2.5	Experimental Design	40
9.2.5.1	Fatigue	40
9.2.5.2	Creep and Creep Rupture	46
9.2.5.3	Fusion-Welded Joints	48
9.3	Submission of Data	50
9.3.1	Recommended Procedures	50

MIL-HDBK-5J
31 January 2003

Section	Description	Page
9.3.2	Computer Software	50
9.3.3	General Data Formats	50
9.3.3.1	Data Format for the Computation of T_{99} and T_{90} Values	51
9.3.3.2	Data Format for Derived Properties	51
9.3.3.3	Data Format for the Construction of Typical Stress-Strain Curves	55
9.3.3.4	Data Format for Fasteners	55
9.3.3.5	Data Format for Other Properties	56
9.4	Substantiation of S-Basis Minimum Properties	59
9.5	Analysis Procedures for Statistically Computed Minimum Static Properties .	60
9.5.1	Specifying the Population	60
9.5.1.1	Deciding Between Direct and Indirect Computation	60
9.5.1.2	Testing for Regression Effects and Homogeneity	63
9.5.2	Regression Analysis	64
9.5.2.1	Linear Regression	67
9.5.2.2	Quadratic Regression	68
9.5.2.3	Tests for Adequacy of a Regression	71
9.5.2.4	Tests for Equality of Several Regressions	74
9.5.3	Combinability of Data	77
9.5.3.1	The k-Sample Anderson-Darling Test	77
9.5.3.2	The F Test	79
9.5.3.3	The t Test	80
9.5.4	Determining the Form of Distribution	82
9.5.4.1	Anderson-Darling Test for Normality	82
9.5.4.2	Normal Probability Plot	83
9.5.4.3	Three-Parameter Weibull Acceptability Test	83
9.5.4.4	Anderson-Darling Test for Pearsonality	85
9.5.4.5	The Pearson Backoff Option	85
9.5.4.6	Pearson Probability Plot	86
9.5.4.7	Modified Anderson-Darling Test for Weibullness	89
9.5.4.8	Identifying Proper Backoff for Weibull Method	91
9.5.4.9	Weibull Probability Plots	92
9.5.5	Direct Computation Without Regression	94
9.5.5.1	Sequential Pearson Procedure	100
9.5.5.2	Sequential Weibull Procedure	102
9.5.5.3	Nonparametric Procedures	103
9.5.6	Direct Computation by Regression Analysis	104
9.5.6.1	Performing the Regression	104
9.5.7	Indirect Computation without Regression (Reduced Ratios/ Derived Properties)	106
9.5.7.1	Treatment of Grain Direction	107
9.5.7.2	Treatment of Test Specimen Location	107
9.5.7.3	Treatment of Clad Aluminum Alloy Plate	108
9.5.7.4	Computational Procedure	108
9.5.8	Indirect Computation using Regression	109

<u>Section</u>	<u>Description</u>	<u>Page</u>
9.6	Analysis Procedures for Dynamic and Time Dependent Properties	110
9.6.1	Load and Strain Control Fatigue Data	110
9.6.1.1	Data Collection and Interpretation	113
9.6.1.2	Analysis of Data	114
9.6.1.3	Fatigue Life Models	115
9.6.1.4	Evaluation of Mean Stress and Strain Effects	117
9.6.1.5	Estimation of Fatigue Life Model Parameters	118
9.6.1.6	Treatment of Outliers	124
9.6.1.7	Assessment of the Fatigue Life Model	125
9.6.1.8	Data Set Combination	127
9.6.1.9	Treatment of Runouts	128
9.6.1.10	Recognition of Time Dependent Effects	130
9.6.2	Fatigue Crack Growth Data	130
9.6.2.1	Data Collection and Interpretation	131
9.6.3	Fracture Toughness Data	133
9.6.3.1	Plane-Strain Fracture Toughness Data	133
9.6.3.2	Plane Stress and Transitional Fracture Toughness	133
9.6.4	Creep and Creep-Rupture Data	135
9.6.4.1	Data Collection and Interpretation	135
9.6.4.2	Analysis of Data	137
9.7	Analysis Procedures for Structural Joint Properties	142
9.7.1	Mechanically Fastened Joints	142
9.7.1.1	Definitions	143
9.7.1.2	Yield Load Determination	144
9.7.1.3	Shear Strength of Fastener	146
9.7.1.4	Sheet Critical and Transition Critical Strengths	148
9.7.1.5	Calculation of Allowable Loads	158
9.7.2	Fusion-Welded Joint Data	158
9.7.2.1	Data Collection and Interpretation	159
9.7.2.2	Data Analysis	161
9.8	Examples of Data Analysis and Data Presentation for Static Properties	162
9.8.1	Direct Analyses of Mechanical Properties	162
9.8.2	Indirect Analyses of Mechanical Properties	175
9.8.3	Tabular Data Presentation	179
9.8.3.1	Mechanical Properties	179
9.8.3.2	Modulus of Elasticity and Poisson's Ratio	183
9.8.3.3	Physical Properties	183
9.8.4	Room Temperature Graphical Mechanical Properties	184
9.8.4.1	Typical Stress-Strain	184
9.8.4.2	Compression-Tangent-Modulus Curves	191
9.8.4.3	Full-Range Tensile Stress-Strain Curves	194
9.8.4.4	Minimum Stress-Strain and Stress-Tangent-Modulus Curves	198
9.8.4.5	Biaxial Stress-Strain Behaviour	198
9.8.4.6	Mathematical Representation of Stress-Strain Curves	198

MIL-HDBK-5J
31 January 2003

<u>Section</u>	<u>Description</u>	<u>Page</u>
9.8.5	Elevated Temperature Graphical Mechanical Properties	202
9.8.5.1	Strength Properties	202
9.8.5.2	Elongation and Reduction of Area	204
9.8.5.3	Modulus of Elasticity	206
9.8.5.4	Physical Properties	207
9.8.5.5	Effect of Thermal Exposure on Room Temperature Strength	208
9.8.5.6	Effect of Thermal Exposure on Elevated Temperature Strength	208
9.8.5.7	Simple Exposure	209
9.8.5.8	Complex Exposure	210
9.9	Examples of Data for Dynamic and Time Dependent Properties	212
9.9.1	Fatigue	212
9.9.1.1	Load Control	219
9.9.1.2	Strain Control	223
9.9.2	Fatigue Crack Growth	228
9.9.3	Fracture Toughness	230
9.9.3.1	Plane Strain	230
9.9.3.2	Plane Stress	230
9.9.4	Creep and Creep Rupture	234
9.9.4.1	Creep-Rupture Example Problem	235
9.9.5	Mechanically Fastened Joints	240
9.9.6	Fusion-Welded Joints	244
9.9.6.1	Additional Information	245
9.9.6.2	Room-Temperature Properties	245
9.9.6.3	Data on Effect of Temperature	246
9.9.6.4	Use of Design Data	246
9.10	Statistical Tables	247
9.10.1	One-Sided Tolerance Limit Factors, K, for the Normal Distribution, 0.95 Confidence, and n-1 Degrees of Freedom	248
9.10.2	0.950 Fractiles of the F Distribution Associated with n_1 and n_2 Degrees of Freedom	250
9.10.3	0.950 Fractiles of the F Distribution Associated with n_1 and n_2 Degrees of Freedom	251
9.10.4	0.95 and 0.975 Fractiles of the t Distribution Associated with df Degrees of Freedom	252
9.10.5	Area Under the Normal Curve from $-\infty$ to the Mean + Z_p Standard Deviations .	253
9.10.6	One-Sided Tolerance-Limit Factors for the Three-Parameter Weibull Acceptability Test with 95 Percent Confidence	254
9.10.7	One-Sided Tolerance Factors for the Three-Parameter Weibull Distribution with 95 Percent Confidence	255
9.10.8	γ -values for Computing Threshold of Three-Parameter Weibull Distribution . .	261
9.10.9	Ranks, r, of Observations, n, for an Unknown Distribution Having the Probability and Confidence of T_{99} and T_{90} Values	264
Standards and References		266

9.1 GENERAL INFORMATION

This section of the Guidelines covers general information. Information specific to individual properties can be found in pertinent sections. Abbreviations, symbols, and definitions can be found in Appendix A.

9.1.1 INTRODUCTION — Design properties in MIL-HDBK-5 are used in the design of aerospace structures and elements. Thus, it is exceedingly important that the values presented in MIL-HDBK-5 reflect as accurately as possible the actual properties of the products covered.

Throughout the Guidelines, many types of statistical computations are referenced. Since these may not be familiar to all who may be analyzing data in the preparation of MIL-HDBK-5 proposals, a detailed description of each operation is required. To present the detailed description in the individual sections, however, would unnecessarily complicate the orderly presentation of the overall computational procedures. Therefore, the detailed description of the statistical techniques have been covered in Sections 9.5, 9.6, and 9.7.

9.1.2 APPLICABILITY — Minimum data requirements and analytical procedures defined in these Guidelines for establishment of MIL-HDBK-5 design properties and elevated temperature curves for these properties should be used to obtain approval of such values or curves when proposed to the MIL-HDBK-5 Coordination Group or a certifying agency. However, the minimum data requirements and analytical procedures are not mandatory; to the extent of precluding use of other analytical procedures which can be substantiated. Any exceptions or deviations must be reported when requesting approval of these values or curves by the Coordination Group or certifying agency.

9.1.3 APPROVAL PROCEDURES — The MIL-HDBK-5 Coordination Group (a voluntary, joint Government-Industry activity) meets twice yearly. At each meeting, this group acts upon proposed changes or additions to the document submitted in writing in advance of the meeting. The agenda is normally mailed to attendees four weeks prior to the meeting date, and the minutes four weeks following the meeting. Attachments for either the agenda or the minutes should be delivered to the Secretariat well in advance of the mailing date.

Attachments containing proposed changes or additions to the document will include specific notations of changes or additions to be made; adequate documentation of supporting data; analytical procedures used; discussion of analysis of data; and a listing of exceptions or deviations from the requirements of these Guidelines.

Approval procedures for establishment of MIL-HDBK-5 equivalent design values are defined by the individual certifying agency.

9.1.4 DOCUMENTATION REQUIREMENTS — The purpose of adequate documentation of proposals submitted to the MIL-HDBK-5 Coordination Group is to permit an independent evaluation of proposals by each interested attendee and to provide a historical record of actions of the Coordination Group. For this reason, both supporting data and a description of analytical procedures employed must be made available to attendees, either as an integral portion of an attachment to the agenda or minutes, or by reference to other documents that may reasonably be expected to be in the possession of MIL-HDBK-5 Meeting attendees. A specific example of the latter would be certain reports of Government-sponsored research or material evaluations for which distribution included the MIL-HDBK-5 attendance list. In some cases involving large quantities of supporting data, it may suffice (at the discretion of the Coordination Group) to furnish a single copy of these data to the Secretariat, from whom they would be available to interested attendees.

MIL-HDBK-5J
31 January 2003

All relevant reference documents (specifications, testing standards, data submissions, etc.) for proposals must be provided in English, to facilitate interpretation and evaluation by the MIL-HDBK-5 Coordination Group. If metric units are used as the primary system of units in these documents, they should be supplied along with a soft conversion to English units. The following English units are standard within MIL-HDBK-5:

- Coefficient of thermal expansion, 10^{-6} in./in./F
- Density, lb./in³
- Fracture toughness, ksi-in^{1/2}
- Frequency, Hz (cycles per second), or cpm (cycles per minute)
- Load, lbs., or kips (10³ lbs.)
- Modulus of elasticity (Tension and Compression), 10³ ksi
- Shear Modulus, 10³ ksi
- Specific heat, Btu/(lb.)(F)
- Strain, in./in.
- Stress or strength, ksi
- Temperature, °F
- Thermal conductivity, Btu/[(hr)(ft²)(F)/ft]
- Thickness, in.
- Time, hrs.

Refer to Section 9.2.3.1 for the terminology used within MIL-HDBK-5 for mechanical properties.

9.1.5 SUMMARY — The objective of this summary is to provide a global overview of Chapter 9 without defining specific statistical details. This overview will be most helpful to those unfamiliar with the statistical procedures used in MIL-HDBK-5 and to those who would like to learn more about the philosophy behind the MIL-HDBK-5 guidelines.

Chapter 9 is the “rule book” for MIL-HDBK-5. Since 1966, these guidelines have described statistical procedures used to calculate mechanical properties for alloys included in the Handbook. Recommended changes in the guidelines are reviewed first by the Guidelines Task Group (GTG) and later approved by the entire coordination committee. Recommended changes in statistical procedures within the guidelines are evaluated first by the Statistics Working Group (SWG), which supports the GTG. Similarly, recommended changes in fastener analysis procedures are examined by the Fastener Task Group (FTG) before approval by the coordination committee.

Chapter 9 is divided into subchapters that cover the analysis methods used to define room and elevated temperature properties. The room temperature mechanical properties are tensile, compression, bearing, shear, fatigue, fracture toughness, elongation and elastic modulus. The elevated temperature properties are the same, except that creep and stress rupture properties are added to the list. Analysis procedures for fatigue, fatigue crack growth and mechanically fastened joints are also covered since these data are commonly used in aircraft design. The presentation of these data varies depending upon the data type. For instance, the room temperature mechanical properties (tensile, compression, bearing, shear, elongation, elastic modulus, and fracture toughness) are provided in a tabular format, while the fatigue, elevated temperature properties, and typical stress-strain curves are presented in graphical format.

The majority, by far, of the data in MIL-HDBK-5 are room temperature design properties: including tensile (F_{tw} , F_{ty}), shear (F_{su}), compression (F_{cy}), bearing ultimate and yield strengths (F_{bru} and F_{bry}), elongation and elastic modulus. Room temperature design properties are the primary focus in the Handbook because most aircraft, commercial and military, typically operate at near-ambient temperatures and because most material specifications include only room temperature property requirements.

MIL-HDBK-5J
31 January 2003

Many different statistical techniques may be useful in analysis of mechanical-property data. Brief descriptions of procedures that will be used most frequently in this application are given in Section 9.5, 9.6, and 9.7. More detailed descriptions of these and other statistical techniques and tables in their various forms can be found in a number of workbooks and texts; Reference 9.1.5 is a particularly useful one.

Before an alloy can be considered for inclusion in MIL-HDBK-5, it must be covered by a commercial or government specification. There are two main reasons for this: (1) the alloy, and its method of manufacture, must be “reduced to standard practice” to increase confidence that the material, if obtained from different suppliers, will still demonstrate similar mechanical properties, and (2) specification minimum properties are included in MIL-HDBK-5 tables as design properties in situations where there are insufficient data to determine statistically based material design values.

Design minimum mechanical properties tabulated in MIL-HDBK-5 are calculated either by “direct” or “indirect” statistical procedures. The minimum sample size required for the direct computation of T_{99} and T_{90} values (from which A and B-basis design properties are established) is 100. These 100 observations must include data from at least 10 heats and lots (as defined in the next paragraph). A T_{99} value is a statistically computed, one-sided lower tolerance limit, representing a 95 percent confidence lower limit on the first percentile of the distribution. Similarly, a T_{90} value is a statistically computed, one-sided lower tolerance limit, representing a 95 percent lower confidence limit on the tenth percentile of the distribution. If the sample cannot be described by a Pearson¹ or Weibull distribution, the T_{99} and T_{90} values must be computed by nonparametric (distribution free) means, which can only be done if there are at least 299 observations. (In most cases, only minimum tensile ultimate and yield strength values are determined by the direct method.) T_{90} values are not computed if there are insufficient data to compute T_{99} values, even though a much smaller sample size is required to compute nonparametric T_{90} values. This is because the general consensus within the MIL-HDBK-5 committee has been that a large number of observations (in the realm of 100) are needed from a large number of heats and lots (e.g. 10) for a particular material to properly characterize the variability in strength of that product.

A lot represents all of the material of a specific chemical composition, heat treat condition or temper, and product form that has passed through all processing operations at the same time. Multiple lots can be obtained from a single heat. A heat of material, in the case of batch melting, is all of the material that is cast at the same time from the same furnace and is identified with the same heat number. In the case of continuous melting, a single heat of material is generally poured without interruption. The exception is for ingot metallurgy wrought aluminum products, where a single heat is commonly cast in sequential aluminum ingots, which are melted from a single furnace charge and poured in one or more drops without changes in the processing parameters.

Minimum compression, bearing, and shear strengths are typically determined through the indirect method. This is done to reduce cost, because as few as 10 data points (from 3 heats and 10 lots) can be used, in combination with “paired” direct properties to compute a design minimum value. In this indirect method, the compression, bearing, and shear strengths are paired with tensile values determined in the same region of the product to produce a ratio. Statistical analyses of these ratios are conducted to obtain lower bound estimates of the relationship between the primary property and the ratioed property. These ratios are then multiplied with the appropriate F_{tu} or F_{ty} in the Handbook to obtain the F_{su} , F_{cy} , F_{bru} , F_{brt} values for shear, compression, and bearing (ultimate and yield), respectively.

When procedures other than those described are employed in preparation of data proposals, they should be described adequately in the proposal.

¹A Pearson distribution analysis with zero skewness is comparable to the normal analysis method used in earlier versions of MIL-HDBK-5.

Many mechanical property tables in the Handbook include data for specific grain directions and thickness ranges. This is done to better represent anisotropic materials, such as wrought products, that often display variations in mechanical properties as a function of grain direction and/or product thickness. Therefore, it is common practice to test for variability in mechanical properties as a function of product thickness. This is done through the use of regression analysis for both direct and indirect properties. If a regression is found to be significant, properties may be computed separately (without regression) for reduced thickness ranges.

To compliment the mechanical property tables, the Handbook also contains typical stress-strain curves. These curves are included to illustrate each material's yield behavior and to graphically display differences in yield behavior for different grain directions, tempers, etc. These curves are identified as typical because they are based upon only a few test points. Typical curves are shown for both tension and compression and are extended to just beyond the 0.2 percent yield stress. Each typical curve also contains a shape factor called the Ramberg-Osgood number (n). These numbers can be used in conjunction with a material's elastic modulus to empirically develop a stress-strain curve. Typical tensile full-range stress-strain curves are also provided that illustrate deformation behavior from the proportional limit to fracture. In addition, compression tangent-modulus curves are provided to describe compression instability.

Effect of temperature and thermal exposure curves are included throughout the Handbook. The curves are presented as a percentage of the room temperature design value. For these curves, there is a minimum data requirement and statistical procedures have been established to construct the curves. The creep rupture plots are shown as typical isothermal curves of stress versus time. The physical properties are shown as a function of temperature for each property, i.e., specific heat, thermal conductivity, etc. Physical properties are reported as average actual values, not a percentage of a room temperature value.

In addition to the mechanical properties, statistically based S/N fatigue curves are provided in the Handbook, since many airframe structures experience dynamic loading conditions. The statistical procedures are fairly rigorous. For example, the procedure describes how to treat outliers and run-outs (discontinued tests), and which models to use to best-fit a specific set of data. Each fatigue figure includes relevant information such as K_f , R value, material properties, sample size and equivalent stress equation. Each figure should be closely examined by the user to properly identify the fatigue curves required for a particular design.

Design properties for mechanical fasteners and mechanically fastened elements are also included in MIL-HDBK-5. A unique analysis procedure has been developed for mechanical fasteners because fasteners generally do not develop the full bearing strength of materials in which they are installed. Joint allowables are determined from test data using the statistical analysis procedures described in section 9.7.

9.1.6 Data Basis — There are four types of room-temperature mechanical properties included in MIL-HDBK-5. They are listed here, in order, from the least statistical confidence to the highest statistical confidence, as follows:

Typical Basis — A typical property value is an average value and has no statistical assurance associated with it.

S-Basis — This designation represents the specification minimum value specified by the governing industry specification (as issued by standardization groups such as SAE Aerospace Materials Division, ASTM, etc.) or federal or military standards for the material. (See MIL-STD-970 for order of preference of specifications.) For certain products heat treated by the user (for example, steels hardened and tempered to a designated F_u), the S-basis value may reflect a specified quality-control requirement. Traditionally, the statistical assurance of S-basis values has not been known. However, the statistical assurance associated with S-basis values established since 1975 is known within the limitations of the qualification sample and the analysis method used to evaluate the data. Within those constraints S-basis values established since 1975 may be viewed as estimated A-basis values.

MIL-HDBK-5J
31 January 2003

Wherever possible, the statistical validity of these estimated A-basis (S-basis) values should be verified as soon as sufficient heats and lots of material are available from the major producers to establish more rigorous A-basis properties by the methods described in MIL-HDBK-5. If the more rigorous A-basis property exceeds the S-basis value, the major suppliers and users of the material may benefit from updating or replacing the specification because then they will be able to take full advantage of the capabilities of the material within the design allowable tables in MIL-HDBK-5.

In the opposite (and fortunately infrequent) situation where the more rigorous A-basis property falls well below the S-basis value, the repercussions may be greater for both the user and producer. Actual design margins (as compared to originally perceived design margins) on primary structure may be reduced below desirable levels if the S-basis value must be downgraded to a lower A-basis value. The perceived adequacy of a material for a particular application may be reduced if the S-basis value is reduced to match a lower A-basis value. However, under most circumstances, the S-basis value should be reduced to match the A-basis value if process improvements cannot be instituted to raise the A-basis value to the level of the original S-basis value.

B-Basis — This designation indicates that at least 90 percent of the population of values is expected to equal or exceed the statistically calculated mechanical property value, with a confidence of 95 percent. This statistically calculated number is computed using the procedures specified in Section 9.5.

A-Basis — The lower value of either the statistically calculated number T_{99} , or the specification minimum (S-basis). The statistically calculated number indicates that at least 99 percent of the population is expected to equal or exceed the statistically calculated mechanical property value with a confidence of 95 percent. This statistically calculated number is computed using the procedures specified in Section 9.5.

Sections 9.2.4.2 and 9.5.1.1 contain discussions of data requirements for direct computation of design properties based on current process capability of the majority of suppliers of a given material and product form. To assure that the A- and B-basis values, defined above, represent true current process capability of a material, all available original test data for current material that is produced and supplied to the appropriate government, industry, or equivalent company specifications are included in calculating these values. (However, to be considered for inclusion in MIL-HDBK-5, a material must be covered by an industry, Federal, or Military specification per Section 9.1.6.) Only positive proof of improper processing or testing is cause for exclusion of original test data, except that the number of tests per lot will not exceed the usual frequency of testing for the product. It is recognized, however, that extensive acceptance testing resulting in elimination of low-strength material from the population may justify establishment of higher mechanical property values for the remaining material. Since this is a function of both the type of product and the nature and frequency of the acceptance tests practiced by each company, it is impractical to attempt to include these considerations in this document.

Usually, only tensile ultimate and yield strengths in a specified testing direction are determined in such a manner that they can be termed A- and B-basis values, in accordance with definitions given above. Only tensile ultimate strength, tensile yield strength, elongation, and reduction of area (for some alloys) are normally specified in the governing specifications and can be termed S-basis values. However, ratioing procedures (described in Section 9.5.4) have been established, by which other property values such as compression, shear, and bearing are computed to have approximately the same assurance levels as A-, B-, or S-basis values for tensile ultimate and yield strength. Property values determined in this manner are presented as having the same data basis as tensile ultimate and yield strengths in the same column of the table.

Current practice regarding the use of the above data bases in the presentation of room-temperature design properties is as follows:

- (1) Room-temperature design properties for tensile ultimate and yield strengths are presented as A- and B- or S-basis values. Calculated T_{99} values that are higher than corresponding S-basis

MIL-HDBK-5J
31 January 2003

values are presented as footnotes in MIL-HDBK-5 property tables, and these T_{99} values are not qualified for general use in design unless the specification requirements are increased to equal the T_{99} value. However, T_{99} values that are equal to or lower than corresponding S-basis values replace S-basis values as the A-basis values in the document.

- (2) The S-basis value is used for elongation and reduction of area.
- (3) If an A-basis value is presented for a strength property, the corresponding B-basis value is also presented.
- (4) A- and B-basis values, when available, replace S-basis values, based upon item (1) conditions.
- (5) A- and B-basis values, based upon data representing samples of material supplied in the annealed, solution treated, or as-fabricated conditions, which were heat treated to demonstrate response to heat treatment by suppliers, are incorporated into MIL-HDBK-5 with an explanatory footnote. It is recognized that structural fabrication and processing can alter mechanical properties. The use of A- and B-basis values for structural design requires consideration of such effects. These material property values are derived from the statistically computed T_{99} and T_{90} values defined earlier.
- (6) Strength at room temperature after thermal exposure is presented graphically as a percentage of the tabulated design property.
- (7) Design data for all other properties, such as elastic modulus, Poisson's ratio, creep, fatigue, and physical properties, are presented on a typical basis unless indicated otherwise.

9.1.7 Rounding Procedures —When the lower tolerance bound (T_{99} or T_{90}) results in a fractional number, the actual mechanical property value used in the room temperature tables is determined by rounding according to Section 6.4 of ASTM E29, Standard Practice for Using Significant Digits in Test Data to Determine Conformance with Specifications. However, if the S value is lower, it is shown in the table and the rounded T_{99} value is included in a footnote.

9.2 MATERIAL, SPECIFICATION, TESTING, AND DATA REQUIREMENTS

9.2.1 MATERIAL REQUIREMENTS — The product used for the determination of minimum design values for incorporation into MIL-HDBK-5 must be production material. The material must have been produced using production facilities and standard fabrication and processing procedures. If a test program to determine requisite mechanical properties is initiated before a public specification describing this product is available, precautionary measures must be taken to ensure that the product supplied for the test program conforms to the specification, when published, and represents production material.

Dimensionally discrepant castings or special test configurations may be used for the development of derived properties with prior approval by the MIL-HDBK-5 Coordination Group, providing these castings meet the requirements of the applicable material specification. Design values for separately cast test specimens are not presented in MIL-HDBK-5.

9.2.2 SPECIFICATION REQUIREMENTS — To be considered for inclusion in MIL-HDBK-5, a product must be covered by an industry specification (AMS specification issued by SAE Aerospace Materials Division or an ASTM standard published by the American Society for Testing and Materials), or a government specification (Military or Federal). If a public specification for the product is not available, action should be initiated to prepare a draft specification. Standard manufacturing procedures will have been established for the fabrication and processing of production material before a draft specification is prepared. The draft specification will describe a product which is commercially available on a production basis. An AMS draft specification should be submitted to the SAE Aerospace Materials Division and an ASTM standard should be transmitted to the American Society for Testing and Materials for publication. See Section 9.4 for requirements to substantiate the S-basis properties.

9.2.3 REQUIRED TEST METHODS/PROCEDURES — Testing standards used in MIL-HDBK-5 are summarized in Table 9.2.3. In most cases, testing standards maintained by the American Society for Testing and Materials, ASTM, are referenced. The primary exception is fastener testing, where NASM-1312 is used as the reference standard. The mostly recently approved version of each standard is used as the baseline for all test data reviewed for inclusion in MIL-HDBK-5.

Table 9.2.3. Summary of Required Testing Standards within MIL-HDBK-5

Property to be Determined or Procedure to be Followed	Designation	Title of Testing Standard	Relevant Section(s) within Guidelines
Bearing	ASTM E 238	Method for Pin-Type Bearing Test of Metallic Materials	9.2.3.2, 1.4.7.1, 3.1.2
Classification of Extensometers	ASTM E 83	Method of Verification and Classification of Extensometers	9.1.3.3, 9.2.4.4.2
Coefficient of Thermal Expansion	ASTM E 228	Test Method for Linear Thermal Expansion of Solid Materials with a Vitreous Silica Dilatometer	9.2.3.4
Compression	ASTM E 9	Compression Testing of Metallic Materials	1.7.1
Creep and Rupture	ASTM E 139	Rec. Practice for Conducting Creep, Creep-Rupture, & Stress-Rupture Tests of Metallic Materials	9.2.3.9
Density	ASTM C 693	Test Method for Density of Glass by Buoyancy	9.2.3.4
Elastic Modulus – Compression	ASTM E 111	Test Method for Young's Modulus, Tangent Modulus, and Chord Modulus	9.2.3.3, 9.8.1.3.1
Elastic Modulus – Shear	ASTM E 143	Test Method for Shear Modulus at Room Temperature	9.8.1.3.1
Elastic Modulus – Tension	ASTM E 111	Test Method for Young's Modulus, Tangent Modulus, and Chord Modulus	9.2.3.3, 9.8.1.3.1
Elongation	ASTM E 8	Test Method for Tension Testing of Metallic Materials	1.4.3.5
Exfoliation Corrosion	ASTM G 34	Test Method for Exfoliation Corrosion Susceptibility in 2XXX and 7XXX Series Aluminum Alloys (EXCO Test)	3.1.2.3.1
Fastener Mechanical Properties	NASM-1312	Fastener Test Methods	9.2.3.10.1
Fatigue - Load Control	ASTM E 466	Recommended Practice for Constant Amplitude Axial Fatigue Tests of Metallic Materials	9.6.1
Fatigue - Strain Control	ASTM E 606	Recommended Practice for Constant Amplitude Low Cycle Fatigue Testing	9.6.1
Fatigue Crack Growth	ASTM E 647	Test Method for Measurement of Fatigue Crack Growth Rates	9.2.3.6

Table 9.2.3. Summary of Required Testing Standards within MIL-HDBK-5, Continued

Property to be Determined or Procedure to be Followed	Designation	Title of Testing Standard	Relevant Section(s) within Guidelines
Fracture Toughness - Plane Strain	ASTM E 399	Test Method for Plane-Strain Fracture Toughness of Metallic Materials	9.6.3
Fracture Toughness - Plane Stress	ASTM E 561	Recommended Practice for R Curve Determination	9.6.3
Poisson's Ratio	ASTM E 132	Test Method for Poisson's Ratio at Room Temperature	9.8.1.3.1
Reduction in Area	ASTM E 8	Test Method for Tension Testing of Metallic Materials	1.4.3.5
Shear – Pin	ASTM B 769	Test Method for Shear Testing of Aluminum Alloys	9.2.3.2, 3.1.2
Shear – Slotted	ASTM B 831	Standard Test Method for Shear Testing of Thin Aluminum Alloy Products	9.2.2
Specific Heat	ASTM D 2766	Test Method for Specific Heat of Liquids and Solids	9.2.3.4
Stress Corrosion Cracking	ASTM G 47	Test Method for Determining Susceptibility to Stress-Corrosion Cracking of High Strength Aluminum Alloy Products	3.1.2.3.1
Tension	ASTM E 8	Test Method for Tension Testing of Metallic Materials	1.4.4.1
	ASTM A 370	Standard Test Methods and Definitions for Mechanical Testing of Steel Products	1.4.4.1
Tension - Elevated Temperatures	ASTM B 557	Test Methods of Tension Testing Wrought and Cast Aluminum- and Magnesium-Alloy Products	1.4.4.1
	ASTM E 21	Recommended Practice for Elevated Temperature Tension Tests of Metallic Materials	1.4.4.1
Thermal Conductivity	ASTM C 714	Test Method for Thermal Diffusivity of Carbon and Graphite by a Thermal Pulse Method	9.2.3.4

9.2.3.1 Mechanical-Property Terms — Mechanical properties that are presented as room-temperature design properties are listed in Table 9.2.3.1. It is important that use of a subscripted, capital letter “F” should be limited to designation of minimum values. Its use to designate an individual test value can lead to confusion and should be avoided in MIL-HDBK-5 data proposals.

The absence of a directionality symbol implies that the property value is applicable to each of the grain directions when the product dimensions exceed approximately 2.5 inches.

Table 9.2.3.1. Mechanical Property Terms

Property	Units	Symbol	
		Room-Temperature Minimum Value	Individual or Typical Value
Tensile Ultimate Strength	ksi	F_{tu}	TUS
Tensile Yield Strength	ksi	F_{ty}	TYS
Compressive Yield Strength	ksi	F_{cy}	CYS
Shear Ultimate Strength	ksi	F_{su}	SUS
Shear Yield Strength*	ksi	F_{sy}	SYS
Bearing Ultimate Strength	ksi	F_{bru}	BUS
Bearing Yield Strength	ksi	F_{bry}	BYS
Elongation	percent	e	elong.
Total Strain at Failure*	percent	e_t	strain at failure
Reduction of Area	percent	RA	red. of area

* As applicable.

The listed mechanical property symbols should be followed by one of the following additional symbols for wrought alloys, not castings.

- L — Longitudinal direction; parallel to the principal direction of flow in a worked metal.
- T — Transverse direction; perpendicular to the principal direction of flow in a worked metal; may be further defined as LT or ST.
- LT — Long-transverse direction; the transverse direction having the largest dimension, often called the “width” direction.
- ST — Short-transverse direction; the transverse direction having the smallest dimension, often called the “thickness” direction.

Values of F_{bru} and F_{bry} should indicate the appropriate edge distance/hole diameter (e/D) ratio. Design properties are presented for two such ratios: e/D = 1.5 and e/D = 2.0.

Data for use in establishing these properties should be based on ASTM standard testing practices. The test practice and any deviations therefrom should be reported when submitting proposals to the MIL-HDBK-5 Coordination Group for consideration.

9.2.3.2 Testing Direction and Specimen Location — Table 9.2.3.2 lists the primary testing direction for various products. When performing derived property test programs it is imperative that the test specimens be taken from the same sheet, plate, bar, extrusion, forging, or casting. Derived property test specimens must also be located in close proximity. If derived property coupons or specimens are machined prior to heat treatment, all specimens representing a lot must be heat treated simultaneously in the same heat

treat load through all heat treating operations. This procedure is necessary to provide precise mechanical property relationships (ratios).

Table 9.2.3.2. Primary^a Testing Direction for Various Alloy Systems

Product Form	Carbon and Low Alloy Steels	Non-Heat Treat-able Alum. Alloys	Heat Treatable Alum. Alloys	Magnesium Alloys	Titanium Alloys	Corrosion and Heat Resistant Alloys	Other Alloys
Sheet and Plate	LT	L	LT	L	^c	LT	^b
Bar	L	L	L	L	^c	L	^b
Tubing	L	L	L	L	L	L	^b
Extrusion	L	L	L	L	^c	L	^b
Die Forging	^b	L	L	L	^c	^b	^b
Hand Forging	^b	LT	LT	LT	^c	^b	^b

- a Although material specifications may contain mechanical-property requirements for two or three grain directions, the primary test direction indicates the grain direction which is tested regularly.
- b See applicable material specification.
- c Since there is no primary test direction for titanium alloys, mechanical property ratios will be formed using strength values which represent the same grain directions in the numerator and denominator. The design allowable is computed as the product of the reduced ratio and the F_{ty} or F_{tu} value for the grain direction represented by the reduced ratio.

Test specimens must be located within the cross section of the product in accordance with the applicable material specification, or applicable sampling specification, such as AMS 2355, AMS 2370, and AMS 2371 (See list of references at the end of Chapter 9). Subsize tensile and compressive test specimens may be used if necessary. Specimen drawings should be provided along with each data proposal, with English units included. The applicable testing standard should be identified along with the specimen drawings. If the standard is not routinely available in English, an English translation of the standard should be provided.

Test specimens must be excised in longitudinal, long transverse, and short transverse (when applicable) grain directions. Mechanical properties must also be obtained in the 45° grain direction for materials that have significantly different properties in this direction than the standard grain directions. For some product configurations, it may be impractical to obtain transverse bearing specimens. For aluminum die forgings, the longitudinal grain direction is defined as orientations parallel, within ±15°, to the predominate grain flow. The preferred definition for long transverse grain direction is perpendicular, within ±15°, to the longitudinal (predominate) grain direction and parallel, within ±15°, to the parting plane. (Both conditions must be met to satisfy this definition.) The short transverse grain direction is defined as perpendicular, within ±15°, to the longitudinal (predominate) grain direction and perpendicular, within ±15°, to the parting plane. (Both conditions must be met.)

9.2.3.3 Tension, Compression, Shear and Bearing — All tests must be performed in accordance with applicable ASTM specifications, or their equivalent. Tensile (ASTM E8, A370, and B557), compression (ASTM E9), shear (ASTM B769), and bearing (ASTM E238) tests must be conducted at room temperature to determine tensile yield and ultimate strengths, compressive yield strength, shear ultimate strength, and bearing yield and ultimate strengths for $e/D = 1.5$ and $e/D = 2.0$ for each grain direction and each lot of material. All data must be identified by lot, or heat, or melt. For materials used exclusively in high temperature applications, such as gas turbine or rocket engines, the determination of design values for compression, shear, and bearing strengths may be waived by the MIL-HDBK-5 Coordination Group. In lieu of data for these properties, sufficient elevated temperature data for tensile yield and ultimate strengths, as well as modulus of elasticity, will be submitted so that elevated temperature curves can be constructed. Data should be submitted for the useful temperature range of the product. See Section 9.2.4.4.3 for data requirements for elevated temperature curves.

The pin shear testing of aluminum alloys should be done in conformance to ASTM B 769, or an equivalent public specification. Grain orientations and loading directions for shear specimens must be defined in accordance with ASTM B 769, or an equivalent specification. Slotted shear testing of thin aluminum alloys should be done in conformance to ASTM B 831. Bearing tests for products from all alloy systems will be conducted in accordance with ASTM E 238, or an equivalent public specification, using “clean pin” test procedures. For aluminum alloy plate, bearing specimens are oriented flatwise and for aluminum alloy die and hand forgings, bearing specimens must be oriented edgewise, as described in Section 3.1.2.1.1.

9.2.3.4 Other Static Properties

9.2.3.4.1 Modulus and Poisson’s Ratio — Tensile and compressive modulus of elasticity values must be determined using a Class B-1 or better extensometer. Measurements must be made on at least three lots of material. The method of determining or verifying the classification of extensometers is identified in ASTM E 83. ASTM E 111 is the standard test method for the determination of Young’s Modulus, tangent modulus, and chord modulus of structural materials. A modulus value will also be obtained for the 45 degree grain orientation for materials that are anticipated to have significantly different properties in this direction than the standard grain directions. Modulus values are “typical”. Poisson’s ratio values must be determined in accordance with ASTM E132.

9.2.3.4.2 Physical Properties — Density, specific heat, thermal conductivity, and mean coefficient of thermal expansion are physical properties normally included in MIL-HDBK-5. Physical properties are presented in the room-temperature property tables if they are not presented in effect-of-temperature curves (see Section 9.8.3.3). The basis for physical properties is “typical”. Table 9.2.3.4.2 displays units and symbols used in MIL-HDBK-5, and also shows recommended ASTM test procedures for measuring these properties. Since other procedures are sometimes employed in measuring physical properties, the methods actually used to develop the values proposed for inclusion in MIL-HDBK-5 should be reported in the supporting data proposal. For specific heat and thermal conductivity values reported in the room temperature property table, the reference temperature of measurement is also shown [for example, for 2017 aluminum the specific heat is 0.23 (at 212°F)]. For tabulated values of mean thermal expansion, temperature range of the coefficient is shown [for example, 12.5 (70 to 212°F)]. The reference temperature of 70°F is used as the standard for mean coefficient of thermal expansion curves shown in MIL-HDBK-5.

Table 9.2.3.4.2. Units, Symbols, and ASTM Test Procedures Used to Compute and Present Physical Property Data in MIL-HDBK-5

Property	Units	Symbol	Recommended ASTM Test Procedures
Density	lb/in. ³	ω	C 693
Specific heat	Btu/lb-°F	C	D 2766
Thermal conductivity	Btu(hr-ft ² -°F/ft)	K	C 714 ^a
Mean coefficient of thermal expansion	10 ⁻⁶ (in./in./°F)	α	E 228

a ASTM C 714 is a test for thermal diffusivity from which thermal conductivity can be computed.

9.2.3.5 Dynamic and Time Dependent Properties

9.2.3.5.1 Fatigue — Both strain-controlled and load-controlled axial fatigue data are included in MIL-HDBK-5. Constant amplitude test data are the primary focus. Well-documented, initial and/or periodic overstrain data may also be included. Data obtained under strain control are considered only for unnotched, uniform-gage-length specimens, while both notched and unnotched specimens are considered for load-control conditions. The relevant standards for strain and load control fatigue testing are ASTM E606 and ASTM E466, respectively.

9.2.3.5.2 Fatigue Crack Growth — Fatigue-crack-propagation data may be generated by several types of fracture mechanics test specimens as described in ASTM E647. The principal criteria for acceptance of data are twofold. One is that a valid stress-intensity-factor formulation be available for the specimen; the other is that nominal net-section stresses, as calculated by concepts of elementary strength of materials, be less than eighty percent (80%) of the tensile yield strength of the material.

Basic data are generated as crack lengths, a , and associated cycle counts, N . These data are interpreted as crack-growth rates determined as slopes, or average slopes, of sequential subsets of data. For MIL-HDBK-5, da/dN is calculated as the weighted average incremental slope approximation

$$\left(\frac{da}{dN}\right) \approx \left(\frac{\Delta a}{\Delta N}\right)_{i-1} + \frac{N_i - N_{i-1}}{(N_{i+1} - N_{i-1})} \left[\left(\frac{\Delta a}{\Delta N}\right)_i - \left(\frac{\Delta a}{\Delta N}\right)_{i-1} \right] \quad i=2, \dots, n-1 \quad [9.2.3.5.2(a)]$$

from the measured crack-growth data as illustrated in Figure 9.2.3.5.2. However, alternative methods, such as polynomial fitting of the “ a ” versus “ N ” curve, are acceptable for computation of da/dN values. By this indexing and calculating procedure “ n ” measurements provide “ $n-2$ ” slope or rate values at all but first and last measurement points. The directly associated stress-intensity factor, K , for each slope computation is computed in accordance with Equation 9.2.3.5.2(b) where $g(a,w)$ is a geometric scaling function dependent on crack and specimen geometry, and S is nominal stress.

$$K = S\sqrt{a} g(a,w) \quad , \quad [9.2.3.5.2(b)]$$

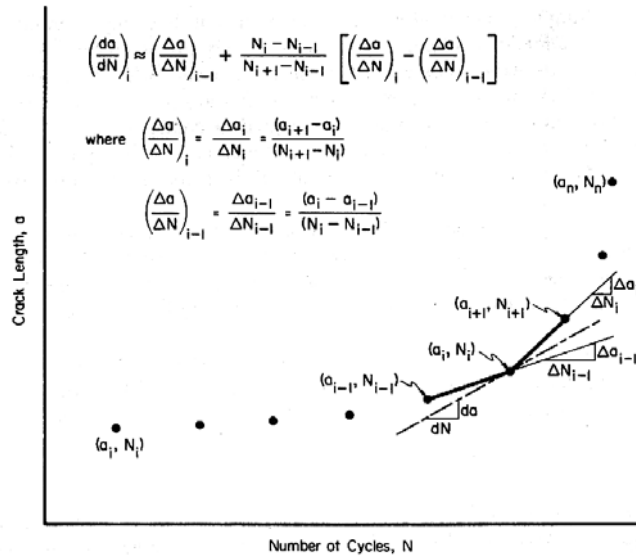

Figure 9.2.3.5.2. Analytical definition of crack-growth rate calculation.

9.2.3.5.3 Fracture Toughness — The degree of lateral constraint at the crack tip determines whether plane strain (high lateral constraint) or plane stress test methods should be used.

Plane-Strain Fracture Toughness — For materials which are inherently brittle, or for structure and flaw configurations which are in triaxial tension due to their thickness or bulk restraint, quasi-plane-strain-stress conditions can be obtained in a finite-sized structural element. Triaxial stress state implicit to plane strain effectively embrittles the material by providing maximum restraint against plastic deformation. In this condition, component behavior is essentially elastic until fracture stress is reached and is readily amenable to analysis in terms of elastic fracture mechanics. This mode of fracture is frequently characteristic of the very high strength metals.

While a wide variety of fracture specimens are available for specified testing objectives, the notch-bend specimen and compact specimen generally offer the greatest convenience and material economics for testing. Details of recommended testing practice are presented in ASTM E399.

Plane-Stress and Transitional-Fracture Toughness — In ductile materials and relatively thin structural elements, stress state may approach plane-stress conditions. As a result, crack tip plasticity and stable-crack growth may be expected in cracked structural components under load prior to reaching a critical stress-intensity factor value. Furthermore, due to the interaction of plasticity and geometry, characteristic fracture toughness of a material may vary with the stress state, as illustrated in Figure 9.2.3.5.3(a).

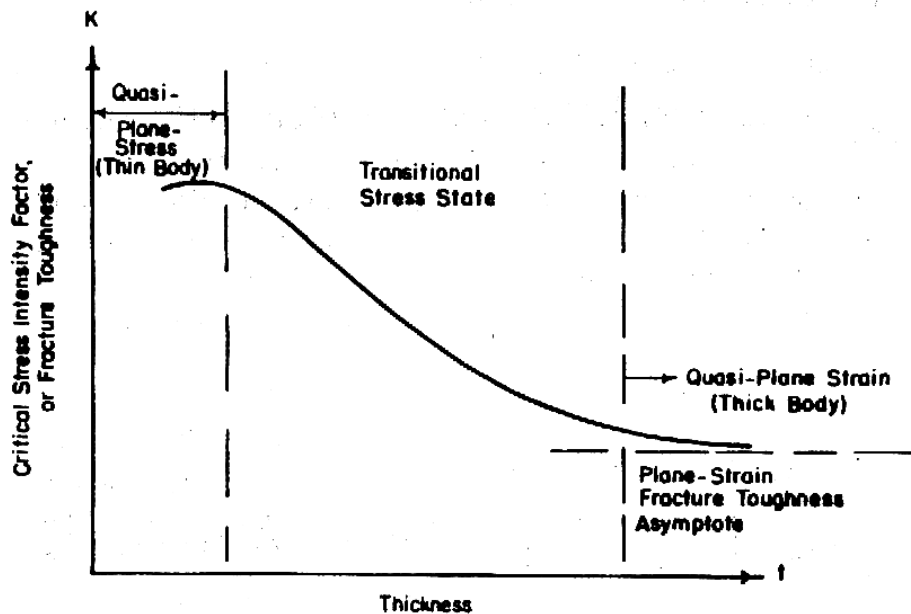
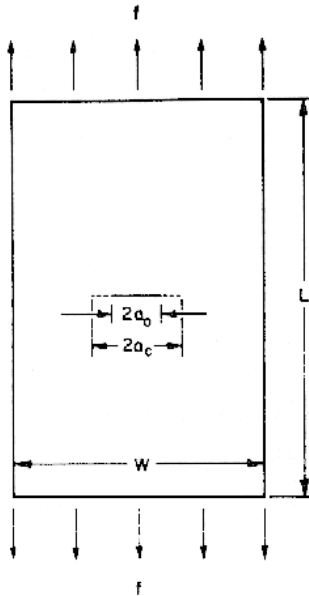

Figure 9.2.3.5.3(a). Variation of fracture toughness with thickness or stress state (size effect).

It is convenient to consider critical stress-intensity factor values, varying with thickness or stress state, as indices of crack-damage resistance. The stress-intensity factor can be used as a consistent measure of crack damage, not only for fracture instability, but also for other levels of crack damage severity, provided the damage is consistently specified and detected. This concept implies that plane-stress and transitional-fracture toughness of metallic materials, while not necessarily a fixed value for the material, is a characteristic value for a given product form, thickness, grain direction, temperature, and strain rate.

Because of the complexity of crack behavior in plane-stress and transitional-stress states, test methods for evaluating material toughness have not been completely standardized; however, several useful methods do exist. One of the most widely used techniques, the R-curve procedure, is documented in ASTM E561. Although each configuration generates nearly consistent results when data are properly evaluated, it is recommended that each general flaw configuration be interpreted and applied within its own design context.

Middle Tension Panels — Because it simulates typical crack conditions in thin-sheet structures, the middle tension panel is a popular testing configuration for evaluating crack behavior. This specimen is illustrated in Figure 9.2.3.5.3(b).



Typical Constraints

Free length of specimen between grips, $L \geq 2W$

Stress intensity factor limit during precracking, $K_{fatigue} \leq K_{app}/2$

Figure 9.2.3.5.3(b). Middle tension panel.

The crack-tip plasticity and slow-stable growth of the crack which are attendant to plane-stress or transitional stress state conditions may cause a deviation from abrupt fracture which is normally associated with crack extension under ideal plane conditions, as illustrated in Figure 9.2.3.5.3(c).

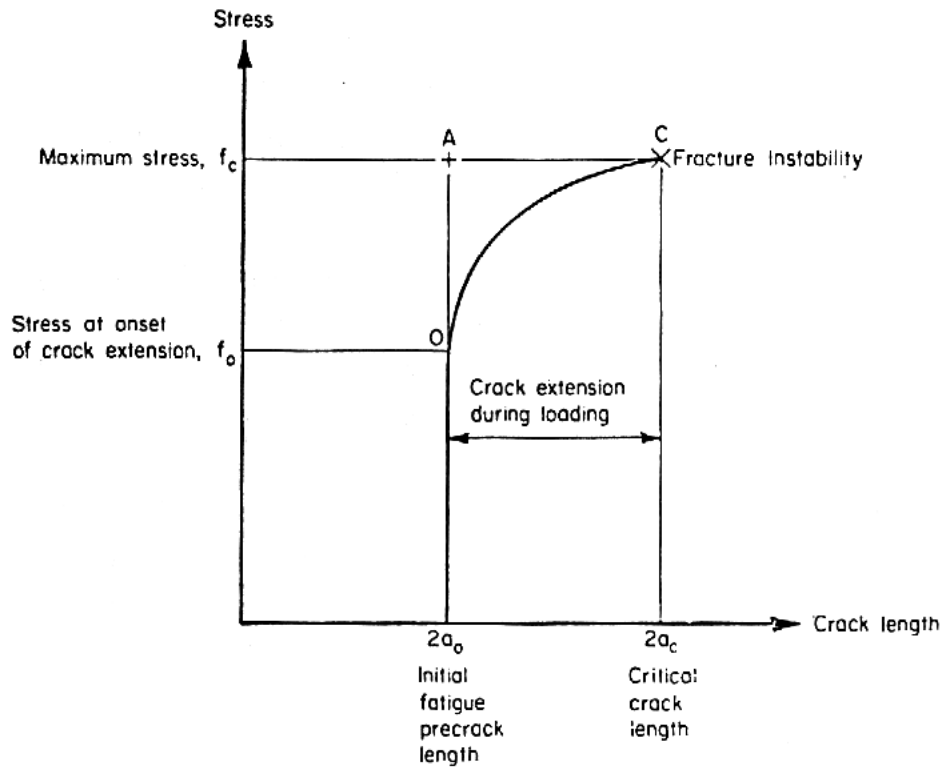

Figure 9.2.3.5.3(c). Crack growth curve.

Two limiting damage levels are noted in this figure. Point O is the threshold or onset of slow, stable tear where the crack slowly extends after reaching a threshold stress level. Point C is fracture instability. Both levels of crack damage can be associated with a different stress intensity factor, or damage index, for product forms and thicknesses of interest. These damage levels can be identified either directly with the K value as determined from instantaneous stress-crack length coordinate dimensions at these points, or approximately by the coordinates of Point A, which is residual strength, or apparent toughness concept of relating initial crack length to final fracture stress.

The stress intensity factor, K, associated with any of these damage levels is determined from

$$K = f \sqrt{a} \cdot Y, \text{ ksi } \sqrt{\text{in}} \quad [9.2.3.5.3(a)]$$

where, for this configuration,

a = half-length of middle crack

$$Y = (\pi \sec \pi a/W)^{1/2}.$$

The locus of data points can be represented by a parametric stress-intensity factor curve, as shown in Figure 9.2.3.5.3(d), where each curve represents a different stress-intensity factor formulation. The slow growth

curve is superimposed on this figure to illustrate the general relationship between the threshold of stable crack extension, apparent instability, and fracture instability for a typical crack.

Because of experimental difficulties associated with precise detection of threshold and instability points, points O and C, apparent toughness, or residual strength concept of crack damage is used in this presentation. This is the locus of data points "A", noted in Figure 9.2.3.5.3(c), which determine apparent fracture toughness.

$$K_{app} = f_c (\pi a_o \sec \pi a_o / W)^{\frac{1}{2}} \quad [9.2.3.5.3(b)]$$

See Reference 9.2.3.5.3 for additional information.

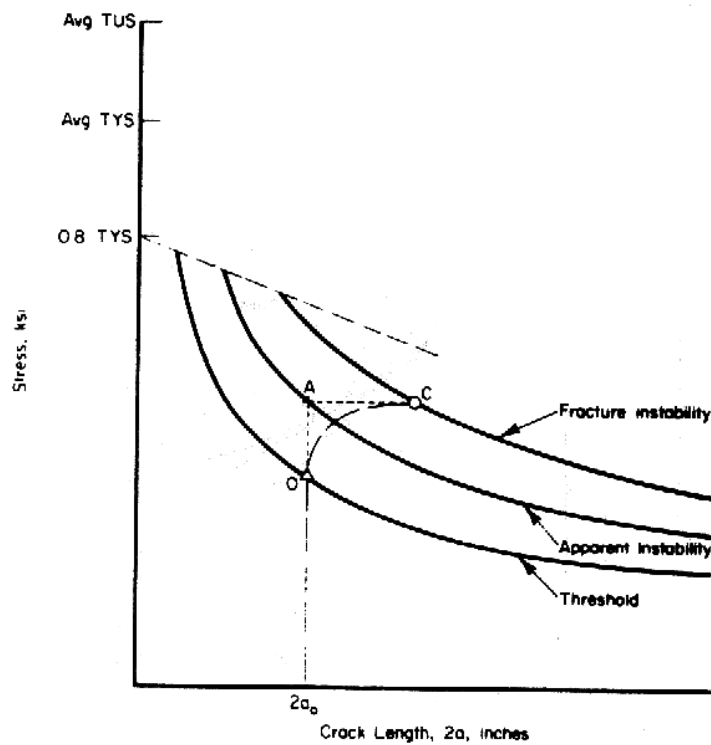

Figure 9.2.3.5.3(d). Stress intensity factor curves as parametric indices of crack damage.

9.2.3.5.4 Creep and Creep Rupture — The following paragraphs provide guidelines on testing methods for developing creep and creep-rupture data.

Test Methods—Test methods must conform to ASTM E139. However, it is recognized that this standard allows considerable latitude in procedures such that the mean trends and variability in the results can be significantly affected.

In case a significant difference is found in results from different testing sources, the following should be evaluated:

- Material Condition
- Specimen Dimensions and Configuration (geometry effect)
- Specimen Surface Preparation (residual stresses)
- Specimen Alignment (concentricity, fixturing, load train, and loading method)
- Temperature Control (number, type, and location of sensors, reference junction temperature control, monitoring and recording)
- Extensometers (type, fixturing, and recording)
- Strain Recording (records inelastic strain on loading and creates a record to be evaluated for test stability)
- Documentation (testing procedures)
- General Laboratory Conditions, Personnel Qualifications, Calibration Intervals.

The submitter of a proposal should provide documentation sufficient to permit a comparative evaluation of data. Inability to do so may cause rejection of some associated data, or the entire proposal.

9.2.3.6 Mechanically Fastened Joints —Although many fasteners for which joint allowables are given in MIL-HDBK-5 are covered by MIL and NAS specifications (which provide for minimum shear strength values), many proprietary fasteners are listed wherein minimum shear strength values are established by the manufacturer. In either case, sufficient testing is necessary to establish minimum values. The intent of this subsection is to provide minimum test procedures to document shear strength of fasteners appearing in MIL-HDBK-5, regardless of specification source.

Shear strengths will be determined from shear-critical single-shear test results or double-shear test results. Double-shear test results performed in accordance with NASM 1312, Test 13, are preferred over single-shear results, except for blind fasteners and driven rivets. For these latter fasteners, shear-critical tests will be conducted with all components in the installed condition in hardened steel test plates. NASM 1312, Test 20, is the required test method. Furthermore, when fasteners of a given configuration and material are identical in every respect except for head size and shape, fastener shear test data are necessary only on one head style.

Room-temperature testing equipment and procedures should comply with the provisions of NASM 1312, Tests 4, 13, and 20 (See list of references at the end of Chapter 9 for both single- and double-shear tests).

Specimen design should be as provided in NASM 1312, Test 4, Figure 1.

9.2.3.7 Fusion-Welded Joints — Two types of transverse-weld tensile coupon configurations are recommended. Use flat coupons for materials up to 0.5-inch thickness. For weld joint thicknesses greater than 0.5-inch, round coupons are recommended. These two configurations are shown in Figure 9.2.3.7(a) and (b), respectively. Exact specimen dimensions are dependent on thickness of the weldment being evaluated, but geometric similitude is maintained within each type of specimen. Appropriate dimensions are given for the reduced test section of each coupon. The dimensions of gripping areas at each end are optional and may be modified to accommodate standard test fixtures.

Remove the weld heads from all flat coupons unless standards have been established regarding weld reinforcement configuration. When data are required for welds with reinforcements intact, their configurations must be specified. When round coupons are used in thick weldments, location within the weldment becomes an additional variable which must be described and associated with data.

At present, coupon configuration requirements for evaluation of properties other than transverse tensile have not been sufficiently defined to be utilized on an industry-wide basis. Due to the nature of fatigue testing, no specific test configurations are recommended. Configurations selected according to standard base metal practices have been used and may be satisfactory. Weld reinforcements are of particular significance in fatigue testing, and should be removed or specified in detail, together with a description of the coupon used.

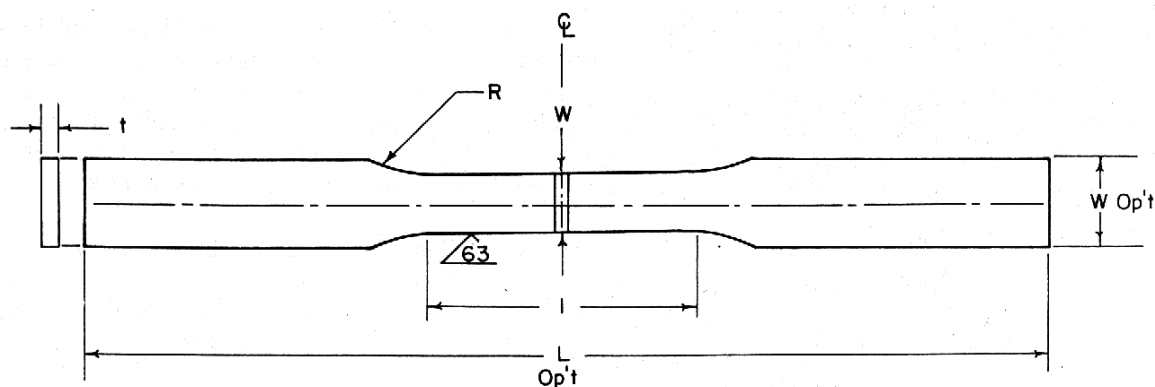

t	w	l	R
< .188	0.5	2.25	1 min.
0.188 to 0.25	0.75	3.0	1.5 min.
0.25 to 0.5	1.0	4.0	2 min.

NOTES:

1. Dimension "W" and "L" optional.
2. Weld bead on or off optional
3. Fillet radii must fair smoothly into reduced section.
4. Material and grain direction per test requirements.
5. Specimens warped from welding or heat treatment shall not be straightened.
6. Reduced section machined surfaces $\frac{63}{\text{°}}$
7. The reduced section and grip ends must be symmetrical about the longitudinal Q within ± 0.01 .
8. Tolerances except otherwise noted: Linear ± 0.03 , Angular $\pm 1^\circ$.

Figure 9.2.3.7(a). Flat transverse-weld tensile coupon.

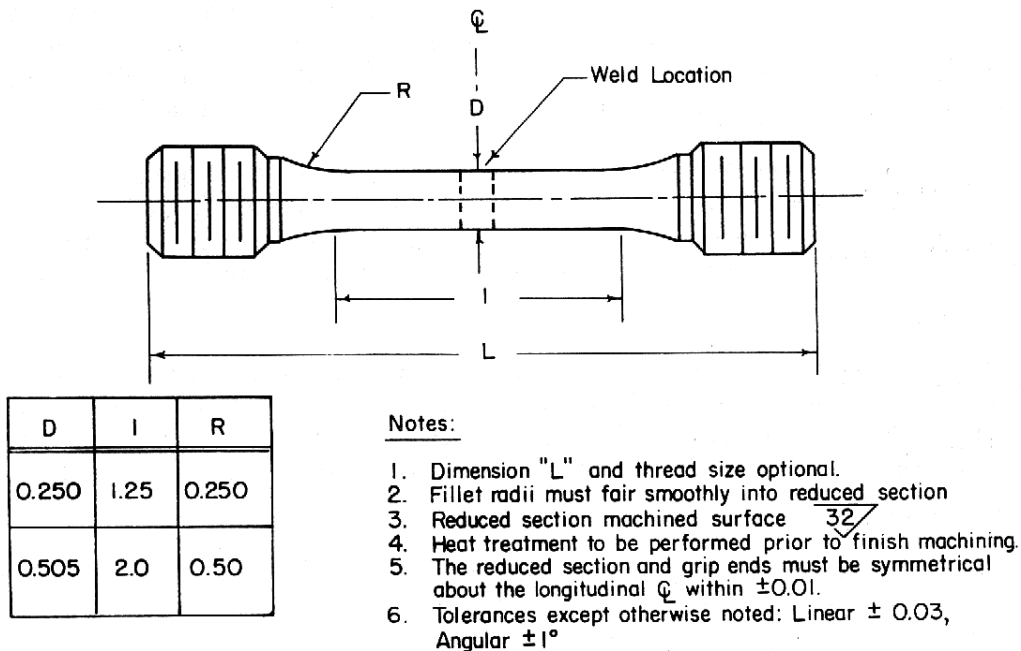

Figure 9.2.3.7(b). Round transverse-weld tensile coupon.

Fracture toughness coupons should conform to the latest requirements defined by ASTM E 399. Crack location with respect to weldment is of particular importance, and the criteria for validity of specimen must be met. Coupons used for evaluation of other weldment properties, such as fillet-weld shear strength and creep or stress rupture, also require definition in order to be used for design strengths.

Availability of accepted test methods for base metal evaluation, as evidence by federal and ASTM standards, has resulted in their general application to testing of weldments. These standards control test equipment, data accuracy, and loading rates. Reference to existing base metal test methods are generally considered satisfactory for mechanical property testing of weldments except for configuration definition. The testing practice and any deviations should be reported when data samples are generated. In no case may a test result be discarded on the basis of a defect found after final inspection—for example, during post-test examination of fractured surfaces.

9.2.4 DATA REQUIREMENTS — Data requirements for the various types of data included in MIL-HDBK-5 are described in this section. Data requirements for determination of mechanical and physical properties within MIL-HDBK-5 are summarized in Table 9.2.4. The customary statistical basis of each material property is listed, along with the relative importance of each data type within the Handbook. Potential extenuating circumstances, such as special material usage requirements, are also considered. Where applicable for each data type, the minimum sample size and the minimum number of heats and lots are identified. Applicable MIL-HDBK-5 introductory or guideline sections are also referenced.

9.2.4.1 S-basis Values —To incorporate a new product into MIL-HDBK-5 on an S-basis it is recommended that at least 30 test samples from at least three heats or lots of material be provided for each thickness range and product form. These requirements are applicable to each alloy, product form and heat

treat condition or temper. Section 9.2.3 delineates the requirements for a test program to generate mechanical property data suitable for computation of derived properties. A test matrix, based on these requirements, is shown in Table 9.2.4.1.

9.2.4.2 A- and B-basis Values — The direct calculation of statistical minimum properties (T_{99} and T_{90} values) requires a substantial quantity of data to determine (1) the form of distribution and (2) reliable estimates of the population parameters describing the distribution. Prior experience with the material under consideration will help in determining sample size requirements. Each material should be represented by a sample containing at least 100 observations, assuming these data are distributed according to a three-parameter Weibull distribution or a Pearson Type III distribution, or 299 observations if neither of these families of distributions adequately describe the data. The sample must include multiple lots, representing at least ten production heats, casts, or melts, from a majority of important producers. See Table 9.2.4.2 for definitions of lot, heat, cast, and melt. The sample should be distributed as evenly as possible over the size range applicable to the tolerance bound for the mechanical property. In order to avoid an undesirable biasing of the sample in favor of lots represented by more observations than other lots, the number of observations from each lot must be nearly equal.

If grouped data are reported in intervals of 1 ksi or less, they may be “ungrouped” and analyzed as described below. The uniform smoothing method for ungrouping grouped data should be used. For the uniform smoothing method, observations in an interval are spread uniformly over that interval. The i^{th} observation in an interval is set equal to

$$a_i = L + \frac{i}{n+1} (U - L) \quad i = 1, 2, \dots, n$$

where

- n = the number of observations in the interval
- L = the lower end point of the interval
- U = the upper end point of the interval.

The amount of data must be adequate to assure that the sample is representative of the population. Although censoring is highly undesirable, parametric techniques will “tolerate” a limited degree of censoring. In contrast, nonparametric techniques will not “tolerate” censoring. Determination of a T_{99} value by nonparametric techniques requires at least 299 individual observations that represent 10 heats, casts, or melts. Additional data are very desirable. The selection of the number 299 is not arbitrary. Rather, 299 represents the smallest sample for which the lowest observation is a 95 percent confidence, 99 percent exceedance tolerance bound, or T_{99} value. For smaller samples, the T_{99} value falls below the lowest observation and thus cannot be determined without knowledge of the form of the distribution. The lowest of 29 observations corresponds to a 95 percent confidence, 90 percent exceedance tolerance bound, or T_{90} value. The T_{90} value must be based on data from at least 10 heats, casts, or melts. It is important to note that B-basis properties are not included in the Handbook without A-basis properties.

Table 9.2.4. Summary of Data Requirements within MIL-HDBK-5

Mechanical or Physical Property	Customary Statistical Basis	Relative Importance in MIL-HDBK-5	Exenuating Circumstances for Special Material Usage Requirements	Minimum Data Requirements			Applicable Handbook Sections
				Sample Size	No. of Heats	No. of Lots	
Bearing Yield and Ultimate Strength ^a (Derived)	Same as Tensile Properties	Mandatory	Except for elevated temperature applications	20	3	10	1.4.7.1, 3.1.2, 9.2.3.2, 9.2.3.3
Coefficient of Thermal Expansion	Typical	Strongly recommended	Especially for anticipated range of usage	Triplicate measurements			9.2.3.4.2, 9.2.4.4
Compression Yield Strength ^a (Derived)	Same as Tensile Properties	Mandatory		20	3	10	1.7.1, 9.2.3.2, 9.2.3.3
Creep and Rupture	Raw Data w/ Best-Fit Curves	Recommended	Especially for elevated temperature applications	6 tests per creep strain level and temp, at least 4 temps over usage range			9.2.3.5.4, 9.2.5.2
Density	Typical	Mandatory		Duplicate measurements			9.2.3.4.2, 9.2.4.4
Effect of Temperature Curves	Same as Room Temperature Properties	Recommended	Especially for elevated temperature applications	5 ^b	2 ^c	5	9.2.3.3, 9.2.4.4.3
Effect of Thermal Exposure	Same as Baseline Properties	Recommended	Especially for elevated temperature applications	5 ^b	2 ^c	5	9.8.5.5, 9.8.5.6
Elastic Modulus (Tension and Compression)	Typical	Mandatory	Clad materials must have primary and secondary modulus properties defined	9	3	Multiple	9.2.3.4.1, 9.2.4.4.1, 9.8.3.2
Elastic Modulus (T and C) - Elevated Temperatures	Typical	Mandatory	For anticipated usage range	9	3	Multiple	9.8.3.2
Elongation	S-basis	Mandatory	Two-inch gage length preferred	30	3	10	1.4.3.5
Fastener Yield and Ultimate Load	B-basis	Mandatory		100	3	10	9.2.3.6, 9.2.4.6.1
Fastener Shear Strength	B-basis	Mandatory	At least 15 tests per fastener diameter	100	3	10	9.2.3.6, 9.2.4.6.1, 9.7.1

a Optional direct property determination involves same minimum data requirements as tension yield and ultimate.

b Tests per temperature, at least 4 temperatures over usage range.

c 5 heats required for single form and thickness.

Table 9.2.4. Summary of Data Requirements within MIL-HDBK-5, Continued

Mechanical or Physical Property	Customary Statistical Basis	Relative Importance in MIL-HDBK-5	Exenuating Circumstances for Special Material Usage Requirements	Minimum Data Requirements			Applicable Handbook Sections
				Sample Size	No. of Heats	No. of Lots	
Fatigue-Load Control	Raw Data w/ Best-Fit Curves	Recommended	Especially for high-cycle fatigue critical applications	6 tests per R ratio, 3 R ratios, no minimum heat or lot requirements			9.2.5.1
Fatigue-Strain Control	Raw Data w/ Best-Fit Curves	Recommended	Especially for low-cycle fatigue critical applications	10 tests for $R_e = -1.0$, 6 tests other strain ratios			9.2.5.1
Fatigue Crack Growth	Raw Data w/ Best-Fit Curves	Recommended	Especially for damage tolerance critical applications	Duplicate da/dN results for relevant stress ratios and stress intensity range			9.2.4.5.2
Fracture Toughness - Plane Strain	Max., Avg., Min., Coef. of Variance, S-basis	Recommended	Mandatory for materials with spec. min. requirements for plain strain fracture toughness	30	3	10	9.2.3.5.3, 9.2.4.6.1, 9.6.3, 9.9.3.1
Fracture Toughness - Plane Stress	Raw Data w/ Best-Fit Curves	Recommended	Mandatory for materials with spec minimum requirements for plane stress fracture toughness	d	2	5	9.2.3.5.3, 9.2.4.5.3, 9.6.3, 9.9.3.2
Poisson's Ratio	Typical	Strongly recommended		Duplicate measurements			9.8.3.2
Reduction In Area	Typical	Recommended		When tested, use same criteria as for elongation			9.8.3
Shear Ultimate Strength ^a	Same as Tensile Properties	Mandatory	Except for elevated temperature applications	20	3	10	1.4.6.4, 9.2.3.2
Specific Heat	Typical	Strongly recommended	Important to document over anticipated usage range	Duplicate measurements			9.2.3.4.2, 9.2.4.4

^d Minimum sample size not specified, testing should be conducted at 6 or more panel widths to confidently represent trends over the panel widths of interest. Refer to ASTM E561 for testing details.

Table 9.2.4. Summary of Data Requirements within MIL-HDBK-5, Concluded

Mechanical or Physical Property	Customary Statistical Basis	Relative Importance in MIL-HDBK-5	Extenuating Circumstances for Special Material Usage Requirements	Minimum Data Requirements			Applicable Handbook Sections
				Sample Size	No. of Heats	No. of Lots	
Stress Corrosion Cracking	Letter Rating	Recommended	Especially for susceptible aluminum alloys	Conform to replication requirements in G47			3.1.2.3
Stress/Strain Curves (To Yield)	Typical	Mandatory	Desirable to have accurate plastic strain offsets from 10^{-6} to 3×10^{-2}	6	3	6	9.8.4.1
Stress/Strain Curves (Full Range)	Typical	Mandatory		6	3	6	9.8.4.1, 9.8.4.3
Tension Yield and Ultimate Strength	S-basis	Mandatory		30	3	Multiple	1.4.4.1
Tension Yield and Ultimate Strength	A- and B-basis	Strongly recommended	Especially for strength critical applications; a parametric representation of data is possible	100	10	10	1.4.4.1
Tension Yield and Ultimate Strength	A- and B-basis	Strongly recommended	Especially for strength critical applications; a parametric representation of data is not possible	299	10	10	1.4.4.1
Tension Yield and Ultimate Strength - Elevated Temps	Typical	Recommended	Mandatory for elevated temperature applications	e	2	5	1.4.4.1
Thermal Conductivity	Typical	Strongly recommended	Important to document over anticipated usage range	Duplicate measurements			9.2.3.4.2, 9.2.4.4

e Minimum sample size not specified, testing should be conducted at 6 or more temperatures to confidently represent trends over the temperature range of interest. Testing in regions where properties are expected to change rapidly with changes in temperature must be done at temperature intervals sufficiently small to clearly identify mean trends.

Table 9.2.4.1 Test Matrix to Provide Required Mechanical Property Data for Determination of Design Values for Derived Properties

Lot Number ^{a,b,c}	Test Specimen Requirements														
	TUS & TYS ^{d,e,f,g}				CYS ^{d,e,g}				SUS ^h			BUS & BYS ⁱ , e/D = 1.5		BUS & BYS ⁱ , e/D = 2.0	
	L	LT	ST ^j	L	LT	ST ^j	L	LT	ST ^j	L	LT ^j	L	LT ^j	L	LT ^j
A	2 ^k	2	2	2	2	2	2	2	2	2	2	2	2	2	2
B	2	2	2	2	2	2	2	2	2	2	2	2	2	2	2
C	2	2	2	2	2	2	2	2	2	2	2	2	2	2	2
D	2	2	2	2	2	2	2	2	2	2	2	2	2	2	2
E	2	2	2	2	2	2	2	2	2	2	2	2	2	2	2
F	2	2	2	2	2	2	2	2	2	2	2	2	2	2	2
G	2	2	2	2	2	2	2	2	2	2	2	2	2	2	2
H	2	2	2	2	2	2	2	2	2	2	2	2	2	2	2
I	2	2	2	2	2	2	2	2	2	2	2	2	2	2	2
J	2	2	2	2	2	2	2	2	2	2	2	2	2	2	2

- a Ten lots, representing at least three production heats, or casts or melts, are required.
- b Thicknesses of ten lots will span thickness range of product form covered by material specification.
- c For a single lot, multiple heat treat lots will not be used to meet 10-lot requirement.
- d If elastic modulus values for E and E_c are not available, elastic modulus tests should be conducted on three lots.
- e Stress-strain data from at least three lots will be submitted.
- f Full-range tensile stress-strain data from at least one lot will be submitted, but data from three or more lots are preferred.
- g Mechanical properties will also be obtained in the 45° grain orientation for materials that are anticipated to have significantly different properties in this direction than the standard grain directions.
- h It is recommended that sheet and strip ≥ 0.050 inch in thickness be selected for shear tests conducted according to ASTM B831. Shear testing of sheet < 0.050 inch in thickness may result in invalid results due to buckling around the pin hole areas during testing.
- i It is recommended that minimum sheet and strip selected for bearing tests comply with the t/D ratio (0.25-0.50) specified in ASTM E238. For failure modes, see Figure 9.3.3.4.
- j As applicable, depending on product form and size.
- k At least two specimens are recommended; however, a single test is acceptable if retesting can be accomplished to replace invalid tests.

Table 9.2.4.2. Definitions of Heat, Melt, and Cast

Material	Heat, Melt, or Cast
Ingot Metallurgy Wrought Products Excluding Aluminum Alloys	A heat is material which, in the case of batch melting, is cast at the same time from the same furnace and is identified with the same heat number; or, in the case of continuous melting, is poured without interruption.
Ingot Metallurgy Wrought Aluminum Alloy Products	A cast consists of the sequential aluminum ingots which are melted from a single furnace charge and poured in one or more drops without changes in the processing parameters. (The cast number is for internal identification and is not reported.)
Powder Metallurgy Wrought Products Including Metal-Matrix Composites	A heat is a consolidated (vacuum hot pressed) billet having a distinct chemical composition.
Cast Alloy Products Including Metal-Matrix Composites	A melt is a single homogeneous batch of molten metal for which all processing has been completed and the temperature has been adjusted and made ready to pour castings. (For metal-matrix composites, the molten metal includes unmelted reinforcements such as particles, fibers, or whiskers.)

9.2.4.3 Derived Property Values — Minimum compression, bearing and shear strength values are typically derived by pairing compression, bearing and shear test results with tensile test values determined in the same region of the product. The computation of a derived value for each significant test direction requires at least ten paired measurements from ten lots of material obtained from at least three production heats, casts, or melts for each product form and heat-treat condition or temper. If two lots are from the same heat, cast, or melt and have the same product form and thickness, they must be heat-treated separately in order to constitute two lots. Therefore, it is recommended that two lots with the same product form and thickness come from a different heat, cast, or melt.

Ten lots of material, as shown in Table 9.2.4, from at least three production heats, casts or melts for each product form and heat treat condition will be tested to determine required mechanical properties. (See Table 9.2.4.2 for definitions of heat, melt and cast.) A lot is defined as all material of a specific chemical composition, heat treat condition or temper, and product form which has been processed at the same time through all processing operations. Different sizes and configurations from a heat cast or melt will be considered different lots. For a single lot of material, only one heat treat lot may be used to meet the ten-lot requirement. Thicknesses of the 10 lots to be tested will span the thickness range of the product form covered by the material specification (or for the thickness range for which design values are to be established). Test specimens for paired ratios will be located in close proximity and will be taken from the same sheet, plate, bar, extrusion, forging, or casting. If coupons or specimens are machined prior to heat treatment, all coupons or specimens from the same lot will be heat treated simultaneously in the same heat-

treat load through all heat-treating operations. Some or all of the lots may be heat treated together provided they are of the same product form that represent different thicknesses or heats, casts, or melts.

In the cases where multiple observations are available from a single lot, the average of those observations will be treated as an individual observation. Since some variation in strength may be expected from one specimen location to another, use of lot averages minimizes the effect of this variable.

9.2.4.4 Other Static Properties—Data requirements for defining elastic properties, stress-strain curves, and effect of temperature curves are described in the following sections.

A precise density value in pounds per cubic inch will be provided. Although not required, physical property data for coefficient of expansion, thermal conductivity, and specific heat should be submitted, when available. Also, information regarding manufacturing (fabrication and processing), environmental effects (corrosion resistance), heat treat condition and applicable specification will be provided so that a comments and properties section can be prepared.

9.2.4.4.1 Modulus of Elasticity—Tensile and compressive modulus of elasticity values will be determined from at least three lots of material. Elastic modulus values are those obtained using a Class B-1 or better extensometer. The method of determining or verifying the classification of extensometers is identified in ASTM E 83. ASTM E 111 is the standard test method for the determination of Young's Modulus, tangent modulus, and chord modulus of structural materials. A modulus value will also be obtained for the 45 degree grain orientation for materials that are anticipated to have significantly different properties in this direction than the standard grain directions.

Typical values for elastic moduli at room temperature are tabulated in MIL-HDBK-5 room-temperature property tables. Values for these properties at other temperatures may be approximated by multiplying the room-temperature value by appropriate percentages from effect-of-temperature curves in MIL-HDBK-5.

9.2.4.4.2 Typical Stress-Strain Curves—Room temperature tensile and compressive load-deformation curves or stress-strain data for each grain direction, from at least three lots will be provided. Room temperature, full-range, tensile load deformation curves or stress-strain data for each grain direction will also be provided. Full-range stress-strain data will be provided from at least one lot, but data from three lots are preferable. For heat resistant materials for which elevated temperature data for tensile yield and ultimate strengths are required, room and elevated temperature stress-strain data will be provided.

Preparation of each typical stress-strain curve requires (1) several representative original stress-strain curves, (2) average values for yield strength from original stress-strain curves, or, when available, product average values for yield strength, and (3) typical elastic-modulus values at test temperature.

Original stress-strain curves are utilized to obtain a representative curve shape, which may be characterized by the Ramberg-Osgood parameter. The minimum number of original stress-strain curves required is dependent on the degree of variation from one curve to another. If curves are found to be similar in shape, and the range of products (thickness, etc.) is small, one curve from each of three plots should be adequate. Otherwise, the number of original curves should be increased as necessary, to insure an adequate sampling.

Original stress-strain curves determined using an ASTM E 83 Class A extensometer (Tuckerman, Martens, etc.) are preferred for preparation of typical stress-strain curves up to 0.005-in./in. plastic strain or higher. When curves having this precision and accuracy are not available (particularly for full-range and elevated-temperature curves), curves determined using Class B-1 extensometers may be used as indicated in ASTM E 83.

MIL-HDBK-5J
31 January 2003

Product average values for yield strength, ultimate strength, and elongation are average values rounded to the nearest whole number, determined from production lots of product form. Product average values represent current production capabilities; hence, these are supplied by producers.

The modulus value used in constructing a stress-strain curve must agree with the value obtained from the room-temperature table value multiplied by the appropriate percentage from the elevated temperature curve.

For some materials, the shape of the stress-strain curve, yield strength, and elastic modulus vary with test direction. When this is the case, individual curves should be prepared for each test direction, and each curve should be labeled accordingly. Likewise, tensile and compressive stress-strain curves usually differ, and individual curves should be prepared for each type of loading. If two or more finished curves are found to be identical, they may be combined in presenting the finished curves.

The selection of test temperatures to be represented by typical stress-strain curves should be guided by the temperatures at which the product is typically used. In the absence of other information, these temperatures should include room temperature, other temperatures at which tensile properties are determined in conformance with the requirement of applicable procurement specifications, and appropriate temperatures within the useful application range for the product.

9.2.4.4.3 Elevated Temperature Curves — An idealistic approach to the establishment of elevated temperature curves would be to have A-basis design values at a sufficient number of temperatures to define corresponding temperature curves on an A-basis. If such data were available, finished curves would be constructed by plotting A-values on a percentage scale and analytically defining a smooth curve, and the procedures described in Section 9.8.5.1.1 would not be applicable. Unfortunately, the cost of generating the required data is prohibitive, and idealism must be tempered with practicality. For this reason, data requirements and the procedures described in Sections 9.8.5.1.1 and 9.8.5.1.2 allow some latitude to make fullest use of whatever data may be available.

These procedures, as described in the indicated sections, are intended both to establish the general shape of curves, and to adjust their scaling in such manner that the resulting product of a percentage value from the curve and a corresponding value from the room-temperature property table will yield a design value, at some designated temperature, that will be a good approximation of a directly computed design value at that temperature.

To establish the shape of an elevated-temperature curve, the sample will include observations from at least five lots* of material, composed of at least two heats at each of several temperatures. Choice of temperatures will be guided by probable range of service temperatures anticipated for the material, as well as by its metallurgical characteristics. For materials used at cryogenic temperatures, testing is normally conducted at -110°F, -320°F, and -423°F; however, no attempt will be made to extrapolate the curve below the lowest temperature for which adequate data are available. For elevated temperature applications, data should normally be available at temperature intervals from 200°F to 300°F except in regions of time-temperature-dependent metallurgical change, where temperature intervals of perhaps 100°F to 150°F are appropriate. Extrapolation beyond the range of temperatures covered by adequate data is not allowed.

For a number of alloys, most specifically heat-resisting alloys, procurement specifications may designate minimum property values at temperatures other than room temperature, and either A- or S-basis

* For single form and thickness, data from no more than one heat treat lot per heat may be used to meet the five lot requirement.

values may be available at both room temperature and secondary testing temperatures. When this is the case, the elevated temperature curve may be scaled by means of these values.

9.2.4.5 Dynamic and Time Dependent Properties

9.2.4.5.1 Fatigue — Most fatigue data generated in load control may be considered for inclusion in MIL-HDBK-5. However, load-control experiments on unnotched samples can produce ratcheting failures rather than true fatigue failures. This can be a problem with materials that cyclically soften. In the absence of cyclic stress-strain data, the acceptability of short-life data obtained under load control on unnotched specimens can be difficult to evaluate. Therefore, results from specimens tested at a maximum stress level greater than the average tensile ultimate strength of the material should not be used. In addition, test results obtained under load control that have produced average fatigue lives on unnotched specimens of less than 10^3 cycles should be excluded. Short-life, load-control data generated on notched samples tested at high stress levels may be considered.

Fatigue data generated under strain control over a wide range of strain ratios and ranges can be acceptable also. High-strain-range tests producing low fatigue lives can be considered, assuming that documented bending strains were held within ASTM E 606 limits and buckling failures were not produced. Documenting the stress response associated with each test result is important. The stress data that are reported should reflect the material's stable response, including effects of cyclic hardening or softening and of mean stress relaxation provided such data were obtained at other than $R_e = -1$. The normal convention is to report the stress values associated with one-half the material's fatigue life to crack initiation. Several criteria are commonly used to define crack initiation in a test under strain control. The primary requirements for inclusion in MIL-HDBK-5 are that the criteria be specific and applied consistently. If multiple sources of data are being considered, the potential problem of inconsistent crack initiation criteria must be addressed before that data are merged.

If strain-control data only are reported with fatigue test results obtained under strain control, these data must be supported by well-documented cyclic stress-strain curves and mean stress relaxation data for that specific material.

For fatigue experiments under load control, data are normally generated at specific stress ratios or mean stress levels. If the stress ratio is held constant, a fatigue curve is generated by performing a series of experiments at prescribed maximum stress levels, such that the desired range of fatigue lives is achieved. If mean stress levels are held constant, a range of maximum stress levels is also used, but the stress ratio for each maximum stress level is different. Presentation of the latter type of data in a traditional S_{\max} -versus-log N_f display, with individual stress ratio curves, can be cumbersome because of the large number of stress ratios involved. For this reason, constant mean-stress fatigue data should be identified by mean stress level, even though they are plotted on a standard S_{\max} -versus-log N_f display. The illustrations should be clearly labeled to properly identify the mean-stress or stress-ratio levels.

To evaluate analytically the effects of stress or strain ratio on the fatigue performance of a particular material, it is recommended that data be available for at least three stress or strain ratios, or alternatively, three mean-stress or strain levels. Similarly, at least three stress or strain levels are recommended to evaluate the effects of mean stress on fatigue performance. In the case of data under strain control, a specific strain ratio or mean strain may not define a mean-stress level uniquely. For $R_e = -1.0$ (mean strain = 0), the stress ratio is usually very close to $R = -1.0$ (mean stress = 0) – if it is not, the data should be examined carefully

for validity. For strain ratios greater than $R_\epsilon = -1.0$, the stress ratio is usually less than the strain ratio, and the difference is generally greater at the greatest strain ranges. For very large strain ranges in ductile

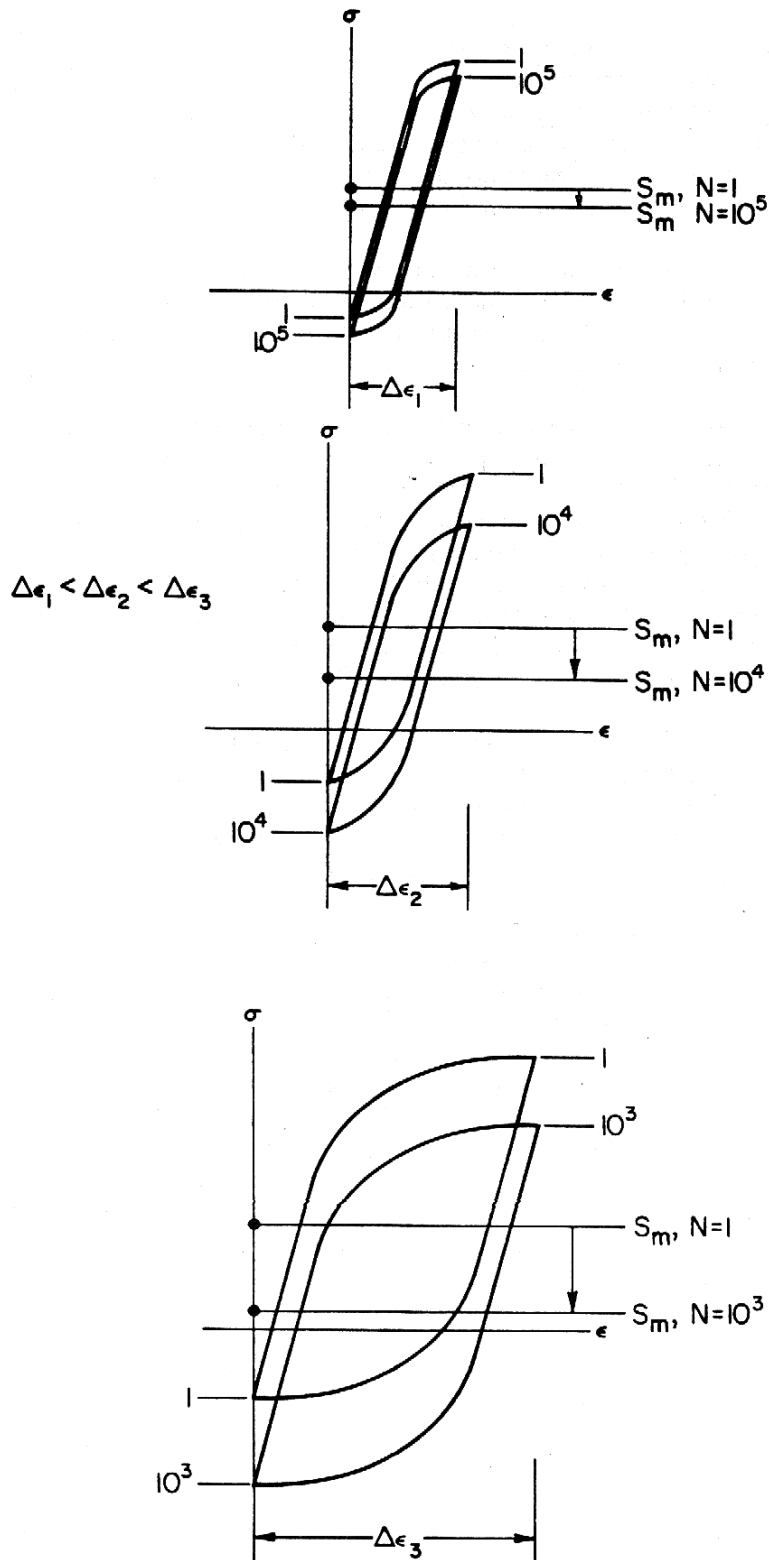

Figure 9.2.4.5.1. Schematic of stabilized mean stress relaxation for different strain ranges at $R_\epsilon = 0$.

materials, the stable stress ratio will approach $R = -1.0$ (mean stress = 0), regardless of the strain ratio, R_ϵ . Mean stress relaxation behavior is illustrated in Figure 9.2.4.5.1.

There should be at least six non-runout fatigue test results for each condition, and these data should be distributed over at least two orders of magnitude in fatigue life. These requirements are the minimum sample sizes normally required to consider developing a fatigue data display. Meeting the minimum data requirements does not ensure an acceptable set of fatigue curves. In cases involving highly scattered data, substantially larger sample sizes may be required to achieve a meaningful description of mean fatigue trends. The statistical procedures used to evaluate the significance of a fatigue data collection are described in Section 9.6.1.7.

9.2.4.5.2 Fatigue Crack Growth — In order to establish a positive trend in rate behavior, it is recommended that rate data be generated over a range of at least two orders of magnitude. In general, this will be associated with a domain of stress-intensity-factor range from one half to a full order of magnitude. Good experimental techniques, coupled with this data-range criterion, should provide a concise and consistent data display for linear or other analysis.

When planning experimental programs to achieve the best, most complete derivation of fatigue-crack-propagation data, the range of ΔK over which tests are conducted should include those which will provide crack-growth rates as low as 10^{-8} inches/cycle. Furthermore, if possible, multiple heats of material should be included. Ideally, to properly document the effects of stress ratio, fatigue crack growth data should also be generated over a range of R ratios (0.1, 0.4, and 0.7 are typically good values). If data representing negative R ratios are available, they should also be included.

9.2.4.5.3 Fracture Toughness — For materials covered by public specifications that include minimum fracture toughness requirements, at least three specimens each from a minimum of ten lots of material for each test direction (at least 30 observations total) are required for inclusion in MIL-HDBK-5.

Middle Tension Panels — To identify the material tested, it is necessary to report alloy temper, product form, and grain directions being tested. Reference tensile properties, actually representative of specimen or material lot (i.e., not specification or MIL-HDBK-5 A and B values), are also necessary information. These will include yield strength, ultimate strength, and elongation.

The specimen configuration is described by measured thickness, panel width, and free length between grips. The minimum flaw details to be reported are fatigue stress levels used in generating the fatigue crack and length of the fatigue crack existent prior to the rising load fracture test.

The test procedure will be described briefly, identifying environment (temperature, humidity, salinity, etc.), loading rate, and the mode of buckling restraint.

The report of test results will include maximum load and stress, and estimated critical crack length (indicate method of detection, such as visual observation, film record, or compliance calibration). It is recommended that whenever practical, a record of load versus crack length be obtained to assess slow stable crack extension prior to fracture.

9.2.4.5.4 Creep and Creep Rupture — A sufficient number of creep and/or creep rupture tests should be performed to clearly define creep and/or creep rupture trends as a function of applied stress for the range of temperatures of interest. Typically, at least eight tests should be completed for each temperature, and at least 20 tests performed for each multi-temperature regression that is performed. The “spacing” of the temperatures tested generally should be close enough that the highest stress level at a given temperature (which can be expected to produce the shortest average creep times) is greater than or equal to the lowest stress level at the next higher temperature, and vice versa.

Another factor to consider when defining a series of creep tests is heat-to-heat variability. The creep test program may be based on as few as two heats of material if the heat-to-heat component of variability is less than 25% of the within-heat variability. On the other hand, the creep test program should be based on at least five heats of material if the heat-to-heat component of variability is greater than 65% of the within-heat variability. In any case, the heats of material that are tested should be distributed randomly and essentially equally throughout the test matrix. Additional experimental design suggestions for creep testing are included in Section 9.2.5.2.

For isostrain creep, collected data will include stress, temperature, modulus and plastic strain on initial loading, and strain-time pairs sufficient to define a curve. While strain-time pairs will be only those for the isostrain of interest, after inelastic strain on loading has been included in the reported strain, it may be that reported data may not correspond to isostrain levels. Consequently, isostrain-time pairs may be read from a smooth curve drawn through the values recorded during the test.

For rupture, collected data will include stress, temperature, time-to-rupture, percent elongation, and reduction of area. Percent elongation and reduction of area can then be used to define rupture ductility curves or equations.

9.2.4.6 Mechanically Fastened Joints

9.2.4.6.1 Introduction of a New Fastener System —When introducing a new fastener for possible inclusion in MIL-HDBK-5, the sponsor will submit a written request (on company letterhead) to the Chairman, MIL-HDBK-5 Coordination Group, providing the following information:

- (1) A description of the fastener such as: (a) type of fastener (driven rivet, blind fastener, swaged collar, etc.), (b) fastener material (alloy and temper), (c) unique or new features, (d) nominal sizes and actual diameters, and (e) part drawings and functional description.
- (2) Reason for fastener usage or intended usage such as: (a) higher strength, (b) higher or lower temperature capability, (c) improved fatigue performance, and (d) lower installed cost.
- (3) Development and use status. (It is not required that the fastener system actually be in use on production airframe structure, but there should be a high level of interest and an intent to use the fastener.) (a) What are current or planned airframe applications? (b) How long has the fastener been produced on a production (nonexperimental) basis? Include preliminary lap joint test data that demonstrates that sufficient diameters and grips are available to conduct a design allowable test program (i.e., data for at least one test for each diameter/grip combination contained in the proposed test plan).
- (4) Specification status. Under what type of specification is the fastener covered (NASM or Company)?
- (5) In what sheet or plate material will the fastener be installed? (The proposed allowables should be for the same or similar sheet or plate material that the sponsor is using or plans to use.)
- (6) Shank deformation. Does shank deform during installation? Verification is desirable. (a) If a blind fastener, is it hole filling or nonhole filling? Verification of hole fill is desirable. (b) If a solid shank fastener, are design values to be presented for clearance or interference holes?

- (7) Has the sponsor conducted any testing on the fastener system (especially joint allowables) and will the sponsor provide data to the MIL-HDBK-5 Coordination Group?
- (8) Has the sponsor reviewed (or will the sponsor review) test program plan, actual testing, analysis of data, and specifications?
- (9) Are the fastener holes to be cold worked or a sleeve inserted? If so, the reproducibility of this part of the fastener installation process must be verified.

9.2.4.6.2 Sample Fasteners —At time of approval of a fastener static joint strength proposal, fastener manufacturer will submit, to the Chairman, MIL-HDBK-5 Coordination Group, 10 fasteners each from maximum and minimum diameter and grip size tested in the allowables program. These 40 samples will be from the same production lots as those used in the test program. Samples will be packaged suitable for storage with full identification of contents on the container. The information may also include any storage time limitation due to coating or lubricant life. The information required to complete the report described in Section 9.3.3.4 must also be included.

9.2.4.6.3 General Data Requirements —The types of data required to develop a fastener system design curve are shown schematically in Figure 9.2.4.6.3. There are three facets to consider, which are described in following subsections: (1) shear strength of the fastener, Region 3; (2) sheet critical strength, bearing and transition regions, Regions 1 and 2; and (3) tensile properties of sheet and plate material used in the joint. Each of these facets is described in the next 3 subsections. The next two subsections address data requirements for determination of the tensile strength of a fastener, and an assembled joint. Recommended data formats are discussed in Section 9.3.3.4.

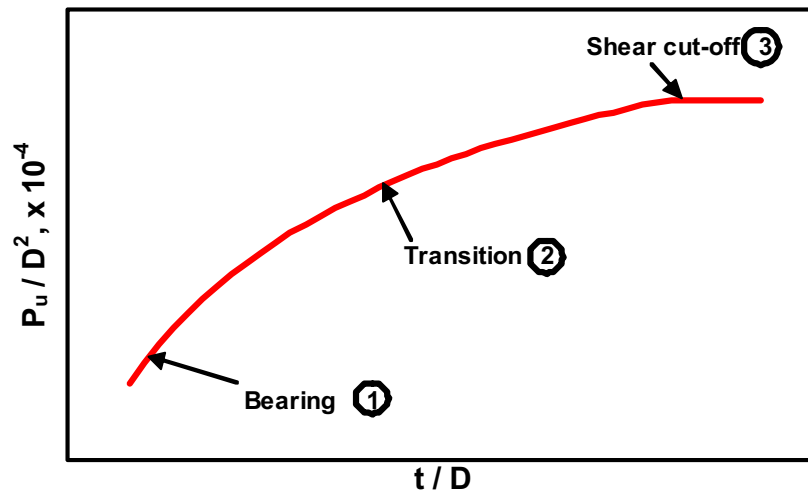

Figure 9.2.4.6.3 Schematic diagram of P_u/D^2 versus t/D .

Shear Strength of Fastener — At least 15 shear tests are required for each fastener diameter for which allowables are to be established. Fasteners for each diameter will be selected from at least three production lots that represent at least two heats of the fastener component materials. The major components of multi-piece fasteners will meet the two heat requirement.

A product lot will consist of finished fasteners of the same part number, class, grip and diameter, which conform to the following:

MIL-HDBK-5J
31 January 2003

- (1) fabricated by the same process
- (2) major components each made from material of the same heat
- (3) major components heat treated in one continuous run or order
- (4) produced as one continuous run or order

The major components of multi-piece fasteners of the production lot will individually meet the definition above.

Fasteners developed from materials not previously used for fastener applications will require additional testing in order to determine statistically reliable minimum shear strengths. Test values should be developed in accordance with the test methods noted above using hole sizes specified in those methods or Table 9.7.1, as appropriate. Test values will represent a minimum of 10 tests from each of 10 production lots made of at least 3 heats of material (100 tests). Fasteners tested should be evenly distributed over the diameter range under consideration with grip ranging from 2 to 3 diameters for solid and blind rivets and any appropriate length for solid shank fasteners. Shear strength (F_{su}) should be computed based on hole size for solid and blind rivets and measured shank diameter for non-hole filling blind fasteners and pins.

In the sheet critical range, fasteners with different head shapes, head sizes (NAS 1097, MS 29694, or MS 20426), material, or heat treatment will be considered different fasteners and will require separate tests. Sheet materials with different heat treatments or compositions will be considered different materials and also will require separate tests. In the case of aluminum alloys, data obtained with clad sheet may be used to determine allowables for clad and bare sheet; however, allowables obtained from tests on bare sheet can be used only to determine allowables for bare sheet. In the case of all sheet materials, data from tests using sheet at one heat-treat level may be used to determine allowables for sheet having higher strength heat treatments. However, the reverse is not permissible.

Tensile Properties of Sheet — At least three sheet tension test results as required by NASM 1312, Test 4, will be provided for each sheet or plate used to make single-shear test specimens described in the previous subsection. Tensile ultimate and yield strengths and percent elongation will be reported in accordance with ASTM E 8. Grain direction will be that applicable to the procurement specification tensile test requirements. Tabulated data will identify single-shear specimens made from sheet to which each group of sheet-tension specimens apply by appropriate coding.

Tensile Strength of Fastener — Tensile strength will be determined for all fastener systems except solid and blind rivets from tests performed in accordance with NASM 1312, Test 8. Tensile test requirements and analytical methods will be the same as for shear strength determination (see Section 9.2.4.6.1).

Assembled Joint Strength — The requirement for data from two fabricating and testing sources applies to assembled joint strength. Approximately 75 percent of required data will come from one source; the remainder from a second source. Data will cover the t/D (thickness/diameter) range that results in bearing, transitional and shear-type failures as shown in Figure 9.2.4.6.4. It is suggested that the second source concentrate testing in the bearing and transition regions. Selection of sheet thickness will be made in such a way that, for each fastener diameter, an even distribution of data is achieved over the t/D range with about 20 percent of the data taken at t/D values for which joint failure will be by fastener shear (not applicable to dimpled joints). Minimum sheet thickness should be restricted to one thickness below knife edge for flush head fasteners and no tests below t/D or 0.18. Sheet thickness/fastener grip combinations will be selected to include a uniform distribution of minimum and maximum grip conditions throughout the t/D range tested. Specimen fabrication and testing will be allocated to provide data from each source, distributed across the sheet critical and transition ranges.

All diameters of a given fastener for which joint allowable loads are established will be included in the test plan. Since a fastener system usually comprises 2 to 5 diameters, the quantity of joint specimens to

MIL-HDBK-5J
31 January 2003

be tested will be expected to vary, depending upon number of fastener diameters. Quantity of data will include results from at least the following valid tests: two diameters, 42 tests; three diameters, 57 tests; four diameters, 72 tests; five diameters, 87 tests. In allocating test joint specimens among fastener diameters, for a three- or four-diameter fastener line a larger quantity of specimens will be used for the largest and smallest diameters with somewhat less testing for intermediate diameter(s). In the case of a five-diameter fastener line, larger quantities of specimens should be allocated to the largest, middlemost, and smallest diameters with somewhat less testing for the two remaining intermediate diameters. For each diameter and t/D combination tested, a minimum of three specimens should be used. In addition, approximately an equal number of tests must be run at each t/D.

9.2.4.6.5 Confirmatory Data — If a manufacturer wishes to have their company name added to the footnote of an existing table as a supplier of confirmatory data, or to add to an existing product, function, or modification, the following procedure will be used:

- (1) Repeat, in total (quantities and conditions), the original test program from which the table was developed.
- (2) The T90 curves, (yield and ultimate), of the original data set will establish the baseline performance requirements, regardless of the construction method employed for the published table, in accordance with section 9.7.1.4.
- (3) The T90 curves, (yield and ultimate), of the proposed supplier's data set will be constructed, and compared to the baseline curves of the original data set in accordance with the criteria defined in section 9.2.4.x.x. (The same criteria defined for sunset clause conformance.)
- (4) If the proposed supplier's data set conforms to the criteria of section 9.2.4.x.x, then the design allowable table will be modified in accordance with Item 17(c) of section 9.9.5.
- (5) Note that the published data values of the original table will not be modified.

If a manufacturer wishes the company name to be added to the footnote of an existing design allowable table with four or more diameters as a supplier of confirmatory data, but does not produce or market the fastener in all diameters contained in the design allowable table, the following procedure will be used:

- (1) The new supplier will test at least three successive diameters, including the smallest diameter in the design table, or at least three successive diameters including the largest diameter in the design allowable table. Test quantities will be the same as defined in section 9.2.4.6.3.
- (2) The T90 curves, (yield and ultimate), of the original data set will establish the baseline performance requirements, regardless of the construction method employed for the published table, in accordance with section 9.7.1.4.
- (3) The T90 curves, (yield and ultimate), of the proposed supplier's data set will be constructed, and compared to the baseline curves of the original data set in accordance with the criteria defined in section 9.2.4.7.2. (The same criteria defined for sunset clause conformance).
- (4) The following footnote will be added to the design allowable table: "Confirmatory data provided by XYZ Company." This footnote will be flagged to the supplier's part number and applicable fastener diameters.
- (5) Note that the published data values of the original table will not be modified.

9.2.4.7 Fusion-Welded Joints — The type of data required (i.e., tension, shear, fatigue, etc.) and general welding conditions of interest must be established first.

The data sample must be adequate to determine form and distribution of the population from which it was drawn. If the weldment population definition is broad and allows considerable latitude in the range of parameters defined, it is obvious that larger sample sizes will be required. Certain minimum requirements can be stated, however, based on statistical considerations.

For data to be directly analyzed on a statistical basis, a typical weldment population exhibiting nearly normal distribution characteristics should be represented by a sample containing a minimum of 100 random observations. These observations should include at least 10 subsamples representing random variables such as base material lots, filler material lots, weld processing variables, and weld machine operators and setups.

Direct analysis of a data sample not normally distributed requires at least 300 observations to establish a minimum value on an A-basis. A B-value may be established from the smaller sample defined above. As in the previous case, the observations should be representative of the total population.

Due to the number of variables inherent in a welding process, it is advisable to make as broad a sampling as practicable within the population definition. The range of material and processing parameters included in the sample will obviously influence sample size. The total number of observations should be sufficient to identify factors that may be significant within the population, such as joint thickness, weld repair, filler material, and heat-treat condition.

9.2.5 EXPERIMENTAL DESIGN — General guidance on experimental design for fatigue, creep-rupture and fusion-welded joints is included in the following subsections.

9.2.5.1 Fatigue — In view of the data requirements in Section 9.2.3.5.1 and 9.2.5.1, fatigue data generated for inclusion in MIL-HDBK-5 should be the result of a well-planned test program. The following general discussion of fatigue test planning is based in large part on the concepts presented in References 9.2.5.1(a) and (b), and ASTM E739. Those interested in the detailed aspects of fatigue test planning should refer to these and other sources. The discussion that follows pertains to fatigue testing under either load control or strain control.

Traditionally, fatigue testing under load control has been performed to evaluate the fatigue performance of engineering materials and components subjected to numerous load fluctuations. Notched specimens are often used to evaluate the effect of stress concentrations upon fatigue life in load-control testing. The nominal stresses during load-control testing are generally below the materials yield strength and the resulting fatigue lives are usually greater than 10^4 cycles. Load-control tests with high mean-stress levels may develop unconstrained cyclic plasticity which may lead to ratcheting failures (see Figure 9.6.1(b) in Section 9.6.1). Unless cyclic strains are monitored in load-control tests, it is not possible to know exactly when unconstrained cyclic plasticity will develop. In general, however, there are test conditions that should be avoided when operating under load control, as follows:

- (1) Unnotched-specimen fatigue tests in which fatigue lives less than 10^3 cycles to failure are expected.
- (2) Fatigue tests involving net-section maximum stresses greater than the yield strength or over 95 percent of the typical monotonic ultimate strength of the material.

Strain-controlled fatigue testing has emerged since the mid-1950s because the fatigue damage process was found to be highly dependent upon cumulative plastic deformation. Cycling a material between two

MIL-HDBK-5J
31 January 2003

strain limits can alter the material's stress-strain response (cyclic hardening or softening) compared to the monotonic response. Fatigue testing under strain control should be considered in cases where constrained inelastic cyclic strains may occur in the actual component. Strain control should also be used for any conditions where unconstrained cyclic plasticity may lead to ratcheting failures in load-control testing.

Fatigue data obtained under load control for use in MIL-HDBK-5 should be generated for at least three stress ratios (see Figure 9.2.5.1). Fatigue lives ranging from approximately 10^3 to 10^6 cycles are most commonly of interest while the stress ratios chosen should normally span the range from about $R = -1.0$ to 0.50 or greater.

Fatigue data obtained under strain control are commonly generated at $R_e = -1.0$. These data will be considered for MIL-HDBK-5, but generating data for at least two other strain ratios is also desirable.

The stabilized value of mean stress attained in a strain-control test at R_e greater than -1.0 will be different from that observed at the beginning of the test for materials that undergo cyclic mean stress relaxation. The degree of stress relaxation will depend on strain range and strain ratio, the magnitude being greater at larger strain ranges or larger strain ratios. Complete relaxation to a zero mean stress is the limiting case. When testing at strain ratios greater than -1.0 , it is appropriate to limit the strain ranges to values below those at which total cyclic mean-stress relaxation occurs.

The amount of cyclic stress relaxation also varies with the anticipated fatigue life. Large-strain-range, low-cycle tests usually exhibit the greatest mean stress relaxation. Because of this behavior, it is usually appropriate to run the positive mean strain experiments at strain ranges less than or equal to the level that produces complete mean stress relaxation.

A given series of fatigue tests conducted under strain control should be targeted to describe the useful life range for the material. The life range explored need only be limited on the low side by the maximum strain ranges that can be performed without specimen buckling problems, and on the high side by the maximum strain rates that are allowable, in combination with the permissible duration of individual tests. Life ranges of 10 to 10^6 cycles are reasonable to explore in strain-control tests with many materials and specimen geometries (see Figure 9.2.5.1). Strain-control tests performed for inclusion in MIL-HDBK-5 should normally be conducted with symmetric waveforms, with no hold times at frequencies ranging from 0.10 to 5 Hz— depending on the response of extensometry and recording equipment. It is important to document the strain rates and conformance of the testing techniques with ASTM E 606.

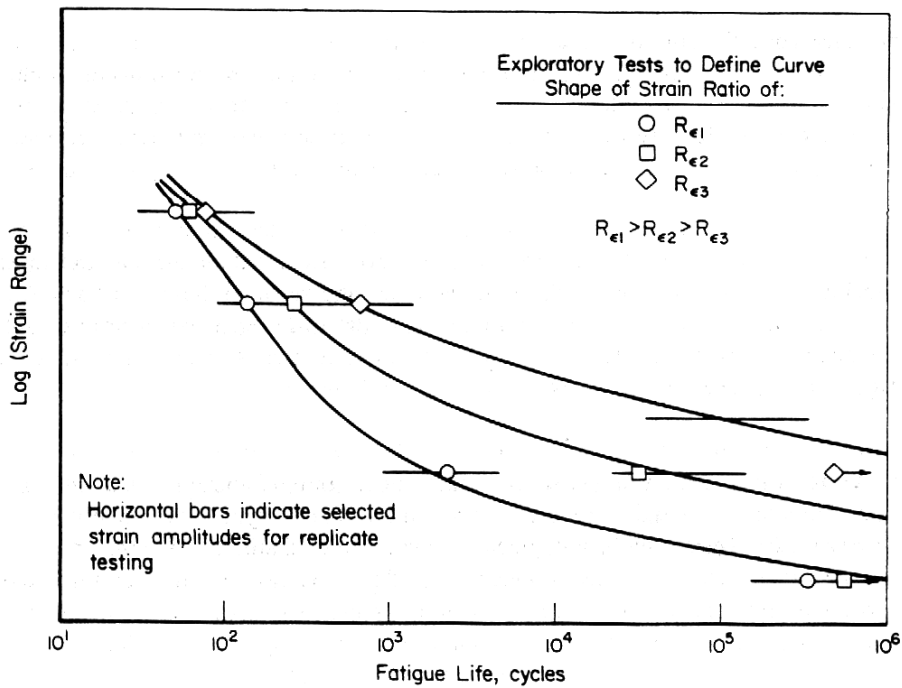
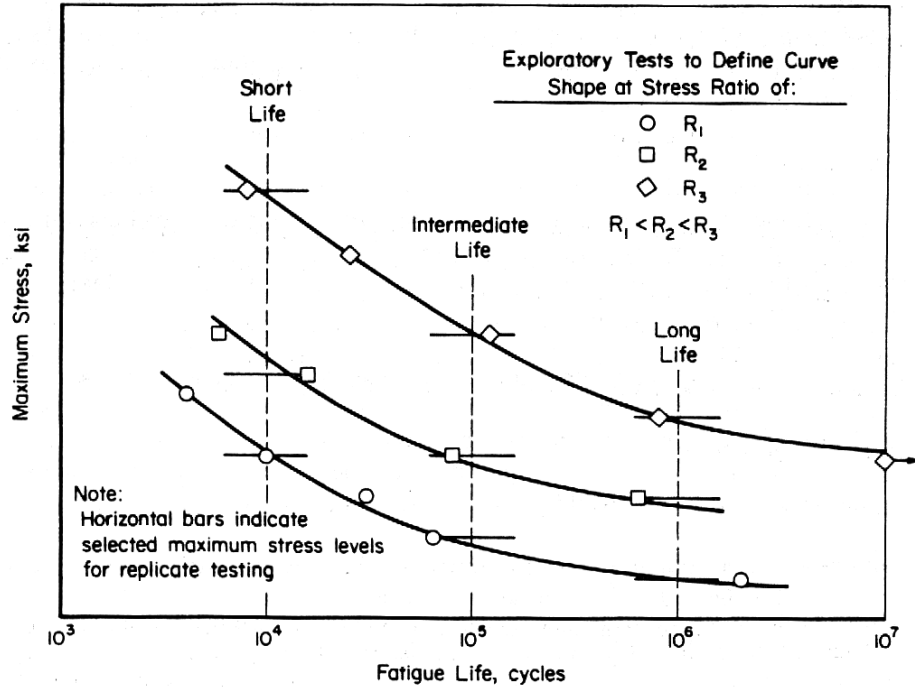

Figure 9.2.5.1. Schematic fatigue data displays (showing the initial exploratory tests as symbols and the strain levels subsequently chosen for replicate fatigue testing as bars; the length of the bars denoting observed data variability).

MIL-HDBK-5J
31 January 2003

Long-life fatigue tests are a special situation in strain-control testing because of the extended test periods that may be required, especially if maximum test frequencies must be kept at or below 1 Hz. For example, a test run at 1 Hz involving one million cycles requires about 11-1/2 days. Decreasing the duration of long-life, strain-control fatigue tests are desirable whenever possible; otherwise, a few tests in the 10^6 to 10^7 cycle range can take as much time as the rest of the life curve.

Switching from strain-control testing to load-control testing at a greater frequency at some point in the life of the specimen is becoming a common practice. This switch is typically done when the cyclic response is nominally elastic. Usually the frequency can be increased by a factor of 10 or more but even a factor of 2 or 3 is certainly worthwhile.

When the control mode and/or frequency are changed, certain criteria should be observed. When generating a strain-control fatigue curve, ranging from the short-life regime (10 to 10^3 cycles) to the long-life regime (10^6 to 10^8 cycles), the fatigue tests can be placed in three groups for consideration.

At the short-life end of the curve, the material response will typically vary throughout the test. In this regime, a significant amount of inelastic strain may be present, cyclic hardening or softening may occur as well as mean stress shifts. In short, no consistent relationships exist between stress and strain and, therefore, no control mode change is recommended in this life regime.

For intermediate life tests, some inelastic strain may be present and, for a period of time, the stress-strain relationship may vary. Generally, however, a stabilized, consistent relationship is eventually achieved. Under these conditions, it may be possible to switch the test mode to load control at a higher frequency.

In the long-life regime, very little inelastic strain will normally be present, and stress-strain stabilization is achieved very rapidly. Here, switching from the strain-control mode to the load-control mode can be accomplished.

The material behavior cited above can only be evaluated by starting all of the tests in the strain-control mode and then switching the mode and frequency when stabilized stress-strain behavior is achieved. An evaluation of the strain rate behavior of the material in the strain-control mode (within the normal response capabilities of the equipment) may be desirable to determine if the stress-strain relationship is likely to change when the frequency is changed.

In summary, do not switch control modes in the low life regime of the fatigue curve. When some inelastic strain is present, switching may be employed if stable stress-strain response can be obtained and a negligible strain rate effect at the test temperature and strain range of interest can be demonstrated (i.e., it can be shown that fatigue life and stress range are not influenced by loading rate). One very good check is to produce overlapping data points in this regime where some tests are run to failure in the strain-control mode while others are switched to high-frequency load-control mode after stabilization is obtained. This is necessary to provide assurance that the switching procedure is not influencing results.

At the very long-life end of the curve, the essentially elastic behavior of the material is most conducive to switching of control modes. The greatest benefit of the increased frequency can also be obtained here. If results have shown that switching is successful at the intermediate strain range level, then the probability of the long-life tests being at least as successful is high. If, however, the material exhibits a measurable inelastic strain and is slow to stabilize even after many cycles, caution should be exercised in making the decision for a control mode change.

When the determination that a test should be switched from strain control to load control has been made, the following sequence is recommended:

MIL-HDBK-5J
31 January 2003

- (1) Note the maximum and minimum stabilized load levels.
- (2) Gradually reduce the strain range to zero. This process should take several cycles (at least 10). If a measurable inelastic strain is present, the strain range reduction should take sufficient cycles so the magnitudes of the maximum and minimum loads are reduced symmetrically.
- (3) At this point (strain range at zero) the load may or may not be at zero, depending on the conditions of strain ratio and strain range to which the specimen was exposed. If a residual load is present, the load should be adjusted to zero by carefully changing the strain level.
- (4) Next, the test system should be switched to the load-control mode and the test restarted. The strain-control cycling may have been performed using a triangular waveform. The higher frequency testing under load control generally employs a sine wave. The waveshape difference is only of secondary importance, and most machines can easily control a high frequency sine wave. The actual frequency used should be well within the capability of the test equipment so that the load can be accurately measured and controlled. Furthermore, care must be taken to avoid frequency effects, e.g., self-heating, and strain-rate effects. This is commonly a problem with tests involving a significant amount of inelastic strain.

When reproducing the maximum and minimum stresses that existed under strain-control testing, first introducing the mean load on the specimen and then gradually increasing the load range symmetrically from this point is generally preferred. Whatever procedures are used should be clearly defined and well documented.

The tendency of the load-control results to be slightly more conservative than those generated in strain-control testing is worth repeating. When a specimen develops a fatigue crack, a test that is being conducted under strain-control mode will generally exhibit a reduced tensile load as the crack propagates. Under load-control testing, the load remains constant and the crack will grow faster, resulting in a lesser life. For this reason, all data generated by this technique should be so noted and identified on data tables and graphs.

Essentially two steps are involved in the generation of a fatigue curve for a specific stress or strain ratio. First, the general shape of the curve should be determined. Nonreplicated fatigue tests completed at not more than four to six maximum stress levels are usually sufficient to define the basic shape of the curve above the fatigue limit. After the shape of the curve is found from test results, or estimated from fatigue data on similar materials, then the mean curve should be verified through carefully planned replicate fatigue tests.

If the lower maximum stress levels or strain ranges chosen result in nonfailures or runouts**, do not repeat these stress levels while defining the general shape of the fatigue curve. Simply focus on relatively evenly spaced stress or strain levels that generally provide fatigue failures.

In performing these exploratory fatigue tests, obtaining the test specimens from a random sample that adequately represents the material is important. In that context, specimens should be taken from several different lots if possible. Particular care should also be given to minimizing nuisance variables such as test machine effects, frequency effects, surface finish irregularities, residual stress effects, or environmental

** A specific fatigue cycle limit should be chosen as a runout point, and that limit should be used for all further tests on that material, regardless of the stress or strain ratio. For materials that typically display constant amplitude fatigue limits (many steels do), a runout limit as low as 3×10^6 cycles may be satisfactory. Normally, however, a runout limit of 10^7 cycles is preferred, especially for materials that typically do not show a definite fatigue limit (many aluminums do not) and for experiments conducted at reasonably high cyclic frequencies (10^7 cycles is accumulated in less than 4 days of continuous cycling at 30 Hz). Fatigue tests for cast metals are traditionally continued to 2×10^7 cycles as a fatigue limit.

variations. Unfortunately, variables such as specimen fabrication can influence fatigue results to such an extent that the effect being studied is eclipsed. Composition, thermal-mechanical processing and the origin of the material should be well documented. The same type documentation should apply to the fabrication of the specimens. ASTM E 606 provides an example of a machining procedure in Appendix X3.

In addition, fabricating fatigue specimens also involves many special considerations. For example, simulating a component fabrication process for making the specimens may be desired, e.g., heat treating before or after machining. The specimens may be ground or lathe turned. A mechanical polish or electro-polish may be employed. Special processing such as shot peening, stress relieving, plating or coating may be used. All of these procedures (including their sequence) must be documented.

The formation of surface residual stresses should be recognized as one of the most influential effects of machining, although it is frequently overlooked. Any mechanical removal of material from the specimen can produce residual stresses on the surface. Even when special care is taken to remove material very gradually, residual stresses (either surface or profile) may approach the yield point of the material. Under certain conditions these stresses can have a dramatic effect on the fatigue life of the specimen. Whenever the test environment and strain range are such that these stresses are not dissipated, they can alter the stress on the surface of the specimen. Crack initiation and propagation life will therefore be affected. Machining processes for producing fatigue specimens, therefore, should be evaluated not only on the basis of machining tolerances and surface finish, but also on the magnitude, consistency, and profile of these residual stresses.

Fatigue tests that exhibit little inelastic strain are especially influenced by the procedures employed in specimen preparation. Test results in these intermediate- and long-life regimes can be very confusing and misleading if the residual stresses are not considered. These stresses should at least be measured and documented and, in some cases, it may be desirable to stress relieve or electro-polish the specimens.

After the general shape of the fatigue curve has been identified (as shown in Figure 9.2.3.6 for three different stress and strain ratios), replicate tests at specific stress or strain levels may be performed to improve the statistical definition of the fatigue curve. Normally, replications at three levels are sufficient, if no fatigue limit is anticipated (or no attempt is to be made to define one).

The replicated stress or strain levels should be selected to represent initial estimates (based on the exploratory experiments) that would be expected to provide average fatigue lives at the extremes of the life interval of interest and at an intermediate fatigue life. For example, if load-control tests are to be performed and the fatigue performance between 10^4 and 10^6 cycles to failure is of concern, select three maximum stress levels for each stress ratio that appear likely to provide average fatigue lives of about 10^4 , 10^5 , and 10^6 cycles to failure, respectively.

Figure 9.2.5.1 illustrates this maximum stress and strain level selection process. As this figure suggests, specifying the levels with great precision is not necessary (or justified). The use of levels that have been established from exploratory testing may be appropriate. Use the same levels as those used on one of the exploratory tests if it results in a fatigue life near one of the life ranges of interest. The order of fatigue testing at these stress levels should be randomized for each series of replicates.

If further definition of the fatigue curve is desired in the long-life regime, replication at a fourth maximum stress level may be helpful*. To select this stress level, examine the number of runouts obtained at the lowest of the three replicated stress levels. If the number of runouts is less than 50 percent at the lowest stress level, select another, somewhat lower stress level for replication (5 to 10 percent is suggested). Alternatively, if the number of runouts at the lowest of the three replicated stress levels is above 50 percent, select a fourth

* It is assumed here that long-life fatigue tests will be run in load control or started in strain control and switched to load control as discussed earlier.

replicated stress level that is somewhat higher (again, 5 to 10 percent is suggested). Using such an approach, defining a fatigue limit stress at the selected runout level in clearly defined statistical terms will, in many cases, be possible.

The amount of replication required at each maximum stress level or strain range is the key remaining issue. Reference 9.2.5.1(a) recommends a minimum of 50 to 75 percent replication for design allowables data. This translates into two to four specimens at each stress or strain level. If the data displays minor variability, two specimens per level may be sufficient. If the data are highly variable, even four specimens per level may still not clearly define a statistically significant mean fatigue curve (see Section 9.6.1.7).

Adding the number of specimens recommended for curve shape definition and the number recommended for replication, the normal minimum number of fatigue tests per curve ranges from 8 to 16. Therefore, the development of fatigue curves for three stress or strain ratios for a fatigue data display in MIL-HDBK-5 might be based on 24 to 48 specimens. If additional stress or strain ratios are to be considered, the number of recommended tests would expand further, although fewer tests may be employed at these R-ratios.

More fatigue specimens are recommended for test in developing a fatigue data display for use in MIL-HDBK-5 than are actually required by current minimum data standards (see Section 9.2.4.5.1). This discrepancy exists primarily because the satisfaction of current minimum data standards does not ensure a statistically significant set of fatigue curves. The chance of producing a significant set of fatigue curves is much greater if the recommended fatigue test planning procedure is used and the designed test matrix is carefully completed.

Strain control fatigue data for a particular material must be accompanied by sufficient information to allow the construction of a cyclic stress-strain curve. Normally, such a curve can be constructed from stress-strain pairs recorded from stable hysteresis loops. Pairs obtained from a number of different tests covering a wide range of plastic strain ranges will allow construction of a complete cyclic stress-strain curve. Results from replicated incremental step tests may also be used to construct cyclic stress-strain tests [Reference 9.2.5.1(c)].

9.2.5.2 Creep-Rupture — A design of experiments approach to creep data development is highly recommended because it provides the maximum amount of useful data for the least expenditure of time and testing funds. If such an approach is not used, it is likely that several times as many test data will not serve as well in developing desired mathematical models of creep behavior as data developed through design of experiments. This section is devoted to a description of design of experiments approach which can be used to develop regression models to mathematically portray creep rupture life and creep as a function of temperature and stress.

One method for planning testing is to develop a test layout in matrix form, with temperatures in rows and expected creep lives in columns. Then, through testing, simply fill out blocks within the matrix. There should be a minimum of eight observations per isothermal line, or twenty observations per Larson-Miller or other regression model. This ensures coverage of all conditions of interest.

Choosing the Number of Temperatures and Life Intervals—Before the test matrix can be formed, interval sizes must be considered, first for temperature and then life.

- (a) Temperature—A range of temperatures is usually required. For example, if experiments must range from 1000°F through 1500°F, a choice must be made whether to perform tests at six levels (1000°F, 1100°F, 1200°F, 1300°F, 1400°F, 1500°F), or maybe at three levels (1000°F, 1300°F, 1500°F). The decision can be quite complicated and based on such phenomena as:

MIL-HDBK-5J
31 January 2003

- (1) The relative closeness of the isothermal lines
- (2) Parallel or divergent isothermal lines
- (3) The precipitation of secondary phases within the life ranges of interest.

However, this selection can be greatly simplified with very little user risk. Start with the lowest temperature, and then choose the next temperature line such that at least one level of testing stress, on log stress-log life plot, will be common to both temperatures. Then, proceed to the next temperature line, etc., ensuring like stress values on adjacent temperature levels.

- (b) Life—Divide a log-life cycle into four equidistant segments. For example, between 100 hours and 1000 hours, the divisions would be approximately 180 hours, 320 hours, and 560 hours on the log-life scale. These divisions are far enough apart to insure a well-defined curve and a minimum overlap of data. To convert from temperature and life desired to temperature and test stress requires that there be some prior knowledge of this relationship. If there is no prior knowledge, a series of “probe” tests must be made to locate the isothermal lines on a log-log plot.

Choosing the Number of Heats—Batch variations in chemistry, heat treating, etc., can cause considerable variations in the mechanical properties of an alloy. This difference is referred to as heat-to-heat components, as opposed to within-heat components of variance.** Heat-to-heat standard deviation is usually 50 to 70 percent of within-heat standard deviation. The root sum square of the two components of variance produces a measure of scatter about the regression that, when added to curve fitting error, gives the regression parameter called SEE (Standard Error of Estimate). SEE is a product of regression analysis; it is rarely determined as defined above. It is this parameter which fixes design minimums about the regression estimates of the typical or mean values.

To make a mathematically sound decision on the minimum number of heats that should be used in a given analysis, it is necessary that an estimate of heat-to-heat and within-heat variance be known. This can usually be estimated from like alloys, or calculated from development data. Simulation has shown the following minimum number of heats to be satisfactory:

- (1) When the heat-to-heat component of variance is less than 25 percent of within-heat variance, use two heats equally.
- (2) When the heat-to-heat component of variance is between 25-65 percent of within-heat variance, use three heats equally.
- (3) When the heat-to-heat component of variance is greater than 65 percent of within-heat variance, use five heats equally.

Heats should be distributed randomly and essentially equally throughout the test matrix to insure an unbiased heat distribution.

When regression models are developed from data that were not taken from an experimental model, heats are rarely chosen randomly. Therefore, unless there are large samples of data in all areas of the regression matrix, this imbalance of heat sample sizes must be accounted for as described in Section 9.6.4.2

** The within heat variance is the pooled variability of data from all heats, where the variability for each heat is calculated about its own average regression line. The heat-to-heat variance is calculated from the variability of each heat's average regression line about the overall average regression line of all heats. All heat average curves are assumed to be parallel in log life.

Order of testing must also be randomized so that any time-, operator-, or machine-oriented effects are randomly distributed within the test matrix as described in Reference 9.2.5.2.

9.2.5.3 Fusion-Welded Joints — Data generation involves developing a testing program based on considerations of design data requirements, population definition, subpopulation definition, welding procedures, testing procedures, and minimum test data requirements. Data generation is in two parts:

- (1) Determination of the properties of weld coupons cut from simple panels welded in accordance with a welding process specification.
- (2) Determination of the strength of welded structural components and the relation between the structural component strength and the coupon strength determined in (1).

9.2.5.3.1 Basic Population Definition — A basic population definition is selected, satisfying the general welding conditions previously established. The procedure for population definition requires a detailed review of applicable welding conditions to select a single population which will provide data consistent with requirements of the specification. The example shown in Figure 9.2.5.3.1 for 6061 aluminum weldments is typical of a basic population definition. In this example, tooling and heat input have not been specified.

9.2.5.3.2 Subpopulation Definition — Appropriate subpopulations must be selected. Obvious subpopulations or associated populations in Figure 9.2.5.3.1 would be alternative weld/heat treating sequences, filler materials, welding processes, weld repair, joint thickness, and weld classes (quality level). Selection of these preplanned subpopulations is dependent upon previous knowledge of their potential effect on weldment properties. However, those mentioned are most frequently encountered subpopulations required.

9.2.5.3.3 Welding Procedure — The variables defining the selected basic and subpopulations must be controlled within (but no better than) their prescribed ranges during test program welding. This requires welding in accordance with a referenced specification and any additional requirements which may limit the population. The generation of data requires that welding be conducted under production conditions rather than closely controlled laboratory conditions. Data for development of design properties must realistically represent the variation allowed in referenced specification and/or supplemental requirements for each variable.

Weldments from which data are generated should represent the product of several welders, welding machines, and weld setups. It is required to select test samples from weldments produced at different times by different operators guided only by specified requirements.

BASE MATERIAL

Alloy: 6061 Aluminum per AMS-QQ-A-250/11
Form: Sheet
Preweld Heat Treat Condition: T4 or T6
Postweld Heat Treat Condition: As-Welded
Material Thickness: 0.09 inch
Filler Material: 4043 per QQ-B-655

WELDING VARIABLES

Joint Preparation
Joint Type: Butt
Edge Preparation: Square Groove
Cleaning: Deoxidize, solvent wipe and hand scrape
Tooling: None Specified
Welding Conditions
Process: Mechanized GTA
Sequence: Single Pass
Position: Flat
Heat Input: Not Specified
Weld Repair: None

WELDMENT QUALITY

Inspection Methods
Visual
Radiographic, Mil-Std-453
Penetrant, Mil-I-6866
Acceptance Levels
External
Weld Beads: Removed Flush
Underfill and Undercut: None Allowed
Cracks: None Allowed
Pores: *Maximum size 0.02-inch, one per inch
Mismatch: 10% of Thickness Maximum
Internal
Pores and Inclusions: *Maximum Size 50% T or 0.12 inch whichever is lesser.
Maximum accumulated amount less than 2% of cross section area.

*Sharp-tailed or crack-like indications not allowed, appropriate acceptance levels will be added.

Figure 9.2.5.3.1. Example population definition.

9.3 SUBMISSION OF DATA

9.3.1 RECOMMENDED PROCEDURES — This section specifies the procedure for submission of mechanical property data for statistical analysis; specifically data supplied for the determination of T_{99} and T_{90} values for F_{tu} and F_{ty} and for data supplied to obtain derived property values for F_{cy} , F_{su} , F_{bru} and F_{bry} . The amount of data to be supplied for both of these are indicated in other sections of Chapter 9, such as Table 9.2.4.1 for derived property values. This section covers the format for submission of data.

9.3.2 COMPUTER SOFTWARE — The data may be supplied on 3.5 inch disks or CD-ROM in a PC-compatible format. The data files may also be submitted as attachments to an e-mail message. It is recommended that the software applications in Table 9.3.2 be used to construct the data files. Along with the electronic version, provide a hard (paper) copy of the data and any other supporting documentation such as specimen dimensions, gage length etc. This information will be stored in the MIL-HDBK-5 archives for future reference. Company-specific data will be treated as proprietary information at the request of the submitting organization.

Table 9.3.2. Software Applications for Data Submission

-
- ASCII text editor
 - Current Spreadsheet or Database Applications
 - The Chairman or Secretary of MIL-HDBK-5 can be contacted concerning software compatibility questions.
-

The data supplied on these disks or sent by e-mail are to be supplied in English units. For example, physical dimensions should be reported in units of inches to the nearest thousandth of an inch (X.XXX), stress should be reported in units of ksi to the nearest one hundredth of a ksi (X.XX), strain is to be reported in percent to the nearest tenth of a percent (X.X) and modulus is to be reported in units of 10^3 ksi to the nearest tenth of a msi (X.X). If necessary, refer to Table 1.2.2 to convert to English units of measure.

9.3.3 GENERAL DATA FORMATS — Table 9.3.3 shows the information that should be supplied in electronic form along with the mechanical test results. The alloy type, temper/heat treatment, product form, specimen location and specification number will be identified. Columns (or data fields), in order, will contain grain direction, product thickness, unit of product thickness, lot number, and heat number. Columns will be added towards the right of the heat number and will contain the individual test results as discussed in Sections 9.3.3.1 and 9.3.3.4.

When specifying grain direction for wrought product strengths, etc., use the conventions identified in Table 9.2.4.3: L for longitudinal, LT for long transverse, and ST for short transverse. Products that are anticipated to have significantly different properties in directions other than those stated above should be tested in the appropriate directions and the results reported.

There are several types of product forms identified in the Handbook; therefore, the term product form should be properly defined and reported in this column. Examples for wrought products are sheet, plate, bar, and forging. Examples for cast products are sand casting, investment casting, and permanent mold casting. For wrought products, specimen location should be $t/2$ or $t/4$. For cast products, specimen location should indicate designated or nondesignated areas.

Table 9.3.3.2(a). Derived Ultimate Properties

Alloy Trade Name	Heat No.	Lot No.	TUS Test 1	TUS Test 2*	SUS Test 1	SUS Test 2*	BUS e/D=1.5 Test 1	BUS e/D=1.5 Test 2*	BUS e/D=2.0 Test 1	BUS e/D=2.0 Test 2*

The information to be entered between these two columns depends upon the product form, see Table 9.3.3.

* Two tests are preferred, only one is required.

9.3.3.3 Data Format for the Construction of Typical Stress-Strain Curves — The individual tensile and compression stress-strain data should also be submitted in electronic form, if possible, so that typical tensile and compression stress-strain curves, compression tangent-modulus and typical (full-range) stress-strain curves can be constructed. In order to construct a typical stress-strain curve, the individual specimen curves must be documented up to slightly beyond the 0.2 percent offset yield strength. To construct a typical (full-range) stress-strain curve, the individual curves must be documented through to failure.

The data for the stress-strain curves must be supplied on separate electronic media from the mechanical property data. The data should be stored in a file which contains the load (or stress) in the first column and the displacement (or strain) in the second column. Each load or displacement stress-strain pair should be identified with its corresponding specimen identification number.

For the load-displacement curves, the load should be reported in pounds (X.) and the displacement should be reported in units of thousandth of an inch (X.XXX). For stress-strain curves, the stress should be reported to the nearest hundredth of a ksi (X.XX) and strain should be reported to the nearest $X.XX \times 10^{-6}$ units.

A hard copy of the load displacement curve should also be submitted for each stress-strain curve.

9.3.3.4 Data Format for Fasteners — A report will be submitted to MIL-HDBK-5 Coordination Group summarizing the test program, results, analysis, and suggested table of joint allowables for MIL-HDBK-5. The following information will be provided in the report:

- (1) A description of sheet and plate material with heat-treatment details and mechanical property test data for each sheet thickness used in the program in accordance with the requirements of Section 9.2.4.6.3.
- (2) A description of fastener, including drawings and specifications. If the fastener is not covered by a government or industry specification, a copy of an appropriate draft specification will be attached to the report.
- (3) A statement of compliance with NASM 1312, including a detailed statement of any differences from this standard.
- (4) Basic test data [see Figure 9.7.1.4(a)], including that required in NASM 1312, and representative load deflection curves.
- (5) Values for fastener shear calculation: as defined in Section 9.7.1.3 and fastener shear stress curves, where applicable.
- (6) Designation of allowable shear strength reliability (90 or 99 percent value).
- (7) Calculated t/D , P_u/D^2 , and P_y/D^2 values [see Figure 9.7.1.4(a) for sample format].
- (8) Seven or more graphs, as required, of P/D^2 versus t/D , as described in detail in Section 9.7.1.4, including the proposed design allowable curves for yield and ultimate load.
- (9) Calculations of allowable loads (see Figure 9.7.1.5 for sample format).
- (10) The suggested allowable load tables in the format shown in Section 9.9.5.

MIL-HDBK-5J
31 January 2003

- (11) Failure identification mode for failure of each fastener and/or joint is required, as shown in Figure 9.3.3.4. If failure is unique or not covered in the figure, so indicate.
- (12) Off-set used to obtain yield data.
- (13) Draft, in NAS or MS format, of specification for applicable fastener system.

9.3.3.5 Data Format for Other Properties — Data submission format for data types not discussed in Section 9.3.3.1 through 9.3.3.4 have not been standardized. The Chairman or Secretary of MIL-HDBK-5 can be contacted concerning most convenient data submission formats.

1. SHEET FAILURE

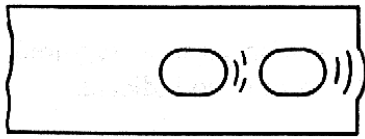

(a) Bearing Deformation of Hole

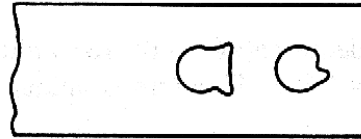

(b) Tearing of Sheet Allowing Fastener Pull-Through, Head Pull-Through or Nut Collar of Formed Head Pull-Through

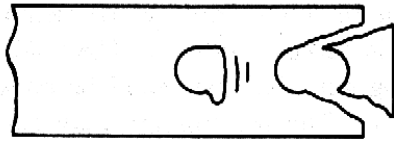

(c) Tearing of Sheet at Edge Margin

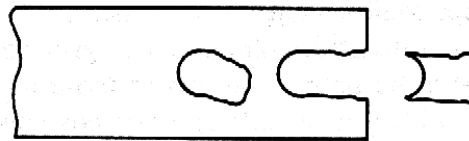

(d) Shear Out of Sheet Through Edge Margin

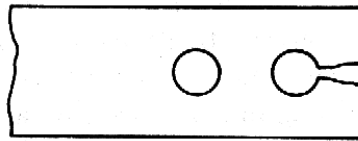

(e) Hoop Tension Failure of Sheet

2. FASTENER HEAD FAILURE

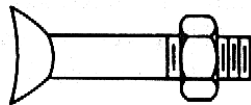

(a) Head Dished in Tension

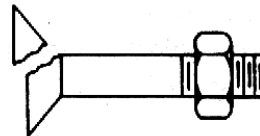

(b) Partial Shear Failure of Head

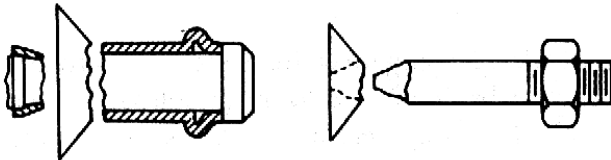

(c) Shear Failure of Head

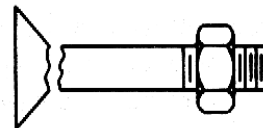

(d) Tensile Failure at Head to Shank Junction

Figure 9.3.3.4. Failure identification code.

3. FASTENER NUT OR
FORMED HEAD FAILURE

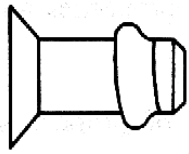

(a) Blind Head Deformed in Tension

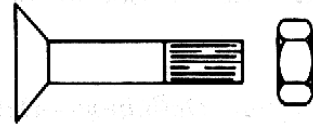

(b) Nut Stripped

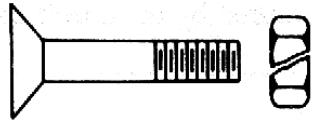

(c) Nut Cracked

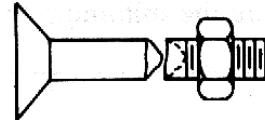

(d) Tensile Failure in Threads

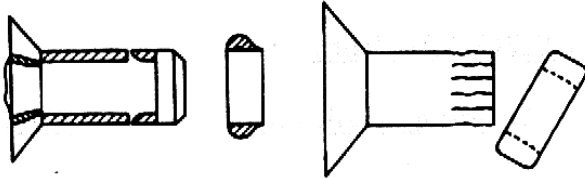

(e) Shear Failure of Blind or Formed Head

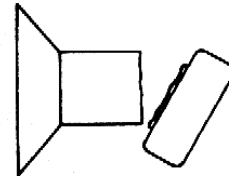

(f) Tension Failure of Formed Head

4. FASTENER SHANK FAILURE

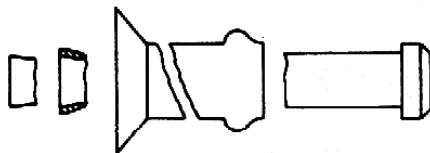

(a) Sleeve or Stem Tensile Failure

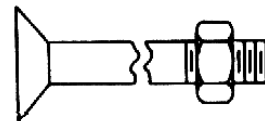

(b) Tensile Failure in Shank

5. FASTENER SHANK SHEAR FAILURE

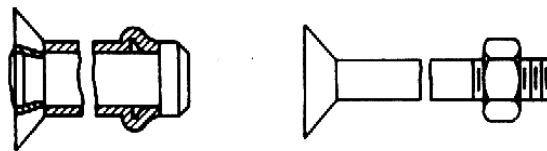

Shear at Midgrip

Figure 9.3.3.4. Failure identification code—Continued.

9.4 SUBSTANTIATION OF S-BASIS MINIMUM PROPERTIES

A product must be covered by an industry specification prior to being considered for inclusion into MIL-HDBK-5. Within a specification, one of the basic requirements is to provide minimum properties (S-basis) which includes tension yield, tension ultimate, elongation and compression yield (when specified). The statistical significance to the S-basis properties is typically not known. However, since ~ 1975, the minimum mechanical properties in the SAE/AMS specifications have been statistically justified with a procedure described in their documents. With that in mind, a procedure has been established to provide a level of statistical significance to S-basis properties contained within the Handbook.

A material being submitted for inclusion into MIL-HDBK-5 must include the basis of the specification properties as part of the substantiation package. This substantiation package should include the number of test samples, the number of lots, and the method used to determine any property covered in the specification, even if it will not be reported in MIL-HDBK-5. This could include the development of minimum as well as maximum properties. Consideration will be given to the specified sizes, product forms, heat treatments and other variables affecting the physical and mechanical properties. It is also expected that the test material chemistry be in the nominal specification range and not tailored to the chemistry extremes.

It is recommended that the substantiation of properties be based on a procedure similar to SAE/AMS in which the analysis of data or other appropriate documentation supports a statistical S-basis value, where at least 99 percent of the population of values is expected to equal or exceed the minimum value with a confidence of 95 percent. The data requirements for an S-basis value are described in Section 9.2.4.1. The S-basis value may be computed by assuming the distribution of the sample population to be normal and using the following equation:

$$\text{Minimum S} = \bar{X} - s \cdot k_{99}$$

where

\bar{X}	=	sample mean
s	=	standard deviation
k_{99}	=	one-sided tolerance-limit factor corresponding to a proportion at least 0.99 of a normal distribution and a confidence coefficient of 0.95 based on the number of specimens (See Table 9.10.1).

All data analyses must to be performed in English units. Strength data recorded in metric units should be converted to English units, to the nearest 0.01 ksi, before data analyses are undertaken. If desired by the data supplier, metric equivalent tables and figures can be included as part of the working data submitted with a data proposal, but the tables and/or figures proposed for inclusion in MIL-HDBK-5 will contain only English units.

When the tensile and compressive properties vary significantly with thickness, regression analysis should be used.

Although the establishment of an S-basis value should be based upon the statistically computed value, the S-basis value may be slightly lower, based on experience and judgement.

9.5 ANALYSIS PROCEDURES FOR STATISTICALLY COMPUTED MINIMUM STATIC PROPERTIES

Procedures used to determine tolerance bounds for mechanical properties vary somewhat from one sample to another. All involve a number of steps that are illustrated by the flowchart in Figure 9.5. These steps can be summarized as follows:

- (1) Specify the population to which the property applies
- (2) Decide on the procedure for computing the property
- (3) Compute the property.

These steps are described in greater detail in Sections 9.5.1 through 9.5.8, and a number of examples of the several procedures are presented in Section 9.8.1.

9.5.1 SPECIFYING THE POPULATION—For computational purposes, definition of a population must be sufficiently restrictive to ensure that computed tolerance bounds for design properties are realistic and useful. This is done by establishing a range of products and test conditions for which a mechanical property can be characterized by a single statistical distribution. In most cases a homogeneous population of data for a measured test parameter should not include more than one alloy, heat-treated condition, or test temperature.

It is not necessarily obvious whether such a population may include more than one product form or size, grain direction or processing history. Strip, plate, bars, and forgings of one alloy may have essentially the same TYS, while for another material the TYS may differ greatly among those product forms. To resolve these questions, appropriate statistical tests of significance should be applied to the respective groups of data. These tests are described in detail in Sections 9.5.3 and 9.5.4. Section 9.8 presents examples of their use in MIL-HDBK-5 data analyses.

The step-by-step procedure for specifying the population is illustrated in Figure 9.5.1 and described below. This procedure is used to determine whether several available data sets may be combined for the purpose of computing design allowables. The procedure is applicable to data collections for which regression analysis is required, as well as those for which regression is not required. In the latter case, an acceptability test is employed to eliminate unacceptable data sets. This procedure is described in Section 9.5.4.3 and 9.5.4.4. A corresponding acceptability test for the regression setting is described in Section 9.5.1.2.

9.5.1.1 Deciding Between Direct and Indirect Computation — The only room-temperature design properties that are regularly determined by direct computation are F_{tu} and F_{ty} . This procedure is usually limited to a specified or usual testing direction because there are seldom enough data available to determine properties in other test directions. Two rules govern the choice between direct and indirect computation:

- (1) F_{tu} and F_{ty} in the specified or usual testing direction may be determined by direct computation only.
- (2) F_{tu} and F_{ty} in other testing directions (as well as F_{cy} , F_{su} , F_{bru} , and F_{bry} in all directions) may be determined by direct computation only if (a) the data are adequate to determine the distribution form and reliable estimates of population parameters, or (b) the sample includes 299 or more individual, representative observations of the property to be determined.

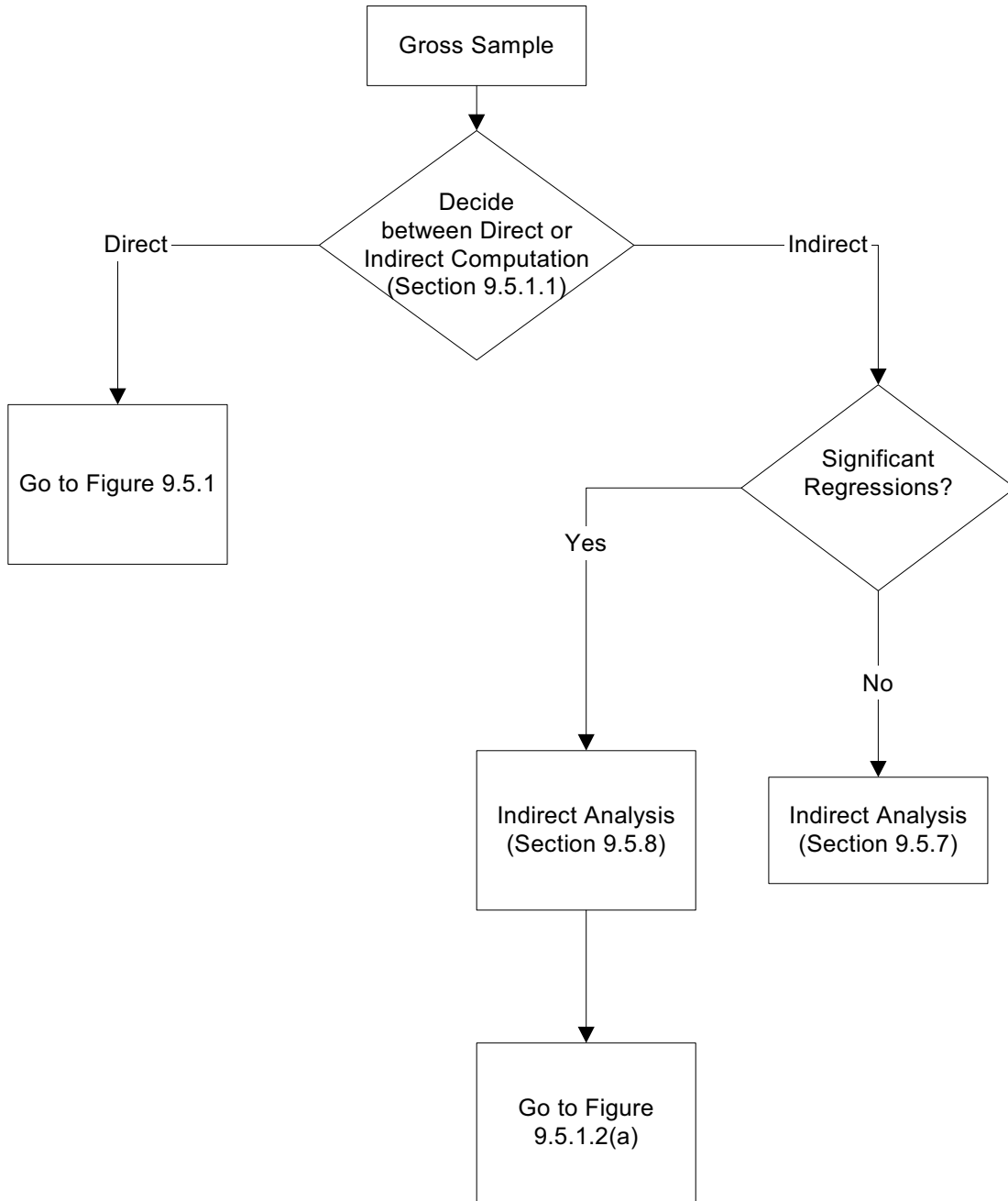

Figure 9.5 Determination of Method of Design Allowable Analysis.

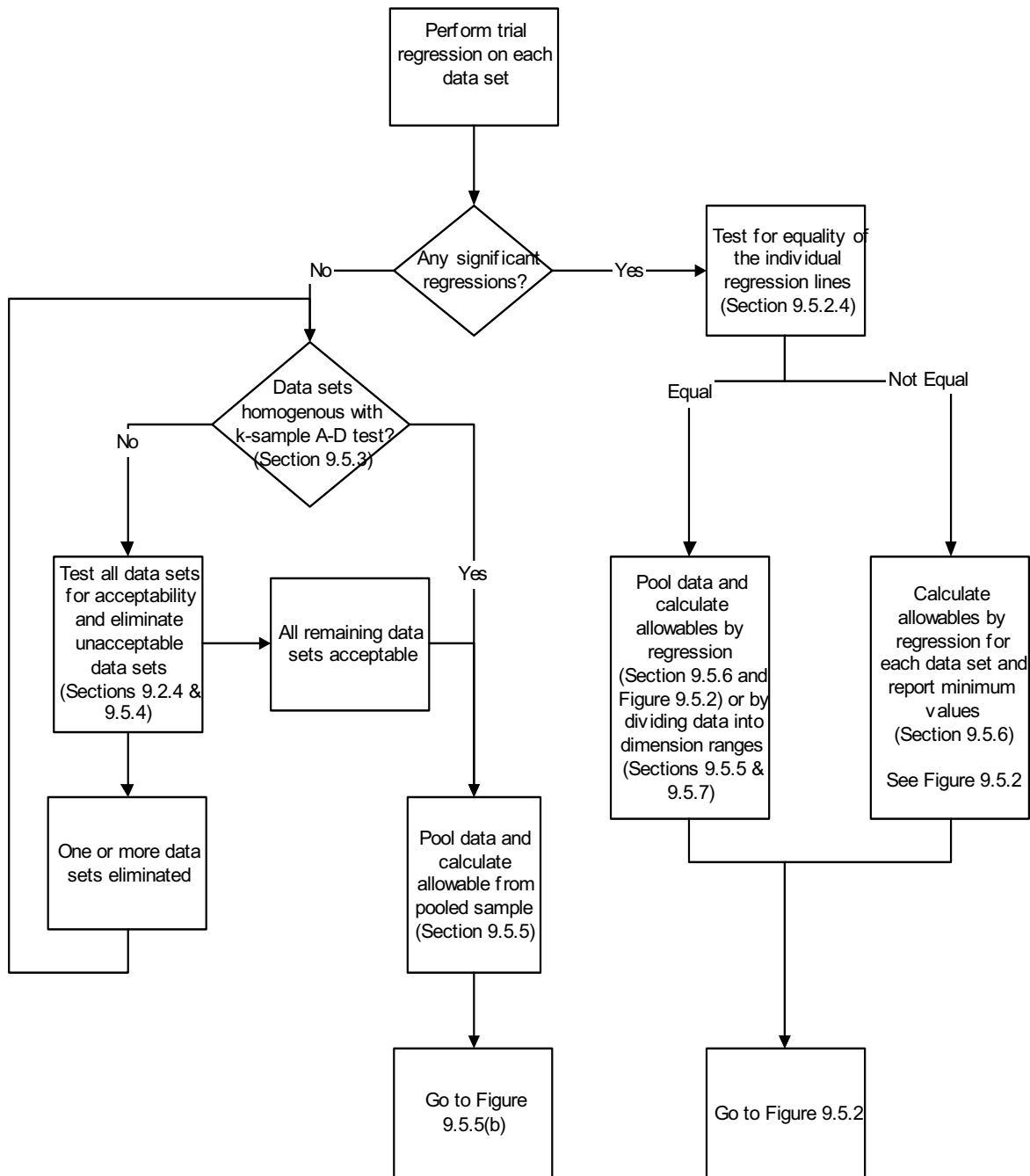

Figure 9.5.1. Determination of Direct Design Allowables.

For example, assume that available data for a relatively new alloy comprise 50 observations of TUS in the specified testing direction. This sample is not considered large enough to determine the distribution form and reliable estimates of population mean and standard deviation. Since only direct computation is permitted in this instance, determination of T_{99} and T_{90} values must be postponed until a larger sample is available. However, these properties may be considered for presentation on the S basis at the discretion of the MIL-HDBK-5 Coordination Group, contingent on availability of an acceptable procurement specification for the material.

If the number of observations increases to 100, this quantity may be adequate to allow determination of T_{99} and T_{90} values, provided data can be described by a Pearson Type III (gamma) (subsequently referred to as simply "Pearson") or Weibull distribution. If the distribution cannot be described parametrically, at least 299 observations are required so that computation can proceed without knowledge of the distributional form.

If the above example involved observations of SUS instead of TUS, the same criteria would apply for direct computation. However, F_{su} could be determined by indirect computation with as few as ten paired observations of SUS and TUS (representing at least ten lots and three heats), provided F_{tu} has been established.

9.5.1.2 Testing for Regression Effects and Homogeneity — In most cases, there will be a fairly clear-cut division between one population and another. For example, L and T properties either are or are not nearly identical. However, wrought product properties may sometimes vary linearly or curvilinearly with some dimensional characteristic, such as thickness. Examples are effect of thickness on TUS, effect of temperature on TUS, and effect of stress on cycles or time to rupture. It is necessary, therefore, to first test the data for the relationship between the property and the material dimension.

Before employing a regression analysis in the determination of material properties, one must ascertain that the average of the property to be regressed varies continuously and linearly or quadratically with some dimensional parameter x (such as $x = t, 1/t$, etc., where t is thickness). If the variation of average is attributable to other causes, regression should not be used.

Regression analysis, as described herein, also assumes that residuals are normally distributed about the regression line. Residuals are the differences between observed data values and the values which are predicted by the fitted regression equation. Validity of this normality assumption should be evaluated by performing the Anderson-Darling test presented in Section 9.5.4.1.

The procedures for fitting a regression equation of the form,

$$\text{TUS} = a + bx,$$

or

$$(\text{SUS}/\text{TUS}) = a + bx,$$

or

$$(\text{SUS}/\text{TUS}) = a + bx + cx^2,$$

to n data points are described in Section 9.5.2. In addition to estimates for a and b (and possibly c), this procedure produces two F statistics. One statistic (F_1) tests the significance of regression. The other statistic (F_2) tests the adequacy of a linear model for describing the relationship between the material property and the dimensional parameter. If F_2 indicates a lack of fit of the model to the data, a transformation of the data may account for the nonlinearity. If F_1 indicates an insignificant regression, one of the other appropriate analysis techniques, as described in Section 9.5.5 for direct computation, or 9.5.7 for indirect computation, should be used.

MIL-HDBK-5J
31 January 2003

If any one of a group of data sets analyzed by regression shows a significant effect on properties due to the selected material dimension, all regressions should be tested for equality to determine whether the data sets may be combined and considered a homogeneous population. The procedure described in Section 9.5.2.4 should be used to perform this test.

If the regressions are accepted as equal, then T_{99} and T_{90} values can be calculated in one of two ways: (1) by regression; or (2) by dividing data into thickness ranges and calculating T_{99} and T_{90} values for each range. If the regressions are not equal, T_{99} and T_{90} values should be calculated separately for each data set and minimum T_{99} and T_{90} values determined for all data sets should be reported. The method for determining T_{99} and T_{90} by regression is described in Section 9.5.6. Figures 9.5.1.2(a) and (b) illustrate the procedures used to determine design allowables when regression is required.

If none of the individual data sets (e.g. different producers) show significant regression due to the chosen material dimension, the different data sets should be tested for homogeneity using a k-sample Anderson-Darling test as described in Section 9.5.3.1. If data sets are found to be homogenous, data should be pooled and T_{99} and T_{90} values should be calculated using the single combined data set. If data from the various producers constitute more than one population, the following procedure should be used.

- (1) Data sets which do not comply to the minimum number of observations as stated in Sections 9.2.4.2 should be excluded from any further evaluation until they meet the minimum requirements.
- (2) Each remaining data set should be tested for acceptability using the three-parameter Weibull acceptability test described in Section 9.5.4.3. If there is statistical evidence that one or more statistically distinct data sets do not meet the specification minimum value, the results will be brought to the Material Data Review Working Group where a decision will be made on whether or not these data sets should be included in the computation of material property values.
- (3) All remaining data sets should be tested for homogeneity using the k-sample Anderson-Darling test. If the data sets are found to be homogeneous, T_{99} and T_{90} values can be calculated using a single combined data set. If the populations are not homogeneous, material property values must be determined by calculating T_{99} and T_{90} values for each data set. In the latter case, the data set with the lowest T_{99} and T_{90} values will generally be used to establish minimum design values.

9.5.2 REGRESSION ANALYSIS—Mathematical techniques for performing a simple linear regression analysis are contained in Section 9.5.2.1. Similar techniques for performing a quadratic regression analysis are contained in 9.5.2.2. Statistical tests to determine whether a linear or quadratic regression adequately describes the data are described in Section 9.5.2.3. A test for equality of several regression lines is presented in Section 9.5.2.4. Example analyses are presented in Section 9.8 using hypothetical data to illustrate the regression calculations. Figure 9.5.1.2(b) provides guidance in choosing an appropriate regression analysis to use for calculating design allowables.

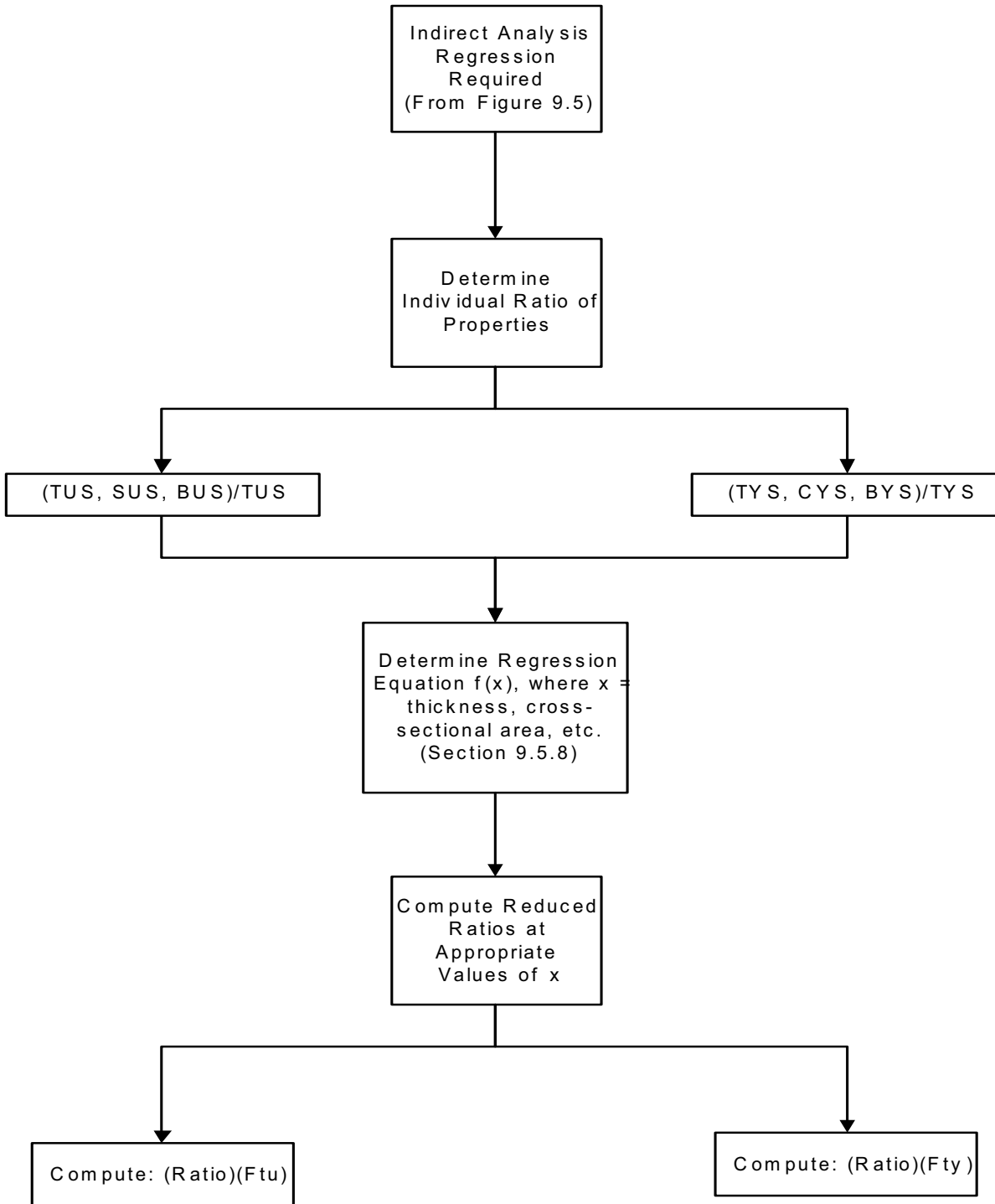

Figure 9.5.1.2(a). Determination of Indirect Design Allowables When Regression is Required.

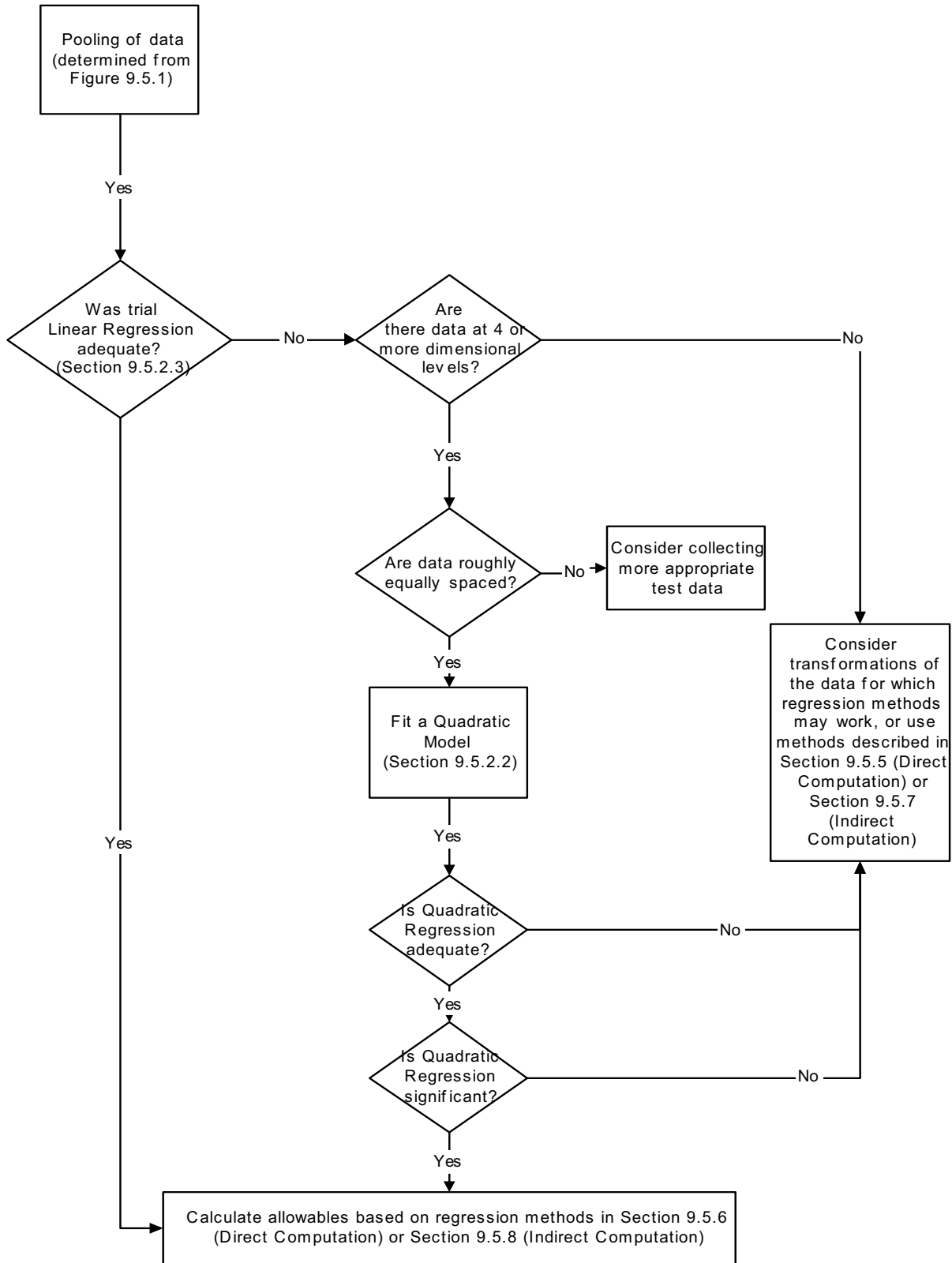

Figure 9.5.1.2(b). Determination of Direct Allowables When Regression is Required

Regression is sometimes employed with transformed variables; that is, it may be necessary to work with $\log(TUS)$, t^2 , or $1/(T + 460)$, for example. When this is the case, the analyst must remember to transform variables back to the original engineering units after final computations.

Regression analysis, as described herein, also assumes that residuals are normally distributed about the regression line. Residuals are the differences between observed data values and the values which are predicted by the fitted regression equation. Validity of this normality assumption should be evaluated by performing the Anderson-Darling test presented in Section 9.5.4.1.

9.5.2.1 Linear Regression — Linear regression is appropriate when there is an approximate linear relationship between two measurable characteristics. Such a relationship is expressed algebraically by an equation that, in the case of two measurable characteristics x and y , has the form

$$y = \alpha + \beta x + \varepsilon \quad [9.5.2.1(a)]$$

where

- x = independent variable
- y = dependent variable
- α = true intercept of the regression equation
- β = true slope of the regression equation
- ε = measurement or experimental error by which y differs from the ideal linear relationship.

Aside from the error term, ε , this is the equation of a straight line. The parameter α determines the point where this line intersects the y -axis, and the β represents its slope. The variables x and y may represent either direct measurements or some transformation measurements of the characteristics under consideration.

Knowing or assuming such an approximate linear relationship, the problem becomes one of estimating the parameters α and β of the regression equations. It is necessary to have a random sample consisting of n pairs of observations, which is denoted by $(x_1, y_1), (x_2, y_2), \dots, (x_n, y_n)$. Such a sample can be represented graphically by n points plotted on a coordinate system, in which x is plotted horizontally and y vertically. A subjective solution can be obtained by drawing a line that, by visual inspection, appears to fit the points satisfactorily. An objective solution is given by the method of least squares.

The method of least squares is a numerical procedure for obtaining a line having the property that the sum of squares of vertical deviations of the sample points from this line is less than that for any other line. In this analysis, the least-squares line is represented by the equation

$$\hat{y} = a + bx \quad , \quad [9.5.2.1(b)]$$

in which

- \hat{y} = predicted value of y for any value of x
- a and b = estimates of the parameters α and β in the true regression equation obtained by the least squares method presented below.

It can be shown with the aid of calculus that the values of a and b that minimize the sum of squares of the vertical deviations are given by the formulas:

$$a = \frac{\sum y - b\sum x}{n} \quad [9.5.2.1(c)]$$

$$b = \frac{S_{xy}}{S_{xx}} \quad [9.5.2.1(d)]$$

where

$$S_{xy} = \sum xy - \frac{\sum x \sum y}{n}, \quad [9.5.2.1(e)]$$

and

$$S_{xx} = \sum x^2 - \frac{(\sum x)^2}{n}. \quad [9.5.2.1(f)]$$

The root mean square error of y is expressed as

$$s_y = \sqrt{\frac{\sum (y - \hat{y})^2}{n - 2}} \quad [9.5.2.1(g)]$$

where \hat{y} is the predicted value of y defined above. This quantity is an estimate of the standard deviation of the distribution of y about the regression line. A convenient computational formula for s_y is

$$s_y = \sqrt{\frac{S_{yy} - b^2 S_{xx}}{n - 2}} \quad [9.5.2.1(h)]$$

where

$$S_{yy} = \sum y^2 - \frac{(\sum y)^2}{n} \quad [9.5.2.1(i)]$$

The quantity $R^2 = (b^2 S_{xx})/S_{yy}$ measures the proportion of total variation in the y data, about its average, that is explained by the regression. An R^2 equal to 1 indicates that the regression model describes the data perfectly, which is rare in practice. R^2 provides a rough idea of how well data is described by a linear regression. A more precise determination of the adequacy of a linear regression is discussed in Section 9.5.2.3.

9.5.2.2 Quadratic Regression — Quadratic regression is appropriate when there is an approximate quadratic relationship between two measurable characteristics. Such a relationship is expressed algebraically by an equation that, in the case of two measurable characteristics x and y, has the form

$$y = \alpha + \beta x + \gamma x^2 + \epsilon, \quad [9.5.2.2(a)]$$

where

- x = independent variable
- y = dependent variable
- α = true intercept of the regression equation
- β = true coefficient of the linear term in the regression equation
- γ = true coefficient of the quadratic term in the regression equation
- ϵ = measurement or experimental error by which y differs from the ideal linear relationship.

Aside from the error term, ϵ , this is the equation of a parabola. The parameter α determines the point where this curve intersects the y-axis. The variable x and y may represent either direct measurements or some transformation measurements of the characteristics under consideration.

Knowing or assuming such an approximately quadratic relationship, the problem becomes one of estimating the parameters α , β , and γ of the regression equation. It is necessary to have a random sample consisting of n pairs of observations, which is denoted by (x_1, y_1) , (x_2, y_2) , ..., (x_n, y_n) . Such a sample can be represented graphically by n points plotted on a coordinate system, in which x is plotted horizontally, y vertically. A subjective solution can be obtained by drawing a curve that, by visual inspection, appears to fit the points satisfactorily. An objective solution is given by the method of least squares.

The method of least squares is a numerical procedure for obtaining a second-degree polynomial having the property that the sum of squares of vertical deviations of the sample points from this curve is less than that for any other second-degree polynomial. In this analysis, the least squares curve is represented by the equation

$$\hat{y} = a + bx + cx^2 \quad , \quad [9.5.2.2(b)]$$

in which

- \hat{y} = predicted value of y for any value of x
- a, b, and c = estimates of the parameters α , β and γ in the true regression equation obtained by the least squares method presented below.

It can be shown with the aid of calculus that the values of a, b, and c that minimize the sum of squares of the vertical deviations are given by the formulas:

$$a = \bar{y} - b \left(\frac{\sum X}{n} \right) - c \left(\frac{\sum X^2}{n} \right)$$

$$b = \frac{(\sum X_1 Y)(\sum X_2^2) - (\sum X_2 Y)(\sum X_1 X_2)}{D}$$

$$c = \frac{(\sum X_2 Y)(\sum X_1^2) - (\sum X_1 Y)(\sum X_1 X_2)}{D} \quad [9.5.2.2(c)]$$

where

$$D = \left(\sum X_1^2 \right) \left(\sum X_2^2 \right) - \left(\sum X_1 X_2 \right)^2 \quad [9.5.2.2(d)]$$

and where $X_1 = x - \Sigma x/n$, $X_2 = x^2 - \Sigma x^2/n$, $Y = y - \Sigma y/n$, all symbols being summed are subscripted by i, and all summations are over i=1 to n.

The root mean square error of y is expressed as

$$s_y = \sqrt{\frac{\sum (y - \hat{y})^2}{n - 3}} \quad [9.5.2.2(e)]$$

where \hat{y} is the predicted value of y defined above. This quantity is an estimate of the standard deviation of the distribution of y about the regression curve. A convenient computational formula for s_y is

$$s_y = \sqrt{\left(\sum Y^2 - b \sum X_1 Y - c \sum X_2 Y \right) / (n-3)} \quad [9.5.2.2(f)]$$

The quantity $R^2 = 1 - (n-3) s_y^2 / \Sigma Y^2$ measures the proportion of total variation in the y data, about its average, that is explained by the regression. An R^2 equal to 1 indicates that the regression model describes the data perfectly, which is rare in practice. R^2 provides a rough idea of how well the data are described by a quadratic regression.

Another quantity, Q, is required to compute allowables by quadratic regression analysis. Q is defined as

$$Q = q_1 + 2q_2 x_0 + (2q_3 + q_4) x_0^2 + 2q_5 x_0^3 + q_6 x_0^4 \quad [9.5.2.2(g)]$$

where x_0 is the value of the independent variable for which the allowable is being calculated and q_1, q_2, q_3, q_4, q_5 and q_6 are defined as:

$$q_1 = k [ce - d^2],$$

$$q_2 = k [cd - be],$$

$$q_3 = k [bd - c^2],$$

$$q_4 = k [ae - c^2],$$

$$q_5 = k [bc - ad], \text{ and}$$

$$q_6 = k [ac - b^2]$$

where*

$$a = n,$$

$$b = \sum x_i,$$

$$c = \sum x_i^2,$$

$$d = \sum x_i^3,$$

$$e = \sum x_i^4, \text{ and}$$

$$k = [(ace + 2bcd) - (c^3 + ad^2 + b^2e)]^{-1}.$$

9.5.2.3 Tests for Adequacy of a Regression — It is possible that the relationship between the dependent variable y and the independent variable x may not be well approximated by the chosen model (linear or quadratic). In that case, the predicted values, modeled by a line or a quadratic curve, would not “fit” the data very well. It is also possible that the relationship between x and y , although well described by the chosen model, is not very strong. That is, there may not be much change in the y values over the range of x considered. This is measured by the “significance” of the regression. Both the lack of fit and the significance of a linear regression equation can be evaluated through an analysis of variance as described in this section.

To evaluate the adequacy of a regression model requires satisfying two conditions. First, it is necessary that there are multiple observations at one or more values of the independent variable x . Second, in the case of a linear regression, there must be three or more distinct x values; in the case of a quadratic regression, there must be four or more distinct x values.

The analysis of variance for testing lack of fit and significance of regression is based on the assumption that the measurement errors, ϵ_i , in the relationship between y_i and x_i [see 9.5.2.1(a) and 9.5.2.2(a)] are independent and normally distributed with an overall mean of zero and a constant variance of σ^2 . Assuming uniformity of variance of measurement errors over the range of the independent variable, the normality assumption concerning unobservable ϵ_i can be checked by performing the Anderson-Darling test for normality on the observed residuals

$$e_i = y_i - \hat{y}_i,$$

$i=1, \dots, n$, where

$$\hat{y}_i = a + bx_i$$

* Although it is not necessary for the computations, the values q_1, q_2, q_3, q_4, q_5 , and q_6 represent elements

$$\text{of the inverted matrix } (X'X)^{-1} = \begin{bmatrix} q_1 & q_2 & q_3 \\ q_2 & q_4 & q_5 \\ q_3 & q_5 & q_6 \end{bmatrix}, \text{ where } X'X = \begin{bmatrix} n & \sum x_i & \sum x_i^2 \\ \sum x_i & \sum x_i^2 & \sum x_i^3 \\ \sum x_i^2 & \sum x_i^3 & \sum x_i^4 \end{bmatrix}.$$

in the case of linear regression, and

$$\hat{y}_i = a + bx_i + cx_i^2$$

in the case of quadratic regression. See Sections 9.5.2.1 and 9.5.2.2 for details on the computation of a, b, and c, and see Section 9.5.4.1 for details on the Anderson-Darling test for normality. By plotting the residuals, e_i , against the respective x_i , an informal check on the assumption of constant variance is possible as well. In such a plot, residuals should vary approximately equally over the range of x_i values.

The analysis of variance table for testing lack of fit and significance of a linear regression is shown below. In this table, n represents the total number of data points for which x and y are available, k represents the number of distinct x values. Formulas for calculating the terms provided in the table are described below.

Source of Variation	Degrees of Freedom		Sum of Squares, SS	Mean Squares, MS	F_{calc}
	Linear	Quadratic			
Regression	1	2	SSR	MSR	F_1
Error	n-2	n-3	SSE	MSE	
Lack of Fit	k-2	k-3	SSLF	MSLF	F_2
Pure Error	n-k	n-k	SSPE	MSPE	
Total	n-1	n-1	SST		

The sums of squares (SS terms) for the Regression, Error, and Total lines of the analysis of variance table are calculated using the following:

$$SSR = \sum (\hat{y}_i - \bar{y})^2$$

$$SST = \sum (y_i - \bar{y})^2$$

$$SSE = \sum (y_i - \hat{y}_i)^2$$

To calculate the sums of squares for lack of fit (SSLF) and pure error (SSPE) requires a relabeling of the data, ordered by x value. To this point, the measured values y_i have been arbitrarily ordered. For these calculations, let Y_{uj} represent the j^{th} data value at the u^{th} x level, and let n_u represent the number of data values at the u^{th} x level. Let

$$\bar{Y}_u = \sum_{j=1}^{n_u} Y_{uj} / n_u$$

Also, let

$$\hat{Y}_{uj} = \hat{y}_i,$$

or the predicted y value corresponding to the x value paired with Y_{uj} . (Notice that

$$\hat{Y}_{u1} = \hat{Y}_{u2} = \hat{Y}_{u3} = \dots = \hat{Y}_{un},$$

because each of these y values have the same x value paired with it.)

Then

$$\text{SSLF} = \sum_{u=1}^k \sum_{j=1}^{n_u} (\bar{Y}_u - \hat{Y}_{uj})^2,$$

and

$$\text{SSPE} = \text{SSE} - \text{SSLF}.$$

The sums of squares are then divided by their respective degrees of freedom to compute mean squares follows:

Mean Square	Linear Regression	Quadratic Regression
MSR	SSR	SSR/2
MSE	SSE/(n-2)	SSE/(n-3)
MSLF	SSLF/(k-2)	SSLF/(k-3)
MSPE	SSPE/(n-k)	SSPE/(n-k)

These mean squares are used to compute two F statistics which test for lack of fit and significance of regression. (Note: If the requirements described at the beginning of this section are not satisfied, then it is not possible to test for lack of fit.)

The two F statistics, F_1 and F_2 , are defined as ratios of the mean squares as specified below:

$$F_1 = \text{MSR}/\text{MSE}$$

$$F_2 = \text{MSLF}/\text{MSPE}.$$

F_2 and Table 9.10.2 are used to test for lack of fit. If F_2 is greater than the 95th percentile of the F distribution with $k - 2$ numerator degrees of freedom ($k - 3$ for quadratic regression) and $n - k$ denominator degrees of freedom (from Table 9.10.2), then there is significant lack of fit. In this case it may be concluded (with a 5 percent risk of error) that linear regression does not adequately describe the relationship between x and y. Otherwise, lack of fit can be considered insignificant and the chosen model can be assumed.

If lack of fit is not significant, the significance of regression may be tested using F_1 and Table 9.10.2. If F_1 is greater than the 95th percentile of the F distribution with 1 numerator degree of freedom (2 for quadratic regression) and $n - 2$ denominator degrees of freedom ($n - 3$ for quadratic regression), then regression is significant and the selected model may be assumed. Otherwise, regression is not significant and x is considered to have little or no predictive value for y.

9.5.2.4 Testing for Equality of Several Regressions — The procedure presented in this section is designed to test the hypothesis that the true regression equations corresponding to two or more independent data sets are equal (linear or quadratic). It is appropriately applied to test the equality of several regressions in determining whether corresponding data sets should be combined for the purpose of calculating design allowables. To test k regressions for equality, the following procedure should be performed.

Perform separate regression analyses for each data set. The same model form should be used in all regressions (all linear or all quadratic). Add error sum of squares (SSE) values from each of the separate regressions to obtain SSE(F), the error sum of squares for the full model which allows separate slope and intercept parameters for each data set. Then fit a single regression to the combined data from all data sets to obtain SSE(R), error sum of squares for the reduced model which contains a single set of coefficients a and b (and c for quadratic models) which apply to all data sets. The F statistic for testing the equality of the k regressions is

$$F = \frac{SSE(R) - SSE(F)}{2(k - 1)} \div \frac{SSE(F)}{n - 2k}$$

for simple linear models, and

$$F = \frac{SSE(R) - SSE(F)}{3(k - 1)} \div \frac{SSE(F)}{n - 3k}$$

for quadratic models, where n denotes total number of observations in all k data sets combined. In the linear case, if F is greater than the 95th percentile of the F distribution with 2(k - 1) numerator degrees of freedom and n - 2k denominator degrees of freedom (from Table 9.10.2), the hypothesis that the regressions are equal is rejected. In the quadratic case, if F is greater than the 95th percentile of the F distribution with 3(k - 1) numerator degrees of freedom, and n - 3k denominator degrees of freedom, the hypothesis that the regressions are equal is rejected. See Reference 9.5.2.4 for more detail.

Example of Computations — In this example, x represents thickness and y represents the TYS values determined from a group of tensile tests. Values of x and y are as follows:

X	Y
0.100	121
0.100	119
0.200	114
0.200	108
0.300	112
0.300	108
0.400	112
0.400	106
0.500	101
0.500	99

MIL-HDBK-5J
31 January 2003

From these data, the following quantities may be calculated:

$$\begin{array}{ll}
 n & = 10 & (\Sigma x)^2 & = 9 \\
 \Sigma x & = 3 & (\Sigma y)^2 & = 121000 \\
 \Sigma y & = 1100.0 & (\Sigma x)(\Sigma y) & = 3300 \\
 \Sigma x^2 & = 1.1 & S_{xx} & = 0.20 \\
 \Sigma y^2 & = 121452 & S_{xy} & = -8.4 \\
 \Sigma xy & = 321.6 & S_{yy} & = 452.
 \end{array}$$

The slope of the regression line is:

$$b = \frac{S_{xy}}{S_{xx}} = \frac{-8.4}{0.20} = -42 \quad .$$

The y-intercept of the regression line is:

$$a = \frac{\Sigma y - b\Sigma x}{n} = \frac{1100}{10} - \frac{(-42)(3)}{10} = 110 + 12.6 = 122.6 \quad .$$

Thus the final equation of the least squares regression line is:

$$\hat{y} = a + b x = 122.6 - 42x \quad .$$

The total of the y data at each x level is needed to calculate lack of fit and pure error sums of squares. These totals are as follows:

x_i	T_i
0.1	240
0.2	222
0.3	220
0.4	218
0.5	200

There are data values at $k = 5$ different x levels, with $n_i = 2$ values at each level and

$$\sum_{i=1}^k (T_i^2/n_i) = \frac{(240)^2}{2} + \dots + \frac{(200)^2}{2} = 121404 \quad .$$

Thus,

$$SSLF = 121404 - (1100)^2/10 - 352.8 = 51.2$$

and

$$SSPE = 99.2 - 51.2 = 48.$$

MIL-HDBK-5J
31 January 2003

The mean square values are computed by dividing corresponding sums of squares by their degrees of freedom. The F_1 and F_2 statistics are then calculated as ratios of mean squares. The analysis of variance table is shown below.

Source of Variation	Degree of Freedom, DF	Sum of Square, SS	Mean Squares, MS	F_{calc}
Regression	1	352.8	352.8	$F_1 = 28.5$
Error	8	99.2	12.4	
Lack of Fit	3	51.2	17.07	$F_2 = 1.78$
Pure Error	5	48.0	9.6	
Total	9	452.0		

Using this equation, the following values of \hat{y} may be computed for the values of x listed previously.

x	\hat{y}
0.100	118.4
0.200	114.2
0.300	110.0
0.400	105.8
0.500	101.6

The root mean square error is computed as follows:

$$S_y = \sqrt{\frac{\sum(y - \hat{y})^2}{n - 2}} = \sqrt{\frac{99.2}{8}}$$

or

$$S_y = \sqrt{\frac{S_{yy} - b^2 S_{xx}}{n - 2}} = \sqrt{\frac{452 - (-42)^2(0.2)}{8}} = 3.52$$

R^2 is computed as follows:

$$R^2 = \frac{b^2 S_{xx}}{S_{yy}} = \frac{(-42)^2(0.2)}{452} = 0.78$$

Thus, 78 percent of the variability in the y data about its average is explained by the linear relationship between y and x.

The sum of squares for the regression, total and error lines are computed as follows:

$$SSR = (-42)^2 (0.20) = 352.8$$

$$SST = 452$$

$$SSE = 452 - 352.8 = 99.2.$$

The F_2 value of 1.78 with $k - 2 = 3$ and $n - k = 5$ degrees of freedom is less than the value of 5.41 from Table 9.6.4.9 corresponding to 3 numerator and 5 denominator degrees of freedom. This indicates that lack of fit can be considered insignificant. Thus, it is reasonable to assume that a linear regression adequately describes the data. The F_1 value of 28.5 with 1 and $n - 2 = 8$ degrees of freedom is greater than the value of 5.32 from Table 9.10.2 corresponding to 1 numerator and 8 denominator degrees of freedom, so the slope of the regression is found to be significantly different from zero.

9.5.3 Combinability of Data — A test of significance is employed to make a decision on a statistical basis. In this section, three tests (k-sample Anderson-Darling test, “F” test, and “t” test) are described for use in determining whether the populations from which two or more samples are drawn are identical. The k-sample Anderson-Darling test is the most general and does not depend on a specific assumed distribution, and may be used to evaluate combinability of two or more data sets.

The “F” and “t” tests should only be used to evaluate combinability of two samples that can be assumed to be normally distributed. The “F” test is used first to determine whether the two sample variances differ significantly or not (with a 5 percent risk of error). If the two sample variances do not differ significantly, the “t” test is used to determine whether the two sample means differ significantly. If either the two sample variances or the two sample means differ significantly (with a 5 percent risk of error), one may conclude (with a 9.75 percent joint risk of error) that the populations from which the two samples were drawn are not identical. Otherwise, the hypothesis that the two populations are identical is not rejected. The tests given are exact when:

- (1) The observations within each sample are taken randomly from a single population of possible observations, and
- (2) The characteristic measured is normally distributed within this population.

To carry out a similar procedure without requiring the assumption of an underlying normal distribution, or if three or more samples are to be compared, the k-sample Anderson-Darling test should be employed. This test is a nonparametric procedure and simply tests the hypothesis that populations from which the samples are drawn are identical.

9.5.3.1 The k-Sample Anderson-Darling Test — The k-sample Anderson-Darling test is designed to test the hypothesis that populations from which two or more independent random samples were drawn are identical. The test is appropriately applied to determine whether two or more products differ with regard to strength distributions. The test is a nonparametric statistical procedure and, thus, requires no assumptions other than the samples are true independent random samples from their respective populations.

Consider the products A_1, A_2, \dots, A_k . Let $X_{11}, X_{12}, \dots, X_{1n_1}$ denote a sample of n_1 data points from product A_1 , let $X_{21}, X_{22}, \dots, X_{2n_2}$ denote a sample of the n_2 data points from product A_2 , and so forth. Furthermore, let $N = n_1 + n_2 + \dots + n_k$ represent the total number of data points in the combined samples.

Let L denote the total number of distinct data points in the combined samples and $Z_{(1)}, Z_{(2)}, \dots, Z_{(L)}$ denote the distinct values in the combined data set ordered from least to greatest. The k -sample Anderson-Darling statistic is defined by

$$ADK = \frac{N-1}{N^2(k-1)} \sum_{i=1}^k \left[\frac{1}{n_i} \sum_{j=1}^L h_j \frac{(NF_{ij} - n_i H_j)^2}{H_j(N - H_j) - Nh_j/4} \right]$$

where

h_j = the number of values in the combined samples equal to $Z_{(j)}$

H_j = the number of values in the combined samples less than $Z_{(j)}$ plus one-half the number of values in the combined samples equal to $Z_{(j)}$

and

F_{ij} = the number of values in sample corresponding to product A_i which are less than $Z_{(j)}$ plus one-half the number of values in the sample corresponding to product A_i which are equal to $Z_{(j)}$.

Under the hypothesis of no differences in the sampled populations, the mean of ADK is approximately one and the variance is approximately

$$\sigma_N^2 = \text{Var}(ADK) = \frac{aN^3 + bN^2 + cN + d}{(k-1)^2 (N-1) (N-2) (N-3)}$$

with

$$a = (4g - 6)(k - 1) + (10 - 6g)S$$

$$b = (2g - 4)k^2 + 8Tk + (2g - 14T - 4)S - 8T + 4g - 6$$

$$c = (6T + 2g - 2)k^2 + (4T - 4g + 6)k + (2T - 6)S + 4T$$

$$d = (2T + 6)k^2 - 4Tk$$

where

$$S = \sum_{i=1}^k \frac{1}{n_i}$$

$$T = \sum_{i=1}^{N-1} \frac{1}{i}$$

and

$$g = \sum_{i=1}^{N-2} \sum_{j=i+1}^{N-1} \frac{1}{(N-i)j}$$

If

$$ADK \geq 1 + \sigma_N \left[1.645 + \frac{0.678}{\sqrt{k-1}} - \frac{0.362}{k-1} \right]$$

one may conclude (with a 5 percent risk error) that samples were drawn from different populations. Otherwise, the hypothesis that samples were selected from identical populations is not rejected. For more information on the k-sample Anderson-Darling test, see Reference 9.5.3.1.

9.5.3.2 The F Test— The F test is used to determine whether the strength of two products differs with regard to variability.

Consider two products, A and B. These might represent two different processes, thickness ranges, or test directions. The statistics for the samples drawn from these products are:

	<u>Product A</u>	<u>Product B</u>
Sample size	n_A	n_B
Sample standard deviation	s_A	s_B
Sample mean	X_A	X_B

F is the ratio of the two sample variances, thus,

$$F = s_A^2/s_B^2 \quad [9.5.3.2]$$

If the true variances of Products A and B are identical at a significance level of $\alpha = 0.05$, F should lie within the interval defined by

$F_{0.975}$ (for $n_A - 1$ and $n_B - 1$ degrees of freedom),

and

$1/F_{0.975}$ (for $n_B - 1$ and $n_A - 1$ degrees for freedom).*

If F does not lie within this interval, it can be concluded that the two products differ with regard to their variability. Values of $F_{0.975}$ are presented in Table 9.10.3.

** Since a two-sided interval is being defined for the population variance, the fractile of the F distribution corresponding to $1-\alpha/2$ should be used, i.e., $F_{0.975}$.

Example of Test Computation — The following sample statistics are reported:

	<u>Product A</u>	<u>Product B</u>
Sample size	20	30
Sample standard deviation, ksi	4.0	5.0
Sample mean, ksi	100.0	102.0

Perform an F test as follows:

$$F = s_A^2/s_B^2 = 4^2/5^2 = 0.64$$

$$df = n_A - 1 = 19$$

$$n_B - 1 = 29$$

$$F_{0.975 (19,29)} = 2.23$$

$$1/F_{0.975 (29,19)} = 1/2.40 = 0.42$$

} From Table 9.10.3

Since 0.64 lies within the interval of 0.42 to 2.23 one can conclude that there is no reason to believe that Products A and B differ with regard to their variability.

9.5.3.3 The t Test — The t test is used to determine whether two products differ with regard to average strength. If they do, one may conclude that the two products do not belong to the same population.

In making the t test, it is assumed that the variances of two products are nearly equal, as first determined from the F test. If the F test shows that the variances are significantly different, there is no need to conduct the t test.

Consider the same products, A and B. The statistics for samples drawn from these products are:

	<u>Product A</u>	<u>Product B</u>
Sample size	n_A	n_B
Sample standard deviation, ksi	s_A	s_B
Sample mean, ksi	\bar{X}_A	\bar{X}_B

$D_{\bar{x}}$ is the absolute difference between the two sample means.

$$D_{\bar{x}} = | \bar{X}_A - \bar{X}_B | \quad [9.5.3.3(a)]$$

If the true means of products A and B are identical, $D_{\bar{x}}$ should not exceed u , which is determined as indicated by the following equation for a significance level of $\alpha = 0.05$.

$$u = t_{0.975} s_p \sqrt{\frac{n_A + n_B}{n_A n_B}} \quad [9.5.3.3(b)]$$

where

$t_{0.975}$ has $n_A + n_B - 2$ degrees of freedom*

and

$$s_p = \sqrt{\frac{(n_A - 1)s_A^2 + (n_B - 1)s_B^2}{n_A + n_B - 2}} \quad [9.5.3.3(c)]$$

Values of $t_{0.975}$ are found in Table 9.10.4.

Example of Test Computation — The following sample statistics are the same as those in Section 9.5.3.2:

	<u>Product A</u>	<u>Product B</u>
Sample size	20	30
Sample standard deviation, ksi	4.0	5.0
Sample mean, ksi	100.0	102.0

It was determined in Section 9.5.3.2 that the variances of Products A and B do not differ significantly. The t test computations to test the sample means are:

$$df = n_A + n_B - 2 = 48$$

$t_{0.975}$ (for 48 df) = 2.011 (from Table 9.10.4)

$$s_p = \sqrt{\frac{(n_A - 1)s_A^2 + (n_B - 1)s_B^2}{n_A + n_B - 2}} = \sqrt{\frac{(19)(4)^2 + (29)(5)^2}{48}} = 4.63 \text{ ksi}$$

$$\sqrt{\frac{n_A + n_B}{n_A n_B}} = \sqrt{\frac{20 + 30}{(20)(30)}} = 0.2887$$

$$u = t_{0.975} s_p \sqrt{\frac{n_A + n_B}{n_A n_B}} = (2.011)(4.63)(0.2887) = 2.7 \text{ ksi}$$

$$D_{\bar{x}} = |\bar{X}_A - \bar{X}_B| = 2.0 \text{ ksi}$$

Since $D_{\bar{x}}$ (2.0) is not greater than u (2.7), it may be concluded that there is no reason to believe that Products A and B differ with regard to their average strength. On the basis of both tests in this example, the conclusion would be that the two products were drawn from the same population.

* Since a two-sided interval is being defined from the population means, the fractile of the t distribution corresponding to $1-\alpha/2$ should be used, i.e., $t_{0.975}$.

9.5.4 Determining the Form of Distribution — The computational procedure selected to establish design-allowable values by statistical techniques is dependent upon distribution of strength measurements in the available sample. Both three-parameter Weibull and Pearson Type III distributions may be used. Some procedures in the Handbook still require that residuals from a model be normally distributed (such as determination of design allowables by regression analysis). As noted previously, references to normal, Weibull, or Pearson Type III distributions will be interpreted as applying either to original measurements or to an appropriate transformation of them. This section contains a discussion and illustration of methods used to establish whether or not a population follows a normal, Weibull, or Pearson Type III distribution.

Various goodness-of-fit test procedures are described in Sections 9.5.4.1 through 9.5.4.9. The purpose of each is to indicate whether an initial distribution assumption should be rejected. The methods presented are based on the “Anderson-Darling” goodness-of-fit family of tests. These tests are objective and indicate (at 5 percent risk of error) whether the sample is drawn from the tested distribution. Unfortunately, these tests may reject the assumed distribution even though the distribution may provide a reasonable approximation within the lower tail. For this reason, the sequential Weibull procedure permits upper tail censoring when found to be appropriate, and the goodness-of-fit test described below allows for this. Nonetheless, some subjective reasoning should be employed after using a goodness-of-fit test.

After a goodness-of-fit test has been performed (especially if the distributional assumption has been rejected), it is generally required that a cumulative probability plot of data be provided to graphically illustrate the degree to which the assumed distribution fits the data. Methods for development of normal probability plots (Section 9.5.4.2), Pearson probability plots (Section 9.5.4.6), and Weibull probability plots (Section 9.5.4.9) are presented.

Sample size is denoted by n , sample observations by X_1, \dots, X_n , and sample observations ordered from least to greatest by $X_{(1)}, \dots, X_{(n)}$. Data must be ungrouped.

9.5.4.1 “Anderson-Darling” Test for Normality — The “Anderson-Darling” test for normality is used to determine whether the curve which fits a given set of data can be approximated by a normal curve. The essence of the test is a numerical comparison of the cumulative distribution function for observed data with that for the fitted normal curve over the entire range of the property being measured. Let

$$Z_{(i)} = (X_{(i)} - \bar{X})/s \quad i = 1, \dots, n$$

where $X_{(i)}$ is the i^{th} smallest sample observation, \bar{X} is the sample average, and s is the sample standard deviation. Equations for computing sample statistics are presented in Appendix A.

The “Anderson-Darling” test statistic is

$$AD = \left[\sum_{i=1}^n \frac{1 - 2i}{n} \left[\ln(F_0(Z_{(i)})) + \ln(1 - F_0(Z_{(n+1-i)})) \right] \right] - n$$

where F_0 is the standard normal distribution function*. If

$$AD > 0.752 / (1 + 0.75/n + 2.25/n^2)$$

* The standard normal distribution function F_0 is that function such that $F_0(x)$ is equal to the area under the standard normal curve to the left of the value x .

one may conclude (at 5 percent risk of error) that the population from which the sample was drawn is not normally distributed. Otherwise, the hypothesis that the population is normally distributed is not rejected. For further information on this test procedure, see References 9.5.4.1(a) and (b).

The same procedure can be used to test the normality of the residuals

$$e_i = y_i - (a + bx_i) \quad i = 1, \dots, n$$

from a regression (see Section 9.5.2.1) assuming uniformity of variance of the residuals over the range of the independent variable. When calculating the test statistic AD, define

$$Z_{(i)} = e_{(i)}/s_y \quad i = 1, \dots, n$$

where $e_{(i)}$, $i = 1, \dots, n$ are the ordered residuals from smallest to largest and s_y is the root mean square error of the regression defined in Section 9.5.5.1 or 9.5.5.2. The justification for this procedure may be found in Reference 9.5.4.1(c).

9.5.4.2 Normal Probability Plot—To graphically illustrate the degree to which a normal distribution fits a set of data, a normal probability plot may be formed by plotting the measured value of each test point versus $\bar{X} + s F_o^{-1}(P/100)$ where F_o^{-1} is the inverse standard normal cumulative distribution function.* The line representing the fitted normal distribution is the line passing through the points with equal horizontal and vertical coordinates. If the horizontal axis is labeled with cumulative probabilities (P values) as in Table 9.10.5 rather than $F_o^{-1}(P/100)$ values, the plot will be identical to a plot formed on normal probability paper.

Figure 9.5.4.2 illustrates the use of a normal probability plot on Alclad 2524-T3 Aluminum Alloy Sheet and Plate data in the 0.063-0.128 inch thickness range. There are 309 measured test values with $\bar{X} = 45.24$ and $s = 1.923$. There appears to be a systematic departure from the model (the measured values are higher than expected) in both tails, suggesting that the distribution of the measured values departs from a normal distribution. This model was rejected by the Anderson-Darling test for normality.

9.5.4.3 Three-Parameter Weibull Acceptability Test — The three-parameter Weibull acceptability test is designed to determine whether an acceptable proportion of a producer's population is likely to exceed the specification limit for corresponding material property. Because this test is only used to screen data sets and is not used in the actual calculation of lower tolerance bounds, it is not required that the data be well-described by a Weibull distribution to apply this test. To carry out this test, an upper confidence bound (UCB) is calculated for the first percentile of the producer's population. This UCB value is calculated in the same manner as a T_{99} value is calculated (in Section 9.5.5.2) with the following modifications:

- (1) In solving for the threshold $\tau(\theta)$ (Section 9.5.5.2.1), θ should be set equal to 0.10.
- (2) The value of V_{99} should be taken from Table 9.10.6 rather than Table 9.10.7 when using the formula for T_{99} (Equation [9.5.5.2(a)]) to calculate the UCB value.

* The point $F_o^{-1}(P/100)$ is that value such that the area under the standard normal curve to the left of $F_o^{-1}(P/100)$ is $P/100$.

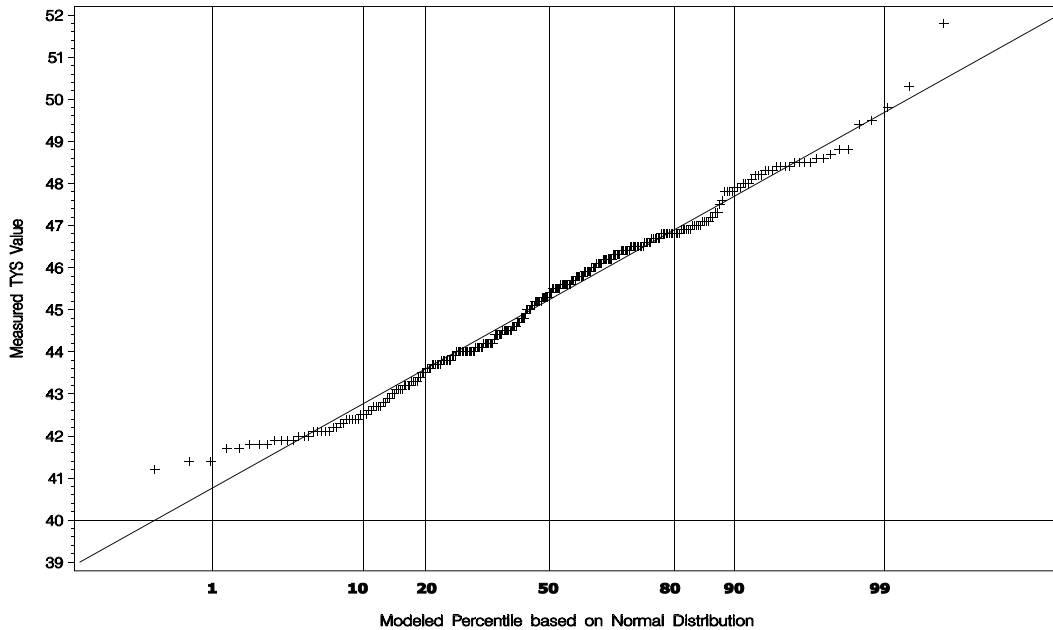

Figure 9.5.4.2 Probability plot for a normal distribution fitted to a complete TYS data set for Alclad 2524-T3 aluminum alloy sheet in the 0.063-0.128 inch thickness range - rejected.

If UCB is greater than or equal to the specification limit, it is concluded that the producer's data is acceptable. If UCB is less than the specification limit, it is concluded (with a 5 percent risk of error) that the producer's data do not meet the specification minimum value.

In statistical terms, this method tests (at 5 percent significance level) the hypothesis that at least 99 percent of the producer's population is greater than the specification limit. If the hypothesis is not rejected (UCB greater than or equal to specification limit), then it is concluded that the producer's data is acceptable. If the hypothesis is rejected (UCB less than the specification limit), it is concluded that the producer's data is unacceptable.

This technique is applicable only when data have not been censored from the sample. It also assumes that the data are distributed according to a three-parameter Weibull distribution (although normally distributed data and Pearson distributed data are also accommodated by this test). If the data sample is highly skewed, background data should be reviewed to determine whether the skewness is caused by a mixed population. If it is not, the Weibull test procedure can be applied. This test should be applied to both tensile yield and ultimate strengths (in appropriate grain directions), and if a producer's data is unacceptable for either property, that producer's data for both properties should be excluded for the purpose of computing T_{99} and T_{90} values.

9.5.4.4 Anderson-Darling Test for Pearsonity – This section describes a test to determine whether data from a population are satisfactorily described by the Pearson Type III (or gamma) distribution.

First compute estimates of the population mean, standard deviation, and skewness (denoted by \bar{X} , S, and q), as described in Section 9.5.5.1. Then calculate the following Anderson-Darling statistic:

$$AD = - \sum_{i=1}^n \left[\frac{(2i-1)}{n} \ln \left(F_{\bar{X},S,q}^-(X_{(i)}) \right) - 2F_{\bar{X},S,q}^-(X_{(i)}) \right] - \frac{3n}{2}$$

where

$$F_{\mu,\sigma,q}(x) = \begin{cases} H \left[\frac{4}{q} \left(\frac{2}{q} + \frac{x-\mu}{\sigma} \right) \right] & q > 0.1265 \\ 1 - H \left[\frac{4}{q} \left(\frac{2}{q} + \frac{x-\mu}{\sigma} \right) \right] & q < -0.1265 \\ \Phi \left\{ \left[\frac{\sqrt[3]{\frac{4}{q} \left(\frac{2}{q} + \frac{x-\mu}{\sigma} \right)}}{\frac{8}{q^2}} - 1 + \frac{2}{9 \cdot \frac{8}{q^2}} \right] / \sqrt{\frac{2}{9 \cdot \frac{8}{q^2}}} \right\} & 0.025 < q \leq 0.1265 \\ 1 - \Phi \left\{ \left[\frac{\sqrt[3]{\frac{4}{q} \left(\frac{2}{q} + \frac{x-\mu}{\sigma} \right)}}{\frac{8}{q^2}} - 1 + \frac{2}{9 \cdot \frac{8}{q^2}} \right] / \sqrt{\frac{2}{9 \cdot \frac{8}{q^2}}} \right\} & -0.1265 \leq q < 0.025 \\ \Phi \left(\frac{x-\mu}{\sigma} \right) & |q| \leq 0.025 \end{cases}$$

$H(x)$ is the cumulative distribution function of a chi-square distribution with $8/q^2$ degrees of freedom. Note that $F(x)$ is the cumulative distribution function of a chi-square distribution with $8/q^2$ degrees of freedom when $q > 0.1265$, and a standard normal distribution when $|q| \leq 0.025$. Because of numerical computing inconsistencies for large degrees of freedom, a normal approximation to the chi-square distribution is recommended for $0.025 < |q| \leq 0.1265$.

If the AD is greater than the critical value of

$$0.3167 + 0.034454 \cdot \ln(n) \cdot [\exp(q) - 1]^2,$$

then the data are rejected by the Anderson-Darling test for Pearsonity.

9.5.4.5 The Pearson Backoff Option – If the data are rejected by the Pearson AD test, the backoff method may be applied. The following formula should be used to calculate the AD statistic of the backoff method:

$$AD_{\text{backoff}}(\mu) = \frac{1}{n} \sum_{i=1}^n i^2 [\ln(b_{i+1,i}) - \ln(b_{i,i})] - 2 \sum_{i=1}^n i (b_{i+1,i} - b_{i,i}) + \frac{n}{2} \sum_{i=1}^n (b_{i+1,i}^2 - b_{i,i}^2)$$

where

$$b_{ij} = \min \left[F_{\mu, S, q} (x_{(i)}), \frac{j}{n} \right] \text{ for } j < n, b_{n,n} = F_{\mu, S, q} (x_{(n)}), \text{ and } b_{n+1,n} = 1.$$

(Notice that this formula has an argument representing the assumed mean of the distribution being tested against.)

Calculate $AD_{backoff}(\bar{X} - \tau)$ for τ equal to 0.1, 0.2, 0.3, 0.4, and 0.5. If any of these values is below the critical value of

$$0.03238 + 0.00001795 \cdot \ln(n)^2 \cdot [\exp(q) + 0.2355]^2,$$

then $\tau_{backoff}$ is defined as the smallest of these τ 's satisfying the inequality. (Note: In calculating the backoff, if q is negative and $\tau_{backoff} > \bar{X} - 2 \cdot S / Q - X_{(n)}$, then the backoff method cannot be applied. S and Q are defined in Section 9.5.5.1.)

If a backoff is identified, then T_{99} and T_{90} should be calculated by the following formulas:

$$T_{99} = \bar{X} - k_{99}(q, n) \cdot S - \tau_{backoff}$$

$$T_{90} = \bar{X} - k_{90}(q, n) \cdot S - \tau_{backoff}$$

where $k_{90}(q, n)$ and $k_{99}(q, n)$ are defined in Section 9.5.5.1.

9.5.4.6 Pearson Probability Plot — To graphically illustrate the degree to which a Pearson Type III (or gamma) distribution fits a set of data, the following procedure for creation of a Pearson probability plot is recommended. This method is appropriate for distributions estimated using uncensored data.

The rank of each point selected for plotting is the number of lower test points plus the plotted point plus one-half the number of other test points equal to the plotted point. Its cumulative probability, P (in percent), is equal to the rank multiplied by 100, divided by one more than the total number of test points:

$$P \text{ (in percent)} = \frac{(\text{rank})(100)}{n + 1}$$

The measured value of each test point is plotted versus $F^{-1}(P/100)$ where

$$F^{-1}(P/100) = \begin{cases} \bar{X} + s \cdot \left[\frac{q}{4} \cdot H^{-1}(P/100) - \frac{2}{q} \right] & \text{when } q > 0.1265 \\ \bar{X} + s \cdot \left[\frac{q}{4} \cdot H^{-1}[1 - (P/100)] - \frac{2}{q} \right] & \text{when } q < -0.1265 \\ \bar{X} + s \cdot \frac{2}{q} \cdot \left\{ \left[\sqrt{\frac{2}{9 \cdot \frac{8}{q^2}}} \cdot F_o^{-1}(P/100) + 1 - \frac{2}{9 \cdot \frac{8}{q^2}} \right]^3 - 1 \right\} & 0.025 < q \leq 0.1265 \\ \bar{X} + s \cdot \frac{2}{q} \cdot \left\{ \left[\sqrt{\frac{2}{9 \cdot \frac{8}{q^2}}} \cdot F_o^{-1}(1 - P/100) + 1 - \frac{2}{9 \cdot \frac{8}{q^2}} \right]^3 - 1 \right\} & -0.1265 \leq q < -0.025 \\ \bar{X} + s \cdot F_o^{-1}(P/100) & |q| \leq 0.025 \end{cases}$$

and \bar{X} , s , and q are population parameter estimates obtained according to the procedures outlined in Section 9.5.5.1. H^{-1} is the cumulative distribution function of a chi-square distribution with $8/q^2$ degrees of freedom and F_o^{-1} is the inverse standard normal cumulative distribution function. A straight line is then drawn to represent the fitted Pearson distribution. This line may be established by plotting any two points with equal vertical and horizontal coordinates and drawing a line through these two points. The horizontal axis is then labeled with cumulative probabilities (P or $P/100$) rather than F^{-1} values.

If the backoff option is used, the selected distribution can then be described as the best-fit distribution shifted by a small constant, τ_{backoff} . In this case, the predicted values should also be shifted by the same constant. That is, plot the measured values versus

$$F^{-1}(P/100) - \tau_{\text{backoff}} .$$

The plotted points should finally be compared with the line to determine whether there appears to be a reasonably good fit. If the backoff option is used, then only deviations where the data fall below the fitted line should be considered as relevant.

Figure 9.5.4.6(a) illustrates the use of a Pearson probability plot on Aluminum Alloy Sheet and Plate data in the 0.063-0.128 inch thickness range. The estimates of the mean, standard deviation, and skewness parameters are 45.24, 1.92, and 0.12, respectively. There appears to be a systematic departure from the model (the measured values are higher than expected) in both tails, suggesting that the distribution of the measured values is not well approximated by a Pearson distribution. Appropriately, this model was rejected by the A-D test for Pearsonality.

Figure 9.5.4.6(b) shows a probability plot for the same data, using the distribution estimated with the backoff option of the sequential Pearson procedure, which identified a backoff of 0.2 ksi. The only difference between the two plots is that the predicted values in Figure 9.5.4.6(a) are shifted 0.2 ksi to the left in Figure 9.5.4.6(b). Although the curve of data in Figure 9.5.4.6(b) is further away (on average) from the $y=x$ reference line than the curve of data in Figure 9.5.4.6(a), only negative deviations from the reference line are recognized in the A-D goodness-of-fit test for a distribution estimated by the backoff method. In

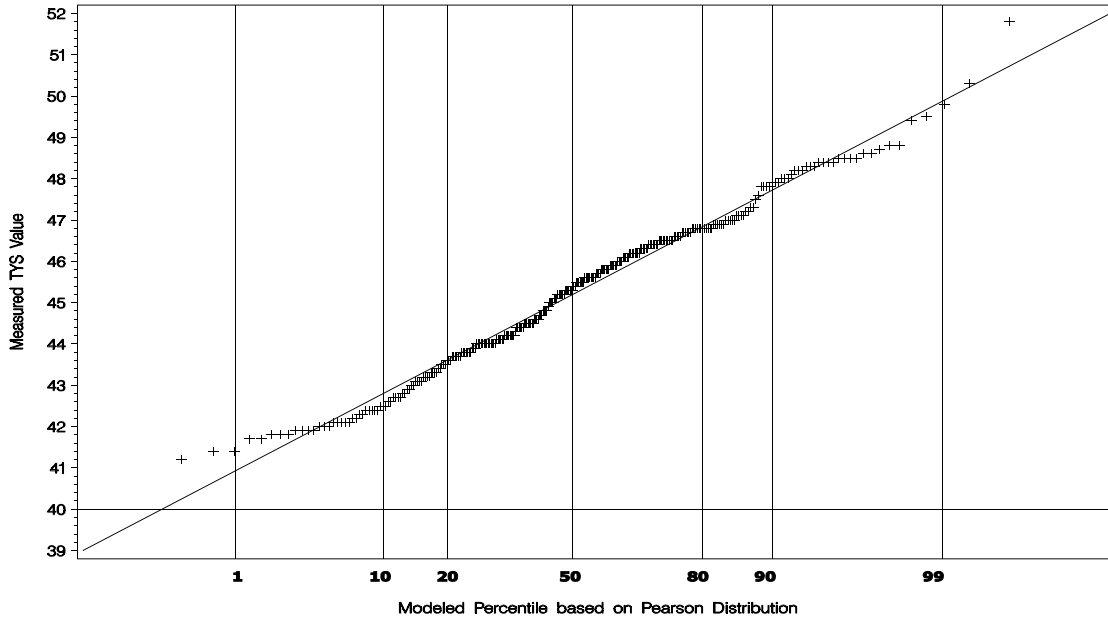

Vertical reference lines plotted at 1st, 10th, 20th, 50th, 80th, 90th, and 99th percentiles of fitted distribution
Horizontal reference line plotted at spec minimum, 40 ksi

Figure 9.5.4.6(a). Probability plot for a Pearson distribution fitted to a complete TYS data set for Alcad 2524-T3 aluminum alloy sheet in the 0.063-0.128 inch thickness range - rejected.

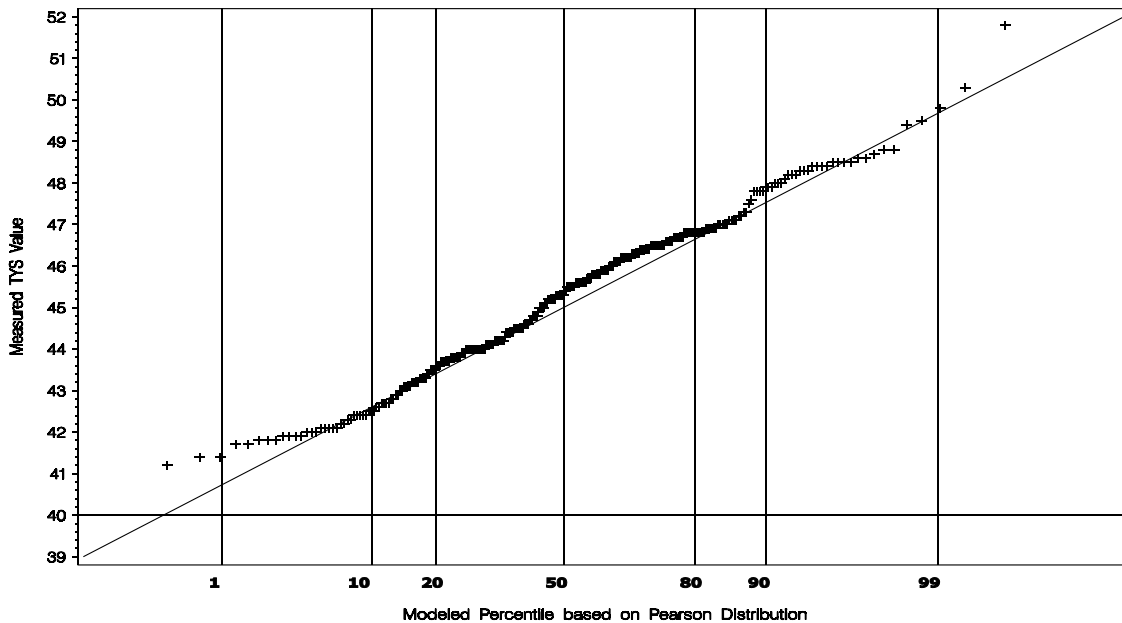

Vertical reference lines plotted at 1st, 10th, 20th, 50th, 80th, 90th, and 99th percentiles of fitted distribution
Horizontal reference line plotted at spec minimum, 40 ksi

Figure 9.5.4.6(b). Probability plot for a Pearson distribution fitted to complete TYS data for Alcad 2524-T3 aluminum alloy plate in the 0.063-0.128 inch thickness range using 0.2 ksi backoff - accepted.

Figure 9.5.4.6(b), only a small proportion of the data are below the predicted values, resulting in an insignificant deviation. The “backoff” model was accepted by the A-D test.

9.5.4.7 Modified “Anderson-Darling” Test for Weibullness—The “Anderson-Darling” test for three-parameter Weibullness is used to determine whether the curve which fits a given set of data can be approximated by a three-parameter Weibull curve. The essence of the test is a numerical comparison of the cumulative distribution function for observed data with that for a fitted Weibull curve over the entire range of property being measured. This test differs from the original version of the Anderson-Darling test in that it emphasizes the lower tail. This method can be applied with complete or censored data.

The first two steps produce estimates of the parameters of a three-parameter Weibull distribution. Be sure to acknowledge the appropriate degree of censoring in computing the threshold, shape, and scale parameters as described in Sections 9.5.4.7.1 and 9.5.4.7.2. Using the procedure outlined in 9.5.4.7.1, compute the threshold for the goodness-of-fit test, τ_{50} . Then, using the method described in 9.5.4.7.2, compute the maximum likelihood estimates of the shape and scale parameters for $\{X_{(i)} - \tau_{50} : i=1, \dots, r\}$ where r equals n for the uncensored data and r represents the smallest integer greater than or equal to $4n/5$ for 20 percent censoring and $n/2$ for 50 percent censoring. Denote these estimates by β_{50} and α_{50} , respectively. Calculate the (censored or uncensored) A-D statistic is described in Section 9.5.4.7.3.

9.5.4.7.1 Estimating the Threshold Parameter—This section describes a method for estimating the threshold of a three-parameter Weibull distribution. The same approach is taken for estimating the threshold, whether the purpose is to test goodness-of-fit (Section 9.5.4.7), or to directly calculate T_{99} or T_{90} values (Section 9.5.5.2). This method applies to uncensored and upper-tail censored data; however, different columns of Table 9.10.8 are used. (References 9.5.4.7.1(a) and 9.5.4.7.1(b) provide details of this method for uncensored data.)

Let K equal the greatest integer less than or equal to $\min \{4n/15, (1-p)n/3\}$, where p represents the proportion of the upper tail that is censored (p equals 0, 0.2, or 0.5). Define the function $R(\tau)$ by

$$R(\tau) = \frac{\sum_{i=K+1}^{3K-2} L_i(\tau)}{\sum_{i=1}^{3K-2} L_i(\tau)}$$

where

$$L_i(\tau) = \frac{1}{D_i} \left[\ln(X_{(i+1)} - \tau) - \ln(X_{(i)} - \tau) \right]$$

with

$$D_1 = n \ln \left(1 + \frac{1}{n-1} \right),$$

$$D_2 = \left(\frac{n(n-1)}{2} \right) \ln \left(1 + \frac{1}{n(n-2)} \right),$$

$$D_3 = \left(\frac{n(n-1)(n-2)}{6} \right) \ln \left(1 + \frac{2n-3}{(n-1)^3(n-3)} \right),$$

$$D_4 = \left(\frac{n(n-1)(n-2)(n-3)}{24} \right) \ln \left(1 + \frac{6n^4 - 48n^3 + 140n^2 - 176n + 81}{n(n-4)(n-2)^6} \right),$$

and

$$D_i = \ln \left[-\ln \left(1 - \frac{i + 0.5}{n + 0.25} \right) \right] - \ln \left[-\ln \left(1 - \frac{i - 0.5}{n + 0.25} \right) \right]$$

for $i=5,6,\dots,3K-2$. Finally, let \bar{X} and S represent the sample mean and sample standard deviation, respectively.

Determine γ using the appropriate column of Table 9.10.8. The first set of columns in Table 9.10.8 is provided for estimating the threshold, τ_{50} , associated with the Anderson-Darling goodness-of-fit test described here. The second and third sets of columns are provided for estimating τ_{99} and τ_{90} , which are needed to determine T_{99} and T_{90} , as described in Section 9.5.5.2. Each set of columns includes a column for uncensored data, 20 percent upper-tail censored data, and 50 percent upper-tail censored data.

The estimated threshold parameter, τ , is the solution to the equation $R(\tau) = \gamma$. The function $R(\tau)$ is a monotonically decreasing continuous function of τ . A simple method for finding the solution is as follows. Start with $L = \min(0, \bar{X} - 100S)$ and $H = 0.999999X_{(1)}$. If $R(L) \leq \gamma$, then set $\tau = L$ or if $R(H) \geq \gamma$ then set $\tau = H$. Otherwise reduce the (L,H) interval by calculating $M = (L+H)/2$ and setting $L = M$ if $R(M) \geq \gamma$ or by setting $H = M$ if $R(M) < \gamma$. If $H - L \leq 2X/10^6$, then set $\tau = M$ and stop. Otherwise, reduce the (L,H) interval again.

9.5.4.7.2 Estimating the Shape and Scale Parameters — This section describes a method for estimation of the shape and scale parameters of the two-parameter Weibull distribution based on data which may be censored in the upper tail. Estimates of the shape and scale parameters are based on the original data corrected for the estimated threshold, τ . That is, the calculations in this section are performed based on $Z_{(1)}, \dots, Z_{(r)}$, where $Z_{(i)} = X_{(i)} - \tau$, with τ estimated as in Section 9.5.4.7.1. The assumption is made here that if the data are censored, then only the r smallest observations in the sample are observed ($1 \leq r \leq n$), where r is some pre-specified number (often based on a percentage); this is called Type II censoring. Thus, the input to this procedure is a total sample size, n , a censored sample size, r , and the sample remaining after censoring $Z_{(1)}, \dots, Z_{(r)}$. Define

$$g(\beta) = \frac{\sum_{i=1}^r Z_{(i)}^\beta \ln Z_{(i)} + (n-r) Z_{(r)}^\beta \ln Z_{(r)}}{\sum_{i=1}^r Z_{(i)}^\beta + (n-r) Z_{(r)}^\beta} - \frac{1}{\beta} - \frac{1}{r} \sum_{i=1}^r \ln Z_{(i)}$$

Note: When implementing the equation for $g(\beta)$ in software, it may be necessary to divide each Z term that is raised to the β power by a normalizing factor, C , in order to avoid computational difficulties. The factor, C , can be any type of average calculated from the Z values (e.g., geometric mean of the uncensored Z values). Because the C -factor algebraically cancels out of the equation for $g(\beta)$, its use does not change the meaning of the equation in any way.

The shape parameter estimate, β , is the solution to the equation $g(\beta) = 0$. The function $g(\beta)$ is a monotonically increasing continuous function of β . A simple method for finding the solution is as follows. Let S_y denote the standard deviation of Y_1, \dots, Y_r where $Y_i = \ln(Z_i)$ for $i=1, \dots, r$. Calculate $I = 1.28/S_y$ as an initial guess at the solution and calculate $g(I)$. If $g(I) > 0$, then find the smallest positive integer k such that $g(I/2^k) < 0$ and let $L = I/2^k$ and $H = I/2^{k-1}$. If $g(I) < 0$, then find the smallest positive integer k such that $g(2^k I) > 0$ and let $L = 2^{k-1} I$, and $H = 2^k I$. Reduce the (L,H) interval by calculating $M = (L+H)/2$ and setting

$L = M$ if $g(M) \leq 0$ and/or by setting $H = M$ if $g(M) \geq 0$. If $H-L \leq 2I/10^6$, then set $\beta = M$ and stop. Otherwise, reduce the (L,H) interval again.

Once β has been determined, the scale parameter estimate is defined by

$$\alpha = \left(\frac{1}{r} \left(\sum_{i=1}^r Z_{(i)}^\beta + (n-r) Z_{(r)}^\beta \right) \right)^{\frac{1}{\beta}}.$$

9.5.4.7.3 Calculating the Anderson-Darling Statistic — Once the parameters have been estimated in Sections 9.5.4.7.1 and 9.5.4.7.2, calculate the Anderson-Darling statistic by the following steps.

For $i=1, \dots, r$, let

$$F_i = 1 - \exp \left(- \left(\frac{X_{(i)} - \tau_{50}}{\alpha_{50}} \right)^{\beta_{50}} \right),$$

let $F_{n+1} = 1$, and let

$$C_i = \frac{2i-1}{n}.$$

Define the A-D statistic as

$$AD = - \sum_{i=1}^r (C_i \ln F_i - 2F_i) + \frac{r^2}{n} \ln F_{r+1} - 2r F_{r+1} + \frac{n}{2} F_{r+1}^2 - \frac{n}{2} F_1^2.$$

If

$$AD \geq \begin{cases} 0.3951 + 4.186 \times 10^{-5} n & \text{(Uncensored)} \\ 0.2603 + 4.182 \times 10^{-5} n & \text{(20 percent censored)} \\ 0.1761 + 1.842 \times 10^{-5} n & \text{(50 percent censored)} \end{cases} \quad [9.5.4.7.3]$$

one may conclude (at 5 percent risk of error) that the population from which the sample was drawn is not a three-parameter Weibull population. Otherwise, the hypothesis that the population is a three-parameter Weibull population is not rejected. Equation 9.5.4.7.3 was derived under the assumption that the threshold parameter is estimated, not known. For further information on this test procedure, see Reference 9.5.4.7.3.

9.5.4.8 Identifying Proper Backoff for Weibull Method — Begin with the estimates τ_{50} , α_{50} , and β_{50} obtained according to the procedures outlined in Sections 9.5.4.7.1 and 9.5.4.7.2. Let $F_\tau(x)$ represent the cumulative distribution function of the three-parameter Weibull distribution with threshold parameter τ , and scale and shape parameters, α_{50} and β_{50} , respectively:

$$F_\tau(x) = 1 - \exp \left(- \left(\frac{x - \tau}{\alpha_{50}} \right)^{\beta_{50}} \right).$$

Define the special “backoff” Anderson Darling statistic by

$$ADB(\tau) = n \sum_{i=1}^n \left[\left(\frac{i}{n} \right)^2 (\ln b_i - \ln a_i) - \frac{2i}{n}(b_i - a_i) + \frac{1}{2}(b_i^2 - a_i^2) \right],$$

where $a_i = \min\{F_\tau(x_{(i)}), i/n\}$, $b_i = \min\{F_\tau(x_{(i+1)}), i/n\}$ for $i < n$, and $b_n = 1$. Let τ_{backoff} be the smallest value among 0.1, 0.2, 0.3, 0.4, and 0.5 such that

$$ADB(\tau_{50} - \tau_{\text{backoff}}) < 0.0359 + 1.2 \times 10^{-5} n. \quad [9.5.4.8]$$

If none of the five values satisfies Equation 9.5.4.8, the backoff procedure cannot be used to compute T_{99} and T_{90} . Otherwise, τ_{backoff} is subtracted from T_{99} and T_{90} as calculated from the complete sample.

9.5.4.9 Weibull Probability Plots —To graphically illustrate the degree to which a three-parameter Weibull distribution fits a set of data, the following procedure for creation of a Weibull probability plot is recommended. This method is appropriate for distributions estimated using censored or uncensored data. A method for displaying the fit using a distribution estimated by a backoff option is also described.

The rank of each point selected for plotting is the number of lower test points plus the plotted point plus one-half the number of other test points equal to the plotted point. Its cumulative probability, P (in percent), is equal to the rank multiplied by 100, divided by one more than the total number of test points:

$$P \text{ (in percent)} = \frac{(\text{rank})(100)}{n + 1}$$

The measured value of each test point is plotted versus $F^{-1}(P/100)$ where

$$F^{-1}(P/100) = \tau_{50} + \alpha_{50} \left[-\ln(1 - (P/100)) \right]^{\frac{1}{\beta_{50}}}$$

and τ_{50} , α_{50} , and β_{50} are population parameter estimates obtained according to the procedures outlined in Sections 9.5.4.7.1 and 9.5.4.7.2. A straight line is then drawn to represent the fitted Weibull distribution. This line may be established by plotting any two points with equal vertical and horizontal coordinates and drawing a line through these two points. The horizontal axis is then labeled with cumulative probabilities rather than F^{-1} values.

If the backoff option is used, the selected distribution can then be described as the best-fit distribution shifted by a small constant, τ_{backoff} . In this case, the predicted values should also be shifted by the same constant. That is, plot the measured values versus

$$F^{-1}(P/100) - \tau_{\text{backoff}}.$$

The plotted points should finally be compared with the line to determine whether there appears to be a reasonably good fit. With sample sizes on the order of 100 test points, only those points lying between about 10 and 90 percent probability should be considered in making this evaluation. With sample sizes of 1000 test points, these limits can be extended to about 1 and 99 percent. If the distribution was estimated using a method for censored data, then only the uncensored portion of the data used to estimate the distribution should be considered when assessing lack of fit. For instance, if the 20 percent censoring method is selected for use by the sequential Weibull method, then only the lower 80 percent of the data should be

examined for agreement with the line of best fit. If the backoff option was used, then only deviations where the data fall below the fitted line should be considered as departures.

Figure 9.5.4.9(a) illustrates the use of a Weibull probability plot on Alclad 2524-T3 Aluminum Alloy Sheet and Plate data in the 0.063-0.128 inch thickness range. This is a probability plot based on a Weibull distribution estimated using the 50 percent censoring method. The estimates of the threshold, scale, and shape parameters based on 50 percent censoring are 40.87, 5.26, and 2.09, respectively. Notice that the lower tail does not exhibit serious departures from the model, but significant departures are apparent in the upper tail. But, as mentioned above, only the lower 50 percent of the data should be included in an assessment of this probability plot, because the rest are not used in fitting the model. The model estimated by this method was accepted by the Anderson-Darling test for Weibullness.

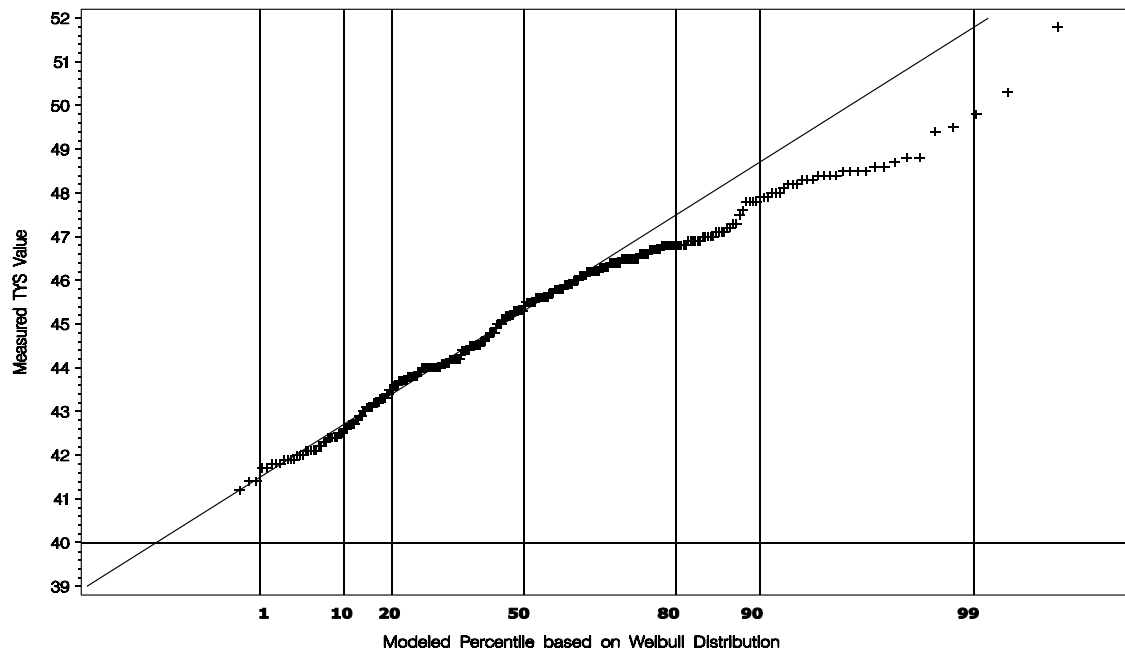

Vertical reference lines plotted at 1st, 10th, 20th, 50th, 80th, 90th, and 99th percentiles of fitted distribution
Horizontal reference line plotted at spec minimum, 40 ksi

Figure 9.5.4.9(a). Probability plot for a Weibull distribution fitted with 50 percent censored TYS data for Alclad 2524-T3 aluminum alloy sheet in the 0.063-0.128 inch thickness range - accepted.

Figures 9.5.4.9(b) and 9.5.4.9(c) illustrate the value of the backoff method and the construction and interpretation of the associated probability plots. Alclad 2524-T3 Aluminum Alloy Sheet and Plate tensile yield data in the 0.250 – 0.310 inch thickness range is used for illustration. There are 1202 measured test values. The estimates of the threshold, scale, and shape parameters of the best-fit Weibull distribution, based on the uncensored data, are 40.00, 3.50, and 2.62, respectively. The departures from the reference line in Figure 9.5.4.9(b) suggest that this Weibull distribution does not provide a good fit for the measured values, and it was rejected by Anderson-Darling test for Weibullness.

Figure 9.5.4.9(c) shows a probability plot of the same data, using the distribution estimated with the backoff option of the sequential Weibull procedure, which identified a backoff of 0.2 ksi. The only difference between the two plots is that the predicted values in Figure 9.5.4.9(b) are shifted 0.2 ksi to the left in Figure 9.5.4.9(c). Although the curve of data in Figure 9.5.4.9(c) is further away (on average) from the $y=x$ reference line than the curve of data in Figure 9.5.4.9(b), only negative deviations from the reference line are recognized in the Anderson-Darling goodness-of-fit test for a distribution estimated by the backoff method. In Figure 9.5.4.9(c), only a small proportion of the data in the very middle of the distribution are below the predicted values, resulting in an insignificant departure from Weibullness.

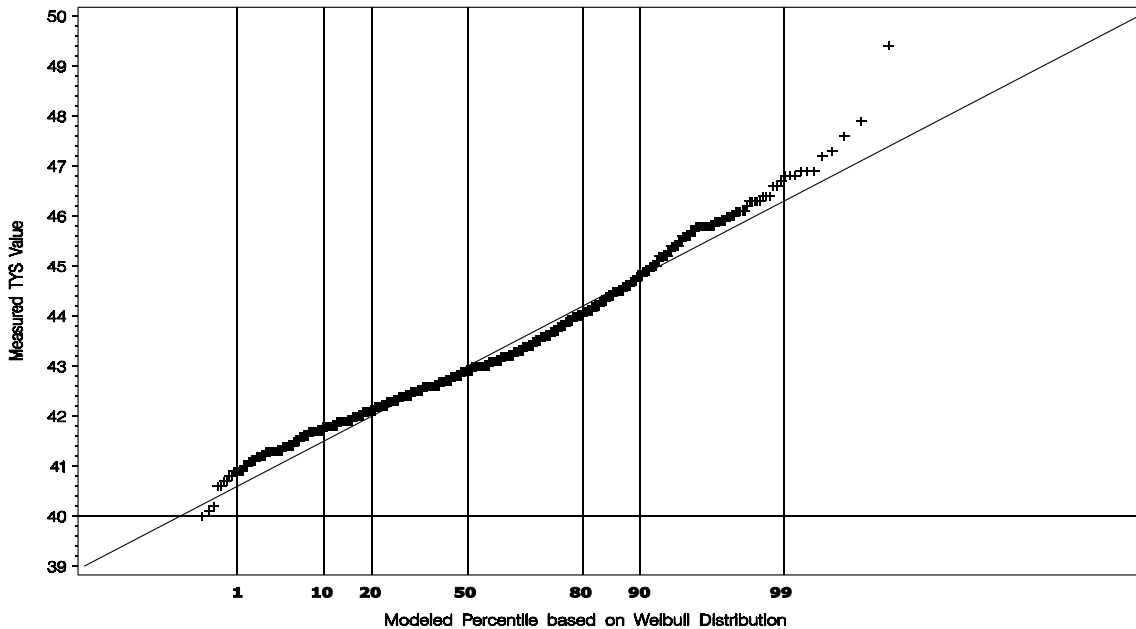

Vertical reference lines plotted at 1st, 10th, 20th, 50th, 80th, 90th, and 99th percentiles of fitted distribution
Horizontal reference line plotted at spec minimum, 40 ksi

Figure 9.5.4.9(b). Probability plot for a Weibull distribution fitted to a complete TYS data set for Alcad 2524-T3 aluminum alloy plate in the 0.250-0.310 inch thickness range - rejected.

9.5.5 DIRECT COMPUTATION WITHOUT REGRESSION —To permit computation of lower tolerance bounds in more of these cases, the Weibull approach was expanded to incorporate two different levels of upper-tail censoring and a last-resort conservative “backoff” option. Also, a modified version of the A-D test was developed which places more emphasis on the lower tail than the upper tail (Section 9.5.4.7).

During the development of the Weibull procedure (Section 9.5.5.2), it became evident how inadequate the traditional normal procedure is for computing tolerance bounds when the data come from a 9.5.5 illustrates the shortcomings of the normal procedure for computing T_{99} and T_{90} for distributions* ranging in skewness from minus 1 to plus 1. The second column provides estimates of the probability that skewed

* Table 9.5.5 is based on data generated from Weibull distributions with varying skewness. All distributions are standardized to a mean of 100 and standard deviation of 5.0.

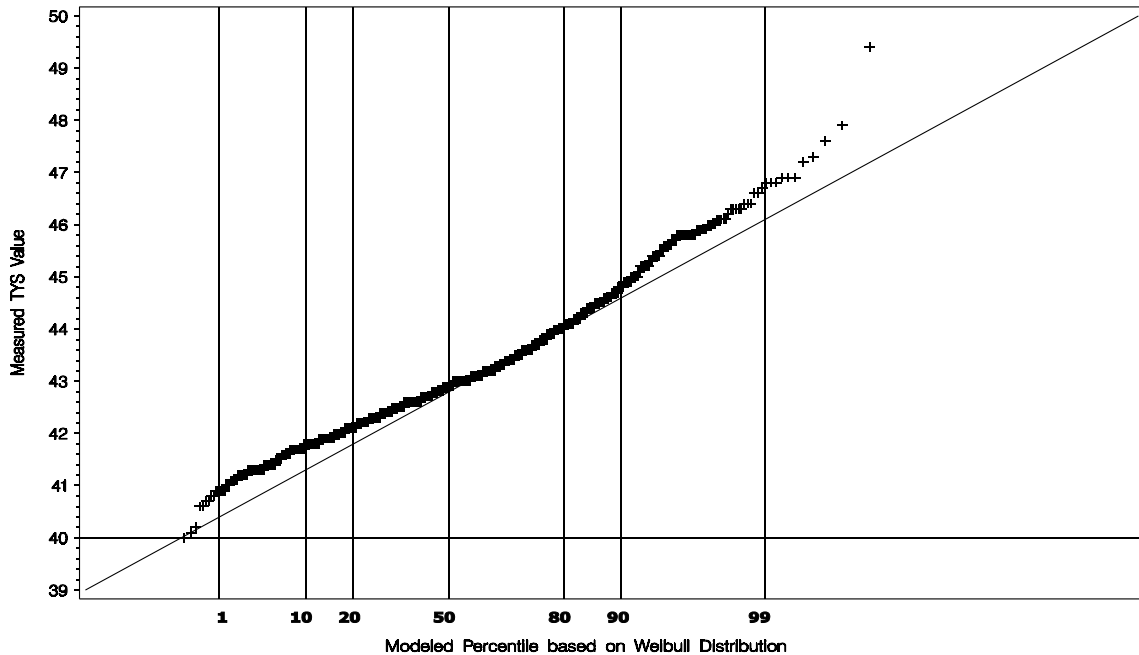

Vertical reference lines plotted at 1st, 10th, 20th, 50th, 80th, 90th, and 99th percentiles of fitted distribution
Horizontal reference line plotted at spec minimum, 40 ksi

Figure 9.5.4.9(c). Probability plot for a Weibull distribution fitted to complete TYS data for Alcad 2524-T3 aluminum alloy plate in the 0.250-0.310 inch thickness range using 0.2 ksi backoff - accepted.

distribution – even if a goodness-of-fit test is applied to screen out non-normal distributions. Table a sample of size 100 will be “accepted” as normal. Notice that for very skewed Weibull distributions, the proportion accepted by the normal Anderson-Darling test is small, but it increases for distributions with skewness near zero. The third column of Table 9.5.5 estimates the coverage, which is the probability (or confidence) that the method will yield a T_{99} below the true first percentile. This should be 95 percent. If the distribution is negatively skewed then the coverage can be substantially lower than the claimed 95 percent. The fourth column estimates the systematic bias of the procedure. Bias for T_{99} represents the difference between the 95th percentile of the T_{99} values produced by the normal procedure minus the true first percentile. (Bias is presented in units of standard deviations. This can be converted to, say, ksi units, if the standard deviation is known.) It can be interpreted as the amount that would have to be subtracted from the T_{99} values produced by the procedure to get an appropriate answer. The problem is, in practice, one never knows true skewness. Notice that as bias goes up, coverage goes down. The last two columns provide coverage and bias estimates for T_{90} . Although still significant, the errors associated with T_{90} are much smaller than those for T_{99} . Figure 9.5.5(a) displays the bias of T_{90} and T_{99} for skewness between minus 1 and plus 1 (again, in units of standard deviations).

Normal-based methods can be very good for estimating the mean of a distribution - which is not very sensitive to skewness. However, in MIL-HDBK-5, much of the emphasis is on estimating the first and tenth percentiles - which are very sensitive to skewness. Table 9.5.5 and Figure 9.5.5(a) are provided to emphasize the notion that applying the normal method can result in very poor tolerance bound estimates due to undetected skewness. It is for this reason that the traditional normal method for computing tolerance bounds is not provided in the Handbook as a recommended procedure.

On the other hand, because methods based on the Weibull distribution are computationally intensive

and have less intuitive appeal than methods based on the normal distribution, an alternative procedure was

Table 9.5.5. Performance of Normal Method for Calculating T_{90} and T_{99} on Samples of Varying Skewness

Skewness	Percent Accepted	T_{99}		T_{90}	
		Percent Coverage	Bias (Std. Dev.)	Percent Coverage	Bias (Std. Dev.)
-1.00	16	3	1.0	66	0.22
-0.75	40	11	0.7	78	0.16
-0.50	68	43	0.4	83	0.12
-0.25	91	82	0.2	88	0.08
0.00	98	98	-0.1	93	0.04
0.25	91	100	-0.4	97	-0.02
0.50	65	100	-0.6	99	-0.06
0.75	21	100	-0.7	100	-0.06
1.00	4	100	-0.7	100	-0.10

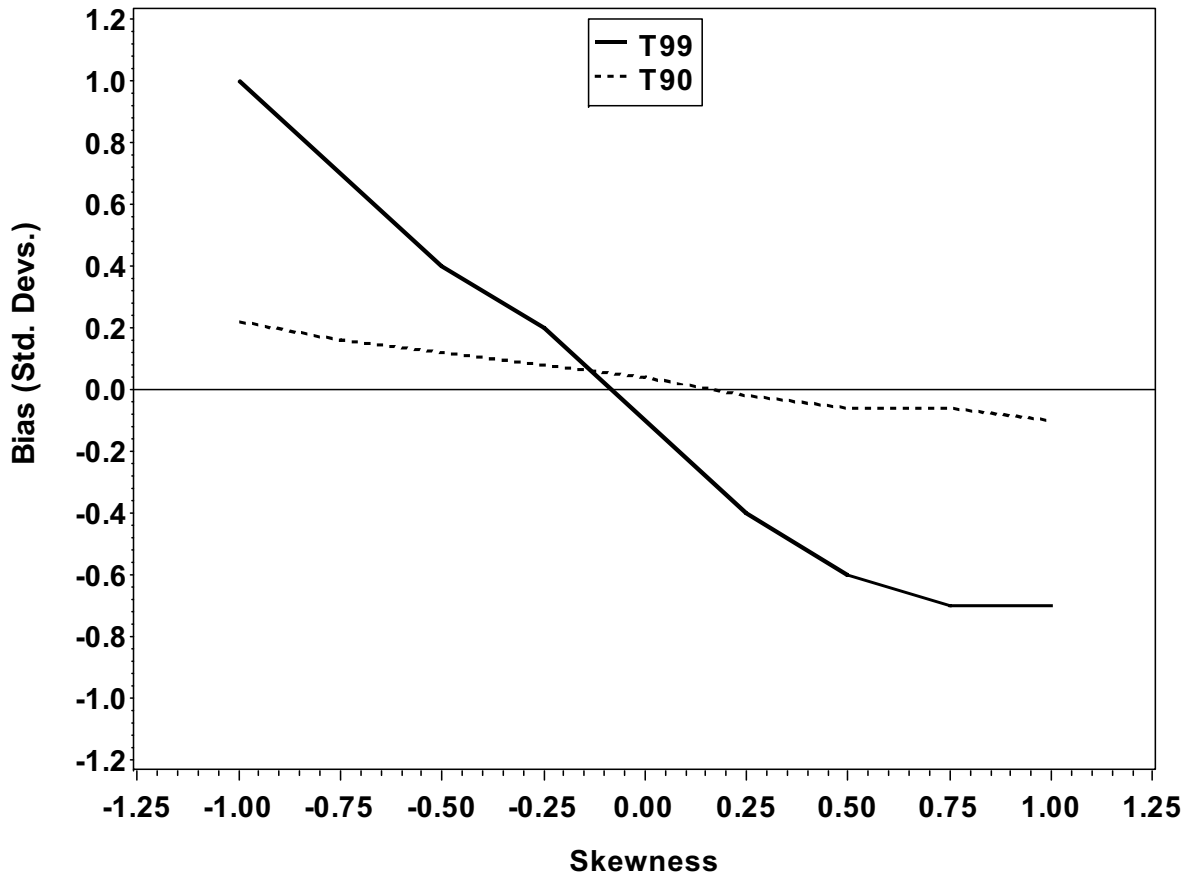

Figure 9.5.5(a). Estimated Bias of T_{99} and T_{90} Using Normal Method on Skewed Data.

developed based on the Pearson Type III family of distributions. The Pearson family includes the normal distribution as a special case. The Pearson method was incorporated into the Guidelines in 1999.

The sequential Weibull procedure (Section 9.5.5.2) and the sequential Pearson procedure (Section 9.5.5.1) were developed based on distributions with skewness between minus 1 and 1. Therefore, the Weibull and Pearson procedures should not be applied if the sample skewness is outside this range. If no systematic effects (e.g., thickness) are identified as significant by regression, then only the nonparametric method (Section 9.5.5.3) should be applied.

Current analysis procedures for computing lower tolerance bounds (T_{90} , T_{99}) are described in Figure 9.5.5(b). Three methods are permitted: the sequential Pearson procedure, the sequential Weibull procedure, and the nonparametric procedure. The remainder of this section provides an overview and a roadmap to these procedures. Figure 9.5.5(c) describes the procedure for translating T_{99} and T_{90} values to A and B values, and values for publication in the mechanical property tables in this Handbook.

In what follows, certain procedures require artificial censoring of the measured data. That is, because the real engineering interest for design lies in lower percentiles of the distribution of a material's properties, some of the following procedures ignore a portion of the observations in the upper tail. Specifically, we use the notation $X_{(1)} \leq X_{(2)} \leq \dots \leq X_{(n)}$ to denote the ordered sample, and will frequently refer to the censored sample:

$$X_{(1)} \leq X_{(2)} \leq \dots \leq X_{(r)}.$$

The ratio r/n represents the proportion of the sample which is uncensored. Alternatively, $(1-r/n)$ represents the proportion of the sample which is censored. The terms r and n will be used throughout subsequent sections without redefinition. In the case of uncensored data, $r=n$.

If the sequential Pearson analysis procedure is applied, the first step is to perform an Anderson-Darling goodness-of-fit test for Pearsonity as described in Section 9.5.4.4. If the assumption of normality is not rejected, the lower tolerance bounds may be computed using the methods described in Section 9.5.5.1. If the assumption of Pearsonity is rejected, then the Pearson backoff method (Section 9.5.4.5) should be attempted. This method decreases the estimate of the mean, while holding the standard deviation and skewness estimates constant, until the percentiles of the resulting model are sufficiently less than the sample percentiles. To avoid accepting an extremely inadequate fit, the decrease in the mean is limited to 0.5 ksi.

Section 9.5.4.5 describes the method for identifying a proper backoff, denoted by τ_{backoff} , for the sequential Pearson method. If the appropriate backoff is less than or equal to 0.5 ksi, the lower tolerance bounds should be calculated by first computing bounds based on the complete sample as specified in Section 9.5.5.1, and then subtracting τ_{backoff} . If an appropriate backoff less than or equal to 0.5 ksi is not identified, then the sequential Weibull procedures described in Section 9.5.5.2 or the nonparametric procedure described in Section 9.5.5.3 should be considered. In most cases it has been found that strength data fit a Pearson distribution better than a Weibull distribution. However, there are times when a Weibull distribution does provide a better fit. Probability plots are helpful in determining which procedure provides the best fit when there is a difference in the T_{99} and T_{90} values for the two methods.

When the sequential Weibull procedure is applied, a modified Anderson-Darling goodness-of-fit-test is conducted as described in Section 9.5.4.7 for the uncensored sample. If the assumption of Weibullness is not rejected, the lower tolerance bound should be computed using methods described in Section 9.5.5.2 for complete samples. (The risk that one may conclude erroneously that a true Weibull distribution is non-

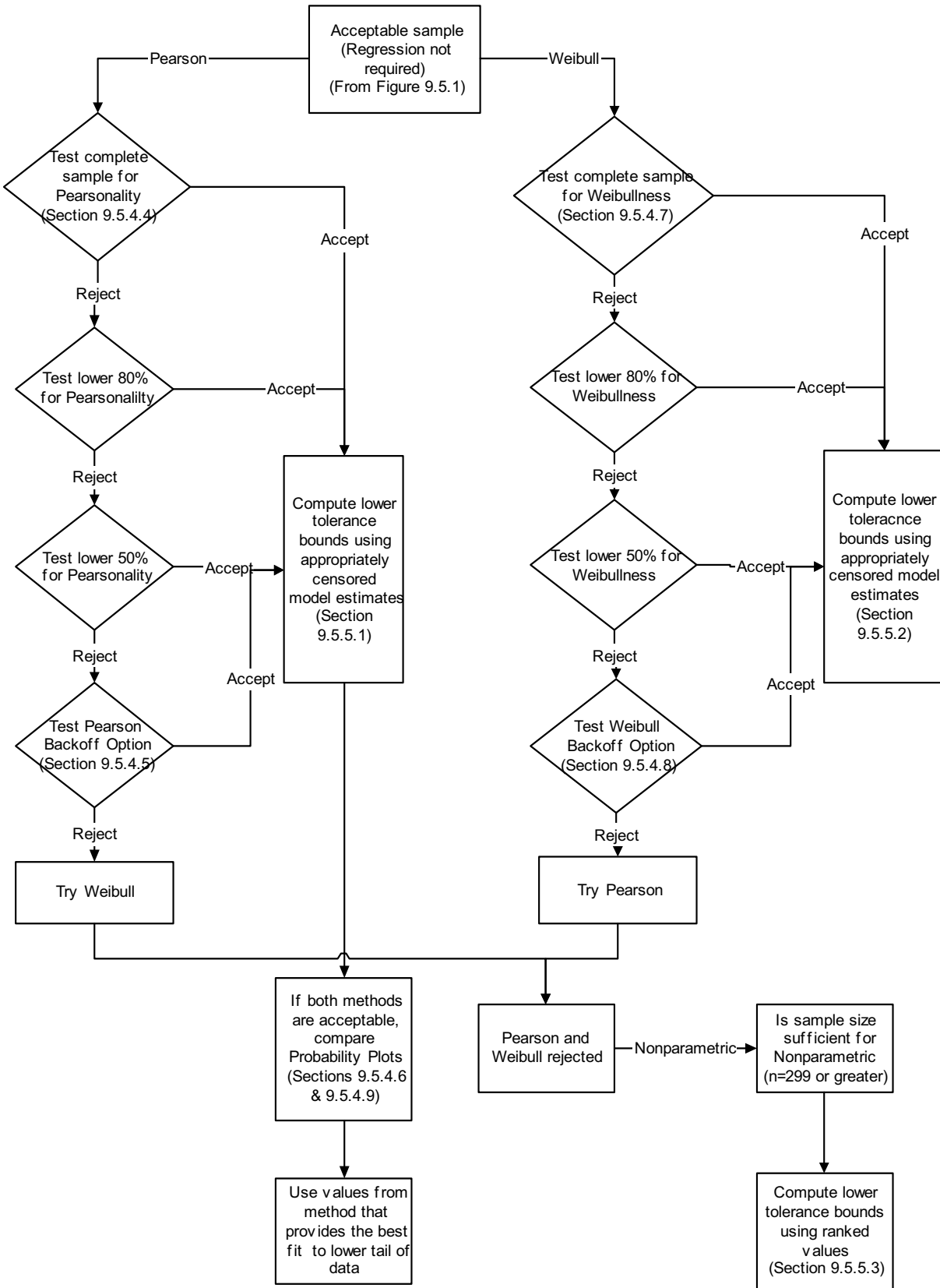

Figure 9.5.5(b). Procedure for Direct Computation of T_{99} and T_{90} When Regression is Not Required.

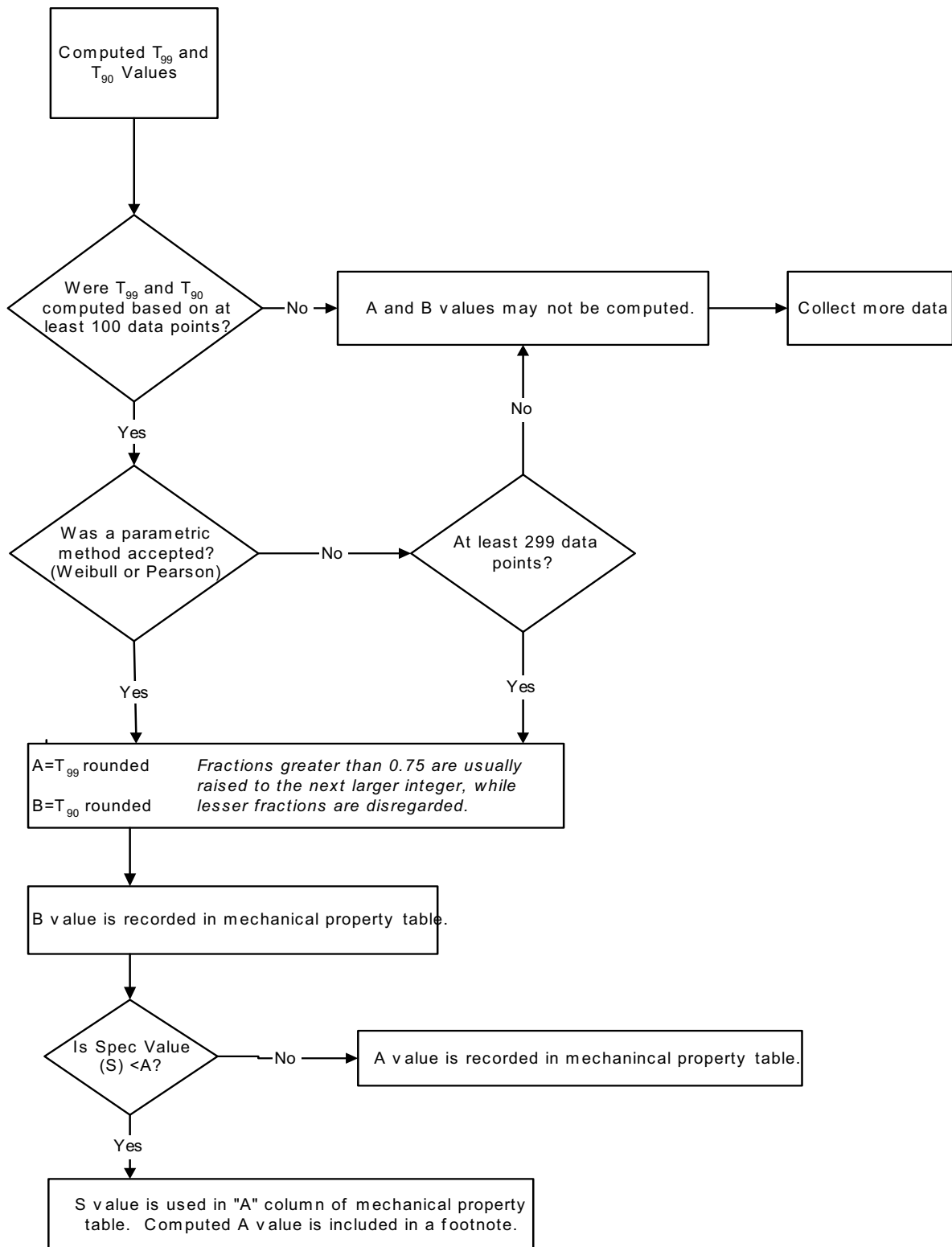

Figure 9.5.5(c). Procedure for Converting T_{99} and T_{90} values [from Figure 9.2.6(a)] to A and B Values, and Mechanical Property Table Values.

Weibull is set at 5 percent.) If the assumption of Weibullness is rejected for the complete sample, then the next step is to test the lower 80 percent of the data for Weibullness by trimming the top 20 percent of the measurements and applying a censored version of the Anderson-Darling test. Use the version of the test described in Section 9.5.4.7 for 20 percent censoring. If this test is not rejected, then the lower tolerance bounds should be computed using the methods described in Section 9.5.5.2 for 20 percent censoring. If the assumption of Weibullness is rejected here, then 50 percent censoring should be attempted, in the same manner as described for 20 percent censoring.

If the Weibull model is still rejected with 50 percent censoring, then a last resort conservative Weibull method should be attempted. This method decreases the initial Weibull threshold estimate while holding the shape and scale parameters constant, until the percentiles of the resulting model are sufficiently less than the sample percentiles. To avoid accepting an extremely inadequate fit, the decrease is limited to 0.5 ksi.

Section 9.5.4.8 describes the method for identifying a proper backoff (the decrease from the initial Weibull threshold estimate), denoted by τ_{backoff} , for this method. If the appropriate backoff is less than or equal to 0.5 ksi, the lower tolerance bounds should be calculated by first computing bounds based on the complete sample as specified in Section 9.5.5.2, and then subtracting the τ_{backoff} value. If an appropriate backoff less than or equal to 0.5 ksi is not identified for either the sequential Pearson or sequential Weibull procedures, then the nonparametric procedures described in 9.5.5.3, should be considered

In those cases where sufficient data are available, one may choose to calculate the lower tolerance bounds by the nonparametric procedure. A T_{99} bound requires 299 data values and a T_{90} bound requires 29 data values.* The nonparametric procedure is described in Section 9.5.5.3. If the sample size is too small for the nonparametric method, sequential Pearson procedure described in Section 9.5.5.1 or the the sequential Weibull procedure described in Section 9.5.5.2, should be considered.

In those cases where sample sizes are insufficient to apply the nonparametric method, and the goodness-of-fit tests will not allow application of the sequential Weibull or sequential Pearson procedures, the lower tolerance bounds cannot be calculated.

9.5.5.1 Sequential Pearson Procedure —This procedure should be used when a lower tolerance bound (T_{99} , T_{90}) is to be computed directly (not paired with another property for computational purposes) and the population may be interpreted to signify either the property measured (TUS, etc.) or some transformation of the measured value that is normally distributed. This procedure is applicable to F_{tu} and F_{ty} . It may also be used for F_{cy} , F_{su} , F_{bru} , and F_{bry} if sufficient quantity of data is available.

To compute lower tolerance bounds for a population from the Pearson Type III (or gamma) family of distributions, it is necessary to have estimates of the mean, standard deviation, and skewness of the population. In what follows, these are denoted respectively by \bar{X} , S , and q . These estimates are also necessary for applying the Anderson-Darling (AD) test for Pearsonality (described in 9.5.4.4) and for the backoff part of the test (described in 9.5.4.5). Background information on the Pearson Type III distribution may be found in References 9.5.5.1(a) and 9.5.5.1(b).

In what follows, $X_{(1)}$, $X_{(2)}$, ..., $X_{(n)}$ represent the sorted observations, from smallest to largest. Calculate the sample mean and sample standard deviation as usual:

* However, according to current guidelines, a T_{90} value cannot be calculated for inclusion in MIL-HDBK-5 with fewer than 100 data values. See Section 9.2.9.1.

$$\bar{X} = \frac{1}{n} \sum_{i=1}^n X_i$$

$$S = \sqrt{\frac{1}{n-1} \sum_{i=1}^n (X_i - \bar{X})^2}$$

The skewness is calculated as follows. First calculate the sample skewness:

$$Q = \frac{\frac{1}{n} \sum_{i=1}^n (X_i - \bar{X})^3}{S^3 \sqrt{(n-1)^3}}$$

If $Q = 0$, then let $q = 0$. If $Q \neq 0$, calculate the estimated threshold

$$T = \bar{X} - 2 \cdot S / Q$$

and use the following rules to define q :

- If $Q > 0$ and $X_{(1)} < T$, then let $q = 2 \cdot S / (\bar{X} - 0.99999 X_{(1)})$.
- If $Q < 0$ and $X_{(n)} > T$, then let $q = 2 \cdot S / (\bar{X} - 1.00001 X_{(n)})$.
- Otherwise, $q = Q$.

If the data are not rejected by the Anderson-Darling test for Pearsonity (described in 9.5.4.4), then T_{99} and T_{90} should be calculated by the following formulae:

$$T_{99} = \bar{X} - k_{99}(q, n) \cdot S$$

$$T_{90} = \bar{X} - k_{90}(q, n) \cdot S$$

where

$$k_{99}(q, n) = z_{99}(q) + \exp \left[2.556 - 1.229q + 0.987q^2 - 0.6542 \cdot \ln(n) + 0.0897q \cdot \ln(n) - 0.1864q^2 \cdot \ln(n) \right]$$

$$k_{90}(q, n) = z_{90}(q) + \exp \left[1.541 - 0.943q - 0.6515q^2 - 0.6004 \cdot \ln(n) + 0.0684q \cdot \ln(n) + 0.0864q^2 \cdot \ln(n) \right]$$

$$z_{99}(q) = \frac{2}{q} \left[1 - \left(1 - \frac{q^2}{36} - 2.326348 \cdot \frac{q}{6} \right)^3 \right] - 0.013133q^2 - 0.003231q^3 + 0.003139q^4 + 0.001007q^5$$

$$z_{90}(q) = \frac{2}{q} \left[1 - \left(1 - \frac{q^2}{36} - 1.281552 \cdot \frac{q}{6} \right)^3 \right] + 0.003814q^2 - 0.002466q^3 - 0.000633q^4 + 0.000122q^5$$

The above formulas for $z_{99}(q)$ and $z_{90}(q)$ should be used for $q \neq 0$. If $q = 0$, then $z_{99}(q) = 2.326348$ and $z_{90}(q) = 1.281552$.

If the data are rejected by the Anderson-Darling test for Pearsonality, but accepted under the backoff option of the test (9.5.4.5) with a reduction in the mean of $\tau_{backoff}$, then the above formulas should be applied to compute then T_{99} and T_{90} with the following slight modification:

$$T_{99} = \bar{X} - k_{99}(q, n) \cdot S - \tau_{backoff},$$

$$T_{90} = \bar{X} - k_{90}(q, n) \cdot S - \tau_{backoff}.$$

9.5.5.2. Sequential Weibull Procedure — This section describes procedures required for modeling data with the three-parameter Weibull distribution. Section 9.5.4.7.1 describes a method for estimating the threshold parameter, τ . Section 9.5.4.7.2 describes a method for estimating the shape and scale parameters, β and α , respectively. Both methods permit estimation with upper-tail censored data. For a good exposition of such procedures, see Reference 9.5.4.1(a).

This procedure should be used when a mechanical property value is to be computed directly (not paired with another property for computational purposes) and the population may be interpreted to signify either the property measured (TUS, etc.) or some transformation of the measured value that follows a three-parameter Weibull distribution. This procedure is applicable to F_{tu} and F_{ty} . It may also be used for F_{cy} , F_{su} , F_{bru} , and F_{bry} if a sufficient quantity of data is available.

In order to compute the lower tolerance bounds for a three-parameter Weibull population, it is necessary to have (1) an estimate of population threshold, (2) estimates of population shape and scale parameters, and (3) tables of one-sided tolerance limit factors for the three-parameter Weibull distribution. The method for estimating the population threshold is presented in Section 9.5.4.7.1, and Section 9.5.4.7.2 contains the method for estimating population shape and scale parameters. Both of these procedures permit estimation with complete or censored data (20 or 50 percent censoring). A tabulation of tolerance limit factors by sample size, censoring level, and population proportion covered by the tolerance interval is presented in Table 9.10.7. For further information on these procedures and tabled values, see References 9.5.5.2.(a) and (b).

Let X_1, \dots, X_n denote sample observations in any order and let $X_{(1)}, \dots, X_{(n)}$ denote sample observations ordered from smallest to largest. The first step in calculating T_{99} and T_{90} for a three-parameter Weibull population is to obtain an estimate of the population threshold. The population threshold is theoretically the minimum achievable value for the property being measured. However, the real population is being empirically modeled by some Weibull population with a threshold. Since this empirical model is not perfect, there may be a small percentage of observations in the population that fall below the model threshold. Separate threshold estimates, denoted by τ_{99} and τ_{90} , will be obtained for T_{99} and T_{90} using the methods described in Section 9.5.4.7.1.

The second step in calculating mechanical properties for a three-parameter Weibull population is to obtain estimates of population shape and scale parameters for each property. Shape parameter estimates will be denoted by β_{99} and β_{90} and scale parameter estimates will be denoted by α_{99} and α_{90} . Estimation of shape and scale parameters is performed using a maximum likelihood procedure for the two-parameter Weibull distribution, after subtracting off the estimated threshold. (The two-parameter Weibull is equivalent to the three-parameter Weibull with threshold zero.)

Using the method outlined in Section 9.5.4.7.2, compute the maximum likelihood estimates of the shape and scale parameters for the censored or uncensored sample $\{X_{(i)} - \tau_{99} : i=1, \dots, r\}$, where r equals n for uncensored data and r represents the smallest integer greater than or equal to $4n/5$ for 20 percent censoring and $n/2$ for 50 percent censoring. Denote these estimates by β_{99} and α_{99} , respectively. Using the same procedure, compute estimates β_{90} and α_{90} based on the sample $\{X_{(i)} - \tau_{90} : i=1, \dots, r\}$.

With population parameter estimates discussed above at hand, the computation of the lower tolerance bounds is carried out by use of the formulas:

$$T_{99} = \tau_{99} + Q_{99} \exp \left[- V_{99}/(\beta_{99}\sqrt{n}) \right], \quad [9.5.5.2(a)]$$

$$T_{90} = \tau_{90} + Q_{90} \exp \left[- V_{90}/(\beta_{90}\sqrt{n}) \right], \quad [9.5.5.2(b)]$$

where

$$Q_{99} = \alpha_{99} (0.01005)^{1/\beta_{99}}$$

$$Q_{90} = \alpha_{90} (0.10536)^{1/\beta_{90}}$$

V_{99} = the value in the V_{99} column of Table 9.10.8 corresponding to a sample of size n and the appropriate degree of censoring, and

V_{90} = the value in the V_{90} column of Table 9.10.8 corresponding to a sample of size n and the appropriate degree of censoring.

Note that the level of censoring used in estimating the threshold, shape, and scale parameters must be used in determining V_{99} and V_{90} . Also, because this censoring level is determined by the goodness-of-fit test (9.5.4.7), the same censoring level is used for both T_{99} and T_{90} .

If the property that follows a three-parameter Weibull distribution represents a transformation, the lower tolerance bounds (T_{99} , T_{90}) computed by the above formulas must be transformed back to the original units in which the mechanical property is conventionally reported.

9.5.5.3 Nonparametric Procedure — This procedure should be used when a mechanical-property value is to be computed directly (not paired with another property for computational purposes) and the form of the distribution of population is unknown (not Pearson Type III or three-parameter Weibull). Distribution should not be considered unknown (1) if tests show it to be Pearson or three-parameter Weibull, (2) if it can be transformed to a Pearson or three-parameter Weibull distribution, or (3) if it can be separated into Pearson or three-parameter Weibull subpopulations. This procedure is applicable to F_{tu} and F_{ty} . It may also be used for F_{cy} , F_{su} , F_{bru} , and F_{bry} if sufficient quantity of data is available.

Nonparametric (or distribution-free) data analysis assumes a random selection of test points and uses only the ranks of individual test points and the total number of test points. If test points have been deleted from a sample, the random basis is violated; consequently, this procedure must not be used when there is reason to suspect that the sample may have been censored.

As an example, assume that a sample consists of 299 test points selected in a random manner. The test point having the lowest value has rank 1, the test point having the next lowest value has rank 2, etc. Thus, an array of ranked test points might appear as follows:

Rank of Test Point	Value of Test Point, ksi
1	73.3
2	74.1
3	75.2
4	75.3
5	75.6
299	85.7

For each rank from a sample of size, n, it is possible to predict, with 0.95 confidence, the least fraction of population that exceeds the value of the test point having rank r. Since only two fractions, or probabilities, are of interest in determination of T_{99} and T_{90} values, only the ranks of test points having the probability and confidence of T_{99} and T_{90} values are presented in Table 9.10.9. To use this table with a sample size of 299, for example, one would designate the value of the lowest (r=1) test measurement as T_{99} and the 22nd lowest (r=22) test measurement as T_{90} . For sample sizes between tabulated values, interpolation is permissible. For sample sizes smaller than 299, T_{99} is smaller than the value of the lowest point and cannot be determined in this manner.

9.5.6 DIRECT COMPUTATION BY REGRESSION ANALYSIS — This section describes the procedure used to determine design allowables by regression analysis if it has been determined that a significant representation relationship exists (see Section 9.5.1.2). Thus a dimensional parameter x (such as x=t, 1/t, etc., where t is thickness) has been determined to be related to the property being considered.

9.5.6.1 PERFORMING THE REGRESSION — The following steps must be performed prior to determining design allowables by regression analysis:

- (1) Express the property as a simple linear (or quadratic) function of the dimensional parameter and obtain estimates of the coefficient using the least squares regression procedure in Section 9.5.2.1 (or Section 9.5.2.2); for example

$$TUS = a + bx$$

or

$$(SUS/TUS) = a + bx + cx^2$$

where x is thickness or area and a, b, and c are constants from the least squares equation.

- (2) Determine the root mean square error of regression (s_y). See 9.5.2.1(h) and 9.5.2.2(e).

The direct computational procedure takes into account errors in the model estimates. If a linear relationship has been determined, compute T_{99} for F_{tu} at $x = x_0$, using Equation [9.5.6.1(a)]

$$T_{99} = a + bx_0 - k'_{99}s_y \quad [9.5.6.1(a)]$$

where a, b, and s_y are computed in the regression of TUS data, k'_{99} is $\sqrt{(1+\Delta)}/n$ times the 95th percentile of the noncentral t distribution with noncentrality parameter $2.326/\sqrt{(1+\Delta)}/n$ and n - 2 degrees of freedom, and

$$\Delta = \frac{(\bar{x}_o - \Sigma x/n)^2}{\Sigma(x - \Sigma x/n)^2/n} \quad [9.5.6.1(b)]$$

The equation for computing a T_{90} is similar with k'_{90} being used in place of k'_{99} . k'_{90} is $\sqrt{(1+\Delta)/n}$ times the 95th percentile of the noncentral t distribution with noncentrality parameter $1.282/\sqrt{(1+\Delta)/n}$ and $n - 2$ degrees of freedom, where Δ is defined above. If calculation of the appropriate noncentral t percentile is not possible, the following approximations to k'_{99} and k'_{90} may be used:

$$k'_{99} = 2.326 + \exp\{0.659 - 0.514 \ln(n) + (0.481 - 1.42/n)\ln(3.71 + \Delta) + 6.58/n\} \quad [9.5.6.1(c)]$$

$$k'_{90} = 1.282 + \exp\{0.595 - 0.508 \ln(n) + (0.486 - 0.986/n)\ln(1.82 + \Delta) + 4.62/n\}. \quad [9.5.6.1(d)]$$

These approximations are accurate to within 1.0 percent for $n \geq 10$ and $\Delta \leq 10$. The square root of Δ is the number of standard deviations between x_o and the arithmetic mean of the x-values. Thus, a Δ value of 10 would represent an extreme x_o value, which is more than three standard deviations from the mean x-value.

If a quadratic relationship has been determined, calculate T_{99} for F_m at $x = x_o$ using Equation [9.5.6.1(e)]

$$T_{99} = a + bx_o + cx_o^2 - \left(t_{0.95, n-3, \frac{2.326}{\sqrt{Q}}} \right) \sqrt{Q} s_y \quad [9.5.6.1(e)]$$

where a, b, c, s_y , and Q are computed by quadratic regression, and the factor $t_{0.95, n-3, \frac{2.326}{\sqrt{Q}}}$ is the 95th percentile of the noncentral t distribution with noncentrality parameter $2.326/\sqrt{Q}$ and $n-3$ degrees of freedom.

To calculate T_{90} in the presence of a quadratic relationship, use Equation 9.5.6.1(f)

$$T_{90} = a + bx_o + cx_o^2 - \left(t_{0.95, n-3, \frac{1.282}{\sqrt{Q}}} \right) \sqrt{Q} s_y \quad [9.5.6.1(f)]$$

where a, b, c, s_y , and Q are computed by quadratic regression, and the factor $t_{0.95, n-3, \frac{1.282}{\sqrt{Q}}}$ is the 95th percentile of the noncentral t distribution with noncentrality parameter $1.282/\sqrt{Q}$ and $n-3$ degrees of freedom.*

The procedures described above permit the determination of design allowables only for specific values of x. When it is desired to present a single allowable covering a range of product thickness (for example, 1.001- to 2.000-inch plate), the lowest allowable for the range should be used. Thus, if TUS(LT) decreases continuously with increasing thickness, the TUS(LT) corresponding to $x = 2.000$ inches would be presented in MIL-HDBK-5. If the decrease is large, a decrease in product thickness interval can be made: for example, by splitting the 1.001- to 2.000-inch interval into two intervals of 1.001 to 1.500 and 1.501 to 2.000 inches.

* Note that critical values for the noncentral t distribution are not tabulated in MIL-HDBK-5.

9.5.7 INDIRECT COMPUTATION WITHOUT REGRESSION (REDUCED RATIOS/DERIVED PROPERTIES) — Ideally, it is desirable to determine F_{cy} , F_{su} , F_{bru} , F_{bry} , as well as F_{tu} and F_{ty} in other than specified test direction by direct computation as described in Sections 9.5.2, and, if sufficient quantity of data is available, direct computation procedures will be used. Unfortunately, the cost of generating required data for these properties is usually prohibitive. Consequently, this section describes an indirect method of computation to determine the mechanical property values.

A derived property is a mechanical property value determined by its relationship to an established tensile property (F_{tu} or F_{ty} , A, B, or S-basis). This indirect method of computation is applicable to F_{tu} and F_{ty} in grain directions other than the specified testing direction, as delineated in the applicable material specification, and for all grain directions for F_{cy} , F_{su} , F_{bru} , and F_{bry} .

The procedure involves pairing of TUS, SUS, or BUS measurements with TUS measurements for which F_{tu} has been established or the pairing of TYS, CYS, and BYS measurements with TYS measurements for which F_{ty} has been established. Average values for each lot will be used when more than one measurement per lot is available.

This technique is based on the premise that the mean ratio of paired observations representing related properties provides an estimate of the ratio of corresponding population means. The ratio consists of measurements of the property to be derived as the numerator and measurement of the established tensile property as the denominator. Thus, TUS or TYS in the specified testing direction always appears in the denominator of the ratio of observed values.

The grain direction to be used for the denominator is the specified test direction as delineated in the applicable material specification. For most materials, routine quality control (certification) tests are usually conducted only in one grain direction even though the specification may contain mechanical property requirements for two or three grain directions. The typically specified or primary test directions for different product forms of each alloy system are shown in Table 9.2.3.2 and discussed in Section 9.5.7.1. Section 9.5.7.2 discusses the treatment of test specimen location. Section 9.5.7.3 discusses the treatment of clad plates, and Section 9.5.7.4 discusses the computation procedure for minimum design values.

9.5.7.1 Treatment of Grain Direction — Tensile allowables are usually listed according to grain direction in material specifications although some specifications do not indicate a grain direction, which implies isotropy. For MIL-HDBK-5, it is recommended that tension allowables be shown for each grain direction. When the material is shown to be isotropic, then the same properties should be shown for each direction.

Compression allowables are shown by grain direction similar to tension allowables. An example of computing compression allowables for heat treatable plate is shown below. The reduced ratio, R, for longitudinal grain direction, is determined from ratios, r, formed from paired observations for each lot of material, CYS(L)/TYS(LT). Although a longitudinal ratio is being obtained, the divisor is long transverse because this is the specified testing direction (refer to Table 9.2.3.2). The reduced ratio, R, for long transverse grain direction, is determined from ratios, r, formed from paired observations for each lot of material, CYS(LT)/TYS(LT). Similarly the reduced ratios, R, for short transverse grain direction, are determined from ratios, r, formed from paired observations for each lot of material, CYS(ST)/TYS(LT). The ratios, r, determined in the above manner are used in conjunction with Equation 9.5.7.4(b) to obtain a reduced ratio, R, for each grain direction. Equating the reduced ratios, design allowable values are determined from the resulting relationships,

$$R = \frac{F_{cy}(L)}{F_{ty}(LT)}$$

or

$$F_{cy}(L) = RF_{ty}(LT)$$

similarly

$$F_{cy}(LT) = RF_{ty}(LT)$$

and

$$F_{cy}(ST) = RF_{ty}(LT)$$

Shear and bearing allowables are usually shown without reference to grain direction. These properties will be analyzed according to grain direction, and design allowables will be based on the lowest reduced ratio obtained for longitudinal, long transverse and short transverse (when applicable) directions. An exception is aluminum hand forgings for which shear values will be presented according to grain direction.

In computing the derived properties, paired ratios representing different grain directions will not be combined in the determination of a reduced ratio. This is based on the premise that, if the ratio for two paired measurements is to provide an estimate of population mean ratio, then paired measurements must represent the same grain direction as that of the corresponding population means.

For aluminum die forgings, the longitudinal grain direction is defined as orientations parallel, within $\pm 15^\circ$, to the predominate grain flow. The long transverse grain direction is defined as perpendicular, within $\pm 15^\circ$, to the longitudinal (predominate) grain direction and parallel, within $\pm 15^\circ$, to the parting plane. (Both conditions must be met.) The short transverse grain direction is defined as perpendicular, within $\pm 15^\circ$, to the longitudinal (predominate) grain direction and perpendicular, within $\pm 15^\circ$, to the parting plane. (Both conditions must be met.) When possible, compression, bearing, and shear tests for three grain directions will be conducted.

9.5.7.2 Treatment of Test Specimen Location — Testing specifications require a change in test specimen location from $t/2$ for ≤ 1.500 - to $t/4$ for > 1.500 -inch thickness for certain products. Although this change in specimen location may result in $t/4$ mechanical property ratios which are significantly different from $t/2$ ratios (different populations), as for aluminum plate, the $t/2$ and $t/4$ mechanical property ratios should be treated together for analysis to determine derived properties.

9.5.7.3 Treatment of Clad Aluminum Alloy Plate — For clad aluminum alloy plate, 0.500 inch and greater in thickness, tensile properties are determined using round tensile specimens; consequently, tensile properties represent core material. To present design values which represent the average tensile properties across the thickness of the clad plate, an adjustment must be made in the tensile yield and ultimate strength values (S- or A- and B-basis), representing core strength, in the primary test direction(s). These strengths will be reduced by a factor equal to twice the percentage of the nominal cladding thickness per side. These adjustments in the tensile yield and ultimate strengths will be made prior to the computation of derived properties, except for short transverse properties. The following footnote, flagged to the appropriate thickness ranges, will be incorporated into the design allowable table: “These values, except in the ST direction, have been adjusted to represent the average properties across the whole section, including X percent per side nominal cladding thickness.”

9.5.7.4 Computational Procedure — Four basic steps are involved in determining design allowable properties by indirect computation:

- (1) Determine the ratios of paired observations for each lot of material.
- (2) Compute the statistics, \bar{r} and s , for the ratios of paired observations.
- (3) Determine the lower confidence interval estimate (reduced ratio) for the mean ratio.
- (4) Use the reduced ratio as the ratio of the derived to the established design allowable.

The ratio of two paired observations is obtained by dividing the measurement of the property to be derived [for example, CYS (LT) for heat-treatable aluminum sheet] by the measurement for established tensile property [for example, TYS (LT)] in the specified testing direction. Equations for computing average and standard deviation of the ratios are the same as those in Appendix A.

The ratio of the two population means [for CYS (LT) and TYS (LT), respectively] is expected to exceed the lower confidence limit defined as

$$\bar{r} - t_{1-\alpha} s / \sqrt{n} \quad [9.5.7.4(a)]$$

where

- n is the number of ratios
- \bar{r} is the average of n ratios
- s is the standard deviation of the ratios
- $t_{1-\alpha}$ is the $1-\alpha$ fractile of the t distribution for $n - 1$ degrees of freedom. At the risk level of $\alpha = 0.05$, the appropriate t value is $t_{0.95}$.

Since the lower confidence interval estimate is used as the ratio between the design allowable properties, the reduced ratio, R , may be defined as

$$R = \bar{r} - t_{0.95} s / \sqrt{n} \quad [9.5.7.4(b)]$$

Values of $t_{0.95}$ for various degrees of freedom, $n - 1$, are tabulated in Table 9.10.4.

The reduced ratio may now be used to establish the design allowable for the property to be derived using the example of aluminum sheet,

$$R = \frac{F_{cy}(LT)}{F_{ty}(LT)} = \frac{\text{allowable to be derived}}{\text{established allowable in specified test direction}} .$$

The derived allowable property is computed by cross multiplying:

$$F_{cy}(LT) = R F_{ty}(LT) .$$

The basis (A, B, or S), defined in Section 9.1.6, for computed or derived property is assumed to be the same as the basis for F_{ty} or F_{tu} tensile property in the right-hand side of the equation. If only the S-basis (integer) properties are available to compute the derived properties, these values must be used. However, the unrounded S-basis F_{ty} or F_{tu} values computed with the method in Section 9.4 must be used to compute the derived properties if there are 100 or more observations representing 10 heats, casts, or melts; this will ensure the proper statistical confidence in the derived values. The lower of either the S-basis value computed from Section 9.4 or the T_{99} value must be used to compute the A-basis derived properties.

In a sample of ratios for a given product, effect of thickness on the ratio should be examined. If there is no effect of thickness, ratios for the various thicknesses can be pooled to compute the average and reduced ratio. If there is an effect of thickness, then a regression with thickness should be computed and the average and reduced ratios determined from the regression. See Section 9.5.8 for procedure.

9.5.8 INDIRECT COMPUTATION USING REGRESSION — Regression may also be used to determine reduced ratios when an allowable for a property, such as SUS, is computed indirectly from an already established allowable for TUS. The following assumptions are inherent to the reduced ratio procedure:

- (1) The two properties must be distributed according to a bivariate normal distribution.
- (2) The coefficient of variation must be the same for the two properties within particular bounds.
- (3) The average of the ratio of the two properties must be well described by a linear function of the independent variable.

It is also important that paired data be available over the entire range of the dimensional parameter for which there is data for the direct property (TUS). Note that the confidence level associated with allowables computed using the reduced ratio technique may be somewhat below 95 percent.

To compute the reduced ratio at $x = x_0$, in the case of linear regression, use Equation [9.5.8(a)],

$$\text{Reduced Ratio} = a + bx_0 - (t_{0.95, n-2}) s_y \sqrt{\frac{1+\Delta}{n}} \quad [9.5.8(a)]$$

where Δ is defined in Equation 9.5.6.1(b), a , b , and s_y are computed in the regression of SUS/TUS data (discussed in Section 9.5.6.1), and $t_{0.95, n-2}$ is selected from Table 9.10.4 corresponding to $n-2$ degrees of freedom. The allowable for F_{su} at x_0 is then computed as the product of the reduced ratio and the established allowable for F_{tu} :

$$F_{su} = (\text{Reduced Ratio})(F_{tu}) .$$

To compute the reduced ratio at $x = x_0$, in the case of quadratic regression, use Equation [9.5.8(b)],

$$\text{Reduced Ratio} = a + bx_0 + cx_0^2 - t_{0.95, n-3} s_y \sqrt{Q} \quad [9.5.8(b)]$$

where a , b , c , s_y , and Q are computed in the quadratic regression of SUS/TUS data (discussed in Section 9.5.6.1), and $t_{0.95, n-3}$ is selected from Table 9.10.3 corresponding to $n-3$ degrees of freedom.

The allowable for F_{su} at x_0 is then computed as the product of the reduced ratio and the established allowable for F_{tu} :

$$F_{su} = (\text{Reduced Ratio})(F_{tu}) .$$

9.6 ANALYSIS PROCEDURES FOR DYNAMIC AND TIME DEPENDENT PROPERTIES

9.6.1 LOAD AND STRAIN CONTROL FATIGUE DATA — Fatigue has been defined as “the process of progressive localized permanent structural change occurring in a material subjected to conditions that produce fluctuating stresses and strains at some point or points, and which may culminate in cracks or complete fracture after a sufficient number of fluctuations.”

For many years, tests have been performed on specimens having simple geometries in attempts to characterize the fatigue properties of particular materials. Fatigue tests have been conducted for many reasons. Basic fatigue-life information may be desired for design purposes, or to evaluate the differences between materials. The effects of heat treatments, mechanical working, or material orientation may also be studied through comparative fatigue testing.

Many types of machines and specimen designs have been used to develop fatigue data. Machine types include mechanical, electromechanical, hydraulic, and ultrasonic. Specimens have been designed for testing in cyclic tension and/or compression, bending, and torsion. Cyclic loading conditions have been produced by rotating bending, axial loading and cantilever bending. In- and out-of-phase biaxial and multiaxial fatigue conditions have also been examined using specially designed specimens. Tests have been conducted in a variety of simulated environments including temperatures ranging from cryogenic to near melting point levels. The fatigue data included in MIL-HDBK-5 are limited to constant-amplitude axial fatigue data on simple laboratory specimens tested according to ASTM E 606. Data obtained under both strain control and load (stress) control are included. Figure 9.6.1(a) shows examples of trends for stress-life and strain-life fatigue data. Generally, stress-life data for unnotched specimens are limited to stress levels that produce intermediate-to-long fatigue lives because of unstable cyclic creep and tensile failure that can occur at high stress ratios in load-control testing. This phenomenon is shown in Figure 9.6.1(b). Strain-life curves are often focused on strain ranges that produce short-to-intermediate fatigue lives because of strain rate and frequency limitations which require long testing times to generate long-life fatigue data under strain control. However, there is no inherent limit to the life range that can be evaluated in strain-control testing.

For fatigue to occur, a material must undergo cyclic plasticity, at least on a localized level. The relationship between total strain, plastic strain, and elastic strain is shown in Figure 9.6.1(c). Low-cycle fatigue tests involve relatively high levels of cyclic plasticity. Intermediate-life fatigue tests usually involve plastic strains of the same order as the elastic strains. Long-life fatigue tests normally involve very low levels of cyclic plasticity. These trends are shown in Figure 9.6.1(d). In the MIL-HDBK-5 fatigue analysis guidelines, engineering strain is denoted as e and true or local strain is denoted as ϵ . These symbols are used interchangeably within MIL-HDBK-5 for small strain values.

The limited plasticity involved in intermediate and long-life fatigue tests often results in a similar stress-strain response for both fully reversed strain-control and fully reversed load-control tests. A fatigue test, under strain control that produces a stable maximum stress of X , should produce (on the average) a fatigue life that is comparable to that obtained for a sample tested under load control at a maximum stress of X . Strictly speaking, the results are likely to be most comparable in terms of crack initiation life and not total life. If the comparison is made in terms of total life, the load-control results will tend to be more conservative than those generated by strain-control testing. When a specimen cracks in a test under strain control, it will usually display a decrease in maximum tensile load. Under load control, the maximum tensile load will remain constant but stress will increase as the crack grows, resulting in a shorter period of crack growth before the specimen fails.

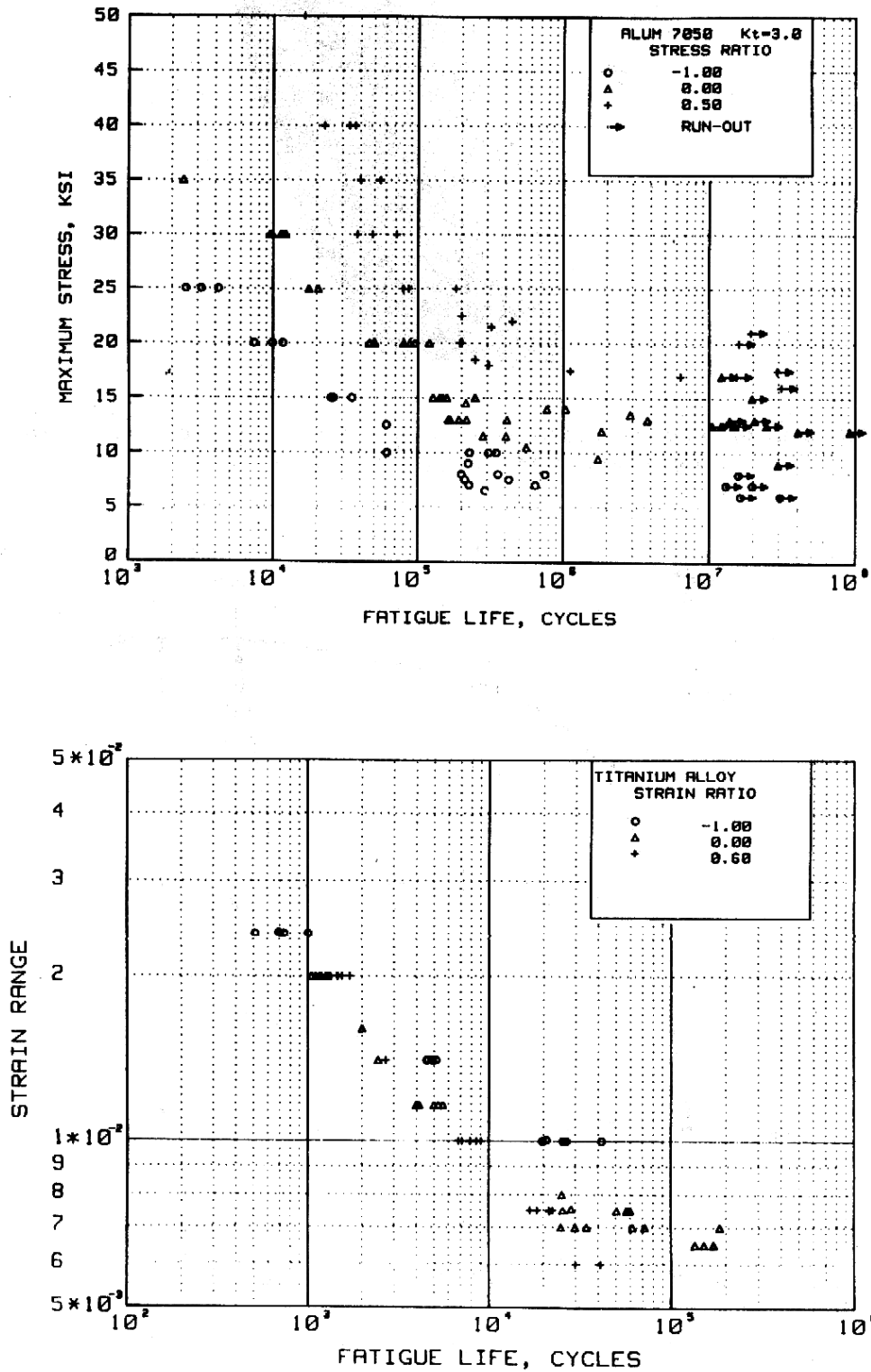

Figure 9.6.1(a). Examples of stress-life and strain-life fatigue trends.

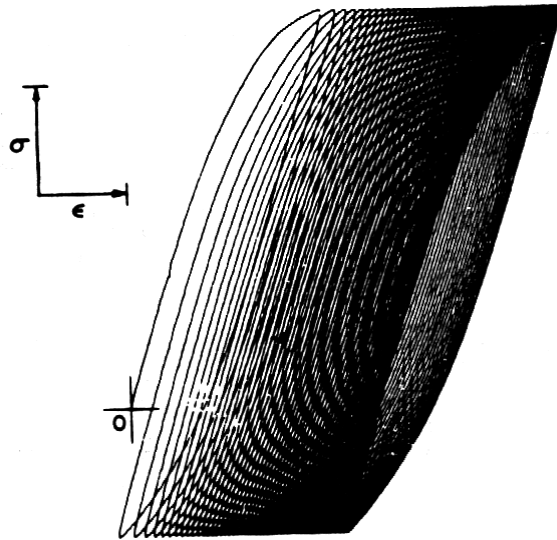

Figure 9.6.1(b). Example of cyclic creep phenomenon that can occur in a load control test with a high tensile mean stress [Reference 9.6.1].

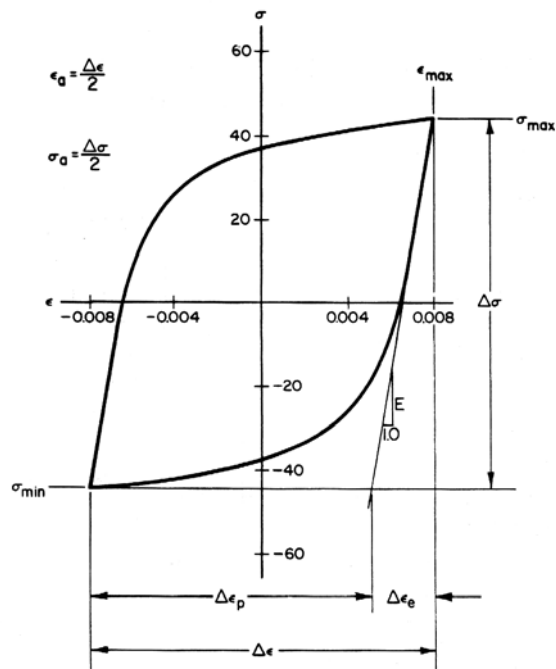

Figure 9.6.1(c). A typical hysteresis loop for a material tested in fatigue under strain control illustrating the relationship between stress and strain parameters.

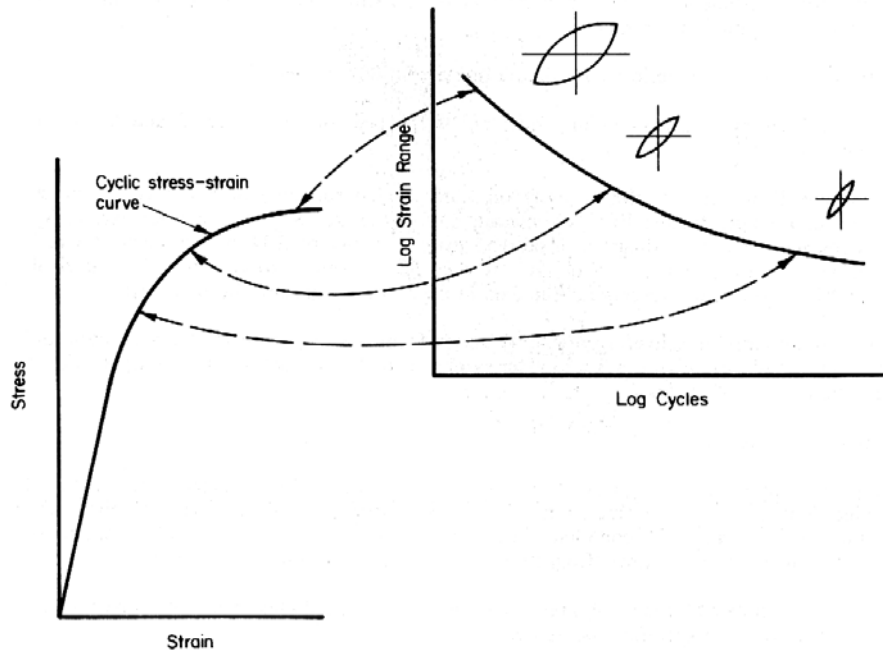

Figure 9.6.1(d). An example of a strain-life fatigue curve and the stress-strain response at short, intermediate, and long fatigue lives.

A number of factors can significantly influence fatigue properties for a particular material—whether the data are developed under load or under strain control. The surface condition (such as surface roughness) of the test specimens is an important factor. The methods used for fabricating the specimens are also important—principally because such methods influence the state of surface residual stresses and residual stress profiles. Other factors such as mean stress or strain, specimen geometry (including notch type), heat treatment, environment, frequency and temperature can also be significant variables. In MIL-HDBK-5, fatigue data are always presented in separate displays for different theoretical stress concentration factors. However, data sets may be presented for various combinations of variables if preliminary analyses indicate that the data sets are compatible. In any case, it is very important to fully document both the input data and their resulting illustrations in MIL-HDBK-5 with regard to variables that can influence fatigue.

The selection of the specific procedures and methods that are outlined in this guideline for fatigue data presentation should not be construed as an endorsement of these procedures and methods for life prediction of components. The selection was made for consistency in data presentation only. For the purpose of life prediction, other methods and models are also commonly employed. Depending on the material, component and loading history, other models may be more appropriate for the particular situation. It is beyond the scope of these guidelines to make recommendations with respect to a specific life prediction methodology (e.g., the construction of design allowable fatigue curves).

9.6.1.1 Data Collection and Interpretation — If a set of strain- or load-control data for a material of interest meet the minimum requirements, the data should be processed for analysis. Load-control data reports should clearly specify the net section stresses, stress ratios, and associated cycles to failure. Strain-control data reports should clearly specify the strain levels used, the stable stress response values, and the associated cycles to initiation and/or failure, along with a clear and concise definition of the failure criterion. Acceptable definitions of failure in a strain-control fatigue test report include:

- (1) Total specimen separation

- (2) Decrease of 50 percent in the maximum or stabilized tensile load value.

Acceptable definitions of crack initiation in a strain-control fatigue test report include:

- (1) First significant deviation from the stabilized load range or a stabilized rate-of-change of the load range. Detection reliability is dependent upon the sensitivity of the monitoring equipment and consequently values as small as 1 to 5 percent are used in some cases, while values as great as 10 to 20 percent are used in other cases.
- (2) Verifiable results from a calibrated nondestructive inspection device, such as an electrical potential drop system.

The definition of crack initiation or failure used in a particular study must be clearly and quantitatively documented. Correlative information that is important for load or strain-control test data includes detailed specimen dimensions, fabrication procedures (and their sequence), surface finish, product form, environment, frequency, waveform, surface residual stresses, and temperature. Other useful information includes average material tensile properties, product dimensions, and manufacturer.

All fatigue data that are not listed as invalid by the author of the test report will be prepared for analysis, except for specimens tested at a maximum stress level greater than the average tensile ultimate strength of the material. The identity of different sources should be retained to determine whether combinations of data are appropriate. If all conditions from the different sources are virtually identical, the data should be analyzed together. Data should be identified as invalid if defects in specimen preparation or testing procedures are discovered.

Runouts should be designated differently from failure data, since runouts are given special consideration in the regression analysis used to define mean fatigue curves. Runouts are generally defined as tests that have accumulated some predetermined number of cycles and have been subsequently stopped to reduce test time. Tests which have been stopped due to distinct problems encountered during testing are termed interrupted tests. Typical problems include power failures, temperature deviations, and load spikes. Interrupted tests are generally valid up until time at which the problem occurred. In this context, interrupted tests are treated the same as runouts in determining the mean fatigue-life trends of a data collection. However, if the interruption occurs long before expected failure of the specimen, the information contributed by the interrupted test is minimal, and the data point should be discarded.

Data from specimens which exhibit failures outside of the gage section may, in certain circumstances, be included in the analysis and treated as interrupted tests. Failures occurring just outside the gage section are essentially normal failures and should be included for analysis. In strain-control tests, however, the crack initiation is not sensed by the extensometer. Failures at threads, shoulders, or button heads may be indicative of a problem with the specimen design or test procedure.

Strain-control fatigue data must be accompanied by sufficient information to construct a cyclic stress-strain curve. The cyclic stress-strain curve may be established based on incremental stress-strain results or multiple specimen data for which stable stress amplitudes are defined for the complete range of strain ranges. The method used to define the cyclic stress-strain curve must be recorded so that it can be included in the correlative information along with the strain-life fatigue data displays.

9.6.1.2 Analysis of Data — Once a collection of data is reviewed (see Section 9.6.1.1) and compiled for the material of interest, analysis of that data may begin. An outline of the analysis procedure that is normally followed is given in Figure 9.6.1.2. Each of the elements in the flow chart are discussed in the following sections.

The same basic analysis procedure is used for strain- and load-control data except these data types are normally analyzed separately even if they represent the same material and product form. The only case where load- and strain-control data can be combined is the situation where some specimens have been switched from strain- to load-control testing. In this case, the load- and strain-control data may be analyzed on an equivalent strain basis. In all other cases, load-control data should be analyzed on an equivalent stress basis. Load-control data generated at different stress concentrations should always be analyzed separately.

9.6.1.3 Fatigue Life Models — To clarify the fatigue data trends for a specific stress or strain ratio, a linear regression model can be applied as follows:

$$\log(N_i \text{ or } N_f) = A_1 + A_2 \log(S_{\max} \text{ or } \Delta\varepsilon). \quad [9.6.1.3(a)]$$

Note that fatigue life is specified as the dependent variable. The alternative approach, using stress or strain as the dependent variable, is sometimes used, but this procedure will not be employed in developing mean fatigue curves in MIL-HDBK-5. The use of fatigue life or, more specifically, logarithm (base 10) of fatigue life as the dependent variable will be used since stress or strain is the controlled parameter in a fatigue experiment, and the resultant fatigue life is a random variable.

If Equation 9.6.1.3(a) does not adequately describe long-life data trends, a nonlinear model (or a more complicated linear model) may be warranted. For example, long-life, load-control data might be modeled by the nonlinear expression

$$\log N_j = A_1 + A_2(S_{\max} - A_3) \quad [9.6.1.3(a)]$$

or by the more complicated equation [Reference 9.6.1.3]

$$\log N_f = A_1 + A_2 \log S_{\max} + A_3 \sqrt{\log S_{\max} + A_4} \quad [9.6.1.3(c)]$$

These more complex forms should only be employed in instances where they are warranted based on a distinct fatigue limit at long lives and when the simpler linear model was inadequate.

Standard least squares regression analysis and the procedure for detecting outliers in Section 9.6.1.6 require that the variance be relatively constant at all fatigue life values. Traditionally, the logarithm of fatigue life is approximated by a normal distribution. However, the variability or scatter of fatigue life is generally not constant, but increases with increasing fatigue life. To ensure the reliable use of the outlier detection procedure, a weighting scheme designed to produce a more uniform distribution of residuals is suggested in Section 9.6.1.5.

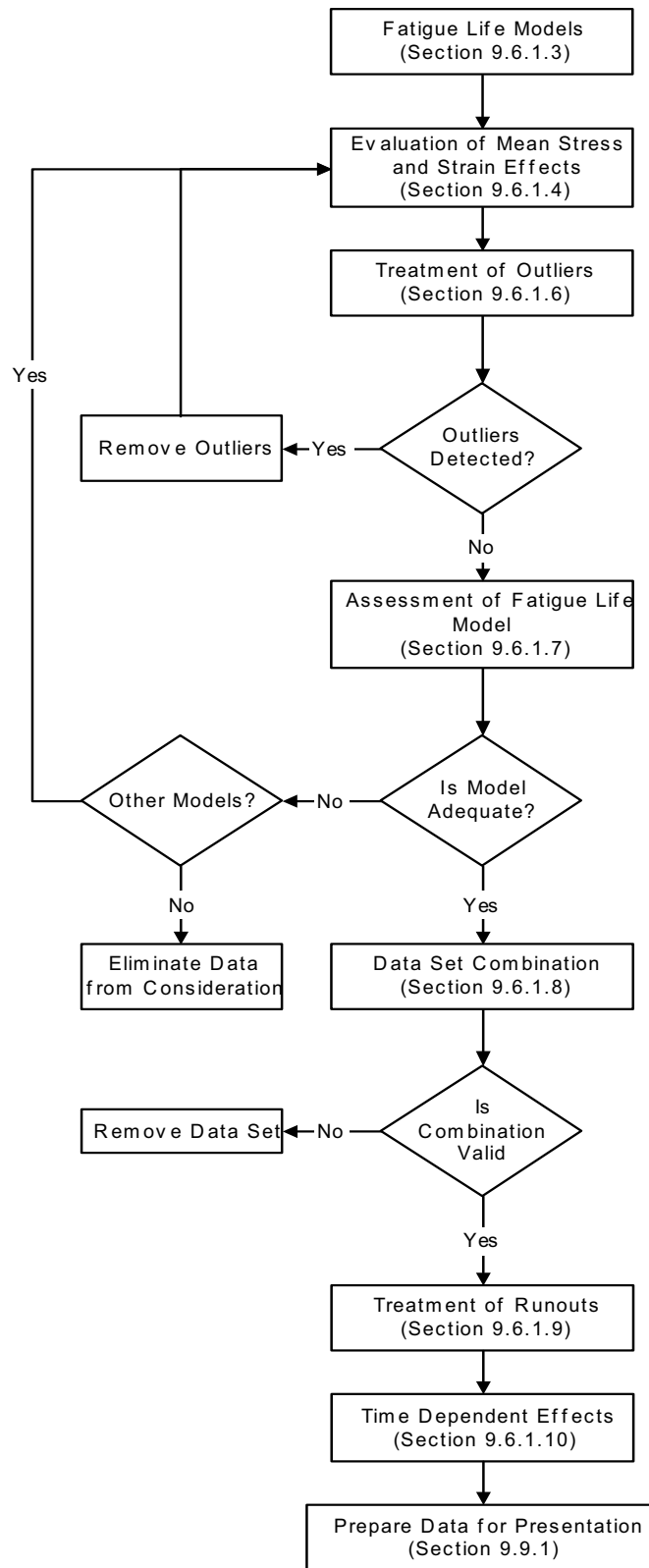

Figure 9.6.1.2. Flow chart of general fatigue analysis procedure.

9.6.1.4 Evaluation of Mean Stress and Strain Effects—Commonly, load-controlled fatigue data generated over a range of stress ratios can be represented by the following equivalent stress-fatigue life formulation:

$$\log N_f = A_1 + A_2 \log (S_{eq} - A_4) \quad [9.6.1.4(a)]$$

where

$$S_{eq} = (\Delta S)^{A_3} (S_{max})^{1-A_3}$$

$$S_{eq} = S_{max} (1 - R)^{A_3}$$

The equivalent stress model (and the related equivalent strain model) are derived from Reference 9.6.1.4(a).

Equation 9.6.1.4(a) is nonlinear in its general form and must, therefore, normally be optimized through use of a nonlinear regression package. However, the above equation can be solved through a linear analysis, if A_3 and A_4 are optimized through an iterative solution. The parameter A_3 normally lies in the range of 0.30 to 0.70, while A_4 represents, in essence, the fatigue limit stress. In cases where the optimum value of A_4 is negative or insignificant, it should be omitted. Unnotched data, especially aluminum alloy data, can frequently be represented without using the nonlinear A_4 term. Parameter optimization is discussed more thoroughly in Section 9.6.1.5.

If A_4 is zero or set equal to zero, Equation 9.6.1.4(a) becomes linear in $\log S_{max}$ and $\log (1-R)$, and it can be written as follows:

$$\log N_f = A_1 + A_2 \log S_{max} + B \log (1-R) \quad [9.6.1.4(b)]$$

where $B = A_2 A_3$. Thus, if A_4 is zero, then

$$A_3 = B/A_2$$

Strain-controlled fatigue data generated over a range of strain ratios often can be consolidated by the following equivalent strain formulation:

$$\log N_f = A_1 + A_2 \log (\epsilon_{eq} - A_4) \quad [9.6.1.4(c)]$$

where

$$\epsilon_{eq} = (\Delta \epsilon)^{A_3} (S_{max}/E)^{1-A_3} .$$

Note that Equation 9.6.1.4(c) is very similar in form to Equation 9.6.1.4(a). It is important to note, however, that the maximum stress value used in Equation 9.6.1.4(c) is not a controlled quantity. It is a measured quantity and its magnitude depends primarily on the amount of cyclic softening or hardening that occurs in combination with mean stress relaxation. Although S_{max} can be predicted with reasonable accuracy if the cyclic response of the material is well established, using the stable measured values of S_{max} , when analyzing strain-control data for presentation in MIL-HDBK-5, is preferred.

The equivalent stress and strain approaches are very useful for computing mean fatigue life estimates for conditions intermediate to those for which the test data have been generated. Caution should be used, however, in making life predictions for stress/strain conditions beyond the range of those represented in the

data base. Also, when only two stress/strain ratios are used in the equivalence formulation, fatigue life estimates at conditions other than those two ratios (either intermediate or beyond) may be unreliable.

If the basic formulations just described do not realistically represent the data, alternative equivalent stress or strain formulations should be considered. Two formulations [References 9.6.1.4(b) and (c)], in particular, may apply in these specific instances where equivalent stress is defined as:

$$S_{eq} = S_a + A_3 S_m \quad [9.6.1.4(d)]$$

or

$$S_{eq} = S_a + S_m^{A_3} \quad [9.6.1.4(e)]$$

and equivalent strain is defined as:

$$\epsilon_{eq} = \epsilon_a + A_3 S_m/E \quad [9.6.1.4(f)]$$

or

$$\epsilon_{eq} = \epsilon_a + (S_m/E)^{A_3} \quad [9.6.1.4(g)]$$

where

S_{eq}	= equivalent stress	ϵ_{eq}	= equivalent strain
S_a	= alternating stress	S_m	= mean stress
ϵ_a	= alternating strain	E	= elastic modulus (from each test result).

Other data consolidation parameters may also be used provided they do not violate other guideline requirements, and they can be proven adequate. Adequacy may be assessed by employing the procedures described in Section 9.6.1.7.

To evaluate the adequacy of one equivalent stress or strain formulation compared to another, it is useful to construct a plot of residuals versus stress or strain identifying individual stress or strain ratios. In this way the usefulness of a given formulation for modeling stress or strain ratio effects is visually apparent.

9.6.1.5 Estimation of Fatigue-Life Model Parameters — The fatigue-life model parameters are estimated to obtain the best-fit S/N or ϵ /N curve for the data. The procedure used to determine the parameters includes a statistical method for adjusting the fatigue model for the nonconstant variance commonly observed in long-life fatigue data. The motivation for this adjustment is the fact that constant variance is an inherent assumption in least squares regression analysis. To estimate the parameters in Equation 9.6.1.4(a) or Equation 9.6.1.4(c) and adjust the model to incorporate nonuniform variance, the following six-step procedure is performed.

Step 1 - Initial Parameter Estimates. If A_4 is assumed to be zero, then a linear least squares regression analysis is performed to obtain the initial parameter estimates for A_1 , A_2 , and A_3 . If A_4 is to be estimated from the data, a nonlinear least squares regression analysis is performed to obtain the initial parameter estimates for A_1 , A_2 , A_3 , and A_4 . Runout observations above the minimum equivalent stress (strain) at which a failure occurred should be included in the calculation of the initial parameter estimates and residuals.

To facilitate convergence of the nonlinear least squares fit when A_4 is to be estimated from the data, the following procedure may be used to obtain starting values. Set A_3 equal to 0.5 and calculate equivalent stress (strain) values for each observation. Set A_4 equal to one-half the smallest equivalent stress (strain) not associated with a runout. Using these values of A_3 and A_4 as constants, obtain least squares estimates of A_1 and A_2 using a linear regression routine.

Step 2 - Fitting the Variability Model. The magnitude of the residuals from these fatigue-life models typically increases with decreasing stress or strain as illustrated in Figure 9.6.1.5(a). The residuals plotted are the observed $\log(\text{life})$ values minus the predicted $\log(\text{life})$ values.

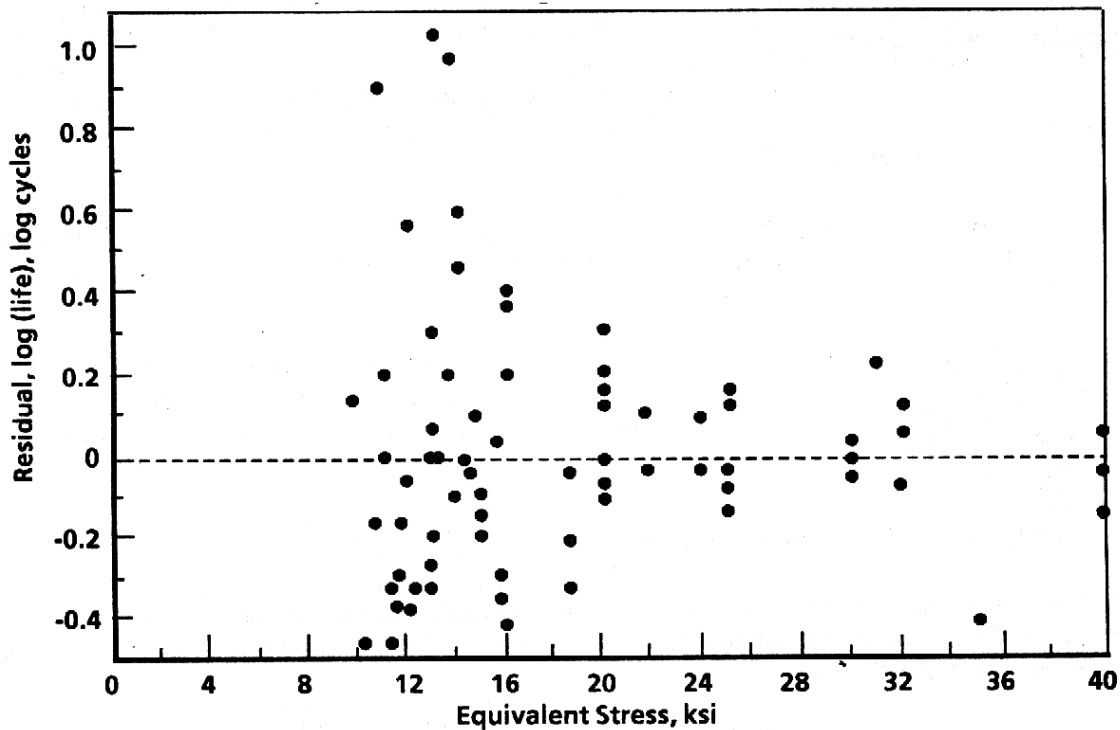

Figure 9.6.1.5(a). Example plot showing increasing magnitude of residuals with decreasing stress/strain levels.

To evaluate the fatigue-life model for nonuniform variance, it is useful to construct a model to estimate the standard deviation of $\log(\text{life})$ as a function of equivalent stress (strain). If there is nonuniform variance, such a model can then be used to perform a weighted regression to estimate the fatigue life model parameters where the weight for each observations inversely proportional to its estimated variance.

The suggested standard deviation model is

$$\frac{|R|}{\sqrt{2/\pi}} = \sigma_o + \sigma_1 \left[\frac{1}{S_{eq}} \right] = g(S_{eq}) \quad [9.6.1.5(a)]$$

or

$$\frac{|R|}{\sqrt{2/\pi}} = \sigma_o + \sigma_1 \left[\frac{1}{\epsilon_{eq}} \right] = h(\epsilon_{eq}) \quad [9.6.1.5(b)]$$

where R (observed log(life) minus predicted log(life)) represents the residuals from the fatigue life model fitted in Step 1. This model assumes that the standard deviation of log(life) is a linear function of the reciprocal of equivalent stress (strain). The absolute values of the residuals are divided by $\sqrt{2/\pi}$ so that $g(S_{eq})$ or $h(\epsilon_{eq})$ is an estimate of the standard deviation of log(life).

The intercept, σ_o , and the slope, σ_1 , are first estimated by ordinary least squares. If the least squares estimate of σ_o is negative, σ_o should be set to zero and σ_1 should be estimated by performing a least squares regression through the origin (no intercept term). A 90 percent confidence interval for σ_1 should also be obtained. If the lower bound of the confidence interval for σ_1 is positive, there is evidence of nonuniform variance and one should proceed to Step 3A. If the confidence interval for σ_1 contains zero, there is no evidence of nonuniform variance and one should proceed to Step 3B. If the upper bound of the confidence interval for σ_1 is negative, this indicates abnormal behavior requiring further examination of the data set before proceeding with the analysis.

Figure 9.6.1.5(b) is a plot of the absolute values of the residuals from Figure 9.6.1.5(a) versus the reciprocal of equivalent stress. The slope and vertical intercept of the least squares line displayed in this plot are the estimated parameters σ_1 and σ_o .

Step 3A - Fitting the Weighted Fatigue Model. Adjust the fatigue model for nonconstant variance by dividing each term in the model by $g(S_{eq})$ or $h(\epsilon_{eq})$, the estimated standard deviation of the dependent regression variable. If the four-parameter fatigue model is being used, the adjusted model becomes

$$\left[\frac{\log(N)}{g(S_{eq})} \right] = A_1 \left[\frac{1}{g(S_{eq})} \right] + A_2 \left[\frac{\log(S_{eq} - A_4)}{g(S_{eq})} \right] \quad [9.6.1.5(c)]$$

or

$$\left[\frac{\log(N)}{g(\epsilon_{eq})} \right] = A_1 \left[\frac{1}{g(\epsilon_{eq})} \right] + A_2 \left[\frac{\log(\epsilon_{eq} - A_4)}{g(\epsilon_{eq})} \right] \quad [9.6.1.5(d)]$$

where S_{eq} and ϵ_{eq} are defined in Equations 9.6.1.4(a) and 9.6.1.4(c). Perform a nonlinear least squares regression analysis (no intercept) using the adjusted model to obtain new estimates of A_1 , A_2 , A_3 , and A_4 .

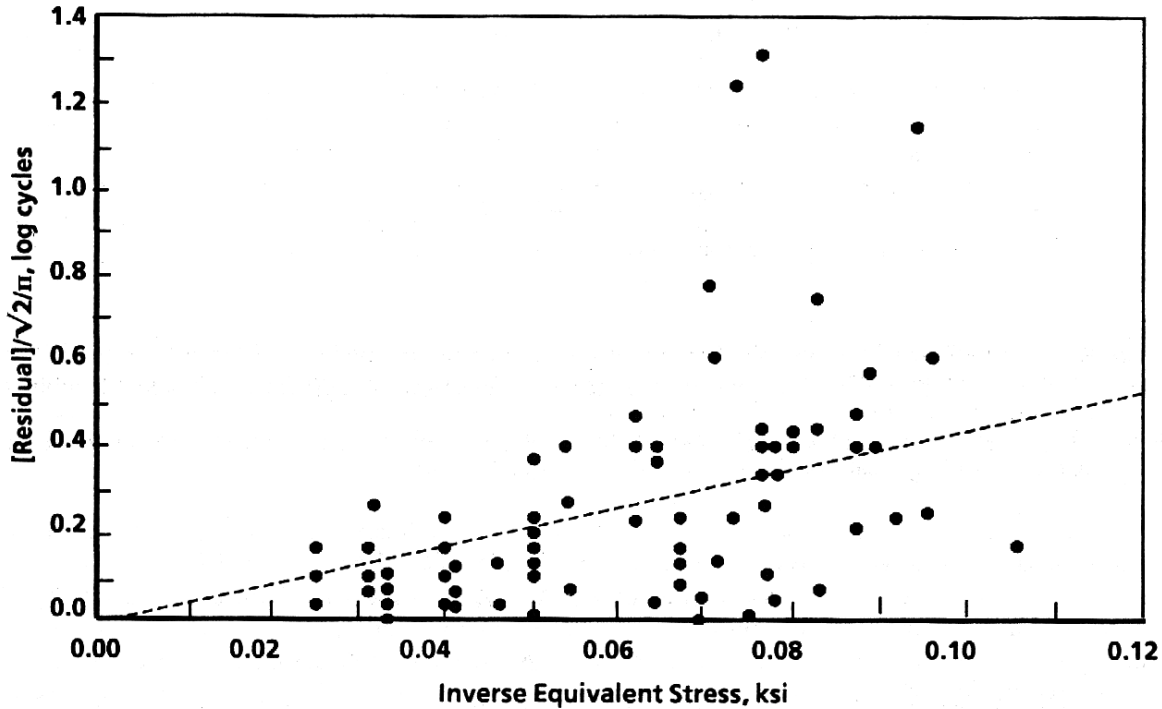

Figure 9.6.1.5(b). Example plot showing the magnitude of the residuals versus the inverse of equivalent stress/strain levels.

When performing this regression, all runouts above the minimum S_{eq} or ϵ_{eq} at which a failure occurred should be included in the analysis and treated as failures. The inclusion of runouts in this step should be determined based on equivalent stress (strain) values using the value of A_3 estimated in Step 1. Assuming that the equivalent stress/strain model is valid, this qualifying stress/strain level allows the use of all runouts above stresses or strains at which failures have been observed. Below this level, there is no statistical evidence that discontinued tests would have failed. Therefore, runouts below the minimum S_{eq} or ϵ_{eq} value at which a failure occurred are not assigned finite life values in estimating the parameters.

It should be noted that the regression analysis performed using the adjusted model [Equation 9.6.1.5(c) or (d)] is equivalent to performing a weighted least squares regression analysis using the original fatigue life model [Equation 9.6.1.4(c)] and weights equal to $1/g^2(S_{eq})$ or $1/g^2(\epsilon_{eq})$. Also, it may be desirable in certain situations to fit alternative standard deviation models to the residuals from Step 1. In this case, simply redefine $g(S_{eq})$ or $g(\epsilon_{eq})$ to be equal to the desired model and follow Steps 1 through 3 above. Upon completion of Step 3A, proceed to Step 4.

Step 3B - Fitting the Unweighted Fatigue Model. Using the initial estimate of A_3 obtained in Step 1, calculate equivalent stress (strain) values for all observations including runouts. All runouts above the minimum equivalent stress (strain) at which a failure occurred should be included in the analysis and treated as failures. (See Step 3A for an explanation of this rationale.) Using the same regression techniques employed in Step 1, obtain least squares estimates of the parameters A_1 , A_2 , A_3 , and A_4 .

Step 4 - Testing the Significance of Model Parameters. Obtain a 90 percent confidence interval for A_4 . If the lower bound of the confidence interval is negative, there is no evidence that A_4 is different from zero. In this case, assume A_4 is equal to zero and repeat Step 3A or 3B, eliminating A_4 from the model.

Next, obtain a 90 percent confidence interval for A_2 . If the upper bound of the confidence interval is negative, this indicates that the relationship between $\log(\text{life})$ and equivalent stress (strain) is significant. If the upper bound of the confidence interval is positive, there is no evidence of a significant relationship between $\log(\text{life})$ and equivalent stress (strain) and the data set should be examined further before proceeding with the analysis.

Step 5 - Re-estimating A_1 and A_2 . If a weighted least squares analysis was performed in Step 3A, A_1 and A_2 should be re-estimated to include the effect of the new value of A_3 on the calculation of weights and the inclusion of runouts. First, recompute the weights $g(S_{eq})$ or $g(\epsilon_{eq})$ using the value of A_3 obtained in Step 3A. Then perform a linear regression (no intercept) to obtain updated estimates of A_1 and A_2 in Equation 9.3.4.10(c) or (d) treating A_3 as a constant. The inclusion of runouts in this linear regression should be determined based on equivalent stress (strain) values using the value of A_3 obtained in Step 3A.

Step 6 - Estimating the Standard Deviation and Calculating Standardized Residuals. The method for estimating the "standard deviation of $\log(\text{life})$ " (SD) depends on whether there is evidence of nonuniform variance in the fatigue life data. If an unweighted regression was performed in Step 3B to obtain the model parameters, SD should be set equal to the root mean square error (RMSE) associated with the fitted and unweighted fatigue life model. In this case, SD may be calculated as

$$SD = RMSE = \sqrt{\sum_{i=1}^n R_i^2 / (n-k)} \quad [9.6.1.5(e)]$$

where k is the number of parameters estimated in Step 3, and

$$R_i = \log N_i - \widehat{\log N_i} \quad [9.6.1.5(f)]$$

where R_i is the residual, $\log N_i$ is the logarithm of observed number of cycles, and $\widehat{\log N_i}$ is the logarithm of predicted number of cycles associated with the i th observation.

If a weighted regression was performed in Step 3A to obtain the model parameters, SD should be reported as linear function of the reciprocal of equivalent stress (strain). This function should be obtained by multiplying the fitted standard deviation model $g(S_{eq})$ or $g(\epsilon_{eq})$ from Step 2 by the root mean square error (RMSE) associated with the fitted and weighted fatigue life model to obtain an updated standard deviation model. In this case, SD may be calculated as

$$SD = RMSE * (\sigma_0 + \sigma_1 / S_{eq}) \quad [9.6.1.5(g)]$$

or

$$SD = RMSE * (\sigma_0 + \sigma_1 / \epsilon_{eq}) \quad [9.6.1.5(h)]$$

where

$$RMSE = \sum WR_i^2 / (n - k) \quad , \quad [9.6.1.5(i)]$$

k is the number of parameters estimated in Step 3, and

$$WR_i = \frac{\log N_i - \log \hat{N}_i}{g(S_{eq,i} \text{ or } \epsilon_{eq,i})} \quad [9.6.1.5(j)]$$

with WR_i denoting the weighted residual and $S_{eq,i}(\epsilon_{eq,i})$ the equivalent stress (strain) associated with the “ith” observation.

As a final step associated with the estimation of fatigue life model parameters, standardized residuals should be calculated for use in the judging the appropriateness of the fitted model. Standardized residuals are calculated as

$$SR_i = R_i / SD \quad [9.6.1.5(k)]$$

where the form of the residual R_i is given in Equation 9.6.1.5(f) and the estimated standard deviation SD is given by either Equation 9.6.1.5(e) or 9.6.1.5(h), (j) or (k).

Figure 9.6.1.5(c) is a plot of the standardized residuals for the same data plotted in Figure 9.6.1.5(d) but based on a standard deviation model to correct the nonuniform variance. Note that the pattern of nonconstant variance has been eliminated.

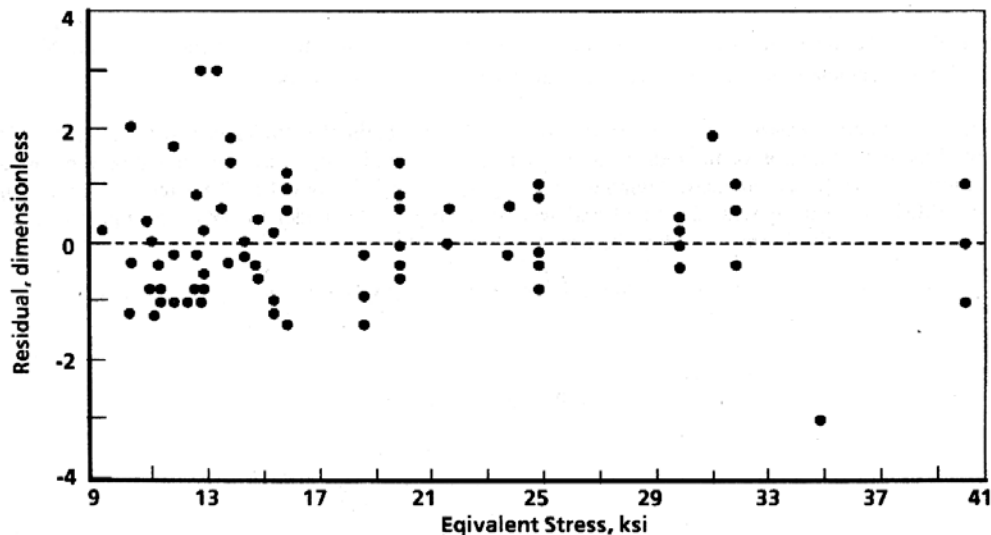

Figure 9.6.1.5(c). Example plot showing constant variance of standardized residuals.

Note - When performing any of the regression analyses described above to estimate the parameters A_1 , A_2 , A_3 , and A_4 , the estimate of A_4 should be restricted to be greater than or equal to zero. Some

regression programs allow such restrictions as an option. If such an option is not available and if the estimate of A_4 is negative, set A_4 equal to zero and refit the model treating A_4 as a constant. Also note that the parameter estimates obtained from the regression analysis of Step 3A or 3B need not necessarily be reported as the final parameter estimates. If the data set includes runout observations, final estimates of the A_1 and A_2 parameters may be calculated using the maximum likelihood techniques presented in Section 9.6.1.9, provided that software for performing this procedure is available.

9.6.1.6 Treatment of Outliers — An outlying observation (or outlier) is one that appears to deviate markedly from other observations in the sample in which it occurs. Outliers may essentially be classified into two groups:

- (1) An extreme value of the random variable inherent in the data (in this case fatigue life). If this is true, the value should be retained in future analyses.
- (2) An unusual result caused by a gross deviation in material or prescribed experimental procedure or an error in calculating or recording any experimental data.

An outlier of the second type is sometimes correctable by a review of the test sample and/or test records, which may provide sufficient evidence for rejection of the observation. An outlying value from a failure that occurred in the fillet of an unnotched fatigue test sample is an example of a potentially rejectable result based on physical evidence alone. The more difficult case is one where an observation is an obvious outlier and no physical reasons can be identified to justify its exclusion.

Assuming uniform variance in the standardized residuals over the complete range in equivalent stress or strain, the problem of identifying certain observations as potential outliers should be addressed as follows. Calculate the studentized residuals,

$$T_i = \frac{SR_i}{(1 - h_i)^{1/2}} \left[\frac{RMSE}{RMSE(i)} \right] \quad [9.6.1.6(a)]$$

for $i = 1, \dots, n$ where SR_i is the standardized residual from Equation 9.6.1.5(k), RMSE is the root mean square error based on the entire sample as calculated in either Equation 9.6.1.5(e) or Equation 9.6.1.5(i), and RMSE(i) is the root mean square error based on the sample which excludes the i th observation as calculated by either Equation 9.6.1.5(e) or Equation 9.6.1.5(i).

The value h_i is calculated using the formula

$$h_i = \frac{X_{1i}^2 \left(\sum X_{2j}^2 \right) - 2 X_{1i} X_{2i} \left(\sum X_{1j} X_{2j} \right) + X_{2i}^2 \left(\sum X_{1j}^2 \right)}{\left(\sum X_{1j}^2 \right) \left(\sum X_{2j}^2 \right) - \left(\sum X_{1j} X_{2j} \right)^2} \quad [9.6.1.6(b)]$$

where X_{1i} is the value of $1/SD$ for the i th specimen, X_{2i} is the value of $\log(S_{eq}-A_4)/SD$ for the i th specimen and all summations are over $j = 1, \dots, n$. Note that

$$\text{RMSE}^2(i) = \frac{(n - k)\text{RMSE}^2 - \text{SR}_1^2/(l - h_i)}{(n - k - 1)} \quad [9.6.1.6(c)]$$

where RMSE is the root mean square error based on the entire sample as calculated in either Equation 9.6.1.5(e) or Equation 9.6.1.5(k) and k is the number of parameters estimated in Step 3 of Section 9.6.1.5.

It can be shown that each T_i has a central t distribution with n-k-1 degrees of freedom. Applying the Bonferroni inequality [Reference 9.6.1.6] to obtain a conservative critical value leads to the following outlier test. Calculate the maximum absolute studentized residual

$$G = \max [T_i] \quad [9.6.1.6(d)]$$

and declare the data value corresponding to G to be an outlier if

$$G > t(\alpha/2n, n - k - 1) \quad [9.6.1.6(e)]$$

where $t(\alpha/2n, n-k-1)$ is the upper $\alpha/2n$ percentile point of the central t distribution with n-k-1 degrees of freedom and α represents the significance level of the outlier test. Under the hypothesis that no outliers are present in the data, the probability is less than α that the data value corresponding to G will be falsely declared an outlier.

In applying this test to fatigue life data, a significance level of $\alpha = 0.05$ is used and the test is first applied to the entire sample. If an outlier is detected, the outlying observation is removed from the sample and the entire analysis is repeated on the smaller sample of n-1 observations starting with Step 1 of Section 9.6.1.5. (When a nonlinear least squares fit is performed in Step 1, use the current estimates for A_1 , A_2 , A_3 , and A_4 as starting values rather than following the starting value algorithm.) This process of removing outliers and repeating the analysis continues until no outliers are detected in the remaining sample. For strain-control data, apply the procedure described above replacing S_{eq} with ϵ_{eq} throughout.

The data analyst may also wish to carry out the outlier test procedure using a significance level of $\alpha = 0.20$ in order to identify additional observations that may warrant investigation. To identify even more suspect observations, a larger significance level may be used. Any data values identified by this procedure should be examined but retained in the data set unless physical evidence justifies their exclusion.

9.6.1.7 Assessment of the Fatigue Life Model — The fit of the fatigue model S/N curve to the data may be assessed in two ways—the adequacy of the equivalent stress/strain model and the adequacy of the fatigue life model. The equivalent stress model lack of fit test and the overall lack of fit test described below provide a reasonable assessment of the fatigue life model.

When three or more stress (strain) ratios are used, the fit of the equivalent stress (strain) model may be tested by determining the relationship between the standardized residuals from Equation 9.6.1.5(k) and stress (strain) ratio. A difference in the means of the standardized residuals at each stress (strain) ratio indicates that the equivalent stress (strain) model is inadequate. To determine whether or not there is a statistically significant difference in the means of the standardized residuals at each stress (strain) ratio, an

analysis of variance should be performed on the standardized residuals using stress (strain) ratio as the treatment variable. A statistical F-test should be used to determine if the effect of stress ratio is significant at the 5 percent level [Reference 9.6.1.7]. The equivalent stress (strain) model should be considered inadequate when the effect of stress (strain) ratio is significant according to the statistical F-test.

The plot of the standardized residuals versus stress ratio shown in Figure 9.6.1.7(a) illustrates such a relationship between the standardized residuals and stress ratio. Since there would be no such relationship if the equivalent stress model were adequate, the plot indicates that the equivalent stress model must have been misspecified in this case. In addition to the lack of fit shown by differences in standardized residual means, other types of lack of fit could exist. Therefore, it would be prudent to examine stress-life plots in addition to performing the statistical test for lack of fit of the equivalent stress model.

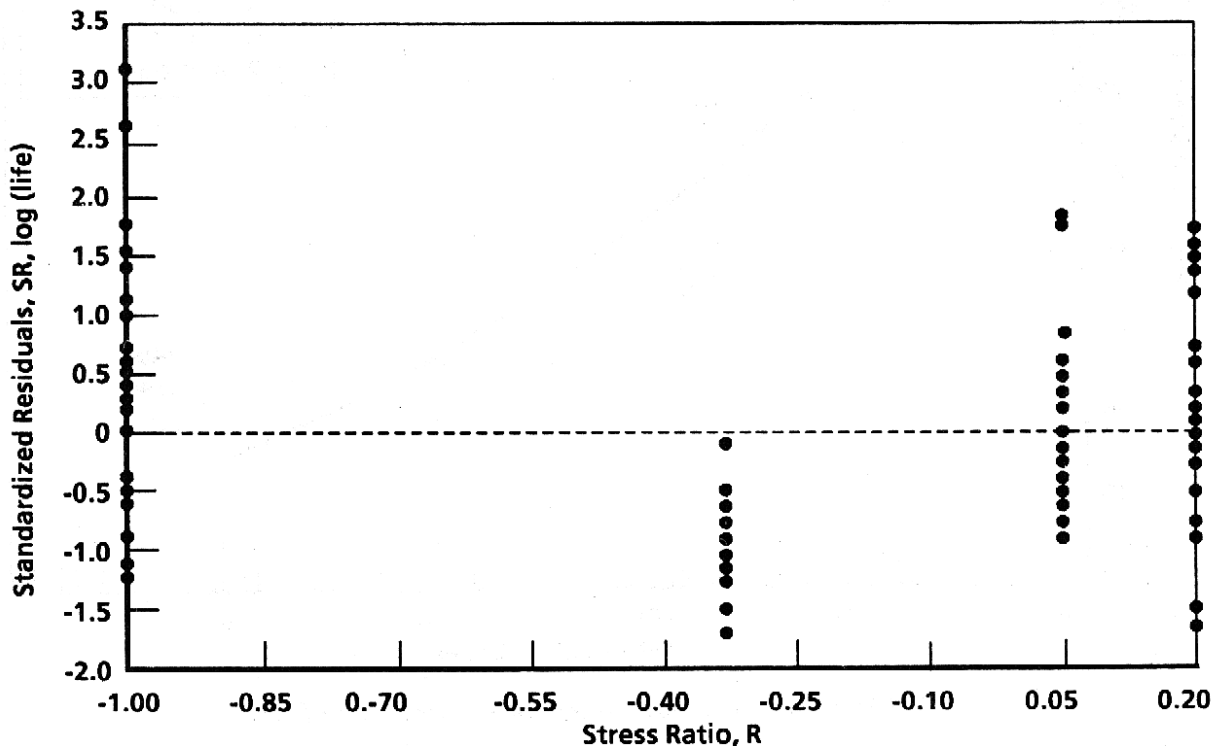

Figure 9.6.1.7(a). Standardized residuals versus stress ratio.

If the equivalent stress (strain) model is inappropriate, then a new equivalent stress (strain) model should be selected. When a suitable stress (strain) model is not available, an alternative strategy is to present the data with best fit regression lines for each stress (strain) ratio. To be acceptable, each curve must meet minimum data requirements and satisfy significance checks as discussed in Section 9.6.1.5. This approach is less desirable than the equivalent stress (strain) modeling approach because it requires the estimation of fatigue trends using a graphical technique for intermediate conditions where no data exist. It should, therefore, be used only in cases where significant fatigue data collections cannot be handled by standard procedures.

Once an equivalent stress (strain) model has been found that describes the general fatigue data trends for all stress (strain) ratios, an overall test of the fit of the fatigue model should be performed. The stress-life plot shown in Figure 9.6.1.7(b) is characteristic of an overall lack of fit. To identify such a lack of fit, the Durbin-Watson test may be used [Reference 9.6.1.7]. The statistic D should be computed according to the formula

$$D_i = \frac{\sum_{i=2}^n (SR_i - SR_{i-1})^2}{\sum_{i=1}^n SR_i^2} \quad [9.6.1.7(a)]$$

where SR_i is the i th standardized residual [Equation 9.6.1.5(k)] ordered by increasing values of equivalent stress(strain).

If

$$D < 2 - 4.73/n^{0.555} \quad [9.6.1.7(b)]$$

conclude that there is a significant lack of fit at the 5 percent significance level. This equation was derived from the conservative critical value (d_L) reported in Table A.6 of Montgomery and Peck [Reference 9.6.1.7]. When an overall lack of fit is determined from this test, the modeling procedure should be repeated with a more appropriate fatigue model.

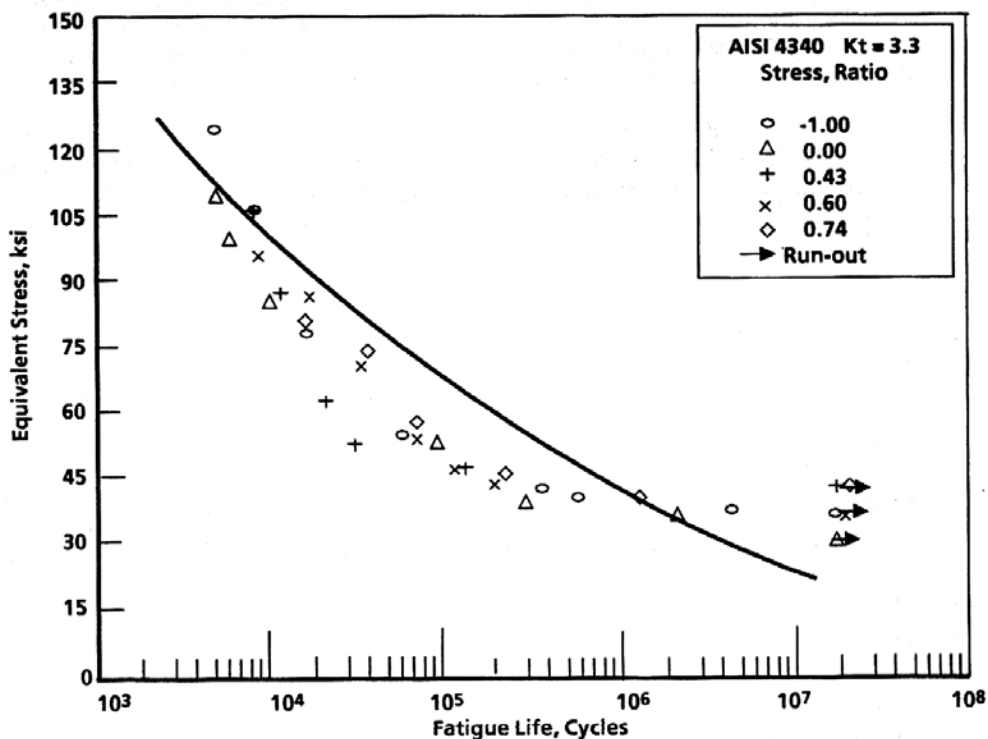

Figure 9.6.1.7(b). Stress-life plot showing lack of fit.

9.6.1.8 Data Set Combination — In many cases, data from different sources, orientations, etc., may need to be combined for analysis. When data set combinations of this sort are performed, the validity of the combination should be tested with the method described below. The test is similar to that used to determine the adequacy of the equivalent stress (strain) model in the previous section.

If there is a relationship between the standardized residuals from Equation 9.6.1.5(k) and the data set from which they were obtained, such as that shown in Figure 9.6.1.8, then the data sets should normally not be combined. To determine whether or not the mean of the standardized residuals is significantly different for any of the data sets, an analysis of variance should be performed on the standardized residuals using data set as the treatment variable. The analysis of variance F-test should be used to determine if the combined data sets are significantly different at the 5 percent level.

When the data sets are found to be significantly different, at least one of the data sets should normally be removed from the data set combination. In this situation, the data analyst may wish to apply a standard multiple comparison procedure to the standardized residual data to determine which standardized residual means are significantly different from the others. For a discussion of standard multiple comparison procedures, see pages 185-201 of Winer [Reference 9.6.1.8].

There may be situations where differences between data sets are found to be statistically significant, yet these differences are so small as to be unimportant from an engineering standpoint. If a particular analysis reveals such a case, exceptions may be taken, if clearly noted and explained in the fatigue data proposal.

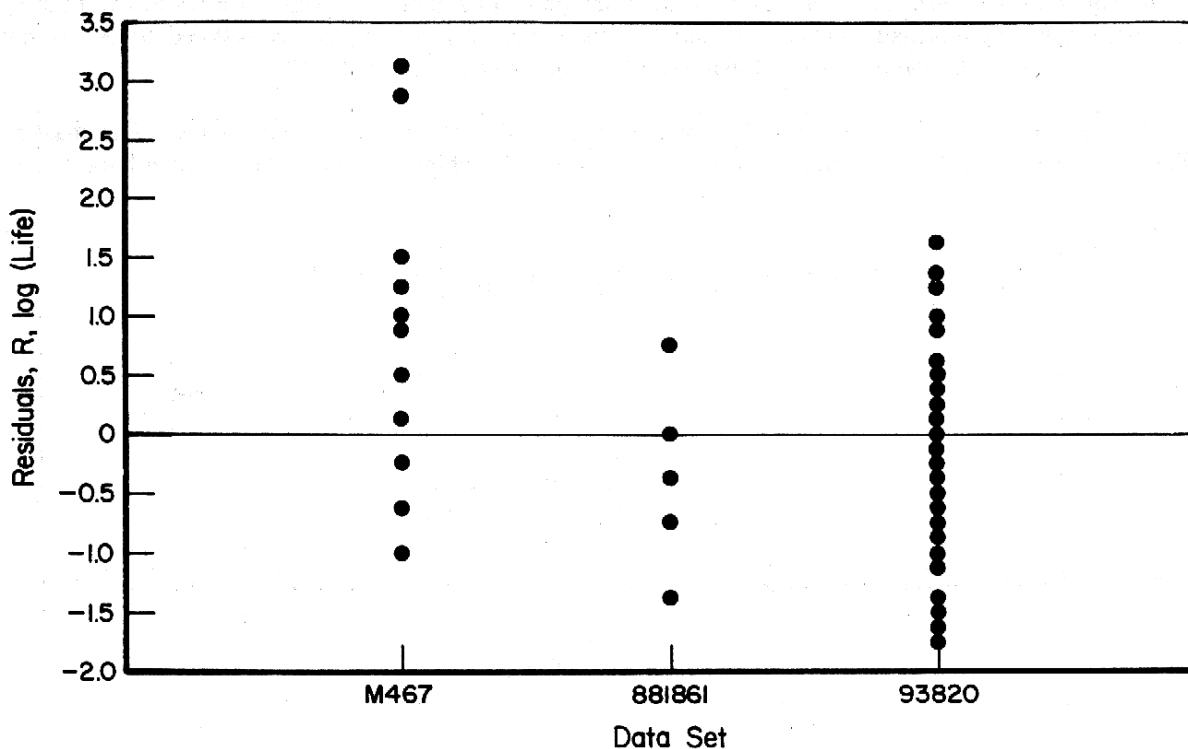

Figure 9.6.1.8. Standardized residual plot showing different mean trends between data sets.

9.6.1.9 Treatment of Runouts — It is difficult to incorporate information from runouts (or interrupted tests) when using the least squares criterion to fit fatigue life models to data since the failure times for these observations are not known. The runouts must be either ignored or treated as failures and neither of these alternatives adequately incorporates the information contained in the runout observations. Both of these approaches tend to produce smaller predicted lives at a given equivalent stress (strain) value than is appropriate. The treatment of runouts presented below is more appropriate but requires that two of the fatigue

life model parameters be estimated by maximum likelihood techniques rather than by least squares procedures.

The maximum likelihood procedure is employed to obtain new estimates for the parameters A_1 and A_2 in Equation 9.6.1.4(a) or 9.6.1.4(c). For the purpose of this analysis, fatigue life (cycles to failure) is assumed to be log normally distributed and the parameters A_3 and A_4 are considered to be constants which are equal to the values obtained using the procedures of Section 9.6.1.5.

The estimated values of A_1 and A_2 obtained previously are used as initial values. The maximum likelihood procedure then determines the values of A_1 and A_2 which maximize the log-likelihood function

$$L(A_1, A_2, \sigma) = \sum_{i=1}^n (1 - d_i) \left[\log f(w_i/\sigma) \right] + d_i \log S(w_i) \quad [9.6.1.9(a)]$$

where

$$f(w) = \frac{1}{\sqrt{2\pi}} \exp \left[-\frac{w^2}{2} \right] \quad [9.6.1.9(b)]$$

is the standard normal density function,

$$S(w) = \int_w^{\infty} f(t) dt \quad [9.6.1.9(c)]$$

is the survival function for the standard normal distribution, d_i is equal to 1 if the i th observation is a runout and zero otherwise, σ is a scale parameter to be estimated, and

$$w_i = \left[\frac{\log(N)}{SD} \right] - A_1 \left[\frac{1}{SD} \right] - A_2 \left[\frac{\log(S_{eq} - A_4)}{SD} \right] \quad [9.6.1.9(d)]$$

where N is the cycles to failure and SD is the standard deviation for the i th observation as calculated from Equation 9.6.1.5(e) or Equation 9.6.1.5(h).

For more information on the maximum likelihood procedure, see Reference 9.6.1.9(a). For use in standard data analysis, the maximum likelihood procedure is conveniently implemented in some statistical software packages such as SAS [see Reference 9.6.1.9(b)].

When runouts are present, the fitted curve produced by maximum likelihood will generally predict longer average cycles to failure at given equivalent stress (strain) values than the fitted curve produced by least squares. Although it would be desirable to update all of the parameters in the fatigue model with

maximum likelihood, algorithms to perform maximum likelihood on nonlinear models are not readily available. For this reason, the least squares estimates of the parameters A_3 and A_4 must be used.

9.6.1.10 Recognition of Time Dependent Effects — All prior discussion has been based on the assumption that time dependent effects in the fatigue data sample of interest are negligible. When dealing with elevated temperature fatigue properties of materials (or room temperature fatigue properties in a corrosive environment, for example), this assumption may not be realistic. Analysis methods that are approved for use in MIL-HDBK-5 do not account for time-dependent effects. Therefore, every effort must be made to identify data that embody significant time-dependent effects.

There are no absolute methods presently available for sensing time-dependent effects in fatigue data; however, there are some useful approximation techniques. One of the more useful approaches applied to “suspect” data is to include time-dependent terms in the regression model. If the terms are significant, there is reason to believe that the population contains time dependent data. Subdividing the data into subsets that do not show time dependent effect may be possible. If this is not possible, the data set should either be rejected or included with a disclaimer restricting usage of the data to predict performance at other frequencies or temperatures.

One other possible indicator of time dependent effects is an abnormal equivalent stress (strain) model. If data for different stress or strain ratios do not fit the customary models (as described in Section 9.6.1.4), or abnormal optimum parameters are defined the problem may be caused by time dependent effects. In the case of the primary equivalent stress (strain) formulation equation the exponent normally is between zero and one. If the A_3 exponent approaches or exceeds one, the influence of maximum stress on fatigue life is negligible. This is a very unusual result that usually indicates problems with the data sample. The problem may result from mixed sources, where the data from each source were generated at different stress (strain) ratios. Rejection of such data sets is discussed in Section 9.6.1.8. In the case of the primary equivalent stress model [Equation 9.6.1.4(a)], if the exponent (A_3) approaches or is less than zero, it indicates the influence of maximum stress on fatigue life is “too strong”. This result implies that creep is affecting the data.

If data are available for a material at a range of different temperatures it may be possible to analyze these sets separately and make comparisons between best-fit mean trend lines for increasing temperatures. If the different mean trend lines are not consistent with the higher-temperature curves converging or diverging from the lower-temperature curves, there is probably a significant time-dependent effect in the data. The suspect data should either be excluded or included with a disclaimer as previously cited. If data are excluded for time-dependent effects, the preliminary analyses of those data should be included in the data proposal and reasons for their exclusion should be given.

9.6.2 FATIGUE CRACK GROWTH DATA — Fatigue-crack-propagation data, recorded in the form of crack-length measurements and cycle counts (a_i, N_i) can be presented as crack-growth curve drawn through the data points as shown in Figure 9.6.2(a).

Although data presented in this form indicate general trends, they are not generally useful for design purposes since a variety of stress levels, stress ratios, initial crack conditions, and environmental conditions are encountered.

It has been found convenient to model fatigue-crack-propagation damage behavior as rate process and formulate a dependent variable based on the slope of this growth curve, or an approximation to it, namely,

$$\frac{da}{dN} \approx \frac{\Delta a}{\Delta N} \quad [9.6.2(a)]$$

Results obtained from the theory of linear elastic fracture mechanics have suggested that rate process at the crack tip might be represented as a function of a stress-intensity factor, K , which, in general form, may be written as

$$K = S\sqrt{a} g(a,w) , \quad [9.6.2(b)]$$

where $g(a,w)$ is a geometric scaling function dependent on crack and specimen geometry, and S is nominal stress. As a result, the independent variable is usually considered as some function of K . At present, in MIL-HDBK-5 the independent variable is considered to be simply the range of the stress intensity factor, ΔK , and data are considered to be parametric on the stress ratio, R , such that

$$da/dN \approx \Delta a/\Delta N = g(\Delta K, R) , \quad [9.6.2(c)]$$

where $\Delta K = K_{\max} - K_{\min}$. Values of maximum and minimum stress intensity factors, K_{\max} and K_{\min} , respectively, are computed with Equation 9.6.2(b) using respective maximum and minimum cyclic stresses.

A crack growth rate curve, as shown in Figure 9.6.2(b), is obtained by plotting the locus of points $(da/dN, \Delta K)$ derived from the crack-growth curve [see Figure 9.6.2(a)] at selected values of crack length, a . Crack-growth-rate curves are generally plotted on log-log coordinates.

Within the general curve shape described above, systematic variations in data point locations are observed. When data from tests conducted at several different stress ratios are present, the plot of crack-growth rate versus stress-intensity-factor range will be layered into distinct bands. Layering of data points may also occur as a result of variation in such parameters as test frequency, environment, temperature, and specimen grain direction.

9.6.2.1 Data Collection and Interpretation — Reporting of basic crack-growth data will be as complete as possible. In addition to reporting cyclic loading conditions, such as maximum cyclic load and/or stress levels, stress ratio, test frequency, and specimen dimensions, it is particularly important to identify environmental conditions associated with the tests. The number of specimens and number of respective heats should also be identified. Table 9.9.2 serves as an example of the type of information which should be available (or at least is desirable) for each collection of FCP data.

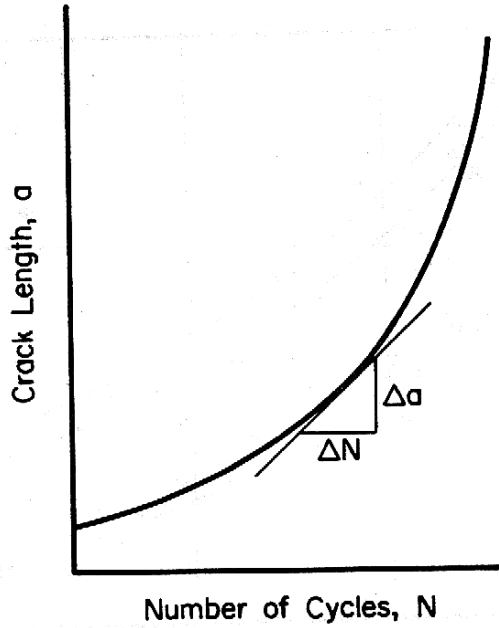

Figure 9.6.2(a). Crack-growth curve.

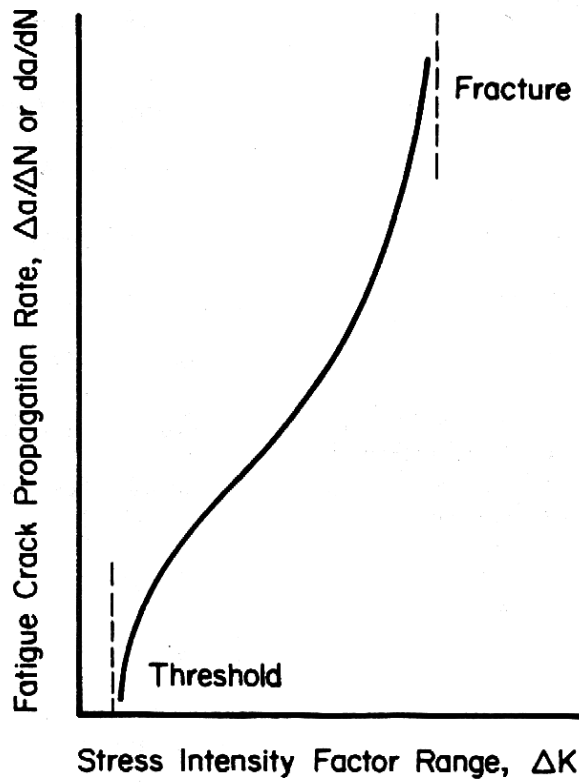

Figure 9.6.2(b). Crack-growth-rate curve.

9.6.3 FRACTURE TOUGHNESS DATA — Fracture toughness of a material is its ability to resist flaw propagation and fracture. This characteristic is a generic quality, somewhat elusive to assess quantitatively. Of several measures of fracture toughness which have evolved for appraising the sensitivity of metals to the presence of small flaws, those based on crack stress or strain analysis appear to be more meaningful for use in design applications. Significant quantification of fracture and flaw propagation behavior of high-strength metals has been achieved through the concept of stress intensity factors. Typical room-temperature values and effect-of-temperature curves for critical stress intensity factors are presented in MIL-HDBK-5 for “information only” where data are available. Basic concepts, testing considerations, and interpretations of fracture toughness are briefly described in the following subsections.

A primary factor in fracture behavior of a material is stress state, i.e., plane-stress or plane-strain. In accord with previous definitions, these stress states may be interpreted mechanically as a size or thickness effect within the material. The ideal plane-stress condition occurs in the two-dimensional ($\sigma_z = 0$) case, in which all stresses are restricted to one plane. Typically material loaded in plane-stress can accommodate extensive plastic deformation adjacent to the flaw prior to fracture, and at fracture exhibit a relatively high K value, as computed by a relationship such as Equation 9.6.2. At the opposite extreme is the ideal plane-strain case, in which the third dimension is essentially infinite so that bulk restraint of the material permits no out-of-plane strains. As a result, plastic deformation is restricted and the material fractures in a nearly elastic manner at a relatively low K value. In real materials, these ideal extremes can be closely approximated by “quasi” conditions of “thin” and “thick” bodies. Variation in stress intensity at fracture over these extremes, and the transition stage between, may be represented as shown previously in Figure 9.2.3.5.3(a).

9.6.3.1 Plane-Strain Fracture Toughness Data — For materials which are inherently brittle, or for structures and flaw configurations which are in triaxial tension due to their thickness or bulk restraint, quasi-plane-strain-stress conditions can be obtained in a finite-sized structural element. Triaxial stress state implicit to plane strain effectively embrittles the material by providing maximum restraint against plastic deformation. In this condition, component behavior is essentially elastic until fracture stress is reached and is readily amenable to analysis in terms of elastic fracture mechanics. This mode of fracture is frequently characteristic of the very high strength metals.

9.6.3.1.1 Data Collection and Interpretation — While a wide variety of fracture specimens are available for specified testing objectives, the notch-bend specimen and compact specimen generally offer the greatest convenience and material economics for testing. Details of recommended testing practice are presented in ASTM E399.

9.6.3.2 Plane Stress and Transitional Fracture Toughness — It is convenient to consider critical stress-intensity factor values, varying with thickness or stress state, as indices of crack-damage resistance. The stress-intensity factor can be used as a consistent measure of crack damage, not only for fracture instability, but also for other levels of crack damage severity, provided the damage is consistently specified and detected. This concept implies that plane-stress and transitional-fracture toughness of metallic materials, while not necessarily a fixed value for the material, is a characteristic value for a given product form, thickness, grain direction, temperature, and strain rate.

9.6.3.2.1 Data Collection and Interpretation — Because of the complexity of crack behavior in plane-stress and transitional-stress states, test methods for evaluating material toughness have not been completely standardized; however, several useful methods do exist. Although each configuration generates nearly consistent results when data are properly evaluated, it is recommended that each general flaw configuration be interpreted and applied within its own design context.

Middle Tension Panels — Because it simulates typical crack conditions in thin-sheet structures, the middle tension panel is a popular testing configuration for evaluating crack behavior. This specimen was illustrated earlier in Figure 9.2.3.5.3(b).

The crack-tip plasticity and slow-stable growth of the crack which commonly occur with plane-stress or transitional stress state conditions may cause a deviation from abrupt fracture, which is normally associated with crack extension under ideal plane conditions, as illustrated earlier in Figure 9.2.3.5.3(c).

Two limiting damage levels are noted in this figure. Point O is the threshold or onset of slow, stable tear where the crack slowly extends after reaching a threshold stress level. Point C is fracture instability. Both levels of crack damage can be associated with a different stress intensity factor, or damage index, for product forms and thicknesses of interest. These damage levels can be identified either directly with the K value as determined from instantaneous stress-crack length coordinate dimensions at these points, or approximately by the coordinates of Point A, which is residual strength, or apparent toughness concept of relating initial crack length to final fracture stress.

The stress intensity factor, K, associated with any of these damage levels is determined from Equation 9.6.2(b) where, for this configuration,

$$a = \text{half-length of center-through crack}$$

$$g(a,w) = (\pi \sec \pi a/W)^{1/2}.$$

The locus of data points can be represented by a parametric stress-intensity factor curve, as shown in Figure 9.2.3.5.3(d), where each curve represents a different stress-intensity factor formulation. The slow growth curve is superimposed on this figure to illustrate the general relationship between the threshold of stable crack extension, apparent instability, and fracture instability for a typical crack.

Because of experimental difficulties associated with precise detection of threshold and instability points, points O and C, apparent toughness, or residual strength concept of crack damage is used in this presentation. This is the locus of data points "A", noted earlier in Figure 9.2.3.5.3(d), which determine apparent fracture toughness.

$$K_{app} = f_c (\pi a_o \sec \pi a_o / W)^{1/2} . \quad [9.6.3.2.1]$$

See Reference 9.2.3.5.3 for additional information.

9.6.3.2.2 Analysis of Data — Since precise definitions of damage mechanisms and their associated instability conditions have not been devised for crack behavior in plane-stress and transitional stress states, only general constraints can be suggested for screening data. To assure that crack damage or fracture instability occurs under predominantly linear elastic conditions the basic criterion is that net section stress must be less than 80 percent of tensile yield strength, TYS, actually representative of that material. Additional criteria may be imposed by stress and boundary constraints characteristic to specific specimen configurations.

Middle Tension Panels — To maintain consistency with the Damage Tolerant Design Handbook [Reference 9.6.3.2.2], a related damage tolerance data document for Air Force contractors, a singular criterion,

$$f_c \leq 0.8 \text{ (TYS)} (1 - 2a/W) \quad [9.6.3.2.2]$$

corresponding to the above net section stress requirement, is imposed on fracture data from middle tension panels. Data which satisfy this criterion are used with Equation 9.6.3.2.1 to define apparent fracture toughness.

The validity of elastic fracture in a given set of data may also be substantiated by additional tests conducted to demonstrate that elastic fracture conditions have been achieved and that the associated K value is nearly constant. For example, once a tentative value of K_{app} has been determined, it can be confirmed by testing additional panels of larger width (at least 50 percent larger) with the same initial crack length, or by testing the same panel width containing a smaller initial crack length (approximately two-thirds of the previous). These additional K_{app} values must confirm to the original tentative value. In any case, it is recommended that tests can be conducted at a variety of crack lengths and panel widths whenever practical to obtain a more complete characterization of panel behavior.

9.6.4 CREEP AND CREEP-RUPTURE DATA — Creep is defined as time-dependent deformation of a material under an applied load. It is usually regarded as an elevated temperature phenomenon, although some materials creep at room temperature. If permitted to continue indefinitely, creep terminates in rupture. (First stage or logarithmic creep exhibited by many materials at lower temperatures is not the subject of this section.) Creep in service usually occurs under varying conditions of temperature and complex (multiaxial) stress, leading to an infinite number of stress-temperature-time combinations. Creep data for use in general design are usually obtained under conditions of constant uniform temperature and uniaxial stress. This type of data is the subject of this section.

9.6.4.1 Data Collection and Interpretation — After a desired group of creep and/or creep-rupture data have been experimentally developed or isolated in preproduction files, it is necessary to carefully collect and interpret these data in accordance with the following guidelines:

State-of-the-art for interpreting these types of creep and rupture data requires that a certain amount of judgment be allowed. The general approach will be to optimize one of several empirical equations that best follows the trend of data, using life (or time) as the dependent variable. Independent variables will include stress and temperature for rupture and isostrain creep curves, and will also include strain for isostrain creep curves.

Rupture ductility can be an exception to the above because of complex behavior and data scatter. At least a cautionary note should be given in the introductory material on times and temperatures included in rupture data. Some materials exhibit such low elongation in certain time-temperature regions that normal, reasonable values of design creep strain cannot be achieved without risk of fracture.

Interpretation of creep and rupture data should also include variables that are reflected in background data reporting requirements (discussed in the next subsection). Depending on the information content of the data, and the type of variable, it may be desirable to develop a series of equations, or to include additional physical variables in the regression analysis. The proposal should demonstrate that these additional variables have been evaluated and appropriately treated in the analysis.

The individual interpreting the data should also take note of the following special types of data, and consider the following recommendations on their use:

Specification Data—Virtually all alloys used for high-temperature applications are controlled and purchased by a process control variable generally called “spec point”. Therefore, there will often be large quantities of data available from quality control data records at the specification condition.

Data will contain many heats, and serve as an excellent measurement source of scatter. Therefore, in

regression modeling, specification data are often the major source of scatter measurements. Slope measurements must come from the experimental design matrix.

Specification data can also be used to (1) determine, through analysis-of-variance techniques, fractions of scatter due to heat-to-heat variations, etc., (2) determine, through distribution analysis, if data are normal, log normal, etc., and (3) find out, if data are not normal, what transformation is required.

Outliers—These can be excluded only if tests are demonstrably invalid, or if the effect on the equation and statistical parameters is unreasonable. Since exclusion of outliers normally involves a certain degree of judgment, it should only be done by a knowledgeable, experienced individual.

Discontinued Tests—These can be included if longer lived, or excluded if shorter lived, than average life of the data subset (lot, section thickness, etc.) to which they belong.

Stepped-Tests—If load on the specimen had been increased or decreased after initial loading, this test result will be excluded.

Truncating Data—Certain equations, notably parametrics, often do not properly represent a mix of shorter and longer time data. These equations can severely overpredict creep and rupture lives less than ten to thirty hours. Similarly a preponderance of short time data can cause long lives to be overpredicted. Eliminating such data requires truncating the data (or subset). This is done by removing all data above (or below) a fixed stress level, even though normally acceptable data are excluded.

Background Data Reporting—The significance and reliability of creep data generated at elevated temperatures for heat-resistant alloys are, to a major extent, a function of detailed factors which relate to the material, its processing, and its testing. Hence, it is necessary to evaluate not only the property data, but also correlative information concerning these factors.

It is not possible to specify individual items of correlative information, or the minimum thereof, which must be provided with elevated temperature property data to make those data properly meaningful. Individual alloy systems, product forms, and testing practices can all be quite unique with regard to associated information which should be provided with the data. A certain minimum amount of information is required for all data, including:

- (1) Identity of alloy
- (2) Chemical composition of the specific material tested
- (3) Form of product (sheet, forging, etc.)
- (4) Heat-treatment condition
- (5) Producer(s)
- (6) Specification to which product was produced (AMS specifications are normally considered standard*)
- (7) Date when part was made.

* Company specification data may be included with federal, military, and industry specification data if it is properly documented and can be shown to compare favorably in creep or stress-rupture behavior.

Lack of such information is sufficient basis for rejection of a particular data set.

In addition, it is vital that the individual submitting data consider those factors which contribute to uniqueness of the alloy, processing, and/or testing, and give thought to information which is pertinent to that uniqueness. Thus, grain size can be a significant variable, not only between cast turbine blades, but within a single blade. Thermomechanical working processes may result in significantly different properties (not only higher, but lower as well); and test specimen design can affect resultant data. It is mandatory that knowledgeable personnel be involved when data are submitted for evaluation and potential use. Any correlative data that can be provided will aid the analyst in identifying valid reasons for rejection of data which may not fit the trends of other data (outliers). Such apparent outliers may be indicated through analysis of between-heat variance as described in Section 9.6.4.2.

These examples illustrate the need for adequate information:

- (1) Creep-rupture specimens are being machined from cast high-strength, nickel-base alloy turbine blades. At center span location, specimens are 0.070- to 0.090-inch diameter, while at the trailing edge, specimens are flat and 0.020-inch thick. Flat specimens are typically about one Larson-Miller parameter weaker than round specimens, which is attributable both to thickness effects of the thin specimens and to finer grain size at the trailing edge. In addition, trailing edge specimens exhibit more scatter. Hence, availability of associated information is vital when considering data from specimens machined from cast turbine blades.
- (2) Comparison of creep-rupture properties of Waspaloy and Superwaspaloy shows that the latter is much weaker at temperatures approaching the upper bounds of utility of the alloy. The significantly lower properties at higher temperatures are attributed to a finer grain size of Superwaspaloy and also to a recovery process that may well be occurring at these temperatures. This alloy is subjected to extensive thermomechanical working, and some strengthening gained by the associated warm working is lost at higher testing temperatures. This effect clearly indicates that processing history significantly affects levels of mechanical properties and, hence, must be adequately documented when property data are submitted.

9.6.4.2 Analysis of Data — After an acceptable data collection has been obtained and interpreted, it is possible to proceed in analyzing those data and developing mathematical models of creep and creep-rupture behavior. The objective of the procedures described in the following paragraphs is to calculate creep and rupture life as a function of test conditions and other significant variables. This calculation is done to provide an average curve and a measure of expected variability about the average. The approach that is discussed involves regression analysis to optimize the fit of an equation to the data set. The following information provides guidelines in the application of regression analysis to creep and rupture data and recommends approaches to specific problems that are frequently encountered.

General—It is assumed that life or time is the dependent variable for rupture or isostrain creep equation analysis, respectively, and logarithmic transformation of the dependent variable is normally distributed.

The data set will nearly always contain a variety of stresses and temperatures. If the data set is the product of a very well-balanced test design, good results may be obtained by independently fitting each temperature. Since this type of data set is often not available, and the approach sacrifices the opportunity for interpolation, the discussion will assume that at least temperature and stress are used as independent variables.

In order to achieve good results, it may be necessary to consider other variables. Some variables are continuous physical variables that are incorporated into regression variables, e.g., section size. Other variables may occur as discrete subsets that require modifying the regression analysis (this is discussed under

Subsets of Data). In such cases, it may be necessary to group data per subset for data reporting if regression analysis cannot easily accommodate the observed subsets.

Selection of Equations—For isostrain and rupture time, as a function of stress and temperature, a number of relationships have been proposed. Some useful ones are:

$$(1) \log t = c + b_1/T + b_2X/T + b_3X^2/T + b_4X^3/T \quad [9.6.4.2(a)]$$

$$(2) \log t = c + b_1/T + b_2X + b_3X^2 + b_4X^3 \quad [9.6.4.2(b)]$$

$$(3) \log t = c + b_1 T + b_2X + b_3X^2 + b_4X^3 \quad [9.6.4.2(c)]$$

$$(4) \log t = c + (T-T_a)(b_1 + b_2X + b_3X^2 + b_4X^3). \quad [9.6.4.2(d)]$$

These are the Larson-Miller, Dorn, Manson-Succop, and Manson-Haferd, respectively, where

- c = the regression constant
- b₁ = coefficients (b₁ through b₄)
- t = time
- T = absolute temperature (T_a is the temperature of convergence of the isostress lines)
- X = log S (stress).

While all forms may be used to model a data set with varying degrees of goodness of fit, experience and practice indicate the Larson-Miller relationship adequately models most materials, and is usually the preferred equation form.

If data for a given material is available at a variety of creep strain levels as well as the stress rupture point, only one model should be used to describe data trends for each strain level. The decision as to which of the four customary models is chosen should be based on a comparative analysis of data for the most comprehensive data collection, whether that collection be for a specific creep strain level or stress rupture point. In addition, the constant term found in the optimum analysis should be held the same for all creep strain levels. If this is done, it will be possible to construct a composite plot of stress versus parameter for all creep strain levels and the stress-rupture level.

If none of these standard forms satisfactorily follows data trends, various combinations of stress and temperature may be tried. For example, terms can be selected from a matrix obtained using cross products of T⁻¹, T⁰, T¹ with S⁻¹, S⁰ and S¹. Methods for generalizing and applying these equations are discussed in Reference 9.6.4.2.

The exact form of the functions should reflect data and reasonable boundary conditions. Quadratic, quartic, etc., can be expected to give poor boundary conditions, e.g., zero life at zero stress, and should be avoided. Extrapolation by users of the equation is inevitable (though it is not recommended), so other general equations must be checked for unusual behavior beyond the data—this can be done, in many cases, by differentiating to obtain maxima and minima. In general, short times should give strengths approximately corresponding to tensile yield and ultimate strength; zero stress should predict infinite life.

Metallurgical instabilities and transition regions may present difficulties in some analyses. Methods for handling such problems have been discussed in Reference 9.6.4.2.

Optimum Fit—Guidelines for an optimum fit are:

- (1) Minimum number of terms. With two independent variables, σ and T , six regression variables are reasonable, each additional physical variable allowing two additional regression variables.
- (2) Reasonable curve characteristics for material behavior, including extrapolation.
- (3) Minimum standard error and maximum correlation coefficient (as long as 1 and 2 are not violated). Standard errors are typically between 0.1 and 0.2.
- (4) Uniform deviations (see a later paragraph on Weights for a brief discussion of nonuniform deviations and their analytical treatment).

Subsets of Data—A non-normal or multimodal population, or an excessive standard error may indicate the presence of subsets. However, an apparently typical data set may contain subsets that should receive special consideration.

One type can be treated by adding physical variables to the regression analysis. For example, different thicknesses of sheet material may give different average lives. Including sheet thickness in the regression should not only improve fit but also avoid the risk of misrepresenting behavior of the material. Section thickness, distance from surface, and grain size are other examples of subsets that can be treated as regression variables. Section thickness and distance from surface refer to location of the specimen in terms of geometry of the original material, e.g., finish work thickness, final heat thickness, etc.

A second type is not typically subject to use as a regression variable. Examples of these are orientation (L, LT, and ST), or different heats (chemistry). A decision must be made whether to treat these as unique subsets to be analyzed separately (if properties are different) or as randomly distributed subsets. Orientation will usually be analyzed separately, while heats will usually be randomly distributed subsets. Other methods (e.g., fixed intercept, centered above mean values for each creep level) may be more suited for a given data set and may be tried. The specific procedure used must be indicated in the data package.

The theory of treatment of randomly distributed subsets has been developed in Reference 9.2.5.2, while application to lots of material (actually “heats” in chemistry) is considered in Reference 9.6.4.2. Treating subsets as random affects calculation of both average curve and standard error. While effect on standard error may become insignificant as the number of subsets exceeds ten (depending on the relative contribution to total standard error), effect on the trend of the calculated average remains. Lots whose average lives are uniformly displaced (parallel) in logarithm of life, or are not significantly non-parallel, are discussed in Reference 9.6.4.2(a). There is no known published reference for treating non-parallel lots. Data permitting, individual lots can be fitted, within-lot variances pooled, and average and variance of lot averages calculated for selected stress-temperature combinations. After calculating total variance and desired lower level tolerance limit* ($\bar{X} - ks$) at each stress level, curves can be drawn and, if desired, equations be fit to X 's and ($\bar{X} - ks$)'s. It should be noted that the equation for ($\bar{X} - ks$) is not likely to properly reflect uncertainty in coefficients obtained by normal fitting procedures. Alternately, all data for non-parallel lots can be pooled and variance weighted, providing sufficient lots are represented and average curve is reasonably similar to the first approach.

* Tolerance limits used here are one-sided and are normally developed for tolerance levels of 90 or 99 percent at a confidence level of 95 percent.

Consistency in Creep and Stress Rupture Trends—When creep data are somewhat limited, an independent analysis of each creep strain level may produce inconsistent trends between different creep strain levels and stress rupture mean curve. There may be cases where very minor extrapolations will produce creep curves that cross over each other or the stress rupture curve. In some instances, this problem can be eliminated, without a significant loss in quality of fit at each creep strain level, by forcing a prescribed relationship to exist between creep curves and stress rupture curve. Parallelism in log(time) is the simplest relationship that can be assumed, but it is also a relationship that is often supported by data trends. A linearly increasing or decreasing separation of creep curves and stress rupture curve in log(time) as a function of stress is also a possibility, but it takes a large quantity of data to verify such trends. If large quantities of data are available, then it is generally preferable to analyze each creep strain level individually. Therefore, about the only practical relationship to assume between individual creep curves and the stress rupture curve is parallelism in log(time).

Parallelism in log(time) can be achieved through the addition of a dummy variable to the stress rupture equation for each creep strain level being added to the regression analysis. For example, in the case of the Larson-Miller equation, which (in its third order form) is normally written as

$$\log t = c + b_1/T + b_2X/T + b_3 X^2/T + b_4 X^3/T, \quad [9.6.4.2(a)]$$

where

t = time, hrs

T = absolute temperature, °R

X = log (stress), ksi,

the equation can be modified to include additional terms for each creep level, as follows

$$\log t = c + b_1/T + b_2X/T + b_3X^2/T + b_4X^3/T + b_5 Y_1 + b_6 Y_2 + \dots b_{4+i} Y_i \quad [9.6.4.2(e)]$$

where the value of Y_i new terms are either 0 or 1. If a creep strain level 1 data point is considered, $Y_1 = 1$ and all other Y's are 0. Similarly, if a creep strain level 2 data point is considered, $Y_2 = 1$ and all other Y's are 0. If a stress rupture data point is considered, all the Y's are 0. In this way, the optimized values of additional b's represent average A in log(time) that each creep curve falls below the stress rupture curve.

The usefulness of such an approach must be verified through an examination of quality of fit for each creep strain level compared to raw data trends.

Weights—Rupture and isostrain creep curves will not normally require weights to obtain uniform variables. Analysis, including strain as a variable, frequently will. Variables other than strain, temperature, and stress will require evaluation for uniform variance. Reference 9.6.4.2(a) provides further discussion of weighting.

MIL-HDBK-5J
31 January 2003

Rejection of Analyses—Regression analyses of specific creep or stress-rupture data sets should normally be rejected if the R^2 statistic for analysis is <75 percent, or there are fewer data than five times the number of temperature levels, or there are <20 data points total available for regression.

If data for several different creep strain levels are analyzed in combination with stress rupture data, R^2 levels below 75 percent for one or two creep strain levels may be acceptable, if the overall R^2 exceeds 75 percent. Separate analyses of low creep strain data may show relatively high variation with R^2 values below 75 percent. In these cases, if there are sufficient data to produce significant regression coefficients at a 95 percent confidence level, the result may still be acceptable for inclusion in MIL-HDBK-5.

9.7 ANALYSIS PROCEDURES FOR STRUCTURAL JOINT PROPERTIES

This section of the guidelines covers analysis procedures for determination of structural joint properties. Reference to the following related sections may be useful:

Test Methods

9.2.3.6 Mechanically Fastened Joints

9.2.3.7 Fusion-Welded Joints

Data Requirements

9.2.4.6 Mechanically Fastened Joints

9.2.4.7 Fusion-Welded Joints

Examples of Data Analyses and Data Presentation

9.9.5 Mechanically Fastened Joints

9.9.6 Fusion-Welded Joints

It is important to recognize that these guidelines for the analysis and presentation of fastener design allowable properties in MIL-HDBK-5 are substantially different than the version that has been used for at least 20 years. These new guidelines are based on standardized statistical procedures, and involve the development of B-basis yield and ultimate load fastener allowables. Fastener tables included in MIL-HDBK-5 prior to Revision J will not be systematically reviewed or updated in accordance with these new guidelines. However, new fastener data proposals, or revisions to existing fastener allowable tables, will be based on the statistical procedures described in this section of the Handbook.

These new procedures were adopted to:

- Migrate toward a consistent level of statistical confidence in tabulated fastener design properties.
- Provide a method that accounts for (but is not driven by) singularity points in the data.
- Allow for greater confidence and accuracy in fastener design allowables as sample sizes increase.
- Ensure that fastener data analysis procedures will provide repeatable, unbiased results when used by different analysts.

Fastener tables approved prior to Revision J of MIL-HDBK-5 include ultimate load design allowables that are approximately equivalent to B-basis design properties. The yield properties shown in these same tables cannot realistically be equated with B-basis design properties; these previously established yield properties should be treated as conservative average fastener yield loads. To avoid confusion the basis of all fastener properties presented in Chapter 8 of MIL-HDBK-5 must be clearly delineated, as illustrated in Section 9.9.5.

9.7.1 MECHANICALLY FASTENED JOINTS — Some mechanical fasteners will not develop full bearing strengths of materials in which they are installed. Joint allowables for these fasteners must therefore be determined from test data. Fasteners for which allowable loads must be determined are:

MIL-HDBK-5J
31 January 2003

- (1) flush-head fasteners in dimpled or countersunk sheet,
- (2) fasteners with hollow or multiple-piece shanks,
- (3) protruding-head fasteners with shear-type heads*, and
- (4) protruding-head bolts and rivets when thickness-to-diameter ratio (t/D) is less than 0.18.

These guidelines define data generation (quality/quantity), analysis methods, and presentation format applicable to mechanically fastened joint allowables. They reflect a need to (1) ensure that the aerospace industry is interested in new fastener systems which are incorporated in MIL-HDBK-5, and (2) ensure that confirmatory data to substantiate allowable loads meet certain stated requirements that simplify the process of acceptance through coordination. To accomplish these needs, fastener systems proposed for inclusion in MIL-HDBK-5 may be introduced (sponsored) by airlines, airframe or engine prime contractors, and Government agencies (DoD, FAA, or NASA); i.e., one of the users. When introducing a new fastener, the sponsoring organization will supply information specified in Section 9.2.4.5.3. The sponsoring organization is also expected to review the test program plan, actual testing, and data analysis. At least 25 percent of the specimen fabrication and testing will be performed at a second facility. It also is expected that fasteners and fastener materials will be obtained from three production runs per diameter as documented in the report. The sponsoring organization will submit a report documenting design allowables to the MIL-HDBK-5 Coordination Group for evaluation. (See Section 9.2.4.5.3.)

Proposals not meeting the requirements described herein will be rejected or require more time-consuming evaluation, inevitably delaying approval and release of proposed allowables. Therefore, use of these guidelines in preparing proposals for MIL-HDBK-5 is essential.

In case of conflict, provisions of this document take precedence over reference documents for any tests or analyses made to provide, substantiate, or revise MIL-HDBK-5 fastener allowables.

9.7.1.1 Definitions — Terms used in Section 9.7.1 vary among users of this Handbook. To provide consistency, these terms are defined herein in accordance with the intent of MIL-HDBK-5.

- (a) Deformable Shank Fasteners—A fastener whose shank is deformed in the grip area during normal installation processes.
- (b) Nominal Hole Diameters—Nominal hole diameters for deformable shank solid, blind rivet and blind fasteners will be according to Table 9.7.1.1. When tests are made with hole diameters other than those tabulated, hole sizes used will be noted in the report and on the proposed joint allowables table.
- (c) Nondeformable Shank Fasteners—A fastener whose shank does not deform in the grip area during normal installation processes.
- (d) Nominal Shank Diameter—Nominal shank diameter of fasteners with shank diameters equal to those used for standard size bolts and screws (NAS 618 sizes) will be the decimal equivalents of stated fractional or numbered sizes. These diameters are those listed in the fourth column of Table 9.7.1.1. Nominal shank diameters for nondeformable shank blind

* For example, protruding-head fasteners with reduced head heights similar to those shown for NAS 529 rivets.

fasteners are listed in the fifth column of Table 9.7.1.1. Nominal shank diameters for other fasteners will be the average of required maximum and minimum shank diameters.

- (e) Yield Load—Joint yield loads for all fasteners are defined as loads which result in 0.04D permanent set in the joint when the fastener is tested in nominal hole size as defined in Table 9.7.1.1. For some fastening systems, tests in larger hole sizes, although within manufacturer's recommended hole size limits, may result in joint permanent sets greater than 0.04D* at yield load.

There are many generically named fasteners for which joint allowables are provided. These fasteners are listed below, followed by the letter H or S. H signifies that, in the analysis, nominal hole diameter (as described above) is used. S signifies that, in the analysis, nominal shank diameter is used.

- (a) Solid rivets and blind fasteners whose shanks deform during installation. (H)
- (b) Solid rivets and blind fasteners whose shanks do not deform during installation. (S)
- (c) Threaded and swaged-collar fasteners whose shanks do not deform during installation. (S)
- (d) All interference-fit and close-tolerance fasteners. (S)

9.7.1.2 Yield Load Determination — The preferred method of determining yield load is by the secondary modulus method.** To obtain secondary modulus line, during the test the joint is unloaded from a load close to, and preferably above, estimated yield load to a load value in the range of about 10 to 20 percent of estimated yield load. The joint then is reloaded and secondary modulus is the slope of this second loading line. This procedure is described in NASM 1312-4 and is illustrated in Figures 9.7.1.2(a) through (e).

If curves similar to Curves A and B in Figure 9.7.1.2(b) are obtained early in the test program, strain hardening will be presumed. In that case, unloading should be delayed in subsequent tests until after anticipated yield load. Curves showing strain hardening may be extrapolated a reasonable amount to determine yield load by the secondary modulus method as shown.

The initial loading line is used to establish the intersection with the abscissa from which to measure yield offset. At times, minor irregularities occur on initial loading which necessitates redrawing of the lower part of the curve as a continuation of the normal curve, as shown in Curves C and D of Figure 9.7.1.2(c).

Unusually shaped curves are sometimes obtained. Typical of these are the illustrations in Figure 9.7.1.2(d). Data which are typified by Curves A or B are unacceptable for analysis. When the secondary modulus has a straight-line portion of recognizable length, do as shown in Curve C. When the secondary curve has two straight parts, but is more in question (as in Curve D), and there are satisfactory curves available from similar group test specimens, use the slope which approximates other curves. Otherwise, the more conservative (steepest) will be used. An acceptable alternate is to draw a straight

* Or previous yield load criteria used prior to 1973. Applicable yield criteria are noted in footnote for design allowable table.

** The primary modulus line has been used in the past, on occasion. It is the slope of the initial loading line and frequently is observed to have greater variability than the secondary modulus line.

line between end points of the off-loading-reloading loop and consider this as the secondary modulus line, as shown in Figure 9.7.1.2(e). The primary modulus method may be used as a last resort, if there is no straight-line portion or usable loop in the secondary modulus curve.

Table 9.7.1.1. Nominal Hole and Shank Diameters, Inches

Fastener Size, Functional or Numbered	Deformable Shank Fasteners		Nondeformable Shank Fasteners	
	Solid	Blind	Solid Shank	Blind
1/16	0.067
3/32	0.096	0.098		0.098
#4	0.112	...
1/8	0.1285	0.130 0.144	0.125	0.130 0.144
#6	0.138	...
5/32	0.159	0.162 0.178	0.156	0.163 0.178
#8	0.164	...
3/16	0.191	0.194 0.207	0.188	0.198 0.207
#10	0.190	...
#12	0.216	...
7/32	0.219	...
1/4	0.257	0.258 0.273	0.250	0.259 0.273
5/16	0.323		0.312	0.311
3/8	0.386	...	0.375	0.373
7/16	0.438	0.436
1/2	0.500	0.497
9/16	0.562	...
5/8	0.625	...
3/4	0.750	...
7/8	0.875	...
1	1.000	...
1-1/8	1.125	...
1-1/4	1.250	...
1-3/8	1.375	...
1-1/2	1.500	...

a In order to standardize test and analysis procedures, nondeformable shank fasteners will be installed in net fit ± 0.0005 inch holes.

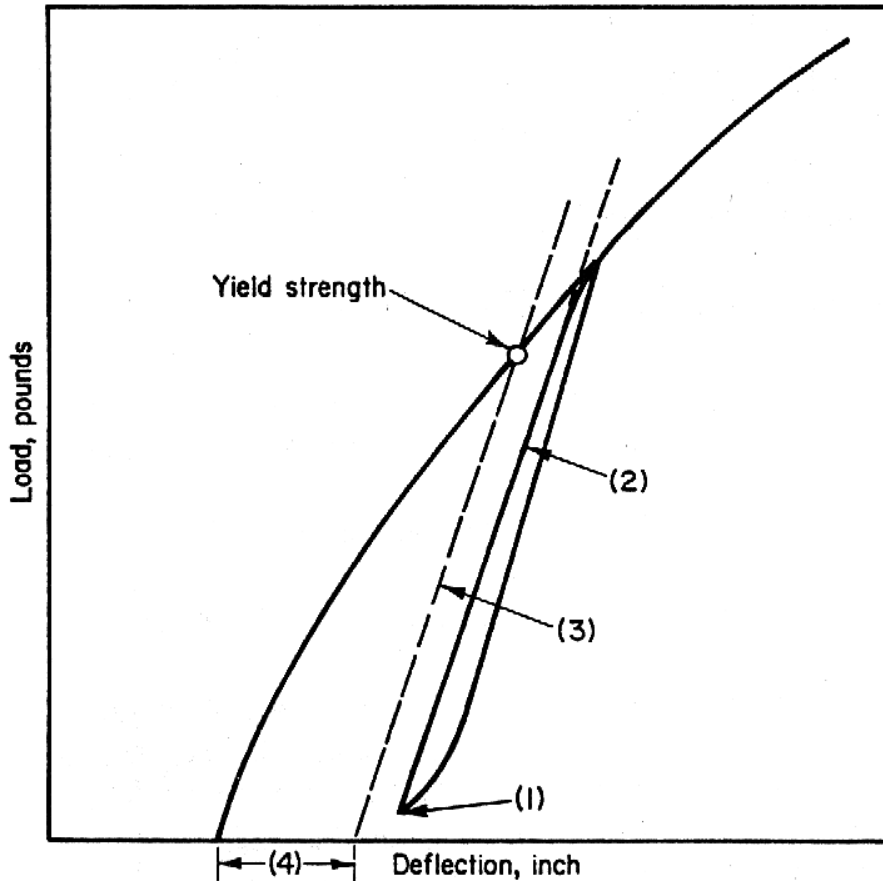

Figure 9.7.1.2(a). Illustration of secondary-modulus method of yield strength determination.

- (1) Reduce load to 10-20 percent of yield load.
- (2) Secondary-modulus line. The straight part of the loading side of the secondary-modulus loop indicating elastic behavior.
- (3) Offset line. A line parallel to the secondary-modulus line.
- (4) Offset. Equal to permanent set value specified in yield load definition in Section 9.7.1.1.

9.7.1.3 Shear Strength of Fastener — Each group of double-shear or single-shear results for a specific fastener type, size, and material will be analyzed to determine an A-value, except driven rivets which will be analyzed to obtain a B-value. Data will be checked for their conformance to a Pearson distribution through use of the Anderson-Darling test described in Section 9.5.4.4. If the assumption of a Pearson distribution is not rejected:

- (a) For solid driven rivets, compute the B-value as shown in Section 9.5.5.1 and select the next lower shear strength from Table 8.1.1.1, if it is within 2 ksi of the computed value. If the computed B value is more than 2 ksi above the next lower value in Table 8.1.1.1, a new value may be proposed.
- (b) For other fasteners, compute the A-value as shown in Section 9.5.5.1 and select the next lower shear strength from Table 8.1.1.1. If the computed A-value is more than 5 ksi above the next lower value in Table 8.1.1.1, a new value may be proposed.

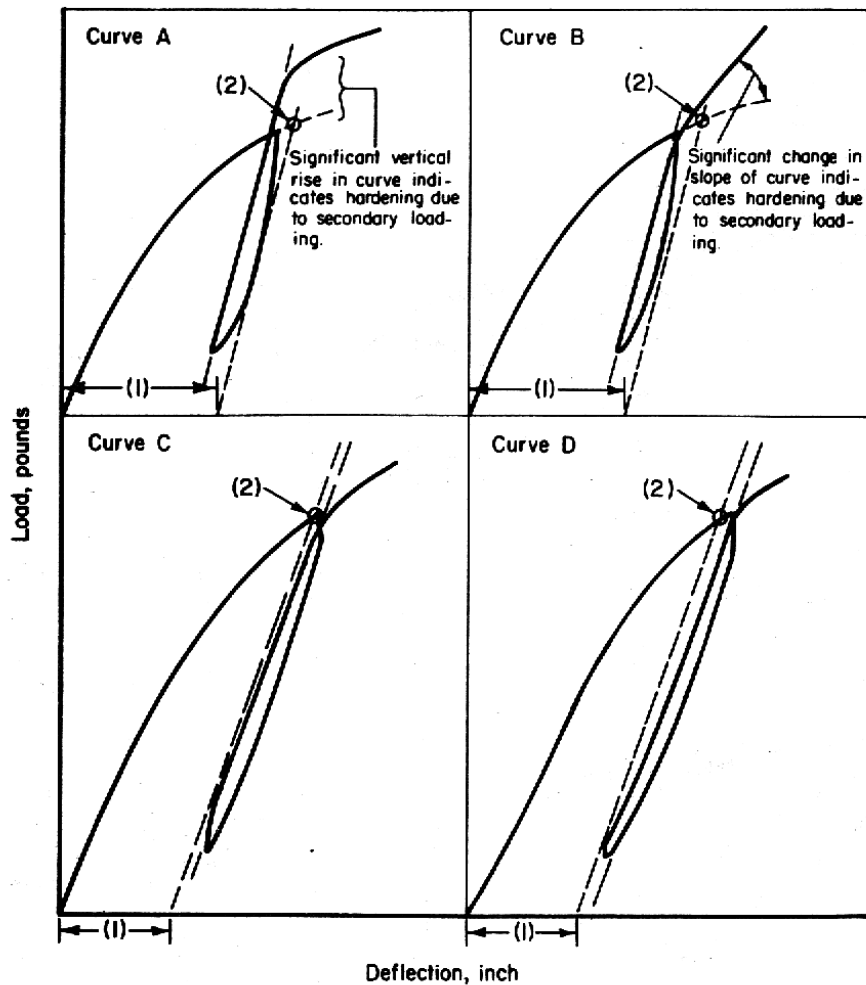

Figure 9.7.1.2(b). Sample secondary modulus load-deflection curves.

- (1) Offset per 9.7.1.1.
- (2) Joint yield strength.

If analysis of data shows a non-Pearson distribution, obtain additional observations (as required) and employ the nonparametric procedure as described in Section 9.5.5.3. Minimum shear strength will then be selected as described in (a) and (b) above.

The calculated design minimum shear values will be equal to or greater than the values in Table 8.1.5(a) (for the appropriate stress level) and the specification value. (For example, the computed minimum shear value for a 0.190 diameter, 95 ksi fastener will be greater than, or equal to, the allowable load value of 2,694 pounds.) The allowable load will be the lower of the appropriate Table 8.1.5(a) value or the specification value.

If Table 8.1.5(a) is not applicable (i.e., driven rivets, blind fasteners, and fasteners without shear-load requirements in the specification), the allowable load values will be converted to stresses for each diameter using nominal shank areas for S fasteners and nominal hole areas for H fasteners.

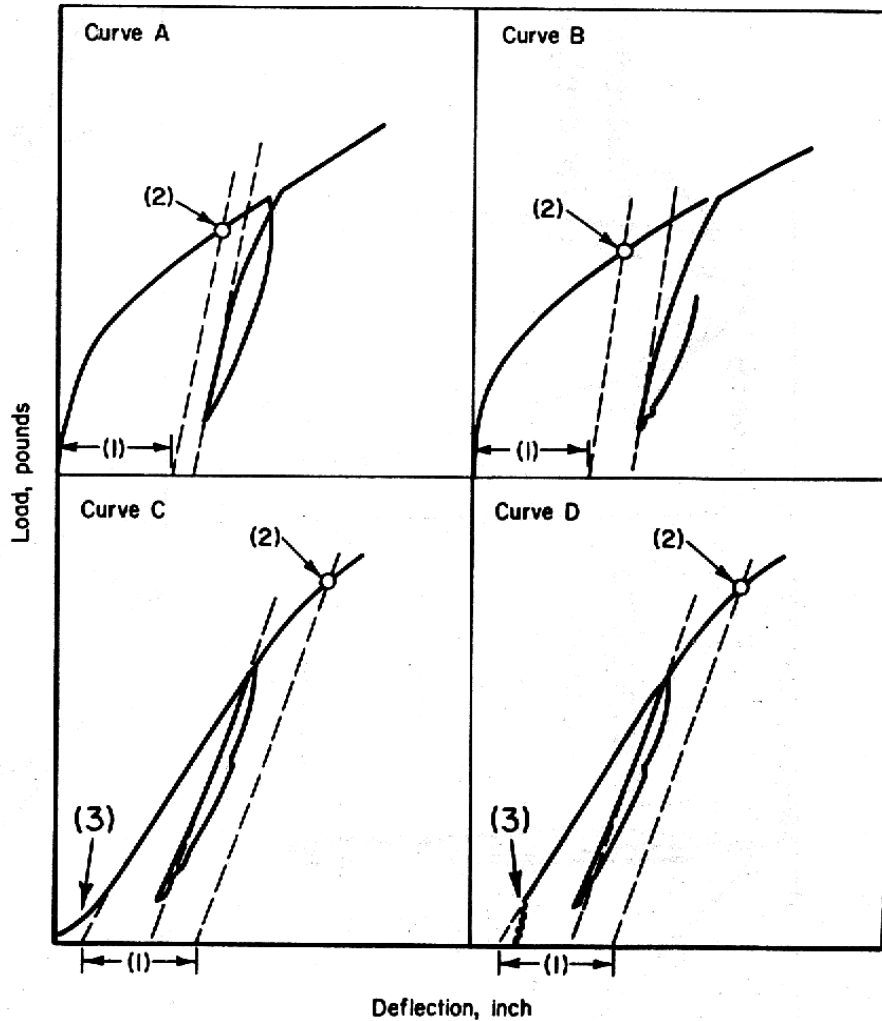

Figure 9.7.1.2(c). Sample secondary-modulus load-deflection curves.

- (1) Offset per yield load definition given in Section 9.7.1.1.
- (2) Joint yield strength.
- (3) Disregarded irregularities, per Section 9.7.1.2.

The allowable stress for the fastener system will be established as the lowest of the above calculated stresses, or the specification stress value, whichever is lower. Allowable fastener shear strength will be the product of this stress and the appropriate (H or S) areas used above.

The shear strengths that are calculated will be clearly identified as either 90 percent (B-value) or 99 percent (A-value) allowables.

9.7.1.4 Sheet Critical and Transition Critical Strengths — The analysis of data in the bearing and transitional regions provides design allowable curves for yield and ultimate strength where sheet or plate material of the joint is generally critical. To accomplish the analysis, tables and graphs are required as detailed in this subsection. The use of computer programs to analyze data and to prepare tables of

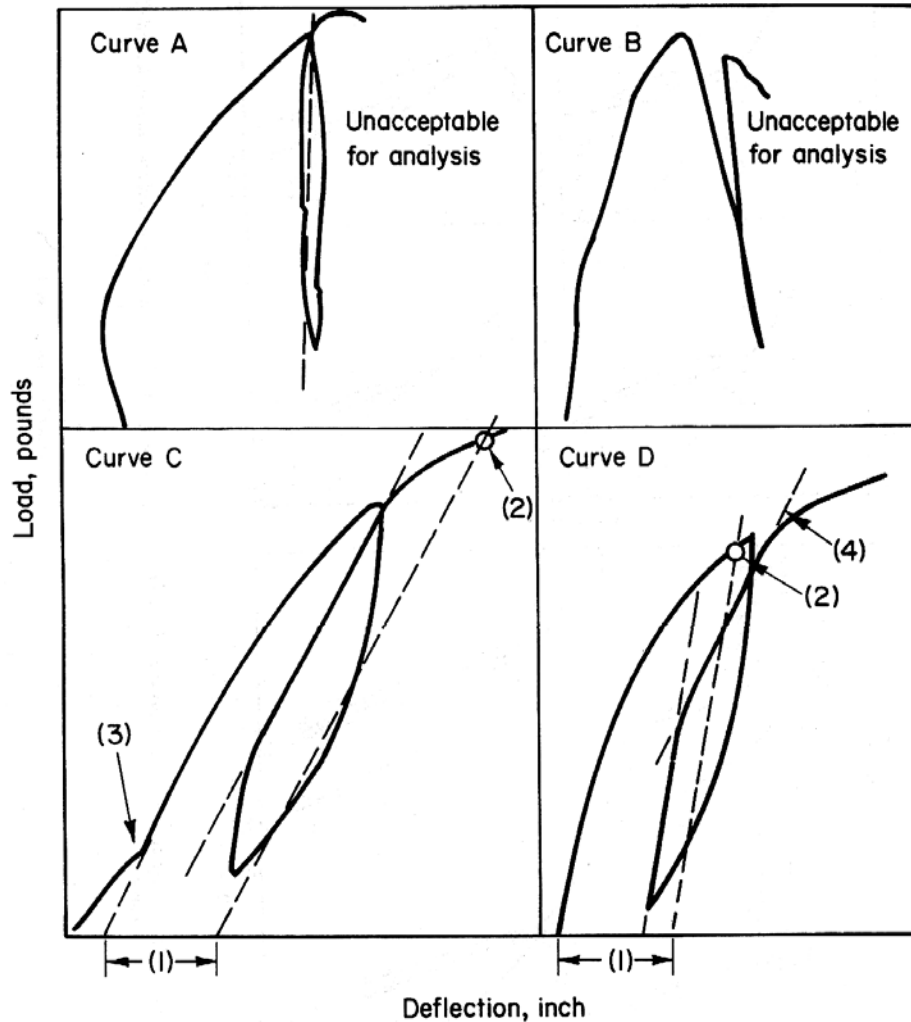

Figure 9.7.1.2(d). Sample secondary-modulus load-deflection curves.

- (1) Offset, per 9.7.1.1
- (2) Joint yield strength.
- (3) Disregarded irregularities, per 9.7.1.2.
- (4) Disregarded second slope in secondary-modulus curve.

calculations and figures, as next described, is acceptable. However, all tables and figures subsequently described should be illustrated in the report. When using a computer program for analysis, some engineering judgements may still be necessary for certain data sets in the transition thickness range.

- (a) Presentation and Analysis of Basic Test Data—The values of the functions t/D , P_u/D^2 , and P_y/D^2 will be calculated from the basic t , D , P_u , and P_y test data obtained on each specimen tested, using the values defined below:

t = measured sheet thickness, inch, for thinnest sheet gage of combination

D = measured hole diameter, inch, for H-type fasteners, nominal shank diameter for S-type fasteners as defined in Section 9.7.1

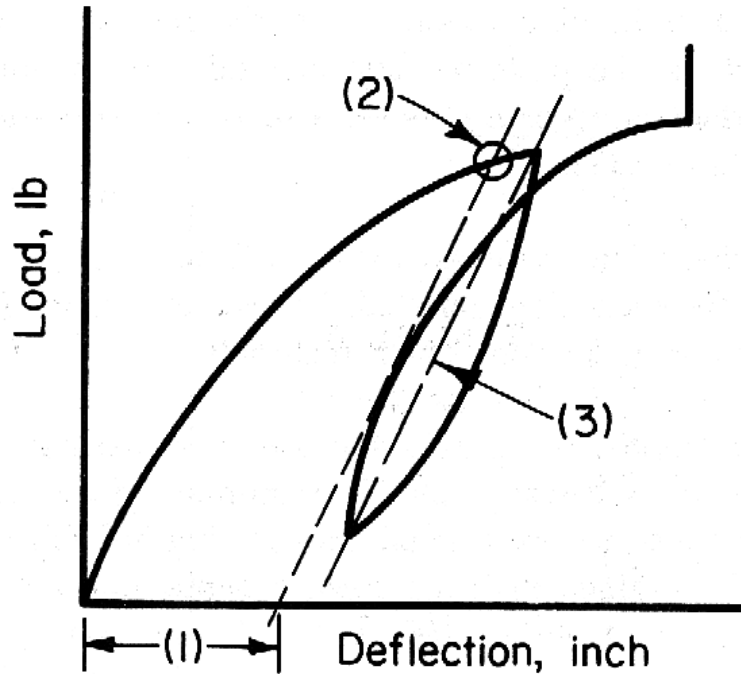

Figure 9.7.1.2(e). Sample alternative secondary-modulus load-deflection curve.

- (1) Offset, per yield load definition given in Section 9.7.1.1
- (2) Joint yield strength.
- (3) Alternative secondary-modulus line.

P_u = test ultimate load, where ultimate load is the maximum load reached by the test specimen prior to load fall off (pounds per fastener)

P_y = test yield load, determined per Section 9.7.1, pounds per fastener.

A suggested format for reporting the basic data and the computed values of t/D , P_u/D^2 , and P_y/D^2 is shown in Figure 9.7.1.4(a). The average P_u/D^2 and P_y/D^2 for each fastener diameter at each t/D will be indicated in the table.

Computation of P/D^2 and t/D from Basic Data									
Test Specimen No.	D Diameter	D^2	t Gage	t/D	Yield Load, P_y	$\frac{P_y}{10^4 D^2}$	Ultimate Load, P_u	$\frac{P_u}{10^4 D^2}$	Type of Failure

t , D , P_u , and P_y , per Section.

Figure 9.7.1.4(a). Suggested tabular layout for basic data and computer P/D^2 and t/D data.

- (b) Regression Analysis to Determine Average Ultimate and Yield Load Curves—The general assumption inherent in a P/D^2 versus t/D analysis procedure is that the dimensions of a fastener system are proportional to the fastener diameter. Therefore, a plot of the average P_u/D^2 and P_y/D^2 values for each t/D tested is expected to yield a compact band of data points through which single ultimate and yield load curves can be determined. The following regression equation can generally be used to represent average t/D trends:

$$P/D^2 = A_0 + A_1 * (t/D) + A_2 * \ln (t/D) \quad [9.7.1.3(d)]$$

where P = applied load,

D = nominal hole or fastener shank diameter (as defined in Table 9.4.1.2),

t = sheet thickness, and

“ln” represents the natural logarithm of the quantity in parentheses.

If the data for different diameter ranges are not combinable based on an F and t test (at a 95% confidence level as described in Section 9.5.2.4) the average regression trends for each diameter must be analyzed separately. Examples of this type of analysis are shown in Figures 9.7.1.4(b) and (c), for yield and ultimate loads, respectively. In this example both the yield and ultimate load t/D trends for the 3 different diameters were statistically combinable.

If applicable, fastener shear failure and sheet critical conditions should be clearly identified and considered in the evaluation of combinability of fastener data for different diameters.

Where applicable, data obtained from different sources must also be identified. The objective in both cases is to establish realistic average ultimate-load and yield-load curves for the fastener system. With the ultimate-load curve, consideration will be given to all test data for which joint failure was by failure modes other than fastener shear.

In the event that the yield and/or ultimate load data for an individual fastener diameter are not combinable with the other available diameters, a separate regression analysis must be performed on this fastener diameter.

Also to be shown on these graphs are one or more horizontal lines representing fastener shear strength (more than one line occurs when shear strength in pounds is not proportional to shank area) and allowable sheet or plate ultimate bearing strength and bearing yield strength lines. For materials where bearing properties vary with thickness, bearing strengths plotted will include the lowest value in the applicable thickness range and the values used will be the S or A values.

Nonshear-critical test data include all data below the fastener shear strength line and all data for joints that failed in sheet bearing, pullout, head failure, combinations of shear, or any other mode of failure, other than shear of fastener shanks, even though same data may lie above the fastener shear strength line. All shear-critical data should fall above the fastener shear strength line. Average t/D curves must not extend beyond the tested t/D range.

- (c) Regression Analysis to Determine Yield and Ultimate Load Design Allowable Curves – The following statistical procedure must be used for definition of yield and ultimate load design allowable curves. This procedure involves generation a B-basis allowables using a quadratic regression of the yield and ultimate load data generated from tests conducted on jointed specimens. Terms used in these statistical calculations are defined as follows:

a , b, c	Best-fit equation coefficients
df	Degrees of freedom
$F_{.05}(M-3,N-M)$	The 5 th percentile of the F distribution with degrees of freedom M-3 and N-M
H	Estimated bound on ratio of MSE to MSPE
ln	Natural logarithm
M	Distinct levels of t/D
MSE	Mean Square Error
MSPE	Mean Square Pure Error
N	Total number of tests
q_1, q_2, \dots, q_6	Sums of the $x_i = \ln(t/D)$
$Q(x)$	A measure of the “nearness” of x to the center of the range of independent variables
RMSE	Root Mean Square Error
(x)	The multiplier on s_y in the calculation of T_{90} values for different t/D ratios
s_y	Unbiased estimated of standard deviation in average joint strengths
t/D	Sheet thickness / fastener diameter
x_i	Independent variable in quadratic regression analysis
y_{ij}	The j th test value at i th t/D ratio, used to compute dependent variable

The following statistical procedure for calculating B-basis (T_{90}) values for fasteners is based on a quadratic regression analysis of the average strength values at each t/D, using a log scale on the t/D axis. In estimating the lower tolerance bounds, the procedure uses an estimate of the standard deviation that incorporates variability within each t/D condition, and random variations between these t/D conditions.

1) Calculate averages of the replicate tests:

$$\bar{y}_i = 1/3 \sum_{j=1}^3 y_{ij}$$

(Nominally, 3 tests are conducted, but use the appropriate divisor, n_i , throughout)

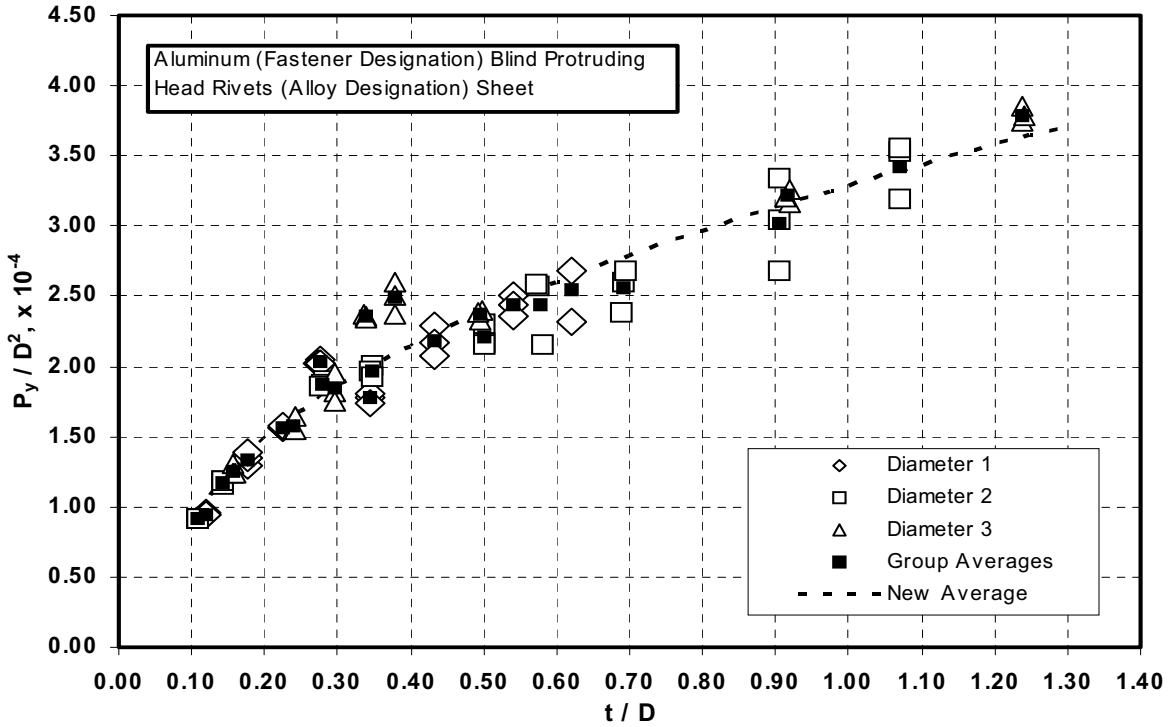

Figure 9.7.1.4(b) Example of Trial Analysis to Compare Mean t/D Yield Load Trends for 3 Different Fastener Diameters

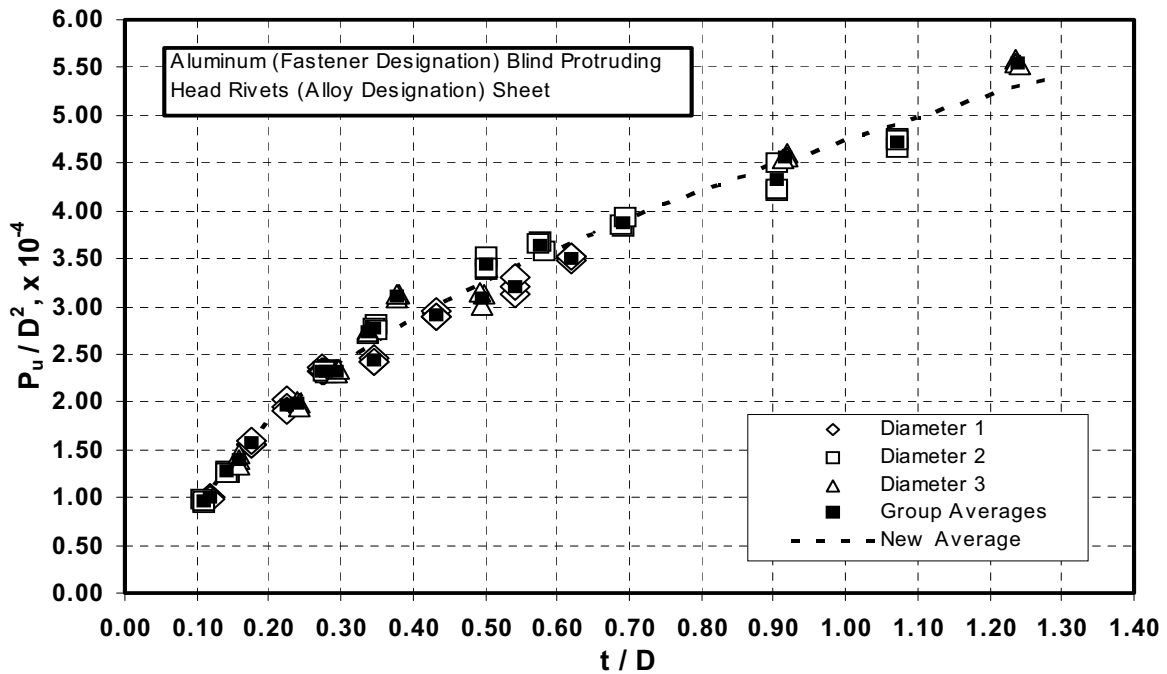

Figure 9.7.1.4(c) Example of Trial Analysis to Compare Mean t/D Ultimate Load Trends for 3 Different Fastener Diameters

2) Fit a quadratic regression of the averages to

$$x_i = \ln(t/D).$$

a) Let $a + b \ln(t/D) + c (\ln(t/D))^2$ be the estimated model where

$$a = \bar{y} - b\bar{x} - c \frac{\sum_{i=1}^M x_i^2}{M}$$

$$b = \frac{\sum_{i=1}^M (x_i \bar{y}_i - \bar{x}\bar{y}) - c \left[\sum_{i=1}^M (x_i - \bar{x}) x_i^2 \right]}{\sum_{i=1}^M (x_i - \bar{x})^2}$$

and $\bar{y} = \sum_{i=1}^M \bar{y}_i$, $\bar{x} = \sum_{i=1}^M x_i$, and M is the number of distinct levels of t/D . The logarithm of t/D is used because it often improves the fit at the lower values of t/D .

b) Let MSE denote the mean squared error of the regression.

$$MSE = (RMSE)^2 = \frac{\sum_{i=1}^M (\bar{y}_i - \hat{y}_i)^2}{(M-3)}$$

where $\hat{y}_i = a + bx_i + cx_i^2$

3) Determine appropriate standard deviation for the tolerance bounds and associated degrees of freedom.

$$c = \frac{\left[\sum_{i=1}^M x_i^2 (\bar{y}_i - \bar{y}) \right] \left[\sum_{i=1}^M (x_i - \bar{x})^2 \right] - \left[\sum_{i=1}^M (x_i \bar{y}_i - \bar{x}\bar{y}) \right] \left[\sum_{i=1}^M (x_i - \bar{x}) x_i^2 \right]}{\left[\sum_{i=1}^M x_i^4 - \frac{\left(\sum_{i=1}^M x_i^2 \right)^2}{M} \right] \left[\sum_{i=1}^M (x_i - \bar{x})^2 \right] - \left[\sum_{i=1}^M (x_i - \bar{x}) x_i^2 \right]^2}$$

- a) Calculate the MSPE (mean squared pure error)

$$MSPE = \frac{\sum_{i=1}^M \sum_{j=1}^{n_i} (y_{ij} - \bar{y}_i)^2}{(N - M)},$$

where $N = \sum_{i=1}^M n_i$ is the total number of tests and M is the number of distinct levels of t/D and n_i is the assumed number of replicates at the i^{th} level of t/D. This represents the variability that can be expected at a particular condition.

- b) Calculate s_y :

$$s_y = \left(MSE + \frac{(n_0 - 1)}{n_0} MSPE \right)^{1/2},$$

where $n_0 = \frac{1}{M-1} \left(N - \frac{\sum_{i=1}^M n_i^2}{N} \right)$. If the number of tests performed at each test condition

is the same, i.e., $n_i = n_0$ or $1 \leq i \leq M$, then this provides an unbiased estimate of the standard deviation of individual observations under a particular, fixed condition.

- c) Calculate H (the upper confidence bound on the ratio of the variability between t/D conditions to the variability within t/D condition):

$$H = \max \left(\frac{MSE}{MSPE} \frac{1}{F_{.05}(M-3, N-M)} - \frac{1}{n_0}, 0 \right)$$

where $F_{.05}(M-3, N-M)$ is the fifth percentile of an F distribution with degrees of freedom $M-3$ and $N-M$. Percentiles of the F distribution can be obtained from Table 9.10.2.

- d) Calculate degrees of freedom, df (Because the standard deviation is estimated by combining two different sums of squared differences, MSPE and MSE, standard statistical procedures do not apply. The formulas below rely on Satterthwaite's approximation for degrees of freedom.)

$$df = \frac{(H+1)^2}{\frac{\left(H + \frac{1}{n_0} \right)^2}{M-3} + \frac{\left[\frac{(n_0-1)}{n_0} \right]^2}{N-M}}$$

The degrees of freedom is estimated using the upper confidence bound on the ratio of the variability between t/D conditions to the variability within t/D condition, instead of the point

estimate of the ratio. This approach for estimating the degrees of freedom ensures that level of confidence that T_{90} is below 90 percent of the fastener strengths, at each value of $x = \ln(t/D)$, is 95 percent when the ratio of the variability between t/D conditions to the variability within t/D condition is large, and it is consistent with a similar approach used in MIL-HDBK-17.

4) **Determine noncentrality parameter for T_{90}**

a) For $x = \ln(t/D)$ in the range being characterized, calculate $Q(x)$:

$$Q(x) = q_1 + 2q_2x + (2q_3 + q_4)x^2 + 2q_5x^3 + q_6x^4,$$

where q_1, q_2, \dots, q_6 are defined as sums of the $x_i = \ln(t/D)$ in 9.6.3.2 of the Guidelines. (With any regression, the further you move away from the bulk of the data, the more uncertain the estimates are. $Q(x)$ provides a measure of the “nearness” of x to the center of the data.)

b) Then calculate $R(x)$:

$$R(x) = \frac{H + \frac{1}{n_0}}{H + 1} Q(x).$$

5) **Finally, calculate T_{90} as in [9.5.6.1(f)]:**

$$T_{90} = a + bx + cx^2 - \left(t_{0.95, df, \frac{1.282}{\sqrt{R(x)}}} \right) \sqrt{R(x)} s_y,$$

where the term in parentheses is the 95th percentile of the noncentral t distribution with df degrees of freedom and noncentrality parameter $1.282/(R(x))^{1/2}$ (as in 9.5.6.1 of these Guidelines).

Examples of this analysis procedure applied to yield and ultimate fastener load test data are given in Figures 9.7.1.4(d) and (e), respectively. Note in Figure 9.7.1.4(d) that it is possible for the B-basis design curve to fall above a small percentage of the actual test results. Note also in Figure 9.7.1.4(e) that the shear cutoff value has been incorporated into the ultimate strength regression curve.

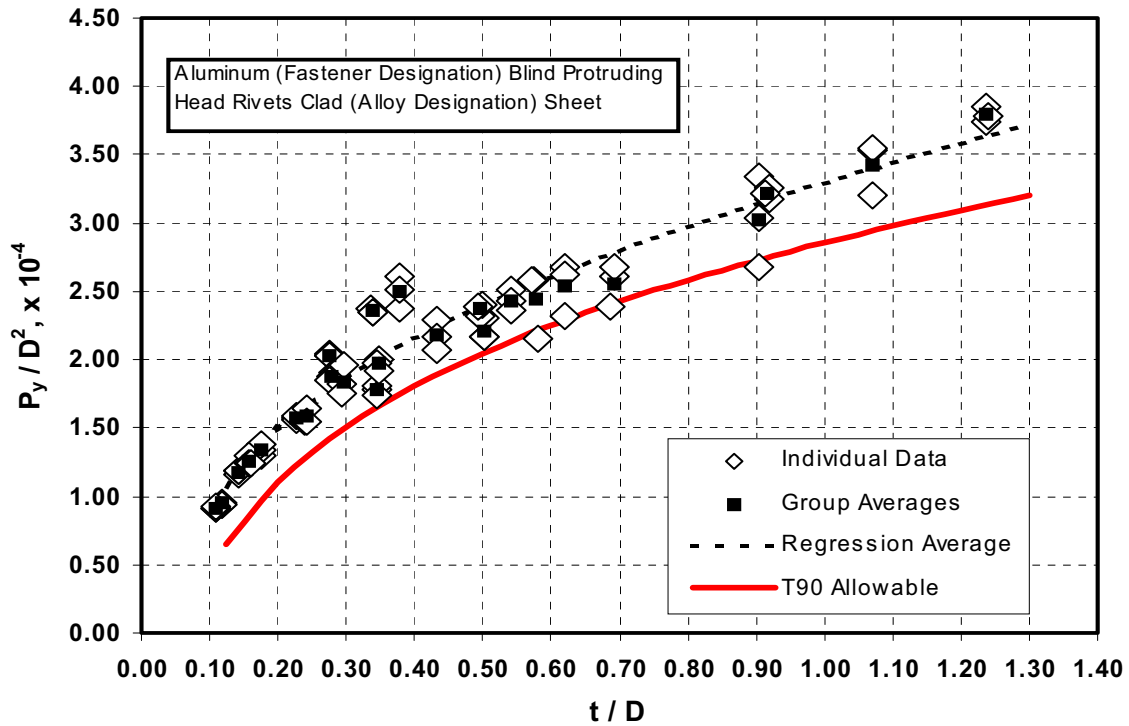

Figure 9.7.1.4(d) Example of Regression Analysis to Define B-Basis (T90) Fastener Yield Load Design Allowables

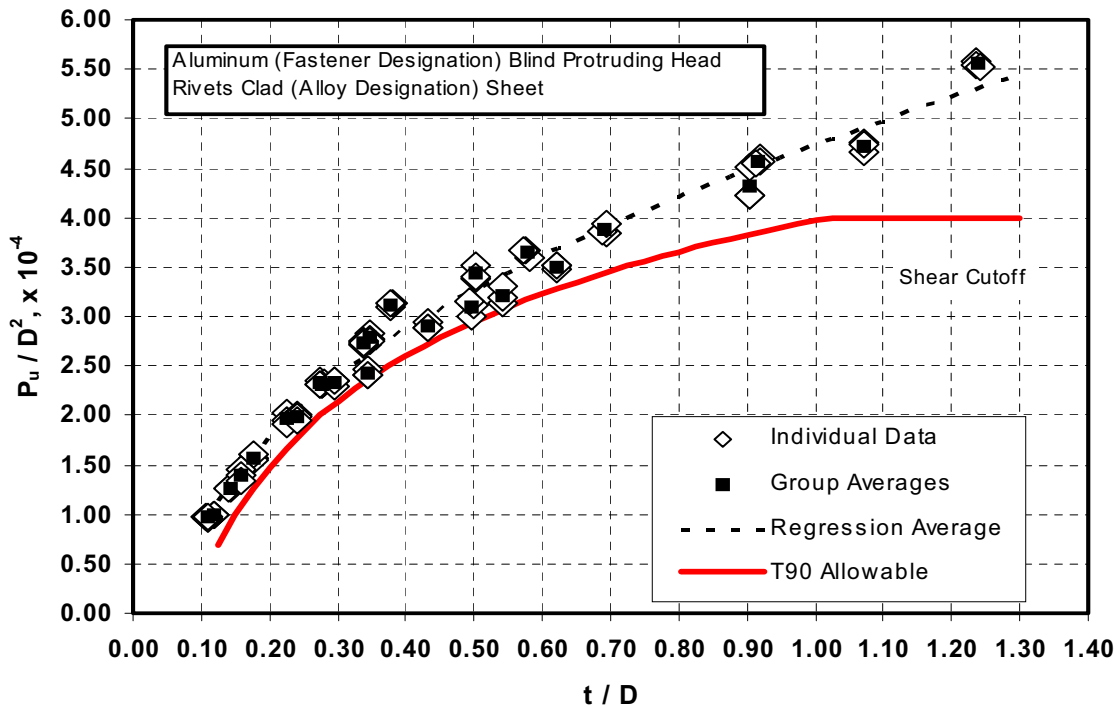

Figure 9.7.1.4(e) Example of Regression Analysis to Define B-Basis (T90) Fastener Ultimate Load Design Allowables

9.7.1.5 Calculation of Allowable Loads — Allowable yield and ultimate loads will be calculated for each thickness and diameter combination using the B-basis lower bound curves described above. Allowable loads will not be calculated for thickness/diameter combinations below the t/D range tested, or for diameters not tested.

In these calculations, thickness (per Section 9.9.5, Note 11), and diameters to be used will be the nominal shank diameter (per Section 9.7.1.1) for S-Type fasteners and recommended nominal hole diameters (per Section 9.7.1.1) for H-type fasteners. Figure 9.7.1.5 shows a suggested format for this set of calculations.

Computation of Allowables from Design Curves

D	D ²	t	t/D		P _y /10 ⁴ D ²	P _y	P _u /10 ⁴ D ²		P _u
---	----------------	---	-----	--	--	----------------	--	--	----------------

D, t, P_u, and P_y, as described in 9.7.1.4

Figure 9.7.1.5. Suggested tabular layout for computing allowables from design curves.

The analysis of joint allowable load data for the case where data are required for procuring or regulatory agency (not for use in MIL-HDBK-5) for a limited range of sheet thickness and fastener diameter is as follows. An analysis similar to that described in Section 9.7.1.4 is required for data over the limited t/D range evaluated. In the special case where one sheet thickness and one fastener diameter have been tested in accordance with the requirements of Section 9.7.1.3, data will be analyzed as follows: the ultimate-load calculations will be made utilizing the statistical formulas listed in Section 9.7.1.3, where the k value is obtained from Table 9.10.1 for the appropriate number of test values (n) and 90 percent probability (B) value at a 95% confidence level. These ultimate-load values will be compared with values computed from bearing ultimate strengths of the joint material. In each comparison, the lower of either (1) statistical value computed from joint test data, (2) computed B-basis ultimate value from regression analysis, (3) computed bearing ultimate strength, or (4) fastener shear ultimate strength, will be the ultimate-load design allowable.

Similarly, the yield-load values will be compared with values computed from bearing yield strengths of the joint material. These yield-load values will be compared with values computed from bearing yield strengths of the joint material. In each comparison, the lower of either (1) statistical value computed from joint test data, (2) computed B-basis yield value from regression analysis, (3) computed bearing yield strength, or (4) fastener shear yield strength, will be the yield-load design allowable.

The load values so calculated will be rounded to three or four significant figures as follows:

- (1) Load values less than 1000 will be rounded to 3 figures (load values less than 100, 2 figures).
- (2) Load values greater than 1000 will be rounded to 4 figures. The fourth figure will be a 0 or 5.

9.7.2 FUSION-WELDED JOINT DATA — The purpose of this section of the guidelines is to provide a uniform procedure by which reliable design data on welded joints can be developed for use within the aerospace industry. Unlike most other guidelines procedures, for which reasonably complete concurrence has been found among the users of MIL-HDBK-5, those relating to fusion-welding allowables are still subject to interpretation by users in view of their own welding processes. An additional consideration is that fusion-welding allowables are highly process-dependent. Design values will not be presented in MIL-HDBK-5 since their application will be limited to the process represented by data from which the allowables were derived.

Consequently, it is the purpose of these guidelines to describe one of possibly many valid procedures, without excluding other procedures that may be authorized for determination of fusion-welding allowables. Basis for this discussion is presented in Reference 9.7.2.

These guidelines generally reflect procedures currently used within the aerospace industry. They are applicable to all types of weldable materials and welding processes. However, recommended test coupon configurations and testing methods described herein have been limited to those used in evaluation of butt-type joints.

A distinction is made in properties of weldments between those applicable to design and those used for welding development and process control. These guidelines are concerned with those properties applicable to design.

The approach followed establishes coupon-derived design properties for weldments produced under known and defined conditions. Appropriate analysis must be conducted to adapt coupon-derived data to design of the structure being considered. This is accomplished by determining the state of stress for the component joint, and/or by relating structural hardware test results to coupon-derived design properties. This approach is consistent with techniques used to obtain design data for MIL-HDBK-5, as defined in other sections of these guidelines.

Current military welding specifications do not contain adequate requirements for defining a meaningful population of weldments. Due to this lack of applicable industry-wide specifications, the necessary specification information must be presented with coupon-derived weldment design data.

Throughout the guidelines and in preparation of data, definitions of the American Welding Society will be used for terms relating to welding. The definitions utilized in MIL-HDBK-5 and in other sections of these guidelines will be used for other terms relating to material properties and statistical treatment of data.

9.7.2.1 Data Collection and Interpretation — Determination and presentation of properties of weldments requires adequate definition of pertinent welding parameters, including a description of base materials, welding process variables, and weld character. The most significant variables considered are divided into three basic categories: base materials, welding process variables, and weld character (see Figure 9.7.2.1). Variables listed are the minimum that must be identified and required by the specification.

In summary, the primary concern of population definition for weldments is to describe welding conditions in a manner that will assure reproducibility of this same population and will be sufficiently detailed to allow proper data analysis.

9.7.2.1.1 Base Materials — Base material variables include appropriate stipulation of alloy, composition form, preweld and postweld heat treat conditions, filler material, and material thickness.

9.7.2.1.2 Welding Process Variables — The most difficult aspect is establishing welding variables. The variables must be sufficiently detailed to represent the population of weldments produced, as well as to assure reproducibility of welds within this population. Appropriate selection of variables to be stipulated must be based on an interpretation of their effect on weldment properties and desirability of control.

<u>BASE MATERIAL</u>			
Alloy, Composition, Form, Pre- and Post-Weld Heat Treat Condition, Material Thickness, Filler Material			
<u>WELDING PROCESS VARIABLES</u>			
<u>Joint Preparation</u>	<u>Tooling</u>	<u>Welding Conditions</u>	<u>Weld Repair</u>
Joint Type	Alignment	Welding Process	Number of Repairs
Edge Preparation	Restraint	Welding Method	Type of Repair
Cleaning	Thermal Control	Welding Position	
		Heat Input (Weld Setting)	
		Preheat	
		Interpress Temperature	
		Shielding Gas	
<u>WELD CHARACTER</u>			
<u>Inspection Methods</u>		<u>Acceptance Levels</u>	
NDT		External	
Visual		Underfill and Undercut	
Radiographic		Cracks	
Magnetic Particle		Pores	
Ultrasonic		Reinforcements	
DT		Internal	
Transverse Tensile Test		Pores	
		Inclusions	
		Cracks	
		Tensile Properties	
		Minimum and Minimum Average	

Figure 9.7.2.1. Summary of population definition considerations.

Using the variable of thermal control tooling as an example, it may be found that various types of tooling influence tensile properties of a weld joint by their effect on cooling rate. However, the difficulty in adequately describing thermal-control tooling for more than a single application makes it desirable to treat tooling as a random and uncontrolled variable. This same judgment of effect on properties and desirability of control must be made for each welding process variable.

9.7.2.1.3 Weld Character — Appropriate levels of weld character must be prescribed in order to define a population of weldments. This includes a description of internal and external quality levels, as well as minimum joint strength requirements. In most specifications there are several weld classes which identify in detail the quality level requirements. In addition, means of determining weldment characteristics are established by stipulation of both nondestructive and destructive test methods.

9.7.2.2 Data Analysis — Some concepts used for base-metal analyses lend themselves to analysis techniques for weldments. The procedures described in other sections of the guidelines may be used as a basis for analysis of mechanical property data for weldments in order to obtain A- and B-values. The procedures involve either direct statistical analysis of weldment data when sufficient data exist, or an indirect statistical analysis of ratios of paired properties.

The data samples required for direct statistical analysis will usually limit its use to tensile ultimate strength of weldment coupons. The indirect analysis may be used to derive other properties of interest using smaller samples. One example is to derive the minimum shear strength for the cases where only tensile distribution is known; one would operate on the ratio SUS/TUS in this case.

The indirect computation method also provides a tool for rational development of weld factors to be used in translating coupon-derived minimum properties to hardware design. In this case, ratio of hardware failure stress to control coupon failure stress is used.

9.8 EXAMPLES OF DATA ANALYSIS AND DATA PRESENTATION FOR STATIC PROPERTIES

Proposals presented to the MIL-HDBK-5 Coordination Group should include (1) new or revised table of room-temperature allowables, (2) raw data used in the analysis, and (3) supporting analysis for the proposed design values.

9.8.1 DIRECT ANALYSES OF MECHANICAL PROPERTIES — Computational procedures described in earlier sections are demonstrated here. Several hypothetical sets of input data were created for these example problems. These datasets were created to represent quality assurance test data, representing one long transverse tensile test per lot, plus other tests from a portion of the lots, at a frequency of one test per lot.

The example problems fall into two major categories. Problems I through VII illustrate techniques based on an underlying normal distribution. Problems VIII through XII illustrate techniques based on an underlying three-parameter Weibull distribution.

The input data for these example problems are described below. Because entire data sets (as opposed to means and standard deviations) are required for Problems VIII through XII, the data points for groups (1) through (4) and group (6) are listed in Tables 9.8.1(a) through (c).

INFORMATION FOR EXAMPLE PROBLEMS

Material Identification: Alloy X sheet, annealed.

Specified Testing Direction: Long Transverse (LT)

Specified Properties:

≤ 0.125 inch — F_{tu} (LT) = 140 ksi, F_{ty} (LT) = 115 ksi;

0.126-0.249 inch — F_{tu} (LT) = 135 ksi, F_{ty} (LT) = 110 ksi.

Available Test Results:

Group (1). 300 observations of TUS(LT) for thickness range 0.020-0.125 inch from Supplier A; no variation with thickness. Go to Problems I, III, VIII, and X.

Group (2). 300 observations of TYS(LT) for thickness range 0.020-0.125 inch from Supplier A; no variation with thickness. Go to Problems II and IX.

Group (3). 30 observations of TUS(LT) for thickness range 0.020-0.125 inch from Supplier B; no variation with thickness. Go to Problems I and VIII.

Group (4). 30 observations of TYS(LT) for thickness range 0.020-0.125 inch from Supplier B; no variation with thickness. Go to Problems II and IX.

Group (5). 100 observations of TUS(LT) for thickness range 0.126-0.249 inch; no variation with thickness. Go to Problems III and X.

Group (6). 30 observations of SUS(LT) for thickness range 0.020-0.249 inch; apparent decrease in SUS(LT) on increasing thickness; observations may be paired with TUS(LT) if desired. Go to Problem VII.

MIL-HDBK-5J
31 January 2003

Table 9.8.1(a). Group (1) Data Set

Group (1)				
139.608	146.534	147.442	151.229	153.792
140.638	146.651	147.489	151.234	153.844
140.711	146.667	147.497	151.283	153.846
140.988	146.699	147.653	151.323	153.855
141.873	146.710	147.752	151.388	153.914
141.940	146.714	147.765	151.425	153.992
142.105	146.766	147.785	151.428	154.021
142.478	146.825	147.803	151.433	154.064
142.597	146.857	147.911	151.471	154.068
142.694	146.876	147.942	151.557	154.077
143.309	146.941	147.952	151.599	154.110
143.502	146.944	147.961	151.609	154.128
143.620	146.970	147.980	151.628	154.149
143.644	147.087	148.001	151.641	154.219
143.674	147.198	148.012	151.670	154.242
143.720	147.284	148.029	151.785	154.297
143.844	147.291	148.038	151.837	154.359
143.865	147.326	148.048	151.876	154.382
143.867	147.334	148.049	151.962	154.508
143.997	147.353	148.051	151.992	154.541
144.221	148.686	148.059	152.015	154.571
144.320	148.691	148.074	152.037	154.781
144.463	148.695	148.091	152.081	154.858
144.508	148.701	148.118	152.101	155.012
144.612	148.714	148.122	152.143	155.077
144.651	148.724	148.197	152.150	155.102
144.837	148.854	148.201	152.151	155.116
144.864	148.868	148.236	152.157	155.231
144.890	148.884	148.267	152.199	155.267
144.973	148.891	148.292	152.207	155.311
145.076	148.919	148.304	152.270	155.336
145.110	148.952	148.334	152.332	155.359
145.122	148.957	148.339	152.352	155.386
145.165	148.982	148.355	152.448	155.422
145.214	149.016	148.368	152.656	155.469
145.229	149.045	148.567	152.736	155.604
145.270	149.103	148.584	152.802	155.627
145.277	149.107	148.620	152.840	155.641
145.325	149.158	148.678	152.882	155.785
145.399	149.180	148.684	152.907	155.823
145.416	149.183	150.194	152.920	155.863
145.577	149.187	150.310	152.929	155.904
145.600	149.321	150.315	153.007	156.078
145.693	149.416	150.340	153.029	156.088
145.709	149.473	150.377	153.049	156.379
145.721	149.571	150.415	153.102	156.616
145.741	149.581	150.423	153.118	156.716
145.872	149.605	150.427	153.206	156.740
145.921	149.605	150.459	153.279	156.924
145.925	149.606	150.579	153.286	157.053
145.966	149.653	150.722	153.296	157.341
145.978	149.707	150.731	153.298	157.357
146.069	149.731	150.739	153.478	157.614
146.136	149.755	150.773	153.504	157.763
146.220	149.798	150.830	153.543	157.980
146.285	149.810	151.019	153.576	158.021
146.301	149.812	151.042	153.648	158.154
146.367	149.894	151.075	153.695	158.518
146.479	149.996	151.111	153.707	159.377
146.500	150.124	151.211	153.715	162.717

MIL-HDBK-5J
31 January 2003

Table 9.8.1(b). Group (2) Data Set

Group (2)				
121.438	126.276	128.823	131.254	133.841
121.614	126.342	128.846	131.325	133.843
121.757	126.388	128.868	131.388	133.893
122.077	126.430	128.966	131.439	133.898
122.109	126.449	128.983	131.444	133.912
122.494	126.535	128.989	131.469	133.922
122.503	126.606	129.029	131.477	133.934
122.543	126.665	129.035	131.677	133.948
122.632	126.668	129.052	131.690	134.089
123.082	126.673	129.083	131.731	134.134
123.101	126.696	129.117	131.754	134.179
123.193	126.727	129.136	131.786	134.194
123.238	126.822	129.148	131.808	134.249
123.296	126.863	129.321	131.816	134.339
123.474	126.877	129.413	131.906	134.351
123.527	126.907	129.434	131.975	134.361
123.616	126.919	129.546	131.977	134.689
123.694	126.972	129.560	132.138	134.747
123.755	126.999	129.596	132.189	134.776
123.770	127.114	129.654	132.223	134.779
123.825	127.140	129.709	132.282	134.873
124.025	127.203	129.715	132.286	134.874
124.055	127.300	129.784	132.296	134.883
124.083	127.322	129.788	132.380	134.890
124.105	127.337	129.891	132.393	134.969
124.121	127.383	129.899	132.436	135.027
124.171	127.387	129.938	132.470	135.064
124.176	127.420	129.940	132.482	135.191
124.223	127.474	130.007	132.511	135.499
124.373	127.579	130.020	132.514	135.513
124.681	127.607	130.070	132.558	135.518
124.691	127.677	130.206	132.564	135.532
124.718	127.695	130.225	132.595	135.545
124.778	127.710	130.237	132.703	135.661
124.793	127.741	130.351	132.718	135.754
124.920	127.761	130.427	132.762	135.836
124.934	127.811	130.457	132.805	135.920
125.000	127.841	130.499	132.849	135.921
125.018	127.859	130.526	132.851	135.944
125.070	127.859	130.528	132.869	136.027
125.070	127.889	130.586	132.952	136.030
125.150	127.946	130.599	133.024	136.032
125.152	128.010	130.624	133.031	136.050
125.247	128.016	130.684	133.049	136.112
125.279	128.153	130.710	133.096	136.149
125.295	128.203	130.765	133.159	136.154
125.350	128.288	130.772	133.166	136.160
125.370	128.309	130.797	133.224	136.204
125.433	128.323	130.895	133.438	136.217
125.531	128.332	131.003	133.441	136.348
125.535	128.341	131.008	133.508	136.855
125.714	128.452	131.040	133.581	136.883
125.717	128.640	131.103	133.592	137.087
125.801	128.672	131.104	133.595	137.115
125.915	128.699	131.125	133.622	137.163
126.083	128.719	131.158	133.683	137.484
126.128	128.723	131.175	133.749	137.618
126.129	128.752	131.176	133.763	137.653
126.194	128.795	131.192	133.768	138.335
126.276	128.819	131.195	133.774	139.141

MIL-HDBK-5J
31 January 2003

Table 9.8.1(c). Groups (3), (4), and (5) Data Sets

<u>Group (3)</u>	<u>Group (4)</u>	<u>Group (5)</u>	
141.914	120.487	135.373	145.061
143.980	122.271	135.500	145.072
145.110	124.167	135.775	145.082
145.681	124.622	136.450	145.082
145.829	124.672	137.114	145.331
145.919	125.280	137.241	145.460
145.981	125.862	137.900	145.606
148.412	126.332	138.916	145.626
148.694	128.860	139.158	145.754
148.772	129.158	139.307	145.785
148.831	129.179	139.626	145.802
148.965	130.238	139.827	145.876
149.197	130.782	139.839	146.091
149.761	130.985	140.022	146.096
150.150	131.612	140.461	146.159
151.472	131.642	140.957	146.302
151.746	132.129	141.083	146.303
152.089	132.147	141.149	146.447
152.564	132.812	141.435	146.797
152.737	133.388	141.473	146.937
152.798	133.716	141.518	146.967
153.857	134.127	141.582	147.149
153.930	135.787	141.592	147.224
154.012	135.836	141.731	147.305
154.024	136.235	141.937	147.500
154.153	136.770	142.125	147.657
155.637	137.068	142.138	147.675
157.118	137.901	142.298	147.833
162.241	137.919	142.441	148.084
164.426	138.017	142.785	148.556
		142.838	148.708
		142.859	148.954
		143.141	148.988
		143.180	149.082
		143.397	149.123
		143.426	149.590
		143.444	149.831
		143.558	149.974
		143.722	150.325
		143.886	151.484
		144.200	151.523
		144.276	151.605
		144.313	152.086
		144.418	152.467
		144.465	152.646
		144.650	152.852
		144.672	153.164
		144.847	153.675
		144.901	155.492
		144.924	157.944

**EXAMPLE PROBLEMS BASED ON AN
ASSUMED UNDERLYING NORMAL DISTRIBUTION***

PROBLEM I

Should the data in Groups (1) and (3) be combined?

Other Information: Neither property varies with thickness. Sample statistics are:

Subpopulation	n	\bar{X} , ksi	s, ksi
Group (1) TUS (LT), 0.020 to 0.125	300	150.0	4.00
Group (3) TUS (LT), 0.020 to 0.125	30	151.0	5.00

Prob. I—Step 1. Test to determine whether the variances differ significantly (refer to Section 9.5.3.2):

$$F = (s_1)^2/(s_3)^2 = (4.00)^2/(5.00)^2 = 0.64$$

Degrees of freedom, numerator = $n_1 - 1 = 300 - 1 = 299$.

Degrees of freedom, denominator = $n_3 - 1 = 30 - 1 = 29$.

$$F_{0.975}(299,29df) \text{ from Table 9.10.3} = 1.87 \text{ (approximately)}$$

$$1/F_{0.975}(29,299df) = 1/1.69 = 0.59$$

Since the computed value of F(0.64) lies within the 0.95 confidence interval (0.59 to 1.87), conclude the variances do not differ significantly.

Prob. I—Step 2. Test to determine whether the averages differ significantly (refer to Section 9.5.3.3):

Difference between averages $D_{\bar{X}} = 150.0 - 151.0 = 1.0$ ksi

$$u = t_{0.975} S_p \sqrt{\frac{n_1 + n_3}{n_1 n_3}}$$

Degrees of freedom = $n_1 + n_3 - 2 = 300 + 30 - 2 = 328$

$t_{0.975}(328 \text{ df})$ from Table 9.10.4 = 1.969

$$S_p = \sqrt{\frac{(n_1 - 2) s_1^2 + (n_3 - 1) s_2^2}{n_1 + n_3 - 2}} = \sqrt{\frac{(300 - 1)(4.00)^2 + (30 - 1)(5.00)^2}{300 + 30 - 2}} = 4.10 \text{ ksi}$$

* The statistical tests described in Problems I through III apply specifically to the case where normality can be assumed. The more general Anderson-Darling procedure described in Problem IV can be applied to normal as well as nonnormal distributions.

MIL-HDBK-5J
31 January 2003

$$u = 1.969 \times 4.10 \times \sqrt{\frac{n_1 + n_3}{n_1 n_3}} = 1.969 \times 4.10 \times \sqrt{\frac{300 + 30}{300 \times 30}} = 1.54 \text{ ksi}$$

Since the observed difference between the averages, \bar{X} (1.0 ksi), is less than u (1.54 ksi), conclude the averages do not differ significantly.

Prob. I—Step 3. Since there is no reason to conclude that the subpopulations represented by Groups (1) and (3) do not belong to the same population, combine these groups.

Subpopulation	n	\bar{X} , ksi	s, ksi
Group (1& 3) TUS (LT), 0.020-0.125, Suppliers A and B	330	150.1	4.10

Go to Problem IV.

PROBLEM II

Should the data in Groups (2) and (4) be combined?

Other Information: Neither property varies with thickness. Sample statistics are:

Subpopulation	n	\bar{X} , ksi	s, ksi
Group (2) TYS (LT), 0.020-0.125, Supplier A	300	130.0	4.00
Group (4) TYS (LT), 0.020-0.125, Supplier B	30	131.0	5.00

The steps involved in this problem are identical to those in Problem I and similar conclusions were obtained from the input, namely, that Groups (2) and (4) should be combined. The sample statistics for the combined groups are:

Subpopulation	n	\bar{X} , ksi	s, ksi
Group (2& 4) TYS (LT), 0.020-0.125, Suppliers A and B	330	130.1	4.10

Go to Problem V.

PROBLEM III

Should the data in Groups (1) and (5) be combined?

Other Information: Neither property varies with thickness. Sample statistics are:

Subpopulation	n	\bar{X} , ksi	s, ksi
Group (1) TUS (LT), 0.020-0.125	300	150.0	4.00
Group (5) TUS (LT), 0.126-0.249	100	145.0	4.47

Prob. III—Step 1. Test to determine whether the variances differ significantly.

$$F = (s_1)^2/(s_5)^2 = (4.00)^2/(4.47)^2 = 0.80$$

Degrees of freedom, numerator = $n_1 - 1 = 300 - 1 = 299$.

Degrees of freedom, denominator = $n_5 - 1 = 100 - 1 = 99$.

$F_{0.975}(299,99df)$ from Table 9.10.3 = 1.46 (approximately)

$$1/F_{0.975}(99,299df) = 1/1.43 = 0.700.$$

Since the computed value of F (0.80) lies within the 0.95 confidence interval (0.700 to 1.46), conclude that the variances do not differ significantly.

Prob. III—Step 2. Test to determine whether the averages differ significantly.

Difference between averages, $D_{\bar{X}} = (150.0 - 145.0) = 5.0$ ksi

$$u = t_{0.975} S_p \sqrt{\frac{n_1 + n_5}{n_1 n_5}}$$

Degrees of freedom = $n_1 + n_5 - 2 = 300 + 100 - 2 = 398$.

$t_{0.975}(398 \text{ df})$ from Table 9.10.4 = 1.968.

$$S_p = \sqrt{\frac{(n_1 - 1)s_1^2 + (n_5 - 1)s_5^2}{n_1 + n_5 - 2}} = \sqrt{\frac{(300 - 1)(4.00)^2 + (100 - 1)(4.47)^2}{300 + 100 - 2}} = 4.20 \text{ ksi}$$

$$u = (1.968)(4.20) \sqrt{\frac{n_1 + n_5}{n_1 n_5}} = (1.968)(4.20) \sqrt{\frac{300 + 100}{(300)(100)}} = 0.95 \text{ ksi}$$

Since the observed difference between the averages $D_{\bar{X}}$ (5.0 ksi) is greater than u (0.95 ksi), conclude that the averages differ significantly and that the subpopulations represented by Groups (1) and (5) do not belong to the same population.

Prob. III—Step 3. Do not combine the sample statistics for these groups.

Go to Problem VI.

PROBLEM IV

What computational method should be used for the combined observations of Groups (1) and (3)?

Other Information: This property does not vary with thickness. Sample statistics for the combined observations are:

Population	n	\bar{X} , ksi	s, ksi
Group (1 & 3) TUS (LT), 0.020-0.125	330	150.1	4.10

Form of the distribution has not been determined.

The sample is large enough to permit direct computation of A and B values by any of the three available methods. Consequently, all three computational methods will be attempted: sequential Weibull, sequential Pearson, and nonparametric.

Prob. IV—Step 1. Test to determine whether the distribution is Weibull. The Anderson-Darling test for Weibullness will be employed in this example. Use the formula:

$$Z_{(i)} = (X_{(i)} - 150.1)/4.10,$$

the values of $Z_{(1)}, \dots, Z_{(330)}$ must be calculated. The first three values are $Z_{(1)} = -2.56$, $Z_{(3)} = -2.31$, and $Z_{(3)} = -2.29$. Now $F_0(Z_{(1)}), \dots, F_0(Z_{(330)})$ must be calculated by finding the area under the standard normal curve to the left of each Z value. The first three values are $F_0(Z_{(1)}) = 0.0052$, $F_0(Z_{(2)}) = 0.0104$, and $F_0(Z_{(3)}) = 0.0110$.

The Anderson-Darling test statistic is then calculated as

$$AD = \left[\sum_{i=1}^{330} \frac{1 - 2i}{330} [\ln(F_0(Z_{(i)})) + \ln(1 - F_0(Z_{(331-i)}))] \right] - 330 = 0.693.$$

The computed value of the test statistic is then compared to the critical value

$$0.750 = 0.752/[1 + 0.75/330 + 2.25/(330)^2]$$

Since the computed value of 0.693 is less than the critical value of 0.750, the hypothesis of normality is not rejected.

Prob. IV—Step 2. Compute F_m (LT), 0.020 to 0.125, for Alloy X, using procedures for the normal distribution.

Population	n	\bar{X} , ksi	s, ksi
Group (1 & 3) TUS (LT), 0.020 to 0.125	330	150.1	4.10

$$k_A = 2.512$$

$$k_B = 1.410$$

$$F_m(\text{LT}), \text{ A basis} = X - k_A s = 150.1 - 2.512 \times 4.10 = 139.8 \text{ or } 140 \text{ ksi (rounded per Section 9.5.4.1)}$$

$$F_m(\text{LT}), \text{ B basis} = X - k_B s = 150.1 - 1.410 \times 4.10 = 144.3 \text{ or } 144 \text{ ksi (rounded per Section 9.5.4.1)}$$

PROBLEM V

What computational method should be used for the combined observations of Groups (2) and (4)?

Other Information: This property does not vary with thickness. Sample statistics for the combined observations are:

Population	n	\bar{X} , ksi	s, ksi
Group (2 & 4) TYS(LT), 0.20 to 0.125	330	130.1	4.10

Form of the distribution has not been determined.

The sample is large enough to permit direct computation of A and B-values. Consequently, the computational method to be used will be determined by whether or not the observations are normally distributed.

Prob. V—Step 1. Test to determine whether or not the distribution is normal. The value of the Anderson-Darling test statistic for normality is 1.315 for Group (2 & 4). Since 1.315 is greater than the critical value of 0.750, the underlying distribution cannot be assumed to be normal. Thus, the underlying distribution will be treated as a three-parameter Weibull or an unknown distributional form.

Prob. V—Step 2. Compute $F_{Ty}(LT)$, 0.020-0.125, using procedures for the unknown distribution. This procedure requires the ranking of observations from lowest to highest. Referring to Table 9.10.9, it is found that for a sample size of 330, the lowest observation (rank = 1) is an A-value and the 24th lowest (rank = 24) is a B-value. The 24 lowest observations are shown below:

Rank	TYS, ksi	Rank	TYS, ksi	Rank	TYS, ksi
1	120.5	9	122.5	17	123.5
2	121.4	10	122.5	18	123.5
3	121.6	11	122.6	19	123.6
4	121.8	12	123.1	20	123.7
5	122.1	13	123.1	21	123.8
6	122.1	14	123.2	22	123.8
7	122.3	15	123.2	23	123.8
8	122.5	16	123.3	24	124.0

Consequently, from these data the following allowables have been computed for Alloy X:

$$F_{Ty}(LT), \text{ A-basis} = 120.5 \text{ ksi.}$$

$$F_{Ty}(LT), \text{ B-basis} = 124.0 \text{ ksi.}$$

PROBLEM VI

What computational procedure should be used for the observations in Group (5)? The data in Group (5) represent a borderline situation. They cannot be combined with data for lesser thicknesses because there is significant difference between the TUS(LT) averages for the two thickness ranges, as shown in Problem III. The sample size is just barely adequate for direct computation if the distribution is found to be normal. If the distribution is not normal, the properties for this product would be presented on an S-basis, pending the accumulation of more data. The test for normality would be conducted as described in Problem IV, and will not be illustrated here.

**EXAMPLE PROBLEMS BASED ON AN ASSUMED UNDERLYING
THREE-PARAMETER WEIBULL DISTRIBUTION**

PROBLEM VII

Should the data in Groups (1) and (3) be combined?

Other Information. Neither property varies with thickness. (Refer to Sections 9.5.1 and 9.5.3.)

The k-sample Anderson-Darling test will be employed in this example to determine whether or not the data in Groups (1) and (2) should be combined. There are 328 distinct values in the combined data from both groups and these are ordered from least to greatest to obtain $Z_{(1)}, \dots, Z_{(328)}$. All values of h_j are equal to 1 except for $h_{34} = 2$ and $h_{160} = 2$. Taking Group (2) to be the first (A_1)-sample and Group (1) to be the second (A_2)-sample, the first 24 Z-values are listed in the table below with the corresponding H- and F-values.

Z_j	H_j	F_{ij}	Z_j	H_j	F_{ij}	Z_j	H_j	F_{ij}
139.61	0.5	0	142.48	8.5	1	143.72	16.5	1
140.64	1.5	0	142.60	9.5	1	143.84	17.5	1
140.71	2.5	0	142.69	10.5	1	143.86	18.5	1
140.99	3.5	0	143.31	11.5	1	143.87	19.5	1
141.87	4.5	0	143.50	12.5	1	143.98	20.5	1.5
141.91	5.5	0.5	143.62	13.5	1	144.00	21.5	2
141.94	6.5	1	143.64	14.5	1	144.22	22.5	2
142.10	7.5	1	143.67	15.5	1	144.32	23.5	2

The k-sample Anderson-Darling test statistic is calculated as

$$ADK = \frac{1}{330(1)} \left[\frac{1}{300} \sum_{j=1}^{328} h_j \frac{(330F_{1j} - 300H_j)^2}{H_j(330 - H_j) - 330h_j/4} + \frac{1}{30} \sum_{j=1}^{328} h_j \frac{(330 F_{2j} - 30H_j)^2}{H_j(330 - H_j) - 330h_j/4} \right] = 0.821$$

The computed value of the test statistic is compared to the critical value of

$$2.488 = 1 + 0.759 \left(1.645 + \frac{0.678}{\sqrt{1}} - \frac{0.362}{1} \right) .$$

Since the computed value of 0.821 is less than the critical value of 2.488, the hypothesis that the populations from which these groups were drawn are identical is not rejected. Thus Groups (1) and (3) will be combined for the computation of allowables.

Go to Problem X.

PROBLEM VIII

Should the data in Groups (2) and (4) be combined?

Other Information: Neither property varies with thickness.

The value of the k-sample Anderson-Darling test statistic for Groups (2) and (4) is 2.147. Since 2.147 is less than the critical value of 2.488, the hypothesis that the populations from which these groups were drawn are identical is not rejected. Thus, Groups (2) and (4) will be combined for the computation of allowables.

Go to Problem XI.

PROBLEM IX

Should the data in Groups (1) and (5) be combined?

Other Information: Neither property varies with thickness.

The k-sample Anderson-Darling test will be employed in this example. Taking Group (5) to be the first sample (A_1) and Group (1) to be the second sample (A_2), the k-sample Anderson-Darling test statistic is calculated as:

$$ADK = \frac{1}{400(1)} \left[\frac{1}{100} \sum_{j=1}^{398} h_j \frac{(400 F_{1j} - 100 H_j)^2}{H_j(400 - H_j) 400 h_j/4} + \frac{1}{300} \sum_{j=1}^{398} h_j \frac{(400 F_{2j} - 300 H_j)^2}{H_j (400 - H_j) - 400 h_j/4} \right] = 44.195$$

Since the computed value of 44.195 is greater than the critical value of

$$2.486 = 1 + 0.758 \left(1.645 + \frac{0.678}{\sqrt{1}} - \frac{0.362}{1} \right) ,$$

the hypothesis that the populations from which these groups are drawn are identical is rejected. Thus Groups (1) and (5) will not be combined for the calculation allowables.

PROBLEM X

What computational method should be used for the combined observations of Groups (1) and (3)?

Other Information: This property does not vary with thickness.

Form of the distribution has not been determined.

The sample is large enough to permit direct computation of A and B-values. Consequently, the computational method will be determined by whether or not the observations may be assumed to follow a three-parameter Weibull distribution.

MIL-HDBK-5J
31 January 2003

Prob. X—Step 1. Test to determine whether the distribution is a three-parameter Weibull distribution. The Anderson-Darling test for three-parameter Weibullness will be employed in this example. Preliminary calculations give

$$\begin{array}{ll} K = 88 & W_{50} = 0.665 \\ \bar{X} = 150.1 & S = 4.10 \\ X_{(1)} = 139.608 & H = 139.6079 \\ L = -259.9 & \end{array}$$

$$R(\tau) = \frac{\sum_{i=89}^{262} L_i(\tau)}{\sum_{i=1}^{262} L_i(\tau)} \quad .$$

It can be verified that $R(-259.9) > 0.665$ and $R(139.6079) < 0.665$. Solving the equation $R(\tau) = 0.665$ with the initial interval $(-259.9, 139.6079)$ gives $\tau_{50} = 138.70$. The function $G_{50}(\beta_{50})$ then becomes

$$G_{50}(\beta_{50}) = \frac{1}{330} \sum_{i=1}^{330} \ln(X_i - 138.70) \left[\left(\frac{X_i - 138.70}{\alpha_{50}} \right)^{\beta_{50}} - 1 \right] - \frac{1}{\beta_{50}}$$

where

$$\alpha_{50} = 10.53 \left[\frac{1}{330} \sum_{i=1}^{330} \left(\frac{X_i - 138.70}{10.53} \right)^{\beta_{50}} \right]^{1/\beta_{50}}$$

Solving the equation $G_{50}(\beta_{50}) = 0$ gives $\beta_{50} = 3.02$ which in turn gives $\alpha_{50} = 12.75$.

The values of $Z_{(1)}, \dots, Z_{(330)}$ are obtained using the formula

$$Z_i = \left(\frac{X_{(i)} - 138.70}{12.75} \right)^{3.02} \quad .$$

The first three Z -values are $Z_{(1)} = 0.000345$, $Z_{(2)} = 0.00339$, and $Z_{(3)} = 0.00378$. The Anderson-Darling test statistic is calculated as

$$AD = \sum_{i=1}^{330} \frac{1 - 2i}{330} \left[\ln(1 - \exp(-Z_{(i)})) + \ln(\exp(-Z_{(331-i)})) \right] - 330 = 0.491 \quad .$$

The computed value of the test statistic is compared to the critical value

$$0.749 = 0.757 / (1 + 1/5\sqrt{330}) \quad .$$

Since the computed value of 0.491 is less than the critical value of 0.749, the hypothesis that the observations follow a three-parameter Weibull distribution is not rejected.

MIL-HDBK-5J
31 January 2003

Prob. X—Step 2. Compute F_{tu} (LT), 0.020-0.125, for Alloy X, using procedures for the three-parameter Weibull distribution. Preliminary calculations give

K = 88	$W_A = 0.698$
$W_\beta = 0.678$	$\bar{X} = 150.1$
S = 4.10	$X_{(1)} = 139.608$
H = 139.6079	L = -259.9

$$R(\tau) = \sum_{i=89}^{262} L_i(\tau) / \sum_{i=1}^{262} L_i(\tau)$$

Solving the equation $R(\tau) = 0.698$ with the interval (-259.9, 139.6079) gives $\tau_A = 136.43$. Solving $R(\tau) = 0.678$ gives $\tau_B = 137.98$.

Solving the equation $G_A(\beta_A) = 0$ gives $\beta_A = 3.63$ which in turn gives $\alpha_A = 15.14$. Solving the equation $G_B(\beta_B) = 0$ gives $\beta_B = 3.22$ which in turn gives $\alpha_B = 13.52$.

Using the formulas from Section 9.5.2.2 the allowables are calculated as follows:

$$Q_A = 15.14 (0.01005)^{1/3.63} = 4.263$$

$$Q_B = 13.52 (0.10536)^{1/3.22} = 6.719$$

$$A = 136.43 + 4.263 \exp(-7.259/3.63 \sqrt{330}) = 140.2$$

$$B = 137.98 + 6.716 \exp(-4.103/3.22 \sqrt{330}) = 144.2$$

PROBLEM XI

What computational method should be used for the combined observations of Groups (2) and (4)?

Other Information: This property does not vary with thickness.

Form of the distribution has not been determined.

The sample is large enough to permit direct computation of A and B values. Consequently, the computational method will be determined by whether or not the observations may be assumed to follow a three-parameter Weibull distribution.

Prob. XI—Step 1. Test to determine whether the distribution is a three-parameter Weibull distribution. The Anderson-Darling test for three-parameter Weibullness will be employed in this example. Preliminary calculations give

K = 88	$\bar{X} = 130.1$
$W_{50} = 0.665$	$X_{(1)} = 120.487$
S = 4.10	H = 120.4869
L = -279.9	

$$R(\tau) = \sum_{i=89}^{262} L_i(\tau) / \sum_{i=1}^{262} L_i(\tau)$$

Solving the equation $R(\tau) = 0.665$ with initial interval (-279.9, 120.4869) gives $\tau_{50} = 119.58$. Solving the equation $G_{50}(\beta_{50}) = 0$ gives $\beta_{50} = 2.84$ which in turn gives $\alpha_{50} = 11.81$.

The values $Z_{(1)}, \dots, Z_{(330)}$ are obtained using these estimates. The value of the Anderson-Darling test statistic is 1.392. Since the computed value of 1.392 is greater than the critical value of 0.749, the hypothesis that the observations follow a three-parameter Weibull distribution is rejected.

Prob. XI—Step 2. Compute $F_y(LT)$, 0.020 to 0.125, using procedures for an unknown distribution. This computation has been carried out in Problem V, Step 2.

9.8.2 INDIRECT ANALYSES OF MECHANICAL PROPERTIES

PROBLEM XII

What computational procedure should be used for the observations in Group (6)?

Other Information: SUS(LT) decreases with increasing thickness, while TUS(LT) does not vary with thickness. Sample statistics are:

Population	n	\bar{X} , ksi	s, ksi
Group (6) SUS(LT), 0.020 to 0.249	30	not determined	

The sample size for these data is too small to permit direct computation. Thus, the procedure that should be used is indirect computation by pairing observations of SUS(LT) with observations of TUS(LT). Also, since a thickness effect was suspected in the original data, a regression against thickness should be made and checked for significance.

Prob. XII—Step 1. Pair SUS(LT) with TUS(LT).

Ratios of SUS(LT)/TUS(LT) are as follows:

SUS(LT)/ TUS(LT)	Thickness, inch	SUS(LT)/ TUS(LT)	Thickness, inch
0.700	0.020	0.640	0.090
0.680	0.020	0.650	0.090
0.660	0.020	0.660	0.090
0.660	0.030	0.630	0.100
0.670	0.030	0.650	0.100
0.680	0.030	0.670	0.100
0.650	0.040	0.640	0.150
0.670	0.040	0.630	0.150
0.690	0.040	0.620	0.150
0.650	0.060	0.610	0.180
0.660	0.060	0.630	0.180
0.670	0.060	0.650	0.180
0.640	0.070	0.600	0.240
0.660	0.070	0.610	0.240
0.680	0.070	0.620	0.240

Prob. XII—Step 2. Determine regression equation in the form $[SUS(LT)/TUS(LT)]' = r' = a + bx$, where $x = \text{thickness}$, using least-squares techniques. (Note—in this example, the letter r , rather than y , is used to denote the dependent variable and the prime (') is used to indicate that the ratio is determined by regression.) The following sums were obtained from analysis of the ratios plotted in Figure 9.8.1.2.1.

Number of ratios, $n = 30$

$\sum(x) = 2.94$	$(\sum r)^2 = 381.4209$
$\sum(x^2) = 0.4260$	$(\sum x)(\sum r) = 57.4182$
$\sum(r) = 19.53$	$S_{xx} = 0.1379$
$\sum(r^2) = 12.7319$	$S_{xr} = -0.0416$
$\sum(xr) = 1.8723$	$S_{rr} = 0.0179$
$(\sum x)^2 = 8.6436$	

Referring to the equations presented in Section 9.5.6:

$$\text{Slope, } b = \frac{S_{xr}}{S_{xx}} = \frac{-0.0416}{0.1379} = -0.302$$

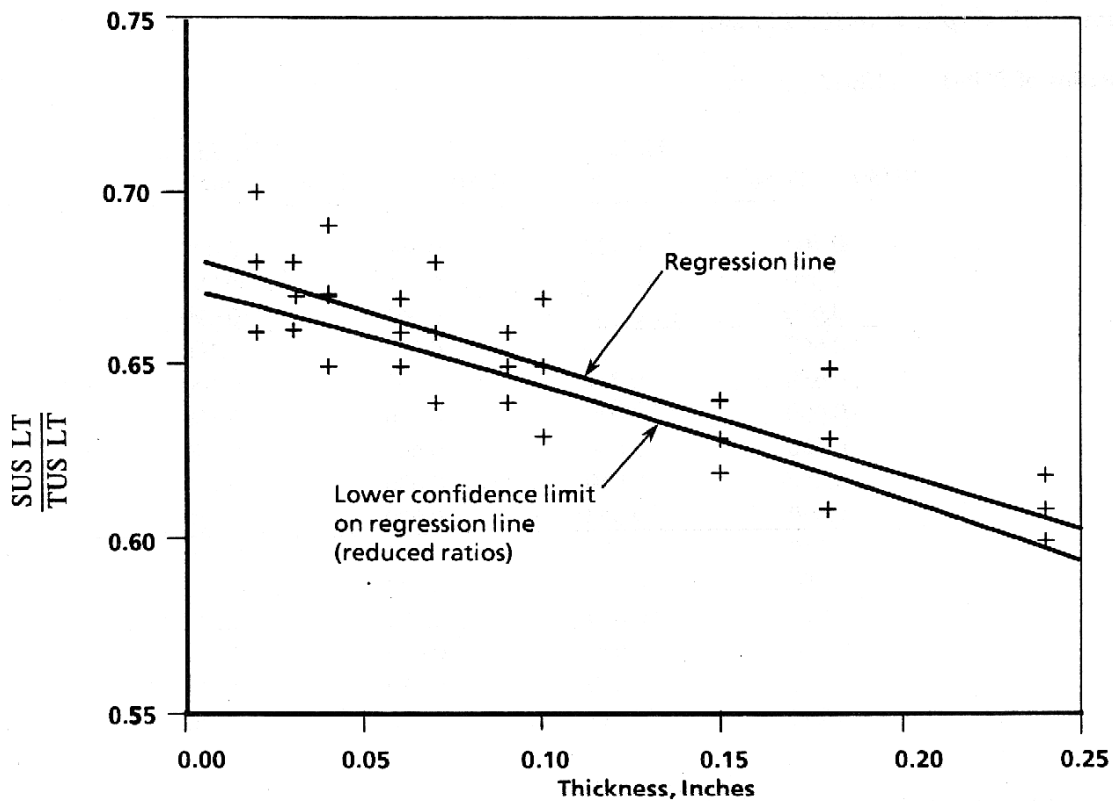

Figure 9.8.1.2.1. Ratios of input data for Problem VII.

Standard Error of Estimate,

$$\begin{aligned} \text{SEE} &= \sqrt{\frac{S_{rr} - b^2 S_{xx}}{(n - 2)}} \\ &= \sqrt{\frac{0.0179 - (-0.302)^2(0.1379)}{(30 - 2)}} \\ \text{SEE} &= 0.014 \end{aligned}$$

The equation of the regression line is $r' = 0.6806 - 0.302x$.

The regression line is shown in Figure 9.8.1.2.1.

Prob. XII—Step 3. Perform an analysis of variance to check the significance and linearity of the regression.

Since there are 30 ratios, the analysis of variance approach rather than the method involving the computation of confidence limits on the slope term can be used to evaluate linearity.

The only information missing from Step 2 required for the analysis of variance is the values of T, or the summed values of r for each x. They are as follows:

x_1	T_1	x_1	T_1
0.02	2.04	0.09	1.95
0.03	2.01	0.10	1.95
0.04	2.01	0.15	1.89
0.06	1.98	0.18	1.89
0.07	1.98	0.24	1.83

Using these values, the analysis of variance, which is illustrated in Section 9.5.6.3, can be completed as follows:

Source of Variation	Sum of Squares	Degrees of Freedom	Mean Squares	F_{calc}
Regression	0.0126	1	0.0126	63.0
Error	0.0053	28	0.0002	
Lack of Fit	0.0004	8	0.00005	0.208
Pure Error	0.0049	20	0.00024	
Total	0.0179	29		

The second calculated F statistic of 0.208 with $k - 2 = 8$ and $n - k = 20$ degrees of freedom is less than the value of 2.45 from Table 9.10.2 corresponding to 8 numerator and 20 denominator degrees of freedom. Thus, the deviation from linearity is not significant. The first F statistic of 63.0 with 1 and 28 degrees of freedom is greater than the value of 4.20 from Table 9.10.2 corresponding to 1 numerator and 28 denominator degrees of freedom, so the slope of the regression is found to be significantly different from zero.

Prob. XII—Step 4. Compute the reduced ratio for SUS(LT)/TUS(LT). In performing this step, the reduced ratio will be computed at each of four thicknesses (0.020, 0.062, 0.125, and 0.249 inch). This is done by

MIL-HDBK-5J
31 January 2003

determining the lower confidence limit for the regression line at the desired thicknesses, using the equation from Section 9.5.3. The computation will be worked in detail for $x_0 = 0.020$ inch:

$$\text{Reduced ratio} = [\text{SUS(LT)/TUS(LT)}]' - t_{0.95} s'_r \sqrt{\frac{1}{n} + \frac{(x_0 - \sum x/n)^2}{(\sum x^2) - (\sum x)^2/n}}$$

$$[\text{SUS(LT)/TUS(LT)}]' = r' = 0.681 - 0.302x_0 \text{ (from Step 2, Problem VII)}$$

$$= 0.681 - 0.302 \times 0.020 = 0.6746.$$

$$t_{0.95} \text{ (for } n - 2 = 30 - 2 = 28 \text{ degrees of freedom)} = 1.701 \text{ (from Table 9.10.4)}$$

$$s'_r = 0.014 \text{ (from Step 2)}$$

$$\sqrt{\frac{1}{n} + \frac{(x_0 - \sum x/n)^2}{(\sum x^2) - (\sum x)^2/n}} = \sqrt{\frac{1}{30} + \frac{(0.020 - 2.94/30)^2}{0.4260 - 8.6436/30}} = 0.2783$$

$$\text{Reduced ratio} = 0.6746 - 1.701 \times 0.014 \times 0.2783 = 0.668.$$

The corresponding ratios for the other thicknesses are tabulated in Step 5. See Figure 9.8.1.2.1 for lower confidence limit curve.

Prob. XII—Step 5. Compute F_{su} This computation will be illustrated for a thickness of 0.020 inch, using the reduced ratio from Step 4.

From Problem IV,

$$F_{tu}(\text{LT}) = 140 \text{ ksi (A-basis)}$$

$$F_{tu}(\text{LT}) = 144 \text{ ksi (B-basis)}$$

$$F_{su}(\text{LT}) = \text{Reduced Ratio} \times F_{tu}(\text{LT})$$

$$F_{su}(\text{LT})(\text{A-Basis}) = 0.668 \times 140 = 93.5 \text{ ksi}$$

$$F_{su}(\text{LT})(\text{B-Basis}) = 0.668 \times 144 = 96.2 \text{ ksi.}$$

For the four thicknesses listed,

t, inch	Reduced Ratio	$F_{su}(\text{LT}), \text{ ksi}$		
		A-basis	B-basis	S-basis
0.020	0.668	93.5	96.2	...
0.062	0.657	92.0	94.6	...
0.125	0.638	89.3	91.9	...
0.249	0.595	80.3

Since F_{su} is shown to decrease with increasing thickness, only the lowest value applicable to the range should be presented in MIL-HDBK-5. By dividing the 0.020 to 0.125 thickness range into two ranges, a somewhat higher $F_{su}(\text{LT})$ value may be presented for thinner material as shown below.

The results of the computations in Problems I through VII have produced the following results (fractions greater than 0.75 are raised to the next higher ksi, while less fractions are dropped):

MIL-HDBK-5J
31 January 2003

Basis	Thickness, inch					
	<0.020	0.020-0.062		0.063-0.125		0.126-0.249
	S	A	B	A	B	S
$F_{tu}(LT)$, ksi	140	140	144	140	144	135
$F_{ty}(LT)$, ksi	115	120	124	120	124	110
F_{su} , ksi	...	92	94	89	92	80

Since SUS(LT) data were not available for thickness <0.020 inch, a design value is not presented for this range.

9.8.3 TABULAR DATA PRESENTATION — The proposal for the incorporation of design allowables into MIL-HDBK-5 will contain supporting data and computations for all design properties. Depending on quantity and availability, data may be tabulated, plotted, or referenced (to readily available technical reports, specifications, etc.). Computations should indicate adequately the manner in which design values were computed and will be presented in an orderly manner. Data sources will be identified.

All minimum mechanical property data analyses must be performed in English units. Strength data recorded in metric units should be converted to English units, to the nearest 0.01 ksi, before data analyses are undertaken. If desired by the data supplier, metric equivalent tables and figures can be included as part of the working data submitted with a data proposal, but the tables and/or figures proposed for inclusion in MIL-HDBK-5 will contain only English units.

9.8.3.1 Mechanical Properties — The table of room-temperature design values will be presented in the format indicated in Figure 9.8.3.1(a) for conventional metallic materials. This format has been designed to accommodate most of these materials; however, some modifications may be required. For example, the format shown in Figure 9.8.3.1(b) will be used for aluminum alloy sheet laminates which are generally anisotropic and have limited ductility. Design values for these hybrid materials are presented for several mechanical properties which differ from those shown for conventional metallic materials. Unused lines (for example, ST properties for sheet) are deleted. Guidance in the use of these formats may be obtained by examining tables throughout this document and by referral to the applicable procurement specification. The following instructions should be followed for the items located in Figure 9.8.3.1(a):

- (1) Table number: If this is a revision of an existing table, use the same table number; otherwise, use a new table number in the proper sequence.
- (2) Material designation: Use a numeric designation where available (for example, 7075 aluminum alloy). Avoid the use of trade names. Include products following the material designation, except products may be omitted from the title if there are many products covered by the table.
- (3) Specification: Refer to a public specification (industry, Military, or Federal), followed by a type or class designation, if appropriate. Do not refer to proprietary specifications.

Table ①. Design Mechanical and Physical Properties of (material designation) ② (products)

Specification	③			
Form				
Condition (or Temper)	④			
Cross-Sectional Area, in. ²	⑤			
Location Within Casting	⑥			
Thickness or Diameter, in.	⑦			
Basis	S	A	B	⑧ S
Mechanical Properties:				
F_{tu} , ksi:				
L	120	120	124	
LT (or T) ⑨ ⑩	...	
ST				
F_{ty} , ksi:				
L				
LT (or T)				
ST				
F_{cy} , ksi:				
L				
LT (or T)				
ST				
F_{su} , ksi				
F_{bru} , ksi:⑪				
(e/D = 1.5)				
(e/D = 2.0)				
F_{bry} , ksi:				
(e/D = 1.5)				
(e/D = 2.0)				
e , percent (S-basis):				
L				
LT (or T)				
ST				
RA , percent (S-basis):				
L				
LT (or T)				
ST				
E , 10 ³ ksi				
E_c , 10 ³ ksi				
G , 10 ³ ksi				
μ				
Physical Properties:				
ω , lb/in. ³	⑫			
C , Btu/(lb)/(°F)				
K , Btu/[(hr)(ft ²)(°F)/ft]				
α , 10 ⁻⁶ in./in./°F				

⑬ (footnotes)

Figure 9.8.3.1(a). Format for room temperature property table.

Table 7.5.X.X(b). Design Mechanical and Physical Properties of (sheet material designation) Aluminum Alloy, Aramid Fiber Reinforced, Sheet Laminate

Specification	Aramid fiber reinforced sheet laminate			
Form	Aramid fiber reinforced sheet laminate			
Laminate Lay-Up	2/1	3/2	4/3	5/4
Nominal Thickness, in.	0.032	0.053	0.074	0.094
Basis	S	S	S	S
Mechanical Properties ^a :				
F_{tu} , ksi:				
L				
LT				
F_{ty} , ksi:				
L				
LT				
F_{cy} , ksi:				
L				
LT				
F_{su} , ksi				
F_{sy} , ksi				
F_{bru} , ksi:				
L (e/D = 1.5)				
LT (e/D = 1.5)				
L (e/D = 2.0)				
LT (e/D = 2.0)				
F_{brt} , ksi:				
L (e/D = 1.5)				
LT (e/D = 1.5)				
L (e/D = 2.0)				
LT (e/D = 2.0)				
ϵ_t , percent:				
L				
LT				
E , 10^3 ksi:				
L				
LT				
E_c , 10^3 ksi:				
L				
LT				
G , 10^3 ksi:				
L				
LT				
μ :				
L				
LT				
Physical Properties:				
ω , lb/in. ³				
C, K, and α				

a Design values were computed using nominal thickness of sheet laminate.

Figure 9.8.3.1(b). Format for room temperature property table for aluminum alloy fiber reinforced sheet laminate.

MIL-HDBK-5J
31 January 2003

- (4) Condition: Use a standard temper designation where applicable. Otherwise, use an easily recognized description, including pertinent details if these are not available in the reference specification. Examples: T651, TH1050, Aged (1400°F), Mill Annealed.
- (5) Cross-sectional area: Use only when applicable.
- (6) Location within casting: Applicable only to castings. Specify “Non-designated area,” or “Designated area,” as applicable.
- (7) Design values will be presented only for the thicknesses covered in the material specification.
- (8) Basis: For each product and size, use two columns covering A- and B-basis properties or one column covering S-basis properties. A-values that are higher than the corresponding S-values are presented only in footnotes to the table. In such instances, A-values are replaced by S-values in the body of the table. When A-values are presented for some properties and S-values are presented for other properties for the same product, values will be shown in a column labeled A-basis, and individual S-values will be identified by appropriate footnotes. Elongation, total strain at failure, and reduction of area values are presented on an S-basis only. When other properties are presented on an A- and B-basis, add “(S-basis)” after “*e*, percent,” or “ ϵ_t percent” and “*RA*, percent.”
- (9) Grain direction: Show design values for grain directions “L, LT, and ST” or for grain directions “L and T” for the properties F_u , F_y , F_{cy} , *e*, and *RA*. For anisotropic materials sheet and plate, present design values for grain directions “L, 45°, and LT” for F_u , F_y , and F_{cy} . For aluminum alloy sheet laminates, show design values for L and LT grain directions of aluminum alloy sheet for all mechanical properties. Grain directions are not applicable to castings.

The T grain direction should be footnoted with the definition used in the specification identified at the top of the mechanical property table. For example, the T grain direction for aluminum die forgings covered in MIL, Federal and some AMS specifications will read as follows: “For die forgings, T indicates any grain direction not within ±15 degrees of being parallel to the forging flow lines.” For updated AMS specifications with the preferred narrower definition of the T grain direction, the footnote should read as follows: “For die forgings, T indicates a grain direction within ±15 degrees of being perpendicular to the forging flow lines.” Specimens to test the transverse properties should be located as close to the short transverse direction as possible.

Transverse F_{cy} values for aluminum die forgings will be shown as $F_{cy}(T)$. If the values are based upon short transverse or long transverse test data, add this information to the above footnote.

- (10) Missing values: For table entries that are missing or not applicable, show a series of three dots aligned with the numbers in that column.
- (11) Bearing values: Add footnote “Bearing values are dry pin values per Section 1.4.7.1” when bearing allowables are based on data from clean pin tests. Supporting information supplied with the proposal should describe the bearing test cleaning procedures used in testing.
- (12) Physical properties: Include a section for physical properties even if properties are not available. If physical property data are presented in an effect-of-temperature curve, use table entry, “See Figure X.X.X.0” to refer to the illustration.

- (13) Footnotes: Use footnotes to indicate anything unusual or restrictive concerning the property description, properties, or individual values; to present supplementary values; or to reference other tables or sections of text. When A-values have been replaced by S-values, the following wording is suggested: “S-basis. The rounded T_{99} values are as follows: (list values).”

In addition, the proposal will contain supporting data and computations for all design properties. Depending on quantity and availability, data may be tabulated, plotted (by cumulative-probability curves or histograms), or referenced (to readily available technical reports, specifications, etc.). Computations should indicate adequately the manner in which design values were computed and will be presented in an orderly manner. Data sources will be identified.

9.8.3.2 Modulus of Elasticity and Poisson’s Ratio — The following room-temperature elasticity values are presented in the room-temperature property tables as typical values:

Property	Units	Symbol	Recommended ASTM Test Procedures
Modulus of Elasticity			
In tension	1000 ksi	E	E 111
In compression	1000 ksi	E_c	E 111
In shear	1000 ksi	G	E 143
Poisson’s Ratio	(Dimensionless)	μ	E 132

If the material is not isotropic, the applicable test direction must be specified. Deviations from isotropy must be suspected if the experimentally determined Poisson’s ratio differs from the value computed by the formula

$$\mu = \frac{\bar{E}}{2G} - 1 \quad [9.8.3.2(a)]$$

where \bar{E} is the average of E and E_c .

Given E , E_c , and G , μ may be computed by this equation. Likewise, given E , E_c , and μ , G may be computed from the equation:

$$G = \frac{\bar{E}}{2(\mu + 1)} \quad [9.8.3.2(b)]$$

In the event E_c is not available, E may be substituted for \bar{E} in the above equations to provide an estimate of either μ or G .

9.8.3.3 Physical Properties — Density, specific heat, thermal conductivity, and mean coefficient of thermal expansion are physical properties normally included in MIL-HDBK-5. Physical properties are presented in the room-temperature property table if they are not presented in effect-of-temperature curves. The basis for physical properties is “typical”. Table 9.8.3.3 displays units and symbols used in MIL-HDBK-5, and also recommended ASTM test procedures for measuring these properties. Since modifications of procedures are employed in measuring physical properties, methods used for values proposed for inclusion in MIL-HDBK-5 should be reported in the supporting data proposal. For specific heat and thermal conductivity values reported in the room temperature property table, the reference temperature of measurement is also shown [for example, for 2017 aluminum the specific heat is 0.23 (at 212°F)]. For tabulated values of mean thermal expansion, temperature range of the coefficient is shown [for example,

12.5 (70 to 212°F)]. The reference temperature of 70°F is established as standard for mean coefficient of thermal expansion curves.

Table 9.8.3.3. Units and Symbols Used to Present Physical Property Data and ASTM Test Procedures

Property	Unit	Symbol	Recommended ASTM Test Procedures
Density	lb/in. ³	ω	C 693
Specific heat	Btu/lb-°F	C	D 2766
Thermal conductivity	Btu(hr-ft ² -°F/ft)	K	C 714 ^a
Mean coefficient of thermal expansion	10 ⁻⁶ (in./in./°F)	α	E 228

a ASTM C 714 is a test for thermal diffusivity from which thermal conductivity can be computed.

9.8.4 ROOM TEMPERATURE GRAPHICAL MECHANICAL PROPERTY DATA

9.8.4.1 Typical Stress-Strain — The stress-strain and tangent-modulus data appearing in MIL-HDBK-5 are described as “typical” stress-strain and compression tangent-modulus curves. The term typical indicates that representative stress-strain data for products covered have been adjusted to reflect precision typical values of the elastic modulus, and product average values of the 0.2 percent offset yield strength in tension or compression. Curves extend to strain somewhat beyond the 0.2 percent offset yield strength. Curves described as “full range” stress-strain curves are also included in MIL-HDBK-5. These curves extend through maximum load and beyond to rupture. Mathematical representations of curves are covered in Section 9.8.4.6.

All curves will be prominently marked “typical”. With regard to tension data, only stress-strain curves are shown; however, compression data should include stress-strain curves and tangent-modulus curves. The Ramberg-Osgood n exponent should appear on all stress-strain curves if n is shown to apply in the approximate range from proportional limit to yield strength. The procedures and methods to be used are described in the following paragraphs.

Two alternative procedures are described for determining typical stress-strain curves.

- (1) The “strain-departure” method, which assumes no parametric relationship between stress and plastic strain, utilizes the full stress-strain curve.
- (2) The Ramberg-Osgood method, which assumes an exponential relationship between stress and plastic strain. Its use requires as few as two points from the original stress-strain curve, once the exponential relationship has been found to be applicable.

Generally, the two methods yield nearly identical results for those portions of the curve lying between proportional limit and yield stress. For plastic strains greater than about 0.002 in./in. and for bimetallic or clad products, only the strain-departure method is applicable.

Stress tangent-modulus curves may be derived graphically from compressive stress-strain curves, or computed, if the Ramberg-Osgood method is used.

9.8.4.1.1 Strain Departure Method — These steps, as illustrated in Table 9.8.4.1.1, should be followed to establish a typical tensile or compressive stress-strain curve using the strain-departure method:

MIL-HDBK-5J
31 January 2003

- (1) The straight-line (modulus) portion of each curve should be extended as in Figure 9.8.4.1.1(a), and the 0.002 (0.2%) offset yield strength should be indicated.
- (2) At appropriate departures or offsets from the modulus line, load should be determined accurately, converted to stress, and recorded. Sufficient departure measurements should be made to accurately describe the curve to just beyond yield load for each load-strain curve.
- (3) At each strain departure, the stresses should be averaged.
- (4) When a product average yield strength value is available, the average stresses at each departure should be converted to product average stresses.
- (5) Elastic strains should be computed for each departure. (Elastic Strain equals Total Stress/Elastic Modulus.)
- (6) Elastic strains (computed) and plastic strains (departure) should be added to obtain total strain for each departure.

Table 9.8.4.1.1. Example of Use of Strain Departures to Establish Typical Stress-Strain Curve

Departure (D) μ in./in.	Stress, ksi				Strain, μ in./in.		
	Test #1	Test #2	Test #3	Average ^a (σ_A)	Product Avg. ^b (σ_T)	Elastic ^c (ϵ_E)	Total ^d (ϵ_T)
0	43.81	42.75	41.20	42.59	42.63	4022	4022
20	49.77	48.81	45.14	47.91	47.95	4524	4544
40	51.41	50.98	47.82	50.17	50.12	4728	4768
100	54.31	53.96	51.24	53.17	53.22	5021	5121
500	60.16	60.37	57.10	59.21	59.27	5592	6092
1000	62.67	62.85	59.45	61.66	61.72	5823	6823
2000	64.95	65.06	61.80	63.94 ^f	64.00 ^e	6038	8038
2200	65.26	65.38	62.12	64.25	64.31	6067	8267

a Average of Tests 1, 2, and 3.

b $\sigma_T = (\text{Product average yield strength} \div \text{average yield strength}) \times \sigma_A$.

c $\epsilon_E = \sigma_T/E$.

d $\epsilon_T = \epsilon_E + D$.

e Product average yield strength.

f Average yield strength.

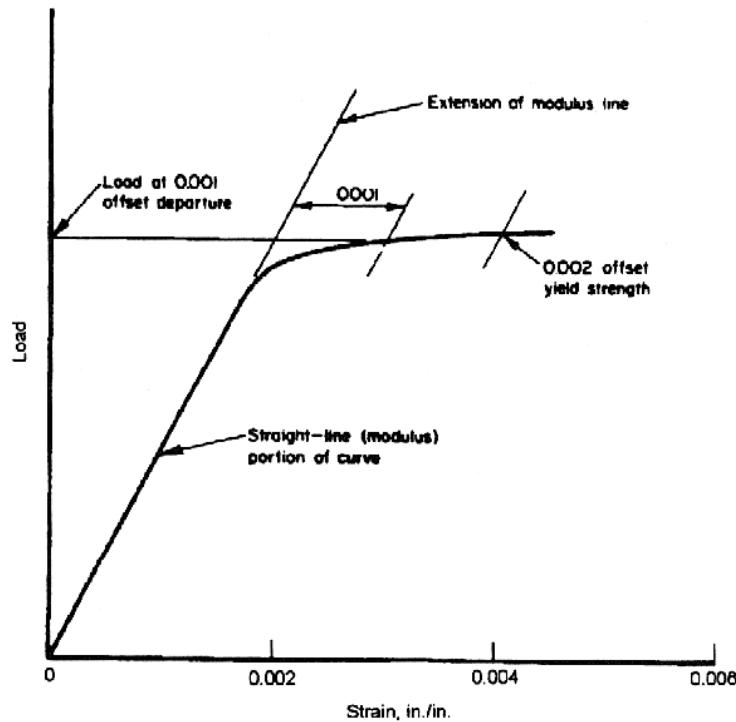

Figure 9.8.4.1.1(a). Measuring loads by strain departure method.

The following guidelines should be used to plot a typical stress-strain curve. The graph axis should be laid out such that there are 10 minor divisions for every major division with every tenth (major) division accented. The ordinate (Y-axis) is used for stress and should be scaled in units of ksi to the major division, as appropriate, to produce a total scale length of approximately 5 major divisions. The abscissa (X-axis) is used for total strain and should be scaled in units of in./in. to the major division, as appropriate, to produce a total scale length of approximately 6 major divisions.

The final step is plotting the values in Table 9.8.4.1.1 to produce the typical stress-strain curve as shown in Figure 9.8.4.1.1(b). In addition to plotting the graphs by hand, they may be plotted with computer software programs. In the latter case, input the stress-strain pairs (σ_T and ϵ_T) from Table 9.8.4.1.1 into the computer and then curve fit the data. In all cases, the elastic section must be linear up to the proportional limit. It is recommended that the Ramberg-Osgood equation be used to fit the data from the proportional limit to just beyond the 0.2% yield stress. If not, a power-law polynomial second order may be used to fit the data points. The stress-strain curve should extend slightly beyond the 0.2% yield strength.

To complete the figure, the Ramberg-Osgood number from Section 9.8.4.1.2 and the typical yield strength (TYS) product average must be contained in a table within the figure. If more than one curve is contained in the figure, information such as the grain direction (L, LT, and ST), and/or temperature for each curve must be indicated in the figure. Figure 9.8.4.1.1(c) shows the proper format of a figure for presentation in Chapters 2 through 7.

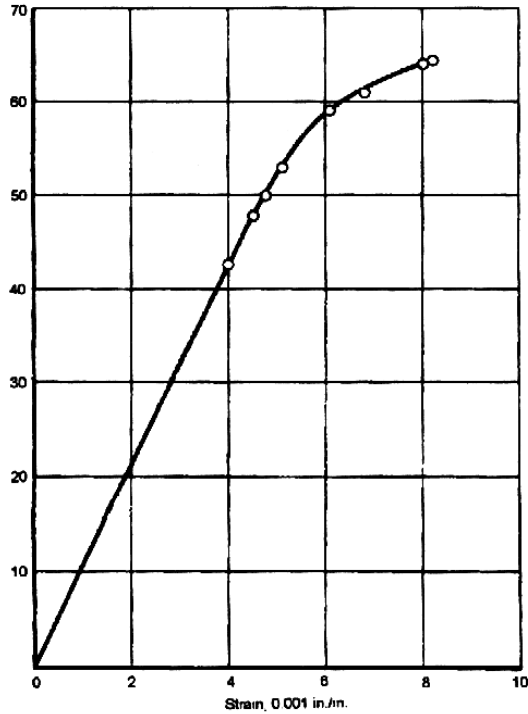

Figure 9.8.4.1.1(b). Plotted data from Table 9.8.4.1.1.

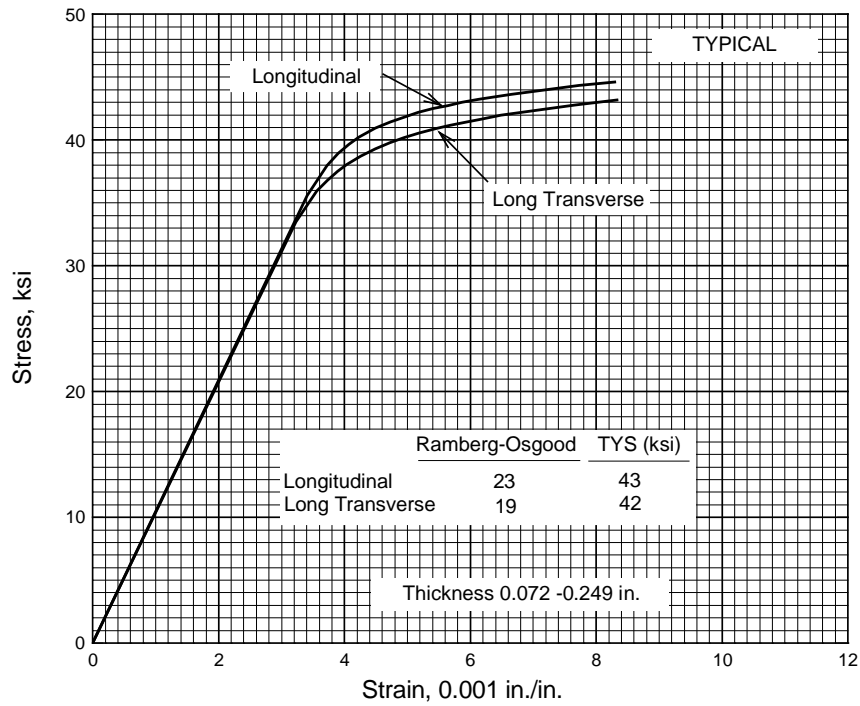

Figure 9.8.4.1.1(c). Typical stress-strain curves showing the proper presentation format.

9.8.4.1.2 Ramberg-Osgood Method — This method, which is based on the work of Ramberg and Osgood [Reference 9.8.4.1.2(a)], and Hill [Reference 9.8.4.1.2(b)], assumes that an exponential relationship exists between stress and plastic strain, as expressed by

$$e_p = 0.002 \left(\frac{f}{f_{0.2ys}} \right)^n \quad [9.8.4.1.2(a)]$$

where

f is stress,
f_{0.2ys} is the 0.2 percent yield stress,
e_p is plastic strain,
n is the Ramberg-Osgood parameter**.

While this relationship may not be exact, it is sufficiently accurate for use up to the yield strength for many materials, but cannot be employed to compute full-range stress-strain curves.

Since total strain equals elastic strain plus plastic strain,

$$e_{total} = f/E + 0.002 \left(\frac{f}{f_{0.2ys}} \right)^n \quad [9.8.4.1.2(b)]$$

where E is the typical value of modulus of elasticity from the room-temperature property tables.

Equation 9.8.4.1.2(b) can be programmed for determination and plotting by a computer, given only values for E, n, and f_{0.2ys}. To obtain typical curves, TYS or CYS is used for f_{0.2ys}. TYS and CYS values are based on product averages when available; in other cases, average values from original stress-strain curves are used. The Ramberg-Osgood parameter, n, will be determined analytically in development of typical stress-strain curves for MIL-HDBK-5.

As the first step in the analytical determination of n, a series of values of stress and strain departure (plastic strain) must be obtained from each original stress-strain curve. These may be determined by the method of strain-departure described in Section 9.8.4.1.1 or the alternate method outlined below:

- (1) Determine the indicated modulus of elasticity for the individual stress-strain curves.
- (2) For each curve, construct two lines parallel to the modulus line and intersecting the stress-strain curve at plastic strains of approximately 0.020 and 0.20 percent. The lines will bound the zone where stress-plastic strain pairs are determined. This zone also eliminates the small plastic strain region where nonlinearities in stress versus plastic strain sometimes exist.
- (3) Digitize each stress-strain curve over the range bounded in Step 2. A series of approximately ten to 12 pairs of stress-total pairs should be taken at nearly equal intervals within this range. A resolution of 0.25 ksi stress and 0.01 percent strain is desirable here.
- (4) Compute plastic strains from each collection of total strains, using the individual curve's modulus to subtract out elastic strains.

** The Ramberg-Osgood parameter, n, should not be confused with the strain hardening coefficient, which is also denoted by the letter n. The one is the reciprocal of the other. Values of the Ramberg-Osgood parameter usually lie within the range of 2 to 40. It should be noted that an occasional practice in the aircraft industry, but not followed in MIL-HDBK-5, is to subtract a small increment of strain from Equation 9.8.2.1.1.2(a) in order to compensate for the existence of a proportional limit.

MIL-HDBK-5J
31 January 2003

Once the stress and plastic strain values are tabulated for available stress-strain curves, it is possible to proceed with determination of the Ramberg-Osgood parameter. To determine n analytically, Equation 9.8.4.1.2(a) is rearranged to solve for stress, f , the dependent variable.

$$f = Ae_p^{1/n} \quad [9.8.4.1.2(c)]$$

where

$$A = \frac{f_{0.2ys}}{(0.002)^{1/n}} \quad [9.8.4.1.2(d)]$$

Taking the natural logarithm of Equation 9.8.4.1.2(c), a transformed equation is obtained which can be analyzed by the method of linear least squares.

$$\ln f = \ln A + 1/n \ln e_p \quad [9.8.4.1.2(e)]$$

The solution for n is the same as that for a linear regression least-squares estimate of the slope, b , as shown in Section 9.6.3.1, Equation 9.8.4.1.2(d) where $b = 1/n$, therefore,

$$n = \frac{\sum x^2 - \frac{(\sum x)^2}{N}}{\sum xy - \frac{\sum x \sum y}{N}} \quad [9.8.4.1.2(f)]$$

where

$$\begin{aligned} x &= \ln e_p \\ y &= \ln f \\ N &= \text{number of data points.} \end{aligned}$$

Correspondingly, A can be obtained from Equation 9.8.4.1.2(d) as

$$\ln A = \frac{\sum y - \frac{1}{n} \sum x}{N} \quad [9.8.4.1.2(g)]$$

Values for stress and strain departure may be input for solution of Equation 9.8.4.1.2(f) by either of two methods. In one method, $x = \ln e_p$ and $y = \ln f$ are input for each value of stress and strain departure for each stress-strain curve used in the analysis. N is the total number of points obtained from stress-departure analysis of all specimens from all heats that are analyzed. Care should be taken to ensure that the same number of data points are collected from each curve. In the other method, average stress (f) is determined for all available curves at designated values of strain departure (e_p). In this case, x and y in Equation 9.8.4.1.2(f) are $\ln e_p$ and $\ln f$, respectively, and N is the number of strain departure points. Again, the same number of data points should be computed for each stress-strain curve.

Some investigators may analyze the results of each individual specimen by the method outlined by Equations 9.8.4.1.2(c) through (g) and record individual values of the parameter n . In these cases, an alternate approach must be used to combine results and establish n . This technique is called the method of computed strain-departure.

In the method of computed strain-departure, results from individual specimen analyses are used to compute stress levels [from Equation 9.8.4.1.2(c)] at specific strain-departure levels for all specimens. In so doing, the original data are used to analytically perform the method of strain-departure of Section 9.8.4.1.1 which should be used as a guideline for doing this analysis. Once these computed stress values are obtained, they can be used to calculate the exponent, n , by Equation 9.8.4.1.2(f) using either of the two methods that are described above for the case when data are recorded by the method of strain-departure.

An approximate value of the Ramberg-Osgood parameter can be found graphically, although this approach will not be used to construct stress-strain curves for MIL-HDBK-5. Graphically determined stress-strain curves must be verified by computer analysis according to previously described techniques before inclusion in MIL-HDBK-5. A graphical procedure is described in the following paragraphs and is illustrated in Figure 9.8.4.1.2.

- (1) Plot at least three pairs of stress-plastic strain points from each original stress-strain curve on log-log graph paper. As illustrated in Figure 9.8.4.1.2(a), the ordinate is conventionally used for log stress, the abscissa is log plastic strain (strain departure method is described in Section 9.8.4.1.1), and the slope is $1/n$.
- (2) A straight line then is drawn through the plotted points and the slope ($1/n$) is computed as shown in the figure.

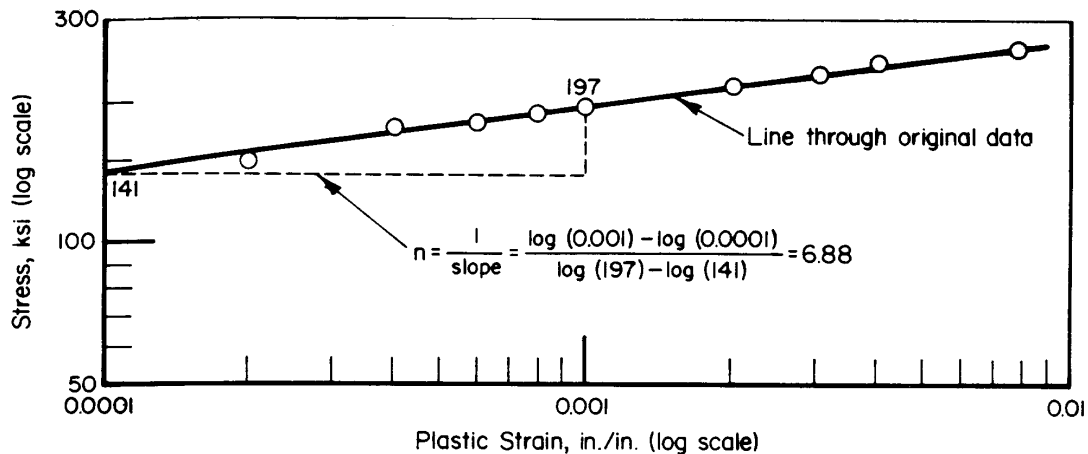

Figure 9.8.4.1.2. Graphical approximation of Ramberg-Osgood Parameter, n .

When using the above-described approaches, it is recommended that a check be made to determine how well the value of n reproduces the stress-strain curve in the approximate range from the proportional limit (defined as $0.02\% y_s$) to $f_{0.2ys}$. This can be done by constructing the stress-strain curve using Equation 9.8.4.1.2(b), and comparing an original stress-strain curve through the yield strength with the computed curve. In checking an original stress-strain curve with the computed curve, some judgment must be exercised in the vicinity of the proportional limit since the Ramberg-Osgood relationship may not precisely represent original stress-strain curves in this area. Stress deviations greater than about 5 percent between the two curves suggest that the Ramberg-Osgood relation is not applicable.

9.8.4.2 Compression-Tangent-Modulus Curves — In deriving tangent-modulus curves graphically from typical compressive stress-strain curves, a number of points are marked off on the latter curves, particularly where the curve departs from linearity and in regions of greatest curvature. At each point on the curve, a line is drawn tangent to the curve as shown in Figure 9.8.4.2(a). The slope of each line is the tangent modulus corresponding to the stress coordinate of the point of tangency. The Ramberg-Osgood relationship, Equation 9.8.4.2(b),

$$e_{\text{total}} = f/E + 0.002 \left(\frac{f}{f_{0.2\%ys}} \right)^n \quad [9.8.4.2(a)]$$

also may be employed to determine the compression tangent-modulus curve.

Tangent modulus is the first derivative of stress with respect to strain, df/de , or

$$E_t = \frac{1}{\frac{1}{E} + \frac{0.002n}{f_{0.2\%ys}} \left(\frac{f}{f_{0.2\%ys}} \right)^{n-1}} \quad [9.8.4.2(b)]$$

This equation can be programmed for determination and plotting by a computer, given only values for E , n , and $f_{0.2\%ys}$. To obtain typical curves, average CYS is used for $f_{0.2\%ys}$.

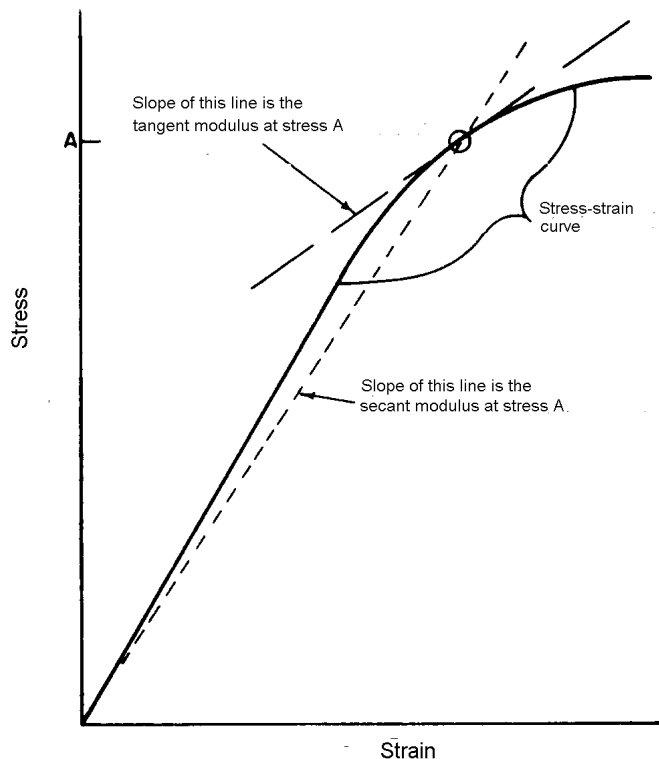

Figure 9.8.4.2(a). Determining tangent modulus and secant modulus.

The following guidelines should be used to plot a compression tangent-modulus curve. For mathematical representations of compression tangent modulus curves see Section 9.8.4.6. The graph axis should be laid out such that there are 10 minor divisions for every major division with every tenth (major) division accented. The ordinate (Y-axis) scale is plotted in the same manner as that used for the stress-strain curves in Section 9.8.4.1.1. The abscissa (X-axis) scale is usually made equal to 2, 4, or 5 x 10³ ksi per major division, depending on material, to produce a total scale length of approximately 6 major divisions.

The compression tangent-modulus curve is illustrated in Figure 9.8.4.2(b) where stress is plotted (on the ordinate) versus tangent modulus (on the abscissa). In addition to plotting the graphs by hand, they may be plotted with computer software programs. In the latter case, input the stress-modulus pairs (σ_T and E_t) from Equation 9.8.4.2(b) into the computer or program the computer with the equation and then curve fit the data. If it will not lead to confusion, stress tangent-modulus curves may be superimposed on the corresponding stress-strain figures as illustrated in Figure 9.8.4.2(c). If, however, several stress-strain curves appear in one figure, it is advisable to present stress tangent-modulus curves in a separate figure, as illustrated in Figure 9.8.4.2(b).

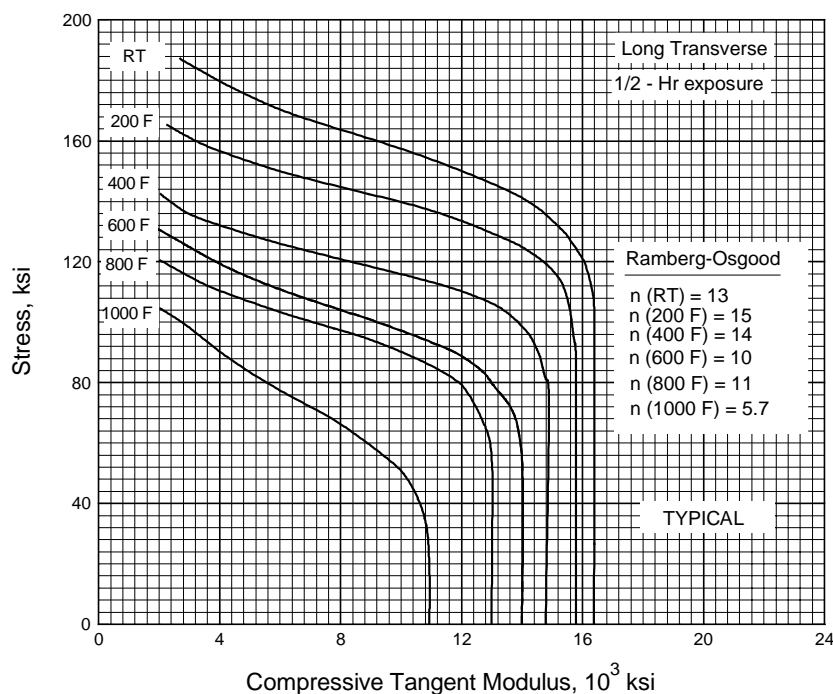

Figure 9.8.4.2(b). Typical compressive tangent-modulus curves.

The compression tangent-modulus curves for clad material should show a primary and secondary modulus as indicated in Figure 9.8.4.2(d). The stress-strain curves of clad material may indicate two modulus lines due to the cladding. The primary modulus is due to the combined modulus of both clad and base materials. However, the clad material is typically weaker than the base material and will yield at a low stress; therefore not contributing to the modulus at higher stresses. At this point, the secondary modulus becomes predominate. The compression tangent-modulus curves should show the primary and secondary modulus and indicated in Figure 9.8.4.2(d).

MIL-HDBK-5J
31 January 2003

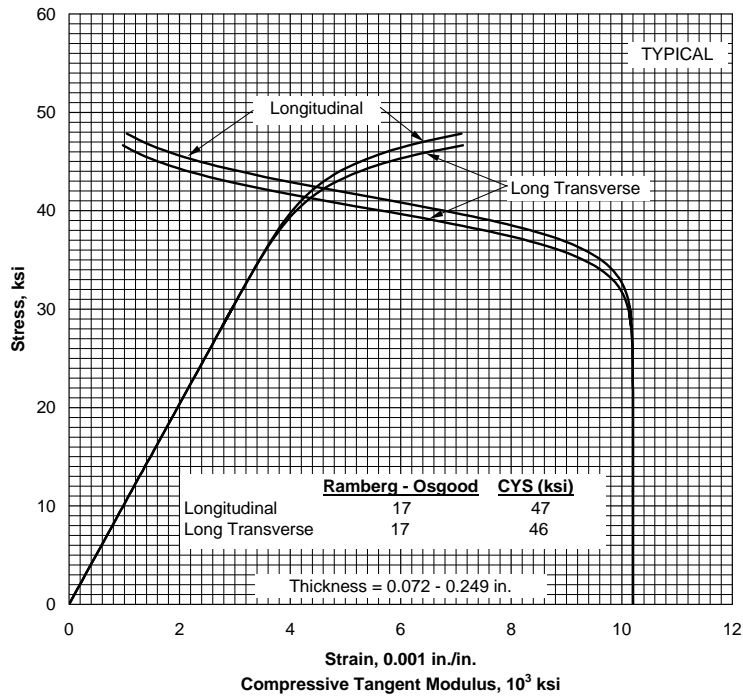

Figure 9.8.4.2(c). Typical compressive stress-strain and compressive tangent-modulus within the same figure.

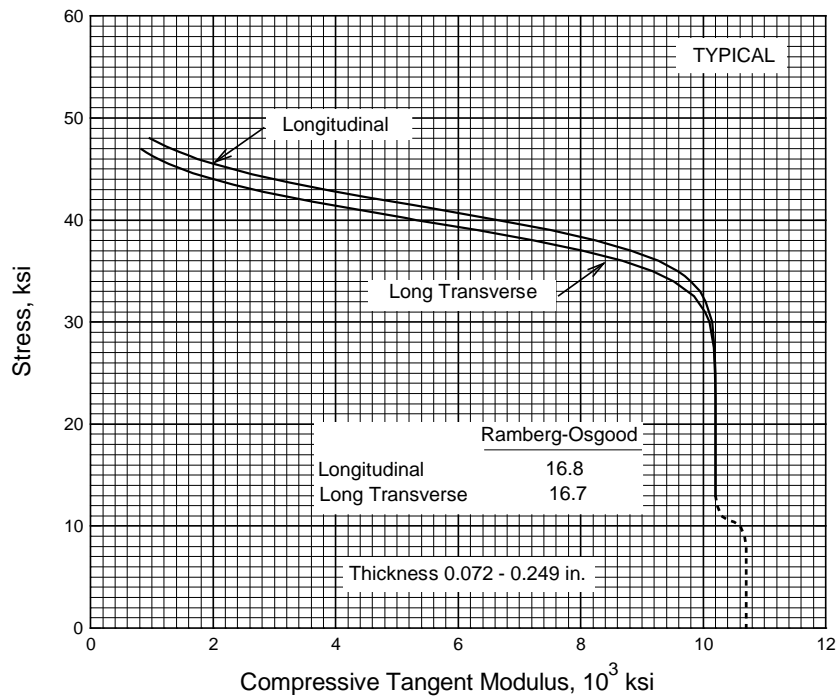

Figure 9.8.4.2(d). Typical compression tangent-modulus curves for clad aluminum alloy sheet showing the primary and secondary modulus.

MIL-HDBK-5J
31 January 2003

To complete the figure, the Ramberg-Osgood number from Section 9.8.4.1.2 must be contained in a table within the figure. If more than one tangent modulus curve is contained in the figure, information such as the grain direction (L, LT, and ST), and/or temperature for each curve must be indicated in the figure. Figures 9.8.4.2(b), (c), and (d) show the proper format for presentation in Chapters 2 through 7.

Stress-secant modulus curves are not presently used in MIL-HDBK-5. Secant or “chord” modulus is determined as illustrated in Figure 9.8.4.2(a) and is plotted in the same manner as the tangent modulus. The equation for secant modulus is:

$$E_s = \frac{f}{e} = \frac{f}{\frac{f}{E} + 0.002\left(\frac{f}{f_y}\right)^n} \quad [9.8.4.2 (c)]$$

at the point of stress.

9.8.4.3 Full-Range Tensile Stress-Strain Curves — Preparation of each typical full-range tensile stress-strain curve requires (1) representative original full-range stress-strain curves, (2) product average values for ultimate strength, yield strength, and elongation, and (3) typical precision elastic-modulus values at test temperature. Full-range tensile stress-strain data for at least one lot of material will be provided, but data from three lots are preferred. If data for less than three lots are submitted, the full-range stress-strain curve will be labeled “BASED ON ONE LOT” or “BASED ON TWO LOTS”, as appropriate.

The procedure for developing typical full-range tensile stress-strain curves is based upon strain departures obtained from several original test curves, and the product average tensile strength, yield strength, and elongation established from production data. Properties of material tested for determining strain departures should be in reasonable agreement with the product average properties.

These steps, as illustrated in Table 9.8.4.3 and Figures 9.8.4.3(a) and (b), should be followed in developing typical full-range tensile stress-strain curves.

- (1) From each stress-strain test curve, measure strain departures (D) between the extension of the modulus line and the curve at stresses determined by taking appropriate percentages of the differences between ultimate stress and yield stress added to the yield stress.

$$\sigma_{(1,n)} = TYS + \% (TUS - TYS)$$

where TUS and TYS are values for each test. Also identify the proportional limit for each test. The proportional limit is defined as the stress level below, which the stress-strain curve is linear; as determined by $\sigma = E\varepsilon$ where σ is the stress, E is Young's Modulus, and ε is the strain.

Table 9.8.4.3. Example of Strain-Departure Method to Establish Typical Full-Range Stress-Strain Curves

Percent	Test 1		Test 2		Average		Typical			
	Stress, ksi σ_1	Strain Departure ^c in./in. (D ₁)	Stress, ksi σ_2	Strain Departure ^c in./in. (D ₂)	Stress, ^d ksi σ_A	Strain Departure ^d in./in. (D _A)	Stress, ksi σ_T	Strain Departure ⁱ in./in. (D _T)	Elastic Strain ⁱ in./in. (ϵ_E)	Total Strain ^k in./in. (ϵ_T)
<u>Yield Stress to Ultimate Stress</u>										
Proportional Limit (PL)	56.5		58.5		57.5 ^h		59.6 ⁱ	0.0000	0.0058	0.0058
0(TYS)	58.8 ^a	0.0020	60.9 ^a	0.0020	59.8	0.0020	62.0 ^e	0.0020	0.0061	0.0081
20	61.0 ^a	0.0106	63.0 ^a	0.0094	62.0	0.0100	64.0 ^e	0.0100	0.0063	0.0163
40	63.2 ^a	0.0204	65.2 ^a	0.0194	64.2	0.0199	66.0 ^e	0.0200	0.0065	0.0265
60	65.4 ^a	0.0302	67.4 ^a	0.0302	66.4	0.0302	68.0 ^e	0.0303	0.0067	0.0370
80	67.7 ^a	0.0452	69.5 ^a	0.0436	68.6	0.0444	70.0 ^e	0.0446	0.0069	0.0515
95	69.3 ^a	0.0640	71.1 ^a	0.0626	70.2	0.0633	71.5 ^e	0.0636	0.0070	0.0706
100(TUS)	69.9 ^a	0.0848	71.7 ^a	0.0838	70.8	0.0843	72.0 ^e	0.0847	0.0071	0.0918
<u>Ultimate Stress to Fracture Stress (FS)</u>										
100(TUS)	69.9 ^b	0.0848	71.7 ^b	0.0838	70.8	0.0843	72.0 ^e	0.0847	0.0071	0.0918
90	69.0 ^b	0.0962	70.9 ^b	0.1014	70.0	0.0988	71.1 ^g	0.0992	0.0070	0.1062
60	66.3 ^b	0.1058	68.5 ^b	0.1156	67.4	0.1107	68.5 ^g	0.1112	0.0067	0.1179
0(FS)	60.9 ^b	0.1210	63.7 ^b	0.1378	62.3	0.1294	63.4 ^f	0.1300	0.0062	0.1362

- a $\sigma_{1,n} = \text{TYS} + \% (\text{TUS}-\text{TYS})$ where TUS and TYS are values for each test.
- b $\sigma_{1,n} = \text{TUS} - (1 - \%) \cdot (\text{TUS}-\text{FS})$ or $\sigma_{1,n} = \text{FS} + \% (\text{TUS}-\text{FS})$ where TUS and FS are values for each test.
- c D = Departure (plastic strain) from modulus line at corresponding stresses.
- d Averages (σ and D) of Tests 1 and 2.
- e $\sigma_T = \text{TYS}_{\text{Prod. Avg.}} + \% (\text{TUS}_{\text{Prod. Avg.}} - \text{TYS}_{\text{Prod. Avg.}})$.
- f $\sigma_T(\text{FS}) = (\text{TUS}_{\text{Prod. Avg.}} / \text{TUS}_{\text{Avg.}}) \cdot \sigma_{\text{Avg.}}(\text{FS})$.
- g $\sigma_T = \text{TUS}_{\text{Prod. Avg.}} - (1 - \%) \cdot (\text{TUS}_{\text{Prod. Avg.}} - \sigma_T(\text{FS}))$ or $\sigma_T = \sigma_T(\text{FS}) + \% (\text{TUS}_{\text{Prod. Avg.}} - \sigma_T(\text{FS}))$.
- h Average proportional limit.
- i $D_T = [(D_A - 0.002) \times (\text{Product Average Elongation} - 0.002)] \div (D_A \text{ at FS} - 0.002) + 0.002$.
- j $\epsilon_E = \sigma_T \div E$ ($E = 10.2 \times 10^3$ ksi in this example).
- k $\epsilon_T = D_T + \epsilon_E$.
- l $\sigma_T(\text{PL}) = (\text{TYS}_{\text{Prod. Avg.}} / \text{TYS}_{\text{Avg.}}) \cdot \sigma_{\text{Avg.}}(\text{PL})$.

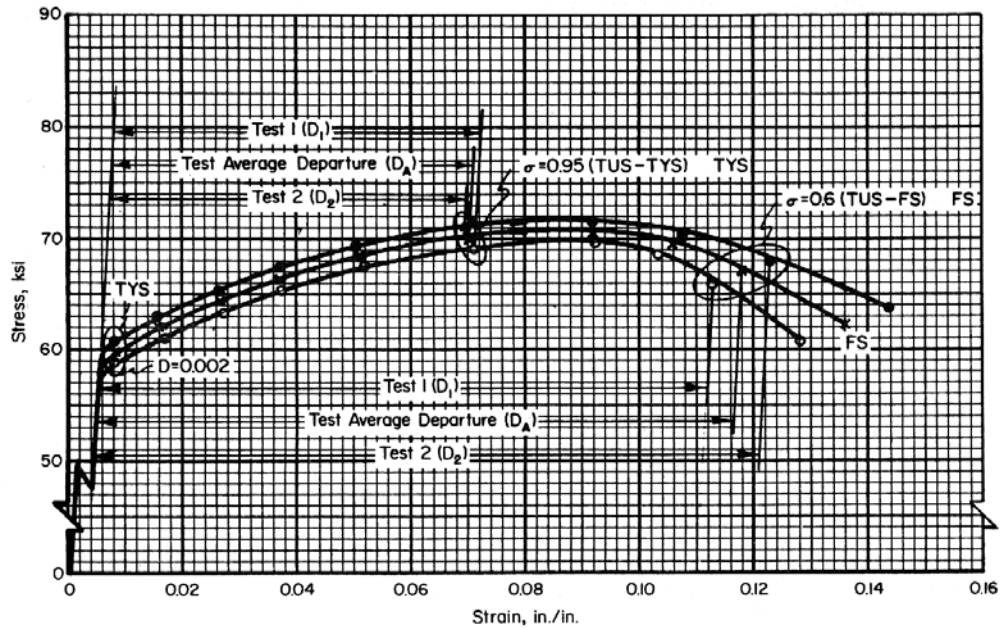

Figure 9.8.4.3(a). Strain departure method for determining average full-range stress-strain curve.

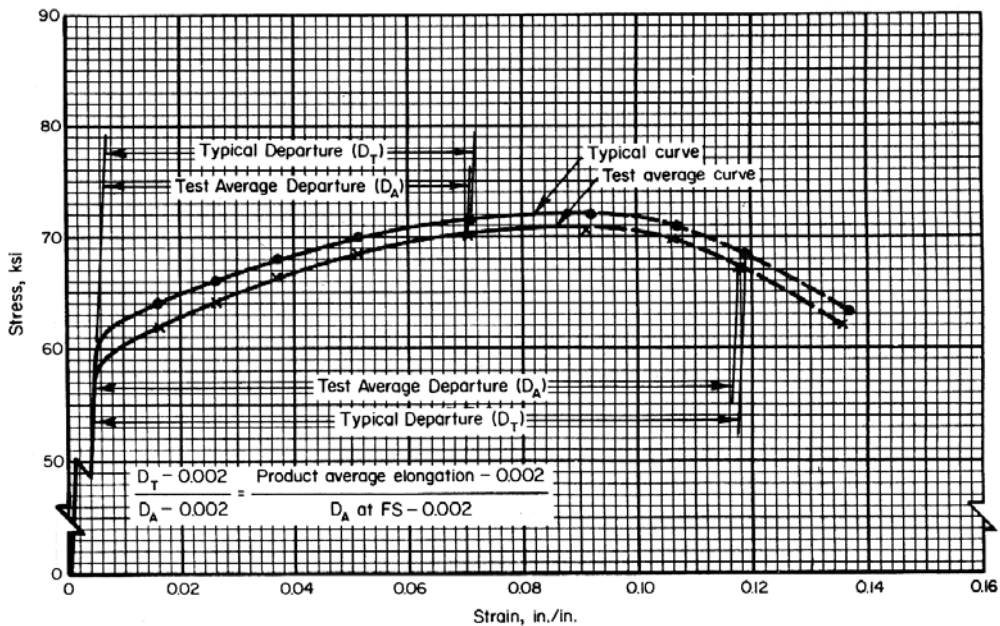

Figure 9.8.4.3(b). Method of adjusting average to typical full-range stress-strain curve.

MIL-HDBK-5J
31 January 2003

- (2) For departures beyond ultimate stress, the stresses are determined by taking the percentage of the difference between the fracture stress and ultimate stress and subtracting it from the ultimate stress.

$$\sigma_{(1,n)} = TUS - (1 - \%) \cdot (TUS - FS)$$

or

$$\sigma_{(1,n)} = FS + \% (TUS - FS)$$

where TUS and FS are values for each specimen.

- (3) For each percentage, average the stresses and strain departures, σ_A and D_A , respectively.
 (4) Compute typical stresses between TYS and TUS using product average yield strengths.

$$\sigma_T = TYS_{\text{Prod. Avg.}} + \% (TUS_{\text{Prod. Avg.}} - TYS_{\text{Prod. Avg.}})$$

- (5) Compute typical fracture stress, $\sigma_T(FS)$, as follows:

$$\sigma_T(FS) = \frac{TUS_{\text{Prod. Avg.}}}{TUS_{\text{Avg.}}} \sigma_{\text{Avg.}}(FS) \quad .$$

- (6) Compute typical stresses between TUS and FS using product average ultimate strength and typical fracture stress.

$$\sigma_T = TUS_{\text{Prod. Avg.}} - (1 - \%) \cdot (TUS_{\text{Prod. Avg.}} - \sigma_T(FS))$$

or

$$\sigma_T = \sigma_T(FS) + \% (TUS_{\text{Prod. Avg.}} - \sigma_T(FS))$$

- (7) Adjust the average departures, D_A , to typical departures, D_T , as follows:

$$D_T = \frac{(D_A - 0.002)(\text{Prod. Avg. Elong.} - 0.002)}{(D_A \text{ at Fracture Stress} - 0.002)} + 0.002 \quad .$$

- (8) Compute elastic strains, ϵ_E , by dividing typical stresses by typical modulus.

$$\varepsilon_E = \frac{\sigma_T}{E}$$

- (9) Obtain total strain, ε_T , by adding D_T and ε_E .
- (10) Calculate the average proportional limit from the stress strain curves and compute the typical proportional limit.

$$\sigma_T(\text{PL}) = \left(\text{TYS}_{\text{Prod. Avg.}} / \text{TYS}_{\text{Avg.}} \right) \cdot \sigma_{\text{Avg.}}(\text{PL})$$

The final step is plotting the full-range stress-strain curves. The following guidelines should be followed to plot the stress-strain curve. There should be 10 minor divisions for every major division with every tenth (major) division accented. The ordinate (Y-axis) is used for stress and should be in units of 5, 10, 20, or 50 ksi to the major division. The abscissa (X-axis) is used for strain and should be in units of 0.01, 0.02, 0.05, or 0.1 in./in. to the major division.

In addition to plotting the graphs by hand, they may be plotted with computer software programs. In the latter case, input the stress-strain pairs (σ_T and ε_T) from Table 9.8.4.3 into the computer and then curve fit the data. The elastic section must be linear up to the proportional limit. It is recommended that a power-law polynomial second order be used to fit the data from the proportional limit to fracture stress. The full-range stress-strain curve should be solid up to maximum stress and dashed from maximum stress to rupture. The fracture point should be indicated with an X. Only one typical full-range stress-strain figure should be plotted per page and should fill as much of the page as possible as illustrated in Figure 9.8.4.3(c). If more than one curve is contained in the figure, information such as the direction (ST, LT, and L), and/or temperature for each curve must be indicated.

9.8.4.4 Minimum Stress-Strain and Stress Tangent-Modulus Curves — Minimum stress-strain and stress tangent-modulus curves are not presented in MIL-HDBK-5, but these are sometimes required by the designer. Procedures for preparing minimum curves are identical to those for preparing typical curves, except for choice of yield-strength values. Product average, or average values of yield strength, are used to determine typical curves; minimum values (F_{ly} or F_{cy} A- or B-basis) are used to determine minimum curves. Average values of precision elastic modulus (E or E_c) are used.

9.8.4.5 Biaxial Stress-Strain Behavior — Procedures for analyzing and presenting biaxial stress-strain properties may be added to the guidelines at a later date. In the interim, procedures described in Reference 9.8.4.5 may be used as a general guide.

9.8.4.6 Mathematical Representation of Stress-Strain Curves — As an aid to computer analyses, the stress-strain curves for most materials can be represented mathematically. This method of representing stress-strain curves may be used for any stress-strain response that can be well characterized by the Ramberg-Osgood Method, and should be used as a supplement to a curve drawn by the Ramberg-Osgood Method.

To represent the stress-strain curves for a particular alloy using this method, a data summary like the one shown in Figure 9.8.4.6 should be constructed.

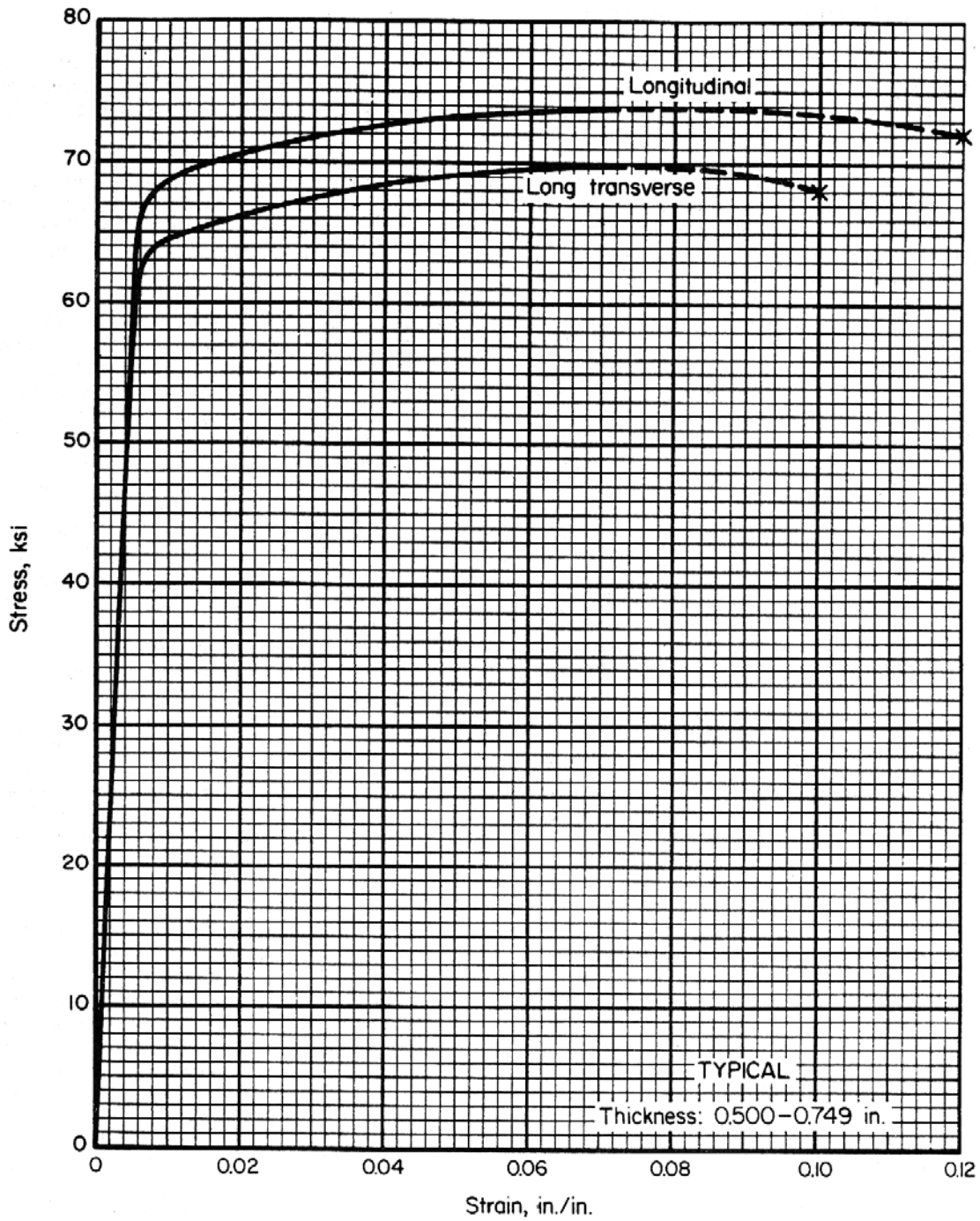

Figure 9.8.4.3(c). Typical full-range curves drawn by the strain-departure method.

Table (table number). Typical Stress-Strain Parameters for (material designation)

Temper/Product Form	Condition	Temperature, °F	Grain Direction	Tension			Compression		
				n	TYS, ksi	TUS	n _c	CYS, ksi	
T6 Clad Sheet	0.02-0.039 in. thickness	RT	L	32	57		17	57	
			LT	17	57		13	60	
	0.04-0.249 in. thickness		L	27	62		15	62	
			LT	20	60		17	65	
	½ hr. exposure	200 F	LT				9.5	60	
	100 hr. exposure						8.0	62	
	½ and 2 hr. exposure	300 F					4.0	54	
	1000 hr. exposure						6.4	46	
	½ hr. exposure	400 F					8.2	47	
	100 hr. exposure						10	20	
	1000 hr. exposure					6.0	16		
	½ hr. exposure	500 F					7.0	22	
	½ hr. exposure						4.3	9	
	10 hr. exposure	600 F					6.0	8	
100 hr. exposure						13	7		
T62 Clad Plate	0.250 - 2.000 in. thickness	RT		L	29	64		27	69
				LT	29	64		27	70
T651 Plate	0.250 - 2.000 in. thickness	RT		L	30	66		15	68
			LT	19	65		18	66	
T6 Bar, Rod and Shapes	> 3 in. thickness	RT	L	31	62		25	60	
T6 Forging		RT	L			70			
			LT			68			
T652 Hand Forging	2.001 - 3.000 in. thickness	RT	L	18	62	67	17	63	
			LT	18	62	66	18	65	
			ST	13	60		22	67	
T6 Extrusion	0.125 - 0.499 in. thickness	RT	L	23	62		15	64	
	> 0.500 in. thickness			26	68		14	72	
T62 Extrusion	< 0.499 in. thickness	RT	L	29	64	71	17	68	
			LT	29	64		32	68	
T651X Extrusion	0.500 - 0.749 in. thickness	RT	L	32	64	74	16	68	
			LT	18	64	70	18	68	

Figure 9.8.4.6. Example of stress-strain parameter table.

MIL-HDBK-5J
31 January 2003

The parameters in the table are defined as follows:

Tension

n = Ramberg-Osgood parameter for small plastic strains in tension from the proportional limit up to the yield stress.

TYS = Typical yield stress in tension.

TUS = Typical ultimate stress in tension.

Compression

n_c = Ramberg-Osgood parameter for small plastic strains in compression up to the yield stress.

CYS = Typical yield stress in compression.

Equation 9.8.4.6(a) shows the relationship between the plastic strain and stress values that hold for many materials up to that material's yield stress. The problem with this equation is that the Ramberg-Osgood parameter (n) typically changes for plastic strains greater than 0.002. Therefore, the variation of plastic strain typically must be expressed with two different equations. For stress values in the range between the proportional limit and yield stress, plastic strain can often be expressed by

$$e_p = 0.002 (f / \text{TYS})^n \quad [9.8.4.6(a)]$$

where

f = any stress value between the proportional limit and tensile yield stress

TYS = the 0.2 percent typical yield stress

e_p = the plastic strain.

In any tabular representation of these data for a given alloy (covering all production thickness and product forms), significant information may be missing. Therefore, only 50 percent of the data are required to be available before a table may be included in MIL-HDBK-5.

The data in this table may also be used to calculate other useful quantities. A table with all elements defined can be used to calculate the proportional limit in tension and compression, and the shear "yield" stress. Each of these calculations are covered below.

9.8.4.6.1 Proportional Limit Stress in Tension and Compression— If the proportional limit stress is equated with a plastic strain level of 0.0002 or a 0.02 percent deviation from linearity, and the Ramberg-Osgood relationship is found to be valid for small plastic strains, then the proportional limit stress (f_{p.l.}) can be approximated from Equation 9.8.4.6(a) as follows:

$$f_{p.l.} = \text{TYS} (0.10)^{\frac{1}{n}}$$

The same basic formulation could be used to define a proportional limit stress in compression, replacing TYS and CYS and n in tension with n_c in compression in Equation 9.8.4.6(b).

9.8.4.6.2 Shear Yield Stress — An estimate of the shear yield stress can be obtained from the equation:

$$F_{sy} = \frac{F_{ty}(L) + F_{ty}(LT) + F_{cy}(L) + F_{cy}(LT)}{4} \times \frac{2F_{su}}{F_{tu}(L) + F_{tu}(LT)} \quad [9.8.4.6.2]$$

where

- (p) = Primary load direction for shear
- $F_{ty}(L)$ = Tensile yield stress, longitudinal direction
- $F_{ty}(LT)$ = Tensile yield stress, long transverse direction
- $F_{cy}(L)$ = Compressive yield stress, longitudinal direction
- $F_{cy}(LT)$ = Compressive yield stress, long transverse direction
- F_{su} = Shear ultimate stress
- $F_{tu}(L)$ = Tensile ultimate stress, longitudinal direction
- $F_{tu}(LT)$ = Tensile ultimate stress, long transverse direction.

9.8.4.6.3 Compression Tangent Modulus Curves — A mathematical procedure for construction of tangent modulus curves from compression stress-strain curves is given in Section 9.8.4.2. The compression stress-strain curve (up to the yield stress) may be constructed by adding the elastic strain component to the plastic strain component given in Equation 9.8.4.6(a). Calculation of the first derivative of stress with respect to strain gives tangent modulus values for specific values of total strain. Within MIL-HDBK-5 the tangent modulus curve is normally computed only up to the yield stress on the stress-strain curve. If tangent modulus values are desired at stress levels above the yield stress, a single function describing the relationship between stress and plastic strain over the range of interest should be used [rather than two separate functions as shown in Equations 9.8.4.6(a) and (b)].

9.8.5 ELEVATED TEMPERATURE GRAPHICAL MECHANICAL PROPERTIES — Effects of temperature and of thermal exposure on strength and certain other properties are presented graphically. Methods for determining these curves differ and are described below.

9.8.5.1 Strength Properties — Tensile ultimate and yield strengths, compressive yield strength, shear ultimate strength, and bearing ultimate and yield strengths at temperatures other than room temperature (80°F) are shown as percentages of room-temperature value for that property. Use of percentage curves allows a single curve to be used in place of multiple curves when more than one room-temperature value is presented for a property, as for example, differing A- and B-design values for each of several thickness ranges. In instances where related properties differ in their response to temperature, additional curves are provided and are labeled to indicate specific properties and forms to which they apply.

No significance level is attached to these curves. For practical purposes, however, the product of a room-temperature A or B design value and an appropriate percentage value from the curve may be regarded as an A or B design value at the indicated temperature.

9.8.5.1.1 Determination of Working Curves — Working curves for each product form, heat treat condition, property, and grain direction should be constructed. Separate curves should be examined to determine if certain data can be combined. For example, it may be possible to combine data for sheet and plate, T73 and T7351 tempers, tensile and compressive yield strengths, or longitudinal and long transverse grain directions.

MIL-HDBK-5J
31 January 2003

The dimensional units of these working curves will be in terms of percentages of corresponding room-temperature value for the property. A percentage may be determined for each lot by dividing the average value of individual measurements (other than at room temperature) by the room-temperature average value for the same lot of material in the same testing direction (for isotropic materials, testing direction may be ignored), then multiplying by 100 to convert from a fraction to a percentage.

At each working temperature, the lower 95 percent confidence interval estimate (reduced ratio) of mean percentage will be determined from percentage values for each lot at that temperature. Letting r equal percentage values, \bar{r} the average of these values, and n the number of such percentages, estimated standard deviation(s) and reduced ratio (R) will be determined from the equation:

$$s^2 = \sum(r - \bar{r})^2 / (n - 1) \quad [9.8.5.1.1(a)]$$

or

$$s^2 = [\sum(r^2) - (\sum r)^2/n] / (n - 1) \quad , \quad [9.8.5.1.1(b)]$$

and

$$R = \bar{r} - t s / \sqrt{n} \quad [9.8.5.1.1(c)]$$

where t is a 0.95 fractile of the t distribution corresponding to $n-1$ degrees of freedom (see Table 9.10.4).

The working curve will be a smooth curve drawn through 100 percent at room temperature and not higher than the computed values of R at each working temperature. When only room-temperature minima are applicable, no further adjustment of the working curve is required. However, when a secondary testing temperature is specified for the property, the working curve will be lowered, if required, so that the product of percentage from this curve and a room-temperature S -value will not exceed the S -value at the secondary testing temperature. In addition, if A -basis values have been established for this temperature, the working curve will be lowered, if required, so that the product of the percentage from this curve and room temperature A -value will not exceed the A -value at the secondary testing temperature.

Each working curve will be labeled appropriately, designating product, property, and testing direction(s) covered by it. In addition, individual percentages, including R values and (if applicable) secondary A or S -values reduced to percentages, will be plotted with the working curve. An example of a working curve is shown in Figure 9.8.5.1.1.

9.8.5.1.2 Preparation of Finished Curves — When two or more working curves are to be combined into a single curve, percentages shown in the finished curve will represent the separate bound of all individual working curves used in its preparation. When corresponding working curves differ substantially in shape or scaling, it may be appropriate to prepare more than one finished curve (for example, separate curves for longitudinal and transverse testing directions). Finished curves will not exhibit “humps”, such as might appear with a temperature range where aging takes place. Where such humps appear in working curves, these will be leveled by means of horizontal line segments.

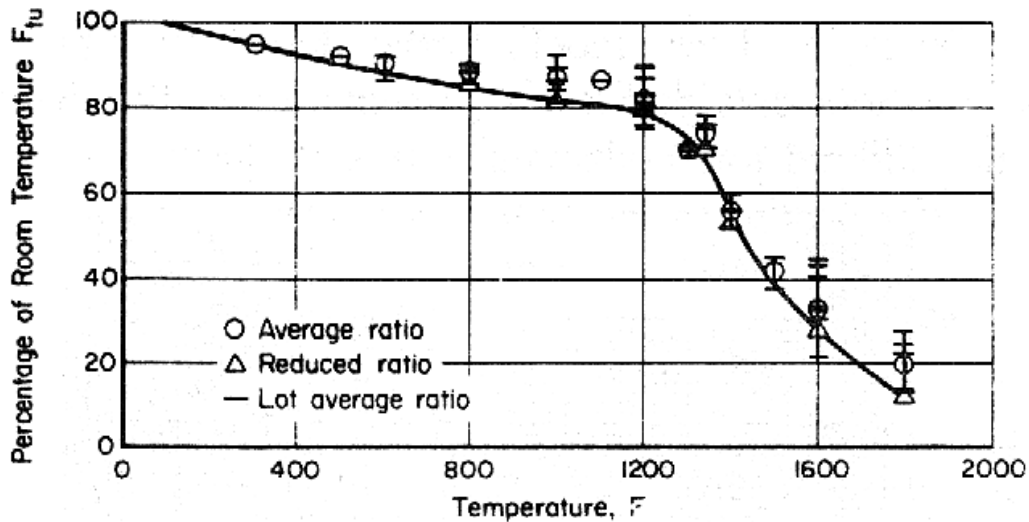

Figure 9.8.5.1.1. Working curve drawn through reduced ratios converted to percentages.

Finished curves will be drawn in reproducible form on grids of 10 lines to the inch, with each tenth line accented. The ordinate will normally be scaled in units of 20 percent per inch and will be labeled “Percentage of Room Temperature Strength”. Abscissa will be scaled in units of 100, 200, or 400°F per inch, as appropriate, and will be labeled “Temperature, °F”. Both axes will be annotated at intervals of 1 inch. Not more than two curves will be drawn in a single figure, and these should be labeled clearly to distinguish between them. In addition, each figure will carry a legend containing the words “strength at temperature”, together with exposure limits and other information that would limit the applicability of the curve.

An example of the finished percentage curve is shown in Figure 9.8.5.1.2(a). When practical, single percentage curves, representing F_{tu} and F_{fy} may be located on a single illustration as shown in Figure 9.8.5.1.2(b). Likewise, single curves representative of F_{cy} and F_{su} may be located on one illustration and curves for F_{bru} and F_{bry} may also be placed on a single illustration.

9.8.5.2 Elongation and Reduction of Area — Elongation and reduction of area are presented as “typical” values at each temperature. If ductility values follow a log-normal distribution, they should be converted to logarithms before averaging. In most cases, the median (middle-most value) will be nearly identical to the average determined in this manner. Ductility values are not converted to percentages of the room-temperature value. Hence, a best smooth curve drawn through the typical values at each temperature is merely redrawn without data points for presentation in the document, as shown in Figure 9.8.5.2. Separate curves may be required for products differing in ductility.

As with strength data, care must be taken to avoid biasing the curve by the inclusion of large quantities of data from some lots and small quantities from others. Use of lot-average values in place of individual measurements is highly recommended.

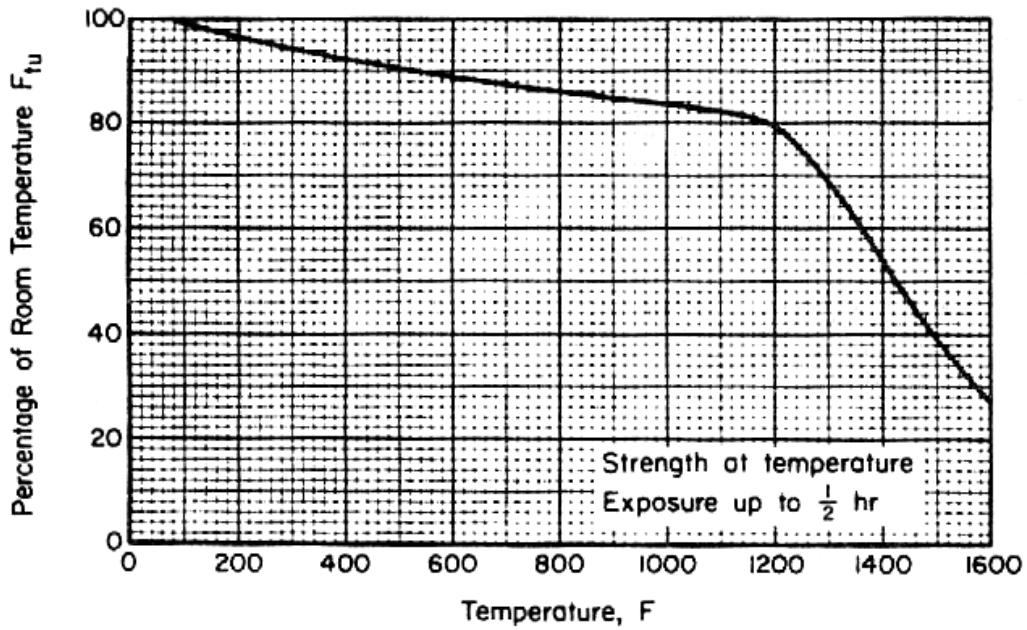

Figure 9.8.5.1.2(a). Working curve from Figure 9.8.5.1.1 redrawn as finished curve.

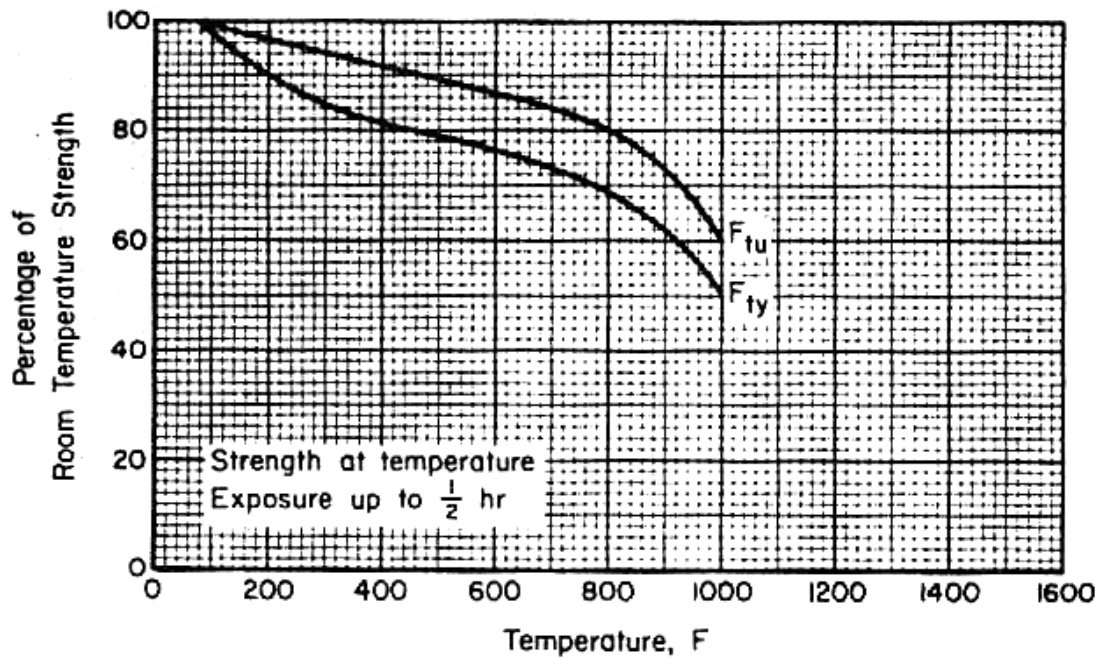

Figure 9.8.5.1.2(b). Multiple percentage curves drawn on a single illustration.

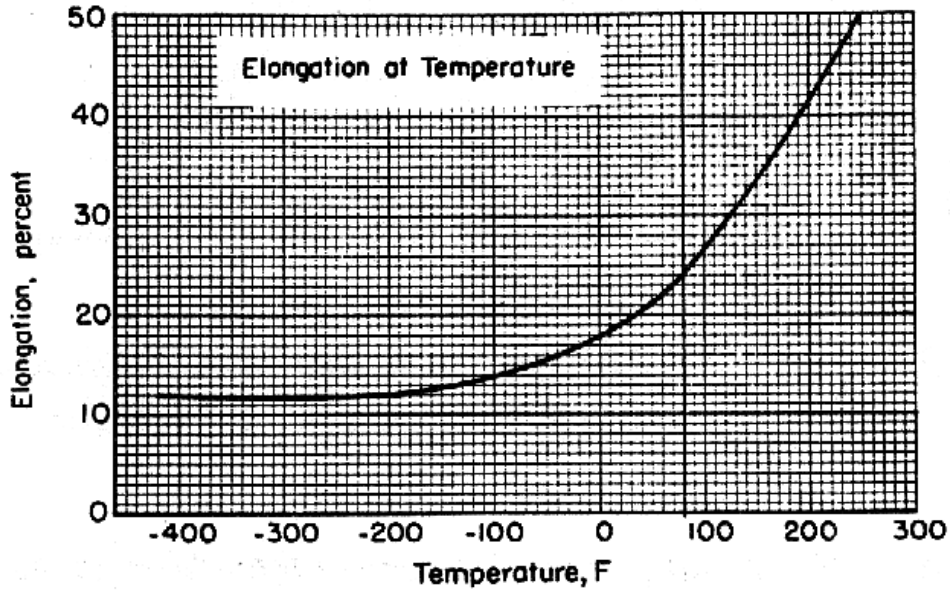

Figure 9.8.5.2. Typical curve for elongation.

9.8.5.3 Modulus of Elasticity — The elastic modulus may vary with test direction and product form. Data should be examined before plotting, and if differences are observed, separate working curves should be prepared for each variable. The percentage curve for modulus of elasticity is a best-fit smooth curve drawn through the average of all percentages at each temperature, where individual percentage values are obtained as described in Section 9.8.5.1.1. As with strength data, temperatures should be so selected that the shape of the curve is defined adequately. Figure 9.8.5.3 illustrates a finished percentage curve representing two moduli, E and E_c , for which working curves were similar enough to permit their combination into a single curve.

9.8.5.4 Physical Properties — When data are adequate to present curves showing specific heat,

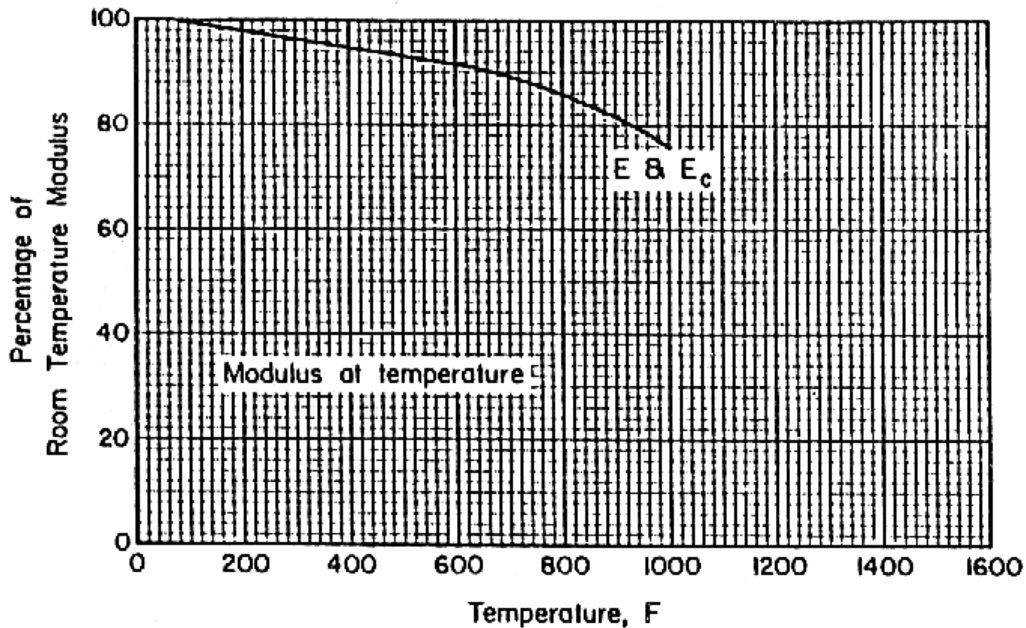

Figure 9.8.5.3. Percentage curve representing two elastic moduli.

thermal conductivity, and mean coefficient of thermal expansion over a range of temperatures, graphical presentation is used in place of tabular presentation described in Section 9.2.1.3. Working curves are first prepared for each property with the actual data plotted over the range of test temperatures.

Figure 9.8.5.4(a) shows a typical working curve. A best-fit smooth curve is drawn through the plotted points to depict the overall trend of data. The smooth curves from the specific heat, thermal conductivity, and thermal expansion working curves are then shown in a single figure as illustrated in Figure 9.8.5.4(b). The reference temperature for thermal expansion should be shown on the figure. In Figure 9.8.5.4(b) the reference temperature of 70°F indicates that the mean coefficient of expansion between 70°F and the indicated temperature is plotted.

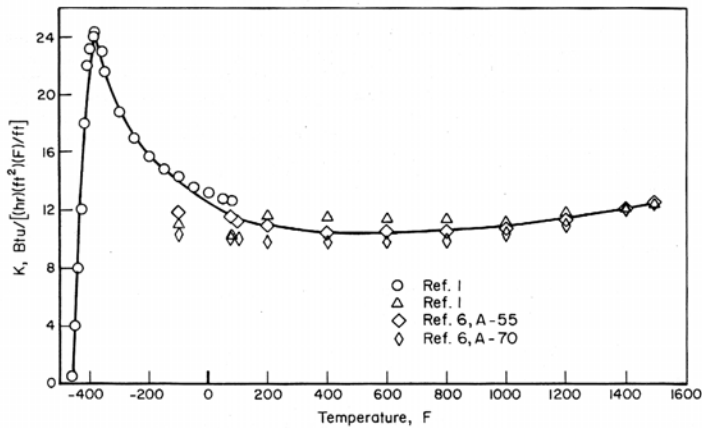

FIGURE 9.3.1.4(a). Typical working curve for thermal conductivity.

Figure 9.8.5.4(a). Typical working curve for thermal conductivity.

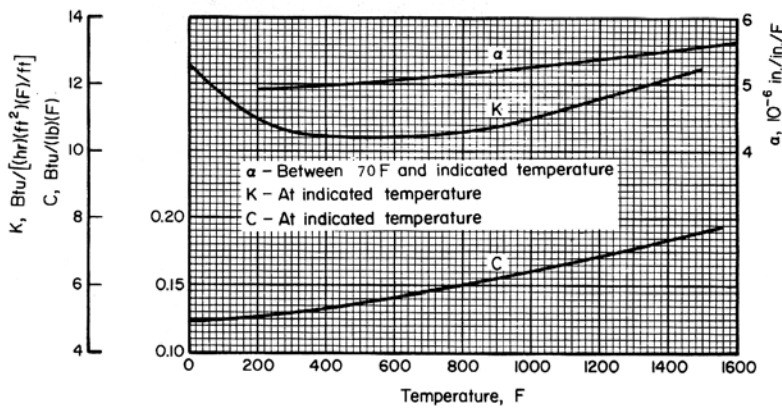

Figure 9.8.5.4(b). Typical curves for physical properties.

9.8.5.5 Effect of Thermal Exposure on Room Temperature Strength — Curves described in this section are presented (1) when the material exhibits a decrease in room-temperature strength as a result of unstressed exposure to elevated temperatures, and (2) when data are not presented in the form of parametric curves (see “Complex-Exposure” in Section 9.8.5.8). Supporting data expressed as percentages of the “no-exposure” strength are plotted with percent of room-temperature strength as the ordinate and exposure temperature as the abscissa. Separate plots are required for each exposure time. Typical exposure times are ½, 10, 100, and 1000 hours. Design curves are drawn in the same manner as for effect of temperature on strength; humps that may appear in the design curve should be leveled off in drawing the final curve.

The following restrictions are placed on effect-of-exposure curves for strength properties at room temperature:

- (1) Percentage curves for a designated exposure temperature may not show increasing percentage values with increasing exposure time.
- (2) Percentage curves for a designated exposure time may not show increasing percentage values with increasing exposure temperature.

A typical effect-of-exposure curve is illustrated in Figure 9.8.5.5.

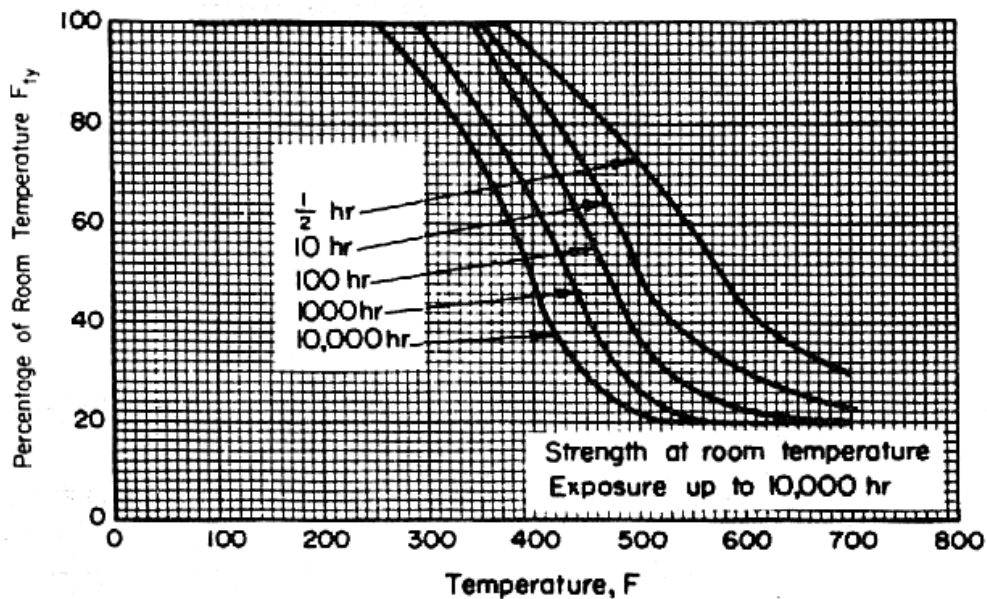

Figure 9.8.5.5. Effect of exposure at elevated temperatures on room-temperature properties.

9.8.5.6 Effect of Thermal Exposure on Elevated Temperature Strength — The effect of thermal exposure on elevated-temperature strength is presented in one of two manners, depending upon whether or not the exposure temperature equals the test temperature. In the case of simple exposure, exposure temperature and test temperature are assumed to be identical. For complex exposure, exposure temperature and test temperature need not be the same. When either of these curves is presented in MIL-HDBK-5, it includes all information normally presented in elevated temperature curves described in Section 9.8.5.1; thus, these curves replace the elevated temperature curves.

9.8.5.7 Simple Exposure — The curves are prepared in the same manner as basic elevated temperature curves described in Section 9.8.5.1. Separate design curves are prepared for each exposure time, and presented in a single figure. Typical exposure times for the curves are ½, 10, 100, and 1000 hours.

The following additional restrictions are placed on effect-of-exposure curves for strength properties at elevated temperatures:

- (1) Percentage curves for a designated exposure (test) temperature may not show increasing percentage values with increasing exposure time.
- (2) Percentage curves for a designated exposure time may not show increasing percentage values with increasing exposure (test) temperature.

A typical set of curves for exposure at test temperature is illustrated in Figure 9.8.5.7.

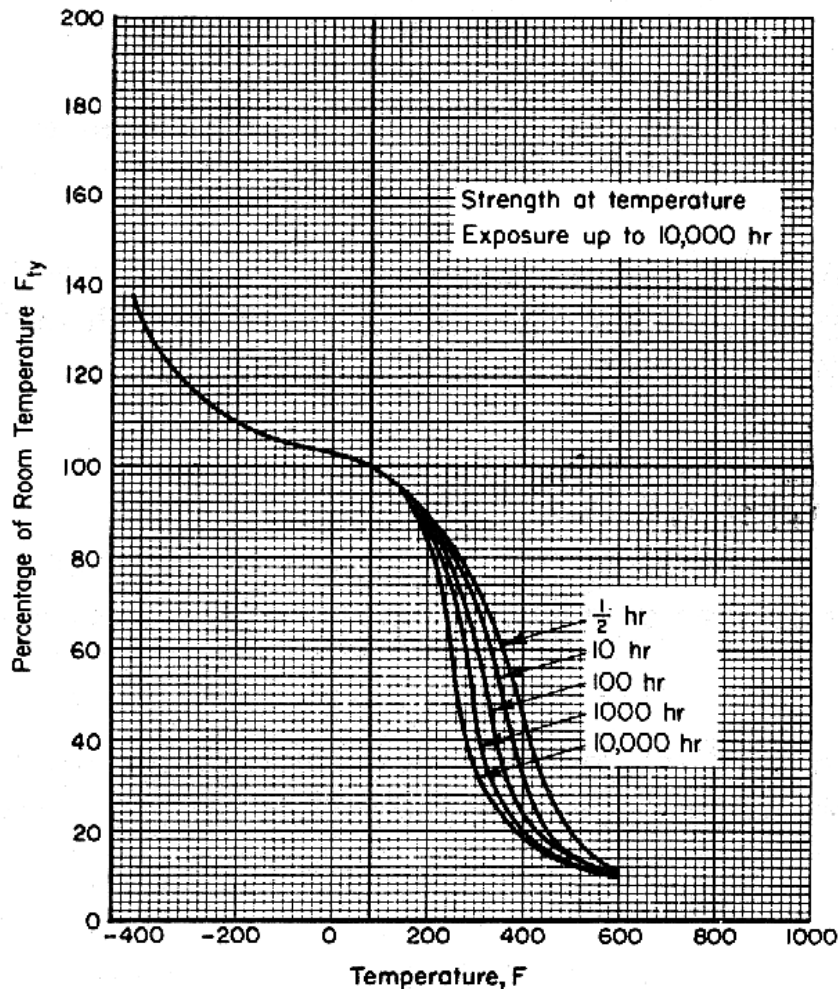

Figure 9.8.5.7. Simple-exposure curves.

9.8.5.8 Complex Exposure — In these curves, thermal-exposure variables, time, and temperature are combined into an exposure parameter, which is plotted as the abscissa. The ordinate is expressed in the same manner as in effect-of-temperature curves. Separate percentage curves are presented for each test temperature. In addition, each figure contains a nomograph for use in converting exposure time and temperature to the exposure parameter.

The exposure parameter may be of the form $P = (T_F + 460) (C + \log t)$, where T_F is exposure temperature in degrees F, C is a constant, and t is exposure time in hours. There are a number of ways to determine the values of C . The simplest method is to select (by interpolation of test data) two exposure conditions that produce the same strength at some designated test temperature, set two parameters equal to each other, and solve for C . For example, assume that the following data are obtained:

Exposure		
Time, hr	Temp, °F	TUS at 400 °F, ksi
1000	400	80.0
1	500	83.0
10	500	78.0

Plot 500°F data as stress versus log time; a straight line between (83, log 1) and (78, log 10) crosses 80 ksi at log 4 (hours). Thus, 4 hours' exposure at 500°F is equal to 1000 hours' exposure at 400°F:

$$(400 + 460) (C + 3) = (500 + 460) (C + 0.602),$$

$$C = 20.$$

This exercise should be repeated for several pairs of exposure conditions to obtain an average value for C .

Alternatively, several equivalent exposure conditions may be plotted as log exposure time (ordinate) versus $1/(T_F + 460)$ (abscissa). A best-fit straight line is drawn through the plotted points and its slope determined. C is then found from the relationship

$$C = m/(T_F + 460) - \log t,$$

where m is slope and $(1/(T_F + 460))$ and $\log t$ are coordinates of any point on the line. This method is amenable to data-regression procedures described in Section 9.5.6, from which a least-squares estimate of C is obtained. Separate data plots are prepared for each test temperature, using percent of "no-exposure" room-temperature strength as the ordinate, and $P = (T_F + 460) (C + \log t)$ as the abscissa. Design curves are then drawn as described in Section 9.8.5.1.1.

A typical complex-exposure curve is illustrated in Figure 9.8.5.8. It should be noted that the abscissa scale is not shown in the figure since the time-temperature nomograph is used directly to locate the position on the abscissa.

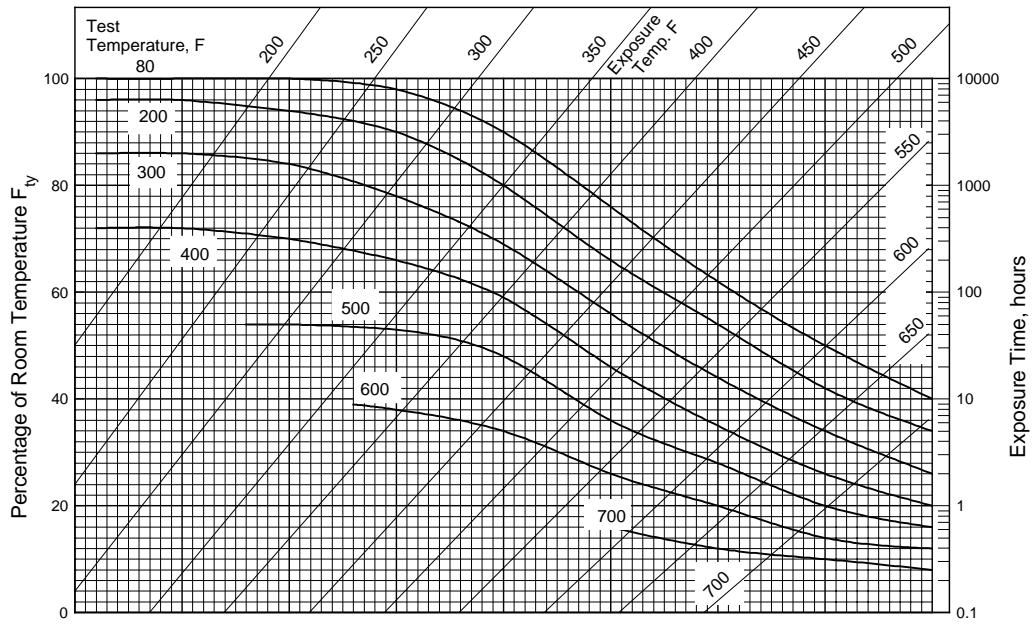

Figure 9.8.5.8. Complex-exposure curves.

9.9 EXAMPLES OF DATA FOR DYNAMIC AND TIME DEPENDANT PROPERTIES

9.9.1 FATIGUE — Separate data presentations are made for strain-controlled and load-controlled data. The only case where load-controlled data can be presented with strain-controlled data is when long-life tests have been switched from strain to load control in accordance with recommended procedures (see Section 9.2.5.1). Separate plots should be constructed for each material, notch concentration (in the case of load-controlled data), temperature, or other documented parameters that have been demonstrated to cause significant variations in fatigue behavior.

Load-controlled data presentations should consist of a family of at least three stress ratio or mean stress curves, with at least six data points per curve covering two orders of magnitude in life. (See exceptions noted in Section 9.2.3.5.1). The basic data should be included on each plot, with separate symbols used for each stress ratio or mean stress. Runouts should be identified with an arrow (→). The analytically defined mean S/N curves for each stress ratio or mean stress should also be included on each plot. These curves should not be extrapolated beyond existing data.

The fatigue curve for each stress ratio should be constructed based on the following criteria:

- (1) The curve should start at the greatest maximum stress for that specific stress ratio. Unnotched fatigue curves should not extend above the average tensile ultimate strength of the material.
- (2) The curve will terminate at the lowest maximum stress or longest life value, whichever is most limiting for that specific stress ratio.

In addition to the stress-life plot [such as shown in Figure 9.9.1.1(e)], a tabulation of test and material conditions should also be included. At a minimum the following information should be included with an S/N plot:

- (1) Material
- (2) Product Form, Grain Direction, Thickness, Processing History, Fabrication Sequence
- (3) Test Parameters
 - Loading
 - Test Frequency
 - Temperature
 - Environment
- (4) Average Tensile Properties
- (5) Specimen Details
 - Notch Description
 - Specimen Dimensions
- (6) Surface Condition/Surface Residual Stresses/Finish
 - Finish
 - Residual Stress Data
- (7) Equivalent Stress Equation
 - Life Equation With Parameter Estimates
 - Standard Deviation of log(Life)
 - Adjusted R-Squared Statistic
 - Sample Size
- (8) Reference Numbers
- (9) No. of Heats/Lots

The following cautionary note should be included with each equivalent stress equation: [Caution: The equivalent stress model may provide unrealistic life predictions for maximum stresses and stress ratios

beyond those represented above.] In calculating the “standard deviation of log(life)” and the adjusted R-squared statistic, all quantities should be computed using the final estimates of the fatigue model parameters and excluding runout observations.

The method for reporting the “standard deviation of log(life)” (SD) depends on whether there is evidence of nonuniform variance in the fatigue life data. If an unweighted fatigue model was fitted to the data, the single SD value from Equation 9.6.1.5(e) should be reported. If a weighted fatigue model was fitted to the data, SD should be reported as the linear function of the reciprocal of equivalent stress (strain) as calculated from Equation 9.6.1.5(g) or (h).

If an unweighted fatigue life model was fitted to the data, the adjusted R-squared statistic is

$$R^2 = 1 - (\text{RMSE})^2/(\text{RTE})^2 \quad [9.9.1(a)]$$

where

$$\text{RTE} = \sqrt{\sum_{i=1}^n D_i^2 / (n - 1)}$$

$$D_i = \log(N_i) - \overline{\log(N)}$$

$$\overline{\log(N)} = \frac{1}{n} \sum_{i=1}^n \log(N_i)$$

If a weighted fatigue life model was fitted to the data, the adjusted R-squared statistic may be calculated as

$$R^2 = 1 - (\text{RMSE})^2/(\text{RTE})^2 \quad [9.9.1(b)]$$

where

$$\text{RTE} = \sqrt{\sum_{i=1}^n \text{WD}_i^2 / (n - 1)}$$

$$\text{WD}_i = \frac{\log(N_i) - \overline{\log(N)}}{g(S_{\text{eq},i} \text{ or } \epsilon_{\text{eq},i})}$$

$$\overline{\log(N)} = \frac{\sum_{i=1}^n \log(N_i) / g(S_{\text{eq},i} \text{ or } \epsilon_{\text{eq},i})}{\sum_{i=1}^n (1/g(S_{\text{eq},i} \text{ or } \epsilon_{\text{eq},i}))}$$

and RMSE is as calculated in Equation 9.6.1.5(i).

Strain-controlled data presentations should consist of a plot of $\log(\text{strain range})$ versus $\log(\text{life})$ and a separate graph displaying the monotonic and cyclic stress-strain response for the material. Normally the fatigue curves should be based on at least six data points for each of three or more strain ratios, and the data should cover at least two orders of magnitude in life. As with the load-controlled data, the individual data points should be included on each plot, with separate symbols used for each strain ratio. If runouts are included in the data, they should be identified with an arrow (\rightarrow). Data points that are based on tests that were switched from strain to load control should be identified clearly. The mean curves should extend from slightly above the greatest strain value to slightly below the least strain value.

Plotting the strain-life curves for different strain ratios is not as straightforward as plotting stress-life curves. The equivalent strain models cannot be written explicitly in terms of R_ϵ . Therefore, other information must be used to model the data trends for the various strain ratios. The mean-stress relaxation behavior for each strain ratio must be identified and mathematically defined. In general, the onset of mean stress relaxation occurs at smaller strain amplitudes for larger strain ratios. This behavior is shown in the mean stress relaxation plot of Figure 9.8.3(a). The elastic response (dashed lines) predicts much higher mean stresses than those actually observed, suggesting that mean stress relaxation has occurred. The regression line correlating the relaxed mean stresses with strain amplitude intersects the elastic response lines at larger strain amplitudes for smaller strain ratios. The elastic response line for the higher strain ratio ($R_\epsilon = 0.6$) intersects the mean stress relaxation line at approximately $\Delta\epsilon/2 = 0.0007$. The elastic response line for the lower strain ratio ($R_\epsilon = 0.0$) intersects the mean stress relaxation at approximately $\Delta\epsilon/2 = 0.002$. This information can be used to construct reasonable mean curves for each strain ratio for which fatigue data are available.

Considering the primary equivalent strain relation [Equation 9.6.1.4(c)]

$$\epsilon_{\text{eq}} = (\Delta\epsilon)^{A_3} (S_{\text{max}}/E)^{1 - A_3} ,$$

S_{max} can be written as

$$S_{\text{max}} = S_m + S_a$$

where S_m is the relaxed mean stress and S_a is the stress amplitude found from the cyclic stress-strain curve. Given the mean stress relaxation data, both S_m and S_a can be estimated for a particular strain amplitude and strain ratio. Once S_{max} is defined, based on S_a and S_m , ϵ_{eq} can be calculated and a fatigue life can be determined. Through this procedure an approximate mean curve can be constructed for each strain ratio as shown in Figure 9.9.1(a).

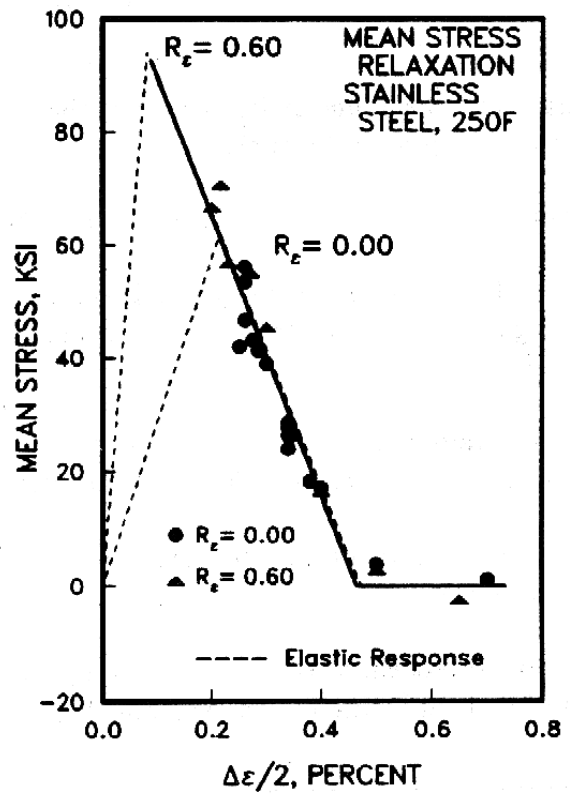
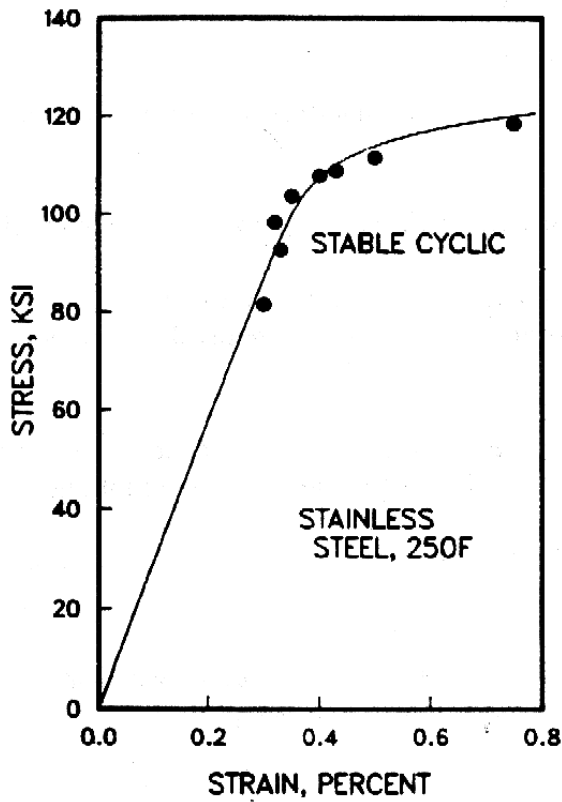
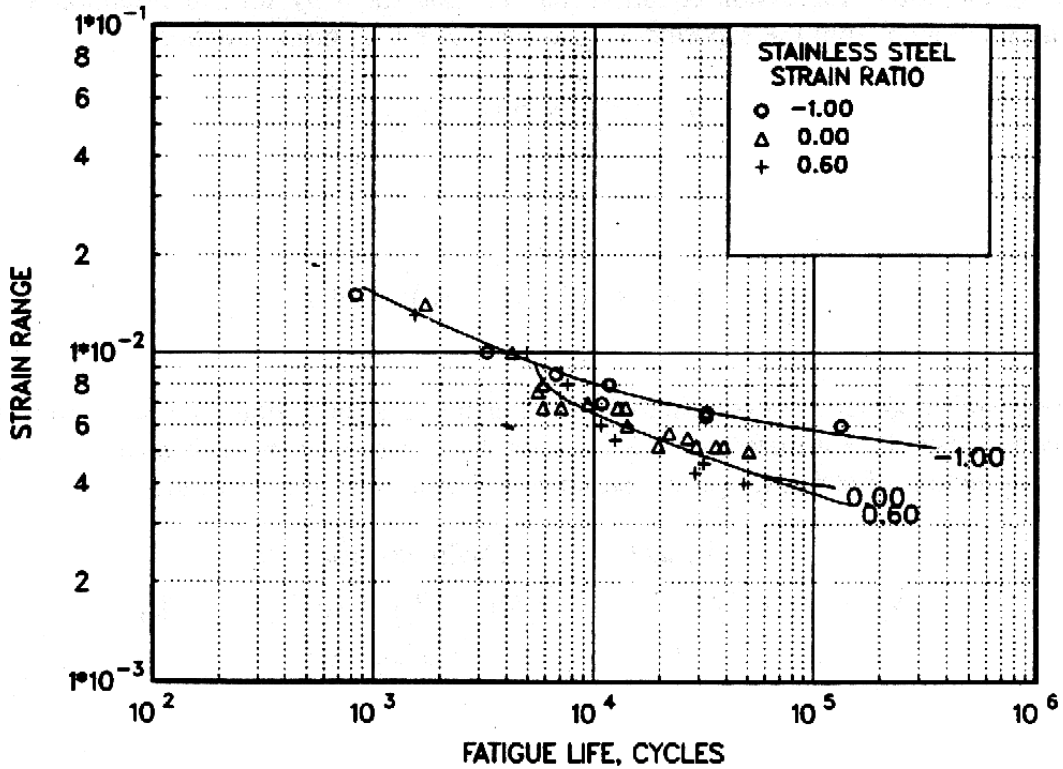

Figure 9.9.1(a). Example strain-life, cycle stress-strain, and mean stress relaxation curves.

MIL-HDBK-5J
31 January 2003

If the stress amplitude (S_a) and the mean stress relaxation pattern can reasonably be assumed to be independent of strain ratio, the following procedure may be used to construct mean curves for each strain ratio by expressing S_a as a function of the strain range and S_m as a function of strain range and strain ratio. Using the data corresponding to a strain ratio of $R_\epsilon = -1$ only, fit the regression equation

$$\log(S_{\max}) = \alpha_1 + \beta_1 \log (\Delta\epsilon/2 - S_{\max}/E)$$

In some cases it may be necessary to exclude small plastic strain observations from the regression because of the scatter (and likely unreliability) in these values. In other words, it is recommended that the cyclic stress-strain curve be defined, through at least squares regression treating stress as the dependent variable, with consideration given to a cutoff in cyclic plastic strain. A cutoff of approximately 0.0001 in plastic strain amplitude is often useful.

Assuming that stress amplitude is independent of strain ratio and provided that the estimate of the parameter β_1 is greater than zero, a mean value for stress amplitude can be determined as a function of strain range by solving the formula

$$S_a / \bar{E} + (S_a/k)^n = \Delta\epsilon/2 \quad [9.9.1(c)]$$

for S_a where \bar{E} is the average elastic modulus for all specimens tested and

$$n = \beta_1 \text{ and } k = A \log (\alpha_1) .$$

If the estimate of the parameter β_1 is less than or equal to zero, the data set should be examined further before proceeding with the analysis.

Using the data corresponding to all strain ratios other than $R_\epsilon = -1$, fit the regression equation

$$S_m = \alpha_2 + \beta_2 (\Delta\epsilon/2)$$

using weighed least squares to give higher weight to the observations which exhibit partial mean stress relaxation. If there is no way to directly calculate S_m from the data reported in the data set, an S_m value for use in fitting the above regression equation may be calculated by solving Equation 9.9.1(c) for S_a and subtracting this value from the reported S_{\max} value. The weighting function

$$w = (|S_m|/S^*) (1 - S_m/S^*)^2$$

where

$$S^* = [(1 + R_\epsilon) / (1 - R_\epsilon)] E (\Delta\epsilon/2)$$

appears to work well in general. Assuming that the mean stress relaxation pattern is independent of strain ratio and provided that the estimate of the parameter β_2 is less than zero, a mean value for S_m can be determined as a function of strain range and strain ratio according to the formula

$$S_m = \begin{cases} \beta_3(\Delta\varepsilon/2) & (\Delta\varepsilon/2) \leq \alpha_2/(\beta_3 - \beta_2) \\ \alpha_2 + \beta_2(\Delta\varepsilon/2) & \alpha_2/(\beta_3 - \beta_2) \leq \Delta\varepsilon/2 \leq -\alpha_2/\beta_2 \\ 0 & -\alpha_2/\beta_2 \leq (\Delta\varepsilon/2) \end{cases}$$

where

$$\beta_3 = \left[\frac{1 + R_e}{1 - R_e} \right] \bar{E} \quad .$$

If the estimate of parameter β_2 is greater than or equal to zero, the data set should be examined further before proceeding with the analysis.

Mean curves determined according to the above procedures exhibit the following characteristics:

- (1) At large strain ranges, enough plastic strain is available to relax at the mean stress to zero, regardless of the strain ratio. Therefore, all strain ratios result in equivalent predicted fatigue lives.
- (2) At strain ranges corresponding to mean stresses represented by the relaxation regression line, strain ratios other than $R_e = -1$ (zero mean stress) result in equivalent predicted fatigue lives.
- (3) At low strain ranges, the individual strain ratios assume their elastic mean stress response and diverge from each other.

The above procedure is used for plotting the strain-life curves in MIL-HDBK-5 when multiple strain ratios are involved.¹ The curves generally represent the mean data trends closely.

In addition to the strain-life plot, stress-strain curves and mean stress relaxation curves should be presented as shown in Figure 9.9.1(a). A tabulation of test and material conditions should also be included as shown in Figure 9.9.1(b). This information should include:

- (1) Material
- (2) Product Form, Grain Direction, Thickness, Processing History, Fabrication Sequence
- (3) Test Parameters
 - Strain Rate and/or Frequency
 - Wave Form
 - Temperature
 - Environment
- (4) Average Tensile Properties
- (5) Stress-Strain Equation
 - Monotonic (if available and appropriate) - Cyclic
- (6) Specimen Details

¹ In the general case, data generated at different strain ratios will not necessarily follow the same mean stress relaxation pattern. If different patterns for each strain ratio are evident in a particular case, it is suggested that a family of mean stress relaxation curves be constructed.

- Specimen Type
- Specimen Dimensions
- Fabrication Sequence
- (7) Surface Condition/Surface Residual Stresses/Finish
 - Finish
 - Residual Stress Data
- (8) Equivalent Strain Equation
 - Life Equation with Parameter Estimates
 - Standard Deviation of log(Life)
 - Adjusted R-Squared Statistic
 - Sample Size
- (9) Reference Numbers
- (10) No. of Heats/Lots.

The following cautionary note should be included with each equivalent strain equation:
[Caution: The equivalent strain model may provide unrealistic life predictions for strain ratios and ranges beyond those represented above.]

Correlative Information for Figure 9.3.4.16(a)

<u>Product Form:</u> Die forging, 2 inch thick	<u>Reference:</u> 3.4.5.6.8(a)
<u>Thermal Mechanical Processing History:</u> Annealed at 1800°F, water quench	<u>Test Parameters:</u> Strain Rate/Frequency - 180 cpm Wave Form - Sinusoidal Temperature - 250°F Atmosphere - Air
<u>Properties:</u>	<u>No. of Heats/Lots:</u> 2
<u>TUS, ksi</u> <u>TYS, ksi</u> <u>E, ksi</u> <u>Temp., °F</u>	
155-160 135-140 29,000 250	
<u>Stress-Strain Equations:</u>	<u>Equivalent Strain Equation:</u>
Monotonic Proportional Limit = 111 ksi $\sigma = 289 (\epsilon_p)^{0.138}$	$\text{Log } N_f = -6.56 - 4.20 \log (\epsilon_{eq} - 0.0022)$ $\epsilon_{eq} = (\Delta\epsilon)^{0.46} (S_{max}/E)^{0.54}$ Standard Error of Estimate, Log (Life) = 0.123 Standard Deviation, Log (Life) = 0.465 Adjusted R ² Statistic = 93%
Cyclic (Companion Specimens) Proportional Limit = 92 ksi $(\Delta\epsilon/2) = 156 (\Delta\epsilon_p/2)^{0.046}$	
Mean Stress Relaxation $\sigma_m = 114.0 - 24562(\Delta\epsilon/2)$	<u>Sample Size</u> = 33
<u>Specimen Details:</u> Uniform gage test section 0.250 inch diameter Polished with increasingly finer grits of emery paper to surface roughness of 10 RMS with polishing marks longitudinal.	[Caution: The equivalent strain model may provide unrealistic life predictions for strain ratios and ranges beyond those represented above.]

Figure 9.9.1(b). Example of correlative information and analysis results for a strain control fatigue data presentation.

9.9.1.1 Load Control — A large collection of 300M alloy die forging fatigue data is presented in Figure 9.9.1.1(a). The required steps for the analysis of the data set are presented below.

MIL-HDBK-5J
31 January 2003

Data Requirements (See Section 9.2.4.8)—The data set consists of four stress ratios ($R = -1.0, -0.33, 0.05, 0.2$). Each stress ratio includes at least twenty-three nonrunout observations, easily satisfying the minimum sample size requirement of six tests per stress ratio.

Data Collection (See Section 9.6.1.1) — The data shown in Figure 9.9.1.1(a) were compiled from four sources. Each source reports the results of fatigue testing programs conducted within two years of each other (1968-1970).

The failure criteria for all tests is reported as complete separation of the specimen. Those tests which did not fail are identified on the S/N plot with an arrow (\rightarrow). These runout observations are treated differently in the regression analysis which define the mean fatigue curves (see Section 9.6.1.9).

Evaluation of Mean Stress Effects (See Section 9.6.1.4)—The collection of data consists of four stress ratios, and therefore, an equivalent-stress formation was used to consolidate the data. Equation 9.6.1.4(a),

$$\log N_f = A_1 + A_2 \log (S_{eq} - A_4)$$

where

$$S_{eq} = S_{max}(1 - R)^{A_3} ,$$

is the initial model attempted for fitting the data, and it proved adequate throughout the analysis.

Estimation of Fatigue Life Model Parameters — Least Squares (See Section 9.6.1.5) — The initial least-squares regression (runouts excluded) results in the following fatigue-life equation parameters:

$$\begin{aligned} A_1 &= 23.7 \\ A_2 &= -8.41 \\ A_3 &= 0.366 \\ A_4 &= 0.0. \end{aligned}$$

The fatigue-limit parameter (A_4) of zero seems somewhat inconsistent with the data shown in Figure 9.9.1.1(a). A visual examination of the S/N plot reveals a tendency for the data to asymptotically approach some limiting value. The zero fatigue limit term suggests that some problem may exist within the data collection. A plot of the residuals for the fatigue model using these parameters is shown in Figure 9.9.1.1(b).

The parameters obtained after the model is adjusted for nonconstant variance are:

$$\begin{aligned} A_1 &= 23.4 \\ A_2 &= -8.38 \\ A_3 &= 0.40 \\ A_4 &= 13.5. \end{aligned}$$

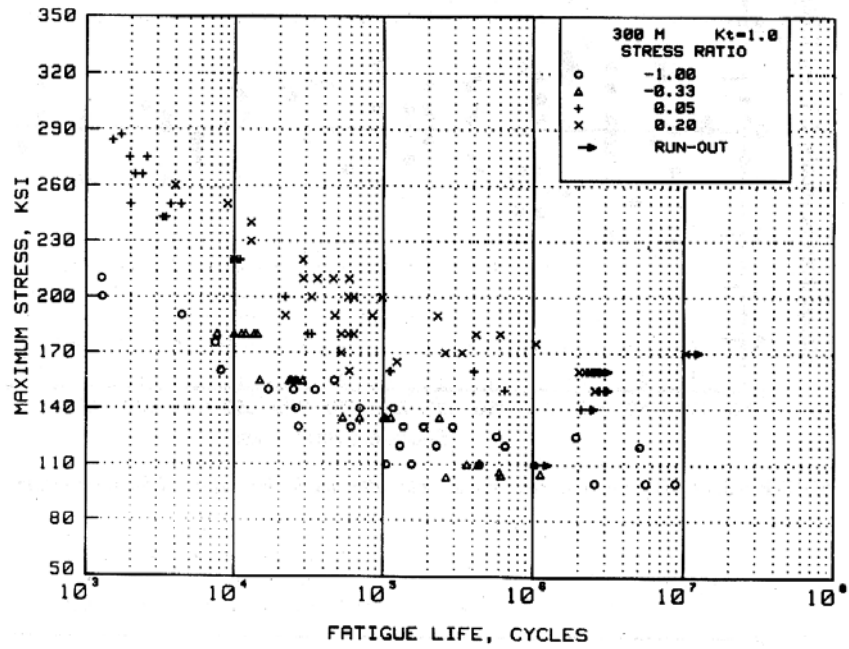

Figure 9.9.1.1(a). S/N plot of unnotched 300M die forging fatigue data, transverse orientation.

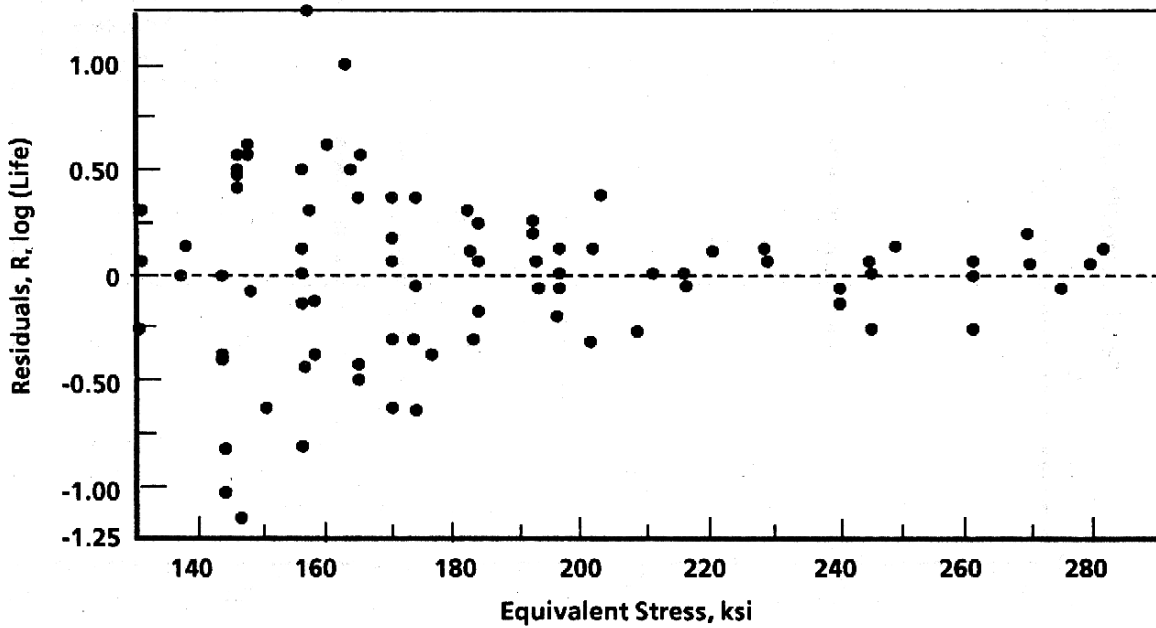

Figure 9.9.1.1(b). Residual plot before model has been adjusted for nonconstant variance.

Note that a fatigue limit term of 13 ksi has now been estimated. However, a check on the significance of the A_4 term revealed that it was clearly insignificant. All of the runouts in the data collection were above this equivalent stress level and, therefore, all runouts were used in the regression procedure. A plot of the residuals after the fatigue life model has been adjusted is shown in Figure 9.9.1.1(c). Note the relative shift in the magnitude of the residuals at the higher and lower S_{eq} values compared to Figure 9.9.1.1(b).

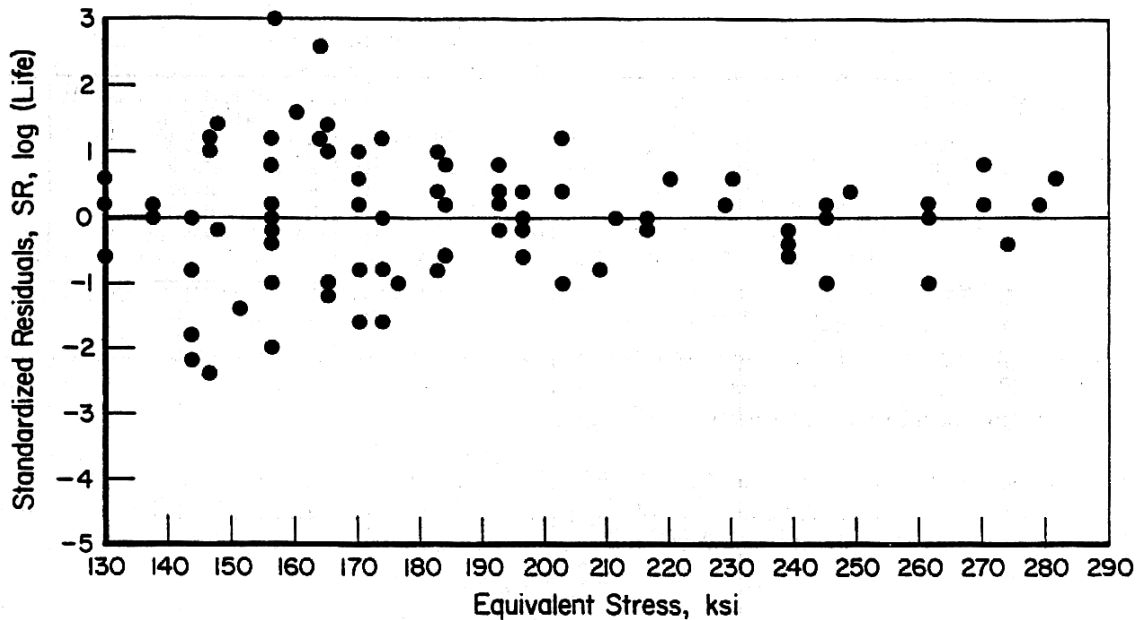

Figure 9.9.1.1(c). Standardized residual plot after model has adjusted for nonconstant variance.

Treatment of Outliers (See Section 9.6.1.6) — None of the observations were identified as outliers. The critical studentized residual at the 5 percent significance level for this data set of 114 observations is 3.63. The largest standardized residual was 3.23, resulting from a runout observation.

Assessment of the Fatigue Life Model (See Section 9.6.1.7) — The equivalent stress model is not able to consolidate the $R = -0.33$ stress ratio with the other stress ratios. The F-test performed on the residuals of the stress ratios proves significant at the 5 percent level for $R = -0.33$. This indicates that the mean of the residuals for $R = -0.33$ differs significantly from the mean of the residuals from the other ratios. The plot of stress ratios versus residuals, as shown in Figure 9.9.1.1(d), illustrates that the mean of the residuals for $R = -0.33$ is significantly different than those for the other stress ratios. A close examination of the original S/N plot shown in Figure 9.9.1.1(a) reveals that the $R = -0.33$ data tend to overlap the $R = -1.0$ data: at the lower maximum stress levels (about 100 ksi), the $R = -1.00$ data actually show longer average fatigue lives than do the $R = -0.33$ data, when the reverse would be expected. The Durbin-Watson D statistic for determining lack of fit is 1.61, indicating a poor fit of the model to the data. The critical value of D for a sample of 114 observations [Equation 9.6.1.7(a)] is 1.66.

This incompatibility among stress ratios indicates that either a problem exists with the data or with the assumed equivalent stress model. The data sources were re-examined to possibly determine if some difference in specimen preparation or testing procedure among the sources may have caused the inconsistencies. Unfortunately, no significant differences were discovered that would provide sufficient reason to exclude the suspect $R = -0.33$ data due to testing methods alone. The problem is confounded because all of

the $R = -0.33$ data comes from a single source which does not include other stress ratios. This precludes examining source to source variability.

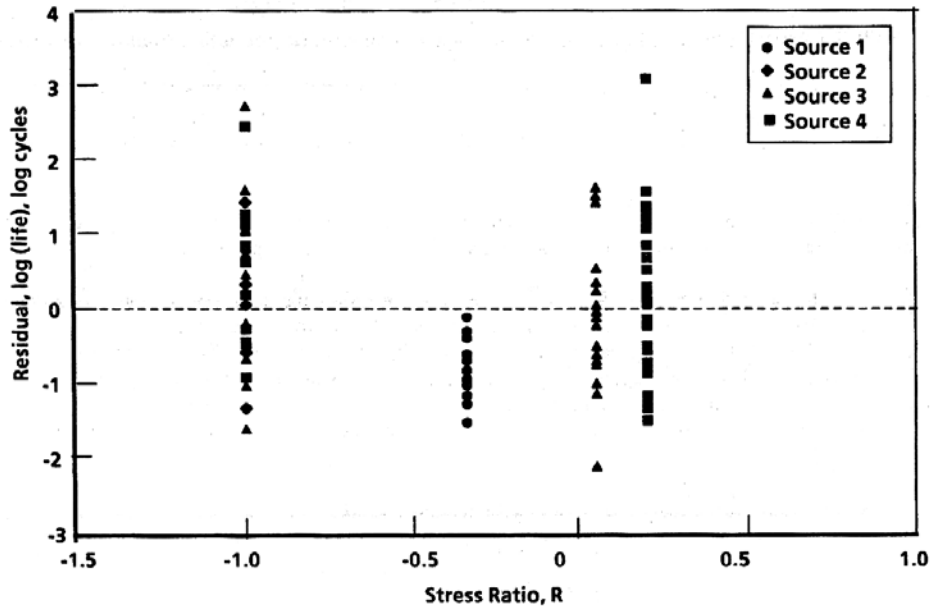

Figure 9.9.1.1(d). Residual plot of stress ratios. Note the low mean value of $R = -0.33$.

In situations such as this where a data set for a single source is determined to statistically deviate from the fatigue trends exhibited by the bulk of the data, it should be evaluated for exclusion. Engineering judgement suggests that the $R = -0.33$ data be excluded from the data collection based on the following:

- (1) Unrealistic fatigue limit
- (2) Lack of fit for fatigue life model based upon Durbin-Watson statistic
- (3) Stress ratio incompatibility.

The modified data collection is now reanalyzed. For the sake of brevity, the details of the analysis procedure for Sections 9.2.4.8 (Data Requirements) and 9.6.1.3 (Fatigue Life Models) through 9.6.1.7 (Fatigue Life Models) will be omitted. It is interesting to note, however, that the fatigue limit term (A_4) resulting from the least squares regression with the $R = -0.33$ data excluded is 94.2 ksi. This result more realistically represents the longer life fatigue trends compared to the previous (insignificant) estimate of 13.5 ksi. With the suspect data removed, the equivalent stress model is determined to be acceptable at the 5 percent level. The Durbin-Watson D statistic also is increased to 2.18 indicating that the model now provides an adequate fit to the data.

Dataset Combination (See Section 9.6.1.8) — With the exclusion of the source containing the $R = -0.33$ data, the remaining data set combination is determined acceptable at the 5 percent level.

Treatment of Runouts (See Section 9.6.1.9) — The data collection includes seven runout observations. The maximum likelihood procedure has the effect of essentially shifting these runouts to the fatigue lives at which they most likely would have failed. The resulting fatigue life model parameters should reflect the slight increase in estimated fatigue life over the least squares parameters, particularly in the long life region. In general, the maximum likelihood regression will result in a higher intercept term (A_1) and a steeper (more negative) slope (A_2). The A_3 and A_4 terms are taken as constants to reduce the problem to a linear analysis.

MIL-HDBK-5J
31 January 2003

The parameters resulting from the least squares regression are:

$$A_1 = 14.54$$

$$A_2 = -5.04$$

$$A_3 = 0.385$$

$$A_4 = 94.2.$$

The maximum likelihood parameters conform to the expected trends for A_1 and A_2 :

$$A_1 = 14.79$$

$$A_2 = -5.16$$

$$A_3 = 0.385$$

$$A_4 = 94.2.$$

Note the increase in A_1 and the decrease (more negative slope) in A_2 .

Presentation of Fatigue Analysis Results—The stress-life curve and correlative information shown in Figure 9.9.1.1(e) is typical of a MIL-HDBK-5 load-control fatigue data proposal.

9.9.1.2 Strain Control—A collection of iron alloy bar strain-controlled fatigue data at 70°F is given in Table 9.9.1.2. The required steps for the analysis of the data set are presented below. The guideline sections relating to each step in the analysis are noted.

Data Requirements (See Section 9.2.4.8)—The data set includes three strain ratios ($R_e = -1.0, 0.0, 0.6$) each consisting of at least eight nonrunout data points. This satisfies the minimum recommended sample size for analysis. Two runouts ($N_f = 10^5$ and 10^6 at $R_e = -1$) are included in the data set.

Data Collection (See Section 9.6.1.1)—The specimen design for the test program is reported as uniform-gage section with a diameter of 0.20 inches. Failure is defined as complete separation. The tensile properties are presented in the correlative information. No information is available regarding the fabrication sequence for the specimens. Fabrication information is important, although in this case it is not considered sufficient cause to reject the data set for analysis. The test data at the $R_e = -1.0$ strain ratio provide information regarding this material's cyclic stress-strain response. The cyclic stress-strain curve constructed from the data is shown in Figure 9.9.1.2(a). The monotonic curve (dashed) is estimated from the reported yield and ultimate strengths.

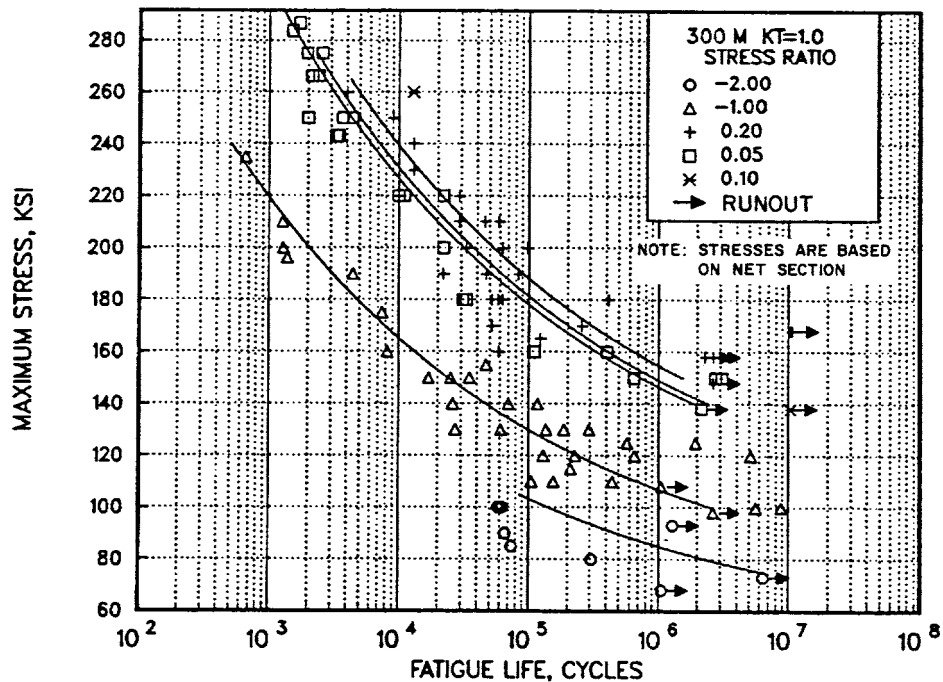

Figure X.X.X.X(a). Best-fit S/N curves for unnotched 300M alloy forging, $F_u = 280$ ksi, longitudinal and transverse directions.

Correlative Information for Figure X.X.X.X.X

Product Forms: Die forging, 10 x 20 inches
CEVM
Die forging, 6-1/2 x 20 inches
CEVM
RCS billet, 6 inches CEVM
Forged Bar, 1.25 x 8 inches
CEVM

Test Parameters:
Loading - Axial
Frequency - 1800 to 2000 cpm
Temperature - RT
Atmosphere - Air

No. of Heat/Lots: 6

Properties: TUS, ksi 274-294 TYS, ksi 227-247 Temp., °F RT

Equivalent Stress Equation:
 $\text{Log } N_f = 14.8 - 5.38 \text{ log } (S_{eq} - 63.8)$
 $S_{eq} = S_a + 0.48 S_m$
Std. Error of Estimate, $\text{Log } (\text{Life}) = 55.7 (1/S_{eq})$
Standard Deviation, $\text{Log } (\text{Life}) = 1.037$
 $R^2 = 82.0$

Specimen Details: Unnotched
0.200 - 0.250 inch diameter

Sample Size = 104

Surface Condition: Heat treat and finish grind to a surface finish of RMS 63 or better with light grinding parallel to specimen length, stress relieve

[Caution: The equivalent stress model may provide unrealistic life predictions for stress ratios beyond those represented above.]

References: 2.3.1.4.8(a), (c), (d), (e)

Figure 9.9.1.1(e). Example S/N curve and correlative information.

Table 9.9.1.2. Iron Alloy Strain-Controlled Fatigue Data at 70°F

Specimen Number	$\Delta\epsilon$	S_{\max} (ksi)	Cycles to Failure	Strain Ratio
1	0.600	71.1	10223	-1.00
2	0.600	77.8	10396	-1.00
3	0.600	79.2	8180	-1.00
4	0.970	117.2	605	-1.00
5	1.000	110.7	672	-1.00
6	1.000	112.8	642	-1.00
7	1.500	126.9	209	-1.00
8	1.500	127.1	340	-1.00
9	0.600	116.6	3958	0.0
10	0.600	124.2	3895	0.0
11	0.597	118.2	3919	0.0
12	0.600	128.3	4050	0.0
13	0.600	122.6	2470	0.0
14	0.400	106.4	16388	0.0
15	0.393	101.9	22896	0.0
16	0.400	102.1	15388	0.0
17	0.400	93.7	38648	0.0
18	0.400	101.2	11960	0.0
19	0.750	139.4	1099	0.60
20	0.750	137.3	1544	0.60
21	0.750	113.0	966	0.60
22	0.500	124.5	4665	0.60
23	0.500	140.6	4342	0.60
24	0.500	138.4	4240	0.60
25	0.400	158.0	7460	0.60
26	0.400	146.1	11134	0.60
27	0.400	119.1	10876	0.60
28	0.440	65.8	100000*	-1.00
29	0.330	50.0	1000000*	-1.00

* Did not fail.

Evaluation of Mean Stress and Strain Effects (See Section 9.6.1.4)—The data set consists of three strain ratios and therefore an equivalent-strain formulation is used to consolidate the data on the basis of equivalent strain. Equation 9.6.1.4(c),

$$\log N_f = A_1 + A_2 \log (\epsilon_{\text{eq}} - A_4)$$

where

$$\epsilon_{\text{eq}} = (\Delta\epsilon)^{A_3} (S_{\max}/E)^{1 - A_3} ,$$

is the initial model attempted for fitting the data and proves to be adequate throughout the analysis.

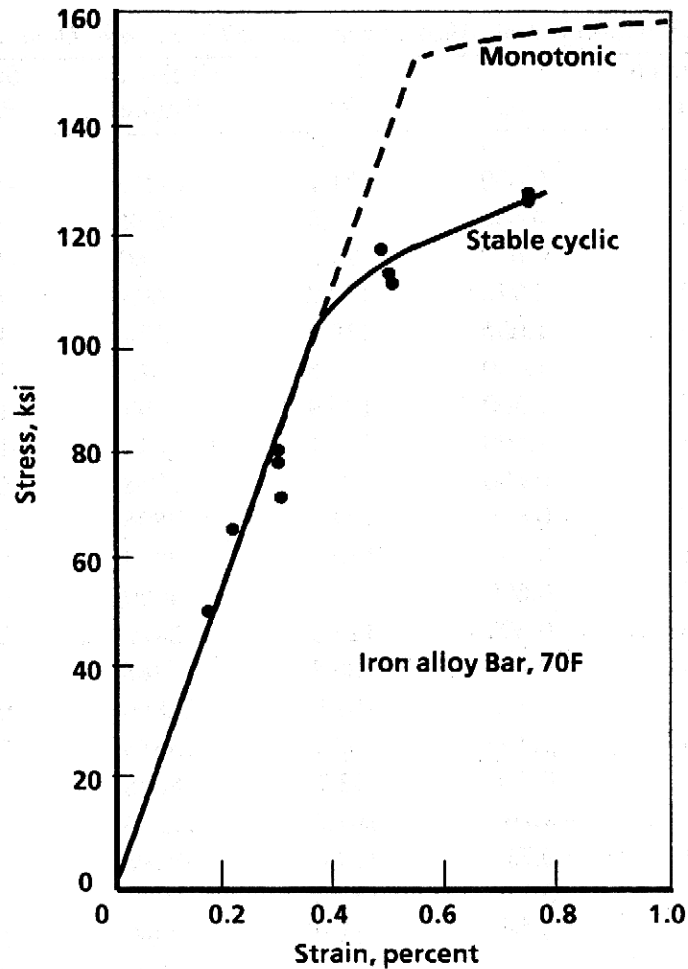

Figure 9.9.1.2(a). Stable cyclic and monotonic stress-strain curves for iron alloy at 70°F.

Estimation of Fatigue Life Model Parameters - Least Squares (See Section 9.6.1.5)—The initial least-squares regression results in the following fatigue-life equation parameters:

$$\begin{aligned}
 A_1 &= -4.62 \\
 A_2 &= -3.28 \\
 A_3 &= 0.610 \\
 A_4 &= 0.00198.
 \end{aligned}$$

A plot of the residuals for the fatigue model using these parameters is shown in Figure 9.9.1.2(b). These residuals do not exhibit the characteristic pattern of increasing residual magnitudes with decreasing equivalent stress or strain levels shown in Figure 9.6.1.5(a). Rather, the variance appears to be relatively uniform. During Step 2 of the parameter estimation procedure, a negative, but insignificant, estimate of the residual model slope, σ_1 , was obtained. This result indicates the residuals are already uniformly distributed and a constant variance model can be used. The constant variance model, in effect, does not weight the fatigue life model, so the initial parameter estimates are retained.

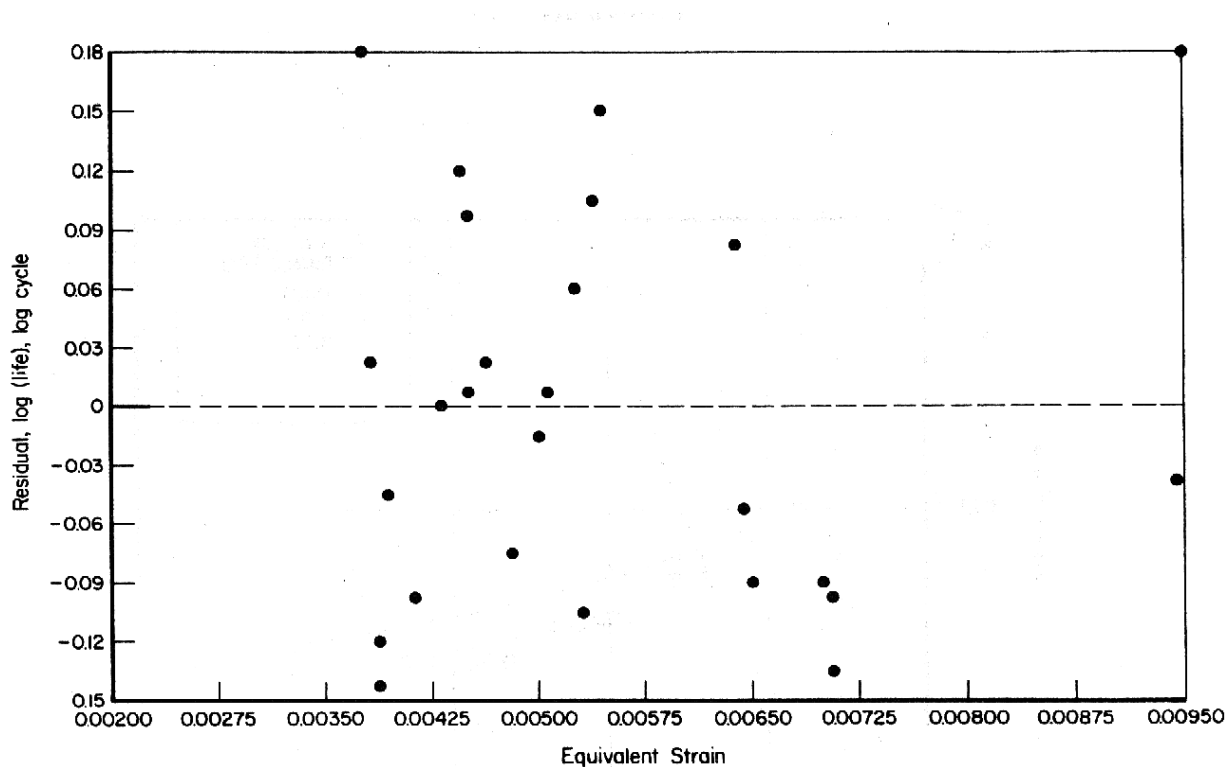

Figure 9.9.1.2(b). Residual plot of fatigue-life model for initial parameter estimates.

Treatment of Outliers (See Section 9.6.1.6) — After the data have been checked for uniformity of variance, they can be screened to determine if any outliers are present. The critical studentized residual at the 5 percent significance level for this sample of 27 observations is found to be 3.53. Any of the observations with the absolute value of the studentized residuals being greater than 3.53 would be considered outliers. The largest studentized residual from the data was 2.09; therefore, none of the observations are identified as statistically significant outliers.

Assessment of the Fatigue Life Model (See Section 9.6.1.7) — The equivalent strain formulation is marginally acceptable at the 5 percent level. The lack of fit test for the fatigue-life model results in a Durbin-Watson D statistic of 1.042. The critical value of D for a sample size of 27 is 1.241 [Equation 9.6.1.7(b)].

Since the Durbin-Watson statistic is less than the critical value, the equivalent strain model must be considered questionable in terms of its compensation for effects of strain ratio. However, no other model was found to perform better and a review of the plotted data revealed very low scatter compared to the predicted trends. Therefore, engineering judgement was used, and the proposed model was accepted.

Data Set Combination (See Section 9.6.1.8) — All of the data for this analysis came from a single source; therefore, this test is not applicable.

Treatment of Runouts (See Section 9.6.1.9) — The data set being considered includes two runout observations. The parameters A_1 and A_2 are therefore reestimated using the maximum likelihood regression to account for censored life values. The maximum likelihood estimates are:

MIL-HDBK-5J
31 January 2003

$$A_1 = -5.07$$

$$A_2 = -3.47$$

$$A_3 = 0.610$$

$$A_4 = 0.00198.$$

The change in parameters A_1 and A_2 shift the predicted lives to greater values than the least squares parameter estimates.

Presentation of Fatigue Analysis Results — The presentation of the strain-life curve and correlative information shown in Figure 9.9.1.2(c) is typical of a MIL-HDBK-5 strain-control fatigue data proposal. Regarding the mean stress relaxation plot, note that a single regression has been performed to represent both the $R_\epsilon = 0.6$ and $R_\epsilon = 0.0$ strain ratios. Although it would be expected that higher strain ratios would result in higher stabilized mean stresses, the limited amount of data precludes performing separate regressions for each strain ratio. It can be seen from the strain-life plot that using the single regression does represent the mean fatigue trends fairly well.

9.9.2 FATIGUE CRACK GROWTH— When preparing fatigue crack growth data proposals for submittal to the MIL-HDBK-5 Coordination Group, several steps must be taken. First, various factors potentially influencing crack-propagation rates should be documented in a fatigue crack growth Data Proposal as shown in Table 9.9.2. Second, data for individual test conditions should be plotted and compared so that a determination can be made as to whether combinations of test conditions are appropriate. If data are available for a range of specimen thicknesses, it may be desirable to treat such data in separate plots, if fatigue crack growth rate behavior is influenced by thickness. Similarly, potential effects of environment, buckling restraints, specimen width, specimen type, crack orientation, temperature, and frequency should be evaluated; and, where visible differences in fatigue crack growth rate trends exist, separate plots must be developed. In some cases, it may be necessary (or helpful) to include working figures of trial combinations of fatigue crack growth data so that reviewers of the data proposal can more easily see reasons for particular data combinations. If a collection of fatigue crack growth data (involving one or more figures) is approved, working curves and background data sheet will be retained in MIL-HDBK-5 files and only the final data plot will be incorporated in the Handbook.

Fatigue crack growth data are presented in the Handbook on double logarithmic graphical displays of crack-growth rate, da/dN , $\mu\text{-in./cycle}$, versus stress-intensity factor range, ΔK . Data points are presented along with a visually best-fit line judged to be most representative of the median behavior of those data. A sample display is presented in Figure 9.9.2.

Since data are not necessarily generated at predesignated stress ratio levels, stress ratio increments which are used on a given display are selected to present the most complete portrayal of available data. Data are summarized in graphical displays in the appropriate chapters of MIL-HDBK-5.

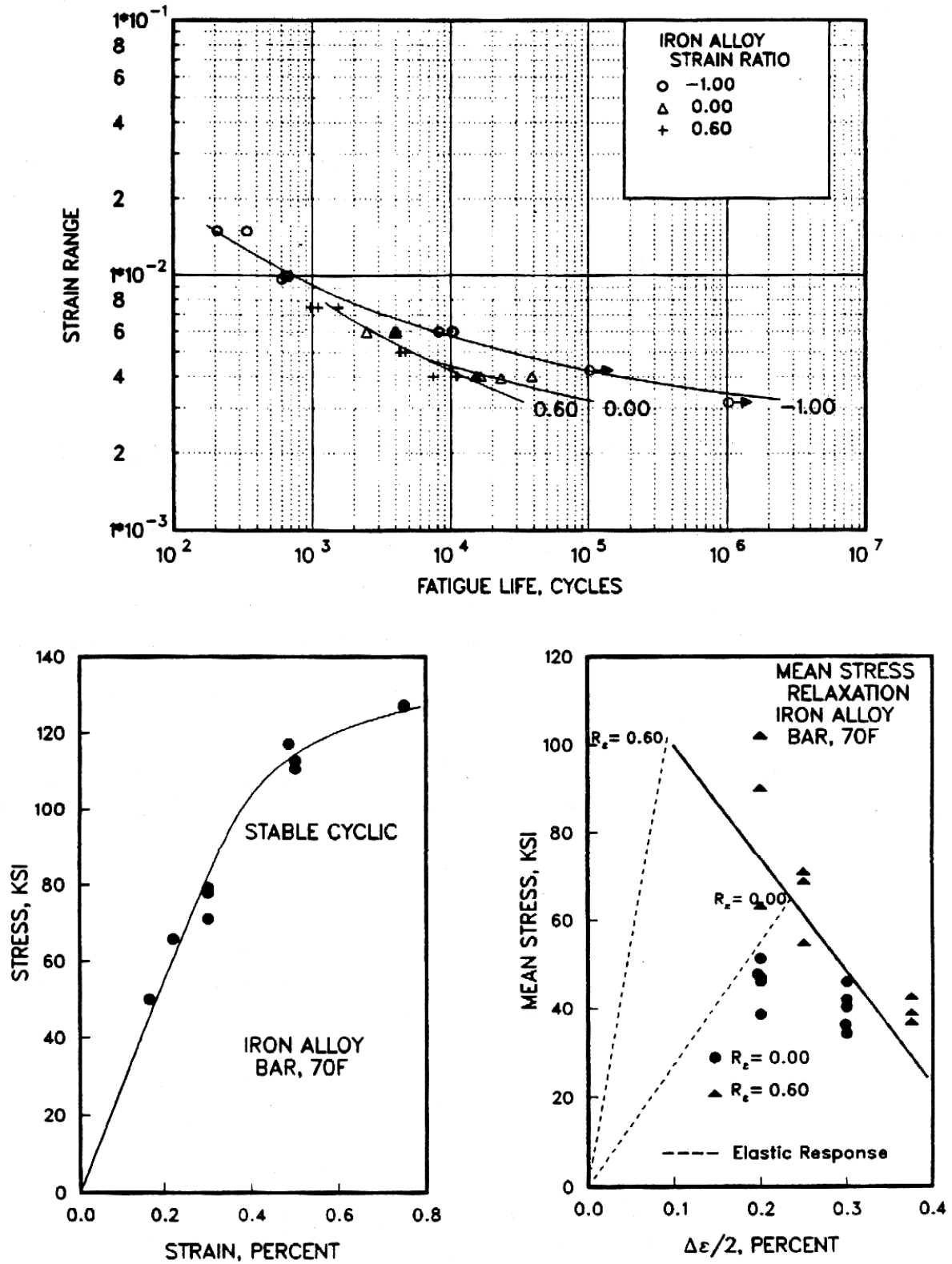

Figure 9.9.1.2(c). ε/N curve and correlative information for iron alloy at 700°F.

Correlative Information for Figure 9.3.4.17(c)

Product Form: Bar, 1 inch thick

Reference: 3.4.5.6.8(a)

Thermal Mechanical Processing History:
Not available

Test Parameters:
Strain Rate/Frequency - 180 cpm
Wave Form - Sinusoidal
Temperature - 70°F

Properties:

TUS, ksi	TYS, ksi	E, ksi	Temp., °F
175-180	150-155	27,500	70

No. of Heats/Lots: 4

Stress-Strain Equations:

Monotonic

Proportional Limit = 150 ksi
 $\sigma = 280 (\epsilon_p)^{0.12}$

Cyclic (Companion Specimens)

Proportional Limit = 105 ksi (est.)
 $(\Delta\sigma/2) = 196 (\Delta\epsilon_p/2)^{0.076}$

Mean Stress Relaxation

$\sigma_m = 125.4-25666(\Delta\epsilon/2)$

Equivalent Strain Equation:

Log N = -5.07-3.47 log (ϵ_{eq} -0.00198)
 $\epsilon_{eq} = (\Delta\epsilon)^{0.61} (S_{max}/E)^{0.39}$
Standard Error of Estimate, Log(Life) = 0.111
Standard Deviation, Log (Life) = 0.555
Adjusted R² Statistic = 96%

Sample Size = 29

Specimen Details: Uniform gage test section
0.200 inch diameter

[Caution: The equivalent strain model may provide unrealistic life predictions for strain ratios and ranges beyond those represented above.]

Figure 9.9.1.2(c). ϵ/N curve and correlative information for iron alloy at 700°F — Continued.

9.9.3 FRACTURE TOUGHNESS (NEED SAMPLE PROBLEMS) — To assure proper evaluation of plane stress and traditional fracture toughness data, adequate documentation of test results must be included with any data submittals for MIL-HDBK-5. The minimum quantity of experimental information considered appropriate for data proposals on the subject is described in Section 9.2.4.10.

9.9.3.1 Plane Strain — (See Section 9.6.3.1) Room temperature values of K_{Ic} are tabulated in the introductory comments for each chapter. This table will include the range (minimum, average, and maximum) in K_{Ic} values, alloy, product form, heat treat condition, TYS range, product thickness, number of test specimens, number of lots, test specimen thickness range, and grain direction represented by data. Where data are available, effect of temperature on K_{Ic} is presented graphically in the appropriate alloy section. It is preferable that data incorporated in MIL-HDBK-5 represent a minimum of three specimens each from a minimum of five lots of material for each test direction.

9.9.3.2 Plane Stress — (See Section 9.6.3.2) Plane stress and transitional fracture toughness data and other crack damage information are presented in each alloy chapter. Data are categorized by product form, grain direction, thickness (or thickness range), temperature, and strain rate. The presentation format is dependent upon the flaw and structural configuration as described in the following paragraphs.

Table 9.9.2. Sample Listing of Fatigue-Crack-Growth Background Data

Materials:	Ti-6Al-4V Titanium		
Alloy Designation or Specification:	MIL-T-9046, Type III, Composition C		
Product Form:	Plate		
Heat Treatment:	Mill Annealed		
Heat Number(s):	Ingot 295338		
Chemistry (% by weight):	C	0.02	
	N	0.010	
	Fe	0.18	
	Al	6.4	
	V	4.2	
	O	0.127	
	H	81 (PPM)	
Data Source(s):	Fedderson, C. E., and Hyler, W. S., "Fracture and Fatigue-Crack Propagation Characteristics of 1/4 Inch Mill Annealed Ti-6Al-4V Titanium Alloy Plate", Report No. G9706, Battelle (1971).		
Specimen Description:			
Type:	M (T) Panel		
Thickness:	0.250 inch		
Width:	9, 16, 32 inches		
Crack Orientation:	L-T		
Location w-r-t Product Thickness:	Through-thickness specimen		
Surface Finish:	Not Indicated		
Test Conditions:			
No. of Specimens:	9	7	6
Maximum <u>Stress</u> or Load:	5, 10, 30 ksi	5, 10, 30, 50 ksi	10, 30, 50 ksi
Stress Ratio:	0.10	0.40	0.70
Cyclic Frequency:	1-25 Hz		
Environment:	50% relative humidity		
Temperature:	68 ± 2°F		
Buckling Restraints?:	Yes		
Crack Monitoring Technique:	Optical		
Additional Comments:	<ol style="list-style-type: none"> 1. Frequency was varied from 1 to 25 Hz according to the magnitude of stress range, no frequency effects were noted in this environment. 2. From 20 to 70 crack readings were made on each specimen. 3. No panel width effects on FCG rates were evident. 		

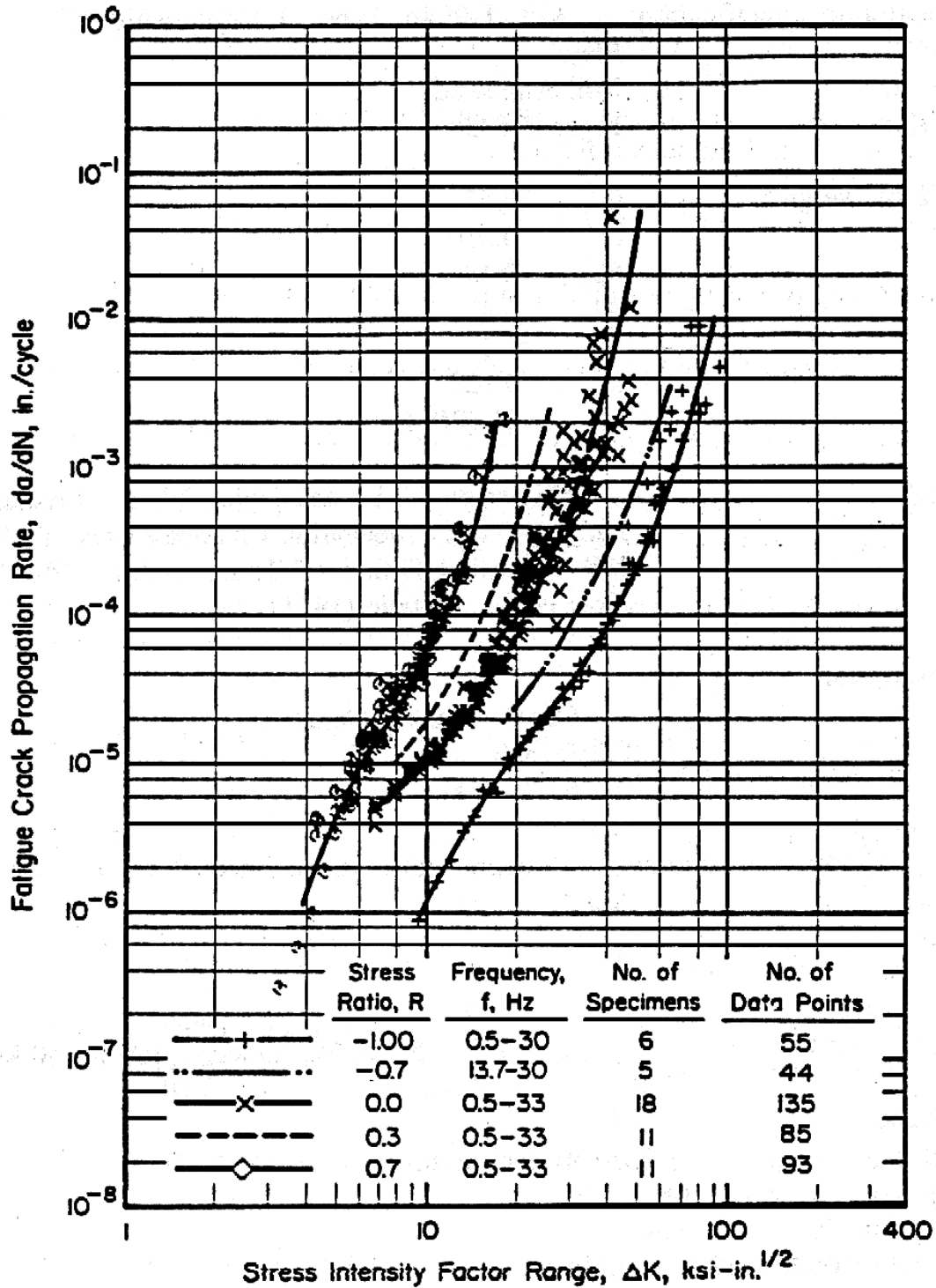

Figure X.X.X.X.X. Typical-crack-growth data for 0.090-inch-thick, 7075-T6 aluminum alloy sheet with buckling restraint. [References 3.7.4.1.9(a) through (e)].

Specimen Thickness:	0.090 inch	Environment:	Lab Air
Specimen Width:	1-1/2 - 12 inches	Temperature:	RT
Specimen Type:	M (T)	Orientation:	L-T

Figure 9.9.2. Sample display of fatigue-crack-growth-rate data.

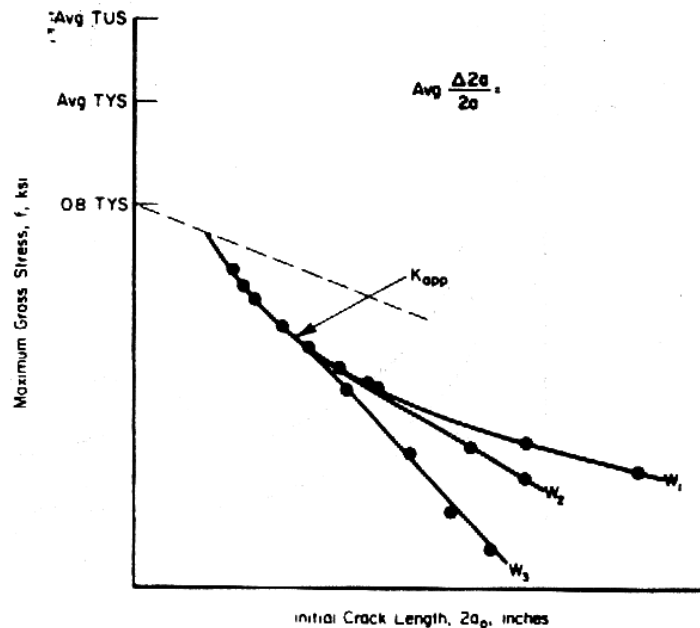

Figure 9.9.3.2. Format for the presentation of middle-tension panel data.

Middle-Tension Panel Data — Apparent fracture instability data for middle-tension panels are presented on the graphical format of maximum gross stress versus initial crack length as illustrated in Figure 9.9.3.2. These data plots are presented as information and not as design allowables; hence, additional testing is necessary to substantiate design allowables over the range of crack lengths of interest.

The data in such graphical display satisfy the screening criterion of Equation 9.6.3.2.

The apparent stability fracture toughness value K_{app} associated with each curve is a simple average of test values determined according to Equation 9.6.3.2.1

The average apparent toughness curve is presented over a range extending from the short crack length associated with a net section stress of 80 percent of tensile yield strength to either the largest crack length contained in the data, or one-third the panel width, whichever is greater.

Since slow, stable tear may occur during the loading of a cracked panel, an approximate measure of crack extension possible prior to fracture is useful to assess conditions of fracture instability. Where data are available, the average ratio, $\Delta(2a)/(2a_0)$, of crack extension prior to fracture to initial crack length is indicated in the field of the graphical display. This ratio is determined through

$$\frac{\Delta 2a}{2a_0} = \frac{2a_c - 2a_0}{2a_0} = \frac{a_c}{a_0} - 1 = \left(\frac{K_c^2}{K_{app}^2} \right) - 1 ,$$

where

$$K_c = f_c (\pi a_c \sec \pi a_c / W)^{1/2}$$

is the average stress intensity factor associated with critical fracture instability as determined by the reporting investigator.

Where data for a material include a thickness range from essentially plane stress to plane strain fracture toughness data will be summarized also as a display of thickness effect similar to Figure 9.9.3.2. From this figure, K values for the appropriate thickness, t , can be selected and residual strength curve similar to Figure 9.9.3.2 can be constructed.

At present, since these are not design allowable data, requirements on the quantity of information necessary will not be specified. Data displays will be prepared for those materials, product forms and thicknesses where a sufficient number of tests at various crack and specimen sizes are available to establish a distinct trend. Correlative information will be appended below such graphical displays to indicate range of test panel sizes, crack lengths, and number of heats or lots of the material from which determination of K_{app} was determined.

9.9.4 CREEP AND CREEP RUPTURE — Creep-rupture proposals developed for review and possible inclusion in MIL-HDBK-5 should contain the following information and meet associated criteria.

Data Reporting—The background information will meet the requirements of Section 9.2.4.11. Test results will be listed in a manner such that all data are identifiable in terms of material and test background information as well as test conditions used in generating data.

Analysis Reporting—The analysis report will display the following;

- (a) Trials—Equations tried and reason for ejecting.
- (b) Data rejected—Reason.
- (c) Best-fit details—Listing of data, calculated values, and deviations. All data are to be clearly traceable in terms of data reporting requirements.
- (d) Standard error or total variance and correlation coefficient.
- (e) Subset variance—If random subsets are used, report both the pooled within-subset variance and the between-subset variances as well as the total variances.
- (f) Constants—Report the average regression constant and regression constants for any subsets.
(g) Coefficients—Report the numerical value of the coefficient of each regression variable and its standard error.
- (h) Equation—Exhibit the equation used; with the coefficients, b_1 , traceable to the numerical listing in above item (g).
- (i) Deviation—Exhibit plots of deviations in life versus calculated life for each temperature and, as far as possible, identify according to subsets. It is also possible to provide a summary table of deviations. As an example of isostrain creep or rupture, divide the life range of data in five equal logarithmic increments and, for each temperature, give the algebraic sum of deviation with that increment. If random subsets are used, deviations summed are to be those from within the respective subsets.
- (j) Data and Curve Comparison—Display data against the calculated average curve. Encode data with symbols as the deviation plots. Scale coordinates such that the curves have an apparent slope of about -1.0. Use scales appropriate for the most significant form of the regression

variable, usually $\log(\text{stress})$ versus $\log(\text{life})$, with life (dependent variable) on the abscissa and stress on the ordinate.

- (k) Curve Extrapolation Tests—Exhibit the average curve from one to 105 hours for corresponding temperature levels. Representative curves may be used including extreme values of independent variables represented in data. Further, calculation of desired tolerance limit (e.g., probability level) should be performed to assist in determining validity of the extrapolation.

The above recommendations apply to incorporation of new creep and/or stress-rupture curves in MIL-HDBK-5. The use of creep nomographs has been discontinued. Creep nomographs in MIL-HDBK-5 will be replaced as data are reanalyzed and new analytically defined creep and stress rupture curves are developed.

The presentation for MIL-HDBK-5 will include one or more pages of correlative information, equations, and curves as needed. Requirements on each will vary with the problem and should be reasonably obvious from data, background information, and analytical results.

An example of a typical data presentation is shown in Figure 9.9.4. Note that raw data are displayed along with mean trend lines, on a semi-logarithmic plot of stress versus time. Supportive data describing alloy, specimen details, and analysis results are also presented. Table 9.9.4 provides even more detailed, but necessary, information on such factors as heat treatment details and inverse matrix (which can be used in conjunction with other analysis results to compute lower level tolerance limits for the data).

Some creep data are still presented in creep nomographs. For these cases, the analysis and presentation were based primarily on Reference 1.4.8.2.1(b). The presentation of creep data in the form of a nomograph is not in compliance with the above guidelines.

9.9.4.1 Creep-Rupture Example Problem —By a slight chemical change and modification of heat, the former Alloy 325 is now believed to have an increased stress-rupture life of 20 percent to 30 percent. It is desired to fully characterize these properties over the 1600 to 1900°F range. Average creep life is to be from 10 hours to 1,000 hours.

Nineteen stress rupture tests from two heats of new alloy averaged 37.4 hours at 30 ksi/1800°F, $s(\log 10) = 0.150$. Figure 9.9.4.1(a) is a log-log mean life plot of predicted stress rupture properties of modified Alloy 325 based on a predicted value. A 1750°F line has been added to the original plot. From this log-log plot, it can be seen that only three temperatures need to be tested because there are stress levels in common with the 1600°F line, and the same is true for the 1750°F and 1900°F lines.

Next, three temperature lines are bracketed with the 10-hours to 1000-hours life range. See Figure 9.9.4.1(b). Stress levels are then chosen to give the desired life. There are 25 tests required with this procedure. All 25 could be run, or 3 tests could be randomly eliminated from the center cells of the matrix (see circled cells). If 3 are deleted this would leave 22 tests, which are near the minimum of 20. These tests could be conducted and these data added to the 19 specific data points at 30 ksi/1800°F. This quantity would constitute the data set. Table 9.9.4.1 shows the results of a simulated sampling.

A Larson-Miller analysis of data produced the curves in Figures 9.9.4.1(c) and (d). Data plotted with the temperature lines of Figure 9.9.4.1(d) confirm a good fit over the range of data. The approach described in this example can be used for any creep or rupture experimental design.

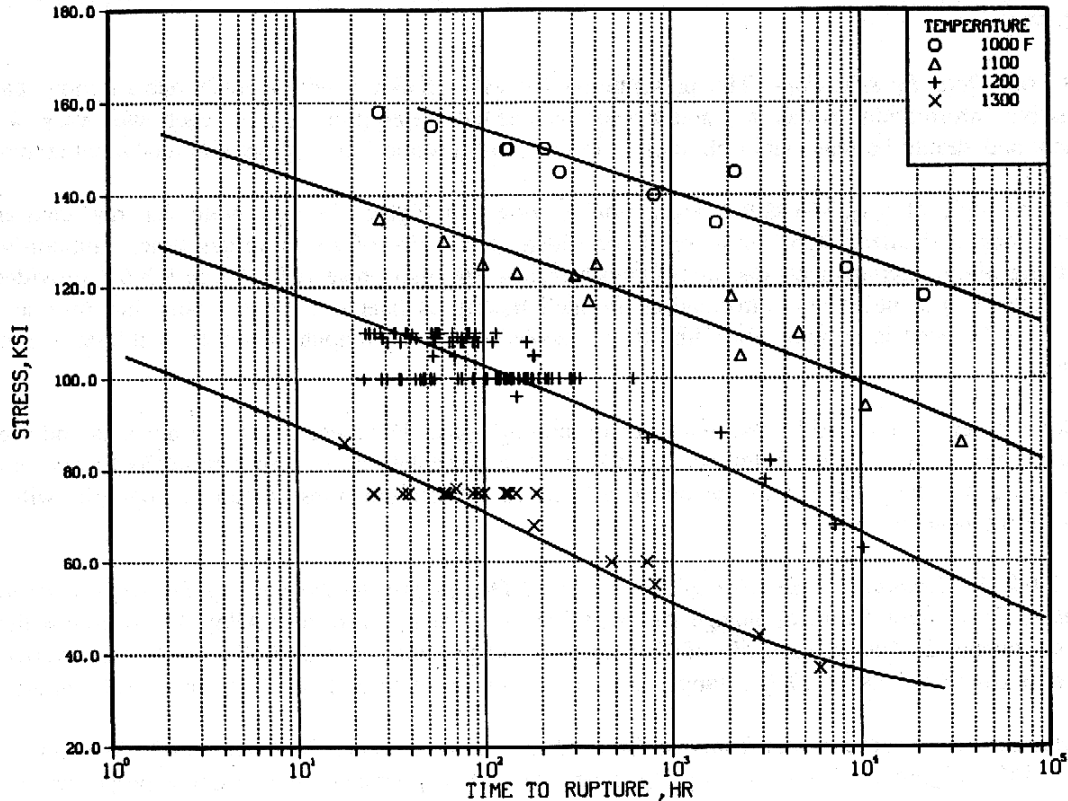

Figure 9.9.4. Average isothermal stress rupture curves for alloy XYZ forging.

Correlative Information for Figure 9.9.4

Makeup of Data Collection:

Public Specifications—AMS 5663
Heat Treatment—2, 21 [See Table 9.3.6.7(a)]
Number of Vendors—Not specified
Number of Heats—7
Number of Test Laboratories = 3
Number of Tests = 347

Specimen Description:

Type—Unnotched round bar
Gage Length—N.A.
Gage Thickness—1/4"—3/8"

Stress Rupture Equation:

$\text{Log } t = c + b_1 T + b_2 X + b_3 X^2 + b_4 X^3$
T = °R, X = log (stress, ksi)
c = 186.27
b₁ = -0.01778
b₂ = -255.25
b₃ = 146.28
b₄ = -28.65

Analysis Details:

Inverse Matrix—See Table 9.3.6.7(a)
Standard Deviation = 0.63
Standard Error of Estimate = 0.29
Within Heat Variance = 0.071
Ratio of Between to Within Heat Variance = (at spec pt.) < 0.10

Table 9.9.4. Supplemental Data Pertaining to the Stress Rupture Behavior of Alloy XYZ Forging

Heat Treatment Details					
Heat Treatment No.	Cycle No.	Temperature, °F	Time, Hours	Cool	
2	1	1800	1	AC, WQ	
	2	1325	8	FC (100 °F/hr)	
	3	1150	8	AC	
21	1	1700-1850	1	AC	
	2	1325	8	FC (100 °F/hr)	
	3	1150	8	AC	

Stress Rupture Equation and Inverse Matrix for the Creep Stress = 0.10, 0.20, 0.50, and 5.00% and Stress Rupture Conditions

$$\log t = c + b_1T + b_2X + b_3X^2 + b_4X^3 + b_5Y_1 + b_6Y_2 + b_7Y_3 + b_8Y_4 + b_9Y_5$$

where
 $Y_1 = 1; Y_2, Y_3, Y_4, Y_5 = 0$ for Creep Strain = 0.10% Data
 $Y_2 = 1; Y_1, Y_3, Y_4, Y_5 = 0$ for Creep Strain = 0.20% Data
 $Y_3 = 1; Y_1, Y_2, Y_4, Y_5 = 0$ for Creep Strain = 0.50% Data
 $Y_4 = 1; Y_1, Y_2, Y_3, Y_5 = 0$ for Creep Strain = 5.00% Data
 $Y_1, Y_2, Y_3, Y_4, Y_5 = 0$ for Stress Rupture Data

Column Row	1	2	3	4	5	6	7	8	9
1	1.809E+00	-1.108E-03	-1.978E+00	6.499E-01	-5.748E-02	-1.606E+00	-1.444E+00	-1.015E+00	-9.777E-01
2	-1.108E-03	6.834E-07	1.212E-03	-3.979E-04	3.517E-05	9.843E-04	8.852E-04	6.219E-04	5.993E-04
3	-1.978E+00	1.212E-03	3.482E+00	-1.657E+00	2.032E-01	1.634E+00	1.359E+00	6.886E-01	5.921E-01
4	6.499E-01	-3.979E-04	-1.657E+00	9.145E-01	-1.220E-01	-4.892E-01	-3.610E-01	-6.305E-02	3.594E-03
5	-5.748E-02	3.517E-05	2.032E-01	-1.220E-01	1.697E-02	3.801E-02	2.248E-02	-1.245E-02	-2.618E-02
6	-1.606E+00	9.843E-04	1.634E+00	-4.892E-01	3.801E-02	1.471E+00	1.303E+00	9.401E-01	9.124E-01
7	-1.444E+00	8.852E-04	1.359E+00	-3.610E-01	2.248E-02	1.303E+00	1.222E+00	8.806E-01	8.600E-01
8	-1.015E+00	6.219E-04	6.886E-01	-6.305E-02	-1.245E-02	9.401E-01	8.806E-01	7.491E-01	6.987E-01
9	-9.777E-01	5.993E-04	5.921E-01	3.594E-03	-2.618E-02	9.124E-01	8.600E-01	6.987E-01	1.195E+00

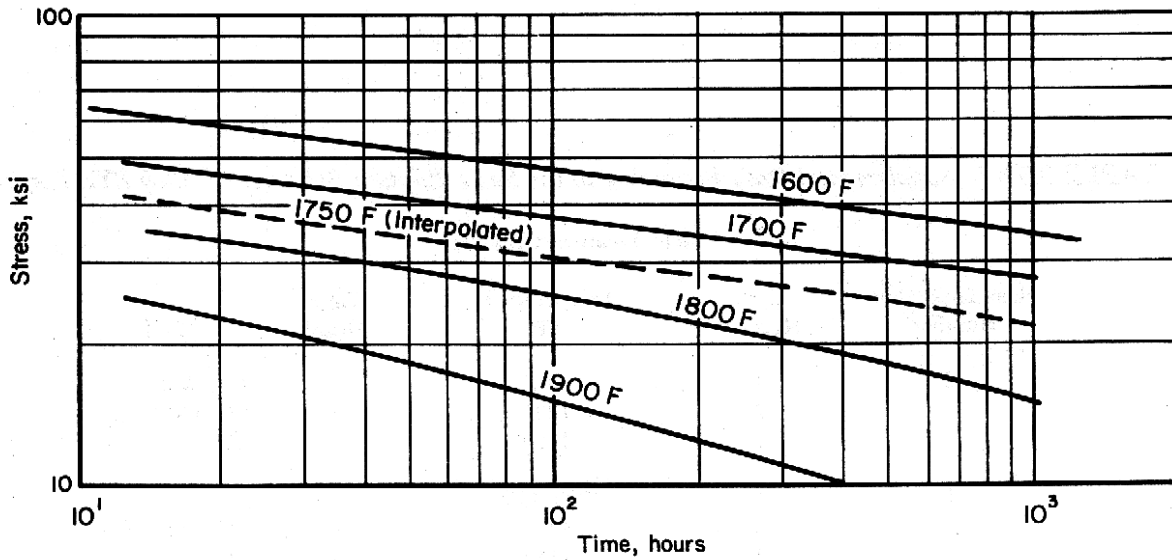

Figure 9.9.4.1(a). Estimated stress rupture curves for Alloy 325 (MOD).

T E M P	HOURS											°F		
	3	6	10	18	32	56	100	180	320	560	1000		3000	5600
T 1			63	59	54	52	48	46	42	39	36			1600
T 2			42	39	36	32	29	27	25	22	20			1750
T 3			25	22	20	17	15	12	10					1900
T 4														
T 5														
T 6														
T 7														
T 8														

Figure 9.9.4.1(b). Experimental design matrix for creep rupture.

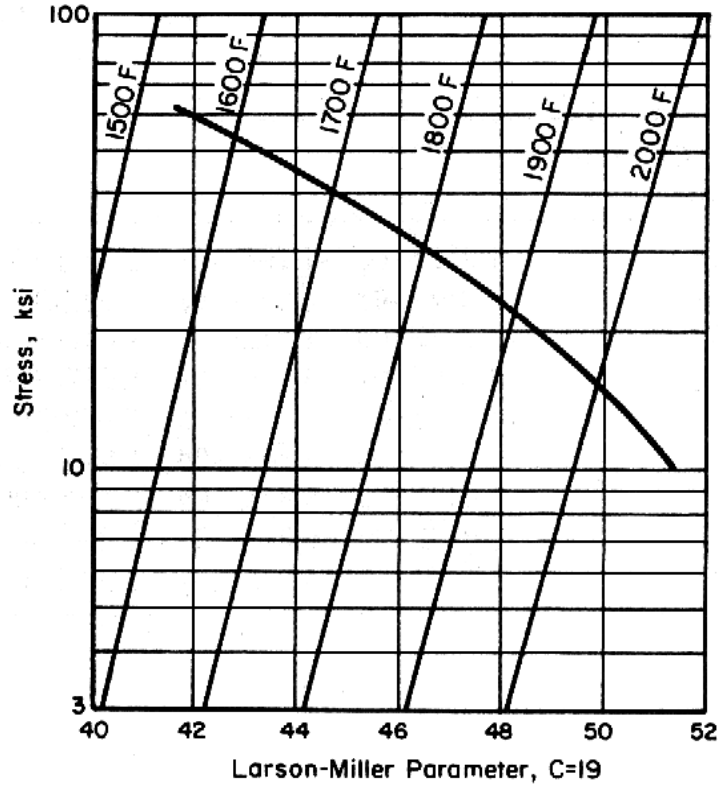

Figure 9.9.4.1(c). Alloy 325 (MOD) stress rupture typical life.

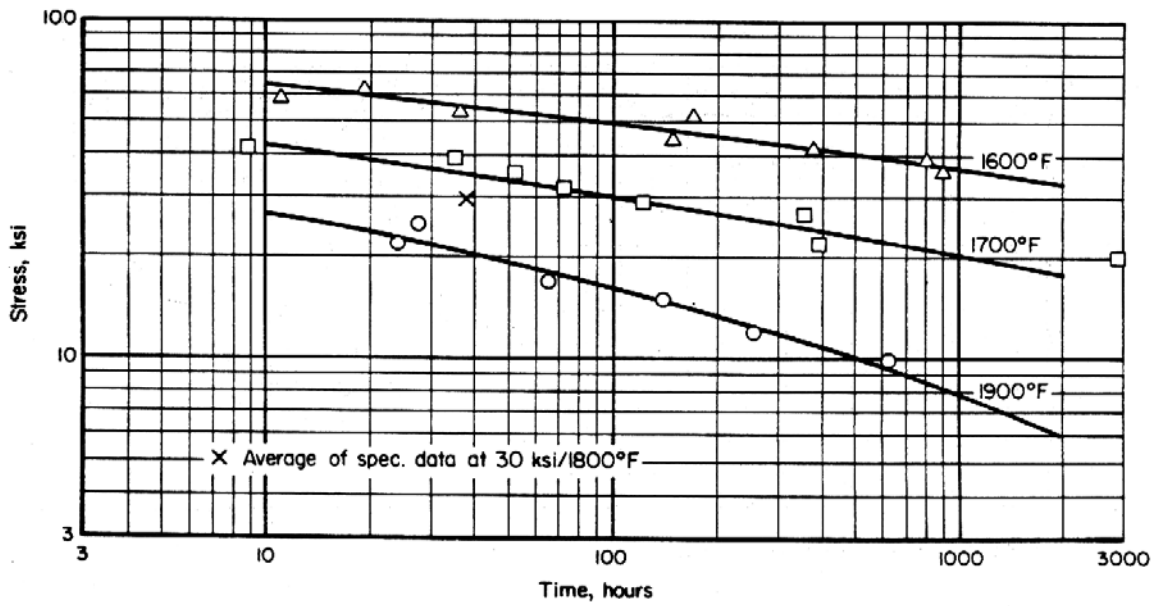

Figure 9.9.4.1(d). Alloy 325 (MOD) stress rupture typical life.

Table 9.9.4.1. Results of Simulated Sampling of Creep-Rupture Data

<u>ksi</u>	<u>1600°F</u>	<u>ksi</u>	<u>1750°F</u>	<u>ksi</u>	<u>1900°F</u>
63	19.0 hrs.	42	8.8 hrs.	25	27.6 hrs.
59	11.1 hrs.	39	35.5 hrs.	22	23.9 hrs.
54	36.3 hrs.	36	52.3 hrs.	17	65.4 hrs.
52	170.7 hrs.	32	71.8 hrs.	15	140.3 hrs.
45	148.0 hrs.	29	121.9 hrs.	12	257.5 hrs.
42	376.0 hrs.	27	355.9 hrs.	10	623.5 hrs.
39	806.9 hrs.	22	389.0 hrs.	*	
36	878.0 hrs.	20	2912.4 hrs.	*	

*No interest.

SPECIFICATION DATA
@ 30 KSI 1800°F

Hours

41.4	33.1	70.5	36.1
16.5	27.4	37.5	34.9
35.0	33.4	48.6	74.2
33.6	51.3	29.0	47.5
32.6	42.7	26.4	

(n = 19, \bar{X} = 37.4, s(log 10) = 0.150)

9.9.5 Mechanically Fastened Joints — The final table of allowable loads must be presented in a format suitable for use in MIL-HDBK-5, as illustrated in Figures 9.9.5.1(a) and (b). Figure 9.9.5.1(a) is the approved format for fastener tables approved prior to December 31, 2002, while Figure 9.9.5.1(b) is the required format for fastener tables approved after December 31, 2002. The distinguishing factor between these two tables is the statistical basis associated with the ultimate and yield loads. Refer to Section 9.7 for a detailed discussion of the currently approved statistical analysis procedures for mechanical fasteners. The following notes apply to the circled numbers in Figures 9.9.5.1(a) and (b).

- (1) Omit table number. (Secretariat will assign table number.)
- (2) Head type: 100° Flush Head, 100° Flush Shear Head, Protruding Head, Protruding Shear Head, etc. The shear designation is applied to 100° or protruding head fasteners with heads similar in size to those on Hi-Shear rivets, shear-type lock-bolts, shear-head Hi-Lok, Taper-Lok, or similar fasteners.
- (3) Fastener material: steel, aluminum alloy, Monel, A286, nickel alloy, etc.
- (4) Type of fastener: blind rivet, rivet, bolt, blind bolt, screw, tapered fastener, etc.
- (5) Type of hole: machine countersunk or dimpled. (Omit for protruding head fasteners.)
- (6) Sheet material: consistent with other MIL-HDBK-5 tables.
- (7) "Rivet" for blind or conventional rivets, "Fastener" for other type fasteners.

MIL-HDBK-5J
31 January 2003

Table XXXX(b). Static Joint Strength of Flush Head 6061-T8 Aluminum Alloy Rivets in Machine-Countersunk Clad Aluminum Alloy Sheet

Rivet Type	NASXXXX ^a (F_{su} = AAA ksi)				
	Clad 7075-T6				
Rivet Diameter, in. (Nominal Hole Diameter, in.) ^b	3/32	1/8	5/32	3/16	1/4
	(0.096)	(0.1285)	(0.159)	(0.191)	(0.257)
Ultimate Strength, lbs (Estimated Lower Bound)					
Sheet thickness:					
0.032	182 ^c
0.040	227	^d 304
0.050	246	381	^d 471
0.063	...	441	594	^d 714	...
0.071	670	805	^d ...
0.080	675	907	... ¹⁶
0.090	974	¹² 1375
0.100	1525 ^d
0.125	1765
Fastener shear strength ^e	246 ¹⁴	441 ¹⁴	675 ¹⁴	974 ¹⁴	1765 ¹⁴
Yield Strength^f, lbs (Conservatively Adjusted Average)					
Sheet thickness, in.:					
0.032	119 ¹⁵
0.040	188	224 ¹⁵
0.050	246	307	349 ¹⁵
0.063	...	414	481	539 ¹⁵	...
0.071	563	637	...
0.080	655	748	...
0.090	870	1060 ¹⁵
0.100	1230
0.125	1640
Fastener tensile strength ^g , lbs	275	495	755	1090	1975
Head height (ref.), in.	0.039	0.049	0.059	0.070	0.091

a Data supplied by ABC Corporation and DEF Company, Confirmatory data provided by XYZ Company.
b Fasteners installed in clearance holes (.00XX-.00YY) (Ref. 8.1.X).
c Yield value is less than 2/3 of indicated ultimate strength value.
¹⁷d Values above line are for knife-edge condition and the use of fasteners in this condition is undesirable. The use of knife-edge condition in design of military aircraft requires specific approval of the procuring agency.
e Rivet shear strength is documented in NAS XXZZ as AAA ksi.
f Permanent set at yield load: 4% of nominal diameter (Ref. 9.4.1.3.3).
g System maximum tensile strength as tested in steel fixture.

NOTE: See Section 9.4.1.6 for format recommendations indicated by circled numbers.

Figure 9.9.5.1(a). Sample format for MIL-HDBK-5 (non B-Basis) allowable joint strength tables published prior to December 31, 2002.

MIL-HDBK-5J
31 January 2003

Table XXXX(b). B-Basis Static Joint Strength of Flush Head 6061-T8 Aluminum Alloy Rivets in Machine-Countersunk Clad Aluminum Alloy Sheet

Rivet Type	NASXXXX ^a (F_{su} = AAA ksi)				
	Clad 7075-T6				
Rivet Diameter, in. (Nominal Hole Diameter, in.) ^b	3/32	1/8	5/32	3/16	1/4
	(0.096)	(0.1285)	(0.159)	(0.191)	(0.257)
Ultimate Strength, lbs (B-Basis)					
Sheet thickness:					
0.032	(12) xxx ^c
0.040	xxx	^d (12) xxx
0.050	xxx	xxx	^d (12) xxx
0.063	...	xxx	xxx	^d (12) xxx	...
0.071 (11)	xxx	xxx	^d ...
0.080	xxx	xxx	... (16)
0.090	xxx	(12) xxxx
0.100	xxxx ^d
0.125	xxxx
Fastener shear strength ^e (13)	xxx (14)	xxx (14)	xxx (14)	xxx (14)	xxxx (14)
Yield Strength ^f , lbs (B-Basis)					
Sheet thickness, in.:					
0.032	xxx (15)
0.040	xxx	xxx (15)
0.050	xxx	xxx	xxx (15)
0.063	...	xxx	xxx	xxx (15)	...
0.071 (11)	xxx	xxx	...
0.080	xxx	xxx	...
0.090	xxx	xxxx (15)
0.100	xxxx
0.125	xxxx
Fastener tensile strength ^g , lbs (18)	xxx	xxx	xxx	xxxx	xxxx
Head height (ref.), in. (19)	x.xxx	x.xxx	x.xxx	x.xxx	x.xxx

a Data supplied by ABC Corporation and DEF Company, Confirmatory data provided by XYZ Company.
b Fasteners installed in clearance holes (.00XX-.00YY) (Ref. 8.1.X).
c Yield value is less than 2/3 of indicated ultimate strength value.
(17)d Values above line are for knife-edge condition and the use of fasteners in this condition is undesirable. The use of knife-edge condition in design of military aircraft requires specific approval of the procuring agency.
e Rivet shear strength is documented in NAS XXZZ as AAA ksi.
f Permanent set at yield load: 4% of nominal diameter (Ref. 9.4.1.3.3).
g System maximum tensile strength as tested in steel fixture.

NOTE: See Section 9.4.1.6 for format recommendations indicated by circled numbers.

Figure 9.9.5.1(b). Sample format for MIL-HDBK-5 allowable joint strength tables published after December 31, 2002.

MIL-HDBK-5J
31 January 2003

- (8) Add footnote indicator to part numbers and indicate in a footnote the vendor(s) whose part number is shown if the fastener is not covered by an MS or NAS part number. Include fastener shear strength, material temper, and nut or collar identification.
- (9) Sheet or plate material and heat treatment or condition.
- (10) Nominal fastener diameter. For H-category fasteners, show nominal fractional hole size and, in parentheses, show actual nominal hole size in decimal equivalent. For S-category fasteners, show nominal fractional shank diameter and, in parentheses, show actual fastener shank diameter in decimals [i.e., a 1/8-inch-diameter NAS1740 rivet would be listed as 1/8 (0.144)].
- (11) Select standard sheet and plate thickness from the following:
- | | | | | | | | |
|-------|-------|-------|-------|-------|-------|-------|-------|
| 0.008 | 0.016 | 0.032 | 0.063 | 0.090 | 0.160 | 0.312 | 0.625 |
| 0.010 | 0.020 | 0.040 | 0.071 | 0.100 | 0.190 | 0.375 | 0.750 |
| 0.012 | 0.025 | 0.050 | 0.080 | 0.125 | 0.250 | 0.500 | 0.875 |
- (12) Present design allowable values starting at first sheet thickness below knife-edge condition and continuing through the first value equal to or greater than shear strength value. Allowable loads will not exceed shear strength. Add footnote indicator to ultimate strength values when yield is less than two-thirds of ultimate loads as indicated in Item (17).
- (13) Use the words: “Rivet shear strength” or “Fastener shear strength” conforming to Item (7) nomenclature.
- (14) Fastener single-shear allowable loads in pounds.
- (15) Present yield strength values for the same thickness and diameters for which ultimate strength values are provided.
- (16) For those countersunk head fasteners for which design values are applicable to thin sheet thicknesses, such that the countersink extends into the bottom sheet, a horizontal line will be drawn in each column of the joint allowables table above the first ultimate strength design value for which the countersink still is contained within the top sheet. For these cases, footnote (f) will be used, as indicated in Item (17).
- (17) Add all applicable footnotes from the list of standard notes shown below. All footnotes will be designated by lower case letters.
- (a) “Yield value is less than two-thirds of the indicated ultimate strength value.” (Place footnote indicator next to applicable ultimate strength value.)
- (b) “These allowables apply to double-dimpled sheets and to the upper sheet dimpled into a machine-countersunk sheet. The thickness of the machine-countersunk sheet must be at least one tabulated gage thicker than the upper dimpled sheet.” (Place footnote indicator next to the words “Ultimate Strength, lbs” at the top of the table.)
- (c) “Data supplied by ABC Corporation.” When applicable add: “Confirmatory data provided by XYZ Company.” (Place footnote indicator next to part number.)
- (d) “Shear strength based on areas computed from nominal hole diameters or nominal shank diameters, as applicable (indicate Table 8.1.2(a), or list hole diameters), and F_{su} = (indicate shear strength).” Indicate the source of the shear strength (MIL or NAS specifications or

MIL-HDBK-5J
31 January 2003

data analysis). The footnote indicator is placed next to the words “Fastener shear strength” indicated by Item 13 above. The shear strength will not be greater than the strength required in the controlling specification or standard.

- (e) “Allowables based on nominal hole diameters of (list hole diameters).” This footnote is used when shear strength is controlled by MIL or NAS specifications, and Table 8.1.2(a) hole diameters are not used.
 - (f) “Values above line are for knife-edge condition and the use of fasteners in this condition is undesirable. The use of knife-edge condition in design of military aircraft requires specific approval of the procuring agency.”
 - (g) “Permanent set at yield load: 4% of nominal diameter (see Section 9.7.1.1).”
 - (h) “Fasteners installed in clearance (or interference) holes.” Indicate actual range of fastener-hole fits (interference-clearance) from test program.
 - (i) “System maximum tensile strength as tested in steel fixture.” This footnote is used when table contains fastener tensile strength values. (Place footnote indicator next to the words “Fastener tensile strength, lbs”.)
- (18) When applicable, add line below yield strength section to present “Fastener tensile strength, lbs”. List the appropriate value for each fastener diameter.
- (19) For flush head fasteners, add line below yield strength section to present “Head height (ref.), in.” List appropriate value for each fastener diameter.

9.9.6 Fusion-Welded Joints — The welding conditions of major significance to potential users of the data should be shown in the data presentation for each basic population of weldments considered. Among these variables, the following are the minimum that should be specified, where applicable:

- (1) Alloys
- (2) Weld-heat-treat conditions
- (3) Filler materials
- (4) Welding processes
- (5) Weld repairs
- (6) Joint thicknesses
- (7) Joint types
- (8) Weld quality levels
- (9) Welding methods, i.e., manual or mechanized.

Since data presented are based on coupon-derived results, it is also necessary to provide comments on use of data in structural design.

9.9.6.1 Additional Information — When weldment data are presented, they should include comments to aid designers in selecting appropriate welding processes or conditions. In addition, comments alerting a designer to possible fabrication problems or environmental effects should be included. These may include:

- (1) Potential weld heat-treating sequences for the alloy
- (2) Applicable welding methods
- (3) Comments on weldment properties
- (4) Discussion of pertinent welding process variables, such as heat input sensitivity or restrictions, preheat requirements, atmospheric contamination, and significant metallurgical phenomena.

9.9.6.2 Room-Temperature Properties — Data on room-temperature properties of weldments are presented in tabular form illustrated in Figure 9.9.6.2. The figure describes base material, welding variables, and weld character conditions that the data represent, as well as properties of interest. Precautionary notes for use of data in design are presented in footnotes and are discussed in Section 9.9.6.4.

Material	Material Thickness	Weld Joint Type	Filler Wire Alloy	Heat Treat After Welding	Properties				Other Properties or Welding Conditions
					F _{tu} ²		F _{tu} ³		
					A	B	A	B	
6061-T4	Up to 0.30 Above 0.30	Sq. Butt Groove	4043 4043	Aged to T6					
6061-T4 6061-T6	Up to 0.30 Above 0.30	Sq. Butt Groove	4043 4043	As- Welded					
6061-F	Up to 0.30 Above 0.30	Sq. Butt Groove	4043 4043	Sol. Ht and Age to T6					

¹ These coupon-derived properties are subject to the usage limitations discussed under "Use of Design Data."

² For the following welding conditions -----

³ For the following welding conditions -----

Figure 9.9.6.2. Typical format for presentation of room-temperature properties of weldments.

9.9.6.3 Data on Effect of Temperature— A typical effect-of-temperature curve of weldment properties is shown in Figure 9.9.6.3. This type of curve should be presented in conjunction with room-temperature properties, referencing welding conditions and precautionary notes of the room-temperature case.

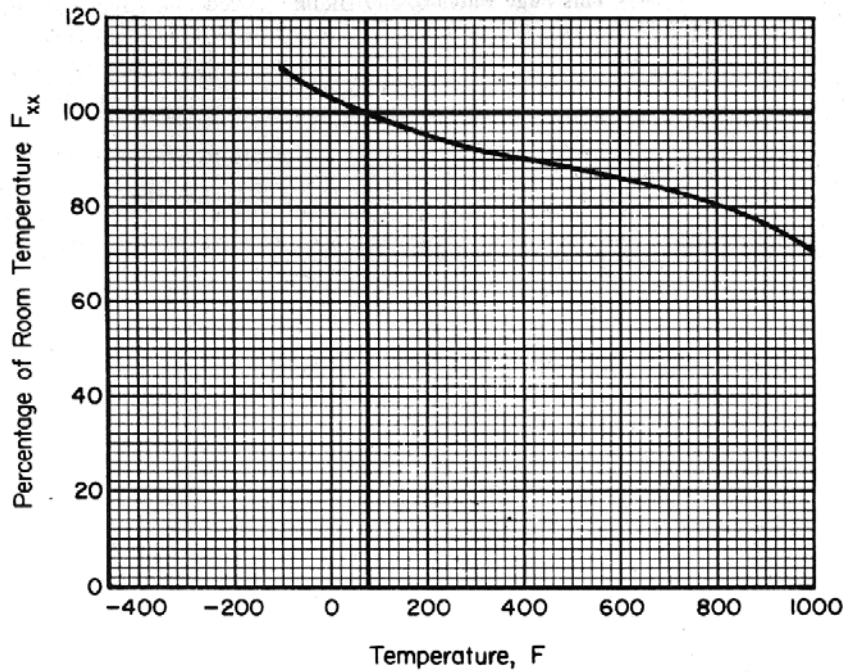

Figure 9.9.6.3. Typical effect of temperature presentation.

9.9.6.4 Use of Design Data— In footnotes to coupon-derived design data, it is necessary to present precautionary notes on the use of data in structural design. It is recognized that structures may not fail under load in the same manner as a coupon. This lack of one-to-one correlation may be due to differences either in weldment character resulting from potentially higher variability of production welding, or state of stress. Coupon-structure ratios are used to account for these differences.

The coupon-derived basic weld allowable accounts for a sizeable portion of the variability in welded joints; coupon-structure ratio accounts for the remainder. Since the state of stress (and to some extent, distribution of stress) is accounted for in the coupon-structure ratio, it is probable that each general structural configuration will have a unique coupon-structure ratio. For example, the coupon-structure ratio for a tank which must resist internal pressure would be different from the ratio for a welded joint in a sandwich panel.

9.10 STATISTICAL TABLES

A number of tables of statistical values that are required for analyses described in the MIL-HDBK-5 Guidelines are presented in this section. For tables containing various fractiles or confidence levels, only applicable portions are reproduced herein. Table 9.10.1 was reproduced by permission from Reference 9.10.1. Tables 9.10.2 through 9.10.6 were reproduced or adapted from tables in Reference 9.1.5, with the addition of a few individual values from various other sources. Tables 9.10.7 through 9.10.9 were created specifically for MIL-HDBK-5J.

Table 9.10.1. One-Sided Tolerance Limit Factors^a, k, for the Normal Distribution, 0.95 Confidence, and n-1 Degrees of Freedom

Note: These P values should only be used for substantiation of S-basis minimum properties (see Section 9.4). Weibull, Pearson, or nonparametric procedures should be used when calculating T_{90} and T_{99} values to determine A- and B-basis minimum static properties (see Section 9.5).

n	P = 0.99	n	P = 0.99	n	P = 0.99	n	P = 0.99
30	3.064						
31	3.048	61	2.802	91	2.704	121	2.648
32	3.034	62	2.798	92	2.701	122	2.646
33	3.020	63	2.793	93	2.699	123	2.645
34	3.007	64	2.789	94	2.697	124	2.643
35	2.995	65	2.785	95	2.695	125	2.642
36	2.983	66	2.781	96	2.692	126	2.640
37	2.972	67	2.777	97	2.690	127	2.639
38	2.961	68	2.773	98	2.688	128	2.638
39	2.951	69	2.769	99	2.686	129	2.636
40	2.941	70	2.765	100	2.684	130	2.635
41	2.932	71	2.762	101	2.682	131	2.634
42	2.923	72	2.758	102	2.680	132	2.632
43	2.914	73	2.755	103	2.678	133	2.631
44	2.906	74	2.751	104	2.676	134	2.630
45	2.898	75	2.748	105	2.674	135	2.628
46	2.890	76	2.745	106	2.672	136	2.627
47	2.883	77	2.742	107	2.671	137	2.626
48	2.876	78	2.739	108	2.669	138	2.625
49	2.869	79	2.736	109	2.667	139	2.624
50	2.862	80	2.733	110	2.665	140	2.622
51	2.856	81	2.730	111	2.663	141	2.621
52	2.850	82	2.727	112	2.662	142	2.620
53	2.844	83	2.724	113	2.660	143	2.619
54	2.838	84	2.721	114	2.658	144	2.618
55	2.833	85	2.719	115	2.657	145	2.617
56	2.827	86	2.716	116	2.655	146	2.616
57	2.822	87	2.714	117	2.654	147	2.615
58	2.817	88	2.711	118	2.652	148	2.613
59	2.812	89	2.709	119	2.651	149	2.612
60	2.807	90	2.706	120	2.649	150	2.611

Table 9.10.1. One-Sided Tolerance Limit Factors^a, k, for the Normal Distribution, 0.95 Confidence, and n-1 Degrees of Freedom (concluded)

Note: These P values should only be used for substantiation of S-basis minimum properties (see Section 9.4). Weibull, Pearson, or nonparametric procedures should be used when calculating T₉₀ and T₉₉ values to determine A- and B-basis minimum static properties (see Section 9.5).

n	P = 0.99	n	P = 0.99	n	P = 0.99	n	P = 0.99
151	2.610	176	2.587	205	2.566	330	2.512
152	2.609	177	2.587	210	2.563	340	2.509
153	2.608	178	2.586	215	2.560	350	2.506
154	2.607	179	2.585	220	2.557	360	2.504
155	2.606	180	2.584	225	2.555	370	2.501
156	2.605	181	2.583	230	2.552	390	2.496
157	2.604	182	2.583	235	2.549	400	2.494
158	2.603	183	2.583	240	2.547	425	2.489
159	2.602	184	2.581	245	2.544	450	2.484
160	2.601	185	2.580	250	2.542	475	2.480
161	2.600	186	2.580	255	2.540	500	2.475
162	2.600	187	2.579	260	2.537	525	2.472
163	2.599	188	2.578	265	2.535	550	2.468
164	2.598	189	2.577	270	2.533	575	2.465
165	2.597	190	2.577	275	2.531	600	2.462
166	2.596	191	2.576	280	2.529	625	2.459
167	2.595	192	2.575	285	2.527	650	2.456
168	2.594	193	2.575	290	2.525	675	2.454
169	2.593	194	2.574	295	2.524	700	2.451
170	2.592	195	2.573	300	2.522	750	2.447
171	2.592	196	2.572	305	2.520	800	2.443
172	2.591	197	2.572	310	2.518	850	2.439
173	2.590	198	2.571	315	2.517	900	2.436
174	2.589	199	2.570	320	2.515	1000	2.430
175	2.588	200	2.570	325	2.514	∞	2.326

a The following equations may be used to compute k factors in lieu of using table values:

$$k_{99} = 2.326 + \exp [1.34 - 0.522 \ln(n) + 3.87/n]$$

$$k_{90} = 1.282 + \exp [0.958 - 0.520 \ln(n) + 3.19/n]$$

These approximations are accurate to within 0.2% of the table values for n greater than or equal to 30.

Table 9.10.2. 0.950 Fractiles of the F Distribution Associated with n_1 and n_2 Degrees of Freedom

n_2^a	n_1 , degrees of freedom for numerator															∞			
	1	2	3	4	5	6	7	8	9	10	12	15	20	24	30		40	60	120
1	161.4	199.5	215.7	224.6	230.2	234.0	236.8	238.9	240.5	241.9	243.9	245.9	248.0	249.0	250.1	251.1	252.2	253.2	254.3
2	18.51	19.00	19.16	19.25	19.30	19.33	19.35	19.37	19.38	19.40	19.41	19.43	19.45	19.45	19.46	19.47	19.48	19.49	19.51
3	10.13	9.55	9.28	9.12	9.01	8.94	8.89	8.85	8.81	8.79	8.74	8.70	8.66	8.64	8.62	8.59	8.57	8.55	8.53
4	7.71	6.94	6.59	6.39	6.26	6.16	6.09	6.04	6.00	5.96	5.91	5.86	5.80	5.77	5.75	5.72	5.69	5.66	5.63
5	6.61	5.79	5.41	5.19	5.05	4.95	4.88	4.82	4.77	4.74	4.68	4.62	4.56	4.53	4.50	4.46	4.43	4.40	4.37
6	5.99	5.14	4.76	4.53	4.39	4.28	4.21	4.15	4.10	4.06	4.00	3.94	3.87	3.84	3.81	3.77	3.74	3.70	3.67
7	5.59	4.74	4.35	4.12	3.97	3.87	3.79	3.73	3.68	3.64	3.57	3.51	3.44	3.41	3.38	3.34	3.30	3.27	3.23
8	5.32	4.46	4.07	3.84	3.69	3.58	3.50	3.44	3.39	3.35	3.28	3.22	3.15	3.12	3.08	3.04	3.01	2.97	2.93
9	5.12	4.26	3.86	3.63	3.48	3.37	3.29	3.23	3.18	3.14	3.07	3.01	2.94	2.90	2.86	2.83	2.79	2.75	2.71
10	4.96	4.10	3.71	3.48	3.33	3.22	3.14	3.07	3.02	2.98	2.91	2.85	2.77	2.74	2.70	2.66	2.62	2.58	2.54
11	4.84	3.98	3.59	3.36	3.20	3.09	3.01	2.95	2.90	2.85	2.79	2.72	2.65	2.61	2.57	2.53	2.49	2.45	2.40
12	4.75	3.89	3.49	3.26	3.11	3.00	2.91	2.85	2.80	2.75	2.69	2.62	2.54	2.51	2.47	2.43	2.38	2.34	2.30
13	4.67	3.81	3.41	3.18	3.03	2.92	2.83	2.77	2.71	2.67	2.60	2.53	2.46	2.42	2.38	2.34	2.30	2.25	2.21
14	4.60	3.74	3.34	3.11	2.96	2.85	2.76	2.70	2.65	2.60	2.53	2.46	2.39	2.35	2.31	2.27	2.22	2.18	2.13
15	4.54	3.68	3.29	3.06	2.90	2.79	2.71	2.64	2.59	2.54	2.48	2.40	2.33	2.29	2.25	2.20	2.16	2.11	2.07
16	4.49	3.63	3.24	3.01	2.85	2.74	2.66	2.59	2.54	2.49	2.42	2.35	2.28	2.24	2.19	2.15	2.11	2.06	2.01
17	4.45	3.59	3.20	2.96	2.81	2.70	2.61	2.55	2.49	2.44	2.38	2.31	2.23	2.19	2.15	2.10	2.06	2.01	1.96
18	4.41	3.55	3.16	2.93	2.77	2.66	2.58	2.51	2.46	2.41	2.34	2.27	2.19	2.15	2.11	2.06	2.02	1.97	1.92
19	4.38	3.52	3.13	2.90	2.74	2.63	2.54	2.48	2.42	2.38	2.31	2.23	2.16	2.11	2.07	2.03	1.98	1.93	1.88
20	4.35	3.49	3.10	2.87	2.71	2.60	2.51	2.45	2.39	2.35	2.28	2.20	2.12	2.08	2.04	1.99	1.95	1.90	1.84
21	4.32	3.47	3.07	2.84	2.68	2.57	2.49	2.42	2.37	2.32	2.25	2.18	2.10	2.05	2.01	1.96	1.92	1.87	1.81
22	4.30	3.44	3.05	2.82	2.66	2.55	2.46	2.40	2.34	2.30	2.23	2.15	2.07	2.03	1.98	1.94	1.89	1.84	1.78
23	4.28	3.42	3.03	2.80	2.64	2.53	2.44	2.37	2.32	2.27	2.20	2.13	2.05	2.01	1.96	1.91	1.86	1.81	1.76
24	4.26	3.40	3.01	2.78	2.62	2.51	2.42	2.36	2.30	2.25	2.18	2.11	2.03	1.98	1.94	1.89	1.84	1.79	1.73
25	4.24	3.39	2.99	2.76	2.60	2.49	2.40	2.34	2.28	2.24	2.16	2.09	2.01	1.96	1.92	1.87	1.82	1.77	1.71
26	4.23	3.37	2.98	2.74	2.59	2.47	2.39	2.32	2.27	2.22	2.15	2.07	1.99	1.95	1.90	1.85	1.80	1.75	1.69
27	4.21	3.35	2.96	2.73	2.57	2.46	2.37	2.31	2.25	2.20	2.13	2.06	1.97	1.93	1.88	1.84	1.79	1.73	1.67
28	4.20	3.34	2.95	2.71	2.56	2.45	2.36	2.29	2.24	2.19	2.12	2.04	1.96	1.91	1.87	1.82	1.77	1.71	1.65
29	4.18	3.33	2.93	2.70	2.55	2.43	2.35	2.28	2.22	2.18	2.10	2.03	1.94	1.90	1.85	1.81	1.75	1.70	1.64
30	4.17	3.32	2.92	2.69	2.53	2.42	2.33	2.27	2.21	2.16	2.09	2.01	1.93	1.89	1.84	1.79	1.74	1.68	1.62
40	4.08	3.23	2.84	2.61	2.45	2.34	2.25	2.18	2.12	2.08	2.00	1.92	1.84	1.79	1.74	1.69	1.64	1.58	1.51
60	4.00	3.15	2.76	2.53	2.37	2.25	2.17	2.10	2.04	1.99	1.92	1.84	1.75	1.70	1.65	1.59	1.53	1.47	1.39
120	3.92	3.07	2.68	2.45	2.29	2.18	2.09	2.02	1.96	1.91	1.83	1.75	1.66	1.61	1.55	1.50	1.43	1.35	1.25
∞	3.84	3.00	2.61	2.37	2.21	2.10	2.01	1.94	1.88	1.83	1.75	1.67	1.57	1.52	1.46	1.39	1.32	1.22	1.00

^a n_2 = degrees of freedom for denominator.

Table 9.10.3. 0.975 Fractiles^a of the F Distribution Associated with n_1 and n_2 Degrees of Freedom, $F_{0.975}(n_1, n_2)$

δ_1^b	δ_1 , degrees of freedom for numerator																∞		
	1	2	3	4	5	6	7	8	9	10	12	15	20	24	30	40		60	120
1	647.8	799.5	864.2	899.6	921.8	937.1	948.2	956.7	963.3	968.6	976.7	984.9	993.1	997.2	1001	1006	1010	1014	1018
2	38.51	39.00	39.17	39.25	39.30	39.33	39.36	39.37	39.39	39.40	39.41	39.43	39.45	39.46	39.45	39.47	39.48	39.99	39.50
3	17.44	16.04	15.44	15.10	14.88	14.73	14.62	14.54	14.47	14.42	14.34	14.25	14.17	14.12	14.08	14.04	13.99	13.95	13.90
4	12.22	10.65	9.98	9.60	9.36	9.20	9.07	8.98	8.90	8.84	8.75	8.66	8.56	8.51	8.46	8.41	8.36	8.31	8.26
5	10.01	8.43	7.76	7.39	7.15	6.98	6.85	6.76	6.68	6.62	6.52	6.43	6.33	6.28	6.23	6.18	6.12	6.07	6.02
6	8.81	7.26	6.60	6.23	5.99	5.82	5.70	5.60	5.52	5.46	5.37	5.27	5.17	5.12	5.07	5.01	4.96	4.90	4.85
7	8.07	6.54	5.89	5.52	5.29	5.12	4.99	4.90	4.82	4.76	4.67	4.57	4.47	4.42	4.36	4.31	4.25	4.20	4.14
8	7.57	6.06	5.42	5.05	4.82	4.65	4.53	4.43	4.36	4.30	4.20	4.10	4.00	3.95	3.89	3.84	3.78	3.73	3.67
9	7.21	5.71	5.08	4.72	4.48	4.32	4.20	4.10	4.03	3.96	3.87	3.77	3.67	3.61	3.56	3.51	3.45	3.39	3.33
10	6.94	5.46	4.83	4.47	4.24	4.07	3.95	3.85	3.78	3.72	3.62	3.52	3.42	3.37	3.31	3.26	3.20	3.14	3.08
11	6.72	5.26	4.63	4.28	4.04	3.88	3.76	3.66	3.59	3.53	3.43	3.33	3.23	3.17	3.12	3.06	3.00	2.94	2.88
12	6.55	5.10	4.47	4.12	3.89	3.73	3.61	3.51	3.44	3.37	3.28	3.18	3.07	3.02	2.96	2.91	2.85	2.79	2.72
13	6.41	4.97	4.35	4.00	3.77	3.60	3.48	3.39	3.31	3.25	3.15	3.05	2.95	2.89	2.84	2.78	2.72	2.66	2.60
14	6.30	4.86	4.24	3.89	3.66	3.50	3.38	3.29	3.21	3.15	3.05	2.95	2.84	2.79	2.73	2.67	2.61	2.55	2.49
15	6.20	4.77	4.15	3.80	3.58	3.41	3.29	3.20	3.12	3.06	2.96	2.86	2.76	2.70	2.64	2.59	2.52	2.46	2.40
16	6.12	4.69	4.08	3.73	3.50	3.34	3.22	3.12	3.05	2.99	2.89	2.79	2.68	2.63	2.57	2.51	2.45	2.38	2.32
17	6.04	4.62	4.01	3.66	3.44	3.28	3.16	3.06	2.98	2.92	2.82	2.72	2.62	2.56	2.50	2.44	2.38	2.32	2.25
18	5.98	4.56	3.95	3.61	3.38	3.22	3.10	3.01	2.93	2.87	2.77	2.67	2.56	2.50	2.44	2.38	2.32	2.26	2.19
19	5.92	4.51	3.90	3.56	3.33	3.17	3.05	2.96	2.88	2.82	2.72	2.62	2.51	2.45	2.39	2.33	2.27	2.20	2.13
20	5.87	4.46	3.86	3.51	3.29	3.13	3.01	2.91	2.84	2.77	2.68	2.57	2.46	2.41	2.36	2.29	2.22	2.16	2.09
21	5.83	4.42	3.82	3.48	3.25	3.09	2.97	2.87	2.80	2.73	2.64	2.53	2.42	2.37	2.31	2.25	2.18	2.11	2.04
22	5.79	4.38	3.78	3.44	3.22	3.05	2.93	2.84	2.76	2.70	2.60	2.50	2.39	2.33	2.27	2.21	2.14	2.08	2.00
23	5.75	4.25	3.75	3.41	3.18	3.02	2.90	2.81	2.73	2.67	2.57	2.47	2.36	2.30	2.24	2.18	2.11	2.04	1.97
24	5.72	4.32	3.72	3.38	3.15	2.99	2.87	2.78	2.70	2.64	2.54	2.44	2.33	2.27	2.21	2.15	2.08	2.01	1.94
25	5.69	4.29	3.69	3.35	3.13	2.97	2.85	2.75	2.68	2.61	2.51	2.41	2.30	2.24	2.18	2.12	2.05	1.98	1.91
26	5.66	4.27	3.67	3.33	3.10	2.94	2.82	2.73	2.65	2.59	2.49	2.39	2.28	2.22	2.16	2.09	2.03	1.95	1.88
27	5.63	4.24	3.65	3.31	3.08	2.92	2.80	2.71	2.63	2.57	2.47	2.36	2.25	2.19	2.13	2.07	2.00	1.93	1.85
28	5.61	4.22	3.63	3.29	3.06	2.90	2.78	2.69	2.61	2.55	2.45	2.34	2.23	2.17	2.11	2.06	1.98	1.91	1.83
29	5.59	4.20	3.61	3.27	3.04	2.88	2.76	2.67	2.59	2.53	2.43	2.32	2.21	2.15	2.09	2.03	1.96	1.89	1.81
30	5.57	4.18	3.59	3.25	3.03	2.87	2.75	2.65	2.57	2.51	2.41	2.31	2.20	2.14	2.07	2.01	1.94	1.87	1.79
40	5.42	4.05	3.46	3.13	2.90	2.74	2.62	2.53	2.45	2.39	2.29	2.18	2.07	2.01	1.94	1.88	1.80	1.72	1.64
60	5.29	3.93	3.34	3.01	2.79	2.63	2.51	2.41	2.33	2.27	2.17	2.06	1.94	1.88	1.82	1.74	1.67	1.58	1.48
120	5.15	3.80	3.23	2.89	2.67	2.52	2.39	2.30	2.22	2.16	2.05	1.94	1.82	1.76	1.69	1.61	1.53	1.43	1.31
∞	5.02	3.69	3.12	2.79	2.57	2.41	2.29	2.19	2.11	2.05	1.94	1.83	1.71	1.64	1.57	1.48	1.39	1.27	1.00

^a See following page for footnote.

^b n_2 = degrees of freedom for denominator

Table 9.10.3. 0.975 Fractiles^a of the F Distribution Associated with n_1 and n_2 degrees of Freedom $F_{.975}(n_1, n_2)$ (Continued)

a The following equation may be used to compute 0.975 fractiles of the F distribution in lieu of using table values:

$$F_{.975} \approx \exp \left[2\delta \left(1 + \frac{z^2 - 1}{3} - \frac{4\sigma^2}{3} \right) + 2\sigma z \left(1 + \frac{\sigma^2(z^2 - 3)}{6} \right)^{1/2} \right]$$

where

$$\begin{aligned} z &= 1.96 \\ \delta &= 0.5 [1/(\gamma_2 - 1) - 1/(\gamma_1 - 1)] \\ \sigma^2 &= 0.5 [(1/(\gamma_2 - 1) + 1/(\gamma_1 - 1))] \\ \gamma_1 &= \text{degrees of freedom for numerator} \\ \gamma_2 &= \text{degrees of freedom for denominator.} \end{aligned}$$

This approximation is accurate to within 0.4% for $\gamma_1 \geq 10$ and $\gamma_2 \geq 16$. See Reference 9.10.3.

Table 9.10.4. 0.95 and 0.975 Fractiles^a of the t Distribution Associated with df Degrees of Freedom

df	$t_{.95}$	$t_{.975}$	df	$t_{.95}$	$t_{.975}$
1	6.314	12.706	21	1.721	2.080
2	2.920	4.303	22	1.717	2.074
3	2.353	3.182	23	1.714	2.069
4	2.132	2.776	24	1.711	2.064
5	2.015	2.571	25	1.708	2.060
6	1.943	2.447	26	1.706	2.056
7	1.895	2.365	27	1.703	2.052
8	1.860	2.306	28	1.701	2.048
9	1.833	2.262	29	1.699	2.045
10	1.812	2.228	30	1.697	2.042
11	1.796	2.201	40	1.684	2.021
12	1.782	2.179	50	1.676	2.009
13	1.771	2.160	60	1.671	2.000
14	1.761	2.145	80	1.664	1.990
15	1.753	2.131	100	1.660	1.984
16	1.746	2.120	120	1.658	1.980
17	1.740	2.110	200	1.653	1.972
18	1.734	2.101	500	1.648	1.965
19	1.729	2.093	∞	1.645	1.960
20	1.725	2.086			

a The following equations may be used to compute 0.95 and 0.975 fractiles of the t distribution in lieu of using table values:

$$\begin{aligned} t_{.95} &\approx 1.645 + \exp [0.377 - 0.990 \ln(\gamma) + 1.15/\gamma] \\ t_{.975} &\approx 1.96 + \exp [0.779 - 0.980 \ln(\gamma) + 1.57/\gamma] \end{aligned}$$

where γ is the degrees of freedom (df). These approximations are accurate to within 0.5% for $\gamma \geq 4$.

MIL-HDBK-5J
31 January 2003

Table 9.10.5. Area Under the Normal Curve from $-\infty$ to the Mean + Z_p Standard Deviations^{a,b}

Z_p	0.00	0.01	0.02	0.03	0.04	0.05	0.06	0.07	0.08	0.09
.0	.5000	.5040	.5080	.5120	.5160	.5199	.5239	.5279	.5319	.5359
.1	.5398	.5438	.5478	.5517	.5557	.5596	.5636	.5675	.5714	.5753
.2	.5793	.5832	.5871	.5910	.5948	.5987	.6026	.6064	.6103	.6141
.3	.6179	.6217	.6255	.6293	.6331	.6368	.6406	.6443	.6480	.6517
.4	.6554	.6591	.6628	.6664	.6700	.6736	.6772	.6808	.6844	.6879
.5	.6915	.6950	.6985	.7019	.7054	.7088	.7123	.7157	.7190	.7224
.6	.7257	.7291	.7324	.7357	.7389	.7422	.7454	.7486	.7517	.7549
.7	.7580	.7611	.7642	.7673	.7704	.7734	.7764	.7794	.7823	.7852
.8	.7881	.7910	.7939	.7967	.7995	.8023	.8051	.8078	.8106	.8133
.9	.8159	.8186	.8212	.8238	.8264	.8289	.8315	.8340	.8365	.8389
1.0	.8413	.8438	.8461	.8485	.8508	.8531	.8554	.8577	.8599	.8621
1.1	.8643	.8665	.8686	.8708	.8729	.8749	.8770	.8790	.8810	.8820
1.2	.8849	.8869	.8888	.8907	.8925	.8944	.8962	.8980	.8997	.9015
1.3	.9032	.9049	.9066	.9082	.9099	.9115	.9131	.9147	.9162	.9177
1.4	.9192	.9207	.9222	.9236	.9251	.9265	.9279	.9292	.9306	.9319
1.5	.9332	.9345	.9357	.9370	.9382	.9394	.9406	.9418	.9429	.9441
1.6	.9452	.9463	.9474	.9484	.9495	.9505	.9515	.9525	.9535	.9545
1.7	.9554	.9564	.9573	.9582	.9591	.9599	.9608	.9616	.9625	.9633
1.8	.9641	.9649	.9656	.9664	.9671	.9678	.9686	.9693	.9699	.9706
1.9	.9713	.9719	.9726	.9732	.9738	.9744	.9750	.9756	.9761	.9767
2.0	.9772	.9778	.9783	.9788	.9793	.9798	.9803	.9808	.9812	.9817
2.1	.9821	.9826	.9830	.9834	.9838	.9842	.9846	.9850	.9854	.9857
2.2	.9861	.9864	.9868	.9871	.9875	.9878	.9881	.9884	.9887	.9890
2.3	.9893	.9896	.9898	.9901	.9904	.9906	.9909	.9911	.9913	.9916
2.4	.9918	.9920	.9922	.9925	.9927	.9929	.9931	.9932	.9934	.9936
2.5	.9938	.9940	.9941	.9943	.9945	.9946	.9948	.9949	.9951	.9952
2.6	.9953	.9955	.9956	.9957	.9959	.9960	.9961	.9962	.9963	.9964
2.7	.9965	.9966	.9967	.9968	.9969	.9970	.9971	.9972	.9973	.9974
2.8	.9974	.9975	.9976	.9977	.9977	.9978	.9979	.9979	.9980	.9981
2.9	.9981	.9982	.9982	.9983	.9984	.9984	.9985	.9985	.9986	.9986
3.0	.9987	.9987	.9987	.9988	.9988	.9989	.9989	.9989	.9990	.9990
3.1	.9990	.9991	.9991	.9991	.9992	.9992	.9992	.9992	.9993	.9993
3.2	.9993	.9993	.9994	.9994	.9994	.9994	.9994	.9995	.9995	.9995
3.3	.9995	.9995	.9995	.9996	.9996	.9996	.9996	.9996	.9996	.9997
3.4	.9997	.9997	.9997	.9997	.9997	.9997	.9997	.9997	.9997	.9998

a For negative values of Z_p , subtract the tabular value from unity.

b The following equation may be used to compute the probabilities in lieu of using table values:

$$p \approx 0.5 \{1 - [1 + (A + BZ_p)^C]^D + [1 + (A - BZ_p)^C]^D\}$$

where

$$A = 0.644693$$

$$B = 0.161984$$

$$C = 4.874$$

$$D = -6.158$$

This approximation is accurate to within 0.07% of the true probabilities, see Reference 9.10.5.

Table 9.10.6. One-Sided Tolerance-Limit Factors for the Three-Parameter Weibull Acceptability Test with 95 Percent Confidence

Sample Size	V_{99}
10	-4.46
15	-4.77
20	-4.98
25	-5.12
30	-5.23
35	-5.32
40	-5.40
50	-5.51
75	-5.71
100	-5.82
150	-5.97
200	-6.05
300	-6.17
400	-6.23
500	-6.27
750	-6.29
1,000	-6.34
2,000	-6.39
5,000	-6.51
10,000	-6.55
∞	-6.65

Table 9.10.7 One-Sided Tolerance Factors for the Three-Parameter Weibull Distribution with 95 Percent Confidence

N	V ₉₉ for T ₉₉			V ₉₀ for T ₉₀		
	Uncensored	20% Censored	50% Censored	Uncensored	20% Censored	50% Censored
10	12.330	16.508	29.921	6.763	8.466	13.182
11	11.885	15.700	27.134	6.529	8.067	12.004
12	11.520	15.053	25.086	6.337	7.747	11.138
13	11.214	14.522	23.514	6.177	7.485	10.474
14	10.955	14.078	22.266	6.040	7.266	9.946
15	10.730	13.700	21.251	5.922	7.079	9.516
16	10.535	13.374	20.406	5.820	6.918	9.159
17	10.362	13.090	19.692	5.729	6.778	8.857
18	10.208	12.840	19.080	5.649	6.655	8.597
19	10.071	12.617	18.548	5.577	6.545	8.372
20	9.946	12.417	18.082	5.512	6.447	8.174
21	9.834	12.238	17.669	5.453	6.358	8.000
22	9.731	12.074	17.300	5.399	6.278	7.843
23	9.636	11.926	16.969	5.349	6.204	7.703
24	9.549	11.789	16.670	5.304	6.137	7.577
25	9.469	11.664	16.398	5.262	6.075	7.461
26	9.394	11.548	16.150	5.223	6.018	7.356
27	9.325	11.441	15.922	5.187	5.966	7.260
28	9.260	11.341	15.712	5.153	5.916	7.171
29	9.199	11.248	15.518	5.121	5.870	7.088
30	9.142	11.160	15.338	5.091	5.828	7.012
31	9.089	11.078	15.170	5.063	5.787	6.941
32	9.038	11.002	15.014	5.037	5.750	6.875
33	8.990	10.929	14.868	5.012	5.714	6.813
34	8.945	10.861	14.730	4.989	5.680	6.754
35	8.902	10.796	14.601	4.966	5.648	6.700
36	8.862	10.735	14.479	4.945	5.618	6.648
37	8.823	10.676	14.364	4.925	5.590	6.599
38	8.786	10.621	14.256	4.906	5.562	6.553
39	8.751	10.568	14.153	4.887	5.537	6.510
40	8.717	10.518	14.055	4.870	5.512	6.468
41	8.685	10.470	13.962	4.853	5.488	6.429
42	8.654	10.424	13.873	4.837	5.466	6.391
43	8.624	10.380	13.789	4.822	5.444	6.356
44	8.596	10.338	13.708	4.807	5.423	6.321
45	8.569	10.298	13.631	4.793	5.404	6.289
46	8.543	10.259	13.558	4.779	5.385	6.258
47	8.517	10.221	13.487	4.766	5.366	6.228
48	8.493	10.186	13.419	4.753	5.349	6.199

Table 9.10.7. One-Sided Tolerance Factors for the Three-Parameter Weibull Distribution with 95 Percent Confidence (Continued)

N	V ₉₉ for T ₉₉			V ₉₀ for T ₉₀		
	Uncensored	20% Censored	50% Censored	Uncensored	20% Censored	50% Censored
49	8.469	10.151	13.354	4.741	5.332	6.171
50	8.447	10.118	13.292	4.729	5.315	6.145
51	8.425	10.086	13.232	4.718	5.300	6.119
52	8.404	10.055	13.174	4.707	5.284	6.095
53	8.383	10.025	13.118	4.696	5.270	6.071
54	8.364	9.996	13.064	4.686	5.255	6.048
55	8.344	9.968	13.012	4.676	5.242	6.026
56	8.326	9.940	12.962	4.666	5.228	6.005
57	8.308	9.914	12.914	4.657	5.216	5.985
58	8.290	9.889	12.867	4.648	5.203	5.965
59	8.273	9.864	12.822	4.639	5.191	5.946
60	8.257	9.840	12.778	4.631	5.179	5.927
61	8.241	9.817	12.735	4.622	5.168	5.909
62	8.225	9.794	12.694	4.614	5.157	5.892
63	8.210	9.772	12.654	4.606	5.146	5.875
64	8.195	9.751	12.615	4.599	5.135	5.858
65	8.181	9.730	12.577	4.591	5.125	5.842
66	8.167	9.709	12.541	4.584	5.115	5.827
67	8.153	9.690	12.505	4.577	5.106	5.811
68	8.140	9.671	12.470	4.570	5.096	5.797
69	8.127	9.652	12.436	4.563	5.087	5.782
70	8.114	9.634	12.404	4.557	5.078	5.769
71	8.102	9.616	12.372	4.550	5.069	5.755
72	8.090	9.598	12.340	4.544	5.061	5.742
73	8.078	9.581	12.310	4.538	5.053	5.729
74	8.067	9.565	12.280	4.532	5.044	5.716
75	8.055	9.549	12.252	4.526	5.036	5.704
76	8.044	9.533	12.223	4.520	5.029	5.692
77	8.034	9.517	12.196	4.515	5.021	5.681
78	8.023	9.502	12.169	4.509	5.014	5.669
79	8.013	9.487	12.143	4.504	5.006	5.658
80	8.003	9.473	12.117	4.499	4.999	5.647
81	7.993	9.459	12.092	4.494	4.992	5.637
82	7.983	9.445	12.067	4.489	4.986	5.626
83	7.974	9.431	12.043	4.484	4.979	5.616
84	7.964	9.418	12.020	4.479	4.973	5.606
85	7.955	9.405	11.997	4.474	4.966	5.596
86	7.946	9.392	11.975	4.470	4.960	5.587
87	7.938	9.380	11.952	4.465	4.954	5.578
88	7.929	9.367	11.931	4.461	4.948	5.568
89	7.921	9.355	11.910	4.456	4.942	5.559

Table 9.10.7. One-Sided Tolerance Factors for the Three-Parameter Weibull Distribution with 95 Percent Confidence (Continued)

N	V ₉₉ for T ₉₉			V ₉₀ for T ₉₀		
	Uncensored	20% Censored	50% Censored	Uncensored	20% Censored	50% Censored
90	7.912	9.344	11.889	4.452	4.936	5.551
91	7.904	9.332	11.869	4.448	4.930	5.542
92	7.896	9.321	11.849	4.444	4.925	5.534
93	7.888	9.309	11.829	4.440	4.919	5.525
94	7.881	9.298	11.810	4.436	4.914	5.517
95	7.873	9.288	11.791	4.432	4.909	5.509
96	7.866	9.277	11.773	4.428	4.904	5.502
97	7.859	9.267	11.755	4.424	4.899	5.494
98	7.851	9.257	11.737	4.420	4.894	5.486
99	7.844	9.247	11.720	4.417	4.889	5.479
100	7.837	9.237	11.703	4.413	4.884	5.472
102	7.824	9.217	11.669	4.406	4.874	5.458
104	7.811	9.199	11.637	4.399	4.865	5.444
106	7.798	9.181	11.606	4.393	4.857	5.431
108	7.786	9.163	11.576	4.387	4.848	5.418
110	7.774	9.146	11.546	4.380	4.840	5.406
112	7.762	9.130	11.518	4.374	4.832	5.394
114	7.751	9.114	11.491	4.369	4.824	5.382
116	7.740	9.099	11.464	4.363	4.816	5.371
118	7.729	9.084	11.439	4.357	4.809	5.360
120	7.719	9.069	11.414	4.352	4.802	5.349
122	7.709	9.055	11.389	4.347	4.795	5.339
124	7.699	9.041	11.366	4.342	4.788	5.329
126	7.690	9.028	11.343	4.337	4.782	5.319
128	7.680	9.015	11.320	4.332	4.775	5.310
130	7.671	9.002	11.299	4.327	4.769	5.301
132	7.663	8.989	11.278	4.323	4.763	5.292
134	7.654	8.977	11.257	4.318	4.757	5.283
136	7.646	8.965	11.237	4.314	4.751	5.275
138	7.637	8.954	11.217	4.310	4.746	5.266
140	7.629	8.943	11.198	4.306	4.740	5.258
142	7.622	8.932	11.180	4.302	4.735	5.250
144	7.614	8.921	11.161	4.298	4.730	5.243
146	7.606	8.910	11.144	4.294	4.724	5.235
148	7.599	8.900	11.126	4.290	4.719	5.228
150	7.592	8.890	11.109	4.286	4.715	5.221
152	7.585	8.880	11.093	4.283	4.710	5.214
154	7.578	8.871	11.077	4.279	4.705	5.207
156	7.571	8.861	11.061	4.276	4.700	5.200
158	7.565	8.852	11.045	4.272	4.696	5.194
160	7.558	8.843	11.030	4.269	4.692	5.187

Table 9.10.7. One-Sided Tolerance Factors for the Three-Parameter Weibull Distribution with 95 Percent Confidence (Continued)

N	V ₉₉ for T ₉₉			V ₉₀ for T ₉₀		
	Uncensored	20% Censored	50% Censored	Uncensored	20% Censored	50% Censored
162	7.552	8.834	11.015	4.266	4.687	5.181
164	7.546	8.826	11.001	4.263	4.683	5.175
166	7.540	8.817	10.987	4.260	4.679	5.169
168	7.534	8.809	10.973	4.257	4.675	5.163
170	7.528	8.801	10.959	4.254	4.671	5.157
172	7.522	8.793	10.946	4.251	4.667	5.151
174	7.517	8.785	10.932	4.248	4.663	5.146
176	7.511	8.777	10.920	4.245	4.659	5.140
178	7.506	8.770	10.907	4.242	4.656	5.135
180	7.501	8.762	10.894	4.239	4.652	5.130
182	7.495	8.755	10.882	4.237	4.649	5.125
184	7.490	8.748	10.870	4.234	4.645	5.120
186	7.485	8.741	10.859	4.231	4.642	5.115
188	7.480	8.734	10.847	4.229	4.638	5.110
190	7.475	8.727	10.836	4.226	4.635	5.105
192	7.471	8.720	10.825	4.224	4.632	5.100
194	7.466	8.714	10.814	4.221	4.629	5.096
196	7.461	8.707	10.803	4.219	4.625	5.091
198	7.457	8.701	10.793	4.217	4.622	5.087
200	7.452	8.695	10.782	4.214	4.619	5.082
204	7.443	8.683	10.762	4.210	4.613	5.074
208	7.435	8.671	10.742	4.206	4.608	5.066
212	7.427	8.659	10.724	4.201	4.602	5.058
216	7.419	8.648	10.705	4.197	4.597	5.050
220	7.411	8.638	10.687	4.193	4.591	5.042
224	7.404	8.627	10.670	4.189	4.586	5.035
228	7.396	8.617	10.653	4.186	4.581	5.028
232	7.389	8.607	10.637	4.182	4.576	5.021
236	7.382	8.597	10.621	4.178	4.572	5.014
240	7.375	8.588	10.606	4.175	4.567	5.008
244	7.369	8.579	10.591	4.171	4.563	5.002
248	7.363	8.570	10.576	4.168	4.559	4.995
252	7.356	8.562	10.562	4.165	4.554	4.990
256	7.350	8.553	10.548	4.162	4.550	4.984
260	7.344	8.545	10.535	4.159	4.546	4.978
264	7.339	8.537	10.522	4.156	4.542	4.972
268	7.333	8.529	10.509	4.153	4.539	4.967
272	7.327	8.522	10.497	4.150	4.535	4.962
276	7.322	8.514	10.485	4.147	4.531	4.957
280	7.317	8.507	10.473	4.145	4.528	4.952
284	7.312	8.500	10.461	4.142	4.524	4.947

Table 9.10.7. One-Sided Tolerance Factors for the Three-Parameter Weibull Distribution with 95 Percent Confidence (Continued)

N	V ₉₉ for T ₉₉			V ₉₀ for T ₉₀		
	Uncensored	20% Censored	50% Censored	Uncensored	20% Censored	50% Censored
288	7.307	8.493	10.450	4.139	4.521	4.942
292	7.302	8.486	10.439	4.137	4.518	4.937
296	7.297	8.479	10.428	4.134	4.514	4.933
300	7.292	8.473	10.417	4.132	4.511	4.928
310	7.281	8.457	10.392	4.126	4.504	4.917
320	7.270	8.442	10.368	4.121	4.496	4.907
330	7.260	8.428	10.345	4.115	4.489	4.898
340	7.250	8.415	10.323	4.110	4.483	4.888
350	7.241	8.402	10.302	4.106	4.477	4.880
360	7.232	8.390	10.282	4.101	4.471	4.871
370	7.223	8.378	10.263	4.097	4.465	4.863
380	7.215	8.367	10.245	4.092	4.459	4.855
390	7.207	8.356	10.227	4.088	4.454	4.848
400	7.200	8.346	10.211	4.084	4.449	4.841
425	7.182	8.321	10.172	4.075	4.437	4.825
450	7.166	8.299	10.136	4.067	4.427	4.810
475	7.151	8.279	10.104	4.060	4.417	4.796
500	7.138	8.261	10.074	4.053	4.408	4.783
525	7.125	8.244	10.047	4.046	4.400	4.772
550	7.114	8.228	10.021	4.040	4.392	4.761
575	7.103	8.213	9.997	4.035	4.385	4.751
600	7.093	8.199	9.975	4.030	4.378	4.742
625	7.083	8.186	9.955	4.025	4.372	4.733
650	7.074	8.174	9.935	4.020	4.366	4.725
675	7.066	8.162	9.917	4.016	4.360	4.717
700	7.058	8.152	9.900	4.012	4.355	4.710
725	7.050	8.141	9.884	4.008	4.350	4.703
750	7.043	8.132	9.868	4.004	4.345	4.697
775	7.037	8.123	9.854	4.001	4.341	4.690
800	7.030	8.114	9.840	3.998	4.337	4.685
825	7.024	8.106	9.827	3.994	4.332	4.679
850	7.018	8.098	9.814	3.991	4.329	4.674
875	7.013	8.090	9.802	3.989	4.325	4.669
900	7.007	8.083	9.791	3.986	4.321	4.664
925	7.002	8.076	9.780	3.983	4.318	4.659
950	6.997	8.069	9.769	3.981	4.315	4.655
975	6.993	8.063	9.759	3.978	4.312	4.651
1000	6.988	8.057	9.750	3.976	4.309	4.646
1100	6.972	8.034	9.714	3.968	4.298	4.632
1200	6.957	8.015	9.684	3.960	4.288	4.619
1300	6.945	7.998	9.657	3.954	4.280	4.608

Table 9.10.7. One-Sided Tolerance Factors for the Three-Parameter Weibull Distribution with 95 Percent Confidence (Continued)

N	V ₉₉ for T ₉₉			V ₉₀ for T ₉₀		
	Uncensored	20% Censored	50% Censored	Uncensored	20% Censored	50% Censored
1400	6.934	7.983	9.633	3.948	4.273	4.597
1500	6.924	7.969	9.612	3.943	4.266	4.589
1600	6.914	7.957	9.593	3.938	4.260	4.580
1700	6.906	7.946	9.575	3.934	4.255	4.573
1800	6.899	7.936	9.560	3.930	4.250	4.567
1900	6.892	7.926	9.545	3.927	4.246	4.560
2000	6.886	7.918	9.532	3.923	4.241	4.555
3000	6.841	7.858	9.438	3.901	4.212	4.515
4000	6.815	7.822	9.383	3.887	4.195	4.492
5000	6.797	7.798	9.346	3.878	4.183	4.477
6000	6.784	7.781	9.319	3.871	4.175	4.465
7000	6.773	7.767	9.298	3.866	4.168	4.456
8000	6.765	7.756	9.281	3.862	4.163	4.449
9000	6.758	7.747	9.267	3.859	4.159	4.443
10000	6.753	7.739	9.255	3.856	4.155	4.438
15000	6.733	7.713	9.215	3.846	4.142	4.422
20000	6.722	7.698	9.192	3.840	4.135	4.412
25000	6.714	7.688	9.176	3.836	4.130	4.405
30000	6.708	7.680	9.164	3.833	4.126	4.400

The values provided in Table 9.10.7 are calculated by the following formula:

$$d^{-1} \left\{ ck_n \frac{(a_{11} + 2a_{01}g(p) + a_{00}g(p)^2 + c^2(a_{01}^2 - a_{00}a_{11})/n)^{1/2}}{1 - c^2a_{00}/n} + n^{1/2} \left[g(p) - k_n \frac{g(p) + c^2a_{01}/n}{1 - c^2a_{00}/n} \right] \right\}$$

where $d=0.7796968$, $c=1.645$, $k_n=(n/(n-1))^{1/2}$, p is the percentile being estimated (T_{99} : $p=0.01$, T_{90} : $p=0.10$), and $g(p)=0.45 + 0.7797 \ln(-\ln(1-p))$. The constants a_{00} , a_{01} , and a_{11} depend on the level of censoring, and are given below. The statistical methodology employed here is discussed in detail in Reference 9.10.7.

Constant	Uncensored	20% Censored	50% Censored
a_{00}	0.6079	0.9282	1.7162
a_{01}	-0.4740	-0.4562	-0.0428
a_{11}	0.9775	0.9841	1.2169

MIL-HDBK-5J
31 January 2003

Table 9.10.8. γ -values for Computing Threshold of Three-Parameter Weibull Distribution

n	Anderson-Darling Test		T ₉₀			T ₉₉		
	Uncensored or 20% Censored	50% Censored	Uncensored	20% Censored	50% Censored	Uncensored	20% Censored	50% Censored
	$\gamma_{50,0}$ or $\gamma_{50,20}$	$\gamma_{50,50}$	$\gamma_{90,0}$	$\gamma_{90,20}$	$\gamma_{90,50}$	$\gamma_{99,0}$	$\gamma_{99,20}$	$\gamma_{99,50}$
10	0.50000	.	0.79644	0.85391	.	0.85162	0.86596	.
15	0.60692	0.50000	0.75277	0.78329	0.97146	0.81292	0.81934	0.86090
20	0.62147	0.57859	0.73316	0.75477	0.91726	0.79728	0.80072	0.83039
25	0.63033	0.60692	0.72186	0.73795	0.86979	0.78583	0.78741	0.80818
30	0.64057	0.62147	0.71316	0.72479	0.83400	0.77155	0.77185	0.79208
35	0.64379	0.62147	0.70831	0.71771	0.81708	0.76529	0.76477	0.78734
40	0.64630	0.63033	0.70472	0.71247	0.79441	0.76006	0.75893	0.77634
45	0.64997	0.63629	0.70113	0.70736	0.77717	0.75255	0.75101	0.76759
50	0.65135	0.64057	0.69900	0.70434	0.76374	0.74903	0.74714	0.76046
55	0.65252	0.64379	0.69724	0.70187	0.75306	0.74592	0.74376	0.75451
60	0.65440	0.64630	0.69522	0.69914	0.74440	0.74113	0.73882	0.74947
65	0.65516	0.64630	0.69401	0.69748	0.73985	0.73881	0.73632	0.74809
70	0.65583	0.64832	0.69296	0.69605	0.73347	0.73670	0.73406	0.74395
75	0.65697	0.64997	0.69163	0.69433	0.72810	0.73331	0.73062	0.74033
80	0.65745	0.65135	0.69084	0.69327	0.72352	0.73164	0.72885	0.73713
85	0.65789	0.65252	0.69013	0.69233	0.71959	0.73009	0.72721	0.73428
90	0.65865	0.65353	0.68917	0.69113	0.71618	0.72753	0.72464	0.73172
95	0.65898	0.65353	0.68860	0.69040	0.71433	0.72625	0.72330	0.73107
100	0.65929	0.65440	0.68808	0.68973	0.71157	0.72505	0.72206	0.72882
105	0.65983	0.65516	0.68735	0.68884	0.70912	0.72303	0.72004	0.72678
110	0.66007	0.65583	0.68692	0.68829	0.70694	0.72201	0.71899	0.72491
115	0.66030	0.65643	0.68652	0.68779	0.70499	0.72105	0.71799	0.72319
120	0.66071	0.65697	0.68593	0.68709	0.70323	0.71940	0.71636	0.72160
125	0.66090	0.65697	0.68559	0.68667	0.70229	0.71857	0.71551	0.72122
130	0.66107	0.65745	0.68528	0.68628	0.70079	0.71778	0.71469	0.71978
135	0.66139	0.65789	0.68479	0.68571	0.69942	0.71640	0.71334	0.71844
140	0.66154	0.65828	0.68452	0.68537	0.69817	0.71570	0.71263	0.71718
145	0.66167	0.65865	0.68425	0.68506	0.69702	0.71503	0.71195	0.71601
150	0.66193	0.65898	0.68385	0.68459	0.69597	0.71385	0.71080	0.71491
155	0.66205	0.65898	0.68361	0.68431	0.69541	0.71325	0.71019	0.71466
160	0.66216	0.65929	0.68339	0.68404	0.69448	0.71268	0.70961	0.71364
165	0.66237	0.65957	0.68304	0.68365	0.69361	0.71166	0.70862	0.71268
170	0.66247	0.65983	0.68284	0.68341	0.69281	0.71114	0.70810	0.71177
175	0.66256	0.66007	0.68266	0.68319	0.69206	0.71064	0.70760	0.71091
180	0.66273	0.66030	0.68235	0.68285	0.69135	0.70975	0.70673	0.71010
185	0.66282	0.66030	0.68218	0.68265	0.69100	0.70930	0.70628	0.70992
190	0.66289	0.66051	0.68201	0.68245	0.69036	0.70886	0.70584	0.70915
195	0.66304	0.66071	0.68174	0.68215	0.68977	0.70806	0.70507	0.70842
200	0.66311	0.66090	0.68159	0.68198	0.68921	0.70766	0.70467	0.70773
205	0.66318	0.66107	0.68145	0.68181	0.68868	0.70727	0.70428	0.70706
210	0.66331	0.66123	0.68121	0.68155	0.68818	0.70656	0.70360	0.70643
215	0.66337	0.66123	0.68108	0.68140	0.68793	0.70620	0.70324	0.70630
220	0.66342	0.66139	0.68095	0.68125	0.68747	0.70585	0.70289	0.70570
225	0.66353	0.66154	0.68073	0.68101	0.68704	0.70521	0.70228	0.70512
230	0.66358	0.66167	0.68061	0.68088	0.68663	0.70489	0.70196	0.70456

Table 9.10.8. γ -values for Computing Threshold of Three-Parameter Weibull Distribution (continued)

n	Anderson-Darling Test		T_{90}			T_{99}		
	Uncensored or 20% Censored	50% Censored	Uncensored	20% Censored	50% Censored	Uncensored	20% Censored	50% Censored
	$\gamma_{50,0}$ or $\gamma_{50,20}$	$\gamma_{50,50}$	$\gamma_{90,0}$	$\gamma_{90,20}$	$\gamma_{90,50}$	$\gamma_{99,0}$	$\gamma_{99,20}$	$\gamma_{99,50}$
235	0.66364	0.66181	0.68049	0.68075	0.68623	0.70457	0.70165	0.70403
240	0.66373	0.66193	0.68030	0.68053	0.68586	0.70399	0.70109	0.70352
245	0.66378	0.66193	0.68019	0.68041	0.68568	0.70370	0.70080	0.70342
250	0.66382	0.66205	0.68009	0.68029	0.68533	0.70341	0.70052	0.70293
255	0.66391	0.66216	0.67991	0.68010	0.68500	0.70288	0.70002	0.70246
260	0.66395	0.66227	0.67981	0.67999	0.68468	0.70261	0.69975	0.70200
265	0.66399	0.66237	0.67971	0.67989	0.68438	0.70235	0.69949	0.70157
270	0.66406	0.66247	0.67955	0.67971	0.68409	0.70186	0.69903	0.70114
275	0.66410	0.66247	0.67946	0.67961	0.68396	0.70161	0.69879	0.70106
280	0.66413	0.66256	0.67937	0.67951	0.68368	0.70137	0.69855	0.70066
285	0.66420	0.66265	0.67922	0.67935	0.68342	0.70093	0.69813	0.70026
290	0.66423	0.66273	0.67914	0.67926	0.68317	0.70070	0.69790	0.69988
295	0.66426	0.66282	0.67906	0.67917	0.68293	0.70047	0.69768	0.69951
300	0.66433	0.66289	0.67892	0.67902	0.68269	0.70006	0.69729	0.69916
310	0.66438	0.66297	0.67877	0.67886	0.68237	0.69964	0.69688	0.69875
320	0.66446	0.66311	0.67857	0.67864	0.68195	0.69906	0.69633	0.69809
330	0.66454	0.66324	0.67838	0.67844	0.68156	0.69851	0.69580	0.69747
340	0.66459	0.66331	0.67825	0.67830	0.68130	0.69815	0.69545	0.69711
350	0.66466	0.66342	0.67807	0.67811	0.68095	0.69764	0.69497	0.69654
360	0.66472	0.66353	0.67790	0.67794	0.68063	0.69716	0.69451	0.69600
370	0.66476	0.66358	0.67779	0.67781	0.68041	0.69684	0.69420	0.69570
380	0.66482	0.66368	0.67764	0.67765	0.68012	0.69639	0.69378	0.69520
390	0.66487	0.66378	0.67749	0.67749	0.67984	0.69596	0.69337	0.69472
400	0.66490	0.66382	0.67739	0.67739	0.67965	0.69568	0.69310	0.69446
425	0.66501	0.66399	0.67707	0.67706	0.67912	0.69477	0.69224	0.69356
450	0.66511	0.66417	0.67678	0.67675	0.67858	0.69395	0.69146	0.69258
475	0.66519	0.66430	0.67655	0.67651	0.67816	0.69328	0.69083	0.69185
500	0.66526	0.66441	0.67631	0.67626	0.67778	0.69258	0.69017	0.69117
525	0.66534	0.66452	0.67608	0.67602	0.67743	0.69193	0.68955	0.69054
550	0.66539	0.66461	0.67589	0.67583	0.67711	0.69140	0.68906	0.68995
575	0.66545	0.66470	0.67569	0.67562	0.67682	0.69083	0.68852	0.68940
600	0.66550	0.66480	0.67551	0.67543	0.67652	0.69030	0.68802	0.68879
625	0.66554	0.66487	0.67536	0.67528	0.67627	0.68986	0.68762	0.68832
650	0.66559	0.66494	0.67519	0.67511	0.67604	0.68939	0.68718	0.68788
675	0.66563	0.66500	0.67503	0.67495	0.67583	0.68895	0.68676	0.68746
700	0.66567	0.66506	0.67490	0.67481	0.67563	0.68859	0.68642	0.68706
725	0.66570	0.66511	0.67476	0.67467	0.67545	0.68819	0.68605	0.68669
750	0.66574	0.66517	0.67463	0.67454	0.67524	0.68781	0.68570	0.68626
775	0.66576	0.66522	0.67452	0.67442	0.67508	0.68750	0.68541	0.68593
800	0.66579	0.66526	0.67440	0.67430	0.67493	0.68715	0.68509	0.68561
825	0.66582	0.66531	0.67428	0.67418	0.67478	0.68683	0.68479	0.68531
850	0.66584	0.66534	0.67419	0.67409	0.67464	0.68656	0.68454	0.68502
875	0.66587	0.66538	0.67408	0.67398	0.67451	0.68626	0.68426	0.68474
900	0.66589	0.66542	0.67398	0.67387	0.67437	0.68597	0.68400	0.68442
925	0.66591	0.66546	0.67389	0.67379	0.67425	0.68573	0.68377	0.68417
950	0.66593	0.66549	0.67380	0.67369	0.67414	0.68547	0.68353	0.68393

MIL-HDBK-5J
31 January 2003

n	Anderson-Darling Test		T ₉₀			T ₉₉		
	Uncensored or 20% Censored	50% Censored	Uncensored	20% Censored	50% Censored	Uncensored	20% Censored	50% Censored
	γ _{50,0} or γ _{50,20}	γ _{50,50}	γ _{90,0}	γ _{90,20}	γ _{90,50}	γ _{99,0}	γ _{99,20}	γ _{99,50}
975	0.66595	0.66552	0.67371	0.67360	0.67403	0.68521	0.68330	0.68369
1000	0.66597	0.66554	0.67363	0.67353	0.67393	0.68500	0.68310	0.68347
1100	0.66603	0.66565	0.67332	0.67322	0.67354	0.68414	0.68231	0.68262
1200	0.66609	0.66574	0.67305	0.67295	0.67321	0.68339	0.68162	0.68188
1300	0.66613	0.66581	0.67282	0.67271	0.67294	0.68275	0.68103	0.68126
1400	0.66617	0.66587	0.67261	0.67250	0.67269	0.68216	0.68049	0.68069
1500	0.66620	0.66592	0.67241	0.67231	0.67246	0.68162	0.68000	0.68017
1600	0.66623	0.66597	0.67225	0.67214	0.67227	0.68116	0.67958	0.67973
1700	0.66626	0.66601	0.67209	0.67198	0.67209	0.68072	0.67918	0.67931
1800	0.66628	0.66605	0.67194	0.67184	0.67193	0.68032	0.67882	0.67893
1900	0.66630	0.66608	0.67181	0.67171	0.67179	0.67997	0.67849	0.67859
2000	0.66632	0.66611	0.67168	0.67158	0.67165	0.67963	0.67819	0.67827
3000	0.66643	0.66630	0.67080	0.67071	0.67072	0.67725	0.67604	0.67604
4000	0.66649	0.66639	0.67027	0.67019	0.67017	0.67584	0.67477	0.67474
5000	0.66653	0.66644	0.66990	0.66983	0.66981	0.67487	0.67390	0.67385
6000	0.66655	0.66648	0.66963	0.66956	0.66953	0.67415	0.67326	0.67321
7000	0.66657	0.66651	0.66942	0.66935	0.66933	0.67360	0.67277	0.67271
8000	0.66658	0.66653	0.66924	0.66919	0.66916	0.67315	0.67237	0.67230
9000	0.66659	0.66654	0.66910	0.66905	0.66902	0.67278	0.67204	0.67197
10000	0.66660	0.66656	0.66898	0.66893	0.66890	0.67247	0.67176	0.67169

The values of γ in Table 9.10.8 can be derived as percentiles of the beta distribution as follows. Let k be the greatest integer less than or equal to the minimum of $4n/15$ and $(1-p)n/3$, where n represents the sample size and p represents the proportion of the sample being censored. When determining the γ value for an Anderson-Darling test (when calculating τ_{50}), let $\theta=0.50$. When calculating τ_{90} or τ_{99} let

$$\theta = \frac{\exp(M)}{1 + \exp(M)}$$

where

$$M = \begin{cases} \frac{0.425384 - 0.74068p + 8.12668/n}{0.58478 - 0.97165p} & \text{for calculating } \tau_{90} \\ \frac{1.778 + 2.748/\sqrt{n} + p(7.051/\sqrt{n} - 1.253)}{0.959} & \text{for calculating } \tau_{99}. \end{cases}$$

The value of γ in Table 9.10.8 represents the θ th percentile of the beta distribution with parameters $2k-2$ and k .

Note: The sequential Weibull procedure which makes use of Table 9.10.8 has only been validated for sample sizes between 50 and 1000.

Table 9.10.9. Ranks, r, of Observations, n, for an Unknown Distribution Having the Probability and Confidence of T₉₉ and T₉₀ Values

T ₉₉ Value						T ₉₀ Value					
n	r ₉₉	n	r ₉₉	n	r ₉₉	n	r ₉₀	n	r ₉₀	n	r ₉₀
≤298	a	4635	36	8643	72	≤28	b	638	52	2693	340
299	1	4749	37	8753	73	29	1	660	54	3797	350
473	2	4862	38	8862	74	46	2	682	56	3901	360
628	3	4975	39	8972	75	61	3	704	58	4005	370
773	4	5088	40	9081	76	76	4	726	60	4109	380
913	5	5201	41	9190	77	89	5	781	65	4213	390
1049	6	5314	42	9300	78	103	6	836	70	4317	400
1182	7	5427	43	9409	79	116	7	890	75	4421	410
1312	8	5539	44	9518	80	129	8	945	80	4525	420
1441	9	5651	45	9627	81	142	9	999	85	4629	430
1568	10	5764	46	9736	82	154	10	1053	90	4733	440
1693	11	5876	47	9845	83	167	11	1107	95	4836	450
1818	12	5988	48	9954	84	179	12	1161	100	4940	460
1941	13	6099	49	10063	85	191	13	1269	110	5044	470
2064	14	6211	50	10172	86	203	14	1376	120	5147	480
2185	15	6323	51	10281	87	215	15	1483	130	5251	490
2305	15	6434	52	10390	88	227	16	1590	140	5354	500
2425	16	6545	53	10498	89	239	17	1696	150	5613	525
2546	18	6657	54	10607	90	251	18	1803	160	5871	550
2665	19	6768	55	10716	91	263	19	1909	170	6130	575
2784	20	6879	56	10824	92	275	20	2015	180	6388	600
2902	21	6990	57	10933	93	298	22	2120	190	6645	625
3020	22	7100	58	11041	94	321	24	2226	200	6903	650
3137	23	7211	59	11150	95	345	26	2331	210	7161	675
3254	24	7322	60	11258	96	368	28	2437	220	7418	700
3371	25	7432	61	11366	97	391	30	2542	230	7727	730
3487	26	7543	62	11475	98	413	32	2647	240	8036	760
3603	27	7653	63	11583	99	436	34	2752	250	8344	790
3719	28	7763	64	11691	100	459	36	2857	260	8652	820
3834	29	7874	65			481	38	2962	270	8960	850
3949	30	7984	66			504	40	3066	280	9268	880
4064	31	8094	67			526	42	3171	290	9576	910
4179	32	8204	68			549	44	3276	300	9884	940
4293	33	8314	69			571	46	3380	310	10191	970
4407	34	8423	70			593	48	3484	320	10499	1000
4521	35	8533	71			615	50	3589	330		

- a T₉₉ value is lower than value of lowest observation.
- b T₉₀ value is lower than value of lowest observation.

The following equations may be used to compute ranks in lieu of using table values or for n values greater than these presented in the table:

$$r_{99} = n/100 - 1.645\sqrt{99n/10000} + 0.29 + 19.1/n, \text{ for } n \geq 299$$

MIL-HDBK-5J
31 January 2003

rounded to the nearest integer. For n less than 299, the T_{99} value does not exist. This approximation is exact for all but 23 values of n in the range of the table ($299 \leq n \leq 11691$), which is an error rate of about 0.2%. For this small percentage of n values, the approximation gives an r value 1 below the actual r , resulting in a conservative T_{99} value. For T_{90} values, the approximation is

$$r_{90} = n/10 - 1.645\sqrt{9n/100} + 0.23, \text{ for } n \geq 29$$

rounded to the nearest integer. For n less than 29, the T_{90} value does not exist. The approximation is exact for all but 12 values of n in the range of the table ($29 \leq n \leq 10499$), and errs conservatively by one rank for this small percentage (0.1%).

STANDARDS AND REFERENCES

STANDARDS

AMS 2355	Quality Assurance Sampling and Testing of Aluminum Alloys and Magnesium Alloys, Wrought Products, Except Forging Stock, and Rolled, Forged, or Flash Welded Rings
AMS 2370	Quality Assurance Sampling and Testing, Carbon and Low-Alloy Steel Wrought Products and Forging Stock
AMS 2371	Quality Assurance Sampling and Testing, Corrosion and Heat Resistant Steels and Alloys, Wrought Products and Forging Stock
ASTM B557	Method of Tension Testing Wrought and Cast Aluminum – and Magnesium-Alloy Products (vol. 02.02, 02.03, 03.01)
ASTM B769	Test Method for Shear Testing of Aluminum Alloys (vol. 02.02)
ASTM B831	Standard Test Method for Shear Testing of Thin Aluminum Alloy Products (vol. 02.02)
ASTM C693	Test Method for Density of Glass by Buoyancy (vol. 15.02)
ASTM C714	Test Method for Thermal Diffusivity of Carbon and Graphite by a Thermal Pulse Method (vol. 15.01)
ASTM D2766	Test Method for Specific Heat of Liquids and Solids (vol. 05.02)
ASTM E8	Test Methods of Tension Testing of Metallic Materials (vol. 01.02, 02.01, 02.03, 03.01)
ASTM E9	Compression Testing of Metallic Materials at Room Temperature (vol. 03.01)
ASTM E21	Recommended Practice for Elevated Temperature Tension Tests of Metallic Materials (vol. 03.01)
ASTM E29	Standard Practice for Using Significant Digits in Test Data to Determine Conformance with Specifications (vol. 14.02)
ASTM E83	Method of Verification and Classification of Extensometers (vol. 03.01)
ASTM E111	Test Method for Young's Modulus, Tangent Modulus, and Chord Modulus (vol. 03.01)
ASTM E132	Test Method for Poisson's Ratio at Room Temperature (vol. 03.01)
ASTM E139	Recommended Practice for Conducting Creep, Creep-Rupture, and Stress-Rupture Tests of Metallic Materials (vol. 03.01)
ASTM E143	Test Method for Shear Modulus at Room Temperature (vol. 03.01)

MIL-HDBK-5J
31 January 2003

ASTM E228	Test Method for Linear Thermal Expansion of Solid Materials with a Vitreous Silica Dilatometer (vol. 03.01, 14.02)
ASTM E238	Method for Pin-Type Bearing Test of Metallic Materials (vol. 03.01)
ASTM E399	Test Method for Plane-Strain Fracture Toughness of Metallic Materials (vol. 02.02, 03.01)
ASTM E466	Recommended Practice for Constant Amplitude Axial Fatigue Tests of Metallic Materials (vol. 03.01)
ASTM E561	Recommended Practice for R-Curve Determination (vol. 03.01)
ASTM E606	Recommended Practice for Constant-Amplitude Low-Cycle Fatigue Testing (vol. 03.01)
ASTM E647	Test Method for Measurement of Fatigue Crack Growth Rates (vol. 03.01)
ASTM E739	Practice for Statistical Analysis of Linear or Linearized Stress-Life (S-N) and Strain-Life (ϵ -N) Fatigue Data (vol. 03.01)
ASTM G34	Test Method for Exfoliation Corrosion Susceptibility in 2XXX and 7XXX Series Aluminum Alloys (EXCO Test) (vol. 03.02)
ASTM G47	Test Method for Determining Susceptibility to Stress-Corrosion Cracking of High-Strength Aluminum Alloy Products (vol. 02.02, 03.02)
NASM 1312-4	Fastener Test Methods- Method 4 Lap Joint Shear
NASM 1312-8	Fastener Test Methods- Method 8 Tensile Strength
NASM 1312-13	Fastener Test Methods- Method 13 Double Shear Test
NASM 1312-20	Fastener Test Methods- Method 20 Single Shear

REFERENCES

9.1.5	Natrella, M.G., <i>Experimental Statistics</i> , National Bureau of Standards Handbook 91 (August 1, 1963).
9.2.3.5.3	Fedderson, C. E., "Evaluation and Prediction of the Residual Strength of Center-Cracked Tension Panels", <i>Damage Tolerance in Aircraft Structures</i> , ASTM STP 486, American Society for Testing and Materials (1971).
9.2.5.1(a)	"Manual on Statistical Planning and Analysis for Fatigue Experiments", ASTM STP 588 (1975).

MIL-HDBK-5J
31 January 2003

- 9.2.5.1(b) ASTM Special Technical Publication No. 91-A, "A Guide for Fatigue Testing and the Statistical Analysis of Fatigue Data", Supplement to Manual on Fatigue Testing, STP No. 91 (1963).
- 9.2.5.1(c) Landgraf, R. W., Morrow, J., and Endo, T., "Determination of the Cyclic Stress-Strain Curve", *Journal of Materials, JMLSA*, Vol. 4, No. 1, March 1969, pp. 176-188.
- 9.2.5.2 Mandel, J., and Paule, R., "Interlaboratory Evaluation of a Material With Unequal Numbers of Replicates", *Analytical Chemistry*, Vol. 42, No. 11, pp. 1194-1197 (September 1979), correction in Vol. 43, No. 10 (August 1971).
- 9.5.2.4 Neter, J., and Wasserman, W., "Applied Linear Statistical Models", Richard D. Irwin (1974), pp. 160-165.
- 9.5.3.1 Scholz, F. W., and Stephens, M. A., "K-Sample Anderson-Darling Tests", *J. Amer. Statist. Assoc.*, 82, pp. 918-924 (Sept. 1987).
- 9.5.4.1(a) Lawless, J. F., *Statistical Models and Methods for Lifetime Data*, John Wiley and Sons (1982), pp. 452-460.
- 9.5.4.1(b) D'Agostina, R. B. and Stephens, M. A., "Goodness-of-Fit Techniques," Marcel Dekker, p. 123 (1987).
- 9.5.4.1(c) Pierce, D. A., and Kopecky, K. J., "Testing Goodness of Fit for the Distribution of Errors in Regression Models", *Biometrika*, 66, pp. 1-5 (1979).
- 9.5.5.1(a) Abramowitz, M. and Stegun, I. A. (Eds.). *Handbook of Mathematical Functions with Formulas, Graphs, and Mathematical Tables*, 9th printing. New York: Dover, pp. 930 (1972).
- 9.5.5.1(b) Vogel, R. M., and McMartin, D. E., Probability Plot Goodness-of-Fit and Skewness Estimation Procedures for the Pearson Type 3 Distribution, *Water Res.*, 27 (12), pp. 3149-3158 (1991).
- 9.5.5.2(a) Jones, R. A., and Scholz, F. W., "A and B-Allowables for the Three Parameter Weibull Distribution", Boeing Computer Services Company Technical Report No. 10 (October 1983).
- 9.5.5.2(b) Jones, R. A., and Scholz, F. W., "Tolerance Limits for the Three Parameter Weibull Distribution", Boeing Computer Service Company Technical Report No. 11 (1983).
- 9.6.1 Landgraf, R. W., "The Resistance of Metals to Cyclic Deformation", Achievement of High Fatigue Resistance in Metals and Alloys, ASTM STP 467, 1970, pp. 3-36.
- 9.6.1.3 Sjodahl, L. H., "Extensions of the Multiple Heat Regression Technique Using Centered Data for Individual Heats", *Progress in Analysis of Fatigue and Stress Rupture (Data)*, MPC-Vol. 23, 1984, pp. 47-86.

MIL-HDBK-5J
31 January 2003

- 9.6.1.4(a) Walker, E. K., “The Effect of Stress Ratio During Crack Propagation and Fatigue for 2024-T3 and 7075-T6 Aluminum”, *Effect of Environment and Complex Load History on Fatigue Life*, ASTM STP 462 (1970) pp. 1-14.
- 9.6.1.4(b) Stulen, F. L., “Fatigue Life Data Displayed by a Single Quantity Relating Alternating and Mean Stresses”, AFML-TR-65-121 (1965).
- 9.6.1.4(c) Topper, T. H., and Sandor, B. I., “Effects of Mean Stress and Prestrain on Fatigue-Damage Summation”, *Effects of Environment and Complex Load History on Fatigue Life*, ASTM STP 462, 1970, pp. 93-104.
- 9.6.1.6 Snedecor, G. W., and Cochran, W. G., *Statistical Methods*, Seventh Edition, The Iowa State University Press, Ames, Iowa (1980), pp. 115-116.
- 9.6.1.7 Montgomery, D. C., and Peck, E. A., *Introduction to Linear Regression Analysis*, Wiley, New York (1982).
- 9.6.1.8 Winer, B. J., *Statistic Principles in Experimental Design*, 2nd Ed., McGraw-Hill, New York (1971).
- 9.6.1.9(a) Kalbfleisch, J. D., and Prentice, R. L., *The Statistical Analysis of Failure Time Data*, Wiley, New York (1982).
- 9.6.1.9(b) *SAS Users Guide: Statistical Version 5 ed.*, Cary, N.C.: SAS Institute, Inc. (1985).
- 9.6.3.2.2 Skinn, D. A., Gallagher, J. P., Berens, A. P., Huber, P.D. and Smith, J., “Damage Tolerant Design Handbook”, Volumes 1-5, WL-TR-94-4052, 4053, 4054, 4055 and 4056, May 1994.
- 9.6.4.2 “Characterization of Materials for Service at Elevated Temperatures”, Report No. MPC-7, Presented at 1978 ASME/CSME Montreal Pressure Vessel and Piping Conference, Montreal, Quebec, Canada (June 25-29, 1978).
- 9.7.2 Hood, D., et al., “An Investigation of the Generation and Utilization of Engineering Data on Weldments”, AFML-TR-68-268 (October 1968).
- 9.8.4.1.2(a) Ramberg, W., and Osgood, W. R., “Description of Stress Strain Curves by Three Parameters”, National Advisory Committee for Aeronautics, Technical Note 902 (July 1943).
- 9.8.4.1.2(b) Hill, H. N., “Determination of Stress-Strain Relations from Offset Yield Strength Values”, National Advisory Committee for Aeronautics, Technical Note 927 (February 1944).
- 9.8.4.5 Burt, C. W., et al., “Mechanical Properties of Aerospace Structural Alloys Under Biaxial-Stress Conditions”, AFML-TR-66-229 (August 1966).
- 9.10(a) Owen, D. B., “Factors for One-Sided Tolerance Limits and for Variables and Sampling Plans”, Sandia Corporation Monograph SCR-607 (March 1963).
- 9.10(b) Johnson, N. L., and Kotz, S., *Distributions in Statistics—Continuous Univariate Distributions—1*, John Wiley & Sons, p. 176 (1970).

MIL-HDBK-5J
31 January 2003

- 9.10(c) Abramovitz, M., and Stegun, I. A., *Handbook of Mathematical Functions*, National Bureau of Standards, AMS 55, pp. 927, 945, 947 (1970).
- 9.10(d) Jones, R. A., Osslander, M., Scholz, F. W., and Shorack, G. R., "Tolerance Bounds for Log-Gamma Regression Models", *Technometrics*, Vol. 27, No. 2, pp. 109-118 (May 1985).

CHAPTER 10

NOTES

10.1 INTENDED USE – The intent of this handbook is to provide standardized design values and related design information for metallic materials and structural elements used in aerospace structures. The data contained herein, or from approved items in the minutes of MIL-HDBK-5 coordination meetings, are acceptable to the Air Force, the Navy, the Army, and the Federal Aviation Administration. Approval by the procuring or certifying agency must be obtained for the use of design values for products not contained herein.

10.2 SUBJECT TERM (KEY WORD) LISTING

alloy
aluminum
bearings
brazing
columns
compression
copper
creep
element
failure
fastener
fatigue
fracture
instability
joints
shear
steel
strain
stress
tensile
titanium
torsion
weld

10.3 CHANGES FROM PREVIOUS ISSUE – Marginal notations are not used in this revision to identify changes with respect to the previous issue due to the extent of changes.

MIL-HDBK-5J
31 January 2003

THIS PAGE INTENTIONALLY BLANK

APPENDIX A

A.0 GLOSSARY

A.1 ABBREVIATIONS

a	— Amplitude; crack or flaw dimension; measure of flaw size, inches.
a_c	— Critical half crack length.
a_o	— Initial half crack length.
A	— Area of cross section, square inches; ratio of alternating stress to mean stress; subscript “axial”; A basis for mechanical-property values (see Section 1.4.1.1 or Section 9.1.6); “A” ratio, loading amplitude/mean load; or area.
A_e	— Strain “A” ratio, strain amplitude/mean strain.
A_i	— Model parameter.
AD	— Anderson-Darling test statistic, computed in goodness-of-fit tests for normality or Weibullness.
AISI	— American Iron and Steel Institute.
AMS	— Aerospace Materials Specification (published by Society of Automotive Engineers, Inc.).
Ann	— Annealed.
AN	— Air Force-Navy Aeronautical Standard.
ASTM	— American Society for Testing and Materials.
b	— Width of sections; subscript “bending”.
br	— Subscript “bearing”.
B	— Biaxial ratio (see Equation 1.3.2.(h)); B-basis for mechanical-property values (see Section 1.4.1.1 or Section 9.1.6).
Btu	— British thermal unit(s).
BUS	— Individual or typical bearing ultimate strength.
BYS	— Individual or typical bearing yield strength.
c	— Fixity coefficient for columns; subscript “compression”.
cpm	— Cycles per minute.
C	— Specific heat; Celsius; Constant.
CEM	— Consumable electrode melted.
CRES	— Corrosion resistant steel (stainless steel).
C(T)	— Compact tension.
CYS	— Individual or typical compressive yield strength.
d	— Mathematical operator denoting differential.
D or d	— Diameter, or Durbin Watson statistic; hole or fastener diameter; dimpled hole.
df	— Degrees of freedom.
e	— Elongation in percent, a measure of the ductility of a material based on a tension test; unit deformation or strain; subscript “fatigue or endurance”; the minimum distance from a hole, center to the edge of the sheet; Engineering strain.
e_e	— Elastic strain.
e_p	— Plastic strain.
e/D	— Ratio of edge distance (center of the hole to edge of the sheet) to hole diameter (bearing strength).
E	— Modulus of elasticity in tension or compression; average ratio of stress to strain for stress below proportional limit.

MIL-HDBK-5J APPENDIX A

31 January 2003

E_c	— Modulus of elasticity in compression; average ratio of stress to strain below proportional limit.
E_s	— Secant modulus of elasticity, Eq. 9.8.4.2(c).
E_t	— Tangent modulus of elasticity.
ELI	— Extra low interstitial (grade of titanium alloy).
ER	— Equivalent round.
ESR	— Electro-slag remelted.
f	— Internal (or calculated) tension stress; stress applied to the gross flawed section; creep stress.
f_b	— Internal (or calculated) primary bending stress.
f_c	— Internal (or calculated) compressive stress; maximum stress at fracture: gross stress limit (for screening elastic fracture data).
f_{pl}	— Proportional limit.
f_s	— Internal (or calculated) shear stress.
f_t	— Internal (or calculated) tensile stress.
ft	— Foot: feet.
F	— Design stress; Fahrenheit; Ratio of two sample variances.
F_A	— Design axial stress.
F_b	— Design bending stress; modulus of rupture in bending.
F_{bru}	— Design ultimate bearing stress.
F_{bry}	— Design bearing yield stress.
F_c	— Design column stress.
F_{cc}	— Design crushing or crippling stress (upper limit of column stress for local failure).
F_{cu}	— Design ultimate compressive stress.
F_{cy}	— Design compressive yield stress at which permanent strain equals 0.002.
F_H	— Design hoop stress.
F_s	— Design shear stress.
F_{sp}	— Design proportional limit in shear.
F_{st}	— Design modulus of rupture in torsion.
F_{su}	— Design ultimate stress in pure shear (this value represents the average shear stress over the cross section).
F_{sy}	— Design shear yield stress.
F_{tp}	— Design proportional limit in tension.
F_{tu}	— Design tensile ultimate stress.
F_{ty}	— Design tensile yield stress at which permanent strain equals 0.002.
g	— Gram(s).
G	— Modulus of rigidity (shear modulus).
Gpa	— Gigapascal(s).
hr	— Hour(s).
H	— Subscript “hoop”.
HIP	— Hot isostatically pressed.
i	— Slope (due to bending) of neutral plane of a beam, in radians (1 radian = 57.3 degrees).
in.	— Inch(es).
I	— Axial moment of inertia.
J	— Torsion constant (= I_p for round tubes); Joule.
k	— Tolerance limit factor for the normal distribution and the specified probability, confidence, and degrees of freedom; Strain at unit stress.
k_{99}, k_{90}	— One-sided tolerance limit factor for T_{99} and T_{90} , respectively (see Section 9.10.1 and 9.10.7).
$k_{A,B}$	— k factor for A basis or B basis, respectively (see Section 9.10.1 and 9.10.7).
ksi	— Kips (1,000 pounds) per square inch.

MIL-HDBK-5J APPENDIX A

31 January 2003

K	— A constant, generally empirical; thermal conductivity; stress intensity; Kelvin; correction factor.
K_{app}	— Apparent plane stress fracture toughness or residual strength.
K_c	— Critical plane stress fracture toughness, a measure of fracture toughness at point of crack growth instability.
K_f	— Fatigue notch factor, or fatigue strength reduction factor.
K_{Ic}	— Plane strain fracture toughness.
K_N	— Empirically calculated fatigue notch factor.
K_t	— Theoretical stress concentration factor.
lb	— Pound.
ln	— Natural (base e) logarithm.
log	— Base 10 logarithm.
L	— Length; subscript “lateral”; longitudinal (grain direction).
LT	— Long transverse (grain direction).
m	— Subscript “mean”; metre; slope.
mm	— Millimeter(s).
M	— Applied moment or couple, usually a bending moment.
M_c	— Machine countersunk.
Mg	— Megagram(s).
MIG	— Metal-inert-gas (welding).
MPa	— Megapascal(s).
MS	— Military Standard.
M.S.	— Margin of safety.
$M(T)$	— Middle tension.
n	— Number of individual measurements or pairs of measurements; subscript “normal”; cycles applied to failure; shape parameter for the standard stress-strain curve (Ramberg-Osgood parameter); number of fatigue cycles endured.
N	— Fatigue life, number of cycles to failure; Newton; normalized.
N_f	— Fatigue life, cycles to failure.
N_i^*	— Fatigue life, cycles to initiation.
N_t^*	— Transition fatigue life where plastic and elastic strains are equal.
NAS	— National Aerospace Standard.
p	— Subscript “polar”; subscript “proportional limit”.
psi	— Pounds per square inch.
P	— Load; applied load (total, not unit, load); exposure parameter; probability.
P_a	— Load amplitude.
P_m	— Mean load.
P_{max}	— Maximum load.
P_{min}	— Minimum load.
Pu	— Test ultimate load, pounds per fastener.
Py	— Test yield load, pounds per fastener.
q	— Fatigue notch sensitivity.
Q	— Static moment of a cross section.
Q&T	— Quenched and tempered.

* Different from ASTM.

MIL-HDBK-5J APPENDIX A

31 January 2003

r	— Radius; root radius; reduced ratio (regression analysis); ratio of two pair measurements; rank of test point within a sample.
\bar{r}	— average ratio of paired measurements.
R	— Load (stress) ratio, or residual (observed minus predicted value); stress ratio, ratio of minimum stress to maximum stress in a fatigue cycle; reduced ratio.
R_b	— Stress ratio in bending.
R_c	— Stress ratio in compression; Rockwell hardness - C scale.
R_e	— Strain ratio, $\epsilon_{\min}/\epsilon_{\max}$.
R_s	— Stress ratio in shear or torsion; ratio of applied load to allowable shear load.
R_t	— Ratio of applied load to allowable tension load.
RA	— Reduction of area.
R.H.	— Relative humidity.
RMS	— Root-mean-square (surface finish).
RT	— Room temperature.
s	— Estimated population standard deviation; sample standard deviation; subscript “shear”.
s^2	— Sample variance.
S	— Shear force; nominal engineering stress, fatigue; S-basis for mechanical-property values (see Section 1.4.1.1).
S_a	— Stress amplitude, fatigue.
S_e	— Fatigue limit.
S_{eq}^*	— Equivalent stress.
S_f	— Fatigue limit.
s_m	— Mean stress, fatigue.
S_{\max}	— Highest algebraic value of stress in the stress cycle.
S_{\min}	— Lowest algebraic value of stress in the stress cycle.
S_r	— Algebraic difference between the maximum and minimum stresses in one cycle.
S_y	— Root mean square error.
SAE	— Society of Automotive Engineers.
SCC	— Stress-corrosion cracking.
SEE	— Estimate population standard error of estimate.
SR	— Studentized residual.
ST	— Short transverse (grain direction).
STA	— Solution treated and aged.
SUS	— Individual or typical shear ultimate strength.
SYS	— Individual or typical shear yield strength.
t	— Thickness; subscript “tension”; exposure time; elapsed time; tolerance factor for the “t” distribution with the specified probability and appropriate degrees of freedom.
T	— Transverse direction; applied torsional moment; transverse (grain direction); subscript “transverse”.
T_F	— Exposure temperature.
T_{90}	— Statistically based lower tolerance bound for a mechanical property such that at least 90 percent of the population is expected to exceed T_{90} with 95 percent confidence.
T_{99}	— Statistically based lower tolerance bound for a mechanical property such that at least 99 percent of the population is expected to exceed T_{99} with 95 percent confidence.
TIG	— Tungsten-inert-gas (welding).
TUS	— Individual or typical tensile ultimate strength.

* Different from ASTM.

MIL-HDBK-5J APPENDIX A

31 January 2003

TUS (S_u)*	— Tensile ultimate strength.
TYS	— Individual or typical tensile yield strength.
u	— Subscript “ultimate”.
U	— Factor of utilization.
V_{99}, V_{90}	— The tolerance limit factor corresponding to T_{99}, T_{90} for the three-parameter Weibull distribution, based on a 95 percent confidence level and a sample of size n.
W	— Width of center-through-cracked tension panel; Watt.
\bar{x}	— Distance along a coordinate axis.
x	— Sample mean based upon n observations.
X	— Value of an individual measurement; average value of individual measurements.
y	— Deflection (due to bending) of elastic curve of a beam; distance from neutral axis to given fiber; subscript “yield”; distance along a coordinate axis.
Y	— Nondimensional factor relating component geometry and flaw size. See Reference 1.4.12.2.1(a) for values.
z	— Distance along a coordinate axis.
Z	— Section modulus, I/y .

A.2 SYMBOLS

α	— (1) Coefficient of thermal expansion, mean; constant. (2) Significance level; probability (risk of erroneously rejecting the null hypothesis (see Section 9.5.3)).
α_{99}, α_{90}	— Shape parameter estimates for a T_{99} or T_{90} value based on an assumed three-parameter Weibull distribution.
α_{50}	— Shape parameter estimate for the Anderson-Darling goodness-of-fit test based on an assumed three-parameter Weibull distribution.
β	— Constant.
β_{99}, β_{90}	— Scale parameter estimate for a T_{99} or T_{90} value based on an assumed three-parameter Weibull distribution.
β_{50}	— Scale parameter estimate for the Anderson-Darling goodness-of-fit test based on an assumed three-parameter Weibull distribution.
$\Delta\varepsilon$ or ε_r^*	— strain range, $\varepsilon_{\max} - \varepsilon_{\min}$.
$\Delta\varepsilon_e$	— Elastic strain range.
$\Delta\varepsilon_p$	— Plastic strain range.
$\Delta S (S_r)^*$	— Stress range.
$\Delta\sigma$	— True or local stress range.
ε	— True or local strain.
ε_{eq}^*	— Equivalent strain.
ε_m	— Mean strain, $(\varepsilon_{\max} + \varepsilon_{\min})/2$.
ε_{\max}	— Maximum strain.
ε_{\min}	— Minimum strain.
ε_t	— Total (elastic plus plastic) strain at failure determined from tensile stress-strain curve.
δ	— Deflection.
Φ	— Angular deflection.
ρ	— Radius of gyration; Neuber constant (block length).
μ	— Poisson’s ratio.
σ	— True or local stress; or population standard deviation.

* Different from ASTM.

MIL-HDBK-5J APPENDIX A
31 January 2003

σ_x	— Population standard deviation of x.
σ_x^2	— Population variance of x.
τ_{99}, τ_{90}	— Threshold estimates for a T_{99} or T_{90} value based on an assumed three-parameter Weibull distribution.
τ_{50}	— Threshold estimate for the Anderson-Darling goodness-of-fit test based on an assumed three-parameter Weibull distribution.
ω	— Density; flank angle.
∞	— Infinity.
Σ	— The sum of.
'	— Superscript that denotes value determined by regression analysis.

A.3 DEFINITIONS

A-Basis.—The lower of either a statistically calculated number, or the specification minimum (S-basis). The statistically calculated number indicates that at least 99 percent of the population of values is expected to equal or exceed the A-basis mechanical design property, with a confidence of 95 percent.

Alternating Load.—See Loading Amplitude.

B-Basis.—At least 90 percent of the population of values is expected to equal or exceed the B-basis mechanical property allowable, with a confidence of 95 percent.

Cast.—Cast consists of the sequential ingots which are melted from a single furnace charge and poured in one or more drops without changes in the processing parameters. (The cast number is for internal identification and is not reported.) (See Table 9.2.4.2).

Casting.—One or more parts which are melted from a single furnace charge and poured in one or more molds without changes in the processing parameters. (The cast number is for internal identification and is not reported.) (See Table 9.2.4.2).

Confidence.—A specified degree of certainty that at least a given proportion of all future measurements can be expected to equal or exceed the lower tolerance limit. Degree of certainty is referred to as the confidence coefficient. For MIL-HDBK-5, the confidence coefficient is 95 percent which, as related to design properties, means that, in the long run over many future samples, 95 percent of conclusions regarding exceedance of A and B-values would be true.

Confidence Interval.—An interval estimate of a population parameter computed so that the statement “the population parameter lies in this interval” will be true, on the average, in a stated proportion of the times such statements are made.

Confidence Interval Estimate.—Range of values, computed with the sample that is expected to include the population variance or mean.

Confidence Level (or Coefficient).—The stated portion of the time the confidence interval is expected to include the population parameter.

MIL-HDBK-5J APPENDIX A
31 January 2003

*Confidence Limits**.—The two numeric values that define a confidence interval.

Constant-Amplitude Loading.—A loading in which all of the peak loads are equal and all of the valley loads are equal.

Constant-Life Fatigue Diagram.—A plot (usually on Cartesian coordinates) of a family of curves, each of which is for a single fatigue life, N —relating S , S_{\max} , and/or S_{\min} to the mean stress, S_m . Generally, the constant life fatigue diagram is derived from a family of S/N curves, each of which represents a different stress ratio (A or R) for a 50 percent probability of survival. NOTE—MIL-HDBK-5 no longer presents fatigue data in the form of constant-life diagrams.

Creep.—The time-dependent deformation of a solid resulting from force.

Note 1—Creep tests are usually made at constant load and temperature. For tests on metals, initial loading strain, however defined, is not included.

Note 2—This change in strain is sometimes referred to as creep strain.

Creep-Rupture Curve.—Results of material tests under constant load and temperature; usually plotted as strain versus time to rupture. A typical plot of creep-rupture data is shown below. The strain indicated in this curve includes both initial deformation due to loading and plastic strain due to creep.

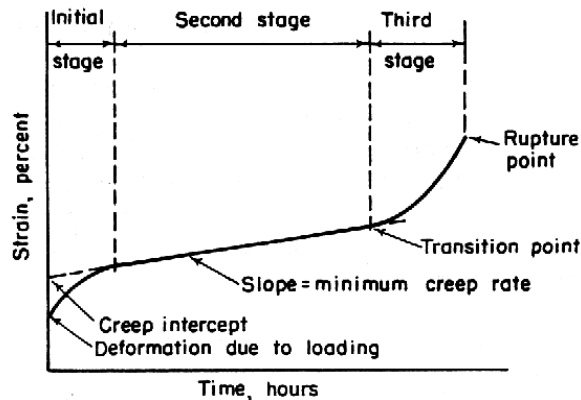

Figure A.1. Typical creep-rupture curve.

Creep-Rupture Strength.—Stress that will cause fracture in a creep test at a given time, in a specified constant environment. Note: This is sometimes referred to as the stress-rupture strength.

Creep-Rupture Test.—A creep-rupture test is one in which progressive specimen deformation and time for rupture are measured. In general, deformation is much larger than that developed during a creep test.

* Different from ASTM.

MIL-HDBK-5J APPENDIX A

31 January 2003

Creep-Strain.—The time-dependent part of the strain resulting from stress, excluding initial loading strain and thermal expansion.

Creep Strength.—Stress that causes a given creep in a creep test at a given time in a specified constant environment.

Creep Stress.—The constant load divided by the original cross-sectional area of the specimen.

Creep Test.—A creep test has the objective of measuring deformation and deformation rates at stresses usually well below those which would result in fracture during the time of testing.

Critical Stress Intensity Factor.—A limiting value of the stress intensity factor beyond which continued flaw propagation and/or fracture may be expected. This value is dependent on material and may vary with type of loading and conditions of use.

Cycle.—Under constant-amplitude loading, the load varies from the minimum to the maximum and then to the minimum load. The symbol n or N (see definition of fatigue life) is used to indicate the number of cycles.

Deformable Shank Fasteners.—A fastener whose shank is deformed in the grip area during normal installation processes.

Degree of Freedom.—Number of degrees of freedom for n variables may be defined as number of variables minus number of constraints between them. Since the standard deviation calculation contains one fixed value (the mean) it has $n - 1$ degrees of freedom.

Degrees of Freedom.—Number of independent comparisons afforded by a sample.

Discontinued Test.—See Runout.

Elapsed Time.—The time interval from application of the creep stress to a specified observation.

Fatigue.—The process of progressive localized permanent structural change occurring in a material subjected to conditions that produce fluctuating stresses and strains at some point or points, and which may culminate in cracks or complete fracture after a sufficient number of fluctuations. NOTE—fluctuations in stress and in time (frequency), as in the case of “random vibration.”

Fatigue Life.— N —the number of cycles of stress or strain of a specified character that a given specimen sustains before failure of a specified nature occurs.

Fatigue Limit.— S_f —the limiting value of the median fatigue strength as N becomes very large. NOTE—Certain materials and environments preclude the attainment of a fatigue limit. Values tabulated as “fatigue limits” in the literature are frequently (but not always) values of S_N for 50 percent survival at N cycles of stress in which $S_m = 0$.

Fatigue Loading.—Periodic or non-periodic fluctuating loading applied to a test specimen or experienced by a structure in service (also known as cyclic loading).

*Fatigue Notch Factor**.—The fatigue notch factor, K_f (also called fatigue strength reduction factor), is the ratio of the fatigue strength of a specimen with no stress concentration to the fatigue strength of a specimen

* Different from ASTM.

MIL-HDBK-5J APPENDIX A

31 January 2003

with a stress concentration at the same number of cycles for the same conditions. NOTE—In specifying K_f , it is necessary to specify the geometry, mode of loading, and the values of S_{max} , S_m , and N for which it is computed.

Fatigue Notch Sensitivity.—The fatigue notch sensitivity, q , is a measure of the degree of agreement between K_f and K_t . NOTE—the definition of fatigue notch sensitivity is $q = (K_f - 1)/(K_t - 1)$.

Heat.—All material identifiable to a single molten metal source. (All material from a heat is considered to have the same composition. A heat may yield one or more ingots. A heat may be divided into several lots by subsequent processing.)

Heat.—Heat is material which, in the case of batch melting, is cast at the same time from the same furnace and is identified with the same heat number; or, in the case of continuous melting, is poured without interruption. (See Table 9.2.4.2)

Heat.—Heat is a consolidated (vacuum hot pressed) billet having a distinct chemical composition. (See Table 9.2.4.2)

Hysteresis Diagram.—The stress-strain path during a fatigue cycle.

Isostrain Lines.—Lines representing constant levels of creep.

Isothermal Lines.—Lines of uniform temperature on a creep or stress-rupture curve.

Interrupted Test.*—Tests which have been stopped before failure because of some mechanical problem, e.g., power failure, load or temperature spikes.

Loading Amplitude.—The loading amplitude, P_a , S_a , or ϵ_a represents one-half of the range of a cycle. (Also known as alternating load, alternating stress, or alternating strain.)

Loading Strain.—Loading strain is the change in strain during the time interval from the start of loading to the instant of full-load application, sometimes called initial strain.

Loading (Unloading) Rate.—The time rate of change in the monotonically increasing (decreasing) portion of the load-time function.

Load Ratio.—The load ratio, R , A , or R_e , A_e , or R_σ , A_σ , is the algebraic ratio of the two loading parameters of a cycle; the two most widely used ratios are

* Different from ASTM.

MIL-HDBK-5J APPENDIX A
31 January 2003

$$R = \frac{\text{minimum load}}{\text{maximum load}} = \frac{P_{\min}}{P_{\max}}$$

or

$$R_{\sigma} = \frac{S_{\min}}{S_{\max}}$$

or

$$R_{\epsilon} = \epsilon_{\min}/\epsilon_{\max}$$

and

$$A = \frac{\text{loading amplitude}}{\text{mean load}} = \frac{P_a}{P_m} \text{ or } \frac{S_a}{S_M}$$

$$A_{\epsilon} = \frac{\text{strain amplitude}}{\text{mean strain}} = \frac{\epsilon_a}{\epsilon_M} \text{ or } \frac{\epsilon_{\max} - \epsilon_{\min}}{\epsilon_{\max} + \epsilon_{\min}} .$$

NOTE—load ratios R or R_{ϵ} are generally used in MIL-HDBK-5.

Longitudinal Direction.—Parallel to the principal direction of flow in a worked metal. For die forgings this direction is within $\pm 15^{\circ}$ of the predominate grain flow.

Long-Transverse Direction.—The transverse direction having the largest dimension, often called the “width” direction. For die forgings this direction is within $\pm 15^{\circ}$ of the longitudinal (predominate) grain direction and parallel, within $\pm 15^{\circ}$, to the parting plane. (Both conditions must be met.)

Lot.—All material from a heat or single molten metal source of the same product type having the same thickness or configuration, and fabricated as a unit under the same conditions. If the material is heat treated, a lot is the above material processed through the required heat-treating operations as a unit.

Master Creep Equation.—An equation expressing combinations of stress, temperature, time and creep, or a set of equations expressing combinations of stress, temperature and time for given levels of creep.

Master Rupture Equation.—An equation expressing combinations of stress, temperature, and time that cause complete separation (fracture or rupture) of the specimen.

MIL-HDBK-5J APPENDIX A

31 January 2003

Maximum Load.—The maximum load, P_{\max} , S_{\max} , ϵ_{\max} is the load having the greatest algebraic value.

Mean Load.—The mean load, P_m , is the algebraic average of the maximum and minimum loads in constant-amplitude loading:

$$P_m = \frac{P_{\max} + P_{\min}}{2}, \text{ or}$$

$$S_m = \frac{S_{\max} + S_{\min}}{2}, \text{ or}$$

$$\epsilon_m = \frac{\epsilon_{\max} + \epsilon_{\min}}{2},$$

or the integral average of the instantaneous load values.

Median Fatigue Life.—The middlemost of the observed fatigue life values (arranged in order of magnitude) of the individual specimens in a group tested under identical conditions. In the case where an even number of specimens are tested, it is the average of the two middlemost values (based on log lives in MIL-HDBK-5). NOTE 1—The use of the sample median instead of the arithmetic mean (that is, the average) is usually preferred. NOTE 2—In the literature, the abbreviated term “fatigue life” usually has meant the median fatigue life of the group. However, when applied to a collection of data without further qualification, the term “fatigue life” is ambiguous.

Median Fatigue Strength at N Cycles.—An estimate of the stress level at which 50 percent of the population would survive N cycles. NOTE—The estimate of the median fatigue strength is derived from a particular point of the fatigue-life distribution, since there is no test procedure by which a frequency distribution of fatigue strengths at N cycles can be directly observed. That is, one can not perform constant-life tests.

Melt.—Melt is a single homogeneous batch of molten metal for which all processing has been completed and the temperature has been adjusted and made ready to pour castings. (For metal-matrix composites, the molten metal includes unmelted reinforcements such as particles, fibers, or whiskers.) (See Table 9.1.6.2)

Minimum Load.—The minimum load, P_{\min} , S_{\min} , or ϵ_{\min} , is the load having the least algebraic value.

Nominal Hole Diameters.—Nominal hole diameters for deformable shank fasteners will be according to Table 9.4.1.2(a). When tests are made with hole diameters other than those tabulated, hole sizes used will be noted in the report and on the proposed joint allowables table.

Nominal Shank Diameter.—Nominal shank diameter of fasteners with shank diameters equal to those used for standard size bolts and screws (NAS 618 sizes) will be the decimal equivalents of stated fractional or numbered sizes. These diameters are those listed in the fourth column of Table 9.7.1.1. Nominal shank diameters for nondeformable shank blind fasteners are listed in the fifth column of Table 9.7.1.1. Nominal shank diameters for other fasteners will be the average of required maximum and minimum shank diameters.

MIL-HDBK-5J APPENDIX A

31 January 2003

Nondeformable Shank Fasteners.—A fastener whose shank does not deform in the grip area during normal installation processes.

*Outlier**—An experimental observation which deviates markedly from other observations in the sample. An outlier is often either an extreme value of the variability in the data, or the result of gross deviation in the material or experimental procedure.

Peak.—The point at which the first derivative of the load-time history changes from a positive to a negative sign; the point of maximum load in constant-amplitude loading.

Plane Strain.—The stress state in which all strains occur only in the principal loading plane. No strains occur out of the plane, i.e., $\epsilon_z = 0$, and $\sigma_z \neq 0$.

Plane Stress.—The stress state in which all stresses occur only in the principal loading plane. No stresses occur out of the plane, i.e., $\sigma_z = 0$, and $\epsilon_z \neq 0$.

Plastic Strain During Loading.—Plastic strain during loading is the portion of the strain during loading determined as the offset from the linear portion to the end of a stress-strain curve made during load application.

Plane-Strain Fracture Toughness.—A generic term now generally adopted for the critical plane-strain stress intensity factor characteristic of plane-strain fracture, symbolically denoted K_{Ic} . This is because in current fracture testing practices, specification of the slowly increasing load test of specimen materials in the plane-strain stress state and in opening mode (I) has been dominant.

Plane-Stress and Transitional Fracture Toughness.—A generic term denoting the critical stress intensity factor associated with fracture behavior under nonplane-strain conditions. Because of plasticity effects and stable crack growth which can be encountered prior to fracture under these conditions, designation of a specific value is dependent on the stage of crack growth detected during testing. Residual strength or apparent fracture toughness is a special case of plane-stress and transitional fracture toughness wherein the reference crack length is the initial pre-existing crack length and subsequent crack growth during the test is neglected.

Population.—All potential measurements having certain independent characteristics in common; i.e., “all possible TUS(L) measurements for 17-7PH stainless steel sheet in TH1050 condition”.

*Precision.**—The degree of mutual agreement among individual measurements. Relative to a method of test, precision is the degree of mutual agreement among individual measurements made under prescribed like conditions. The lack of precision in a measurement may be characterized as the standard deviation of the errors in measurement.

Primary Creep.—Creep occurring at a diminishing rate, sometimes called initial stage of creep.

Probability.—Ratio of possible number of favorable events to total possible number of equally likely events. For example, if a coin is tossed, the probability of heads is one-half (or 50 percent) because heads can occur one way and the total possible events are two, either heads or tails. Similarly, the probability of

* Different from ASTM.

MIL-HDBK-5J APPENDIX A
31 January 2003

throwing a three or greater on a die is 4/6 or 66.7 percent. Probability, as related to design allowables, means that chances of a material-property measurement equaling or exceeding a certain value (the one-sided lower tolerance limit) is 99 percent in the case of a A-basis value and 90 percent in the case of a B-basis value.

Range.—Range, ΔP , S_r , $\Delta \epsilon$, ϵ_r , $\Delta \sigma$ is the algebraic difference between successive valley and peak loads (positive range or increasing load range) or between successive peak and valley loads (negative range or decreasing load range), see Figure 9.3.4.3. In constant-amplitude loading, for example, the range is given by $\Delta P = P_{\max} - P_{\min}$.

Rate of Creep.—The slope of the creep-time curve at a given time determined from a Cartesian plot.

*Residual.**—The difference between the observed fatigue (log) life and the fatigue (log) life estimated from the fatigue model at a particular stress/strain level.

*Runout.**—A test that has been terminated prior to failure. Runout tests are usually stopped at an arbitrary life value because of time and economic considerations. NOTE—Runout tests are useful for estimating a pseudo-fatigue-limit for a fatigue data sample.

Sample.—A finite number of observations drawn from the population.

Sample.—The number of specimens selected from a population for test purposes. NOTE—The method of selecting the sample determines the population about which statistical inferences or generalization can be made.

Sample Average (Arithmetic Mean).—The sum of all the observed values in a sample divided by the sample size (number). It is a point estimate of the population mean.

Sample Mean.—Average of all observed values in the sample. It is an estimate of population mean. A mean is indicated by a bar over the symbol for the value observed. Thus, the mean of n observations of TUS would be expressed as:

$$\overline{\text{TUS}} = \frac{\text{TUS}_1 + \text{TUS}_2 + \dots + \text{TUS}_n}{n} = \frac{\sum_{i=1}^n (\text{TUS}_i)}{n}$$

Sample Median.—Value of the middle-most observation. If the sample is nearly normally distributed, the sample median is also an estimate of the population mean.

Sample Median.—The middle value when all observed values in a sample are arranged in order of magnitude if an odd number of samples are tested. If the sample size is even, it is the average of the two middlemost values. It is a point estimate of the population median, or 50 percentile point.

Sample Point Deviation.—The difference between an observed value and the sample mean.

*Sample Standard Deviation.***—The standard deviation of the sample, s, is the square root of the sample variance. It is a point estimate of the standard deviation of a population, a measure of the "spread" of the

* Different from ASTM.

** Different from ASTM.

MIL-HDBK-5J APPENDIX A

31 January 2003

frequency distribution of a population. NOTE—This value of s provides a statistic that is used in computing interval estimates and several test statistics.

*Sample Variance.**—Sample variance, s^2 , is the sum of the squares of the differences between each observed value and the sample average divided by the sample size minus one. It is a point estimate of the population variance. NOTE—This value of s^2 provides both an unbiased point estimate of the population variance and a statistic that is used on computing the interval estimates and several test statistics. Some texts define s^2 as “the sum of the squared differences between each observed value and the sample average divided by the sample size”, however, this statistic underestimates the population variance, particularly for small sample sizes.

Sample Variance.—The sum of the squared deviations, divided by $n - 1$, and, based on n observations of TUS, expressed as

$$S_{\text{TUS}}^2 = \frac{\sum_{i=1}^n (\text{TUS}_i - \overline{\text{TUS}})^2}{n - 1} = \frac{n \sum_{i=1}^n (\text{TUS}_i)^2 - \left(\sum_{i=1}^n \text{TUS}_i \right)^2}{n(n - 1)}$$

S-Basis.—The S-value is the minimum property value specified by the governing industry specification (as issued by standardization groups such as SAE Aerospace Materials Division, ASTM, etc.) or federal or military standards for the material. (See MIL-STD-970 for order of preference for specifications.) For certain products heat treated by the user (for example, steels hardened and tempered to a designated F_{tu}), the S-value may reflect a specified quality-control requirement. Statistical assurance associated with this value is not known.

Secondary Creep.—Creep occurring at a constant rate, sometimes called second stage creep.

Short-Transverse Direction.—The transverse direction having the smallest dimension, often called the “thickness” direction. For die forgings this direction is within $\pm 15^\circ$ of the longitudinal (predominate) grain direction and perpendicular, within $\pm 15^\circ$, to the parting plane. (Both conditions must be met.) When possible, short transverse specimens will be taken across the parting plane.

Significance Level (As Used Here).—Risk of concluding that two samples were drawn from different populations when, in fact, they were drawn from the same population. A significance level of $\alpha = 0.05$ is employed through these Guidelines.*

Significance Level.—The stated probability (risk) that a given test of significance will reject the hypothesis that a specified effect is absent when the hypothesis is true.

Significant (Statistically Significant).—An effect or difference between populations is said to be present if the value of a test statistic is significant, that is, lies outside of predetermined limits. NOTE—An effect that is statistically significant may not have engineering importance.

*S/N Curve for 50 Percent Survival.***—A curve fitted to the median values of fatigue life at each of several stress levels. It is an estimate of the relationship between applied stress and the number of cycles-to-failure that 50 percent of the population would survive. NOTE 1—This is a special case of the more general

* This is appropriate, since a confidence level of $1 - \alpha = 0.95$ is used in establishing A and B-values.

** Different from ASTM.

MIL-HDBK-5J APPENDIX A

31 January 2003

definition of S/N curve for P percent survival. NOTE 2—In the literature, the abbreviated term “S/N Curve” usually has meant either the S/N curve drawn through the mean (averages) or through the medians (50 percent values) for the fatigue life values. Since the term “S/N Curve” is ambiguous, it should be used only when described appropriately. NOTE 3—Mean S/N curves (based on log lives) are shown in MIL-HDBK-5.

S/N Diagram.—A plot of stress against the number of cycles to failure. The stress can be S_{max} , S_{min} , or S_a . The diagram indicates the S/N relationship for a specified value of S_m , A, or R and a specified probability of survival. Typically, for N, a log scale (base 10) is used. Generally, for S, a linear scale is used, but a log scale is used occasionally. NOTE— S_{max} -versus-log N diagrams are used commonly in MIL-HDBK-5.

Standard Deviation.—An estimate of the population standard deviation; the square root of the variance, or

$$S_{TUS} = \sqrt{\frac{\sum_{i=1}^n (TUS_i - \overline{TUS})^2}{n - 1}} = \sqrt{\frac{n \sum_{i=1}^n (TUS_i)^2 - \sum_{i=1}^n (TUS_i)^2}{n(n - 1)}}$$

Stress Intensity Factor.—A physical quantity describing the severity of a flaw in the stress field of a loaded structural element. The gross stress in the material and flaw size are characterized parametrically by the stress intensity factor,

$$K = f\sqrt{a} Y, \text{ ksi} \cdot \text{in.}^{1/2}$$

Stress-Rupture Test.—A stress-rupture test is one in which time for rupture is measured, no deformation measurement being made during the test.

Tertiary Creep.—Creep occurring at an accelerating rate, sometimes called third stage creep.

Theoretical Stress Concentration Factor (or Stress Concentration Factor).—This factor, K_t , is the ratio of the nominal stress to the greatest stress in the region of a notch (or other stress concentrator) as determined by the theory of elasticity (or by experimental procedures that give equivalent values). NOTE—The theory of plasticity should not be used to determine K_t .

Tolerance Interval.—An interval computed so that it will include at least a stated percentage of the population with a stated probability.

Tolerance Level.—The stated probability that the tolerance interval includes at least the stated percentage of the population. It is not the same as a confidence level, but the term confidence level is frequently associated with tolerance intervals.

MIL-HDBK-5J APPENDIX A
31 January 2003

Tolerance Limits.—The two statistics that define a tolerance interval. (One value may be “minus infinity” or “plus infinity”.)

Total Plastic Strain.—Total plastic strain at a specified time is equal to the sum of plastic strain during loading plus creep.

Total Strain.—Total strain at any given time, including initial loading strain (which may include plastic strain in addition to elastic strain) and creep strain, but not including thermal expansion.

*Transition Fatigue Life.**—The point on a strain-life diagram where the elastic and plastic strains are equal.

Transverse Direction.—Perpendicular to the principal direction of flow in a worked metal; may be defined as T, LT or ST.

Typical Basis.—A typical property value is an average value and has no statistical assurance associated with it.

Waveform.—The shape of the peak-to-peak variation of a controlled mechanical test variable (for example, load, strain, displacement) as a function of time.

* Different from ASTM.

MIL-HDBK-5J APPENDIX A

31 January 2003

A.4 Conversion of U.S. Units of Measure Used in MIL-HDBK-5 to SI Units

Quantity or Property	To Convert From U. S. Unit	Multiply by ^a	SI Unit ^b
Area	in. ²	645.16 ^c	Millimeter ² (mm ²)
Force	lb	4.4482	Newton (N)
Length	in.	25.4 ^c	Millimeter (mm)
Stress	ksi	6.895	Megapascal (MPa) ^d
Stress intensity factor	ksi $\sqrt{\text{in.}}$	1.0989	Megapascal $\sqrt{\text{meter}}$ (MPa \cdot m ^{1/2}) ^d
Modulus	10 ³ ksi	6.895	Gigapascal (GPa) ^d
Temperature	°F	$\frac{F + 459.67}{1.8}$	Kelvin (K)
Density (ω)	lb/in. ³	27.680	Megagram/meter ³ (Mg/m ³)
Specific heat (C)	Btu/lb·F (or Btu·lb ⁻¹ ·F ⁻¹)	4.1868 ^c	Joule/(gram·Kelvin) (J/g·K) or (J·g ⁻¹ ·K ⁻¹)
Thermal conductivity (K)	Btu/[(hr)(ft ²)(F)/ft] (or Btu·hr ⁻¹ ·ft ⁻² ·F ⁻¹ ·ft)	1.7307	Watt/(meter·Kelvin) W/(m·K) or (W·m ⁻¹ ·K ⁻¹)
Thermal expansion (α)	in./in./F (or in.·in. ⁻¹ ·F ⁻¹)	1.8	Meter/meter/Kelvin m/(m·K) or (m·m ⁻¹ ·K ⁻¹)

a Conversion factors to give significant figures are as specified in ASTM E 380, NASA SP-7012, second revision. NBS Special Publication 330, and *Metals Engineering Quarterly*. Note: Multiple conversions between U.S. and SI units should be avoided because significant round-off errors may result.

b Prefix	Multiple	Prefix	Multiple
giga (G)	10 ⁹	milli (m)	10 ⁻³
mega (M)	10 ⁶	micro (μ)	10 ⁻⁶
kilo (k)	10 ³		

c Conversion factor is exact.

d One Pascal (Pa) = one Newton/meter².

THIS PAGE INTENTIONALLY BLANK

APPENDIX B**B.0 Alloy Index**

Alloy Name	Form	Specification	Section
250	Bar	AMS 6512	2.5.1
250	Sheet and Plate	AMS 6520	2.5.1
<u>280</u>	Sheet and Plate	AMS 6521	2.5.1
280	Bar	AMS 6514	2.5.1
354.0	Casting	AMS-A-21180	3.9.1
355.0	Permanent Mold Casting	AMS 4281	3.9.2
356.0	Sand Casting	AMS 4217	3.9.4
356.0	Investment Casting	AMS 4260	3.9.4
356.0	Permanent Mold Casting	AMS 4284	3.9.4
359.0	Casting	AMS-A-21180	3.9.8
2014	Bare Sheet and Plate	AMS 4028	3.2.1
2014	Bare Sheet and Plate	AMS 4029	3.2.1
2014	Bar and Rod, Rolled or Cold Finished	AMS 4121	3.2.1
2014	Forging	AMS 4133	3.2.1
2014	Extrusion	AMS 4153	3.2.1
2014	Forging	AMS-A-22771	3.2.1
2014	Extruded Bar, Rod and Shapes	AMS-QQ-A-200/2	3.2.1
2014	Rolled or Drawn Bar, Rod and Shapes	AMS-QQ-A-225/4	3.2.1
2014	Clad Sheet and Plate	AMS-QQ-A-250/3	3.2.1
2014	Forging	AMS-QQ-A-367	3.2.1
2017	Bar and Rod, Rolled or Cold-Finished	AMS 4118	3.2.2
2017	Rolled Bar and Rod	AMS-QQ-A-225/5	3.2.2
2024	Bare Sheet and Plate	AMS 4035	3.2.3
2024	Bare Sheet and Plate	AMS 4037	3.2.3
2024	Tubing, Hydraulic, Seamless, Drawn	AMS 4086	3.2.3
2024	Bar and Rod, Rolled or Cold-Finished	AMS 4120	3.2.3
2024	Extrusion	AMS 4152	3.2.3
2024	Extrusion	AMS 4164	3.2.3
2024	Extrusion	AMS 4165	3.2.3
2024	Extruded Bar, Rod and Shapes	AMS-QQ-A-200/3	3.2.3
2024	Rolled or Drawn Bar, Rod and Wire	AMS-QQ-A-225/6	3.2.3
2024	Bare Sheet and Plate	AMS-QQ-A-250/4	3.2.3
2024	Clad Sheet and Plate	AMS-QQ-A-250/5	3.2.3
2024	Tubing	AMS-WW-T-700/3	3.2.3
2025	Die Forging	AMS 4130	3.2.4
2026	Extruded Bars, Rods, and Profiles	AMS 4338	3.2.5
2090	Sheet	AMS 4251	3.2.6
2124	Plate	AMS 4101	3.2.7
2124	Plate	AMS-QQ-A-250/29	3.2.7
2219	Sheet and Plate	AMS 4031	3.2.8
2219	Hand Forging	AMS 4144	3.2.8
2219	Extrusion	AMS 4162	3.2.8
2219	Extrusion	AMS 4163	3.2.8
2219	Sheet and Plate	AMS-QQ-A-250/30	3.2.8
2297	Plate	AMS 4330	3.2.9

MIL-HDBK-5J APPENDIX B

31 January 2003

Alloy Name	Form	Specification	Section
2424	Sheet (Clad)	AMS 4270	3.2.10
2424	Sheet (Bare)	AMS 4273	3.2.10
2519	Plate	MIL-DTL-46192	3.2.11
2524	Sheet and Plate	AMS 4296	3.2.12
2618	Die and Hand Forgings	AMS 4132	3.2.13
2618	Die Forging	AMS-A-22771	3.2.13
2618	Forging	AMS-QQ-A-367	3.2.13
4130	Bar and Forging	AMS 6348	2.3.1
4130	Sheet, Strip and Plate	AMS 6350	2.3.1
4130	Sheet, Strip and Plate	AMS 6351	2.3.1
4130	Tubing	AMS 6361	2.3.1
4130	Tubing	AMS 6362	2.3.1
4130	Bar and Forging	AMS 6370	2.3.1
4130	Tubing	AMS 6371	2.3.1
4130	Tubing	AMS 6373	2.3.1
4130	Tubing	AMS 6374	2.3.1
4130	Bar and Forging	AMS 6528	2.3.1
4130	Sheet, Strip and Plate	AMS-S-18729	2.3.1
4130	Bar and Forging	AMS-S-6758	2.3.1
4130	Tubing	AMS-T-6736	2.3.1
4135	Sheet, Strip and Plate	AMS 6352	2.3.1
4135	Tubing	AMS 6365	2.3.1
4135	Tubing	AMS 6372	2.3.1
4135	Tubing	AMS-T-6735	2.3.1
4140	Bar and Forging	AMS 6349	2.3.1
4140	Tubing	AMS 6381	2.3.1
4140	Bar and Forging	AMS 6382	2.3.1
4140	Sheet, Strip and Plate	AMS 6395	2.3.1
4140	Bar and Forging	AMS 6529	2.3.1
4140	Bar and Forging	AMS-S-5626	2.3.1
4340	Sheet, Strip and Plate	AMS 6359	2.3.1
4340	Bar and Forging	AMS 6414	2.3.1
4340	Tubing	AMS 6414	2.3.1
4340	Bar and Forging	AMS 6415	2.3.1
4340	Tubing	AMS 6415	2.3.1
4340	Sheet, Strip and Plate	AMS 6454	2.3.1
4340	Bar and Forging	AMS-S-5000	2.3.1
5052	Sheet and Plate	AMS 4015	3.5.1
5052	Sheet and Plate	AMS 4016	3.5.1
5052	Sheet and Plate	AMS 4017	3.5.1
5052	Sheet and Plate	AMS-QQ-A-250/8	3.5.1
5083	Bare Sheet and Plate	AMS 4056	3.5.2
5083	Extruded Bar, Rod and Shapes	AMS-QQ-A-200/4	3.5.2
5083	Bare Sheet and Plate	AMS-QQ-A-250/6	3.5.2
5086	Extruded Bar, Rod and Shapes	AMS-QQ-A-200/5	3.5.3
5086	Sheet and Plate	AMS-QQ-A-250/7	3.5.3
5454	Extruded Bar, Rod and Shapes	AMS-QQ-A-200/6	3.5.4
5454	Sheet and Plate	AMS-QQ-A-250/10	3.5.4
5456	Extruded Bar, Rod and Shapes	AMS-QQ-A-200/7	3.5.5
5456	Sheet and Plate	AMS-QQ-A-250/9	3.5.5
6013	Sheet (T4)	AMS 4347	3.6.1
6013	Sheet (T6)	AMS 4216	3.6.1
6061	Sheet and Plate	AMS 4025	3.6.2
6061	Sheet and Plate	AMS 4026	3.6.2

Key: Underline indicates inactive for new design.

MIL-HDBK-5J APPENDIX B

31 January 2003

Alloy Name	Form	Specification	Section
6061	Sheet and Plate	AMS 4027	3.6.2
6061	Tubing Seamless, Drawn	AMS 4080	3.6.2
6061	Tubing Seamless, Drawn	AMS 4082	3.6.2
6061	Bar and Rod, Rolled or Cold Finished	AMS 4115	3.6.2
6061	Bar and Rod, Cold Finished	AMS 4116	3.6.2
6061	Bar and Rod, Rolled or Cold Finished	AMS 4117	3.6.2
6061	Forging	AMS 4127	3.6.2
6061	Extrusion	AMS 4160	3.6.2
6061	Extrusion	AMS 4161	3.6.2
6061	Extrusion	AMS 4172	3.6.2
6061	Hand Forging	AMS 4248	3.6.2
6061	Forging	AMS-A-22771	3.6.2
6061	Extruded Rod, Bar Shapes and Tubing	AMS-QQ-A-200/8	3.6.2
6061	Rolled Bar, Rod and Shapes	AMS-QQ-A-225/8	3.6.2
6061	Extruded Rod, Bars and Shapes	AMS 4150	3.6.2
6061	Extruded Rod, Bars and Shapes	AMS 4173	3.6.2
6061	Sheet and Plate	AMS-QQ-A-250/11	3.6.2
6061	Forging	AMS-QQ-A-367	3.6.2
6061	Tubing Seamless, Drawn	AMS-WW-T-700/6	3.6.2
6151	Die Forging	AMS 4125	3.6.3
6151	Forging	AMS-A-22771	3.6.3
7010	Plate	AMS 4204	3.7.1
7010	Plate	AMS 4205	3.7.1
7040	Plate	AMS 4211	3.7.2
7049	Forging	AMS-QQ-A-367	3.7.3
7049	Forging	AMS 4111	3.7.3
7049	Extrusion	AMS 4157	3.7.3
7049	Forging	AMS-A-2271	3.7.3
7049	Plate	AMS 4200	3.7.3
7050	Bare Plate	AMS 4050	3.7.4
7050	Die Forging	AMS 4107	3.7.4
7050	Hand Forging	AMS 4108	3.7.4
7050	Bare Plate	AMS 4201	3.7.4
7050	Die Forging	AMS 4333	3.7.4
7050	Extruded Shape	AMS 4340	3.7.4
7050	Extruded Shape	AMS 4341	3.7.4
7050	Extruded Shape	AMS 4342	3.7.4
7050	Forging	AMS-A-22771	3.7.4
7055	Plate	AMS 4206	3.7.5
7055	Extrusion	AMS 4337	3.7.5
7055	Extrusion	AMS 4324	3.7.5
7055	Extrusion	AMS 4336	3.7.5
7075	Bare Sheet and Plate	AMS 4044	3.7.6
7075	Bare Sheet and Plate	AMS 4045	3.7.6
7075	Clad Sheet and Plate	AMS 4049	3.7.6
7075	Bare Plate	AMS 4078	3.7.6
7075	Bar and Rod, Rolled or Cold Finished	AMS 4122	3.7.6
7075	Bar and Rod, Rolled or Cold Finished	AMS 4123	3.7.6
7075	Bar and Rod, Rolled or Cold Finished	AMS 4124	3.7.6
7075	Forging	AMS 4126	3.7.6
7075	Die Forging	AMS 4141	3.7.6
7075	Forging	AMS 4147	3.7.6
7075	Bar and Rod, Rolled or Cold Finished	AMS 4186	3.7.6
7075	Bar and Rod, Rolled or Cold Finished	AMS 4187	3.7.6

MIL-HDBK-5J APPENDIX B

31 January 2003

<u>Alloy Name</u>	<u>Form</u>	<u>Specification</u>	<u>Section</u>
7075	Forging	AMS-A-22771	3.7.6
7075	Extruded Bar, Rod and Shapes	AMS-QQ-A-200/11, 15	3.7.6
7075	Rolled or Drawn Bar and Rod	AMS-QQ-A-225/9	3.7.6
7075	Bare Sheet and Plate	AMS-QQ-A-250/12, 24	3.7.6
7075	Clad Sheet and Plate	AMS-QQ-A-250/13, 25	3.7.6
7075	Forging	AMS-QQ-A-367	3.7.6
7149	Forging	AMS 4320	3.7.3
7149	Forging	AMS-A-2271	3.7.3
7149	Extrusion	ASM 4343	3.7.3
7150	Bare Plate	AMS 4252 (T7751)	3.7.7
7150	Bare Plate	AMS 4306 (T6151)	3.7.7
7150	Extrusion	AMS 4307 (T61511)	3.7.7
7150	Extrusion	AMS 4345 (T77511)	3.7.7
7175	Die Forging	AMS 4148 (T66)	3.7.8
7175	Die and Hand Forging	AMS 4149 (T74)	3.7.8
7175	Hand Forging	AMS 4179 (T7452)	3.7.8
7175	Extrusion	AMS 4344 (T73511)	3.7.8
7175	Forging	AMS-A-22771	3.7.8
7249	Hand Forging	AMS 4334	3.7.9
7475	Bare Sheet	AMS 4084 (T61)	3.7.10
7475	Bare Sheet	AMS 4085 (T761)	3.7.10
7475	Bare Plate	AMS 4089 (T7651)	3.7.10
7475	Bare Plate	AMS 4090 (T651)	3.7.10
7475	Clad Sheet	AMS 4100 (T761)	3.7.10
7475	Bare Plate	AMS 4202 (T7351)	3.7.10
7475	Clad Sheet	AMS 4207 (T61)	3.7.10
8630	Bar and Forging	AMS 6280	2.3.1
8630	Tubing	AMS 6281	2.3.1
8630	Sheet, Strip and Plate	AMS-S-18728	2.3.1
8630	Bar and Forging	AMS-S-6050	2.3.1
8630	Sheet, Strip and Plate	AMS 6350	2.3.1
8735	Tubing	AMS 6282	2.3.1
8735	Bar and Forging	AMS 6320	2.3.1
8735	Sheet, Strip and Plate	AMS 6357	2.3.1
8740	Bar and Forging	AMS 6322	2.3.1
8740	Tubing	AMS 6323	2.3.1
8740	Bar and Forging	AMS 6327	2.3.1
8740	Sheet, Strip and Plate	AMS 6358	2.3.1
8740	Bar and Forging	AMS-S-6049	2.3.1
15-5PH	Investment Casting	AMS 5400	2.6.7
15-5PH	Bar, Forging, Ring and Extrusion (CEVM)	AMS 5659	2.6.7
15-5PH	Sheet, Strip and Plate (CEVM)	AMS 5862	2.6.7
17-4PH	Investment Casting (H1100)	AMS 5342	2.6.9
17-4PH	Investment Casting (H1000)	AMS 5343	2.6.9
17-4PH	Investment Casting (H900)	AMS 5344	2.6.9
17-4PH	Sheet, Strip and Plate	AMS 5604	2.6.9
17-4PH	Bar, Forging and Ring	AMS 5643	2.6.9
17-7PH	Plate, Sheet and Strip	AMS 5528	2.6.10
2024-T3 ARAMID Fiber Reinforced	Sheet Laminate	AMS 4254	7.5.1
280 (300)	Bar	AMS 6514	2.5.1
280 (300)	Sheet and Plate	AMS 6521	2.5.1
300M (0.42C)	Bar and Forging	AMS 6257	2.3.1
300M (0.42C)	Tubing	AMS 6257	2.3.1
300M (0.42C)	Bar and Forging	AMS 6419	2.3.1

Key: Underline indicates inactive for new design.

MIL-HDBK-5J APPENDIX B

31 January 2003

<u>Alloy Name</u>	<u>Form</u>	<u>Specification</u>	<u>Section</u>
300M (0.42C)	Tubing	AMS 6419	2.3.1
300M (0.4C)	Bar and Forging	AMS 6417	2.3.1
300M (0.4C)	Tubing	AMS 6417	2.3.1
4130 - N	Tubing	AMS 6360	2.3.1
4330V	Bar and Forging	AMS 6411	2.3.1
4330V	Tubing	AMS 6411	2.3.1
4330V	Bar and Forging	AMS 6427	2.3.1
4330V	Tubing	AMS 6427	2.3.1
4335V	Bar and Forging	AMS 6429	2.3.1
4335V	Tubing	AMS 6429	2.3.1
4335V	Bar and Forging	AMS 6430	2.3.1
4335V	Tubing	AMS 6430	2.3.1
4335V	Sheet, Strip and Plate	AMS 6433	2.3.1
4335V	Sheet, Strip and Plate	AMS 6435	2.3.1
5Cr-Mo-V	Sheet, Strip and Plate	AMS 6437	2.4.1
5Cr-Mo-V	Bar and Forging (CEVM)	AMS 6487	2.4.1
5Cr-Mo-V	Bar and Forging	AMS 6488	2.4.1
7475-T761 ARAMID Fiber Reinforced	Sheet Laminate	AMS 4302	7.5.2
9Ni-4Co-0.20C	Sheet, Strip and Plate	AMS 6523	2.4.2
9Ni-4Co-0.20C	Sheet, Strip and Plate	AMS 6524	2.4.3
9Ni-4Co-0.20C	Bar and Forging, Tubing	AMS 6526	2.4.3
A201.0	Casting (T7 Temper)	AMS-A-21180	3.8.1
A-286	Sheet, Strip and Plate	AMS 5525	6.2.1
A-286	Bar, Forging, Tubing and Ring	AMS 5731	6.2.1
A-286	Bar, Forging, Tubing and Ring	AMS 5732	6.2.1
A-286	Bar, Forging and Tubing	AMS 5734	6.2.1
A-286	Bar, Forging and Tubing	AMS 5737	6.2.1
A356.0	Casting	AMS 4218	3.9.5
A356.0	Casting	AMS-A-21180	3.9.5
A357.0	Casting	AMS-A-21180	3.9.6
AerMet 100	Bar and Forging	AMS 6478	2.5.3
AerMet 100	Bar and Forging	AMS 6532	2.5.3
AF1410	Bar and Forging	AMS 6527	2.5.2
AISI 1025	Sheet, Strip, and Plate	AMS 5046	2.2.1
AISI 1025	Bar	ASTM A 108	2.2.1
AISI 1025	Sheet and Strip	AMS-S-7952	2.2.1
AISI 1025	Tubing	AMS 5077	2.2.1
AISI 1025 - N	Seamless Tubing	AMS 5075	2.2.1
AISI 1025 - N	Tubing	AMS 5077	2.2.1
AISI 1025 - N	Tubing	AMS-T-5066	2.2.1
AISI 301	Sheet and Strip	AMS 5517	2.7.1
AISI 301	Sheet and Strip	AMS 5518	2.7.1
AISI 301	Sheet and Strip	AMS 5519	2.7.1
AISI 301	Sheet, Strip and Plate	AMS 5901	2.7.1
AISI 301	Sheet and Strip (175 ksi)	AMS 5902	2.7.1
AISI 302	Sheet, Strip and Plate	AMS 5516	2.7.1
AISI 302	Sheet and Strip (125 ksi)	AMS 5903	2.7.1
AISI 302	Sheet and Strip (150 ksi)	AMS 5904	2.7.1
AISI 302	Sheet and Strip (175 ksi)	AMS 5905	2.7.1
AISI 302	Sheet and Strip (185 ksi)	AMS 5906	2.7.1
AISI 304	Sheet and Strip	AMS 5913	2.7.1
AISI 304	Sheet, Strip and Plate (125 ksi)	AMS 5910	2.7.1
AISI 304	Sheet and Strip (150 ksi)	AMS 5911	2.7.1
AISI 304	Sheet and Strip (175 ksi)	AMS 5912	2.7.1

Key: Underline indicates inactive for new design.

MIL-HDBK-5J APPENDIX B

31 January 2003

<u>Alloy Name</u>	<u>Form</u>	<u>Specification</u>	<u>Section</u>
AISI 304	Sheet and Strip (185 ksi)	AMS 5913	2.7.1
AISI 316	Sheet and Strip	AMS 5524	2.7.1
AISI 316	Sheet, Strip and Plate (125 ksi)	AMS 5907	2.7.1
AM100A	Investment Casting	AMS 4455	4.3.1
<u>AM100A</u>	<u>Permanent Mold Casting</u>	<u>AMS 4483</u>	<u>4.3.1</u>
AM-350	Sheet and Strip	AMS 5548	2.6.1
AM-355	Sheet and Strip	AMS 5547	2.6.2
AM-355	Plate	AMS 5549	2.6.2
AM-355	Bar, Forging and Forging Stock	AMS 5743	2.6.2
AZ31B	Sheet and Plate	AMS 4375	4.2.1
AZ31B	Plate	AMS 4376	4.2.1
AZ31B	Sheet and Plate	AMS 4377	4.2.1
AZ31B	Forging	ASTM B 91	4.2.1
AZ31B	Extrusion	ASTM B 107	4.2.1
AZ61A	Extrusion	AMS 4350	4.2.2
AZ61A	Forging	ASTM B 91	4.2.2
AZ91C/AZ91E	Sand Casting	AMS 4437	4.3.2
AZ91C/AZ91E	Sand Casting	AMS 4446	4.3.2
AZ91C/AZ91E	Investment Casting	AMS 4452	4.3.2
AZ92A	Sand Casting	AMS 4434	4.3.3
<u>AZ92A</u>	<u>Permanent Mold Casting</u>	<u>AMS 4484</u>	<u>4.3.3</u>
AZ92A	Investment Casting	AMS 4453	4.3.3
C355.0	Casting	AMS-A-21180	3.9.3
<u>Copper Beryllium</u>	<u>Strip (TB00)</u>	<u>AMS 4530</u>	<u>7.3.2</u>
<u>Copper Beryllium</u>	<u>Strip (TD02)</u>	<u>AMS 4532</u>	<u>7.3.2</u>
Copper Beryllium	Bar and Rod (TF00)	AMS 4533	7.3.2
Copper Beryllium	Bar and Rod (TH04)	AMS 4534	7.3.2
Copper Beryllium	Mechanical tubing (TF00)	AMS 4535	7.3.2
Copper Beryllium	Bar, Rod, Shapes and Forging (TB00)	AMS 4650	7.3.2
Copper Beryllium	Bar and Rod (TD04)	AMS 4651	7.3.2
Copper Beryllium	Sheet (TB00, TD01, TD02, TD04)	ASTM B 194	7.3.2
CP Titanium	Sheet, Strip and Plate	AMS 4900	5.2.1
CP Titanium	Sheet, Strip and Plate	AMS 4901	5.2.1
CP Titanium	Sheet, Strip and Plate	AMS 4902	5.2.1
CP Titanium	Bar	AMS 4921	5.2.1
CP Titanium	Extruded Bars and Shapes	AMS-T-81556	5.2.1
CP Titanium	Sheet, Strip and Plate	AMS-T-9046	5.2.1
CP Titanium	Bar	MIL-T-9047	5.2.1
Custom 450	Bar, Forging, Tubing, Wire and Ring (air melted)	AMS 5763	2.6.3
Custom 450	Bar, Forging, Tubing, Wire and Ring (CEM)	AMS 5773	2.6.3
Custom 455	Tubing (welded)	AMS 5578	2.6.4
Custom 455	Bar and Forging	AMS 5617	2.6.4
Custom 465	Bars, Wires, and Forgings	AMS 5936	2.6.5
D357.0	Sand Composite Casting	AMS 4241	3.9.7
D6AC	Bar and Forging	AMS 6431	2.3.1
D6AC	Tubing	AMS 6431	2.3.1
D6AC	Bar and Forging	AMS 6439	2.3.1
D6AC	Sheet, Strip and Plate	AMS 6439	2.3.1
EZ33A	Sand Casting	AMS 4442	4.3.4
Hastelloy X	Sheet and Plate	AMS 5536	6.3.1
Hastelloy X	Bar and Forging	AMS 5754	6.3.1
Haynes®230®	Plate, Sheet, and Strip	AMS 5878	6.3.9
Haynes®230®	Bar and Forging	AMS 5891	6.3.9
Haynes HR 120	Sheet, Strip and Plate	AMS 5916	6.3.10

Key: Underline indicates inactive for new design.

MIL-HDBK-5J APPENDIX B
31 January 2003

Alloy Name	Form	Specification	Section
HS 188	Sheet and Plate	AMS 5608	6.4.2
HS 188	Bar and Forging	AMS 5772	6.4.2
Hy-Tuf	Bar and Forging	AMS 6425	2.3.1
Hy-Tuf	Tubing	AMS 6425	2.3.1
Inconel 718	Investment Casting	AMS 5383	6.3.5
Inconel 718	Tubing; Creep Rupture	AMS 5589	6.3.5
Inconel 718	Tubing; Short-Time	AMS 5590	6.3.5
Inconel 718	Sheet, Strip and Plate; Creep Rupture	AMS 5596	6.3.5
Inconel 718	Sheet, Strip and Plate; Short-Time	AMS 5597	6.3.5
Inconel 718	Bar and Forging; Creep Rupture	AMS 5662	6.3.5
Inconel 718	Bar and Forging; Creep Rupture	AMS 5663	6.3.5
Inconel 718	Bar and Forging; Short-Time	AMS 5664	6.3.5
Inconel Alloy 600	Plate, Sheet and Strip	AMS 5540	6.3.2
Inconel Alloy 600	Tubing, Seamless	AMS 5580	6.3.2
Inconel Alloy 600	Bar and Rod	ASTM B 166	6.3.2
Inconel Alloy 600	Forging	ASTM B 564	6.3.2
Inconel Alloy 625	Sheet, Strip and Plate	AMS 5599	6.3.3
Inconel Alloy 625	Bar, Forging and Ring	AMS 5666	6.3.3
Inconel Alloy 706	Sheet, Strip and Plate	AMS 5605	6.3.4
Inconel Alloy 706	Sheet, Strip and Plate	AMS 5606	6.3.4
Inconel Alloy 706	Bar, Forging and Ring	AMS 5701	6.3.4
Inconel Alloy 706	Bar, Forging and Ring	AMS 5702	6.3.4
Inconel Alloy 706	Bar, Forging and Ring	AMS 5703	6.3.4
Inconel Alloy X-750	Sheet, Strip and Plate; Annealed	AMS 5542	6.3.6
Inconel Alloy X-750	Bar and Forging; Equalized	AMS 5667	6.3.6
L-605	Sheet	AMS 5537	6.4.1
L-605	Bar and Forging	AMS 5759	6.4.1
Manganese Bronzes	Casting	AMS 4860	7.3.1
Manganese Bronzes	Casting	AMS 4862	7.3.1
MP159 Alloy	Bar (solution treated and cold drawn)	AMS 5842	7.4.2
MP159 Alloy	Bar (solution treated, cold drawn and aged)	AMS 5843	7.4.2
MP35N Alloy	Bar (solution treated and cold drawn)	AMS 5844	7.4.1
MP35N Alloy	Bar (solution treated, cold drawn and aged)	AMS 5845	7.4.1
N-155	Sheet	AMS 5532	6.2.2
N-155	Tubing (welded)	AMS 5585	6.2.2
N-155	Bar and Forging	AMS 5768	6.2.2
N-155	Bar and Forging	AMS 5769	6.2.2
PH13-8Mo	Bar, Forging Ring and Extrusion (VIM+CEVM)	AMS 5629	2.6.5
PH15-7Mo	Plate, Sheet and Strip	AMS 5520	2.6.7
QE22A Magnesium	Sand Casting	AMS 4418	4.3.5
René 41	Plate, Sheet and Strip	AMS 5545	6.3.7
René 41	Bar and Forging	AMS 5713	6.3.7
René 41 - STA	Bar and Forging	AMS 5712	6.3.7
Standard Grade Beryllium	Sheet and Plate	AMS 7902	7.2.1
Standard Grade Beryllium	Bar, Rod, Tubing and Machined Shapes	AMS 7906	7.2.1
Ti-10V-2Fe-3Al (Ti-10-2-3)	Forging	AMS 4983	5.5.3
Ti-10V-2Fe-3Al (Ti-10-2-3)	Forging	AMS 4984	5.5.3
Ti-10V-2Fe-3Al (Ti-10-2-3)	Forging	AMS 4986	5.5.3
Ti-13V-11Cr-3Al	Sheet, Strip and Plate	AMS-T-9046	5.5.1
Ti-13V-11Cr-3Al	Bar	MIL-T-9047	5.5.1
Ti-15V-3Cr-3Sn-3Al (Ti-15-3-3-3)	Sheet and Strip	AMS 4914	5.5.2
Ti-4.5Al-3V-2Fe-2Mo	Sheet	AMS 4899	5.4.3
Ti-4.5Al-3V-2Fe-2Mo	Bars, Wires, forgings and Rings	AMS 4964	5.4.3
Ti-5Al-2.5Sn	Sheet, Strip and Plate	AMS 4910	5.3.1

Key: Underline indicates inactive for new design.

MIL-HDBK-5J APPENDIX B
31 January 2003

Alloy Name	Form	Specification	Section
Ti-5Al-2.5Sn	Bar	AMS 4926	5.3.1
Ti-5Al-2.5Sn	Forging	AMS 4966	5.3.1
Ti-5Al-2.5Sn	Extruded Bar and Shapes	AMS-T-81556	5.3.1
Ti-5Al-2.5Sn	Sheet, Strip and Plate	AMS-T-9046	5.3.1
Ti-5Al-2.5Sn	Bar	MIL-T-9047	5.3.1
Ti-6Al-2Sn-4Zr-2Mo	Sheet, Strip and Plate	AMS 4919	5.3.3
Ti-6Al-2Sn-4Zr-2Mo	Bar	AMS 4975	5.3.3
Ti-6Al-2Sn-4Zr-2Mo	Forging	AMS 4976	5.3.3
Ti-6Al-2Sn-4Zr-2Mo	Sheet and Strip	AMS-T-9046	5.3.3
Ti-6Al-4V	Sheet, Strip and Plate	AMS 4911	5.4.1
Ti-6Al-4V	Die Forging	AMS 4920	5.4.1
Ti-6Al-4V	Bar and Die Forging	AMS 4928	5.4.1
Ti-6Al-4V	Extrusion	AMS 4934	5.4.1
Ti-6Al-4V	Extrusion	AMS 4935	5.4.1
Ti-6Al-4V	Casting	AMS 4962	5.4.1
Ti-6Al-4V	Bar	AMS 4967	5.4.1
Ti-6Al-4V	Sheet, Strip and Plate	AMS-T-9046	5.4.1
Ti-6Al-4V	Bar	AMS 4965	5.4.1
Ti-6Al-4V	Bar	MIL-T-9047	5.4.1
Ti6Al-6V-2Sn	Sheet, Strip and Plate	AMS 4918	5.4.2
Ti6Al-6V-2Sn	Bar and Forging	AMS 4971	5.4.2
Ti6Al-6V-2Sn	Bar and Forging	AMS 4978	5.4.2
Ti6Al-6V-2Sn	Bar and Forging	AMS 4979	5.4.2
Ti6Al-6V-2Sn	Extruded Bar and Shapes	AMS-T-81556	5.4.2
Ti6Al-6V-2Sn	Sheet, Strip and Plate	AMS-T-9046	5.4.2
Ti-8Al-1Mo-1V	Sheet, Strip and Plate	AMS 4915	5.3.2
Ti-8Al-1Mo-1V	Sheet, Strip and Plate	AMS 4916	5.3.2
Ti-8Al-1Mo-1V	Forging	AMS 4973	5.3.2
Ti-8Al-1Mo-1V	Sheet, Strip and Plate	AMS-T-9046	5.3.2
Ti-8Al-1Mo-1V	Bar	MIL-T-9047	5.3.2
Waspaloy	Plate, Sheet and Strip	AMS 5544	6.3.8
Waspaloy	Forging	AMS 5704	6.3.8
Waspaloy	Bar, Forgings and Ring	AMS 5706	6.3.8
Waspaloy	Bar, Forgings and Ring	AMS 5707	6.3.8
Waspaloy	Bar, Forgings and Ring	AMS 5708	6.3.8
Waspaloy	Bar, Forgings and Ring	AMS 5709	6.3.8
ZE41A Magnesium	Sand Casting	AMS 4439	4.3.6
ZK60A-F	Extrusion	ASTM B 107	4.2.3
ZK60A-T5	Extrusion	AMS 4352	4.2.3
ZK60A-T5	Die and Hand Forging	AMS 4362	4.2.3

APPENDIX C

C.0 Specification Index

Specification	Alloy Name	Form/Application	Section
AMS 4015	5052	Sheet and Plate	3.5.1
AMS 4016	5052	Sheet and Plate	3.5.1
AMS 4017	5052	Sheet and Plate	3.5.1
AMS 4025	6061	Sheet and Plate	3.6.2
AMS 4026	6061	Sheet and Plate	3.6.2
AMS 4027	6061	Sheet and Plate	3.6.2
AMS 4028	2014	Bare Sheet and Plate	3.2.1
AMS 4029	2014	Bare Sheet and Plate	3.2.1
AMS 4031	2219	Sheet and Plate	3.2.8
AMS 4035	2024	Bare Sheet and Plate	3.2.3
AMS 4037	2024	Bare Sheet and Plate	3.2.3
AMS 4044	7075	Bare Sheet and Plate	3.7.6
AMS 4045	7075	Bare Sheet and Plate	3.7.6
AMS 4049	7075	Clad Sheet and Plate	3.7.6
AMS 4050	7050	Bare Plate	3.7.4
AMS 4056	5083	Bare Sheet and Plate	3.5.2
AMS 4078	7075	Bare Plate	3.7.6
AMS 4080	6061	Tubing Seamless, Drawn	3.6.2
AMS 4082	6061	Tubing Seamless, Drawn	3.6.2
AMS 4084 (T61)	7475	Bare Sheet	3.7.10
AMS 4085 (T761)	7475	Bare Sheet	3.7.10
AMS 4086	2024	Tubing, Hydraulic, Seamless, Drawn	3.2.3
AMS 4089 (T7651)	7475	Bare Plate	3.7.10
AMS 4090 (T651)	7475	Bare Plate	3.7.10
AMS 4100 (T761)	7475	Clad Sheet	3.7.10
AMS 4101	2124	Plate	3.2.7
AMS 4107	7050	Die Forging	3.7.4
AMS 4108	7050	Hand Forging	3.7.4
AMS 4111	7049	Forging	3.7.3
AMS 4115	6061	Bar and Rod, Rolled or Cold Finished	3.6.2
AMS 4116	6061	Bar and Rod, Cold Finished	3.6.2
AMS 4117	6061	Bar and Rod, Rolled or Cold Finished	3.6.2
AMS 4118	2017	Bar and Rod, Rolled or Cold-Finished	3.2.2
AMS 4120	2024	Bar and Rod, Rolled or Cold-Finished	3.2.3
AMS 4121	2014	Bar and Rod, Rolled or Cold Finished	3.2.1
AMS 4122	7075	Bar and Rod, Rolled or Cold Finished	3.7.6
AMS 4123	7075	Bar and Rod, Rolled or Cold Finished	3.7.6
AMS 4124	7075	Bar and Rod, Rolled or Cold Finished	3.7.6
AMS 4125	6151	Die Forging	3.6.3
AMS 4126	7075	Forging	3.7.6
AMS 4127	6061	Forging	3.6.2
AMS 4130	2025	Die Forging	3.2.4
AMS 4132	2618	Die and Hand Forgings	3.2.13
AMS 4133	2014	Forging	3.2.1
AMS 4141	7075	Die Forging	3.7.6

MIL-HDBK-5J APPENDIX C
31 January 2003

Specification	Alloy Name	Form/Application	Section
AMS 4144	2219	Hand Forging	3.2.8
AMS 4147	7075	Forging	3.7.6
AMS 4148 (T66)	7175	Die Forging	3.7.8
AMS 4149 (T74)	7175	Die and Hand Forging	3.7.8
AMS 4150	6061	Extruded Rod, Bars, and Shapes	3.6.2
AMS 4152	2024	Extrusion	3.2.3
AMS 4153	2014	Extrusion	3.2.1
AMS 4157	7049	Extrusion	3.7.3
AMS 4160	6061	Extrusion	3.6.2
AMS 4161	6061	Extrusion	3.6.2
AMS 4162	2219	Extrusion	3.2.8
AMS 4163	2219	Extrusion	3.2.8
AMS 4164	2024	Extrusion	3.2.3
AMS 4165	2024	Extrusion	3.2.3
AMS 4172	6061	Extrusion	3.6.2
AMS 4173	6061	Extruded Rod, Bars, and Shapes	3.6.2
AMS 4179 (T7452)	7175	Hand Forging	3.7.8
AMS 4186	7075	Bar and Rod, Rolled or Cold Finished	3.7.6
AMS 4187	7075	Bar and Rod, Rolled or Cold Finished	3.7.6
AMS 4200	7049	Plate	3.7.3
AMS 4201	7050	Bare Plate	3.7.4
AMS 4202 (T7351)	7475	Bare Plate	3.7.10
AMS 4204	7010	Plate	3.7.1
AMS 4205	7010	Plate	3.7.1
AMS 4206	7055	Plate	3.7.5
AMS 4207 (T61)	7475	Clad Sheet	3.7.10
AMS 4211	7040	Plate	3.7.2
AMS 4216	6013 (T4)	Sheet	3.6.1
AMS 4217	356.0	Sand Casting	3.9.4
AMS 4218	A356.0	Casting	3.9.5
AMS 4241	D357.0	Sand Composite Casting	3.9.7
AMS 4248	6061	Hand Forging	3.6.2
AMS 4251	2090	Sheet	3.2.6
AMS 4252 (T7751)	7150	Bare Plate	3.7.7
AMS 4254	2024-T3 ARAMID Fiber Reinforced	Sheet Laminate	7.5.1
AMS 4260	356.0	Investment Casting	3.9.4
AMS 4270	2424 (Clad)	Sheet	3.2.10
AMS 4273	2424 (Bare)	Sheet	3.2.10
AMS 4281	355.0	Permanent Mold Casting	3.9.2
AMS 4284	356.0	Permanent Mold Casting	3.9.4
AMS 4296	2524-T3	Sheet and Plate	3.2.12
AMS 4302	7475-T761 ARAMID Fiber Reinforced	Sheet Laminate	7.5.2
AMS 4306 (T6151)	7150	Bare Plate	3.7.7
AMS 4307 (T61511)	7150	Extrusion	3.7.7
AMS 4320	7149	Forging	3.7.3
AMS 4324	7055	Extrusion	3.7.5
AMS 4330	2297	Plate	3.2.9
AMS 4333	7050	Die Forging	3.7.4
AMS 4334	7249	Hand Forging	3.7.9
AMS 4336	7055	Extrusion	3.7.5
AMS 4337	7055	Extrusion	3.7.5
AMS 4338	2026	Bars, Rods, and Profiles	3.2.5
AMS 4340	7050	Extruded Shape	3.7.4
AMS 4341	7050	Extruded Shape	3.7.4
AMS 4342	7050	Extruded Shape	3.7.4

Key: Underline indicates inactive for new design.

MIL-HDBK-5J APPENDIX C
31 January 2003

Specification	Alloy Name	Form/Application	Section
AMS 4343	7149	Extrusion	3.7.3
AMS 4344 (T73511)	7175	Extrusion	3.7.8
AMS 4345 (T77511)	7150	Extrusion	3.7.7
AMS 4347	6013 (T6)	Sheet	3.6.1
AMS 4350	AZ61A	Extrusion	4.2.2
AMS 4352	ZK60A-T5	Extrusion	4.2.3
AMS 4362	ZK60A-T5	Die and Hand Forging	4.2.3
AMS 4375	AZ31B	Sheet and Plate	4.2.1
AMS 4376	AZ31B	Plate	4.2.1
AMS 4377	AZ31B	Sheet and Plate	4.2.1
AMS 4418	QE22A Magnesium	Sand Casting	4.3.5
AMS 4434	AZ92A	Sand Casting	4.3.3
AMS 4437	AZ91C/AZ91E	Sand Casting	4.3.2
AMS 4439	ZE41A Magnesium	Sand Casting	4.3.6
AMS 4442	EZ33A	Sand Casting	4.3.4
AMS 4446	AZ91C/AZ91E	Sand Casting	4.3.2
AMS 4452	AZ91C/AZ91E	Investment Casting	4.3.2
AMS 4453	AZ92A	Investment Casting	4.3.3
AMS 4455	AM100A	Investment Casting	4.3.1
<u>AMS 4483</u>	<u>AM100A</u>	<u>Permanent Mold Casting</u>	<u>4.3.1</u>
<u>AMS 4484</u>	<u>AZ92A</u>	<u>Permanent Mold Casting</u>	<u>4.3.3</u>
AMS 4530	Copper Beryllium	Strip (TB00)	7.3.2
AMS 4532	Copper Beryllium	Strip (TD02)	7.3.2
AMS 4533	Copper Beryllium	Bar and Rod (TF00)	7.3.2
AMS 4534	Copper Beryllium	Bar and Rod (TH04)	7.3.2
AMS 4535	Copper Beryllium	Mechanical tubing (TF00)	7.3.2
AMS 4650	Copper Beryllium	Bar, Rod, Shapes and Forging (TB00)	7.3.2
AMS 4651	Copper Beryllium	Bar and Rod (TD04)	7.3.2
AMS 4860	Manganese Bronzes	Casting	7.3.1
AMS 4862	Manganese Bronzes	Casting	7.3.1
AMS 4899	Ti-4.5Al-3V-2Fe-2Mo	Sheet	5.4.3
AMS 4900	CP Titanium	Sheet, Strip and Plate	5.2.1
AMS 4901	CP Titanium	Sheet, Strip and Plate	5.2.1
AMS 4902	CP Titanium	Sheet, Strip and Plate	5.2.1
AMS 4910	Ti-5Al-2.5Sn	Sheet, Strip and Plate	5.3.1
AMS 4911	Ti-6Al-4V	Sheet, Strip and Plate	5.4.1
AMS 4914	Ti-15V-3Cr-3Sn-3Al (Ti-15-3)-3-3	Sheet and Strip	5.5.2
AMS 4915	Ti-8Al-1Mo-1V	Sheet, Strip and Plate	5.3.2
AMS 4916	Ti-8Al-1Mo-1V	Sheet, Strip and Plate	5.3.2
AMS 4918	Ti6Al-6V-2Sn	Sheet, Strip and Plate	5.4.2
AMS 4919	Ti-6Al-2Sn-4Zr-2Mo	Sheet, Strip and Plate	5.3.3
AMS 4920	Ti-6Al-4V	Die Forging	5.4.1
AMS 4921	CP Titanium	Bar	5.2.1
AMS 4926	Ti-5Al-2.5Sn	Bar	5.3.1
AMS 4928	Ti-6Al-4V	Bar and Die Forging	5.4.1
AMS 4934	Ti-6Al-4V	Extrusion	5.4.1
AMS 4935	Ti-6Al-4V	Extrusion	5.4.1
AMS 4962	Ti-6Al-4V	Casting	5.4.1
AMS 4964	Ti-4.5Al-3V-2Fe-2Mo	Bars, Wires, Forgings and Rings	5.4.3
AMS 4965	Tii-6Al-4V	Bar	5.4.1
AMS 4966	Ti-5Al-2.5Sn	Forging	5.3.1
AMS 4967	Ti-6Al-4V	Bar	5.4.1
AMS 4971	Ti6Al-6V-2Sn	Bar and Forging	5.4.2
AMS 4973	Ti-8Al-1Mo-1V	Forging	5.3.2
AMS 4975	Ti-6Al-2Sn-4Zr-2Mo	Bar	5.3.3
AMS 4976	Ti-6Al-2Sn-4Zr-2Mo	Forging	5.3.3

Key: Underline indicates inactive for new design.

MIL-HDBK-5J APPENDIX C

31 January 2003

Specification	Alloy Name	Form/Application	Section
AMS 4978	Ti6Al-6V-2Sn	Bar and Forging	5.4.2
AMS 4979	Ti6Al-6V-2Sn	Bar and Forging	5.4.2
AMS 4983	Ti-10V-2Fe-3Al (Ti-10-2-3)	Forging	5.5.3
AMS 4984	Ti-10V-2Fe-3Al (Ti-10-2-3)	Forging	5.5.3
AMS 4986	Ti-10V-2Fe-3Al (Ti-10-2-3)	Forging	5.5.3
AMS 5046	AISI 1025	Sheet, Strip, and Plate	2.2.1
AMS 5075	AISI 1025 - N	Seamless Tubing	2.2.1
AMS 5077	AISI 1025 - N	Tubing	2.2.1
AMS 5342	17-4PH	Investment Casting (H1100)	2.6.9
AMS 5343	17-4PH	Investment Casting (H1000)	2.6.9
AMS 5344	17-4PH	Investment Casting (H900)	2.6.9
AMS 5383	Inconel 718	Investment Casting	6.3.5
AMS 5400	15-5PH	Investment Casting	2.6.7
AMS 5513	AISI 301	Sheet, Strip and Plate	2.7.1
AMS 5516	AISI 302	Sheet, Strip and Plate	2.7.1
AMS 5517	AISI 301	Sheet and Strip (125 ksi)	2.7.1
AMS 5518	AISI 301	Sheet and Strip (150 ksi)	2.7.1
AMS 5519	AISI 301	Sheet and Strip (185 ksi)	2.7.1
AMS 5520	PH15-7Mo	Plate, Sheet and Strip	2.6.8
AMS 5524	AISI 316	Sheet, Strip and Plate	2.7.1
AMS 5525	A-286	Sheet, Strip and Plate	6.2.1
AMS 5528	17-7PH	Plate, Sheet and Strip	2.6.10
AMS 5532	N-155	Sheet	6.2.2
AMS 5536	Hastelloy X	Sheet and Plate	6.3.1
AMS 5537	L-605	Sheet	6.4.1
AMS 5540	Inconel Alloy 600	Plate, Sheet and Strip	6.3.2
AMS 5542	Inconel Alloy X-750	Sheet, Strip and Plate; Annealed	6.3.6
AMS 5544	Waspaloy	Plate, Sheet and Strip	6.3.8
AMS 5545	René 41	Plate, Sheet and Strip	6.3.7
AMS 5547	AM-355	Sheet and Strip	2.6.2
AMS 5548	AM-350	Sheet and Strip	2.6.1
AMS 5549	AM-355	Plate	2.6.2
AMS 5578	Custom 455	Tubing (welded)	2.6.4
AMS 5580	Inconel Alloy 600	Tubing, Seamless	6.3.2
AMS 5585	N-155	Tubing (welded)	6.2.2
AMS 5589	Inconel 718	Tubing; Creep Rupture	6.3.5
AMS 5590	Inconel 718	Tubing; Short-Time	6.3.5
AMS 5596	Inconel 718	Sheet, Strip and Plate; Creep Rupture	6.3.5
AMS 5597	Inconel 718	Sheet, Strip and Plate; Short-Time	6.3.5
AMS 5599	Inconel Alloy 625	Sheet, Strip and Plate	6.3.3
AMS 5604	17-4PH	Sheet, Strip and Plate	2.6.9
AMS 5605	Inconel Alloy 706	Sheet, Strip and Plate	6.3.4
AMS 5606	Inconel Alloy 706	Sheet, Strip and Plate	6.3.4
AMS 5608	HS 188	Sheet and Plate	6.4.2
AMS 5617	Custom 455	Bar and Forging	2.6.4
AMS 5629	PH13-8Mo	Bar, Forging Ring and Extrusion (VIM+CEVM)	2.6.6
AMS 5643	17-4PH	Bar, Forging and Ring	2.6.9
AMS 5659	15-5PH	Bar, Forging, Ring and Extrusion (CEVM)	2.6.7
AMS 5662	Inconel 718	Bar and Forging; Creep Rupture	6.3.5
AMS 5663	Inconel 718	Bar and Forging; Creep Rupture	6.3.5
AMS 5664	Inconel 718	Bar and Forging; Short-Time	6.3.5
AMS 5666	Inconel Alloy 625	Bar, Forging and Ring	6.3.3
AMS 5667	Inconel Alloy X-750	Bar and Forging; Equalized	6.3.6
AMS 5701	Inconel Alloy 706	Bar, Forging and Ring	6.3.4
AMS 5702	Inconel Alloy 706	Bar, Forging and Ring	6.3.4
AMS 5703	Inconel Alloy 706	Bar, Forging and Ring	6.3.4

Key: Underline indicates inactive for new design.

MIL-HDBK-5J APPENDIX C

31 January 2003

Specification	Alloy Name	Form/Application	Section
AMS 5704	Waspaloy	Forging	6.3.8
AMS 5706	Waspaloy	Bar, Forgings and Ring	6.3.8
AMS 5707	Waspaloy	Bar, Forgings and Ring	6.3.8
AMS 5708	Waspaloy	Bar, Forgings and Ring	6.3.8
AMS 5709	Waspaloy	Bar, Forgings and Ring	6.3.8
AMS 5712	René 41 - STA	Bar and Forging	6.3.7
AMS 5713	René 41	Bar and Forging	6.3.7
AMS 5731	A-286	Bar, Forging, Tubing and Ring	6.2.1
AMS 5732	A-286	Bar, Forging, Tubing and Ring	6.2.1
AMS 5734	A-286	Bar, Forging and Tubing	6.2.1
AMS 5737	A-286	Bar, Forging and Tubing	6.2.1
AMS 5743	AM-355	Bar, Forging and Forging Stock	2.6.2
AMS 5754	Hastelloy X	Bar and Forging	6.3.1
AMS 5759	L-605	Bar and Forging	6.4.1
AMS 5763	Custom 450	Bar, Forging, Tubing, Wire and Ring (air melted)	2.6.3
AMS 5768	N-155	Bar and Forging	6.2.2
AMS 5769	N-155	Bar and Forging	6.2.2
AMS 5772	HS 188	Bar and Forging	6.4.2
AMS 5773	Custom 450	Bar, Forging, Tubing, Wire and Ring (CEM)	2.6.3
AMS 5842	MP159 Alloy	Bar (solution treated and cold drawn)	7.4.2
AMS 5843	MP159 Alloy	Bar (solution treated, cold drawn and aged)	7.4.2
AMS 5844	MP35N Alloy	Bar (solution treated and cold drawn)	7.4.1
AMS 5845	MP35N Alloy	Bar (solution treated, cold drawn and aged)	7.4.1
AMS 5862	15-5PH	Sheet, Strip and Plate (CEVM)	2.6.7
AMS 5878	Haynes®230®	Plate, Sheet and Strip	6.3.9
AMS 5891	Haynes®230®	Bar and Forging	6.3.9
AMS 5901	AISI 301	Plate, Sheet and Strip	2.7.1
AMS 5902	AISI 301	Sheet and Strip (175 ksi)	2.7.1
AMS 5903	AISI 302	Sheet and Strip (125 ksi)	2.7.1
AMS 5904	AISI 302	Sheet and Strip (150 ksi)	2.7.1
AMS 5905	AISI 302	Sheet and Strip (175 ksi)	2.7.1
AMS 5906	AISI 302	Sheet and Strip (185 ksi)	2.7.1
AMS 5907	AISI 316	Sheet, Strip and Plate (125 ksi)	2.7.1
AMS 5910	AISI 304	Sheet, Strip and Plate (125 ksi)	2.7.1
AMS 5911	AISI 304	Sheet and Strip (150 ksi)	2.7.1
AMS 5912	AISI 304	Sheet and Strip (175 ksi)	2.7.1
AMS 5913	AISI 304	Sheet and Strip (185 ksi)	2.7.1
AMS 5916	Haynes HR-120	Sheet, Strip and Plate	6.3.10
AMS 5936	Cutsom 465	Bar, Wires and Forgings	2.6.5
AMS 6257	300M (0.42C)	Bar and Forging	2.3.1
AMS 6257	300M (0.42C)	Tubing	2.3.1
AMS 6280	8630	Bar and Forging	2.3.1
AMS 6281	8630	Tubing	2.3.1
AMS 6282	8735	Tubing	2.3.1
AMS 6320	8735	Bar and Forging	2.3.1
AMS 6322	8740	Bar and Forging	2.3.1
AMS 6323	8740	Tubing	2.3.1
AMS 6327	8740	Bar and Forging	2.3.1
AMS 6348	4130	Bar and Forging	2.3.1
AMS 6349	4140	Bar and Forging	2.3.1
AMS 6350	4130	Sheet, Strip and Plate	2.3.1
AMS 6350	8630	Sheet, Strip and Plate	2.3.1
AMS 6351	4130	Sheet, Strip and Plate	2.3.1
AMS 6352	4135	Sheet, Strip and Plate	2.3.1
AMS 6355	8630	Tubing	2.3.1
AMS 6357	8735	Sheet, Strip and Plate	2.3.1

Key: Underline indicates inactive for new design.

MIL-HDBK-5J APPENDIX C

31 January 2003

Specification	Alloy Name	Form/Application	Section
AMS 6358	8740	Sheet, Strip and Plate	2.3.1
AMS 6359	4340	Sheet, Strip and Plate	2.3.1
AMS 6360	4130	Tubing (normalized)	2.3.1
AMS 6361	4130	Tubing	2.3.1
AMS 6362	4130	Tubing	2.3.1
AMS 6365	4135	Tubing	2.3.1
AMS 6370	4130	Bar and Forging	2.3.1
AMS 6371	4130	Tubing	2.3.1
AMS 6372	4135	Tubing	2.3.1
AMS 6373	4130	Tubing	2.3.1
AMS 6374	4130	Tubing	2.3.1
AMS 6381	4140	Tubing	2.3.1
AMS 6382	4140	Bar and Forging	2.3.1
AMS 6395	4140	Sheet, Strip and Plate	2.3.1
AMS 6411	4330V	Bar and Forging	2.3.1
AMS 6411	4330V	Tubing	2.3.1
AMS 6414	4340	Bar and Forging	2.3.1
AMS 6414	4340	Tubing	2.3.1
AMS 6415	4340	Bar and Forging	2.3.1
AMS 6415	4340	Tubing	2.3.1
AMS 6417	300M (0.4C)	Bar and Forging	2.3.1
AMS 6417	300M (0.4C)	Tubing	2.3.1
AMS 6419	300M (0.42C)	Bar and Forging	2.3.1
AMS 6419	300M (0.42C)	Tubing	2.3.1
AMS 6425	Hy-Tuf	Bar and Forging	2.3.1
AMS 6425	Hy-Tuf	Tubing	2.3.1
AMS 6427	4330V	Bar and Forging	2.3.1
AMS 6427	4330V	Tubing	2.3.1
AMS 6429	4335V	Bar and Forging	2.3.1
AMS 6429	4335V	Tubing	2.3.1
AMS 6430	4335V	Bar and Forging	2.3.1
AMS 6430	4335V	Tubing	2.3.1
AMS 6431	D6AC	Bar and Forging	2.3.1
AMS 6431	D6AC	Tubing	2.3.1
AMS 6433	4335V	Sheet, Strip and Plate	2.3.1
AMS 6435	4335V	Sheet, Strip and Plate	2.3.1
AMS 6437	5Cr-Mo-V	Sheet, Strip and Plate	2.4.1
AMS 6439	D6AC	Sheet, Strip and Plate	2.3.1
AMS 6439	D6AC	Bar and Forging	2.3.1
AMS 6454	4340	Sheet, Strip and Plate	2.3.1
AMS 6478	AerMet 100	Bar and Forging	2.5.3
AMS 6487	5Cr-Mo-V	Bar and Forging (CEVM)	2.4.1
AMS 6488	5Cr-Mo-V	Bar and Forging	2.4.1
AMS 6512	250	Bar	2.5.1
AMS 6514	280 (300)	Bar	2.5.1
AMS 6520	250	Sheet and Plate	2.5.1
AMS 6521	280 (300)	Sheet and Plate	2.5.1
AMS 6523	9Ni-4Co-0.20C	Sheet, Strip and Plate	2.4.2
AMS 6524	9Ni-4Co-0.20C	Sheet, Strip and Plate	2.4.3
AMS 6526	9Ni-4Co-0.20C	Bar and Forging, Tubing	2.4.3
AMS 6527	AF1410	Bar and Forging	2.5.2
AMS 6528	4130	Bar and Forging	2.3.1
AMS 6529	4140	Bar and Forging	2.3.1
AMS 6532	AerMet 100	Bar and Forging	2.5.3
AMS 7902	Standard Grade Beryllium	Sheet and Plate	7.2.1
AMS 7906	Standard Grade Beryllium	Bar, Rod, Tubing and Machined Shapes	7.2.1

Key: Underline indicates inactive for new design.

MIL-HDBK-5J APPENDIX C

31 January 2003

Specification	Alloy Name	Form/Application	Section
AMS-A-21180	A201.0	Casting (T7 Temper)	3.8.1
AMS-A-21180	354.0	Casting	3.9.1
AMS-A-21180	C355.0	Casting	3.9.3
AMS-A-21180	A356.0	Casting	3.9.5
AMS-A-21180	A357.0	Casting	3.9.6
AMS-A-21180	359.0	Casting	3.9.8
AMS-A-22771	2014	Forging	3.2.1
AMS-A-22771	2618	Die Forging	3.2.13
AMS-A-22771	6061	Forging	3.6.2
AMS-A-22771	6151	Forging	3.6.3
AMS-A-22771	7049/7149	Forging	3.7.3
AMS-A-22771	7050	Forging	3.7.4
AMS-A-22771	7075	Forging	3.7.6
AMS-A-22771	7175	Forging	3.7.8
AMS-QQ-A-367	2014	Forging	3.2.1
AMS-QQ-A-367	2618	Forging	3.2.13
AMS-QQ-A-367	6061	Forging	3.6.2
AMS-QQ-A-367	7049/7149	Forging	3.7.3
AMS-QQ-A-367	7075	Forging	3.7.6
AMS-QQ-A-200/2	2014	Extruded Bar, Rod and Shapes	3.2.1
AMS-QQ-A-200/3	2024	Extruded Bar, Rod and Shapes	3.2.3
AMS-QQ-A-200/4	5083	Extruded Bar, Rod and Shapes	3.5.2
AMS-QQ-A-200/5	5086	Extruded Bar, Rod and Shapes	3.5.3
AMS-QQ-A-200/6	5454	Extruded Bar, Rod and Shapes	3.5.4
AMS-QQ-A-200/7	5456	Extruded Bar, Rod and Shapes	3.5.5
AMS-QQ-A-200/8	6061	Extruded Rod, Bar Shapes and Tubing	3.6.2
AMS-QQ-A-200/11, 15	7075	Extruded Bar, Rod and Shapes	3.7.6
AMS-QQ-A-225/4	2014	Rolled or Drawn Bar, Rod and Shapes	3.2.1
AMS-QQ-A-225/5	2017	Rolled Bar and Rod	3.2.2
AMS-QQ-A-225/6	2024	Rolled or Drawn Bar, Rod and Wire	3.2.3
AMS-QQ-A-225/8	6061	Rolled Bar, Rod and Shapes	3.6.2
AMS-QQ-A-225/9	7075	Rolled or Drawn Bar and Rod	3.7.6
AMS-QQ-A-250/3	2014	Clad Sheet and Plate	3.2.1
AMS-QQ-A-250/4	2024	Bare Sheet and Plate	3.2.3
AMS-QQ-A-250/5	2024	Clad Sheet and Plate	3.2.3
AMS-QQ-A-250/6	5083	Bare Sheet and Plate	3.5.2
AMS-QQ-A-250/7	5086	Sheet and Plate	3.5.3
AMS-QQ-A-250/8	5052	Sheet and Plate	3.5.1
AMS-QQ-A-250/9	5456	Sheet and Plate	3.5.5
AMS-QQ-A-250/10	5454	Sheet and Plate	3.5.4
AMS-QQ-A-250/11	6061	Sheet and Plate	3.6.2
AMS-QQ-A-250/12, 24	7075	Bare Sheet and Plate	3.7.6
AMS-QQ-A-250/13, 25	7075	Clad Sheet and Plate	3.7.6
AMS-QQ-A-250/29	2124	Plate	3.2.7
AMS-QQ-A-250/30	2219	Sheet and Plate	3.2.8
AMS-QQ-A-367	7049	Forging	3.7.3
AMS-S-5000	4340	Bar and Forging	2.3.1
AMS-S-5626	4140	Bar and Forging	2.3.1
AMS-S-6049	8740	Bar and Forging	2.3.1
AMS-S-6050	8630	Bar and Forging	2.3.1
AMS-S-6758	4130	Bar and Forging	2.3.1
AMS-S-7952	AISI 1025	Sheet and Strip	2.2.1
AMS-S-18728	8630	Sheet, Strip and Plate	2.3.1
AMS-S-18729	4130	Sheet, Strip and Plate	2.3.1
AMS-T-5066	AISI 1025 - N	Tubing	2.2.1
AMS-T-6735	4135	Tubing	2.3.1

Key: Underline indicates inactive for new design.

MIL-HDBK-5J APPENDIX C

31 January 2003

Specification	Alloy Name	Form/Application	Section
AMS-T-6736	4130	Tubing	2.3.1
AMS-T-81556	CP Titanium	Extruded Bars and Shapes	5.2.1
AMS-T-81556	Ti-5Al-2.5Sn	Extruded Bar and Shapes	5.3.1
AMS-T-81556	Ti6Al-6V-2Sn	Extruded Bar and Shapes	5.4.2
AMS-T-9046	CP Titanium	Sheet, Strip and Plate	5.2.1
AMS-T-9046	Ti-5Al-2.5Sn	Sheet, Strip and Plate	5.3.1
AMS-T-9046	Ti-8Al-1Mo-1V	Sheet, Strip and Plate	5.3.2
AMS-T-9046	Ti-6Al-2Sn-4Zr-2Mo	Sheet and Strip	5.3.3
AMS-T-9046	Ti-6Al-4V	Sheet, Strip and Plate	5.4.1
AMS-T-9046	Ti6Al-6V-2Sn	Sheet, Strip and Plate	5.4.2
AMS-T-9046	Ti-13V-11Cr-3Al	Sheet, Strip and Plate	5.5.1
AMS-WW-T-700/3	2024	Tubing	3.2.3
AMS-WW-T-700/6	6061	Tubing Seamless, Drawn	3.6.2
ASTM A 108	AISI 1025	Bar	2.2.1
ASTM B 91	AZ31B	Forging	4.2.1
ASTM B 91	AZ61A	Forging	4.2.2
ASTM B 107	ZK60A-F	Extrusion	4.2.3
ASTM B 107	AZ31B	Extrusion	4.2.1
ASTM B 166	Inconel Alloy 600	Bar and Rod	6.3.2
ASTM B 194	Copper Beryllium	Sheet (TB00, TD01, TD02, TD04)	7.3.2
ASTM B 564	Inconel Alloy 600	Forging	6.3.2
MIL-DTL-46192	2519	Plate	3.2.11
MIL-T-9047	CP Titanium	Bar	5.2.1
MIL-T-9047	Ti-5Al-2.5Sn	Bar	5.3.1
MIL-T-9047	Ti-8Al-1Mo-1V	Bar	5.3.2
MIL-T-9047	Ti-6Al-4V	Bar	5.4.1
MIL-T-9047	Ti-13V-11Cr-3Al	Bar	5.5.1

APPENDIX D**D.0 Subject Index**

- A-Basis, 1-5, 9-9, 9-25
- AMS Specifications, 9-11
- Anderson-Darling Test
 - k-Sample Test, 9-77
 - Normality, 9-82
 - Pearsonality, 9-85
 - Weibullness, 9-89
- Applicability of Procedures, 9-5
- Approval Procedures, 9-5
- ASTM
 - ASTM A 370, 9-13, 9-15
 - ASTM B 557, 9-13, 9-15
 - ASTM B 769, 1-12, 9-13, 9-15
 - ASTM B 831, 1-12, 9-13, 9-16
 - ASTM C 693, 9-12, 9-16, 9-184
 - ASTM C 714, 9-13, 9-16, 9-184
 - ASTM D 2766, 9-13, 9-16, 9-184
 - ASTM E 8, 1-8, 1-21, 9-12, 9-13, 9-15, 9-38
 - ASTM E 9, 1-11, 9-12, 9-15
 - ASTM E 21, 9-13
 - ASTM E 29, 9-10
 - ASTM E 83, 9-12, 9-31
 - ASTM E 111, 9-12, 9-31, 9-183
 - ASTM E 132, 9-13, 9-16, 9-183
 - ASTM E 139, 9-12, 9-22
 - ASTM E 143, 9-12, 9-183
 - ASTM E 228, 9-12, 9-16, 9-184
 - ASTM E 238, 1-12, 9-12, 9-15, 9-16
 - ASTM E 399, 1-21, 9-13, 9-18, 9-24, 9-133
 - ASTM E 466, 9-12, 9-17
 - ASTM E 561, 9-13
 - ASTM E 606, 9-12, 9-17, 9-33, 9-41, 9-45, 9-110
 - ASTM E 647, 9-12, 9-17
 - ASTM E 739, 9-40
 - ASTM G 34, 9-12
 - ASTM G 47, 9-13
- B-Basis, 1-7, 9-9, 9-25
- Beams, Properties of
 - Aluminum, 3-518
 - Magnesium, 4-53
 - Steel, 2-237
 - Titanium, 5-144
- Bearing Failure, 1-28
- Bearing Properties, 1-12, 9-7
- Bearing Test Procedures, 9-106, 9-109
- Bearings, 8-172
- Bending Failure, 1-28
- Biaxial Properties, 1-17
 - Modulus of Elasticity, 1-18
 - Ultimate Stress, 1-19
 - Yield Stress, 1-18
- Biaxial Stress-Strain Curves, 9-198
- Brittle Fracture, 1-20
 - Analysis, 1-20
- Cast, Definition of, 9-30
- Clad Aluminum Alloy Plate, 9-107
- Coefficient of Thermal Expansion, 9-16
- Columns, 1-30
 - Aluminum, 3-519
 - Local Instability, 1-30
 - Magnesium, 4-53
 - Primary Instability, 1-30
 - Stable Sections, 1-30
 - Steel, 2-237
 - Test Results, 1-30
 - Yield Stress, 1-32
- Combinability of Data, 9-77
 - Anderson-Darling k-Sample Test, 9-77
 - F-Test, 9-77, 9-79
 - t-Test, 9-77, 9-80
- Compressive Failure, 1-26
- Compressive Properties, 1-11, 9-7
- Computational Procedures, 9-60
 - Derived Properties, 9-106, 9-109
 - Nonparametric, 9-103
 - Normal Distribution, 9-82
 - Pearson Distribution, 9-82, 9-100
 - Population Specification, 9-60
 - Unknown Distribution, 9-103
 - Weibull Distribution, 9-82, 9-102
- Confidence, 9-9, A-6
- Confidence Interval, A-6
- Confidence Level, A-6
- Confidence Limit, A-7
- Creep/Stress Rupture, 1-13, 9-22, 9-234
 - Data Analysis, 9-137
 - Data Generation, 9-46, 9-135
 - Data Requirements, 9-35
 - Equations, 9-138, 9-140
 - Example Problems, 9-235
 - Presentation of Data, 9-235
 - Terminology, 9-135, 9-140
- Data Basis, 9-8

MIL-HDBK-5J APPENDIX D

31 January 2003

- Data Format, 9-50
 - A- and B-basis, 9-52
 - Derived Properties, 9-51
 - Fasteners, 9-55
 - Stress-Strain Curves, 9-55
 - Other Property, 9-56
- Data Generation, 9-24
 - Creep/Stress Rupture, 9-46
 - Fatigue, 9-40
 - Fatigue Crack Growth, 9-130
 - Fracture Toughness, 9-133
 - Fusion-Welded Joints, 9-48
 - Mechanically Fastened Joints, 9-142
 - Mechanical Properties, 9-24, 9-30
 - Stress-Strain, 9-184
- Data Presentation
 - Creep-Rupture, 9-234
 - Elevated Temperature Curves, 9-202
 - Fatigue, 9-212
 - Fatigue Crack Growth, 1-26, 9-228
 - Fracture Toughness, 9-230
 - Fusion-Welded Joints, 9-244
 - Mechanically Fastened Joints, 9-240
 - Room-Temperature Design Values, 9-179, 9-184
 - Typical (Full-Range) Stress-Strain, 9-194
 - Typical Stress-Strain, 9-184
- Data Requirements, 9-24, 9-26, 9-29
 - Creep/Stress Rupture, 9-26, 9-35
 - Derived Properties, 9-26, 9-30
 - Directly Calculated, 9-9, 9-26
 - Elevated Temperature Properties, 9-26, 9-32
 - Experimental Design, 9-40
 - Fatigue, 9-27, 9-32, 9-40
 - Fatigue Crack Growth, 9-27, 9-35
 - Fracture Toughness, 9-35
 - Fusion-Welded Joints, 9-40
 - Mechanically Fastened Joints, 9-36
 - Mechanical Properties, 9-24, 9-25, 9-27
 - Modulus, 9-26, 9-31
 - New Materials, 9-7, 9-24
 - Physical Properties, 9-26, 9-27
 - Stress-Strain, 9-28, 9-31
- Data Submission, 9-50
- Definition of Terms, 9-30
 - Creep/Stress Rupture, 9-135
 - Fatigue, 9-110
 - Fracture Toughness, 9-133
 - Mechanically Fastened Joints, 9-142
 - Mechanical Properties, 9-14
 - Statistics, A-6
- Degrees of Freedom, 9-81, A-8
- Density, 9-16
- Derived Properties, 9-30
- Design Mechanical Properties, 9-60
 - By Regression, 9-63, 9-64
 - Determining Form of Distribution, 9-82
 - Determining Population, 9-60
 - Direct Computation,
 - Non Parametric, 9-103
 - Pearson, 9-100
 - Weibull, 9-102
 - Example Problems, 9-162, 9-175
 - Presentation, 9-179
- Dimensionally Discrepant Castings, 9-11
- Direct Computation of Allowables, 9-60, 9-94, 9-104, 9-162
 - Nonparametric Distribution, 9-103
 - Pearson Distribution, 9-100
 - Weibull Distribution, 9-102
- Distribution, Form of, 9-82
- Documentation Requirements, 9-5
- Elastic Properties, 9-183
- Element Properties
 - Aluminum, 3-518
 - Magnesium, 4-53
 - Steel, 2-237
 - Titanium, 5-144
- Elevated Temperature Curves, 1-13, 9-68, 9-202
 - Data Requirements, 9-32
 - Presentation, 9-203
 - Working Curves, 9-202
- Environmental Effects, 1-21
- Elongation, 1-8, 9-204
- Examples of Computation Procedures
 - Complex Exposure, 9-210
 - Creep/Stress Rupture, 9-235
 - Design Allowables, 9-162
 - Fatigue, 9-212, 9-219, 9-223
 - F-Test, 9-79
 - Linear Regression, 9-104
 - Strain-Departure Method, 9-185
 - t-Test, 9-80
- F-Distribution Fractiles, 9-253, 9-254
- F-Test, 9-79
- Failure
 - General, 1-28
 - Identification code, 9-57, 9-58
 - Instability, 1-29
 - Local, 1-30
 - Material, 1-28
 - Types, 1-28
- Fasteners, 9-142
 - Data Format, 9-55
 - H-Type, 9-144
 - S-Type, 9-144

MIL-HDBK-5J APPENDIX D

31 January 2003

- Fatigue, 9-8, 9-17, 9-110
 - Data Analysis, 9-114, 9-127
 - Data Generation, 9-40, 9-113, 9-223
 - Data Requirements, 9-17, 9-110, 9-223, 9-34
 - Example Problems, 9-212, 9-223
 - Life Models, 9-115, 9-125, 9-221, 9-226, 9-227
 - Load Control, 9-219
 - Outliers, 9-124, 9-221, 9-227
 - Presentation of Data, 1-15, 9-223
 - Properties, 1-14
 - Run-outs, 9-128, 9-222, 9-228
 - Strain Control, 9-223
 - Terminology, 9-40
 - Test Planning, 9-40
 - Time Dependent Effects, 9-130
- Fatigue Crack Growth, 1-24, 9-17, 9-130, 9-228
 - Crack-Growth Analysis, 1-24
 - Data Analysis, 9-134
 - Data Generation, 9-133
 - Data Requirements, 9-35, 9-131
 - Presentation of Data, 1-26, 9-228
- Forgings, Definition of Grain Directions in, 9-15
- Fracture Toughness, 1-19, 9-18, 9-230
 - Analysis, 1-20, 9-133
 - Apparent Fracture Toughness, 1-23
 - Brittle Fracture, 1-20
 - Critical Plane-Strain, 1-21
 - Data Analysis, 9-133
 - Data Generation, 9-35
 - Data Requirements, 9-35
 - Definitions, 9-133
 - Environmental, 1-21
 - Middle Tension Panels, 1-23, 9-19, 9-35, 9-134
 - Plane Stress, 1-22, 9-18, 9-133
 - Plane Strain, 1-21, 9-18, 9-133
 - Presentation of Data, 9-230
 - Transitional Stress States, 1-22, 9-133
- Full-Range Stress-Strain Curves, 9-194
- Fusion-Welded Joints, 9-23, 9-40, 9-158
 - Data Analysis, 9-161
 - Data Generation, 9-48, 9-159, 9-160
 - Data Requirements, 9-40, 9-160
 - Presentation of Data, 9-244
- Goodness-of-Fit Tests, 9-82
 - Anderson-Darling, 9-82
 - Normality, 9-82
 - Pearsonality, 9-85
 - Weibullness, 9-83
- Grain Direction, Treatment of, 9-106
- Grouped Data Analysis, 9-77
- Heat Requirements, 9-7
- Indirect Design Allowables, 9-7, 9-60, 9-106
 - Without Regression, 9-108
 - With Regression, 9-109
- Instability, 1-29
 - Bending, 1-29
 - Combined Loadings, 1-29
 - Compression, 1-29
 - Local, 1-30
 - Torsion, 1-29
- International System of Units, 1-3
- k-Sample Anderson-Darling Test, 9-77
- Larson-Miller Analysis, 9-138
- Location of Test Specimens, 9-14
- Lot Requirements, 9-7
- Material Failures, 1-28
 - Bearing, 1-28
 - Bending, 1-28
 - Combined Stress, 1-28
 - Compression, 1-28
 - Shear, 1-28
 - Stress Concentrations, 1-28
 - Tension, 1-28
- Material Specifications, 9-11
- Maximum Likelihood Estimation, 9-129
- Mean Stress/Strain Effects, Evaluation of, 9-117
- Mechanical Properties, 9-60
 - Computation of Design Allowables, 9-60
 - Derived Properties, 9-30, 9-106, 9-109
 - Example Problems, 9-162, 9-175
 - Presentation, 9-179
 - Terminology for, 9-14
 - Test Matrix, 9-29
- Mechanically Fastened Joints, 9-22, 9-142
 - Data Analysis, 9-144, 9-146, 9-148, 9-158
 - Data Requirements, 9-36
 - Definitions, 9-143
 - Presentation of Data, 9-240
- Melt, Definition of, 9-30
- Metallurgical Instability, 1-17
- Modulus of Elasticity, 1-9, 9-16, 9-31, 9-183, 9-206
- Modulus of Rigidity, 1-12
- NASM-1312, 9-11, 9-12, 9-22, 9-23, 9-38, 9-144
- Nomenclature, 1-3
- Nonparametric Data Analysis, 9-103
- Normal Curve Statistics, 9-256
- Normality, Assessment of, 9-82
- Outliers, Treatment of, 9-124, 9-221, 9-227
- Pearson Method, 9-100
 - Anderson-Darling, 9-85
 - Backoff, 9-85
 - Probability Plot, 9-86

MIL-HDBK-5J APPENDIX D

31 January 2003

Physical Properties, 9-16, 9-207
Poisson's Ratio, 1-8, 9-16, 9-183
Presentation of Data, 9-162, 9-212
 Creep/Stress Rupture, 9-234
 Design Allowables, 9-179
 Effect of Temperature Curves, 9-246
 Fatigue, 9-212
 Fatigue Crack Growth, 9-228
 Fracture Toughness, 9-230
 Fusion-Welded Joints, 9-244, 9-245
 Mechanically Fastened Joints, 9-240
 Physical Properties, 9-183
 Stress-Strain, 9-184
Primary Test Direction, 9-15
Probability, A-12
Probability Plots
 Normal, 9-83
 Pearson, 9-86
 Weibull, 9-92
Proportional Limit
 Shear, 1-12
 Stress, 9-201
 Tension and Compression 9-201
Pulleys, 8-172
Ramberg-Osgood Method, 9-8, 9-188, 9-191
Ratioed Values, 1-7
Rank Values for A- and B-Basis, 9-267
Ratioing of Mechanical Properties, 9-106
Reduced Ratios
 By Regression, 9-109
 Direct Computation, 9-106
Reduction in Area, 1-8, 1-11, 9-204
Reduction of Column Test Results, 1-31
Regression, 9-63, 9-64
 Direct Computation, 9-104
 Determining Design Allowables, 9-65
 Determining Reduced Ratios, 9-106
 Example Computations, 9-175
 Least Squares, 9-67
 Linear, 9-67
 Tests for Adequacy of, 9-71
 Tests for Equality, 9-74
 Quadratic, 9-68
Rounding, 9-10
Runouts, Treatment of, 9-128
S-Basis, 1-7, 9-24, 9-59
Separately Cast Test Bars, 9-11
Shear Failure, 1-28
Shear Properties, 1-11, 9-7
Shear Test Procedures, 9-106, 9-109
Shear Yield Stress, 9-202
Significance, A-14
Skewness, 9-101
Specific Heat, 9-16
Specifying the Population, 9-60
Statistics
 Symbols, A-5
 Terms/Definitions, A-6
Strain, 1-8
 Rate, 1-8
 Shear, 1-8
Strain Departure Method, 9-194
Stress, 1-8, 1-28
Stress-Strain Curves, 9-184
 Biaxial, 9-198
 Compression Tangent Modulus, 9-202
 Data Requirements, 9-31, 9-55
 Example Computation, 9-198
 Full-Range, 9-194
 Presentation, 9-184
 Typical, 9-184
Stress Rupture, 1-13
Symbols and Definitions, 1-3
 Creep/Stress Rupture, 9-136, A-7
 Fatigue, 9-110, A-8
 Fracture Toughness, 9-133
 General, 1-3, A-5, A-6
 Mechanically Fastened Joints, 9-143
 Mechanical Properties, 9-14
 Physical Properties, 9-16, 9-183, 9-184
 Statistics, A-5, A-6
t-Distribution Fractiles, 9-255
t-Test, 9-80
Tangent Modulus Curves, 9-202
Temperature Effects, 1-13, 9-202
Tensile Properties, 1-9
 Tensile Proportional Limit, 1-9
 Tensile Ultimate Stress, 1-11
 Tensile Yield Stress, 1-9
Terminology
 Creep Rupture, 9-135
 Fatigue, 1-15, 9-110
 Mechanical Property, 9-14
Test Specimens, 9-14
 Duplication, 9-29
 Location, 9-14, 9-107
 Orientation, 9-14
 Primary Test Direction, 9-15
Testing Procedures, 9-11
 Bearing, 9-12
 Creep/Stress Rupture, 9-12, 9-22
 Elastic Properties, 9-12
 Fatigue, 9-12, 9-17
 Fatigue Crack Growth, 9-12, 9-17
 Fusion-Welded Joints, 9-23
 Fracture Toughness, 9-18

MIL-HDBK-5J APPENDIX D

31 January 2003

Mechanically Fastened Joints, 9-22
Mechanical Properties, 9-15
Modulus, 9-16
Physical Properties, 9-16
Shear, 9-13
Stress-Strain, 9-28, 9-184
Testing Standards, 9-12, 9-15
Tests of Significance, 9-77
 Definitions, A-6
 F-Test, 9-79
 t-Test, 9-80
Thermal Conductivity, 9-16
Thermal Exposure, 9-8, 9-208
 Complex, 9-210
 Simple, 9-209
Thin Walled Sections, 1-40
Tolerance Bounds, A-15
 T_{90} , 9-10
 T_{99} , 9-10
Tolerance Interval, A-15
Tolerance Level, A-15
Tolerance Limit Factors
 Normal, One-Sided, 9-248
 Weibull, One-Sided, 9-257, 9-258
Torsion, Properties
 Aluminum, 3-521
 Magnesium, 4-56
 Steel, 2-240
Typical Basis, 9-8
Ultimate Bearing Stress, 1-12
Ultimate Compression Stress, 1-1
Ultimate Shear Stress, 1-12
Ultimate Tensile Stress, 1-11
Units, 9-16
Weibull Procedure, 9-102
Weibull Acceptability Test, 9-83, 9-89
Weibull Back-Off, 9-91
Weibull Distribution Estimating, 9-89
Weibullness, Assessment of, 9-215
Weibull Probability Plot, 9-92
Wire Rope, 8-172
Working Curves, Determination of, 9-202
Yield Stress
 Bearing, 1-12
 Compression, 1-11
 Shear, 1-12
 Tensile, 1-9 Tensile Proportional Limit, 1-7

THIS PAGE INTENTIONALLY BLANK

APPENDIX E**E.0 Figure Index**

<u>Figure No.</u>	<u>Current Form</u>	<u>Figure No.</u>	<u>Current Form</u>
1.4.4.1	Scanned	2.3.1.3.6(d)	Scanned
1.4.8.2.1(a)	Scanned	2.3.1.3.6(e)	Vector Graphic
1.4.8.2.1(b)	Scanned	2.3.1.3.6(f)	Vector Graphic
1.4.9.3(a)	Scanned	2.3.1.3.6(g)	Vector Graphic
1.4.11.1	Scanned	2.3.1.3.8(a)	Vector Graphic
1.4.11.3	Scanned	2.3.1.3.8(b)	Vector Graphic
1.4.12.2	Scanned	2.3.1.3.8(c)	Vector Graphic
1.4.12.3	Scanned	2.3.1.3.8(d)	Vector Graphic
1.4.12.4	Scanned	2.3.1.3.8(e)	Vector Graphic
1.4.12.4.1	Scanned	2.3.1.3.8(f)	Vector Graphic
1.4.13.2(a)	Scanned	2.3.1.3.8(g)	Vector Graphic
1.4.13.2(b)	Scanned	2.3.1.3.8(h)	Vector Graphic
1.4.13.4	Scanned	2.3.1.3.8(i)	Vector Graphic
1.6.2.2	Scanned	2.3.1.3.8(j)	Vector Graphic
1.6.4.4(a)	Vector Graphic	2.3.1.3.8(k)	Vector Graphic
1.6.4.4(b)	Vector Graphic	2.3.1.3.8(l)	Vector Graphic
1.6.4.4(c)	Vector Graphic	2.3.1.3.8(m)	Vector Graphic
1.6.4.4(d)	Vector Graphic	2.3.1.3.8(n)	Vector Graphic
1.6.4.4(e)	Vector Graphic	2.3.1.3.8(o)	Vector Graphic
1.6.4.4(f)	Vector Graphic	2.3.1.4.8(a)	Scanned
1.6.4.4(g)	Vector Graphic	2.3.1.4.8(b)	Scanned
1.6.4.4(h)	Vector Graphic	2.3.1.4.8(c)	Scanned
1.6.4.4(i)	Vector Graphic	2.3.1.4.8(d)	Scanned
2.2.1.0	Vector Graphic	2.3.1.4.9	Scanned
2.3.0.2	Scanned	2.3.1.5.9	Scanned
2.3.1.0	Vector Graphic	2.4.1.0	Vector Graphic
2.3.1.1.1	Vector Graphic	2.4.1.1.1(a)	Vector Graphic
2.3.1.1.2	Vector Graphic	2.4.1.1.1(b)	Vector Graphic
2.3.1.1.3	Vector Graphic	2.4.1.1.2(a)	Vector Graphic
2.3.1.1.4	Vector Graphic	2.4.1.1.2(b)	Vector Graphic
2.3.1.2.6(a)	Vector Graphic	2.4.1.1.3(a)	Vector Graphic
2.3.1.2.6(b)	Vector Graphic	2.4.1.1.3(b)	Vector Graphic
2.3.1.2.6(c)	Vector Graphic	2.4.1.1.4	Vector Graphic
2.3.1.2.8(a)	Vector Graphic	2.4.2.0	Vector Graphic
2.3.1.2.8(b)	Vector Graphic	2.4.2.1.1	Vector Graphic
2.3.1.2.8(c)	Vector Graphic	2.4.2.1.2	Vector Graphic
2.3.1.2.8(d)	Vector Graphic	2.4.2.1.4	Vector Graphic
2.3.1.2.8(e)	Vector Graphic	2.4.2.1.6(a)	Vector Graphic
2.3.1.2.8(f)	Vector Graphic	2.4.2.1.6(b)	Vector Graphic
2.3.1.2.8(g)	Vector Graphic	2.4.3.0	Vector Graphic
2.3.1.2.8(h)	Vector Graphic	2.4.3.1.1	Vector Graphic
2.3.1.3.6(a)	Vector Graphic	2.4.3.1.2	Vector Graphic
2.3.1.3.6(b)	Vector Graphic		
2.3.1.3.6(c)	Vector Graphic		

MIL-HDBK-5J APPENDIX E

31 January 2003

<u>Figure No.</u>	<u>Current Form</u>	<u>Figure No.</u>	<u>Current Form</u>
2.4.3.1.3	Vector Graphic	2.6.4.0	Vector Graphic
2.4.3.1.4	Vector Graphic	2.6.4.1.1	Vector Graphic
2.4.3.1.6(a)	Vector Graphic	2.6.4.1.2	Vector Graphic
2.4.3.1.6(b)	Vector Graphic	2.6.4.1.5	Vector Graphic
2.4.3.1.6(c)	Vector Graphic	2.6.4.1.6	Vector Graphic
2.4.3.1.6(d)	Vector Graphic	2.6.4.1.8(a)	Scanned
2.4.3.1.8	Scanned	2.6.4.1.8(b)	Scanned
2.5.0.2(a)	Vector Graphic	2.6.4.2.1	Vector Graphic
2.5.1.0	Vector Graphic	2.6.4.2.2	Vector Graphic
2.5.1.1.1	Vector Graphic	2.6.4.2.5	Scanned
2.5.1.1.2	Vector Graphic	2.6.4.2.6	Vector Graphic
2.5.1.1.3	Vector Graphic	2.6.4.2.8	Scanned
2.5.1.1.4	Vector Graphic	2.6.5.0(a)	Vector Graphic
2.5.1.1.6(a)	Vector Graphic	2.6.5.1(a)	Vector Graphic
2.5.1.1.6(b)	Vector Graphic	2.6.5.1(b)	Vector Graphic
2.5.1.1.6(c)	Vector Graphic	2.6.5.1(c)	Vector Graphic
2.5.1.1.6(d)	Vector Graphic	2.6.6.0	Vector Graphic
2.5.1.1.6(e)	Scanned	2.6.6.1.1	Vector Graphic
2.5.2.1.6(a)	Vector Graphic	2.6.6.1.6(a)	Vector Graphic
2.5.2.1.6(b)	Vector Graphic	2.6.6.1.6(b)	Vector Graphic
2.5.3.1.6(a)	Vector Graphic	2.6.6.1.6(c)	Vector Graphic
2.5.3.1.6(b)	Vector Graphic	2.6.6.1.8(a)	Vector Graphic
2.5.3.1.6(c)	Vector Graphic	2.6.6.1.8(b)	Vector Graphic
2.5.3.2.6(a)	Vector Graphic	2.6.6.1.8(c)	Vector Graphic
2.5.3.2.6(b)	Vector Graphic	2.6.7.0	Vector Graphic
2.5.3.2.6(c)	Vector Graphic	2.6.7.1.1	Vector Graphic
2.6.1.0	Vector Graphic	2.6.7.1.4	Vector Graphic
2.6.1.1.1	Vector Graphic	2.6.7.1.6(a)	Vector Graphic
2.6.1.1.2	Vector Graphic	2.6.7.1.6(b)	Scanned
2.6.1.1.3	Vector Graphic	2.6.7.1.6(c)	Vector Graphic
2.6.1.1.4	Vector Graphic	2.6.7.2.2	Vector Graphic
2.6.1.1.6(a)	Vector Graphic	2.6.7.2.6(a)	Scanned
2.6.1.1.6(b)	Vector Graphic	2.6.7.2.6(b)	Vector Graphic
2.6.2.0	Vector Graphic	2.6.7.2.8(a)	Vector Graphic
2.6.2.1.1	Scanned	2.6.7.2.8(b)	Vector Graphic
2.6.2.1.2	Vector Graphic	2.6.7.2.8(c)	Vector Graphic
2.6.2.1.3	Scanned	2.6.7.3.2	Scanned
2.6.2.1.4	Vector Graphic	2.6.7.3.6	Scanned
2.6.3.0	Vector Graphic	2.6.8.0	Vector Graphic
2.6.3.1.1	Vector Graphic	2.6.8.1.1	Scanned
2.6.3.1.2	Vector Graphic	2.6.8.1.4	Scanned
2.6.3.1.5	Vector Graphic	2.6.8.1.6(a)	Scanned
2.6.3.1.6	Vector Graphic	2.6.8.1.6(b)	Scanned
2.6.3.1.8	Scanned	2.6.8.1.6(c)	Scanned
2.6.3.2.1	Vector Graphic	2.6.8.1.8(a)	Scanned
2.6.3.2.2	Vector Graphic	2.6.8.1.8(b)	Scanned
2.6.3.2.5	Vector Graphic	2.6.8.1.8(c)	Scanned
2.6.3.2.6	Vector Graphic	2.6.8.1.8(d)	Scanned
2.6.3.2.8	Scanned	2.6.8.1.8(e)	Vector Graphic

MIL-HDBK-5J APPENDIX E

31 January 2003

<u>Figure No.</u>	<u>Current Form</u>	<u>Figure No.</u>	<u>Current Form</u>
2.6.8.1.8(f)	Scanned	2.8.3.2(b)	Vector Graphic
2.6.9.0	Vector Graphic	2.8.3.2(c)	Vector Graphic
2.6.9.1.2	Vector Graphic	2.8.3.2(d)	Scanned
2.6.9.1.3	Vector Graphic	2.8.3.2(e)	Scanned
2.6.9.1.4	Vector Graphic	2.8.3.2(f)	Vector Graphic
2.6.9.1.8(a)	Scanned	2.8.3.2(g)	Scanned
2.6.9.1.8(b)	Scanned	2.8.3.2(h)	Scanned
2.6.9.1.8(c)	Scanned	2.8.3.2(i)	Vector Graphic
2.6.9.2.1	Vector Graphic	2.8.3.2(j)	Scanned
2.6.9.2.6(a)	Vector Graphic	3.1.2.1.1(a)	Scanned
2.6.9.2.6(b)	Vector Graphic	3.1.2.1.1(b)	Scanned
2.6.9.3.6(a)	Vector Graphic	3.1.2.1.1(c)	Scanned
2.6.9.3.6(b)	Vector Graphic	3.2.1.0	Vector Graphic
2.6.9.4.8	Scanned	3.2.1.1.1(a)	Scanned
2.6.9.5.8	Scanned	3.2.1.1.1(b)	Vector Graphic
2.6.9.6.1	Vector Graphic	3.2.1.1.1(c)	Vector Graphic
2.6.10.0	Vector Graphic	3.2.1.1.1(d)	Vector Graphic
2.6.10.1.1	Vector Graphic	3.2.1.1.1(e)	Vector Graphic
2.6.10.1.2	Vector Graphic	3.2.1.1.1(f)	Vector Graphic
2.6.10.1.4(a)	Vector Graphic	3.2.1.1.2(a)	Vector Graphic
2.6.10.1.4(b)	Vector Graphic	3.2.1.1.2(b)	Vector Graphic
2.6.10.1.6(a)	Vector Graphic	3.2.1.1.3(a)	Vector Graphic
2.6.10.1.6(b)	Vector Graphic	3.2.1.1.3(b)	Vector Graphic
2.6.10.1.6(c)	Vector Graphic	3.2.1.1.4	Scanned
2.7.1.0	Vector Graphic	3.2.1.1.5(a)	Vector Graphic
2.7.1.1.1(a)	Vector Graphic	3.2.1.1.5(b)	Vector Graphic
2.7.1.1.1(b)	Vector Graphic	3.2.1.1.6(a)	Vector Graphic
2.7.1.2.6(a)	Vector Graphic	3.2.1.1.6(b)	Vector Graphic
2.7.1.2.6(b)	Vector Graphic	3.2.1.1.6(c)	Vector Graphic
2.7.1.3.1	Vector Graphic	3.2.1.1.6(d)	Vector Graphic
2.7.1.3.2	Vector Graphic	3.2.1.1.6(e)	Vector Graphic
2.7.1.3.3	Vector Graphic	3.2.1.1.6(f)	Vector Graphic
2.7.1.3.4	Vector Graphic	3.2.1.1.6(g)	Vector Graphic
2.7.1.3.6(a)	Vector Graphic	3.2.1.1.6(h)	Vector Graphic
2.7.1.3.6(b)	Vector Graphic	3.2.1.1.6(i)	Vector Graphic
2.7.1.4.6(a)	Vector Graphic	3.2.1.1.6(j)	Vector Graphic
2.7.1.4.6(b)	Vector Graphic	3.2.1.1.6(k)	Vector Graphic
2.7.1.5.1	Vector Graphic	3.2.1.1.6(l)	Vector Graphic
2.7.1.5.2(a)	Vector Graphic	3.2.1.1.6(m)	Vector Graphic
2.7.1.5.2(b)	Vector Graphic	3.2.1.1.6(n)	Vector Graphic
2.7.1.5.3	Vector Graphic	3.2.1.1.6(o)	Vector Graphic
2.7.1.5.4	Vector Graphic	3.2.1.1.6(p)	Vector Graphic
2.7.1.5.6(a)	Vector Graphic	3.2.1.1.6(q)	Vector Graphic
2.7.1.5.6(b)	Vector Graphic	3.2.1.1.6(r)	Vector Graphic
2.7.1.5.6(c)	Vector Graphic	3.2.1.1.6(s)	Vector Graphic
2.7.1.5.6(d)	Vector Graphic	3.2.1.1.6(t)	Vector Graphic
2.8.1.1(a)	Vector Graphic	3.2.1.1.6(u)	Vector Graphic
2.8.1.1(b)	Vector Graphic	3.2.1.1.6(v)	Vector Graphic
2.8.3.2(a)	Vector Graphic	3.2.1.1.8(a)	Scanned

MIL-HDBK-5J APPENDIX E
31 January 2003

<u>Figure No.</u>	<u>Current Form</u>	<u>Figure No.</u>	<u>Current Form</u>
3.2.1.1.8(b)	Vector Graphic	3.2.3.1.8(c)	Vector Graphic
3.2.1.1.8(c)	Vector Graphic	3.2.3.1.8(d)	Vector Graphic
3.2.1.1.8(d)	Vector Graphic	3.2.3.1.8(e)	Scanned
3.2.1.1.8(e)	Vector Graphic	3.2.3.1.8(f)	Vector Graphic
3.2.2.0	Vector Graphic	3.2.3.1.8(g)	Vector Graphic
3.2.2.1.4	Vector Graphic	3.2.3.1.8(h)	Vector Graphic
3.2.3.0	Vector Graphic	3.2.3.1.8(i)	Vector Graphic
3.2.3.1.1(a)	Vector Graphic	3.2.3.3.1(a)	Vector Graphic
3.2.3.1.1(b)	Vector Graphic	3.2.3.3.1(b)	Vector Graphic
3.2.3.1.1(c)	Vector Graphic	3.2.3.3.1(c)	Vector Graphic
3.2.3.1.1(d)	Vector Graphic	3.2.3.3.1(d)	Vector Graphic
3.2.3.1.1(e)	Vector Graphic	3.2.3.3.5(a)	Vector Graphic
3.2.3.1.1(f)	Vector Graphic	3.2.3.3.5(b)	Vector Graphic
3.2.3.1.2(a)	Vector Graphic	3.2.3.3.6(a)	Vector Graphic
3.2.3.1.2(b)	Vector Graphic	3.2.3.3.6(b)	Vector Graphic
3.2.3.1.3(a)	Vector Graphic	3.2.3.3.6(c)	Vector Graphic
3.2.3.1.3(b)	Vector Graphic	3.2.3.3.6(d)	Vector Graphic
3.2.3.1.4	Scanned	3.2.3.3.6(e)	Vector Graphic
3.2.3.1.5(a)	Vector Graphic	3.2.3.4.1(a)	Vector Graphic
3.2.3.1.5(b)	Vector Graphic	3.2.3.4.1(b)	Vector Graphic
3.2.3.1.6(a)	Vector Graphic	3.2.3.4.1(c)	Vector Graphic
3.2.3.1.6(b)	Vector Graphic	3.2.3.4.1(d)	Vector Graphic
3.2.3.1.6(c)	Vector Graphic	3.2.3.4.1(e)	Scanned
3.2.3.1.6(d)	Vector Graphic	3.2.3.4.1(f)	Scanned
3.2.3.1.6(e)	Vector Graphic	3.2.3.4.2(a)	Vector Graphic
3.2.3.1.6(f)	Vector Graphic	3.2.3.4.2(b)	Vector Graphic
3.2.3.1.6(g)	Vector Graphic	3.2.3.4.3(a)	Vector Graphic
3.2.3.1.6(h)	Vector Graphic	3.2.3.4.3(b)	Vector Graphic
3.2.3.1.6(i)	Vector Graphic	3.2.3.4.5(a)	Vector Graphic
3.2.3.1.6(j)	Vector Graphic	3.2.3.4.5(b)	Vector Graphic
3.2.3.1.6(k)	Vector Graphic	3.2.3.4.6(a)	Vector Graphic
3.2.3.1.6(l)	Vector Graphic	3.2.3.4.6(b)	Vector Graphic
3.2.3.1.6(m)	Vector Graphic	3.2.3.4.6(c)	Vector Graphic
3.2.3.1.6(n)	Vector Graphic	3.2.3.4.6(d)	Vector Graphic
3.2.3.1.6(o)	Vector Graphic	3.2.3.4.6(e)	Vector Graphic
3.2.3.1.6(p)	Vector Graphic	3.2.3.4.6(f)	Vector Graphic
3.2.3.1.6(q)	Vector Graphic	3.2.3.4.6(g)	Vector Graphic
3.2.3.1.6(r)	Vector Graphic	3.2.3.4.6(h)	Vector Graphic
3.2.3.1.6(s)	Vector Graphic	3.2.3.4.6(i)	Vector Graphic
3.2.3.1.6(t)	Vector Graphic	3.2.3.4.6(j)	Vector Graphic
3.2.3.1.6(u)	Vector Graphic	3.2.3.5.1(a)	Vector Graphic
3.2.3.1.6(v)	Vector Graphic	3.2.3.5.1(b)	Vector Graphic
3.2.3.1.6(w)	Vector Graphic	3.2.3.5.1(c)	Vector Graphic
3.2.3.1.6(x)	Vector Graphic	3.2.3.5.1(d)	Vector Graphic
3.2.3.1.6(y)	Vector Graphic	3.2.3.5.2(a)	Vector Graphic
3.2.3.1.6(z)	Vector Graphic	3.2.3.5.2(b)	Vector Graphic
3.2.3.1.6(aa)	Vector Graphic	3.2.3.5.3(a)	Vector Graphic
3.2.3.1.8(a)	Scanned	3.2.3.5.3(b)	Vector Graphic
3.2.3.1.8(b)	Vector Graphic	3.2.3.5.3(c)	Vector Graphic

MIL-HDBK-5J APPENDIX E
31 January 2003

<u>Figure No.</u>	<u>Current Form</u>	<u>Figure No.</u>	<u>Current Form</u>
3.2.3.5.5(a)	Scanned	3.2.11.1.6(c)	Vector Graphic
3.2.3.5.5(b)	Scanned	3.2.12.0	Vector Graphic
3.2.3.5.6(a)	Vector Graphic	3.2.12.1.1(a)	Vector Graphic
3.2.3.5.6(b)	Vector Graphic	3.2.12.1.1(b)	Vector Graphic
3.2.3.5.6(c)	Vector Graphic	3.2.12.1.1(c)	Vector Graphic
3.2.3.5.6(d)	Vector Graphic	3.2.12.1.1(d)	Vector Graphic
3.2.3.5.10(a)	Scanned	3.2.12.1.2	Vector Graphic
3.2.3.5.10(b)	Scanned	3.2.12.1.3	Vector Graphic
3.2.4.0	Vector Graphic	3.2.12.1.4	Vector Graphic
3.2.6.1.6(a)	Vector Graphic	3.2.12.1.5	Vector Graphic
3.2.6.1.6(b)	Vector Graphic	3.2.12.1.6(a)	Vector Graphic
3.2.7.1.1(a)	Vector Graphic	3.2.12.1.6(b)	Vector Graphic
3.2.7.1.1(b)	Vector Graphic	3.5.1.0	Vector Graphic
3.2.7.1.6(a)	Scanned	3.5.1.1.1	Vector Graphic
3.2.7.1.6(b)	Scanned	3.5.1.1.4	Vector Graphic
3.2.7.1.9(a)	Scanned	3.5.1.1.5	Vector Graphic
3.2.7.1.9(b)	Scanned	3.5.1.3.1(a)	Vector Graphic
3.2.7.1.9(c)	Scanned	3.5.1.3.1(b)	Vector Graphic
3.2.7.1.9(d)	Scanned	3.5.1.3.1(c)	Vector Graphic
3.2.7.1.9(e)	Scanned	3.5.1.3.1(d)	Vector Graphic
3.2.8.0	Vector Graphic	3.5.1.3.5(a)	Vector Graphic
3.2.8.1.1(a)	Vector Graphic	3.5.1.3.5(b)	Vector Graphic
3.2.8.1.1(b)	Vector Graphic	3.5.1.5.1(a)	Vector Graphic
3.2.8.1.6(a)	Vector Graphic	3.5.1.5.1(b)	Vector Graphic
3.2.8.1.6(b)	Vector Graphic	3.5.1.5.1(c)	Vector Graphic
3.2.8.2.1(a)	Vector Graphic	3.5.1.5.1(d)	Vector Graphic
3.2.8.2.1(b)	Vector Graphic	3.5.1.5.5(a)	Vector Graphic
3.2.8.2.6(a)	Vector Graphic	3.5.1.5.5(b)	Vector Graphic
3.2.8.2.6(b)	Vector Graphic	3.5.2.0	Vector Graphic
3.2.8.2.8(a)	Scanned	3.5.2.1.6(a)	Vector Graphic
3.2.8.2.8(b)	Scanned	3.5.2.1.6(b)	Vector Graphic
3.2.8.2.8(c)	Scanned	3.5.2.1.6(c)	Vector Graphic
3.2.8.2.8(d)	Scanned	3.5.3.1.6(a)	Vector Graphic
3.2.8.3.6(a)	Vector Graphic	3.5.3.1.6(b)	Vector Graphic
3.2.8.3.6(b)	Vector Graphic	3.5.3.1.6(c)	Vector Graphic
3.2.8.3.6(c)	Vector Graphic	3.5.3.2.6(a)	Vector Graphic
3.2.8.3.6(d)	Vector Graphic	3.5.3.2.6(b)	Vector Graphic
3.2.8.3.6(e)	Vector Graphic	3.5.3.2.6(c)	Vector Graphic
3.2.8.4.1(a)	Vector Graphic	3.5.3.3.6(a)	Vector Graphic
3.2.8.4.1(b)	Vector Graphic	3.5.3.3.6(b)	Vector Graphic
3.2.8.4.6(a)	Vector Graphic	3.5.3.3.6(c)	Vector Graphic
3.2.8.4.6(b)	Vector Graphic	3.5.3.4.6	Vector Graphic
3.2.8.4.6(c)	Vector Graphic	3.5.3.7.6	Vector Graphic
3.2.8.4.6(d)	Vector Graphic	3.5.4.1.6	Vector Graphic
3.2.8.4.6(e)	Vector Graphic	3.5.4.2.6	Vector Graphic
3.2.10.1.6(a)	Vector Graphic	3.5.4.3.6(a)	Vector Graphic
3.2.10.1.6(b)	Vector Graphic	3.5.4.3.6(b)	Vector Graphic
3.2.11.1.6(a)	Vector Graphic	3.5.5.0	Vector Graphic
3.2.11.1.6(b)	Vector Graphic	3.5.5.1.6(a)	Vector Graphic

MIL-HDBK-5J APPENDIX E

31 January 2003

<u>Figure No.</u>	<u>Current Form</u>	<u>Figure No.</u>	<u>Current Form</u>
3.5.5.1.6(b)	Vector Graphic	3.7.3.1.8(b)	Scanned
3.5.5.2.6	Vector Graphic	3.7.3.1.8(c)	Scanned
3.5.5.4.6	Vector Graphic	3.7.3.1.8(d)	Scanned
3.6.1.1.6(a)	Vector Graphic	3.7.3.1.8(e)	Scanned
3.6.1.1.6(b)	Vector Graphic	3.7.3.1.8(f)	Scanned
3.6.2.0	Vector Graphic	3.7.3.1.8(g)	Scanned
3.6.2.2.1(a)	Vector Graphic	3.7.4.1.6(a)	Vector Graphic
3.6.2.2.1(b)	Vector Graphic	3.7.4.1.6(b)	Vector Graphic
3.6.2.2.1(c)	Vector Graphic	3.7.4.1.6(c)	Vector Graphic
3.6.2.2.1(d)	Vector Graphic	3.7.4.1.6(d)	Vector Graphic
3.6.2.2.4	Vector Graphic	3.7.4.1.8(a)	Scanned
3.6.2.2.5(a)	Vector Graphic	3.7.4.1.8(b)	Scanned
3.6.2.2.5(b)	Vector Graphic	3.7.4.2.1	Vector Graphic
3.6.2.2.6(a)	Vector Graphic	3.7.4.2.6(a)	Vector Graphic
3.6.2.2.6(b)	Vector Graphic	3.7.4.2.6(b)	Vector Graphic
3.6.2.2.6(c)	Vector Graphic	3.7.4.2.6(c)	Vector Graphic
3.6.2.2.6(d)	Vector Graphic	3.7.4.2.6(d)	Vector Graphic
3.6.2.2.6(e)	Vector Graphic	3.7.4.2.6(e)	Vector Graphic
3.6.2.2.6(f)	Vector Graphic	3.7.4.2.6(f)	Vector Graphic
3.6.2.2.6(g)	Vector Graphic	3.7.4.2.6(g)	Vector Graphic
3.6.2.2.6(h)	Vector Graphic	3.7.4.2.6(h)	Vector Graphic
3.6.2.2.6(i)	Vector Graphic	3.7.4.2.6(i)	Vector Graphic
3.6.2.2.6(j)	Vector Graphic	3.7.4.2.6(j)	Vector Graphic
3.6.2.2.6(k)	Vector Graphic	3.7.4.2.8(a)	Scanned
3.6.2.2.6(l)	Vector Graphic	3.7.4.2.8(b)	Vector Graphic
3.6.2.2.6(m)	Vector Graphic	3.7.4.2.8(c)	Vector Graphic
3.6.2.2.6(n)	Vector Graphic	3.7.4.2.8(d)	Vector Graphic
3.6.2.2.6(o)	Vector Graphic	3.7.4.2.8(e)	Scanned
3.6.2.2.8	Vector Graphic	3.7.4.2.8(f)	Scanned
3.6.3.0	Vector Graphic	3.7.4.2.8(g)	Scanned
3.7.1.1.1	Vector Graphic	3.7.4.2.8(h)	Scanned
3.7.1.1.6(a)	Vector Graphic	3.7.4.2.8(i)	Scanned
3.7.1.1.6(b)	Vector Graphic	3.7.4.2.8(j)	Scanned
3.7.1.1.6(c)	Vector Graphic	3.7.4.2.8(k)	Scanned
3.7.1.1.6(d)	Vector Graphic	3.7.4.2.8(l)	Scanned
3.7.1.2.6(a)	Vector Graphic	3.7.4.2.9(a)	Scanned
3.7.1.2.6(b)	Vector Graphic	3.7.4.2.9(b)	Scanned
3.7.1.2.6(c)	Vector Graphic	3.7.4.2.9(c)	Scanned
3.7.1.2.6(d)	Vector Graphic	3.7.4.3.6(a)	Vector Graphic
3.7.2.0	Vector Graphic	3.7.4.3.6(b)	Vector Graphic
3.7.3.1.1	Vector Graphic	3.7.4.3.6(c)	Vector Graphic
3.7.3.1.6(a)	Vector Graphic	3.7.4.3.6(d)	Vector Graphic
3.7.3.1.6(b)	Vector Graphic	3.7.4.3.6(e)	Vector Graphic
3.7.3.1.6(c)	Vector Graphic	3.7.4.3.6(f)	Vector Graphic
3.7.3.1.6(d)	Vector Graphic	3.7.4.3.8(a)	Scanned
3.7.3.1.6(e)	Vector Graphic	3.7.4.3.8(b)	Scanned
3.7.3.1.6(f)	Vector Graphic	3.7.6.0	Vector Graphic
3.7.3.1.6(g)	Vector Graphic	3.7.6.1.1(a)	Scanned
3.7.3.1.8(a)	Scanned	3.7.6.1.1(b)	Scanned

MIL-HDBK-5J APPENDIX E

31 January 2003

<u>Figure No.</u>	<u>Current Form</u>	<u>Figure No.</u>	<u>Current Form</u>
3.7.6.1.1(c)	Vector Graphic	3.7.6.2.9(a)	Scanned
3.7.6.1.1(d)	Vector Graphic	3.7.6.2.9(b)	Scanned
3.7.6.1.2(a)	Vector Graphic	3.7.6.2.9(c)	Scanned
3.7.6.1.2(b)	Vector Graphic	3.7.6.2.10(a)	Scanned
3.7.6.1.3(a)	Vector Graphic	3.7.6.2.10(b)	Scanned
3.7.6.1.3(b)	Vector Graphic	3.7.7.1.6(a)	Vector Graphic
3.7.6.1.4	Vector Graphic	3.7.7.1.6(b)	Vector Graphic
3.7.6.1.5(a)	Vector Graphic	3.7.7.1.6(c)	Vector Graphic
3.7.6.1.5(b)	Vector Graphic	3.7.7.1.6(d)	Vector Graphic
3.7.6.1.6(a)	Vector Graphic	3.7.7.2.6(a)	Vector Graphic
3.7.6.1.6(b)	Vector Graphic	3.7.7.2.6(b)	Vector Graphic
3.7.6.1.6(c)	Vector Graphic	3.7.7.2.6(c)	Vector Graphic
3.7.6.1.6(d)	Vector Graphic	3.7.7.2.6(d)	Vector Graphic
3.7.6.1.6(e)	Vector Graphic	3.7.7.2.8(a)	Vector Graphic
3.7.6.1.6(f)	Vector Graphic	3.7.7.2.8(b)	Vector Graphic
3.7.6.1.6(g)	Vector Graphic	3.7.7.2.8(c)	Vector Graphic
3.7.6.1.6(h)	Vector Graphic	3.7.8.1.6(a)	Vector Graphic
3.7.6.1.6(i)	Vector Graphic	3.7.8.1.6(b)	Vector Graphic
3.7.6.1.6(j)	Vector Graphic	3.7.8.1.8(a)	Vector Graphic
3.7.6.1.6(k)	Vector Graphic	3.7.8.1.8(b)	Vector Graphic
3.7.6.1.6(l)	Vector Graphic	3.7.8.1.8(c)	Vector Graphic
3.7.6.1.6(m)	Vector Graphic	3.7.8.1.8(d)	Vector Graphic
3.7.6.1.6(n)	Vector Graphic	3.7.8.2.6(a)	Vector Graphic
3.7.6.1.6(o)	Vector Graphic	3.7.8.2.6(b)	Vector Graphic
3.7.6.1.6(p)	Vector Graphic	3.7.8.2.6(c)	Vector Graphic
3.7.6.1.6(q)	Vector Graphic	3.7.8.2.6(d)	Vector Graphic
3.7.6.1.8(a)	Scanned	3.7.8.2.6(e)	Vector Graphic
3.7.6.1.8(b)	Scanned	3.7.8.2.6(f)	Vector Graphic
3.7.6.1.8(c)	Scanned	3.7.8.2.8(a)	Scanned
3.7.6.1.8(d)	Vector Graphic	3.7.8.2.8(b)	Scanned
3.7.6.1.8(e)	Scanned	3.7.9.1.6(a)	Vector Graphic
3.7.6.1.8(f)	Vector Graphic	3.7.9.1.6(b)	Vector Graphic
3.7.6.1.8(g)	Scanned	3.7.9.1.6(c)	Vector Graphic
3.7.6.1.8(h)	Vector Graphic	3.7.10.1.6(a)	Vector Graphic
3.7.6.1.9	Scanned	3.7.10.1.6(b)	Vector Graphic
3.7.6.1.10(a)	Scanned	3.7.10.1.6(c)	Vector Graphic
3.7.6.1.10(b)	Scanned	3.7.10.1.6(d)	Vector Graphic
3.7.6.1.10(c)	Scanned	3.7.10.1.6(e)	Vector Graphic
3.7.6.1.10(d)	Scanned	3.7.10.1.6(f)	Vector Graphic
3.7.6.1.10(e)	Scanned	3.7.10.1.6(g)	Vector Graphic
3.7.6.1.10(f)	Scanned	3.7.10.1.8(a)	Scanned
3.7.6.1.10(g)	Scanned	3.7.10.1.8(b)	Vector Graphic
3.7.6.1.10(h)	Scanned	3.7.10.1.8(c)	Scanned
3.7.6.2.6(a)	Vector Graphic	3.7.10.1.10(a)	Scanned
3.7.6.2.6(b)	Vector Graphic	3.7.10.1.10(b)	Scanned
3.7.6.2.6(c)	Vector Graphic	3.7.10.1.10(c)	Scanned
3.7.6.2.6(d)	Vector Graphic	3.7.10.1.10(d)	Scanned
3.7.6.2.6(e)	Vector Graphic	3.7.10.2.6(a)	Vector Graphic
3.7.6.2.6(f)	Vector Graphic	3.7.10.2.6(b)	Vector Graphic

MIL-HDBK-5J APPENDIX E
31 January 2003

<u>Figure No.</u>	<u>Current Form</u>	<u>Figure No.</u>	<u>Current Form</u>
3.7.10.2.8(a)	Scanned	4.2.3.0	Vector Graphic
3.7.10.2.8(b)	Scanned	4.2.3.2.6(a)	Vector Graphic
3.7.10.2.9(a)	Scanned	4.2.3.2.6(b)	Scanned
3.7.10.2.9(b)	Scanned	4.2.3.2.8(a)	Scanned
3.7.10.3.6(a)	Vector Graphic	4.2.3.2.8(b)	Scanned
3.7.10.3.6(b)	Vector Graphic	4.2.3.2.8(c)	Scanned
3.7.10.3.6(c)	Vector Graphic	4.3.2.1.4	Vector Graphic
3.7.10.3.6(d)	Vector Graphic	4.3.2.1.6	Vector Graphic
3.7.10.3.6(e)	Vector Graphic	4.3.3.0	Vector Graphic
3.7.10.3.6(f)	Vector Graphic	4.3.3.1.1(a)	Vector Graphic
3.7.10.3.6(g)	Vector Graphic	4.3.3.1.1(b)	Vector Graphic
3.7.10.3.6(h)	Vector Graphic	4.3.3.1.1(c)	Vector Graphic
3.7.10.3.6(i)	Vector Graphic	4.3.3.1.4	Vector Graphic
3.7.10.3.6(j)	Vector Graphic	4.3.3.1.6(a)	Vector Graphic
3.7.10.3.6(k)	Vector Graphic	4.3.3.1.6(b)	Vector Graphic
3.7.10.3.6(l)	Vector Graphic	4.3.4.0	Vector Graphic
3.7.10.3.10(a)	Scanned	4.3.4.1.1(a)	Scanned
3.7.10.3.10(b)	Scanned	4.3.4.1.1(b)	Scanned
3.8.1.0	Vector Graphic	4.3.4.1.1(C)	Scanned
3.8.1.1.6	Vector Graphic	4.3.4.1.6	Vector Graphic
3.8.1.1.8(a)	Scanned	4.3.5.1.1	Scanned
3.8.1.1.8(b)	Scanned	4.3.5.1.4	Scanned
3.8.1.1.8(c)	Scanned	4.3.5.1.6	Vector Graphic
3.9.2.0	Vector Graphic	4.3.6.0	Scanned
3.9.4.0	Vector Graphic	4.3.6.1.1	Scanned
3.9.5.1.6(a)	Vector Graphic	4.3.6.1.4	Scanned
3.9.5.1.6(b)	Vector Graphic	4.3.6.1.6(a)	Scanned
3.9.6.1.6	Vector Graphic	4.3.6.1.6(b)	Vector Graphic
3.9.7.1.6	Vector Graphic	4.4.2.3(a)	Scanned
3.10.1.1.1	Vector Graphic	4.4.2.3(b)	Scanned
3.10.2.3(a)	Scanned	4.4.3.2	Scanned
3.10.2.3(b)	Scanned	5.2.1.0	Scanned
3.10.3.2(a)	Scanned	5.2.1.1.1(a)	Scanned
3.10.3.2(b)	Vector Graphic	5.2.1.1.1(b)	Scanned
3.10.3.2(c)	Scanned	5.2.1.1.2(a)	Scanned
3.10.3.2(d)	Scanned	5.2.1.1.2(b)	Scanned
3.10.3.2(e)	Vector Graphic	5.2.1.1.3(a)	Scanned
3.10.3.2(f)	Vector Graphic	5.2.1.1.3(b)	Scanned
3.10.3.2(g)	Vector Graphic	5.2.1.1.6(a)	Scanned
4.2.1.0	Vector Graphic	5.2.1.1.6(b)	Scanned
4.2.1.1.4	Scanned	5.3.1.0	Vector Graphic
4.2.1.1.6	Vector Graphic	5.3.1.1.1	Scanned
4.2.1.2.1	Scanned	5.3.1.1.2	Scanned
4.2.1.2.2	Scanned	5.3.1.1.3	Scanned
4.2.1.2.3	Scanned	5.3.1.1.4	Scanned
4.2.1.2.4	Scanned	5.3.1.1.5	Scanned
4.2.1.2.6	Vector Graphic	5.3.1.1.9(a)	Scanned
4.2.1.4.8(a)	Vector Graphic	5.3.1.1.9(b)	Scanned
4.2.1.4.8(b)	Scanned	5.3.1.1.9(c)	Scanned

MIL-HDBK-5J APPENDIX E
31 January 2003

<u>Figure No.</u>	<u>Current Form</u>	<u>Figure No.</u>	<u>Current Form</u>
5.3.2.0	Scanned	5.4.1.2.6(g)	Vector Graphic
5.3.2.1.1	Scanned	5.4.1.2.6(h)	Scanned
5.3.2.1.4	Scanned	5.4.1.2.7	Scanned
5.3.2.1.6(a)	Vector Graphic	5.4.1.2.8(a)	Scanned
5.3.2.1.6(b)	Vector Graphic	5.4.1.2.8(b)	Scanned
5.3.2.2.1	Scanned	5.4.1.2.8(c)	Scanned
5.3.2.2.6(a)	Vector Graphic	5.4.1.2.8(d)	Scanned
5.3.2.2.6(b)	Vector Graphic	5.4.1.2.8(e)	Scanned
5.3.2.2.8(a)	Scanned	5.4.1.2.8(f)	Scanned
5.3.2.2.8(b)	Scanned	5.4.1.2.8(g)	Scanned
5.3.2.2.8(c)	Scanned	5.4.1.2.8(h)	Scanned
5.3.2.2.8(d)	Scanned	5.4.1.2.8(i)	Scanned
5.3.2.2.8(e)	Scanned	5.4.2.0	Scanned
5.3.2.2.8(f)	Scanned	5.4.2.1.1(a)	Scanned
5.3.3.0	Scanned	5.4.2.1.1(b)	Scanned
5.3.3.1.1	Scanned	5.4.2.1.2(a)	Scanned
5.3.3.1.2	Scanned	5.4.2.1.2(b)	Scanned
5.3.3.1.4	Scanned	5.4.2.1.3(a)	Scanned
5.3.3.1.6(a)	Vector Graphic	5.4.2.1.3(b)	Scanned
5.3.3.1.6(b)	Vector Graphic	5.4.2.1.6(a)	Vector Graphic
5.3.3.1.6(c)	Scanned	5.4.2.1.6(b)	Vector Graphic
5.4.1.0	Vector Graphic	5.4.2.1.6(c)	Scanned
5.4.1.1.1	Vector Graphic	5.4.2.1.8(a)	Scanned
5.4.1.1.2	Scanned	5.4.2.1.8(b)	Scanned
5.4.1.1.3	Scanned	5.4.2.2.1	Scanned
5.4.1.1.4	Scanned	5.4.2.2.2	Scanned
5.4.1.1.5	Scanned	5.4.3.1(a)	Vector Graphic
5.4.1.1.6(a)	Vector Graphic	5.4.3.1(b)	Vector Graphic
5.4.1.1.6(b)	Vector Graphic	5.4.3.1(c)	Vector Graphic
5.4.1.1.6(c)	Vector Graphic	5.4.3.2(a)	Scanned
5.4.1.1.6(d)	Scanned	5.4.3.2(b)	Scanned
5.4.1.1.8(a)	Scanned	5.4.3.3	Scanned
5.4.1.1.8(b)	Scanned	5.5.1.0	Scanned
5.4.1.1.8(c)	Scanned	5.5.1.1.1	Scanned
5.4.1.1.8(d)	Scanned	5.5.1.1.2	Scanned
5.4.1.1.8(e)	Scanned	5.5.1.1.3(a)	Scanned
5.4.1.1.8(f)	Scanned	5.5.1.1.3(b)	Scanned
5.4.1.1.8(g)	Scanned	5.5.1.1.4	Scanned
5.4.1.1.9	Scanned	5.5.1.1.6	Vector Graphic
5.4.1.2.1	Scanned	5.5.1.1.8(a)	Scanned
5.4.1.2.2	Scanned	5.5.1.1.8(b)	Scanned
5.4.1.2.3	Scanned	5.5.1.1.8(c)	Scanned
5.4.1.2.4	Scanned	5.5.1.1.8(d)	Scanned
5.4.1.2.6(a)	Vector Graphic	5.5.1.2.1	Scanned
5.4.1.2.6(b)	Vector Graphic	5.5.1.2.2	Scanned
5.4.1.2.6(c)	Vector Graphic	5.5.1.2.3	Scanned
5.4.1.2.6(d)	Vector Graphic	5.5.1.2.4	Scanned
5.4.1.2.6(e)	Vector Graphic	5.5.1.2.6	Vector Graphic
5.4.1.2.6(f)	Vector Graphic	5.5.1.2.8(a)	Scanned

MIL-HDBK-5J APPENDIX E
31 January 2003

<u>Figure No.</u>	<u>Current Form</u>	<u>Figure No.</u>	<u>Current Form</u>
5.5.1.2.8(b)	Scanned	6.3.4.1.4	Vector Graphic
5.5.1.2.8(c)	Scanned	6.3.4.1.5	Vector Graphic
5.5.2.0	Scanned	6.3.4.1.6(a)	Vector Graphic
5.5.2.1.6(a)	Vector Graphic	6.3.4.1.6(b)	Vector Graphic
5.5.2.1.6(b)	Vector Graphic	6.3.4.1.6(c)	Scanned
5.5.3.1.6	Vector Graphic	6.3.5.0	Vector Graphic
5.5.3.2.6	Vector Graphic	6.3.5.1.1	Scanned
5.6.1.1.1	Scanned	6.3.5.1.4(a)	Scanned
6.2.1.0	Scanned	6.3.5.1.4(b)	Scanned
6.2.1.1.1	Scanned	6.3.5.1.4(c)	Scanned
6.2.1.1.3	Scanned	6.3.5.1.6(a)	Vector Graphic
6.2.1.1.4(a)	Scanned	6.3.5.1.6(b)	Vector Graphic
6.2.1.1.4(b)	Scanned	6.3.5.1.6(c)	Vector Graphic
6.2.1.1.4(c)	Scanned	6.3.5.1.6(d)	Scanned
6.2.1.1.8(a)	Scanned	6.3.5.1.7(a)	Scanned
6.2.1.1.8(b)	Scanned	6.3.5.1.7(b)	Scanned
6.2.1.1.8(c)	Scanned	6.3.5.1.7(c)	Scanned
6.2.1.1.8(d)	Scanned	6.3.5.1.7(d)	Vector Graphic
6.2.1.1.8(e)	Scanned	6.3.5.1.7(e)	Vector Graphic
6.2.2.0	Scanned	6.3.5.1.8(a)	Vector Graphic
6.2.2.1.1(a)	Scanned	6.3.5.1.8(b)	Vector Graphic
6.2.2.1.1(b)	Scanned	6.3.5.1.8(c)	Vector Graphic
6.2.2.1.4(a)	Scanned	6.3.5.1.8(d)	Vector Graphic
6.2.2.1.4(b)	Scanned	6.3.5.1.8(e)	Vector Graphic
6.3.1.0	Scanned	6.3.5.1.8(f)	Vector Graphic
6.3.1.1.1	Scanned	6.3.5.1.8(g)	Vector Graphic
6.3.1.1.4	Scanned	6.3.5.1.9(a)	Vector Graphic
6.3.1.1.6(a)	Vector Graphic	6.3.5.1.9(b)	Scanned
6.3.1.1.6(b)	Vector Graphic	6.3.5.1.9(c)	Scanned
6.3.2.0	Scanned	6.3.6.0	Scanned
6.3.2.1.1	Scanned	6.3.6.1.1	Scanned
6.3.2.1.2	Scanned	6.3.6.1.2	Scanned
6.3.2.1.3	Scanned	6.3.6.1.3	Scanned
6.3.2.1.4	Scanned	6.3.6.2.1(a)	Scanned
6.3.3.0	Scanned	6.3.6.2.1(b)	Scanned
6.3.3.1.1(a)	Scanned	6.3.6.2.4(a)	Scanned
6.3.3.1.1(b)	Scanned	6.3.6.2.4(b)	Scanned
6.3.3.1.4(a)	Scanned	6.3.7.0	Scanned
6.3.3.1.4(b)	Scanned	6.3.7.1.1	Vector Graphic
6.3.3.1.6(a)	Vector Graphic	6.3.7.1.2	Vector Graphic
6.3.3.1.6(b)	Vector Graphic	6.3.7.1.3(a)	Scanned
6.3.3.1.6(c)	Vector Graphic	6.3.7.1.3(b)	Scanned
6.3.3.1.6(d)	Vector Graphic	6.3.7.1.4	Scanned
6.3.3.1.8(a)	Scanned	6.3.7.1.5	Scanned
6.3.3.1.8(b)	Scanned	6.3.7.1.7	Scanned
6.3.3.1.8(c)	Scanned	6.3.8.0	Scanned
6.3.3.1.8(d)	Scanned	6.3.8.1.1	Scanned
6.3.4.0	Vector Graphic	6.3.8.1.4	Scanned
6.3.4.1.1	Vector Graphic	6.3.8.1.5(a)	Scanned

MIL-HDBK-5J APPENDIX E
31 January 2003

<u>Figure No.</u>	<u>Current Form</u>	<u>Figure No.</u>	<u>Current Form</u>
6.3.8.1.5(b)	Scanned	7.2.1.1.1	Vector Graphic
6.3.8.1.6(a)	Scanned	7.2.1.1.4	Vector Graphic
6.3.8.1.6(b)	Scanned	7.3.2.0	Vector Graphic
6.3.9.0(a)	Vector Graphic	7.3.2.1.6(a)	Vector Graphic
6.3.9.0(b)	Vector Graphic	7.3.2.1.6(b)	Vector Graphic
6.3.9.0(c)	Vector Graphic	7.3.2.2.6	Vector Graphic
6.3.9.1.1(a)	Vector Graphic	7.4.1.0	Scanned
6.3.9.1.1(b)	Vector Graphic	7.4.1.1.1	Scanned
6.3.9.1.4	Vector Graphic	7.4.1.1.4(a)	Scanned
6.3.9.1.5	Vector Graphic	7.4.1.1.4(b)	Scanned
6.3.9.1.6(a)	Vector Graphic	7.4.1.1.5	Scanned
6.3.9.1.6(b)	Vector Graphic	7.4.1.1.6	Vector Graphic
6.3.9.1.6(c)	Vector Graphic	7.4.2.0	Scanned
6.3.9.1.6(d)	Vector Graphic	7.4.2.1.4	Scanned
6.3.9.1.6(e)	Vector Graphic	7.4.2.1.6	Vector Graphic
6.3.9.1.6(f)	Vector Graphic	7.5.1.1.6(a)	Vector Graphic
6.3.9.1.6(g)	Vector Graphic	7.5.1.1.6(b)	Vector Graphic
6.3.9.1.6(h)	Vector Graphic	7.5.1.1.6(c)	Vector Graphic
6.3.9.1.6(i)	Vector Graphic	7.5.1.1.6(d)	Vector Graphic
6.3.10.0(a)	Vector Graphic	7.5.1.1.6(e)	Vector Graphic
6.3.10.0(b)	Vector Graphic	7.5.1.1.6(f)	Vector Graphic
6.3.10.0(c)	Vector Graphic	7.5.1.1.6(g)	Vector Graphic
6.3.10.0(d)	Vector Graphic	7.5.1.1.6(h)	Vector Graphic
6.3.10.1.1(a)	Vector Graphic	7.5.1.1.6(i)	Vector Graphic
6.3.10.1.7(a)	Vector Graphic	7.5.1.1.6(j)	Vector Graphic
6.3.10.1.7(b)	Vector Graphic	7.5.1.1.6(k)	Vector Graphic
6.4.1.0	Scanned	7.5.1.1.6(l)	Vector Graphic
6.4.1.1.1	Vector Graphic	7.5.2.1.6(a)	Vector Graphic
6.4.1.1.2	Vector Graphic	7.5.2.1.6(b)	Vector Graphic
6.4.1.1.3	Vector Graphic	7.5.2.1.6(c)	Vector Graphic
6.4.1.1.4(a)	Vector Graphic	7.5.2.1.6(d)	Vector Graphic
6.4.1.1.4(b)	Scanned	7.5.2.1.6(e)	Vector Graphic
6.4.1.1.5	Scanned	7.5.2.1.6(f)	Vector Graphic
6.4.1.1.7	Scanned	7.5.2.1.6(g)	Vector Graphic
6.4.2.0	Scanned	7.5.2.1.6(h)	Vector Graphic
6.4.2.1.1(a)	Scanned	7.5.2.1.6(i)	Vector Graphic
6.4.2.1.1(b)	Scanned	7.5.2.1.6(j)	Vector Graphic
6.4.2.1.2	Scanned	8.2.1	Scanned
6.4.2.1.4(a)	Scanned	8.2.2.3.1.1(a)	Scanned
6.4.2.1.4(b)	Scanned	8.2.2.3.1.1(b)	Scanned
6.4.2.1.4(c)	Scanned	8.2.2.3.1.1(c)	Scanned
6.4.2.1.5	Scanned	8.2.2.3.2.1	Scanned
6.4.2.1.6(a)	Vector Graphic	8.2.2.3.2.2(a)	Scanned
6.4.2.1.6(b)	Vector Graphic	8.2.2.3.2.2(b)	Scanned
6.4.2.1.8(a)	Scanned	8.2.2.3.2.2(c)	Scanned
6.4.2.1.8(b)	Scanned	8.2.2.3.2.2(d)	Scanned
6.4.2.1.8(c)	Scanned	8.2.2.3.2.2(e)	Scanned
6.4.2.1.8(d)	Scanned	9.2.3	Scanned
7.2.1.0	Vector Graphic	9.2.4	Scanned

MIL-HDBK-5J APPENDIX E**31 January 2003**

<u>Figure No.</u>	<u>Current Form</u>	<u>Figure No.</u>	<u>Current Form</u>
9.2.6	Scanned	9.3.5.1(a)	Scanned
9.2.11	Scanned	9.3.5.1(b)	Scanned
9.2.12	Scanned	9.3.5.2	Scanned
9.2.15(a)	Scanned	9.3.5.6	Scanned
9.2.15(b)	Scanned	9.3.6.2	Scanned
9.3.1.1.2	Scanned	9.3.6.7	Scanned
9.3.1.1.3(a)	Scanned	9.3.6.8(a)	Scanned
9.3.1.1.3(b)	Scanned	9.3.6.8(b)	Scanned
9.3.1.2	Scanned	9.3.6.8(c)	Scanned
9.3.1.3	Scanned	9.3.6.8(d)	Scanned
9.3.1.4(a)	Scanned	9.4.1.3	Scanned
9.3.1.4(b)	Scanned	9.4.1.3.4(a)	Scanned
9.3.1.5	Scanned	9.4.1.3.4(b)	Scanned
9.3.1.6.1	Scanned	9.4.1.3.4(c)	Scanned
9.3.1.6.2	Vector Graphic	9.4.1.3.4(d)	Scanned
9.3.2.3(a)	Scanned	9.4.1.3.4(e)	Scanned
9.3.2.3(b)	Scanned	9.4.1.5.2(a)	Scanned
9.3.2.3(c)	Vector Graphic	9.4.1.5.2(b)	Scanned
9.3.2.4	Scanned	9.4.1.5.2(c)	Scanned
9.3.2.5(a)	Scanned	9.4.1.5.2(d)	Scanned
9.3.2.5(b)	Vector Graphic	9.4.1.5.2(e)	Scanned
9.3.2.5(c)	Vector Graphic	9.4.1.5.2(f)	Scanned
9.3.2.5(d)	Vector Graphic	9.4.1.5.2(g)	Scanned
9.3.2.7(a)	Scanned	9.4.1.5.2(h)	Scanned
9.3.2.7(b)	Scanned	9.4.1.5.3	Scanned
9.3.2.7(c)	Scanned	9.4.1.6	Scanned
9.3.4.1(a)	Scanned	9.4.1.7.2	Scanned
9.3.4.1(b)	Scanned	9.4.1.7.2, cont.	Scanned
9.3.4.1(c)	Scanned	9.4.2.2	Scanned
9.3.4.1(d)	Scanned	9.4.2.3.2	Scanned
9.3.4.3	Scanned	9.4.2.3.5(a)	Scanned
9.3.4.4	Scanned	9.4.2.3.5(b)	Scanned
9.3.4.5	Scanned	9.4.2.5.2	Scanned
9.3.4.7	Scanned	9.4.2.5.3	Scanned
9.3.4.10(a)	Scanned	9.5.1.3	Scanned
9.3.4.10(b)	Scanned	9.5.1.5.1(a)	Scanned
9.3.4.10(c)	Scanned	9.5.1.5.1(b)	Scanned
9.3.4.12(a)	Scanned	9.5.1.5.1(c)	Scanned
9.3.4.12(b)	Scanned	9.5.1.5.3	Scanned
9.3.4.13	Scanned	9.6.3	Scanned
9.3.4.16(a)	Scanned	A.1	Scanned
9.3.4.17(a)	Scanned		
9.3.4.17(b)	Scanned		
9.3.4.17(c)	Scanned		
9.3.4.17(d)	Scanned		
9.3.4.17(e)	Scanned		
9.3.4.17(f)	Scanned		
9.3.4.17(g)	Scanned		
9.3.4.17(h)	Scanned		

MIL-HDBK-5J
31 January 2003

Custodians:

Army – AV
Navy – AS
Air Force – 11

Preparing activity:

Air Force – 11
(Project 1560-0027)

Review activities:

Army – MI
Navy – CG
Air Force – 84, 99

Civil Agency Coordinating Activity:

FAA Technical Center

THIS PAGE INTENTIONALLY BLANK

STANDARDIZATION DOCUMENT IMPROVEMENT PROPOSAL

INSTRUCTIONS

1. The preparing activity must complete blocks 1, 2, 3, and 8. In block 1, both the document number and revision letter should be given.
2. The submitter of this form must complete blocks 4, 5, 6, and 7, and send to preparing activity.
3. The preparing activity must provide a reply within 30 days from receipt of the form.

NOTE: This form may not be used to request copies of documents, nor to request waivers, or clarification of requirements on current contracts. Comments submitted on this form do not constitute or imply authorization to waive any portion of the referenced document(s) or to amend contractual requirements.

I RECOMMEND A CHANGE:		1. DOCUMENT NUMBER MIL-HDBK-5J	2. DOCUMENT DATE (YYYYMMDD) 20030131
3. DOCUMENT TITLE METALLIC MATERIALS AND ELEMENTS FOR AEROSPACE VEHICLE STRUCTURES			
4. NATURE OF CHANGE <i>(Identify paragraph number and include proposed rewrite, if possible. Attach extra sheets as needed.)</i>			
5. REASON FOR RECOMMENDATION			
6. SUBMITTER			
a. NAME <i>(Last, First, Middle Initial)</i>		b. ORGANIZATION	
c. ADDRESS <i>(Include Zip Code)</i>		d. TELEPHONE <i>(Include Area Code)</i> (1) Commercial (2) DSN <i>(if applicable)</i>	7. DATE SUBMITTED (YYYYMMDD)
8. PREPARING ACTIVITY			
a. NAME AIR FORCE CODE 11		b. TELEPHONE <i>Include Area Code</i> (1) Commercial (937) 255-6282 (2) DSN 785-6282	
c. ADDRESS <i>(Include Zip Code)</i> ASC/ENOI 2530 LOOP ROAD WEST WRIGHT-PATTERSON AFB OH 45433-7101		IF YOU DO NOT RECEIVE A REPLY WITHIN 45 DAYS, CONTACT: Defense Standardization Program Office (DLSC-LM) 8725 John J. Kingman road, Suite 2533, Ft. Belvoir, VA 22060-2533 Telephone (703) 767-6888 DSN 427-6888	