

Steve Krug



**DON'T  
MAKE  
ME  
THINK**

*revisited*

*and Mobile*

A Common Sense Approach to Web Usability

# **Don't Make Me Think, Revisited**

**A Common Sense Approach to Web Usability**

**Steve Krug**



# **Don't Make Me Think, Revisited**

## **A Common Sense Approach to Web Usability**

Copyright © 2014 Steve Krug

New Riders

[www.newriders.com](http://www.newriders.com)

To report errors, please send a note to [errata@peachpit.com](mailto:errata@peachpit.com)

New Riders is an imprint of Peachpit, a division of Pearson Education.

Editor: Elisabeth Bayle

Project Editor: Nancy Davis

Production Editor: Lisa Brazieal

Copy Editor: Barbara Flanagan

Interior Design and Composition: Romney Lange

Illustrations by Mark Matcho and Mimi Heft

Farnham fonts provided by The Font Bureau, Inc. ([www.fontbureau.com](http://www.fontbureau.com))

### **Notice of Rights**

All rights reserved. No part of this book may be reproduced or transmitted in any form by any means, electronic, mechanical, photocopying, recording, or otherwise, without the prior written permission of the publisher. For information on getting permission for reprints and excerpts, contact [permissions@peachpit.com](mailto:permissions@peachpit.com).

### **Notice of Liability**

The information in this book is distributed on an “As Is” basis, without warranty. While every precaution has been taken in the preparation of the book, neither the author nor Peachpit shall have any liability to any person or entity with respect to any loss or damage caused or alleged to be caused directly or indirectly by the instructions contained in this book or by the computer software and hardware products described in it.

### **Trademarks**

It's not rocket surgery™ is a trademark of Steve Krug.

Many of the designations used by manufacturers and sellers to distinguish their products are claimed as trademarks. Where those designations appear in this book, and Peachpit was aware of a trademark claim, the designations

appear as requested by the owner of the trademark. All other product names and services identified throughout this book are used in editorial fashion only and for the benefit of such companies with no intention of infringement of the trademark. No such use, or the use of any trade name, is intended to convey endorsement or other affiliation with this book.

ISBN-13: 978-0-321-96551-6

ISBN-10: 0-321-96551-5

9 8 7 6 5 4 3 2 1

Printed and bound in the United States of America



## First Edition

*To my father, who always wanted me to write a book,  
My mother, who always made me feel like I could,  
Melanie, who married me—the greatest stroke of good fortune of my life,  
and my son, Harry, who will surely write books much better than this one  
whenever he wants to.*

## Second Edition

*To my big brother, Phil, who was a mensch his whole life.*



## Third Edition

*To all the people—from all parts of the world—who have been so nice about  
this book for fourteen years. Your kind words—in person, in email, and in  
your blogs—have been one of the great joys of my life.*

*Especially the woman who said it made her laugh so hard that milk came out  
of her nose.*

# Contents

## PREFACE [About this edition](#)

### INTRODUCTION [Read me first](#)

*Throat clearing and disclaimers*

## GUIDING PRINCIPLES

### CHAPTER 1 [Don't make me think!](#)

*Krug's First Law of Usability*

### CHAPTER 2 [How we really use the Web](#)

*Scanning, satisficing, and muddling through*

### CHAPTER 3 [Billboard Design 101](#)

*Designing for scanning, not reading*

### CHAPTER 4 [Animal, Vegetable, or Mineral?](#)

*Why users like mindless choices*

### CHAPTER 5 [Omit ~~needless~~ words](#)

*The art of not writing for the Web*

## THINGS YOU NEED TO GET RIGHT

### CHAPTER 6 [Street signs and Breadcrumbs](#)

*Designing navigation*

### CHAPTER 7 [The Big Bang Theory of Web Design](#)

*The importance of getting people off on the right foot*

## MAKING SURE YOU GOT THEM RIGHT

### CHAPTER 8 ["The Farmer and the Cowman Should Be Friends"](#)

*Why most arguments about usability are a waste of time, and how to*

*avoid them*

**[CHAPTER 9 Usability testing on 10 cents a day](#)**

*Keeping testing simple—so you do enough of it*

**LARGER CONCERNS AND OUTSIDE INFLUENCES**

**[CHAPTER 10 Mobile: It's not just a city in Alabama anymore](#)**

*Welcome to the 21st Century. You may experience a slight sense of vertigo*

**[CHAPTER 11 Usability as common courtesy](#)**

*Why your Web site should be a mensch*

**[CHAPTER 12 Accessibility and you](#)**

*Just when you think you're done, a cat floats by with buttered toast strapped to its back*

**[CHAPTER 13 Guide for the perplexed](#)**

*Making usability happen where you live*

**[Acknowledgments](#)**

**[Index](#)**

## Preface: About this edition

*People come and go so quickly here!*

—DOROTHY GALE (JUDY GARLAND) IN *THE WIZARD OF OZ* (1939)

I wrote the first edition of *Don't Make Me Think* back in 2000.

By 2002, I began to get a few emails a year from readers asking (very politely) if I'd thought about updating it. Not complaining; just trying to be helpful. "A lot of the examples are out of date" was the usual comment.

My standard response was to point out that since I wrote it right around the time the Internet bubble burst, many of the sites I used as examples had already disappeared by the time it was published. But I didn't think that made the examples any less clear.

Finally, in 2006 I had a strong personal incentive to update it.<sup>1</sup> But as I reread it to see what I should change, I just kept thinking "This is all still true." I really couldn't find much of anything that I thought should be changed.

<sup>1</sup> *Half of the royalties for the book were going to a company that no longer existed, and doing a new edition meant a new contract—and twice the royalties—for me.*

If it was a new edition, though, *something* had to be different. So I added three chapters that I didn't have time to finish back in 2000, hit the snooze button, and happily pulled the covers back over my head for another seven years.

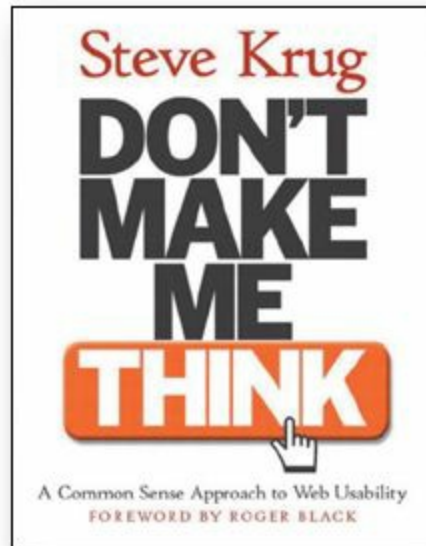

2000

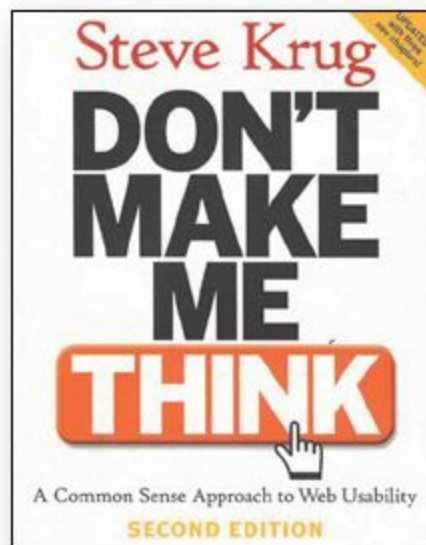

2006

(Writing is really hard for me, and I'm always happy to have a reason not to do it. Give me a good old root canal over writing any day.)

So why now, finally, a new edition? Two reasons.

### **#1. Let's face it: It's old**

There's no doubt about it at this point: It feels dated. After all, it's thirteen

years old, which is like a hundred years in Internet time. (See? Nobody even says things like “in Internet time” anymore.)

Most of the Web pages I used for examples, like Senator Orrin Hatch’s campaign site for the 2000 election, look really old-fashioned now.

Sites these days tend to look a lot more sophisticated, as you might expect.



[www.orrinhatch.com](http://www.orrinhatch.com) 1999

The screenshot shows the website for Orrin Hatch's 2012 campaign. At the top left is the logo 'Orrin ORRIN HATCH FOR UTAH'. A navigation bar includes links for 'Orrin', 'Issues', 'Multimedia', 'Volunteer', 'Blog', and a 'CONTRIBUTE' button. The main banner features a portrait of Orrin Hatch and the text: 'THANK YOU UTAH NOW ITS ON TO NOVEMBER IT'S UTAH'S TIME TO LEAD'. Below the banner is a 'DONATE NOW' section with a progress bar showing donation levels from \$100k to \$900k, and a 'LATEST NEWS' section with an article titled '5 Entitlement Reforms For A Better Fiscal Course'. On the right side, there is a '3 WAYS TO GET INVOLVED' section with options to 'JOIN THE TEAM', 'SHARE WITH FRIENDS', and 'VOTE EARLY FOR HATCH'.

[www.orrinhatch.com](http://www.orrinhatch.com) 2012

Recently I've been starting to worry that the book would finally reach a point where it felt so dated that it would stop being effective. I know it hasn't happened yet because

- It's still selling steadily (thank heavens), without any sign of slowing down. It's even become required reading in a lot of courses, something I never expected.
- New readers from all over the world continue to tweet about things they've learned from it.



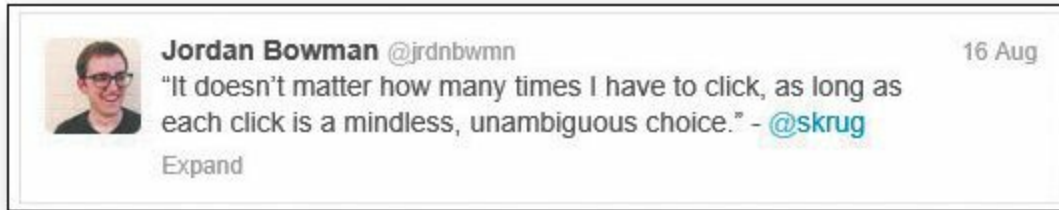

- I still keep hearing this story: “I gave it to my boss, hoping he’d finally understand what I’m talking about. He actually read it, and then he bought it for our whole team/department/company!” (I love that story.)
- People keep telling me that they got their job thanks in part to reading it or that it influenced their choice of a career.<sup>2</sup>

<sup>2</sup> *I'm enormously pleased and flattered, but I have to admit there's always a part of me that's thinking "Yikes! I hope she wasn't meant to be a brain surgeon. What have I done?"*

But I know that eventually the aging effect is going to keep people from reading it, for the same reason that it was so hard to get my son to watch black and white movies when he was young, no matter how good they were. Clearly, it's time for new examples.

## **#2. The world has changed**

To say that computers and the Internet and the way we use them have changed a lot lately is putting it mildly. Very mildly.



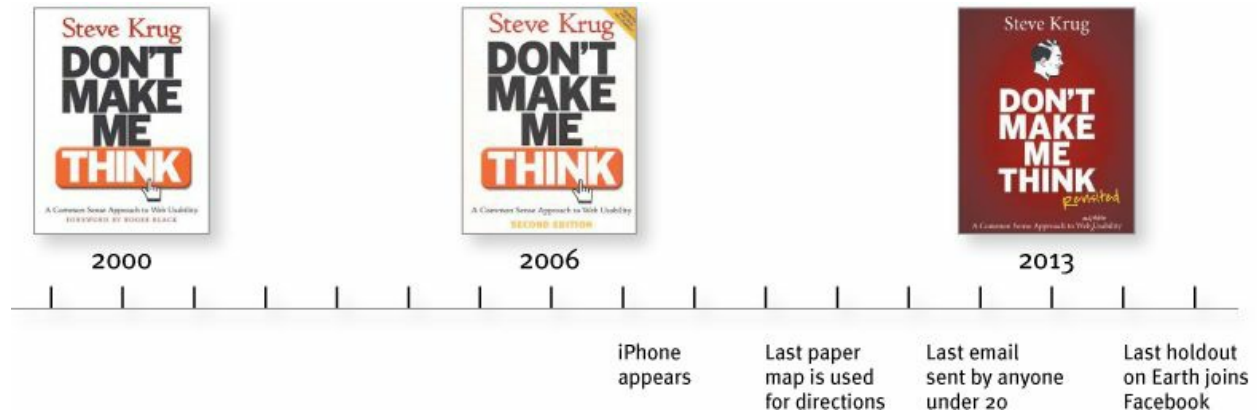

The landscape has changed in three ways:

- **Technology got its hands on some steroids.** In 2000, we were using the Web on relatively large screens, with a mouse or touchpad and a keyboard. And we were sitting down, often at a desk, when we did. Now we use tiny computers that we carry around with us all the time, with still and video cameras, magical maps that know exactly where we are, and our entire libraries of books and music built in. And are always connected to the Internet. Oh, and they're phones, too.

Heck, I can use my “phone” to

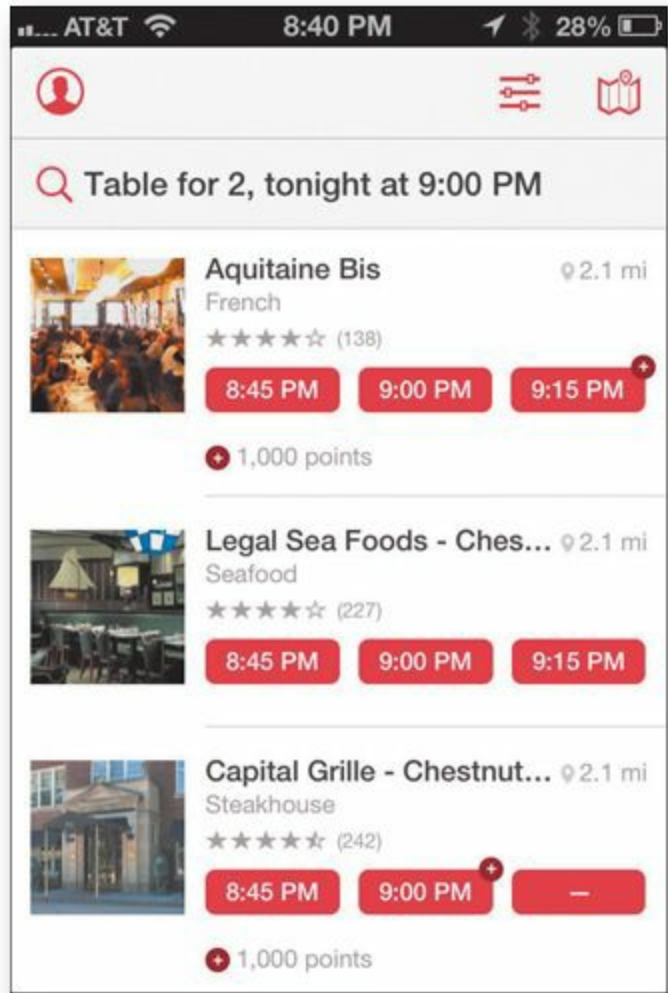

...book a restaurant reservation in seconds



...adjust the heat in my house from anywhere

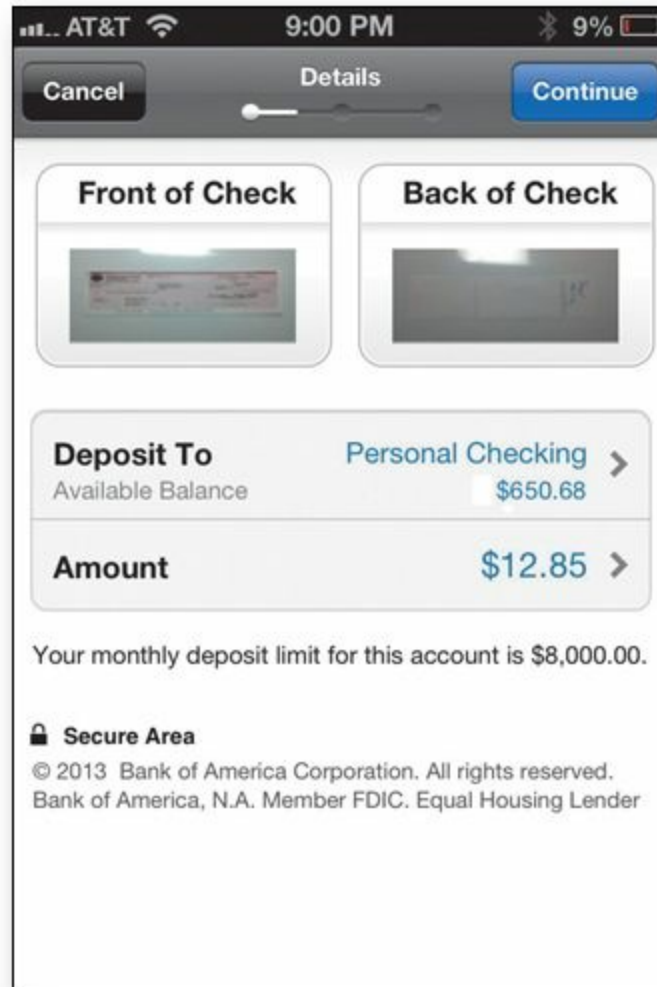

...or deposit a check without going to an ATM

It's no flying car (which, come to think of it, we were promised we'd have by now), but it's pretty impressive.

- **The Web itself kept improving.** Even when I'm using my desktop computer to do all the things I've always done on the Web (buying stuff, making travel plans, connecting with friends, reading the news, and settling bar bets), the sites I use tend to be much more powerful and useful than their predecessors.

We've come to expect things like autosuggest and autocorrect, and we're annoyed when we *can't* pay a parking ticket or renew a driver's license online.

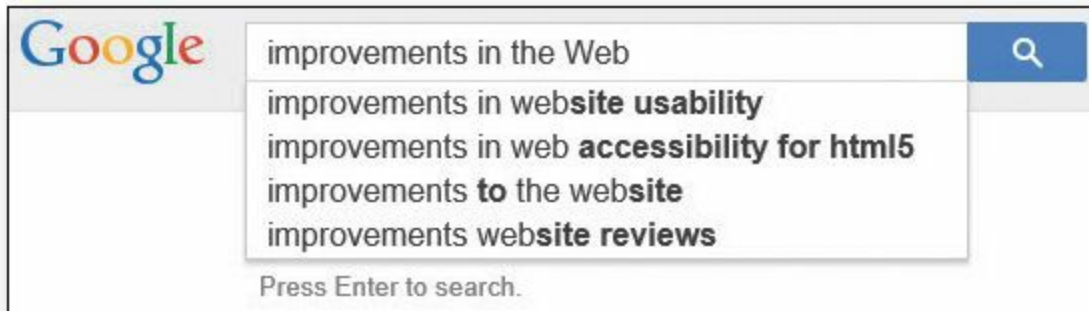

- **Usability went mainstream.** In 2000, not that many people understood the importance of usability.

Now, thanks in large part to Steve Jobs (and Jonathan Ive), almost everyone understands that it's important, even if they're still not entirely sure what it is. Except now they usually call it User Experience Design (UXD or just UX), an umbrella term for any activity or profession that contributes to a better experience for the user.

It's great that there's now so much more emphasis on designing for the user, but all the new job descriptions, subspecialties, and tools that have come along with this evolution have left a lot of people confused about what they should actually *do* about it.

I'll be talking about all three of these changes throughout the book.

### **Don't get me wrong...**

This edition has new examples, some new principles, and a few things I've learned along the way, but it's still the same book, with the same purpose: It's still a book about designing great, usable Web sites.

And it's also still a book about designing anything that people need to interact with, whether it's a microwave oven, a mobile app, or an ATM.

The basic principles are the same even if the landscape has changed, because usability is about people and how they understand and use things, not about technology. And while technology often changes quickly, people change very slowly.<sup>3</sup>

<sup>3</sup> *There's a wonderful Norwegian video (with subtitles) about this that shows a monk getting help as he struggles to use the newfangled "book." (Search for "medieval helpdesk" on YouTube.)*



Or as Jakob Nielsen so aptly put it:

The human brain's capacity doesn't change from one year to the next, so the insights from studying human behavior have a very long shelf life. What was difficult for users twenty years ago continues to be difficult today.

I hope you enjoy the new edition. And don't forget to wave in a few years when you pass me in your flying car.

STEVE KRUG

NOVEMBER 2013

# Introduction: Read me first

## THROAT CLEARING AND DISCLAIMERS

*I can't tell you anything you don't already know. But I'd like to clarify a few things.*

—JOE FERRARA, A HIGH SCHOOL FRIEND OF MINE

I have a great job. I'm a usability consultant. Here's what I do:

- People (“clients”) send me something they're working on.

It could be designs for a new Web site they're building, or the URL of a site that they're redesigning, or a prototype of an app.

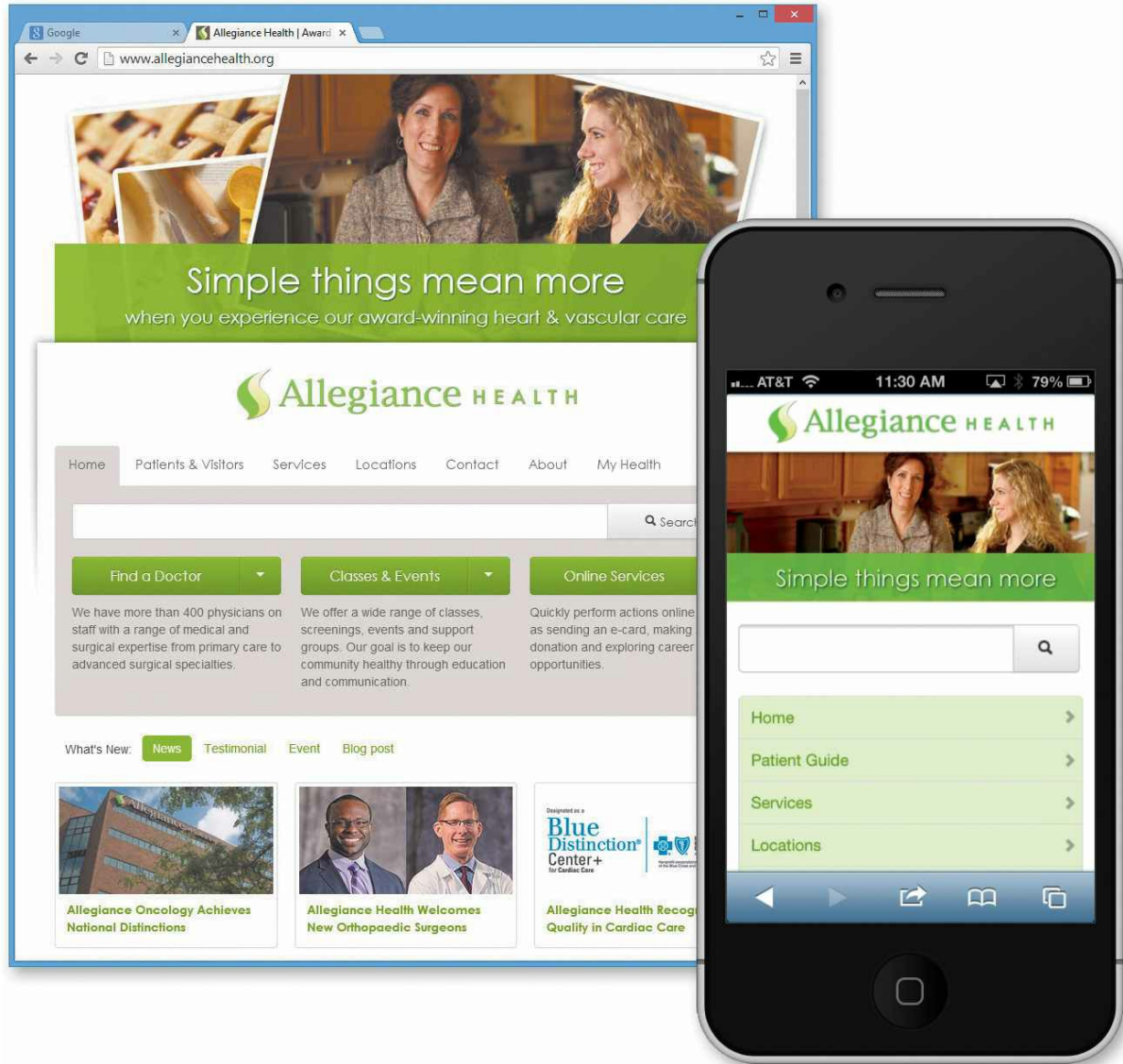

- I try using what they send me, doing the things that their users would need or want to do with it. I note the places where people are likely to get stuck and the things that I think will confuse them (an “expert usability review”).

Sometimes I get other people to try using it while I watch to see where *they* get stuck and confused (“usability testing”).



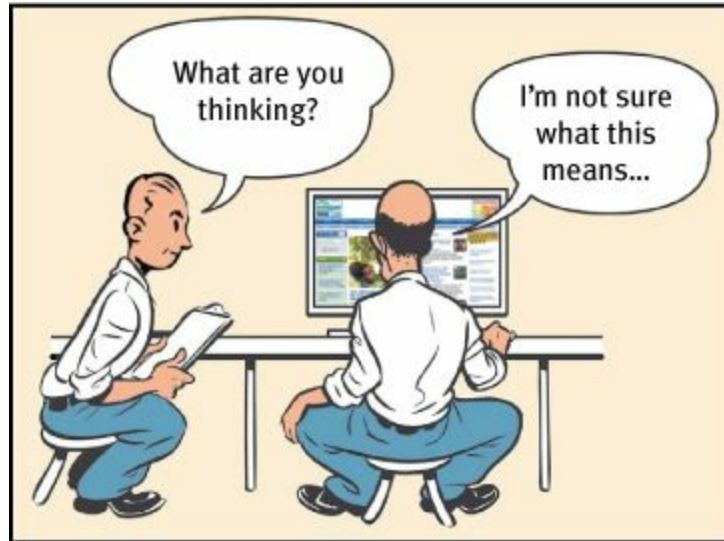

- I have a meeting with the client's team to describe the problems I found that are likely to cause users grief ("usability issues") and help them decide which ones are most important to fix and how best to fix them.



Sometimes we work by the phone...



...and sometimes in person

I used to write what I called the “big honking report” detailing my findings, but I finally realized that it wasn’t worth the time and effort. A live presentation allows people to ask me questions and voice their concerns—something a written report doesn’t do. And for teams doing Agile or Lean development, there’s no time for written reports anyway.

- They pay me.

Being a consultant, I get to work on interesting projects with a lot of nice, smart people. I get to work at home most of the time and I don’t have to sit in mind-numbing meetings every day or deal with office politics. I get to say what I think, and people usually appreciate it. And I get paid well.

On top of all that, I get a lot of job satisfaction, because when we’re finished, the things they’re building are almost always much better than when we started.<sup>1</sup>

<sup>1</sup> Almost always. Even when people know about usability problems, they can’t always fix them completely, as I’ll explain in [Chapter 9](#).

## **The bad news: You probably don’t have a usability professional**

Almost every development team could use somebody like me to help them build usability into their products. Unfortunately, the vast majority of them can’t afford to hire a usability professional.

And even if they could, there aren't enough to go around. At last count there were umpteen billion Web sites (and umpteen billion apps for the iPhone alone<sup>2</sup>) and only about 10,000 usability consultants worldwide. You do the math.

<sup>2</sup> *I'm not quite sure why Apple brags about this. Having thousands of good apps for a platform is a really good thing. Having millions of mediocre apps just means it's really hard to find the good ones.*

And even if you do have a professional on your team, that person can't possibly look at everything the team produces.

In the last few years, making things more usable has become almost everybody's responsibility. Visual designers and developers now often find themselves doing things like interaction design (deciding what happens next when the user clicks, taps, or swipes) and information architecture (figuring out how everything should be organized).

I wrote this book mainly for people who can't afford to hire (or rent) someone like me.

Knowing some usability principles will help you see the problems yourself—and help keep you from creating them in the first place.

No question: If you can afford to, hire someone like me. But if you can't, I hope this book will enable you to do it yourself (in your copious spare time).

### **The good news: It's not rocket surgery™**

Fortunately, much of what I do is just common sense, and anyone with some interest can learn to do it.

Like a lot of common sense, though, it's not necessarily obvious until *after* someone's pointed it out to you.<sup>3</sup>

<sup>3</sup> *...which is one reason why my consulting business is called Advanced Common Sense. "It's not rocket surgery" is my corporate motto.*

I spend a lot of my time telling people things they already know, so don't be surprised if you find yourself thinking "I knew *that*" a lot in the pages ahead.



© 2013. The New Yorker Collection from cartoonbank.com All Rights Reserved.

## It's a thin book

More good news: I've worked hard to keep this book short—hopefully short enough so you can read it on a long plane ride. I did this for two reasons:



- **If it's short, it's more likely to actually be used.**<sup>4</sup> I'm writing for the people who are in the trenches—the designers, the developers, the site producers, the project managers, the marketing people, and the people

who sign the checks—and for the one-man-bands who are doing it all themselves.

<sup>4</sup> *There's a good usability principle right there: If something requires a large investment of time—or looks like it will—it's less likely to be used.*

Usability isn't your life's work, and you don't have time for a long book.

- **You don't need to know everything.** As with any field, there's a lot you *could* learn about usability. But unless you're a usability professional, there's a limit to how much is *useful* for you to learn.<sup>5</sup>

<sup>5</sup> *I've always liked the passage in A Study in Scarlet where Dr. Watson is shocked to learn that Sherlock Holmes doesn't know that the earth travels around the sun. Given the finite capacity of the human brain, Holmes explains, he can't afford to have useless facts elbowing out the useful ones:*

*"What the deuce is it to me? You say that we go round the sun. If we went round the moon it would not make a pennyworth of difference to me or to my work."*

I find that the most valuable contributions I make to each project always come from keeping just a few key usability principles in mind. I think there's a lot more leverage for most people in understanding these principles than in another laundry list of specific do's and don'ts. I've tried to boil down the few things I think everybody involved in design should know about usability.

## Not present at time of photo

Just so you don't waste your time looking for them, here are a few things you won't find in this book:

- **Hard and fast usability rules.** I've been at this for a long time, long enough to know that there is no one "right" answer to most usability questions. Design is a complicated process and the real answer to most of the questions people ask me is "It depends." But I do think that there are a few useful guiding principles it always helps to have in mind, and those are what I'm trying to convey.
- **Predictions about the future of technology and the Web.** Honestly, your guess is as good as mine. The only thing I'm sure of is that (a) most of the predictions I hear are almost certainly wrong, and (b) the things that will turn out to be important will come as a surprise, even though in hindsight they'll seem perfectly obvious.
- **Bad-mouthing of poorly designed sites and apps.** If you enjoy people

poking fun at things with obvious flaws, you're reading the wrong book. Designing, building, and maintaining a great Web site or app isn't easy. It's like golf: a handful of ways to get the ball in the hole, a million ways not to. Anyone who gets it even half right has my admiration.

As a result, you'll find that the examples I use tend to be from excellent products with minor flaws. I think you can learn more from looking at good designs than bad ones.

## **Now with Mobile!**

One of the dilemmas I faced when updating this book was that it's always been a book about designing usable Web sites. Even though the principles apply to the design of anything people have to interact with (including things like election ballots and voting booths, and even PowerPoint presentations), its focus was clearly on Web design, and all the examples were from Web sites. Until recently, that's what most people were working on.

But now there are a lot of people designing mobile apps, and even the people working on Web sites have to create versions of them that work well on mobile devices. I know they're very interested in how all of this applies to them.

So I did three things:

- Included mobile examples wherever it made sense
- Added a new chapter about some mobile-specific usability issues
- And the most important one: Added "and Mobile" to the subtitle on the cover

And as you'll see, in some places where it made things clearer, instead of "Web site" I've written "Web site or mobile app." In most cases, though, I used the Web-centric wording to keep things from getting cumbersome and distracting.

## **One last thing, before we begin**

One crucial thing, really: My definition of usability.

You'll find a lot of different definitions of usability, often breaking it down into attributes like

- **Useful:** Does it do something people need done?



- **Learnable:** Can people figure out how to use it?
- **Memorable:** Do they have to relearn it each time they use it?
- **Effective:** Does it get the job done?
- **Efficient:** Does it do it with a reasonable amount of time and effort?
- **Desirable:** Do people want it?

and recently even

- **Delightful:** Is using it enjoyable, or even fun?

I'll talk about these later. But to me, the important part of the definition is pretty simple. If something is usable—whether it's a Web site, a remote control, or a revolving door—it means that

A person of average (or even below average) ability and experience can figure out how to use the thing to accomplish something without it being more trouble than it's worth.

Take my word for it: It's really that simple.

I hope this book will help you build better products and—if it lets you skip a few of the endless arguments about design—maybe even get home in time for dinner once in a while.

# Guiding Principles



# Chapter 1. Don't make me think!

## KRUG'S FIRST LAW OF USABILITY

*Michael, why are the drapes open?*

—KAY CORLEONE IN *THE GODFATHER, PART II*

People often ask me:

“What’s the most important thing I should do if I want to make sure my site or app is easy to use?”

The answer is simple. It’s not “Nothing important should ever be more than two clicks away” or “Speak the user’s language” or “Be consistent.”

It’s...

### **“Don’t make me think!”**

For as long I can remember, I’ve been telling people that this is my first law of usability.

It’s the overriding principle—the ultimate tie breaker when deciding whether a design works or it doesn’t. If you have room in your head for only one usability rule, make this the one.

For instance, it means that as far as is humanly possible, when I look at a Web page it should be self-evident. Obvious. Self-explanatory.

I should be able to “get it”—what it is and how to use it—without expending any effort thinking about it.

Just how self-evident are we talking about?

Well, self-evident enough, for instance, that your next door neighbor, who has no interest in the subject of your site and who barely knows how to use the Back button, could look at your Home page and say, “Oh, it’s a \_\_\_\_.” (With any luck, she’ll say, “Oh, it’s a \_\_\_\_\_. Great!” But that’s another subject.)

Think of it this way:

When I’m looking at a page that doesn’t make me think, all the thought

balloons over my head say things like “OK, there’s the\_\_\_\_\_. And that’s a  
\_\_\_\_\_. And there’s the thing that I want.”

---

---

**Not Thinking**

OK. This looks like the product categories...

Laptops, Memory... There it is: Monitors. *Click*

...and these are today's special deals.

But when I'm looking at a page that makes me think, all the thought balloons over my head have question marks in them.

**Thinking**

Hmm. Pretty busy. Where should I start?

Hmm. Why did they call it that?

Can I click on that?

Is that the navigation? Or is that it over there?

Why did they put that there?

Those two links seem like they're the same thing. Are they really?

When you're creating a site, your job is to get rid of the question marks.

**Things that make us think**

All kinds of things on a Web page can make us stop and think unnecessarily. Take names, for example. Typical culprits are cute or clever names, marketing-induced names, company-specific names, and unfamiliar technical names.

For instance, suppose a friend tells me that XYZ Corp is looking to hire someone with my exact qualifications, so I head off to their Web site. As I scan the page for something to click, the name they've chosen for their job listings section makes a difference.

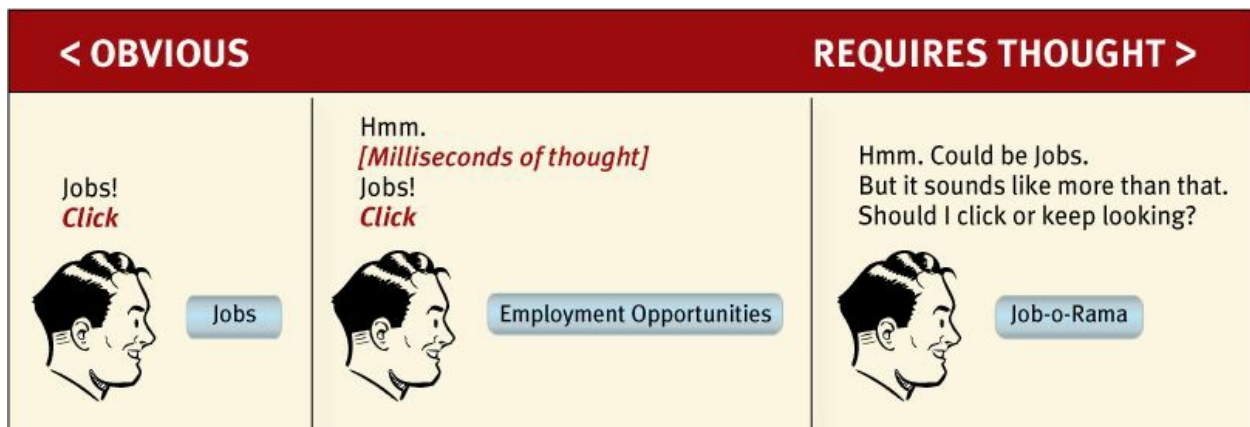

Note that these things are always on a continuum somewhere between “Obvious to everybody” and “Truly obscure,” and there are always tradeoffs involved.

For instance, “Jobs” may sound too undignified for XYZ Corp, or they may be locked into “Job-o-Rama” because of some complicated internal politics or because that’s what it’s always been called in their company newsletter.<sup>1</sup> My main point is that the tradeoffs should usually be skewed further in the direction of “Obvious” than we think.

<sup>1</sup> *There’s almost always a plausible rationale—and a good, if misguided, intention—behind every usability flaw.*

Another needless source of question marks over people’s heads is links and buttons that aren’t obviously clickable. As a user, I should never have to devote a millisecond of thought to whether things are clickable—or not.



You may be thinking, “Well, it really doesn’t matter that much. If you click or tap it and nothing happens, what’s the big deal?”

The point is that every question mark adds to our cognitive workload, distracting our attention from the task at hand. The distractions may be slight but they add up, especially if it’s something we do all the time like deciding what to click on.

And as a rule, people don’t *like* to puzzle over how to do things. They enjoy puzzles in their place—when they want to be entertained or diverted or challenged—but not when they’re trying to find out what time their dry cleaner closes. The fact that the people who built the site didn’t care enough to make things obvious—and easy—can erode our confidence in the site and the organization behind it.

Another example from a common task: booking a flight.

FROM	TO
City or Airport	City or Airport
Depart Date	Return Date



Let's see. "City or Airport."  
I'll put in the city names.

FROM	TO
bos	City or Airport
Boston, MA, US (BOS)	Return Date



*Types "bos"*  
Oh, good. It knows Boston.  
*Picks Boston from the dropdown*

FROM	TO
BOS	
Depart Date	Return Date



But why does it just put BOS  
after I pick Boston?

FROM	TO
BOS	ny
12/17/2013	12/19/2013



I'm sure it'll know "ny" ...  
*Types "ny" and fills in dates,  
then clicks "Find Flights"*

**Please enter a valid 'TO' City or Airport code.**

FROM	TO
BOS	ny
12/17/2013	12/19/2013



Why doesn't it recognize  
New York?

Granted, most of this "mental chatter" takes place in a fraction of a second, but you can see that it's a pretty noisy process, with a lot of question marks. And then there's a puzzling error at the end.

Another site just takes what I type and gives me choices that make sense, so it's hard to go wrong.

From	To
<input type="text" value="bos"/>	<input type="text" value="City or Airport"/>
<ul style="list-style-type: none"> <li>BOS - Boston Logan International - Boston, MA</li> <li>BOS - [Amtrak] South Station, Boston, Massachusetts</li> <li>BON - [Amtrak] North Station, Boston, Massachusetts</li> </ul>	



*Starts typing "bos" and gets a list of choices*

From	To
<input type="text" value="BOS - Boston Logan Inter"/>	<input type="text" value="ny"/>
	<ul style="list-style-type: none"> <li>NYC - New York City, NY (Area)</li> <li>NYO - Skavsta - Stigtomta, Sweden</li> <li>NYU - Bagan - Bagan, Myanmar</li> </ul>



*Starts typing "ny" and gets a list of choices*

From	To
<input type="text" value="BOS - Boston Logan Inter"/>	<input type="text" value="NYC - New York City, NY"/>
Depart	Return
<input type="text" value="Dec 06"/>	<input type="text" value="Dec 08"/>



Good.

No question marks. No mental chatter. And no errors.

I could list dozens of things that users shouldn't spend their time thinking about, like

- Where am I?
- Where should I begin?
- Where did they put \_\_\_\_\_?
- What are the most important things on this page?
- Why did they call it that?
- Is that an ad or part of the site?

But the last thing you need is another checklist to add to your stack of design checklists. The most important thing you can do is to understand the basic principle of eliminating question marks. When you do, you'll begin to notice all the things that make *you* think in the sites and apps *you* use. And eventually you'll learn to recognize and avoid them in the things you're building.

**You can't make everything self-evident**



Your goal should be for each page or screen to be self-evident, so that just by looking at it the average user<sup>2</sup> will know what it is and how to use it. In other words, they'll "get it" without having to think about it.

<sup>2</sup> *The actual Average User is kept in a hermetically sealed vault at the International Bureau of Standards in Geneva. We'll get around to talking about the best way to think about the "average user" eventually.*

Sometimes, though, particularly if you're doing something original or groundbreaking or something that's inherently complicated, you have to settle for *self-explanatory*. On a self-explanatory page, it takes a *little* thought to "get it"—but only a little. The appearance of things (like size, color, and layout), their well-chosen names, and the *small* amounts of carefully crafted text should all work together to create a sense of nearly effortless understanding.

Here's the rule: If you can't make something self-evident, you at least need to make it self-explanatory.

## Why is all of this so important?

Oddly enough, not for the reason people usually cite:



On the Internet, the competition is always just one click away, so if you frustrate users they'll head somewhere else.

It's true that there's a lot of competition out there. Especially in things like mobile apps, where there are often many readily available (and equally attractive) alternatives, and the cost of changing horses is usually negligible (99 cents or even "Free").

But it's not *always* true that people are fickle. For instance:

- They may have no choice but to stick with it, if it's their only option (e.g., a company intranet, or their bank's mobile app, or the only site that sells the rattan they're looking for).
- You'd be surprised at how long some people will tough it out on sites that frustrate them, often blaming themselves and not the site. There's



also the “I’ve waited ten minutes for this bus already, so I may as well hang in a little longer” phenomenon.

- Besides, who’s to say that the competition will be any less frustrating?

## **So why, then?**

Making every page or screen self-evident is like having good lighting in a store: it just makes everything seem better. Using a site that doesn’t make us think about unimportant things feels effortless, whereas puzzling over things that don’t matter to us tends to sap our energy and enthusiasm—and time.

But as you’ll see in the next chapter when we examine how we really use the Web, the main reason why it’s important not to make me think is that most people are going to spend far less time looking at the pages we design than we’d like to imagine.

As a result, if Web pages are going to be effective, they have to work most of their magic at a glance. And the best way to do this is to create pages that are self-evident, or at least self-explanatory.

## Chapter 2. How we *really* use the Web

### SCANNING, SATISFICING, AND MUDDLING THROUGH

*Why are things always in the last place you look for them? Because you stop looking when you find them!*

—CHILDREN’S RIDDLE

In all the time I’ve spent watching people use the Web, the thing that has struck me most is the difference between how we think people use Web sites and how they actually use them.

When we’re creating sites, we act as though people are going to pore over each page, reading all of our carefully crafted text, figuring out how we’ve organized things, and weighing their options before deciding which link to click.

What they actually do most of the time (if we’re lucky) is *glance* at each new page, scan *some* of the text, and click on the first link that catches their interest or vaguely resembles the thing they’re looking for. There are almost always large parts of the page that they don’t even look at.

We’re thinking “great literature” (or at least “product brochure”), while the user’s reality is much closer to “billboard going by at 60 miles an hour.”

## WHAT WE DESIGN FOR... THE REALITY...

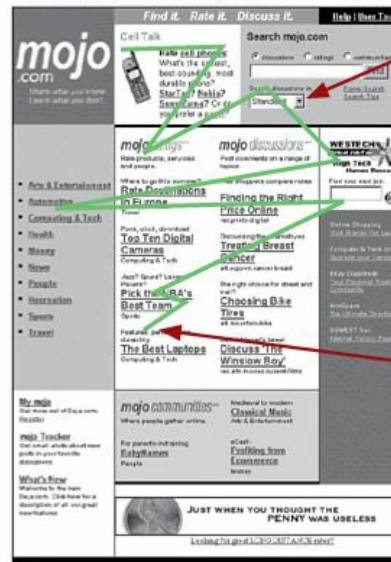
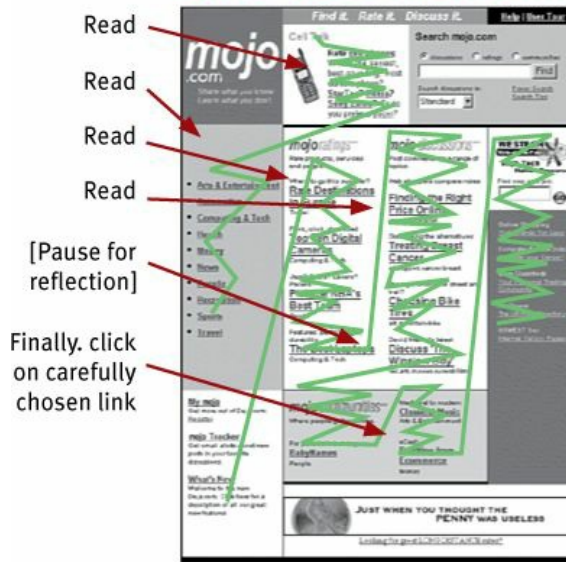

Look around feverishly for anything that

a) is interesting, or vaguely resembles what you're looking for, and

b) is clickable.

As soon as you find a halfway-decent match, click.

If it doesn't pan out, click the Back button and try again.

As you might imagine, it's a little more complicated than this, and it depends on the kind of page, what the user is trying to do, how much of a hurry she's in, and so on. But this simplistic view is much closer to reality than most of us imagine.

It makes sense that we picture a more rational, attentive user when we're designing pages. It's only natural to assume that everyone uses the Web the same way we do, and—like everyone else—we tend to think that our own behavior is much more orderly and sensible than it really is.

If you want to design effective Web pages, though, you have to learn to live with three facts about real-world Web use.

### FACT OF LIFE #1: **We don't read pages. We scan them.**

One of the very few well-documented facts about Web use is that people tend to spend very little time *reading* most Web pages. Instead, we scan (or skim) them, looking for words or phrases that catch our eye.

The exception, of course, is pages that contain documents like news stories, reports, or product descriptions, where people will revert to reading—but even then, they're often alternating between reading and scanning.

Why do we scan?

- **We're usually on a mission.** Most Web use involves trying to get something done, and usually done quickly. As a result, Web users tend to act like sharks: They have to keep moving, or they'll die. We just

don't have the time to read any more than necessary.

- **We know we don't need to read everything.** On most pages, we're really only interested in a fraction of what's on the page. We're just looking for the bits that match our interests or the task at hand, and the rest of it is irrelevant. Scanning is how we find the relevant bits.
- **We're good at it.** It's a basic skill: When you learn to read, you also learn to scan. We've been scanning newspapers, magazines, and books—or if you're under 25, probably reddit, Tumblr, or Facebook—all our lives to find the parts we're interested in, and we know that it works.

The net effect is a lot like Gary Larson's classic Far Side cartoon about the difference between what we say to dogs and what they hear. In the cartoon, the dog (named Ginger) appears to be listening intently as her owner gives her a serious talking-to about staying out of the garbage. But from the dog's point of view, all he's saying is "blah blah GINGER blah blah blah GINGER blah blah blah."

What we see when we look at a page depends on what we have in mind, and it's usually just a fraction of what's there.

### WHAT DESIGNERS BUILD...



### WHAT USERS SEE...

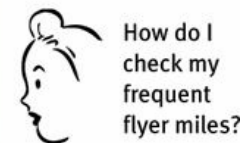
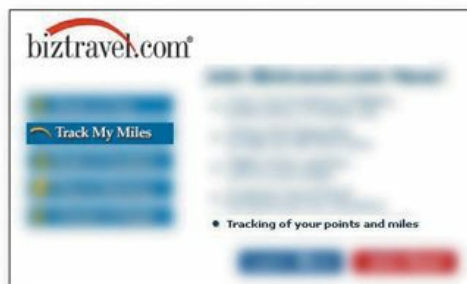

Like Ginger, we tend to focus on words and phrases that seem to match (a) the task at hand or (b) our current or ongoing personal interests. And of course, (c) the trigger words that are hardwired into our nervous systems, like "Free," "Sale," and "Sex," and our own name.

## **FACT OF LIFE #2: We don't make optimal choices. We satisfice.**

When we're designing pages, we tend to assume that users will scan the page, consider all of the available options, and choose the best one.

In reality, though, most of the time we *don't* choose the best option—we choose the *first reasonable option*, a strategy known as satisficing.<sup>1</sup> As soon as we find a link that seems like it might lead to what we're looking for, there's a very good chance that we'll click it.

<sup>1</sup> Economist Herbert Simon coined the term (a cross between satisfying and sufficing) in *Models of Man: Social and Rational* (Wiley, 1957).

I'd observed this behavior for years, but its significance wasn't really clear to me until I read Gary Klein's book *Sources of Power: How People Make Decisions*.

Klein spent many years studying naturalistic decision making: how people like firefighters, pilots, chessmasters, and nuclear power plant operators make high-stakes decisions in real situations with time pressure, vague goals, limited information, and changing conditions.

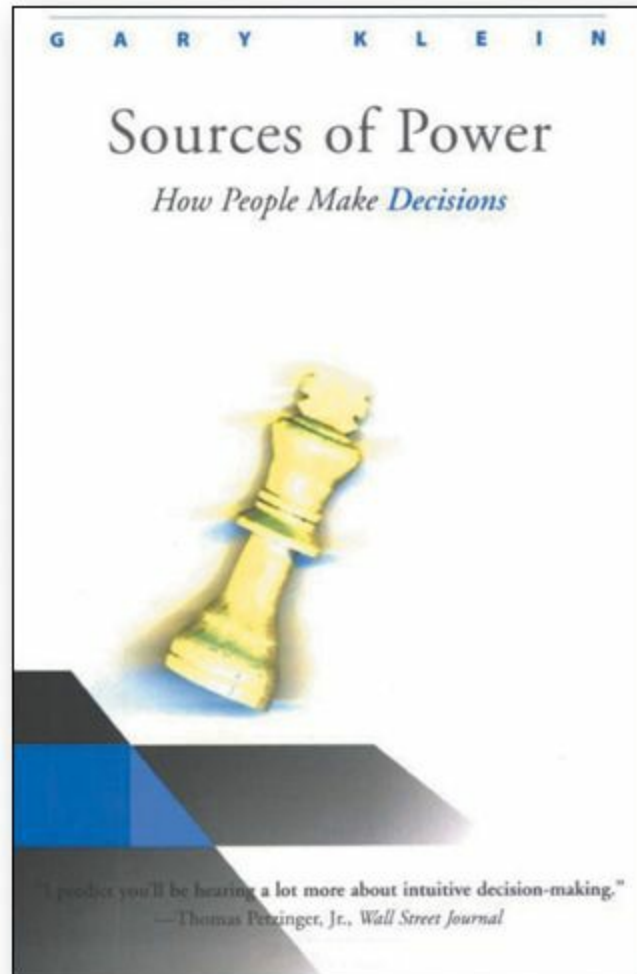

Klein's team of observers went into their first study (of field commanders at fire scenes) with the generally accepted model of rational decision making: Faced with a problem, a person gathers information, identifies the possible solutions, and chooses the best one. They started with the hypothesis that because of the high stakes and extreme time pressure, fire captains would be able to compare only two options, an assumption they thought was conservative.

As it turned out, the fire commanders didn't compare *any* options. They took the first reasonable plan that came to mind and did a quick mental test for possible problems. If they didn't find any, they had their plan of action.

So why don't Web users look for the best choice?

- **We're usually in a hurry.** And as Klein points out, "Optimizing is hard, and it takes a long time. Satisficing is more efficient."

- **There's not much of a penalty for guessing wrong.** Unlike firefighting, the penalty for guessing wrong on a Web site is usually only a click or two of the Back button, making satisficing an effective strategy. (Back is the most-used button in Web browsers.)
- **Weighing options may not improve our chances.** On poorly designed sites, putting effort into making the best choice doesn't really help. You're usually just as well off going with your first guess and using the Back button if it doesn't work out.
- **Guessing is more fun.** It's less work than weighing options, and if you guess right, it's faster. And it introduces an element of chance—the pleasant possibility of running into something surprising and good.

Of course, this is not to say that users never weigh options before they click. It depends on things like their frame of mind, how pressed they are for time, and how much confidence they have in the site.

### **FACT OF LIFE #3: We don't figure out how things work. We muddle through.**

One of the things that becomes obvious as soon as you do any usability testing—whether you're testing Web sites, software, or household appliances—is the extent to which people use things all the time without understanding how they work, or with completely wrong-headed ideas about how they work.

Faced with any sort of technology, very few people take the time to read instructions. Instead, we forge ahead and muddle through, making up our own vaguely plausible stories about what we're doing and why it works.

It often reminds me of the scene at the end of *The Prince and the Pauper* where the real prince discovers that the look-alike pauper has been using the Great Seal of England as a nutcracker in his absence. (It makes perfect sense—to him, the seal is just this great big, heavy chunk of metal.)



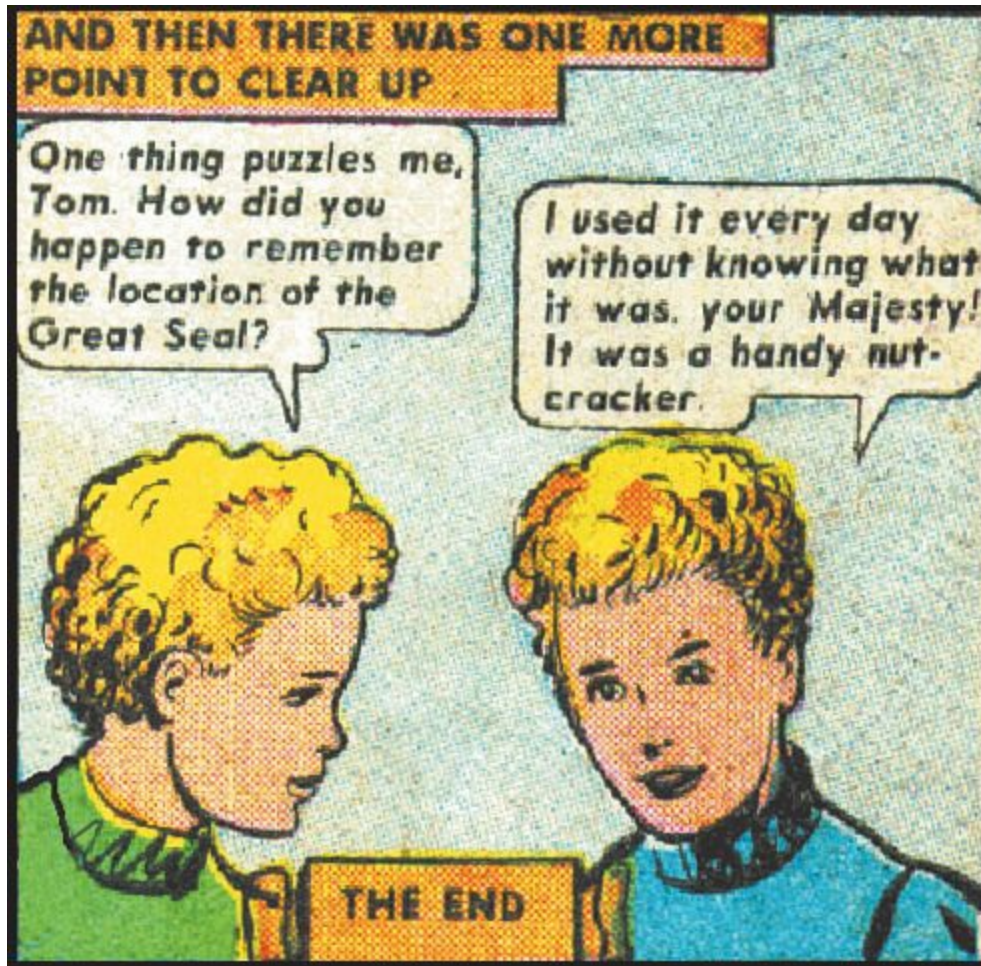

*The Prince and the Pauper* (Classics Illustrated)

And the fact is, we get things done that way. I've seen lots of people use software, Web sites, and consumer products effectively in ways that are nothing like what the designers intended.

Take the Web browser, for instance—a crucial part of Internet use. To people who build Web sites, it's an application that you use to view Web pages. But if you ask users what a browser is, a surprisingly large percentage will say something like "It's what I use to search...to find things" or "It's the search engine." Try it yourself: ask some family members what a Web browser is. You may be surprised.

Many people use the Web extensively without knowing that they're using a browser. What they know is you type something in a box and stuff appears.<sup>2</sup> But it doesn't matter to them: They're muddling through and using the thing successfully.

<sup>2</sup> Usually a box with the word “Google” next to it. A lot of people think Google is the Internet.

And muddling through is not limited to beginners. Even technically savvy users often have surprising gaps in their understanding of how things work. (I wouldn’t be surprised if even Mark Zuckerberg and Sergey Brin have some bits of technology in their lives that they use by muddling through.)

Why does this happen?

- **It’s not important to us.** For most of us, it doesn’t matter to us whether we understand how things work, as long as we can use them. It’s not for lack of intelligence, but for lack of caring. It’s just not important to us.<sup>3</sup>

<sup>3</sup> Web developers often have a particularly hard time understanding—or even believing—that people might feel this way, since they themselves are usually keenly interested in how things work.

- **If we find something that works, we stick to it.** Once we find something that works—no matter how badly—we tend not to look for a better way. We’ll use a better way if we stumble across one, but we seldom look for one.

It’s always interesting to watch designers and developers observe their first usability test. The first time they see a user click on something completely inappropriate, they’re surprised. (For instance, when the user ignores a nice big fat “Software” button in the navigation bar, saying something like, “Well, I’m looking for software, so I guess I’d click here on ‘Cheap Stuff’ because cheap is always good.”) The user may even find what he’s looking for eventually, but by then the people watching don’t know whether to be happy or not.

The second time it happens, they’re yelling “Just click on ‘Software!’” The third time, you can see them thinking: “Why are we even bothering?”

And it’s a good question: If people manage to muddle through so much, does it really matter whether they “get it”? The answer is that it matters a great deal because while muddling through may work sometimes, it tends to be inefficient and error-prone.

On the other hand, if users “get it”:

- There’s a much better chance that they’ll find what they’re looking for, which is good for them and for you.
- There’s a better chance that they’ll understand the full range of what your site has to offer—not just the parts that they stumble across.

- You have a better chance of steering them to the parts of your site that you want them to see.
- They'll feel smarter and more in control when they're using your site, which will bring them back. You can get away with a site that people muddle through only until someone builds one down the street that makes them feel smart.

### **If life gives you lemons...**

By now you may be thinking (given this less than rosy picture of your audience and how they use the Web), "Why don't I just get a job at the local 7-Eleven? At least there my efforts *might* be appreciated."

So, what's a girl to do?

I think the answer is simple: If your audience is going to act like you're designing billboards, then design great billboards.

# Chapter 3. Billboard Design 101

## DESIGNING FOR SCANNING, NOT READING

*If you / Don't know / Whose signs / These are You can't have / Driven very far / Burma-Shave!*

—SEQUENCE OF ROADSIDE BILLBOARDS PROMOTING SHAVING CREAM, CIRCA 1935

Faced with the fact that your users are whizzing by, there are some important things you can do to make sure they see and understand as much of what they need to know—and of what you *want* them to know—as possible:

- Take advantage of conventions
- Create effective visual hierarchies
- Break pages up into clearly defined areas
- Make it obvious what's clickable
- Eliminate distractions
- Format content to support scanning

### Conventions are your friends

One of the best ways to make almost anything easier to grasp in a hurry is to follow the existing conventions—the widely used or standardized design patterns. For example:

- **Stop signs.** Given how crucial it is that drivers see and recognize them at a glance, at a distance, in all kinds of weather and lighting conditions, it's a really good thing that all stop signs look the same. (Some of the specifics may vary from country to country, but overall they're remarkably consistent around the world.)



The convention includes a distinctive shape, the word for “Stop,” a highly visible color that contrasts with most natural surroundings, and standardized size, height, and location.

- **Controls in cars.** Imagine trying to drive a rental car if the gas pedal wasn’t always to the right of the brake pedal, or the horn wasn’t always on the steering wheel.

In the past twenty years, many conventions for Web pages have evolved. As users, we’ve come to have a lot of expectations about

- **Where things will be located on a page.** For example, users expect the logo identifying the site to be in the top-left corner (at least in countries where reading is left-to-right) and the primary navigation to be across the top or down the left side.
- **How things work.** For example, almost all sites that sell products use the metaphor of a shopping cart and a very similar series of forms for specifying things like your method of payment, your shipping address, and so on.
- **How things look.** Many elements have a standardized appearance, like the icon that tells you it’s a link to a video, the search icon, and the social networking sharing options.



[f Share](#) 36 [T](#) Tweet 244 [✉ Email](#) 0

Conventions have also evolved for different *kinds* of sites—commerce, colleges, blogs, restaurants, movies, and many more—since all the sites in each category have to solve the same set of problems.



# Some Slightly Irregular

Steve Krug's blog about usability (mostly)

Home About this blog About Steve Krug Subscribe Sensible.com

Search

Home > Usability

## You say "potato," I say "focus group"

August 12th, 2011

8 comments

There's one phenomenon you really should be prepared for when you introduce the idea of usability tests in your organization...



Seriously. This really happens. All the time.

The problem is that a lot more people are familiar with focus groups than with usability tests. So sometimes no matter how often you correct them (politely and patiently, of course), they'll still refer to your upcoming usability tests as...focus groups.

The good news is that as soon as you get them to actually come and observe a test, the difference becomes clear and the problem goes away. But until then, it can be disconcerting. And sometimes amusing.

Usability



Leave a comment

Comments (8)



Michael Straker

August 16th, 2011 at 12:03 | #1

Reply | Quote

Love that video. It's funny 'cause it's SO true.

And it's not just the clients who don't get the difference. It's the participants too. When recruiting, I explain what usability testing is all about and how it works. But when the participants show up, guess what they're expecting...



Deaf

August 23rd, 2011 at 15:58 | #4

Reply | Quote

The video is not captioned - there are 37 millions of people with hearing loss in USA alone that cannot access audio. As part of usability/accessibility, would you please make any of your video/audio captioned/transcribed? Thank you.

*Some Slightly Irregular* is the blog of usability consultant Steve Krug, best known for his books about Web usability and usability testing.



Steve's Web site is Advanced Common Sense™ (www.sensible.com), and in the twitterverse he goes by @skrug.

### Upcoming events

- July 9-13 | Washington, DC  
UXPA 2013  
I won't be presenting at the annual UXPA conference this year, but I'm looking forward to attending in "tourist mode": just enjoying and learning from the sessions. If you see me, please come up and say Hi.

### Categories

- Usability (6)
- Shameless self-promotion (4)
- Other (3)

### Archives

- July 2013 (1)
- May 2013 (1)
- March 2013 (1)
- September 2012 (2)
- May 2012 (1)
- February 2012 (1)
- October 2011 (1)
- September 2011 (3)
- August 2011 (2)

### Follow this blog



SomeSlightlyIrregular.com





[cityislandmovie.com](http://cityislandmovie.com)

These conventions didn't just come out of thin air: They all started life as somebody's bright idea. If an idea works well enough, other sites imitate it and eventually enough people have seen it in enough places that it needs no explanation.

When applied well, Web conventions make life easier for users because they don't have to constantly figure out what things are and how they're supposed to work as they go from site to site.

注目キーワード > [メニュー表示問題][みずほ暴力団融資][原発][米盗難騒ぎ]

最終更新: 2013年11月7日(木) 6時34分

**NEW 「三越伊勢丹」も不適切表示、他の百貨店にも拡大**



大手百貨店の三越伊勢丹ホールディングスは、グループの百貨店などにあるレストラン14店で、メニューと違う食材を使った料理を提供していたことを明らかにしました。不適切な表示は、小田急、そごうなどの百貨店にも広がっています。

続きを読む

ステップワゴン スズキ  
家族の冒険プロジェクト  
ニッポン 家族冒険スポット  
**総選挙!**  
ドンドン投票してね!  
HONDA

TBSニュース番組ダイジェスト配信中

TBSニュースバード NEWS 23

NBS JNN

**NEW 日本人初の船長・若田さん、きょう宇宙へ**



日本人で初めて国際宇宙ステーションの船長を務める若田光一さんが、日本時間7日午後の...

**NEW 「特定秘密保護法案」きょうから国会審議**



政府が指定する特定秘密を漏らした公務員らへの罰則を強化する特定秘密保護法案は、きょう...

**NEW 猪木議員、金正恩氏の後見人・張成沢氏と会談**



北朝鮮が訪問中のアントニオ猪木参議院議員らと、金正恩(キム・ジョンウン)第一書記の...

**NEW 山西省連続爆発事件、共産党本部狙った計画的犯行か**



6日、中国・山西省の共産党本部ビルで起きた連続爆発事件です。爆弾がビル周辺の数か所...

台風情報  
Smart News  
スマートニュース

地震情報  
JNN LIVE  
福島第一原発情報カメラ

**社会** >> 一覧へ

- ネット販売、23品目“3年間安全調査後”解禁へ
- 福島第一原発4号機を公開、燃料取り出しへ高いハードル
- 「もんじゅ」で核物質管理に不備、原子力機構に厳重注意
- NEW 温室効果ガスの平均濃度、過去最高値を記録
- カルガモから鳥インフル、北海道で今シーズン初
- 一転 食材偽装を認める、「三笠」運営会社の社長辞任へ
- 安楽楽牧場「和牛画法」、関連会社などを提訴へ
- NEW 表示適正化対策、消費者庁が業界3団体に要請文
- 「嵐」など芸能人の偽サイン販売、容疑の親子らを3人逮捕
- 大阪・川に少年突き落とし、遺体は下着姿
- 歌舞伎町のホスト変死、何者かが暴行か
- NEW 小学校の4階から小6男児転落、意識不明の重体

**政治** >> 一覧へ

- NEW 「特定秘密保護法案」きょうから国会審議
- 日本版NSC法案、衆院特別委で可決
- 自衛隊が離島防衛演習、沖縄・宮古島に地对艦ミサイル展開
- 岸田外相、中国・韓国との民間交流が重要という認識示す
- 「婚外子」遺産相続の民法改正案、自公が成立目指す
- 原発事故の対応見直し、国が積極的関与へ

**経済** >> 一覧へ

- NEW 「三越伊勢丹」も不適切表示、他の百貨店にも拡大
- NEW 東武鉄道系ホテルでもメニュー表示と異なる食材を使用
- 食材「虚偽」問題で注目、「成型肉」とは？

Want proof that conventions help? See how much you know about this page—even if you can't understand a word of it—just because it follows some conventions.

One problem with conventions, though: Designers are often reluctant to take advantage of them.

Faced with the prospect of following a convention, there's a great temptation for designers to try reinventing the wheel instead, largely because they feel (not incorrectly) that they've been hired to do something new and different, not the same old thing. Not to mention the fact that praise from peers, awards, and high-profile job offers are rarely based on criteria like “best use of conventions.”

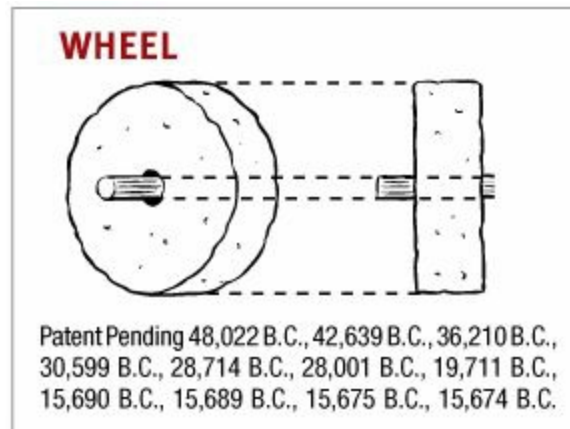

Occasionally, time spent reinventing the wheel results in a revolutionary new rolling device. But usually it just amounts to time spent reinventing the wheel.

If you're going to innovate, you have to understand the value of what you're replacing (or as Dylan put it, “To live outside the law, you must be honest”), and it's easy to underestimate just how much value conventions provide. The classic example is custom scrollbars. Whenever a designer decides to create scrollbars from scratch—usually to make them prettier—the results almost always make it obvious that the designer never thought about how many hundreds or thousands of hours of fine tuning went into the evolution of the standard operating system scrollbars.

If you're not going to use an existing Web convention, you need to be sure that what you're replacing it with either (a) is so clear and self-explanatory that there's no learning curve—so it's as good as the convention, or (b) adds

so much value that it's worth a small learning curve.

My recommendation: Innovate when you *know* you have a better idea, but take advantage of conventions when you don't.

Don't get me wrong: I'm not in any way trying to discourage creativity. I love innovative and original Web design.

One of my favorite examples is Harlem.org. The whole site is built around Art Kane's famous photo of 57 jazz musicians, taken on the steps of a brownstone in Harlem in August 1957. Instead of text links or menus, you use the photo to navigate the site.

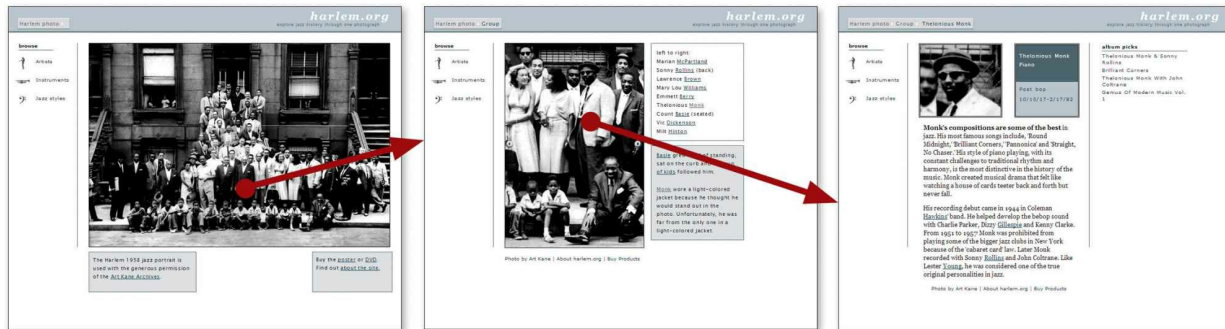

Clicking on any area of the photo... identifies the people there and... lets you click on them to see their bios.

Not only is it innovative and fun, but it's easy to understand and use. And the creators were smart enough to understand that the fun might wear off after a while so they also included a more conventional category-based navigation.



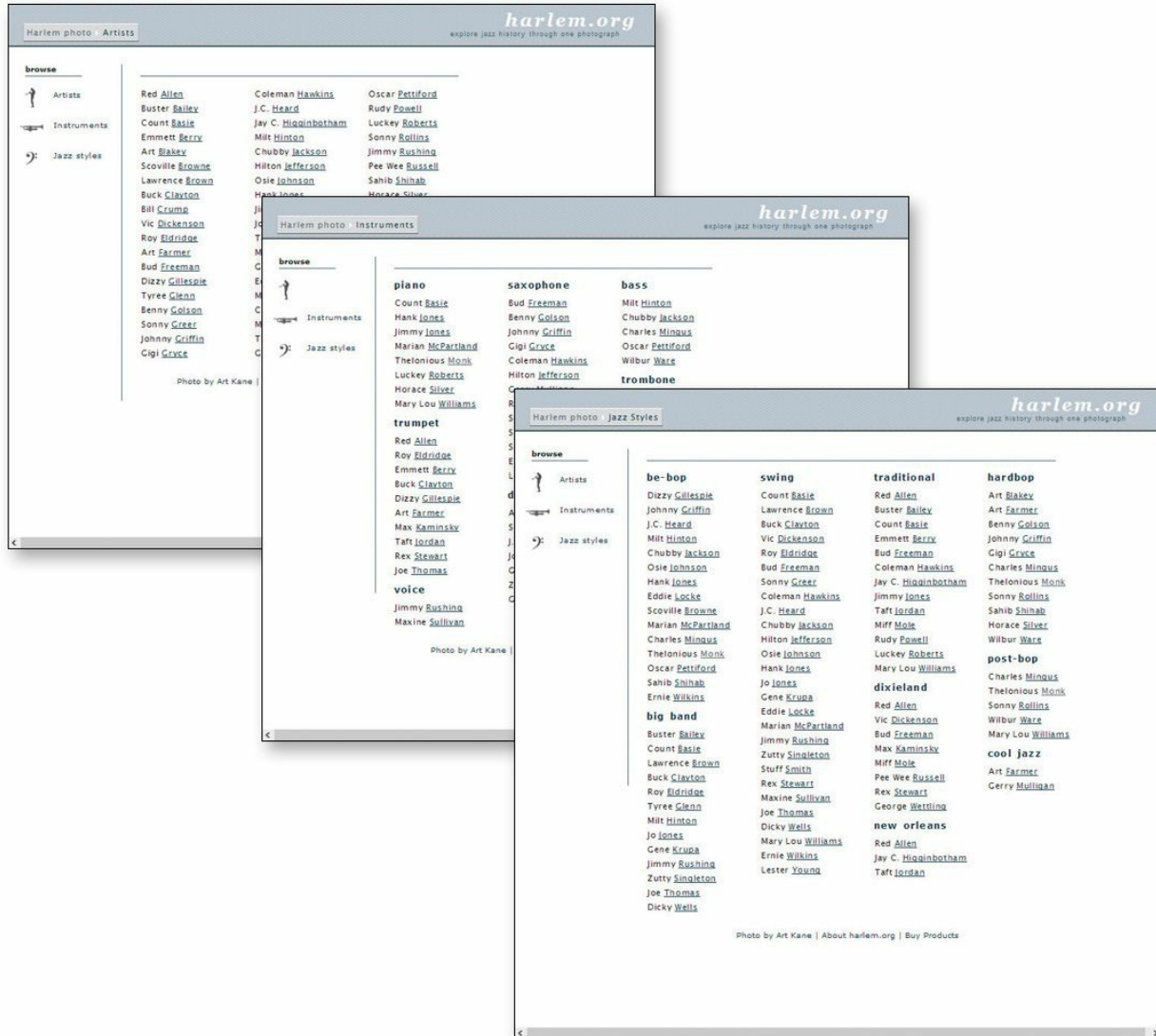

You can also browse the musicians by name, instrument, or jazz style.

The rule of thumb is that you can—and *should*—be as creative and innovative as you want, and add as much aesthetic appeal as you can, *as long as you make sure it's still usable*.

And finally, a word about consistency.

You often hear consistency cited as an absolute good. People win a lot of design arguments just by saying “We can’t do that. It wouldn’t be consistent.”

Consistency *is* always a good thing to strive for within your site or app. If your navigation is always in the same place, for instance, I don’t have to think about it or waste time looking for it. But there will be cases where

things will be clearer if you make them *slightly* inconsistent.  
Here's the rule to keep in mind:

## CLARITY TRUMPS CONSISTENCY

If you can make something *significantly* clearer by making it *slightly* inconsistent, choose in favor of clarity.

### Create effective visual hierarchies

Another important way to make pages easy to grasp in a hurry is to make sure that the appearance of the things on the page—all of the visual cues—accurately portray the relationships between the things on the page: which things are most important, which things are similar, and which things are part of other things. In other words, each page should have a clear visual hierarchy.

Pages with a clear visual hierarchy have three traits:

- **The more important something is, the more prominent it is.** The most important elements are either larger, bolder, in a distinctive color, set off by more white space, or nearer the top of the page—or some combination of the above.



- **Things that are related logically are related visually.** For instance, you can show that things are similar by grouping them together under a heading, displaying them in the same visual style, or putting them all in a clearly defined area.

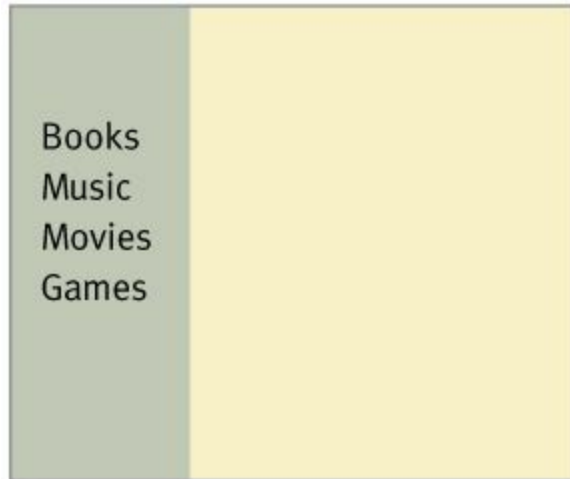

- **Things are “nested” visually to show what’s part of what.** For instance, a site section name (“Computer Books”) would appear above the titles of the individual books, reflecting the fact that the books are part of the section. And each book title in turn would span all the elements that make up the description of that book.

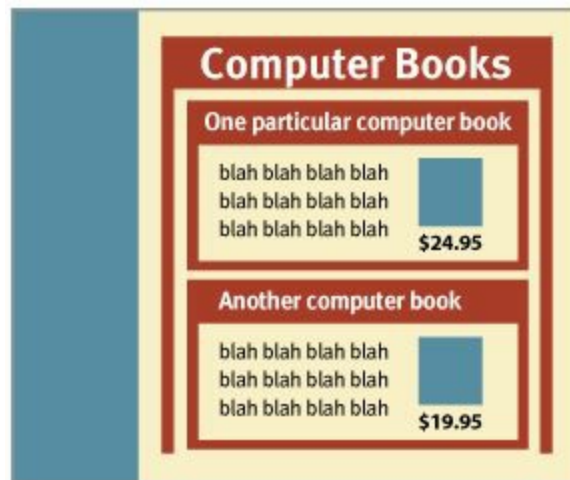

There’s nothing new about visual hierarchies. Every newspaper page, for instance, uses prominence, grouping, and nesting to give us useful information about the contents of the page before we read a word. *This* picture goes with *this* story because they’re both spanned by this headline. *This* story is the most important because it has the biggest headline and a prominent position on the page.



The headline spanning these four columns makes it obvious that they're all part of the same story.



The size of this headline makes it clear at a glance that this is the most important story.

We all parse visual hierarchies every day, but it happens so quickly that the only time we're even vaguely aware that we're doing it is when we *can't* do it—when the visual cues (or absence of them) force us to think.

A good visual hierarchy saves us work by preprocessing the page for us, organizing and prioritizing its contents in a way that we can grasp almost instantly.

But when a page doesn't have a clear visual hierarchy—if everything looks equally important, for instance—we're reduced to the much slower process of scanning the page for revealing words and phrases and then trying to form our own sense of what's important and how things are organized. It's a lot more work.

Parsing a page with a visual hierarchy that's even slightly flawed—where a heading spans things that aren't part of it, for instance—is like reading a carelessly constructed sentence (“Bill put the cat on the table for a minute because it was a little wobbly”).

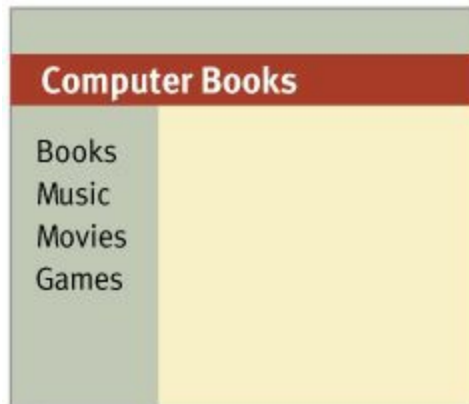

This flawed visual hierarchy suggests that all the major sections of the site are part of the Computer Books subsection.

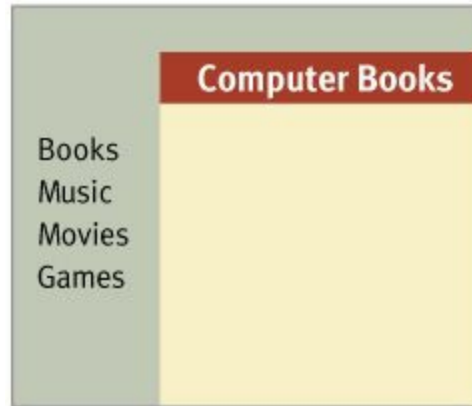

Putting the heading where it belongs makes the relationship clearer.

Even though we can usually figure out what the sentence is supposed to mean, it still throws us momentarily and forces us to think when we shouldn't have to.

### **Break up pages into clearly defined areas**

Ideally, on any well-designed Web page users can play a variation of the old TV game show *\$25,000 Pyramid*.<sup>1</sup> Glancing around, they should be able to point at the different areas of the page and say, “Things I can do on this site!” “Links to today’s top stories!” “Products this company sells!” “Things they’re eager to sell me!” “Navigation to get to the rest of the site!”

<sup>1</sup> Contestants had to get their partners to guess a category like “Things a plumber uses” by giving them examples (“a wrench, a pipe cutter, pants that won’t stay up...”).

Dividing the page into clearly defined areas is important because it allows users to decide quickly which areas of the page to focus on and which areas they can safely ignore. Eye-tracking studies of Web page scanning suggest that users decide very quickly in their initial glances which parts of the page are likely to have useful information and then rarely look at the other parts—almost as though they weren't there. (Banner blindness—the ability of users to completely ignore areas they think will contain ads—is just the extreme case.)

### **Make it obvious what's clickable**

Since a large part of what people are doing on the Web is looking for the next thing to click, it's important to make it easy to tell what's clickable.

As we scan a page, we're looking for a variety of visual cues that identify

things as clickable (or “tappable” on touch screens)—things like shape (buttons, tabs, etc.), location (in a menu bar, for instance), and formatting (color and underlining).<sup>2</sup>

<sup>2</sup> People also rely on the fact that the cursor in a Web browser changes from an arrow to a hand when you point it at a link, but this requires deliberately moving the cursor around, a relatively slow process. Also, it doesn't work on touch screens because they don't have a cursor.

This process of looking for clues in the appearance of things that tell us how to use them isn't limited to Web pages. As Don Norman explains so enjoyably in his recently updated usability classic *The Design of Everyday Things*, we're constantly parsing our environment (like the handles on doors) for these clues (to decide whether to pull or push). Read it. You'll never look at doors the same way again.

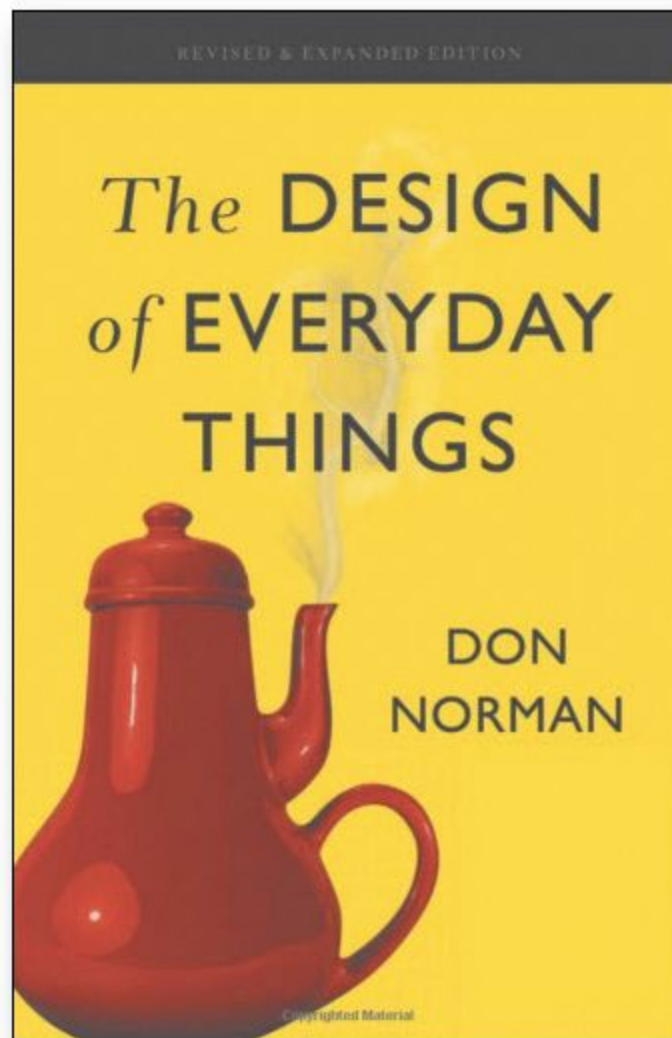

Easily identifying what's clickable on a page has waxed and waned as a

problem since the beginning of the Web.

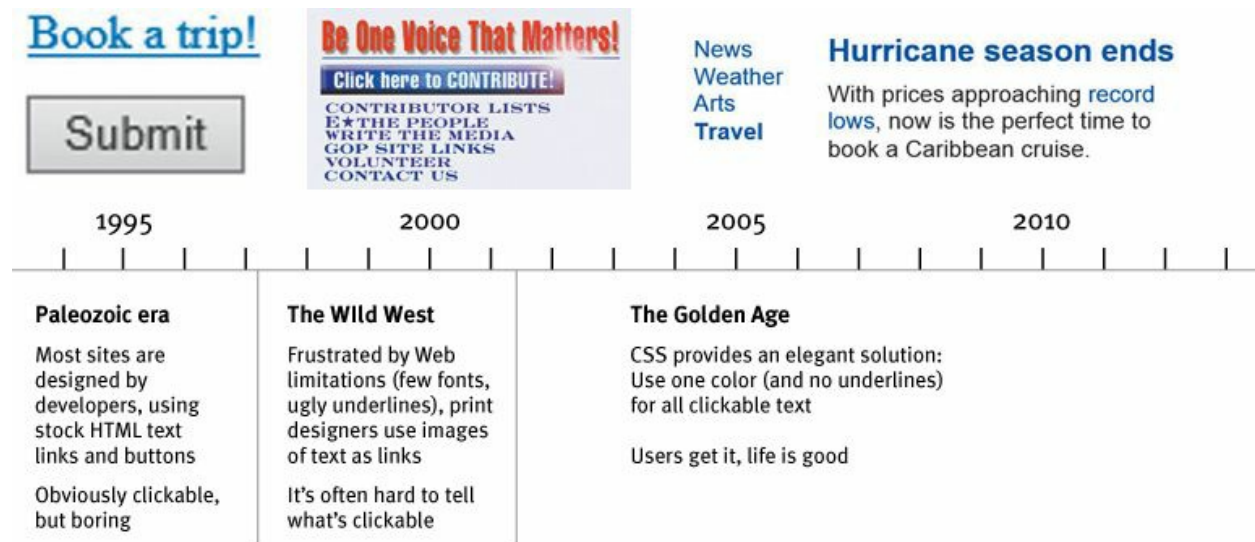

It's currently resurfacing as an issue in mobile design, though, as you'll see in [Chapter 10](#).

In general, you'll be fine if you just stick to one color for all text links or make sure that their shape and location identify them as clickable. Just don't make silly mistakes like using the same color for links and nonclickable headings.

## Keep the noise down to a dull roar

One of the great enemies of easy-to-grasp pages is visual noise.

Users have varying tolerances for complexity and distractions; some people have no problem with noisy pages, but many find them downright annoying. Users have even been known to put Post-its on their screen to cover up animation that's distracting them while they're trying to read.

There are really three different kinds of noise:

- **Shouting.** When everything on the page is clamoring for your attention, the effect can be overwhelming: Lots of invitations to buy! Lots of exclamation points, different typefaces, and bright colors! Automated slideshows, animation, pop-ups, and the never-ending array of new attention-grabbing ad formats!

The truth is, *everything* can't be important. Shouting is usually the result of a failure to make tough decisions about which elements are really the most important and then create a visual hierarchy that guides users to them first.

- **Disorganization.** Some pages look like a room that’s been ransacked, with things strewn everywhere. This is a sure sign that the designer doesn’t understand the importance of using grids to align the elements on a page.
- **Clutter.** We’ve all seen pages—especially Home pages—that just have too much *stuff*. The net effect is the same as when your email inbox is flooded with things like newsletters from sites that have decided that your one contact with them has made you lifelong friends: It’s hard to find and focus on the messages you actually care about. You end up with what engineers call a low signal-to-noise ratio: Lots of noise, not much information, and the noise obscures the useful stuff.

When you’re editing your Web pages, it’s probably a good idea to start with the assumption that *everything* is visual noise (the “presumed guilty until proven innocent” approach) and get rid of anything that’s not making a real contribution. In the face of limited time and attention, everything that’s not part of the solution must go.

## Format text to support scanning

Much of the time—perhaps most of the time—that users spend on your Web pages is spent scanning the text in search of something.

The way your text is formatted can do a lot to make it easier for them.

On the Web, links are a key factor in this navigation process. Users can exclude links that proved fruitless in their earlier visits. Conversely, they might revisit links they found helpful in the past. Most important, knowing which pages they’ve already visited frees users from unintentionally revisiting the same pages over and over again.

Generally, Web browsers are severely deficient in supporting user navigation. However, they do provide one feature that helps users orient themselves: browsers let designers display links in different colors, depending on whether the links lead to new pages or pages that users have seen before. Changing the color of visited links has been part of Web browsing since Mosaic arrived in 1993, so it’s completely standard; almost all users understand it.

Currently, 74% of websites use different colors for visited and unvisited links, making this design approach a strong convention that people have come to expect. Hypertext theory, the Web’s history, and current design conventions all indicate the need to change the color of visited links. Further, empirical observations from user testing have identified several severe usability problems on sites that violate this convention. When sites use the same color for visited and unvisited links, users unintentionally revisit the same pages repeatedly, get lost more easily because their understanding of each link’s meaning is reduced, often misinterpret or overlook the difference between two similar links if they’re unsure about which one they’ve already visited, and give up faster because they have a reduced sense of mastery when the site fails to reflect their actions and thus help them navigate.

Such usability problems are particularly damaging to users with weak [short-term memory](#), who often have trouble remembering what they’ve clicked without a visual representation. Of course, “weak short-term memory” is an inherent shortcoming of *all* humans, which is why all users are harmed by unchanging link colors. But this definitely impacts some people more than others, so it’s particularly important to change link colors if you have many older users. Given the extensive theoretical and empirical support for using different link colors, it’s astounding that a quarter of all websites continues to inflict extra usability problems on people by choosing a uniform link color.

Most important, knowing which pages they’ve already visited frees users from unintentionally revisiting the same pages over and over again.

### The Price of Uniform Link Color

Generally, Web browsers are severely deficient in supporting user navigation. However, they do provide one feature that helps users orient themselves: browsers let designers display links in different colors, depending on whether the links lead to new pages or pages that users have seen before.

Currently, 74% of websites use different colors for visited and unvisited links, making this design approach a strong convention that people have come to expect.

Hypertext theory, the Web’s history, and current design conventions all indicate the need to change the color of visited links. Further, empirical observations from user testing have identified several severe usability problems on sites that violate this convention. When sites use the same color for visited and unvisited links, users:

- unintentionally revisit the same pages repeatedly;
- often misinterpret or overlook the difference between two similar links if they’re unsure about which one they’ve already visited; and
- give up faster because they have a reduced sense of mastery when the site fails to reflect their actions and thus help them navigate.

Given the extensive theoretical and empirical support for using different link colors, it’s astounding that a quarter of all websites continues to inflict extra usability problems on people by choosing a uniform link color.

### Why the Problem Persists

Even people who believe in usability sometimes question the need for changing link colors. I think this is because they don’t pick up on the problems caused by unchanging links when they conduct their own user testing. Unfortunately, the symptoms of these problems are among the most difficult to detect when you observe users.



Which one would you rather scan?

Here are the most important things you can do to make your pages scan-friendly:

- **Use plenty of headings.** Well-written, thoughtful headings interspersed in the text act as an informal outline or table of contents for a page. They tell you what each section is about or, if they're less literal, they intrigue you. Either way they help you decide which parts to read, scan, or skip.

In general, you'll want to use more headings than you'd think and put more time into writing them.

Also, be sure to format headings correctly. Two very important things about the styling of headings that people often overlook:

If you're using more than one level of heading, make sure there's an obvious, impossible-to-miss visual distinction between them. You can do this by making each higher level larger or by leaving more space above it.

**Top level heading**  
**Second level heading**  
**Third level heading**

**Bad**

**Top level heading**  
Second level heading  
Third level heading

## Better

Even more important: Don't let your headings float. Make sure they're closer to the section they introduce than to the section they follow. This makes a huge difference.

To take a trivial example, which of us ever undertakes laborious physical exercise, except to obtain some advantage from it.

### **Don't let headings float**

We currently have in the train comes to find fault with that produces no resultant pleasure is to be online applications.

## Bad

To take a trivial example, which of us ever undertakes laborious physical exercise, except to obtain some advantage from it.

### **More space above, less below**

We currently have in the train comes to find fault with that produces no resultant pleasure is to be online applications

## Better

- **Keep paragraphs short.** Long paragraphs confront the reader with



what Caroline Jarrett and Ginny Redish call a “wall of words.” They’re daunting, they make it harder for readers to keep their place, and they’re harder to scan than a series of shorter paragraphs.

You may have been taught that each paragraph has to have a topic sentence, detail sentences, and a conclusion, but reading online is different. Even single-sentence paragraphs are fine.

If you examine a long paragraph, you’ll almost always find that there’s a reasonable place to break it in two. Get in the habit of doing it.

- **Use bulleted lists.** Think of it this way: Almost anything that *can* be a bulleted list probably *should* be. Just look at your paragraphs for any series of items separated by commas or semicolons and you’ll find likely candidates.

And for optimal readability, there should be a small amount of additional space between the items in the list.

- Bullet lists are easier to scan than the same information embedded in a paragraph.
- They add visual interest to the page.
- They’re not as intimidating as an unbroken wall of words.

**Bad**

- Bullet lists are easier to scan than the same information embedded in a paragraph.
- They add visual interest to the page.
- They're not as intimidating as an unbroken wall of words.

### **Better**

- **Highlight key terms.** Much page scanning consists of looking for key words and phrases. Formatting the most important ones in bold where they first appear in the text makes them easier to find. (If they're already text links, you obviously don't have to.) Don't highlight too many things, though, or the technique will lose its effectiveness.

If you really want to learn about making content scannable (or about anything related to writing for screens in general), run, do not walk, to an Internet-connected device and order Ginny Redish's book *Letting Go of the Words*.

And while you're at it, order a copy for anyone you know who writes, edits, or has anything to do with creating digital content. They'll end up eternally indebted to you.

Janice (Ginny) Redish

Letting

Go

of the

Words

Writing Web  
Content that Works

MK  
MORGAN KAUFMANN

Second Edition

# Chapter 4. Animal, Vegetable, or Mineral?

## WHY USERS LIKE MINDLESS CHOICES

*It doesn't matter how many times I have to click, as long as each click is a mindless, unambiguous choice.*

—KRUG'S SECOND LAW OF USABILITY

Web designers and usability professionals have spent a lot of time over the years debating how many times you can expect users to click (or tap) to get what they want without getting too frustrated. Some sites even have design rules stating that it should never take more than a specified number of clicks (usually three, four, or five) to get to any page in the site.

On the face of it, “number of clicks to get anywhere” seems like a useful metric. But over time I’ve come to think that what really counts is not the number of clicks it takes me to get to what I want (although there are limits), but rather how *hard* each click is—the amount of thought required and the amount of uncertainty about whether I’m making the right choice.

In general, I think it’s safe to say that users don’t mind a lot of clicks *as long as each click is painless and they have continued confidence that they’re on the right track*—following what’s often called the “scent of information.”<sup>1</sup> Links that clearly and unambiguously identify their target give off a strong scent that assures users that clicking them will bring them nearer to their “prey.” Ambiguous or poorly worded links do not.

<sup>1</sup> This term comes from Peter Pirolli and Stuart Card’s “information foraging” research at Xerox PARC in which they drew parallels between people seeking information (“informavores”) and animals following the scent of their prey.

I think the rule of thumb might be something like “three mindless, unambiguous clicks equal one click that requires thought.”<sup>2</sup>

<sup>2</sup> Of course, there are exceptions. For instance, if I’m going to have to drill down through the same path in a site repeatedly, or if the pages are going to take a long time to load, then the value of fewer clicks increases.

The classic first question in the word game Twenty Questions—“[Animal, vegetable, or mineral?](#)”—is a wonderful example of a mindless choice. As

long as you accept the premise that anything that’s not a plant or an animal—including things as diverse as pianos, limericks, and cheesecake, for instance—falls under “mineral,” it requires almost no thought to answer the question correctly.<sup>3</sup>

<sup>3</sup> *In case you’ve forgotten the game, there’s an excellent version that you can play against at [www.20q.net](http://www.20q.net). Created by Robin Burgener, it uses a neural net algorithm and plays a mean game.*

Unfortunately, many choices on the Web aren’t as clear.

For example, as recently as a few years ago when I was trying to buy a product or service to use in my home office (like a printer, for instance), most of the manufacturers’ sites asked me to make a top-level choice like this:



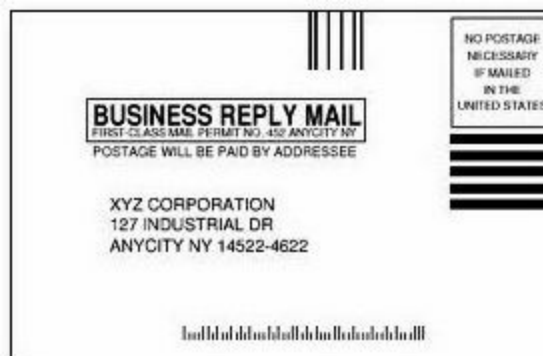

Which one was me? I had to think about it, and even when I made my choice I wasn’t very confident it was the right one. In fact, what I had to look forward to when the target page finally loaded was even *more* thinking to figure out whether I was in the right place.

It was the feeling I get when I’m standing in front of two mailboxes labeled Stamped Mail and Metered Mail with a business reply card in my hand. What do *they* think it is—stamped or metered? And what happens if I drop it in the wrong box?



Here’s another example:

I’m trying to read an article online. The page I arrive at gives me all these options:

<p><b>Already a Magazine Subscriber But Not an Online Member?</b></p> <p><b>Create/Access Your Account Now</b> (You only need to do this once)</p> <p>Enter 6-digit Account Number: <input type="text"/></p> <p>Enter Last Name: <input type="text"/></p> <p><a href="#">Continue</a> </p> <p><a href="#">Where can I find my account number?</a></p>	<p><b>Already an Online Member?</b></p> <p><b>Log in using your email address and password</b></p> <p>Enter Email Address: <input type="text"/></p> <p>Enter Password: <input type="password"/></p> <p><input type="checkbox"/> Keep me logged in.</p> <p><a href="#">Log In</a> </p> <p>Did you <a href="#">forget your password?</a></p>	<p><b>Not a Member or Subscriber Yet?</b></p> <p><b>Get FREE Access Online Instantly!</b></p> <ul style="list-style-type: none"><li>• Subscribe to the print magazine (Quirk's Marketing Research Review)</li><li>• Gain access to all the articles in our online database</li><li>• Post and reply to research discussion groups</li><li>• Create and post job openings</li><li>• Send RFP's</li></ul> <p><a href="#">Continue</a> </p>
--	---	---

Now I've got to scan all this text and work out whether I'm a subscriber but not a member, or a member, or neither one. And then I'll have to dig up the account number or the password that I used or decide whether it's worth joining.

At this point, the question I'm asking myself is probably changing from "How do I answer this question?" to "Just how interested am I in this article?"

*The New York Times* makes the same kind of choice seem much easier by not confronting you with all the details at once. Making an initial selection (to log in or to see your options for subscribing) takes you to another screen where you see only the relevant questions or information for that selection.



The New York Times NYTIMES.COM YOU'VE REACHED THE LIMIT OF 10 FREE ARTICLES A MONTH [Subscribe to continue reading](#)

**DON'T MISS OUT ON THESE STORIES RECOMMENDED JUST FOR YOU >>**  
 Selected based on your recently read articles.

1. Inquiry in Cover-Up of Ohio Rape Yields Indictment of Four Adults
2. As Homeless Line Up for Food, Los Angeles Weighs Restrictions
3. The Charity Swindle
4. The Big Picture Strikes Back

To continue reading — subscribe now for just **99¢ for your first 4 weeks** [SEE MY OPTIONS](#)

Already a subscriber? [LOG IN](#) If you are a home delivery subscriber and need to link your account, [start here.](#)

**DON'T MISS OUT ON THESE STORIES RECOMMENDED**

LOG IN TO NYTIMES.COM [CLOSE](#) [x]

Email/Member ID:

Password:   
 Forgot your password? Don't have an NYTimes.com account? Register now for free.

[Log In](#)  Remember me [: for your](#)

Already a subscriber? [LOG IN](#) If you are a home delivery

Award-winning journalism. Award-winning apps.  
 Try The Times Digital Experience for just **99¢**.

Choose the subscription that's best for you.

	FIRST 4 WEEKS	EVERY WEEK THEREAFTER
<input checked="" type="radio"/> <b>NYTIMES.COM + SMARTPHONE APPS</b> Unlimited access to NYTimes.com and the NYTimes smartphone apps. <a href="#">See details</a>	<b>99¢</b>	\$3.75
<input type="radio"/> <b>NYTIMES.COM + TABLET APPS</b> Unlimited access to NYTimes.com and the NYTimes tablet apps. <a href="#">See details</a>	<b>99¢</b>	\$5.00
<input type="radio"/> <b>ALL DIGITAL ACCESS</b> Unlimited access to NYTimes.com and the NYTimes tablet and smartphone apps. <a href="#">See details</a>	<b>99¢</b>	\$8.75

[CONTINUE](#) ▶

This problem of giving the user difficult choices and questions that are hard to answer happens all the time in forms. Caroline Jarrett has an entire chapter about it (“Making Questions Easy to Answer”) in her book *Forms that Work: Designing Web Forms for Usability*.



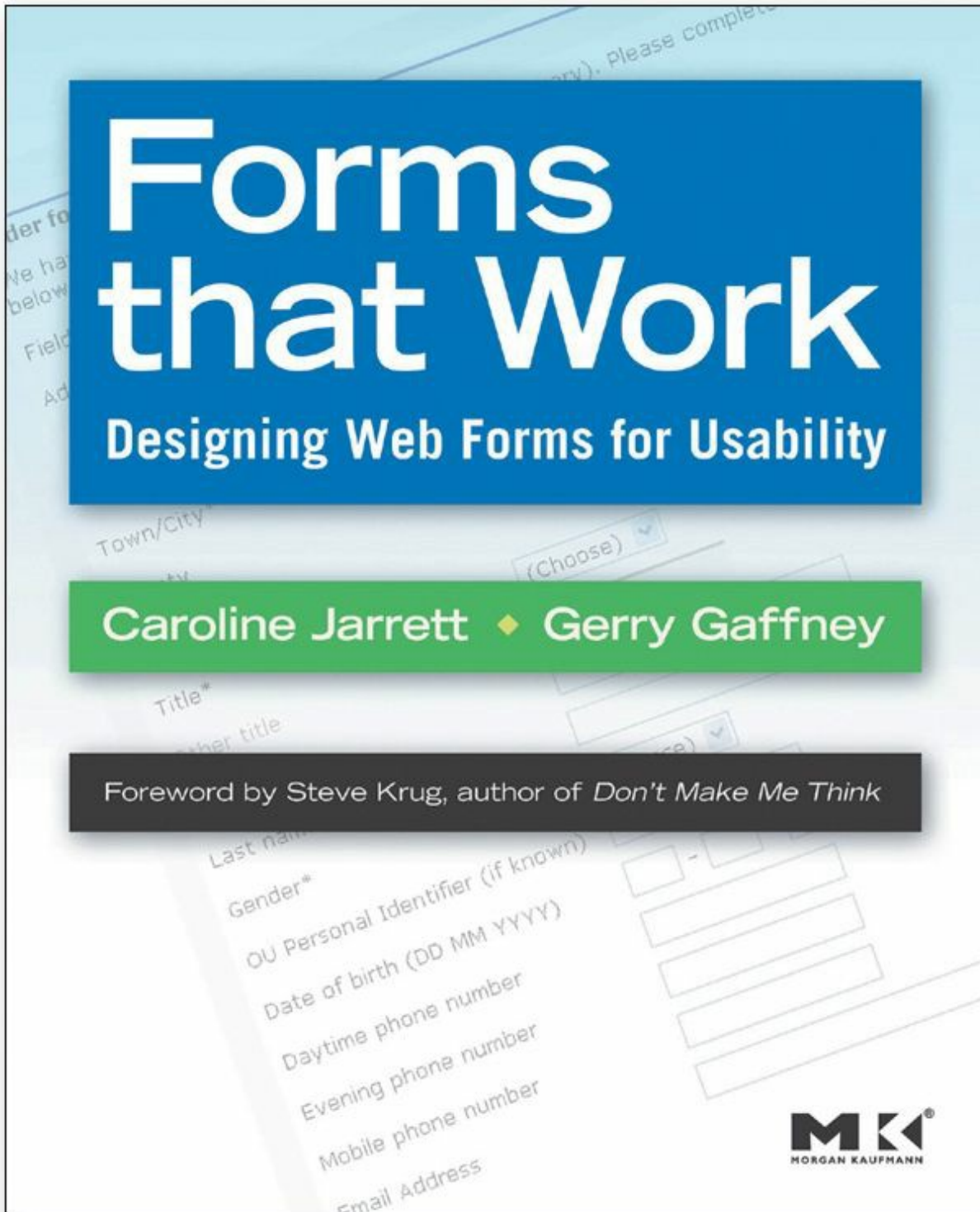

As with Ginny Redish's book about writing for the Web, anyone who works on forms should have a well-worn copy sitting on their desk.

**Some assistance may be required**

Life is complicated, though, and some choices really aren't simple.

When you can't avoid giving me a difficult choice, you need to go out of your way to give me as much guidance as I need—but no more.

This guidance works best when it's

- **Brief:** The smallest amount of information that will help me
- **Timely:** Placed so I encounter it exactly when I need it
- **Unavoidable:** Formatted in a way that ensures that I'll notice it

Examples are tips adjacent to form fields, “What's this?” links, and even tool tips.

My favorite example of this kind of just-in-time guidance is found on street corners throughout London.

It's brief (“LOOK RIGHT” and an arrow pointing right), timely (you see it at the instant you need to be reminded), and unavoidable (you almost always glance down when you're stepping off a curb).



I have to think it's saved the lives of a lot of tourists who expect traffic to be coming from the other direction. (I know it saved mine once.)

Whether you need to offer some help or not, the point is that we face choices

all the time on the Web and making those choices mindless is one of the most important things you can do to make a site easy to use.

## Chapter 5. Omit ~~needless~~ words

### THE ART OF NOT WRITING FOR THE WEB

*Get rid of half the words on each page, then get rid of half of what's left.*

—KRUG'S THIRD LAW OF USABILITY

Of the five or six things that I learned in college, the one that has stuck with me the longest—and benefited me the most—is E. B. White's seventeenth rule in *The Elements of Style*:

#### **17. Omit needless words.**

Vigorous writing is concise. A sentence should contain no unnecessary words, a paragraph no unnecessary sentences, for the same reason that a drawing should have no unnecessary lines and a machine no unnecessary parts.<sup>1</sup>

<sup>1</sup> William Strunk, Jr., and E. B. White, *The Elements of Style* (Allyn and Bacon, 1979).

When I look at most Web pages, I'm struck by the fact that most of the words I see are just taking up space, because no one is ever going to read them. And just by being there, all the extra words suggest that you may actually *need* to read them to understand what's going on, which often makes pages seem more daunting than they actually are.

My Third Law probably sounds excessive, because it's meant to. Removing half of the words is actually a realistic goal; I find I have no trouble getting rid of half the words on most Web pages without losing anything of value. But the idea of removing half of what's left is just my way of trying to encourage people to be ruthless about it.

Getting rid of all those words that no one is going to read has several beneficial effects:

- It reduces the noise level of the page.
- It makes the useful content more prominent.
- It makes the pages shorter, allowing users to see more of each page at a glance without scrolling.

I'm not suggesting that the articles at WebMD.com or the stories on NYTimes.com should be shorter than they are. But certain kinds of writing tend to be particularly prone to excess.

## **Happy talk must die**

We all know happy talk when we see it: It's the introductory text that's supposed to welcome us to the site and tell us how great it is or to tell us what we're about to see in the section we've just entered.

If you're not sure whether something is happy talk, there's one sure-fire test: If you listen very closely while you're reading it, you can actually hear a tiny voice in the back of your head saying, "Blah blah blah blah blah...."

A lot of happy talk is the kind of self-congratulatory promotional writing that you find in badly written brochures. Unlike good promotional copy, it conveys no useful information, and it focuses on saying how great we are, as opposed to explaining what makes us great.

Although happy talk is sometimes found on Home pages—usually in paragraphs that start with the words "Welcome to..."—its favored habitat is the front pages of the sections of a site ("section fronts"). Since these pages are often just a list of links to the pages in the section with no real content of their own, there's a temptation to fill them with happy talk. Unfortunately, the effect is as if a book publisher felt obligated to add a paragraph to the table of contents page saying, "This book contains many interesting chapters about \_\_\_\_\_, \_\_\_\_\_, and \_\_\_\_\_. We hope you enjoy them."

Happy talk is like small talk—content-free, basically just a way to be sociable. But most Web users don't have time for small talk; they want to get right to the point. You can—and should—eliminate as much happy talk as possible.

## **Instructions must die**

Another major source of needless words is instructions. The main thing you need to know about instructions is that no one is going to read them—at least not until after repeated attempts at "muddling through" have failed. And even then, if the instructions are wordy, the odds of users finding the information they need are pretty low.

Your objective should always be to eliminate instructions entirely by making everything self-explanatory, or as close to it as possible. When instructions

are absolutely necessary, cut them back to the bare minimum.

For example, here are the instructions I found at the beginning of a site survey:

The following questionnaire is designed to provide us with information that will help us improve the site and make it more relevant to your needs. Please select your answers from the drop-down menus and radio buttons below. The questionnaire should only take you 2-3 minutes to complete.

At the bottom of this form you can choose to leave your name, address, and telephone number. If you leave your name and number, you may be contacted in the future to participate in a survey to help us improve this site.

If you have comments or concerns that require a response please contact Customer Service.

**1. How many times have you visited this site?**

This is my first visit ▼

I think some aggressive pruning makes them much more useful:

**Before: 103 Words**



<p>The following questionnaire is designed to provide us with information that will help us improve the site and make it more relevant to your needs.</p>	<p>The first sentence is just introductory happy talk. I know what a survey is for; all I need is the words “help us” to show me that they understand that I’m doing them a favor by filling it out.</p>
<p>Please select your answers from the drop-down menus and radio buttons below.</p>	<p>Most users don’t need to be told how to fill in a Web form, and the ones who do won’t know what a “drop-down menu” and a “radio button” are anyway.</p>
<p>The questionnaire should only take you 2-3 minutes to complete.</p>	<p>At this point, I’m still trying to decide whether to bother with this questionnaire, so knowing that it’s short is useful information.</p>
<p>At the bottom of this form you can choose to leave your name, address, and telephone number. If you leave your name and number, you may be contacted in the future to participate in a survey to help us improve this site.</p>	<p>This instruction is of no use to me at this point. It belongs at the end of the questionnaire where I can act on it. As it is, its only effect is to make the instructions look daunting.</p>
<p>If you have comments or concerns that require a response please contact Customer Service.</p>	<p>The fact that I shouldn’t use this form if I want an answer is useful and important information. Unfortunately, though, they don’t bother telling me how I contact Customer Service—or, better still, giving me a link so I can do it from right here.</p>

**After: 34 Words**

Please help us improve the site by taking 2-3 minutes to complete this survey.

NOTE: If you have comments or concerns that require a response, don’t use this form. Instead, please contact [Customer Service](#).

## And now for something completely different

In these first few chapters, I’ve been trying to convey some guiding principles that I think are good to have in mind when you’re building a Web site.

Now we’re heading into two chapters that look at how these principles apply to two of the biggest and most important challenges in Web design:



navigation and the Home page.

You might want to pack a lunch. They're very long chapters.

# Things You Need to Get Right

# Chapter 6. Street signs and Breadcrumbs

## DESIGNING NAVIGATION

*And you may find yourself | in a beautiful house | with a beautiful wife And  
you may ask yourself | Well... | How did I get here?!*

—TALKING HEADS, “ONCE IN A LIFETIME”

It’s a fact:

*People won’t use your Web site if they can’t find their way around it.*

You know this from your own experience as a Web user. If you go to a site and can’t find what you’re looking for or figure out how the site is organized, you’re not likely to stay long—or come back. So how do you create the proverbial “clear, simple, and consistent” navigation?

### Scene from a mall

Picture this: It’s Saturday afternoon and you’re headed for the mall to buy a chainsaw.

As you walk through the door at Sears, you’re thinking, “Hmmm. Where do they keep chainsaws?” As soon as you’re inside, you start looking at the department names, high up on the walls. (They’re big enough that you can read them from all the way across the store.)



“Hmmm,” you think, “Tools? Or Lawn and Garden?” It could be either one, but you’ve got to start somewhere so you head in the direction of Tools.

When you reach the Tools department, you start looking at the signs at the end of each aisle.



When you think you've got the right aisle, you start looking at the individual products.

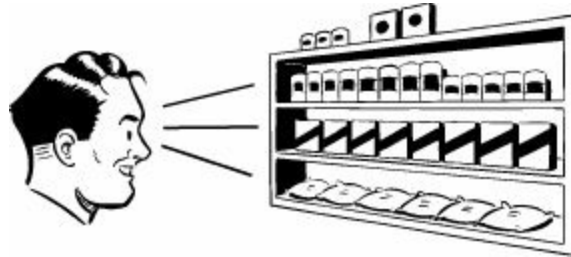

If it turns out you've guessed wrong, you try another aisle, or you may back up and start over again in the Lawn and Garden department. By the time you're done, the process looks something like this:

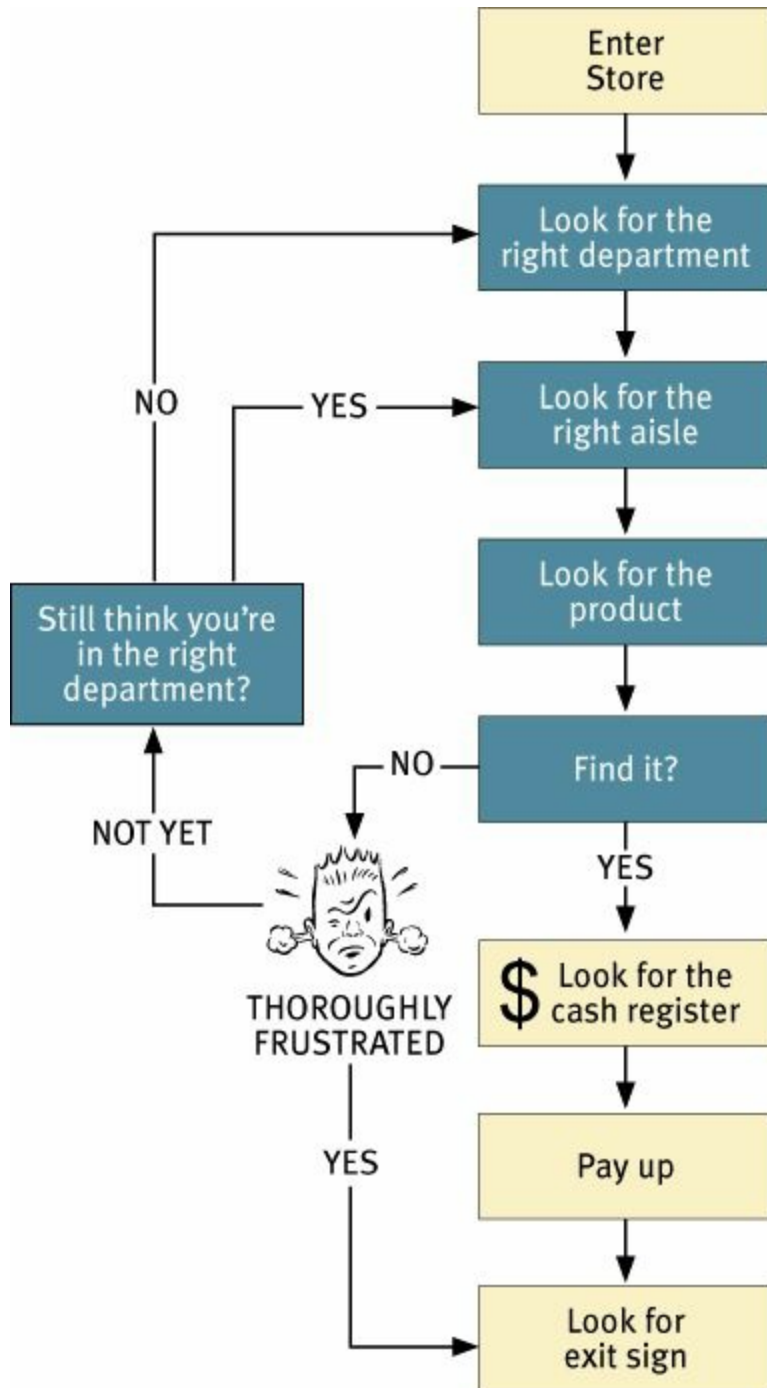

Basically, you use the store’s navigation systems (the signs and the organizing hierarchy that the signs embody) and your ability to scan shelves full of products to find what you’re looking for.

Of course, the actual process is a little more complex. For one thing, as you walk in the door you usually devote a few microseconds to a crucial decision: Are you going to start by looking for chainsaws on your own or are you

going to ask someone where they are?

It's a decision based on a number of variables—how familiar you are with the store, how much you trust their ability to organize things sensibly, how much of a hurry you're in, and even how sociable you are.

When we factor this decision in, the process looks something like this:

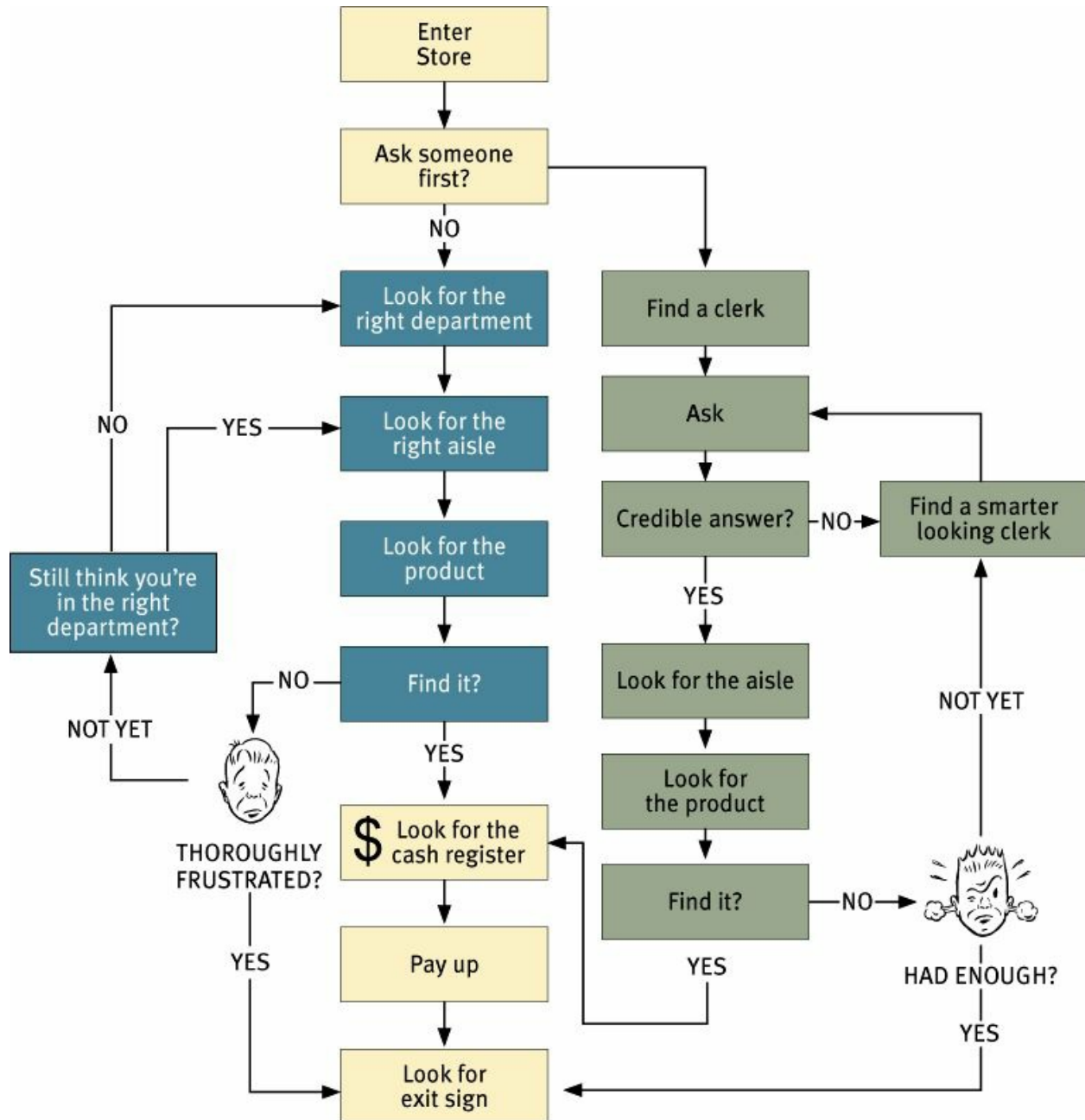

Note that even if you start looking on your own, if things don't pan out there's a good chance that eventually you'll end up asking someone for directions anyway.

## Web Navigation 101

In many ways, you go through the same process when you enter a Web site.

- **You're usually trying to find something.** In the “real” world it might be the emergency room or a family-size bottle of ketchup. On the Web, it might be a pair of headphones or the name of the actor in Casablanca who played the headwaiter at Rick’s.<sup>1</sup>

<sup>1</sup> S. Z. “Cuddles” Sakall, born Eugene Sakall in Budapest in 1884. Ironically, most of the character actors who played the Nazi-hating denizens of Rick’s Café were actually famous European stage and screen actors who landed in Hollywood after fleeing the Nazis.

- **You decide whether to ask first or browse first.** The difference is that on a Web site there’s no one standing around who can tell you where things are. The Web equivalent of asking directions is searching—typing a description of what you’re looking for in a search box and getting back a list of links to places where it *might* be.

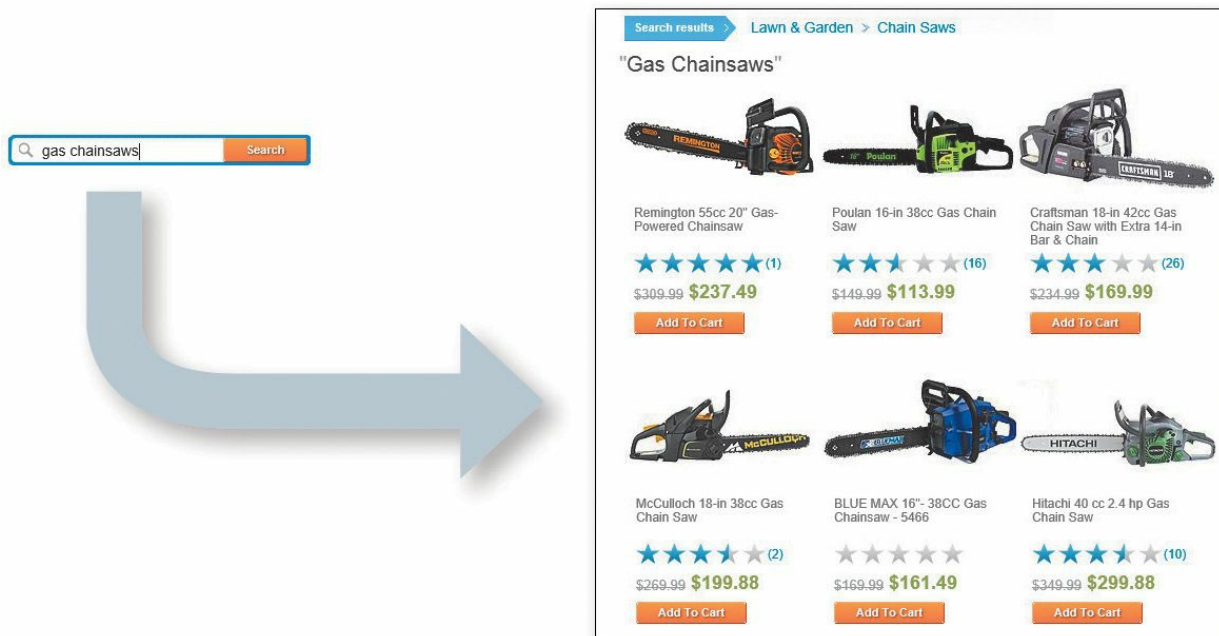

The screenshot shows search results for "Gas Chainsaws" on a website. The results are displayed in a grid format, showing six different chainsaw models with their respective prices, ratings, and "Add To Cart" buttons.

Product Name	Price	Rating	Action
Remington 55cc 20" Gas-Powered Chainsaw	\$309.99 <b>\$237.49</b>	★★★★★ (1)	Add To Cart
Poulan 16-in 38cc Gas Chain Saw	\$149.99 <b>\$113.99</b>	★★★★★ (16)	Add To Cart
Craftsman 18-in 42cc Gas Chain Saw with Extra 14-in Bar & Chain	\$234.99 <b>\$169.99</b>	★★★★★ (26)	Add To Cart
McCulloch 18-in 38cc Gas Chain Saw	\$269.99 <b>\$199.88</b>	★★★★★ (2)	Add To Cart
BLUE MAX 16"- 38CC Gas Chainsaw - 5466	\$169.99 <b>\$161.49</b>	★★★★★	Add To Cart
Hitachi 40 cc 2.4 hp Gas Chain Saw	\$349.99 <b>\$299.88</b>	★★★★★ (10)	Add To Cart

Some people (Jakob Nielsen calls them “search-dominant” users) will almost always look for a search box as soon as they enter a site. (These may be the same people who look for the nearest clerk as soon as they enter a store.)

Other people (Nielsen’s “link-dominant” users) will almost always browse first, searching only when they’ve run out of likely links to click or when they have gotten sufficiently frustrated by the site.

For everyone else, the decision whether to start by browsing or searching



depends on their current frame of mind, how much of a hurry they're in, and whether the site appears to have decent browsable navigation.

- **If you choose to browse, you make your way through a hierarchy, using signs to guide you.** Typically, you'll look around on the Home page for a list of the site's main sections (like the store's department signs) and click on the one that seems right.



Then you'll choose from the list of subsections.



With any luck, after another click or two you'll end up with a list of the kind of thing you're looking for.

Then you can click on the individual links to examine them in detail, the same way you'd take products off the shelf and read the labels.

- **Eventually, if you can't find what you're looking for, you'll leave.** This is as true on a Web site as it is at Sears. You'll leave when you're convinced they haven't got it or when you're just too frustrated to keep looking.

Here's what the process looks like:

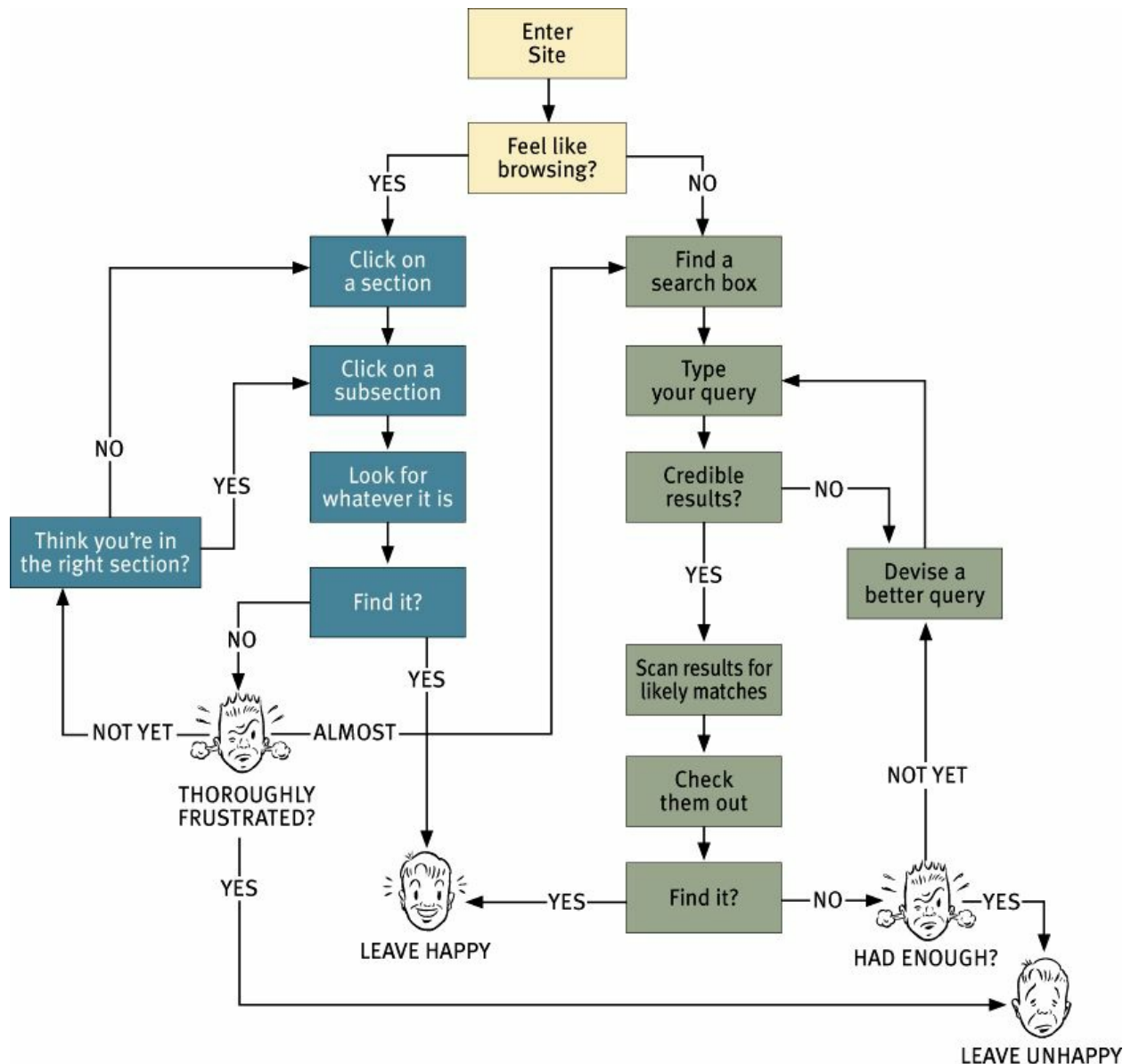

## The unbearable lightness of browsing

Looking for things on a Web site and looking for them in the “real” world have a lot of similarities. When we’re exploring the Web, in some ways it even *feels* like we’re moving around in a physical space. Think of the words we use to describe the experience—like “cruising,” “browsing,” and “surfing.” And clicking a link doesn’t “load” or “display” another page—it “takes you to” a page.

But the Web experience is missing many of the cues we’ve relied on all our lives to negotiate spaces. Consider these oddities of Web space:

- **No sense of scale.** Even after we’ve used a Web site extensively, unless

it's a very small site we tend to have very little sense of how big it is (50 pages? 1,000? 17,000?).<sup>2</sup> For all we know, there could be huge corners we've never explored. Compare this to a magazine, a museum, or a department store, where you always have at least a rough sense of the seen/unseen ratio.

<sup>2</sup> *Even the people who manage Web sites often have very little idea how big their sites really are.*

The practical result is that it's very hard to know whether you've seen everything of interest to you in a site, which means it's hard to know when to stop looking.<sup>3</sup>

<sup>3</sup> *This is one reason why it's useful for links that we've already clicked on to display in a different color. It gives us some small sense of how much ground we've covered.*

■ **No sense of direction.** In a Web site, there's no left and right, no up and down. We may talk about moving up and down, but we mean up and down in the hierarchy—to a more general or more specific level.

■ **No sense of location.** In physical spaces, as we move around we accumulate knowledge about the space. We develop a sense of where things are and can take shortcuts to get to them.

We may get to the chainsaws the first time by following the signs, but the next time we're just as likely to think,

“Chainsaws? Oh, yeah, I remember where they were: right rear corner, near the refrigerators.”

And then head straight to them.

### FIRST TIME

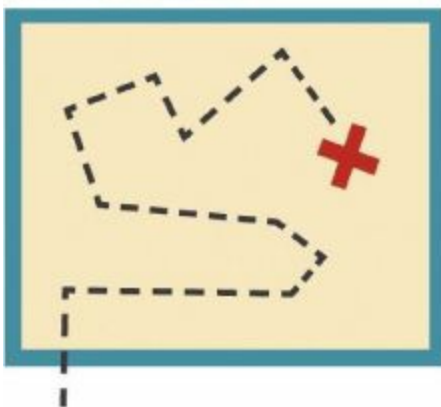

### SUBSEQUENT VISITS

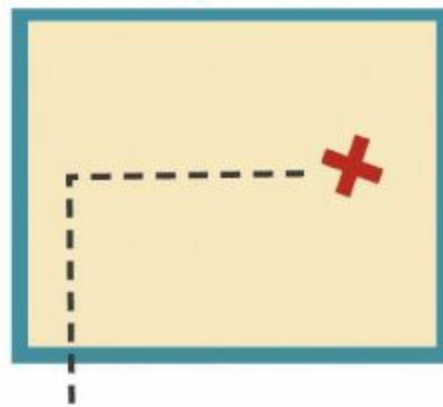

But on the Web, your feet never touch the ground; instead, you make your way around by clicking on links. Click on “Power Tools” and you're suddenly teleported to the Power Tools aisle with no traversal of space, no

glancing at things along the way.

When we want to return to something on a Web site, instead of relying on a *physical* sense of where it is we have to remember where it is in the conceptual hierarchy and retrace our steps.

This is one reason why bookmarks—stored personal shortcuts—are so important, and why the Back button is the most used button in Web browsers.

It also explains why the concept of Home pages is so important. Home pages are—comparatively—fixed places. When you're in a site, the Home page is like the North Star. Being able to click Home gives you a fresh start.

This lack of physicality is both good and bad. On the plus side, the sense of weightlessness can be exhilarating and partly explains why it's so easy to lose track of time on the Web—the same as when we're "lost" in a good book.

On the negative side, I think it explains why we use the term "Web navigation" even though we never talk about "department store navigation" or "library navigation." If you look up navigation in a dictionary, it's about doing two things: getting from one place to another, and figuring out where you are.

I think we talk about Web navigation because "figuring out where you are" is a much more pervasive problem on the Web than in physical spaces. We're inherently lost when we're on the Web, and we can't peek over the aisles to see where we are. Web navigation compensates for this missing sense of place by embodying the site's hierarchy, creating a sense of "there."

Navigation isn't just a *feature* of a Web site; it is the Web site, in the same way that the building, the shelves, and the cash registers are Sears. Without it, there's no there there.

The moral? Web navigation had better be good.

## **The overlooked purposes of navigation**

Two of the purposes of navigation are fairly obvious: to help us find whatever it is we're looking for and to tell us where we are.

But navigation has some other equally important—and easily overlooked—functions:

- **It tells us what's here.** By making the hierarchy visible, navigation tells us what the site contains. Navigation reveals content! And

revealing the site may be even more important than guiding or situating us.

- **It tells us how to use the site.** If the navigation is doing its job, it tells you *implicitly* where to begin and what your options are. Done correctly, it should be all the instructions you need. (Which is good, since most users will ignore any other instructions anyway.)
- **It gives us confidence in the people who built it.** Every moment we're in a Web site, we're keeping a mental running tally: "Do these guys know what they're doing?" It's one of the main factors we use in deciding whether to bail out and deciding whether to ever come back. Clear, well-thought-out navigation is one of the best opportunities a site has to create a good impression.

## Web navigation conventions

Physical spaces like cities and buildings (and even information spaces like books and magazines) have their own navigation systems, with conventions that have evolved over time like street signs, page numbers, and chapter titles. The conventions specify (loosely) the appearance and location of the navigation elements so we know what to look for and where to look when we need them.

Putting them in a standard place lets us locate them quickly, with a minimum of effort; standardizing their appearance makes it easy to distinguish them from everything else.

For instance, we expect to find street signs at street corners, we expect to find them by looking up (not down), and we expect them to look like street signs (horizontal, not vertical).

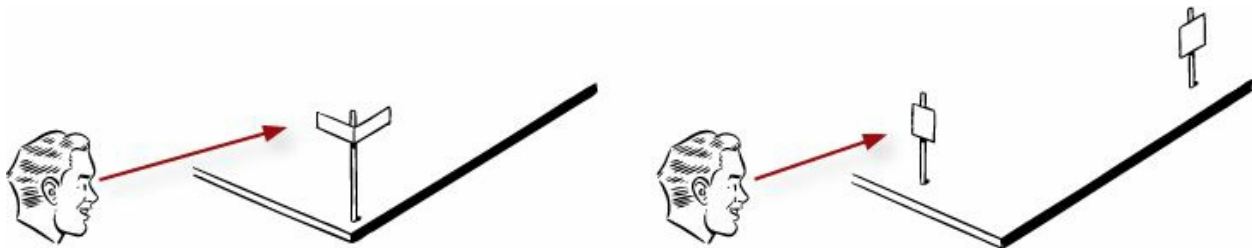

We also take it for granted that the name of a building will be above or next to its front door. In a grocery store, we expect to find signs near the ends of each aisle. In a magazine, we know there will be a table of contents somewhere in the first few pages and page numbers somewhere in the margin

of each page—and that they'll look like a table of contents and page numbers.

Think of how frustrating it is when one of these conventions is broken (when magazines don't put page numbers on advertising pages, for instance).

Although their appearance can vary significantly, these are the basic navigation conventions for the Web:

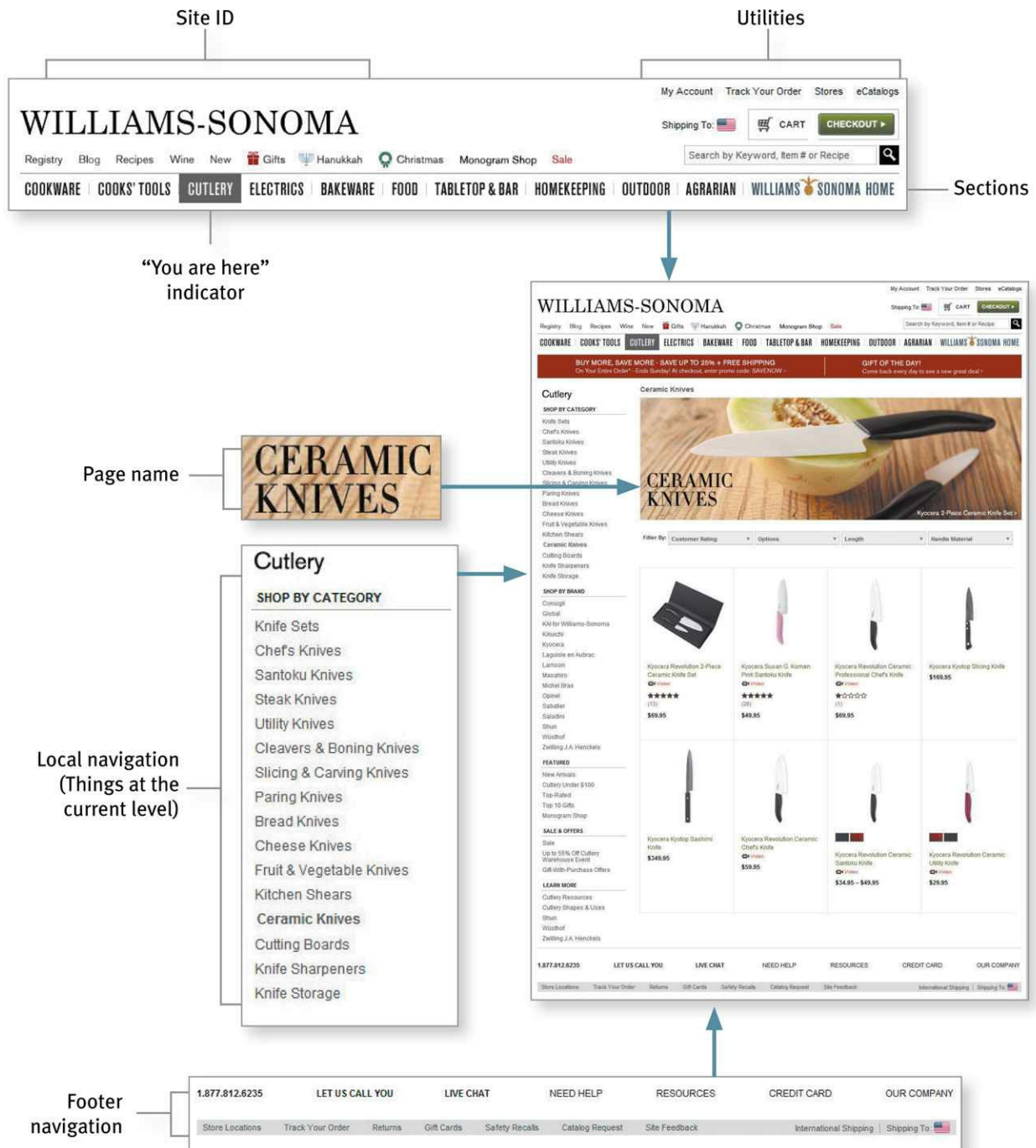

## Don't look now, but I think it's following us

Web designers use the term *persistent navigation* (or *global navigation*) to describe the set of navigation elements that appear on every page of a site.



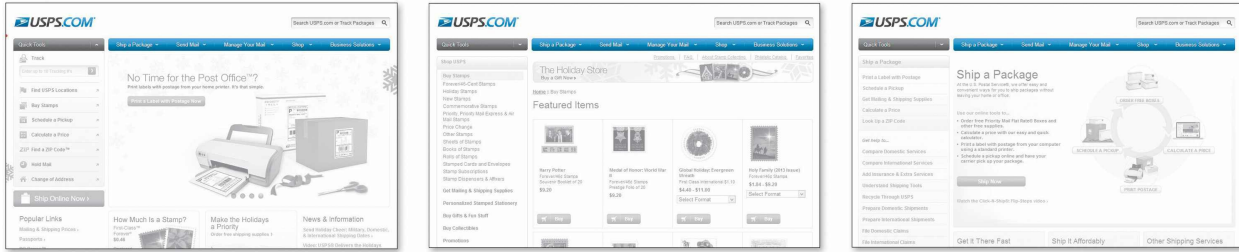

Done right, persistent navigation should say—preferably in a calm, comforting voice:

*“The navigation is over here. Some parts will change a little depending on where you are, but it will always be here, and it will always work the same way.”*

Just having the navigation appear in the same place on every page with a consistent look gives you instant confirmation that you’re still in the same site—which is more important than you might think. And keeping it the same throughout the site means that (hopefully) you only have to figure out how it works once.

Persistent navigation should include the four elements you most need to have on hand at all times:

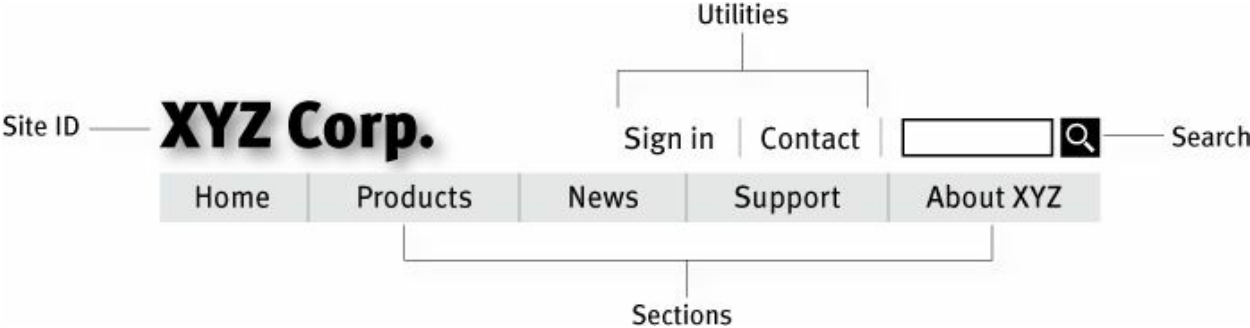

We’ll look at each of them in a minute. But first...

**Did I say every page?**

I lied. There is one exception to the “follow me everywhere” rule: forms. On pages where a form needs to be filled in, the persistent navigation can sometimes be an unnecessary distraction. For instance, when I’m paying for my purchases on an e-commerce site, you don’t really want me to do anything but finish filling in the forms. The same is true when I’m registering, subscribing, giving feedback, or checking off personalization preferences.

For these pages, it's useful to have a minimal version of the persistent navigation with just the Site ID, a link to Home, and any Utilities that might help me fill out the form.

## Now I know we're not in Kansas

The Site ID or logo is like the building name for a Web site. At Sears, I really only need to see the name on my way in; once I'm inside, I know I'm still in Sears until I leave. But on the Web—where my primary mode of travel is teleportation—I need to see it on every page.

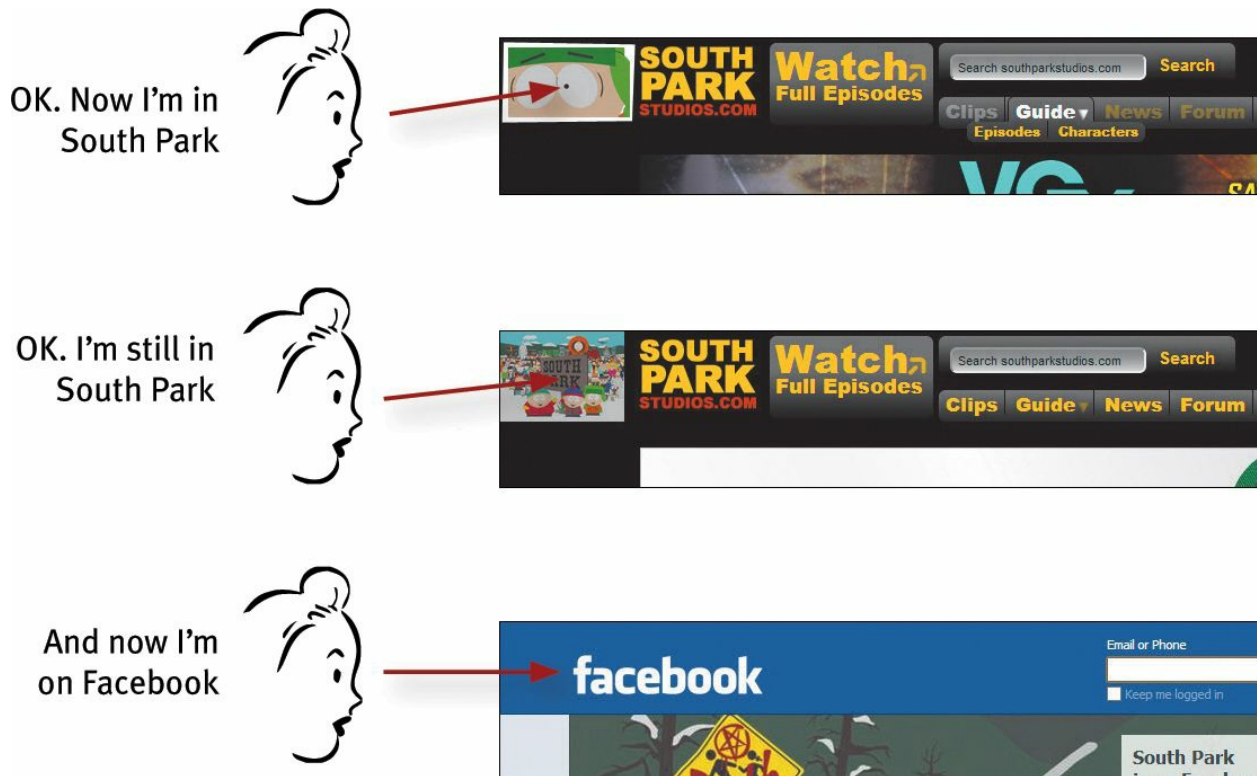

In the same way that we expect to see the name of a building over the front entrance, we expect to see the Site ID at the top of the page—usually in (or at least near) the upper left corner.<sup>4</sup>

<sup>4</sup> ... on Web pages written for left-to-right reading languages.

Why? Because the Site ID represents the whole site, which means it's the highest thing in the logical hierarchy of the site.

This site

Sections of this site

Subsections

Sub-subsections, etc.

This page

Areas of this page

Items on this page

And there are two ways to get this primacy across in the visual hierarchy of the page: either make it the most prominent thing on the page, or make it frame everything else.

Since you don't want the ID to be the most prominent element on the page (except, perhaps, on the Home page), the best place for it—the place that is least likely to make me think—is at the top, where it frames the entire page.

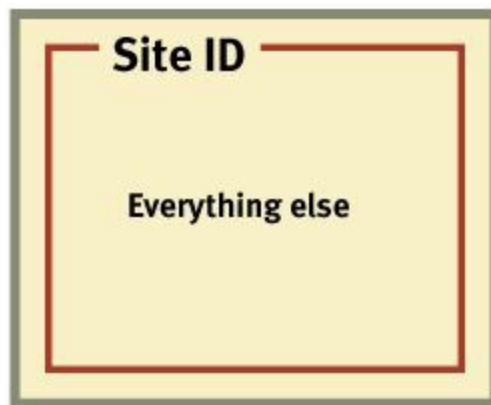

And in addition to being where we would expect it to be, the Site ID also needs to *look* like a Site ID. This means it should have the attributes we would expect to see in a brand logo or the sign outside a store: a distinctive typeface and a graphic that's recognizable at any size from a button to a billboard.



## The Sections

The Sections—sometimes called the *primary navigation*—are the links to the main sections of the site: the top level of the site's hierarchy.

**XYZ Corp.**

Sign in | Contact |  

Home | Products | News | Support | About XYZ | \_\_\_\_\_ Sections

In some designs the persistent navigation will also include space to display the *secondary* navigation: the list of subsections in the current section.

**XYZ Corp.**

Sign in | Contact |  

Home | Products | News | Support | About XYZ  
Bivalves | Lug Nuts | Protein Shakes | \_\_\_\_\_ Subsections

In others, pointing at a section name or clicking on it reveals a dropdown menu. And in others, clicking takes you to the front page of the section, where you'll find the secondary navigation.

## The Utilities

Utilities are the links to important elements of the site that aren't really part of the content hierarchy.

**XYZ Corp.**

Sign in | Contact |   \_\_\_\_\_ Utilities

Home | Products | News | Support | About XYZ

These are things that either can help me use the site (like Sign in/Register, Help, a Site Map, or a Shopping Cart) or provide information about its publisher (like About Us and Contact Us).

Like the signs for the facilities in a store, the Utilities list should be slightly less prominent than the Sections.

**Men's Shoes**

Restrooms ►  
◄ Telephones  
◄ Customer Service  
Gift Wrapping ►

Utilities will vary for different types of sites. For a corporate or e-commerce site, for example, they might include any of the following:

- About Us
- Archives
- Checkout
- Company Info

Contact Us  
Customer Service  
Discussion Boards  
Downloads  
Directory  
Forums  
FAQs  
Help  
Home  
Investor Relations  
How to Shop  
Jobs  
My \_\_\_\_\_  
News  
Order Tracking  
Press Releases  
Privacy Policy  
Register  
Search  
Shopping Cart  
Sign in  
Site Map  
Store Locator  
Your Account

As a rule, the persistent navigation can accommodate only four or five Utilities—the ones users are likely to need most often. If you try to squeeze in more than that, they tend to get lost in the crowd. The less frequently used leftovers belong in the footer: the small text links at the bottom of each page.

**Just click your heels three times and say, “There’s no place like home”**

One of the most crucial items in the persistent navigation is a button or link that takes me to the site's Home page.

Having a Home button in sight at all times offers reassurance that no matter how lost I may get, I can always start over, like pressing a Reset button or using a "Get out of Jail Free" card.

Almost all Web users expect the Site ID to be a button that can take you to the Home page. I think it's also a good idea to include Home with the main sections of the site.

## A way to search

Given the power of searching and the number of people who prefer searching to browsing, unless a site is very small and very well organized, every page should have either a search box or a link to a search page. And unless there's very little reason to search your site, it should be a search box.

Keep in mind that for a large percentage of users their first official act when they reach a new site will be to scan the page for something that matches one of these three patterns:



It's a simple formula: a box, a button, and either the word "Search" or the universally recognized magnifying glass icon. Don't make it hard for them—stick to the formula. In particular, avoid

- **Fancy wording.** They'll be looking for the word "Search," so use the word Search, not Find, Quick Find, Quick Search, or Keyword Search. (If you use "Search" as the label for the box, use the word "Go" as the button name.)
- **Instructions.** If you stick to the formula, anyone who has used the Web for more than a few days will know what to do. Adding "Type a keyword" is like saying, "Leave a message at the beep" on your voice mail message: There was a time when it was necessary, but now it just makes you sound clueless.
- **Options.** If there is any possibility of confusion about the *scope* of the search (what's being searched: the site, part of the site, or the whole Web), by all means spell it out.



But think very carefully before giving me options to limit the scope (to search just the current section of the site, for instance). And also be wary of providing options for how I specify what I'm searching for (search by title or by author, for instance, or search by part number or by product name).

I seldom see a case where the potential payoff for adding options to the persistent search box is worth the cost of making me figure out what the options are and whether I need to use them (i.e., making me think).

If you want to give me the option to scope the search, give it to me when it's useful—when I get to the search results page and discover that searching everything turned up far too many hits, so I *need* to limit the scope.

## Secondary, tertiary, and whatever comes after tertiary

It's happened so often I've come to expect it: When designers I haven't worked with before send me preliminary page designs so I can check for usability issues, I almost inevitably get a flowchart that shows a site four levels deep...

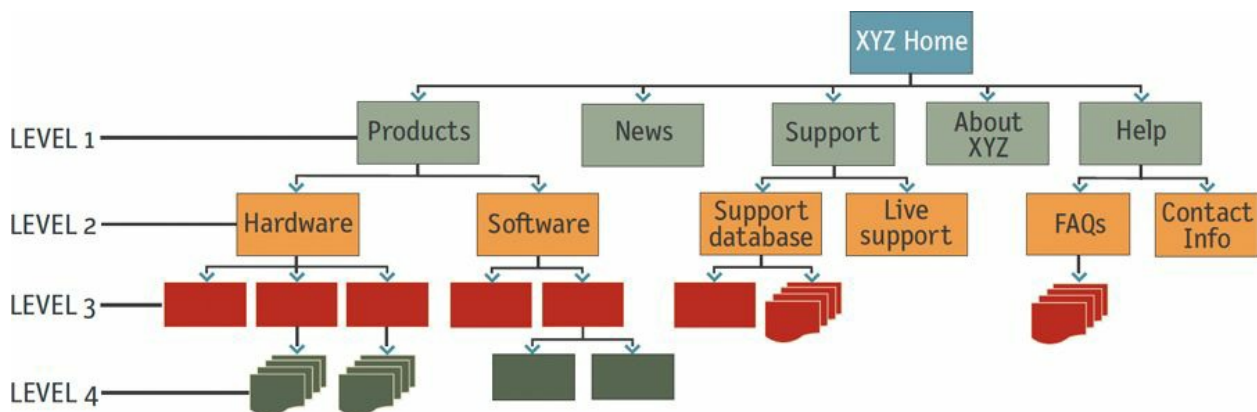

...and sample pages for the Home page and the top two levels.





Home



Second-level page



Subsection page

I keep flipping the pages looking for more, or at least for the place where

they've scrawled "Some magic happens here," but I never find even that. I think this is one of the most common problems in Web design (especially in larger sites): failing to give the lower-level navigation the same attention as the top. In so many sites, as soon as you get past the second level, the navigation breaks down and becomes *ad hoc*. The problem is so common that it's actually hard to find good examples of third-level navigation.

Why does this happen?

Partly, I think, because good multi-level navigation is just plain hard to design—given the limited amount of space on the page and the number of elements that have to be squeezed in.

Partly because designers usually don't even have enough time to figure out the first two levels.

Partly because it just doesn't seem that important. (After all, how important can it be? It's not primary. It's not even secondary.) And there's a tendency to think that by the time people get that far into the site, they'll understand how it works.

And then there's the problem of getting sample content and hierarchy examples for lower-level pages. Even if designers ask, they probably won't get them, because the people responsible for the content usually haven't thought things through that far, either.

But the reality is that users usually end up spending as much time on lower-level pages as they do at the top. And unless you've worked out top-to-bottom navigation from the beginning, it's very hard to graft it on later and come up with something consistent.

The moral? It's vital to have sample pages that show the navigation for all the potential levels of the site before you start arguing about the color scheme.

## **Page names, or Why I love to drive in L.A.**

If you've ever spent time in Los Angeles, you understand that it's not just a song lyric—L.A. really *is* a great big freeway. And because people in L.A. take driving seriously, they have the best street signs I've ever seen. In L.A.,

- **Street signs are big.** When you're stopped at an intersection, you can read the sign for the next cross street.
- **They're in the right place**—hanging over the street you're driving on, so all you have to do is glance up.

Now, I'll admit I'm a sucker for this kind of treatment because I come from Boston, where you consider yourself lucky if you can manage to read the street sign while there's still time to make the turn.



The result? When I'm driving in L.A., I devote less energy and attention to dealing with where I am and more to traffic, conversation, and listening to *All Things Considered*. I love driving in L.A.

Page names are the street signs of the Web. Just as with street signs, when things are going well I may not notice page names at all. But as soon as I start to sense that I may not be headed in the right direction, I need to be able to spot the page name effortlessly so I can get my bearings.

There are four things you need to know about page names:

- **Every page needs a name.** Just as every corner should have a street sign, every page should have a name.

Designers sometimes think, “Well, we’ve highlighted the page name in the navigation. That’s good enough.” It’s a tempting idea because it can save space, and it’s one less element to work into the page layout, but it’s not enough. You need a page name, too.

- **The name needs to be in the right place.** In the visual hierarchy of the page, the page name should appear to be framing the content that is unique to this page. (After all, that’s what it’s naming—not the navigation or the ads, which are just the infrastructure.)

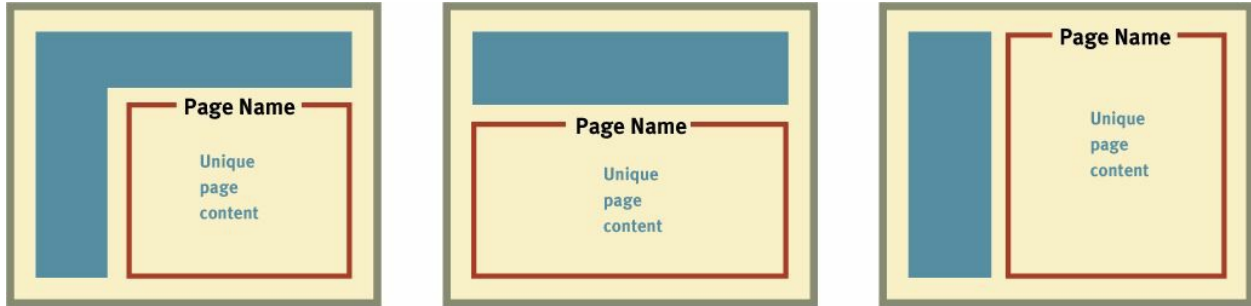

- **The name needs to be prominent.** You want the combination of position, size, color, and typeface to make the name say “This is the heading for the entire page.” In most cases, it will be the largest text on the page.
- **The name needs to match what I clicked.** Even though nobody ever mentions it, every site makes an implicit social contract with its visitors:

*The name of the page will match the words I clicked to get there.*

In other words, if I click on a link or button that says “Hot mashed potatoes,” the site will take me to a page named “Hot mashed potatoes.”

It may seem trivial, but it’s actually a crucial agreement. Each time a site violates it, I’m forced to think, even if only for milliseconds, “Why are those two things different?” And if there’s a major discrepancy between the link name and the page name or a lot of minor discrepancies, my trust in the site—and the competence of the people who publish it—will be diminished.

**WHAT I CLICK...**

[Lug nuts](#)

**WHAT I GET...**



Names match. Comfort, trust, no thought required.



Names don't match. Frustration, loss of trust.

Of course, sometimes you have to compromise, usually because of space limitations. If the words I click on and the page name don’t match exactly, the important thing is that (a) they match as closely as possible, and (b) the reason for the difference is obvious. For instance, if I click buttons labeled “Gifts for Him” and “Gifts for Her” and get pages titled “Gifts for Men” and “Gifts for Women,” even though the wording isn’t identical they feel so

equivalent that I'm not going to think about the difference.

## “You are here”

One of the ways navigation can counteract the Web's inherent “lost in space” feeling is by showing me where I am in the scheme of things, the same way that a “You are here” indicator does on the map in a shopping mall—or a National Park.



©2000. The New Yorker Collection from cartoonbank.com. All Rights Reserved.

On the Web, this is accomplished by highlighting my current location in whatever navigation bars, lists, or menus appear on the page.



Looks like I'm in bedroom lighting

In this example, the current section (Bedroom) and subsection (Lighting) have both been “marked.”

There are a number of ways to make the current location stand out:



Put a pointer next to it	Change the text color	Use bold text	Reverse the button	Change the button color
Sports Business ▶ Entertainment Politics	Sports Business Entertainment Politics	Sports Business Entertainment Politics	Sports Business Entertainment Politics	Sports Business Entertainment Politics

The most common failing of “You are here” indicators is that they’re too subtle. They need to stand out; if they don’t, they lose their value as visual cues and end up just adding more noise to the page. One way to ensure that they stand out is to apply more than one visual distinction—for instance, a different color *and* bold text.

Too-subtle visual cues are actually a very common problem. Designers love subtle cues, because subtlety is one of the traits of sophisticated design. But Web users are generally in such a hurry that they routinely miss subtle cues. In general, if you’re a designer and you think a visual cue is sticking out like a sore thumb, it probably means you need to make it twice as prominent.

## Breadcrumbs

Like “You are here” indicators, Breadcrumbs show you where you are.

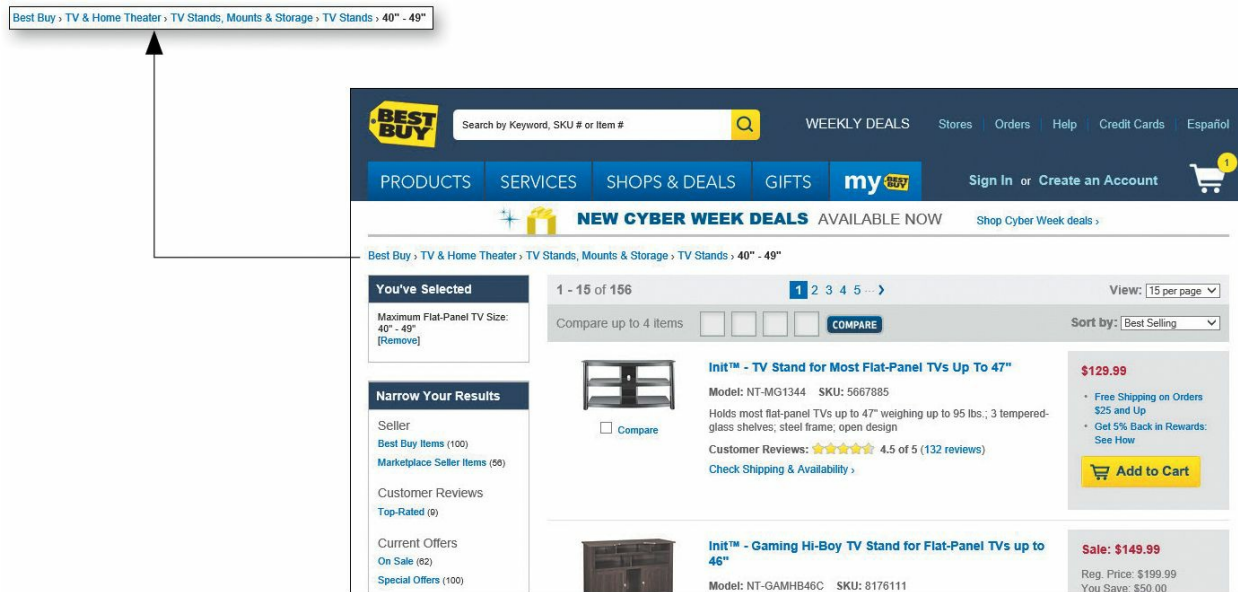

They’re called Breadcrumbs because they’re reminiscent of the trail of crumbs Hansel dropped in the woods so he and Gretel could find their way back home.<sup>5</sup>

<sup>5</sup> In the original story, H & G’s stepmother persuades their father to lose them in the forest during lean times so the whole family won’t have to starve. The suspicious and resourceful H spoils the

*plot by dropping pebbles on the way in and following them home. But the next time (!) H is forced to use breadcrumbs instead, which prove to be a less-than-suitable substitute since birds eat them before H & G can retrace their steps. Eventually the tale devolves into attempted cannibalism, grand larceny, and immolation, but basically it's a story about how unpleasant it is to be lost.*

Breadcrumbs show you the path from the Home page to where you are and make it easy to move back up to higher levels in the hierarchy of a site.

For a long time, Breadcrumbs were an oddity, found only in sites that were really just enormous databases with very deep hierarchies. But these days they show up in more and more sites, sometimes in lieu of well-thought-out navigation.

Done right, Breadcrumbs are self-explanatory, they don't take up much room, and they provide a convenient, consistent way to do two of the things you need to do most often: back up a level or go Home. They're most useful in a large site with a deep hierarchy.

Here are a few best practices for implementing them:

- **Put them at the top.** Breadcrumbs seem to work best if they're at the top of the page. I think this is probably because it literally marginalizes them—making them seem like an accessory, like page numbers in a book or magazine.
- **Use > between levels.** Trial and error seems to have shown that the best separator between levels is the “greater than” character (>), probably because it visually suggests forward motion down through the levels.
- **Boldface the last item.** The last item in the list should be the name of the current page, and making it bold gives it the prominence it deserves. And because it's the page that you're on, naturally it's not a link.

### **Three reasons why I still love tabs**

I haven't been able to prove it (yet), but I strongly suspect that Leonardo da Vinci invented tab dividers sometime in the late 15th century. As interface devices go, they're clearly a product of genius.

Tabs are one of the very few cases where using a physical metaphor in a user interface actually works. Like the tab dividers in a three-ring binder or tabs on folders in a file drawer, they divide whatever they're sticking out of into sections. And they make it easy to open a section by reaching for its tab (or, in the case of the Web, clicking on it).



I think they're an excellent and underused navigation choice. Here's why I like them:

- **They're self-evident.** I've never seen anyone—no matter how “computer illiterate”—look at a tabbed interface and say, “Hmmm. I wonder what *those* do?”
- **They're hard to miss.** When I do usability tests, I'm surprised at how often people can overlook horizontal navigation bars at the top of a Web page. But tabs are so visually distinctive that they're hard to overlook. And because they're hard to mistake for anything *but* navigation, they create the kind of obvious-at-a-glance division you want between navigation and content.
- **They're slick.** Web designers are always struggling to make pages more visually interesting. If done correctly, tabs can add polish and serve a useful purpose.

If you're going to use tabs, though, you have to do them right.

For tabs to work to full effect, the graphics have to create the visual illusion that the active tab is in front of the other tabs. This is the main thing that makes them feel like tabs—even more than the distinctive tab shape.

To create this illusion, the active tab needs to be a different color or contrasting shade, and it has to physically connect with the space below it. This is what makes the active tab “pop” to the front.

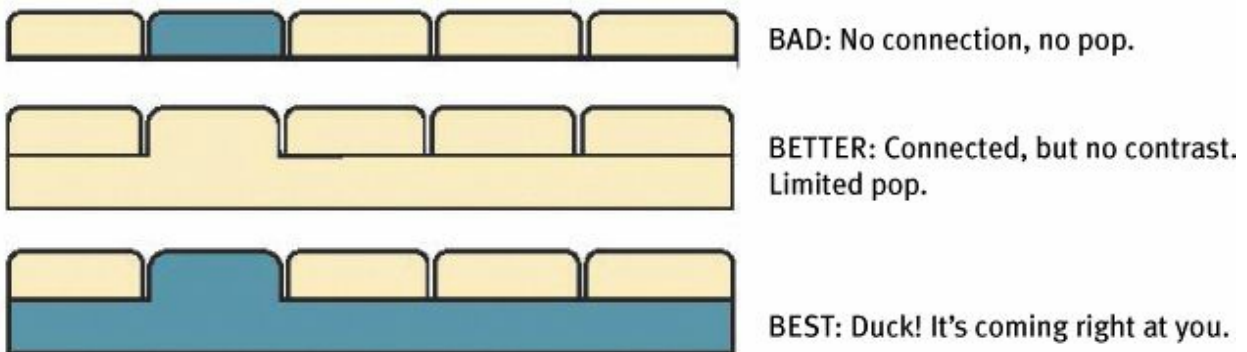

## Try the trunk test

Now that you have a feeling for all of the moving parts, you're ready to try my acid test for good Web navigation. Here's how it goes:

Imagine that you've been blindfolded and locked in the trunk of a car, then driven around for a while and dumped on a page somewhere deep in the

bowels of a Web site. If the page is well designed, when your vision clears you should be able to answer these questions without hesitation:

- What site is this? (Site ID)
- What page am I on? (Page name)
- What are the major sections of this site? (Sections)
- What are my options at this level? (Local navigation)
- Where am I in the scheme of things? (“You are here” indicators)
- How can I search?

Why the *Goodfellas* motif? Because it’s so easy to forget that the Web experience is often more like being abducted than following a garden path. When you’re designing pages, it’s tempting to think that people will reach them by starting at the Home page and following the nice, neat paths you’ve laid out. But the reality is that we’re often dropped down in the middle of a site with no idea where we are because we’ve followed a link from a search engine, a social networking site, or email from a friend, and we’ve never seen this site’s navigation scheme before.

And the blindfold? You want your vision to be slightly blurry, because the true test isn’t whether you can figure it out given enough time and close scrutiny. The standard needs to be that these elements pop off the page so clearly that it doesn’t matter whether you’re looking closely or not. You want to be relying solely on the overall appearance of things, not the details.

Here’s how you perform the trunk test:

**Step 1:** Choose a page anywhere in the site at random, and print it.

**Step 2:** Hold it at arm’s length or squint so you can’t really study it closely.

**Step 3:** As quickly as possible, try to find and circle each of these items:

- Site ID
- Page name
- Sections (Primary navigation)
- Local navigation
- “You are here” indicator(s)
- Search

Try it on your own site and see how well it works. Then ask some friends to

try it, too. You may be surprised by the results.

# Chapter 7. The Big Bang Theory of Web Design

## THE IMPORTANCE OF GETTING PEOPLE OFF ON THE RIGHT FOOT

*Lucy, you got some 'splainin' to do.*

—DESI ARNAZ, AS RICKY RICARDO

Designing a Home page often reminds me of the classic TV game show *Beat the Clock*.

Each contestant would listen patiently while emcee Bud Collyer explained the “stunt” she had to perform. For instance, “You have 45 seconds to toss five of these water balloons into the colander strapped to your head.”

The stunt always looked tricky, but doable with a little luck.

But then just as the contestant was ready to begin, Bud would always add, “Oh, there’s just one more thing: you have to do it...blindfolded.” Or “...under water.” Or “...in the fifth dimension.”



Bud Collyer offers words of encouragement to a plucky contestant

It’s that way with the Home page. Just when you think you’ve covered all the bases, there’s always just *one...more...thing*.

Think about all the things the Home page has to accommodate:

- **Site identity and mission.** Right off the bat, the Home page has to tell me what site this is and what it's for—and if possible, why I should be here and not at some other site.
- **Site hierarchy.** The Home page has to give an overview of what the site has to offer—both content (“What can I find here?”) and features (“What can I do here?”)—and how it's all organized. This is usually handled by the persistent navigation.
- **Search.** Most sites need to have a prominently displayed search box on the Home page.
- **Teases.** Like the cover of a magazine, the Home page needs to entice me with hints of the “good stuff” inside.
- **Content promos** spotlight the newest, best, or most popular pieces of content, like top stories and hot deals.
- **Feature promos** invite me to explore additional sections of the site or try out features.
- **Timely content.** If the site's success depends on my coming back often, the Home page probably needs to have some content that gets updated frequently. And even a site that doesn't need regular visitors needs some signs of life—even if only a link to a recent press release—to signal to me that it's not abandoned or hopelessly outdated.

**Identity & Mission**  
 The Hoover's Online Network

**Feature promos**  
 THE BEST Who Are The THE EMERGI...  
 Get the scoop on today's news  
 HOOVER'S DAILY SCOOP

IPO Central Main Directory  
 Search Company for  **Search** GO Power Tool

members only

Wednesday, March 15, 2000

**6 FIGURE JOBS**  
 Search Jobs  
 Post Resume  
 Search Recruiters  
 Click Here

**Feature Promos**  
 IPO Syndicate.com  
 Click Now  
 here!

**Beginner's Guide**  
 Hoover's IPO Central

**Short cuts**  
 What does the key mean?  
 Find out more about member benefits.

**Free Newsletters**  
 • Week at a glance  
 • IPO Updates

**Visit Our Directory**  
 Full of links to the best business sites on the web.

**Deals**  
 AN INTERNATIONAL ORGANIZATION OF CEOs  
**TEC**  
 A KNOWLEDGE UNIVERSE COMPANY

**Purchase Power**  
 Dell may have pioneered the notion of direct corporate computer sales, but a smaller Texas-based company's software tailored the concept for the entire dot-com-merce industry. Read this week's [Dot-Com Wednesday](#) to find out what sets pcOrder.com apart, and how it intends to stay that way.  
 Sponsored by [eBay Corp.com](#)

---

**Content promos**

---

**What's On The Web?**  
 South by Southwest Interactive Festival panelists pitch the Internet's potential for the entertainment industry.  
[Read this feature](#)

**FREE PERSONALIZED E-MAILS**  
 FROM THE WALL STREET JOURNAL  
**SIGN UP TODAY**

**IPOs On Deck: Week of Mar. 13**

Company	Symbol	Status
<a href="#">Bio-Aqua Systems, Inc.</a>	SEA	
<a href="#">Caldera Systems, Inc.</a>	CALD	
<a href="#">Digitas Inc.</a>	DTAS	trading
<a href="#">FairMarket, Inc.</a>	FAIM	trading
<a href="#">ImageWare Systems, Inc.</a>	IWSI	
<a href="#">ImproveNet, Inc.</a>	IMPV	
<a href="#">Infineon</a>	IFIN	trading
<a href="#">Integrated Information Systems, Inc.</a>	IISX	
<a href="#">Loudaye Technologies, Inc.</a>	LOUD	trading
<a href="#">Netpliance, Inc.</a>	NPLI	
<a href="#">PartsBase.com, Inc.</a>	PRTS	
<a href="#">RADvision Ltd.</a>	RYSN	trading
<a href="#">Shochet Holding Corp.</a>	SHOC	trading
<a href="#">Universal Access, Inc.</a>	UAXS	

**More Scheduled Pricings:**  
 Week of Mar. 13 | [Week of Apr. 3](#)  
 Week of Mar. 20 | [Week of Apr. 10](#)  
 Week of Mar. 27 | [Week of Apr. 17](#)

For more information, visit [IPO Central](#).

**Hoover's Headlines**  
 Selected by our editors

[With So Much Subscriber Data, AOL Walks A Cautious Line On Privacy](#)  
(dowjones.com)

[Qwest Chief Softens Tone](#)  
(The Denver Post)

[What's Next For Entertainment?](#)  
(The Industry Standard)

[VCs In Emerg](#)  
(Red Herring)

[Ford To Offer Web-Ready Car Phones](#)  
(The Washington Post)

[More Hoover's Headlines](#)

---

**Get Stock Quotes**  
 **Go**

[Check your portfolio or set one up now.](#)

Sponsored by  
**b2bNow.com**  
 A ShopNow Division

amazon.com AOL 5 500 hours Deals Publications Library As low as 9.9% APR

- **Deals.** Home page space needs to be allocated for whatever advertising, cross-promotion, and co-branding deals have been made.
- **Shortcuts.** The most frequently requested pieces of content (software updates, for instance) may deserve their own links on the Home page so that people don't have to hunt for them.
- **Registration.** If the site uses registration, the Home page needs links or text boxes for new users to register and old users to sign in and a way to let me know that I'm signed in ("Welcome back, Steve Krug").

In addition to these concrete needs, the Home page also has to meet a few abstract objectives:

- **Show me what I'm looking for.** The Home page needs to make it obvious how to get to whatever I want—assuming it's somewhere on the site.
- **...and what I'm not looking for.** At the same time, the Home page needs to expose me to some of the wonderful things the site has to offer that I might be interested in—even though I'm not actively looking for them.
- **Show me where to start.** There's nothing worse than encountering a new Home page and having no idea where to begin.
- **Establish credibility and trust.** For some visitors, the Home page will be the only chance your site gets to create a good impression.

## And you have to do it...blindfolded

As if that wasn't daunting enough, it all has to be done under adverse conditions. Some of the usual constraints:

- **Everybody wants a piece of it.** Since it's likely to be the page seen by more visitors than any other—and the only page some visitors will see—things that are prominently promoted on the Home page tend to get significantly greater traffic.

As a result, the Home page is the waterfront property of the Web: It's the most desirable real estate, and there's a very limited supply. Everybody who has a stake in the site wants a promo or a link to their section on the Home page, and the turf battles for Home page visibility can be fierce. Sometimes when I look at a Home page, I feel like the boy in *The Sixth Sense*: "I see stakeholders."



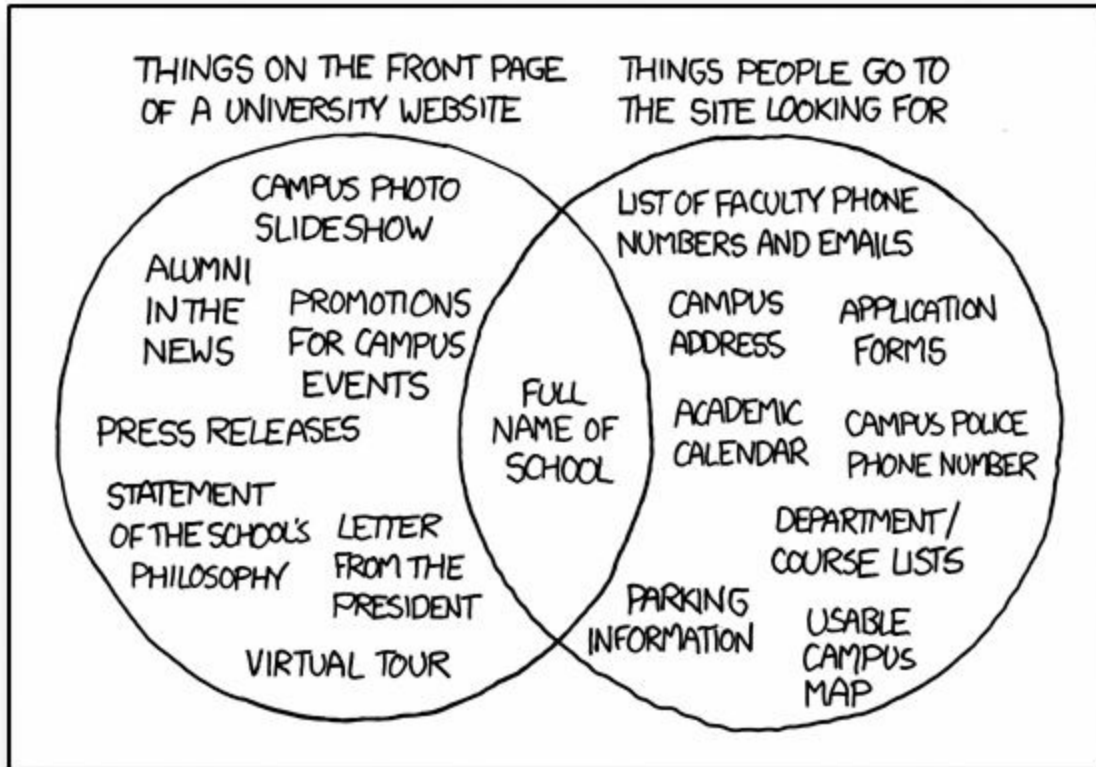

"University Website" | xkcd.com

The result of design by stakeholders.

The Venn diagram isn't entirely accurate: Some university sites don't have the full name of the school on the Home page.

And given the tendency of most users to scan down the page just far enough to find an interesting link, the comparatively small amount of space "above the fold" on the Home page is the *choice* waterfront property, even more fiercely fought over.

- **Too many cooks.** Because the Home page is so important, it's the one page that everybody (even the CEO) has an opinion about.
- **One size fits all.** Unlike lower-level pages, the Home page has to appeal to everyone who visits the site, no matter how diverse their interests.

## The First Casualty of War

Given everything the Home page has to accomplish, if a site is at all complex

even the best Home page design can't do it all. Designing a Home page inevitably involves compromise. And as the compromises are worked out and the pressure mounts to squeeze in just one more thing, some things inevitably get lost in the shuffle.

The one thing you can't afford to lose in the shuffle—and the thing that most often gets lost—is **conveying the big picture**. Whenever someone hands me a Home page design to look at, there's one thing I can almost always count on: They haven't made it clear enough *what the site is*.

As quickly and clearly as possible, the Home page needs to answer the four questions I have in my head when I enter a new site for the first time:

What is this?

What do they have here?

What can I do here?

Why should I be here—and not somewhere else?

The central screenshot shows the Kickstarter homepage with the following elements:

- Header: KICKSTARTER logo, navigation links (What is Kickstarter?, Discover great projects, Start a project), search bar, and user links (Help, Sign up, Log in).
- Main Hero Section: A video thumbnail featuring a man with a beard, with text: "Bring creativity to life", "Curious how Kickstarter works?", "Learn more >", and "Michael painted 91 paintings of Don Quixote in 91 days."
- Staff Picks: "Film & Video" section, "See all 882 Film & Video projects".
- Project of the Day: "Mycophilia - a short documentary" by Madison McCintock in Bozeman, MT. Description: "Come explore the strange and curious world of mushrooms, you may even discover something new about yourself." Funding progress: 104% funded, \$5,663 pledged, 15 days to go.
- Right Sidebar: A list of categories: Art, Comics, Dance, Design, Fashion, Film & Video (highlighted), Food, Games, Music, Photography, Publishing, Technology, Theater.

I need to be able to answer these questions at a glance, correctly and unambiguously, with very little effort.

If it's not clear to me what I'm looking at in the first few seconds, interpreting everything else on the page is harder, and the chances are greater that I'll misinterpret something and get frustrated.

But if I do "get it," I'm much more likely to correctly interpret everything I see on the page, which greatly improves my chances of having a satisfying, successful experience.

This is what I call the Big Bang Theory of Web Design. Like *the Big Bang Theory*, it's based on the idea that the first few seconds you spend on a new Web site or Web page are critical.

We know now from a very elegant experiment (search for "Attention Web Designers: You Have 50 Milliseconds to Make a Good First Impression!") that a lot happens as soon as you open a page. For instance, you take a quick look around (in milliseconds) and form a number of general impressions: Does it look good? Is there a lot of content or a little? Are there clear regions

of the page? Which ones attract you?

The most interesting thing about the experiment was that they showed that these initial impressions tended to be very similar to the impressions people had after they actually had a chance to spend time on the page. In other words, we make snap judgments, but they tend to be a pretty reliable predictor of our more reasoned assessments.





This is not to say that our initial understanding of things is always right. In fact, one of the things I've seen most often in usability tests is that people form ideas about what things are and how they work which are just wrong. Then they use these first bits of "knowledge" to help interpret everything they see.

If their first assumptions are wrong ("This is a site for \_\_\_\_"), they begin to try to force-fit that explanation on to everything they encounter. And if it's wrong, they'll end up creating more misinterpretations. If people are lost when they start out, they usually just keep getting...lost.

This is why it's so crucial that you get them off on the right foot, making sure that they're clear on the big picture.

Don't get me wrong: Everything else *is* important. You *do* need to impress me, entice me, direct me, and expose me to your deals. But these things won't slip through the cracks; there will always be plenty of people—inside and outside the development team—seeing to it that they get done. All too often, though, no one has a vested interest in getting the main point across.

### **The Top Four Plausible Excuses for not Spelling Out the Big Picture on the Home Page**

 <p>We don't need to. It's obvious.</p>	<p>When you're involved in building a site, it's so obvious to you what you're offering and why it's insanely great that it's hard to remember that it's not obvious to everybody.</p>
 <p>After people have seen the explanation once, they'll find it annoying.</p>	<p>Very few people will avoid a site just because they see the same explanation of what it is every time they go there — unless it takes up half the page. Think about it: Even if you know what JAMA is, will you be offended by seeing "Journal of the American Medical Association" next to the logo in small print?</p>
 <p>Anybody who really needs our site will know what it is.</p>	<p>It's tempting to think that the people who don't "get" your site right away probably aren't your real audience, but it's just not true.</p> <p>When testing sites, it's not at all unusual to have people say, "Oh, is that what it is? I'd use that all the time, but it wasn't clear what it was."</p>
 <p>That's what our advertising is for.</p>	<p>Even if people understood your TV, radio, Web, and print ads, by the time they get to your site will they remember exactly what it was that caught their interest?</p>

## But...the Home page? Really?

I know what some of you are thinking:

"Nobody enters a site through the Home page anymore. That's so 2004."

And you're right, of course. Compared to the early days of the Web, the Home page has lost its preeminence. Now people are just as likely—or more likely—to enter your site by clicking on a link in an email, a blog, or something from a social network that takes them directly to a page deep in your site.

Because of this, every page of your site should do as much as it can to orient them properly: to give them the right idea about who you are, what you do, and what your site has to offer.

The problem is, though, there's not much space on most pages to do that well. As a result, many users have formed a new behavior.

People will teleport into the depths of a site and look at the page the link took them to. Very often, though, the next thing they'll do is visit the Home page

to get their bearings. (I like to think of it as divers bobbing up to the surface to see where they are.) If the page they went to was interesting, they want to see what else is on the site. If it contained information they need to rely on, they may want to find out who publishes it, and how credible it is.

The Home page is still the place where this happens, and you need to do it well.

## How to get the message across

Everything on the Home page can contribute to our understanding of what the site is. But there are three important places on the page where we expect to find explicit statements of what the site is about.

- **The tagline.** One of the most valuable bits of real estate is the space right next to the Site ID. When we see a phrase that's visually connected to the ID, we know it's meant to be a tagline, and so we read it as a description of the whole site. We'll look at taglines in detail in the next section.

Tagline

RESERVATION READY

Welcome blurb

Online Booking Software

Rezdy is the easiest way to take online bookings for tours, activities, rentals, charters, shuttles & tickets.

The image shows a screenshot of the Rezdy website home page. A red arrow points from the 'RESERVATION READY' tagline callout to the Rezdy logo on the website. Another red arrow points from the 'Welcome blurb' callout to the main content area of the website. The website features a teal header with the Rezdy logo and navigation links: FEATURES, PRICING, CASE STUDIES, RESOURCES, BLOG, FREE TRIAL, and LOGIN. The main content area has the heading 'Online Booking Software' and a sub-heading 'Rezdy is the easiest way to take online bookings for tours, activities, rentals, charters, shuttles & tickets.' Below this is a list of three bullet points: 'Quick set up. Accept online bookings the same day you start your free trial.', 'Simple to use. Update your prices and availability in minutes.', and 'Easy payment. Straight into your bank account.' At the bottom of this section are two buttons: 'FREE TRIAL' and 'REQUEST A DEMO'. To the right of the text is a large image of a computer monitor displaying a dashboard with various charts and a smartphone displaying the Rezdy app interface.

- **The Welcome blurb.** The Welcome blurb is a terse description of the site, displayed in a prominent block on the Home page, usually at the top left or center of the content space so it's the first thing that catches your eye.





- **The “Learn more.”** Innovative products and business models tend to require a fair amount of explanation, often more than most people have the patience for. But people have become accustomed to watching short videos on their computers and mobile devices. As a result, people have now come to expect a short explanatory video on most sites and are often willing to watch them.

The point isn't that everyone will use these three elements—or even that everyone will notice them. Most users will probably try to guess what the site is first from the overall content of the Home page. But if they can't guess, you want to have someplace on the page where they can go to find out.

Here are a few guidelines for getting the message across:

- **Use as much space as necessary.** The temptation is to not want to use any space because (a) you can't imagine that anybody doesn't know what this site is, and (b) everyone's clamoring to use the Home page space for other purposes.

Take Kickstarter.com, for example. Because of their novel proposition, Kickstarter has a lot of 'splainin' to do, so they wisely use a lot of Home page space to do it. Almost every element on the page helps explain or reinforce what the site is about.

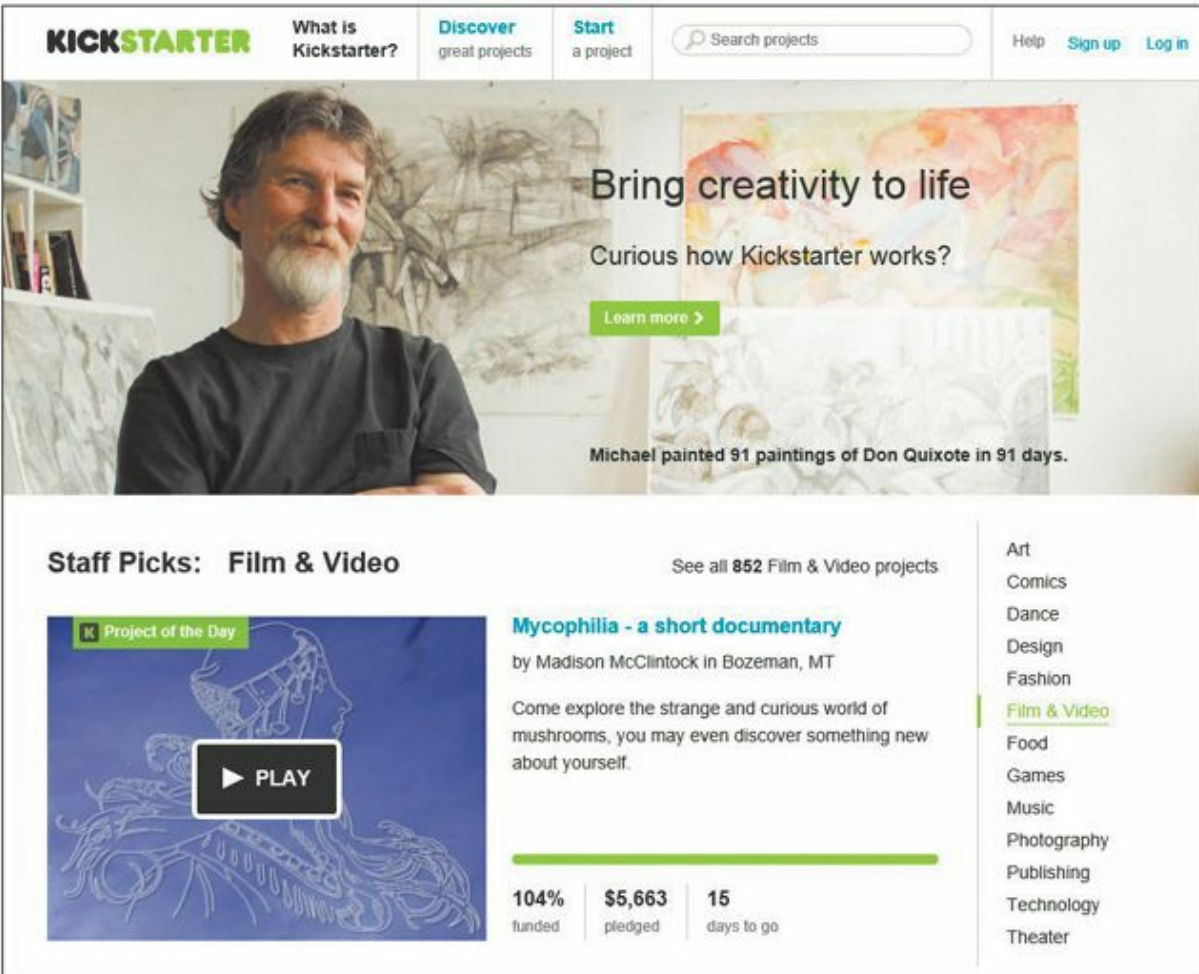

Kickstarter may not have a tagline (unless it's "Bring creativity to life") but they do put an admirable amount of effort into making sure people understand what they do and how it works.

"What is Kickstarter?" is clearly the most prominent item in the primary navigation.

- **...but don't use any more space than necessary.** For most sites, there's no need to use a lot of space to convey the basic proposition, and messages that take up the entire Home page are usually too much for people to bother absorbing anyway. Keep it short—just long enough to get the point across, and no longer. Don't feel compelled to mention every great feature, just a few of the most important ones.
- **Don't use a mission statement as a Welcome blurb.** Many sites fill their Home page with their corporate mission statement that sounds like



it was written by a Miss America finalist. “XYZCorp offers world-class solutions in the burgeoning field of blah blah blah blah blah....” Nobody reads them.

- **It’s one of the most important things to test.** You can’t trust your own judgment about this. You need to show the Home page to people from outside your organization to tell you whether the design is getting this job done because the “main point” is the one thing nobody inside the organization will notice is missing.

## Nothing beats a good tagline!<sup>TM</sup>

A tagline is a pithy phrase that characterizes the whole enterprise, summing up what it is and what makes it great. Taglines have been around for a long time in advertising, entertainment, and publishing: “Thousands of cars at impossibly low prices,” “More stars than there are in the heavens,”<sup>1</sup> and “All the News That’s Fit to Print,”<sup>2</sup> for example.

<sup>1</sup> Metro-Goldwyn-Mayer studios, in the 1930s and ’40s.

<sup>2</sup> The New York Times. *I have to confess a personal preference for the Mad magazine parody version, though: “All the News That Fits, We Print.”*

On a Web site, the tagline appears right below, above, or next to the Site ID. Taglines are a very efficient way to get your message across, because they’re the one place on the page where users most expect to find a concise statement of the site’s purpose.

Some attributes to look for when choosing a tagline:

- Good taglines are **clear** and **informative** and explain exactly what your site or your organization does.



- Good taglines are **just long enough, but not too long**. Six to eight words seem to be long enough to convey a full thought, but short enough to absorb easily.



- Good taglines **convey differentiation** and a clear benefit. Jakob Nielsen has suggested that a really good tagline is one that no one else in the world could use except you, and I think it's an excellent way to look at it.



- Bad taglines sound **generic**.



NationalGrid can probably get away with using a motto instead of a differentiating tagline, because they're a public utility with a captive audience, so differentiation isn't an issue.

Don't confuse a tagline with a motto, like "We bring good things to life," "You're in good hands," or "To protect and to serve." A motto expresses a guiding principle, a goal, or an ideal, but a tagline conveys a value proposition. Mottos are lofty and reassuring, but if I don't know what the thing is, a motto isn't going to tell me.

- Good taglines are **personable**, **lively**, and **sometimes clever**. Clever is good, but only if the cleverness helps convey—not obscure—the benefit.



**Tagline? We don't need no stinking tagline**

Some sites can get by without a tagline. For instance:

- The relative handful of sites that have already achieved household word status.
- Sites that are very well known from their offline origins.

Personally, though, I'd argue that even *these* sites would benefit from a tagline. After all, no matter how well known you are, why pass up an unobtrusive chance to tell people why they're better off at your site? And even if a site comes from a strong offline brand, the mission online is never exactly the same and it's important to explain the difference.

## The fifth question

Once I know what I'm looking at, there's still one more important question that the Home page has to answer for me:

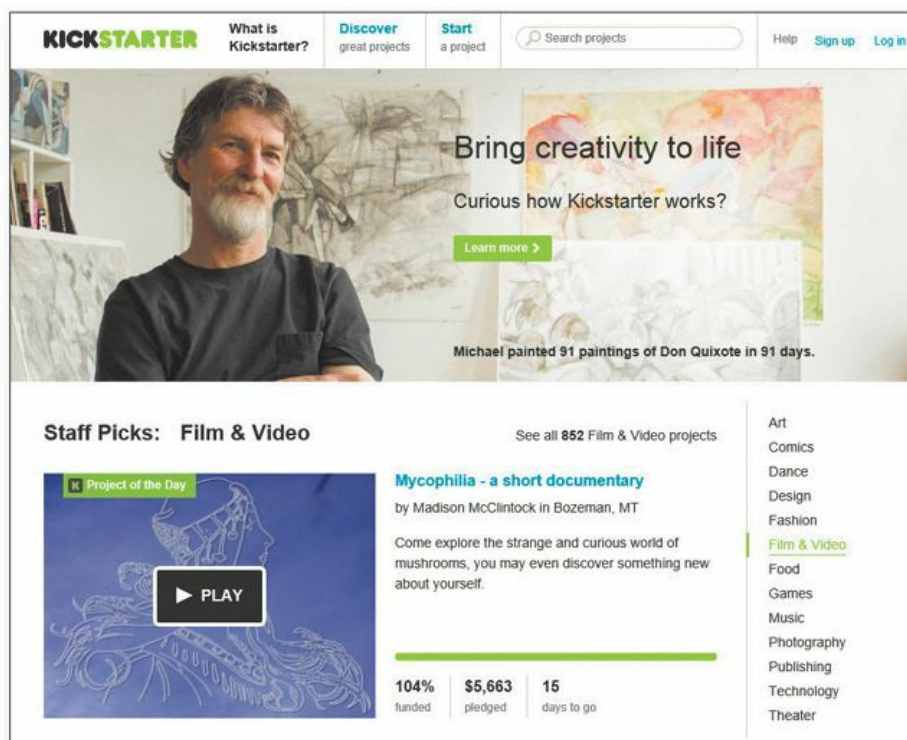

Where do I start?

When I enter a new site, after a quick look around the Home page I should be able to say with confidence:

- Here's where to start if I want to search.
- Here's where to start if I want to browse.
- Here's where to start if I want to sample their best stuff.

On sites that are built around a step-by-step process (applying for a mortgage, for instance), the entry point for the process should leap out at me. And on sites where I have to register if I'm a new user or sign in if I'm a returning user, the places where I register or sign in should be prominent.

Unfortunately, the need to promote *everything* (or at least everything that supports this week's business model) sometimes obscures these entry points. It can be hard to find them when the page is full of promos yelling "Start here!" and "No, click *me* first!"

The best way to keep this from happening is to make the entry points look like entry points (i.e., make the search box look like a search box and the list of sections look like a list of sections). It also helps to label them clearly, with labels like "Search," "Browse by Category," "Sign in," and "Start here" (for a step-by-step process).

## Why Golden Geese make such tempting targets

There's something about the Home page that seems to inspire shortsighted behavior. When I sit in on meetings about Home page design, I often find the phrase "killing the golden goose" running through my head.<sup>3</sup>

<sup>3</sup> *I always thought that the phrase came from the story of Jack and the Beanstalk. In fact, Jack's Giant did have a goose that laid golden eggs, but nobody tried to kill it. The senseless slaughter occurs in one of Aesop's fables, and there's not much to it, plot-wise: Man finds goose, man gets greedy, man kills goose, man gets no more eggs. Moral: "Greed often overreaches itself."*

The worst of these behaviors, of course, is the tendency to try to promote everything.

The problem with promoting things on the Home page is that it works too well. Anything with a prominent Home page link is virtually guaranteed to get more traffic—usually a great deal more—leading all of the site's stakeholders to think, "Why don't I have one?"

The problem is, the rewards and the costs of adding more things to the Home page aren't shared equally. The section that's being promoted gets a huge gain in traffic, while the overall loss in effectiveness of the Home page as it gets more cluttered is shared by all sections.

It's a perfect example of the tragedy of the commons.<sup>4</sup> The premise is simple:

<sup>4</sup> *The concept, originated by nineteenth-century amateur mathematician William Forster Lloyd, was popularized in a classic essay on overpopulation by biologist Garrett Hardin ("The Tragedy of the Commons," Science, December 1968).*

*Any shared resource (a “commons”) will inevitably be destroyed by overuse.*

Take a town pasture, for example. For each animal a herdsman adds to the common pasture, he receives all proceeds from the sale of the animal—a positive benefit of +1. But the negative impact of adding an animal—its contribution to overgrazing—is shared by all, so the impact on the individual herdsman is less than -1.

The only sensible course for each herdsman is to add another animal to the herd. And another, and another—preferably before someone else does. And since each rational herdsman will reach the same conclusion, the commons is doomed.

Preserving the Home page from promotional overload requires constant vigilance, since it usually happens gradually, with the slow, inexorable addition of just...one...more...thing.

All the stakeholders need to be educated about the danger of overgrazing the Home page and offered other methods of driving traffic, like cross-promoting from other popular pages or taking turns using the same space on the Home page.

# **Making Sure You Got them Right**



# Chapter 8. “The Farmer and the Cowman Should Be Friends”

## WHY MOST ARGUMENTS ABOUT USABILITY ARE A WASTE OF TIME, AND HOW TO AVOID THEM

*One man likes to push a plough The other likes to chase a cow But that’s no reason why they can’t be friends!*

—OKLAHOMA!, OSCAR HAMMERSTEIN II

Left to their own devices, Web teams aren’t notoriously successful at making decisions about usability questions. Most teams end up spending a lot of precious time rehashing the same issues over and over.

Consider this scene:

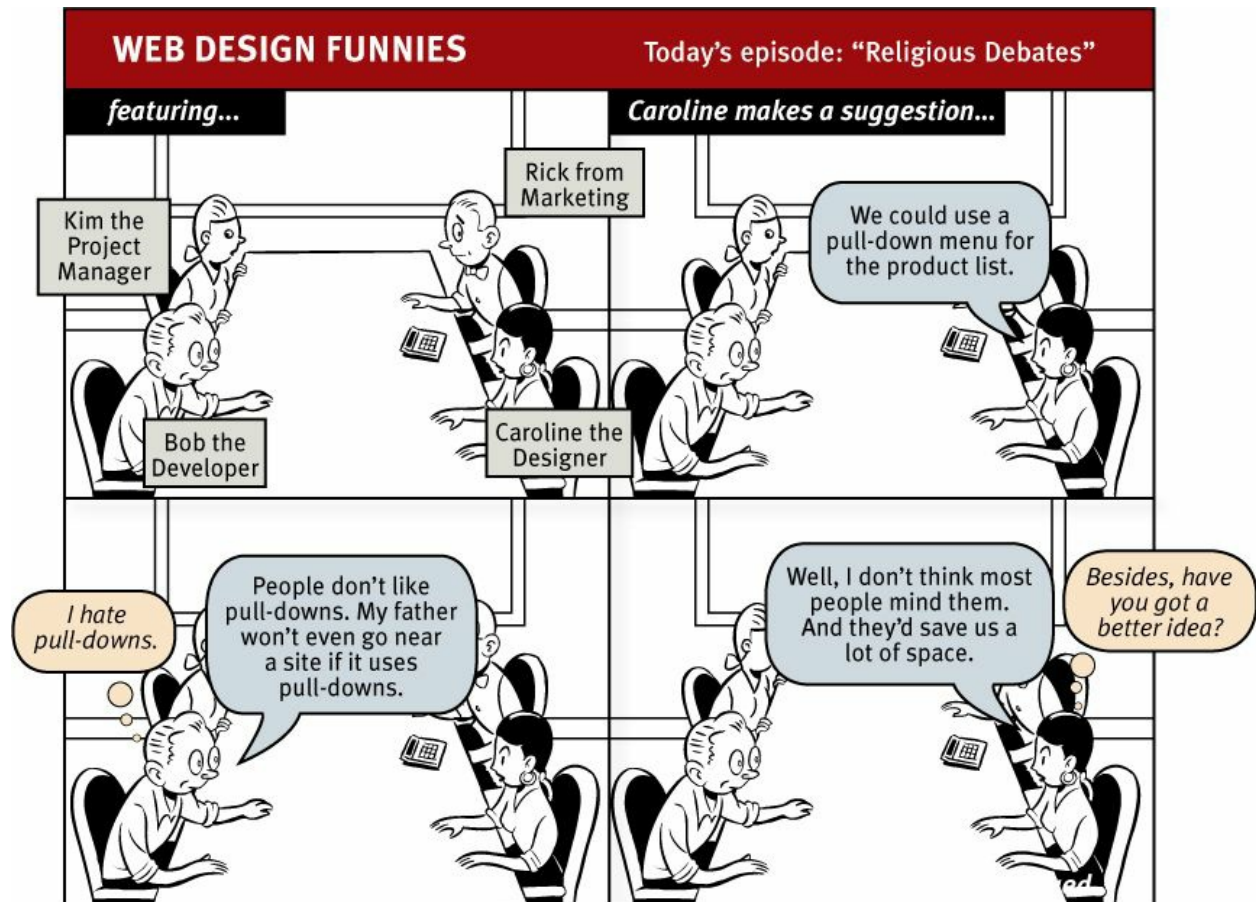

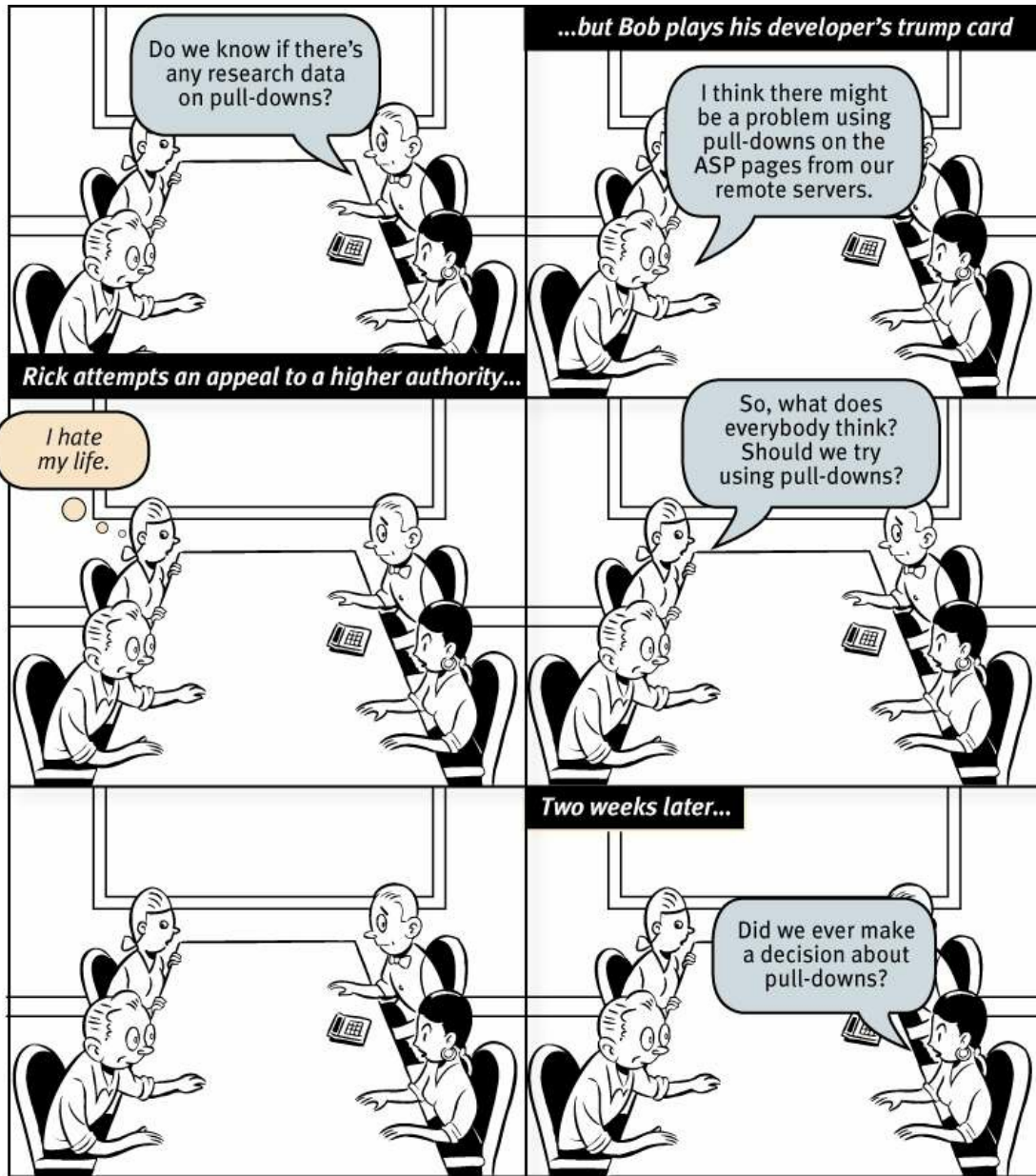

I usually call these endless discussions “religious debates,” because they have a lot in common with most discussions of religion and politics: They consist largely of people expressing strongly held personal beliefs about things that can’t be proven—supposedly in the interest of agreeing on the best way to do something important (whether it’s attaining eternal peace, governing effectively, or just designing Web pages). And, like most religious debates, they rarely result in anyone involved changing his or her point of view.

Besides wasting time, these arguments create tension and erode respect among team members and can often prevent the team from making critical

decisions.

Unfortunately, there are several forces at work in most Web teams that make these debates almost inevitable. In this chapter, I'll describe these forces and explain what I think is the best antidote.

### ***“Everybody likes \_\_\_\_\_.”***

All of us who work on Web sites have one thing in common—we're also Web users. And like all Web users, we tend to have strong feelings about what we like and don't like about Web sites.

As individuals, we love pages with main menus across the top and submenus down the left side because they're familiar and easy to use, or we hate them because they're so boring. We love pages with large evocative images because they're engaging, or we hate them because we just want to get to the content. We really enjoy using sites with \_\_\_\_\_, or we find \_\_\_\_\_ to be a royal pain.

And when we're working on a Web team, it turns out to be very hard to check those feelings at the door.

The result is usually a room full of individuals with strong personal convictions about what makes for a good Web site.

And given the strength of these convictions—and human nature—there's a natural tendency to project these likes and dislikes onto users in general: to think that most users like the same things we like. We tend to think that most users are like us.

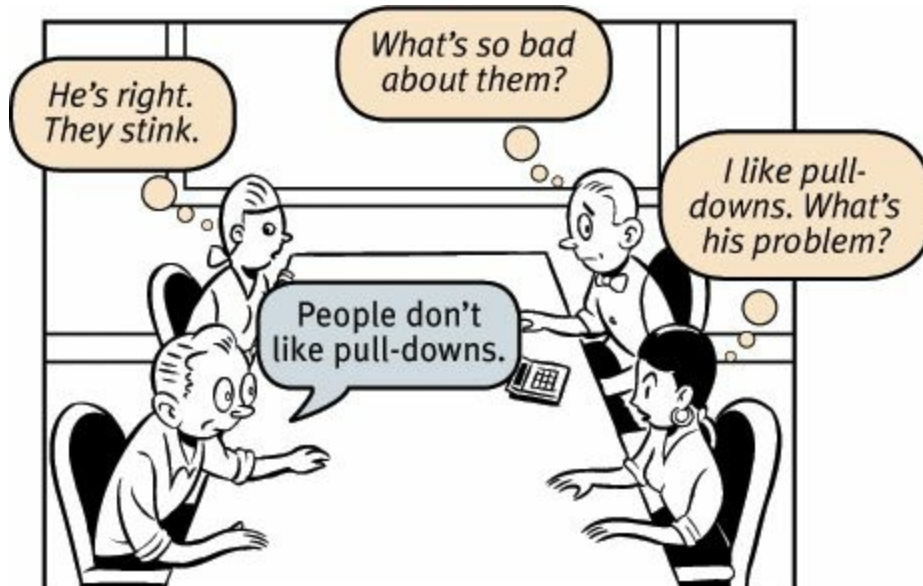

It's not that we think that *everyone* is like us. We know there are *some* people out there who hate the things we love—after all, there are even some of them on our own Web team. But not *sensible* people. And there aren't many of them.

## Farmers vs. cowmen

On top of this layer of personal passion, there's another layer: professional passion. Like the farmers and the cowmen in *Oklahoma!*, the players on a Web team have very different perspectives on what constitutes good Web design based on what they do for a living.<sup>1</sup>

<sup>1</sup> *In the play, the thrifty, God-fearing, family-oriented farmers are always at odds with the freewheeling, loose-living cowmen. Farmers love fences, cowmen love the open range.*



CEO

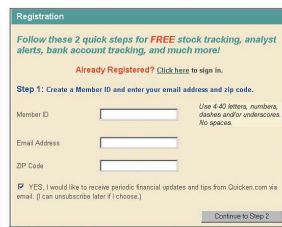

Developer

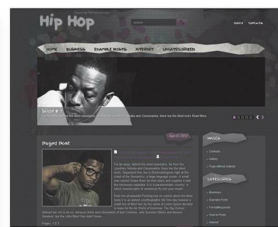

Designer



Business Development

The ideal Web page as seen by someone whose job is...

It's always seemed to me that these people probably have the jobs they do because of who they *are*. Designers, for instance, probably became designers because they enjoy pleasant visual experiences. They get visceral pleasure from looking at pages full of elegant type and subtle visual cues. There are endorphins involved.

And developers tend to like complexity. They enjoy figuring out how things work, reverse engineering them in their head, and looking for ideas they can use. Again, there are endorphins at work.

And because these reactions are happening at a brain-chemical level, it's very difficult for them to imagine that everybody doesn't feel exactly the same way.

The result is that designers want to build sites that look great, and developers want to build sites with interesting, original, ingenious features. I'm not sure who's the farmer and who's the cowman in this picture, but I do know that their differences in perspective often lead to conflict—and hard feelings—



when it comes time to establish design priorities.

At the same time, designers and developers often find themselves siding together in another, larger clash between what Art Kleiner describes as the cultures of hype and craft.<sup>2</sup>

<sup>2</sup> See “Corporate Culture in Internet Time” in *strategy+business* magazine at [strategy-business.com/press/article/10374](http://strategy-business.com/press/article/10374).

While the hype culture (upper management, marketing, and business development) is focused on making whatever promises are necessary to attract venture capital, revenue-generating deals, and users to the site, the burden of delivering on those promises lands on the shoulders of the craft culture artisans like the designers and developers.

This modern high-tech version of the perennial struggle between art and commerce (or perhaps farmers and cowmen vs. the railroad barons) adds another level of complexity to any discussions of usability issues—often in the form of apparently arbitrary edicts handed down from the hype side of the fence.<sup>3</sup>

<sup>3</sup> I once saw a particularly puzzling feature on the Home page of a prominent—and otherwise sensibly designed—site. When I asked about it, I was told, “Oh, that. It came to our CEO in a dream, so we had to add it.” True story.

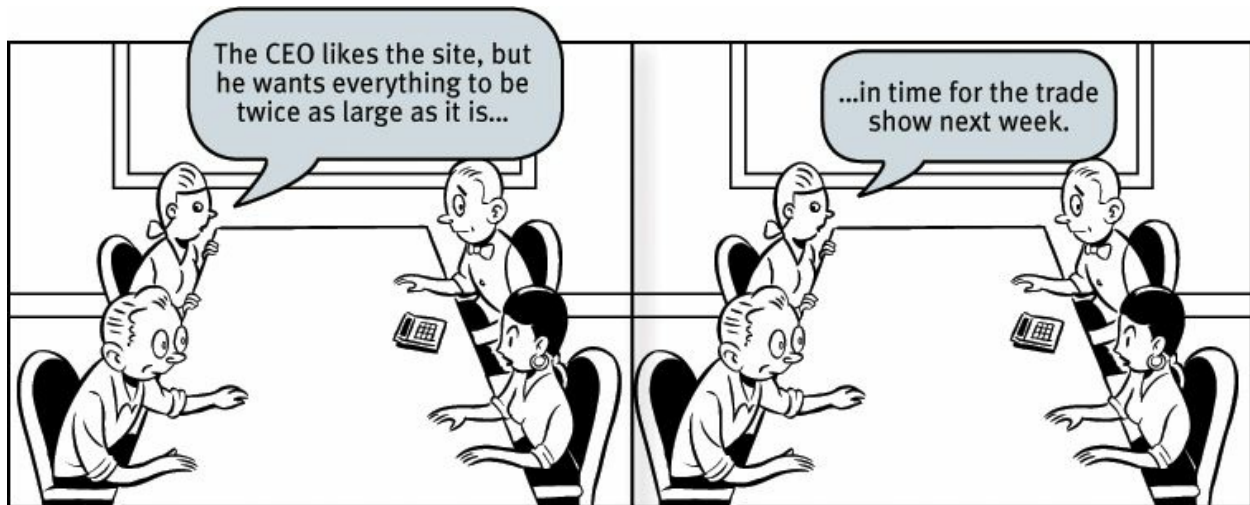

## The myth of the Average User

The belief that most Web users are like us is enough to produce gridlock in the average Web design meeting. But behind that belief lies another one, even more insidious: the belief that most Web users are like *anything*.

As soon as the clash of personal and professional opinions results in a

stalemate, the conversation usually turns to finding some way (whether it's the opinion of an outside expert, published research, a survey, or focus groups) to determine what *most* users like or don't like—to figure out what the Average Web User is really like. The only problem is, there is no Average User.

In fact, all of the time I've spent watching people use the Web has led me to the opposite conclusion:

## ALL WEB USERS ARE UNIQUE AND ALL WEB USE IS BASICALLY IDIOSYNCRATIC

The more you watch users carefully and listen to them articulate their intentions, motivations, and thought processes, the more you realize that their individual reactions to Web pages are based on so many variables that attempts to describe users in terms of one-dimensional likes and dislikes are futile—and counter-productive.

And the worst thing about the myth of the Average User is that it reinforces the idea that good Web design is largely a matter of figuring out what people like. It's an attractive notion: Either pull-downs are good (because most people like them), or they're bad (because most people don't). Stories should be on a single long page or they should be broken up into many shorter pages. Home page carousels, mega menus, rollovers, etc. are either good or bad, black or white.

The problem is there *are* no simple “right” answers for most Web design questions (at least not for the important ones). What works is good, integrated design that fills a need—carefully thought out, well executed, and tested.

That's not to say that there aren't some things you should *never* do, and some things you should *rarely* do. There are some ways to design Web pages that are clearly wrong. It's just that they aren't the things that Web teams usually argue about.

### **The antidote for religious debates**

The point is, it's not productive to ask questions like “Do most people like pull-down menus?” The right kind of question to ask is “Does *this* pull-down, with *these* items and *this* wording in *this* context on *this* page create a good experience for most people who are likely to use *this* site?”

And there's really only one way to answer that kind of question: testing. You have to use the collective skill, experience, creativity, and common sense of the team to build some version of the thing (even a crude version), then watch some people carefully as they try to figure out what it is and how to use it.

There's no substitute for it.

Where debates about what people like waste time and drain the team's energy, usability testing tends to defuse most arguments and break impasses by moving the discussion away from the realm of what's right or wrong and what people like or dislike and into the realm of what works or doesn't work. And by opening our eyes to just how varied users' motivations, perceptions, and responses are, testing makes it hard to keep thinking that all users are like us.

Can you tell that I think usability testing is a good thing?

The next chapter explains how to test your own site.



## Chapter 9. Usability testing on 10 cents a day

### KEEPING TESTING SIMPLE—SO YOU DO ENOUGH OF IT

*Why didn't we do this sooner?*

—WHAT EVERYONE SAYS AT SOME POINT DURING THE FIRST USABILITY TEST OF THEIR WEB SITE

I used to get a lot of phone calls like this:

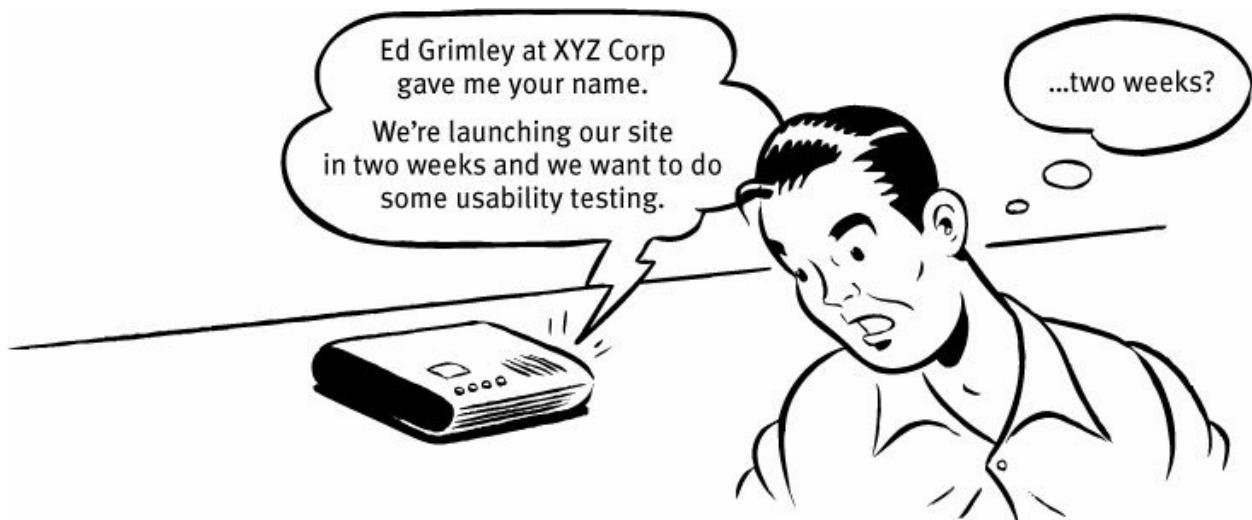

As soon as I'd hear "launching in two weeks" (or even "two months") and "usability testing" in the same sentence, I'd start to get that old fireman-headed-into-the-burning-chemical-factory feeling, because I had a pretty good idea of what was going on.

If it was two weeks, then it was almost certainly a request for a disaster check. The launch was fast approaching and everyone was getting nervous, and someone had finally said, "Maybe we better do some usability testing."

If it was two months, then odds were that what they wanted was to settle some ongoing internal debates—usually about something like aesthetics. Opinion around the office was split between two different designs; some people liked the sexy one, some liked the elegant one. Finally someone with enough clout to authorize the expense got tired of the arguing and said, "All right, let's get some testing done to settle this."

And while usability testing will sometimes settle these arguments, the main

thing it usually ends up doing is revealing that the things they were arguing about weren't all that important. People often test to decide which color drapes are best, only to learn that they forgot to put windows in the room. For instance, they might discover that it doesn't make much difference whether you go with cascading menus or mega menus if nobody understands the value proposition of your site.

I don't get nearly as many of these calls these days, which I take as a good sign that there's more awareness of the need to make usability part of every project right from the beginning.

Sadly, though, this is still how a lot of usability testing gets done: too little, too late, and for all the wrong reasons.

### **Repeat after me: Focus groups are not usability tests.**

Sometimes that initial phone call is even scarier:



When the last-minute request is for a focus group, it's usually a sign that the request originated in Marketing. If the Marketing people feel that the site is headed in the wrong direction as the launch date approaches, they may feel that their only hope of averting potential disaster is to appeal to a higher authority: market research. And one of the types of research they know best is focus groups. I've often had to work very hard to make clients understand that what they need is usability testing, not focus groups—so often that I finally made a short animated video about just how hard it can be ([someslightlyirregular.com/2011/08/you-say-potato](http://someslightlyirregular.com/2011/08/you-say-potato)).



Here's the difference in a nutshell:

- In a **focus group**, a small group of people (usually 5 to 10) sit around a table and talk about things, like their opinions about products, their past experiences with them, or their reactions to new concepts. Focus groups are good for quickly getting a sampling of users' feelings and opinions about things.
- **Usability tests** are about watching one person at a time try to use something (whether it's a Web site, a prototype, or some sketches of a new design) to do typical tasks so you can detect and fix the things that confuse or frustrate them.

The main difference is that in usability tests, you watch people actually *use* things, instead of just listening to them talk about them.

Focus groups can be great for determining what your audience wants, needs, and likes—in the abstract. They're good for testing whether the idea behind your site makes sense and your value proposition is attractive, to learn more about how people currently solve the problems your site will help them with, and to find out how they feel about you and your competitors.

But they're *not* good for learning about whether your site works and how to improve it.

The kinds of things you learn from focus groups—like whether you're building the right product—are things you should know *before* you begin

designing or building anything, so focus groups are best used in the planning stages of a project. Usability tests, on the other hand, should be used through the entire process.

## Several true things about usability testing

Here are the main things I know about usability tests:

- **If you want a great site, you've got to test.** After you've worked on a site for even a few weeks, you can't see it freshly anymore. You know too much. The only way to find out if it really works is to watch other people try to use it.

Testing reminds you that not everyone thinks the way you do, knows what you know, and uses the Web the way you do.

I used to say that the best way to think about testing is that it's like travel: a broadening experience. It reminds you how different—and the same—people are and gives you a fresh perspective on things.<sup>1</sup>

<sup>1</sup> *As the Lean Startup folks would say, it gets you out of the building.*

But I finally realized that testing is really more like having friends visiting from out of town. Inevitably, as you make the rounds of the local tourist sites with them, you see things about your hometown that you usually don't notice because you're so used to them. And at the same time, you realize that a lot of things that you take for granted aren't obvious to everybody.

- **Testing one user is 100 percent better than testing none.** Testing always works, and even the worst test with the wrong user will show you important things you can do to improve your site.

When I teach workshops, I make a point of always doing a live usability test at the beginning so that people can see that it's very easy to do and it always produces valuable insights.

I ask for a volunteer to try to perform a task on a site belonging to one of the other attendees. These tests last less than fifteen minutes, but in that time the person whose site is being tested usually scribbles several pages of notes. And they always ask if they can have the recording of the test to show to their team back home. (One person told me that after his team saw the recording, they made one change to their site which they later calculated had resulted in \$100,000 in savings.)

- **Testing one user early in the project is better than testing 50 near the end.** Most people assume that testing needs to be a big deal. But if you make it into a big deal, you won't do it early enough or often enough to get the most out of it. A simple test early—while you still have time to use what you learn from it—is almost always more valuable than an elaborate test later.

Part of the conventional wisdom about Web development is that it's very easy to go in and make changes. The truth is, it's often not that easy to make changes—especially major changes—to a site once it's in use. Some percentage of users will resist almost any kind of change, and even apparently simple changes often turn out to have far-reaching effects. Any mistakes you can correct early in the process will save you trouble down the line.

## Do-it-yourself usability testing

Usability testing has been around for a long time, and the basic idea is pretty simple: If you want to know whether something is easy enough to use, watch some people while they try to use it and note where they run into problems.

In the beginning, though, usability testing was a very expensive proposition. You had to have a usability lab with an observation room behind a one-way mirror and video cameras to record the users' reactions and the screen. You had to pay a usability professional to plan and facilitate the tests for you. And you had to recruit a lot of participants<sup>2</sup> so you could get results that were statistically significant. It was Science. It cost \$20,000 to \$50,000 a shot. It didn't happen very often.

<sup>2</sup> We call them participants rather than “test subjects” to make it clear that we're not testing them; we're testing the site.

Then in 1989 Jakob Nielsen wrote a paper titled “Usability Engineering at a Discount” and pointed out that it didn't have to be that way. You didn't need a usability lab, and you could achieve the same results with far fewer participants. The price tag dropped to \$5,000 to \$10,000 per round of testing. The idea of discount usability testing was a huge step forward. The only problem is that every Web site (and app) needs testing and \$5,000 to \$10,000 is still a lot of money, so it doesn't happen nearly often enough.

What I'm going to commend to you in this chapter is something even simpler (and a lot less expensive): Do-it-yourself usability testing.

I'm going to explain how you can do your own testing when you have no time and no money.

Don't get me wrong: If you can afford to hire a professional to do your testing, do it. Odds are they'll be able to do a better job than you can. But if you can't hire someone, do it yourself.

I believe in the value of this kind of testing so much that I wrote an entire (short) book about how to do it. It's called *Rocket Surgery Made Easy: The Do-It-Yourself Guide to Finding and Fixing Usability Problems*.



The how-to companion to the bestselling *Don't Make Me Think!*  
*A Common Sense Approach to Web Usability*

Steve Krug

# ROCKET SURGERY MADE EASY



The Do-It-Yourself Guide to Finding  
and Fixing Usability Problems

It covers the topics in this chapter in a lot more detail and gives you step-by-step directions for the whole process.

	<b>TRADITIONAL TESTING</b>	<b>DO-IT-YOURSELF TESTING</b>
TIME SPENT FOR EACH ROUND OF TESTING	1–2 days of tests, then a week to prepare a briefing or report, followed by some process to decide what to fix	One morning a month includes testing, debriefing, and deciding what to fix By early afternoon, you're done with usability testing for the month
WHEN DO YOU TEST?	When the site is nearly complete	Continually, throughout the development process
NUMBER OF ROUNDS OF TESTING	Typically only one or two per project, because of time and expense	One every month
NUMBER OF PARTICIPANTS IN EACH ROUND	Eight or more	Three
HOW DO YOU CHOOSE THE PARTICIPANTS?	Recruit carefully to find people who are like your target audience	Recruit loosely, if necessary Doing frequent testing is more important than testing "actual" users
WHERE DO YOU TEST?	Off-site, in a rented facility with an observation room with a one-way mirror	On-site, with observers in a conference room using screen sharing software to watch
WHO WATCHES?	Full days of off-site testing means not many people will observe firsthand	Half day of on-site testing means more people can see the tests "live"
REPORTING	Someone takes at least a week to prepare a briefing or write a Big Honkin' Report (25–50 pages)	A 1–2 page email summarizes decisions made during the team's debriefing
WHO IDENTIFIES THE PROBLEMS?	The person running the tests usually analyzes the results and recommends changes	The entire development team and any interested stakeholders meet over lunch the same day to compare notes and decide what to fix
PRIMARY PURPOSE	Identify as many problems as possible (sometimes hundreds), then categorize them and prioritize them by severity	Identify the most serious problems and commit to fixing them before the next round of testing
OUT-OF-POCKET COSTS	\$5,000 to \$10,000 per round if you hire someone to do it	A few hundred dollars or less per round

## How often should you test?

I think every Web development team should spend one morning a month doing usability testing.

In a morning, you can test three users, then debrief over lunch. That's it.

When you leave the debriefing, the team will have decided what you're going to fix before the next round of testing, and you'll be done with testing for the month.<sup>3</sup>

<sup>3</sup> *If you're doing Agile development, you'll be doing testing more frequently, but the principles are still the same. For instance, you might be testing with two users every two weeks. Creating a fixed schedule and sticking to it is what's important.*

Why a morning a month?

- **It keeps it simple so you'll keep doing it.** A morning a month is about as much time as most teams can afford to spend doing testing. If it's too complicated or time-consuming, it's much more likely that you won't make time for it when things get busy.
- **It gives you what you need.** Watching three participants, you'll identify enough problems to keep you busy fixing things for the next month.
- **It frees you from deciding when to test.** You should pick a day of the month—like the third Thursday—and make that your designated testing day.

This is much better than basing your test schedule on milestones and deliverables (“We’ll test when the beta’s ready to release”) because schedules often slip and testing slips along with them. Don’t worry, there will always be *something* you can test each month.

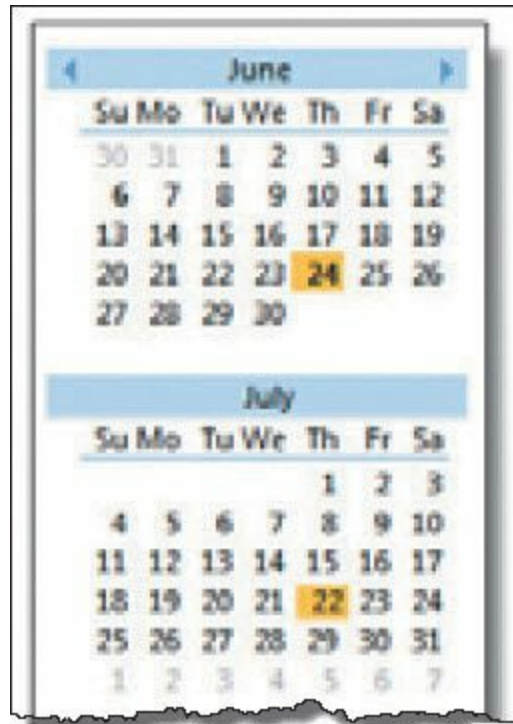

- **It makes it more likely that people will attend.** Doing it all in a morning on a predictable schedule greatly increases the chances that team members will make time to come and watch at least some of the sessions, which is highly desirable.

## How many users do you need?

I think the ideal number of participants for each round of do-it-yourself testing is three.

Some people will complain that three aren't enough. They'll say that it's too small a sample to prove anything and that it won't uncover all of the problems. Both of these are true but they just don't matter, and here's why:

- **The purpose of this kind of testing isn't to *prove anything*.** Proving things requires *quantitative* testing, with a large sample size, a clearly defined and rigorously followed test protocol, and lots of data gathering and analysis.

Do-it-yourself tests are a qualitative method whose purpose is to *improve* what you're building by identifying and fixing usability problems. The process isn't rigorous at all: You give them tasks to do, you observe, and you learn. The result is actionable insights, not proof.

- **You don't need to find all of the problems.** In fact, you'll *never* find

*all* of the problems in anything you test. And it wouldn't help if you did, because of this fact:

*You can find more problems in half a day than you can fix in a month.*

You'll always find more problems than you have the resources to fix, so it's very important that you focus on fixing the most serious ones first. And three users are very likely to encounter many of the most significant problems related to the tasks that you're testing.

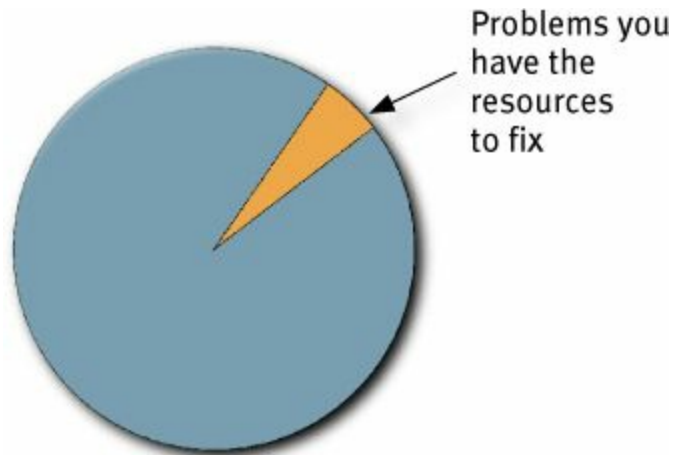

Problems you can find with just a few test participants

Also, you're going to be doing another round each month. It's much more important to do more rounds of testing than to wring everything you can out of each round.

## **How do you choose the participants?**

When people decide to test, they often spend a lot of time trying to recruit users who they think will precisely reflect their target audience—for instance, “male accountants between the ages of 25 and 30 with one to three years of computer experience who have recently purchased expensive shoes.”

It's good to do your testing with participants who are like the people who will use your site, but the truth is that recruiting people who are from your target audience isn't quite as important as it may seem. For many sites, you can do a lot of your testing with almost anybody. And if you're just starting to do testing, your site probably has a number of usability flaws that will cause real problems for almost anyone you recruit.

Recruiting people who fit a narrow profile usually requires more work (to



find them) and often more money (for their stipend). If you have plenty of time to spend on recruiting or you can afford to hire someone to do it for you, then by all means be as specific as you want. But if finding the ideal users means you're going to do less testing, I recommend a different approach:

### RECRUIT LOOSELY AND GRADE ON A CURVE

In other words, try to find users who reflect your audience, but don't get hung up about it. Instead, loosen up your requirements and then make allowances for the differences between your participants and your audience. When somebody has a problem, ask yourself "Would our users have that problem, or was it only a problem because they didn't know what our users know?"

If using your site requires specific domain knowledge (e.g., a currency exchange site for money management professionals), then you'll need to recruit *some* people with that knowledge. But they don't all have to have it, since many of the most serious usability problems are things that anybody will encounter.

In fact, I'm in favor of always using some participants who *aren't* from your target audience, for three reasons:

- **It's usually not a good idea to design a site so that only your target audience can use it.** Domain knowledge is a tricky thing, and if you design a site for money managers using terminology that you think all money managers will understand, what you'll discover is that a small but not insignificant number of them won't know what you're talking about. And in most cases, you need to be supporting novices as well as experts anyway.
- **We're all beginners under the skin.** Scratch an expert and you'll often find someone who's muddling through—just at a higher level.
- **Experts are rarely insulted by something that is clear enough for beginners.** Everybody appreciates clarity. (True clarity, that is, and not just something that's been "dumbed down.") If "almost anybody" can use it, your experts will be able to use it, too.

### How do you find participants?

There are many places and ways to recruit test participants, like user groups, trade shows, Craigslist, Facebook, Twitter, customer forums, a pop-up on

your site, or even asking friends and neighbors.

If you're going to do your own recruiting, I recommend that you download the Nielsen Norman Group's free 147-page report *How to Recruit Participants for Usability Studies*.<sup>4</sup> You don't have to read it all, but it's an excellent source of advice.

<sup>4</sup> ...at [nngroup.com/reports/tips/recruiting](http://nngroup.com/reports/tips/recruiting). It's from 2003, but if you factor in 20% inflation for the dollar amounts, it's all still valid. And did I mention that it's free?

Typical participant incentives for a one-hour test session range from \$50 to \$100 for "average" Web users to several hundred dollars for busy, highly paid professionals, like cardiologists for instance.

I like to offer people a little more than the going rate, since it makes it clear that I value their time and improves the chances that they'll show up. Remember that even if the session is only an hour, people usually have to spend another hour traveling.

### **Where do you test?**

To conduct the test, you need a quiet space where you won't be interrupted (usually either an office or a conference room) with a table or desk and two chairs. And you'll need a computer with Internet access, a mouse, a keyboard, and a microphone.

You'll be using screen sharing software (like GoToMeeting or WebEx) to allow the team members, stakeholders, and anyone else who's interested to observe the tests from another room.





You should also run screen recording software (like Camtasia from Techsmith) to capture a record of what happens on the screen and what the facilitator and the participant say. You may never refer to it, but it's good to have in case you want to check something or use a few brief clips as part of a presentation.

### **Who should do the testing?**

The person who sits with the participant and leads them through the test is called the facilitator. Almost anyone can facilitate a usability test; all it really takes is the courage to try it, and with a little practice, most people can get quite good at it.

I'm assuming that you're going to facilitate the tests yourself, but if you're not, try to choose someone who tends to be patient, calm, empathetic, and a good listener. Don't choose someone whom you would describe as "definitely not a people person" or "the office crank."

Other than keeping the participants comfortable and focused on doing the tasks, the facilitator's main job is to encourage them to think out loud as much as possible. The combination of watching what the participants do and hearing what they're thinking while they do it is what enables the observers to see the site through someone else's eyes and understand why some things that are obvious to them are confusing or frustrating to users.

### **Who should observe?**

As many people as possible!

One of the most valuable things about doing usability testing is the effect it can have on the observers. For many people, it's a transformative experience that dramatically changes the way they think about users: They suddenly "get it" that users aren't all like them.

You should try to do whatever you can to encourage everyone—team members, stakeholders, managers, and even executives—to come and watch the test sessions. In fact, if you have any money for testing, I recommend using it to buy the best snacks you can to lure people in. (Chocolate croissants seem to work particularly well.)



You'll need an observation room (usually a conference room), a computer with Internet access and screen sharing software, and a large screen monitor or projector and a pair of external speakers so everyone can see and hear what's happening in the test room.

During the break after each test session, observers need to write down the

three most serious usability problems they noticed during that session so they can share them in the debriefing. You can download a form I created for this purpose from my Web site. They can take as many notes as they want, but it's important that they make this short list because, as you'll see, the purpose of the debriefing is to identify the most serious problems so they get fixed first.

## Top Three Usability Problems

After each test session, list the three most serious usability problems you noticed.

Participant #1

1. ....
2. ....
3. ....

Participant #2

1. ....
2. ....
3. ....

Participant #3

1. ....
2. ....
3. ....

**What do you test, and when do you test it?**

As any usability professional will tell you, it's important to start testing as early as possible and to keep testing through the entire development process. In fact, it's never *too* early to start. Even before you begin designing your site, for instance, it's a good idea to do a test of competitive sites. They may be actual competitors, or they may just be sites that have the same style, organization, or features that you plan on using. Bring in three participants and watch them try to do some typical tasks on one or two competitive sites and you'll learn a lot about what works and doesn't work without having to design or build anything.

If you're redesigning an existing site, you'll also want to test it before you start, so you'll know what's not working (and needs to be changed) and what is working (so you don't break it).

Then throughout the project, continue to test everything the team produces, beginning with your first rough sketches and continuing on with wireframes, page comps, prototypes, and finally actual pages.

## **How do you choose the tasks to test?**

For each round of testing, you need to come up with tasks: the things the participants will try to do.

The tasks you test in a given round will depend partly on what you have available to test. If all you have is a rough sketch, for instance, the task may consist of simply asking them to look at it and tell you what they think it is.

If you have more than a sketch to show them, though, start by making a list of the tasks people need to be able to do with whatever you're testing. For instance, if you're testing a prototype of a login process, the tasks might be

- Create an account

- Log in using an existing username and password

- Retrieve a forgotten password

- Retrieve a forgotten username

- Change answer to a security question

Choose enough tasks to fill the available time (about 35 minutes in a one-hour test), keeping in mind that some people will finish them faster than you expect.

Then word each task carefully, so the participants will understand exactly

what you want them to do. Include any information that they'll need but won't have, like login information if you're having them use a demo account. For example:

You have an existing account with the username delphi21 and the password correcthorsebatterystaple. You've always used the same answers to security questions on every site, and you just read that this is a bad idea. Change your answer for this account.

You can often get more revealing results if you allow the participants to choose some of the details of the task. It's much better, for instance, to say "Find a book you want to buy, or a book you bought recently" than "Find a cookbook for under \$14." It increases their emotional investment and allows them to use more of their personal knowledge of the content.

## What happens during the test?

You can download the script that I use for testing Web sites (or the slightly different version for testing apps) at [rocketsurgerymadeeasy.com](http://rocketsurgerymadeeasy.com). I recommend that you read your "lines" exactly as written, since the wording has been carefully chosen.

A typical one-hour test would be broken down something like this:

- **Welcome** (4 minutes). You begin by explaining how the test will work so the participant knows what to expect.
- **The questions** (2 minutes). Next you ask the participant a few questions about themselves. This helps put them at ease and gives you an idea of how computer-savvy and Web-savvy they are.
- **The Home page tour** (3 minutes). Then you open the Home page of the site you're testing and ask the participant to look around and tell you what they make of it. This will give you an idea of how easy it is to understand your Home page and how much the participant already knows your domain.
- **The tasks** (35 minutes). This is the heart of the test: watching the participant try to perform a series of tasks (or in some cases, just one long task). Again, your job is to make sure the participant stays focused on the tasks and keeps thinking aloud.

If the participant stops saying what they're thinking, prompt them by saying—wait for it—"What are you thinking?" (For variety, you can

also say things like “What are you looking at?” and “What are you doing now?”)

During this part of the test, it’s crucial that you let them work on their own and don’t do or say anything to influence them. Don’t ask them leading questions, and don’t give them any clues or assistance unless they’re hopelessly stuck or extremely frustrated. If they ask for help, just say something like “What would you do if I wasn’t here?”

- **Probing** (5 minutes). After the tasks, you can ask the participant questions about anything that happened during the test and any questions that the people in the observation room would like you to ask.
- **Wrapping up** (5 minutes). Finally, you thank them for their help, pay them, and show them to the door.

## A sample test session

Here’s an annotated excerpt from a typical—but imaginary—test session. The participant’s name is Janice, and she’s about 25 years old.

---

### Introduction

Hi, Janice. My name is Steve Krug, and I’m going to be walking you through this session. Before we begin, I have some information for you, and I’m going to read it to make sure I cover everything.

You probably already have a good idea of why we’ve asked you to come here today, but let me go over it again briefly. We’re testing a Web site that we’re working on so we can see what it’s like for people to use it. The session should take about an hour.

I want to make it clear right away that we’re testing the *site*, not you. You can’t do anything wrong here. In fact, this is probably the one place today where you don’t have to worry about making mistakes.

We want to hear exactly what you think, so please don’t worry that you’re going to hurt our feelings. We want to improve it, so we need to know honestly what you think.

As we go along, I’m going to ask you to think out loud, to tell me what’s going through your mind. This will help us.

---

I’m reading from the script that I use when I do usability tests.



You can download this script at [rocketsurgerymadeeasy.com](http://rocketsurgerymadeeasy.com).

If you have questions, just ask. I may not be able to answer them right away, since we're interested in how people do when they don't have someone sitting next to them to help, but I will try to answer any questions you still have when we're done.

And if you need to take a break at any point, just let me know.

It's important to mention this, because it will seem rude not to answer their questions as you go along. You have to make it clear before you start that (a) it's nothing personal and (b) you'll try to answer them at the end if they still want to know.

You may have noticed the microphone. With your permission, we're going to record what happens on the screen and what you say. The recording will be used only to help us figure out how to improve the site, and it won't be seen by anyone except the people working on the project. It also helps me, because I don't have to take as many notes. Also, there are a few people from the Web design team observing the session in another room. (They can't see us, just the screen.)

At this point, most people will say something like, "I'm not going to end up on *america's Funniest Home Videos*, am I?"

If you would, I'm going to ask you to sign a simple permission form for us. It just says that we have your permission to record you, but that it will only be seen by the people working on the project.

Do you have any questions before we begin?

No. I don't think so.

Give them the recording permission form to sign.

You'll find a sample form and some other useful forms and checklists at [rocketsurgerymadeeasy.com](http://rocketsurgerymadeeasy.com).

---

## Background Questions

Before we look at the site, I'd like to ask you just a few quick questions. First, what's your occupation? What do you do all day?

I'm a router.

I've never heard of that before. What does a router do, exactly?

I take orders as they come in and send them to the right office.

We're a big multinational company, so there's a lot to sort out.

OK. Now, roughly how many hours a week would you say you spend using the Internet, including Web browsing *and* email? Just a ballpark estimate.

---

I find it's good to start with a few questions to get a feel for who they are and how they use the Internet. It gives them a chance to loosen up a little and gives you a chance to show that you're going to be listening attentively to what they say—and that there are no wrong or right answers.

Don't hesitate to admit your ignorance about anything. Your role here is not to come across as an expert, but as a good listener.

---

Oh, I don't know. Probably four hours a day at work, and maybe eight hours a week at home. Mostly that's on the weekend. I'm too tired at night to bother. But I like playing games sometimes.

What's the split between email and browsing—a rough percentage?

Well, at the office I spend most of my time checking email. I get a lot of email, and a lot of it's junk but I have to go through it anyway. Maybe two-thirds of my time is on email and one-third is browsing.

---

Notice that she's not sure how much time she really spends on the Internet. Most people aren't. Don't worry. Accurate answers aren't important here. The main point here is just to get her talking and thinking about how she uses the Internet and to give you a chance to gauge what kind of user she is.

---

What kinds of sites are you looking at when you browse the Web?

At work, mostly our corporate intranet. And some competitors' sites. At home, game sites and some shopping.

Do you have any favorite Web sites?

Well, Google, of course. I use it all the time. And something called Snakes.com, because I have a pet snake.

Really? What kind of snake?

A python. He's about four feet long, but he should get to be eight or nine when he's fully grown.

OK, great. We're done with the questions, and we can start looking at things.

OK, I guess.

Don't be afraid to digress and find out a little more about the user, as long as you come back to the topic before long.

---

---

## **The Home Page Tour**

First, I'm just going to ask you to look at this page and tell me what you make of it: what strikes you about it, whose site you think it is, what you can do here, and what it's for. Just look around and do a little narrative.

You can scroll if you want to, but don't click on anything yet.

Until now, the browser has been opened to Google so there's nothing distracting to look at.

At this point, I reach over and open a tab with the site we're testing and give the mouse to the participant.

**eLance** The Global Services Marketplace beta

home | buy | sell | my elance | register | search | help

**"Where the world competes to get your job done."**

- 1 Post a Project
- 2 Take Bids
- 3 Pick a Winner
- 4 Get It Done
- 5 Send Payment

[View the RFP Marketplace](#) [Post Your RFP](#)

**eLance Marketplaces** Search the Markets

View all Requests for Proposals (RFPs) [More search options](#)

**Business**  
Consulting, Data Entry, Report Production, Startup Services, Transcription, Translation, Word Processing...  
RFPs | Fixed-Price

**Financial**  
Accounting, Auditing, Bookkeeping, Estate Planning, Insurance, Financial Planning, Loans, Taxes...  
RFPs | Fixed-Price

**Legal**  
Claims, Corporate, Family, Immigration, Intellectual Property, International, Patent, Personal, Research, Wills/Trusts...  
RFPs | Fixed-Price

**Marketing**  
Advertising, Direct...  
RFPs | Fixed-Price

**Medical**  
Advice, Alternative Medicine, Beauty, Counseling, Diet & Nutrition, Fitness Planning, Transcription...  
RFPs | Fixed-Price

**Personal**  
Astrology, Counseling, Cultural Interpretation, Hobbies, Shopping Assistant, Relationship/Romance...  
RFPs | Fixed-Price

**Travel & Entertainment**  
Concierge, Event Planning, Relocation, Travel Services...  
RFPs | Fixed-Price

**Computer**  
Consulting, Software Development, Tech Support...  
RFPs | Fixed-Price

**Creative**  
Design, Illustration, Music, Photography, Writing...  
RFPs | Fixed-Price

**Education/Career**  
Career Counseling, Research, Papers/Essays, Resumes, College Guidance, Tutoring...  
RFPs | Fixed-Price

**Engineering**  
Architecture, Consulting, Design...  
RFPs | Fixed-Price

**Family & Household**  
Food & Cooking, Gardening, Genealogy, Home Improvement, Interior Design, Parenting, Pets, Real Estate...  
RFPs | Fixed-Price

**Cool Stuff**

- Animate Your Logo: *Free!*
- Graphic Design Marketplace
- Build Your Site: Web Site in a Box
- Translation services—Find Language Experts

**eLance Community**

UNIX Artisans  
A Zurich web host brings UNIX and Tuscany together. more

[Message Board](#)

**Featured**

**Get these services**

- Software Development (from markgavin)
- Flash Banners (from potentdesign)
- Graphic Design (from rdgraphics)
- Financial Management and Accounting Systems Consulting (from ChuckSheridan)
- Technology Assessment for Small Businesses (from maureen-b)
- Press Releases, Newsletters, Articles for your Website (from MelissaK)

**Do these projects**

- Advertising Sales - Start-up Website
- CG Database
- SELF REPLICATING WEB SITE
- Evolvesoft Inc needs logo, etc
- NY factory and retail store layout

[Join the eLance Team](#) | [Tell a Friend About eLance](#)

Well, I guess the first thing I notice is that I like the color. I like the shade of orange, and I like the little picture of the sun [at the top of the page, in the eLance logo].

Let's see. [Reads.] "The global services market." "Where the world competes to get your job done."

In an average test, it's just as likely that the next user will say that she hates this shade of orange and that the drawing is too simplistic. Don't get too excited by individual reactions to site aesthetics.



I don't know what that means. I have no idea.

“Animate your logo: free.” [Looking at the Cool Stuff section on the left.] “Graphic design marketplace.” “View the RFP marketplace.” “eLance marketplaces.”



There's a lot going on here. But I have no idea what any of it is.

If you had to take a guess, what do you think it might be?

Well, it seems to have something to do with buying and selling...something.

[Looks around the page again.] Now that I look at the list down here [the category list halfway down the page], I guess maybe it must be services. Legal, financial, creative... they all sound like services.

This user has been doing a good job of thinking out loud on her own. If she wasn't, this is where I'd start asking her, “What are you thinking?”





So I guess that's what it is. Buying and selling services.

OK. Now, if you were at home, what would you click on first?

I guess I'd click on that graphic design thing. I'm interested in graphic design.

---

---

## The Tasks

OK, now we're going to try doing some specific tasks.

And again, as much as possible, it will help us if you can try to think out loud as you go along.

Can you think of some service that you need that you could use this site to get help with?

Hmm. Let me think. I think I saw "Home Improvement" there somewhere. We're thinking of building a deck. Maybe I could find somebody to do that.

So if you were going to look for somebody to build your deck, what would you do first?

I guess I'd click on one of the categories down here. I think I saw home improvement. [Looks.] There it is, under "Family and Household."

So what would you do?

Well, I'd click.... [Hesitates, looking at the two links under "Family and Household."]

Now I give her a task to perform so we can see whether she can use the site for its intended purpose.

Whenever possible, it's good to let the user have some say in choosing the task.



Well, now I'm not sure what to do. I can't click on Home Improvement, so it looks like I have to click on either "RFPs" or "Fixed-Price." But I don't know what the difference is.

Fixed-price I sort of understand; they'll give me a quote, and then they have to stick to it. But I'm not sure what RFPs is.

As it turns out, she's mistaken. Fixed-price (in this case) means services available for a fixed hourly rate, while an RFP (or Request for Proposal) is actually the choice that will get her the kind of quote she's looking for. This is the kind of misunderstanding that often surprises the people who built the site.

Well, which one do you think you'd click on?

Fixed-price, I guess.

Why don't you go ahead and do it?

From here on, I just watch while she tries to post a project, letting her continue until either (a) she finishes the task, (b) she gets really frustrated, or (c) we're not learning anything new by watching her try to muddle through.

I'd give her three or four more tasks to do, which should take not more than 45 minutes altogether.



---

---

## Probing

Now that we're done with the tasks, I have a few questions.

What about these pictures near the top of the page—the ones with the numbers? What did you make of them?

While the participant is doing the tasks, I'm careful not to ask leading questions because I don't want to bias her.

But I always save some time at the end specifically to ask probing questions so I can understand more about what happened and why it happened.



I noticed them, but I really didn't try to figure them out. I guess I thought they were telling me what the steps in the process would be.

Any reason why you didn't pay much attention to them?

No. I guess I just wasn't ready to start the process yet. I didn't know if I wanted to use it yet. I just wanted to look around first.

OK. Great.

In this case, I ask this question because the site's designers think most users are going to start by clicking on the pictures of the five steps and that everyone will at least look at them.

---

---

That's really all there is to it.

If you'd like to see a more complete test, you'll find a twenty-minute video on my site. Just go to [rocketsurgerymadeeasy.com](http://rocketsurgerymadeeasy.com) and click on "Demo test video."

## Typical problems

Here are some of the types of problems you're going to see most often:

- **Users are unclear on the concept.** They just don't get it. They look at the site or a page and either they don't know what to make of it or they think they do but they're wrong.
- **The words they're looking for aren't there.** This usually means that either you failed to anticipate what they'd be looking for or the words you're using to describe things aren't the words they'd use.
- **There's too much going on.** Sometimes what they're looking for is right there on the page, but they're just not seeing it. In this case, you need to either reduce the overall noise on the page or turn up the volume on the things they need to see so they "pop" out of the visual hierarchy more.

## The debriefing: Deciding what to fix

After each round of tests, you should make time as soon as possible for the team to share their observations and decide which problems to fix and what you're going to do to fix them.

I recommend that you debrief over lunch right after you do the tests, while everything is still fresh in the observers' minds. (Order the really good pizza from the expensive pizza place to encourage attendance.)

Whenever you test, you're almost always going to find some serious usability problems. Unfortunately, they aren't always the ones that get fixed. Often, for instance, people will say, "Yes, that's a real problem. But that functionality is all going to change soon, and we can live with it until then." Or faced with a choice between trying to fix one serious problem or a lot of simple problems, they opt for the low-hanging fruit.

This is one reason why you can so often run into serious usability problems even on large, well-funded Web sites, and it's why one of my maxims in *Rocket Surgery* is

FOCUS RUTHLESSLY ON FIXING THE MOST SERIOUS PROBLEMS  
FIRST

Here's the method I like to use to make sure this happens, but you can do it

any way that works for your team:

- **Make a collective list.** Go around the room giving everyone a chance to say what they thought were the three most serious problems they observed (of the nine they wrote down; three for each session). Write them down on a whiteboard or sheets of easel pad paper. Typically, a lot of people will say “Me, too” to some of them, which you can keep track of by adding checkmarks.

There’s no discussion at this point; you’re just listing the problems. And they have to be *observed* problems; things that actually happened during one of the test sessions.

- **Choose the ten most serious problems.** You can do informal voting, but you can usually start with the ones that got the most checkmarks.
- **Rate them.** Number them from 1 to 10, 1 being the worst. Then copy them to a new list with the worst at the top, leaving some room between them.
- **Create an ordered list.** Starting at the top, write down a rough idea of how you’re going to fix each one in the next month, who’s going to do it, and any resources it will require.

You don’t have to fix each problem perfectly or completely. You just have to do something—often just a tweak—that will take it out of the category of “serious problem.”

When you feel like you’ve allocated all of the time and resources you have available in the next month for fixing usability problems, STOP. You’ve got what you came for. The group has now decided what needs to be fixed and made a commitment to fixing it.

Here are some tips about deciding what to fix—and what not to.

- **Keep a separate list of low-hanging fruit.** You can also keep a list of things that aren’t serious problems but are very easy to fix. And by very easy, I mean things that one person can fix in less than an hour, *without* getting permission from anyone who isn’t at the debriefing.
- **Resist the impulse to add things.** When it’s obvious in testing that users aren’t getting something, the team’s first reaction is usually to add something, like an explanation or some instructions. But very often the right solution is to take something (or some *things*) away that are obscuring the meaning, rather than adding yet another distraction.

- **Take “new feature” requests with a grain of salt.** Participants will often say, “I’d like it better if it could do x.” It pays to be suspicious of these requests for new features. I find that if you ask them to describe how that feature would work—during the probing time at the end of the test—it almost always turns out that by the time they finish describing it they say something like “But now that I think of it, I probably wouldn’t use that.” Participants aren’t designers. They may occasionally come up with a great idea, but when they do you’ll know it immediately, because your first thought will be “Why didn’t we think of that?!”
- **Ignore “kayak” problems.** In any test, you’re likely to see several cases where users will go astray momentarily but manage to get back on track almost immediately without any help. It’s kind of like rolling over in a kayak; as long as the kayak rights itself quickly enough, it’s all part of the so-called fun. In basketball terms, no harm, no foul. As long as (a) everyone who has the problem notices that they’re no longer headed in the right direction quickly, and (b) they manage to recover without help, and (c) it doesn’t seem to faze them, you can ignore the problem. In general, if the user’s second guess about where to find things is always right, that’s good enough.

## Alternative lifestyles

Here are two other ways to do testing that have distinct advantages:

- **Remote testing.** The difference here is that instead of coming to your office, participants do the test from the comfort of their own home or office, using screen sharing. Eliminating the need to travel can make it much easier to recruit busy people and, even more significantly, it expands your recruiting pool from “people who live near your office” to “almost anyone.” All they need is high-speed Internet access and a microphone.
- **Unmoderated remote testing.** Services like UserTesting.com provide people who will record themselves doing a usability test. You simply send in your tasks and a link to your site, prototype, or mobile app. Within an hour (on average), you can watch a video of someone doing your tasks while thinking aloud.<sup>5</sup> You don’t get to interact with the participant in real time, but it’s relatively inexpensive and requires

almost no effort (especially recruiting) on your part. All you have to do is watch the video.





<sup>5</sup> *Full disclosure: I receive some compensation from UserTesting.com for letting them use my name. But I only do that because I've always thought they have a great product—which is why I'm mentioning them here.*

## Try it, you'll like it

Whatever method you use, try doing it. I can almost guarantee that if you do, you'll want to keep doing it.

Here are some suggestions for fending off any objections you might encounter:

### The Top Five Plausible Reasons for not Testing Web Sites

 <p>We don't have the time.</p>	<p>It's true that most Web development schedules seem to be based on the punchline from a Dilbert cartoon. If testing is going to add to everybody's to-do list, then it won't get done. That's why you have to make testing as simple as possible.</p> <p>Done right, it will save time because you won't have to (a) argue endlessly and (b) redo things at the end.</p>
 <p>We don't have the money.</p>	<p>Forget \$5,000 to \$10,000. You should only have to spend a few hundred dollars for each round of testing—even less if your participants are volunteers.</p>
 <p>We don't have the expertise.</p>	<p>The least-known fact about usability testing is that it's incredibly easy to do. Yes, some people will be better at it than others, but I've rarely seen a usability test fail to produce useful results, no matter how poorly it was conducted.</p>
 <p>We don't have a usability lab.</p>	<p>You don't need one.</p> <p>All you really need is a room with a desk, a computer, and two chairs where you won't be interrupted and another room where the observers can watch on a large screen.</p>
 <p>We wouldn't know how to interpret the results.</p>	<p>One of the nicest things about usability testing is that the important lessons tend to be obvious to everyone who's watching. The most serious problems are hard to miss.</p>

# **Larger Concerns and Outside Influences**



## Chapter 10. Mobile: It's not just a city in Alabama anymore

### WELCOME TO THE 21ST CENTURY — YOU MAY EXPERIENCE A SLIGHT SENSE OF VERTIGO

*[shouting] PHENOMENAL COSMIC POWERS! [softly] Itty-bitty living space!*

—ROBIN WILLIAMS AS THE GENIE IN *ALADDIN*, COMMENTING ON THE UPSIDE AND DOWNSIDE OF THE GENIE LIFESTYLE

Ahh, the smartphone.

Phones had been getting gradually smarter for years, gathering in desk drawers and plotting amongst themselves. But it wasn't until the Great Leap Forward<sup>1</sup> that they finally achieved consciousness.

<sup>1</sup> *Introduction of the iPhone June 2007.*

I, for one, was glad to welcome our tiny, time-wasting overlords. I know there was a time when I didn't have a powerful touch screen computer with Internet access in my pocket, but it's getting harder and harder to remember what life was like then.

And of course it was about this same time that the Mobile Web finally came into its own. There *had* been Web browsers on phones before, but they—to use the technical term—sucked.

The problem had always been—as the Genie aptly put it—the itty-bitty living space. Mobile devices meant cramped devices, squeezing Web pages the size of a sheet of paper into a screen the size of a postage stamp. There were various attempts at solutions, even some profoundly debased “mobile” versions of sites (remember pressing numbers to select numbered menu items?) and, as usual, the early adopters and the people who really needed the data muddled through.

But Apple married more computer horsepower (in an emotionally pleasing, thin, aesthetic package—why are thin watches so desirable?) with a carefully wrought browser interface. One of Apple's great inventions was the ability to

scroll (swiping up and down) and zoom in and out (pinching and...unpinching) very quickly. (It was the *very quickly* part—the responsiveness of the hardware—that finally made it useful.)

For the first time, the Web was fun to use on a device that you could carry with you at all times. With a battery that lasted all day. You could look up anything anywhere anytime.

It's hard to overestimate what a sea change this was.

Of course, it wasn't only about the Web. Just consider how many things the smartphone allowed you to carry in your pocket or purse at all times: a camera (still *and* video, and, for many people, the best one they'd ever owned), a GPS with maps of the whole world, a watch, an alarm clock, all of your photos and music, etc., etc.



It's true: The best camera really is the one you have with you.

And think about the fact that for most people in emerging countries, in the same way they bypassed landlines and went straight to cellphones, the smartphone is their first—and only—computer.

There's not much denying that mobile devices are the wave of the future, except for things where you need enormous horsepower (professional video editing, for example, at least for now) or a big playing surface (Photoshop or CAD).

## **What's the difference?**

So, what's different about usability when you're designing for use on a mobile device?

In one sense, the answer is: Not much. The basic principles are still the same. If anything, people are moving faster and reading even less on small screens. But there are *some* significant differences about mobile that make for challenging new usability problems.

As I write this, Web and app design for mobile devices is still in its formative “Wild West” days in many ways. It’s going to take another few years for things to shake out, probably just in time for innovations that will force the whole cycle to start over again.

I’m not going to talk very much about specific best practices because many of the bright interface design ideas that will eventually become the prevailing conventions probably haven’t emerged yet. And of course the technology is going to keep changing under our feet faster than we can run.



“App” | xkcd.com

What I *will* do is tell you a few things that I’m sure will continue to be true. And the first one is...

### **It’s all about tradeoffs**

One way to look at design—any kind of design—is that it’s essentially about constraints (things you *have to* do and things you *can’t* do) and tradeoffs (the less-than-ideal choices you make to live within the constraints).

To paraphrase Lincoln, the best you can do is please some of the people some of the time.<sup>2</sup>

<sup>2</sup> ...if, in fact, he ever actually said “You can fool some of the people all of the time, and all of the people some of the time, but you cannot fool all of the people all of the time.” One of the things I’ve learned from the Internet is that when it comes to memorable sayings attributed to famous people, 92% of the time they never said them. See [en.wikiquote.org/wiki/Abraham\\_Lincoln](http://en.wikiquote.org/wiki/Abraham_Lincoln).

There’s a well-established meme that suggests that rather than being the negative force that they often feel like, constraints actually make design easier and foster innovation.

And it’s true that constraints are often helpful. If a sofa has to fit in *this* space and match *this* color scheme, it’s sometimes easier to find one than if you just go shopping for any sofa. Having *something* pinned down can have a focusing effect, where a blank canvas with its unlimited options—while it sounds liberating—can have a paralyzing effect.

You may not buy the idea that constraints are a positive influence, but it really doesn’t matter: Whenever you’re designing, you’re dealing with constraints. And where there are constraints, there are tradeoffs to be made.

In my experience, many—if not most—serious usability problems are the result of a poor decision about a tradeoff.

For example, I don’t use CBS News on my iPhone.

I’ve learned over time that their stories are broken up into too-small (for me) chunks, and each one takes a long time to load. (If the pages loaded faster, I might not mind.) And to add insult to injury, on each new page you have to scroll down past the same photo to get to the next tiny morsel of text.

Here’s what the experience looks like:

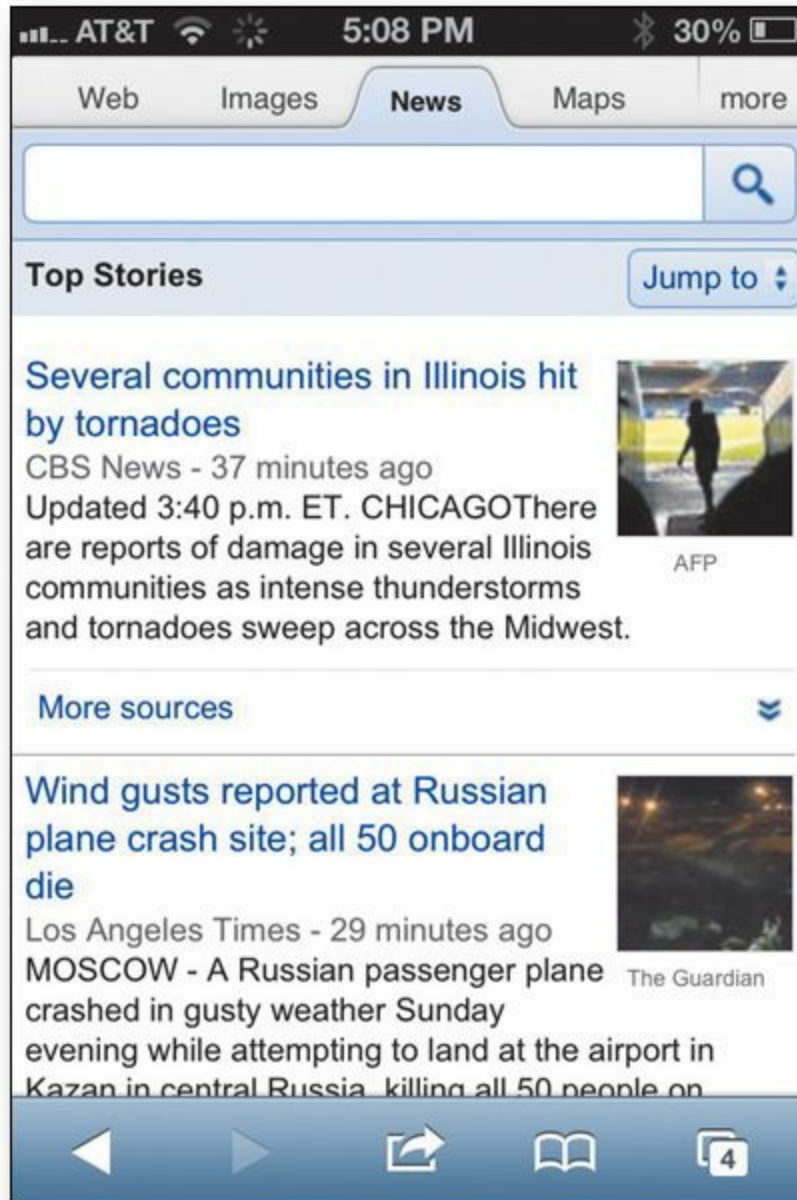

Tap to open the story, then wait. And wait. And wait.



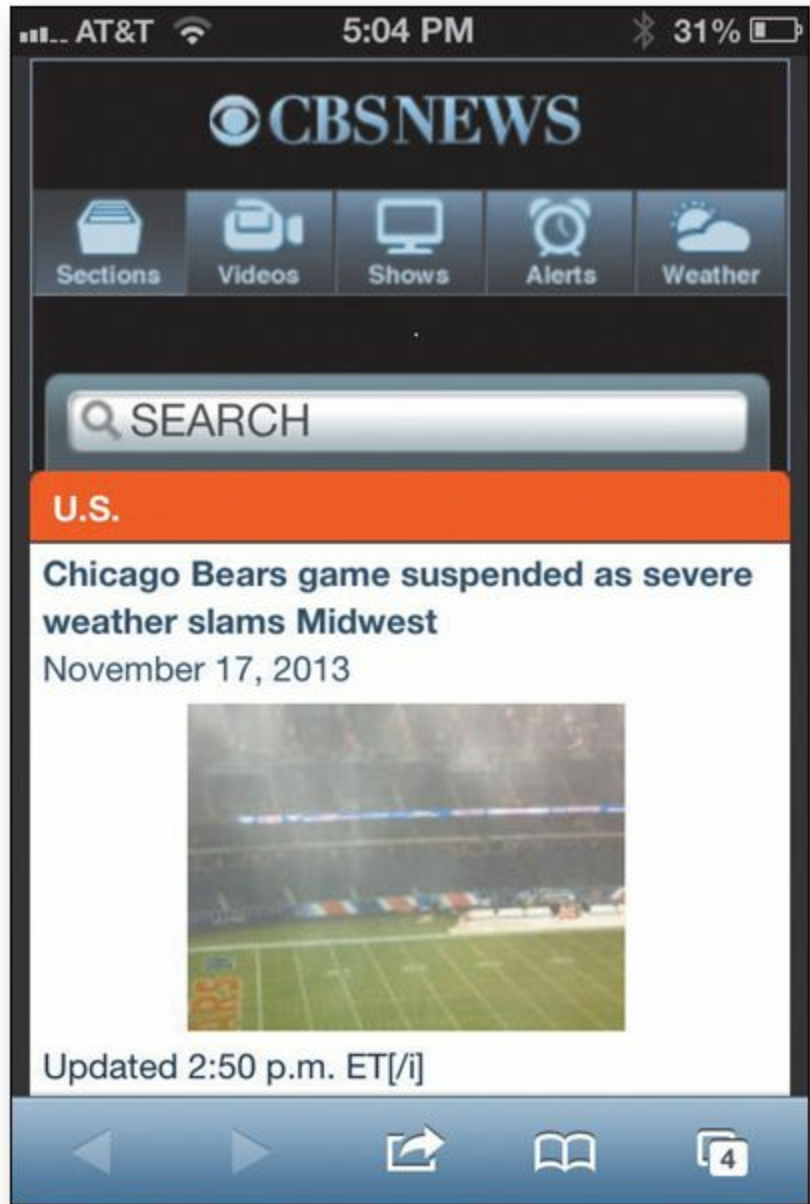

When the page finally loads, swipe to scroll down past the photo.

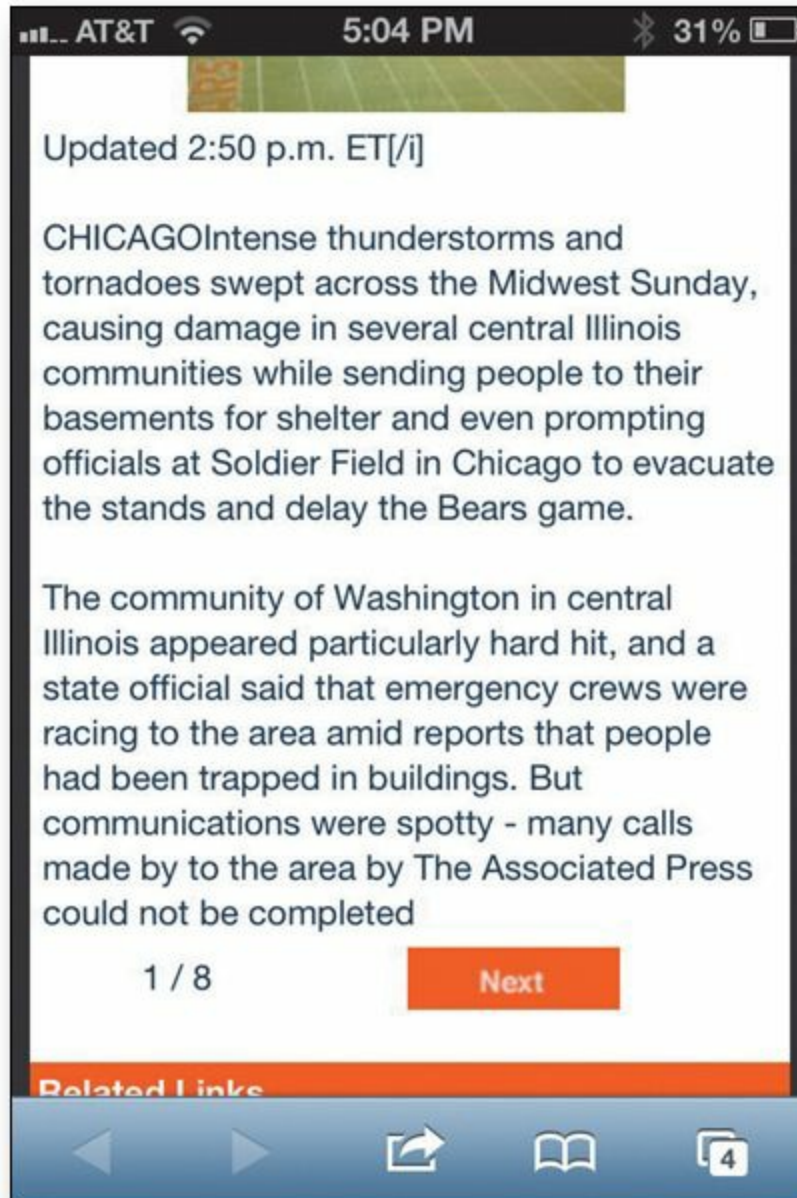

Read the two paragraphs of text, then tap Next and wait. And wait.

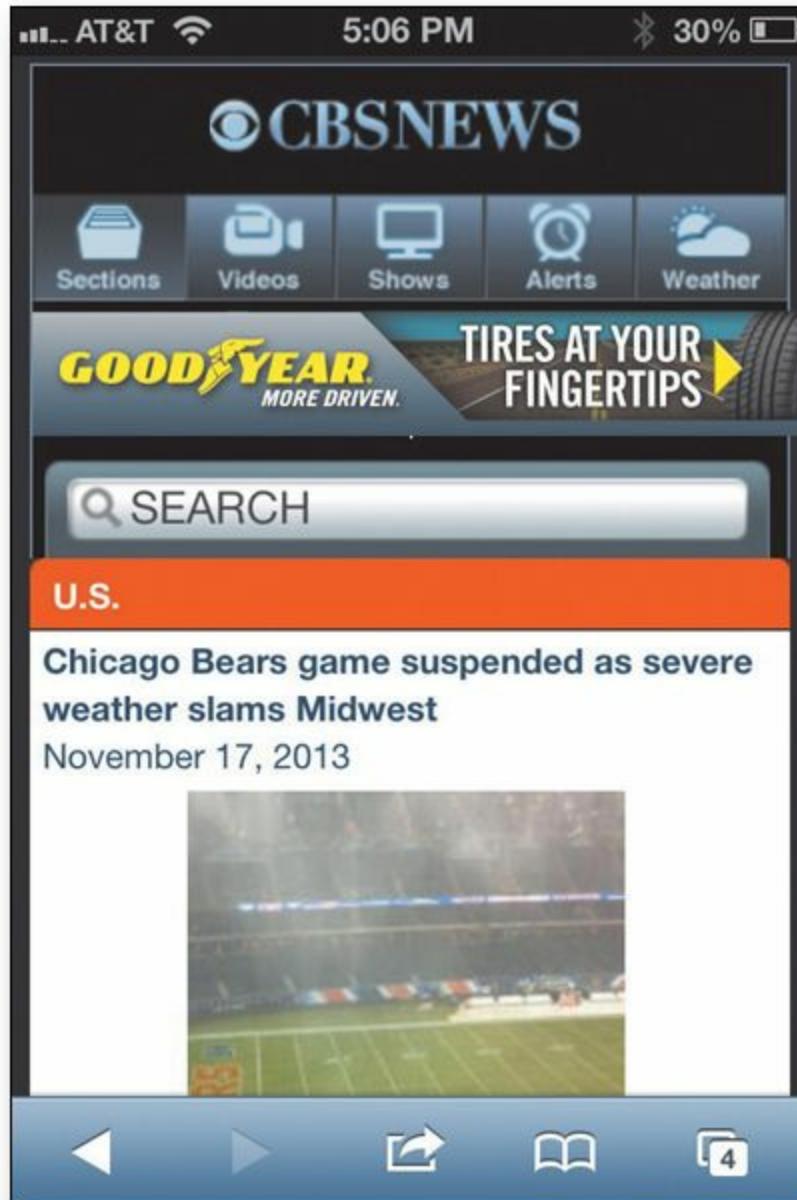

Repeat 8 times to read the whole story.

It's so annoying that when I'm scanning Google News (which I do several times a day) and notice that the story I'm about to tap is linked to CBS News, I always click on Google's "More stories" link to choose another source.

When I run into a problem like this, I know that it's not there because the people who designed it didn't think about it. In fact, I'm sure it was the subject of some intense debate that resulted in a compromise.

I don't know what constraints were at work in this particular tradeoff. Since

there are ads on the pages, it may have been a need to generate more page views. Or it could have something to do with the way the content is segmented for other purposes in their content management system. I have no idea. All I do know is that the choice they made didn't place enough weight on creating a good experience for the user.

Most of the challenges in creating good mobile usability boil down to making good tradeoffs.

## **The tyranny of the itty-bitty living space**

The most obvious thing about mobile screens is that they're small. For decades, we've been designing for screens which, while they may have felt small to Web designers at the time, were luxurious by today's standards. And even then, designers were working overtime trying to squeeze everything into view.

But if you thought Home page real estate was precious before, try accomplishing the same things on a mobile site. So there are definitely many new tradeoffs to be made.

One way to deal with a smaller living space is to leave things out: Create a mobile site that is a subset of the full site. Which, of course, raises a tricky question: Which parts do you leave out?

One approach was Mobile First. Instead of designing a full-featured (and perhaps bloated) version of your Web site first and then paring it down to create the mobile version, you design the mobile version first based on the features and content that are most important to your users. Then you add on more features and content to create the desktop/full version.

It was a great idea. For one thing, Mobile First meant that you would work hard to determine what was really essential, what people needed most. Always a good thing to do.

But some people interpreted it to mean that you should choose what to include based on what people want to do when they're mobile. This assumed that when people accessed the mobile version they were "on the move," not sitting at their desk, so they'd only need the kinds of features you'd use on the move. For example, you might want to check your bank balances while out shopping, but you wouldn't be likely to reconcile your checkbook or set up a new account.

Of course, it turned out this was wrong. People are just as likely to be using their mobile devices while sitting on the couch at home, and they want (and expect) to be able to do everything. Or at least, everybody wants to do *some* things, and if you add them all up it amounts to everything.

If you're going to include everything, you have to pay even more attention to prioritizing.

Things I want to use in a hurry or frequently should be close at hand.

Everything else can be a few taps away, but there should be an obvious path to get to them.

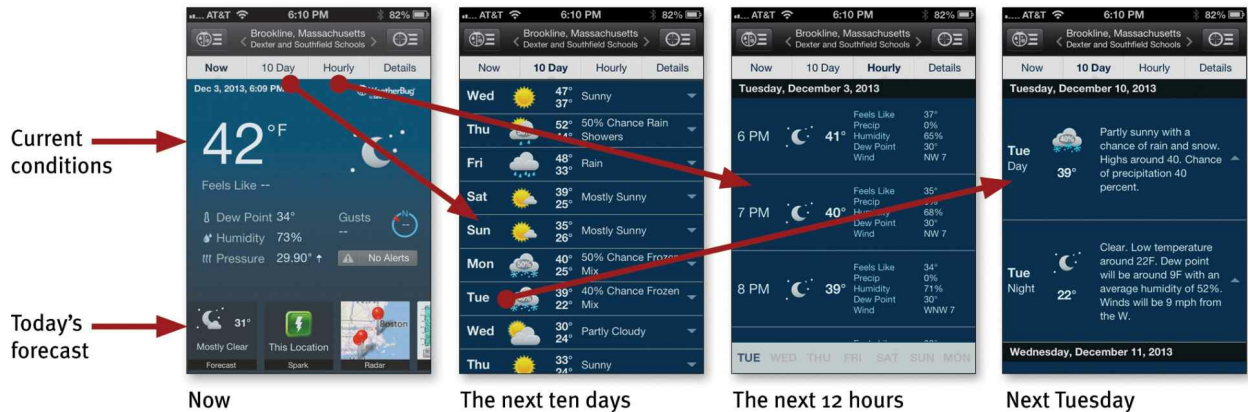

In some cases, the lack of space on each screen means that mobile sites become much deeper than their full-size cousins, so you might have to tap down three, four, or five “levels” to get to some features or content.

This means that people will be tapping more, but that's OK. With small screens it's inevitable: To see the same amount of information, you're going to be either tapping or scrolling a lot more. As long as the user continues to feel confident that what they want is further down the screen or behind that link or button, they'll keep going.

Here's the main thing to remember, though:

MANAGING REAL ESTATE CHALLENGES SHOULDN'T BE DONE  
AT THE COST OF USABILITY<sup>3</sup>

<sup>3</sup> Thanks to Manikandan Baluchamy for this maxim.

## Breeding chameleons

The siren song of one-design-fits-all-screen-sizes has a long history of bright hopes, broken promises, and weary designers and developers.



If there are two things I can tell you about scalable design (a/k/a dynamic layout, fluid design, adaptive design, and responsive design), they're these:

- It tends to be a lot of work.
- It's very hard to do it well.

In the past, scalable design—creating one version of a site that would look good on many different size screens—was optional. It *seemed* like a good idea, but very few people actually cared about it. Now that small screens are taking over, everybody cares: If you have a Web site, you have to make it usable on any size screen.

Developers learned long ago that trying to create separate versions of anything—keeping two sets of books, so to speak—is a surefire path to madness. It doubles the effort (at least) and guarantees that either things won't be updated as frequently or the versions will be out of sync.

It's still getting sorted out. This time, the problem has real revenue implications, so there will be technical solutions, but it will take time.

In the meantime, here are three suggestions:

- **Allow zooming.** If you don't have the resources to “mobilize” your site at all and you're not using responsive design, you should at least make sure that your site doesn't *resist* efforts to view it on a mobile device. There are few things more annoying than opening up a site on your phone and discovering that you can't zoom in on the tiny text at all. (Well, all right. Actually there are a lot of things more annoying. But it's pretty annoying.)
- **Don't leave me standing at the front door.** Another real nuisance: You tap on a link in an email or a social media site and instead of taking you to the article in question it takes you to the mobile Home page, leaving you to hunt for the thing yourself.



- Always provide a link to the “full” Web site. No matter how fabulous and complete your mobile site is, you do need to give users the option of viewing the non-mobile version, especially if it has features and information that aren’t available in your mobile version. (The current convention is to put a Mobile Site/Full Site toggle at the bottom of every page.)

There are many situations where people will be willing to zoom in and out through the small viewport of a mobile device in return for access on the go to features they’ve become accustomed to using or need at that moment. Also, some people will prefer to see the desktop pages when using 7” tablets with high-resolution screens in landscape mode.

## Don’t hide your affordances under a bushel

Affordances are visual clues in an object’s design that suggest how we can use it. (I mentioned them back in [Chapter 3](#). Remember the doorknobs and the book by Don Norman? He popularized the term in the first edition of *The Design of Everyday Things* in 1988 and the design world quickly adopted it.<sup>4</sup>)

<sup>4</sup> Unfortunately, the way they used it wasn’t exactly what he intended. He’s clarified it in the new edition of *Everyday Things* by proposing to call the clues “signifiers” instead, but it may be too late to put that genie back in the bottle. With apologies to Don, I’m going to keep calling them affordances here because (a) it’s still the prevailing usage, and (b) it makes my head hurt too much otherwise.

Affordances are the meat and potatoes of a visual user interface. For instance, the three-dimensional style of some buttons makes it clear they’re meant to be clicked. The same as with the scent of information for links, the clearer the visual cues, the more unambiguous the signal.



In the same way, a rectangular box with a border around it suggests that you can click in it and type something. If you had an editable text box without a border, the user could still click on it and type in it if he knew it was there. But it’s the affordance—the border—that makes its function clear.



Name

Name

Name John Smij

Name

For affordances to work, they need to be noticeable, and some characteristics of mobile devices have made them less noticeable or, worse, invisible. And by definition, affordances are the *last* thing you should hide.

This is not to say that all affordances need to hit you in the face. They just have to be visible enough that people can notice the ones they need to get their tasks done.

### **No cursor = no hover = no clue**

Before touch screens arrived, Web design had come to rely heavily on a feature called hover—the ability of screen elements to change in some way when the user points the cursor at them without clicking.

But a capacitive touch screen (used on almost all mobile devices) can't accurately sense that a finger is hovering above the glass, only when the finger has touched it. This is why they don't have a cursor.<sup>5</sup>

<sup>5</sup> *Did you ever notice that the cursor was missing? I have to admit that I used my first iPhone for several months before it dawned on me that there was no cursor.*

As a result, many useful interface features that depended on hover are no longer available, like tool tips, buttons that change shape or color to indicate that they're clickable, and menus that drop down to reveal their contents without forcing you to make a choice.

As a designer, you need to be aware that these elements don't exist for mobile users and try to find ways to replace them.

### **Flat design: Friend or foe?**

Affordances require visual distinctions. But the recent trend in interface design (which may have waned by the time you read this) has moved in exactly the opposite direction: removing visual distinctions and “flattening” the appearance of interface elements.

It looks darned good (to some people, anyway), and it can make screens less cluttered-looking. But at what price?

In this case the tradeoff is between a clean, uncluttered look on one hand and providing sufficient visual information so people can perceive affordances on

the other.

Unfortunately, Flat design has a tendency to take along with it not just the potentially distracting decoration but also the useful information that the more textured elements were conveying.



The distinctions required to draw attention to an affordance often need to be multi-dimensional: It's the position of something (e.g., in the navigation bar) *and* its formatting (e.g., reversed type, all caps) that tell you it's a menu item.

By removing a number of these distinctions from the design palette, Flat design makes it harder to differentiate things.

Flat design has sucked the air out of the room. It reminds me of the pre-color world in my favorite *Calvin and Hobbes* cartoon/comic/comic strip. (The rest of the cartoon is at the end of [Chapter 13](#).)

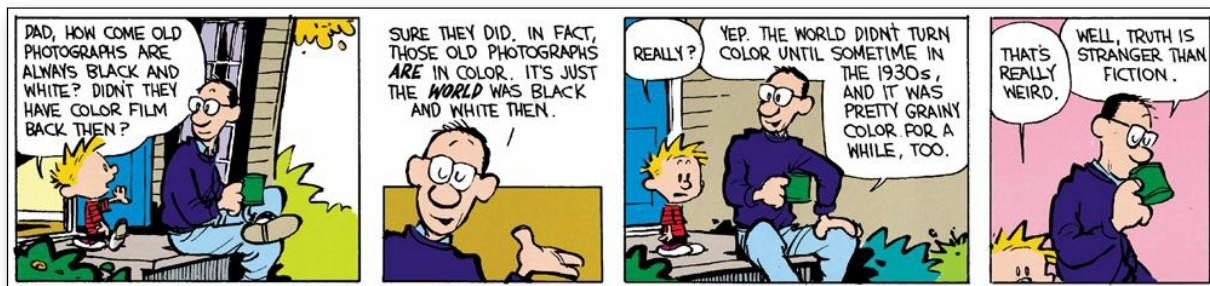

CALVIN AND HOBBS © 1989 Watterson. Reprinted with permission of UNIVERSAL UCLICK. All rights reserved.

You can do all the Flat design you want (you may have to, it may be forced on you), but make sure you're using all of the remaining dimensions to compensate for what you lose.

## **You actually can be too rich or too thin**

...but computers can never be too fast. Particularly on mobile devices, speed just makes everything feel better. Slow performance equals frustration for users and loss of goodwill for publishers.

For instance, I prize the breaking news alerts from the AP (Associated Press)

mobile app. They're always the first hint I get of major news stories.

Unfortunately for AP, though, whenever I tap on one of their alerts, the app insists on loading a huge chunk of photos for all the other current top stories before showing me any details about the alert.

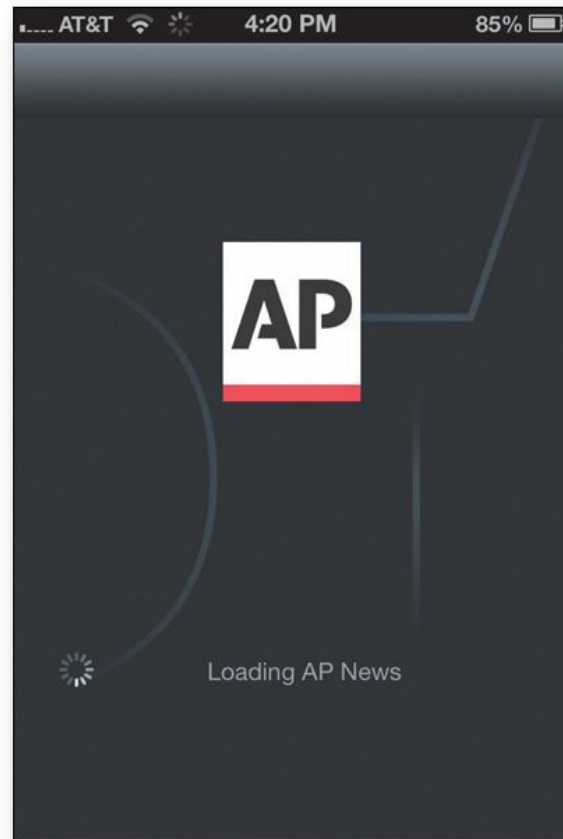

As a result, I've formed a new habit: When an AP alert arrives, I immediately open *the New York Times* site or Google News to see if they've picked up the story yet.

We're all used to very fast connections nowadays, but we have to remember that mobile download speeds are unreliable. If people are at home or sitting at Starbucks, download speeds are probably good, but once they leave the comfort of Wi-Fi and revert to 4G or 3G or worse, performance can vary widely.

Be careful that your responsive design solutions aren't loading up pages with huge amounts of code and images that are larger than necessary for the user's screen.

**Mobile apps, usability attributes of**

You may remember that way back on [page 9](#) I mentioned that I'd talk later about attributes that some people include in their definitions of usability: useful, learnable, memorable, effective, efficient, desirable, and delightful. Well, that time has arrived.

Personally, my focus has always been on the three that are central to my definition of usability:

A person of average (or even below average) ability and experience can figure out how to use the thing [i.e., it's *learnable*] to accomplish something [*effective*] without it being more trouble than it's worth [*efficient*].

I don't spend much time thinking about whether things are *useful* because it strikes me as more of a marketing question, something that should be established before any project starts, using methods like interviews, focus groups, and surveys. Whether something is *desirable* seems like a marketing question too, and I'll have more to say about that in the final chapter.

For now let's talk about *delight*, *learnability*, and *memorability* and how they apply to mobile apps.

## **Delightful is the new black**

What is this "delight" stuff, anyway?

Delight is a bit hard to pin down; it's more one of those "I'll know it when I feel it" kind of things. Rather than a definition, it's probably easier to identify some of the words people use when describing delightful products: fun, surprising, impressive, captivating, clever, and even magical.<sup>6</sup>

<sup>6</sup> My personal standard for a delightful app tends to be "does something you would have been burned at the stake for a few hundred years ago."

Delightful apps usually come from marrying an idea about something people would really enjoy being able to do, but don't imagine is possible, with a bright idea about how to use some new technology to accomplish it.

SoundHound is a perfect example.

Not only can it identify that song that you hear playing wherever you happen to be, but it can display the lyrics and scroll them in sync with the song.

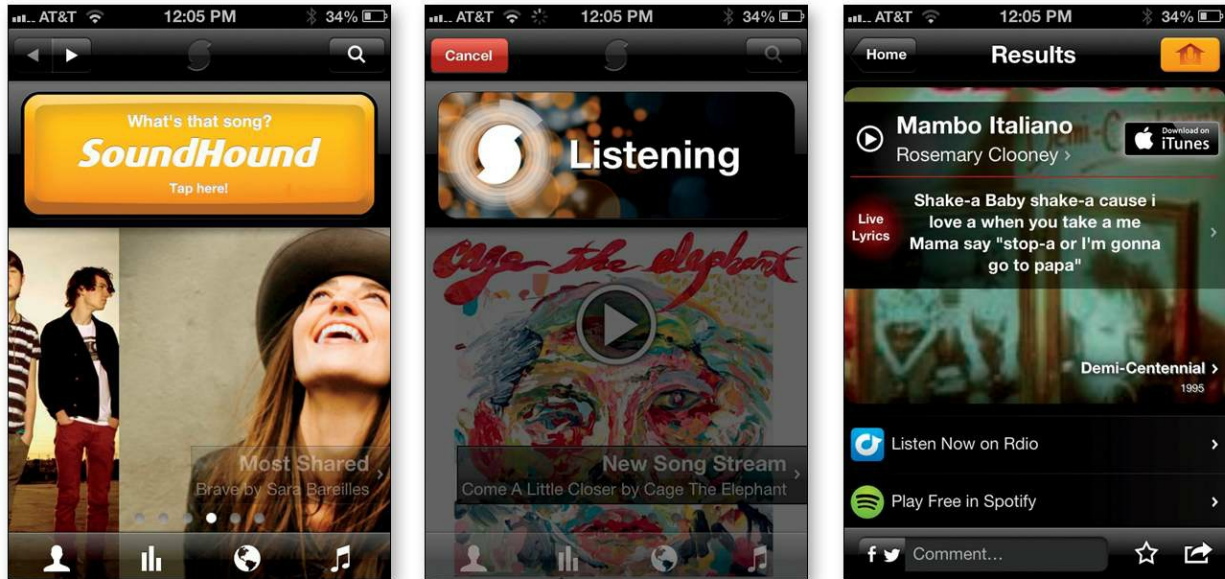

And Paper is not your average drawing app. Instead of dozens of tools with thousands of options, you get five tools with no options. And each one is optimized to create things that look good.

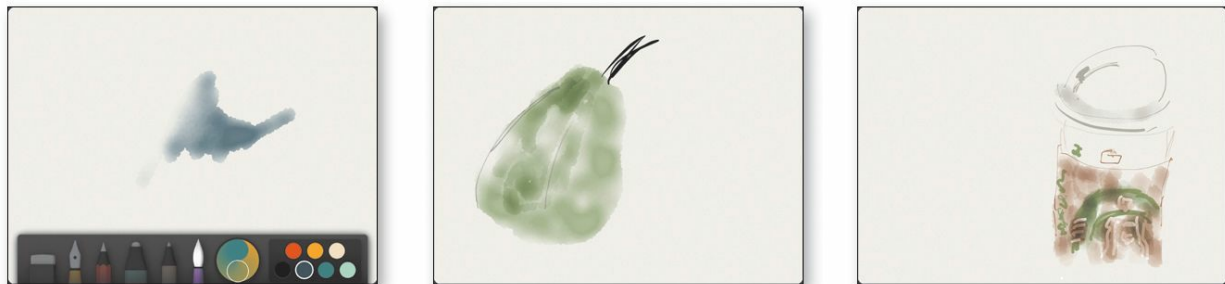

Building delight into mobile apps has become increasingly important because the app market is so competitive. Just doing something well isn't good enough to create a hit; you have to do something incredibly well. Delight is sort of like the extra credit assignment of user experience design.

Making your app delightful is a fine objective. Just don't focus so much attention on it that you forget to make it usable, too.

## Apps need to be learnable

One of the biggest problems with apps is that if they have more than a few features they may not be very easy to learn.

Take Clear, for example. It's an app for making lists, like to-do lists. It's brilliant, innovative, beautiful, useful, and fun to use, with a clean minimalist interface. All of the interactions are elegantly animated, with sophisticated



sound effects. One reviewer said, “It’s almost like I’m playing a pinball machine while I’m staying productive.”

The problem is that one reason it’s so much fun to use is that they’ve come up with innovative interactions, gestures, and navigation, but there’s a lot to learn.

With most apps, if you get any instructions at all it’s usually one or two screens when you first launch the app that give a few essential hints about how the thing works. But it’s often difficult or impossible to find them again to read later.

And if help exists at all (and you can find it), it’s often one short page of text or a link to the developer’s site with no help to be found or a customer support page that gives you the email address where you can send your questions.

This can work for apps that are only doing a very few things, but as soon as you try to create something that has a lot of functionality—and particularly any functions that don’t follow familiar conventions or interface guidelines—it’s often not enough.

The people who made Clear have actually done a very good job with training compared to most apps. The first time you use it, you tap your way through a nicely illustrated ten-screen quick tour of the main features.

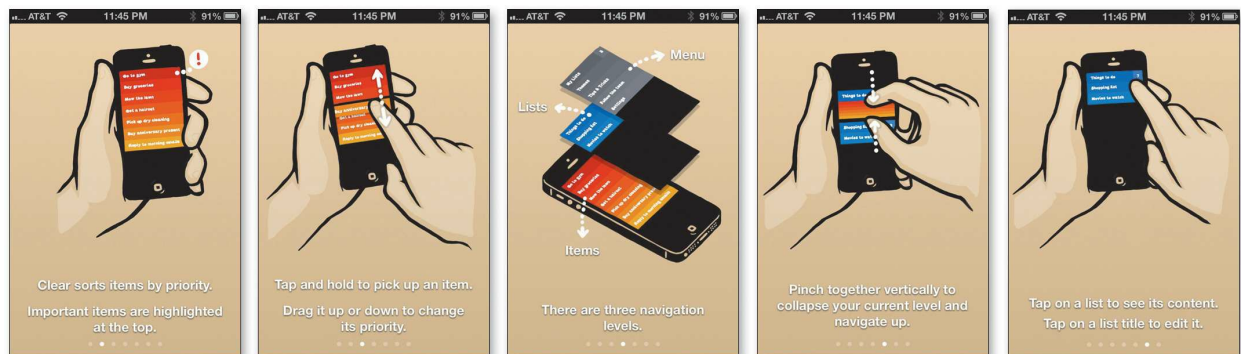

This is followed by an ingenious tutorial that’s actually just one of their lists. Each item in the list tells you something to try, and by the time you’re done you’ve practiced using almost all of the features.



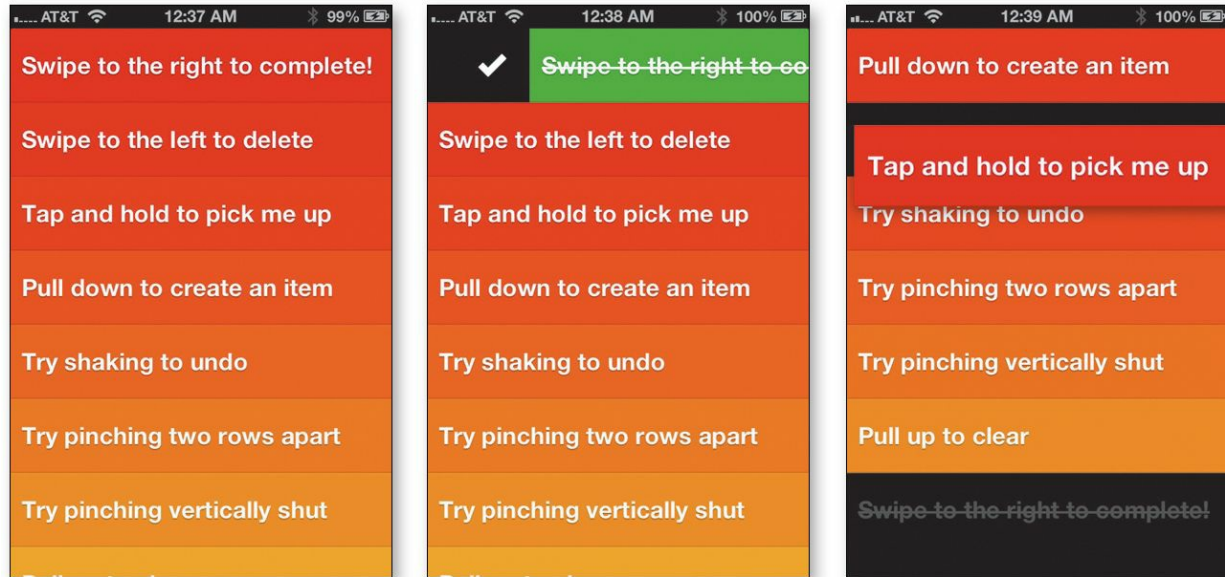

But when I've used it to do demo usability tests during my presentations, it hasn't fared so well.

I give the participant/volunteer a chance to learn about the app by reading the description in the app store, viewing the quick tour, and trying the actions in the tutorial. Then I ask them to do the type of primary task the app is designed for: create a new list called "Chicago trip" with three items in it — Book hotel, Rent car, and Choose flight.

So far, no one has succeeded.

Even though it's shown in the slide show on the way in, people don't seem to get the concept that there are levels: the level of lists, the level of items in lists, and the level of settings. And even if they remember seeing it, they still can't figure out how to navigate between levels. And if you can't figure that out, you can't get to the Help screens. Catch-22.

That's not to say that no one in the real world learns how to use it. It gets great reviews and is consistently a best seller. But I have to wonder how many people who bought it have never mastered it, or how many more sales they could make if it were easier to learn.

And this is a company that's put a lot of effort into training and help. Most don't.

You need to do better than most, and usability testing will help you figure out how.

**Apps need to be memorable, too**

There's one more attribute that's important: memorability. Once you've figured out how to use an app, will you remember how to use it the next time you try or will you have to start over again from scratch?

I don't usually talk much about memorability because I think the best way to make things easy to *relearn* is to make them incredibly clear and easy to *learn* in the first place. If it's easy to learn the first time, it's easy to learn the second time.

But it's certainly a serious problem with some apps.

One of my favorite drawing apps is ASketch. I *love* this app because no matter what you try to draw and how crudely you draw it, it ends up looking interesting.

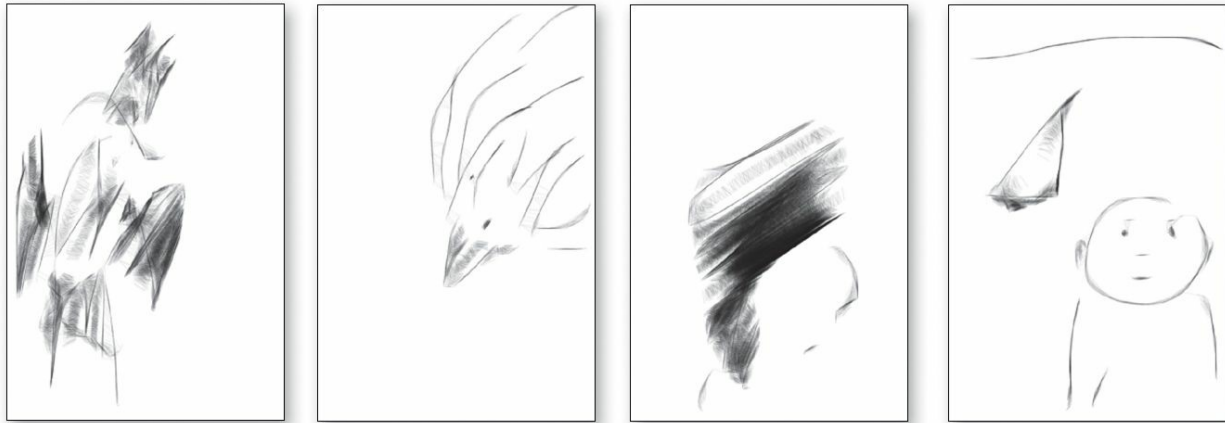

But for months, each time I opened it I couldn't remember how to start a new drawing.

In fact, I couldn't remember how to get to *any* of the controls. To maximize the drawing space there weren't any icons on the screen.

I'd try all the usual suspects: double tap, triple tap, tap near the middle at the top or bottom of the screen, various swipes and multi-finger taps, and finally I'd hit on it. But by the next time I went to use it I'd forgotten what the trick was again.



Memorability can be a big factor in whether people adopt an app for regular use. Usually when you purchase one, you'll be willing to spend some time right away figuring out how to use it. But if you have to invest the same effort the next time, it's unlikely to feel like a satisfying experience. Unless you're very impressed by what it does, there's a good chance you'll abandon it—which is the fate of most apps.

Life is cheap (99 cents) on mobile devices.

### **Usability testing on mobile devices**

For the most part, doing usability testing on mobile devices is exactly the same as the testing I described in [Chapter 9](#).

You're still making up tasks for people to do and watching them try to do them. You still prompt them to say what they're thinking while they work. You still need to keep quiet most of the time and save your probing questions for the end. And you should still try to get as many stakeholders as possible to come and observe the tests in person.

Almost everything that's different when you're doing mobile testing isn't about the process; it's about logistics.

## The logistics of mobile testing

When you're doing testing on a personal computer, the setup is pretty simple:

- The facilitator looks at the same screen as the participant.
- Screen sharing software allows the observers to see what's happening.
- Screen recording software creates a video of the session.

But if you've ever tried doing tests on mobile devices, you know that the setup can get very complicated: document cameras, Webcams, hardware signal processors, physical restraints (well, maybe not physical restraints, but "Don't move the device beyond this point" markers to keep the participant within view of a camera), and even things called sleds and goosenecks.

Here are some of the issues you have to deal with:

- Do you need to let the participants use their own devices?
- Do they need to hold the device naturally, or can it be sitting on a table or propped up on a stand?
- What do the observers need to see (e.g., just the screen, or both the screen and the participant's fingers so they can see their gestures)? And how do you display it in the observation room?
- How do you create a recording?

One of the main reasons why mobile testing is complicated is that some of the tools we rely on for desktop testing don't exist yet for mobile devices. As of this writing, robust mobile screen recording and screen sharing apps aren't available, mainly because the mobile operating systems tend to prohibit background processes. And the devices don't really have quite enough horsepower to run them anyway.

I expect this to change before long. With so many mobile sites and apps to test, there are already a lot of companies trying to come up with solutions.

## My recommendations

Until better technology-based solutions come along, here's what I'd lean toward:

- **Use a camera pointed at the screen instead of mirroring.** Mirroring

is the same as screen sharing: It displays what's on the screen. You can do it with software (like Apple's Airplay) or hardware (using the same kind of cable you use to play a video from your phone or tablet on a monitor or TV).

But mirroring isn't a good way to watch tests done on touch screen devices, because you can't see the gestures and taps the participant is making. Watching a test without seeing the participant's fingers is a little like watching a player piano: It moves very fast and can be hard to follow. Seeing the hand and the screen is much more engaging.

If you're going to capture fingers, there's going to be a camera involved. (Some mirroring software will show dots and streaks on the screen, but it's not the same thing.)

- **Attach the camera to the device so the user can hold it naturally.** In some setups, the device sits on a table or desk and can't be moved. In others, the participant can hold the device, but they're told to keep it inside an area marked with tape. The only reason for restricting movement of the device is to make it easier to point a camera at it and keep it in view.

If you attach the camera to the device, the participant can move it freely and the screen will stay in view and in focus.

- **Don't bother with a camera pointed at the participant.** I'm really not a fan of the face camera. Some observers like seeing the participant's face, but I think it's actually a distraction. I'd much rather have observers focus on what's happening on the screen, and they can almost always tell what the user is feeling from their tone of voice anyway.

Adding a second camera inevitably makes the configuration much more complicated, and I don't think it's worth the extra complexity. Of course, if your boss insists on seeing faces, show faces.

## Proof of concept: My Brundlefly<sup>7</sup> camera

<sup>7</sup> Brundlefly is the word Jeff Goldblum's character (Seth Brundle) in *The Fly* uses to describe himself after his experiment with a teleportation device accidentally merges his DNA with that of a fly.

Out of curiosity, I built myself a camera rig by merging a clip from a book light with a Webcam. It weighs almost nothing and captures the audio with

its built-in microphone. Mine cost about \$30 in parts and took about an hour to make. I'm sure somebody will manufacture something similar—only much better—before long. I'll put instructions for building one yourself online at [rocketsurgerymadeeasy.com](http://rocketsurgerymadeeasy.com).



Lightweight webcam + Lightweight clamp and Gooseneck = Brundlefly

Attaching a camera to the device creates a very easy-to-follow view. The observers get a stable view of the screen even if the participant is waving it around.

I think it solves most of the objections to other mounted-camera solutions:

- **They're heavy and awkward.** It weighs almost nothing and barely changes the way the phone feels in your hand.
- **They're distracting.** It's very small (smaller than it looks in the photo) and is positioned out of the participant's line of sight, which is focused on the phone.
- **Nobody wants to attach anything to their phone.** Sleds are usually attached to phones with Velcro or double-sided tape. This uses a padded clamp that can't scratch or mar anything but still grips the device firmly.

One limitation of this kind of solution is that it is tethered: It requires a USB extension cable running from the camera to your laptop. But you can buy a long extension inexpensively.

The rest of the setup is very straightforward:

- Connect the Brundlefly to the facilitator's laptop via USB.
- Open something like AmCap (on a PC) or QuickTime Player (on a Mac) to display the view from the Brundlefly. The facilitator will watch this view.
- Share the laptop screen with the observers using screen sharing



(GoToMeeting, WebEx, etc.)

- Run a screen recorder (e.g., Camtasia) on the computer in the observation room. This reduces the burden on the facilitator's laptop.

That's it.

## Finally...

In one form or another, it seems clear that mobile is where we're going to live in the future, and it provides enormous opportunities to create great user experiences and usable things. New technologies and form factors are going to be introduced all the time, some of them involving dramatically different ways of interacting.<sup>8</sup>

<sup>8</sup> *Personally, I think talking to your computer is going to be one of the next big things. Recognition accuracy is already amazing; we just need to find ways for people to talk to their devices without looking, sounding, and feeling foolish. Someone who's seriously working on the problems should give me a call; I've been using speech recognition software for 15 years, and I have a lot of thoughts about why it hasn't caught on.*

Just make sure that usability isn't being lost in the shuffle. And the best way to do this is by testing.

# Chapter 11. Usability as common courtesy

## WHY YOUR WEB SITE SHOULD BE A MENSCH<sup>1</sup>

<sup>1</sup> *Mensch*: a German-derived Yiddish word originally meaning “human being.” A person of integrity and honor; “a stand-up guy”; someone who does the right thing.

*Sincerity: that’s the hard part. If you can fake that, the rest is easy.*

—OLD JOKE ABOUT A HOLLYWOOD AGENT

Some time ago, I was booked on a flight to Denver. As it happened, the date of my flight also turned out to be the deadline for collective bargaining between the airline I was booked on and one of its unions.

Concerned, I did what anyone would do: (a) Start checking Google News every hour to see if a deal had been reached, and (b) visit the airline’s Web site to see what *they* were saying about it.

I was shocked to discover that not only was there nothing about the impending strike on the airline’s Home page, but there wasn’t a word about it to be found anywhere on the entire site. I searched. I browsed. I scrolled through all of their FAQ lists. Nothing but business as usual. “Strike? What strike?”

Now, on the morning of a potential airline strike, you have to know that there’s really only one frequently asked question related to the site, and it’s being asked by hundreds of thousands of people who hold tickets for the coming week: What’s going to happen to me?

I might have expected to find an entire FAQ list dedicated to the topic:

[Is there really going to be a strike?](#)

[What’s the current status of the talks?](#)

[If there is a strike, what will happen?](#)

[How will I be able to rebook my flight?](#)

[What will you do to help me?](#)

Nothing.

What was I to take away from this?

Either (a) the airline had no procedure for updating their Home page for special circumstances, (b) for some legal or business reason they didn't want to admit that there might be a strike, (c) it hadn't occurred to them that people might be interested, or (d) they just couldn't be bothered.

No matter what the real reason was, they did an outstanding job of depleting my goodwill towards both the airline and their Web site. Their brand—which they spend hundreds of millions of dollars a year polishing—had definitely lost some of its luster for me.

Most of this book has been about building *clarity* into Web sites: making sure that users can understand what it is they're looking at—and how to use it—without undue effort. Is it clear to people? Do they “get it”?

But there's another important component to usability: doing the right thing—being considerate of the user. Besides “Is my site clear?” you also need to be asking, “Does my site behave like a mensch?”

## The reservoir of goodwill

I've always found it useful to imagine that every time we enter a Web site, we start out with a reservoir of goodwill. Each problem we encounter on the site lowers the level of that reservoir. Here, for example, is what my visit to the airline site might have looked like:



I enter the site.

My goodwill is a little low, because I'm not happy that their negotiations may seriously inconvenience me.



I glance around the Home page.

It feels well organized, so I relax a little. I'm confident that if the information is here, I'll be able to find it.



There's no mention of the strike on the Home page.

I don't like the fact that it feels like business as usual.



There's a list of five links to News stories on the Home page but none are relevant.

I click on the Press Releases link at the bottom of the list.



Latest press release is five days old.

I go to the About Us page.



No promising links, but plenty of promotions, which is very annoying. Why are they trying to sell me more tickets when I'm not sure they're going to fly me tomorrow?



I search for "strike" and find two press releases about a strike a year ago and pages from the corporate history about a strike in the 1950s.

At this point, I would like to leave, but they're the sole source for this information.



I look through their FAQ lists, then leave.

The reservoir is limited, and if you treat users badly enough and exhaust it there's a good chance that they'll leave. But leaving isn't the only possible negative outcome; they may not be as eager to use your site in the future, or they may think less of your organization and savage you on Facebook or Twitter. For those of you in marketing, your NPS (Net Promoter Score) probably goes down.

There are a few things worth noting about this reservoir:

- **It's idiosyncratic.** Some people have a large reservoir, some small. Some people are more suspicious by nature, or more ornery; others are inherently more patient, trusting, or optimistic. The point is, you can't count on a very large reserve.



- **It's situational.** If I'm in a huge hurry, or have just come from a bad experience on another site, my expendable goodwill may already be low when I enter your site, even if I naturally have a large reserve.



- **You can refill it.** Even if you've made mistakes that have diminished my goodwill, you can replenish it by doing things that make me feel like you're looking out for my best interests.



- **Sometimes a single mistake can empty it.** For instance, just opening up a registration form with tons of fields may be enough to cause some people's reserve to plunge instantly to zero.



## Things that diminish goodwill

Here are a few of the things that tend to make users feel like the people publishing a site don't have their best interests at heart:



**Hiding information that I want.** The most common things to hide are customer support phone numbers, shipping rates, and prices.

The whole point of hiding support phone numbers is to try to keep users from calling, because each call costs money. The usual effect is to diminish goodwill and ensure that they'll be even more annoyed when they do find the number and call. On the other hand, if the 800 number is in plain sight—perhaps even on every page—somehow knowing that they *can* call if they want to is often enough to keep people looking for the information on the site longer, increasing the chances that they'll solve the problem themselves.

Some sites hide pricing information in hopes of getting users so far into the process that they'll feel vested in it by the time they experience the sticker shock. My favorite example is Web sites for wireless access in public places like airports. Having seen a "Wireless access available!" sign and knowing that it's free at some airports, you open up your laptop, find a signal, and try to connect. But then you have to scan, read, and click your way through three pages, following links like "Wireless Access" and "Click here to connect" before you get to a page that even hints at what it might cost you. It feels like an old phone sales tactic: If they can just keep you on the line long enough and keep throwing more of their marketing pitch at you, maybe they can convince you along the way.



**Punishing me for not doing things your way.** I should *never* have to think about formatting data: whether or not to put dashes in my Social Security number, spaces in my credit card number, or parentheses in my



phone number. Many sites perversely insist on no spaces in credit card numbers, when the spaces actually make it much easier to type the number correctly. Don't make me jump through hoops just because you don't want to write a little bit of code.



**Asking me for information you don't really need.** Most users are

very skeptical of requests for personal information and find it annoying if a site asks for more than what's needed for the task at hand.



**Shucking and jiving me.** We're always on the lookout for faux

sincerity, and disingenuous attempts to convince me that you care about me can be particularly annoying. Think about what goes through your head every time you hear "Your call is important to us."

*Right. That's why your "unusually high call volume" is keeping me on hold for 20 minutes: because my call is important to you, but my time isn't.*



**Putting sizzle in my way.** Having to wade through pages bloated

with feel-good marketing photos makes it clear that you don't understand—or care—that I'm in a hurry.



**Your site looks amateurish.** You can lose goodwill if your site looks

sloppy, disorganized, or unprofessional, like *no* effort has gone into making it presentable.

Note that while people love to make comments about the appearance of sites—especially about whether they like the colors—almost no one is going to leave a site just because it doesn't look *great*. (I tell people to ignore all comments that users make about colors during a user test,

unless three out of four people use a word like “puke” to describe the color scheme. Then it’s worth rethinking.<sup>2</sup>)

<sup>2</sup> *This actually happened once during a round of testing I facilitated. We changed the color.*

There may be times when you’ll choose to have your site do some of these user-unfriendly things deliberately. Sometimes it makes business sense not to do exactly what the customer wants. For instance, uninvited pop-ups almost always annoy people to some extent. But if your statistics show you can get 10 percent more revenue by using pop-ups and you think it’s worth annoying your users, you can do it. It’s a business decision. Just be sure you do it in an informed way, rather than inadvertently.

## Things that increase goodwill

The good news is that even if you make mistakes, it’s possible to restore my goodwill by doing things that convince me that you *do* have my interests at heart. Most of these are just the flip side of the other list:



### **Know the main things that people want to do on your site and**

**make them obvious and easy.** It’s usually not hard to figure out what people want to do on a given Web site. I find that even people who disagree about everything else about their organization’s site almost always give me the same answer when I ask them, “What are the three main things your users want to do?” The problem is, making those things easy doesn’t always become the top priority it should be. (If most people are coming to your site to apply for a mortgage, nothing should get in the way of making it dead easy to apply for a mortgage.)



### **Tell me what I want to know.** Be upfront about things like shipping

costs, hotel daily parking fees, service outages—anything you’d rather *not* be upfront about. You may lose points if your shipping rates are higher than I’d like, but you’ll often gain enough points for candor and for making it easy for me to compensate for the price difference.



### **Save me steps wherever you can.** For instance, instead of giving me

the shipping company’s tracking number for my purchase, put a link in

my email receipt that opens their site and submits my tracking number when I click it. (As usual, Amazon was the first site to do this for me.)



**Put effort into it.** My favorite example is the HP technical support

site, where it seems like an enormous amount of work has gone into (a) generating the information I need to solve my problems, (b) making sure that it's accurate and useful, (c) presenting it clearly, and (d) organizing it so I can find it. I've had a lot of HP printers, and in almost every case where I've had a problem I've been able to solve it on my own. As a result, I keep buying HP printers.



**Know what questions I'm likely to have, and answer them.**

Frequently Asked Questions lists are enormously valuable, especially if

- They really are FAQs, not marketing pitches masquerading as FAQs (also known as QWWPWAs: Questions We *Wish* People Would Ask).
- You keep them up to date. Customer Service and Technical Support can easily give you a list of this week's five most frequently asked questions. I would always put this list at the top of any site's Support page.
- They're candid. Often people are looking in the FAQs for the answer to a question you'd rather they hadn't asked. Candor in these situations goes a *long* way to increasing goodwill.



**Provide me with creature comforts like printer-friendly pages.**

Some people love being able to print stories that span multiple pages with a single click, and CSS makes it relatively easy to create printer-friendly pages with little additional effort. Drop the ads (the possibility of a banner ad having any impact other than being annoying is even greater when it's just taking up space on paper), but *don't* drop the illustrations, photos, and figures.



**Make it easy to recover from errors.** If you actually do enough user

testing, you'll be able to spare me from many errors before they happen. But where the potential for errors is unavoidable, always provide a graceful, obvious way for me to recover.



**When in doubt, apologize.** Sometimes you can't help it: You just don't have the ability or resources to do what the user wants (for instance, your university's library system requires separate passwords for each of your catalog databases, so you can't give users the single login they'd like). If you can't do what they want, at least let them know that *you* know you're inconveniencing them.

## Chapter 12. Accessibility and you

### JUST WHEN YOU THINK YOU'RE DONE, A CAT FLOATS BY WITH BUTTERED TOAST STRAPPED TO ITS BACK

*When a cat is dropped, it always lands on its feet, and when toast is dropped, it always lands with the buttered side facing down. I propose to strap buttered toast to the back of a cat; the two will hover, spinning, inches above the ground. With a giant buttered-cat array, a high-speed monorail could easily link New York with Chicago.*

—JOHN FRAZEE, IN *THE JOURNAL OF IRREPRODUCIBLE RESULTS*

People sometimes ask me, “What about accessibility? Isn’t that part of usability?”

And they’re right, of course. Unless you’re going to make a blanket decision that people with disabilities aren’t part of your audience, you really can’t say your site is usable unless it’s accessible.

At this point, everyone involved in Web design knows at least a little bit about Web accessibility. And yet almost every site I go to still fails my three-second accessibility test—increasing the size of the type.<sup>1</sup>

<sup>1</sup> *If you’re about to send me email reminding me that Zoom has replaced Text Size in most browsers, thanks, but you can save those keystrokes. Every site gets larger if you use Zoom, but only sites that have moved beyond fixed-size fonts (usually a good indicator of effort to make things accessible) respond to Text Size.*

Change browser  
"Text Size"  
to "Largest"

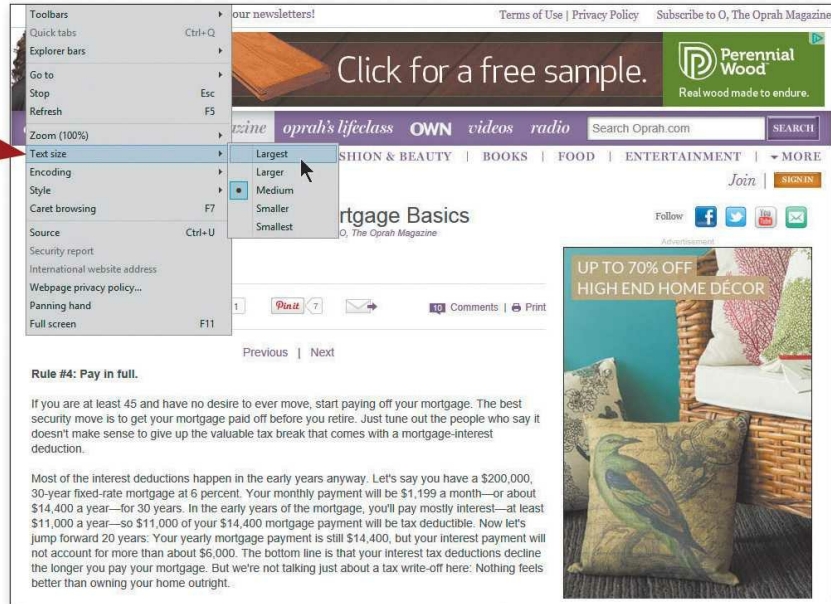

Before





After (no difference)

Why is that?

## What developers and designers hear

In most organizations, the people who end up being responsible for doing something about accessibility are the people who actually build the thing: the designers and the developers.

When they try to learn about what they should do, whatever books or articles they pick up inevitably list the same set of reasons why they need to make their sites accessible:



There's a lot of truth in all of these. Unfortunately, there's also a lot that's unlikely to convince 22-year-old developers and designers that they should be "doing accessibility." Two arguments in particular tend to make them skeptical:

- **\_\_\_% of the population has a disability.** Since their world consists largely of able-bodied 22-year-olds, it's very hard for them to believe that a large percentage of the population actually needs help accessing the Web. They're willing to write it off as the kind of exaggeration that people make when they're advocating for a worthy cause, but there's also a natural inclination to think, "If one of their claims is so clearly untrue, I'm entitled to be skeptical about the rest."
- **Making things more accessible benefits everyone.** They know that some adaptations do, like the classic example, closed captioning, which does often come in handy for people who can hear.<sup>2</sup> But since this



always seems to be the only example cited, it feels a little like arguing that the space program was worthwhile because it gave us Tang.<sup>3</sup> It's much easier for developers and designers to imagine cases where accessibility adaptations are likely to make things worse for "everyone else."

<sup>2</sup> *Melanie and I often use it when watching British films, for instance.*

<sup>3</sup> *A powdered orange-flavored breakfast drink, invented for the astronauts (see also: freeze-dried food).*

The worst thing about this skepticism is that it obscures the fact that there's really only one reason that's important:

- **It's the right thing to do.** And not just the right thing; it's *profoundly* the right thing to do, because the one argument for accessibility that doesn't get made nearly often enough is how extraordinarily better it makes some people's lives. Personally, I don't think anyone should need more than this one example: Blind people with access to a computer can now read almost any newspaper or magazine on their own. Imagine that.

How many opportunities do we have to dramatically improve people's lives just by doing our job a little better?

And for those of you who don't find this argument compelling, be aware that even if you haven't already encountered it, there will be a legislative stick coming sooner or later. Count on it.

## What designers and developers fear

As they learn more about accessibility, two fears tend to emerge:

- **More work.** For developers in particular, accessibility can seem like just one more complicated new thing to fit into an already impossible project schedule. In the worst case, it gets handed down as an "initiative" from above, complete with time-consuming reports, reviews, and task force meetings.
- **Compromised design.** What designers fear most is what I refer to as buttered cats: places where good design for people with disabilities and good design for everyone else are going to be in direct opposition. They're worried that they're going to be forced to design sites that are less appealing—and less useful—for the majority of their audience.

In an ideal world, accessibility would work like a sign I saw in the back of a Chicago taxi. At first it looked like an ordinary sign. But something about the way it caught the light made me take a closer look, and when I did, I realized that it was ingenious.



The sign was overlaid with a thin piece of Plexiglas, and the message was embossed in Braille on the Plexiglas. Ordinarily, both the print and the Braille would have been half as large so they could both fit on the sign, but with this design each audience got the best possible experience. It was an elegant solution.

I think for some designers, though, accessibility conjures up an image something like the Vonnegut short story where the government creates equality by handicapping everyone.<sup>4</sup>

<sup>4</sup> In “Harrison Bergeron,” the main character, whose intelligence is “way above normal,” is required by law to wear a “mental handicap radio” in his ear that blasts various loud noises every 20 seconds “to keep people like George from taking unfair advantage of their brains.”

## **The truth is, it *can* be complicated**

When people start reading about accessibility, they usually come across one piece of advice that sounds very promising:



The problem is, when they run their site through a validator, it turns out to be more like a grammar checker than a spell checker. Yes, it does find some obvious mistakes and oversights that are easy to fix, like missing alt text.<sup>5</sup> But it also inevitably turns up a series of vague warnings that you *may* be doing something wrong and a long list of recommendations of things for you to check that it admits may *not* be problems at all.

<sup>5</sup> *Alt text provides a text description of an image (“Picture of two men on a sailboat,” for example), which is essential for people using screen readers or browsing with images turned off.*

This can be very discouraging for people who are just learning about accessibility, because the long lists and ambiguous advice suggest that there’s an awful lot to learn.

And the truth is, it’s a lot harder than it ought to be to make a site accessible. After all, most designers and developers are not going to become accessibility experts. If Web accessibility is going to become ubiquitous, it’s going to have to be easier to do. Screen readers and other adaptive technologies have to get smarter, the tools for building sites (like Dreamweaver) have to make it easier to code correctly for accessibility, and our design processes need to be updated to include thinking about accessibility from the beginning.

## **The four things you can do right now**

The fact that it’s not a perfect world at the moment doesn’t let any of us off the hook, though.

Even with current technology and standards, it’s possible to make any site very accessible without an awful lot of effort by focusing on a few things that will have the most impact. And they don’t involve getting anywhere near a buttered cat.

## #1. Fix the usability problems that confuse everyone

One of the things that I find annoying about the Tang argument (“making sites accessible makes them more usable for everyone”) is that it obscures the fact that the reverse actually *is* true: Making sites more usable for “the rest of us” is one of the most effective ways to make them more effective for people with disabilities.

If something confuses most people who use your site, it’s almost certain to confuse users who have accessibility issues. (After all, people don’t suddenly become remarkably smarter just because they have a disability.) And it’s very likely that they’re going to have a harder time recovering from their confusion.

For instance, think of the last time you had trouble using a Web site (running into a confusing error message when you submitted a form, for example).

Now imagine trying to solve that problem without being able to see the page.

The single best thing you can do to improve your site’s accessibility is to test it often, and continually smooth out the parts that confuse everyone. In fact, if you don’t do this first, no matter how rigorously you apply accessibility guidelines, people with disabilities still won’t be able to use your site. If it’s not clear to begin with, just fixing code problems is like [insert your favorite putting-lipstick-on-a-pig metaphor here].

## #2. Read an article

As I hope you’ve seen by now, the best way to learn how to make anything more usable is to watch people actually try to use it. But most of us have no experience at using adaptive technology, let alone watching other people use it.

If you have the time and the motivation, I’d highly recommend locating one or two blind Web users and spending a few hours with them observing how they actually use their screen reader software.

Fortunately, someone has done the heavy lifting for you. Mary Theofanos and Janice (Ginny) Redish watched 16 blind users using screen readers to do a number of tasks on a variety of sites and reported what they observed in an article titled “Guidelines for Accessible and Usable Web Sites: Observing Users Who Work with Screen Readers.”<sup>6</sup>

<sup>6</sup> Published in the ACM magazine *Interactions* (November-December 2003). With permission from

ACM, Ginny has made it available for personal use at [redish.net/images/stories/PDF/InteractionsPaperAuthorsVer.pdf](http://redish.net/images/stories/PDF/InteractionsPaperAuthorsVer.pdf). Yes, it's ten years old, but it's still relevant.

As with any kind of user testing, it produced invaluable insights. Here's one example of the kinds of things they learned:

**Screen-reader users scan with their ears.** Most blind users are just as impatient as most sighted users. They want to get the information they need as quickly as possible. They do not listen to every word on the page—just as sighted users do not read every word. They “scan with their ears,” listening to just enough to decide whether to listen further. Many set the voice to speak at an amazingly rapid rate.

They listen to the first few words of a link or line of text. If it does not seem relevant, they move quickly to the next link, next line, next heading, next paragraph. Where a sighted user might find a keyword by scanning over the entire page, a blind user may not hear that keyword if it is not at the beginning of a link or a line of text.

I recommend that you read this article before you read anything else about accessibility. In 20 minutes, it will give you an appreciation for the problems you're trying to solve that you won't get from any other articles or books.

### **#3. Read a book**

After you've read Ginny and Mary's article, you're ready to spend a weekend reading a book about Web accessibility. These two are particularly good:

- *A Web for Everyone: Designing Accessible User Experiences* by Sarah Horton and Whitney Quesenbery. (Their approach: “Good UX equals good accessibility. Here's how to do both.”)
- *Web Accessibility: Web Standards and Regulatory Compliance* by Jim Thatcher et al. (“Here are the laws and regulations, and we'll help you understand how to meet them.”)



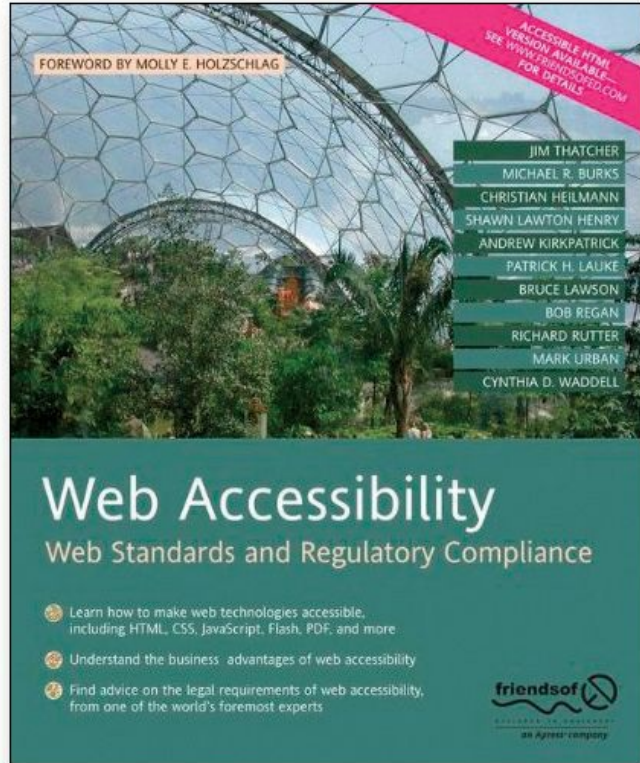

These books cover a lot of ground, so don't worry about absorbing all of it. For now, you just need to get the big picture.

#### #4. Go for the low-hanging fruit

Now you're ready to do what most people think of as Web accessibility: implementing specific changes in your pages.

As of right now, these are probably the most important things to do:

- **Add appropriate alt text to every image.** Add an empty (or “null”) alt attribute (`<alt="">`) for images that screen readers should ignore, and add helpful, descriptive text for the rest.

To learn how to write good alt text—and in fact to learn how to do any of the things in this list—head over to [webaim.org](http://webaim.org). The folks at WebAIM have written excellent practical articles covering the nuts-and-bolts details of almost every accessibility technique.

- **Use headings correctly.** The standard HTML heading elements convey useful information about the logical organization of your content to people using screen readers and make it easier for them to navigate via the keyboard. Use `<h1>` for the page title or main content



heading, `<h2>` for the major section headings, `<h3>` for subheadings, and so on, and then use CSS to redefine the visual appearance of each level.

- **Make your forms work with screen readers.** This largely boils down to using the HTML `<label>` element to associate the fields with their text labels, so people know what they're supposed to enter.
- **Put a "Skip to Main Content" link at the beginning of each page.** Imagine having to spend 20 seconds (or a minute, or two) listening to the global navigation at the top of every page before you could look at the content, and you'll understand why this is important.
- **Make all content accessible by keyboard.** Remember, not everyone can use a mouse.
- **Create significant contrast between your text and background.** Don't ever use light grey text on a dark grey background, for instance.
- **Use an accessible template.** If you're using WordPress, for example, make sure that the theme you choose has been designed to be accessible.

That's it. You'll probably learn how to do a lot more as you go along, but even if you do only what I've covered here, you'll have made a really good start.

When I wrote this chapter seven years ago, it ended with this:

Hopefully in five years I'll be able to just remove this chapter and use the space for something else because the developer tools, browsers, screen readers, and guidelines will all have matured and will be integrated to the point where people can build accessible sites without thinking about it.

Sigh.

Hopefully we'll have better luck this time.

## Chapter 13. Guide for the perplexed<sup>1</sup>

<sup>1</sup> The Guide for the Perplexed (*the real one*) is a seminal commentary on the meaning of the Talmud written in the 12th century by Rabbi Moshe ben Maimon (better known as Maimonides). I've just always thought it was the best title I've ever heard.

### MAKING USABILITY HAPPEN WHERE YOU LIVE

*I am the Lorax. I speak for the trees.*

—THE LORAX, DR. SEUSS

I get a lot of email from people asking me some variation of this question:

OK, I get it. This usability stuff is important, and I really want to work on it myself. How do I convince my boss—and his boss—that they should be taking users seriously and allow me to spend time making it happen?

What *can* you do if you find yourself in an environment where your desire to “do usability” isn't supported?

### **Ya gotta know the territory**

First, a little background about how the place of usability in the world has changed.

Back in the late 1990s, Usability and User Centered Design (UCD) were the terms most people used to describe any efforts to design with the user in mind. And there were essentially two “professions” that focused on making Web sites more usable: Usability (making sure things are designed in a way that enables people to use them successfully) and Information Architecture (making sure the content is organized in a way that allows people to find what they need).

Now the term you hear most often is User Experience Design, or just User Experience (UXD or UX, for short), and there are probably a dozen specialties involved, like Interaction Design, Interface Design, Visual Design, and Content Management—and, of course, Usability and Information Architecture—all under the UX umbrella.

One difference between User Centered Design and User Experience Design is their scope. UCD focused on designing the right product and making sure that it was usable. UX sees its role as taking the users' needs into account at every stage of the product life cycle, from the time they see an ad on TV, through purchasing it and tracking its delivery online, and even returning it to a local branch store.

The good news is that there's a lot more awareness now of the importance of focusing on the user. Steve Jobs (and Jonathan Ive) made a very compelling business case for UX, and as a result usability is an easier sell than it was even a few years ago.

The bad news is that where usability used to be the standard bearer for user-friendly design, now it's got a lot of siblings looking for seats at the table, each convinced that their set of tools are the best ones for the job. The worse news is that not many people understand the differences between the specialties or the unique contributions they can make.

This is the field you're playing on. So when someone tells you: "I'm in UX" or "Usability is so 2002—it's all UX now," smile graciously and ask them a few questions about how they're learning about users, how they're testing whether people can use what they're building, and how they get changes to happen. If they don't do any of those things, they need your help. If they do, learn from them. It's not what we call ourselves that matters, it's the attitude we bring and the skills we can contribute.

## The usual advice

Here are the two suggestions I've always heard for convincing management to support (and fund) usability work:

- **Demonstrate ROI.** In this approach, you gather and analyze data to prove that a usability change you've made resulted in cost savings or additional revenue ("Changing the label on this button increased sales by 0.25%"). There's an excellent book about it: *Cost-justifying Usability: An Update for the Internet Age*, edited by Randolph Bias and Deborah Mayhew.
- **Speak their language.** Instead of talking about the benefits for users, learn what the current vexing corporate problems are and describe your efforts in a way that makes it clear that they're part of the solution: Talk about things like pain points, touch points, KPIs, and CSI, or whatever

management buzzwords are trending in your organization.

These are both fine ideas and worth doing if you can manage it. But making an ROI case tied to costs and revenues can be a lot of work, and unless it's rigorously implemented there'll always be someone who'll claim that the added value was caused by something else. And learning to speak "business" can be challenging, too. That's what MBA degrees are for.

## If I were you...

...I'd last about a week at your job. Every time I go to a client's office I spend most of my time marveling at the fact that so many people can survive in the corporate world. I'm just not equipped for dealing with the office politics in a large (i.e., more than two people) organization and sitting in meetings all day. But I have spent a fair amount of time *visiting* corporate offices and getting managers to take usability seriously. So I do have some ideas about tactics that work, and people who have tried them tell me they've had some success. So here's what I'd do if I were you:

- **Get your boss (and her boss) to watch a usability test.** The tactic that I think works best is getting people from higher up the food chain to come and observe even one usability test. Tell them that you're going to be doing some testing and it would be great for the Web team's morale if they could just poke their head in for a few minutes.

In my experience, executives often become fascinated and stay longer than they'd planned, because it's the first time they've seen anyone try to use the company's site and it's often not nearly as pretty a picture as they'd imagined.

It's important to get them to come in person. The difference between watching a usability test live and hearing a presentation about it is like the difference between watching a sporting event while it's happening versus listening to a recap of it on the evening news. Live games create memorable experiences; the evening news not so much.

If you can't get them to come, then settle for second best: include clips of highlights from tests in your presentations. If you don't get to do a presentation, post a short clip (less than 3 minutes) on your intranet and send out email with an intriguing description and a link to the video. Even executives like watching short videos.

- **Do the first one on your own time.** When you do your first test, don't ask for permission; just keep it incredibly simple and informal, and find volunteers for participants so it doesn't cost anything.

And try to make sure that something improves as a result. Pick an easy target to test—something that you know has at least one serious usability problem that can be fixed quickly without having to get a lot of people to sign off on the change—renaming a poorly labeled button, for instance. Then test it, fix it, and publicize it.

If you can find a simple way to measure the improvement, do so. For instance, you might test something that's been causing a lot of support calls and then show how much the calls on that issue decreased after you fixed the problem.

- **Do a test of the competition.** I mentioned in [Chapter 9](#) that it's a good idea to test some competitive sites at the start of any project. But it's also a great way to drum up support for testing. Everybody loves learning about the competition, and because it's not your site being tested, no one has anything personally on the line. It makes a great brown bag lunch event.

- **Empathize with management.** A few years ago at the UXPA annual conference, I looked around and thought “What a nice group of people!” Then it dawned on me: of course they're nice. Empathy is virtually a professional requirement for usability work. And if you're interested in doing it, you're probably empathetic too. I recommend that you apply that empathy to your bosses. Not in the “how can I figure out what motivates these people so I can get them to do what I want” way, but more in the “understand the position they find themselves in” way, having real, emotional empathy for them. You may be surprised by the effect.

- **Know your place in the grand scheme of things.** Personally, in the situation you're in, I think a little bit of humility goes a long way. The reality is that in the business world almost everyone is just a very small cog in a huge collection of cogs.<sup>2</sup>

<sup>2</sup> Sorry. Try not to take it personally. Do good work. Enjoy your home life. Be happy.

You want your enthusiasm for usability to be infectious, but it just doesn't work to go around with the attitude that you're bringing the

truth—about usability, or anything else—to the unwashed masses. Your primary role should be to share what you know, not to tell people how things should be done.

I'd also recommend two books that can help.

First there's Tomer Sharon's *It's Our Research: Getting Stakeholder Buy-In for User Experience Research Projects*. Tomer is a UX Researcher at Google, and I've never heard him say anything that wasn't true, pithy, and actionable.



# IT'S OUR RESEARCH

Getting Stakeholder Buy-in for User Experience Research Projects



**MK**  
MORGAN KAUFMANN

**TOMER SHARON**

Foreword by Rolf Molich

Any book with section titles like “Become the voice of reason” and “Accept the fact that it might not work and that it’s okay” is obviously worth reading. Leah Buley’s *The User Experience Team of One: A Research and Design*

*Survival Guide* is written specifically for people who are “the only person in your company practicing (or aspiring to practice) user centered design” or who “regularly work on a team where you are the *only* UX person.” [Chapters 3](#) (Building Support for Your Work) and [4](#) (Growing Yourself and Your Career) are full of good advice and useful resources.

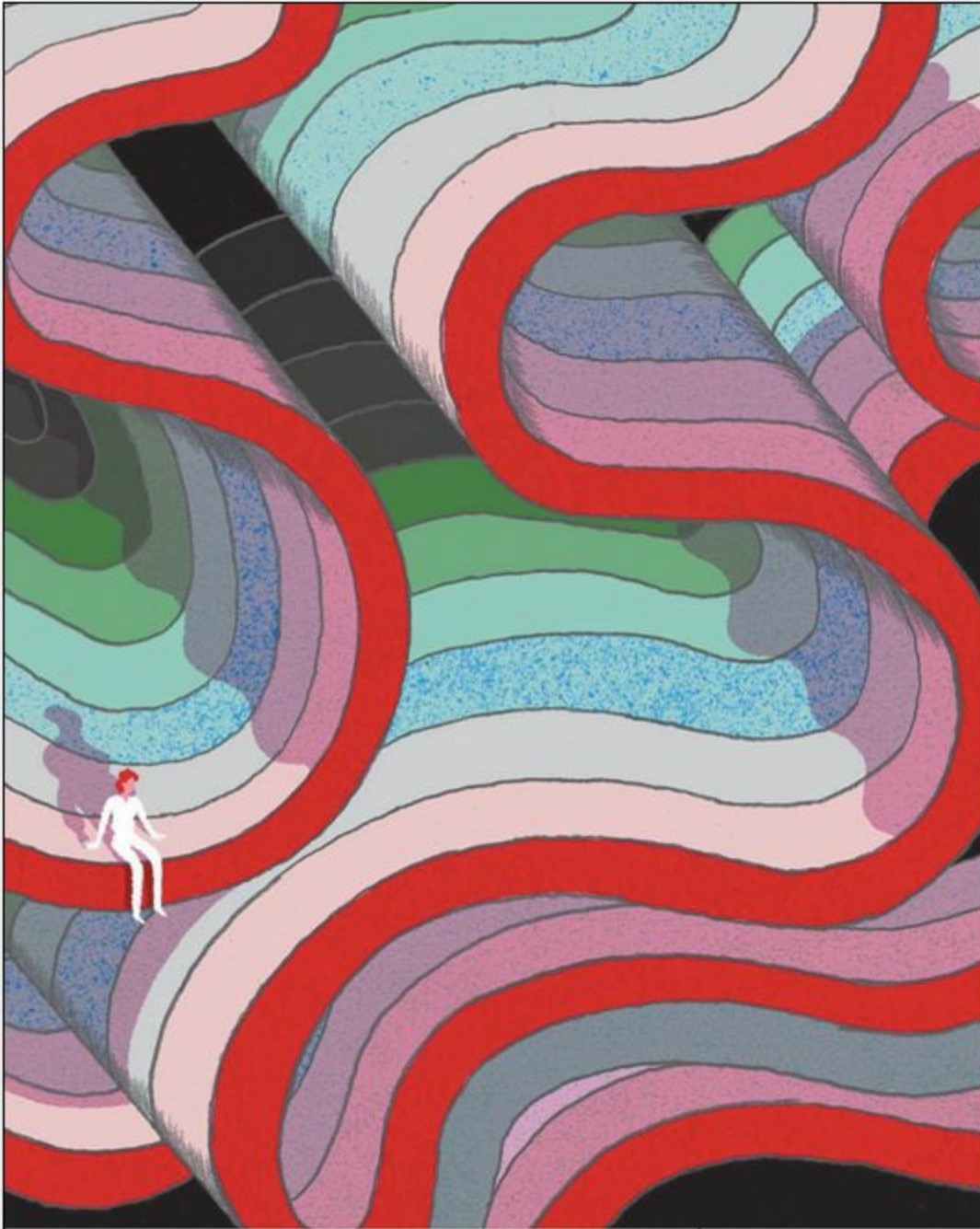

## THE USER EXPERIENCE TEAM OF ONE

A Research and Design Survival Guide

by **Leah Buley** Foreword by Stephen Anderson

 Rosenfeld

## Resist the dark forces

Usability is, at its heart, a user advocate job: Like the Lorax, you speak for the trees. Well, the users, actually. Usability is about serving people better by building better products.

But there's a trend—which I first noticed about five years ago—for some people<sup>3</sup> to try to get usability practitioners to help them figure out how to manipulate users rather than serve their needs.<sup>4</sup>

<sup>3</sup> [cough] marketing [cough]

<sup>4</sup> There's even a book called *Evil by Design: Interaction Design to Lead Us into Temptation* by Chris Nodder that explains how an understanding of human frailties can guide your design decisions. Each chapter deals with one of the Seven Deadly Sins (Gluttony, Pride, Sloth, and so on).

I have no problem with the idea of people asking for our help influencing users.

If you want to know how to influence people, just read Robert Cialdini's classic book on the subject, *Influence: The Psychology of Persuasion*. It's brilliant and effective, full of time-proven ideas.

Or read any of Susan Weinschenk's books about the useful lessons that neuropsychology research can teach us about human motivation and decision making.

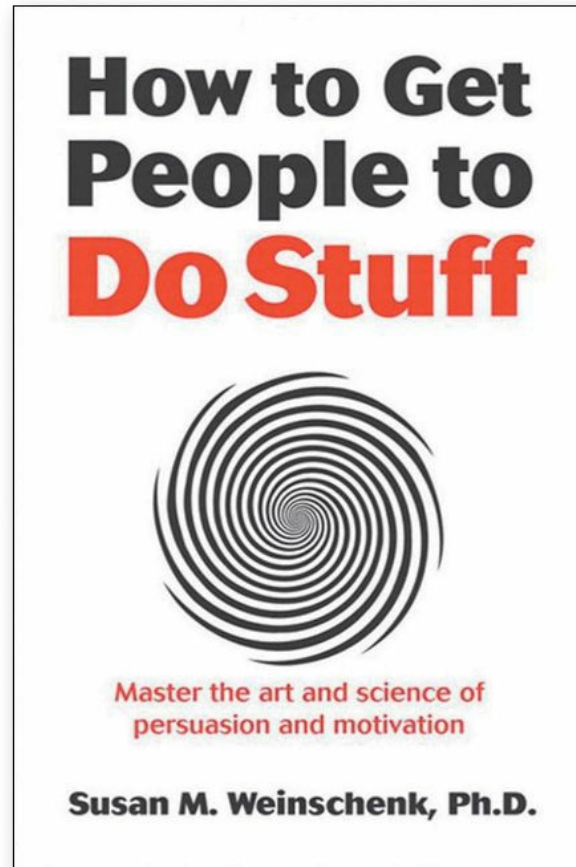
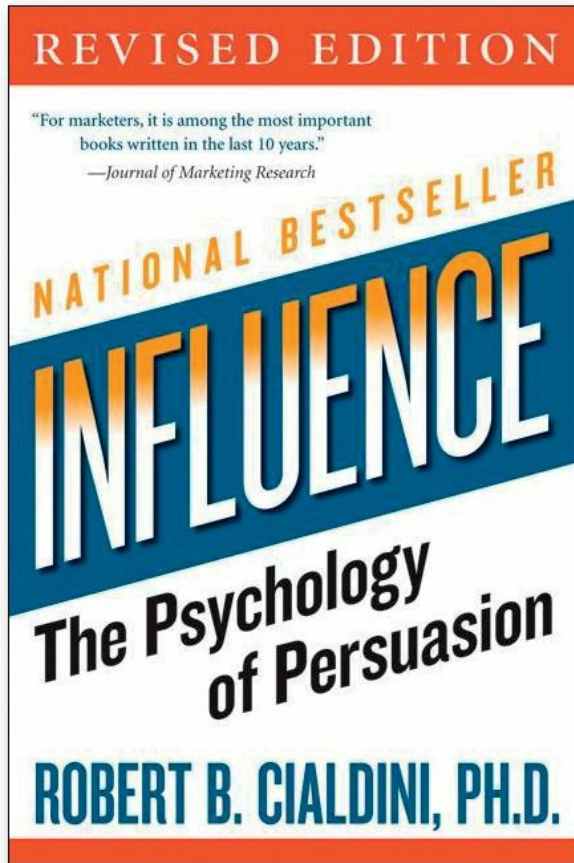

I don't have a problem with helping to *persuade* people to do things, either, as long as it's not deceptive. The think-aloud protocol in usability tests can often produce valuable insights into why attempts at persuasion succeed or fail.

But I get anxious whenever I hear people talk about using usability tests to help determine whether something is *desirable*, because it's just not something usability tests are good for measuring. You may get a sense during a test session that the participant finds something desirable, but it's just that: a sense. Whether something is desirable is a market research question, best answered by using market research tools and instruments.

The real problem is that these people often aren't actually asking for our help determining whether something is desirable, or even for help in figuring out how to make what they produce *more* desirable. Instead, they're looking to usability to tell them how to make people *think* it's desirable, i.e., to manipulate them.

Sometimes the intended manipulation is relatively benign, like using a



slightly hidden checkbox checked by default to automatically sign you up for a newsletter.

Sometimes it inches closer to the darkness, doing things like tricking people into installing an unwanted browser toolbar<sup>5</sup> and changing their default search and Home page settings while they're not looking. We've all been on the receiving end of this kind of deception.

<sup>5</sup> [cough] Yahoo [cough]



You click on a link to download some free software.





This opens a screen with three big “Start Download” links.

Your download will begin in a moment. If it doesn't, [restart the download.](#)



Not noticing the nearly invisible instructions, when nothing happens you click one of them to start the download.



[Click to start your download...](#)

A free FLV Video player. The Install Converter software is easy to use, simple & fast. Within a few seconds you can start playing your FLV video and also convert it to other formats. Supported formats: FLV, AVI, WMV, MP4, MOV, MPEG-2, OGG, 3G2, 3GP, MKV, and more.

**Step 1:** Download Setup File →

**Step 2:** Click "Run"

**Step 3:** Click "Run" once more

**Step 4:** Easy installation will now begin

Free Full Version for Windows 7, Vista, XP

**START DOWNLOAD**

Like 5.8k

By installing this software you agree to the [terms of service](#)

<b>License:</b>	Freeware
<b>Requirements:</b>	No special requirements
<b>OS:</b>	Windows 7, Vista, XP
<b>Last Updated:</b>	April 21st, 2012

What can you do?

- Supports more than 10 video formats.
- Also includes Image Converter and Video Converter
- Easy-to-use!
- Free software.

A new page appears with another “Start Download” link, so you click it...and end up downloading some software you don’t want.

At its extreme, though, it can cross the line into true black hat practices, like phishing, scamming, and identity theft.

Just be aware that if people ask you to do any of this, it’s not part of your job. The users are counting on you.

## A few definitive answers

Before I wrap up, a little bonus for hanging in this far.

Almost everything in this book has been about how much the answer to usability questions depends on the context and that the answer to most usability questions is “It depends.”

But I know that we all love to have definitive answers, so here’s a tiny collection of things that you should always do or never do.

- **Don’t use small, low-contrast type.** You can use large, low-contrast type, or small (well, smallish) high-contrast type. But *never* use small, low-contrast type. (And try to stay away from the other two, too.)

Unless you're designing your own design portfolio site, and you really, truly don't care whether anybody can read the text or not.

- **Don't put labels inside form fields.** Yes, it can be very tempting, especially on cramped mobile screens. But don't do it unless all of these are true: The form is exceptionally simple, the labels disappear when you start typing and reappear if you empty the field, the labels can never be confused with answers, and there's no possibility that you'll end up submitting the labels along with what you type ("Job TiAssistant Managertle"). *And* you've made sure they're completely accessible.

If you don't agree, before you send me email please search for "Don't Put Labels Inside Text Boxes (Unless You're Luke W)" and read it.

- **Preserve the distinction between visited and unvisited text links.** By default, Web browsers display links to pages that you've already opened in a different color so you can see which options you've already tried. This turns out to be very useful information, especially since it's tracked by URL, not by the wording of the link. So if you clicked on [Book a trip](#), when you see [Book a flight](#) later you know that it would take you to the same page.

You can choose any colors you want, as long as they're noticeably different.

- **Don't float headings between paragraphs.** Headings should be closer to the text that follows them than the text that precedes them. (Yes, I know I mentioned this is [Chapter 3](#), but it's so important it's worth repeating.)

That's all, folks.

As Bob and Ray used to say, "Hang by your thumbs, and write if you get work."

I hope you'll check in at my Web site [stevekrug.com](http://stevekrug.com) from time to time, and always feel free to send me email at [stevekrug@gmail.com](mailto:stevekrug@gmail.com). I can promise you I will read it and appreciate it, even if I can't always find enough time to reply.

But above all, be of good cheer. As I said at the beginning, building a great Web site or app is an enormous challenge, and anyone who gets it even half right has my admiration.

And please don't take anything I've said as being against breaking "the rules"—or at least bending them. I know there are even sites where you *do* want the interface to make people think, to puzzle or challenge them. Just be sure you know which rules you're bending and that you at least *think* you have a good reason for bending them.

Oh, by the way, here's the rest of *Calvin and Hobbes*.

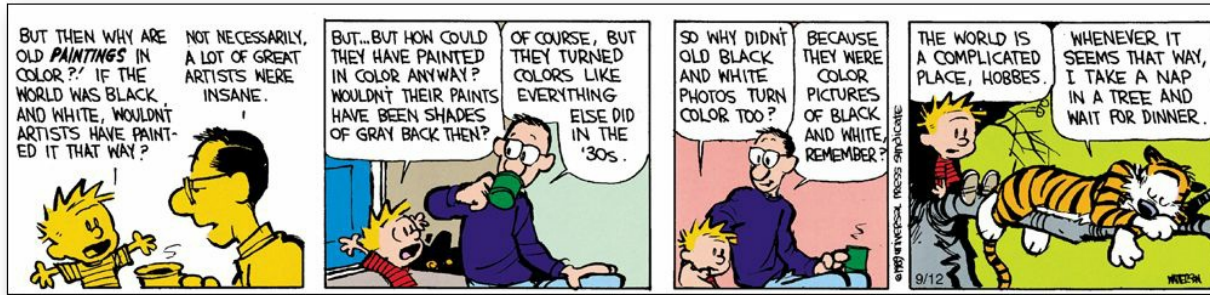

CALVIN AND HOBBS © 1989 Watterson. Reprinted with permission of UNIVERSAL UCLICK.  
All rights reserved.

# Acknowledgments

## ...AND ALL I GOT WAS THIS LOUSY T-SHIRT

*...and the men of the U.S.S. Forrestal, without whose cooperation this film would never have been made.*

—CONVENTIONAL MOVIE ACKNOWLEDGMENT

[Insert some variation of the “It takes a village” meme here.]

But it’s true. Not only *couldn’t I* have done this alone—I wouldn’t have wanted to. Again, I was fortunate enough to be able to round up the usual suspects who got me through the earlier editions and *Rocket Surgery*.

I have relied deeply on their kindness and their extraordinary goodwill in the face of my writing habits.

As usual, my peculiar relationship to time has made life difficult for everyone involved. (Have you ever heard the expression “If it weren’t for the last minute, I wouldn’t get anything done at all”?) Honestly, it’s just that someone keeps setting my clock ahead every time I’m not looking.

Thanks—and in most cases apologies—are due to

**Elisabeth Bayle**, who has been my interlocutor, sounding board, and friend for some years now, and—even though she doesn’t want to admit it—editor of this edition. If you’re ever going to write a book, my best advice is to find someone who’s smart, funny, and knows as much about the subject matter as you do, and then convince them to spend long hours listening, making great suggestions, and editing your work.

It’s not so much that this book wouldn’t have happened without her (although it wouldn’t). It’s that I wouldn’t have considered doing it unless I knew she’d be involved. My thanks also go out to **Elliott** for always renewing her spirits after another long day working with me had drained them.

**Barbara Flanagan**, copy editor and dear old friend. To paraphrase an old joke, “Barbara has never been wrong about a point of grammar in her life. Well, there was that one time when she *thought* she was wrong, but she wasn’t.” Before you write me about some error in usage, be aware that

Barbara long ago beat you to it, and then said, “But it’s your voice. Your book. Your call.” That’s generosity of spirit.

**Nancy Davis**, editor-in-chief at Peachpit, who stepped away from that desk just far enough to be my *consigliere* and champion. She’s one of those rare people whose praise means about ten times as much as normal praise. I will deeply miss having an excuse to chat with her about her ornithology-lovin’ boys.

**Nancy Ruenzel, Lisa Brazieal, Romney Lange, Mimi Heft, Aren Straiger, Glenn Bisignani**, and all the other smart, nice, talented, hardworking people at Peachpit who have been so supportive (often while biting their tongues, I’m sure).

My reviewers—**Caroline Jarrett** and **Whitney Quesenberg**—who volunteered some of their precious time to keep me from appearing foolish. In another time, the right description for them would have been “fellow travelers.” We see eye to eye on many things, and I’m just shallow enough to enjoy the company of people who agree with me. To protect the innocent, however, I feel compelled to note that inclusion in this list does not imply agreement with everything in this book.

**Randall Munroe** for his generous attitude about reprinting his work, and for giving my son and me a lot to laugh about over the years at [xkcd.com](http://xkcd.com).<sup>1</sup>

<sup>1</sup> *If you don’t “get” some of them, there’s a cottage industry of sites that will explain them to you, in the same way that Rex Parker does with each day’s crossword puzzle in The New York Times.*

Smart and funny colleagues like **Ginny Redish, Randolph Bias, Carol Barnum, Jennifer McGinn, Nicole Burden, Heather O’Neill, Bruno Figuereido**, and **Luca Salvino**.

People who contributed specific bits of their knowledge, like **Hal Shubin, Joshua Porter, Wayne Pau, Jacqueline Ritacco**, and the folks at the **Bayard Institute** in Copenhagen.

**Lou Rosenfeld** for moral support, good counsel, and for just being Lou.

**Karen Whitehouse** and **Roger Black**, the spiritual godmother and godfather of the book, who got me into this mess in the first place by giving me the opportunity to write the first edition 14 years ago.

The large **community of usability professionals**, who tend to be a very nice bunch of folks. Go to an annual UXPA conference and find out for yourself.

The friendly **baristas** at the Putterham Circle Starbucks, often the only



people I see during the day other than my wife. (It's not *their* fault that when corporate redesigned the place recently they decided that good lighting wasn't something people really needed.)

My son, **Harry**, now finishing his degree at RPI, whose company I treasure more than he knows. I exhaust his patience regularly by asking him to explain to me just one more time the difference between a meme and a trope.



If anyone has a job opening for a Cognitive Science major with a minor in Game Design, I'll be happy to pass it on.

And finally, **Melanie**, who has only one known failing: an inherited lack of superstition that leads her to say things like "Well, I haven't had a cold all Winter." Apart from that, I am, as I say so often, among the most fortunate of husbands.



If you'd like your life to be good, marry well.

# Index

*\$25,000 Pyramid*, [36](#)

## A

accessibility, [173–81](#)

affordances, [151–53](#)

Agile development, [4](#), [118](#)

Animal, Vegetable, or Mineral?, [42–47](#)

Apple, [143](#)

apps, mobile, [155–59](#)

average user, [9](#)

    myth of the, [18](#), [108](#)

## B

*Beat the Clock*, [85](#)

Big Bang Theory of Web Design, [89](#)

big honking report, [4](#), [117](#)

Breadcrumbs, [79–80](#)

Brin, Sergey, [26](#)

browse-dominant users, [59](#)

browser

    what users say it is, [26](#)

browsing, [60–62](#)

Brundlefly, [162](#)

Burma-Shave, [29](#)

## C

*Calvin and Hobbes*, [153](#), [191](#)

Camtasia, [122](#), [163](#)

Cascading Style Sheets (CSS)

    and accessibility, [181](#)

    earliest use of, [37](#)

and usability, [171](#)  
clickability, [15](#), [37](#)  
Collyer, Bud, [85](#)  
conventions, [29–33](#), [64](#)  
culture clash, [107](#)  
cursor, [37](#), [152](#)

## D–E

delight, [155–56](#)  
designing  
    conventions and, [29–33](#)  
    Home page, [84](#)  
    navigation, [54](#)  
    and satisficing, [24–25](#)  
    Web sites, intention vs. reality, [21](#), [23](#)  
do-it-yourself usability testing, [115](#)  
*Elements of Style, The*, [49](#)  
expert usability review, [3](#)

## F

FAQ list, [165](#), [171](#)  
“Farmer and the Cowman Should Be Friends, The,” [102](#)  
Flat design, [152–53](#)  
focus groups, [112–13](#)  
font size, in browser, [173](#)  
forms, [46–47](#), [67](#)

## G

golden goose, temptation to kill, [99–100](#)  
goodwill reservoir, [166–71](#)

## H

Hansel and Gretel, [79](#)  
happy talk, eliminating, [50](#)

Hatch, Sen. Orrin, Web site, [viii](#)

Holmes, Sherlock, [7](#)

Home page

cluttered, [39](#)

designing, [84](#)

happy talk on, [50](#)

link to, [70](#)

hover, [152](#)

## **I–K**

instructions, eliminating, [51–52](#)

Ive, Jonathan, [x](#), [184](#)

Jarrett, Caroline, [40](#), [46](#), [194](#)

Jobs, Steve, [x](#), [184](#)

“kayak” problems, [139](#)

Klein, Gary, [24–25](#)

Kleiner, Art, [107](#)

Krug’s laws of usability, [10–11](#), [43](#), [49](#)

## **L**

Larson, Gary, [23](#)

Lean startup, [4](#), [114](#)

Lincoln, Abraham, [145](#)

link-dominant users, [59](#)

links, visited vs. unvisited, [190](#)

logo. *See* [Site ID](#)

## **M**

memorability, [159](#)

mensh, [164](#)

mindless choices, [42–47](#)

mirroring, [161](#)

mission statement, [95](#)

mobile

apps, [155](#)  
usability testing, [160](#)  
Mobile First, [147–49](#)  
muddling through, [25–27](#)

## N

names, importance of, [14](#)  
navigation  
    conventions, [64](#)  
    designing, [58](#)  
    lower-level, [72](#)  
    persistent, [66](#)  
    revealing content, [63](#)  
needless words, omitting, [48–52](#)  
new feature requests, [139](#)  
Nielsen, Jakob, [xi](#), [54](#), [58–59](#), [96](#), [115](#), [121](#)  
noise. See [visual noise](#)  
Norman, Don, [151](#)

## P

page name  
    importance of, [74–76](#)  
    matching what user clicked, [76](#)  
    position on page, [75](#)  
persistent navigation, [66](#)  
primary navigation. See [Sections](#)  
*Prince and the Pauper, The*, [26](#)  
printer-friendly pages, [171](#)  
promos  
    content promos, [86](#)  
    feature promos, [86](#)  
pull-down menus, limitations of, [108–09](#)

## R



recruiting test participants, [120–21](#)  
Redish, Janice (Ginny), [40](#), [41](#), [46](#), [179](#), [194](#)  
registration, [87](#), [99](#)  
reinventing the wheel, [31](#)  
religious debates, [103](#), [104](#), [109](#)  
reservoir of goodwill, [166–71](#)  
responsive design, [149](#), [150](#)  
“right” way to design Web sites, [7](#)  
Rosenfeld, Louis, [194](#)

## S

satisficing, [24–25](#)  
scanning pages, [22–23](#)  
scent of information, [43](#),  
script for usability test, [125](#), [127–36](#)  
search box, [16–17](#), [30](#), [58](#), [71–72](#), [86](#), [99](#)  
    on Home page, [86](#)  
    options, [71](#)  
    wording, [71](#)  
search-dominant users, [58](#)  
secondary navigation. *See* [subsections](#)  
section fronts, [50](#)  
Sections, [69–70](#)  
signifiers, [151](#)  
Site ID, [67–68](#)  
sizzle, [169](#)  
slow-loading pages, [59](#)  
stop signs, [29](#)  
street signs, [64](#), [74](#)  
subsections, [68–69](#)

## T

tabs, [80–81](#)  
    color coding, [81](#)

importance of drawing correctly, [81](#)  
tagline, [93](#), [95–98](#)  
Talking Heads, [55](#)  
teleportation, [62](#), [67](#), [92](#)  
Theofanos, Mary, [179](#)  
tradeoffs, [145–47](#)  
tragedy of the commons, [100](#)  
trunk test, [82–83](#)

## U

usability  
    attributes of, [155](#)  
    defined, [9](#)  
usability lab, [115](#)  
usability testing, [3](#), [110](#)  
    do-it-yourself, [115](#)  
    vs. focus groups, [112–13](#)  
    of mobile devices, [160–63](#)  
    number of users to test, [119](#)  
    observers, [124](#)  
    recruiting participants, [120–21](#)  
    remote, [140](#)  
    reviewing results, [137–39](#)  
    sample session, [127](#)  
    unmoderated, [140](#)  
    value of starting early, [115](#)  
    what to test, [124](#)  
User Experience Design (UXD, UX), [x](#), [183](#)  
UserTesting.com, [140](#)  
Utilities, [65](#), [69–70](#)

## V–Z

validator, accessibility, [177](#)  
visual hierarchy, [33–36](#)

visual noise, [38](#)

Welcome blurb, [93](#)

White, E. B., [49](#)

xkcd, [194](#)

Zuckerberg, Mark, [26](#)

## Also Available

It's been known for years that usability testing can dramatically improve products. But with a typical price tag of \$5,000 to \$10,000 for a usability consultant to conduct each round of tests, it rarely happens.

In this how-to companion to *Don't Make Me Think: A Common Sense Approach to Web Usability*, Steve Krug spells out a streamlined approach to usability testing that anyone can easily apply to their own Web site, application, or other product. (As he said in *Don't Make Me Think*, "It's not rocket surgery".)

The how-to companion to the bestselling *Don't Make Me Think!*  
A Common Sense Approach to Web Usability

Steve Krug

# ROCKET SURGERY MADE EASY



The Do-It-Yourself Guide to Finding  
and Fixing Usability Problems

Using practical advice, plenty of illustrations, and his trademark humor, Steve explains how to:

- Test any design, from a sketch on a napkin to a fully functioning Web site or application
- Keep your focus on finding the most important problems (because no one has the time or resources to fix them all)
- Fix the problems that you find, using his “The least you can do” approach

By paring the process of testing and fixing products down to its essentials (“A morning a month, that’s all we ask”), *Rocket Surgery* makes it realistic for teams to test early and often, catching problems while it’s still easy to fix them. *Rocket Surgery Made Easy* uses the same proven mix of clear writing, before-and-after examples, witty illustrations, and practical advice that made *Don’t Make Me Think* an instant classic.

**Steve Krug** (pronounced “kroog”) is best known as the author of *Don’t Make Me Think: A Common Sense Approach to Web Usability*, now in its third edition with over 350,000 copies in print. Ten years later, he finally gathered enough energy to write another one: the usability testing handbook *Rocket Surgery Made Easy*. The books were based on the 20+ years he’s spent as a usability consultant for a wide variety of clients like Apple, Bloomberg.com, Lexus.com, NPR, the International Monetary Fund, and many others.

His consulting firm, Advanced Common Sense is based in Chestnut Hill, MA. Steve currently spends most of his time teaching usability workshops, consulting, and watching black-and-white movies from the ’30s and ’40s.

**Rocket Surgery Made Easy: The Do-It-Yourself Guide to Finding and Fixing Usability Problems**

Steve Krug, ISBN: 9780321657299

[www.newriders.com](http://www.newriders.com)









Unlimited online access to all Peachpit, Adobe Press, Apple Training and New Riders videos and books, as well as content from other leading publishers including: O'Reilly Media, Focal Press, Sams, Que, Total Training, John Wiley & Sons, Course Technology PTR, Class on Demand, VTC and more.

No time commitment or contract required!  
Sign up for one month or a year.  
All for \$19.99 a month

**SIGN UP TODAY**  
[peachpit.com/creativeedge](http://peachpit.com/creativeedge)

creative  
edge