



**IASS 2023**  
July 10–14 Melbourne  
Integration of Design  
and Fabrication

**International Association for Shell and  
Spatial Structures Annual Symposium**

# **Program Book**

---

# **2023**

# Thank you to our Sponsors and Supporters

## DIAMOND SPONSOR



## PLATINUM SPONSORS



## SILVER SPONSORS



## BRONZE SPONSOR



## GALA DINNER SPONSOR



## SUPPORTERS



**Nohmura Foundation**  
for Membrane Structure's Technology



# Contents

<b>Forward from the IASS President.....</b>	<b>5</b>	<b>Tuesday 11 July 2023 .....</b>	<b>110</b>
<b>Message from Co-Chairs.....</b>	<b>5</b>	Session 11: Investigation of load conditions .....	112
<b>Committee Lists .....</b>	<b>6</b>	Session 12: Timber and bio-based structures 2 .....	117
Local Organising Committee.....	6	Session 13: Numerical methods .....	122
International Advisory Committee .....	8	Session 14: Form-finding 1 .....	127
Scientific Committee.....	9	Session 15: Additive manufacturing 2 .....	131
<b>Delegate Information .....</b>	<b>10</b>	Masterclass 3: Ameba: Topology Optimisation Design .....	136
<b>Program Overview.....</b>	<b>12</b>	Session 17: Origami 1 .....	137
Monday 10 July 2023.....	12	Session 18: Dynamic response of structures 2 .....	141
Tuesday 11 July 2023 .....	13	Session 19: Historical structures.....	146
Wednesday 12 July 2023 .....	14	Session 20: Tension and membrane structures 2 .....	150
Thursday 13 July 2023 .....	15	Masterclass 4: Aelous: An Acoustic Solver .....	155
Friday 14 July 2023 Technical Tours.....	16	Session 22: Additive manufacturing 3 .....	156
<b>Plenary Speakers .....</b>	<b>18</b>	Session 23: Form-finding 2 .....	161
<b>Hangai Prize 2023 Winners.....</b>	<b>27</b>	Session 24: Concrete structures .....	166
<b>Parallel Sessions .....</b>	<b>31</b>	Session 25: Digital modelling and fabrication 1 .....	170
Monday 10 July 2023.....	32	<b>Wednesday 12 July 2023.....</b>	<b>176</b>
Tuesday 11 July 2023 .....	38	Session 26: Life-cycle design and assessment of structures 1 .....	178
Wednesday 12 July 2023 .....	44	Session 27: Tension and membrane structures 3 .....	183
Thursday 13 July 2023 .....	52	Session 28: Sustainable construction 1 .....	188
<b>Accompanying Persons Program .....</b>	<b>58</b>	Session 29: Structural design and analysis .....	192
Melbourne City Walking Tour .....	58	Session 30: Optimisation methods and applications 1 .....	197
Welcome Reception .....	58	Masterclass 5: Fologram: AR-assisted Fabrication Technique .....	202
Guided Tour of the National Gallery of Victoria (NGV-I) .....	58	Session 32: Teaching.....	203
Guided Tour of the State Library of Victoria.....	59	Session 33: Tensegrity systems and cable structures.....	208
Guided Tour of the .....	59	Session 34: Digital modelling and fabrication 2 .....	213
Royal Botanical Gardens .....	59	Session 35: Origami 2 .....	217
<b>Sponsors and Exhibitors .....</b>	<b>60</b>	Masterclass 6: PolyFrame: Computational framework for form finding ..	222
Exhibitors .....	63	Session 37: Bio-inspired structures and architecture .....	223
<b>Presentation Details.....</b>	<b>66</b>	Session 38: Topology Optimisation 1.....	228
<b>Monday 10 July 2023.....</b>	<b>68</b>	Session 39: Optimisation methods and applications 2 .....	233
Masterclass 1: Tensys: Physical Form-Finding Method .....	70	Session 40: Metal gridshell structures 1 .....	238
Session 2: Timber and bio-based structures 1 .....	71	<b>Thursday 13 July 2023.....</b>	<b>242</b>
Session 3: Dynamic response of structures 1.....	76	Session 41: Sustainable construction 2 .....	244
Session 4: Construction techniques .....	80	Session 42: Life-cycle design and assessment of structures 2 .....	249
Masterclass 2: Karamba 3D: Parametric Engineering Analysis Method .....	90	Session 43: Lattice structures .....	254
Session 7: Gridshell and lattice structures .....	91	Session 44: Civil structures .....	258
Session 8: Additive manufacturing 1 .....	96	Session 45: Topology Optimisation.....	263
Session 9: Architectural geometry .....	101	Session 46: Conceptual design .....	268
Session 10: Tension and membrane structures 1 .....	106	Session 47: Transformable structures .....	272
		Session 48: Digital modelling and fabrication 3 .....	275
		Session 49: Deployable and inflatable structures .....	279
		Session 50: Next generation parametric design.....	283
		Session 51: Optimisation methods and applications 3 .....	287
		Session 52: Active bending and graphical methods.....	291
		Session 53: Building and construction.....	295
		Session 54: Design Competition .....	299
		Session 55: Bamboo structures .....	303

# About the IASS



In September 1959, the leading structural engineer, Eduardo Torroja, organised and convened an international colloquium on Shell Structures in Madrid. During this colloquium, Professor Torroja proposed the founding of the International Association for Shell and Spatial Structures (IASS). He wanted to create a platform where the top engineers, designers and constructors in the field would meet and exchange their ideas and experiences. There should be regular meetings, correspondence and a bulletin published regularly. His proposal was enthusiastically accepted by the distinguished group of designers and engineers at the colloquium, and the IASS was born with Torroja as both the inspiration and the founding president.

The IASS welcomes to membership all individuals and organisations who share its aims, with reduced rates available for students. Members receive benefits including electronic access to the Journal of the IASS, the proceedings of annual symposia and reports and recommendations of IASS working groups.

A comprehensive list of membership benefits and the possibility to join online are available on the [IASS website](#).

# Forward from the IASS President

It is with great pleasure that the International Association for Shell and Spatial Structures welcomes you to the IASS 2023 Annual Symposium in the vibrant city of Melbourne, the cultural capital of Australia. Co-organised by RMIT University and Swinburne University of Technology, this Symposium marks our return to Australia after the highly successful conference in Sydney in 1998. Under the “Integration of Design and Fabrication” theme, the Symposium addresses the challenges and opportunities posed by incorporating digital design workflows and new manufacturing technologies for spatial structures. It also encompasses a wide range of topics reflecting the latest advancements in the field.

Melbourne, a world-class city renowned for its cultural richness and economic vitality, is an ideal backdrop for this Symposium. Its dynamic atmosphere adds another layer of inspiration as we delve into the scientific content of the conference.

The organising committee, led by Professors Yi Min ‘Mike’ Xie and Jane Burry, has done exceptional work in curating a program that reflects the state-of-the-art in spatial structures. The Symposium features nine invited plenary lectures delivered by international and local experts, including the recipients of the IASS Torroja Medal and the IASS Isler Prize. The plenary lectures will provide an inspiring view of the global advancements in spatial structures from various perspectives. Additionally, the program includes around 350 technical presentations across 60 sessions, shaping an exciting and comprehensive experience.

This year, the Association has conferred the IASS Torroja Medal upon Professor Mutsuro Sasaki, recognising his exceptional achievements in the field. We also extend our congratulations to architect Michael Balz, who receives an Honorary Membership of the IASS, and to the artist Janet Echelman who receives the inaugural Isler Prize of the Association. The recipients of the prestigious Tsuboi Awards 2022 for the best paper in the Journal of the IASS and the best paper in the Proceedings of the IASS Symposium 2022 will be announced during the Symposium. Additionally, we will celebrate the winners of the Hangai Prize 2023 competition, which recognises the exceptional contributions of Symposium participants under 30.

On behalf of the IASS and of all the Symposium participants, I would like to express our deepest gratitude to all members of the organising and scientific committees, as well as to RMIT University, Swinburne University of Technology and the supporting institutions and companies for their invaluable contributions to the success of this Symposium. I would like to extend my heartfelt appreciation to Professors Yi Min ‘Mike’ Xie and Jane Burry for their enthusiastic efforts and exceptional organisation of this event.

This Symposium holds special significance as it marks our first in-person IASS meeting following the challenging times of the global pandemic. May this gathering foster connections, inspire collaboration and propel innovation in the exciting field we are working in!

**Carlos Lázaro**  
President of the IASS

# Message from Co-Chairs

The International Association for Shell and Spatial Structures (IASS) symposia are a unique forum for engineers, architects and researchers to exchange exciting ideas and latest developments in the field of shell and spatial structures. The IASS symposia have been successfully held for over 60 years in various countries such as Brazil, China, Germany, Japan, the Netherlands, Poland, South Korea, Spain, the UK and the USA. The only time the symposia graced the Oceania region was in 1998, in Sydney, Australia.

After three years of travel restrictions due to the worldwide COVID-19 pandemic, it is wonderful that the IASS community is able to meet face-to-face again, this time in Melbourne. We are excited to welcome around 450 delegates from around the world to IASS 2023.

We would like to take this opportunity to thank all authors for submitting their contributions, the Scientific Committee for reviewing the abstracts and full papers, and the sponsors and supporters for their generous support.

We are very grateful for the extraordinary effort of members of the local organising committee and other volunteers. This symposium would not be possible without their invaluable contribution.

We sincerely hope you enjoy your time at IASS 2023 and relish your stay in Melbourne.

**Yi Min ‘Mike’ Xie and Jane Burry**  
Co-Chairs of the Local Organising Committee

# Committee Lists

## Local Organising Committee



**Prof Yi Min 'Mike' Xie**  
RMIT University



**Prof Jane Burry**  
Swinburne University of Technology



**Mr Peter Lim**  
Lightweight Structures Association of Australasia (LSAA)



**Prof Guoxing Lu**  
Swinburne University of Technology



**Dr Ding Wen 'Nic' Bao**  
RMIT University



**Dr Sascha Bohnenberger-Fehr**  
Swinburne University of Technology



**Dr Dan Luo**  
The University of Queensland



**Dr Jiaming Ma**  
RMIT University



**Mr Canhui Chen**  
Swinburne University of Technology



**Dr Sofia Colabella**  
The University of Melbourne



**Dr Nico Pietroni**  
University of Technology Sydney

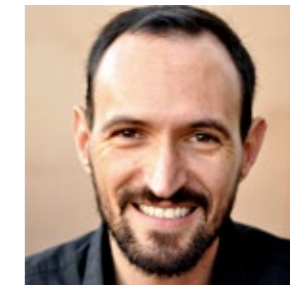

**Dr Alberto Pugnale**  
The University of Melbourne



**Assoc Prof Joe Gattas**  
The University of Queensland



**Dr Ting-Uei 'Jeff' Lee**  
RMIT University



**Prof Tim Schork**  
Queensland University of Technology

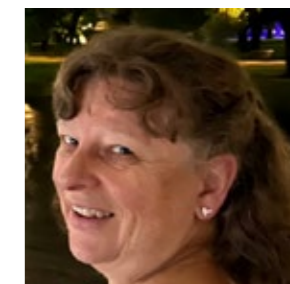

**Mrs Mary Tomlinson**  
RMIT University

# Committee Lists

## International Advisory Committee

Görün Arun (Turkey)
Alireza Behnejad (UK)
Ken'ichi Kawaguchi (Japan)
Olga Popovic Larsen (Denmark)
Carlos Lázaro (Spain)
Juan Gerardo Oliva Salinas (Mexico)
Sergio Pellegrino (USA)
Jenny Sabin (USA)
Su-Duo Xue (China)



## Scientific Committee

Karim Abedi (Iran)	Charis Gantes (Greece)	(Australia)	Brian Uy (Australia)
John F. Abel (USA)	Wei Gao (Australia)	Richard Jat Yuen Liew (Singapore)	Petr Vegh (Canada)
Sigrid Adriaenssens (USA)	Christoph Gengnagel (Germany)	Susanna Lin (Australia)	Andrew Viquerat (UK)
Masoud Akbarzadeh (USA)	Matthew Gilbert (UK)	Hongjia Lu (Australia)	Peter Von Buelow (USA)
Ding Wen 'Nic' Bao (Australia)	Arndt Goldack (Germany)	Yaozhi Luo (China)	Chris Williams (UK)
Minghao Bi (Australia)	Mohamed Gomaa (Australia)	Ramesh B. Malla (USA)	Jinzhi Wu (China)
Annette Boegle (Germany)	Jinghai Gong (China)	Hazrina Binti Mansor (Malaysia)	Minger Wu (China)
Dan Bomba (UK)	Manfred Grohmann (Germany)	Priyan Mendis (Australia)	Yue Wu (China)
Andrew Borgart (Netherlands)	Lei Gu (China)	Marisela Mendoza (UK)	Yi Min 'Mike' Xie (Australia)
Maurizio Brocato (France)	Hong Guan (Australia)	René Motro (France)	Tetsuo Yamashita (Japan)
Jane Burry (Australia)	Nayar Gutierrez Astudillo (Mexico)	Shoji Nakazawa (Japan)	Yeong-Bin Yang (China)
Michael Burt (Israel)	Ngoc San Ha (Australia)	Tuan Ngo (Australia)	Zhong You (UK)
Jianguo Cai (China)	Muhammad Hadi (Australia)	John A. Ochsendorf (USA)	Jingyao Zhang (Japan)
Wujun Chen (China)	Hong Hao (Australia)	Makoto Ohsaki (Japan)	Lihai Zhang (Australia)
Yao Chen (China)	Reinhard Harte (Germany)	Manolis Papadarakakis (Greece)	Qilin Zhang (China)
Zihua Chen (China)	Minjuan He (China)	Gerry Parke (UK)	Sarah Zhang (Australia)
John Chilton (UK)	Mahmoud Heristchian (Iran)	Ruy Marcelo Pauletti (Brazil)	Lin Zhao (China)
Kok Keong Choong (Malaysia)	Xiaodong Huang (Australia)	Arno Pronk (Netherlands)	Xiao-Lin Zhao (China)
Paolo Cignoni (Italy)	Koichiro Ishikawa (Japan)	Ekkehard Ramm (Germany)	Shiwei Zhou (Australia)
Jeroen Coenders (Netherlands)	Tian-Jian Ji (UK)	Janusz Rębielak (Poland)	Zhongyi Zhu (China)
Pierluigi D'Acunto (Germany)	Yoshihiro Kanno (Japan)	Mohammad Reza Chenaghloou (Iran)	Yan Zhuge (Australia)
Fevzi Dansik (Turkey)	Shiro Kato (Japan)	Anooshe Rezaee Javan (Australia)	Alphose Zingoni (South Africa)
Raj Das (Australia)	Anahita Khodadadi (USA)	Edmond Saliklis (USA)	
Lars De Laet (Belgium)	Jae-Yeol Kim (Korea)	Omidali Samavati (UK)	
Niels De Temmerman (Belgium)	Seung-Deog Kim (Canada)	Jaime Sanchez-Alvarez (Germany)	
Alberto Domingo (Spain)	Toni Kotnik (Finland)	Narendra K. Srivastava (Canada)	
Cyril Douthe (France)	Dmitri Kozlov (Russia)	Romuald Tarczewski (Poland)	
Andreas Falk (Sweden)	Sudarshan Krishnan (USA)	Tibor Tarnai (Hungary)	
Feng Fan (China)	Haresh Lalvani (USA)	Jonathan Tran (Australia)	
Ruoqiang Feng (China)	Seung-Jae Lee (Korea)		
Günther H. Filz (Austria)	Wanda J. Lewis (UK)		
Corentin Fivet (Switzerland)	Qing Quan (Stephen) Liang		
Stefano Gabriele (Italy)			

# Delegate Information

## Venue

Melbourne Convention and Exhibition Centre (MCEC)  
1 Convention Centre Place, South Wharf, VIC 3006

## Parking

If you are driving to MCEC we recommend parking in the Melbourne Exhibition Centre Car Park (entry from Normanby Road). Tickets can be pre-booked online and the carpark is monitored by security and accessibly 24-hours a day.

## Transport

MCEC is easily accessible via Public Transport. The closest train station is Southern Cross. From Southern Cross the venue is an easy 10-minute walk or can alternatively be accessed by tram numbers 96, 109 and 12 which stop outside at the Convention Centre/ Crown Casino stop.

For further Public Transport information visit the [PTV website](#).

## Accessibility

MCEC is an inclusive and accessible venue for all guests. The centre has lift and ramp access for those with mobility requirements in addition to braille signage, hearing ability services and accessible restrooms for guests using mobility devices, stroller and prams.

Find out more on the [MCEC website](#).

## Emergency details

In the case of an emergency alert tones will sound throughout the Centre. Should such an emergency occur, please follow all instructions given by Conference and Convention Centre staff.

For immediate contact with Police, Ambulance or Fire Services please dial **000**.

## First aid

In any medical emergency notify the onsite conference staff team immediately or call **000** to request and ambulance.

## Security

There is security available onsite at all times at the MCEC to keep delegates, speakers and members of the public safe.

However, to ensure the security of your personal property, please ensure that you take all items of value with you at all times when leaving a room. Do not leave bags or laptops unattended.

## Disclaimer of Liability

The Organising Committee will not accept liability for damages of any nature sustained by participants or their accompanying persons or loss of or damage to their personal property as a result of the meeting or related events.

## Registration desk

The registration desk is located in the Convention Centre Foyer. Please visit the registration desk to pick up your name badge and symposium materials upon arrival.

The registration desk will be open during the below times;

Monday 10 July: 8:00 – 16:30  
Tuesday 11 July: 8:30 – 16:30  
Wednesday 12 July: 8:30 – 16:30  
Thursday 13 July: 8:30 – 16:30

## Name badges

For security purposes, delegates, speakers and sponsors are asked to wear their name badges to the exhibition and all sessions.

Entrance into the exhibition and sessions is restricted to registered delegates only. If you misplace your name badge, please see the friendly staff at the Registration Desk to arrange a replacement.

## Exhibition

The exhibition is set to be the primary networking arena for delegates, speakers and symposium partners. The symposium program has been designed to maximise the opportunity for delegates to visit the exhibition with all refreshment breaks and seating areas located within the exhibition area.

## Digital devices

As a courtesy to speakers and your fellow delegates, please set all devices to silent whilst in sessions.

Please also respect the wishes of any presenter who requests that their slides not be photographed and/or shared on social media.

## Wi-Fi

Free wireless internet is available for symposium delegates.

1. Select the MCEC Free WiFi wireless service on your device
2. Open your preferred internet web browser
3. Agree to the terms and conditions of use
4. Then press 'Connect Now'

# LANDREAM

The International, Brighton VIC  
Artist's Impression

## CULTIVATING SPACES THAT ENRICH LIVES AND EMPOWER DREAMS

Landream develop, manage and own a diverse portfolio of property across Victoria and New South Wales.

Established in 2005, over the next five years, Landream will deliver projects of international standing worth more than \$2 billion.



700 HOMES DELIVERED



PROJECT SECTORS:  
BUILD-TO-RENT, RESIDENTIAL,  
RETAIL, COMMERCIAL & INDUSTRIAL



Opera Residences, Bennelong Point NSW  
Actual Photography



Fig and Wattle, Pyrmont NSW  
Artist's Impression

LANDREAM.COM.AU

# Program Overview

## Monday 10 July 2023

SESSION ROOM

8.00- 16.00	Registration Open	
9.00- 11.00	Opening Ceremony and Award Session	PLENARY
<b>11.00 - 11.30</b>	<b>Morning Tea</b>	
11.30- 12.30	<b>Plenary Session 1 - Ms Janet Echelman and Prof Mutsuro Sasaki</b>	PLENARY 3
12.30 – 13:00	Hangai Prize Winner Presentations - <b>Mr Jonas Warmuth</b> and <b>Dr Kentaro Hayakawa</b>	PLENARY 3
<b>13.00 - 14.00</b>	<b>Lunch</b>	
14.00- 16.00	Concurrent Sessions	
	<b>Masterclass 1</b> Tensys: Physical Form-Finding Method	215
	<b>Session 2</b> Timber and bio-based structures 1	216
	<b>Session 3</b> Dynamic response of structures 1	217
	<b>Session 4</b> Construction techniques	218
	<b>Session 5</b> Form-finding and building design	PLENARY 3
<b>16.00 - 16.30</b>	<b>Afternoon Tea</b>	
16.30- 18.30	Concurrent Sessions	
	<b>Masterclass 2</b> Karamba 3D: Parametric Engineering Analysis Method	215
	<b>Session 7</b> Gridshell and lattice structures	216
	<b>Session 8</b> Additive manufacturing 1	217
	<b>Session 9</b> Architectural geometry	218
	<b>Session 10</b> Tension and membrane structures 1	PLENARY 3
18.30- 21.00	Welcome Reception in the MCEC Foyer	

## Tuesday 11 July 2023

SESSION ROOM

8:30- 16:00	Registration Open	
9.00- 11.00	Concurrent Sessions	
	<b>Session 11</b> Investigation of load conditions	215
	<b>Session 12</b> Timber and bio-based structures 2	216
	<b>Session 13</b> Numerical methods	217
	<b>Session 14</b> Form-finding 1	218
	<b>Session 15</b> Additive manufacturing 2	PLENARY 3
<b>11.00 - 11.30</b>	<b>Morning Tea</b>	
11.30- 12.30	<b>Plenary Session 2 – Prof Philip Yuan and Dr Mariana Popescu</b>	PLENARY
12.30 – 13:00	Hangai Prize Winner Presentations - <b>Mr Yiwei Zhang</b> and <b>Ms Zoe Cooperband</b>	PLENARY 3
<b>13.00 - 14.00</b>	<b>Lunch</b>	
14.00- 16.00	Concurrent Sessions	
	<b>Masterclass 3</b> Ameba: Topology Optimisation Design	215
	<b>Session 17</b> Origami 1	216
	<b>Session 18</b> Dynamic response of structures 2	217
	<b>Session 19</b> Historical structures	218
	<b>Session 20</b> Tension and membrane structures 2	PLENARY 3
<b>16.00 - 16.30</b>	<b>Afternoon Tea</b>	
16.30- 18.30	Concurrent Sessions	
	<b>Masterclass 4</b> Aelous: An Acoustic Solver	215
	<b>Session 22</b> Additive manufacturing 3	216
	<b>Session 23</b> Form-finding 2	217
	<b>Session 24</b> Concrete structures	218
	<b>Session 25</b> Digital modelling and fabrication 1	PLENARY 3

# Program Overview

## Wednesday 12 July 2023

SESSION ROOM

8:30- 16:00	Registration Open	
9.00- 11.00	Concurrent Sessions	
	<b>Session 26</b> Life-cycle design and assessment of structures 1	<b>215</b>
	<b>Session 27</b> Tension and membrane structures 3	<b>216</b>
	<b>Session 28</b> Sustainable construction 1	<b>217</b>
	<b>Session 29</b> Structural design and analysis	<b>218</b>
	<b>Session 30</b> Optimisation methods and applications 1	<b>PLENARY 3</b>
<b>11.00 - 11.30</b>	<b>Morning Tea</b>	
11.30 – 13:00	<b>Plenary Session 3 – Prof Jan Knippers, Ms Karen Lynch and Prof Arno Pronk</b>	<b>PLENARY 3</b>
<b>13.00 - 14.00</b>	<b>Lunch</b>	
14.00- 16.00	Concurrent Sessions	
	<b>Masterclass 5</b> Fologram: AR-assisted Fabrication Technique	<b>215</b>
	<b>Session 32</b> Teaching	<b>216</b>
	<b>Session 33</b> Tensegrity systems and cable structures	<b>217</b>
	<b>Session 34</b> Digital modelling and fabrication 2	<b>218</b>
	<b>Session 35</b> Origami 2	<b>PLENARY 3</b>
<b>16.00 - 16.30</b>	<b>Afternoon Tea</b>	
16.30- 18.30	Concurrent Sessions	
	<b>Masterclass 6</b> PolyFrame: Computational framework for form finding	<b>215</b>
	<b>Session 37</b> Bio-inspired structures and architecture	<b>216</b>
	<b>Session 38</b> Topology Optimisation 1	<b>217</b>
	<b>Session 39</b> Optimisation methods and applications 2	<b>218</b>
	<b>Session 40</b> Metal gridshell structures 1	<b>PLENARY 3</b>
19.00 – 22.30	Symposium Gala Dinner at State Library of Victoria	

## Thursday 13 July 2023

SESSION ROOM

8:30- 16:00	Registration Open	
9.00- 11.00	Concurrent Sessions	
	<b>Session 41</b> Sustainable construction 2	<b>215</b>
	<b>Session 42</b> Life-cycle design and assessment of structures 2	<b>216</b>
	<b>Session 43</b> Lattice structures	<b>217</b>
	<b>Session 44</b> Civil structures	<b>218</b>
	<b>Session 45</b> Topology Optimisation 2	<b>PLENARY 3</b>
<b>11.00 - 11.30</b>	<b>Morning Tea</b>	
11.30 – 13:00	Concurrent Sessions	
	<b>Session 46</b> Conceptual design	<b>215</b>
	<b>Session 47</b> Transformable structures	<b>216</b>
	<b>Session 48</b> Digital modelling and fabrication 3	<b>217</b>
	<b>Session 49</b> Deployable and inflatable structures	<b>218</b>
	<b>Session 50</b> Next generation parametric design	<b>PLENARY 3</b>
<b>13.00 - 14.00</b>	<b>Lunch</b>	
14.00- 16.00	Concurrent Sessions	
	<b>Session 51</b> Optimisation methods and applications 3	<b>215</b>
	<b>Session 52</b> Active bending and graphical methods	<b>216</b>
	<b>Session 53</b> Building and construction	<b>217</b>
	<b>Session 54</b> Design Competition	<b>218</b>
	<b>Session 55</b> Bamboo structures	<b>PLENARY 3</b>
<b>16.00 - 16.30</b>	<b>Afternoon Tea</b>	
16.30- 17.30	<b>Plenary Session 4 – Prof Donald Bates and Mr Neil Stonell</b>	<b>PLENARY 3</b>
17.30 – 18.00	Closing Ceremony in Plenary 3	



# Program Overview

## Friday 14 July 2023 Technical Tours

10.00	Meet at Convention Centre entry to walk to Federation Square for Group 1
10.30	Depart on bus from Convention Centre entry to Philip Island for Group 2
10.30 – 18.00	Philip Island Day Trip for Group 2
10.30 – 12.00	Tour of Federation Square with Prof Donald Bates for Group 1
12.00 – 12.30	Group 1 walk from Federation Square to Southern Cross Station
12.30 – 14:00	Tour of Southern Cross with Mr Neil Stonell for Group 1



Venture into our hidden spaces to discover a blend of lively laneways, evolving art, and exhilarating events.

Then make the most of your business trip by extending your stay. Melbourne is the gateway to Victoria's natural springs, peninsulas and spectacular coastline that are just waiting to be discovered.



[melbournecb.com.au/welcome-to-melbourne](http://melbournecb.com.au/welcome-to-melbourne)



# Plenary Speakers



## Prof Donald Bates

Professor Donald Bates (LFRAIA; FRIBA) is the Chair of Architectural Design, and Associate Dean (Engagement) for the Faculty of Architecture, Building and Planning, University of Melbourne. He is a Founder and Director of LAB Architecture Studio.

Bates graduated with a B.Arch from University of Houston, and an M.Arch from Cranbrook Academy of Art. He has taught at the Architectural Association, Cooper Union and other schools, and founded and directed the independent architecture school LoPSiA, in France, from 1990-94.

In 1994, Prof Bates and Peter Davidson founded LAB Architecture Studio, and in 1997, LAB won the competition for Federation Square, Melbourne. LAB has designed award-winning large-scale commercial, cultural, civic and residential projects, with built works in Australia, Asia, the Middle East, and Europe.

### Abstract

Undecided, midway between two alternatives, neither here nor there. To be betwixt is to be between, but to be betwixt and between is to be caught in a liminal position – neither on one side of a line nor the other. Not at the threshold, but rather, IN the threshold. There is often an assumed linearity from design into fabrication. From thought into material. But I would suggest that all design is less linear (sequential, step-by-step, procedural) and more haze, blur, cloud and coalescence. Operating betwixt and between, design's very uncertainty, its undecidability, its liminal, transitional neither here nor there is its operational advantage. In order to integrate design and fabrication, we need to be able to write this as one word:

**fathesignion**



## Ms Janet Echelman

Artist Janet Echelman defies categorization. She creates billowing sculpture engineered to the scale of buildings, choreographed by wind and light, that shifts from being an object you look at, to a living environment you can get lost in.

Echelman's TED talk "Taking Imagination Seriously" has been translated into 35 languages and viewed by millions. Recipient of the Guggenheim Fellowship, Smithsonian American Ingenuity Award, Harvard Loeb Fellowship, and Fulbright Lectureship, Echelman was named an Architectural Digest Innovator for "changing the very essence of urban spaces." Oprah ranked Echelman's work #1 on her "List of 50 Things That Make You Say Wow!"

### Abstract

How can we design experiential private and public spaces to embody a spirit of innovation, foster spontaneous communities, and engage viewers in new and powerful ways? Janet Echelman presents ways to harness the creative power of the flexible, the soft, and the transparent in cities around the world. Her experiential sculptures at the scale of buildings have become inviting focal points for civic life, combining ancient craft with the newest design and interactive technology. The result is a communal urban experience that is simultaneously virtual and physical. Echelman's ingenuity, exuberance, critical eye, and community engagement reminds the design world of America's long history of creative dynamism, at a time when our ability to project these values carries particular importance.



# Plenary Speakers



## Prof Jan Knippers

Jan Knippers is a consulting structural engineer and since 2000 head of the Institute for Building Structures and Structural Design (ITKE) at the University of Stuttgart. His interest is in innovative and resource-efficient structures at the intersection of research and development and practice. He co-developed a robotic winding process for fibre composite systems that enables novel lightweight building systems. Another interest is advanced timber structures for segmental shells or multi-storey buildings. He designed the Central Axis for EXPO 2010 in Shanghai, one of the largest membrane structures in the world. Since 2019 he has been Deputy Director of the Cluster of Excellence “Integrative Computational Design and Construction” and is currently Dean of the Faculty of Architecture and Urban Planning at the University of Stuttgart.

### Abstract

The climate crisis is forcing us to drastically reduce the consumption of fossil resources for construction. This requires new lightweight building structures and alternative bio-based building materials. At the same time, the volume of global construction must increase significantly in order to provide sufficient living space for the growing world population. The consistent digitalization is the key to increasing the productivity of construction processes and thus reconciling the opposing goals of saving resources and increasing construction activities at the same time. In the presentation, we will show how fundamental and mutually influencing research of digital planning methods and robotic manufacturing processes enables new load adapted and resource efficient building systems made of timber and natural fibre composites, that respond to the challenges of the future.



## Ms Karen Lynch

Karen A. Lynch, P.E. is one of the managing principals of Geiger Engineers, the engineering practice founded by Dr. David H. Geiger and associates specialising in long-span lightweight structures and a pioneer of tension membrane structures in North America.

Karen received her Bachelor’s degree in Civil Engineering at Rensselaer Polytechnic Institute and her Master’s at Columbia University. In her 35 years at Geiger Engineers, Karen has been involved in the design and construction of many significant lightweight membrane structures and sports facility projects, including the Geiger Cabledome for Tropicana Field in St. Petersburg, Florida; Allegiant Stadium, Las Vegas, Nevada; the New Louis Armstrong Stadium, New York and the new retractable roof for BC Place Stadium in Vancouver, British Columbia, Canada.

### Abstract

There are many advantages to building with tension membranes. Low unit mass and shop fabrication facilitates construction of structures with long spans and unique shapes. Prestress and shape play an important role in the load resisting capacity of the structure. Tension membranes can be used as a primary structure or as a secondary structure tensioned over steel, aluminum, or wood. Various membrane types commonly in use, including coated textiles, composite laminates, and films, provide a spectrum of material properties to suit a wide variety of applications. Specific steps are required in engineering of tension membrane structures to optimize the advantages from design to construction to service.



# Plenary Speakers



## A/Prof Mariana Popescu

Dr Mariana Popescu is Assistant Professor of Parametric Structural Design and Digital Fabrication at the Delft University of Technology. She is a computational architect and structural designer with a strong interest and experience in innovative ways of approaching the fabrication process and use of materials in construction. She obtained her PhD in 2019 from ETH Zurich with a research focus on the development of KnitCrete, a novel, material-saving, labour-reducing, cost-effective formwork system for casting doubly-curved geometries in concrete using 3D knitting. She is the main author of the award-winning KnitCandela shell and was named a "Pioneer" in the MIT Technology Review Innovator Under 35 list of 2019.

### Abstract

Computational tools and digital fabrication give us the possibility to have a positive impact in the built environment by enabling us to design more efficient and materially effective structures. Including intelligence in material systems needs sustained development of computational design and fabrication pipelines. This presentation will give you an overview of my related work centred around such design and fabrication pipelines specifically applied to the architecture and construction sector.



## A/Prof Arno Pronk

Arno Pronk graduated as an architect from the Delft University of Technology in 1994. He developed a patented flooring system, which was successfully introduced on the Dutch market and used in several high-profile buildings. He had two years' experience as an assistant professor at TU Delft, and 20 years of experience at the Eindhoven University of Technology. His PhD research on flexible moulding for fluid architecture has resulted in the realization of several projects and technologies. Since 2014, he has designed and realized a number of groundbreaking constructions with fiber-reinforced ice, such as the largest igloo with a span of 29.1 meters, the highest thin shell ice structure with a height of 30.5 meters and the first 3D printed grid structure of ice composites.

### Abstract

We have done extensive research and design about ice structures in the Netherlands, Finland and China. Ice can be reinforced by adding (cellulose) fibers such as wood and paper. These fibers make the ice up to three times stronger and increase the ductility, thus creating a reliable building material. The Flamenco Ice Tower was the world record for the largest thin shell structure in ice and achieved the WA design award for most innovative architectural experiment in China.

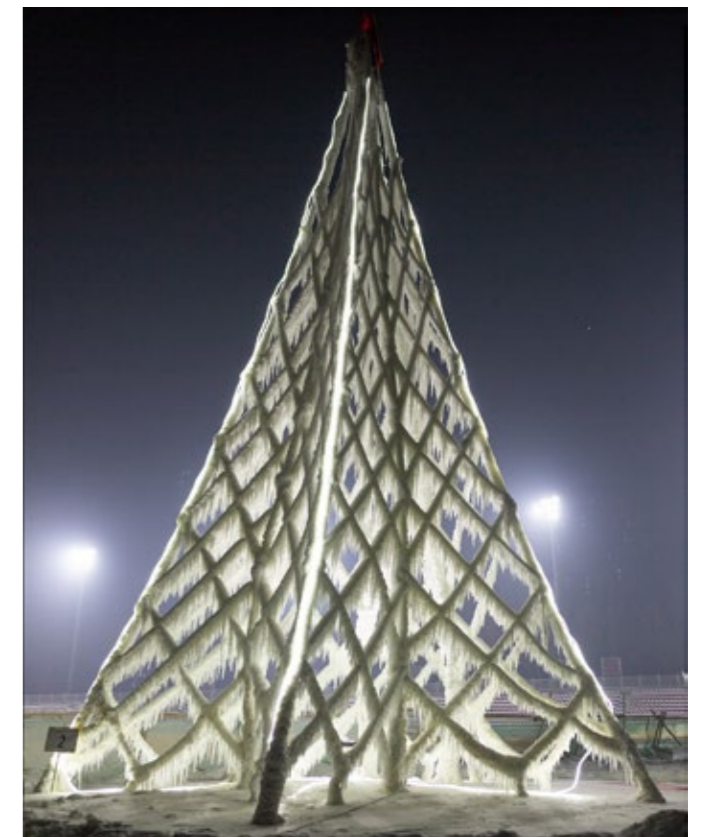

# Plenary Speakers



## Prof Mutsuro Sasaki

Mutsuro Sasaki is an expert of shell structures and a pioneer in the field of computational morphogenesis in structural engineering. His research focuses on the development of design techniques using structural optimisation and form finding based on the mathematical principles of structural mechanics. Completed works in which he played a pivotal role include Meiso-no-Mori Crematorium (2006), Rolex Learning Centre (2008, shown about), and Teshima Art Museum (2010). Sasaki has been a long-term collaborator of Toyo Ito, Sejima and Nishizawa of SANAA, and Arata Isozaki. He has received numerous awards including AIJ Prize in 2003 for Sendai Mediateque and IASS Tuboi Prize for the Extended ESO method in 2004.

### Abstract

In this lecture, I will talk about the morphogenesis of flux structure. I have developed and applied the research for computational morphogenesis since early 2000. I will explain my design and engineering philosophy by unfolding the process behind my projects from Sendai Mediateque (2000) to more recent work on RC free-form shell structures (2005–2010). I have developed theoretical process to drive these forms that can synthesize the aesthetics with the principle of structural mechanics. These structures often take fluid and dynamic form. These forms are what make them stronger and more resistant against external loads. I call these form-resistant structures as flux structure.



## Mr Neil Stonell

Neil Stonell is the Managing Partner of Grimshaw's Melbourne Studio, where he is jointly responsible for the practice's Australian operations. With extensive experience across a variety of building sectors and typologies including rail, aviation, workplace, university buildings, retail and master planning, Neil has been instrumental in the delivery of complex projects throughout the region and globally for Grimshaw, including the practice's first Australian project—Southern Cross Station, the recipient of the prestigious Lubetkin Prize. Neil's project leadership encompasses the design and delivery of award-winning architecture and the effective management of large design teams and stakeholder groups. He strives to design and deliver places that are vibrant and cohesive; architecture that is responsible and timeless while supporting the ambitions of the clients, the end-user and the practice.

### Abstract

Grimshaw has always approached building design from the perspective that anything other than performance driven interrogation is irresponsible, especially in today's climate of change and the drive for carbon reduction. Nature plays its role in how we observe efficient design systems and informs how we approach building envelope design. Neil will present how Grimshaw has approached building and façade design over almost 40 years of thinking; from Europe in the 1990s through to Southern Cross Station, which leveraged a simple brief into a responsible and highly effective city shaping development, and then beyond to look at projects of recent times in Australia, the US and the Middle East, drawing linkages from projects in Seville in 1992 through to Dubai in 2020.



# Plenary Speakers



## Philip F. Yuan

Philip F. Yuan is a professor at the College of Architecture and Urban Planning at Tongji University, Thomas Jefferson professor at the University of Virginia (UVA, 2019), visiting professor at Massachusetts Institute of Technology (MIT, 2019), and Royal Melbourne Institute of Technology (RMIT, 2021). He is also the co-founder of DigitalFUTURES Association, Editor-in-Chief of the Architectural Intelligence journal. His research and practice bridge innovative technology and architectural culture, constantly seeking human-machine collaboration in the era of post-humanism. He has been awarded a variety of educational and design prizes, including 2022 AIA Open International | Architecture Honour Award, 2022 Dezeen Award Best Civic Building, 2020 ACADIA Innovative Academic Program Award of Excellence, and 2023 UIA's Auguste Perret Prize for Technology in Architecture.

### Abstract

The post-humanistic era places great importance on reducing embodied carbon during the construction process. To achieve efficient design and precision in construction, computational design and robotic fabrication are being utilized, resulting in high-performance building structures that align with advancements in intelligent construction. The design of large-span and spatial structures is based on a performance-based generative process, which is highly relevant to the accurate fabrication process. This coupling of computational form-finding methods and robotic fabrication technology has led to significant improvements. In recent years, robotic construction technology has been introduced into the building practice, specifically in mold formwork technology, node joint fabrication technology, building skin systems, and construction positioning technology, among others. This lecture will delve into practical experiences in constructing large-span spatial structures in recent years.



# Hangai Prize 2023 Winners



## Zoe Cooperband

### Towards Homological Methods in Graphic Statics

Authors: Zoe Cooperband and Robert Ghrist

### Abstract

Recent developments in applied algebraic topology can simplify and extend results in graphic statics. The techniques introduced here are inspired by recent developments in cellular cosheaf theory. While the general theory has a few technical prerequisites, an elementary introduction based on little more than linear algebra is possible. Contributions include: (1) a reformulation of statics and planar graphic statics in terms of cosheaves and their homology; (2) a new proof of Maxwell's Rule in arbitrary dimensions using Euler characteristic; and (3) derivation of a novel relationship between mechanisms of the form diagram and obstructions to the generation of force diagrams. This last contribution presages deeper results beyond planar graphic statics.

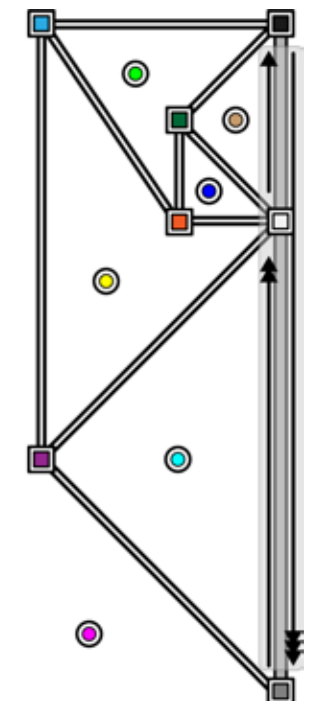
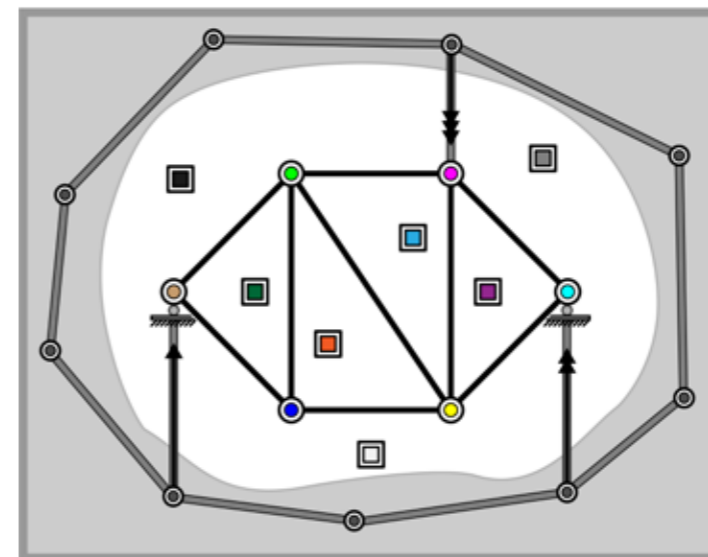

# Hangai Prize 2023 Winners



**Kentaro Hayakawa**

**Panel-pin model for kinematic and equilibrium analysis of rigid origami**

Authors: Kentaro Hayakawa and Makoto Ohsaki

## Abstract

The panel-pin model is proposed for analyzing the infinitesimal-deformation mechanism and the large-deformation equilibrium path of a rigid origami. The panel-pin model represents a rigid origami as a structure of rigid panels pin-connected at the vertices and has the following advantages: 1) consistent formulation of compatibility equations for any type of the rigid origami structure; 2) systematic computation of vertex displacements, folding angles, and their derivatives; and 3) ease of accounting for gravity acting on the panels. The infinitesimal mechanism of this model is studied according to the standard procedure for mechanisms and linkages, and an equilibrium path is traced as the trajectory of equilibrium points obtained by minimizing the total potential energy of the model.

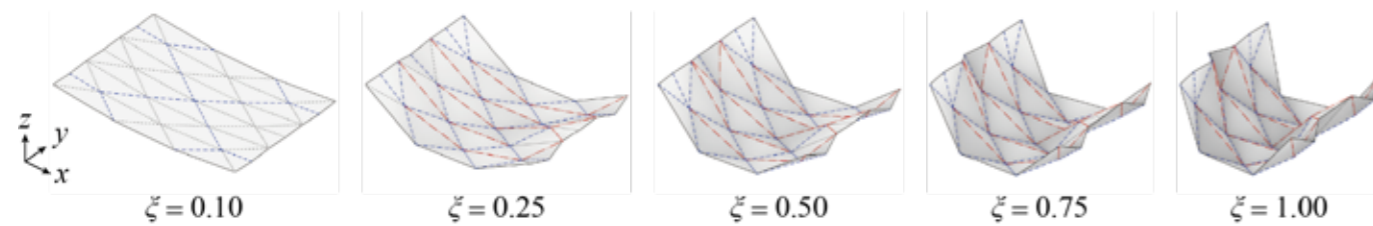

**Jonas Warmuth**

**Computational Conceptual Design – Typological Exploration of Spatial Truss Systems through Optimization**

Authors: Jonas Warmuth, Pierluigi D'Acunto, Corentin Fivet

## Abstract

This paper introduces a new method for the generation of structural forms that emphasizes both performance and the exploration of a diverse set of design briefs. The method employs layout optimization in a new way and aims to find close-to-optimal yet diverse structures. First, a parametric ground structure is generated. Second, this ground structure is used to produce a structure in equilibrium based on different user-defined goals. By varying ground structures and balancing the different goals, the method produces a series of designs that are both diverse and well-performing. The applicability of the method is demonstrated through several case studies. Using this approach, designers can move beyond the limitations of established typologies and explore a new variety of structural forms.

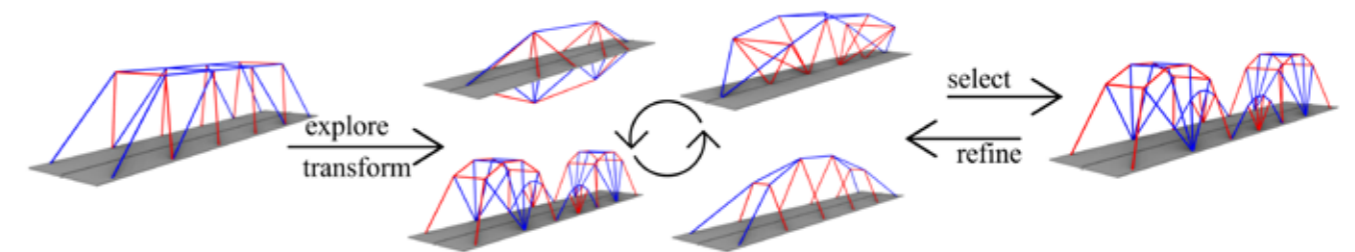

# Hangai Prize 2023 Winners



**Yiwei Zhang**

**Modular Design of Multistable Pneumatic Structures from a Flat Pattern of Air Pouches**

Authors: Yiwei Zhang, Tomoya Tendo, and Tomohiro Tachi

## Abstract

We introduce a structure that can be inflated from a plane to form a 3D surface using articulated straight air pouches with inextensible membranes. Specifically, we propose a design for quadrangular modules with four straight pouches, whose inflation causes the surface to form a saddle. We show fabrication methods using nylon films with paper mask patterns inside and explain the out-of-plane deformation of the bistability effect in this structure with a geometric model. We carry out analysis and simulation to show that lowering the width-length ratio of pouches results in better shapes. We further propose a method for controlling the height of saddles using concentric patterns. We then extend structural modules into multiple-grid systems and identify behaviors of the structure.

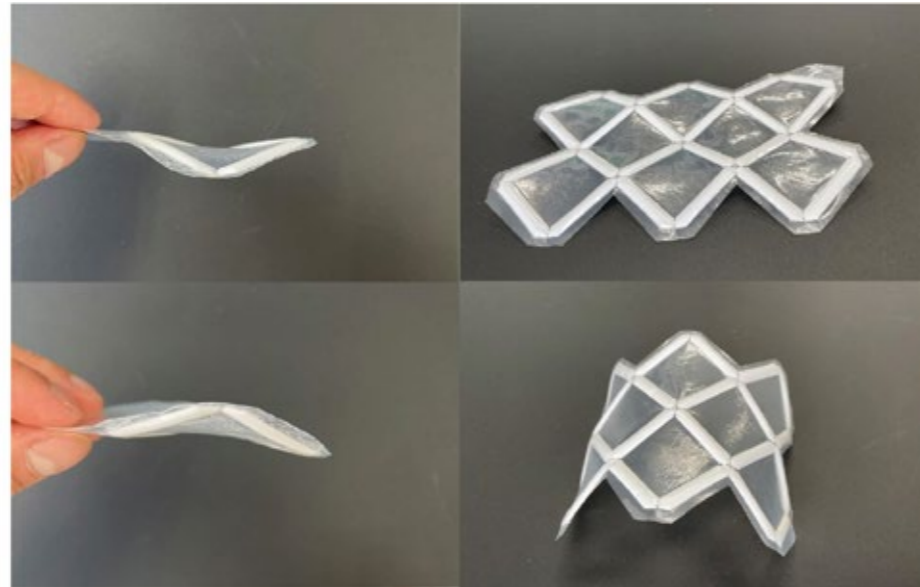
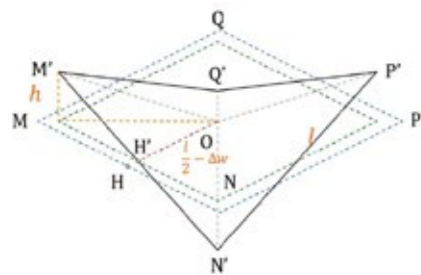

# Parallel Sessions



# Parallel Sessions

Monday 10 July 2023

8:00 - 16:00	Registration Open
	<b>ROOM: PLENARY</b>
9:00- 11:00	Opening Ceremony and Award Session
11:00 - 11:30	<b>MORNING TEA</b>
	<b>ROOM: PLENARY 3</b>
11:30 - 12:00	Taking Imagination Seriously: Reshaping Urban Airspace <b>Ms Janet Echelman</b>
	<b>ROOM: PLENARY 3</b>
12:00 - 12:30	Range of my structural design <b>Prof Mutsuro Sasaki</b>
	<b>ROOM: PLENARY 3</b>
12:30 - 12:45	<b>Hangai Prize 1</b> #496- Computational Conceptual Design – Typological Exploration of Spatial Truss Systems through Optimization <b>Mr Jonas Warmuth</b>
12:45 - 13:00	<b>Hangai Prize 2</b> #120- Panel-pin model for kinematic and equilibrium analysis of rigid origami <b>Dr Kentaro Hayakawa</b>
13:00 - 14:00	<b>LUNCH</b>
	<b>Concurrent Sessions (next page)</b>

# Parallel Sessions

Monday 10 July 2023

ROOM	215	216	217	218	PLENARY 3
<b>14:00 - 16:00</b>	<b>Masterclass 1</b>	<b>Session 2 Timber and bio-based structures 1 Working Group 12</b>	<b>Session 3 Dynamic response of structures 1 Working Group 8</b>	<b>Session 4 Construction techniques</b>	<b>Session 5 Form-finding and building design</b>
14:00 - 14:15	Tensys: Physical Form-Finding Method  <b>Mr Peter Lim</b> 14:00- 16:00	#577- Inventory-Constrained Design of a Variable Small Diameter Round Timber Structure <b>Mr Kim Baber</b>	#448- Collapse mechanism under strong earthquake and seismic design of single-layer aluminum alloy latticed shells <b>Prof Jinzhi Wu</b>	#29- Inflatable flexible factory formwork construction: most recent construction techniques and details <b>Mr Alex Bell</b>	#117- Form-finding of membrane structures using transfinite interpolated initial shapes <b>Mr Allan Marbaniang</b>
14:15 - 14:30		#379- Digital twin of wooden shingle envelopes <b>Ms Farzaneh Eskandari</b>	#419- Mechanical properties of the curvature-consistent frictional pendulum isolation system and vibration control of spherical reticulated shell <b>Dr Niyi Liang</b>	#129- Cast glass arches and shell structures: case studies and design methodology <b>Dr Telesilla Bristogianni</b>	#522- A BESO aid to efficient form finding <b>Prof Andre Brown</b>
14:30 - 14:45		#589- Experimental investigation on the bending response of reuse-ready timber slabs – The Pixel Slab System <b>Dr Xavier Estrella</b>	#411- Hysteretic behavior of members in aluminum alloy latticed shell <b>Ms Xingye Wang</b>	#261- Enhancing Construction of Complex Compression-Based Structures through Holographic-Assisted Assembly <b>Mr Ertunc Hunkar</b>	#272- Integration of Structural Optimisation with Aesthetic Evaluation by Facial Expression Analysis <b>Dr Manuel Muehlbauer</b>
14:45 - 15:00		#63- Post-tensioned strapping connections for rapid assembly of low-cost timber structures <b>A/Prof Joseph Gattas</b>	#371- Study on finite element numerical simulation of seismic response of suspended-dome structure <b>A/Prof Guojun Sun</b>	#109- Anti-fragile Shell Aggregations on the Moon <b>Mr Xavier De Kestelier</b>	#304- Implementation of Algebraic Polyhedral Graphic Statics in Generating Muti-Span Undulating Funicular Beam Structure <b>Mr Hua Chai</b>
15:00 - 15:15		#509- Testing on the shear performance of embedded steel tube glulam joints in arched timber structures <b>Ph.D Candidate Chengyang He</b>	#31- Seismic Force Reduction Factor Evaluation for Double-layered Domes Supported by Single-Story Substructures <b>Dr Yuki Terazawa</b>	#347- Research on digital fabrication for flexible mass customization: The Case of Chengdu Agricultural Expo Exhibition Hall <b>Mr Tianyi Gao</b>	#61- Theoretically minimum material vault designs generated via adaptive layout optimization <b>Dr Linwei He</b>
15:15 - 15:30		#217- Derivation of wind loads for shell structures using CFD analyses <b>Prof Christian Heidenreich</b>	#410- Estimation Method for Critical Seismic Intensity of Pin-Supported Arch Structures <b>Prof Shoji Nakazawa</b>	#16- Application of reciprocal frame structure in robotic construction <b>Mr Cheav Por Chea</b>	#265- Towards a novel form-finding approach using matrix analysis: exploiting nodal displacements of pin-jointed frameworks <b>Mr Yao Lu</b>
15:30 - 15:45		#374- Reversible timber only connections – an investigation into the potential of threaded dowels and swelling for reconfigurable truss components <b>Ms Olga Popovic Larsen</b>		#7- Retooling the Vernacular: Augmenting the craft of timber house-building in southern China through the integration of remote-sensing and computational design <b>Mr Donn Holohan</b>	Challenges and Triumphs in the Creative Integration of Structural Engineering and Architecture <b>Andrew Shehadeh &amp; Milad Sayyadi</b>
15:45- 16:00					
<b>16:00 - 16:30</b>	<b>AFTERNOON TEA</b>				

# Parallel Sessions

Monday 10 July 2023

ROOM	215	216	217	218	PLENARY 3
<b>16:30 - 18:30</b>	<b>Masterclass 2</b>	<b>Session 7 Gridshell and lattice structures</b>	<b>Session 8 Additive manufacturing 1 Working Group 21</b>	<b>Session 9 Architectural geometry</b>	<b>Session 10 Tension and membrane structures 1 Working Group 6</b>
16:30 - 16:45	Karamba 3D: Parametric Engineering Analysis Method  <b>Dr Sascha Bohnenberger</b> <b>Mr Matthew Tam</b>	#47- FreeGrid: a benchmark on design and optimisation of free-edge gridshells <b>Dr Lorenzo Raffaele &amp;</b> <b>Dr Francesco Laccone</b>	#10- Multi-material Components for a Sustainable Built Environment: Integration of Design by Topology Optimisation and Fabrication by 3D Printing <b>Dr Hèrm Hofmeyer</b>	#308- Designing the West Gate Tunnel portals: Timber gridshells <b>Mr Andre Ferro Pereira</b>	#558 Design Considerations for Tension Membranes on Optus Stadium and other Modern Australian Stadiums <b>Mr Scott Rathie</b>
16:45 - 17:00	16:30- 18:30	#571- Development of the Design of the new Sydney Football Stadium <b>Mr Alex Edwards</b>	#283- 4D printed textile formwork for robotic concrete spraying <b>Mr Guillaume Jami</b>	#267- Form dictated by material-specific properties of a mycelium composite <b>Mrs Dana Saez</b>	#351 Steel structural design of a 60,000-seats stadium <b>Mr Yan Zhang</b>
17:00 - 17:15		#75- Design and construction of the ReciPlyDome, a lightweight modular reciprocal dome <b>Ms Ellen Leemans</b>	#426- An assembly-oriented novel low-carbon masonry building method with unfired 3D printed earthen blocks <b>Ms Yelda Gin</b>	#599- Arkansas Museum of Fine Arts: Organic Shaped Concrete Folded Plate <b>Mr Ben Sexton</b>	#137 Numerical simulation of snowdrift on a membrane structure <b>Ms Jialin Zou</b>
17:15 - 17:30		#389- A new assembled spatial structure system composed of triangular components <b>Mr Zhengning Li</b>	#55- Mechanical characteristics of FDM printed parts affected by an air gap <b>Miss Meiyu Li</b>	#367- A multi-objective progressive optimization method for free-form canopy based on fabrication morphology <b>Miss Sijia Gu</b>	#500 The mechanical properties of membrane material STFE <b>Prof Qilin Zhang</b>
17:30 - 17:45		#49- Reducing the number of different facade panels for structurally optimised gridshells <b>Dr Hongjia Lu</b>	#459- 3D-printed clay formwork for fabrication of concrete elements <b>Dr Salma Mozaffari</b>	#208- Rethinking geometry of grapevine structure proposed by Konrad Wachsmann <b>Dr Toshiaki Kimura</b>	#556 The constitutive model of STFE membrane material <b>Prof Qilin Zhang</b>
17:45 - 18:00		#282- Simultaneous stress-aligned and flat-panel-aligned grids on mixed tension-compression membrane shells <b>Dr Masaaki Miki</b>	#554- Liquid printed reusable dredged-based material for concrete formwork <b>Prof Bosheng Liu</b>	#147- Reducing the number of different faces in free-form surface tessellations <b>Mr Yuanpeng Liu</b>	#74- Form-finding of tensile membrane structures by solving the Generalised Laplace equation using Physics-Informed Neural Networks <b>Mr Sounak Kabasi</b>
18:00 - 18:15		#473- Leveraging structural steel castings for modern grid shell structures <b>Ms Jennifer Anna Pazdon</b>	#244- Hyperbolo-ICE: an efficient and expressive ice shell <b>Dr Rui Liu</b>	#517- Creating various 3D surfaces using a single tile or a few tiles <b>Dr Anooshe Rezaee Javan</b>	
18:15 - 18:30		#202- Sydney Football Stadium redevelopment – An efficient design, manufacturing and on-site assembly approach to a complex form-found roof shell structure <b>Mr Michael Chernyavsky</b>		#519- A new method of architectural scheme design considering structural optimization <b>Miss Ruowei Gong</b>	
<b>18:30 - 21:00</b>	<b>WELCOME RECEPTION</b>				

# Parallel Sessions

Tuesday 11 July 2023

8:30- 16:00	Registration Open				
<b>Concurrent Sessions</b>					
<b>ROOM</b>	<b>215</b>	<b>216</b>	<b>217</b>	<b>218</b>	<b>PLENARY 3</b>
<b>9:00 - 11:00</b>	<b>Session 11 Investigation of load conditions</b>	<b>Session 12 Timber and bio-based structures 2 Working Group 12</b>	<b>Session 13 Numerical methods Working Group 13</b>	<b>Session 14 Form-finding 1</b>	<b>Session 15 Additive manufacturing 2 Working Group 21</b>
9:00 - 9:15	#336- Research of snow distribution on long-span roof with local obstructions <b>Mr Rui Li</b>	#197- Cross Laminated Plywood Construction of a Free Form Roof <b>Prof Paul Loh</b>	#130- A novel generatively designed and additively fabricated ankle-foot orthosis <b>Mr Ryan Blakis</b>	#38- Optimisation of a Satellite Antenna Bracket using the BESO Method <b>Mr Joshua Rodrigues</b>	#132- Additively manufactured steel joints for structural frames: A concept proposal and numerical simulations <b>Mr Seyed Pouya Afshar Imani</b>
9:15 - 9:30	#393- Analytical simulation of roof snow load on flat roofs considering a probabilistic model of wind speed <b>Mr Yuanyuan Li</b>	#568- Material Efficiency in Local Timber Construction: Unlocking the Potential of English Timber <b>Mr Harry Mills</b>	#77- Behavior and design of innovative cold-formed steel channel beams with edge-stiffened web openings <b>Dr Boshan Chen</b>	#116- A numerical comparison between geometric stiffness- and elastic stiffness-based structural shape optimization for gridshells <b>Mr Gaoyuan Wu</b>	#270- Continuous fibre additive manufacturing of topological spatial lattices for fabrication-aware design processes <b>Mr Eduardo Chamorro</b>
9:30 - 9:45	#96- Effect of stochastic imperfections on the buckling of open-top storage tanks under wind loads <b>Dr Liang Liu`</b>	#596- Research on clay mixtures for sustainable building materials <b>Dr Andreea-Terezia Mircea</b>	#322- Designing the West Gate Tunnel portals: Façade geometry and structure <b>Mr Benjamin Coop</b>	#66- A novel approach to generating diverse and competitive structural designs through load perturbation in topology optimisation <b>Mr Yulin Xiong</b>	#170- Additively Manufactured Micro Channel by Combining Binder Jetting Printing and Diffusion Bonding <b>Dr Tho Truong Do</b>
9:45 - 10:00	#93- CFD Investigation of Snow Drifting on Long-Span Dome Roofs <b>A/Prof Qingwen Zhang</b>	#67- Reliability framework for CLT floors in out-of-plane bending using Monte Carlo simulation <b>Mr Richard Nero</b>	#524- An efficient shape optimization algorithm for gridshells based on node shifting <b>Dr Chao Ding</b>	#395- Graphic statics and topology optimization: An integrated approach to designing architecture structures <b>Mr Xinjie Zhou</b>	#582- Structural Connection Design Possibilities with Reclaimed Elements Using 3D Concrete Printing <b>Ms Gülay Elbasdi</b>
10:00 - 10:15	#35- A modified Finite Area Element model for simulating the evolution of roof snow loads <b>A/Prof Huamei Mo</b>	#353- Integrative approach to a timber gridshell formed on-site <b>Ms Evy Slabbinck</b>	#143- Simultaneous optimization of geometry and topology for grid-shells under self-weight loading <b>Dr Helen Fairclough</b>	#521- Aeolus: a Grasshopper plugin for the interactive design and optimisation of acoustic shells <b>Mr Michael Mack</b>	#527- Additive Manufacturing of Fully Recyclable Walls solely made from Renewables – A possible Quantum Leap in Sustainable Building Construction <b>Prof Benjamin Kromoser</b>
10:15 - 10:30	#188- Control objectives for adaptive slabs with integrated fluidic actuators, a comparison of effects <b>Mr Markus Nitzlader</b>	#198- Structural design of canoe club house <b>Mr Naoyuki Takayama</b>	#216- Multi-objective optimization of the large telescope structure under temperature loading <b>Dr Hiroaki Kawamura</b>	#123- Fundamental study on form-finding of tensegrity-membrane structures using a dynamic relaxation method <b>Mr Yohei Nagano</b>	#15- Robotically assisted manufacturing for free-form rammed earth <b>Dr Mohamed Gomaa</b>
10:30 - 10:45	#133- Experimental Study on Estimation of Water Content and Compaction of Soil by SDS Test <b>Mr Sakamoto Tomoyuki</b>	#482- Systematically ranking of mycelium composites used for facade construction via a fuzzy comprehensive evaluation <b>Dr Ali Hadigheh</b>	#91- Sizing optimization of free-form lattice shells using deep deterministic policy gradient and graph convolutional networks <b>Mr Chi-Tathon Kupwiat</b>	#446- Digital Ceramics: High Hyperbolic Curvature Fabrication Technologies in Paste-Based Additive Manufacturing <b>Mr Lei Gong</b>	
10:45 - 11:00	#92- Numerical Simulations of Snow Loads on Long-Span Curved Roofs <b>A/Prof Guolong Zhang</b>	#58- Design Opportunities and Limitations of Catenary Wood Structures <b>Mr Nichol Long Hin Wong</b>			#228 Phase field fracture modelling for laser powder bed fusion metals <b>Mr Cunyi Li</b>
11:00 - 11:30	MORNING TEA				

# Parallel Sessions

Tuesday 11 July 2023

<b>ROOM: PLENARY</b>					
11:30 - 12:00	Crafting Robotics in Spatial Structures <b>Prof Philip Yuan</b>				
<b>ROOM: PLENARY 3</b>					
12:00 - 12:30	Tailored Materiality <b>Dr Mariana Popescu</b>				
<b>ROOM: PLENARY 3</b>					
12:30 - 12:45	#335- Modular Design of Multistable Pneumatic Structures From a Flat Pattern of Air Pouches <b>Mr Yiwei Zhang</b>				
12:45 - 13:00	#196- Towards Homological Methods in Graphic Statics <b>Ms Zoe Cooperband</b>				
<b>LUNCH</b>					
<b>ROOM</b>	<b>215</b>	<b>216</b>	<b>217</b>	<b>218</b>	<b>PLENARY 3</b>
<b>14:00 - 16:00</b>	<b>Masterclass 3</b>	<b>Session 17 Origami 1 Working Group 15</b>	<b>Session 18 Dynamic response of structures 2</b>	<b>Session 19 Historical structures Working Group 17</b>	<b>Session 20 Tension and membrane structures 2</b>
14:00- 14:15	Ameba: Topology Optimisation Design <b>Prof Yi Min 'Mike' Xie</b> <b>Dr Ding Wen 'Nic' Bao</b> 14:00- 16:00	#181- Design and Evaluation of Compliant Hinges for Deployable Thick Origami Structures <b>Mr Munkyun Lee</b>	#287- A possible substitute for an ice ball in an impact test <b>Ms Siyu Chen</b>	#160- Translucent concrete shells in Ecuador <b>Dr Mauricio Luzuriaga</b>	#592- Textile façades with a bottle past – comparing the mechanical properties of new and recycled fabrics <b>Mrs Katja Bernert</b>
14:15- 14:30		#269- Experimental Study on a Type of Foldable Structure with Asymmetrical Crease Line Pattern <b>Mr Khai Seng Chew</b>	#418- Modal identifications of a scaling stratospheric airship in still air <b>Mr Longlong Chen</b>	#451- Digital tools and technologies in the preservation of historic concrete shells <b>Dr Marisela Mendoza Ramos</b>	#470- FDMremote: Interactive inverse design of tensile structures with differentiable FDM <b>Mr Adam Burke</b>
14:30- 14:45		#298- Diffusion behavior analysis of local folding of Miura origami <b>Prof Jianguo Cai</b>	#477- Dynamics analysis of floating offshore wind turbines <b>Dr Haoran Zuo</b>	#264- Naiju Community Center by Shoei Yoh: Pioneering Computational Architecture Applying Origami Geometry and Bamboo Formwork <b>Dr Masaaki Iwamoto</b>	#276-Effect of temperature on strength of PVC coated fabrics <b>Dr Chengjun Gao</b>
14:45- 15:00		#37- Curved, elastically-deformed origami and kirigami: an overview of recent progress <b>Dr Ting-Uei Lee</b>	#578- Structural design of a gymnasium with warren trusses in a grid arrangement supported by thin columns and damping braces <b>Prof Eisuke Mitsuda</b>	#340- Pier Luigi Nervi 's arch in E'42 <b>Dr Satoru Kimura</b>	#383- Experimental methods and performance of membrane structures: A systematic literature review <b>Mr Haonan Huang</b>
15:00- 15:15		#413- Study on the performance of the space structure using CLT folded plate structure <b>Mr Kaito Ikawa</b>	#334- Damage modelling of hailstone impact on aluminium claddings <b>Mr Shuangmin Shi</b>	#483- Stone reciprocal structures: suggestions from ancient Greece <b>Dr Valentina Beatini</b>	#469- Application of Partial factors to Actions in Case of Membrane Structures <b>Prof Wolfram Jaeger</b>
15:15- 15:30		#573- Analysis of bending behaviour in simple flexible honeycomb cores with tetradecagonal cells <b>Mr Chisaki Kitajima</b>	#95- Stochastic Uncertainty Quantification for 3D Elastic Metamaterials through a Hyperplane Modelling Technique <b>Miss Minghui Zhang</b>		#342-Creep and residual strain elimination of large-scale tensioned fabric membrane radome structure <b>Dr Runzhi Lu</b>
15:30- 15:45			#164- Design and Construction of Music arena of 110m span with Parallel Chord Trusses <b>Mr Yuya Mori</b>		#439- Temperature field analysis of air-supported membrane structure for coal storage sheds <b>Dr Xiuliang Lu</b>
15:45- 16:00					Architectural Membrane Association Presentation <b>Katja Bernert</b>

# Parallel Sessions

Tuesday 11 July 2023

16:00 - 16:30					
AFTERNOON TEA					
ROOM	215	216	217	218	PLENARY 3
<b>16:30 - 18:30</b>	<b>Masterclass 4</b>	<b>Session 22</b> <b>Additive manufacturing 3</b> <b>Working Group 21</b>	<b>Session 23</b> <b>Form-finding 2</b> <b>Working Group 13</b>	<b>Session 24</b> <b>Concrete structures</b>	<b>Session 25</b> <b>Digital modelling and fabrication 1</b>
16:30 - 16:45	Aelous: An Acoustic Solver <b>Dr Alberto Pugnale</b> <b>Dr Sofia Colabella</b> <b>Dr Gabriele Mirra</b> <b>Mr Michael Mack</b>	#595- Form finding for post tensioned, 3D printed fluid containers <b>Mr Patrick Schäferling</b>	#108- Chain mail assembly: a new model of programmable modular structure <b>Mrs Nabila Afif</b>	#279- A Group-Theoretic Approach for Constructing Spherical Interlocking Assemblies <b>Mr Reymond Oluwaseun Akpanya</b>	#498- Process Simulation for Enhancing Self-Supporting Printability in 3D Curvature-Oriented Clay Form Printing with an Additional-Axis Base <b>Mr Xuanyu Lu</b>
16:45 - 17:00	16:30- 18:30	#281- Continuous multi-filament 3D printing for functionally-graded structural components <b>Mr Teng Teng</b>	#357- Joint Layout Design: finding the strongest unit layout within interlocking discrete assemblies <b>Dr Elham Mousavian</b>	#323- Effect of biochar on the impact resistance of alkali-activated slag concrete <b>Ms Harshani Egodagamage</b>	#462- Robotically Fabricated Structure: Integrative Design and Analysis <b>Prof Arash Adel</b>
17:00 - 17:15		#268- Local optimization of self-supporting shell structures in 3D printing: a skeleton method <b>Mr Yefan Zhi</b>	#119- Nonparametric shape optimization of piecewise developable surfaces for maximum stiffness using discrete differential geometry <b>Prof Makoto Ohsaki</b>	#341- Automated modelling and nonlinear analysis of concrete shells in ATENA including soil-structure interactions <b>Dr Mohammadmahdi Gharib</b>	#422- Complex digital modelling for low-cost construction of East African vernacular architecture <b>Mr Xavier De Kestelier</b>
17:15 - 17:30		#513- Model test of sunflower triple-strut cable dome structure with metal additive manufacturing nodes <b>Dr Zhen Wang</b>	#240- Tailoring Poisson's ratio of bending-active mechanical metamaterials with periodic and nonperiodic pentagonal grids <b>Dr Yusuke Sakai</b>	#223- Evaluation system of Concrete Defect Based on Deep Learning Algorithm and Thermography Using UAV <b>Ms Arum Jang</b>	#504- GOOSE: Integrated non-commercial software for shell and spatial structures design, calculation, fabrication, and assembly engineering <b>Mr Josu Goñi</b>
17:30 - 17:45		#288- Reversed mechanism for fabrication of flexible structural node joint using 6-axis robots and 3D printing technology <b>Dr Lei Yu</b>	#209-Double-curved plate components in configurable systems <b>Mr Ahmed Soliman</b>	#352- Analysis and codified design of reinforced concrete shell structures <b>Mr Michael King</b>	#110- Structural design and construction of a large building with a 3D 'circle truss' and ETFE membrane roof <b>Mr Tatsuya Idogawa &amp; Mr Takashi Kurata</b>
17:45 - 18:00		#176- Topology optimized cellular structure for material extrusion additive manufacturing <b>Mr Lingwei Xia</b>	#523- Study on quasi-static compression performance of honeycomb structures with negative Poisson's ratio <b>Prof Yiyi Zhou</b>	#481 Investigation on the effects of self-healing agents on the shrinkage of low-carbon biochar mortar paste <b>Xuqun Lin</b>	#301- Computational Design Thinking: An Integrated Education Approach with Shell Structure Design <b>Prof Yasushi Ikeda</b>
18:00 - 18:15		#99- Rapid fabrication system for large-scale free-form double curved shell <b>Mr Zhuoyang Xin</b>	#100- A novel modular technique for creating diverse curvatures in free-form rammed earth walls <b>Mr Ahmed Abdelaal</b>		#488- Digital Design, Optimisation and Automated Construction of a Curved Wooden Truss – Housing for the BOKU Robot Laboratory <b>Prof Benjamin Kromoser</b>
18:15 - 18:30		#171- Mechanical design of additive manufactured lightweight multifunctional structures and performance evaluations based on X-ray 3D imaging technology <b>Prof Wenwang Wu</b>			

# Parallel Sessions

Wednesday 12 July 2023

8.00- 16:00

Registration Open

Concurrent Sessions					
ROOM	215	216	217	218	PLENARY 3
<b>9:00 - 11:00</b>	<b>Session 26</b> Life-cycle design and assessment of structures 1	<b>Session 27</b> Tension and membrane structures 3	<b>Session 28</b> Sustainable construction 1 Working Group 5	<b>Session 29</b> Structural design and analysis Working Group 8 and Working Group 21	<b>Session 30</b> Optimisation methods and applications 1
9:00 - 9:15	#83- Designing Structures from Reused Steel: A Cost-Effective Carbon Mitigation Strategy <b>Ms Juliana Berglund-Brown</b>	#247- Study on wind response properties of roof structures composed of radially arranged cables considering roof deformation <b>Mr Akira Oshiumi</b>	#300- Bio-based Composite Spatial Shell Structures <b>Prof Masoud Akbarzadeh</b>	#529- Plastic buckling test of axially compressed aluminum latticed cylinders formed by 3D-printer <b>Prof Tetsuo Yamashita</b>	#255- An Advanced Crow Search Algorithm for Truss Optimization <b>Mr Hyukjin Kim</b>
9:15 - 9:30	#405- Discrete systems for resource-efficient and adaptable timber structures <b>Dr Stijn Brancart</b>	#441- Numerical and experimental modelling of pneumatic structures <b>A/Prof Ruy Marcelo Pauletti</b>	#73- Experimental investigations of textile fabrication processes for steel shell and lattice structures <b>Mr Baris Wenzel</b>	#102- Influence of axial force on the dynamic response of the aluminum foam-filled 6082-T6 aluminum tube under lateral impact <b>Prof Ximei Zhai</b>	#377- Functionally graded CharCrete slabs for embodied carbon optimisation in architecture <b>Miss Nikol Kirova</b>
9:30 - 9:45	#548- Applications of nonlinear guided wave mixing for early damage detection of partially immersed metallic plates <b>Prof Ching Tai (Alex) Ng</b>	#242- The roof structure design of the professional football stadium of Chengdu Phoenix Mountain Sports Center <b>Ms Yuan Feng</b>	#127- Isogeometric refinement for shells' shape optimization <b>Prof Stefano Gabriele</b>	#142- 3D printed reusable and mechanically tunable tensegrity energy absorber <b>Mr Di Zhang</b>	#234- Numerical analysis and design of welded I-section steel beams with longitudinally profiled flanges under elastic overall buckling <b>A/Prof Xiaoling Liu</b>
9:45 - 10:00	#333- Algorithmic investigation of structural system utility for urban development reusing existing foundations <b>Ms Kiley Feickert</b>	#530- Construction of Developable Freeform Membrane Tensegrity Structures <b>Mr Yuta Shimoda</b>	#76- Leaned brick shells with Mexican quoins and steel edges <b>Prof Juan Gerardo Oliva-Salinas</b>	#325- Static performance of an open Levy cable dome with partial CFRP cables <b>Prof Weijing Zhang</b>	#166- Topology optimisation of free-form shells for architectural applications <b>Dr Jiaming Ma</b>
10:00 - 10:15	#155- Predicting the embodied greenhouse gas emissions of building structures through Machine Learning. <b>Miss Sandie Kate Fenton</b>	#199- PTFE membrane privacy screen structure for National Palace Malaysia <b>Ms Migico Sing Si Wei</b>	#237- Simulation and analysis of generalised automated interleaved layered construction process for shell structures <b>Dr Shadi Ostovari</b>	#250- Web crippling of 7A04-T6 high strength aluminium alloy SHS and RHS members <b>Dr Xinhang Zhi</b>	#537- Enhancing interactivity in structural optimisation through Reinforcement Learning: an application on shell structures <b>Mr Gabriele Mirra</b>
10:15 - 10:30	#115- Reconstruction home after the 2016 Kumamoto earthquake and community preparedness for disaster <b>Dr Yuuki Kuroiwa</b>	#52- Defining Design Limits for ETFE Foils determined in Bubble Inflation Tests <b>Mr Felix Surholt</b>	#211- Efficient steel-concrete slab designed using multi-material topology optimisation <b>Mr Yu Li</b>	#59- State-of-the-art Review of Initial Imperfection Field Simulation Methods for Single-Layer Gridshells <b>Dr Shaojun Zhu</b>	#44- Stress reduction effect by changing the upper and lower surfaces near the boundary of a spherical shell <b>Prof Shigehiro Morooka</b>
10:30 - 10:45	#150- Aurecon Buildings Carbon sketcher: A cross-disciplinary webtool for carbon neutral building design <b>Dr Max Marschall</b>	#227- Active Control of Hybrid String Structure <b>Mr Wucheng Xu</b>		#503- The transformable envelope of Moscow-City concert hall <b>Mr Josu Goñi</b>	#437- Global Topology Optimization of Lattice Shell Considering Constructability Dependent on Connection Relationships of Members <b>Mr Naoto Okuzono</b>
10:45 - 11:00	#354- Using vision-based method to measure vibration responses of structures <b>A/Prof Jun Li</b>	#320- Large Span Membrane Architecture: How to Accomplish Carbon Neutral with Innovative Photovoltaic and Adaptive Control Strategy <b>Mr Yongsheng Yan</b>			#145- Performance-based fire protection design and practical application of large-space aluminum alloy structure <b>Liqui Qiu</b>

11:00 - 11:30

MORNING TEA

# Parallel Sessions

Wednesday 12 July 2023

ROOM: PLENARY 3

11:30 - 12:00

Integrative Computational Design and Construction for Resource Efficient Building Structures

**Prof. Jan Knippers**

ROOM: PLENARY 3

12:00- 12:30

Design and Construction with Tension Membranes

**Ms Karen Lynch**

ROOM: PLENARY 3

12:30- 13:00

Innovative Ice Structures

**Prof. Arno Pronk**

13:00 - 14:00

LUNCH

**Concurrent Sessions (see next page)**



# Parallel Sessions

Wednesday 12 July 2023

ROOM	215	216	217	218	PLENARY 3
<b>14:00 - 16:00</b>	<b>Masterclass 5</b>	<b>Session 32 Teaching Working Group 20</b>	<b>Session 33 Tensegrity systems and cable structures Working Group 21</b>	<b>Session 34 Digital modelling and fabrication 2</b>	<b>Session 35 Origami 2 Working Group 15</b>
14:00- 14:15	Fologram: AR-assisted Fabrication Technique <b>Dr Gwyllim Jahn</b> <b>Mr Cameron Newnham</b> 14:00- 16:00	#586- Full-scale Teaching Kits for the Education of Tensile Membrane Structures <b>Dr Alireza Behnejad</b>	#295- Exploration on the shape and force of large-span steel structure of Chengdu Open-air Music Park <b>Ms Yuan Feng</b>	#294- Steel connection design of complex and repetitive geometries through visual programming <b>Mr Nathan Luke</b>	#584- Study on seismic behavior of origami-based buckling-controlled concentric braces with beam-column-brace connections <b>Prof Yangqing Liu</b>
14:15- 14:30		#491- Acoustic and structural design embedded in design studio pedagogy <b>Dr Sofia Colabella</b>	#532- Locomotive performance evaluation of the spherical tensegrity robots <b>Miss Meijia Wang</b>	#478- Field-based generative design and augmented robotic fabrication of material-efficient ribbed-slab structures <b>A/Prof Roberto Naboni</b>	#141- Multi-stability of hexagonal origami hyper structures based on group theory and symmetry breaking <b>Mr Chenhao Lu</b>
14:30- 14:45		#443- Educational tools for arch and frame structures <b>Ms Ayaka Kondo</b>	#229- Evaluation and improvement of bearing capacity of annular crossed cable net structure after local cable failure <b>Mr Xuanzhi Li</b>	#567- Guided Irregular Cement Geometry Stacking using Real-time Optimization and Motion Tracking <b>Mr Alex Orsholits</b>	#225- Bridging the gap- A study on foldable tubular Bridges <b>Dr Rupert Maleczek</b>
14:45- 15:00		#273- New Master's Education: Innovative teaching of sustainable design approaches for handling uncertainty <b>Prof Olga Popovic Larsen</b>	#518- Design and research on roof structure of the stadium of Sanya International Sports Industry Park <b>Mr Chenyu Liang</b>	#438- KNOTSHELL pavilion – Development of a low-tech approach for transferring complex digital data to building elements <b>Mr Alec Singh</b>	#226- Multi-layered Curved Folding <b>Dr Rupert Maleczek</b>
15:00- 15:15		#570- A modular approach to repurposing timber structural elements <b>Mr Matthew Tam</b>	#62- Suspended Tensegrity: The Anthropomorphic Machine <b>Prof Paul Loh</b>	#278- Optical Parametric Component Referencing for the Facilitated Prefabrication of Timber Wall Elements <b>Mr Felix Schmidt-Kleespies</b>	#449- Tessellated Origami Surface and Soft Robotics <b>Mr Youness Yousefi</b>
15:15- 15:30		#179- Seismic retrofitting by Double Layer Grids for HP Suspension Gymnasium <b>Mr Kazuya Miyagawa</b>	#105- Kinematic performance of a vibration-driven six-bar tensegrity structure <b>Ms Ruhe Mei</b>		#328- A New Data-driven Framework for Energy Absorption Analysis of a Miura-origami Structure Using Machine Learning Methods <b>Mr Dian Zhang</b>
15:30- 15:45		#186- Reflections on an International Collaboration Initiative <b>Miss Ramsha Saleem</b>	#124- Structural behaviours of arch SCS with “pin-pin” support <b>Dr Akira Tanaka</b>		#284- Tunable and Programmable Perforated Graded Miura-ori Phononic Structures <b>Mr Xi Zhang</b>
15:45- 16:00					#285- Mechanical characteristics of graded origami bellows under tension <b>Ms Xinyi Zhang</b>
16:00 - 16:30	AFTERNOON TEA				

# Parallel Sessions

Wednesday 12 July 2023

ROOM	215	216	217	218	PLENARY 3
<b>16:30 - 18:30</b>	<b>Masterclass 6</b>	<b>Session 37</b> <b>Bio-inspired structures and architecture</b>	<b>Session 38</b> <b>Topology Optimisation 1</b>	<b>Session 39</b> <b>Optimisation methods and applications 2</b>	<b>Session 40</b> <b>Metal gridshell structures 1</b> <b>Working Group 8</b>
16:30- 16:45	PolyFrame: Computational framework for form finding <b>Dr Masoud Akbarzadeh</b> <b>Mr Yao Lu</b>	#475- Material Matters: A Möbius Strip in Laminated Bamboo <b>Dr Bhavna Sharma</b>	#195- Topology computation of novel auxetic structures: A systematic design framework <b>Mr Rajendra Prasad Bohara</b>	#24- Slimline floor an invention by Pronk and Lichtenberg <b>A/Prof Arno Pronk</b>	#139- Novel schemes on improvement the progressive collapse resistance of hybrid cable domes <b>Prof Karim Abedi</b>
16:45- 17:00	16:30- 18:30	#396- A double phase field method for mixed-mode crack modelling in 3D elastoplastic solids with crack-direction-based strain energy decomposition <b>Mr Yang Jiang</b>	#207- Topology optimization of truss structure with nodal stability and local buckling of member constraints <b>Dr Qi Cai</b>	#502- Applications of Shape-Optimised Cold-Formed Steel Cross-Sections for Roof Purlin and Wall Stud Construction <b>Miss Ziqi Zhao</b>	#144- The effects of different self-stress states on the stability behaviour of cable-strut pyramid dome <b>Prof Karim Abedi</b>
17:00- 17:15		#192- Vibration analysis of the real shaped bi-valve shell model created by CT images <b>Ms Minori Ogoshi</b>	#138- Topology optimization of dynamic stiffness response of constrained damping laminate structures <b>Mr Xiangyang Chen</b>	#54- Interactive Gradient-Based Optimization Method for Column-slab Structures using Agent Based Modelling <b>Ms Keerthana Udaykumar</b>	#153- Design and construction of two tree-columns supported gridshells in Canberra <b>Miss Catherine Poirriez</b>
17:15- 17:30		#57- Comparison of four current low-density concrete technologies emphasis on the criteria's of performance, fabrication, and mixtures <b>Dr Ferdinand Oswald</b>	#274- Multi-scale graded-density topology optimisation for lattice orthopaedic implant with different unit cell topologies <b>Mr Jiajun Chen</b>	#214- Optimization design of bone scaffolds using physics-informed machine learning <b>Dr Chi Wu</b>	#506- Grid shell for Hamad Airport expansion in Doha <b>Mr Josu Goñi</b>
17:30- 17:45		#135- Energy absorption of the cylindrical sandwich structures with a bio-inspired core <b>Dr Ngoc San Ha</b>	#11- Non-penalization topology optimization for maximizing natural frequency using SEMDOT <b>Dr Yun-Fei Fu</b>	#297- Simultaneous topology optimization and fiber path optimization of CFRP structures using level set method <b>Miss Yanan Xu</b>	#158- Characterization of the rotational hinge stiffness for metallic kirigami space frame <b>Dr Eduardo Sosa</b>
17:45- 18:00		#505- Insights on buckling modes of polygonal ring frames under symmetric compressive joint loads <b>Prof Alphose Zingoni</b>	#45- Topology optimisation of support-free structures for multi-axis additive manufacture <b>Mr Qichen Guo</b>	#603- Optimization of corrugation direction on corrugated shells <b>Prof Kenji Yamamoto</b>	#251- Design of a brace-stiffened bi-directional single-layer lattice dome using h-shaped steel with a span of 116m <b>Dr Yuki Nagai</b>
18:00- 18:15		#14- Analysis and design of functionally graded porous structures <b>Dr Da Chen</b>	#364- Topology Optimization of Reinforced Concrete Structures Using a Variable Sheet Method <b>Mr Jackson Jewett</b>	#30- Optimisation of railway pantograph-catenary structures <b>Prof Wenyi Yan</b>	#392- A Stress Triaxiality and Lode Angle Dependent Plasticity Model for Structural Aluminium Alloys <b>Mr Xiaonong Guo</b>
18:15- 18:30			#48- Topology Optimisation for Lightweight Structures with Multiple Cellular Materials <b>Dr Weibai Li</b>	#50- Structural optimization based on quantum genetic algorithm <b>Mr Hongyuan Ren</b>	
19.00 - 22.30	SYMPOSIUM BANQUET DINNER				

# Parallel Sessions

Thursday 13 July 2023

8.00- 16.00

Registration Open

Concurrent Sessions					
ROOM	215	216	217	218	PLENARY 3
<b>9.00 - 11.00</b>	<b>Session 41 Sustainable construction 2 Working Group 5 and Working Group 21</b>	<b>Session 42 Life-cycle design and assessment of structures 2</b>	<b>Session 43 Lattice structures</b>	<b>Session 44 Civil structures</b>	<b>Session 45 Topology Optimisation 2</b>
9:00- 9:15	#201- Sydney's Central Station upgrade – Design modularity and heritage enhancement in the renewal of the Grand and Northern Concourse <b>Mr Michael Chernyavsky</b>	#23- Autarkic office boat <b>A/Prof Arno Pronk</b>	#121- Structural Design of a Public Library with Lamella Shell Roof <b>Dr Yoshiharu Kanebako</b>	#94- Innovative design of a pedestrian bridge using multi-material topology optimisation <b>Mr Lai Yaping</b>	#78- Topology optimisation considering buckling in architectural design <b>Mr Tao Xu</b>
9:15- 9:30	#560- Built Environment Prototyping for Design-Value <b>Mr Darcy Zelenko</b>	#312- Exploring selected LCA factors for tall buildings in today's growing cities <b>Dr Petr Vegh</b>	#221- An analytical solution to measure stress concentration factors of additive manufactured surface <b>Miss Mengna Zheng</b>	#487- Multi-Modal Transportation-Hub: Marine-Air-Land Terminal, the Israeli Case Study <b>Prof Michael Burt</b>	#39- Research on generative generation of rigid joints in single-layer space grid structures <b>Dr Fengcheng Liu</b>
9:30- 9:45	#309- CLT Requires a New Approach to Design: A Case Study in CLT Folded-Plate Structure <b>Ms Yoko Masuda</b>	#397- Optimal sensor placement of large-span spatial structures based on sensitivity analysis <b>Miss Yiqun Wang</b>	#425- Structural Optimization of Lattice Shells with Geometric Nonlinearity using Machine Learning <b>Mr Yuma Yabuuchi</b>	#34- Investigation of frequency variation in a moving mass-beam system <b>Prof Judy P. Yang</b>	#190- Truss topology optimisation considering constructability constraints <b>Mr Ajmal Babu Mahasrankintakam</b>
9:45- 10:00	#501- ReconWood Slab. Computational Design and Structural Optimization of Reconfigurable Timber Slabs <b>A/Prof Roberto Naboni</b>	#497- Interactive design with optimum matchmaking of reused structural elements – a software implementation <b>Mr Jonas Warmuth</b>	#51- Crushing of functionally graded hybrid lattice structures <b>Ms Chamini Thuppa Mudalige Rodrigo</b>	#520- Integrated bridge structure design process through Finite element analysis (FEA) and pixel-based visibility culling method <b>Ms Ana Gabriela Loayza</b>	#254- Intelligent parametric optimization design of three-centered circular reticulated shell structures <b>A/Prof Guozhi Qiu</b>
10:00- 10:15	#384- A convolutional neural processes-based approach for anomaly detection of structures <b>Mr Jingyu Zhao</b>	#260- Long-term strength prediction model for structural glass <b>Miss Siyi Yi</b>	#485- Topology Optimization of Three-dimensional Isotropic Auxetic Metamaterials with Unusual Thermal Expansion <b>Mr Zuyu Li</b>	#292- Numerical study of structural behaviour of bridge link slabs constructed using hybrid fibre reinforced engineered cementitious composites <b>Prof Yixia (Sarah) Zhang</b>	#103- Multi-loading topology optimization and additive manufacturing of joints of reticulated shells <b>Prof Bingbing San</b>
10:15- 10:30	#212- Bridging Design and Fabrication: BIM Application in Two Prefabrication Projects <b>Mr Hing Ching Lau</b>	#262- Probability-based Life Cycle Carbon Emission Assessment for Space Grid Structures <b>Mr Jianzhou You</b>	#499- Research progress on materials and structures with negative Poisson's ratio <b>Prof Xin Ren</b>	#602- Structural Health Monitoring for Bridge using Improved Vehicle Scanning Method <b>Dr D.S. 'Ted' Yang</b>	#442- A boundary-finite element coupling framework for topology optimization in unbounded media <b>Mr Aldemar Siqueira</b>
10:30- 10:45	#126- Compression resistance of digitally fabricated hollow timber columns <b>Dr Dan Bempa &amp; Stephan Rapley</b>	#361- Neural ODE-based data-driven approach for prediction of the creep behavior of steel cables <b>Mr Weijia Zhang</b>		#406- BuildDigiCraft: New Mindset for High-quality Baukultur in Europe <b>Prof Annette Boegle</b>	#104- Topology optimization of spatial grid structures considering member stability based on linear allowable stress iteration <b>Prof Ruo-Qiang Feng</b>
10:45- 11:00	#553- Digital control of trihexagonal weaving pattern for fabrication at an architectural scale <b>Mr Mohaimeen Islam</b>				#423- A reaction diffusion-based B-spline level set method using body-fitted mesh for structural topology optimization <b>Ms Cong Wang</b>

11.00 - 11.30

MORNING TEA

# Parallel Sessions

Thursday 13 July 2023

ROOM	215	216	217	218	PLENARY 3
<b>11.30 - 13.00</b>	<b>Session 46</b> <b>Conceptual design</b>	<b>Session 47</b> <b>Transformable structures</b> <b>Working Group 15</b>	<b>Session 48</b> <b>Digital modelling and fabrication 3</b>	<b>Session 49</b> <b>Deployable and inflatable structures</b>	<b>Session 50</b> <b>Next generation parametric design</b> <b>Working Group 13</b>
11:30- 11:45	#495- A Conceptual Numerical Analysis Tool for Development of Spatial Structures <b>Mr Sverre Haakonsen</b>	#400- Design and development of a hybrid deployable spherical shield based on foldable plate structures and scissor systems <b>Mr Kevin Moreno Gata</b>	#546- Towards upscaling membrane tensegrity shells: A design-to-fabrication workflow <b>Dr Ying Yi Tan</b>	#575- Manual Deployment and Shape Determining Method of Guide Frame for Tunnel Inspection by Force Control <b>Prof Fumihiko Inoue</b>	#569- Design workflows for a complex urban steel artwork <b>Dr Sascha Bohnenberger-Fehr</b>
11:45- 12:00	#430- Contribution of structural intuition at early conceptual stage in efficient workflow: A precedent study of Oscar Niemeyer <b>Ms Irem Serefoglu</b>	#339- Snap-through buckling detection and analysis method for multi-stable structures <b>Ms Ruta Stankeviciute</b>	#330- Morphogenesis method for thin metal plate with non-uniform stiffness distribution by applying auxetic mechanism <b>Mr Hirotaka Ujioka</b>	#185- A Foldable Modular Structure Unit Inspired by Kirigami <b>Prof Jae Yeol Kim</b>	#465- Pixel Program: a filter-feature/quantitative-based approach towards a parametric program distribution Method for hybrid buildings <b>Mr Alejandro Fuentes</b>
12:00- 12:15	#510- Conceptual design and parametric modelling of pretensioned stiffened membranes <b>Mrs Iuliia Lebedeva</b>	#455- Grasshopper Workflow for Designing and Fabricating Hoberman-type Double-Curved Kinetic Structures <b>Mr Wei Wang</b>	#434- Digitization and Construction of Steel-frame Double Curvature Façade with A Spatial Element: Chongqing Center for Planning and Exhibition as Example <b>Mr Menghao Yuan</b>	#233- Section design and performance optimization of C-cross section thin-walled deployable boom <b>Mr Fengyuan Liu</b>	#161- Isogeometric deep learning framework to predict the structural performance of free-form surfaces <b>Dr Kazuki Hayashi</b>
12:15- 12:30	#205- Structural Design of Flat and Spiral Buildings with Inclined Pillars <b>Mr Ken Noda</b>		#572- Xtect: A digital intelligence platform for off-site prefabricated construction <b>Mrs Wanyu He</b>	#60- Comparison of biologically inspired functionally graded deployable geosystems with experimental measurements <b>Prof Ann Sychterz</b>	#275- Using Data-Rich Objects in Geometric Parametric Modelling <b>Prof Lennert Loos</b>
12:30- 12:45	#64- Using Augmented Reality for interactive value engineering of structural steel connections <b>Ms Yuyu Wang</b>		#200- Nonlinear Analysis of Multi-scale Coupling Based On Coordinated Distributing Method <b>Mr Junjie Yao</b>	#232- Surface Accuracy Analysis and Test on 0.5 m Aperture Wrap-rib Deployable Antenna <b>Mr Han Zhang</b>	#97- Form finding and structural analysis of free-form shells with specified horizontal projected stress distribution <b>Mr Taku Nakajima</b>
12:45- 13:00	#118- Topology optimisation considering subjective preferences: current progress and challenges <b>Mr Zhi Li</b>		#193- Design and construction complex shell structure using U-shaped glass and steel frame with collaborative robotics and human expertise <b>Dr Lei Yu</b>		#151- Real-world medical research centre in Melbourne, Australia: An exemplar project for cross-disciplinary parametric modelling to reduce building lifecycle carbon emissions. <b>Mrs Amy Nuccio</b>
<b>13.00 - 14.00</b>	<b>LUNCH</b>				

# Parallel Sessions

Thursday 13 July 2023

ROOM	215	216	217	218	PLENARY 3
<b>14:00 - 16:00</b>	<b>Session 51 Optimisation methods and applications 3 Working Group 5</b>	<b>Session 52 Active bending and graphical methods Working Group 15</b>	<b>Session 53 Building and construction</b>	<b>Session 54 Design Competition Working Group 21</b>	<b>Session 55 Bamboo structures</b>
14:00- 14:15	#187- Development of 3D mathematical models for tendon layout optimization by strain energy minimization <b>Miss Hanna Domnick</b>	#375- The extended affine method for form finding of a spoke wheel system in light of graphic statics: part 2 <b>Dr Hiroki Tamai</b>	#349- Tile patterning on free-form surfaces that reduces tile cutting <b>Ms Chaoyu Du</b>	#313- Constructing topologically optimized spatial structure using innovative mortise-and-tenon joints <b>Dr Nic (Ding Wen) Bao</b>	#398- Development of Full-Scale Bamboo Kits for Educational Activities <b>Dr Alireza Behnejad</b>
14:15- 14:30	#338- The stability of laminated glass plate during anticlastic cold bending <b>Miss Xiaohan Hao</b>	#401- Interlocking connections for bending-active timber structures with variable stiffness <b>Ms Maren Zywiets</b>	#271- The hybridstatics by Heinz Hossdorf- interaction between physical models, material and the first computers <b>Mr Baris Wenzel</b>	#114- Clustering and optimisation of nodes, beams and panels for cost effective fabrication of free-form surfaces <b>Dr Minghao Bi</b>	#125- Experimental evaluation of load-induced cracking in moso bamboo tubes <b>Dr Dan Bompa</b>
14:30- 14:45	#359- Shape optimization of hyperellipsoid long-span structures <b>Mrs Y. Q. Qu</b>	#266- 3D auxetic materials designed with algebraic polyhedral graphic statics <b>Mr Yao Lu</b>	#82- Fabrication methods for topology-optimized massive glass structures <b>Dr Faidra Oikonomopoulou</b>	#404- A reconfigurable construction system based on hyper timber components <b>Dr Markus Hudert</b>	#516- Morphological generation of bamboo arched reciprocal frame structures considering variation in diameters by means of GA <b>Prof Koichiro Ishikawa</b>
14:45- 15:00	#302- A Study on the Binary Harmony Search Algorithms for an Optimal Design of Truss System <b>Miss Ha Hyeonju</b>	#168- Calculation Method for Restoring Force of Member and Deformation Occurred by in Curved Surface Combined with Flat Plates and Bolts <b>Mr Daichi Mori</b>	#319- Structural features of Dong'an Lake Stadium roof <b>Dr Xin An Xiang</b>	#378- Triply periodic discrete surface of constant negative curvature constructed from one type of piece <b>Mr Kanata Warisaya</b>	#239- The potential of engineered bamboo for lamellar gridshells <b>Dr Leila Meneghetti</b>
15:00- 15:15	#355- Study on the influence of structural optimization techniques on architectural design, with a focus on topology optimization methods <b>Mr Bunji Izumi</b>	#540- Study on shape control method for active bending arch structures using kerf bending technique <b>Prof Yuki Ozawa</b>	#346- Study on the dismantling method of cable-strut tension structures <b>Dr Jiaqi Yang</b>	#177- Controlling Frills of Bending-Active Negative Curvature Surface <b>Prof Tomohiro Tachi</b>	#56- Preliminary study on relationship between culm morphology and mechanical characteristics of Japanese bamboo <b>Dr Takuo Nagai</b>
15:15- 15:30	#559- Reconfigurable form-finding adopting tessellation and auxetic concepts <b>Mrs Sabrina Sparano</b>	#536- Investigation of cross-sections for hybrid gridshells based on bending-active formwork <b>Ms Yasaman Yavaribajestani</b>	#131- Shape generation of hexagonal lattice shell consisting of edge offset mesh <b>A/Prof Ryo Watada</b>	#526- Coupled thick-panel origami tubes along creases for stiff deployable structures <b>Mr Sunao Tomita</b>	#253- Study on compression strength of Japanese full-culm bamboo columns using short length specimens <b>Mr Keisuke Oki</b>
15:30- 15:45					#277- Drying-induced cracking in bamboo <b>Prof Moe Pourghaz</b>
15:45- 16:00					#508- An investigation of the mechanical test methods for bamboo characterization <b>Holmer Savastano Junior</b>
16:00- 16:30	AFTERNOON TEA				
	ROOM: PLENARY 3				
16:30- 17:00	Betwixt and Between <b>Prof Donald Bates</b>				
	ROOM: PLENARY 3				
17:00 - 17:30	Inspiration and Evolution <b>Mr Neil Stonell</b>				
	ROOM: PLENARY 3				
17:30 - 18:00	Closing Ceremony				

# Accompanying Persons Program

## Melbourne City Walking Tour

**Date: Monday 10 July 2023**  
**Time: 14:00 – 17:00**

Across the 3 hours, guests will explore the city by foot and visit:

- Federation Square
- Flinders St Station
- Degraives St
- Centre Place
- Collins St
- Block Arcade
- Royal Arcade
- Bourke St
- Fashion Quarter
- China Town
- Greek Quarter
- ACDC Lane
- Flinders Lane
- Duckboard Place
- Hosier Lane

The tour is set to cover these destinations so that it includes a true Melbourne feel of street art, local culture, coffee culture, art and history.

## Welcome Reception

**Date: Monday 10 July 2023**  
**Time: 18:30 – 21:00**

Guests can take this opportunity to unwind with some music, food and drinks with the other delegates, at the IASS 2023 Welcome Reception.

## Guided Tour of the National Gallery of Victoria (NGV-I)

**Date: Tuesday 11 July 2023**  
**Time: 13:00 – 16:00**

After enjoying a delightful lunch at the NGV-guests will get to explore some of the highlights of the galleries collection with one of the knowledgeable NGV Guides. See not-to-be-missed historical and contemporary works and visitor favourites from around the world and hear the stories and ideas behind them.



## Guided Tour of the State Library of Victoria

**Date: Wednesday 12 July 2023**  
**Time: 11:00 – 12:00**

Guests will get a behind the scenes an historic tour of the beautiful State Library of Victoria, Australia's oldest public library. The library's collection houses over four million items, which in addition to books includes, manuscripts, paintings, maps, photographs and newspapers with a special focus on material from Victoria, including the diaries of the founders of Melbourne. Enjoy this guided tour with a State Library team member who will cover the exciting history, stories and hidden secrets the library is keeping.

## Guided Tour of the Royal Botanical Gardens

**Date: Wednesday 12 July 2023**  
**Time: 15:00 – 18:00**

Guests get a guided tour to enjoy the most iconic of Melbourne's Gardens'. Led by a passionate guide, discover sensational views and the remarkable plant diversity of this sanctuary in the middle of bustling Melbourne.



fabricate for you

### FAB-UNION 一造科技

**FUGenerator**  
A cloud-based platform powered by artificial intelligence that helps designers generate inspiration.

**FURobot**  
A user-friendly robot control software with eight functional modules.

**FUMeta**  
Creates metaverse scenarios that combine the virtual and real in interactive scenes.

**FUSense**  
A construction robot sensing, positioning, response, and control software platform.

**FUConstruction**  
Redefine the robotic platform for building construction.

**FUDesign**  
A premium product design brand affiliated with FAB-UNION.

**Fab-Union**, a Shanghai-based high-tech enterprise, seamlessly integrates AI design and digital construction using architectural robots. With 15 innovative intelligent construction processes, **Fab-Union** has successfully implemented their technology in over 30 demonstration projects worldwide.

- AIGC leveraging cloud-based services in construction
- Intelligent Fabrication revolutionize the manufacturing process
- Robot Construction Technology Innovative, Efficient, Cutting-edge
- Green Building sustainable & energy-efficient with intelligent features

www.fab-union.com  
 Email: info@fab-union.com  
 81 GONGGONG RD, YANGPU DISTRICT, SHANGHAI

# Sponsors and Exhibitors



LANDREAM

## Landream

### Booth Number: 1

Contact Person: Iris Xiong  
Address: L12, 41 Exhibition St  
Melbourne VIC 3000  
Australia

Phone: 0451 461 678  
Email: [iris@landream.com.au](mailto:iris@landream.com.au)  
Web: [www.landream.com.au](http://www.landream.com.au)

With a vision of cultivating spaces that enrich lives and empower dreams, Landream develop, manage and own a diverse portfolio of property across Victoria and New South Wales.

Established in 2005, over the next five years, Landream will deliver a combination of residential, commercial, industrial, build-to-rent and mixed-use projects worth more than \$2 billion. Landream's investment portfolio holds a number of strategic sites earmarked for future development and further acquisitions remain a key focus.

With over 150 years of combined expertise in property development, construction and investment, Landream's professional team has forged a reputation for consistently delivering outstanding projects within Australia of a global standard.

Landream always strives to deliver on its promise, in line with the company's values of integrity, design intelligence, enrichment and respect.

Ensuring considered and innovative design outcomes that enhance people's lives, Landream recognises the importance of all collaborators and client relationships, only partnering with companies of the same high standards.

Landream's development capabilities enable the Group to also provide development management services through all stages of the development process, from pre-acquisition through to post-settlement management.

With a robust pipeline of exciting projects, Landream is well positioned to continue delivering enduring, visionary projects of international standing.



## Fab-Union

### Booth Number: 2

Contact Person: Yuting Chen  
Address: Gongqing Road 81, Yangpu District  
Shanghai, China

Phone: +86 18961743232  
Email: [info@fab-union.com](mailto:info@fab-union.com)  
Web: [www.fab-union.com](http://www.fab-union.com)

Fab-Union, a high-tech enterprise based in Shanghai, seamlessly integrates AI design and digital construction using architectural robots. As a pioneer in the development of integrated application technology for intelligent construction, Fab-Union harnesses the creative design principles of AIGC and Metaverse scene art for virtual digital design and construction.

As a leading robotic intelligent construction service provider in the industry, Fab-Union Technology has independently developed a diverse array of construction robot hardware platforms tailored for both prefabrication and on-site construction. This has led to the redefinition of the digital economic platform for intelligent production of digital intelligent building products, incorporating numerous innovative building construction processes.

With 15 innovative intelligent construction processes, Fab-Union has successfully implemented their technology in over 30 demonstration projects worldwide. Fab-Union's continuous integration mindset and cognitive iteration of urban renewal and building intelligence enable a multitude of processes and technologies to support urban renewal and development in this new era.



*Melbourne Australia*

## MOR Melbourne Australia

### Booth No. 3

Contact Person: Katherine Shang  
Address: Suite 901, 580 Collins St,  
Melbourne, VIC, 3000  
Australia

Phone: 0424566060  
Email: [katherine.shang@uaholdings.com.au](mailto:katherine.shang@uaholdings.com.au)  
Web: [www.morboutique.com](http://www.morboutique.com)

Established in 2001, MOR has been on an ever-evolving journey relling in tales of by-gone eras, travel, apothecary and art, inspiring the creation of luxe bath, body and lifestyle products.

Each one of the collections strives to capture the essence of luxury and an evocative story; emanating a moment of time and enrapturing you on a journey where your senses are ignited and reimagined.

With distinctive ranges admired globally, MOR's philosophy is to provide a unique sensory journey where an everyday practice turns into an indulgent ritual – from the finely curated formulation to the exceptionally detailed and opulent packaging.

MOR invites you to experience and surrender to the awakening of your senses with the blending of old-time ingredients, beautifully selected fragrances and luxuriously rich creations.

Welcome to the world of MOR.

# Sponsors and Exhibitors



## Eureka Technology

### Table Top Display No: 1

Contact Person: Lisa Lu  
Address: Level 19, 357 Collins Street  
Melbourne, 3000  
Australia

Phone: +61481961624  
Email: [lisa.lu@eurekaintl.com.au](mailto:lisa.lu@eurekaintl.com.au)  
Web: [www.eurekatechin.com.au/](http://www.eurekatechin.com.au/)

Eureka Technology Innovation & Investment (Eureka TechIN) was established in 2017, affiliated with Eureka International Group. It was built to serve as a major platform for technology innovation and investment for small/medium-sized enterprises in the Asia-Pacific region. Our service leading-edge platform promotes international matchmaking for technology translation projects, capital raising, and government investment resources.



## The University of Queensland

Contact Person: Rachael Woodman  
Address: Zelman Cowen Building (51), Staff House Rd  
St Lucia, Queensland, 4072  
Australia

Phone: 07 3365 3843  
Email: [engagement@architecture.uq.edu.au](mailto:engagement@architecture.uq.edu.au)  
Web: [www.architecture.uq.edu.au](http://www.architecture.uq.edu.au)

For more than a century, The University of Queensland has educated and worked with outstanding people to deliver unparalleled teaching, learning and research excellence that creates positive change globally.

The newly formed School of Architecture, Design and Planning paves the way for a future where creativity, innovation, and sustainability converge to empower students to become transformative leaders who shape the design and built environments of tomorrow.



## TTW

### Table Top Display No: 2

Contact Person: Atreyu de Lacy  
Address: Level 13, 379 Collins Street  
Melbourne VIC 3000  
Australia

Phone: (03) 9602 1433  
Email: [Atreyu.delacy@ttw.com.au](mailto:Atreyu.delacy@ttw.com.au)  
Web: [www.ttw.com.au](http://www.ttw.com.au)

For over 65 years TTW have partnered with architects, developers, builders and project managers to tackle the most complex projects and engineer their vision.

We are a privately owned company of 350+ employees working on a global scale. Our services include Structural, Civil, Traffic, Façade, Construction, Applied Science and Digital Engineering.



## Ezsteel

Contact Person: Dongliang Fu  
Address: Factory 3/6-16 Joseph Street,  
Blackburn North, VIC 3130  
Australia

Phone: 1300 188 388  
Email: [info@ezsteel.com.au](mailto:info@ezsteel.com.au)  
Web: [www.ezsteel.com.au/](http://www.ezsteel.com.au/)

Ezsteel provides high-quality design, fabrication and maintenance of light-gauge steel and structural steel frames for residential and commercial buildings.



## The University of Melbourne

Contact Person: Prof Tuan Ngo  
Address: Dept of Infrastructure Engineering,  
The University of Melbourne  
VIC 3010

Australia  
Phone: +61383447950  
Email: [dtngo@unimelb.edu.au](mailto:dtngo@unimelb.edu.au)  
Web: <https://www.unimelb.edu.au/>

The Advanced Protective Technologies of Engineering Structures (APTES) Group led by Prof Tuan Ngo at the University of Melbourne is as one of the leading centres in advanced materials & structural systems, and physical infrastructure protection in Australia and the Asia Pacific region.



## Exhibitors

### FreeGrid

#### Table Top Display No: 3

Contact Person: Stefano GABRIELE  
Address: Via Aldo Manuzio 68L  
Roma, RM, 00153  
Italy

Phone: +39-(0)6-5733.6364  
Email: [freegrid@ctanet.it](mailto:freegrid@ctanet.it)  
Web: [www.sites.google.com/view/freegrid](http://www.sites.google.com/view/freegrid)

FreeGrid is an international benchmark intended to test and compare different approaches to the design of gridshells, from man-based heuristic design to AI-based one.



# Exhibition Floor Plan

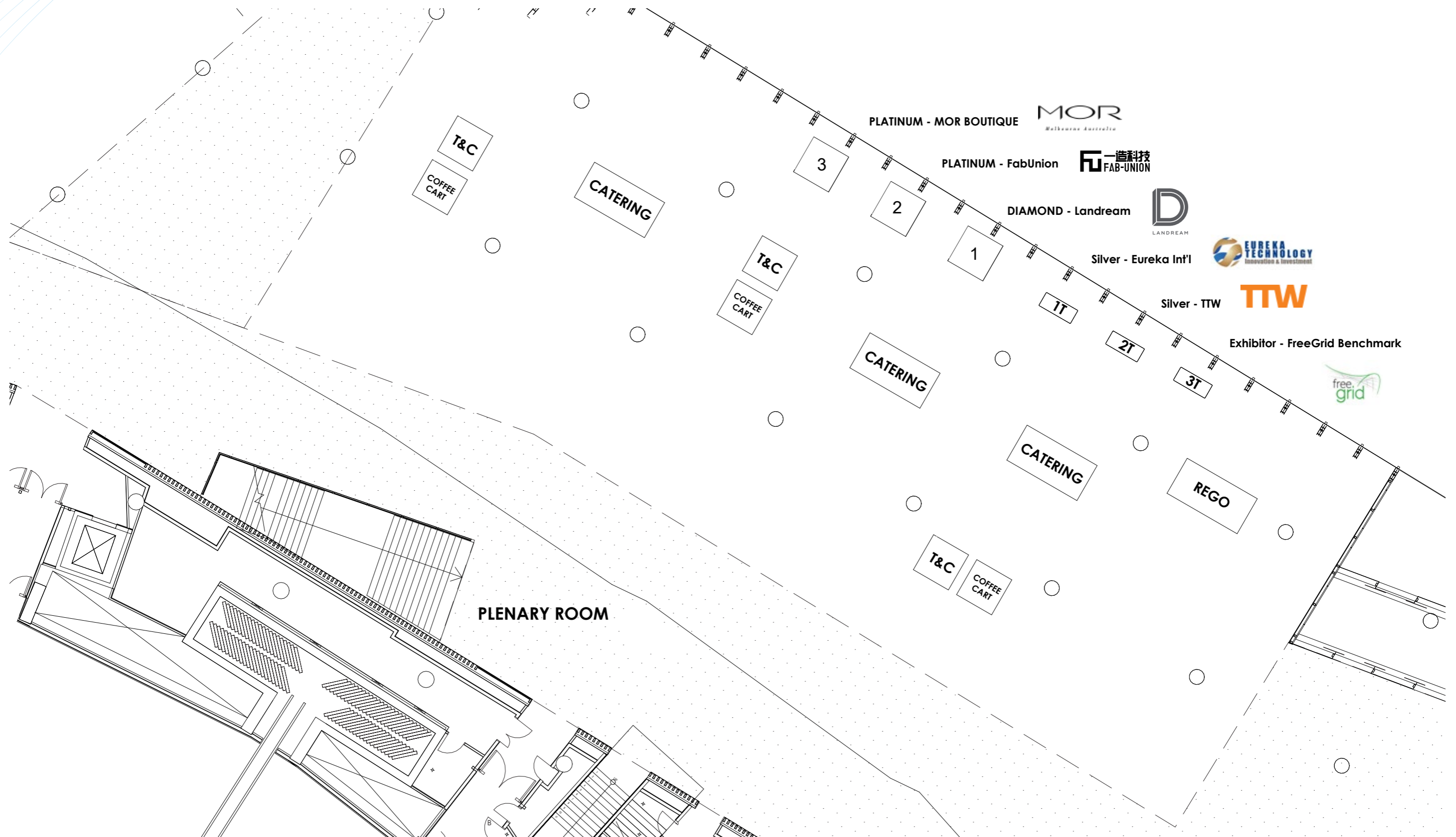



**IASS 2023**  
July 10–14 Melbourne  
Integration of Design  
and Fabrication

International Association for Shell and  
Spatial Structures Annual Symposium

# Presentation Details

---

# 2023

# Monday 10 July 2023



Monday 10 July 2023

# Masterclass 1

**Tensys: Physical Form-Finding Method**

Room 215  
14:00 - 16:00

Presented by

**Peter Lim**



Monday 10 July 2023

# Session 2

**Timber and bio-based structures 1**

Room 216  
14:00 - 16:00

# Monday 10 July 2023



## Derivation of wind loads for shell structures using CFD analyses

**Prof Christian Heidenreich<sup>1</sup>**, Mr. André Kilian<sup>1</sup>, Ms. Josephin Büttner<sup>2</sup>, Ms. Sophie Scherer<sup>1</sup>, Mr. Max Launer<sup>2</sup>

<sup>1</sup>HTW Dresden / Chair Statics And Structural Analysis, <sup>2</sup>HTW Dresden / Research Project TimberPlan+

The construction of buildings consumes a large proportion of the energy and raw materials available worldwide. In order to increase sustainability in construction, high-performance structural systems are required. In particular, load-flow matched shell structures can bridge large spans with low material consumption. Asymmetric snow and wind loads are to be considered relevant for the design. By means of a comparison of standards, it is shown that the lateral wind flow on shell structures is represented very differently. In this study, an approach to determine the wind load pressure coefficients for a timber shell structure using computational fluid dynamics (CFD) is presented. Using a parametric structure, different geometries can be generated and analyzed for wind load coefficients.

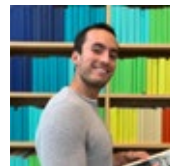
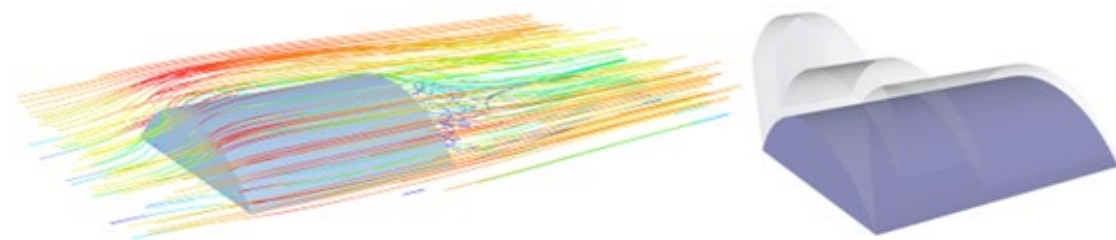

## Experimental investigation on the bending response of reuse-ready timber slabs – The Pixel Slab System

**Dr Xavier Estrella<sup>1</sup>**, Mr Johnny Syriani<sup>1</sup>, Dr Corentin Fivet<sup>1</sup>

<sup>1</sup>École Polytechnique Fédérale de Lausanne (EPFL), Structural Xploration Lab (SXL)

This paper presents an experimental investigation on the bending behavior of reusable glue-laminated timber (GLT) slabs-Pixel Slab System- designed under Circular Economy principles. The system employs an arrangement of orthogonally intersecting GLT beams to form a reusable grid slab, relying on reversible connections and standard elements to guarantee easy assembly/disassembly. To evaluate the system performance, twelve full-scale GLT beams were tested under bending load, employing different spans, depths, and connection placements. Results showed that the system has adequate performance under 3- and 4-point loads; however, the use of notches at the intersections reduced its stiffness and moment capacity by 23% and 29%, respectively.

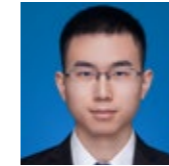
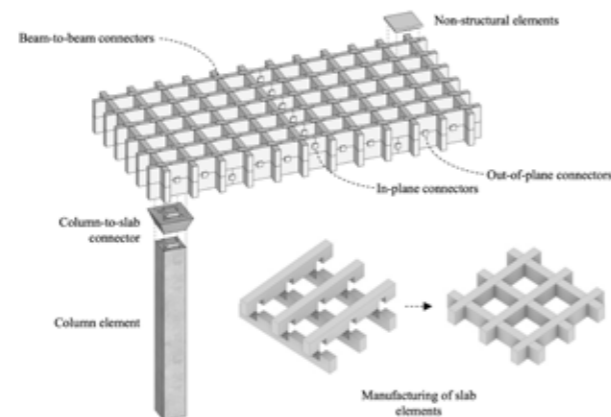

## Testing on the shear performance of embedded steel tube glulam joints in arched timber structures

**Ph.D Candidate Chengyang HE<sup>1</sup>**, Prof Minjuan He<sup>1</sup>, Associate Prof Zheng LI<sup>1</sup>, Senior Engineer Yong Liang SUN<sup>2</sup>

<sup>1</sup>Tongji University, <sup>2</sup>Tongji Architectural Design(Group) Co.

Glulam arches have promising mechanical properties in large-span structures. In some cases, several arches are connected with each other with members, where the connections between web members and arches come into place. This paper studies the mechanical properties of a type of embedded steel-tube glulam joint applied in Tianfu Agricultural Exposition project, which contains five long-span timber arch truss structures, achieving clear spans up to 118m and heights up to 44m. Experimental tests were conducted on three full-scale joint specimens with two dimensions of steel tubes. The test results proved the shearing capacity to be reliable compared to the design forces. The theoretical results prove to be conservative mainly because such large steel tubes in glulam joints were seldom considered.

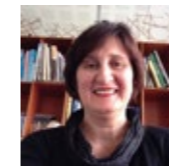
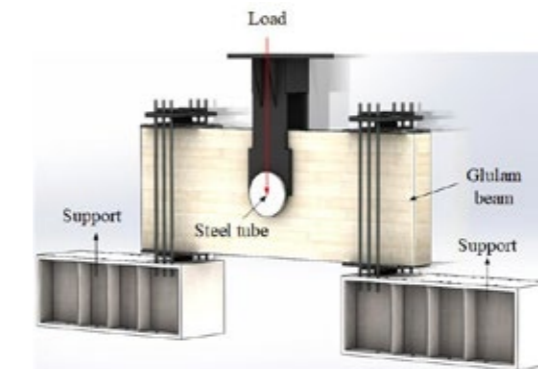

## Reversible timber only connections – an investigation into the potential of threaded dowels and swelling for reconfigurable truss components

**Ms Olga Popovic Larsen<sup>1</sup>**, Mr Xan Browne<sup>2</sup>,

<sup>1</sup>Royal Danish Academy: Architecture, Design, Conservation

Current design for disassembly strategies rely on geometry relations between parts, with little thought given to the potential of inherent material properties to foster reversibility. This study investigates methods for the assembly and disassembly of timber only structures, utilising reclaimed timber and wood's swelling and shrinkage to create reversible connections. The paper contributes with experimental data to demonstrate ideal assembly, in-use, and disassembly conditions, with significant variation demonstrated. This practical approach is then applied in a truss structure, a component-based typology that is reconfigurable to different spans, geometries and scales. Finally, the project's opportunities and challenges are evaluated, offering insights into how the project can contribute to a more sustainable building practice, in balance with the resources it depends on.



# Monday 10 July 2023



## Digital twin of wooden shingle envelopes

**Ms Farzaneh Eskandari<sup>1</sup>**, Dr Petras Vestartas<sup>1</sup>, Prof. Dr. Yves Weinand<sup>1</sup>

<sup>1</sup>École polytechnique fédérale de Lausanne

Wooden shingles have long been used as a vernacular roofing technique. Although shingles are low in embodied energy, nowadays they are not used in construction as the craft knowledge for building shingle envelopes has not been well-documented. This research provides a technical approach for digitization and generation of an as-built three-dimensional reconstruction of shingle envelopes. Towards this aim, digital twins of these envelopes are generated based on step-by-step 3D scanning of shingles and point-cloud processing. Furthermore, all assembly rules, and technical details of the construction process are documented and explained in detail. This work concludes with potential research directions including design automation of wooden shingle envelopes which could help the industry re-introduce the use of local raw wood in contemporary architectural constructions.

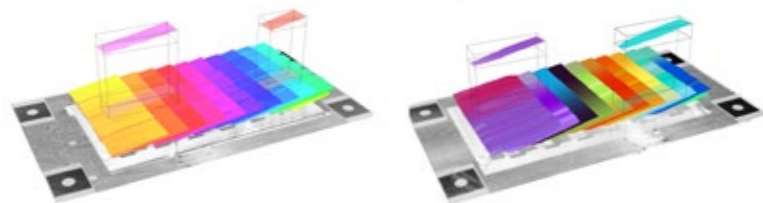

Digital Twin of wooden shingle envelopes  
 a. Digitization of an envelope built with Bardean  
 b. Digitization of an envelope built with Tafilien



## Post-tensioned strapping connections for rapid assembly of low-cost timber structures

**A/Prof Joseph Gattas<sup>1</sup>**, Mr Shaobo Xu<sup>1</sup>, Mr Zhengtao Lu<sup>1</sup>, Mr Zhuo-Yang Xin<sup>1</sup>,

<sup>1</sup>University of Queensland

This paper explores the development of novel post-tensioned strapping connections for low-cost and high-speed timber framed construction. The strapping is made from a cheap and widely-available polyester packaging material, which can be tensioned and sealed using inexpensive hand tools. The connections are designed conceptually as adaptations of semi-rigid post-tensioned or mortise-and-tenon connections used for permanent timber constructions. Two types of semi-rigid joints were developed which achieve a rotational stiffness via different mechanical behaviours. Connection rotational stiffness and strength capacity is established with experimental testing. Full-scale prototypes were built to establish connection suitability for the rapid structural assembly of lightweight timber elements and prefabricated panels.



## Inventory-Constrained Design of a Variable Small Diameter Round Timber Structure

**Mr Kim Baber<sup>1</sup>**, Mr Aaron Barton, Professor Jane R Burry, Mr Canhui Chen, Dr Joseph M Gattas, Dr Christoph Koch

<sup>1</sup>University of Queensland

To improve the supply of renewable building materials, forestry industries are seeking better ways to yield structural timber products from low diameter logs. This paper investigates the design of an optimised branched timber structure that utilises minimally processed round logs using a digital form-finding tool that combines the dual processes of Inventory-Constrained Design and Combinatorial Equilibrium modelling (CEM). The CEM model optimises the geometric assignment of an inventory in a branched column structure, and this geometry was developed into a proof-of-concept design with physical prototyping of the connection nodes undertaken. The development of this optimisation tool and the prototyping of the nodes, demonstrates a novel application for marginally valued forest resources, reducing waste within the forestry and wood product industry.

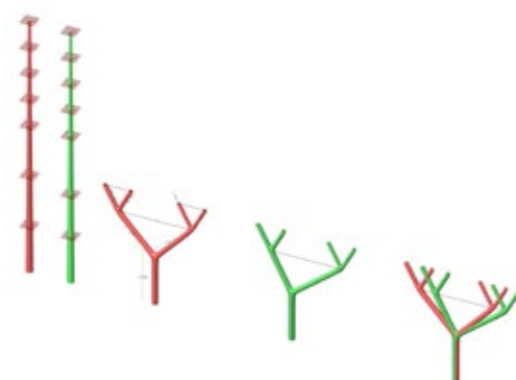

Monday 10 July 2023

# Session 3

## Dynamic response of structures 1

Room 217  
14:00 - 16:00



### Seismic Force Reduction Factor Evaluation for Double-layered Domes Supported by Single-Story Substructures

Dr Yuki Terazawa<sup>1</sup>, Ms. Haruna Shijo<sup>1</sup>, Dr. Deepshikha Nair<sup>1</sup>, Dr. Toru Takeuchi<sup>1</sup>

<sup>1</sup>Tokyo Institute of Technology

Static elastic analysis procedures with seismic force reduction factor remain the cornerstone of seismic design practice even now because it is simple to use and does not require engineers to have an understanding of structural dynamics. However, particularly for metal spatial structures with complicated vibration characteristics, the actual (appropriate) force reduction factor has not been investigated yet in detail. Therefore, in this study, a series of nonlinear response history analyses for double-layered domes supported by single-story substructures were performed to investigate the effect of the design specification of the dome structures on the seismic force reduction factor  $D_s$  and ductility ratio  $\mu$ .

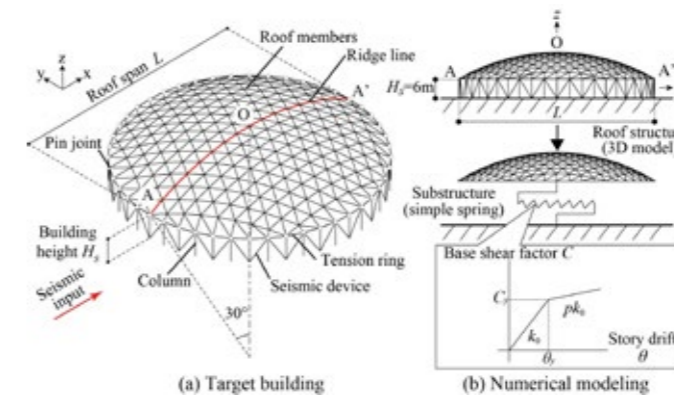

### Study on finite element numerical simulation of seismic response of suspended-dome structure

A/Prof Guojun Sun<sup>1</sup>, Dr. Shuo Xiao<sup>1</sup>, Prof Xiongyan Li<sup>1</sup>, Prof Suduo Xue<sup>1</sup>

<sup>1</sup>Faculty of Architecture, Civil and Transportation Engineering, Beijing University of Technology

Suspended-dome structures are widely used as a typical representative of spatial structures with large spans. While there have been many studies on the seismic performance of traditional spatial grid structures, such as reticulated shells, trusses, and arches, there are relatively few studies on the seismic performance of suspended-dome structures under strong seismic. This paper aims to investigate the mechanical response and failure mechanism of suspended-dome structures under strong seismic considering different bearing conditions. The results indicate that the displacement under the action of three-way hinged constraints is smaller than that of the radial release structure, and the failure mode of the suspended-dome structure under different support conditions during strong seismic is steel tie rod failure.

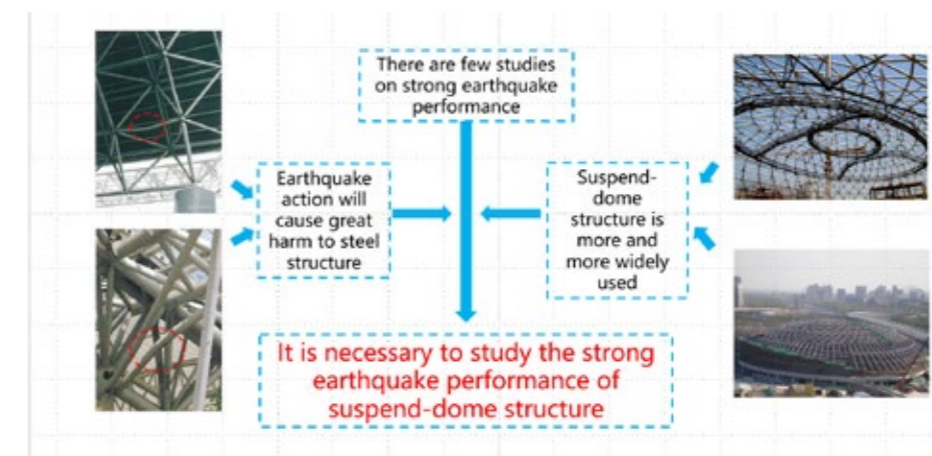

# Monday 10 July 2023



## Collapse mechanism under strong earthquake and seismic design of single-layer aluminum alloy latticed shells

Prof Jinzhi Wu<sup>1</sup>

<sup>1</sup>Beijing University Of Technology

In order to study the seismic performance of aluminum alloy latticed shells, the material properties, the cyclic behaviour of H-section aluminium alloy members under axial and eccentric loads have been studied, and then two shaking table tests of a cylindrical and a spherical single-layer latticed shells have been carried out. The nodal displacement and acceleration and member forces of the shells are studied under frequent and rare earthquakes, when both models keep in elastic stage. And then, the collapse tests have been conducted to both model shells under severe earthquakes, and the whole collapse processes are studied



## Mechanical properties of the curvature-consistent frictional pendulum isolation system and vibration control of spherical reticulated shell

Dr Niyi Liang<sup>1</sup>, Prof Xudong ZHI<sup>1</sup>

<sup>1</sup>Harbin Institute of Technology

We proposed a type of curvature-consistent frictional pendulum isolation system that may induce notable seismic isolation effects in long-period and long-span spatial structures during rare earthquakes in this study. Taking the isolation system as the research object, a series of mechanical performance tests were carried out. The hysteretic characteristics and energy dissipation mechanism of the isolation system were analysed, and a refined numerical simulation method was established. The accuracy of the simulation method was verified by comparing the simulation results with experimental results. The isolation system was applied to a double-layer spherical reticulated shell structure, and the dynamic time history response of the structure was analysed.

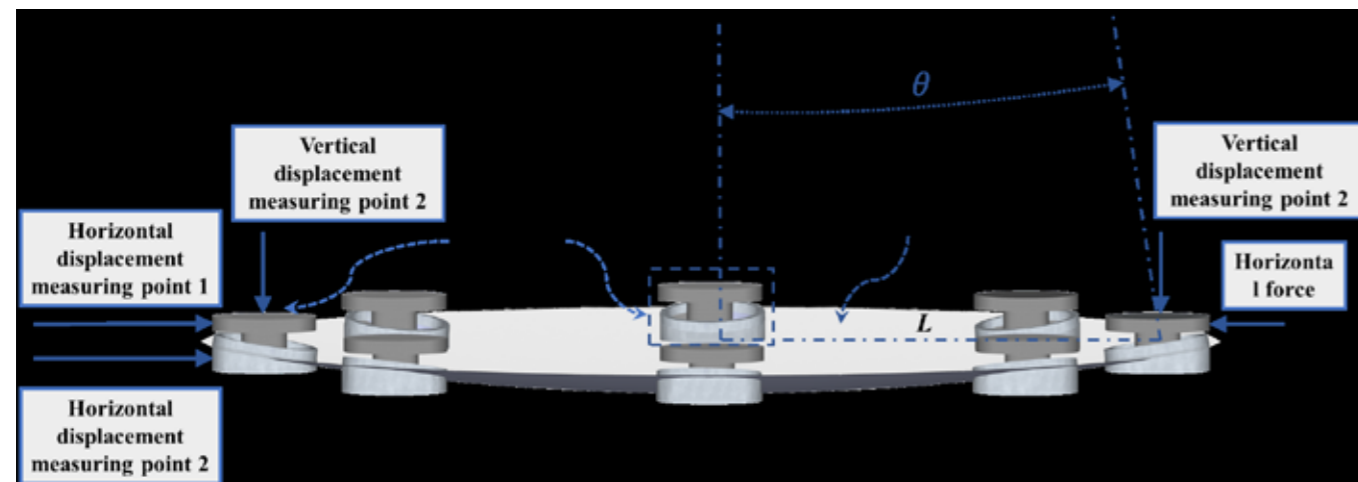

## Estimation Method for Critical Seismic Intensity of Pin-Supported Arch Structures

Prof Shoji Nakazawa<sup>1</sup>

<sup>1</sup>Toyohashi University of Technology

No short abstract submission recieved



## Hysteretic behavior of members in aluminum alloy latticed shell

Ms Xingye Wang<sup>1</sup>, Dr Xiaonong Guo<sup>1</sup>

<sup>1</sup>Tongji University

With the popularization of aluminum alloy structures, more and more latticed shells are built in high seismic intensity areas, and the seismic performance analysis is essential. In this paper, eight aluminum alloy members are conducted hysteresis testing. The main test parameters are length, section and loading history. The hysteresis curves of aluminum alloy members are obtained. The refined numerical model was established by using the finite element software ABAQUS, and parameter analysis was carried out, obtaining the hysteresis characteristic of aluminum alloy members.

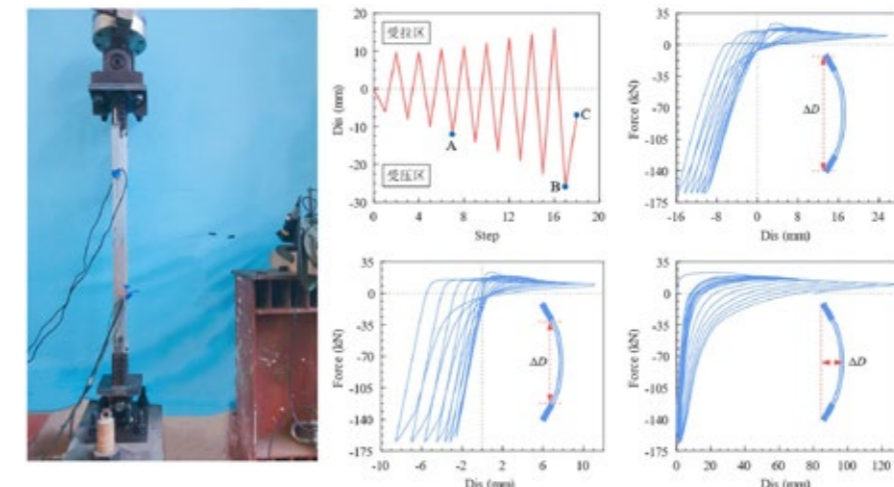



Monday 10 July 2023

# Session 4

## Construction techniques

Room 218

14:00 - 16:00



### Cast glass arches, vaults and domes: case studies and design methodology

Dr Telesilla Bristogianni<sup>1</sup>, Dr Faidra Oikonomopoulou<sup>1</sup>

<sup>1</sup>TU Delft, Faculty of Architecture and the Built Environment

Cast glass is an excellent candidate for achieving fully transparent arch, vault and dome structures. By casting, voluminous, free-form glass components can be produced that fulfil the complex geometry requirements, offer increased compressive strength and maximize the incoming sunlight. This paper explores several realised and theoretical case studies of curved structures, where the TU Delft Glass Research group was involved. The main challenges and developed solutions for each project are described, focusing on three main aspects: (i) the manufacturing challenges linked with achieving the desired curvature, (ii) the assembly method and mechanical validation of the system, and (iii) the construction ease. Based on this comparative study, a design methodology for future projects employing cast glass curved structures is provided.

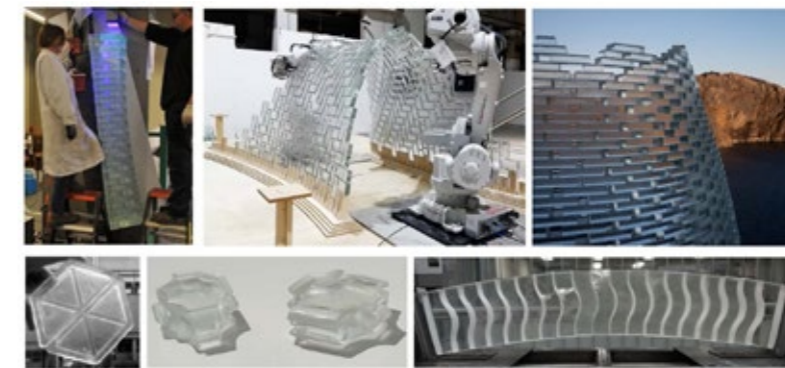

### Application of reciprocal frame structure in robotic construction

Mr Cheav Por Chea<sup>1</sup>, Prof Yu Bai<sup>1</sup>

<sup>1</sup>Monash University

Robotic technology holds potential to enhance efficiency and safety in the construction industry, yet its application often necessitates dedicated robots and advanced sensors due to the precision required. Reciprocal frame (RF) structures, with their self-interlocking mechanism, present a less complex solution, allowing efficient assembly without sacrificing load capacity. A robotic construction process for RF structures was tested in a lab, utilizing two teams of robots equipped with mobile robots, robotic arms, grippers, RGB-D cameras, and computers. These robots successfully assembled a six-unit RF structure, proving that the application of robotics in construction can be simplified without losing precision and capacity.

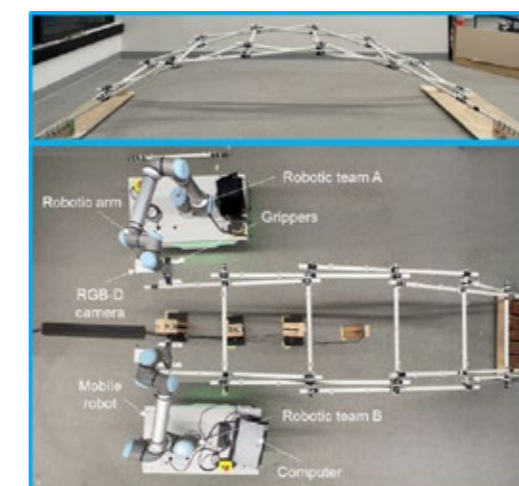

# Monday 10 July 2023



## Enhancing Construction of Complex Compression-Based Structures through Holographic-Assisted Assembly

Mr Ertunc Hunkar<sup>1</sup>, Mr David Lee<sup>1</sup>, Ms Arielle Spencer<sup>1</sup>

<sup>1</sup>Clemson University

With the aim of contributing to a higher degree of circularity in the building construction sector, and a more efficient use of resources, the here presented research explores the potential of upcycling scrap wood into modular construction components with a hyper geometry, to be used as part of reusable and reconfigurable construction systems. In addition to introducing a new approach toward upcycling scrap wood, it also presents a novel method for building hyper components from planar wooden pieces. On a more general note, the work suggests going beyond the use of shell structures as monolithic and static artefacts. By investigating reusable and reconfigurable shell-based structures, it adds to and expands on existing research on segmented shells.



## Anti-fragile Shell Aggregations on the Moon

Mr Xavier De Kestelier<sup>1</sup>, Mr Xavier de Kestelier<sup>1</sup>

<sup>1</sup>Hassell

Research on novel shell structures has been pursued by many in the AEC industry. Most precedents can be considered under one of the following approaches: subdivided vaults, continuous 3D printing, and discrete assembly. Each of the three approaches relies on high precision, or in other words, they only allow for a low degree of construction tolerance. Whilst high precision is a manageable concern in controlled, accessible sites, we argue that a different approach is needed in remote sites like the Moon to minimize the fragility of the construction system towards construction errors. The construction method we propose allows for loosely defined positioning and orientation of each aggregate, giving no single element a crucial role in the integrity of the structure.

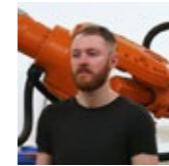
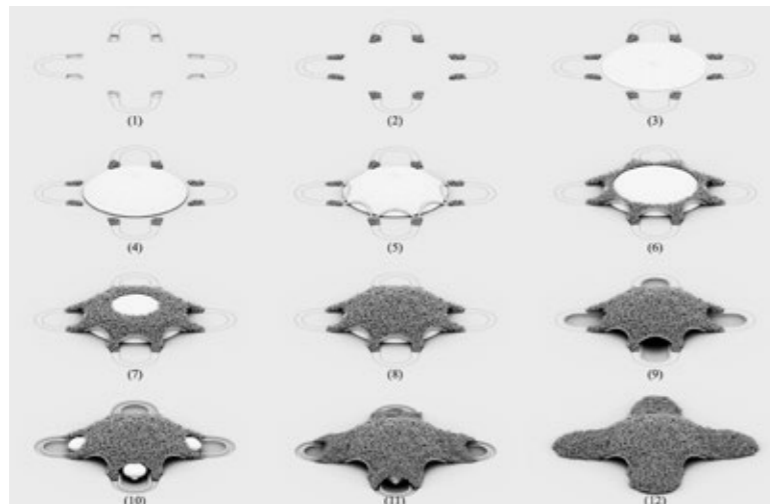

## Retooling the Vernacular: Augmenting the craft of timber house-building in southern China through the integration of remote-sensing and computational design

Mr Donn Holohan<sup>1</sup>

<sup>1</sup>The University Of Hong Kong

No short abstract submission recieved



## Research on digital design and optimisation method for large-scale reciprocal frame structure: The Case of Chengdu Agricultural Expo Exhibition Hall

Mr Tianyi Gao<sup>2</sup>, Ms Yingzi Hu<sup>1</sup>, Mr Liming Zhang<sup>1</sup>, Mr Philip F. Yuan<sup>1</sup>

<sup>1</sup>College of Architecture and Urban Planning, Tongji University College of Architecture and Urban Planning, Tongji University, <sup>2</sup>Shanghai Research Institute for Intelligent Autonomous Systems, Tongji University

The timber reciprocal frame structure is a building structure form with a long history, which has played an important role in history with its concise and practical characteristics. In the field of architecture and engineering, the current trend of combining traditional material and craft with digital technology is promoting the development of timber structure buildings, creating more elegant, environmentally friendly, and low-carbon buildings for humanity. This paper introduces the integrated design and optimisation process, with robotic construction method of large-scale timber reciprocal frame structure, taking the Chengdu Agricultural Expo Exhibition Hall as an example.



# Monday 10 July 2023



## Inflatable flexible factory formwork construction: most recent construction techniques and details

Mr Alex Bell<sup>1</sup>, Mr Tyler Robins<sup>1</sup>

<sup>1</sup>Automatic Construction Inc

Inflatable flexible factory formwork construction presented here, replaces the onsite labor of concrete construction with inexpensive-to-transport-and-manufacture flexible formwork. This flexible formwork is erected using pumps that supply a) air for shoring, and b) a cementitious material, such as concrete, for the building's structure. The buildings constructed with inflatable flexible formwork are identical in constituent parts, placement, size, architecture, safety and building code compliance to cast-in place concrete/masonry buildings. Constructed using drop stitch fabrics, the formwork contains traditional steel reinforcement to create conventional flat walls, floors and roofs. The form is held in position (shored) by pressurized air while cementitious material is injected. In this paper, updates on buildings constructed, cost and experience are detailed.



# Monday 10 July 2023

## Session 5

### Form-finding and building design

Room Plenary 3  
14:00 - 16:00

# Monday 10 July 2023



## Towards a novel form-finding approach using matrix analysis: exploiting nodal displacements of pin-jointed frameworks

Mr Yao Lu<sup>1</sup>, Mr Hua Chai<sup>1</sup>, Dr. Prof. Masoud Akbarzadeh<sup>1</sup>

<sup>1</sup>University Of Pennsylvania

This paper presents a simple method to calculate nodal displacements of kinematically indeterminate pin-jointed frameworks using matrix analysis, aiming to facilitate the early-stage design and analysis of space frames. This method can also inform a novel funicular form-finding approach by iteratively accumulating nodal displacements until reaching a new state of equilibrium. This method assumes that the framework is massless and inextensible, and requires only minimal inputs such as the frame geometry, support locations, and force vectors. The method intends to provide fast and preliminary engineering insights into the kinematic behavior of the framework, like identifying critical locations and suggesting new forms that best fit the force vectors.

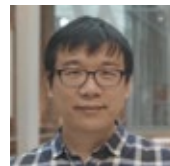
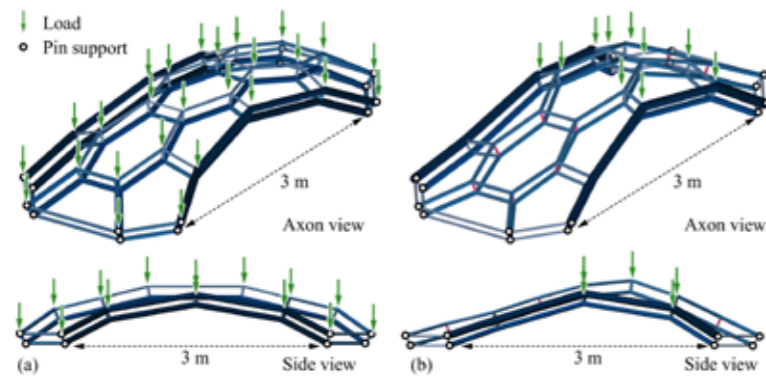

## Theoretically minimum material vault designs generated via adaptive layout optimization

Dr Linwei He<sup>1</sup>, Dr Helen Fairclough<sup>1</sup>, Dr Karol Bołbotowski<sup>2</sup>, Prof. Matthew Gilbert<sup>1</sup>

<sup>1</sup>University of Sheffield, <sup>2</sup>Warsaw University of Technology

Vaults are common structural solutions for long span, lightweight, and aesthetically pleasing architectural designs. Various form-finding methods are available to generate bending-free designs, though the need to predefine structural layouts means that the designs generated are unlikely to be minimum material solutions. To address this, a numerical layout optimization method employing the 'ground structure' approach is considered, where the form-finding problem is reformulated as a conic quadratic programming problem, simultaneously identifying optimal structural layouts and joint elevations. Since the optimization problem is convex, globally optimal solutions are guaranteed. In addition, an adaptive 'member adding' technique is used to significantly improve computational efficiency, permitting large-scale problem to be solved to generate high-precision numerical benchmarks for theoretically minimum material designs.

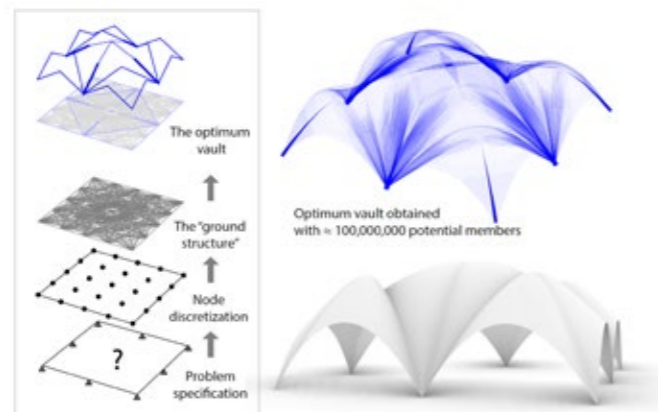

## Form-finding of membrane structures using transfinite interpolated initial shapes

Mr Allan Marbaniang<sup>1</sup>, Mr Sounak Kabasi<sup>1</sup>, Dr Siddhartha Ghosh<sup>2</sup>, Dr Subhrajit Dutta<sup>3</sup>

<sup>1</sup>Department of Civil Engineering, Indian Institute of Technology Bombay, <sup>2</sup>Structural Safety, Risk & Reliability (SSRR) Lab, Department of Civil Engineering, Indian Institute of Technology Bombay, <sup>3</sup>Department of Civil Engineering, National Institute of Technology Silchar

An increase in popularity and an expansion in the range of applications for tensile membrane structures has created a demand for professionals with knowledge and experience in this category of spatial structures. Due to geometric and material nonlinearity, the design and analysis of tensile membrane structures require a fundamentally different approach to typical structures covered in a standard civil engineering curriculum. The ultimate aim of the present work is to develop, implement and evaluate a curriculum for tensile membrane structures for architecture and civil engineering students at an early undergraduate level to achieve teaching excellence in this specialised field. This includes the design and prototype of tensile membrane structures as full-scale teaching kits to provide students with hands-on experience.

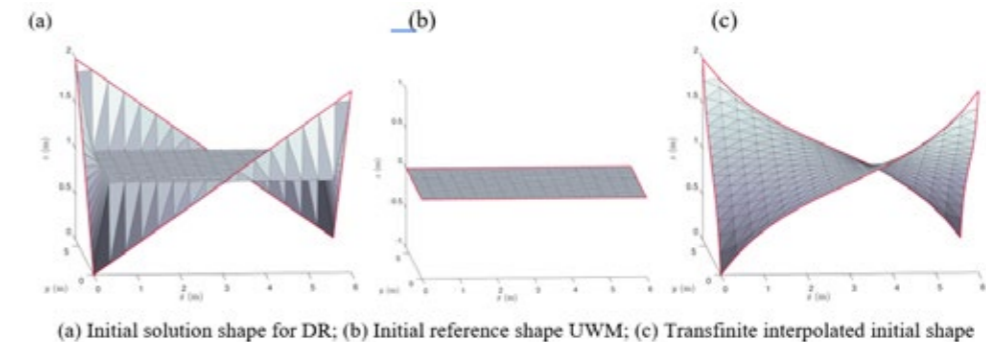

## Integration of Structural Optimisation with Aesthetic Evaluation by Facial Expression Analysis

Dr Manuel Muehlbauer<sup>1</sup>, Lukas Himsel, Markus Schaller

<sup>1</sup>RMIT University

Generative design is widely used by architects and engineers to create innovative designs that catch the eye. However, this process involves user interfaces that need integrated design systems for combining structural optimisation and human-in-the-loop technology. The system uses a standard mobile device for user input and facial expression analysis to evaluate aesthetics. The interactive structural design framework is based on virtual prototyping and allows users to generate building designs while controlling the shape generation process using various mobile-based haptic sensors. During the preliminary design phase, users can modify the structural system and receive informed feedback on the same mobile device. By incorporating facial expression analysis into generative design process, an open-ended design approach was tested.



# Monday 10 July 2023



## A BESO aid to efficient form finding

Prof Andre Brown<sup>1</sup>

<sup>1</sup>Victoria University Of Wellington, <sup>2</sup>NOC Ltd

The desire for material economy and efficient structural performance has been prevalent for many years. The research in this paper adds a new perspective and strategic means of achieving efficient performance of architectural structural systems through the lens of topological optimization. The process developed applies computational bi-directional evolutionary structural optimization (BESO), the research presented illustrates how architectural design can be supported by a digital environment that automatically proposes reconfigurations by reprioritizing material to areas of maximum efficiency; the idea of form follows force.

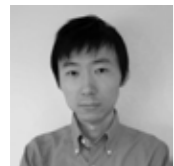
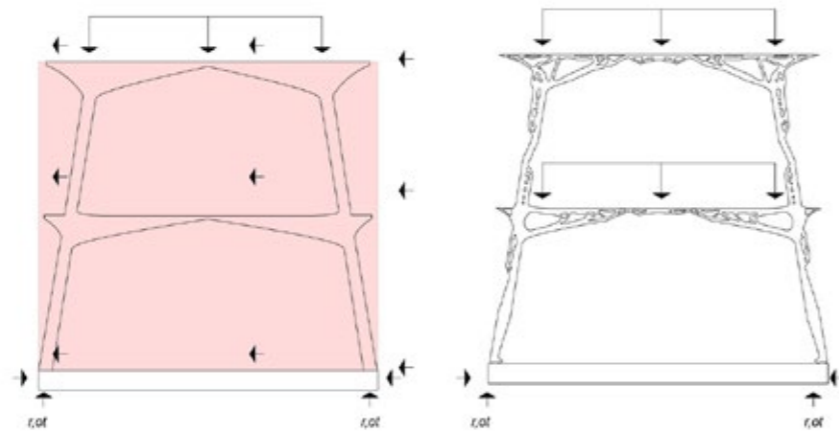

## Generation of a compression-tension combined funicularpolyhedral beam structure

Mr Hua Chai<sup>1</sup>, Mr Yao Lu<sup>1</sup>, Dr Márton Hablicsek<sup>2</sup>, Dr Masoud Akbarzadeh<sup>1,3</sup>

<sup>1</sup>Polyhedral Structures Laboratory, Weitzman School of Design, University of Pennsylvania, <sup>2</sup>Mathematical Institute, Leiden University, <sup>3</sup>General Robotic, Automation, Sensing and Perception (GRASP) Lab, School of Engineering and Applied Science, University of Pennsylvania

This paper presents a robust form-finding method by implementing algebraic polyhedral graphic statics to generate compression-tension combined beam structure. Applying the algebraic method will provide a clearer direction for the user to easily modify the initial design parameter without extra manual adjustment. Moreover, different from the existing algebraic method that needs non-intersected planar surfaces as the potential input to construct the cells, the proposed method is to convert intersected geometries to convex polyhedrons that share the same planar surface as the input. The cells will be flipped by changing the force diagram's normal direction. The presented approach allows for a comprehensive understanding of equilibrium and constraint requirements in form and force diagrams.

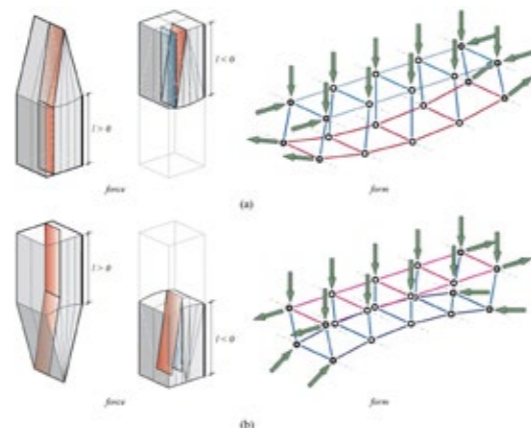

## Special Landream Presentation: Challenges and Triumphs in the Creative Integration of Structural Engineering and Architecture

Mr Andrew Shehadeh, Milad Sayyadi

Established in 2005, over the next five years, Landream will deliver a combination of residential, commercial, industrial, build-to-rent and mixed-use projects worth more than \$2 billion across Victoria and New South Wales. Hear about some of the challenges and triumphs related to the creative integration of structural engineering and architecture, from a developer's and manufacturer's perspective. Featuring some of Landream's iconic projects, including Opera Residences and Fig and Wattle Pyrmont located in New South Wales, as well as The International Brighton located in Victoria.

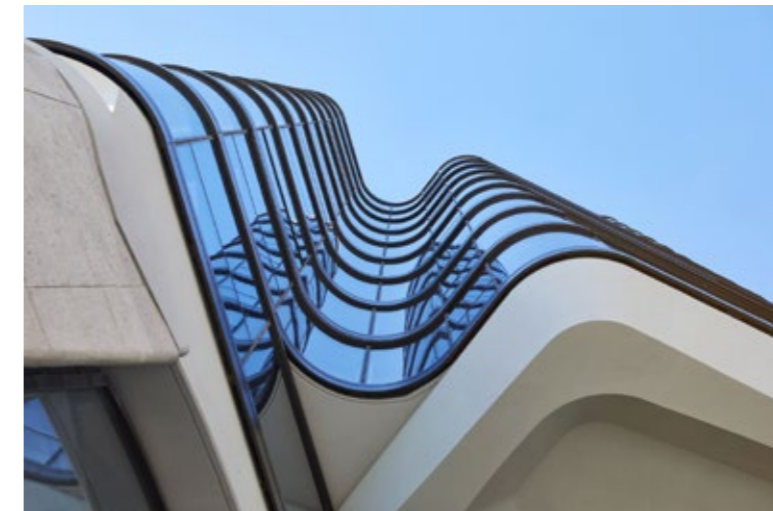

Monday 10 July 2023

# Masterclass 2

**Karamba 3D: Parametric  
Engineering Analysis Method**

Room 215  
16:30 - 18:30

Presented by

**Sascha Bohnenberger-Hehr &  
Matthew Tam**

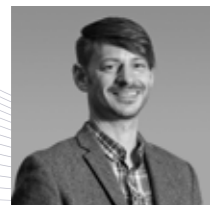

Monday 10 July 2023

# Session 7

**Gridshell and lattice structures**

Room 216  
16:30 - 18:30

# Monday 10 July 2023



## FreeGrid: a benchmark on design and optimisation of free-edge gridshells

**Dr Raffaele Lorenzo<sup>1</sup>, Dr Francesco Laccone<sup>2</sup>**, Prof Luca Bruno<sup>1</sup>, Prof Paolo Cignoni<sup>2</sup>, Prof Stefano Gabriele<sup>3</sup>, Prof Ernesto Grande<sup>4</sup>, Prof Maura Imbimbo<sup>5</sup>, Prof Francesco Marmo<sup>6</sup>, Prof Elena Mele<sup>6</sup>, PhD Valentina Tomei<sup>5</sup>, PhD Fiammetta Venuti<sup>1</sup>,

<sup>1</sup>Politecnico di Torino, <sup>2</sup>Visual Computing Lab – Institute for Computer Science and Technologies, Italian National Research Council, <sup>3</sup>Università degli studi Roma Tre, <sup>4</sup>Università degli studi Guglielmo Marconi, <sup>5</sup>Università degli studi di Cassino e del Lazio Meridionale, <sup>6</sup>Università degli studi di Napoli Federico II

FreeGrid is meant to offer a common benchmark to test and compare different approaches to the design of gridshells, from man-based heuristic design to AI-based one. FreeGrid sets three design baseline problems: a barrel vault, a paraboloidal dome, and a hyperbolic paraboloid, having their spring line partially not constrained. Participants are called to modify them in order to improve their structural performances, buildability, and sustainability, all three of them weighted in a single, performance metric. Participants shall comply with a limited number of design constraints. FreeGrid is conceived with the support of the Italian Council for Steel Structures, under the umbrella of the IASS, and in partnership with ArcelorMittal Steligenca. FreeGrid will be launched within the IASS 2023.

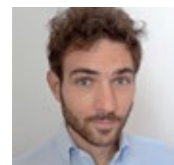
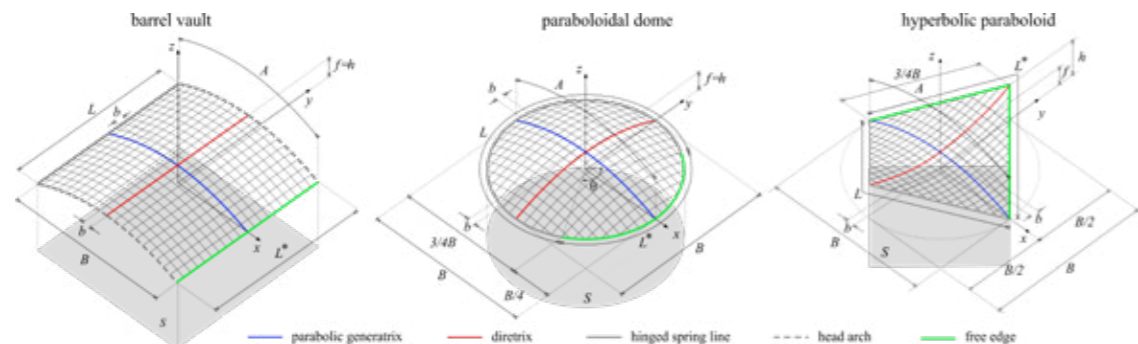

## Reducing the number of different facade panels for structurally optimised gridshells

**Dr Hongjia Lu<sup>1</sup>**, Master Yuanpeng Liu<sup>1</sup>, Professor Yi Min Xie<sup>1</sup>

<sup>1</sup>RMIT

Gridshell structures have attracted much interest due to their interesting appearance and superior performance. The shape optimisation of grid-shell structures has been extensively investigated in previous studies. Whilst superior performance (e.g., high stiffness) can be obtained via customising the structural geometry, the optimised geometry typically contains a complex free-form shape that demands high manufacturing costs. Therefore, to address this problem, a novel two-step optimisation approach is developed in this study, aiming to reduce the number of different facade panels for optimised grid-shell structures. With the proposed approach, grid-shell structures with both high stiffness and low manufacturing costs can be identified.

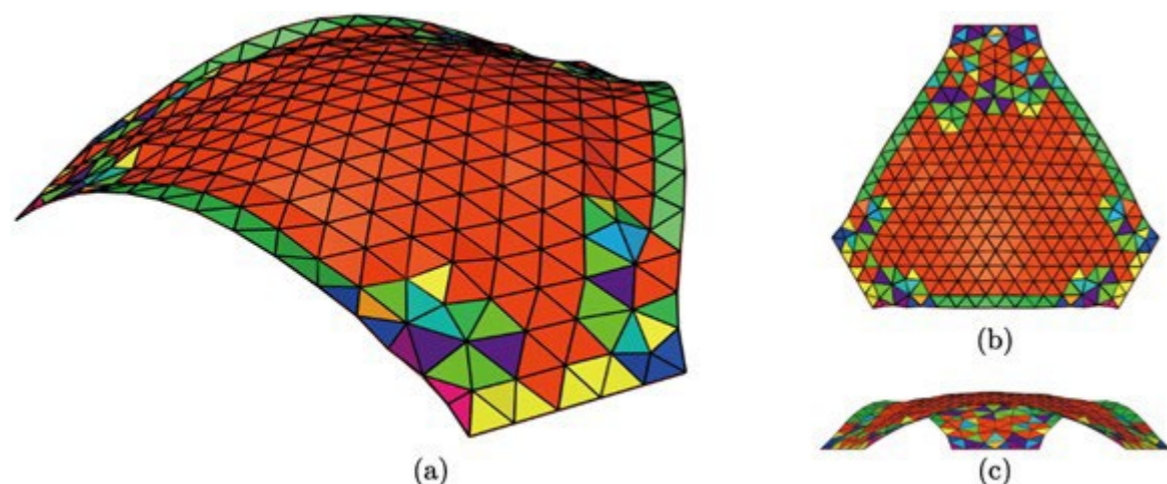

## Design and construction of the ReciPlyDome, a lightweight modular reciprocal dome

**Ms Ellen Leemans<sup>1</sup>**, Mr. Ahmed Soliman<sup>1</sup>, Prof. Niels De Temmerman<sup>1</sup>, Prof. Lars De Laet<sup>1</sup>

<sup>1</sup>Vrije Universiteit Brussel

To strive towards more sustainable temporary structures, reuse is key. However, temporary structures are often hard to assemble, which compromises their reusability. The difficulties of assembly are usually induced by the morphology of the modules or by using certain connection types. The main objective of this research is to reimagine a developed lightweight modular reciprocal dome, the ReciPlyDome, and optimize it in terms of assembly. This resulted in the development of a new connection system and improved shape for the beams. Their successful cooperation is demonstrated in a new full-scale prototype.



## A new assembled spatial structure system composed of triangular components

**Mr Zhengning Li<sup>1</sup>**, Mr Xiaonong Guo<sup>1</sup>, Mr Hui Ouyang<sup>1</sup>, Mr Jinhui Luo<sup>1</sup>

<sup>1</sup>Tongji University

This paper proposes a new type of spatial structure assembly composed of numerous triangular basic elements with mechanical connections. It is easy to fabricate and doesn't require twisted members or curved gussets. The structure system is versatile and can be used in various shapes. Even for complex surfaces, this system is easy to construct. A curved surface model was designed and constructed to verify its feasibility. A flattening algorithm was used to create the basic elements' flattened drawings, and the overall model was created by printing and cutting A4 paper accordingly.

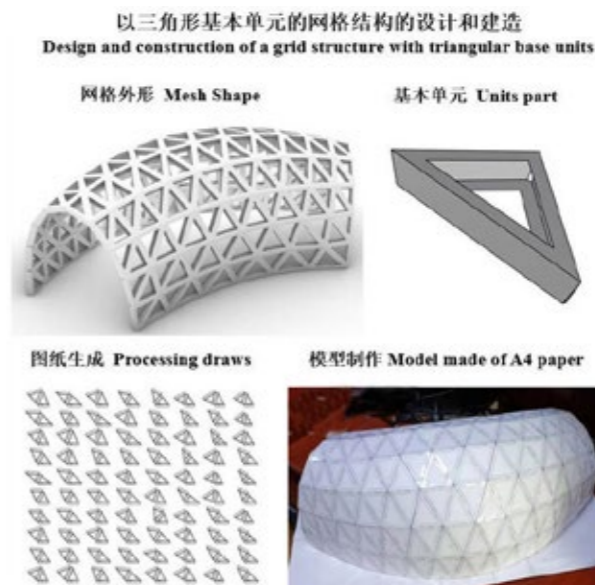

# Monday 10 July 2023

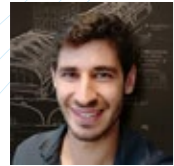

## Sydney Football Stadium redevelopment – An efficient design, manufacturing and on-site assembly approach to a complex form-found roof shell structure

Mr Michael Chernyavsky<sup>1</sup>, Mr Hudson Kestel<sup>2</sup>

<sup>1</sup>Aurecon Australasia, <sup>2</sup>Aurecon Australasia

The Sydney Football Stadium is an \$828m AUD state-of-the-art stadium near Sydney’s CBD. This paper focuses on the collaborative approach to design, fabrication and erection that enabled the complex 2,000 tonne synclastic diagrid shell roof to be successfully brought to life in a fast-tracked design and construction programme. The unique 25,000m<sup>2</sup> roof is constructed using prefabrication and modular techniques to limit working at heights and improve the erection efficiency on site, it enabled over 85% of steelwork installation to be undertaken at ground level. A novel digital workflow ensured the seamless translation of data between each sub-consultant, saving time and improving quality assurance. The stadium was delivered on-time and on-budget and will facilitate many memorable moments in sports history.



## Simultaneous stress-aligned and flat-panel-aligned grids on mixed tension-compression membrane shells

Dr Masaaki Miki<sup>1</sup>, Dr Toby Mitchell<sup>2</sup>

<sup>1</sup>The University Of Tokyo, <sup>2</sup>Skidmore, Owings and Merrill

2022, we have proposed a novel NURBS-based form-finding method that can handle mixed tension-compression stress state correctly. In this study, using the obtained solutions, we compute stress-aligned conjugate networks. By discretizing the shell surface by those networks, a grid shell structure with no bending action that can be covered by planar quadrilateral panels can be obtained.

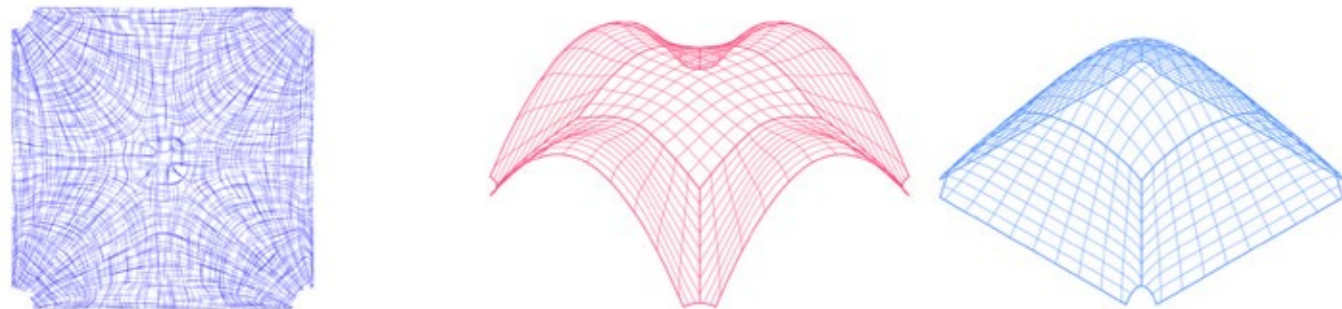

## Leveraging structural steel castings for modern grid shell structures

Ms Jennifer Anna Pazdon<sup>1</sup>, Mr Carlos de Oliveira, Mr Justin Binder

<sup>1</sup>Cast Connex Corporation

Grid shell structures offer enclosure of volumes with minimal visual mass. Long spans and lightweight structure is achieved with single and doubly curved surfaces. Precision in fabrication and construction is vital to successfully achieve these often complex structures. In large part, the proliferation of grid shell structures has been impeded by perceived risk due to the complexity of the construction. A solution to this challenge lies in the use of modern cast steel connection design and manufacturing techniques to simplify fabrication and erection while offering enhanced aesthetics and improved economy for grid shell structures. This paper will present the advantages of steel castings for grid shell structures in general and in the context of extant projects wherein the use of castings has provided significant benefit.



## Development of the Design of the new Sydney Football Stadium

Mr Alex Edwards<sup>1</sup>, Mr Tristram Carfrae<sup>1</sup>, Mr Andrew Johnson<sup>1</sup>

<sup>1</sup>Arup

The original Sydney Football Stadium (SFS) [1], completed in 1988, was demolished to make way for a new stadium that opened in 2022. The roof of the new stadium is twice as efficient as its predecessor, and twice the size. Structurally, it is an evolution of AAMI Park in Melbourne and Adelaide Oval with a dash of Suncorp from Brisbane. The Arup team developed the roof through design development including the fabric, steelwork connections and indicative construction sequencing, which was then finalised, documented and constructed by the John Holland design and construct team





Monday 10 July 2023

# Session 8

## Additive manufacturing 1

Room 217  
16:30 - 18:30



### Hyperbolo-ICE: an efficient and expressive ice shell

Dr Rui Liu<sup>1</sup>

<sup>1</sup>Kent State University

Hyperbolo-ICE is a free-standing ice shell with a design inspired by the hexagonal shape of a snowflake. The construction of the pavilion utilized a flexible formwork that comprised of a rope net and fabric supported by three temporary wood columns. Tension was applied to the rope net through the adjustable knots to find the form of the structure. A pre-sewn muslin fabric was attached to the rope net, onto which the water-cellulose was sprayed and then frozen into an ice shell. The thickness of the shell was determined to be at least 6cm at the bottom to support the weight of the structure.



### Multi-material Components for a Sustainable Built Environment: Integration of Design by Topology Optimisation and Fabrication by 3D Printing

Dr Hèrm Hofmeyer<sup>1</sup>, Motahareh Youshi, Arjen Deetman

<sup>1</sup>Eindhoven University of Technology

For a sustainable built environment, a general approach is presented to translate design problems into a Topology Optimisation (TO) strategy. This strategy is extended to multi-disciplinary TO for multi-material components, including concrete, which behaves differently under compression and tension. Applying the general approach and TO, two cases are studied: a part of a façade panel and a sandwich panel. A TO design for the sandwich panel was tested for fabrication by functional grading and black-and-white printing. The TO typical design requires dedicated print paths, and tweaking of the dynamics of print and material dosing systems. Vice versa, fabrication requires modifications of the TO design strategy, e.g. geometrical adjustments and the future inclusion of print path shaped density filtering.

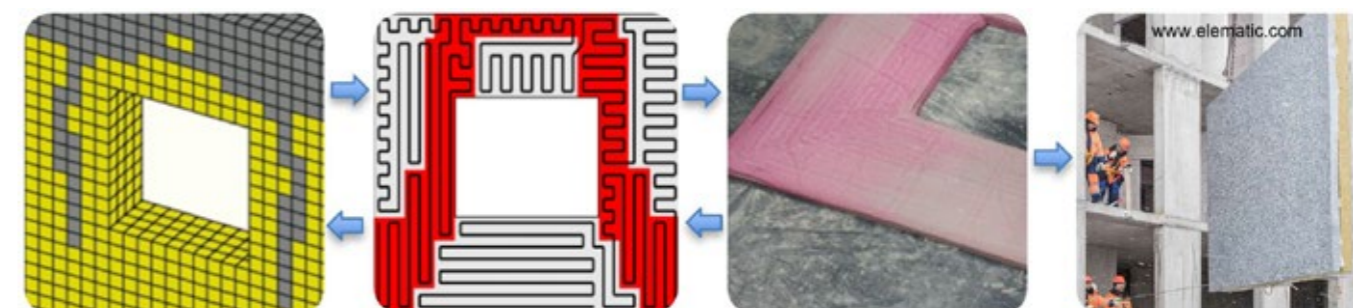

# Monday 10 July 2023



## Mechanical characteristics of FDM printed parts affected by an air gap

Miss Meiyu Li<sup>1</sup>, Dr Jianguang Fang<sup>1</sup>

<sup>1</sup>University Of Technology Sydney

The air gap can effectively adjust the bonding quality between adjacent rasters. Positive, zero, and negative air gaps are achieved by controlling the deposition distance between filaments. We conducted a series of mechanical experiments to examine the effects of air gaps on the mechanical performance and fracture modes of FDM parts. Results showed that a proper negative air gap contributes to reliable bonding strength between rasters. The anisotropy induced by the raster angle gradually fades away with the increase of the negative air gap.

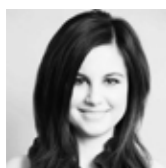
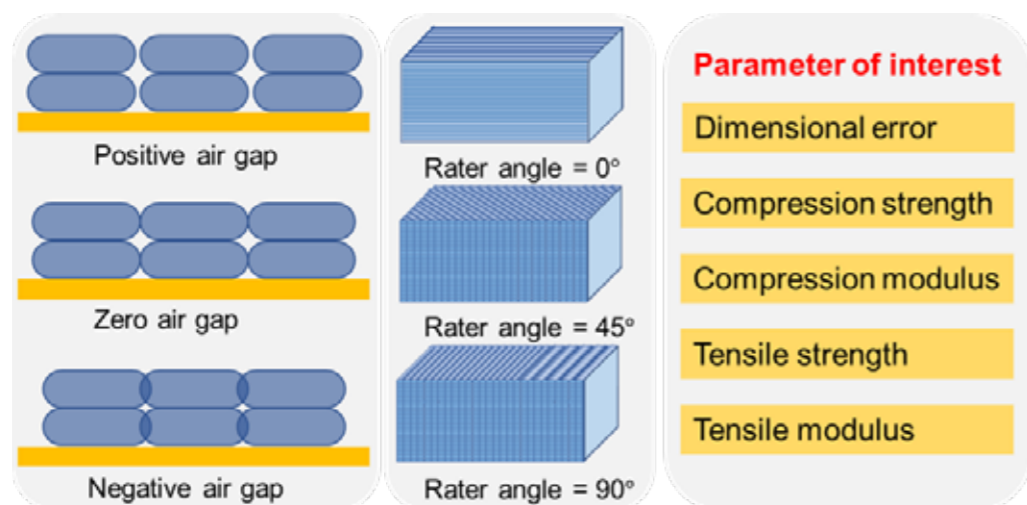

## An assembly-oriented novel low-carbon masonry building method with unfired 3D printed earthen blocks

Ms Yelda Gin<sup>1</sup>

<sup>1</sup>Cambridge University

Conventional earthen building methods such as cob and adobe are relevant for developing countries but labour-intensive, expensive and slow for developed countries. Automation in construction has been increasingly favourable in developed countries, especially buildings constructed with 3D printed cementitious materials. 3D printed earthen materials demonstrate a better environmental performance than 3D printed cementitious materials while providing structural strength with less material than conventional earthen building methods. Despite the benefits, the research on the mechanical strength of 3D-printed earthen structures is still limited. Our research investigates an assembly-oriented novel low-carbon masonry building method with unfired 3D-printed earthen blocks and explores its adaptability to the mainstream construction industry with a critical comparison based on mechanical properties.

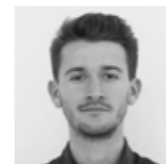

## 4D printed textile formwork for robotic concrete spraying

Mr Guillaume Jami<sup>1</sup>, Ms Selen Ercan-Jenny<sup>1</sup>, Mr Chenguyan Wei<sup>1</sup>, Mr Hamilton Forsythe<sup>3</sup>, Mr Nicolas Feihl<sup>1</sup>, Prof Skylar Tibbitts<sup>3</sup>, Prof Matthias Kohler<sup>1</sup>, Prof. Fabio Gramazio<sup>1</sup>, Prof Ena Lloret-Fritschl<sup>1,2</sup>

<sup>1</sup>ETH Zurich, <sup>2</sup>Universita della Svizzera italiana, <sup>3</sup>Massachusetts Institute of Technology

Globally, concrete is the second most used material after water and because of its negative environmental impact, research institutions and industry seek to reduce concrete usage. In this material-optimized structures offer one approach; however, such structures often require custom-made formworks that are disposed of after a single use and are thus expensive and waste-generating. Recently, several unconventional solutions for formwork have emerged that produce material-optimized structures without generating significant waste, including the examples of lost-, stay-in-place, and dynamic-formworks. This paper examines 4D-printing technology, to assess the possibility to produce building component through fiber-reinforced concrete (FRC) spraying. With an empirical study, we evaluate two different 4D-printing techniques: textile 4D-printing and thermoplastic 4D-printing, both enabling the production of self-shaping, lightweight textile formworks.

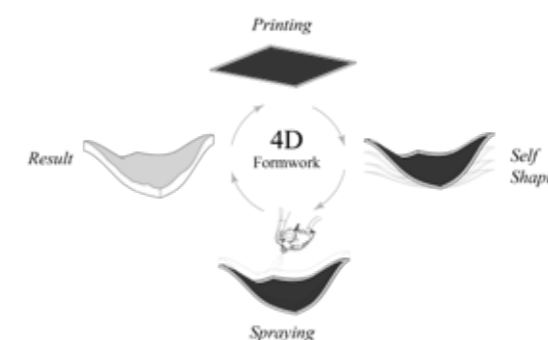

## 3D-printed clay formwork for fabrication of concrete elements

Dr Salma Mozaffari<sup>1</sup>, Prof. Arash Adel<sup>1</sup>

<sup>1</sup>University of Michigan

uses easily demoldable and nearly zero-waste clay formwork that can be recycled. Using a sequential process of clay 3D printing and concrete casting reduces the pressure from the concrete, allowing the casts to cure. The formwork shrinks and cracks as the clay dries, making it easy to remove. This allows for efficient recycling of the formwork. The study's unique approach extends the height limit for clay formwork, producing customizable shapes using a more sustainable material than concrete and polymer, often used in formwork additive manufacturing. As demonstrated in a case study, the technique can also create complex surfaces and integrate openings.



# Monday 10 July 2023



## Liquid printed reusable dredged-based material for concrete formwork

Prof Bosheng Liu<sup>1</sup>

<sup>1</sup>Feng Chia University

A dredged-based material infused in the additive manufacturing method using the Rapid Liquid Printing technique was applied to fabricate recyclable concrete formwork. This research RLP additive manufacturing process and its material improve the formwork's adaptability, mobility, and reusability compared to the conventional formwork method. This paper presents the critical findings of Slit Dredged Material mixed with soy-based hydrogenated vegetable glycerides material, and unhydrolyzed beeswax-based esters material printed in water that can instantly harden. The slit DM based material mixture's unconfined compression value is related to extrudability, and workability that coordinate with the printing process. This dredged-based material and printing technique are predictable making it possible to deliver a higher degree of fabricability suitable for greater design freedom.

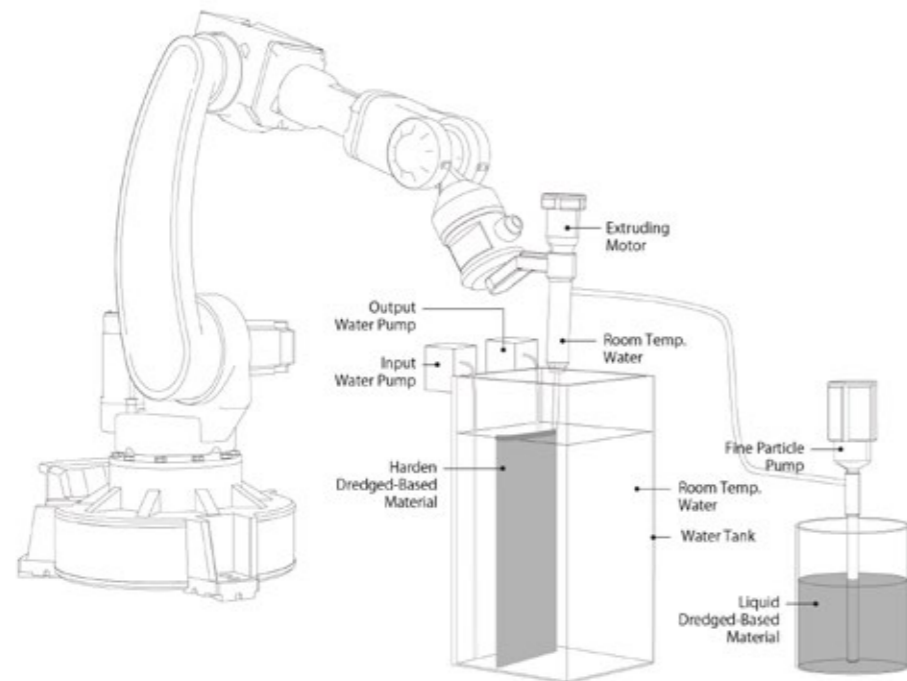

# Monday 10 July 2023

## Session 9

### Architectural geometry

Room 218

16:30 - 18:30

# Monday 10 July 2023



## A multi-objective progressive optimization method for free-form canopy based on fabrication morphology

Miss Sijia Gu<sup>1</sup>, Mr Li Han<sup>2</sup>, Prof Philip F. Yuan<sup>1</sup>

<sup>1</sup>College of Architecture and Urban Planning, Tongji University, <sup>2</sup>Shanghai Fab-Union Technology Co., Ltd

As a new trend of architectural system, free-form structure expands the possibilities of architectural form. However, in the real construction process, the lack of connection between the parameters of fabrication morphology and the misalignment of the workflow lead to unsatisfactory results in appearance. The paper proposes a multi-objective progressive optimization method based on fabrication morphology. The method explores the geometric relationships among free-form surface, component geometry, function, and fabrication feasibility, which could be implemented in 3D modelling. To verify the effectiveness of the method, a project of a lightweight glass canopy structure was executed. The successful implementation of the project demonstrates the effectiveness of the method in bridging the gap between design and construction.

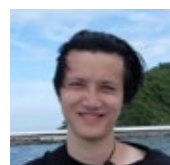
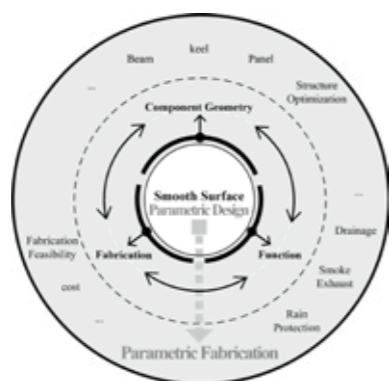

## Reducing the number of different faces in free-form surface tessellations

Mr Yuanpeng Liu<sup>1</sup>, Dr Ting-Uei Lee<sup>1</sup>, Prof Yi Min Xie<sup>1</sup>

<sup>1</sup>RMIT University

Free-form structures are highly valued for their aesthetic appeal in architecture, but they typically comprise panels of many different shapes, which can pose great challenges for building construction. We aim to address this issue by proposing a novel clustering-optimisation method to reduce the number of different n-gonal faces in free-form surface tessellations. The method partitions the faces into several groups of similar shapes through clustering and transforms the ones within each group toward congruent polygons through optimisation. By utilising this approach, the number of geometrically different panels can be minimised while also satisfying a user-specified gap requirement. The potential practical application of this method is demonstrated by redesigning the façade of a real architectural project to achieve cost-effective solutions.

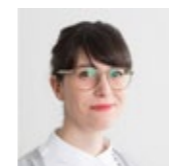
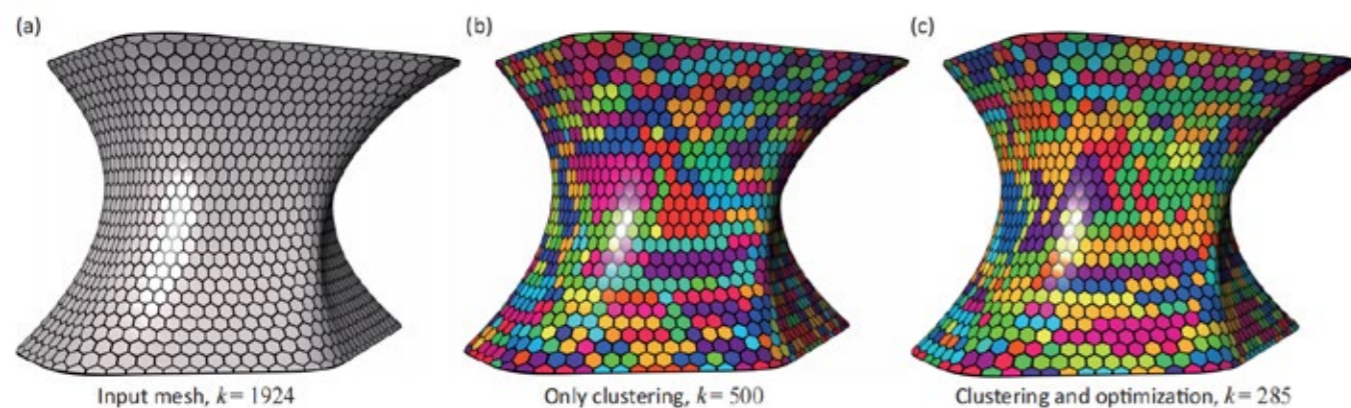

## Form dictated by material-specific properties of a mycelium composite

Mrs Dana Saez<sup>1</sup>, Mrs Alexandra Bertsch<sup>1</sup>, Mr Denis Grizmann<sup>1</sup>, Prof Martin Trautz<sup>1</sup>, Dr Anett Werner<sup>2</sup>

<sup>1</sup>RWTH Aachen- Architektur, <sup>2</sup>TU Dresden- Institute of Natural Materials Technology

Mycelium-based composites can rapidly build up complex structures with extreme precision to 'take shape' into larger structures. Within this context, we present the Myco Pavilion, as case study for a deep understanding of the material properties of mycelium-based materials and critically analyze how they influence the transformation of a given geometry. The goal was to integrate a bot-tom-up design process where we developed a construction system based on material-specific construction details. The hemisphere typology can only absorb pressure and must therefore be relieved of tension, condition that correspond to the mechanical properties of mycelium-based composites. For material manufacturing reasons, the hemisphere was divided into modules connected by a material-specific joinery system.

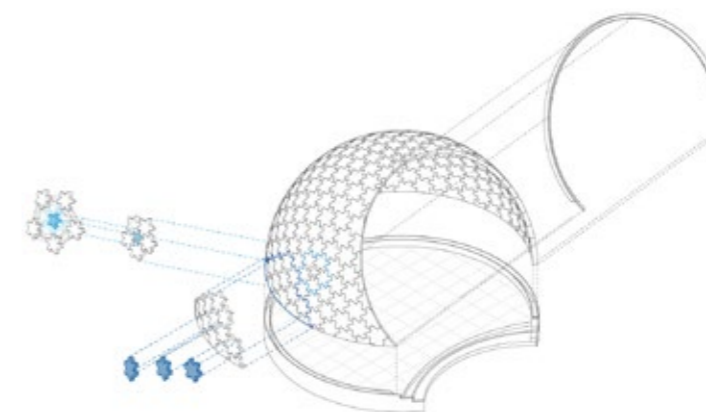

## A new method of architectural scheme design considering structural optimization

Miss Ruowei Gong<sup>1</sup>

<sup>1</sup>University Of Virginia

No short abstract submission provided

# Monday 10 July 2023



## Creating various 3D surfaces using a single tile or a few tiles

**Dr Anooshe Rezaee Javan<sup>1</sup>**, Mr Ahmed Abdelaal, Prof Yi Min Xie

<sup>1</sup>RMIT University, CISM centre

Tessellations are commonly used in architecture to create visually striking surfaces with a limited set of elements. This study focuses on developing a technique for constructing 3D curved surfaces using 2D identical tiles, which is crucial for cost-effective architectural design. By employing parametric CAD software, the technique is extended and generalized, allowing for the creation of diverse 3D tiles through mathematical methods. These parametric models enable the modular construction of a wide range of curved surfaces, considering the influence of neighboring tiles. The study demonstrates the possibility of arranging identical 2D tiles into different configurations, resulting in smooth transitions between adjacent tiles and offering affordable modular construction for stunning facades and other 3D surfaces. Additionally, the technique proves versatile by producing attractive non-periodic surfaces using triangular, square, and hexagonal tiles

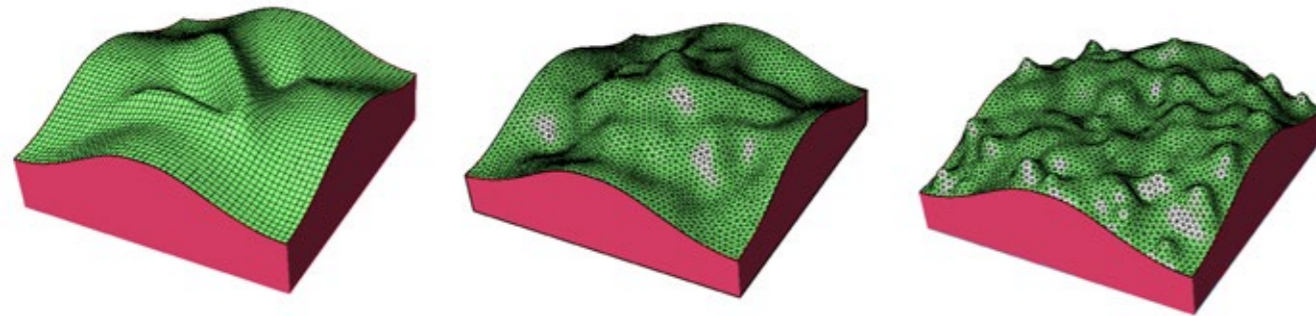

## Rethinking geometry of grapevine structure proposed by Konrad Wachsmann

**Dr Toshiaki Kimura<sup>1</sup>**, Mr Tsubasa Inoue<sup>2</sup>, Dr Yosuke Komiyama<sup>2</sup>, Dr Satoru Kimura<sup>3</sup>

<sup>1</sup>Nagoya City University, <sup>2</sup>Kyoto University, <sup>3</sup>Ristumeikan University

Konrad Wachsmann proposed the Grapevine Structure (GS) in 1953. GS is a unique pre-fabrication technique with the freedom to select cross-sections of members, while its detail and structural properties have not been discussed well. The authors think it is significant to explore the possibility of new architectural geometry realizing more construction efficiencies. In this study, we focus on the GS to generate its structure and observe its mechanical characteristics. GS is reproduced using 3D CAD by referring to the previous literature. Through comparison with the original model and previous example, we proposed an improved generating algorithm. Then, linear static FE analysis is conducted to discuss the mechanical properties. The potential applications of the GS for architectural geometry will be discussed.

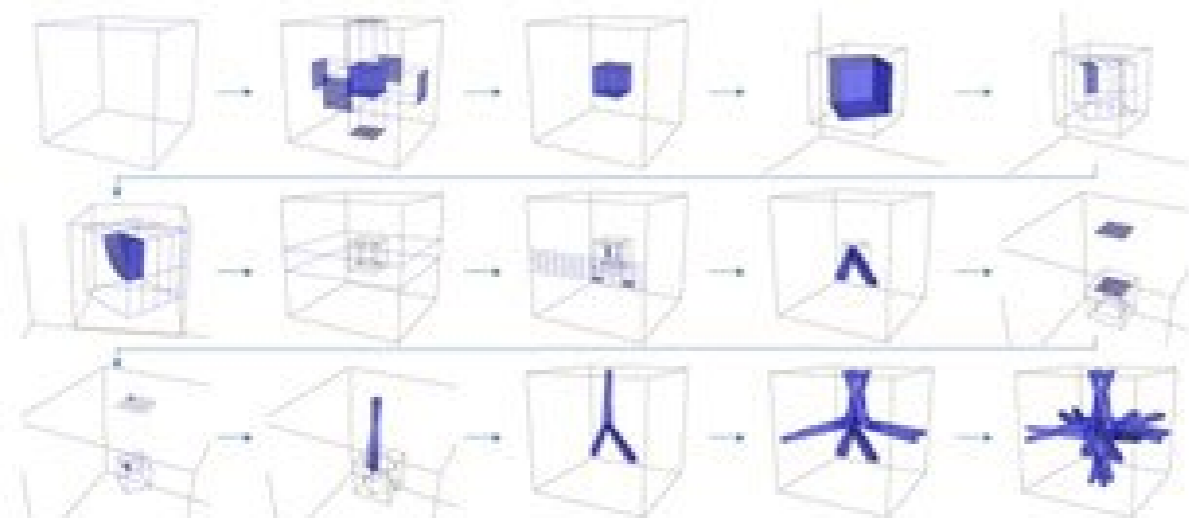

## Designing the West Gate Tunnel portals: Timber gridshells

**Mr Andre Ferro Pereira<sup>1</sup>**, Mr Benjamin Coop<sup>1</sup>, Mr Dmitry Zelenkin<sup>1</sup>, Mr Richard Whitfield<sup>1</sup>, Mr Kevin Berry<sup>1</sup>

<sup>1</sup>Taylor Thomson Whitting (TTW)

This study showcases TTW's architectural geometry and structural engineering efforts for the timber structures in the West Gate Tunnel Project portals. Two geometric discretisation patterns were explored: diamond-shaped and triangular grid. The diagonal grid scheme used genetic algorithms to simplify portal envelope surfaces, generating its topology with geodesic curves and COBYLA optimisation. Node connection types were minimised through mesh relaxation and clustering algorithms. The triangular grid scheme employed primary parallel hoops and secondary diagonal infill members, optimising the angle between primary and secondary timber members with COBYLA. Both schemes integrated in-house structural timber design libraries compliant with AS 1720.1:2010 into the structural optimisation processes. These workflows enhanced cost efficiency, fabrication, and preserved architectural design integrity.

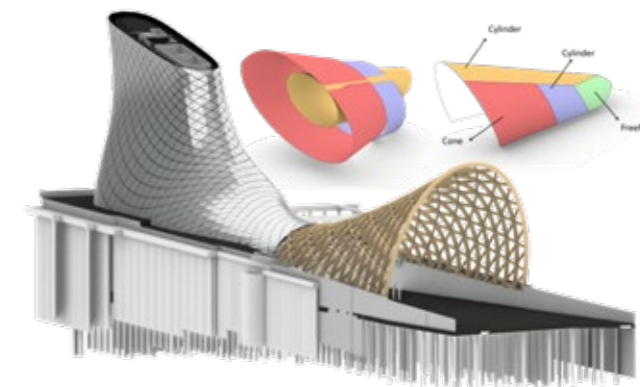

## Arkansas Museum of Fine Arts: Organic Shaped Concrete Folded Plate

**Mr Ben Sexton<sup>1</sup>**

<sup>1</sup>Thornton Tomasetti

The Arkansas Museum of Fine Arts is a project that added an organic shaped concrete folded plate roof over an existing site of 7 buildings. The architectural Rhino model was translated into a SAP2000 model to allow the team to analyse the structure. Shell local axes were oriented to follow the roof's curving geometry which allowed for stress output in the direction of the chosen reinforcement scheme. A uniform mat of reinforcement was used as a lower bound on the stresses, and areas that exceeded this lower bound were manually detailed with additional rebar. The resulting design was a 200mm slab with mild reinforcement which used the folded plate geometry to span up to 25 meters longitudinally and cantilever up to 8 meters.



Monday 10 July 2023

# Session 10

## Tension and membrane structures 1

Room: Plenary 3  
16:30 - 18:30



### Numerical simulation of snowdrift on a membrane structure

Ms Jialin Zou<sup>1</sup>, Ms Xiaoying Sun<sup>1</sup>, Mr Yue Wu<sup>1</sup>

<sup>1</sup>Harbin Institute of Technology

In snowy and windy regions, snowdrift may lead to uneven snow distribution on the roofs. Uneven snow distribution cause snow sliding from the edge of roofs and frequent collapsing, which threatens people's lives and properties. An increasing number of these structures have been built in cold regions at high latitudes and altitudes. And climate-related disasters including heavy snow on membrane structures for roofing have increased globally. Therefore, the snowdrift on membrane structures has received increasing attention. In this paper, based on the Euler-Euler method in multi-phase flow theory, the Mixture model using the secondary development method for commercial CFD software Fluent is adopted. The snowdrift on a long-span membrane structure is simulated under different wind velocities and wind directions.

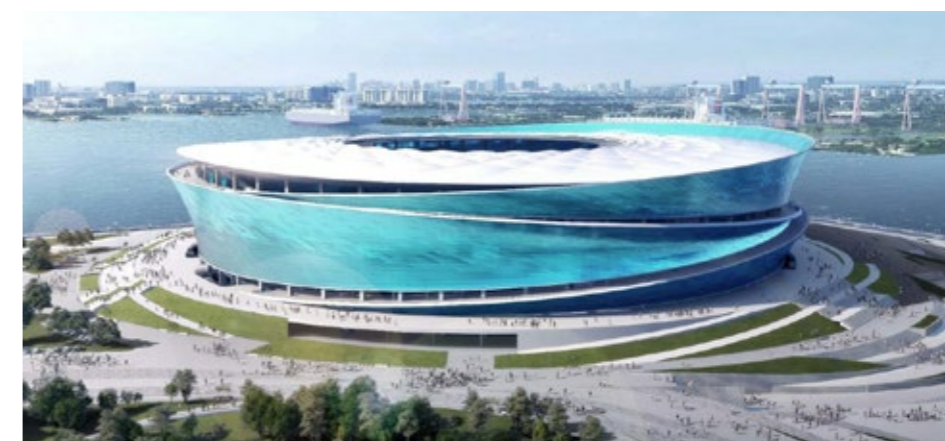

### Steel structural design of a 60,000-seats stadium

Mr Yan Zhang, Dr Xin An Xiang<sup>1</sup>

<sup>1</sup>China Southwest Architectural Design and Research Institute Corp. LTD

The Zhengzhou Olympic Center Sports Stadium has 60000 seats. The steel structure of the Stadium roof is 291.5m in the north-south direction, 311.6m in the east-west direction and the maximum length of cantilever is 54.1m. The steel structure of roof is composed of four components: the canopy of large-opening spoke-wheel-type cable-supported grid structure with the largest cantilever length in the world, the double-layer grid roof, plane truss and the spatial corridor of triangular mega truss with largest span in China.



# Monday 10 July 2023



## The mechanical properties of membrane material STFE

Prof Qilin Zhang<sup>1</sup>, Rujie Gu<sup>1</sup>, Mr Xiaoqun Luo<sup>1</sup>, Mr Ye Yuan<sup>1</sup>

<sup>1</sup>Tongji University

STFE studied in this paper is a new kind of building membrane material, which is composed of polyarylate structural mesh with high tenacity yarn and transparent hybrid fluoropolymer film. This study shows that STFE membrane material has superior mechanical properties and can be an alternative material for membrane structure. Meanwhile, Material parameters given in this paper can provide reference for the design and application of membrane structure made of STFE.

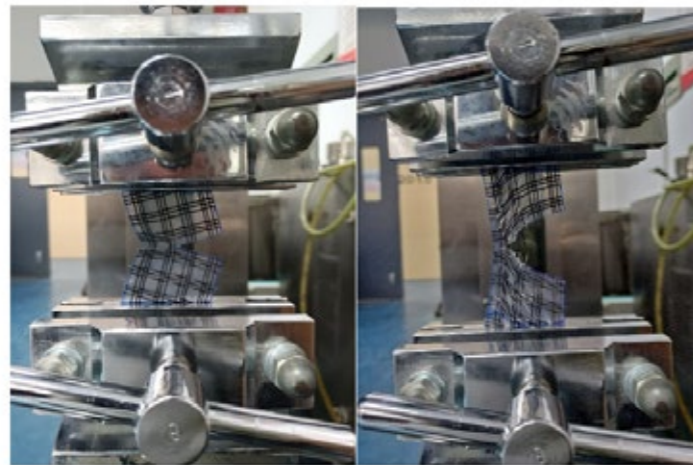

## Form-finding of tensile membrane structures by solving the Generalised Laplace equation using Physics-Informed Neural Networks

Mr Sounak Kabasi<sup>1</sup>, Mr Allan L. Marbaniang, Dr Siddhartha Ghosh

<sup>1</sup>Indian Institute of Technology Bombay

Tensile membrane structures (TMS) are gaining popularity due to their light weight, high material usage efficiency, and ability to span large areas. Form finding is necessary for TMS, as the structure's form is unknown beforehand and depends on stress and boundary conditions. However, mainstream form finding algorithms have issues such as mesh distortion and severe computational burden. The authors propose a new method based on the theory of a general curved interface and the solution to the general Laplace equation. The proposed methodology involves the solution of a modified form of this equation using a newly developed method in the field of supervised learning known as Physics Informed Neural Network. The proposed meshless method is seen to be independent of dimensionality and initial shape, making it more efficient for TMS design.

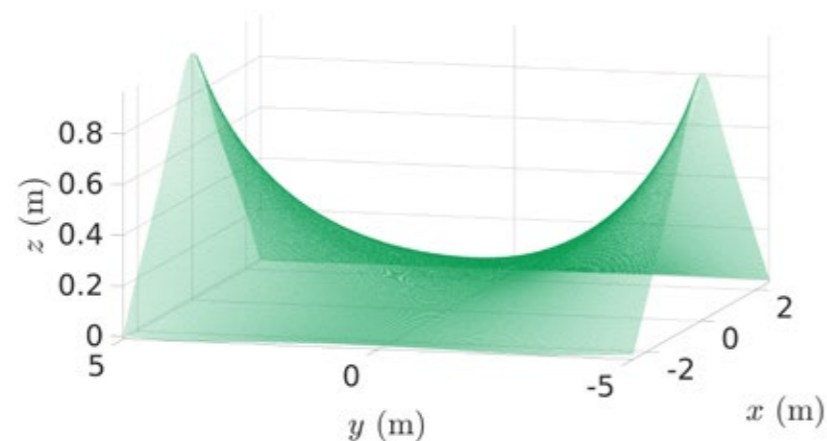

## Design Considerations for Tension Membranes on Optus Stadium and other Modern Australian Stadiums

Mr Scott Rathie<sup>1</sup>

<sup>1</sup>Arup

The Architectural intent for the Optus Stadium Roof at concept stage was for it to be a floating "halo." This concept was the inspiration for the choice of material used, form and detailing. To achieve this lightweight "halo" Arup worked closely with the Architect to develop efficient fabric forms that minimised the forces on the supporting roof structure. The main roof panel fabric between roof trusses is a conventional barrel vault supported by three arches. This presentation will also discuss similar design aspects and details in comparison to other Modern Stadium such as Queensland Country Bank and Metricon stadium among others.



## The constitutive model of STFE membrane material

Prof Qilin Zhang<sup>1</sup>, Ye YUAN, Mr Xiaoqun Luo<sup>1</sup>, Mr Ruijie Gu<sup>1</sup>

<sup>1</sup>Tongji University

STFE membrane is a new type of transparent membrane material with sufficient strength to be used in tensioned membrane structures. In this paper, uniaxial and biaxial tensile tests were conducted on this membrane material to obtain its stress-strain curves at different load ratios in the warp and weft directions, and to calibrate its material parameters such as elastic modulus and Poisson's ratio. Further, a biaxial nonlinear intrinsic model is also proposed, which provides a higher accuracy for the description of stress-strain relationship.

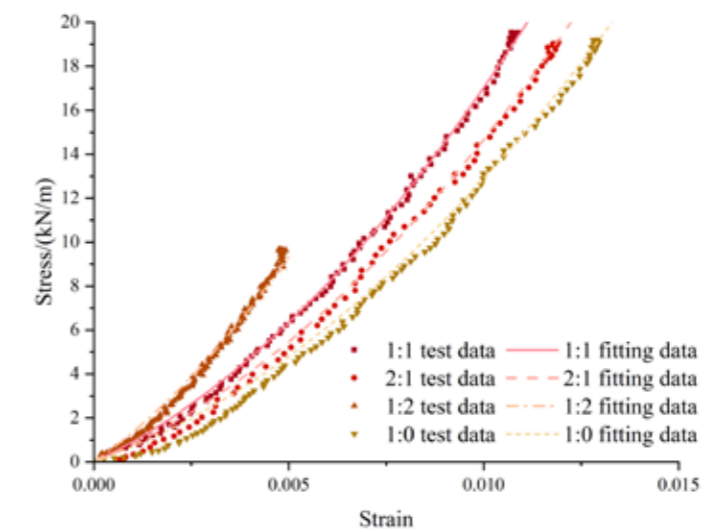

# Tuesday 11 July 2023





Tuesday 11 July 2023

# Session 11

## Investigation of load conditions

Room 215  
09:00 - 11:00

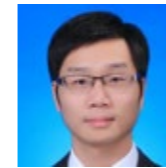

### Numerical Simulations of Snow Loads on Long-Span Curved Roofs

A/Prof Guolong Zhang<sup>1,2,3</sup>, A/Prof Qingwen Zhang<sup>1,2,3</sup>, Prof Feng Fan<sup>1,2,3</sup>

<sup>1</sup>Harbin Institute Of Technology, <sup>2</sup>Key Lab of Structures Dynamic Behavior and Control of the Ministry of Education, <sup>3</sup>Key Lab of Smart Prevention and Mitigation of Civil Engineering Disasters of the Ministry of Industry and Information Technology

Snow-induced building collapses are on the rise in long-span structures. According to the accident investigation, the sudden increase in the snowfall and unbalanced snow distribution, which leads to an excessive snow load in a local area, are the main reasons for such collapses. Therefore, based on a revised multiphase model, the numerical simulation of snowdrifts on a long-span curved roof was carried out with different inflow velocities and inflow directions. It is found that the unbalanced distribution of snow on the roof becomes more obvious with the increasing inflow velocity, showing a half-span snowdrift on the leeward side. Furthermore, for different inflow directions, the snow distribution pattern is mainly related to the building cross section parallel to the downstream direction.

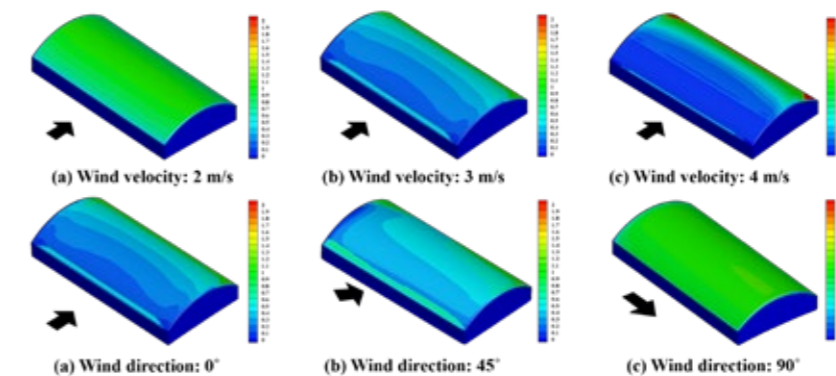

### CFD Investigation of Snow Drifting on Long-Span Dome Roofs

A/Prof Qingwen Zhang<sup>1,2,3</sup>, A/Prof Guolong Zhang<sup>1,2,3</sup>, Prof Feng Fan<sup>1,2,3</sup>

<sup>1</sup>Harbin Institute of Technology, <sup>2</sup>Key Lab of Structures Dynamic Behavior and Control of the Ministry of Education, <sup>3</sup>Key Lab of Smart Prevention and Mitigation of Civil Engineering Disasters of the Ministry of Industry and Information Technology

Under specific conditions of snowfall and wind, a large amount of snowdrift forms on buildings. At the worst, a significant amount of snowdrift will result in building collapse or cracking because of the unbalanced snow loads. This study aims to provide a new numerical approach, and apply it to the investigation of snowdrift development on a long-span dome roof. Firstly, the CFD prediction accuracy for snowdrifts was confirmed by comparing simulated results with field measurements. Then, the roof snow distribution characteristics on a long-span dome roof was predicted for different inflow wind velocities and roof spans. It is found that the uneven distribution of roof snow is weakened with the decreasing wind velocity and the increasing roof span.

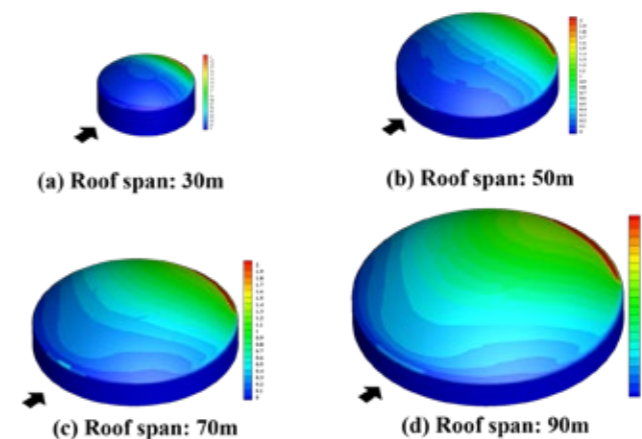

# Tuesday 11 July 2023



## Control objectives for adaptive slabs with integrated fluidic actuators, a comparison of effects

Mr Markus Nitzlader<sup>1</sup>, Mr Matthias J. Bosch<sup>2</sup>, Prof Hansgeorg Binz<sup>2</sup>, Prof Matthias Kreimeyer<sup>2</sup>, Prof Lucio Blandini<sup>1</sup>

<sup>1</sup>University of Stuttgart (ILEK), <sup>2</sup>University of Stuttgart (IKTD)

Fluidic actuators have been developed to be embedded in the compression region of reinforced concrete slabs under bending action. Through the controlled expansion of such fluidic actuators, deflections and stresses caused by vertical loads are reduced within the required limits. This work offers a benchmark study evaluating the effect of actuator placement and actuation forces for two different objectives: reduction of displacements and reduction of bending moments. A method to fulfil both objectives simultaneously has also been investigated. Results show that the efficacy of uni- and biaxial actuation modes depend on the control objective. To compensate for displacements and moments simultaneously, biaxial actuation is most effective and requires the lowest actuation forces.

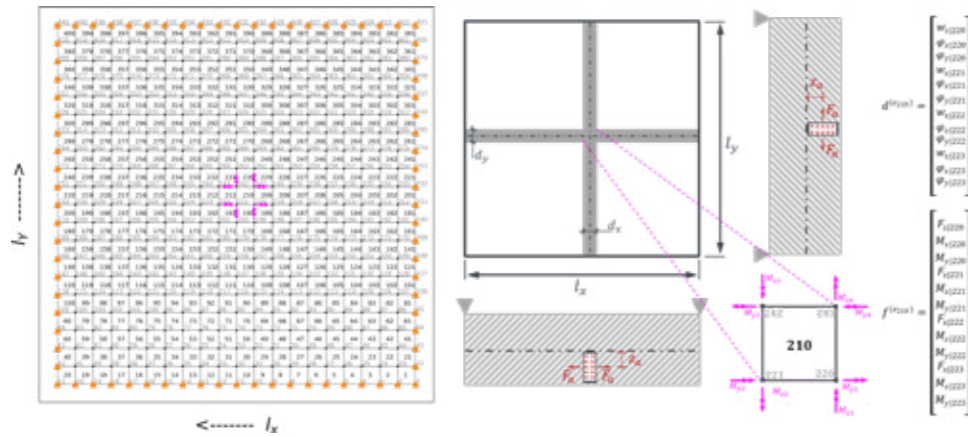

## Analytical simulation of roof snow load on flat roofs considering a probabilistic model of wind speed

Mr Yuanyuan Li<sup>1,2</sup>, Dr Huamei Mo<sup>1,2</sup>, Prof Feng Fan<sup>1,2</sup>

<sup>1</sup>Key Lab of Structures Dynamic Behavior and Control of the Ministry of Education, Harbin Institute of Technology, <sup>2</sup>Key Lab of Smart Prevention and Mitigation of Civil Engineering Disasters of the Ministry of Industry and Information Technology, Harbin Institute of Technology

This study conducts the analytical simulation of snowdrift to study snow load on a flat roof in Harbin, China. Meteorological records covering the time range of 1971 to 2018 are considered, and a probabilistic wind speed model is used to model the wind speed and improve the accuracy of the simulation. Finally, the ground-to-roof conversion factors for the flat roof are calculated, and the result is compared with those obtained from field measurements to demonstrate the simulation's validation.

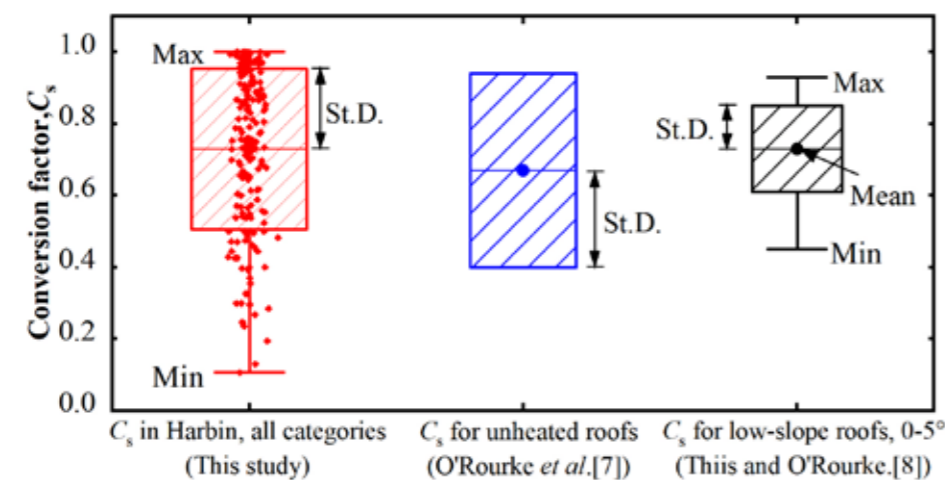

## Research of snow distribution on long-span roof with local obstructions

Mr Rui Li<sup>1</sup>

<sup>1</sup>Harbin Institute of Technology

With the frequent occurrence of extreme ice and snow weather, engineering accidents have happened increasingly, resulting in huge economic losses and a large number of casualties. Due to functional requirements, various forms of local obstructions are often arranged on long-span roofs. Such a structural form will exacerbate the uneven distribution of snow cover, which can more easily cause damage and destruction of the roof structures. Therefore, based on the wind-snow combined experiment facility and the similarity criteria based on snowfall, this paper systematically investigated the characteristics of snow distribution on long-span roofs with local obstructions under the effects of different inflow wind velocities, different lengths of the windward side of the obstructions, different heights of the obstructions, and different distances between obstruction center and long-span roof edge.

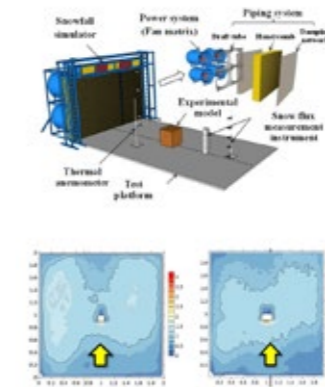

## Experimental Study on Estimation of Water Content and Compaction of Soil by SDS Test

Mr Tomoyuki Sakamoto<sup>1</sup>

<sup>1</sup>Tokai University

In Japan, when designing small-scale buildings, the ground is often investigated using the SWS test. The purpose of the SWS test is to estimate the strength of the ground, and it cannot clearly estimate the soil texture, water content ratio, degree of compaction, etc., which greatly affect the amount of settlement. The SDS test, on the other hand, is an improved version of the SWS test. The authors hypothesized that it would be possible to estimate the water content ratio and degree of compaction of the ground from the measured torque. To test the validity of this hypothesis, the authors confirmed the correlation of water content and degree of compaction from the measured values of the SDS test.

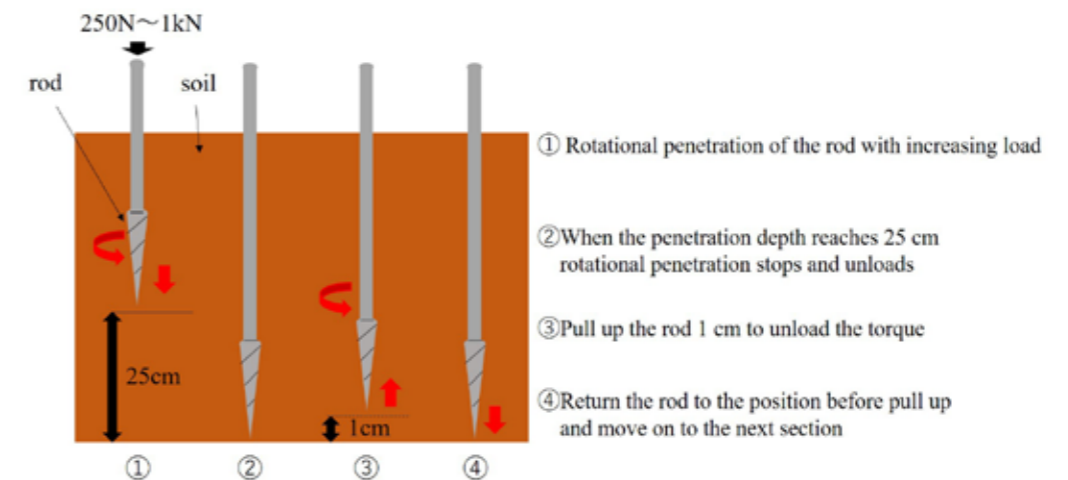

Tuesday 11 July 2023



**Effect of stochastic imperfections on the buckling of open-top storage tanks under wind loads**

Dr Liang Liu<sup>1</sup>, Prof Yin Sun<sup>1</sup>, Dr Ning Su<sup>2</sup>, Prof Zhenggang Cao<sup>1</sup>

<sup>1</sup>Key Lab of Structures Dynamic Behavior and Control of China Ministry of Education, Harbin Institute of Technology, <sup>2</sup>Key Lab of Environmental Protection Technology on Water Transport, Ministry of Transport, Tianjin Research Institute for Water Transport Engineering, M.O.T

Through the stochastic imperfection modal superposition method (SIMSM) and Monte Carlo simulation, the stochastic structural buckling analyses are carried out on 1000 sample tanks under wind loads. The results show that the first buckling eigenmode is not always the most unfavorable initial imperfection shape, but the difference of buckling load factors is minor. Besides, multi-parameter empirical formulas to accurately estimate the knock-down factor  $\eta$  of unstiffened and stiffened open-top tanks with different geometries are obtained through parameter fitting.

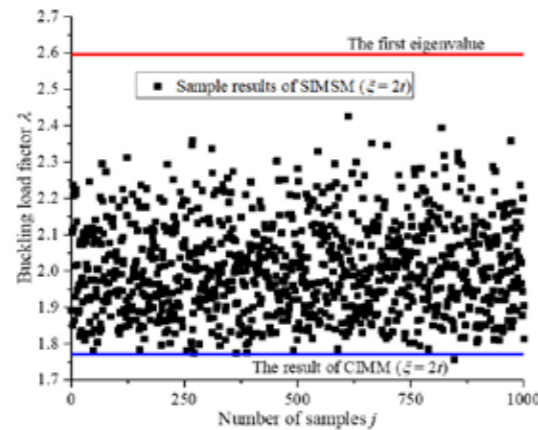

**A modified Finite Area Element model for simulating the evolution of roof snow loads**

A/Prof Huamei Mo<sup>1</sup>, Mr Zhiheng Luo<sup>1</sup>, Mr Ziwei Tai<sup>2</sup>, Mr Yuanyuan Li<sup>1</sup>, Prof Feng Fan<sup>1</sup>

<sup>1</sup>Harbin Institute of Technology, <sup>2</sup>Gemdale Corporation

The Finite Area Element (FAE) method proposed by Irwin and Gamble was modified to analytically simulate the evolution of roof snow load on a cylindrical roof. The modifications include three aspects: 1) the formula to estimate roof snow transport rate due to snow drifting; 2) the method of evaluating the wind field around the roof; and 3) the estimation of roof snow depletion. Using the modified model, the evolution of roof snow load on a cylindrical roof in Harbin China is simulated and analyzed for the period of 1971 – 2017. Results indicated that the modified model is easy to implement and could be a useful tool to aid the design of roof snow load for long-span, complex roofs.

**IASS 2023**  
July 10–14 Melbourne  
Integration of Design and Fabrication

**A modified Finite Area Element model for simulating the evolution of roof snow load**

Huamei MO, Zhiheng LUO, Ziwei TAI, Yuanyuan LI, Feng FAN

**Finite Area Element Model**

**Original**      **Modified**

**Estimation of drifting rate**

- Wind velocity at a height of 1 m above the roof surface
- Friction velocity on the roof surface

**Wind field**

- Wind tunnel tests
- Numerical simulation

**Reduction of roof snow due to melting**

- Energy-balance based model
- Proportional to the reduction in ground snow depth

**Flowchart of the model**

**Snow on a cylindrical roof**

**Conclusion:** The modified model is easy to implement and could be a useful tool to aid the design of roof snow load for long-span, complex roofs, but the assumption that snow transport rate is solely related to the wind speed needs further improvement by considering the fetch length of the drift development.

Tuesday 11 July 2023

# Session 12

## Timber and bio-based structures 2

Room 216

09:00 - 11:00

# Tuesday 11 July 2023



## Design Opportunities and Limitations of Catenary Wood Structures

Mr Nichol Long Hin Wong<sup>1</sup>, Dr Kristof Crolla<sup>1</sup>

<sup>1</sup>The University of Hong Kong

This paper examines the design space and limitations of suspended wooden roofs using (near-) catenary-shaped glue-laminated beams as the main feature. Through four pilot design studies and historical precedents, the research identifies the potential opportunities and constraints of the system. An optimisation algorithm is introduced to reduce the number of jigs required for fabricating non-identical catenary beams of physical and digital prototypes at different scales. Thus, to test the refined and optimised design and fabrication methodology. The study shows that the expanded tectonic system provides a more sustainable construction system for suspended wooden roof structures, promoting the use of timber as a major low-carbon material. The paper concludes by discussing future research opportunities in this field.



## Reliability framework for CLT floors in out-of-plane bending using Monte Carlo simulation

Mr Richard Nero<sup>1</sup>

<sup>1</sup>The University of Melbourne

The use of sustainably sourced engineered wood products, like cross-laminated timber (CLT), can reduce the carbon footprint of our built environment. However, the natural variability of CLT limits its widespread adoption due to perceived risks. A Monte Carlo simulation (MCS) approach was adopted to capture this inherent variability by defining the material, geometrical and loading parameters as random variables in the model. The study compares reliability levels across international CLT design codes and conducts a sensitivity analysis on expected failure probabilities. Additionally, the study calibrates an appropriate resistance factor for CLT design within the context of the existing Australian timber codes, potentially enabling the creation of an Australian CLT design code.

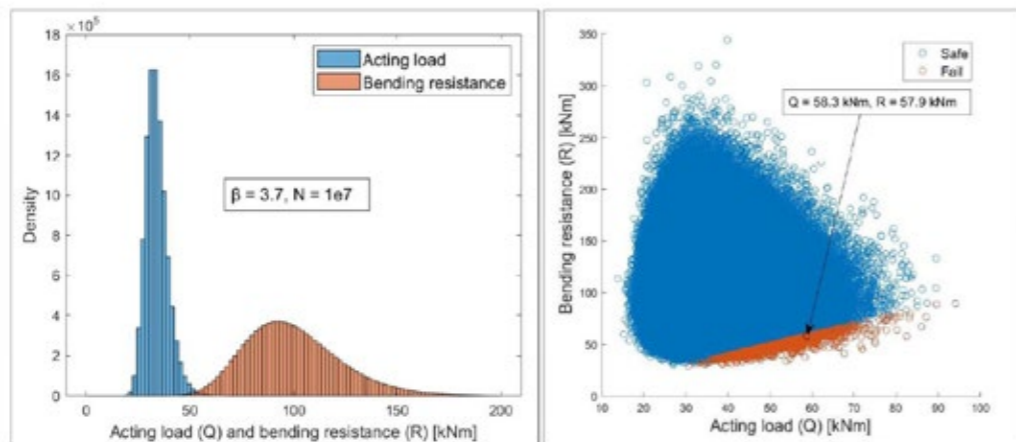

## Material Efficiency in Local Timber Construction: Unlocking the Potential of English Timber

Mr Harry Mills, Dr Dario Marino, Dr Darshil Shah, Dr Antiopi Koronaki, Prof Michael Ramage

<sup>1</sup>Centre for Natural Material Innovation, Department of Architecture, University of Cambridge, 1-5 Scroope Terrace

In this paper, we present the designs and simulation of structural prototypes incorporating local underutilised English timber. The structural performance of a timber-based truss system is analysed, looking at member utilisation, material volume and embodied carbon. The preliminary results show effective and scalable approaches for optimised truss, beam, and joist systems. The study is relevant to audiences interested in material-efficient topology-optimised timber structures and who can apply the insights to where stock of underutilised timber resources exists.

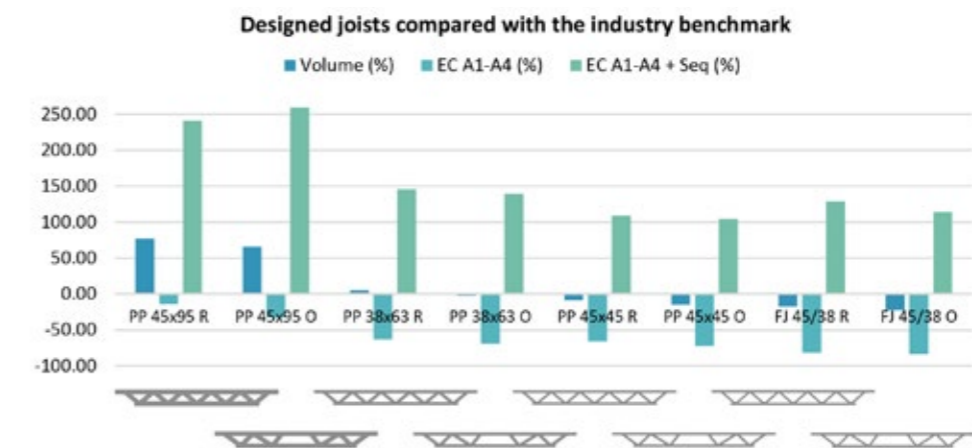

## Structural design of canoe club house

Mr Naoyuki Takayama<sup>1</sup>

<sup>1</sup>Takenaka Corporation

This paper presents the structural design of a club house with a catenary-shaped wooden roof. Use of a catenary shape for the roof has created a column-free space for the training room by making use of the small section of wood and ensuring that the main stresses in the members are axial forces. The author has determined the roof shape by considering the creep deformation properties of wood, and parametrically verifying the shape with a computer, to meet various constraints such as the required roof drainage slope and smoke exhaust area, building height restrictions, and effective ceiling height requirements.



# Tuesday 11 July 2023



## Integrative approach to a timber gridshell formed on-site

**Ms Evy Slabbinck<sup>1</sup>**, Mr Hermann Blumer<sup>4</sup>, Mr Stefan Rick<sup>3</sup>, Mr David Riggenbach<sup>2</sup>, Mr Martin Antemann<sup>1</sup>, Mr Fabian Scheurer<sup>1</sup>

<sup>1</sup>Design-to-Production, <sup>2</sup>Blumer-Lehmann AG, <sup>3</sup>SJB Kempter Fitze, <sup>4</sup>Création Holz

This paper describes the integrative approach of timber experts to achieve an innovative bent on-site timber gridshell in a combined effort and focusses on the different challenges and how each discipline responded to them, including workflow, exchange, and an interdisciplinary digital master model. The timber gridshell 'Wisdom Stockholm' is an extension of the Tekniska Museet in Sweden. The gridshell is constructed out of five crossing layers supported by pre-tensioned timber columns. The lower layer acts as falsework and is assembled from pre-curved, CNC-machined beams, while the upper four beam layers are bent on-site from laminated-veneer-lumber (LVL), a planar sheet material, held in place by wooden dowels and screws enabling loads to be transferred via contact.



## Cross Laminated Plywood Construction of a Free Form Roof

**Prof Paul Loh<sup>1</sup>**, Mr David Leggett<sup>2</sup>

<sup>1</sup>Bond University, <sup>2</sup>Power to Make/LLDS

The paper discusses the design, fabrication and assembly of a free-form roof structure constructed using a hybrid method of cross-laminating structural plywood. The research outlined the roof's design, fabrication and engineering workflow within an integrated fabrication environment led by the architect in collaboration with the engineer. Such workflow allows resilience in the design and manufacturing process. The digital fabrication of the structure is developed in a single parametric model informed through 3 sets of physical prototypes. By incorporating as-built site information through digital scans, the assembly process is enhanced with feedback to ensure precision in manufacturing, thereby demonstrating care in construction through digital technology.

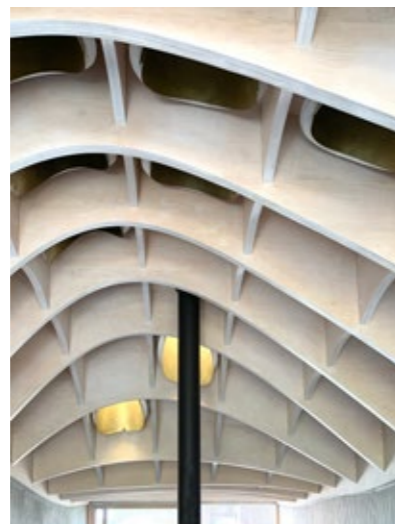

## Systematically ranking of mycelium composites used for facade construction via a fuzzy comprehensive evaluation

**Dr Ali Hadigheh<sup>1</sup>**, Ms Yaning Wei<sup>1</sup>

<sup>1</sup>The University of Sydney

This study compares various mycelium composites manufactured using different fungal species and provides a decision-making guide for selecting the most suitable material of secondary structure member for built environment applications. To determine the most important variables in the selection process, the analytic hierarchy process (AHP) was employed, revealing that tensile strength is the most critical factor, followed by flexural strength, manufacturing period, density, and water absorption. This study also used the Fuzzy Comprehensive Evaluation (FCE) approach to establish a rational rating system for making the decision of material selection, which indicate that Ganoderma lucidum is the most promising material, as it has an optimal balance of material performance and material manufacturing time.

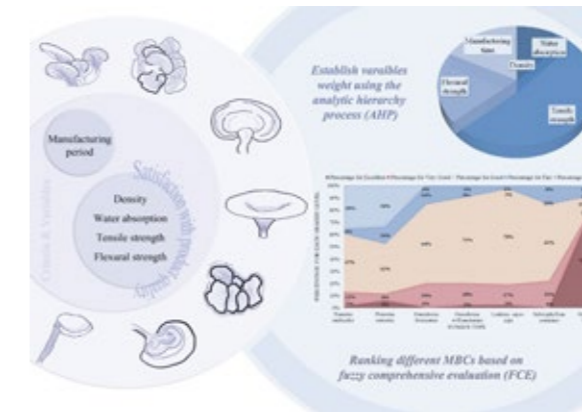

## Research on clay mixtures for sustainable building materials

**Dr Andreea-Terezia Mircea<sup>1</sup>**, Dr Gabriela Calatan

<sup>1</sup>Department of Civil Engineering and Management, Technical University of Cluj-Napoca

An important feature of sustainable building is represented by the construction materials derived directly from surroundings, supporting the local development and cultural independence of the region, along with the use of simple techniques that don't further pollute the environment, don't consume more fossil fuel, or unnecessarily extract resources. Earthen architecture can be linked to a technological continuity common all over the world, dating back to ancient periods. In this aim, clay mixtures are able to be successfully used to build masonry bricks, mortars, plasters and finishes. The paper presents experimental studies and results made in the field of eco-friendly building materials, emphasizing contributions for reevaluation of traditional and local construction materials, conservation of natural resources, protection of landscape and bionetwork

Hemp and wheat straw fibres for clay mixtures



Specimens in test devices

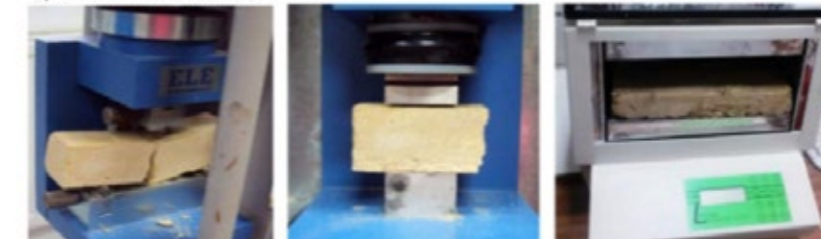

Tuesday 11 July 2023

# Session 13

## Numerical methods

Room 217  
09:00 - 11:00

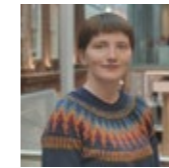

### Simultaneous optimization of geometry and topology for grid-shells under self-weight loading

Dr Helen Fairclough<sup>1</sup>, Dr Linwei He<sup>1</sup>, Dr Karol Bołbotowski<sup>2</sup>, Prof Matthew Gilbert<sup>1</sup>

<sup>1</sup>University of Sheffield, <sup>2</sup>Warsaw University of Technology

There are many effective form-finding methods for grid-shell structures, but these typically require manual selection of the structure's topology. An inappropriate topology can significantly increase material usage and embodied carbon. Recently, a novel method has been proposed for simultaneous optimization of the topology and geometry of grid-shell structures. The globally optimal topology is selected from a dense 2D ground structure and the optimal elevation field is also obtained. Here, this approach is extended to consider the self-weight of the structural members. This is especially important for long spanning structures. The inclusion of self-weight can significantly alter the topology and elevation of the optimal structures, demonstrating the importance of explicit and accurate modelling of self-weight in these problems.

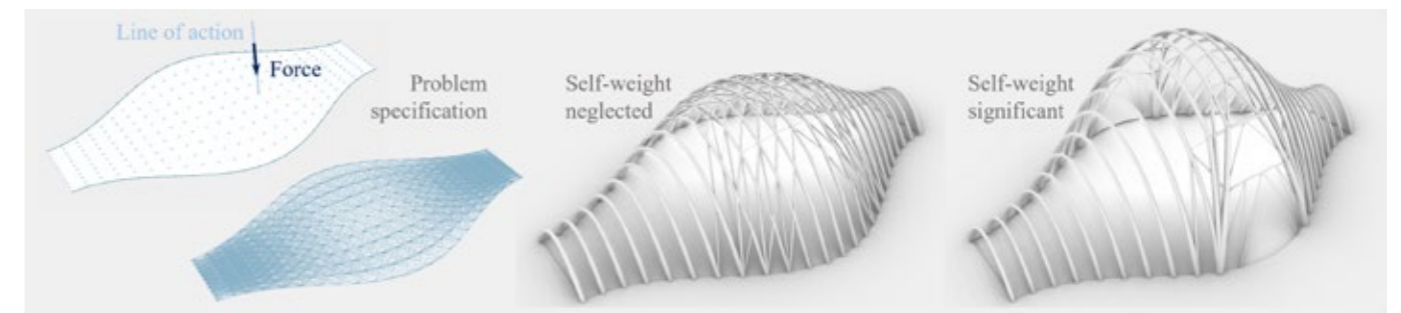

### Behavior and design of innovative cold-formed steel channel beams with edge-stiffened web openings

Dr Boshan Chen<sup>1</sup>

<sup>1</sup>Tsinghua University

A new generation of cold-formed steel channel beams with edge-stiffened web holes was developed, and this study investigated the effects of edge-stiffened web holes on the capacity of such CFS channel beams in bending, shear, and web crippling. In total, 82 laboratory tests were performed, covering web crippling tests, bending tests, and shear tests. The results show that the CFS channel beams with edge-stiffened web holes performed better than those with unstiffened web holes. Nonlinear finite-element (FE) models were also established and validated against the test results. The validated FE models were then used to perform a parametric study involving 1335 FE models. Finally, suitable design equations were developed for calculating the capacity of such CFS channel beams.

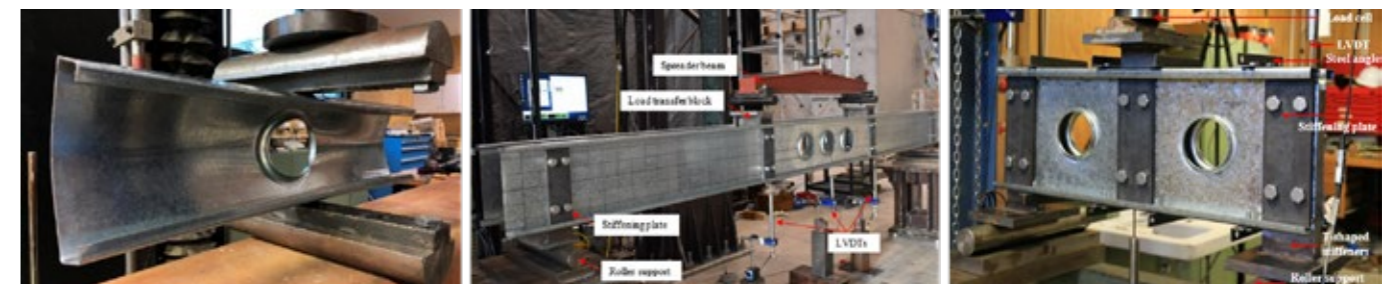

# Tuesday 11 July 2023



## An efficient shape optimization algorithm for gridshells based on node shifting

Dr Chao Ding<sup>1</sup>, A/Prof Zhen Wang<sup>1</sup>, Prof Yang Zhao<sup>2,3</sup>, Prof Yi Min Xie<sup>4</sup>

<sup>1</sup>Advanced Materials Additive Manufacturing Innovation Research Center, Hangzhou City University, <sup>2</sup>Space Structures Research Center, Zhejiang University, <sup>3</sup>School of Civil Engineering, Shaoxing University, <sup>4</sup>Centre for Innovative Structures and Materials, School of Engineering, RMIT University

In this paper, a novel and efficient shape optimisation algorithm for gridshells, especially for cantilevering structures, is proposed based on the evolutionary node shifting method, where the nodal positions are iteratively updated to minimise the structural compliance. The surface smoothness is significantly improved by the introduction of the distributed load filter scheme, where the negative sensitivity numbers are applied to each node as the fictitious external load to ensure both the smoothness of surfaces and the sustained reduction of structural compliance at each iteration. A much more stable and faster convergence is achieved compared to the conventional nodal shifting methods. The numerical example of a rectangular gridshell is presented to demonstrate the effectiveness and the efficiency of the proposed algorithm.

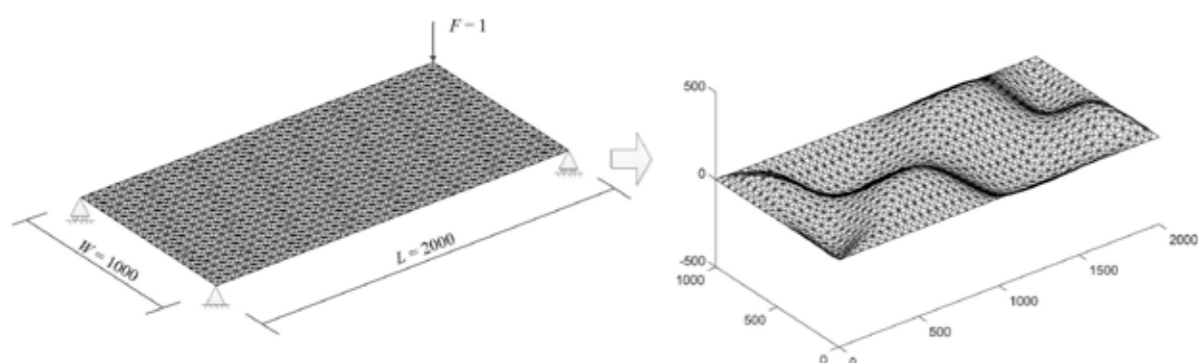

## Multi-objective optimization of the large telescope structure under temperature loading

Dr Hiroaki Kawamura<sup>1</sup>, Ms Ayame Usui<sup>1</sup>, Mr Chihiro Imamura<sup>2</sup>, Dr Akio Taniguchi<sup>2</sup>, Dr Kohei Shintani<sup>3</sup>, A/Prof Takayuki Yamada<sup>3</sup>, Prof Yoichi Tamura<sup>2</sup>, A/Prof Toshiaki Kimura<sup>1</sup>

<sup>1</sup>Nagoya City University, <sup>2</sup>Nagoya University, <sup>3</sup>University of Tokyo

This study proposed a new multi-objective optimization for the backup structure of the Large Submillimeter Telescope (LST) by extending to previous papers. In addition to the total mass, the surface accuracy of the primary reflector, which is expressed by root-mean-square (RMS) of deformation subjected to vertical and thermal load for the normal direction of the reflector, is assigned as the objective function. The shape of the primary reflector is evaluated by considering homologous structures. Its focus point can vary through optimization to obtain the optimal shape. The effectiveness of the proposed method is discussed through numerical examples.

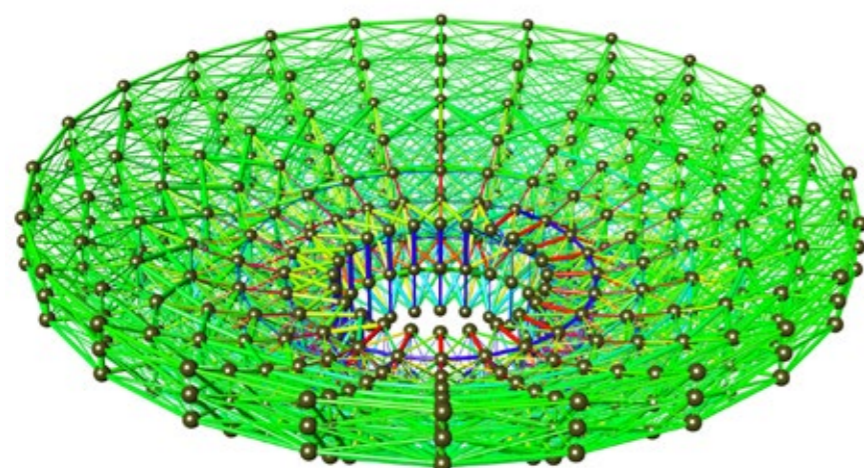

## Sizing optimization of free-form lattice shells using deep deterministic policy gradient and graph convolutional networks

Mr Chi-Tathon Kupwiwat<sup>1</sup>, A/Prof Kazuki Hayashi<sup>1</sup>, Prof Makoto Ohsaki<sup>1</sup>

<sup>1</sup>Kyoto University

This paper proposes a method for sizing optimization of free-form lattice shells using a Deep Deterministic Policy Gradient (DDPG) agent with Graph Convolutional Networks (GCNs). The problem aims to minimize the volume of the structure by choosing sizes of structural members where the objective function is the total structural volume subjected to the stress constraints of the members. The agent observes the structure, represented as a graph, chooses the elements to reduce the size, and receives a reward computed from the reduction of the structural volume and the maximum stress to be constrained. Results show that the GCN-DDPG agent can learn to minimize the structural volume. It can be applied to large free-form lattice shells using a small computational cost.

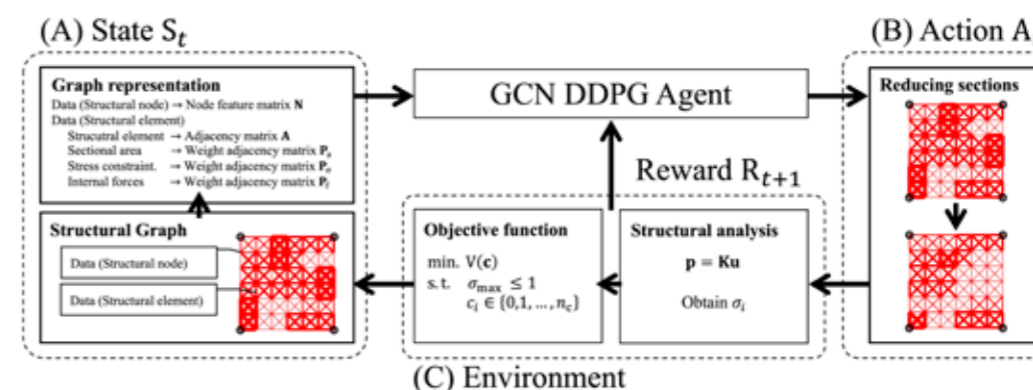

## A novel generatively designed and additively fabricated ankle-foot orthosis

Mr Ryan Blakis<sup>1</sup>, Dr Peter Dabnichki<sup>2</sup>, Dr Mladenko Kajtaz<sup>1</sup>

<sup>1</sup>Centre for Additive Manufacturing, School of Engineering, RMIT University, <sup>2</sup>School of Engineering, RMIT University, Australia

An ankle-foot orthosis (AFO) is an external mechanical device that is prescribed to control or support the ankle-foot complex. Traditionally, they are designed and fabricated manually, using methods that may restrict design outcomes. To overcome this, additive manufacturing (AM) has been investigated. However, despite the ability to produce optimised topology with AM, traditional designs are often produced. Therefore, although additive manufacturing can produce optimised topology, it is not being leveraged within this context. This research features a methodology that leverages generative design and shape optimisation to reduce AFO mass whilst maintaining fundamental mechanical behaviour. This study demonstrated the suitability of the method by producing an AFO design that was 30% lighter and suitable for fabrication with HP multi-jet fusion (MJF).

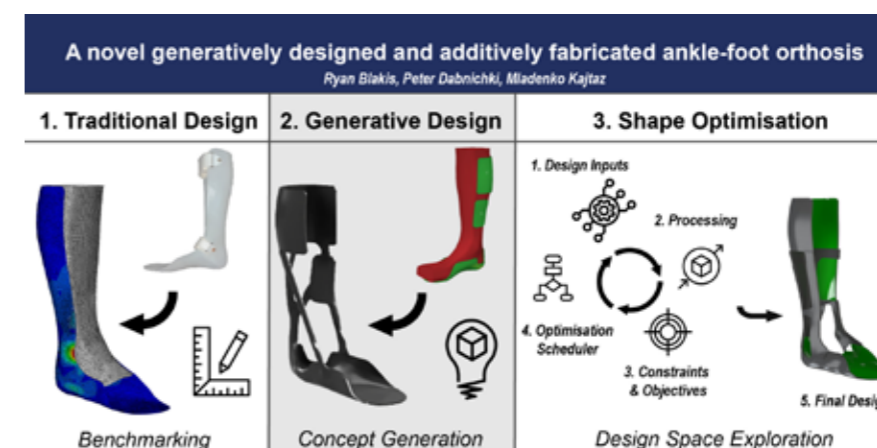

# Tuesday 11 July 2023

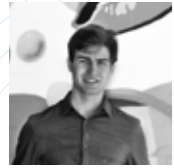

## Designing the West Gate Tunnel portals: Façade geometry and structure

Mr Benjamin Coop<sup>1</sup>, Mr Andre Pereira<sup>1</sup>, Mr Hieu Tran<sup>1</sup>, Mr Dwayne Van Halewijn<sup>1</sup>, Mr Manning Thomson<sup>1</sup>, Mr Atreyu De Lacy<sup>1</sup>

<sup>1</sup>Taylor Thomson Whitting (TTW)

This paper explores the design process of the decorative entrance and exit exhaust vent structures for the West Gate Tunnel Project in Melbourne, designed by Wood Marsh Architecture. Taylor Thomson Whitting focused on optimizing the supporting structural steel and panelising the freeform aluminium façade, using a distorted UV space grid and K-means clustering for geometric optimization. C# libraries and Grasshopper scripts were used to automate the structural design process, along with Strand7 FEA models, AS4100 design checks, and an optimization framework inspired by bone mechanobiology research. These computational design methods allowed for rapid and precise structural feedback, facilitating informed decision-making among stakeholders regarding geometric changes that could impact architectural intent and structural design.

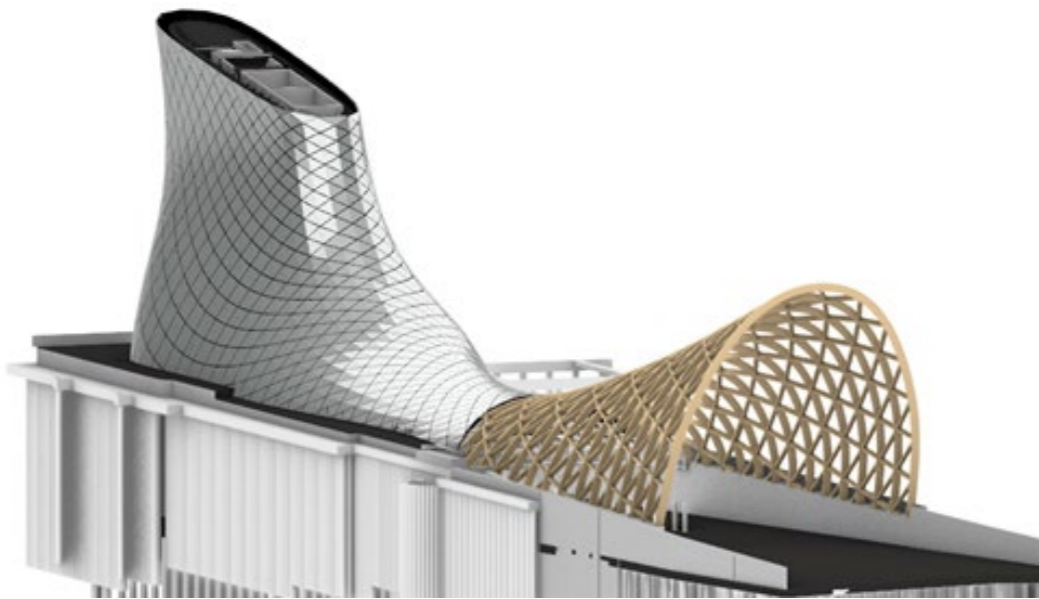

Tuesday 11 July 2023

# Session 14

## Form-finding 1

Room 218

09:00 - 11:00



# Tuesday 11 July 2023



## A numerical comparison between geometric stiffness- and elastic stiffness-based structural shape optimization for gridshells

Mr Gaoyuan Wu<sup>1</sup>, Mr Rafael Pastrana<sup>1</sup>, Prof Sigrid Adriaenssens<sup>1</sup>, Prof Maria Garlock<sup>1</sup>

<sup>1</sup>Princeton University

Numerical form-finding methods coupled with optimization algorithms generate efficient shapes for gridshells based on different stiffness assumptions. This paper presents a comparative study between the constrained force density method (FDM) and the finite element analysis (FEA)-based shape optimization (FSO) in the generation of shapes of gridshells that make the optimal use of material as quantified by their strain energy. Three different gridshells with fixed horizontal projection are optimized for minimal strain energy with each form-finding method: a barrel vault, a dome and a gridshell with complex plan view. High-performance numerical computing is utilized to execute experiments efficiently and automatic differentiation is leveraged. The findings of this work provide insights on the strengths and weaknesses of these two form-finding methods.

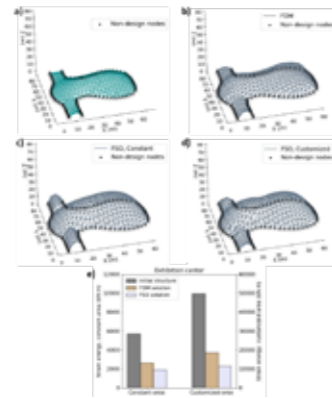

## A novel approach to generating diverse and competitive structural designs through load perturbation in topology optimisation

Mr Yulin Xiong<sup>1</sup>, Dr Hongjia Lu<sup>1</sup>, Prof Yi Min Xie<sup>1</sup>

<sup>1</sup>RMIT University

We have developed a novel approach based on the bidirectional evolutionary structural optimisation (BESO) method to generate diverse designs. In this approach, the optimisation process is perturbed by applying randomly varied angles to the applied loads, and the interim results are presented to the designer for selection based on their aesthetic and functional preferences. By incorporating human guidance, this approach enables a trade-off between exploring diverse solutions and integrating the designer's preferences into the optimisation process, making it suitable for architectural and structural designs. Furthermore, serialised diverse designs can be easily generated by using combinations of perturbations at different iteration steps. Potential applications of this approach in architectural and structural designs are presented, demonstrating the ability of the proposed method to produce optimised solutions that effectively integrate the designer's functional requirements and aesthetic preferences.



## Graphic statics and topology optimization: An integrated approach to designing architecture structures

Mr Xinjie Zhou<sup>1</sup>, Mr Yu Li<sup>1</sup>, Prof Philip F. Yaun<sup>1</sup>

<sup>1</sup>Tongji University

This paper presents a method for the structural optimization of a railway station. As opposed to traditional structural optimization techniques, which are typically conducted by manipulating the geometry of the structure using a single optimization method, this approach presented in this paper establishes a multi-strategy solution to the problem, where structural optimization is conducted using two structural optimization design tools- BESO and graphic statics. The approach in this paper combines these two methods to optimize the structural design of the trusses for a railway station. The algorithm implementation of the graphic statics part is mainly based on vector-based graphic statics. This approach solves the discretization problem in topology optimization and dramatically accelerates design iterations' efficiency.



## Optimisation of a Satellite Antenna Bracket using the BESO Method

Mr Joshua Rodrigues<sup>1</sup>, Prof Simon Barter<sup>1</sup>, Prof Raj Das<sup>1</sup>

<sup>1</sup>RMIT University

The advancement of technology and research in the space domain has sparked interest towards increasing the efficiency and duration of satellite operations for Earth-orbit missions. Reducing the weight of structures by removing inefficient material is highly advantageous to such weight-conscious applications. This paper presents a case study for the optimisation of a satellite antenna bracket structure using the bi-directional evolutionary structural optimisation (BESO) method. It is observed that the BESO method can reduce the weight of a structure through efficient material allocation whilst maintaining critical strength and stiffness qualities. The findings of this study inform the ability of the BESO method as a functional tool for the future design optimisation of spacecraft structures.

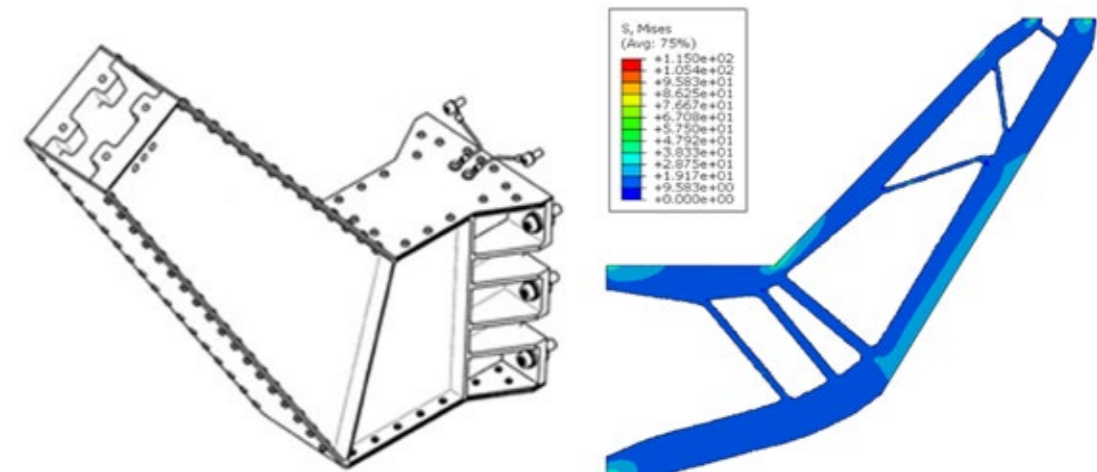

Tuesday 11 July 2023



**Aeolus: A Grasshopper plugin for the interactive design and optimisation of acoustic shells**

Mr Michael Mack<sup>1</sup>, Mr Gabriele Mirra<sup>1</sup>, Dr Alberto Pugnale<sup>1</sup>

<sup>1</sup>Faculty of Architecture, Building and Planning, The University of Melbourne

The design of music venues, such as concert halls and open-air concert stages, requires an integrated approach in which the acoustic response of the space being created is evaluated at every stage of the process to inform its formal development and associated performance. This paper introduces Aeolus, an acoustic modelling plugin for Grasshopper. Unlike other similar Grasshopper plugins, Aeolus allows users to control the simulation accuracy and can therefore be used to rapidly test the performance of design ideas. Aeolus can also easily be interfaced with various Grasshopper optimisation plugins. Aeolus v0.1 was publicly released on 7 March 2023, and will be the focus of a Masterclass offered at the IASS Symposium 2023 in Melbourne, Australia.

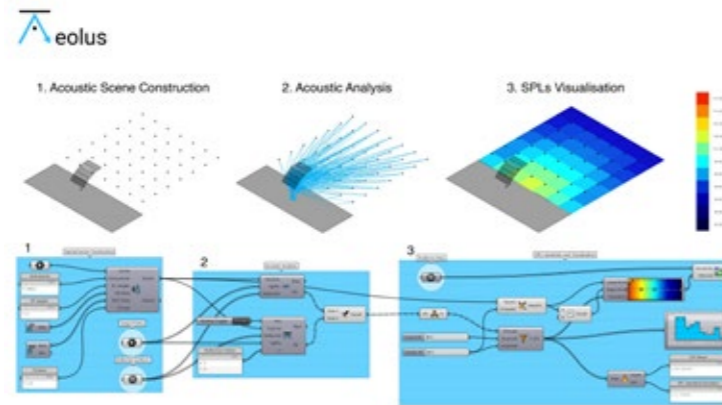

**Fundamental study on form-finding of tensegrity-membrane structures using a dynamic relaxation method**

Mr Yohei Nagano<sup>1</sup>, Lecture Takuo Nagai<sup>1</sup>

<sup>1</sup>The University of Shiga Prefecture

This study explores a method for form-finding of tensegrity-membrane structures by replacing the membrane material with truss elements and estimating their behavior against external forces accurately. The dynamic relaxation method is used for numerical analysis, and the analysis model is created by replacing the membrane material with truss elements based on the physical model. The form-finding is performed by using load-strain relationship expression obtained from the tension tests of the membrane material. The study compares the actual measurements of the physical model with the form-finding results and discusses the analysis method used in this research.

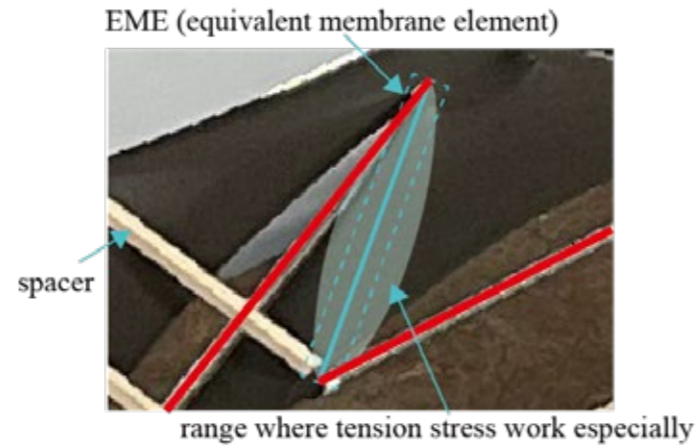
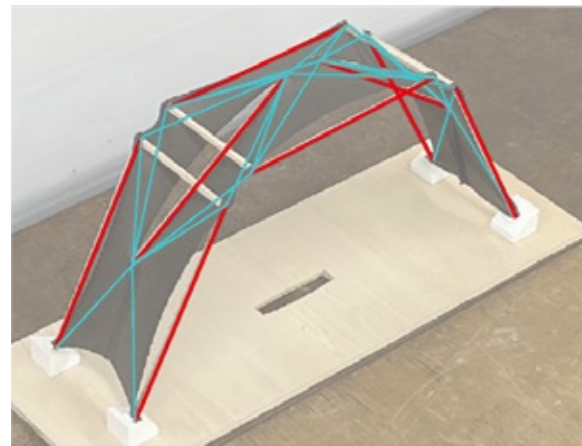

— compression element — EME (equivalent membrane element)

Tuesday 11 July 2023

Session 15

Additive manufacturing 2

Room: Plenary 3

09:00 - 11:00

# Tuesday 11 July 2023



## Additively manufactured steel joints for structural frames: A concept proposal and numerical simulations

Mr Seyed Pouya Afshar Imani<sup>1</sup>, Dr Mani Khezri<sup>1</sup>, Prof Kim J.R. Rasmussen<sup>1</sup>

<sup>1</sup>The University of Sydney

The novel and advantageous features of additive manufacturing can be exploited to address the current challenges in the construction of structural steel structures. Connections of steel structural systems are such essential components as their properties greatly influence the global response of the frame and control the collapse behaviour of the entire system. The conventional approach for the design and analysis of structural frames offers a narrow range of pre-defined connection types and limited scope for optimising their rigidity and strength, and the fabrication of connections is labour-intensive. This study aims to investigate the potential application of additively manufactured connections for steel frames by introducing an alternative conceptual design achieved by topology optimisation showing a superior structural performance to that of a conventionally designed connection.



## Continuous fibre additive manufacturing of topological spatial lattices for fabrication-aware design processes

Mr Eduardo Chamorro<sup>1</sup>, Prof Mark Burry<sup>1</sup>, PhD Mathilde Marengo<sup>1</sup>

<sup>1</sup>Institute for Advanced Architecture of Catalonia (IAAC)

This paper discusses a novel design for manufacturing framework for building structural 3D spatial lattices with continuous fibre additive manufacturing processes. The proposed method uses an optimization form-finding approach based on stress-lines generation, which overcomes the traditional challenges of non-regular topology sequencing and improves material efficiency, weight, and structural performance compared to standard 3D lattices. The method produces load-bearing designs for functionally graded lattice cellular topologies that respond to stress distribution and structural requirements. Specific non-standard load-based lattice geometries have the potential to significantly reduce material usage, a major drawback of composite materials in the architecture, engineering, and construction additive manufacturing field. The framework presented in this research aims to manufacture a globally continuous 3D spatial lattices toolpath for 2.5d structural designs, which takes advantage of the benefits of continuous fibre placement as structural reinforcement for composite elements.

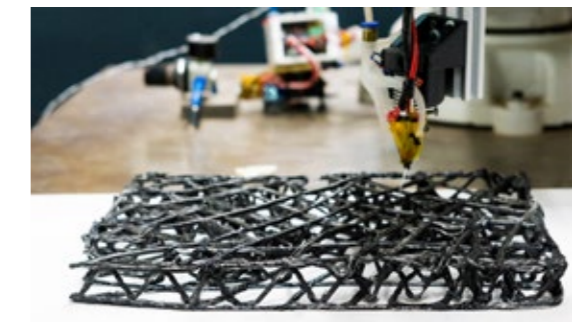

## Digital Ceramics: High Hyperbolic Curvature Fabrication Technologies in Paste-Based Additive Manufacturing

Mr Lei Gong<sup>1</sup>, Prof Philip F. Yuan<sup>1</sup>

<sup>1</sup>Tongji University

This paper takes clay materials as an example to propose an innovative robotic 3D printing technique suitable for high hyperbolic complex-shaped surfaces of non-rapid-setting paste-based materials, and summarizes it as Hybrid Craft. This study analyzes the shaping principles and limitations of the primary Contour Craft and Lattice Craft via multiple cases which adopted several sets of modified toolpath planning schemes and associated technological parameters. As the empirical cases are printed and evaluated, craft characteristics parameters that meet the standards for creating high-curvature objects can be deduced, resulting in the better-performing Hybrid Craft. Through the above methods, users can easily achieve the fabrication of high hyperbolic complex components using non-rapid-setting paste-based materials and standard six-axis robot arms.



## Robotically assisted manufacturing for free-form rammed earth

Dr Mohamed Gomaa<sup>1</sup>, Mr Sascha Schade<sup>1</sup>, Dr Ding Wen Bao<sup>1</sup>, Prof Yi Min Xie<sup>1</sup>

<sup>1</sup>RMIT University

In this works, a unique method is proposed to make a completely enclosed serpentine channel with the dimensions of 0.35mm x 2mm x 500mm by combining the binder jetting printing technique with diffusion bonding method taking advantage of liquid phase sintering happening when adding boron. The accomplished results are very promising with the completed joining area and the good channel shape. This primary result can be further developed to apply in the gas chromatography, heat exchanger and internal cooling channel and other applications requiring intricate internal structures



# Tuesday 11 July 2023



## Structural Connection Design Possibilities with Reclaimed Elements Using 3D Concrete Printing

Ms Gülay Elbasdi<sup>1</sup>, A/Prof Torsten Schröder<sup>1</sup>, A/Prof Sandra Lucas<sup>1</sup>

<sup>1</sup>Eindhoven University of Technology

We explore how architects and structural engineers can take advantage of 3D printing technology to overcome the limitations of supply-driven design and resource-intensive fabrication of new custom components when designing new structures.

### Problem

**Linear Supply Chain**  
Demand-driven design

### Solution

**Circular Supply Chain**  
Supply-driven design  
  
+ On-demand 3D printing of customized components



## Phase field fracture modelling for laser powder bed fusion metals

Mr Cunyi Li<sup>1</sup>, Dr Jianguang Fang<sup>1</sup>, Prof Grant Steven<sup>2</sup>, Prof Qing Li<sup>2</sup>

<sup>1</sup>University of Technology Sydney, <sup>2</sup>University of Sydney

This study proposes a phase field framework for modelling complex mechanical behaviours of laser powder bed fusion printed metals. To consider the fabrication induced microstructural orientation, transversely isotropic Hill48 and modified Mohr-Coulomb constitutive models are incorporated to describe the plastic and fracture behaviours, respectively. Material specimens, covering a wide spectrum of stress states, are designed to identify material properties of plasticity and fracture. Crack propagation specimens are tested to demonstrate the capability of the developed model. The numerical results divulge that, by considering the stress state-dependent crack initiation, the proposed phase field model can better reproduce global responses. Remarkably, the complex cracking sequences, including crack initiation, propagation and final rupture, can be properly captured by the proposed phase field model.

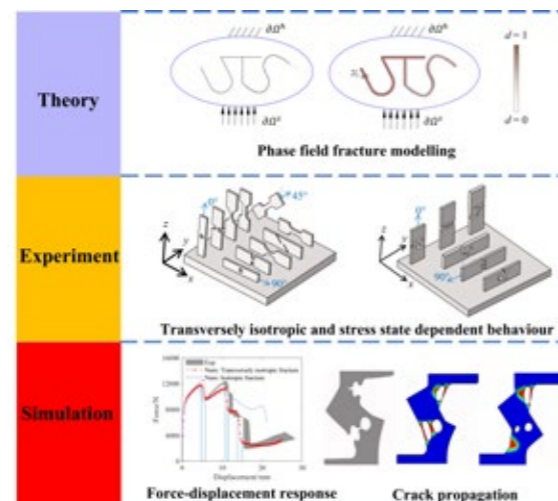

## Additive Manufacturing of Fully Recyclable Walls solely made from Renewables – A possible Quantum Leap in Sustainable Building Construction

Prof Benjamin Kromoser<sup>1</sup>, Bernhard Reinholz, Roman Myna, Dr Sara Reichenbach, Prof Rupert Wimmer

<sup>1</sup>University of Natural Resources and Life Sciences

Based on a recent study revealing the unique bonding/debonding capabilities of hot-pressed mixtures of equal quantities of corn starch and sodium lignosulfonate (“BIOMIX”), this paper presents a novel technological approach targeting the additive manufacture of recyclable bio-based wall elements [1]. It is based on dry blending of wood particles with BIOMIX in a weight ratio of 1:1 (referred to as “BIOMIX-w”), subsequent adjustment of a certain surface moisture, extrusion through a printing nozzle and final application of heat and pressure to facilitate bonding within and between the printed layers. Different from conventional adhesives, the bonds between the individual constituents can be re-opened by joint exposure to steam and gentle shear force, allowing for lossless reprocessing and recycling of all constituents.

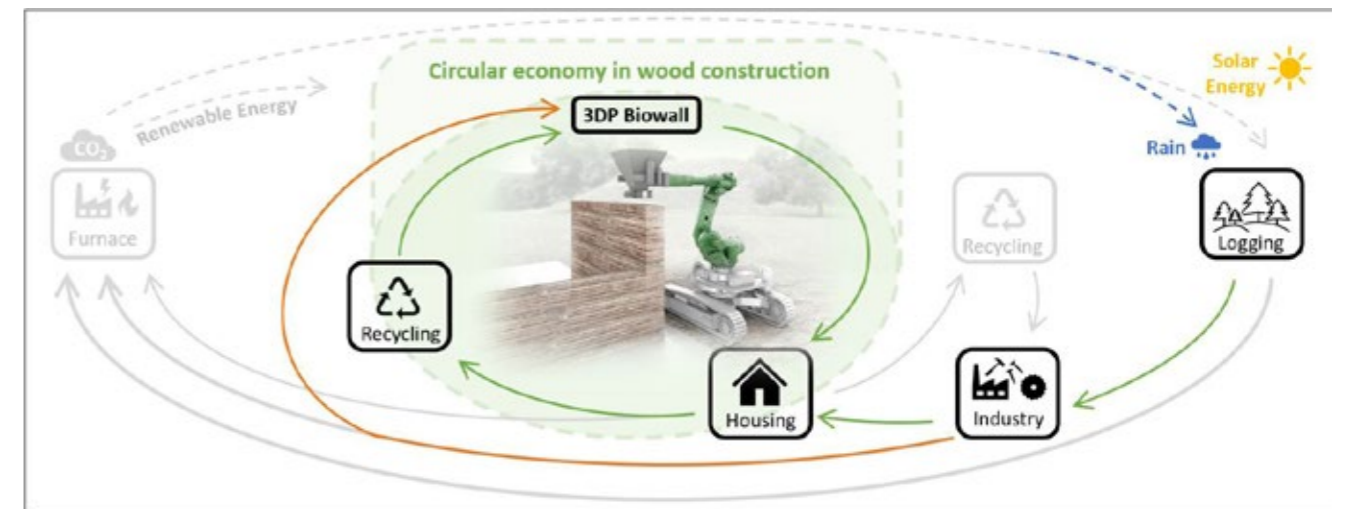

Tuesday 11 July 2023

# Masterclass 3

**Ameba: Topology Optimisation  
Design**

Room 215  
14:00 - 16:00

Presented by

**Yi Min 'Mike' Xie &  
Ding Wen 'Nic' Bao**



Tuesday 11 July 2023

# Session 17

**Origami 1**

Room 216  
14:00 - 16:00

# Tuesday 11 July 2023



## Analysis of bending behaviour in simple flexible honeycomb cores with tetradecagonal cells

Mr Chisaki Kitajima<sup>1</sup>, A/Prof Kazuya Saito<sup>1</sup>, Dr Taiju Yoneda<sup>1</sup>, Hiroshi Okubo<sup>2</sup>, Prof Kaoru Suehiro<sup>1</sup>

<sup>1</sup>Kyushu University, <sup>2</sup>Nissan Motor Corporation

Honeycomb core sandwich panels are commonly used in various engineering applications due to their light weight, sufficient rigidity, and strength. However, the standard hexagonal honeycomb cores have low formability and deform into an anticlastic shape during bending. Special honeycomb cores with good curved surface moldability have been proposed, but they have poorer mechanical properties and complex shapes that increase manufacturing costs. The article proposes a simple and flexible honeycomb core with tetragonal cells that have excellent mechanical properties and are easy to manufacture. An algorithmic design tool was used to analyze the deformation of cells, and the results show that tetradecagonal honeycomb cores can realize curvature on the panels due to minute strains on the cell walls.

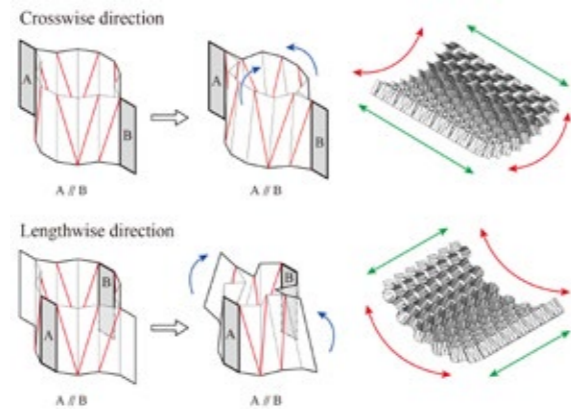

## Experimental Study on a Type of Foldable Structure with Asymmetrical Crease Line Pattern

Mr Khai Seng Chew<sup>1</sup>, Prof Jae Yeol Kim

<sup>1</sup>Universiti Sains Malaysia

This paper aims to highlight an experimental study of a 4m x 4m light weight foldable structure with asymmetrical crease line pattern that geometrically transforms from a flat planar state to a folded one with depth. Prior to the experimental study, a theoretical simulation of the folding process was carried out using Rhinoceros and Grasshopper to understand the transformation of the structure when it is being folded. The paper will also look into the various challenges faced during the fabrication and deployment of the actual model, the mechanism of folding, hinges used as well as the method of data collection to form a comparison against the simulated model.

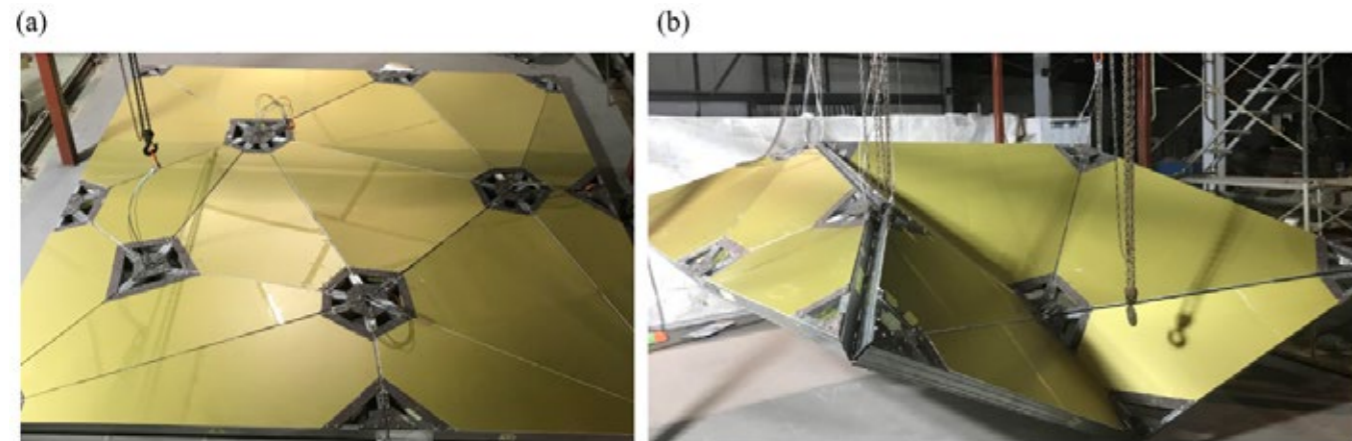

Figure 1. Transformation of the foldable structure: (a) flat geometry before folding, (b) folded geometry



## Design and Evaluation of Compliant Hinges for Deployable Thick Origami Structures

Mr Munkyun Lee<sup>1</sup>, Prof Tomohiro Tachi<sup>1</sup>

<sup>1</sup>The University of Tokyo

Origami models are often idealized by discrete folding of zero-thickness sheets; however, the thickness and the elastic limit of the material cannot be ignored in engineering practice. One solution is the compliant hinge, which realizes the folding deformation in the elastic range of the material by replacing the crease line with a wide deformation zone where the compliant structure is installed. However, conventional compliant hinges do not maintain the center of rotation between panels which causes problems with origami kinematics, and have excessive degrees of freedom due to play which causes instability. To solve these problems, we propose three new types of compliant hinges and evaluate their performance based on two methods that consider the center of rotation and play.

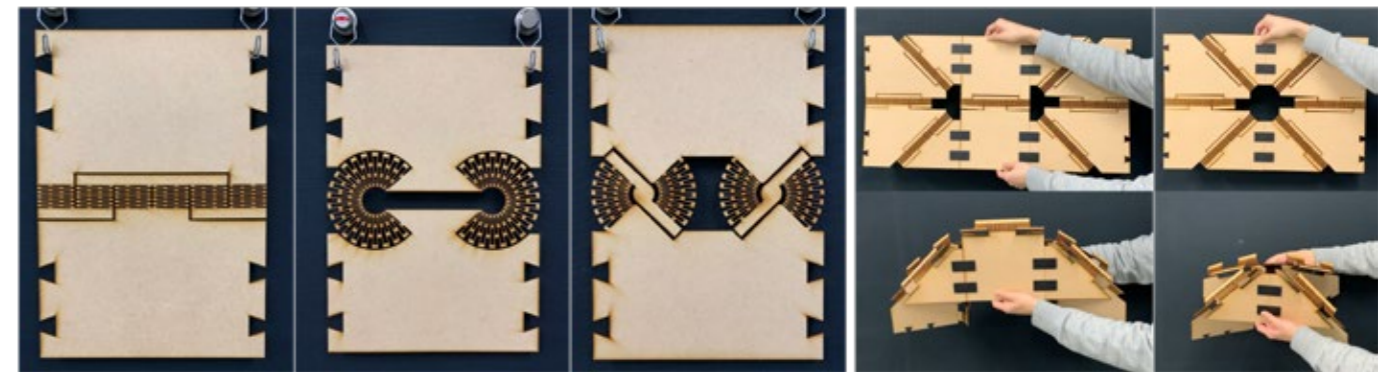

## Curved, elastically-deformed origami and kirigami: an overview of recent progress

Dr Ting-Uei Lee<sup>1</sup>, Prof Yi Min Xie<sup>1</sup>

<sup>1</sup>RMIT University

This study summarises the recent progress in understanding the elastic energy behaviour of curved-crease origami and bending-active kirigami. We use the elastica curves, the minimum elastic bending energy deformations of a straight slender beam, as the generating curvatures for pattern construction. This approach is shown to enable several key advancements in the characterisation of pattern behaviour. First, the folded shapes can be concisely and accurately predicted. Second, the folding motion can be conveniently described based on the bent states of elastica curves, enabling subsequent use in the development of a compliant mechanism with a programmable force-displacement response. Third, potential practical applications are presented, including controlling elastic buckling modes in thin-walled cylinders, and utilising adjustable boundary conditions to achieve deployable structures.

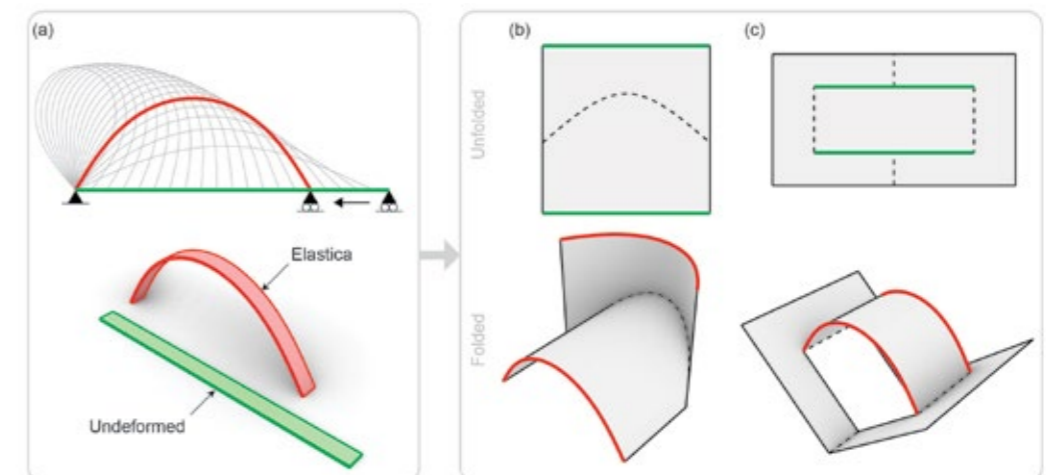

# Tuesday 11 July 2023



## Study on the performance of the space structure using CLT folded plate structure

Mr Kaito Ikawa<sup>1</sup>, Prof Shinta Yoshitomi<sup>1</sup>

<sup>1</sup>Ritsumeikan University

This paper aims to be systematically clarified how each form design parameters of CLT folded parameters affects deformation, and unit stress. An analysis model of a 20m x 20m CLT folded plate catenary arch roof using three form design parameters: mountain height the folded plate, arch rise-span ratio, and the number of arch divisions is constructed. As for this model, the relationship between form design parameters and the maximum and average values of each of the fulcrum reaction forces, vertical displacements, and unit stress of the nodes due to their own weight will be investigated.



## Diffusion behavior analysis of local folding of Miura origami

Prof Jianguo Cai<sup>1</sup>, Prof Jian Feng<sup>1</sup>

<sup>1</sup>Southeast University

*No short abstract submission provided*

Tuesday 11 July 2023

# Session 18

## Dynamic response of structures 2

Room 217

14:00 - 16:00

# Tuesday 11 July 2023



## Design and Construction of Music arena of 110m span with Parallel Chord Trusses

Mr Yuya Mori<sup>1</sup>, Mr Taiga Sasaki<sup>1</sup>, Mr Tomoyoshi Sugano<sup>2</sup>, Mr Shunji Endoh<sup>3</sup>, Mr Takuma Shiomi<sup>3</sup>

<sup>1</sup>Azusa Sekkei, <sup>2</sup>Kajima Corporation, <sup>3</sup>Nippon Steel Engineering

This paper describes the design and construction of the 20,000 seat K-Arena music hall. Located in the high seismic zone of Yokohama, Japan, it will be the largest dedicated indoor music arena once completed in July 2023. The arena features a fan-shaped plan and the roof structure consists of parallel chord main trusses with a maximum span of 110 m and a maximum depth of 8.25 m, with bridge trusses running in the orthogonal direction to stabilize the main trusses. The steel frame was fully modelled in Tekla Structures to verify the complex joint details and the complex construction staging was analysed to justify a partial jack down of the temporary roof supports and shorten the construction period.

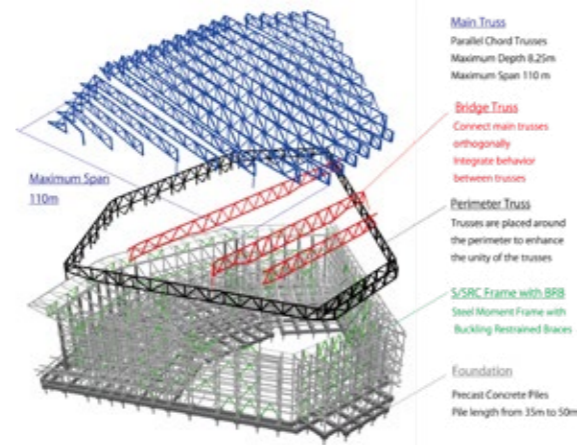

## Structural design of a gymnasium with warren trusses in a grid arrangement supported by thin columns and damping braces

Prof Eisuke Mitsuda<sup>1</sup>

<sup>1</sup>Kyoto Institute of Technology

This paper describes the structural design of a gymnasium with a 36.36m x 36.36m sq. arena. On the ground floor, steel columns are erected, on top of which the roof structure is placed. The roof structure consists of girded warren trusses. All truss's sections were unified with H-beams of the 150-width series.  $\phi 165.2$  steel pipes were used for the columns to match the H-beam trusses. In addition, buckling-restrained braces are used. The size of the brace core members was determined so that the stiffening tubes for buckling restraint were the same diameter as the columns,  $\phi 165.2$ . In this gymnasium, all structural elements- trusses, columns and braces- are holistically designed.



## Stochastic Uncertainty Quantification for 3D Elastic Metamaterials through a Hyperplane Modelling Technique

Miss Minghui Zhang<sup>1</sup>, Mr Qihan Wang<sup>1</sup>, Prof Wei Gao<sup>1</sup>

<sup>1</sup>University of New South Wales

Elastic metamaterials (EMMs) with engineered bandgaps have an extraordinary performance to attenuate elastic waves, attributed to their artificially designed structures. Stimulated by real-life engineering applications, systematic uncertainties are intrinsic features within the structures, which would influence the bandgap in EMMs. A hyperplane model-aided uncertainty quantification framework is developed for EMMs to investigate the effects of structural uncertainty on wave-suspending performance. A freshly established virtual modelling technique, namely the Extended Support Vector Regression (X-SVR) approach, is employed to reveal the implicit relationship between the stochastic material properties and any concerned bandgap feature for EMMs. By implementing the established approach, adequate statistical information on any concerned bandgap feature is furnished effectively and efficiently.

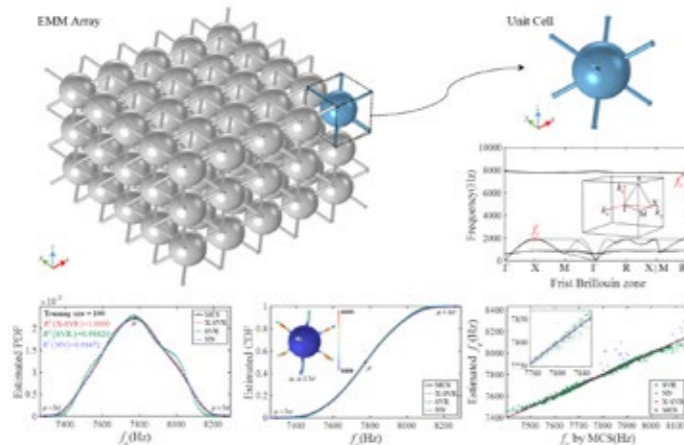

## Modal identifications of a scaling stratospheric airship in still air

Mr Longlong Chen<sup>1</sup>

<sup>1</sup>Shanghai Jiao Tong University

Modal is the most basic and important dynamic characteristic of a structure. In this paper, a scaling stratospheric airship with a length of 2.4m was used to study the dynamic mechanical properties of the airship envelope under different pressure. To obtain the overall vibration modes of the inflatable airship, the 3D laser vibrometers were arranged at four positions under each pressure condition, and the results were combined to obtain the global vibration mode diagram. This study realized the full-field modal testing and analysis of the flexible airship envelope, which can provide experimental system support and test program reference for the dynamic characteristics of stratospheric airships as well as other inflatable membrane structures.

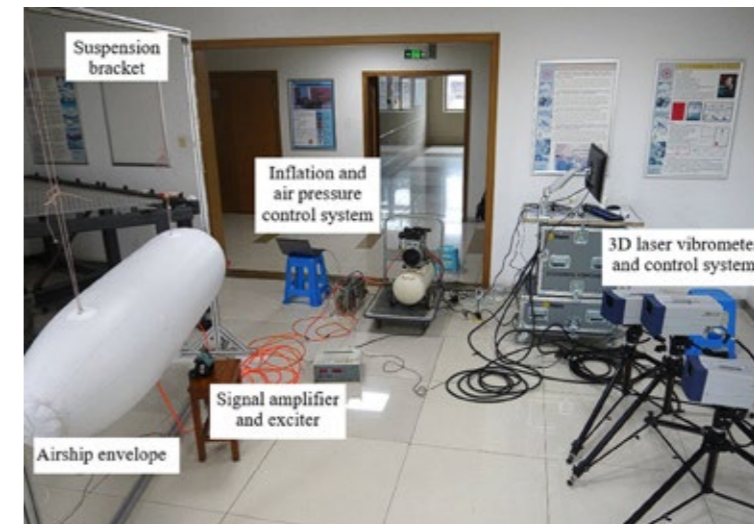



# Tuesday 11 July 2023

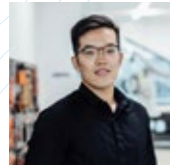

## Damage modelling of hailstone impact on aluminium claddings

Mr Shuangmin Shi<sup>1</sup>, Prof Nelson Lam<sup>1</sup>, Mr Yiwen Cui<sup>1</sup>, Prof Guoxing Lu<sup>2</sup>, Prof Emad Gad<sup>2</sup>, Prof Lihai Zhang<sup>1</sup>

<sup>1</sup>The University of Melbourne, <sup>2</sup>Swinburne University of Technology

Aluminium cladding panels that have been impacted by hailstones may have defaced surfaces requiring up to billions of dollars' replacement bills. Existing methodologies for evaluating the performance of buildings do not address hailstorms events. Instead, the robustness of claddings to hailstorms is left to the discretion of the product manufacturers. Rudimentary approaches to assess performance are generally adopted, via costly and limited pass/fail prototype testing, or highly simplified calculations based on an equivalent static force. Neither of these approaches offer realistic and satisfactory predictions. From the users' perspectives in the context of day-to-day engineering practices, an experimentally validated analytical model is much preferred and introduced herein.

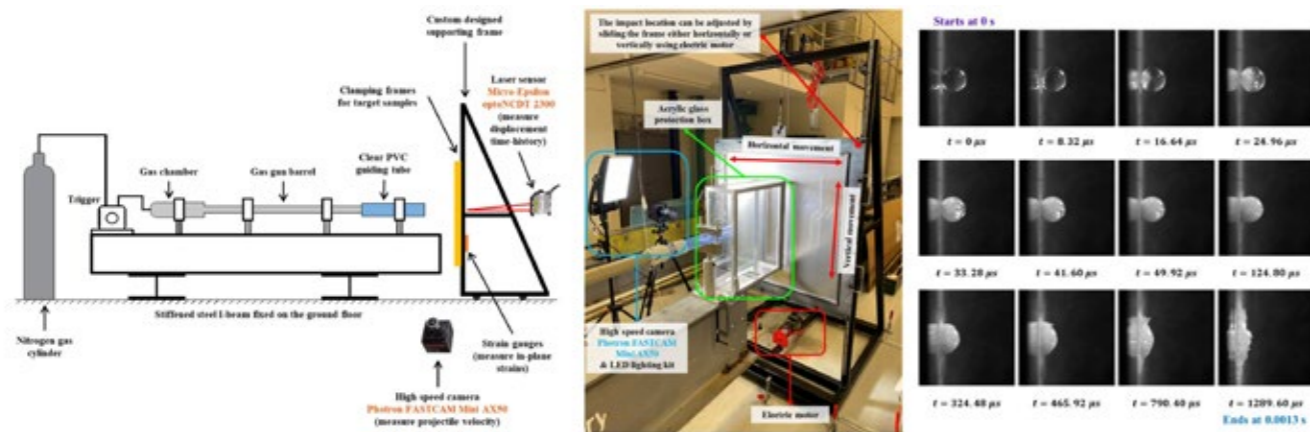

## A possible substitute for an ice ball in an impact test

Ms Siyu Chen<sup>1</sup>, Prof Emad Gad<sup>1</sup>, Prof Lihai Zhang<sup>2</sup>, Prof Nelson Lam<sup>2</sup>, Dr Shanqing Xu<sup>1</sup>, Prof Guoxing Lu<sup>1</sup>

<sup>1</sup>Swinburne University of Technology, <sup>2</sup>University of Melbourne

Ice impact tests are conducted by the industry to test the impact resistance of products in hailstorms. This study proposed 3 possible substitutes for an ice ball in an impact test to make the test easier. Plaster balls and plastic balls were launched onto aluminium plates to obtain the deformation profiles. It was found that the normalised deformation profiles are very similar for all the balls impact. The relationship between the kinetic energy of an impactor and the maximum permanent deformation on the plate was summarised by empirical equations. This study provides a guide to conducting ice impact test with the substitute designed when it's not practical to prepare ice balls.

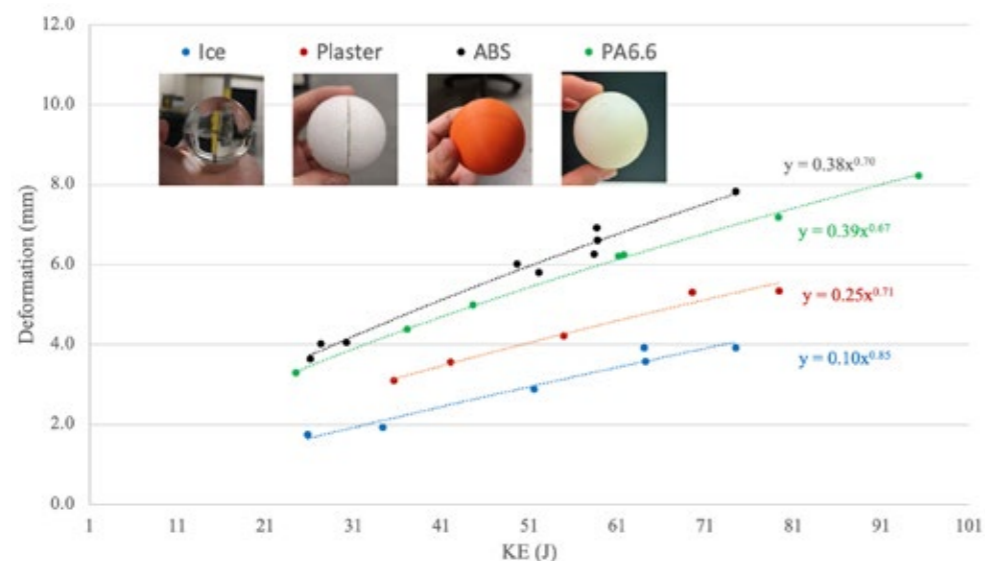

## Dynamics analysis of floating offshore wind turbines

Dr Haoran Zuo<sup>1,2</sup>, A/Prof Kaiming Bi<sup>1</sup>, Prof Songye Zhu<sup>3</sup>, Prof Hong Hao<sup>1</sup>

<sup>1</sup>Curtin University, <sup>2</sup>South China University of Technology, <sup>3</sup>The Hong Kong Polytechnic University

An OC3-Hywind spar-buoy FOWT is chosen as a prototype structure to develop an in-house model of FOWT. The blades and tower are modelled by three-dimensional Euler-Bernoulli beam elements, and the floating platform is assumed to be a rigid body. The pre-twist, pitch, and rotating angles of the blades are considered to develop the time-varying mass, stiffness, and damping matrices of the FOWT. In addition, the forces generated by the mooring system are simulated and compared between the linear and nonlinear quasi-static models. The straightforward and efficient in-house model is validated against FAST. Results show that the developed model gives a deep understanding of the FOWT dynamics and is of high accuracy in capturing the structural responses of the FOWT.

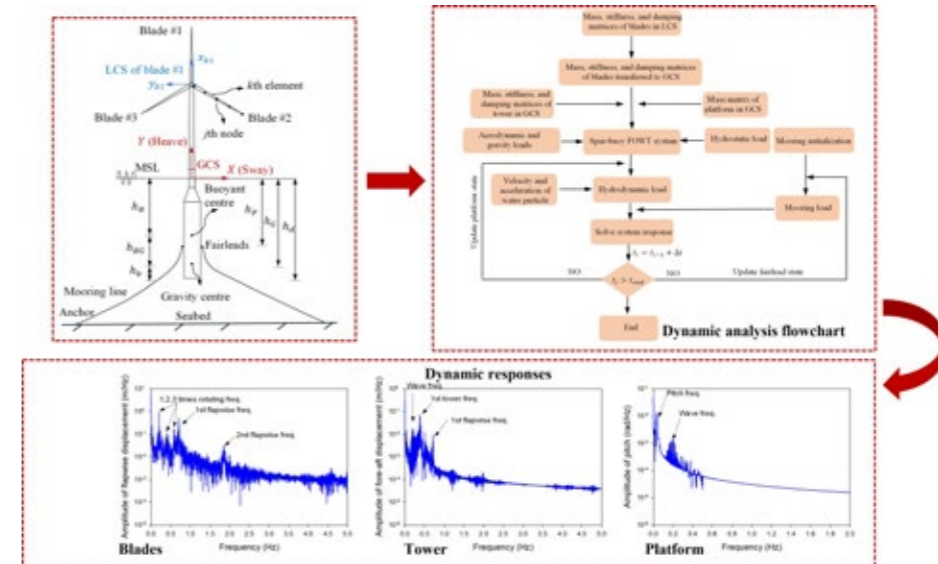

Tuesday 11 July 2023

# Session 19

## Historical structures

Room 218

14:00 - 16:00



### Pier Luigi Nervi 's arch in E'42

**Dr Satoru Kimura**<sup>1</sup>, Dr Toshiaki Kimura<sup>2</sup>, Dr Yosuke Komiyama<sup>3</sup>

<sup>1</sup>Ritsumeikan University, <sup>2</sup>Nagoya City University, <sup>3</sup>Kyoto University

Pier Luigi Nervi is an engineer who contributed to the development of construction technology for reinforced concrete in Italy. The engineer is developing Hennebique system in Italy. Also two types of airplane hangars are built just before World War II by the construction company of Nervi & Bartoli. Changes in the construction between the two hangars are due to the inadequate use of reinforcing bars and woods as a formwork, and a new construction technique called a prefabricated construction method has been used.

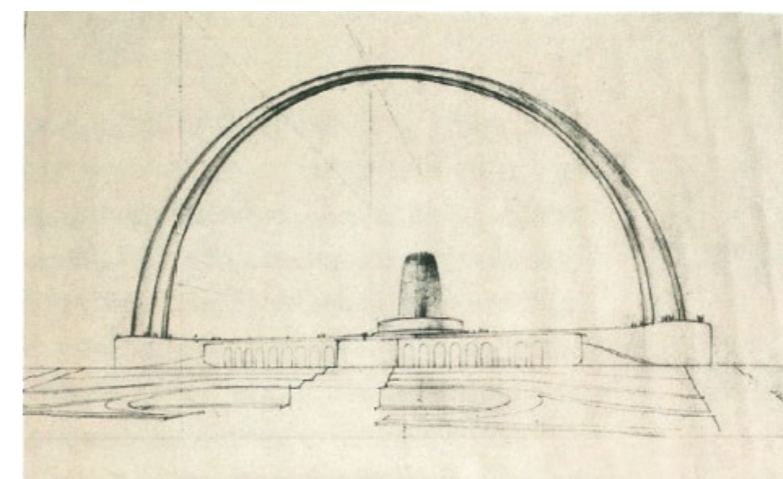

### Translucent concrete shells in Ecuador

**Dr Mauricio Luzuriaga**<sup>1</sup>

<sup>1</sup>Universidad San Francisco de Quito

Thin shells pierced with glass bricks are scarce however beautiful. Translucent concrete shells appeared in meaningful numbers with compelling aesthetic and constructive solutions in Ecuador. The study centers itself in works designed and build by architect Gilberto Gatto Sobral at Universidad Central del Ecuador in the capital City of Quito. Primary sources, entailing site visits, study of construction archives, and interviews were done to document the development of translucent concrete shells, an unheard-of feature in the history of Modern Architecture in Ecuador.

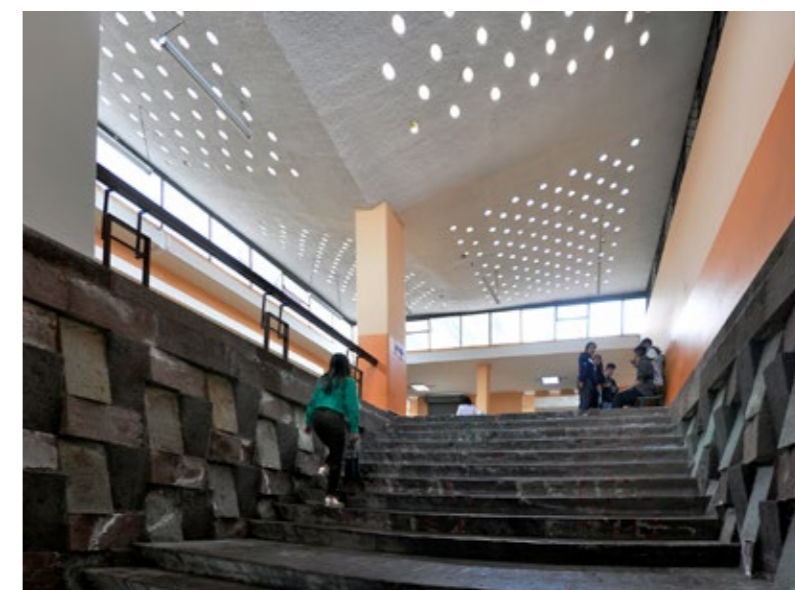

# Tuesday 11 July 2023

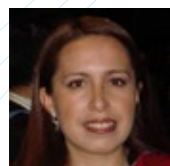

## Digital tools and technologies in the preservation of historic concrete shells.

**Dr Marisela Mendoza Ramos**<sup>1</sup>, Dr Mariana Esponda<sup>2</sup>, Dr Alberto Muciño-Vélez<sup>3</sup>, Dr Alejandro Leal-Menegus<sup>3</sup>, Dr Juan Ignacio Del Cueto Ruiz-Funes<sup>3</sup>, Mtra Nohema Cassandra Ruiz-Gómez<sup>3</sup>

<sup>1</sup>Nottingham Trent University, <sup>2</sup>Carleton University, <sup>3</sup>Universidad Nacional Autonoma de Mexico

This paper analyses the technology advancements related to digital technology and Non-Destructive Testing (NDT) and their potential to complement traditional methods in the assessment, documentation, and intervention of heritage buildings. Two case studies are presented in this paper which aimed to explore and advance the use of digital technology and NDT to assess the current state of the iconic Cosmic Rays Pavilion historic concrete shell built in 1951 by the architect Félix Candela. The Cosmic Rays Pavilion possess a significant architectural heritage value as it represents Candela's step-in stone to further develop some of the most ingenious and elegant 20th Century hyper shells worldwide and it is also part of the UNESCO heritage site of Ciudad Universitaria in Mexico City.



## Naiju Community Center by Shoei Yoh: Pioneering Computational Architecture Applying Origami Geometry and Bamboo Formwork

**Dr Masaaki Iwamoto**<sup>1</sup>, Dr Tomo Inoue<sup>1</sup>, Mr Shoichi Nakamoto<sup>2</sup>, Dr Nicole Gardner<sup>3</sup>, Dr Hank Haeusler<sup>3</sup>

<sup>1</sup>Kyushu University, <sup>2</sup>Shigeru Aoki Architects and Associates, <sup>3</sup>The University of New South Wales

For Naiju Community Center, Shoei Yoh envisioned an undulated roof that resembles the moment a handkerchief is picked up. He collaborated with Gengo Matsui and decided to apply bamboo as the formwork of a concrete shell. For its form-finding, physical models were created using origami geometry, from which the coordinates of the surface were determined. Then this coordinate was utilized by Yoichi Minagawa, who analyzed the stresses in the shell using a computer. Regarding the construction, a square bamboo net was woven by the locals, then lifted by a crane, and formed a complex surface. The key to realizing unprecedented computational design was the application of origami, flexible bamboo formwork, the collaboration of experts, and construction with local participation.

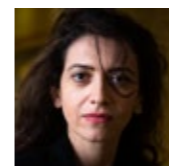

## Stone reciprocal structures: suggestions from ancient Greece

**Dr Valentina Beatini**<sup>1</sup>, A/Prof Valentina Beatini<sup>2</sup>, Prof Elsa Garavaglia<sup>1</sup>, A/Prof Vittorio Paris<sup>3</sup>, Prof Attilio Pizzigoni, A/Prof Luca Sgambi<sup>4</sup>

<sup>1</sup>Department of Civil and Environmental Engineering, Politecnico di Milano, Italy, <sup>2</sup>Department of Civil and Architectural Engineering, Aarhus University, Denmark, <sup>3</sup>Dipartimento di Ingegneria e Scienze Applicate, University of Bergamo, Italy, <sup>4</sup>Louvain research Institut for Landscape, Architecture, Built Environment, Université catholique de Louvain-la-Neuve, Belgium

This research started from the fascination exerted by some mysterious stone tiles belonging to the architecture of ancient Greece, the roof of the tholos of Athena Pronaia in Delphi. According to Vitruvius (De Architectura), the temple was one of the most important architectures of the classical period. Despite the number of studies on this sanctuary, the poor state of preservation has not allowed scholars to perform concluding research on its original configuration. This research proposes a structural and technical analysis of the hypotheses of the roof developed so far, that can help identify critical elements for further surveys. The results of this research, therefore, shall act as a stimulus for a collaboration between archeological, surveying, and technical sciences.



Tuesday 11 July 2023

# Session 20

## Tension and membrane structures 2

Room 218

14:00 - 16:00



### Textile façades with a bottle past – comparing the mechanical properties of new and recycled fabrics

Mrs Katja Bernert<sup>1</sup>

<sup>1</sup>Mehler Technologies GmbH

PET recycling is a sourcing strategy for coated textiles that offers both economic and environmental benefits. Currently there is only limited data comparing the mechanical properties of architectural fabrics made from non-recycled polyester (PET) and from recycled yarns. This is because there are still only a few membranes for textile architecture that contain recycling material on the hand and because these membranes have only very rarely been used in the built environment on the other. The paper highlights the differences when comparing the mechanical properties of virgin and recycled PET (rPET) fabrics. On the basis of this comparison the pros and cons of using recycled fabrics are evaluated.



### FDMremote: Interactive inverse design of tensile structures with differentiable FDM

Mr Adam Burke<sup>1</sup>, Mr Keith Lee<sup>1</sup>, Mrs Janet Echelman<sup>2</sup>, Mr David Feldman<sup>2</sup>, Prof. Caitlin Mueller<sup>1</sup>

<sup>1</sup>Massachusetts Institute of Technology, <sup>2</sup>Studio Echelman

We present FDMremote, an interactive inverse form-finding tool based on the force density method for the design of tensile networks by non-specialist users in the fields of art and architecture. We use gradient-based optimization to find force density distributions that best satisfy given objectives and automatic differentiation tools are deployed to provide exact gradients with respect to objective functions. This functionality is wrapped with a graphical interface built as a plugin for Grasshopper for real-time design and optimization of tensile structures. We review the functionality of our tool, demonstrate our workflow for optimization of a single objective and multiple design optimization objectives. We conclude with a case study, developing a tensile structure from design to fabrication during a short workshop.

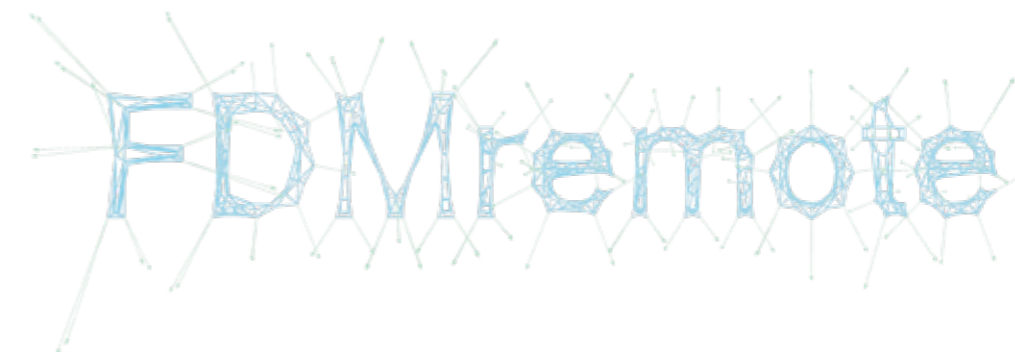

# Tuesday 11 July 2023

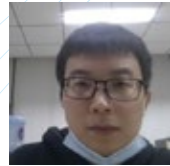

## Temperature field analysis of air-supported membrane structure for coal storage sheds

Dr Xiuliang Lu<sup>1</sup>, Dr Zhang Cong<sup>1</sup>, Pro Li Xiongyan<sup>1</sup>, Dr Yan Fei<sup>1</sup>, Pro Xue Suduo<sup>1</sup>

<sup>1</sup>Faculty of Urban Construction, Beijing University of Technology

This study focuses on the temperature field analysis of air-supported membrane structures. A numerical model under various fire conditions of rectangular air-supported membrane structures for coal storage sheds was established using the Pyrosim field simulation software. An empirical formula for the relationship between the maximum temperature and the spatial position was proposed. This paper analysed flue gas emissions and construction. The influence of building height and the power of the fire source on the maximum temperature was also investigated.

No figure submission provided



## Creep and residual strain elimination of large-scale tensioned fabric membrane radome structure

Dr Runzhi Lu<sup>1</sup>, Dr Huizhong Zhang<sup>1</sup>, Prof Jianguo Cai<sup>1</sup>, Prof Jian Feng<sup>1</sup>

<sup>1</sup>Southeast University

Analyzing the influence of pre-tension on the 13 m×9.1 m membrane and the residual strain of the membrane. Besides, a test to eliminated residual strain effect of radome structure with the consideration of the material nonlinearity is established, which is verified by the secondary wind pressure test results. Finally, the method of eliminating creep and strain residual is revealed. Both the numerical and experimental study shows that secondary tension can effectively reduce the impact of creep and the effect of residual strain can be eliminated by a prior actual working condition loading.

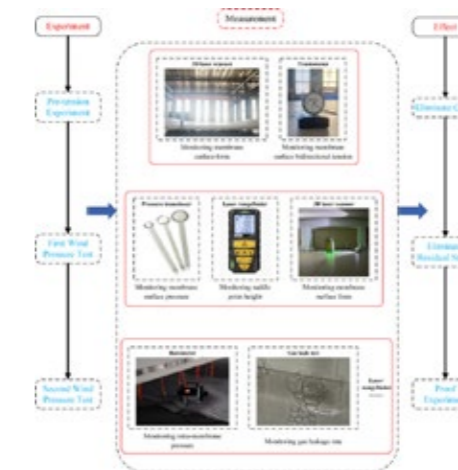

## Application of Partial factors to Actions in Case of Membrane Structures

Prof Wolfram Jaeger<sup>1</sup>

<sup>1</sup>Planungs- Und Ingenieurbüro Radebeul

The application of partial factors for actions is a challenge as membrane structures behaves nonlinear. Membrane and cable structures include areas where the relative increase in effect is less than the relative increase in action, raising empirical concerns about safety deficits. The safety deficit that has been suspected in this context for a long time has been included in the basics of structural design according to EN 1990:2012 without further background. The paper highlights that the over-linearity and under-linearity alone do not sufficiently characterize a nonlinear system without considering the design point. However, under the practically existing range of both types of nonlinearity, the application of partial factors on the action side is sufficient to achieve the target reliability index.

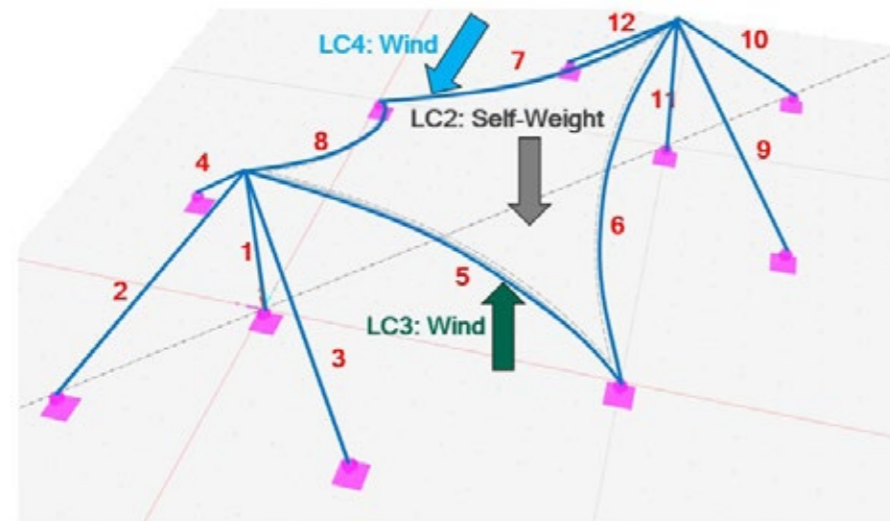

## Effect of temperature on strength of PVC coated fabrics

Dr Chengjun Gao<sup>1</sup>

<sup>1</sup>Shanghai Jiao Tong University

PVC coated polyester fibre membrane is one of the most widely used materials since its good mechanical properties and durability. In this paper, the strength of PVC coated polyester fibre membrane under different temperature were studied. The results showed the strength and stiffness decreased significantly with the increasement of test temperatures, which may be the cause of stress relaxation and wrinkles of the membrane structure. This study can provide reference for fire safety design, as well as for product design of material manufacturers.



# Tuesday 11 July 2023



## Experimental methods and performance of membrane structures: A systematic literature review

Mr Haonan Huang<sup>1</sup>

<sup>1</sup>Zhejiang University

Membrane structures have become popular in various areas due to their characteristics. However, the application of membrane structures and the assessment of their structural qualities are constrained by the fact that only a few studies have been conducted using response data of models or actual structures. An effective method for analyzing the properties of membrane structures involves obtaining response data or environmental characteristics from a model or building. This method can also aid in the advancement of theoretical studies and simulation techniques. This paper provides a thorough discussion of the several aspects of membrane structures. The composition of the structure is the most essential component influencing its performance. The advantages and challenges of the current literature are also discussed.

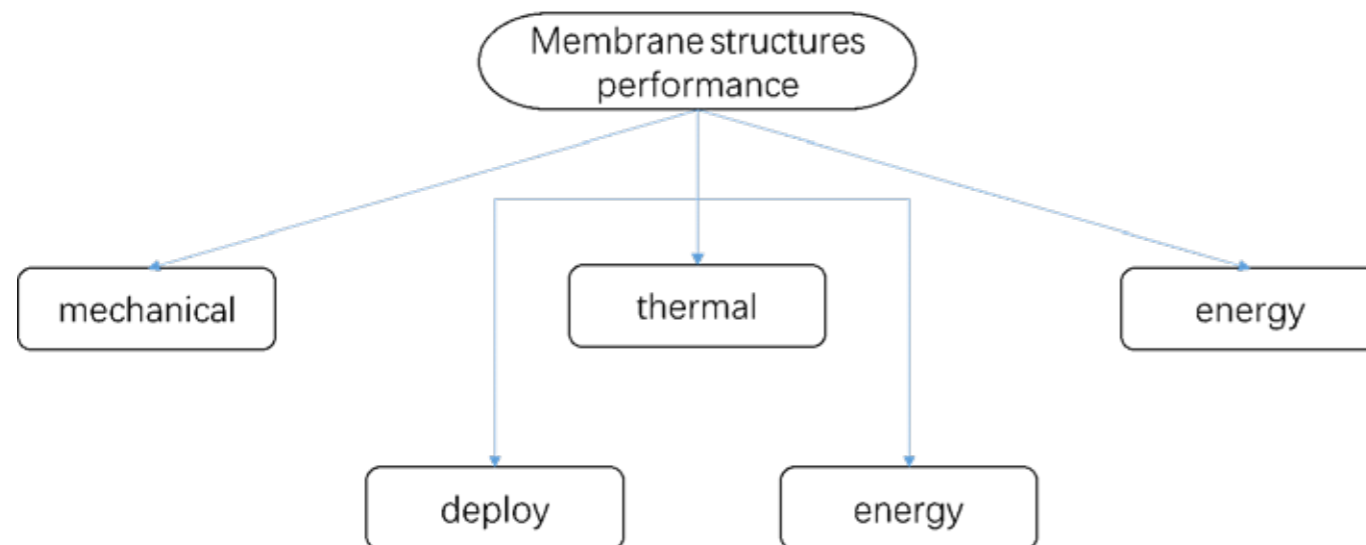

# Tuesday 11 July 2023

# Masterclass 4

## Aelous: An Acoustic Solver

Room 215

16:30 - 18:30

Presented by

**Alberto Pugnale, Sofia Colabella  
Gabriele Mirra & Michael Mack**

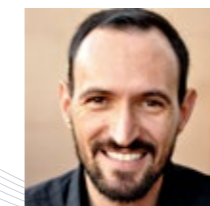

Tuesday 11 July 2023

# Session 22

## Additive manufacturing 3

Room 216

16:30 - 18:30

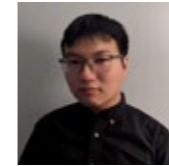

### Local optimization of self-supporting shell structures in 3D printing: a skeleton method

Mr Yefan Zhi<sup>1</sup>, Mr Hua Chai<sup>1</sup>, Mr Teng Teng<sup>1</sup>, Dr Masoud Akbarzadeh<sup>1,2</sup>

<sup>1</sup>Polyhedral Structures Laboratory, Stuart Weitzman School of Design, University of Pennsylvania, <sup>2</sup>General Robotic, Automation, Sensing and Perception (GRASP) Lab, School of Engineering and Applied Science, University of Pennsylvania

This paper proposes a post-slicing optimization method to make porous shell structures self-supporting for 3D printing purposes by reducing the overhang when necessary. After slicing, we represent the planar wall toolpaths using medial axes and maximal disks. The method then examines the proximity between the medial axes of adjacent layers to build a skeleton model and makes adjustments when the overhang exceeds a limit. Finally, the planar toolpaths are updated through linkage to the medial axes. An example of a Triply Periodic Minimal Surface (TPMS) geometry is illustrated.

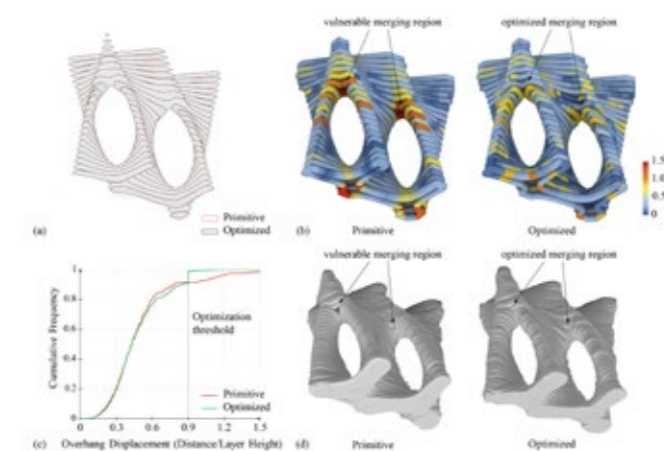

### Reversed mechanism for fabrication of flexible structural node joint using 6-axis robots and 3D printing technology

Dr Lei Yu<sup>1</sup>

<sup>1</sup>Bond University

This research proposes a novel 3D printing approach to overcome limitations in producing structural nodes in free directions using FDM technology. The current approach generates 3D printing contour path in parallel planes, which can lead to structural flaws, low productivity and higher material costs. To address these issues, this research developed a 6-axis robotic printing system that executes a spatial contour path for each branch of the node, enhancing structural quality, reducing production time, and saving printing materials. The proposed approach was successfully tested by producing a tree-structure installation with unique node joints. This new process of fabrication can create templates or moulds for complex network structures in steel and concrete through computational design and digital fabrication.

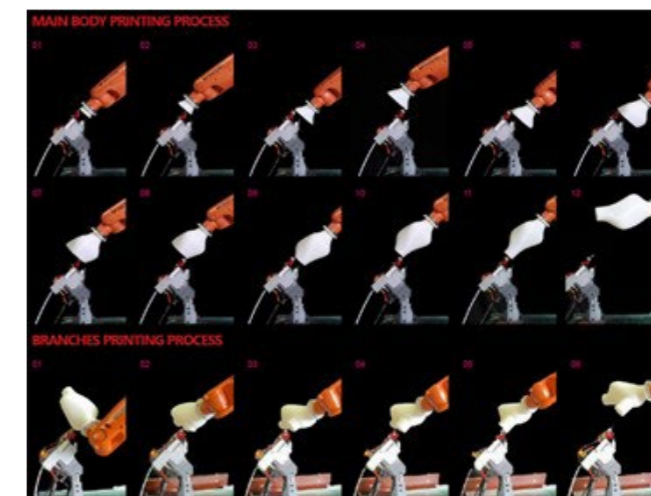

# Tuesday 11 July 2023



## Mechanical design of additive manufactured lightweight multifunctional structures and performance evaluations based on X-ray 3D imaging technology

Prof Wenwang Wu<sup>1</sup>

<sup>1</sup>Shanghai Jiao Tong University

No short abstract submission provided



## Continuous multi-filament 3D printing for functionally-graded structural components

Mr Teng Teng<sup>1</sup>, Mr Yefan Zhi<sup>1</sup>, Dr Masoud Akbarzadeh<sup>1,2</sup>

<sup>1</sup>Polyhedral Structures Laboratory, Stuart Weitzman School of Design, University of Pennsylvania, <sup>2</sup>General Robotic, Automation and Perception (GRASP) Lab, School of Engineering and Applied Science, University of Pennsylvania

We propose a Multi-Filament Fused Deposit Modelling (MFFMD) printer and generator workflow for 3D printing structural parts with locally tailored properties. Current multi-material printing methods face limitations such as delamination and longer production time. Our MFFMD printer features a single custom nozzle for seamless material switching and a method to generate continuous toolpaths based on stress conditions. Using a Pratt truss as a case study, we demonstrate performance enhancements compared to single-filament prints. This small-scale prototypical study can be expanded to other materials and scales, improving structural performance, facilitating design communication, and providing a tangible visualization of printed components' properties.

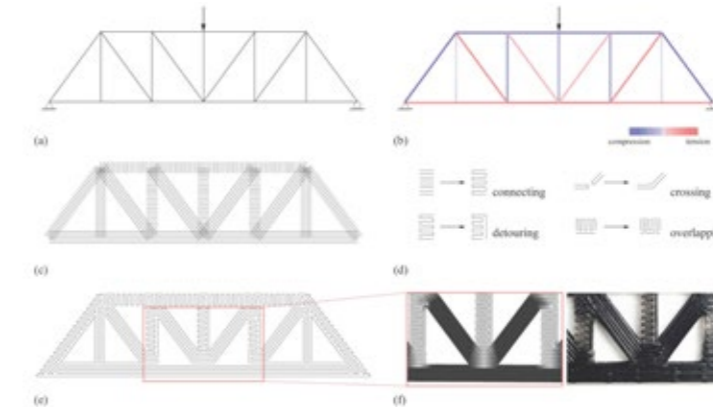

## Rapid fabrication system for large-scale free-form double curved shell

Mr Zhuoyang Xin<sup>1</sup>, Mr Guanqi Zhu<sup>1</sup>, Dr Dan Luo<sup>1</sup>

<sup>1</sup>The University of Queensland

Additive manufacturing in the construction industry has reformed traditional construction approaches, allowing for the realization of customizable structure design in low cost and low waste manner. This paper explores a new additive construction system, namely additive lamination manufacturing (ALM), to construct large-scale structural components. The ALM utilizes Fibre Reinforced Polymer (FRP) fabric materials and the lamination approach to additively extrude the formwork structure with robotic technique. The adaption of conventional manual lamination technique into robotic construction enables the technique to build very structural components in mouldless and support-free process. This paper further compares the fabricated components performance with different composite materials, and the optimal materials are then used to fabricate a double curved shell structure.

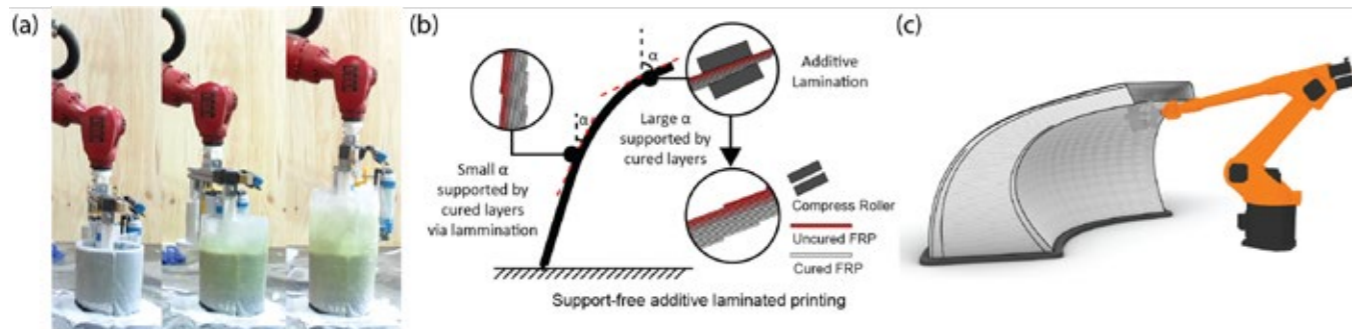

## Topology optimized cellular structure for material extrusion additive manufacturing

Mr Lingwei Xia<sup>1</sup>

<sup>1</sup>Hebei University of Technology

When the width of the filling area is not a multiple of the path width, underfilled and overfilled areas will occur. We propose a topology optimized cellular structure to improve the manufacturability of models fabricated by material extrusion. The wall thickness is specified by the multiple path width. The pore diameter of Voronoi cells is optimized based on the relative Young's modulus by combining graded Poisson-disc sampling. Finally, a globally continuous path is generated on the basis of the skeleton of cells and the wall thickness. Several typical cases are presented to validate the feasibility of the proposed method. The results indicate that structures optimized by our method fulfill high filling quality and appreciable mechanical performance.

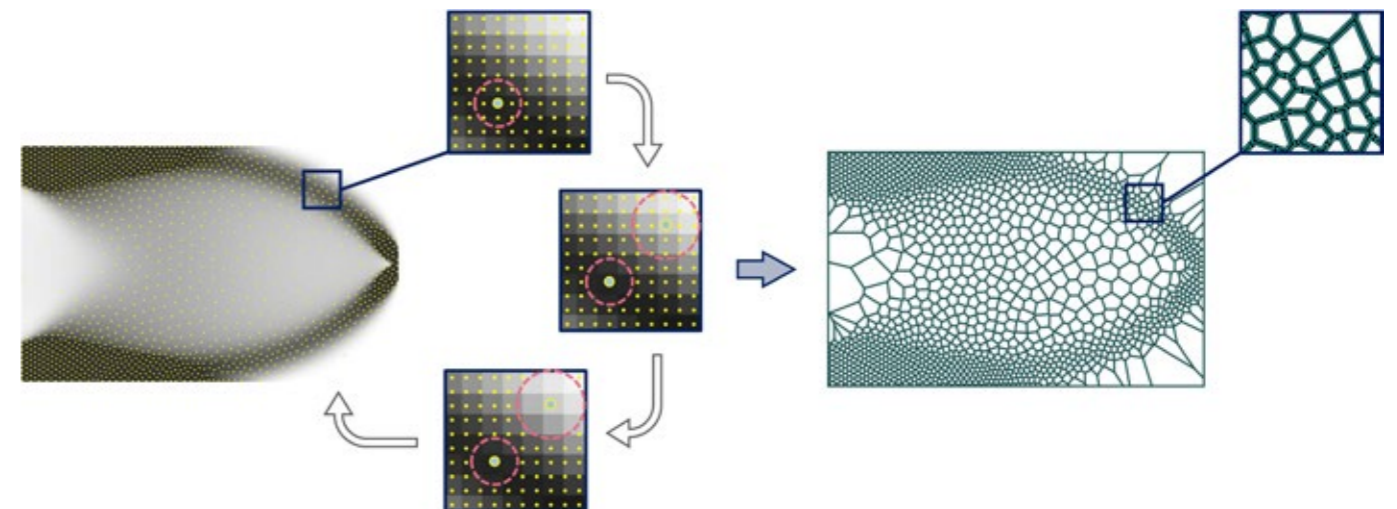



# Tuesday 11 July 2023



## Form finding for post tensioned, 3D printed fluid containers

Mr Patrick Schäferling<sup>1</sup>, Prof Matthias Beckh<sup>1</sup>

<sup>1</sup>Chair of Structural Design- Technische Universität Dresden

In this paper, we explore the strategy of combining large-scale 3D printed, purely compression-loaded components with post-tensioned, unbonded tendons, to generate statically and economically efficient systems. The separation into mineral, purely compression-loaded and metallic, tension-loaded elements allows the advantages of the printing technology and the material's specific load bearing behaviour to be exploited, as well as enabling better recyclability through the separation of construction materials. Using the example of large fluid containers, the form finding for systems under (hydro-) static pressure and their construction with the described static system of separated compression and tension elements is investigated. These tanks are considered highly relevant structures in the wake of energy transition and climate change.

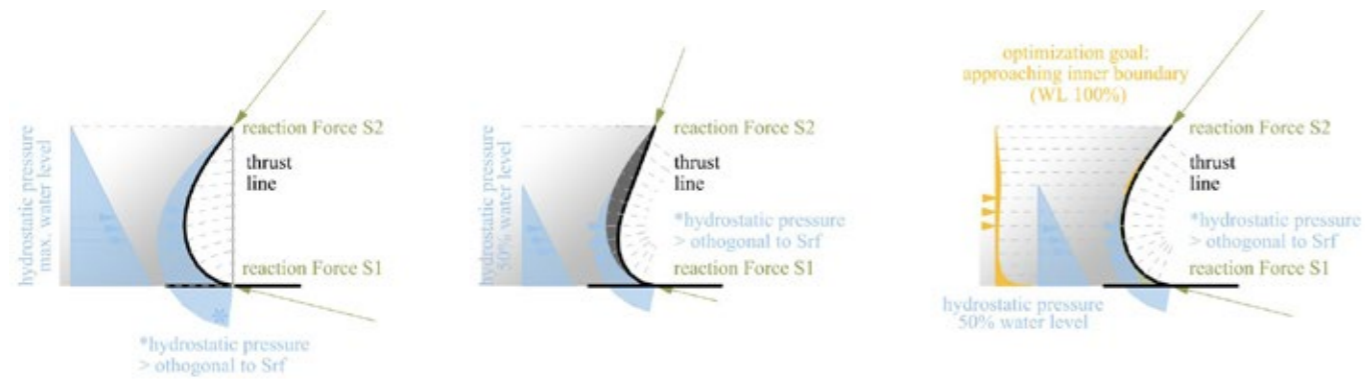

## Model test of sunflower triple-strut cable dome structure with metal additive manufacturing nodes

Dr Zhen Wang<sup>2</sup>, Prof Yang Zhao<sup>1,3</sup>, Mrs Ruolan Fan<sup>1</sup>, Mr Ruhao Wang<sup>1</sup>, Prof Shilin Dong<sup>1</sup>

<sup>1</sup>Zhejiang University, <sup>2</sup>Hangzhou City University, <sup>3</sup>Shaoxing University

The variable density method method was employed to optimize the topology of two typical nodes in cable dome. Stainless steel additive manufacturing of the two topology nodes was completed by selective laser melting (SLM) technology. In order to study the behavior of metal additive manufacturing nodes under actual 3D loading conditions, two models using conventional nodes and two of them replaced by metal additive manufacturing nodes were experimentally studied for a sunflower triple-strut cable dome model with a diameter of 10 m. Construction forming and static loading tests under full-span were carried out on the model. Results showed that the topology nodes fabricated by SLM technology instead of conventional nodes have little influence on overall behavior of the cable dome.

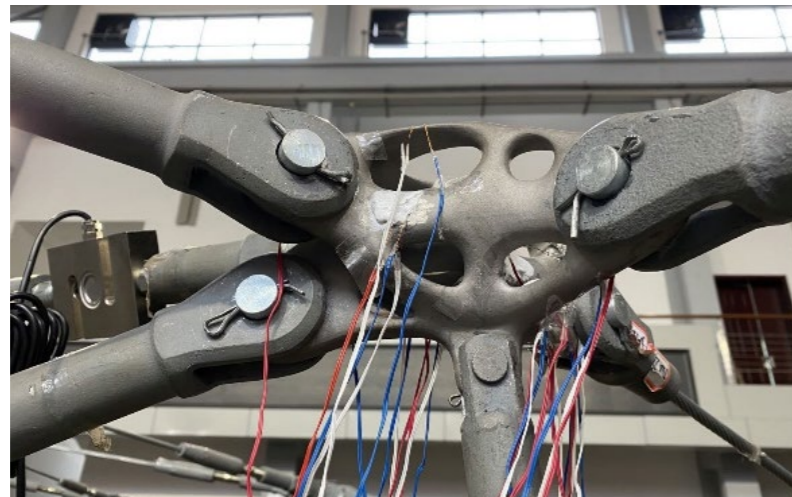

# Tuesday 11 July 2023

# Session 23

## Form-finding 2

Room 217

16:30 - 18:30

# Tuesday 11 July 2023

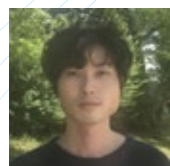

## Tailoring Poisson's ratio of bending-active mechanical metamaterials with periodic and nonperiodic pentagonal grids

Dr Yusuke Sakai<sup>1</sup>

<sup>1</sup>Sony Computer Science Laboratories Inc.

This study proposes a design method for a bending-active mechanical metamaterial using a three-dimensional pentagonal grid with a tailorable Poisson's ratio. The use of pentagonal grids overcomes the limitations of existing patterns and allows for obtaining a complex free-form surface with positive and negative Gaussian curvatures. In numerical examples, the mechanical properties of models for in-plane and out-of-plane deformations are investigated using finite element analysis. The bending stiffness of members and several shape parameters are tuned for exploring the values of Poisson's ratio. We also investigate the distribution of discrete Gaussian curvature on nodes of a curved surface obtained by out-of-plane deformation.

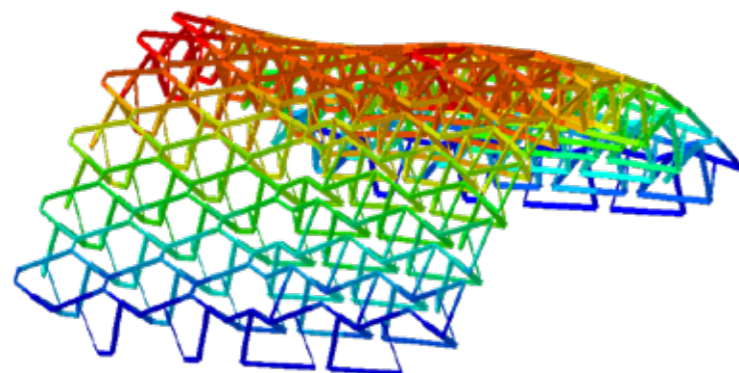

## Nonparametric shape optimization of piecewise developable surfaces for maximum stiffness using discrete differential geometry

Mr Kentaro Hayakawa, Prof Makoto Ohsaki<sup>1</sup>, Prof Jingyao Zhang

<sup>1</sup>Kyoto University

A shape optimization method of curved surfaces is presented for the limited class of surface, namely, piecewise developable surfaces. The surfaces are generated using the nonparametric method proposed by the authors based on the formulations of discrete differential geometry, and the locations of selected points on the surface are optimized for minimizing the compliance. The developability of the polyhedral surface with triangular mesh is defined using the discretized Gauss map at each vertex. The heights of the specified points are optimized using simulated annealing. Responses to static loads are evaluated using finite element analysis with quadrilateral elements. It is shown that various optimal shapes in view of structural performance and constructional cost can be generated using the proposed method.

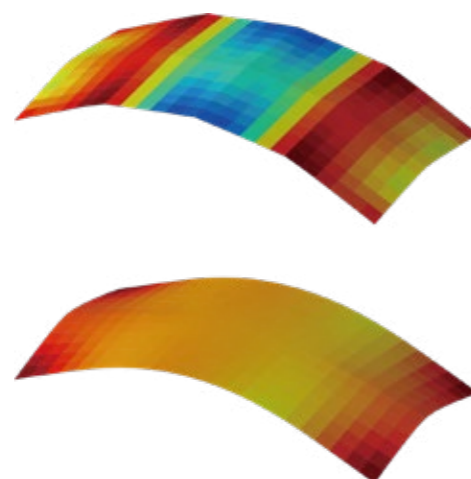

## Double-curved plate components in configurable systems

Mr Ahmed Soliman<sup>1,2</sup>, Mrs Ellen Leemans<sup>1</sup>, Prof Lars De Laet<sup>1</sup>, Prof Niels De Temmerman<sup>1</sup>

<sup>1</sup>Vrije Universiteit Brussel, Department of Architectural Engineering (ARCH), <sup>2</sup>Vrije Universiteit Brussel, Department of Mechanics of Materials and Constructions (MEMC)

This paper discusses the potential for sustainable development in the temporary structures sector, through double-curved plate modular components that can be adjustably connected to create different spatial configurations. Two case studies and multiple possible configurations are presented, exploring demountable and reversible systems with dry connections that can be reused and reconfigured. Digital and physical models are used to analyse the design and structure of the systems.

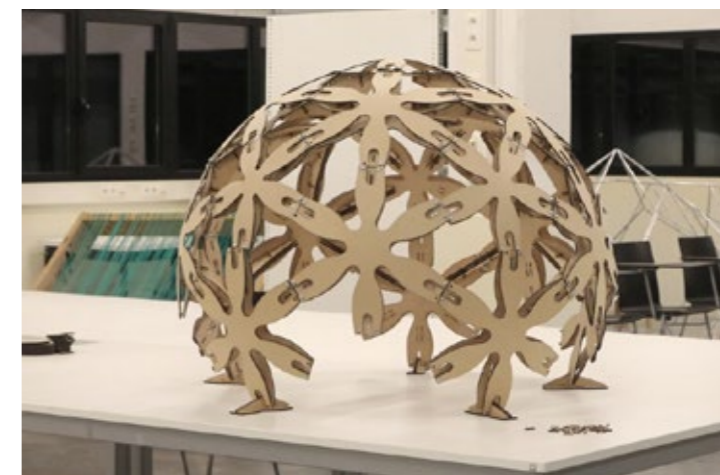

## Joint Layout Design: finding the strongest unit layout within interlocking discrete assemblies

Dr Elham Mousavian<sup>1</sup>, Dr Antonino Iannuzzo<sup>2</sup>

<sup>1</sup>Department of Structures for Engineering and Architecture, University of Naples Federico II, <sup>2</sup>Department of Civil and Construction Engineering and Department of Architectural and Industrial Design, Swinburne University of Technology

Form-finding methods have long been used to maximize the buildings' structural efficiency. State-of-the-art digital tools allow us to design and construct complex structures. However, these frameworks typically focus on the overall structural shape, whereas real-life structures are often segmented into smaller parts whose shapes and connections impact the structural performance. This paper presents a novel form-finding process to segment free-form discrete assemblies composed of convex and concave interlocking segments. The method uses multi-surface plasticity theory to represent segmented assemblies as combinations of joints and cracking-faces. An optimization strategy is proposed to find the optimal combination of joints and cracking-faces that corresponds to the maximum load-bearing capacity. This is a promising approach to design efficient and sustainable structures considering construction limitations.

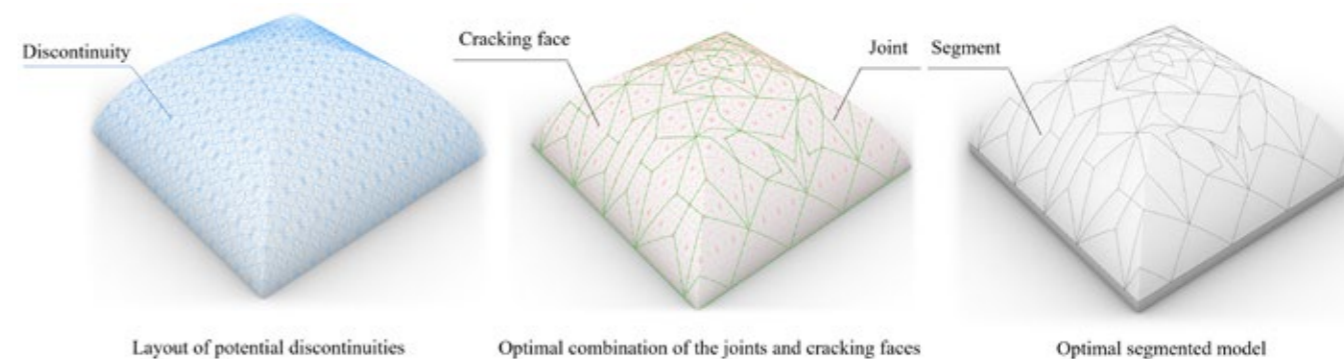

# Tuesday 11 July 2023

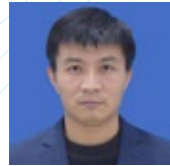

## Study on quasi-static compression performance of honeycomb structures with negative Poisson's ratio

Prof Yiyi Zhou<sup>1</sup>

<sup>1</sup>Hohai University

To examine the quasi-static compression performance of a honeycomb structure with a negative Poisson's ratio, this paper employs finite element analysis software, Abaqus, and utilizes stainless steel property data for numerical simulation analysis of the honeycomb structure with a negative Poisson's ratio. Concurrently, through a comparison of honeycomb structures with zero and positive Poisson's ratios, the mechanical and energy dissipation properties of negative Poisson's ratio honeycomb structures are investigated under varying length-thickness ratios and cell configurations. Key parameters such as nominal stress-strain, platform stress, energy absorption capacity, specific energy absorption, and Poisson's ratio are considered in the study.

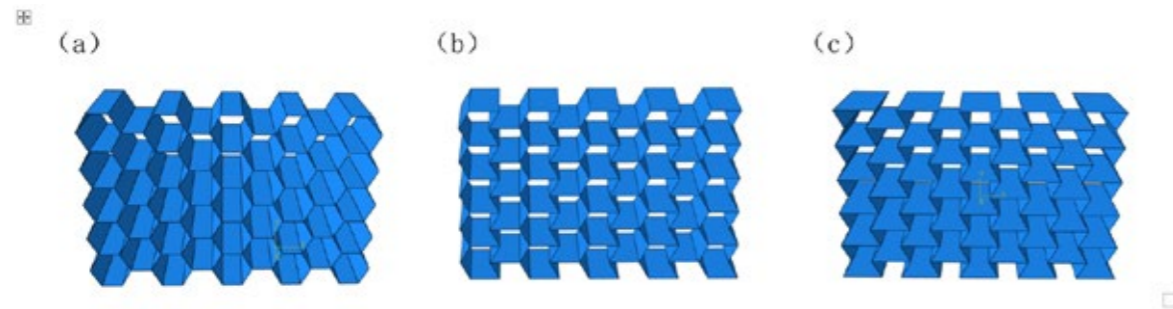

(a) Positive Poisson's ratio honeycomb, (b) Zero Poisson's ratio honeycomb, (c) Negative Poisson's ratio honeycomb



## Chain mail assembly: a new model of programmable modular structure

Mrs Nabila Afif<sup>1</sup>, Dr Gergana Rusenova<sup>1</sup>, Prof Jane Burry<sup>1</sup>

<sup>1</sup>Swinburne University of Technology

This paper presents a new type of programmable structural system using interlocking skeletal cubes that form chain mail-like structures. By placing the planar identical chain mail structure in different orientations and actuating it, self-supporting curved structures can be created. The study demonstrates that a range of dimensional variations can be achieved by modifying orientation and actuation sequence parameters. Applying a local transformation to a single row of interlocking modules enables two-thirds of the modules to be actuated to create a curved structure. This study provides a systematic investigation of the impact of a simple transformation mechanism on the behaviour of the chain mail structure, which has potential as a model of programmable modular structures for flexible, adaptable, and easy-to-construct applications.



## A novel modular technique for manufacturing free-form rammed earth walls

Mr Ahmed Abdelaal<sup>1</sup>, Dr Mohamed Gomaa<sup>1</sup>, Prof Yi Min Xie<sup>1</sup>

<sup>1</sup>Centre for Innovative Structures and Materials, School of Engineering, RMIT University

This research proposes an innovative method of rammed earth manufacturing that combines modular design and digital fabrication techniques to leverage the potential of mass customisation and mass production. A production system for modular RE tiles with intricate curvatures is introduced, where the tiles can be aggregated to create continuous free-form RE walls. The number of potential alternatives increases to 512 when using four different tile designs. This method merges the benefits of rammed earth construction with those of Modular Integrated Construction (MiC), which involves off-site production of fully completed 3D modules. The proposed system offers a novel approach that can provide an alternative to conventional RE construction processes, offering higher productivity, sustainability, and efficiency of the built environment.



Tuesday 11 July 2023

# Session 24

## Concrete structures

Room 218  
16:30 - 18:30



### Automated modelling and nonlinear analysis of concrete shells in ATENA including soil-structure interactions

Dr Mohammadmahdi Gharib<sup>1</sup>, Mr Michael King<sup>1</sup>, Dr Andre Pereira<sup>1</sup>

<sup>1</sup>Taylor Thomson Whitting (TTW)

Concrete shell structures are extensively used in civil-structural engineering applications. However, their analysis and design for arbitrary geometry and support/loading conditions can be complex, which is intensified by the inelastic anisotropic behaviour of concrete. This paper presents an automated procedure for the unified modelling, nonlinear static analysis, and direct design of reinforced/unreinforced concrete shell elements in ATENA software, which is sought per standard requirements for nonlinear stress analysis. This is achieved through an automatic generation of the input file and batch solutions using Rhinoceros software and Grasshopper scripts, which improves computational efficiency, reduces modelling errors, and facilitates parametric studies. The postprocessing is also automated using Phyton scripting. Examples are provided to showcase the performance and versatility of the developed tool.

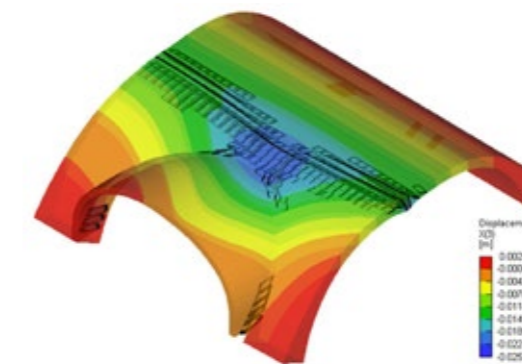

### Effect of biochar on the impact resistance of alkali-activated slag concrete

Ms Harshani Egodagamage<sup>1,2</sup>, Dr Kate Nguyen<sup>1</sup>, Dr Hiran Yapa<sup>2</sup>, Dr Satheeskumar Navaratnam<sup>1</sup>, Dr Samith Buddika<sup>2</sup>

<sup>1</sup>School of Engineering, RMIT University, <sup>2</sup>Faculty of Engineering, University of Peradeniya

Biochar and slag are considered to be sustainable replacements for Portland cement. Accordingly, the aim of this paper is to assess the feasibility of supplementing biochar in alkali-activated slag (AAS) composites in terms of compressive strength, workability and the impact resistance. A suitable biochar type, biochar replacement level and Na<sub>2</sub>O content were considered in the mix design optimizations. In AAS mortar, both 2% and 5% rice husk biochar (RB) with 10% Na<sub>2</sub>O showed improvements in compressive strength. In AAS concrete, 6% RB with 10% Na<sub>2</sub>O showed the highest 28-day compressive strength and the impact resistance compared to the control. The densified microstructure due to the high-water absorption and retention properties of biochar is attributed to these improvements.

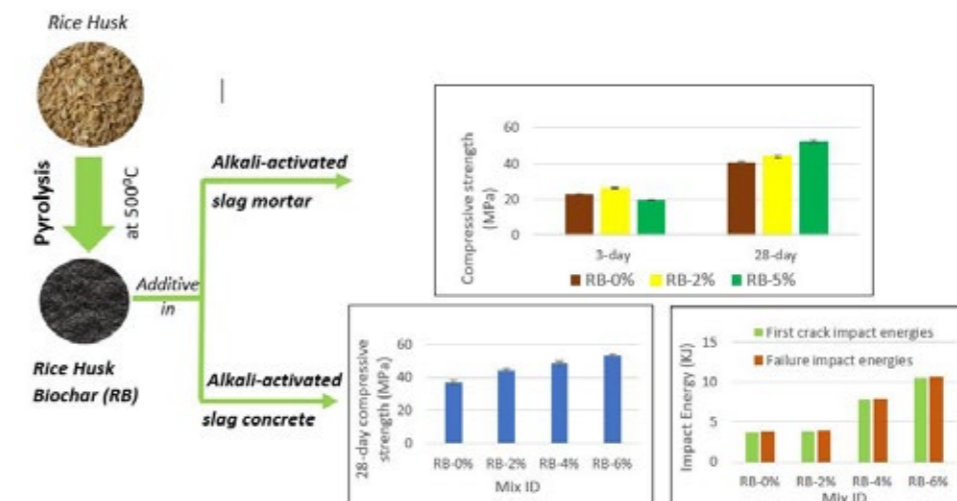

# Tuesday 11 July 2023

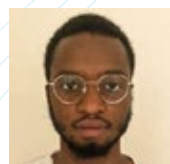

## A Group-Theoretic Approach for Constructing Spherical Interlocking Assemblies

Mr Raymond Oluwaseun Akpanya<sup>1</sup>, Mr Tom Goertzen<sup>1</sup>, Dr Jesse Lansdown<sup>2</sup>, Dr Alice Niemeyer<sup>1</sup>

<sup>1</sup>Rwth Aachen University, <sup>2</sup>The University of Western Australia

A topological interlocking is an assembly of blocks constrained by a fixed frame such that each set of blocks is kinematically constrained. Estrin et al. [3] provide a recent overview of progress in the study of topologically interlocking assemblies. Using a group-theoretic approach, we give examples of interlocking assemblies which form platonic solids and of tubular interlocking structures. For our examples we use an algorithmic approach that can be easily generalized to arbitrary tessellations of spheres and tubes.

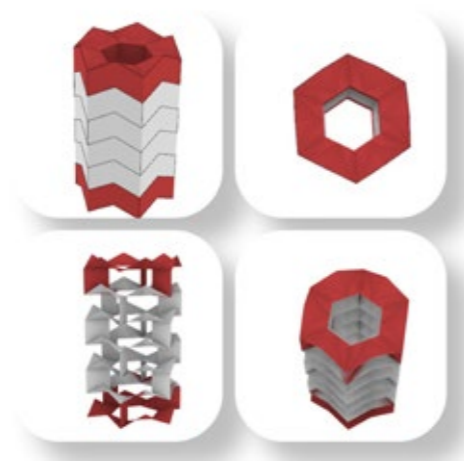

## Analysis and codified design of reinforced concrete shell structures

Mr Michael King<sup>1</sup>, Dr Mohammadmahdi Gharib<sup>1</sup>, Mr Mohamed Moussa<sup>1</sup>

<sup>1</sup>Taylor Thomson Whitting (TTW)

Concrete shell structures are commonly considered to consist of self-supporting and/or sparsely-supported continuums. Australian concrete design standards are primarily written for the design and detailing of regular structures consisting of common structural layouts and framing. This paper discusses the issues with designing concrete shell structures to be compliant with Australian concrete design standards and presents the implementation of an in-house developed post-processor for Finite Element Analysis (FEA) packages Strand7 and ETABS to extract analysis force quantities, perform design calculations, and visualise results. The methodology draws on various sources, such as the sandwich model and cracked membrane theory, and uses a novel approach to model cracked stiffness in Strand7.

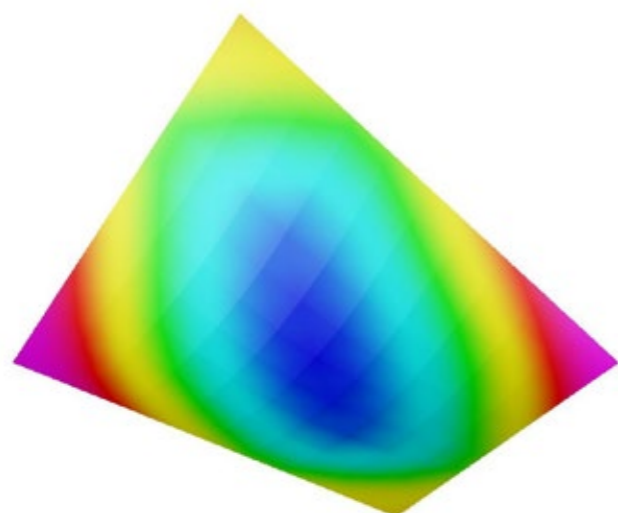

## Investigation on the effects of self-healing agents on the shrinkage of low-carbon biochar mortar paste

Xuqun Lin<sup>1</sup>, Xuqun Lin<sup>1</sup>, Prof Arnaud Castel<sup>1</sup>

<sup>1</sup>University of Technology Sydney

Crystalline admixtures (CA) is one of most popular self-healing agents, providing proper self-healing efficiency with desirable cracking closure. However, the information of how CA may affect the shrinkage behaviour of cementitious composites is very limited.

This study aimed to perform experiments to explore potential effects of CA on the resistance improvement to shrinkage deformation for biochar-cementitious paste. The raw materials included OPC, grounded biochar, CA, and superabsorbent polymer, and the testing programme included autogenous shrinkage, drying shrinkage, and total shrinkage. It was found that the reduction of drying and total shrinkage by CA addition was approximately 20% and 10% respectively, and the addition of biochar and CA further reduce shrinkage of biochar-cement composites.

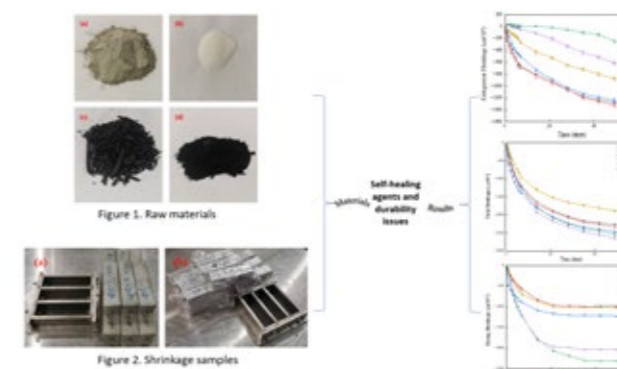

## Evaluation system of Concrete Defect Based on Deep Learning Algorithm and Thermography Using UAV

Ms Arum Jang<sup>1</sup>, Mr Sanggi Jeong<sup>2</sup>, Ph.D. Young K. Ju<sup>3</sup>

<sup>1</sup>Korea University, <sup>2</sup>Korea University, <sup>3</sup>Korea University

Much research with high technologies is being conducted in building inspection. Defects in concrete structures can lead to major structural failure if not noticed correctly at the right time. This study proposes the NDT method was introduced for detecting crack depth using thermography and machine learning. The thermal data of the cracked specimens were obtained using a constant test setup in daylight conditions. Moreover, external parameters measured in the experiment were organized and big data. The stored data was used in algorithmic design to estimate the crack depth. In addition, this study confirmed the reliability of the model by applying it to the experiment.

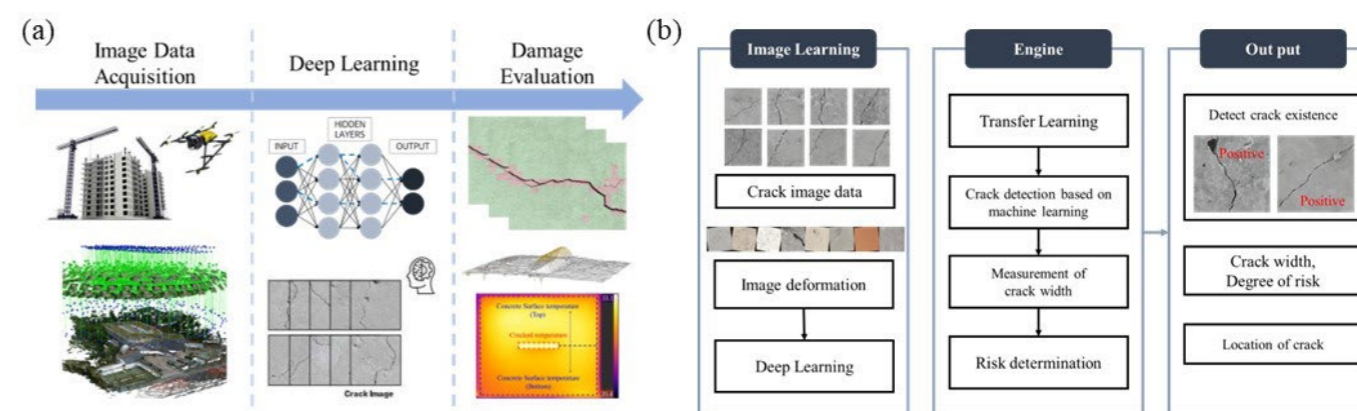

Tuesday 11 July 2023

# Session 25

## Digital modelling and fabrication 1

Room: Plenary 3  
16:30 - 18:30



### Structural design and construction of a large building with a 3D 'circle truss' and ETFE membrane roof

Mr Tatsuya Idogawa<sup>1</sup>, Mr Taisuke Miyasaka<sup>1</sup>, Mr Masahiro Ueda, Mr Masaya Komiya, Mr Takashi Kurata

<sup>1</sup>Azusa Sekkei Co Ltd.

This paper describes the structural design and construction of a three-dimensionally curved 'circle truss' and ETFE membrane roof, which is a key design element of the Haneda Airport (Tokyo International Airport) Terminal 2 expansion.

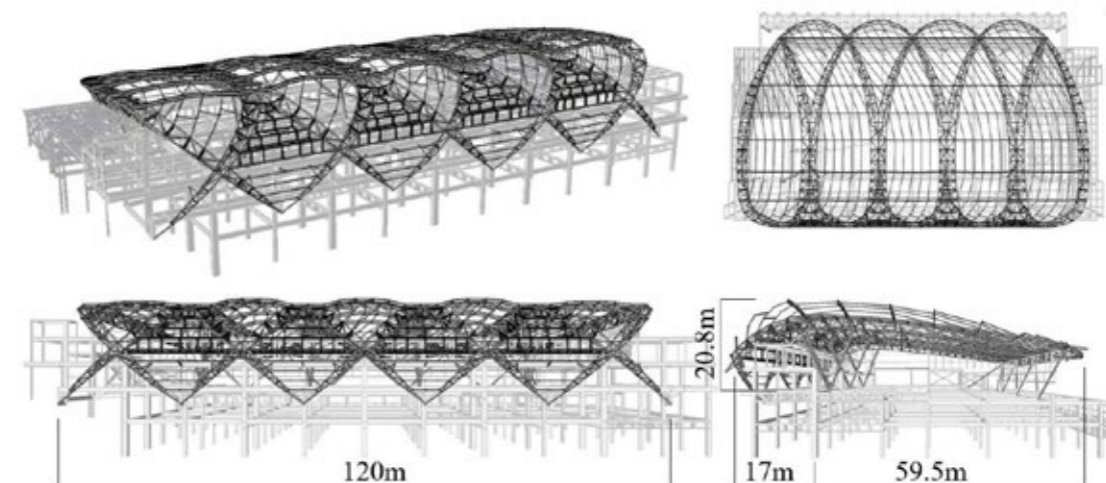

### GOOSE: Integrated non-commercial software for shell and spatial structures design, calculation, fabrication, and assembly engineering

Mr Josu Goñi<sup>1</sup>, Mr Iker Montoya<sup>1</sup>, Mr Aitor Souto<sup>1</sup>, Mr Borja Ochoa<sup>1</sup>, Mr Raul Virto<sup>1</sup>

<sup>1</sup>Lanik

In the last 5 years Lanik has developed a completely new software system called GOOSE. This internal use system allows for geometrical design with Rhino-grasshopper, calculation pre-processing inside Rhino, direct use of Sofistik non-linear engine from goose Rhino plugin (automatic resizing), automatic 3D solid and parametrical fabrication engineering inside Rhino, and assembly phases definition in Rhino for its simulation in Sofistik. Databases are directly edited via goose web application.

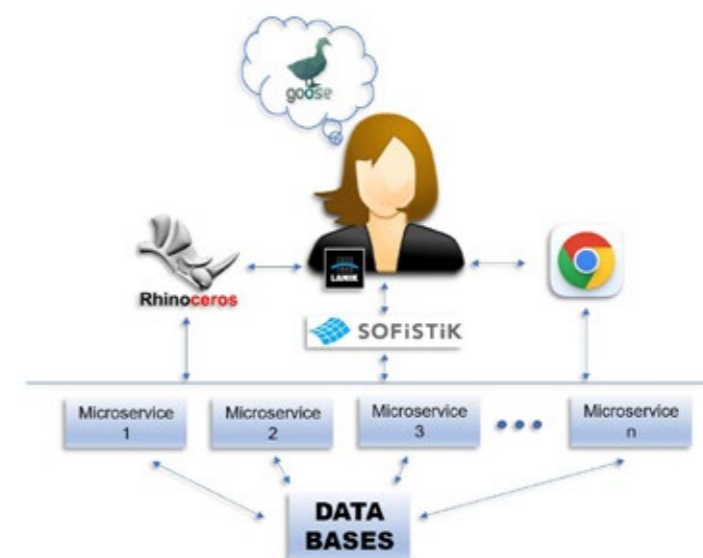

# Tuesday 11 July 2023



## Robotically Fabricated Structure: Integrative Design and Analysis

Prof Arash Adel<sup>1</sup>, Dr. Salma Mozaffari<sup>1</sup>, Dr. Omid Oliyan<sup>2</sup>, Justin Den Herder<sup>2</sup>

<sup>1</sup>University of Michigan, <sup>2</sup>Robert Silman Associates

Robotically Fabricated Structure (RFS) is a non-standard timber pavilion made from regionally sourced short 2x4 dimensional lumber. This structure is built through state-of-the-art human-robot collaborative assembly. It is designed as a defined gathering point situated in a public conservatory. The pavilion consists of a raised platform that creates an opportunity for small public events and performances, an exterior seating area, and a semi-enclosed walkway that offers opportunities for exhibitions and intimate conversations. In this paper, we discuss the structural design, modelling, and analysis of RFS in detail and deliberate on the opportunities for incorporating it into the design and manufacture of novel timber structures. Furthermore, we summarize the limitations of the research and present an outlook for future research.



## Process Simulation for Enhancing Self-Supporting Printability in 3D Curvature-Oriented Clay Form Printing with an Additional-Axis Base

Mr Xuanyu Lu<sup>1</sup>

<sup>1</sup>Keio University

This paper introduces a process simulation tool to enhance Self-support printability in 3D Curvature-orient printing with an Additional-axis base, addressing limitations in printing overhanging structures without support. Developed based on Shaun Wu's work, the tool predicts Self-support limitations for various materials and shapes, optimizing printing actions accordingly. Simulation parameters, derived from previous studies and physical experiments, ensure realism. Validated through actual printing tests, the proposed tool demonstrates its potential to improve parametric shape design freedom in the construction industry. The Grasshopper file is freely available for educational and academic use.

Printed Layers : 8L  
Will Print Layers: 9L to 32L  
Rotation DegreeA: -25° DegreeB: 0°  
MaximumDisplacement: 2.439 mm  
Can Be Printed Beautifully.

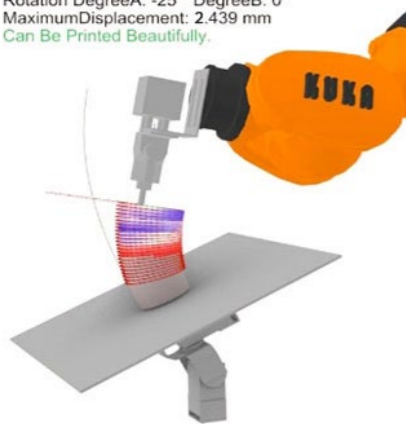

## Complex digital modelling for low-cost construction of East African vernacular architecture.

Mr Xavier De Kestelier<sup>1</sup>

<sup>1</sup>Hassell

This research paper explores the use of computer-aided design (CAD) in building sustainable structures in remote and underprivileged areas. It describes the Bidi Bidi Music Academy and Art Centre project, where a small computational design team collaborated with a local architect to create a complex building in one of the world's biggest refugee settlements in East Africa. The project combined advanced design tools with traditional construction methods to optimize material usage, maximize performance and sustainability, and provide equal opportunities to support the most vulnerable. The paper details the process of developing the complex global geometry of the Academy for local fabrication and construction, emphasizing the translation of complex digital models into simple elements for local workers to produce. The publication highlights the potential for affordable, environmentally friendly building materials and construction technologies to meet rigorous building standards while reducing the carbon footprint in underprivileged areas.



## Digital Design, Optimisation and Automated Construction of a Curved Wooden Truss – Housing for the BOKU Robot Laboratory

Prof Benjamin Kromoser<sup>1</sup>, Maximilian Ortner, Dr. Matthias Braun

<sup>1</sup>University of Natural Resources and Life Sciences

The authors' goals are to industrialise the design and optimise the production process of wooden trusses in order to compete with plate girders, which are characterised by an easy production yet comparatively low material utilisation. The housing of the new robot laboratory of the Institute of Green Civil Engineering at BOKU Vienna is considered a special use case. The main support structure was designed inspired by the work area of the robot resulting in a curved wooden truss. The two research areas: (1) Optimisation of the truss geometry and (2) Optimisation of the joints by using solely wood-wood connections, are addressed in this paper.



# Tuesday 11 July 2023



## Computational Design Thinking: An Integrated Education Approach with Shell Structure Design

Prof Yasushi Ikeda<sup>1</sup>, Mr Arastoo Khajehee<sup>1</sup>

<sup>1</sup>The University of Tokyo

In the architectural design of space with shell structures, understanding the advantage of construction robotics with automated fabrication machines and exploring how digital geometry can solve the complexities of component production and assembly along with the structural conditions is an excellent pedagogical opportunity for architectural design. Through the educational setting of the design studio program at the university, the author observed that the subject is very suitable for learning digital construction technology, which has the potential for integrated design of the relationship between construction method, function, and form in a comprehensive manner. Students positively evaluate it in terms of motivating the use of parametric modeling in the design process of form, reflecting its fabrication methods and spatial feature.

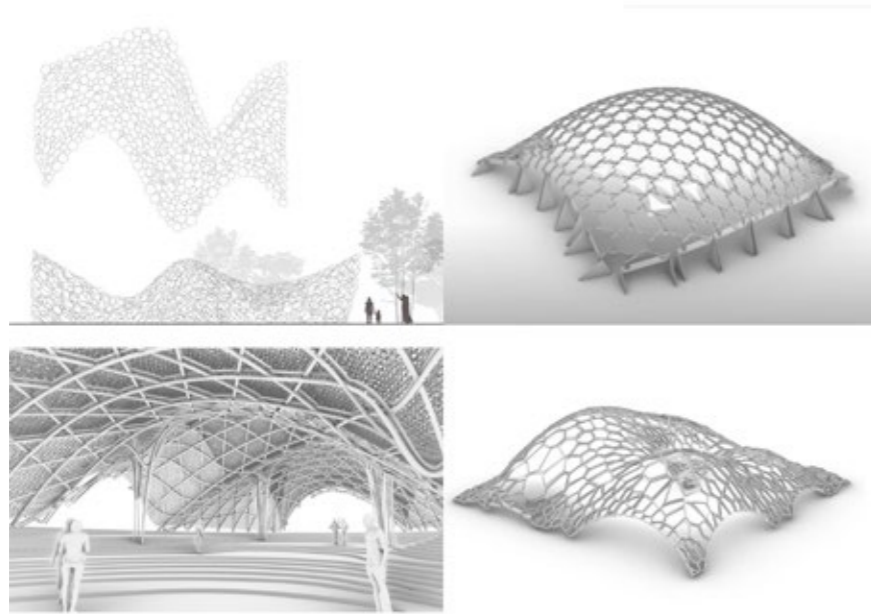



# Wednesday 12 July 2023



Wednesday 12 July 2023

# Session 26

## Life-cycle design and assessment of structures 1

Room 215  
09:00 - 11:00

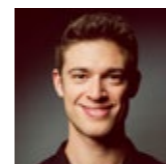

### Aurecon Buildings Carbon sketcher: A cross-disciplinary webtool for carbon neutral building design

Dr Max Marschall<sup>1</sup>, Dr Hamed Seifi<sup>1</sup>, Mr Tristan Morgan<sup>1</sup>, Mr Jack Walker<sup>1</sup>, Mr Pablo Sepulveda<sup>1</sup>, Mr Matthew Austin<sup>1</sup>, Mr Daniel Fitzmaurice<sup>1</sup>

<sup>1</sup>Aurecon

The most consequential building design decisions are made in the early design phase, but lifecycle assessments are commonly conducted later in the planning phases where the analysis has limited potential to meaningfully affect the design. It would be ideal to front-load this analysis into the early-design phase, however, this is challenging since project information at this stage is limited and the design process is fast-paced. This paper addresses this challenge by creating a user-friendly, interactive webtool for indicative lifecycle assessments. The tool was created by a cross-disciplinary team of industry professionals, and is novel in that it addresses both embodied and operational emissions, including structural and façade elements as well as energy consumption, while considering error margins.



### Algorithmic investigation of structural system utility for urban development reusing existing foundations

Ms Kiley Feickert<sup>1</sup>, Dr Caitlin T. Mueller<sup>1</sup>

<sup>1</sup>Massachusetts Institute of Technology

In a context of simultaneous rising global temperatures and increasing urban density, the need to build additional floor area while reducing the building sector's environmental impact is extremely pressing. Reusing existing structural elements, such as the foundations, presents an opportunity to significantly reduce the carbon emissions associated with constructing a building. This paper presents and deploys a method that demonstrates how designing different superstructures, constrained by the capacity of an existing foundation, leads to different utility. The impact of occupancy, materiality, and efficient structural design on potential floor area is demonstrated, which can vary up to 90 percent, for an office, for example. The impact of these combinations on embodied carbon is also demonstrated, as well as the fact that materiality does not preclude carbon competitive solutions if they are designed efficiently.

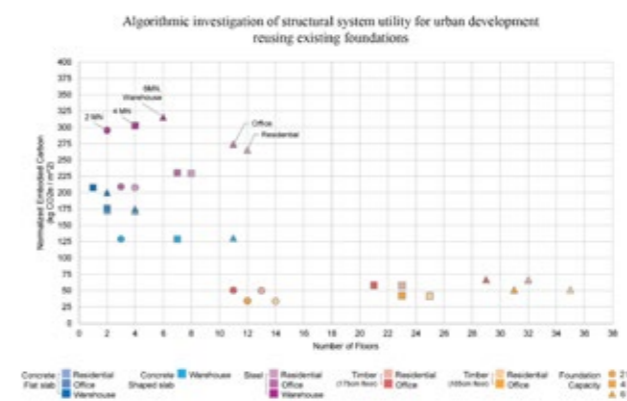
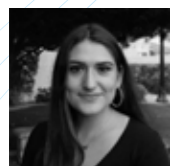

Figure 3. Normalized embodied carbon and allowable number of floors for flat concrete, shape-optimized concrete, steel, and timber structures designed for a foundation capacity of 2-, 4-, and 6MN/82m<sup>2</sup> tributary area

# Wednesday 12 July 2023



## Designing Structures from Reused Steel: A Cost-Effective Carbon Mitigation Strategy

Ms Juliana Berglund-Brown<sup>1</sup>, Dr. John Ochsendorf<sup>1</sup>

<sup>1</sup>Massachusetts Institute of Technology

New structures can be designed from existing steel elements at lower cost and with dramatically lower carbon emissions. This paper establishes more certainty about the supply of steel elements, quantifies potential carbon and cost savings, and identifies the variables that most impact such savings to better enable cost-effective steel frame design. This work outlines why reusing gravity beams and columns is particularly advantageous via a state-of-the-art overview of the steel value-chain. Next, a high-level material flow analysis is conducted for three of the largest steel producing markets globally. A partial LCA utilizing a comparative cut-off method is then performed coupled with cost estimation. Based on the findings of the partial LCA, a factor analysis is performed with both a stochastic sampling and nine real building projects to identify the variables impacting carbon cost associated with reuse. This paper then proposes strategies for practitioners to deploy reused elements in their designs.

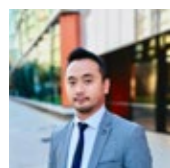

## Applications of nonlinear guided wave mixing for early damage detection of partially immersed metallic plates

Prof Ching Tai (Alex) Ng<sup>1</sup>, Dr Xianwen Hu<sup>1,2</sup>, Dr Tingyuan Yin<sup>1</sup>, Mr Hankai Zhu<sup>1</sup>, Prof Andrei Kotousov<sup>1</sup>

<sup>1</sup>The University of Adelaide, <sup>2</sup>Guangdong University of Technology

This paper presents a study of applying nonlinear guided wave mixing to detect early-stage damage in partially immersed metallic plates. The proposed method relies on the generation of combination harmonic at sum frequency due to the microstructural change at the defect in the damage detection. Numerical and experimental studies are carried out to investigate the sensitivity and capability of the combination harmonic at sum frequency in detecting early-stage damage, and particular focus is on the effect of the water exposed to one side of the metallic plates. The results show that the combination harmonic at sum frequency by mixing the fundamental leaky symmetrical mode of Lamb waves at two different frequencies is sensitive to early-stage damage.

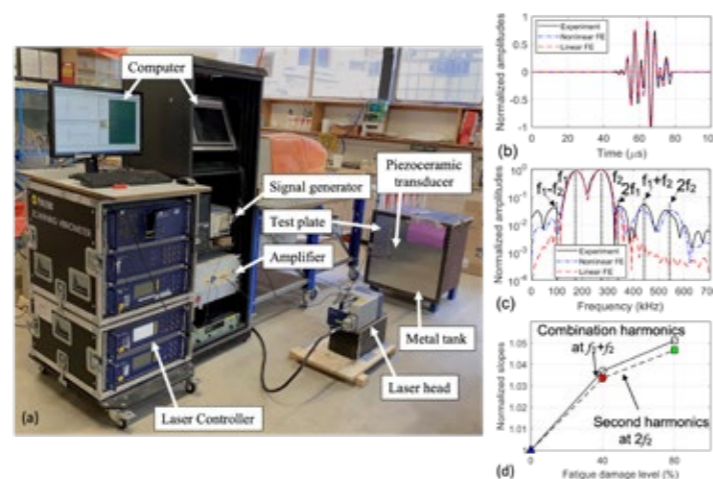

## Reconstruction home after the 2016 Kumamoto earthquake and community preparedness for disaster

Dr Yuuki Kuroiwa<sup>1</sup>

<sup>1</sup>Kuroiwa Structural Engineers

In 2016, the Kumamoto earthquake occurred twice. I had to rebuild my home, and the neighbourhood was losing liveliness. Alternatively, the water supply was cut off. The public bath was overflowing with people. Since there was a rich of groundwater on new site, the first floor will be disaster relief architecture that be used a public bath on daily life, provide water on disaster. Serve as a small but useful community preparedness architecture. The first floor ceiling uses superimposed openwork beams made of thinned wood to improve rigidity and strength. Since the Kumamoto earthquake occurred twice, we designed the damaged structure will bear the subsequent second earthquake. The roof is designed arch for loft with CLT without any metal.



## Predicting the embodied greenhouse gas emissions of building structures through Machine Learning

Miss Sandie Kate Fenton<sup>1</sup>

<sup>1</sup>Bollinger + Grohmann, <sup>2</sup>Ecole nationale supérieure d'architecture Versailles, <sup>3</sup>Vrije Universiteit Brussel

Structural design has a strong impact on the total greenhouse gas emissions of buildings. Methods to assess GHG emissions of structures are rarely computed at early design stages, when changes with highest impact are made, but quantitative volumetric and material information, 'hard' features, are unavailable. This research uses machine learning models to predict the GHG emissions of buildings from small databases available. Models are trained on descriptive data found in competition briefs, 'soft' features. The methodology is tested on buildings with different structure types from the EUCB-D database. Results prove its potential and motivates its further developments into a tool for data-driven low carbon structural design. Moreover, it identifies impactful soft features and motivates assembling learning databases for future studies.

FEATURE	HARD		SOFT Quantitative		SOFT Qualitative		Target
	CONCRETE 32/40 (kgCO2e/m2)	Steel - Reinforcement (kgCO2e/m2)	'Storeys'	Typ Span (m)	'Sector'	'Basement'	Cal kgCO2e/m2
Ex:	122,81	97,27	8	7.5	Educational	'None'	220,08
Formula	$\sum [x_{HARD} \times CO2e_{material}]$		$h(x_{SOFT Q}, x_{SOFT Q}, \theta)$				(kgCO2e)

COMPUTE

PREDICT ?

Wednesday 12 July 2023

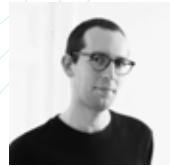

**Discrete systems for resource-efficient and adaptable timber structures**

**Dr Stijn Brancart<sup>1</sup>**

<sup>1</sup>Delft University of Technology

In a circular built environment, adaptable systems can facilitate reuse of load-bearing structures and components. Ideally, both structure and components would be fit for reuse in different scenarios, including different geometric configurations. In many cases, this leads to over-dimensioning of the structure. While this might constitute embodied energy savings in a life-cycle perspective, over-dimensioning does increase the environmental impact at the time of initial construction. The urgency of the climate crisis urges to reconsider the strategy of over-dimensioning and investigate more resource-efficient strategies for the design of adaptable structures. This research investigates the potential of discrete systems for the development of timber structures that can be adapted to different functional and geometric configurations without the need for considerable over-dimensioning.

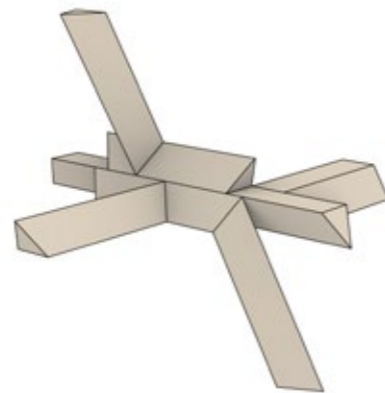

**Using vision-based method to measure vibration responses of structures**

**A/Prof Jun Li<sup>1</sup>, Mr Dong Tan<sup>1</sup>, Prof Hong Hao<sup>1</sup>**

<sup>1</sup>Curtin University

This paper proposes a vision-based approach for vibration displacement measurement and modal identification of a simply-supported bridge under moving loads using a consumer-grade camera. Repeated roving tests are conducted by placing a single camera targeting at different segments of the bridge to capture the vibration displacement responses at different locations of a bridge under a moving load. Then the natural frequencies and global mode shapes of the bridge are obtained by integrating the identified mode shapes of different segments of the bridge. Comparison of natural frequencies and mode shapes against the results from wired displacement sensor responses is conducted to demonstrate the accuracy of the proposed approach for displacement measurement and modal identification.

**Vision based displacement measurement and modal identification of a bridge under a moving load using a consumer-grade camera**

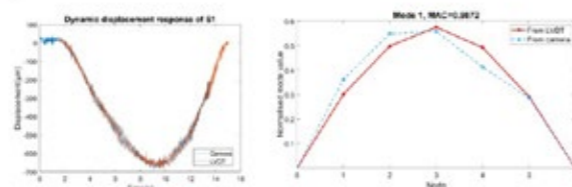
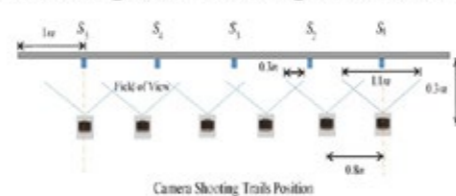

Wednesday 12 July 2023

**Session 27**

**Tension and membrane structures 3**

Room 216

09:00 - 11:00

# Wednesday 12 July 2023



## Defining Design Limits for ETFE Foils determined in Bubble Inflation Tests

Mr Felix Surholt<sup>1</sup>, Dr Jörg Uhlemann<sup>1</sup>, Prof Natalie Stranghöner<sup>1</sup>

<sup>1</sup>University of Duisburg-Essen, Institute for Metal and Lightweight Structures

Membrane materials can be distinguished between textiles and foils, whereas the latter are oftentimes ETFE foils. Recently, the final draft of the technical specification (TS) prEN/TS 19102 has been submitted to CEN, which focuses on the design of tensioned membrane structures. Rules for the design of membranes are given, distinguishing between the Ultimate Limit State (ULS) and the Serviceability Limit State (SLS). For ETFE foils, the ULS and SLS design are based on uniaxially determined material properties. However, the majority of membranes are biaxially stressed. To determine the biaxial material behaviour of ETFE foils, bubble inflation tests are performed on materials from three different producers. The tests are presented and used to formulate design limits considering the biaxial material behaviour.

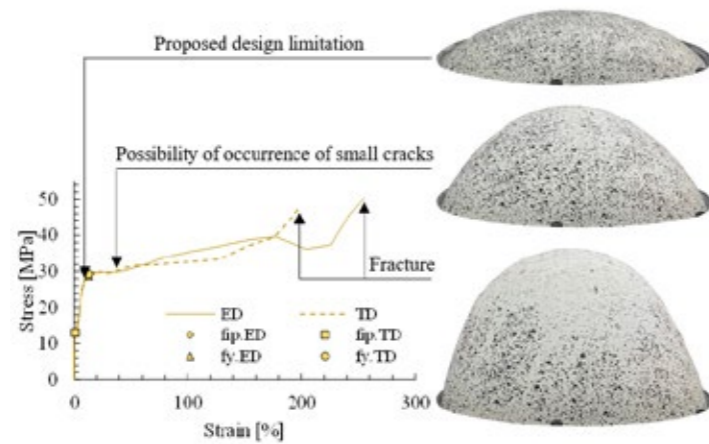

## PTFE membrane privacy screen structure for National Palace Malaysia

Ms Migico Sing Si Wei<sup>2</sup>, Prof Jae Yeol Kim<sup>1</sup>, Mr. Azri Hariz Che Malid<sup>2</sup>, Mr. Chong Kiat Ng<sup>2</sup>,

<sup>1</sup>Universiti Sains Malaysia, <sup>2</sup>Tensioned Fabric Structure Sdn Bhd

This paper presents a unique application of tensile membrane as a shield for privacy protection purpose within the compound of National Palace in Kuala Lumpur Malaysia. The final design of the privacy screen is a frame supported PTFE membrane structure. The height of the membrane screen structure is 11.36 m with cantilever parts of 8.53 m(front) and 3 m(back). The total length of the screen is about 25 m in plan. Several challenges were faced. First and foremost was the lack of information on the supporting RC structure. Other challenge was site accessibility for logistic and installation purpose and strict rules regarding working time and entry check into compound of National Palace.

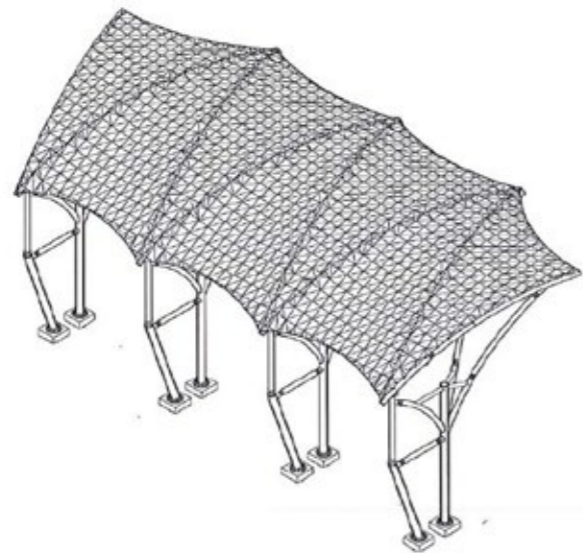

## The roof structure design of the professional football stadium of Chengdu Phoenix Mountain Sports Center

Ms Yuan Feng<sup>1</sup>, Mr Tian Qiu<sup>1</sup>, Mr Liwei Wang<sup>1</sup>, Mr Yan Zhang<sup>1</sup>, Mr Xin-an Xiang<sup>1</sup>

<sup>1</sup>Cswadi

The professional football stadium of Chengdu Phoenix Mountain Sports Center will host the 31st World University Games in 2023. The number of seats designed for professional football stadiums has reached 60000. The maximum overhanging length of the roof is 64 meters. The roof covering material is ETFE membrane material in the inner circle area and metal material in the outer circle area. By using an inner ring steel truss at the edge of the central large opening, the weakening of the stiffness and integrity of the cable dome structure due to the large opening is compensated. The practice of this project has expanded the application scope of cable dome structures to achieve lightweight and unique architectural effects.



## Study on wind response properties of roof structures composed of radially arranged cables considering roof deformation

Mr Akira Oshiumi<sup>1</sup>

<sup>1</sup>Nihon University

SCS is a unique masonry structure proposed by the presenter. In this paper, the components of SCS are blocks, lower string and PS Cable. The material of PS Cable is the stranded cable, are placed along the midpoint of the blocks. The arch-shape with pin-pin support is used to ensure better stability of SCS. An analysis was done to confirm the mechanical behavior of this structure and PS effect. These results were as follows. The lower strings under all load occurred non-tension, but that under partial distributed load occurred the tension. PS effect at full load was an increase in stiffness, but this PS effect did not appear in some cases due to the difference in load conditions.

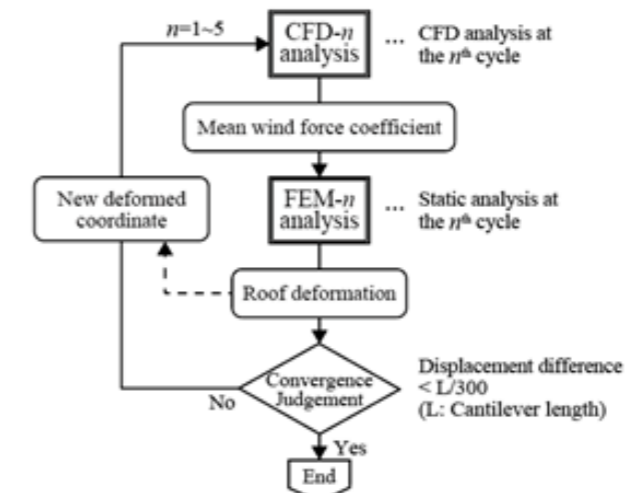

# Wednesday 12 July 2023



## Large Span Membrane Architecture: How to Accomplish Carbon Neutral with Innovative Photovoltaic and Adaptive Control Strategy

Mr Yongsheng Yan<sup>1</sup>, Prof Wujun Chen<sup>1</sup>, Prof Jianhui Hu<sup>1</sup>

<sup>1</sup>Space Structure Research Center, Shanghai Jiao Tong University

As an important form of large-span space structure, membrane structure has encountered some problems in the development of photovoltaic integration, and its engineering practicability has not been well verified, such as low energy conversion efficiency, and the integration of photovoltaic modules and structural system. This paper introduces several new building integrated photovoltaic technologies, such as photovoltaic membrane structures, photovoltaic glass, phase changed materials (PCM), semiconductor refrigeration, etc.

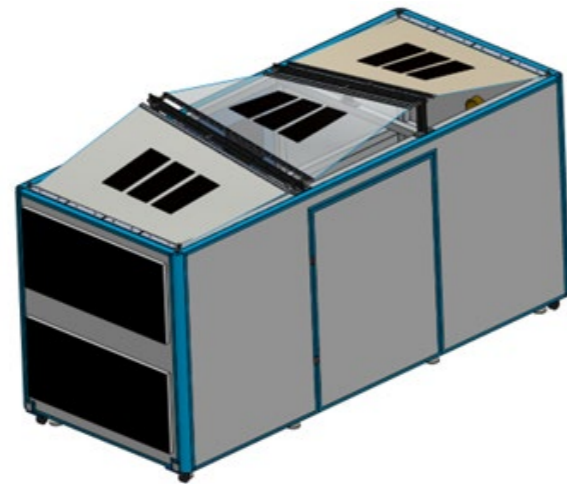

## Construction of Developable Freeform Membrane Tensegrity Structures

Mr Yuta Shimoda<sup>2</sup>, Dr Sei Hayashi<sup>1</sup>, Mr Hiroki Awajiri<sup>3</sup>, Mr Taichi Nakamura<sup>1</sup>, Mr Haruto Kamijo<sup>1</sup>, Dr Tomoyuki Gondo<sup>1</sup>, Dr Tomohiro Tachi<sup>1</sup>, Mr Jun Sato<sup>1,2</sup>

<sup>1</sup>The University of Tokyo, <sup>2</sup>Jun Sato Structural Engineers Co. Ltd., <sup>3</sup>Asahi Building-Wall Co., Ltd.

We propose a design method of membrane tensegrity structures by solving the inverse problem using freeform origami tessellations by generalizing Resch's patterns. In this paper, we demonstrate the feasibility of our method by constructing a full-scale mock-up. In constructing the structure, we sewed pockets, shorter in length than compression members, into the mountain fold lines and applied tensile force across the membrane by inserting Carbon fiber reinforced plastic (CFRP) rods as the compression members while pulling the membrane material. Furthermore, we measured the coordinates of each joint of the structure with a three-dimensional laser distance meter. We compared them with the design model to assess the reproducibility of its geometry.



## Active Control of Hybrid String Structure

Mr Wucheng Xu<sup>1</sup>, Dr Yanbin Shen<sup>1</sup>

<sup>1</sup>Zhejiang University

Based on an optimization-based model, this paper proposes a set of active control approach for hybrid string structures including the beam string structure (BBS) and suspen-dome structure (SDS) by applying the genetic gradient algorithm (GGA) and multi-population genetic algorithm (MPGA). To verify the validity of GGA and MPGA in terms of search control strategies, an experimental case and two numerical cases are investigated. The test and simulation results show that the active control based on the GGA and MPGA can effectively optimize the mechanical properties of BBS and SDS (e.g., the stress, displacement, and strain energy), which validates the validity of GGA and MPGA.

## Numerical and experimental modelling of pneumatic structures

A/Prof Ruy Marcelo Pauletti<sup>1</sup>, Ms. Karina Rocha<sup>2</sup>

<sup>1</sup>University of São Paulo, <sup>2</sup>Mauá Institute of Technology

As other types of tensile structures, pneumatics rely on geometric stiffness for stability. However, pneumatic structures are also endowed with a 'pneumatic stiffness', which corresponds to a reluctance of the pressure envelope to change its volume. The higher the inside pressure, the more relevant this component can be. Most civil and architectural applications of pneumatic structures are low to moderate-energy systems, for which simplified material models may suffice, if a sound model to cope with membrane wrinkling is also considered. This paper presents a simple yet effective model to cope with the nonlinear analysis of pneumatic membranes under wind loads, incorporating an effective wrinkling criterion into a simple membrane element, and deriving new expressions for its pneumatic stiffness. The model was tested through an inexpensive experiment, comprising the compression of an exercise ball, which corroborated the importance of considering variable inside pressures for moderate-energy systems. The relevance reduces, however, as the dimensions of the structures increase, especially in the case of large, insufflate domes, which are also discussed in the paper.

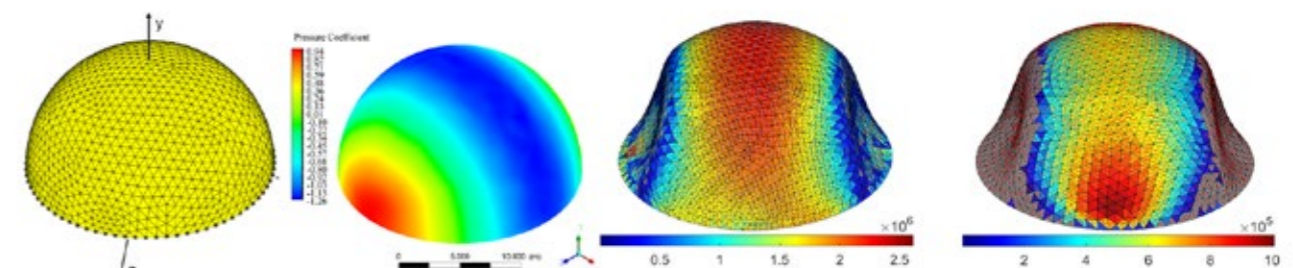

Wednesday 12 July 2023

# Session 28

## Sustainable construction 1

Room 217

Sustainable construction 1



### Simulation and analysis of generalised automated interleaved layered construction process for shell structures

Dr Shadi Ostovari<sup>1</sup>, Dr Hooman Shayan<sup>2,3</sup>

<sup>1</sup>Cranfield University, <sup>2</sup>Autodesk Research, <sup>3</sup>University College London

This study presents a method for analyzing and simulating a generalized version of an automated construction process that involves the interleaved construction of formwork and concrete using a poly-articulated robotic arm. The proposed process has the potential to enable the creation of free-form shell structures without some of the limitations of other automated construction methods. The study provides a framework for finite element analysis and simulation of the construction process, enabling optimization of various aspects of the structure and construction process, including material usage, energy consumption, sustainability, and construction time. The framework also introduces failure criteria for the construction process and structural performance of the shell structure, allowing for optimization of the design and construction parameters. The proposed method offers designers and construction professionals the opportunity to improve the structural performance of shell structures while reducing costs, complexity, and environmental impacts.

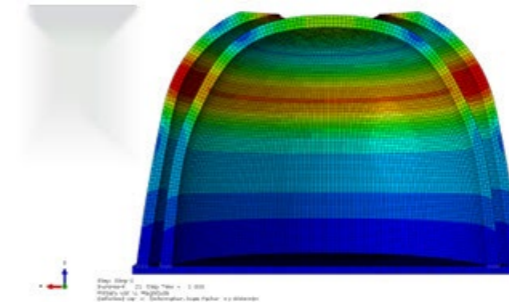

### Bio-based Composite Spatial Shell Structures

Prof Masoud Akbarzadeh, Mr Mostafa Akbari<sup>1</sup>, Ms Farzaneh Oghazian<sup>2</sup>, Ms Felecia Davis<sup>2</sup>, Ms Laia Mogas-Soldevila<sup>1</sup>

<sup>1</sup>University of Pennsylvania, <sup>2</sup>PennState University

This research investigates the possibility of fabricating shell-based cellular structures using knitting techniques. Shellular Funicular Structures are two-manifold single-layer structures that can be designed in the context of graphic statics. These are efficient compression/tension-only structures that have been designed for a certain boundary condition. Although the shellular funicular structures are efficient geometries in transferring the forces, the fabrication process is challenging due to the geometric complexity of the structure. Since Shellular structures comprise a single surface, they are suitable candidates to be fabricated using knitting technique, a method by which yarn is manipulated to create a textile or fabric. Using knitting approach, one can fabricate shellular structures with minimum production waste in which the knit can work as a formwork for actual structure or act as a composite structure combined with bio-based resin. This research proposes a workflow to fabricate shellular structures using knitting that can be scaled up for industrial purposes.

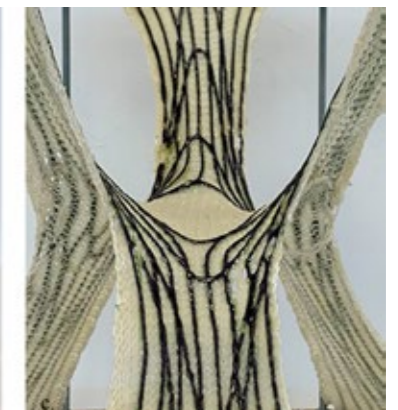

# Wednesday 12 July 2023



## Leaned brick shells with Mexican quoins and steel edges

Prof Juan Gerardo Oliva-Salinas<sup>1</sup>, Architect Marcos Javier Ontiveros-Hernández<sup>1</sup>

<sup>1</sup>Universidad Nacional Autónoma De México

The Lightweight Structures Laboratory – LSL constructed the experimental pavilion PabUNAM at the Faculty of Architecture in the Universidad Nacional Autónoma de México – UNAM. The LSL Research Group aims to demonstrate that bricks are still in force for conceiving, designing, and constructing continuous shells with a complex geometry, which shape may vary beyond the traditional geometric forms. The Mexican Technique, “leaned bricks,” is practiced in many areas of central Mexico to construct vaults and was applied to build this pavilion. The so-called quoins (“cuñas” in Spanish) are the most used burnt bricks, with 20 X 10 X 5 cm dimensions. No falsework is necessary.

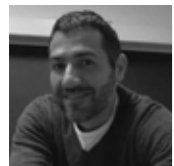

## Isogeometric refinement for shells' shape optimization

Prof Stefano Gabriele<sup>1</sup>, Mrs Gloria Rita Argento<sup>1</sup>, Prof Enzo Marino<sup>2</sup>, Prof Valerio Varano<sup>1</sup>

<sup>1</sup>University Roma Tre, <sup>2</sup>University of Florence

The R-Funicularity for shell structures can be quantified using the generalized eccentricity. A shell is defined R Funicular when the generalized eccentricity doesn't exceed admissibility limits. A shells' shape optimization process aiming at finding R-Funicular shells is here proposed. The geometry of the shell is described through spline surfaces and optimized using the coordinates of the control polygon vertices as variables. An isogeometric refinement is applied in order to improve the local control of the shape in the optimization, allowing for tuning the number of variables. After generating the initial geometry, additional vertices can be entered as new variables, whenever a more accurate local control of the surface is needed. Significant numerical examples are presented.

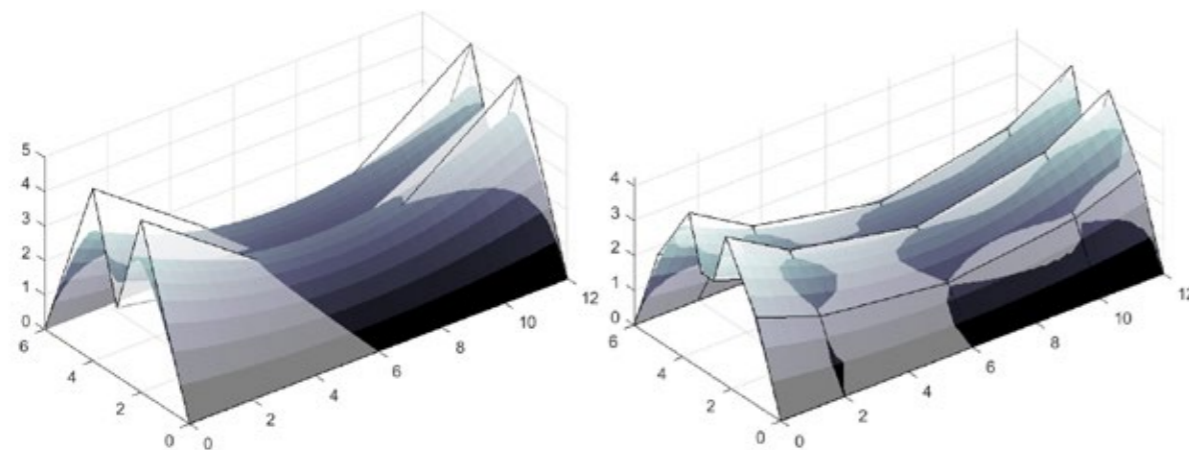

## Efficient steel-concrete slab designed using multi-material topology optimisation

Mr Yu Li<sup>1,2</sup>, Mr Hao Wu<sup>1</sup>, Prof Philip F. Yuan<sup>1</sup>, Prof Yi Min Xie<sup>2</sup>

<sup>1</sup>Tongji University, <sup>2</sup>RMIT University

Advanced concrete techniques like 3D-printed moulds and 3D concrete printing have enabled construction of free-form structures, but poor tensile capacity of concrete makes it challenging to design efficient concrete structures applicable to automated construction. The multi-material bi-directional evolutionary structural optimisation (MBESO) method can be used to address this challenge by arranging two different materials suitable for tension and compression in the respective tensile and compressive regions of the structure. A steel-cable supported concrete slab is designed using this method. The composite slab is structurally efficient and offers an innovative design strategy for concrete structures, maximizing compressive properties and circumventing poor tensile ability. This method can also be applied to other materials like clay and gypsum.

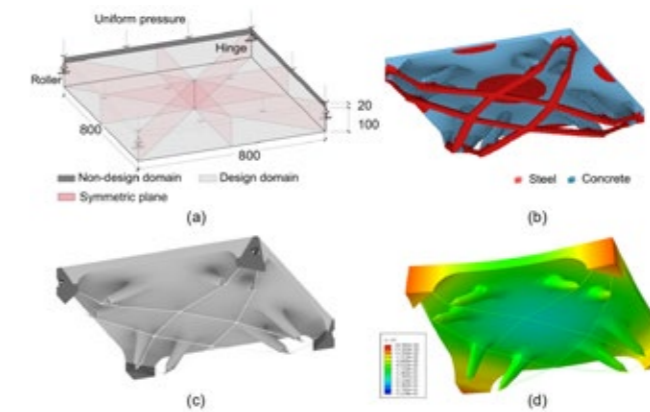

## Experimental investigations of textile fabrication processes for steel shell and lattice structures

Mr Baris Wenzel<sup>1</sup>, Mr. Vincent Witt<sup>1</sup>, Mr. Erik Zanetti<sup>1</sup>, Mr. Moritz Doerstelmann<sup>1</sup>

<sup>1</sup>Karlsruhe Institute of Technology

Steel can be recycled without loss of properties, a huge potential for urban mining and the circular economy, yet, the demand for new steel is higher than the offer of secondary raw material. Digital circular construction concepts can enable material savings and help to reduce primary material extraction and optimise the use of secondary material. At the intersection of research and teaching, the paper examines novel fabrication concepts for textile steel structures, starting from an understanding of thin steel wires and threads and their potential to be utilized in textile fabrication processes. The presented work reconceptualizes existing steel fabrication methods with strong focus on computational design and digital fabrication processes that enable novel concepts for circular economy in construction.

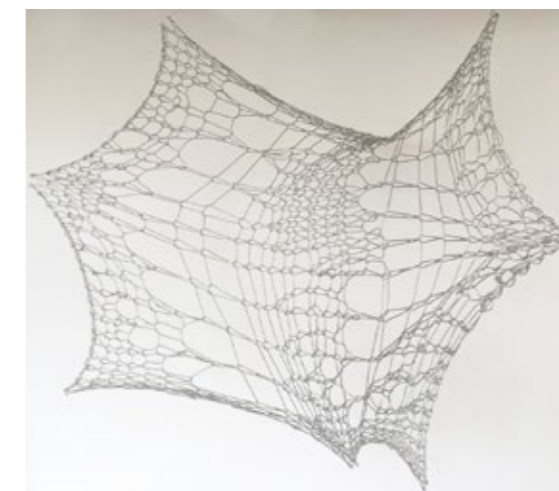



Wednesday 12 July 2023

# Session 29

## Structural design and analysis

Room 218  
09:00 - 11:00



### Influence of axial force on the dynamic response of the aluminum foam-filled 6082-T6 aluminum tube under lateral impact

Prof Ximei Zhai<sup>1,2</sup>, Mr Lingzhao Meng<sup>1,2</sup>, Mr Guangming Cui<sup>1,2</sup>

<sup>1</sup>Key Lab of Structures Dynamic Behavior and Control of the Ministry of Education, Harbin Institute of Technology, <sup>2</sup>Key Lab of Smart Prevention and Mitigation of Civil Engineering Disasters of the Ministry of Industry and Information Technology, Harbin Institute of Technology

Aluminum alloy circular tube is widely utilized in the field of spatial structures and bridges for its advantages of high strength–mass ratio, excellent corrosion resistance, and great durability. To improve the impact resistance of the tube, aluminum foam-filled composite tube is proposed and laterally impacted by a drop hammer in this work. Moreover, the axial force is applied to composite tubes before impact to investigate the dynamic response of tubes under the combined load of axial force and lateral impact. The results show that axial tension benefits the impact resistance of tubes while axial compression is unfavorable. Furthermore, the adverse effect of axial compression is weakened by filling aluminum foam due to its supporting effect on tube wall.

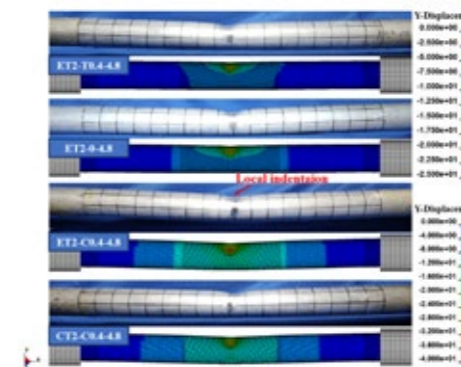

### Static performance of an open Levy cable dome with partial CFRP cables

Prof Weijing Zhang<sup>1</sup>

<sup>1</sup>Beijing University of Technology

In order to study the static performance of the cable dome after the application of CFRP cables, part of the steel cables in a Levy type open cable dome with span of 120m was replaced with CFRP cables. The simulation results show that the stress level of the cable dome is reduced after CFRP cables are used, and the stress of each group of cables decreases within 8%, and the maximum vertical displacement of nodes changes within 10%. The replacement of ridge cables and upper inner ring cable can increase the structure stiffness. The research in this paper can provide reference for the application of CFRP cables in cable domes

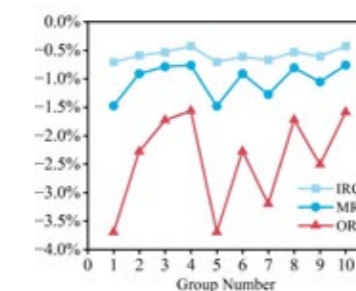
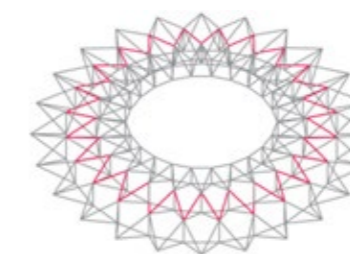

# Wednesday 12 July 2023



## Web crippling of 7A04-T6 high strength aluminium alloy SHS and RHS members

Dr Xinhang Zhi<sup>1</sup>, Prof Yuanqing Wang<sup>1</sup>, Dr Beibei Li<sup>1</sup>

<sup>1</sup>Department of Civil Engineering, Tsinghua University

The web crippling behaviour of 7A04-T6 high strength aluminium alloy square and rectangular hollow section (SHS/RHS) members were investigated in this paper. Both the experimental and numerical modelling results were presented. A total of 18 web crippling tests were conducted under end-two-flange (ETF) and interior-two-flange (ITF) loading conditions. Finite element models were developed and validated by test results, moreover, 360 further numerical results were generated over different cross-section dimensions and bearing lengths. The current design provisions in EN 1999-1-1:2007 (EC9) and American Aluminum Design Manual 2020 (AADM) were assessed. The revised direct strength method (DSM) was also proposed to provide both convenient and accurate predictions for the web crippling of 7A04-T6 high strength aluminium alloy SHS and RHS members.

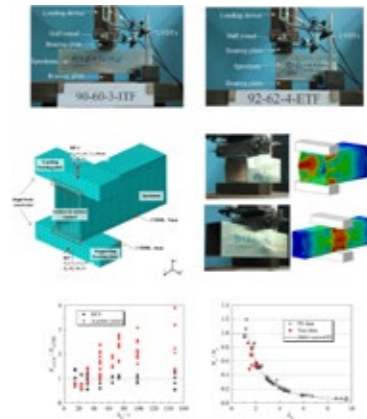

## The transformable envelope of Moscow-City concert hall

Mr Josu Goñi<sup>1</sup>, Mr Garikoitz Mendizabal<sup>1</sup>, Mrs Amaia Linazasoro<sup>1</sup>, Mr Oscar Batuecas<sup>1</sup>, Mr Santiago Cizaurre<sup>1</sup>, Dr. Gabriel Ruiz<sup>2</sup>, Dr. Jose Miguel Rico<sup>2</sup>

<sup>1</sup>Lanik, <sup>2</sup>School of Architecture University of the Basque Country (UPV/EHU)

The main goal in this project was to create a very transparent envelope for a 65m circular space, with the option half its surface to be opened, supporting the big snow loads of a City like Moscow, and being totally airtight in the closed position so the inner space remains comfortable. The asymmetry of the dome's structure, combination of rolling supports with need of retaining grid shell's boundary, big thermal loads, and many other factors, make this project unique as engineering challenge.



## State-of-the-art Review of Initial Imperfection Field Simulation Methods for Single-Layer Gridshells

Dr Shaojun Zhu<sup>1</sup>, Mr Qiang Zeng<sup>1</sup>, Dr Xu Yang<sup>1</sup>

<sup>1</sup>Tongji University

The safety of single-layer reticulated shells depends largely on their buckling capacity, on which the initial geometric imperfections of joint deviations generated during the installation of the structure have a significant impact. By reviewing existing simulation methods on the initial geometric imperfection field of single-layer gridshells, it is concluded that existing stochastic, deterministic, and semi-stochastic simulation methods are all with deficiencies, and it is impossible to determine the real probability model of the buckling capacity of single-layer gridshells. This study proposes initial imperfection field simulation method considering fabrication constraints, with reasonable basic assumptions and controllable computational costs, providing a scientific basis for improving the stability analysis method for single-layer gridshells and a theoretical foundation for the analysis of stability reliability.

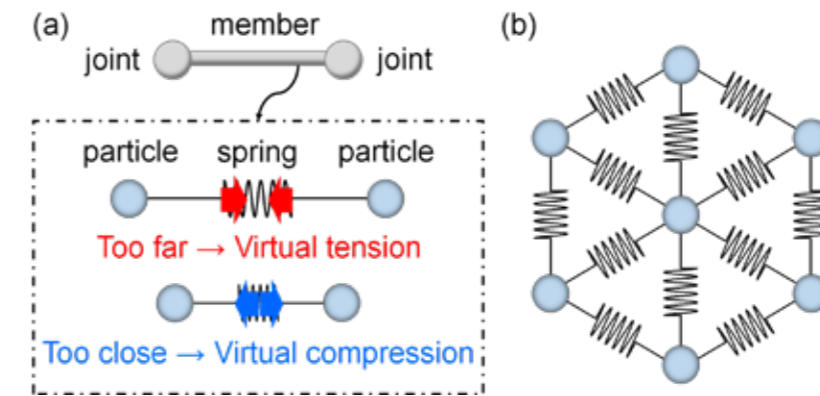

## 3D printed reusable and mechanically tunable tensegrity energy absorber

Mr Di Zhang<sup>1</sup>, Dr Jianguang Fang<sup>1</sup>

<sup>1</sup>University of Technology Sydney

Traditional lattice energy absorbers are usually disposable once used and have fixed energy absorption performance after fabrication. Comparably, meta-lattices manufactured with shape memory polymers (SMPs) can be used as reusable and tunable energy absorbers because of the shape memory effect (SME) of SMPs. Less occurrence of material fracture in meta-lattice gives it better reusability, which can be achieved by using SMPs with more ductility as printing materials and applying metastructure with better failure resistance. A tensegrity structure is one of the best failure-resistant structures among all the truss systems. Thus, tensegrity meta-structures fabricated with SMPs exhibit reusability and tunability when used as energy absorbers.

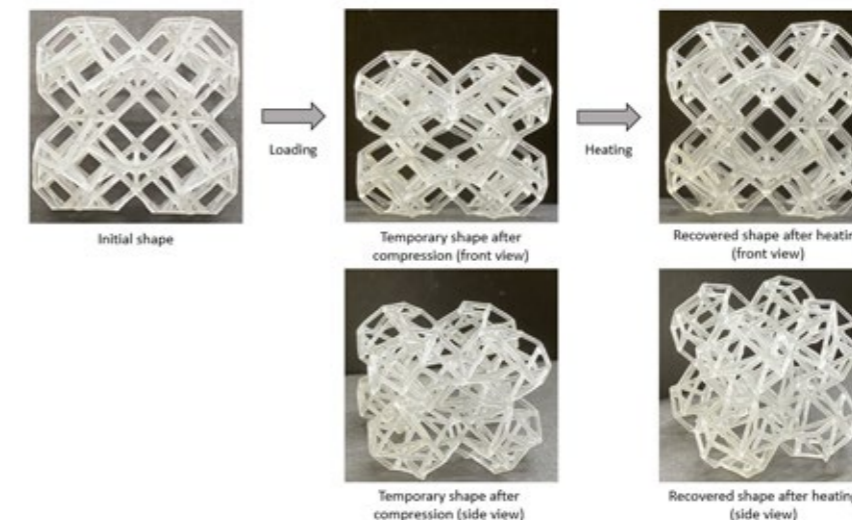

# Wednesday 12 July 2023



## Plastic buckling test of axially compressed aluminum latticed cylinders formed by 3D-printer

Prof Tetsuo Yamashita<sup>1</sup>, Mr Kohki Uchida<sup>1</sup>

<sup>1</sup>Kogakuin University

This paper describes a buckling test of two latticed cylinders, made of aluminium alloy and formed by 3D-printer. "Elephant-leg-like" plastic buckling was observed for axial compression. To make FE model composed of linear beam-elements as the digital-twin, nodal coordinates were specified in the 3D-scanned volume of the test bodies using Grasshopper. The maximum radial deviation was identified 0.56% of the specified radius of the cylinder. The calculated buckling strength of the hexagonally latticed cylinder was considerably higher than the test results because of bending crack, while good agreement was found for the triangularly latticed cylinder where axial stress dominates. The buckling strength was also verified according to the IASS-WG8 recommendation.

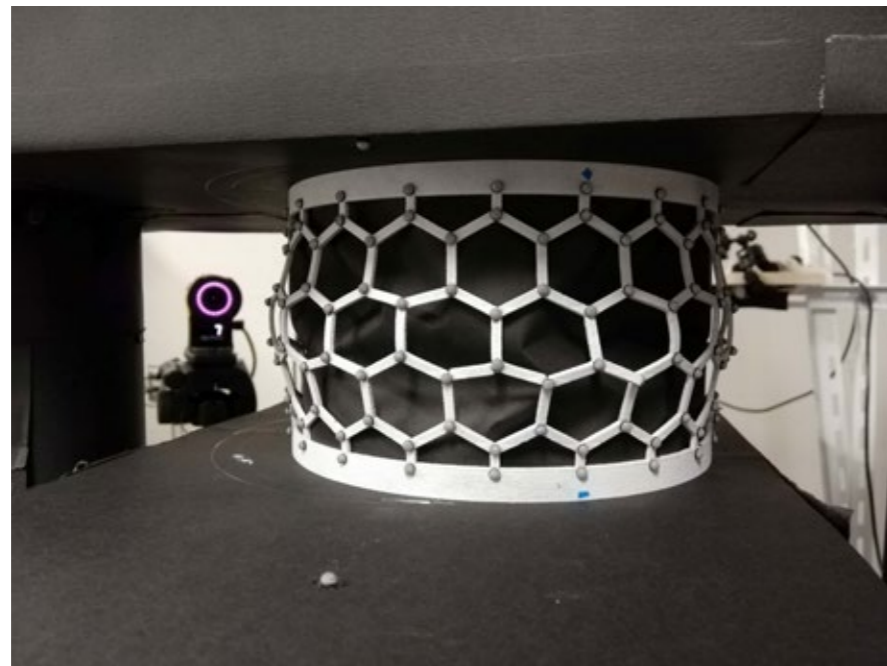

# Wednesday 12 July 2023

## Session 30

### Optimisation methods and applications 1

Room: Plenary 3  
09:00 - 11:00

# Wednesday 12 July 2023

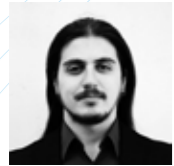

## Enhancing interactivity in structural optimisation through Reinforcement Learning: an application on shell structures

Mr Gabriele Mirra<sup>1</sup>, Dr Alberto Pugnale<sup>1</sup>

<sup>1</sup>The University of Melbourne

This paper describes a novel approach to structural optimisation based on learning design strategies rather than searching for optimal solutions. An AI agent is trained through Reinforcement Learning (RL) to iteratively morph a flat NURBS surface into a shell structure. Unlike current applications of RL in structural design, where the AI agent recombines a predefined set of design variables, our approach aims to create structural forms through the interaction of a designer and an AI agent within a 3D modelling environment. Our AI agent can be trained to produce structurally sound design options through iterative formal variations of an initial geometry. This AI agent can be used for the development of more interactive tools for structural design and optimisation.

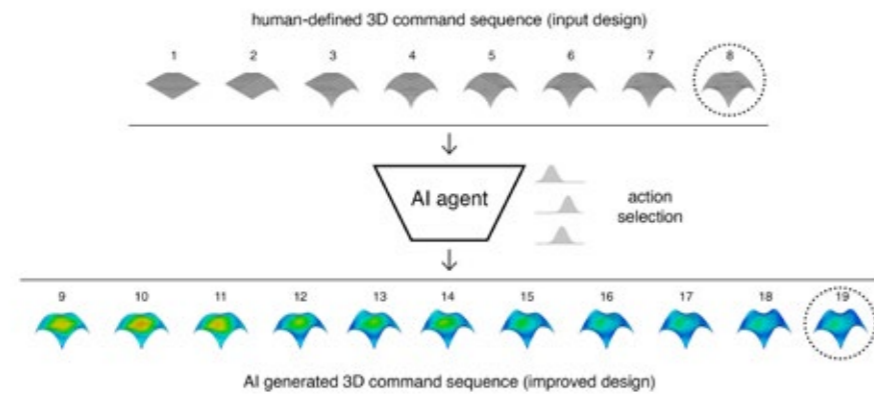

## Topology optimisation of free-form shells for architectural applications

Dr Jiaming Ma<sup>1</sup>, Dr Hongjia Lu<sup>1</sup>, Dr Ting-Uei Lee<sup>1</sup>, Prof Yi Min Xie<sup>1</sup>

<sup>1</sup>Centre for Innovative Structures and Materials, School of Engineering, RMIT University

Free-form shells are increasingly used in architectural applications. However, the utilisation of existing topology optimisation techniques in the real-world architectural design of shells remains rare. This paper presents various strategies for optimising free-form shells that are useful for architectural applications. First, we show that the ribs of shells can be optimised into free-form layouts with improved stiffness. Second, we demonstrate that topology optimisation can be combined with funicular form-finding techniques to generate diverse designs with high structural performance. Third, we illustrate how to combine surface tessellation and periodic constraints to achieve shell designs for cost-effective construction. Finally, we present a new method that can optimise free-form shells with Voronoi patterns to facilitate aesthetic expression and functional design for architects.



## An Advanced Crow Search Algorithm for Truss Optimization

Mr Hyukjin Kim<sup>1</sup>, Donwoo Lee<sup>1</sup>, Prof Sudeok Shon<sup>1</sup>, Prof Seungjae Lee<sup>1</sup>

<sup>1</sup>Koreatech

The CS algorithm proposed by Askarzadeh is a Swarm Intelligence algorithm inspired by the collective behavior of social animals such as birds, bees, and fish. The CS algorithm is easy to apply to problems because of the number of parameters is small. Still, it has the disadvantage of low search ability and convergence rate because AP and fl use fixed values. Therefore, this paper proposed an ACS algorithm that can solve these problems. The ACS algorithm improved the convergence performance of the algorithm by using additional crow characteristics and dynamic AP. The convergence performance of each algorithm was compared by applying it to a truss and it was confirmed that the ACS algorithm had excellent convergence performance.

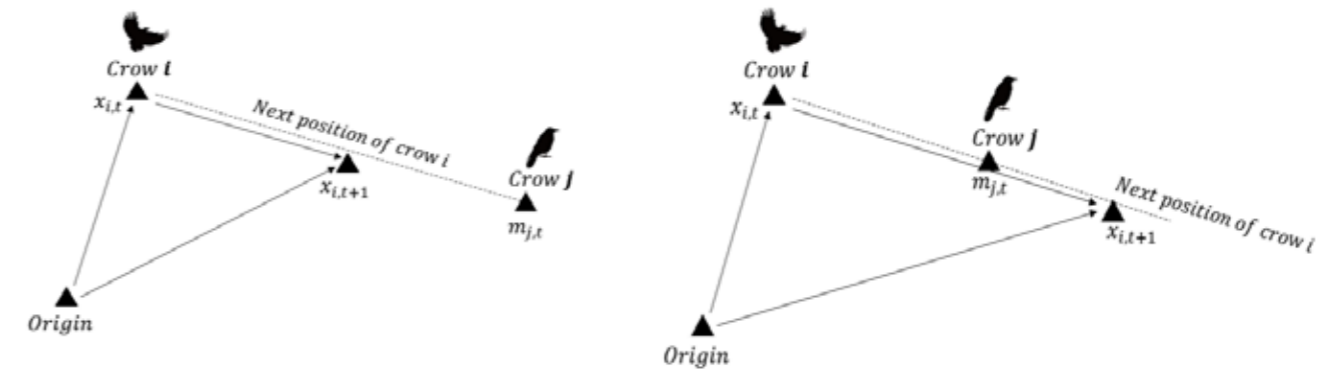

## Global Topology Optimization of Lattice Shell Considering Constructability Dependent on Connection Relationships of Members

Mr Naoto Okuzono<sup>1</sup>, A/Prof Shinnosuke Fujita<sup>1</sup>

<sup>1</sup>The University of Kitakyushu

In general, it is known that the topology optimization problem of steel structures can be formulated as a mixed-integer second order cone programming problem (MISOCP), when the compliance is minimized and the cross-section of each member is chosen from a set of predetermined candidates. Previous studies have demonstrated the effectiveness of the topology optimization method formulated as MISOCP which are considered constructability like the number of nodes and joint angles. However, the analytical model of these studies is two-dimensional steel structures. Therefore, in this paper, the conventional MISOCP method is extended to 3D lattice shells. Additionally, a new constraint on the connection relationships between members that affect welding difficulty and cost is considered.

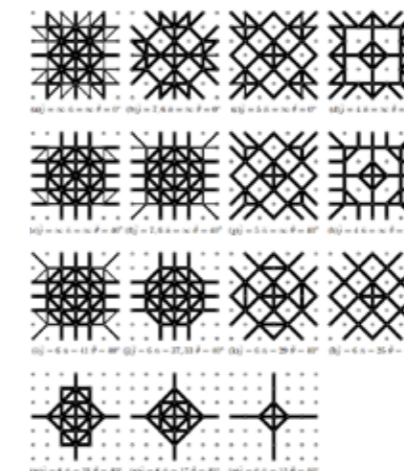

# Wednesday 12 July 2023

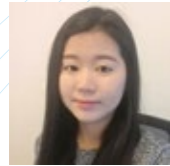

## Numerical analysis and design of welded I-section steel beams with longitudinally profiled flanges under elastic overall buckling

A/Prof Xiaoling Liu<sup>1</sup>, Mr Yuanqing Wang<sup>2</sup>, Mr Dongdong Xu<sup>2</sup>, Mr Huiyong Ban<sup>2</sup>, Mr Honggang Lei<sup>1</sup>

<sup>1</sup>Taiyuan University of Technology, <sup>2</sup>Tsinghua University

The application of longitudinally profiled (LP) steel plates in the flange of flexural members provides a good solution to optimize their mechanical performance and improve the efficiency of steel use. To clarify the elastic lateral-torsional buckling behavior of such LPB members, refined finite element (FE) models were developed by ANSYS, and a subsequent parametric study of 480 specimens was carried out. The analysis results show that with the increase of flange thickness change rate, the elastic critical moment LPB members decrease linearly, with the maximum reduction of 48 % and 37 % for members under three-point and four-point loading respectively. Finally, the approximate design calculation formulae were obtained, which is the basis of the subsequent research on elastoplastic stability performance.

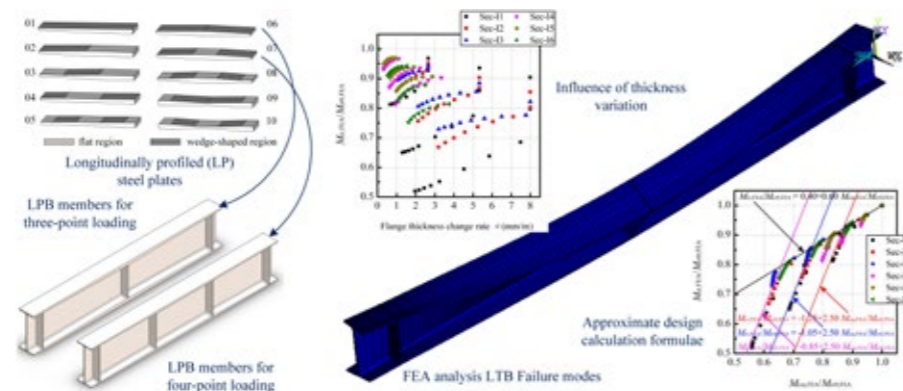

## Stress reduction effect by changing the upper and lower surfaces near the boundary of a spherical shell

Prof Shigehiro Morooka<sup>1</sup>, Mr Shouhei Ohyama<sup>2</sup>

<sup>1</sup>Tokai University, <sup>2</sup>RISE Structural Design Inc.

This paper examines a method to modify the geometry near the boundary of a spherical shell to produce only beneficial compressive stresses. To simplify the modification of the shape, a shell of revolution was modelled using axisymmetric elements. The change in the normal direction of the upper and lower surfaces near the boundary was expressed as a quadratic function passing through the midpoint of the change value and the change at the boundary. We have also examined what kind of objective function would suit the purpose of this paper, as well as the shell shape and stress intensity distribution. We have also evaluated how much the stress intensity can be reduced by the shell opening angle and the range of change.

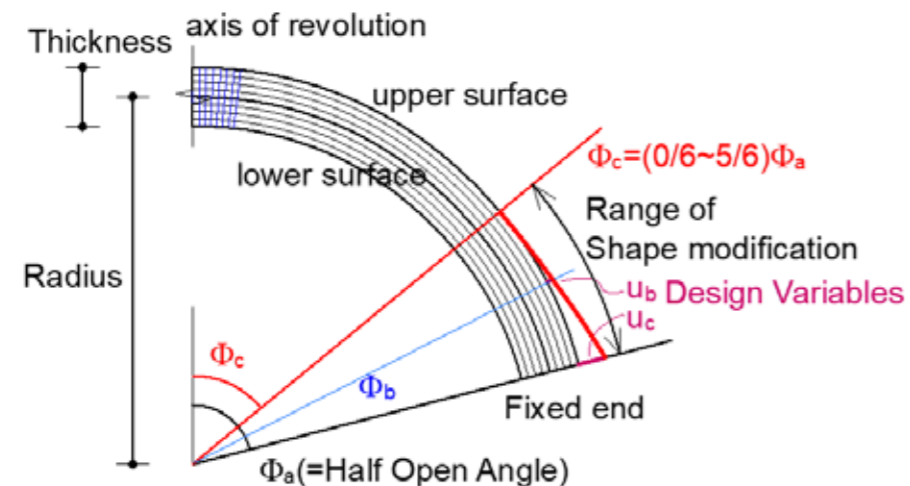

## Functionally graded CharCrete slabs for embodied carbon optimisation in architecture

Miss Nikol Kirova<sup>1</sup>, Mr Ashkan Foroughi<sup>1</sup>, Prof Jane Burry<sup>2</sup>, Dr Areti Markopoulou<sup>1</sup>, Dr Mehrnoush Latifi<sup>2</sup>

<sup>1</sup>Institute for Advanced Architecture of Catalonia, <sup>2</sup>Swinburne University of Technology School of Design in the Faculty of Health Arts and Design

The research presents a computational method for designing architectural elements using functionally graded cementitious materials to reduce embodied carbon and mass. CharCrete, a cementitious material that includes biochar, is used in the method to attain a range of structural performances and carbon footprint. Topology optimization is commonly used in architectural design, but it is typically more suited to homogeneous material systems. In contrast, the proposed method is tailored to heterogeneous material systems. The finite element analysis method is used to optimise the distribution of different grades of CharCrete according to structural requirements. The method aims to minimise embodied carbon and mass while maintaining structural integrity. The research shows that the computational method is effective in generating carbon-offsetting digital designs while maintaining structural integrity, suggesting integration of optimisation techniques and generative design methods into architectural design to address decarbonisation.

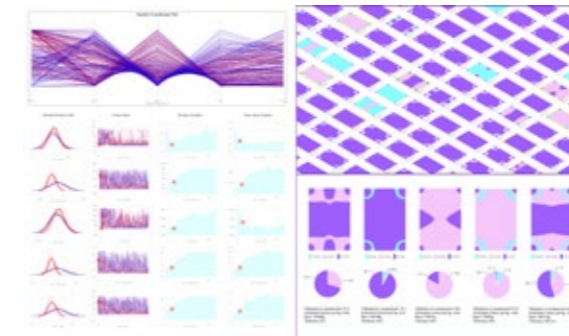

## Performance-based fire protection design and practical application of large-space aluminum alloy structure

Liqiu Qui, Yuanwen Ouyang<sup>1,2</sup>, Yufeng Jiao<sup>2</sup>, Zhiqiang Li<sup>2</sup>, Xiaowei Liu<sup>2</sup>

<sup>1</sup>Shanghai Jianke Aluminum Structure Engineering Research Institute, <sup>2</sup>Shanghai Tongzheng Construction Technology Group Co. Ltd

The use of aluminium alloys in the construction industry is becoming increasingly popular owing to their favourable mechanical properties. However, a substantial number of studies have shown that high temperature will significantly reduce the strength and elastic modulus of aluminium alloys. This paper presents a review of recent studies on the structural behaviour and performance-based design of aluminium alloy structures exposed to fire. Then, based on cases of some practical aluminium alloy large-span projects in China, the performance-based design and passive fire protection methods of large-span aluminium alloy structures are studied. The results show that FDS technology can accurately predict the non-uniform distribution of smoke temperature field.

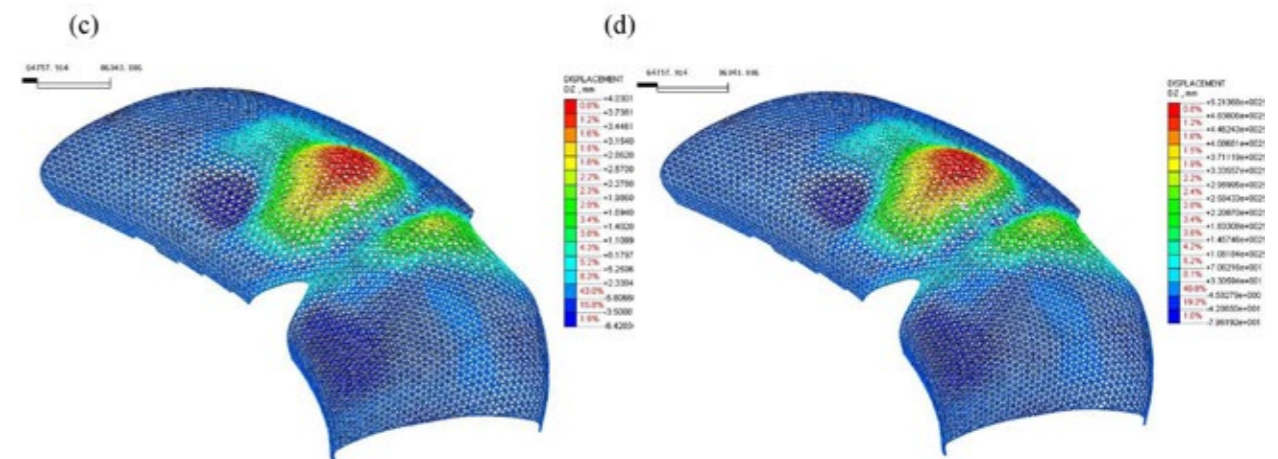

Wednesday 12 July 2023

# Masterclass 5

**Fologram: AR-assisted  
Fabrication Technique**

Room 215  
14:00 - 16:00

Presented by

**Gwyllim Jahn & Cameron Newnham**



Wednesday 12 July 2023

# Session 32

**Teaching**

Room 216  
14:00 - 16:00

# Wednesday 12 July 2023



## Reflections on an International Collaboration Initiative

**Miss Ramsha Saleem<sup>1</sup>, Mr Alireza Behnejad<sup>2</sup>, Dr Anesa Hosein<sup>3</sup>**

<sup>1</sup>WSP, <sup>2</sup>University of Surrey, <sup>3</sup>Surrey Institute of Education

Civil engineering education is in a state of flux with universities facing demand from the ever-evolving industry to develop graduates with the desired skillsets. This paper explores the transition in pedagogic approaches towards learner-centred models and evaluates the implementation of Project-Based Learning to shape the next generation of civil engineers through a case study application of the Design, Assemble and Dismantle Project delivered at the University of Surrey. Interviews with 20 participants of the Project were conducted to understand the advantages of implementing this pedagogic tool. The reflections attribute the development of an array of skills and cultivation of holistic, active, and conscious learners with increased accountability to the Project; paramount for the challenges of the 21st century.



## Seismic retrofitting by Double Layer Grids for HP Suspension Gymnasium

**Mr Kazuya Miyagawa<sup>1</sup>**

<sup>1</sup>Osaka Metropolitan University

Double layer grids of three lattice patterns are applied to the gymnasiums with cable suspensions and concrete slabs for seismic retrofit and multipurpose facility. The axial force distributions of two layers are compared with different lattice patterns and support conditions under the same members and vertical loads, to make clear the load resistance mechanism of each lattice pattern. The double-layer grids considered are square-on-square (SS), square-on-diagonal (SD), and diagonal-on-square (DS) meshes. The SS type has the greatest material efficiency but is remarkably affected by boundary conditions. The SD type is stronger than the others against the difference of boundary conditions.

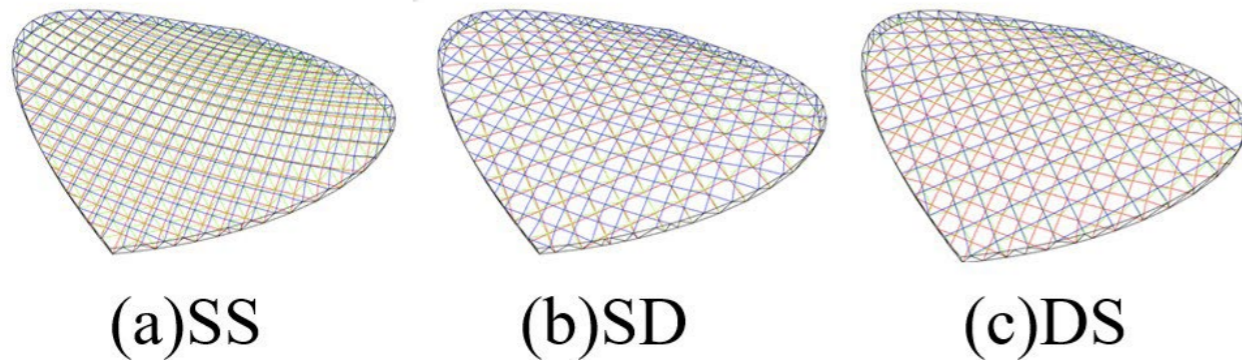

Figure 2. Lattice pattern



## A modular approach to repurposing timber structural elements

**Mr Matthew Tam<sup>1</sup>, Dr Sascha Bohnenberger-Fehr<sup>1,2</sup>, Chris Fox<sup>3,4</sup>, Tommaso Pagani<sup>3</sup>, Dr Clemens Preisinger<sup>5</sup>**

<sup>1</sup>Bollinger+grohmann, <sup>2</sup>Swinburne University of Technology, <sup>3</sup>Studio Chris Fox, <sup>4</sup>University of Sydney, <sup>5</sup>University of Applied Arts

In the ever so prevalent drive to reduce the environmental impacts of the construction industry, the (re)emergence of opting for a circular economy through repurposing of structural elements is gaining traction. This paper explores an approach to develop modular systems that could be assembled and reassembled in a vast array of options thus further extending the lifespan of existing structural elements. The project consists of that were designed with a self-assembly process in mind that solely relies on the utilisation of bolted connections. This paper outlines the digital workflow working with inventories of reclaimed stock material to design the modules and methodologies to populate them in a three-dimensional framework.

4x4ft = 66.5m length  
 7x4ft = 39.5m length  
 9x4ft = 41.5m length  
 10x4ft = 22.7m length  
  
 Wall Module = 11.5m length  
 Washroom Module = 20.67m length  
 Roof Module = 17.25m length  
  
 Wall Module Count = 20  
 Washroom Module Count = 10  
 Roof Module Count = 19  
 Ridge Module Count = 11  
 Total Module Count = 60  
  
 Facade Area = 23.96m<sup>2</sup>  
 Facade Side = 3.38m<sup>2</sup>  
 Facade Roof = 39.13m<sup>2</sup>  
  
 Load Combination = 1.35 DL + 1.5 W1  
 max utilization = 10.4% to 20%  
 max deformation = 4.9cm  
 max reaction force (kN) = 24.2(kN)  
 max reaction force (kN/m) = 28.7(kN)

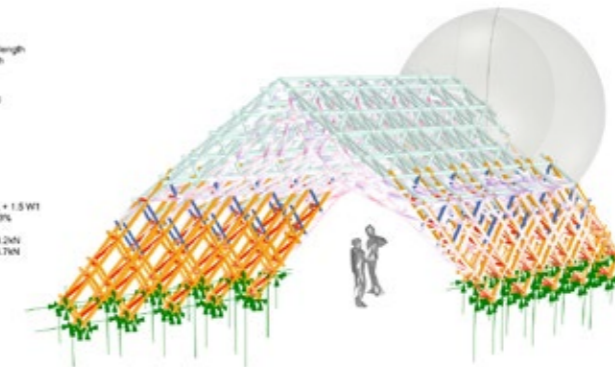

## Acoustic and structural design embedded in design studio pedagogy

**Dr Sofia Colabella<sup>1</sup>, Mr Michael Mack<sup>1</sup>**

<sup>1</sup>The University of Melbourne

This paper presents a theoretical framework and pedagogical principles for performance-based design education focusing on acoustics and structural behaviour within the architectural context of the Melbourne School of Design of The University of Melbourne. A design studio, CDE Studio 45, developed and taught by the authors within the Master of Architecture of the Melbourne School of Design, is showcased to illustrate how structural behaviour, acoustics and music can drive design education and engage students intellectually and creatively, shifting between analytic, synthetic, and evaluative modes of design thinking. Physical models of shell-like structures are recursively tested and finally optimised via MOGA. Students' final designs demonstrate a capacity for critical design thinking driven by landscape, acoustics, structural and material systems, and detailing.

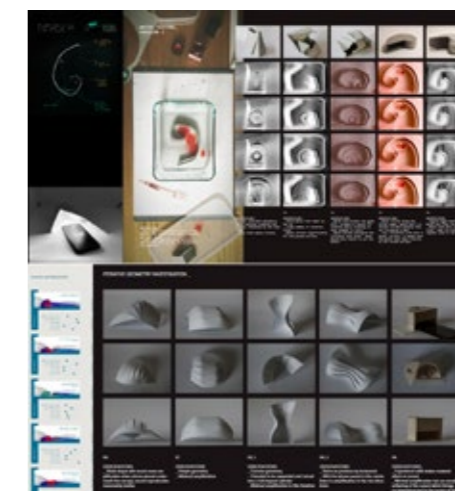

# Wednesday 12 July 2023



## New Master's Education: Innovative teaching of sustainable design approaches for handling uncertainty

Prof Olga Popovic Larsen<sup>1</sup>

<sup>1</sup>Royal Danish Academy: Architecture, Design, Conservation

The climate emergency requires all sectors of Society to work together. Yet, the building sector remains a segmented industry- with responsibilities, but also visions, values, and approaches that are fragmented. In the search for more holistic approaches/solutions that will reduce/revert the negative impacts of the building sector collaboration across disciplines is essential. This is both the vision, starting point and main aim of the new master's education at the Royal Danish Academy in Copenhagen- Architectural Technology. The paper presents the aims and vision for the program, the Nordic educational context, course structure and modules descriptions, project examples as well as a reflection for further developments.

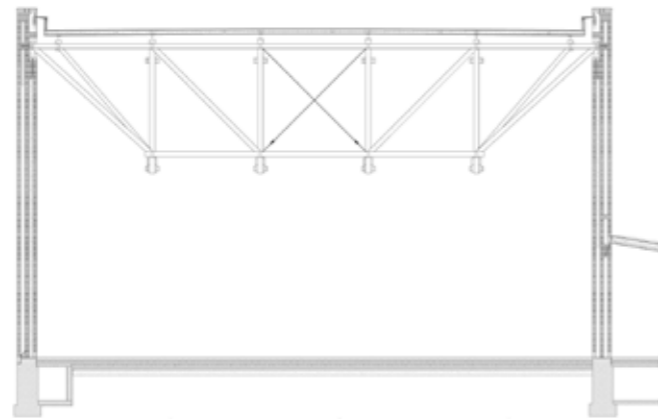

## Educational tools for arch and frame structures

Ms Ayaka Kondo<sup>1</sup>

<sup>1</sup>Tokai University

It is difficult for those new to structural mechanics to imagine a cross-sectional force diagram. For this reason, we have created structural educational tools aimed at deepening the understanding of structural mechanics for students studying structure. It is capable of vibrating a small model and visualizing the cross-sectional forces of the structure. To calculate the cross-sectional forces from the deformation of the structure, ArUco markers in OpenCV were pasted on the nodes to obtain the deformation. Calculate the cross-sectional force using the amount of rotation obtained from the coordinates of the four corners of the marker. The calculated cross-sectional forces can be viewed in real time by drawing them on the model in the shooting screen.

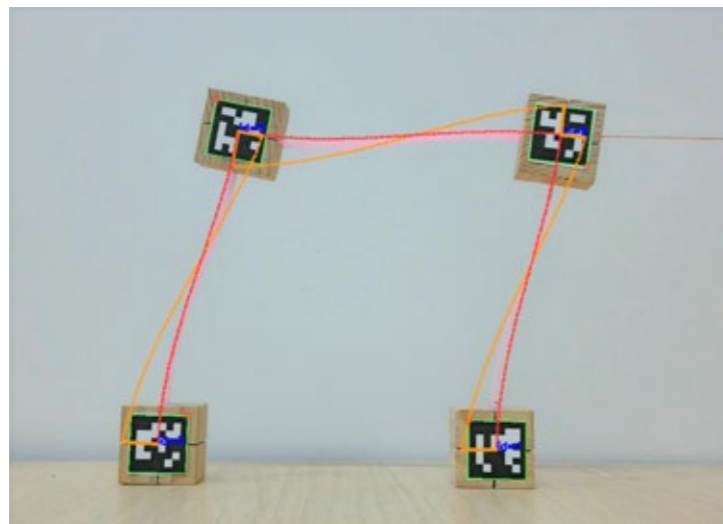

## Full-scale Teaching Kits for the Education of Tensile Membrane Structures

Dr Alireza Behnejad<sup>1</sup>, Ms Charlotte Caldwell-Kyd<sup>1</sup>

<sup>1</sup>Spatial Structures Research Centre, University Of Surrey

An increase in popularity and an expansion in the range of applications for tensile membrane structures has created a demand for professionals with knowledge and experience in this category of spatial structures. Due to geometric and material nonlinearity, the design and analysis of tensile membrane structures require a fundamentally different approach to typical structures covered in a standard civil engineering curriculum. The ultimate aim of the present work is to develop, implement and evaluate a curriculum for tensile membrane structures for architecture and civil engineering students at an early undergraduate level to achieve teaching excellence in this specialised field. This includes the design and prototype of tensile membrane structures as full-scale teaching kits to provide students with hands-on experience.





Wednesday 12 July 2023

# Session 33

## Tensegrity systems and cable structures

Room 217  
14:00 - 16:00



### Locomotive performance evaluation of the spherical tensegrity robots

Miss Meijia Wang<sup>1</sup>, Prof Xian Xu<sup>1</sup>, Prof Yaozhi Luo<sup>1</sup>

<sup>1</sup>Zhejiang University

This paper proposes an optimization approach to design regular spherical tensegrities that can generate both classical and novel configurations. To evaluate the adaptability of different tensegrity configurations as locomotive robots, an evaluation method considering various geometric indicators such as foldability, inner space, prestress evenness, surface smoothness, and geometrical instability is proposed. These indicators assess not only the locomotive capability but also the manufacturing difficulty, storage ratio, and other characteristics of different tensegrity configurations as potential robot candidates. The 12-strut and 15-strut tensegrities are identified as the most promising designs for future study. Overall, our work provides a practical way to design and evaluate tensegrity robots, and presents promising new configurations for future research.

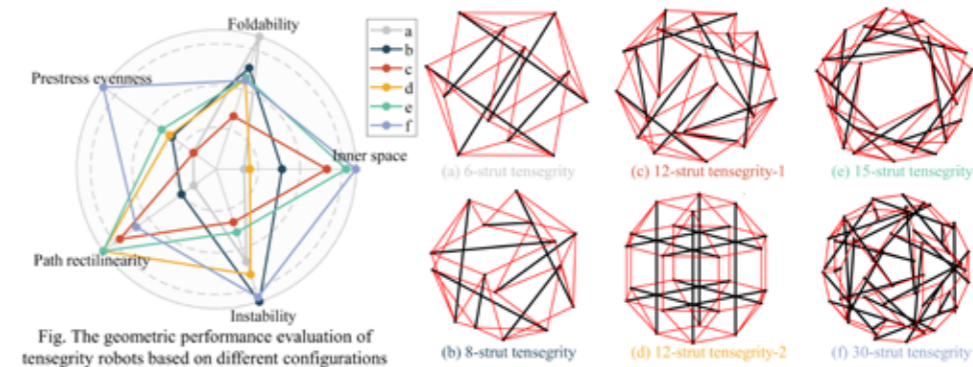

Fig. The geometric performance evaluation of tensegrity robots based on different configurations



### Exploration on the shape and force of large-span steel structure of Chengdu Open-air Music Park

Ms Yuan Feng, Mr Li An Liao<sup>1</sup>

<sup>1</sup>China Southwest Architecture Design & Research Institute Co., Ltd

The main stage of Chengdu Open-Air Music Park is the world's largest semi-open-air and semi-indoor double-sided theater with panoramic sound and will also serve as the main venue for the closing ceremony of the 31st World University Games. The main stage roof is composed of two parts: an independent canopy and a grandstand canopy. This article focuses on the independent canopy. The independent canopy adopts a system of inclined plane arches, single-layer cable nets, and double-sided covering membranes. The arch span is 180 meters, and use a pentagon-shaped solid rib arch with a jewel cross-section. Hyperbolic paraboloid cable nets were used between the inclined arches, with a load-bearing span of 90 meters and a stable span of 136 meters.



# Wednesday 12 July 2023



## Kinematic performance of a vibration-driven six-bar tensegrity structure

Ms Ruhe Mei<sup>1,2</sup>, Prof Xian XU<sup>1,2</sup>, Mr Ruizhi LIU<sup>1,2</sup>

<sup>1</sup>College of Civil Engineering, <sup>2</sup>Zhejiang University, Space structures key laboratory of Zhejiang Province

Vibration excitation can fully exploit the complex dynamic characteristics of tensegrity structure being the simplest method to achieve efficient structural locomotion. This paper proposes that applying a vibration-driven tensegrity robot to the disaster rescue scene to explore the unknown environment. Numerical simulation shows that the low-order vibration-modes of the structure can be excited to achieve potential jumping, creeping and rotating gaits, the control strategy of vibration motors including the location and quantity has profound effect on efficiency and directionality of structure-motion. A small low-cost wireless vibration-driven tensegrity structure prototype was established and allowed to move in the designed 2D and 3D spatial paths. Its success rate for finding the exit is increased by proactive altering the vibration strategy.

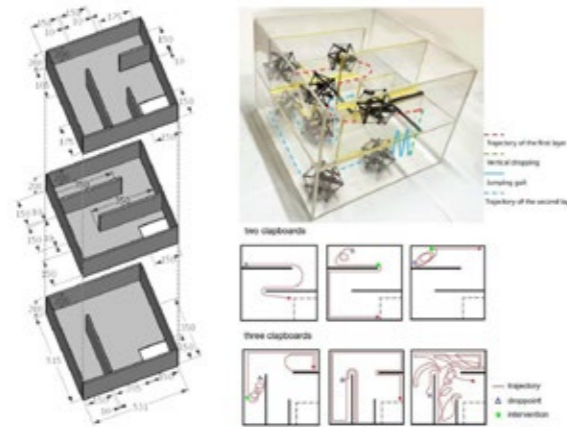

## Suspended Tensegrity: The Anthropomorphic Machine

Prof Paul Loh<sup>1</sup>, Dr Sascha Bohnenberger<sup>2</sup>, Mr David Leggett<sup>3</sup>

<sup>1</sup>Bond University, <sup>2</sup>Swinburne University of Technology, <sup>3</sup>Architectural Research Laboratory | LLDS

The paper presents a suspended tensegrity cloud structure as an interactive art installation with computer vision. Actuated by 12 pneumatic rubber muscles, the research discusses the design, engineering and fabrication challenges of a dynamic tensegrity "cloud". Through material testing and physical prototyping processes, the design workflow enables a cross-disciplinary approach to the problems with feedback and an iterative static analysis approach. The project demonstrates a cross-disciplinary design collaboration between artists, architects, engineers, and the fabricator towards refinement in the engineering of dynamic structures. Using a pneumatic actuation system combined with tensegrity structures demonstrates a method to develop active, controlled, deployable and form-changing envelopes and structures on a larger scale.

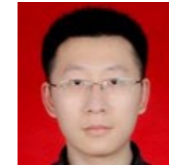
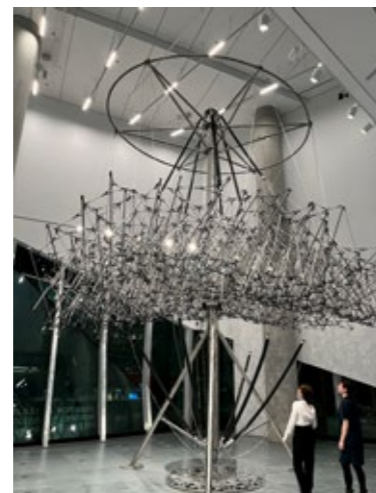

## Evaluation and improvement of bearing capacity of annular crossed cable net structure after local cable failure

Mr Xuanzhi Li<sup>1</sup>, Prof Xuduo Xue<sup>1</sup>, Prof Xiongyan Li<sup>1</sup>, Prof Renjie Liu<sup>2</sup>, Prof Yue Liu<sup>3</sup>

<sup>1</sup>Beijing University of Technology, <sup>2</sup>Yantai University, <sup>3</sup>University of Science and Technology Beijing

The annular crossed cable net structure has strong collapse resistance and can continue to bear the load after local cable breaking. To quantitatively evaluate the bearing capacity of the structure after cable failure, a multiple-step loading and unloading method was proposed. The failure grades of cables were classified in the gradual cable breaking process. In addition, the bearing capacity reduction coefficient was put forward to quantitatively evaluate the reduction degree of bearing capacity. According to the curve of bearing capacity reduction coefficient, the residual ultimate load corresponding to different cable failure numbers can be quantitatively evaluated.

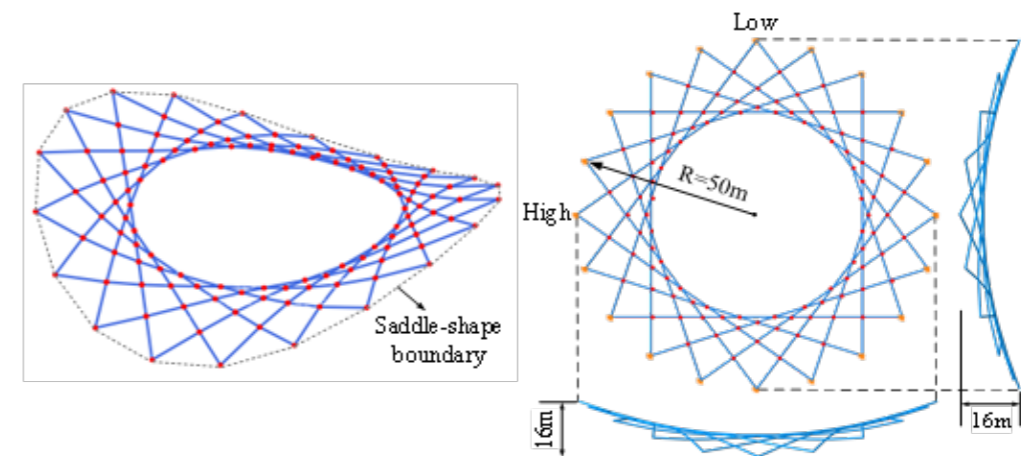

## Design and research on roof structure of the stadium of Sanya International Sports Industry Park

Mr Chenyu Liang<sup>1</sup>, Dr Zhongyi Zhu<sup>1</sup>, Dr Guangbo Bai<sup>1</sup>, Mr Yi Chen<sup>1</sup>, Mr Xuyang Deng<sup>1</sup>, Dr Wei Wang<sup>1</sup>, Dr Xiaogang Liu<sup>2</sup>

The stadium is the main venue of the Asian Beach Games located in the tropical area where severe typhoon lands frequently. With a construction area of 86,000 m<sup>2</sup>, the stadium can host up to 45,000 seats. The outline of stadium roof is 305m long and 270m wide. The long-span roof structure is composed of inner cable-membrane structure with a cantilever of 45m and outer steel structure. CFRP cable and high-strength cast steel G10MnMoV6-3 were used for the first time in large-scale spatial structures, realizing the lightweight of the structure and promoting the technological progress of the new material manufacturing industry. The use of hinged columns and cable-membrane structure save the steel consumption, minimise the work of manufacture and on-site installation.

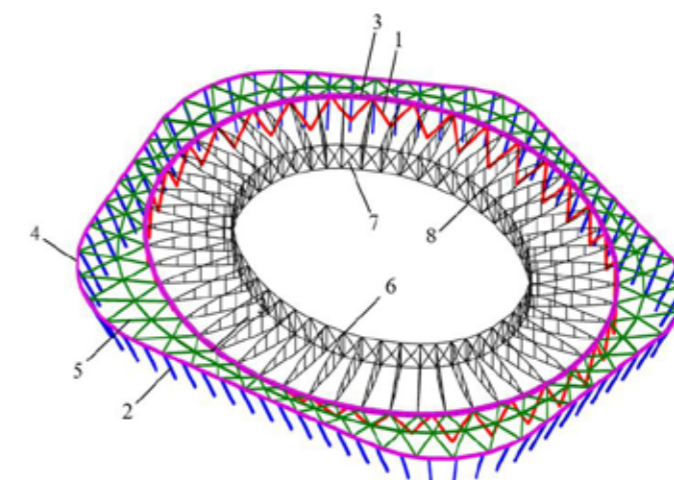

1 – Inner hinged V-shape columns; 2 – Outer hinged columns; 3 – Inner ring beam; 4 – Outer ring beam; 5 – Cross-intersected beams; 6 – Cable truss; 7 – Cross-bracing cable (CFRP cable); 8 – Cable clamp (G10MnMoV6-3)

# Wednesday 12 July 2023



## Structural behaviours of arch SCS with “pin-pin” support

Dr Akira Tanaka<sup>1</sup>

<sup>1</sup>Tsukuba University of Technology

SCS is a unique masonry structure proposed by the presenter. In this paper, the components of SCS are blocks, lower string and PS Cable. The material of PS Cable is the stranded cable, are placed along the midpoint of the blocks. The arch-shape with pin-pin support is used to ensure better stability of SCS. An analysis was done to confirm the mechanical behavior of this structure and PS effect. These results were as follows. The lower strings under all load occurred non-tension, but that under partial distributed load occurred the tension. PS effect at full load was an increase in stiffness, but this PS effect did not appear in some cases due to the difference in load conditions.

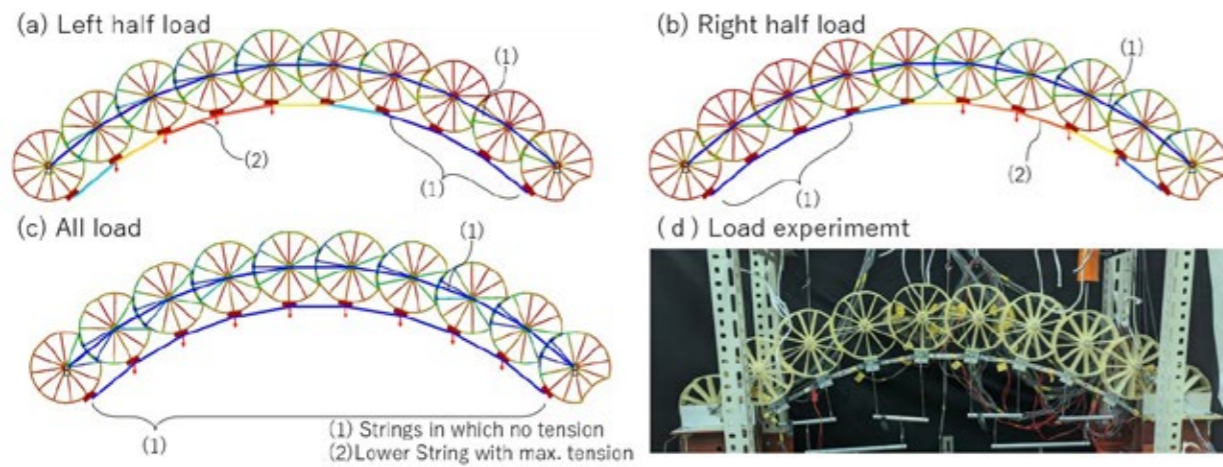

# Wednesday 12 July 2023

## Session 34

### Digital modelling and fabrication 2

Room 218

14:00 - 16:00

# Wednesday 12 July 2023

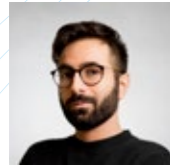

## Generative design of isostatic ribbed slabs using anisotropic Reaction-Diffusion

A/Prof Roberto Naboni<sup>1</sup>

<sup>1</sup>CREATE- University of Southern Denmark

Principal stresses and moments are increasingly used to design efficient structural geometries in concrete slabs and shells. These are typically obtained through Finite Element Analysis (FEA) packages and represented as vector fields with singularities, such as high convergence or divergence areas. Designing architectural structures interpreting these fields currently relies on laborious parametric modelling. This paper introduces a generative method for isostatic ribbed slab design, where the stiffening topology layout is found with an anisotropic Reaction-Diffusion system. Based on FEA for a given slab design, the system emergently finds structural patterns along the principal stress and moment fields, which can be easily tuned into rib stiffeners, controlling their density and thickness. This bio-inspired approach, associated with field compositing, allows us to streamline the accurate modelling of structural elements with appropriate geometrical and dimensional control, which considers fabrication constraints. The workflow is successfully applied to proof-of-concept ribbed concrete slab prototypes, which were successfully designed, built and tested using this novel method.

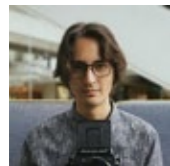

## Guided Irregular Cement Geometry Stacking using Real-time Optimization and Motion Tracking

Mr Alex Orsholits<sup>1</sup>, Mr Ren Imai<sup>2</sup>, Mr Hirotaka Ujioka<sup>2</sup>, Mr Shimpei Kojima<sup>2</sup>, Ms Mika Araki<sup>3</sup>, Mr Yusuke Obuchi<sup>1</sup>, Mr Jun Sato<sup>2</sup>

<sup>1</sup>The University Of Tokyo, Graduate School of Engineering, <sup>2</sup>The University Of Tokyo, Graduate School of Frontier Sciences, <sup>3</sup>Kwansei Gakuin University, School of Architecture

In this presentation, we introduce a highly adaptable construction process designed to address the challenges posed by non-uniform materials and ambiguous site conditions in construction and architecture. Our approach incorporates feedback-loop generative design, continuous structural safety analysis, cloud-based data management, and real-time spatial data acquisition and guidance by equipping users with motion-tracking hardware and LED-equipped accessories. Our construction process involves the development of a macro-scale aggregate structural model for safely stacking randomly formed cement geometries and implementing a cloud-based data interlink and visualization system. Successfully applied at the 2021 Venice Biennale for the United Arab Emirates pavilion and smaller prototypes in Tokyo and Dubai, we will discuss this novel method's potential to transform the industry.

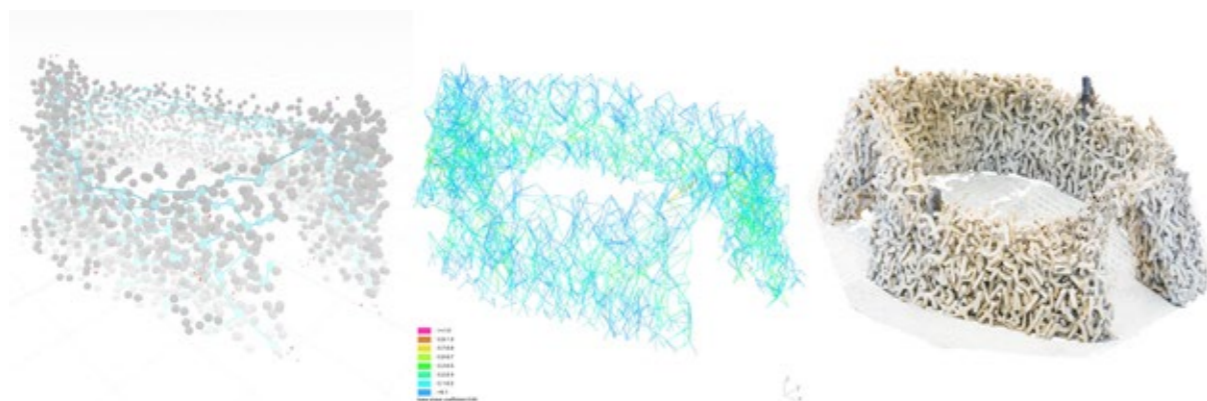

## Optical Parametric Component Referencing for the Facilitated Prefabrication of Timber Wall Elements

Mr Felix Schmidt-Kleespies<sup>1</sup>, Laurenz Andritz, Cristoph Dijoux

<sup>1</sup>Leipzig University of Applied Sciences / FLEX

A guidance system for three-dimensionally accurate projections of timber frame construction elements was developed. Employing augmented reality (AR) glasses, interactive assembly instructions are projected onto the work environment of a timber construction company and integrated into their operational workflow. The purpose of this was to restructure the conventional assembly process utilising paper plans into a semi-digital, temporally relevant and accelerated process. Compared to preceding systems, the developed solution applies a successive relevant temporal filter as well as a fitting algorithm that refers to several localisation markers. Specifically developed software facilitates the levelling of the projection plane, measuring functions as well as approval and monitoring functions of individual components.



## Steel connection design of complex and repetitive geometries through visual programming

Mr Nathan Luke<sup>1</sup>

<sup>1</sup>IDEA StatiCa

This paper looks to introduce a plugin for visual programming application Grasshopper, to enable the parametric generation of steel connection models in IDEA StatiCa Connection. Traditional analysis and design of complex steel connections is typically conducted using advanced general FEA analysis packages and often requires substantial work on the designer when modelling geometry, meshing, and considering connection components (plates, bolts, welds, contacts, etc). The plugin simplifies the process by enabling designers to generate connection model geometry parametrically using Grasshopper and the IDEA Open Model format. Using the plugin, connections can be quickly modelled, imported, and calculated using IDEA StatiCa Connection. This approach can be particularly useful for complex and repetitive geometries, which are common in many tensile and spatial structures.

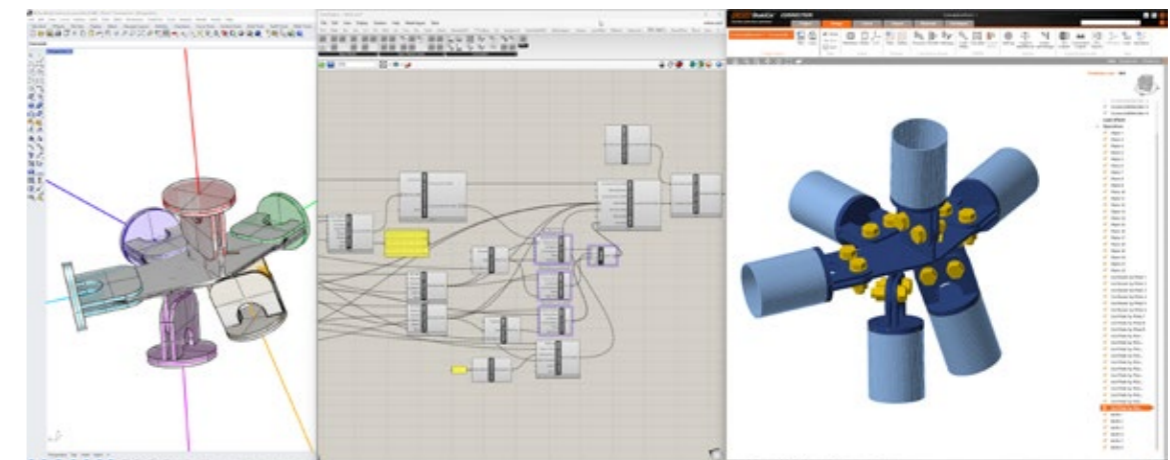

# Wednesday 12 July 2023



## **KNOTSHELL pavilion – Development of a low-tech approach for transferring complex digital data to building elements**

**Mr Alec Singh<sup>1</sup>**, Mrs. Alec Singh<sup>1</sup>

<sup>1</sup>University of Wuppertal, Faculty of Architecture and Civil Engineering Chair of Structural Engineering and Building Construction Pauluskirchstrasse 7, Germany

The challenges associated with timber grid shells are discussed in this paper. Despite their high efficiency, their manufacture requires expertise and assembly effort. The research explores alternative irregular lattice shells based on geodesic patterns that are suitable for low-tech manufacturing and limited budgets. The design process for multi-layer geodesic lattice shells and the advantages and challenges of this approach are explained. The special focus is on the transfer of the data from the design process to the lattice shell. For this purpose, a low-tech tool was developed from conventional elements that uses G-code to transfer data to the construction elements. The article concludes with a report on the experience of building a timber lattice shell according to this concept.



# Wednesday 12 July 2023

# Session 35

## Origami 2

Room: Plenary 3

14:00 - 16:00

# Wednesday 12 July 2023



## Tunable and Programmable Perforated Graded Miura-ori Phononic Structures

Mr Xi Zhang<sup>1</sup>, Prof Xiaodong Huang<sup>1</sup>, Prof Guoxing Lu<sup>1</sup>

<sup>1</sup>Swinburne University of Technology

We propose a novel perforated graded Miura-ori phononic structure (PGMPS) that leverages origami's unique tunability for programmable acoustic applications. By using perforated Miura-ori panels in phononic crystals (PnCs), we achieve flexible bandgap frequency ranges. Employing Bloch's theorem and numerical simulations, we create tunability maps for PGMPSs, enabling series-parallel configurations of structures for tunable and programmable bandgaps. PGMPSs' significant bandgap changes during folding make them suitable for acoustic filters, sound barriers, and waveguides.

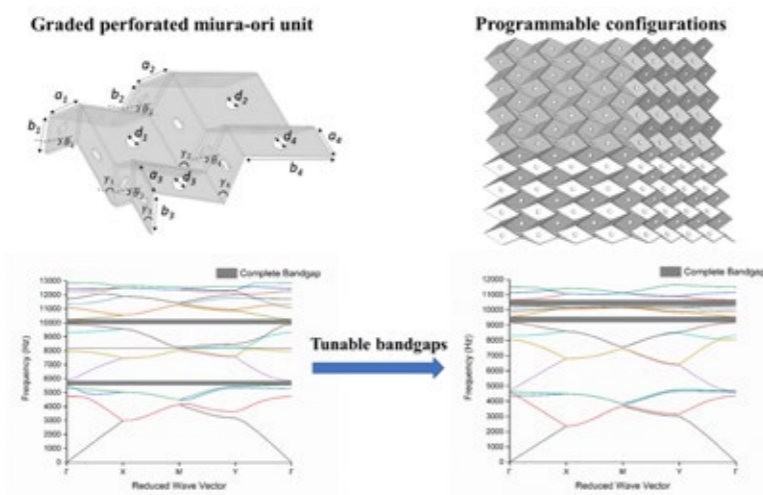

## Multi-stability of hexagonal origami hyper structures based on group theory and symmetry breaking

Mr Chenhao Lu<sup>1</sup>, Miss Ruizhi Xu<sup>1</sup>, Prof Yao Chen<sup>1</sup>, Dr Ke Liu<sup>2</sup>, Prof Jian Feng<sup>1</sup>, Dr Pooya Sareh<sup>3</sup>

<sup>1</sup> Key Laboratory of Concrete and Prestressed Concrete Structures of Ministry of Education, and National Prestress Engineering Research Center, Southeast University, <sup>2</sup>Department of Advanced Manufacturing and Robotics, Peking University, <sup>3</sup>School of Engineering, University of Liverpool

Origami hyperbolic paraboloid provides an avenue to be multi-stable via bifurcation branches of kinematic paths. However, some symmetry properties make origami hyper possess subtle multi-stability. Here, group theory and symmetry breaking are applied to the multi-stability analysis of hexagonal hyper to eliminate singularity in the stiffness matrix near bifurcations. Results show a hexagonal hyper has six steady states and the tessellation shows more stable states. Different bifurcation branches convert to each other only if structures are fully flattened. Notably, the energy barrier between two stable states increases with the symmetry order of the branch. The ease of the transition among steady states is determined by the difference between the potential energies of the initial steady state and the fully-flattened state.

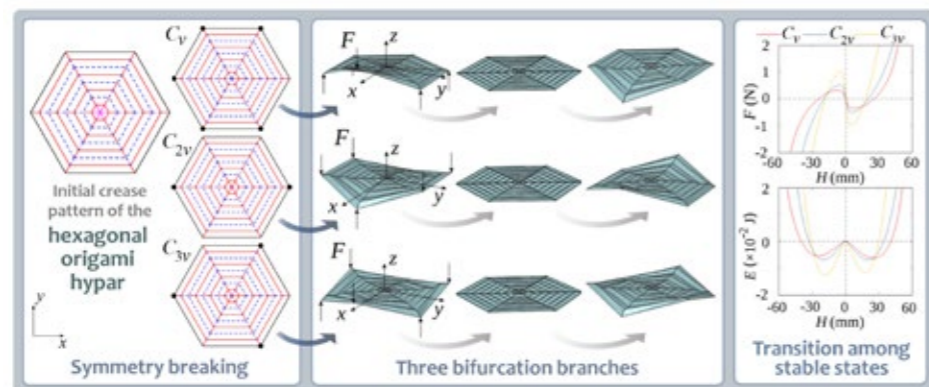

## A New Data-driven Framework for Energy Absorption Analysis of a Miura-origami Structure Using Machine Learning Methods

Mr Dian Zhang<sup>1</sup>, Professor Kai Qin<sup>1</sup>, Professor Guoxing Lu<sup>1</sup>

<sup>1</sup>Swinburne University of Technology

Origami is the art of paper folding. In recent years, origami structures have been widely applied to the field of energy absorption structure because of their low-weight and high-energy absorbability. However, due to huge computational cost and time consumption, designing or optimizing origami-based metamaterials is a highly iterative process. Therefore, a new data-driven framework was proposed in this study to overcome the major obstacle above and shorten the design cycle using machine learning methods. The feasibility and value of the framework were demonstrated through the analysis of in-plane quasi static compression of a Miura-origami-based structure. The example verified that the data-driven framework was a promising alternative method when analytical and empirical solutions are not accessible for complex origami structure problems.

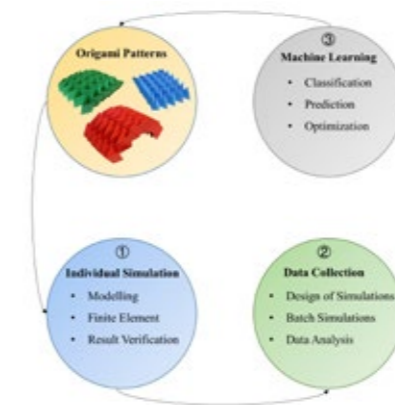

## Mechanical characteristics of graded origami bellows under tension

Ms Xinyi Zhang<sup>1</sup>, Professor Guoxing Lu<sup>1</sup>, Associate Professor Yvonne Durandeta<sup>1</sup>, Professor Suresh Palanisamy<sup>1</sup>, Associate Professor Shenghai Wang<sup>2</sup>

<sup>1</sup>Swinburne University Of Technology, <sup>2</sup>Shandong University

A rigid tubular device is easy to damage forced by tensile displacement in practical application, which requires the tube effectively absorbs tensile strain energy. The uniform origami bellows has been demonstrated high efficiency in absorbing tensile strain in the previous study. Here, we focus on the origami bellows, based on the modified Miura-ori folding pattern, which is composed of gradient geometry over layers. The finite element results show that the deployment sequence of the layers of the graded origami bellows follows the deployment principle of those of the counterpart uniform ones, and the tensile response can be programmed by tuning the geometric design. The graded origami bellows show a similar performance in energy absorption as its uniform counterpart.

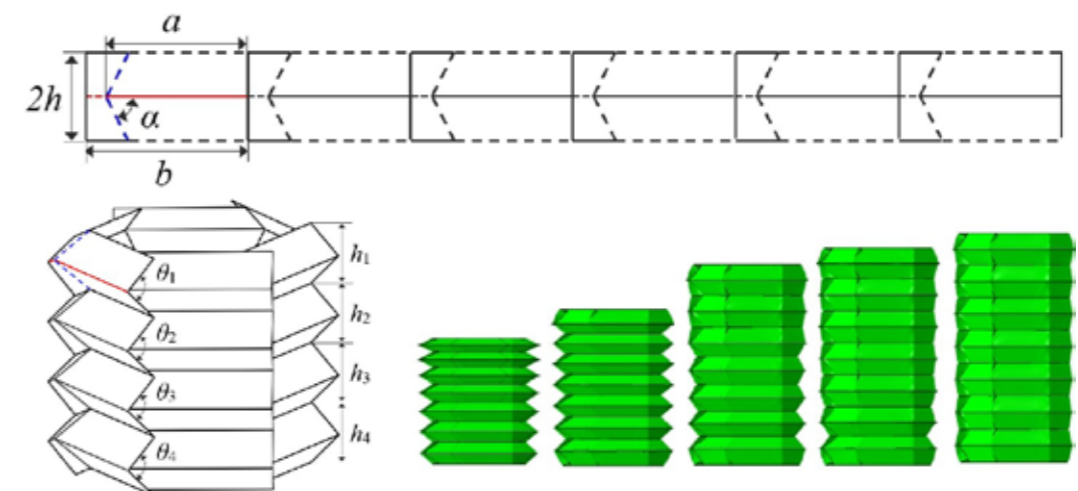

# Wednesday 12 July 2023



## Study on seismic behavior of origami-based buckling-controlled concentric braces with beam-column-brace connections

Prof Yangqing Liu<sup>1,2</sup>, Ms Tian Deng<sup>2</sup>, Mr Dongping Mei<sup>2</sup>, Ms Qin Yu<sup>2</sup>

<sup>1</sup>State Key Laboratory of Mountain Bridge and Tunnel Engineering, <sup>2</sup>Chongqing Jiaotong University

In order to accommodate special demands in load carrying capacity and deformation on the beam-column-brace connections of a proposed origami-based buckling-controlled concentric brace (OBBCCB). As follow-up work, this study proposes a design method of the beam-column-brace connection based on the generalized uniform force method to ensure the connection failure after the brace failure. Numerical study is conducted on the seismic behavior of the brace-connection subassembly under axial compression and reversed cyclic load. The results show that the OBBCCB with the connection can still preclude the global buckling and thus guarantee their energy dissipation capacity in the frame, although suffering from the negative effects of the connections.

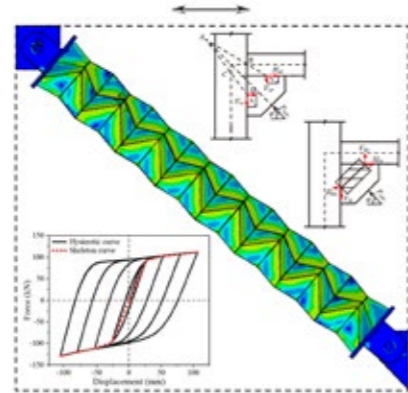

## Multi-layered Curved Folding

Dr Rupert Maleczek<sup>1</sup>, DI Marcus Bernhard

<sup>1</sup>University of Innsbruck

In this paper, the authors present their development of a (partially) multi-layered curved folding construction that generates one or more folded tubes during the folding process, thus optimising the static properties and the folding mechanism. The tubes can be generated adjacent to two fold lines. The result is a multi-layered structure that can have either a constant thickness of the entire folded configuration or explicit individual tubes attached to a given folded configuration.

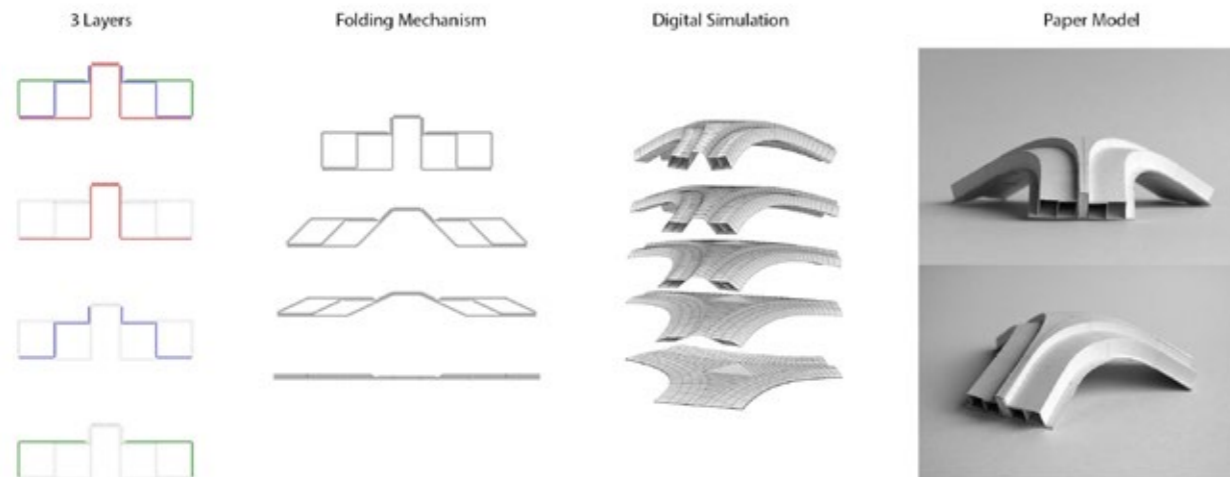

## Bridging the gap - A study on foldable tubular Bridges

Dr Rupert Maleczek<sup>1</sup>, Dr Georg Nawratil, Kiumars Sharifmoghaddam, Dr Clemens Preisinger

<sup>1</sup>University of Innsbruck

This paper will answer some questions concerning foldable structures and their geometry-related structural performance. During the ongoing research on T-hedral tubes, the authors developed a strategy to generate flat-foldable tubular beams, on which this particular investigation is based. For the paper at hand a set of these beams, with different cross-sections and variable amount of folds will be compared with respect to their structural performance. The study will focus on their geometry without exact detailing of the hinges or the material thickness.

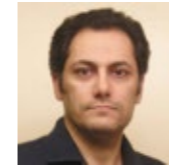
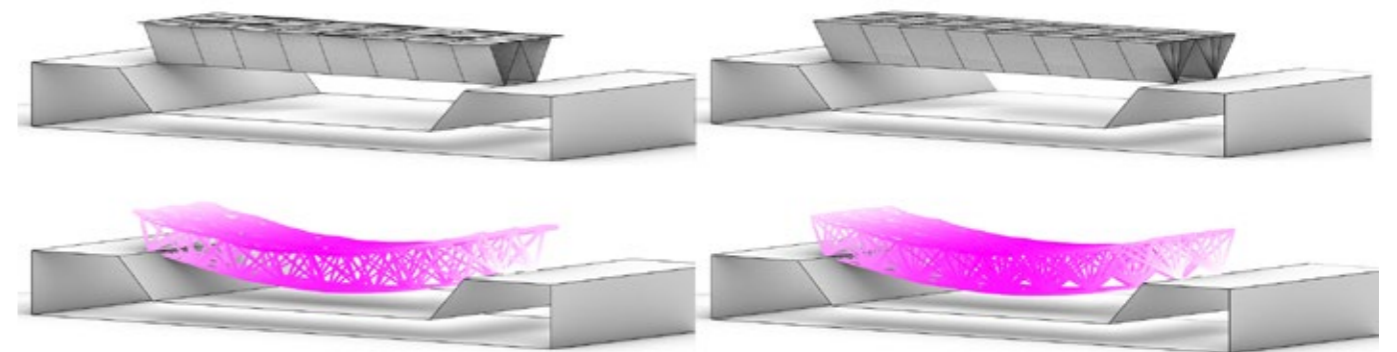

## Tessellated Origami Surface and Soft Robotics

Mr Youness Yousefi<sup>1</sup>, Mrs Vera Parlac<sup>2</sup>

<sup>1</sup>University of Calgary, <sup>2</sup>New Jersey Institute of Technology

This project explores the kinetic capacity of tessellated origami surfaces by incorporating pneumatic muscles into the structure. Folding surfaces such as origami are intrinsically dynamic and offer an opportunity to design dynamic architectural spatial geometries capable of transforming in real-time through kinetic technologies. The research begins with a computational investigation of the folding mechanism of triangular tessellated origami and is followed by physical experiments that involve integrating pneumatic silicone actuators into the origami structure. The results reveal that the origami unit module scale and the actuator's position are two primary factors that impact the global deformation of the structure. The application of soft robotics in kinetic architecture enables the creation of structures capable of providing more intricate movements than their hard-bodied analogues.



Wednesday 12 July 2023

# Masterclass 6

**PolyFrame: Computational  
framework for form finding**

Room 215  
16:30 - 18:30

Presented by

**Masoud Akbarzadeh and Yao Lu**

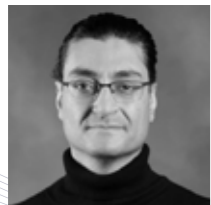

Wednesday 12 July 2023

# Session 37

**Bio-inspired structures and  
architecture**

Room 216  
16:30 - 18:30



# Wednesday 12 July 2023



## Comparison of four current low-density concrete technologies emphasis on the criteria's of performance, fabrication, and mixtures

Dr Ferdinand Oswald<sup>1</sup>, A/Prof Richard Henry<sup>2</sup>, Djordje Nikolic<sup>3</sup>

<sup>1</sup>University of Auckland- Architecture & Planning, <sup>2</sup>University of Auckland- Civil and Environmental Engineering, <sup>3</sup>University of Auckland- Architecture & Planning

By using low-density aggregates in concrete, reductions in weight and density are achievable, as well as the carbon footprint of concrete, therefore. The study found that improved thermal performances are also possible with all four of the technologies: Pumice aggregate concrete, Infra-Lightweight concrete, Ultra-lightweight concrete, and functionally graded concrete. This paper serves as an analysis of the contemporary homogeneous and inhomogeneous low-density concrete technologies that succeed in exhibiting the aforementioned characteristics. The advantages of the technologies that are highlighted in this analysis show innovative advancement in the field of concrete technologies, as well as the possibility of concrete being used on a larger variety of site and environmental conditions across the world.

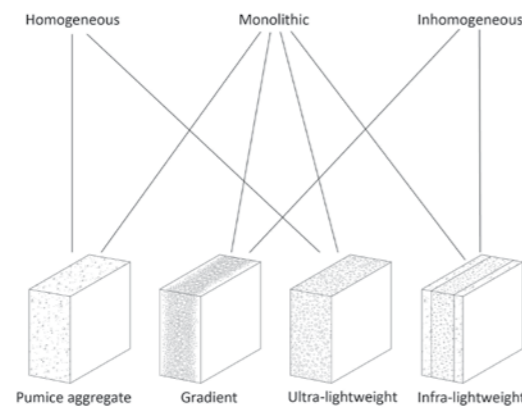

## Insights on buckling modes of polygonal ring frames under symmetric compressive joint loads

Prof Alphose Zingoni<sup>1</sup>, Mr Chisanga Kaluba<sup>1</sup>

<sup>1</sup>University of Cape Town

It is well-known that symmetric spatial configurations can exhibit complex instability behaviour under applied loads. Group theory is well-suited to studying such systems, as it allows the vector space of the problem to be decomposed into smaller subspaces. Computational simplifications aside, useful insights on structural behaviour may also be gained prior to any detailed computations. In this paper, we consider the in-plane buckling of rigidly jointed regular polygonal ring frames under a symmetric system of self-equilibrating in-plane compressive joint loads. We show how group theory predicts the properties of deformation modes without the need for detailed computations. These modes all exhibit the symmetries of the subspaces of the problem. The predictions are compared with the results of finite-element analysis.

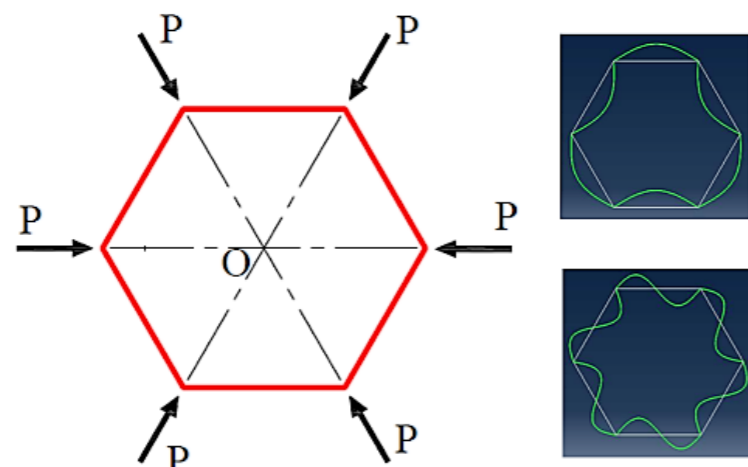

## Vibration analysis of the real shaped bi-valve shell model created by CT images

Ms Minori Ogoshi<sup>1</sup>, Dr Masaki Teranishi<sup>1</sup>

<sup>1</sup>Niigata University

Natural thin-shell structures have been in focus owing to their interesting forms and features. This study presents a natural vibration analysis of the bivalve-shell form using modified FE models to reveal its vibration features. By comparing this with the results of the FE model reflected a hemisphere form same as building size, the response properties of the FE models reflected bivalve shell form to vibration are revealed. Up to the 100th order mode, the shell model had a broader range frequency than the dome model by natural vibration analysis. Consideration of the cumulative mass participation showed that the shell model has fewer natural period to consider when structural designed than the dome model in the case of vertical vibration.

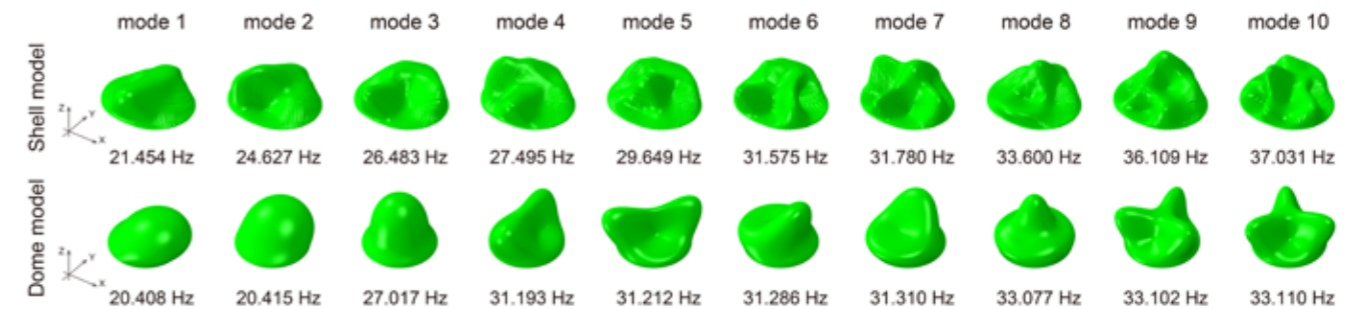

## Energy absorption of the cylindrical sandwich structures with a bio-inspired core

Dr Ngoc San Ha<sup>1</sup>, Prof Yin Min Xie<sup>1</sup>, Dr Ting-Uei Lee<sup>1</sup>, Dr Jiaming Ma<sup>1</sup>, Prof Jie Li<sup>1</sup>

<sup>1</sup>RMIT University

(BCSS), for energy absorption. The BCSS consists of a bio-inspired core sandwiched by two hollow tubes: an inner tube and an outer tube. The core is inspired by the skeletal systems of the deep-sea glass sponges (*Euplectella aspergillum*), which consists of a square lattice architecture reinforced by a double set of diagonal bracings. The energy absorption performances of the BCSS are numerically investigated and indicated that the proposed sandwich structures with a bio-inspired core have superior energy absorption compared to that with a conventional lattice core. Finally, a theoretical derivation is proposed to predict the mean crushing force of the BCSS.

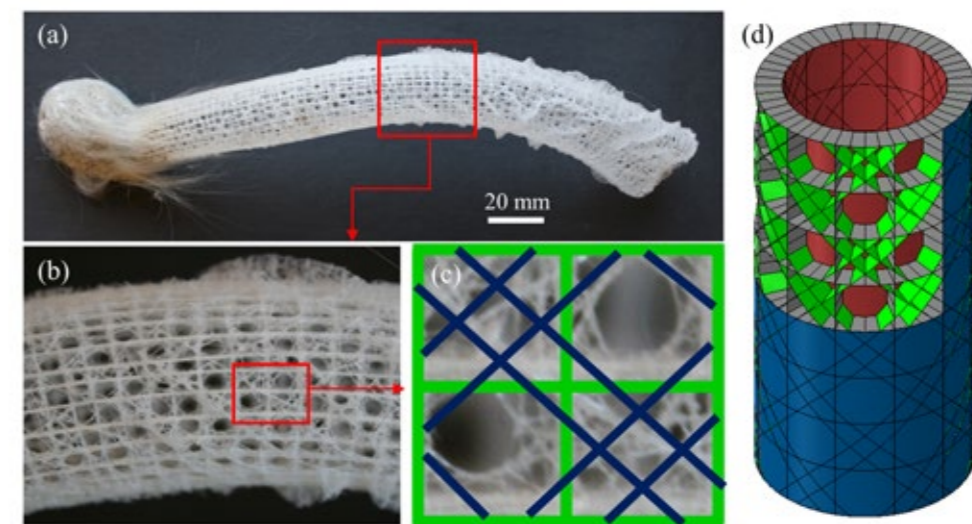

# Wednesday 12 July 2023

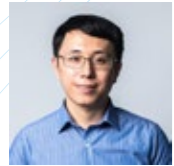

## Analysis and design of functionally graded porous structures

Dr Da Chen<sup>1</sup>, Prof. Lihai Zhang<sup>1</sup>

<sup>1</sup>The University of Melbourne

This study is focused on the analysis and design of functionally graded (FG) porous structures, ranging from bending, buckling, and vibration analyses of beams and plates made of non-uniform open- and closed-cell metal foams, as well as the dynamic crushing study to examine the effect of graded porosity geometries on the energy absorption of closed-cell Aluminium foams, of which the relation between mesoscopic features and macroscopic properties is determined via multiscale modelling. A deep learning CNN (convolutional neural network) model is also developed to directly identify the stiffness of metal foams based on their cellular morphologies. This study provides an in-depth while compressive overview of recent research on FG porous structures, providing insights into the novel lightweight structural design.

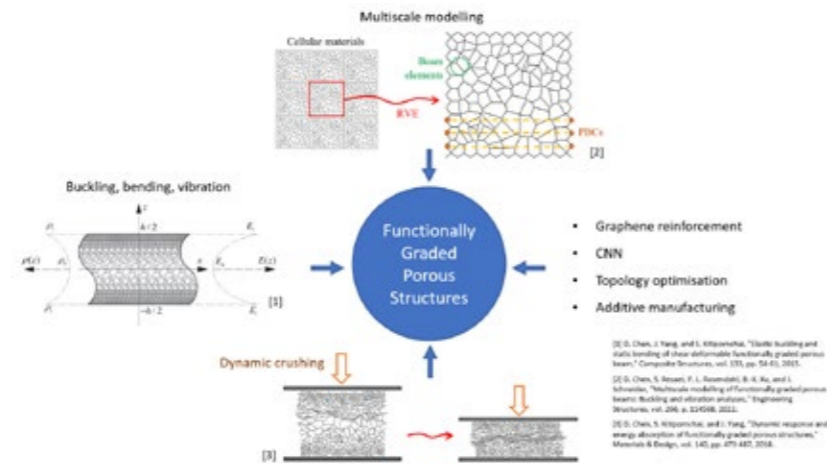

## Material Matters: A Möbius Strip in Laminated Bamboo

Dr Bhavna Sharma<sup>1</sup>

<sup>1</sup>University of Southern California

The original recycling symbol was designed in 1970 by Gary Anderson, a University of Southern California student. Anderson designed a symbol based on a Möbius strip, with a continuous loop of arrows. The symbol portrayed an idealist perspective of the recycling process at the time, with a continuous use of material at the end of a product's life cycle. In all aspects of the built environment, from the primary structure to surface materials, material selection will need to be at the core of design and engineering to reduce carbon emissions and achieve circular supply chains. To explore this concept further, the presented work will investigate why material selection matters through design and fabrication of a laminated bamboo Möbius strip.

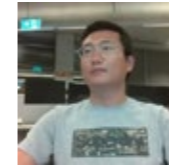

## A double phase field method for mixed-mode crack modelling in 3D elastoplastic solids with crack-direction-based strain energy decomposition

Mr Yang Jiang<sup>1</sup>, Dr Jianguang Fang<sup>1</sup>, Mr Cunyi Li<sup>1</sup>

<sup>1</sup>University of Technology Sydney

Crack-direction-based decomposition of elastic strain energy could effectively control the propagation of tensile and shear cracks in a phase field modelling context. The objective of the proposed double-phase field model is to extend the crack-direction-based decomposition strategy from 2D brittle fracture to complex mixed-mode crack modelling in a 3D setting, with plastic deformation incorporated. Both effective (undamaged) stress and plastic strain are split in the crack-orientation-based coordinate system. The decomposed tensile/shear stress contribute to tensile/shear damage evolution, respectively. The plastic contribution is coupled by relating the decomposed tensile/shear plastic strain to the corresponding tensile/shear crack energy release rates. Crack surface normal direction, represented by two orientation variables in 3D spatial domains, is determined by the F-criterion. The proposed model is implemented via ABAQUS subroutines with a staggered scheme for two phase field variables and crack direction. The simulation of a single-edge notch specimen under shear loading demonstrates that the ratio between shear and tensile crack energy release rates plays a significant role in the crack mode and mechanical response. Numerical results of a group of uniaxial tension, simple shear and tension shear specimens show good agreement with the experimental data in terms of the force-displacement curve and crack path, exhibiting the validity of the proposed model for capturing different crack modes. This model has also been proven effective for complex 3D problems via the third Sandia Challenge example.

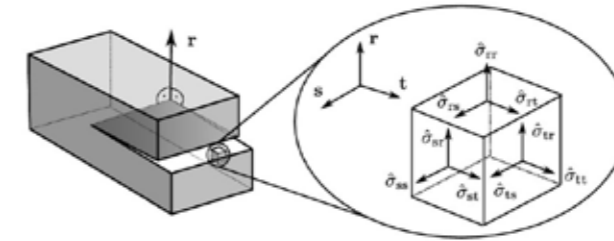

$$\bar{\sigma} = \begin{cases} \bar{\sigma}_I^+ = \langle \bar{\sigma}_{rr} \rangle_+ \cdot M^{rr} + \frac{\lambda}{\lambda + 2G} \cdot \langle \bar{\sigma}_{rr} \rangle_+ \cdot (M^{ss} + M^{tt}) \\ \bar{\sigma}_{II}^+ = \bar{\sigma}^{rs} + \bar{\sigma}^{sr} + \bar{\sigma}^{rt} + \bar{\sigma}^{tr} \\ \bar{\sigma}^- = \langle \bar{\sigma}_{rr} \rangle_- \cdot M^{rr} - \frac{\lambda}{\lambda + 2G} \cdot \langle \bar{\sigma}_{rr} \rangle_+ \cdot (M^{ss} + M^{tt}) + \bar{\sigma}^{st} + \bar{\sigma}^{ts} + \bar{\sigma}^{ss} + \bar{\sigma}^{tt} \end{cases}$$

Tensile fracture      shear fracture      No fracture

Nominal degraded stress stress:  $\sigma = g(d_t)\bar{\sigma}_I^+ + g(d_s)\bar{\sigma}_{II}^+ + \bar{\sigma}^-$

Wednesday 12 July 2023

# Session 38

## Topology Optimisation 1

Room 217  
16:30 - 18:30



### Topology Optimisation for Lightweight Structures with Multiple Cellular Materials

Dr Weibai Li<sup>1</sup>, Professor Xiangdong Huang<sup>1</sup>

<sup>1</sup>Swinburne University of Technology

This paper develops a topology optimization algorithm for a lightweight design of structures constructed by multiple cellular materials with specified microstructures. The optimisation problem is defined by minimising structural compliance subject to a specified mass constraint. Numerical examples demonstrate the successful implementation of the proposed algorithm by the optimal distribution and selection of multiple cellular materials.

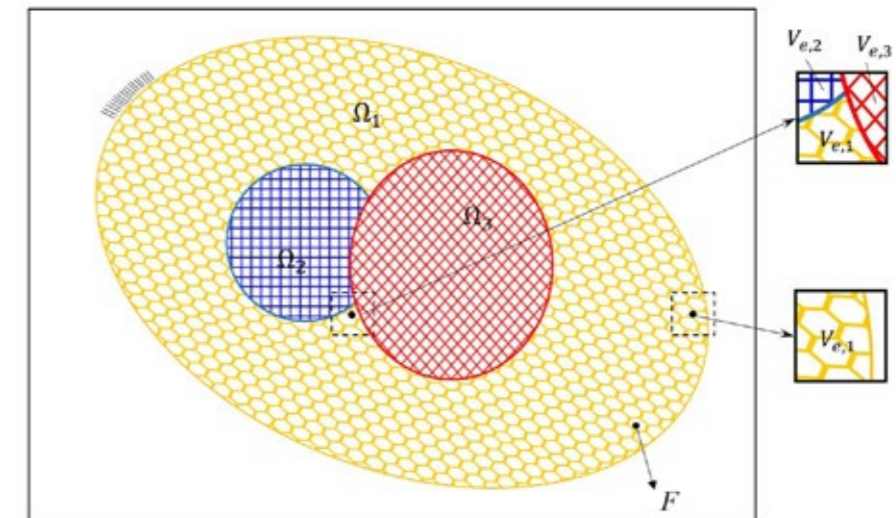

### Topology computation of novel auxetic structures: A systematic design framework

Mr Rajendra Prasad Bohara<sup>1</sup>, Dr Steven Linforth<sup>1</sup>, Dr Tuan Nguyen<sup>1</sup>, Dr Abdallah Ghazlan<sup>1</sup>, Prof Tuan Ngo<sup>1</sup>

<sup>1</sup>University of Melbourne

This paper proposes a simple but rational auxetic design framework with a density-based topology optimisation algorithm. In this method, first, mechanical indicators are identified to represent the intended application of the auxetic structure. Then, a topology optimisation model is set up in various design domains to search for auxetic unit cell topology. In the optimisation model, the identified mechanical indicators are used as the objective functions and constraints. Furthermore, the design domains are subjected to bi-directional compression to induce a negative Poisson's ratio in the structure. Finally, the obtained raw unit cell topologies were simplified with respect to fabrication practicality and analytical design formulations.

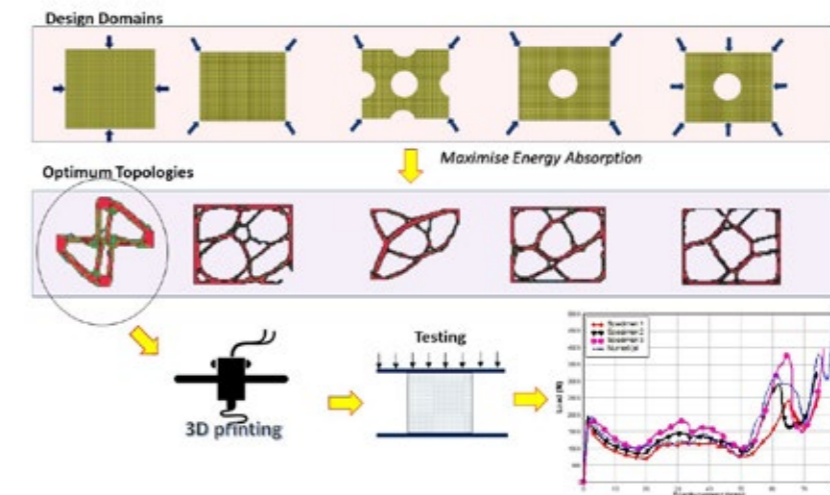

# Wednesday 12 July 2023

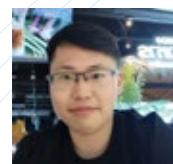

## Topology optimisation of support-free structures for multi-axis additive manufacture

Mr Qichen Guo<sup>1</sup>, Dr Hongjia Lu<sup>2</sup>, Prof Jun Ye<sup>1</sup>

<sup>1</sup>Zhejiang University, <sup>2</sup>RMIT University

The overhang problem remains a critical issue that prevents components from being fabricated by additive manufacture (AM). Previous studies investigated the design of support-free structures by including overhang constraints which are for 3-axis AM in topology optimisation. This causes a large structural performance sacrifice. Therefore, this paper proposes an optimisation approach that considers the overhang constraints for multi-axis AM. Firstly, an optimised structure obtained by using the free-form topology optimisation is divided into several zones. Then the local build directions for each zone is determined by solving a linear optimisation problem. It is found that the performance sacrifice can be reduced to a negligible level with this novel approach.

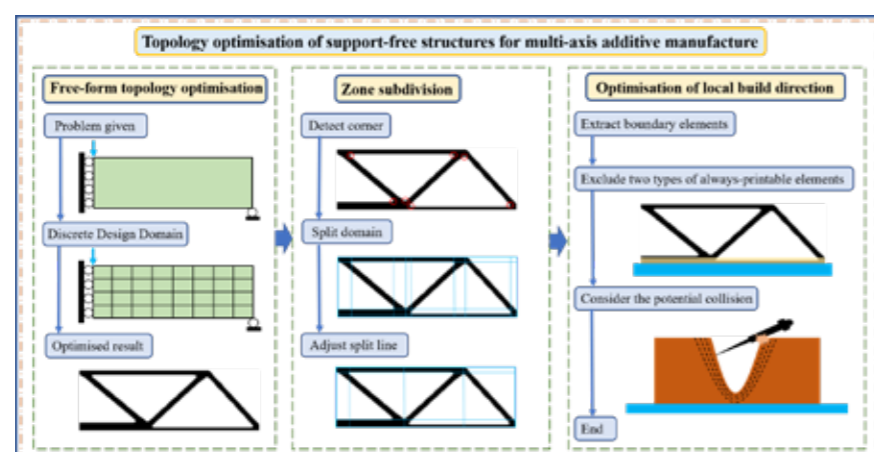

## Multi-scale graded-density topology optimisation for lattice orthopaedic implant with different unit cell topologies

Mr Jiajun Chen<sup>1</sup>, Dr Xiaowei Deng<sup>1</sup>

<sup>1</sup>Department of Civil Engineering, The University of Hong Kong

Lattice orthopaedic implant has drawn increasing attention attributed to its excellent performance of facilitating osseointegration. Nevertheless, conventional design for spinal cage adopts uniform-density lattice structure, which cannot restore the actual stress distribution. The authors dedicate to develop a tailored and automated topology optimisation design framework for graded-density spinal cage to cater for patient-specific situation. Multi-scale topology optimisation has been conducted based on three types of unit cell topologies. The results show that the optimised cage with graded-density structure could yield more impressive effect in alleviating stress shielding than that of uniform-density spinal cage. And the optimisation efficacy varies depending on different unit cell topologies. Integrated with additive manufacturing technique, this framework can produce tailored implant for patients automatically.

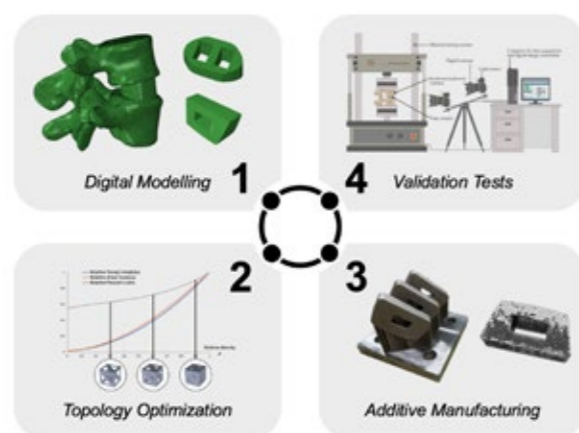

## Non-penalization topology optimization for maximizing natural frequency using SEMDOT

Dr Yun-Fei Fu<sup>1</sup>, Dr Johannes Reiner<sup>2</sup>, Prof Bernard Rolfe<sup>2</sup>

<sup>1</sup>Instit for Frontier Materials, Deakin University, <sup>2</sup>School of Engineering, Deakin University

This work aims to conduct the topological design for the natural frequency maximization problems using non-penalization Smooth-Edged Material Distribution for Optimizing Topology (SEMDOT) algorithm. Pin-pin, fix-pin, and clamped beams are used to demonstrate the effectiveness of the proposed non-penalization SEMDOT algorithm in solving natural frequency maximization problems. Comparisons with Evolutionary Topology Optimization (ETO) and Floating Projection Topology Optimization (FPTO) algorithms, which are capable of generating smooth boundaries, are conducted, showing that non-penalized SEMDOT can obtain comparable results.

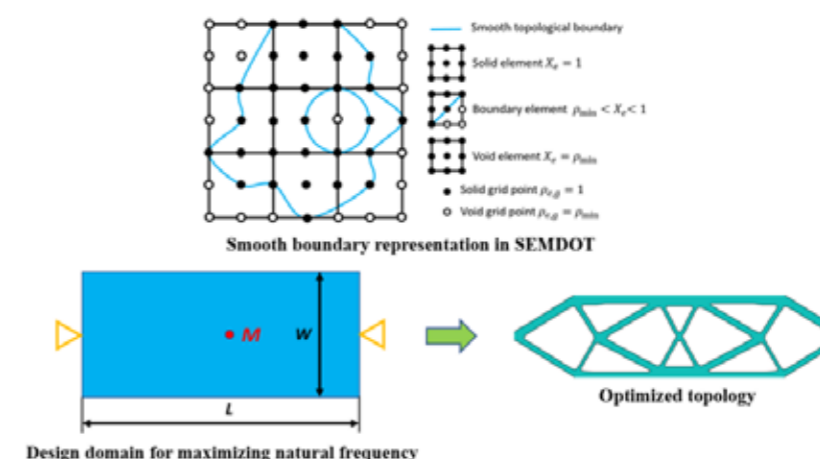

## Topology optimization of truss structure with nodal stability and local buckling of member constraints

Dr Qi Cai<sup>1</sup>

<sup>1</sup>Hohai University

In this study, the nominal perturbing force (NPF) method and the allowable stress iteration (ASI) method are proposed to address nodal instability and local buckling instability problems in truss topology optimization, respectively. In the NPF approach, an infinite number of disturbing forces that a node may suffer are considered by a finite number of nominal perturbation force conditions whose magnitude and direction are analyzed to capture the worst-case perturbation. In the ASI method, the allowable compressive stresses in the members are recalculated according to Euler buckling criterion in each iteration to make the buckling constraint active. Finally, a truss topology optimization formulation incorporating the NPF and ASI methods is proposed and demonstrated through several numerical examples.

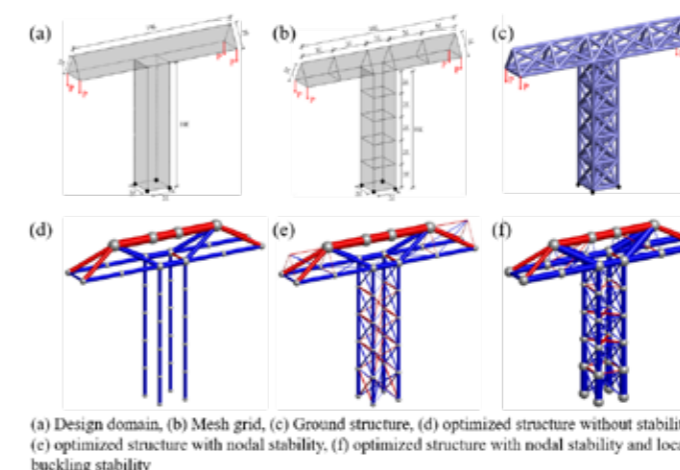

(a) Design domain, (b) Mesh grid, (c) Ground structure, (d) optimized structure without stability, (e) optimized structure with nodal stability, (f) optimized structure with nodal stability and local buckling stability

# Wednesday 12 July 2023

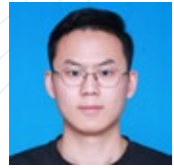

## Topology optimization of dynamic stiffness response of constrained damping laminate structures

Mr Xiangyang Chen<sup>1</sup>, Ms Xiaoyan Teng<sup>1</sup>, Mr Xudong Jiang<sup>2</sup>

<sup>1</sup>Harbin Engineering University, <sup>2</sup>Harbin University of Science and Technology

The constrained damping laminate structure is used as an optimization object in this paper, the optimization of the optimal layout of the constrained damping in the substrate is taken as the research problem, a finite element model of a 7-degree of freedom constrained damping laminate structure is established. The BESO optimization method is combined with the finite element analysis model to analyse the optimal topological configuration of the constrained damping on the substrate structure with the optimization objective of maximizing the dynamic stiffness, and a MATLAB program is written for the topological optimization algorithm of the dynamic stiffness response based on the equivalent static load method. The optimal layout of the restrained damping on the substrate is obtained.

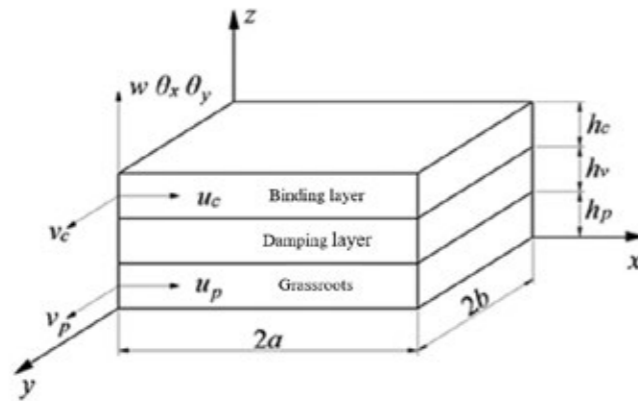

## Topology Optimization of Reinforced Concrete Structures Using a Variable Sheet Method

Mr Jackson Jewett<sup>1</sup>, Dr Josephine Carstensen

<sup>1</sup>Massachusetts Institute Of Technology

Topology optimization (TO) is a powerful free-form design method that has been shown to generate high-performing structures with a limited volume of material. It has enormous potential in the construction industry because it can help reduce the manufacturing of building materials, which produces approximately 10% of greenhouse gasses worldwide. This research proposes a novel approach to TO of concrete structures that uses a variable thickness approach. A two-material algorithm will be used that can place continuum elements representing concrete in compression, and truss elements representing steel in tension. Continuum elements will be allowed to take intermediate densities, which will correspond to varying thicknesses through the design domain. Several numerical design examples will be presented demonstrate the efficacy of this method.



# Wednesday 12 July 2023

# Session 39

## Optimisation methods and applications 2

Room 218

16:30 - 18:30

# Wednesday 12 July 2023



## Applications of Shape-Optimised Cold-Formed Steel Cross-Sections for Roof Purlin and Wall Stud Construction

Miss Ziqi Zhao<sup>1</sup>, Miss Zichen Wei<sup>1</sup>, Professor Hong Guan<sup>1</sup>, Dr Bin Wang<sup>2</sup>

<sup>1</sup>School of Engineering And Built Environment, Griffith University, <sup>2</sup>Xstructe Consulting

This study presents two applications of an optimised folded-flange lipped channel section for roof purlins and a “Sigma” section for wall studs, aiming at minimising the cross-sectional areas of the shape-optimised (SO) cold-formed steel (CFS) sections with the same load-bearing capacity as the corresponding conventional CFS (CCFS). The optimisation process for each application results in five SO sections having 100%, 80%, 60%, 40% and 20% of the CCFS cross-sectional area. Bearing capacities of all the SOCFCS sections are determined through elastic buckling analyses and using the Direct Strength Method. The area-capacity curves indicate that the cross-sectional areas of the optimal CFS members for a roof purlin and a wall stud are 89.2% and 52.7% of the CCFS area, respectively.

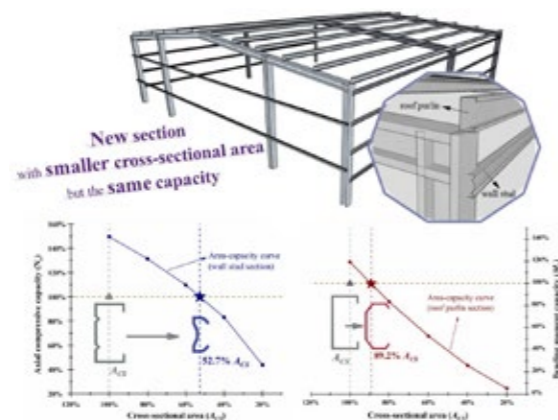

## Optimization design of bone scaffolds using physics-informed machine learning

Dr Chi Wu<sup>1</sup>, Dr Jianguang Fang<sup>2</sup>, Prof Grant Steven<sup>1</sup>, Prof Qing Li<sup>1</sup>

<sup>1</sup>The University of Sydney, <sup>2</sup>University of Technology Sydney

Bone scaffolds are of great potential for the treatment of bone loss caused by trauma, injuries or diseases, which can overcome limitations associated with traditional methods using autografts or allografts. We propose here a novel design framework for 3D printed patient-specific scaffolds by using a physics-informed machine learning approach. The objective of this study was to achieve a most possible uniform strain pattern within a 3D printed scaffold to overcome the strain shielding issue. A multiscale optimization approach was proposed to design the 3D printed scaffold under patient-specific loads. A jawbone reconstruction case was presented to demonstrate the effectiveness and efficiency of the proposed framework.

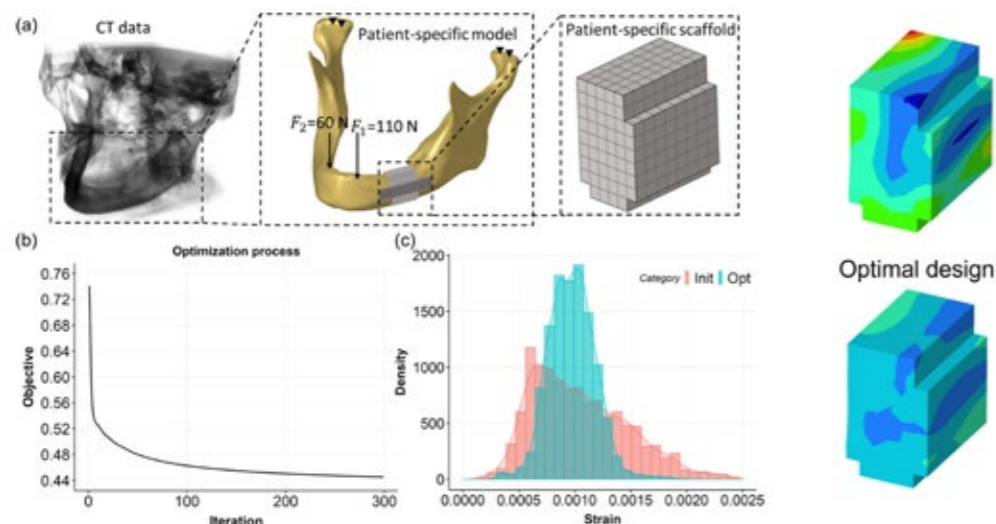

## Interactive gradient-decent optimization method for timber column-slab structures

Ms Keerthana Udaykumar<sup>1</sup>, Ms Anna Krtschil<sup>2</sup>, Mr Luis Orozco<sup>3</sup>, Prof Achim Menges<sup>3</sup>, Prof Jan Knippers<sup>2</sup>

<sup>1</sup>University Of Stuttgart, <sup>2</sup>ITKE Institute of Building Structures and Structural Design, University of Stuttgart, <sup>3</sup>ICD Institute for Computational Design and Construction, University of Stuttgart

This paper proposes an interactive computational approach to design material-saving and structurally aware timber column-slab layouts. An agent system approach is integrated with gradient-based optimization to generate column-slab layouts that meet the serviceability limit state deflection criteria. The ABxM framework was extended with an interactive timber column-slab (TCS) solver. Within this framework, the slab nodal displacements are computed rapidly at each agent-system cycle. The agent-based model uses numerical analysis results to refine adaptive agent decisions. The real-time interaction within the agent-based model enables live user guidance and design-software integration. The entire methodology is encapsulated into a C# environment and has been shown to effectively identify deflection-criteria optimal column-slab configurations when tested on a wide range of building layouts.

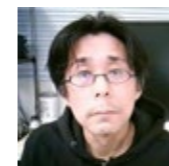
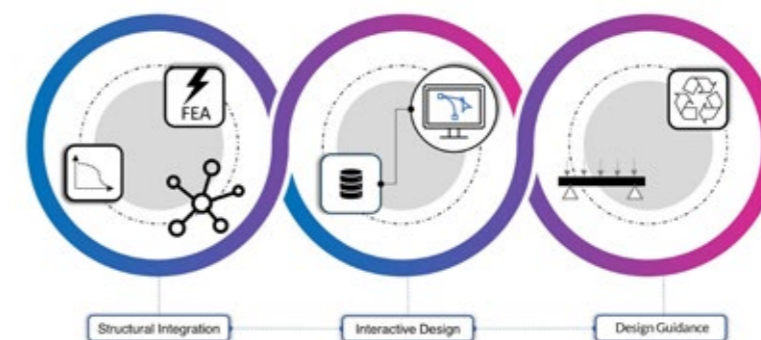

## Optimization of corrugation direction on corrugated shells

Prof Kenji Yamamoto<sup>1</sup>, Mr Kentarou Doi<sup>1</sup>

<sup>1</sup>Tokai University

When using corrugation on shell surfaces to enhance structural performance, it is important to consider the arrangement of the corrugations based on the direction of the forces acting on them. This paper investigates the optimal corrugation directions of corrugated shells using mathematical programming. The finite element method is used for the structural analysis. However, instead of directly discretizing the surface of corrugated shell, we approximate it as an anisotropic shell and used its constitutive law in the analysis. The objective of the optimization is to minimize the strain energy under self-weight, and the corrugation direction of each finite element is considered as design variable. We apply this method to two models with different boundary conditions, cylindrical shells and EP shells.

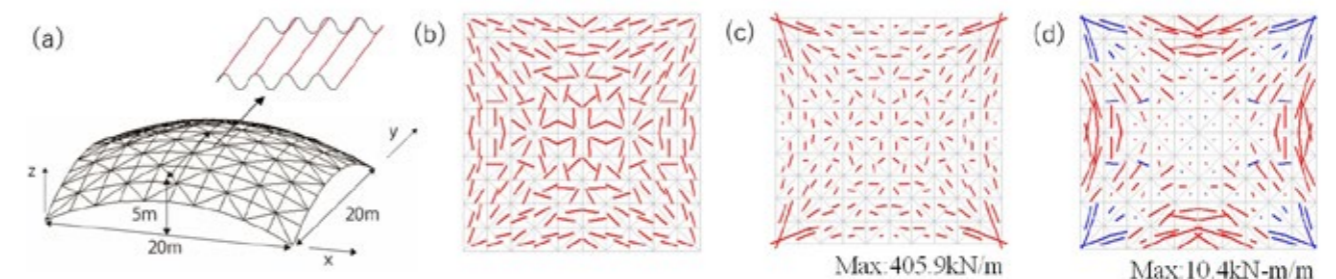

Numerical example of optimization: (a) analysis model (EP shell with four corner supports), (b) optimal direction of corrugation ridge line, (c) principal membrane force diagram and (d) principal bending moment diagram.

# Wednesday 12 July 2023

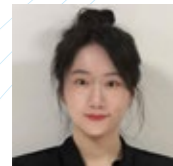

## Simultaneous topology optimization and fiber path optimization of CFRP structures using level set method

Miss Yanan Xu<sup>1</sup>, Dr Chi Wu<sup>1</sup>, Dr Jianguang Fang<sup>2</sup>, Prof Grant Steven<sup>1</sup>, Prof Qing Li<sup>1</sup>

<sup>1</sup>the University of Sydney, <sup>2</sup>University of Technology Sydney

This study simultaneously conducts topology and fiber path optimization using the level set function to maximize the structural performances. Primary fiber paths can be determined with the zero level set; secondary fiber paths can be defined with the fast marching method. Gaps and overlaps can be alleviated to a large extent. Several examples are presented. The optimized CFRP structures are then manufactured using the 3D printing technique. Samples with unidirectional fibers and various fiber paths are all manufactured and tested to verify the improvement of the structural performance due to the introduced variable stiffness composites. Mechanical experiments are recorded with digital image correlation (DIC). It's found that the optimized samples present higher stiffness compared with samples made of unidirectional fibers.

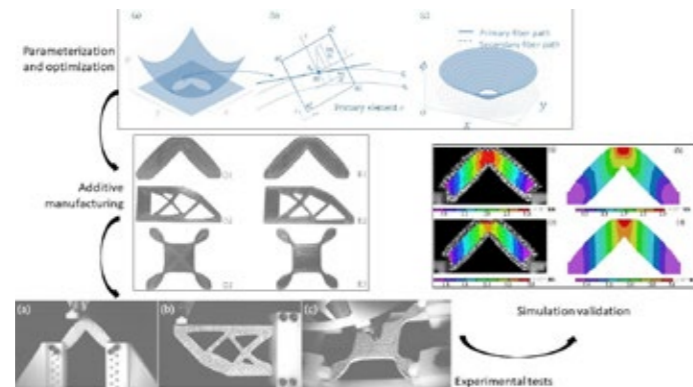

## Structural optimization based on quantum genetic algorithm

Mr Hongyuan Ren<sup>1</sup>, A/Prof Jianbin Du<sup>1</sup>

<sup>1</sup>Tsinghua University

No short abstract submission provided



## Optimisation of railway pantograph-catenary structures

Prof Wenyi Yan<sup>1</sup>

<sup>1</sup>Monash University

No short abstract submission provided



## Slimline floor an invention by Pronk and Lichtenberg

A/Prof Arno Pronk<sup>1</sup>, Dr Elke Mergny

<sup>1</sup>Eindhoven University of Technology

Slimline flooring makes it possible to realize distinctive designs for both high, utility and residential construction. The floor elements can span more than 16 meters, which offers great opportunities for large open, freely arranged spaces. Because the installation space is not filled with concrete, the own weight of the total floor package is relatively low, resulting in a weight reduction of 50% compared to traditional systems. In combination with the advantage that installations at Slimline are placed in the floor and therefore not in a suspended ceiling, it is possible to design main supporting structures and lighter foundations. Slimlinefloors also offers great freedom of form. Building with Slimlinefloors means prefab, dry, fast and stamp-free construction.

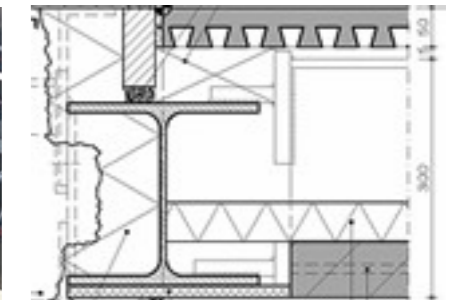
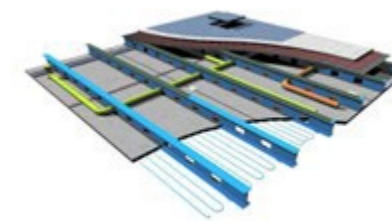

Wednesday 12 July 2023

# Session 40

## Metal gridshell structures 1

Room: Plenary 3  
16:30 - 18:30

### The effects of different self-stress states on the stability behaviour of cable-strut pyramid dome

Prof Karim Abedi<sup>1</sup>, Houshan Qhaderi<sup>2</sup>, Kamal Mirzaaghazadeh<sup>3</sup>

<sup>1</sup>Sahand University of Technology, <sup>2</sup>Sahand University of Technology, <sup>3</sup>Sahand University of Technology

In this study, the effects of different self-stress states on the stability behaviour of cable-strut pyramid dome have been investigated. The pyramid domes were designed using three different self-stress states in order to investigate their effects on the critical load level, collapse mechanism and designed sections.

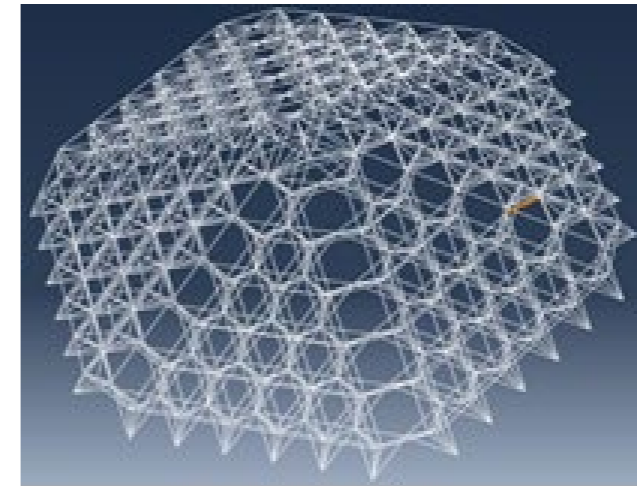

### Characterization of the rotational hinge stiffness for metallic kirigami space frame

Dr Eduardo Sosa<sup>2</sup>, Ms Isabel de Oliveira<sup>1</sup>, Prof Sigrud Adriaenssens<sup>1</sup>

<sup>1</sup>Princeton University, <sup>2</sup>West Virginia University

We characterize the rotational stiffness of a steel sheet to be used in bar and hinge models of a rotational kirigami system. This deployable system is made from patterned cuts in sheet material. Cut patterns comprise a polygonal hub nested within a boundary polygon, and cross-sectional widths define hinge formation areas during deployment. To capture the system's global nonlinear mechanical behaviour, we characterize the stiffness of the hinges to implement its behaviour in simplified bar and hinge models for faster future design iterations. This behaviour is characterized with a shell finite element model with material plasticity and validated experimentally using A1008 carbon steel sheets. The characterized rotational hinge with nonlinear behaviour enables future implementation of bar and hinge models.

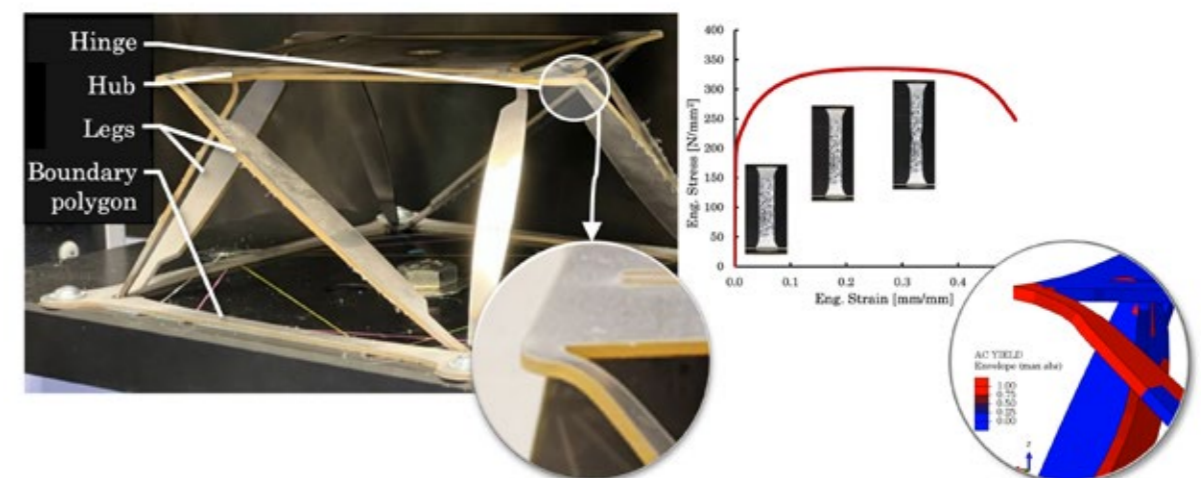



# Wednesday 12 July 2023

## Novel schemes on improvement of the progressive collapse resistance of hybrid cable domes

Prof Karim Abedi<sup>1</sup>, Dr Rasoul Asghari<sup>2</sup>, Prof Mohammad Reza Chenaghlou<sup>3</sup>, A/Prof Behzad Shekastehband<sup>4</sup>

<sup>1</sup>Sahand University of Technology, <sup>2</sup>Sahand University of Technology, <sup>3</sup>Sahand University of Technology, <sup>4</sup>Urmia University of Technology

This paper concerns the progressive collapse behavior of a hybrid cable dome consisting of a tensegrity ring with 32 semi-regular modules and a Levy-type cable dome with 3 hoops and 16 sectors.

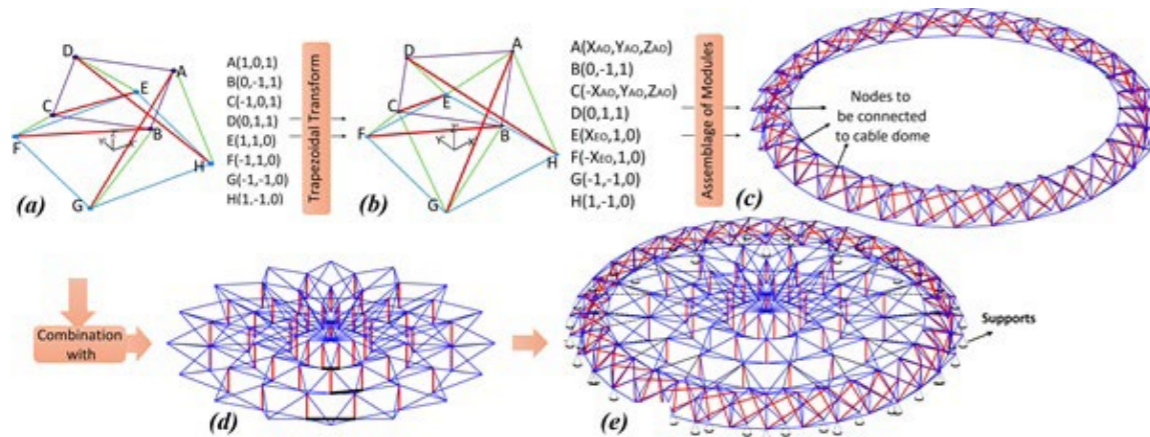

## Design and construction of two tree-columns supported gridshells in Canberra

Miss Catherine Poirriez<sup>1</sup>, Mr Yacine Bouzida<sup>1</sup>

<sup>1</sup>Passage Projects

Canberra centre is an existing commercial development in Canberra. The development is divided into several buildings, each of the buildings being separated by street crossings accessible by cars. In order to bring back a sense of unity in the shopping centre, make the restaurants attractive again, it was decided to close to traffic one of the streets separating the buildings. The newly pedestrian Scott's crossing street has been covered by two new steel and ETFE canopies. Although complex, the geometry of the canopies was generated to fully take into account buildability. The resulting structure is an elegant lightweight structure providing protection from the rain, reviving an underused part of the shopping centre and bringing pride to the adjacent shop owners.

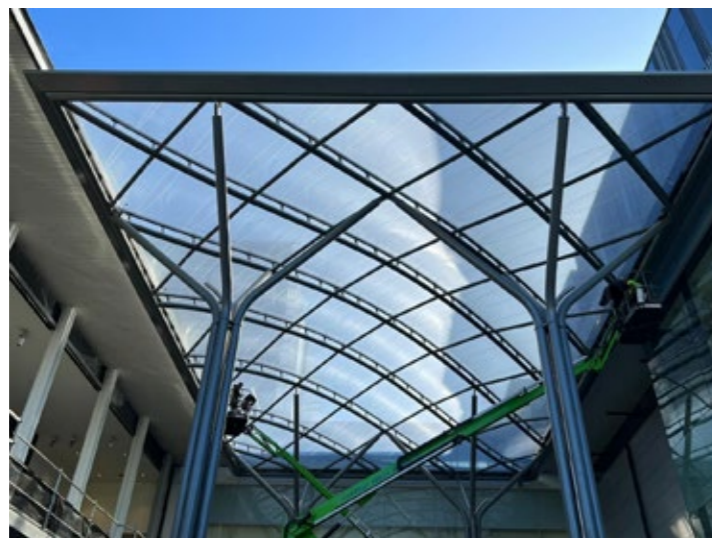

## Grid shell for Hamad Airport expansion in Doha

Mr Josu Goñi<sup>1</sup>, Mr David Caballero<sup>1</sup>, Mr Mikel Monasterio<sup>1</sup>, Mr Oscar Batuecas<sup>1</sup>, Dr Gabriel Ruiz<sup>2</sup>, Dr Jose Miguel Rico<sup>2</sup>

<sup>1</sup>Lanik, <sup>2</sup>School of Architecture University of the Basque Country

new expansion of Hamad Airport in Doha includes a very big atrium covered by a glazed grid shell of 14052 m<sup>2</sup> surface. The intention was to create a very big organic space with the perception of being in an openair garden. The scope of Lanik in this project included geometrical design, calculation, fabrication, and installation of the metallic grid shell structure. This paper shows the geometrical design, dynamic analysis and parametric integrated design and fabrication method used to develop the project.



## Design of a brace-stiffened bi-directional single-layer lattice dome using h-shaped steel with a span of 116m

Dr Yuki Nagai<sup>1</sup>, Emeritus Prof. Mutsuro Sasaki<sup>1</sup>, Motoshi Inukai<sup>1</sup>

<sup>1</sup>Sasaki Structural Consultants

*No short abstract submission provided*

## A Stress Triaxiality and Lode Angle Dependent Plasticity Model for Structural Aluminium Alloys

Mr Xiaonong Guo<sup>1</sup>, Shaohan Zong<sup>1</sup>, Zhengning Li<sup>1</sup>, Jinhui Luo<sup>1</sup>

<sup>1</sup>Tongji University

*No short abstract submission provided*

# Thursday 13 July 2023



Thursday 13 July 2023

# Session 41

## Sustainable construction 2

Room 215

09:00 - 11:00



### CLT Requires a New Approach to Design: A Case Study in CLT Folded-Plate Structure

Ms Yoko Masuda<sup>1</sup>

<sup>1</sup>Tourisha Structural Design Office

This paper describes the design and construction of an office building using CLT (Cross Laminated Timber). The potential to produce CLT panels in sizes as large as 12m by 3m was key to all design and building processes. By using such large panels, we could reduce the number of parts and joints, resulting in a shorter construction period. Bold structural designs can also be realized. We devised V-shaped beam and roof using CLT folded-plate structure, and diagonal-lattice glulam wall that rationally support these beams and roofs. CLT requires thinking that integrates manufacturing and assembly methods in the design phase. The first author invented a matrix chart (INDEX), to bring all parties involved together to reach the optimal solution through discussion.

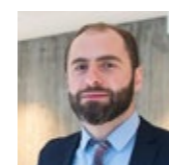
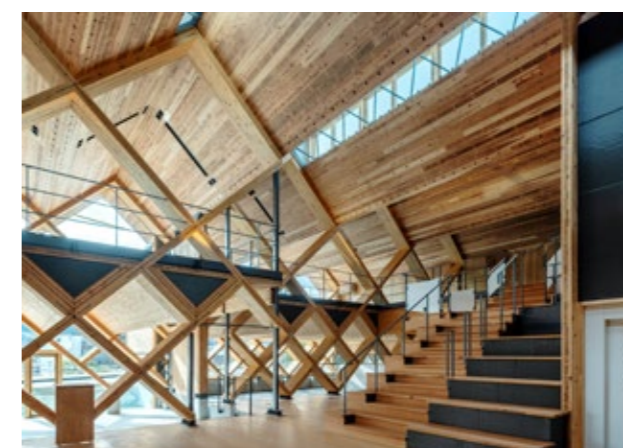

### Compression resistance of digitally fabricated hollow timber columns

Dr Dan Bompa<sup>1</sup>, Mr Stephan Rapley<sup>1</sup>, Dr Suryakanta Biswal<sup>1</sup>

<sup>1</sup>School of Sustainability, Civil and Environmental Engineering, University of Surrey

This study examines the response of hollow timber columns with dry mechanical connections (DMC). Four sets of columns with different aspect ratios were tested to assess the influence of member slenderness on the structural response. Complementary compression and tension samples, as well as single tab and slot joint shear and pull-out samples were also tested. The load-shortening response indicated that the stiffness and strength of the columns reduces with increasing slenderness. Relatively slender columns with an aspect ratio of 5.0, had about 22% less strength than stub columns with an aspect ratio of 1.0. These results provide an insight into the structural performance of digitally manufactured hollow timber columns for temporary lightweight structures that can be disassembled and reused.

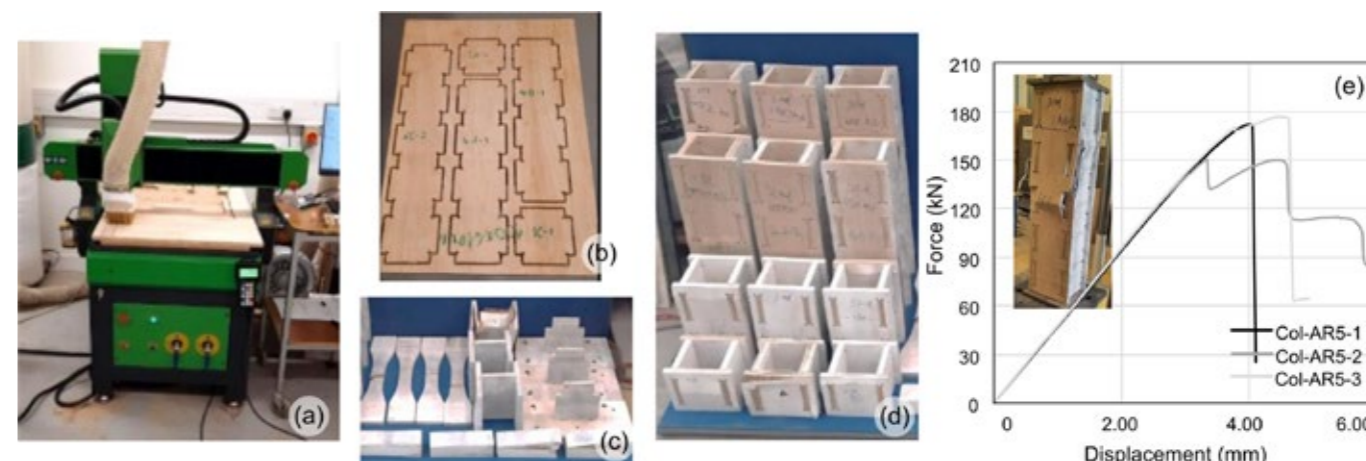

# Thursday 13 July 2023



## Bridging Design and Fabrication: BIM Application in Two Prefabrication Projects

Mr Hing Ching Lau<sup>1</sup>

<sup>1</sup>The Chinese University of Hong Kong

The paper introduces two prefabrication projects: New Lawuga School (2015) and Meili Transitional School (2018). These two projects have different scales and contexts: New Lawuga School is a charity school of 200 m<sup>2</sup> built in a plateau village; Meili Transitional School is a public transitional school of 5275 m<sup>2</sup> built in a high-density urban condition. The authors participated in the projects in person and applied Building Information Modelling (BIM) technology from design to construction. Details of BIM application in these two prefabrication projects, particularly those related to fabrication, are explained and reviewed to provide a springboard to explore the BIM potential in practice.

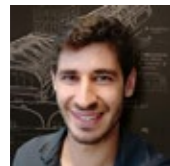
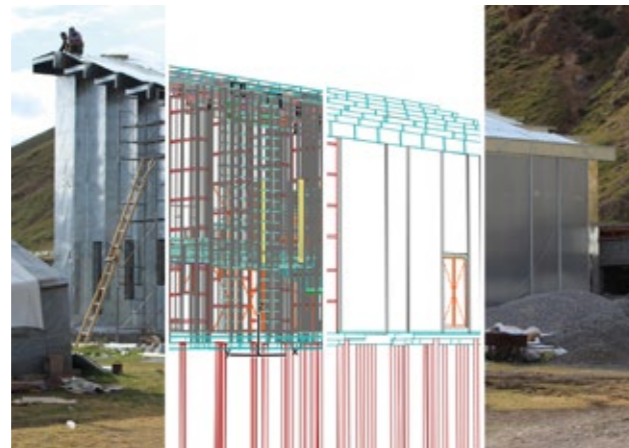

## Sydney's Central Station upgrade – Design modularity and heritage enhancement in the renewal of the Grand and Northern Concourse

Mr Michael Chernyavsky<sup>1</sup>, Ms Amy Clark<sup>2</sup>

<sup>1</sup>Aurecon Australasia, <sup>2</sup>Aurecon Australasia

The Central Station Metro Works will deliver the most significant upgrades to Central Railway Station in decades, comprising an integral part of the NSW Government's Sydney Metro City & Southwest project. As the only underground station to be erected integrally within a live station environment, prioritisation of 'design for manufacture and assembly' (herein DfMA) and heritage interfaces, whilst minimising disruption to 270,000 daily commuters (pre-covid), were the fundamental design drivers. This paper focusses on how the DfMA approach championed in delivering the Grand & Northern Concourse (herein GNC) Intercity cantilever slab and centrepiece canopy roof made viable 'open-heart surgery' within Australia's busiest railway interchange.

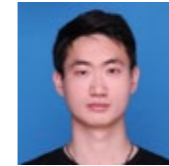

## A convolutional neural processes-based approach for anomaly detection of structures

Mr Jingyu Zhao<sup>1</sup>

<sup>1</sup>Zhejiang University

Structural health monitoring plays an important role in the maintenance of existing civil structures due to the ability to provide a continuous stream of data, which makes it possible to perform automatic anomaly detection on a data-driven approach. In this paper, we develop a novel anomaly detection method based on Convolutional Neural Process (ConvNP) to reconstruct the measured stress data. The proposed method is based on residual indicators, which is established to determine the presence of structural damage based on the Kolmogorov Smirnov (KS) test. By introducing the strategy of moving time windows, the anomaly occurrence time is effectively identified based on the anomaly detection. The proposed method is validated using monitoring data of a spatial structure.

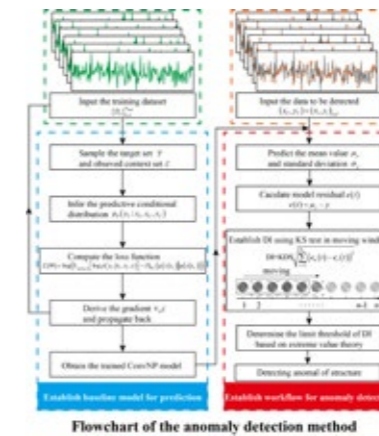

## Digital control of trihexagonal weaving pattern for fabrication at an architectural scale

Mr Mohaimen Islam<sup>1</sup>

<sup>1</sup>Monash University

The research explores the potential of digitally-controlled techniques in fabricating large-span lattice structures using the trihexagonal weaving pattern or Kagome lattice, found in traditional crafts like basketry. The paper analyses previous academic experiments that integrated digital manufacturing techniques into construction, and evaluates the Woven Lattice Prototype developed in the AA's Design & Make program, UK. The experimental project created a parametric model of the trihexagonal pattern, transferred the model onto a free-form surface, and finally extracted CNC-milled laminated ply-sheet striped components to assemble into a self-supported scaled prototype structure. The paper argues that this weaving logic is re-applicable on any defined surface to formulate complex geometric forms at an architectural scale. The limitations and future research opportunities are further discussed.

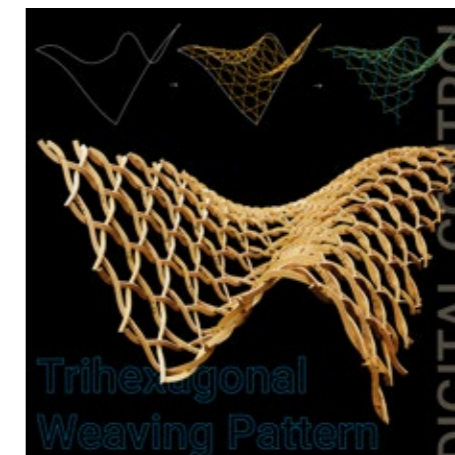

# Thursday 13 July 2023

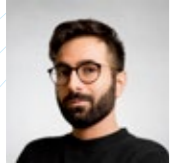

## ReconWood Slab. Computational Design and Structural Optimization of Reconfigurable Timber Slabs

A/Prof Roberto Naboni<sup>1</sup>, PhD Anja Kunic<sup>1</sup>

<sup>1</sup>CREATE - University of Southern Denmark

Slab structures in buildings account for the most significant amount of material employed due to their load-bearing requirements. In timber buildings lately (re)gaining importance thanks to their environmental and structural performance, it is imperative to rethink material usage to reduce the pressure on the forests and optimize how the harvested material is used. To achieve environmental decarbonization and truly circular building construction, this work introduces a stress-driven computational workflow for the design and optimization of reconfigurable timber slabs which rely on automation-driven reversible joints and reusable building elements. The developed workflow is demonstrated on the ReconWood Slab, an experimental prototype featuring a stress-based multi-resolution timber frame made of primary and secondary ReconWood beams stacked one upon the other. The developed research results and the constructed prototype show the possibility of controlling and manipulating material organization and stress distribution in the structures, providing a virtually infinite automated re-configuration of varying slab structures in response to changing boundary conditions. The work findings contribute to enhancing the reconfigurability of timber structures, which is discussed as a fundamental property to extend the life-cycle of wood carbon sinks.

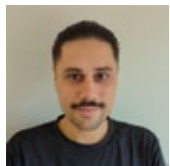
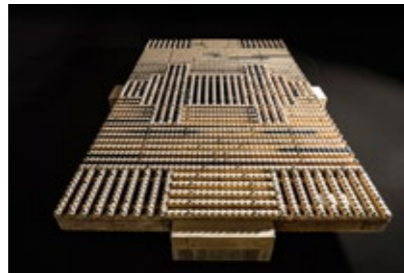

## Built Environment Prototyping for Design-Value

Mr Darcy Zelenko<sup>1</sup>, Dr Duncan Maxwell<sup>1</sup>

<sup>1</sup>Monash University

This paper examines the use of prototyping in the built environment, where it is currently underutilised. Prototyping is defined broadly as a functional form of a new type or design of a construction. The critical review of literature develops an understanding of the variety of prototyping methods and terminology currently used by different practitioners in the built environment, and compares them to influential approaches developed in product design and engineering. The paper argues that a better use of prototyping can enable richer design outcomes, help validate design decisions, and resolve detail issues before construction commences, ultimately leading to more efficient and effective construction processes. This could be achieved with a method of prototyping, tailored to the built environment.



# Thursday 13 July 2023

# Session 42

## Life-cycle design and assessment of structures 2

Room 216

09:00 - 11:00

# Thursday 13 July 2023



## Autarkic office boat

A/Prof Arno Pronk<sup>1</sup>

<sup>1</sup>Eindhoven University of Technology

The installation concept for this office boat is based on three pillars: energy generation, storage and consumption. Energy generation Close to the water there is 40%- 60% more wind than in the built environment. When there is no wind, the office boat is supplied with energy by the PV cells that are directed at the sun at an angle of 36 degrees. Energy storage the storage of energy is equipped with PCM panels (Phase Changing Materials). The buffer makes it possible to significantly reduce the power to be reduced. Energy consumption the energy consumption of the office boat will be limited by ensuring a low surface, good insulation, heat recovery, energy efficient devices.

No figure provided



## Interactive design with optimum matchmaking of reused structural elements – a software implementation

Mr Jonas Warmuth<sup>1</sup>, Dr Jan Brütting<sup>2</sup>, Prof Corentin Fivet<sup>1</sup>

<sup>1</sup>EPFL, <sup>2</sup>schlaich bergemann partner

This paper extends current research developments of Phoenix 3D by integrating the tool into a more flexible multi-objective optimization framework. Hence, the outcomes obtained from Phoenix3D are employed as an objective function in the optimization workflow. This enables designers to move from a mere assignment operation on a predetermined structural system to a more comprehensive approach, wherein alternative design options are thoroughly investigated. Two case studies are conducted here to showcase this extension's effectiveness: (1) a theoretical study that compares generated designs with established typologies; and (2) a real-world application of the proposed tool to design a façade system using only reclaimed steel elements.

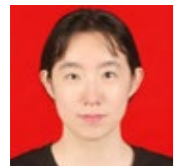
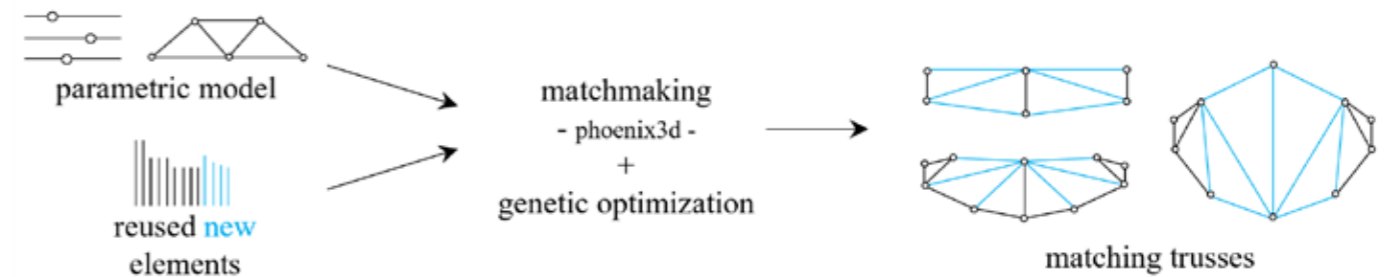

## Optimal sensor placement of large-span spatial structures based on sensitivity analysis

Miss Yiqun Wang<sup>1</sup>

<sup>1</sup>Zhejiang University

Large-span spatial structures are widely used in public facilities. In order to ensure the safety and durability of the structures and to provide security for the life and property of occupants, it is necessary to monitor the health of the structures. Sensor placement is a critical part of the structural health monitoring system. In this paper, a sensitivity analysis method based on static properties is proposed for the characteristics of large-span spatial structures. This method can select the key members which are sensitive to load changes and have high influence on stress state of whole structure, and arrange sensors on the basis. The stress sensors of the Ou Hai Olympic Centre Stadium were arranged based on this sensitivity analysis method.

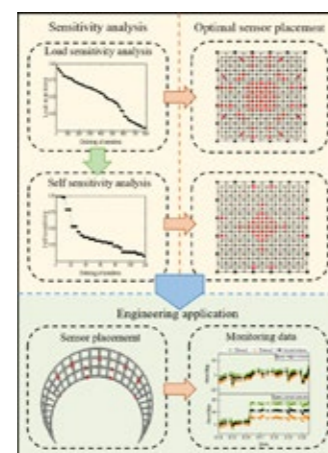

## Long-term strength prediction model for structural glass

Miss Siyi Yi<sup>1</sup>, Prof Suwen Chen<sup>1,2</sup>, Prof Roberto Ballarini<sup>3</sup>

<sup>1</sup>College of Civil Engineering, Tongji University, <sup>2</sup>State Key Laboratory for Disaster Reduction in Civil Engineering, Tongji University, <sup>3</sup>Department of Civil and Environmental Engineering, Cullen College of Engineering

To examine the quasi-static compression performance of a honeycomb structure with a negative Poisson's ratio, this paper employs finite element analysis software, Abaqus, and utilizes stainless steel property data for numerical simulation analysis of the honeycomb structure with a negative Poisson's ratio. Concurrently, through a comparison of honeycomb structures with zero and positive Poisson's ratios, the mechanical and energy dissipation properties of negative Poisson's ratio honeycomb structures are investigated under varying length-thickness ratios and cell configurations. Key parameters such as nominal stress-strain, platform stress, energy absorption capacity, specific energy absorption, and Poisson's ratio are considered in the study.

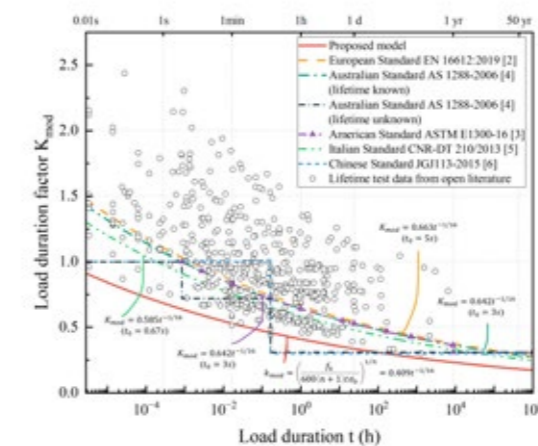

# Thursday 13 July 2023



## Exploring selected LCA factors for tall buildings in today's growing cities

Dr Petr Vegh<sup>1</sup>

<sup>1</sup>Pretium Engineering Inc.

This presentation explores the use of Life Cycle Analysis (LCA) in evaluating the environmental impact of tall buildings in growing cities and possible problems in predicting some LCA factors over the lifespan of a building. While there are many factors that contribute to the impact of structures on the environment, energy consumption is currently viewed as one of the most important. The presentation highlights the importance of energy consumption in minimizing a structure's impact on the environment and discusses current high-rise building development and construction practices in North American cities. It also explores strategies for minimizing energy consumption over the building's lifespan. Overall, the presentation highlights problems with predicting LCA factors in designing sustainable tall buildings in today's urban environments.

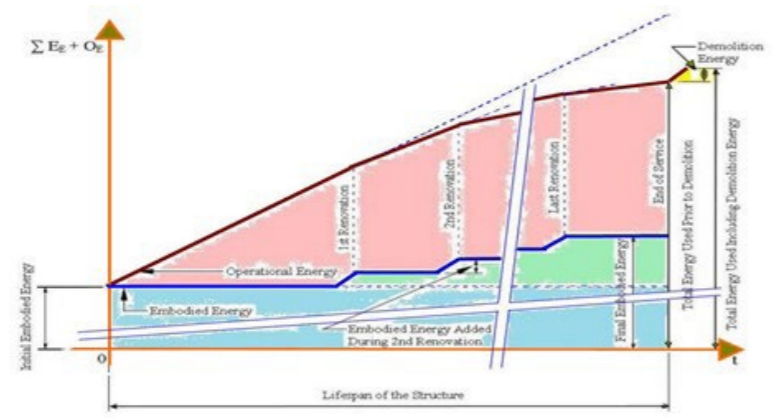

## Probability-based Life Cycle Carbon Emission Assessment for Space Grid Structures

Mr Jianzhou You<sup>1</sup>, Prof. Xian Xu<sup>1</sup>, Dr. Yafeng Wang<sup>2</sup>

<sup>1</sup>Space Structures Research Center, Zhejiang University, <sup>2</sup>Department of Mechanical Engineering, Technical University of Denmark

Current studies often ignore the carbon emissions of repair and replacement in the use phase. The omission of in-service impacts increases the uncertainty of the results and might lead to wrong judgments. This paper proposes a probability-based method to calculate the structure carbon emissions generated by the repair and replacement during life cycle. An orthogonal pyramid space grid structure is used as a case study to evaluate its life cycle carbon emissions. The effects of different load distribution models on its life cycle carbon emissions are discussed. The result shows that carbon emissions from repair and replacement due to loads with high variability should be considered in the design of low carbon structures.

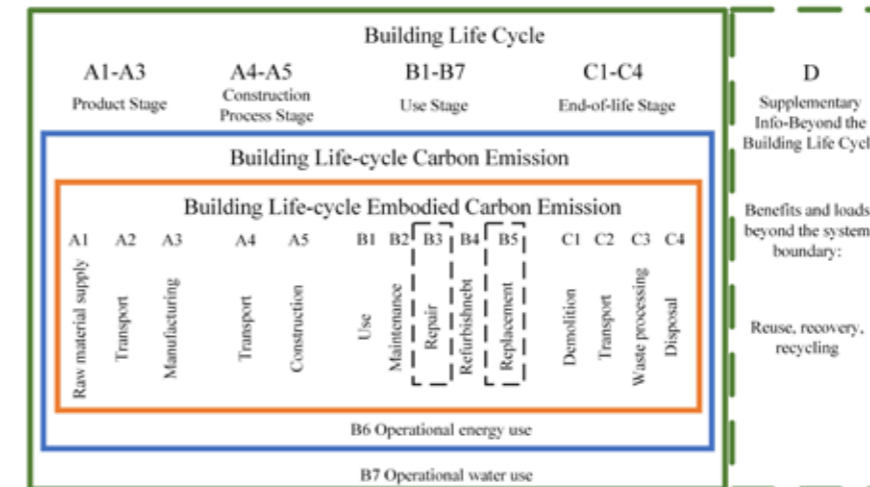

## Neural ODE-based data-driven approach for prediction of the creep behavior of steel cables

Mr Weijia Zhang<sup>1</sup>, Prof Xingfei Yuan<sup>2</sup>, Prof Yi-Qing Ni<sup>1</sup>, Dr Su-Mei Wang<sup>1</sup>

<sup>1</sup>The Hong Kong Polytechnic University, <sup>2</sup>Zhejiang University

This study investigates a physical model based on viscoelastic theory and a Neural Ordinary Differential Equation (Neural ODE)-based data-driven approach for predicting long-term creep behavior in steel cables. The Neural ODE approach uses deep neural networks to learn the changing trends from measured data and can flexibly integrate other physical information. The comparison of both methods based on a long-term creep test concludes that Neural ODE is more accurate in predicting creep behavior.

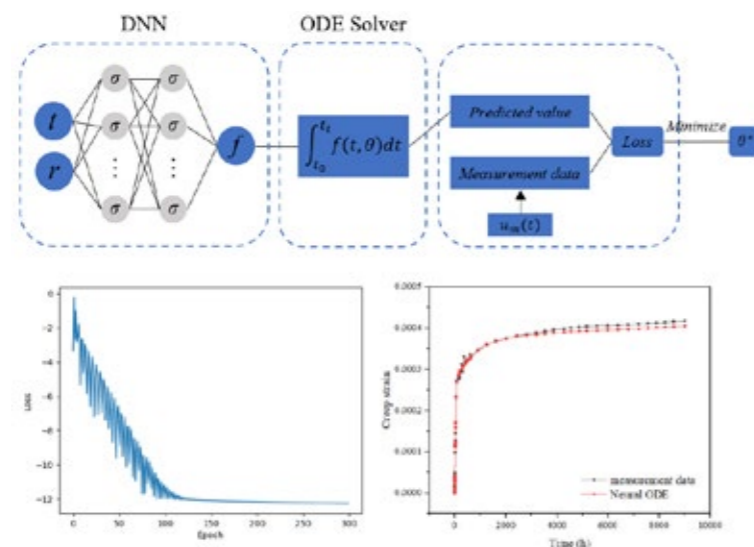

Thursday 13 July 2023

# Session 43

## Lattice structures

Room 217  
09:00 - 11:00



### Crushing of functionally graded hybrid lattice structures

**Ms Chamini Thuppa Mudalige Rodrigo**<sup>1</sup>, Dr Shanqing Xu<sup>1</sup>, Associate Professor Yvonne Durandet<sup>1</sup>, Professor Dong Ruan<sup>1</sup>

<sup>1</sup>Swinburne University of Technology

This study aims on evaluating the quasi-static compressive performance of multi-layer hybrid lattice structures comprising three different unit cell topologies, body-centred cubic (BCC), rhombic dodecahedron (RD), and octet (OT). Three types of bi-directionally graded hybrid lattices were designed by varying the unit cell diameters and layer relative densities. The lattices were fabricated using Polyamide PA11. The deformation patterns, stress-strain relationships, and energy absorption capacities of the lattices were investigated through experiments and finite element models. The results showed that the collapse mechanism was mainly controlled by the layer relative density and the corresponding strut diameters of the unit cells. The study demonstrated that functional grading could be used to tailor the mechanical response and energy absorption capacity of hybrid lattices.

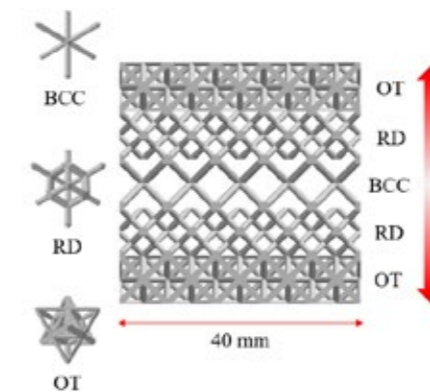

### Structural Design of a Public Library with Lamella Shell Roof

**Dr Yoshiharu Kanebako**<sup>1</sup>, Mr Yasuhiro Mochizuki<sup>1</sup>

<sup>1</sup>Kanebako Structural Engineers

Structural design of a public library with single-layered lamella shell roof is introduced in this paper. The large reading room is covered with flat roof, which is supported with dome shaped lamella shell structure. The planarly shape of lamella dome is ellipse. The members are arranged diagonally in two directions to become a diamond-shaped grid. Since there are no horizontal members, the dome doesn't have the properties of a triangular grid dome, and is closer to the stress state of arch. The members are used angle shaped steel doubly with the corners on the outside. The members are connected to the gusset plate with high strength bolt fastening the plate attached to the inside at the end of the members.

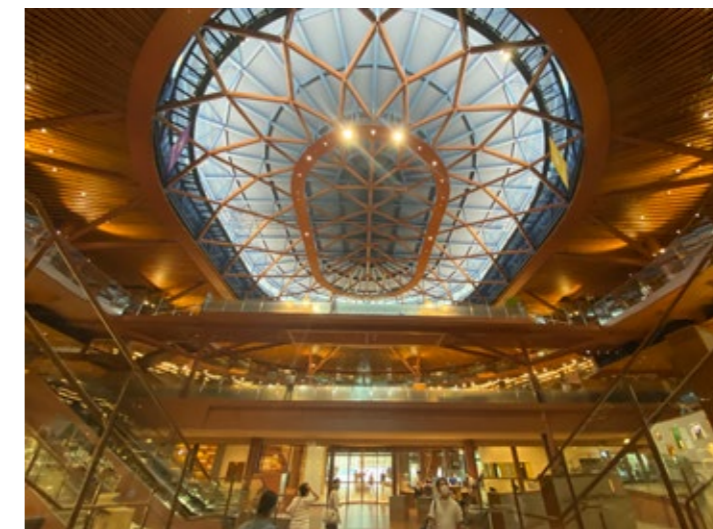



# Thursday 13 July 2023



## An analytical solution to measure stress concentration factors of additive manufactured surface

Miss Mengna Zheng<sup>1</sup>, Mr Kazem Ghabraie<sup>1</sup>, Mr Wei Xu<sup>1</sup>, Mr Yanan Wang<sup>1</sup>

<sup>1</sup>Deakin University

An analytical method to measure the stress concentration factors (SCF) of additive manufactured surface is presented. The proposed method extends the single-notch stress concentration factor model from 2D to 3D based on the reconstructed Micro-CT surface. A global and Localised SCF can be calculated based on the effective key features of the tomographic surface after segmentation according to the standards. A portion of scanned surface is analysed using FEA to evaluate the error of the localised SCF. The proposed method demonstrates relatively good validity and high efficiency in terms of the computational cost compared to FEA. Such model can assist fatigue-oriented design of AM components to save time and sample prints for destructive fatigue testing at prototyping and design-proofing phase.

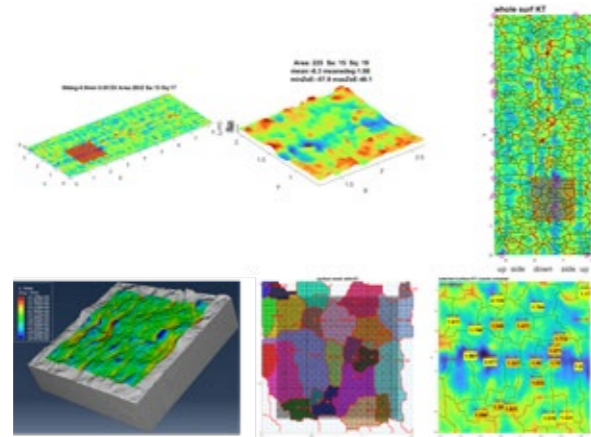

## Structural Optimization of Lattice Shells with Geometric Nonlinearity using Machine Learning

Mr Yuma Yabuuchi<sup>1</sup>, Prof Sinnosuke Hujita<sup>2</sup>

<sup>1</sup>The University of Kitakyushu, <sup>2</sup>The University of Kitakyushu

In this paper, prediction models of the nonlinear buckling load calculated by the geometric nonlinear analysis are constructed by supervised learning for lattice shells composed of steel pipes. Then, structural optimization was performed using the obtained prediction models. Specifically, shell shapes with high nonlinear buckling loads are generated in realistic computational time by solving optimization problems in which nonlinear buckling load calculations are replaced by the obtained prediction models. The effectiveness of the proposed method is verified through several numerical examples.

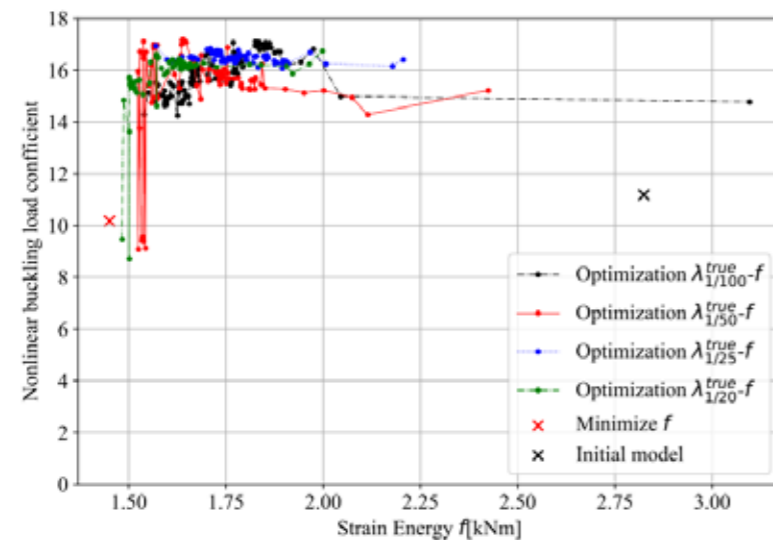

## Topology Optimization of Three-dimensional Isotropic Auxetic Metamaterials with Unusual Thermal Expansion

Dr Zuyu Li<sup>1</sup>, A/Prof Zhen (Jeff) Luo<sup>1</sup>,

<sup>1</sup>University of Technology Sydney

This work will develop systematic and rational methods for the design of novel metamaterials that simultaneously possess elastic isotropy, negative Poisson's ratios, and unusual coefficients of thermal expansion. First, a density-based continuum topology optimization method is proposed for designing three-dimensional isotropic auxetic metamaterials with thermal dimensional stability. Then, a discrete topology optimization method based on a multi-material ground structure is developed to find three-dimensional strut-based metamaterials that can exhibit tunabilities of both auxeticity and thermal expansion while remaining elastically isotropic. Novel multi-functional microstructures will be numerically demonstrated through finite element analyses to validate their effective material properties and macroscopic deformation behaviors.

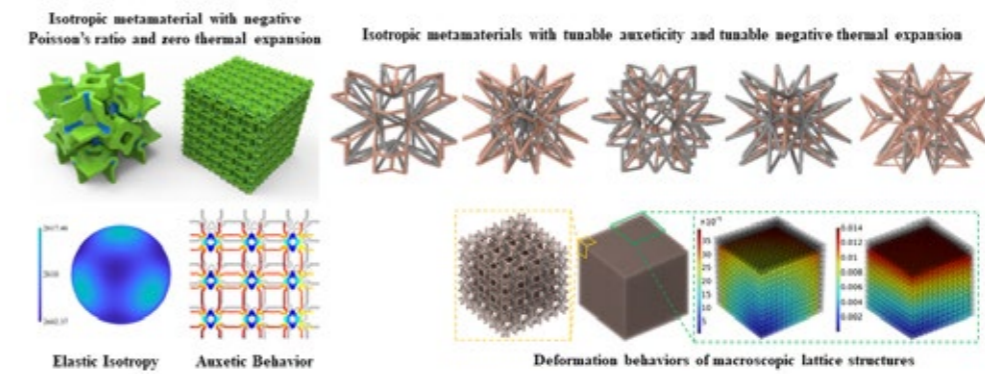

## Research progress on materials and structures with negative Poisson's ratio

Prof Xin Ren<sup>1</sup>, Mr Dong Han<sup>1</sup>, Mr Xue Gang Zhang<sup>1</sup>, Mr Wei Jiang<sup>1</sup>, Mrs Xiang Yu Zhang<sup>1</sup>

<sup>1</sup>Nanjing Tech University

No short abstract submission provided

Thursday 13 July 2023

# Session 44

Civil structures

Room 218  
09:00 - 11:00



## Numerical study of structural behaviour of bridge link slabs constructed using hybrid fibre reinforced engineered cementitious composites

Prof Yixia (Sarah) Zhang<sup>1,2</sup>, Mr Shiyao Zhu<sup>1</sup>, Prof Chiking Lee<sup>1</sup>,

<sup>1</sup>UNSW Canberra, <sup>2</sup>Western Sydney University

Link slab is one of the important structural components of the jointless bridge deck system. Numerical analyses are conducted to investigate the structural behaviour of link slabs built with different hybrid fibre reinforced engineered cementitious composites (hybrid ECCs) using polyethylene (PE) and steel (ST) fibres. The finite element (FE) analysis is performed to investigate the effects of material properties of hybrid ECCs on the structural performance of the link slabs. The load-deflection relationship, the strain developed in the reinforcement bars, and the damage pattern of the link slabs were evaluated by static FE analyses. Among the three link slabs, the one using 1.25%PE+0.75%ST hybrid ECC achieves a balanced structural performance in terms of the ductility and strength.

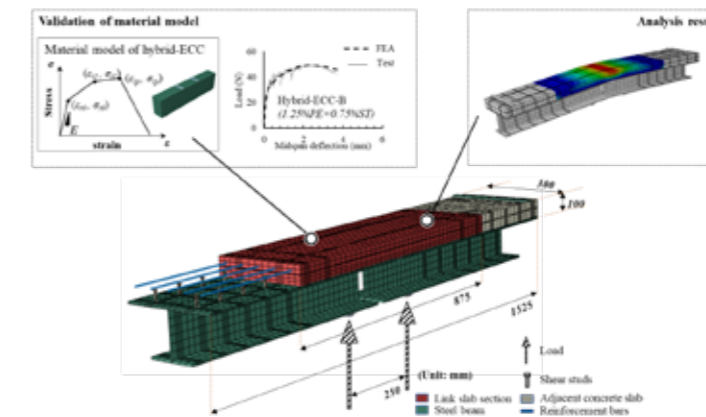

## Structural Health Monitoring for Bridge using Improved Vehicle Scanning Method

Dr D.S. 'Ted' Yang, Prof Wenhui Duan

In this work, the improved vehicle scanning method (VSM) is adopted for bridge SHM. Using this vibration-based method, the bridge is excited by the passing vehicles. Then, an instrumented vehicle will scan over the bridge while collecting its contact point (CP) response. To extract information from the collected response, the improved VSM uses a designed elliptic filter to decompose the CP response into narrowband signals, which generally have a good signal-to-noise ratio. As a result, the signals are able to reconstruct accurate vibration modes that reveal kinks that indicate the bridge damage locations.

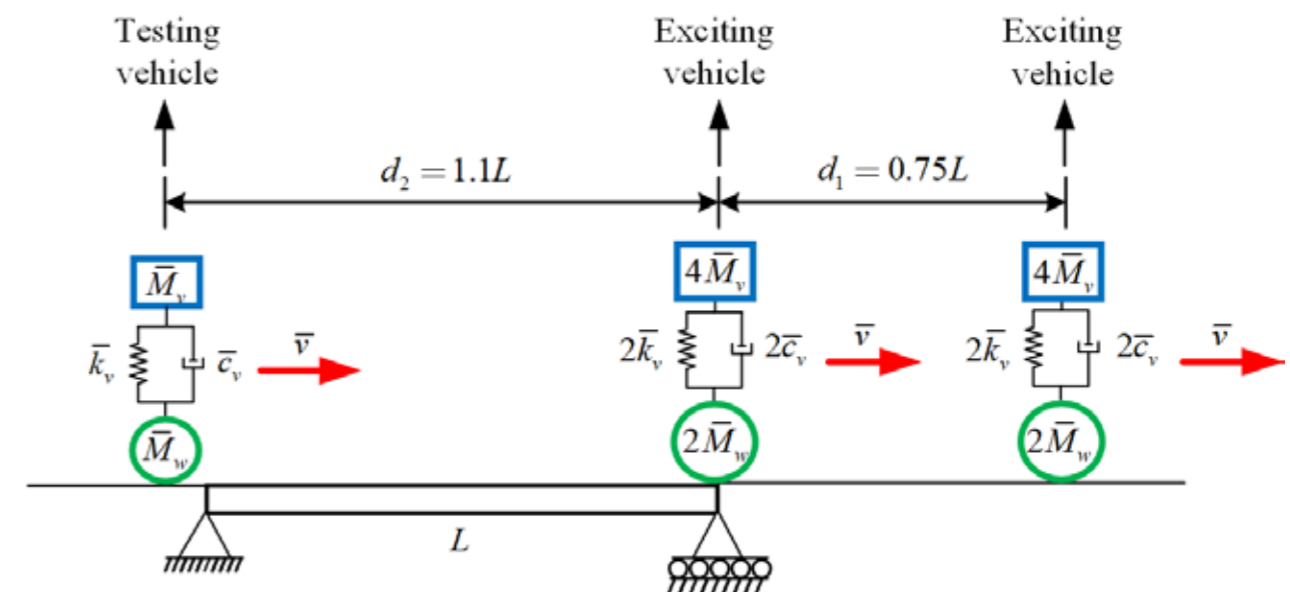

# Thursday 13 July 2023



## Multi-Modal Transportation-Hub: Marine-Air-Land Terminal, the Israeli Case Study

Prof Michael Burt<sup>1</sup>, Prof Yehiel Rosenfeld

<sup>1</sup>Technion Israel Institute of Technology Faculty of Architecture

Short abstract submission not provided



## BuildDigiCraft: New Mindset for High-quality Baukultur in Europe

Prof Annette Boegle<sup>1</sup>, Emiliya Popova<sup>1</sup>, Prof Olga Popovic Larsen<sup>2</sup>, Prof Lotte Bjerregaard Jensen<sup>3</sup>

<sup>1</sup>HafenCity University Hamburg, <sup>2</sup>Royal Danish Academy, <sup>3</sup>Aarhus School of Architecture

Short abstract submission not provided



## Innovative design of a pedestrian bridge using multi-material topology optimisation

Mr Lai Yaping<sup>1,2</sup>, Dr Li Yu<sup>3</sup>, Mr Chen Peixin<sup>2</sup>, Mr Liu Yanchen<sup>2</sup>, Mr Zhao Lijun<sup>2</sup>, Professor Xie Yi Min<sup>4</sup>

<sup>1</sup>School of Civil Engineering, Chongqing University, <sup>2</sup>T.Y. Lin International Engineering Consulting (China) Co. Ltd, <sup>3</sup>College of Architecture and Urban Planning, Tongji University, <sup>4</sup>Centre for Innovative Structures and Materials, School of Engineering, RMIT University

To facilitate commuters crossing the railways near the high-speed rail station in Shenzhen, China, a five-span pedestrian bridge with a main span of 152 m is being planned. We propose an innovative pedestrian bridge design based on multi-material topology optimisation, which realises the process from conceptualisation to detailed design considerations. The superstructure was designed for a variable-depth spinal-shaped girder in the centre of the deck with an elegant curving facade, from which one pathway cantilevers on either side. In this paper, the main aspects of the construction requirements and challenges, conceptual development process, form-finding with the bi-directional evolutionary structural optimisation (BESO) strategy, structural design, and construction method of the bridge are presented.

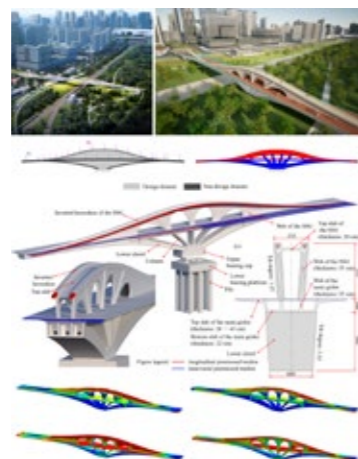

## Investigation of frequency variation in a moving mass-beam system

Prof Judy P. Yang<sup>1</sup>, Mr ZY Su<sup>1</sup>, Prof JD Yau<sup>2</sup>, Dr DS Yang<sup>3</sup>

<sup>1</sup>National Yang Ming Chiao Tung University, <sup>2</sup>Tamkang University, <sup>3</sup>Monash University

Due to limited research on the frequency variation concerning the effects of moving mass on a beam, the analytical solution to present the spatial-varying frequency of a moving mass-beam system is first derived by introducing the inertial and centrifugal forces in the beam equation. A three-dimensional model is numerically built to investigate the frequency variation for higher modes of the system. The following conclusions are drawn: (1) The spatial-varying frequency of the system changes with vehicular velocity and location. (2) The decrement in the spatial-varying frequency ratio becomes smaller with respect to the increasing mode order. (3) For high suspension stiffness and large vehicle-to-bridge mass ratio, the maximum variation of spatial-varying frequency ratio for the first mode can reach 30-40%.

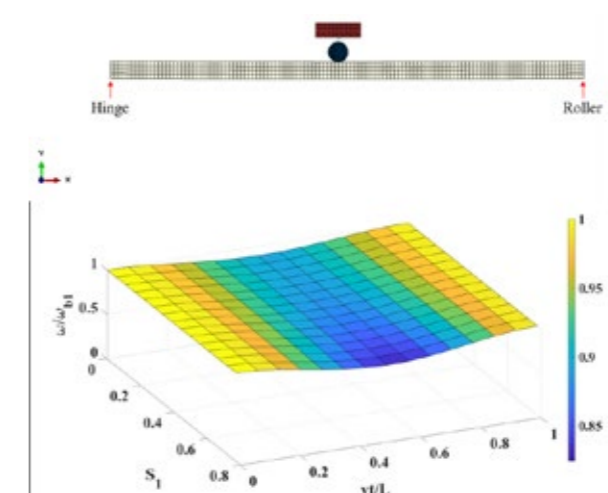

# Thursday 13 July 2023



## Integrated bridge structure design process through Finite element analysis (FEA) and pixel-based visibility culling method.

Ms Ana Gabriela Loayza<sup>1</sup>, Mr. Taeyong Kim<sup>2</sup>

<sup>1</sup>Rhode Island School of Design, <sup>2</sup>Harvard Graduate School of Design

This study proposes a novel bridge design method for pedestrian bridges that maximizes structural performance and material efficiency while minimizing visual impact on the surrounding environment. The method utilizes a building system of multiple slender columns and follows a two-fold structural and visual analysis that assists in iterations on the section and allocation of columns to create different densities, transit paths, and boundary conditions. The analysis relies in a parametric design method that computes results from Finite Element Analysis, shape optimization, and visibility analysis using Rhino 3D, Grasshopper, Millipede plug-in, and pixel tracing techniques. The method provides numeric values and graphical analysis, estimating deflection, smallest column section, and visibility levels inside and outside the bridge. By exploring the limits of a minimal building system, this method helps to unveil the hidden structural and visual implications of early design decisions and prototyping.



# Thursday 13 July 2023

# Session 45

## Topology Optimisation

Room: Plenary 3

09:00 - 11:00

# Thursday 13 July 2023



## Research on generative generation of rigid joints in single-layer space grid structures

Dr Fengcheng Liu<sup>1</sup>

<sup>1</sup>Yangzhou University

This paper proposes a generative generation method for rigid joints of single-layer spatial grid structures: Firstly, the basic principle of generative generation method is introduced, and its mathematical model is given. Secondly, based on the generative generation method, the diversified design results of the new rigid joint configurations of single-layer spatial grid structures with different reserved masses, circumferential symmetry constraints and the changed reserved geometry are obtained. Then, the static performance of the new rigid joint configuration is compared with that of the traditional welded hollow spherical joints. The results show that the generative generation method has a strong exploration and innovation ability, and the new rigid joints obtained are novel in shape, light and beautiful, which can realize the diversified design of lightweight, high-strength, safe and beautiful rigid joints of single-layer space grid structure.



## Topology optimization of spatial grid structures considering member stability based on linear allowable stress iteration

Prof Ruo-Qiang Feng, Dr Hui Wang<sup>1</sup>, Dr Qi Cai<sup>1</sup>

<sup>1</sup>Southeast University

To address low efficiency and inaccurate identification of member stability in topology optimization models with section area as design variables, a linear allowable stress iteration method was proposed that considers member stability limits. By transforming the nonlinear structural optimization problem into a linear one, an optimization model and program for spatial grid structures were developed. Numerical examples showed that the iterative allowable stress method could change the structure's topology to meet stable buckling requirements. The method not only optimized spatial grid structures based on Euler buckling but also through Chinese codes, enabling practical engineering applications. The proposed method improves the accuracy and efficiency of member stability identification and provides a useful tool for topology optimization of spatial grid structures.

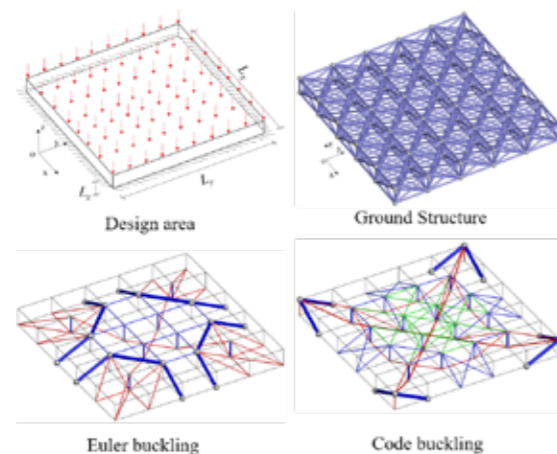

## Multi-loading topology optimization and additive manufacturing of joints of reticulated shells

Prof Bingbing San<sup>1</sup>

<sup>1</sup>Hohai University

To obtain the desired design of joints of shells, a novel topology optimization algorithm considering multiple load cases is proposed in this paper. In this algorithm, multiple load cases are converted into load intervals, the multi-island genetic algorithm is used to find the worst case within the given load interval and the RBF surrogate model is introduced to improve the computational efficiency. The accuracy of the algorithm is validated by benchmark examples, then topology optimization of several typical joints is conducted considering multiple loading. Finally, additive manufacturing is applied to produce the optimized joints. The study shows that it is a promising way to use the combined technology of topology optimization and additive manufacturing to design and manufacture novel joints.

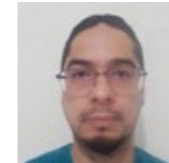
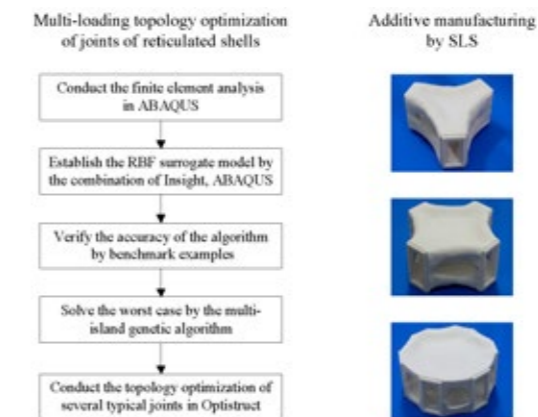

## A boundary-finite element coupling framework for topology optimization in unbounded media

Mr Aldemar Siqueira<sup>1</sup>, Dr Pérsio Barros<sup>1</sup>, Dr Renato Picelli<sup>2</sup>, Dr Josué Labaki<sup>1</sup>

<sup>1</sup>University of Campinas, <sup>2</sup>University of São Paulo

This article presents a framework for topology optimisation in unbounded media. The air in electromagnetic and acoustic problems and the soil in soil-structure interaction problems are examples of unbounded media. Unbounded media have characteristics that require special methods to describe them properly. Domain discretization methods such as the classical Finite Element Method (FEM) resort to truncation of the unbounded domain, which not only results in computational cost issues, but also violates radiation conditions for the unbounded domain. In this paper, we focus on the case of a soil-structure interaction problem and present a strategy to design via topology optimisation. The unbounded region surrounding this domain is modelled via Boundary Element Method (BEM). Coupling between the two methods is obtained by imposing continuity and equilibrium conditions at their interface. We also present a strategy to describe this coupling in the case in which the finite and boundary element meshes have different orders. The paper discusses the derivation of sensitivity and filtering schemes based on the coupled FEM-BEM equilibrium equation. As an illustrative example, this framework is used in this paper to compute optimised designs for buried foundations. In order to show the flexibility of the framework, we have used both the Solid Isotropic Microstructure with Penalization (SIMP) and the Bi-Directional Evolutionary Structural Optimisation (BESO) methods to solve this foundation optimisation problem. The results show that the present framework is computationally efficient and yields physically consistent results.

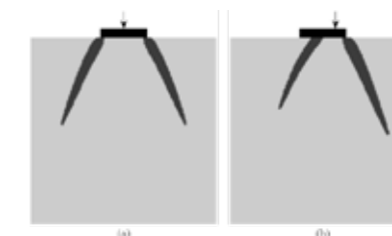

# Thursday 13 July 2023



## Topology optimisation considering buckling in architectural design

Mr Tao Xu<sup>1</sup>, Dr Xiaoshan Lin<sup>1</sup>, Prof Yi Min Xie<sup>1</sup>

<sup>1</sup>RMIT University

Topology optimisation techniques have been increasingly employed in architectural designs to achieve efficient and elegant structures with minimal material. Current architectural applications of topology optimisation focus on structural stiffness, often neglecting buckling, a critical phenomenon that can lead to catastrophic failures. In this study, a buckling-constrained bi-directional evolutionary optimisation (BC-BESO) algorithm is presented for designing buckling-resistant structures. The proposed algorithm aims to minimise the compliance of a structure under predefined buckling constraints, thus ensuring both stiffness and stability of the structure. The application of the proposed method in the structural design of high-rise buildings demonstrates that the algorithm can significantly enhance buckling resistance with a slight sacrifice of stiffness.

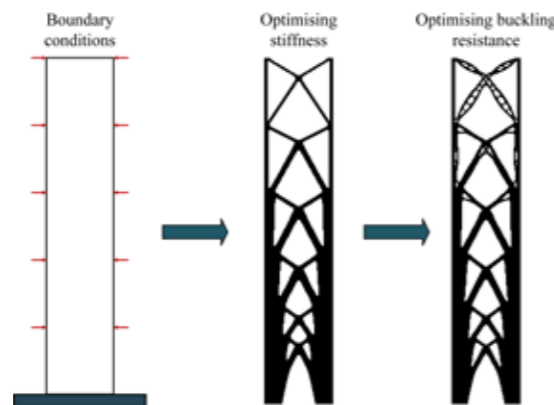

## A reaction diffusion-based B-spline level set method using body-fitted mesh for structural topology optimization

Ms Cong Wang<sup>1</sup>, Mr Zicheng Zhuang<sup>1</sup>, Mr Xuyu Zhang, Mr Yi Min Xie<sup>1</sup>, Mr Shiwei Zhou<sup>1</sup>

<sup>1</sup>RMIT University

The work proposes a reaction diffusion-based B-spline level set method using adaptive triangular mesh. The level set function is a linear combination of cubic B-spline basis functions to increase optimisation flexibility and structural smoothness. The edges of the triangular mesh are equivalent to a balanced truss network, with its adaptivity adjusted by the distance between the nodes to the boundaries. The sensitivity of design variables, the coefficients of the B-spline basis functions, should be interpolated from the nodes of the body-fitted mesh to the nodes of rectangular elements. A reaction-diffusion method and void elements-excluding scheme are used to update and reduce the design variables. Numerical examples illustrate that elegant structures with ultra-smooth boundaries can be generated with high efficiency.

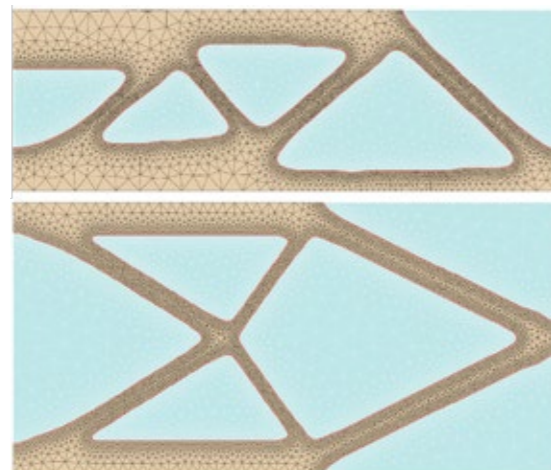

## Truss topology optimisation considering constructability constraints

Mr Ajmal Babu Mahasrankintakam<sup>1</sup>, Mr Allan L Marbaniang<sup>1</sup>, Prof Siddhartha Ghosh<sup>1,2</sup>, Prof Subhrajit Dutta<sup>3</sup>

<sup>1</sup>Indian Institute of Technology Bombay, <sup>2</sup>Structural Safety, Risk & Reliability (SSRR) Lab, <sup>3</sup>National Institute of Technology Silchar

Trusses, known for their efficiency and aesthetic appeal, are often used in large-span bridges, roofs, and stadiums, and the study aims to produce constructible and conceptually feasible optimal structures that meet regulatory standards. The study discusses the application of discrete topology optimisation for different types of truss structures, considering both structural and architectural constraints based on design codes and constructability considerations. The optimal truss configuration and cross-sectional dimension for truss members are sought within a specific domain with given boundary and loading conditions using a heuristic optimiser. The study investigates the impact of various design constraints on the final optimal solutions, also focusing on their feasibility and constructability.

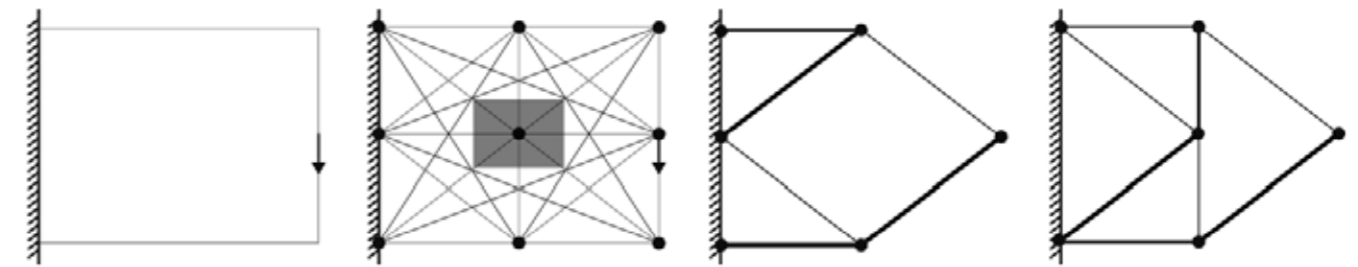

(a) Initial domain; (b) Ground-structure with region of interest  $I$  (shaded area); (c) Optimal solution without interest region constraint; (d) Optimal solution with interest region constraint



## Intelligent parametric optimization design of three-centered circular reticulated shell structures

A/Prof Guozhi Qiu<sup>1</sup>, Mr Yijie Zhang<sup>1</sup>, Mrs Shanshan Shen<sup>1</sup>

<sup>1</sup>Shanghai Jiao Tong University

The influence of key parameters on steel consumption of three-centered circular reticulated shell structures is studied based on a large span shell structure. Key parameters with great influence are summarized, including height of shell structure, height of arc, grid size, thickness of reticulated shell, bending moment adjustment index and empty grid proportion of the lower chord. The influence of each parameter is preliminarily studied. An intelligent parametric design software for three-centered circular reticulated shell structure is developed to check each model to ensure the safety and economy. The research results are contributed to improving calculation efficiency, saving construction material and providing an intelligent design method for three-centered circular reticulated shell structures.vvvvvvvvvvvv

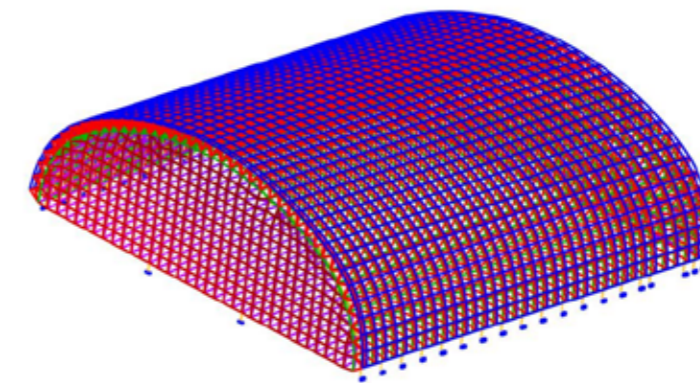

Thursday 13 July 2023

# Session 46

## Conceptual design

Room 215  
11:30 - 13:00



### Topology optimisation considering subjective preferences: current progress and challenges

Mr Zhi Li<sup>1</sup>

<sup>1</sup>RMIT University

This research reviews the latest topology optimisation methods considering subjective preferences. The techniques are classified into three groups based on when subjective interventions are introduced: pre-processing, post-processing and interactive processing strategies. The advantages and limitations of each strategy are discussed. Moreover, the challenges involved in extending these new techniques are indicated in this study, including applying strategies to other topology optimisation methods, considering design objectives beyond compliance minimisation, incorporating geometric constraints, and extending strategies to 3D structural design problems. Overall, this paper aims to serve as a helpful guide for future developments of topology optimisation techniques that consider subjective preferences, hoping to create more practical and customised structural designs that better meet the needs of users.

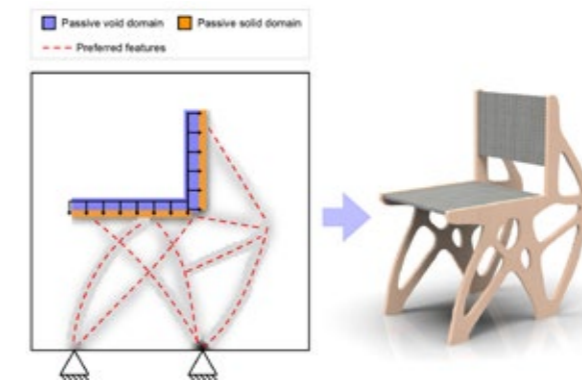

### Using Augmented Reality for interactive value engineering of structural steel connections

Ms Yuyu Wang<sup>1</sup>, Dr Vitor Bottazzi<sup>2</sup>, A/Prof Joseph Gattas<sup>1</sup>

<sup>1</sup>University of Queensland, <sup>2</sup>Watkins Steel Pty Ltd

Steel connection detailing in routine building design highly relies on standardised connections specified by national trade organizations or in-house. However, sophisticated design rules and multiple knowledge bases can make component selection difficult for junior engineers. This paper proposes using Augmented Reality tools for interactive design exploration and value engineering of structural steel connections. Connection component descriptions and structural design data is stored and accessed from a 'component-set' connection database. The database is connected to a Rhino/Grasshopper parametric model, with connection model visualisation and interactivity enabled via the Fologram mixed reality plug-in. By enabling users to explore real-time design variation of connection component, this tool enhances collaboration and understanding between designers and fabricators for more efficient co-designed structures.

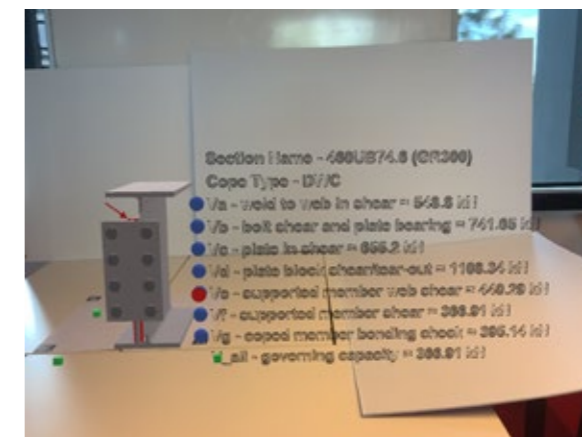

# Thursday 13 July 2023

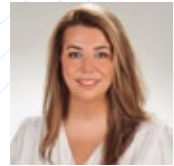

## Contribution of structural intuition at early conceptual stage in efficient workflow: A precedent study of Oscar Niemeyer

Ms Irem Serefoglu<sup>1</sup>, Miss Luiza Wanderley, Prof Remo Pedreschi

<sup>1</sup>The University of Edinburgh

This paper examines the impact of structural intuition on design efficiency in architecture, focusing on Brazilian architect Oscar Niemeyer's work. Early conceptual design decisions are crucial for achieving aesthetic, structurally efficient, and budget-compliant results. Niemeyer's designs exhibit architectural expressiveness and efficiency, attributed to his innate understanding of structural requirements. The study analyzes two case studies, the University of Constantine and the National Congress, through computational modeling, 3D printing, and precedent analysis to demonstrate the benefits of structurally intuitive design methods. The results highlight efficient workflow and parametric modeling applications. This research is part of a broader PhD investigation into complex structure conceptual design and workflow using precedent-based design methodology.

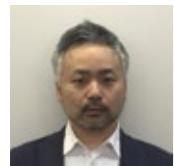
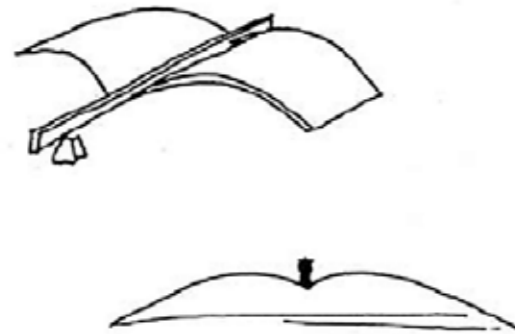

## Structural Design of Flat and Spiral Buildings with Inclined Pillars

Mr Ken Noda<sup>1</sup>, Prof Yoshiharu Kanebako<sup>1,2</sup>

<sup>1</sup>Kanabako Structural Engineers, <sup>2</sup>Tokyo Institute of Technology

This paper is the structural design proposal for a bridge-like observatory with a spiral stairway. The building is located on a top of a mountain. Moreover, the site is undulating and complex ground containing many rocks. The main issues in the structural design were as follows: 1. Design of forms considering both architectural aesthetics and structural rationality; 2. Implementation of systems which properly resist seismic forces on undulating ground; and 3. Reduction of underground rock excavation in foundation construction. The authors propose a structural system with an L-shaped beams on inclined pillars. It effectively uses the pillars as seismic elements. This system was achieved by using slender pillars to provide sufficient horizontal stiffness, while minimizing the amount of rock excavation.



## Conceptual design and parametric modelling of pretensioned stiffened membranes

Mrs Iuliia Lebedeva<sup>1</sup>, Mr Martin Friedrich Eichenauer<sup>2</sup>, Prof Peer Haller<sup>2</sup>

<sup>1</sup>Chair of Structural Design, Technische Universität Dresden, <sup>2</sup>Institute of Steel and Timber Construction, Technische Universität Dresden

The research focused on the conceptual development of innovative architectural forms that meet both aesthetic and practical criteria by combining physical experimentation with computer simulation. The experimental approach utilized pretensioned fabric models as a membrane and glued-on grid patterns as stiffeners. The influence of different patterns of rigid elements, prestress intensity and direction were investigated. The results were used as a basis for parametric modelling in Grasshopper for Rhino3D, optimizing the final shape by varying parameters such as the configuration of stiffeners and membrane strength. The resulting prestressed stiffened membrane structures have the potential for practical applications such as pavilions, roofs, and awnings.

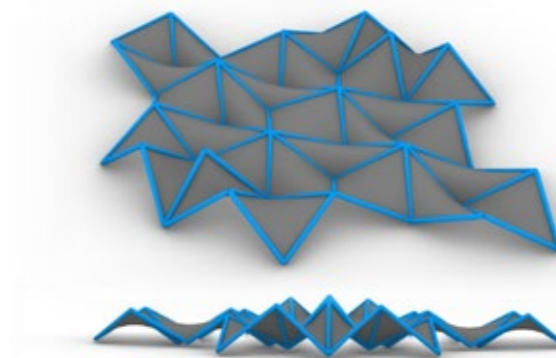

## A Conceptual Numerical Analysis Tool for Development of Spatial Structures

Sverre Haakonsen<sup>1</sup>, Mr Sverre Magnus Haakonsen<sup>1</sup>, Steinar Dyvik<sup>1</sup>

<sup>1</sup>NTNU

This work presents current results and experiences from our ongoing project developing a finite element analysis tool for volumetric elements in a parametric environment. Demonstrations of its application with a node development project are included, together with a discussion about the strengths and limitations. The presented tool already shows promising trends, especially the possibility of evaluating every modification done by the designer in near real-time without exporting and importing files between software. However, the problem of generating fast and robust meshes still needs to be explored and will be addressed in future work.

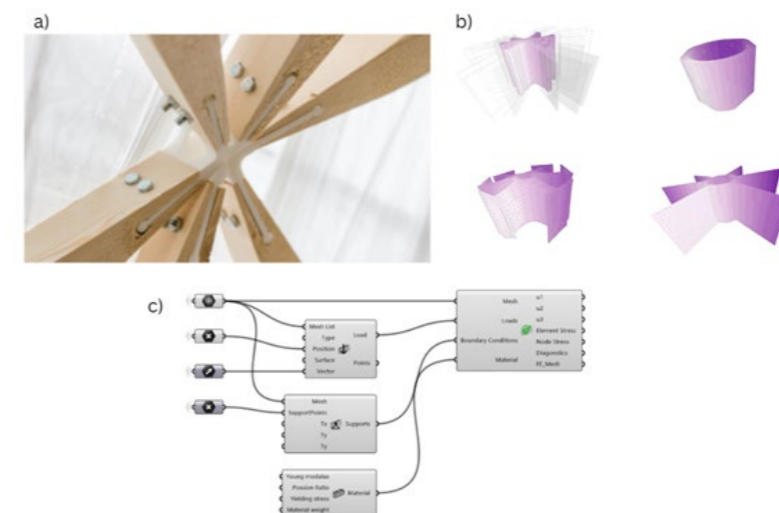



Thursday 13 July 2023

# Session 47

## Transformable structures

Room 216  
11:30 - 13:00



### Snap-through buckling detection and analysis method for multi-stable structures

Ms Ruta Stankeviciute<sup>1</sup>, Mr Jun Sato<sup>1</sup>

<sup>1</sup>Graduate School of Frontier Sciences, The University of Tokyo

Using snap-through buckling, multi-stability can be achieved in animated structures. While there is numerous research on analysing the structural behaviour of snapping-through, there is little study on detecting the occurrence of the phenomenon. In this paper, we propose a computational method for detecting snap-through buckling events using eigenvalue buckling analysis. The workflow was developed by first simulating the multi-stable structure using the dynamic relaxation method and then analysing recorded iterations while transforming from one stable state to another. A drastic fluctuation in eigenvalue was detected, which correlated with geometry changes from the simulation and physical experiment. A sudden drop in eigenvalue corresponded with large deformation of the structure, indicating snap-through occurrence.

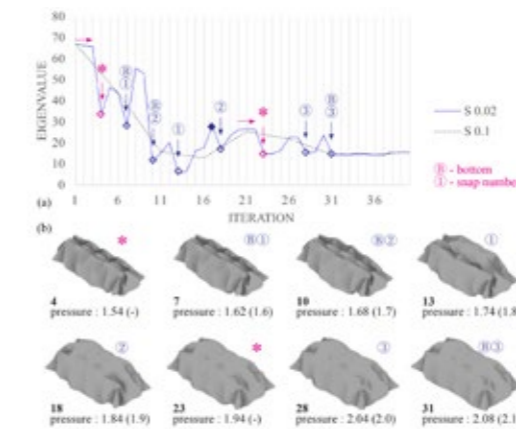

### A Kinetic Workflow: Designing and Fabricating Hoberman-type Double-Curved Kinetic Structures

Mr Wei Wang<sup>1</sup>

<sup>1</sup>Pratt Institute

This paper was developed in an undergraduate elective course within the Morphology program, School of Architecture, Pratt Institute. A workflow is proposed for designing deployable structures derived from doubly-curved surfaces using Grasshopper with the circle packing method developed by Chuck Hoberman. Using component Mobius Transformation, a surface and its circle packings are morphed in certain way that preserves tangency and circularity, and generate predictable geometries, and structures are generated accordingly. Several physical models are built and tested, in which computer-aided manufacturing are used. Future research will explore more complex geometries to demonstrate the success of the workflows, as well as consider potential practical applications.



# Thursday 13 July 2023

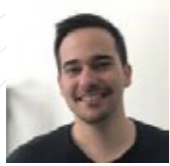

## Design and development of a hybrid deployable spherical shield based on foldable plate structures and scissor systems

Mr Kevin Moreno Gata<sup>1</sup>, Mr Alex Seiter<sup>1</sup>, Dr. Martin Trautz<sup>1</sup>

<sup>1</sup>RWTH-Aachen

Transformable structures that utilize rigid folding origami can generate self-supporting enclosures that are both transportable and easily accessible, offering an answer to the adaptable production environments required in the manufacturing industry. This study presents the design and implementation of a hybrid folding and scissors system enclosure that can be manually opened and closed and compacts to less than one-third of its original size. The prototype, composed of composite panels with elastic hinges, was developed and tested for manufacturing tasks. The study suggests that the system has the potential to provide protection in manufacturing environments and can be further optimized for various applications.

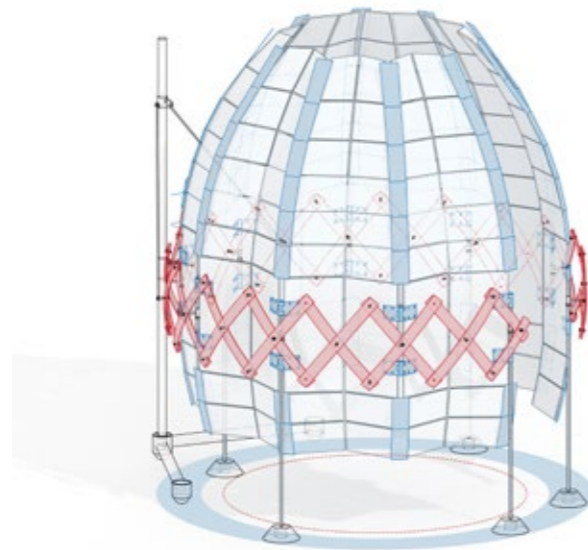

# Thursday 13 July 2023

# Session 48

## Digital modelling and fabrication 3

Room 217

11:30 - 13:00

# Thursday 13 July 2023



## Digitization and Construction of Steel-frame Double Curvature Façade with A Spatial Element: Chongqing Center for Planning and Exhibition as Example

Mr Menghao Yuan<sup>1</sup>

<sup>1</sup>Shanghai Research Institute for Intelligent Autonomous Systems

As the need for the complexity of architectural form in the design market increases, there is an ever-growing challenge to the existing façade design and construction system with the emergence of complex forms. However, the application of digital tools still lacks in prevalence and depth. This article, with an example of a recently completed project, aims at tackling this challenge through discussions on establishing a unified design and construction workflow centered around an exclusive digital fabrication team and a digital framework, making Building Information Modelling a crucial vessel for data management, and how the construction process is empowered by such frameworks and information.



## Design and construction complex shell structure using U-shaped glass and steel frame with collaborative robotics and human expertise

Dr Lei Yu<sup>1</sup>

<sup>1</sup>Bond University, <sup>2</sup>Archi-Solution Workshop

This study presents the design and construction of a unique extension space using a 60-meter-long and 6-meter-wide curved glass shell structure. The project employs digital design and robotic technology to facilitate a well-coordinated dataflow from design to construction. U-shaped glass panels with a steel structural frame embedded within are used to create the curved surfaces. An on-site robot arm system assists human workers in ensuring the accuracy of the steel frame installation, saving time and building materials. This experimental project investigates the potential of automation in construction for free-formed building and highlights the benefits of using advanced manufacturing and digital design techniques in complex shell structures. Future developments in the industry are also discussed.

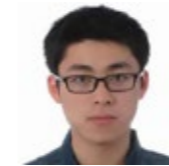

## Nonlinear Analysis of Multi-scale Coupling Based On Coordinated Distributing Method

Mr Junjie Yao<sup>1</sup>, Dr Yanfeng Zheng<sup>1</sup>, Prof Yaozhi Luo<sup>1</sup>

<sup>1</sup>College of Civil Engineering And Architecture, Zhejiang University

Multi-scale simulation is a widely used method for balancing the accuracy and cost of numerical simulations of structures. In this paper, we propose a coordinated distributing multi-scale coupling method based on the Finite Particle Method. The method aims at deformable interfaces. We derive the basic principles of the coordinated distributing coupling which includes the force balance relationship and the displacement coordination relationship. This method enables the coupling of beam-plane, beam-shell and beam-solid, while avoiding stress concentration on the coupling interface. Numerical tests have been conducted to validate the stability and reliability of the proposed method in dynamic nonlinear problems.

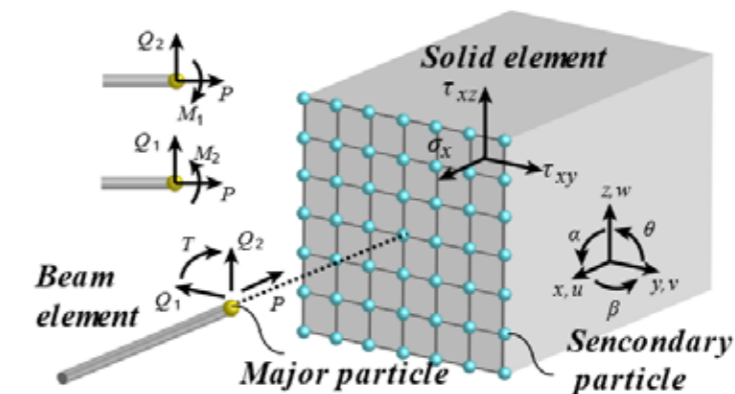

## Morphogenesis method for thin metal plate with non-uniform stiffness distribution by applying auxetic mechanism

Mr Hirotaka Ujioka<sup>1</sup>, A/Prof Mika Araki<sup>2</sup>, Mr Kai Morinaga<sup>3</sup>, Dr Masaaki Iwamoto<sup>4</sup>, Ms Yuri Iwata<sup>4</sup>, Prof Akitoshi Iwamoto<sup>5</sup>, Ms Miki Katsuki<sup>4</sup>, Ms Hanano Tanaka<sup>4</sup>

<sup>1</sup>Graph Studio Inc., <sup>2</sup>Kwansei Gakuin University, <sup>3</sup>The University of Tokyo, <sup>4</sup>Kyushu University, <sup>5</sup>Kanagawa University

Computational methods have made it possible to design complex curved surfaces. Finding an easy, economical way to create free-form surfaces is important for extending design possibilities. Based on a biomimetics approach, this paper develops a new method for creating porous curved surfaces by applying the auxetic structures, inspired by the cellular morphological changes of floral organs. Free-form surface is obtained by suspending thin metal plate with triangular repeated incision under equally distributed load. In this paper, it was clarified through material tensile testing that the physical properties depend on incision patterns, analysis method was developed and a mock-up was constructed. It is expected that our unique method of creating free-form surfaces will be applied to a variety of spatial structures.



Thursday 13 July 2023

**Xtect: A digital intelligence platform for off-site prefabricated construction**

Mrs Wanyu He<sup>1</sup>, Mr Jackie, Leong Shong Yong<sup>1</sup>, Mr Lei Gu<sup>2</sup>

<sup>1</sup>Shenzhen XKool Technology Co., Ltd., <sup>2</sup>China Construction Science and Industry Co., Ltd.

A cloud platform integrating artificial intelligence and cloud computing technology is presented in this paper and applied specifically to off-site prefabricated construction. AI generative modules shorten model creation and accelerate optimised solution finding, while cloud computing provides economical deployment with shared computing resources. In addition to global optimised prefabrication schemes generation in the investment or planning phase, this platform allows associative interaction between a standardised library and multiple disciplines and supports real-time spreadsheet calculation and IFC format export. These features facilitate further fabrication in the construction phase. With the use of a platform and factory production, off-site prefabricated construction has improved design efficiency and reduced loss in a hotel example project.

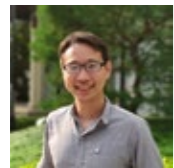

**Towards upscaling membrane tensegrity shells: A design-to-fabrication workflow**

Dr Ying Yi Tan<sup>1</sup>, A/Prof Kenneth Joseph Tracy<sup>1</sup>, A/Prof Christine Yogiarnan<sup>1</sup>

<sup>1</sup>Singapore University of Technology And Design

Membrane tensegrity shells use tensegrity structural principles to create self-supporting and wide-spanning spatial enclosures. These consist of a network of discrete struts pre-tensioning a single customised membrane surface, in place of multiple linear cables. While previous literature has documented the installation of occupiable pavilions, there are challenges in upscaling membrane tensegrity shells to be viable as larger outdoor shelters. Our research tackles these challenges in the ongoing development of an 8.0m span pavilion, entitled 'M-shell'. To achieve this, we implement our computational design-to-fabrication workflow consisting of four main phases: (a) determining optimal strut placement; (b) validating the model via finite element analysis (FEA); (c) extracting fabrication data; and (d) manufacturing and assembly. This paper documents the execution of this workflow for our half prototype 'M-shell' pavilion.

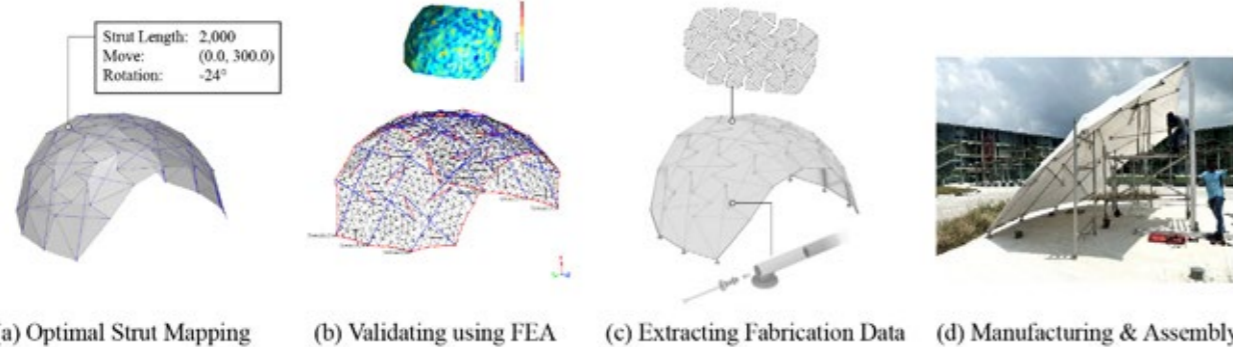

Thursday 13 July 2023

**Session 49**

**Deployable and inflatable structures**

Room 218

11:30 - 13:00

# Thursday 13 July 2023



## A Foldable Modular Structure Unit Inspired by Kirigami

Prof Jae Yeol Kim<sup>1</sup>, Ms. Zafira Nur Ezzati Mustafa<sup>2</sup>, Prof Jae-Yeol Kim<sup>3</sup>

<sup>1</sup>Universiti Sains Malaysia, <sup>2</sup>Toyohashi University of Technology, <sup>3</sup>Hyupsung University

Foldable modular structure unit inspired by kirigami has been explored in this study. This study focuses on application of the idea of kirigami in structures such as bus stops, exhibition booths and structures of temporary nature. In order to achieve a structural concept of kirigami inspired modular foldable structure unit, this study has experimented with three different planar geometrical shapes upon which kirigami patterns are cut: triangle, square and hexagon. Triangular modular structure unit was chosen for further study into possibility of forming different structures through different arrangement of the units. A full scale kirigami inspired triangular foldable modular unit made of plywood was also constructed.

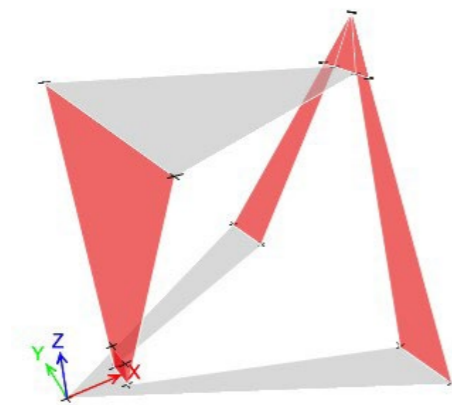

## Section design and performance optimization of C-cross section thin-walled deployable boom

Mr Fengyuan Liu<sup>1</sup>, Prof Minger Wu<sup>1</sup>, Prof Ping Xiang<sup>1</sup>

<sup>1</sup>Tongji University

The C-cross section thin-walled deployable boom (C boom) is used in various deployable structures. In the storage state, the C boom should have no material failure, and in the working state, it should provide high bending stiffness and natural frequency. This paper studies the mechanical properties of C booms in folded and deployed states. The change of maximum stress in the folding process of C booms and the boundary effect on stress are studied in ABAQUS. The C boom with variable cross-section and the perforated C boom are proposed and studied to reduce mass and improve stiffness. The bending stiffness and natural frequency of these two types of booms are studied and compared with C booms with the same mass.

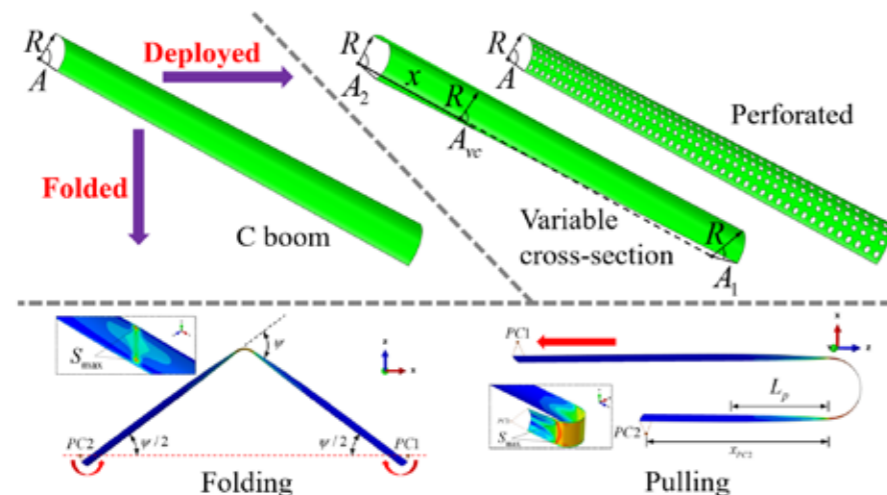

## Surface Accuracy Analysis and Test on 0.5 m Aperture Wrap-rib Deployable Antenna

Mr Han Zhang<sup>1</sup>, Prof Minger Wu<sup>1</sup>, Prof Ping Xiang<sup>1</sup>

<sup>1</sup>Tongji University

A 0.5 m aperture wrap-rib deployable paraboloidal antenna was developed in this paper. The antenna was less than 0.6 kg, and could be stowed in 1.5 U (10 cm× 10 cm× 15 cm). Its reflector was designed for X-band operation. The reflector was composed of ribs, metal mesh and side cables. The wrapping process stress of C-shaped stainless-steel rib was analyzed theoretically and numerically. The number of ribs was determined as 16. The optimal curve of ribs was designed by minimizing the surface error through genetic algorithm. Two prototype antennas were assembled and the shapes of reflector surface were measured before and after shaking table tests. The surface RMS error was 0.8-1.0 mm and had little change after multi-deployment.

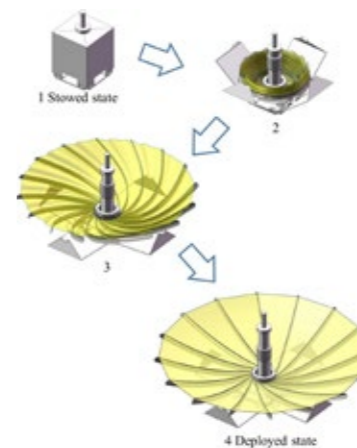

## Manual Deployment and Shape Determining Method of Guide Frame for Tunnel Inspection by Force Control

Prof Fumihiko Inoue<sup>1</sup>, Ms Suzuno Fukunaga<sup>1</sup>, Ms Momoe Terata<sup>1</sup>, Ms Shy Li<sup>1</sup>, Mr Satoru Nakamura<sup>2</sup>

<sup>1</sup>Shonan Institute Of Technology, <sup>2</sup>Tokyu Vonstruction

This study describes a new shape control method for inspection guide frames that can change according to the shape of obstacles in tunnels. We have developed a feedback control method that allows the guide frame to be freely deformed by pulling the force handel in the desired direction. Based on the information from the force sensor, the axial force acting on the guide frame was analyzed by using the FEM, and established a mechanism that can change its shape according to the magnitude of the attractive force. This control method is a simple method of manually deforming the guide frame, and it can be applied to a variety of shapes because the shape can be changed instantly in an emergency.

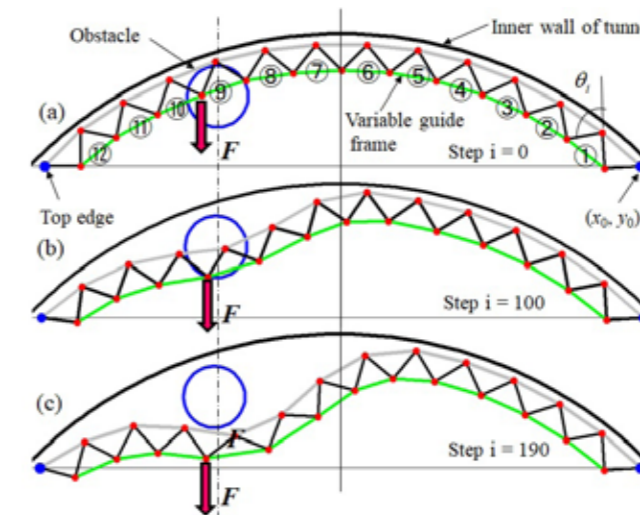

# Thursday 13 July 2023



## Comparison of biologically inspired functionally graded deployable geosystems with experimental measurements

Prof Ann Sychterz<sup>1</sup>, Kaylee Tucker<sup>1</sup>

<sup>1</sup>University of Illinois Urbana-Champaign

Deployable structures provide novel methods for resisting tensile forces for underground geosystems. A rigidity-based graded design is biologically inspired and is matched with the expected function of the geosystem. This paper presents an experimental methodology to design and test the optimization of the existing geosystem through the use of functionally graded materials (FGMs). The paper also presents awn grading patterns using FGMs and their experimental results using the developed methodology. A parametric design script will translate planar patterns onto the curved awns and they will be manufactured by a multi-material 3D-printer. This paper determines whether the presented experimental methodology is appropriate for testing material optimization of the awns.

### Flexible Awn

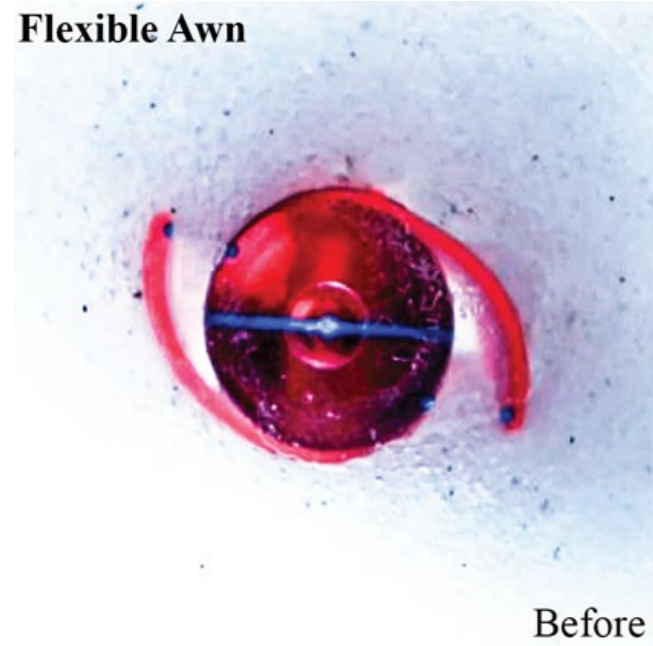

Before

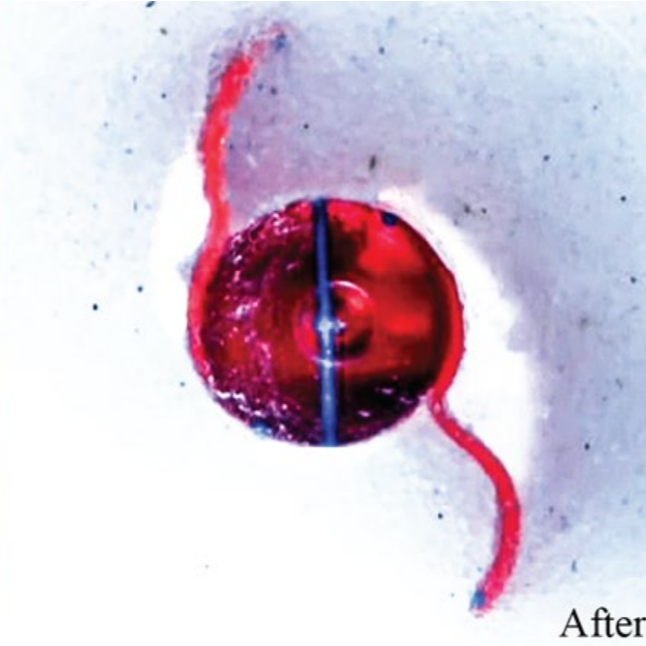

After

Thursday 13 July 2023

# Session 50

## Next generation parametric design

Room: Plenary 3  
11:30 - 13:00

# Thursday 13 July 2023



## Isogeometric deep learning framework to predict the structural performance of free-form surfaces

Dr Kazuki Hayashi<sup>1</sup>, Prof. Makoto Ohsaki<sup>1</sup>

<sup>1</sup>Kyoto University

By combining isogeometric analysis and geometric deep learning, a new machine learning method is developed for free-form structures that consistently perform surface representation, structural analysis, and machine learning to capture the latent information of free-form structures. This study utilizes hierarchical graphs to represent the structural model; the connectivity of patches is represented by a graph, where its nodes is associated with another subgraph representing the shape and connectivity of the control polygon. The proposed workflow will be applied to predict the maximum displacement of free-form shell structures, which requires a large computational load when using the conventional FEM.



## Using Data-Rich Objects in Geometric Parametric Modelling

Prof Lennert Loos<sup>1</sup>

<sup>1</sup>Katholieke Universiteit Leuven

Earlier research by the author investigated how using data visualisations could be helpful to structural designers. The research implicitly showed that the versatile handling, management and manipulation of data is important in order to fully exploit the benefits of parametric design. This paper presents the development of Inkbeagle Data, a new Grasshopper3d plugin that aims to facilitate data management in parametric modelling. The paper discusses how the use of data-rich objects can help make it easier to work with geometric objects and the custom data associated with them. The implementation of the plugin is explained, as well as its user interface, and a small example of its use in practical applications in the field of structural design is given.

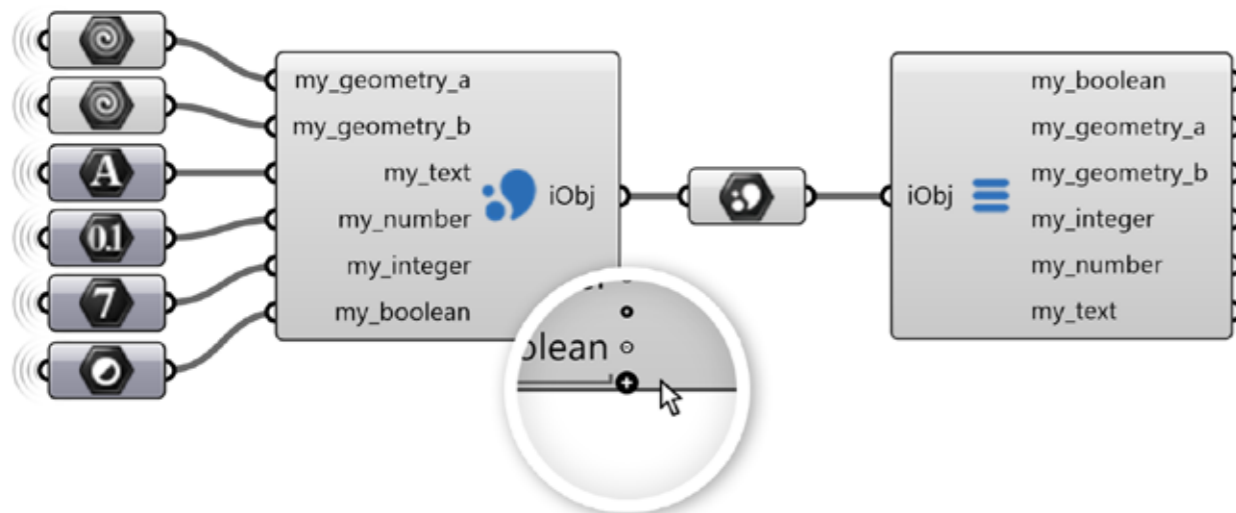

## Design workflows for a complex urban steel artwork

Dr Sascha Bohnenberger-Fehr<sup>1</sup>, Matthew Tam<sup>1</sup>, Csaba Böhm<sup>1</sup>, Gergely Pillmann<sup>1</sup>, Ven Iyer<sup>1</sup>

<sup>1</sup>Bollinger+Grohmann

Computational design is now ubiquitous in building practice having led to integrative, yet robust digital workflows. In a culture of highly interdisciplinary collaboration, information transfer, data management and communication are critical for the successful completion of a built project. Architects, engineers, and contractors are now able to communicate in a more common language, however contrary to industry demand, software does not often natively communicate to the same degree. To deliver optimal results a multi-faceted tool environment often ad-hoc solutions coupled with open-source tools provide much needed link to connect communication, processes and people. This paper presents a one such case study of a design and construction of a landmark urban artwork located in Sydney, Australia.

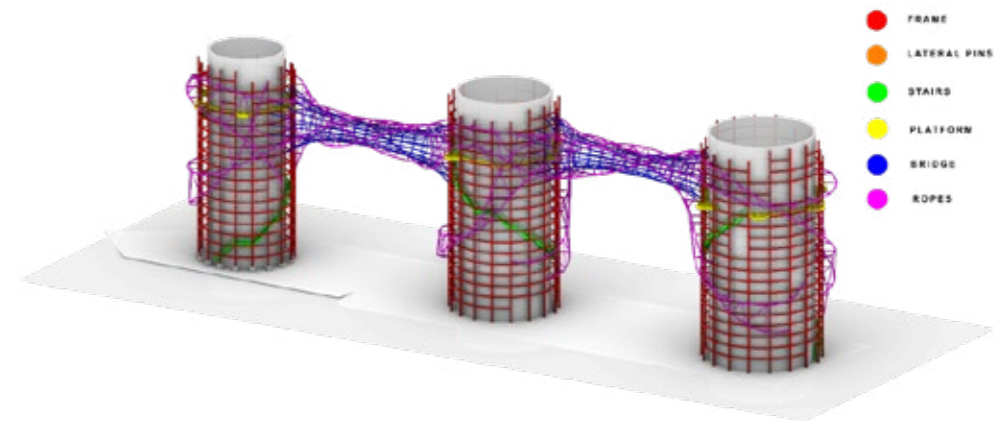

## Form finding and structural analysis of free-form shells with specified horizontal projected stress distribution

Mr Taku Nakajima<sup>1</sup>, Prof Makoto Ohsaki<sup>1</sup>

<sup>1</sup>Department of Architecture and Architectural Engineering, Kyoto University

This paper presents a form finding method for free-form shells that specifies the distribution of stresses projected onto the horizontal plane. The vertical coordinate of the shell surface is defined as a graph surface. The shell shape is given as a solution to the vertical equilibrium equations of the surface heights at the grid points discretized by the finite difference method. The equilibrium shape is found by sequentially solving the linear system of equations. We specify the shear stress distribution that satisfies horizontal equilibrium to generate various shell shapes. Finite element analysis is carried out to investigate the effect of elastic deformation on the stress distribution and to demonstrate that form found shell shapes resist external loads by membrane action.

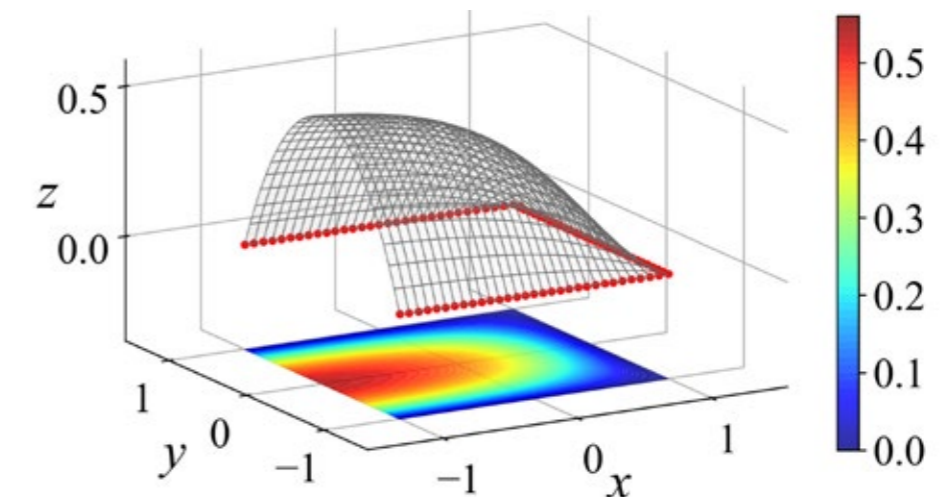

Thursday 13 July 2023



**Pixel Program: a filter-feature/quantitative-based approach towards a parametric program distribution Method for hybrid buildings**

Mr Alejandro Fuentes<sup>1</sup>, Mrs Marina Bonet<sup>2</sup>, Mrs Iris Wijn<sup>1</sup>

<sup>1</sup>KCAP, <sup>2</sup>OMA

In an era where Houses are as much benchmarked as technological devices, Could we be able to define a home just by the numerical point of view? This paper discusses the role of quantitative and data-driven approaches by integrating different analysis in program distribution in Architectural and Urban Design, using the concept of filtering and Boolean definitions. We rely on regulations to set the limits of welfare; can we use these quantifications and rules to abstractly to talk about concepts such as “house” or “school”? This methodology relies in syncretizing architectural and urban massing by voxelizing and addressing the spatial feasibility with the demanded features of each program. This enables a flexible and resilient assessment of a massing design.



**Real-world medical research centre in Melbourne, Australia: An exemplar project for cross-disciplinary parametric modelling to reduce building lifecycle carbon emissions.**

Mrs Amy Nuccio<sup>1</sup>, Mr Nader Nader Burjiawi<sup>2</sup>, Dr Max Marshall<sup>1</sup>, Mr Theodoros Galanos<sup>1</sup>, Mr Juan Pablo Sepulveda Corradini

<sup>1</sup>Aurecon, <sup>2</sup>Swinburne University of Technology

Given climate change predictions, designing low-emissions and high-performance buildings is becoming a pressing necessity for the AEC industry. Some researchers are focusing on novel structural systems with lower embodied emissions, whilst others designing high-performance façade systems to address these challenges. Our research employed both approaches to design a medical research center in Melbourne. We assessed the impacts of timber and concrete structural systems on embodied emissions, operational performance, façade airtightness, and thermal bridging. Using multidisciplinary parametric modeling, we evaluated different building fabric types and structural systems while considering factors such as daylighting, thermal comfort, current and future weather, and neighbouring developments.

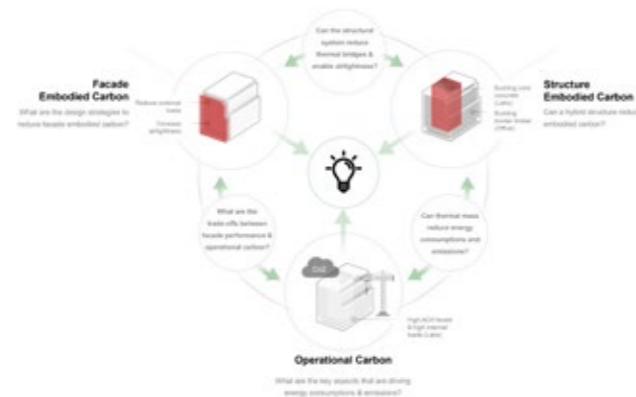

Thursday 13 July 2023

# Session 51

## Optimisation methods and applications 3

Room 215

14:00 - 16:00



# Thursday 13 July 2023



## Reconfigurable form-finding adopting tessellation and auxetic concepts

Mrs Sabrina Sparano<sup>1</sup>, Prof Alessandro Palermo<sup>1</sup>, Dr Thomas Woods<sup>1</sup>

<sup>1</sup>University of Canterbury

Auxetic structures present geometric tessellated patterns that exhibit a negative Poisson's Ratio, which can open novel applications in the structural engineering arena. The authors present preliminary results of an experimental campaign to study a modified re-entrant honeycomb auxetic structure. An analytical model of the structure is presented, considering the bending, shear, and axial deformations. The model is verified using finite element analysis (FEA) and physical testing. The structure is also compared to different tessellation patterns within different materials and scaling effects. Different loading protocols are also explored, including tension and compression-only and a combined cyclic (tension-compression) load with increasing displacement amplitudes. The preliminary results show that the failure mechanism can be predicted and tailored to the designer's needs.

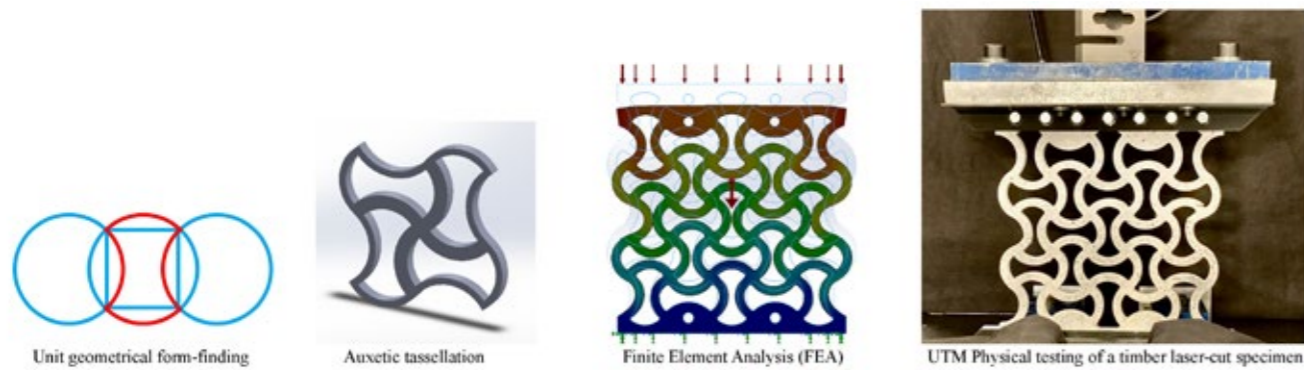

## Development of 3D mathematical models for tendon layout optimization by strain energy minimization

Miss Hanna Domnick<sup>1</sup>, Mr Juan Pablo Osman-Letelier<sup>2</sup>

<sup>1</sup>Technical University Berlin, <sup>2</sup>schlaich bergemann partner (sbp)

This paper proposes an efficient and practical tendon optimization method for tendon layouts in spatial structures. It is based on the minimization of strain energy, while also taking geometrical boundary conditions into consideration. The constrained optimization problem is solved using approaches from variational calculus, including the Rayleigh-Ritz method and Lagrange multipliers. The consideration of practical boundary conditions and the precise polynomial solution reduce post-processing and facilitate implementation in the structural design process. Numerical examples that apply the method to thin-walled beamlike structures demonstrate its applicability for both simple and complex systems with a variety of design constraints. The proposed method is efficient, flexible, and accurate, thus making it a powerful, yet user-friendly tool for designing more sustainable and lightweight structures.

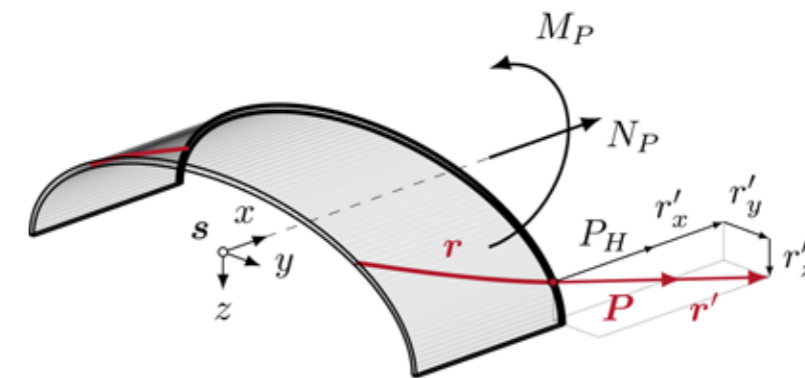

## The stability of laminated glass plate during anticlastic cold bending

Miss Xiaohan Hao<sup>1</sup>, Prof Suwen Chen<sup>1,2</sup>

<sup>1</sup>College of civil engineering, Tongji University, <sup>2</sup>State Key Laboratory for Disaster Reduction in Civil Engineering, Tongji University

The instability phenomena of monolithic glass plates in cold bending process are summarized, and the instability modes of monolithic glass plates are defined clearly. Detailed FEM models simulating cold bending process of laminated glass plates are established and validated against existing experimental results. The effects of different supporting conditions, laminate compositions, width-thickness ratios are investigated. Bifurcation instability is identified to be the only control condition for both monolithic and laminated glass plates. The instability mechanisms of laminated glass are discussed. A bidirectional compression area in the center of the plate is observed to dominate instability, but the compression area changes from bidirectional to unidirectional for laminated glass with larger width-thickness ratio and PVB thickness-glass thickness ratio.

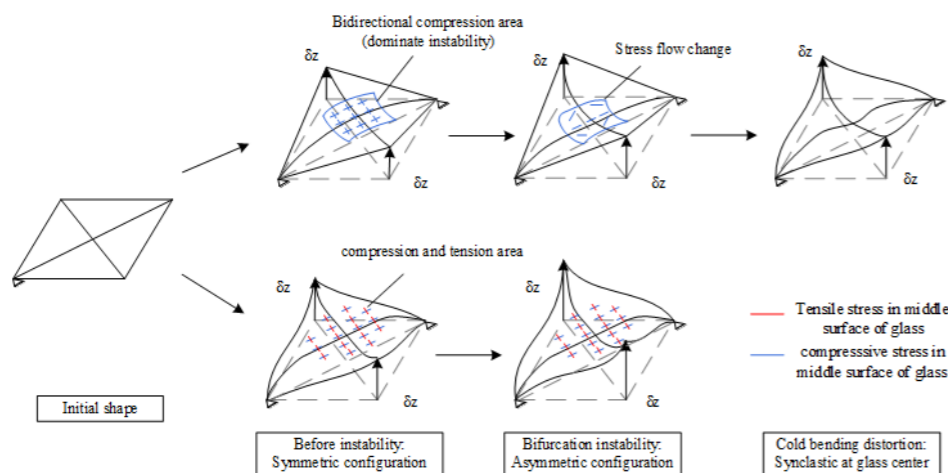

## Shape optimization of hyperellipsoid long-span structures.

Dr Zheng He, Mrs Y. Q. Qu<sup>1</sup>, Mr Z. Guo<sup>1</sup>, Mr Z. H. Li<sup>1</sup>, Mr X. Lai<sup>1</sup>

<sup>1</sup>Dalian University of Technology

This paper presents a modification on the height adjustment method (HAM) proposed by Cui and Yan for the shape optimization hyperellipsoid shells. In the modified HAM, all the joints of a shell of concern are always maintained to be located in hyperellipsoid surface during the optimization process. The sensitivity of total strain energy with respect to joint height originally provided by HAM is converted into that with respect to the control parameters of hyperellipsoid shells. The implementation of the modified HAM involves the construction of hyperellipsoid surface, finite element (FE) analysis and the optimal solution. The sensitivity and FE analysis parts, and its efficiency of the modified HAM is demonstrated by a case study.

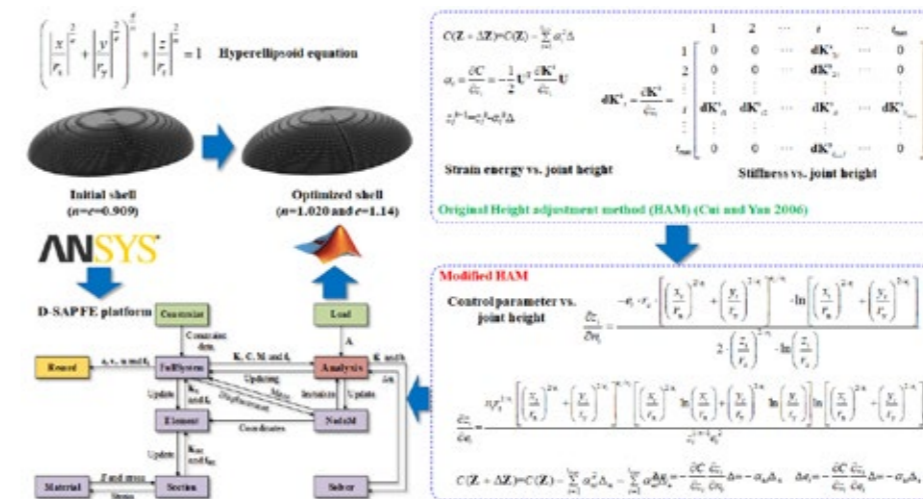

# Thursday 13 July 2023

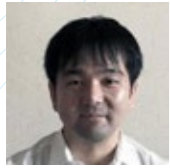

## Study on the influence of structural optimization techniques on architectural design, with a focus on topology optimization methods

Mr Bunji Izumi<sup>1</sup>, Prof Anders Rønquist<sup>1</sup>, Prof Bendik Manum<sup>1</sup>

<sup>1</sup>Norwegian University of Science and Technology

Structural optimization, which emerged in the 1960s, has played a significant role in modern structural design by reducing material consumption while maintaining performance. It can also make architecture more attractive. The author's research group examined structural optimization methods proposed between 2012-2021 and found that topology optimization is essential for architectural design. The study explores the application of these methods to architectural design by analyzing the content of a major online architectural magazine. The projects were investigated to determine if and how structural optimization methods were used and provide an analysis and discussion of the results to evaluate the impact of structural optimization in architectural design objectively.



## A Study on the Binary Harmony Search Algorithms for an Optimal Design of Truss System

Miss Ha Hyeonju<sup>1</sup>

<sup>1</sup>Korea Technology and Education

The Harmony Search (HS) algorithm, inspired by the process of tuning musical instruments, is widely used in optimizing various fields due to its simplicity and ease of use. The Binary Harmony Search (BHS) algorithm was developed to enhance search techniques in binary number optimization problems such as the knapsack problem of the decimal-based HS algorithm. In the development of BHS, it was discovered that the role of the pitch-adjust rate (PAR) operator could be improved by addressing the issue of the mutation operator. However, the success of binary-based algorithms in more complex problems heavily depends on how the PAR operator is defined. To address this issue, this study compared the characteristics of the algorithm according to the PAR operator with the decimal-based HS and bit-based algorithms and analyzed the results.

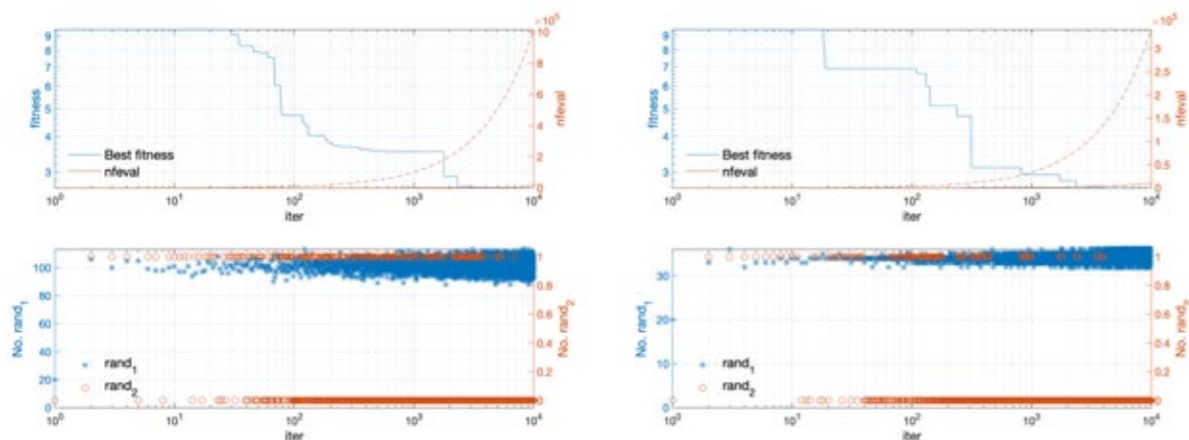

# Thursday 13 July 2023

# Session 52

## Active bending and graphical methods

Room 216

14:00 - 16:00

# Thursday 13 July 2023



## Calculation Method for Restoring Force of Member and Deformation Occurred by in Curved Surface Combined with Flat Plates and Bolts

Mr Daichi Mori<sup>1</sup>

<sup>1</sup>Tokai University

Morooka proposed a method for creating a curved surface structure by stacking bent flat plates together. However, the resulting model differs from the original surface, and this study aims to identify the cause of the shape difference and develop a division method to minimize it. The study suggests that the restoring force generated by elastically bending the plates causes them to deform differently from the target shape. The validity of this assumption was confirmed through numerical analysis. The study also developed a general equation for the restoring force that considers the effect of the flat plate shape, enabling the calculation of the restoring force and displacement for any division shape. The study explored division shapes that could reduce displacement.

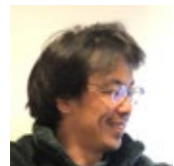
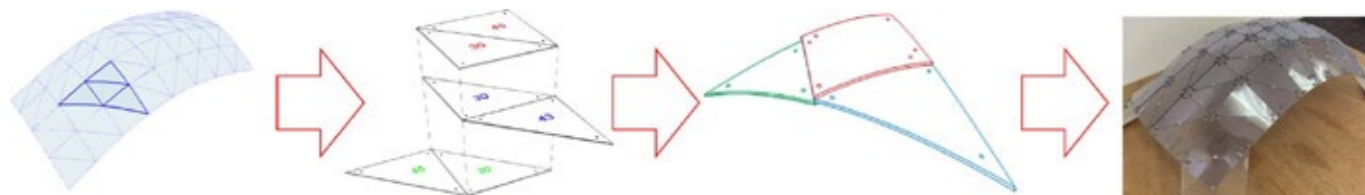

## The extended affine method for form finding of a spoke wheel system in light of graphic statics: part 2

Dr Hiroki Tamai<sup>1</sup>

<sup>1</sup>Nikken Sekkei

This paper provides an alternative proof for the proposition that the ring shapes of a spoke wheel system, having equal and uniform magnitude of forces in the compression and tension rings and equal forces in the radial cables, as well as minimizing the sum of the squared segment lengths, approach to a cycloid if the division number increases infinitely. The proof is rendered in the dual space expressed by the Airy stress force polyhedra. The optimality condition about the minimum sum in terms of x and y coordinates in the form diagram can be translated in terms of only z\* coordinates of the force polyhedra, and the recursive expression represents a polyline inscribing to the trajectory of a rotating regular n-polygon.

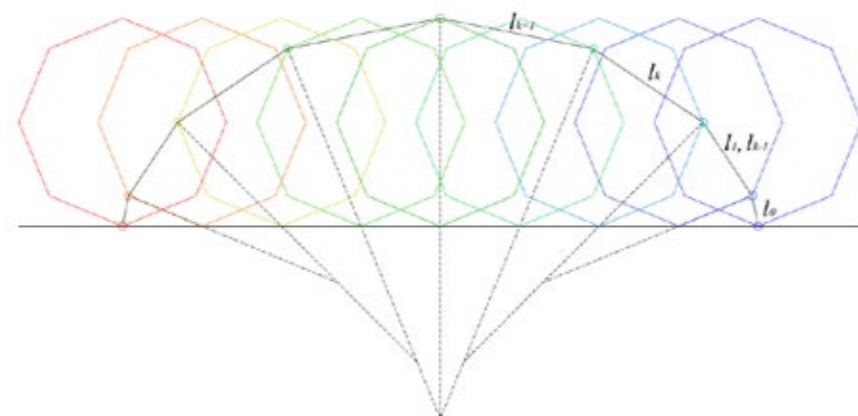

## Investigation of cross-sections for hybrid gridshells based on bending-active formwork

Ms Yasaman Yavaribajestani<sup>1</sup>, Dr Michael Herrmann<sup>2</sup>, Professor Khalid M. Mosalam<sup>3</sup>, Dr Simon Schleicher<sup>1</sup>

<sup>1</sup>University of California, Berkeley, Department of Architecture, <sup>2</sup>structure GmbH Stuttgart and Technische Hochschule (TH) Lübeck, <sup>3</sup>University of California, Berkeley, Department of Civil and Environmental Engineering and Pacific Earthquake Engineering Research Center

This study explores the behavior of hybrid concrete-carbon fiber reinforced polymer (CFRP) cross-sections for use in bending-active gridshells as lost formwork and external reinforcement. Eighteen test specimens were tested under a four-point bending arrangement, with variations in their internal and external reinforcement and bonding properties between the two materials. The results show that the load-bearing capacity of gridshell beams, with full bonding between CFRP and concrete, is more than 320% higher than that of the concrete-only control beams. This study concludes that externally bonded CFRP strips not only serve as effective formwork for concrete gridshells, but also exhibit a beneficial composite effect in the interaction between the two materials of a hybrid cross-section.



## Interlocking connections for bending-active timber structures with variable stiffness

Ms Maren Zywietz<sup>1</sup>, Ms Annette Bögle<sup>1</sup>, Mr Ehsan Taghiyar<sup>1</sup>

<sup>1</sup>HafenCity University Hamburg

Material and energy shortages make efficient material use, reuse and recycling urgent issues in 21st century construction. Wood as a renewable resource is back in focus, with potential use in lightweight gridshells. Many timber gridshells use the principle of bending-active structures, with their shape largely determined by material and cross-sectional properties. However, commonly used timber with non-biodegradable glue and inseparable connections cannot be returned to material cycles. Consequently, this challenges sustainable building practices. This paper presents a reconfigurable modular system for elastically bent solid timber laths using interlocking connections and segmented cross-sections, while providing novel design possibilities through variable stiffness. The results show that circular design in bending-active timber structures can contribute to quality craftsmanship and a new architectural language.



Thursday 13 July 2023



**3D auxetic materials designed with algebraic polyhedral graphic statics**

Mr Yao Lu<sup>1</sup>, Dr Márton Hablicsek<sup>2</sup>, Dr Abdolhamid Akbarzadeh<sup>3</sup>, Dr Masoud Akbarzadeh<sup>1</sup>

<sup>1</sup>University of Pennsylvania, <sup>2</sup>Leiden University, <sup>3</sup>McGill University

As a continuation of the previous research that proposes to use algebraic 2D graphic statics for the design of 2D auxetic metamaterials, this paper presents a novel approach to designing 3D auxetic metamaterials using an algebraic formulation of polyhedral reciprocal diagrams (PGS), resulting in concave geometric configurations that are shared by many auxetic materials. The proposed method offers two approaches for generating these concave configurations: modifying a convex polyhedral framework using geometric transformations or constructing a concave polyhedral framework directly using the algebraic formulation of PGS. The validity of the proposed method is demonstrated by testing two models using the finite element method, which clearly shows a negative Poisson's ratio.

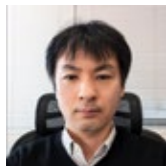
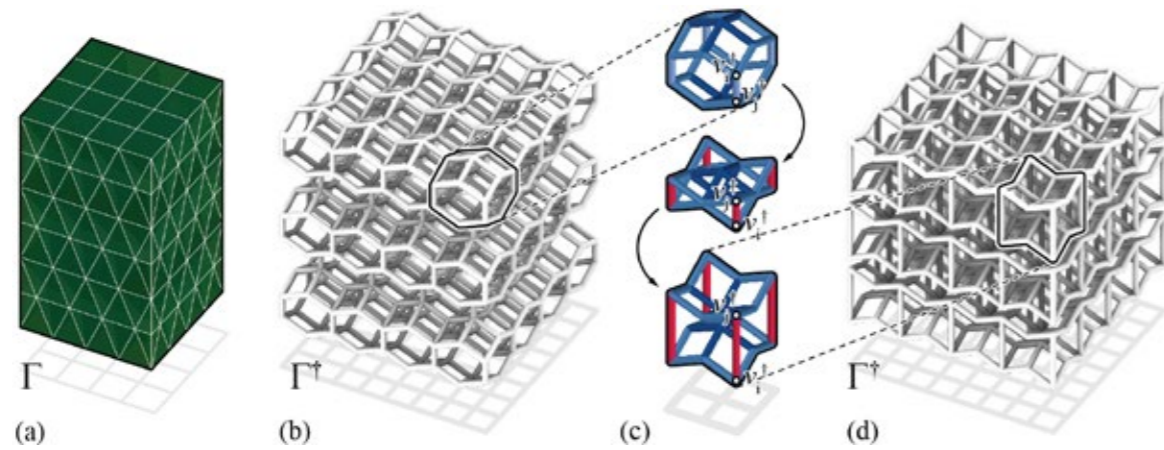

**Study on shape control method for active bending arch structures using kerf bending technique**

Prof Yuki Ozawa<sup>1</sup>, Mr Akihito Yokota<sup>2</sup>, Mr Satoshi Ohki<sup>1</sup>

<sup>1</sup>Shibaura Institute of Technology, <sup>2</sup>VUILD Inc

Kerf bending (KB) is a technique to reduce bending stiffness and enabling curvature by providing openings or cutouts in inflexible flat materials. This study focuses on the application of the KB technique for unidirectional bending and proposes a shape control method for active bending arch structures generated through movement of supported points to attain target shapes. The efficiency of this approach is validated through experimental and analytical examinations. By combining information about the required curvature distribution and the slit arrangement- stiffness reduction relationship, the optimal slit arrangement can be determined.

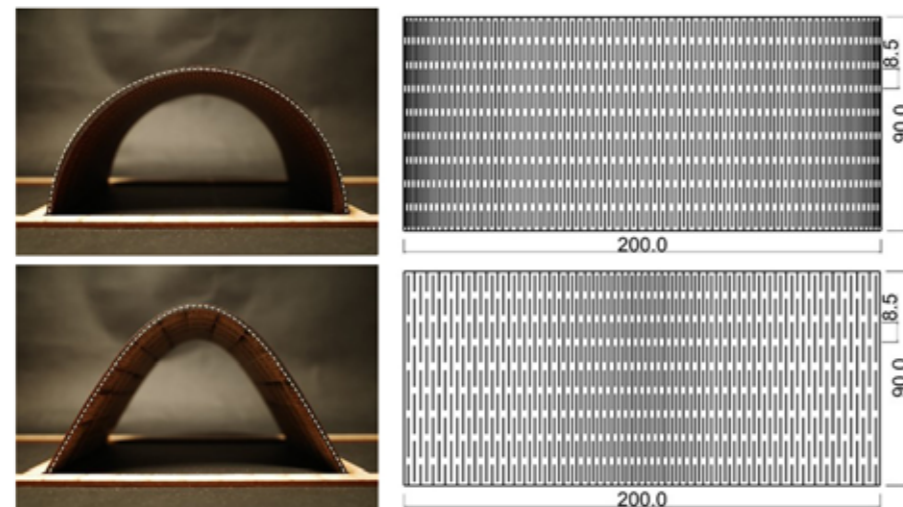

Thursday 13 July 2023

**Session 53**

**Building and construction**

Room 217

14:00 - 16:00

# Thursday 13 July 2023

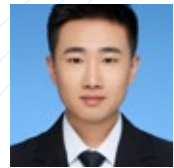

## Study on the dismantling method of cable-strut tension structures

Dr Jiaqi Yang<sup>1</sup>, Prof Yue Wu<sup>1</sup>

<sup>1</sup>Harbin Institute of Technology

In order to promote the application of building deconstruction for prestressed structures, the dismantling methods of cable-strut tension structures were investigated in this study. Four possible dismantling methods were proposed based on the idea of releasing inside prestress by relaxing cables, and their mechanical state of the structure during dismantling, dismantling efficiency and cost of the four methods were compared using the numerical simulation method based on VFIFE. Results indicated that the method of relaxing radial cables and method of dropping inner rings has more advantages. Then, a dismantling experiment was carried out that confirmed the dismantling method of dropping inner rings is feasible and the numerical simulation method is accurate.



## Shape generation of hexagonal lattice shell consisting of edge offset mesh

A/Prof Ryo Watada<sup>1</sup>, Prof Makoto Ohsaki<sup>2</sup>

<sup>1</sup>Osaka Sangyo University, <sup>2</sup>Kyoto University

In the process of designing latticed shells, it is important that the lattice members have the same crosssection (height) and no torsion to avoid eccentricity at the joints and reduce the manufacturing cost, which is known as the property of edge offset mesh (EO mesh). We propose a two-level optimization approach to generating hexagonal meshes which satisfy the properties of EO mesh for all edges. In our method, each face of the EO mesh is sequentially added in a manner that the new face is close to a predefined target surface keeping parallelity to a Koebe mesh which is determined by Möbius transformation from a planar circular net. The effectiveness of the proposed method is demonstrated by a numerical example.

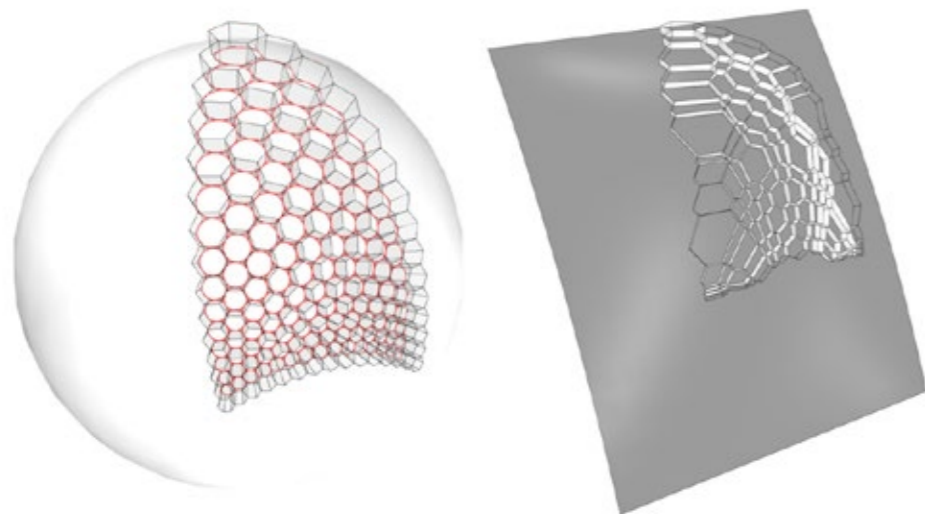

## Structural features of Dong'an Lake Stadium roof

Mr Xin-an Xiang, Mrs Yuan Feng<sup>1</sup>, Mr Wen-ming Chen<sup>1</sup>, Mr Quan Zhou, Dr Xin An Xiang<sup>1</sup>

<sup>1</sup>China Southwest Architectural Design and Research Institute Corp. Ltd

The Dong'an Lake Sports Park Stadium will serve as the main venue for the opening ceremony of the 31st World University Games. Its roof is a perfect circle with a projected diameter of 295m and a cantilever length of 45m. Through fine structural design, the Sun Bird pattern was realized on the light roof with extra-long, large-span and large-cantilever. Different from the conventional design, a 25m wide viewing platform of 300m long was set on the large-span steel roof. In this paper, the selection of structural system, optimization of structural arrangement, resolution of complex space and realization of rapid construction are introduced. The perfect integration of structural force and architectural beauty was achieved through refined design.

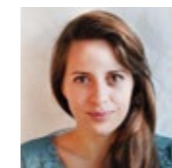

## Fabrication methods for topology-optimized massive glass structures

Dr Faidra Oikonomopoulou<sup>1</sup>, Mr Menandros Ioannidis<sup>1</sup>, Ms Anna Maria Koniari<sup>1</sup>, Dr Telesilla Bristogianni<sup>1</sup>

<sup>1</sup>Delft University of Technology, Faculty of Architecture + The Built Environment

In this work, we discuss (i) casting in disposable moulds, (ii) waterjet cutting and lamination of float glass panes and (iii) additive manufacturing of glass, as possible fabrication methods for three-dimensional glass structures of complex and customized geometries derived from structural Topology Optimization. We assess these methods according to a set of criteria linked to the structural performance, visual quality, fabrication limitations and sustainability. Accordingly, we discuss the potential, challenges and practical limitations of each fabrication method for real-world applications of TO glass structures. Subsequently, we propose the integration of alternative constraints into the TO formulation, so that customized TO tools that better reflect each fabrication method for glass can be created.

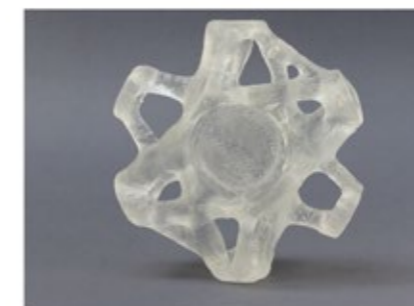

Glass casting in disposable moulds (image by Wilfried Damen)



Waterjet-cutting and bonding of float glass (image by Faidra Oikonomopoulou)

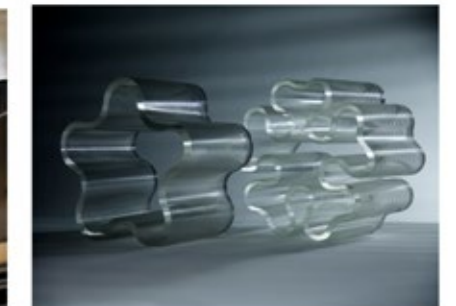

Additive manufacturing of glass (image by Chikara Inamura)

# Thursday 13 July 2023



## Tile patterning on free-form surfaces that reduces tile cutting

Ms Chaoyu Du<sup>1</sup>

<sup>1</sup>Eth Zurich

We propose a new strategy for generating staggered patterns for standard, rectangular tiles on free-form surface. The given input surface is firstly tessellated into near-square quadrilateral faces using a re-meshing algorithm. Afterwards, we run a matching algorithm that assigns each tile to two adjacent faces. We use binary integer programming to find a tessellation on the surface that minimises the number of unique tiles and tiles that are not staggered. Lastly, we generate the tiles and post-process the tessellation result.

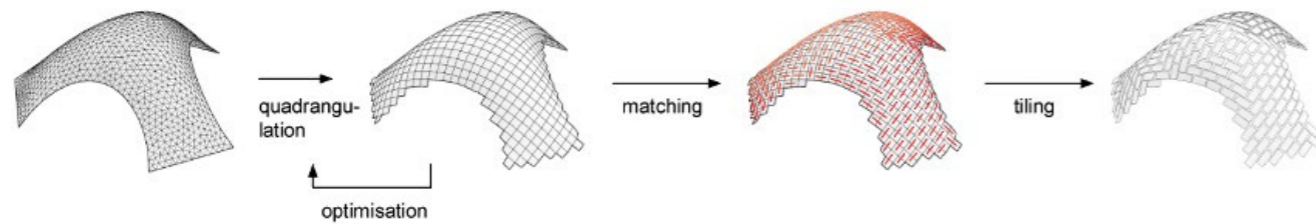

## The hybridstatics by Heinz Hossdorf - interaction between physical models, material and the first computers

Mr Baris Wenzel<sup>1</sup>, Mr Eberhard Moeller<sup>1</sup>, Mr Benjamin Schmid<sup>2</sup>, Ms Christiane Weber<sup>2</sup>

<sup>1</sup>Karlsruhe University of Applied Sciences, <sup>2</sup>University of Innsbruck

Heinz Hossdorf (1925-2006) was an exceptional engineer. His research and work included very different fields, such as small-scale physical model tests, electronics, structural engineering, architecture, computer applications, three-dimensional CAD (ITS-10), revolutionary calculation methods such as the Finite Element Method, and the development of new materials [1]. For him, model statics was well on the way to overcoming its conventional cumbersomeness through the sensible integration of electronic calculating machines as process computers in the test sequence and to increasing the reliability of the experimentally recorded data. This paper gives an overview of the wide range of hybrid static including materials, which Heinz Hossdorf used to achieve technological progress in the field of civil engineering.



# Thursday 13 July 2023

# Session 54

## Design Competition

Room 218

14:00 - 16:00

# Thursday 13 July 2023



## Controlling Frills of Bending-Active Negative Curvature Surface

Prof Tomohiro Tachi<sup>1</sup>, Fuki Ono<sup>3</sup>, Miwako Kase<sup>2</sup>, Kotaro Sempuku<sup>2</sup>, Mizuki Shigematsu<sup>2</sup>, Hiroki Tamai<sup>2</sup>, Seri Nishimoto<sup>1</sup>

<sup>1</sup>The University of Tokyo, <sup>2</sup>Nikken Sekkei Ltd., <sup>3</sup>Taiyo Kogyo Corporation

Frilly ruffles appearing in natural forms, such as coral and leaves, are induced by in-plane differential growth. Previously, we proposed a mechanism using bending-active scissors that reproduces these self-organized ruffles through the incompatibility of in-plane deformation produced by scissor units; however, the study left unsolved questions. This study analyzes the symmetry-breaking process of deployment and zero-stiffness wave-like motion after deployment through simulation. We propose how to control this wave-like motion by pulling the group of threads. We fabricated a meter-scale structure by assembling bar and pivot parts made of vulcanized fiber, chemically processed cellulose paper. The joint parts are utilized the material's plasticity in a wet state and stiffness in a dried state.

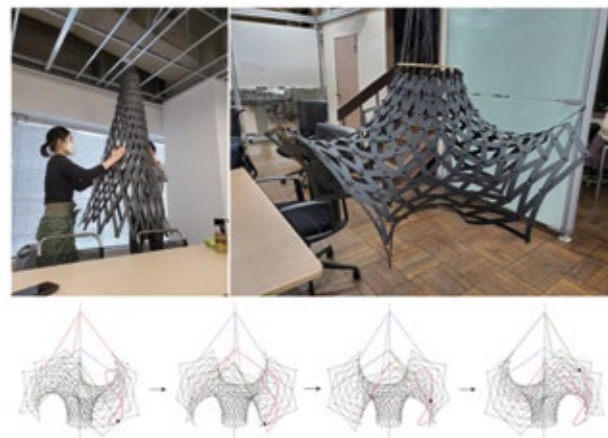

## Clustering and optimisation of nodes, beams and panels for cost effective fabrication of free-form surfaces

Dr Minghao Bi<sup>1</sup>, Mr Yuanpeng Liu<sup>1</sup>, Prof Yi Min Xie<sup>1</sup>

<sup>1</sup>Centre for Innovative Structures and Materials, School of Engineering, RMIT University

In this work, we present a mesh-based computational design framework that clusters and optimises nodes, beams and panels together to reduce the shape variety of elements for free-form surfaces. The proposed method uses a vertex-based similarity metric to partition panels into a user-specified number of groups and cluster beams based on the associated edge lengths. Box-constrained optimisation is then employed to obtain congruent faces and matching beam lengths while satisfying gap size, fairness and shape preservation constraints. Finally, connection holes on the spherical surfaces of nodes are clustered and optimised to allow their use at multiple locations. The practicality of the proposed method is demonstrated through the design and fabrication of a full-scale pavilion with doubly curved surfaces.



## A reconfigurable construction system based on hypar timber components

Dr Markus Hudert<sup>1</sup>, Mr László Mangliár

<sup>1</sup>Aarhus University

With the aim of contributing to a higher degree of circularity in the building construction sector, and a more efficient use of resources, the here presented research explores the potential of upcycling scrap wood into modular construction components with a hypar geometry, to be used as part of reusable and reconfigurable construction systems. In addition to introducing a new approach toward upcycling scrap wood, it also presents a novel method for building hypar components from planar wooden pieces. On a more general note, the work suggests going beyond the use of shell structures as monolithic and static artefacts. By investigating reusable and reconfigurable shell-based structures, it adds to and expands on existing research on segmented shells.

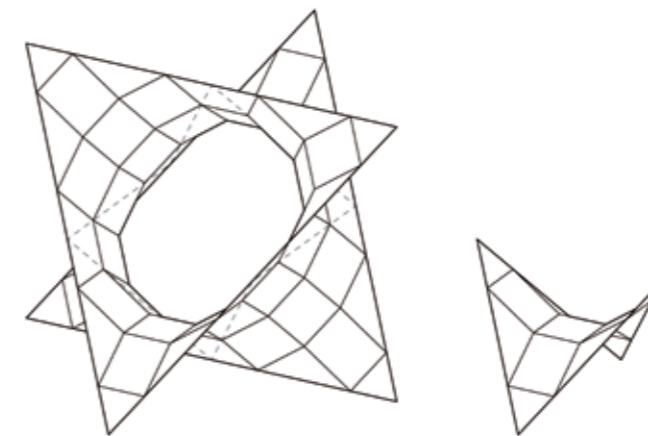

## Triply periodic discrete surface of constant negative curvature constructed from one type of piece

Mr Kanata Warisaya<sup>1</sup>, Ms Seri Nishimoto<sup>1</sup>, Mr Toshiyuki Morishima<sup>2</sup>, Prof Tomohiro Tachi<sup>1</sup>

<sup>1</sup>The University of Tokyo, <sup>2</sup>Kawakami Sangyo Co., Ltd.

Shellular structures, i.e., cellular structures composed of a single smooth 2-manifold surface, have recently received attention in the context of architecture, structures, and materials. This study aims to efficiently construct shellular structures using sheet materials by dividing the surfaces into a single type of piece by using the geometry of hypar surfaces, discrete surfaces of constant negative curvature consisting of congruent triangles. We realize the shellular structure homeomorphic to but slenderer (or thicker) than Schwarz's D-surface with a variant of the hypar surfaces. Each piece with integrated joints were fabricated by cutting and perforating a sandwich panel of polypropylene. We build a pavilion that can be assembled and disassembled and compactly folded for convenient storage and transportation.



# Thursday 13 July 2023



## Coupled thick-panel origami tubes along creases for stiff deployable structures

Mr Sunao Tomita<sup>1</sup>, Mr Kento Shimanuki<sup>1</sup>, Dr Kazuhiko Umeoto U<sup>1</sup>, Dr Atsushi Kawamoto<sup>1</sup>, Dr Tsuyoshi Nomura<sup>1</sup>, Dr Tomohiro Tachi<sup>2</sup>

<sup>1</sup>Toyota Central R&D Labs., Inc., <sup>2</sup>The University of Tokyo

The coupling of origami tubes along the creases for easy coupling of thick-panel origami tubes is proposed. As thick origami tubes can generate one-degree-of-freedom (DOF) motions based on a hinge-shift technique, coupling of origami tubes mirrored along creases also provides one-DOF motions because of the mirror symmetry along the creases. To demonstrate that the proposed coupling method contributes to the high stiffness of the coupled origami tubes, an eigenvalue analysis by bar and hinge models is performed. A wide gap in eigenfrequencies is obtained between the one-DOF mode and elastic modes, indicating that the one-DOF motion provides flexible deployment, and the elastic deformations retain high stiffness. In addition, meter-scale coupled origami tubes are fabricated based on the proposed coupling method.

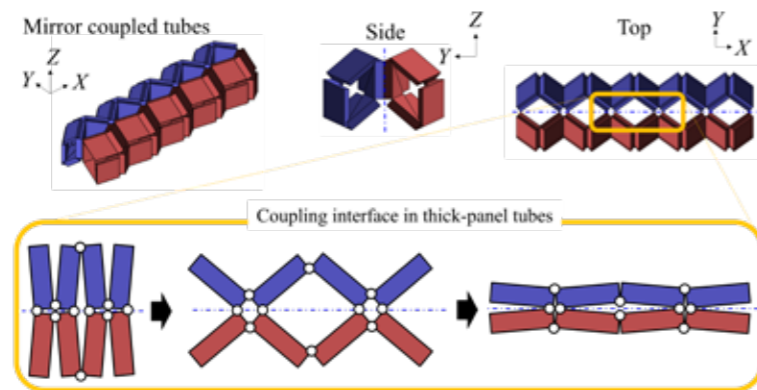

## Constructing topologically optimized spatial structure using innovative mortise-and-tenon joints

Dr Ding Wen Bao<sup>1</sup>, Dr Congcong Ren<sup>2</sup>, Dr Xin Yan<sup>3</sup>, Prof Yi Min Xie<sup>1</sup>

<sup>1</sup>RMIT University, <sup>2</sup>Beijing University of Civil Engineering and Architecture, <sup>3</sup>Tsinghua University

This research investigates the development of a topologically optimized model that combines the fabrication method of timber mortise-and-tenon joints. The model provides an innovative design tool that facilitates the exploration of topologically optimized form whilst simultaneously satisfying the criteria of spatial quality and functions. This paper introduces an innovative mortise-and-tenon joint fabrication method that can be easily generated based on a finite element model after topology optimization, with the convenience of on-site augmented reality (AR) assisted assembling. This project aims to achieve material efficiency and light-weighting through a combination of innovative advanced tools and traditional woodworking techniques. The prototype pavilion is proof of the concept for the great potential in applications of on-site modular buildings, installations, and artworks.



# Thursday 13 July 2023

# Session 55

## Bamboo structures

Room: Plenary 3

14:00 - 16:00



# Thursday 13 July 2023



## Preliminary study on relationship between culm morphology and mechanical characteristics of Japanese bamboo

Dr Takuo Nagai<sup>1</sup>

<sup>1</sup>The University of Shiga Prefecture

Recently, there has been growing interest in bamboo as a building material, with challenges in understanding its mechanical properties, durability, and construction methods. The anisotropic nature of bamboo causes variations in its physical properties. This study investigates the morphology and mechanical properties of Japanese bamboo species *Phyllostachys edulis* and *Phyllostachys bambusoides*. Geometric properties were standardized based on culm diameter at the base. The strength and elastic modulus in the fiber parallel direction varied greatly depending on culm morphology and position, while the fiber perpendicular direction showed low sensitivity to these factors and exhibited little influence. Further research is needed to systematically develop bamboo's properties.

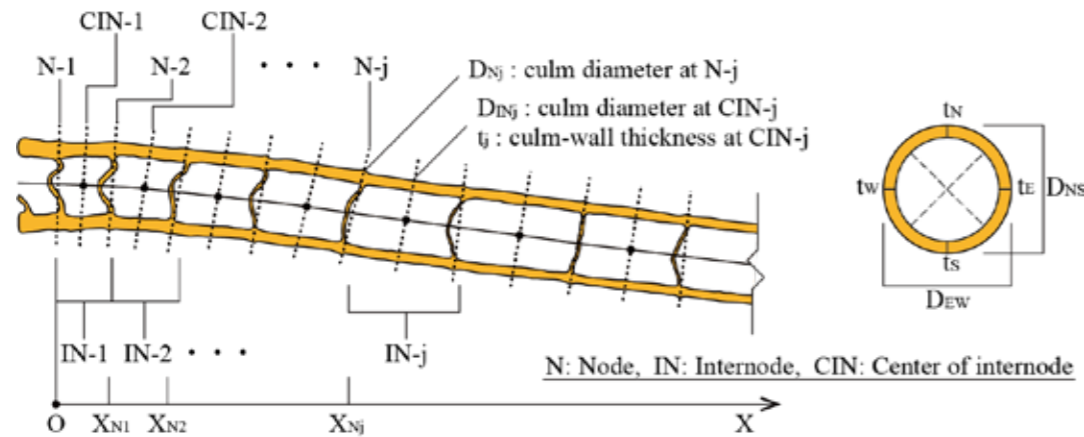

## Experimental evaluation of load-induced cracking in moso bamboo tubes

Dr Dan Bompa<sup>1</sup>, Mr Emmanuel Ebo<sup>1</sup>, Dr S. Alireza Behnejad<sup>1</sup>, Prof Holmer Savastano Jr<sup>2</sup>, Dr Arash Azadeh<sup>2</sup>, Dr Moe Pourghaz<sup>3</sup>

<sup>1</sup>School of Sustainability, Civil and Environmental Engineering, University of Surrey, <sup>2</sup>Department of Biosystems Engineering, Faculty of Animal Science and Food Engineering, University of São Paulo, <sup>3</sup>Department of Civil, Construction, and Environmental Engineering, North Carolina State University

This paper evaluates the experimental compression, shear, and splitting response of moso bamboo. Culm tubes with an aspect ratio of 1.0 and 3.0 were tested in oven-dry, ambient-dry, or wet conditions. Apart from conventional measurements, the use of digital image correlation enables an assessment of stress localisation characteristics. The results indicate that depending on the loading type, a rise in moisture levels from oven-dry to ambient-dry to wet conditions results in a proportional reduction in strength but a marginal increase in ductility. Short samples failed at a higher average stress compared to long samples, suggesting that increasing the aspect ratio of the sample leads to a decrease in tube strength.

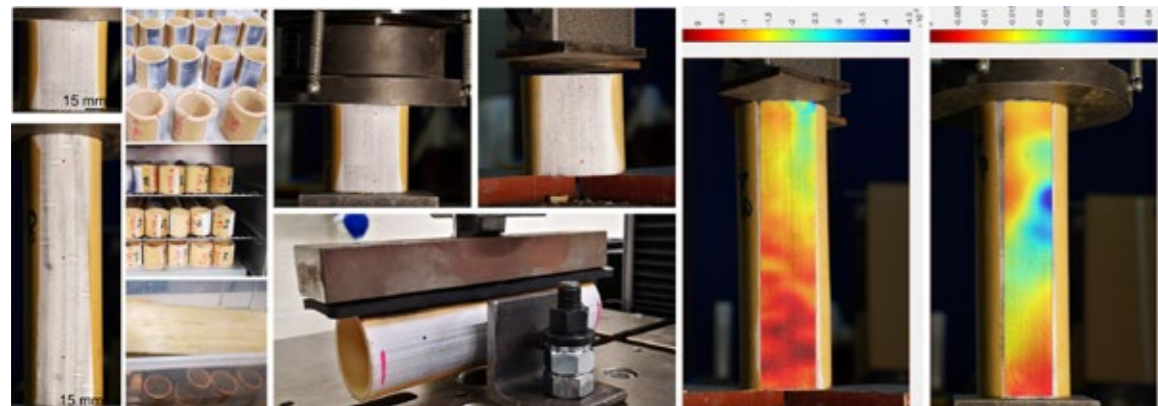

## The potential of engineered bamboo for lamellar gridshells

Dr Leila Meneghetti<sup>1</sup>, Professor Ruy Pauletti<sup>1</sup>, Dr Mônica Garcez<sup>2</sup>

<sup>1</sup>University Of São Paulo, <sup>2</sup>University of São Paulo, <sup>3</sup>Federal University of Rio Grande do Sul

Bamboo is a popular and sustainable material for traditional and high-end construction, but its natural variability limits its potential for mainstream construction. Engineered Bamboo (EB) is a composite material that overcomes these limitations and has been used primarily for decorative and surface applications. However, EB has the potential for more demanding structures such as lamellar gridshells, which are composed of short elements connected at their ends. This paper investigates the performance of alternative connections made of EB for Voronoi tessellated gridshells. Preliminary results of different node configurations under bending and compression are presented, which encourage the application of EB in lamellar gridshell structures.

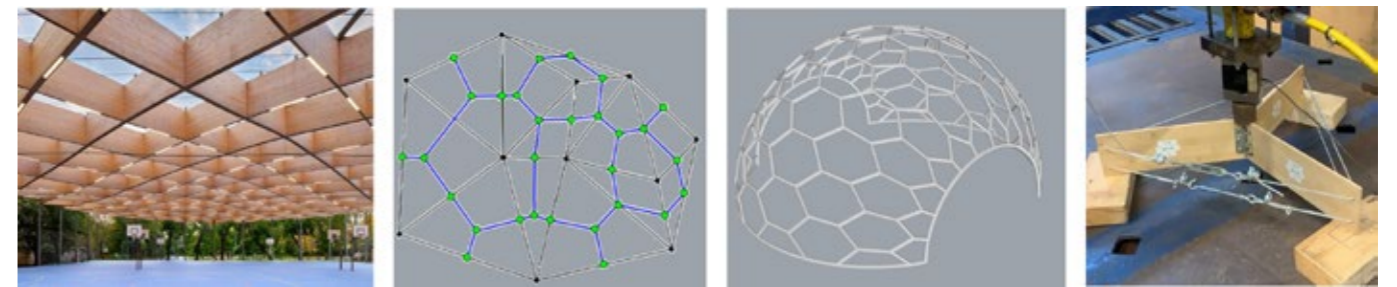

## Morphological generation of bamboo arched reciprocal frame structures considering variation in diameters by means of GA

Prof Koichiro Ishikawa<sup>1</sup>

<sup>1</sup>University of Fukui

This paper proposes many mathematical formulas for defining the limitation of the number of the elements and gaining more morphologies caused by the variable domains of the parameters known as engagement ratios ( $\lambda$ ). After that, to apply bamboo culms to the structures, Moso bamboos widely grown in Japan are used as the structural materials and their taper ratio known as a new parameter of configurations is measured to determine the variable eccentricities ( $e$ ). By mixing up all the parameters, basically translational and rotational methods are introduced.

**Figure 1:**  
Morphologies due to  $\lambda$

$$f(e_i, \theta_i) = \sum_{i=1}^{k-1} \omega_i^1 (\omega_1^2 |e'_i - e_i| - \omega_2^2 \theta_i)$$

$$\omega_i^1 = \frac{1}{2^i}, \sum_{i=1}^k \omega_i^1 = 1$$

$$\omega_1^2 + \omega_2^2 = 1, \omega_2^2 = 4\omega_1^2$$

**Equation 1: The composite weight optimization method**

$k$ : Number of elements  
 $\theta$ : Rotational angles  
 $e$ : Target eccentricities  
 $e'$ : Optimized eccentricities  
 $|e' - e|$ : Gaps  
 $\omega$ : Weights due to the relationship between connections  
 $\omega$ : Weights due to the relationship between Rotational angles and Gaps

(a)

(b)

**Figure 3: The topology**

# Thursday 13 July 2023



## Study on compression strength of Japanese full-culm bamboo columns using short length specimens

Mr Keisuke Oki<sup>1</sup>, Dr. Takuo Nagai<sup>1</sup>

<sup>1</sup>The University of Shiga Prefecture

This study presents a method for estimating the compression strength of full-culm bamboo columns. The method uses FEM linear buckling analysis and takes into account the variation of the bamboo culm cross-sectional area and bending Young's modulus. Results show that the buckling load of the full-culm bamboo column can be estimated with high accuracy. However, physical properties such as moisture content and dry density can affect bending Young's modulus, and their relationship needs further clarification. This research contributes to a better understanding of how to evaluate compression strength in full-culm bamboo columns, which is essential for the development of sustainable building materials. The proposed method could be useful in future studies and applications related to bamboo structures.

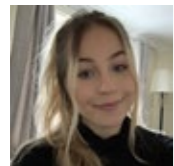
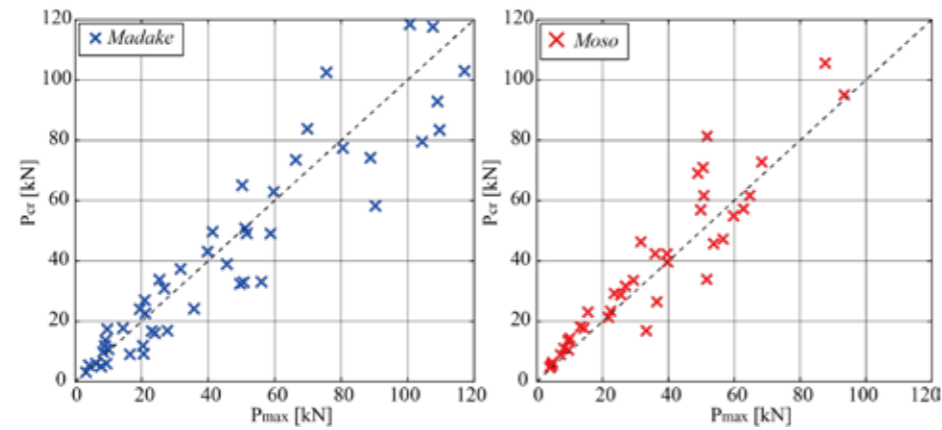

## Development of Full-Scale Bamboo Kits for Educational Activities

Miss Hanna Stoneman<sup>1</sup>, Dr Alireza Behnejad<sup>1</sup>

<sup>1</sup>Spatial Structures Research Centre, School of Sustainability, Civil and Environmental Engineering, University Of Surrey

This paper discusses the suitability of bamboo as a green and cost-effective material for lattice spatial structures in construction. It focuses on educating Civil Engineering students on the techniques used in bamboo construction by assembling three full-scale kits with different connection methods: steel single bolt, aluminium steel nodal, and bamboo triangles with glue. The kits are assessed based on constructability, time and ease of construction, and visual appeal to determine the preferred connection method. The study aims to improve practical considerations in bamboo design and increase confidence in using bamboo as a structural material. This paper aims to promote the use of bamboo in construction and serve as a reference for future engineering and research.



## An investigation of the mechanical test methods for bamboo characterization

Dr Holmer Savastano junior<sup>1</sup>, Dr Arash Azadeh<sup>1</sup>, Dr Alireza Behnejad<sup>2</sup>, Dr Mohammad Pour-Ghaz<sup>3</sup>, Dr Dan V. Bompa<sup>2</sup>

<sup>1</sup>University of São Paulo, Faculty of Animal Science and Food Engineering, Department of Biosystems Engineering, <sup>2</sup>School of Sustainability, Civil and Environmental Engineering, University of Surrey, <sup>3</sup>Department of Civil, Construction, and Environmental Engineering

The objective of this presentation is a new approach to bamboo mechanical test methods, challenges, and comparing the efficiency of different mechanical test methods for bamboo as a functionally graded material. Tensile, compression, bending, and shear test methods are considered and different test methods for each single test are compared and suggestions are proposed to improve each test method. For the tensile test study, the effect of sample shape and size, for the bending test, the effect of fiber distribution and sample positioning on bending resistance, and for the shear test, the different shear test methods will be discussed.

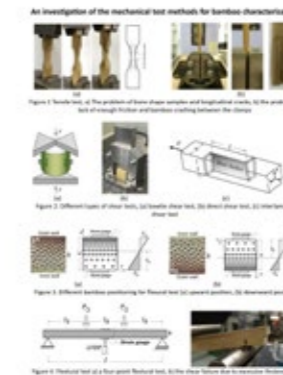

## Drying-induced cracking in bamboo

Prof Moe Pourghaz<sup>1</sup>

<sup>1</sup>Nc State University

The construction industry is the largest consumer of natural resources, and sustainable construction materials are urgently needed. Bamboo has potential as a sustainable construction material, but its widespread application is hindered by drying-induced cracking. The main goal of this presentation is to understand the factors contributing to drying-induced cracking of bamboo. The hypothesis is that the rate and extent of drying, combined with porosity gradient and geometry effects, result in the formation of cracks. Dynamic Mechanical Analysis (DMA) is used to experimentally evaluate the viscoelastic properties of bamboo equilibrated at different relative humidity values. Linear length-change measurements are also performed to understand contributing factors to drying-induced cracking. DMA results indicate the presence of a mechanical property gradient, which can be quantified to understand its impact on drying-induced cracking.

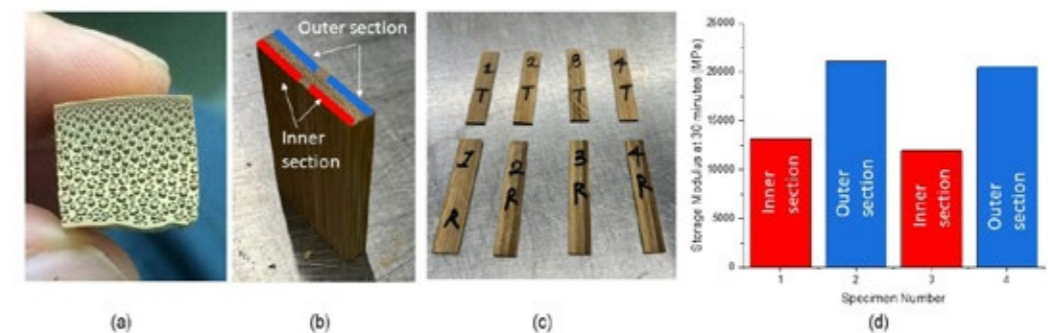

Figure 1: (a) A photograph of cross section of bamboo (*Dendrocalamus Asper*); (b) slab sample cut from the cross section of bamboo; (c) Dynamic Mechanical Analysis (DMA) samples cut from the slab geometry to quantify the mechanical property gradient; (d) Storage modulus measured using DMA corresponding to the highlighted section in image (b), showing the gradient of storage modulus in the cross section of bamboo.



**IASS 2023**  
July 10–14 Melbourne  
Integration of Design  
and Fabrication