



SEM-0534 Processos de Fabricação Mecânica

Aula 1

Processo de Torneamento

Professor:

Alessandro Roger Rodrigues



Processo: Torneamento

Definições:

Torneamento é o processo de usinagem para superfícies cilíndricas externas e cônicas com uma ferramenta com geometria monocortante.

O processo usa uma máquina ferramenta denominada Torno.

Processo: Torneamento

- Torneamento cilíndrico externo: avanço paralelo ao eixo da peça
- Faceamento: avanço perpendicular ao eixo da peça.
- Superfícies chanfradas ou perfiladas: avanço simultâneo nos dois sentidos

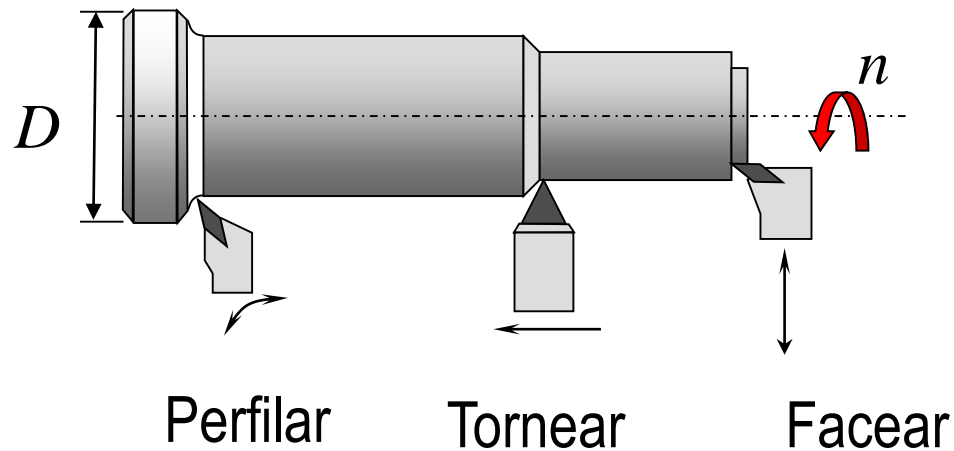

Operações de Torneamento



Operações de Torneamento e Ferramentas Usadas	Esquema	Operações de Torneamento e Ferramentas Usadas	Esquema
<p>a - Torneamento Cilíndrico Externo com ferramenta reta</p>		<p>b - Torneamento Cilíndrico Interno ou Mandrilamento com um bit fixado em uma barra</p>	
<p>c - Torneamento Cônico Externo com ferramenta reta</p>		<p>d - Torneamento Cônico Interno com barra de mandrilar</p>	
<p>e - Torneamento de Faceamento com peça presa na placa ou entre centros</p>		<p>f - Sangramento Radial Externo com ferramenta de sangramento externo</p>	
<p>g - Sangramento Radial Interno com ferramenta de sangramento interno</p>		<p>h - Sangramento Axial com ferramenta de sangramento axial</p>	

Operações de Torneamento

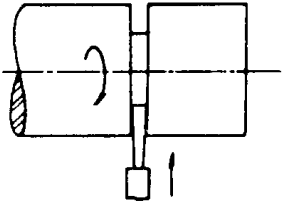
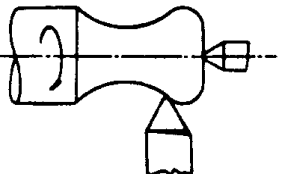
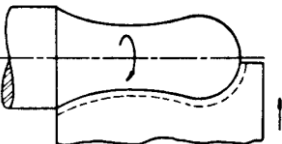
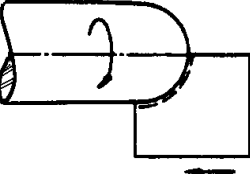
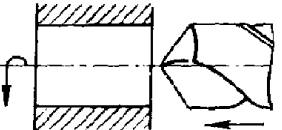
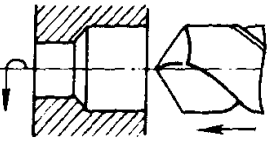
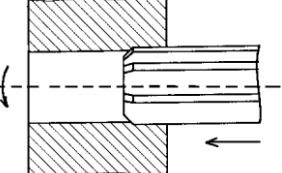
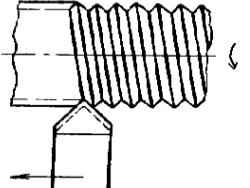

Operações de Torneamento e Ferramentas Usadas	Esquema	Operações de Torneamento e Ferramentas Usadas	Esquema
<p>i - Corte com uma ferramenta bedame</p>		<p>j - Torneamento Curvilíneo com ferramenta reta de ponta arredondada</p>	
<p>k - Perfilamento Radial com ferramenta de forma</p>		<p>m - Perfilamento Axial com ferramenta de forma</p>	
<p>n - Furação com broca helicoidal</p>		<p>o - Alargamento de um furo com broca helicoidal</p>	
<p>p - Alargamento de um furo com alargador</p>		<p>q - Roscamento Externo com ferramenta de rosca de ponta única</p>	

Pastilhas de Metal Duro

- **Excelente resistência, permitindo usinar com altas velocidades.**
- **Diversas formas e geometrias padronizadas**
- **Diversas classes de M.D. para materiais e condições diferentes de usinagem**
- **Baixo custo de reposição**
- **Dispensa reafiação**



Classes

P

M

K

N

S

H

Aço

**Aço
Inoxidável**

**Ferro
Fundido**

**Não
Ferroso**

**Ligas
Resistentes
Temperaturas**

**Materiais
Endurecidos**

01

10

15

20

25

30

50

01

10

15

20

25

30

50

01

50

01

50

01

50

01

50

Dureza

Tenacidade

Tenacidade

Como identificar os insertos (Pastilhas)?

Existem **NORMAS Internacionais** :







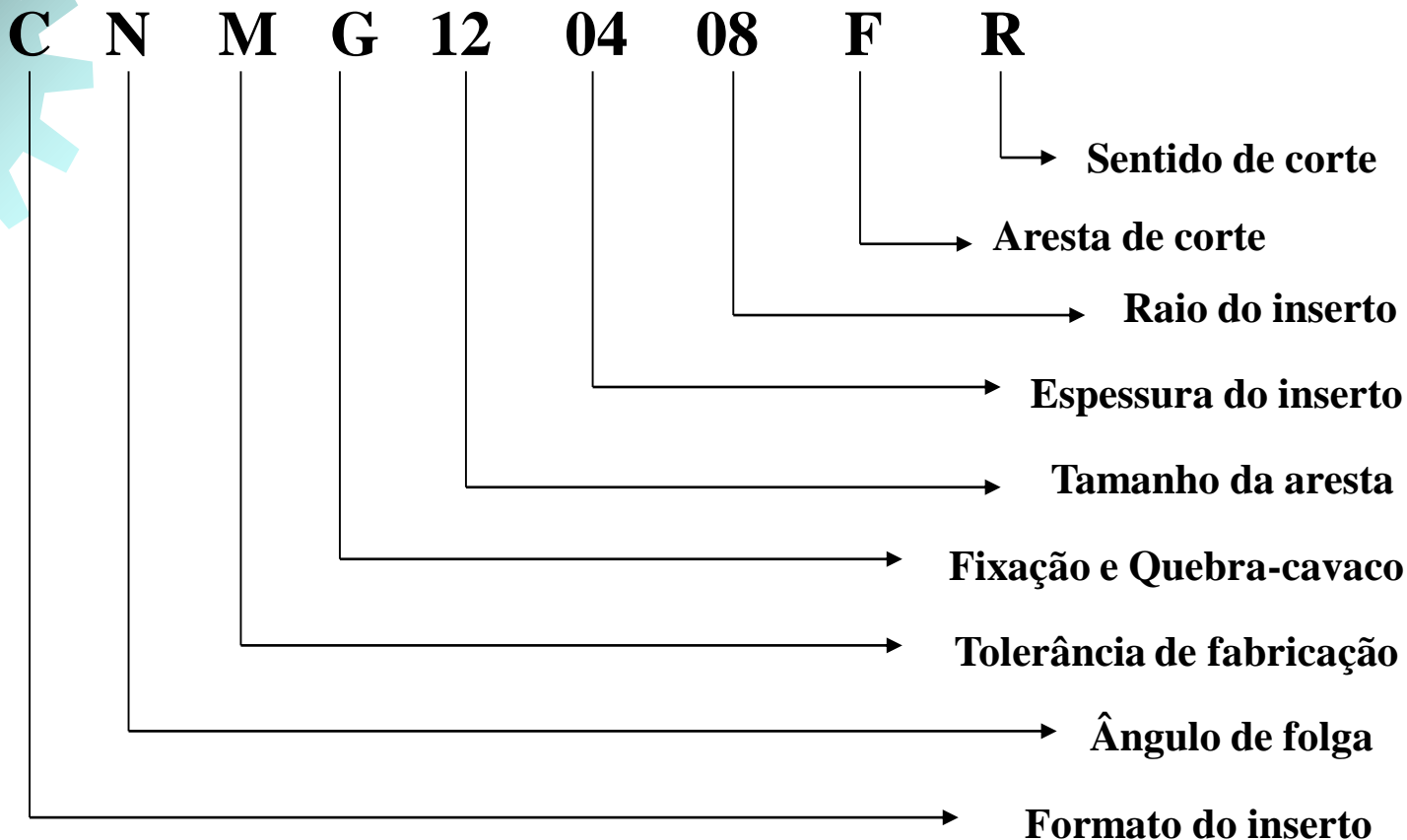
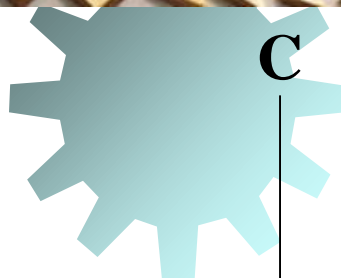



- **ISO - Internacional**
- **ANSI - Americana**



Codificação ISO - Insertos



Formato dos Insertos

Símbolo do Formato	Inserto	Formato	Ângulo de Ponta (graus)
S		Quadrado	90
T		Triangular	60
C		Romboidal (diamante)	80
D			55
E			75
F			50
M			86
V			35
W		Trigonal	80
H		Hexagonal	120
O		Octogonal	135
P		Pentagonal	108
L		Retangular	90
A		Formato de Paralelograma	85
B			82
N/K			55
R		Redondo	-

Ângulo de folga

↓
T N M G - 22 04 08

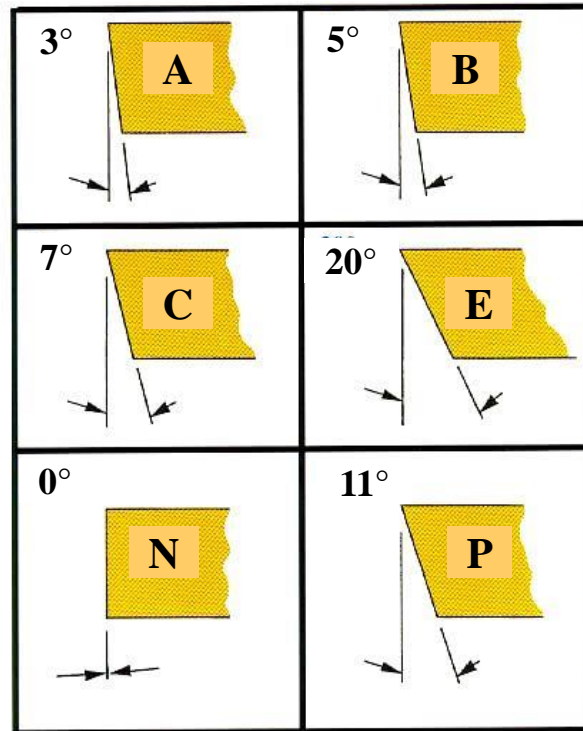

N - 0°
A - 3°
B - 5°
C - 7°
P - 11°
D - 15°
E - 20°
F - 25°
G - 30°

Tolerância



Símbolo	Tolerâncias em mm	
	s	d
A	0.025 ±	0.025 ±
F	0.025 ±	0.025 ±
C	0.025 ±	0.025 ±
H	0.025 ±	0.025 ±
E	0.025 ±	0.025 ±
G	0.13 ±	0.025 ±
J	0.025 ±	0.05 ± 0.13 ±
K	0.025 ±	0.05 ± 0.13 ±
L	0.025 ±	0.05 ± 0.13 ±
M	0.13 ±	0.05 ± 0.13 ±
U	0.13 ±	0.08 ± 0.25 ±



T N M G - 22 04 08

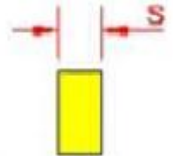
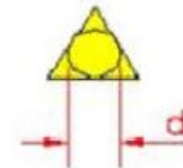
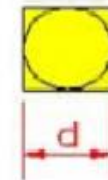
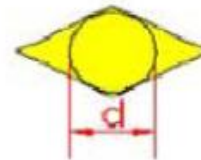
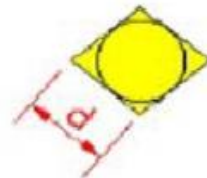
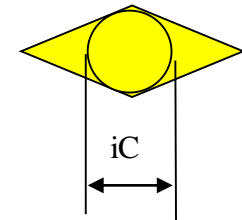
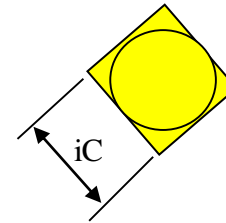
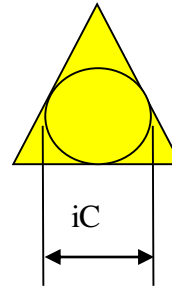





Tipo de inserto

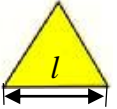
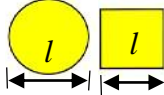

T N M G - 22 04 08

Símbolo	Furo	Formato do Furo	Quebra-cavaco	Formato da Secção do Inserto	Símbolos Alternativos	
					Sistema Comum	"D" menor que 1/4"
N	Sem		Sem		N	E
R			Face Única		R	
F			Dupla Face		F	
A		Furo Cilíndrico	Sem		A	D
M,P,S			Face Única		M	
G,P,Z			Dupla Face		G	
W	Com	Furo Parcialmente Cilíndrico, escareamento de 40-60°	Sem		A	
T			Face Única		M	
Q		Furo Parcialmente Cilíndrico, escareamento duplo de 40-60°	Sem		A	
U			Dupla Face		G	
B		Furo Parcialmente Cilíndrico, escareamento de 70-90°	Sem		A	
H			Face Única		M	
C		Furo Parcialmente Cilíndrico, escareamento duplo de 70-90°	Sem		A	
J			Dupla Face		G	
X	Especial				X	X
*Sómente para sistema em polegadas						

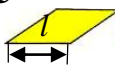
Tamanho da aresta de corte l (mm)

d (iC) →	6.35 (1/4")	9.52 (3/8")	12.70 (1/2")	15.88 (5/8")	19.05 (3/4")	25.40 (1")
	11	16	22	27	33	44
	06	09	12	15	19	25
55° 	07	11	15	19		
80° 	06	09	12	16	11	25
35° 	11	16	22			
	04	06	08	10	13	17

iC = Círculo Inscrito

Espessura “S”



01	S = 1,59
T1	S = 1,98
02	S = 2,38
03	S = 3,18
T3	S = 3,97
04	S = 4,76
05	S = 5,56
06	S = 6,35
07	S = 7,94
09	S = 9,52
10	S = 10,00
12	S = 12,00

← **CPGM - 16 T3 08**

← **TNMG - 22 04 08**

Raio de Ponta

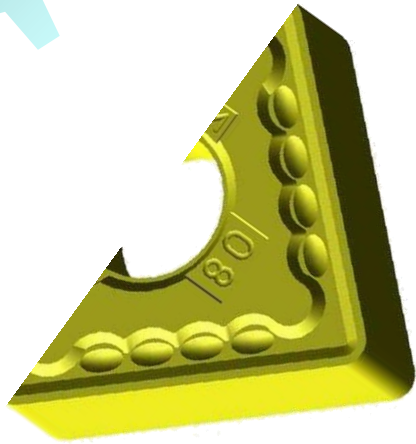

T N M G - 22 04 **08**

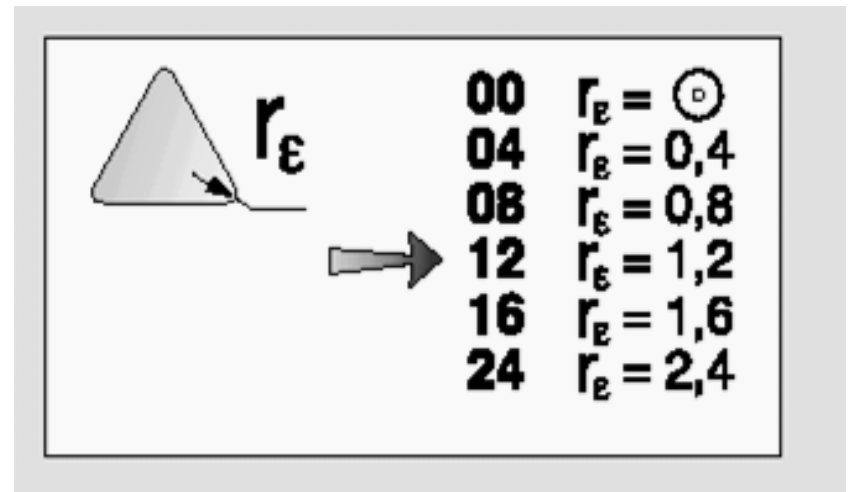



Aresta de Corte



T N M G - 22 04 08 **F**



F  Aresta de corte viva

E  Aresta de corte com tratamento ER

T  Fase negativa

K  Fases duplas negativas

S  Fase negativa e aresta de corte com tratamento ER

Sentido de Corte

T N M G - 22 04 08 F **R**



R

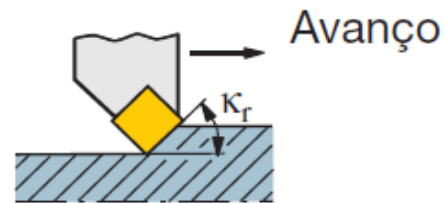

L

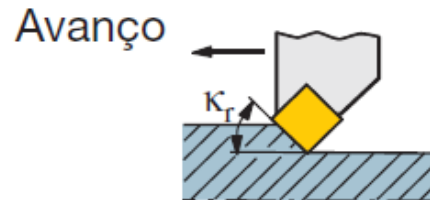

N

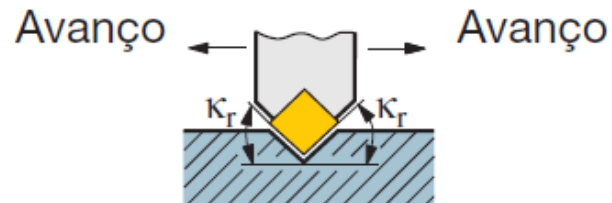

Codificação ISO

Porta-ferramenta Externo

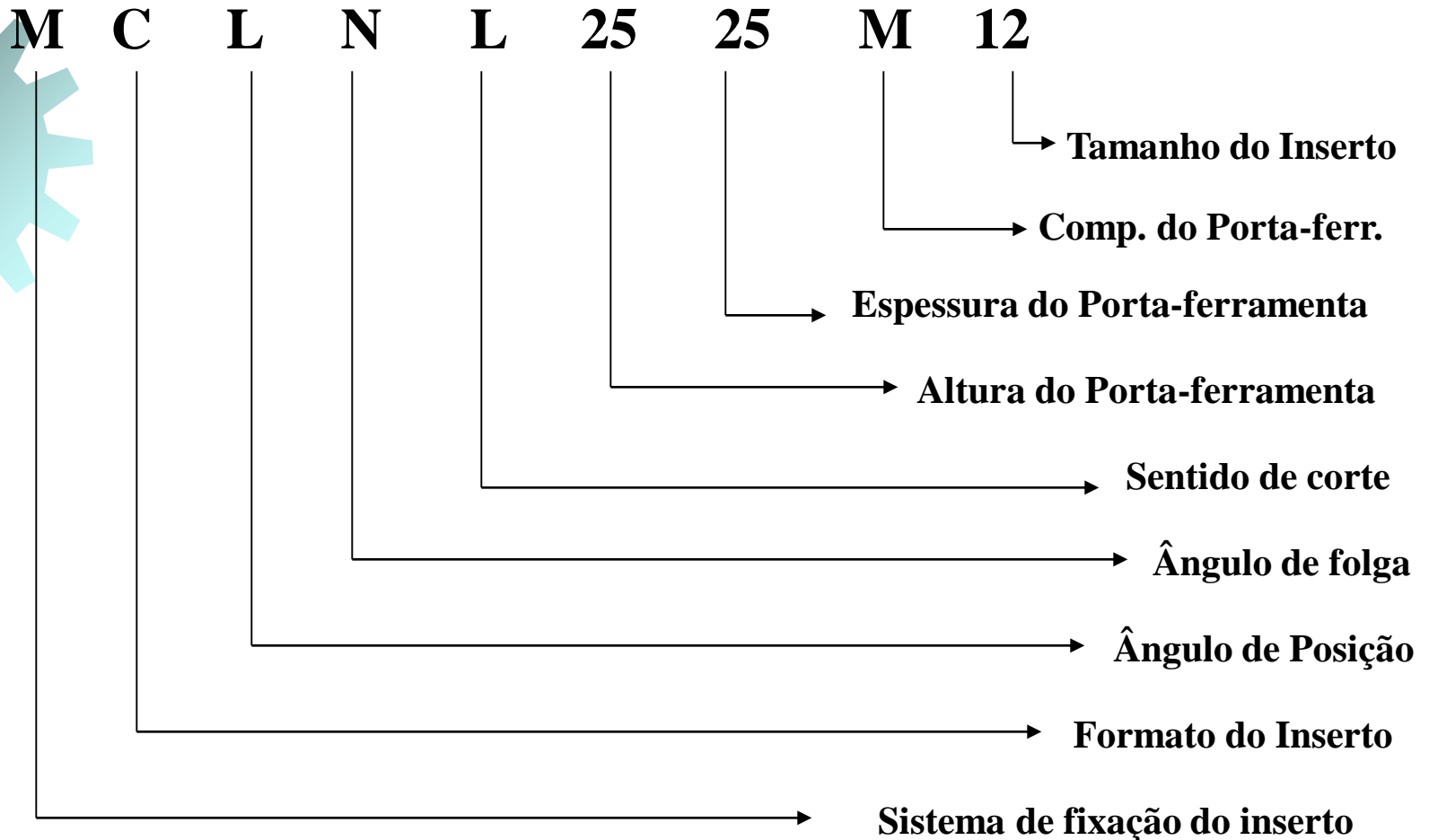
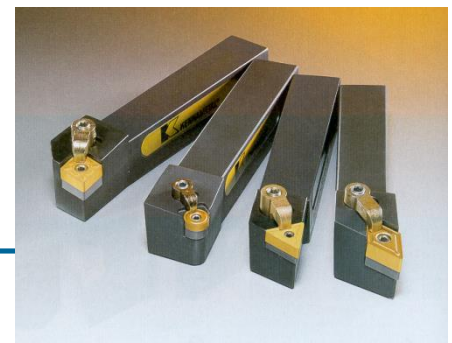

Codificação ISO

Porta-Ferramenta Externo



M C L N L 25 25 M 12

C



Fixação por grampo



D

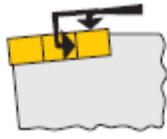

Fixação Rígida (RC)



M



Fixação tipo cunha-grampo

P



Fixação por alavanca

S



Fixação por parafuso











Codificação ISO

Porta-Ferramenta Externo



M **C** L N L 25 25 M 12

C		D	
K		R	
S		T	
V		W	















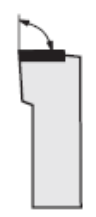

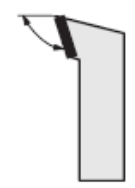

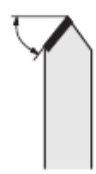

...

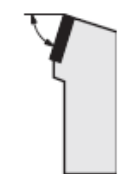
Codificação ISO

Porta-Ferramenta Externo



M C L N L 25 25 M 12

A 90° 	B 75° 	D 45° 	E 60° 	F 91° 	G 91° 	H 107° 30' 
J 93° 	K 75° 	L 95° 	M 50° 	N 63° 30' 	Q 117° 30' 	R 75° 
S 45° 	T 60° 	U 93° 	V 72° 30' 	Y(X) 85° 	Y(Z) 85° 	P 117° 30' 

Codificação ISO

Porta-Ferramenta Externo

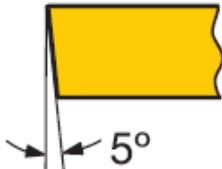
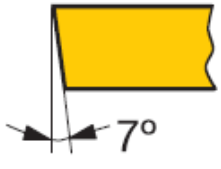
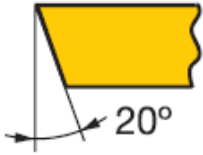
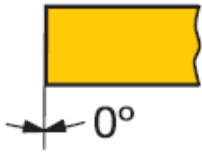
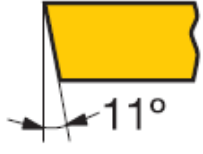

M C L N L 25 25 M 12

B		C		
E		N		...
P		O	Descrição específica	

Codificação ISO

Porta-Ferramenta Externo

M C L N **L** 25 25 M 12

R

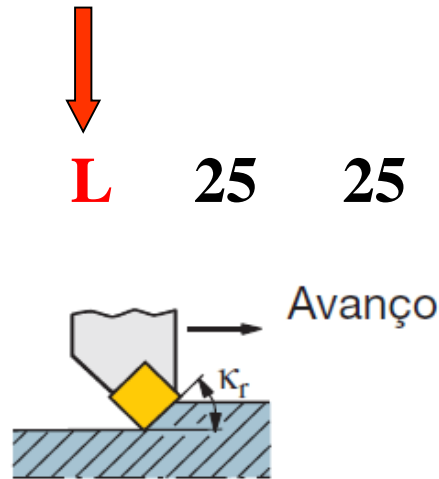

L

Avanço

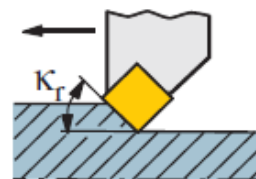

N

Avanço

Avanço

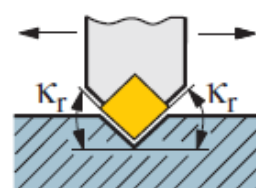

Codificação ISO

Porta-Ferramenta Externo

M C L N L **25** 25 M 12



Números inteiros devem ser precedidos por zero, p.
ex., $b = 8$ é indicado por 08

Codificação ISO

Porta-Ferramenta Externo

M C L N L 25 **25** M 12

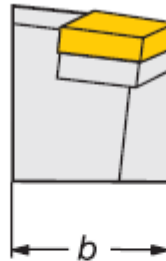

Números inteiros devem ser precedidos por zero, p. ex., $b = 8$ é indicado por 08

Codificação ISO

Porta-Ferramenta Externo



M C L N L 25 25 M 12

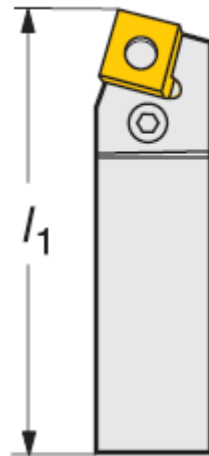

A = 32	N = 160
B = 40	P = 170
C = 50	Q = 180
D = 60	R = 200
E = 70	S = 250
F = 80	T = 300
G = 90	U = 350
H = 100	V = 400
J = 110	W = 450
K = 125	Y = 500
L = 140	X = Especial
M = 150	

Codificação ISO

Porta-Ferramenta Externo



M C L N L 25 25 M **12**

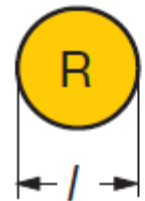

...

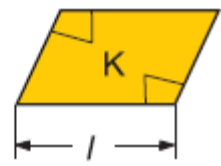
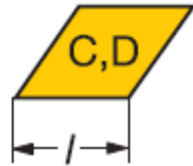

Parâmetros de Corte

Notação

V_c : Velocidade de Corte [m/min]

f_n : Avanço [mm/volta]

a_p : Profundidade de usinagem [mm]

$$v_c = \frac{\pi \cdot D \cdot n}{1000}$$

$$a_p = \frac{D - d}{2}$$

$$t_c = \frac{L}{V_f}$$

$$V_f = f_n \times n$$

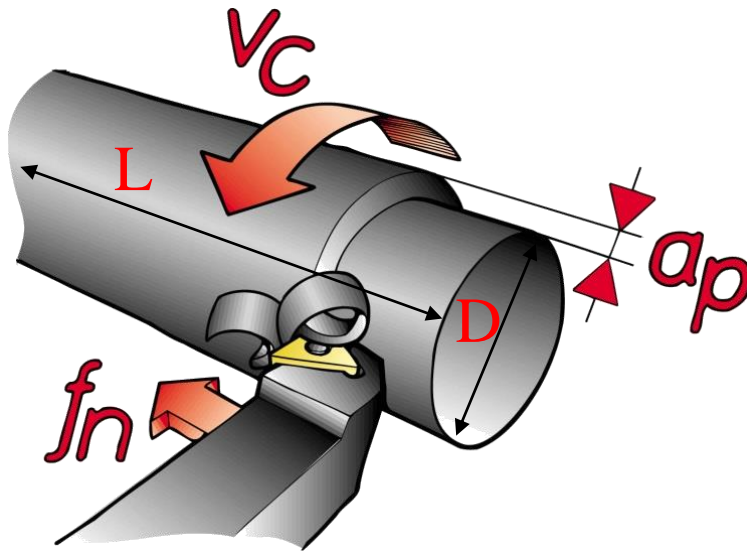



Condições de operação

As condições de operação controlam 3 variáveis importante no corte dos metais:

1. Taxa de remoção de material
2. Vida da ferramenta e
3. Acabamento

Cada uma dessas variáveis pode ser estimada através das seguintes fórmulas:

1. $Q = V_c \cdot a_p \cdot f_n$ (mm³/min)
2. $V_c \cdot T^y = C$
3. $R_{teorica} = f_n^2 / 8R_p$

Condições de operação

$$R_{\max} = \frac{fn^2}{8 \cdot R_p}$$

$$R_a = \frac{0,0321 \cdot fn^2}{R_p}$$

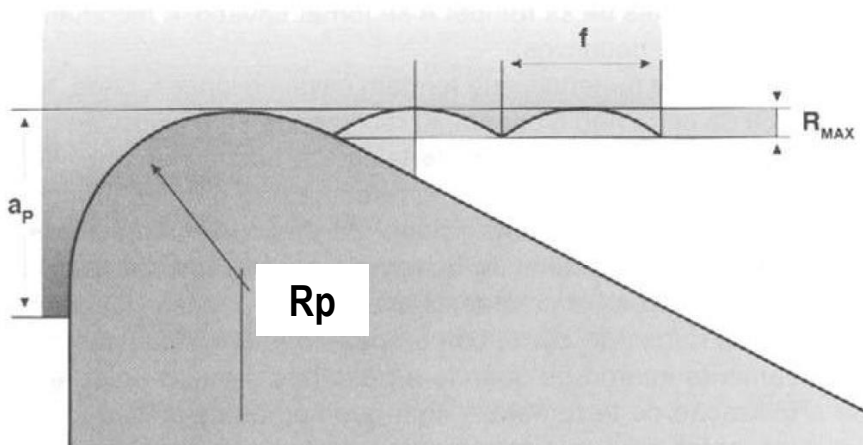

<i>Rugosidade Ra</i> (μm)	Gradação de Rugosidade
50	N12
25	N11
12,5	N10
6,3	N9
3,2	N8
1,6	N7
0,8	N6
0,4	N5
0,2	N4
0,1	N3
0,05	N2
0,025	N1

Condições de Operação

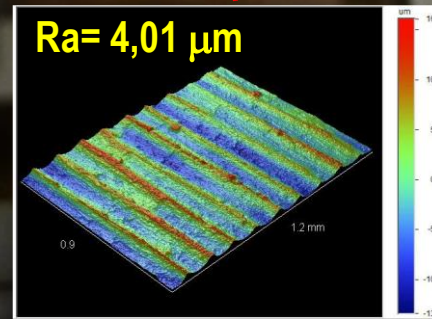
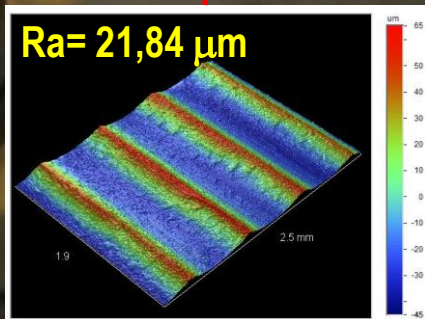
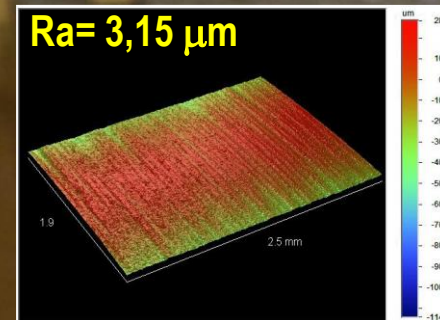
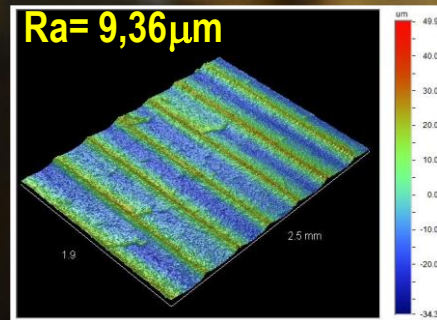

Condições de operação

Tabela 1 - Recomendações gerais para operações de torneamento

Material de trabalho	Ferramenta de Corte	Propósito para condições iniciais de corte		
		Profundidade de corte mm (ap)	Avanço mm/rev (f)	Velocidade de Corte m/min (Vc)
Aço de baixo carbono	Carbeto sem cobertura	1,5 – 6,3	0,35	90
	Carbeto com cobertura de cerâmica	1,5 – 6,3	0,35	245 - 275
	Carbeto com tripla cobertura	1,5 – 6,3	0,35	185 - 200
	Carbeto com cobertura de TiN	1,5 – 6,3	0,35	105 - 150
	Cerâmica – Al ₂ O ₃	1,5 – 6,3	0,25	395 – 440
	Cermet	1,5 – 6,3	0,30	215 - 290
Aços de Médio e alto carbono	Carbeto sem cobertura	1,2 – 4,0	0,30	75
	Carbeto com cobertura de cerâmica	1,2 – 4,0	0,30	185 – 230
	Carbeto com tripla cobertura	1,2 – 4,0	0,30	120 – 150
	Carbeto com cobertura de TiN	1,2 – 4,0	0,30	90 – 200
	Cerâmica – Al ₂ O ₃	1,2 – 4,0	0,25	335
	Cermet	1,2 – 4,0	0,25	170 - 245

Torno Paralelo

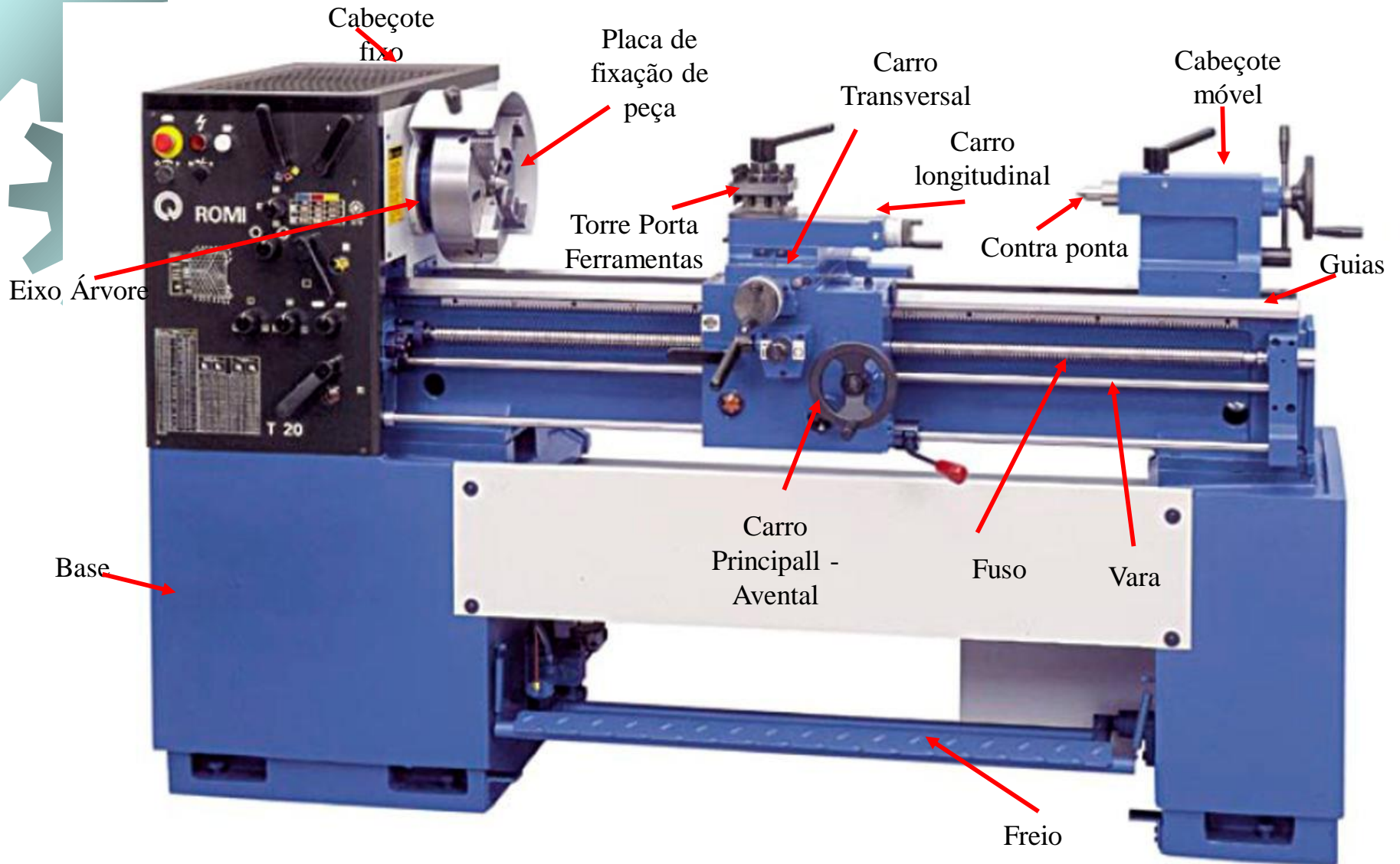

Fixação da Peça

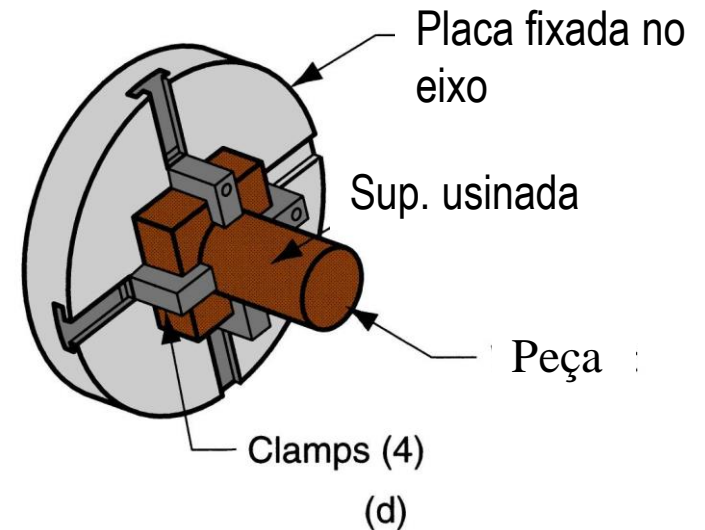
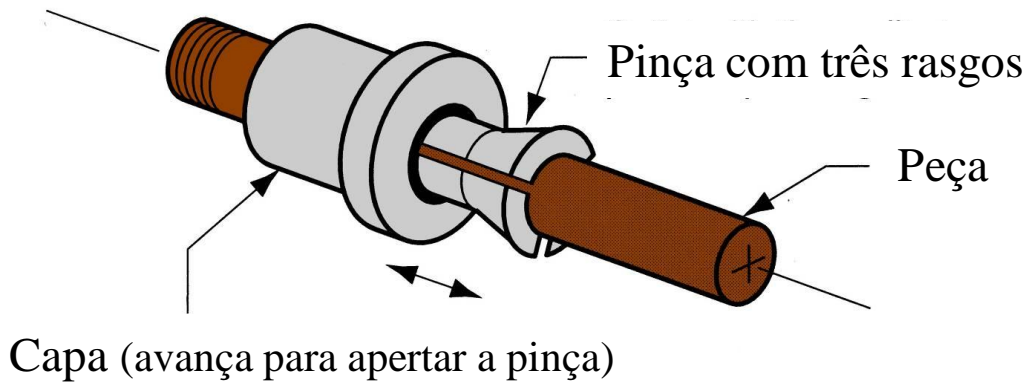
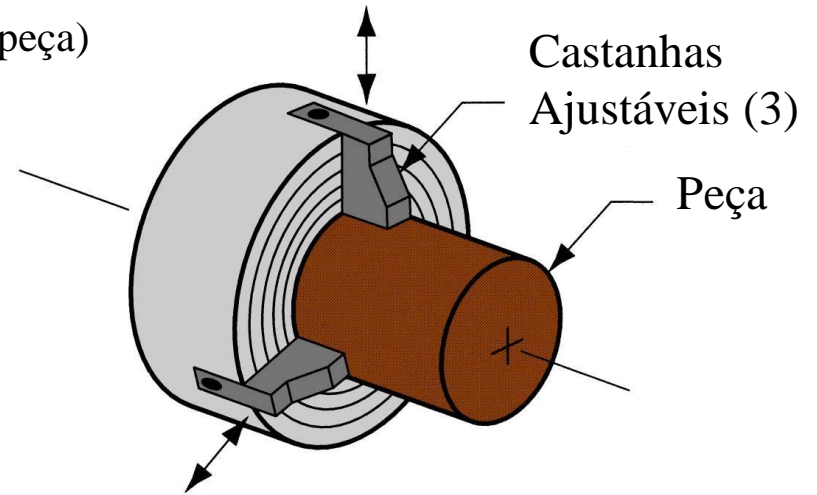
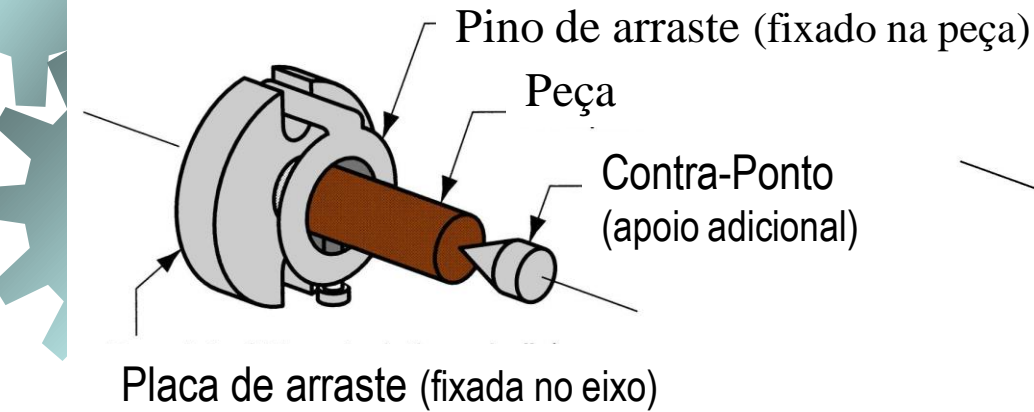

Arrastador

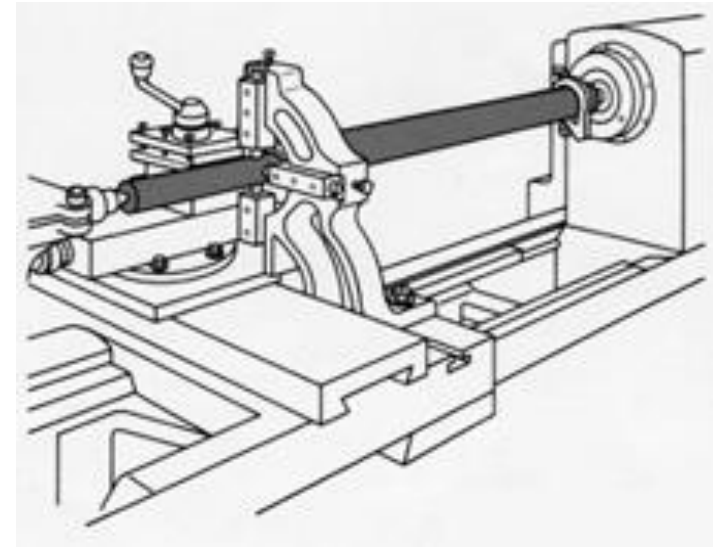
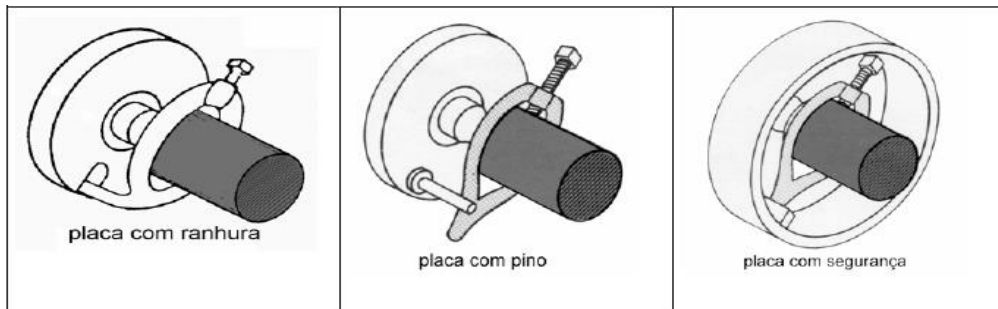

Placa de arraste e arrastador

Luneta

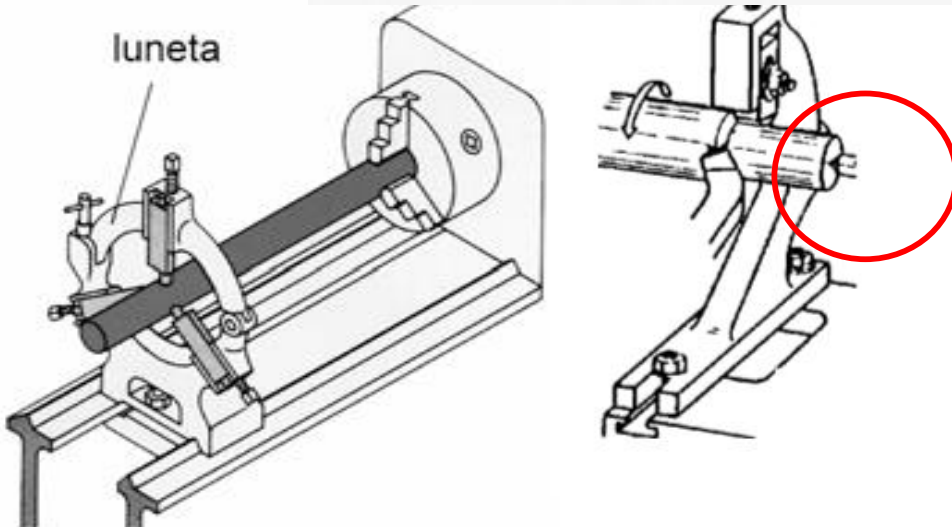
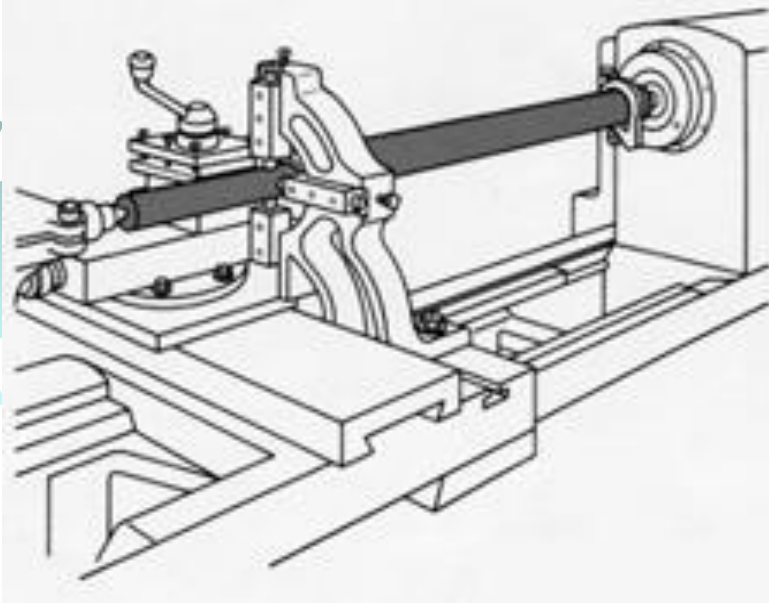

Luneta

Torno Revólver

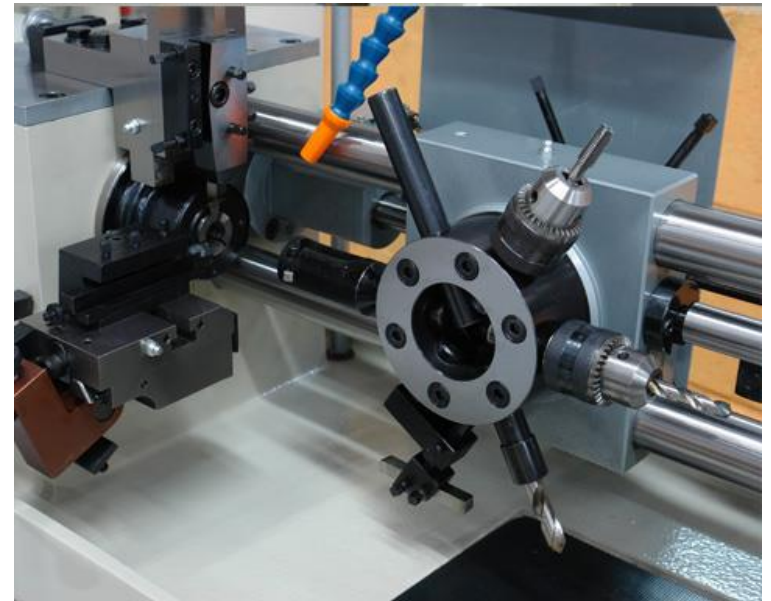

Exemplo de Ferramentas no Torno Revólver

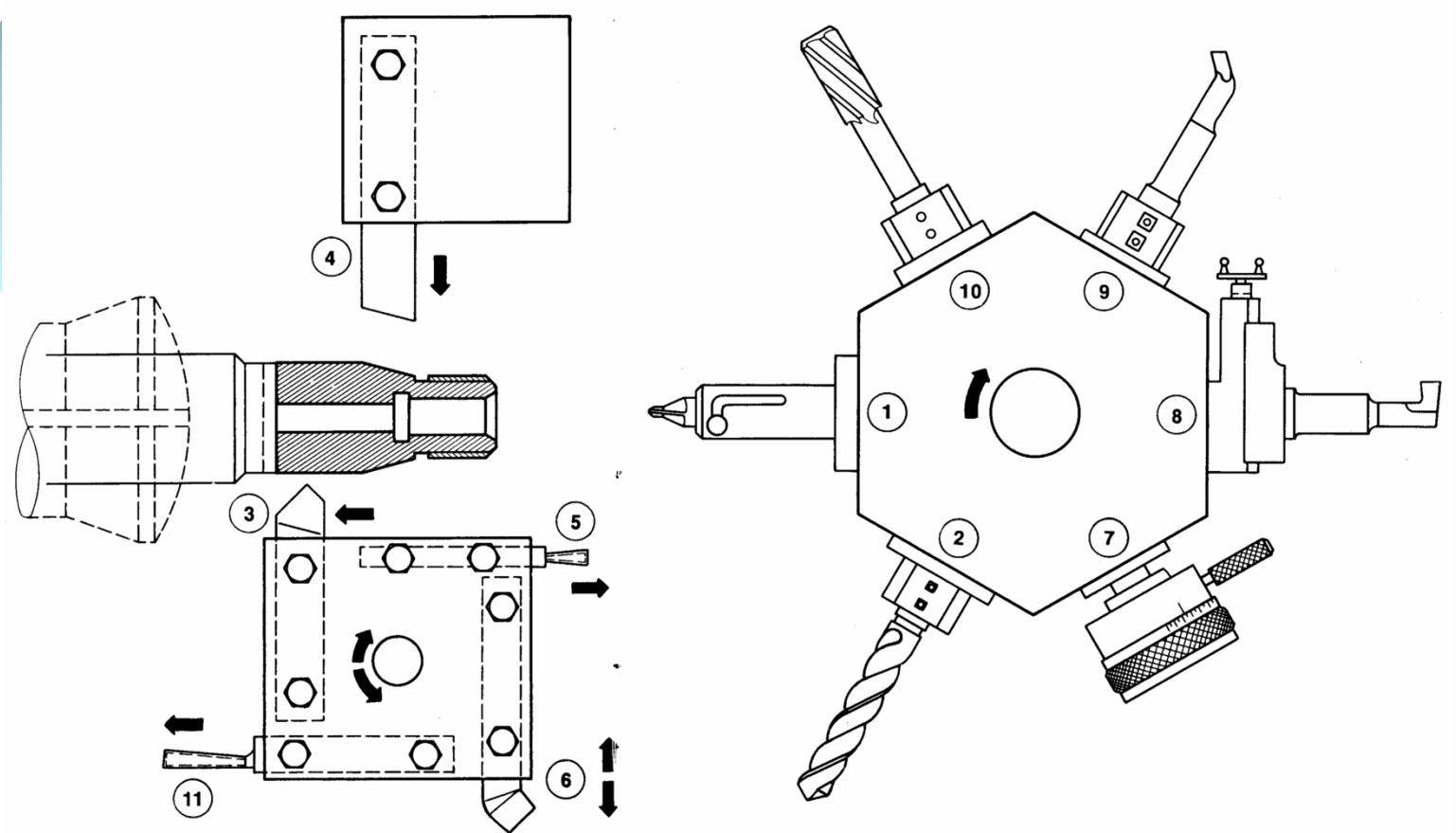

Torno Verticais



Placa, de 5 m de diâmetro, suporta até 90 toneladas



Torno Horizontais



Tipos de Tornos

- Tornos especiais: Torno de Ultraprecisão



Torno a Comando Numérico – Torno CNC



Torno a Comando Numérico – Torno CNC

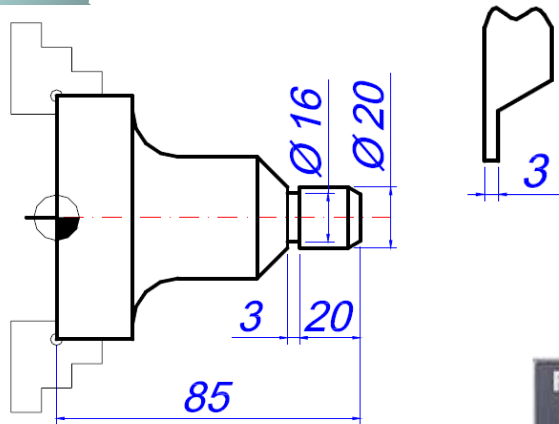

Programa NC

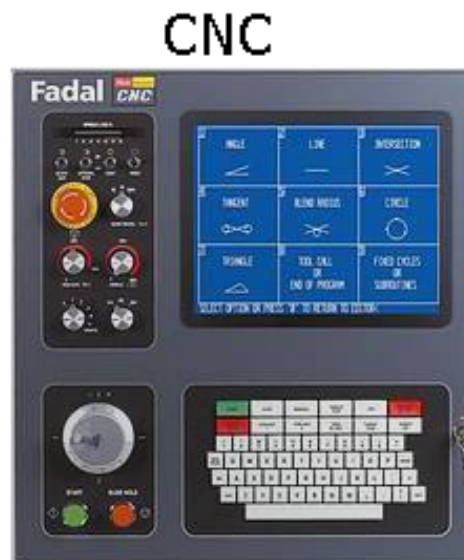

Máquina-ferramenta



Exemplo (Torno):

```
...  
N70 G0 X50 Z90;  
N80 G1 X22 Z62 F1;  
N90 X16 F0.08;  
N100 G4 X1;  
N110 G1 X22 F0.5;  
...
```