

---

# Fluxo de calor na placa sul americana

---

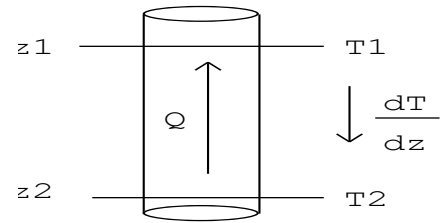
Fluxo de calor global

<https://engineering.und.edu/research/global-heat-flow-database/data.html>

# Densidade de fluxo de calor

A quantidade de calor através da superfície  $S$  em um intervalo de tempo  $\Delta t$  será dado por:

O fluxo de calor  $Q \propto -\frac{T_2 - T_1}{\Delta z} S \Delta t$        $q \propto -\frac{T_2 - T_1}{\Delta z}$



$$T_2 > T_1$$
$$z_2 > z_1$$
$$\Delta z = z_2 - z_1$$

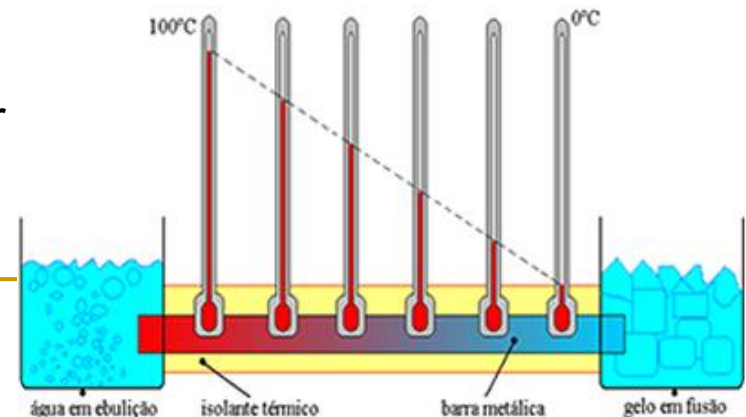
Densidade de fluxo de calor - Lei de Fourier  $q \propto -\frac{dT}{dz}$       ou       $q = -k \frac{dT}{dz}$

A dimensão da densidade de fluxo de calor é  $[E/L^2t]$ .  
Unidade no SI:  $W/m^2$ , no caso da Terra utiliza-se um submúltiplo:  $10^{-3} W/m^2$  ( $mW/m^2$ ).

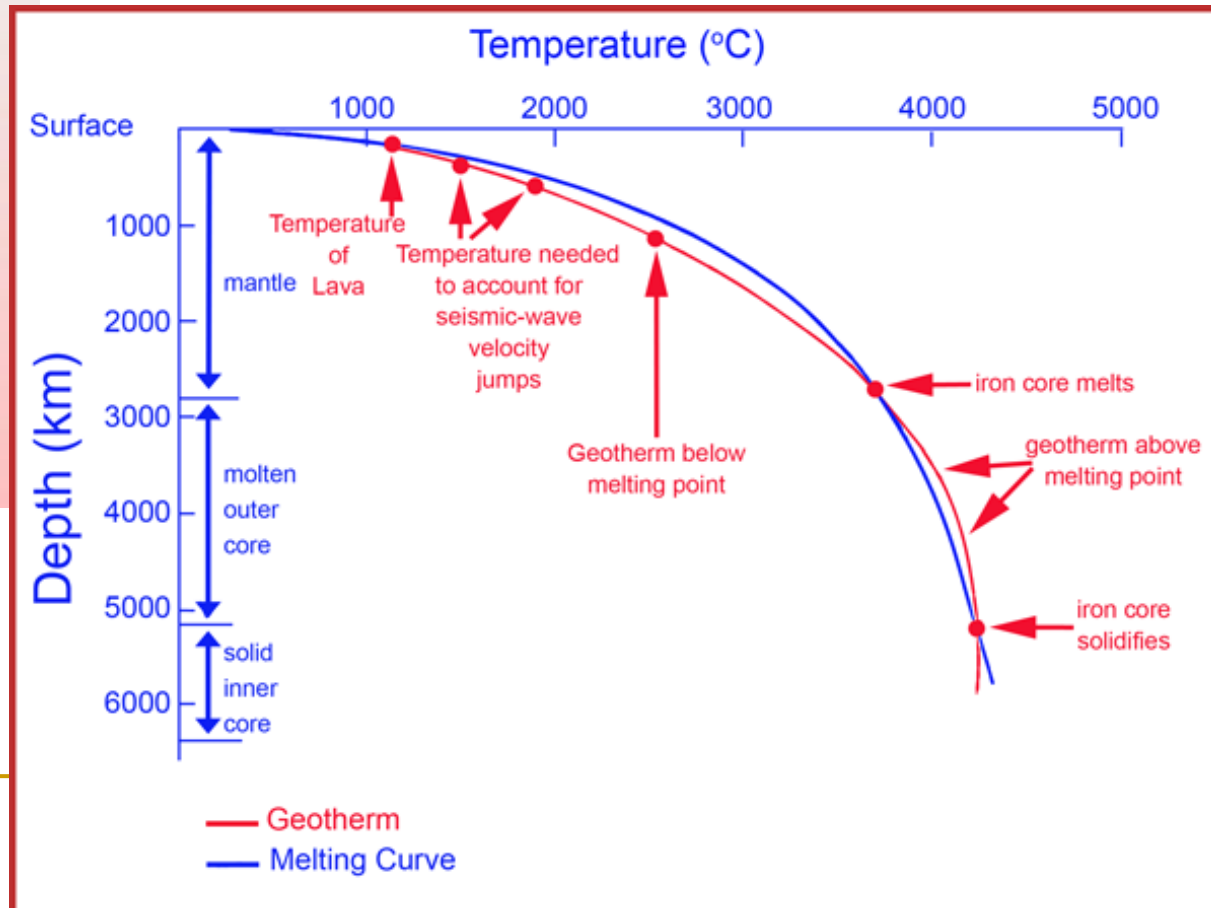
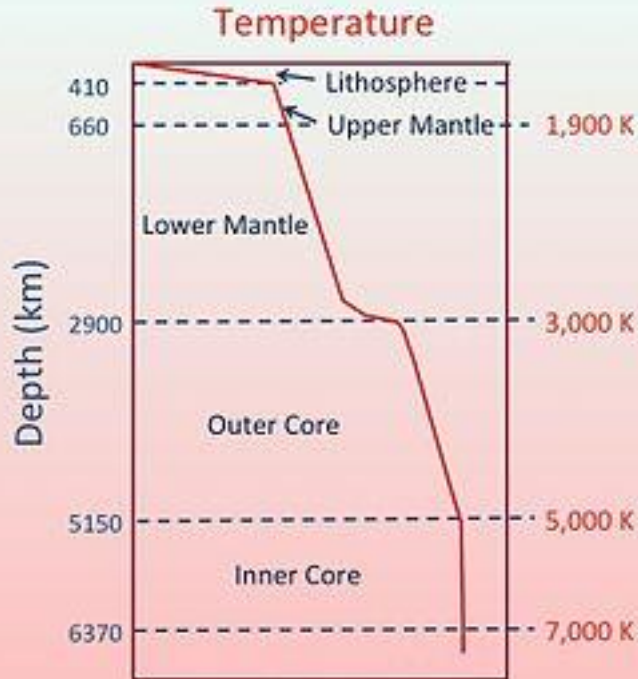
Valores típicos de densidade de fluxo de calor são da ordem de  $(40 \text{ a } 90)10^{-3} Wm^{-2}$

$dT/dz \sim 20\text{-}40 \text{ }^\circ\text{C/km}$  na crosta - condução de calor

$dT/dz \sim 0,2 \text{ }^\circ\text{C/km}$  no manto - calor transferido por convecção



# Temperaturas no interior da Terra



# Temperatura na crosta

- Crosta continental – poço
- Crosta oceânica –  
Fundo do mar

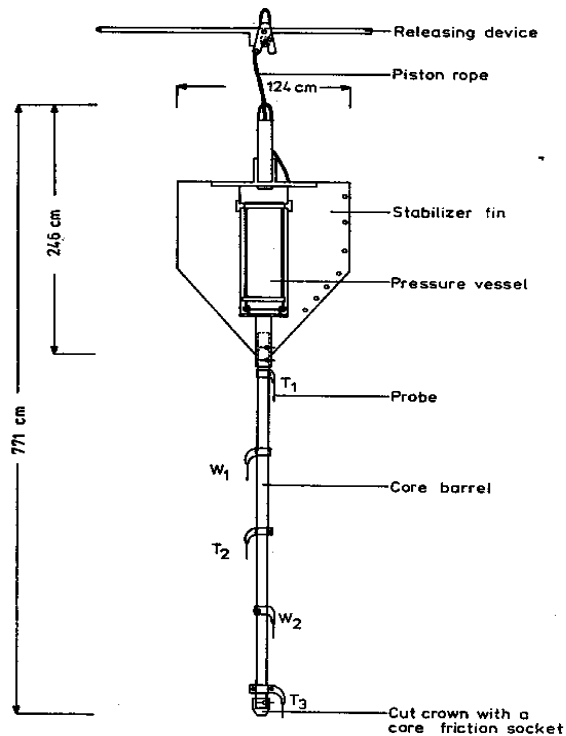
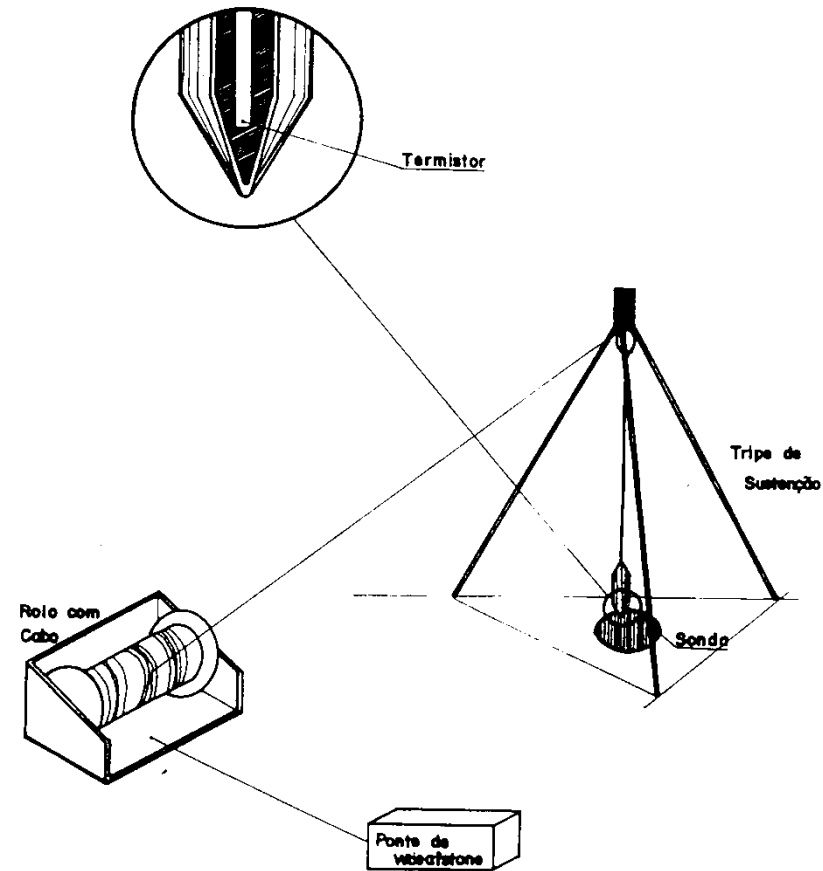
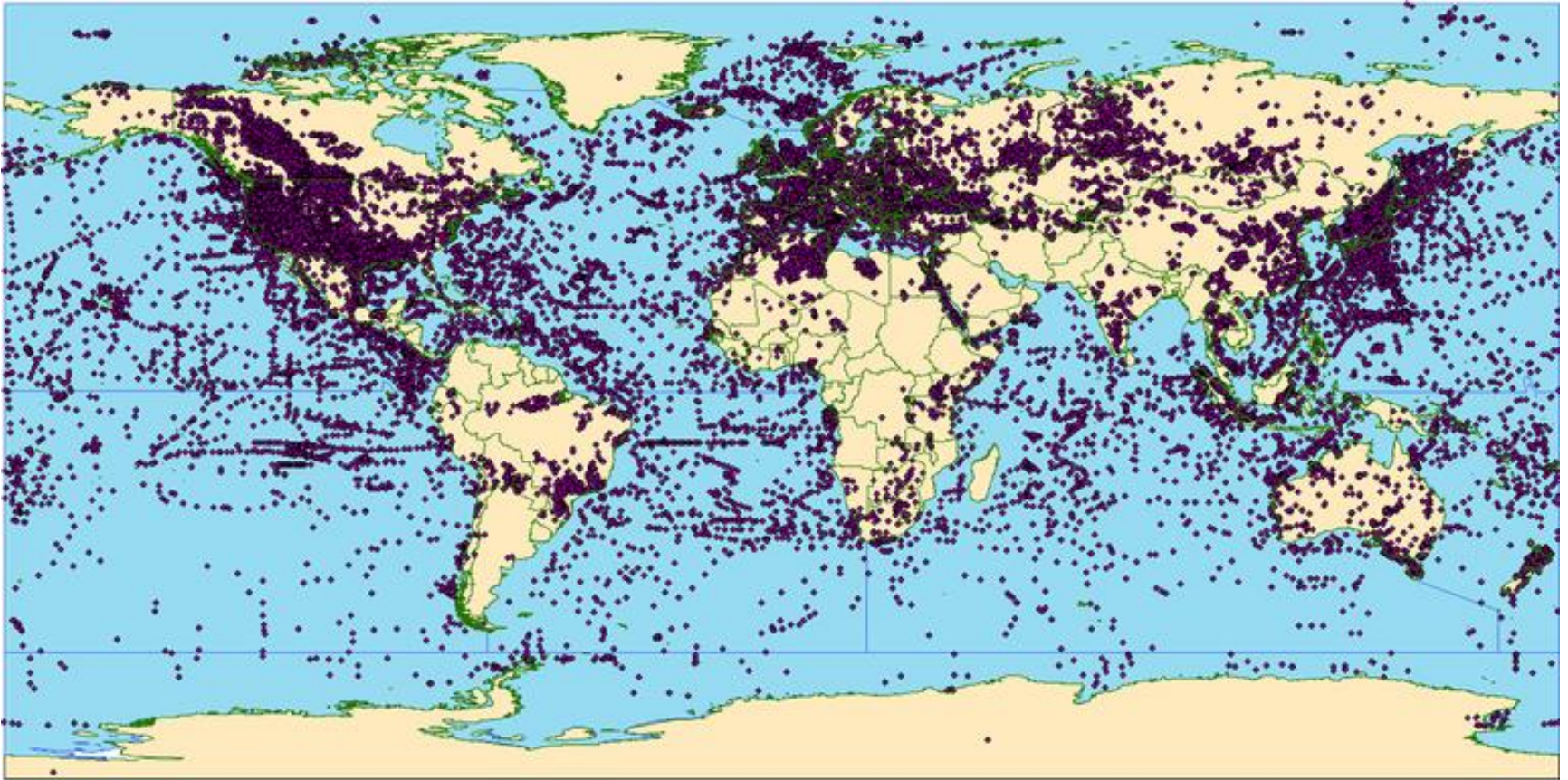


Fig. 4.7. Design of a deep sea probe for determination of terrestrial heat flow in the ocean floor.

$T_{1,2,3}$  = fin probes for thermometers  
 $W_{1,2}$  = probes with electrical heater and thermometer for in situ measurements of thermal conductivity of sediments.



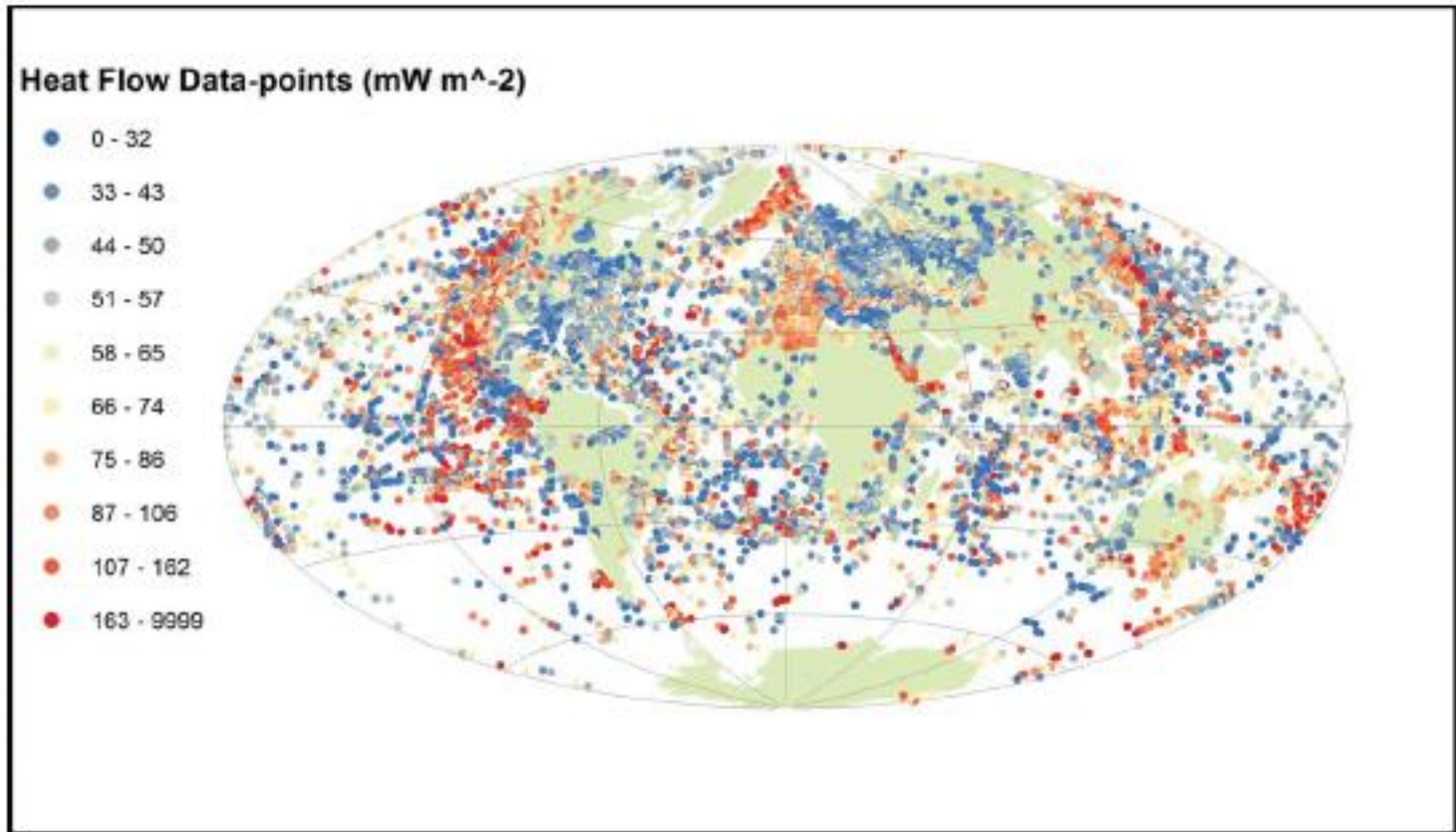
# Distribuição de dados



Dados de <http://www.datapages.com/gis-map-publishing-program/gis-open-files/global-framework/global-heat-flow-database>

2019

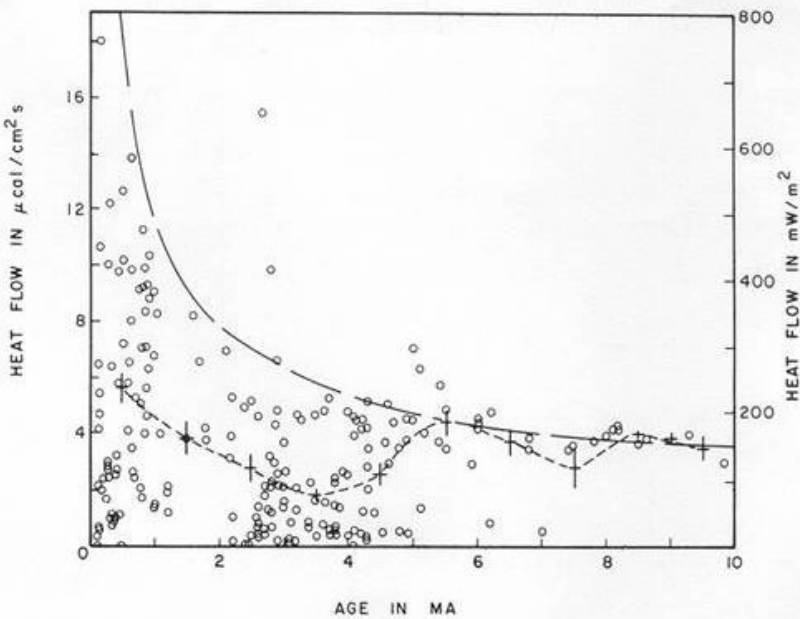
# Distribuição de dados



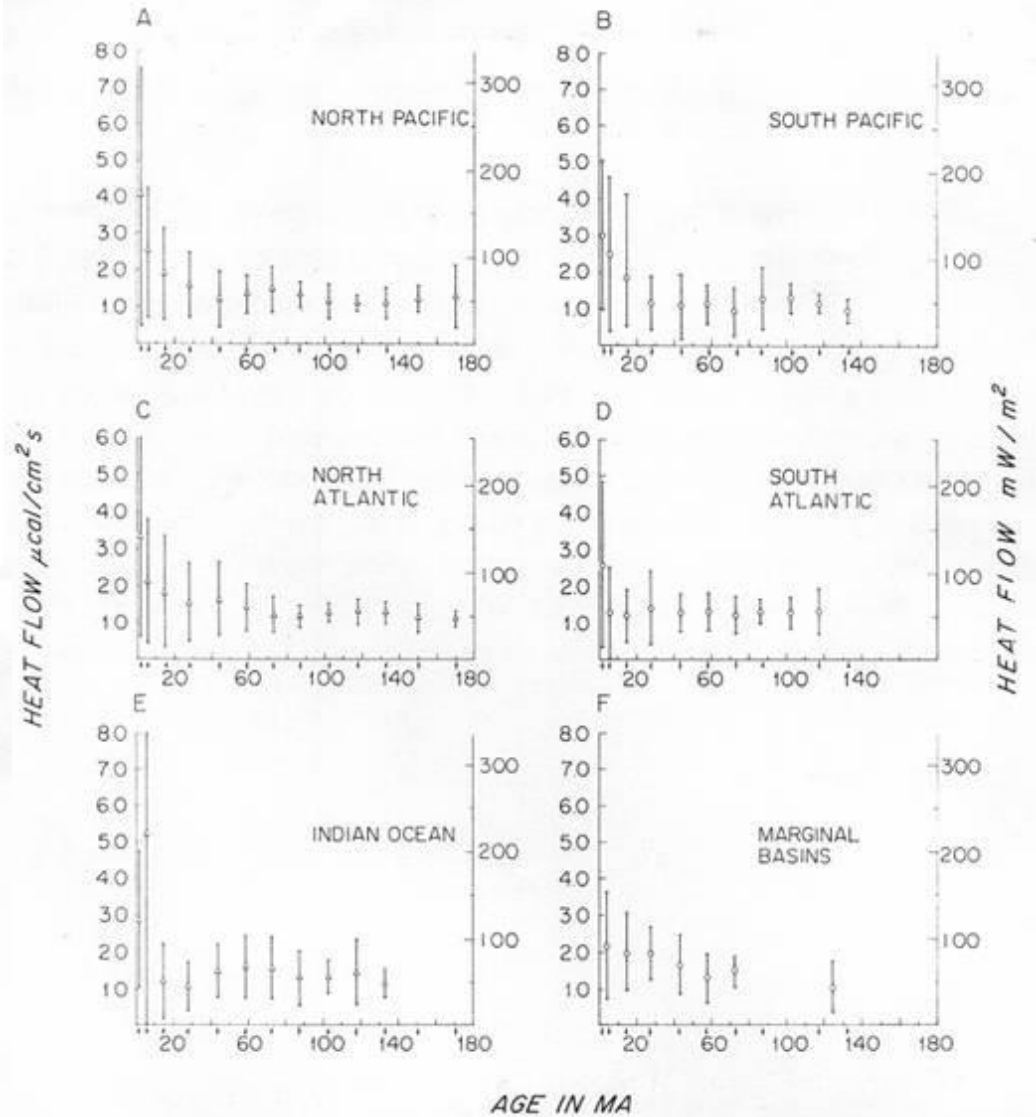
**Figure 1.** Map of heat flow measurement points. Many data points are hidden by later plotted points. Note the very inhomogeneous distribution (Aitoff World Projected Projection).

# Fluxo de calor nos oceanos

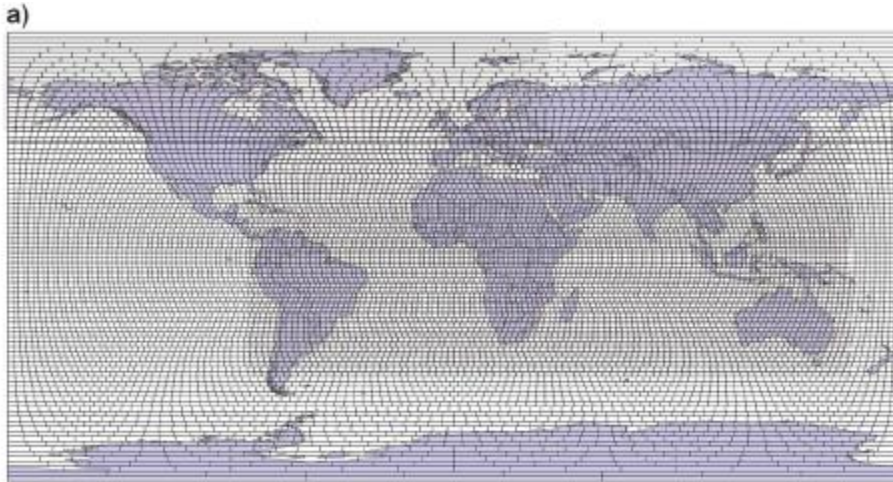
SCLATER ET AL.: OCEANIC AND CONTINENTAL HEAT FLOW



SCLATER ET AL.: OCEANIC AND CONTINENTAL HEAT FLOW



# Mapa global de fluxo de calor grid 2°



[10] Therefore to limit the effects of hydrothermal circulation, I have applied a simple half-space model (equation (1)) in regions of young ocean crust

$$Q = Cr^{-0.5} \quad (1)$$

where  $Q$  is surface heat flow ( $\text{mW m}^{-2}$ ),  $t$  is age (Myr), and  $C$  is a constant ( $\text{mW m}^{-2} \text{Myr}^{0.5}$ ). I use the value  $C = 490 \text{ mW m}^{-2} \text{Myr}^{0.5}$ , as derived by Jaupart *et al.* [2007]. They derive this value by using data beyond the age affected by hydrothermal circulation and adding the additional data point that conductive heat flow would be zero at infinite age.

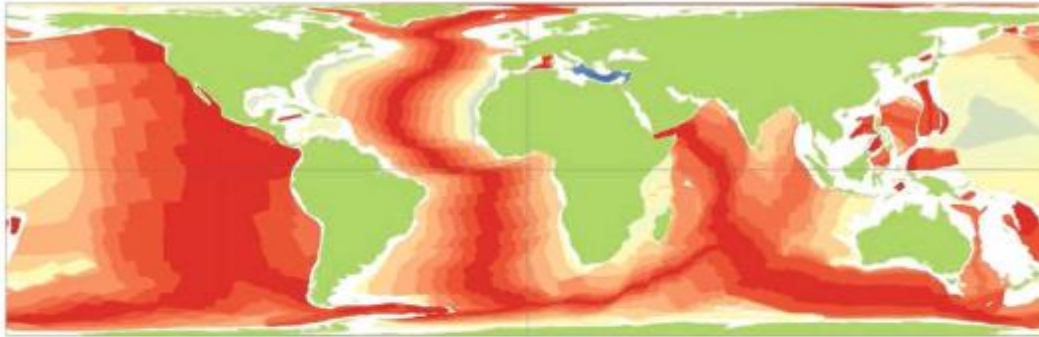
Evaluate heat flow in cells with ocean crust younger than 67.7Ma using age and half-space model (eq 1)

Evaluate value in remaining cells with Heat Flow Data using the mean (fig7) or median (fig 8) value area-weighted

Evaluate value in remaining cells using area-weighted mean assuming correlation between geology and heat flow using mean (fig 7) or median (fig 8)



# Mapa global de fluxo de calor grid 2°



Age Ocean Crust (Ma)

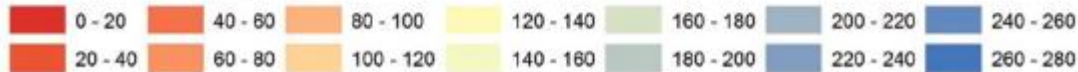
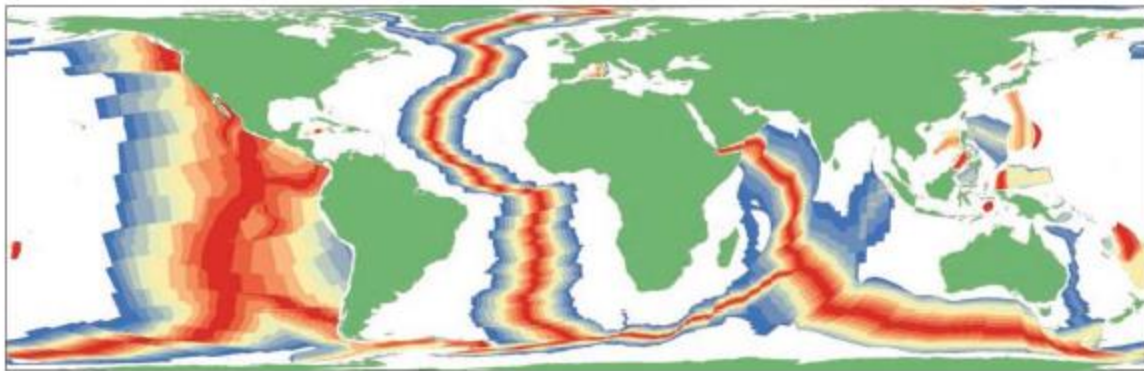


Figure 3. Map of the age of the ocean crust in millions of years before present (Ma). From Sclater et al.



Young Ocean Crust Heat Flow ( $\text{mW m}^{-2}$ )

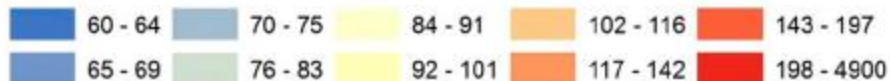
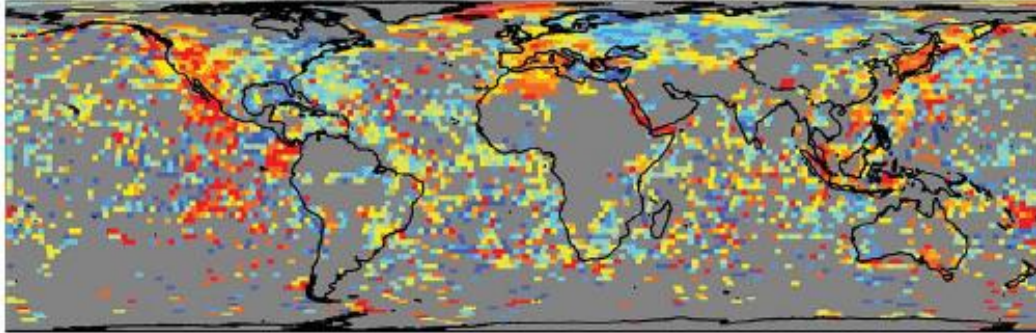


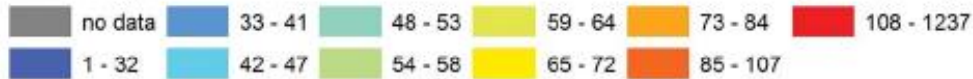
Figure 4. Map of the predicted heat flow in regions with oceanic crust younger than 67.7 Ma. Prediction uses equation (1) and the ages from Figure 3, area weighted. The legend uses deciles for the classes. The same legend classification is used for all the following maps unless otherwise stated.

# Mapa global de fluxo de calor grid 2°

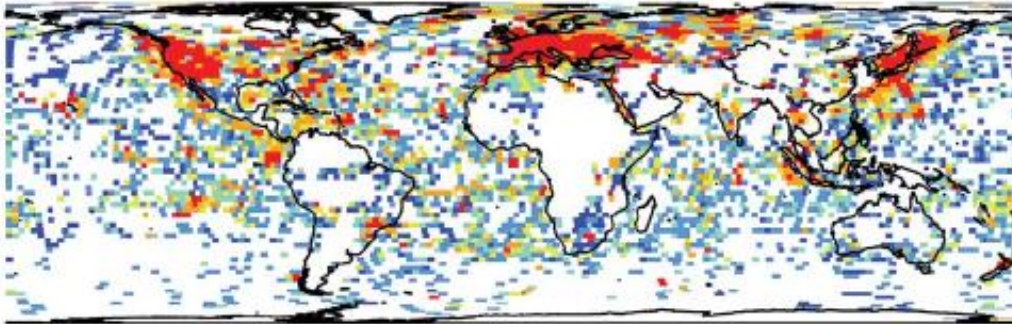
a)



Area-weighted Data based Heat Flow estimate on 2 degree grid ( $\text{mW m}^{-2}$ )



b)

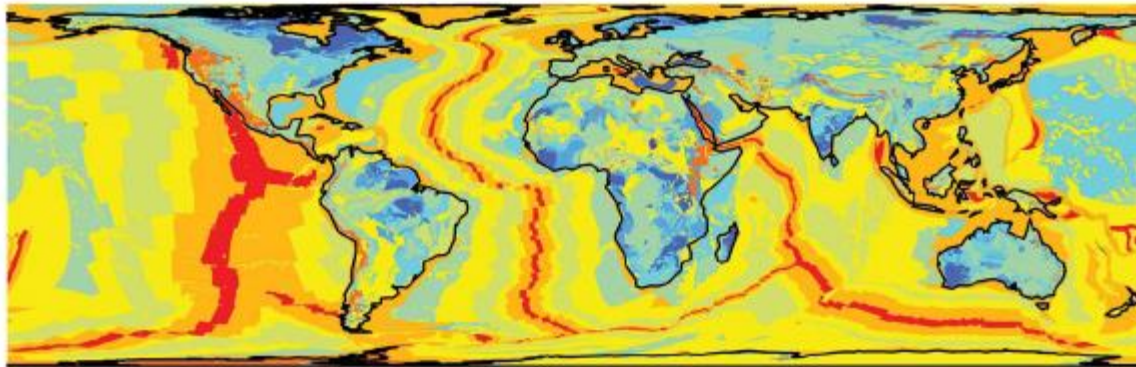


Number of Heat Flow measurements per cell

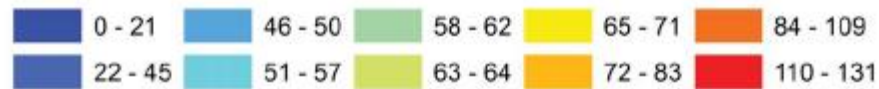


Figure 5. (a) Area weighted heat flow on the 2° equal area grid in regions with heat flow measurements and (b) global map of the number of heat flow measurements in each cell.

# Mapa global de fluxo de calor grid 2°



## Heat Flow based on Geology (mW m<sup>-2</sup>)



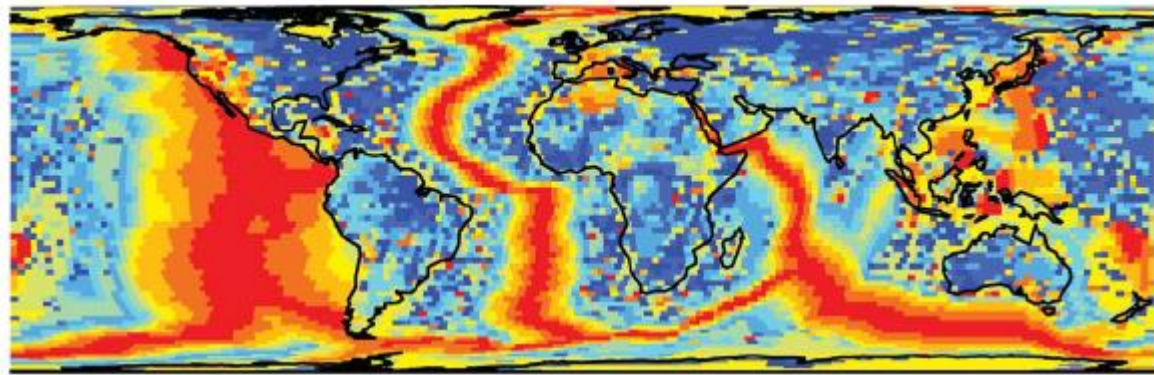
**Figure 6.** Global map showing the heat flow assuming that a correlation between heat flow and geology held everywhere.

# Mapa global de fluxo de calor grid 2º

Tabela 1 : Valores de densidade de fluxo térmico para feições geológicas nos continentes e oceanos (Pollack et al., 1993).

Description	Global		Mean Heat Flow, $mW m^{-2}$		Age Range, Ma	
	Number of 1° Elements	Area of Earth, %	Observed	Standard Deviation,		
<i>Oceanic</i>						
Cenozoic undifferentiated	1,038	2.2	89.3	43.7	0.0	66.4
Mesozoic undifferentiated	88	0.2	44.6	22.2	66.4	245.0
Quaternary	653	1.2	139.5*	93.4	0.0	1.6
Pliocene	1,571	2.4	109.1*	81.2	1.6	5.3
Miocene	5,120	9.2	81.9*	55.5	5.3	23.7
Oligocene	5,152	7.7	62.3*	39.9	23.7	36.6
Eocene	5,028	7.8	61.7*	29.3	36.6	57.8
Paleocene	2,117	3.9	65.1*	34.3	57.8	66.4
Late Cretaceous	3,857	6.9	61.5	31.5	66.4	84.0
Middle Cretaceous	5,641	11.2	56.3	21.8	84.0	119.0
Early Cretaceous	2,609	4.3	53.0	21.6	119.0	144.0
Late Jurassic	1,868	3.8	51.3	16.9	144.0	163.0
Oceanic totals	34,742	60.6				
<i>Continental</i>						
Subaqueous continental undifferentiated	5,461	9.1	77.7	53.6		
Cenozoic sedimentary and metamorphic	4,115	8.1	63.9	27.5		
Cenozoic igneous	666	1.1	97.0	66.9		
Mesozoic sedimentary and metamorphic	2,681	4.5	63.7	28.2		
Mesozoic igneous	2,459	1.6	64.2	28.8		
Paleozoic sedimentary and metamorphic	5,126	5.9	61.0	30.2		
Paleozoic igneous	236	0.4	57.7	20.5		
Proterozoic	7,700	6.2	58.3	23.6		
Archean	1,544	2.5	51.5	25.6		
Continental totals	30,058	39.4				

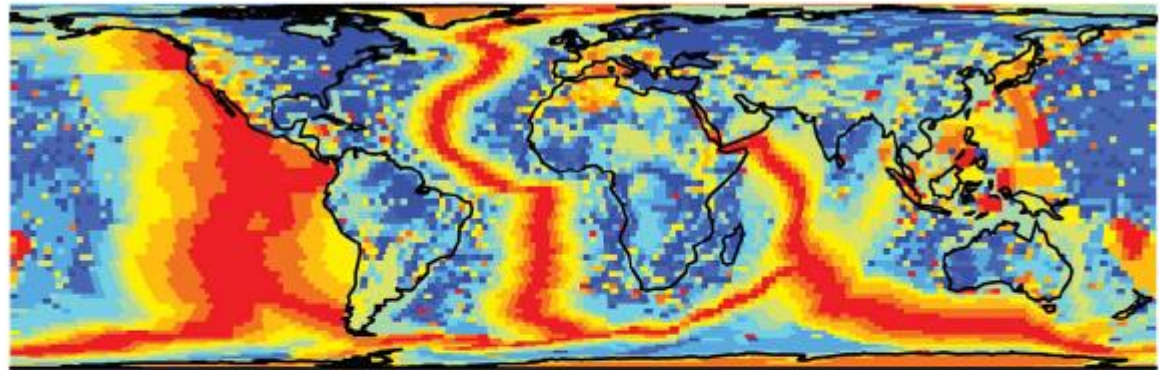
# Mapa global de fluxo de calor grid 2°



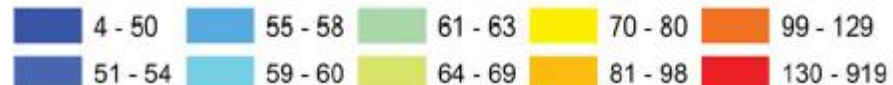
**Final Estimate of Heat Flow ( $\text{mW m}^{-2}$ ) (Area-weighted Mean)**



**Figure 7.** Global map of Earth Surface Heat Flow, in  $\text{mW m}^{-2}$ . It uses the individual components given by Figures 4-6. All component estimates were derived using the mean.

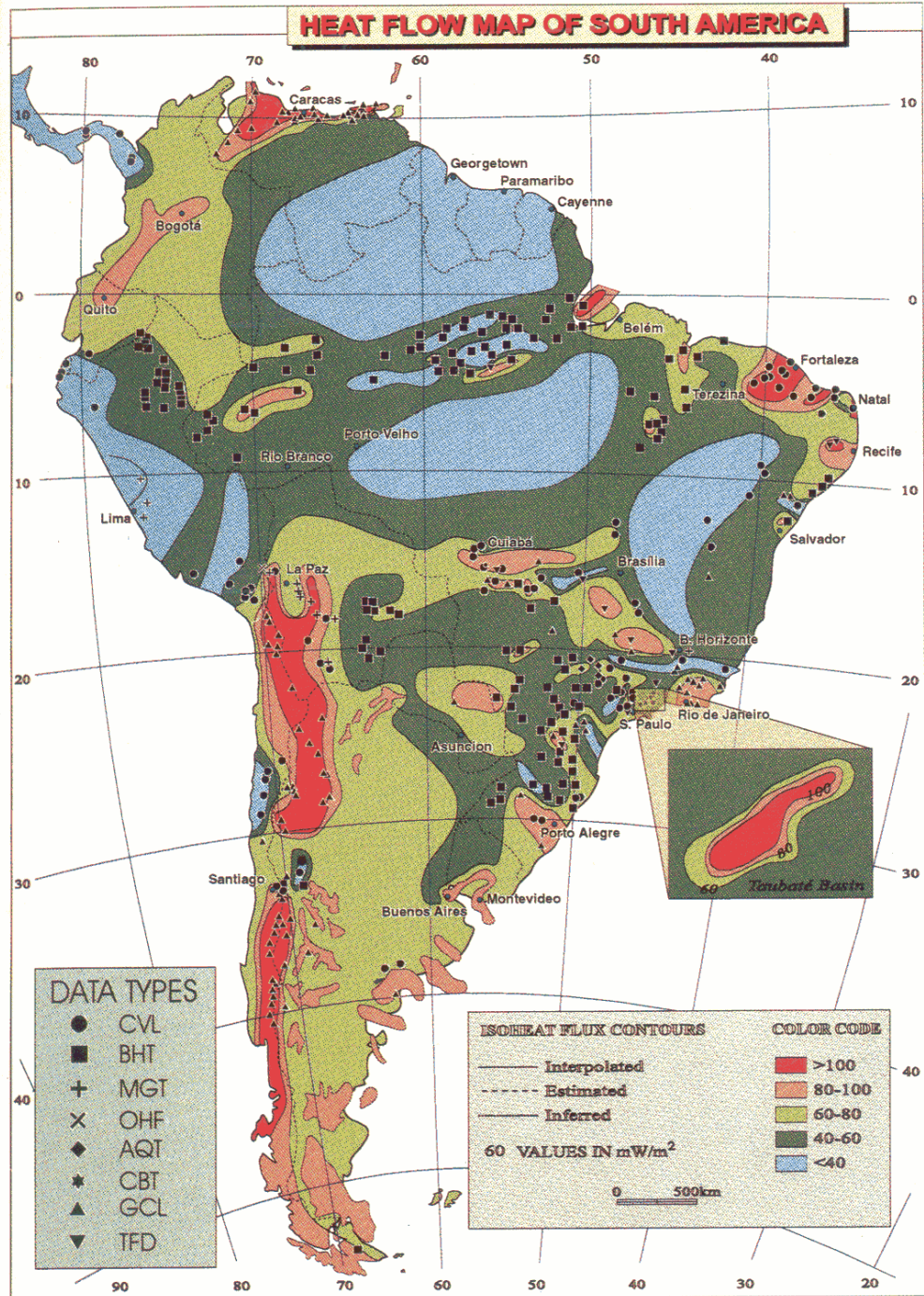


**Final Estimate of Heat Flow ( $\text{mW m}^{-2}$ ) (Area-weighted Median)**



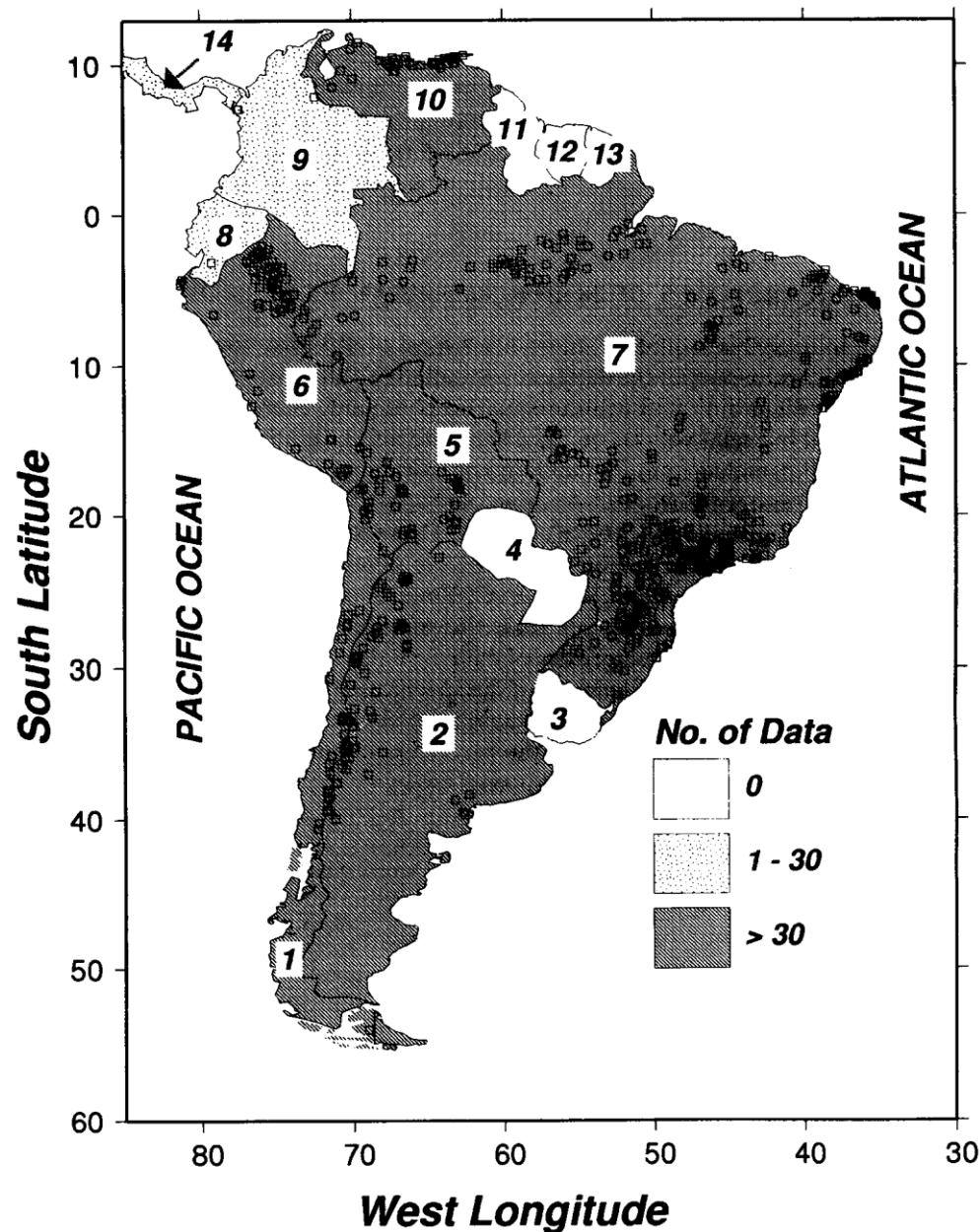
**Figure 8.** Global map of Earth Surface Heat Flow, in  $\text{mW m}^{-2}$ . It uses the ocean heat flux estimate given by Figure 4, but the data and geology correlation components use the median as opposed to the mean in deriving the estimate in the unioned polygons.

# Mapa geotermal da América do Sul



# Dados de fluxo de calor na América do Sul

- Dados na área continental até 1992: 655 pontos em 8 dos 13 países
- Convencional  $\Rightarrow$  21,5% medida de temperatura em profundidade dentro de um poço
- Temperatura de fundo de poço (BHT)  $\Rightarrow$  37% medida da temperatura no fundo do poço junto com as perfilagens geofísicas durante a perfuração de poços de petróleo.
- Convencional + fundo de poço  $\Rightarrow$  2,6% perfilagem convencional, mas apenas no trecho final da perfilagem.
- Aquífero  $\Rightarrow$  2% mede a temperatura da água bombeada mais a produtividade do poço
- Mina  $\Rightarrow$  2,6% mede temperatura na superfície e em profundidade dentro de minas.
- Geotermômetros  $\Rightarrow$  28% os geotermômetros de Na-K-Ca e  $\text{SiO}_2$  determinar a temperatura da água no reservatório
- Descarga do aquífero  $\Rightarrow$  5,6% geotermômetros mais a temperatura da fonte e descarga da fonte para modelar o fluxo em profundidade.
- Medidas oceânicas  $\Rightarrow$  1 medida no Lago Titicaca  $\Rightarrow$  perfilador mede a temperatura em 5 posições diferentes e a condutividade térmica em 3 posições diferentes ao longo da



# Distribuição dos dados

- Distribuição regional: possível dividir em 5 grupos: (figura 2)
- Região da Cordilheira dos Andes  $\Rightarrow$  distribuição razoável;
- Bacias Pré-Cordilheira  $\Rightarrow$  distribuição razoável;
- Bacias e depressões do norte;
- Plataforma Brasileira  $\Rightarrow$  distribuição razoável;
- Plataforma Patagônica.

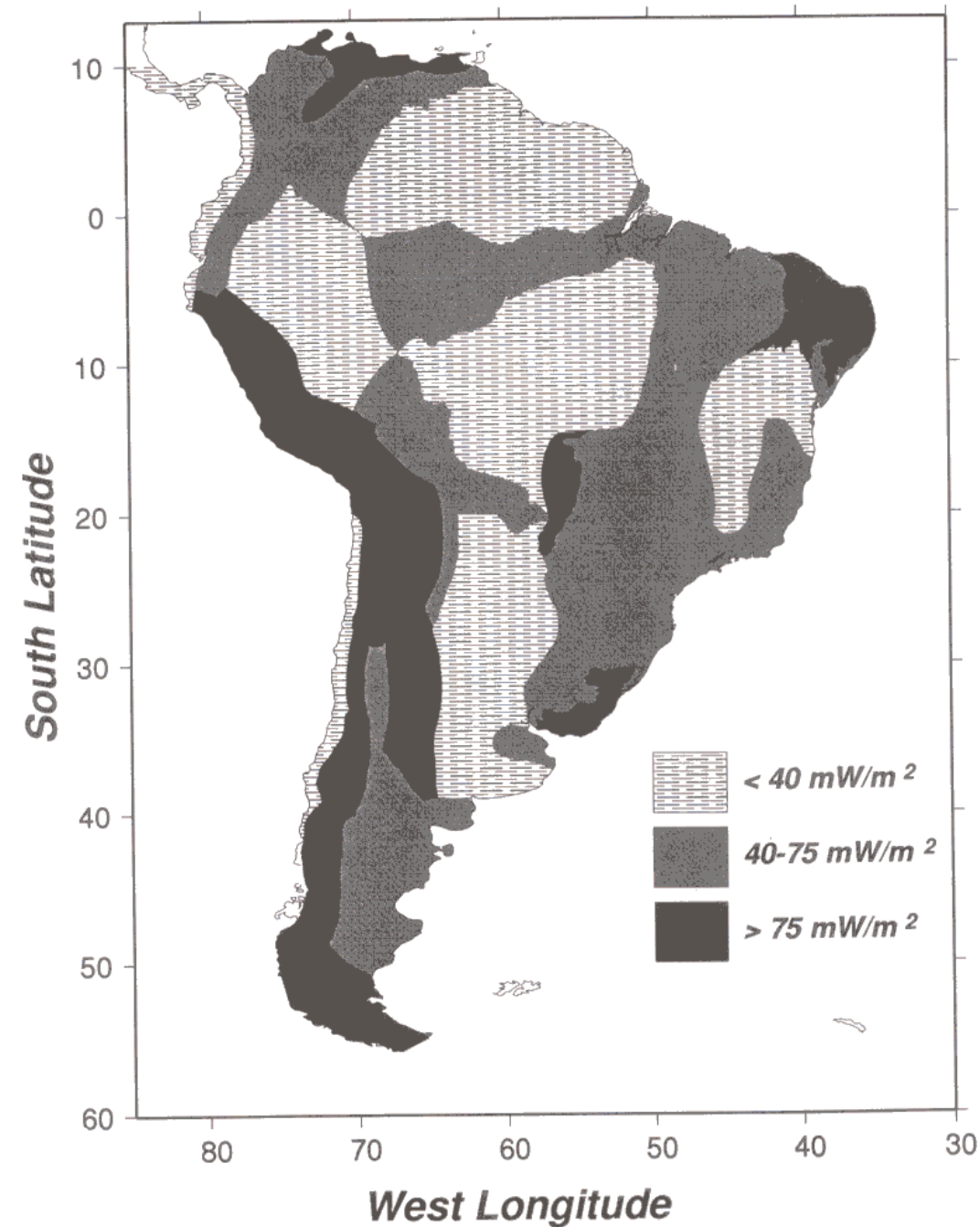


---

# Distribuição dos fluxo de calor

dados representativos (sem os dados de geotermômetros) e relação entre fluxo de calor e idade onde não tem nenhuma informação.

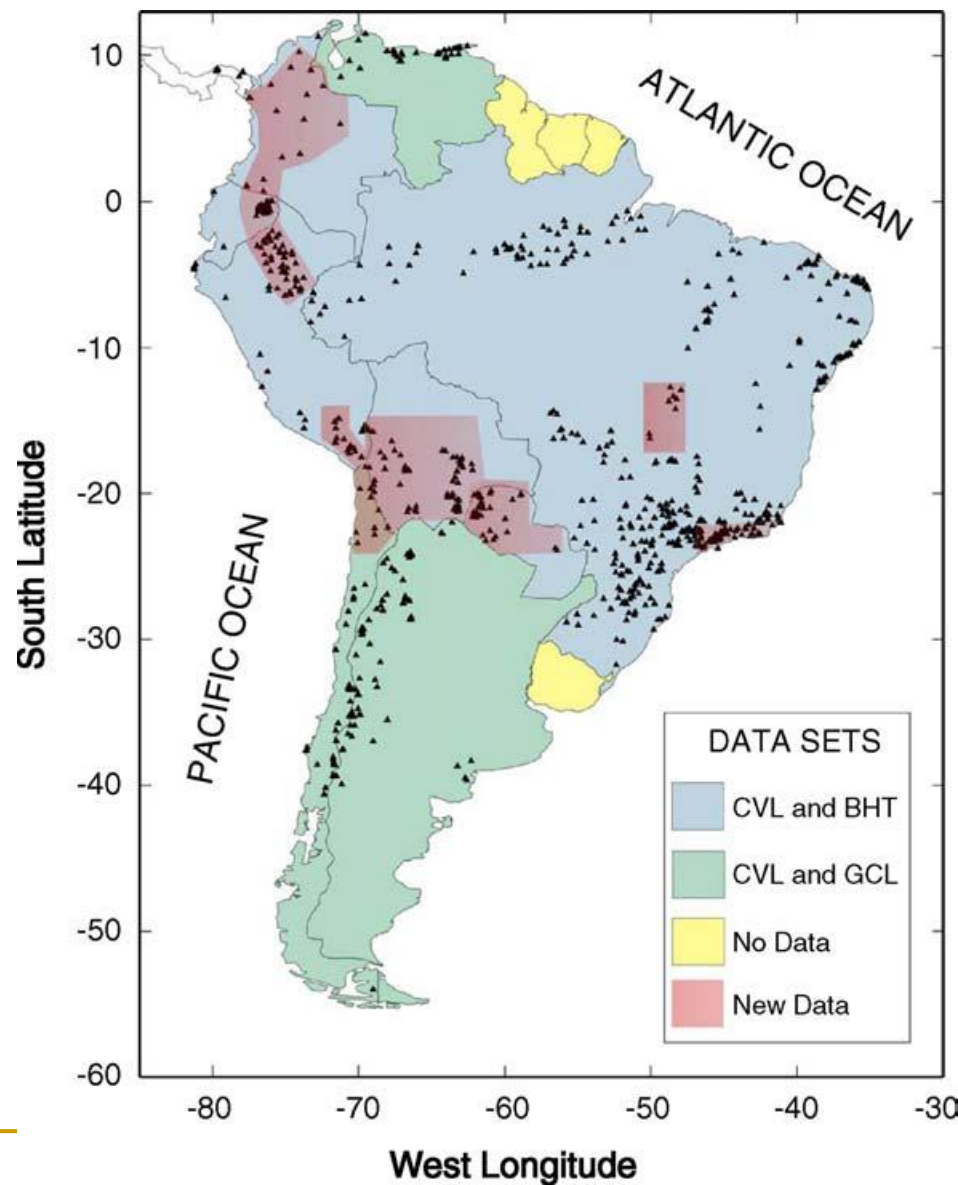
a maior parte dos Andes, os valores são maiores que  $75\text{mW/m}^2$  e que para a Plataforma Brasileira variam entre  $45$  e  $75\text{mW/m}^2$ .



# Distribuição de fluxo de calor mais recente

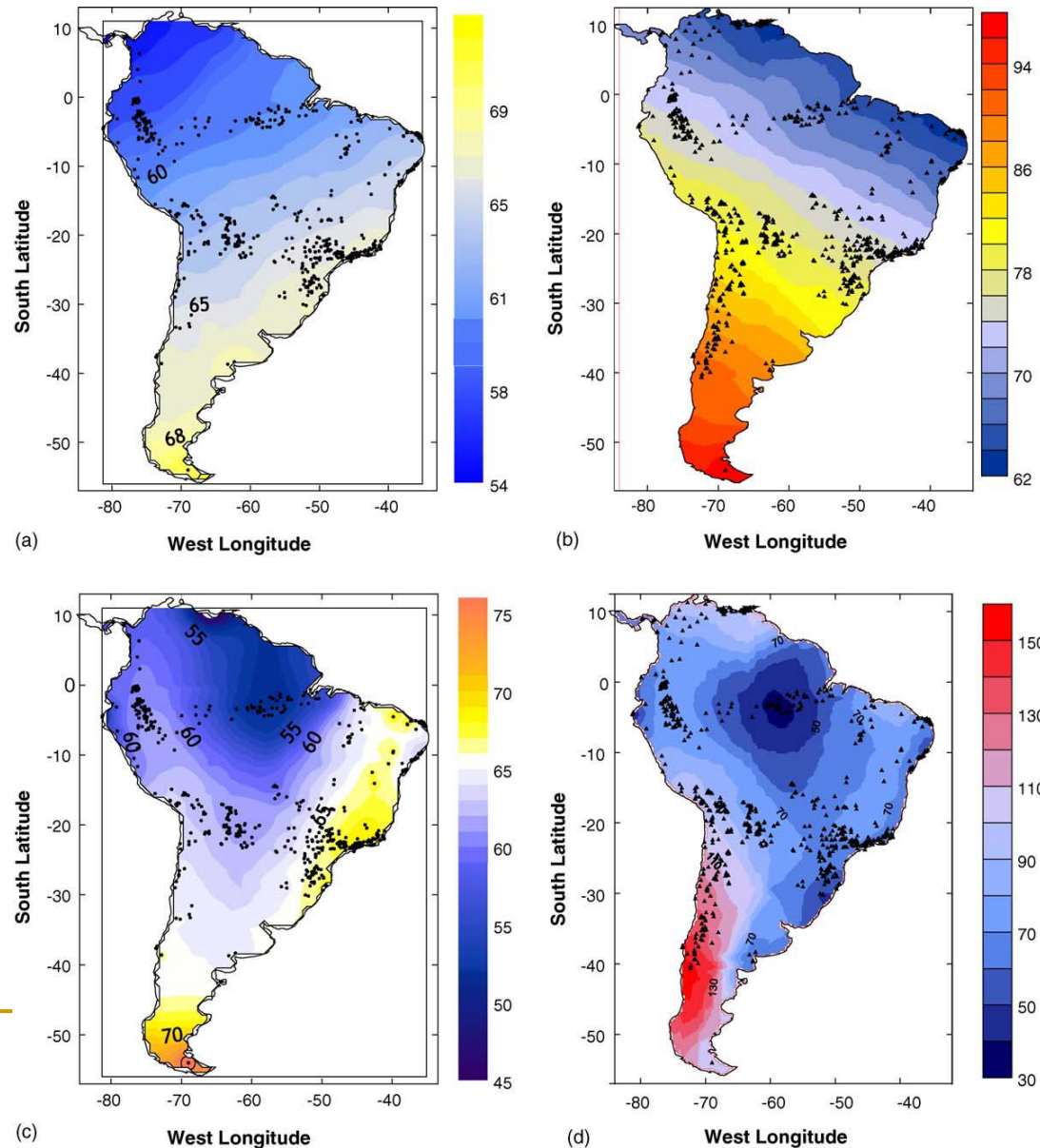
159 medidas convencionais e 26 estimativas baseadas em geotermômetros

840 medidas: 591 diretas e 249 estimativas



# Distribuição de fluxo de calor mais recente

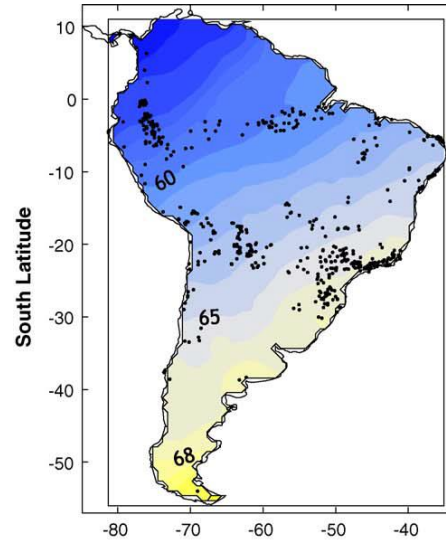
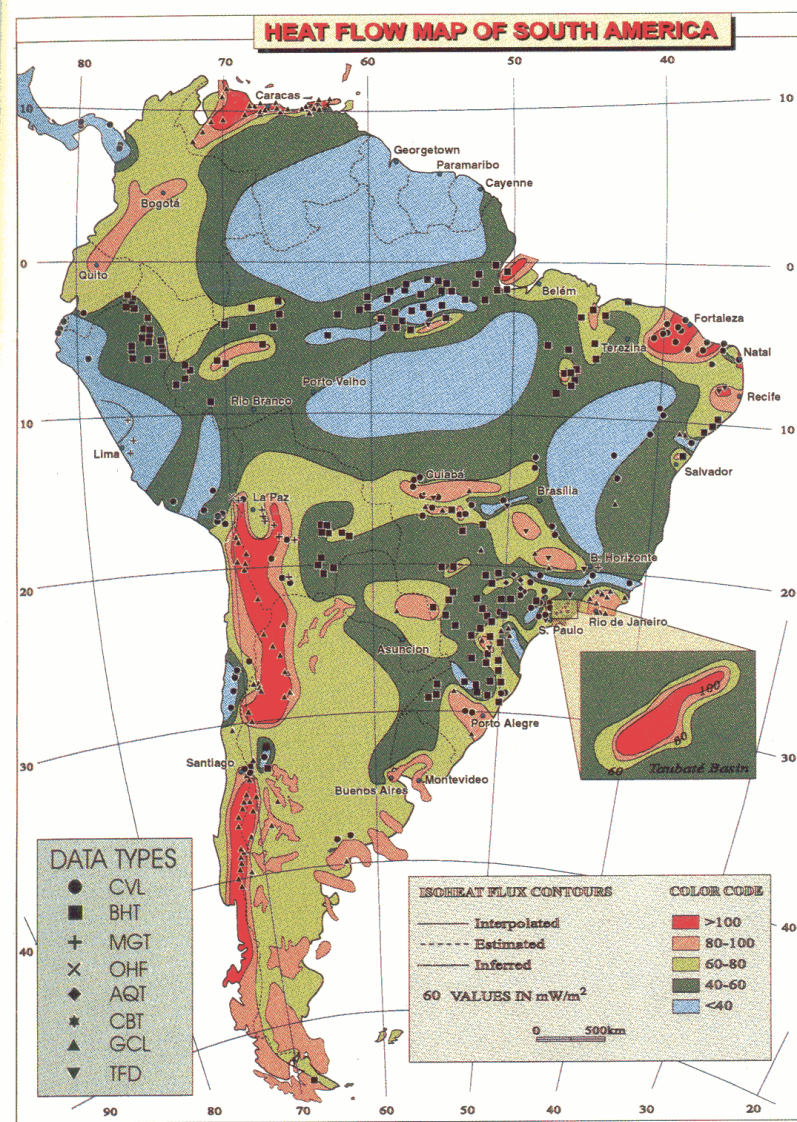
(a) First order polynomial representation of heat flow in South America, based on conventional and BHT data sets. (b) First order polynomial representation of heat flow in South America, based on data set of mixed quality (see text for details). (c) Fourth order polynomial representation of heat flow in South America, based on conventional and BHT data sets. The contour interval is  $5\text{mW/m}^2$ . (d) Fourth order polynomial representation of heat flow in South America, based on data set of mixed quality (see text for details). The contour interval is  $10\text{mW/m}^2$ . The points are locations of heat flow measurements.



# Comparando mapas de fluxo de calor

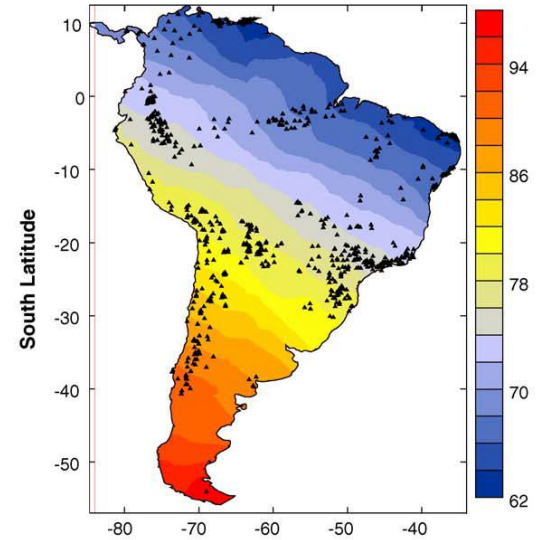
Heat Flow Map of South America

621



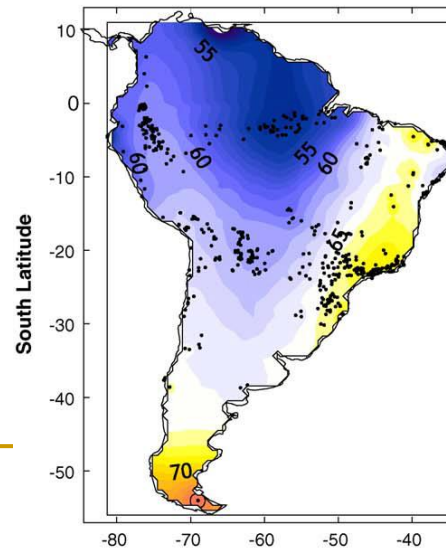
(a)

West Longitude



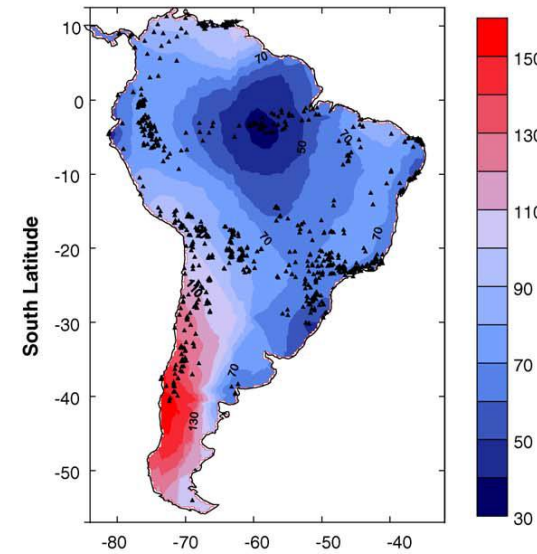
(b)

West Longitude



(c)

West Longitude



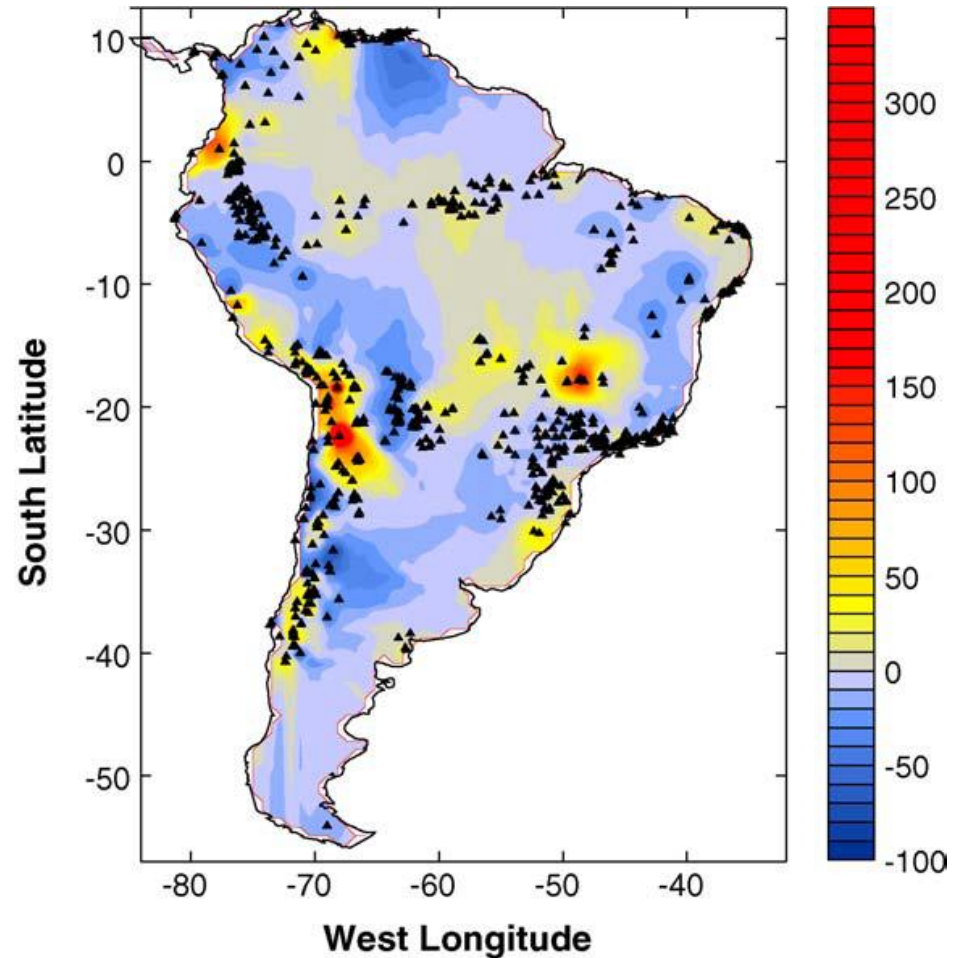
(d)

West Longitude

Fig. 6. (caption opposite)

# Distribuição de fluxo de calor mais recente

Residual anomalies of fourth order polynomial representation relative to observed values of heat flow in South America. The triangles indicate locations of heat flow measurements. The contour interval (see side bar) is  $10\text{mW/m}^2$ .



# Comparação de mapas de fluxo de calor

Heat Flow Map of South America

621

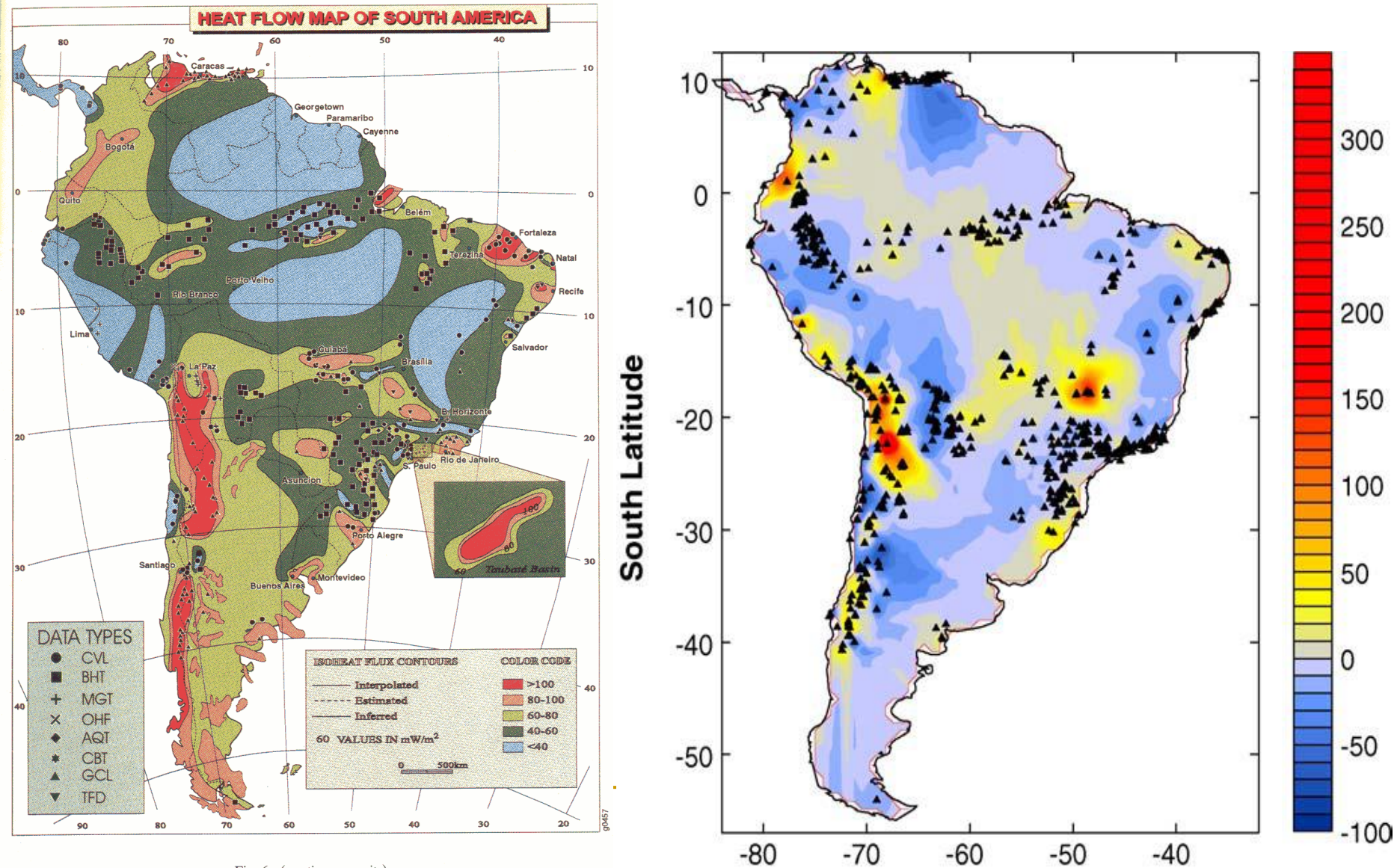


Fig. 6. (caption opposite)

# Dados da AS no banco mundial de dados.

## South America

