

*Geometria Analítica*

**Coordenadas polares**

**Prof. Dr. Lucas Barboza Sarno da Silva**

# *Circunferências*

Circunferência centrada no pólo e raio  $c$

$$r = c, \quad c \in \mathbb{R}$$

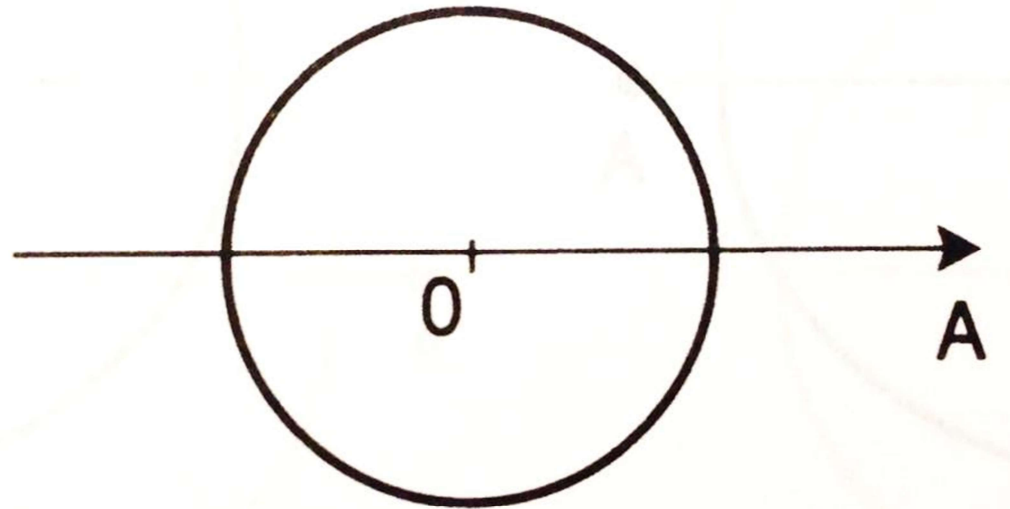

# Circunferências

$$r = 2a \cos \theta$$

Circunferência de centro no eixo polar, tangente ao eixo  $\theta = \pi/2$

- Se  $a > 0$ , o gráfico está à direita do pólo
- Se  $a < 0$ , o gráfico está a esquerda do pólo

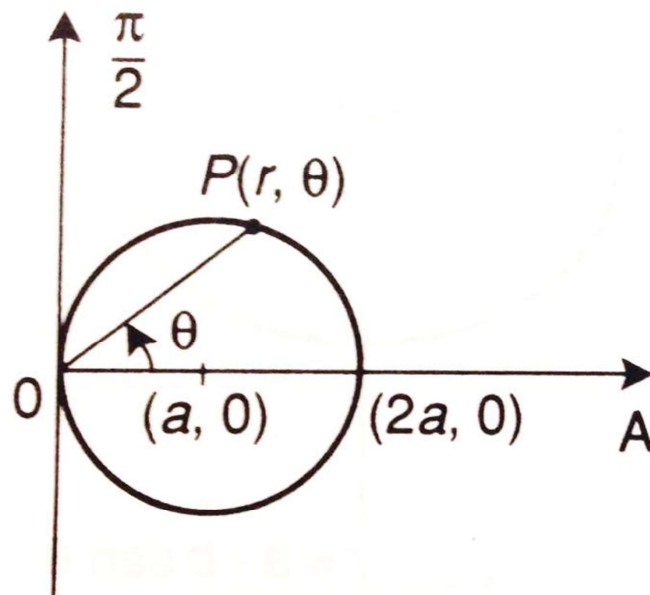

$$[r = 2a \cos \theta, a > 0]$$

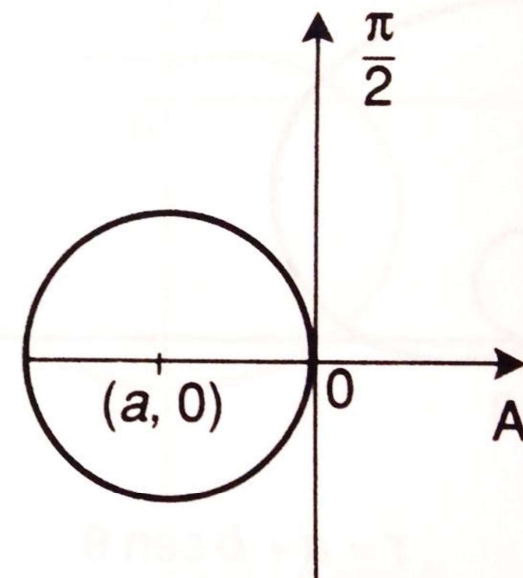

$$[r = 2a \cos \theta, a < 0]$$

# Circunferências

$$r = 2b \operatorname{sen}\theta$$

Circunferência de centro no eixo  $\pi/2$  e tangente ao eixo polar

- Se  $b > 0$ , o gráfico está acima do pólo
- Se  $b < 0$ , o gráfico está abaixo do pólo

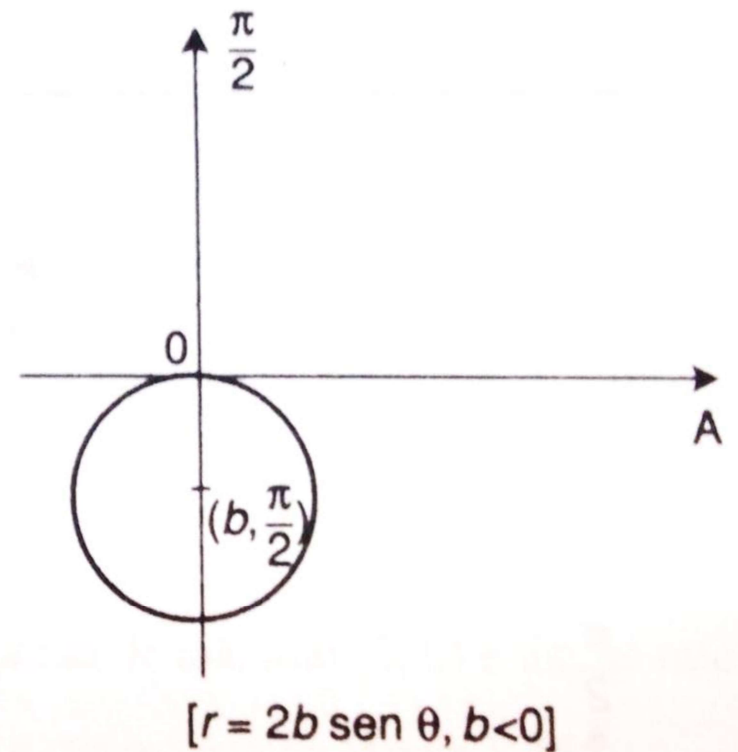
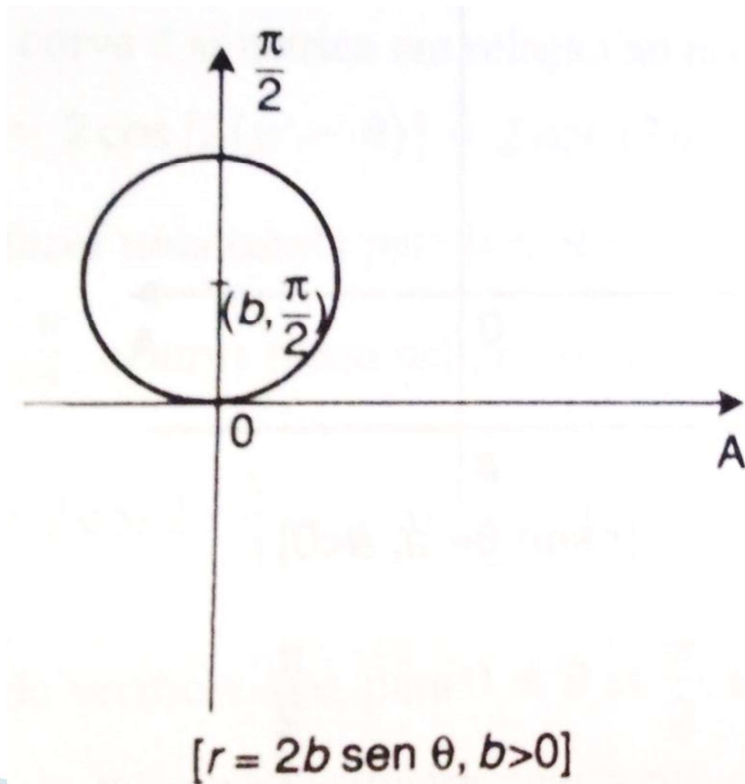

# Limaçons

→  $r = a \pm b \cos \theta$       $a, b \in \mathbb{R}; b > a$

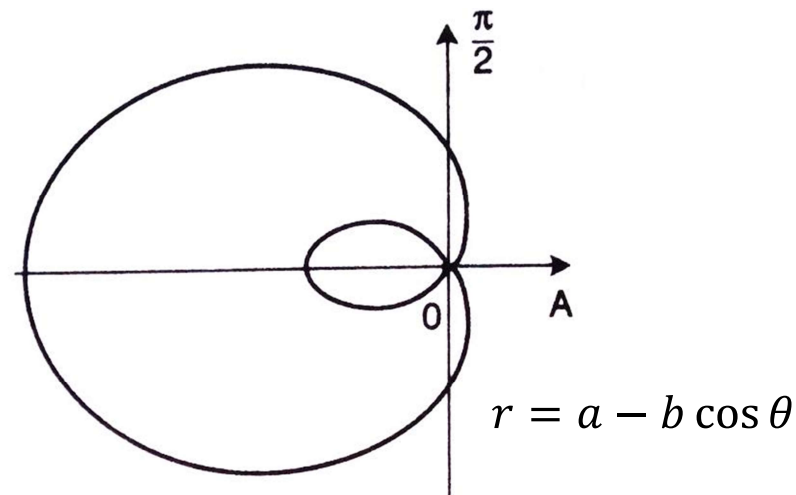
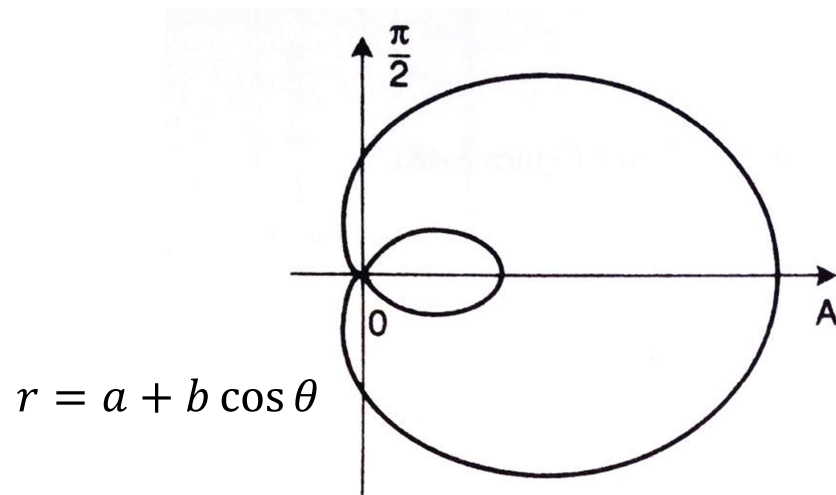

→  $r = a \pm b \sin \theta$       $a, b \in \mathbb{R}; b > a$

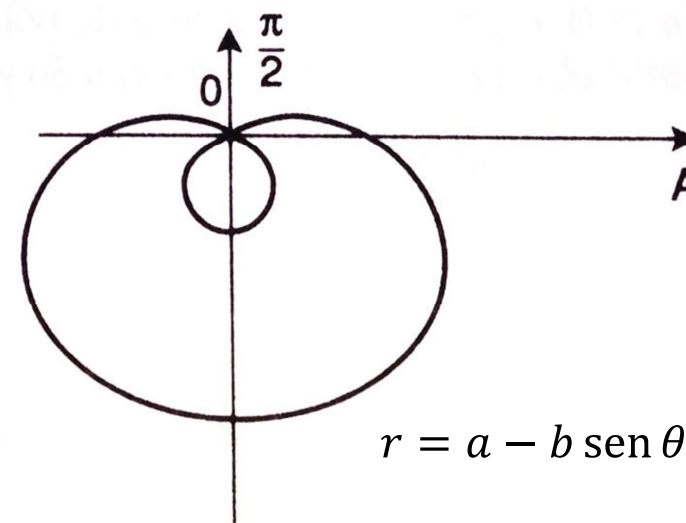
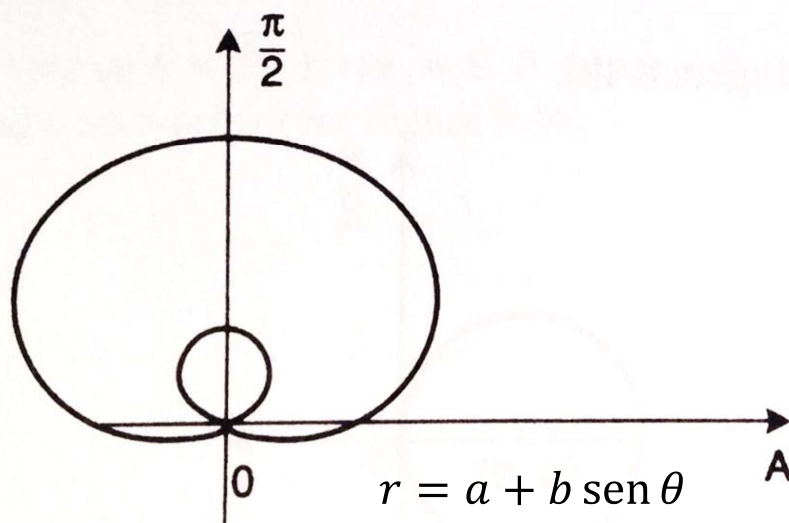

# *Limaçon (cardióide)*

→  $r = a \pm b \cos \theta$       $a, b \in \mathbb{R}; b = a$

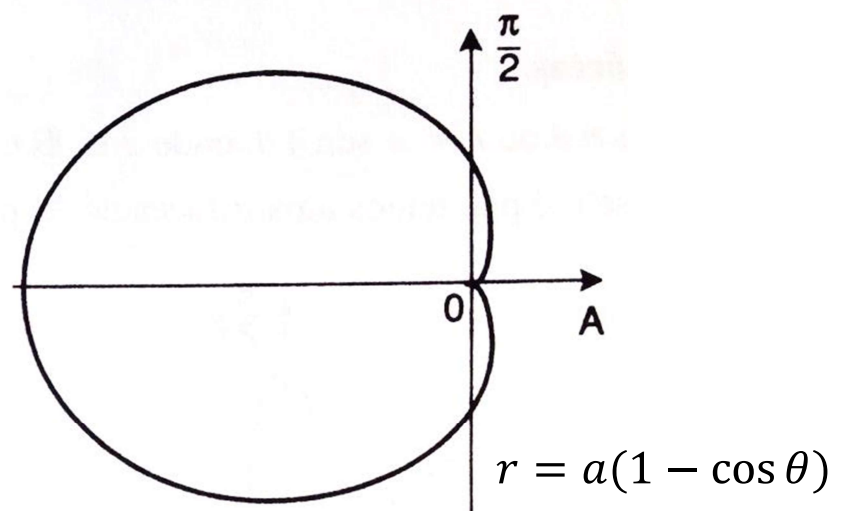
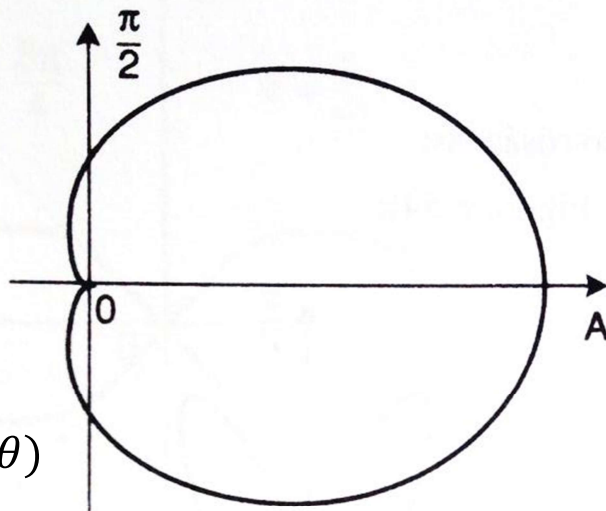

→  $r = a \pm b \sin \theta$       $a, b \in \mathbb{R}; b = a$

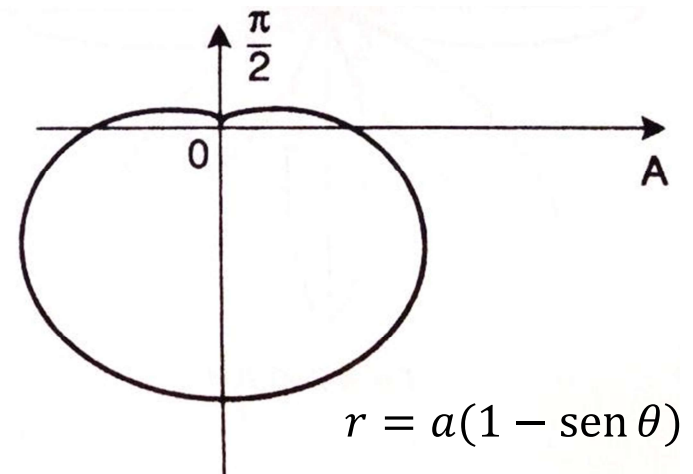
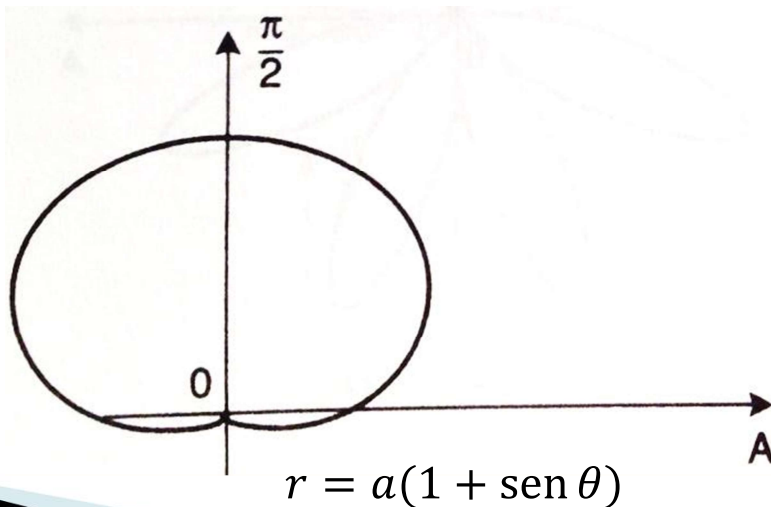

# Limaçons

→  $r = a \pm b \cos \theta$       $a, b \in \mathbb{R}; b < a$

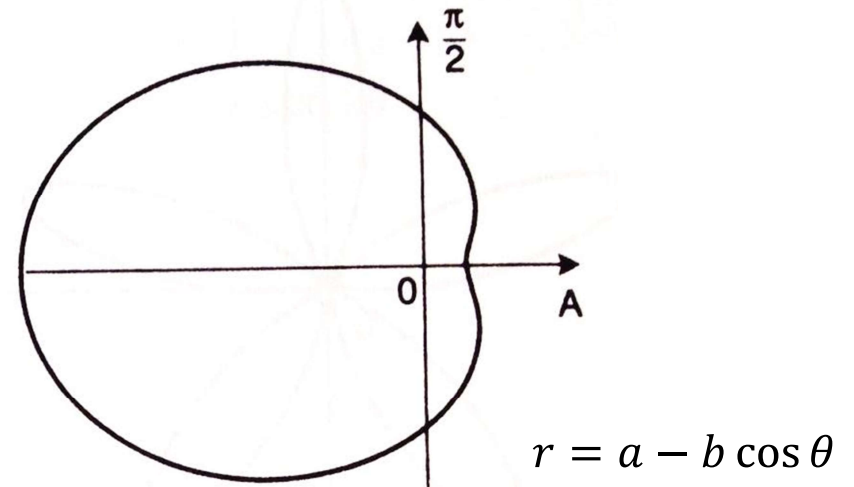
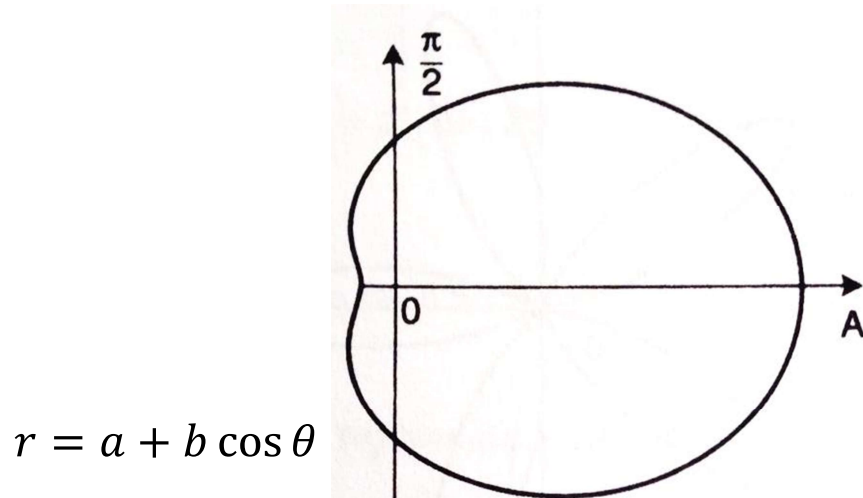

→  $r = a \pm b \sin \theta$       $a, b \in \mathbb{R}; b < a$

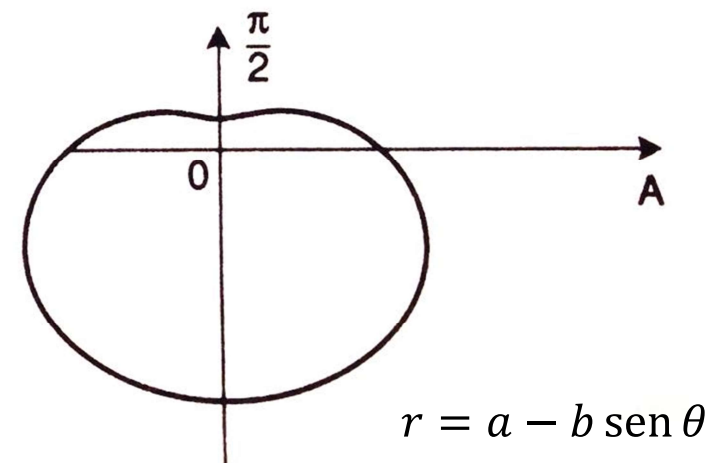
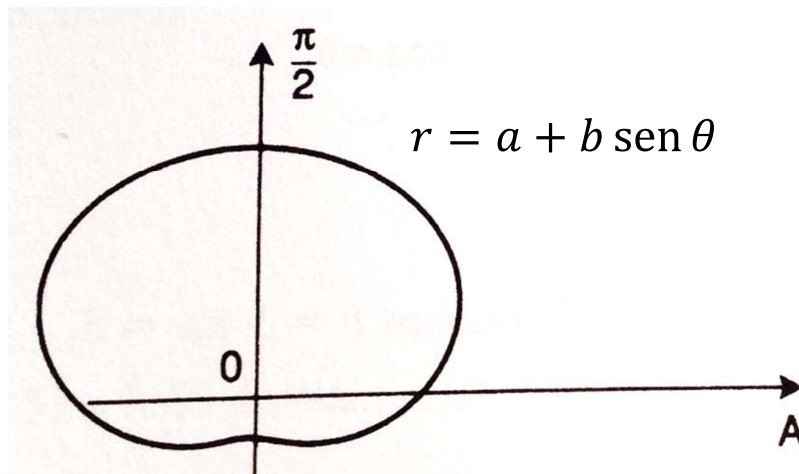

# Rosáceas

$$r = a \cos n\theta \quad \text{ou} \quad r = a \sen n\theta \quad a \in \mathbb{R}; n \in \mathbb{N}$$

- Se  $n$  é par, temos uma rosácea de  $2n$  pétalas

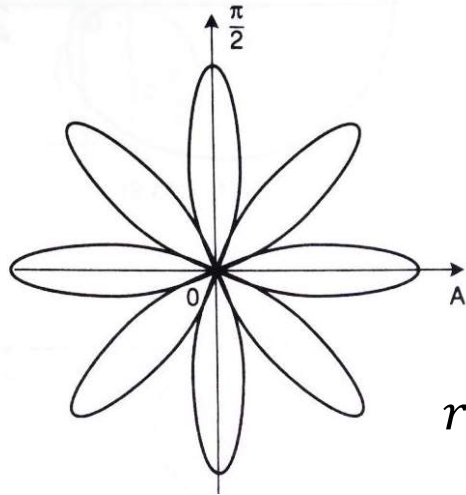

$$r = a \cos n\theta$$

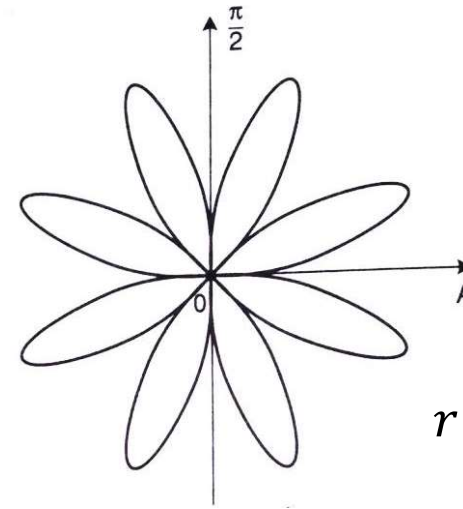

$$r = a \sen n\theta$$

- Se  $n$  é impar, temos uma rosácea de  $n$  pétalas

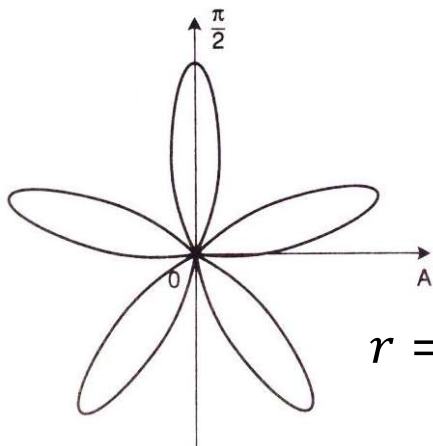

$$r = a \sen n\theta$$

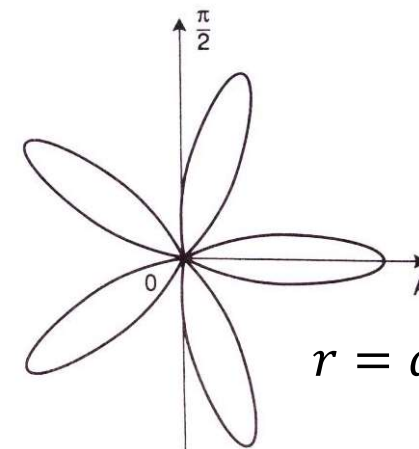

$$r = a \cos n\theta$$



# Lemniscatas

$$r^2 = \pm a^2 \cos 2\theta \quad \text{ou} \quad r^2 = \pm a^2 \sin 2\theta \quad a \in \mathbb{R}$$

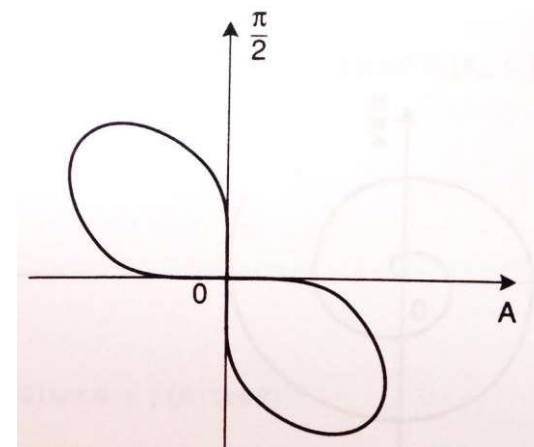
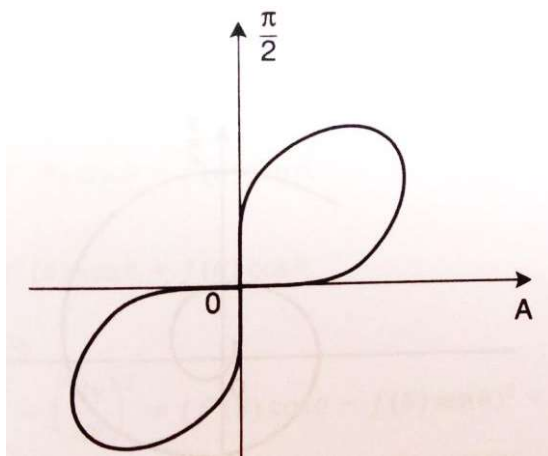
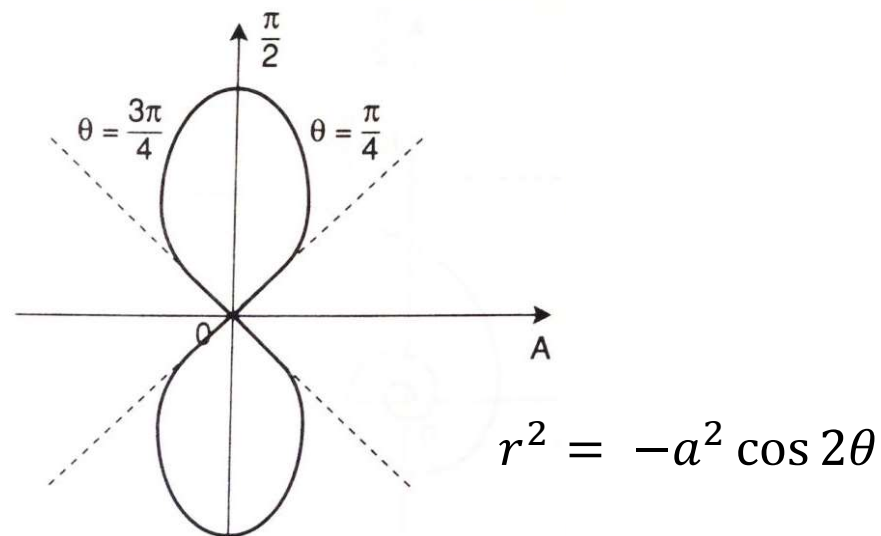
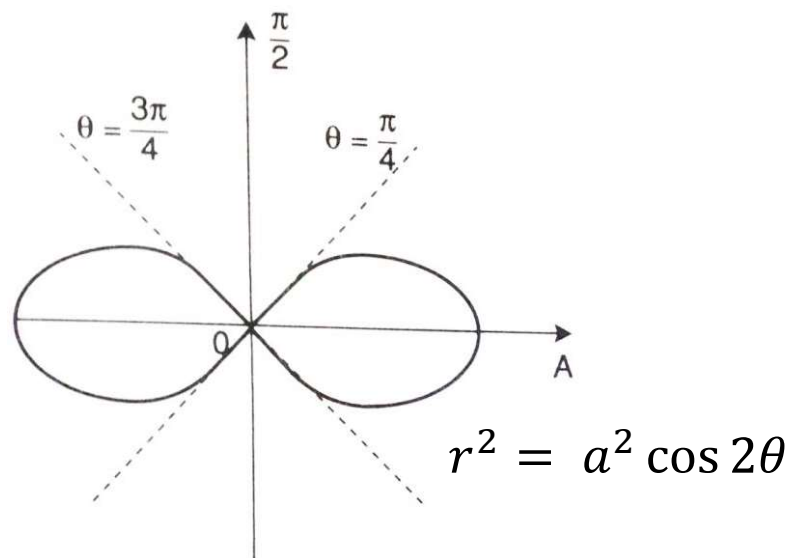

$$r^2 = a^2 \sin 2\theta$$

$$r^2 = -a^2 \sin 2\theta$$

# *Espirais*

Espiral hiperbólica:  $r\theta = a, a > 0$

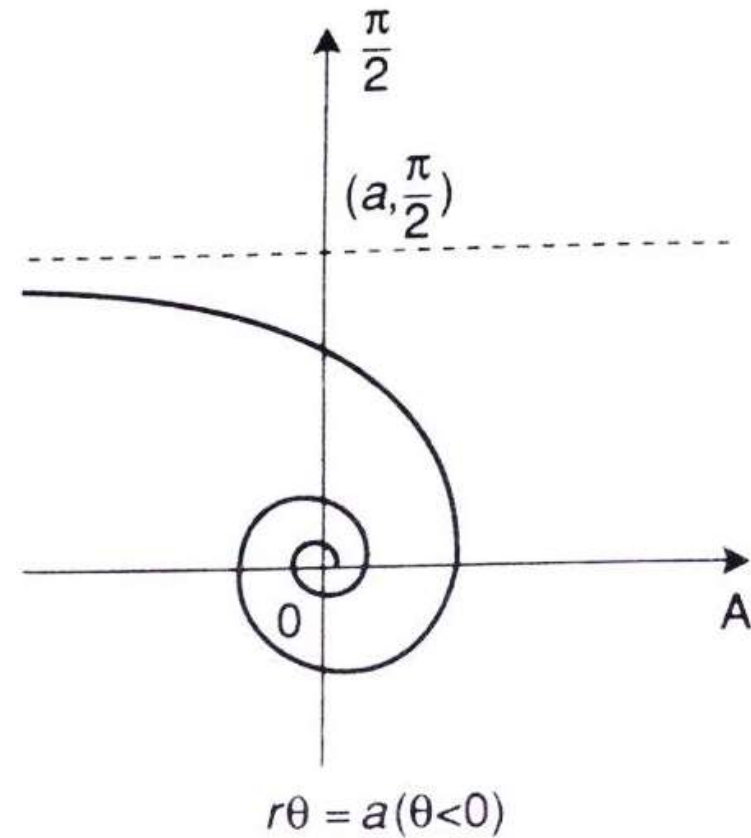
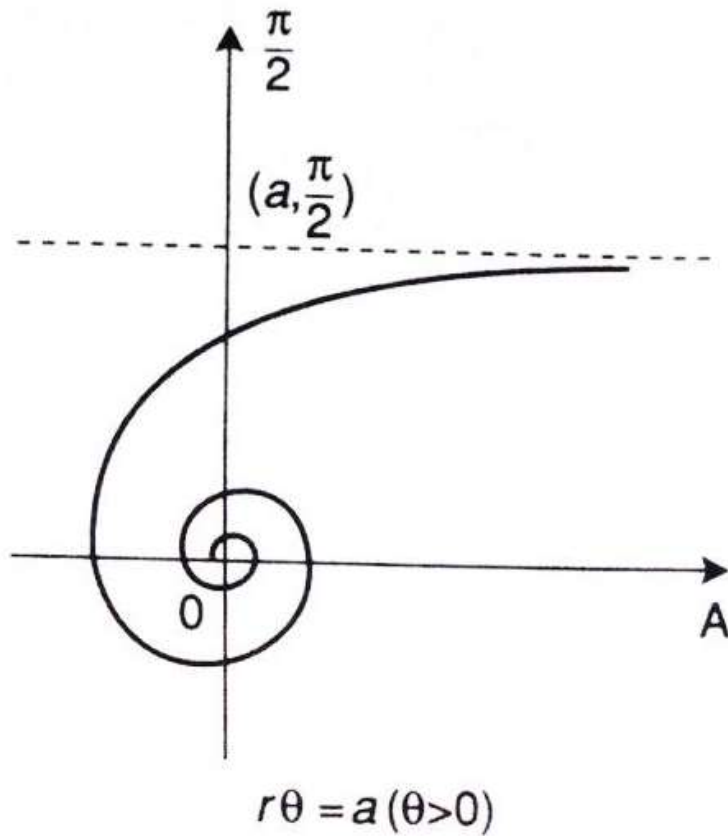

# *Espirais*

Espiral de Arquimedes:  $r = a\theta, a > 0$

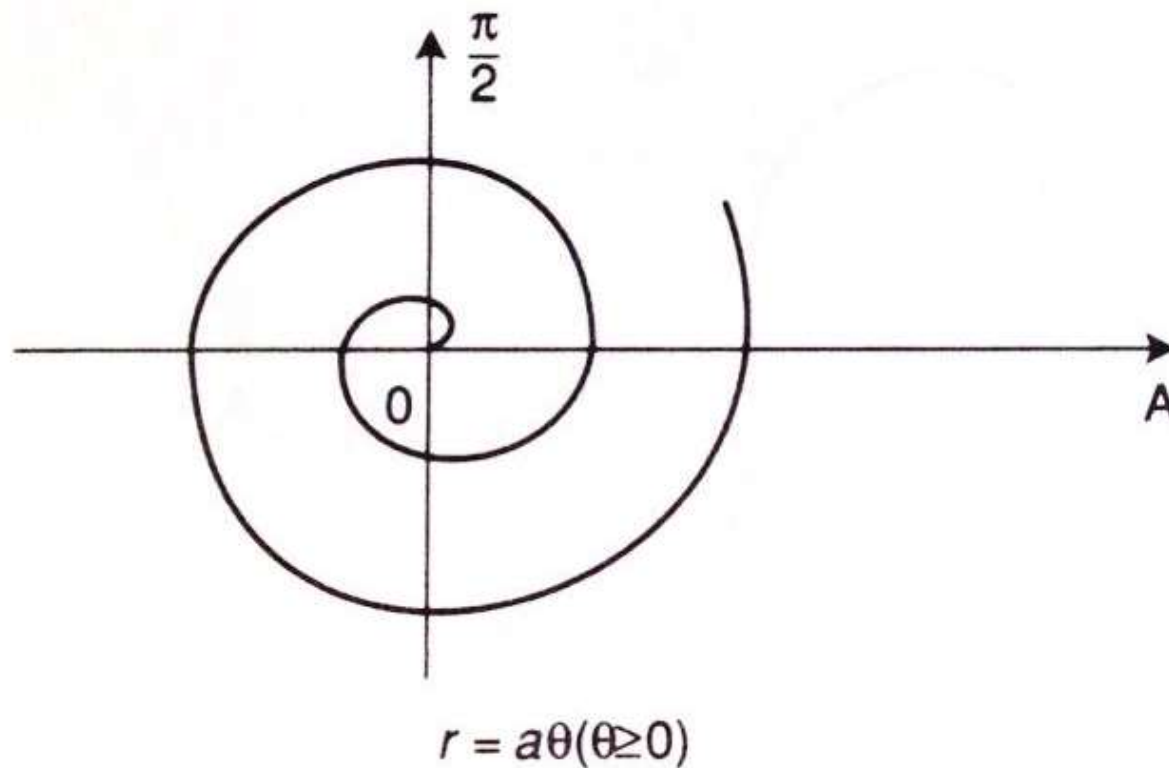

# *Espirais*

Espiral logarítmica:  $r = e^{a\theta}$

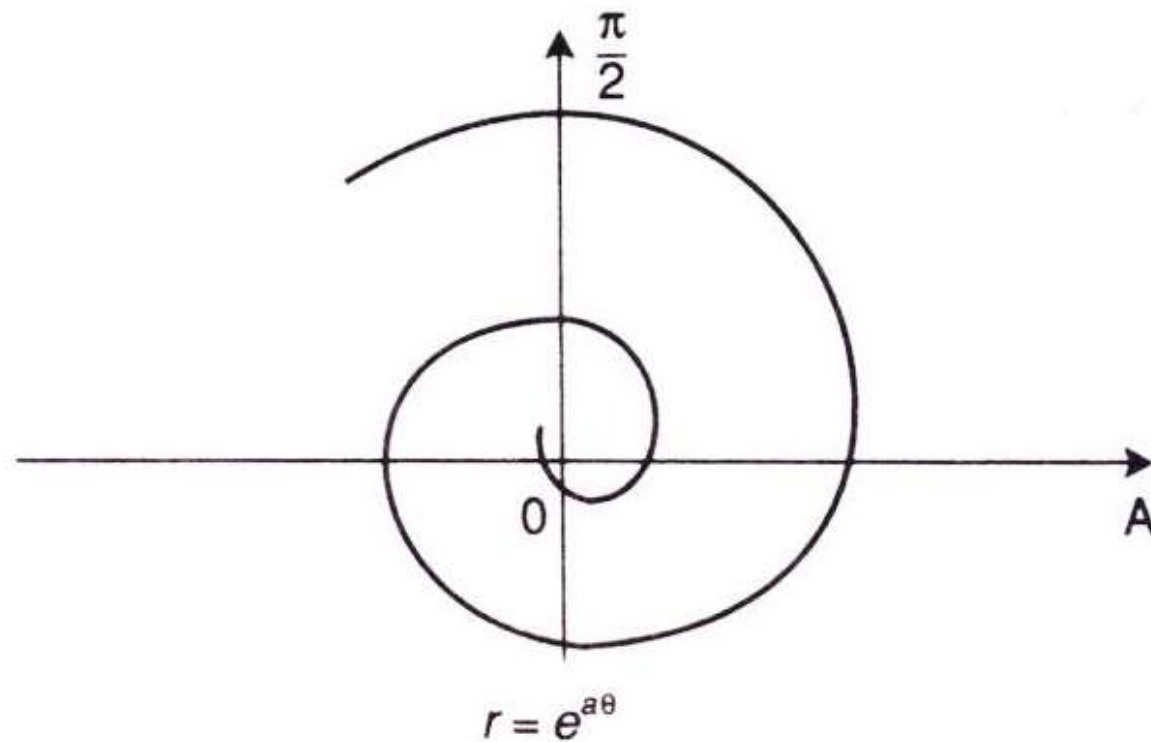

# *Espirais*

Espiral parabólica:  $r^2 = \theta$

