

# Biorefinarias (conceitos de uso integrado da biomassa vegetal)

## O problema

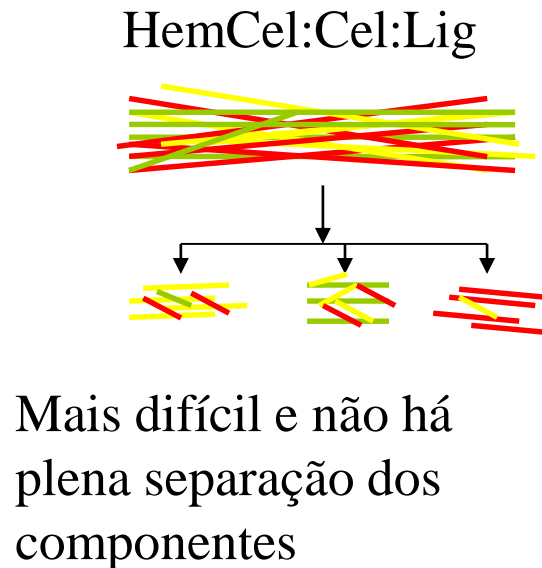
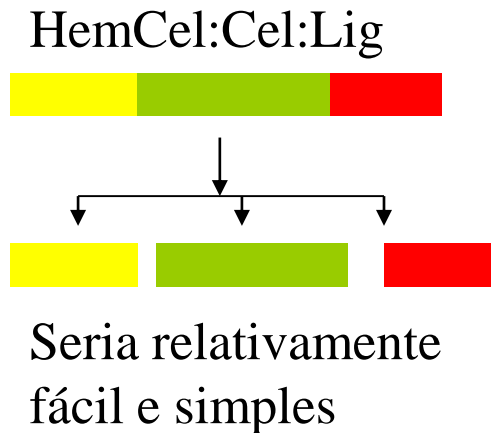

## A solução:????

Há uma infinidade de processos (planejados, algumas vezes testados e **poucas vezes demonstrados em escala ampliada**) que propõem vias de fracionamento

## Definição do NREL para biorrefinarias

<http://www.nrel.gov/biomass/biorefinery.html>

A biorefinery is a facility that **integrates biomass conversion processes and equipment to produce fuels, power, and chemicals from biomass**. The biorefinery concept is analogous to today's petroleum refineries, which produce multiple fuels and products from petroleum. Industrial biorefineries have been identified as the most promising route to the creation of a new domestic biobased industry.

By producing multiple products, a biorefinery can take advantage of the differences in biomass components and intermediates and maximize the value derived from the biomass feedstock. **A biorefinery might, for example, produce one or several low-volume, but high-value, chemical products and a low-value, but high-volume liquid transportation fuel, while generating electricity and process heat for its own use and perhaps enough for sale of electricity.** The high-value products enhance profitability, the high-volume fuel helps meet national energy needs, and the power production reduces costs and avoids greenhouse-gas emissions.

# **Soluções usadas em escala industrial ou escala ampliada**

## **Polpação kraft**

**(produz celulose/hemicelulose polimérica na forma de fibras, além de vapor/eletricidade para uso próprio e excedente)**

- A celulose é recuperada com rendimento elevado;
- Há perda significativa das polioses na forma polimérica;
- A lignina é recuperada na forma quebrada e dissolvida. Para ser usada na geração de calor, demanda concentração até cerca de 60-70% de sólidos

# Biorefinaria associada com o processo kraft

*Pense >> como maximizar a utilização dos componentes??*

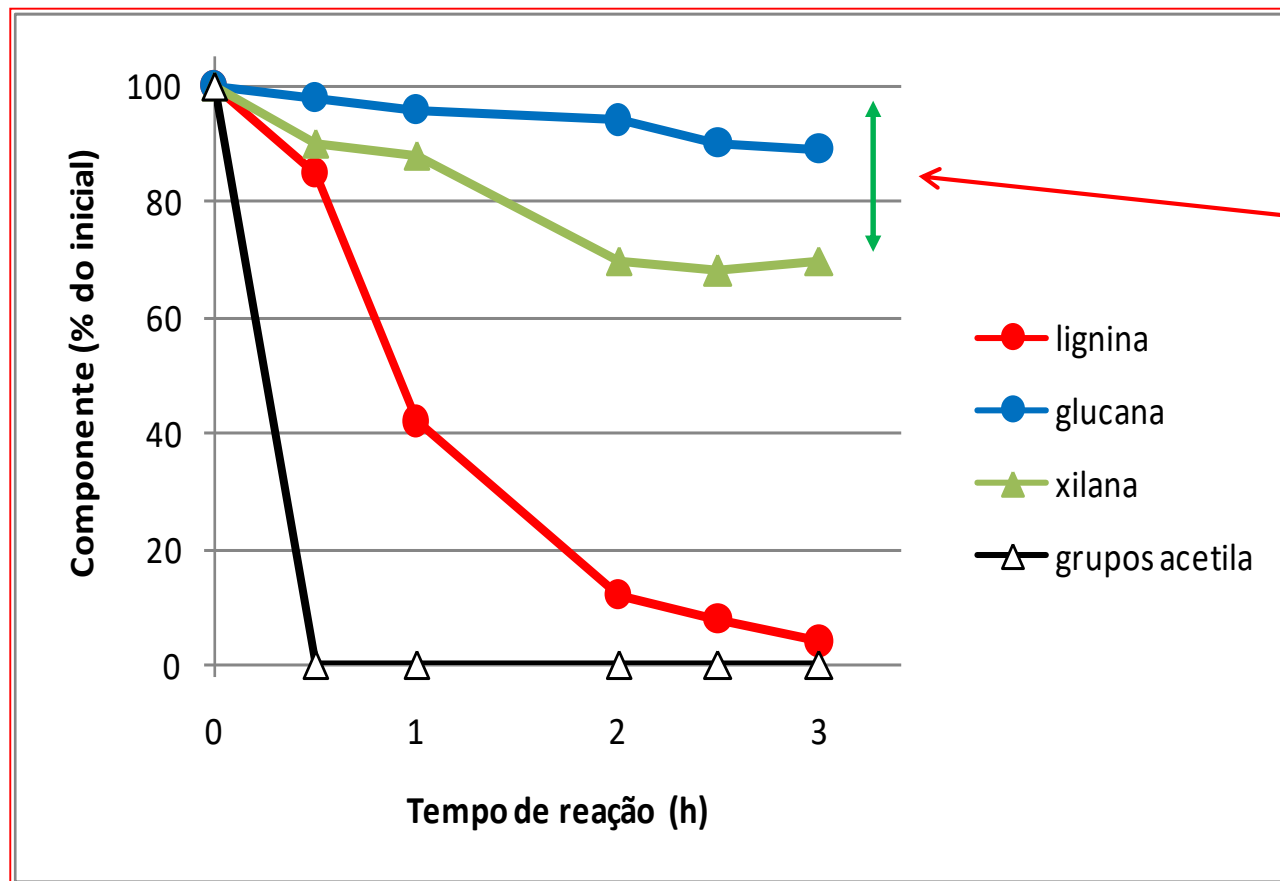

**Parte importante da hemicelulose é perdida no processo**

Dissolução dos principais componentes durante um processo de polpação kraft (Gomide e Almeida, Proc. BSCLWC 2001)

Alternativa para recuperar hemicelulose perdida

Remover a parte lábil por hidrólise ácida branda ou dissolução em meio alcalino, antes de iniciar o processo de polpação kraft.

O licor contendo as frações de hemicelulose dissolvida pode ser destinado a processos de bioconversão, por exemplo

**Um modelo conceitual de biorrefinaria aplicado ao processo kraft**

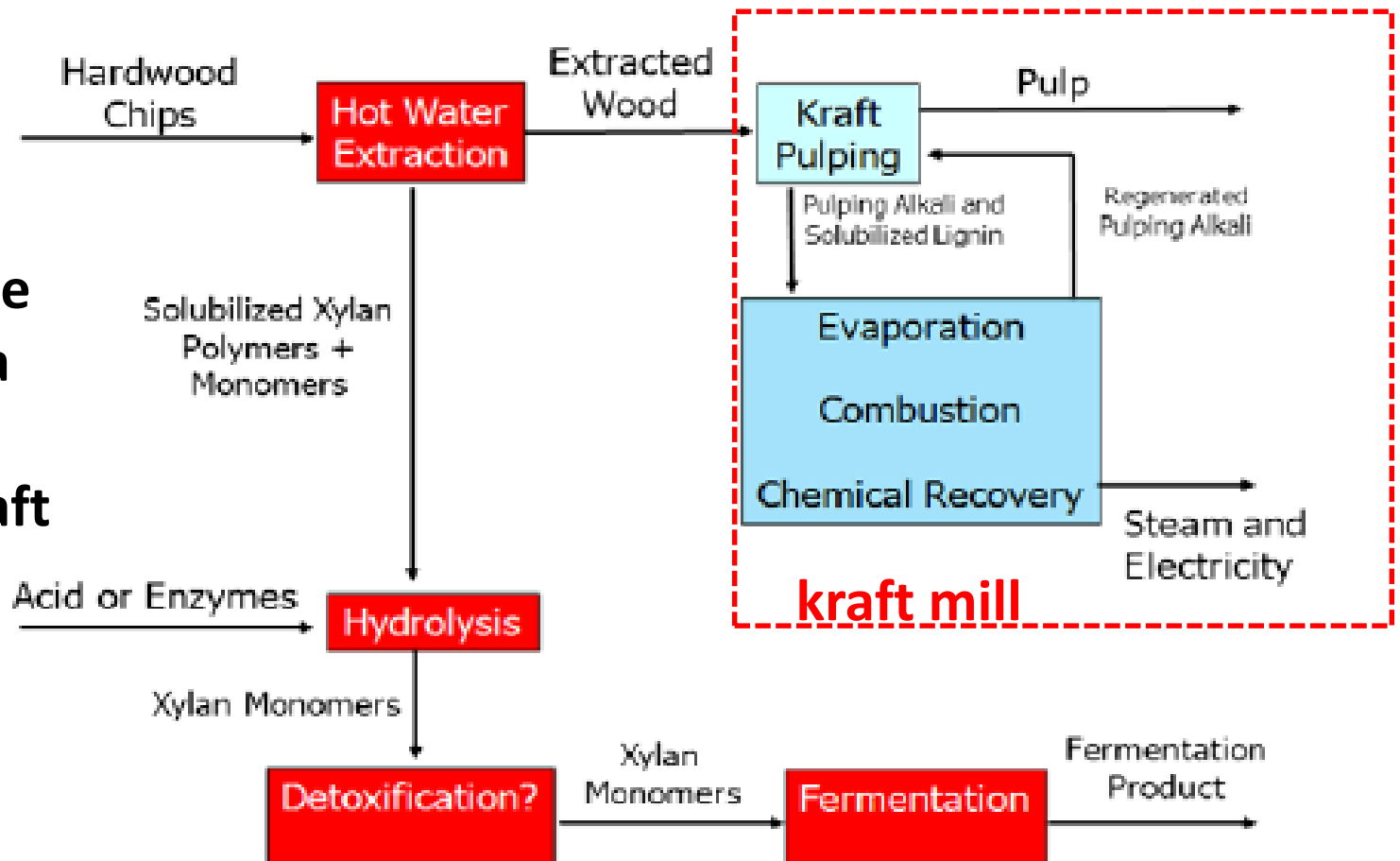

## Exemplo com Eucalipto e autohidrólise

$T_{MAX}$ (°C)	195	200
$S_o$ (dimensionless)	3.64	3.79
<i>Material balance data (g/100 g raw material, oven dry basis)</i>		
Solid yield (SY)	74.7	71.0
Non-volatile compounds (NVC)	20.8	20.4
<i>Spent solids composition (g/100 g spent solids, oven dry basis)</i>		
Cellulose	57.9	58.6
Xylan	3.90	4.21
Arabinan	0.21	0.11
Acetyl groups	0.85	0.67
Klason lignin	34.4	32.4
<i>Liquid phase composition (g monomer equivalent/L or g/L)</i>		
Gluco-oligomers	0.772	0.893
Xylo-oligomers	13.8	12.2
Arabino-oligomers	0.237	0.000
Acetyl groups-oligomers	2.83	2.70
Glucose	0.149	0.188
Xylose	2.39	4.45
Arabinose	0.239	0.620
Acetic acid	0.575	0.859
Hydroxymethylfurfural	0.024	0.102
Furfural	0.050	0.059

remoção  
intensa de  
hemicelulose

## Exemplo com Eucalipto: autohidrólise seguida de **polpação kraft**

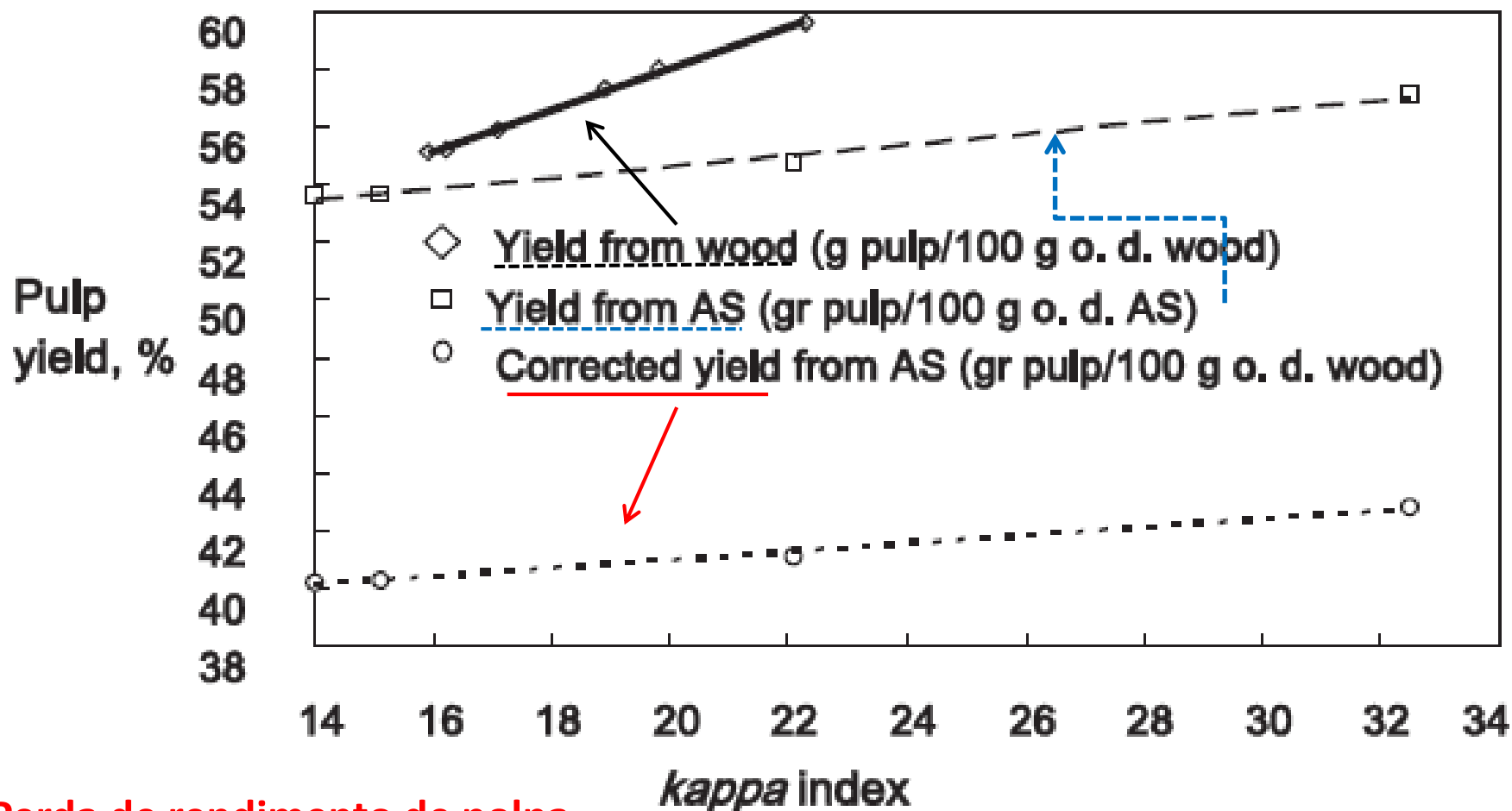

**Perda de rendimento de polpa**

**Qualidade da polpa indica produto útil para polpa de dissolução  
(preparação de derivados de celulose)**

# A larch based biorefinery: pre-extraction and extract fermentation to lactic acid

Hanna Hörhammer<sup>1,\*</sup>, Sara Walton<sup>2</sup> and Adriaan van Heiningen<sup>1,2</sup>

Holzforschung, Vol. 65, pp. 491–496, 2011

Água quente  
(autohidrólise)

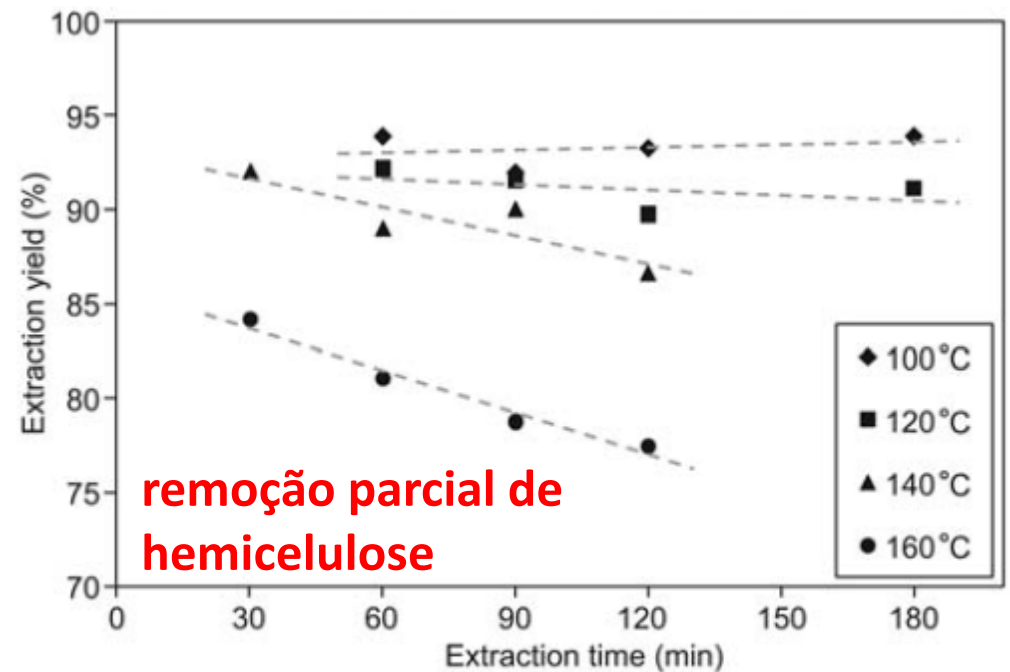
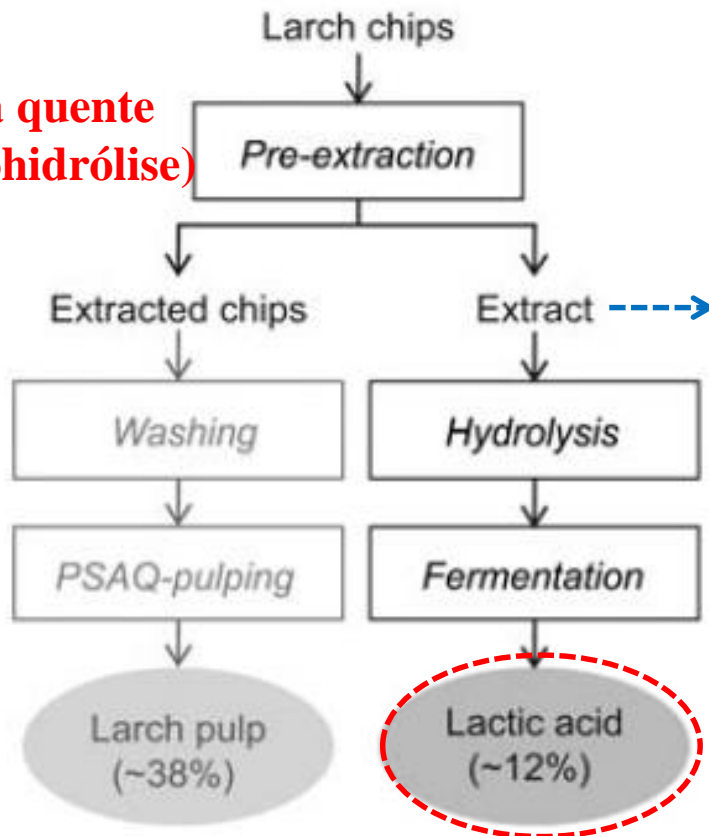

Figure 2 Yields from pre-extraction trials with Siberian larch (*L. sibirica*).



# A larch based biorefinery: pre-extraction and extract fermentation to lactic acid

## Balanço de massas dos componentes retidos na fração sólida

		Water extraction								
Ext temp., °C		100	100	120	120	140	140	160	160	160
Ext time, min	Orig. wood	60	90	60	90	60	90	30	60	90
Extract pH		5.4	5.2	4.7	5.1	4.6	4.6	4.4	3.9	3.9
Wood										
Carbohydrates	71.7	68.9	65.8	65.3	63.6	62.4	60.5	58.1	57.1	53.5
Arabinose	2.9	2.3	1.9	2.3	1.9	1.4	1.2	0.3	0.2	0.2
Galactose	12.8	8.6	8.1	8.1	8.4	6.4	7.3	5.0	4.6	4.2
Glucose	39.9	41.1	40.1	38.6	38.2	38.9	37.5	40.3	39.2	37.7
Xylose	5.0	4.9	4.7	4.9	4.5	4.7	4.3	3.7	3.8	3.2
Mannose	11.1	11.8	11.0	11.4	10.5	10.9	10.1	8.8	9.2	8.0
Lignin	24.9	24.7	24.1	25.1	25.7	24.6	25.2	24.6	24.8	24.2
Extractives	1.8	1.3	1.1	1.3	1.1	1.4	1.3	1.7	1.7	1.7
Other	1.4	1.3	1.3	1.3	1.2	1.2	1.0	1.0	1.0	0.8
Acetyl groups	0.9	0.9	0.9	0.9	0.9	0.9	0.8	0.8	0.8	0.7
Ash	0.5	0.4	0.4	0.4	0.3	0.3	0.2	0.2	0.2	0.2
Total in wood	99.8	96.2	92.3	93.1	91.6	89.6	88.0	85.3	84.6	80.2
Total carbohydrates	71.1	73.8	70.6	71.2	70.2	70.1	69.5	69.4	70.1	69.7
Total	99.8	101.2	97.4	99.5	98.7	98.1	98.0	98.0	99.4	98.4

remoção parcial de hemicelulose

In earlier studies, pre-extraction of larch chips was followed by polysulfide-anthraquinone (PSAQ) pulping (Kämpfi et al. 2010). The synergism of PS and AQ is beneficial for the pre-extracted larch chips. Water extraction before pulping resulted in lower (4–5%) pulp yield than control kraft pulps. However, with addition of PS and AQ the yield loss was mostly compensated. The techno-economics of a process based on Siberian larch for production of papermaking pulp and lactic acid have been reported (Hörhammer et al. 2009).

### **Polpa ainda útil para fabricação de papéis**

Kämpfi, R., Hörhammer, H., Leponiemi, A., van Heiningen A. (2010) Pre-extraction and PSAQ pulping of Siberian larch. Nord. Pulp Paper Res. J. 25: 243–248.

**Fermentação  
dos açúcares  
monoméricos  
liberados no  
extrato  
aquoso para  
produção de  
ácido láctico**

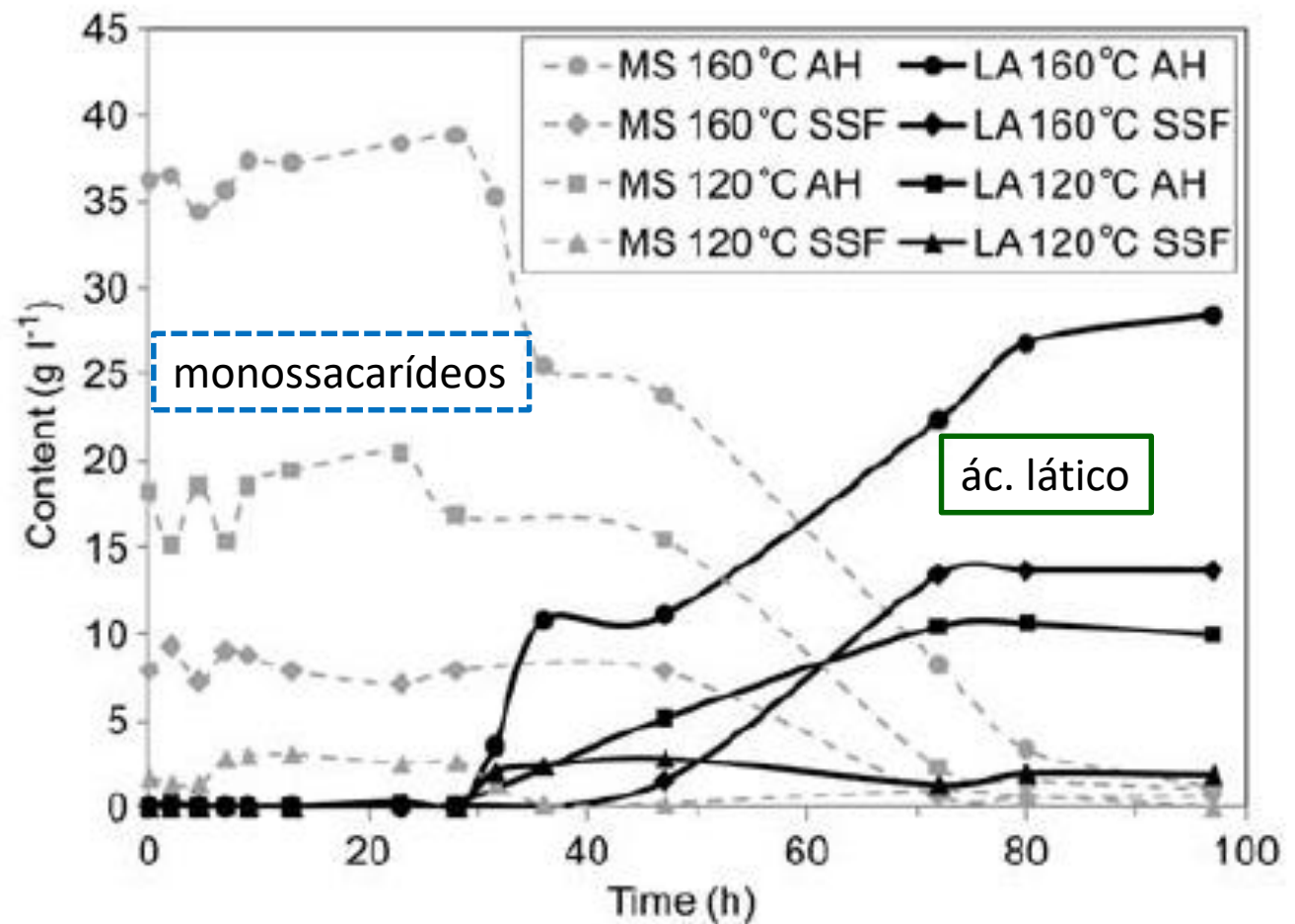

Figure 4 Lactic acid production through fermentation of larch (*L. sibirica*) extracts produced at 120°C and 160°C. Two different hydrolysis methods were tested; acid hydrolysis prior to fermentation (AH) and simultaneous enzymatic hydrolysis and fermentation (SSF). The consumption of monosugars (MS) and production of lactic acid (LA) are presented as a function of fermentation time.

# Outra abordagem de biorrefinaria dentro do processo kraft

Recuperar a lignina na forma sólida

(*usualmente por precipitação em meio ácido*)

Visa minimizar o gasto energético necessário nas etapas de concentração do licor, além de proporcionar o desafogamento das indústrias na etapa de recuperação

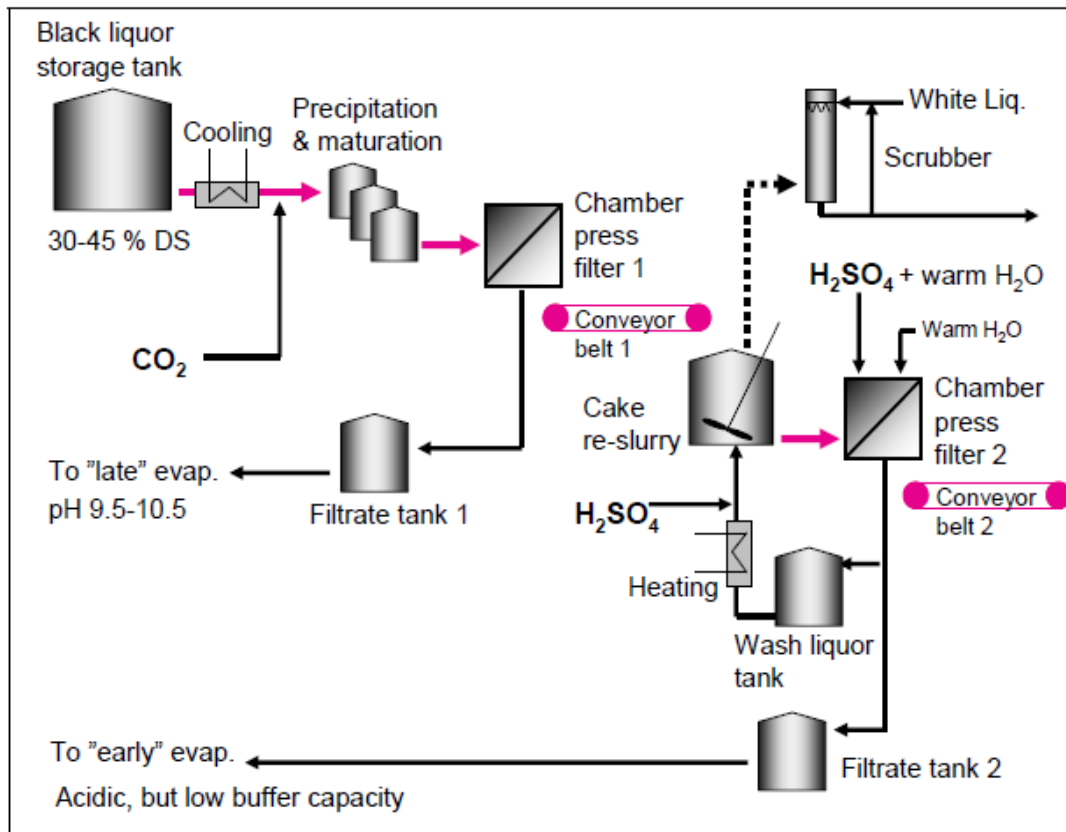

## Lignoboost process Inventia, Sweden

THE LIGNOBOOST PROCESS & USE OF LIGNIN AS A NEW BIO-FUEL

Per Tomani, Niklas Berglin, Peter Axegård

TAPPI Engineering, Pulping & Environmental Conference, October 11-14, 2009, Memphis, Tennessee

→ Lignina

*Cellulose Chem. Technol.*,  
**44** (1-3), 53-58 (2010)

Figure 1 General layout of the lignin removal process (post-treatment, drying & pulverizing are excluded).

## The NEW lignin precipitation process, 8 bar

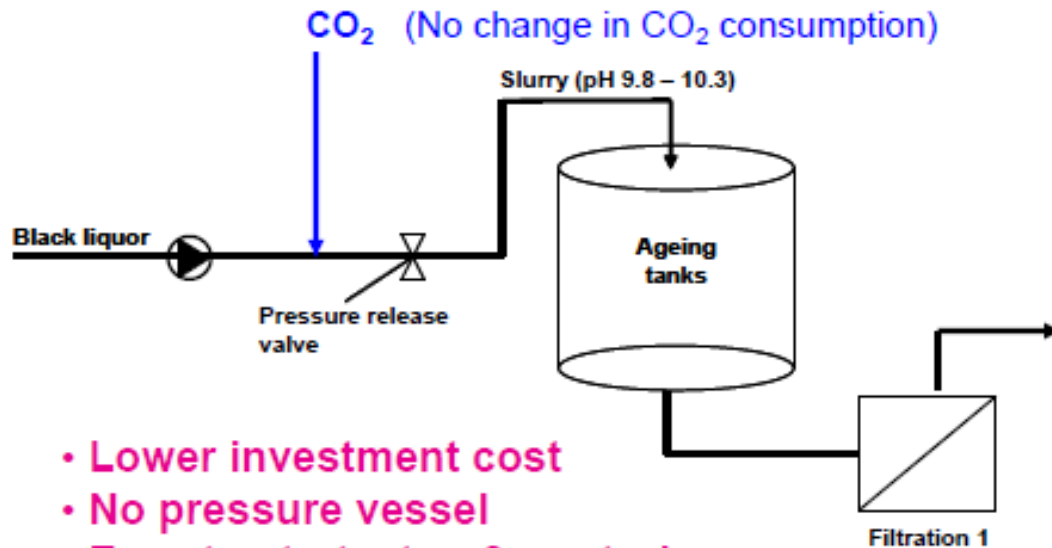

- Lower investment cost
- No pressure vessel
- Easy to start, stop & control
- Lower maintenance cost

Intermediate lignin filter cake from filtration stage 1

Dry solids: 65-70 %

ry-over of alkaline black  
or effects the demand  
cid in the last part of the  
cess.

ge amount of carry-over  
acts the Na/S balance.



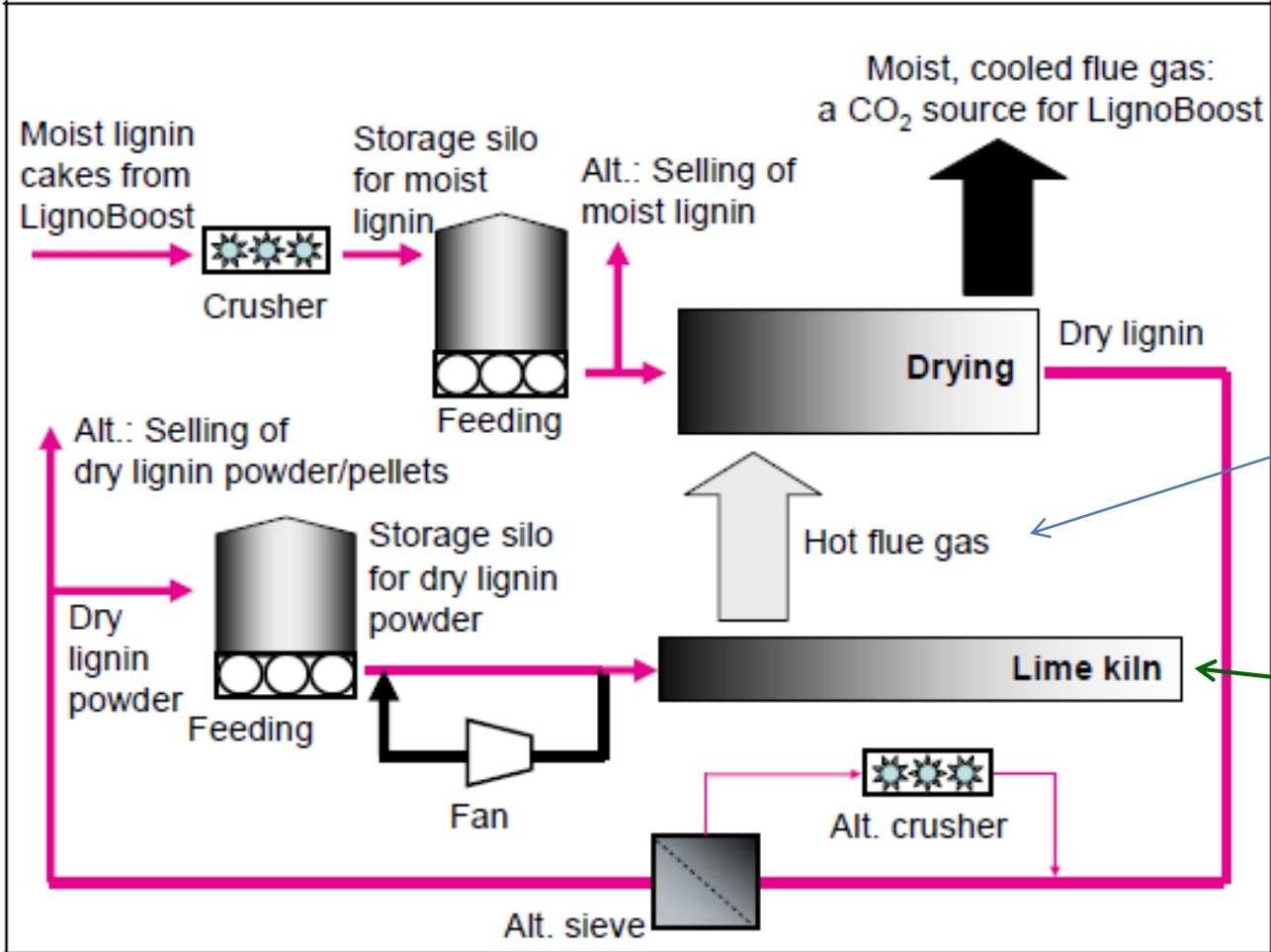

Aproveitamento do ar quente gerado >> secagem da lignina

Lignina **como fonte de energia para o forno de cal:**  
 $\text{CaCO}_3 \gg \text{CaO} + \text{CO}_2$

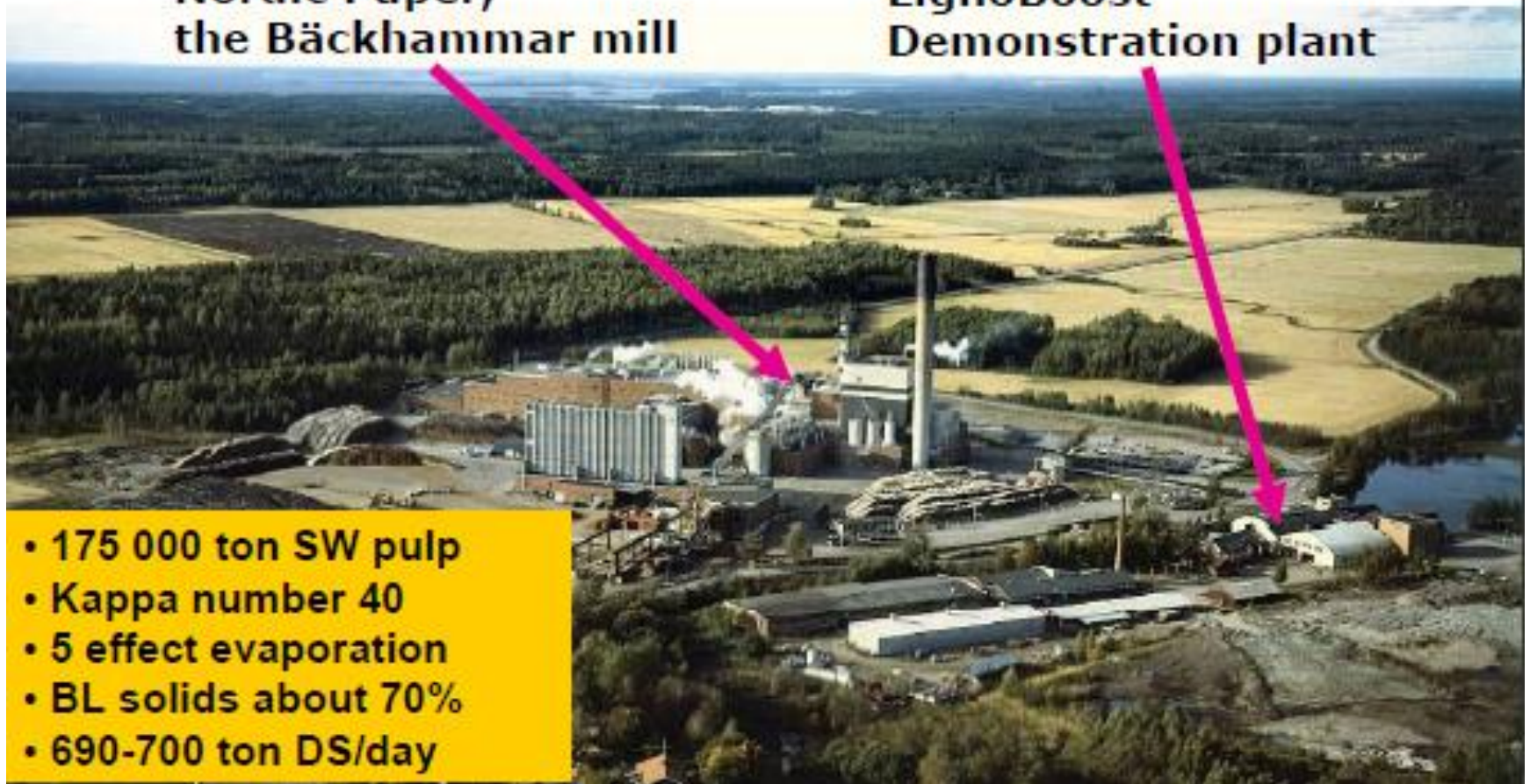

Figure 6. Lignin produced in the demonstration plant at Bäckhammar – filter cake and lignin pellets.

# Demonstration in Bäckhammar by LignoBoost Demo AB

**Nordic Paper,  
the Bäckhammar mill**

**LignoBoost  
Demonstration plant**



- 175 000 ton SW pulp
- Kappa number 40
- 5 effect evaporation
- BL solids about 70%
- 690-700 ton DS/day

# The chamber pressfilter in Bäckhammar

Supplier: Metso Minerals







- **Max capacity: 10 000 tonnes/year**
- **190-210 kg lignin/ ton DS, but just a partial flow of BL**
- **Our production rate March 2007 to September 2008 :150-350 ton/month**
- **Today mainly R&D activities – not a commercial delivery of fuel**
- **Production manager & 4 process operators in Bäckhammar**
- **Technical & administrative management from INNVENTIA**

# LignoBoost Demonstration plant

Samples from the first year of operation

Dry solids in the final lignin product, %

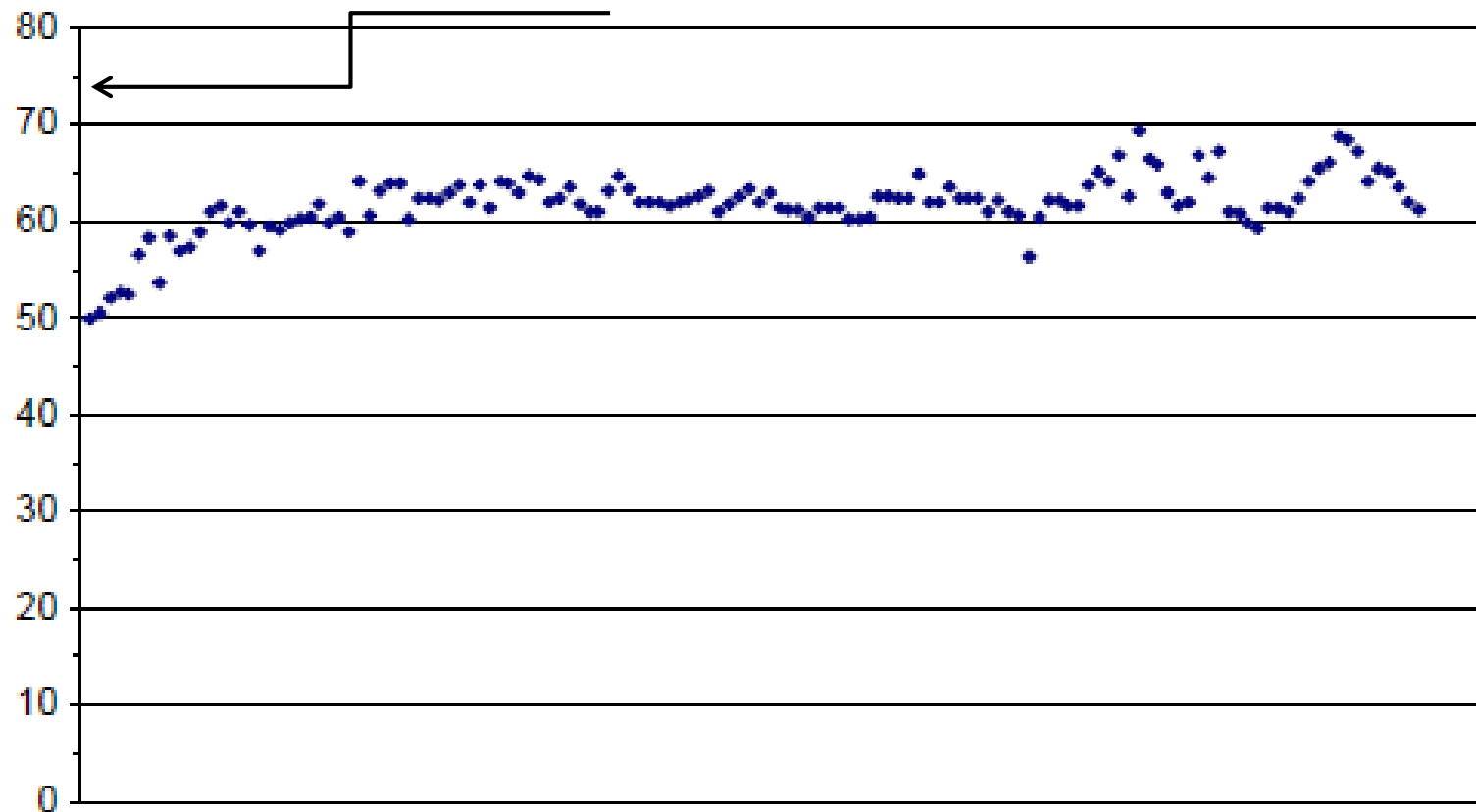

February  
2007

One year of operation

February  
2008

# Poder calorífico da lignina produzida

**Table 2.** Analysis of kraft lignin from the lignin removal demonstration plant

Parameter	Median values	Variation in samples	
		Min	Max
<b>Content in fuel (weight- %)</b>			
Moisture <sup>a)</sup>	32.3	29.3	40.0
Ash (dry)	1	0.2	1.4
<b>Heat value (MJ/kg)</b>			
HHV (dry ash free)	27.1	26.6	27.3
HHV (moist) <sup>a)</sup>	18.2	15.9	18.6
LHV (dry ash free)	25.9	25.3	26.0
LHV (moist) <sup>a)</sup>	16.6	14.2	16.9
<b>Elementary analysis ( % dry ash free)</b>			
C	65.1	63.6	66.2
H	5.8	5.7	6.2
O	26.1	25.9	27.5
S	2.5	1.8	3.2
N	0.1	0.1	0.2
Cl	0,01	0.01	0.01

**HHV**

highest heating value

(considera a energia liberada a uma temperatura suposta de 25oC

>> água na forma líquida)

**LHV**

lowest heating value

desconta a energia consumida com a vaporização da >> água na forma vapor)

## Conceito do emprego da lignina como "óleo" bombeável

Pumpable lignin

33% lignin (on energy basis) in fuel oil 5



We have also successfully mixed lignin with glycerine (from bio-diesel production) and also with the tar oil from refining of crude tall-oil

## Emprego da lignina no forno de cal

Full scale trial with lignin fuel as fuel in a lime kiln

Södra Cell Mönsterås 15-17 April 2008

- 37 tonne lignin to a lime kiln (275 ton lime/day) during 32 hours
- The lime kiln burner is designed for simultaneous co-firing of oil, bio-mass powder, gas (NCG) and methanol



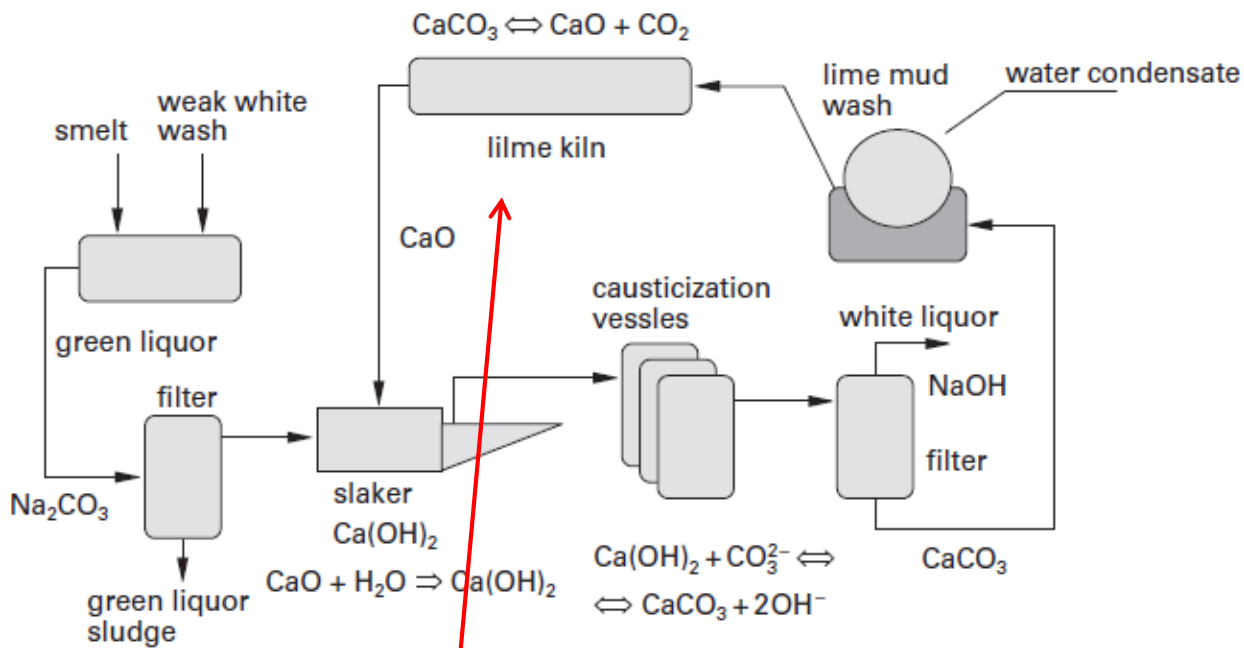

Lime product

**Mesma qualidade como fonte de CaO**

Visible specks of lignin dust

**Lignina como fonte de energia na calcinação no lugar de combustível fóssil**



Reference lime before trial (Sample K2)



Lime at 100% lignin firing (Sample K32)