

Regeneração no processo kraft

- recuperação de inorgânicos e produção de energia

Ref. básica para estudo: **Capítulos 12 e 13: Ek M, Gellerstedt G, Henriksson G. *Pulping Chemistry and Technology* (Volume 2). Berlin, Walter de Gruyter, 2009**

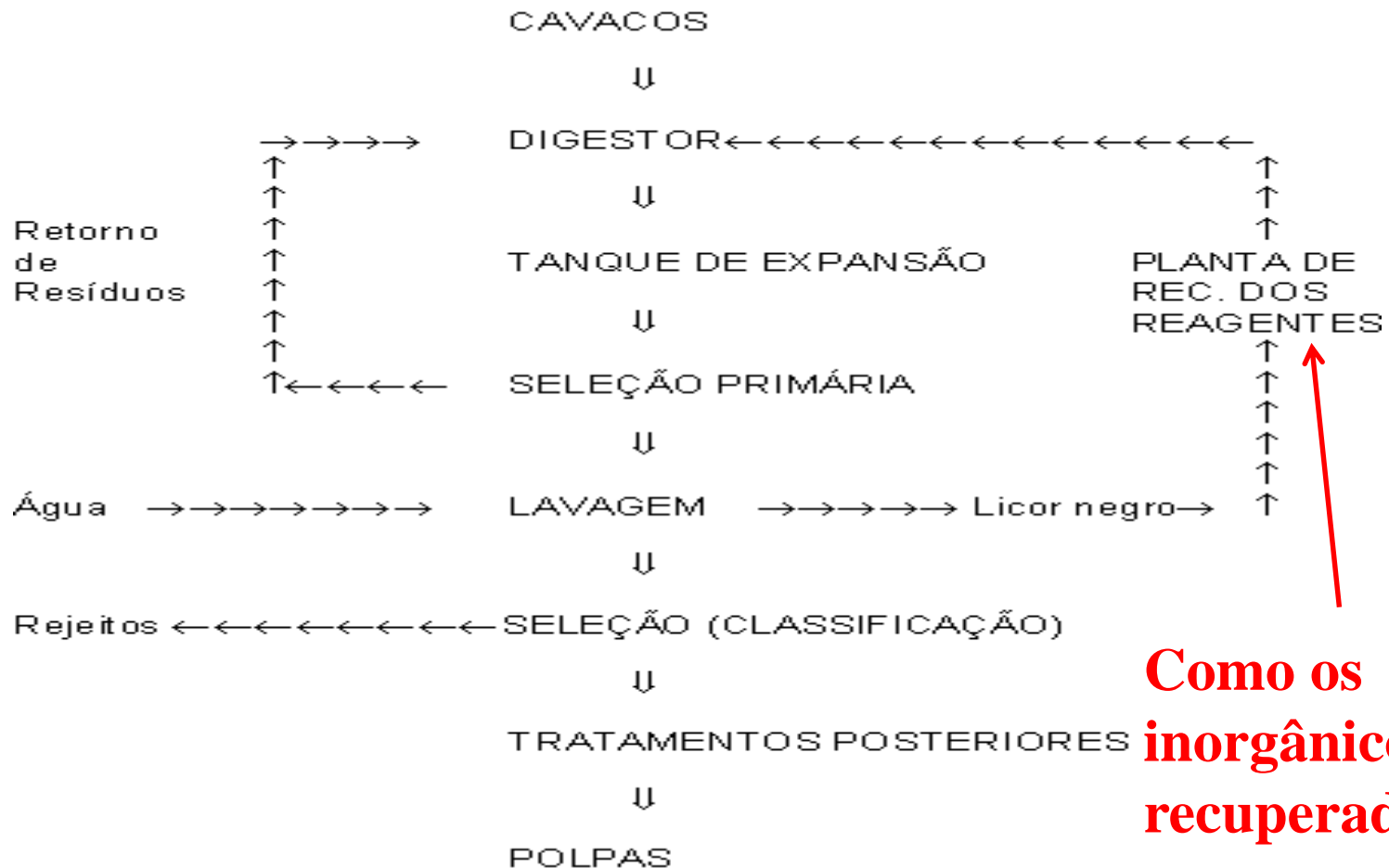

Como os inorgânicos são recuperados?

Recuperação de inorgânicos e geração de calor no processo kraft: esquema simplificado e visão geral

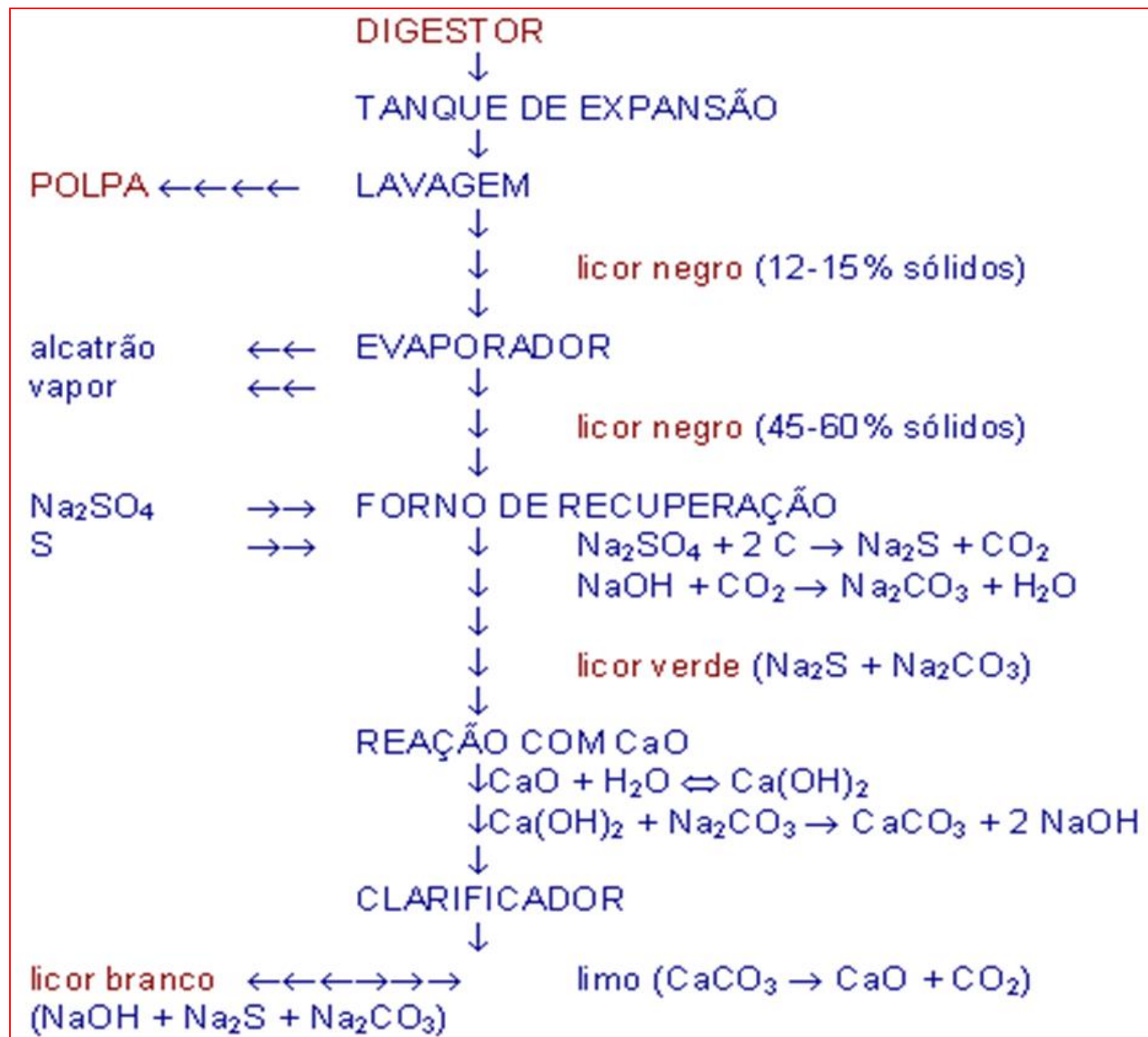

A planta de recuperação no processo kraft

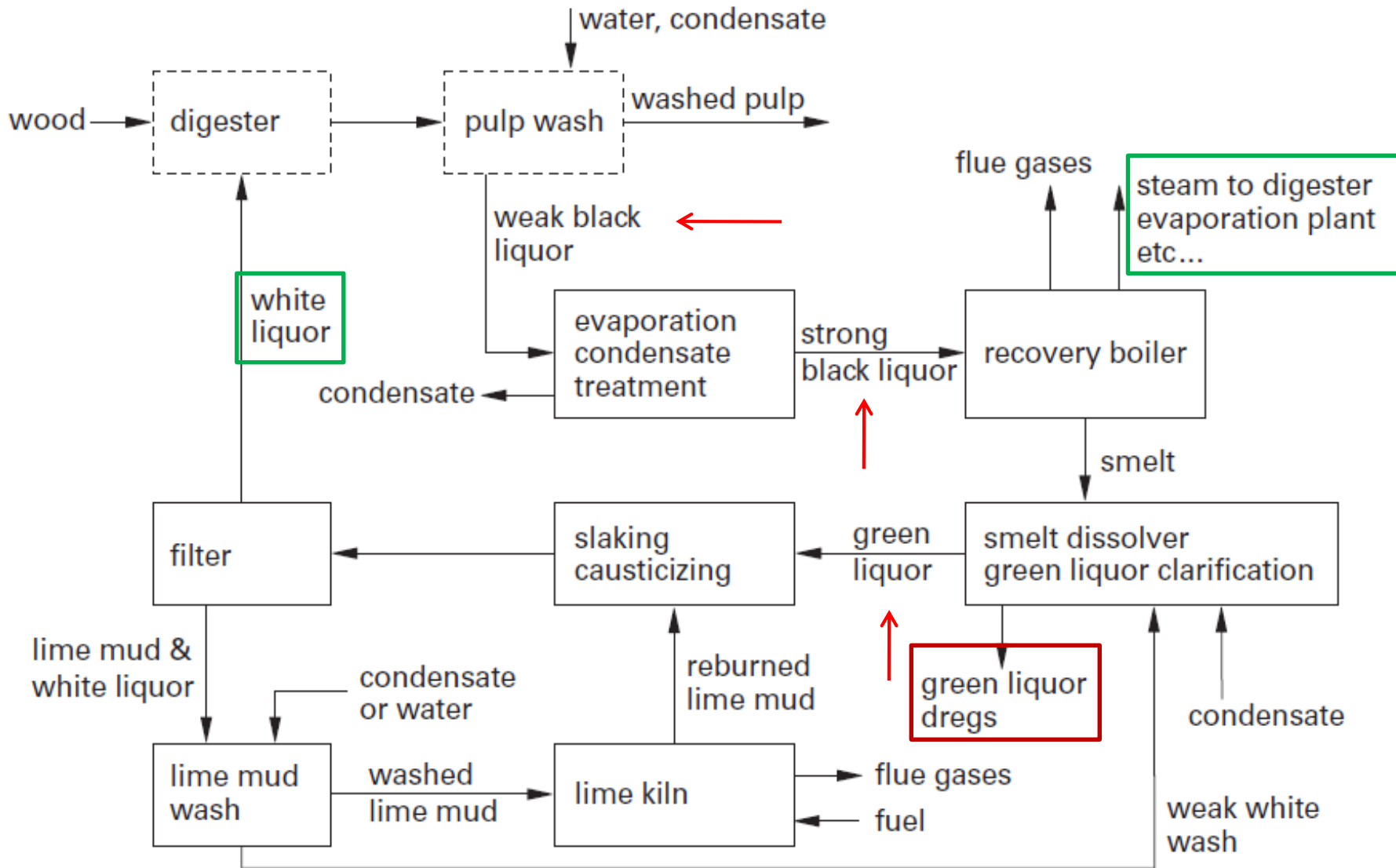

Etapas essenciais na planta de recuperação no processo kraft

1. Evaporação do licor negro
2. Queima do licor concentrado
3. Preparação do licor branco (conversão do licor verde em branco)
4. Regeneração de CaO (limo)

Evaporação do licor negro

Proporção de componentes no licor negro

Table 12.1. Approximate composition of black liquor.

Element	Amount (weight %)	Organic material	Amount (weight %)
Carbon	34–39	Lignin	29–45
Hydrogen	3–5	Hydroxy acids	
Oxygen	33–38		
Sodium	17–25	Extractives	25–35
Sulfur	3–7	Formic acid	3–5
Potassium	0.1–2	Acetic acid	~5
Chlorine	0.2–2	Methanol	~3
Nitrogen	0.05–0.2		~1

Table 12.2. Properties of black liquor and their importance on the process.

Property	Importance
Density	To obtain correct mass balances. Density is also an indication of amount of solid/dissolved material in the liquor.
Viscosity	Influences the flow conditions and therefore also the heat transfer conditions in the evaporation plant as well as drop formation in the recovery boiler.
Surface tension	Drop formation in the recovery boiler and the formation of a film in the evaporators (particularly falling film evaporators).
Heat conductivity	Heat transfer in the evaporators.
Specific heat capacity	To obtain correct heat balances and it influences the heat transfer in the evaporators.
Specific heating value	The amount of chemical energy that can be converted into heat. Important for the heat balance of the recovery boiler.
Boiling point rise (Vapor pressure depression)	Determines the number of evaporators at a given maximum total temperature difference.
Vapor pressure	The vapor pressure data determines the composition of the evaporated steam and the liquor in the evaporation plant. Is of crucial importance in the design and operation of the columns in the condensate treatment system.

Evaporadores usados para concentrar o licor negro

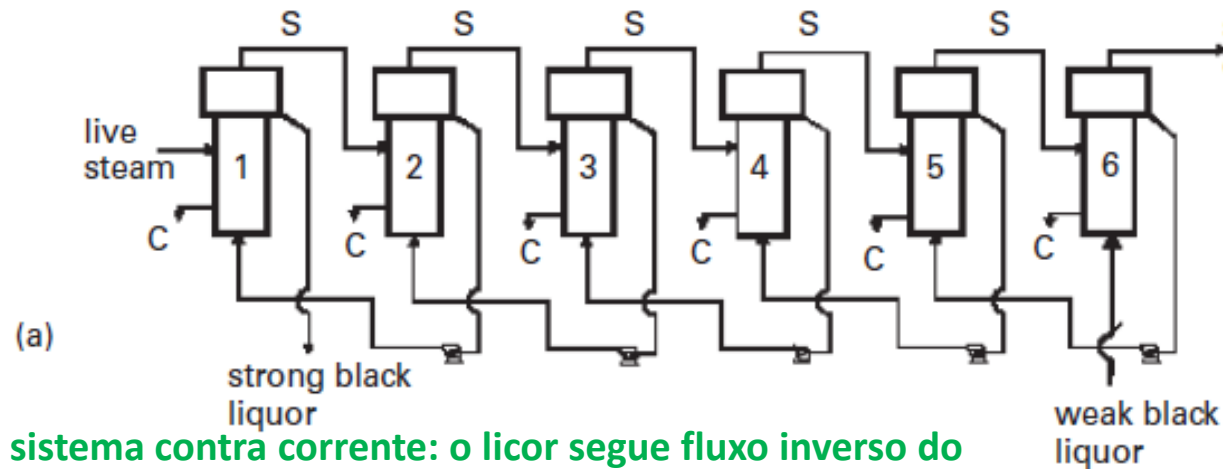

Licor negro não concentrado: 15-20% de sólidos (ainda não pode ser queimado, pois há excesso de água)

sistema contra corrente: o licor segue fluxo inverso do fluxo de entrada de vapor

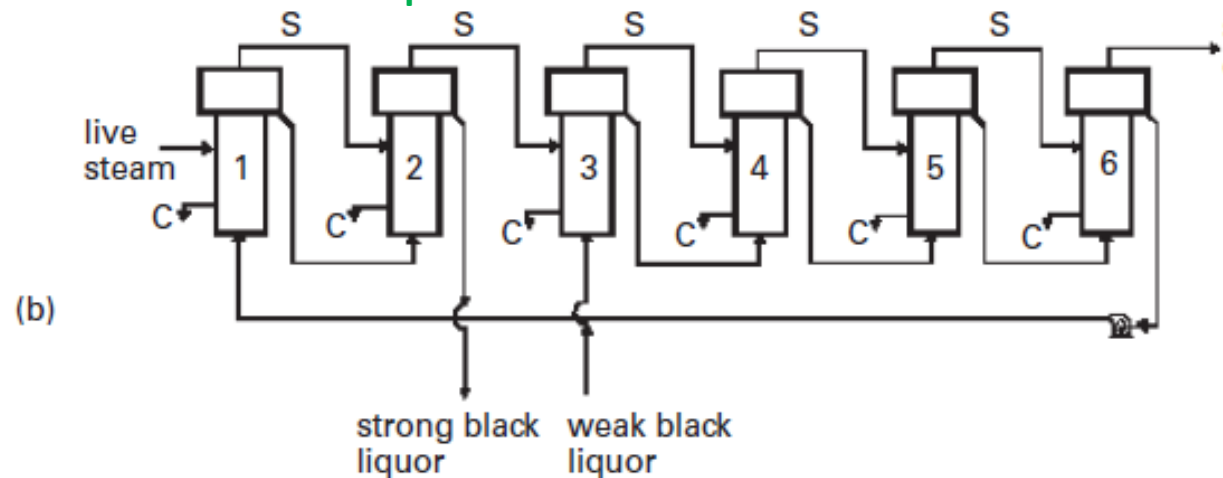

Licor negro concentrado: 70-80% de sólidos

Figure 12.3. Schematic diagram of a counter-current (a), and a mixed co- and counter-current (b), plant respectively. (S is steam and C is condensate).

Visão detalhada de um tipo de evaporador

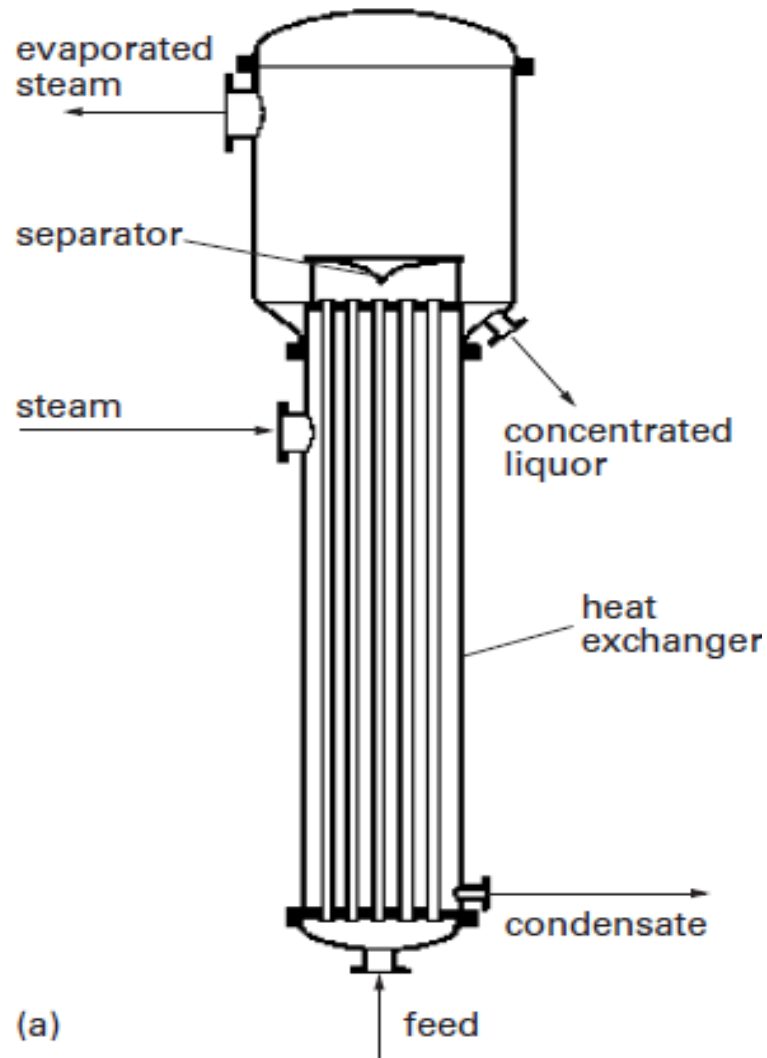

Figure 12.4. Diagram of a Kestner apparatus (A) :

Visão detalhada de um tipo de evaporador

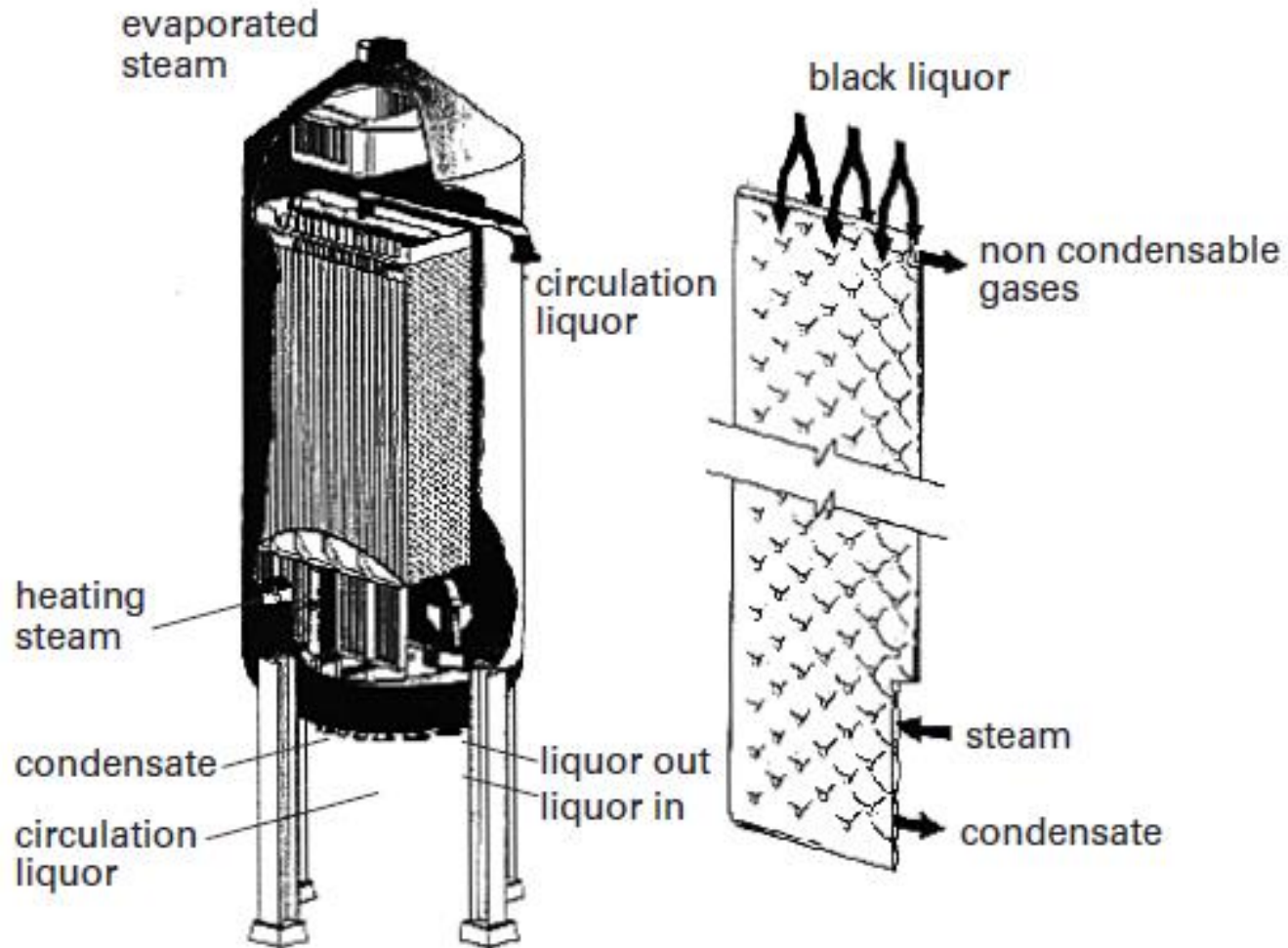
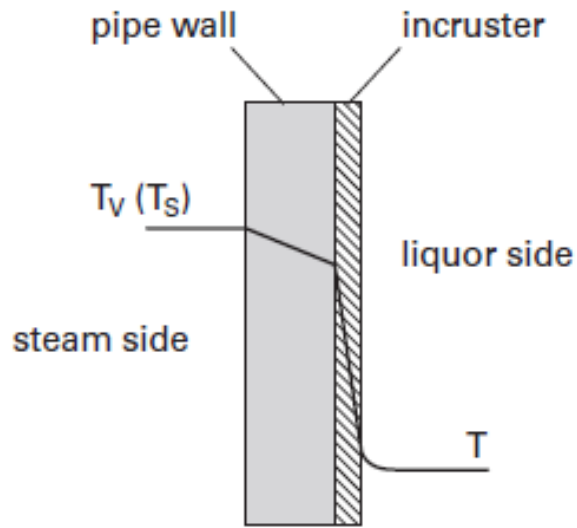

Figure 12.9. Example of an evaporator having plates as the heat exchanger device.



Problemas de incrustação em evaporadores de licor negro

Figure 12.13. Schematic diagram of the temperature profile of a pipe with scales.

Table 12.3. Different types of scales on the liquor side of the tubes.

A. Scales formed from insoluble material in the black liquor

- 1) Organic material: fibers etc.
- 2) Inorganic material: rust flakes, sand, etc.

B. Precipitation of dissolved material in the black liquor

- 1) Organic material
 - i Tall oil soap (at dry contents above 25–30 %)
 - ii Lignin (ph < 11)
- 2) Inorganic material
 - i Calcium carbonate (at temperatures above 120 °C)
 - ii Burkite, a double salt of sodium sulfate and carbonate (dry contents above 50 %)
 - iii Sodium-silicon-aluminum scales (high contents of silicon and/or aluminum)

Queima do licor concentrado

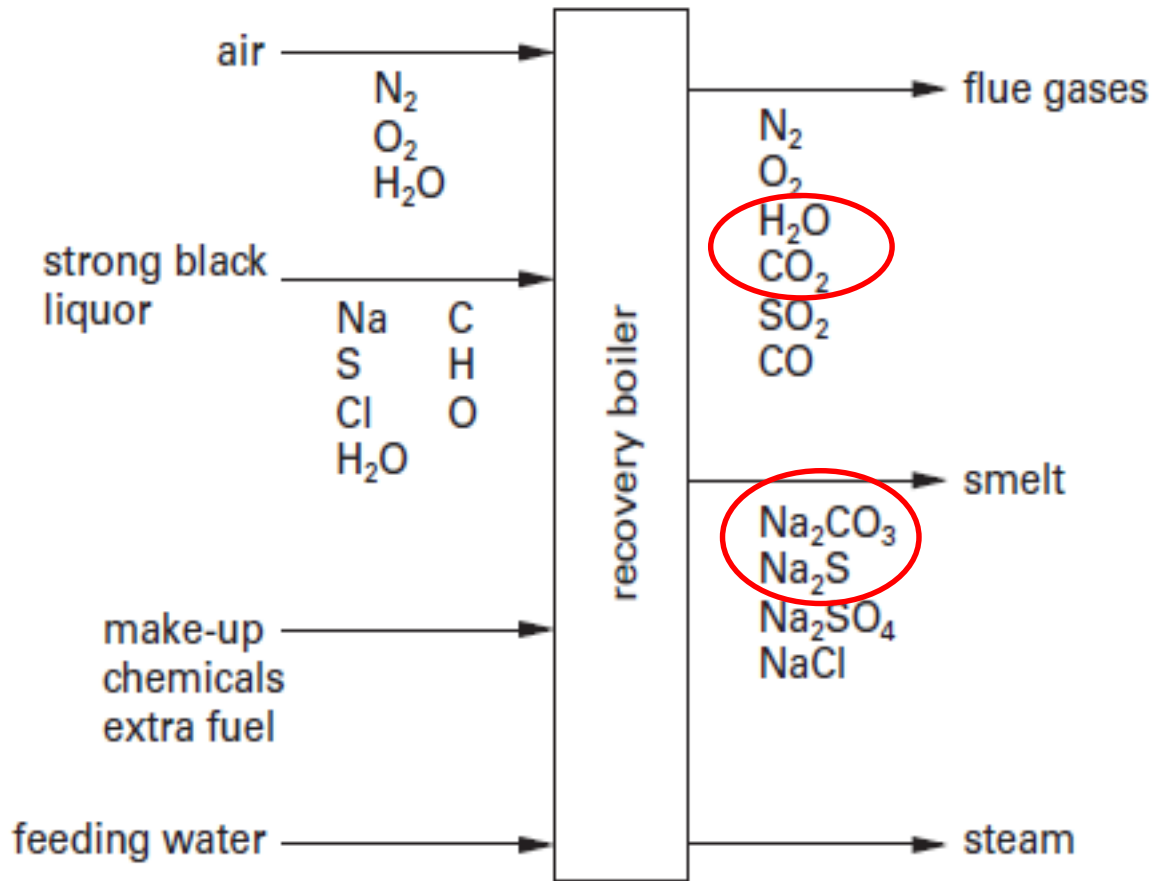

Figure 12.15. Schematic illustration of the chemical processes that take place when black liquor is combusted.

Esquema de um forno de recuperação (queima do licor negro)

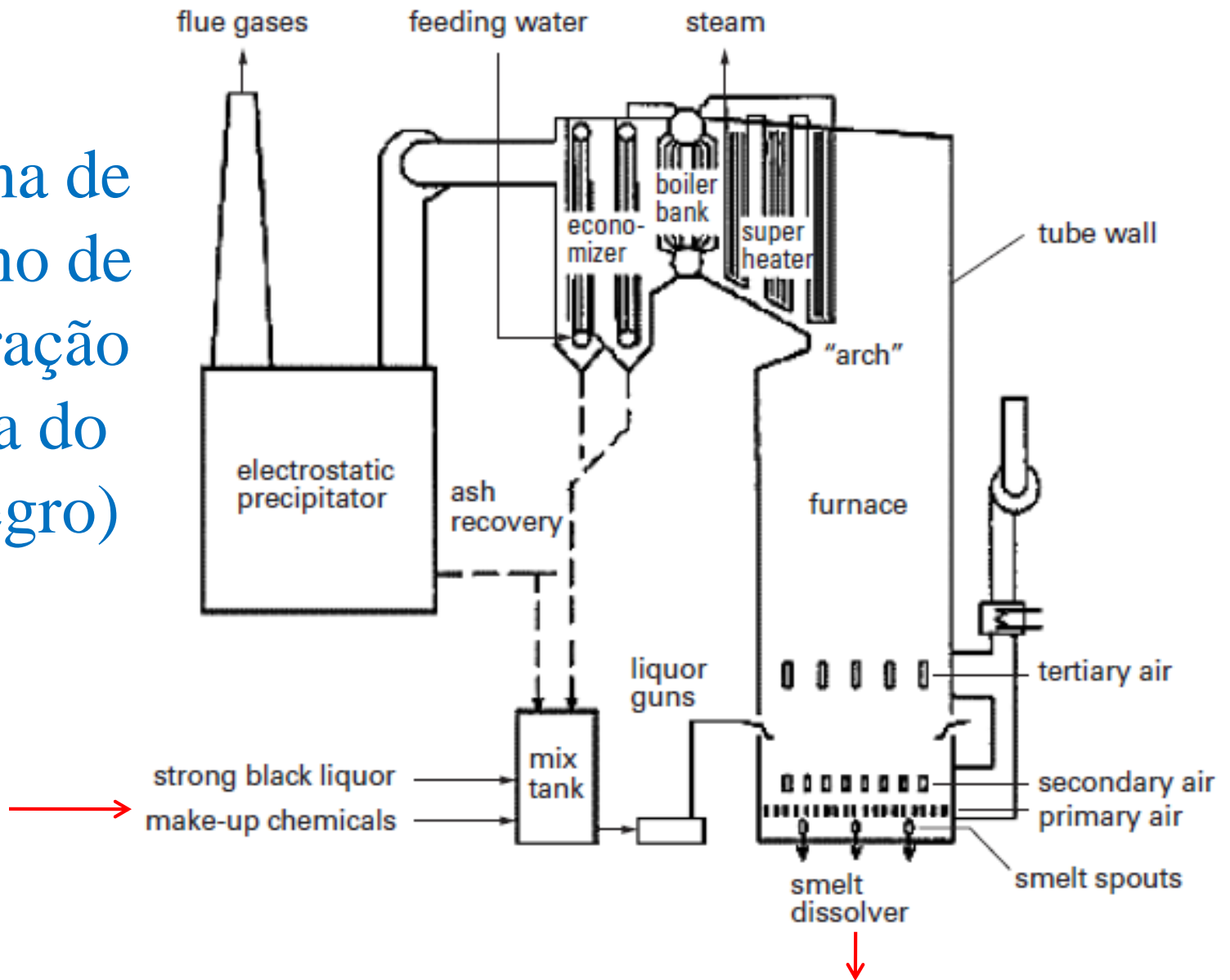
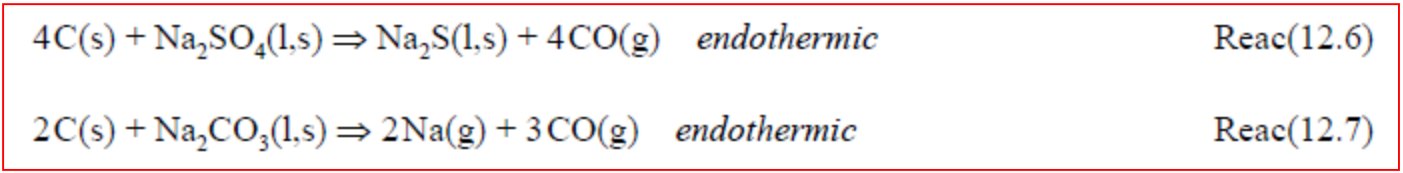
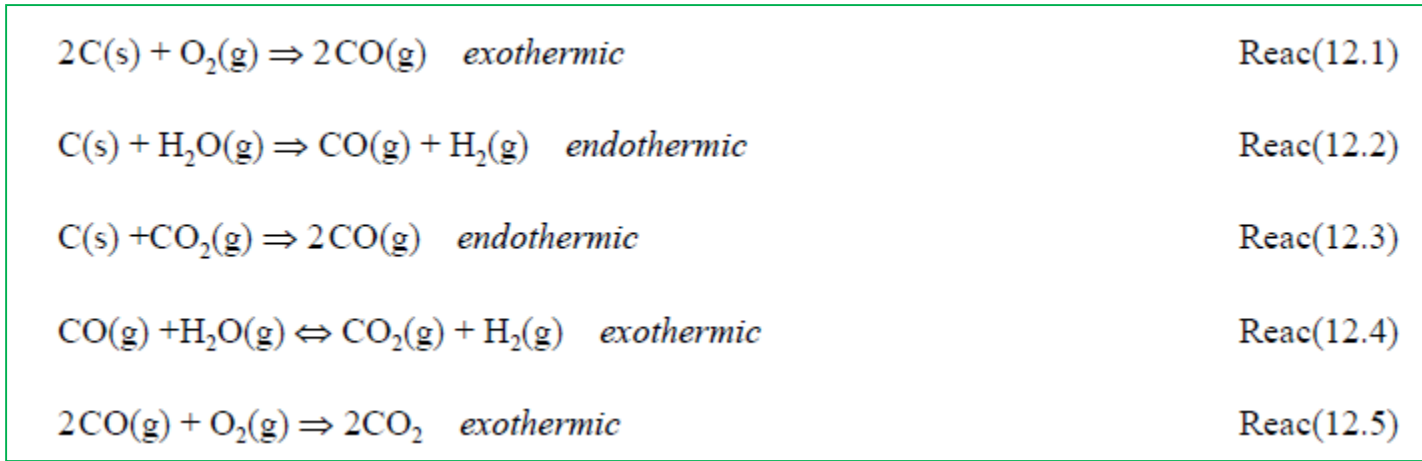

Figure 12.16. A schematic diagram of the recovery boiler.

Reações que ocorrem durante a queima do licor negro



Ciclo do S

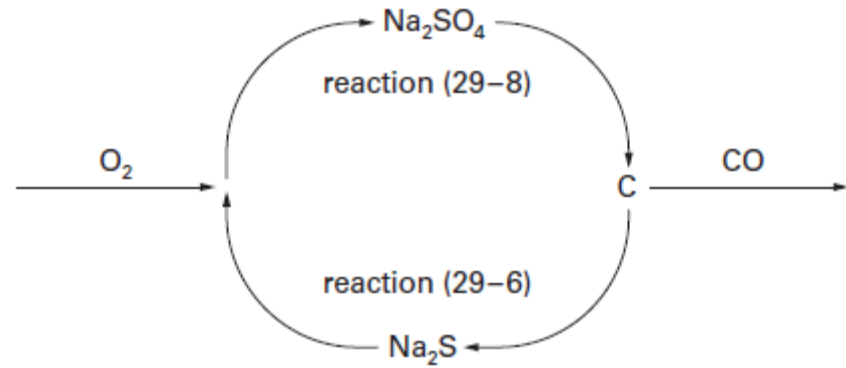
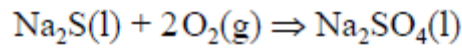
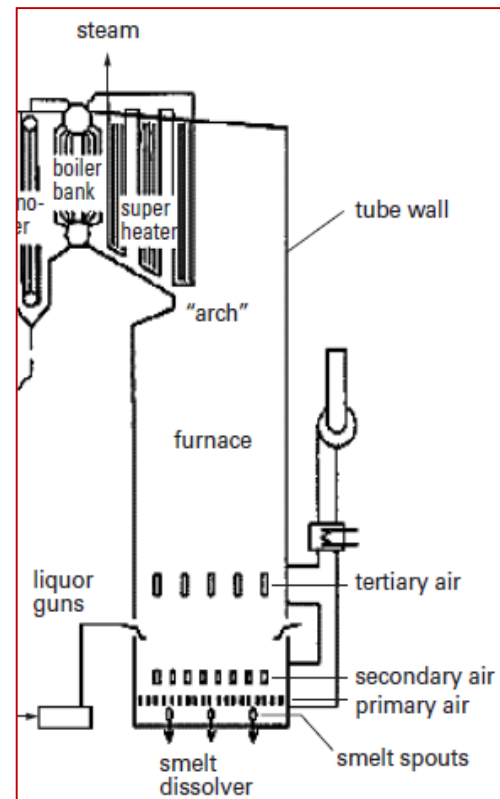
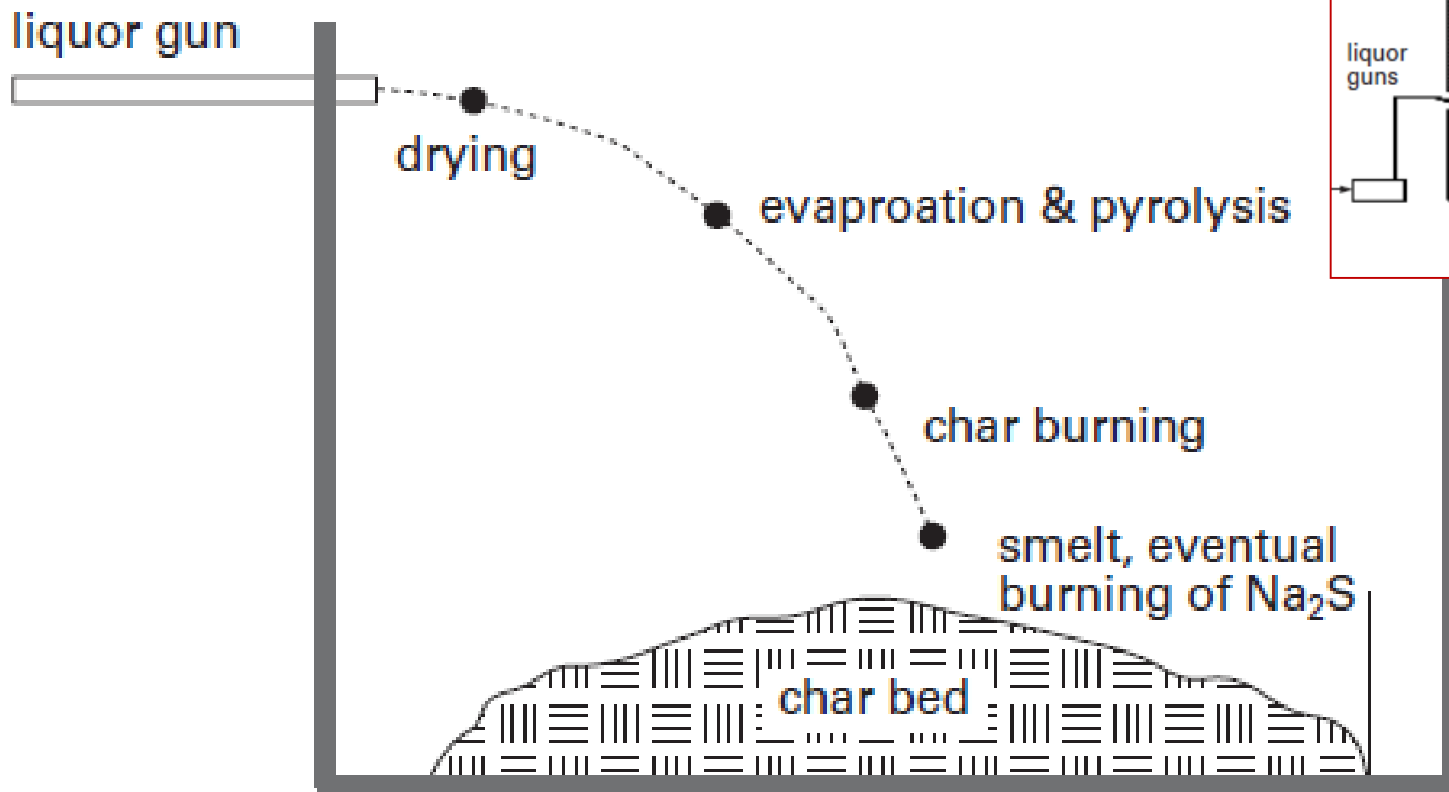

Figure 12.20. The sulfate/sulfide cycle.

O que ocorre com uma gota de licor dentro do forno de recuperação



Visão aproximado da zona de queima na parte inferior do forno de recuperação

<https://youtu.be/zz26bPtahUY>

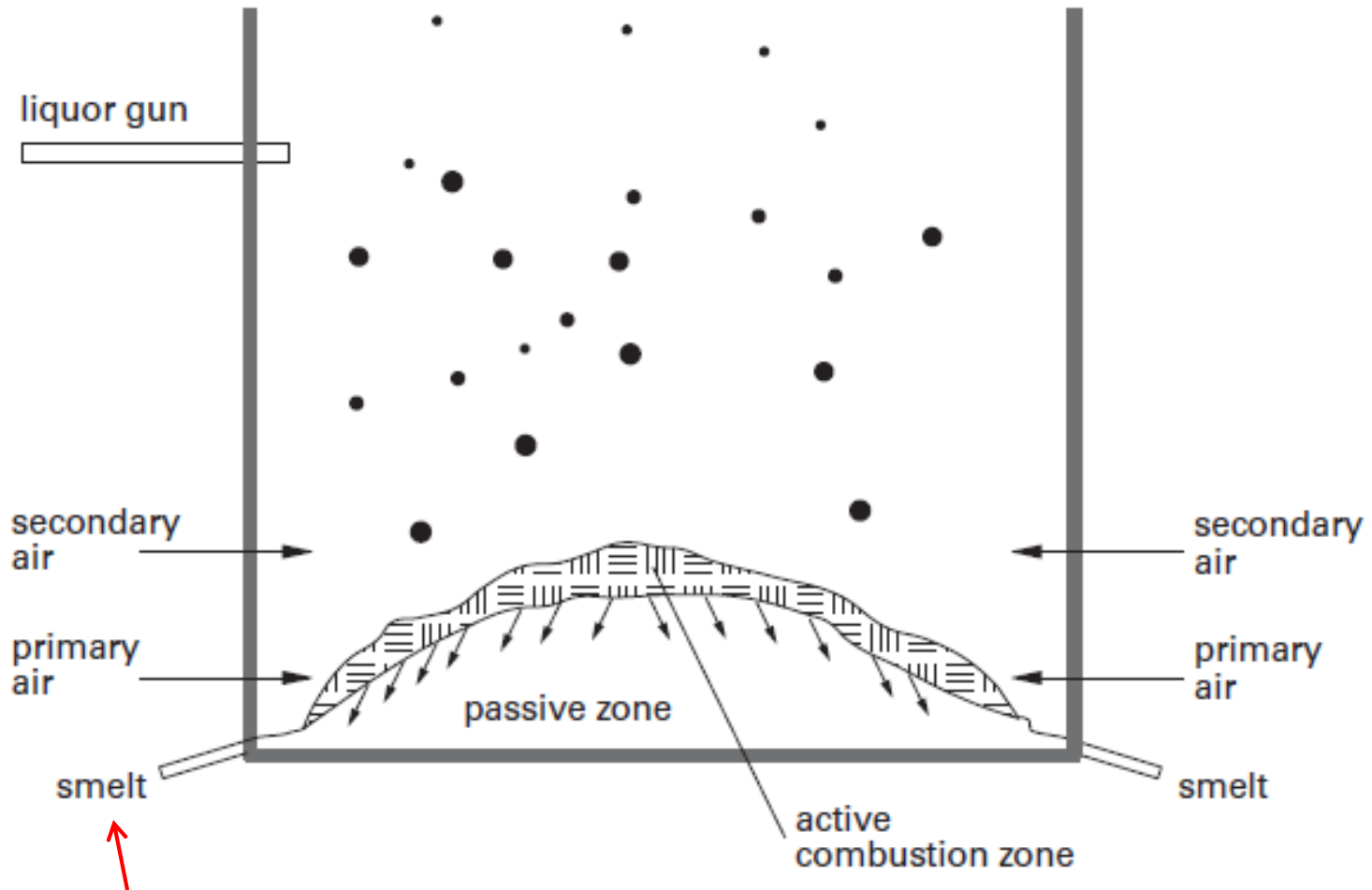

Figure 12.21. A schematic figure of the lower part of the furnace.

Thermal image >>>> <https://www.youtube.com/watch?v=Ti6M2pgIFZI>

Sumário das reações no interior do forno de recuperação

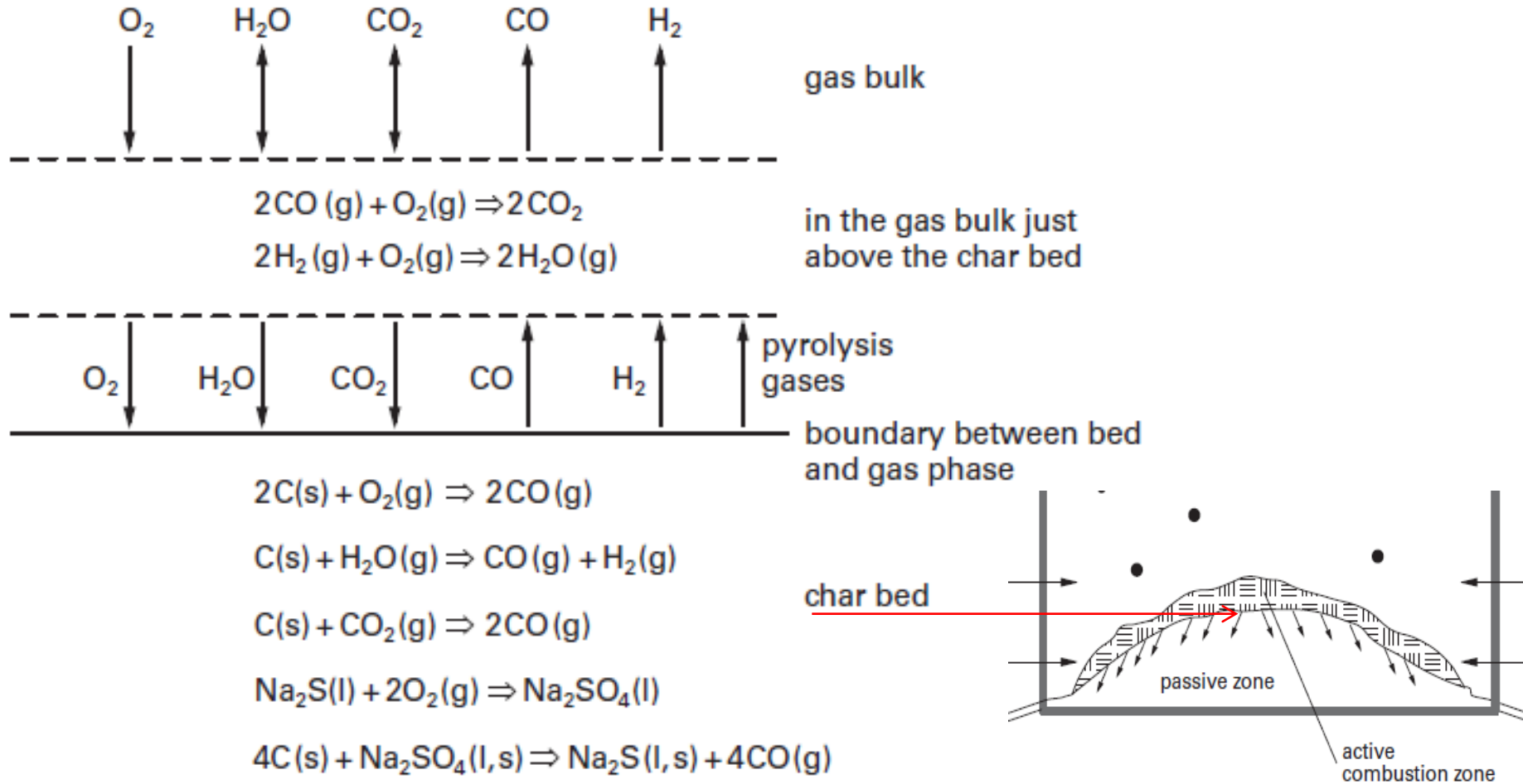
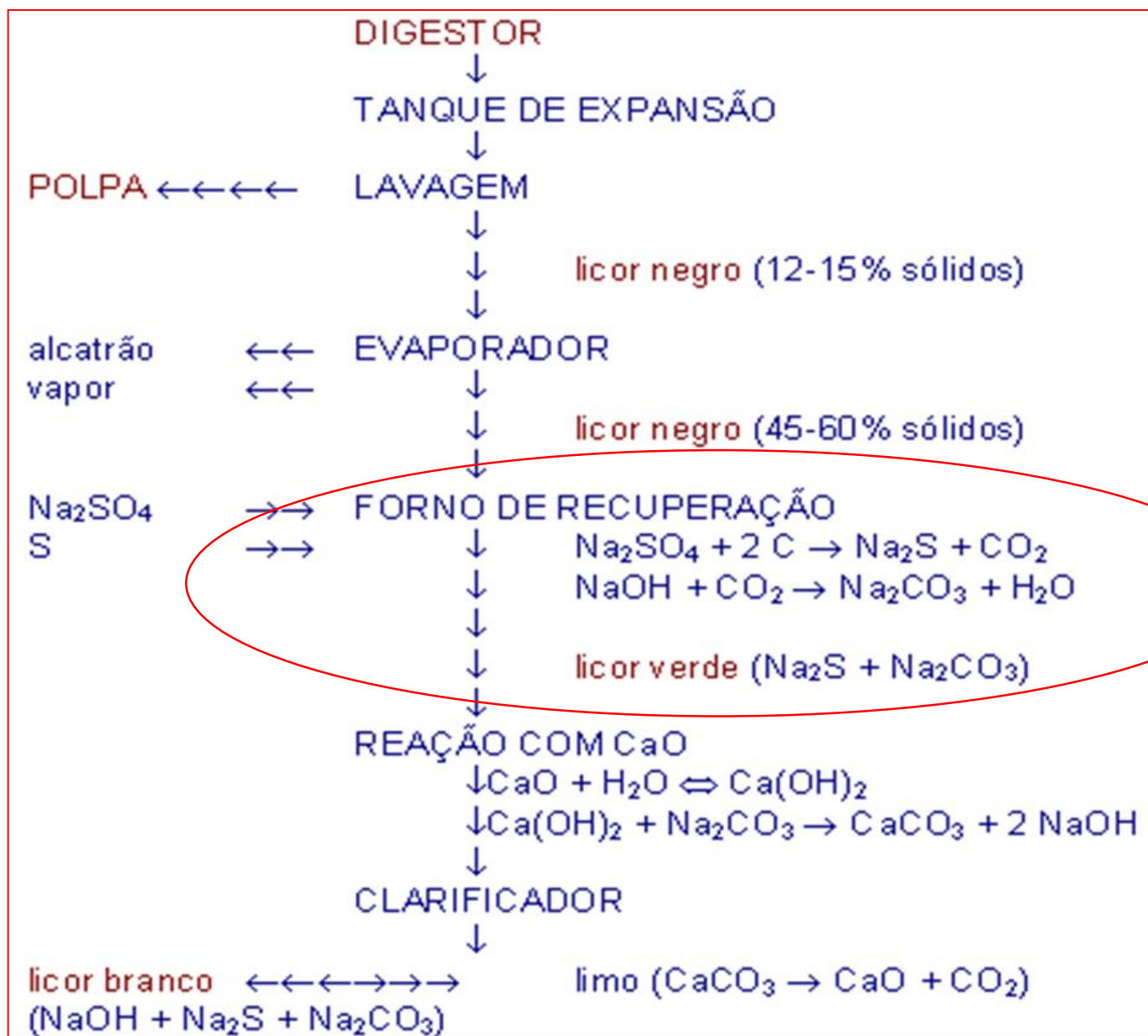

Figure 12.22. Summary of the most important reactions in the char bed, and mass transfer between the bed and the gas bulk.



Preparação do licor branco (conversão do licor verde em branco)

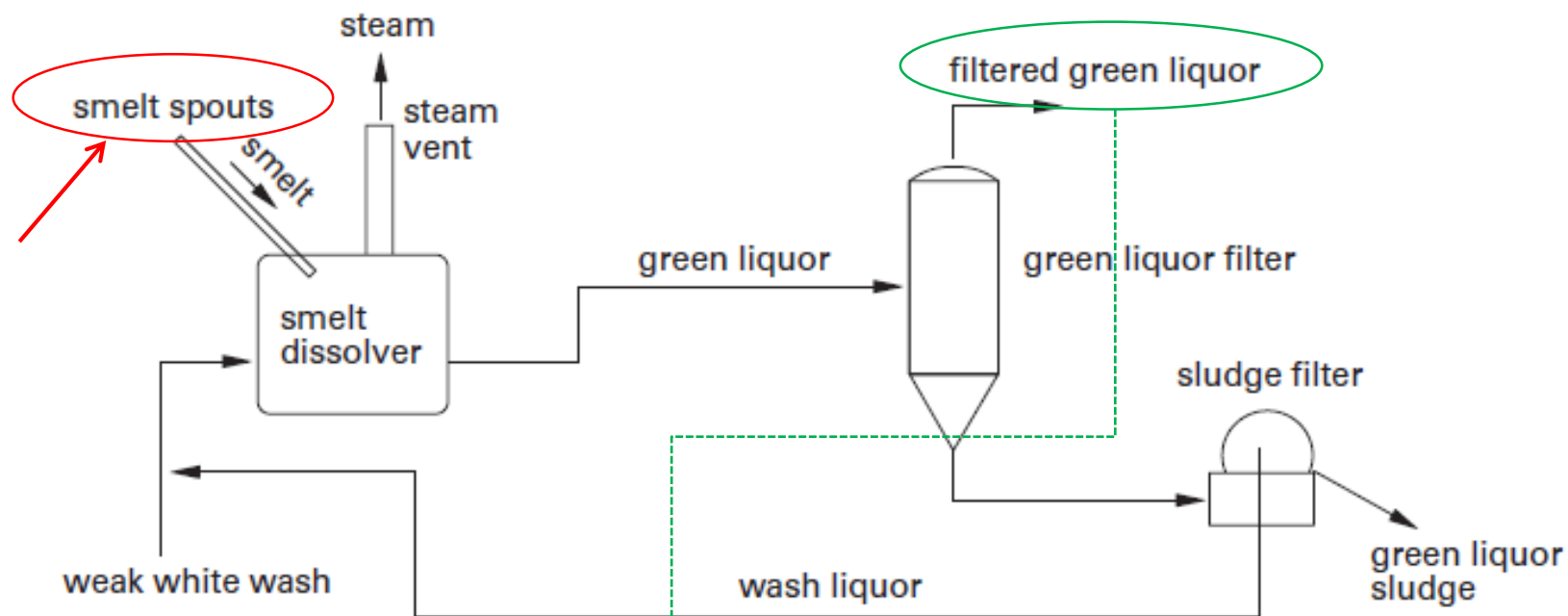

Figure 13.2. Schematic diagram of the green liquor system.

Table 13.2. Approximate concentrations of the main salts in „normal“ green liquor.

Salt/ion	Na	K	Na_2CO_3	Na_2S	NaOH	Na_2SO_4	$\text{Na}_2\text{S}_2\text{O}_3$	NaCl
Conc. (g/kg)	70–95	5–15	100–140	30–60	2–25	1–15	1–10	1–10

Conversão do licor verde em licor branco

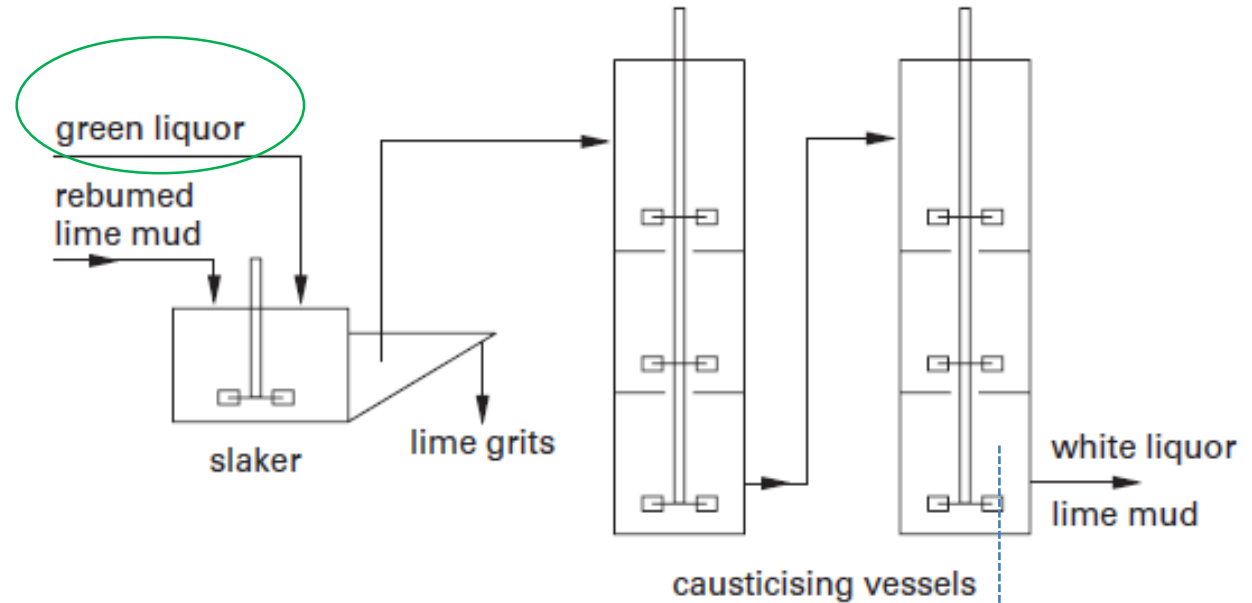
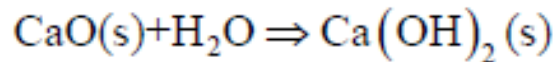
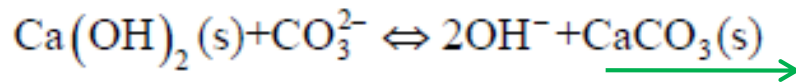

Figure 13.9. A flow sheet of the causticising department.



Reac (13.5)



Reac (13.6)

Table 13.4. Approximate composition of white liquor.

Salt/ion	Na	K	NaOH	Na ₂ S	Na ₂ CO ₃	Na ₂ SO ₄	Na ₂ S ₂ O ₃	NaCl
Conc. [g/kg]	70–95	5–15	75–100	30–60	20–45	1–15	1–10	1–10

Composição aproximada do licor branco na saída do sistema de regeneração

Compounds in white liquor	[mole/l]
Hydroxide ions OH^-	2.5
Hydrogen sulphide ions HS^-	0.5
Sulphate ions SO_4^{2-}	0.04
Carbonate ions CO_3^{2-}	0.3
Sulphite ions SO_3^{2-}	0.03
Tiosulphate ions $\text{S}_2\text{O}_3^{2-}$	0.007

Regeneração de CaO (limo)

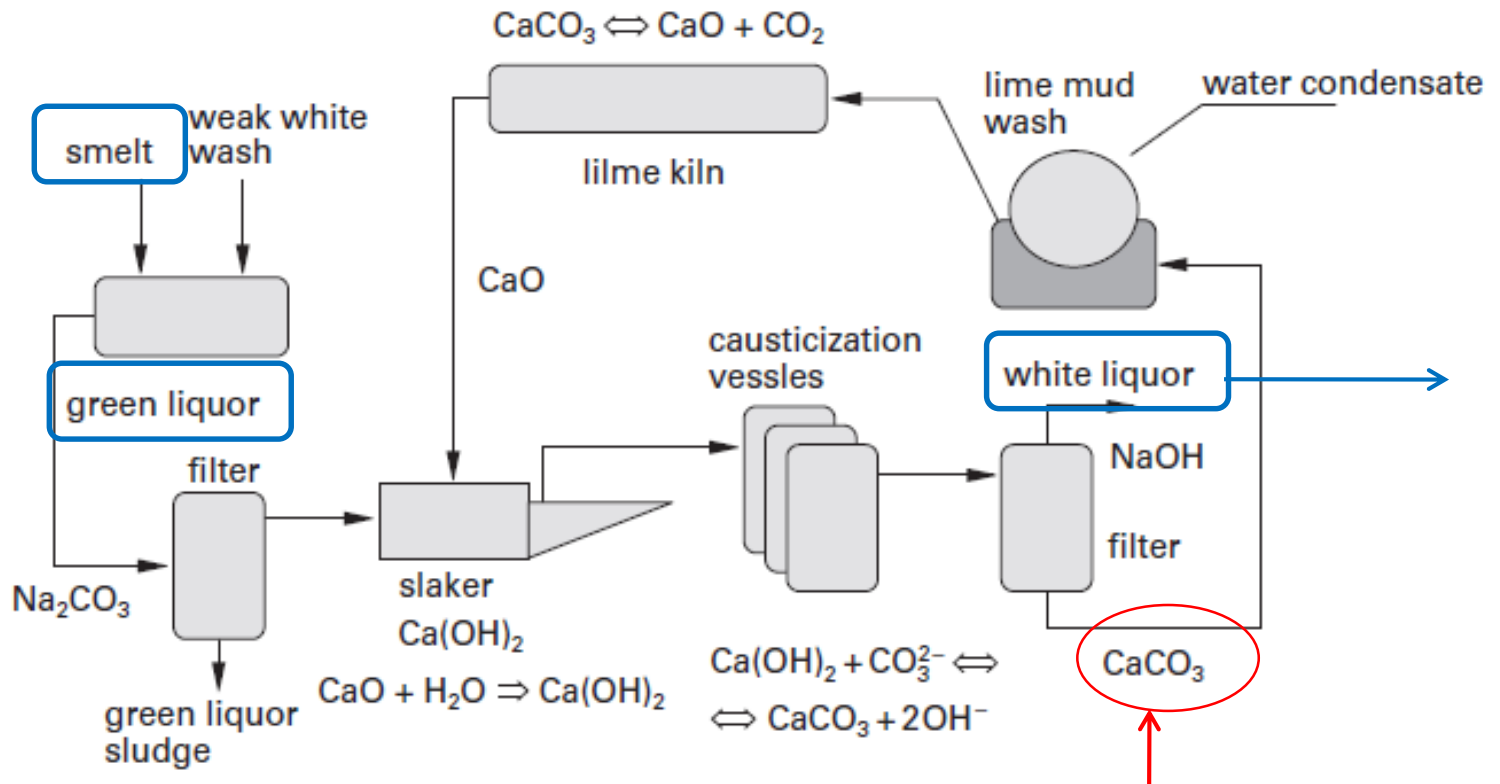

Etapas:

1. Secagem do limo
2. Aquecimento do limo
3. Calcinação do limo



1. Evaporação do licor negro
2. Queima do licor concentrado
3. Preparação do licor branco (conversão do licor verde em branco)
4. Regeneração de CaO (limo)

