

# Enzimas



Classificação das enzimas

Carlos Hotta

# Existem 6 tipos reações enzimáticas

## 1. Oxidoreduktases - reações de óxido-redução (redox)

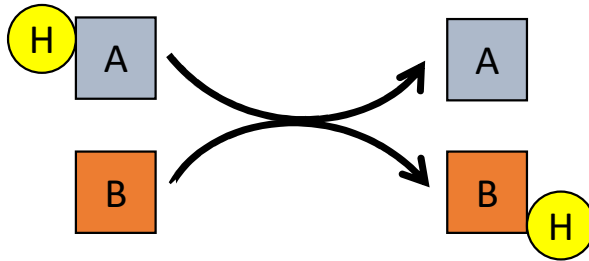

Estas reações possuem um doador e um receptor de elétrons  
Exemplo: álcool desidrogenase

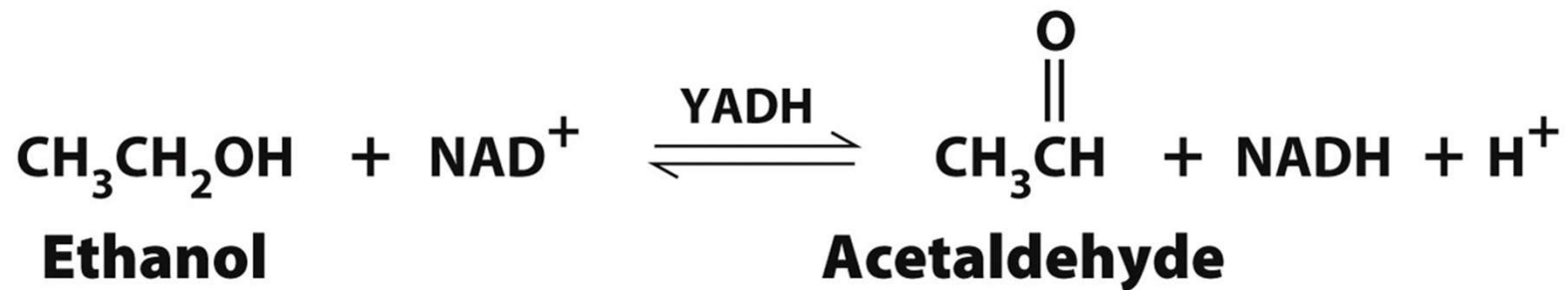

# Existem 6 tipos reações enzimáticas

## 2. Transferases - transfere grupos funcionais

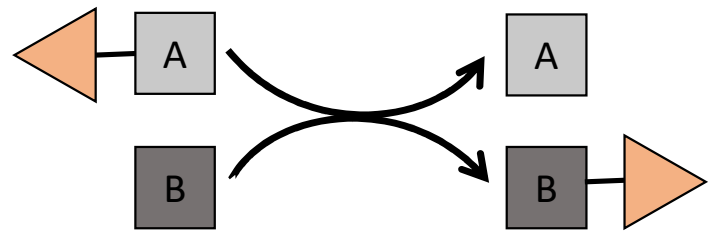

Exemplo: Hexoquinase

Quinases são enzimas que transferem grupamentos fosfato

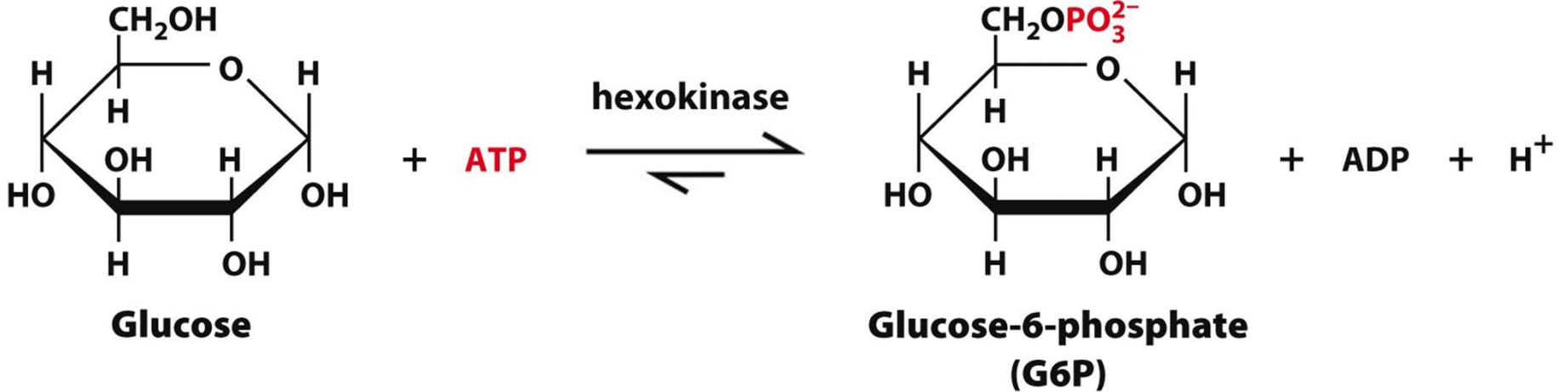

# Existem 6 tipos reações enzimáticas

## 3. Hidrolases - reações de hidrólise

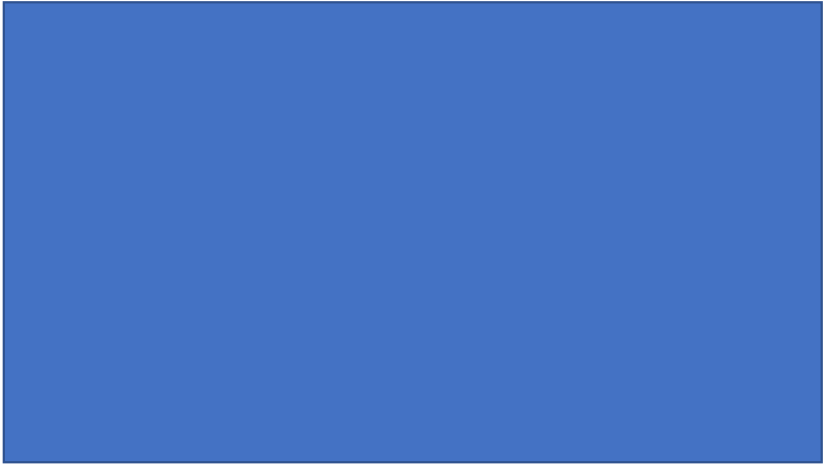
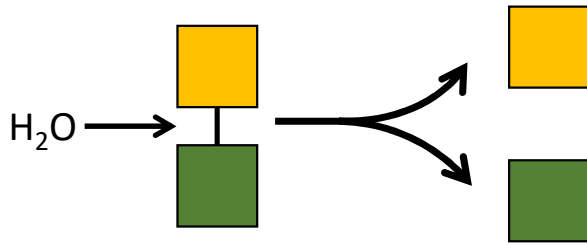

Exemplo: Quimotripsina (digere proteínas)

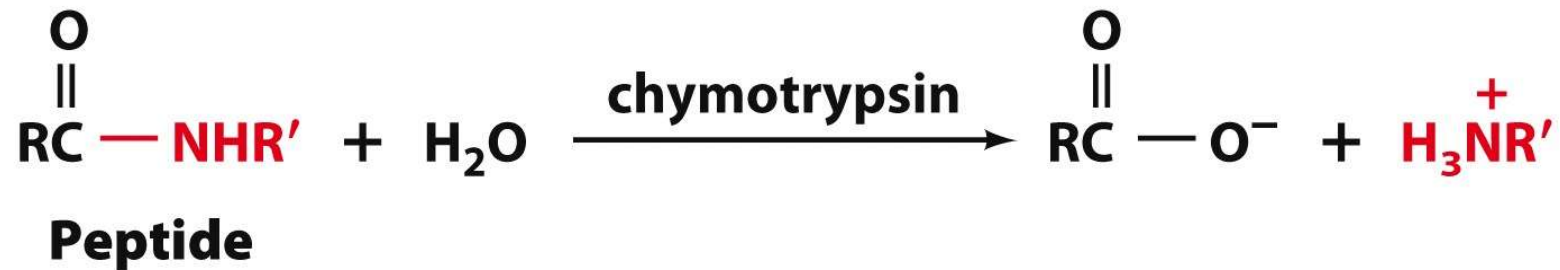

# Existem 6 tipos reações enzimáticas

4. Liases – quebram a ligação entre um C e um outro átomo, frequentemente formando ligações duplas

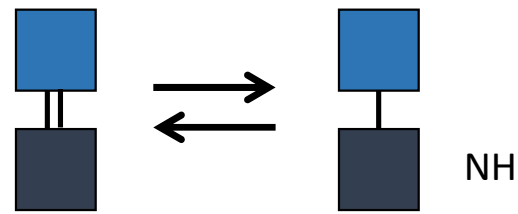

Exemplo: Piruvato decarboxilase

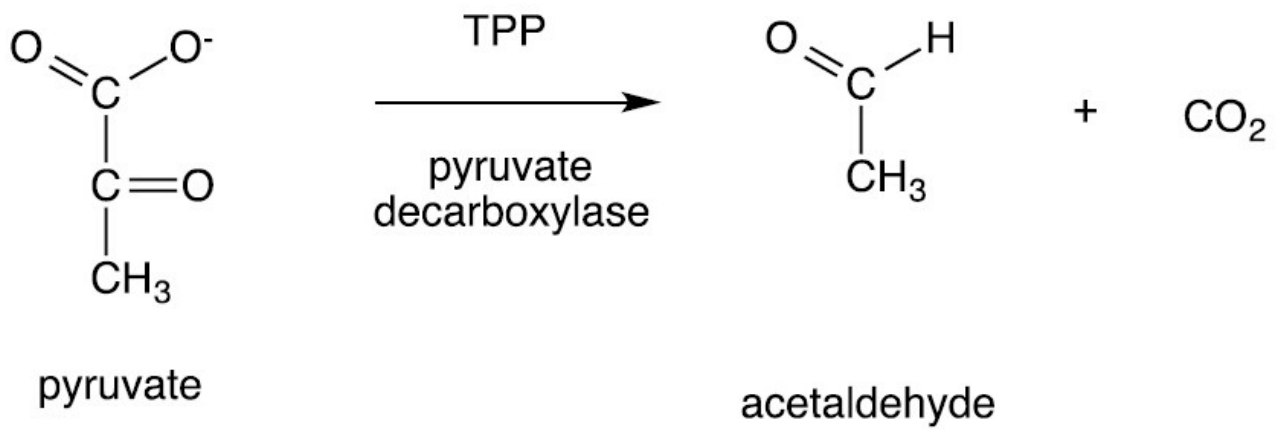

# Existem 6 tipos reações enzimáticas

## 5. Isomerases - isomerização

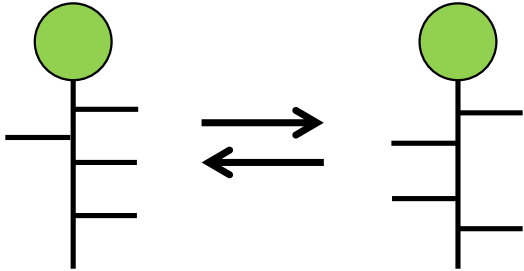

Exemplo: Glicose 6-fosfato isomerase

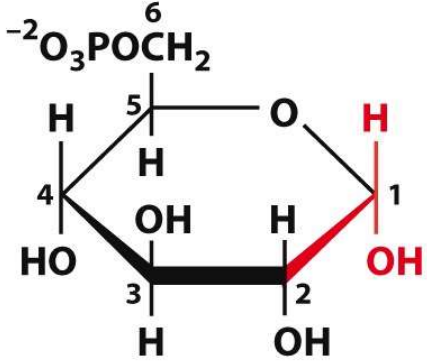

**Glucose-6-phosphate (G6P)**

phosphoglucose isomerase (PGI)

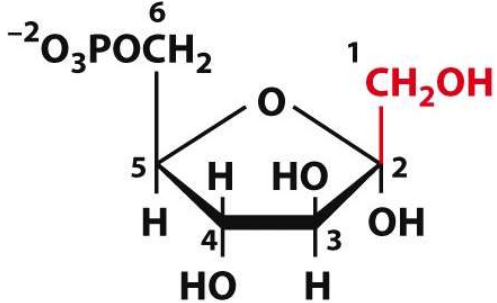

**Fructose-6-phosphate (F6P)**

# Existem 6 tipos reações enzimáticas

6. Ligase - formação de ligações novas com o gasto de ATP

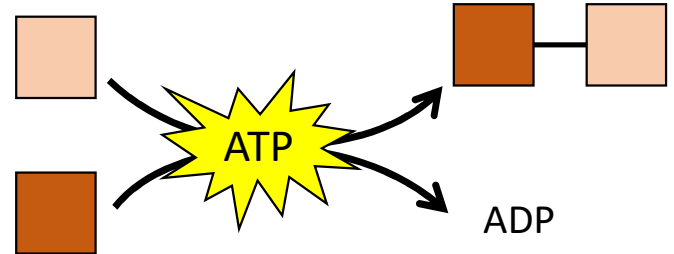

Exemplo: DNA ligase

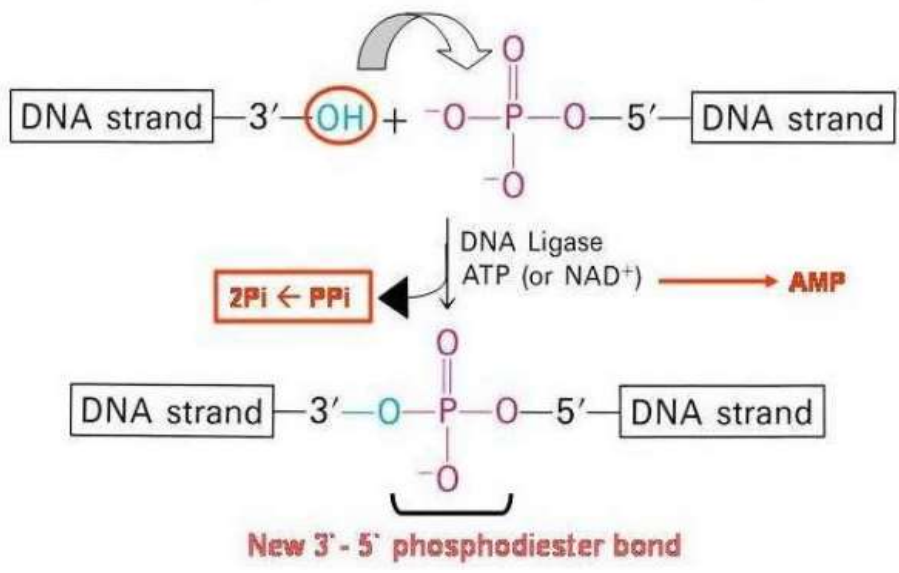

# Que tipo de enzima é a anidrase carbônica?

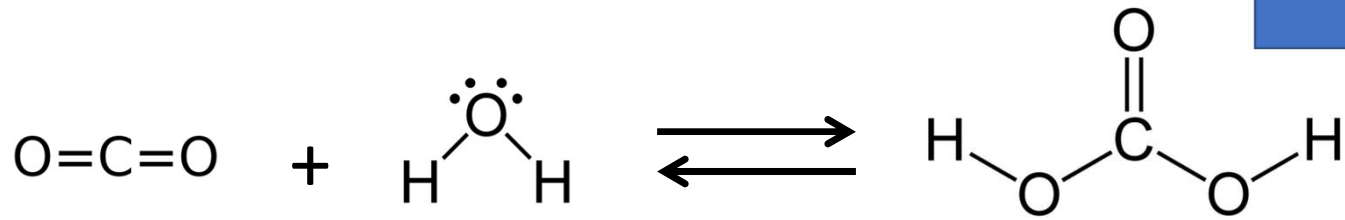

Classificação	Tipos de reação catalisadas
1. Oxidoredutases	Reações de óxido-redução
2. Transferases	Transfere grupos funcionais
3. Hidrolases	Reações de hidrólise
4. Liases	Eliminação de grupos para formar ligações duplas
5. Isomerasas	Isomerização
6. Ligases	Formação de ligações novas com o gasto de ATP



# Nomenclatura das enzimas

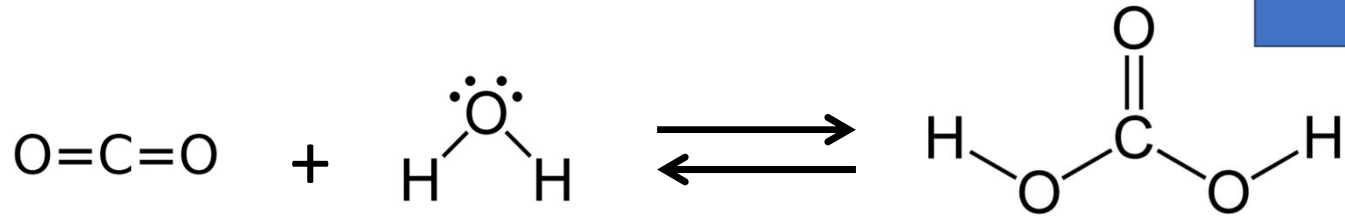

Enzimas são classificadas por um sistema chamado *Enzyme Commission Number*

EC 4. Liases

EC 4.2 Liase Carbono-Oxigênio

EC 4.2.1 Hidro-Liases

EC 4.2.1.1 Carbonato Desidratase



## RESUMO DA AULA

- As enzimas podem ser divididas em seis categorias: óxido-redutases, transferases, hidrolases, liases, isomerasas e ligases
- As enzimas podem ser divididas em mais subcategorias