

Aconselhamento Genético

Um modelo particular de relação
médico-paciente...

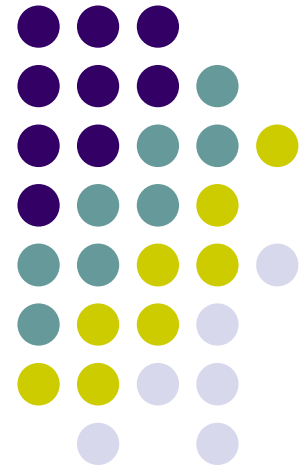

Como viemos lidando com a questão das doenças genéticas até hoje?

Algumas lições para não esquecermos...

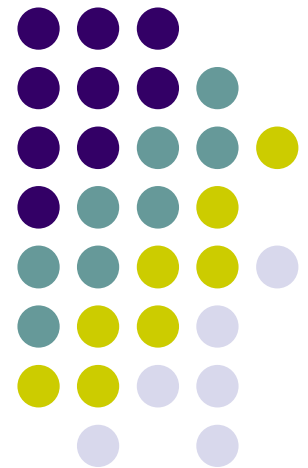

Sir Francis Galton

1822-1911

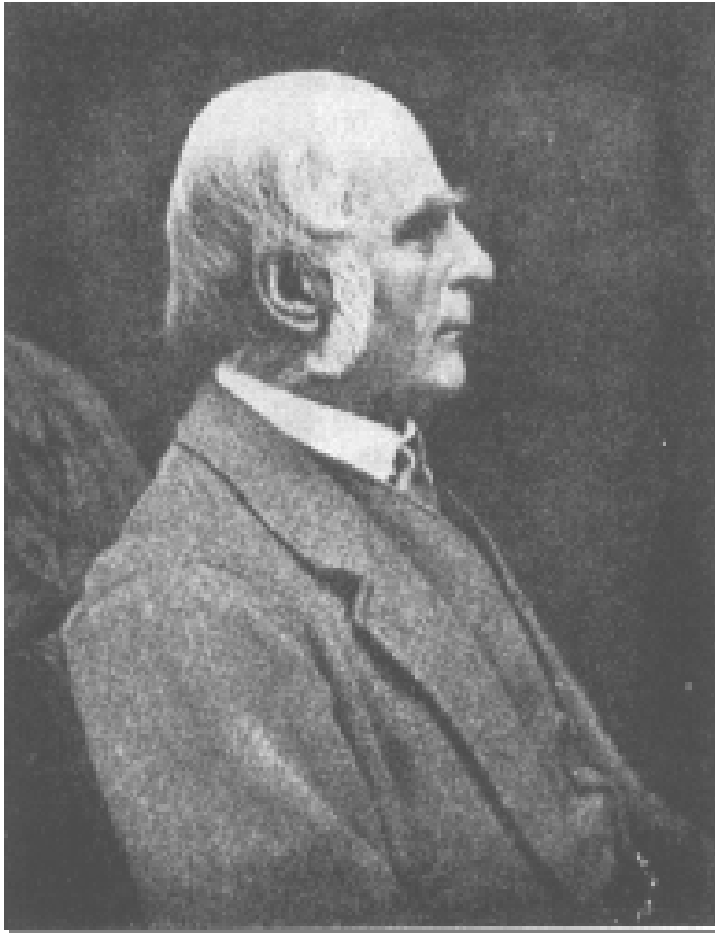
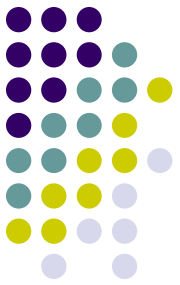

EUGENIA (1865)

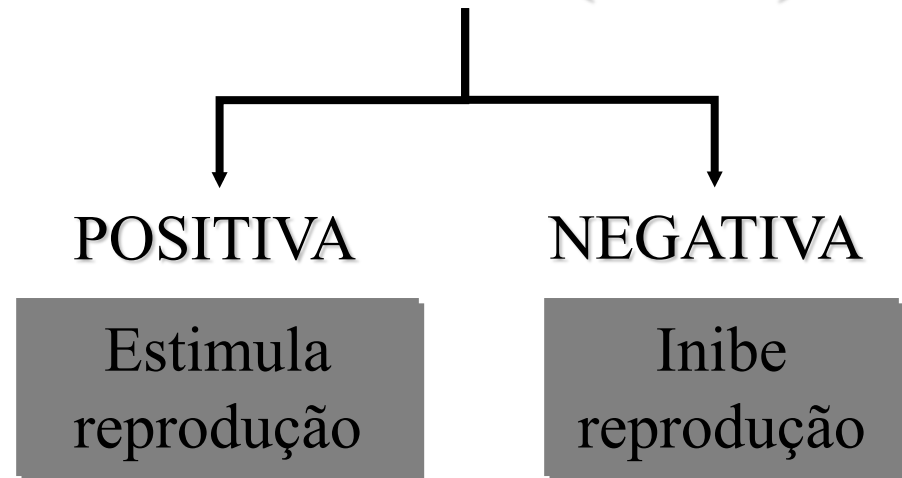

Movimento Eugenista



- 1900-1940
 - Instituições de Genética Humana
 - The Eugenics Records Office (EUA)
 - The Francis Galton Institute (RU)
 - 1933: Leis Eugênicas do Estado Alemão
 - Aryan Youth Study Farm
 - 1935: EUTELOGÊNESE (Brewrer)
 - Fertilização Assistida/Banco de Espermatozóides
 - HJ Miller Repository for Germinal Choice

The Eugenics Records Office (EUA)

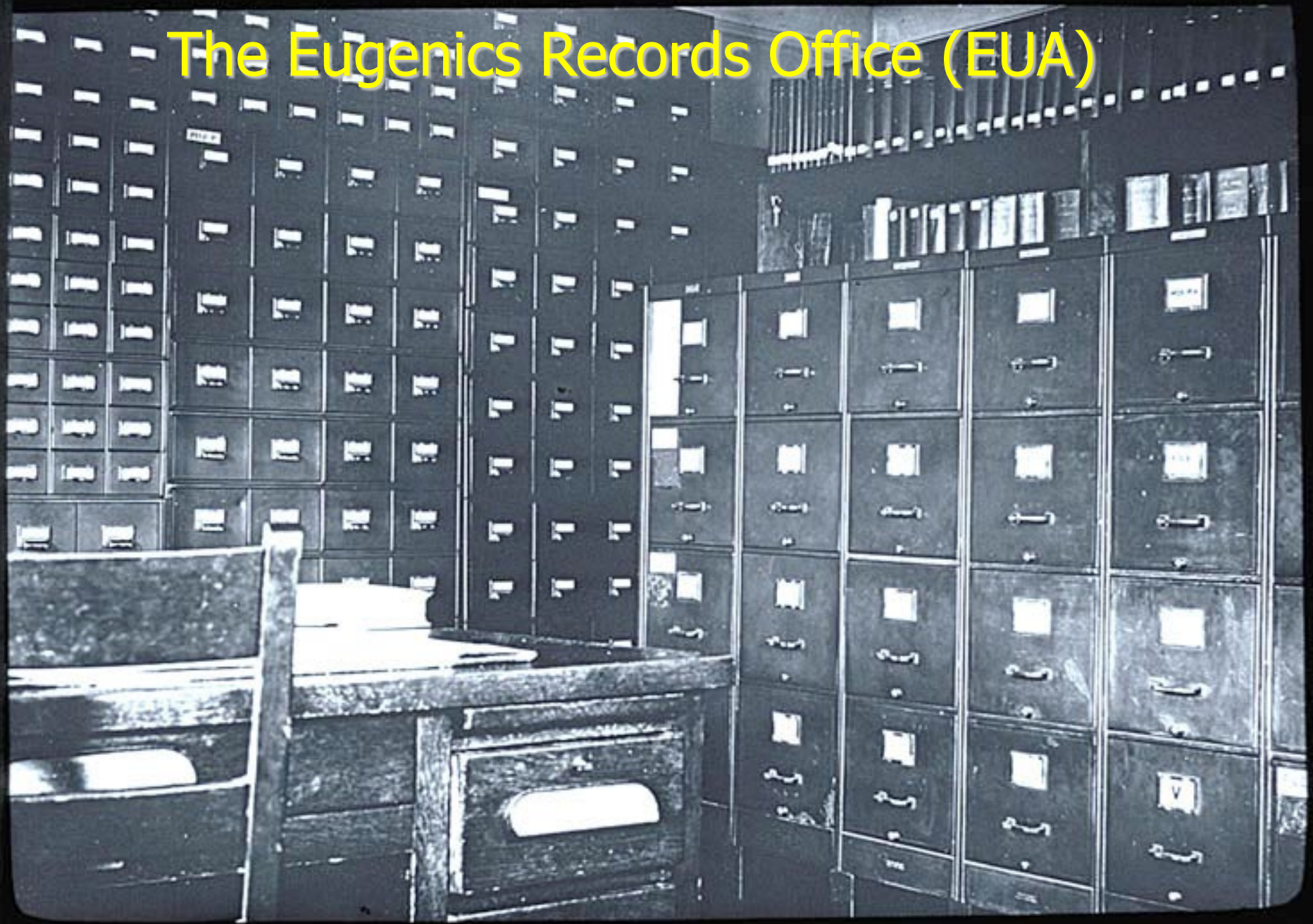

Eugenics Seeks to Improve the Natural, Physical,
Mental and Temperamental Qualities of
the Human Family



CARNEGIE INSTITUTION OF WASHINGTON

DEPARTMENT OF GENETICS

The Eugenics Record Office, Cold Spring Harbor, Long Island, N. Y.

Founded by Mrs. E. H. Harriman

Established October 1, 1910

CHARLES B. DAVENPORT, Director

HARRY H. LAUGHLIN, Assistant Director

This office is devoted to the study of the biological forces which determine the natural capacities and limitations of mankind. It looks forward to having ultimately a good working pedigree-index of the natural traits of a large portion of the families of America.

Science can not experiment with human beings. It desires merely to learn and publish the actual results of man's experiments on himself. Every marriage is an experiment in heredity. Every person should be interested in the actual

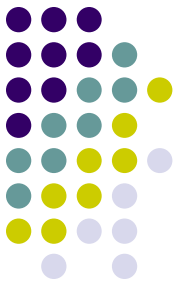

A Reação

- Penrose, 1932: Crítica ao uso indevido da Genética Humana
- Década de 40: Separação da Genética Humana da Eugenia
- Reed, 1949:
 - ACONSELHAMENTO GENÉTICO
 - NEUTRALIDADE

Evolução Histórica do Aconselhamento Genético



PARADIGMA EUGÊNICO

- OBJETIVO: melhorar a raça humana
- AÇÃO: social e política
 - Restrição a imigração
 - Esterilização de criminosos e deficientes
 - eutelogênese e bancos de esperma
- ACONSELHAMENTO: **DIRETIVO**
 - prioridade na defesa do pool gênico em detrimento das necessidades individuais

Evolução Histórica do Aconselhamento Genético

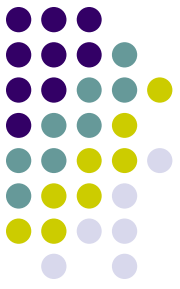

PARADIGMA PREVENTIVISTA

- A partir da década de 50
- MEDICALIZAÇÃO do AG
 - Serviços em Centros Médicos
 - Base do AG: Diagnóstico
 - Médico é o provedor do aconselhamento
 - Relação médico-paciente clássica
 - ATIVIDADE-PASSIVIDADE; LIDERANÇA-COOPERAÇÃO
 - AG:
 - Neutralidade
 - OBJETIVO: Eliminar a doença genética

Evolução Histórica do Aconselhamento Genético

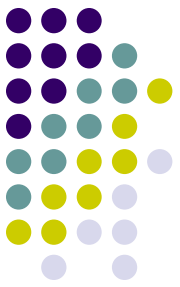

PARADIGMA PSICOLÓGICO

- Justificativas
 - Dificuldade para prevenir doença genética
 - tecnologia inadequada; não adesão; mutação recorrente; medicina disgênica
- Comunicação/Educação Genética Inapropriada
 - Alto grau de não entendimento
- Dilema entre o PREVENTIVISMO e o DIREITO DE ESCOLHA
- Informação Genética NÃO É NEUTRA
- Problemas psicológicos interferem no AG

Evolução Histórica do Aconselhamento Genético



PARADIGMA PSICOLÓGICO

- ACONSELHAMENTO: **NÃO DIRETIVO**
- BASE: relação CONSELHEIRO-CONSULENTE, tipo PARTICIPAÇÃO MÚTUA
- BASE: PSICOLÓGICA
 - Empatia
 - Fases do luto: choque, negação, raiva, depressão e aceitação
 - Comunicação humana
 - Mecanismos de Defesa
 - Processo decisório e personalidade
- PROVEDOR: CONSELHEIRO GENÉTICO

Aconselhamento Genético



- Processo de comunicação que trata de **problemas humanos** relacionados com a **ocorrência ou risco de ocorrência** de uma **afecção genética**, envolvendo auxiliar a **família** quanto a:
 - Compreensão do fato médico (diagnóstico, etiologia, tratamento)
 - Apreciação da hereditariedade e risco de recorrência
 - Entender as opções frente ao risco de recorrência
 - Escolha da conduta mais apropriada
 - Ajuste dos membros à informação

Aconselhamento Genético

Princípio Básico Atual :

NÃO
DIRETIVIDADE!

Fases do Aconselhamento Genético



- Consulta Inicial
- Diagnóstico e Manejo Clínico
- Estimativa de Recorrência
- Aconselhamento Genético
- Seguimento

Fases do Aconselhamento Genético



- **Consulta Inicial**
- Diagnóstico e Manejo Clínico
- Estimativa de Recorrência
- Aconselhamento Genético
- Seguimento
- Encaminhamento
- História familiar
- Exame clínico
- Exame laboratorial

Fases do Aconselhamento Genético



- Consulta Inicial
 - **Diagnóstico e Manejo Clínico**
 - Estimativa de Recorrência
 - Aconselhamento Genético
 - Seguimento
- **Clínico e Laboratorial**
 - Paciente
 - Outros familiares

Fases do Aconselhamento Genético



- Consulta Inicial
 - Diagnóstico e Manejo Clínico
 - **Estimativa de Recorrência**
 - Aconselhamento Genético
 - Seguimento
- **Baseado em:**
 - diagnóstico
 - Heredograma (história familiar)
 - exames laboratoriais
 - **Risco**
 - Modelos Matemáticos
 - Ex.: Doenças Mendelianas
 - Empíricos
 - Doenças Multifatoriais

Risco baseado em modelo matemático



Doença dominante

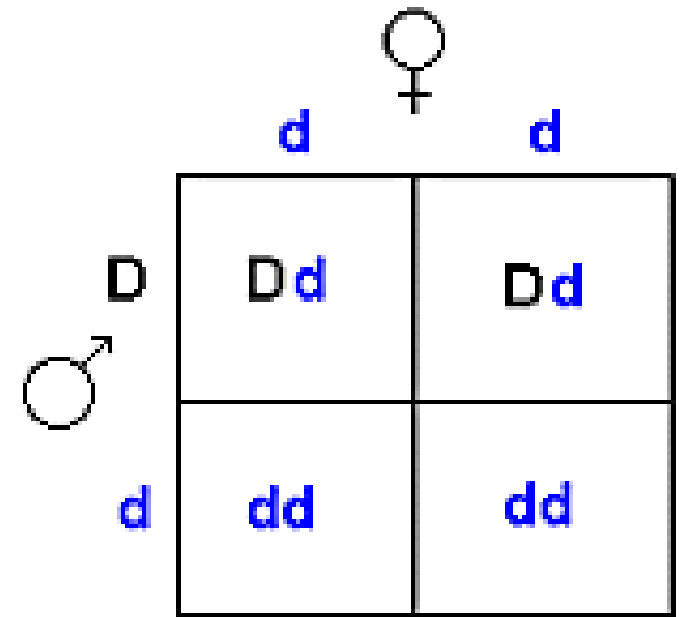
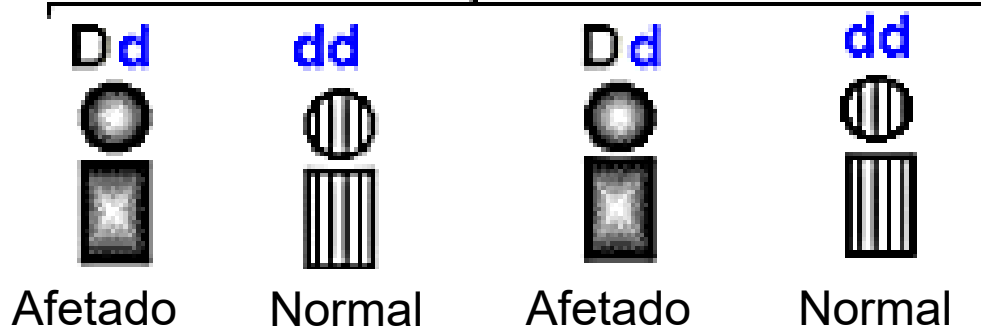
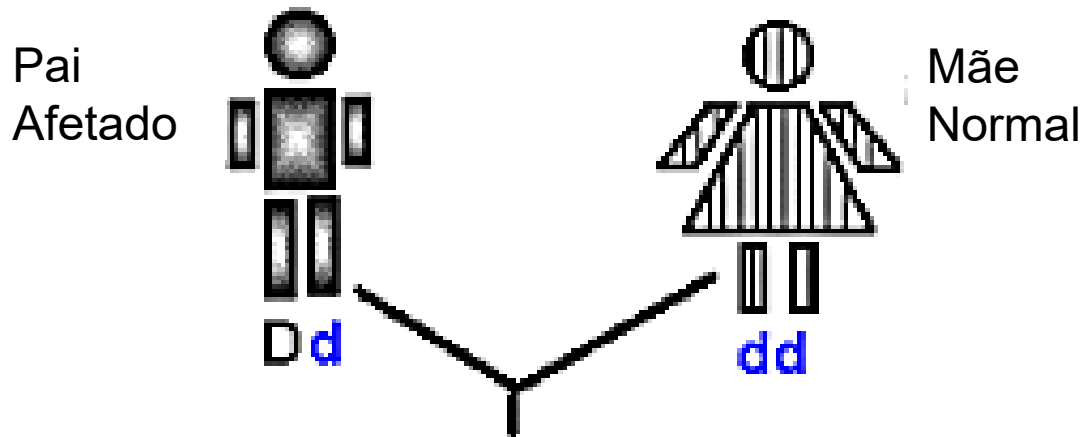

Síndrome de Marfan

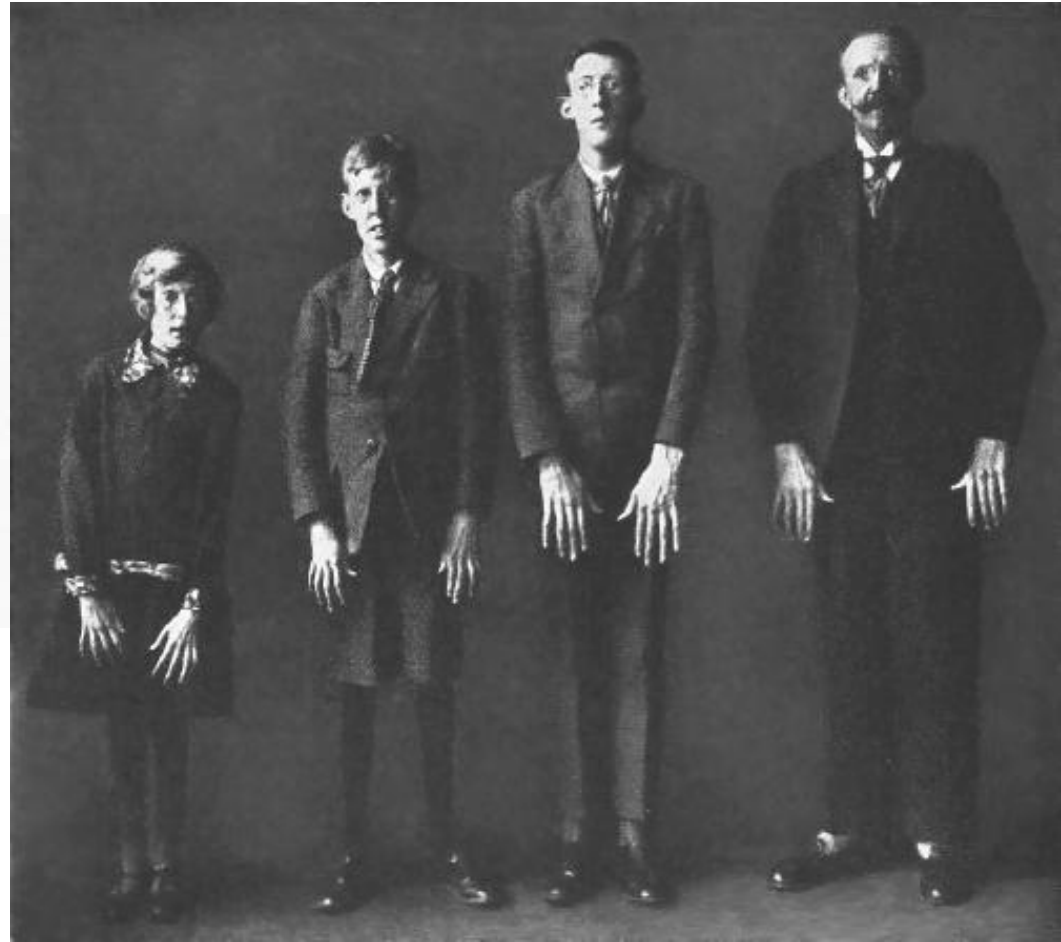
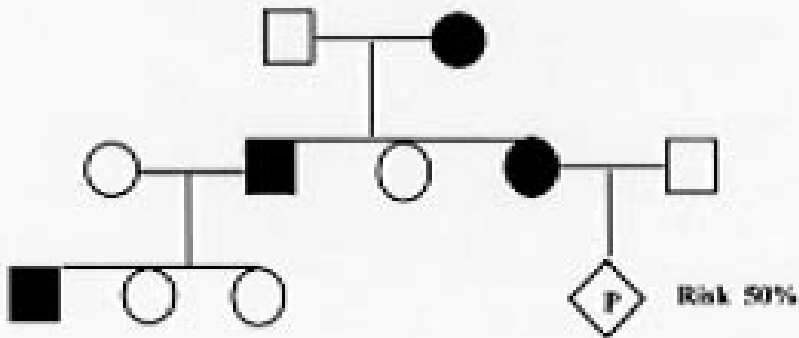
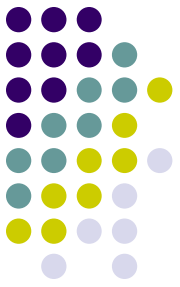

Risco baseado em modelo matemático



Doença recessiva

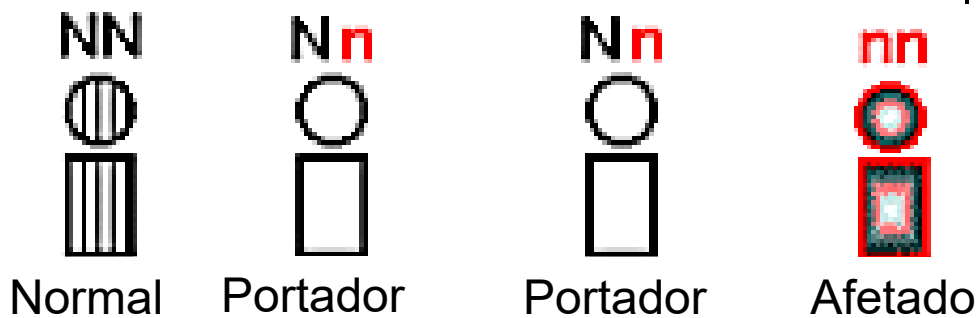
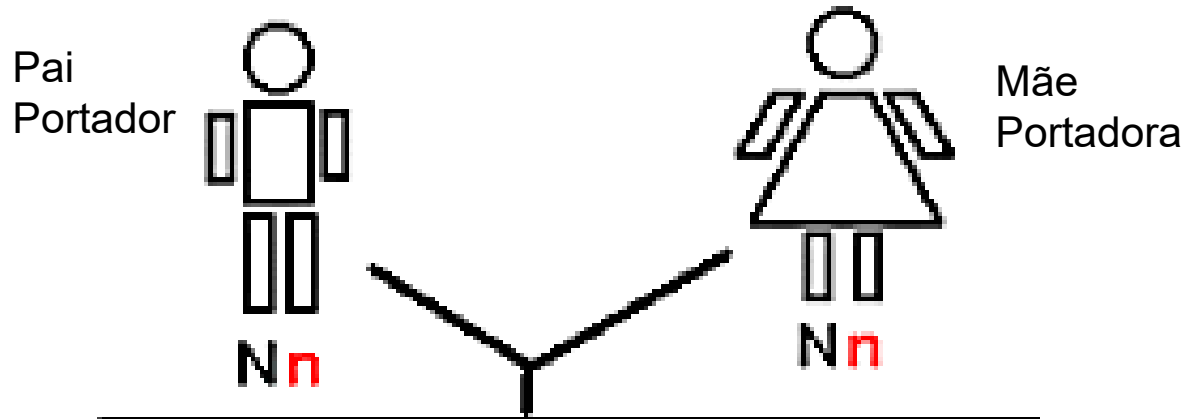

	N	n
N	NN	Nn
n	Nn	nn

Mucopolissacaridose: Síndrome de Morquio

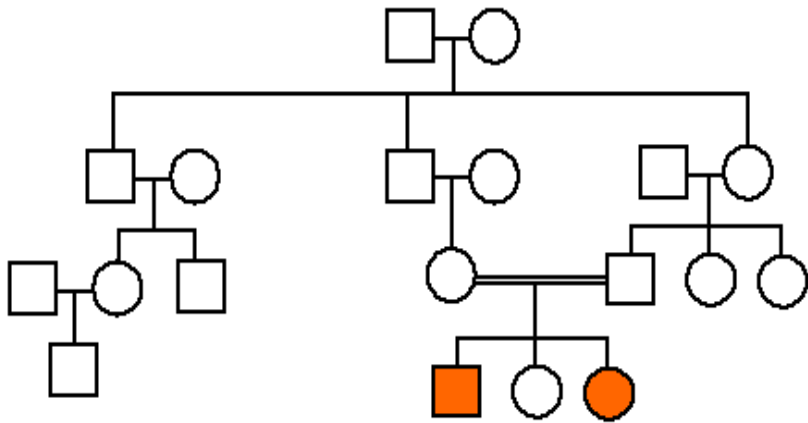
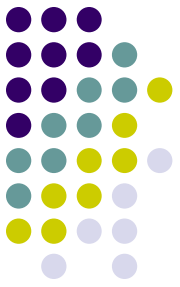

Risco baseado em modelo matemático



Doença ligada ao X recessiva

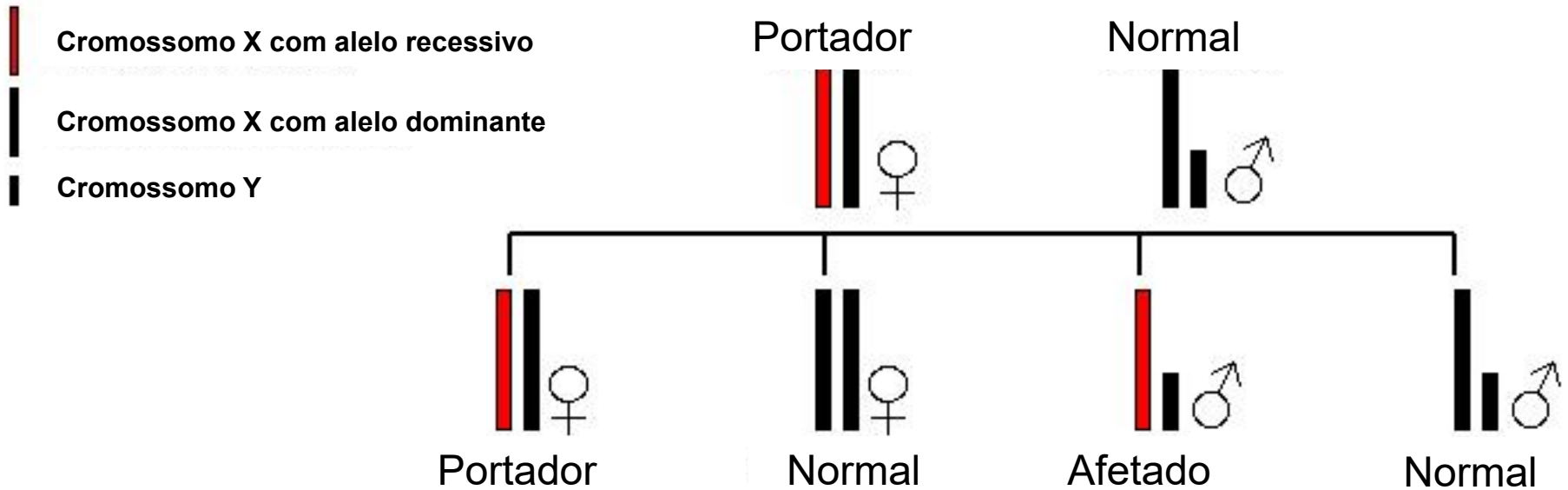

Adrenoleucodistrofia

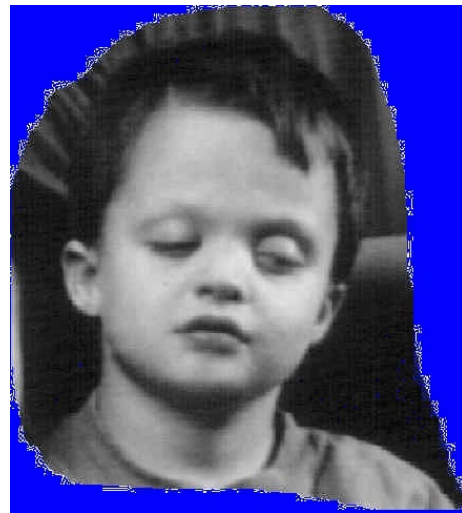
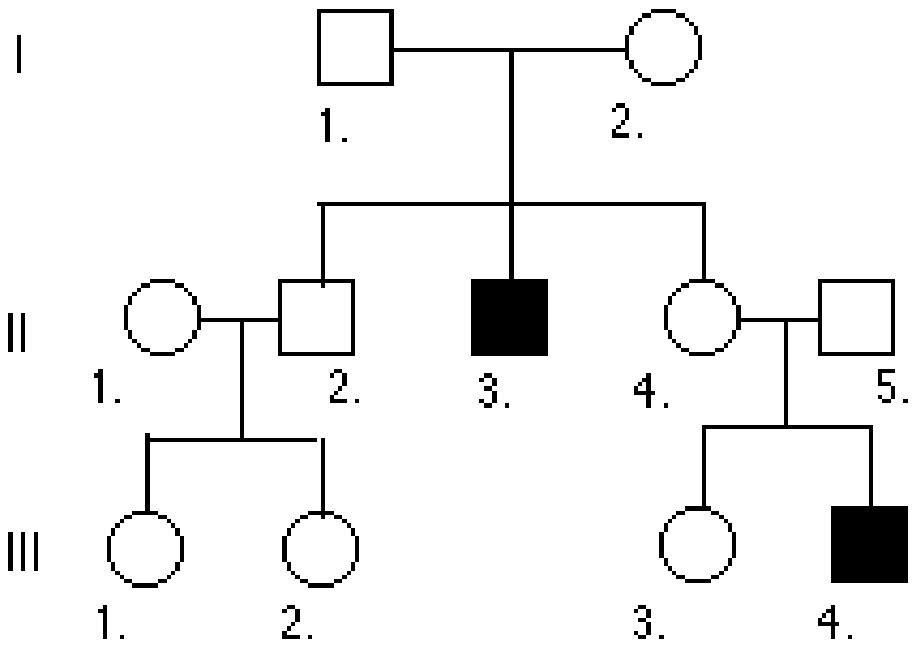
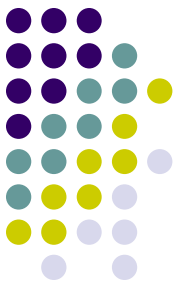

Risco Empírico

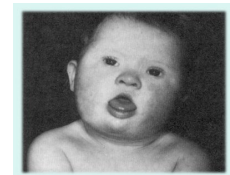
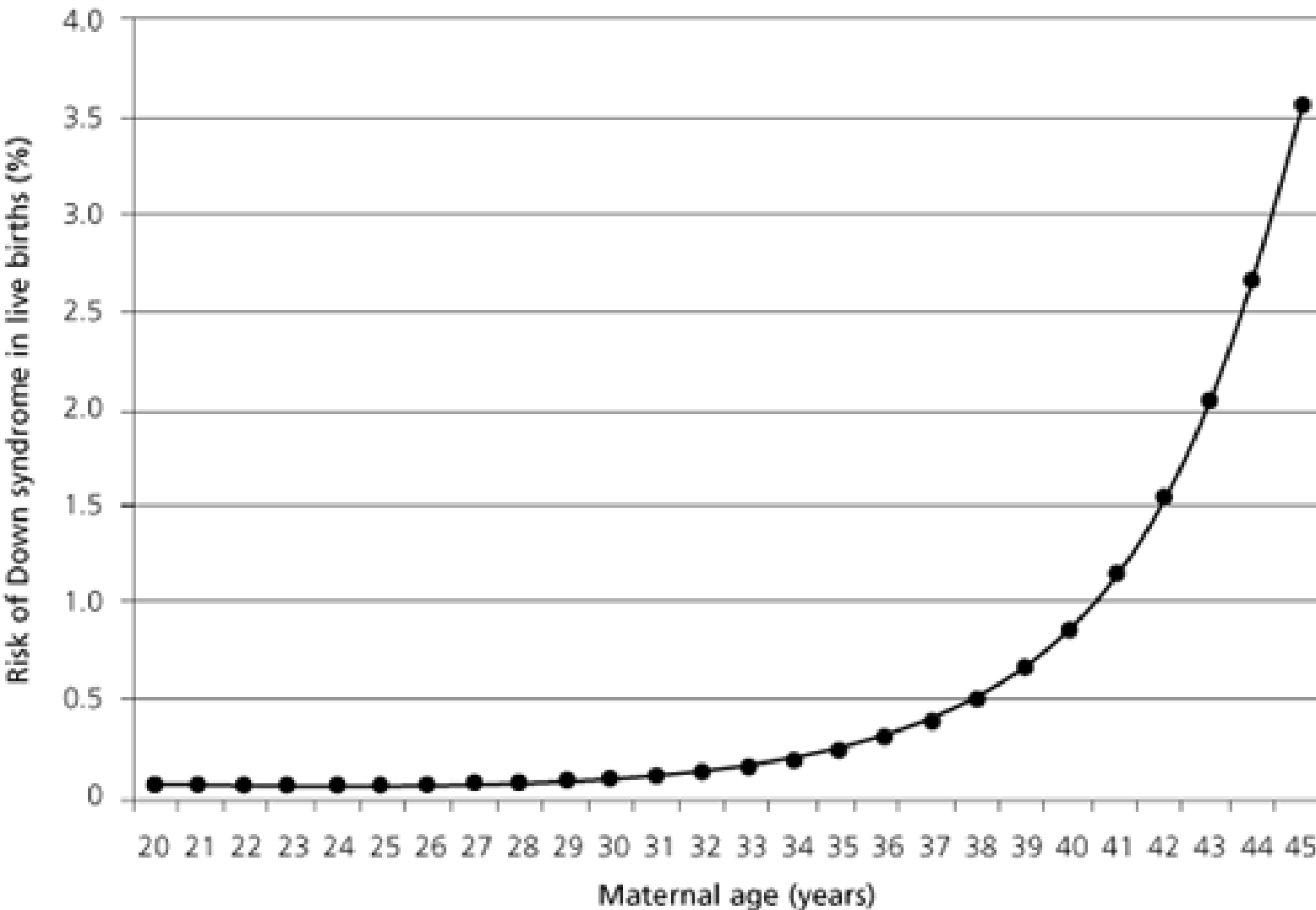
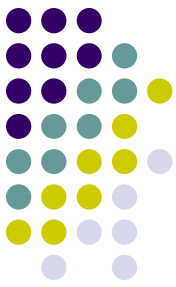

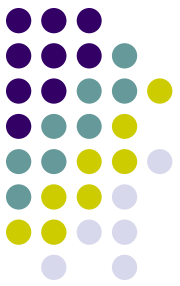

Testes Genéticos:

- Utilidade na Saúde Humana
 - Diagnóstico de doenças presentes
 - Diagnóstico preditivo e antecipatório de doenças genéticas (inclui-se o diagnóstico pré-natal)
 - Avaliação de risco para doenças multifatoriais
- 3 componentes principais:
 1. Informação, consentimento e preparação psicológica
 2. Análise laboratorial
 3. Interpretação e suporte

Testes Preditivos



Testes Preditivos

Sociedade Brasileira de Genética Clínica

Elaboração Final: 01 de Maio de 2001

Autoria: Lopes-Cendes I, Rocha JCC, Jardim LB

- 3 Situações:
 - doenças de início tardio para as quais não existe tratamento;
 - doenças para as quais existe tratamento ou medidas preventivas;
 - doenças em que apenas a predisposição aumentada pode ser detectada.
- Normas de Aplicação:
 - somente em adultos, quando sem tratamento;
 - por procura espontânea;
 - com avaliação psicológica e acompanhamento pré e pós-teste;
 - com fornecimento de informações a respeito do TP e da doença;
 - com completo sigilo.



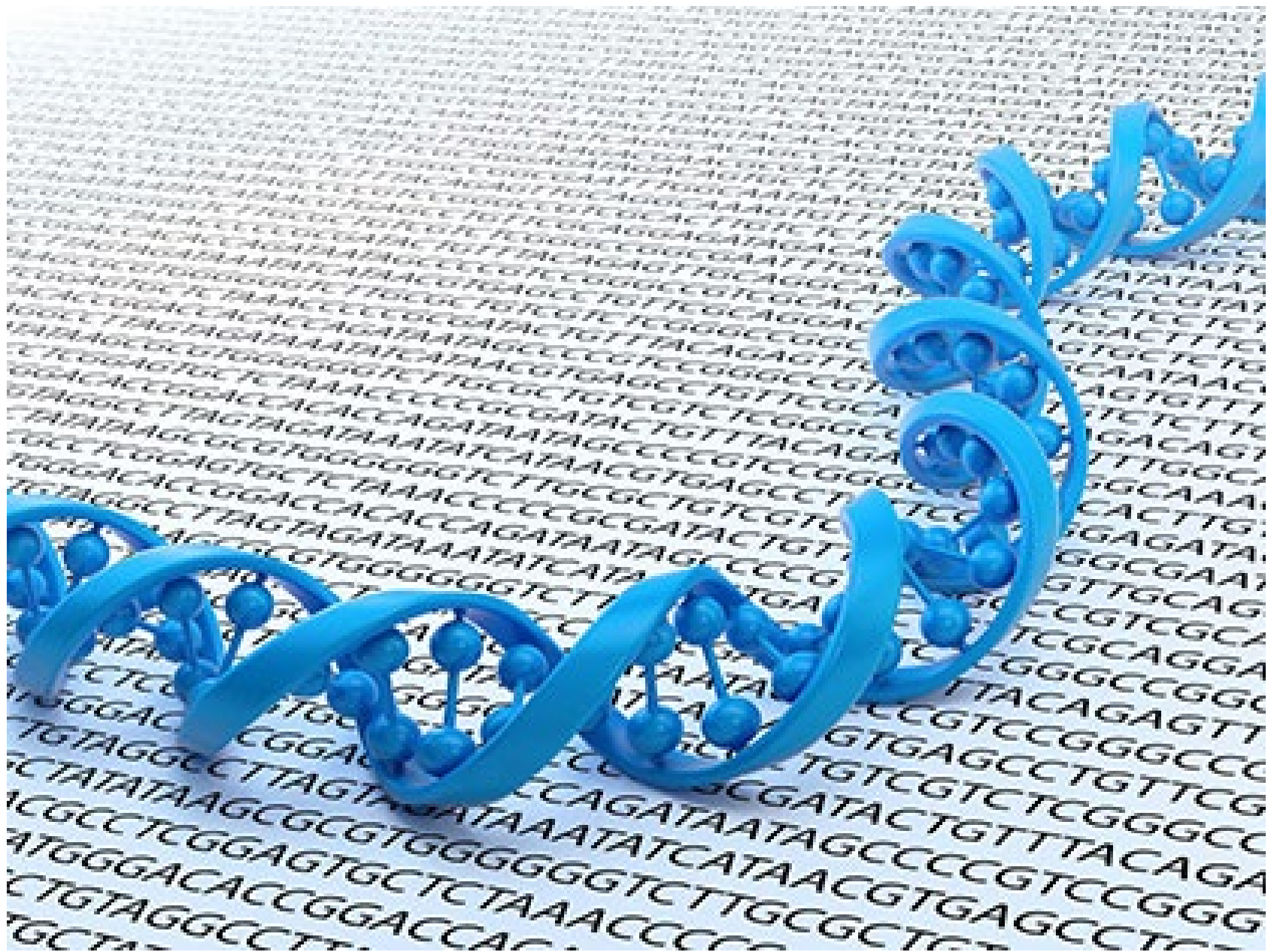

Desafios do Aconselhamento Genético



VUS

Variantes de Significado Incerto



PATOGÊNICA

- Pathogenic
- (i) 1 Very strong (PVS1) AND
 - (a) ≥ 1 Strong (PS1-PS4) OR
 - (b) ≥ 2 Moderate (PM1-PM6) OR
 - (c) 1 Moderate (PM1-PM6) and 1 supporting (PP1-PP5) OR
 - (d) ≥ 2 Supporting (PP1-PP5)
 - (ii) ≥ 2 Strong (PS1-PS4) OR
 - (iii) 1 Strong (PS1-PS4) AND
 - (a) ≥ 3 Moderate (PM1-PM6) OR
 - (b) 2 Moderate (PM1-PM6) AND ≥ 2 Supporting (PP1-PP5) OR
 - (c) 1 Moderate (PM1-PM6) AND ≥ 4 supporting (PP1-PP5)

PROVAVELMENTE PATOGÊNICA

- Likely pathogenic
- (i) 1 Very strong (PVS1) AND 1 moderate (PM1-PM6) OR
 - (ii) 1 Strong (PS1-PS4) AND 1-2 moderate (PM1-PM6) OR
 - (iii) 1 Strong (PS1-PS4) AND ≥ 2 supporting (PP1-PP5) OR
 - (iv) ≥ 3 Moderate (PM1-PM6) OR
 - (v) 2 Moderate (PM1-PM6) AND ≥ 2 supporting (PP1-PP5) OR
 - (vi) 1 Moderate (PM1-PM6) AND ≥ 4 supporting (PP1-PP5)

© American College of Medical Genetics and Genomics

ACMG STANDARDS AND GUIDELINES

Genetics
inMedicine

Standards and guidelines for the interpretation of sequence variants: a joint consensus recommendation of the American College of Medical Genetics and Genomics and the Association for Molecular Pathology

Sue Richards, PhD¹, Nazneen Aziz, PhD^{2,16}, Sherri Bale, PhD³, David Bick, MD⁴, Soma Das, PhD⁵, Julie Gastier-Foster, PhD^{6,7,8}, Wayne W. Grody, MD, PhD^{9,10,11}, Madhuri Hegde, PhD¹², Elaine Lyon, PhD¹³, Elaine Spector, PhD¹⁴, Karl Voelkerding, MD¹³ and Heidi L. Rehm, PhD¹⁵; on behalf of the ACMG Laboratory Quality Assurance Committee

BENIGNA

- Benign
- (i) 1 Stand-alone (BA1) OR
 - (ii) ≥ 2 Strong (BS1-BS4)

PROVAVELMENTE BENIGNA

- Likely benign
- (i) 1 Strong (BS1-BS4) and 1 supporting (BP1-BP7) OR
 - (ii) ≥ 2 Supporting (BP1-BP7)

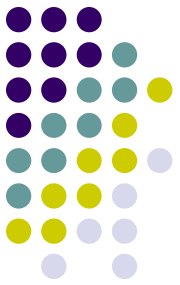

VARIANTE DE SIGNIFICADO INCERTO

Uncertain
significance

- (i) Other criteria shown above are not met OR
- (ii) the criteria for benign and pathogenic are contradictory



ClinVar ClinVar Search ClinVar for gene symbols, HGVS expressions, conditions, and more Search Help

```
ACTGATGGTATGGGGCCAAGAGATATATCT
CAGGTACGGCTGTCATCACTTAGACCTCAC
CAGGGCTGGGCATAAAAAGTCAGGGCAGAGC
CCATGGTGCATCTGACTCCTGAGGAGAAGT
GCAGGTTGGTATCAAGGTTACAAGACAGGT
GGCACTGACTCTCTGCCTATTGGTCTAT
```

ClinVar

ClinVar aggregates information about genomic variation and its relationship to human health.

- ### Using ClinVar
- [About ClinVar](#)
 - [Data Dictionary](#)
 - [Downloads/FTP site](#)
 - [FAQ](#)
 - [Contact Us](#)
 - [RSS feed/What's new?](#)
 - [Factsheet](#)

- ### Tools
- [ACMG Recommendations for Reporting of Incidental Findings](#)
 - [ClinVar Submission Portal](#)
 - [Submissions](#)
 - [Variation Viewer](#)
 - [Clinical Remapping - Between assemblies and RefSeqGenes](#)
 - [RefSeqGene/LRG](#)

- ### Related Sites
- [ClinGen](#)
 - [GeneReviews®](#)
 - [GTR®](#)
 - [MedGen](#)
 - [OMIM®](#)
 - [Variation](#)

Submitter highlights

We gratefully acknowledge those who have submitted data and provided advice during the development of ClinVar.

Follow us on [Twitter](#) to receive announcements of the release of new datasets.

Want to learn more about who submits to ClinVar?

- [Read information about groups that submit to ClinVar](#)
- [See the list of submitters with the number of records each has submitted](#)
- [View a world map of ClinVar submitters](#)

Disclaimer

The information on this website is not intended for direct diagnostic use or medical decision-making without review by a genetics professional. Individuals should not change their health behavior solely on the basis of information contained on this website. NIH does not independently verify the submitted information. If you have questions about the information contained on this website, please see a health care professional. More information about [NCBI's disclaimer policy](#) is available.



BRCA1 -> 6380 variantes

41,7%
VUS ou Conflitantes!

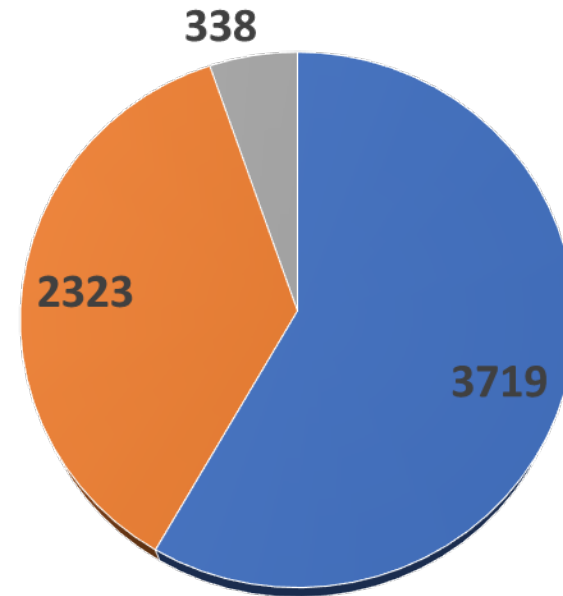

■ Pat/PrPat/Bem/ProBen ■ VUS ■ Conflitantes

Clinvar – 31/01/2018

AS VARIANTES PODEM MUDAR DE CLASSIFICAÇÃO COM O TEMPO



Genet Med. 2011 Dec;13(12):998-1005. doi: 10.1097/GIM.0b013e318226fc15.

Follow-up of carriers of BRCA1 and BRCA2 variants of unknown significance: variant reclassification and surgical decisions.

Murray ML¹, Cerrato F, Bennett RL, Jarvik GP.

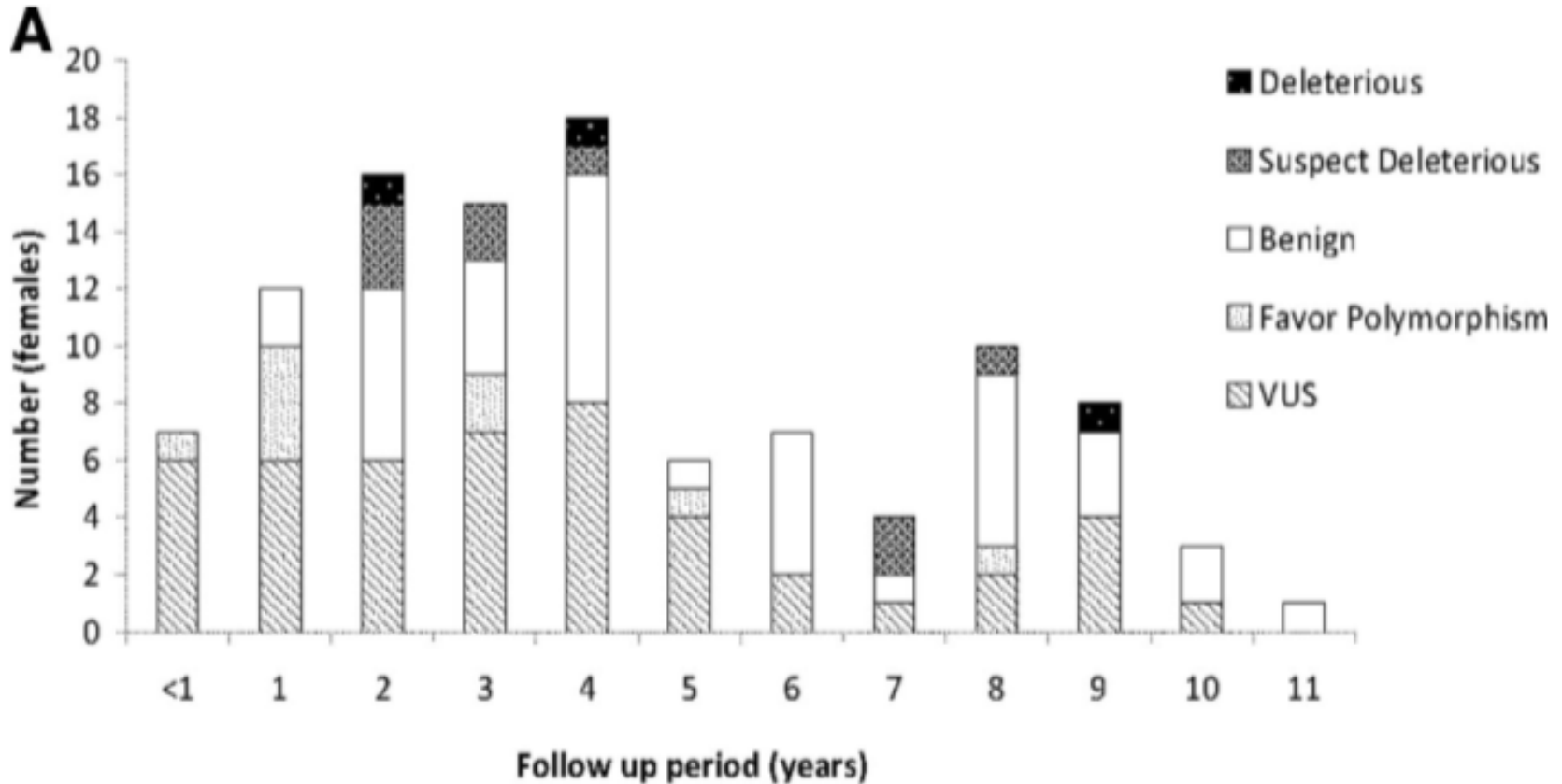



**Todo teste genético deve
ser oferecido com
Aconselhamento Genético
Pré-Teste e Pós Teste!**

Fases do Aconselhamento Genético

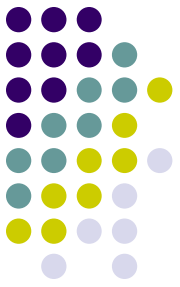

- Consulta Inicial
 - Diagnóstico e Manejo Clínico
 - Estimativa de Recorrência
 - **Aconselhamento Genético**
 - Seguimento
- **Natureza e consequência do distúrbio**
 - Medidas para modificar consequência
 - **Recorrência**
 - Medidas para evitar recorrência

Fases do Aconselhamento Genético



- Consulta Inicial
 - Diagnóstico e Manejo Clínico
 - Estimativa de Recorrência
 - Aconselhamento Genético
 - **Seguimento**
- **Apoio**
 - grupo de pais
 - clínicas especializadas
 - psicólogo
 - etc
 - **Seguimento**
 - Clínico
 - AG

