

Universidade de São Paulo – USP
Faculdade de Zootecnia e Engenharia de
Alimentos - FZEA

Peças Mecânicas

Prof. Dr. Juliano Fiorelli
Prof. Dr. Celso Oliveira

2020

projeções

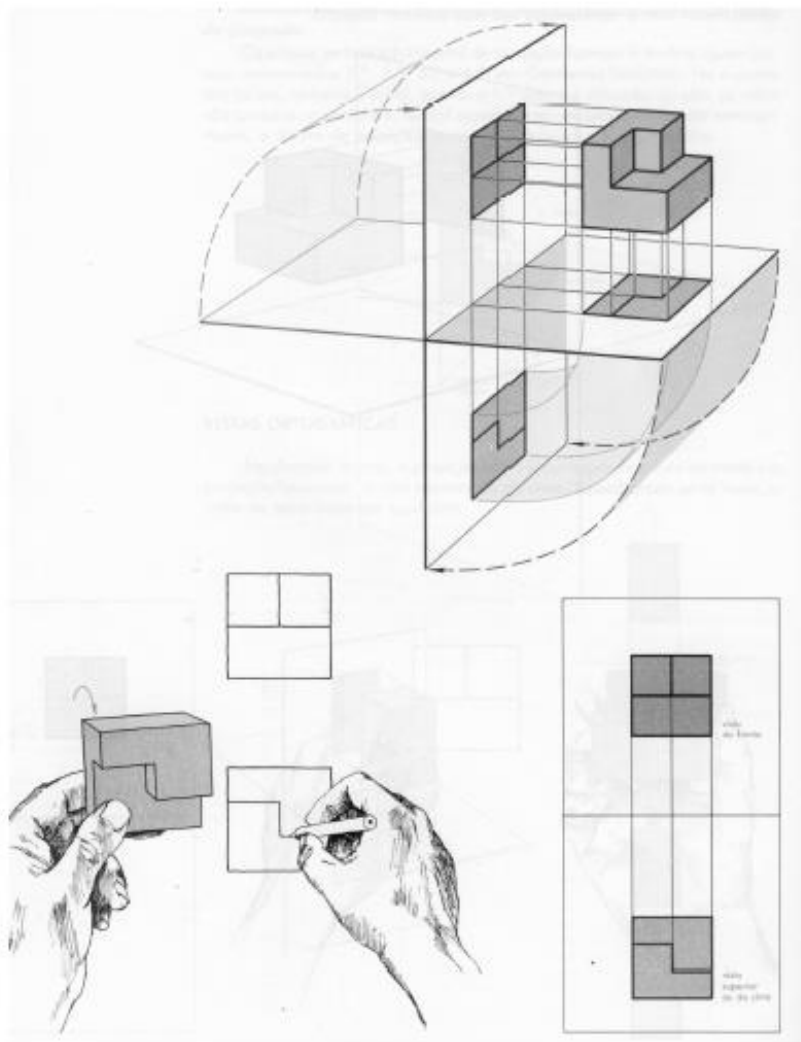

aldper70 ,71

Desenho Técnico
MEC Fename, p.70 e 71

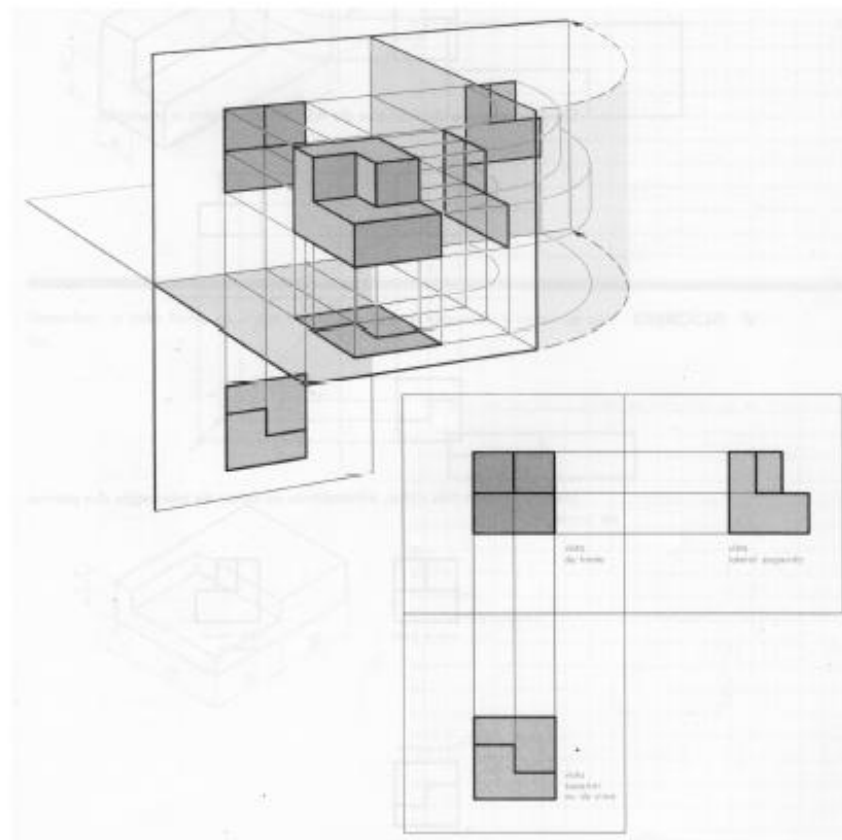

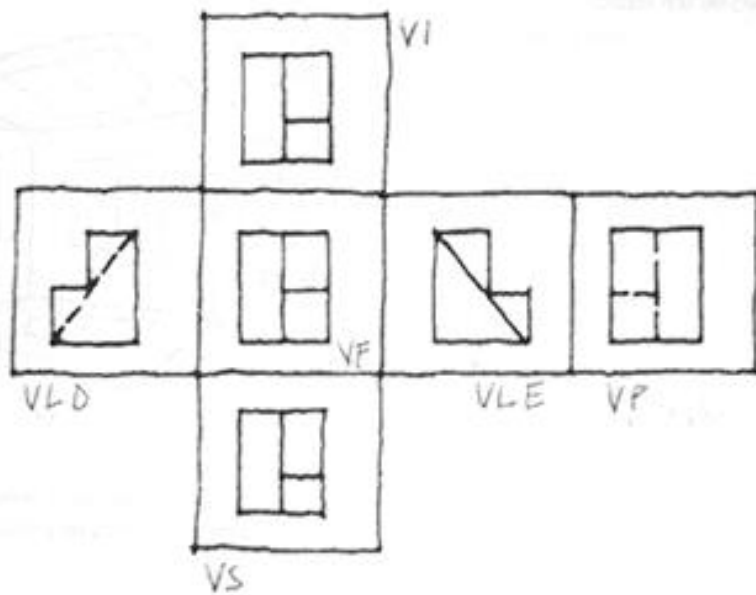
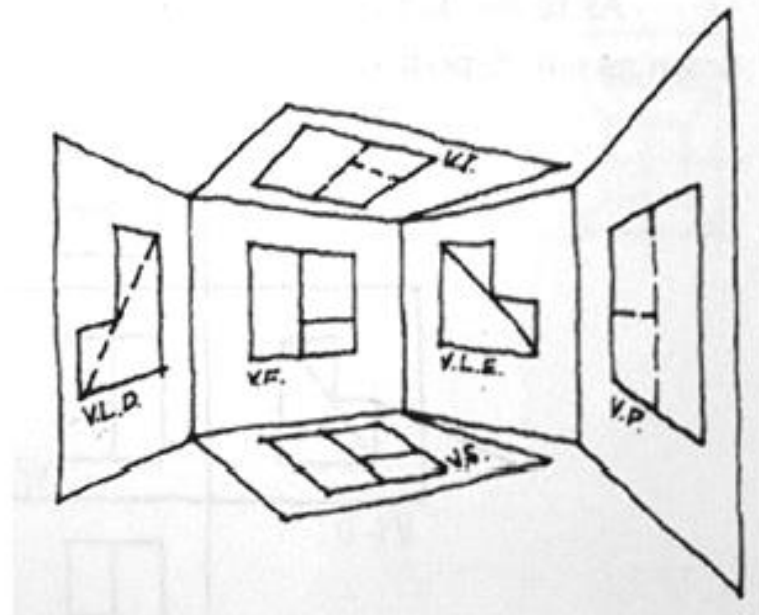
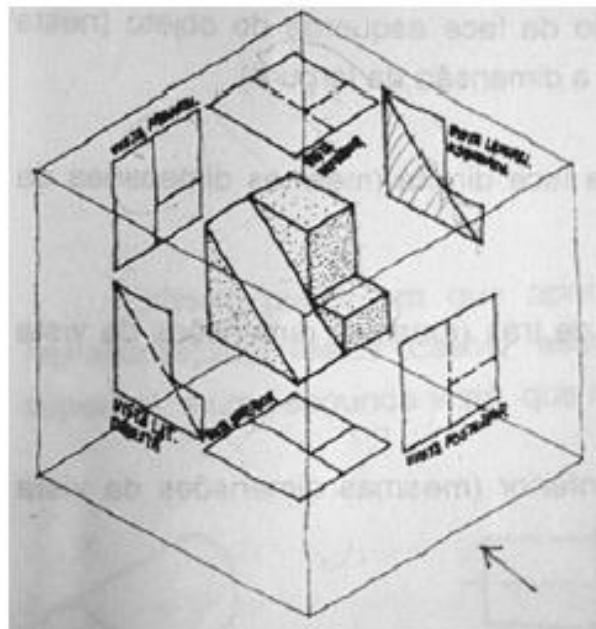

ang-1, -2, -3







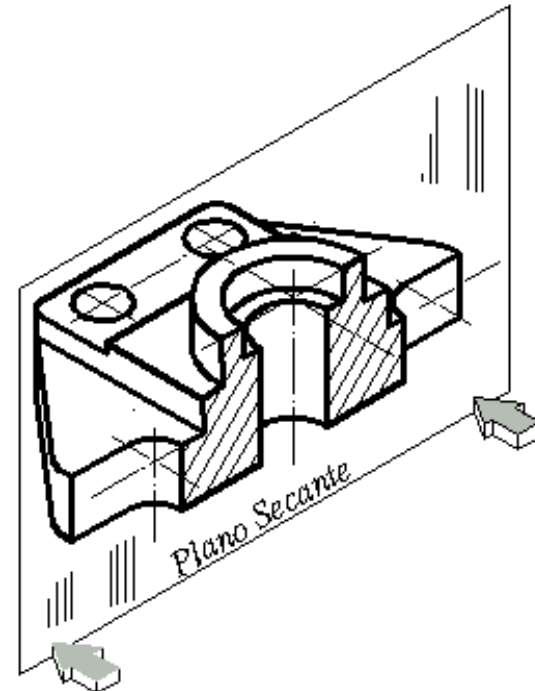
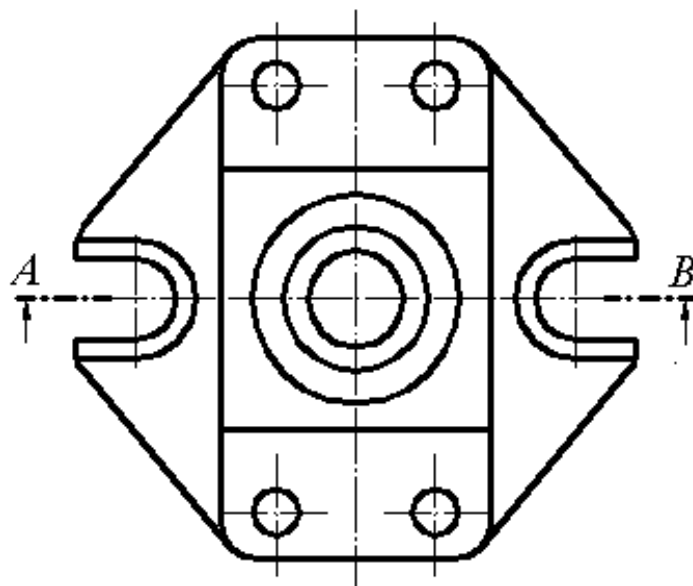
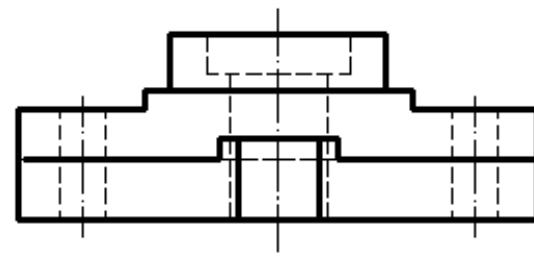
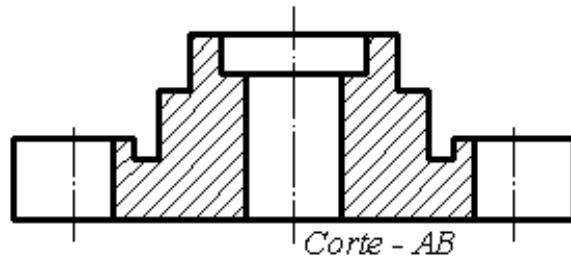



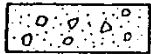

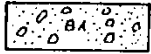
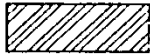
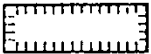

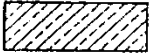
Desenho Técnico, apostila, EESC, 1996

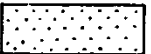
Maria Angela Bortolucci e Myrian V. P. Cortesi

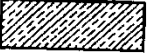
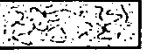
cortes

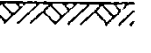
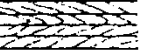
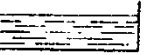
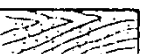

hachuras

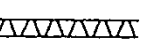
Metais em geral		Cinzentos	Betão		Cinzentos
Ferro fundido Ferro maleável		Azul	Betão armado		Cinzentos
Ferro forjado Aço		Lilás	Pedra natural		Cinzentos
Aço inoxidável		Lilás	Pedra artificial em blocos		Cinzentos
Cobre e suas ligas		Alaranjado	Elementos cerâmicos resistentes		Vermelho-de- -vенеza
Estanho, chumbo e zinco		Verde claro	Elementos cerâmicos de enchimento ou de revestimento		Vermelho-de- -vенеza
Alumínio, magnésio e suas ligas		Verde	Rebocos e argamassas		Branco sujo
Metal branco (Liga antifricção)		Lilás claro	Fibrocimento, gesso e outros materiais minerais em blocos ou placas		Cinzentos claros
Fibras, cortiça, couro, feltro e materiais similares		Sépias	Vidro		Verde claro
Madeira		Alaranjado	Terreno		Sépias
Contraplacado		Alaranjado	Líquido		Azul claro
Aglomerados de madeira		Alaranjado	Isolamento hidrófugo		—
Plásticos, borracha e betuminosos		Verde claro	Isolamentos acústico e térmico		—

- Elementos de União

Roscas, Ribites e Soldas

- Elementos de Transmissão

Engrenagens

Representação simplificada de roscas

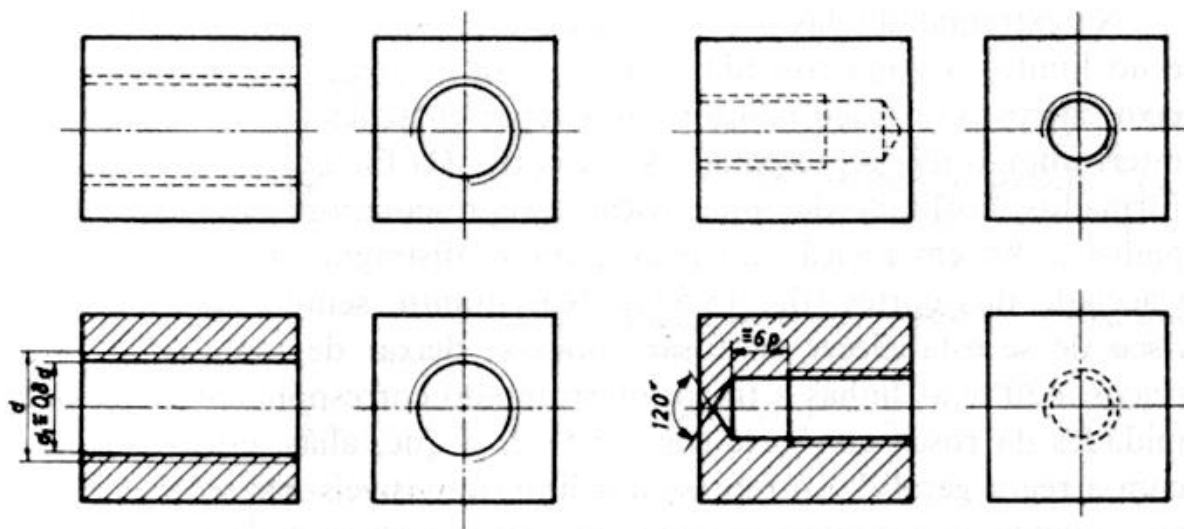
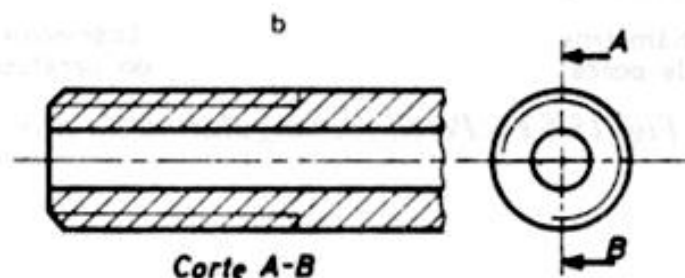
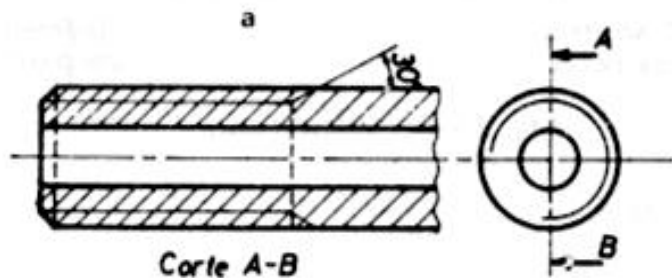
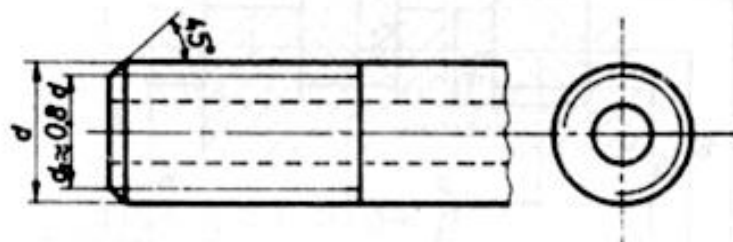
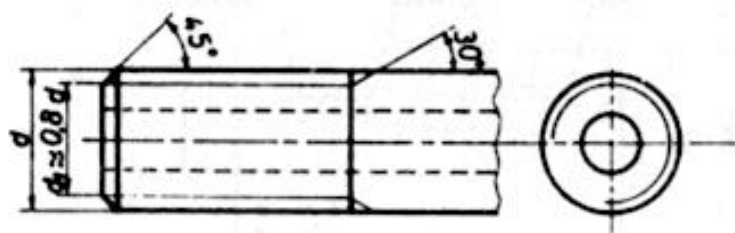

Representação simplificada de engrenagens

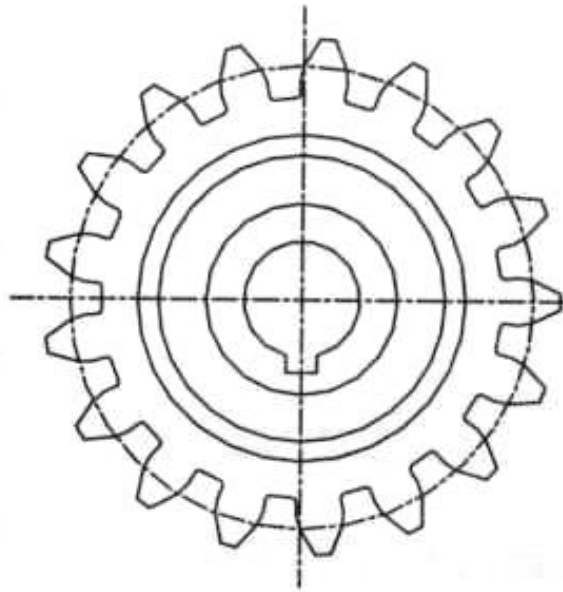

Representação Convencional

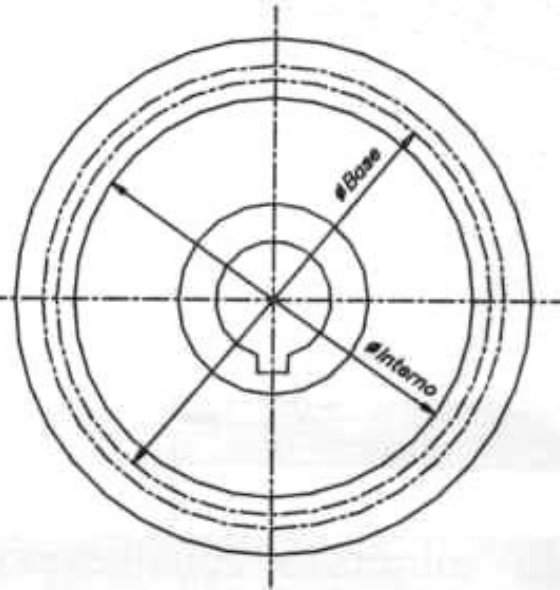

Representação Simbólica

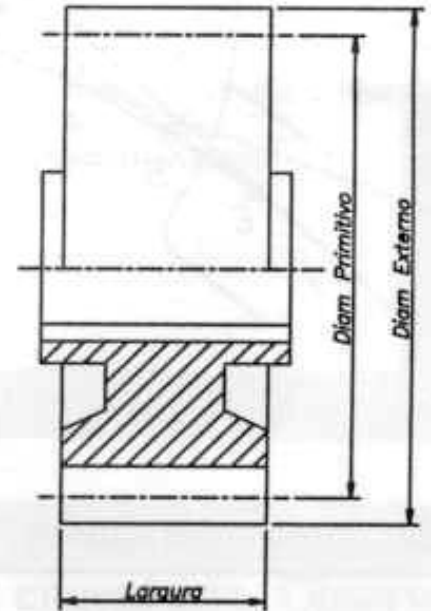

Tubulações



