5

KINETICS: FORCES AND MOMENTS OF FORCE

5.0 BIOMECHANICAL MODELS

Chapter 3 dealt at length with the movement itself, without regard to the forces that cause the movement. The study of these forces and the resultant energetics is called *kinetics*. Knowledge of the patterns of the forces is necessary for an understanding of the cause of any movement.

Transducers have been developed that can be implanted surgically to measure the force exerted by a muscle at the tendon. However, such techniques have applications only in animal experiments and, even then, only to a limited extent. It, therefore, remains that we attempt to calculate these forces indirectly, using readily available kinematic and anthropometric data. The process by which the reaction forces and muscle moments are calculated is called *link-segment modeling*. Such a process is depicted in Figure 5.1. If we have a full kinematic description, accurate anthropometric measures, and the external forces, we can calculate the joint reaction forces and muscle moments. This prediction is called an *inverse solution* and is a very powerful tool in gaining insight into the net summation of all muscle activity at each joint. Such information is very useful to the coach, surgeon, therapist, and kinesiologist in their diagnostic assessments. The effect of training, therapy, or surgery is extremely evident at this level of assessment, although it is often obscured in the original kinematics.

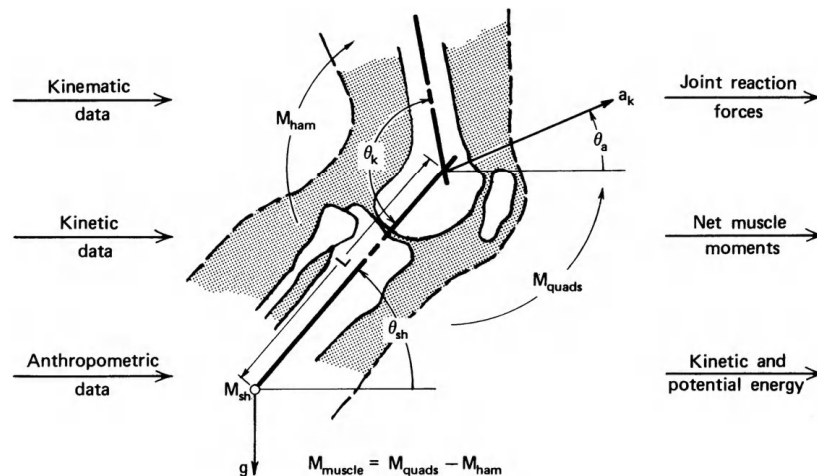

Figure 5.1 Schematic diagram of the relationship between kinematic, kinetic, and anthropometric data and the calculated forces, moments, energies, and powers using an inverse solution of a link-segment model.

5.0.1 Link-Segment Model Development

The validity of any assessment is only as good as the model itself. Accurate measures of segment masses, centers of mass (COMs), joint centers, and moments of inertia are required. Such data can be obtained from statistical tables based on the person's height, weight, and, sometimes, sex, as was detailed in Chapter 4. A limited number of these variables can be measured directly, but some of the techniques are time-consuming and have limited accuracy. Regardless of the source of the anthropometric data, the following assumptions are made with respect to the model:

1. Each segment has a fixed mass located as a point mass at its COM (which will be the center of gravity in the vertical direction).
2. The location of each segment's COM remains fixed during the movement.
3. The joints are considered to be hinge (or ball-and-socket) joints.
4. The mass moment of inertia of each segment about its mass center (or about either proximal or distal joints) is constant during the movement.
5. The length of each segment remains constant during the movement (e.g., the distance between hinge or ball-and-socket joints remains constant).

Figure 5.2 shows the equivalence between the anatomical and the link-segment models for the lower limb. The segment masses m_1 , m_2 , and m_3 are considered to be concentrated at points. The distance from the proximal joint to the mass centers is considered to be fixed, as are the length of the

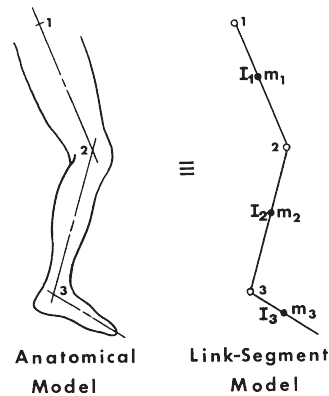

Figure 5.2 Relationship between anatomical and link-segment models. Joints are replaced by hinge (pin) joints and segments are replaced by masses and moments of inertia located at each segment's center of mass.

segments and each segment's moment of inertia I_1 , I_2 , and I_3 about each COM.

5.0.2 Forces Acting on the Link-Segment Model

1. *Gravitational Forces*. The forces of gravity act downward through the COMs of each segment and are equal to the magnitude of the mass times acceleration due to gravity (normally 9.8 m/s^2).
2. *Ground Reaction or External Forces*. Any external forces must be measured by a force transducer. Such forces are distributed over an area of the body (such as the ground reaction forces under the area of the foot). In order to represent such forces as vectors, they must be considered to act at a point that is usually called the center of pressure (COP). A suitably constructed force plate, for example, yields signals from which the COP can be calculated.
3. *Muscle and Ligament Forces*. The net effect of muscle activity at a joint can be calculated in terms of net muscle moments. If a cocontraction is taking place at a given joint, the analysis yields only the net effect of both agonist and antagonistic muscles. Also, any friction effects at the joints or within the muscle cannot be separated from this net value. Increased friction merely reduces the effective "muscle" moment; the muscle contractile elements themselves are actually creating moments higher than that analyzed at the tendon. However, the error at low and moderate speeds of movement is usually only a few percent. At the extreme range of movement of any joint, passive structures such as ligaments come into play to contain the range. The moments generated by these tissues will add to or subtract from those generated by the

muscles. Thus, unless the muscle is silent, it is impossible to determine the contribution of these passive structures.

5.0.3 Joint Reaction Forces and Bone-on-Bone Forces*

The three forces described in the preceding sections constitute all the forces acting on the total body system itself. However, our analysis examines the segments one at a time and, therefore, must calculate the reaction between segments. A free-body diagram of each segment is required, as shown in Figure 5.3. Here the original link-segment model is broken into its segmental parts. For convenience, we make the break at the joints and the forces that act across each joint must be shown on the resultant free-body diagram. This procedure now permits us to look at each segment and calculate all unknown joint reaction forces. In accordance with Newton’s third law, there is an equal and opposite force acting at each hinge joint in our model. For example, when a leg is held off the ground in a static condition, the foot is exerting a downward force on the tendons and ligaments crossing the ankle

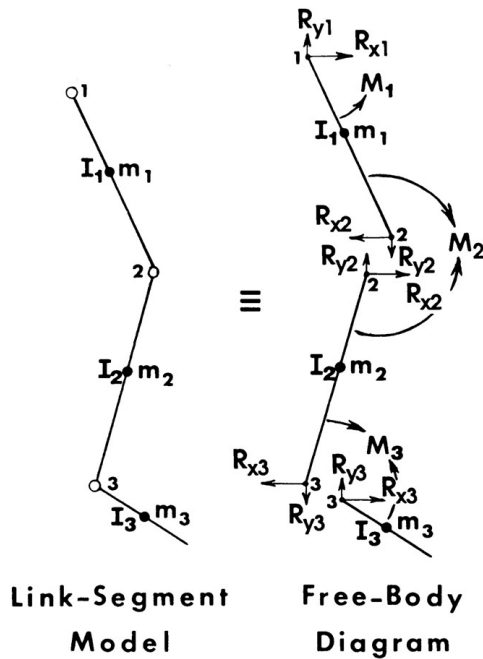

Figure 5.3 Relationship between the free-body diagram and the link-segment model. Each segment is “broken” at the joints, and the reaction forces and moments of force acting at each joint are indicated.

*Representative paper: Paul, 1966.

joint. This is seen as a downward force acting on the leg equal to the weight of the foot. Likewise, the leg is exerting an equal upward force on the foot through the same connective tissue.

Considerable confusion exists regarding the relationship between joint reaction forces and joint bone-on-bone forces. The latter forces are the actual forces seen across the articulating surfaces and include the effect of muscle activity and the action of ligaments. Actively contracting muscles pull the articulating surfaces together, creating compressive forces and, sometimes, shear forces. In the simplest situation, the bone-on-bone force equals the active compressive force due to muscle plus joint reaction forces. Figure 5.4 illustrates these differences. Case 1 has the lower segment with a weight of 100 N hanging passively from the muscles originating in the upper segment. The two muscles are not contracting but are, assisted by ligamentous tissue, pulling upward with an equal and opposite 100 N. The link-segment model shows these equal and opposite reaction forces. The bone-on-bone force is zero, indicating that the joint articulating surfaces are under neither tension nor compression. In case 2, there is an active contraction of the muscles, so that the total upward force is now 170 N. The bone-on-bone force is 70 N compression. This means that a force of 70 N exists across the articulating surfaces. As far as the lower segment is concerned, there is still a net reaction force of 100 N upward (170 N upward through muscles and 70 N downward across the articulating surfaces). The lower segment is still acting downward with a force of 100 N; thus, the free-body diagram remains the same. Generally the anatomy is not as simple as depicted. More than one muscle is usually active on each side of the joint, so it is difficult to apportion the forces among the muscles. Also, the exact angle of pull of each tendon and the geometry of the articulating surfaces are not always readily available. Thus, a much more

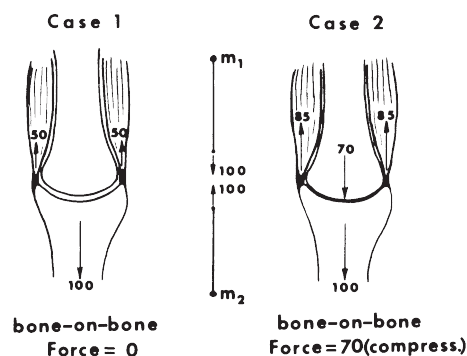

Figure 5.4 Diagrams to illustrate the difference between joint reaction forces and bone-on-bone forces. In both cases, the reaction force is 100 N acting upward on M_2 and downward on M_1 . With no muscle activity (case 1), the bone-on-bone force is zero; with muscle activity (case 2) it is 70 N.

complex free-body diagram must be used, and the techniques and examples are described in Section 5.3.

5.1 BASIC LINK-SEGMENT EQUATIONS—THE FREE-BODY DIAGRAM*

Each body segment acts independently under the influence of reaction forces and muscle moments, which act at either end, plus the forces due to gravity. Consider the planar movement of a segment in which the kinematics, anthropometrics, and reaction forces at the distal end are known (see Figure 5.5).

Known

- a_x, a_y = acceleration of segment COM
- θ = angle of segment in plane of movement
- α = angular acceleration of segment in plane of movement
- R_{xd}, R_{yd} = reaction forces acting at distal end of segment, usually determined from a prior analysis of the proximal forces acting on distal segment
- M_d = net muscle moment acting at distal joint, usually determined from an analysis of the proximal muscle acting on distal segment

Unknown

- R_{xp}, R_{yp} = reaction forces acting at proximal joint
- M_p = net muscle moment acting on segment at proximal joint

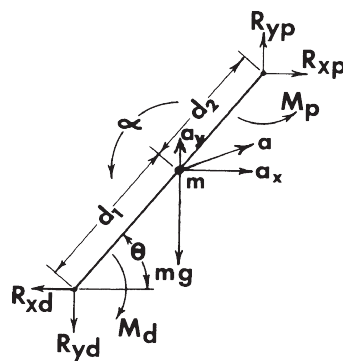

Figure 5.5 Complete free-body diagram of a single segment, showing reaction and gravitational forces, net moments of force, and all linear and angular accelerations.

*Representative paper: Bresler and Frankel, 1950.

Equations

1. $\Sigma F_x = ma_x$

$$R_{xp} - R_{xd} = ma_x \quad (5.1)$$

2. $\Sigma F_y = ma_y$

$$R_{yp} - R_{yd} - mg = ma_y \quad (5.2)$$

3. About the segment COM, $\Sigma M = I_0\alpha$ (5.3)

Note that the muscle moment at the proximal end cannot be calculated until the proximal reaction forces R_{xp} and R_{yp} have first been calculated.

Example 5.1 (see **Figure 5.6**). In a static situation, a person is standing on one foot on a force plate. The ground reaction force is found to act 4 cm anterior to the ankle joint. Note that convention has the ground reaction force R_{y1} always acting upward. We also show the horizontal reaction force R_{x1} to be acting in the positive direction (to the right). If this force actually acts to the left, it will be recorded as a negative number. The subject's mass is 60 kg, and the mass of the foot is 0.9 kg. Calculate the joint reaction forces and net muscle moment at the ankle. $R_{y1} = \text{body weight} = 60 \times 9.8 = 588 \text{ N}$.

1. $\Sigma F_x = ma_x,$

$$R_{x2} + R_{x1} = ma_x = 0$$

Note that this is a redundant calculation in static conditions.

2. $\Sigma F_y = ma_y,$

$$R_{y2} + R_{y1} - mg = ma_y$$

$$R_{y2} + 588 - 0.9 \times 9.8 = 0$$

$$R_{y2} = -579.2 \text{ N}$$

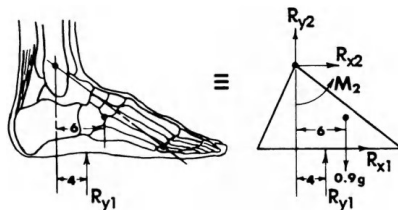

Figure 5.6 Anatomical and free-body diagram of foot during weight bearing.

The negative sign means that the force acting on the foot at the ankle joint acts *downward*. This is not surprising because the entire body weight, less that of the foot, must be acting downward on the ankle joint.

3. About the COM, $\Sigma M = I_0\alpha$,

$$M_2 - R_{y1} \times 0.02 - R_{y2} \times 0.06 = 0$$

$$M_2 = 588 \times 0.02 + (-579.2 \times 0.06) = -22.99 \text{ N} \cdot \text{m}$$

The negative sign means that the real direction of the muscle moment acting on the foot at the ankle joint is clockwise, which means that the plantarflexors are active at the ankle joint to maintain the static position. These muscles have created an action force that resulted in the ground reaction force that was measured, and whose center of pressure was 4 cm anterior to the ankle joint.

Example 5.2 (see Figure 5.7). From the data collected during the swing of the foot, calculate the muscle moment and reaction forces at the ankle. The subject's mass was 80 kg and the ankle-metatarsal length was 20.0 cm. From Table 4.1, the inertial characteristics of the foot are calculated:

$$m = 0.0145 \times 80 = 1.16 \text{ kg}$$

$$\rho_0 = 0.475 \times 0.20 = 0.095 \text{ m}$$

$$I_0 = 1.16(0.095)^2 = 0.0105 \text{ kg} \cdot \text{m}^2$$

$$\alpha = 21.69 \text{ rad/s}^2$$

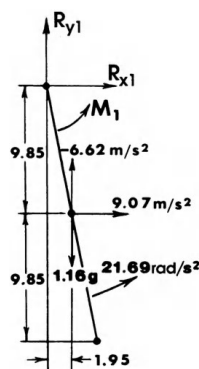

Figure 5.7 Free-body diagram of foot during swing showing the linear accelerations of the center of mass and the angular acceleration of the segment. Distances are in centimeters. Three unknowns, R_{x1} , R_{y1} , and M_1 , are to be calculated assuming a positive direction as shown.

$$1. \Sigma F_x = ma_x,$$

$$R_{x1} = 1.16 \times 9.07 = 10.52 \text{ N}$$

$$2. \Sigma F_y = ma_y,$$

$$R_{y1} - 1.16g = m(-6.62)$$

$$R_{y1} = 1.16 \times 9.8 - 1.16 \times 6.62 = 3.69 \text{ N}$$

$$3. \text{ At the COM of the foot, } \Sigma M = I_0\alpha,$$

$$M_1 - R_{x1} \times 0.0985 - R_{y1} \times 0.0195 = 0.0105 \times 21.69$$

$$\begin{aligned} M_1 &= 0.0105 \times 21.69 + 10.52 \times 0.0985 + 3.69 \times 0.0195 \\ &= 0.23 + 1.04 + 0.07 = 1.34 \text{ N} \cdot \text{m} \end{aligned}$$

Discussion

1. The horizontal reaction force of 10.52 N at the ankle is the cause of the horizontal acceleration that we calculated for the foot.
2. The foot is decelerating its upward rise at the end of lift-off. Thus, the vertical reaction force at the ankle is somewhat less than the static gravitational force.
3. The ankle muscle moment is positive, indicating net dorsiflexor activity (tibialis anterior), and most of this moment (1.04 out of 1.34 N · m) is required to cause the horizontal acceleration of the foot's center of gravity, with very little needed (0.23 N · m) to angularly accelerate the low moment of inertia of the foot.

Example 5.3 (see Figure 5.8). For the same instant in time, calculate the muscle moments and reaction forces at the knee joint. The leg segment was 43.5 cm long.

$$m = 0.0465 \times 80 = 3.72 \text{ kg}$$

$$\rho_0 = 0.302 \times 0.435 = 0.131 \text{ m}$$

$$I_0 = 3.72(0.131)^2 = 0.0638 \text{ kg} \cdot \text{m}^2$$

$$\alpha = 36.9 \text{ rad/s}^2$$

From Example 5.2, $R_{x1} = 10.52 \text{ N}$, $R_{y1} = 3.69 \text{ N}$, and $M_1 = 1.34 \text{ N} \cdot \text{m}$.

$$1. \Sigma F_x = ma_x,$$

$$R_{x2} - R_{x1} = ma_x$$

$$R_{x2} = 10.52 + 3.72(-0.03) = 10.41 \text{ N}$$

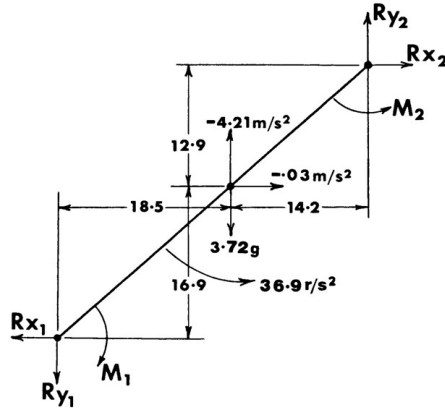

Figure 5.8 Free-body diagram of leg at the same instant in time as the foot in Figure 5.7. Linear and angular accelerations are as shown. Distances are in centimeters. The distal end and reaction forces and moments have been reversed, recognizing Newton’s third law. Again the three unknowns, R_{x2} , R_{y2} , and M_2 , are assumed to be positive with direction as indicated.

2. $\Sigma F_y = ma_y$,

$$R_{y2} - R_{y1} - mg = ma_y$$

$$R_{y2} = 3.69 + 3.72 \times 9.8 + 3.72(-4.21) = 24.48 \text{ N}$$

3. About the COM of the leg, $\Sigma M = I\alpha$,

$$M_2 - M_1 - 0.169R_{x1} + 0.185R_{y1} - 0.129R_{x2} + 0.142R_{y2} = I\alpha$$

$$M_2 = 1.34 + 0.169 \times 10.52 - 0.185 \times 3.69 + 0.129 \times 10.41$$

$$- 0.142 \times 24.48 + 0.0638 \times 36.9$$

$$= 1.34 + 1.78 - 0.68 + 1.34 - 3.48 + 2.35 = 2.65 \text{ N} \cdot \text{m}$$

Discussion

1. M_2 is positive. This represents a counterclockwise (extensor) moment acting at the knee. The quadriceps muscles at this time are rapidly extending the swinging leg.
2. The angular acceleration of the leg is the net result of two reaction forces and one muscle moment acting at each end of the segment. Thus, there may not be a single primary force causing the movement we observe. In this case, each force and moment had a significant influence on the final acceleration.

5.2 FORCE TRANSDUCERS AND FORCE PLATES

In order to measure the force exerted by the body on an external body or load, we need a suitable force-measuring device. Such a device, called a *force transducer*, gives an electrical signal proportional to the applied force. There are many kinds available: strain gauge, piezoelectric, piezoresistive, capacitive, and others. All these work on the principle that the applied force causes a certain amount of strain within the transducer. For the strain gauge type, a calibrated metal plate or beam within the transducer undergoes a very small change (strain) in one of its dimensions. This mechanical deflection, usually a fraction of 1%, causes a change in resistances connected as a bridge circuit (see Section 3.2.3), resulting in an unbalance of voltages proportional to the force. Piezoelectric and piezoresistive types require minute deformations of the atomic structure within a block of special crystalline material. Quartz, for example, is a naturally found piezoelectrical material, and deformation of its crystalline structure changes the electrical characteristics such that the electrical charge across appropriate surfaces of the block is altered and can be translated via suitable electronics to a signal proportional to the applied force. Piezoresistive types exhibit a change in resistance which, like the strain gauge, upset the balance of a bridge circuit.

5.2.1 Multidirectional Force Transducers

In order to measure forces in two or more directions, it is necessary to use a bi- or tridirectional force transducer. Such a device is nothing more than two or more force transducers mounted at right angles to each other. The major problem is to ensure that the applied force acts through the central axis of each of the individual transducers.

5.2.2 Force Plates*

The most common force acting on the body is the ground reaction force, which acts on the foot during standing, walking, or running. This force vector is three-dimensional and consists of a vertical component plus two shear components acting along the force plate surface. These shear forces are usually resolved into anterior—posterior and medial—lateral directions.

The fourth variable needed is the location of the center of pressure of this ground reaction vector. The foot is supported over a varying surface area with different pressures at each part. Even if we knew the individual pressures under every part of the foot, we would be faced with the expensive problem of calculating the net effect of all these pressures as they change with time. Some attempts have been made to develop suitable pressure-measuring shoes,

*Representative paper: Elftman, 1939.

but they have been very expensive and are limited to vertical forces only. It is, therefore, necessary to use a force plate to give us all the forces necessary for a complete inverse solution.

Two common types of force plates are now explained. The first is a flat plate supported by four triaxial transducers, depicted in Figure 5.9. Consider the coordinates of each transducer to be $(0,0)$, $(0,Z)$, $(X,0)$, and (X,Z) . The location of the center of pressure is determined by the relative vertical forces seen at each of these corner transducers. If we designate the vertical forces as F_{00} , F_{X0} , F_{0Z} , and F_{XZ} , the total vertical force is $F_Y = F_{00} + F_{X0} + F_{0Z} + F_{XZ}$. If all four forces are equal, the COP is at the exact center of the force plate, at $(X/2, Z/2)$. In general,

$$x = \frac{X}{2} \left[1 + \frac{(F_{X0} + F_{XZ}) - (F_{00} + F_{0Z})}{F_Y} \right] \quad (5.4)$$

$$z = \frac{Z}{2} \left[1 + \frac{(F_{0Z} + F_{XZ}) - (F_{00} + F_{X0})}{F_Y} \right] \quad (5.5)$$

A second type of force plate has one centrally instrumented pillar that supports an upper flat plate. Figure 5.10 shows the forces that act on this instrumented support. The action force of the foot F_y acts downward, and the anterior-posterior shear force can act either forward or backward. Consider a reverse shear force F_x , as shown. If we sum the moments acting about the central axis of the support, we get:

$$M_z - F_y \cdot x + F_x \cdot y_0 = 0$$

$$x = \frac{F_x \cdot y_0 + M_z}{F_y} \quad (5.6)$$

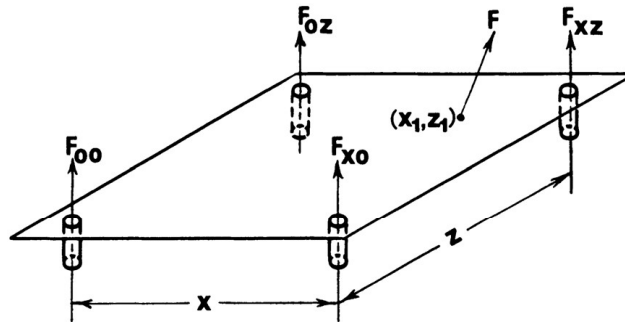

Figure 5.9 Force plate with force transducers in the four corners. Magnitude and location of ground reaction force F can be determined from the signals from the load cells in each of the support bases.

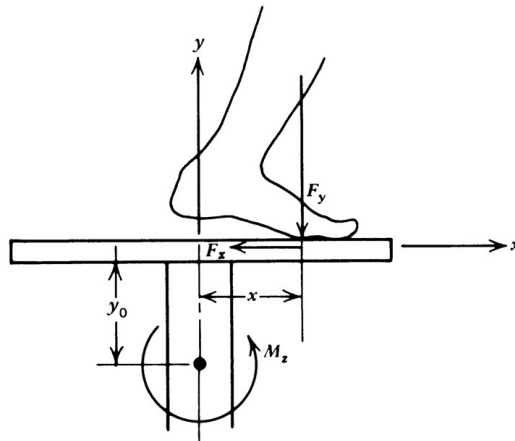

Figure 5.10 Central support type force plate, showing the location of the center of pressure of the foot and the forces and moments involved.

where: M_z = bending moment about axis of rotation of support
 y_0 = distance from support axis to force plate surface

Since F_x , F_y , and M_z continuously change with time, x can be calculated to show how the COP moves across the force plate. Caution is required for both types of force platforms when F_y is very low (<2% of body weight). During this time, a small error in F_y represents a large percentage error in x and z , as calculated by Equations (5.4), (5.5), and (5.6).

Typical force plate data are shown in Figure 5.11 plotted against time for a subject walking at a normal speed. The vertical reaction force F_y is very characteristic in that it shows a rapid rise at heel contact to a value in excess of body weight as full weight bearing takes place (i.e., the body mass is being accelerated upward). Then as the knee flexes during midstance, the plate is partially unloaded and F_y drops below body weight. At pushoff the plantarflexors are active in causing ankle plantarflexion. This causes a second peak greater than body weight. Finally, the weight drops to zero as the opposite limb takes up the body weight. The anterior-posterior reaction force F_x is the horizontal force exerted by the force plate on the foot. Immediately after heel contact, it is negative, indicating a backward horizontal friction force between the floor and the shoe. If this force were not present, the foot would slide forward, as sometimes happens when walking on icy or slippery surfaces. Near midstance, F_x goes positive, indicating that the force plate reaction is acting forward as the muscle forces (mainly plantarflexor) cause the foot to push back against the plate.

The COP starts at the heel, assuming that initial contact is made by the heel, and then progresses forward toward the ball and toe. The position of the COP relative to the foot cannot be obtained from the force plate data

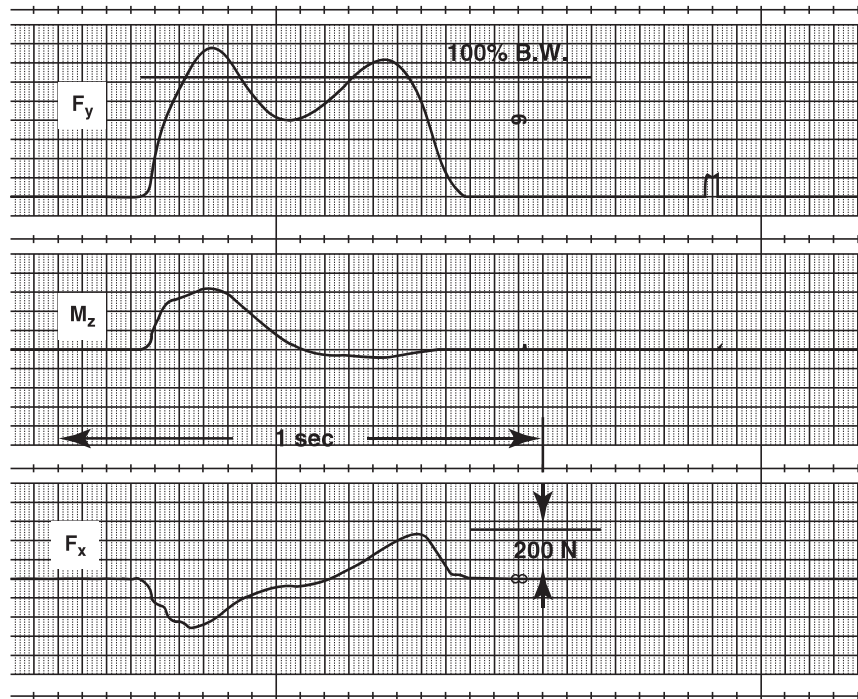

Figure 5.11 Force plate record obtained during gait, using a central support type as shown in Figure 5.10.

themselves. We must first know where the foot is, relative to the midline of the plate. The type of force plate used to collect these data is the centrally instrumented pillar type depicted in Figure 5.10. The student should note that M_z is positive at heel contact and then becomes negative as the body weight moves forward. The centers of pressure X_{cp} and Y_{cp} are calculated in absolute coordinates to match those given in the kinematics listing. Y_{cp} was set at 0 to indicate ground level.

It is very important to realize that these reaction forces are merely the algebraic summation of all mass-acceleration products of all body segments. In other words, for an N -segment system the reaction force in the x direction is:

$$F_x = \sum_{i=1}^N m_i a_{xi} \quad (5.7)$$

where: m_i = mass of i th segment

a_{xi} = acceleration of i th-segment COM in the x direction

Similarly, in the vertical direction,

$$F_y = \sum_{i=1}^N m_i (a_{yi} + g) \quad (5.8)$$

where: a_{yi} = acceleration of i th-segment COM in the y direction
 g = acceleration due to gravity

With a person standing perfectly still on the platform, F_y will be nothing more than the sum of all segment masses times g , which is the body weight. The interpretation of the ground reaction forces as far as what individual segments are doing is virtually impossible. In the algebraic summation of mass-acceleration products, there can be many cancellations. For example, F_y could remain constant as one arm is accelerating upward, while the other has an equal and opposite downward acceleration. Thus, to interpret the complete meaning of any reaction force, we would be forced to determine the accelerations of the COMs of all segments and carry out the summations seen in Equations (5.7) and (5.8).

5.2.3 Special Pressure-Measuring Sensory Systems

The COP measured by the force plate is a weighted average of the distributed COPs under the two feet if both are in contact with the ground or under the one foot that is in contact. However, the COP signal tells us nothing about the pressure at any of the contact points under the foot. For example, during midstance in walking or running, there are two main pressure areas: the ball of the foot and the heel, but the force plate records the COP as being under the arch of the foot, where there may in fact be negligible pressure. To get some insight into the distributed pressures around all contact points, a number of special pressure measurement systems have been developed. A typical pressure measurement system was introduced a number of years ago by Tekscan and is schematically shown in Figure 5.12. It is a flexible sheet of tactile force sensors that is cut in the shape of a shoe insole and that can be trimmed down to any shoe size. Each sensel shown in the exploded view is about 0.2 in. \times 0.2 in. (5 mm \times 5 mm), giving 25 sensels/sq. in. Two thin flexible polyester sheets have electrically conductive electrodes deposited in rows and columns. A thin semiconductive coating is applied between the conductive rows and columns, and its electrical resistance changes with the pressure applied. The matrix of sensels results in a matrix of voltage changes that are computer displayed as different colors for different pressure levels. Colors range from blue through green, yellow, orange, and red (1–125 psi). Thus, the high- and low-pressure areas under the foot are visually evident as the pressure moves from the heel to the toes over the stance period (Hsiao et al., 2002). Such devices have been valuable in identifying high-pressure

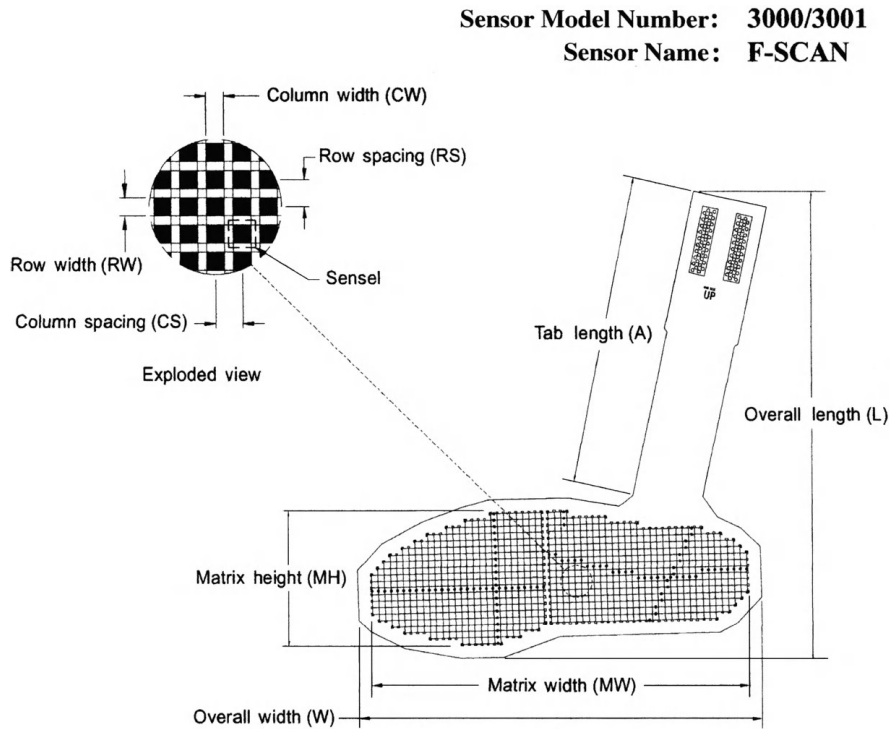

Figure 5.12 Foot pressure measurement system introduced by Tekscan, Inc. It is a shoe insole insert with an array of pressure sensors that vary their resistance with applied pressure. See the text for detailed operation of sensor and computer display system. (Reproduced with permission of Tekscan, Inc.)

points in various foot deformities and in diabetic feet (Pitie et al., 1999). The results of surgery and shoe orthotics to relieve the pressure points are also immediately available.

5.2.4 Synchronization of Force Plate and Kinematic Data

Because kinematic data are coming from a completely separate system, there may be problems in time synchronization with the ground reaction data. Most optoelectric systems have synchronizing pulses that must be recorded simultaneously with the force records. Similarly, TV systems must generate a pulse for each TV field that can be used to synchronize with the force signals. The major imaging system that has problems is cine. Here, the movie cameras must have a sync pulse generated every frame, and somehow the number of the pulse must be made available to the person doing the film digitization.

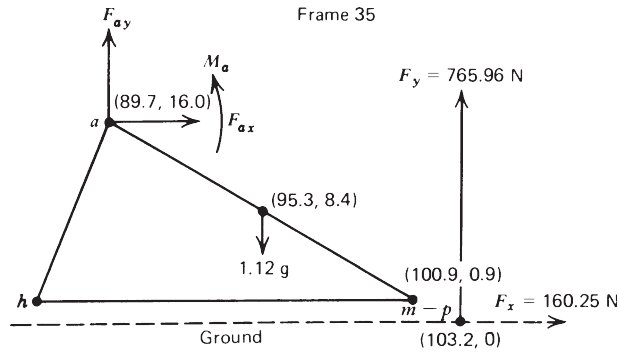

Figure 5.13 Free-body diagram of foot during weight bearing with the ground reaction forces, F_x and F_y , shown as being located at the COP.

5.2.5 Combined Force Plate and Kinematic Data

It is valuable to see how the reaction force data from the force plate are combined with the segment kinematics to calculate the muscle moments and reaction forces at the ankle joint during dynamic stance. This is best illustrated in a sample calculation. For a subject in late stance (see Figure 5.13), during pushoff the following foot accelerations were recorded: $a_x = 3.25 \text{ m/s}^2$, $a_y = 1.78 \text{ m/s}^2$, and $\alpha = -45.35 \text{ rad/s}^2$. The mass of the foot is 1.12 kg , and the moment of inertia is $0.01 \text{ kg} \cdot \text{m}^2$.

Example 5.4 (see Figure 5.13). From Equation (5.1),

$$F_{ax} + F_x = ma_x$$

$$F_{ax} = 1.12 \times 3.25 - 160.25 = -156.6 \text{ N}$$

From Equation (5.2),

$$F_{ay} + F_y - mg = ma_y$$

$$F_{ay} = 1.12 \times 1.78 - 765.96 + 1.12 \times 9.81 = -753.0 \text{ N}$$

From Equation (5.3), about the center of mass of the foot, $\Sigma M = I\alpha$,

$$M_a + F_x \times 0.084 + F_y \times 0.079 - F_{ay} \times 0.056 - F_{ax} \times 0.076$$

$$= 0.01(-45.35)$$

$$M_a = -0.01 \times 45.35 - 0.084 \times 160.25 - 0.079 \times 765.96 - 0.056$$

$$\times 753.0 - 0.076 \times 156.6 = -128.5 \text{ N} \cdot \text{m}$$

The polarity and the magnitude of this ankle moment indicate strong plantarflexor activity acting to push off the foot and cause it to rotate clockwise about the metatarsophalangeal joint.

5.2.6 Interpretation of Moment-of-Force Curves*

A complete link-segment analysis yields the net muscle moment at every joint during the time course of movement. As an example, we discuss in detail the ankle moments of force of a hip joint replacement patient, as shown in Figure 5.14. Three repeat trials are plotted. The convention for the moments is shown to the right of the plot. Counterclockwise moments acting on a

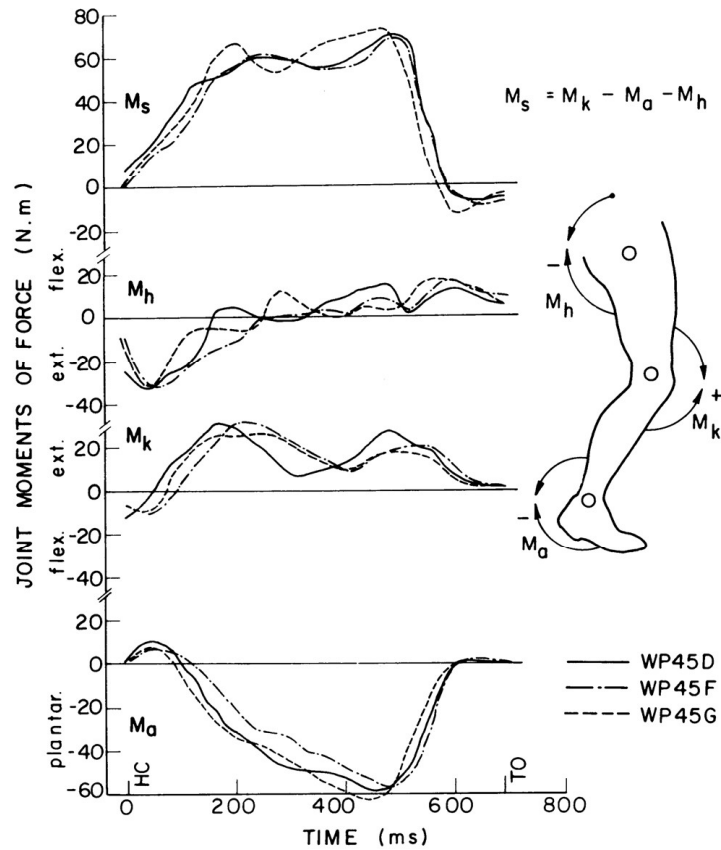

Figure 5.14 Joint moment-of-force profiles from three repeat trials of a patient fitted with a total hip replacement. See the text for a detailed discussion.

*Representative paper: Pedotti, 1977.

segment distal to the joint are positive; clockwise moments are negative. Thus, a plantarflexor moment (acting on its distal segment) is negative, a knee extensor moment is shown to be positive, and a hip extensor moment is negative.

The moments are plotted during stance, with heel contact at 0 and toe-off at 680 ms. The ankle muscles generate a positive (dorsiflexor) moment for the first 80 ms of stance as the pretibial muscles act eccentrically to lower the foot to the ground. Then the plantarflexors increase their activity during mid- and late stance. During midstance they act to control the amount of forward rotation of the leg over the foot, which is flat on the ground. As the plantarflexors generate their peak of about $60 \text{ N} \cdot \text{m}$, they cause the foot to plantarflex and create a pushoff. This concentric action results in a major generation of energy in normals (Winter, 1983), but in this patient it was somewhat reduced because of the pathology related to the patient's hip joint replacement. Prior to toe-off, the plantarflexor moment drops to 0 because that limb is now unloaded due to the fact that the patient is now weight bearing on his good limb and, for the last 90 ms prior to toe-off, the toe is just touching the ground with a light force. At this same point in time, the hip flexors are active to pull this limb upward and forward as a first phase of lower limb swing.

The knee muscles effectively show one pattern during all of stance. The quadriceps are active to generate an extensor moment, which acts to control the amount of knee flexion during early stance and also extends the knee during midstance. Even during pushoff, when the knee starts flexing in preparation for swing, the quadriceps act eccentrically to control the amount of knee flexion. At heel contact, the hip moment is negative (extensor) and remains so until midstance. Such activity has two functions. First, the hip muscles act on the thigh to assist the quadriceps in controlling the amount of knee flexion. Second, the hip extensors act to control the forward rotation of the upper body as it attempts to rotate forward over the hip joint (the reaction force at the hip has a backward component during the first half of stance). Then, during the latter half of stance, the hip moment becomes positive (flexor), initially to reverse the backward rotating thigh and then, as described earlier, to pull the thigh forward and upward.

The fourth curve, M_s , bears some explanation. It is the net summation of the moments at all three joints, such that extensor moments are positive. It is called the *support moment* (Winter, 1980) because it represents a total limb pattern to push away from the ground. In scores of walking and running trials on normal subjects and patients, this synergy has been shown to be consistently positive during single support, in spite of considerable variability at individual joints (Winter, 1984). This latter curve is presented as an example to demonstrate that moment-of-force curves should not be looked at in isolation but rather as part of a total integrated synergy in a given movement task. A complete discussion and analysis of this synergy is presented in Section 11.1.

5.2.7 A Note about the Wrong Way to Analyze Moments of Force

In the 1980s, an erroneous technique has evolved and is still in use in the clinical area in spite of technical notes and letters to the editor. This technique is referred as the FRFV (floor reaction force vector) approach and calculates the moments as depicted in Figure 5.15, which shows the ground reaction vector directed posteriorly during early stance. The FRFV approach calculates the moment to be equal to the magnitude of the vector times the perpendicular distance between the joint axis and the vector. Thus, the ankle moment would be described as plantarflexor; at the knee, it would be flexor; and it would be extensor at the hip. The folly of this technique becomes obvious if we extend the vector to calculate the moment of force at the neck. We would estimate an extensor neck moment several times larger than any moment calculated at the ankle, knee, or hip. There are three errors or shortcomings in the technique.

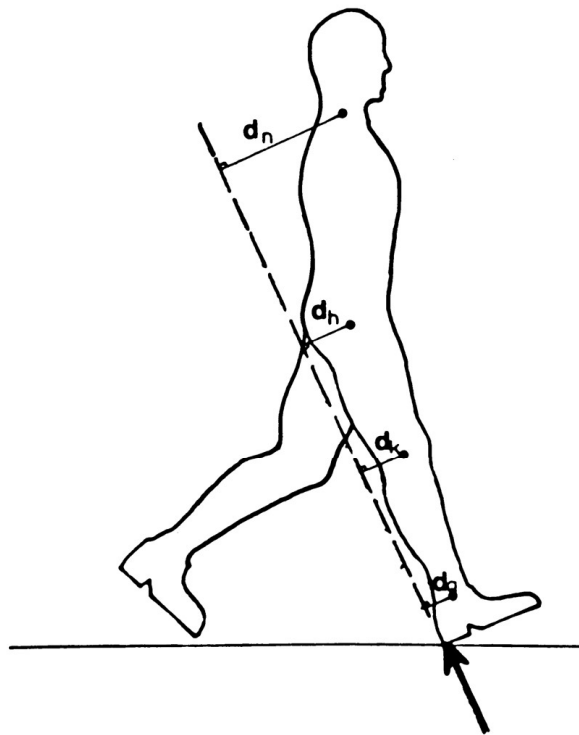

Figure 5.15 Projection of the ground reaction force vector that is used erroneously to predict the joint moments of force. The distance of the projection from the relevant joint center to the vector times the magnitude of that vector gives the net joint moment using FRFV approach. (Reproduced with permission of R. Wells.)

1. Numerically, the magnitude of the moment is incorrect because the mass-acceleration products and the moment of inertia–angular acceleration products of the stance limb are not accounted for. As was discussed in Section 5.2.2, the ground reaction vectors represent the algebraic summation of the mass-acceleration products of all segments. Using the correct technique, those effects must be subtracted as our calculation moves from the ground upward. Thus, by the time we reach the hip joint calculation, we have taken into account all inertial forces in the thigh, leg, and foot. The FRFV approach does not do this. Numerically, the error has been shown to be negligible at the ankle, small but significant at the knee, and large at the hip (Wells, 1981).
2. The second error in the FRFV technique is the polarity that is attributed to the moment at the joint, and this reflects basic misconceptions about action and reaction. The FRFV is a reaction to the gravitational (external) and muscle (internal) forces acting on the body. As such, the reaction force does not cause the moment of force; it merely reflects the cause. An ankle plantarflexor moment, for example, causes a ground action vector to move forward of the ankle joint, and this is reflected in the magnitude and the forward location (COP) of the ground reaction vector. If the ankle muscles were not generating any force, the FRFV would remain under the ankle joint.
3. A final shortcoming of the FRFV approach is that it is not capable of calculating moments during non-weight-bearing periods. Such a deficiency is significant in the assessment of the swing phase of walking and more so during running, and it is even more critical during athletic jumping events.

5.2.8 Differences between Center of Mass and Center of Pressure

For many students and for many in the applied and clinical areas the terms *center of mass* (COM) and *center of pressure* (COP) are often misinterpreted or even interchanged. The COM of the body is the net location of the center of mass in three-dimensional (3D) space and is the weighted average of the COM of each segment as calculated in Section 4.1.4. The location of the COM in the vertical direction is sometimes called the *center of gravity* (COG). The trajectory of this vertical line from the COM to the ground allows us to compare the trajectories of the COM and COP. The trajectory of the COP is totally independent of the COM, and it is the location of the vertical ground reaction force vector from a single force platform, assuming that all body contact points are on that platform. The vertical ground reaction force is a weighted average of the location of all downward (action) forces acting on the force plate. These forces depend on the foot placement and the motor control of the ankle muscles. Thus, the COP is the neuromuscular response to the imbalances of the body's COM. The major misuse of the COP comes

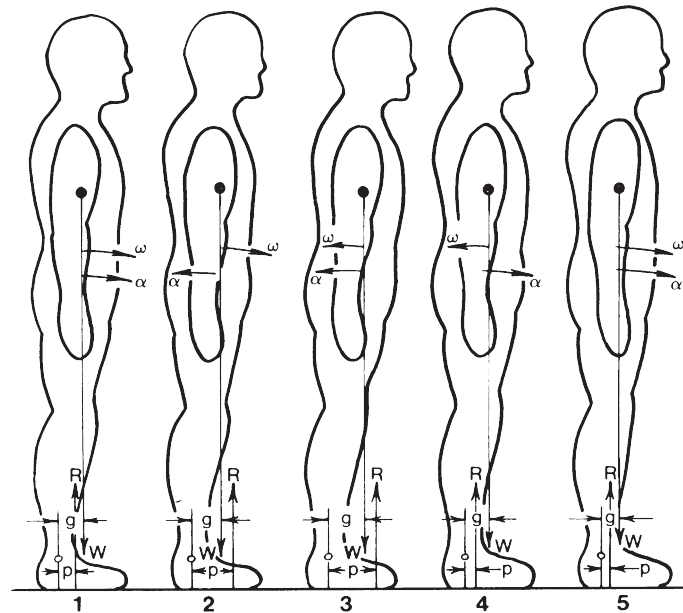

Figure 5.16 A subject swaying back and forth while standing on a force platform. Five different points in time are described, showing the COM and the COP locations along with the associated angular accelerations and velocities of the body. See the text for a detailed description.

from researchers who refer to COP as “sway,” thereby inferring it to be the kinematic measure COM.

The difference between COM and COP is demonstrated in Figure 5.16. Here, we see a subject swaying back and forth while standing erect on a force plate. Each figure shows the changing situation at one of five different points in time. Time 1 has the body’s COM (shown by the vertical body weight vector, W) to be ahead of the COP (shown by the vertical ground reaction vector, R). This “parallelogram of forces” acts at distances g and p , respectively, from the ankle joint. The magnitudes of W and R are equal and constant during quiet standing. Assuming that the body to be pivoting about the ankles and neglecting the small mass of the feet, a counterclockwise moment equal to Rp and a clockwise moment equal to Wg will be acting. At Time 1, $Wg > Rp$ and the body will experience a clockwise angular acceleration, α . It will also have a clockwise angular velocity, ω . In order to correct this forward imbalance, the subject will increase his or her plantarflexor activity, which will increase the COP such that at Time 2 the COP will be anterior of the COM. Now $Rp > Wg$. Thus, α will reverse and will start to decrease ω until, at Time 3, the time integral of α will result in a reversal of ω . Now both ω and α are counterclockwise, and the body will be experiencing a backward sway. The subject’s response to the backward sway

at Time 4 is to decrease his or her COP by reduced plantarflexor activation. Now $Wg > Rp$ and α will reverse, and, after a period of time, ω will decrease and reverse, and the body will return to the original conditions, as seen at Time 5. From this sequence of events relating COP to COM, it is evident that the plantarflexors/dorsiflexors vary the net ankle moment to control the COP and thereby regulate the body's COM. However, it is apparent that the COP must be continuously moving anterior and posterior of the COM; thus, the dynamic range of the COP must be somewhat greater than that of the COM. If the COM were allowed to move within a few centimeters of the toes, it is possible that a corrective movement of the COP to the extremes of the toes might not be adequate to reverse ω . Here, the subject would be forced to take a step forward to arrest a forward fall.

Figure 5.17 is a typical 40-s record of the center of pressure (COP_x) and center of mass (COM_x) in the anterior/posterior direction of an adult subject standing quietly. Note that both signals are virtually in phase and that COP is slightly greater than COM. As was seen in the discussion regarding Figure 5.16, the COP must move ahead of and behind the COM in order to

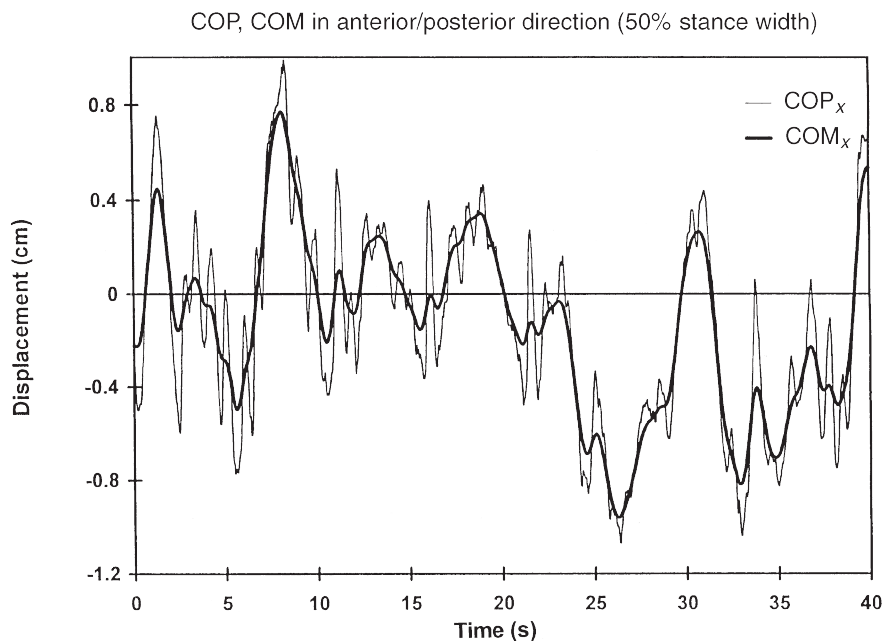

Figure 5.17 Typical 40-s record of the total body center of mass (COM_x) and center of pressure (COP_x) in the anterior/posterior direction during quiet standing. The COP amplitude exceeds that of the COM, and the reversals of direction of the COM (i.e., high $+ve$ or $-ve$ accelerations) are caused by overshoots of COP, as predicted by the discussion related to Figure 5.16.

decelerate it and reverse its direction. Note that all reversals of direction of COM coincide with an overshoot of the COP signal.

5.2.9 Kinematics and Kinetics of the Inverted Pendulum Model

All human movement (except in space flights) is done in a gravitational environment, and, therefore, posture and balance are continuous tasks that must be accomplished. In normal daily activity at home, at work, and in our sports and recreation, we must maintain a safe posture and balance. The base of support can vary from one foot (running) to a four-point support (football), and it is essential that the COM remain within that base of support or move safely between the two feet if it lies temporarily outside the base of support (as it does in running and during the single-support phase of walking). There is a common model that allows us to analyze the dynamics of balance: the inverted pendulum model, which relates the trajectories of the COP and COM. As was seen in Section 5.2.8, the position of the COP relative to the COM decides the direction of the angular acceleration of the inverted pendulum. A full biomechanical analysis of the inverted pendulum model in both sagittal and frontal planes has been presented by Winter et al. (1998). In the sagittal plane, assuming that the body swayed about the ankles, it was shown that:

$$\text{COP}_x - \text{COM}_x = -\frac{I_s \ddot{\text{COM}}_x}{Wh} \quad (5.9)$$

where: I_s = moment of inertia of body about ankles in sagittal plane
 $\ddot{\text{COM}}_x$ = forward acceleration of COM
 W = body weight above ankles
 h = height of COM above ankles

In the frontal plane, the balance equation is virtually the same:

$$\text{COP}_z - \text{COM}_z = -\frac{I_f \ddot{\text{COM}}_z}{Wh} \quad (5.10)$$

where: I_f = moment of inertia of body about ankles in frontal plane
 $\ddot{\text{COM}}_z$ = medial/lateral acceleration of COM

The major difference between Equations (5.9) and (5.10) is in the muscle groups that control the COP. In Equation (5.9), $\text{COP}_x = M_a/R$, where M_a is the sum of the right and left plantarflexor moments and R is the total vertical reaction force at the ankles. In Equation (5.10), $\text{COP}_z = M_t/R$, where $M_t = M_{al} + M_{ar} + M_{hl} + M_{hr}$. M_{al} with M_{ar} are the left and right frontal ankle moments, while M_{hl} and M_{hr} are the left and right frontal plane hip moments. Thus, frontal plane balance is controlled by four torque motors, one at each

corner of the closed-link parallelogram consisting of the two lower limbs and the pelvis. The hip abductor/adductor moments have been shown to be totally dominant in side-by-side standing (Winter et al., 1996), while the ankle invertor/evertor moments play a negligible role in balance control.

The validity of the inverted pendulum model is evident in the validity of Equations (5.9) and (5.10). As COP and COM are totally independent measures, then the correlation of (COP – COM) with $\dot{C}OM$ will be a measure of the validity of this simplified model. Recent validations of the model during quiet standing (Gage et al., 2004) showed a correlation of $r = -0.954$ in the anterior/posterior (A/P) direction and $r = -0.85$ in the medial/lateral (M/L) direction. The lower correlation in the M/L direction was due to the fact that the M/L COM displacement was about 45% of that in the A/P direction. Similar validations have been made to justify the inverted pendulum model during initiation and termination of gait (Jian et al., 1993); correlations averaged -0.94 in both A/P and M/L directions.

5.3 BONE-ON-BONE FORCES DURING DYNAMIC CONDITIONS

Link-segment models assume that each joint is a hinge joint and that the moment of force is generated by a torque motor. In such a model, the reaction force calculated at each joint would be the same as the force across the surface of the hinge joint (i.e., the bone-on-bone forces). However, our muscles are not torque motors; rather, they are linear motors that produce additional compressive and shear forces across the joint surfaces. Thus, we must overlay on the free-body diagram these additional muscle-induced forces. In the extreme range of joint movement, we would also have to consider the forces from the ligaments and anatomical constraints. However, for the purposes of this text, we will limit the analyses to estimated muscle forces.

5.3.1 Indeterminacy in Muscle Force Estimates

Estimating muscle force is a major problem, even if we have good estimates of the moment of force at each joint. The solution is indeterminate, as initially described in Section 1.3.5. Figure 5.18 demonstrates the number of major muscles responsible for the sagittal plane joint moments of force in the lower limb. At the knee, for example, there are nine muscles whose forces create the net moment from our inverse solution. The line of action of each of these muscles is different and continuously changes with time. Thus, the moment arms are also dynamic variables. Therefore, the extensor moment is a net algebraic sum of the cross product of all force vectors and moment arm vectors,

$$M_j(t) = \sum_{i=1}^{N_e} F_{ei}(t) \times d_{ei}(t) - \sum_{i=1}^{N_f} F_{fi}(t) \times d_{fi}(t) \quad (5.11)$$

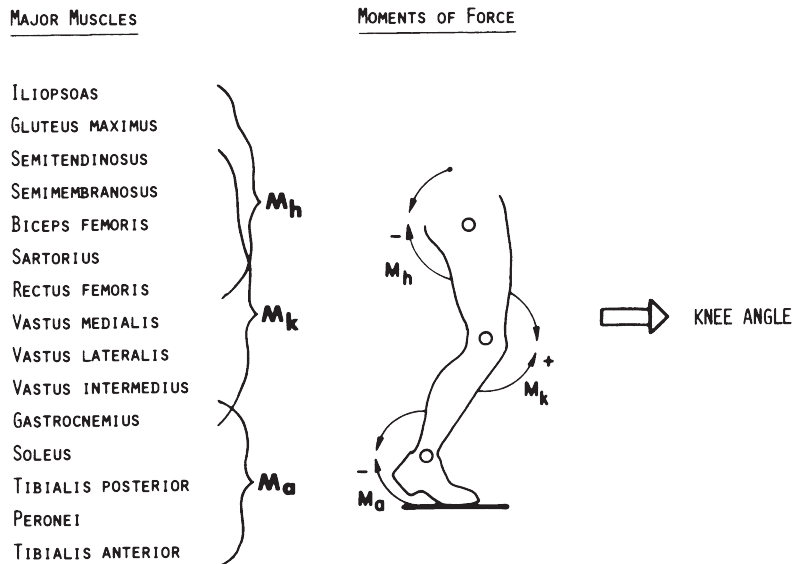

Figure 5.18 Fifteen major muscles responsible for the sagittal plane moments of force at the ankle, knee, and hip joints. During weight bearing, all three moments control the knee angle. Thus, there is considerable indeterminacy when relating knee angle changes to any single moment pattern or to any unique combination of muscle activity.

where: N_e = number of extensor muscles
 N_f = number of flexor muscles
 $F_{ei}(t)$ = force in i th extensor muscle at time t
 $d_{ei}(t)$ = moment arm of i th extensor muscle at time t

Thus, a first major step is to make valid estimates of individual muscle forces and to combine them with a detailed kinematic/anatomical model of lines of pull of each muscle relative to the joint's center (or our best estimate of it). Thus, a separate model must be developed for each joint, and a number of simplifying assumptions are necessary in order to resolve the indeterminacy problem. An example is now presented of a runner during the rapid pushoff phase when the plantarflexors are dominant.

5.3.2 Example Problem (Scott and Winter, 1990)

During late stance, a runner's foot and ankle are shown (see Figure 5.19) along with the direction of pull of each of the plantarflexors. The indeterminacy problem is solved assuming that there is no cocontraction and that each active muscle's stress is equal [i.e., its force is proportional to its physiological cross-sectional area (PCA)]. Thus, Equation (5.11) can be modified

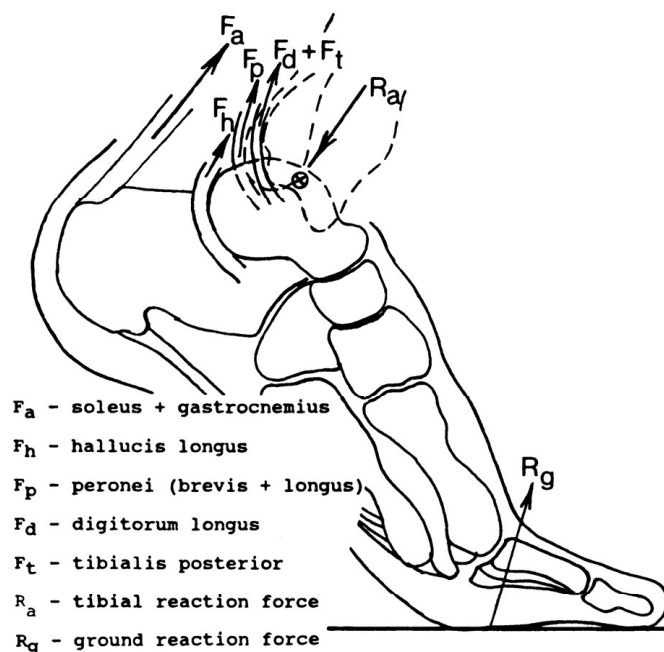

Figure 5.19 Anatomical drawing of foot and ankle during the pushoff phase of a runner. The tendons for the major plantarflexors as they cross the ankle joint are shown, along with ankle and ground reaction forces.

as follows for the five major muscles of the extensor group acting at the ankle:

$$M_a(t) = \sum_{i=1}^5 PCA_i \times S_{ei}(t) \times d_{ei}(t) \quad (5.12)$$

Since the PCA for each muscle is known and d_{ei} can be calculated for each point in time, the stress, $S_{ei}(t)$ can be estimated.

For this model, the ankle joint center is assumed to remain fixed and is located as shown in Figure 5.20. The location of each muscle origin and insertion is defined from the anatomical markers on each segment, using polar coordinates. The attachment point of the i th muscle is defined by a distance R_i from the joint center and an angle θ_{mi} between the segment's neutral axis and the line joining the joint center to the attachment point. Thus, the coordinates of any origin or insertion at any instant in time are given by:

$$X_{mi}(t) = X_i(t) + R_i \cos[\theta_{mi}(t) + \theta_s(t)] \quad (5.13a)$$

$$Y_{mi}(t) = Y_i(t) + R_i \sin[\theta_{mi}(t) + \theta_s(t)] \quad (5.13b)$$

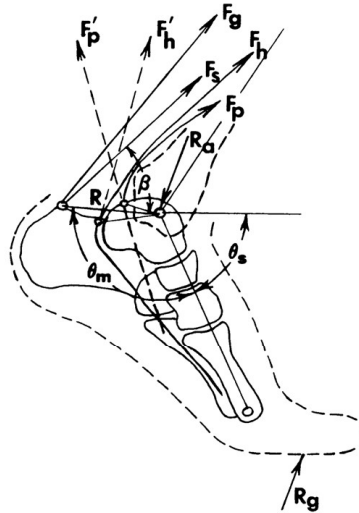

Figure 5.20 Free-body diagram of foot segment showing the actual and effective lines of pull of four of the plantarflexor muscles. Also shown are the reaction forces at the ankle and the ground as they act on the foot segment.

where $\theta_s(t)$ is the angle of the foot segment in the spatial coordinate system. In Figure 5.20, the free-body diagram of the foot is presented, showing the internal anatomy to demonstrate the problems of defining the effective insertion point of the muscles and the effective line of pull of each muscle. Four muscle forces are shown here: soleus F_s , gastrocnemius F_g , flexor hallucis longus F_h , and peronei F_p . The ankle joint's center is defined by a marker on the lateral malleolus. The insertion of the Achilles tendon is at a distance R with an angle θ_m from the foot segment (defined by a line joining the ankle to the fifth-metatarsal-phalangeal joint). The foot angular position is θ_s in the plane of movement. The angle of pull for the soleus and gastrocnemius muscles from this insertion is rather straightforward. However, for F_h and F_p the situation is quite different. The effective angle of pull is the direction of the muscle force as it leaves the foot segment. The flexor hallucis longus tendon curves under the talus bone and inserts on the distal phalanx of the big toe. As this tendon leaves the foot, it is rounding the pulleylike groove in the talus. Thus, its effective direction of pull is F'_h . Similarly, the peronei tendon curves around the distal end of the lateral malleolus. However, its effective direction of pull is F'_p .

The moment arm length d_{ei} for any muscle required by Equation (5.12) can now be calculated:

$$d_{ei} = R_i \sin \beta_i \quad (5.14)$$

where: β_i is the angle between the effective direction of pull and the line joining the insertion point to the joint center.

In Figure 5.20, β for the soleus only is shown. Thus, it is now possible to calculate $S_{ei}(t)$ over the time that the plantarflexors act during the stance phase of a running cycle. Thus, each muscle force $F_{ei}(t)$ can be estimated by multiplying $S_{ei}(t)$ by each PCA_i . With all five muscle forces known, along with R_g and R_a , it is possible to estimate the total compressive and shear forces acting at the ankle joint. Figure 5.21 plots these forces for a middle-distance runner over the stance period of 0.22 s. The compressive forces reach a peak of more than 5500 N, which is in excess of 11 times this runner's body weight. It is interesting to note that the ground reaction force accounts for only 1000 N of the total force, but the muscle forces themselves account for over 4500 N. The shear forces (at right angles to the long axis of the tibia) are actually reduced by the direction of the muscle forces. The

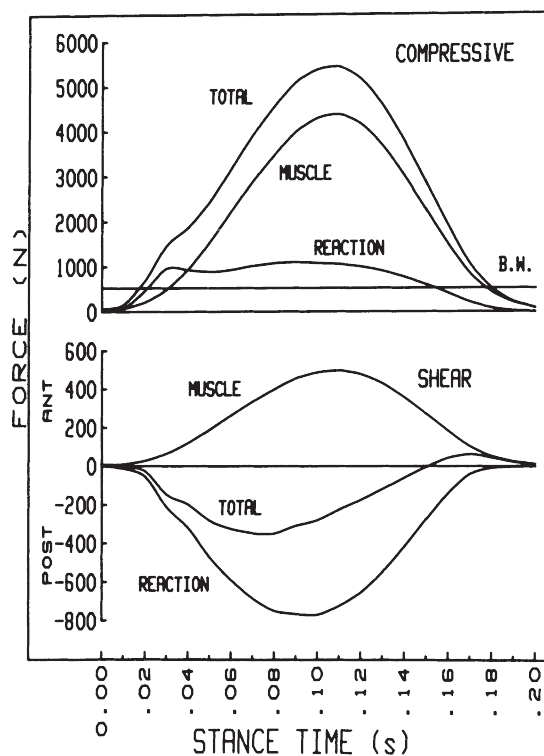

Figure 5.21 Compressive and shear forces at the ankle calculated during the stance phase of a middle-distance runner. The reaction force accounts for less than 20% of the total compressive force. The direction of pull of the major plantarflexors is such as to cause an anterior shear force (the talus is shearing anteriorly with respect to the tibia), which is opposite to that caused by the reaction forces. Thus, the muscle action can be classified as an antishear mechanism.

reaction shear force is such as to cause the talus to move posteriorly under the tibia. However, the line of pull of the major plantarflexors (soleus and gastrocnemius) is such as to pull the foot in an anterior direction. Thus, the total shear force is drastically reduced from 800 N to about 300 N, and the muscle action has been classified as an antishar mechanism.

5.4 PROBLEMS BASED ON KINETIC AND KINEMATIC DATA

1. (a) Plot the vertical ground reaction force (Table A.5a in the Appendix A) over the stance period (frames 28–69) and draw a line indicating the body weight. Discuss the reasons why this force exceeds the body weight during early stance and again during late stance. During the period in midstance, when this force is less than the body weight, what can we say about the acceleration of the center of mass of the body?
 - (b) At heel contact right (HCR), the horizontal ground reaction force is positive. What does this tell you about the way the heel made contact with the ground?
 - (c) If this subject were walking at a perfectly constant speed, how would this be indicated in the horizontal ground reaction force curve? Was this subject speeding up, slowing down, or at a constant speed?
2. (a) Calculate the reaction forces at the ankle in the x and y directions for frames 20 and 60, and compare your answers with those listed in Table A.5a.
 - (b) Calculate the ankle moment of force for frame 72 using appropriate kinematic data plus data listed in Table A.5a. Discuss your answer in terms of ankle function during early swing.
 - (c) Repeat Problem 2b for frame 60. Discuss your answer in terms of the role of the ankle muscles during late stance.
3. (a) Given the calculated ankle reaction forces, calculate the reaction forces at the knee in the x and y directions for frames 20 and 60 and compare your answers with those listed in Table A.5a.
 - (b) Given the calculated ankle reaction forces and moments of force, calculate the knee moment of force for frame 90 using appropriate kinematic data plus data listed in Table A.5a. Discuss your answer in terms of the role of knee muscles during late swing.
 - (c) Repeat Problem 3b for frame 35. Discuss your answer in terms of the role of knee muscles during the weight acceptance phase of stance.
4. (a) Given the calculated knee reaction forces, calculate the reaction forces at the hip in the x and y directions for frames 20 and 60 and compare your answers with those listed in Table A.5b.
 - (b) Given the calculated knee reaction forces and moment of force, calculate the hip moment of force from frame 90 using appropriate

kinematic data plus data listed in Table A.5*b*. Discuss your answer in terms of hip muscle activity during late swing.

- (c) Repeat Problem 4*b* for frame 30. Discuss your answer in terms of the role of hip muscles during early weight acceptance.
- 5. (a) Calculate and plot the support moment for the total lower limb during stance (every second frame commencing with frame 28). The support moment M_s is the total extensor pattern at all three joints and $M_s = -M_a + M_k - M_h$. Note that the negative sign for M_a and M_h is introduced to make the clockwise extensor moments at those two joints positive, and vice versa when the moments are flexor. Discuss total lower limb synergy as seen in this total limb pattern.
- (b) Scan the polarity and magnitude of the ankle moments during the entire stride, commencing at heel contact right (HCR) (frame 28) and proceeding to the next HCR (frame 97), and describe the function of the ankle muscles over the stride period.
- (c) Repeat Problem 5*b* for the knee moments.
- (d) Repeat Problem 5*b* for the hip moments.

5.5 REFERENCES

- Bresler, B. and J. P. Frankel. "The Forces and Moments in the Leg during Level Walking," *Trans. ASME* **72**:27–36, 1950.
- Elftman, H. "Forces and Energy Changes in the Leg during Walking," *Am. J. Physiol.* **125**:339–356, 1939.
- Gage, W. G., D. A. Winter, J. S. Frank, and A. L. Adkin. "Kinematic and Kinetic Validation of Inverted Pendulum Model in Quiet Standing," *Gait & Posture* **19**:124–132, 2004.
- Hsiao, H., J. Guan, and M. Wetherly. "Accuracy and Precision of Two In-Shoe Pressure Measurement Systems," *Ergonomics* **45**:537–555, 2002.
- Jian, Y., D. A. Winter, M. G. Ishac, and L. Gilchrist. "Trajectory of the Body COG and COP during Initiation and Termination of Gait," *Gait and Posture* **1**:9–22, 1993.
- Paul, J. P. "Forces Transmitted by Joints in the Human Body," *Proc. Inst. Mech. Eng.* **18**(3):8–15, 1966.
- Pedotti, A. "A Study of Motor Coordination and Neuromuscular Activities in Human Locomotion," *Biol. Cybern.* **26**:53–62, 1977.
- Pitie, D. L., M. Lord, A. Foster, S. Wilson, P. Watkins, and M. E. Edmonds. "Plantar Pressures Are Elevated in the Neuroischemic and Neuropathic Diabetic Foot," *Diabetic Care* **23**:1966–1970, 1999.
- Scott, S. H. and D. A. Winter. "Internal Forces at Chronic Running Injury Sites," *Med. Sci. in Sports & Exercise* **22**:357–369, 1990.
- Wells, R. P. "The Projection of Ground Reaction Force as a Predictor of Internal Joint Moments," *Bull. Prosthet. Res.* **18**:15–19, 1981.
- Winter, D. A. "Overall Principle of Lower Limb Support during Stance Phase of Gait," *J. Biomech.* **13**:923–927, 1980.

- Winter, D. A. "Energy Generation and Absorption at the Ankle and Knee during Fast, Natural and Slow Cadences," *Clin. Orthop. Rel. Res.* **197**:147–154, 1983.
- Winter, D. A. "Kinematic and Kinetic Patterns in Human Gait: Variability and Compensating Effects," *Human Movement Sci.* **3**:51–76. 1984.
- Winter, D. A., F. Prince, J. S. Frank, C. Powell, and K. F. Zabjek. "A Unified Theory Regarding A/P and M/L Balance During Quiet Standing," *J. Neurophysiol.* **75**:2334–2343, 1996.
- Winter, D. A., A. E. Patla, F. Prince, M. G. Ishac, and K. Gielo-Periczak. "Stiffness Control of Balance in Quiet Standing," *J. Neurophysiol.* **80**:1211–1221, 1998.