

Exemplo de funcionamento da pilha de execução

Volnys Borges Bernal
volnys@lsi.usp.br

Depto. de Eng. de Sistemas Eletrônicos (PSI)
Escola Politécnica da USP

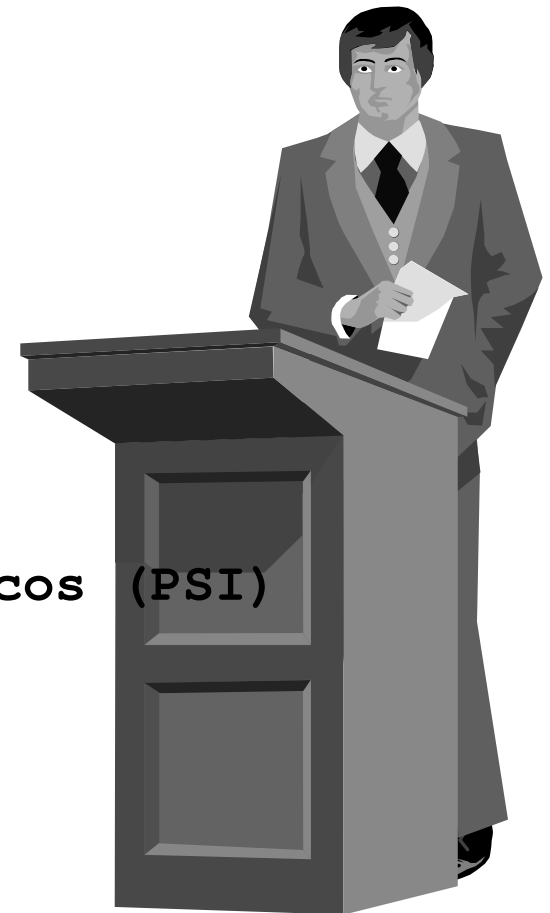

Exemplo de funcionamento da pilha

```
#include <stdio.h>
char versao[] = "2.1";
int n;
int resultado;

int fatorial (int x)
{
    int y;

    if (x <= 1)
        y = 1;
    else
        y = x * fatorial(x-1);
    return(y);
}

int main(int argc, char **argv)
{
    printf("Programa fatorial, versao %s \n", versao);
    printf("Entre com o valor: " );
    scanf("%d",&n);
    resultado = fatorial(n);
    printf("Resultado: %d \n",resultado);
}
```

Exemplo

Memória virtual

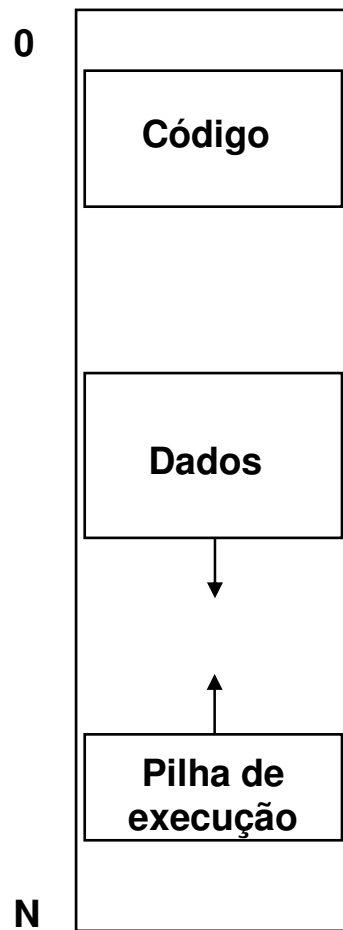

Estado inicial, logo após a criação do processo "fatorial"

Exemplo

Memória virtual

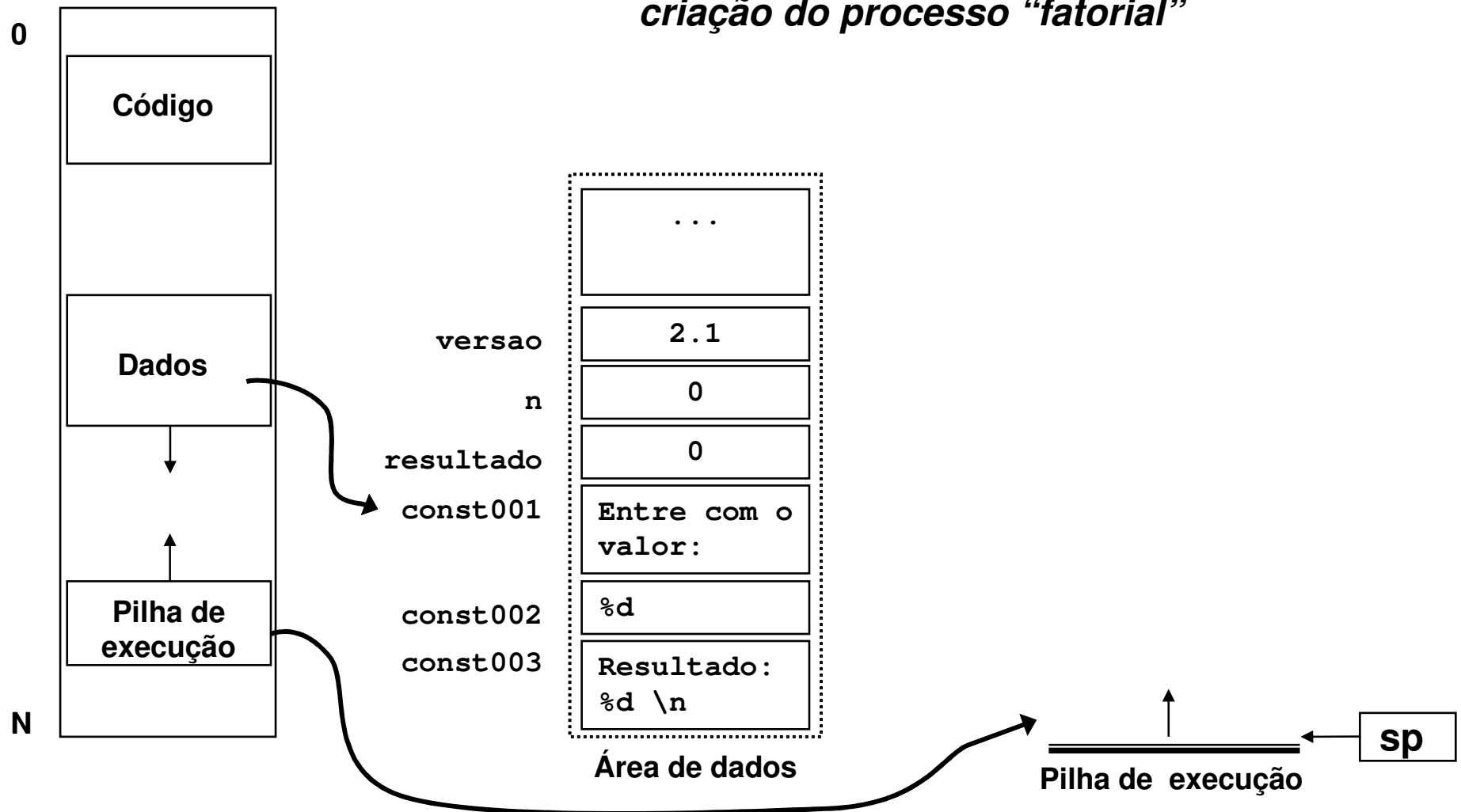

Exemplo

*Logo após ativar a
função main()*

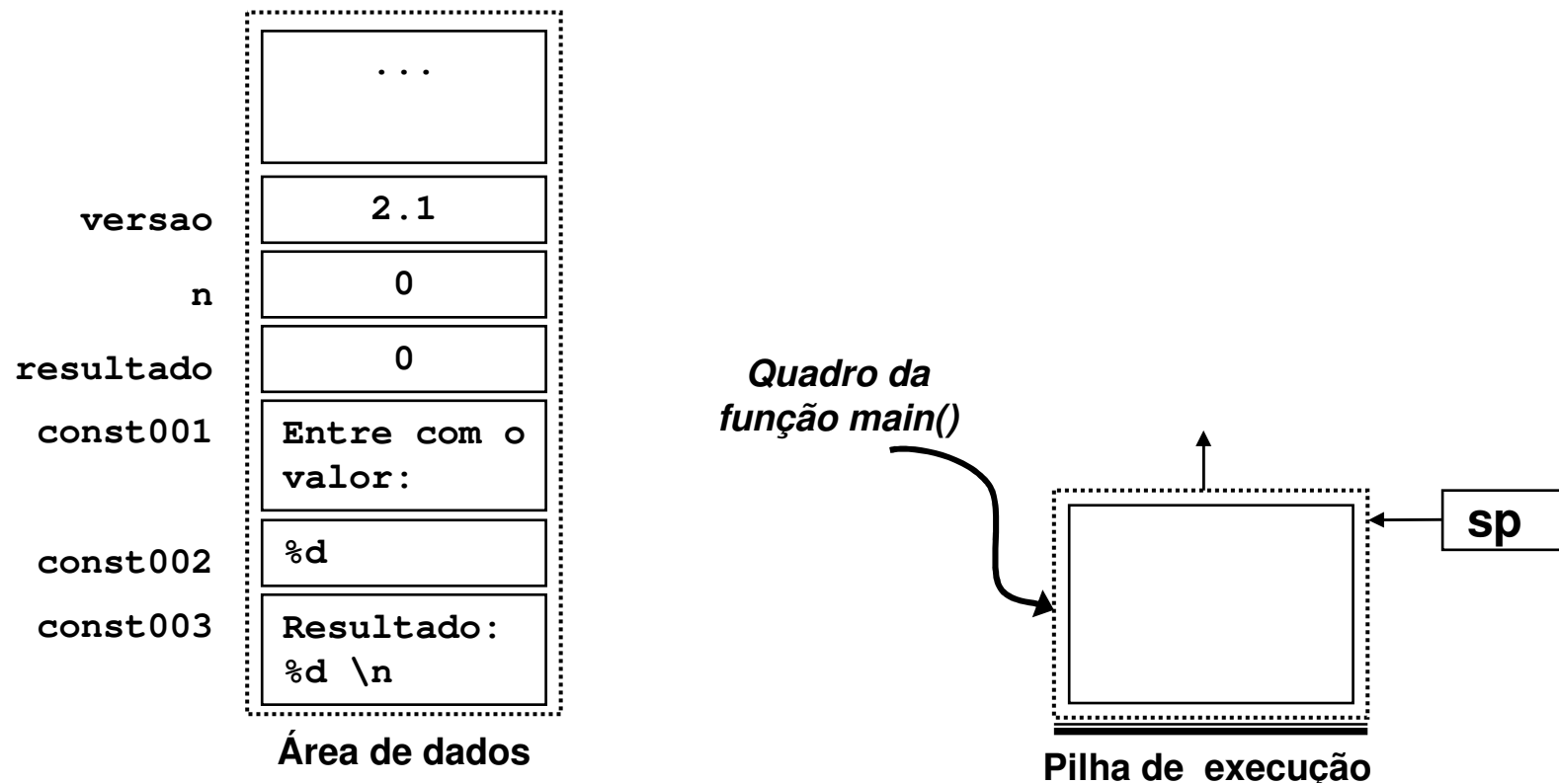

Exemplo

*Logo após executar
scanf("%d",&n); na
função main()*

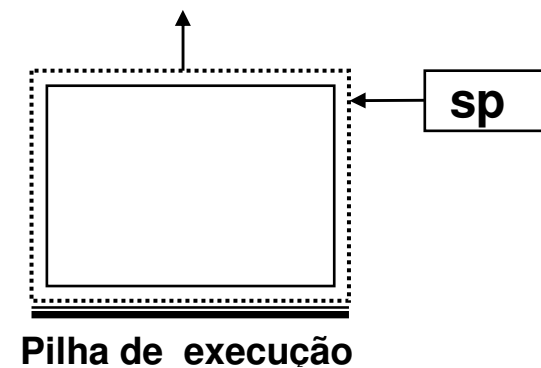
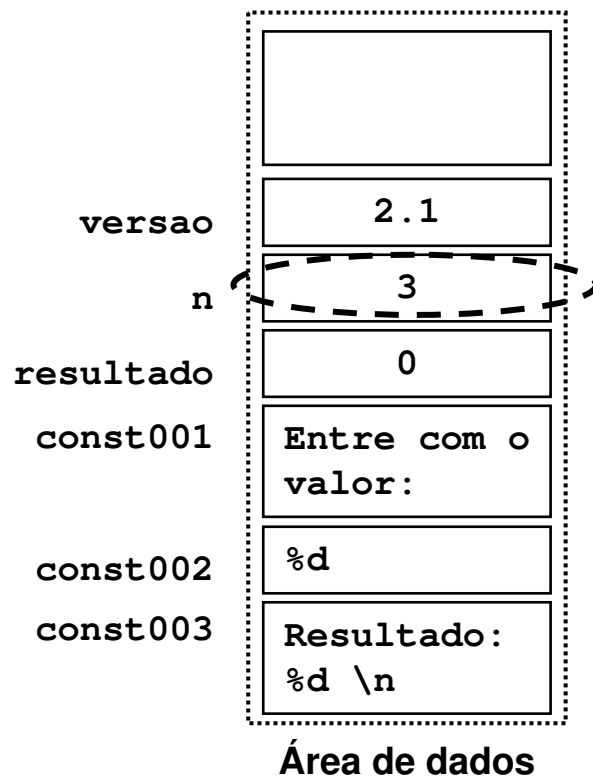

Exemplo

*Logo após ativar
fatorial(3)*

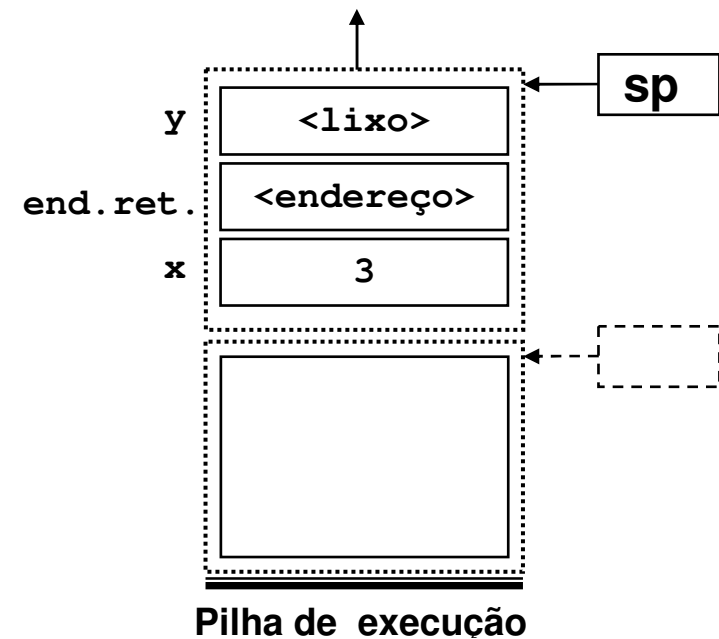
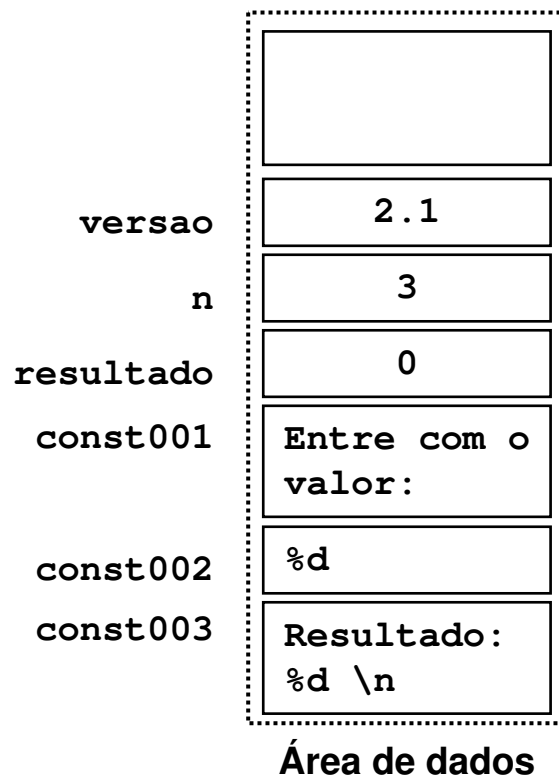

Exemplo

*Logo após ativar
fatorial(2)*

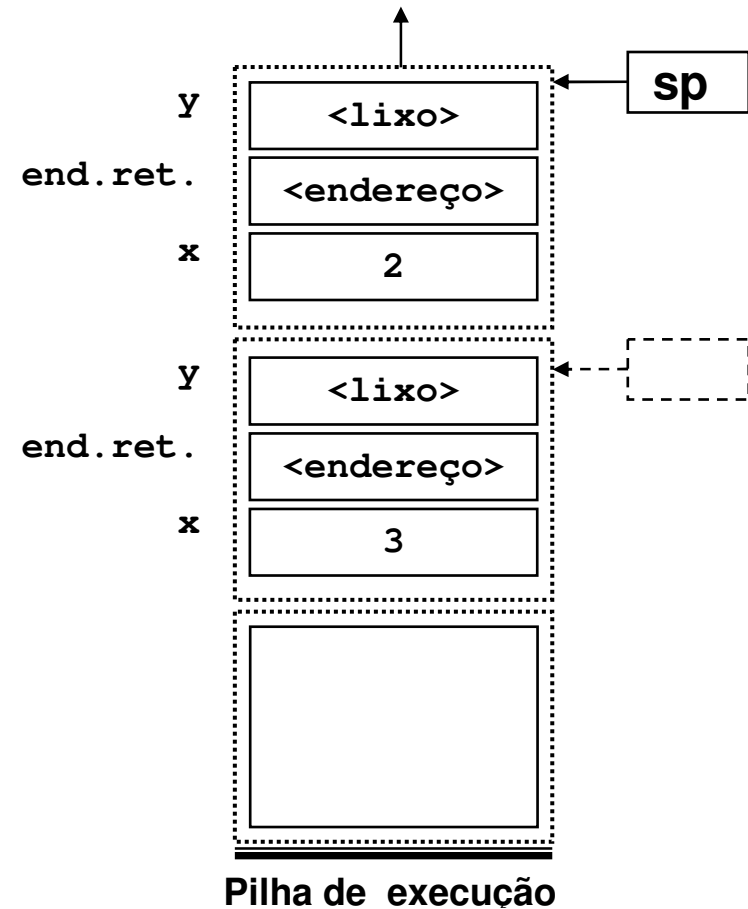
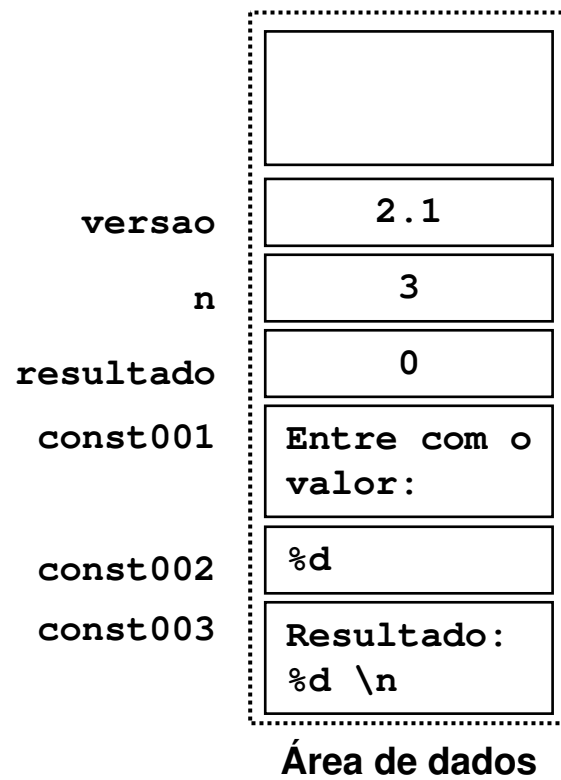

Exemplo

*Logo após ativar
fatorial(1)*

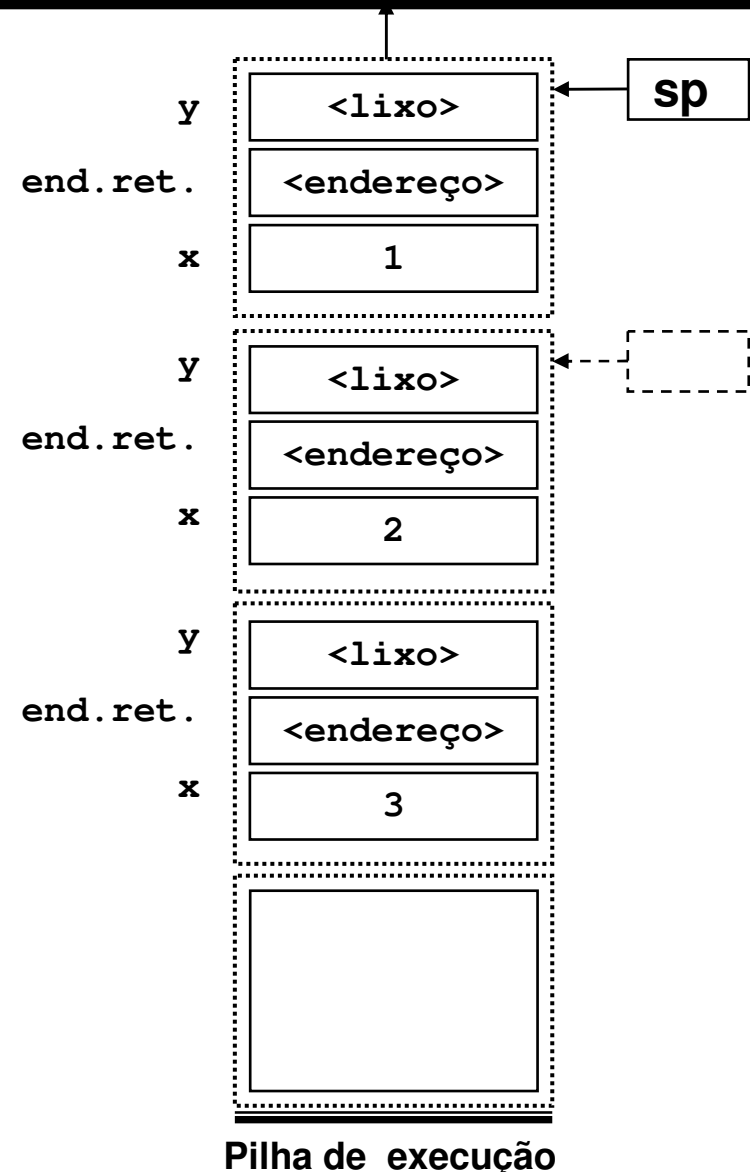
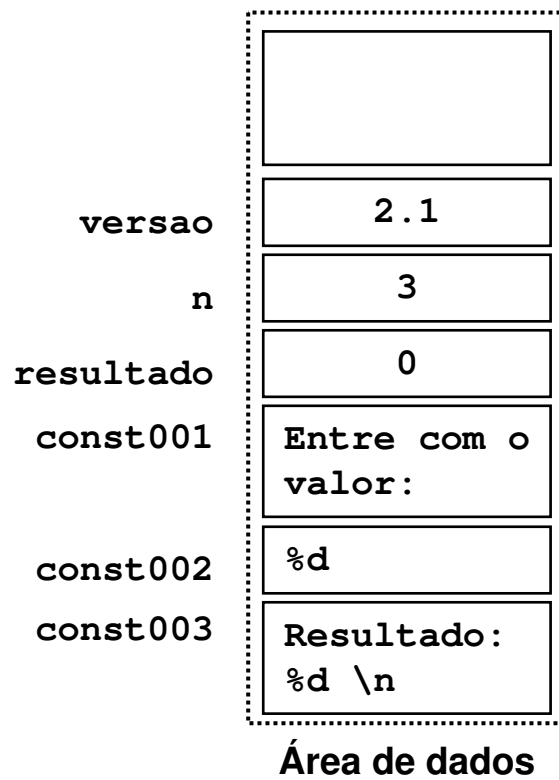

Exemplo

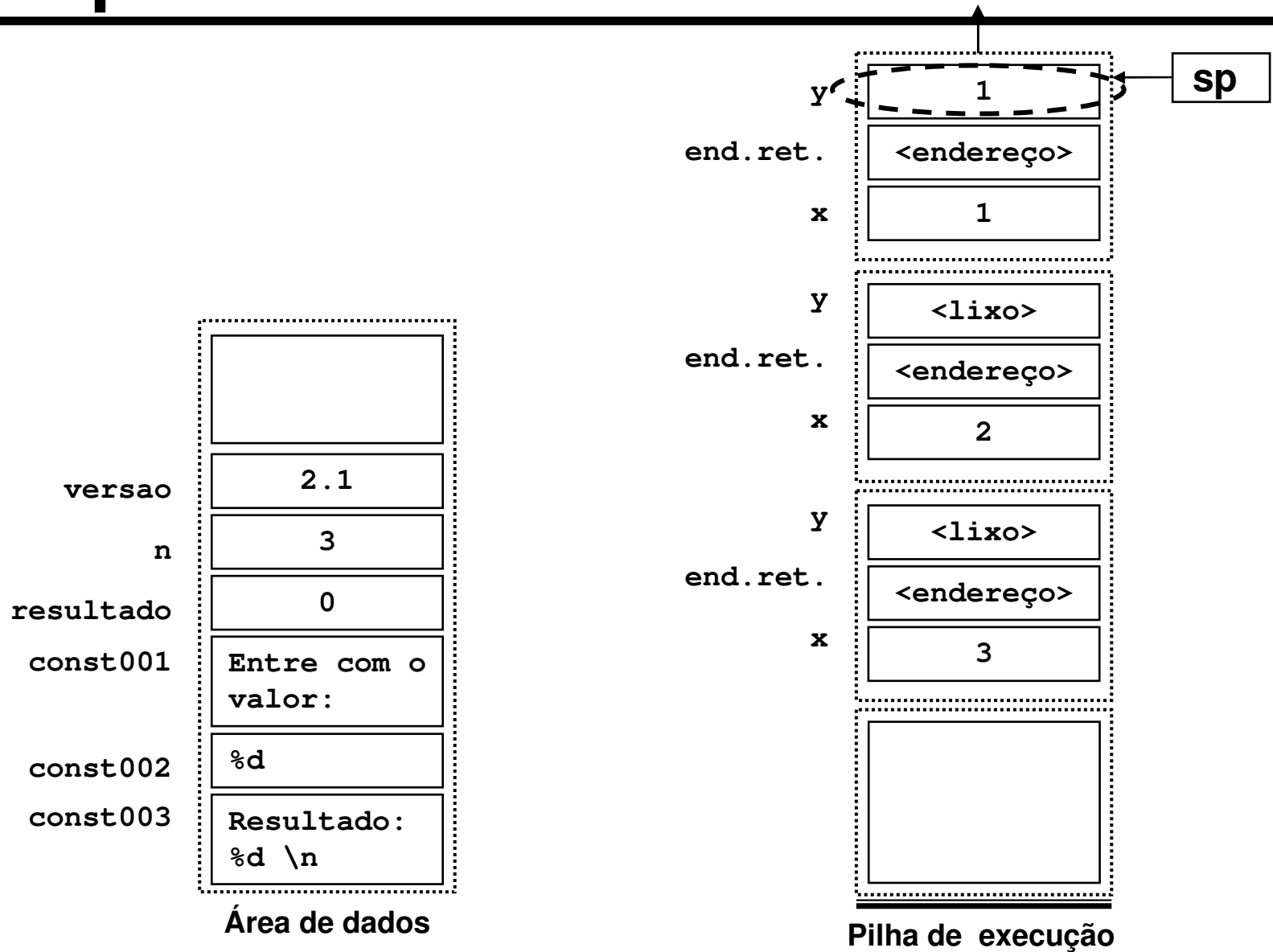

Exemplo

*Logo após terminar
fatorial(1)*

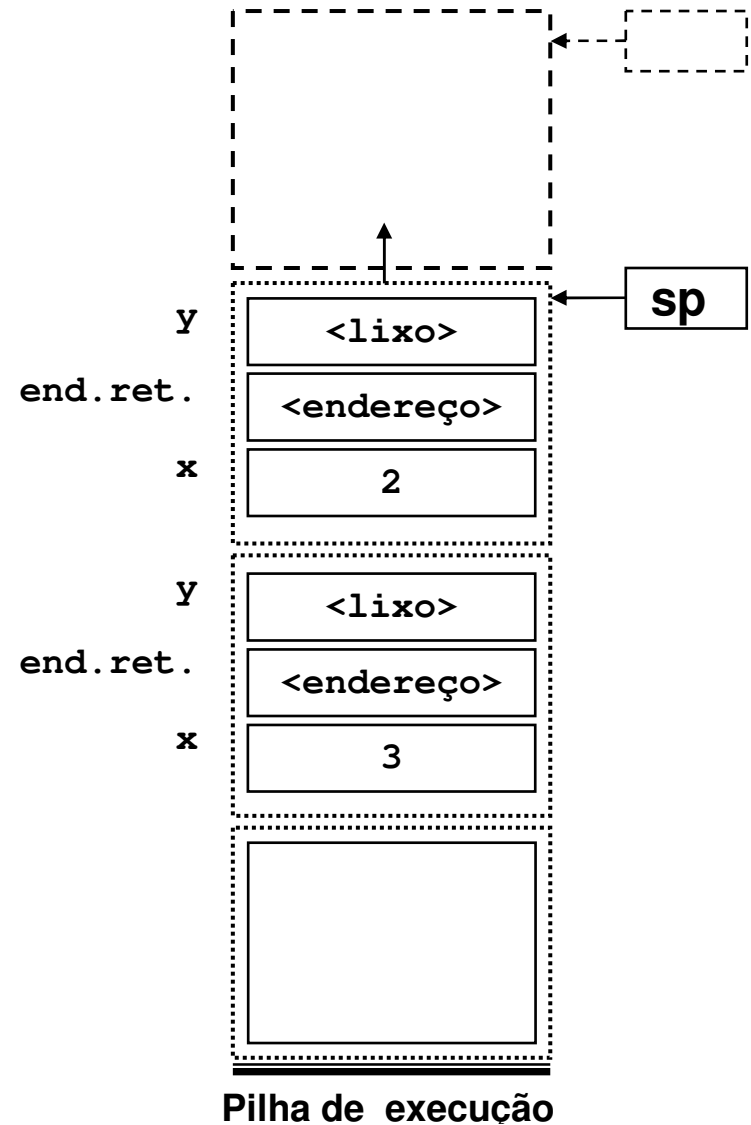
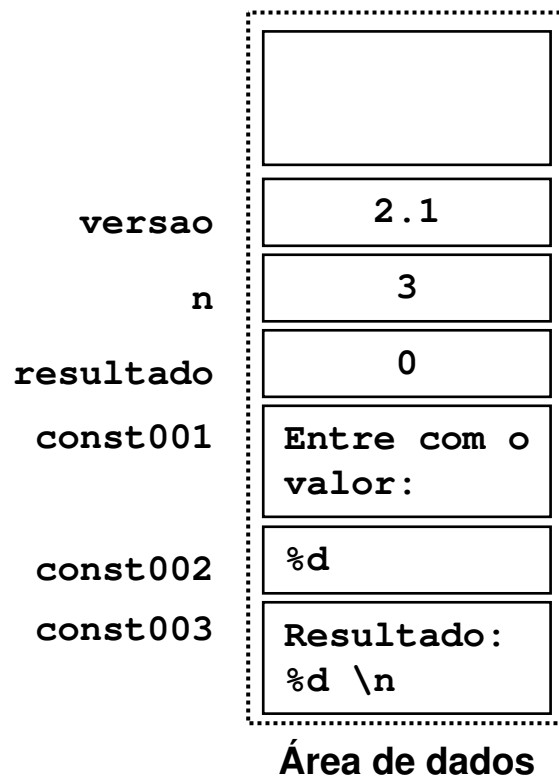

Exemplo

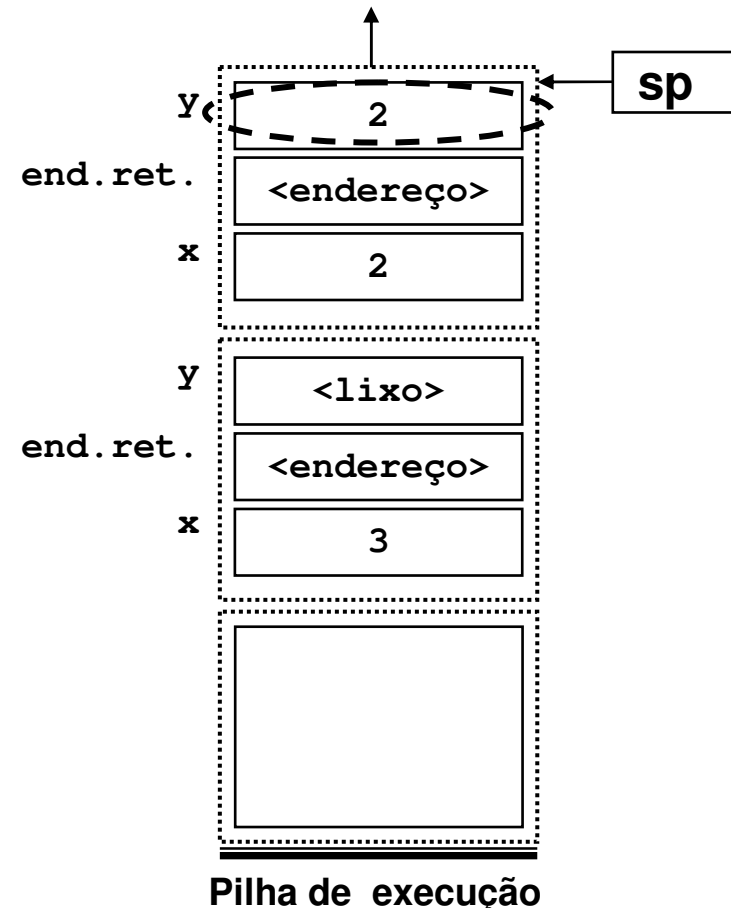
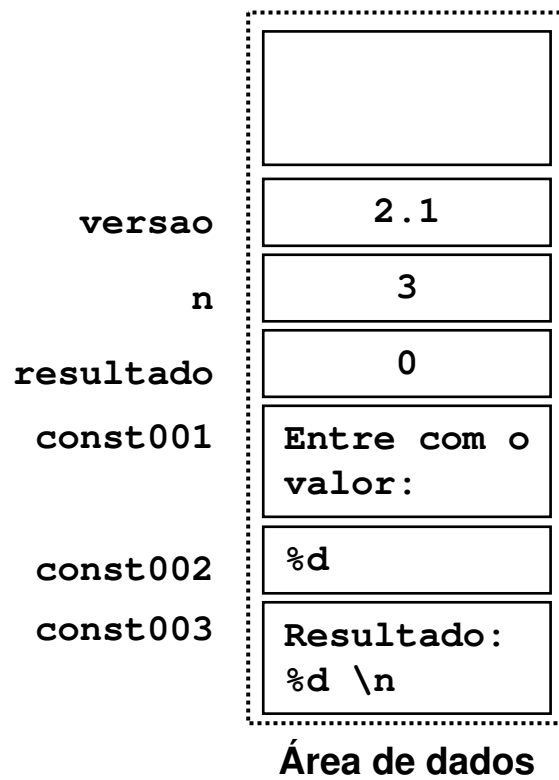

Exemplo

*Logo após terminar
fatorial(2)*

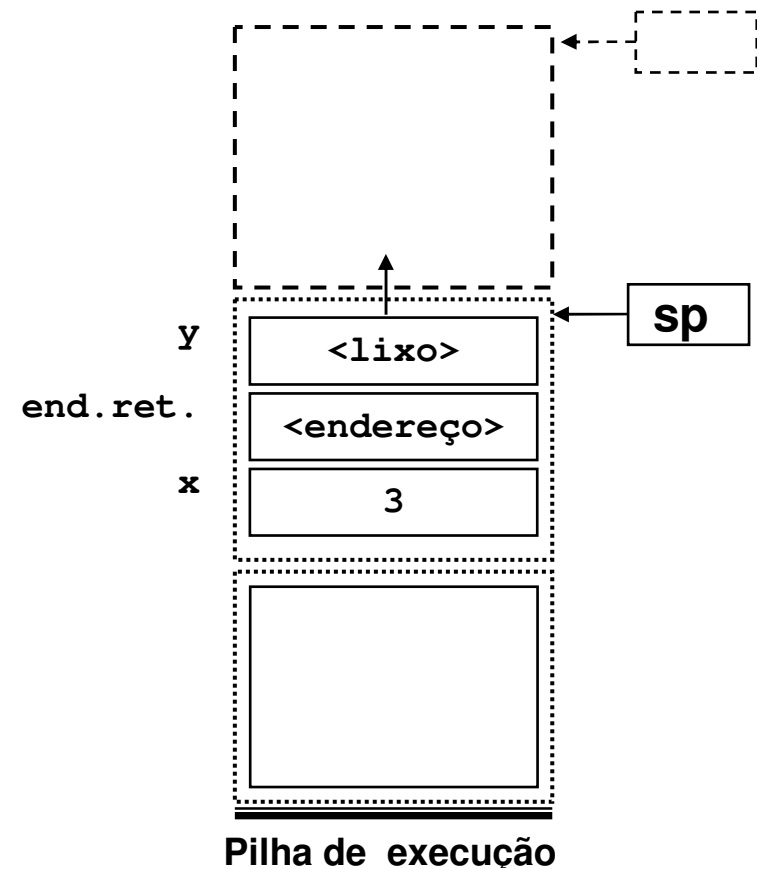
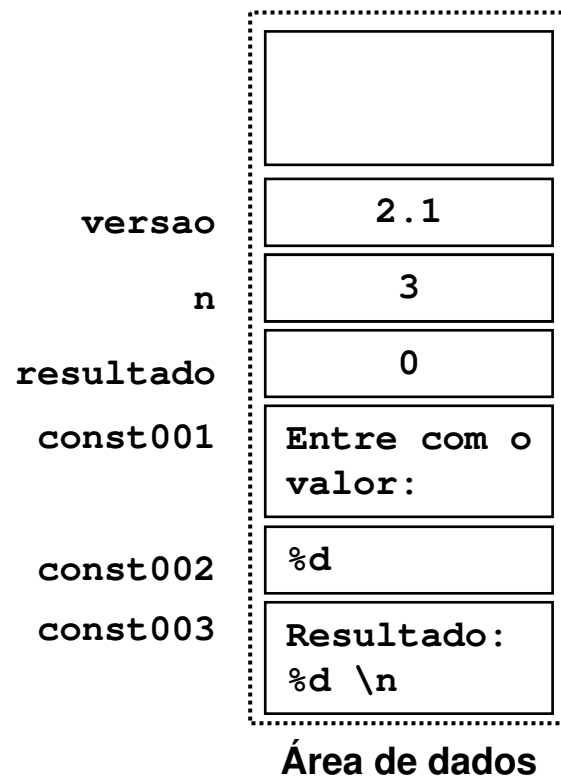

Exemplo

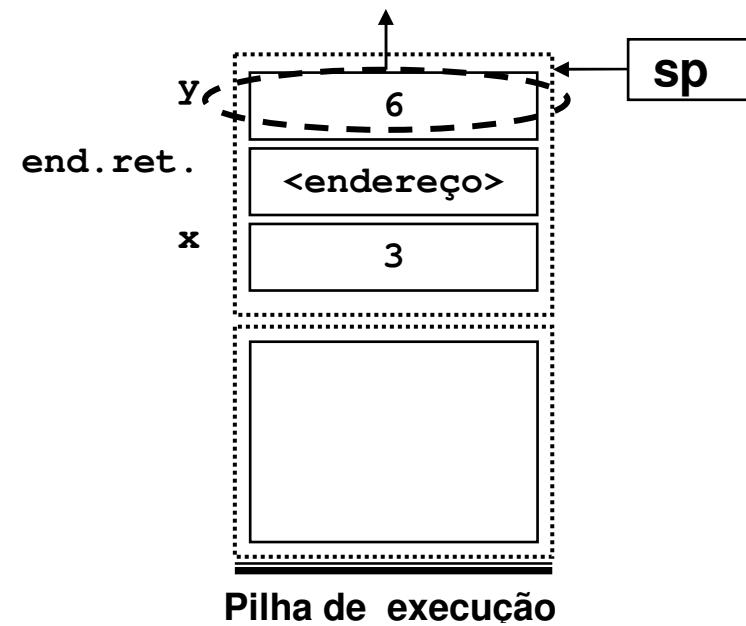
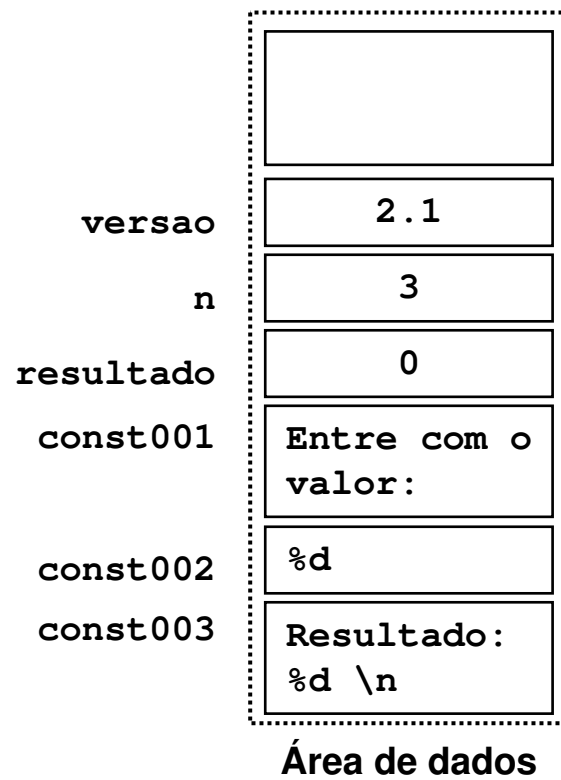

Exemplo

*Logo após terminar
fatorial(3)*

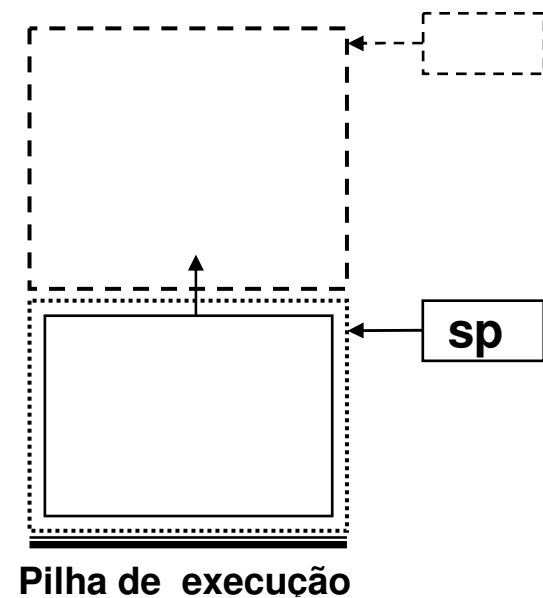
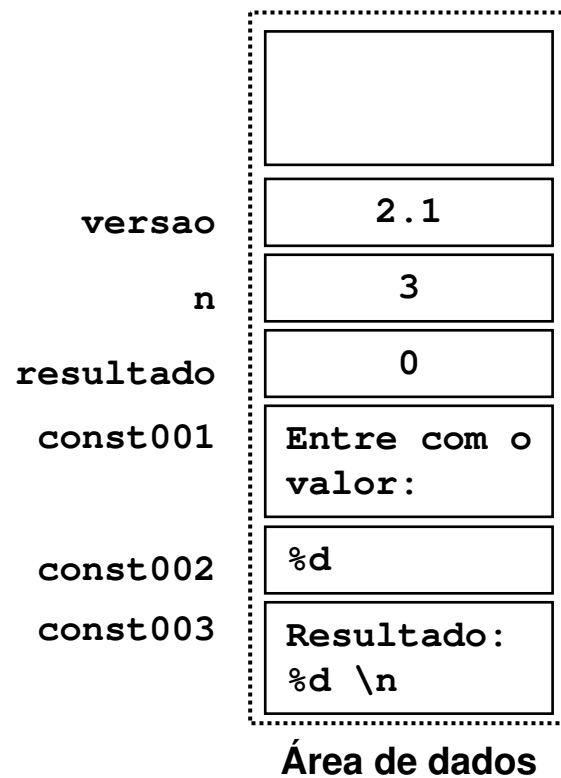

Exemplo

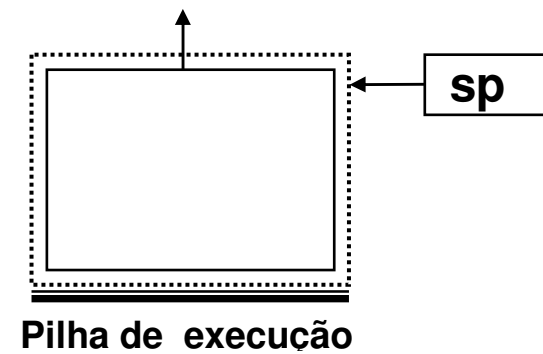
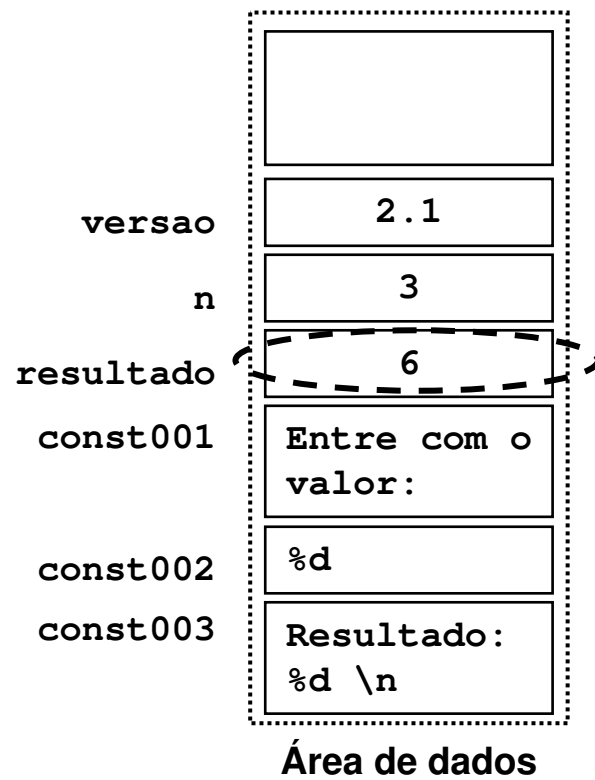

Exemplo

*Logo após terminar
a função main()*

