

# **PEF 2308**

Aula 2 – Conceitos iniciais

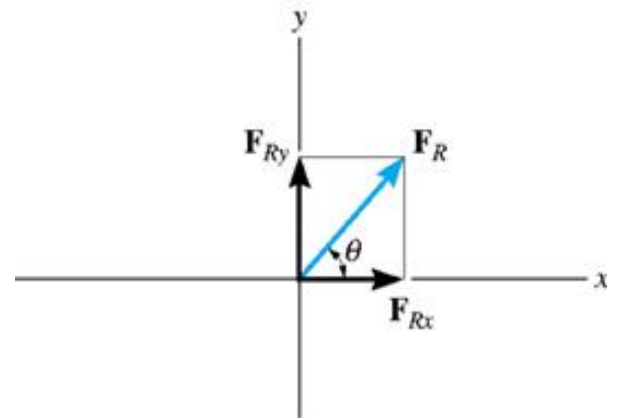

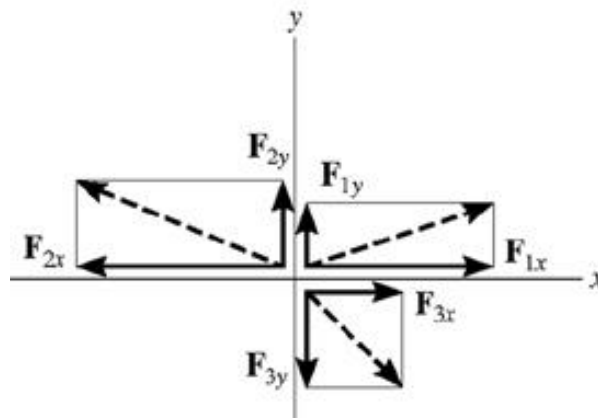
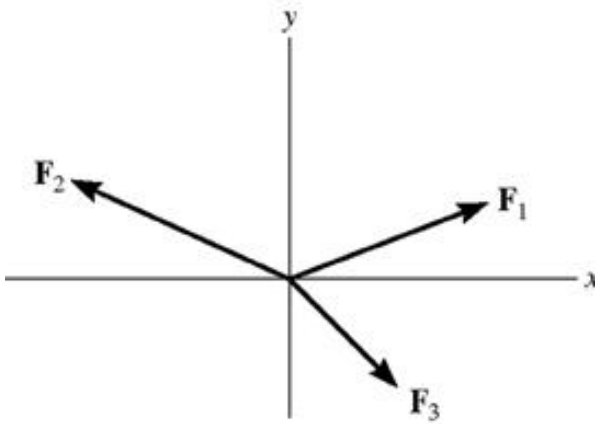
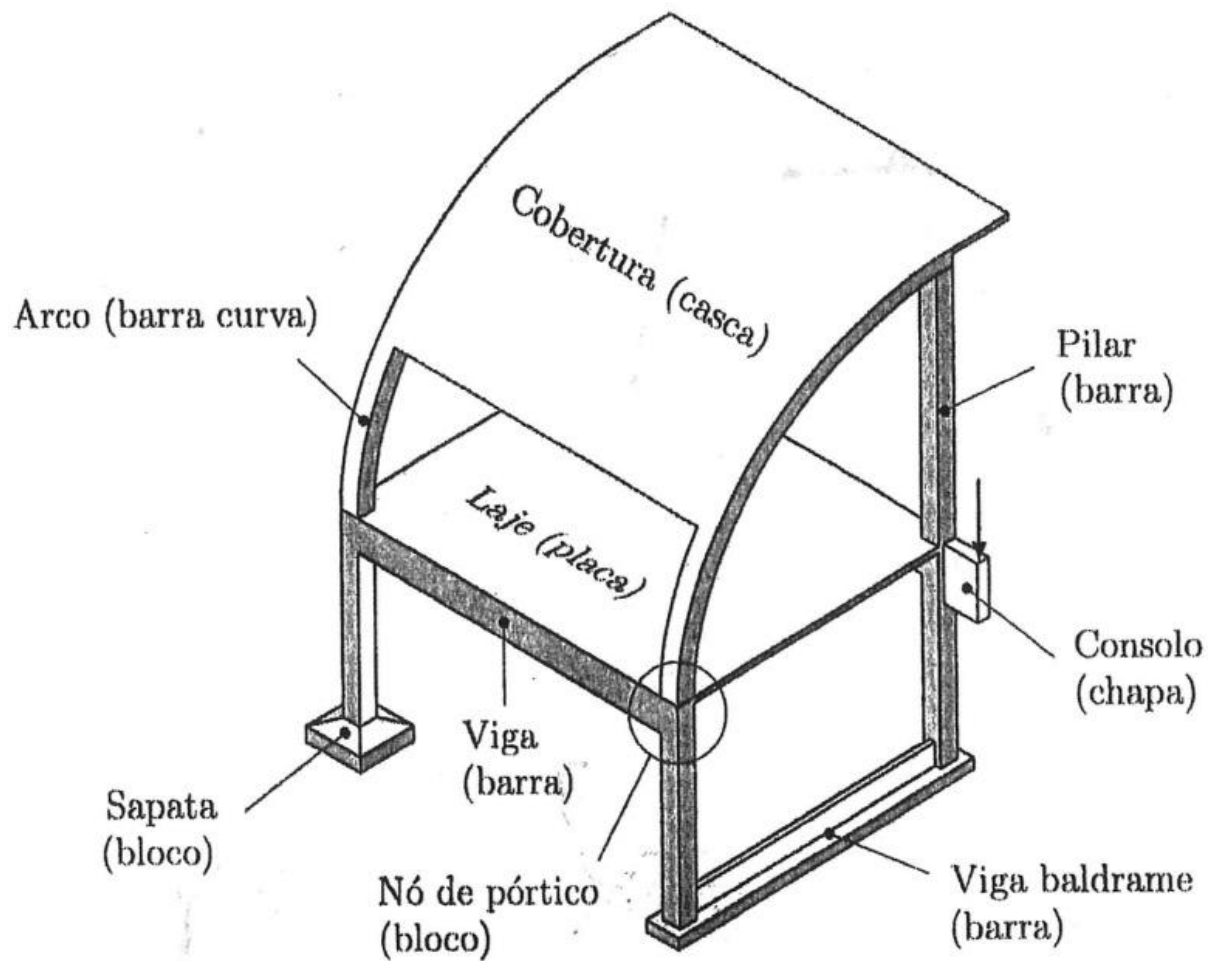
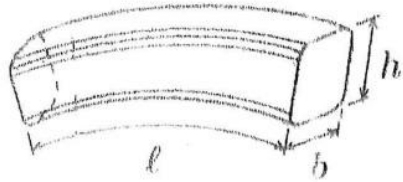
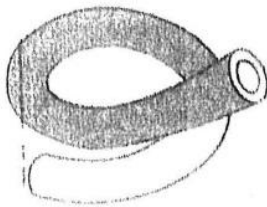

Fig. 1: Elementos estruturais de uma edificação.

(a) Barra



$$b, h \ll l$$



(b) Folha

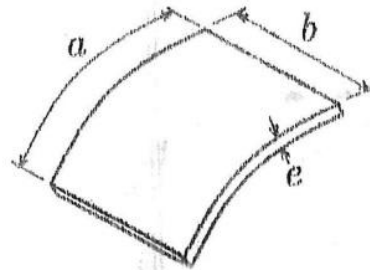

$$e \ll a, b$$

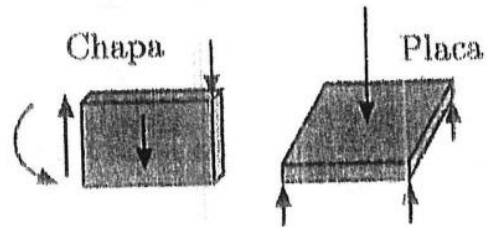

(c) Bloco

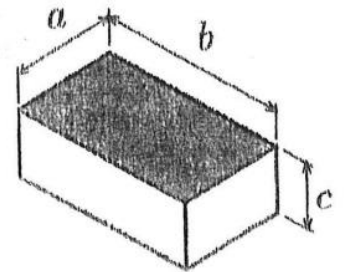

$$a \approx b \approx c$$



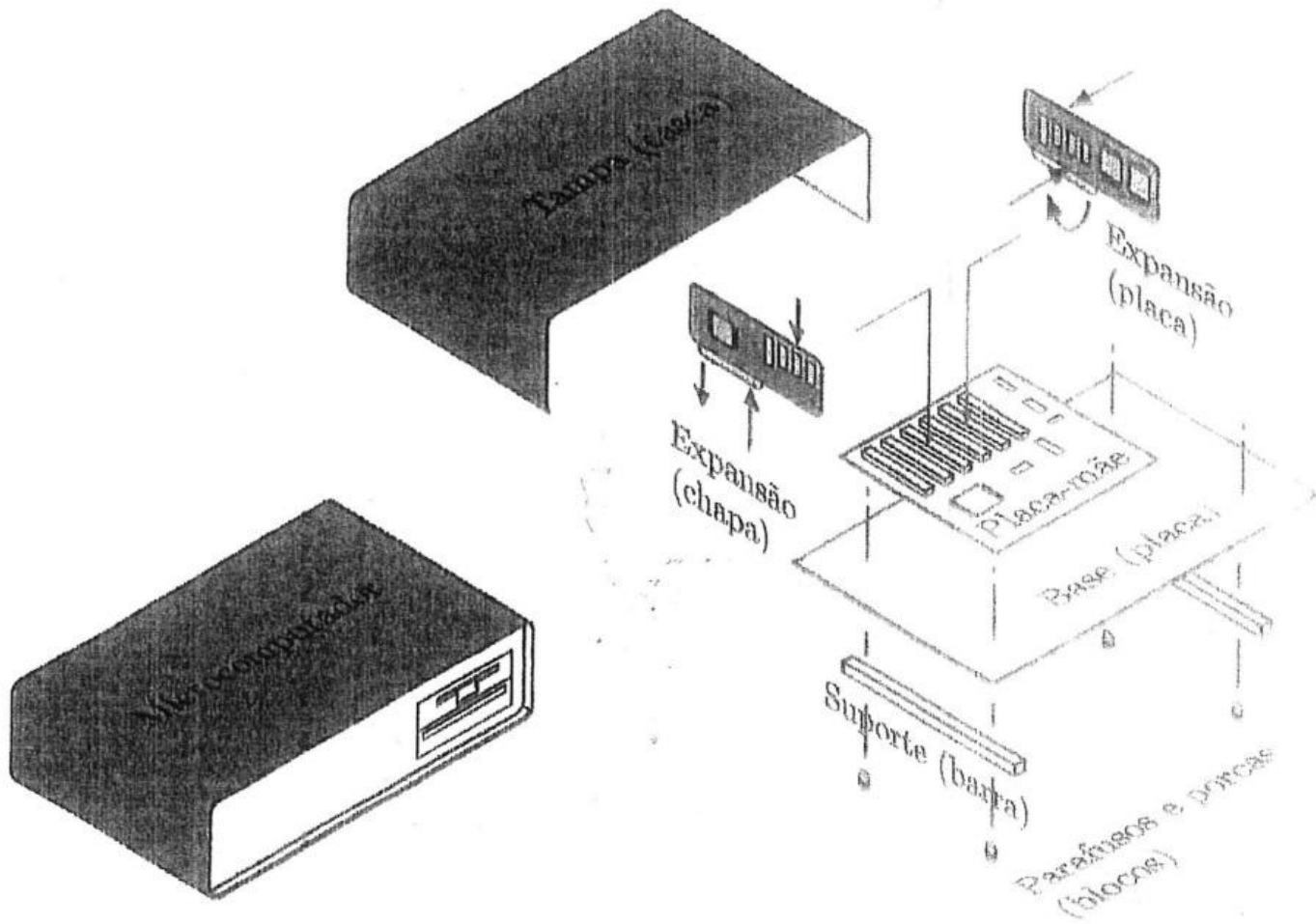

Para um corpo em repouso em relação a um sistema inercial, as leis de Euler<sup>3</sup> fornecem:

$$\sum_{i=1}^{n_F} \mathbf{F}_i = \mathbf{0}, \quad \sum_{j=1}^{n_M} M_{Oj} = 0, \quad (2.1)$$

correspondendo ao equilíbrio de  $n_F$  forças  $\mathbf{F}_i$  e  $n_M$  momentos  $M_j$  em relação a um polo arbitrário O. Reescrevendo a equação acima empregando as componentes de força e momento em relação a três eixos ortogonais  $x$ ,  $y$  e  $z$  passando por O, obtemos

$$\begin{aligned} \sum F_x &= 0, & \sum M_{Ox} &= 0, \\ \sum F_y &= 0, & \sum M_{Oy} &= 0, \\ \sum F_z &= 0, & \sum M_{Oz} &= 0, \end{aligned} \quad (2.2)$$

onde os índices foram omitidos. Para um sistema de forças coplanares em que as forças e momentos atuam no plano definido pelos eixos  $x$  e  $y$ , restam apenas três equações não-identicamente nulas:

$$\begin{aligned} \sum F_x &= 0, & \sum M_{Oz} &= 0, \\ \sum F_y &= 0, & & \end{aligned} \quad (2.3)$$

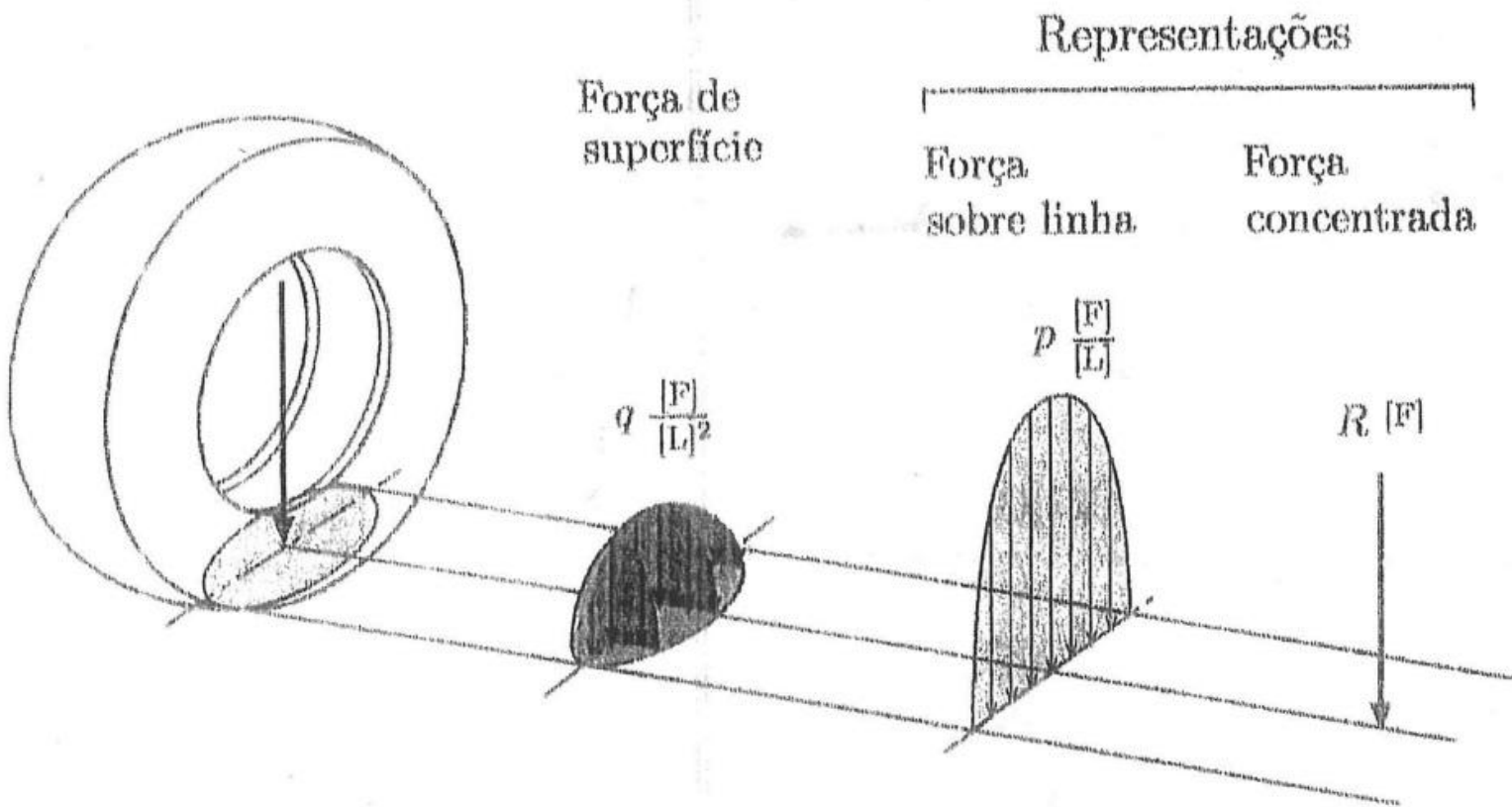

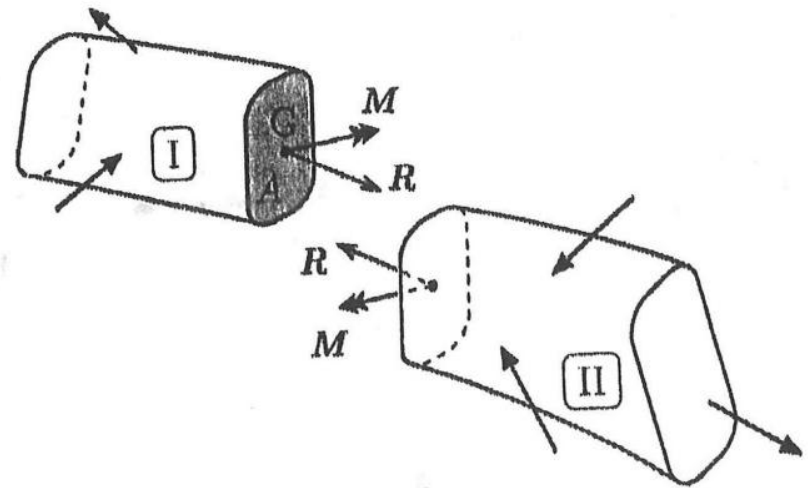
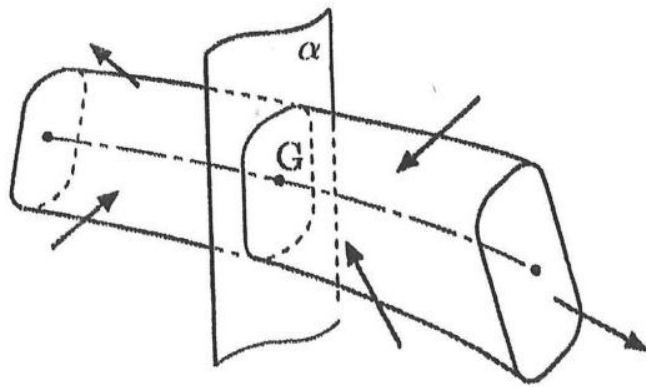



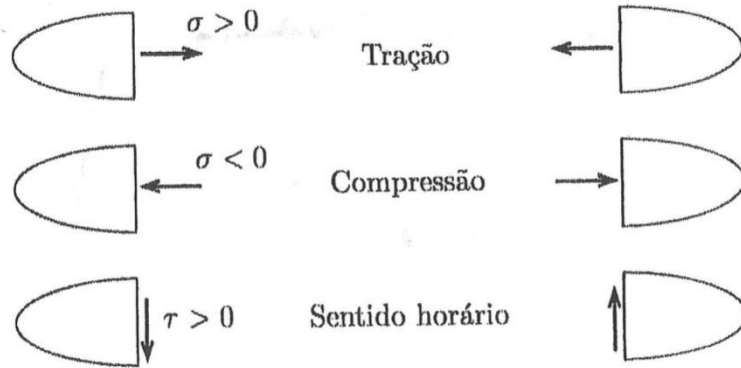

$$dN = \sigma dA,$$

$$dV_y^* = \tau_{xy} dA,$$

$$dV_z^* = \tau_{xz} dA,$$

$$dM_y = \sigma z dA,$$

$$dM_z = -\sigma y dA,$$

$$dM_x = (\tau_{xz} y - \tau_{xy} z) dA$$

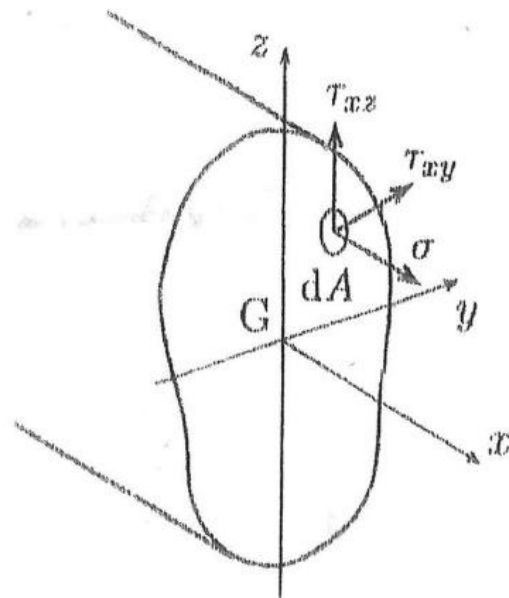
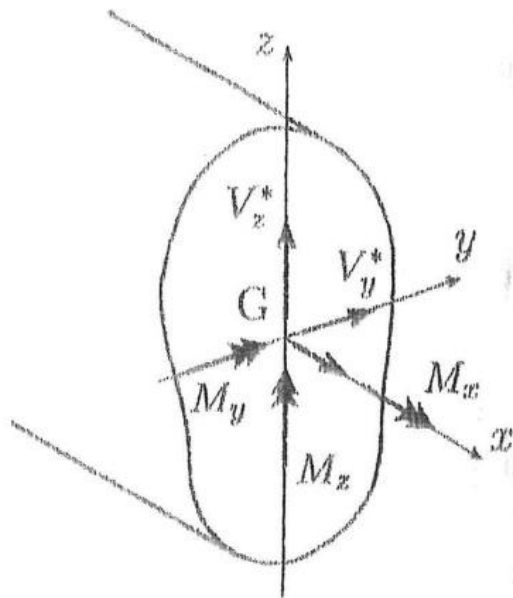

Esforços solicitantes e componentes de tensão na seção transversal.

$$dN = \sigma dA,$$

$$dV_y^* = \tau_{xy} dA,$$

$$dV_z^* = \tau_{xz} dA,$$

$$dM_y = \sigma z dA,$$

$$dM_z = -\sigma y dA,$$

$$dM_x = (\tau_{xz} y - \tau_{xy} z) dA$$

$$N = \int_A \sigma dA,$$

$$V_y^* = \int_A \tau_{xy} dA,$$

$$V_z^* = \int_A \tau_{xz} dA,$$

$$M_y = \int_A \sigma z dA,$$

$$M_z = - \int_A \sigma y dA,$$

$$M_x = \int_A (\tau_{xz} y - \tau_{xy} z) dA.$$

## APOIOS NO PLANO

ARTICULAÇÃO MÓVEL:



ARTICULAÇÃO FIXA:

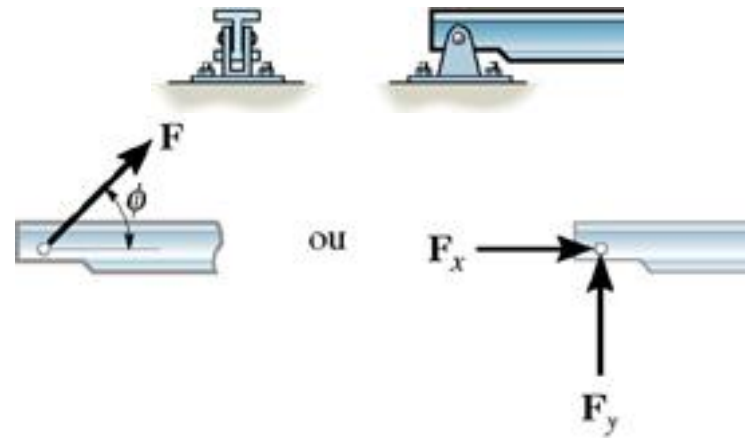

ENGASTAMENTO:

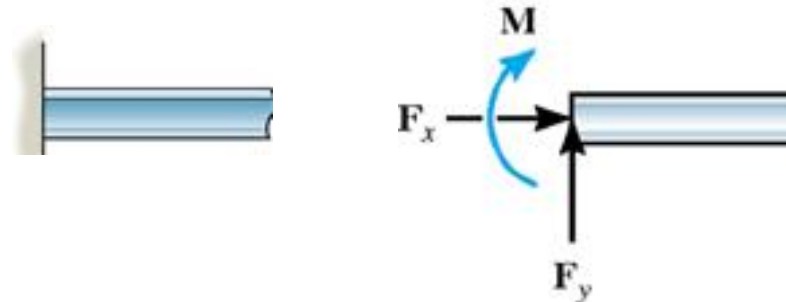









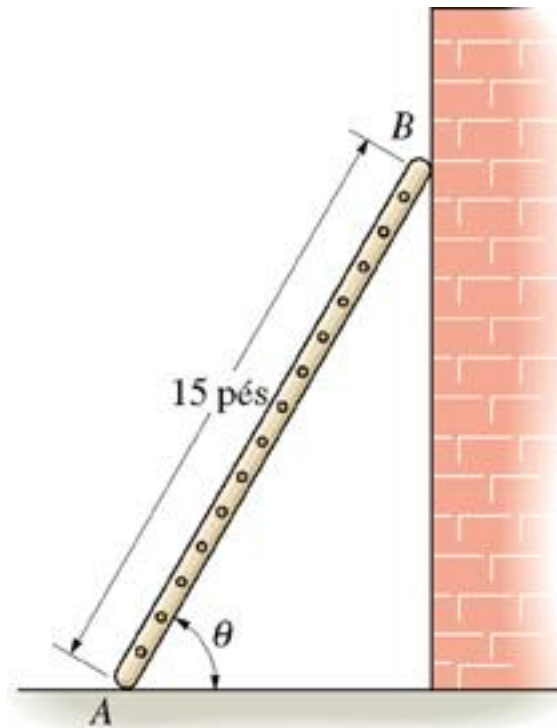

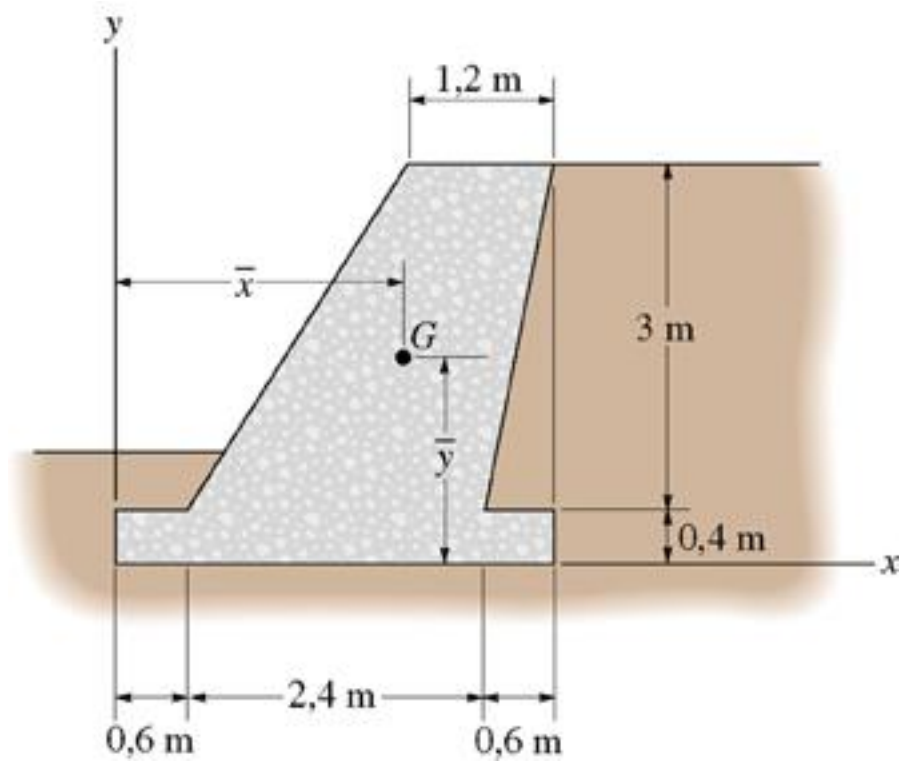



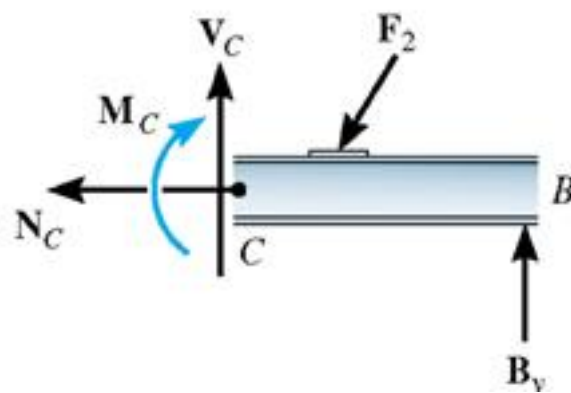
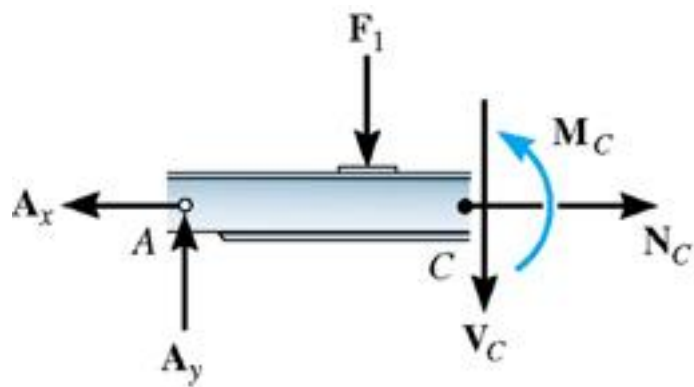
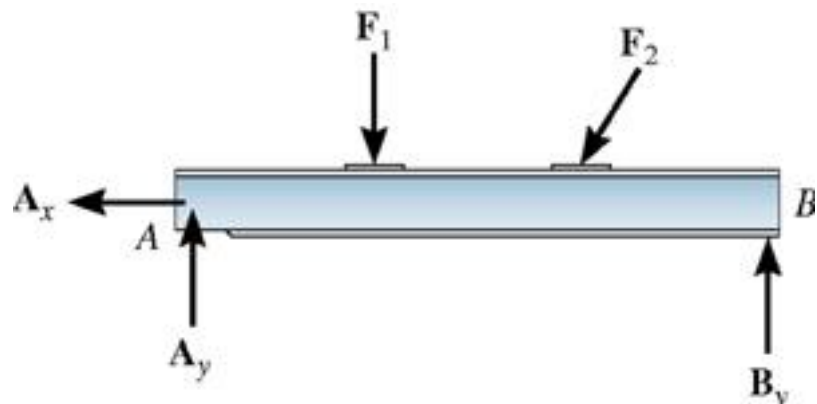
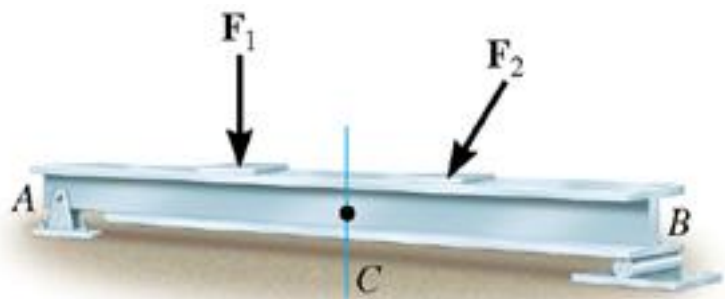

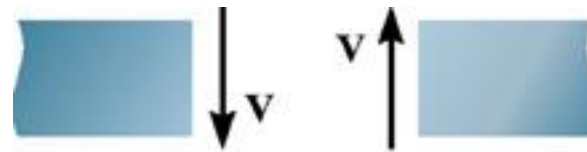

Força de cisalhamento positiva

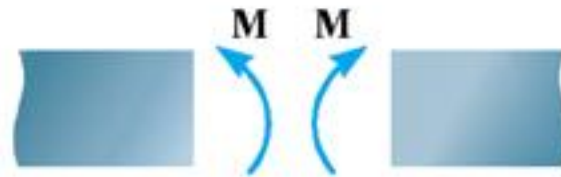

Momento fletor positivo



Convenção de sinais para a viga

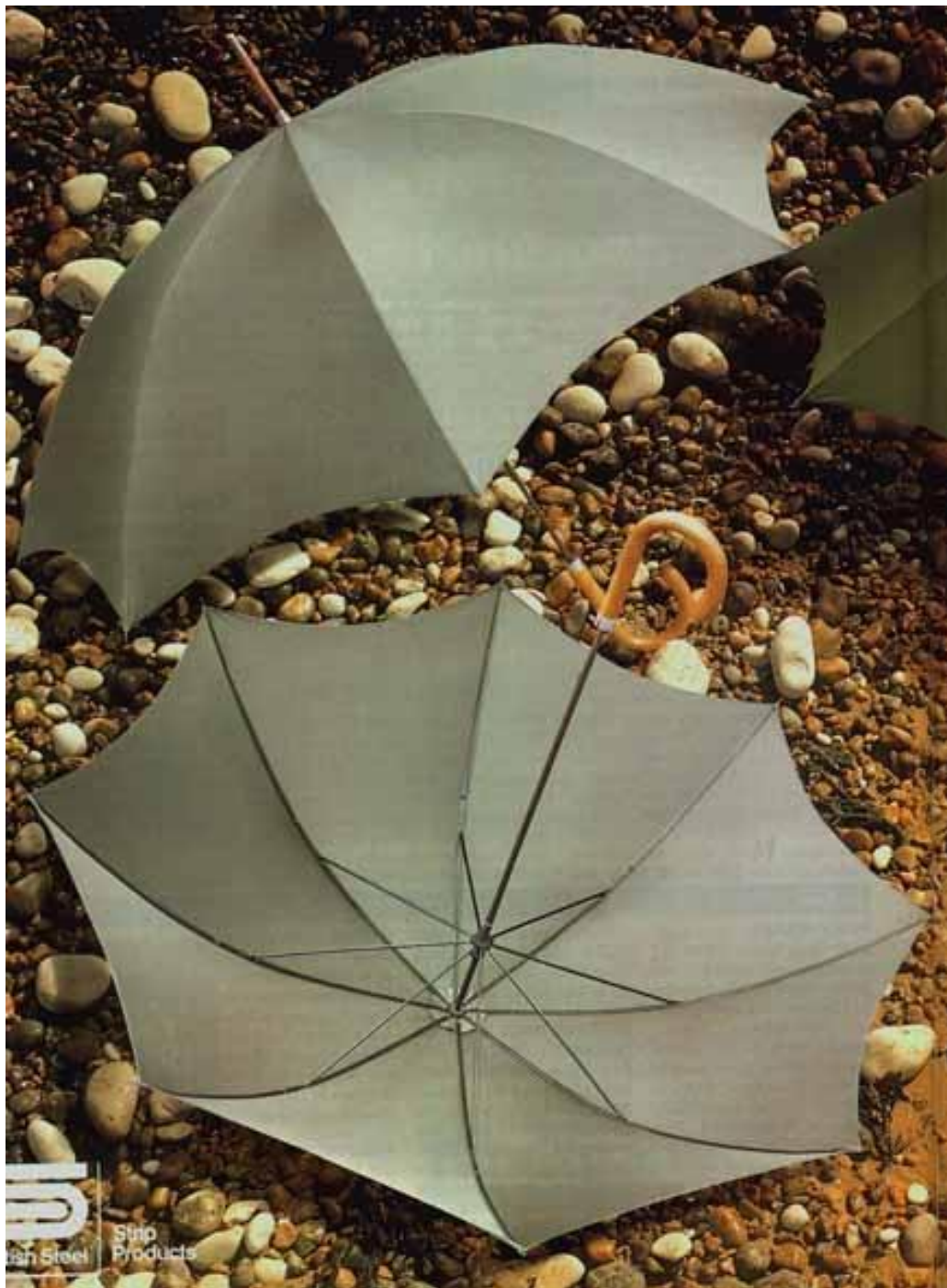

**S**  
Ship  
Products





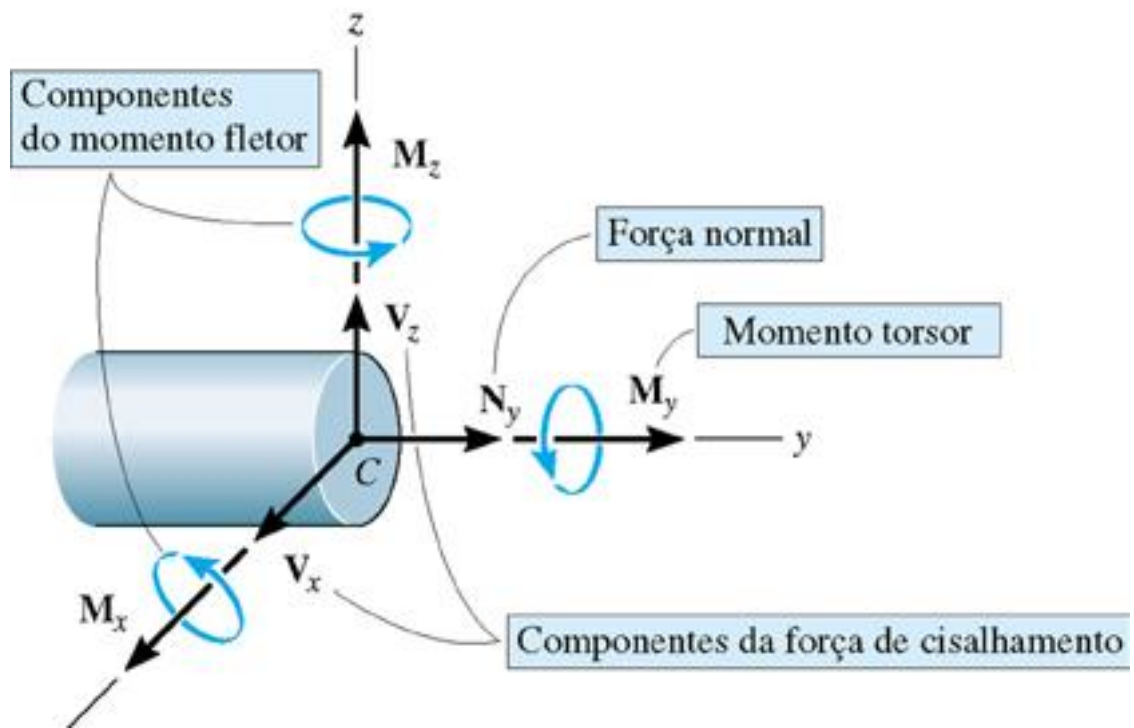

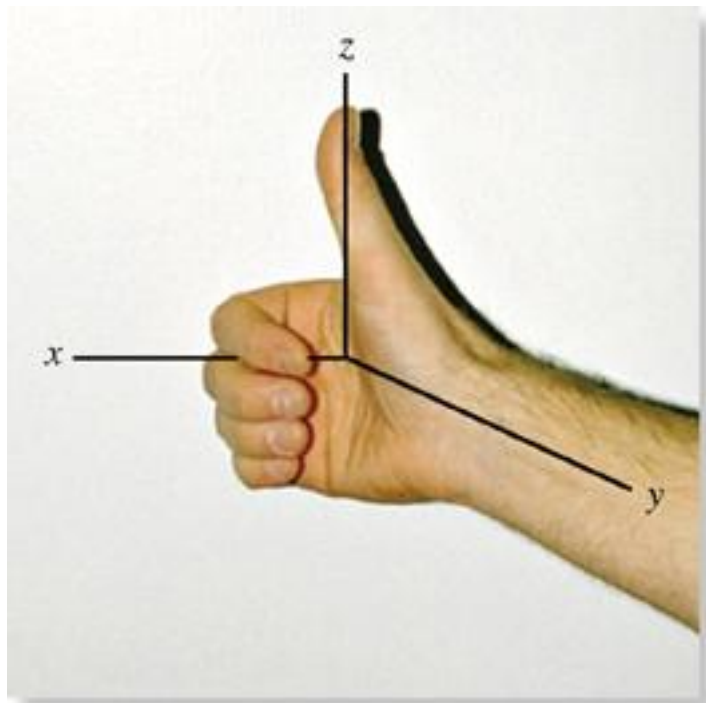

*Sistema de coordenadas da mão direita*

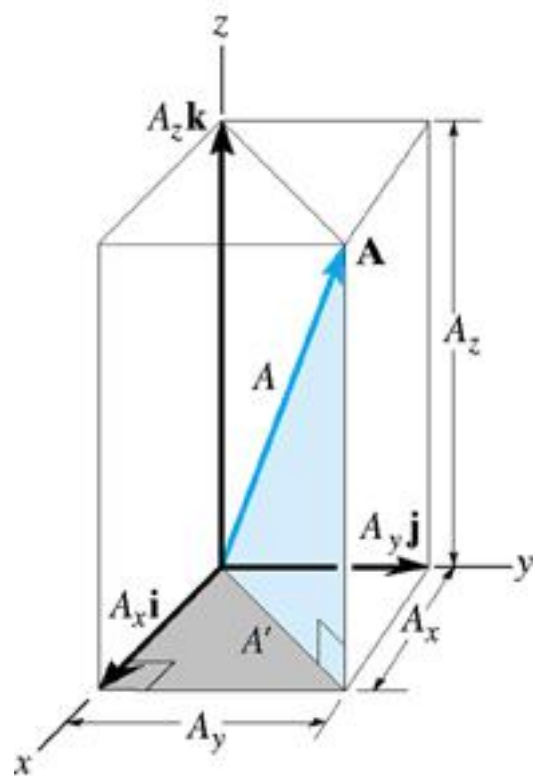

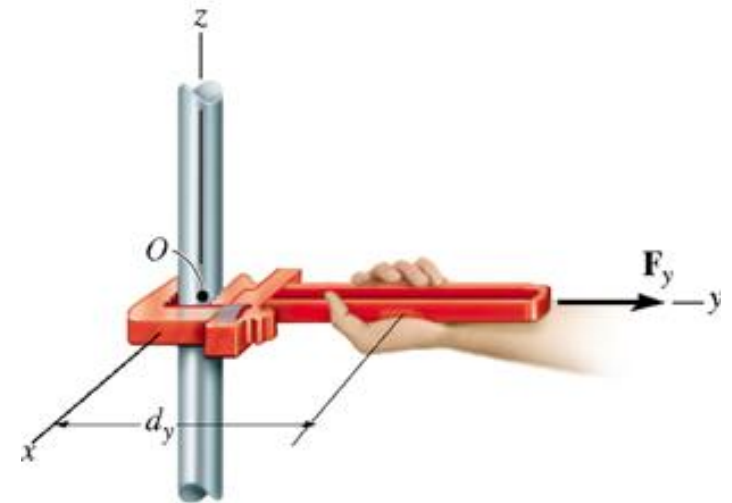
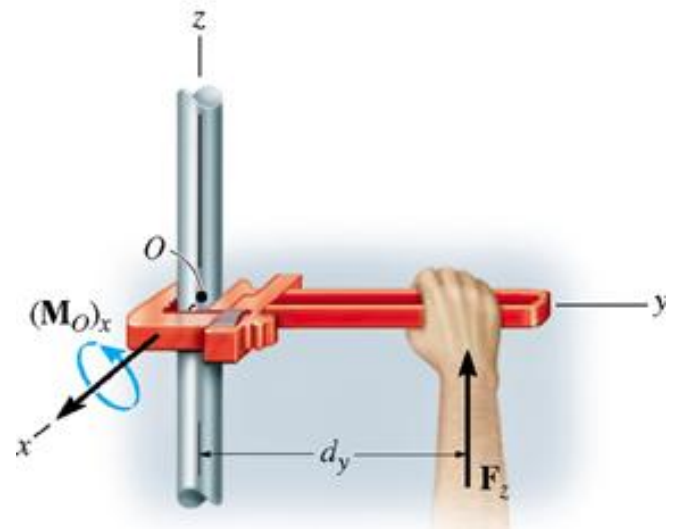
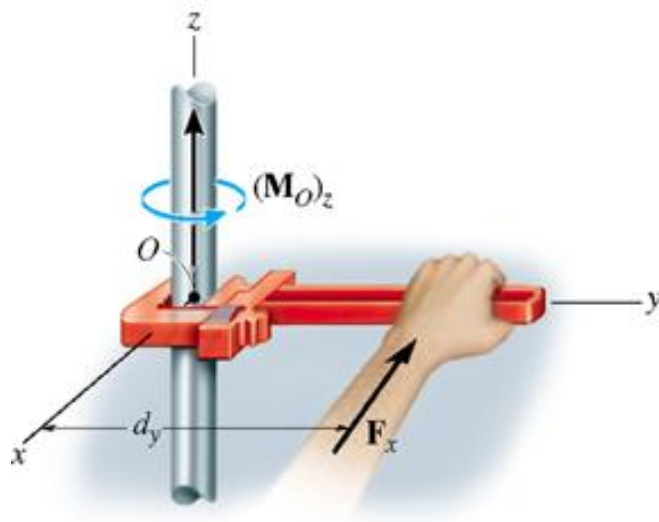

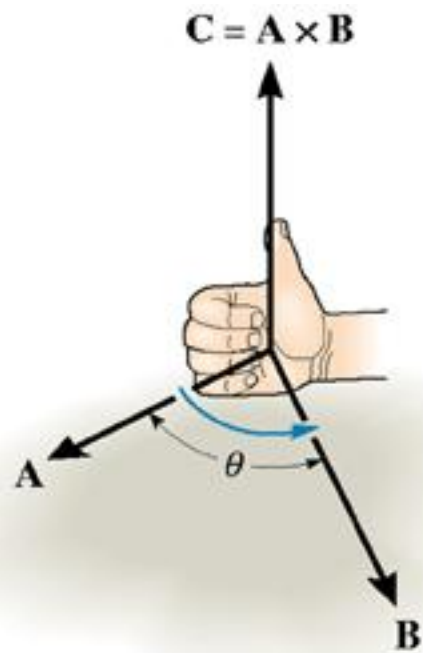
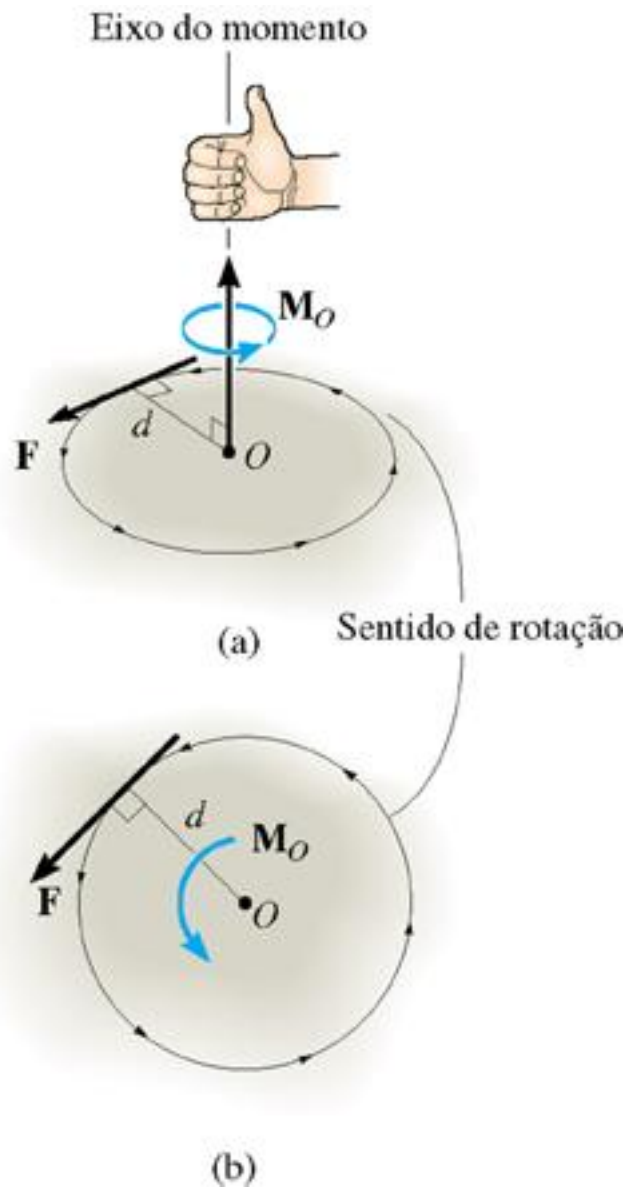



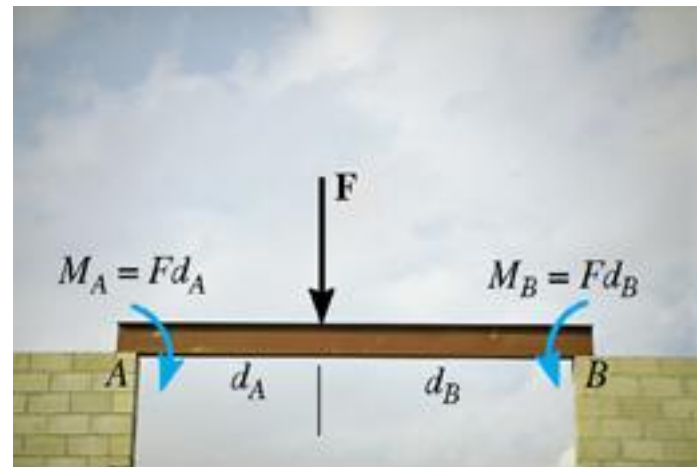
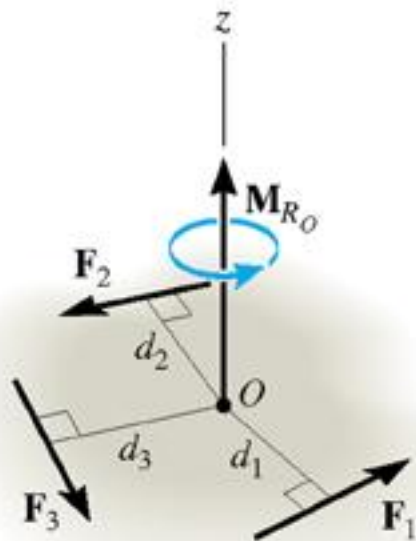

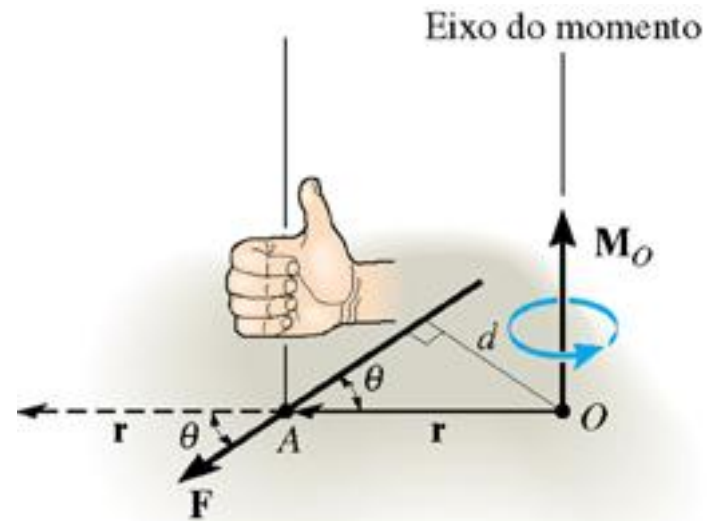
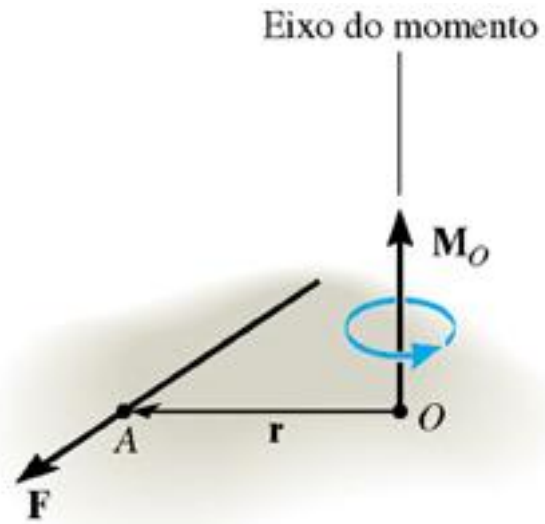

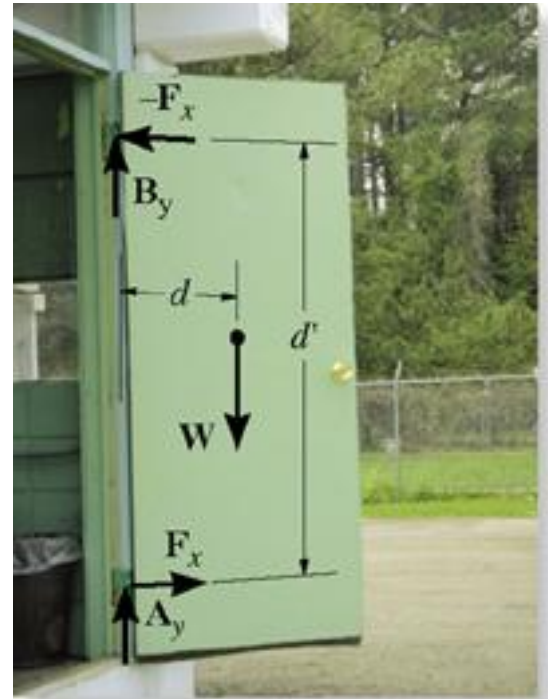
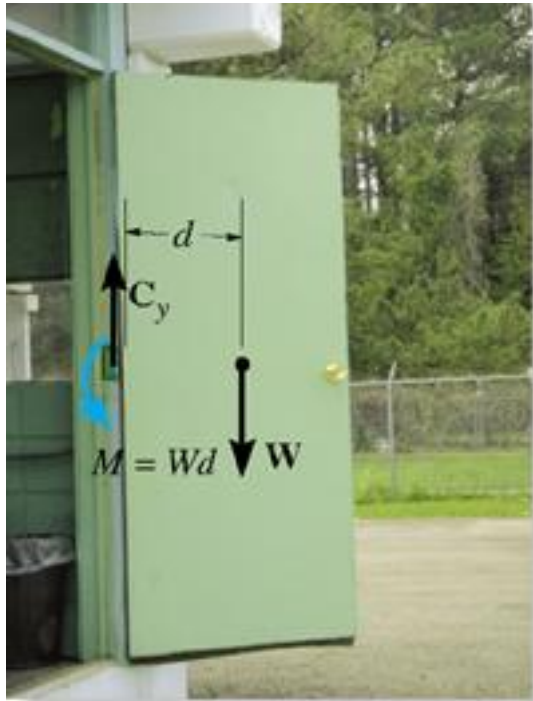

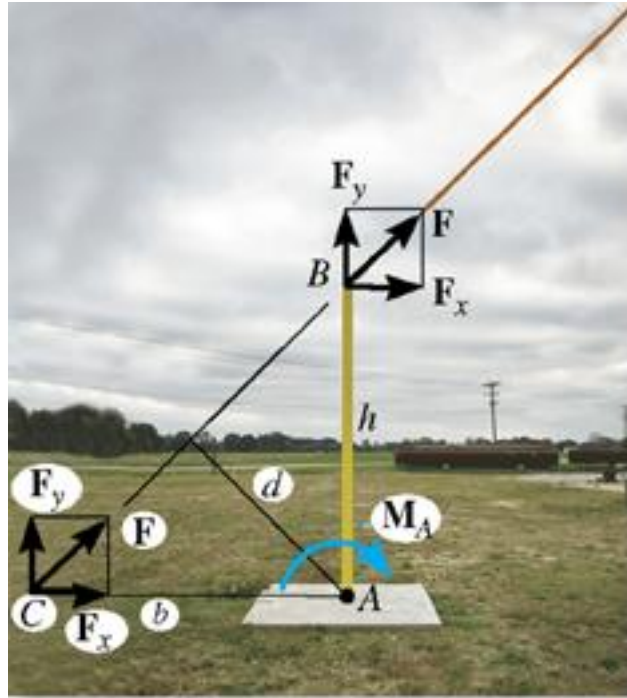

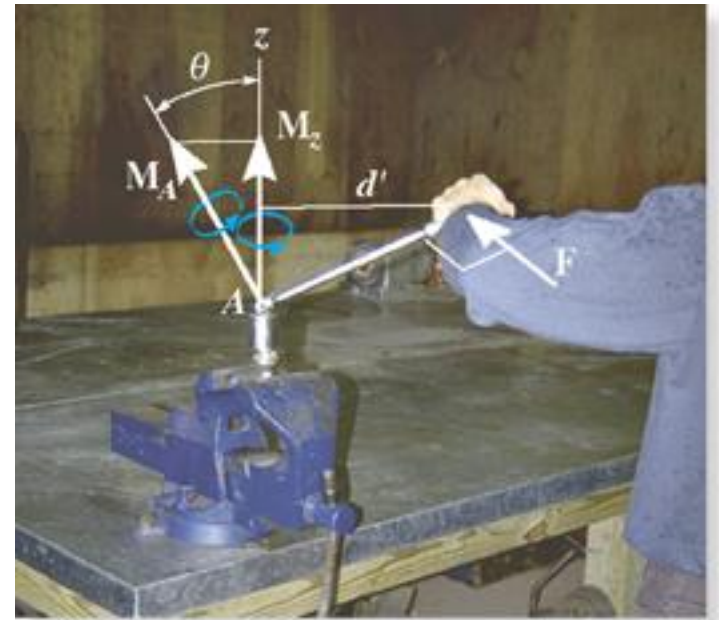
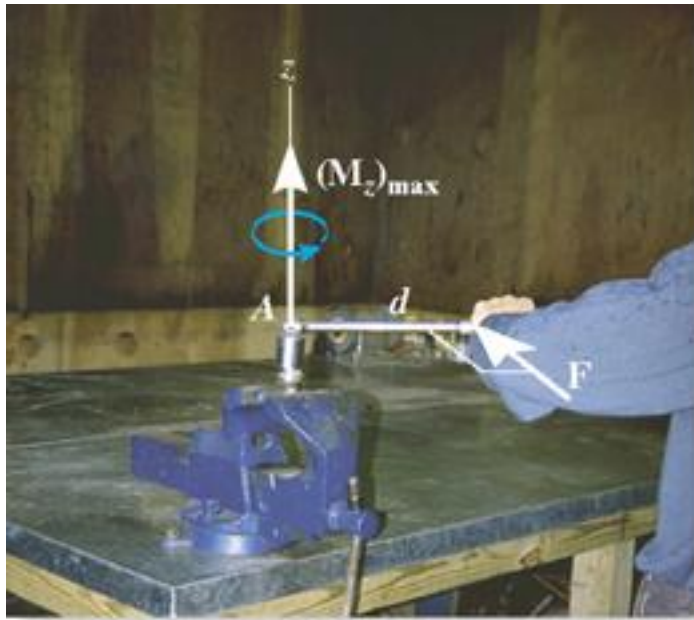

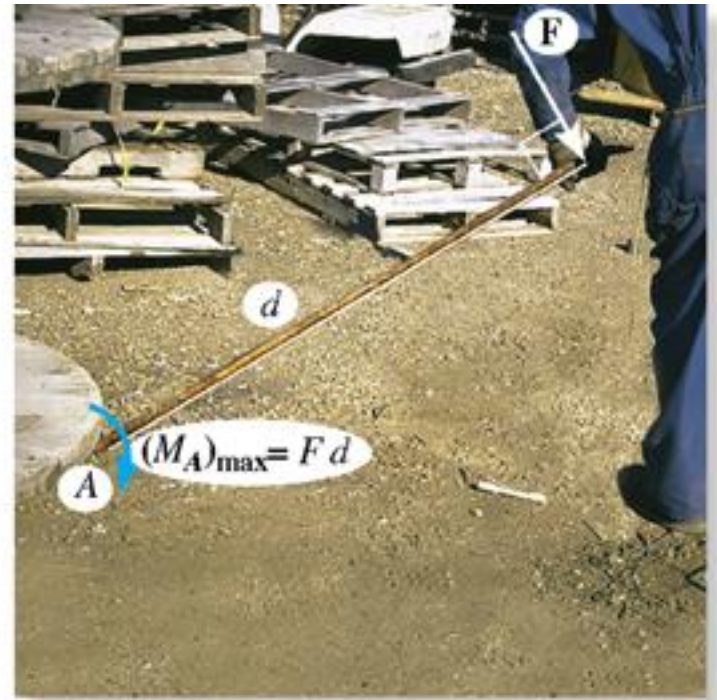
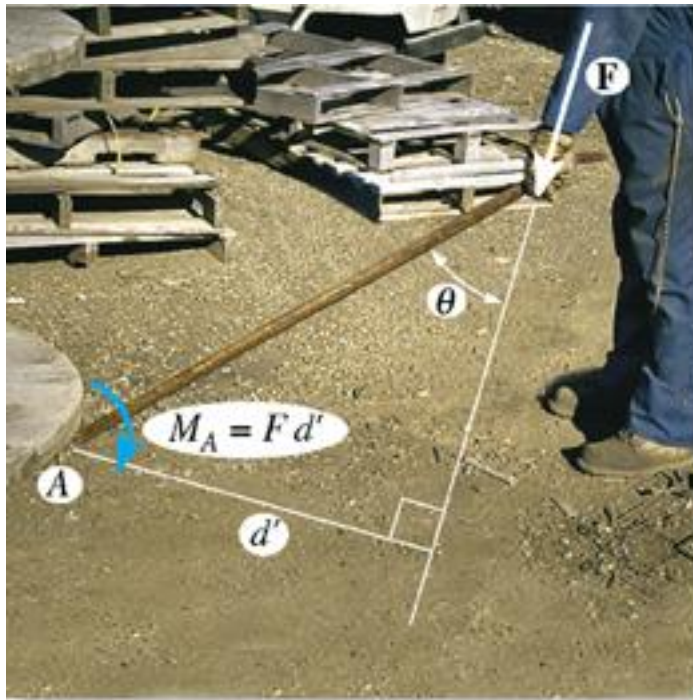



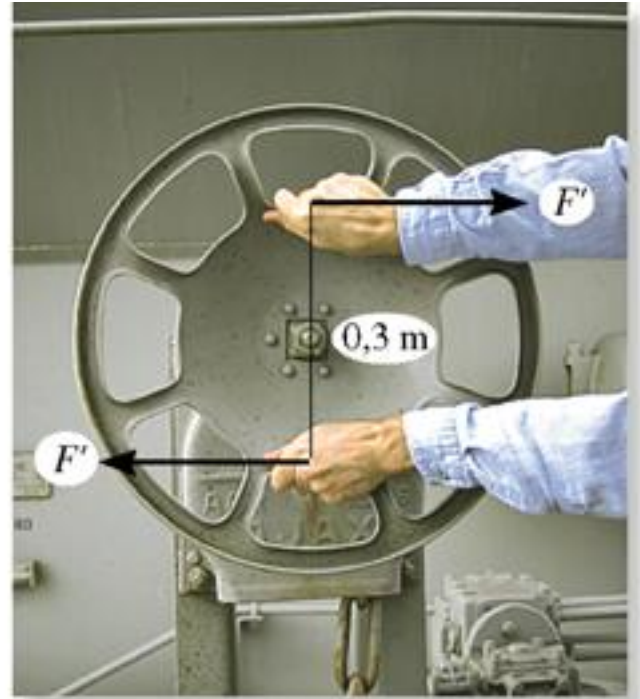
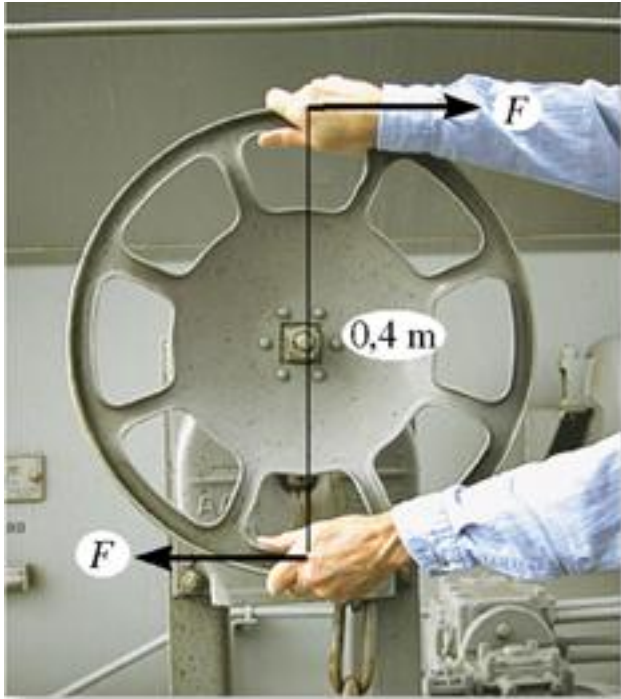

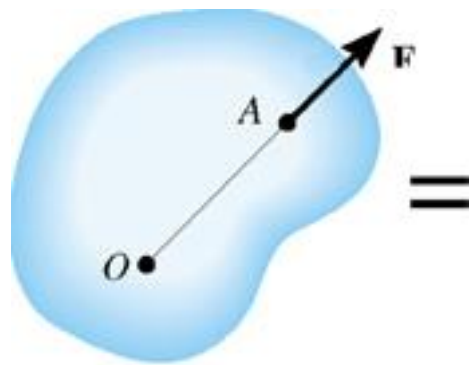

=

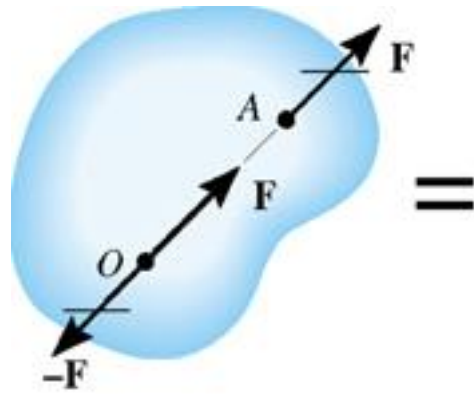

=

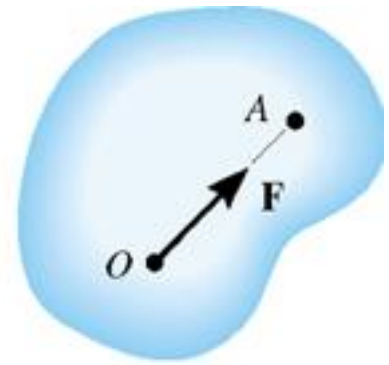



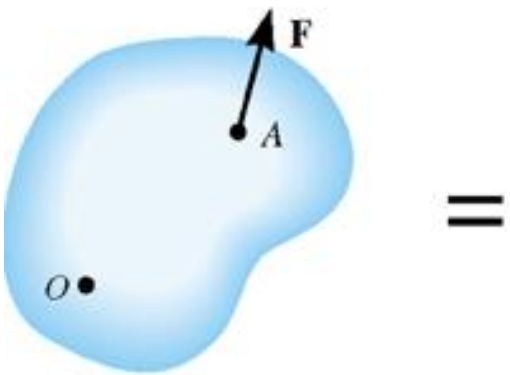

=

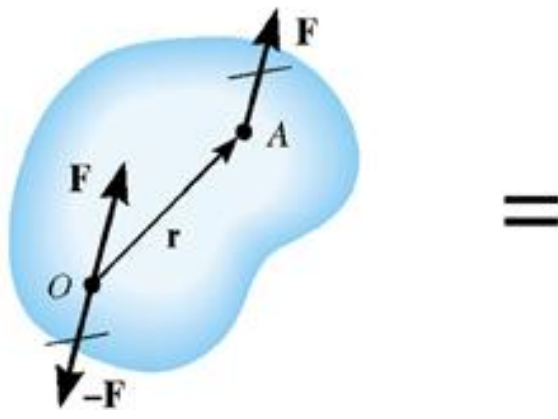

=

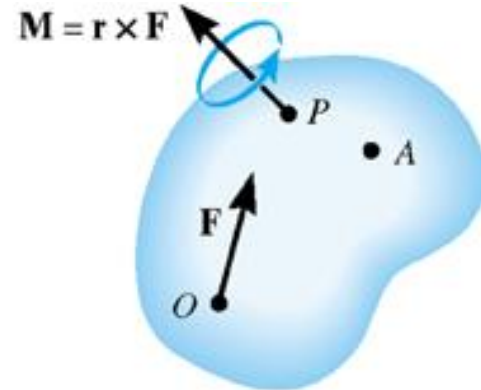

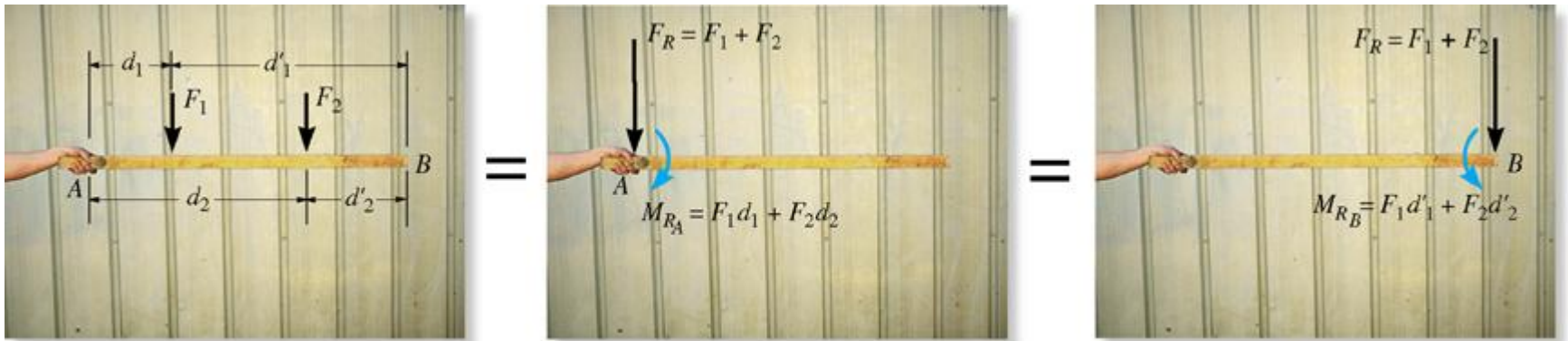
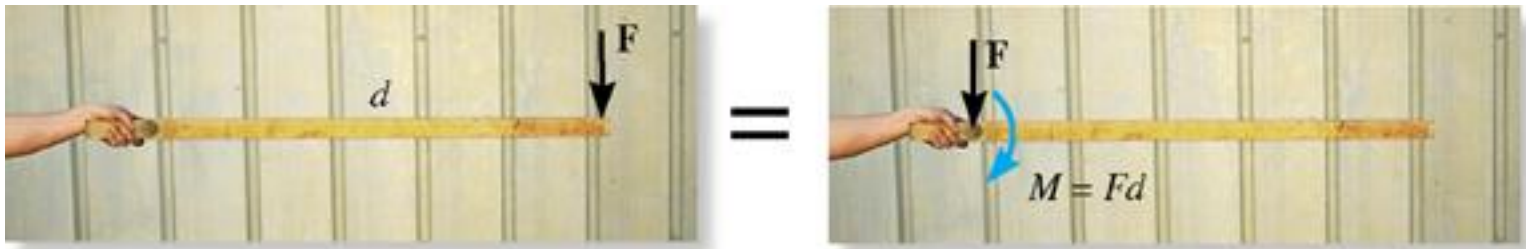
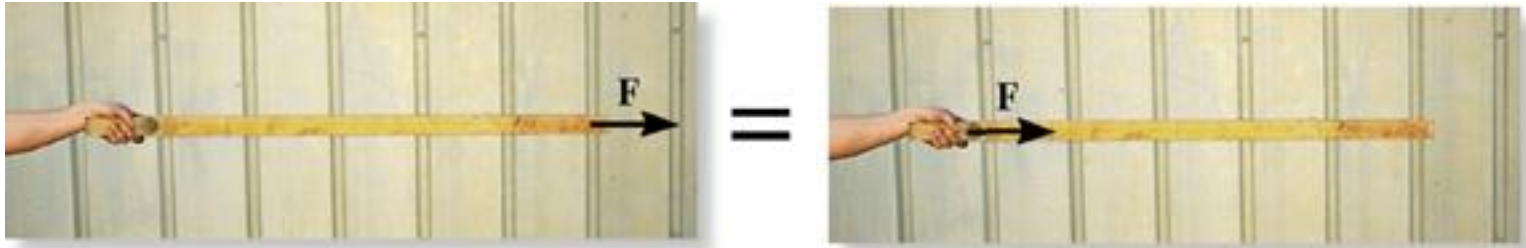

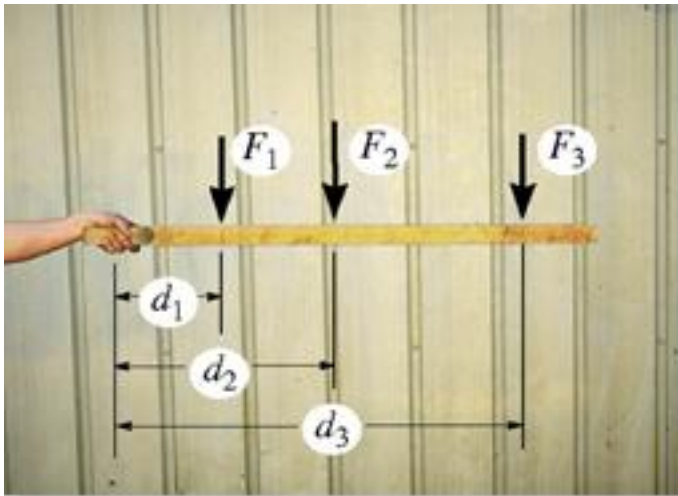

=

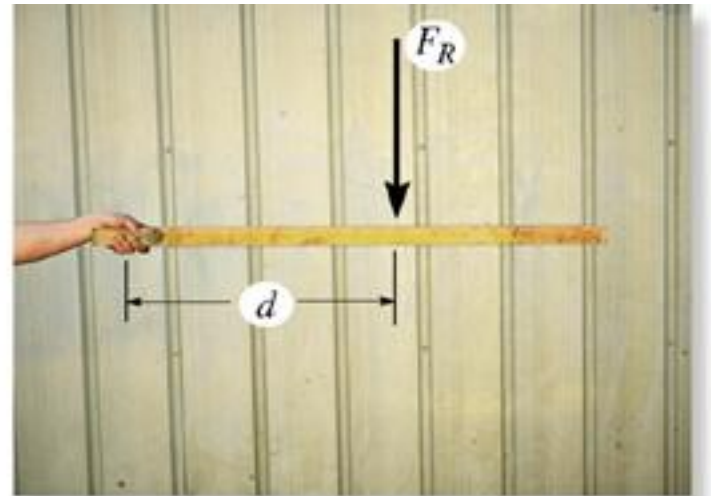

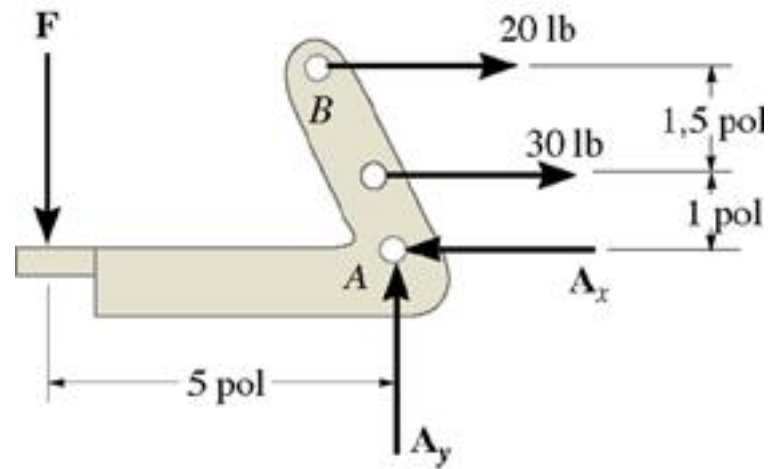
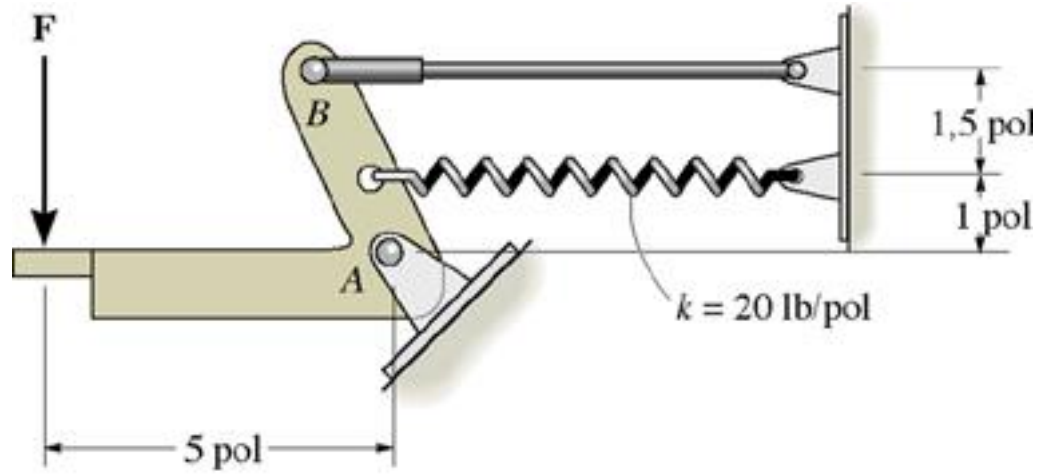
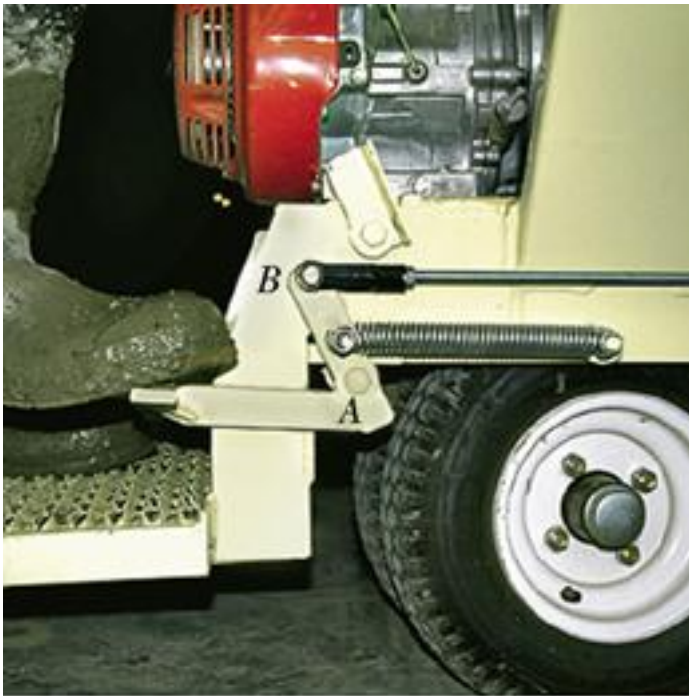

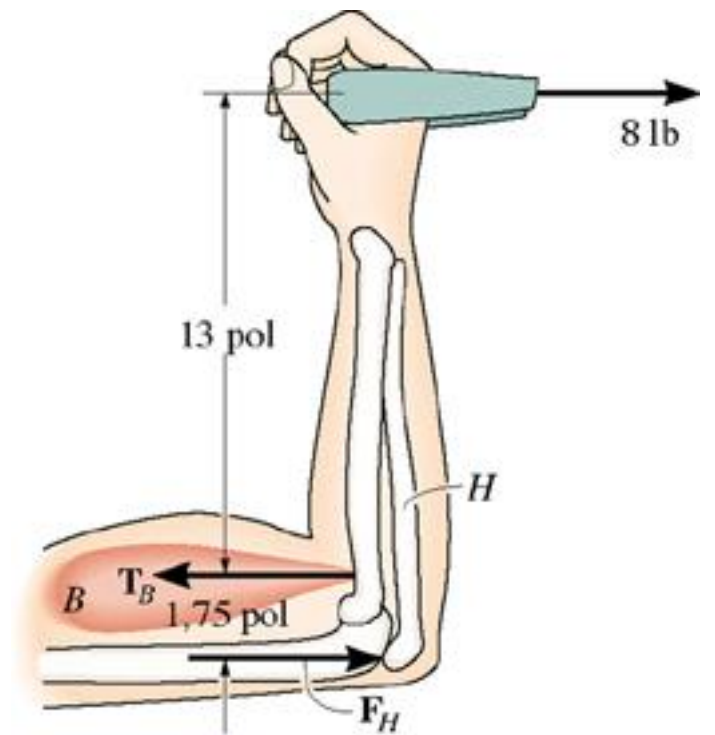
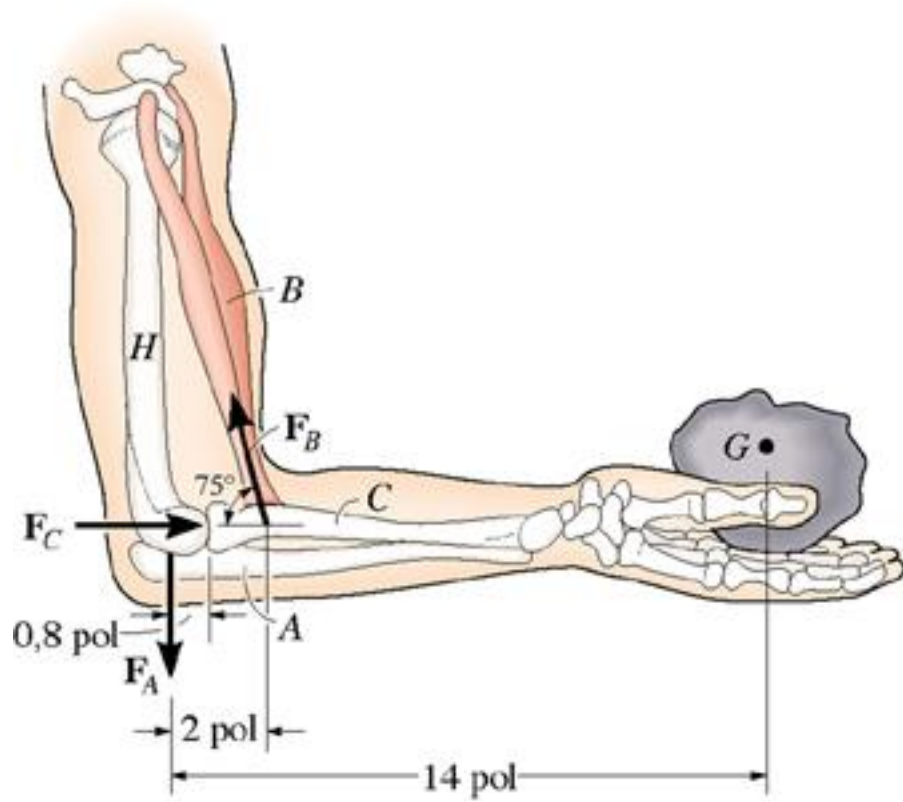

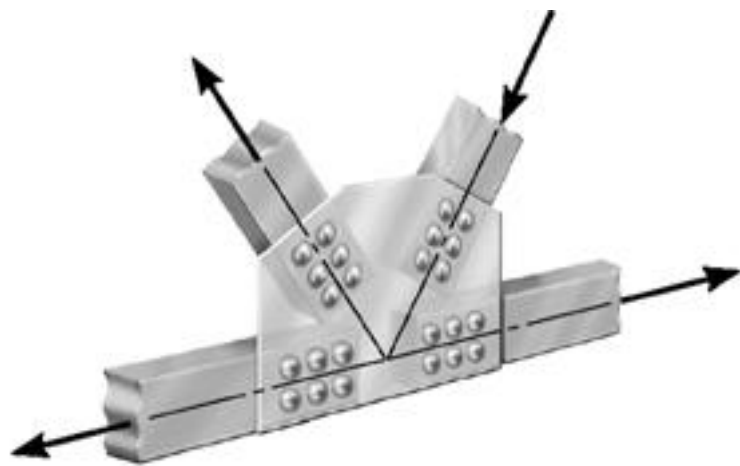

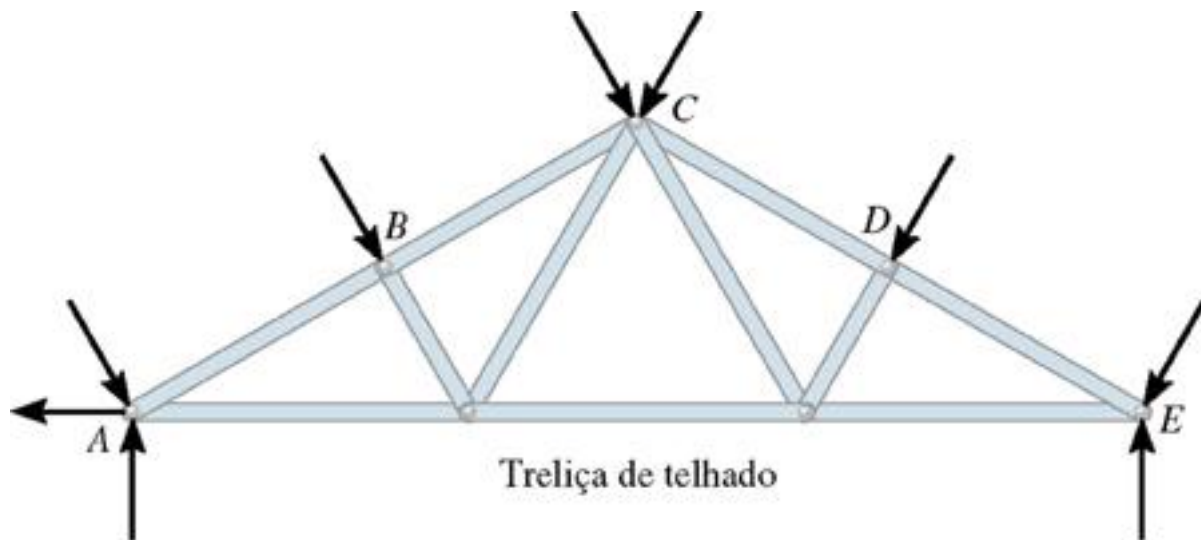
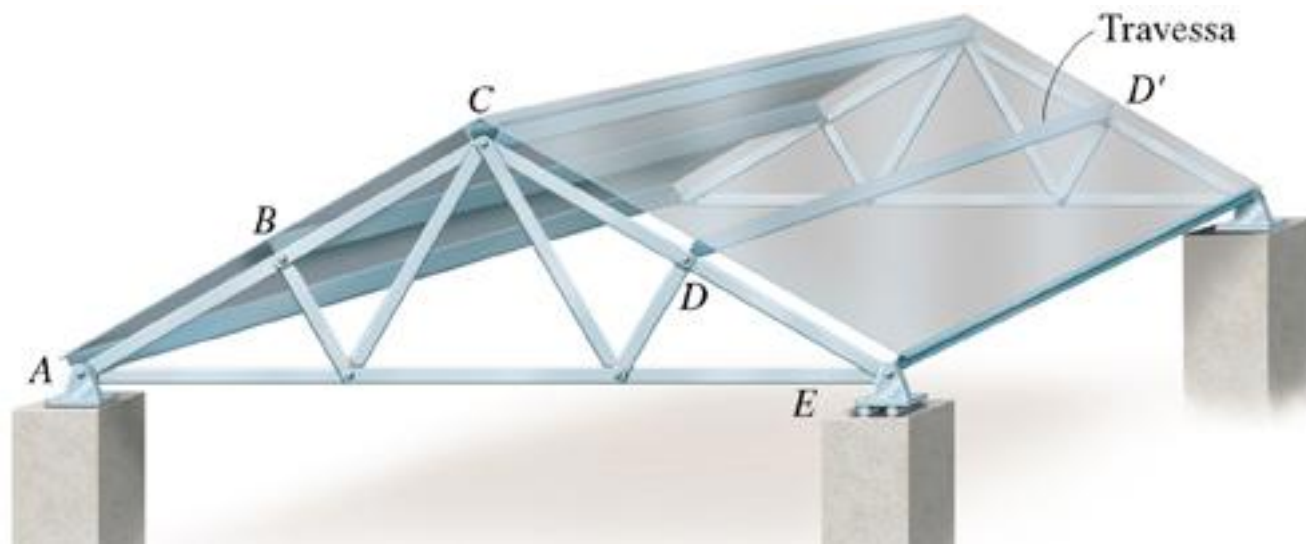



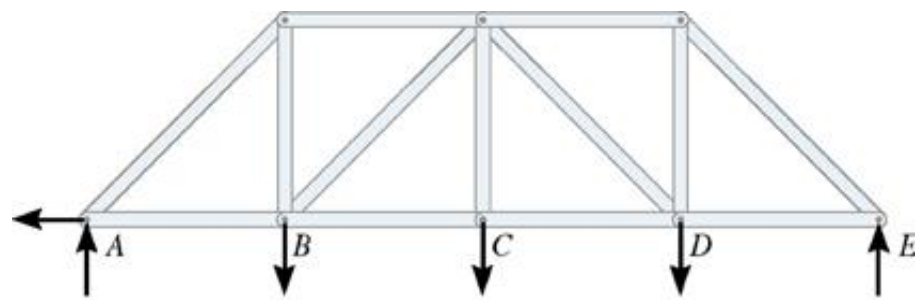
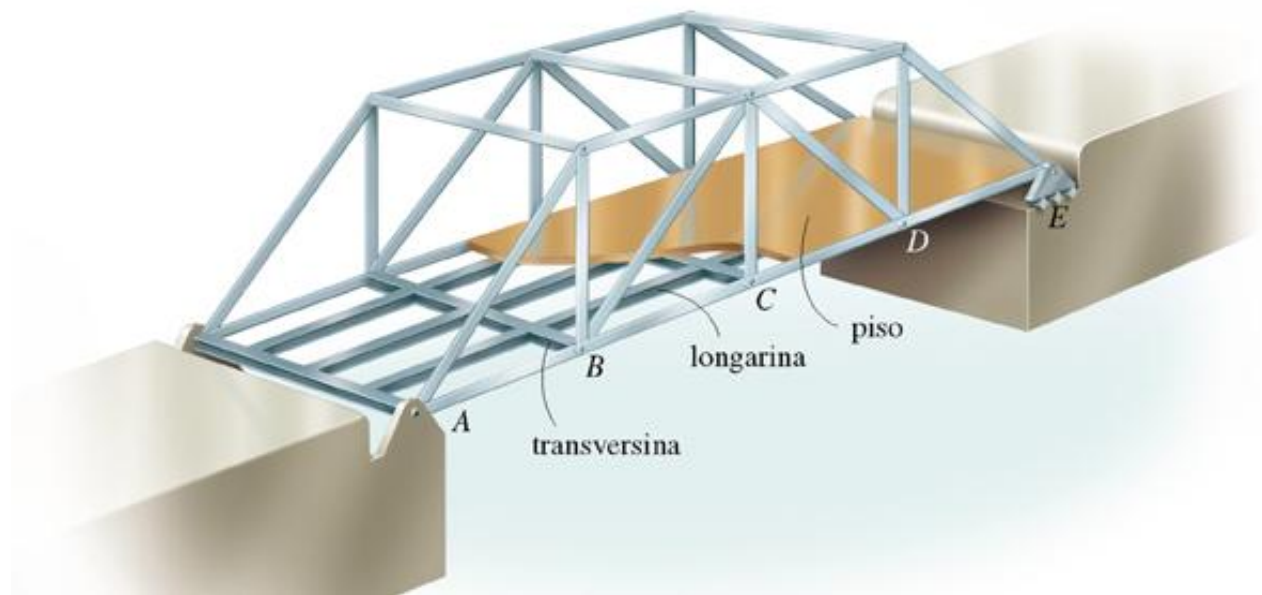

Treliça da Ponte





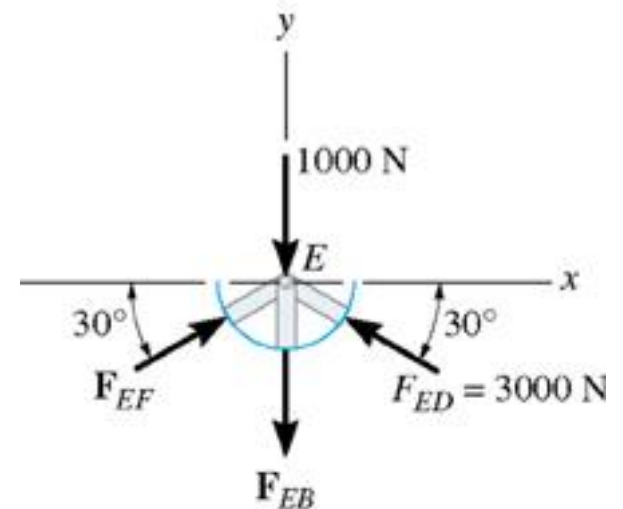
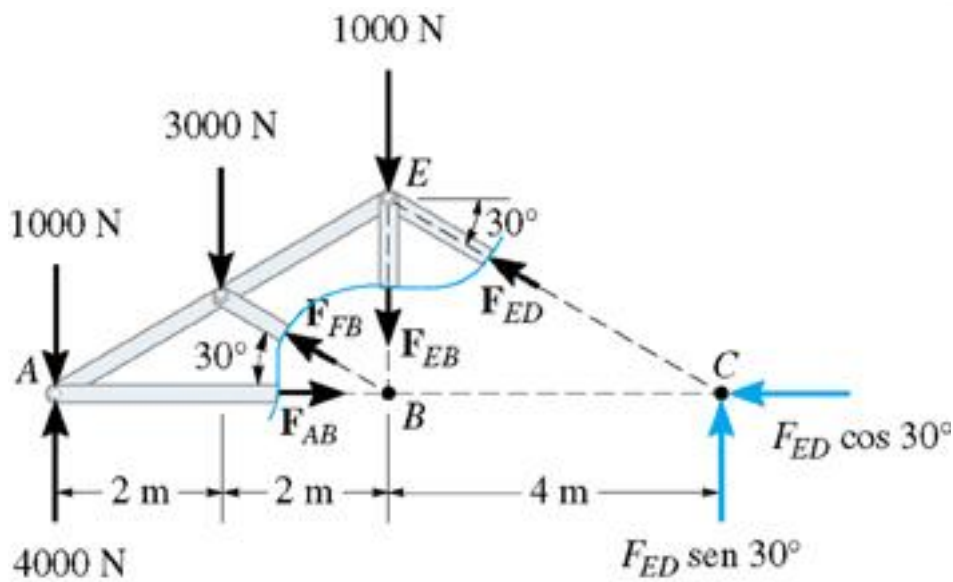
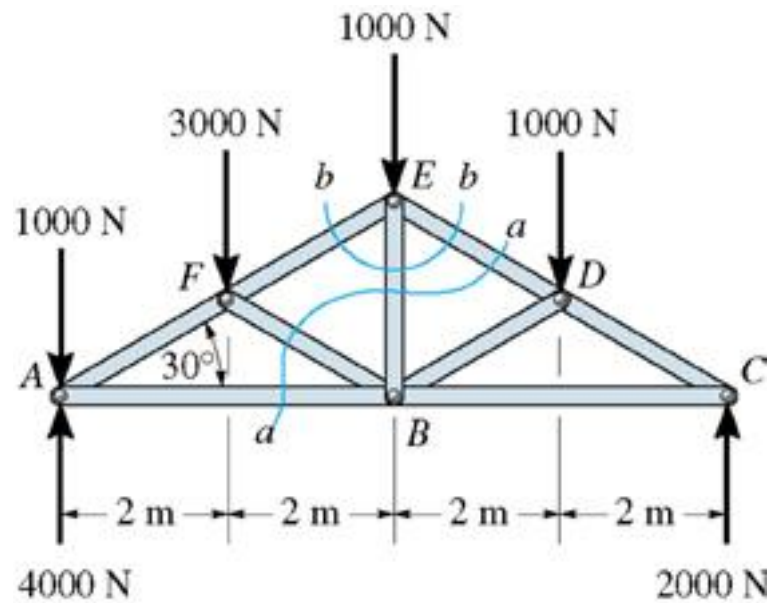

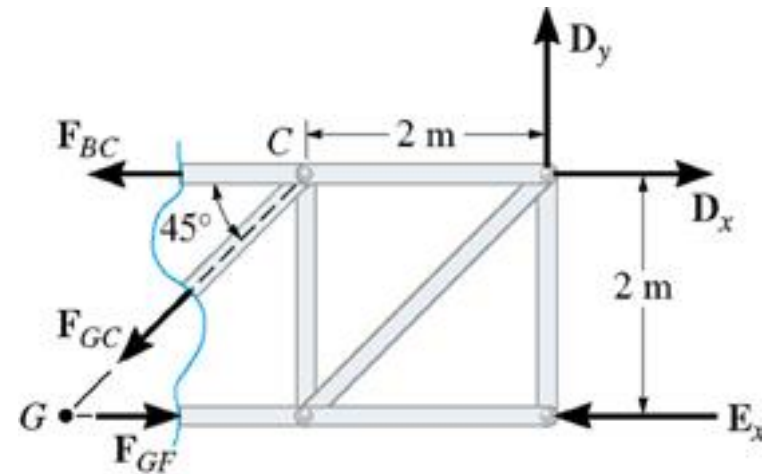
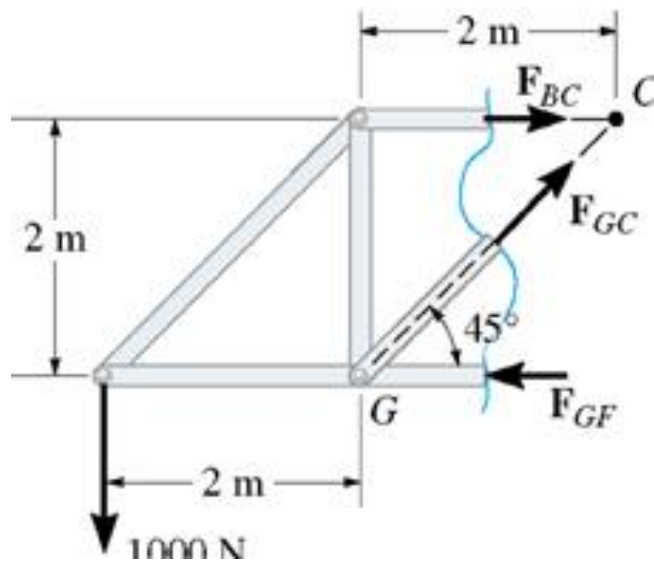
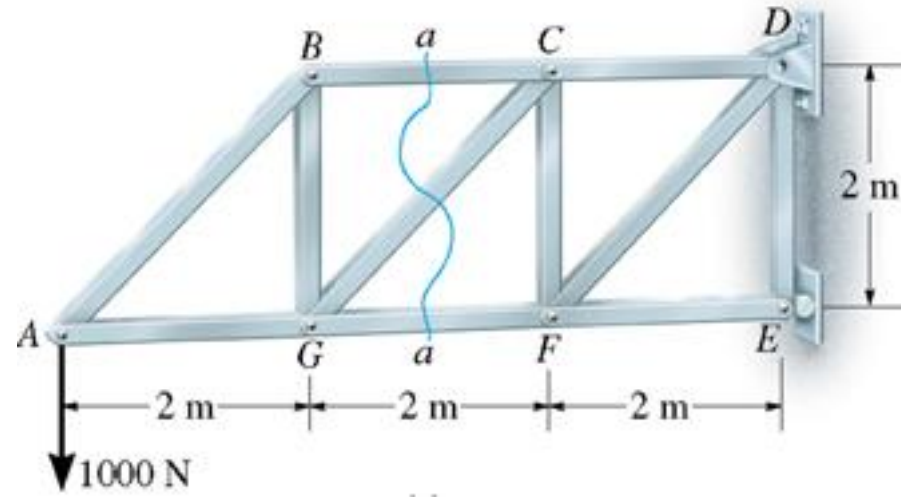

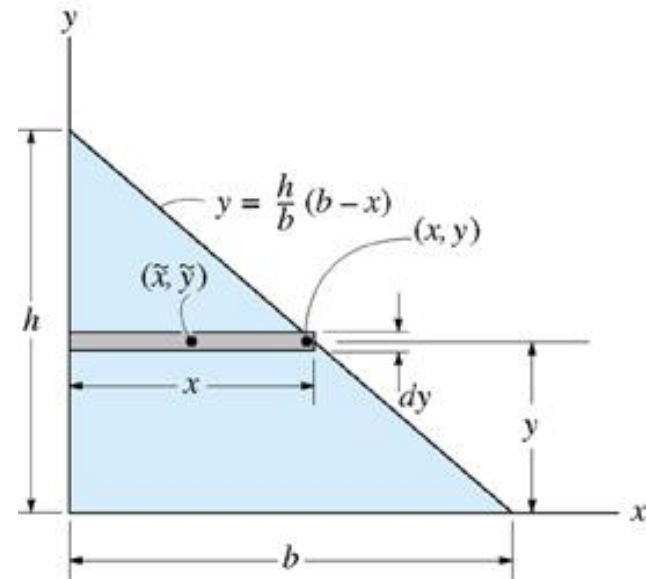
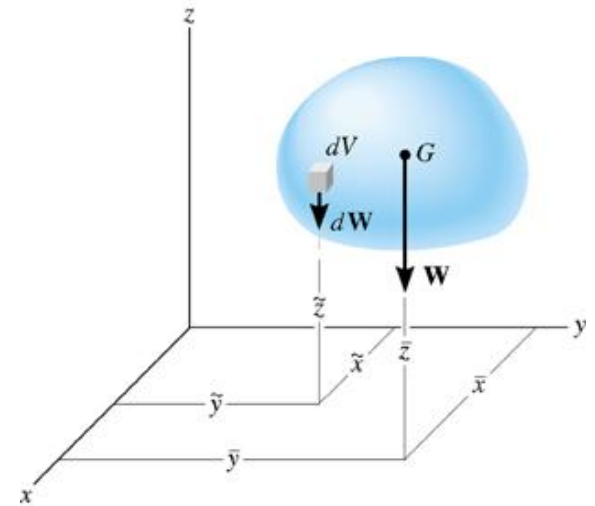



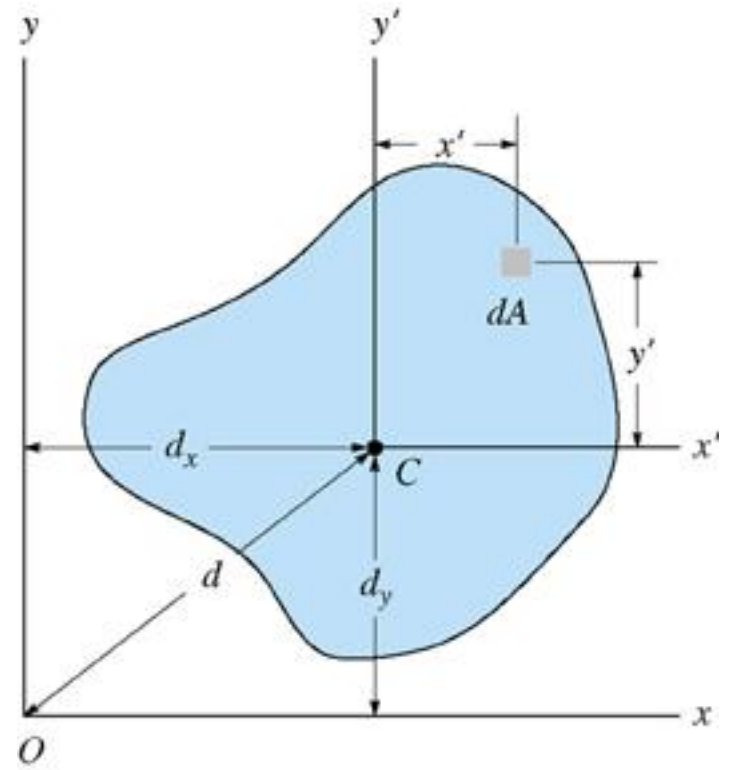
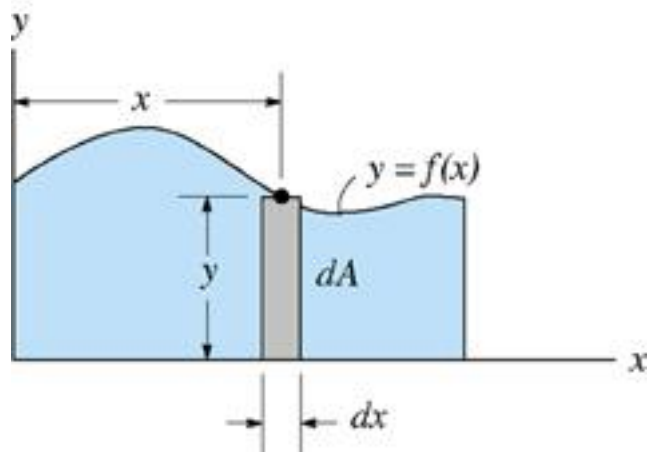
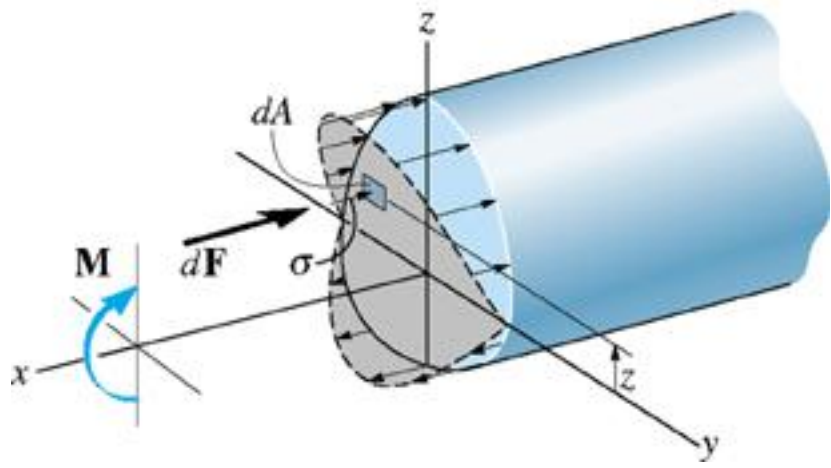

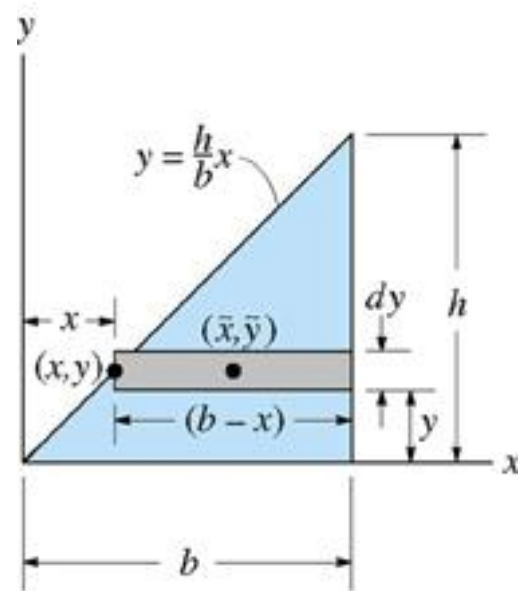
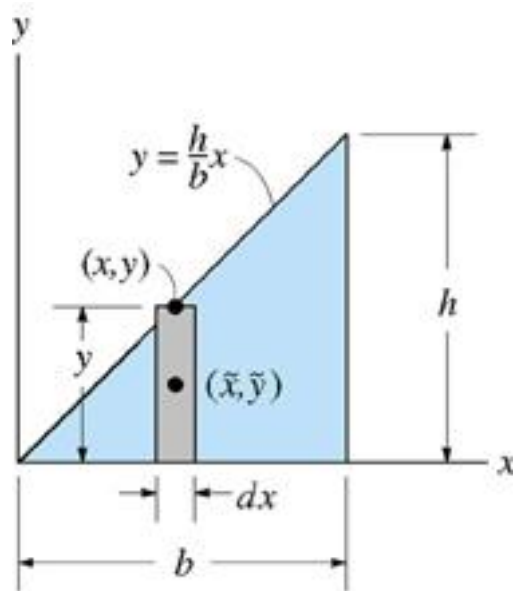
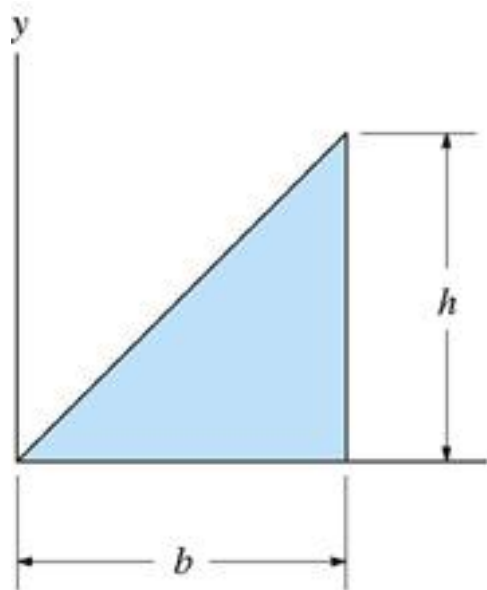

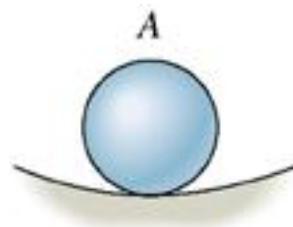

Equilíbrio estável

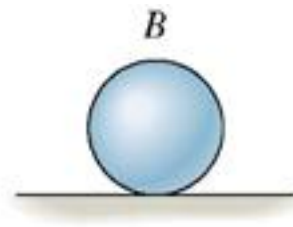

Equilíbrio indiferente

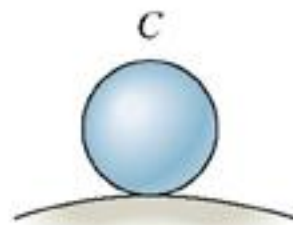

Equilíbrio instável