

“Nova mecânica quântica”

$$\left\{ \begin{array}{l} L_z = m_l \hbar \\ L^2 = l(l + 1) \hbar^2 \end{array} \right.$$

$l = 0, 1, 2, \dots$ inteiro

$-l \leq m_l \leq l$ inteiro

$$L = \sqrt{l(l + 1)} \hbar$$

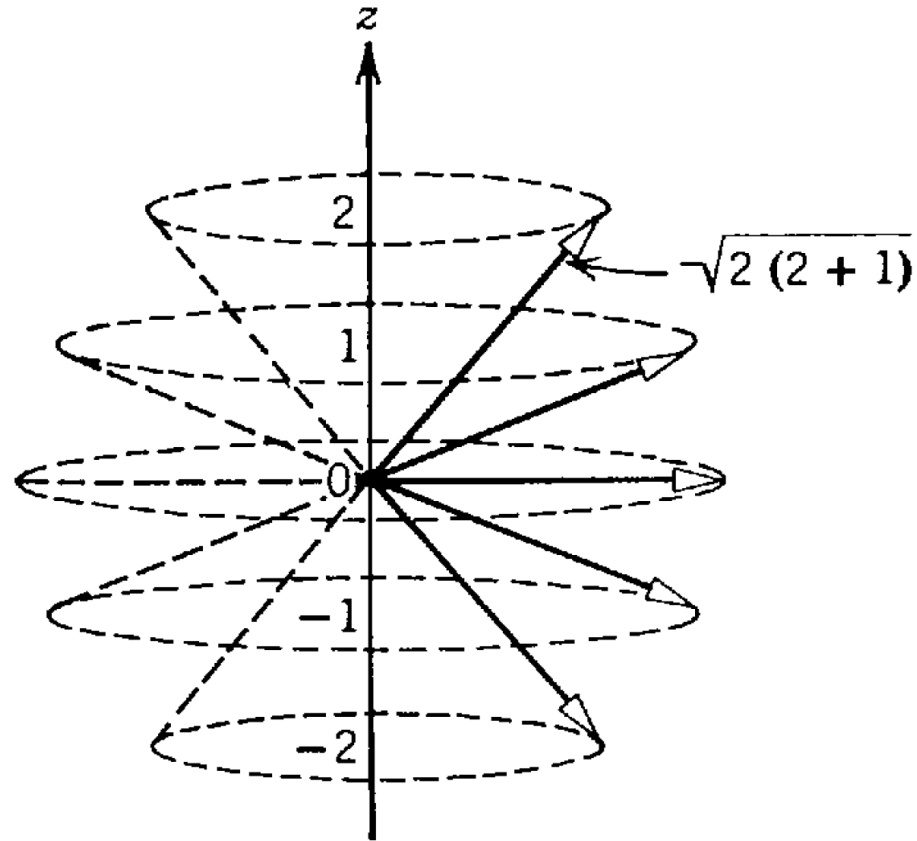

Aula 3

Momento de dipolo magnético

Espira num campo magnético

Precessão de Larmor

Experiência de Stern-Gerlach

Spin como rotação

Momento de dipolo magnético

Espira de corrente

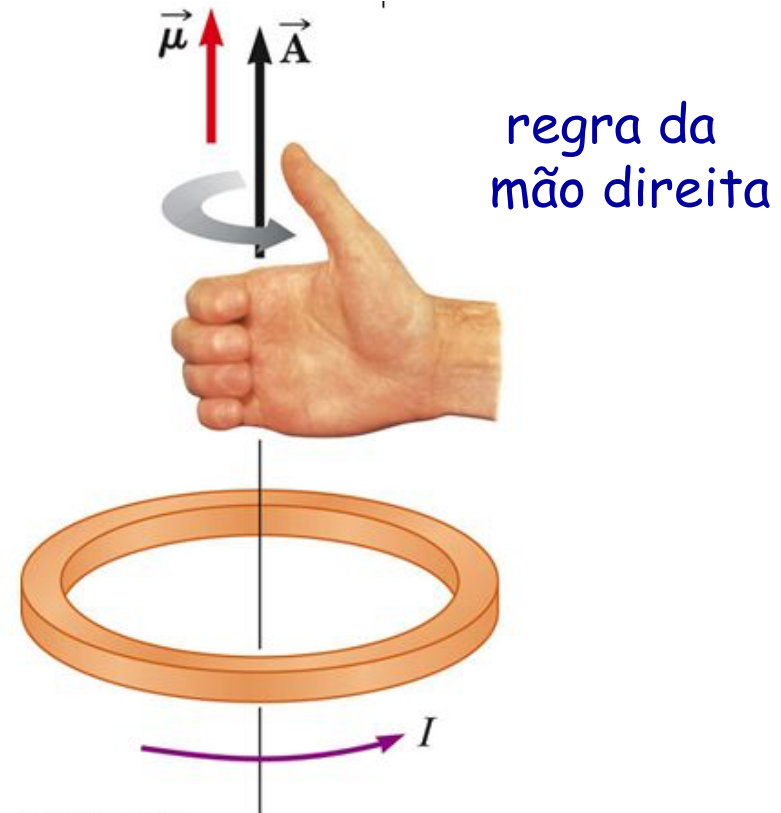
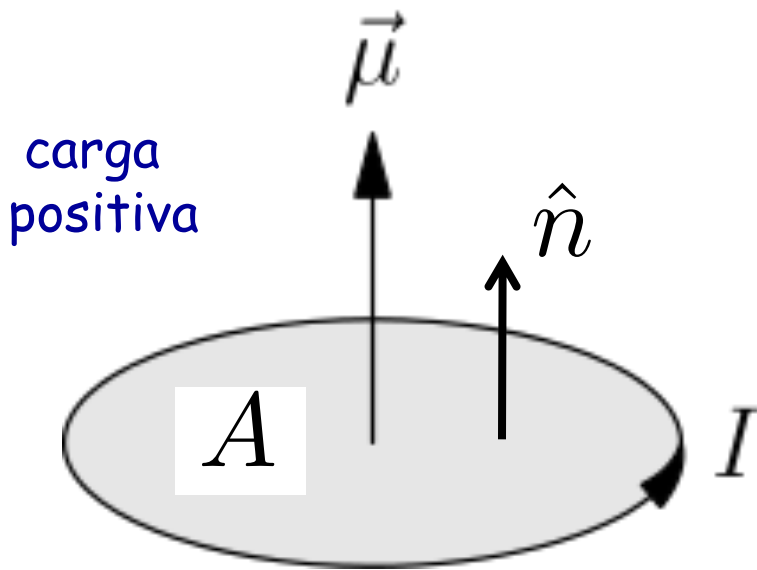

$$\vec{A} = A \hat{n}$$

$$\vec{\mu} = I \vec{A}$$

Momento magnético e momento angular

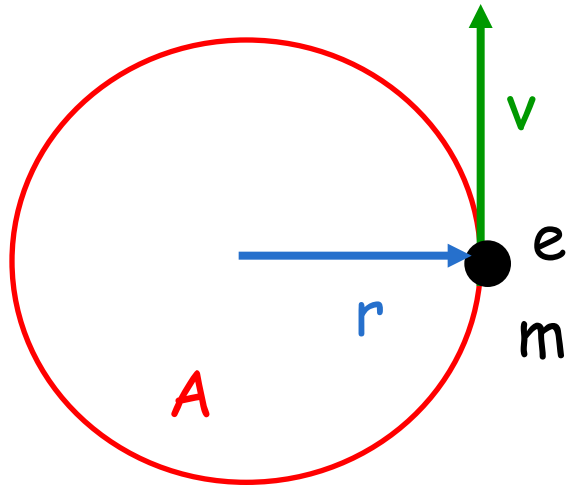

corrente = carga / tempo

$$i = \frac{e}{T}$$

$$v = \frac{2\pi r}{T} \longrightarrow \frac{1}{T} = \frac{v}{2\pi r}$$

$$i = \frac{ev}{2\pi r}$$

$$A = \pi r^2$$

$$\left. \begin{aligned} \mu &= i A = \frac{ev}{2\pi r} \pi r^2 = \frac{evr}{2} \\ L &= m v r \end{aligned} \right\} \frac{\mu}{L} = \frac{e}{2m}$$

$$\frac{\mu}{L} = \frac{e}{2m} \frac{\hbar}{\hbar}$$

$$\mu_b = \frac{e \hbar}{2m}$$

magneton de Bohr

$$g_l = 1$$

fator g orbital

$$\frac{\mu}{L} = \frac{g_l \mu_b}{\hbar}$$

$$\vec{\mu} = - \frac{g_l \mu_b}{\hbar} \vec{L}$$

$$\vec{\mu} = \frac{g_l \mu_b}{\hbar} \vec{L}$$

carga positiva

carga negativa
(eletron)

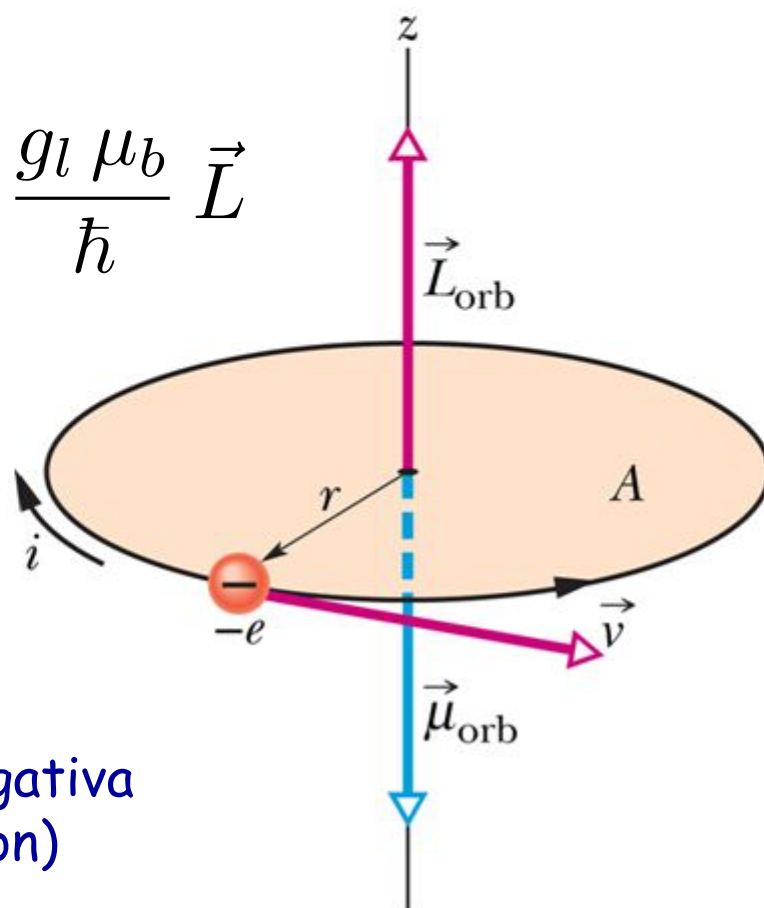

Momento magnético do elétron é quantizado !

$$\mu = \frac{g_l \mu_b}{\hbar} L = \frac{g_l \mu_b}{\hbar} \sqrt{l(l+1)} \hbar = g_l \mu_b \sqrt{l(l+1)}$$

$$\mu_z = -\frac{g_l \mu_b}{\hbar} L_z = -\frac{g_l \mu_b}{\hbar} m_l \hbar = -g_l \mu_b m_l$$

$$\left\{ \begin{array}{l} l = 0, 1, 2, \dots \quad \text{inteiro} \\ -l \leq m_l \leq l \quad \text{inteiro} \end{array} \right.$$

Espira é um dipolo magnético

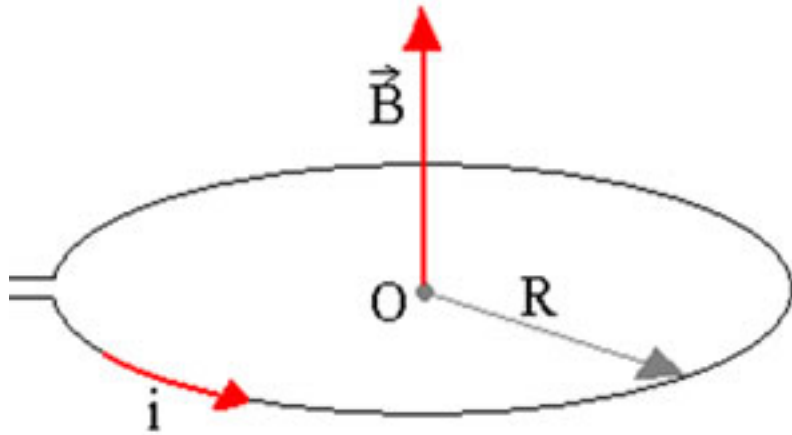

Espira gera campo magnético semelhante ao de um ímã :

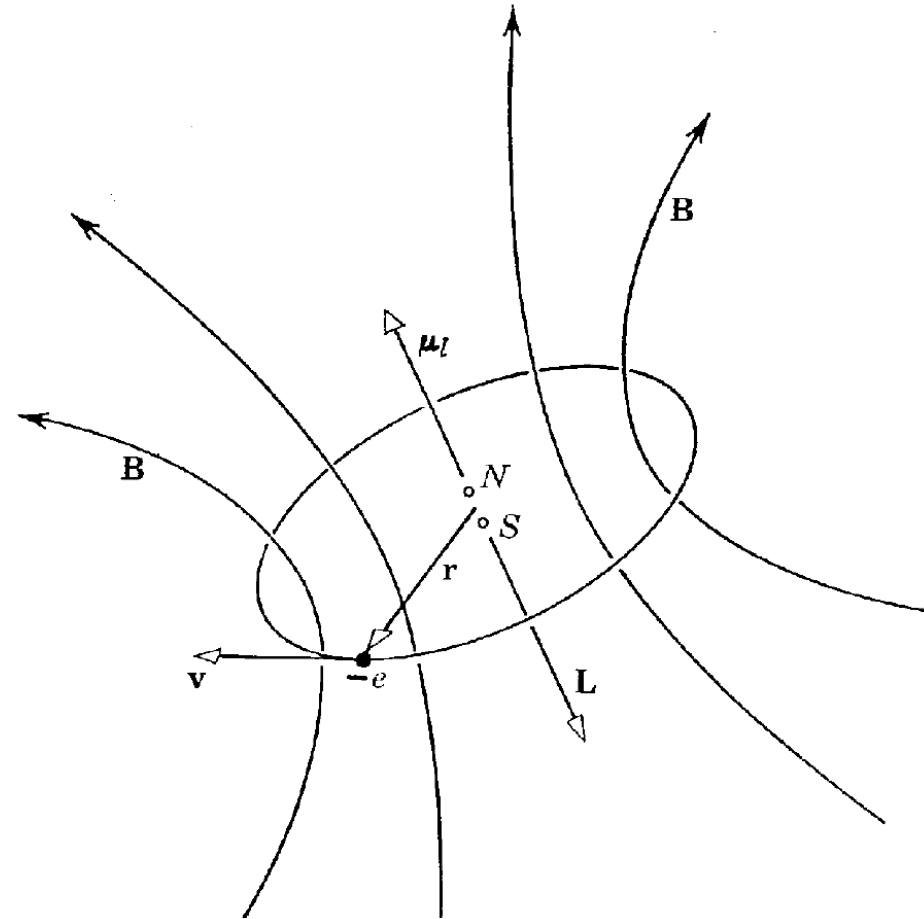
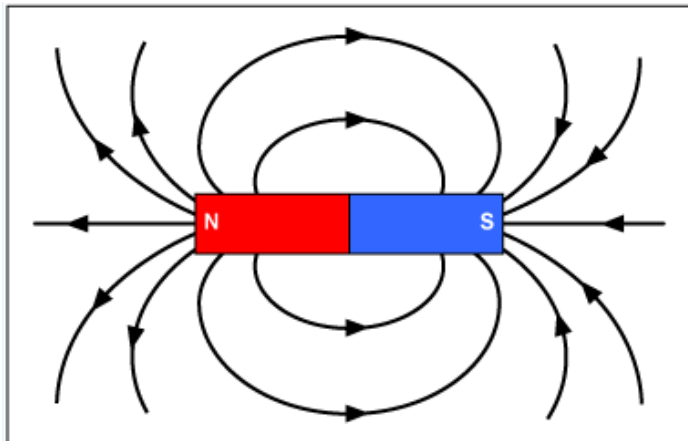

Dipolo magnético !

Espira num campo magnético uniforme

Força magnética sobre uma carga em movimento

$$\vec{F} = q \vec{v} \times \vec{B}$$

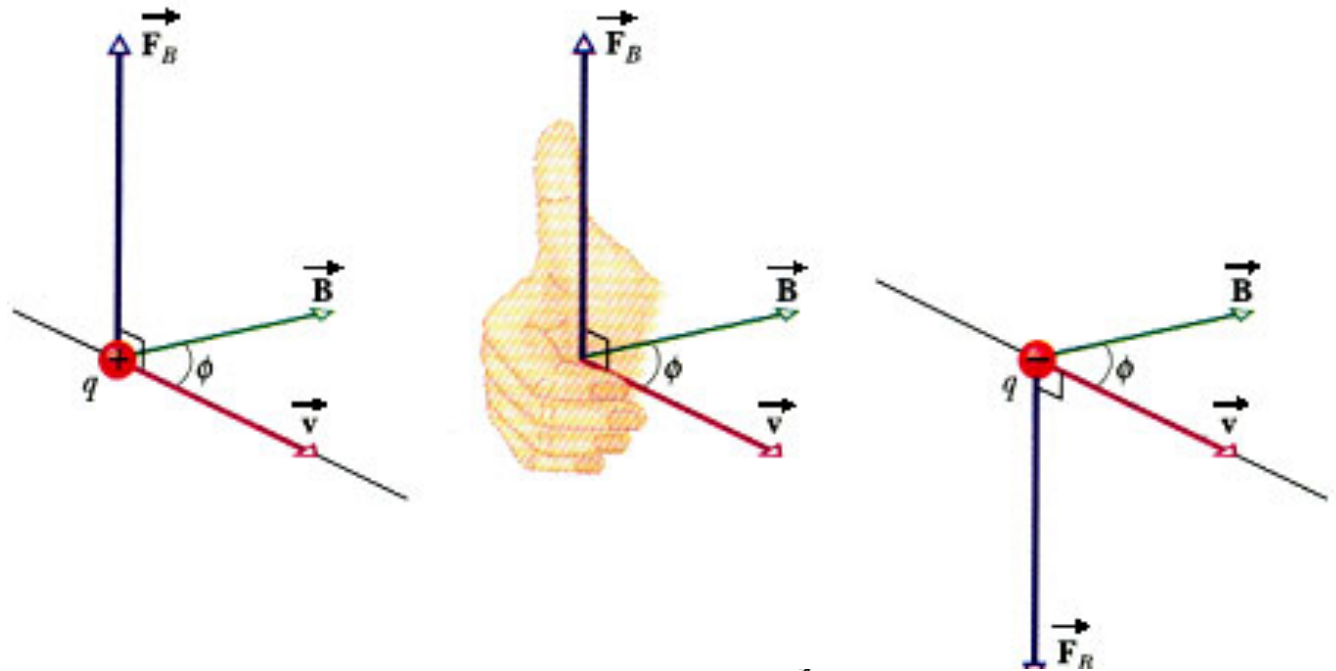

Força magnética sobre uma corrente

$$\vec{F} = I \vec{L} \times \vec{B}$$

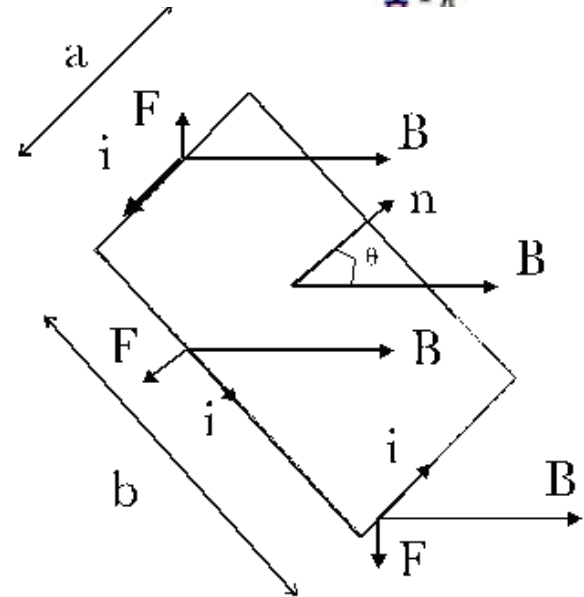

Espira sofre um torque !

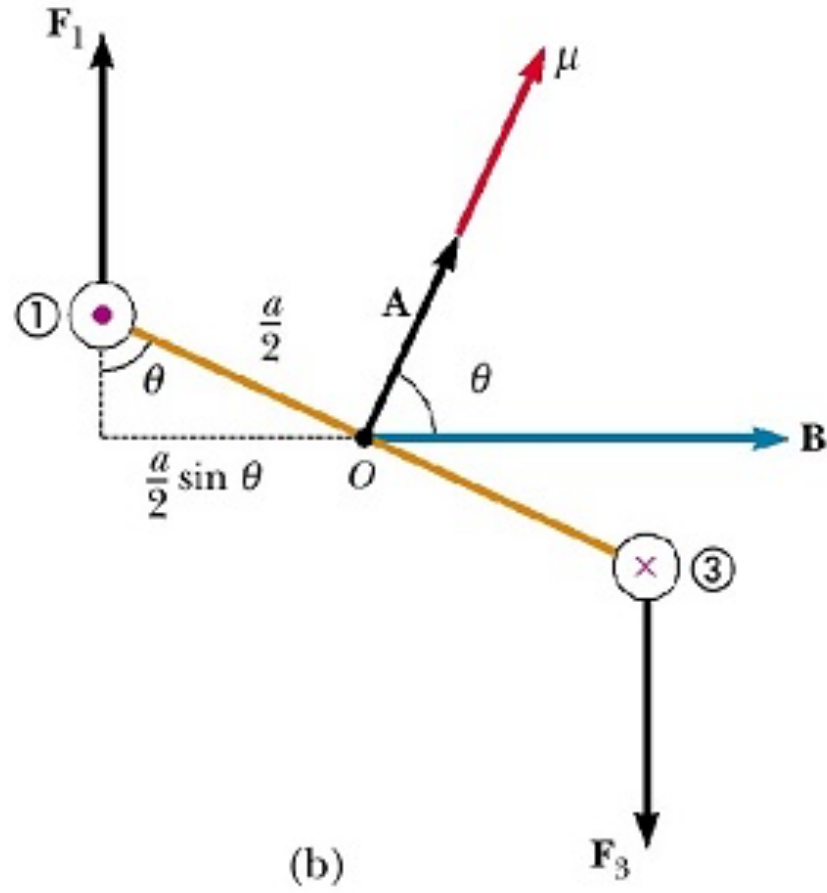
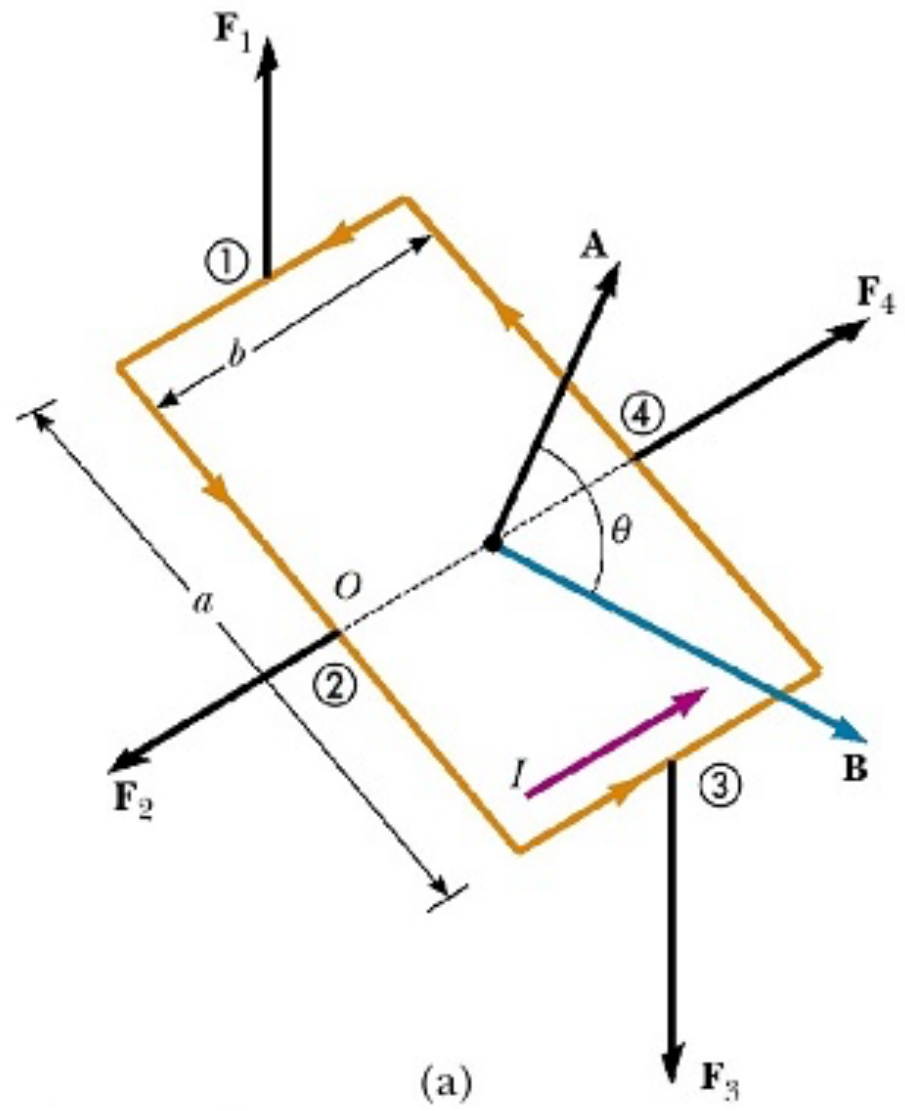

Espira tenta se alinhar como uma bússola !

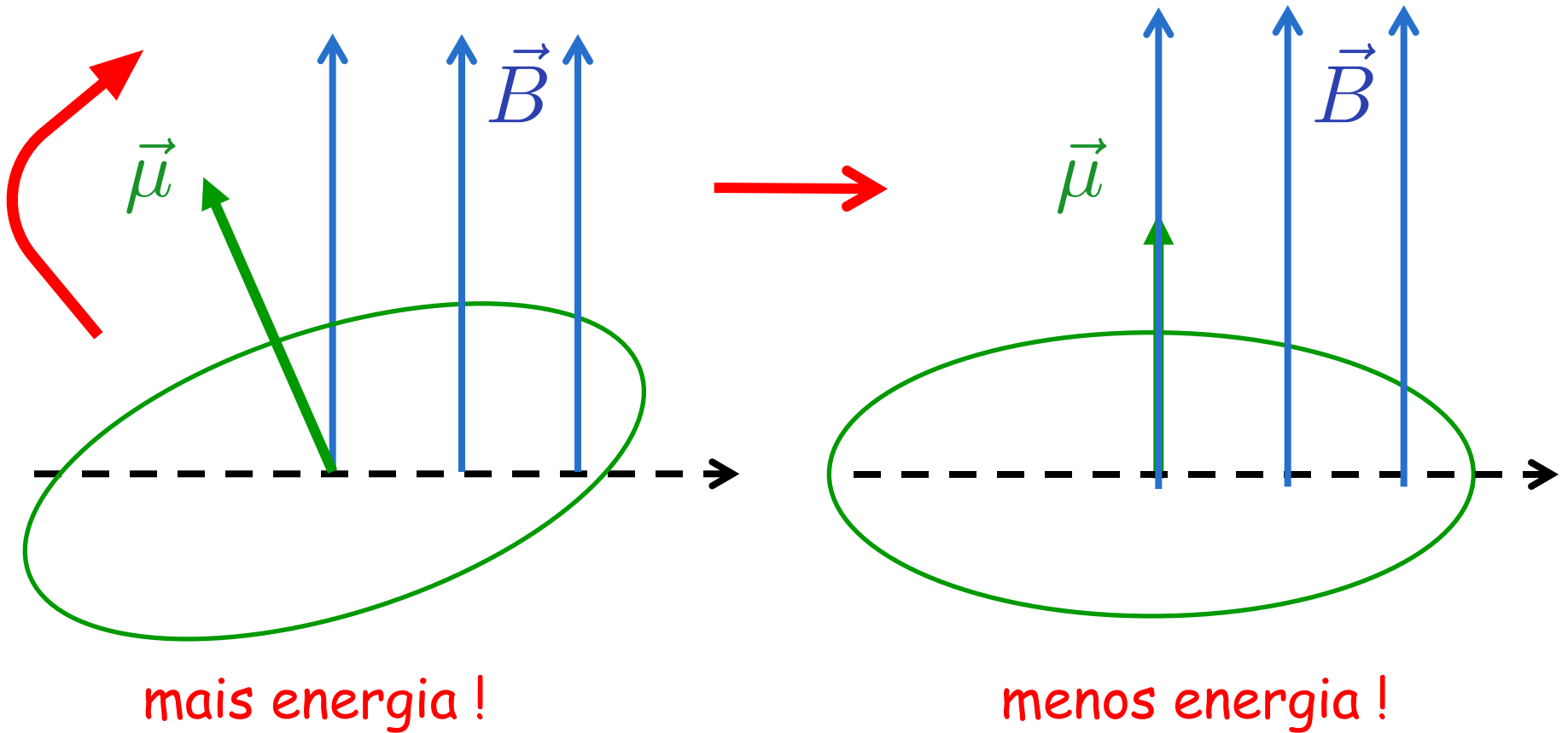

Energia potencial de orientação

$$U = -\vec{\mu} \cdot \vec{B}$$

Mas nunca se alinha! Precessiona!

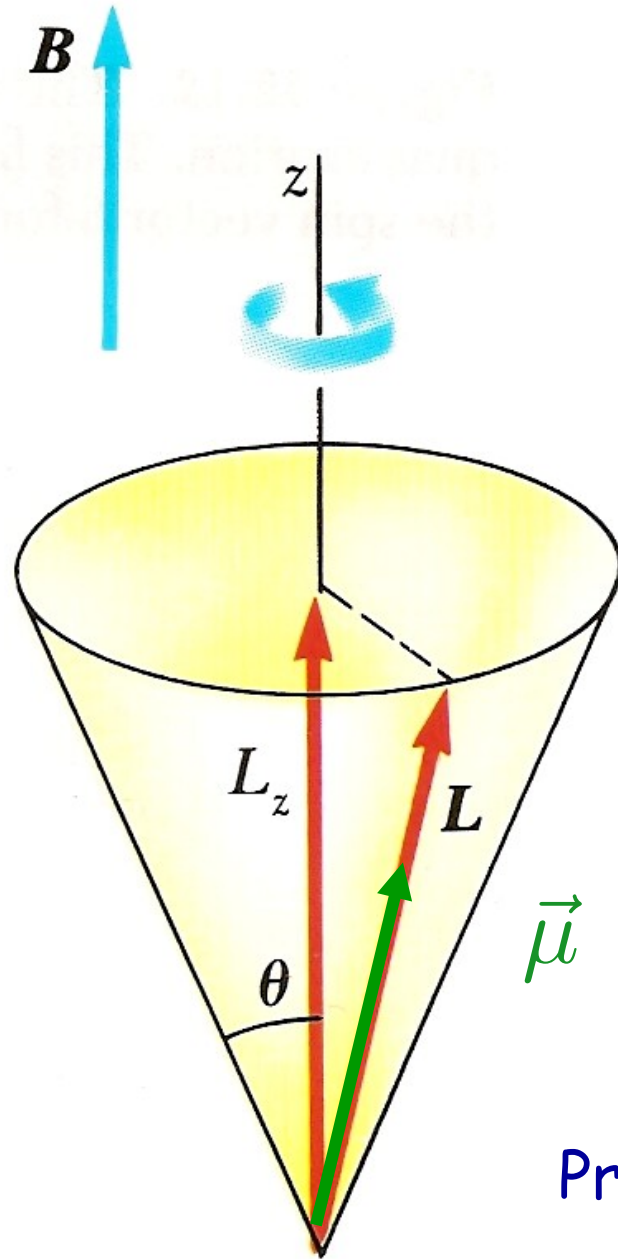

$$\vec{\mu} = \frac{g_l \mu_b}{\hbar} \vec{L}$$

Precessão de Larmor

Mas nunca se alinha ! Precessiona !

Precessão de Larmor

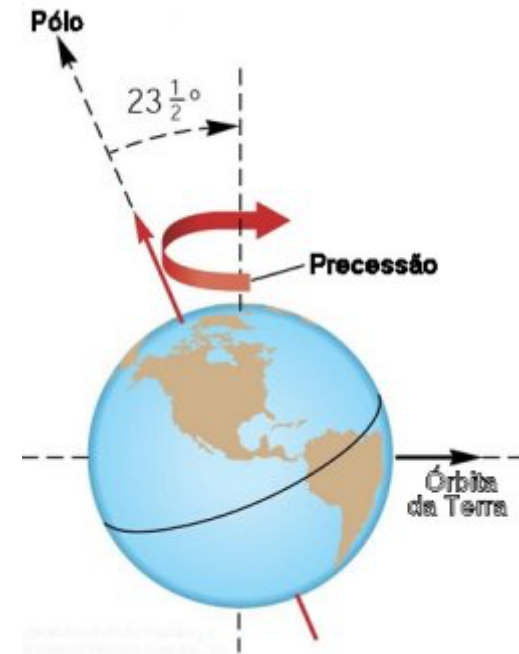
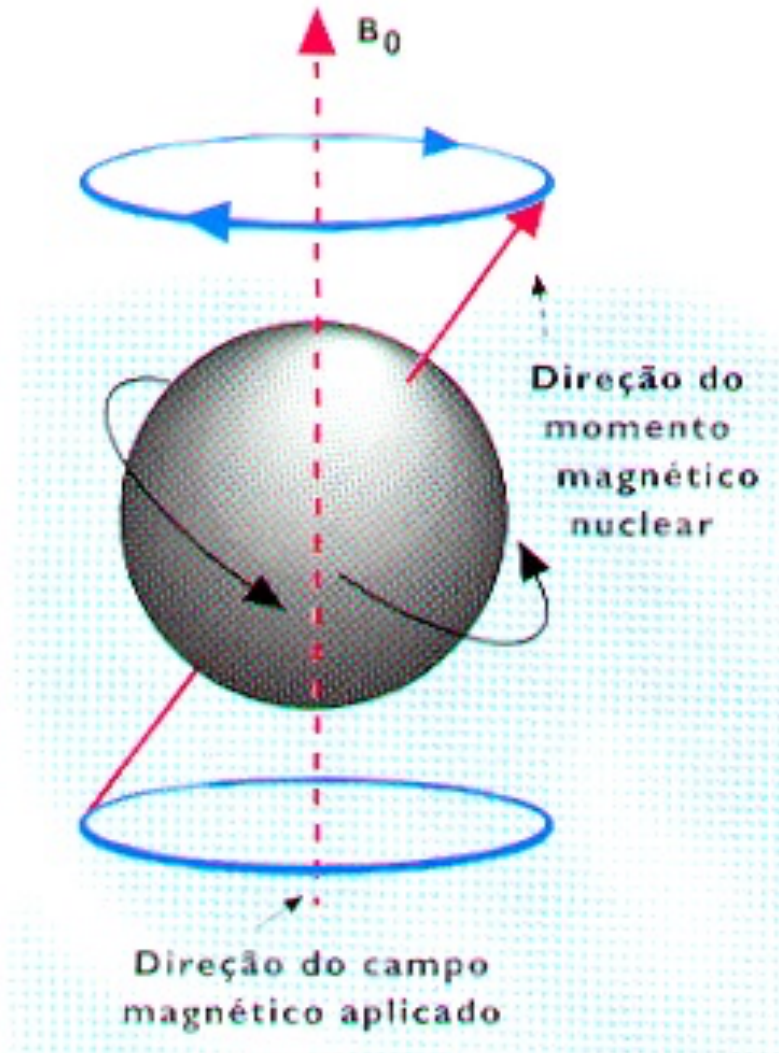

Espira se alinha como uma bússola !

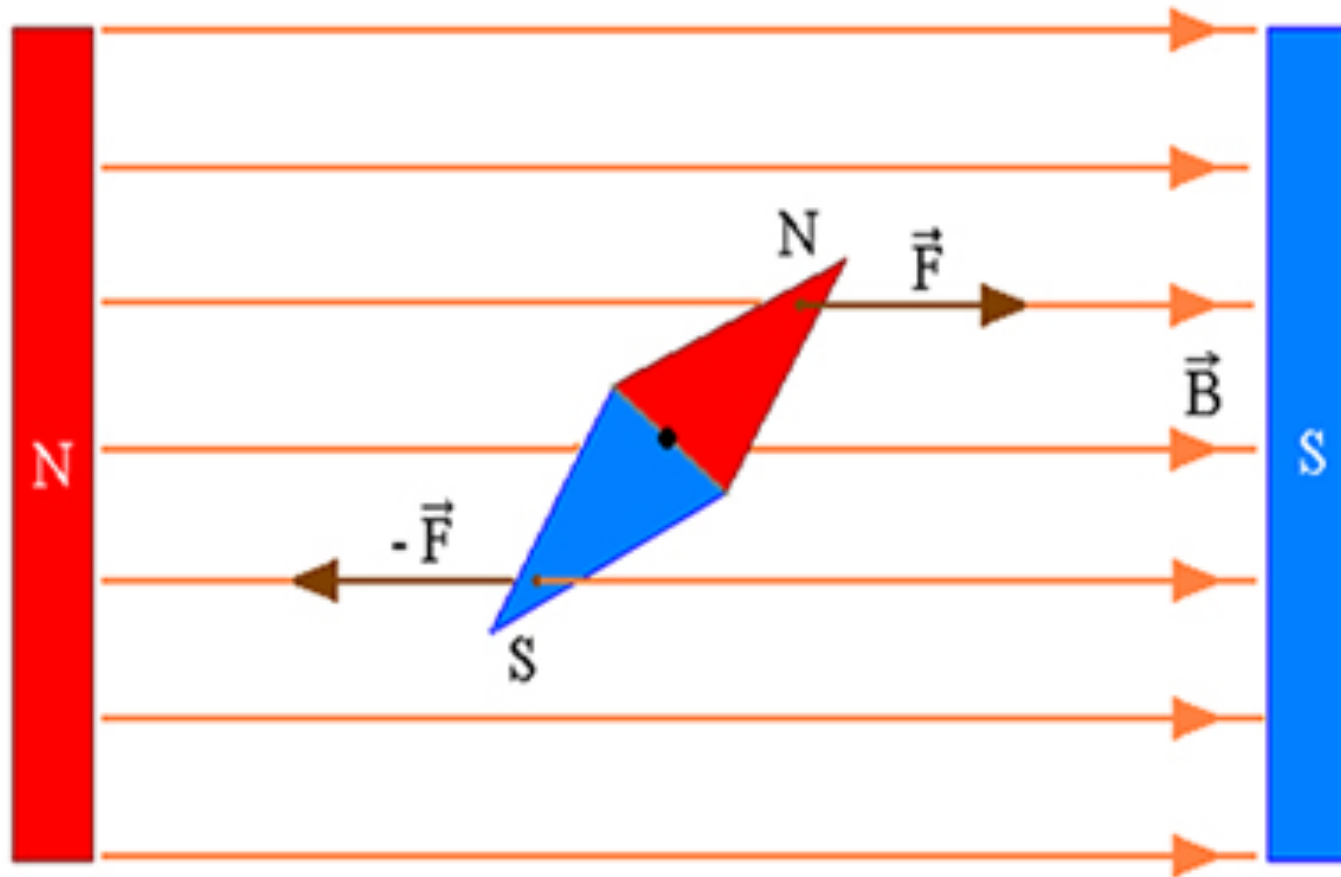

Um imã é uma espira ?



Espira num campo magnético não uniforme

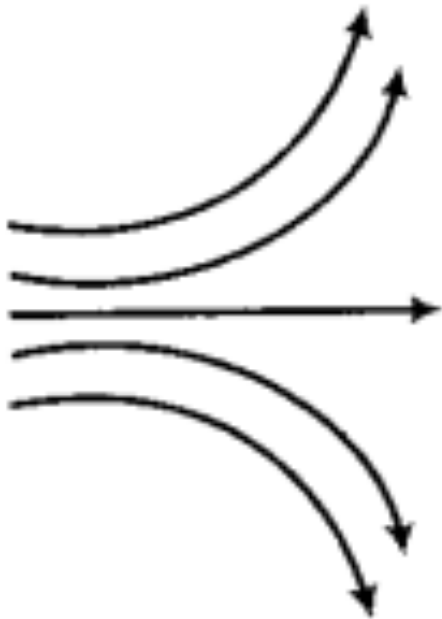
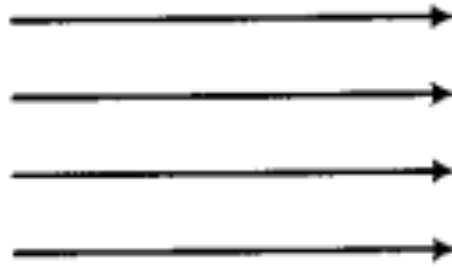

não uniforme

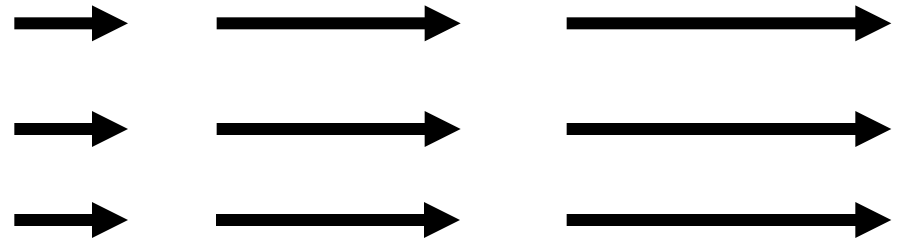

não uniforme

Espira num campo magnético não uniforme

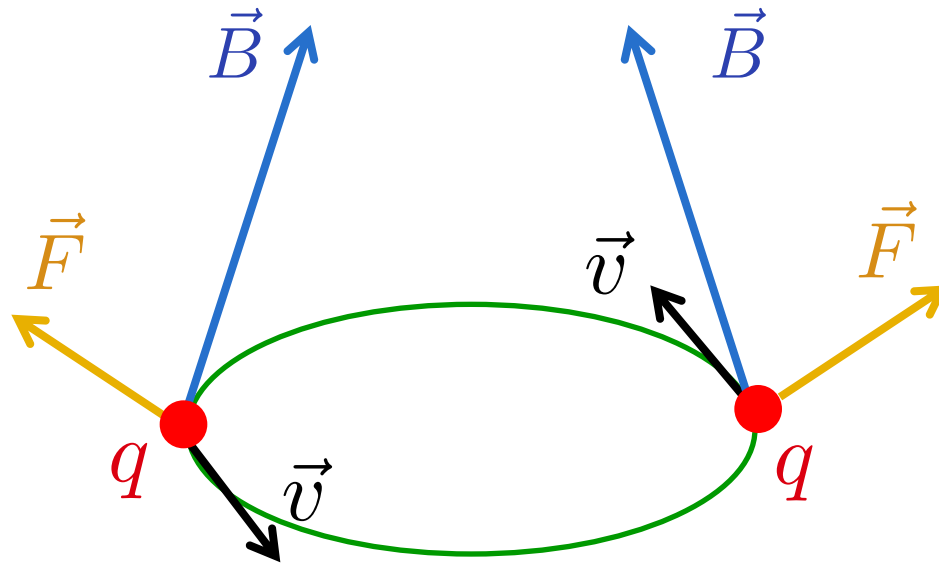

Espira num campo magnético não uniforme

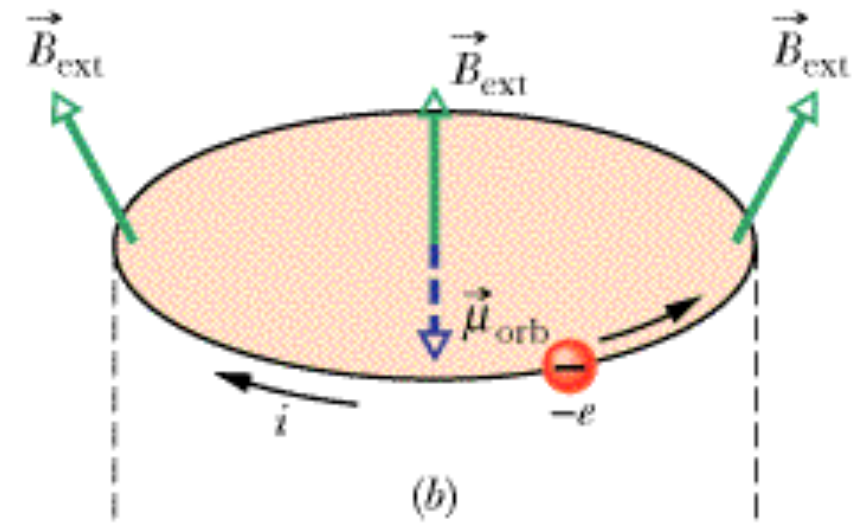
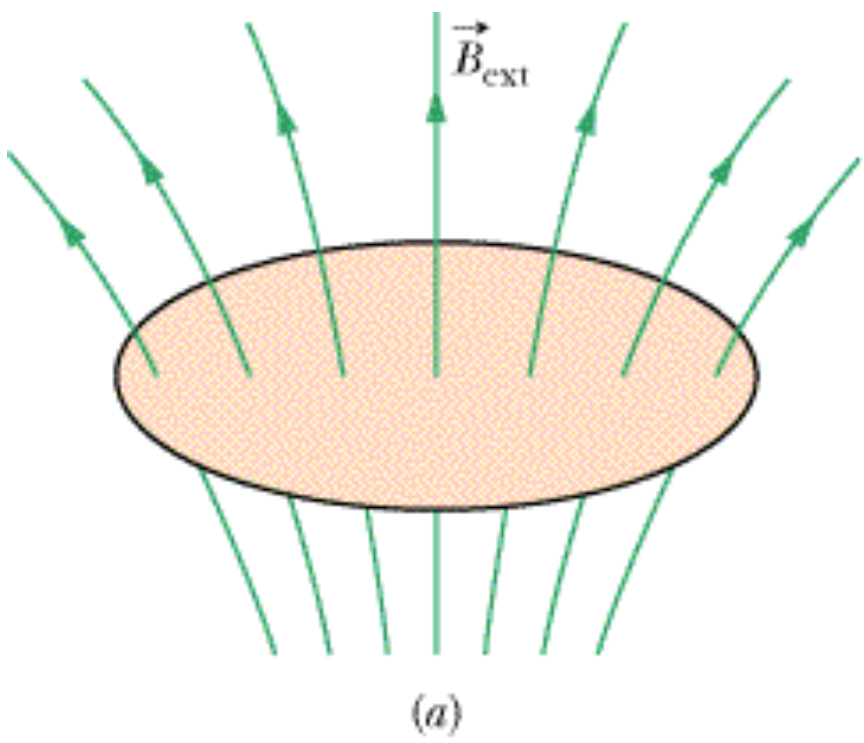

Levitação magnética!

maglev



**How to
levitate
a frog?**



sapo



sapo no youtube

Campo magnético não uniforme

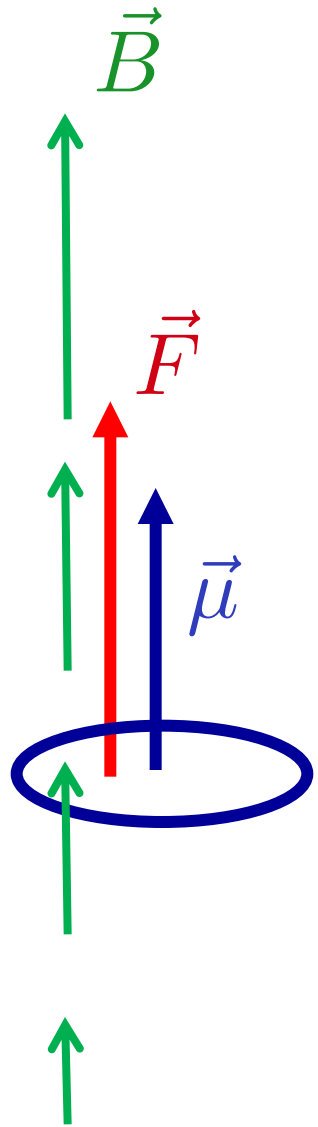

$$\vec{B} = B_z \hat{k} \quad \vec{\mu} = \mu_z \hat{k}$$

$$U = -\vec{\mu} \cdot \vec{B} = -\mu_z B_z \quad \text{energia potencial mínima}$$

$$\vec{F} = -\vec{\nabla} U = - \left[\hat{i} \frac{\partial}{\partial x} + \hat{j} \frac{\partial}{\partial y} + \hat{k} \frac{\partial}{\partial z} \right] U$$

$$\vec{F} = \mu_z \frac{\partial B_z}{\partial z} \hat{k} \quad \mu_z = \frac{g_l \mu_b}{\hbar} L_z$$

$$F = \frac{g_l \mu_b L_z}{\hbar} \frac{\partial B_z}{\partial z}$$

Mecânica clássica :

L_z assume valores contínuos !

$$F = \frac{g_l \mu_b L_z}{\hbar} \frac{\partial B_z}{\partial z}$$

F assume valores contínuos

Mecânica quântica :

$$L_z = m_l \hbar$$

$$\left\{ \begin{array}{ll} l = 0, 1, 2, \dots & \text{inteiro} \\ -l \leq m_l \leq l & \text{inteiro} \end{array} \right.$$

$$F = g_l \mu_b m_l \frac{\partial B_z}{\partial z}$$

F assume valores discretos

Experiência de Stern-Gerlach (1922)

Medida do momento magnético de átomos de prata

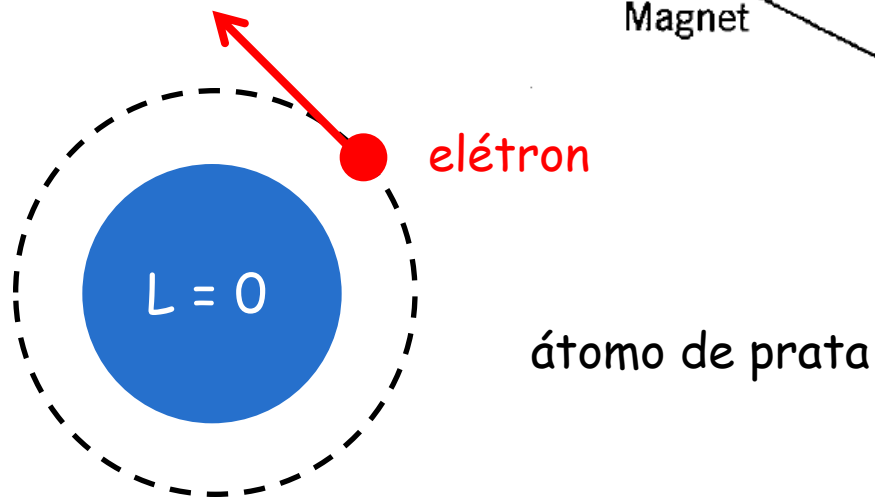
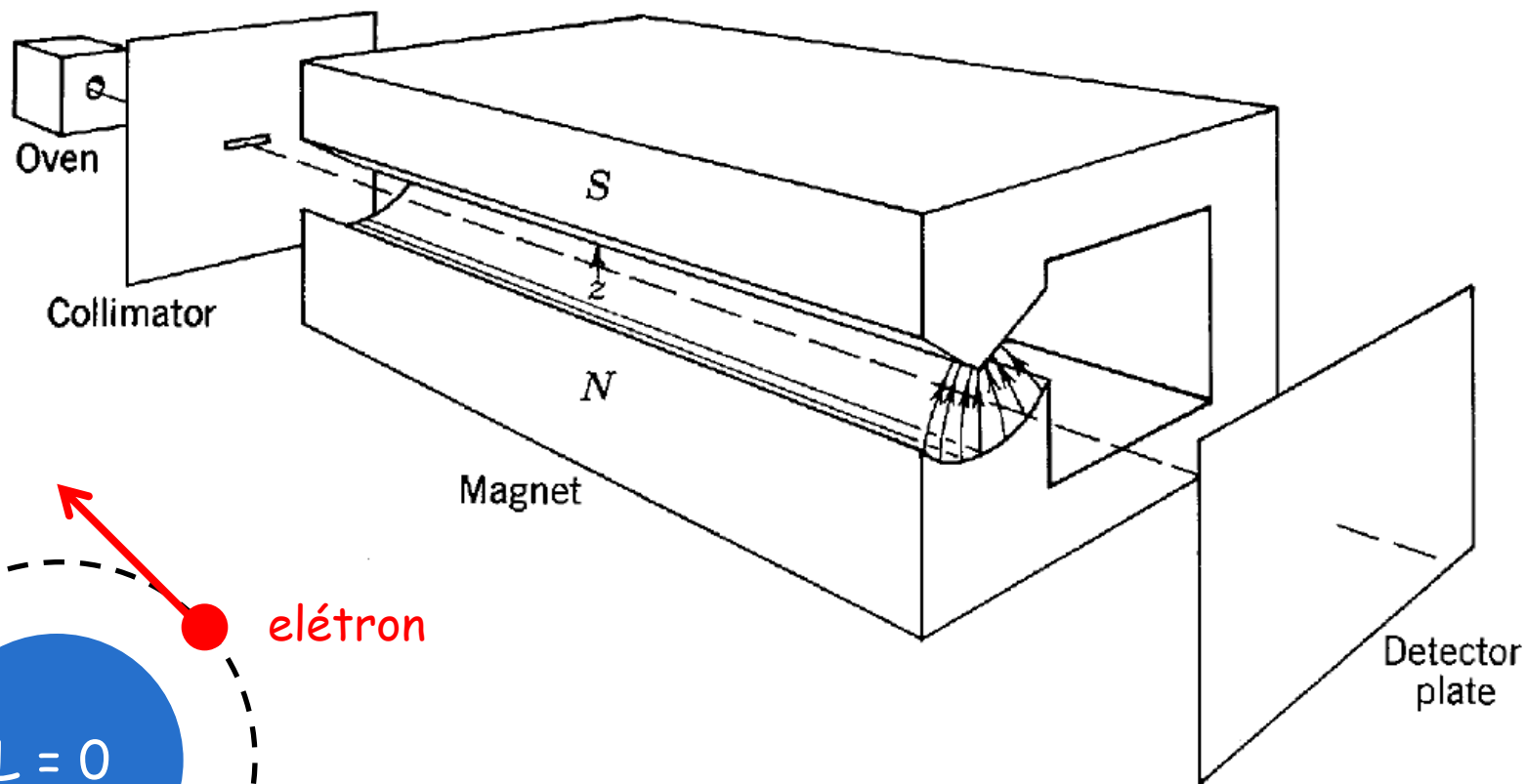

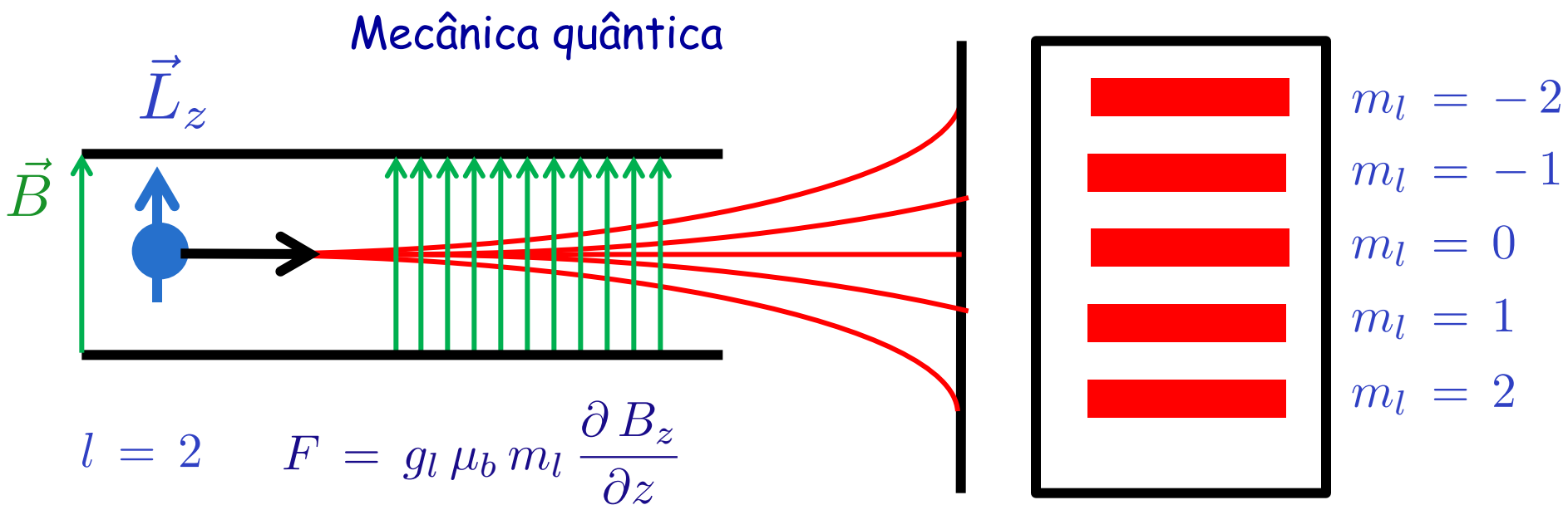
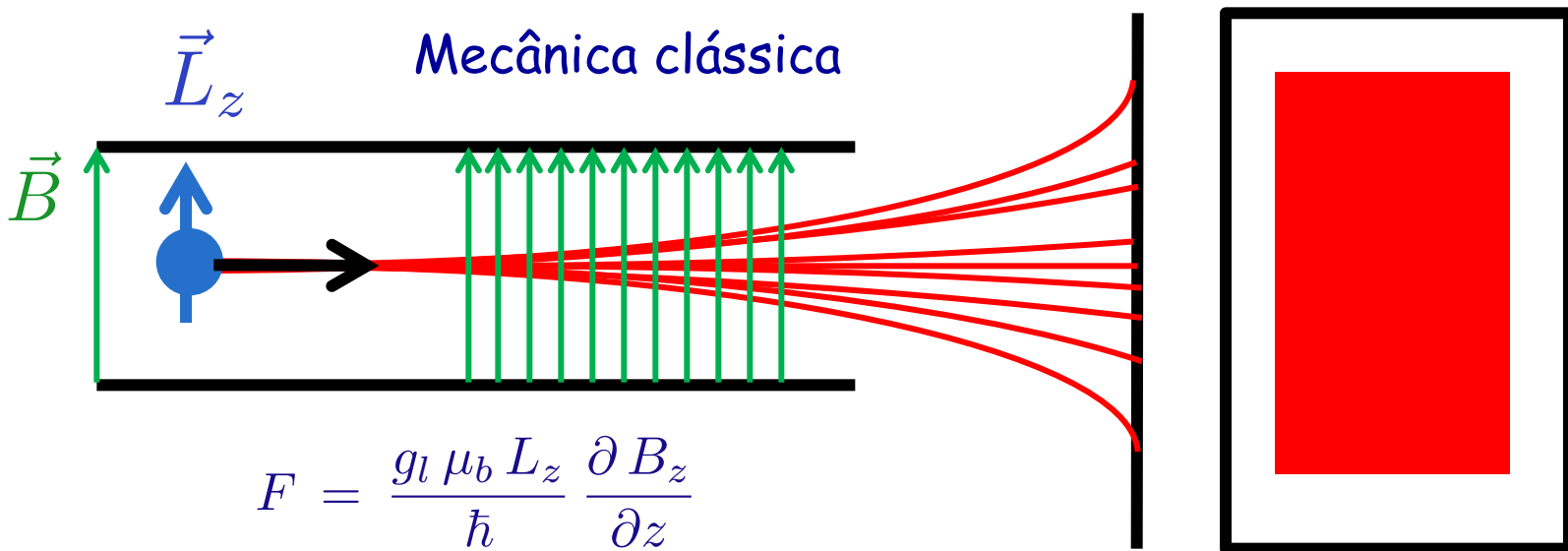

Observação :

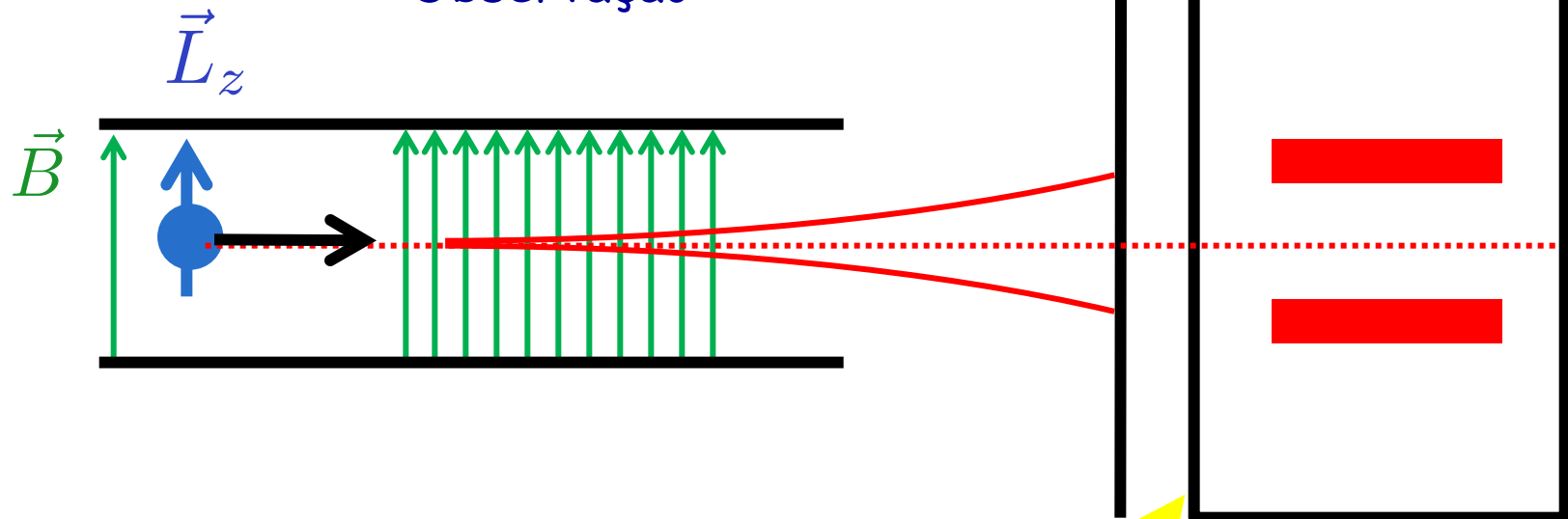

Só duas franjas sempre ! Dois valores de m : $+m$ e $-m$

Não existe $m = 0$!

clássico

quântico

observado

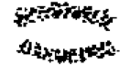
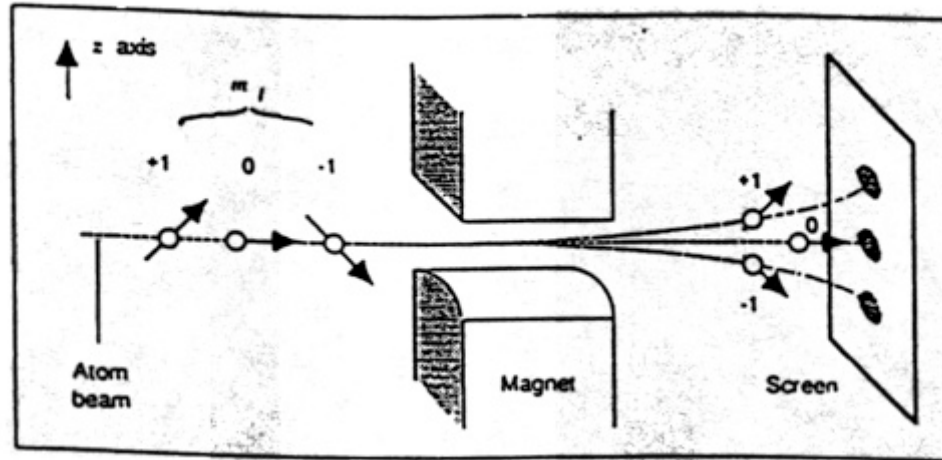

Elétron tem momento angular intrínseco : spin !

Copiamos a teoria do momento angular

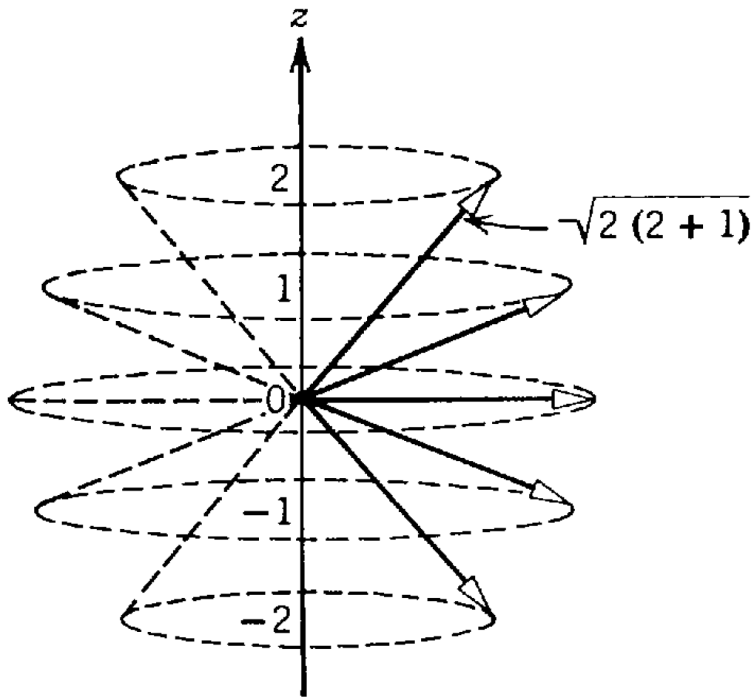

$$L = \sqrt{l(l+1)} \hbar$$

$$L_z = m_l \hbar$$

$$-l \leq m_l \leq l$$

$$l = 0, 1, 2, \dots$$

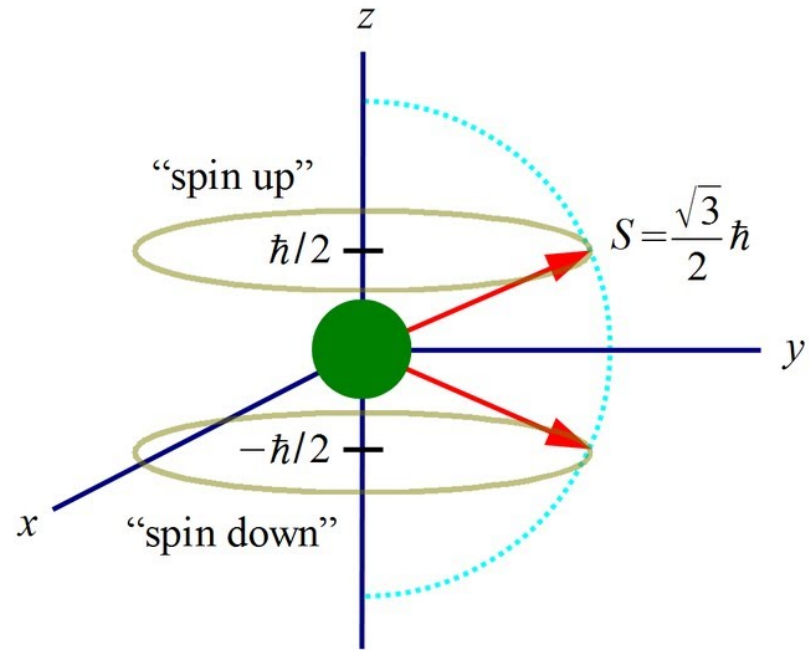

$$S = \sqrt{s(s+1)} \hbar$$

$$S_z = m_s \hbar$$

$$m_s = -s, -s+1, \dots, s$$

$$s = \frac{1}{2} \quad m_s = -\frac{1}{2}, +\frac{1}{2}$$

A Little History of Spin in Quantum Mechanics

- 1922 – Otto Stern & Walter Gerlach – The existence of spin angular momentum is inferred from their experiment, in which particles (Ag atoms) are observed to possess angular momentum that cannot be accounted for by orbital angular momentum alone.
- 1924 – Wolfgang Pauli – proposed a new quantum degree of freedom (or quantum number) with two possible values and formulated the Pauli exclusion principle.
- 1925 – Ralph Kronig, George Uhlenbeck & Samuel Goudsmit – identified Pauli's new degree of freedom as electron spin and suggested a physical interpretation of particles spinning around their own axis.
- 1926 – Enrico Fermi & Paul Dirac – formulated (independently) the Fermi-Dirac statistics, which describes distribution of many identical particles obeying the Pauli exclusion principle (fermions with half-integer spins – contrary to bosons satisfying the Bose-Einstein statistics)
- 1926 – Erwin Schrödinger – formulated his non-relativistic Schrödinger equation, but it incorrectly predicted the magnetic moment of H to be zero in its ground state.
- 1927 – T.E. Phipps & J.B. Taylor – reproduced the effect using H atoms in the ground state, thereby eliminating any doubts that may have been caused by the use of Ag atoms.
- 1927 – Wolfgang Pauli – worked out on mathematical formulation of spin (2×2 matrices).
- 1928 – Paul Dirac – showed that spin comes naturally from his relativistic Dirac equation.